

# CONTENTS

## BRAKE APPLICATIONS

US Built Motorcycles.....	21-25	Pads for Aftermarket Calipers .....	118-121
Japanese Built Motorcycles .....	26-117	Non-Japanese Built Motorcycles .....	122-327
Road Racing Motorcycles.....	118		

BRAKE  
APPLICATIONS

## DISC PAD BUYERS GUIDE

Buyers Guide - Disc Brake Pads .....	328-542
Brake Pad Competitor Interchange Numbers .....	543-553

DISC PADS  
BUYERS GUIDE

## SHOE BUYERS GUIDE

Buyers Guide - Brake Shoes .....	554-579
Brake Shoe Illustrations.....	580-586
Brake Shoe Competitor Interchange Numbers .....	587-589

SHOE  
BUYERS GUIDE

## DISC BUYERS GUIDE

Buyers Guide - Streetbike Discs .....	590-624
Buyers Guide - Off Road Discs .....	625-638

DISC  
BUYERS GUIDE

## CLUTCH APPLICATIONS

Clutch Introduction Page .....	639
EBC Coil Spring Kits/Spring Tension Measuring Machine/EBC Diaphragm Clutch Springs.....	640
CKF Clutch Kits/DRC-F Clutch Kits/Clutch Removal Tools .....	641
Clutch Applications .....	642-675

CLUTCH  
APPLICATIONS

## BUYERS GUIDE CLUTCH

Buyers Guide - Clutch Kits .....	676-698
Buyers Guide - DRC Kits .....	699-707
Buyers Guide - SRC Kits.....	708-711
Buyers Guide - SRK Kits.....	712-716

CLUTCH  
BUYERS GUIDE

## ACCESSORY PAGES

Pilot Jets.....	717-719	Baffle Pac Silencer Wool .....	723
Main Jets.....	720-721	Brake Fluid/Brake Caliper Lube .....	723
S & B Filters .....	721	Galindo & Baja Grips, Ledar Nozzles & Racing Reeds ...	724
Hy-Tech Racing Reeds.....	722	Mountain Bike Information .....	725-732
Cleanstuff Brake Cleaner .....	723		

ACCESSORY  
PAGES

# CHOOSE THE RIGHT EBC PADS FOR YOUR MOTORCYCLE OR ATV

EBC Brakes® offer an extensive range of pad compounds for every style of riding and the guide below will help you get the best value for money and offset the chances of any damage to your new rotors.

Numerous lightweight composite rotor materials are now on the world markets that are expensive and using the wrong pads will simply SHRED these rotors. EBC has tested popular offerings and found no frictional/brake performance advantage at all in using these rotors. Also friction levels were found to be extremely low and brakes ineffective in the wet. We do not recommend the use of any EBC pads in connection with composite rotors of any kind and no warranty exists in their use.

Also certain Classic and heavier bikes feature 6 or 7mm thick rotor blades and EBC make those with what we call a "Billet Steel". This steel is LESS HARD than OEM discs and the use of V-Pads™ is the perfect solution for those. Inside each box is a warning note for consumers, at the bottom of this page also is a list of EBC rotors made in BILLET STEEL that demand the use of V-Pads™ only to avoid rotor galling.

Type of Brake Rotor	Best Pad To Use
<b>OEM Stainless Steel</b>	<b>Any</b>
<b>EBC Stainless Steel X, XC or SBD Series</b>	<b>Any</b>
<b>EBC Billet Rotor (front or rear) (see list below)</b>	<b>FA Series Organic Pads or Vee/VLD Pads</b>
<b>EBC Oversize Rotors (OS and SM Series)</b>	<b>EBC X Series Carbon, R Series Sintered, MXS Series Sintered or EPFA Series Sintered</b>
<b>EBC Stainless Steel Rear Brake Rotors (MD Series)</b>	<b>Any</b>
<b>EBC Stainless Off Road Series for Moto-X or ATV (MD Series)</b>	<b>Any</b>
<b>Composite lightweight rotors (such as carbon fiber, metal matrix, silicone carbide)</b>	<b>DO NOT USE any EBC product on these rotors. Tests have shown rotor damage</b>

<b>EBC Rotors Made From Billet Steel That Require EBC V-Pad™ Use Only</b>			
MD517	MD1126	MD3036	MD4082
MD521	MD1127	MD3041	MD4123
MD615	MD1133	MD3043	MD4128
MD658	MD1135	MD3064	MD4146
MD670	MD1148	MD3079	MD4147
MD1052	MD1163	MD3086	MD4148
MD1056	MD2025	MD3097	MD4150
MD1062	MD2068	MD4010	
MD1064	MD2069	MD4017	
MD1071	MD2075	MD4019	
MD1077	MD2078	MD4054	
MD1078	MD2081	MD4062	
MD1082	MD2088	MD4068	
MD1125	MD3019	MD4069	

# EBC NEW V Pads™

**New for  
2013**



- **Life of sintered pad - feel of an organic pad**
- **Zero brake noise**
- **Zero rotor galling, gentle on rotors**

Another world first debut of a SEMI-SINTERED™ pad compound. This new material uses a 30% weight percentage of copper in a high density matrix that combines the best of both worlds. Longer life, similar to sintered and great brake “feel” with lower heat transfer and less rotor abrasion. The new V-Pads™ are available for ALL Cruisers and Big Twins and for rear applications on numerous Sportbikes where extended wear life may be an advantage.

**How to order** - select regular part number from application listings in the appropriate column.

## NEW VLD Limited Edition Chrome Pads



- **Life of sintered pad - feel of an organic pad**
- **Zero brake noise**
- **Zero rotor galling, gentle on rotors**

Using the exact same compound as V-Pads™ above, a limited range of pads for the cruiser market is now available with polished chrome backing plates. Bonding of friction material onto backing plates could not be achieved without the NUCAP of Canada NRS system featuring a hook pattern which EBC Brakes applies to its backing plates under licence from NUCAP.

**British  
Made** 

**NRS HOOKS**



STANDARD PAD NO	CHROME BACKED NO.
FA216/3V	FA216/3VLD
FA400V	FA400VLD
FA409V	FA409VLD
FA434V	FA434VLD
FA457V	FA457VLD
FA458V	FA458VLD

**How to order** - select the correct pad for your application and suffix with VLD. Please note only the above references available for 2013.



# EBC Brakes - World Leader in Manufacturing

**EBC New World Headquarters, Northampton, UK**



The new Northampton headquarters of EBC Brakes® includes full press shop facilities (lower right) and brake rotor manufacturing (lower left). Examples of the new NRS backplate hook system produced under licence from NUCAP Canada are shown in the lower centre picture above.



Manufacturing the largest range of organic brake pads in the world, the ISO approved facilities at EBC Bristol produce world class products which conform to every known industry standard. The two production facilities have ability to produce over 12 million pieces of disc brake pads per year.



# of Motorcycle Brake Rotors and Pads



**EBC USA Inc,  
Los Angeles, USA**



## EBC Brakes® USA - LA Distribution

EBC Brakes USA Inc. in Los Angeles holds massive inventory of EBC Brakes® products for same day shipment and has a facility to ship dozens of pallets and up to 4000 parcels per day on its automated packaging line.

## EBC Brakes® USA Sintered Pad Plant

North America's premier sintered pad manufacturer is located in Ohio and as part of the EBC family of companies is fully ISO compliant with its own R&D facilities including two LINK dynamometers and full time chemists producing parts for original equipment and the EBC aftermarket programme of sintered brake pads.

**EBC Sintered Pad  
Manufacturing Plant,  
Cleveland, Ohio**



Equipped with full R&D facilities including two of the latest LINK dynamometer banks for full product development and quality control.

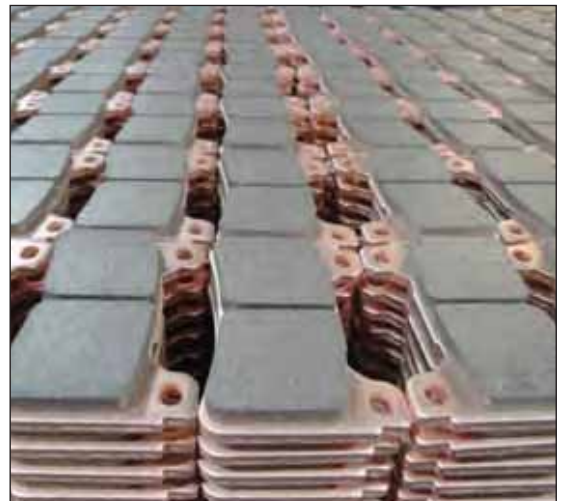

# CX Extreme® MOTO-X BRAKE ROTORS



- Heat treated and tempered stainless steel
- Lightest weight profile with new Vee design
- Great looks for modern motocross machines
- Balanced front and rear designs

A new ultra lightweight performance brake rotor to provide superb visual appeal for riders wishing to replace or upgrade their original brake rotors. The new Vee-Notch™ design offers a self cleaning high pressure contact pad-to-rotor brake enhancement.

The rotors are available for all modern fitments as shown on the chart below.

To order simply change the "D" or "C" suffix of a standard rotor to the suffix "CX".



**CX EXTREME®**  
**MOTO-X BRAKE ROTORS**

FRONT		REAR	
STANDARD #	EXTREME #	STANDARD #	EXTREME #
MD649	MD649CX	MD6002D	MD6002CX
MD6001D/C	MD6001CX	MD6005C/D	MD6005CX
MD6010D	MD6010CX	MD6013D/C	MD6013CX
MD6015D/C	MD6015CX	MD6014D/C	MD6014CX
MD6017D/C	MD6015CX	MD6024D/C	MD6024CX
MD6028D/C	MD6028CX	MD6031D/C	MD6031CX
MD6030D/C	MD6030CX	MD6035D/C	MD6035CX
MD6032C	MD6032CX	MD6038D	MD6038CX
MD6037C	MD6037CX	MD6045D	MD6045CX
MD6040D	MD6040CX	MD6082D	MD6082CX
MD6042D	MD6042CX	MD6095D	MD6095CX
MD6058C	MD6058CX	MD6105D	MD6105CX
MD6083D	MD6083CX	MD6110D	MD6110CX
MD6094D	MD6094CX	MD6124D/C	MD6124CX
MD6166D	MD6166CX	MD6135D/C	MD6135CX
MD6186D/C	MD6186CX	MD6157D/C	MD6157CX
MD6213D/C	MD6213CX	MD6166D	MD6166CX
MD6243D/C	MD6243CX	MD6181D/C	MD6181CX
MD6254D/C	MD6254CX	MD6187D/C	MD6187CX
MD6264D/C	MD6264CX	MD6190D/C	MD6190CX
MD6309C	MD6309CX	MD6191D/C	MD6191CX
MD6314D/C	MD6314CX	MD6208D/C	MD6208CX
MD6330D/C	MD6330CX	MD6232D	MD6232CX
MD6356D/C	MD6356CX	MD6246C	MD6246CX
MD6372C	MD6372CX	MD6249C	MD6249CX
		MD6255D/C	MD6255CX
		MD6305D/C	MD6305CX
		MD6310C	MD6310CX
		MD6316D/C	MD6316CX
		MD6373C	MD6373CX



## EBC Vee-Rotors™ - Front

- Fully floating design
- Lightest weight rotor profile
- Features patented SD system hardware
- Black hubs as standard
- Colour options

In line with the ongoing trend for riders to customize machines rather than simply replace parts, the new Vee-Rotors™ from EBC Brakes® offer an exciting new lightweight rotor program with an exciting range of colour options. The standard offering of hub colour is BLACK.

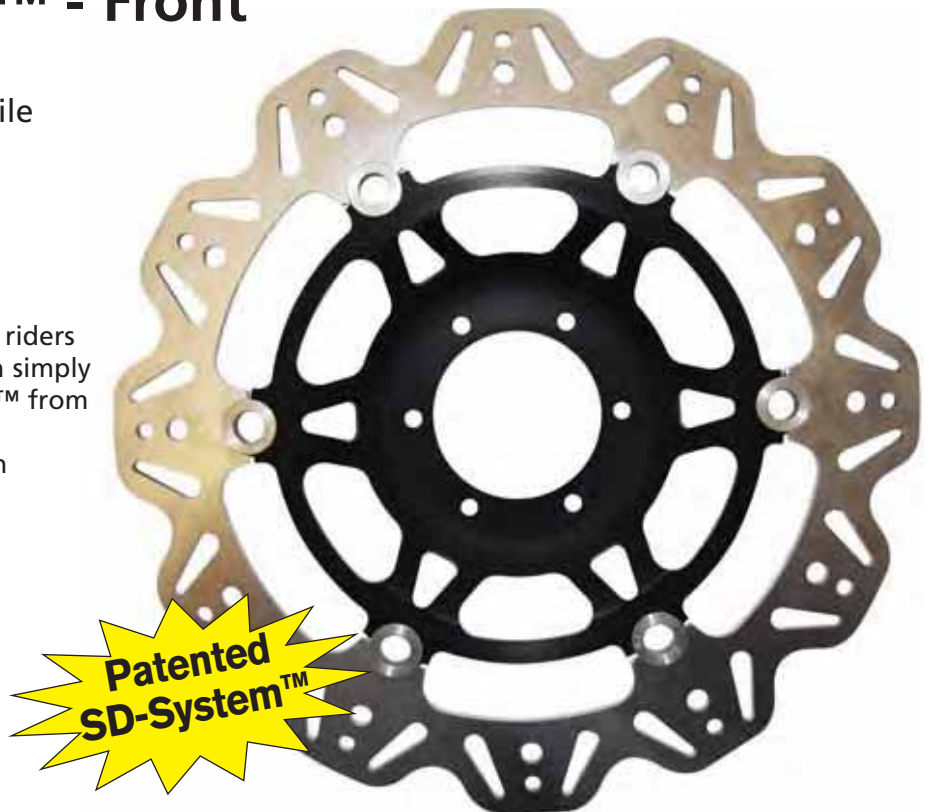

## EBC Vee-Rotors™ - Rear

- Heat treated stainless steel
- Lightest weight rotor profile
- Matching design to Vee-Rotor™ fronts

To compliment the front floating rotors in the Vee-Rotor™ range, these British made heat treated and tempered stainless steel brake rotors are available for most popular bikes.

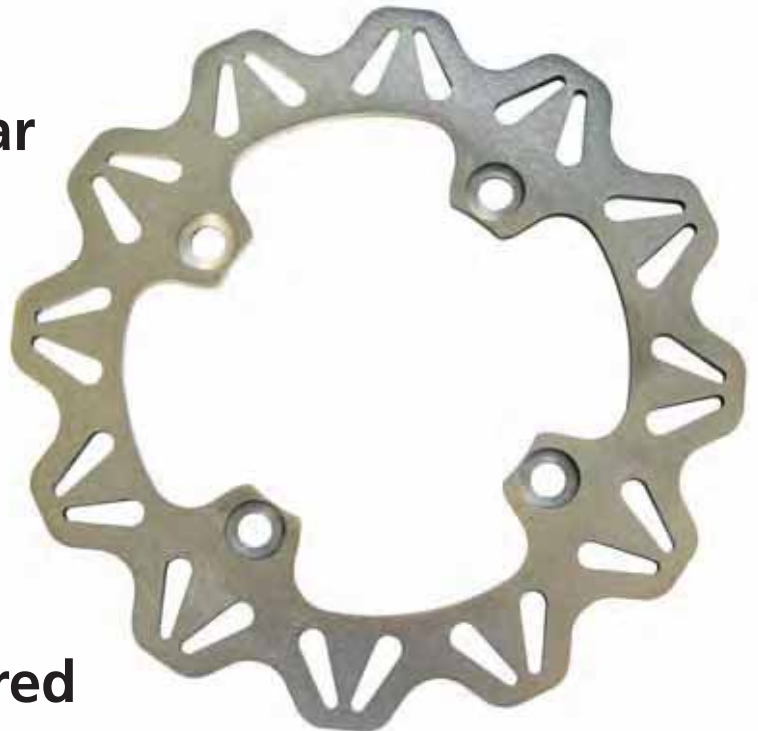

## Heat Treated & Tempered

This product is fully stainless steel heat treated and tempered back to the optimum hardness.

**BEWARE** - of companies merely stating their product is stainless steel. Some of these are not hardened and of those that are, some are hardened to the excess and can exhibit cracks through over hardness between the holes and edges. EBC has worked long and hard on choosing the exact correct hardness and temper procedure for their brake rotors.

# NEW STREET BIKE ROTOR PROGRAMMES FOR 2013

## Colour Options for EBC Vee-Rotors™

- Option of five hub colours
- Features patented SD system hardware
- Black hubs are standard
- Colour options - see below

Although the standard hub colour for the Vee-Rotor™ programme is BLACK, these colours are available by special order options. Historically, red and blue anodized alloy fades badly over a period of 1-2 years in the sunlight. The special colour application process that we have devised for our Vee-Rotors™ uses a "FIX" process that seals the colour and minimizes colour loss.

### Availability Chart for Coloured Hub Vee-Rotors™

Black Centre Hub	Green Centre Hub	Blue Centre Hub	Red Centre Hub	Gold Centre Hub	Silver Centre Hub
VR614BLK		VR614BLU	VR614RED	VR614GLD	VR618
VR621BLK		VR621BLU	VR621RED	VR621GLD	VR627
VR622BLK		VR622BLU	VR622RED	VR622GLD	VR632
VR624BLK		VR624BLU	VR624RED	VR624GLD	VR641
VR626BLK		VR626BLU	VR626RED	VR626GLD	VR643
VR629BLK		VR629BLU	VR629RED	VR629GLD	VR648
VR640BLK		VR640BLU	VR640RED	VR640GLD	VR663
VR646BLK		VR646BLU	VR646RED	VR646GLD	VR681
VR647BLK		VR647BLU	VR647RED	VR647GLD	VR695
VR662BLK		VR662BLU	VR662RED	VR662GLD	VR1004
VR669BLK		VR669BLU	VR669RED	VR669GLD	VR1006
VR679BLK		VR679BLU	VR679RED	VR679GLD	VR1020
VR694BLK		VR694BLU	VR694RED	VR694GLD	VR1173
VR800BLK		VR800BLU	VR800RED	VR800GLD	VR2002
VR817BLK		VR817BLU	VR817RED	VR817GLD	VR2011
VR841BLK		VR841BLU	VR841RED	VR841GLD	VR2021
VR842BLK		VR842BLU	VR842RED	VR842GLD	VR2084
VR843BLK		VR843BLU	VR843RED	VR843GLD	VR2086
VR1003BLK		VR1003BLU	VR1003RED		VR2091
VR1014BLK		VR1014BLU	VR1014RED		VR2092
VR1120BLK		VR1120BLU	VR1120RED		VR2093
VR1134BLK		VR1134BLU	VR1134RED		VR2100
VR1136BLK		VR1136BLU	VR1136RED		VR2103
VR1137BLK		VR1137BLU	VR1137RED		VR2116
VR1141BLK		VR1141BLU	VR1141RED		VR2117
VR1152BLK		VR1152BLU	VR1152RED		VR3002
VR1153BLK		VR1153BLU	VR1153RED		VR3008
VR1161BLK		VR1161BLU	VR1161RED		VR3060
VR1171BLK		VR1171BLU	VR1171RED		VR3093
VR2001BLK		VR2001BLU	VR2001RED		VR3099
VR2003BLK		VR2003BLU	VR2003RED		VR4007
VR2074BLK		VR2074BLU	VR2074RED		VR4009
VR2082BLK		VR2082BLU	VR2082RED		VR4013
VR2089BLK		VR2089BLU	VR2089RED		VR4014
VR2094BLK		VR2094BLU	VR2094RED		VR4015
VR2095BLK		VR2095BLU	VR2095RED		VR4023
VR2101BLK		VR2101BLU	VR2101RED		VR4027
VR2102BLK		VR2102BLU	VR2102RED		VR4130
VR2105BLK		VR2105BLU	VR2105RED		VR4133
VR3003BLK		VR3003BLU	VR3003RED		VR4138
VR3006BLK		VR3006BLU	VR3006RED		VR4157
VR3007BLK		VR3007BLU	VR3007RED		VR4160
VR3058BLK		VR3058BLU	VR3058RED		VR4165
VR3088BLK		VR3088BLU	VR3088RED		
VR3089BLK		VR3089BLU	VR3089RED		
VR3090BLK		VR3090BLU	VR3090RED		
VR3091BLK		VR3091BLU	VR3091RED		
VR3092BLK		VR3092BLU	VR3092RED		
VR3098BLK		VR3098BLU	VR3098RED		
VR3100BLK		VR3100BLU	VR3100RED		
VR3102BLK		VR3102BLU	VR3102RED		
VR3104BLK		VR3104BLU	VR3104RED		
VR4008BLK	VR4008GRN				
VR4012BLK	VR4012GRN				
VR4022BLK	VR4022GRN				
VR4132BLK	VR4132GRN				
VR4136BLK	VR4136GRN				
VR4152BLK	VR4152GRN				
VR4153BLK	VR4153GRN				
VR4154BLK	VR4154GRN				
VR4155BLK	VR4155GRN				
VR4159BLK	VR4159GRN				
VR4161BLK	VR4161GRN				



# NEW STREET BIKE ROTOR PROGRAMMES FOR 2013



## How To Order

Five new colour options exist for the new Vee-Rotor™ range as described above. To specify your chosen hub colour, add the suffix letters after the part number, e.g. MD1003XC as a standard brake rotor becomes VR (Vee-Rotor™), followed by the part number (in this case 1003) and the hub colour selection, BLU for blue etc. In this case the new number will be VR1003BLU.

Please note optional hub colours are not available for any other EBC rotor programs except the new Vee-Rotor™ series.

# EBC<sup>®</sup> BRAKES

## GPFA Full Race Pads EPFA Trackday Pads

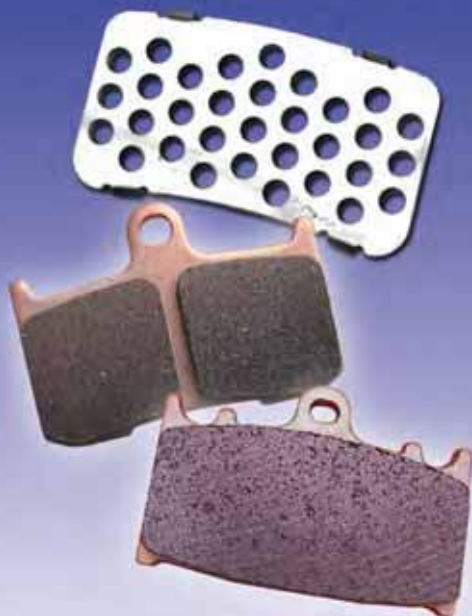

- **MORE** stability
- **FASTER** bed-in
- **MORE** bite
- **STAINLESS** radiator plates
- **Better** heat cycling
- **LONGER** life
- **REDUCED** rotor damage

Two great choices for high end pad requirements from EBC.

The EPFA series is a premium long life street pad with improved fade resistance and heat cycling and improved noise characteristics making a great pad for heavy streetbikes and cruisers and also faster superbikes including intermittent track use. For exclusive track use we recommend our GPFA range.

GPFA pads are an ultra high friction race only pad and not designed for the street due to their friction level. They have been used globally for two years now by numerous professional race teams.

GPFA pads are priced identically to EPFA, range available shown below.

### The Dyno Test Results

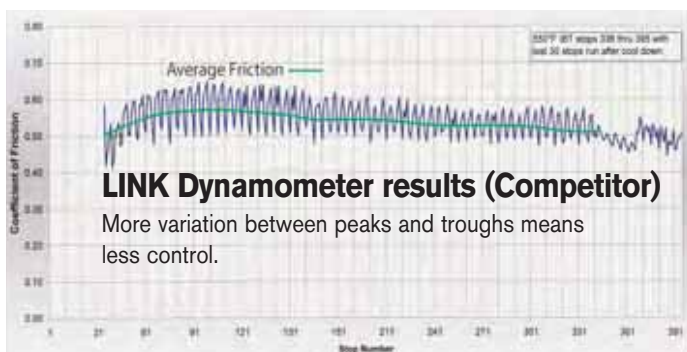
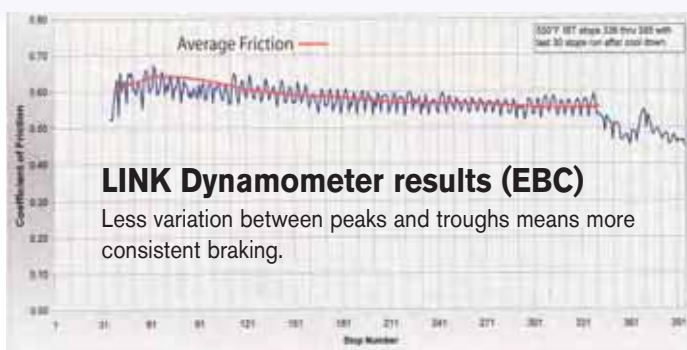

### GPFA Range for 2013

Set No.	Set No.	Set No.
GPFA016HH	GPFA347HH	GPFA442/4HH
GPFA218HH	GPFA379HH	GPFA447HH
GPFA218/2HH	GPFA380HH	GPFA604/4HH
GPFA244HH	GPFA390HH	GPFA611HH
GPFA296HH	GPFA417/4HH	

### EPFA Range for 2013

Set No.	Set No.	Set No.
EPFA16HH	EPFA249HH	EPFA390HH
EPFA94HH	EPFA252HH	EPFA400HH
EPFA95HH	EPFA261HH	EPFA405HH
EPFA129HH	EPFA261/2HH	EPFA406HH
EPFA131HH	EPFA263HH	EPFA407HH
EPFA145HH	EPFA265HH	EPFA409HH
EPFA158HH	EPFA294HH	EPFA417/4HH
EPFA175HH	EPFA295HH	EPFA424HH
EPFA181HH	EPFA296HH	EPFA433/4HH
EPFA185HH	EPFA322/4HH	EPFA434HH
EPFA187HH	EPFA335HH	EPFA435/4HH
EPFA188HH	EPFA345HH	EPFA442/4HH
EPFA197HH	EPFA346HH	EPFA447HH
EPFA200HH	EPFA347HH	EPFA450HH
EPFA208HH	EPFA367HH	EPFA454/4HH
EPFA218HH	EPFA368HH	EPFA457HH
EPFA218/2HH	EPFA369/4HH	EPFA458HH
EPFA226HH	EPFA379HH	EPFA491HH
EPFA229HH	EPFA380HH	EPFA604/4HH
EPFA231HH	EPFA381HH	
EPFA239HH	EPFA387HH	
EPFA244HH	EPFA388HH	

For pad fitment information, please see the pad buyers guide.



# CKF Clutch Kits



See application pages for availability and fitments.

CKF is the name of the new EBC carbon fibre impregnated motocross and ATV clutches and they are built tough to last longer, grip better, feel better and drive better than stock cork based units.

PLUS the high heat ability of these CKF Carbon Fibre clutch plates handles much higher stresses and temperatures encountered in racing yet feel gentle and smooth in everyday riding.

One day all motocross bikes and ATV will be built using a clutch like this but for now the only way to get the best clutch in the game is to step up to an EBC CKF plate set or go the whole hog and invest in the DRCF clutch kits which are sold as an assembly with a stack height measured to precisely reset your bike to the original sizing.

# DRC-F Clutch Kits

**The toughest off road clutch yet.**

**Tested for 12 months in the toughest moto-x applications, these new heavy duty kits are ideal for fast off road use especially on modern 4 stroke engines.**



More added for 2013, the ultimate moto-x and ATV heavy duty clutch kit designed for race use. These new kits feature carbon fibre lined clutch plates plus a full set of steel plates and heavy duty springs.

# Clutch Removal Tools



EBC Brakes® now produces a range of clutch tools to allow easy install of all EBC clutch kits. Range covers 95% of US market motorcycles and ATVs and allow positive holding of the clutch basket or centre boss to allow untightening and retightening of securing nuts.

Clutch application pages show appropriate tool and below is a list of the available 2013 programme.

## PART NUMBERS AVAILABLE AT TIME OF PRINT

CT001	CT012SP	CT024	CT037SP	CT051
CT002	CT013	CT024SP	CT038SP	CT052
CT003	CT013SP	CT025	CT039	CT053SP
CT004	CT014	CT026	CT040SP	CT054SP
CT005	CT014SP	CT027	CT041	CT055SP
CT006	CT015	CT028	CT042	CT056SP
CT007	CT016	CT029	CT043SP	CT057SP
CT008	CT017	CT029SP	CT044	CT058
CT009	CT018SP	CT030	CT045	CT060
CT009SP	CT019	CT031	CT046	CT061
CT010	CT020	CT032	CT047SP	
CT010SP	CT021	CT033SP	CT048SP	
CT011	CT022	CT035SP	CT049	
CT012	CT023	CT036SP	CT050SP	



**Costing far less than OE manufacturer tools, EBC strongly recommend selling a clutch tool for every clutch sold.**

**Many dealers have already ordered one of each tool and loan these to customers with a deposit to gain tool loan income.**



# EBC Off Road PAD Options

## “TT” Series Moto-X Sport and Enduro Pads

Cool running carbon based brake pad compound for sport use in moto-x and ATV applications. For mud, sand or wet conditions requiring longer life, use our sintered range below.



## “R” Series Sintered ATV and Moto-X Replacement Pads

US made sintered copper alloy pads for sport and utility riding alike in normal off road riding.

## “MXS” Moto-X Race Pads

Ultra high friction American made sintered copper alloy pads with diamond ground surface finish for fast brake-in, these pads come complete with external hex drive slider pins and are suitable for all fast moto-x riding.



# EBC Brakes® Shoes



EBC brake shoes are made using high pressure Die cast aluminium platforms with bonded brake linings. All shoes are radius ground and edge trimmed and also feature lead in and lead out chamfers at lining ends and original equipment style brake shoe springs.



**WATER GROOVED EBC** series brake shoes are made using high pressure Die cast aluminium platforms with bonded brake linings. All shoes are radius ground and edge trimmed and also feature lead in and lead out chamfers at lining ends and original equipment style brake shoe springs.

The multiple angled liner grooves are designed to channel away dirt, dust, water and debris from the braking area to improve braking and extend shoe and drum life.

## EBC Off Road ROTOR Options



Tough heat treated carbon steel with zinc coat rust prevention, the D series rotors are a direct replacement for original parts. Add C suffix for contoured profile

### EBC OE Replacement Rotor

Part No carries "D" Suffix



### EBC Supercross Contour Rotor

Part No carries "C" Suffix

### NEW Enduro CE Series

Made from tough German mill rolled heat treated stainless steel, the new Enduro rotors have no vent holes in the pad sweep area to improve pad and disc wear in enduro riding.

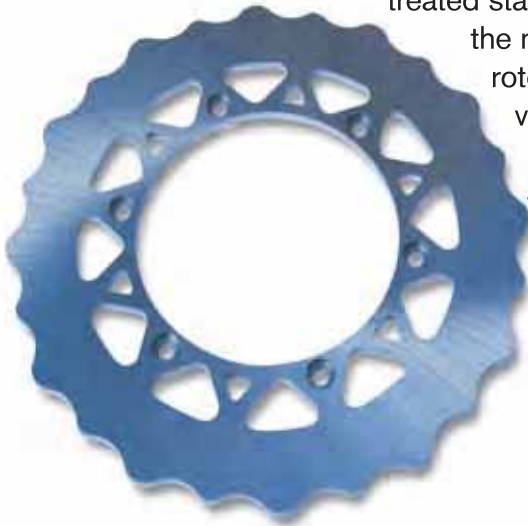

### Moto-X Mini Oversize Kit for 65/80/85/150 cc MX bikes

Optimum 250mm diameter and comes complete with relocation bracket. All rotors feature contoured profile as standard.

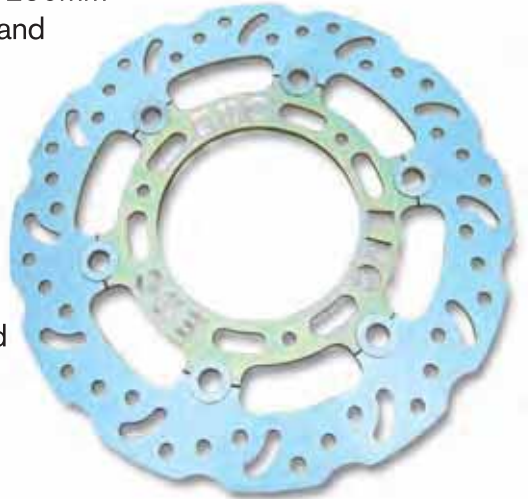

### EBC Oversize MX Disc Kits

280mm oversize disc kit complete with relocation bracket for improved brake power and control. C suffix for contoured profile with even lighter rotor weight and improved cleaning and cooling.



### EBC Supermotard Contour Rotor Kit

320mm rotor upgrade kits complete with relocation bracket.

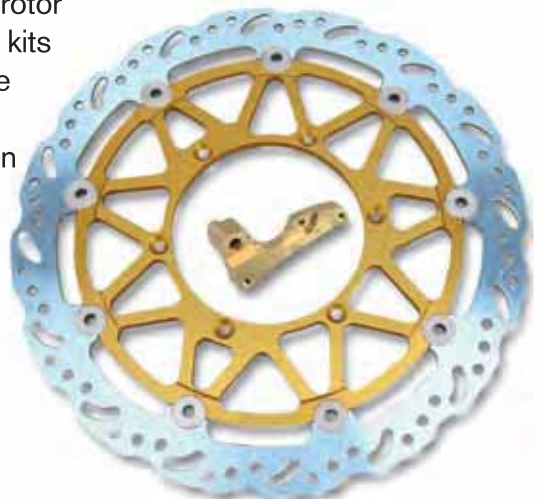



# EBC Sportbike & Scooter Pad Range

## EBC Organic Brake Pads

FA series Kevlar® organic pads provide fingertip stopping power and are the preferred choice for many sportbike riders, having low disc attack characteristics and medium lifetime.



## EBC Double-H™ Superbike Pads

FA series, with HH suffix, denotes EBC's American made ultra high friction Double-H™ sintered copper alloy brake pads for maximum stopping power and lifetime. Fitted with stainless steel radiator plates for bikes without built in piston insulators to reduce heat transfer into hydraulics and new double compact vented technology for wider pads, reducing backplate bending.



## EBC SFA & SFAHH Scooter Pads

A new range of organic and sintered scooter pads in premium quality materials designed specifically for lighter weight motorcycles, such as scooters to give good lifetime and good initial brake response at a price point appropriate for the market.



# EBC Streetbike Disc Range

## Custom Discs for Naked Bikes

Universal for left and right with stainless steel rotor blade and polished and heat lacquered alloy center hubs. For a list of available discs in the CC suffix custom series, see buyers guide.



## Oversize Floating Disc Conversion

For use on freestyle stunt bike riding where increased control of the rear brake is essential and was pioneered by stunt stars such as Aaron Colton in the USA.





# EBC Streetbike Disc Range Contd.

## Special Application Discs and Floating Conversions

The EBC brake disc range now comprises over 1000 different designs and some of the more exotic ones are shown here, such as type A which is a floating conversion rotor for BMW classic motorcycles, also available for many early classic Japanese bikes, then type B which shows an EBC disc with ABS ring and type C which is a floating disc for a motocross bike.

## EBC Pro-lite Street & Race Hybrid Brake Discs (below)

The X and XC series discs perform so well with the new stainless steel rotor blades, ultra light 6 button construction and SD system square drive technology that these rotors are now standard fitment for both road race use and street sport applications. These units are riveted together and are no longer rebuildable due to the infinite service life obtained with the SD square drive button system.



Type A

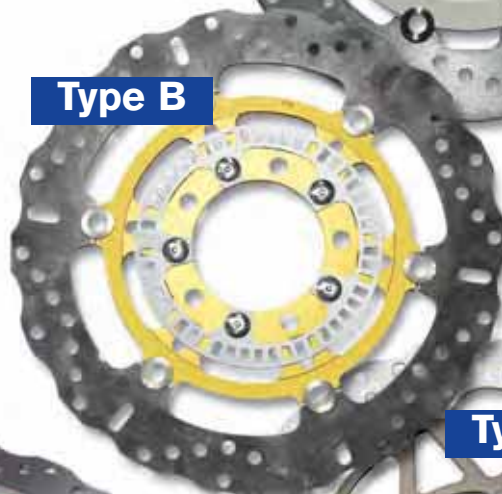

Type B

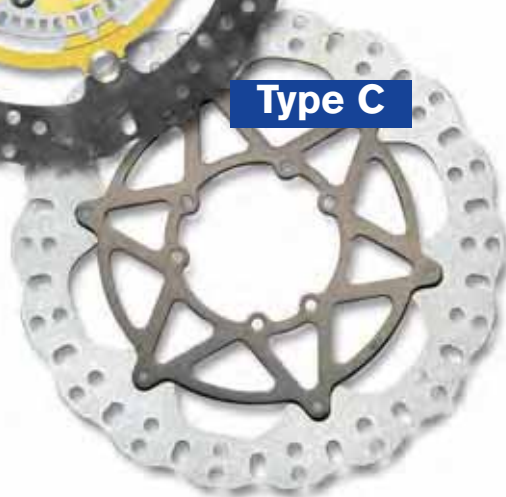

Type C



## EBC Stainless Steel Rear Brake Discs

Now made from stainless steel and available in full circle or contoured profile, suitable for performance street use or racing with new lightweight hole pattern construction.

# AMERICAN MOTORCYCLE PAD OPTIONS

## Kevlar® Organic Pads

- **Superb brake feel and modulation**
  - **Super quiet in operation**
    - **Made in the UK**

Organic pads have always been extremely popular amongst big twin and cruiser bike users, especially those using custom brake rotors due to the reduced dusting and reduced rotor galling that organic pads deliver. These quality pads 100% made in the UK have been a world market number one seller in their category with over 35 million sets sold worldwide.

### How to select your pads

Select part number from application pages E.g. **FA400**



## Semi-Sintered Pads

- **30% copper content extends life**
  - **Super quiet in operation**
    - **Made in the UK**

Combining the very best features of organic pads with the lifetime of a sintered pad, these part sintered 30% copper content organic pads extend lifetime considerably over Kevlar® organics or any other semi metallic pads significantly. On a scale of 1-10, a semi-metallic pad would last 10,000 miles, the semi-sintered pad would last 25,000 and a sintered pad probably 30,000 miles.

### How to select your pads

Select part number from application pages and suffix with letter V E.g. **FA400V**



## Extreme Pro Sintered Pads

- **Longest life of any sintered material**
  - **Super quiet in operation**
    - **Made in the USA**

Made in the USA, the EBC Extreme Pro range is a highly refined copper alloy including extra expensive ingredients to further enhance lifetime and quieten the brakes during operation. If you are looking for the ultimate in lifetime and brake performance on a big cruiser, these are the brakes to buy.

### How to select your pads

Select part number from application pages and prefix with letters EP and suffix with letters HH E.g. **EPFA400HH**



## Double-H™ Sintered Pads

- **Original equipment grade sintered pad**
  - **Super quiet in operation**
    - **Made in the USA**

Made in the USA, the EBC Double-H sintered pads are an exact equivalent of the sintered pad grade supplied in your motorcycle when it was made. Lifetime is extremely high with a high friction brake effect that gives fingertip stopping power. Best used on heat treated stainless steel discs.

### How to select your pads

Select part number from application pages and suffix with letters HH E.g. **FA400HH**

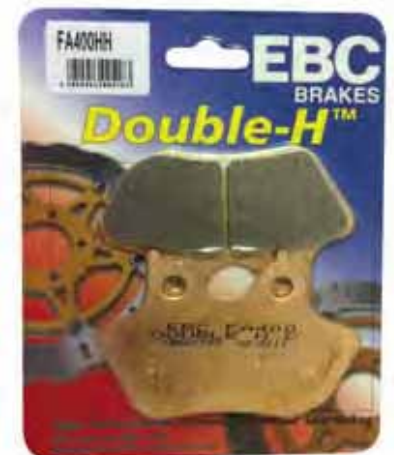

# **EBC Stainless Steel Custom Rotors for American Motorcycles**

**All rotors fit standard 5 bolt hubs and are 11.5 inch diameter.  
Front rotors use 5mm rotor thickness, rears use 6mm rotor thickness.**

<b>New # for Polished Stainless Rotors</b>	<b>Old EBC # As in Listings</b>	
FSD007	MD506	Solid wide band
FSD008	MD512	Solid wide band
FSD009	MD506	5 button floater wide band
FSD010	MD512	5 button floater wide band
FSD011C	MD506	5 button floater contour wide band
FSD012C	MD512	5 button floater contour wide band
RSD017C	MD508	10 button floater contour wide band
RSD018C	MD513	10 button floater contour wide band
RSD019	MD508	10 button floater wide band
RSD020	MD513	10 button floater wide band
FSD001	MD506	Solid narrow band
FSD002	MD512	Solid narrow band
FSD003	MD506	5 button floater narrow band
FSD004	MD512	5 button floater narrow band
FSD005C	MD506	5 button floater contour narrow band
FSD006C	MD512	5 button floater contour narrow band
RSD013C	MD508	10 button floater contour narrow band
RSD014C	MD513	10 button floater contour narrow band
RSD015	MD508	10 button floater narrow band
RSD016	MD513	10 button floater narrow band



## FRONT ROTORS

All rear rotor  
thicknesses 5mm/  $\frac{3}{8}$ "

### NARROW BAND SERIES

FSD001 (2" bore)  
FSD002 (2.25" bore)

**Solid Rotor**

This rotor will accept pads FA216/3, FA299, FA381 & FA400.

### WIDE BAND SERIES

FSD007 (2" bore)  
FSD008 (2.25" bore)

**Solid Rotor**

This rotor will accept pads FA94, FA299, FA381 & FA400.



### NARROW BAND SERIES

FSD003 (2" bore)  
FSD004 (2.25" bore)

**5 Button full floater**

This rotor will accept pads FA216/3, FA299, FA381 & FA400.

### WIDE BAND SERIES

FSD009 (2" bore)  
FSD010 (2.25" bore)

**5 Button full floater**

This rotor will accept pads FA94, FA299 & FA400.



### NARROW BAND SERIES

FSD005C (2" bore)  
FSD006C (2.25" bore)

**5 Button full floater**

This rotor will accept pads FA216/3, FA299, FA381 & FA400.

### WIDE BAND SERIES

FSD011C (2" bore)  
FSD012C (2.25" bore)

**5 Button full floater**

This rotor will accept pads FA94, FA299 & FA400.



**REAR ROTORS**

All rear rotor thicknesses 6mm ¼"

**NARROW BAND SERIES**

RSD013C (2" bore)  
RSD014C (2.25" bore)

**10 Button Full Floater**

This rotor will accept pads FA216/3 & FA387.

**WIDE BAND SERIES**

RSD017C (2" bore)  
RSD018C (2.25" bore)

**10 Button Full Floater**

This rotor will accept pads FA200, FA201, FA299 & FA400.



**NARROW BAND SERIES**

RSD015 (2" bore)  
RSD016 (2.25" bore)

**10 Button Full Floater**

This rotor will accept pads FA216/3 & FA387.

**WIDE BAND SERIES**

RSD019 (2" bore)  
RSD020 (2.25" bore)

**10 Button Full Floater**

This rotor will accept pads FA200, FA201, FA299 & FA400.

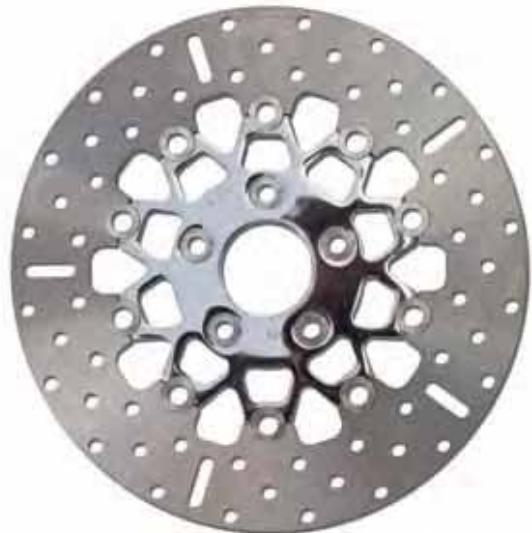

**ALL EBC ROTORS ARE 100% BRITISH MADE  
USING POLISHED STAINLESS STEEL CENTRE HUBS  
AND HEAT TREATED STAINLESS STEEL ROTOR BLADES**





# PAD/SHOE/ROTOR Applications for AMERICAN PRODUCED MOTORCYCLES

		← FRONT →					← REAR →				
		Organic Pads	Semi-Sintered V-Pads	Sintered Pads	FSD (Left)	FSD (Right)	Organic Pads	Semi-Sintered V-Pads	Sintered Pads	FSD (Left)	FSD (Right)
<b>HARLEY DAVIDSON®</b>											
Make / Model / Year											
<b>PICK UP TRUCK SPECIAL EDITION</b>											
<b>F-150 PICK UP TRUCK</b>											
Note there is a choice of pad material for both pads and discs, check website <a href="http://www.ebcbrakes.com">www.ebcbrakes.com</a> for details of parts	00-04	DP61259		GREEN	GD7130	GD7130	DP61633		GREEN	GD7154	GD7154
		DP41259R		YELLOW	USR7130	USR7130	DP41633R		YELLOW	USR7154	USR7154
<b>SPORTSTER SERIES</b>											
<b>XL, XLH, XLCH, XLS, XLX (Sportster®, 53C Custom®)</b>											
54-78	54-78	N/A			N/A		N/A				N/A
54-72	54-72	N/A			N/A		N/A				N/A
(XLH, XLCH) (Rivet Type)	73-77	FA026				N/A	FA072	FA072V			N/A
(Twin fronts)	79-81	FA071*	FA071V*				FA072	FA072V			N/A
(Twin fronts) (Girling caliper)	82-83	FA071*	FA071V*		N/A	N/A	FA078	FA078V		N/A	
84- Early 87(Girling caliper)	84-Early 87	FA094	FA094V	FA094HH	FSD009		FA078	FA078V	FA078HH	N/A	
Late 87-99	Late 87-99	FA094	FA094V	FA094HH	FSD009		FA200	FA200V	FA200HH	RSD019	
XL 50 50th Anniversary Sportster	07	FA381	FA381V	FA381HH	FSD010		FA387	FA387V	FA387HH	RSD020	
XLH Sportster 883	00-03	FA400	FA400V	FA400HH	FSD010		USE FA400V	FA400V	FA400HH	RSD020	
XLH Sportster 883 R Flat Track	00-03	FA400	FA400V	FA400HH	FSD010		USE FA400V	FA400V	FA400HH	RSD020	
XL Sportster 883 Hugger	00-03	FA400	FA400V	FA400HH	FSD010		USE FA400V	FA400V	FA400HH	RSD020	
XL Sportster 53c Custom (883cc)	00-03	FA400	FA400V	FA400HH	FSD010		USE FA400V	FA400V	FA400HH	RSD020	
XL 883 Sportster Standard	00-03	FA400	FA400V	FA400HH	FSD010		USE FA400V	FA400V	FA400HH	RSD020	
XL 883 R 100th Anniversary Edition	03	FA400*	FA400V*	FA400HH*	FSD010	FSD010	USE FA400V	FA400V	FA400HH	RSD020	
XL 883 C Sportster Custom	04-08	FA381	FA381V	FA381HH	FSD010		FA387	FA387V	FA387HH	RSD020	
XL 883 L 883 Low	04-10	FA381	FA381V	FA381HH	FSD010		FA387	FA387V	FA387HH	RSD020	
XL 883 L Superlow	11-13	FA381	FA381V	FA381HH	FSD010		FA387	FA387V	FA387HH	RSD020	
XL 883 R Sportster R	05-13	FA381*	FA381V*	FA381HH*	FSD010	FSD010	FA387	FA387V	FA387HH	RSD020	
XL 883 R Roadster	10	FA381*	FA381V*	FA381HH*	FSD010	FSD010	FA387	FA387V	FA387HH	RSD020	
XL 883 N Iron	09-13	FA381	FA381V	FA381HH	FSD010		FA387	FA387V	FA387HH	RSD020	
XL Sportster 1200c Custom	00-03	FA400	FA400V	FA400HH	FSD010		USE FA400V	FA400V	FA400HH	RSD020	
XL Sportster 1200s Sport	00-03	FA400*	FA400V*	FA400HH*	FSD010	FSD010	USE FA400V	FA400V	FA400HH	RSD020	
XL 1200 C Sportster Custom	04-13	FA381	FA381V	FA381HH	FSD004		FA387	FA387V	FA387HH	RSD020	
XL 1200 L Sportster Low	07-11	FA381	FA381V	FA381HH	FSD010		FA387	FA387V	FA387HH	RSD020	
XL 1200 N Nightster (Spoke wheel)	08-12	FA381	FA381V	FA381HH	FSD010		FA387	FA387V	FA387HH	RSD020	
XL 1200 R Sportster Roadster	04-08	FA381*	FA381V*	FA381HH*	FSD004	FSD004	FA387	FA387V	FA387HH	RSD020	
XL 1200 V - Seventy Two	12-13	FA381	FA381V	FA381HH	FSD010		FA387	FA387V	FA387HH	RSD020	
XL 1200 X - Forty Eight	10-13	FA381	FA381V	FA381HH	FSD010		FA387	FA387V	FA387HH	RSD020	
XR 1200	08-10			FA296HH*	MD523X	MD523X	FA387	FA387V	FA387HH	MD524	
XR 1200 X	10-12			FA296HH*	MD523X	MD523X	FA387	FA387V	FA387HH	MD524	
<b>DYNA SERIES</b>											
<b>FX, FXE, FXEF, FXWG, FXS</b>											
(FX, FXE) (Rivet Type)	73-77	FA026			N/A		FA024/2	FA024/2V			N/A
(Twin Fronts)	Late 78-83	FA071	FA071V		N/A		FA024/2	FA024/2V			N/A
	84-86	FA094*	FA094V*	FA094HH*	FSD009	FSD009	FA078	FA078V	FA078HH		N/A
(FXWG, FXSB)	83	FA071	FA071V		N/A		FA078	FA078V	FA078HH		N/A
<b>FL, FLH</b>	49-71	N/A					N/A				
	58-62	N/A					N/A				
(Banana Caliper)	72-84	FA024/2	FA024/2V		N/A		FA024/2	FA024/2V		N/A	
(Banana Caliper)	72-80	FA024/2	FA024/2V		N/A		FA024/2	FA024/2V		N/A	
	81-84	FA024/2	FA024/2V		N/A		FA079	FA079V		N/A	

\*-2 Sets Required. ■ - Also available in MX-S race compound. ✖ - Oversize and Supermoto disc available.

**SAFETY WARNING-** DO NOT USE HH PADS ON REAR UNLESS ALSO USED ON FRONT TO AVOID BRAKE IMBALANCE.

**R** Suffix = High Durability Sintered Pad. **HH** Suffix = High Performance Sintered Pad. **G** Suffix = Grooved Shoe.  
**D** Suffix = Drilled Disc. **C** Suffix = Contoured Disc. **LS** Suffix = Left/Steel Disc. **RS** = Right/Steel Disc.

**BRAKE APPLICATIONS**

# PAD/SHOE/ROTOR Applications for AMERICAN PRODUCED MOTORCYCLES

**APPLICATIONS**

**BRAKE**

**RS** = Right/Steel Disc.

**LS** = Left/Steel Disc.

**HH** Suffix = High Performance Sintered Pad. **G** Suffix = Grooved Shoe.

**DD** Suffix = Drilled Disc. **C** Suffix = Contoured Disc.

**HH** Suffix = High Durability Sintered Pad. **HH** Suffix = High Performance Sintered Pad.

**DD** Suffix = Drilled Disc. **C** Suffix = Contoured Disc.

**HH** Suffix = High Durability Sintered Pad. **HH** Suffix = High Performance Sintered Pad.

**DD** Suffix = Drilled Disc. **C** Suffix = Contoured Disc.

**HH** Suffix = High Durability Sintered Pad. **HH** Suffix = High Performance Sintered Pad.

**DD** Suffix = Drilled Disc. **C** Suffix = Contoured Disc.

**HH** Suffix = High Durability Sintered Pad. **HH** Suffix = High Performance Sintered Pad.

## HARLEY DAVIDSON®

Make / Model / Year

FXD, FXDL, FXDWG, FXR, FXRS, FXRT, FXRD, FXLR

(Convertible®, Dyna®, Superglide®, Sportglide®, Lowrider®, Wide Glide®)

	FRONT					REAR				
	Organic Pads	Semi-Sintered V-Pads	Sintered Pads	FSD (Left)	FSD (Right)	Organic Pads	Semi-Sintered V-Pads	Sintered Pads	FSD (Left)	FSD (Right)
(Twin Fronts)	82-83	FA071	FA071V		N/A					
(Girling Caliper)	84-99	FA094*	FA094V*	FA094HH*	FSD009	FSD009				
	82-Early 87						FA078	FA078V	FA078HH	N/A
	Late 87-99						FA200	FA200V	FA200HH	RSD019
FLD Switchback	12-13		FA457V	FA457HH	MD516◆			FA458V	FA458HH	RSD020
FXD Super Glide	00-03	FA400	FA400V	FA400H	FSD010		USE FA400V	FA400V	FA400HH	RSD020
FXD Super Glide (Cast wheel)	08-10		FA457V	FA457H	MD516◆			FA458V	FA458HH	RSD020
NOTE ◆ MD516X Floating conversion in place of solid MD516 disc.										
FXDF Fat Bob (Cast wheel)	08-13		FA457V*	FA457HH*	MD518	MD518		FA458V	FA458HH	RSD020
FXDX Super Glide Sport	00-03	FA400*	FA400V*	FA400HH*	FSD010	FSD010	USE FA400V	FA400V	FA400HH	RSD020
FXDL Low Rider	00-03	FA400*	FA400V*	FA400HH*	FSD010	FSD010	USE FA400V	FA400V	FA400HH	RSD020
FXDWG Wide Glide	00-03	FA400*	FA400V*	FA400HH*	FSD010		USE FA400V	FA400V	FA400HH	RSD020
FXDWG Wide Glide (Spoke wheel)	08-13		FA457V	FA457HH	MD518			FA458V	FA458HH	RSD020
FXDS-CON Dyna Convertible	00-02	FA400*	FA400V*	FA400HH*	FSD010	FSD010	USE FA400V	FA400V	FA400HH	RSD020
FXDXT Superglide T-Sport	01-03	FA400*	FA400V*	FA400HH*	FSD010	FSD010	USE FA400V	FA400V	FA400HH	RSD020
FXDi Super Glide 1450	04-05	FA400	FA400V	FA400HH	FSD010		USE FA400V	FA400V	FA400HH	RSD020
FXDi 35 35th Anniversary Super Glide (Spoke wheels)	06	FA400	FA400V	FA400HH	MD518		USE FA400V	FA400V	FA400HH	RSD020
FXDXi Super Glide Sport	04-05	FA400*	FA400V*	FA400HH*	FSD010	FSD010	USE FA400V	FA400V	FA400HH	RSD020
FXDLi Low Rider 1450	04-05	FA400	FA400V	FA400HH	FSD010		USE FA400V	FA400V	FA400HH	RSD020
FXDLi Dyna Low Rider (Spoke wheels)	06	FA400	FA400V	FA400HH	MD518		USE FA400V	FA400V	FA400HH	RSD020
FXDWGi Wide Glide 1450	04-05	FA400	FA400V	FA400HH	FSD010		USE FA400V	FA400V	FA400HH	RSD020
FXDWGi Dyna Wide Glide (Spoke wheels)	06-07	FA400	FA400V	FA400HH	MD518		USE FA400V	FA400V	FA400HH	RSD020
FXDCi Super Glide Custom	05	FA400	FA400V	FA400HH	FSD010		USE FA400V	FA400V	FA400HH	RSD020
FXDCi Dyna Superglide Custom (Spoke wheels)	06-07	FA400	FA400V	FA400HH	MD518		USE FA400V	FA400V	FA400HH	RSD020
FXDC Super Glide Custom (Spoke wheel)	08-13		FA457V	FA457HH	MD518			FA458V	FA458HH	RSD020
FXDBi Street Bob (Spoke wheels)	06-07	FA400	FA400V	FA400HH	MD518		USE FA400V	FA400V	FA400HH	RSD020
FXDB Street Bob (Spoke wheel)	08-13		FA457V	FA457HH	MD518			FA458V	FA458HH	RSD020
FXDi Super Glide (Cast wheel)	06-07	FA400	FA400V	FA400HH	MD516◆		USE FA400V	FA400V	FA400HH	RSD020
NOTE ◆ MD516X Floating conversion in place of solid MD516 disc.										
FXDLi (Cast wheel)	06-07	FA400	FA400V	FA400HH	MD516◆		USE FA400V	FA400V	FA400HH	RSD020
NOTE ◆ MD516X Floating conversion in place of solid MD516 disc.										
FXDL Low Rider (Cast wheel)	08-09		FA457V	FA457HH	MD516◆			FA458V	FA458HH	RSD020
NOTE ◆ MD516X Floating conversion in place of solid MD516 disc.										
FXDCi Superglide Custom (Cast wheel)	06	FA400	FA400V	FA400HH	MD516◆		USE FA400V	FA400V	FA400HH	RSD020
NOTE ◆ MD516X Floating conversion in place of solid MD516 disc.										
<b>SOFTAIL SERIES</b>										
<b>FXST, FXSTB, FXSTC, FXSTS, FLST, FLSTC, FLSTF, FLSTI, FLSTN</b>										
<b>(Fat boy®, Softail®, Softail Custom®, Heritage Softail®, Heritage Softail Custom®, Heritage Springer®, Springer®, Night train®)</b>										
(Girling Caliper)	84-99	FA094	FA094V	FA094HH	FSD009					
	84- Early 87						FA078	FA078V	FA078HH	N/A
	Late 87-99						FA200	FA200V	FA200HH	RSD019
FXST/FXSTi Softail Standard	00-05	FA400	FA400V	FA400HH	FSD010		USE FA400V	FA400V	FA400HH	RSD020
FXSTB/FXSTBi Night Train	00-05	FA400	FA400V	FA400HH	FSD010		USE FA400V	FA400V	FA400HH	RSD020
FXSTDI/FXSTDi Softail Deuce/i	00-07	FA400	FA400V	FA400HH	FSD010		USE FA400V	FA400V	FA400HH	RSD020
FXSTS/FXSTSi Softail Springer	00-05	FA094	FA094V	FA094HH		FSD009	USE FA400V	FA400V	FA400HH	RSD020
FLSTF/FLSTFi Fat Boy	00-06	FA400	FA400V	FA400HH	FSD010		USE FA400V	FA400V	FA400HH	RSD020
FLSTF/FLSTFi Fat Boy	07	FA400	FA400V	FA400HH	FSD010		FA434	FA434V	FA434HH	RSD020
FLSTFB Fat Boy Special/LO	10-13		FA457V	FA457HH	FSD010			FA458V	FA458HH	RSD020

\*-2 Sets Required. ■ - Also available in MX-S race compound. ✕ - Oversize and Supermoto disc available.

**SAFETY WARNING-** DO NOT USE HH PADS ON REAR UNLESS ALSO USED ON FRONT TO AVOID BRAKE IMBALANCE.

# PAD/SHOE/ROTOR Applications for AMERICAN PRODUCED MOTORCYCLES

## HARLEY DAVIDSON®

Make / Model / Year

	FRONT					REAR				
	Organic Pads	Semi-Sintered V-Pads	Sintered Pads	FSD (Left)	FSD (Right)	Organic Pads	Semi-Sintered V-Pads	Sintered Pads	FSD (Left)	FSD (Right)
FLSTFi Fat Boy 15th Anniversary Edition 05	FA400	FA400V	FA400HH	FSD010		USE FA400V	FA400V	FA400HH		RSD020
FLSTCi/FLSTC Heritage Classic/i 00-07	FA400	FA400V	FA400HH	FSD010		USE FA400V	FA400V	FA400HH		RSD020
FLSTS Heritage Springer 00-03	FA094	FA094V	FA094HH	FSD010		USE FA400V	FA400V	FA400HH		RSD020
FLSTM/FLSTNi Softail Deluxe 05-07	FA400	FA400V	FA400HH	FSD010		USE FA400V	FA400V	FA400HH		RSD020
FLSTSC/FLSTSCi Springer Classic 05-07	FA094	FA094V	FA094HH	FSD010		USE FA400V	FA400V	FA400HH		RSD020
FLST/FLSTi Heritage Softail 06	FA400	FA400V	FA400HH	FSD010		USE FA400V	FA400V	FA400HH		RSD020
FLSTSB Softail Cross Bones 08-11	FA094	FA094V	FA094HH	FSD010			FA458V	FA458HH		RSD020
FXS Blackline 11-13		FA457V	FA457HH	FSD010			FA458V	FA458HH		RSD020
FXST/FXSTi Softail Standard 06-07	FA400	FA400V	FA400HH	FSD010		FA434	FA434V	FA434HH		RSD020
FXSTB/FXSTBi Night Train Softail 06-07	FA400	FA400V	FA400HH	FSD010		FA434	FA434V	FA434HH		RSD020
FXSTB Night Train (Spoke wheel) 08-09		FA457V	FA457HH	FSD010			FA458V	FA458HH		RSD020
FXSTC Softail Custom 07	FA400	FA400V	FA400HH	FSD010		FA434	FA434V	FA434HH		RSD020
FXSTC Softail Custom (Spoke wheel) 08-10		FA457V	FA457HH	FSD010			FA458V	FA458HH		RSD020
FLSTSC/FLSTSCi Springer Softail Classic 06-07	FA094	FA094V	FA094HH	FSD010		FA434	FA434V	FA434HH		RSD020
FLSTC Heritage Softail Classic 07	FA400	FA400V	FA400HH	FSD010		USE FA400V	FA400V	FA400HH		RSD020
FLSTC Heritage Softail Classic 08-13		FA457V	FA457HH	FSD010			FA458V	FA458HH		RSD020
FLSTF Fat Boy (Solid wheel) 08-13		FA457V	FA457HH	FSD010			FA458V	FA458HH		RSD020
FLSTN Softail Deluxe (Spoke wheel) 08-13		FA457V	FA457HH	FSD010			FA458V	FA458HH		RSD020
FLS Softail Slim 12-13		FA457V	FA457HH	FSD010			FA458V	FA458HH		RSD020
FXCW Rocker (Cast wheel) 08-09		FA457V	FA457HH	FSD010			FA458V	FA458HH		RSD020
FXCWC Rocker C (Cast wheel) 08-11		FA457V	FA457HH	FSD010			FA458V	FA458HH		RSD020
<b>TOURING SERIES</b>										
<b>FLT, FLHT, FLHTCI</b>										
<b>(Ultraglide®, Electraglide®, Electraglide Classic® /Ultra Classic®)</b>										
80-83	FA072*	FA072V*		N/A	N/A	FA079	FA079V			N/A
84-85	FA094*	FA094V*	FA094HH*	N/A	N/A	FA079	FA079V			N/A
86-99	FA094*	FA094V*	FA094HH*	FSD009	FSD009	FA201	FA201V	FA201HH		MD509SR
<b>FLHR, FLHRCI (Road King®, Road King Classic®)</b>										
94-99	FA094*	FA094V*	FA094HH*	FSD009	FSD009	FA201	FA201V	FA201HH		MD509SR
FLHRi/FLHR Road King 00-07	FA400*	FA400V*	FA400HH*	FSD010	FSD010	USE FA400V	FA400V	FA400HH		RSD020
FLHRCi Road King Classic 00-07	FA400*	FA400V*	FA400HH*	FSD010	FSD010	USE FA400V	FA400V	FA400HH		RSD020
FLHR Road King 08-12	FA409*	FA409V*	FA409HH*	MD520	MD520	FA409	FA409V	FA409HH		MD521
FLHRC Road King Classic 08-13	FA409*	FA409V*	FA409HH*	MD520	MD520	FA409	FA409V	FA409HH		MD521
FLHT/FLHTi Electra Glide Standard 00-07	FA400*	FA400V*	FA400HH*	FSD010	FSD010	USE FA400V	FA400V	FA400HH		RSD020
FLHTK Electra Glide Ultra LTD 10-12	FA409*	FA409V*	FA409HH*	MD520	MD520	FA409	FA409V	FA409HH		MD521
FLTR/FLTR-i Road Glide 00-07	FA400*	FA400V*	FA400HH*	FSD010	FSD010	USE FA400V	FA400V	FA400HH		RSD020
FLTR Road Glide 08-09	FA409*	FA409V*	FA409HH*	MD520	MD520	FA409	FA409V	FA409HH		MD521
FLTRX Road Glide Custom 10-12	FA409*	FA409V*	FA409HH*	MD520	MD520	FA409	FA409V	FA409HH		MD521
FLTRU Road Glide Ultra 11-12	FA409*	FA409V*	FA409HH*	MD520	MD520	FA409	FA409V	FA409HH		MD521
FLHTCU-I Electra Glide Ultra Classic 00-07	FA400*	FA400V*	FA400HH*	FSD010	FSD010	USE FA400V	FA400V	FA400HH		RSD020
FLHRS/FLHRSi Road King Custom 04-07	FA400*	FA400V*	FA400HH*	FSD010	FSD010	USE FA400V	FA400V	FA400HH		RSD020
FLHTC/FLHTCi Electra Glide Classic 04-07	FA400*	FA400V*	FA400HH*	FSD010	FSD010	USE FA400V	FA400V	FA400HH		RSD020
FLHTC Electra Glide Classic 08-12	FA409*	FA409V*	FA409HH*	MD520	MD520	FA409	FA409V	FA409HH		MD521
FLHTCU Ultra Classic Electra Glide 08-13	FA409*	FA409V*	FA409HH*	MD520	MD520	FA409	FA409V	FA409HH		MD521
FLHT Electra Glide Standard 08-10	FA409*	FA409V*	FA409HH*	MD520	MD520	FA409	FA409V	FA409HH		MD521
FLHX/FLHXi Street Glide 06-07	FA400*	FA400V*	FA400HH*	FSD010	FSD010	USE FA400V	FA400V	FA400HH		RSD020
FLHX Street Glide 08-13	FA409*	FA409V*	FA409HH*	MD520	MD520	FA409	FA409V	FA409HH		MD521
FLHTCUTG Tri Glide Ultra Classic Trike 09-13	FA409*	FA409V*	FA409HH*	MD520	MD520	N/A*	FA605/4V	FA605/4HH	N/A	N/A
FLHXXX Street Glide Trike 10-11	FA409*	FA409V*	FA409HH*	MD520	MD520	N/A*	FA605/4V	FA605/4HH	N/A	N/A
<b>VRSCA/VRSCB</b>										
V-Rod (Hayes Caliper) 02-05	FA400*	FA400V*	FA400HH*	MD514LS	MD514RS	USE FA400V	FA400HH	FA400HH		MD515
V-Rod (Brembo Caliper) 06	FA409*	FA409V*	FA409HH*	MD516◆	MD516◆	FA409	FA409V	FA409HH		MD517
NOTE ◆ MD516X Floating conversion in place of solid MD516 disc.										
VRSCAW V-Rod 07	FA409*	FA409V*	FA409HH*	MD516◆	MD516◆	FA409	FA409V	FA409HH		MD517
NOTE _ MD516X Floating conversion in place of solid MD516 disc.										

\*-2 Sets Required. ■ - Also available in MX-S race compound. ✖ - Oversize and Supermoto disc available.

**SAFETY WARNING-** DO NOT USE HH PADS ON REAR UNLESS ALSO USED ON FRONT TO AVOID BRAKE IMBALANCE.

**BRAKE APPLICATIONS**

**R** Suffix = High Durability Sintered Pad. **HH** Suffix = High Performance Sintered Pad. **G** Suffix = Grooved Shoe.  
**D** Suffix = Drilled Disc. **C** Suffix = Contoured Disc. **LS** Suffix = Left/Steel Disc. **RS** = Right/Steel Disc.



# PAD/SHOE/ROTOR Applications for AMERICAN PRODUCED MOTORCYCLES

## APPLICATIONS

**BRAKE**

**R** Suffix = High Durability Sintered Pad. **HH** Suffix = High Performance Sintered Pad. **G** Suffix = Grooved Shoe.

**D** Suffix = Drilled Disc. **C** Suffix = Contoured Disc. **LS** Suffix = Left/Steel Disc. **RS** = Right/Steel Disc.

### VRSCA/VRSCB Contd

Make / Model / Year	FRONT					REAR				
	Organic Pads	Semi-Sintered V-Pads	Sintered Pads	FSD (Left)	FSD (Right)	Organic Pads	Semi-Sintered V-Pads	Sintered Pads	FSD (Left)	FSD (Right)
VRSCAW V-Rod (Spoke wheel) 08-09	FA409*	FA409V*	FA409HH*	MD519	MD519	FA409	FA409V	FA409HH		MD517
VRSCR Street Rod 06-07	FA409*	FA409V*	FA409HH*	MD516◆	MD516◆	FA409	FA409V	FA409HH		MD517
NOTE ◆ MD516X Floating conversion in place of solid MD516 disc.										
VRSCD Night Rod (Cast Wheel) 06-08	FA409*	FA409V*	FA409HH*	MD516◆	MD516◆	FA409	FA409V	FA409HH		MD517
NOTE ◆ MD516X Floating conversion in place of solid MD516 disc.										
VRSCDX Night Rod Special (Cast Wheel) 07-11	FA409*	FA409V*	FA409HH*	MD516◆	MD516◆	FA409	FA409V	FA409HH		MD517
NOTE ◆ MD516X Floating conversion in place of solid MD516 disc.										
VRSCX V-Rod 07	FA409*	FA409V*	FA409HH*	MD519	MD519	FA409	FA409V	FA409HH		MD517
VRSCF V-Rod Muscle 08-13	FA409*	FA409V*	FA409HH*	MD516◆	MD516◆	FA409	FA409V	FA409HH		MD525
NOTE ◆ MD516X Floating conversion in place of solid MD516 disc.										

### BUELL

<b>(M2 Cyclone®, S1 Lightning®, S2 Thunderbolt®, S3 Thunderbolt®)</b>										
94-97	FA210	FA210V			MD719RS	FA251				MD511
<b>(M2 Cyclone®, S1 Lightning®, S1 Whitelighting®, S3 Thunderbolt®, S3T Thunderbolt®, X1 Lightning®)</b>										
(Countersunk screws fixing disc)										
98-00	FA424		FA424HH		MD719RS	FA140	FA140V	FA140HH		MD511
<b>M2 Cyclone, X1 Lightning</b>										
(Counterbored screws fixing disc)										
00-05	FA424		FA424HH		MD734RS	FA140	FA140V	FA140HH		MD511
Blast 00-07	FA196	FA196V	FA196HH		N/A	FA140	FA140V	FA140HH		N/A
Firebolt XB9R 02-07			FA345HH		MD735RS	FA140	FA140V	FA140HH		MD522
XB9S Lightning 03-04			FA345HH		MD735RS	FA140	FA140V	FA140HH		MD522
XB 12 S Lightning 04-08			FA345HH		MD735RS	FA140	FA140V	FA140HH		MD522
XB9SX Lightning CityX 05-09			FA345HH		MD735RS	FA140	FA140V	FA140HH		MD522
XB9 SX Lightning 08-10			FA345HH		MD735RS	FA140	FA140V	FA140HH		MD522
XB 12 X Ulysses 06-10			FA345HH		MD735RS	FA140	FA140V	FA140HH		MD522
XB12 XT Ulysses 08-10			FA345HH		MD735RS	FA140	FA140V	FA140HH		MD522
XB 12 SCG Lightning 06-08			FA345HH		MD735RS	FA140	FA140V	FA140HH		MD522
XB 12 Ss Lightning Long 06-08			FA345HH		MD735RS	FA140	FA140V	FA140HH		MD522
XB 12 Ss Lightning Long 09-10			FA454/4HH		MD735RS	FA140	FA140V	FA140HH		MD522
XB12 STT Lightning 08			FA345HH		MD735RS	FA140	FA140V	FA140HH		MD522
XB12 SCG Lightning 09-10			FA454/4HH		MD735RS	FA140	FA140V	FA140HH		MD522
XB 12 R Firebolt 04-08			FA345HH		MD735RS	FA140	FA140V	FA140HH		MD522
XB 12 R Firebolt 09-10			FA454/4HH		MD735RS	FA140	FA140V	FA140HH		MD522
1125 R 08-10			FA454/4HH		MD735RS			FA460HH		N/A
1125 CR 09-10			FA454/4HH		MD735RS			FA460HH		N/A

### VICTORY

Victory "V92C" (All models single front rotor) 98-03	FA244	FA244V	FA244HH	MD727		FA209/2	FA209/2V	FA209/2HH		MD727
Victory "V92SC" 00-03	FA244*	FA244V*	FA244HH*	MD727	MD727	FA209/2	FA209/2V	FA209/2HH		MD727
Arlen Ness Victory Vision 10-12			FA261HH*	MD678	MD678	FA196	FA196V	FA196HH		MD678
Cross Country 10-12			FA347HH*	MD678	MD678	FA196	FA196V	FA196HH		MD678
Cross Country Tour 12			FA347HH*	MD678	MD678	FA196	FA196V	FA196HH		MD678
Cory Ness Cross Country 11-12			FA347HH*	MD678	MD678	FA196	FA196V	FA196HH		MD678
Cross Roads 10-12			FA347HH*	MD678	MD678	FA196	FA196V	FA196HH		MD678
Cory Ness Jackpot 08-10			FA347HH	MD678		FA196	FA196V	FA196HH		MD678
Ness Signature Series 05-07	FA244	FA244V	FA244HH	MD678		FA209/2	FA209/2V	FA209/2HH		MD678
Hammer 05-07	FA244*	FA244V*	FA244HH*	MD678	MD678	FA209/2	FA209/2V	FA209/2HH		MD678
Hammer 08-11			FA347HH*	MD678	MD678	FA196	FA196V	FA196HH		MD678
Hammer 8 Ball 10-11			FA347HH*	MD678	MD678	FA196	FA196V	FA196HH		MD678
Hammer S 07	FA244*	FA244V*	FA244HH*	MD678	MD678	FA209/2	FA209/2V	FA209/2HH		MD678
Hammer S 08-12			FA347HH*	MD678	MD678	FA196	FA196V	FA196HH		MD678
Hard Ball 12-13			FA347HH*	MD678	MD678	FA196	FA196V	FA196HH		MD678
Highball 12			FA347HH*	MD678	MD678	FA196	FA196V	FA196HH		MD678
Jackpot 10-11			FA347HH*	MD678	MD678	FA196	FA196V	FA196HH		MD678
Judge 12-13	FA244	FA244V	FA244HH	MD678		FA196	FA196V	FA196HH		MD678

\*-2 Sets Required. ■ - Also available in MX-S race compound. ✖ - Oversize and Supermoto disc available.

**SAFETY WARNING-** DO NOT USE HH PADS ON REAR UNLESS ALSO USED ON FRONT TO AVOID BRAKE IMBALANCE.

# PAD/SHOE/ROTOR Applications for AMERICAN PRODUCED MOTORCYCLES

**BRAKE APPLICATIONS**

## VICTORY

Make / Model / Year

		FRONT					REAR				
		Organic Pads	Semi-Sintered V-Pads	Sintered Pads	FSD (Left)	FSD (Right)	Organic Pads	Semi-Sintered V-Pads	Sintered Pads	FSD (Left)	FSD (Right)
King Pin	04-07	FA244	FA244V	FA244HH	MD678		FA209/2	FA209/2V	FA209/2HH	MD678	
King Pin	08-12			FA347HH	MD678		FA196	FA196V	FA196HH	MD678	
King Pin Tour	04-07	FA244	FA244V	FA244HH	MD678		FA209/2	FA209/2V	FA209/2HH	MD727	
King Pin Tour	08-09			FA347HH	MD678		FA196	FA196V	FA196HH	MD678	
King Pin 8-Ball	08-11			FA347HH	MD678		FA196	FA196V	FA196HH	MD678	
King Pin-Low	09			FA347HH	MD678		FA196	FA196V	FA196HH	MD678	
Vegas	03-07	FA244	FA244V	FA244HH	MD678		FA209/2	FA209/2V	FA209/2HH	MD678	
Vegas 8-Ball	05-07	FA244	FA244V	FA244HH	MD678		FA209/2	FA209/2V	FA209/2HH	MD678	
Vegas 8-Ball	08-12			FA347HH	MD678		FA196	FA196V	FA196HH	MD678	
Vegas Jackpot	06-07	FA244	FA244V	FA244HH	MD678		FA209/2	FA209/2V	FA209/2HH	MD678	
Vegas	08-12			FA347HH	MD678		FA196	FA196V	FA196HH	MD678	
Zach Ness Vegas	08-12			FA347HH	MD678		FA196	FA196V	FA196HH	MD678	
Vegas Low	08-09			FA347HH	MD678		FA196	FA196V	FA196HH	MD678	
Vegas Jackpot	08-09			FA347HH	MD678		FA196	FA196V	FA196HH	MD678	
Vision 8 Ball	10-11			FA261HH*	MD678	MD678	FA196	FA196V	FA196HH	MD678	
Vision Street	08-09			FA261HH*	MD678	MD678	FA196	FA196V	FA196HH	MD678	
Vision Tour (All models)	08-12			FA261HH*	MD678	MD678	FA196	FA196V	FA196HH	MD678	

## INDIAN

Chief All models Chief/Deluxe/Springfield/Spirit

All models Deluxe/Springfield/Roadblaster	02-08	FA216/3	FA216/3V	FA216/3HH	N/A		FA216/3	FA216/3V	FA216/3HH		N/A
Scout All models Scout/Deluxe/Springfield	02-08	FA216/3	FA216/3V	FA216/3HH	N/A		FA216/3	FA216/3V	FA216/3HH		N/A
Road Master/Vintage	02-08	FA216/3	FA216/3V	FA216/3HH	N/A		FA216/3	FA216/3V	FA216/3HH		N/A
Chief Blackhawk (Brembo calipers)	11	FA095*	FA095V*	FA095HH*	N/A	N/A	FA018	FA018V	FA018HH		N/A
Chief Blackhawk Dark (Brembo calipers)	11	FA095*	FA095V*	FA095HH*	N/A	N/A	FA018	FA018V	FA018HH		N/A
Chief Classic (Brembo calipers)	11-12	FA095*	FA095V*	FA095HH*	N/A	N/A	FA018	FA018V	FA018HH		N/A
Chief Standard (Brembo calipers)	09-11	FA095*	FA095V*	FA095HH*	N/A	N/A	FA018	FA018V	FA018HH		N/A
Chief Deluxe (Brembo calipers)	09	FA095*	FA095V*	FA095HH*	N/A	N/A	FA018	FA018V	FA018HH		N/A
Chief Roadmaster (Brembo calipers)	09-11	FA095*	FA095V*	FA095HH*	N/A	N/A	FA018	FA018V	FA018HH		N/A
Chief Vintage (Brembo calipers)	09-12	FA095*	FA095V*	FA095HH*	N/A	N/A	FA018	FA018V	FA018HH		N/A
Bomber (Brembo Calipers)	10-11	FA095*	FA095V*	FA095HH*	N/A	N/A	FA018	FA018V	FA018HH		N/A
Dark Horse (Brembo calipers)	10-12	FA095*	FA095V*	FA095HH*	N/A	N/A	FA018	FA018V	FA018HH		N/A

## CAN-AM

Spyder RS SE5	08-09	FA474*	FA474V*		MD801	MD801	FA473	FA473V			MD802
Spyder RS SM5	08-09	FA474*	FA474V*		MD801	MD801	FA473	FA473V			MD802
Spyder RS Phantom Black	09	FA474*	FA474V*		MD801	MD801	FA473	FA473V			MD802
Spyder RT	10-12	FA474*	FA474V*		MD801	MD801	FA473	FA473V			MD802
Spyder RT LTD	10-12	FA474*	FA474V*		MD801	MD801	FA473	FA473V			MD802
Spyder RT-S	10-12	FA474*	FA474V*		MD801	MD801	FA473	FA473V			MD802
Spyder RS	10-12	FA474*	FA474V*		MD801	MD801	FA473	FA473V			MD802
Spyder RS-S	10-12	FA474*	FA474V*		MD801	MD801	FA473	FA473V			MD802
Spyder RT (Brembo Calipers)	13		FA630V*	FA630HH*	MD853	MD853		FA631V	FA631HH		MD854
Spyder RT-S (Brembo Calipers)	13		FA630V*	FA630HH*	MD853	MD853		FA631V	FA631HH		MD854
Spyder RT - LTD (Brembo Calipers)	13		FA630V*	FA630HH*	MD853	MD853		FA631V	FA631HH		MD854
Spyder ST (Brembo Calipers)	13		FA630V*	FA630HH*	MD853	MD853		FA631V	FA631HH		MD854
Spyder ST - S (Brembo Calipers)	13		FA630V*	FA630HH*	MD853	MD853		FA631V	FA631HH		MD854
Spyder ST - LTD (Brembo Calipers)	13		FA630V*	FA630HH*	MD853	MD853		FA631V	FA631HH		MD854
Spyder RS (Brembo Calipers)	13		FA630V*	FA630HH*	MD853	MD853		FA631V	FA631HH		MD854
Spyder RS-S (Brembo Calipers)	13		FA630V*	FA630HH*	MD853	MD853		FA631V	FA631HH		MD854

\*-2 Sets Required. ■ - Also available in MX-S race compound. ✖ - Oversize and Supermoto disc available.

**SAFETY WARNING-** DO NOT USE HH PADS ON REAR UNLESS ALSO USED ON FRONT TO AVOID BRAKE IMBALANCE.

**R** Suffix = High Durability Sintered Pad. **HH** Suffix = High Performance Sintered Pad. **G** Suffix = Grooved Shoe.  
**D** Suffix = Drilled Disc. **C** Suffix = Contoured Disc. **LS** Suffix = Left/Steel Disc. **RS** = Right/Steel Disc.

# JAPANESE Built Motorcycles



← FRONT / AVANT / VORN FRENTE / ANTERIORE →

HONDA	Year	Model	DISC PAD CHOICES				BRAKE ROTOR CHOICES								
			NEW SFAC Scooter Carbon Pads	Semi-Sintered V-Pads™	Sintered/HH Pads/ Grooved shoes	Left/Gauche/Links	Right/Droite/Rechts	Contour Rotor Universal left and right fitment	NEW Vee-Rotors™ CONTOUR	NEW CX Extreme® ROTOR	Oversize 250/280mm Rotor Kit	Relocating Bracket for 250/280mm Rotor	Oversize 320mm Rotor Kit	Relocating Bracket for 320mm Rotor	
C 50 All Models	75-93	H303													
C 50 N (Single seat model)	95	H303													
C 50 P/S/V/X/Y/1/2 (Single seat model)	96-02	H303													
CB 50 J	81	FA040						N/A							
CB 50 V/W Dream 50	97-98	FA197			FA197HH			N/A							
CD 50 ST/SV/SW/SX Benley 50 S	96-99	H304													
CF 50 Chaly	79	H303													
CHF 50-1/Scoopy 50 (Drum brake model)	01-05	H333													
CL 50 V/X Benley CL50	97-99	H304													
CR 50 RE/RF	84-85	H333			H333G										
CRF 50 F4/F5/F6/F7/F8/F9/FA/FB/FC/FD	04-13	H301													
CRM 50 RN/RP/RR/RT	93-96	FA125TT			FA125R ■	MD6001D			MD6001C		MD6001CX				
MB 5 S	80-82	SFA054	SFAC054		FA054HH			N/A							
MBX 50 SD/SF	83-85	FA086			FA086HH			N/A							
MG 50 SX/1/3 Magna 50 (AC13)	95-03	SFA054	SFAC054		FA054HH ■			N/A							
MP 50 3DX3 (AC17) Solo	03	H304													
MRX 50	88-	FA054TT						N/A							
MT 50 SA/SE/SG/SJ/SL	80-93	H304			H304G										
MTX 50 SC	83-84	H304			H304G										
NB 50 ME Aero	84	H301													
NB 50 MF/MG/TH Vision	86-88	H301													
NC 50 K1/Z Express	79-82	H301													
NC 50 C Express 2	82	H301													
NC 50 A/B Express 3 Delux	82	H301													
NE 50 MF/MG Vision	86-87	H301													
NH 50 Lead 50 SS	84	SFA176						N/A							
NH 50 Lead AF01/D716	84-85	SFA176						N/A							
NJ 50 MDY/M2/MD2 (TD01) Gyro-X	00-02	H333													
NP 50 D Melody Mini	83	H301													
NPC 50 2/3 (AF59) Bite	02-03	H333													
NPS 50 1/2/3/5/6/7/8/9 (AF58) Zoomer	01-12	H333													
NS 50 Melody	82	H301													
NS 50 MSB Melody Delux	82	H301													
NSC 50 C - Vision 50 14" Wheels	12-13	SFA603			SFA603HH	MD9140D				VR9140					
NSC 50 AC - Vision 50 16" Wheels	12-13	SFA603			SFA603HH	MD9140D				VR9140					
NSC 50 R - 14" Wheels	12-13	SFA603			SFA603HH	MD9140D				VR9140					
NSR 50 FP/FR/FS	93-95	FA086			FA086HH			N/A							
NSR 50 RV/RW/RX/RY	97-00	FA197			FA197HH			MD1142RS							
NSR 50 SK/SP/SR/SS	89-95	FA086						N/A							
NSR 50 V (AC10-180)	97	FA197			FA197HH				MD1169C/CF						
NSR 50 X (AC10-190)	99	FA197			FA197HH				MD1169C/CF						
NT 50 FIG/H Melody Mini	85-87	H301													
NU 50 MC Runaway	82	H333													
NV 50 MSD Stream	84	H302													
NVS 501SH2/Today 50	01-05	H333													
NX 50 A/B/M/B Caren	80-82	H301													
PA 50 Camino	80	H322													
PC 50 K1	79	H301													
PF 50 M Novio	75	H322													
PK 50 Wallaro All models	90-01	H333													
PX 50	82-83	H322													
PX 50	84	H322													
PXR 50	84	H335													
SA 50 J/M/P/R/S Vision Metin	88-95	H333													
SFX 50 S/T/V/W/X/Y/1	95-04	SFA193	SFAC193		SFA193HH	MD906D				VR906					
SGX 50 V/W/X/Y/1 Sky/Sky Deluxe	97-03	SFA193	SFAC193		SFA193HH	MD931D									
SH 50 E/H/K/M/P/DP City Express	85-96	H303													
SH 50 T Fifty/Scoopy W/X/Y/1	97-03	SFA193	SFAC193		SFA193HH	MD918D									
SJ 50 P/R/S/T/V/W/X/Ball	93-99	SFA256	SFAC256		SFA256HH	MD923D			MD923C	VR923					

\*-2 Sets Required. ■ - Also available in MX-S race compound.

**SAFETY WARNING:** DO NOT USE HH PADS ON REAR UNLESS ALSO USED ON FRONT TO AVOID BRAKE IMBALANCE

**APPLICATIONS**  
**BRAKE**

**R** Suffix = High Durability Sintered Pad. **HH** Suffix = High Performance Sintered Pad. **G** Suffix = Grooved Shoe.  
**D** Suffix = Drilled Disc. **C** Suffix = Contoured Disc. **LS** Suffix = Left/Steel Disc. **RS** = Right/Steel Disc.



# JAPANESE Built Motorcycles



**HONDA**



← REAR / ARRIÈRE / HINTEN POSTERIOR / POSTERIORE →

			DISC PAD CHOICES			BRAKE ROTOR CHOICES		
			NEW SFAC Scooter Carbon Pads	Semi-Sintered V-Pads™	Sintered/HH Pads/ Grooved shoes	Contour Rotor Rear Fitment	NEW Vee-Rotors™ CONTOUR	NEW CX Extreme® ROTOR
C 50 All Models	75-93	H303						
C 50 N (Single seat model)	95	H304						
C 50 P/S/V/X/Y/1/2 (Single seat model)	96-02	H304						
CB 50 J	81	H304						
CB 50 V/W Dream 50	97-98	FA131TT				N/A		
CD 50 ST/SV/SW/SX Benley 50 S	96-99	H304						
CF 50 Chaly	79	H303						
CHF 50-1 Scoopy 50 (Drum brake model)	01-05	H333						
CL 50 V/X Benley CL50	97-99	H304						
CR 50 RE/RF	84-85	H333			H333G			
CRF 50 F4/F5/F6/F7/F8/F9/FA/FB/FC/FD	04-13	H301						
CRM 50 RN/RP/RR/RT	93-96	H304						
MB 5 S	80-82	H304						
MBX 50 SD/SF	83-85	H304						
MG 50 S/X/1/3 Magna 50 (AC13)	95-03	H304						
MP 50 3DX3 (AC17) Solo	03	H304						
MRX 50	88-	H304						
MT 50 SA/SE/SG/SJ/SJL	80-93	H304			H304G			
MTX 50 SC	83-84	H304			H304G			
NB 50 ME Aero	84	H302						
NB 50 MFM/GTH Vision	86-88	H302						
NC 50 K1/Z Express	79-82	H301						
NC 50 C Express 2	82	H302						
NC 50 A/B Express 3 Delux	82	H302						
NE 50 MFM/G Vision	86-87	H302						
NH 50 Lead 50 SS	84	H302						
NH 50 Lead AF01/D716	84-85	H302						
NJ 50 MDY/M2/MD2 (TD01) Gyro-X	00-02	H333*						
NP 50 D Melody Mini	83	H302						
NPC 50 2/3 (AF59) Bite	02-03	H333						
NPS 50 1/2/3/5/6/7/8/9 (AF58) Zoomer	01-12	H333						
NS 50 Melody	82	H302						
NS 50 MSB Melody Delux	82	H302						
NSC 50 C - Vision 50 14" Wheels	12-13	H352						
NSC 50 AC - Vision 50 16" Wheels	12-13	H352						
NSC 50 R - 14" Wheels	12-13	H352						
NSR 50 FP/FR/FS	93-95	H304						
NSR 50 RV/RW/RX/RY	97-00	SFA131/3			SFA131/3HH	MD1143		
NSR 50 SK/SP/SR/SS	89-95	H304						
NSR 50 V (AC10-180)	97	SFA131/3			SFA131/3HH	MD1170C		
NSR 50 X (AC10-190)	99	SFA131/2			SFA131/2HH	MD1170C		
NT 50 FIG/H Melody Mini	85-87	H301						
NU 50 MC Runaway	82	H302						
NV 50 MSD Stream	84	H302						
NVS 501SH2/Today 50	01-05	TBA						
NX 50 A/B/M/B Caren	80-82	H302						
PA 50 Camino	80	H322						
PC 50 K1	79	H301						
PF 50 M Novio	75	H322						
PK 50 Wallaro All models	90-01	H303						
PX 50	82-83	H302						
PX 50	84	H337						
PXR 50	84	H334						
SA 50 J/M/P/R/S Vision Metin	88-95	H333						
SFX 50 S/T/W/X/Y/1	95-04	H303						
SGX 50 V/W/X/Y/1 Sky/Sky Deluxe	97-03	H303						
SH 50 E/H/K/M/P/DP City Express	85-96	H336						
SH 50 T Fifty/Scoopy W/X/Y/1	97-03	H303						
SJ 50 P/R/S/T/W/X Bali	93-99	H303						

\*-2 Sets Required. ■ - Also available in MX-S race compound.

**SAFETY WARNING:** DO NOT USE HH PADS ON REAR UNLESS ALSO USED ON FRONT TO AVOID BRAKE IMBALANCE

**R** Suffix = High Durability Sintered Pad. **HH** Suffix = High Performance Sintered Pad. **G** Suffix = Grooved Shoe.  
**D** Suffix = Drilled Disc. **C** Suffix = Contoured Disc. **LS** Suffix = Left/Steel Disc. **RS** = Right/Steel Disc.

**BRAKE APPLICATIONS**

# JAPANESE Built Motorcycles



← FRONT / AVANT / VORN FRENTE / ANTERIORE →

## HONDA Contd.

Model	Year	DISC PAD CHOICES				BRAKE ROTOR CHOICES							
		NEW SFAC Scooter Carbon Pads	Semi-Sintered V-Pads™	Sintered/HH Pads/ Grooved shoes	Left/Gauche/Links	Right/Droite/Rechts	Contour Rotor Universal left and right fitment	NEW Vee-Rotors™ CONTOUR	NEW CX Extreme® ROTOR	Oversize 250/280mm Rotor Kit	Relocating Bracket for 250/280mm Rotor	Oversize 320mm Rotor Kit	Relocating Bracket for 320mm Rotor
SK 50 MM/MM-YA/MM-YC/MN/MN-YA/MN-YB/M/PMP-YA/MR/M/MT (AF27) DIO Drum Front & Rear		H333											
SK 50 MM-H/MM-YD/MN-H/M-P-II (AF28) DIO SR		SFA257	SFAC257			MD919D							
SK 50 MN/H/M/P/II/M-P-IV (AF28) DIO-ZX		SFA257	SFAC257			MD919D							
SK 50 MR-H/MMT-II DIO XR (AF28)		SFA257	SFAC257			MD919D							
SN 50 N/R/S Giomo	94	H333											
SS 50 ZK2	75-77	H303											
SS 50 ZB2	77-80	FA040				N/A							
SRX 50 T/W/X Joker/Shadow	97-99	SFA131/3				SFA131/3HH	MD931D						
ST 50 J/K Dax	78-93	H303											
SXR 50 W/S/W/X/SX	98-99	SFA193	SFAC193			SFA193HH	MD906D			VR906			
XBR-S Super Sport Scooter (SZX 50 SW/SX/SY/S1)	98-04	SFA193	SFAC193			SFA193HH	MD920D			VR920			
XBR-X Cross Sport Scooter (SZX 50 XW/XXX/YX1)	98-04	SFA193	SFAC193			SFA193HH	MD920D			VR920			
Tact 50		SFA257	SFAC257				N/A						
TC 50 M/P/V Gyro Canopy (TA02)	96-00	H303											
TC 50 Y/2 (TA02) Gyro Canopy	00-02	H304											
TLM 50 F	85	H333				H333G							
QR 50 D/E/F	83-87	H301											
QR 50 M/R/V/W/Y	93-03	H301											
XR 50 R1/R2/R3	01-03	H301											
XR 50 M5 (AD14) Motard	05	FA197				FA197HH		TBA					
XZ 50 1/2 APE-AC16	01-02	H304											
Z 50 R All Models	79-86	H301											
CR 60 R/F/R/G	85-86	H333				H333G							
ATC 70 All Models	78-85	None											
C 70 All Models	75-85	H303											
CF 70 C	77-78	H303											
CRF 70 F4/F5/F6/F7/F8/F9/FA/FB/FC/FD	04-13	H333				H333G							
TRX 70 Fourtrax	86-87	H346*				H346G*							
XR 70 R/V/RW/RX/R/Y/R1/R2/R3	97-03	H333				H333G							
CRM 75 R/K/R/L/R/M/R/P/R	89-94	FA125TT				FA125R ■	MD6001D			MD6001C		MD6001CX	
NF 75	79	H303											
NSR 75 N/P/R/X/Y (NS-1)	92-00	FA197				FA197HH				MD1142RS			
SA 75 Vision	89-	H303											
SH 75 Scoopy H/K/M/P/D/P/S/D/S	87-95	H303											
XR 75 K4	75-78	H304				H304G							
XR 75 K5	79	H303				H303G							
CR 80 R/A/R/B	80-81	H304				H304G							
CR 80 RC	82	H304				H304G							
CR 80 RD/RE	83-84	H333				H333G							
CR 80 RF	85	H333				H333G							
CR 80 R2/F/R2G	85-86	H304				H304G							
CR 80 R/G/R/H/R/J/R/K/R/L/R/M	86-91	FA084TT				FA084R ■	MD6004D						
CR 80 R/V/R/P/R/R/R/S	92-95	FA084TT				FA084R ■	MD6004D						
CR 80 R/T/R/B/T/R/V/R/B/V/R/W/R/B/W/R/X/R/B/X/R/Y/R/B/Y/R1/RB1/R2/RB2	96-02	FA084TT				FA084R ■	MD6058D			MD6058C		MD6058CX	OS6058C BRK026
CRE 80	98-	FA084TT				FA084R ■	MD6058D			MD6058C		MD6058CX	OS6058C BRK026
CRF 80 F4/F5/F6/F7/F8/F9/FB/FC	04-12	H333				H333G							
MB 80 (MB8)	80-	FA083/2TT											
MBX 80 FWDD/FWDF	83-86	SFA054*	SFA054*			FA054HH*	N/A	N/A					
MCX 80	82-	FA083/2TT					N/A						
MTX 80 RFD/RFF	83-84	H304				H304G							
NH 80 MD-D/MD-G	83-86	H303											
NH 80 Lead 80	85	SFA176								N/A			
NH 80 Lead 80 SS	85	SFA176								N/A			
NH 80 MDR	94-	H303											
NSR 80 J-2/K/L/N (HC06)	88-92	FA086				FA086HH				MD1169C/CF			
NSR 80 P/R/S (HC06)	93-95	FA197				FA197HH				MD1169C/CF			
NSR 80 V (HC06-170)	97	FA197				FA197HH				MD1169C/CF			
NSR 80 X (HC06-180)	99	FA197				FA197HH				MD1169C/CF			
XR 80 Z/A/B	80-81	H304				H304G							

\*-2 Sets Required. ■ - Also available in MX-S race compound.

**SAFETY WARNING:** DO NOT USE HH PADS ON REAR UNLESS ALSO USED ON FRONT TO AVOID BRAKE IMBALANCE

APPLICTIONS  
BRAKE

R Suffix = High Durability Sintered Pad. HH Suffix = High Performance Sintered Pad. G Suffix = Grooved Shoe.

D Suffix = Drilled Disc. C Suffix = Contoured Disc. LS Suffix = Left/Steel Disc. RS = Right/Steel Disc.

# JAPANESE Built Motorcycles



## HONDA Contd.



← REAR / ARRIÈRE / HINTEN POSTERIOR / POSTERIORE →

		DISC PAD CHOICES			BRAKE ROTOR CHOICES			
		NEW SFAC Scooter Carbon Pads	Semi-Sintered V-Pads™	Sintered/HH Pads/ Grooved shoes	Contour Rotor Rear Fitment	NEW Vee-Rotors™ CONTOUR	NEW CX Extreme® ROTOR	
SK 50 MM/MM-YA/MM-YC/MN/MN-YA/MN-YB/M/PMP-YA/M/MR/MT (AF27) DIO Drum Front & Rear								
SK 50 MM-H/MM-YD/MN-HIMP-II (AF28) DIO SR								
SK 50 MN/II/MP/III/MP-IV (AF28) DIO-ZX								
SK 50 MR-H/MT-II DIO XR (AF28)								
SN 50 N/R/S Giomo	94							
SS 50 ZK2	75-77							
SS 50 ZB2	77-80							
SRX 50 T/W/X Joker/Shadow	97-99							
ST 50 J/K Dax	78-93							
SXR 50 W/S/WX/SX	98-99							
X8R-S Super Sport Scooter (SZX 50 SW/SX/SYS1)	98-04	SFA234			MD921D		VR921	
X8R-X Cross Sport Scooter (SZX 50 XW/XX/YX1)	98-04	SFA234			MD921D		VR921	
Tact 50		H333		H333G				
TC 50 MP/IV Gyro Canopy (TA02)	96-00	H333						
TC 50 Y/2 (TA02) Gyro Canopy	00-02	H333						
TLM 50 F	85	H333		H333G				
QR 50 D/E/F	83-87	H302						
QR 50 M/R/V/W/Y	93-03	H333						
XR 50 R1/R2/R3	01-03	H301						
XR 50 M5 (AD14) Motard	05	FA131TT			TBA			
XZ 50 1/2 APE-AC16	01-02	H304						
Z 50 R All Models	79-86	H301						
CR 60 R/F/RG	85-86	H333		H333G				
ATC 70 All Models	78-85	H310						
C 70 All Models	75-85	H303						
CF 70 C	77-78	H303						
CRF 70 F4/F5/F6/F7/F8/F9/FA/FB/FC/FD	04-13	H333		H333G				
TRX 70 Fourtrax	86-87	H306		H306G				
XR 70 R/V/RW/RX/RV/R1/R2/R3	97-03	H333		H333G				
CRM 75 R/K/L/RM/RP/RR	89-94	H304		H304G				
NF 75	79	H303						
NSR 75 N/P/R/X/Y (NS-1)	92-00	SFA131/2		SFA131/2HH	MD1143			
SA 75 Vision	89-	H333						
SH 75 Scoopy H/K/M/P/DP/S/DS	87-95	H336						
XR 75 K4	75-78	H303		H303G				
XR 75 K5	79	H303		H303G				
CR 80 RA/RB	80-81	H304		H304G				
CR 80 RC	82	H333		H333G				
CR 80 RD/RE	83-84	H333		H333G				
CR 80 RF	85	H338		H338G				
CR 80 R2F/R2G	85-86	H304		H304G				
CR 80 RG/RH/RJ/RK/RL/RM	86-91	H338		H338G				
CR 80 R/V/RP/RR/RS	92-95	FA131TT		FA131R ■	MD6005D	MD6005C		
CR 80 RT/RBT/RV/RB/RW/RB/RX/RB/RX/RV/RB/R1/RB1/R2/RB2	96-02	FA131TT		FA131R ■	MD6005D	MD6005C		MD6005CX
CRE 80	98-	FA131TT		FA131R ■	MD6005D	MD6005C		MD6005CX
CRF 80 F4/F5/F6/F7/F8/F9/FB/FC	04-12	H333		H333G				
MB 80 (MB8)	80-	H304						
MBX 80 FWDD/FWDF	83-86	H304						
MCX 80	82-	H304						
MTX 80 RFD/RF	83-84	H304		H304G				
NH 80 MD-D/MD-G	83-86	H302						
NH 80 Lead 80	85	H302						
NH 80 Lead 80 SS	85	H333						
NH 80 MDR	94-	H333						
NSR 80 J-2/K/L/N (HC06)	88-92	SFA131/3		SFA131/3HH		MD1170C		
NSR 80 P/R/S (HC08)	93-95	SFA131/3		SFA131/3HH		MD1170C		
NSR 80 V (HC06-170)	97	SFA131/3		SFA131/3HH		MD1170C		
NSR 80 X (HC06-180)	99	SFA131/3		SFA131/3HH		MD1170C		
XR 80 Z/A/B	80-81	H304		H304G				

\*-2 Sets Required. ■ - Also available in MX-S race compound.

**SAFETY WARNING:** DO NOT USE HH PADS ON REAR UNLESS ALSO USED ON FRONT TO AVOID BRAKE IMBALANCE

**R** Suffix = High Durability Sintered Pad. **HH** Suffix = High Performance Sintered Pad. **G** Suffix = Grooved Shoe.  
**D** Suffix = Drilled Disc. **C** Suffix = Contoured Disc. **LS** Suffix = Left/Steel Disc. **RS** = Right/Steel Disc.

**BRAKE APPLICATIONS**



# JAPANESE Built Motorcycles



← FRONT / AVANT / VORN FRENTE / ANTERIORE →

## HONDA Contd.

Model	Year	DISC PAD CHOICES				BRAKE ROTOR CHOICES							
		NEW SFAC Scooter Carbon Pads	Semi-Sintered V-Pads™	Sintered/HH Pads/ Grooved shoes	Left/Gauche/Links	Right/Droite/Rechts	Contour Rotor Universal left and right fitment	NEW Vee-Rotors™ CONTOUR	NEW CX Extreme® ROTOR	Oversize 250/280mm Rotor Kit	Relocating Bracket for 250/280mm Rotor	Oversize 320mm Rotor Kit	Relocating Bracket for 320mm Rotor
XR 80 R	87-88		H333										
CR 85 R3/RB3/R4/RB4/R5/RB5/R6/RB6/R7/RB7	03-07	FA084TT		FA084R ■	MD6058D			MD6058C		MD6058CX	OS6058C	BRK026	
C 90 All Models	75-92		H303										
C 90 All Models	93-03		H304										
EZ 90 Cub	91-95		H303										
Lead 90	88-	SFA131/3		SFA131/3HH	N/A								
NH 90 M/PR Yuppy	91-94	SFA131/3		SFA131/3HH	TBA								
SRX 90 Shadow T/W/X	97-99	SFA131/3		SFA131/3HH	MD931D								
TRX 90 Fourtrax/Sportrax P/R/S/T/W/WX/Y/1-6	93-06	H303*		H303G*									
TRX 90 EX	07-08	H303*		H303G*									
TRX 90 X9/XB	09-11	H303*		H303G*									
Astrea Supra NF 100	99	SFA197		FA197HH	N/A								
Astrea Grand/Supra (Drum Model)	97-98		H303										
CB 100 N	78-80	FA52			N/A								
CRF 100 F4/F5/F6/F7/F8/F9/FA/FB/FC	04-12	H333		H333G									
H 100 A/SD/SG/SJ	82-92		H303										
SCV 100-3/F5 Lead	03-08		H352										
SH 100 T/W/X/Y/1 Scoopy	96-01	SFA193	SFAC193	SFA193HH	MD918D								
SJ 100 T/W/WX Bali Ex	96-99	SFA256	SFAC256	SFA256HH	MD923D		MD923C		VR923				
XL 100 All models	78-82		H304	H304G									
XR 100 R/P/R/R/S/R/T/R/V/R/W/RX/R/Y/R1-R3	93-03		H333	H333G									
XR 100 M5 (HD13) Motard	05	FA197		FA197HH		TBA							
XZ 100 2 APE-HC07	02		H304										
AFS 110 2SHC Wave	12-13	SFA625				MD9134D		VR9134					
ATC 110 All models	79-84		None										
CRF 110 FD	13		H333	H333G									
CT 110 A/B/C/D/K/M	80 - 88		H303										
CT 110 P	89-04		H304										
CT 110 X	05-09		H304										
NSC 110 WHB - Vision 110 14" Wheels	11-12	SFA603		SFA603HH	MD9140D				VR9140				
NSC 110 AC - Vision 110 16" Wheels	12	SFA603		SFA603HH	MD9140D				VR9140				
SCV 110 Lead (NHX 110-WH8 - 3 Bolt Front Disc Fixing)	08-09	SFA323	SFAC323	SFA323HH	MD923D		MD923C		VR923				
SCV 110 Lead (NHX 110-WHA - 4 Bolt Front Disc Fixing)	10-11	SFA603		SFA603HH	MD9140D				VR9140				
ANF 125-3/5/7/5/6/7/A Innova	03-11	SFA375			N/A								
ATC 125 MEMG	84-85		H303	H303G									
CA 125 S/T Rebel	95-97	FA228		FA228HH	MD1030								
CA 125 V/W/X Rebel	98-00	FA256		FA256HH	MD1030								
CB 125 K1-K5	72-76		H308										
CB 125 K6/S2	76		N/A			N/A							
CB 125 S	75-79		H303										
CB 125 J	79	FA040			N/A								
CB 125 T	78	FA040			N/A								
CB 125 T2	79	FA052			N/A								
CB 125 TDC/TDE/TDJ	83-89	FA069		FA069HH	N/A								
CB 125 RS	83	SFA054	SFAC054	FA054HH		N/A							
CBF 125 M9/MAMB	09-12	FA375				MD1030							
CBR 125 R4/R5/R5/RW5/RS6/RW6 (6 Bolt Front Disc Fixing)	04-06	FA375				MD644RS							
CBR 125 RW7/RW8/RW9/RWA (6 Bolt Front Disc Fixing)	07-10	FA375				MD644RS							
CBR 125 RWB (5 Bolt Front Disc Fixing)	11-13	FA375				MD1166RS							
CBX 125 TS Custom	82-	SFA054	SFAC054	FA054HH		N/A							
CBX 125 F	84-	FA069		FA069HH	N/A								
CBX 125 Custom	88-	FA086		FA086HH	N/A								
CD 125 TC	78		H312										
CG125 Cargo	09-10		H352										
CG 125 K1/B/C/E	77-84		H303										
CG 125 BR-K/BR-T/95	85-97		H330										
CG 125 T/W/M1/1	98-03		H330										
CG 125-ES4-ES8	04-08	SFA054	SFAC054	FA054HH		N/A							
CG 125 Job	05		H352										
CH 125 D/E/G Spacy	84-86		H303										

\*-2 Sets Required. ■ - Also available in MX-S race compound.

**SAFETY WARNING:** DO NOT USE HH PADS ON REAR UNLESS ALSO USED ON FRONT TO AVOID BRAKE IMBALANCE

APPLICATIONS  
BRAKE

R Suffix = High Durability Sintered Pad. HH Suffix = High Performance Sintered Pad. G Suffix = Grooved Shoe.

D Suffix = Drilled Disc. C Suffix = Contoured Disc. LS Suffix = Left/Steel Disc. RS = Right/Steel Disc.

# JAPANESE Built Motorcycles



## HONDA Contd.



← REAR / ARRIÈRE / HINTEN  POSTERIOR / POSTERIORE →

		DISC PAD CHOICES				BRAKE ROTOR CHOICES			
		NEW SFAC Scooter Carbon Pads	Semi-Sintered V-Pads™	Sintered/HH Pads/ Grooved shoes		Contour Rotor Rear Fitment	NEW Vee-Rotors™ CONTOUR	NEW CX Extreme® ROTOR	
XR 80 R	87-88			H333					
CR 85 R3/RB3/R4/RB4/R5/RB5/R6/RB6/R7/RB7	03-07	FA131TT			FA131R ■	MD6005D	MD6005C	MD6005CX	
C 90 All Models	75-92			H303					
C 90 All Models	93-03			H304					
EZ 90 Cub	91-95			H303					
Lead 90	88-			H336					
NH 90 M/P/R Yuppy	91-94			H303					
SRX 90 Shadow T/W/X	97-99			H303					
TRX 90 Fourtrax/Sportrax P/R/S/T/W/W/X/Y/1-6	93-06			H306		H306G			
TRX 90 EX	07-08			H306		H306G			
TRX 90 X9/XB	09-11			H306		H306G			
Astrea Supra NF 100	99			H303					
Astrea Grand/Supra (Drum Model)	97-98			H303					
CB 100 N	78-80			H304					
CRF 100 F4/F5/F6/F7/F8/F9/FA/FB/FC	04-12			H333		H333G			
H 100 A/SD/SG/SJ	82-92			H303					
SCV 100-3/F5 Lead	03-08			H352					
SH 100 T/W/X/Y/1 Scoopy	96-01			H303					
SJ 100 T/V/W/X Ball Ex	96-99			H303					
XL 100 All models	78-82			H304		H304G			
XR 100 RP/RP/RS/RT/RV/RW/RX/RY/R1-R3	93-03			H333		H333G			
XR 100 M5 (HD13) Motard	05	FA131TT				TBA			
XZ 100 2 APE-HC07	02			H304					
AFS 110 2SHC Wave	12-13			H353					
ATC 110 All models	79-84			H306		H306G			
CRF 110 FD	13			H333		H333G			
CT 110 A/B/C/D/K/M	80 - 88			H304					
CT 110 P	89-04			H304					
CT 110 X	05-09			H352					
NSC 110 WHB - Vision 110 14" Wheels	11-12			H352					
NSC 110 AC - Vision 110 16" Wheels	12			H352					
SCV 110 Lead (NHX 110-WH8 - 3 Bolt Front Disc Fixing)	08-09			H352					
SCV 110 Lead (NHX 110-WHA - 4 Bolt Front Disc Fixing)	10-11			H352					
ANF 125-3/5/T5/6/7/A Innova	03-11			H353					
ATC 125 MEM/G	84-85			H306		H306G			
CA 125 S/T Rebel	95-97			H318					
CA 125 V/W/X Rebel	98-00			H318					
CB 125 K1-K5	72-76			H310					
CB 125 K6/S2	76			H310					
CB 125 S	75-79			H303					
CB 125 J	79			H304					
CB 125 T	78			H310					
CB 125 T2	79			H310					
CB 125 TDC/TDE/TDJ	83-89			H310					
CB 125 RS	83			H310					
CBF 125 M9/MAMB	09-12			H352					
CBR 125 R4/R5/R5S/RW5/RS8/RW6 (6 Bolt Front Disc Fixing)	04-06	FA343				MD1151			
CBR 125 RW7/RW8/RW9/RWA (6 Bolt Front Disc Fixing)	07-10	FA343				MD1151			
CBR 125 RWB (5 Bolt Front Disc Fixing)	11-13	FA629				MD1151			
CBX 125 TS Custom	82-			H310					
CBX 125 F	84-			H318					
CBX 125 Custom	88-			H304					
CD 125 TC	78			H310					
CG125 Cargo	09-10			H352					
CG 125 K1/B/C/E	77-84			H303					
CG 125 BR-K/BR-T/95	85-97			H303					
CG 125 T/W/M1/1	98-03			H304					
CG 125-ES4-ES8	04-08			H352					
CG 125 Job	05			H353					
CH 125 D/E/G Spacy	84-86			H303					

\*-2 Sets Required. ■ - Also available in MX-S race compound.

**SAFETY WARNING:** DO NOT USE HH PADS ON REAR UNLESS ALSO USED ON FRONT TO AVOID BRAKE IMBALANCE

**R** Suffix = High Durability Sintered Pad. **HH** Suffix = High Performance Sintered Pad. **G** Suffix = Grooved Shoe.  
**D** Suffix = Drilled Disc. **C** Suffix = Contoured Disc. **LS** Suffix = Left/Steel Disc. **RS** = Right/Steel Disc.

**BRAKE APPLICATIONS**

# JAPANESE Built Motorcycles



← FRONT / AVANT / VORN FRENTE / ANTERIORE →

## HONDA Contd.

Model	Year	DISC PAD CHOICES				BRAKE ROTOR CHOICES							
		NEW SFAC Scooter Carbon Pads	Semi-Sintered V-Pads™	Sintered/HH Pads/ Grooved shoes	Left/Gauche/Links	Right/Droite/Rechts	Contour Rotor Universal left and right fitment	NEW Vee-Rotors™ CONTOUR	NEW CX Extreme® ROTOR	Oversize 250/280mm Rotor Kit	Relocating Bracket for 250/280mm Rotor	Oversize 320mm Rotor Kit	Relocating Bracket for 320mm Rotor
CH 125 JK/LM/P/R/T Spacy	88-96	H303											
CLR 125 W City Fly	99-03	FA256		FA256HH	MD1147LS								
CM 125 CC/CF	82-85	H312											
CR 125 M2-M4	76-78	H304		H304G									
CR 125 RZ/RA/RB	79-81	H324		H324G									
CR 125 RC	82	H319		H319G									
CR 125 RD	83	H331		H331G									
CR 125 RE/RF	84-85	FA092TT		FA092R	MD6087D								
CR 125 RG	86	FA092TT		FA092R	MD6087D								
CR 125 RHR/J	87-88	FA125TT		FA125R ■	MD6087D								
CR 125 RK	89	FA125TT		FA125R ■	MD6008D								
CR 125 RL/RM	90-91	FA125TT		FA125R ■	MD6003D								
CR 125 RN/RP/RR	92-94	FA125TT		FA125R ■	MD6001D		MD6001C		MD6001CX	OS6001EC	BRK004	NA	NA
CR 125 RS/RT/RV	95-97	FA185TT		FA185R ■	MD6037D		MD6037C		MD6037CX	OS6037C	BRK004	SM6037C	BRK009
CR 125 RW/RX/RY/R1	98-01	FA185TT		FA185R ■	MD6037D		MD6037C		MD6037CX	OS6037C	BRK004	SM6037C	BRK009
CR 125 R2/R3	02-03	FA185TT		FA185R ■	MD6037D		MD6037C		MD6037CX	OS6037C	BRK004	SM6037C	BRK009
CR 125 R4/R5/R6/R7	04-07	FA185TT		FA185R ■	MD6037D		MD6037C		MD6037CX	OS6037C	BRK004	SM6037C	BRK009
CRM 125 RL/RM/RP/RR/RV/RX	90-99	FA256TT		FA256HH	MD1147LS								
CT 125 C	85	H304											
FES 125 WY11/2 Pantheon	98-02	SFA281		SFA281HH	MD922D		MD922C		VR922				
FES 125 3/4/5 Pantheon	03-06	SFA281		SFA281HH	MD922D		MD922C		VR922				
FES 125 7/9/A S-Wing (Non ABS Model)	07-13	SFA388	SFAC388	SFA388HH	MD922D		MD922C		VR922				
FES 125 A7/A9/A S-Wing (ABS Model)	07-13	SFA388	SFAC388	SFA388HH	MD922D		MD922C		VR922				
FS 125 Sonic	03-04	SFA086	SFAC086	SFA086HH		NA							
LS 125 RY	00-	FA086		FA086HH		NA							
MBX 125 FE	84-86	FA086		FA086HH		NA							
MSX 125	13	TBA		TBA		TBA							
MTX 125 RWD	83-84	H304											
MTX 125 RWR/RWF/RWH/RWL	85-95	FA092TT		FA092R	MD6087D								
NES 125 Y1/2/3/4/5/6 (© 125 Scooter)	00-06	SFA323	SFAC323	SFA323HH	MD970D		MD970C		VR970				
NH 125 MD-D Lead	83	H303											
NH 125 Lead 125	86-87	SFA176				N/A							
NS 125 FG/FHRH	86-87	FA256		FA256HH	MD1084LS								
NSR 125 FJ/FK/FL/FM/FN	88-92	FA256		FA256HH	MD1088LS								
NSR 125 RK/RL/RM/RN	89-92	FA256		FA256HH	MD1088LS								
NSR 125 RR/RS/RV/RW/RX/RY/R1	93-01	FA256		FA256HH	MD1109LS								
NX 125 K/S/F Transcity	89-97	FA256TT		FA256HH	MD1147LS								
NXR 125 Bros ES/KS	05	H352											
PCX125 (WW125 EX2A-10)	10-13	SFA603		SFA603HH	MD9134D				VR9134				
PES 125 67/8/9/A/PS125	06-09	SFA323	SFAC323	SFA323HH	MD970D		MD970C		VR970				
PES 125 R8/R9/RA (PS125)	08-09	SFA323	SFAC323	SFA323HH	MD970D		MD970C		VR970				
SES 125 2/3/4 Dylan	02-07	SFA323	SFAC323	SFA323HH	MD970D		MD970C		VR970				
SH 125 1/3 (Carb/Rear drum model)	01-03	SFA323	SFAC323	SFA323HH	MD970D		MD970C		VR970				
SH 125i 4/5/6/7/8 (Fuel Injection/Rear Drum Model)	04-08	SFA323	SFAC323	SFA323HH	MD970D		MD970C		VR970				
SH 125i 9/A/B (Fuel Injection/Rear Disc Model)	09-12	SFA388	SFAC388	SFA388HH	MD922D		MD922C		VR922				
SH 125i D9 (Fuel Injection/Rear Drum Model)	09	SFA323	SFAC323	SFA323HH	MD922D		MD922C		VR922				
SH125i RB (Fuel Injection/Rear Drum Model)	08	SFA323	SFAC323	SFA323HH	MD970D		MD970C		VR970				
SH 125i RA (Fuel Injection/Rear Disc Model)	10-13	SFA388	SFAC388	SFA388HH	MD922D		MD922C		VR922				
SH125i S7/S8 (Fuel Injection/Rear Drum Model)	07-08	SFA323	SFAC323	SFA323HH	MD970D		MD970C		VR970				
SL 125 KIA	76	H303											
SL 125 KID/E/F/G/K2A	76-80	H304											
TL 125	76	H304		H304G									
TRX 125 J	88	H303*		H303G*									
VT 125 CX/CY/C2/CY2/C1/C1-C8 Shadow	99-08	FA197		FA197HH		MD1030							
XL 125 K2	78	H304		H304G									
XL 125 K3/K4	79	H303		H303G									
XL 125 SZ/SA/SB/SC/RC	79-82	H304		H304G									
XL 125 Paris-Dakar	85	FA256TT		FA256HH		N/A							
XL 125 RF/RH	85-86	FA092TT		FA092R	MD6087D								
XL 125 V1/V2/V3/V4/V5/V6/V7/V8/V9/V9A Varadero	01-11	FA197		FA197HH		MD1150RS							

\*-2 Sets Required. ■ - Also available in MX-S race compound.

**SAFETY WARNING:** DO NOT USE HH PADS ON REAR UNLESS ALSO USED ON FRONT TO AVOID BRAKE IMBALANCE

**R** Suffix = High Durability Sintered Pad. **HH** Suffix = High Performance Sintered Pad. **G** Suffix = Grooved Shoe.  
**D** Suffix = Drilled Disc. **C** Suffix = Contoured Disc. **LS** Suffix = Left/Steel Disc. **RS** = Right/Steel Disc.



# JAPANESE Built Motorcycles



## HONDA Contd.



← REAR / ARRIÈRE / HINTEN POSTERIOR / POSTERIORE →

			DISC PAD CHOICES			BRAKE ROTOR CHOICES			
			NEW SFAC Scooter Carbon Pads	Semi-Sintered V-Pads™	Sintered/HH Pads/ Grooved shoes	Contour Rotor Rear Fitment	NEW Vee-Rotors™ CONTOUR	NEW CX Extreme® ROTOR	
CH 125 JKL/MP/RT Spacy	88-96	H303							
CLR 125 W City Fly	99-03	H304							
CM 125 CC/CF	82-85	H310							
CR 125 M2-M4	76-78	H304			H304G				
CR 125 RZ/RA/RB	79-81	H330			H330G				
CR 125 RC	82	H330			H330G				
CR 125 RD	83	H331			H331G				
CR 125 RE/RF	84-85	H331			H331G				
CR 125 RG	86	H344			H344G				
CR 125 RH/RJ	87-88	FA131TT			FA131R ■	MD6009D			
CR 125 RK	89	FA131TT			FA131R ■	MD6002D			
CR 125 RL/RM	90-91	FA131TT			FA131R ■	MD6002D			
CR 125 RN/RP/RR	92-94	FA131TT			FA131R ■	MD6002D			
CR 125 RS/RT/RV	95-97	FA131TT			FA131R ■	MD6002D			
CR 125 RWRX/RV/R1	98-01	FA131TT			FA131R ■	MD6124D	MD6124C		MD6124CX
CR 125 R2/R3	02-03	FA346TT			FA346R ■	MD6191D	MD6191C◆		MD6191CX◆
CR 125 R4/R5/R6/R7	04-07	FA346TT			FA346R ■	MD6191D	MD6191C◆		MD6191CX◆
CRM 125 RL/RM/RP/RR/RV/RX	90-99	FA047/3				N/A			
CT 125 C	85	H304							
FES 125 W/Y/1/2 Pantheon	98-02	H351							
FES 125 3/4/5 Pantheon	03-06	SFA140	SFAC140		SFA140HH	MD9135D			
FES 125 7/8/A S-Wing (Non ABS Model)	07-13	SFA415	SFAC415		SFA415HH	MD9135D			
FES 125 A7/A9/AA S-Wing (ABS Model)	07-13	SFA415	SFAC415		SFA415HH	MD9135D			
FS 125 Sonic	03-04	SFA375				N/A			
LS 125 RY	00-	FA197			FA197HH	N/A			
MBX 125 FE	84-86	H304							
MSX 125	13	TBA			TBA	TBA			
MTX 125 RWD	83-84	H304							
MTX 125 RWE/RWF/RWH/RWL	85-95	H304			H304G				
NES 125 Y1/2/3/4/5/6 (© 125 Scooter)	00-06	H352							
NH 125 MD-D Lead	83	H303							
NH 125 Lead 125	86-87	H303							
NS 125 FG/FH/RH	86-87	H303							
NSR 125 FJ/FK/FL/FM/FN	88-92	FA047/3				N/A			
NSR 125 RK/RL/RM/RN	89-92	FA047/3				N/A			
NSR 125 RR/RS/RV/RW/RX/RV/R1	93-01	FA047/3				N/A			
NX 125 K/S/F Transcity	89-97	H303							
NXR 125 Bros ES/KS	05	H353							
PCX125 (WW125 EX2A- 10)	10-13	H352							
PES 125 6/7/8/9/A/PS125	06-09	H352							
PES 125 R8/R9/RA (PS125)	08-09	H352							
SES 125 2/3/4 Dylan	02-07	H352							
SH 125 1/3 (Carb/Rear drum model)	01-03	H352							
SH 125i 4/5/6/7/8 (Fuel Injection/Rear Drum Model)	04-08	H352							
SH 125i 9/A/B (Fuel Injection/Rear Disc Model)	09-12	SFA415	SFAC415		SFA415HH	MD9139D		VR9139	
SH 125 i-D9 (Fuel Injection/Rear Drum Model)	09	H352							
SH125i RB (Fuel Injection/Rear Drum Model)	08	H352							
SH 125i RA (Fuel Injection/Rear Disc Model)	10-13	SFA415	SFAC415		SFA415HH	MD9139D		VR9139	
SH125i S7/S8 (Fuel Injection/Rear Drum Model)	07-08	H352							
SL 125 KIA	76	H303							
SL 125 KID/E/F/G/K2A	76-80	H304							
TL 125	76	H304			H304G				
TRX 125 J	88	H306			H306G				
VT 125 CX/CY/C2Y/C21/C1-C8 Shadow	99-08	H318							
XL 125 K2	78	H304			H304G				
XL 125 K3/K4	79	H304			H304G				
XL 125 SZ/SA/SB/SC/RC	79-82	H304			H304G				
XL 125 Paris-Dakar	85	H303							
XL 125 RFRH	85-86	H304			H304G				
XL 125 V1/V2/V3/V4/V5/V6/V7/V8/V9/VA Varadero	01-11	FA343				MD1151			

\*-2 Sets Required. ■ - Also available in MX-S race compound.

**SAFETY WARNING:** DO NOT USE HH PADS ON REAR UNLESS ALSO USED ON FRONT TO AVOID BRAKE IMBALANCE

**R** Suffix = High Durability Sintered Pad. **HH** Suffix = High Performance Sintered Pad. **G** Suffix = Grooved Shoe.  
**D** Suffix = Drilled Disc. **C** Suffix = Contoured Disc. **LS** Suffix = Left/Steel Disc. **RS** = Right/Steel Disc.

**BRAKE APPLICATIONS**

# JAPANESE Built Motorcycles



← FRONT / AVANT / VORN FRENTE / ANTERIORE →

## HONDA Contd.

		DISC PAD CHOICES				BRAKE ROTOR CHOICES							
		NEW SFAC Scooter Carbon Pads	Semi-Sintered V-Pads™	Sintered/HH Pads/ Grooved shoes	Left/Gauche/Links	Right/Droite/Rechts	Contour Rotor Universal left and right fitment	NEW Vee-Rotors™ CONTOUR	NEW CX Extreme® ROTOR	Oversize 250/280mm Rotor Kit	Relocating Bracket for 250/280mm Rotor	Oversize 320mm Rotor Kit	Relocating Bracket for 320mm Rotor
XLR 125 RW	98-01	FA185TT		FA185R ■	MD6001D		MD6001C		MD6001CX				
XR 125 L3/L4/L5/L6/L7/L8	03-08	FA185TT		FA185R ■	N/A								
CBR 150 R	00-03	FA375				MD644RS							
CG 150 ESD Titan	04-05	FA054TT		FA054R ■	N/A								
CG 150 KS/ES Titan	04-05	FA054TT		FA054R ■	N/A								
CRF 150 F3/F4/F5/F6/F7	03-07	FA185TT		FA185R ■	MD6317D					OS6317C	BRK009	N/A	N/A
CRF 150 RB7/R7/RB8/R8/RB9/R9/RC/RBC/RD/RBD	07-13	FA084TT		FA084R ■	MD6314D		MD6314C		MD6314CX	OS6314C	BRK026	N/A	N/A
FES 150 WY/1/2 Pantheon	98-02	SFA281		SFA281HH	MD922D		MD922C	VR922					
FES 150 3/4/5 Pantheon	03-06	SFA281		SFA281HH	MD922D		MD922C	VR922					
FES 150 7/9 S-Wing (Non ABS Model)	07-13	SFA388	SFAC388	SFA388HH	TBA								
FES 150 A7/A9 S-Wing (ABS Model)	07-13	SFA388	SFAC388	SFA388HH	TBA								
NES 150 Y1/2/3/4/5/6 @ 150 Scooter	01-06	SFA323	SFAC323	SFA323HH	MD970D		MD970C	VR970					
NSR 150 RR (Malaysian Market)		FA197		FA197HH	N/A								
PES 150 6/7/8/9/A (PS150)	06-10	SFA323	SFAC323	SFA323HH	MD970D		MD970C	VR970					
PES 150 R8/R9/RA (PS150)	08-11	SFA323	SFAC323	SFA323HH	MD970D		MD970C	VR970					
SES 150 2/3/4 Dylan	02-06	SFA323	SFAC323	SFA323HH	MD970D		MD970C	VR970					
SH 150 1/3 (CARB/Rear Drum Model)	01-03	SFA323	SFAC323	SFA323HH	MD970D		MD970C	VR970					
SH 150i 4/5/6/7/8 (Fuel Injection/Rear Drum Model)	04-08	SFA323	SFAC323	SFA323HH	MD970D		MD970C	VR970					
SH 150i 9/A/B (Fuel Injection/Rear Disc Model)	09-12	SFA388	SFAC388	SFA388HH	MD922D		MD922C	VR922					
SH 150 i-D9 (Fuel Injection/Rear Drum Model)	09	SFA323	SFAC323	SFA323HH	MD922D		MD922C	VR922					
SH150i F8 (Fuel Injection/Rear Drum Model)	08	SFA323	SFAC323	SFA323HH	MD970D		MD970C	VR970					
SH 150i RA (Fuel Injection/Rear Disc Model)	10-13	SFA388	SFAC388	SFA388HH	MD922D		MD922C	VR922					
SH150i S7/S8 (Fuel Injection/Rear Drum Model)	07-08	SFA323	SFAC323	SFA323HH	MD970D		MD970C	VR970					
CB 175 All models	74-76	H308											
CD 175 All models	71-78	H306											
ATC 185 A/SB	80-81	H303		H303G									
CD 185 T	78	H312											
XL 185 SZ/S4/SB	80-82	H304		H304G									
ATC 200 B/ESE/ESF/SE	81-84	H303		H303G									
ATC 200 XD	83			FA0842R	MD6069D								
TRX 200 L/M/D/M/DN	90-93	H345*		H345G*									
CB 200 B	76-79	N/A			N/A								
CBX 200 Strada	97-01	SFA054	SFAC054	FA054HH		N/A							
CD 200 TA/TB	79-80	H312											
CM 200 TA/TB	79-80	H312											
CTX 200/CTX 200 A Bushlander	04-05	FA185TT		FA185R ■	MD6001D		MD6001C		MD6001CX				
MTX 200 RWD	83-84	H304		H304G									
MTX 200 RWF	85	FA092TT		FA092R	MD6087D								
TA 200 (TA Shadow)	02-05	FA197		FA197HH	TBA	TBA							
TL 200 JY Colin Seeley	76-78	H304		H304G									
TLR 200 D/E	83-85	H333		H333G									
TLR 200 G/H	86-87	H304		H304G									
TRX 200 LM	90-91	H345*		H345G*									
TRX 200 D	91-97	H345*		H345G*									
TRX 200 SX	86-87	H345*		H345G*									
XL 200 L	85	FA256TT		FA256HH	N/A								
XL 200 R	85	FA092TT		FA092R	N/A								
XR 200	80-84	H304		H304G									
XR 200 R	81-83	H304		H304G									
XR 200 R	84-85	H304		H304G									
XR 200 R	86-02	H304		H304G									
TLM 220 R	88-92	FA624TT			N/A								
FTR 223 Y2/A2 (MC34)	00-02	FA092TT		FA092R	TBA								
CRF 230 F4/F5/F6/F7/F8/F9	04-09	FA185TT		FA185R ■	MD6001D		MD6001C		MD6001CX	OS6001C	BRK008	SM6001C	BRK009
CRF 230 L	08-10	FA185TT		FA185R ■	MD6001D		MD6001C		MD6001CX	OS6001C	BRK008	SM6001C	BRK009
CRF 230 M (Supernova)	09-10	FA185TT		FA185R ■	MD6001D		MD6001C		MD6001CX	OS6001C	BRK008	SM6001C	BRK009
SL 230 Free Landsports (MD33) VWX/1	97-01	FA185TT		FA185R ■	MD6001D		MD6001C		MD6001CX	N/A	N/A	N/A	N/A
XL 230 2 (MC36)	02	H352											
ATC 250 RB	81	FA054TT		FA054R ■		MD6060D							
ATC 250 RC	82	FA084TT		FA084R ■		MD6060D							

\*-2 Sets Required. ■ - Also available in MX-S race compound.

**SAFETY WARNING:** DO NOT USE HH PADS ON REAR UNLESS ALSO USED ON FRONT TO AVOID BRAKE IMBALANCE

APPLICTIONS  
BRAKE

R Suffix = High Durability Sintered Pad. HH Suffix = High Performance Sintered Pad. G Suffix = Grooved Shoe.

D Suffix = Drilled Disc. C Suffix = Contoured Disc. LS Suffix = Left/Steel Disc. RS = Right/Steel Disc.

# JAPANESE Built Motorcycles



## HONDA Contd.



← REAR / ARRIÈRE / HINTEN POSTERIOR / POSTERIORE →

		DISC PAD CHOICES				BRAKE ROTOR CHOICES			
		NEW SFAC Scooter Carbon Pads	Semi-Sintered V-Pads™	Sintered/HH Pads/ Grooved shoes		Contour Rotor Rear Fitment	NEW Vee-Rotors™ CONTOUR	NEW CX Extreme® ROTOR	
XL R 125 RW	98-01	H304		H304G					
XR 125 L3/L4/L5/L6/L7/L8	03-08	H304		H304G					
CBR 150 R	00-03	FA343			MD1151				
CG 150 ESD Titan	04-05	H352							
CG 150 KS/ES Titan	04-05	H352							
CRF 150 F3/F4/F5/F6/F7	03-07	H304		H304G					
CRF 150 RB7/R7/RB8/R8/RB9/R9/R10/R10C/R10D/R10E	07-13	FA346TT		FA346R ■	MD6316D	MD6316C		MD6316CX	
FES 150 W/Y1/1/2 Pantheon	98-02	H351							
FES 150 3/4/5 Pantheon	03-06	SFA140	SFAC140	SFA140HH	MD9135D				
FES 150 7/9 S-Wing (Non ABS Model)	07-13	SFA415	SFAC415	SFA415HH	MD9135D				
FES 150 A7/A9 S-Wing (ABS Model)	07-13	SFA415	SFAC415	SFA415HH	MD9135D				
NES 150 Y1/2/3/4/5/6 @ 150 Scooter	01-06	H352							
NSR 150 RR (Malaysian Market)		FA197		FA197HH	N/A				
PES 150 6/7/8/9/A (PS150)	06-10	H352							
PES 150 R8/R9/RA (PS150)	08-11	H352							
SES 150 2/3/4 Dylan	02-06	H352							
SH 150 1/3 (CARB/Rear Drum Model)	01-03	H352							
SH 150 4/5/6/7/8 (Fuel Injection/Rear Drum Model)	04-08	H352							
SH 150 9/A/B (Fuel Injection/Rear Disc Model)	09-12	SFA415	SFAC415	SFA415HH	MD9139D		VR9139		
SH 150 i/D9 (Fuel Injection/Rear Drum Model)	09	H352							
SH150I RB (Fuel Injection/Rear Drum Model)	08	H352							
SH 150I RA (Fuel Injection/Rear Disc Model)	10-13	SFA415	SFAC415	SFA415HH	MD9139D		VR9139		
SH150I S7/S8 (Fuel Injection/Rear Drum Model)	07-08	H352							
CB 175 All models	74-76	H309							
CD 175 All models	71-78	H307							
ATC 185 A/SB	80-81	H306		H306G					
CD 185 T	78	H310							
XL 185 SZ/SA/SB	80-82	H304		H304G					
ATC 200 B/ES/E/ESF/ISE	81-84	H306		H306G					
ATC 200 XD	83			FA0842R	MD6059D				
TRX 200 L/M/D/M/D/N	90-93	H306		H306G					
CB 200 B	76-79	H309							
CBX 200 Strada	97-01	H352							
CD 200 TA/TB	79-80	H310							
CM 200 TA/TB	79-80	H310							
CTX 200/CTX 200 A Bushlander	04-05	H304		H304G					
MTX 200 RWD	83-84	H304		H304G					
MTX 200 RWF	85	H304		H304G					
TA 200 (TA Shadow)	02-05	FA197		FA197HH	N/A				
TL 200 J/Y Colin Seeley	76-78	H304		H304G					
TLR 200 D/E	83-85	H333		H333G					
TLR 200 G/H	86-87	H333		H333G					
TRX 200 LM	90-91	H306		H306G					
TRX 200 D	91-97	H306		H306G					
TRX 200 SX	86-87	H306		H306G					
XL 200 L	85	H303							
XL 200 R	85	H303							
XR 200	80-84	H304		H304G					
XR 200 R	81-83	H304		H304G					
XR 200 R	84-85	H304		H304G					
XR 200 R	86-02	H304		H304G					
TLM 220 R	88-92	H304		H304G					
FTR 223 Y2/A2 (MC34)	00-02	H352							
CRF 230 F4/F5/F6/F7/F8/F9	04-09	H304		H304G					
CRF 230 L	08-10	FA131TT		FA131R ■	MD6013D	MD6013C		MD6013CX	
CRF 230 M (Supernova)	09-10	FA131TT		FA131R ■	MD6013D	MD6013C		MD6013CX	
SL 230 Free Landsports (MD33) V/W/X/1	97-01	FA131TT		FA131R ■	MD6013D	MD6013C		MD6013CX	
XL 230 2 (MC36)	02	H352							
ATC 250 RB	81	H306		H306G					
ATC 250 RC	82	H306		H306G					

\*-2 Sets Required. ■ - Also available in MX-S race compound.

**SAFETY WARNING:** DO NOT USE HH PADS ON REAR UNLESS ALSO USED ON FRONT TO AVOID BRAKE IMBALANCE

**BRAKE APPLICATIONS**

**R** Suffix = High Durability Sintered Pad. **HH** Suffix = High Performance Sintered Pad. **G** Suffix = Grooved Shoe.  
**D** Suffix = Drilled Disc. **C** Suffix = Contoured Disc. **LS** Suffix = Left/Steel Disc. **RS** = Right/Steel Disc.



# JAPANESE Built Motorcycles



← FRONT / AVANT / VORN FRENTE / ANTERIORE →

## HONDA Contd.

Model	Year	Part No.	DISC PAD CHOICES				BRAKE ROTOR CHOICES									
			NEW SFAC Scooter Carbon Pads	Semi-Sintered V-Pads™	Sintered/HH Pads/ Grooved shoes	Left/Gauche/Links	Right/Droite/Rechts	Contour Rotor Universal left and right fitment	NEW Vee-Rotors™ CONTOUR	NEW CX Extreme® ROTOR	Oversize 250/280mm Rotor Kit	Relocating Bracket for 250/280mm Rotor	Oversize 320mm Rotor Kit	Relocating Bracket for 320mm Rotor		
ATC 250 RD	83-84	FA084TT			FA084R ■			MD6059D								
ATC 250 RF/RG	85-86	FA092TT			FA092R		MD6059D									
ATC 250 ESF/ESG/ESH/ESJ	85-88	H306			H306G											
AX-1 (NX 250 JK/R/R3)	89-94	FA125TT			FA125R ■		MD6001D		MD6001C		MD6001CX					
CB 250 K3-K5	73-75	H314														
CB 250 G5	75	FA013							NA							
CB 250 T	78	FA045						N/A								
CB 250 N/NA/NB/NB/ND/NC	78-82	FA045					MD1036LS									
CB 250 RSA/RSD	81-84	FA045					N/A									
CB 250 FT/FV/FX/FY/F1 Homet	96-01	FA187			FA187HH			MD1144RS								
CB 250 NT/W/X/Y1/1.4 Two Fifty	92-05	FA196			FA196HH		MD1089LS									
CBF 250 46	04-06	FA197			FA197HH			MD1166RS								
CBR 250 FG/FGYA (MC14)	86	FA121*			FA121HH*		MD1006	MD1006	MD1006C*							
CBR 250 RH (MC17)	87	FA121*			FA121HH*		MD1006	MD1006	MD1006C*							
CBR 250 RJ/RK/RK2 (MC19)	88-89	FA142			FA142HH			MD1140RS								
CBR 250 RRL/RRV/RRR (MC22)	90-94	FA142*			FA142HH*		MD1145LS	MD1145RS								
CBR 250 RB/RC (Non ABS Model)	11-13	FA142			FA142HH			MD1180X								
CBR 250 RAB/RAC (ABS Model)	11-13	FA388			FA388HH			MD1180X								
CBX 250 RSE	84	FA069			FA069HH		MD1090LS									
CBX 250 Twister		TBA														
CBX 250	84-98	FA086			FA086HH			MD1030								
CD 250 UJ	88-92	FA124/2			FA124/2HH		MD1090LS									
CH 250 F/G Spacy	85-86	SFA323/2			SFA323/2HH		MD913D									
CJ 250 T	77	FA013					N/A									
C 250 SC	81	H312														
CM 250 TB	81	FA045					MD1036LS									
CMX 250 CT Rebel (Nissin Caliper)	96	FA228			FA228HH		MD1030									
CMX 250 CV/CW/CX Rebel (Grimeca Caliper)	97-00	FA256			FA256HH		MD1030									
CN 250 H/U/K/L/M/P/R/S/T/W/X Spazio/Helix	87-98	FA069/2					MD908D		VR908							
CN 250 3 (MF02) Fusion/Fusion X/Fusion X Special	03	SFA196	SFAC196		SFA196HH		MD908D		VR908							
CR 250 RZ/RA	79-80	H324			H324G											
CR 250 RB	81	H327			H327G											
CR 250 RC/RD	82-83	H328			H328G											
CR 250 RE/RF	84-85	FA092TT			FA092R		MD6087D									
CR 250 RG	86	FA092TT			FA092R		MD6087D									
CR 250 RH/RJ	87-88	FA125TT			FA125R ■		MD6087D									
CR 250 RK	89	FA125TT			FA125R ■		MD6008D									
CR 250 RL/RM	90-91	FA125TT			FA125R ■		MD6003D									
CR 250 RN/RP/RR	92-94	FA125TT			FA125R ■		MD6001D		MD6001C		MD6001CX	OS6001EC	BRK004	NA	NA	
CR 250 RS/RT	95-96	FA185TT			FA185R ■		MD6037D		MD6037C		MD6037CX	OS6037C	BRK008	SM6037C	BRK009	
CR 250 RV/RW/RX/RY/R1	97-01	FA185TT			FA185R ■		MD6037D		MD6037C		MD6037CX	OS6037C	BRK008	SM6037C	BRK009	
CR 250 R2/R3	02-03	FA185TT			FA185R ■		MD6037D		MD6037C		MD6037CX	OS6037C	BRK008	SM6037C	BRK009	
CR 250 R4/R5/R6/R7	04-07	FA185TT			FA185R ■		MD6037D		MD6037C		MD6037CX	OS6437C	BRK005	SM6437C	BRK006	
CRF 250 LD	13	FA465TT			FA465R				MD6372C		MD6372CX	NA	N/A	NA	N/A	
CRF 250 R4/R5/R6/R7	04-07	FA185TT			FA185R ■		MD6037D		MD6037C		MD6037CX	OS6437C	BRK005	SM6437C	BRK006	
CRF 250 R8/R9/RA/RB/RC/RD	08-13	FA185TT			FA185R ■				MD6037C		MD6037CX	OS6437C	BRK005	SM6437C	BRK006	
CRF 250 X4/X5/X6/X7	04-07	FA185TT			FA185R ■		MD6037D		MD6037C		MD6037CX	OS6437C	BRK005	SM6437C	BRK006	
CRF 250 X8/X9/XC/XCD	08-13	FA185TT			FA185R ■				MD6037C		MD6037CX	OS6437C	BRK005	SM6437C	BRK006	
CRF 250 XRLD	13	FA185TT			FA185R ■				MD6037C		MD6037CX	OS6437C	BRK005	SM6437C	BRK006	
CRM 250 R (RK) MK1 MD24 (100001-1008385)	89-90	FA125TT			FA125R ■		MD6087D									
CRM 250 R (RM) MK2 MD24 (1200001-1211634)	91-92	FA125TT			FA125R ■		MD6001D		MD6001C		MD6001CX	OS6001EC	BRK004	NA	NA	
CRM 250 R (RP/RR-II) MK2 MD24 (1300001-)	93	FA125TT			FA125R ■		MD6001D		MD6001C		MD6001CX	OS6001EC	BRK004	NA	NA	
CRM 250 (MD24) 140 (MK3) RR-RR-II	94-96	FA185TT			FA185R ■		MD6001D		MD6001C		MD6001CX	OS6001C	BRK008	SM6001C	BRK009	
CRM 250 ARV/ARW Active Radical (MD32)	97-98	FA185TT			FA185R ■		MD6001D		MD6001C		MD6001CX	OS6001C	BRK008	SM6001C	BRK009	
FES 250 W/X Foresight	98-99	SFA281			SFA281HH		MD922D		MD922C		VR922					
FES 250 Y1/12/5 Foresight	00-05	SFA281			SFA281HH		MD922D		MD922C		VR922					
FES 250 Y1/12/5 Foresight Note - Brake shoes (Parking)	00-05	H361														
FL 250 Odyssey	77-84	FA040						N/A								
GB 250 E/H Clubman (MC10 101-110)	84-87	FA069/2					TBA									
GB 250 J/L/P/S/V Clubman (MC 10-120-150)	89-97	FA124/2			FA124/2HH		TBA									

\*-2 Sets Required. ■ - Also available in MX-S race compound.

**SAFETY WARNING:** DO NOT USE HH PADS ON REAR UNLESS ALSO USED ON FRONT TO AVOID BRAKE IMBALANCE

APPLICATIONS  
BRAKE

R Suffix = High Durability Sintered Pad. HH Suffix = High Performance Sintered Pad. G Suffix = Grooved Shoe.  
D Suffix = Drilled Disc. C Suffix = Contoured Disc. LS Suffix = Left/Steel Disc. RS = Right/Steel Disc.

# JAPANESE Built Motorcycles



## HONDA Contd.



← REAR / ARRIÈRE / HINTEN POSTERIOR / POSTERIORE →

			DISC PAD CHOICES			BRAKE ROTOR CHOICES			
			NEW SFAC Scooter Carbon Pads	Semi-Sintered V-Pads™	Sintered/HH Pads/ Grooved shoes	Contour Rotor Rear Fitment	NEW Vee-Rotors™ CONTOUR	NEW CX Extreme® ROTOR	
ATC 250 RD	83-84	FA084TT			FA084R ■	MD6059D			
ATC 250 RF/RG	85-86	FA092TT			FA092R	MD6007D			
ATC 250 ESF/ESG/ESH/ESJ	85-88	H315			H315G				
AX-1 (NX 250 JK/R/R3)	89-94	FA153				MD6198D			
CB 250 K3-K5	73-75	H315							
CB 250 G5	75	H315							
CB 250 T	78	H313							
CB 250 NNA/NB/NDB/NDC	78-82	H313							
CB 250 RSA/RSD	81-84	H309							
CB 250 FT/FV/FX/FY/F1 Hornet	96-01	FA140		FA140V	FA140HH	MD1004	MD1004C		
CB 250 NVT/WX/Y1/A Two Fifty	92-05	H310							
CBF 250 4i6	04-06	H352							
CBR 250 FG/FGYA (MC14)	86	H309							
CBR 250 RH (MC17)	87	FA140		FA140V	FA140HH	MD1002			
CBR 250 RJ/RK/RK2 (MC19)	88-89	FA140		FA140V	FA140HH	MD1002			
CBR 250 RRL/RRN/RRR (MC22)	90-94	FA140		FA140V	FA140HH	MD1004	MD1004C		
CBR 250 RB/RC (Non ABS Model)	11-13	FA496			FA496HH	MD1004			
CBR 250 RAB/RAC (ABS Model)	11-13	FA496			FA496HH	MD1181			
CBX 250 RSE	84	H318							
CBX 250 Twister		H352							
CBX 250	84-98	H304							
CD 250 UJ	88-92	H310							
CH 250 F/G Spacy	85-86	H341							
CJ 250 T	77	H315							
C 250 SC	81	H309							
CM 250 TB	81	H313							
CMX 250 CT Rebel (Nissin Caliper)	96	H318							
CMX 250 CV/CW/CX Rebel (Grimeca Caliper)	97-00	H318							
CN 250 H/J/K/L/M/P/R/S/T/W/X Spazio/Helix	87-98	H350							
CN 250 3 (MF02) Fusion/Fusion X/Fusion X Special	03	H350							
CR 250 RZ/RA	79-80	H325			H325G				
CR 250 RB	81	H330			H330G				
CR 250 RC/RD	82-83	H331			H331G				
CR 250 RE/RF	84-85	H331			H331G				
CR 250 RG	86	H344			H344G				
CR 250 RH/RJ	87-88	FA131TT			FA131R ■	MD6009D			
CR 250 RK	89	FA131TT			FA131R ■	MD6002D			
CR 250 RL/RM	90-91	FA131TT			FA131R ■	MD6002D			
CR 250 RN/RP/RR	92-94	FA131TT			FA131R ■	MD6002D			
CR 250 RS/RT	95-96	FA131TT			FA131R ■	MD6002D			
CR 250 RV/RW/RX/RV/R1	97-01	FA131TT			FA131R ■	MD6124D	MD6124C	MD6124CX	
CR 250 R2/R3	02-03	FA346TT			FA346R ■	MD6191D	MD6191C◆	MD6191CX◆	
CR 250 R4/R5/R6/R7	04-07	FA346TT			FA346R ■	MD6191D	MD6191C◆	MD6191CX◆	
CRF 250 LD	13	FA629TT			FA629R	MD6373C		MD6373CX	
CRF 250 R4/R5/R6/R7	04-07	FA346TT			FA346R ■	MD6191D	MD6191C◆	MD6191CX◆	
CRF 250 R8/R9/RA/RB/RC/RD	08-13	FA346TT			FA346R ■		MD6191C◆	MD6191CX◆	
CRF 250 X4/X5/X6/X7	04-07	FA346TT			FA346R ■	MD6191D	MD6191C◆	MD6191CX◆	
CRF 250 X8/X9/XB/XC/XD	08-13	FA346TT			FA346R ■		MD6191C◆	MD6191CX◆	
CRF 250 XRLD	13	FA346TT			FA346R ■		MD6191C◆	MD6191CX◆	
CRM 250 R (RK) MK1 MD24 (100001-1008385)	89-90	FA153				MD6165D			
CRM 250 R (RM) MK2 MD24 (1200001-1211634)	91-92	FA131TT			FA131R ■	MD6013D	MD6013C	MD6013CX	
CRM 250 R (RP/RP-II) MK2/2 MD24 (1300001-)	93	FA131TT			FA131R ■	MD6013D	MD6013C	MD6013CX	
CRM 250 (MD24) 140 (MK3) RR-RR-II	94-96	FA131TT			FA131R ■	MD6013D	MD6013C	MD6013CX	
CRM 250 ARW/ARW Active Radical (MD32)	97-98	FA131TT			FA131R ■	MD6013D	MD6013C	MD6013CX	
FES 250 WIX Foresight	98-99	H351							
FES 250 Y1/2/5 Foresight	00-05	SFA140			SFA140HH	MD1004		VR1004	
FL 250 Odyssey	77-84	H306			H306G				
GB 250 EH Clubman (MC10 101-110)	84-87	H318							
GB 250 J/L/P/S/V Clubman (MC 10-120-150)	89-97	H318							

\*-2 Sets Required. ■ - Also available in MX-S race compound.

**SAFETY WARNING:** DO NOT USE HH PADS ON REAR UNLESS ALSO USED ON FRONT TO AVOID BRAKE IMBALANCE

**BRAKE APPLICATIONS**

**R** Suffix = High Durability Sintered Pad. **HH** Suffix = High Performance Sintered Pad. **G** Suffix = Grooved Shoe.  
**D** Suffix = Drilled Disc. **C** Suffix = Contoured Disc. **LS** Suffix = Left/Steel Disc. **RS** = Right/Steel Disc.

# JAPANESE Built Motorcycles



← FRONT / AVANT / VORN FRENTE / ANTERIORE →

## HONDA Contd.

		DISC PAD CHOICES				BRAKE ROTOR CHOICES							
		NEW SFAC Scooter Carbon Pads	Semi-Sintered V-Pads™	Sintered/HH Pads/ Grooved shoes	Left/Gauche/Links	Right/Droite/Rechts	Contour Rotor Universal left and right fitment	NEW Vee-Rotors™ CONTOUR	NEW CX Extreme® ROTOR	Oversize 250/280mm Rotor Kit	Relocating Bracket for 250/280mm Rotor	Oversize 320mm Rotor Kit	Relocating Bracket for 320mm Rotor
MXV 250 F (MC92)	83-88	FA080/2			N/A								
NS 250 FE/RE (MC11-100)	84	FA069/2*			MD1006	MD1006	MD1006C*						
NS 250 RG (MC11-102)	86	FA069/2*			MD1006	MD1006	MD1006C*						
NSR 250 RG (MC16-100)	86	FA121*		FA121HH*	MD1129LS	MD1129RS							
NSR 250 R2J (MC18-100) R4J (MC18-100)	88	FA187*		FA187HH*	MD1117LS	MD1117RS							
NSR 250 R5K/R6K-2 (MC18-110)	89	FA187*		FA187HH*	MD1117LS	MD1117RS							
NSR 250 R6K/R6K-2 (MC18-110)	89	FA187*		FA187HH*	MD1117LS	MD1117RS							
NSR 250 R7L/R7N (MC21-106)	90	FA187*		FA187HH*	MD1117LS	MD1117RS							
NSR 250 R8L-3 (MC21-101) R9L (MC21-102) R8N/R9N-3 (MC21-106)	90-92	FA187*		FA187HH*	MD1117LS	MD1117RS							
NSR 250 R9N (MC21-106)	92	FA187*		FA187HH*	MD1117LS	MD1117RS							
NSR 250 RR (MC28-100)	94	FA187*		FA187HH*	MD1117LS	MD1117RS							
NSR 250 R2R/R3R (MC28-110) R2T/R3T (MC28-120)	94	FA187*		FA187HH*	MD1117LS	MD1117RS							
NSS 250 Y/AV1/A1/A3/3 Forza/Forza-ST/S/T/Jazz/Reflex (MF04/MF06)	00-04	SFA281		SFA281HH	MD922D		MD922C	VR922					
NSS 250 EX5/EX7/EX8 Forza EX (ABS)	05-08	SFA388	SFAC388	SFA388HH	MD922D		MD922C	VR922					
NSS 250 EX5/EX7/EX8 Forza EX (ABS) Parking brake	05-08	H333											
NSS 250 AX5/AX6 Forza Z (ABS)	05-06	SFA388	SFAC388	SFA388HH	MD922D		MD922C	VR922					
NSS 250 AX5/AX6 Forza Z (ABS) Parking brake	05-06	H333											
NSS 250 X5/X7/X8 Forza X	05-08	SFA388	SFAC388	SFA388HH	MD922D		MD922C	VR922					
NSS 250 X5/X7/X8 Forza X (Parking Brake)	05-08	H333											
NX 250 JK (MD21)	87-90	FA125TT		FA125R ■	MD6008D								
NX 250 2L/M/P/2P (MD25)	90-93	FA125TT		FA125R ■	MD6001D		MD6001C		MD6001CX				
PS 250 5/6 Big Ruckus	05-06	SFA388	SFAC388	SFA388HH	MD922D		MD922C	VR922					
RTL 250 SG	86	H304		H304G									
RTL 250 S	88-89	FA624TT			N/A								
TL 250 K1	79	H304		H304G									
TLR 250 F	85	H304		H304G									
TLM 250 RJ	89	H304		H304G									
TRX 250 F/G/H	85-87	H339*		H339G*									
TRX 250 R/G/RH	86-87	FA125TT*		FA125R* ■	MD6046D	MD6046D							
TRX 250 R/J/RK	88-89	FA125TT*		FA125R* ■	MD6006D	MD6006D							
TRX 250 VM/XY/Y1/TE2-9/TEA/TEB/TEC/TM2-9/TMA/TMB/TMC													
Re Con/ES	97-12	H345*		H345G*									
TRX 250 EX1/2/3/4/5/6/7/8	01-08	FA084TT*		FA084R* ■	MD6006D	MD6006D							
TRX 250 X9/XA/XB	09-11	FA084TT*		FA084R* ■	MD6006D	MD6006D							
VT 250 FL Spada/Castel	88-90	FA142		FA142HH		TBA							
XL 250 K3/K4	78-79	H311		H311G									
XL 250 S/SZ/SA	78-81	H312		H312G									
XL 250 SB	82	H312		H312G									
XL 250 RE/RF	84-85	H330		H330G									
XL 250 RC	82	H330		H330G									
XL 250 RL	90	FA125TT		FA125R ■	MD6001D		MD6001C		MD6001CX				
XL 250 Degree (MD26)		FA185TT		FA185R ■	MD6001D		MD6001C		MD6001CX				
XR 250 SZ/SA	79-80	H312		H312G									
XR 250 RB/RC/RD	81-83	H327		H327G									
XR 250 RE/RF	84-85	FA092TT		FA092R	MD6001D		MD6001C		MD6001CX				
XR 250 R/G/RH	86-87	FA092TT		FA092R	MD6087D								
XR 250 R/J/RK	88-89	FA125TT		FA125R ■	MD6087D								
XR 250 RL	90	FA125TT		FA125R ■	MD6087D								
XR 250 RM/RN/RP/R/R/S	91-95	FA125TT		FA125R ■	MD6001D		MD6001C		MD6001CX	OS6001EC	BRK004	N/A	N/A
XR 250 RT/RV/RW/RX/R/Y/R1/R2/R3/R4	96-04	FA185TT		FA185R ■	MD6001D		MD6001C		MD6001CX	OS6001C	BRK008	SM6001C	BRK009
XR 250 Y/3 (MD30)	00-03	FA185TT		FA185R ■	MD6001D		MD6001C		MD6001CX				
XR 250 3/5 (MD30) Motard	03-05	FA185TT		FA185R ■	MD6001D		MD6001C		MD6001CX				
XR 250 Tornado	05	TBA		TBA									
XR 250 III Y/3 Baja	00-03	FA185TT		FA185R ■	MD6001D		MD6001C		MD6001CX				
XLR 250 Baja MK1 R/R/R2/RH (MD22)		FA092TT		FA092R	MD6001D		MD6001C		MD6001CX				
XLR 250 Baja MK2 R3 (MD22)		FA185TT		FA185R ■	MD6001D		MD6001C		MD6001CX				
XLR 250 R/R3/R/RK/R/L/R3/L/R3/M/RN (MD22)	88-90	FA092TT		FA092R	MD6087D								
XLR 250 RM/RN/RP/R/R/R3R (MD22)	91-	FA185TT		FA185R ■	MD6001D		MD6001C		MD6001CX				
VT 250 FD	83	FA080/2			N/A								
VT 250 CR/CT/CV Magna	95-97	FA196		FA196HH	MD1021LS								

\*-2 Sets Required. ■ - Also available in MX-S race compound.

**SAFETY WARNING:- DO NOT USE HH PADS ON REAR UNLESS ALSO USED ON FRONT TO AVOID BRAKE IMBALANCE**

APPLICATIONS  
BRAKE

R Suffix = High Durability Sintered Pad. HH Suffix = High Performance Sintered Pad. G Suffix = Grooved Shoe.  
D Suffix = Drilled Disc. C Suffix = Contoured Disc. LS Suffix = Left/Steel Disc. RS = Right/Steel Disc.



# JAPANESE Built Motorcycles



## HONDA Contd.



← REAR / ARRIÈRE / HINTEN POSTERIOR / POSTERIORE →

		DISC PAD CHOICES				BRAKE ROTOR CHOICES			
		NEW SFAC Scooter Carbon Pads	Semi-Sintered V-Pads™	Sintered/HH Pads/ Grooved shoes		Contour Rotor Rear Fitment	NEW Vee-Rotors™ CONTOUR	NEW CX Extreme® ROTOR	
MXV 250 F (MC92)	83-88	H315							
NS 250 FEIRE (MCIH-100)	84	FA069/3		FA069/3V		MD1002			
NS 250 RG (MCIH-102)	86	FA069/3		FA069/3V		MD1002			
NSR 250 RG (MC16-100)	86	FA069/3		FA069/3V	FA069/3HH	MD1002			
NSR 250 R2J (MC18-100) RAJ (MC18-100)	88	FA140		FA140V	FA140HH	MD1002			
NSR 250 R5K/R5K-2 (MC18-110)	89	FA140		FA140V	FA140HH	MD1002			
NSR 250 R6K/R6K-2 (MC18-110)	89	FA140		FA140V	FA140HH	MD1002			
NSR 250 R7L/R7V (MC21-106)	90	FA140		FA140V	FA140HH	MD1002			
NSR 250 R8L-3 (MC21-101) R9L (MC21-102) R8N/R8N-3 (MC21-106)	90-92	FA140		FA140V	FA140HH	MD1002			
NSR 250 R9N (MC21-106)	92	FA140		FA140V	FA140HH	MD1002			
NSR 250 RR (MC28-100)	94	FA143				MD1111			
NSR 250 R2R/R3R (MC28-110) R2T/R3T (MC28-120)	94	FA143				MD1111			
NSS 250 Y/AY1/A1/A3/3 Forza/Forza-ST/ST/Jazz/Relax (MF04/MF06)	00-04	SFA358		SFA358HH		MD1004	VR1004		
NSS 250 EX5/EX7/EX8 Forza EX (ABS)	05-08	SFA415	SFAC415	SFA415HH		MD1020	MD1020C	VR1020	
NSS 250 AX5/AX6 Forza Z (ABS)	05-06	SFA415	SFAC415	SFA415HH		MD1020	MD1020C	VR1020	
NSS 250 X5/X7/X8 Forza X	05-08	SFA415	SFAC415	SFA415HH		MD1020	MD1020C	VR1020	
NX 250 JK (MD21)	87-90	H323		H323G					
NX 250 2LM/P2P (MD25)	90-93	H323		H323G					
PS 250 5/6 Big Ruckus	05-06	H351							
RTL 250 SG	86	H304		H304G					
RTL 250 S	88-89	FA153							
TL 250 K1	79	H304		H304G					
TLR 250 F	85	H304		H304G					
TLM 250 RJ	89	H304		H304G					
TRX 250 F/G/H	85-87	H315		H315G					
TRX 250 RG/RH	86-87	FA092TT		FA092R		MD6007D			
TRX 250 RJ/RK	88-89	FA092TT		FA092R		MD6007D			
TRX 250 V/W/X/Y1/TE2-9/TEA/TEB/TEC/TM2-9/TMA/TMB/TMC									
Re ConES	97-12	H340		H340G					
TRX 250 EX1/2/3/4/5/6/7/8	01-08	H340		H340G					
TRX 250 X9/XA/XB	09-11	H340		H340G					
VT 250 FL Spada/Castel	88-90	FA140		FA140V	FA140HH	MD1002			
XL 250 K3/K4	78-79	H312		H312G					
XL 250 S/SZ/SA	78-81	H323		H323G					
XL 250 SB	82	H318		H318G					
XL 250 RE/RF	84-85	H323		H323G					
XL 250 RC	82	H323		H323G					
XL 250 RL	90	FA131TT		FA131R ■		MD6013D	MD6013C	MD6013CX	
XL 250 Degree (MD26)		H323		H323G					
XR 250 SZ/SA	79-80	H323		H323G					
XR 250 RB/RC/RD	81-83	H323		H323G					
XR 250 RE/RF	84-85	H304		H304G					
XR 250 RG/RH	86-87	H304		H304G					
XR 250 RJ/RK	88-89	H304		H304G					
XR 250 RL	90	FA131TT		FA131R ■		MD6013D	MD6013C		
XR 250 RM/RN/RP/RR/RS	91-95	FA131TT		FA131R ■		MD6013D	MD6013C	MD6013CX	
XR 250 RT/RV/RW/RX/RV/R1/R2/R3/R4	96-04	FA131TT		FA131R ■		MD6013D	MD6013C	MD6013CX	
XR 250 Y/3 (MD30)	00-03	FA131TT		FA131R ■		MD6013D	MD6013C	MD6013CX	
XR 250 3/5 (MD30) Motard	03-05	FA131TT		FA131R ■		MD6013D	MD6013C	MD6013CX	
XR 250 Tomado	05	H352							
XR 250 III Y/3 Baja	00-03	FA131TT		FA131R ■		MD6013D	MD6013C	MD6013CX	
XLR 250 Baja MK1 RF/R2F/RH (MD22)		H323		H323G					
XLR 250 Baja MK2 R3 (MD22)		FA153				MD6013D	MD6013C	MD6013CX	
XLR 250 R/R3/RJ/RK/R3L/R3M/RN (MD22)	88-90	FA153				MD6013D	MD6013C		
XLR 250 RM/R3N/RP/RR/R3R (MD22)	91-	FA131TT		FA131R ■		MD6013D	MD6013C	MD6013CX	
VT 250 FD	83	H309							
VT 250 CR/CT/CV Magna	95-97	H321							

\*-2 Sets Required. ■ - Also available in MX-S race compound.

**SAFETY WARNING:** DO NOT USE HH PADS ON REAR UNLESS ALSO USED ON FRONT TO AVOID BRAKE IMBALANCE

**R** Suffix = High Durability Sintered Pad. **HH** Suffix = High Performance Sintered Pad. **G** Suffix = Grooved Shoe.  
**D** Suffix = Drilled Disc. **C** Suffix = Contoured Disc. **LS** Suffix = Left/Steel Disc. **RS** = Right/Steel Disc.

**BRAKE APPLICATIONS**

# JAPANESE Built Motorcycles



← FRONT / AVANT / VORN FRENTE / ANTERIORE →

## HONDA Contd.

### DISC PAD CHOICES

### BRAKE ROTOR CHOICES

Model	Year	FA Part	NEW SFAC Scooter Carbon Pads	Sintered/HH Pads/Grooved shoes	Left/Gauche/Links		Right/Droite/Rechts		Contour Rotor Universal left and right fitment	NEW Vee-Rotors™ CONTOUR	NEW CX Extreme® ROTOR	Oversize 250/280mm Rotor Kit	Relocating Bracket for 250/280mm Rotor	Oversize 320mm Rotor Kit	Relocating Bracket for 320mm Rotor
					Left/Gauche/Links	Right/Droite/Rechts	Left/Gauche/Links	Right/Droite/Rechts							
VTR 250 WY1-7 (MC33)	98-07	FA196		FA196HH				MD1144RS							
VTR 250 9	09-10	FA196		FA196HH				TBA							
VTZ 250 HJK	86-88	FA124/2		FA124/2HH				TBA							
TLM 260	89-93	FA624TT					N/A								
CB 300 R10	10	FA197		FA197HH				MD1166RS							
NSS 300 AD Forza	13	SFA388	SFAC388	SFA388HH				TBA							
SH 300i 7/8/9/AB (Non ABS Model)	07-12	SFA388	SFAC388	SFA388HH	MD9118D				VR9118						
SH 300i A7/A8/A9/AA/AB/AC (ABS Model)	07-13	SFA388	SFAC388	SFA388HH	MD9118D				VR9118						
SH 300i R8/R9/RA (Non ABS Model)	08-10	SFA388	SFAC388	SFA388HH	MD9118D				VR9118						
SH 300i AR8/AR9/ARA (ABS Model)	08-10	SFA388	SFAC388	SFA388HH	MD9118D				VR9118						
TRX 300 J/K/L/T/V/W/X/Y (2WD)	88-00	H345*		H345G*											
TRX 300 F/W/J/K/L/T/V/W/X/Y (4WD)	88-00	H347*		H347G*											
TRX 300 EX P/R/S/T/V/W/X/Y/1-8	93-08	FA084TT*		FA084R* ■	MD6006D			MD6006D							
TRX 300 X9	09	FA084TT*		FA084R* ■	MD6006D			MD6006D							
XR 300 R10	10	FA185TT		FA185R ■	MD6010D					MD6010CX	N/A	N/A	N/A	N/A	
CB 350 K4	74	H314													
CB 350 SG/SJ	86-90	FA121*		FA121HH*	MD1005LS			MD1005RS							
FL 350 R Odysey	85-87	H339*		H339G*											
TRX 350 G/H/J/K/L/M/N	86-93	H342*		H342G*											
TRX 350 Rancher ES 4x4/2x4 (FMV/1/2/3)															
/Rancher 4x4 & 2x4 (FEY/1/2/3)	00-03	H347S*		H347SG*											
XR 350 RD	83	H331		H331G											
XR 350 RE	84	FA092TT		FA092R	MD6087D										
CB 360 G5	75	FA013						N/A							
CJ 360 T	78	FA013					N/A								
CB-1 (CB 400 F)	89-90	FA142		FA142HH				MD1038RS							
CB 400 SF (F2N/F2R/F2S/F2T/F3S) Superfour (NC31)	92-95	FA142*		FA142HH*	MD1132			MD1132	MD1132C*						
CB 400 SF (F2V/F3T) Superfour (NC31)	96-97	FA187*		FA187HH*	MD1132			MD1132	MD1132C*						
CB 400 SF (F3V) Superfour (NC31)	97	FA244*		FA244HH*	MD1132			MD1132	MD1132C*						
CB 400 F/F1/F2	75-79	FA013					N/A								
CB 400 A Honda-Matic	79	FA045					N/A								
CB 400 T	78	FA045					N/A								
CB 400 N/NA/NB	78-81	FA030*					N/A	N/A							
CB 400 NC	82	FA069/2*					N/A	N/A							
CB 400 Four V/V1/W/W1/II (NC36)	97-98	FA142*		FA142HH*	TBA			TBA							
CB 400 SFX/SFY/SF1/SF2/SF3 Superfour (NC39 - Superfour/Superfour Bol Dor)	99-03			FA296HH*	TBA			TBA							
CB 400 SS (SS2/NC41)	01-05	FA196		FA196HH	TBA										
CB 400 SF4/5/SS (NC39 - Superfour/Superfour Bol Dor)	04-05			FA296HH*	TBA			TBA							
CBR 400 RG (NC23) 100	86	FA121*		FA121HH*	MD1001			MD1001							
CBR 400 RH-YA (NC23) 101	86	FA121*		FA121HH*	MD1001			MD1001							
CBR 400 RRJ/RRK (NC23) Tri-Arm (102/109)	87-89	FA142*		FA142HH*	MD1003X			MD1003X	MD1003XC*	VR1003BLK*					
CBR 400 RRL/RRV/RRR (NC29) Gull Arm	90-94	FA142*		FA142HH*	MD1003X			MD1003X	MD1003XC*	VR1003BLK*					
CL 400 (NC38)	98-03	FA196		FA196HH	TBA										
FJS 400 Silverwing D6/D7/D8 Non ABS 256mm front disc	06-08	SFA281		SFA281HH	MD1006				MD1006C						
FJS 400 Silverwing D6/D7/D8 Non ABS 256mm front disc Parking brake	06-08	SFA257/2													
FL 400 R RK/RL Pilot	89-93	H339*		H339G*											
NS 400 RF/RG	85-87	FA069*		FA069HH*	MD1006			MD1006	MD1006C*						
NT 400 Bros (NC25)		FA187		FA187HH	MD1124LS										
NV 400 CJ/CK Steed	92-93	FA124/2		FA124/2HH	TBA										
NV 400 CS/IV Steed	95-97	FA142		FA142HH	TBA										
NV 400 DCY/DC1/DC2 (NC40) Shadow Slasher	00-02	FA196		FA196HH	MD1159										
NX 4 Falcon	02-05	FA185TT			TBA										
RVF 400 RR/RR1/RR2/RT-II (NC35)	94-96	FA187*		FA187HH*	MD1003X			MD1003X	MD1003XC*	VR1003BLK*					
SW-T 400 (FJS400D9)	09	SFA388	SFAC388	SFA388HH	MD1172LS										
SW-T 400 (FJS400D9) Parking Brake	09	SFA257/2													
SW-T 400 (FJS400A9/AB) Parking Brake	09-13	SFA388	SFAC388	SFA388HH	MD1172LS										
TRX 400 FWS/T/V/W/X/Y	95-00	H347*		H347G*											
TRX 400 EXX/EXY/EX1-EX8	99-08	FA084TT*		FA084R* ■	MD6006D			MD6006D							

\*-2 Sets Required. ■ - Also available in MX-S race compound.

**SAFETY WARNING:** DO NOT USE HH PADS ON REAR UNLESS ALSO USED ON FRONT TO AVOID BRAKE IMBALANCE

APPLICATIONS  
BRAKE

R Suffix = High Durability Sintered Pad. HH Suffix = High Performance Sintered Pad. G Suffix = Grooved Shoe.  
D Suffix = Drilled Disc. C Suffix = Contoured Disc. LS Suffix = Left/Steel Disc. RS = Right/Steel Disc.

# JAPANESE Built Motorcycles



## HONDA Contd.



← REAR / ARRIÈRE / HINTEN POSTERIOR / POSTERIORE →

			DISC PAD CHOICES			BRAKE ROTOR CHOICES			
			NEW SFAC Scooter Carbon Pads	Semi-Sintered V-Pads™	Sintered/HH Pads/ Grooved shoes	Contour Rotor Rear Fitment	NEW Vee-Rotors™ CONTOUR	NEW CX Extreme® ROTOR	
VTR 250 WY1-7 (MC33)	98-07	FA140		FA140V	FA140HH	MD1004	MD1004C		
VTR 250 9	09-10	FA140		FA140V	FA140HH	TBA			
VTZ 250 H/J/K	86-88	H309							
TLM 260	89-93	FA153							
CB 300 R10	10	H352							
NSS 300 AD Forza	13	SFA415	SFAC415		SFA415HH	TBA			
SH 300i 7/8/9/A/B (Non ABS Model)	07-12	SFA415	SFAC415		SFA415HH	MD9119D		VR9119	
SH 300i A7/A8/A9/AA/AB/AC (ABS Model)	07-13	SFA415	SFAC415		SFA415HH	MD9119D		VR9119	
SH 300i R8/R9/RA (Non ABS Model)	08-10	SFA415	SFAC415		SFA415HH	MD9119D		VR9119	
SH 300i AR8/AR9/ARA (ABS Model)	08-10	SFA415	SFAC415		SFA415HH	MD9119D		VR9119	
TRX 300 J/K/L/T/V/W/X/Y (2WD)	88-00	H315			H315G				
TRX 300 FW/J/K/L/T/V/W/X/Y (4WD)	88-00	H315			H315G				
TRX 300 EX P/R/S/T/V/W/X/Y1-8	93-08	FA084TT			FA084R ■	MD6064D			
TRX 300 X9	09	FA084TT			FA084R ■	MD6064D			
XR 300 R10	10	FA131TT			FA131R ■	MD6013D			MD6013C
CB 350 K4	74	H315							
CB 350 SG/SJ	86-90	H313							
FL 350 R Odyssey	85-87	FA111			FA111R	N/A			
TRX 350 G/H/J/K/L/M/N	86-93	H343			H343G				
TRX 350 Rancher ES 4x4/2x4 (FMY1/2/3)									
/Rancher 4x4 & 2x4 (FEY1/2/3)	00-03	H351			H351G				
XR 350 RD	83	H304			H304G				
XR 350 RE	84	H304			H304G				
CB 360 G5	75	H315							
CJ 360 T	78	H315							
CB-1 (CB 400 F)	89-90	FA140		FA140V	FA140HH	MD1020			
CB 400 SF (F2N/F2R/F2S/F2T/F3S) Superfour (NC31)	92-95	FA140		FA140V	FA140HH	MD1020	MD1020C	VR1020	
CB 400 SF (F2V/F3T) Superfour (NC31)	96-97	FA140		FA140V	FA140HH	MD1020	MD1020C	VR1020	
CB 400 SF (F3V) Superfour (NC31)	97	FA140		FA140V	FA140HH	MD1020	MD1020C	VR1020	
CB 400 F1/F1/F2	75-79	H315							
CB 400 A Honda-Matic	79	H313							
CB 400 T	78	H313							
CB 400 NNANB	78-81	H313							
CB 400 NC	82	H313							
CB 400 Four V/V-II/III/IV (NC36)	97-98	FA140		FA140V	FA140HH	MD1020			
CB 400 SFX/SFY/SF1/SF2/SF3 Superfour (NC39 - Superfour/Superfour Bol Dor)	99-03	FA254			FA254HH	TBA			
CB 400 SS (SS2-NC41)	01-05	H351							
CB 400 SF4/5/S5 (NC39 - Superfour/Superfour Bol Dor)	04-05	FA174		FA174V	FA174HH	TBA			
CBR 400 RG (NC23) 100	86	FA069/3		FA069/3V	FA069/3HH	MD1002			
CBR 400 RH-YA (NC23) 101	86	FA069/3		FA069/3V	FA069/3HH	MD1002			
CBR 400 RRJ/RRK (NC23) Tri-Arm (102/109)	87-89	FA140		FA140V	FA140HH	MD1002			
CBR 400 RRL/RRN/RRR (NC29) Gull Arm	90-94	FA140		FA140V	FA140HH	MD1004	MD1004C	VR1004	
CL 400 (NC38)	98-03	H351							
FJS 400 Silverwing D6/D7/D8 Non ABS 256mm front disc	06-08	SFA196			FA196HH	MD1149	MD1149C		
FL 400 R/RK/RL Pilot	89-93	FA111			FA111R	MD6144D			
NS 400 RF/RG	85-87	FA069		FA069V	FA069HH	MD1002			
NT 400 Bros (NC25)		FA140		FA140V	FA140HH	MD1022			
NV 400 CJ/CK Steed	92-93	H321							
NV 400 CS/CV Steed	95-97	H321							
NV 400 DCY/DC1/DC2 (NC40) Shadow Slasher	00-02	H343							
NX 4 Falcon	02-05	FA131TT			FA131R ■	MD1004			
RVF 400 RR/RR-II/RT/RT-II (NC35)	94-96	FA143				MD1111			
SW-T 400 (FJS400D9)	09	SFA196	SFAC196		SFA196HH	MD1149			
SW-T 400 (FJS400A9/AB)	09-13	SFA196	SFAC196		SFA196HH	MD1149			
TRX 400 FWS/T/V/W/X/Y	95-00	H351			H351G				
TRX 400 EXX/EXY/EX1-EX8	99-08	FA084TT			FA084R	MD6164D			

\*-2 Sets Required. ■ - Also available in MX-S race compound.

**SAFETY WARNING:** DO NOT USE HH PADS ON REAR UNLESS ALSO USED ON FRONT TO AVOID BRAKE IMBALANCE

**R** Suffix = High Durability Sintered Pad. **HH** Suffix = High Performance Sintered Pad. **G** Suffix = Grooved Shoe.  
**D** Suffix = Drilled Disc. **C** Suffix = Contoured Disc. **LS** Suffix = Left/Steel Disc. **RS** = Right/Steel Disc.

**BRAKE APPLICATIONS**



# JAPANESE Built Motorcycles



← FRONT / AVANT / VORN FRENTE / ANTERIORE →

## HONDA Contd.

Model	Year	Disc Pad	DISC PAD CHOICES				BRAKE ROTOR CHOICES									
			NEW SFAC Scooter Carbon Pads	Semi-Sintered V-Pads™	Sintered/HH Pads/ Grooved shoes	Left/Gauche/Links	Right/Droite/Rechts	Contour Rotor Universal left and right fitment	NEW Vee-Rotors™ CONTOUR	NEW CX Extreme® ROTOR	Oversize 250/280mm Rotor Kit	Relocating Bracket for 250/280mm Rotor	Oversize 320mm Rotor Kit	Relocating Bracket for 320mm Rotor		
TRX 400 FA4/5/6/7 Fourtrax AT	04-07	H347*			H347G*											
TRX 400 FGA4/5/6/7 Fourtrax Rancher at Gscape	04-07	H347*			H347G*											
TRX 400 X9	09	FA084TT*			FA084R* ■	MD6006D	MD6006D									
VF 400 FD	83-85	FA0802			N/A											
VFR 400 ZG/ZH/RG/RG-YA (NC21)	85-87	FA121*			FA121HH*	MD1006	MD1006	MD1006C*								
VFR 400 RH2/RJ (NC24)	87-88	FA121*			FA121HH*	MD1001	MD1001									
VFR 400 R3K/R3N (NC30)	89-92	FA187*			FA187HH*	MD1003X	MD1003X	MD1003XC*	VR1003BLK*							
VFR 400 R3L/R3M (NC30)	90-91	FA187*			FA187HH*	MD1003X	MD1003X	MD1003XC*	VR1003BLK*							
VRX 400 T (NC33)	96	FA196			FA196HH		TBA									
XL 400 R	82	H332			H332G											
XR 400 RT/RV/RW/RX/RV/R1/R2/R3/R4	96-04	FA185TT			FA185R ■	MD6001D		MD6001C		MD6001CX	OS6001C	BRK008	SM6001C	BRK009		
XR 400 M Supermotard (ND08/NC38E)	06-08	FA142			FA142HH	TBA										
TRX 420 FE7/FE8/FE9/FEA/FEB 4WD - Fourtrax ES	07-11	FA084TT*			FA084R* ■	MD6302D	MD6302D									
TRX 420 FM7/FM8/FM9/FMA/FMB 4WD Fourtrax Auto	07-11	FA084TT*			FA084R* ■	MD6302D	MD6302D									
TRX 420 FPA9/FPAA/FPAB Fourtrax - Auto - Power Steering	09-11	FA084TT*			FA084R* ■	MD6302D	MD6302D									
TRX 420 FA9/FAA/FAB Fourtrax Auto 4WD	09-11	FA084TT*			FA084R* ■	MD6302D	MD6302D									
TRX 420 FPM9/FPMA/FPMB Fourtrax - 4WD - Power Steering	09-11	FA084TT*			FA084R* ■	MD6302D	MD6302D									
TRX 420 TE7/TE8/TE9 Fourtrax ES - 2WD	07-09	FA084TT*			FA084R* ■	MD6302D	MD6302D									
TRX 420 TM7/TM8/TM9/TMA/TMB	07-11	FA084TT*			FA084R* ■	MD6302D	MD6302D									
CB 450 SG/SJ	86-88	FA121*			FA121HH*	MD1005LS	MD1005RS									
CB 450 DX-K	89-92	FA122*			N/A	N/A										
CMX 450 CH/CJ Rebel	87-88	FA069			FA069HH	MD1041LS										
CR 450 RB	81	H327			H327G											
CRF 450 R2/R3	02-03	FA185TT			FA185R ■	MD6037D		MD6037C		MD6037CX	OS6037C	BRK008	SM6037C	BRK009		
CRF 450 R4/R5/R6/R7	04-07	FA185TT			FA185R ■	MD6037D		MD6037C		MD6037CX	OS6437C	BRK005	SM6437C	BRK006		
CRF 450 R8/R9/RB/RB/RC/RD	08-13	FA185TT			FA185R ■			MD6037C		MD6037CX	OS6437C	BRK005	SM6437C	BRK006		
CRF 450 X5/X6/X7	05-07	FA185TT			FA185R ■	MD6037D		MD6037C		MD6037CX	OS6437C	BRK005	SM6437C	BRK006		
CRF 450 X8/X9/XB/XC/XD	08-13	FA185TT			FA185R ■			MD6037C		MD6037CX	OS6437C	BRK005	SM6437C	BRK006		
CRF 450 XRLD	13	FA185TT			FA185R ■			MD6037C		MD6037CX	OS6437C	BRK005	SM6437C	BRK006		
TRX 450 ES/WS/ES/YS/ES1	98-01	H347S*			H347SG*											
TRX 450 R4/R5/R6/ER6/R7/ER7/R8/ER8/R9/ER9	04-09	FA185TT*			FA185R* ■	MD6006D	MD6006D									
CR 480 RC	82	H327			H327G											
CR 480 RD	83	H328			H328G											
CB 500 FAD (Twin)	13	FA196		FA196V	FA196HH			TBA								
CB 500 T (Twin)	75-77	FA013					N/A									
CB 500 K1/K2/F (Four)	75-77	FA013					N/A									
CB 500 R/T (Twin)	94-96	FA196			FA196HH			MD1008								
CB 500 V/W/S/WX/SX/Y/SY/2/S2 (Twin)	97-03	FA209/2			FA209/2HH			MD1008								
CB 500 XD (Twin)	13	FA196		FA196V	FA196HH			TBA								
CBF 500 A4/A5/A6/A7 (ABS Model)	04-07	FA388			FA388HH			MD1155RS								
CBF 500 4 (Non ABS Model)	04	FA196			FA196HH			MD1155RS								
CBR 500 FH/FJ/FK/FL (Four)	87-90	FA121*			FA121HH*	MD1001	MD1001									
CBR 500 RD (Twin)	13	FA196		FA196V	FA196HH			TBA								
CR 500 RE/RF	84-85	FA092TT			FA092R	MD6087D										
CR 500 RG	86	FA092TT			FA092R	MD6087D										
CR 500 RH/RJ	87-88	FA125TT			FA125R ■	MD6087D										
CR 500 RK	89	FA125TT			FA125R ■	MD6008D										
CR 500 RL/RM	90-91	FA125TT			FA125R ■	MD6003D										
CR 500 RNR/RR	92-94	FA125TT			FA125R ■	MD6001D		MD6001C		MD6001CX	OS6001EC	BRK004	N/A	N/A		
CR 500 RS/RT/RV/RW/RX/RV/R1	95-01	FA185TT			FA185R ■	MD6037D		MD6037C		MD6037CX	OS6037C	BRK008	SM6037C	BRK009		
CX 500 CA/CB/ZI/AB	79-81	FA029*				N/A	N/A									
CX 500 CC	82	FA069*			FA069HH*	N/A	N/A									
CX 500 EC	82	FA069*			FA069HH*	MD1036LS	MD1036RS									
FT 500 C	82	FA069			FA069HH	MD1131LS										
GL 500 DC	82	FA069			FA069HH	N/A	N/A									
CX 500 TCC Turbo	83	FA069*			FA069HH*	N/A	N/A									
NX 500 JK/L/M Dominator	88-91	FA124/2			FA124/2HH	MD6010D				MD6010CX	N/A	N/A	N/A	N/A		
NX 500 N/P/R/S/T	92-96	FA124/2			FA124/2HH	MD6010D				MD6010CX	N/A	N/A	N/A	N/A		
NX 500 V/W/X Dominator	97-99	FA209/2			FA209/2HH	MD6010D				MD6010CX	N/A	N/A	N/A	N/A		

\*-2 Sets Required. ■ - Also available in MX-S race compound.

**SAFETY WARNING:** DO NOT USE HH PADS ON REAR UNLESS ALSO USED ON FRONT TO AVOID BRAKE IMBALANCE

**R** Suffix = High Durability Sintered Pad. **HH** Suffix = High Performance Sintered Pad. **G** Suffix = Grooved Shoe.  
**D** Suffix = Drilled Disc. **C** Suffix = Contoured Disc. **LS** Suffix = Left/Steel Disc. **RS** = Right/Steel Disc.

# JAPANESE Built Motorcycles



## HONDA Contd.



← REAR / ARRIÈRE / HINTEN POSTERIOR / POSTERIORE →

			DISC PAD CHOICES			BRAKE ROTOR CHOICES			
			NEW SFAC Scooter Carbon Pads	Semi-Sintered V-Pads™	Sintered/HH Pads/ Grooved shoes	Contour Rotor Rear Fitment	NEW Vee-Rotors™ CONTOUR	NEW CX Extreme® ROTOR	
TRX 400 FA4/5/6/7 Fourtrax AT	04-07	H351			H351G				
TRX 400 FGA4/5/6/7 Fourtrax Rancher at Gscape	04-07	H351			H351G				
TRX 400 X9	09	FA084TT			FA084R	MD6164D			
VF 400 FD	83-85	FA0802				N/A			
VFR 400 ZG/ZH/RG/RG-YA (NC21)	85-87	FA069/3		FA069/3V	FA069/3HH	MD1002			
VFR 400 RH2/RJ (NC24)	87-88	FA140		FA140V	FA140HH	MD1022			
VFR 400 R3K/R3N (NC30)	89-92	FA143				MD1111			
VFR 400 R3L/R3M (NC30)	90-91	FA143				MD1111			
VRX 400 T (NC33)	96	FA174		FA174V	FA174HH	TBA			
XL 400 R	82	H318			H318G				
XR 400 RT/RV/RW/RX/R1/R2/R3/R4	96-04	FA131TT			FA131R ■	MD6013D	MD6013C		MD6013CX
XR 400 M Supermotard (ND08/NC38E)	06-08	FA131TT			FA131R ■	TBA			
TRX 420 FE7/FE8/FE9/FEA/FEB 4WD - Fourtrax ES	07-11	H351			H351G				
TRX 420 FM7/FM8/FM9/FMA/FMB 4WD Fourtrax Auto	07-11	H351			H351G				
TRX 420 FPA9/FPA/FPAB Fourtrax - Auto - Power Steering	09-11	FA373TT			FA373R	MD6217D			
TRX 420 FA9/FAA/FAB Fourtrax Auto 4WD	09-11	FA373TT			FA373R	MD6217D			
TRX 420 FPM9/FPMA/FPMB Fourtrax - 4WD - Power Steering	09-11	H351			H351G				
TRX 420 TE7/TE8/TE9 Fourtrax ES - 2WD	07-09	H351			H351G				
TRX 420 TM7/TM8/TM9/TMA/TMB	07-11	H351			H351G				
CB 450 SG/SJ	86-88	H313							
CB 450 DX-K	89-92	FA122				N/A			
CMX 450 CH/CJ Rebel	87-88	H313							
CR 450 RB	81	H319			H319G				
CRF 450 R2/R3	02-03	FA346TT			FA346R ■	MD6191D	MD6191C◆		MD6191CX◆
CRF 450 R4/R5/R6/R7	04-07	FA346TT			FA346R ■	MD6191D	MD6191C◆		MD6191CX◆
CRF 450 R8/R9/RA/RB/RC/RD	08-13	FA346TT			FA346R ■		MD6191C◆		MD6191CX◆
CRF 450 X5/X6/X7	05-07	FA346TT			FA346R ■	MD6191D	MD6191C◆		MD6191CX◆
CRF 450 X8/X9/XB/XC/XD	08-13	FA346TT			FA346R ■		MD6191C◆		MD6191CX◆
CRF 450 XRLD	13	FA346TT			FA346R ■		MD6191C◆		MD6191CX◆
TRX 450 ESW/ESX/ESY/ES1	98-01	H351			H351G				
TRX 450 R4/R5/R6/ER6/R7/ER7/R8/ER8/R9/ER9	04-09	FA373TT			FA373R	MD6233D			
CR 480 RC	82	H330			H330G				
CR 480 RD	83	H331			H331G				
CB 500 FAD (Twin)	13	FA140		FA140V	FA140HH	TBA			
CB 500 T (Twin)	75-77	H316							
CB 500 K1/K2/F (Four)	75-77	H316							
CB 500 R/T (Twin)	94-96	H321							
CB 500 VM/SW/SX/SY/S2/S2 (Twin)	97-03	FA213			FA213HH	MD1020			
CB 500 XD (Twin)	13	FA140		FA140V	FA140HH	TBA			
CBF 500 A4/A5/A6/A7 (ABS Model)	04-07	FA174		FA174V	FA174HH	MD1156			
CBF 500 4 (Non ABS Model)	04	FA174		FA174V	FA174HH	MD1156			
CBR 500 FH/FJ/FK/FL (Four)	87-90	FA069/3		FA069/3V	FA069/3HH	MD1002			
CBR 500 RD (Twin)	13								
CR 500 RE/RF	84-85	H331			H331G				
CR 500 RG	86	H344			H344G				
CR 500 RH/RJ	87-88	FA131TT			FA131R ■	MD6009D			
CR 500 RK	89	FA131TT			FA131R ■	MD6002D			
CR 500 RL/RM	90-91	FA131TT			FA131R ■	MD6002D			
CR 500 RN/RP/RR	92-94	FA131TT			FA131R ■	MD6002D			
CR 500 RS/RT/RV/RW/RX/R1/R2	95-01	FA131TT			FA131R ■	MD6002D			
CX 500 CA/CB/Z/A/B	79-81	H321							
CX 500 CC	82	H321							
CX 500 EC	82	FA069		FA069V	FA069HH	N/A			
FT 500 C	82	FA069		FA069V	FA069HH	MD1048			
GL 500 DC	82	H321							
CX 500 TCC Turbo	83	FA069		FA069V	FA069HH	N/A			
NX 500 JK/L/M Dominator	88-91	FA140			FA140HH	MD6013D			MD6013C
NX 500 NP/R/S/T	92-96	FA140			FA140HH	MD6099D			
NX 500 VM/X Dominator	97-99	FA213			FA213HH	MD6099D			

\*-2 Sets Required. ■ - Also available in MX-S race compound.

**SAFETY WARNING:** DO NOT USE HH PADS ON REAR UNLESS ALSO USED ON FRONT TO AVOID BRAKE IMBALANCE

**R** Suffix = High Durability Sintered Pad. **HH** Suffix = High Performance Sintered Pad. **G** Suffix = Grooved Shoe.  
**D** Suffix = Drilled Disc. **C** Suffix = Contoured Disc. **LS** Suffix = Left/Steel Disc. **RS** = Right/Steel Disc.

**BRAKE APPLICATIONS**

# JAPANESE Built Motorcycles



FRONT / AVANT / VORN FRENTE / ANTERIORE

## HONDA Contd.

Model	Year	DISC PAD CHOICES				BRAKE ROTOR CHOICES							
		NEW SFAC Scooter Carbon Pads	Semi-Sintered V-Pads™	Sintered/HH Pads/ Grooved shoes	Left/Gauche/Links	Right/Droite/Rechts	Contour Rotor Universal left and right fitment	NEW Vee-Rotors™ CONTOUR	NEW CX Extreme® ROTOR	Oversize 250/280mm Rotor Kit	Relocating Bracket for 250/280mm Rotor	Oversize 320mm Rotor Kit	Relocating Bracket for 320mm Rotor
TRX 500 FA1/FA2/FA3/FA4/FA5/FA6/FA7/FA8/FA9/FAA/FAB													
Fourtrax Foreman - Auto	01-04	H347*		H347G*									
TRX 500 FA5/FA6/FA7/FA8/FA9/FAA/FAB Fourtrax Foreman - Auto	05-11	FA410TT*		FA410R*	MD6251D	MD6251D							
TRX 500 FAC Fourtrax Foreman AT 2/4 WD	12	FA084TT*		FA084R*	MD6365D	MD6365D							
TRX 500 FE5/FE6/FE7/FE8/FE9/FAA/FAB Fourtrax Foreman 4WD/ES	05-11	FA410TT*		FA410R*	MD6251D	MD6251D							
TRX 500 FEC Fourtrax Foreman ES 2/4 WD	12	FA084TT*		FA084R*	MD6365D	MD6365D							
TRX 500 FM5/FM6/FM7/FM8/FM9/FMA/FMB Fourtrax Foreman 4x4	05-11	FA410TT*		FA410R*	MD6251D	MD6251D							
TRX 500 FMC Fourtrax Foreman S 2/4 WD	12	FA084TT*		FA084R*	MD6365D	MD6365D							
TRX 500 FPE6/FPE9/FPEA/FPEB Fourtrax Foreman - Power Steering	05-11	FA410TT*		FA410R*	MD6251D	MD6251D							
TRX 500 FPAC Fourtrax Foreman 2/4 WD	12	FA084TT*		FA084R*	MD6365D	MD6365D							
TRX 500 TM5/TM6 Fourtrax Foreman	05-06	FA410TT*		FA410R*	MD6251D	MD6251D							
VF 500 FE/F2E/FF/F2F	84-85	FA069*		FA069HH*	MD1006	MD1006	MD1006C*						
VT 500 ED/EF	83-85	FA080J2			N/A								
XL 500 SZ	80	H312		H312G									
XL 500 SB	81	H325		H325G									
XL 500 RC	82	H332		H332G									
XR 500 SZ/SA	79-80	H324		H324G									
XR 500 RB	81	H327		H327G									
XR 500 RD/RE	84-85	FA092TT		FA092R	MD6001D								
XBR 500 F/G/H/S/J	85-89	FA069		FA069HH	MD1001								
CB 550 F1/F1/F2/K3	78-80	FA013			N/A								
CBX 550 FC/F2C/FD/F2D	82-84	FA080*			N/A	N/A							
CB 600 FW/FX Hornet (16" wheel)	98-99	FA226*		FA226HH*	MD1132	MD1132	MD1132C*						
CB 600 FY/F1/F2/F3/F4/F5/F6 Hornet (17" wheel)	00-06	FA226*		FA226HH*	MD1139	MD1139	MD1139C*						
CB 600 F7/F8/F9/FA/FB/FC Hornet	07-13	FA226*		FA226HH*	MD1168X	MD1168X	MD1168XC*						
CB 600 FA7/FA7/FA8/FA9/FAA/FAB/FAC Hornet (ABS)	07-13	FA388*		FA388HH*	MD1168X	MD1168X	MD1168XC*						
CB 600 F2Y/F21/F22 Hornet S (17" wheel)	00-04	FA226*		FA226HH*	MD1139	MD1139	MD1139C*						
CBF 600 N4/S4/N5/N6	04-06	FA226*		FA226HH*	MD1008	MD1008							
CBF 600 N8/N9/NA (Non ABS)	08-11	FA226*		FA226HH*	MD1160	MD1160							
CBF 600 NA4/NA5/NA6 (ABS Model)	04-06	FA226*		FA226HH*	MD1008	MD1008							
CBF 600 NA8/NA9/NAA (ABS)	08-11	FA388*		FA388HH*	MD1160	MD1160							
CBF 600 S4/S5 (Non ABS)	04-05	FA226*		FA226HH*	MD1008	MD1008							
CBF 600 S8/S9 (Non ABS)	08-09	FA226*		FA226HH*	MD1160	MD1160							
CBF 600 SA4/SA5/SA6/SA7 (ABS Model)	04-08	FA226*		FA226HH*	MD1008	MD1008							
CBF 600 SA8/SA9/SAA (ABS)	08-12	FA388*		FA388HH*	MD1160	MD1160							
CBR 600 FH/FJ/FK/FL	87-90	FA121*		FA121HH*	MD1001	MD1001							
CBR 600 FM/FN/FP/FR	91-94	FA203*		FA203HH*	MD1001	MD1001							
Oversize disc conversion for above models		FA203*		FA203HH*	MD601LS	MD601RS							
CBR 600 FS/FT/FV/FW	95-98	FA226*		FA226HH*	MD1003X	MD1003X	MD1003XC*	VR1003BLK*					
CBR 600 FX/FY	99-00			FA296HH*	MD1014X	MD1014X	MD1014XC*	VR1014BLK*					
CBR 600 F1/F2/FS1/FS2 Sport	01-02			FA296HH*	MD1141X	MD1141X	MD1141XC*	VR1141BLK*					
CBR 600 F3/F4/F5/F6	03-06			FA296HH*	MD1141X	MD1141X	MD1141XC*	VR1141BLK*					
CBR 600 FB/FC (Non ABS Model)	11-13	FA226*		FA226HH*	MD1168X	MD1168X	MD1168XC*						
CBR 600 FAB/FAC (ABS Model)	11-13	FA388*		FA388HH*	MD1168X	MD1168X	MD1168XC*						
CBR 600 RR3/RR4	03-04			FA296HH*	MD1152X	MD1152X	MD1152XC*	VR1152BLK*					
CBR 600 RR5/RR6 (Radial Caliper)	05-06			FA390HH*	MD1152X	MD1152X	MD1152XC*	VR1152BLK*					
CBR 600 RR7/RR8/RR9/RAA/RBB/RRC/RDD (Radial Caliper)	07-13			FA390HH*	MD1152X	MD1152X	MD1152XC*	VR1152BLK*					
CBR 600 RR Hannspree	08			FA390HH*	MD1152X	MD1152X	MD1152XC*	VR1152BLK*					
CBR 600 RA9/RAA/RAB/RAC/RAD (C-ABS)	09-13			FA390HH*	MD1152X	MD1152X	MD1152XC*	VR1152BLK*					
FJS 600 1/2/D3/D4/D5/D6 Silverwing (Non ABS 256mm front disc)	01-06	SFA281		SFA281HH	MD1006		MD1006C						
FJS 600 1/2/D3/D4/D5/D6 Silverwing (Non ABS 256mm front disc) Parking brake	01-06	SFA257/2											
FJS 600 A3-A7/D7 Silverwing (ABS Model 276mm front disc)	03-09	SFA281		SFA281HH	MD1172LS								
FJS 600 A3-A7/D7 Silverwing (ABS Model 276mm front disc) Parking brake	03-09	SFA257/2											
NTV 600 JKIM Reverse	88-92	FA142		FA142HH	MD1021LS								
SW-T 600 - Silverwing (FJS600AB)	11-13	SFA388	SFAC388	SFA388HH	MD1172LS								
SW-T 600 - Silverwing (FJS600AB) Parking Brake	11-13	SFA257/2											
VT 600 CN Shadow Custom	93	FA124/2		FA124/2HH	MD1047LS								
VT 600 CR/CS/CT/CV/CW/CX Shadow Custom	94-00	FA142		FA142V	FA142HH	MD1047LS							
XL 600 RD/LD/RE/LE/RF/RG/RH	83-87	FA092TT		FA092R	MD6087D								
XL 600 LMF/RM/LMH	85-87	FA069		FA069HH	MD6096D								

\*-2 Sets Required. ■ - Also available in MX-S race compound.

**SAFETY WARNING:** DO NOT USE HH PADS ON REAR UNLESS ALSO USED ON FRONT TO AVOID BRAKE IMBALANCE

APPLICATIONS  
BRAKE

R Suffix = High Durability Sintered Pad. HH Suffix = High Performance Sintered Pad. G Suffix = Grooved Shoe.  
D Suffix = Drilled Disc. C Suffix = Contoured Disc. LS Suffix = Left/Steel Disc. RS = Right/Steel Disc.

# JAPANESE Built Motorcycles



## HONDA Contd.



← REAR / ARRIÈRE / HINTEN POSTERIOR / POSTERIORE →

			DISC PAD CHOICES			BRAKE ROTOR CHOICES				
			NEW SFAC Scooter Carbon Pads	Semi-Sintered V-Pads™	Sintered/HH Pads/ Grooved shoes	Contour Rotor Rear Fitment	NEW Vee-Rotors™ CONTOUR	NEW CX Extreme® ROTOR		
TRX 500 FA1/FA2/FA3/FA4/FA5/FA6/FA7/FA8/FA9/FAA/FAB										
Fourtrax Foreman - Auto	01-04	H343			H343G					
TRX 500 FA5/FA6/FA7/FA8/FA9/FAA/FAB Fourtrax Foreman - Auto	05-11	H343			H343G					
TRX 500 FAC Fourtrax Foreman AT 2/4 WD	12	H343			H343G					
TRX 500 FE5/FE6/FE7/FE8/FE9/FAA/FAB Fourtrax Foreman 4WD/ES	05-11	H343			H343G					
TRX 500 FEC Fourtrax Foreman ES 2/4 WD	12	H343			H343G					
TRX 500 FM5/FM6/FM7/FM8/FM9/FMA/FMB Fourtrax Foreman 4x4	05-11	H343			H343G					
TRX 500 FMC Fourtrax Foreman S 2/4 WD	12	H343			H343G					
TRX 500 FPE8/FPE9/FPEA/FPEB Fourtrax Foreman - Power Steering	05-11	H343			H343G					
TRX 500 FPAC Fourtrax Foreman 2/4 WD	12	H343			H343G					
TRX 500 TMS/TM6 Fourtrax Foreman	05-06	H343			H343G					
VF 500 FE/F2E/FF/F2F	84-85	FA069		FA069V	FA069HH	MD1006	MD1006C			
VT 500 ED/EF	83-85	H313								
XL 500 SZ	80	H318			H318G					
XL 500 SB	81	H309								
XL 500 RC	82	H318			H318G					
XR 500 SZ/SA	79-80	H318			H318G					
XR 500 RB	81	H318			H318G					
XR 500 RD/RE	84-85	H304			H304G					
XBR 500 F/G/H/S/J	85-89	H340								
CB 550 F/F1/F2/K3	78-80	H316								
CBX 550 FC/F2C/FD/F2D	82-84	FA080/2				NA				
CB 600 FW/FX Hornet (16" wheel)	98-99	FA174		FA174V	FA174HH	MD1004	MD1004C			
CB 600 FY/F1/F2/F3/F4/F5/F6 Hornet (17" wheel)	00-06	FA174		FA174V	FA174HH	MD1004	MD1004C			
CB 600 F7/F8/F9/FA/FB/FC Hornet	07-13	FA436		FA436V	FA436HH	MD1156				
CB 600 FA7/FA7/FA8/FA9/FAA/FAB/FAC Hornet (ABS)	07-13	FA174		FA174V	FA174HH	MD1156				
CB 600 F2Y/F21/F22 Hornet S (17" wheel)	00-04	FA174		FA174V	FA174HH	MD1004	MD1004C			
CBF 600 N4/S4/N5/N6	04-06	FA174		FA174V	FA174HH	MD1156				
CBF 600 N8/N9/NA (Non ABS)	08-11	FA174		FA174V	FA174HH	MD1156				
CBF 600 NA4/NA5/NA6 (ABS Model)	04-06	FA174		FA174V	FA174HH	MD1156				
CBF 600 NA8/NA9/NAA (ABS)	08-11	FA174		FA174V	FA174HH	MD1156				
CBF 600 S4/S5 (Non ABS)	04-05	FA174		FA174V	FA174HH	MD1156				
CBF 600 S8/S9 (Non ABS)	08-09	FA174		FA174V	FA174HH	MD1156				
CBF 600 SA4/SA5/SA6/SA7 (ABS Model)	04-08	FA174		FA174V	FA174HH	MD1156				
CBF 600 SA8/SA9/SAA (ABS)	08-12	FA174		FA174V	FA174HH	MD1156				
CBR 600 FH/FJ/FK/FL	87-90	FA069/3		FA069/3V	FA069/3HH	MD1002				
CBR 600 FM/FN/FP/FR	91-94	FA174		FA174V	FA174HH	MD1004	MD1004C			
CBR 600 FS/FT/FV/FW	95-98	FA174		FA174V	FA174HH	MD1004	MD1004C	VR1004		
CBR 600 FX/FY	99-00	FA174		FA174V	FA174HH	MD1004	MD1004C	VR1004		
CBR 600 F1/F2/CRB 600 FS1/FS2 Sport	01-02	FA174		FA174V	FA174HH	MD1004	MD1004C	VR1004		
CBR 600 F3/F4/F5/F6	03-06	FA174		FA174V	FA174HH	MD1004	MD1004C	VR1004		
CBR 600 FB/FC (Non ABS Model)	11-13	FA436		FA436V	FA436HH	MD1156				
CBR 600 FAB/FAC (ABS Model)	11-13	FA174		FA174V	FA174HH	MD1156				
CBR 600 RR3/RR4	03-04	FA174		FA174V	FA174HH	MD1004	MD1004C	VR1004		
CBR 600 RR5/RR6 (Radial Caliper)	05-06	FA174		FA174V	FA174HH	MD1004	MD1004C	VR1004		
CBR 600 RR7/RR8/RR9/RAA/RRB/RRC/RRD (Radial Caliper)	07-13	FA436		FA436V	FA436HH	MD1004	MD1004C	VR1004		
CBR 600 RR Hannspree	08	FA436		FA436V	FA436HH	MD1004	MD1004C	VR1004		
CBR 600 RA9/RAA/RAB/RAC/RAD (C-ABS)	09-13	FA436		FA436V	FA436HH	MD1173	MD1173C	VR1173		
FJS 600 1/2/D3/D4/D5/D6 Silverwing (Non ABS 256mm front disc)	01-06	SFA196			FA196HH	MD1149	MD1149C			
FJS 600 A3-A7/D7 Silverwing (ABS Model 276mm front disc)	03-09	SFA196			FA196HH	MD1149				
NTV 600 J/K/M Revere	88-92	FA140		FA140V	FA140HH	MD1025				
SW-T 600 - Silverwing (FJS600AB)	11-13	SFA196	SFAC196		SFA196HH	MD1149				
VT 600 CN Shadow Custom	93	H321								
VT 600 CR/CS/CT/CV/CW/CX Shadow Custom	94-00	H321								
XL 600 RD/LD/RE/LE/RF/RG/RH	83-87	H318			H318G					
XL 600 LMF/RMG/LMH	85-87	H318			H318G					

\*-2 Sets Required. ■ - Also available in MX-S race compound.

**SAFETY WARNING:** DO NOT USE HH PADS ON REAR UNLESS ALSO USED ON FRONT TO AVOID BRAKE IMBALANCE

**R** Suffix = High Durability Sintered Pad. **HH** Suffix = High Performance Sintered Pad. **G** Suffix = Grooved Shoe.  
**D** Suffix = Drilled Disc. **C** Suffix = Contoured Disc. **LS** Suffix = Left/Steel Disc. **RS** = Right/Steel Disc.

**BRAKE APPLICATIONS**



# JAPANESE Built Motorcycles



← FRONT / AVANT / VORN FRENTE / ANTERIORE →

## HONDA Contd.

Model	Year	Part No.	DISC PAD CHOICES				BRAKE ROTOR CHOICES								
			NEW SFAC Scooter Carbon Pads	Semi-Sintered V-Pads™	Sintered/HH Pads/ Grooved shoes	Left/Gauche/Links	Right/Droite/Rechts	Contour Rotor Universal left and right fitment	NEW Vee-Rotors™ CONTOUR	NEW CX Extreme® ROTOR	Oversize 250/280mm Rotor Kit	Relocating Bracket for 250/280mm Rotor	Oversize 320mm Rotor Kit	Relocating Bracket for 320mm Rotor	
XL 600 VHM/JNK Trans Alp	87-90	FA069			FA069HH	MD6044D									
XL 600 VM/VNVP Trans Alp	91-93	FA124/2			FA1242HH	MD6044D									
XL 600 VR/VT Transalp	94-96	FA196			FA196HH	MD6044D									
XL 600 VVV/VVX Transalp	97-99	FA185TT*			FA185R* ■	MD6010D	MD6010D			MD6010CX	NA	NA	NA	NA	NA
XR 600 RF/RG/RH	85-87	FA092TT			FA092R	MD6087D									
XR 600 RJ/RK/RL	88-90	FA125TT			FA125R ■	MD6087D									
XR 600 RM/RN	91-92	FA125TT			FA125R ■	MD6001D		MD6001C		MD6001CX	OS6001EC	BRK004	NA	NA	NA
XR 600 RP/RR/RS/RT/RV/RW/RX/RY	93-00	FA185TT			FA185R ■	MD6001D		MD6001C		MD6001CX	OS6001C	BRK008	SM6001C	BRK009	
CB 650 ZB	79-81	FA045*		FA045V*		N/A	N/A								
CB 650 SCC Nighthawk	82	FA090*		FA090V*		MD1036LS	MD1036RS								
CX 650 ED	83	FA069/2*				MD1036LS	MD1036RS								
CX 650 TD Turbo	83	FA069/2*				N/A	N/A								
FMX 650 5/6	05-08	FA196			FA196HH	MD6300D									
FX 650 XY Vigor	99-03	FA209/2			FA2092HH	MD6044D									
GL 650 D2-E	84	FA069/2*				MD1040LS	MD1040RS								
NT 650 JKL (Bros)	88-92	FA187			FA187HH	MD1124LS									
NT 650 VVV/VVY/V1/1 Deauville	98-01	FA209/2*			FA2092HH*	MD1008	MD1008								
NT 650 V2/V3/V4/V5 Deauville	02-05				FA261HH*	MD1008	MD1008								
NTV 650 JKL/MP/PS/TV	88-97	FA142		FA142V	FA142HH	MD1021LS									
NX 650 JKL/LJ/M Dominator	88-91	FA124/2			FA1242HH	MD6010D				MD6010CX	NA	NA	NA	NA	NA
NX 650 NP/RS/T Dominator	92-96	FA124/2			FA1242HH	MD6010D				MD6010CX	NA	NA	NA	NA	NA
NX 650 VWX Dominator	97-02	FA209/2			FA2092HH	MD6010D				MD6010CX	NA	NA	NA	NA	NA
SLR 650 VW	97-98	FA209/2			FA2092HH	MD6044D									
TRX 650 FA3/FA4/FA5 Rincon	03-05	H347*			H347G*										
XL 650 VV/V1-V7 Transalp	00-07	FA185TT*			FA185R* ■	MD6346D	MD6346D								
XR 650 L	93-12	FA185TT			FA185R ■	MD6010D				MD6010CX	NA	NA	SM6010C	BRK009	
XR 650 RY/R1-R7	00-07	FA185TT			FA185R ■	MD6001D		MD6001C		MD6001CX	OS6001C	BRK008	SM6001C	BRK009	
XRV 650 JK Africa Twin	88-89	FA124/2			FA1242HH	MD6168D									
DN-01 (680cc) (NSA 700 AB/A9)	08-11	FA388*			FA388HH*	TBA	TBA								
DN-01 (680cc) (NSA 700 AB/A9) Parking brake	08-11	SFA257/2													
TRX 680 FA6/FA7/FA8/FA9/FAA/FAB Rubicon 4X4 Auto	06-10	FA410TT*			FA410R*	MD6251D	MD6251D								
NC 700 DC - 700 Integra Scooter	12-13	SFA388	SFAC388		SFA388HH			TBA							
NC 700 DC - 700 Integra Scooter (Parking brake)	12-13	SFA257/2													
NC 700 SAC/SAD - DCT (Auto Gearbox)	12-13	FA388			FA388HH			TBA							
NC 700 SAC/SAD - DCT (Parking brake)	12-13	SFA257/2													
NC 700 SC/SD (Manual G/Box)	12-13	FA388			FA388HH			TBA							
NC 700 XAC/XAD - DCT (Auto Gearbox)	12-13	FA388			FA388HH			TBA							
NC 700 XAC/XAD - DCT (Parking brake)	12-13	SFA257/2													
NC 700 XC/XD (Manual Gearbox)	12-13	FA388			FA388HH			TBA							
NT 700 V6/V7/V8/VA Deauville	06-13	FA388*			FA388HH*	MD1008	MD1008								
NT 700 VA6/VA7/VA8/VAA Deauville	07-13	FA388*			FA388HH*	MD1008	MD1008								
MUV 700-9 Big Red Side x Side	Left 09	FA476TT				MD6341D									
	Right	FA477TT				MD6341D									
TRX 700 XX8/XX9/XXB	08-12	FA185TT*			FA185R*	MD6006D	MD6006D								
XL 700 V8/V9/VA (Transalp/2 Piston Front Caliper/ ABS on Rear Disc)	08-11	FA185TT*			FA185R* ■	MD6346D	MD6346D								
XL 700 VA8/VA9/VAA (Transalp/3 Piston Front Caliper/ ABS Front & Rear wheels)	08-11	FA388*			FA388HH*	MD6346D	MD6346D								
CB 750 F/F1	76-77	FA013		FA013V		N/A									
CB 750 F2	78	FA031*		FA031V*		N/A	N/A								
CB 750 FZ/FA/FB	78-82	FA031*		FA031V*		MD1036LS	MD1036RS								
CB 750 FC/F2C/FD/F2D	83-84	FA069/2*		FA069/2V*		MD1036LS	MD1036RS								
CB 750 F2N/F2R/F2S/F2T/F2V/F2W/F2X/F2Y/F21 CB Seven Fifty	92-02	FA142*		FA142V*	FA142HH*	MD1008	MD1008								
CB 750 K0-K5	69-75	FA012		FA012V		N/A									
CB 750 K6	76	FA012		FA012V		MD1062LS									
CB 750 K7	78	FA013		FA013V		MD1062LS									
CB 750 KZ	80	FA045*		FA045V*		MD1036LS	MD1036RS								
CBR 750 FH Superaero (RC27)	87	FA124*			FA124HH*	MD1001	MD1001								
CBR 750 FJ Superaero (RC27)	88	FA142*			FA142HH*	MD1162LS	MD1162RS								
CBX 750 FE	84	FA069*			FA069HH*	MD1001	MD1001								
NR 750 N	92	FA187*			FA187HH*	N/A	N/A								

\*-2 Sets Required. ■ - Also available in MX-S race compound.

**SAFETY WARNING:** DO NOT USE HH PADS ON REAR UNLESS ALSO USED ON FRONT TO AVOID BRAKE IMBALANCE

APPLICATIONS  
BRAKE

R Suffix = High Durability Sintered Pad. HH Suffix = High Performance Sintered Pad. G Suffix = Grooved Shoe.  
D Suffix = Drilled Disc. C Suffix = Contoured Disc. LS Suffix = Left/Steel Disc. RS = Right/Steel Disc.

# JAPANESE Built Motorcycles



## HONDA Contd.



← REAR / ARRIÈRE / HINTEN POSTERIOR / POSTERIORE →

			DISC PAD CHOICES			BRAKE ROTOR CHOICES			
			NEW SFAC Scooter Carbon Pads	Semi-Sintered V-Pads™	Sintered/HH Pads/ Grooved shoes	Contour Rotor Rear Fitment	NEW Vee-Rotors™ CONTOUR	NEW CX Extreme® ROTOR	
XL 600 VH/VJ/VK Trans Alp	87-90	H318			H318G				
XL 600 VM/VNVP Trans Alp	91-93	FA140			FA140HH	MD6097D			
XL 600 VR/VT Transalp	94-96	FA140			FA140HH	MD6097D			
XL 600 VW/WNX Transalp	97-99	FA140			FA140HH	MD6097D			
XR 600 RF/RG/RH	85-87	H304			H304G				
XR 600 RJ/RK/RL	88-90	H304			H304G				
XR 600 RM/RN	91-92	FA131TT			FA131R ■	MD6013D	MD6013C		MD6013CX
XR 600 RP/RR/RS/RT/RV/RW/RX/RY	93-00	FA131TT			FA131R ■	MD6013D	MD6013C		MD6013CX
CB 650 Z/B	79-81	H320							
CB 650 SCC Nighthawk	82	H320							
CX 650 ED	83	FA069		FA069V		N/A			
CX 650 TD Turbo	83	FA069		FA069V		N/A			
FMX 650 S/B	05-08	FA140			FA140HH	MD6099D			
FX 650 XY Vigor	99-03	FA213			FA213HH	MD6099D			
GL 650 D2-E	84	H321							
NT 650 J/K/L (Bros)	88-92	FA140		FA140V	FA140HH	MD1022			
NT 650 VW/VX/VY/V1 Deauville	98-01	FA140			FA140HH	MD1016			
NT 650 V2/V3/V4/V5 Deauville Ⓟ	02-05				FA261HH	MD1016			
NTV 650 J/K/L/M/P/S/T/V	88-97	FA140			FA140HH	MD1025			
NX 650 J/K/L/M Dominator	88-91	FA140			FA140HH	MD6013D	MD6013C		MD6013CX
NX 650 N/P/R/S/T Dominator	92-96	FA140			FA140HH	MD6099D			
NX 650 VMX Dominator	97-02	FA213			FA213HH	MD6099D			
SLR 650 V/W	97-98	FA213			FA213HH	MD6099D			
TRX 650 FA3/FA4/FA5 Rincon	03-05	FA373TT			FA373R	MD6217D			
XL 650 VY/V1-V7 Transalp	00-07	FA140				MD6097D			
XR 650 L	93-12	FA131TT			FA131R ■	MD6045D			MD6045CX
XR 650 RY/R1-R7	00-07	FA131TT			FA131R ■	MD6181D	MD6181C		MD6181CX
XRV 650 J/K Africa Twin	88-89	FA140			FA140HH	MD6097D			
DN-01 (680cc) (NSA 700 A8/A9)	08-11	FA196		FA196V	FA196HH	TBA			
TRX 680 FA6/FA7/FA8/FA9/FAA/FAB Rubicon 4X4 Auto	06-10	FA373TT			FA373R	MD6217D			
NC 700 DC- 700 Integra Scooter	12-13	FA174		FA174V	FA174HH		TBA		
NC 700 SAC/SAD - DCT (Auto Gearbox)	12-13	FA174		FA174V	FA174HH		TBA		
NC 700 SC/SD (Manual G/Box)	12-13	FA140		FA140V	FA140HH		TBA		
NC 700 XAC/XAD - DCT (Auto Gearbox)	12-13	FA174		FA174V	FA174HH		TBA		
NC 700 XC/XD (Manual Gearbox)	12-13	FA140		FA140V	FA140HH		TBA		
NT 700 V6/V7/V8/VAA Deauville	06-13				FA261HH	MD1016			
NT 700 VA6/VA7/VA8/VAA Deauville	07-13				FA261HH	MD1016			
MUV 700-9 Big Red Side x Side	Left 09	FA478TT				MD6341D			
	Right 09	FA479TT				MD6341D			
TRX 700 XX8/XX9/XXB	08-12	FA410TT			FA410R	MD6331D			
XL 700 V8/V9/VA (Transalp/2 Piston Front Caliper/ ABS on Rear Disc)	08-11	FA140			FA140HH	MD6345D			
XL 700 VA8/VA9/VAA (Transalp/3 Piston Front Caliper/ ABS Front & Rear wheels)	08-11	FA174			FA174HH	MD6345D			
CB 750 F/F1	76-77	FA032		FA032V		MD1064			
CB 750 F2	78	FA030		FA030V		MD1064			
CB 750 FZ/FA/FB	78-82	FA031		FA031V		MD1071			
CB 750 FC/F2C/FD/F2D	83-84	FA069		FA069V		MD1082			
CB 750 F2N/F2R/F2S/F2T/F2W/F2X/F2Y/F21 CB Seven Fifty	92-02	FA174		FA174V	FA174HH	MD1020			
CB 750 K0-K5	69-75	H320							
CB 750 K6	76	H320							
CB 750 K7	78	H320							
CB 750 KZ	80	H320							
CBR 750 FH Superaero (RC27)	87	FA069/3		FA069/3V	FA69/3HH	MD1006			
CBR 750 FJ Superaero (RC27)	88	FA196		FA196V	FA196HH	MD1006			
CBX 750 FE	84	FA069/3		FA069/3V	FA069/3HH	MD1079			
NR 750 N	92	FA143				N/A			

\*-2 Sets Required. ■ - Also available in MX-S race compound.

**SAFETY WARNING:** DO NOT USE HH PADS ON REAR UNLESS ALSO USED ON FRONT TO AVOID BRAKE IMBALANCE

**R** Suffix = High Durability Sintered Pad. **HH** Suffix = High Performance Sintered Pad. **G** Suffix = Grooved Shoe.  
**D** Suffix = Drilled Disc. **C** Suffix = Contoured Disc. **LS** Suffix = Left/Steel Disc. **RS** = Right/Steel Disc.

**BRAKE APPLICATIONS**

# JAPANESE Built Motorcycles



← FRONT / AVANT / VORN FRENTE / ANTERIORE →

## HONDA Contd.

Model	Year	FA Part	DISC PAD CHOICES			BRAKE ROTOR CHOICES									
			NEW SFAC Scooter Carbon Pads	Semi-Sintered V-Pads™	Sintered/HH Pads/ Grooved shoes	Left/Gauche/Links	Right/Droite/Rechts	Contour Rotor Universal left and right fitment	NEW Vee-Rotors™ CONTOUR	NEW CX Extreme® ROTOR	Oversize 250/280mm Rotor Kit	Relocating Bracket for 250/280mm Rotor	Oversize 320mm Rotor Kit	Relocating Bracket for 320mm Rotor	
RVF 750 RR/RS RC45	94-98	FA187*			FA187HH*	MD1012LS	MD1012RS								
VF 750 C Shadow	83	FA069		FA069V	FA069HH	MD1047LS									
VF 750 CH	87	FA069/3		FA069/3V	FA069/3HH	MD1059LS									
VF 750 CP/CR/CS/CT/CV/CW/CX	93-99	FA196		FA196V	FA196HH	MD1021LS									
VF 750 FD/FE	83-84	FA069*			FA069HH*	MD1083LS	MD1083RS								
VF 750 SC (V45 Sabre)	82	FA069*		FA069V*	FA069HH*	MD1001	MD1001								
VFR 750 FG/FH	86-87	FA124*			FA124HH*	MD1001	MD1001								
VFR 750 FJ/FK	88-89	FA142*			FA142HH*	MD1008	MD1008								
VFR 750 FL/FM/FN/FP	90-93	FA142*			FA142HH*	MD1008	MD1008								
VFR 750 FR/FS/FT/FV	94-97	FA142*			FA142HH*	MD1003X	MD1003X	MD1003XC*	VR1003BLK*						
VFR 750 RJ/RK/RL RC30	88-90	FA187*			FA187HH*	MD1010LS	MD1010RS								
VT 750 CV/C2V/C3V/C2W/C3W/CX/C2Y/C3Y/C21/C1/C31/C4/C5															
VT 750 C6/C7/C8 Shadow	97-09	FA196		FA196V	FA196HH	MD1159									
VT 750 C2BA/C2BB/C2BC Shadow Black Spirit															
(21" Front Wheel/Rear Drum Model)	10-13	FA196		FA196V	FA196HH		MD1159								
VT 750 C2SA/C2SB Shadow (3 Piston Caliper/ 17" Front Wheel/ABS/Rear Disc)	10-12	FA388			FA388HH				TBA						
VT 750 DC1/DC2 Black Widow	01-04	FA196		FA196V	FA196HH	MD1159									
VT 750 DC7/DC8 Shadow Spirit	07-09	FA196		FA196V	FA196HH	MD1159									
VT 750 S (V7750SA/SB)	10-12	FA196		FA196V	FA196HH	MD1159									
XLV 750 R (RD/RF)	83-88	FA069			FA069HH	MD604D									
XRV 750 LMN Africa Twin	90-93	FA121*			FA121HH*	MD6102	MD6102								
XRV 750 P/R/S/T/W/V/X/Y Africa Twin	94-03	FA185TT*			FA185R* ■	MD6102	MD6102								
PC 800 Pacific Coast	89-97	FA142*		FA142V*	FA142HH*	MD1001	MD1001								
VFR 800 FW/FX	98-99				FA261HH*	MD1014X	MD1014X	MD1014XC*	VR1014BLK*						
VFR 800 FY/F11/2/3/4/5	00-05				FA261HH*	MD1014X	MD1014X	MD1014XC*	VR1014BLK*						
VFR 800 6/8/9	06-09				FA388HH*	MD1157X	MD1157X	MD1157XC*							
VFR 800 A2/A3/A4/A5 (ABS Model)	02-05				FA261HH*	MD1157X	MD1157X	MD1157XC*							
VFR 800 A6/A8/A9 (ABS Model)	06-13				FA388HH*	MD1157X	MD1157X	MD1157XC*							
VFR 800 XC (Crossrunner)	12-13				FA388HH*	MD1157X	MD1157X	MD1157XC*							
CB 900 FZ/FA	80-81	FA031*				MD1036LS	MD1036RS								
CB 900 FB/F2B	82-83	FA069/2*				MD1036LS	MD1036RS								
CB 900 FC/F2C/FD/F2D	84-85	FA069*			FA069HH*	MD1036LS	MD1036RS								
CB 900 F2/F3/F4/F5/F6/F7 Hornet	02-07	FA187*			FA187HH*	MD1141X	MD1141X	MD1141XC*	VR1141BLK*						
CBR 900 RR/RRP Fireblade (893cc)	92-93	FA187*			FA187HH*	MD1014X	MD1014X	MD1014XC*	VR1014BLK*						
CBR 900 RRR Fireblade (893cc)	94-97	FA187*			FA187HH*	MD1003X	MD1003X	MD1003XC*	VR1003BLK*						
CBR 900 RRS/RRT/RRV Fireblade (918cc)	94-97	FA187*			FA187HH*	MD1003X	MD1003X	MD1003XC*	VR1003BLK*						
CBR 900 RRW/RRX Fireblade (918cc)	98-99				FA265HH*	MD1134X	MD1134X	MD1134XC*	VR1134BLK*						
CBR 900 Evolution Blade	99	FA095*			FA095HH*	TBA	TBA								
CBR 900 RRY/RR1 (929cc) Fireblade	00-01				FA265HH*	MD1137X	MD1137X	MD1137XC*	VR1137BLK*						
CBR 900 RR2/RR3 (954cc) Fireblade	02-03				FA265HH*	MD1137X	MD1137X	MD1137XC*	VR1137BLK*						
CB 1000 FP/FR/FS/FT/FV	93-97	FA187*			FA187HH*	MD1056	MD1056								
CB 1000 R9/RA/RB/RC (Non ABS Model)	09-13				FA390HH*	MD1152X	MD1152X	MD1152XC*	VR1152BLK*						
CB 1000 RA9/RAA/RAB/RAC (ABS Model)	09-13				FA388HH*	MD1152X	MD1152X	MD1152XC*	VR1152BLK*						
CBF 1000 6/7/8/9/A (2 Piston Front Calipers/Non ABS Model)	06-11	FA226*			FA226HH*	MD1160	MD1160								
CBF 1000 A A6/A7/A8/A9/AA (3 Piston Front Caliper/ABS Model)	06-10				FA388HH*	MD1160	MD1160								
CBF 1000 S S7/S8/S9/SA (3 Piston Front Caliper/ABS Model)	07-11				FA388HH*	MD1160	MD1160								
CBF 1000 T T7/T8/T9/TA (3 Piston Front Caliper/ABS Model)	07-12				FA388HH*	MD1160	MD1160								
CBF 1000 F FA (2 Piston Front Caliper/Non ABS)	10-11	FA226*			FA226HH*	MD1160	MD1160								
CBF 1000 FA FAA (3 Piston Front Caliper/ABS Model)	10-13				FA388HH*	MD1160	MD1160								
CBF 1000 FS FSA (3 Piston Front Caliper/ABS Model)	10-11				FA388HH*	MD1160	MD1160								
CBF 1000 FT FTA (3 Piston Front Caliper/ABS Model)	10-11				FA388HH*	MD1160	MD1160								
CBR 1000 FH/FJ	87-88	FA124*			FA124HH*	MD1008	MD1008								
CBR 1000 FK/FL/FM/FN	89-92	FA142*			FA142HH*	MD1008	MD1008								
CBR 1000 FP/FR/FS/FT/FV/FW/FX ⊗	93-99	FA189*			FA189HH*	MD1008	MD1008								
CBR 1000 RR4/RR5 Fireblade	04-05				FA390HH*	MD1153X	MD1153X	MD1153XC*	VR1153BLK*						
CBR 1000 RR6/RR7	06-07				FA390HH*	MD1161X	MD1161X	MD1161XC*	VR1161BLK*						
CBR 1000 RR8/RR9/RRR/RRB/RRC/RRD Fireblade	08-13				FA390HH*	MD1171X	MD1171X	MD1171XC*	VR1171BLK*						
CBR 1000 RA9/RAA/RAB/RAC/RAD Fireblade (C-ABS)	09-13				FA390HH*	MD1171X	MD1171X	MD1171XC*	VR1171BLK*						
CBX 1000 Z	79-80	FA031*				MD1036LS	MD1036RS								

\*-2 Sets Required. ■ - Also available in MX-S race compound.

**SAFETY WARNING:** DO NOT USE HH PADS ON REAR UNLESS ALSO USED ON FRONT TO AVOID BRAKE IMBALANCE

APPLICTIONS  
BRAKE

R Suffix = High Durability Sintered Pad. HH Suffix = High Performance Sintered Pad. G Suffix = Grooved Shoe.

D Suffix = Drilled Disc. C Suffix = Contoured Disc. LS Suffix = Left/Steel Disc. RS = Right/Steel Disc.

# JAPANESE Built Motorcycles



## HONDA Contd.



← REAR / ARRIÈRE / HINTEN POSTERIOR / POSTERIORE →

			DISC PAD CHOICES			BRAKE ROTOR CHOICES		
			NEW SFAC Scooter Carbon Pads	Semi-Sintered V-Pads™	Sintered/HH Pads/ Grooved shoes	Contour Rotor Rear Fitment	NEW Vee-Rotors™ CONTOUR	NEW CX Extreme® ROTOR
RVF 750 RR/RS RC45	94-98	FA143				MD1013		
VF 750 C Shadow	83	H343						
VF 750 CH	87	H343						
VF 750 CP/CR/CS/CT/CV/CW/CX	93-99	H343						
VF 750 FD/FE	83-84	FA069/3		FA069/3V	FA069/3HH	MD1068		
VF 750 SC (V45 Sabre)	82	H321						
VFR 750 FG/FH	86-87	FA069/3		FA069/3V	FA069/3HH	MD1006		
VFR 750 FJ/FK	88-89	FA196		FA196V	FA196HH	MD1006		
VFR 750 FL/FLM/FVFP	90-93	FA196		FA196V	FA196HH	MD1007		
VFR 750 FR/FS/FT/FV	94-97	FA196		FA196V	FA196HH	MD1007	MD1007C	
VFR 750 RJ/RK/RL/RC30	88-90	FA143				MD1011		
VT 750 CV/C2V/CWC/C2WC/CXC/C2Y/C2Y/C21/C1/C31/C4/C5								
/C8/C7/C8 Shadow	97-09	H343						
VT 750 C2BA/C2BB/C2BC Shadow Black Spirit								
(21" Front Wheel/Rear Drum Model)	10-13	H343						
VT 750 C2SA/C2SB Shadow (3 Piston Caliper/								
17" Front Wheel/ABS/Rear Disc)	10-12	FA254			FA254HH	TBA		
VT 750 DC1/DC2 Black Widow	01-04	H343						
VT 750 DC7/DC8 Shadow Spirit	07-09	H343						
VT 750 S (VT750SA/SB)	10-12	H343						
XLV 750 R (RD/RF)	83-88	H340			H340G			
XRV 750 LMN Africa Twin	90-93	FA140			FA140HH	MD6103D		
XRV 750 P/IR/S/TN/WIX/Y Africa Twin	94-03	FA140				MD6103D		
PC 800 Pacific Coast	89-97	H343						
VFR 800 FIW/PIX	98-99				FA261HH	MD1165	MD1165C	
VFR 800 FY/F1/2/3/4/5	00-05				FA261HH	MD1164	MD1164C	
VFR 800 6/8/9	06-09				FA261HH	MD1164	MD1164C	
VFR 800 A2/A3/A4/A5 (ABS Model)	02-05				FA261HH	MD1164	MD1164C	
VFR 800 A6/A8/A9 (ABS Model)	06-13				FA261HH	MD1164	MD1164C	
VFR 800 XC (Crossrunner)	12-13				FA488HH	TBA		
CB 900 FZ/FA	80-81	FA031		FA031V		MD1071		
CB 900 FB/F2B	82-83	FA069		FA069V		MD1082		
CB 900 FC/F2C/FD/F2D	84-85	FA069		FA069V	FA069HH	MD1082		
CB 900 F2/F3/F4/F5/F6/F7 Hornet	02-07	FA174		FA174V	FA174HH	MD1020	MD1020C	VR1020
CBR 900 RRN/RRP Fireblade (893cc)	92-93	FA174		FA174V	FA174HH	MD1004	MD1004C	VR1004
CBR 900 RRR Fireblade (893cc)	94-97	FA174		FA174V	FA174HH	MD1004	MD1004C	VR1004
CBR 900 RRS/RRT/RRV Fireblade (918cc)	94-97	FA174		FA174V	FA174HH	MD1004	MD1004C	VR1004
CBR 900 RRW/RRX Fireblade (918cc)	98-99	FA174		FA174V	FA174HH	MD1004	MD1004C	VR1004
CBR 900 Evolution Blade	99	FA047			FA047HH	TBA		
CBR 900 RRY/RR1 (929cc) Fireblade	00-01	FA174		FA174V	FA174HH	MD1004	MD1004C	VR1004
CBR 900 RR2/RR3 (954cc) Fireblade	02-03	FA174		FA174V	FA174HH	MD1004	MD1004C	VR1004
CB 1000 FP/FR/FS/FT/FV	93-97	FA174		FA174V	FA174HH	MD1016		
CB 1000 R9/RA/RB/RC (Non ABS Model)	09-13				FA488HH	MD1177	MD1177C	
CB 1000 RA9/RAA/RAB/RAC (ABS Model)	09-13				FA488HH	MD1177	MD1177C	
CBF 1000 6/7/8/9/A (2 Piston Front Calipers/Non ABS Model)	06-11	FA174		FA174V	FA174HH	MD1156		
CBF 1000 A A6/A7/A8/A9/AA (3 Piston Front Caliper/ABS Model)	06-10				FA388HH	MD1178		
CBF 1000 S S7/S8/S9/SA (3 Piston Front Caliper/ABS Model)	07-11				FA388HH	MD1178		
CBF 1000 T T7/T8/T9/TA (3 Piston Front Caliper/ABS Model)	07-12				FA388HH	MD1178		
CBF 1000 F FA (2 Piston Front Caliper/Non ABS)	10-11	FA174		FA174V	FA174HH	MD1156		
CBF 1000 FA FAA (3 Piston Front Caliper/ABS Model)	10-13				FA388HH	MD1178		
CBF 1000 FS FSA (3 Piston Front Caliper/ABS Model)	10-11				FA388HH	MD1178		
CBF 1000 FT FTA (3 Piston Front Caliper/ABS Model)	10-11				FA388HH	MD1178		
CBR 1000 FH/FJ	87-88	FA069/3		FA069/3V	FA069/3HH	MD1001		
CBR 1000 FK/FL/FM/FN	89-92	FA196		FA196V	FA196HH	MD1016		
CBR 1000 FP/FR/FS/FT/FV/FW/FX	93-99	FA189			FA189HH	MD1006		
CBR 1000 RR4/RR5 Fireblade	04-05	FA174		FA174V	FA174HH	MD1004	MD1004C	VR1004
CBR 1000 RR6/RR7	06-07	FA436		FA436V	FA436HH	MD1004	MD1004C	VR1004
CBR 1000 RR8/RR9/RRR/RRB/RRC/RRD Fireblade	08-13	FA436		FA436V	FA436HH	MD1004	MD1004C	VR1004
CBR 1000 RA9/RAA/RAB/RAC/RAD Fireblade (C-ABS)	09-13	FA436		FA436V	FA436HH	MD1004	MD1004C	VR1004
CBX 1000 Z	79-80	FA031		FA031V		MD1071		

\*-2 Sets Required. ■ - Also available in MX-S race compound.

**SAFETY WARNING:** DO NOT USE HH PADS ON REAR UNLESS ALSO USED ON FRONT TO AVOID BRAKE IMBALANCE

**R** Suffix = High Durability Sintered Pad. **HH** Suffix = High Performance Sintered Pad. **G** Suffix = Grooved Shoe.  
**D** Suffix = Drilled Disc. **C** Suffix = Contoured Disc. **LS** Suffix = Left/Steel Disc. **RS** = Right/Steel Disc.

**BRAKE APPLICATIONS**



# JAPANESE Built Motorcycles



FRONT / AVANT / VORN FRENT / ANTERIORE

## HONDA Contd.

		DISC PAD CHOICES				BRAKE ROTOR CHOICES							
		NEW SFAC Scooter Carbon Pads	Semi-Sintered V-Pads™	Sintered/HH Pads/ Grooved shoes	Left/Gauche/Links	Right/Droite/Rechts	Contour Rotor Universal left and right fitment	NEW Vee-Rotors™ CONTOUR	NEW CX Extreme® ROTOR	Oversize 250/280mm Rotor Kit	Relocating Bracket for 250/280mm Rotor	Oversize 320mm Rotor Kit	Relocating Bracket for 320mm Rotor
CBX 1000 B/C	81-82	FA069/2*			N/A	N/A							
GL 1000 KK1/K2 Goldwing (6 Bolt disc fixing)	75-77	FA030*		FA030V*	MD1074LS	MD1074RS							
GL 1000 K3 Goldwing	78	FA029*		FA029V*	N/A	N/A							
GL 1000 Z Goldwing (5 Bolt disc fixing)	79	FA029*		FA029V*	MD1036LS	MD1036RS							
VF 1000 FE/FF/FG/F2F/F2G	84-86	FA069*			FA069HH*	MD1001	MD1001						
VF 1000 RE/RF/RG	84-86	FA069*			FA069HH*	MD1146	MD1146						
VTR 1000 FV/FW/FX/FY/F1-F6 Firestorm	97-06	FA187*			FA187HH*	MD1003X	MD1003X	MD1003XC*	VR1003BLK*				
VTR 1000 SP-Y/SP-1 (SC45) (SP1)	00-01				FA265HH*	MD1138X	MD1138X	MD1138XC*					
VTR 1000 SP-2/SP-3/SP-4/SP-5/SP-6 (SP2)	02-07				FA265HH*	MD1138X	MD1138X	MD1138XC*					
XL 1000 VX/Y/V1/V2 Varadero - Non ABS Model ①	99-02				FA261HH*	MD1014X	MD1014X	MD1014XC*	VR1014BLK*				
XL 1000 V3/V4/V5/V6 Varadero - Non ABS Model ①	03-06				FA261HH*	MD1014X	MD1014X	MD1014XC*	VR1014BLK*				
XL 1000 V7/V8/V9/V10 Varadero - Non ABS Model ①	07-11				FA388HH*	MD1014X	MD1014X	MD1014XC*	VR1014BLK*				
XL 1000 V4/V5/V6/V7/V8/V9/V10/V11 Varadero - ABS Model ①	07-11				FA388HH*	MD1157X	MD1157X	MD1157XC*					
CB 1100 RB2/RC2/RD2	80-83	FA069*			FA069HH*	N/A	N/A						
CB 1100 SFY/SF1 X11	00-03				FA261HH*	MD1136	MD1136	MD1136C*	VR1136BLK*				
CB 1100 D	13				FA388HH*	TBA	TBA						
CBR 1100 XXV/XXW Blackbird ①	97-98				FA261HH*	MD1120	MD1120		VR1120BLK*				
CBR 1100 XXX/XXY/XX1-XX6 Blackbird ①	99-08				FA261HH*	MD1136	MD1136	MD1136C*	VR1136BLK*				
GL 1100 AD Goldwing Aspencade	83	FA069/2*		FA069/2V*	MD1133	MD1133							
GL 1100 ADA/ADB (SC02)	80-82	FA030*		FA030V*	MD1036LS	MD1036RS							
GL 1100 C/DC Goldwing	82	FA069/2*		FA069/2V*	MD1036LS	MD1036RS							
ST 1100 LMN/PR/ST/WX/Y/Y1/2 Pan European - Non ABS Model	90-02	FA142*			FA142HH*	MD1101	MD1101						
ST 1100 AN/AP/AR/AS (Pan European - ABS Model) ①	92-95	FA142*			FA142HH*	MD1101	MD1101						
ST 1100 AT/AV/AW/AX/AY/A1/A2 (Pan European - ABS Model) ①	96-02				FA261HH*	MD1008	MD1008						
VT 1100 CH/CJ/CN/CP Shadow	87-93	FA069/3		FA069/3V	FA069/3HH		MD1080RS						
VT 1100 CR/CS/CT/CV/CW Shadow	94-98	FA196		FA196V	FA196HH		MD1167RS						
VT 1100 C2 (S/T/V)	95-97	FA196		FA196V	FA196HH	MD1179							
VT 1100 C2 (W/X/Y1/2/3/4/5)	98-05	FA196		FA196V	FA196HH	MD1179							
VT 1100 C3 (W/X/Y)	98-00	FA196		FA196V	FA196HH	MD1179							
GL 1200 DED/DF/DG Goldwing ①	84-86	FA069/3*		FA069/3V*	FA069/3HH*	MD1083LS	MD1083RS						
GL 1200 AE/AF/AG Goldwing ②	84-86	FA069/3*		FA069/3V*	FA069/3HH*	MD1125	MD1125						
VFR 1200 FA/FA (Manual Gearbox Model)	10-13				FA493/4HH*	MD1176X	MD1176X						
VFR 1200 FDA/FDB - DCT (Automatic Transmission Model)	10-13				FA493/4HH*	MD1176X	MD1176X						
VFR 1200 XC Crosstourer (Manual G/Box)	12-13				FA388HH*	TBA	TBA						
VFR 1200 XDC - DCT Crosstourer (Automatic Transmission Model)	12-13				FA388HH*	TBA	TBA						
X4 CB 1300 DCV/DCW/DCX/DCY (SC38)	97-00	FA187*			FA187HH*	N/A	N/A						
CB 1300 FW/FX/FY (SC40)	98-00	FA424*			FA424HH*	MD1136	MD1136	MD1136C*	VR1136BLK*				
CB 1300 F1 (SC40)	01				FA265HH*	TBA	TBA						
CB 1300 F3/F13 Super Four	03-04				FA296HH*	TBA	TBA						
CB 1300 5/6/7/8/9 (Superfour)	05-09				FA296HH*	MD1152X	MD1152X	MD1152XC*	VR1152BLK*				
CB 1300 A5/A6/A7/A8/A9 (Superfour ABS)	05-09				FA296HH*	MD1152X	MD1152X	MD1152XC*	VR1152BLK*				
CB 1300 S5/S6/S7/S8/S9	05-09				FA296HH*	MD1152X	MD1152X	MD1152XC*	VR1152BLK*				
CB 1300 SA5-SAA	05-11				FA296HH*	MD1152X	MD1152X	MD1152XC*	VR1152BLK*				
ST 1300 2/3/4/6 Pan European - Non ABS Model ①	02-07				FA261HH*	MD1154X	MD1154X	MD1154XC*					
ST 1300 8/9 Pan European - Non ABS Model ①	08-09				FA388HH*	MD1154X	MD1154X	MD1154XC*					
ST 1300 A2/A3/A4/A6 Pan European - ABS Model ①	02-07				FA261HH*	MD1154X	MD1154X	MD1154XC*					
ST 1300 A8/A9/AA Pan European - ABS Model ①	08-13				FA388HH*	MD1154X	MD1154X	MD1154XC*					
VT 1300 CXA (Fury/Chopper/Non ABS/9 Spoke Cast Wheel)	10-12	FA196		FA196V	FA196HH	TBA							
VT 1300 CXAA (Fury/Chopper/ABS/9 Spoke Cast Wheel)	10-11	FA388			FA388HH	TBA							
VTX 1300 S3/S4/S5/S6/S7/S8	03-08	FA196		FA196V	FA196HH		MD1158RS						
GL 1500 JK Goldwing	88-89	FA124/2*		FA124/2V*	FA124/2HH*	MD1126	MD1126						
GL 1500 L/SEM/SEN/SEP/SER/SES/SEV/SEW/SEX/SEY Goldwing	90-00	FA124/2*		FA124/2V*	FA124/2HH*	MD1126	MD1126						
GL 1500 CV/CW/CX (F6C)	97-99	FA142*		FA142V*	FA142HH*	MD1014X	MD1014X	MD1014XC*	VR1014BLK*				
GL 1500 CY/C1/C2 (F6C)	00-03	FA142*		FA142V*	FA142HH*	MD1014X	MD1014X	MD1014XC*	VR1014BLK*				
F6B Goldwing	13				FA261HH*	MD1014X	MD1014X	MD1014XC*	VR1014BLK*				
GL 1800 A1/A2/A3/A4/A5 Goldwing	01-05				FA261HH*	MD1014X	MD1014X	MD1014XC*	VR1014BLK*				
GL 1800 6/7/8/9/A Goldwing	06-13				FA261HH*	MD1014X	MD1014X	MD1014XC*	VR1014BLK*				
VTX 1800 C2/C3/C4/C15/CA6/CA7 ①	02-08				FA261HH*	MD1141X	MD1141X	MD1141XC*	VR1141BLK*				

① = with 4.7mm front disc ② = with 10.0mm vented front disc  
 ① = Note: Linked brake system - fit all three sets at pad change. NOTE - MD6191C ◆ = MD6191CE Undrilled rear disc available for Enduro use

\*-2 Sets Required. ■ - Also available in MX-S race compound.

**SAFETY WARNING:** DO NOT USE HH PADS ON REAR UNLESS ALSO USED ON FRONT TO AVOID BRAKE IMBALANCE

**R** Suffix = High Durability Sintered Pad. **HH** Suffix = High Performance Sintered Pad. **G** Suffix = Grooved Shoe.  
**D** Suffix = Drilled Disc. **C** Suffix = Contoured Disc. **LS** Suffix = Left/Steel Disc. **RS** = Right/Steel Disc.

**APPLICATIONS**  
**BRAKE**

# JAPANESE Built Motorcycles



## HONDA Contd.



← REAR / ARRIÈRE / HINTEN POSTERIOR / POSTERIORE →

			DISC PAD CHOICES			BRAKE ROTOR CHOICES			
			NEW SFAC Scooter Carbon Pads	Semi-Sintered V-Pads™	Sintered/HH Pads/ Grooved shoes	Contour Rotor Rear Fitment	NEW Vee-Rotors™ CONTOUR	NEW CX Extreme® ROTOR	
CBX 1000 B/C	81-82	FA069		FA069V		MD1071			
GL 1000 K/K1/K2 Goldwing (6 Bolt disc fixing)	75-77	FA032		FA032V		MD1064			
GL 1000 K3 Goldwing	78	FA032		FA032V		MD1064			
GL 1000 Z Goldwing (5 Bolt disc fixing)	79	FA032		FA032V		MD1064			
VF 1000 FE/FF/FG/F2F/F2G	84-86	FA069/3		FA069/3V	FA069/3HH	MD1079			
VF 1000 RE/RF/RG	84-86	FA109				N/A			
VTR 1000 FV/FW/FX/FY/F1-F6 Firestorm	97-06	FA174		FA174V	FA174HH	MD1004	MD1004C	VR1004	
VTR 1000 SP-Y/SP-1 (SC45) (SP1)	00-01	FA174		FA174V	FA174HH	MD1004	MD1004C		
VTR 1000 SP-2/SP-3/SP-4/SP-5/SP-6 (SP2)	02-07	FA174		FA174V	FA174HH	MD1004	MD1004C		
XL 1000 VXX/VY/V1/V2 Varadero - Non ABS Model	99-02				FA261HH	MD6103D			
XL 1000 V3/V4/V5/V6 Varadero - Non ABS Model	03-06				FA261HH	MD1006	MD1006C	VR1006	
XL 1000 V7/V8/V9/VAVB Varadero - Non ABS Model	07-11				FA261HH	MD1006	MD1006C	VR1006	
XL 1000 VA4/VA5/VA6/VA7/VA8/VA9/VAVB Varadero - ABS Model	07-11				FA261HH	MD1006	MD1006C		
CB 1100 RB2/R2/RD2	80-83	FA069/3		FA069/3V	FA069/3HH	MD1116			
CB 1100 SFY/SF1 X11	00-03				FA261HH	MD1006	MD1006C	VR1006	
CB 1100 D	13	FA174		FA174V	FA174HH	TBA			
CBR 1100 XXV/XXW Blackbird	97-98				FA261HH	MD1006	MD1006C	VR1006	
CBR 1100 XXX/XXY/XX1-XX6 Blackbird	99-08				FA261HH	MD1006	MD1006C	VR1006	
GL 1100 AD Goldwing Aspencade	83	FA069		FA069V		MD1082			
GL 1100 ADA/DB (SC02)	80-82	FA030		FA030V		MD1071			
GL 1100 CDC Goldwing	82	FA069		FA069V		MD1071			
ST 1100 LMN/PR/ST7/W/WX/Y/1/2 Pan European - Non ABS Model	90-02	FA196		FA196V	FA196HH	MD1077			
ST 1100 AN/AP/AR/AS (Pan European - ABS Model)	92-95	FA196		FA196V	FA196HH	MD1077			
ST 1100 AT/AV/AW/AX/AY/A1/A2 (Pan European - ABS Model)	96-02				FA261HH	MD1135			
VT 1100 CH/CJ/CN/CP Shadow	87-93	H343							
VT 1100 CR/CS/CT/CV/CW Shadow	94-98	H343							
VT 1100 C2 (S/T/V)	95-97	FA174		FA174V	FA174HH	MD1016			
VT 1100 C2 (W/X/Y/1/2/3/4/5)	98-05	FA174		FA174V	FA174HH	MD1016			
VT 1100 C3 (W/X/Y)	98-00	FA174		FA174V	FA174HH	MD1016			
GL 1200 DED/DF/DG Goldwing	84-86	FA069/3		FA069/3V	FA069/3HH	MD1082			
GL 1200 AE/AF/AG Goldwing	84-86	FA069/3		FA069/3V	FA069/3HH	MD1082			
VFR 1200 FA/FB (Manual Gearbox Model)	10-13				FA488HH	MD1175			
VFR 1200 FDA/FDB - DCT (Automatic Transmission Model)	10-13				FA488HH	MD1175			
VFR 1200 XC Crosstourer (Manual G/Box)	12-13				FA636HH	TBA			
VFR 1200 XDC - DCT Crosstourer (Automatic Transmission Model)	12-13				FA636HH	TBA			
X4 CB 1300 DCV/DCW/DCX/DCY (SC38)	97-00	FA254			FA254HH	MD1001			
CB 1300 FW/FX/FY (SC40)	98-00	FA254			FA254HH	TBA			
CB 1300 F1 (SC40)	01	FA254			FA254HH	TBA			
CB 1300 F3/F13 Super Four	03-04	FA174		FA174V	FA174HH	MD1006			
CB 1300 5/6/7/8/9 (Superfour)	05-09	FA174		FA174V	FA174HH	TBA			
CB 1300 A5/A6/A7/A8/A9 (Superfour ABS)	05-09	FA174		FA174V	FA174HH	MD1174	MD1174C		
CB 1300 S5/S6/S7/S8/S9	05-09	FA174		FA174V	FA174HH	MD1174	MD1174C		
CB 1300 SA5-SAA	05-11	FA174		FA174V	FA174HH	MD1174	MD1174C		
ST 1300 2/3/4/6 Pan European - Non ABS Model	02-07				FA261HH	MD1163			
ST 1300 8/9 Pan European - Non ABS Model	08-09				FA261HH	MD1163			
ST 1300 A2/A3/A4/A6 Pan European - ABS Model	02-07				FA261HH	MD1163			
ST 1300 A8/A9/AA Pan European - ABS Model	08-13				FA261HH	MD1163			
VT 1300 CXA (Fury/Chopper/Non ABS/9 Spoke Cast Wheel)	10-12	FA174		FA174V	FA174HH	TBA			
VT 1300 CXAA (Fury/Chopper/ABS/9 Spoke Cast Wheel)	10-11	FA174		FA174V	FA174HH	TBA			
VTX 1300 S3/S4/S5/S6/S7/S8	03-08	FA174		FA174V	FA174HH	MD1159			
GL 1500 JK Goldwing	88-89	FA069/3		FA069/3V	FA069/3HH	MD1127			
GL 1500 L/SE/SEN/SEP/SE/SE/SE/SE/SE/SE/SE/SE Goldwing 90-00	90-00	FA069/3		FA069/3V	FA069/3HH	MD1077			
GL 1500 CV/CW/CX (F6C)	97-99	FA196		FA196V	FA196HH	MD1077			
GL 1500 CY/C1/C2 (F6C)	00-03	FA196		FA196V	FA196HH	MD1148			
F6B Goldwing	13				FA2612HH	N/A			
GL 1800 A1/A2/A3/A4/A5 Goldwing	01-05				FA2612HH	N/A			
GL 1800 6/7/8/9/A Goldwing	06-13				FA2612HH	N/A			
VTX 1800 C2/C3/C4/C15/CA6/CA7	02-08				FA261HH	MD1148			

\*-2 Sets Required. ■ - Also available in MX-S race compound.

**SAFETY WARNING:** DO NOT USE HH PADS ON REAR UNLESS ALSO USED ON FRONT TO AVOID BRAKE IMBALANCE

**R** Suffix = High Durability Sintered Pad. **HH** Suffix = High Performance Sintered Pad. **G** Suffix = Grooved Shoe.  
**D** Suffix = Drilled Disc. **C** Suffix = Contoured Disc. **LS** Suffix = Left/Steel Disc. **RS** = Right/Steel Disc.

**BRAKE APPLICATIONS**

# JAPANESE Built Motorcycles



← FRONT / AVANT / VORN FRENTE / ANTERIORE →

## KAWASAKI

### DISC PAD CHOICES

### BRAKE ROTOR CHOICES

Model	Year	NEW SFAC Scooter Carbon Pads	Sintered/HH Pads/ Grooved shoes	Left/Gauche/Links		Right/Droite/Rechts		Contour Rotor Universal left and right fitment	NEW Vee-Rotors™ CONTOUR	NEW CX Extreme® ROTOR	Oversize 250/280mm Rotor Kit	Relocating Bracket for 250/280mm Rotor	Oversize 320mm Rotor Kit	Relocating Bracket for 320mm Rotor
				Left/Gauche/Links	Right/Droite/Rechts	Left/Gauche/Links	Right/Droite/Rechts							
AE 50 A1/A2	81-82	S603		S603G										
AR 50 A1/C2-C10	81-97	FA083TT		FA083HH	MD4040LS									
KDX 50 A1/A2/A3	03-05	S613		S613G										
KFX 50 (KSF 50 A1/A2/A3)	03-05	S614*		S614G*										
KSR1 (KMX 50 B1/B2)	90-91	FA083/2TT				TBA								
KXF 50 (KSF 50 B7F/B8F)	07-08	H338*		H338G*										
KX 60 A1/A2/B1-B19	83-03	K715		K715G										
KX 65 A1/A2/A3/A4/A5/A6/A6F/A6F/A9F/AAF/ABF/ACF/ADF	00-13	FA302TT		FA302R	MD6166D					MD6166CX				
AE 80 A1/B1	81-82	S603		S603G										
AR 80 A1/C1-C8	81-91	FA083TT		FA083HH	MD4040LS									
KFX 80 (KSF 80 A1/A2/A3/A6F)	03-06	S614*		S614G*										
KX 80 B1/B2/D1/D2	79-83	K701		K701G										
KX 80 E1	83	K714		K714G										
KX 80 E2/E3/G1/G2/U1/U2	84-87	FA083TT		FA083R	MD6027D									
KX 80 L1/L2/N2/L3/N3/R1/T1	88-91	FA083TT		FA083R	MD6027D									
KX 80 R2/T2/R3/T3/R4/T4/R5/T5/R6/T6	92-96	FA083TT		FA083R	MD6026D									
KX 80 R7/W1/W2/W3	97-00	FA258TT		FA258R	MD6026D									
KX 85 A1-A5/A6F/A7F/A8F/A9F/AAF/ABF/ACF/ADF (17" Front / 14" Rear Wheel)	01-13	FA258TT		FA258R	MD6186D			MD6186C		MD6186CX	OS6186C	BRK025	N/A	N/A
KX 85 11 B1-B5/B6F/B7F/B8F/B9F/BAF/BBF/BCF/BCF (19" Front / 16" Rear Wheel)	01-13	FA258TT		FA258R	MD6186D			MD6186C		MD6186CX	OS6186C	BRK025	N/A	N/A
KSR II (KMX 80 B1/B2)	90-91	FA083/2TT				TBA								
KXF 90 (KSF 90 A7F/A8F/A9F/AAF/ABF/ACF)	07-12	H338*		H338G*										
KC 100 C1-C4	80-83	S603												
KE 100 A7-A10/B1-B15	79-98	S603		S603G										
KH 100 A2-A4	78-81	S602												
KH 100 G2/G3	81-83	FA048			MD4116LS									
KH 100 G4	83	FA067		FA067HH	MD4116LS									
KH 100 G5-G8 (EX)	84-87	FA067		FA067HH	MD4105LS									
KM 100 A4-A6	78-81	S603		S603G										
KX 100 A1/A2/B1	89-91	FA083TT		FA083R	MD6027D									
KX 100 B2-B6	92-96	FA083TT		FA083R	MD6026D									
KX 100 B7/C1/C2/C3	97-00	FA258TT		FA258R	MD6026D									
Max 100		S603												
KLF 110 B1-B2 Mojave	87-88	S603		S603G										
KLX 110 R (KLX 110 A1/A2/A3/A4/A6F/A7F/A8F/A9F/CAF/CBF/CCF/CDF)	02-13	K715		K715G										
Kaze-r 112cc	04	FA197		FA197HH	N/A									
AR 125 A1-A7/B1-B8	82-94	FA067		FA067HH	MD4099									
BN 125 A1/A2 Eliminator	98-99	FA054TT		FA054HH			MD4137RS							
BN 125 A3/A4/A5/A6/A6F/A7F Eliminator	00-07	FA197		FA197HH			MD4137RS							
KDX 125 A1/A2/B1/B2	90-94	FA083TT		FA083R	MD6083D					MD6083CX				
KE 125 A4-A12	76-85	K704		K704G										
KH 125 A1-A4	77-81	FA039			N/A									
KH 125 K1	83	FA054TT		FA054HH	N/A									
KH 125 K2-K10	82-98	FA067		FA067HH	N/A									
KH 125 L1 (EX)	84	FA067		FA067HH	MD4105LS									
KLX 125 A1/A2/A3/A6F	03-06	S604		S604G										
KLX 125 L (B1/B2/B3/B6F)	03-06	FA230TT		FA230R	MD6212D									
KLX 125 CAF/CBF/CCF/CDF	10-13	FA135TT		FA135R ■				MD6363C						
KLX 125 DAF/DBF/DCF/DDF (D-Tracker)	10-13	FA135TT		FA135R ■				MD6363C						
KMX 125 A1-A5/B1-B9	86-98	FA083TT		FA083R	MD6106D									
KMX 125 B10-B12	99-03	FA230TT		FA230R	MD6106D									
KX 125 A3-A7	74-80	K704		K704G										
KX 125 B1	82	FA083TT		FA083R	N/A									
KX 125 B2/C1	83-84	FA067TT		FA067R	N/A									
KX 125 D1	85	FA067TT		FA067R	MD6036D									
KX 125 E1	86	FA067TT		FA067R	MD6036D									
KX 125 E2/F1	87-88	FA130TT		FA130R	MD6036D									
KX 125 G1/H1/H2/U1/U2	89-93	FA135TT		FA135R ■	MD6015D		MD6015C		MD6015CX	N/A	N/A	N/A	N/A	N/A

\*-2 Sets Required. ■ - Also available in MX-S race compound.

**SAFETY WARNING:** DO NOT USE HH PADS ON REAR UNLESS ALSO USED ON FRONT TO AVOID BRAKE IMBALANCE

APPLICATIONS  
BRAKE

R Suffix = High Durability Sintered Pad. HH Suffix = High Performance Sintered Pad. G Suffix = Grooved Shoe.  
D Suffix = Drilled Disc. C Suffix = Contoured Disc. LS Suffix = Left/Steel Disc. RS = Right/Steel Disc.

# JAPANESE Built Motorcycles



**KAWASAKI**



← REAR / ARRIÈRE / HINTEN  POSTERIOR / POSTERIORE →

		DISC PAD CHOICES				BRAKE ROTOR CHOICES			
		NEW SFAC Scooter Carbon Pads	Semi-Sintered V-Pads™	Sintered/HH Pads/ Grooved shoes		Contour Rotor Rear Fitment	NEW Vee-Rotors™ CONTOUR	NEW CX Extreme® ROTOR	
AE 50 A1/A2	81-82	S603		S603G					
AR 50 A1/C2-C10	81-97	S603							
KDX 50 A1/A2/A3	03-05	S613		S613G					
KFX 50 (KSF 50 A1/A2/A3)	03-05	S604		S604G					
KSR1 (KMX 50 B1/B2)	90-91	FA67			TBA				
KXF 50 (KSF 50 B7F/B8F)	07-08	FA305		FA305R	MD6267D				
KX 80 A1/A2/B1-B19	83-03	K715		K715G					
KX 85 A1/A2/A3/A4/A5/A6/A6F-A9F/AAF/ABF/ACF/ADF	00-13	FA054TT		FA054R ■	MD6166D			MD6166CX	
AE 80 A1/B1	81-82	S603		S603G					
AR 80 A1/C1-C8	81-91	S603							
KFX 80 (KSF 80 A1/A2/A3/A6F)	03-06	S618		S618G					
KX 80 B1/B2/D1/D2	79-83	K701		K701G					
KX 80 E1	83	K715		K715G					
KX 80 E2/E3/G1/G2/J1/J2	84-87	K715		K715G					
KX 80 L1/L2/N2/L3/N3/R1/T1	88-91	FA084TT		FA084R	MD6025D				
KX 80 R2/T2/R3/T3/R4/T4/R5/T5/R6/T6	92-96	FA084TT		FA084R	MD6025D				
KX 80 R7/W1/W2/W3	97-00	FA084TT		FA084R	MD6025D				
KX 85 A1-A5/A6F/A7F/A8F/A9F/AAF/ABF/ACF/ADF (17" Front / 14" Rear Wheel)	01-13	FA084TT		FA084R	MD6187D	MD6187C		MD6187CX	
KX 85 11 B1-B5/B6F/B7F/B8F/B9F/B9F/BAF/BBF/BCF/BDF (19" Front / 16" Rear Wheel)	01-13	FA084TT		FA084R	MD6187D	MD6187C		MD6187CX	
KSR II (KMX 80 B1/B2)	90-91	FA067TT			TBA				
KXF 90 (KSF 90 A7F/A8F/A9F/AAF/ABF/ACF)	07-12	FA305		FA305R	MD6267D				
KC 100 C1-C4	80-83	S603							
KE 100 A7-A10/B1-B15	79-98	S603		S603G					
KH 100 A2-A4	78-81	S603							
KH 100 G2/G3	81-83	S603							
KH 100 G4	83	S603							
KH 100 G5-G8 (EX)	84-87	S602							
KM 100 A4-A6	78-81	S603		S603G					
KX 100 A1/A2/B1	89-91	FA084TT		FA084R	MD6025D				
KX 100 B2-B6	92-96	FA084TT		FA084R	MD6025D				
KX 100 B7/C1/C2/C3	97-00	FA084TT		FA084R	MD6025D				
Max 100		S603							
KLF 110 B1-B2 Mojave	87-88	S602		S602G					
KLX 110 R (KLX 110 A1/A2/A3/A4/A6F/A7F/A8F/A9F/CAF/CBF/CCF/CDF)	02-13	S603		S603G					
Kazer 112cc	04	S603							
AR 125 A1-A7/B1-B8	82-94	S602							
BN 125 A1/A2 Eliminator	98-99	S602							
BN 125 A3/A4/A5/A6/A6F/A7F Eliminator	00-07	S602							
KDX 125 A1/A2/B1/B2	90-94	FA152TT		FA152R ■	MD6105D			MD6105CX	
KE 125 A4-A12	76-85	S602		S602G					
KH 125 A1-A4	77-81	K702							
KH 125 K1	83	S602							
KH 125 K2-K10	82-98	S602							
KH 125 L1 (EX)	84	S602							
KLX 125 A1/A2/A3/A6F	03-06	S604		S604G					
KLX 125 L (B1/B2/B3/B6F)	03-06	S604		S604G					
KLX 125 CAF/CBF/CCF/CDF	10-13	FA054TT		FA054R ■		MD6362C			
KLX 125 DAF/DBF/DCF/DDF (D-Tracker)	10-13	FA054TT		FA054R ■		MD6362C			
KMX 125 A1-A5/B1-B9	86-98	FA067		FA067R	MD6107D				
KMX 125 B10-B12	99-03	FA067		FA067R	MD6107D				
KX 125 A3-A7	74-80	S602		S602G					
KX 125 B1	82	S602		S602G					
KX 125 B2/C1	83-84	K702		K702G					
KX 125 D1	85	K702		K702G					
KX 125 E1	86	FA067TT		FA067R	MD6161D				
KX 125 E2/F1	87-88	FA067TT		FA067R	MD6161D				
KX 125 G1/H1/H2/J1/J2	89-93	FA152TT		FA152R ■	MD6024D	MD6024C		MD6024CX	

\*-2 Sets Required. ■ - Also available in MX-S race compound.

**SAFETY WARNING:** DO NOT USE HH PADS ON REAR UNLESS ALSO USED ON FRONT TO AVOID BRAKE IMBALANCE

**R** Suffix = High Durability Sintered Pad. **HH** Suffix = High Performance Sintered Pad. **G** Suffix = Grooved Shoe.  
**D** Suffix = Drilled Disc. **C** Suffix = Contoured Disc. **LS** Suffix = Left/Steel Disc. **RS** = Right/Steel Disc.

**BRAKE APPLICATIONS**



# JAPANESE Built Motorcycles



**KAWASAKI Contd.**

← FRONT / AVANT / VORN  FRENTE / ANTERIORE →

Model	Year	DISC PAD CHOICES					BRAKE ROTOR CHOICES						
		NEW SFAC Scooter Carbon Pads	Semi-Sintered V-Pads™	Sintered/HH Pads/ Grooved shoes	Left/Gauche/Links	Right/Droite/Rechts	Contour Rotor Universal left and right fitment	NEW Vee-Rotors™ CONTOUR	NEW CX Extreme® ROTOR	Oversize 250/280mm Rotor Kit	Relocating Bracket for 250/280mm Rotor	Oversize 320mm Rotor Kit	Relocating Bracket for 320mm Rotor
KX 125 K1	94	FA185TT		FA185R ■	MD6015D		MD6015C		MD6015CX	OS6015C			
KX 125 K2/K3/K4/K5/L1/L2/L3/L4	95-02	FA185TT		FA185R ■	MD6015D		MD6015C		MD6015CX	OS6015C	BRK023	SM6015C	BRK024
KX 125 M1/M2/M3	03-05	FA185TT		FA185R ■	MD6213D		MD6213C		MD6213CX	OS6213C	BRK023	SM6213C	BRK024
KX 125 M6FM7/M8F	06-08	FA185TT		FA185R ■	MD6264D		MD6264C		MD6264CX	OS6264C	BRK023	SM6264C	BRK024
ZX 130 R	08-10	SFA197	SFAC197	SFA197HH		TBA							
SC 150 A1 (Epsilon 150)	02	SFA396		SFA396HH	MD934D								
BN 175 Boss 175	02	TBA				NA							
KDX 175 A1-A3	80-82	K704		K704G									
KE 175 B1-B3	76-78	K704		K704G									
KE 175 D2-D5	79-83	K704		K704G									
KLF 185 A1	87	None											
KDX 200 A1-A3	83-85	K703		K703G									
KDX 200 C1/C2/C3	86-88	FA067TT		FA067R	MD6036D								
KDX 200 E1/E2/E3/E4	89-92	FA067TT		FA067R	MD6036D								
KDX 200 E5/E6	93-94	FA135TT		FA135R ■	MD6015D		MD6015C		MD6015CX				
KDX 200 H1/H2/H3/H4/H5	95-99	FA185TT		FA185R ■	MD6083D				MD6083CX				
KDX 200 SR (DX 200 G)		FA135TT		FA135R ■	MD6036D								
KLT 200 A1/A4A/C1/C2	81-84	S603		S603G									
KMX 200 A2/A3	88-92	FA083TT		FA083R	MD6057D								
Z 200 A1-A5	77-82	FA039			N/A								
Z 200 A6	83	FA067		FA067HH	N/A								
KLF 220 A1-A15	88-02	K705*		K705G*									
KDX 220 R A4-A12/A6F	97-06	FA185TT		FA185R ■	MD6083D				MD6083CX				
KDX 220 SR (DX 220 B)		FA185TT		FA185R ■	MD6083D				MD6083CX				
250 SIB	75	K711											
ER 250 B1/B2/B3 (Z 250 T Scorpion)	83-88	FA085		FA085HH	MD4099								
EL 250 D1-D5	90-94	FA085		FA085HH	MD4002LS								
EL 252 (EL 250 F2/F3/F5/F6)	96-03	FA085		FA085HH		MD4002RS							
EL 250 Eliminator	87-89	FA085		FA085HH		MD4002RS							
BJ 250 B1-B7A Estrella	92-99	FA067		FA067HH		TBA							
BJ 250 C1-C7 Estrella-RS	99-02	FA067		FA067HH		TBA							
BJ 250 D1-D7 Estrella Custom	96-02	S612											
BJ 250 E1-E4A Estrella RS Custom	96-99	S612											
BJ 250 F1/F2 (250 TR)	02-03	FA231		FA231HH	TBA								
EX 250 K8F/K9F/KAF/KBF/KBFA/KCF Ninja 250R (Standard Solid Front Disc)	08-12	FA197		FA197HH			MD4162C						
EX 250 K8F/K9F/KAF/KBF/KBFA/KCF Ninja 250R (Front Floating Disc Conversion)	08-12						MD4162XC						
GPX 250 R (ZX 250 F2-F9)	88-95	FA129		FA129HH		MD4041RS							
GPX 250 R (EX 250 E)	86	FA085		FA085HH	MD4002LS								
GPX 250 R (EX 250 F)	87	FA129		FA129HH		MD4041RS							
GPX 250 RII (EX 250 G)	88	FA141*			TBA	TBA							
KDX 250 B1	79	K705		K705G									
KDX 250 B2/B3	80-84	K705		K705G									
KDX 250 D1	91-93	FA135TT		FA135R ■	MD6083D				MD6083CX				
KH 250 B1-B5	77-82	FA033			N/A								
KDX 250 SR (KDX 250 F1)	91	FA135TT		FA135R ■	MD6083D				MD6083CX				
KL 250 A1/A2	78-79	K705		K705G									
KL 250 A3/A4/C1/C2	80-84	K704		K704G									
KL 250 J1/J3 Stockman		FA258TT		FA258R	MD6239D								
KL 250 G1/G1A Super Sherpa	97	FA258TT		FA258R	MD6239D								
KLE 250 A2 Anhelo	95	FA129		FA129R	TBA								
KLE 250 A3	97	FA129		FA129R	TBA								
KLE 250 A5/A6	00-01	FA129		FA129R	TBA								
KLX 250 H1 Super Sherpa	98	FA258TT		FA258R	MD6239D								
KLF 250 A1/A2/A3/A6F-A9F/AAF/ABF (Bayou 250)	03-11	K705*		K705G*									
KLR 250 D2-D22	84-05	FA067		FA067R	MD6057D								
KLT 250 C1-C3 Prairie	83-85	S603		S603G									
KLX 250 R D1/D2	93-94	FA185TT		FA185R ■	MD6015D		MD6015C		MD6015CX				
KLX 250 F1-F4 (KLX 250 ES)	94-97	FA185TT		FA185R ■	MD6091D								

\*-2 Sets Required. ■ - Also available in MX-S race compound.

**SAFETY WARNING:** DO NOT USE HH PADS ON REAR UNLESS ALSO USED ON FRONT TO AVOID BRAKE IMBALANCE

APPLICATIONS  
BRAKE

R Suffix = High Durability Sintered Pad. HH Suffix = High Performance Sintered Pad. G Suffix = Grooved Shoe.  
D Suffix = Drilled Disc. C Suffix = Contoured Disc. LS Suffix = Left/Steel Disc. RS = Right/Steel Disc.

# JAPANESE Built Motorcycles



**KAWASAKI Contd.**



← REAR / ARRIÈRE / HINTEN  POSTERIOR / POSTERIORE →

		DISC PAD CHOICES				BRAKE ROTOR CHOICES			
		NEW SFAC Scooter Carbon Pads	Semi-Sintered V-Pads™	Sintered/HH Pads/ Grooved shoes		Contour Rotor Rear Fitment	NEW Vee-Rotors™ CONTOUR	NEW CX Extreme® ROTOR	
KX 125 K1	94	FA152TT		FA152R ■	MD6024D	MD6024C		MD6024CX	
KX 125 K2/K3/K4/K5/L1/L2/L3/L4	95-02	FA131TT		FA131R ■	MD6024D	MD6024C		MD6024CX	
KX 125 M1/M2/M3	03-05	FA131TT		FA131R ■	MD6208D	MD6208C◆		MD6208CX◆	
KX 125 M6F/M7F/M8F	06-08	FA131TT		FA131R ■	MD6208D	MD6208C◆		MD6208CX◆	
ZX 130 R	08-10	S603							
SC 150 A1 (Epsilon 150)	02	S635							
BN 175 Boss 175	02	TBA							
KDX 175 A1-A3	80-82	S602		S602G					
KE 175 B1-B3	76-78	S602		S602G					
KE 175 D2-D5	79-83	K703		K703G					
KLF 185 A1	87	K706		K706G					
KDX 200 A1-A3	83-85	K702		K702G					
KDX 200 C1/C2/C3	86-88	K702		K702G					
KDX 200 E1/E2/E3/E4	89-92	FA152TT		FA152R ■	MD6024D				
KDX 200 E5/E6	93-94	FA152TT		FA152R ■	MD6024D	MD6024C		MD6024CX	
KDX 200 H1/H2/H3/H4/H5	95-99	FA152TT		FA152R ■	MD6105D			MD6015CX	
KDX 200 SR (DX 200 G)		FA152TT		FA152R ■	MD6105D				
KLT 200 A1/A4A/C1/C2	81-84	K705		K705G					
KMX 200 A2/A3	88-92	FA067TT		FA067R	MD6108D				
Z 200 A1-A5	77-82	S602							
Z 200 A6	83	S602							
KLF 220 A1-A15	88-02	K706		K706G					
KDX 220 R A4-A12/A6F	97-06	FA152TT		FA152R ■	MD6105D			MD6105CX	
KDX 220 SR (DX 220 B)		FA152TT		FA152R ■	MD6105D			MD6105CX	
250 SIB	75	K708							
ER 250 B1/B2/B3 (Z 250 T Scorpion)	83-88	K706							
EL 250 D1-D5	90-94	K706							
EL 252 (EL 250 F2/F3/F5/F6)	96-03	K706							
EL 250 Eliminator	87-89	K706							
BJ 250 B1-B7A Estrella	92-99	FA067		FA067HH	TBA				
BJ 250 C1-C7 Estrella-RS	99-02	FA067		FA067HH	TBA				
BJ 250 D1-D7 Estrella Custom	96-02	K706							
BJ 250 E1-E4A Estrella RS Custom	96-99	K706							
BJ 250 F1/F2 (250 TR)	02-03	K706							
EX 250 K8F/K9F/KAF/KBF/KBFA/KCF Ninja 250R (Standard Solid Front Disc)	08-12	FA197		FA197HH		MD4163C			
GPX 250 R (ZX 250 F2-F9)	88-95	FA141			MD4042				
GPX 250 R (EX 250 E)	86	FA085	FA085V	FA085HH	MD4032				
GPX 250 R (EX 250 F)	87	FA141			MD4042				
GPX 250 RII (EX 250 G)	88	FA141			MD4042				
KDX 250 B1	79	S605		S605G					
KDX 250 B2/B3	80-84	S602		S602G					
KDX 250 D1	91-93	FA152TT		FA152R ■	MD6105D			MD6105CX	
KH 250 B1-B5	77-82	K708							
KDX 250 SR (KDX 250 F1)	91	FA152TT		FA152R ■	MD6105D			MD6105CX	
KL 250 A1/A2	78-79	S605		S605G					
KL 250 A3/A4/C1/C2	80-84	K703		K703G					
KL 250 J1/J3 Stockman		FA067TT		FA067R	MD6107D				
KL 250 G1/G1A Super Sherpa	97	FA067TT		FA067R	MD6107D				
KLE 250 A2 Anhelo	95	FA067/3			TBA				
KLE 250 A3	97	FA067/3			TBA				
KLE 250 A5/A6	00-01	FA067/3			TBA				
KLX 250 H1 Super Sherpa	98	FA067TT		FA067R	MD6107D				
KLF 250 A1/A2/A3/A6F-A9F/AAF/ABF (Bayou 250)	03-11	K706		K706G					
KLR 250 D2-D22	84-05	K703		K703G					
KLT 250 C1-C3 Prairie	83-85	K705		K705G					
KLX 250 R D1/D2	93-94	FA152TT		FA152R ■	MD6085D				
KLX 250 F1-F4 (KLX 250 ES)	94-97	FA152TT		FA152R ■	MD6085D				

\*-2 Sets Required. ■ - Also available in MX-S race compound.

**SAFETY WARNING:** DO NOT USE HH PADS ON REAR UNLESS ALSO USED ON FRONT TO AVOID BRAKE IMBALANCE

**R** Suffix = High Durability Sintered Pad. **HH** Suffix = High Performance Sintered Pad. **G** Suffix = Grooved Shoe.  
**D** Suffix = Drilled Disc. **C** Suffix = Contoured Disc. **LS** Suffix = Left/Steel Disc. **RS** = Right/Steel Disc.

**BRAKE APPLICATIONS**

# JAPANESE Built Motorcycles



## KAWASAKI Contd.

← FRONT / AVANT / VORN FRENTE / ANTERIORE →

Model	Year	DISC PAD CHOICES				BRAKE ROTOR CHOICES								
		NEW SFAC Scooter Carbon Pads	Semi-Sintered V-Pads™	Sintered/HH Pads/ Grooved shoes	Left/Gauche/Links	Right/Droite/Rechts	Contour Rotor Universal left and right fitment	NEW Vee-Rotors™ CONTOUR	NEW CX Extreme® ROTOR	Oversize 250/280mm Rotor Kit	Relocating Bracket for 250/280mm Rotor	Oversize 320mm Rotor Kit	Relocating Bracket for 320mm Rotor	
KLX 250 G1	94	FA185TT		FA185R ■	MD6091D									
KLX 250 J1-J6 D-Tracker	98-03	FA185TT		FA185R ■	MD6240D		MD6240C			OS6240C	BRK023	SM6240C	BRK024	
KLX 250 S H6FH7F	06-07	FA185TT		FA185R ■	MD6330D		MD6330C			MD6330CX	OS6330C	BRK021	SM6330C	BRK022
NOTE - When installing oversize disc kit also order Hose Bracket KH-B1, and requires longer hose. Order Goodridge ref. 62024														
KLX 250 (KLX 250 S9F/SAF/SBF/SCF/SDF)	09-13	FA135TT		FA135R ■			MD6329C							
KR-1 (KR 250 B2)	89	FA141*			MD4095LS	MD4095RS								
KR-1S (KR 250 C2/C3)	90-92	FA158*		FA158HH*	MD4008	MD4008	MD4008C*	VR4008BLK*						
KR 250 A1/A2	84-86	FA067*		FA067HH*	TBA	TBA								
KSF 250 A1-A18 (KFX 250 Mojave)	87-04	FA128TT*		FA128R*	MD6133D	MD6133D								
KT 250 All models	75-80	K704		K704G										
KX 250	74	S602		S602G										
KX 250 A/A3/A4/A5	75-79	K705		K705G										
KX 250 A6/A7	80-81	K705		K705G										
KX 250 B1	82	FA083TT		FA083R	N/A									
KX 250 C1/C2	83-84	FA067TT		FA067R	N/A									
KX 250 D1	85	FA067TT		FA067R	MD6036D									
KX 250 D2	86	FA067TT		FA067R	MD6036D									
KX 250 E1/F1	87-88	FA130TT		FA130R	MD6036D									
KX 250 G1/H1/H2/J1/J2	89-93	FA135TT		FA135R ■	MD6015D		MD6015C			MD6015CX	N/A	N/A	N/A	N/A
KX 250 K1	94	FA185TT		FA185R ■	MD6015D		MD6015C			MD6015CX	OS6015C	BRK023	SM6015C	BRK024
KX 250 K2/K3/K4/K5/L1/L2/L3/L4	95-02	FA185TT		FA185R ■	MD6015D		MD6015C			MD6015CX	OS6015C	BRK023	SM6015C	BRK024
KX 250 M1/M2/R1 (2T)	03-05	FA185TT		FA185R ■	MD6213D		MD6213C			MD6213CX	OS6213C	BRK023	SM6213C	BRK024
KX 250 R6F/R7F/R8F (2T)	06-08	FA185TT		FA185R ■	MD6264D		MD6264C			MD6264CX	OS6264C	BRK023	SM6264C	BRK024
KX 250 F (KX 250 N1/N2) (4T)	04-05	FA185TT		FA185R ■	MD6213D		MD6213C			MD6213CX	OS6213C	BRK023	SM6213C	BRK024
KX 250 F (T6F/T7F/T8F) (4T)	06-08	FA185TT		FA185R ■	MD6264D		MD6264C			MD6264CX	OS6264C	BRK023	SM6264C	BRK024
KX 250 F (KX 250 W6F/X6F/Y6F/Z6F) (4T)	09-13	FA185TT		FA185R ■			MD6264C			MD6264CX	OS6264C	BRK023	SM6264C	BRK024
KXF 250 A1/A2 Tecate 4	87-88	FA128TT*		FA128R*	MD6133D	MD6133D								
KXT 250 A1 Tecate - 3 Wheel Model	84	K705		K705G										
KXT 250 A2 Tecate - 3 Wheel Model	85	FA067TT		FA067R	N/A									
KXT 250 B1 Tecate - 3 Wheel Model	86	FA067TT		FA067R	MD6138D									
KXT 250 B2 Tecate - 3 Wheel Model	87	FA067TT		FA067R	MD6138D									
SC 250 A1 (Epsilon 250)	02	SFA283*	SFAC283*	SFA283HH*	MD929D		MD929C	VR929						
S1-A/B/C (250cc)	73-75	K711												
Z 250 A1/A2	78-80	FA073			N/A									
Z 250 A3	81	FA068		FA068HH	MD4010LS									
Z 250 B1/B2	80-83	K711												
Z 250 C1/C2/G1/G2	81-83	K711												
ZR 250 A1-A5 Balus	91-95	FA129		FA129HH		MD4008	MD4008C	VR4008BLK						
ZR 250 B6 (Balus-II)	02	FA231		FA231HH		MD4008	MD4008C	VR4008BLK						
ZZR 250 (EX 250 H1-H13)	90-01	FA129		FA129HH		MD4008	MD4008C	VR4008BLK						
ZXR 250 (ZX 250 A1/A2)	89-90	FA141*			MD4008	MD4008	MD4008C*	VR4008BLK*						
ZXR 250 R (ZX 250 B1/B2)	89-90	FA141*			MD4008	MD4008	MD4008C*	VR4008BLK*						
ZXR 250 C1-C3 (ZX 250 C1-C3)	91-95	FA141*			MD4149LS	MD4149RS								
ZXR 250 R (ZX 250 D1)	91	FA141*			MD4149LS	MD4149RS								
EX 300 ADF (Non ABS)	13	FA197		FA197			MD4166C							
EX 300 BDF (ABS)	13	FA197		FA197			MD4166C							
KAF 300 A1/B1/B2 (Mule 500)		S628*		S628G*										
KAF 300 C1/C2/C3/C4/C6/C7/D1 (Mule 550)		S628*		S628G*										
KEF 300 B1/B2/B3 Lakota Sport	01-03	FA128TT*		FA128R*	MD6133D	MD6133D								
KLF 300 A1/A2 Bayou	86-87	K717*		K717G*										
KLF 300 B1-B17 Bayou	88-04	FA067*		FA067R*	MD6133D	MD6133D								
KLF 300 C1-C17 Bayou	Left	89-05	FA165TT	FA165R ■	MD6131D									
	Right		FA135TT	FA135R ■		MD6131D								
KLX 300 A2-A10/A6F/A7F	97-07	FA185TT		FA185R ■	MD6015D					MD6015CX				
KVF 300 A1/A2/A3/A4 (Prairie 4 x 4)	99-02	FA054TT*		FA054R* ■	MD6131D	MD6131D								
KVF 300 B1/B2/B3/B4 (Prairie 2 x 4)	99-02	FA054TT*		FA054R* ■	MD6131D	MD6131D								
KVF 300 CCF/CFD 2X4	13	FA377TT*		FA377R*	MD6267D	MD6267D								
GPZ 305 A1/B1-B10	83-96	FA067*		FA067HH*	MD4105LS	MD4105RS								
S2 (350cc)	72-73	K711												
S2-A (350cc)	72-73	FA033			N/A									

\*-2 Sets Required. ■ - Also available in MX-S race compound.

**SAFETY WARNING-** DO NOT USE HH PADS ON REAR UNLESS ALSO USED ON FRONT TO AVOID BRAKE IMBALANCE

APPLICATIONS

**BRAKE**  
**R** Suffix = High Durability Sintered Pad. **HH** Suffix = High Performance Sintered Pad. **G** Suffix = Grooved Shoe.  
**D** Suffix = Drilled Disc. **C** Suffix = Contoured Disc. **LS** Suffix = Left/Steel Disc. **RS** = Right/Steel Disc.

# JAPANESE Built Motorcycles



**KAWASAKI Contd.**



← REAR / ARRIÈRE / HINTEN  POSTERIOR / POSTERIORE →

		DISC PAD CHOICES				BRAKE ROTOR CHOICES			
		NEW SFAC Scooter Carbon Pads	Semi-Sintered V-Pads™	Sintered/HH Pads/ Grooved shoes		Contour Rotor Rear Fitment	NEW Vee-Rotors™ CONTOUR	NEW CX Extreme® ROTOR	
KLX 250 G1	94	FA152TT		FA152R ■	MD6085D				
KLX 250 J1-J6 D-Tracker	98-03	FA131TT		FA131R ■	MD6105D				
KLX 250 S H6FH7F	06-07	FA131TT		FA131R ■	MD6105D			MD6105CX	
KLX 250 (KLX 250 S9F/SAF/SBF/SCF/SDF)	09-13	FA131TT		FA131R ■		MD6326C			
KR-1 (KR 250 B2)	89	FA141			MD4096				
KR-1S (KR 250 C2/C3)	90-92	FA141			MD4096				
KR 250 A1/A2	84-86	FA085	FA085V	FA085HH	TBA				
KSF 250 A1-A18 (KFX 250 Mojave)	87-04	FA084TT		FA084R	MD6132D				
KT 250 All models	75-80	S602		S602G					
KX 250	74	S605		S605G					
KX 250 A/A3/A4/A5	75-79	S605		S605G					
KX 250 A6/A7	80-81	S605		S605G					
KX 250 B1	82	S602		S602G					
KX 250 C1/C2	83-84	S602		S602G					
KX 250 D1	85	S602		S602G					
KX 250 D2	86	FA067TT		FA067R	MD6161D				
KX 250 E1/F1	87-88	FA067TT		FA067R	MD6161D				
KX 250 G1/H1/H2/J1/J2	89-93	FA152TT		FA152R ■	MD6024D	MD6024C		MD6024CX	
KX 250 K1	94	FA152TT		FA152R ■	MD6024D	MD6024C		MD6024CX	
KX 250 K2/K3/K4/K5/L1/L2/L3/L4	95-02	FA131TT		FA131R ■	MD6024D	MD6024C		MD6024CX	
KX 250 M1/M2/R1 (2T)	03-05	FA131TT		FA131R ■	MD6208D	MD6208C◆		MD6208CX◆	
KX 250 R6F/R7F/R8F (2T)	06-08	FA131TT		FA131R ■	MD6208D	MD6208C◆		MD6208CX◆	
KX 250 F (KX 250 N1/N2) (4T)	04-05	FA367TT		FA367R ■	MD6208D	MD6208C◆		MD6208CX◆	
KX 250 F (T6F/T7F/T8F) (4T)	06-08	FA367TT		FA367R ■	MD6208D	MD6208C◆		MD6208CX◆	
KX 250 F (KX 250 W9F/XAFB/YBF/YCF/ZDF) (4T)	09-13	FA367TT		FA367R ■		MD6208C◆		MD6208CX◆	
KXF 250 A1/A2 Tecate 4	87-88	FA083TT		FA083R	MD6136D				
KXT 250 A1 Tecate - 3 Wheel Model	84	FA083TT		FA083R	N/A				
KXT 250 A2 Tecate - 3 Wheel Model	85	FA067TT		FA067R	N/A				
KXT 250 B1 Tecate - 3 Wheel Model	86	FA067TT		FA067R	MD6138D				
KXT 250 B2 Tecate - 3 Wheel Model	87	FA084TT		FA084R	MD6134D				
SC 250 A1 (Epsilon 250)	02	SFA323/3		SFA323/3HH	MD930D	MD930C	VR930		
S1-A/B/C (250cc)	73-75	K708							
Z 250 A1/A2	78-80	FA161			N/A				
Z 250 A3	81	FA161		FA161HH	N/A				
Z 250 B1/B2	80-83	K706							
Z 250 C1/C2/G1/G2	81-83	S602							
ZR 250 A1-A5 Balius	91-95	FA067/3			MD4051	MD4051C			
ZR 250 B6 (Balius-II)	02	FA067		FA067HH	MD4051	MD4051C			
ZZR 250 (EX 250 H1-H13)	90-01	FA067/3			MD4117				
ZXR 250 (ZX 250 A1/A2)	89-90	FA141			MD4051	MD4051C			
ZXR 250 R (ZX 250 B1/B2)	89-90	FA141			MD4051	MD4051C			
ZXR 250 C1-C3 (ZX 250 C1-C3)	91-95	FA067/3			MD4051	MD4051C			
ZXR 250 R (ZX 250 D1)	91	FA067/3			MD4051	MD4051C			
EX 300 ADF (Non ABS)	13	FA197		FA197		MD4163C			
EX 300 BDF (ABS)	13	FA197		FA197		MD4163C			
KAF 300 A1/B1/B2 (Mule 500)		K718*		N/A					
KAF 300 C1/C2/C3/C4/C6/C7/D1 (Mule 550)		K718*		N/A					
KEF 300 B1/B2/B3 Lakota Sport	01-03	FA084TT		FA084R	MD6132D				
KLF 300 A1/A2 Bayou	86-87	K706		K706G					
KLF 300 B1-B17 Bayou	88-04	K706		K706G					
KLF 300 C1-C17 Bayou	89-05	K710		K710G					
KLX 300 A2-A10/A6F/A7F	97-07	FA131TT		FA131R ■	MD6105D			MD6105CX	
KVF 300 A1/A2/A3/A4 (Prairie 4 x 4)	99-02	K710		K710G					
KVF 300 B1/B2/B3/B4 (Prairie 2 x 4)	99-02	K710		K710G					
KVF 300 CCF/CDF 2X4	13	FA377TT		FA377R	MD6267D				
GPZ 305 A1/B1-B10	83-96	K706							
S2 (350cc)	72-73	K708							
S2-A (350cc)	72-73	K708							

\*-2 Sets Required. ■ - Also available in MX-S race compound.

**SAFETY WARNING:** DO NOT USE HH PADS ON REAR UNLESS ALSO USED ON FRONT TO AVOID BRAKE IMBALANCE

**R** Suffix = High Durability Sintered Pad. **HH** Suffix = High Performance Sintered Pad. **G** Suffix = Grooved Shoe.  
**D** Suffix = Drilled Disc. **C** Suffix = Contoured Disc. **LS** Suffix = Left/Steel Disc. **RS** = Right/Steel Disc.

**BRAKE APPLICATIONS**



# JAPANESE Built Motorcycles



## KAWASAKI Contd.



		FRONT / AVANT / VORN				FRENTE / ANTERIORE							
		DISC PAD CHOICES				BRAKE ROTOR CHOICES							
		NEW SFAC Scooter Carbon Pads	Semi-Sintered V-Pads™	Sintered/HH Pads/ Grooved shoes	Left/Gauche/Links	Right/Droite/Rechts	Contour Rotor Universal left and right fitment	NEW Vee-Rotors™ CONTOUR	NEW CX Extreme® ROTOR	Oversize 250/280mm Rotor Kit	Relocating Bracket for 250/280mm Rotor	Oversize 320mm Rotor Kit	Relocating Bracket for 320mm Rotor
KVF 360 A1-A3/A6F/A7F/A8F/A9F/AA/AF/ABF/ACF/ADF	03-13	FA054TT*		FA054R* ■	MD6188D	MD6188D							
KVF 360 B1-B3/B6F/B7F/B8F/B9F	03-09	FA054TT*		FA054R* ■	MD6188D	MD6188D							
KVF 360 C1-C3/C6F/C7F/C8F Prairie All models	03-08	FA054TT*		FA054R* ■	MD6188D	MD6188D							
KAF 400 A6F/A7F/A8F/A9F/AAF (Mule 610 4x4)	06-10	K718*											
KAF 400 ABF/ACF/ADF (Mule 610 4x4)	11-13	K718*											
KAF 400 B6F/B7F/B8F/B9F/BAF/BBF/BCF/BDF (Mule 600)	06-13	K718*											
KH 400 A3/A4/A5	76-78	FA033			N/A								
KLF 400 B1-B7 Bayou	Left	93-99	FA165TT	FA165R ■	MD6131D								
	Right		FA135TT	FA135R ■		MD6131D							
KSF 400 A1/A2/A3/A6F (KFX 400)	03-06	FA084TT*		FA084R* ■	MD6210D	MD6210D							
KVF 400 A1/A2/B1 Prairie	97-98	FA054TT*		FA054R* ■	MD6131D	MD6131D							
KVF 400 C1/C2/C3/C4 (Prairie 4 x 4)	99-02	FA054TT*		FA054R* ■	MD6131D	MD6131D							
KVF 400 D1/D2/D3 (Prairie 2 x 4)	99-01	FA054TT*		FA054R* ■	MD6131D	MD6131D							
S3/S3-A (400cc)	74-75	FA033			N/A								
Z 400 B1/B2	78-80	FA048			N/A								
Z 400 G1	79	FA033			N/A								
Z 400 J1	80	FA073*			MD4047LS	MD4047RS							
Z 400 J2/J3	81-83	FA068*		FA068HH*	MD4010LS	MD4010RS							
ZR 400 A1/B1 (Z 400 F)	83-84	FA067*		FA067HH*	MD4108LS	MD4108RS							
Z 400 C2/C3 (Z 400 F2)	85-87	FA067*		FA067HH*	MD4028	MD4028							
ZL 400 A Eliminator	86-87	FA085		FA085HH	MD4016								
ZL 400 B Eliminator 400 SE	88	FA067*		FA067HH*	MD4135LS	MD4135RS							
ZL 400 D1/D2	94-95	FA129		FA129HH		MD4008	MD4008C						
FX 400 R (ZX 400 E1-E3)	86-88	FA067*		FA067HH*	MD4135LS	MD4135RS							
GPZ 400 R (ZX 400 D/D3/D3A)	85-87	FA067*		FA067HH*	MD4135LS	MD4135RS							
GPZ 400 R D4	88	FA141*			MD4143LS	MD4143RS							
GPX 400 R (ZX 400 F1)	87	FA141*			MD4140LS	MD4140RS							
KLX 400 R (KLX 400 B1/B2)	03-04	FA185TT		FA185R ■	MD6017D		MD6017C		MD6017CX	OS6017C	BRK023	SM6017C	BRK024
ZR 400 D1/D3/D4 Xanithus	92-95	FA141*			TBA	TBA							
ZR 400 Zephyr (G2/G3/G3A/G4/G5)	97-01	FA158*		FA158HH*	TBA	TBA							
ZRX 400 (ZR 400 E1/E2)	94-95	FA129		FA129HH	MD4008	MD4008	MD4008C*	VR4008BLK*					
ZRX 400 E3 (ZR 400 E3)	Left	96	FA229	FA229HH	MD4008	MD4008	MD4008C*	VR4008BLK*					
	Right		FA231	FA231HH									
ZPX 400 (ZX 400 E4/E5/E7)	98-01			FA294HH*	MD4008	MD4008	MD4008C*	VR4008BLK*					
ZX-4 (ZX 400 G1/G1A/G1B)	88	FA141*			MD4134	MD4134							
ZXR 400 H1/H2	89-90	FA158*		FA158HH*	MD4008	MD4008	MD4008C*	VR4008BLK*					
ZXR 400 R (ZXR 400 J1)	89	FA158*		FA158HH*	MD4008	MD4008	MD4008C*	VR4008BLK*					
ZXR 400 R (ZX 400 J2)	90	FA158*		FA158HH*	MD4008	MD4008	MD4008C*	VR4008BLK*					
ZXR 400 R (ZX 400 M1-M4)	91-94	FA158*		FA158HH*	MD4005	MD4005							
ZXR 400 L1-L9	91-03	FA180*		FA180HH*	MD4005	MD4005							
ZZ-R 400 (ZX 400 K1/K2/K3)	90-92	FA158*		FA158HH*	MD4008	MD4008	MD4008C*	VR4008BLK*					
ZZ-R 400 (ZX 400 N1-N7)	93-99	FA158*		FA158HH*	MD4008	MD4008	MD4008C*	VR4008BLK*					
KX 420 A1/A2	80-81	K705		K705G									
Z 440 A2 LTD	79	FA073			MD4047LS								
Z 440 C1	80	FA073			N/A								
Z 440 C2	81	FA068		FA068HH	MD4010LS								
Z 440 D4 LTD	82	FA073			MD4047LS								
Z 440 D5/D6 LTD	83-84	FA068		FA068HH	MD4010LS								
Z 440 H1/H2	82-83	FA068		FA068HH	MD4010LS								
LTD 454 (EN 450 A1-A5)	86-89	FA085		FA085HH	MD4006LS								
KFX 450 R Quad (KSF 450 B8F/B9F/BAF/BBF/BCS)	Left	08-12		FA342R	MD6137D								
	Right			FA349R		MD6137D							
KLX 450 R (A8F/A9F/AA/AF/ABF/ACF)	08-12	FA185TT		FA185R ■	MD6264D		MD6264C		MD6264CX	OS6264C	BRK023	SM6264C	BRK024
KX 450 F (D6F/D7F/D8F/E9F/EA/EBF/FCF/FDF)	06-13	FA185TT		FA185R ■	MD6264D		MD6264C		MD6264CX	OS6264C	BRK023	SM6264C	BRK024
EN 500 A1-A3	90-93	FA085		FA085HH	MD4006LS								
EN 500 B1-B2/C1-C9	94-04	FA085		FA085HH	MD4124LS								
ER-5 (ER 500 A1/A2/A3/A4)	97-00	FA129		FA129HH	MD4016								
ER-5 (ER 500 C1/C3/C4/C5P)	01-07	FA229		FA229HH	MD4016								
GPZ 500 S (EX 500 A1-A6)	87-93	FA129		FA129HH	MD4016								

\*-2 Sets Required. ■ - Also available in MX-S race compound.

**SAFETY WARNING:** DO NOT USE HH PADS ON REAR UNLESS ALSO USED ON FRONT TO AVOID BRAKE IMBALANCE

APPLICTIONS  
BRAKE

R Suffix = High Durability Sintered Pad. HH Suffix = High Performance Sintered Pad. G Suffix = Grooved Shoe.

D Suffix = Drilled Disc. C Suffix = Contoured Disc. LS Suffix = Left/Steel Disc. RS = Right/Steel Disc.

# JAPANESE Built Motorcycles



## KAWASAKI Contd.



← REAR / ARRIÈRE / HINTEN  POSTERIOR / POSTERIORE →

			DISC PAD CHOICES			BRAKE ROTOR CHOICES			
			NEW SFAC Scooter Carbon Pads	Semi-Sintered V-Pads™	Sintered/HH Pads/ Grooved shoes	 Contour Rotor Rear Fitment	NEW Vee-Rotors™ CONTOUR	NEW CX Extreme® ROTOR	
KVF 360 A1-A3/A6/A7/A8/A9/A9F/AA/ABF/AC/ADF	03-13	N/A							
KVF 360 B1-B3/B6/FB7F/B8F/B9F	03-09	N/A							
KVF 360 C1-C3/C8F/C7F/C8F Prairie All models	03-08	N/A							
KAF 400 A6F/A7F/A8F/A9F/AAF (Mule 610 4x4)	06-10	K718*							
KAF 400 ABF/AC/ADF (Mule 610 4x4)	11-13	K719*							
KAF 400 B6F/B7F/B8F/B9F/BAF/BBF/BCF/BDF (Mule 600)	06-13	K718*							
KH 400 A3/A4/A5	76-78	K708							
KLF 400 B1-B7 Bayou	93-99	K710			K710G				
KSF 400 A1/A2/A3/A6F (KFX 400)	03-06	FA137TT			FA137R	MD6211D			
KVF 400 A1/A2/B1 Prairie	97-98	K710			K710G				
KVF 400 C1/C2/C3/C4 (Prairie 4 x 4)	99-02	K710			K710G				
KVF 400 D1/D2/D3 (Prairie 2 x 4)	99-01	K710			K710G				
S3/S3-A (400cc)	74-75	K708							
Z 400 B1/B2	78-80	K706							
Z 400 G1	79	K706							
Z 400 J1	80	K709							
Z 400 J2/J3	81-83	K709							
ZR 400 A1/B1 (Z 400 F)	83-84	K706							
Z 400 C2/C3 (Z 400 F2)	85-87	FA085		FA085V	FA085HH	MD4001			
ZL 400 A Eliminator	86-87	K709							
ZL 400 B Eliminator 400 SE	88	K709							
ZL 400 D1/D2	94-95	K709							
FX 400 R (ZX 400 E1-E3)	86-88	FA085		FA085V	FA085HH	MD4015			
GPZ 400 R (ZX 400 D/D3/D3A)	85-87	FA085		FA085V	FA085HH	MD4015			
GPZ 400 R D4	88	FA129				TBA			
GPX 400 R (ZX 400 F1)	87	FA129				MD4027			
KLX 400 R (KLX 400 B1/B2)	03-04	FA131TT			FA131R ■	MD6014D	MD6014C		MD6014CX
ZR 400 D1/D3/D4 Xanthus	92-95	FA067/3				TBA			
ZR 400 Zephyr (G2/G3/G3A/G4/G5)	97-01	FA192		FA192V	FA192HH	MD4009			
ZRX 400 (ZR 400 E1/E2)	94-95	FA192		FA192V	FA192HH	TBA			
ZRX 400 E3 (ZR 400 E3)	96	FA192		FA192V	FA192HH	TBA			
ZRX 400 (ZX 400 E4/E5/E6/E7)	98-01	FA192		FA192V	FA192HH	TBA			
ZX-4 (ZX 400 G1/G1A/G1B)	88	FA141				MD4009			
ZXR 400 H1/H2	89-90	FA161		FA161HH	FA161HH	MD4009	MD4009C	VR4009	
ZXR 400 R (ZXR 400 J1)	89	FA161		FA161HH	FA161HH	MD4009	MD4009C	VR4009	
ZXR 400 R (ZX 400 J2)	90	FA161		FA161HH	FA161HH	MD4009	MD4009C	VR4009	
ZXR 400 R (ZX 400 M1-M4)	91-94	FA161		FA161HH	FA161HH	MD4009			
ZXR 400 L1-L9	91-03	FA161		FA161HH	FA161HH	MD4009			
ZZ-R 400 (ZX 400 K1/K2/K3)	90-92	FA129		FA129V	FA129HH	MD4007		VR4007	
ZZ-R 400 (ZX 400 N1-N7)	93-99	FA192		FA192V	FA192HH	MD4009	MD4009C	VR4009	
KX 420 A1/A2	80-81	S605			S605G				
Z 440 A2 LTD	79	K706							
Z 440 C1	80	K706							
Z 440 C2	81	K706							
Z 440 D4 LTD	82	K706							
Z 440 D5/D6 LTD	83-84	K706							
Z 440 H1/H2	82-83	K706							
LTD 454 (EN 450 A1-A5)	86-89	K709							
KAF 450 B1 (Mule 1000)		K720*			N/A				
KFX 450 R Quad (KSF 450 B8F/B9F/BAF/BBF/BCS)	08-12	FA084TT			FA084R		MD6304C		
KLX 450 R (A8F/A9F/AA/ABF/AC/AF)	08-12	FA367TT			FA367R ■	MD6208D	MD6208C◆		MD6208CX◆
KX 450 F (D6F/D7F/D8F/E9F/EA/EBF/FC/FF/DF)	06-13	FA367TT			FA367R ■	MD6208D	MD6208C◆		MD6208CX◆
EN 500 A1-A3	90-93	K709							
EN 500 B1-B2/C1-C3	94-04	K709							
ER-5 (ER 500 A1/A2/A3/A4)	97-00	K706							
ER-5 (ER 500 C1/C3/C4/C5P)	01-07	K706							
GPZ 500 S (EX 500 A1-A6)	87-93	K706							

\*-2 Sets Required. ■ - Also available in MX-S race compound.

**SAFETY WARNING:** DO NOT USE HH PADS ON REAR UNLESS ALSO USED ON FRONT TO AVOID BRAKE IMBALANCE

**R** Suffix = High Durability Sintered Pad. **HH** Suffix = High Performance Sintered Pad. **G** Suffix = Grooved Shoe.  
**D** Suffix = Drilled Disc. **C** Suffix = Contoured Disc. **LS** Suffix = Left/Steel Disc. **RS** = Right/Steel Disc.

**BRAKE APPLICATIONS**

# JAPANESE Built Motorcycles



## KAWASAKI Contd.

		FRONT / AVANT / VORN						FRENT / ANTERIORE					
		DISC PAD CHOICES						BRAKE ROTOR CHOICES					
		NEW SFAC Scooter Carbon Pads	Semi-Sintered V-Pads™	Sintered/HH Pads/ Grooved shoes	Left/Gauche/Links	Right/Droite/Rechts	Contour Rotor Universal left and right fitment	NEW Vee-Rotors™ CONTOUR	NEW CX Extreme® ROTOR	Oversize 250/280mm Rotor Kit	Relocating Bracket for 250/280mm Rotor	Oversize 320mm Rotor Kit	Relocating Bracket for 320mm Rotor
GPZ 500 S (EX 500 B1-B5)	88-93	FA067*		FA067HH*	MD4144	MD4144							
GPZ 500 S (EX 500 D1-D7)	94-01	FA129		FA129HH		MD4016							
GPZ 500 S (EX 500 E1-E10)	94-04	FA141*			MD4144	MD4144							
H1 500 Mach 111	69-70	NA											
H1-A 500 S Mach 111	71	NA											
H1-B/C 500 Mach 111	72	NA											
H1-D/E/F 500	73-75	FA055		FA055HH	MD4069LS								
KH 500 A8	76	FA033			MD4052LS								
KLE 500 A1-A12	91-04	FA129		FA129R	MD6093D								
KLE 500 B1P/B6F/B7F	05-07	FA129		FA129HH	MD6093D								
KX 500 A1/A2	83-84	FA067TT		FA067R	N/A								
KX 500 B1	85	FA067TT		FA067R	MD6036D								
KX 500 B2	86	FA067TT		FA067R	MD6036D								
KX 500 C1/D1	87-88	FA130TT		FA130R	MD6036D								
KX 500 E1-E5	89-93	FA135TT		FA135R ■	MD6015D		MD6015C		MD6015CX	N/A	N/A	N/A	N/A
KX 500 E6/E7	94-95	FA185TT		FA185R ■	MD6015D		MD6015C		MD6015CX	OS6015C	BRK023	SM6015C	BRK024
KX 500 E8-E16	96-04	FA185TT		FA185R ■	MD6015D		MD6015C		MD6015CX	OS6015C	BRK023	SM6015C	BRK024
Z 500 B1-B2	79-80	FA073*			MD4047LS	MD4047RS							
KAF 540 C1 (Mule 2010)		K719*		N/A									
KAF 540 D1 (Mule 2020)		K719*		N/A									
KAF 540 E1 (Mule 2030)		K719*		N/A									
GPZ 550 D1	82	FA068*		FA068HH*	MD4010LS	MD4010RS							
GPZ 550 H1/H2	82-83	FA068*		FA068HH*	MD4099	MD4099							
GPZ 550 A1-A4 (ZX 550 A1-A4)	84-87	FA085*		FA085HH*	MD4002LS	MD4002RS							
GT 550 G1-G9	83-01	FA067*		FA067HH*	MD4006LS	MD4006RS							
Z 550 A1	80	FA073*			MD4047LS	MD4047RS							
Z 550 A2/A3	81-82	FA068*		FA068HH*	MD4010LS	MD4010RS							
Z 550 C1/C2 LTD	82-84	FA068*		FA068HH*	MD4010LS	MD4010RS							
ZR 550 A1/A2 (Z 550 F)	83-84	FA067*		FA067HH*	MD4108LS	MD4108RS							
ZR 550 B2/B3 Zephyr	91-93	FA129*		FA129HH*	MD4008	MD4008	MD4008C*	VR4008BLK*					
ZR 550 B4-B6 Zephyr	94-99	FA129*		FA129HH*	MD4008	MD4008	MD4008C*	VR4008BLK*					
GPX 600 R (ZX 600 C1-C7)	88-96	FA129*		FA129HH*	MD4026LS	MD4026RS							
GPZ 600 R A1-A5A	85-89	FA085*		FA085HH*	MD4028	MD4028							
KLR 600 A1/B2/B1-B4/B6-B9	84-94	FA067		FA067R	MD6080D								
ZL 600 B1 Eliminator	95-97	FA129*	FA129V*	FA129HH		MD4008	MD4008C	VR4008BLK*					
ZZR 600 (ZX 600 D1-D3)	90-93	FA158*		FA158HH*	MD4141	MD4141	MD4141C*	VR4141BLK*					
ZZR 600 (ZX 600 E1-E13)	93-05	FA158*		FA158HH*	MD4153X	MD4153X	MD4153XC*	VR4153BLK*					
ZZR 600 (ZX 600 E6F)	06-07	FA158*		FA158HH*	MD4153X	MD4153X	MD4153XC*	VR4153BLK*					
ZX-6R (ZX 600 F1-F3)	95-97	FA158*		FA158HH*	MD4008	MD4008	MD4008C*	VR4008BLK*					
ZX-6R (ZX 600 G1/G2/J1/J2)	98-01	FA188*		FA188HH*	MD4136X	MD4136X	MD4136XC*	VR4136BLK*					
ZX-6R (ZX 600 P7F/P8F)	07-08			FA417/4HH*			MD4152XC*	VR4152BLK*					
ZX-6R (ZX 600 R9F/RAF/RBF/RCF/RDF/599cc)	09-13			FA417/4HH*			MD4152XC*	VR4152BLK*					
ZX-6R (ZX 636 A1P) 636cc	02	FA188*		FA188HH*	MD4136X	MD4136X	MD4136XC*	VR4136BLK*					
ZX-6R (ZX 636 B1/B2)	03-04			FA369/4HH*	MD4151X	MD4151X	MD4151XC*	VR4151BLK*					
ZX-6R (ZX 636 C1/C6F)	05-06			FA369/4HH*			MD4152XC*	VR4152BLK*					
ZX-6R (ZX 636 EDF - Non ABS - 636cc)	13			FA417/4HH*			TBA*						
ZX-6R (ZX 636 FDF - ABS - 636cc)	13			FA417/4HH*			TBA*						
ZX-6RR (ZX 600 K1/M1)	03-04			FA369/4HH*	MD4151X	MD4151X	MD4151XC*	VR4151BLK*					
ZX-6RR (ZX 600 N1/M6F)	05-06			FA369/4HH*			MD4152XC*	VR4152BLK*					
KAF 620 A1/A2/A3/A6 (Mule 2510)		K719*		N/A									
KAF 620 B1/B2/B6 (Mule 2520)		K719*		N/A									
KAF 620 C1/C2/C3/C6 (Mule 2500)		K719*		N/A									
KAF 620 E1/E2/E3/E4/E5 Mule 3010		K719*		N/A									
KAF 620 F1/F2 Mule 3020		K719*		N/A									
KAF 620 G1/G2/G3/G4/G5 Mule 3000		K719*		N/A									
KAF 620 H1/H2/H3 (Mule 3010 4x4)		K719*		N/A									
KAF 620 J1/K1/K6F/K7F (Mule 3010 Trans 4x4)	05-07	K719*		N/A									
KAF 620 M9F/MAF/MBF/MCF (Mule 4010 Trans 4x4)	09-12	K719*		N/A									
KAF 620 N9F (Mule 4010 Trans 4x4 Hardwoods Green)	09	K719*		N/A									
KAF 620 P9F/PAF (Mule 4000)	09	K719*		N/A									

\*-2 Sets Required. ■ - Also available in MX-S race compound.

**SAFETY WARNING:** DO NOT USE HH PADS ON REAR UNLESS ALSO USED ON FRONT TO AVOID BRAKE IMBALANCE

APPLICATIONS  
BRAKE

R Suffix = High Durability Sintered Pad. HH Suffix = High Performance Sintered Pad. G Suffix = Grooved Shoe.

D Suffix = Drilled Disc. C Suffix = Contoured Disc. LS Suffix = Left/Steel Disc. RS = Right/Steel Disc.

# JAPANESE Built Motorcycles



**KAWASAKI** Contd.



← REAR / ARRIÈRE / HINTEN  POSTERIOR / POSTERIORE →

		DISC PAD CHOICES				BRAKE ROTOR CHOICES			
		NEW SFAC Scooter Carbon Pads	Semi-Sintered V-Pads™	Sintered/HH Pads/ Grooved shoes		Contour Rotor Rear Fitment	NEW Vee-Rotors™ CONTOUR	NEW CX Extreme® ROTOR	
GPZ 500 S (EX 500 B1-B5)	88-93								
GPZ 500 S (EX 500 D1-D7)	94-01	FA067/3			MD4051	MD4051C			
GPZ 500 S (EX 500 E1-E10)	94-04	FA067			MD4051	MD4051C			
H1 500 Mach 111	69-70	N/A							
H1-A 500 S Mach 111	71	N/A							
H1-B/C 500 Mach 111	72	N/A							
H1-D/E/F 500	73-75	K710							
KH 500 A8	76	K710							
KLE 500 A1-A12	91-04	FA067/3			MD6082D				
KLE 500 B1P/B6F/B7F	05-07	FA067/3			MD6082D				
KX 500 A1/A2	83-84	S602		S602G					
KX 500 B1	85	S602		S602G					
KX 500 B2	86	FA067TT		FA067R	MD6161D				
KX 500 C1/D1	87-88	FA067		FA067R	MD6161D				
KX 500 E1-E5	89-93	FA152TT		FA152R ■	MD6024D	MD6024C	MD6024CX		
KX 500 E6/E7	94-95	FA152TT		FA152R ■	MD6024D	MD6024C	MD6024CX		
KX 500 E8-E16	96-04	FA131TT		FA131R ■	MD6024D	MD6024C	MD6024CX		
Z 500 B1-B2	79-80	FA036			N/A				
KAF 540 C1 (Mule 2010)		K720*		N/A					
KAF 540 D1 (Mule 2020)		K720*		N/A					
KAF 540 E1 (Mule 2030)		K720*		N/A					
GPZ 550 D1	82	FA068	FA068V	FA068HH	MD4010				
GPZ 550 H1/H2	82-83	FA068	FA068V	FA068HH	MD4024				
GPZ 550 A1-A4 (ZX 550 A1-A4)	84-87	FA085	FA085V	FA085HH	MD4001				
GT 550 G1-G9	83-01	K709							
Z 550 A1	80	K709							
Z 550 A2/A3	81-82	K709							
Z 550 C1/C2 LTD	82-84	K709							
ZR 550 A1/A2 (Z 550 F)	83-84	K706							
ZR 550 B2/B3 Zephyr	91-93	FA141			MD4009	MD4009C	VR4009		
ZR 550 B4-B6 Zephyr	94-99	FA192	FA192V	FA192HH	MD4009	MD4009C	VR4009		
GPX 600 R (ZX 600 C1-C7)	88-96	FA129	FA129V	FA129HH	MD4027				
GPZ 600 R A1-ASA	85-89	FA085	FA085V	FA085HH	MD4015				
KLR 600 A1/B2/B1-B4/B6-B9	84-94	S602		S602G					
ZL 600 B1 Eliminator	95-97	K709							
ZZR 600 (ZX 600 D1-D3)	90-93	FA129	FA129V	FA129HH	MD4007		VR4007		
ZZR 600 (ZX 600 E1-E13)	93-05	FA192	FA192V	FA192HH	MD4009	MD4009C	VR4009		
ZZR 600 (ZX 600 E6F)	06-07	FA192	FA192V	FA192HH	MD4009	MD4009C	VR4009		
ZX-6R (ZX 600 F1-F3)	95-97	FA192	FA192V	FA192HH	MD4023	MD4023C	VR4023		
ZX-6R (ZX 600 G1/G2/J1/J2)	98-01	FA192	FA192V	FA192HH	MD4138	MD4138C	VR4138		
ZX-6R (ZX 600 P7F/P8F)	07-08	FA192	FA192V	FA192HH		MD4138C	VR4138		
ZX-6R (ZX 600 R9F/RAF/RBF/RCF/RDF 599cc)	09-13	FA192	FA192V	FA192HH		MD4138C	VR4138		
ZX-6R (ZX 636 A1P) 636cc	02	FA192	FA192V	FA192HH	MD4138	MD4138C	VR4138		
ZX-6R (ZX 636 B1/B2)	03-04	FA192	FA192V	FA192HH	MD4138	MD4138C	VR4138		
ZX-6R (ZX 636 C1/C6F)	05-06	FA192	FA192V	FA192HH	MD4138	MD4138C	VR4138		
ZX-6R (ZX 636 EDF - Non ABS - 636cc)	13	FA436		FA436HH		MD4165C			
ZX-6R (ZX 636 FDF - ABS - 636cc)	13	FA436		FA436HH		MD4165C			
ZX-6RR (ZX 600 K1/M1)	03-04	FA192	FA192V	FA192HH	MD4138	MD4138C	VR4138		
ZX-6RR (ZX 600 N1/N6F)	05-06	FA192	FA192V	FA192HH		MD4138C	VR4138		
KAF 620 A1/A2/A3/A6 (Mule 2510)		K720*		N/A					
KAF 620 B1/B2/B6 (Mule 2520)		K720*		N/A					
KAF 620 C1/C2/C3/C6 (Mule 2500)		K720*		N/A					
KAF 620 E1/E2/E3/E4/E5 Mule 3010		K720*		N/A					
KAF 620 F1/F2 Mule 3020		K720*		N/A					
KAF 620 G1/G2/G3/G4/G5 Mule 3000		K720*		N/A					
KAF 620 H1/H2/H3 (Mule 3010 4x4)		K720*		N/A					
KAF 620 J1/K1/K6F/K7F (Mule 3010 Trans 4x4)	05-07	K720*		N/A					
KAF 620 M9F/MAF/MBF/MCF (Mule 4010 Trans 4x4)	09-12	K720*		N/A					
KAF 620 N9F (Mule 4010 Trans 4x4 Hardwoods Green)	09	K720*		N/A					
KAF 620 P9F/PAF (Mule 4000)	09	K720*		N/A					

\*-2 Sets Required. ■ - Also available in MX-S race compound.

**SAFETY WARNING:** DO NOT USE HH PADS ON REAR UNLESS ALSO USED ON FRONT TO AVOID BRAKE IMBALANCE

**R** Suffix = High Durability Sintered Pad. **HH** Suffix = High Performance Sintered Pad. **G** Suffix = Grooved Shoe.  
**D** Suffix = Drilled Disc. **C** Suffix = Contoured Disc. **LS** Suffix = Left/Steel Disc. **RS** = Right/Steel Disc.

**BRAKE APPLICATIONS**



# JAPANESE Built Motorcycles



## KAWASAKI Contd.

		FRONT / AVANT / VORN		FRENTE / ANTERIORE											
		DISC PAD CHOICES				BRAKE ROTOR CHOICES									
		NEW SFAC Scooter Carbon Pads	Semi-Sintered V-Pads™	Sintered/HH Pads/ Grooved shoes	Left/Gauche/Links	Right/Droite/Rechts	Contour Rotor Universal left and right fitment	NEW Vee-Rotors™ CONTOUR	NEW CX Extreme® ROTOR	Oversize 250/280mm Rotor Kit	Relocating Bracket for 250/280mm Rotor	Oversize 320mm Rotor Kit	Relocating Bracket for 320mm Rotor		
KAF 620 R9F/RA9F/RBF/RCF (Mule 4010 Trans 4x4)	09-12	K719*		N/A											
KAF 620 S9F/SA9F/SBF/SCF (Mule 4010 Trans 4x4 Hardwoods Green)	09-12	K719*		N/A											
ER-6f Non ABS Model / EX 650 A6F/A7F/	Left 06-11	FA229	FA229V	FA229HH			MD4159XC	VR4159BLK							
A8F/C9F/CAF/CBF	Right	FA231	FA231V	FA231HH			MD4159XC	VR4159BLK							
ER-6f (ABS Model) / EX 650 B6F/B7F/B8F	Left 06-11	FA229	FA229V	FA229HH			MD4156AXC								
/D9F/DAF/DBF	Right	FA231	FA231V	FA231HH			MD4156XC								
ER-6f - ECF/EDF (Double Pipe Type Frame / Non ABS Model)	Left 12-13	FA229	FA229V	FA229HH			MD4159XC	VR4159BLK							
Right		FA231	FA231V	FA231HH			MD4159XC	VR4159BLK							
ER-6f - FCF/FDF (Double Pipe Type Frame / ABS Model)	Left 12-13	FA229	FA229V	FA229HH			MD4156AXC								
Right		FA231	FA231V	FA231HH			MD4156XC								
ER-6n (Non ABS Model) /	Left 06-11	FA229	FA229V	FA229HH			MD4159XC	VR4159BLK							
ER 650 A6F/A7F/A8F/C9F/CAF/CBF	Right	FA231	FA231V	FA231HH			MD4159XC	VR4159BLK							
ER-6n (ABS Model)	Left 06-11	FA229	FA229V	FA229HH			MD4156AXC								
(ER 650 B6F/B7F/B8F/D9F/DAF/DBF)	Right	FA231	FA231V	FA231HH			MD4159XC								
ER-6n - ECF (Double Pipe Type Frame / Non ABS Model)	Left 12-13	FA229	FA229V	FA229HH			MD4159XC	VR4159BLK							
Right		FA231	FA231V	FA231HH			MD4159XC	VR4159BLK							
ER-6n - FCF (Double Pipe Type Frame / ABS Model)	Left 12-13	FA229	FA229V	FA229HH			MD4156AXC								
Right		FA231	FA231V	FA231HH			MD4156XC								
KLR 650 A1-A3	87-89	FA130TT	FA130V	FA130R	MD6042D					MD6042CX	N/A	N/A	SM6042C	BRK017	
KL 650 B1-B3 Tengai	89-92	FA129	FA129V*	FA129R	MD6081D										
KLE 650 A7F/A8F/A9F/CAF Versys	Left 07-10	FA229	FA229V	FA229HH			MD4159XC	VR4159BLK							
Right		FA231	FA231V	FA231HH			MD4159XC	VR4159BLK							
KLE 650 B7F/B8F/B9F/DAF Versys ABS	Left 07-10	FA229	FA229V	FA229HH			MD4156AXC								
Right		FA231	FA231V	FA231HH			MD4156XC								
KLE 650 CBF/CCF/DCF Versys / Non ABS	Left 11-13	FA229	FA229V	FA229HH			MD4159XC	VR4159BLK							
Right		FA231	FA231V	FA231HH			MD4159XC	VR4159BLK							
KLE 650 DBF/DF/DFV Versys/ ABS	Left 11-13	FA229	FA229V	FA229HH			MD4156AXC								
Right		FA231	FA231V	FA231HH			MD4156XC								
KLR 650 C1-C10	95-04	FA229	FA229V	FA229HH	MD6081D										
KLR 650 (KL650 E8F/E9F)	08-09	FA228		FA228HH			MD6309C			N/A	N/A	SM6309C	BRK018		
KLX 650 C1/C2/C3	93-97	FA185TT		FA185R ■	MD6086D										
KVF 650 A1/A2 Prairie	Left 02-03	N/A		FA342R	MD6188D										
Right		N/A		FA349R		MD6188D									
KVF 650 D1/D6F/D7F/D8F/D9F/DAF/DBF	Left 05-11			FA342R	MD6188D										
Brute Force 4x4	Right			FA349R		MD6188D									
KVF 650 E1/E6F/E7F/E8F/E9F Brute Force	Left 05-09			FA342R	MD6188D										
4x4 Hardwoods Green HD	Right			FA349R		MD6188D									
KVF 650 E8FA Brute Force 4x4	Left 08	FA165TT		FA165R ■	MD6188D										
Hardwoods Green HD	Right	FA135TT		FA135R ■		MD6188D									
KVF 650 F7F/F8F Brute Force 4x4i	Left 07-08	FA165TT		FA165R ■	MD6188D										
Hardwoods Green	Right	FA135TT		FA135R ■		MD6188D									
KVF 650 H7F/H8F Brute Force 4x4i	Left 07-08	FA165TT		FA165R ■	MD6188D										
Hardwoods Green	Right	FA135TT		FA135R ■		MD6188D									
KVF 650 G7F/G8F Brute Force 4x4i	Left 07-08	FA165TT		FA165R ■	MD6188D										
Hardwoods Green	Right	FA135TT		FA135R ■		MD6188D									
W 650 (EJ 650-A1/C3/C4/C5/C6/C7)	99-05	FA231		FA231HH		MD4008RS	MD4008C	VR4008BLK							
Z 650 B1/B2/B3	77-79	FA033			MD4062LS										
Z 650 C1/C2	77-78	FA033*			MD4069LS	MD4059RS									
Z 650 C3	79	FA073*			MD4069LS	MD4059RS									
Z 650 D2/D3 (SR)	79-80	FA073*			MD4069LS	MD4059RS									
Z 650 F1	80	FA073*			MD4062LS	MD4052RS									
Z 650 F2/F3/F4	81-83	FA068*	FA068V*	FA068HH*	MD4010LS	MD4010RS									
KSV 700 A1/A2/A6F/A7F/A8F/A9F/ABF	Left 04-11			FA342R	MD6137D										
(KFX 700) V-Force	Right			FA349R		MD6137D									
KVF 700 B1/B6F/A7F/A8F 4x4 (Prairie)	Left 04-08			FA342R	MD6188D										
(KVF 700 A1/A2/A6F/B2)	Right			FA349R		MD6188D									
KVF 700 D1 Team Green	Left 05			FA342R	MD6188D										
Right				FA349R		MD6188D									
Z 700 A1 LTD	84	FA068*	FA068V*	FA068HH*	MD4010LS	MD4010RS									
VN 700 A1 Vulcan	85	FA085*	FA085V*	FA085HH*	MD4010LS	MD4010RS									

\*-2 Sets Required. ■ - Also available in MX-S race compound.

**SAFETY WARNING:** DO NOT USE HH PADS ON REAR UNLESS ALSO USED ON FRONT TO AVOID BRAKE IMBALANCE

APPLICATIONS  
BRAKE

R Suffix = High Durability Sintered Pad. HH Suffix = High Performance Sintered Pad. G Suffix = Grooved Shoe.  
D Suffix = Drilled Disc. C Suffix = Contoured Disc. LS Suffix = Left/Steel Disc. RS = Right/Steel Disc.

# JAPANESE Built Motorcycles



## KAWASAKI Contd.



← REAR / ARRIÈRE / HINTEN  POSTERIOR / POSTERIORE →

			DISC PAD CHOICES			BRAKE ROTOR CHOICES		
			NEW SFAC Scooter Carbon Pads	Semi-Sintered V-Pads™	Sintered/HH Pads/ Grooved shoes	Contour Rotor Rear Fitment	NEW Vee-Rotors™ CONTOUR	NEW CX Extreme® ROTOR
KAF 620 R9F/R4F/RBF/RCF (Mule 4010 Trans 4x4)	09-12	K720*			N/A			
KAF 620 S9F/S4F/SBF/SCF (Mule 4010 Trans 4x4 Hardwoods Green)	09-12	K720*			N/A			
ER-6f Non ABS Model / EX 650 A6F/A7F/A8F/C9F/CAF/CBF	06-11	FA192		FA192V	FA192HH	MD4138C	VR4138	
ER-6f (ABS Model) (EX 650 B6F/B7F/B8F/D9F/DAF/DBF)	06-11	FA192		FA192V	FA192HH	MD4164AC		
ER-6f - ECF/EDF (Double Pipe Type Frame / Non ABS Model)	12-13	FA192		FA192V	FA192HH	MD4138C	VR4138	
ER-6f - FCF/FDF (Double Pipe Type Frame / ABS Model)	12-13	FA192		FA192V	FA192HH	MD4164AC		
ER-6n (Non ABS Model / ER 650 A6F/A7F/A8F/C9F/CAF/CBF)	06-11	FA192		FA192V	FA192HH	MD4138C	VR4138	
ER-6n (ABS Model) (ER 650 B6F/B7F/B8F/D9F/DAF/DBF)	06-11	FA192		FA192V	FA192HH	MD4164AC		
ER-6n - ECF (Double Pipe Type Frame / Non ABS Model)	12-13	FA192		FA192V	FA192HH	MD4138C	VR4138	
ER-6n - FCF (Double Pipe Type Frame / ABS Model)	12-13	FA192		FA192V	FA192HH	MD4164AC		
KLR 650 A1-A3	87-89	FA067/3				MD6082D		MD6082CX
KL 650 B1-B3 Tengai	89-92	FA067		FA067R		MD6082D		
KLE 650 A7F/A8F/A9F/CAF Versys	07-10	FA192		FA192HH		MD4138C	VR4138	
KLE 650 B7F/B8F/B9F/DAF Versys ABS	07-10	FA192		FA192HH		MD4164AC		
KLE 650 CBF/CCF/CDF Versys / Non ABS	11-13	FA192		FA192HH		MD4138C	VR4138	
KLE 650 DBF/DCF/DDF Versys/ ABS	11-13	FA192		FA192HH		MD4164AC		
KLR 650 C1-C10	95-04	FA067		FA067R		MD6082D		
KLR 650 (KL650 E8F/E9F)	08-09	FA197		FA197HH		MD6310C		
KLX 650 C1/C2/C3	93-97	FA152TT		FA152R ■		MD6085D		
KVF 650 A1/A2 Prairie	02-03	N/A						
KVF 650 D1/D6F/D7F/D8F/D9F/DAF/DBF Brute Force 4x4	05-11	N/A						
KVF 650 E1/E6F/E7F/E8F/E9F Brute Force 4x4 Hardwoods Green HD	05-09	N/A						
KVF 650 E8FA Brute Force 4x4 Hardwoods Green HD	08	N/A						
KVF 650 F7F/F8F Brute Force 4x4 Hardwoods Green	07-08	N/A						
KVF 650 H7F/H8F Brute Force 4x4 Hardwoods Green	07-08	N/A						
KVF 650 G7F/G8F Brute Force 4x4 Hardwoods Green	07-08	N/A						
W 650 (EJ 650-A1/C3/C4/C5/C6/C7)	99-05	K706						
Z 650 B1/B2/B3	77-79	K709						
Z 650 C1/C2	77-78	FA037				MD4062		
Z 650 C3	79	FA036		FA036V		N/A		
Z 650 D2/D3 (SR)	79-80	FA036		FA036V		MD4063		
Z 650 F1	80	K709						
Z 650 F2/F3/F4	81-83	K709						
KSV 700 A1/A2/A6F/A7F/A8F/A9F/ABF (KFX 700) V-Force	04-11	N/A						
KVF 700 B1/B6F/A7F/A8F 4x4 (Prairie) (KVF 700 A1/A2/A6F/B2)	04-08							
KVF 700 D1 Team Green	05	N/A						
Z 700 A1 LTD	84	FA068		FA068V	FA068HH	MD4010		
VN 700 A1 Vulcan	85	K709						

\*-2 Sets Required. ■ - Also available in MX-S race compound.

**SAFETY WARNING-** DO NOT USE HH PADS ON REAR UNLESS ALSO USED ON FRONT TO AVOID BRAKE IMBALANCE

**BRAKE APPLICATIONS**

**R** Suffix = High Durability Sintered Pad. **HH** Suffix = High Performance Sintered Pad. **G** Suffix = Grooved Shoe.  
**D** Suffix = Drilled Disc. **C** Suffix = Contoured Disc. **LS** Suffix = Left/Steel Disc. **RS** = Right/Steel Disc.

# JAPANESE Built Motorcycles



**KAWASAKI Contd.**



← FRONT / AVANT / VORN  FRENTE / ANTERIORE →

Model	Year	Side	DISC PAD CHOICES				BRAKE ROTOR CHOICES								
			NEW SFAC Scooter Carbon Pads	Semi-Sintered V-Pads™	Sintered/HH Pads/ Grooved shoes	Left/Gauche/Links	Right/Droite/Rechts	Contour Rotor Universal left and right fitment	NEW Vee-Rotors™ CONTOUR	NEW CX Extreme® ROTOR	Oversize 250/280mm Rotor Kit	Relocating Bracket for 250/280mm Rotor	Oversize 320mm Rotor Kit	Relocating Bracket for 320mm Rotor	
ZN 700 A1/A2 LTD	84-85		FA085*		FA085V*	FA085HH*	MD4067LS	MD4067RS							
GPX 750 R (ZX 750 F1-F3)	87-89		FA129*			FA129HH*	MD4071LS	MD4071RS							
GT 750 P1-P9	82-96		FA068*		FA068V*	FA068HH*	MD4010LS	MD4010RS							
GPZ 750 R1	82		FA068*		FA068V*	FA068HH*	MD4010LS	MD4010RS							
GPZ 750 A1-A5	83-87		FA085*			FA085HH*	MD4028	MD4028							
GPZ 750 E1/E2 Turbo	84-87		FA085*			FA085HH*	MD4016	MD4016							
GPZ 750 R G2/G3	85-86		FA085*			FA085HH*	MD4016	MD4016							
H2/H2-A (750cc) Mach IV	72-73		FA055			FA055HH	MD4069LS								
H2-B/H2-C (750cc) Mach IV	74-75		FA055			FA055HH	MD4069LS								
KRF 750 ABF/B8F Teryx 750 4x4 (RUV)		Left	FA165TT			FA165R ■	MD6325D								
		Right	FA135TT			FA135R ■		MD6325D							
KRF 750 C8F/D8F Teryx 750 4x4 LE (RUV)		Left	FA165TT			FA165R ■	MD6325D								
		Right	FA135TT			FA135R ■		MD6325D							
KRF 750 F8F Teryx 750 4x4 NRA Outdoors (RUV)		Left	FA165TT			FA165R ■	MD6325D								
		Right	FA135TT			FA135R ■		MD6325D							
KRF 750 G9F/NAF/NBF/NCFS/INDF Teryx 750 Fi 4x4		Left	FA165TT			FA165R ■	MD6325D								
		Right	FA135TT			FA135R ■		MD6325D							
KRF 750 J9FA/K9F/PAF/PAF/PBF/RBF/RCS		Left	FA165TT			FA165R ■	MD6325D								
/PDF/RDF Teryx 750 Fi 4x4 LE		Right	FA135TT			FA135R ■		MD6325D							
KRF 750 L9F Teryx 750 Fi 4x4 LE Sport		Left	FA165TT			FA165R ■	MD6325D								
		Right	FA135TT			FA135R ■		MD6325D							
KRF 750 M9F Teryx 750 Fi 4x4 NRA Outdoors		Left	FA165TT			FA165R ■	MD6325D								
		Right	FA135TT			FA135R ■		MD6325D							
KRF 750 SAF/SAFA/SBF/SBFASCS/SCSA/SDF Teryx 750 Fi 4x4 Sport LE		Left	FA165TT			FA165R ■	MD6325D								
		Right	FA135TT			FA135R ■		MD6325D							
KRF 750 TAF/VBF Teryx 750 Fi 4x4 SGE		Left	FA165TT			FA165R ■	MD6325D								
		Right	FA135TT			FA135R ■		MD6325D							
KVF 750 D8F/D9F/D4F		Left	FA165TT			FA165R ■	MD6188D								
		Right	FA135TT			FA135R ■		MD6188D							
VN 750 A2-A5/A10	86-94		FA085*		FA085V*	FA085HH*	MD4010LS	MD4010RS							
Z 750 E1	80		FA068*		FA068V*	FA068HH*	MD4010LS	MD4010RS							
Z 750 H1/H2 LTD	80-81		FA068*		FA068V*	FA068HH*	MD4010LS	MD4010RS							
Z 750 L1-L4	81-84		FA068*		FA068V*	FA068HH*	MD4010LS	MD4010RS							
Z 750 Y1 LTD	82		FA068*		FA068V*	FA068HH*	MD4043LS	MD4043RS							
Z 750 B1/B2	77-78		FA033				N/A								
Z 750 D1	76		FA033				N/A								
Z 750 N1/N2 Spectre	82-83		FA068*		FA068V*	FA068HH*	MD4010LS	MD4010RS							
Z 750 S (ZR 750 K1/K6F)		Left	FA229		FA229V	FA229HH	MD4141X		MD4141XC	VR4141BLK					
		Right	FA231		FA231V	FA231HH		MD4141X	MD4141XC	VR4141BLK					
Z 750 (ZR 750 J1/J2/J6F)		Left	FA229		FA229V	FA229HH	MD4141X		MD4141XC	VR4141BLK					
		Right	FA231		FA231V	FA231HH		MD4141X	MD4141XC	VR4141BLK					
Z 750 (ZR 750 L7FL/L8FL/L9FL/LAF)			FA142*			FA142HH*			MD4159XC*	VR4159BLK*					
Z 750 ABS (ZR 750 M7F/M8F/M9F/MAF/MBF)		Left	FA142*			FA142HH*			MD4156XC						
		Right							MD4156XC						
Z 750 R Non ABS (ZR 750 NBF/NCF)						FA417/4HH*			MD4152XC*	VR4152BLK*					
Z 750 R Black Edition (ZR 750 NBFA)						FA417/4HH*			MD4152XC*	VR4152BLK*					
Z 750 R ABS (ZR 750 PBF/PCF)						FA417/4HH*			MD4152XC*	VR4152BLK*					
ZR 750 C1-C5 Zephyr			FA129*		FA129V*	FA129HH*	MD4008	MD4008	MD4008C*	VR4008BLK*					
ZR 750 D1 Zephyr		Left	FA229		FA229V	FA229HH	MD4008		MD4008C	VR4008BLK					
		Right	FA231		FA231V	FA231HH		MD4008	MD4008C	VR4008BLK					
ZR-7 (ZR 750 F1/F3/F5)		Left	FA229		FA229V	FA229HH	MD4141X		MD4141XC	VR4141BLK					
		Right	FA231		FA231V	FA231HH		MD4141X	MD4141XC	VR4141BLK					
ZR-7S (ZR 750 H1/H3)		Left	FA229		FA229V	FA229HH	MD4141X		MD4141XC	VR4141BLK					
		Right	FA231		FA231V	FA231HH		MD4141X	MD4141XC	VR4141BLK					
ZXR 750 H1/H2			FA158*			FA158HH*	MD4012X	MD4012X	MD4012XC*	VR4012BLK*					
ZXR 750 K1/K2/J1/J2			FA158*			FA158HH*	MD4022X	MD4022X	MD4022XC*	VR4022BLK*					
ZXR 750 M1/M2/L1-L3			FA158*			FA158HH*	MD4022X	MD4022X	MD4022XC*	VR4022BLK*					
ZK7-R (ZX 750 P1/P2/P3/P4/P5/P6/P7)			FA188*			FA188HH*	MD4022X	MD4022X	MD4022XC*	VR4022BLK*					
ZK7-RR (ZX 750 N1/N2)			FA424*			FA424HH*	MD4022X	MD4022X	MD4022XC*	VR4022BLK*					
VN 800 A1/A2/A3	95-99		FA085		FA085V	FA085HH	MD4124LS								

\*-2 Sets Required. ■ - Also available in MX-S race compound.

**SAFETY WARNING:** DO NOT USE HH PADS ON REAR UNLESS ALSO USED ON FRONT TO AVOID BRAKE IMBALANCE

APPLICATIONS

**BRAKE**  
**R** Suffix = High Durability Sintered Pad. **HH** Suffix = High Performance Sintered Pad. **G** Suffix = Grooved Shoe.  
**D** Suffix = Drilled Disc. **C** Suffix = Contoured Disc. **LS** Suffix = Left/Steel Disc. **RS** = Right/Steel Disc.

# JAPANESE Built Motorcycles



## KAWASAKI Contd.



← REAR / ARRIÈRE / HINTEN POSTERIOR / POSTERIORE →

			DISC PAD CHOICES			BRAKE ROTOR CHOICES		
			NEW SFAC Scooter Carbon Pads	Semi-Sintered V-Pads™	Sintered/HH Pads/ Grooved shoes	Contour Rotor Rear Fitment	NEW Vee-Rotors™ CONTOUR	NEW CX Extreme® ROTOR
ZN 700 A1/A2 LTD	84-85	FA085		FA085V	FA085HH	MD4068		
GPX 750 R (ZX 750 F1-F3)	87-89	FA129		FA129V	FA129HH	MD4007		
GT 750 P1-P9	82-96	FA068		FA068V	FA068HH	MD4010		
GPZ 750 R1	82	FA068		FA068V	FA068HH	MD4010		
GPZ 750 A1-A5	83-87	FA085		FA085V	FA085HH	MD4019		
GPZ 750 E1/E2 Turbo	84-87	FA085		FA085V	FA085HH	MD4017		
GPZ 750 R G2/G3	85-86	FA085		FA085V	FA085HH	MD4017		
H2/H2-A (750cc) Mach IV	72-73	K713						
H2-B/H2-C (750cc) Mach IV	74-75	K713						
KRF 750 A8F/B8F Teryx 750 4x4 (RUV)	08	N/A						
KRF 750 C8F/D8F Teryx 750 4x4 LE (RUV)	08	N/A						
KRF 750 F8F Teryx 750 4x4 NRA Outdoors (RUV)	08	N/A						
KRF 750 G9F/NAF/NBF/NCNS/NDF Teryx 750 Fi 4x4	09-13	N/A						
KRF 750 J9FA/K9F/PAF/RAF/PBF/RBF/RCS /PDF/RDF Teryx 750 Fi 4x4 LE	09-13	N/A						
KRF 750 L9F Teryx 750 Fi 4x4 LE Sport	09	N/A						
KRF 750 M9F Teryx 750 Fi 4x4 NRA Outdoors	09	N/A						
KRF 750 SAF/SAFA/SBF/SBFASCS/SCSA/SDF Teryx 750 Fi 4x4 Sport LE	10-13	N/A						
KRF 750 TAF/NBF Teryx 750 Fi 4x4 SGE	10-11	N/A						
KVF 750 D8F/D9F/DAF	08-11	N/A						
VN 750 A2-A5/A10	86-94	K709						
Z 750 E1	80	FA068		FA068V	FA068HH	MD4010		
Z 750 H1/H2 LTD	80-81	FA068		FA068V	FA068HH	MD4010		
Z 750 L1-L4	81-84	FA068		FA068V	FA068HH	MD4010		
Z 750 Y1 LTD	82	K709						
Z 750 B1/B2	77-78	FA037				N/A		
Z 750 D1	76	FA037				N/A		
Z 750 N1/N2 Spectre	82-83	FA068		FA068V	FA068HH	MD4010		
Z 750 S (ZR 750 K1/K6F)	05-07	FA192		FA192V	FA192HH	MD4138	MD4138C	VR4138
Z 750 (ZR 750 J1/J2/J6F)	04-06	FA192		FA192V	FA192HH	MD4138	MD4138C	VR4138
Z 750 (ZR 750 L7FL8FL9FLAF)	07-11	FA174		FA174V	FA174HH		MD4157C	VR4157
Z 750 ABS (ZR 750 M7F/M8F/M9F/MAF/MBF)	07-11	FA174		FA174V	FA174HH		MD4157C	
Z 750 R Non ABS (ZR 750 NBF/NCNF)	11-12	FA140		FA140V	FA140HH		MD4157C	VR4157C
Z 750 R Black Edition (ZR 750 NBFA)	12	FA140		FA140V	FA140HH		MD4157C	VR4157C
Z 750 R ABS (ZR 750 PBF/PCF)	11-12	FA140		FA140V	FA140HH		MD4157C	VR4157C
ZR 750 C1-C5 Zephyr	91-95	FA129		FA129V	FA129HH	MD4007		VR4007
ZR 750 D1 Zephyr	96-98	FA129		FA129V	FA129HH	MD4007		VR4007
ZR-7 (ZR 750 F1/F3/F5)	99-04	FA231			FA231HH	MD4142	MD4142C	
ZR-7S (ZR 750 H1/H3)	01-04	FA231			FA231HH	MD4142	MD4142C	
ZXR 750 H1/H2	89-90	FA161		FA161V	FA161HH	MD4013	MD4013C	VR4013
ZXR 750 K1/K2/J1/J2	91-92	FA161		FA161V	FA161HH	MD4013	MD4013C	VR4013
ZXR 750 M1/M2/L1-L3	93-95	FA161		FA161V	FA161HH	MD4013	MD4013C	VR4013
ZX7-R (ZX 750 P1/P2/P3/P4/P5/P6/P7)	96-03	FA161		FA161V	FA161HH	MD4013	MD4013C	VR4013
ZX7-RR (ZX 750 N1/N2)	96-99	FA254			FA254HH	MD4013	MD4013C	VR4013
VN 800 A1/A2/A3	95-99	K709						

\*-2 Sets Required. ■ - Also available in MX-S race compound.

**SAFETY WARNING:** DO NOT USE HH PADS ON REAR UNLESS ALSO USED ON FRONT TO AVOID BRAKE IMBALANCE

**R** Suffix = High Durability Sintered Pad. **HH** Suffix = High Performance Sintered Pad. **G** Suffix = Grooved Shoe.  
**D** Suffix = Drilled Disc. **C** Suffix = Contoured Disc. **LS** Suffix = Left/Steel Disc. **RS** = Right/Steel Disc.

**BRAKE APPLICATIONS**



# JAPANESE Built Motorcycles



**KAWASAKI Contd.**



← FRONT / AVANT / VORN FRENTE / ANTERIORE →

		DISC PAD CHOICES			BRAKE ROTOR CHOICES								
		NEW SFAC Scooter Carbon Pads	Semi-Sintered V-Pads™	Sintered/HH Pads/ Grooved shoes	Left/Gauche/Links	Right/Droite/Rechts	Contour Rotor Universal left and right fitment	NEW Vee-Rotors™ CONTOUR	NEW CX Extreme® ROTOR	Oversize 250/280mm Rotor Kit	Relocating Bracket for 250/280mm Rotor	Oversize 320mm Rotor Kit	Relocating Bracket for 320mm Rotor
VN 800 B1-B10/B6F Classic	96-06	FA229	FA229V	FA229HH	MD4125LS								
VN 800 C1/C2/E1/E2/E3 Drifter	99-04	FA229	FA229V	FA229HH	MD4125LS								
EJ 800 ABF/ACF (W800 Solid Front Disc)	11-12	FA231	FA231V	FA231HH		MD4158							
EJ 800 (W 800 Cafe Style/Cockpit Fairing)	11	FA231	FA231V	FA231HH		MD4008	MD4008C	VR4008BLK					
EJ800 ACFA (W 800 Special Edition Black Exhaust/Gold Rims)	12	FA231	FA231V	FA231HH		MD4008	MD4008C	VR4008BLK					
EJ800 ADF (W 800)	13	FA231	FA231V	FA231HH		MD4008	MD4008C	VR4008BLK					
ZL 900 A1/A2 Eliminator	85-86	FA085*	FA085V*	FA085HH*	MD4016	MD4016							
GPZ 900 R A1-A6	84-89	FA085*		FA085HH*	MD4016	MD4016							
GPZ 900 R A7/A8	90-96	FA158*		FA158HH*	MD4008	MD4008	MD4008C*	VR4008BLK*					
GPZ 900 R (ZX 900 A11)	98	FA158*		FA158HH*	MD4008	MD4008	MD4008C*	VR4008BLK*					
GPZ 900 R (ZX 900 A12-A15)	99-02	FA188*		FA188HH*	TBA	TBA							
VN 900 A6F Classic	06	FA229	FA229V	FA229HH	MD4158								
VN 900 B7F/B8F/B9F/BAF/BBF/BCF/BCF/BDFA Classic (Spoke wheel)	07-13	FA229	FA229V	FA229HH	MD4158								
VN 900 BBFA/BCFA/BDFA Classic Special Edition													
White Wall Tyres (Spoke wheel)	11-13	FA229	FA229V	FA229HH	MD4158								
VN 900 C7F/C8F/C9F/CAF/CBF/CCF/CDF Custom (Cast wheel)	07-13	FA229	FA229V	FA229HH	MD4158								
Z 900 Z1A/Z1B	74-76	FA055*		FA055HH*	MD4069LS	MD4069RS							
Z 900 A4	77	FA033*			MD4052LS	MD4052RS							
ZX 9 R (ZX 900 B1/B2)	94-95	FA158*		FA158HH*	MD4022X	MD4022X	MD4022XC*	VR4022BLK					
ZX 9 R (ZX 900 B3/B4)	96-97	FA188*		FA188HH*	MD4022X	MD4022X	MD4022XC*	VR4022BLK					
ZX 9 R (ZX 900 C1/C2)	98-99	FA188*		FA188HH*	MD4136X	MD4136X	MD4136XC*	VR4136BLK*					
ZX 9 R (ZX 900 E1/E2)	00-01	FA188*		FA188HH*	MD4012X	MD4012X	MD4012XC*	VR4012BLK*					
ZX 9 R (ZX 900 F1/F2)	02-04			FA347HH*	MD4022X	MD4022X	MD4022XC*	VR4022BLK*					
KAF 950 A1/A2/A3 (Mule 2510 Diesel)		K719*		N/A									
KAF 950 B1/B2/B3 (Mule 3010 Diesel)		K719*		N/A									
KAF 950 D8F Mule 3010 Diesel 4x4	08	K719*											
KAF 950 E8F Mule 3010 Trans Diesel 4x4	08	K719*											
KAF 950 F9F/FAF/FBF/FCF (Mule 4010 Diesel 4x4)	09-12	K719*											
KAF 950 G9F/GAF/GBF/GCF (Mule 4010 Trans 4x4 Diesel)	09-12	K719*											
GPZ 1000 RX (A1-A3)	86-88	FA085*		FA085HH*	MD4016	MD4016							
KLZ 1000 ACF/ADF - Versys	12-13	FA158*		FA158HH*			TBA*						
KLZ 1000 (LV 1000 A1H/A2H)	Left 04-05	FA229	FA229V	FA229HH	MD3088X		MD3088XC	VR3088BLK					
	Right	FA231	FA231V	FA231HH		MD3088X	MD3088XC	VR3088BLK					
Z 1000 A1/A2	77-78	FA033*			MD4064LS	MD4064RS							
Z 1000 A3/A4	79-80	FA073*			MD4064LS	MD4064RS							
Z 1000 D1 (Z1R)	78	FA033*			MD4076LS	MD4076RS							
Z 1000 D3 (Z1R)	79	FA073*			MD4076LS	MD4076RS							
Z 1000 ST (E1-E2 Shaft)	79-82	FA062*			MD4078LS	MD4078RS							
Z 1000 H1	80	FA033*			MD4064LS	MD4064RS							
Z 1000 J1/J2	81-82	FA068*		FA068HH*	MD4006LS	MD4006RS							
Z 1000 J3	83	FA068*		FA068HH*	MD4038	MD4038							
Z 1000 K1/K2 LTD	81-83	FA068*	FA068V*	FA068HH*	MD4006LS	MD4006RS							
Z 1000 R2	83	FA068*		FA068HH*	MD4038	MD4038							
Z 1000 (ZR 1000 A1/A2/A3/A6F)	03-06			FA347HH*	MD4154X	MD4154X	MD4154XC*	VR4154BLK*					
Z 1000 (ZR 1000 B7F/B8F)	07-08			FA417/4HH*			MD4152XC*	VR4152BLK*					
Z 1000 ABS (ZR 1000 C7F/C8F/C9F)	07-09			FA417/4HH*			MD4152XC*	VR4152BLK*					
Z 1000 (ZR 1000 DAF/DBF/DCF/DDF)	10-13			FA379HH*			MD4152XC*	VR4152BLK*					
Z 1000 (ZR 1000 DCF/DDFA)	12-13			FA379HH*			MD4152XC*	VR4152BLK*					
Z 1000 SX (ZR 1000 HBF/HCF/HDF) ABS Model	11-13			FA379HH*			TBA*						
Z 1000 SX (ZR 1000 GBF/GCF/GDF) Non ABS Model	11-13			FA379HH*			TBA*						
ZL 1000 A1	87	FA085*	FA085V*	FA085HH*	MD4016	MD4016							
ZX 1000 B1-B3 (ZX-10)	88-90	FA129*		FA129HH*	MD4021	MD4021							
ZG 1000 A1-A7 (1000 GTR)	86-93	FA085*	FA085V*	FA085HH*	MD4028	MD4028							
ZG 1000 A9-A18 (1000 GTR)	94-03	FA129*	FA129V*	FA129HH*	MD4008	MD4008	MD4008C*	VR4008BLK*					
ZX 10 R (ZX 1000 C1/C2/D6F/D7F)	04-07			FA369/4HH*			MD4152XC*	VR4152BLK*					
ZX 10 R (ZX 1000 E8F/E9F/FAF)	08-10			FA379HH*			MD4161XC*	VR4161BLK*					
ZX 10 R (ZX 1000 JBF/JCF/JDF)	11-13			FA379HH*			MD4161XC*	VR4161BLK*					
ZX 10 R ABS (ZX 1000 KBF/KCF/KDF)	11-13			FA379HH*			MD4161XC*	VR4161BLK*					
GPZ 1100 B1	82	FA068*		FA068HH*	MD4006LS	MD4006RS							
GPZ 1100 B2	83	FA068*		FA068HH*	MD4038	MD4038							

\*-2 Sets Required. ■ - Also available in MX-S race compound.

**SAFETY WARNING:** DO NOT USE HH PADS ON REAR UNLESS ALSO USED ON FRONT TO AVOID BRAKE IMBALANCE

APPLICATIONS

**BRAKE**  
**R** Suffix = High Durability Sintered Pad. **HH** Suffix = High Performance Sintered Pad. **G** Suffix = Grooved Shoe.  
**D** Suffix = Drilled Disc. **C** Suffix = Contoured Disc. **LS** Suffix = Left/Steel Disc. **RS** = Right/Steel Disc.

# JAPANESE Built Motorcycles



**KAWASAKI** Contd.



← REAR / ARRIÈRE / HINTEN  POSTERIOR / POSTERIORE →

			DISC PAD CHOICES			BRAKE ROTOR CHOICES			
			NEW SFAC Scooter Carbon Pads	Semi-Sintered V-Pads™	Sintered/HH Pads/ Grooved shoes	 Contour Rotor Rear Fitment	NEW Vee-Rotors™ CONTOUR	NEW CX Extreme® ROTOR	
VN 800 B1-B10/B6F Classic	96-06	K709							
VN 800 C1/C2/E1/E2/E3 Drifter	99-04	FA231		FA231V	FA231HH	MD4148			
EJ 800 ABF/ACF (W800 Solid Front Disc)	11-12	K706							
EJ 800 (W 800 Cafe Style/Cockpit Fairing)	11	K706							
EJ800 ACFA (W 800 Special Edition Black Exhaust/Gold Rims)	12	K706							
EJ800 ADF (W 800)	13	K706							
ZL 900 A1/A2 Eliminator	85-86	FA085		FA085V	FA085HH	MD4017			
GPZ 900 R A1-A6	84-89	FA085		FA085V	FA085HH	MD4017			
GPZ 900 R A7/A8	90-96	FA129		FA129V	FA129HH	MD4015	MD4015C	VR4015	
GPZ 900 R (ZX 900 A11)	98	FA129		FA129V	FA129HH	MD4015	MD4015C	VR4015	
GPZ 900 R (ZX 900 A12-A15)	99-02	FA129		FA129V	FA129HH	MD4015	MD4015C	VR4015	
VN 900 A6F Classic	06	FA231		FA2312V	FA231HH	MD4085			
VN 900 B7F/B8F/B9F/BAF/BBF/BCF/BDF Classic (Spoke wheel)	07-13	FA231		FA2312V	FA231HH	MD4085			
VN 900 BBFA/BCFA/BDFA Classic Special Edition									
White Wall Tyres (Spoke wheel)	11-13	FA231		FA2312V	FA231HH	MD4085			
VN 900 C7F/C8F/C9F/CAF/CBF/CCF/CFD Custom (Cast wheel)	07-13	FA231		FA2312V	FA231HH	MD4085			
Z 900 Z1A/Z1B	74-76	K713							
Z 900 A4	77	K713							
ZX 9 R (ZX 900 B1/B2)	94-95	FA192		FA192V	FA192HH	MD4013	MD4013C	VR4013	
ZX 9 R (ZX 900 B3/B4)	96-97	FA192		FA192V	FA192HH	MD4013	MD4013C	VR4013	
ZX 9 R (ZX 900 C1/C2)	98-99	FA192		FA192V	FA192HH	MD4138	MD4138C	VR4138	
ZX 9 R (ZX 900 E1/E2)	00-01	FA192		FA192V	FA192HH	MD4138	MD4138C	VR4138	
ZX 9 R (ZX 900 F1/F2)	02-04	FA192		FA192V	FA192HH	MD4138	MD4138C	VR4138	
KAF 950 A1/A2/A3 (Mule 2510 Diesel)		K720*			N/A				
KAF 950 B1/B2/B3 (Mule 3010 Diesel)		K720*			N/A				
KAF 950 D8F Mule 3010 Diesel 4x4	08	K720*							
KAF 950 E8F Mule 3010 Trans Diesel 4x4	08	K720*							
KAF 950 F9F/FAF/FBF/FCF (Mule 4010 Diesel 4x4)	09-12	K720*							
KAF 950 G9F/GAF/GBF/GCF (Mule 4010 Trans 4x4 Diesel)	09-12	K720*							
GPZ 1000 RX (A1-A3)	86-88	FA085		FA085V	FA085HH	MD4019			
KLZ 1000 ACF/ADF - Versys	12-13	FA174		FA174V	FA174HH		MD4157C		
KLV 1000 (LV 1000 A1H/A2H)	04-05	FA174		FA174V	FA174HH	MD6232D			MD6232CX
Z 1000 A1/A2	77-78	FA036		FA036V		MD4077			
Z 1000 A3/A4	79-80	FA036		FA036V		MD4077			
Z 1000 D1 (Z1R)	78	FA036		FA036V		MD4077			
Z 1000 D3 (Z1R)	79	FA036		FA036V		MD4077			
Z 1000 ST (E1-E2 Shaft)	79-82	FA036		FA036V		MD4090			
Z 1000 H1	80	FA036		FA036V		MD4077			
Z 1000 J1/J2	81-82	FA068		FA068V	FA068HH	MD4054			
Z 1000 J3	83	FA068		FA068V	FA068HH	MD4054			
Z 1000 K1/K2 LTD	81-83	FA068		FA068V	FA068HH	MD4054			
Z 1000 R2	83	FA068		FA068V	FA068HH	MD4054			
Z 1000 (ZR 1000 A1/A2/A3/A6F)	03-06	FA192		FA192V	FA192HH	MD4138	MD4138C	VR4138	
Z 1000 (ZR 1000 B7F/B8F)	07-08	FA174		FA174V	FA174HH		MD4157C	VR4157	
Z 1000 ABS (ZR 1000 C7F/C8F/C9F)	07-09	FA174		FA174V	FA174HH		MD4157C	VR4157	
Z 1000 (ZR 1000 DAF/DBF/DCF/DDF)	10-13	FA192		FA192V	FA192HH		MD4157C	VR4157	
Z 1000 (ZR 1000 DCFA/DDFA)	12-13	FA192		FA192V	FA192HH		MD4157C	VR4157	
Z 1000 SX (ZR 1000 HBF/HCF/HDF) ABS Model	11-13	FA192		FA192V	FA192HH		MD4157C		
Z 1000 SX (ZR 1000 GBF/GCF/GDF) Non ABS Model	11-13	FA192		FA192V	FA192HH		MD4157C		
ZL 1000 A1	87	FA085		FA085V	FA085HH	MD4017			
ZX 1000 B1-B3 (ZX-10)	88-90	FA129		FA129V	FA129HH	MD4015			
ZG 1000 A1-A7 (1000 GTR)	86-93	FA085		FA085V	FA085HH	MD4082			
ZG 1000 A9-A18 (1000 GTR)	94-03	FA085		FA085V	FA085HH	MD4082			
ZX 10 R (ZX 1000 C1/C2/D6F/D7F)	04-07	FA192		FA192V	FA192HH		MD4138C	VR4138	
ZX 10 R (ZX 1000 E8F/E9F/FAF)	08-10	FA192		FA192V	FA192HH		MD4138C	VR4138	
ZX 10 R (ZX 1000 JBF/JCF/JDF)	11-13	FA436		FA436V	FA436HH		MD4165C	VR4165	
ZX 10 R ABS (ZX 1000 KBF/KCF/KDF)	11-13	FA436		FA436V	FA436HH		MD4165C	VR4165	
GPZ 1100 B1	82	FA068		FA068V	FA068HH	MD4054			
GPZ 1100 B2	83	FA068		FA068V	FA068HH	MD4054			

\*-2 Sets Required. ■ - Also available in MX-S race compound.

**SAFETY WARNING:** DO NOT USE HH PADS ON REAR UNLESS ALSO USED ON FRONT TO AVOID BRAKE IMBALANCE

**R** Suffix = High Durability Sintered Pad. **HH** Suffix = High Performance Sintered Pad. **G** Suffix = Grooved Shoe.  
**D** Suffix = Drilled Disc. **C** Suffix = Contoured Disc. **LS** Suffix = Left/Steel Disc. **RS** = Right/Steel Disc.

**BRAKE APPLICATIONS**

# JAPANESE Built Motorcycles



**KAWASAKI Contd.**

← FRONT / AVANT / VORN FRENTE / ANTERIORE →

Model	Year	FA	DISC PAD CHOICES				BRAKE ROTOR CHOICES								
			NEW SFAC Scooter Carbon Pads	Semi-Sintered V-Pads™	Sintered/HH Pads/ Grooved shoes	Left/Gauche/Links	Right/Droite/Rechts	Contour Rotor Universal left and right fitment	NEW Vee-Rotors™ CONTOUR	NEW CX Extreme® ROTOR	Oversize 250/280mm Rotor Kit	Relocating Bracket for 250/280mm Rotor	Oversize 320mm Rotor Kit	Relocating Bracket for 320mm Rotor	
Z 1100 D1/D2 Spectre	82-83	FA088*		FA068V*	FA068HH*	MD4006LS	MD4006RS								
GPZ 1100 A1-A3	83-85	FA085*				MD4016	MD4016								
Z 1100 A1-A3	81-83	FA088*		FA068V*	FA068HH*	MD4006LS	MD4006RS								
Z 1100 R1 Lawson Replica	84	FA085*			FA085HH*	MD4038	MD4038								
ZR 1100 A1-A4 Zephyr	92-95	FA158*			FA158HH*	MD4012X	MD4012X	MD4012XC*	VR4012BLK*						
ZR 1100 B1 Zephyr	Left 96-97	FA229			FA229HH	MD4012X		MD4012XC	VR4012BLK*						
	Right	FA231			FA231HH		MD4012X	MD4012XC	VR4012BLK*						
ZR 1100 B5 (Zephyr 1100 RS)	Left 02	FA229			FA229HH	MD4012X		MD4012XC	VR4012BLK*						
	Right	FA231			FA231HH		MD4012X	MD4012XC	VR4012BLK*						
ZRX 1100 (ZR 1100 C1/C2/C3/C4)	97-00	FA188*			FA188HH*	MD4012X	MD4012X	MD4012XC*	VR4012BLK*						
ZZR 1100 (ZX 1100 C1-C3)	90-92	FA158*			FA158HH*	MD4012X	MD4012X	MD4012XC*	VR4012BLK*						
ZZR 1100 (ZX 1100 D1-D9)	93-01	FA158*			FA158HH*	MD4022X	MD4022X	MD4022XC*	VR4022BLK*						
GPZ 1100 E1/E2	Left 95-97	FA229			FA229HH	MD4008		MD4008C	VR4008BLK						
	Right	FA231			FA231HH		MD4008	MD4008C	VR4008BLK						
GPZ 1100 F1 (ABS Model)	Left 96-98	FA229			FA229HH	MD4008		MD4008C	VR4008BLK						
	Right	FA231			FA231HH		MD4132	MD4132C	VR4132BLK						
ZX 12 R (ZX 1200 A1/A2/B1/B2)	00-03	FA188*			FA188HH*	MD4022X	MD4022X	MD4022XC*	VR4022BLK*						
ZX 12R (ZX 1200 B3/B4/B6F)	04-06				FA369/4HH*	MD4154X	MD4154X	MD4154XC*	VR4154BLK*						
ZRX 1200 R (ZR 1200 A1/A2/A3/A4/A5/A6F)	01-08	FA188*			FA188HH*	MD4012X	MD4012X	MD4012XC*	VR4012BLK*						
ZRX 1200 S (ZR 1200 B1/B2/B3)	01-07	FA188*			FA188HH*	MD4012X	MD4012X	MD4012XC*	VR4012BLK*						
ZZR 1200 C1H/C2H	02-04	FA158*			FA158HH*	MD4022X	MD4022X	MD4022XC*	VR4022BLK*						
Z 1300 A1-A5	79-83	FA082*				MD4089LS	MD4089RS								
ZG 1300 A1-A3	84-86	FA082*				MD4089LS	MD4089RS								
GTR 1400 (ZG 1400 A8F/A9F/CAF/CBF) ABS	08-11				FA417/4HH*			MD4155XC*	VR4155BLK*						
GTR 1400 ABS (ZG1400 CCF/ICDF)	12-13				FA417/4HH*			MD4155XC*	VR4155BLK*						
ZZR 1400 (ZX 1400 A6F/A7F)	06-07				FA417/4HH*			MD4155XC*	VR4155BLK*						
ZZR 1400 ABS (ZX 1400 B6F/B7F)	06-07				FA417/4HH*			MD4155XC*	VR4155BLK*						
ZZR 1400 ABS (ZX 1400 D8F/D9F/DAF/DBF)	08-11				FA417/4HH*			MD4155XC*	VR4155BLK*						
ZZR 1400 ABS (FCF/FDF)	12-13				FA417/4HH*			MD4155XC*	VR4155BLK*						
VN 1500 B2-B6 (VN 15 SE)	88-92	FA085		FA085V	FA085HH	MD4094LS									
VN 1500 A6 (VN15)	92	FA085		FA085V	FA085HH	MD4124LS									
VN 1500 C1/C2 (VN15)	94-95	FA085		FA085V	FA085HH	MD4124LS									
VN 1500 D1/D2/E1/E2 Classic	96-99	FA229		FA229V	FA229HH	MD4131LS									
VN 1500 G1/G2 Classic Tourer	Left 98-99	FA229		FA229V	FA229HH	MD4150									
	Right	FA231		FA231V	FA231HH		MD4150								
VN 1500 J1/J2/R1/R2/R3 Dripper	99-04	FA229		FA229V	FA229HH	MD4125LS									
VN 1500 N1/N2/N3 Classic Fi	00-04	FA229		FA229V	FA229HH	MD4125LS									
VN 1500 L1/L2/L3/L4 Nomad Fi	Left 00-03	FA229		FA231V	FA229HH	MD4150									
	Right	FA231		FA231V	FA231HH		MD4150								
VN 1500 P1/P2 Mean Streak	02-04	FA188*			FA188HH*	MD4022X	MD4022X	MD4022XC*	VR4022BLK*						
VN 1600 A1/A2/A3/A6F Classic	Left 03-08	FA229		FA229V	FA229HH	MD4158									
	Right	FA231		FA231V	FA231HH		MD4158								
VN 1600 B1 Mean Streak	04	FA188*			FA188HH*	MD4022X	MD4022X	MD4022XC*	VR4022BLK*						
VN 1600 B2H/B6F/B7F (Mean Streak)	05-08				FA369/4HH*	MD4022X	MD4022X	MD4022XC*	VR4022BLK*						
VN 1600 D1H/D6F Classic Tourer	Left 05-08	FA229		FA229V	FA229HH	MD4158									
	Right	FA231		FA231V	FA231HH		MD4158								
VN 1700 B9F/BAFBBF/BCF/BDF Voyager ABS	09-13	FA158*			FA158HH*	MD4158	MD4158								
VN 1700 C9F Classic Tourer	Left 09	FA229		FA229V	FA229HH	MD4158									
	Right	FA231		FA231V	FA231HH		MD4158								
VN 1700 DAF/DBF/DCF/DDF Classic Tourer ABS	Left 10-13	FA229		FA229V	FA229HH	MD4158									
	Right	FA231		FA231V	FA231HH		MD4158								
VN 1700 E9F Classic	Left 09	FA229		FA229V	FA229HH	MD4158									
	Right	FA231		FA231V	FA231HH		MD4158								
VN 1700 FAF/FBF/FCF/FDF Classic ABS	Left 10-13	FA229		FA229V	FA229HH	MD4158									
	Right	FA231		FA231V	FA231HH		MD4158								
VN 1700 KBF/KCF/KDF Voyager Custom	11-13	FA158*			FA158HH*	MD4158	MD4158								
VN 2000 A1/A2/AGF	04-07	FA158*			FA158HH*	MD4158	MD4158								
VN 2000 H8F/H9F Classic	08-09	FA158*			FA158HH*	MD4158	MD4158								

NOTE - MD6208C ◆ = MD6208CE Undrilled rear disc available for Enduro use

\*-2 Sets Required. ■ - Also available in MX-S race compound.

**SAFETY WARNING:** DO NOT USE HH PADS ON REAR UNLESS ALSO USED ON FRONT TO AVOID BRAKE IMBALANCE

APPLICATIONS

R Suffix = High Durability Sintered Pad. HH Suffix = High Performance Sintered Pad. G Suffix = Grooved Shoe.

D Suffix = Drilled Disc. C Suffix = Contoured Disc. LS Suffix = Left/Steel Disc. RS = Right/Steel Disc.

# JAPANESE Built Motorcycles



**KAWASAKI Contd.**



← REAR / ARRIÈRE / HINTEN  POSTERIOR / POSTERIORE →

		DISC PAD CHOICES				BRAKE ROTOR CHOICES			
		NEW SFAC Scooter Carbon Pads	Semi-Sintered V-Pads™	Sintered/HH Pads/ Grooved shoes		Contour Rotor Rear Fitment	NEW Vee-Rotors™ CONTOUR	NEW CX Extreme® ROTOR	
Z 1100 D1/D2 Spectre	82-83	FA068		FA068V	FA068HH	MD4054			
GPZ 1100 A1-A3	83-85	FA085		FA085V	FA085HH	MD4017			
Z 1100 A1-A3	81-83	FA068		FA068V	FA068HH	MD4054			
Z 1100 R1 Lawson Replica	84	FA068		FA068V	FA068HH	MD4054			
ZR 1100 A1-A4 Zephyr	92-95	FA129		FA129V	FA129HH	MD4027	VR4027		
ZR 1100 B1 Zephyr	96-97	FA129		FA129V	FA129HH	MD4027	VR4027		
ZR 1100 B5 (Zephyr 1100 RS)	02	FA129		FA129V	FA129HH	MD4027	VR4027		
ZRX 1100 (ZR 1100 C1/C2/C3/C4)	97-00	FA161		FA161V	FA161HH	MD4133	MD4133C	VR4133	
ZZR 1100 (ZX 1100 C1-C3)	90-92	FA129		FA129V	FA129HH	MD4015	MD4015C	VR4015	
ZZR 1100 (ZX 1100 D1-D9)	93-01	FA161		FA161V	FA161HH	MD4014	MD4014C	VR4015	
GPZ 1100 E1/E2	95-97	FA192		FA192V	FA192HH	MD4130	MD4130C	VR4130	
GPZ 1100 F1 (ABS Model)	96-98	FA192		FA192V	FA192HH	MD4130	MD4130C	VR4130	
ZX 12 R (ZX 1200 A1/A2/B1/B2)	00-03	FA161		FA161V	FA161HH	MD4023	MD4023C	VR4023	
ZX 12R (ZX 1200 B3/B4/B6F)	04-06	FA161		FA161V	FA161HH	MD4023	MD4023C	VR4023	
ZRX 1200 R (ZR 1200 A1/A2/A3/A4/A5/A6F)	01-08	FA161		FA161V	FA161HH	MD4133	MD4133C	VR4133	
ZRX 1200 S (ZR 1200 B1/B2/B3)	01-07	FA161		FA161V	FA161HH	MD4133	MD4133C	VR4133	
ZZR 1200 C1H/C2H	02-04	FA161		FA161V	FA161HH	MD4133	MD4133C	VR4133	
Z 1300 A1-A5	79-83	FA036		FA036V		MD4090			
ZG 1300 A1-A3	84-86	FA036		FA036V		MD4090			
GTR 1400 (ZG 1400 A8F/A9F/CAF/CBF) ABS	08-11	FA254			FA254HH	MD4160C	VR4160		
GTR 1400 ABS (ZG1400 CCF/CDF)	12-13	FA254			FA254HH	MD4160C	VR4160		
ZZR 1400 (ZX 1400 A6F/A7F)	06-07	FA254			FA254HH	MD4157C	VR4157		
ZZR 1400 ABS (ZX 1400 B6F/B7F)	06-07	FA254			FA254HH	MD4157C	VR4157		
ZZR 1400 ABS (ZX 1400 D8F/D9F/DAF/DBF)	08-11	FA254			FA254HH	MD4157C	VR4157		
ZZR 1400 ABS (FCF/FDF)	12-13	FA254			FA254HH	MD4157C	VR4157		
VN 1500 B2-B6 (VN 15 SE)	88-92	FA085		FA085V	FA085HH	MD4054			
VN 1500 A6 (VN15)	92	FA085		FA085V	FA085HH	MD4054			
VN 1500 C1/C2 (VN15)	94-95	FA085		FA085V	FA085HH	MD4128			
VN 1500 D1/D2/E1/E2 Classic	96-99	FA085		FA085V	FA085HH	MD4128			
VN 1500 G1/G2 Classic Tourer	98-99	FA085		FA085V	FA085HH	MD4147			
VN 1500 J1/J2/R1/R2/R3 Drifter	99-04	FA231		FA231V	FA231HH	MD4148			
VN 1500 N1/N2/N3 Classic Fi	00-04	FA231		FA231V	FA231HH	MD4148			
VN 1500 L1/L2/L3/L4 Nomad Fi	00-03	FA231		FA231V	FA231HH	MD4147			
VN 1500 P1/P2 Mean Streak	02-04	FA231		FA231V	FA231HH	MD4146			
VN 1600 A1/A2/A3/A6F Classic	03-08	FA231		FA231V	FA231HH	MD4146			
VN 1600 B1 Mean Streak	04	FA231		FA231V	FA231HH	MD4146			
VN 1600 B2H/B6F/B7F (Mean Streak)	05-08	FA231		FA231V	FA231HH	MD4146			
VN 1600 D1H/D6F Classic Tourer	05-08	FA231		FA231V	FA231HH	MD4146			
VN 1700 B9F/BAF/BBF/BCF/BDF Voyager ABS	09-13	FA231		FA231V	FA231HH	TBA			
VN 1700 C9F Classic Tourer	09	FA231		FA231V	FA231HH	TBA			
VN 1700 DAF/DBF/DCF/DDF Classic Tourer ABS	10-13	FA231		FA231V	FA231HH	TBA			
VN 1700 E9F Classic	09	FA231		FA231V	FA231HH	TBA			
VN 1700 FAF/FBF/FCF/FDF Classic ABS	10-13	FA231		FA231V	FA231HH	TBA			
VN 1700 KBF/KCF/KDF Voyager Custom	11-13	FA231		FA231V	FA231HH	TBA			
VN 2000 A1/A2/A6F	04-07	FA231		FA231V	FA231HH	TBA			
VN 2000 H8F/H9F Classic	08-09	FA231		FA231V	FA231HH	TBA			

\*-2 Sets Required. ■ - Also available in MX-S race compound.

**SAFETY WARNING:** DO NOT USE HH PADS ON REAR UNLESS ALSO USED ON FRONT TO AVOID BRAKE IMBALANCE

**BRAKE APPLICATIONS**

**R** Suffix = High Durability Sintered Pad. **HH** Suffix = High Performance Sintered Pad. **G** Suffix = Grooved Shoe.  
**D** Suffix = Drilled Disc. **C** Suffix = Contoured Disc. **LS** Suffix = Left/Steel Disc. **RS** = Right/Steel Disc.



# JAPANESE Built Motorcycles



← FRONT / AVANT / VORN FRENTE / ANTERIORE →

SUZUKI	Year	DISC PAD CHOICES				BRAKE ROTOR CHOICES							
		NEW SFAC Scooter Carbon Pads	Semi-Sintered V-Pads™	Sintered/HH Pads/ Grooved shoes	Left/Gauche/Links	Right/Droite/Rechts	Contour Rotor Universal left and right fitment	NEW Vee-Rotors™ CONTOUR	NEW CX Extreme® ROTOR	Oversize 250/280mm Rotor Kit	Relocating Bracket for 250/280mm Rotor	Oversize 320mm Rotor Kit	Relocating Bracket for 320mm Rotor
A 50	71-76	S603											
AD 50 T/Tune/V-Tune	88	SFA083	SFAC083	SFA083HH	TBA								
AE 50 R		SFA083	SFAC083	SFA083HH	TBA								
AE 50 L/NT Style	90-96	S632											
AH 50 N Address (CA1GA)	92-95	S624											
AH 50 N Address (CA1GA) Italian Market	92-95	SFA083	SFAC083	SFA083HH	TBA								
AJ 50 ZZ/RS Sepia	92-	SFA083	SFAC083	SFA083HH	TBA								
AP 50	75-78	S603											
AP 50 R/S/T/V/W	96-02	SFA193	SFAC193	SFA193HH	MD937D								
AY 50 V/W/VW/WWR/WK1-K4 Katana	97-04	SFA193	SFAC193	SFA193HH	MD938D			VR938					
AY 50 WRX/WX/WRY/WY/WRK1/WRK2/WRK3/WRK4 Katana (Girmeza caliper)	99-04	SFA193	SFAC193	SFA193HH	MD938D			VR938					
AY 50 WRK1/WRK2/WRK3/WRK4/AK5 (AJP Caliper)	01-05	SFA115	SFAC115	SFA115HH	MD938D			VR938					
AZ 50 X/LX/UX/Y/LY/LYU/YK2/UK2 (LETS II)		S632											
AZ 50 RY/RK2 (ZZ Inch Up Sport)	00-02	SFA396		SFA396HH	TBA								
AZ 50 7/8 Let. 4/G (CA45A)	07-08	S632											
CL 50 D Suzi/Love	83	S614											
CP 50 CHF (CA14C)	85	S624											
CP 50 C		SFA083	SFAC083	SFA083HH	TBA								
CR 50 DC		SFA083	SFAC083	SFA083HH	TBA								
CS 50 Z/D Roadie	83-84	S613											
CX 50 DF (CA15A)	85	S614											
F 50	71-73	S603											
FR 50	74-81	S603											
FS 50 TX Snip	81-82	S614											
FZ 50 N/X/Z Suzy	80-82	S601											
GS 50 K5 (NA41A)	05	S604											
GT 50 KB/KEN	77-80	FA039			N/A								
JR 50 (All models)	78-07	S613		S613G									
LT 50 GH/J/K/L/X/Y/K1	86-02	None											
LT-A 50 K2/K3/K4/K5 Quadmaster	02-05	S614*		S614G*									
LT-Z 50 K6/K7/K8/K9 Quadsport	06-12	S614*		S614G*									
OR 50 ET	80	FA067			N/A								
RB 50 H GSXR 50	87	FA067			MD901OLS								
RG 50 EW		FA067			N/A								
RM 50 C/INT	78-80	S603		S603G									
RM 50 X/Z	81-82	S604		S604G									
RMX 50		FA115		FA115R	N/A								
TR 50 SW/SX Street Magic	98-00	SFA396		SFA396HH	MD911D		MD911C	VR911					
TS 50 W		S617											
TS 50 KN	79	S603		S603G									
TS 50 ERK/TX/Z/D	80-83	S603		S603G									
TS 50 XKE/XKG/XKH/XKJ/XKM/XKR	84-02	S617		S617G									
UF 50 Y Estilete	00-02	SFA115		SFA115HH	MD938D			VR938					
UR 50 W/Y/K1/K2/K3 (CA1MA/B) Verde	99-03	S632											
UX 50 WX/WY Zillion	99-02	SFA193		SFA193HH	MD938D			VR938					
XSK3/BK3/DK3/DBK3 (CZ41A) Choinori	03	S632											
ZR 50 KEN/KEX X1	79-83	FA039			N/A								
ZR 50 SLKX	81	FA067		FA067HH	N/A								
ZR 50 SKX/SKE/SKH	83-87	FA067		FA067HH	N/A								
RM 60 K3	03	K715		K715G									
RM 65 K3/K4/K5	03-05	FA302TT		FA302R	MD6166D			MD6166CX					
DR-Z 70 K8/K9/L0	08-13	H301											
FR 70	74-76	S603											
AH 80 Address	92-94	SFA083	SFAC083	SFA083HH	MD939D								
CP 80 CHF	85-93	S624											
CS 80 CD	83	S601											
DS 80 T/X/Z/D/F/G/H/J/K/L/M/N/P/R/S/T/V/W/X/Y	80-00	S604		S604G									
FR 80 M/B/N/X/Z/D	76-83	S603											
JR 80 K1/K2/K3/K4/K5/K6/K7	01-07	S604		S604G									
LT 80 L/M/N/P/R/S/T/V/W/X/Y/K1-K6	87-06	S614*		S614G*									

\*-2 Sets Required. ■ - Also available in MX-S race compound.

**SAFETY WARNING:** DO NOT USE HH PADS ON REAR UNLESS ALSO USED ON FRONT TO AVOID BRAKE IMBALANCE

APPLICTIONS  
BRAKE

R Suffix = High Durability Sintered Pad. HH Suffix = High Performance Sintered Pad. G Suffix = Grooved Shoe.  
D Suffix = Drilled Disc. C Suffix = Contoured Disc. LS Suffix = Left/Steel Disc. RS = Right/Steel Disc.

# JAPANESE Built Motorcycles

**BRAKE APPLICATIONS**



**SUZUKI**



← REAR / ARRIÈRE / HINTEN POSTERIOR / POSTERIORE →

		DISC PAD CHOICES			BRAKE ROTOR CHOICES			
		NEW SFAC Scooter Carbon Pads	Semi-Sintered V-Pads™	Sintered/HH Pads/ Grooved shoes	Contour Rotor Rear Fitment	NEW Vee-Rotors™ CONTOUR	NEW CX Extreme® ROTOR	
A 50	71-76	S603						
AD 50 TT/Tune/V-Tune	88	S632						
AE 50 R		S632						
AE 50 L/NT Style	90-96	S632						
AH 50 N Address (CA1GA)	92-95	S624						
AH 50 N Address (CA1GA) Italian Market	92-95	S624						
AJ 50 ZZ/RS Sepia	92-	S624						
AP 50	75-78	S603						
AP 50 R/S/T/V/W	96-02	S624						
AY 50 V/W/VW/WWR/WK1-K4 Katana	97-04	S624						
AY 50 WRX/WX/WRY/WY/WRK1/WRK2/WRK3/WRK4 Katana (Gimeca caliper)	99-04	SFA115	SFAC115	SFA115HH	MD940D		VR940	
AY 50 WRK1/WRK2/WRK3/WRK4/AG (AJP Caliper)	01-05	SFA115	SFAC115	SFA115HH	MD940D		VR940	
AZ 50 XLX/UX/Y/LY/LYU/YK2/UK2 (LETS II)		S624						
AZ 50 RY/RK2 (ZZ Inch Up Sport)	00-02	TBA						
AZ 50 7/8 Let. 4/G (CA45A)	07-08	S624						
CL 50 D SuziLove	83	S613						
CP 50 CHF (CA14C)	85	S624						
CP 50 C		S631						
CR 50 DC		S632						
CS 50 Z/D Roadie	83-84	S613						
CX 50 DF (CA15A)	85	S614						
F 50	71-73	S603						
FR 50	74-81	S603						
FS 50 T/X Snip	81-82	S614						
FZ 50 N/X/Z Suzy	80-82	S601						
GS 50 K5 (NA41A)	05	S604						
GT 50 KB/KEN	77-80	S603						
JR 50 (All models)	78-07	S613		S613G				
LT 50 GH/J/K/LX/Y/K1	86-02	S613		S613G				
LT-A 50 K2/K3/K4/K5 Quadmaster	02-05	S604		S604G				
LT-Z 50 K6/K7/K8/K9 Quadsport	06-12	S604		S604G				
OR 50 ET	80	S604						
RB 50 H GSXR 50	87	S604						
RG 50 EW		S601						
RM 50 CNT	78-80	S603		S603G				
RM 50 X/Z	81-82	S604		S604G				
RMX 50		FA115		FA115R	N/A			
TR 50 SW/SX Street Magic	98-00	897						
TS 50 W		S601						
TS 50 KN	79	S603		S603G				
TS 50 ERKT/X/Z/D	80-83	S604		S604G				
TS 50 XKE/XKG/XKH/XKJ/XKM/XKR	84-02	S601						
UF 50 Y Estilete	00-02	S624						
UR 50 W/Y/K1/K2/K3 (CA1MA/B) Verde	99-03	S624						
UX 50 WX/WY Zillion	99-02	S624						
X5/K3/BK3/DK3/DBK3 (CZ41A) Choinori	03	S632						
ZR 50 KEN/KEX X1	79-83	S603						
ZR 50 SL/KX	81	S604						
ZR 50 SKX/SKE/SKH	83-87	S604						
RM 60 K3	03	K715		K715G				
RM 65 K3/K4/K5	03-05	FA054TT		FA054R	MD6166D		MD6166CX	
DR-Z 70 K3/K3/L0	08-13	H301						
FR 70	74-76	S603						
AH 80 Address	92-94	S624						
CP 80 CHF	85-93	S624						
CS 80 CD	83	S601						
DS 80 TX/Z/D/G/H/J/K/L/M/N/P/R/S/T/V/W/X/Y	80-00	S604		S604G				
FR 80 M/B/N/X/Z/D	76-83	S603						
JR 80 K1/K2/K3/K4/K5/K6/K7	01-07	S604		S604G				
LT 80 L/M/N/P/R/S/T/V/W/X/Y/K1-K6	87-06	S618		S618G				

\*-2 Sets Required. ■ - Also available in MX-S race compound.

**SAFETY WARNING:** DO NOT USE HH PADS ON REAR UNLESS ALSO USED ON FRONT TO AVOID BRAKE IMBALANCE

**R** Suffix = High Durability Sintered Pad. **HH** Suffix = High Performance Sintered Pad. **G** Suffix = Grooved Shoe.  
**D** Suffix = Drilled Disc. **C** Suffix = Contoured Disc. **LS** Suffix = Left/Steel Disc. **RS** = Right/Steel Disc.

# JAPANESE Built Motorcycles

## APPLICATIONS

### BRAKE



## SUZUKI Contd.



		FRONT / AVANT / VORN ← → FRENTE / ANTERIORE														
		DISC PAD CHOICES					BRAKE ROTOR CHOICES									
		NEW SFAC Scooter Carbon Pads	Semi-Sintered V-Pads™	Sintered/HH Pads/ Grooved shoes	Left/Gauche/Links	Right/Droite/Rechts	Contour Rotor Universal left and right fitment	NEW Vee-Rotors™ CONTOUR	NEW CX Extreme® ROTOR	Oversize 250/280mm Rotor Kit	Relocating Bracket for 250/280mm Rotor	Oversize 320mm Rotor Kit	Relocating Bracket for 320mm Rotor			
RM 80 B/C/N	77-79	S603		S603G												
RM 80 XT/XX	80-81	S604		S604G												
RM 80 XZ/XD/XE/XF	82-85	S615		S615G												
RM 80 HD/HF	83-85	S602		S602G												
RM 80 XG/XH/XJ/XK (RC12A)	86-89	FA083TT		FA083R	MD6018D		MD6018C									
RM 80 XL/XM/XN/XP/XR/XS (RC12A)	90-95	FA083TT		FA083R	MD6018D		MD6018C									
RM 80 TV/VW/XY/YK1	96-01	FA230TT		FA230R	MD6018D		MD6018C		OS6018C	BRK001	N/A	N/A				
RM 85 K2/LK2/LK3/LK4/LK4	02-04	FA230TT		FA230R	MD6018D		MD6018C		OS6018C	BRK001	N/A	N/A				
RM 85 K5/K6/K7/K8/K9/L0/L1/L2 (Small 17" Front Wheel)	05-12	FA258TT		FA258R	MD6030D		MD6030C		MD6030CX	OSS6030C	BRK029	N/A	N/A			
RM 85 LK5/LK6/LK7/LK8/LK9/L10/L12 (Large 21" Front Wheel)	05-13	FA258TT		FA258R	MD6030D		MD6030C		MD6030CX	OSS6030C	BRK029	N/A	N/A			
FB 90 K1 (BD42A)	01	S602														
LT-Z 90 K7/K8/K9/L0 Quadsport	07-12	S604*		S604G*												
TS 90 RIJ	71-73	S603		S603G												
ASS 100	69-71	S602														
ACC 100	70-72	S602														
A 100 All Models	74-80	S603														
AH 100 Address	92-94	SFA083	SFAC083	SFA083HH	MD939D											
AH 100 P Address (CE12A)	95-96	SFA083	SFAC083	SFA083HH	MD912D											
GP 100 C/NX/DED	78-87	FA046			N/A											
GP 100 UN/UX/UD/UJUL	79-92	S602														
RM 100 AB/C	76-78	S603		S603G												
RM 100 NT/XX	79-81	S603		S603G												
RM 100 K3	03	FA258TT		FA258R	MD6186D		MD6186C		MD6186CX	OS6186C	BRK025	N/A	N/A			
TS 100 K/L/M	73-75	S603		S603G												
TS 100 AB/C/ERN/ERT/ERX	75-81	S602		S602G												
TS 100 ERZ/ERH	82-87	S602		S602G												
DR-Z 110 K3/K4/K5	03-05	K715		K715G												
110cc Smash	03	S603														
FX 110 Shogun		S603														
UG 110 W/SW/Y/SY/SK1 Hokuto/Address	98-02	SFA396		SFA396HH	MD911D		MD911C	VR911								
Shogun-R FD-112	04	FA197		FA197HH	N/A											
B 120	71-77	S602														
AN 125 S/T/V/W/X	95-00	SFA396		SFA396HH	MD911D		MD911C	VR911								
AN 125 HK/K5	06-08	SFA083/2		SFA083/2HH	MD911D		MD911C	VR911								
CS 125 D	83	S603														
DF 125		FA054TT		FA054R ■	MD6073D											
DR 125 SZ/SD/SE	82-84	S602		S602G												
DR 125 SF/SH/SJ	85-94	FA054TT		FA054R ■	MD6073D											
DR 125 SEX/SEY	99-01	FA054TT		FA054R ■	MD6073D											
DR 125 SMK8/SMK9/SML0	08-12	FA185TT		FA185R ■	MD6017D		MD6017C		MD6017CX							
DR-Z 125 K3/K4/K5/K6/K7/K8/K9	03-12	S604														
DR-Z 125 LK3/LK4/LK5/LK6/LK7/LK8/LK9	03-13	FA230TT		FA230R	MD6212D											
EN 125-2	05	FA135TT			N/A											
EN 125-2A	05	FA135TT			N/A											
FL 125 SD/WK7/SD/WK8 Address/Underbone	07-10	SFA197		SFA197HH		MD9120D										
FX 125		FA197		FA197HH	TBA											
GN 125 R/V/W/X/Y/K1 (NF41A)	94-01	FA067		FA067HH	N/A											
GN 125 ER/VE/WE/VE/VE/K1 (NF41A)	94-01	FA067		FA067HH	N/A											
GN 125 Z/D/K (NF41A/Cast wheel/Ashin Caliper)	82-90	FA093			N/A											
GN 125 HS (LC6PCJ/B1/Chinese production)	00-10	FA067		FA067HH	N/A											
GP 125 C/NX/D	78-84	FA056			N/A											
GS 125 Z/D	82-84	S602														
GS 125 ESZ	82	FA067		FA067HH	N/A											
GS 125 ESD/ESF/ESK/ESM	83-94	FA093			N/A											
GS 125 ESR/ESX	95-00	FA067		FA067HH	N/A											
GT 125 L/M/A/B	74-77	FA055		FA055HH		N/A										
GT 125 C/E/C/EN	78-79	FA038				N/A										
GX 125 (SJ 125)	03	FA093			N/A											
GZ 125 W/X/Y/K1-K9 Marauder	98-11	FA106TT			N/A											
LT 125 D	83	None														

\*-2 Sets Required. ■ - Also available in MX-S race compound.

**SAFETY WARNING:** DO NOT USE HH PADS ON REAR UNLESS ALSO USED ON FRONT TO AVOID BRAKE IMBALANCE

# JAPANESE Built Motorcycles



## SUZUKI Contd.



← REAR / ARRIÈRE / HINTEN POSTERIOR / POSTERIORE →

		DISC PAD CHOICES				BRAKE ROTOR CHOICES			
		NEW SFAC Scooter Carbon Pads	Semi-Sintered V-Pads™	Sintered/HH Pads/ Grooved shoes		Contour Rotor Rear Fitment	NEW Vee-Rotors™ CONTOUR	NEW CX Extreme® ROTOR	
RM 80 B/C/N	77-79	S603		S603G					
RM 80 XT/XX	80-81	S604		S604G					
RM 80 XZ/XD/XE/XF	82-85	Y502		Y502G					
RM 80 HD/HF	83-85	S604		S604G					
RM 80 XG/XH/XJ/XK (RC12A)	86-89	Y502		Y502G					
RM 80 XL/XM/XN/XP/XR/XS (RC12A)	90-95	FA083TT		FA083R	MD6025D	MD6025C			
RM 80 TV/VW/XY/YK1	96-01	FA083TT		FA083R	MD6025D	MD6025C			
RM 85 K2/LK2/K3/LK3/K4/LK4	02-04	FA083TT		FA083R	MD6025D	MD6025C			
RM 85 K5/K6/K7/K8/K9/LD/LL2 (Small 17" Front Wheel)	05-12	FA401TT		FA401R	MD6246D	MD6246C		MD6246CX	
RM 85 LK5/LK6/LK7/LK8/LK9/LL0/LL2 (Large 21" Front Wheel)	05-13	FA401TT		FA401R	MD6246D	MD6246C		MD6246CX	
FB 90 K1 (BD42A)	01	S602							
LT-Z 90 K7/K8/K9/L0 QuadSport	07-12	S618		S618G					
TS 90 RJ	71-73	S602		S602G					
ASS 100	69-71	S603							
ACC 100	70-72	S602							
A 100 All Models	74-80	S603							
AH 100 Address	92-94	S624							
AH 100 P Address (CE12A)	95-96	S624							
GP 100 C/NX/D/ED	78-87	S603							
GP 100 UN/UX/UD/UL	79-92	S603							
RM 100 A/B/C	76-78	S602		S602G					
RM 100 NT/X	79-81	S617		S617G					
RM 100 K3	03	FA084TT		FA084R	MD6187D	MD6187C		MD6187CX	
TS 100 K/L/M	73-75	S602		S602G					
TS 100 A/B/C/ERN/VERT/ERX	75-81	S602		S602G					
TS 100 ERZ/ERH	82-87	S604		S604G					
DR-Z 110 K3/K4/K5	03-05	S603		S603G					
110cc Smash	03	S603							
FX 110 Shogun		S603							
UG 110 W/SW/Y/SY/SK1 Hokuto/Address	98-02	897							
Shogun-R FD-112	04	S603							
B 120	71-77	S602							
AN 125 S/T/V/W/X	95-00	S624							
AN 125 HK/K5	06-08	S624							
CS 125 D	83	S603							
DF 125		S602							
DR 125 SZ/SD/SE	82-84	S602		S602G					
DR 125 SF/SH/SJ	85-94	S602		S602G					
DR 125 SEX/SEY	99-01	S602		S602G					
DR 125 SM/K8/SM/K9/SM/L0	08-12	FA131TT		FA131R ■	MD6014D	MD6014C		MD6014CX	
DR-Z 125 K3/K4/K5/K6/K7/K8/K9	03-12	S604							
DR-Z 125 LK3/LK4/LK5/LK6/LK7/LK8/LK9	03-13	S604							
EN 125-2	05	S602							
EN 125-2A	05	S602							
FL 125 SD/WK7/SD/WK8 Address/Underbone	07-10	H353							
FX 125		S603							
GN 125 R/V/W/X/Y/K1 (NF41A)	94-01	S602							
GN 125 ER/EV/EW/EX/EY/EK1 (NF41A)	94-01	S602							
GN 125 Z/DK (NF41A/Cast wheel/Ashin Caliper)	82-90	S602							
GN 125 HS (LC6PCJ/B1/Chinese production)	00-10	S602							
GP 125 C/NX/D	78-84	S602							
GS 125 Z/D	82-84	S602							
GS 125 ESZ	82	S602							
GS 125 ESD/ESF/ESK/ESM	83-94	S602							
GS 125 ESR/ESX	95-00	S602							
GT 125 L/M/A/B	74-77	S602							
GT 125 C/EC/EN	78-79	S602							
GX 125 (SJ 125)	03	S602							
GZ 125 W/X/Y/K1-K9 Marauder	98-11	S602							
LT 125 D	83	S621		S621G					

\*-2 Sets Required. ■ - Also available in MX-S race compound.

**SAFETY WARNING:** DO NOT USE HH PADS ON REAR UNLESS ALSO USED ON FRONT TO AVOID BRAKE IMBALANCE

**BRAKE APPLICATIONS**

**R** Suffix = High Durability Sintered Pad. **HH** Suffix = High Performance Sintered Pad. **G** Suffix = Grooved Shoe.  
**D** Suffix = Drilled Disc. **C** Suffix = Contoured Disc. **LS** Suffix = Left/Steel Disc. **RS** = Right/Steel Disc.



# JAPANESE Built Motorcycles



**SUZUKI Contd.**



← FRONT / AVANT / VORN FRENTE / ANTERIORE →

Model	Year	Disc	DISC PAD CHOICES				BRAKE ROTOR CHOICES								
			NEW SFAC Scooter Carbon Pads	Semi-Sintered V-Pads™	Sintered/HH Pads/ Grooved shoes	Left/Gauche/Links	Right/Droite/Rechts	Contour Rotor Universal left and right fitment	NEW Vee-Rotors™ CONTOUR	NEW CX Extreme® ROTOR	Oversize 250/280mm Rotor Kit	Relocating Bracket for 250/280mm Rotor	Oversize 320mm Rotor Kit	Relocating Bracket for 320mm Rotor	
LT 125 E	84	None													
LT 125 F/G/H	85-87	None													
RG 125 CG/CH/U (NF12A) (Gamma/Rear Drum Brake Model)	86-90	FA110					MD3048LS								
RG 125 UCG/UCH/UCJ/UBU (NF12B) (Gamma/Rear Drum Model)	86-90	FA110					MD3048LS								
RG 125 FN/FP/FR Gamma (NF13A/Rear Disc Model)	92-94	FA158			FA158HH			MD3045							
RG 125 FUN/FUP/FUR Gamma (NF13B/Rear Disc Model)	92-94	FA158			FA158HH			MD3045							
RG 125 UN - Wolf (NF13E/Naked)	92-94	FA129			FA129HH			MD3045							
RM 125 M/A/B/C	75-78	S602			S602G										
RM 125 N/T	79-80	S602			S602G										
RM 125 X/Z/D	81-83	S602			S602G										
RM 125 E	84	S622			S622G										
RM 125 F/G	85-86	FA106TT			FA106R		MD6163D								
RM 125 H	87	FA135TT			FA135R ■		MD6163D								
RM 125 J	88	FA135TT			FA135R ■		MD6163D								
RM 125 K/L/M	89-91	FA135TT			FA135R ■		MD6017D		MD6017C		MD6017CX	OS6017EC	BRK031	N/A	N/A
RM 125 N/P/R/S (PF14A)	92-95	FA135TT			FA135R ■		MD6017D		MD6017C		MD6017CX	OS6017EC	BRK031	N/A	N/A
RM 125 T/V/W	96-98	FA185TT			FA185R ■		MD6017D		MD6017C		MD6017CX	OS6017C	BRK023	SM6017C	BRK024
RM 125 X/Y/K1/K2/K3/K4/K5	99-05	FA185TT			FA185R ■		MD6017D		MD6017C		MD6017CX	OS6017C	BRK023	SM6017C	BRK024
RM 125 K6/K7/K8/K9	06-12	FA185TT			FA185R ■		MD6017D		MD6017C		MD6017CX	OS6017C	BRK023	SM6017C	BRK024
RM 125 X/C/K8	09	FA185TT			FA185R ■		MD6017D		MD6017C		MD6017CX	OS6017C	BRK023	SM6017C	BRK024
RV 125 K	73	S603			S603G										
RV 125 L/M/A	74-76	S602			S602G										
RV 125 K2-K9/L0 Van-Van	02-13	FA231			FA231HH			MD6281D							
T 125/125 II/125 R Stinger	69-71	S602			S602G										
TF 125 Farm Bike (All models)	78-05	S602			S602G										
TS 125 K	72	S603			S603G										
TS 125 L/M/A/B/C/CZ/ERN/ERT/ERX	73-81	S602			S602G										
TS 125 ERZ	82	S602			S602G										
TS 125 N	84	S602			S602G										
TS 125 XE	84	S602			S602G										
TS 125 XUF/XUG/XUH/XUJ	86-90	FA054TT			FA054R ■		MD6073D								
TS 125 RK/RL/RM/RN/RR (SF15A)	90-96	FA135TT			FA135R ■		MD6109D								
TU 125 X Super Classic	99	FA106TT					N/A								
UC 125 XY Epicuro	99-02	SFA396			SFA396HH		MD934D								
UE 125 CTK1	01-03	SFA083	SFAC083		SFA083HH		MD911D		MD911C		VR911				
UH 125 K2/K3/K4/K5/K6 Burgman	02-06	SFA181	SFAC181		SFA181HH		MD976D		MD976C		VR976				
UH 125 K2/K3/K4/K5/K6 Burgman Parking brake	02-06	S602			S602G										
UH 125 K7/K8/K9/L0/L1/L3 Burgman	07-13	SFA388	SFAC388		SFA388HH			MD9117D			VR9117				
UX 125 K8/K9/L0/L1 Sixteen	08-12	SFA388	SFAC388		SFA388HH			MD9142D							
UZ 125 K5/G/K5 (CF46A) (V 125 G)	05	SFA396			SFA396HH		TBA								
VL 125 Y/K1-K7 Intruder	00-08	FA106TT					N/A								
X4 125		FA067			FA067HH		N/A								
UE 150 CTK1	01	SFA083	SFAC083		SFA083HH			MD9117D			VR9117				
UX 150 K8/K9/L0/L1 Sixteen	08-12	SFA388	SFAC388		SFA388HH			MD9142D							
LT 160 EK/EL/EM/EN	89-92	S624*			S624G*										
LT-F 160 LM/N/P/R/S/T/V/W/X/Y/K1-K3	90-03	S624*			S624G*										
LT 160 K3/K4 QuadSport	03-04	S624*			S624G*										
PE 175 CN	78-79	S602			S602G										
PE 175 TX	80-81	S602			S602G										
PE 175 Z	82	S618			S618G										
GT 185 K	73	N/A													
GT 185 L/M/A/B/C/EC	74-79	FA055			FA055HH										
LT 185 E/F	84-85	None													
TS 185 K	73	S603			S603G										
TS 185 L/M/B/C/ERN/ERT/ERX	74-81	S602			S602G										
DF 200 EV/EW/EY (SH42A)	98-00	FA054TT			FA054R ■		MD6073D								
DR 200 G/H/J	86-89	FA054TT			FA054R ■		MD6073D								
DR 200 SEP/SER/SES/SEV/SEW/SEX/SEY (SH42A) Djebel	93-00	FA054TT			FA054R ■		MD6073D								
DR 200 SEK1-SEK9	01-09	FA054TT			FA054R ■		MD6073D								
DR 200 SE Trojan		FA054TT			FA054R ■		MD6073D								

\*-2 Sets Required. ■ - Also available in MX-S race compound.

**SAFETY WARNING:** DO NOT USE HH PADS ON REAR UNLESS ALSO USED ON FRONT TO AVOID BRAKE IMBALANCE

APPLICATIONS  
BRAKE

R Suffix = High Durability Sintered Pad. HH Suffix = High Performance Sintered Pad. G Suffix = Grooved Shoe.  
D Suffix = Drilled Disc. C Suffix = Contoured Disc. LS Suffix = Left/Steel Disc. RS = Right/Steel Disc.

# JAPANESE Built Motorcycles



## SUZUKI Contd.



← REAR / ARRIÈRE / HINTEN POSTERIOR / POSTERIORE →

			DISC PAD CHOICES			BRAKE ROTOR CHOICES			
			NEW SFAC Scooter Carbon Pads	Semi-Sintered V-Pads™	Sintered/HH Pads/ Grooved shoes	Contour Rotor Rear Fitment	NEW Vee-Rotors™ CONTOUR	NEW CX Extreme® ROTOR	
LT 125 E	84	S605			S605G				
LT 125 F/G/H	85-87	S621			S621G				
RG 125 CG/CHU (NF12A) (Gamma/Rear Drum Brake Model)	86-90	S602							
RG 125 UCG/UCH/UJU/JBUJ (NF12B) (Gamma/Rear Drum Model)	86-90	S602							
RG 125 FNF/FR Gamma (NF13A/Rear Disc Model)	92-94	FA157				MD3059			
RG 125 FUN/FUP/FUR Gamma (NF13B/Rear Disc Model)	92-94	FA157				MD3059			
RG 125 UN - Wolf (NF13E/Naked)	92-94	FA157				MD3059			
RM 125 M/A/B/C	75-78	S602			S602G				
RM 125 NT	79-80	S617			S617G				
RM 125 X/Z/D	81-83	S616			S616G				
RM 125 E	84	S616			S616G				
RM 125 F/G	85-86	S616			S616G				
RM 125 H	87	S616			S616G				
RM 125 J	88				FA084/3R	MD6014D	MD6014C		
RM 125 K/L/M	89-91	FA152TT			FA152R ■	MD6014D	MD6014C		MD6014CX
RM 125 NP/R/S (RF14A)	92-95	FA152/2TT			FA152/2R ■	MD6014D	MD6014C		MD6014CX
RM 125 T/V/W	96-98	FA131TT			FA131R ■	MD6014D	MD6014C		MD6014CX
RM 125 X/Y/K1/K2/K3/K4/K5	99-05	FA131TT			FA131R ■	MD6157D	MD6157C		MD6157CX
RM 125 K6/K7/K8/K9	06-12	FA131TT			FA131R ■	MD6305D	MD6305C		MD6305CX
RM 125 X/C/K8	09	FA131TT			FA131R ■	MD6305D	MD6305C		MD6305CX
RV 125 K	73	S602			S602G				
RV 125 L/M/A	74-76	S602			S602G				
RV 125 K2/K9/L0 Van-Van	02-13	S603							
T 125/125 II/125 R Stinger	69-71	S602							
TF 125 Farm Bike (All models)	78-05	S602			S602G				
TS 125 K	72	S602			S602G				
TS 125 L/M/A/B/C/C2/ERNVERT/ERX	73-81	S602			S602G				
TS 125 ERZ	82	S604			S604G				
TS 125 N	84	S602			S602G				
TS 125 XE	84	S627							
TS 125 XUF/XUG/XUH/XUJ	86-90	S627							
TS 125 RK/RL/RM/RN/RP/RR (SF15A)	90-96	FA152TT			FA152R ■	MD6038D			
TU 125 X Super Classic	99	S602							
UC 125 X/Y Epicuro	99-02	S635							
UE 125 CTK1	01-03	S624							
UH 125 K2/K3/K4/K5/K6 Burgman	02-06	SFA266	SFAC266		FA266HH	MD975D		VR975	
UH 125 K7/K8/K9/L0/L1/L3 Burgman	07-13	SFA413	SFAC413		SFA413HH	MD9117D		VR9117	
UX 125 K8/K9/L0/L1 SIXteen	08-12	SFA307			SFA307HH	MD9142D			
UZ 125 K5/GK5 (CF46A) (V 125 G)	05	TBA							
VL 125 Y/K1-K7 Intruder	00-08	S602							
X4 125		S602							
UE 150 CTK1	01	S624							
UX 150 K8/K9/L0/L1 SIXteen	08-12	SFA307			SFA307HH	MD9142D			
LT 160 EK/EL/EM/EN	89-92	S605			S605G				
LT-F 160 L/M/N/P/R/S/T/W/WX/Y/K1-K3	90-03	S605			S605G				
LT 160 K3/K4 Quadsport	03-04	S605			S605G				
PE 175 CN	78-79	S602			S602G				
PE 175 T/X	80-81	S619			S619G				
PE 175 Z	82	S619			S619G				
GT 185 K	73	S602							
GT 185 L/M/A/B/C/EC	74-79	S602							
LT 185 E/F	84-85	S605			S605G				
TS 185 K	73	S602			S602G				
TS 185 L/M/B/C/ERNVERT/ERX	74-81	S602			S602G				
DF 200 EV/EW/EVY (SH42A)	98-00	S602			S602G				
DR 200 G/H/J	86-89	S602			S602G				
DR 200 SEP/SEI/SES/SEW/SEX/SEY (SH42A) Djebel	93-00	S602			S602G				
DR 200 SEK1-SEK9	01-09	S602			S602G				
DR 200 SE Trojan		S602			S602G				

\*-2 Sets Required. ■ - Also available in MX-S race compound.

**SAFETY WARNING:** DO NOT USE HH PADS ON REAR UNLESS ALSO USED ON FRONT TO AVOID BRAKE IMBALANCE

**R** Suffix = High Durability Sintered Pad. **HH** Suffix = High Performance Sintered Pad. **G** Suffix = Grooved Shoe.  
**D** Suffix = Drilled Disc. **C** Suffix = Contoured Disc. **LS** Suffix = Left/Steel Disc. **RS** = Right/Steel Disc.

**BRAKE APPLICATIONS**

# JAPANESE Built Motorcycles



**SUZUKI Contd.**

FRONT / AVANT / VORN      FRENTE / ANTERIORE

**DISC PAD CHOICES**

**BRAKE ROTOR CHOICES**

Model	Year	FA Part	NEW SFAC Scooter Carbon Pads	Semi-Sintered V-Pads™	Sintered/HH Pads/ Grooved shoes	Left/Gauche/Links		Right/Droite/Rechts		Contour Rotor Universal left and right fitment	NEW Vee-Rotors™ CONTOUR	NEW CX Extreme® ROTOR	Oversize 250/280mm Rotor Kit	Relocating Bracket for 250/280mm Rotor	Oversize 320mm Rotor Kit	Relocating Bracket for 320mm Rotor
						Left	Right	Left	Right							
GT 200 ENEX X5	79-82	FA038							N/A							
RV 200 K2/K3	02-03	FA231			FA231HH				MD6281D							
SB 200 NX	79-81	S605														
SX 200 RR-2/RJ/RM (SH41A)	90-91	FA054TT			FA054R ■		MD6073D									
TS 200 RK/RL/RM/RN/RP/RR	89-94	FA135TT			FA135R ■		MD6109D									
UH 200 K7/K8/K9/L0/L1/L3 Burgman	07-13	SFA388	SFAC388		SFA388HH			MD9117D			VR9117					
LT 230 GEF/GEG	85-86	S625*			S625G*											
LT-F 230 G/H	86-87	S625*			S625G*											
LT-F4WDX HJ/K/L/M/N/P/R/S/T/V/W	87-98	S633*			S633G*											
250 SBK 2 (LX 250 L)	02	FA185TT			FA185R ■		MD6240D		MD6240C			OS6240C	BRK023	SM6240C	BRK024	
AN 250 W/X/Y Burgman/Skywave	98-02	SFA283*	SFAC283*		SFA283HH*		MD929D		MD929C		VR929					
AN 250 K1/K2 Burgman/Skywave	01-02	SFA283*	SFAC283*		SFA283HH*		MD929D		MD929C		VR929					
AN 250 K3-K6 Burgman (CJ43A)	03-06	SFA283*	SFAC283*		SFA283HH*		MD994D				VR994					
AN 250 Skywave Type M (BA-CJ45A)	Left 07-08	SFA228	SFAC228		SFA228HH		MD994D				VR994					
	Right	SFA197	SFAC197		SFA197HH			MD994D			VR994					
AN 250 Skywave Type S (BA-CJ44A)	Left 07-08	SFA228	SFAC228		SFA228HH		MD994D				VR994					
	Right	SFA197	SFAC197		SFA197HH			MD994D			VR994					
AN 250 8 Skywave SS	Left 08	SFA228	SFAC228		SFA228HH		MD994D				VR994					
	Right	SFA197	SFAC197		SFA197HH			MD994D			VR994					
DR 250 SL/SM/SN/SE/SE/SES (SJ 44A)	90-95	FA135TT			FA135R ■		MD6040D				MD6040CX	OS6040C	BRK031	N/A	N/A	
DR 250 BS/PLS/RT/RV/RLV/RLW/RW/RV (SJ45A/DOHC)	95-00	FA185TT			FA185R ■		MD6017D		MD6017C		MD6017CX	OS6017C	BRK023	SM6017C	BRK024	
DR 250 RXT/RXL/TRXV/RXLV/RXW/RXLW/RXGW/RXGLW/RXY																
/RXGY (Djebel 250 XC/GPS (SJ45A)	96-98	FA185TT			FA185R ■		MD6017D		MD6017C		MD6017CX	OS6017C	BRK023	SM6017C	BRK024	
DR-Z 250 K1-K7 (SJ 44 A)	01-07	FA185TT			FA185R ■		MD6017D		MD6017C		MD6017CX	OS6017C	BRK023	SM6017C	BRK024	
GN 250 FJ/JM/RJT (NJ41A)	85-97	FA051					MD3014LS									
GT 250 K/L/M/N/A/B/C	73-78	FA055			FA055HH			MD3014RS								
GT 250 EN/ET/EX X7	78-81	FA038						N/A								
GS 250 TT/TX	80-81	FA051					MD3014LS									
GSF 250 N/Z/M/P/NP/ZP/R/RN Bandit (GJ74A)	92-96	FA129			FA129HH		MD3006X		MD3006XC		VR3006BLK					
GSF 250 VS/VT/VW/VZ/VW/VX/VY Bandit (GJ77A)	95-00	FA229			FA229HH		MD3006X		MD3006XC		VR3006BLK					
GSX 250 ET/EX/EZ	80-82	FA051					MD3014LS									
GSX 250 FL/FM/FN/FP/FR/FS/FT/FV/FW - Across	90-98	FA129			FA129HH		MD3006X		MD3006XC		VR3006BLK					
GSX 250 RCHH (GJ72A)	87	FA103*			FA103HH*		MD3074	MD3074								
GSX 250 SSM Katana (GJ76A)	91	FA129			FA129HH		MD3006X		MD3006XC		VR3006BLK					
GSX 250 FX/K2/K3/K4/K5 (ZR 250 C)	02-05	FA231			FA231HH			MD4008RS	MD4008C		VR4008BLK					
GSXR 250 CJ (GJ72A)	88	FA103*			FA103HH*		MD3074	MD3074								
GSXR 250 CK (GJ72A)	89	FA103*			FA103HH*		MD3074	MD3074								
GSXR 250 RK (GJ73A)	89	FA158*			FA158HH*		MD3003X	MD3003X	MD3003XC*		VR3003BLK*					
GW 250 L3 Inazuma	13	FA142		FA142V	FA142HH		MD3105LS									
GZ 250 XY/YK1	99-01	FA106TT					N/A									
GZ 250 K2-K8 Marauder	02-08	FA106TT					N/A									
LT 250 EFF/IEFG	85-86	S625*			S625G*											
LT 250 RH/RJ/RK/RL	87-90	FA128TT*			FA128R*		MD6020D	MD6020D								
LT-F 250 J/K/L/M/N/P/R/S/T/V/W/X/Y/K1	88-01	S628*			S628G*											
LT-F 250 FX/FY/FK1/FK2	99-02	S628*			S628G*											
LT-F 250 K2/K3/K4/K5/K6/K7/K8/K9/L2 Ozark	02-12	FA054TT*			FA054R*		MD6207D	MD6207D								
LT-Z 250 K4/K5/K6/K7/K8/K9/L0 Quadspart	04-12	FA084TT*			FA084R* ■		MD6210D	MD6210D								
LT-F4WD HJ/K/L/M/N/P/S/T/V/W	87-98	S628*			S628G*											
PE 250 B/C/N	77-79	S605			S605G											
PE 250 T/X/Z	80-82	S605			S605G											
RL 250 LM	74-75	S603			S603G											
RL 250 Beamish Model Reed Valve Engine	78-82	S603			S603G											
RM 250 A/B/C	76-78	S602			S602G											
RM 250 N	79	S605			S605G											
RM 250 T	80	S618			S618G											
RM 250 X/Z	81-82	S621			S621G											
RM 250 D	83	S622			S622G											
RM 250 E	84	S622			S622G											
RM 250 FIG	85-86	FA106TT			FA106R		MD6163D									
RM 250 HJ	87-88	FA135TT			FA135R ■		MD6163D									

\*-2 Sets Required. ■ - Also available in MX-S race compound.

**SAFETY WARNING:** DO NOT USE HH PADS ON REAR UNLESS ALSO USED ON FRONT TO AVOID BRAKE IMBALANCE

APPLICATIONS  
BRAKE

R Suffix = High Durability Sintered Pad. HH Suffix = High Performance Sintered Pad. G Suffix = Grooved Shoe.  
D Suffix = Drilled Disc. C Suffix = Contoured Disc. LS Suffix = Left/Steel Disc. RS = Right/Steel Disc.

# JAPANESE Built Motorcycles



## SUZUKI Contd.



← REAR / ARRIÈRE / HINTEN POSTERIOR / POSTERIORE →

			DISC PAD CHOICES			BRAKE ROTOR CHOICES			
			NEW SFAC Scooter Carbon Pads	Semi-Sintered V-Pads™	Sintered/HH Pads/ Grooved shoes	Contour Rotor Rear Fitment	NEW Vee-Rotors™ CONTOUR	NEW CX Extreme® ROTOR	
GT 200 ENVEI X5	79-82	S602							
RV 200 K2/K3	02-03	S603							
SB 200 NX	79-81	S602							
SX 200 R/R-2/RJ/RM (SH41A)	90-91	S605			S605G				
TS 200 RK/RL/RM/RN/RP/RR	89-94	FA152TT			FA152R ■	MD6038D			
UH 200 K7/K8/K9/L0/L1/L3 Burgman	07-13	SFA413	SFAC413		SFA413HH	MD9117D		VR9117	
LT 230 GEF/GEG	85-86	S605			S605G				
LT-F 230 GH	86-87	S605			S605G				
LT-F4WDX H/J/K/L/M/N/P/R/S/T/V/W	87-98	S634			S634G				
250 SBK 2 (LX 250 L)	02	FA131TT			FA131R ■	MD6105D			
AN 250 W/X/Y Burgman/Skywave	98-02	SFA323/3			SFA323/3HH	MD930D	MD930C	VR930	
AN 250 K1/K2 Burgman/Skywave	01-02	SFA411	SFAC411		SFA411HH	MD930D	MD930C	VR930	
AN 250 K3-K6 Burgman (CJ43A)	03-06	SFA411	SFAC411		SFA411HH	N/A			
AN 250 Skywave Type M (BA-CJ45A)	07-08	SFA412	SFAC412		SFA412HH	MD9109D		VR9109	
AN 250 Skywave Type S (BA-CJ44A)	07-08	SFA412	SFAC412		SFA412HH	MD9109D		VR9109	
AN 250 8 Skywave SS	08	SFA412	SFAC412		SFA412HH	MD9109D		VR9109	
DR 250 SL/SN/SE/SEP/SER/SES (SJ 44A)	90-95	FA152TT			FA152R ■	MD6038D			
DR 250 RS/RLS/RT/RV/RLV/RLW/RW/RVY (SJ45A/DOHC)	95-00	FA1522TT			FA1522R ■	MD6110D			
DR 250 RXT/RLT/RXV/RXLV/RXW/RXLW/RXGW/RXGLW/RXY									
/RXGY (Djebel 250 XC/GPS (SJ45A)	96-98	FA152TT			FA152R ■	MD6110D			
DR-Z 250 K1-K7 (SJ 44 A)	01-07	FA1522TT			FA1522R ■	MD6110D			
GN 250 F/J/M/R/T (NJ41A)	85-97	S602							
GT 250 K/L/M/N/A/B/C	73-78	S609							
GT 250 ENVEI EX X7	78-81	S606							
GS 250 TT/TX	80-81	S606							
GSF 250 NZM/IN/P/ZIP/RNR Bandit (GJ74A)	92-96	FA063		FA063V	FA063HH	MD3002	MD3002C	VR3002	
GSF 250 VSN/VN/VN/VZ/VW/VX/VY Bandit (GJ77A)	95-00	FA063		FA063V	FA063HH	MD3084			
GSX 250 ET/EX/EZ	80-82	S606							
GSX 250 FL/FM/FN/FP/FR/FS/FT/FV/FW - Across	90-98	FA063		FA063V	FA063HH	MD3002	MD3002C	VR3002	
GSX 250 RCH/H (GJ72A)	87	FA063		FA063V	FA063HH	MD3064			
GSX 250 SSM Katana (GJ76A)	91	FA063		FA063V	FA063HH	MD3002	MD3002C	VR3002	
GSX 250 FXK2/K3/K4/K5 (ZR 250 C)	02-05	FA067			FA067HH	MD4051	MD4051C	VR4015	
GSXR 250 CJ (GJ72A)	88	FA063		FA063V	FA063HH	MD3081			
GSXR 250 CK (GJ72A)	89	FA063		FA063V	FA063HH	MD3081			
GSXR 250 FK (GJ73A)	89	FA063		FA063V	FA063HH	TBA			
GW 250 L3 Inazuma	13	FA496		FA496V	FA496HH	MD3093			
GZ 250 X/Y/K1	99-01	S602							
GZ 250 K2-K8 Marauder	02-08	S602							
LT 250 EFF/FG	85-86	S634			S634G				
LT 250 RH/RJ/RK/RL	87-90	FA137TT			FA137R	MD6021D			
LT-F 250 J/K/L/M/N/P/R/S/T/V/W/X/Y/K1	88-01	S629			S629G				
LT-F 250 FX/FY/FK1/FK2	99-02	S629			S629G				
LT-F 250 K2/K3/K4/K5/K6/K7/K8/K9/L2 Ozark	02-12	S636			S636G				
LT-Z 250 K4/K5/K6/K7/K8/K9/L0 Quadsport	04-12	S636			S636G				
LT-F4WD H/J/K/L/M/N/P/S/T/V/W	87-98	S629			S629G				
PE 250 B/C/N	77-79	S605			S605G				
PE 250 T/X/Z	80-82	S605			S605G				
RL 250 LM	74-75	S602			S602G				
RL 250 Beamish Model Reed Valve Engine	78-82	S602			S602G				
RM 250 A/B/C	76-78	S605			S605G				
RM 250 N	79	S620			S620G				
RM 250 T	80	S620			S620G				
RM 250 XZ	81-82	S616			S616G				
RM 250 D	83	S616			S616G				
RM 250 E	84	S602			S602G				
RM 250 F/G	85-86	S602			S602G				
RM 250 H/J	87-88				FA084/3R	MD6014D			

\*-2 Sets Required. ■ - Also available in MX-S race compound.

**SAFETY WARNING:** DO NOT USE HH PADS ON REAR UNLESS ALSO USED ON FRONT TO AVOID BRAKE IMBALANCE

**R** Suffix = High Durability Sintered Pad. **HH** Suffix = High Performance Sintered Pad. **G** Suffix = Grooved Shoe.  
**D** Suffix = Drilled Disc. **C** Suffix = Contoured Disc. **LS** Suffix = Left/Steel Disc. **RS** = Right/Steel Disc.

**BRAKE APPLICATIONS**



# JAPANESE Built Motorcycles



## SUZUKI Contd.



		DISC PAD CHOICES				BRAKE ROTOR CHOICES							
		NEW SFAC Scooter Carbon Pads	Semi-Sintered V-Pads™	Sintered/HH Pads/ Grooved shoes	Left/Gauche/Links	Right/Droite/Rechts	Contour Rotor Universal left and right fitment	NEW Vee-Rotors™ CONTOUR	NEW CX Extreme® ROTOR	Oversize 250/280mm Rotor Kit	Relocating Bracket for 250/280mm Rotor	Oversize 320mm Rotor Kit	Relocating Bracket for 320mm Rotor
RM 250 K/L/M	89-91	FA135TT		FA135R ■	MD6017D		MD6017C		MD6017CX	OS6017EC	BRK031	N/A	N/A
RM 250 N/P/R/S (R116A)	92-95	FA135TT		FA135R ■	MD6017D		MD6017C		MD6017CX	OS6017EC	BRK031	N/A	N/A
RM 250 T/V/W	96-98	FA185TT		FA185R ■	MD6017D		MD6017C		MD6017CX	OS6017C	BRK023	SM6017C	BRK024
RM 250 X/Y/K1/K2/K3/K4/K5/K6/K7	99-05	FA185TT		FA185R ■	MD6017D		MD6017C		MD6017CX	OS6017C	BRK023	SM6017C	BRK024
RM 250 K6/K7/K8/K9	06-12	FA185TT		FA185R ■	MD6017D		MD6017C		MD6017CX	OS6017C	BRK023	SM6017C	BRK024
RM 250 XCK8	09	FA185TT		FA185R ■	MD6017D		MD6017C		MD6017CX	OS6017C	BRK023	SM6017C	BRK024
RMX 250 K/M/N/P	89-93	FA135TT		FA135R ■	MD6017D		MD6017C		MD6017CX	OS6017EC	BRK031	N/A	N/A
RMX 250 R/S	94-95	FA135TT		FA135R ■	MD6017D		MD6017C		MD6017CX	OS6017EC	BRK031	N/A	N/A
RMX 250 T/V/W	96-98	FA185TT		FA185R ■	MD6017D		MD6017C		MD6017CX	OS6017C	BRK023	SM6017C	BRK024
RMX 250 ST/SV/SW/SX (S114A)	96-99	FA185TT		FA185R ■	MD6017D		MD6017C		MD6017CX	OS6017C	BRK023	SM6017C	BRK024
RMX 250 SN/SR/SS (S113A)	95-97	FA135TT		FA135R ■	MD6017D		MD6017C		MD6017CX	OS6017C	BRK023	SM6017C	BRK023
RM-Z 250 K4/K5/K6	04-06	FA185TT		FA185R ■	MD6213D		MD6213C		MD6213CX	OS6213C	BRK023	SM6213C	BRK023
RM-Z 250 K7	07	FA185TT		FA185R ■	MD6254D		MD6254C		MD6254CX	OS6254C	BRK023	SM6254C	BRK023
RM-Z 250 K7/K8/K9/L0/L1/L2/L3	08-13	FA185TT		FA185R ■			MD6254C		MD6254CX	OS6254C	BRK023	SM6254C	BRK023
RG 250 WD Gamma	83	FA063		FA063HH	MD3014LS								
RG 250 WE	84	FA102			MD3014LS								
RG 250 FG/CH/FCH/FH Gamma (GJ21B)	85-88	FA102*				N/A	N/A						
RGV 250 J	88	FA158*		FA158HH*	MD3003X	MD3003X	MD3003XC*	VR3003BLK*					
RGV 250 K/L (VJ21A)	89-90	FA158*		FA158HH*	MD3003X	MD3003X	MD3003XC*	VR3003BLK*					
RGV 250 M/N/P/R/S (VJ22A)	91-95	FA158*		FA158HH*	MD3045	MD3045							
RGV 250 T (RGVR 250 SP VJ23A)	96	FA180*		FA180HH*	MD3082LS	MD3082RS							
SW-1 (NJ45A)	92	FA129		FA129HH	N/A								
T 20 Super Six	66-68	N/A											
T 250 I/RI/J	70-72	N/A											
TS 250 L/M/A/B/C/ERN/ERT/ERX	74-82	S605		S605G									
TS 250 XE/XG/XH/XJ/XK	85-89	FA054TT		FA054R ■	MD6075D								
TU 250 S/T/X/SX/TX-IX-ST/XSV/XT-W Volty (NJ47A 100001-115972)	92-97	FA106TT			N/A								
TU 250 XV/XW	97-00	FA106TT			N/A								
TU 250 XTXX/XTY (NJ47A-115-) Volty	99-00	FA229		FA229HH	N/A								
TU 250 GY/GBK1 Grass Tracker - Big Boy (NJ47A-117/123)	00-01	FA229		FA229HH	N/A								
TV 250 JK/AKL (VJ21A) Wolf	88-90	FA158		FA158HH		MD3007	MD3007C	VR3007BLK					
VL 250 YK1/K5/K6/K7 Intruder	00-01/05-07	FA106TT				NA							
LT-F 300 J/K	88-89	S625*		S625G*									
LT-F 300 FX/FY/FK1	99-01	S633*		S633G*									
LT-F 300 FK2	Left 02	FA165TT		FA165R ■	MD6206D								
	Right	FA135TT		FA135R ■		MD6206D							
LT-F 4WD XH/J/K/L/M/N/P/R/S/T/V/W	87-98	S633*		S633G*									
RL 325		S603		S603G									
DR 350 SL/SM/SN/SP (4 Bolt Front Disc/Kick Start)	90-93	FA135TT		FA135R ■	MD6040D				MD6040CX	OS6040C	BRK031	N/A	N/A
DR 350 SER/SES (Electric Start/4 Bolt Front Disc)	94-95	FA135TT		FA135R ■	MD6040D				MD6040CX	OS6040C	BRK031	N/A	N/A
DR 350 SET/SEV/SEW/SEX (Electric Start/4 Bolt Front Disc/UK/Europe)	96-99	FA135TT		FA135R ■	MD6040D				MD6040CX	OS6040C	BRK031	N/A	N/A
DR 350 SEW/SEX (Electric Start/6 Bolt Front Disc/USA Only)	98-99	FA185TT		FA185R ■	MD6017D				MD6017CX	OS6017C	BRK023	SM6017C	BRK024
RL 350 Beamish Model Reed Valve Engine	78-82	S603		S603G									
SG 350 N Goose	92	FA158		FA158HH		MD3080RS							
T 350 1/2/RI/J	69-72	N/A											
SP 370 CN	77-80	S605		S605G									
GT 380 J	72	N/A											
GT 380 K/L/M/A/B	73-77	FA055		FA055HH		MD3014RS							
AN 400 X/Y Burgman	99-00	SFA283*	SFAC283*	SFA283HH*	MD929D		MD929C	VR929					
AN 400 K1/K2	01-02	SFA283*	SFAC283*	SFA283HH*	MD929D		MD929C	VR929					
AN 400 K3-K6	03-06	SFA283*	SFAC283*	SFA283HH*	MD994D			VR994					
AN 400 K7/ZK7/K8/ZK8/K9/L0/L1/L2/L3 Burgman	Left 07-13	SFA228	SFAC228	SFA228HH	MD994D			VR994					
	Right	SFA197	SFAC197	SFA197HH		MD994D		VR994					
/Skywave (Non ABS)	Right 07-13	SFA228	SFAC228	SFA228HH	MD994D			VR994					
AN 400 AK9/ZAK9/AL0/ZAL0/AL1/ZAL1/AL2/AL3	Left 07-13	SFA197	SFAC197	SFA197HH		MD994D		VR994					
	Right	SFA197	SFAC197	SFA197HH		MD994D		VR994					
Burgman/Skywave (ABS)	Right	SFA197	SFAC197	SFA197HH		MD994D		VR994					
DR 400 ST/SX	79-81	S605		S605G									
DR-Z 400 SY/EY/SEK1/EK1/K1/SK2/EK2/K2/K3/SK3/EK3/K4/SK4/EK4													
/SK5/EK5/K5/EK6/SK6/K6/SK7/EK7/K7/SK8	00-08	FA185TT		FA185R ■	MD6017D		MD6017C		MD6017CX	OS6017C	BRK023	SM6017C	BRK024
DR-Z 400 SMK5/SMK6/SMK7/SMK8/SMK9	05-09	FA185TT		FA185R ■	MD6247D		MD6247C						
GN 400 TT	80	FA051			MD3014LS								

\*-2 Sets Required. ■ - Also available in MX-S race compound.

**SAFETY WARNING:** DO NOT USE HH PADS ON REAR UNLESS ALSO USED ON FRONT TO AVOID BRAKE IMBALANCE

APPLICATIONS  
BRAKE

R Suffix = High Durability Sintered Pad. HH Suffix = High Performance Sintered Pad. G Suffix = Grooved Shoe.  
D Suffix = Drilled Disc. C Suffix = Contoured Disc. RS Suffix = Right/Steel Disc. LS Suffix = Left/Steel Disc.

# JAPANESE Built Motorcycles



## SUZUKI Contd.



← REAR / ARRIÈRE / HINTEN POSTERIOR / POSTERIORE →

			DISC PAD CHOICES			BRAKE ROTOR CHOICES			
			NEW SFAC Scooter Carbon Pads	Semi-Sintered V-Pads™	Sintered/HH Pads/ Grooved shoes	Contour Rotor Rear Fitment	NEW Vee-Rotors™ CONTOUR	NEW CX Extreme® ROTOR	
RM 250 K/L/M	89-91	FA152TT			FA152R ■	MD6014D	MD6014C		MD6014CX
RM 250 NP/P/R/S (RJ16A)	92-95	FA1522TT			FA1522R ■	MD6014D	MD6014C		MD6014CX
RM 250 T/V/W	96-98	FA131TT			FA131R ■	MD6014D	MD6014C		MD6014CX
RM 250 XY/K1/K2/K3/K4/K5/K6/K7	99-05	FA131TT			FA131R ■	MD6157D	MD6157C		MD6157CX
RM 250 K6/K7/K8/K9	06-12	FA131TT			FA131R ■	MD6305D	MD6305C		MD6305CX
RM 250 XCX8	09	FA131TT			FA131R ■	MD6305D	MD6305C		MD6305CX
RMX 250 K/M/N/P	89-93	FA152TT			FA152R ■	MD6014D	MD6014C		MD6014CX
RMX 250 R/S	94-95	FA1522TT			FA1522R ■	MD6014D	MD6014C		MD6014CX
RMX 250 T/V/W	96-98	FA152TT			FA152R ■	MD6014D	MD6014C		MD6014CX
RMX 250 ST/SV/SW/SX (SJ14A)	96-99	FA131TT			FA131R ■	MD6014D	MD6014C		MD6014CX
RMX 250 SN/SP/SS (SJ13A)	95-97	FA1522TT			FA1522R ■	MD6014D	MD6014C		MD6014CX
RM-Z 250 K4/K5/K6	04-06	FA367TT			FA367R ■	MD6208D	MD6208C ◆		MD6208CX ◆
RM-Z 250 K7	07	FA367TT			FA367R ■	MD6255D	MD6255C ◆		MD6255CX ◆
RM-Z 250 K7/K8/K9/L0/L1/L2/L3	08-13	FA367TT			FA367R ■		MD6255C ◆		MD6255CX ◆
RG 250 WD Gamma	83	FA063		FA063V	FA063HH	MD3064			
RG 250 WE	84	FA063		FA063V		MD3064			
RG 250 FG/CH/FCH/FH Gamma (GJ21B)	85-88	FA063		FA063V		MD3064			
RGV 250 J	88	FA063		FA063V	FA063HH	MD3081			
RGV 250 K/L (VJ21A)	89-90	FA063		FA063V	FA063HH	MD3081			
RGV 250 MN/P/R/S (VJ22A)	91-95	FA141				MD3059			
RGV 250 T (RGVR 250 SP VJ23A)	96	FA141				MD3059			
SW-1 (NJ45A)	92	S606							
T 20 Super Six	66-68	S609							
T 250 I/R/J	70-72	S609							
TS 250 L/M/A/B/C/ERN/ERT/ERX	74-82	S605			S605G				
TS 250 XE/XG/XH/XJ/XK	85-89	S627							
TU 250 S/T/XS/XTX-ST/XSV/XT-W Volty (NJ47A 100001-115972)	92-97	S602							
TU 250 XV/XW	97-00	S602							
TU 250 XTX/XTY (NJ47A-115-) Volty	99-00	S602							
TU 250 GY/GBK1 Grass Tracker - Big Boy (NJ47A-117/123)	00-01	S602							
TV 250 J/K/L (VJ21A) Wolf	88-90	FA063		FA063V	FA063HH	MD3081			
VL 250 Y/K1/K5/K6/K7 Intruder	00-01/05-07	S602							
LT-F 300 J/K	88-89	S634			S634G				
LT-F 300 FX/FY/FK1	99-01	S634			S634G				
LT-F 300 FK2	02	S634			S634G				
LT-F 4WD XH/J/K/L/M/N/P/R/S/T/V/W	87-98	S634			S634G				
RL 325		S602			S602G				
DR 350 SL/SM/SN/SP (4 Bolt Front Disc/Kick Start)	90-93	FA152TT			FA152R ■	MD6038D			MD6038CX
DR 350 SER/SES (Electric Start/4 Bolt Front Disc)	94-95	FA152TT			FA152R ■	MD6038D			MD6038CX
DR 350 SET/SEV/SEW/SEX (Electric Start/4 Bolt Front Disc/UK/Europe)	96-99	FA152TT			FA152R ■	MD6110D			MD6110CX
DR 350 SEW/SEX (Electric Start/6 Bolt Front Disc/USA Only)	98-99	FA152TT			FA152R ■	MD6110D			MD6110CX
RL 350 Beamish Model Reed Valve Engine	78-82								
SG 350 N Goose	92	FA063		FA063V	FA063HH	MD3081			
T 350 1/2/R/J	69-72	S609							
SP 370 CN	77-80	S605			S605G				
GT 380 J	72	S609							
GT 380 K/L/M/A/B	73-77	S609							
AN 400 XY Burgman	99-00	SFA323/3			SFA323/3HH	MD930D	MD930C	VR930	
AN 400 K1/K2	01-02	SFA411	SFAC411		SFA411HH	MD930D	MD930C	VR930	
AN 400 K3-K6	03-06	SFA411	SFAC411		SFA411HH	N/A			
AN 400 K7/ZK7/K8/ZK8/K9/L0/L1/L2/L3 Burgman /Skywave (Non ABS)	07-13	SFA412	SFAC412		SFA412HH	MD9109D		VR9109	
AN 400 AK9/ZAK9/AL0/ZAL0/AL1/ZAL1/AL2/AL3 Burgman/Skywave (ABS)	07-13	SFA412	SFAC412		SFA412HH	MD9109D		VR9109	
DR 400 ST/SX	79-81	S605			S605G				
DR-Z 400 SY/EY/Y/SEK1/EK1/K1/SK2/EK2/K2/K3/SK3/EK3/K4/SK4/EK4									
SK5/EK5/K5/EK6/SK6/K6/SK7/EK7/K7/SK8	00-08	FA131TT			FA131R ■	MD6014D	MD6014C		MD6014CX
DR-Z 400 SMK5/SMK6/SMK7/SMK8/SMK9	05-09	FA131TT			FA131R ■	MD6157D	MD6157C		
GN 400 TT	80	S606							

\*-2 Sets Required. ■ - Also available in MX-S race compound.

**SAFETY WARNING:** DO NOT USE HH PADS ON REAR UNLESS ALSO USED ON FRONT TO AVOID BRAKE IMBALANCE

**R** Suffix = High Durability Sintered Pad. **HH** Suffix = High Performance Sintered Pad. **G** Suffix = Grooved Shoe.  
**D** Suffix = Drilled Disc. **C** Suffix = Contoured Disc. **LS** Suffix = Left/Steel Disc. **RS** = Right/Steel Disc.

**BRAKE APPLICATIONS**

# JAPANESE Built Motorcycles



← FRONT / AVANT / VORN FRENTE / ANTERIORE →

## SUZUKI Contd.

			DISC PAD CHOICES				BRAKE ROTOR CHOICES									
			NEW SFAC Scooter Carbon Pads	Semi-Sintered V-Pads™	Sintered/HH Pads/ Grooved shoes	Left/Gauche/Links	Right/Droite/Rechts	Contour Rotor Universal left and right fitment	NEW Vee-Rotors™ CONTOUR	NEW CX Extreme® ROTOR	Oversize 250/280mm Rotor Kit	Relocating Bracket for 250/280mm Rotor	Oversize 320mm Rotor Kit	Relocating Bracket for 320mm Rotor		
GS 400 B/C	77-78		FA035			MD3014LS										
GS 400 LX	81		FA051			MD3014LS										
GS 400 TX	81		FA051			MD3014LS										
GSF 400 K/NK/Z/V/M/N/P/NP/V/VZP/NVR Bandit (GK75A)	89-94		FA158*		FA158HH*	MD3003X	MD3003X	MD3003XC*	VR3003BLK*							
GSF 400 M/N/P Bandit	91-95		FA129		FA129HH	MD3006X		MD3006XC	VR3006BLK							
GSF 400 S/V/SV-V/VZ-V Bandit (GK7AA)	95-97		FA158*		FA158HH*	MD3003X	MD3003X	MD3003XC*	VR3003BLK*							
GSR 400 K6	06		FA158*		FA158HH*	MD3092X	MD3092X	MD3092XC*	VR3092BLK*							
GSX 400 ET/EX/EZ	81-83		FA051			MD3014LS										
GSX 400 F/W/FWS/FWS-2			FA063*		FA063HH*	MD3024LS	MD3024RS									
GSX 400 R2 (GK 71B)			FA102*			N/A	N/A									
GSX 400 R3 (GK 71F)			FA103*		FA103HH*	MD3001LS	MD3001RS									
GSX 400 FX/FZ/FD	81-83		FA067*		FA067HH*	MD3068LS	MD3068RS									
GSX 400 FJ/FK/FAK/FL (GK74A)	88-90		FA146*		FA146HH*	MD3003X	MD3003X	MD3003XC*	VR3003BLK*							
GSX 400 X/XA/XS Impulse			FA103*		FA103HH*	MD3001LS	MD3001RS									
GSX 400 SSN (GK77A) Katana	92		FA158*		FA158HH*	MD3003X	MD3003X	MD3003XC*	VR3003BLK*							
GSX 400 R/S/T/ZR/ZS/ZT (GK79A) Impulse Type S	94-96		FA142*		FA142HH*	MD3003X	MD3003X	MD3003XC*	VR3003BLK*							
GSX 400 X (GK79A) Impulse	99		FA244*		FA244HH*	MD3003X	MD3003X	MD3003XC*	VR3003BLK*							
GSX 400 FSV/FSK1 (GK7B) Inazuma	00		FA244*		FA244HH*	MD3003X	MD3003X	MD3003XC*	VR3003BLK*							
GSXR 400 H	87		FA103*		FA103HH*	MD3001LS	MD3001RS									
GSXR 400 J/R/R/PAK (GK73A)	88-90		FA158*		FA158HH*	MD3003X	MD3003X	MD3003XC*	VR3003BLK*							
GSXR 400 R/L/R/M/R/N/R/P/RS (GK76A)	90-95		FA145*		FA145HH*	MD3045	MD3045									
LT-A 400 FK2-FK7 Eiger 4WD	02-07		FA054TT*		FA054R* ■	MD6195D	MD6195D									
LT-A 400 K2/K3/K4 Eiger	02-04		FA054TT*		FA054R* ■	MD6195D	MD6195D									
LT-A 400 FK8/FK9/FL0/FL1 King Quad Auto 4WD	Left 08-12		FA413TT		FA413R	MD6195D										
	Right		FA414TT		FA414R		MD6195D									
LT-F 400 FK8/FK9/FL0/FL1 King Quad 4WD	Left 08-12		FA413TT		FA413R	MD6195D										
	Right		FA414TT		FA414R		MD6195D									
LT-F 400 FK2/FK3/FK4/FK5/FK6/FK7 (Eiger 4WD)	02-07		FA054TT*		FA054R* ■	MD6195D	MD6195D									
LT-F 400 K2-K7 Eiger	02-07		FA054TT*		FA054R* ■	MD6195D	MD6195D									
LT-Z 400 K3/K4/K5/K6/K7/K8/K9/L0/L1	03-12		FA084TT*		FA084R* ■	MD6210D	MD6210D									
PE 400 TX	79-81		S605		S605G											
RF 400 R/P/R/R/V/R/T/R/V/T/RV-V (GK78A)	93-97		FA142*		FA142HH*	MD3003X	MD3003X	MD3003XC*	VR3003BLK*							
RG 400 E/W/F/E/W-2G/E/W/H Walter Wolf (Type 1 & 2)	85-87		FA103*		FA103HH*	MD3070LS	MD3070RS									
RM 400 C	78		S602		S602G											
RM 400 N	79		S605		S605G											
RM 400 T	80		S618		S618G											
SP 400 T	80		S605		S605G											
ST 400 V/W/X/Y/K1/K2/K3 Templer	97-03		N/A			MD3014LS										
SV 400 N (VK53A)	98		FA231		FA231HH		MD3006X	MD3006XC	VR3006BLK							
SV 400 X/Y/K1/K2	Left 99-02		FA229		FA229V	FA229HH	MD3003X	MD3003XC	VR3003BLK							
	Right		FA231		FA231V	FA231HH	MD3003X	MD3003XC	VR3003BLK							
SV 400 K3/K4/K5	Left 03-05		FA229		FA229V	FA229HH	MD3090X	MD3090XC	VR3090BLK							
	Right		FA231		FA231V	FA231HH	MD3090X	MD3090XC	VR3090BLK							
SV 400 SN (VK53A)	98		FA231		FA231HH		MD3006X	MD3006XC	VR3006BLK							
SV 400 S/X/SY/SK1/SK2	Left 99-02		FA229		FA229V	FA229HH	MD3003X	MD3003XC	VR3003BLK							
	Right		FA231		FA231V	FA231HH	MD3003X	MD3003XC	VR3003BLK							
SV 400 SK3/SK4/SK5	Left 03-05		FA229		FA229V	FA229HH	MD3090X	MD3090XC	VR3090BLK							
	Right		FA231		FA231V	FA231HH	MD3090X	MD3090XC	VR3090BLK							
VS 400 V/R/F/R/V/R/T/R/V/T-RV-T Intruder	94-		FA103		FA103HH		MD3032RS									
GS 425 EN	79		FA035			MD3014LS										
RM-X 450 ZL0	10-12		FA185TT		FA185R ■			MD6254C		MD6254CX	OS6254C	BRK023	SM6254C	BRK024		
RM-Z 450 K5/K6/K7	05-07		FA185TT		FA185R ■	MD6254D		MD6254C		MD6254CX	OS6254C	BRK023	SM6254C	BRK024		
RM-Z 450 K8/K9/L0/L1/L2/L3	08-13		FA185TT		FA185R ■			MD6254C		MD6254CX	OS6254C	BRK023	SM6254C	BRK024		
GS 450 ET/EG/EJ	80-88		FA051			MD3014LS										
LT-A 450 X/K7/X/K8/X/K9	Left 07-10		FA413TT		FA413R	MD6261D										
	Right		FA414TT		FA414R		MD6261D									
LT-R 450 K6/K7/K8/K9/L0/L1	Left 06-12		FA165TT		FA165R ■	MD6277D										
	Right		FA135TT		FA135R ■		MD6277D									
RM 465 X/Z	81-82		S621		S621G											
DR 500 X/ZD	81-83		S602		S602G											

\*-2 Sets Required. ■ - Also available in MX-S race compound.

**SAFETY WARNING:** DO NOT USE HH PADS ON REAR UNLESS ALSO USED ON FRONT TO AVOID BRAKE IMBALANCE

APPLICATIONS  
BRAKE

R Suffix = High Durability Sintered Pad. HH Suffix = High Performance Sintered Pad. G Suffix = Grooved Shoe.  
D Suffix = Drilled Disc. C Suffix = Contoured Disc. LS Suffix = Left/Steel Disc. RS = Right/Steel Disc.

# JAPANESE Built Motorcycles



## SUZUKI Contd.



← REAR / ARRIÈRE / HINTEN POSTERIOR / POSTERIORE →

			DISC PAD CHOICES			BRAKE ROTOR CHOICES		
			NEW SFAC Scooter Carbon Pads	Semi-Sintered V-Pads™	Sintered/HH Pads/ Grooved shoes	Contour Rotor Rear Fitment	NEW Vee-Rotors™ CONTOUR	NEW CX Extreme® ROTOR
GS 400 B/C	77-78	S609						
GS 400 LX	81	S606						
GS 400 TX	81	S609						
GSF 400 K/NK/Z/V/M/ZM/P/N/PV/PVZP/V/R Bandit (GK75A)	89-94	FA063		FA063V	FA063HH	MD3002	MD3002C	VR3002
GSF 400 M/N/P Bandit	91-95	FA063		FA063V	FA063HH	MD3002	MD3002C	VR3002
GSF 400 S/V/SV/VVZ-V Bandit (GK7AA)	95-97	FA063		FA063V	FA063HH	MD3084		
GSR 400 K6	06	FA419		FA419V	FA419HH	MD3093	MD3093C	VR3093
GSX 400 ET/EX/EZ	81-83	S606						
GSX 400 FW/FWS/FWS-2		FA063		FA063V	FA063HH	MD3025		
GSX 400 R2 (GK 71B)		FA063		FA063V		MD3064		
GSX 400 R3 (GK 71F)		FA063		FA063V	FA063HH	MD3064		
GSX 400 FX/FZ/FD	81-83	FA036		FA036V		MD3025		
GSX 400 FJ/FK/FAK/FL (GK74A)	88-90	FA063		FA063V	FA063HH	MD3002	MD3002C	VR3002
GSX 400 X/XA/XS Impulse		FA063		FA063V	FA063HH	MD3064		
GSX 400 SSN (GK77A) Katana	92	FA063		FA063V	FA063HH	MD3002	MD3002C	VR3002
GSX 400 R/S/T/ZR/ZS/ZT (GK79A) Impulse Type S	94-96	FA063		FA063V	FA063HH	MD3002	MD3002C	VR3002
GSX 400 X (GK79A) Impulse	99	FA063		FA063V	FA063HH	MD3002	MD3002C	VR3002
GSX 400 FSV/FSK1 (GK7B) Inazuma	00	FA063		FA063V	FA063HH	MD3008	MD3008C	VR3008
GSXR 400 H	87	FA063		FA063V	FA063HH	MD3069		
GSXR 400 J/RR/RAK (GK73A)	88-90	FA063		FA063V	FA063HH	MD3081		
GSXR 400 RL/RM/RN/RP/RS (GK76A)	90-95	FA063		FA063V	FA063HH	MD3081		
LT-A 400 FK2-FK7 Eiger 4WD	02-07	S606			S606G			
LT-A 400 K2/K3/K4 Eiger	02-04	S606			S606G			
LT-A 400 FK8/FK9/FL0/FL1 King Quad Auto 4WD	08-12	S626			S626G			
LT-F 400 FK8/FK9/FL0/FL1 King Quad 4WD	08-12	S626			S626G			
LT-F 400 FK2/FK3/FK4/FK5/FK6/FK7 (Eiger 4WD)	02-07	S606			S606G			
LT-F 400 K2-K7 Eiger	02-07	S606			S606G			
LT-Z 400 K3/K4/K5/K6/K7/K8/K9/L0/L1	03-12	FA137TT			FA137R	MD6211D		
PE 400 TIX	79-81	S605			S605G			
RF 400 RP/RR/RV/RVTR/RVTV/RV-V (GK78A)	93-97	FA063		FA063V	FA063HH	MD3008	MD3008C	VR3008
RG 400 EW/F/EW-2G/EWH Walter Wolf (Type 1 & 2)	85-87	FA063		FA063V	FA063HH	MD3064		
RM 400 C	78	S605			S605G			
RM 400 N	79	S620			S620G			
RM 400 T	80	S620			S620G			
SP 400 T	80	S605			S605G			
ST 400 VM/X/Y/K1/K2/K3 Tempter	97-03	S606						
SV 400 N (VK53A)	98	FA063		FA063V	FA063HH	MD3008	MD3008C	VR3008
SV 400 X/Y/K1/K2	99-02	FA063		FA063V	FA063HH	MD3008	MD3008C	VR3008
SV 400 K3/K4/K5	03-05	FA174		FA174V	FA174HH	MD3060	MD3060C	VR3060
SV 400 SN (VK53A)	98	FA063		FA063V	FA063HH	MD3008	MD3008C	VR3008
SV 400 SX/SY/SK1/SK2	99-02	FA063		FA063V	FA063HH	MD3008	MD3008C	VR3008
SV 400 SK3/SK4/SK5	03-05	FA174		FA174V	FA174HH	MD3060	MD3060C	VR3060
VS 400 VR/FR/VTR/FTR/RV-T/F-T Intruder	94-	S626						
GS 425 EN	79	S606						
RM-X 450 ZL0	10-12	FA367TT			FA367R ■		MD6255C◆	MD6255CX◆
RM-Z 450 K5/K6/K7	05-07	FA367TT			FA367R ■	MD6255D	MD6255C◆	MD6255CX◆
RM-Z 450 K8/K9/L0/L1/L2/L3	08-13	FA367TT			FA367R ■		MD6255C◆	MD6255CX◆
GS 450 ET/EG/EJ	80-88	S606						
LT-A 450 XK7/XK8/XK9	07-10	N/A						
LT-R 450 K6/K7/K8/K9/L0/L1	06-12	FA137TT			FA137R	MD6278D		
RM 465 X/Z	81-82	S602			S602G			
DR 500 X/ZD	81-83	S605			S605G			

\*-2 Sets Required. ■ - Also available in MX-S race compound.

**SAFETY WARNING:** DO NOT USE HH PADS ON REAR UNLESS ALSO USED ON FRONT TO AVOID BRAKE IMBALANCE

**R** Suffix = High Durability Sintered Pad. **HH** Suffix = High Performance Sintered Pad. **G** Suffix = Grooved Shoe.  
**D** Suffix = Drilled Disc. **C** Suffix = Contoured Disc. **LS** Suffix = Left/Steel Disc. **RS** = Right/Steel Disc.

**BRAKE APPLICATIONS**



# JAPANESE Built Motorcycles



## SUZUKI Contd.



		FRONT / AVANT / VORN										FRETE / ANTERIORE				
		DISC PAD CHOICES					BRAKE ROTOR CHOICES									
		NEW SFAC Scooter Carbon Pads	Semi-Sintered V-Pads™	Sintered/HH Pads/ Grooved shoes	Left/Gauche/Links	Right/Droite/Rechts	Contour Rotor Universal left and right fitment	NEW Vee-Rotors™ CONTOUR	NEW CX Extreme® ROTOR	Oversize 250/280mm Rotor Kit	Relocating Bracket for 250/280mm Rotor	Oversize 320mm Rotor Kit	Relocating Bracket for 320mm Rotor			
DR 500 S/SA		84-88	S605		S605G											
GS 500 EK/EL/EM/EN/EP/ER/ES (GM51A)		89-95	FA129		FA129HH		MD3006X	MD3006XC	VR3006BLK							
GS 500 ET/EV/EX/EV/K1/K2/K3		96-03	FA231		FA231HH		MD3006X	MD3006XC	VR3006BLK							
GS 500 FK4/K4/FK5/K5/FK6/K6/FK7/K7/K8/FK8		04-08	FA231		FA231HH		MD3006X	MD3006XC	VR3006BLK							
T 500 1/2/3/R/J/K/L/M		68-75	S612													
GT 500 AB		76-77	FA055		FA055HH		MD3019RS									
RE 5 M/A		75-77	FA055*		FA055HH	MD3019LS	MD3019RS									
RG 500 G/CH		85-87	FA103*		FA103HH*	MD3070LS	MD3070RS									
RM 500 D/E		83-84	S622		S622G											
LT 500 RL		90	FA128TT*		FA128R*	MD6022D	MD6022D									
LT-A 500 FY/FK1	Left	00-01	FA165TT		FA165R ■	MD6145D										
	Right		FA135TT		FA135R ■		MD6145D									
LT-A 500 FK2 Vision 4WD		02	FA054TT*		FA054R* ■	MD6195D	MD6195D									
LT-A 500 FK3/FK4/FK5/FK6/FK7 Vinson 4WD Auto		03-07	FA054TT*		FA054R* ■	MD6195D	MD6195D									
LT-A 500 XP/K9/XPZ/K9/XPLO/XPL1 (Power Steering)	Left	09-12	FA413TT		FA413R	MD6355D										
	Right		FA414TT		FA414R		MD6355D									
LT-F 500 FW/FX/FY/FK1/FK2	Left	98-02	FA165TT		FA165R ■	MD6145D										
	Right		FA135TT		FA135R ■		MD6145D									
LT-F 500 FK3-FK7 Vinson QuadrRunner		03-07	FA054TT*		FA054R* ■	MD6195D	MD6195D									
GT 550 J (4 Shoe type front brake)		72	N/A													
GT 550 K/L/M		73-75	FA055		FA055HH		MD3019RS									
GT 550 A/B		76-77	FA055		FA055HH		MD3019RS									
GS 550 DB/DC		77-78	FA038*			MD3014LS	MD3014RS									
GS 550 EC/EN		78-79	FA038*			MD3014LS	MD3014RS									
GS 550 ET/EX/EZ/LTLX/MX/MZ		80-84	FA065*			MD3014LS	MD3014RS									
G SX 550 ESD/ES/E/EF/EF/ESH/EEFG (GN71D)		84-87	FA063*		FA063HH*	MD3024LS	MD3024RS									
DR 600 RG/RH/RJ (SN41A) (Rear drum model)		86-88	FA106/2TT		FA106/2R	MD6075D										
DR 600 RK (SN41A) (Rear disc model)		89	FA106/2TT		FA106/2R	MD6075D										
DR 600 SF/SG/SH/SJ/SK (SN41A)		85-89	FA106/2TT		FA106/2R	MD6075D										
GSF 600 S/T/W/WX (Naked Bandit)		95-99	FA142*		FA142HH*	MD3003X	MD3003X	MD3003XC*	VR3003BLK*							
GSF 600 ST/SV/SW/SX (Faired Bandit)		96-99	FA142*		FA142HH*	MD3003X	MD3003X	MD3003XC*	VR3003BLK*							
GSF 600 Y/K1/K2/K3/K4 (Naked Bandit)	Left	00-04	FA229		FA229HH	MD3003X		MD3003XC	VR3003BLK							
	Right		FA231		FA231HH		MD3003X	MD3003XC	VR3003BLK							
GSF 600 SY/K1/K2/K3/K4 (Faired Bandit)	Left	00-04	FA229		FA229HH	MD3003X		MD3003XC	VR3003BLK							
	Right		FA231		FA231HH		MD3003X	MD3003XC	VR3003BLK							
GSR 600 K6/K7/K8		06-08	FA158*		FA158HH*	MD3092X	MD3092X	MD3092XC*	VR3092BLK*							
G SX 600 F/J (GN72A)		88	FA146*		FA146HH*	MD3001LS	MD3001RS									
G SX 600 FK/FL/FM/FN/FP/FR/FS/FT/FV (GN72A)		89-97	FA146*		FA146HH*	MD3003X	MD3003X	MD3003XC*	VR3003BLK*							
G SX 600 FW/FX/FY/FK1/FK2	Left	98-02	FA229		FA229HH	MD3003X		MD3003XC	VR3003BLK							
	Right		FA231		FA231HH		MD3003X	MD3003XC	VR3003BLK							
G SX 600 FK3/FK4/FK5/FK6	Left	03-04	FA229		FA229HH	MD3090X		MD3090XC	VR3090BLK							
	Right		FA231		FA231HH		MD3090X	MD3090XC	VR3090BLK							
G SX R 600 V/W/X/Y (SRAD)		97-00	FA158*		FA158HH*	MD3058X	MD3058X	MD3058XC*	VR3058BLK*							
G SX R 600 K1/K2/K3/Z/K3		01-03	FA158*		FA158HH*	MD3058X	MD3058X	MD3058XC*	VR3058BLK*							
G SX R 600 K4/K5		04-05			FA379HH*	MD3104X	MD3104X	MD3104XC*	VR3104BLK*							
G SX R 600 K6/K7		06-07			FA379HH*	MD3091X	MD3091X	MD3091XC*	VR3091BLK*							
G SX R 600 K8/K9/L0		08-10			FA379HH*	MD3100X	MD3100X	MD3100XC*	VR3100BLK*							
G SX R 600 L1/L2/L3 (Brembo Calipers)		11-13			FA447HH*	MD3100X	MD3100X	MD3100XC*	VR3100BLK*							
RF 600 RP/RR/RS/RT/RV (GN76A)		93-97	FA142*		FA142HH*	MD3003X	MD3003X	MD3003XC*	VR3003BLK*							
VS 600 GLS/GLT/GLV		95-97	FA103	FA103V	FA103HH		MD3032RS									
UV 620 FK5 Side x Side		05	K719*													
AN 650 K3 Burgman (4 Bolt Fixing Front/Rear Discs)		03	SFA142*	SFAC142*	SFA142HH*	MD987D	MD987D		VR987							
AN 650 K4/K5/K6/K7/K8/K9/L0 Burgman/Skywave (Non ABS)																
(5 Bolt Fixing Front/Rear Discs)		04-11	SFA142*	SFAC142*	SFA142HH*	MD994D	MD994D		VR994							
AN 650 AK4/ AK5/ AK6/ AK7/AK8/ZAK8/AK9/ALO Burgman Executive																
/Skywave (ABS) (5 Bolt F/ R Discs)		04-12	SFA142*	SFAC142*	SFA142HH*	MD994D	MD994D		VR994							
AN 650 L3 Burgman Non ABS		13	SFA142*	SFAC142*	SFA142HH*	TBA	TBA									
AN 650 ZL3 Burgman ABS Executive		13	SFA142*	SFAC142*	SFA142HH*	TBA	TBA									
DL 650 K4/K5/K6 V-Strom	Left	04-06	FA229	FA229V	FA229HH	MD3088X		MD3088XC	VR3088BLK							
	Right		FA231	FA231V	FA231HH		MD3088X	MD3088XC	VR3088BLK							

\*-2 Sets Required. ■ - Also available in MX-S race compound.

**SAFETY WARNING:** DO NOT USE HH PADS ON REAR UNLESS ALSO USED ON FRONT TO AVOID BRAKE IMBALANCE

APPLICATIONS  
BRAKE

R Suffix = High Durability Sintered Pad. HH Suffix = High Performance Sintered Pad. G Suffix = Grooved Shoe.  
D Suffix = Drilled Disc. C Suffix = Contoured Disc. LS Suffix = Left/Steel Disc. RS = Right/Steel Disc.



# JAPANESE Built Motorcycles



**SUZUKI Contd.**

FRONT / AVANT / VORN ← → FRENTE / ANTERIORE

**DISC PAD CHOICES**

**BRAKE ROTOR CHOICES**

Model	Side	Year	DISC PAD CHOICES			BRAKE ROTOR CHOICES								
			NEW SFAC Scooter Carbon Pads	Semi-Sintered V-Pads™	Sintered/HH Pads/ Grooved shoes	Left/Gauche/Links	Right/Droite/Rechts	Contour Rotor Universal left and right fitment	NEW Vee-Rotors™ CONTOUR	NEW CX Extreme® ROTOR	Oversize 250/280mm Rotor Kit	Relocating Bracket for 250/280mm Rotor	Oversize 320mm Rotor Kit	Relocating Bracket for 320mm Rotor
DL 650 XK7/XK8/XK9/XA0 V-Strom X	Left	07-11	FA229	FA229V	FA229HH	MD3092X		MD3092XC	VR3092BLK					
	Right		FA231	FA231V	FA231HH		MD3092X	MD3092XC	VR3092BLK					
DL 650 AK7/AK8/AK9/ALO V-Strom ABS	Left	07-11	FA229	FA229V	FA229HH	MD3092X		MD3092XC	VR3092BLK					
	Right		FA231	FA231V	FA231HH		MD3092X	MD3092XC	VR3092BLK					
DL 650 AL1XP V-Strom Xpedition	Left	11	FA229	FA229V	FA229HH	MD3092X		MD3092XC	VR3092BLK					
	Right		FA231	FA231V	FA231HH		MD3092X	MD3092XC	VR3092BLK					
DL 650 AK9GT V-Strom Traveller/ABS	Left	07-11	FA229	FA229V	FA229HH	MD3092X		MD3092XC	VR3092BLK					
	Right		FA231	FA231V	FA231HH		MD3092X	MD3092XC	VR3092BLK					
DL 650 AL2/AL3 V-Strom ABS	Left	12-13	FA229	FA229V	FA229HH	MD3092X		MD3092XC	VR3092BLK					
	Right		FA231	FA231V	FA231HH		MD3092X	MD3092XC	VR3092BLK					
DR 650 RL/RM (SP41A)		90-91	FA147		FA147R	MD6078D								
DR 650 RSL/RSM (SP42A)		90-91	FA147		FA147R	MD6078D								
DR 650 RSEM/RSEN/RSEP (SP43A/B)		91-93	FA147		FA147R	MD6078D								
DR 650 RER/RES (SP45A/B)		94-95	FA147		FA147R	MD6078D								
DR 650 RUN/RN/RUP/RP (SP44A/B)		92-93	FA147		FA147R	MD6078D								
DR 650 SET/SEV (SP46A/B)		96-97	FA185TT		FA185R	MD6094D			MD6094CX	NA	N/A	SM6094C	BRK003	
GR 650 D/DX Tempter		83	FA065	FA065V		MD3014LS								
GS 650 GTX/GTZ/GTD/GX/GZ		81-83	FA065*	FA065V*		MD3014LS	MD3014RS							
GSF 650 K5/K6 (Naked Bandit - Non ABS)	Left	05-06	FA229	FA229V	FA229HH	MD3090X		MD3090XC	VR3090BLK					
	Right		FA231	FA231V	FA231HH		MD3090X	MD3090XC	VR3090BLK					
GSF 650 SK5/SK6 (Faired Bandit - Non ABS)	Left	05-06	FA229	FA229V	FA229HH	MD3090X		MD3090XC	VR3090BLK					
	Right		FA231	FA231V	FA231HH		MD3090X	MD3090XC	VR3090BLK					
GSF 650 AK5/AK6 (Naked Bandit - ABS)	Left	05-06	FA229	FA229V	FA229HH	MD3101X		MD3101XC	VR3101BLK					
	Right		FA231	FA231V	FA231HH		MD3101X	MD3101XC	VR3101BLK					
GSF 650 SAK5/SAK6 (Faired Bandit - ABS)	Left	05-06	FA229	FA229V	FA229HH	MD3101X		MD3101XC	VR3101BLK					
	Right		FA231	FA231V	FA231HH		MD3101X	MD3101XC	VR3101BLK					
GSF 650 K7/K8/K9/OL0 (Naked Bandit Non ABS)		07-11	FA158*		FA158HH*	MD3092X	MD3092X	MD3092XC*	VR3092BLK*					
GSF 650 AK7/AK8/AK9 (Naked Bandit - ABS)		07-09	FA158*		FA158HH*	MD3092X	MD3092X	MD3092XC*	VR3092BLK*					
GSF 650 SK7/SK8/SK9 (Faired Bandit Non ABS)		07-08	FA158*		FA158HH*	MD3092X	MD3092X	MD3092XC*	VR3092BLK*					
GSF 650 SAK7/SAK8/SAK9/SALO (Faired Bandit - ABS)		07-11	FA158*		FA158HH*	MD3092X	MD3092X	MD3092XC*	VR3092BLK*					
GSX 650 FK8/FK9/FL0/FL1/FL2 (Non ABS)		08-13	FA158*		FA158HH*	MD3092X	MD3092X	MD3092XC*	VR3092BLK*					
GSX 650 FAK8/FAK9/FAL0/FAL1/FAL2 (ABS Model)		08-13	FA158*		FA158HH*	MD3092X	MD3092X	MD3092XC*	VR3092BLK*					
XN 85 Turbo		83	FA065*	FA065V*		MD3028LS	MD3028RS							
LS 650 FG/PG/PP/PI/PJ/PT/PV/PW/PX Savage NP41A		87-99	FA106TT	FA106V		MD3017LS								
SFV 650 K9/LOL1 Gladius (Non ABS)	Left	09-12	FA229	FA229V	FA229HH	MD3103X		MD3103XC	VR3103BLK					
	Right		FA231	FA231V	FA231HH		MD3103X	MD3103XC	VR3103BLK					
SFV 650 AK9/ALO/AL1/AL3 Gladius (ABS)	Left	09-13	FA229	FA229V	FA229HH	MD3103X		MD3103XC	VR3103BLK					
	Right		FA231	FA231V	FA231HH		MD3103X	MD3103XC	VR3103BLK					
SV 650 XY/Y1/K1/K2 (Naked - Non ABS)	Left	99-02	FA229	FA229V	FA229HH	MD3003X		MD3003XC	VR3003BLK					
	Right		FA231	FA231V	FA231HH		MD3003X	MD3003XC	VR3003BLK					
SV 650 SX/SY/SK1/SK2 (Top Fairing - Non ABS)	Left	99-02	FA229	FA229V	FA229HH	MD3003X		MD3003XC	VR3003BLK					
	Right		FA231	FA231V	FA231HH		MD3003X	MD3003XC	VR3003BLK					
SV 650 K3/K4/K5/K6/K7/K8/K9/LO (Naked - Non ABS)	Left	03-10	FA229	FA229V	FA229HH	MD3090X		MD3090XC	VR3090BLK					
	Right		FA231	FA231V	FA231HH		MD3090X	MD3090XC	VR3090BLK					
SV 650 SK3/SK4/SK5/SK6/SK7/SK8/SK9/SLO (Top Fairing - Non ABS)	Left	03-12	FA229	FA229V	FA229HH	MD3090X		MD3090XC	VR3090BLK					
	Right		FA231	FA231V	FA231HH		MD3090X	MD3090XC	VR3090BLK					
SV 650 AK7/AK8/AK9/ALO (Naked - ABS Model)	Left	07-10	FA229	FA229V	FA229HH	MD3103X		MD3103XC	VR3103BLK					
	Right		FA231	FA231V	FA231HH		MD3103X	MD3103XC	VR3103BLK					
SV 650 SAK7/SAK8/SAK9/SALO (Top Fairing - ABS Model)	Left	07-13	FA229	FA229V	FA229HH	MD3103X		MD3103XC	VR3103BLK					
	Right		FA231	FA231V	FA231HH		MD3103X	MD3103XC	VR3103BLK					
XF 650 VW/XY Freewind		97-02	FA231	FA231V	FA231HH		MD6113D							
GS 700 EF/ESF		85	FA051*	FA051V*		MD3028LS	MD3028RS							
LT-A 700 XK5/XC6/XK6/XK7 King Quad	Left	05-07	FA413TT		FA413R	MD6261D								
	Right		FA414TT		FA414R		MD6261D							
LT-V 700 FK4/FK5 Twin Peaks	Left	04-05			FA342R	MD6188D								
	Right				FA349R		MD6188D							
VS 700 GLEFG/GLEPG/GLEFH/GLEPH (Cast wheel 5 bolt)		86-87	FA103	FA103V	FA103HH	MD3073LS								
VS 700 GLFG/GLPG (Spoke wheel 5 bolt)		86	FA103	FA103V	FA103HH	MD3031LS								
VS 700 GLFH/GLPH (Spoke wheel 6 bolt)		87	FA103	FA103V	FA103HH	MD3032LS								
DR 750 SJ (SR41A)		88	FA147		FA147R	MD6078D								

\*-2 Sets Required. ■ - Also available in MX-S race compound.

**SAFETY WARNING:** DO NOT USE HH PADS ON REAR UNLESS ALSO USED ON FRONT TO AVOID BRAKE IMBALANCE

**R** Suffix = High Durability Sintered Pad. **HH** Suffix = High Performance Sintered Pad. **G** Suffix = Grooved Shoe.  
**D** Suffix = Drilled Disc. **C** Suffix = Contoured Disc. **LS** Suffix = Left/Steel Disc. **RS** = Right/Steel Disc.

**APPLICATIONS**

**BRAKE**

# JAPANESE Built Motorcycles



## SUZUKI Contd.



← REAR / ARRIÈRE / HINTEN POSTERIOR / POSTERIORE →

			DISC PAD CHOICES			BRAKE ROTOR CHOICES		
			NEW SFAC Scooter Carbon Pads	Semi-Sintered V-Pads™	Sintered/HH Pads/ Grooved shoes	Contour Rotor Rear Fitment	NEW Vee-Rotors™ CONTOUR	NEW CX Extreme® ROTOR
DL 650 XK7/XK8/XK9/XA0 V-Strom X	07-11	FA174		FA174V	FA174HH	MD6232D		MD6232CX
DL 650 AK7/AK8/AK9/AL0 V-Strom ABS	07-11	FA174		FA174V	FA174HH	MD6232D		MD6232CX
DL 650 AL1XP V-Strom Xpedition	11	FA174		FA174V	FA174HH	MD6232D		MD6232CX
DL 650 AK9GT V-Strom Traveller /ABS	07-11	FA174		FA174V	FA174HH	MD6232D		MD6232CX
DL 650 AL2/AL3 V-Strom ABS	12-13	FA174		FA174V	FA174HH	MD6232D		MD6232CX
DR 650 RL/RM (SP41A)	90-91	FA157			FA157R	MD6077D		
DR 650 RSL/RSM (SP42A)	90-91	FA157			FA157R	MD6077D		
DR 650 RSEM/RSENV/SEP (SP43A/B)	91-93	FA157			FA157R	MD6077D		
DR 650 RER/PES (SP45A/B)	94-95	FA157			FA157R	MD6077D		
DR 650 RUN/RN/RUP/RP (SP44A/B)	92-93	FA157			FA157R	MD6077D		
DR 650 SET/SEV (SP46A/B)	96-97	FA152TT			FA152R ■	MD6095D		
GR 650 D/XD Tempter	83	S606						
GS 650 GTX/GTZ/GTD/GX/GZ	81-83	FA036		FA036V		MD3027		
GSF 650 K5/K6 (Naked Bandit - Non ABS)	05-06	FA254			FA254HH	MD3008	MD3008C	VR3008
GSF 650 SK5/SK6 (Faired Bandit - Non ABS)	05-06	FA254			FA254HH	MD3008	MD3008C	VR3008
GSF 650 AK5/AK6 (Naked Bandit - ABS)	05-06	FA174		FA174V	FA174HH	MD3093	MD3093C	VR3093
GSF 650 SAK5/SAK6 (Faired Bandit - ABS)	05-06	FA174		FA174V	FA174HH	MD3093	MD3093C	VR3093
GSF 650 K7/K8/K9/OL0 (Naked Bandit Non ABS)	07-11	FA174		FA174V	FA174HH	MD3093	MD3093C	VR3093
GSF 650 AK7/AK8/AK9 (Naked Bandit - ABS)	07-09	FA174		FA174V	FA174HH	MD3093	MD3093C	VR3093
GSF 650 SK7/SK8/SK9 (Faired Bandit Non ABS)	07-08	FA174		FA174V	FA174HH	MD3093	MD3093C	VR3093
GSF 650 SAK7/SAK8/SAK9/SAL0 (Faired Bandit - ABS)	07-11	FA174		FA174V	FA174HH	MD3093	MD3093C	VR3093
GSX 650 FK8/FK9/FL0/FL1/FL2 (Non ABS)	08-13	FA174		FA174V	FA174HH	MD3093	MD3093C	VR3093
GSX 650 FAK8/FAK9/FAL0/FAL1/FAL2 (ABS Model)	08-13	FA174		FA174V	FA174HH	MD3093	MD3093C	VR3093
XN 85 Turbo	83	FA036		FA036V		MD3014RS		
LS 650 FG/PG/PM/PR/PG/PT/PV/PW/PX Savage NP41A	87-99	S606						
SFV 650 K9/LO/L1 Gladius (Non ABS)	09-12	FA496			FA496HH	MD3093	MD3093C	
SFV 650 AK9/AL0/AL1/AL3 Gladius (ABS)	09-13	FA496			FA496HH	MD3093	MD3093C	
SV 650 XY/K1/K2 (Naked - Non ABS)	99-02	FA063		FA063V	FA063HH	MD3008	MD3008C	VR3008
SV 650 SX/SY/SK1/SK2 (Top Fairing - Non ABS)	99-02	FA063		FA063V	FA063HH	MD3008	MD3008C	VR3008
SV 650 K3/K4/K5/K6/K7/K8/K9/LO (Naked - Non ABS)	03-10	FA174		FA174V	FA174HH	MD3060	MD3060C	VR3060
SV 650 SK3/SK4/SK5/SK6/SK7/SK8/SK9/SLO (Top Fairing - Non ABS)	03-12	FA174		FA174V	FA174HH	MD3060	MD3060C	VR3060
SV 650 AK7/AK8/AK9/AL0 (Naked - ABS Model)	07-10	FA174		FA174V	FA174HH	MD3093	MD3093C	
SV 650 SAK7/SAK8/SAK9/SAL0 (Top Fairing - ABS Model)	07-13	FA174		FA174V	FA174HH	MD3093	MD3093C	
XF 650 VW/WX/Y Freewind	97-02	FA140		FA140V	FA140HH	MD6095		
GS 700 EF/ESF	85	FA036		FA036V		MD3029		
LT-A 700 XK5/XCK6/XK6/XK7 King Quad	05-07	N/A						
LT-V 700 FK4/FK5 Twin Peaks	04-05	N/A						
VS 700 GLEFG/GLEPG/GLEFH/GLEPH (Cast wheel 5 bolt)	86-87	S626						
VS 700 GLFG/GLPG (Spoke wheel 5 bolt)	86	S626						
VS 700 GLFH/GLPH (Spoke wheel 6 bolt)	87	S626						
DR 750 SJ (SR41A)	88	S606						

\*-2 Sets Required. ■ - Also available in MX-S race compound.

**SAFETY WARNING:** DO NOT USE HH PADS ON REAR UNLESS ALSO USED ON FRONT TO AVOID BRAKE IMBALANCE

**R** Suffix = High Durability Sintered Pad. **HH** Suffix = High Performance Sintered Pad. **G** Suffix = Grooved Shoe.  
**D** Suffix = Drilled Disc. **C** Suffix = Contoured Disc. **LS** Suffix = Left/Steel Disc. **RS** = Right/Steel Disc.

**BRAKE APPLICATIONS**



# JAPANESE Built Motorcycles



## SUZUKI Contd.



		FRONT / AVANT / VORN		FRENTE / ANTERIORE									
		DISC PAD CHOICES			BRAKE ROTOR CHOICES								
		NEW SFAC Scooter Carbon Pads	Semi-Sintered V-Pads™	Sintered/HH Pads/ Grooved shoes	Left/Gauche/Links	Right/Droite/Rechts	Contour Rotor Universal left and right fitment	NEW Vee-Rotors™ CONTOUR	NEW CX Extreme® ROTOR	Oversize 250/280mm Rotor Kit	Relocating Bracket for 250/280mm Rotor	Oversize 320mm Rotor Kit	Relocating Bracket for 320mm Rotor
DR 750 SK (SR41A)	89	FA147		FA147R	MD6076D								
GT 750 J (4 Shoe type front brake)	72	N/A											
GT 750 K/L/M/A/B	73-77	FA065*		FA055HH*	MD3019LS	MD3019RS							
GS 750 B	77	FA035				MD3019RS							
GS 750 DB/DC/EC/EN	77-80	FA035*			MD3014LS	MD3014RS							
GSR 750 L1/L2/L3	Left 11-13	FA229		FA229HH	MD3092X		MD3092XC	VR3092BLK					
	Right	FA231		FA231HH		MD3092X	MD3092XC	VR3092BLK					
GSX 750 ET/EX	80-81	FA051*	FA051V*		MD3014LS	MD3014RS							
GSX 750 ESD/EF/E/ESG/ESE/ESH/IEFF	82-86	FA051*	FA051V*		MD3028LS	MD3028RS							
GSX 750 S/SS (GS75X-106815-)	84	FA065*	FA065V*		MD3028LS	MD3028RS							
GSX 750 S-2/S-2C Katana (FS75X-114747-)	84	FA065*	FA065V*		MD3028LS	MD3028RS							
GSX 750 SE Katana (GR72A)	85	FA063*	FA063V*	FA063HH*	MD3014LS	MD3014RS							
GSXR 750 F/G/H (GR75A)	85-87	FA103*		FA103HH*	MD3005	MD3005							
GSXR 750 RG	86	FA145*		FA145HH*	MD3005	MD3005							
GSXR 750 J/K/L/M/W/N/WP	88-93	FA145*		FA145HH*	MD3007	MD3007	MD3007C*	VR3007BLK*					
GSXR 750 WR/WS	94-95	FA188*		FA188HH*	MD3007	MD3007	MD3007C*	VR3007BLK*					
GSXR 750 T/V/W/X (SRAD)	96-99	FA188*		FA188HH*	MD3058X	MD3058X	MD3058XC*	VR3058BLK*					
GSXR 750 Y/K1/K2/K3	00-03	FA158*		FA158HH*	MD3058X	MD3058X	MD3058XC*	VR3058BLK*					
GSXR 750 K4/K5	04-05			FA379HH*	MD3104X	MD3104X	MD3104XC*	VR3104BLK*					
GSXR 750 K6/K7	06-07			FA379HH*	MD3091X	MD3091X	MD3091XC*	VR3091BLK*					
GSXR 750 K8/K9/L0	08-10			FA379HH*	MD3100X	MD3100X	MD3100XC*	VR3100BLK*					
GSXR 750 L1/L2/L3 (Brembo Caliper)	11-13			FA447HH*	MD3100X	MD3100X	MD3100XC*	VR3100BLK*					
GSX 750 W/X/Y/K1	Left 98-03	FA229		FA229HH	MD3045								
	Right	FA231		FA231HH		MD3045							
GSX 750 FK/FL/FM/FN/FP/FR/FS/FT/FV (GR78A)	89-97	FA146*	FA146V*	FA146HH*	MD3003X	MD3003X	MD3003XC*	VR3003BLK*					
GSX 750 FW/FX/FY/FK1/FK2	Left 98-02	FA229		FA229HH	MD3003X		MD3003XC	VR3003BLK					
	Right	FA231		FA231HH		MD3003X	MD3003XC	VR3003BLK					
GSX 750 FK3/FK4/FK5/FK6	Left 03-06	FA229		FA229HH	MD3090X		MD3090XC	VR3090BLK					
	Right	FA231		FA231HH		MD3090X	MD3090XC	VR3090BLK					
LT-A 750 XK8/XZK8/XK9/XZK9/XLO King Quad	Left 08-10	FA413TT		FA413R	MD6261D								
	Right	FA414TT		FA414R		MD6261D							
LT-A 750 XP/K9/XPZK9/XPLO/XPL1 (Power Steering)	Left 10-12	FA413TT		FA413R	MD6355D								
	Right	FA414TT		FA414R		MD6355D							
VS 750 GLF/GLFG/GLPG Intruder (Spoke wheel 5 bolt) (VR51A)	85-90	FA103	FA103V	FA103HH	MD3031LS								
VS 750 GLFH/GLPH Intruder (Spoke Wheel 6 bolt) (VR51A)	87	FA103	FA103V	FA103HH	MD3032LS								
VS 750 GLEFH/GLEPH Intruder (Cast Wheel 5 bolt) (VR51A)	87	FA103	FA103V	FA103HH	MD3073LS								
VS 750 GLPK/GLPL/GLPLM Intruder (Spoke Wheel 6 bolt) (VR51A)	88-91	FA103	FA103V	FA103HH		MD3032RS							
DR 800 SL (SR43A)	90	FA147		FA147R	MD6076D								
DR 800 SM/SN/SP (SR43B)	91-93	FA129		FA129R	MD6113D								
VL 800 K1/K2/K3/K4/K5 Intruder Volusia	01-05	FA231	FA231V	FA231HH		MD3095RS							
C 800 Intruder - Spoke Wheels (VL 800 KG/K7/K8/K9/L0/L1/L2/L3)	05-13	FA231	FA231V	FA231HH		MD3095RS							
C 800 C Intruder - Cast Wheels (VL 800 CK7/CK8/CK9/CL0/CL1/CL2/CL3)	07-13	FA231	FA231V	FA231HH		MD3095RS							
VS 800 GLN/GLP/GLR/GLS/GLT/GLV/GLW/GLX Intruder (VS52A)	92-99	FA103	FA103V	FA103HH		MD3032RS							
VX 800 L/M/N/P/R	90-95	FA129	FA129V	FA129HH	MD3033LS								
VX 800 T	96	FA229	FA229V	FA229HH	MD3033LS								
VZ 800 V/W/X/Y/K1/K2 Marauder	97-03	FA231	FA231V	FA231HH		MD3045							
M 800 (VZ 800 K5-K9/L0/L1/L3 Intruder M800)	05-13	FA231	FA231V	FA231HH		MD3096RS							
M 800 Z (VZ 800 K9Z M800 Intruder)	09-10	FA231	FA231V	FA231HH		MD3096RS							
GS 850 GNGT/GX	79-81	FA038*			MD3014LS	MD3014RS							
GS 850 GZ/GE/GG	82-85	FA051*	FA051V*		MD3014LS	MD3014RS							
RF 900 RR/RS/RS2	94-95	FA145*		FA145HH*	MD3006X	MD3006X	MD3006XC*	VR3006BLK*					
RF 900 RT/RV/RW	96-99	FA145*		FA145HH*	MD3006X	MD3006X	MD3006XC*	VR3006BLK*					
DL 1000 K2-K9/L0 V-Strom	Left 02-10	FA229	FA229V	FA229HH	MD3088X		MD3088XC	VR3088BLK					
	Right	FA231	FA231V	FA231HH		MD3088X	MD3088XC	VR3088BLK					
GS 1000 HC/EC/EN/SN	78-80	FA038*			MD3014LS	MD3014RS							
GS 1000 ET	81	FA065*			MD3014LS	MD3014RS							
GS 1000 GT/GX	81-82	FA051*			MD3014LS	MD3014RS							
GSX 1000 SZ Katana	82	FA065*			MD3014LS	MD3014RS							
GSXR 1000 K1/K2	01-02	FA188*		FA188HH*	MD3058X	MD3058X	MD3058XC*	VR3058BLK*					
GSXR 1000 K3	03			FA369/4HH*	MD3089X	MD3089X	MD3089XC*	VR3089BLK*					

\*-2 Sets Required. ■ - Also available in MX-S race compound.

**SAFETY WARNING:** DO NOT USE HH PADS ON REAR UNLESS ALSO USED ON FRONT TO AVOID BRAKE IMBALANCE

APPLICATIONS  
BRAKE

R Suffix = High Durability Sintered Pad. HH Suffix = High Performance Sintered Pad. G Suffix = Grooved Shoe.  
D Suffix = Drilled Disc. C Suffix = Contoured Disc. LS Suffix = Left/Steel Disc. RS = Right/Steel Disc.

# JAPANESE Built Motorcycles



## SUZUKI Contd.



← REAR / ARRIÈRE / HINTEN POSTERIOR / POSTERIORE →

			DISC PAD CHOICES			BRAKE ROTOR CHOICES				
			NEW SFAC Scooter Carbon Pads	Semi-Sintered V-Pads™	Sintered/HH Pads/ Grooved shoes	Contour Rotor Rear Fitment	NEW Vee-Rotors™ CONTOUR	NEW CX Extreme® ROTOR		
DR 750 SK (SR41A)	89	FA157			FA157R	MD6077D				
GT 750 J (4 Shoe type front brake)	72	S634								
GT 750 K/L/M/A/B	73-77	S634								
GS 750 B	77	FA036		FA036V		MD3014RS				
GS 750 DB/DC/EC/EN	77-80	FA036		FA036V		MD3014RS				
GSR 750 L1/L2/L3	11-13	FA174		FA174V	FA174HH	MD3093	MD3093C	VR3093		
GSX 750 ET/EX	80-81	FA036		FA036V		MD3014RS				
GSX 750 ESD/EF/E/ESG/ESE/ESH/IEFF	82-86	FA036		FA036V		MD3029				
GSX 750 S/SS (GS75X-106815-)	84	FA036		FA036V		MD3014RS				
GSX 750 S-2/S-2C Katana (FS75X-114747-)	84	FA036		FA036V		MD3014RS				
GSX 750 SE Katana (GR72A)	85	FA036		FA036V		MD3029				
GSXR 750 F/G/H (GR75A)	85-87	FA063		FA063V	FA063HH	MD3009				
GSXR 750 RG	86	FA063		FA063V	FA063HH	MD3009				
GSXR 750 J/K/L/M/W/N/WP	88-93	FA063		FA063V	FA063HH	MD3008	MD3008C	VR3008		
GSXR 750 WR/WS	94-95	FA063		FA063V	FA063HH	MD3008	MD3008C	VR3008		
GSXR 750 T/V/W/X (SRAD)	96-99	FA063		FA063V	FA063HH	MD3060	MD3060C	VR3060		
GSXR 750 YK1/K2/K3	00-03	FA063		FA063V	FA063HH	MD3060	MD3060C	VR3060		
GSXR 750 K4/K5	04-05	FA254			FA254HH	MD3060	MD3060C	VR3060		
GSXR 750 K6/K7	06-07	FA419		FA419V	FA419HH	MD3060	MD3060C	VR3060		
GSXR 750 K8/K9/L0	08-10	FA419		FA419V	FA419HH	MD3060	MD3060C	VR3060		
GSXR 750 L1/L2/L3 (Brembo Caliper)	11-13	FA436		FA436V	FA436HH	MD3060	MD3060C	VR3060		
GSX 750 W/X/Y/K1	98-03	FA063		FA063V	FA063HH	MD3008	MD3008C			
GSX 750 FK/FL/FM/FN/FP/FR/FS/FT/FV (GR78A)	89-97	FA063		FA063V	FA063HH	MD3002	MD3002C	VR3002		
GSX 750 FW/FX/FY/FK1/FK2	98-02	FA063		FA063V	FA063HH	MD3008	MD3008C	VR3008		
GSX 750 FK3/FK4/FK5/FK6	03-06	FA063		FA063V	FA063HH	MD3008	MD3008C	VR3008		
LT-A 750 XK8/XZK8/XK9/XZK9/XLO King Quad	08-10	N/A								
LT-A 750 XPK9/XPZK9/XPLO/XPL1 (Power Steering)	10-12	N/A								
VS 750 GLF/GLFG/GLPG Intruder (Spoke wheel 5 bolt) (VR51A)	85-90	S626								
VS 750 GLFH/GLPH Intruder (Spoke Wheel 6 bolt) (VR51A)	87	S626								
VS 750 GLEFH/GLEPH Intruder (Cast Wheel 5 bolt) (VR51A)	87	S626								
VS 750 GLPK/GLPL/GLPM Intruder (Spoke Wheel 6 bolt) (VR51A)	88-91	S626								
DR 800 SL (SR43A)	90	FA157			FA157R	MD6077D				
DR 800 SM/SN/SP (SR43B)	91-93	FA165/2TT			FA165/2R	MD6077D				
VL 800 K1/K2/K3/K4/K5 Intruder Volusia	01-05	S626								
C 800 Intruder - Spoke Wheels (VL 800 K6/K7/K8/K9/L0/L1/L2/L3)	05-13	S626								
C 800 C Intruder - Cast Wheels (VL 800 CK7/CK8/CK9/CL0/CL1/CL2/CL3)	07-13	S626								
VS 800 GLN/GLP/GLR/GLS/GLT/GLV/GLW/GLX Intruder (VS52A)	92-99	S626								
VX 800 L/M/N/P/R	90-95	FA146		FA146V	FA146HH	MD3061				
VX 800 T	96	FA146		FA146V	FA146HH	MD3061				
VZ 800 V/W/X/Y/K1/K2 Marauder	97-03	S626								
M 800 (VZ 800 K5-K9/L0/L1/L3 Intruder M800)	05-13	S626								
M 800 Z (VZ 800 K9Z M800 Intruder)	09-10	S626								
GS 850 GN/GT/GX	79-81	FA036		FA036V		MD3014RS				
GS 850 GZ/GE/IG	82-85	FA036		FA036V		MD3027				
RF 900 RR/RS/RS2	94-95	FA222				MD3008	MD3008C	VR3008		
RF 900 RT/RV/RW	96-99	FA063		FA063V	FA063HH	MD3008	MD3008C	VR3008		
DL 1000 K2-K9/L0 V-Strom	02-10	FA174			FA174HH	MD6232D				MD6232CX
GS 1000 HQ/EC/EN/NSN	78-80	FA036		FA036V		MD3014RS				
GS 1000 ET	81	FA036		FA036V		MD3014RS				
GS 1000 GT/GX	81-82	FA036		FA036V		MD3014RS				
GSX 1000 SZ Katana	82	FA036		FA036V		MD3014RS				
GSXR 1000 K1/K2	01-02	FA254			FA254HH	MD3060	MD3060C	VR3060		
GSXR 1000 K3	03	FA254			FA254HH	MD3060	MD3060C	VR3060		

\*-2 Sets Required. ■ - Also available in MX-S race compound.

**SAFETY WARNING:** DO NOT USE HH PADS ON REAR UNLESS ALSO USED ON FRONT TO AVOID BRAKE IMBALANCE

**R** Suffix = High Durability Sintered Pad. **HH** Suffix = High Performance Sintered Pad. **G** Suffix = Grooved Shoe.  
**D** Suffix = Drilled Disc. **C** Suffix = Contoured Disc. **LS** Suffix = Left/Steel Disc. **RS** = Right/Steel Disc.

**BRAKE APPLICATIONS**

# JAPANESE Built Motorcycles



**SUZUKI Contd.**



← FRONT / AVANT / VORN FRENTE / ANTERIORE →

		DISC PAD CHOICES				BRAKE ROTOR CHOICES						
		NEW SFAC Scooter Carbon Pads	Semi-Sintered V-Pads™	Sintered/HH Pads/ Grooved shoes	Left/Gauche/Links	Right/Droite/Rechts	Contour Rotor Universal left and right fitment	NEW Vee-Rotors™ CONTOUR	NEW CX Extreme® ROTOR	Oversize 250/280mm Rotor Kit	Relocating Bracket for 250/280mm Rotor	Oversize 320mm Rotor Kit
GSXR 1000 K4	04			FA379HH*	MD3104X	MD3104X	MD3104XC*	VR3104BLK*				
GSXR 1000 K5/K6	05-06			FA379HH*	MD3091X	MD3091X	MD3091XC*	VR3091BLK*				
GSXR 1000 K7/K8	07-08			FA379HH*	MD3091X	MD3091X	MD3091XC*	VR3091BLK*				
GSXR 1000 K9/L0/L1	09-11			FA379HH*	MD3102X	MD3102X	MD3102XC*	VR3102BLK*				
GSXR 1000 L2 /L3/ZL3 (Brembo Caliper)	12-13			FA447HH*	MD3100X	MD3100X	MD3100XC*	VR3100BLK*				
SV 1000 K3/K4/K5/K6/K7 (Naked)	03-07	FA158*		FA158HH*	MD3088X	MD3088X	MD3088XC*	VR3088BLK*				
SV 1000 SK3/SK4/SK5/SK6/SK7 (Faired)	03-07	FA158*		FA158HH*	MD3088X	MD3088X	MD3088XC*	VR3088BLK*				
TL 1000 SV/SW/SX/SY/SK1	97-01	FA158*		FA158HH*	MD3058X	MD3058X	MD3058XC*	VR3058BLK*				
TL 1000 RW/RX/RY/RK1	98-02	FA188*		FA188HH*	MD3058X	MD3058X	MD3058XC*	VR3058BLK*				
GSX 1100 ET/EX/EZ	80-82	FA065*			MD3014LS	MD3014RS						
GSX 1100 ESD	83	FA065*			MD3014LS	MD3014RS						
GSX 1100 SZ/SD Katana	82-83	FA065*			MD3014LS	MD3014RS						
GS 1100 GZ	82	FA051*			MD3014LS	MD3014RS						
GSX 1100 EFE/EF/ESE	84-86	FA103*		FA103HH*	MD3039LS	MD3039RS						
GSX 1100 FJ/FK/FL/FM/FN/FP/FR (GV72A)	88-94	FA146*		FA146HH*	MD3039LS	MD3039RS						
GSXR 1100 GH/J (GV74B)	86-88	FA103*		FA103HH*	MD3004	MD3004						
GSXR 1100 K/L/M/N (GV73B)	89-92	FA145*		FA145HH*	MD3007	MD3007	MD3007C*	VR3007BLK*				
GSXR 1100 WP/WR/WS/WT (GU75A)	93-96	FA188*		FA188HH*	MD3007	MD3007	MD3007C*	VR3007BLK*				
GSX 1100 GM/GN/GR	91-96	FA129*		FA129HH*	MD3037LS	MD3037RS						
GS 1200 SSK1/ZK1 (GV78A)	01	FA188*		FA188HH*	MD3006X	MD3006X	MD3006XC*	VR3006BLK*				
GSF 1200 T/W/WX/Y (Naked Bandit - 4 Piston Caliper)	96-00	FA145*		FA145HH*	MD3006X	MD3006X	MD3006XC*	VR3006BLK*				
GSF 1200 ST/SV/SW/SX/SY (Naked Bandit - 4 Piston Caliper)	96-00	FA145*		FA145HH*	MD3006X	MD3006X	MD3006XC*	VR3006BLK*				
GSF 1200 SAV (Faired Bandit - ABS Model- 4 Piston Caliper)	97	FA145*		FA145HH*	MD3075LS	MD3075RS						
GSF 1200 K1/K2/K3/K4/K5 (Naked Bandit - 6 Piston Caliper)	01-05	FA188*		FA188HH*	MD3006X	MD3006X	MD3006XC*	VR3006BLK*				
GSF 1200S SK1/SK2/SK3/SK4/SK5 (Faired Bandit - 6 Piston Caliper)	01-05	FA188*		FA188HH*	MD3006X	MD3006X	MD3006XC*	VR3006BLK*				
GSF 1200 K6/AK6 (Naked Bandit/Non & ABS Models/4 Piston Caliper)	06	FA158*		FA158HH*	MD3092X	MD3092X	MD3092XC*	VR3092BLK*				
GSF 1200 SK6/SAK6 (Faired Bandit/Non & ABS Models/4 Piston Caliper)	06	FA158*		FA158HH*	MD3092X	MD3092X	MD3092XC*	VR3092BLK*				
GSX 1200 FSW/FSX Inazuma	98-99	FA244*		FA244HH*	MD3006X	MD3006X	MD3006XC*	VR3006BLK*				
GV 1200 GL/GL2/GL3 Madura	85-86	FA051*	FA051V*		MD3030LS	MD3030RS						
GSF 1250 K7/K8/K9/L0 (Naked Bandit - Non ABS - 4 Piston Caliper)	07-11	FA158*		FA158HH*	MD3092X	MD3092X	MD3092XC*	VR3092BLK*				
GSF 1250 AK7/AK8 (Naked Bandit - ABS Model-4 Piston Caliper)	07-10	FA158*		FA158HH*	MD3092X	MD3092X	MD3092XC*	VR3092BLK*				
GSF 1250 SK7/SK8/SK9/S10 (Faired Bandit - ABS Model-4 Piston Caliper)	07-10	FA158*		FA158HH*	MD3092X	MD3092X	MD3092XC*	VR3092BLK*				
GSF 1250 SAK7/SAK8/SAK9/SAZK9/SALO (Faired Bandit - ABS Model - 4 Piston Caliper)	07-12	FA158*		FA158HH*	MD3092X	MD3092X	MD3092XC*	VR3092BLK*				
GSX 1250 FALO/FAL1/FAL2	10-13	FA158*		FA158HH*	MD3092X	MD3092X	MD3092XC*	VR3092BLK*				
GSX 1250 FALOST Sports Touring	10-12	FA158*		FA158HH*	MD3092X	MD3092X	MD3092XC*	VR3092BLK*				
GSX 1300 RX/RX1/RX2/RK3/RZK3/RK4/RK5/K6/K7 Hayabusa	99-07	FA188*		FA188HH*	MD3058X	MD3058X	MD3058XC*	VR3058BLK*				
GSX 1300 RK8/RK9/RL0/RL1/RL2 Hayabusa	08-12			FA379HH*	MD3098X	MD3098X	MD3098XC*	VR3098BLK*				
GSX 1300 RL3 Hayabusa (Brembo Calipers)	13			FA447HH*	TBA	TBA						
GSX 1300 BK8/BK9/BK10/BK11 B-King	08-12			FA347HH*	MD3098X	MD3098X	MD3098XC*	VR3098BLK*				
GSX 1400 K1/K2/K3/K4/K5/K6/K7/FE	01-07	FA188*		FA188HH*	MD3058X	MD3058X	MD3058XC*	VR3058BLK*				
GV 1400 GDG/GTG Cavalcade (Up to F/No 103764)	86	FA103*	FA103V*	FA103HH*	MD3042LS	MD3042RS						
GV 1400 GDG/GCG/GDH/GDJ/GGH Cavalcade (From f/No 103765)	86-88	FA146*	FA146V*	FA146HH*	MD3042LS	MD3042RS						
VS 1400 GLPH/GLFH/GLP/J/GLFJ/GLPR/GLPT/GLPV/GLPW/GLPX /GLPY/GLPK1/GLPK2 Intruder (VX51L)	87-03	FA103	FA103V	FA103HH		MD3032RS						
VL 1500 WX Intruder Legendary Classic	98-99	FA103	FA103V	FA103HH		MD3078RS						
VL 1500 YK1 Intruder Legendary Classic	00-01	FA103	FA103V	FA103HH		MD3078RS						
VL 1500 K2/K3 Intruder Legendary Classic	Left 02-03	FA229	FA229V	FA229HH	MD3087LS							
	Right	FA231	FA231V	FA231HH		MD3087RS						
VL 1500 K5/K6/K7/K8/K9 (C 1500 Intruder)	Left 05-09	FA229	FA229V	FA229HH	MD3087LS							
	Right 05-09	FA231	FA231V	FA231HH		MD3087RS						
VL 1500 L3 (CT 1500 T Intruder)	13	FA196	FA196V	FA196HH	TBA							
M1500 -VZ 1500 K9/L0 (M 1500 Intruder)	Left 09-13	FA229	FA229V	FA229HH	MD3090X							
	Right	FA231	FA231V	FA231HH		MD3090X						
M 1600 (VZ 1600 K4 - M1600 Marauder)	04	FA188*		FA188HH*	MD4022X	MD4022X	MD4022XC*	VR4022BLK*				
M 1600 (VZ 1600 K5 - M1600 Intruder)	05			FA369/4HH*	MD4022X	MD4022X	MD4022XC*	VR4022BLK*				
C 1800 R (VLR 1800 K8/K9/L0/L1 (C1800R Intruder)	08-13	FA388*		FA388HH*	MD3090X	MD3090X	MD3090XC*	VR3090BLK*				
C 1800RT (VLR 1800 8RT/K9RT (C1800 RT Intruder)	08-09	FA388*		FA388HH*	MD3090X	MD3090X	MD3090XC*	VR3090BLK*				
M 1800 R (VZR 1800 K6/K7/K8/K9												
(M 1800 R Intruder with handlebar cowling)	06-09			FA379HH*	MD3091X	MD3091X	MD3091XC*	VR3091BLK*				

\*-2 Sets Required. ■ - Also available in MX-S race compound.

**SAFETY WARNING:** DO NOT USE HH PADS ON REAR UNLESS ALSO USED ON FRONT TO AVOID BRAKE IMBALANCE

**R** Suffix = High Durability Sintered Pad. **HH** Suffix = High Performance Sintered Pad. **G** Suffix = Grooved Shoe. **D** Suffix = Drilled Disc. **C** Suffix = Contoured Disc. **LS** Suffix = Left/Steel Disc. **RS** = Right/Steel Disc.

# JAPANESE Built Motorcycles



## SUZUKI Contd.



← REAR / ARRIÈRE / HINTEN POSTERIOR / POSTERIORE →

		DISC PAD CHOICES			BRAKE ROTOR CHOICES		
		NEW SFAC Scooter Carbon Pads	Semi-Sintered V-Pads™	Sintered/HH Pads/ Grooved shoes	Contour Rotor Rear Fitment	NEW Vee-Rotors™ CONTOUR	NEW CX Extreme® ROTOR
GSXR 1000 K4	04	FA254		FA254HH	MD3060	MD3060C	VR3060
GSXR 1000 K5/K6	05-06	FA254		FA254HH	MD3060	MD3060C	VR3060
GSXR 1000 K7/K8	07-08	FA419	FA419V	FA419HH	MD3060	MD3060C	VR3060
GSXR 1000 K9/LO/L1	09-11	FA436	FA436V	FA436HH	MD3060	MD3060C	VR3060
GSXR 1000 L2 /L3/LZ/L3 (Brembo Caliper)	12-13	FA436	FA436V	FA436HH	MD3060	MD3060C	VR3060
SV 1000 K3/K4/K5/K6/K7 (Naked)	03-07	FA174	FA174V	FA174HH	MD3060	MD3060C	VR3060
SV 1000 SK3/SK4/SK5/SK6/SK7 (Faired)	03-07	FA174	FA174V	FA174HH	MD3060	MD3060C	VR3060
TL 1000 SV/SV/SX/SY/SK1	97-01	FA063	FA063V	FA063HH	MD3060	MD3060C	VR3060
TL 1000 RW/RX/RY/RK1	98-02	FA063	FA063V	FA063HH	MD3060	MD3060C	VR3060
GSX 1100 ET/EX/EZ	80-82	FA036	FA036V		MD3014RS		
GSX 1100 ESD	83	FA036	FA036V		MD3014RS		
GSX 1100 SZ/SD Katana	82-83	FA036	FA036V		MD3014RS		
GS 1100 GZ	82	FA036	FA036V		MD3027		
GSX 1100 EFE/EF/ESE	84-86	FA103	FA103V	FA103HH	MD3039		
GSX 1100 FJ/FK/FL/FM/FN/FP/FR (GV72A)	88-94	FA103	FA103V	FA103HH	MD3036		
GSXR 1100 GI/HJ (GV74B)	86-88	FA063	FA063V	FA063HH	MD3009		
GSXR 1100 K/L/M/N (GV73B)	89-92	FA063	FA063V	FA063HH	MD3008	MD3008C	VR3008
GSXR 1100 WP/WP/RWS/WT (GU75A)	93-96	FA063	FA063V	FA063HH	MD3008	MD3008C	VR3008
GSX 1100 GM/GN/GR	91-96	FA146	FA146V	FA146HH	MD3038		
GS 1200 SSK1/ZK1 (GV78A)	01	FA254		FA254HH	MD3008	MD3008C	VR3008
GSF 1200 TV/W/XY (Naked Bandit - 4 Piston Caliper)	96-00	FA063	FA063V	FA063HH	MD3008	MD3008C	VR3008
GSF 1200 ST/SV/SW/SX/SY (Naked Bandit - 4 Piston Caliper)	96-00	FA063	FA063V	FA063HH	MD3008	MD3008C	
GSF 1200 SAV (Faired Bandit - ASB Model- 4 Piston Caliper)	97	FA063	FA063V	FA063HH	MD3076		
GSF 1200 K1/K2/K3/K4/K5 (Naked Bandit - 6 Piston Caliper)	01-05	FA063	FA063V	FA063HH	MD3008	MD3008C	VR3008
GSF 1200S SK1/SK2/SK3/SK4/SK5 (Faired Bandit - 6 Piston Caliper)	01-05	FA063	FA063V	FA063HH	MD3008	MD3008C	VR3008
GSF 1200 K6/AK6 (Naked Bandit/Non & ABS Models/4 Piston Caliper)	06	FA174	FA174V	FA174HH	MD3093	MD3093C	VR3093
GSF 1200 SK6/SAK6 (Faired Bandit/Non & ABS Models/4 Piston Caliper)	06	FA174	FA174V	FA174HH	MD3093	MD3093C	VR3093
GSX 1200 FSW/FSX Inazuma	98-99	FA063	FA063V	FA063HH	MD3008	MD3008C	VR3008
GV 1200 GLF/GLF2/GLG Madura	85-86	FA036	FA036V		MD3041		
GSF 1250 K7/K8/K9/LO (Naked Bandit - Non ABS - 4 Piston Caliper)	07-11	FA174	FA174V	FA174HH	MD3093	MD3093C	VR3093
GSF 1250 AK7/AK8 (Naked Bandit - ABS Model-4 Piston Caliper)	07-10	FA174	FA174V	FA174HH	MD3093	MD3093C	VR3093
GSF 1250 SK7/SK8/SK9/SLO (Faired Bandit - ABS Model-4 Piston Caliper)	07-10	FA174	FA174V	FA174HH	MD3093	MD3093C	VR3093
GSF 1250 SAK7/SAK8/SAK9/SAZK9/SALO (Faired Bandit - ABS Model - 4 Piston Caliper)	07-12	FA174	FA174V	FA174HH	MD3093	MD3093C	VR3093
GSX 1250 FALO/FAL1/FAL2	10-13	FA174	FA174V	FA174HH	MD3093	MD3093C	VR3093
GSX 1250 FALOST Sports Touring	10-12	FA174	FA174V	FA174HH	MD3093	MD3093C	VR3093
GSX 1300 RX/RX/RK1/RK2/RK3/RZK3/RK4/RK5/K6/K7 Hayabusa	99-07	FA063	FA063V	FA063HH	MD308C	MD308C	VR3008
GSX 1300 RK8/RK9/RL0/RL1/RL2 Hayabusa	08-12	FA419	FA419V	FA419HH	MD3099	MD3099C	VR3099
GSX 1300 RL3 Hayabusa (Brembo Calipers)	13	FA419	FA419V	FA419HH	MD3099	MD3099C	
GSX 1300 BK8/BK9/BK10/BK11 B-King	08-12	FA419	FA419V	FA419HH	MD3099	MD3099C	VR3099
GSX 1400 K1/K2/K3/K4/K5/K6/K7FE	01-07	FA254		FA254HH	MD3083	MD3083C	
GV 1400 GDG/GTG Cavalcade (Up to F/No 103764)	86	FA103	FA103V	FA103HH	MD3043		
GV 1400 GDG/GCG/GDH/GDJ/GCH Cavalcade (From f/No 103765)	86-88	FA150	FA150V	FA150HH	MD3043		
VS 1400 GLPH/GLFH/GLPJ/GLFJ/GLPP/GLPT/GLPV/GLPW/GLPX /GLPY/GLPK1/GLPK2 Intruder (VX51L)	87-03	FA103	FA103V	FA103HH	MD3044		
VL 1500 WX Intruder Legendary Classic	98-99	FA103	FA103V	FA103HH	MD3079		
VL 1500 YK1 Intruder Legendary Classic	00-01	FA103	FA103V	FA103HH	MD3086		
VL 1500 K2/K3 Intruder Legendary Classic	02-03	FA366TT	FA366V	FA366HH	MD3086		
VL 1500 K5/K6/K7/K8/K9 (C 1500 Intruder)	05-09	FA366TT	FA366V	FA366HH	MD3086		
VL 1500 L3 (CT 1500 T Intruder)	13	USE FA231/2V	FA231/2V	FA231HH	TBA		
M1500 - VZ 1500 K9/LO (M 1500 Intruder)	09-13	USE FA231/2V	FA231/2V	FA231HH	MD3097		
M 1600 (VZ 1600 K4 - M1600 Marauder)	04	USE FA231/2V	FA231/3V	FA231HH	MD4146		
M 1600 (VZ 1600 K5 - M1600 Intruder)	05	USE FA231/2V	FA231/3V	FA231HH	MD4146		
C 1800 R (VLR 1800 K8/K9/LO/L1 (C1800R Intruder)	08-13	USE FA231/2V	FA231/2V	FA231HH	MD3097		
C 1800RT (VLR 1800 8RT/9RT (C1800 RT Intruder)	08-09	USE FA231/2V	FA231/2V	FA231HH	MD3097		
M 1800 R (VZR 1800 K6/K7/K8/K9 (M 1800 R Intruder with handlebar cowling)	06-09	USE FA231/2V	FA231/3V	FA231HH	MD3097		

\*-2 Sets Required. ■ - Also available in MX-S race compound.

**SAFETY WARNING:** DO NOT USE HH PADS ON REAR UNLESS ALSO USED ON FRONT TO AVOID BRAKE IMBALANCE

**R** Suffix = High Durability Sintered Pad. **HH** Suffix = High Performance Sintered Pad. **G** Suffix = Grooved Shoe.  
**D** Suffix = Drilled Disc. **C** Suffix = Contoured Disc. **LS** Suffix = Left/Steel Disc. **RS** = Right/Steel Disc.

**BRAKE APPLICATIONS**







# JAPANESE Built Motorcycles



**YAMAHA**



← FRONT / AVANT / VORN FRENTE / ANTERIORE →

Model	Year	DISC PAD CHOICES				BRAKE ROTOR CHOICES							
		NEW SFAC Scooter Carbon Pads	Semi-Sintered V-Pads™	Sintered/HH Pads/ Grooved shoes	Left/Gauche/Links	Right/Droite/Rechts	Contour Rotor Universal left and right fitment	NEW Vee-Rotors™ CONTOUR	NEW CX Extreme® ROTOR	Oversize 250/280mm Rotor Kit	Relocating Bracket for 250/280mm Rotor	Oversize 320mm Rotor Kit	Relocating Bracket for 320mm Rotor
BA 50 C (4KNH) Gear-C (UA03J)	04-08	Y531											
BA 50 S/V (UA03J)	08	Y531											
BW S (3TX/4CA) CW 50 T Bi-Wizz	90-94	Y518											
BW S 50 Next Generation (Twin headlight model) (190mm disc)	99-07	SFA193	SFAC193	SFA193HH	MD923D		MD923C	VR923					
BW-S 50 Original (180mm disc)	99-02	SFA193	SFAC193	SFA193HH	MD916D								
BW's 50 (5WW1)	04	SFA193	SFAC193	SFA193HH	MD916D								
BW's 50 (5WW4/6/8/9/B/D/F/H/K/M/P)	05-13	SFA193	SFAC193	SFA193HH	MD916D								
BW's 50 Naked (1D11/2B71)	03-04	SFA193	SFAC193	SFA193HH	MD916D								
BW's 50 Naked (2B7B/D/F/H)	09-13	SFA193	SFAC193	SFA193HH	MD916D								
BW's 50 R (5SX1)	01	SFA193	SFAC193	SFA193HH	MD916D								
CA 50 Salient	83-85	Y501											
CG 50 Jog	88-92	Y501											
CR-Z 50 (3WN)	91-95	SFA169	SFAC169	SFA169HH	MD904D		MD904C	VR904					
CS 50 Jog R	02-05	SFA193	SFAC193	SFA193HH	MD943D		MD943C	VR943					
CS 50 Jog R	06-11	SFA193	SFAC193	SFA193HH	MD943D		MD943C	VR943					
CS 50 Z (Jog RR)	03-05	SFA193	SFAC193	SFA193HH	MD943D		MD943C	VR943					
CS 50 Z (Jog RR)	06-12	SFA193	SFAC193	SFA193HH	MD943D		MD943C	VR943					
CT 50 S (3NT6)	90-95	Y503											
CT 50 SS (3NTC)	92-95	Y503											
CV 50 Jog (5KN1/2) (Coolstyle)	00-02	SFA336			MD965D								
CV 50 ZR Evolution (SPT1)	01-02	SFA336			MD965D								
CV 50 A/R Jog (5SU2/1)SA/EJ	03-08	SFA384			MD965D								
CW 50 RS (4YA1/2/BWS) (180mm front disc)	96-97	SFA193	SFAC193	SFA193HH	MD916D								
CW 50 RSP (5CC1/3/4YA BW S Spy) (180mm front disc)	97-98	SFA193	SFAC193	SFA193HH	MD916D								
CW 50 RS (4YA4/BW's NG) (180mm front disc)	98	SFA193	SFAC193	SFA193HH	MD916D								
CW 50 RS (5FXA/VG5SA BW S) (190mm front disc)	99	SFA193	SFAC193	SFA193HH	MD923D		MD923C	VR923					
CW 50 RS (5FXJ/VG5SA BW S) (190mm front disc)	00	SFA193	SFAC193	SFA193HH	MD923D		MD923C	VR923					
CW 50 RS (5FXM/VG5SA BW S) (190mm front disc)	01-05	SFA193	SFAC193	SFA193HH	MD923D		MD923C	VR923					
CW 50 (5MS2/4G54R)	02	SFA193	SFAC193	SFA193HH	MD923D		MD923C	VR923					
CW 50 (5WW4/BWS)	04-07	SFA193	SFAC193	SFA193HH	MD916D								
CY 50 Jog-in	91-95	Y519											
DT 50 LC	98	FA119TT		FA119R	MD6158D		MD6158C						
DT 50 MMX	78-86	Y504		Y504G									
DT 50 MX	87-91	Y518		Y518G									
DT 50 MX	92-95	Y503		Y503G									
DT 50 R	97-01	FA116			MD6214D								
DT 50 R	02-08	FA350		FA350HH	MD6297D								
DT 50 X (Supermotard)	04-08	FA194		FA194HH	MD6279D								
DT 50 R-L (SM-5VB1/VG56BK)	02-03	FA116			MD6214D								
EC-03 (Electric Bike)	11-13	TBA											
EW 50 Slider	00-05	SFA268	SFAC268	SFA268HH	MD923D		MD923C	VR923					
FS1E	74-76	Y504											
FS1E DX	77-79	FA028											
FS1 DX	79-80	FA042					NA						
FS1 SE	81-82	Y504					NA						
FS1	87-90	Y518											
CY 50 RS Jog R	96	SFA169	SFAC169	SFA169HH	MD904D		MD904C	VR904					
LC 50 M Bop	80	Y519											
MA 50 M QT 50	80-86	Y501											
MJ 50 M Towny	82	Y501											
MS 50	85-86	Y501											
NS 50 Aerax-R (1PH1)	13	SFA193	SFAC193	SFA193HH	MD923D		MD923C	VR923					
NS 50 Aerax-R Naked (1PL1)	13	SFA193	SFAC193	SFA193HH	MD923D		MD923C	VR923					
PW 50 HJ/K/S/U/90-13	80-13	Y501											
RD 50 M	78	FA028					NA						
RD 50 M	79-80	FA042					NA						
RD 50/RD 50 MIX	81-87	FA070					NA						
RZ 50 (5FC1/2)	02	FA275		FA275HH	TBA								
SA 50 MME Passola	80-84	Y501											
T 50 Townmate	86	Y518											

\*-2 Sets Required. ■ - Also available in MX-S race compound.

**SAFETY WARNING:** DO NOT USE HH PADS ON REAR UNLESS ALSO USED ON FRONT TO AVOID BRAKE IMBALANCE

APPLICATIONS

BRAKE

R Suffix = High Durability Sintered Pad. HH Suffix = High Performance Sintered Pad. G Suffix = Grooved Shoe.

D Suffix = Drilled Disc. C Suffix = Contoured Disc. LS Suffix = Left/Steel Disc. RS = Right/Steel Disc.

# JAPANESE Built Motorcycles



**YAMAHA**



← REAR / ARRIÈRE / HINTEN POSTERIOR / POSTERIORE →

			DISC PAD CHOICES			BRAKE ROTOR CHOICES			
			NEW SFAC Scooter Carbon Pads	Semi-Sintered V-Pads™	Sintered/HH Pads/ Grooved shoes	Contour Rotor Rear Fitment	NEW Vee-Rotors™ CONTOUR	NEW CX Extreme® ROTOR	
BA 50 C (4KNH) Gear-C (UA03J)	04-08	Y530							
BA 50 SV (UA03J)	08	Y530							
BW S (3TX/4CA) CW 50 T Bi-Wizz	90-94	Y518							
BW S 50 Next Generation (Twin headlight model) (190mm disc)	99-07	Y503							
BW-S 50 Original (180mm disc)	99-02	Y503							
BW's 50 (5WW1)	04	Y503							
BW's 50 (5WW4/6/8/9/B/D/F/H/K/M/P)	05-13	Y530							
BW's 50 Naked (1D11/2B71)	03-04	Y503							
BW's 50 Naked (2B7B/D/F/H)	09-13	Y530							
BW's 50 R (5SX1)	01	Y503							
CA 50 Sallent	83-85	Y519							
CG 50 Jog	88-92	Y519							
CR-Z 50 (3WN)	91-95	Y503							
CS 50 Jog R	02-05	Y503							
CS 50 Jog R	06-11	Y530							
CS 50 Z (Jog RR)	03-05	Y503							
CS 50 Z (Jog RR)	06-12	Y530							
CT 50 S (3NT6)	90-95	Y503							
CT 50 SS (3NTC)	92-95	Y503							
CV 50 Jog (5KN1/2) (Coolstyle)	00-02	Y530							
CV 50 ZR Evolution (5PT1)	01-02	Y530							
CV 50 A/R Jog (5SU2/1) (SAEJ)	03-08	Y530							
CW 50 RS (4YA1/2/BWS) (180mm front disc)	96-97	Y503							
CW 50 RSP (5CC1/3/4YA BW S Spy) (180mm front disc)	97-98	Y503							
CW 50 RS (4YA4/BWs NG) (180mm front disc)	98	Y503							
CW 50 RS (5FXA/VG5SA BW S) (190mm front disc)	99	Y503							
CW 50 RS (5FXJ/VG5SA BW S) (190mm front disc)	00	Y503							
CW 50 RS (5FXM/VG5SA BW S) (190mm front disc)	01-05	Y503							
CW 50 (5MS2/4/G54R)	02	Y503							
CW 50 (5WW4/BWS)	04-07	Y530							
CY 50 Jog-in	91-95	Y518							
DT 50 LC	98-	Y503							
DT 50 MMX	78-86	Y504			Y504G				
DT 50 MX	87-91	Y518			Y518G				
DT 50 MX	92-95	Y503			Y503G				
DT 50 R	97-01	Y503							
DT 50 R	02-08	FA350			FA350HH	MDR280D			
DT 50 X (Supermotard)	04-08	FA350			FA350HH	MDR280D			
DT 50 R-L (SM-5V/B1/VG55BK)	02-03	FA382				MDR286D			
EC-03 (Electric Bike)	11-13	TBA							
EW 50 Slider	00-05	Y503							
FS1E	74-76	Y504							
FS1E DX	77-79	Y504							
FS1 DX	79-80	Y504							
FS1 SE	81-82	Y504							
FS1	87-90	Y518							
CY 50 RS Jog R	96-	Y503							
LC 50 M Bop	80	Y519							
MA 50 M QT 50	80-86	Y501							
MJ 50 M Towny	82	Y501							
MS 50	85-86	Y519							
NS 50 Aerox-R (1PH1)	13	SFA268	SFAC268		SFA268HH	MD923D	MD923C	VR923	
NS 50 Aerox-R Naked (1PL1)	13	SFA268	SFAC268		SFA268HH	MD923D	MD923C	VR923	
PW 50 H/J/K/S/U/90-13	80-13	Y501							
RD 50 M	78	Y504							
RD 50 M	79-80	Y504							
RD 50/RD 50 MX	81-87	Y504							
RZ 50 (5FC1/2)	02	Y503							
SA 50 MME Passola	80-84	Y519							
T 50 Townmate	86	Y518							

\*-2 Sets Required. ■ - Also available in MX-S race compound.

**SAFETY WARNING:** DO NOT USE HH PADS ON REAR UNLESS ALSO USED ON FRONT TO AVOID BRAKE IMBALANCE

**R** Suffix = High Durability Sintered Pad. **HH** Suffix = High Performance Sintered Pad. **G** Suffix = Grooved Shoe.  
**D** Suffix = Drilled Disc. **C** Suffix = Contoured Disc. **LS** Suffix = Left/Steel Disc. **RS** = Right/Steel Disc.

**BRAKE APPLICATIONS**



# JAPANESE Built Motorcycles



← FRONT / AVANT / VORN FRENTE / ANTERIORE →

## DISC PAD CHOICES

## BRAKE ROTOR CHOICES

### YAMAHA Contd.

			NEW SFAC Scooter Carbon Pads	Semi-Sintered V-Pads™	Sintered/HH Pads/ Grooved shoes	Left/Gauche/Links	Right/Droite/Rechts	Contour Rotor Universal left and right fitment	NEW Vee-Rotors™ CONTOUR	NEW CX Extreme® ROTOR	Oversize 250/280mm Rotor Kit	Relocating Bracket for 250/280mm Rotor	Oversize 320mm Rotor Kit	Relocating Bracket for 320mm Rotor
TT-R 50 EV/EV/EV/EV/EZ/EV/EB/ED	06-13	H301												
TY 50/50 M	77-80	Y504			Y504G									
TZR 50 Thunderkid (41V21) (5DU1/3)	97-00	FA197			FA197HH		MD2067RS							
TZR 50	03-13	FA194			FA194HH	MD672LS								
V 50 MP	74-82	Y504												
V 50 M	83	Y518												
XC 50 X Vino Classic (SA26J)	08	Y530												
XF 50 Giggle/Vox	07-12	Y530												
YA 50 R Axis (4PC)	95-96	SFA193	SFAC193		SFA193HH	MD904D		MD904C	VR904					
YA 50 ZA Jog Z (4SC1)	95	SFA169	SFAC169		SFA169HH	N/A								
YB-1 (50cc) (5JE1/3)	01-02	Y531												
YFM 50 S/T/R/V/RW/RX Raptor	04-09	Y503*			Y503G*									
YSR 50 T	87	FA101				N/A								
YJ 50 R (5AU1-3) Vino	98-	Y519												
YZ 50 G/H/J/K	80-83	Y502			Y502G									
YE 50 Zest	93-95	SFA193	SFAC193		SFA193HH	MD904D		MD904C	VR904					
YH 50 Why	99-09	SFA193	SFAC193		SFA193HH	MD928D								
YM 50 Breeze (4KH)	94-95	SFA193	SFAC193		SFA193HH	MD904D		MD904C	VR904					
YN 50 R Neo's (5AD/5MR/5RN3)	97-02	SFA193	SFAC193		SFA193HH	MD943D		MD943C	VR943					
YN 50 Neo's (5RN1P9)	02-06	SFA193	SFAC193		SFA193HH	MD943D		MD943C	VR943					
YN 50 Neo's (2T) (1F5C2/1H5C2)	07-13	SFA193	SFAC193		SFA193HH	MD943D		MD943C	VR943					
YN 50 Neo's (4T) (5C3)	09-13	SFA193	SFAC193		SFA193HH	MD943D		MD943C	VR943					
YV 50 (5BM2) Jog Space Innovation	97-	Y519												
YQ 50 Aerov/Aerov-R	97-12	SFA193	SFAC193		SFA193HH	MD923D		MD923C	VR923					
YT 60 Tri Zinger	83	None												
YF 60 S	88	None												
V 70 A	76	Y504												
V 75 A	77	Y504												
CV 80 Beluga	81-83	Y503												
DT 80 LC (37A)	81-84	FA081			FA081R	N/A								
DT 80 LC-2 (53V)	85-92	FA101TT			FA101R	N/A								
DT 80 MX	81-83	Y504			Y504G									
DT 80 MX 36N TypeMXS	83-85	Y518			Y518G									
LB280 Bop 2	80	Y504												
PW 80 K/S/91	83-91	Y502			Y502G									
PW 80	93-13	Y502			Y502G									
RD 80 (Air cooled)	82	FA070					N/A							
RD 80 LC	82	FA081					N/A							
T 80 Townmate	83-97	Y518												
TY 80	77	Y502			Y502									
TY 80	83-	Y502			Y502									
V 80	79-82	Y504												
V 80 DL	83	Y518												
YFM 80 S	87	None												
YFM 80 D/E/F/G/H/J/K/L/M/N Badger	92-01	Y503*			Y503G*									
YFM 80 W/P/W/R/W/S/R/T/R/V/RW/RX Raptor	02-08	Y503*			Y503G*									
YFM 80 GT/GV/GW/GX Grizzly	05-08	Y503*			Y503G*									
YZ 80 D/E/F	77-79	Y502			Y502G									
YZ 80 G/H/J/K/L/N	80-85	Y502			Y502G									
YZ 80 S/T/U/W	86-89	FA119TT			FA119R	MD6029D								
YZ 80 E/F/L/W/LWG/GLV/H/H/LW/J/LWK/K/L/LWL/M/LVM/N/LWN	93-01	FA119TT			FA119R	MD6030D		MD6030C		MD6030CX	OSY6030C	BRK036	N/A	N/A
YZ 85 P/L/W/P/L/W/R/S/L/W/S/L/W/T/V/L/W/V/L/W/W/L/W/X/L/W/Y/L/W/Y														
Z/L/W/L/W/L/W/L/W/L/W/D	02-13	FA119TT			FA119R	MD6030D		MD6030C		MD6030CX	OSY6030C	BRK036	N/A	N/A
T 90 N (4NM1/2/3/6)	94-99	Y530												
T 90 D (4NM4/5/7)	97-99	Y530												
T 90 D 4NM8/UB02J	00-08	Y530												
T 90 N 4NM9/UB02J	00-08	Y530												
TT-R 90 MNP/R/ES/S/T/T/ET/VEVW	00-07	Y502			Y502G									
V 90	78	Y504												
YFM 90 RY Raptor (No Rear Parking Brake)	09	Y536*			Y536G*									

\*-2 Sets Required. ■ - Also available in MX-S race compound.

**SAFETY WARNING:** DO NOT USE HH PADS ON REAR UNLESS ALSO USED ON FRONT TO AVOID BRAKE IMBALANCE

APPLICATIONS  
BRAKE

R Suffix = High Durability Sintered Pad. HH Suffix = High Performance Sintered Pad. G Suffix = Grooved Shoe.  
D Suffix = Drilled Disc. C Suffix = Contoured Disc. LS Suffix = Left/Steel Disc. RS = Right/Steel Disc.

# JAPANESE Built Motorcycles



## YAMAHA Contd.



← REAR / ARRIÈRE / HINTEN POSTERIOR / POSTERIORE →

			DISC PAD CHOICES			BRAKE ROTOR CHOICES			
			NEW SFAC Scooter Carbon Pads	Semi-Sintered V-Pads™	Sintered/HH Pads/ Grooved shoes		Contour Rotor Rear Fitment	NEW Vee-Rotors™ CONTOUR	NEW CX Extreme® ROTOR
TT-R 50 EV/EV/EV/EV/EZ/EA/EB/ED	06-13	H301							
TY 50/50 M	77-80	Y504			Y504G				
TZR 50 Thunderkid (41V21) (5DU1/3)	97-00	FA101				MD2077			
TZR 50	03-13	FA115			FA115HH	MD2113			
V 50 MP	74-82	Y504							
V 50 M	83	Y518							
XC 50 X Vino Classic (SA26J)	08	Y530							
XF 50 GiggleVox	07-12	Y530							
YA 50 R Axis (4PC)	95-96	Y503							
YA 50 ZA Jog Z (4SC1)	95	Y503							
YB-1 (50cc) (5JE1/3)	01-02	Y531							
YFM 50 S/T/RV/RW/RX Raptor	04-09	Y527			Y527G				
YSR 50 T	87	Y503							
YJ 50 R (5AU1-3) Vino	98-	Y503							
YZ 50 GH/J/K	80-83	Y502			Y502G				
YE 50 Zest	93-95	Y518							
YH 50 Why	99-09	Y503							
YM 50 Breeze (4KH)	94-95	Y503							
YN 50 R Neo's (5AD/5MR/5RN3)	97-02	Y503							
YN 50 Neo's (5RN1/P9)	02-06	Y503							
YN 50 Neo's (2T) (1F5C2/1H5C2)	07-13	Y530							
YN 50 Neo's (4T) (5C3)	09-13	Y530							
YV 50 (5BM2) Jog Space Innovation	97-	Y503							
YQ 50 Aerox/Aerox-R	97-12	SFA268	SFAC268		SFA268HH	MD923D	MD923C	VR923	
YT 60 Tri Zinger	83	Y518			Y518G				
YF 60 S	88	Y518			Y518G				
V 70 A	76	Y504							
V 75 A	77	Y504							
CV 80 Beluga	81-83	Y503							
DT 80 LC (37A)	81-84	Y506							
DT 80 LC-2 (53V)	85-92	Y506							
DT 80 MX	81-83	Y504			Y504G				
DT 80 MX 36N Type/MXS	83-85	Y518			Y518G				
LB2/80 Bop 2	80	Y504							
PW 80 K/S/91	83-91	Y518			Y518G				
PW 80	93-13	Y503			Y503G				
RD 80 (Air cooled)	82	Y504							
RD 80 LC	82	Y504							
T 80 Townmate	83-97	Y518							
TY 80	77	Y504			Y504G				
TY 80	83-	Y503			Y503G				
V 80	79-82	Y504							
V 80 DL	83	Y518							
YFM 80 S	87	Y506			Y506G				
YFM 80 D/E/F/G/H/J/K/L/M/N Badger	92-01	Y527			Y527G				
YFM 80 W/P/W/R/S/R/T/R/V/R/W/RX Raptor	02-08	Y527			Y527G				
YFM 80 G/T/G/V/G/W/GX Grizzly	05-08	Y527			Y527G				
YZ 80 D/E/F	77-79	Y504			Y504G				
YZ 80 G/H/J/K/L/N	80-85	Y502			Y502G				
YZ 80 S/T/U/V	86-89	Y502			Y502G				
YZ 80 E/F/L/W/L/W/G/L/W/H/H/L/W/J/L/W/K/L/L/W/L/M/L/M/N/L/W/N	93-01				FA084/3R	MD6031D	MD6031C	MD6031CX	
YZ 85 P/L/W/P/R/L/W/R/S/L/W/S/T/L/W/T/V/L/W/W/L/W/W/X/L/W/X/Y/L/W/Y									
Z/L/W/Z/L/W/L/W/L/W/D	02-13				FA084/3R	MD6031D	MD6031C	MD6031CX	
T 90 N (4NM1/2/3/6)	94-99	Y530							
T 90 D (4NM4/5/7)	97-99	Y530							
T 90 D 4NM8/UB02J	00-08	Y530							
T 90 N 4NM9/UB02J	00-08	Y530							
TT-R 90 M/N/P/R/S/S/T/ET/EV/EW	00-07	Y503			Y503G				
V 90	78	Y504							
YFM 90 RY Raptor (No Rear Parking Brake)	09	FA083TT			FA083R	MD6282D			

\*-2 Sets Required. ■ - Also available in MX-S race compound.

**SAFETY WARNING:** DO NOT USE HH PADS ON REAR UNLESS ALSO USED ON FRONT TO AVOID BRAKE IMBALANCE

**R** Suffix = High Durability Sintered Pad. **HH** Suffix = High Performance Sintered Pad. **G** Suffix = Grooved Shoe.  
**D** Suffix = Drilled Disc. **C** Suffix = Contoured Disc. **LS** Suffix = Left/Steel Disc. **RS** = Right/Steel Disc.

**BRAKE APPLICATIONS**

# JAPANESE Built Motorcycles



← FRONT / AVANT / VORN FRENTE / ANTERIORE →

## YAMAHA Contd.

### DISC PAD CHOICES

### BRAKE ROTOR CHOICES

			NEW SFAC Scooter Carbon Pads	Semi-Sintered V-Pads™	Sintered/HH Pads/ Grooved shoes	Left/Gauche/Links	Right/Droite/Rechts	Contour Rotor Universal left and right fitment	NEW Vee-Rotors™ CONTOUR	NEW CX Extreme® ROTOR	Oversize 250/280mm Rotor Kit	Relocating Bracket for 250/280mm Rotor	Oversize 320mm Rotor Kit	Relocating Bracket for 320mm Rotor
YFM 90 RZ/RA/RB/RD Raptor (With Rear Parking Brake)	10-13	Y536*			Y536G*									
AG 100 J (3HAA)	82	Y503			Y503G									
AG 100 E Farm Bike	93	Y503			Y503G									
DT 100	76-80	Y504			Y504G									
FIZ	97-	SFA275	SFAC275		SFA275HH	TBA								
RT 100 E/F/K	93-03	Y503			Y503G									
RS 100 (478)	75-76	Y504												
RS 100 (1Y8 / Europe) Front Disc Model / Round Type Pad	77-78	FA028					N/A							
RS 100 (1Y8 /UK)	77-78	Y504												
RS 100 (1Y9 /UK)	79-81	Y504												
RS 100 DX (1Y8 Europe) Front Disc Model / Round Type Pad	79	FA028					N/A							
RS 100 (1Y8 / Europe) Front Disc Model / Square Type Pad	80-82	FA028					N/A							
RXS 100	83-97	Y518												
YB 100	78-81	Y504												
YB 100	82-86	Y504												
YB 100	87-92	Y503												
YN 100 Neo's 100	99-03	SFA193	SFAC193		SFA193HH	MD943D		MD943C	VR943					
YQ 100 Aerox 100	00-04	SFA193	SFAC193		SFA193HH	MD923D		MD923C	VR923					
YW 100 T Booster BW S	96	SFA169			SFA169HH	N/A								
YZ 100 E/F/G/H	78-81	Y504			Y504G									
YZ 100 J/K	82-83	Y503			Y503G									
T 105/105 E Crypton	96	Y518												
T 105E (5ER1/2) Crypton-R	99	SFA275	SFAC275		SFA275HH	MD963D								
T 105 SE Crypton (SER3)	02	SFA275	SFAC275		SFA275HH	MD963D								
Alba (106cc 4T) (Cast wheel)	08	TBA												
G5 Libero (106cc 4T) (Cast wheel)	08	TBA												
Crux (106cc 4T) (Spoke wheel)	08	TBA												
Crypton 110cc	04	SFA197	SFAC197		SFA197HH	N/A								
TT-R 110 EX/EY	08-09	Y502			Y502G									
V 110 ZE/ZK/ZHE/ZHK FIZR/FIZR Sporty	96	SFA275	SFAC275		SFA275HH	MD963D								
MIO (113cc)	05-07	SFA336					TBA							
MIO Sporty (113cc)	05-07	SFA336					TBA							
Nouvo-Z (113cc)	06-07	SFA336					TBA							
AT 115 (2B81/2/3) Neo (Brasil)	05-07	SFA275	SFAC275		SFA275HH		MD963D							
AT 115 (15S1) (Neo CVT/Brasil)	08	SFA275	SFAC275		SFA275HH		MD963D							
RX 115 (5FS3)	99	FA081					N/A							
BL 125 Beluga	85	Y521												
BW's 125 - See YW125	10-13													
Cygnus X (5ML) 220mm O/D Disc - See NXC 125	04-06													
Cygnus X (4P9) 240mm O/D Disc - See NXC 125	07-13													
DT 125 EIMX/LC	74-85	Y506			Y506									
DT 125 LC	86-87	FA101TT			FA101R ■	MD6067D								
DT 125 R	88-03	FA101TT			FA101R ■	MD6039D								
DT 125 RE	04	FA101TT			FA101R ■	MD6039D								
DT 125 RE	05-07	FA101TT			FA101R ■	MD6039D								
DT-Z 125 Tenere/Tenere Scout	89-90	FA166				N/A								
DT 125 Chesterfield Scout	89-90	FA166				N/A								
DT 125 (3TT4)	96	Y527			Y527G									
DT 125 X	05-06	FA209/2			FA209/2HH	MD6235D								
HW 125 - Xenter 125	12-13	SFA492				MD9136D			VR9136					
IT 125 GI/HU	80-82	Y504			Y504G									
XQ 125/150 N Maxster - See XQ 125/150 N	01-03													
Majesty 125 - See YP 125	98-00													
Majesty 125 - See YP 125	01-06													
Majesty 125 FA (SCA9) (Taiwan Production) - see YP125	02													
Majesty 125 - See YP125	04-09													
NCX 125 K Cygnus X Cab (4C6-1)	07-10	SFA632					MD9133D	MD9133C	VR9133					
NCX 125 L Cygnus X Injection (4C6-2)	07-10	SFA632					MD9133D	MD9133C	VR9133					
NXC 125 Cygnus X (5ML) 220mm O/D Disc	04-06	SFA393	SFAC393				MD986D		VR986					
NXC 125 Cygnus X (4P9) 240mm O/D Disc	07-13	SFA393	SFAC393				MD9133D	MD9133C	VR9133					

\*-2 Sets Required. ■ - Also available in MX-S race compound.

**SAFETY WARNING:** DO NOT USE HH PADS ON REAR UNLESS ALSO USED ON FRONT TO AVOID BRAKE IMBALANCE

APPLICATIONS  
BRAKE

R Suffix = High Durability Sintered Pad. HH Suffix = High Performance Sintered Pad. G Suffix = Grooved Shoe.

D Suffix = Drilled Disc. C Suffix = Contoured Disc. LS Suffix = Left/Steel Disc. RS = Right/Steel Disc.

# JAPANESE Built Motorcycles



## YAMAHA Contd.



← REAR / ARRIÈRE / HINTEN POSTERIOR / POSTERIORE →

			DISC PAD CHOICES			BRAKE ROTOR CHOICES		
			NEW SFAC Scooter Carbon Pads	Semi-Sintered V-Pads™	Sintered/HH Pads/ Grooved shoes	Contour Rotor Rear Fitment	NEW Vee-Rotors™ CONTOUR	NEW CX Extreme® ROTOR
YFM 90 RZ/RA/RB/RD Raptor (With Rear Parking Brake)	10-13	FA067TT			FA067R	MD6282D		
AG 100 J (3HAA)	82	Y527			Y527G			
AG 100 E Farm Bike	93	Y527			Y527G			
DT 100	76-80	Y506			Y506G			
FIZ	97-	Y503						
RT 100 E/FK	93-03	Y503			Y503G			
RS 100 (478)	75-76	Y504						
RS 100 (1Y8 / Europe) Front Disc Model / Round Type Pad	77-78	Y504						
RS 100 (1Y8 /UK)	77-78	Y504						
RS 100 (1Y9 /UK)	79-81	Y504						
RS 100 DX (1Y8 Europe) Front Disc Model / Round Type Pad	79	Y504						
RS 100 (1Y8 / Europe) Front Disc Model / Square Type Pad	80-82	Y504						
RXS 100	83-97	Y518						
YB 100	78-81	Y504						
YB 100	82-86	Y503						
YB 100	87-92	Y503						
YN 100 Neo's 100	99-03	Y527						
YQ 100 Aerox 100	00-04	Y527						
YW 100 T Booster BW S	96	Y527						
YZ 100 E/F/G/H	78-81	Y506			Y506G			
YZ 100 J/K	82-83	Y506			Y506G			
T 105/105 E Crypton	96	Y518						
T 105E (5ER1/2) Crypton-R	99	Y518						
T 105 SE Crypton (SER3)	02	Y518						
Alba (106cc 4T) (Cast wheel)	08	TBA						
G5 Libero (106cc 4T) (Cast wheel)	08	TBA						
Crux (106cc 4T) (Spoke wheel)	08	TBA						
Crypton 110cc	04	Y518						
TT-R 110 EX/EY	08-09	Y503			Y503G			
V 110 ZE/ZK/ZHE/ZHK FIZR/FIZR Sporty	96	Y518						
MIO (113cc)	06-07	TBA						
MIO Sporty (113cc)	06-07	TBA						
Nouvo-Z (113cc)	06-07	TBA						
AT 115 (2B81/23) Neo (Brasil)	05-07	Y531						
AT 115 (15S1) (Neo CVT/Brasil)	08	Y531						
RX 115 (5FSS)	99	Y518						
BL 125 Beluga	85	Y506						
DT 125 E/MX/LC	74-85	Y506			Y506G			
DT 125 LC	86-87	Y506			Y506G			
DT 125 R	88-03	FA101TT			FA101R ■	MD6115D		
DT 125 RE	04	FA101TT			FA101R ■	MD6115D		
DT 125 RE	05-07	FA152TT			FA152R ■	MD6121D		
DT-Z 125 Tenere/Tenere Scout	89-90	FA157				N/A		
DT 125 Chesterfield Scout	89-90	FA157				N/A		
DT 125 (3TT4)	96	Y527			Y527G			
DT 125 X	06-06	FA152TT			FA152R ■	MD6121D		
HW 125 - Xenter 125	12-13	Y533						
IT 125 GHU	80-82	Y506			Y506G			
NCX 125 K Cygnus X Cab (4C6-1)	07-10	Y533						
NCX 125 L Cygnus X Injection (4C6-2)	07-10	Y533						
NXC 125 Cygnus X (5ML) 220mm O/D Disc	04-06	Y533						
NXC 125 Cygnus X (4P9) 240mm O/D Disc	07-13	Y533						

\*-2 Sets Required. ■ - Also available in MX-S race compound.

**SAFETY WARNING:- DO NOT USE HH PADS ON REAR UNLESS ALSO USED ON FRONT TO AVOID BRAKE IMBALANCE**

**R** Suffix = High Durability Sintered Pad. **HH** Suffix = High Performance Sintered Pad. **G** Suffix = Grooved Shoe.  
**D** Suffix = Drilled Disc. **C** Suffix = Contoured Disc. **LS** Suffix = Left/Steel Disc. **RS** = Right/Steel Disc.

**BRAKE APPLICATIONS**



# JAPANESE Built Motorcycles



FRONT / AVANT / VORN FRENT / ANTERIORE

APPLICATIONS  
BRAKE

## YAMAHA Contd.



### DISC PAD CHOICES

### BRAKE ROTOR CHOICES

Model	Year	Part No.	DISC PAD CHOICES		Left/Gauche/Links		Right/Droite/Rechts		BRAKE ROTOR CHOICES						
			NEW SFAC Scooter Carbon Pads	Semi-Sintered V-Pads™	Sintered/HH Pads/ Grooved shoes	Contour Rotor Universal left and right fitment	NEW Vee-Rotors™ CONTOUR	NEW CX Extreme® ROTOR	Oversize 250/280mm Rotor Kit	Relocating Bracket for 250/280mm Rotor	Oversize 320mm Rotor Kit	Relocating Bracket for 320mm Rotor			
RD 125 DX	75-77	FA028					N/A								
RD 125 DX	78-81	FA042					N/A								
RD 125 LC	82-84	FA081					N/A								
RD 125 LC (MK2/3)	85-87	FA104			FA104HH		MD2053RS								
RS 125	75	Y510													
RS 125 DX	76-80	FA028					N/A								
RS 125 DX	81	FA042					N/A								
RZ 125 (1GV 030101-)	85	FA104			FA104HH		MD2053RS								
SR 125 SE	82	Y506													
SR 125 (3MW2 Type)	89-91	Y506													
SR 125 (3MW2 Type)	89-91	or Y527													
SR 125 SE	92-96	FA081					N/A								
SR 125	97-03	FA199			FA199HH	MD2085LS									
TDR 125 (4GW/GX12/3/4)	93-03	FA199			FA199HH	MD6116D									
TDR 125 (3HS1/3XD0/3SH3/3XD1)	89-93	FA134				MD2003X		MD2003XC	VR2003BLK						
TDR 125 R (3SH2/3XE2) Lightburner	93-94	FA134				MD2003X		MD2003XC	VR2003BLK						
TT-R 125 M/N/P/R/S/E/S/T/ET/ET/EV/EW/EX/EY	00-09	Y503			Y503G										
TT-R 125 LW/ML/WN/WP/LW/R/LWS/LWS/LWET/LWT/LV/LE/LW/LWX															
TLWEX/LV/LW/LWZ/LWEL/LWED (Large Wheel)	00-13	FA119TT			FA119R	MD6138D		MD6138C							
TW 125 (6EK)	99-02	FA275TT			FA275HH	MD6067D									
TW 125 (6RS)	03-04	FA275TT			FA275HH	MD6067D									
TY 125	82	Y504			Y504G										
TZR 125 (2RK/3PC1)	87-89	FA104			FA104HH		MD2053RS								
TZR 125 (3PC2/3PC3)	90-92	FA088			FA088HH		MD2056RS								
TZR 125 (3JB/4JB/4HW/4HY)	93-95	FA252			FA252HH		MD2022RS								
TZR 125 R (4DL1/4DL2) Brembo caliper	91-93	FA095			FA095HH	MD2003X	MD2003XC	VR2003BLK							
TZR 125 RR (4DL3) Brembo caliper	94-95	FA095			FA095HH	MD2003X	MD2003XC	VR2003BLK							
Vity 125 - See XC 125	08-13														
VP 125 X-City (16P)	08-13	SFA196	SFAC196		SFA196HH	MD9130D									
WR 125 X (Supernoto)	09-13	FA142			FA142HH	MD6235D									
WR 125 R	09-13	FA142			FA142HH			MD6347C							
X-City - See VP 125 X-City	08-13														
XC 125 Beluga	92	Y521													
XC 125 Beluga	93-95	Y521													
XC 125 T Cygnus	95-98	Y527													
XC 125 TR Cygnus	96-03	SFA101	SFAC101		SFA101HH		N/A								
XC 125 Vity (4P7)	08-13	SFA464					MD9127D		VR9127						
Xenter 125 - See HW 125	12-13	SFA492				MD9136D			VR9136						
X-MAX 125 R (1B9/Brembo F/Caliper) - See XP 125 R	06-09	SFA430	SFAC430		SFA430HH		MD9102D		VR9102						
X-MAX 125 Non ABS (39D1/5/Nissin F/Caliper) - See XP 125 R	10-12	SFA196	SFAC196		SFA196HH		MD9102D		VR9102						
X-MAX 125 R Sport Non ABS (Nissin F/Caliper) - See XP 125 R Sport	11-12	SFA196	SFAC196		SFA196HH		MD9102D		VR9102						
X-MAX 125 ABS (39D2/Nissin F/Caliper) - See XP 125 R	11-13	SFA196	SFAC196		SFA196HH		MD9102D		VR9102						
X-MAX 125 R Business ABS - See XP 125 R	11	SFA196	SFAC196		SFA196HH		MD9102D		VR9102						
XVI 125 N Teo s	00-03	SFA193	SFAC193		SFA193HH	MD907D		MD907C	VR907						
XT 125	82	Y506			Y506G										
XT 125 R (3D61/3D63)	05-06	FA350			FA350HH	MD6297D									
XT 125 R (13D1)	07	FA350			FA350HH	MD6297D									
XT 125 R (13D3/13D5)	07-11	FA350			FA350HH	MD6297D									
XT 125 X (3D62/3D64)	05-06	FA194			FA194HH	MD6279D									
XT 125 X (13D2)	07	FA194			FA194HH	MD6279D									
XT 125 X (13D4/13D6)	07-11	FA194			FA194HH	MD6279D									
XTZ 125 (5RM)	03-10	FA135TT			FA135R	MD6067D									
XV 125 Virago	97-00	FA199			FA199HH	MD2067LS									
XVS 125 Dragstar	00-04	FA199			FA199HH		MD2067RS								
XQ 125/150 N Maxster	01-03	SFA181	SFAC181		SFA181HH	MD957D			VR957						
YFA1W/A/B Breeze	89-91	Y503*			Y503G*										
YFA1D/F/G/H/J/K/L/M/N/P/R Breeze	92-03	Y503*			Y503G*										
YBA 125 ENTICER (3P01/3P41)	05-06	SFA181	SFAC181		SFA181HH		TBA								
YBR 125 E/K (5HH/1/2/C/G/U/S/LX/SLX9) (Drum front/ Brasil)	00-08	Y527													
YBR 125 ED (5HHB/F/H) (Disc front/ Brasil)	06-08	FA228			FA228HH		TBA								

\*-2 Sets Required. ■ - Also available in MX-S race compound.

**SAFETY WARNING:** DO NOT USE HH PADS ON REAR UNLESS ALSO USED ON FRONT TO AVOID BRAKE IMBALANCE

# JAPANESE Built Motorcycles



## YAMAHA Contd.



← REAR / ARRIÈRE / HINTEN POSTERIOR / POSTERIORE →

			DISC PAD CHOICES			BRAKE ROTOR CHOICES			
			NEW SFAC Scooter Carbon Pads	Semi-Sintered V-Pads™	Sintered/HH Pads/ Grooved shoes	Contour Rotor Rear Fitment	NEW Vee-Rotors™ CONTOUR	NEW CX Extreme® ROTOR	
RD 125 DX	75-77	Y506							
RD 125 DX	78-81	Y510							
RD 125 LC	82-84	Y506							
RD 125 LC (MK2/3)	85-87	Y506							
RS 125	75	Y506							
RS 125 DX	76-80	Y506							
RS 125 DX	81	Y506							
RZ 125 (1GV 030101-)	85	Y506							
SR 125 SE	82	Y503							
SR 125 (3MW2 Type)	89-91	Y503							
SR 125 (3MW2 Type)	89-91	or Y518							
SR 125 SE	92-96	Y518							
SR 125	97-03	Y503							
TDR 125 (4GW/GX12/3/4)	93-03	FA101TT				MD6115D			
TDR 125 (3HS1/3XD0/3SH3/3XD1)	89-93	FA173				TBA			
TDR 125 R (3SH2/3XE2) Lightburner	93-94	FA047				MD2021	MD2021C	VR2021	
TT-R 125 MNP/R/S/ES/T/ET/EV/EW/EX/EY	00-09	Y503			Y503G				
TT-R 125 LWML/WNL/WLP/LWR/LWES/LWS/LWET/LWT/LV/LEVL/LEWL/WX					Y503G				
LWEX/LEY/LWEZ/LWEAL/WED (Large Wheel)	00-13	Y503			Y503G				
TW 125 (5EK)	99-02	Y503			Y503G				
TW 125 (5RS)	03-04	Y531							
TY 125	82	Y506			Y506G				
TZR 125 (2RK/3PC1)	87-89	Y506							
TZR 125 (3PC2/3PC3)	90-92	FA104			FA104HH	MD2021			
TZR 125 (3JB/4JB/4HW/4HX)	93-95	FA104			FA104HH	MD2021			
TZR 125 R (4DL1/4DL2) Brembo caliper	91-93	FA047			FA047HH	MD2021	MD2021C	VR2021	
TZR 125 RR (4DL3) Brembo caliper	94-95	FA047			FA047HH	MD2021	MD2021C	VR2021	
VP 125 X-City (16P)	08-13	SFA266	SFAC266		SFA266HH	MD9104D			
WR 125 X (Supermoto)	09-13	FA213			FA213HH	MD6121D			
WR 125 R	09-13	FA213			FA213HH		MD6121C		
XC 125 Beluga	92	Y506							
XC 125 Beluga	93-95	Y527							
XC 125 T Cygnus	95-98	Y503							
XC 125 TR Cygnus	96-03	Y503							
XC 125 Vity (4P7)	08-13	Y530							
Xenter 125 - See HW 125	12-13	Y533							
X-MAX 125 R (1B9/Brembo F/Caliper) - See XP 125 R	06-09	SFA266	SFAC266		SFA266HH	MD9104D		VR9104	
X-MAX 125 Non ABS (39D1/5Nissin F/Caliper) - See XP 125 R	10-12	SFA266	SFAC266		SFA266HH	MD9104D		VR9104	
X-MAX 125 R Sport Non ABS (Nissin F/Caliper) - See XP 125 R Sport	11-12	SFA266	SFAC266		SFA266HH	MD9104D		VR9104	
X-MAX 125 ABS (39D2/Nissin F/Caliper) - See XP 125 R	11-13	SFA275	SFAC275		SFA275HH	MD9108D			
X-MAX 125 R Business ABS - See XP 125 R	11	SFA275	SFAC275		SFA275HH	MD9108D			
XN 125 N Teo s	00-03	Y527							
XT 125	82	Y503			Y503G				
XT 125 R (3D61/3D63)	05-06	FA350			FA350HH	MD6280D			
XT 125 R (13D1)	07	FA350			FA350HH	MD6280D			
XT 125 R (13D3/13D5)	07-11	FA350			FA350HH	MD6280D			
XT 125 X (3D62/3D64)	05-06	FA350			FA350HH	MD6280D			
XT 125 X (13D2)	07	FA350			FA350HH	TBA			
XT 125 X (13D4/13D6)	07-11	FA350			FA350HH	TBA			
XTZ 125 (SRM)	03-10	Y527			Y527G				
XV 125 Virago	97-00	Y527							
XVS 125 Dragstar	00-04	Y527							
XQ 125/150 N Master	01-03	SFA266	SFAC266		SFA266HH	MD958D		VR958	
YFA1W/A/B Breeze	89-91	Y506			Y506G				
YFA1D/F/G/H/J/K/L/M/N/P/R Breeze	92-03	Y527			Y527G				
YBA 125 ENTICER (3P01/3P41)	05-06	Y506							
YBR 125 EK (5HH1/2/C/G/J/S/LX/S/LX9) (Drum front/ Brasil)	00-08	Y527							
YBR 125 ED (5HHB/F/H) (Disc front/ Brasil)	06-08	Y527							

\*-2 Sets Required. ■ - Also available in MX-S race compound.

**SAFETY WARNING:** DO NOT USE HH PADS ON REAR UNLESS ALSO USED ON FRONT TO AVOID BRAKE IMBALANCE

**R** Suffix = High Durability Sintered Pad. **HH** Suffix = High Performance Sintered Pad. **G** Suffix = Grooved Shoe.  
**D** Suffix = Drilled Disc. **C** Suffix = Contoured Disc. **LS** Suffix = Left/Steel Disc. **RS** = Right/Steel Disc.

**BRAKE APPLICATIONS**

# JAPANESE Built Motorcycles



← FRONT / AVANT / VORN FRENTE / ANTERIORE →

## YAMAHA Contd.

		DISC PAD CHOICES				BRAKE ROTOR CHOICES							
		NEW SFAC Scooter Carbon Pads	Semi-Sintered V-Pads™	Sintered/HH Pads/ Grooved shoes	Left/Gauche/Links	Right/Droite/Rechts	Contour Rotor Universal left and right fitment	NEW Vee-Rotors™ CONTOUR	NEW CX Extreme® ROTOR	Oversize 250/280mm Rotor Kit	Relocating Bracket for 250/280mm Rotor	Oversize 320mm Rotor Kit	Relocating Bracket for 320mm Rotor
YBR 125 Custom	08-13	FA464					MD2104RS						
YBR 125 ED (3D91)	05-06	FA101					MD2097RS						
YBR 125 (3D92/9)	07-09	FA464					MD2104RS						
YBR 125 (51D1/2)	10-13	FA464					MD2104RS						
YFM 125 S/GT/GV/GW/GX/GY/GZ/GA/GB Grizzly	04-12	Y503*		Y503G*									
YP 125 Majesty	98-00	SFA181	SFAC181	SFA181HH	MD907D		MD907C	VR907					
YP 125 Majesty	01-06	SFA181	SFAC181	SFA181HH	MD907D		MD907C	VR907					
YP 125 Majesty FA (SCA9) (Taiwan Production)	02	SFA196	SFAC196	SFA196HH		MD979D							
YP 125 Majesty	04-09	SFA181	SFAC181	SFA181HH	MD907D		MD907C	VR907					
YP 125 R X-MAX (1B9/Brembo F/Caliper)	06-09	SFA430	SFAC430	SFA430HH		MD9102D		VR9102					
YP 125 R X-MAX Non ABS (39D1/5/Nissin F/Caliper)	10-13	SFA196	SFAC196	SFA196HH		MD9102D		VR9102					
YP 125 R X-MAX Sport Non ABS (39D1/5/Nissin F/Caliper)	11-12	SFA196	SFAC196	SFA196HH		MD9102D		VR9102					
YP 125 R X-MAX ABS (39D2/Nissin F/Caliper)	11-13	SFA196	SFAC196	SFA196HH		MD9102D		VR9102					
YP 125 R X-MAX Business ABS	11	SFA196	SFAC196	SFA196HH		MD9102D		VR9102					
YW 125 (BW's 125 /1CE1)	10-13	SFA492			MD986D			VR986					
YW 125 X (1DN1/2)	10-13	SFA632					MD9133C	VR9133					
YZ 125 C/D/E/F/G/H/J (2T)	76-82	Y507		Y507G									
YZ 125 K (2T)	83	Y507		Y507G									
YZ 125 L (2T)	84	Y508		Y508G									
YZ 125 N (2T)	85	FA105TT		FA105R	MD6324D								
YZ 125 S (2T)	86	FA105TT		FA105R	MD6067D								
YZ 125 T (2T)	87	FA105TT		FA105R	MD6067D								
YZ 125 U (2T)	88	FA105TT		FA105R	MD6039D								
YZ 125 W (2T)	89	FA135TT		FA135R ■	MD6016D								
YZ 125 D/E/F/G/H/J (2T)	92-97	FA135TT		FA135R ■	MD6028D		MD6028C		MD6028CX	OS6028EC	BRK035	N/A	N/A
YZ 125 K/L/M (2T)	98-00	FA185TT		FA185R ■	MD6028D		MD6028C		MD6028CX	OS6028C	BRK008	SM6028C	BRK009
YZ 125 N (2T)	01	FA185TT		FA185R ■	MD6356D		MD6356C		MD6356CX	OS6028C	BRK008	SM6028C	BRK009
YZ 125 P (2T)	02	FA185TT		FA185R ■	MD6356D		MD6356C		MD6356CX	OS6028C	BRK008	SM6028C	BRK009
YZ 125 R/S/T/W (2T)	03-07	FA185TT		FA185R ■	MD6356D		MD6356C		MD6356CX	OS6028C	BRK008	SM6028C	BRK009
YZ 125 X/Y/Z/A/B/D (2T)	08-13	FA450TT		FA450R ■			MD6356C		MD6356CX	OS6728C	BRK002	SM6728C	BRK034
YZF-R 125	08-13	FA181TT		FA181HH	MD2110LS								
RX 135 (13X)	81	FA081											
T135 HClS (2S61) Crypton X/Jupiter MX/Spark 135/Exciter/135LC Sniper	06-08	SFA464			MD963D								
T135-SE (1S71) Crypton X/Jupiter MX/Spark 135/Exciter													
135LC Sniper (Automatic clutch)	06-08	SFA464			MD963D								
HW 150 - Xenter 150	12-13	SFA492			MD9136D			VR9136					
TZR 150 R (4AP2)	00	FA199		FA199HH									
Xenter 150 - See HW 150	12-13	SFA492			MD9136D			VR9136					
DT 175 All models	74-83	Y506		Y506G									
DT 175 (3TS4)	96	Y527		Y527G									
IT 175 G/H/J	80-82	Y507		Y507G									
TY 175	77-80	Y504		Y504G									
AG 200 E (3GX6)	93	Y503		Y503G									
DT 200 (2LR)	87	FA101TT		FA101R ■	MD6067D								
DT 200 R	93	FA101TT		FA101R ■	MD6039D								
DT 200 WR (3XP)	92-93	FA135TT		FA135R ■	MD6068D								
IT 200 L	84	Y517		Y517G									
RD 200 DX	75-78	FA028					N/A						
RD 200 DX	78-80	FA042					N/A						
RS 200	79	Y510											
SDR 200 (2TV)	87-89	FA104		FA104HH		MD2056RS							
TW 200 (2JL/4CS1/2/3/5)	91-98	FA275TT		FA275HH	MD6067D								
TW 200 (4CS4/6/5LB1/2)	98-01	FA275TT		FA275HH	MD6067D								
YFM 200 N	85	Y503*		Y503G*									
YFM 200 DX/WD/DXA	89-90	Y503*		Y503G*									
YFS 200 B/F/G/H/J/K/L/M/N/P Blaster	91-02	Y503*		Y503G*									
YFS 200 R/S/T/V Blaster	03-06	FA054TT*		FA054R*	MD6054D	MD6054D							
YTM 200 EL/DX	89	Y503		Y503G									
WR 200 D/E/F	92-94	FA135TT		FA135R ■		MD6066D							
ST 225 (5BT) Bronco	97	FA275TT		FA275HH	MD6067D								

\*-2 Sets Required. ■ - Also available in MX-S race compound.

**SAFETY WARNING:** DO NOT USE HH PADS ON REAR UNLESS ALSO USED ON FRONT TO AVOID BRAKE IMBALANCE

**R** Suffix = High Durability Sintered Pad. **HH** Suffix = High Performance Sintered Pad. **G** Suffix = Grooved Shoe.  
**D** Suffix = Drilled Disc. **C** Suffix = Contoured Disc. **LS** Suffix = Left/Steel Disc. **RS** = Right/Steel Disc.

**APPLICATIONS**  
**BRAKE**

# JAPANESE Built Motorcycles



## YAMAHA Contd.



← REAR / ARRIÈRE / HINTEN POSTERIOR / POSTERIORE →

		DISC PAD CHOICES				BRAKE ROTOR CHOICES			
		NEW SFAC Scooter Carbon Pads	Semi-Sintered V-Pads™	Sintered/HH Pads/ Grooved shoes		Contour Rotor Rear Fitment	NEW Vee-Rotors™ CONTOUR	NEW CX Extreme® ROTOR	
YBR 125 Custom	08-13		Y535						
YBR 125 ED (3D91)	05-06		Y527						
YBR 125 (3D92/9)	07-09		Y535						
YBR 125 (51D1/2)	10-13		Y535						
YFM 125 S/GT/GV/GW/GX/GY/GZ/GA/GB Grizzly	04-12		Y527		Y527G				
YP 125 Majesty	98-00		Y527						
YP 125 Majesty	01-06	SFA266	SFAC266	SFA266HH	MD962D		VR962		
YP 125 Majesty FA (SCA9) (Taiwan Production)	02		Y527						
YP 125 Majesty	04-09	SFA266	SFAC266	SFA266HH	MD962D		VR962		
YP 125 R X-MAX (1B9/Brembo F/Caliper)	06-09	SFA266	SFAC266	SFA266HH	MD9104D		VR9104		
YP 125 R X-MAX Non ABS (39D1/5/Nissin F/Caliper)	10-13	SFA266	SFAC266	SFA266HH	MD9104D		VR9104		
YP 125 R X-MAX Sport Non ABS (39D1/5/Nissin F/Caliper)	11-12	SFA266	SFAC266	SFA266HH	MD9104D		VR9104		
YP 125 R X-MAX ABS (39D2/Nissin F/Caliper)	11-13	SFA275	SFAC275	SFA275HH	MD9108D				
YP 125 R X-MAX Business ABS	11	SFA275	SFAC275	SFA275HH	MD9108D				
YW 125 (BW's 125 /1CE1)	10-13		Y533						
YW 125 X (1DN1/2)	10-13		Y533						
YZ 125 C/D/E/F/G/H/J (2T)	76-82		Y506		Y506G				
YZ 125 K (2T)	83		Y517		Y517G				
YZ 125 L (2T)	84		Y517		Y517G				
YZ 125 N (2T)	85		Y517		Y517G				
YZ 125 S (2T)	86		Y517		Y517G				
YZ 125 T (2T)	87		Y506		Y506G				
YZ 125 U (2T)	88	FA101TT		FA101R ■	MD6011D				
YZ 125 W (2T)	89			FA0843R	MD6011D				
YZ 125 D/E/F/G/H/J (2T)	92-97	FA1522TT		FA1522R ■	MD6011D				
YZ 125 K/L/M (2T)	98-00	FA131TT		FA131R ■	MD6135D	MD6135C		MD6135CX	
YZ 125 N (2T)	01	FA131TT		FA131R ■	MD6135D	MD6135C		MD6135CX	
YZ 125 P (2T)	02	FA131TT		FA131R ■	MD6190D	MD6190C◆		MD6190CX◆	
YZ 125 R/S/T/W (2T)	03-07	FA367TT		FA367R ■	MD6190D	MD6190C◆		MD6190CX◆	
YZ 125 X/Y/Z/A/B/D (2T)	08-13	FA367TT		FA367R ■		MD6190C◆		MD6190CX◆	
YZF-R 125	08-13	FA377			MD2111				
RX 135 (13X)	81		Y506						
T135 HC/S (2S81) Crypton X/Jupiter MX/Spark 135/Exciter/135LC Sniper	06-08		Y531						
T135-SE (1S71) Crypton X/Jupiter MX/Spark 135/Exciter									
/135LC Sniper (Automatic clutch)	06-08		Y531						
HW 150 - Xenter 150	12-13		Y533						
TZR 150 R (4AP2)	00	FA104		FA104HH	MD2021				
Xenter 150 - See HW 150	12-13		Y533						
DT 175 All models	74-83		Y506		Y506G				
DT 175 (3TS4)	96		Y527		Y527G				
IT 175 G/H/J	80-82		Y506		Y506G				
TY 175	77-80		Y506		Y506G				
AG 200 E (3GX6)	93		Y527		Y527G				
DT 200 (2LR)	87		Y506		Y506G				
DT 200 R	93	FA101TT		FA101R ■	MD6115D				
DT 200 WR (3XP)	92-93	FA1522TT		FA1522R ■	MD6121D				
IT 200 L	84		Y517		Y517G				
RD 200 DX	75-78		Y510						
RD 200 DX	78-80		Y510						
RS 200	79		Y510						
SDR 200 (2TV)	87-89	FA104		FA104HH	MD2021				
TW 200 (2JL/4CS1/2/3/5)	91-98		Y503		Y503G				
TW 200 (4CS4/6/5LB1/2)	98-01		Y503		Y503G				
YFM 200 N	85	FA021		FA021R	N/A				
YFM 200 DX/W/DX/DA	89-90	FA021		FA021R	N/A				
YFS 200 B/F/G/H/K/L/M/N/P Blaster	91-02	FA155		FA155R	MD6050D				
YFS 200 R/S/T/V Blaster	03-06	FA084TT		FA084R	MD6237D				
YTM 200 EL/DX	89	FA021		FA021R	N/A				
WR 200 D/E/F	92-94	FA152TT		FA152R ■	MD6121D				
ST 225 (5BT) Bronco	97		Y503		Y503G				

\*-2 Sets Required. ■ - Also available in MX-S race compound.

**SAFETY WARNING:** DO NOT USE HH PADS ON REAR UNLESS ALSO USED ON FRONT TO AVOID BRAKE IMBALANCE

**R** Suffix = High Durability Sintered Pad. **HH** Suffix = High Performance Sintered Pad. **G** Suffix = Grooved Shoe.  
**D** Suffix = Drilled Disc. **C** Suffix = Contoured Disc. **LS** Suffix = Left/Steel Disc. **RS** = Right/Steel Disc.

**BRAKE APPLICATIONS**

# JAPANESE Built Motorcycles



← FRONT / AVANT / VORN FRENTE / ANTERIORE →

## DISC PAD CHOICES

## BRAKE ROTOR CHOICES

YAMAHA Contd.	Year	Model	DISC PAD CHOICES			BRAKE ROTOR CHOICES									
			NEW SFAC Scooter Carbon Pads	Semi-Sintered V-Pads™	Sintered/HH Pads/ Grooved shoes	Left/Gauche/Links	Right/Droite/Rechts	Contour Rotor Universal left and right fitment	NEW Vee-Rotors™ CONTOUR	NEW CX Extreme® ROTOR	Oversize 250/280mm Rotor Kit	Relocating Bracket for 250/280mm Rotor	Oversize 320mm Rotor Kit	Relocating Bracket for 320mm Rotor	
TDM 225	05	TBA				TBA									
TW 225 E (5VC1/2)	02-03	FA275TT			FA275HH	MD6067D									
YFM 225 S/T/U	86-89	Y503*			Y503G*										
YTM 225 DRN	85	Y503			Y503G										
XT 225 (2LN) (1KH 020101-) Serrow	86-87	FA101TT			FA101R ■	MD6067D									
XT 225 (3RW1-5 Serrow) (1KH 034101 - 132000)	89-93	FA101TT			FA101R ■	MD6067D									
XT 225 S (3RW3) (1KH 102101 - 109000) Serrow	92	FA101TT			FA101R ■	MD6067D									
XT 225 (3RW4) (1KH 080101-) Serrow	92	FA101TT			FA101R ■	MD6067D									
XT 225 W (4JG1/2/3/4) Serrow	93-96	FA101TT			FA101R ■	MD6067D									
XT 225 WE (4JG5/6) Serrow	97-98	FA275TT			FA275HH	MD6067D									
XT 225 (4VW1/3/5/7/9) (4VWA/B/D/G/J/L) (Brasil)	97-06	FA101TT			FA101R ■	MD6067D									
DT 230 (4TP1/2) Lanza	97-98	FA136TT			FA136R ■	MD6068D									
CP 250 (1B71) Maxam/Morphus	05-08	SFA199	SFAC199		SFA199HH		MD9107D								
DT 250 All models	75-80	Y528			Y528G										
FZR 250	87	FA123			FA123HH		MD2003X	MD2003XC	VR2003BLK						
FZR 250 R (3LN)		FA220*				MD2022LS	MD2022RS								
FZX 250 (3YX1/2/4) Zeal	91-92	FA179			FA179HH		TBA								
IT 250 G	80	Y507			Y507G										
IT 250 HU	81-82	Y507			Y507G										
IT 250 L	84	Y508			Y508G										
Majesty - See YP 250 Majesty	96-98														
Majesty - See YP 250 DX/A Majesty	98-99														
Majesty - See YP 250 Majesty	00-03														
RD 250 A/B/C	75-77	FA011					N/A								
RD 250 D	77	FA011					N/A								
RD 250 E/F	78-79	FA041					MD2025RS								
RD 250 LC	80	FA064					MD2019RS								
RD 250 LC	80-83	FA070					MD2019RS								
RZ 250 R (1AR/1XG)		FA104*			FA104HH*	MD2011	MD2011	MD2011C*							
RZ 250 R (29L)		FA081*				MD2011	MD2011	MD2011C*							
RZ 250 RR (5IL)		FA104*			FA104HH*	MD2011	MD2011	MD2011C*							
RZ 250 (4L3)		FA070					MD2019RS								
Ri-Z (250cc/3XC)	90-92	FA220*				MD2022LS	MD2022								
Serrow 250 (3C51/52)	05	FA275TT			FA275HH	MD6067D									
SR 250 SE (3Y8)	81-83	Y522													
SR 250 (4GR1/2/3/4)	93-94	Y522													
SR 250 (CLASSIC/ 21L)	96-00	FA081					MD2019RS								
SRV 250 Soufflotwin/Renaissa (4DN1-6)	92-97	FA179			FA179HH	MD2067LS									
SRX 250 (51Y/52E/1JA)		FA104			FA104HH		MD2056RS								
TDR 250 (3CK1/3CK2 Europe - Eng/Frame 3CK -)	88-92	FA123			FA123HH		MD2003X	MD2003XC	VR2003BLK						
TT 250	90	FA105TT			FA105R	MD6039D									
TT 250 R (4GY Japan)	93-94	FA135TT			FA135R ■	MD6066D									
TT 250 R (4RR1/2 Japan)	95-97	FA135TT			FA135R ■	MD6066D									
TT 250 R (4GY3/4GY5/4WA1 - Japan - Raid)	94-96	FA135TT			FA135R ■	MD6066D									
TT 250 R (4MR2 UK)	96	FA135TT			FA135R ■	MD6066D									
TT 250 RL (4PX5)	99	FA135TT			FA135R ■	MD6066D									
TT 250 RM (4PX6)	00	FA135TT			FA135R ■	MD6066D									
TY 250 D/E	77-78	Y504			Y504G										
TY 250 H	81	Y507			Y507G										
TY 250 SR	84-90	Y517			Y517G										
TY 250 R	91-92	FA115TT			FA115R ■	N/A									
TY 250 R	93-94	FA115TT			FA115R ■	N/A									
TY 250 Z	93-96	FA115TT			FA115R ■	N/A									
TZR 250 (1KT/2AW Japan - Eng/Frame # 1KT)	87	FA123			FA123HH		MD2003X	MD2003XC	VR2003BLK						
TZR 250 (2MA/2XW1/2XW2 Europe - Eng/Frame # 2MA -)	87-92	FA123			FA123HH		MD2003X	MD2003XC	VR2003BLK						
TZR 250 (3MA1 Reverse Cylinder - Eng/Frame # 3MA-)	89	FA252*			FA252HH*	MD2001X	MD2001X	MD2001XC*	VR2001BLK*						
TZR 250 (3MA3/3MA5 Reverse Cylinder - Eng/Frame # 3MA -046/058-)	90	FA252*			FA252HH*	TBA	TBA								
TZR 250 SP (3MA4 - Eng/Frame # 3MA 055)	90	FA252*			FA252HH*	TBA	TBA								
TZR 250 R (3XV1/3XV4/3XV6 V-Twin - Eng/Frame # 3XV 000101-08600)	91-93	FA252*			FA252HH*	TBA	TBA								

\*-2 Sets Required. ■ - Also available in MX-S race compound.

**SAFETY WARNING:** DO NOT USE HH PADS ON REAR UNLESS ALSO USED ON FRONT TO AVOID BRAKE IMBALANCE



# JAPANESE Built Motorcycles



## YAMAHA Contd.



← REAR / ARRIÈRE / HINTEN POSTERIOR / POSTERIORE →

			DISC PAD CHOICES			BRAKE ROTOR CHOICES			
			NEW SFAC Scooter Carbon Pads	Semi-Sintered V-Pads™	Sintered/HH Pads/ Grooved shoes	Contour Rotor Rear Fitment	NEW Vee-Rotors™ CONTOUR	NEW CX Extreme® ROTOR	
TDM 225	05	TBA							
TW 225 E (5VC1/2)	02-03	Y531							
YFM 225 S/T/U	86-89	FA021			FA021R	N/A			
YTM 225 DPN	85	FA021			FA021R	N/A			
XT 225 (2LN) (1KH 020101-) Serrow	86-87	Y503			Y503G				
XT 225 (3RW1-5 Serrow) (1KH 034101 - 132000)	89-93	Y503			Y503G				
XT 225 S (3RW3) (1KH 102101 - 109000) Serrow	92	Y503			Y503G				
XT 225 (3RW4) (1KH 080101-) Serrow	92	Y503			Y503G				
XT 225 W (4JG1/2/3/4) Serrow	93-96	FA152/2TT			FA152/2R ■	MD6244D			
XT 225 WE (4JG5/6) Serrow	97-98	FA152/2TT			FA152/2R ■	MD6244D			
XT 225 (4VW1/3/5/7/9) (4VWA/B/D/G/J/L) (Brasil)	97-06	Y527							
DT 230 (4TP1/2) Lanza	97-98	FA152/2TT			FA152/2R ■	MD6121D			
CP 250 (1B71) Maxam/Morphus	05-08	SFA408	SFAC408		SFA408HH	MD9108D			
DT 250 All models	75-80	Y510			Y510G				
FZR 250	87	FA104		FA104V	FA104HH	MD2021	MD2021C	VR2021	
FZR 250 R (3LN)		FA104				MD2021			
FZX 250 (3YX1/2/4) Zeal	91-92	FA104		FA104V	FA104HH	MD2021			
IT 250 G	80	Y528			Y528G				
IT 250 HU	81-82	Y510			Y510G				
IT 250 L	84	Y510			Y510G				
RD 250 A/B/C	75-77	Y514							
RD 250 D	77	FA011				N/A			
RD 250 EF	78-79	FA041				MD2025RS			
RD 250 LC	80	Y514							
RD 250 LC	80-83	Y514							
RZ 250 R (1AR1/XG)		FA104		FA104V	FA104HH	MD2011	MD2011C		
RZ 250 R (29L)		FA104		FA104V		MD2011	MD2011C		
RZ 250 RR (51L)		FA104		FA104V	FA104HH	MD2011	MD2011C		
RZ 250 (4L3)		Y514							
Ri-Z (250cc/3XC)	90-92	FA104		FA104V		MD2021			
Serrow 250 (3C51/52)	05	FA152TT			FA152R	MD6244D			
SR 250 SE (3V8)	81-83	Y506							
SR 250 (4GR1/2/3/4)	93-94	Y527							
SR 250 (CLASSIC/ 21L)	96-00	Y527							
SRV 250 Soufultwin/Renaissa (4DN1-6)	92-97	Y527							
SRX 250 (51Y/52E1/JA)		Y510							
TDR 250 (3CK1/3CK2 Europe - Eng/Frame 3CK -)	88-92	FA104		FA104V	FA104HH	MD2021	MD2021C	VR2021	
TT 250	90	Y506			Y506G				
TT 250 R (4GY Japan)	93-94	FA152/2TT			FA152/2R ■	MD6121D			
TT 250 R (4RR1/2 Japan)	95-97	FA152/2TT			FA152/2R ■	MD6121D			
TT 250 R (4GY3/4GY5/4WA1 - Japan - Raid)	94-96	FA152/2TT			FA152/2R ■	MD6121D			
TT 250 R (4MR2 UK)	96	FA152/2TT			FA152/2R ■	MD6121D			
TT 250 RL (4PX5)	99	FA152/2TT			FA152/2R ■	MD6121D			
TT 250 RM (4PX6)	00	FA152/2TT			FA152/2R ■	MD6121D			
TY 250 D/E	77-78	Y506			Y506G				
TY 250 H	81	Y510			Y510G				
TY 250 S/R	84-90	Y504			Y504G				
TY 250 R	91-92	Y504			Y504G				
TY 250 R	93-94	FA115TT			FA115R ■	N/A			
TY 250 Z	93-96	FA115TT			FA115R ■	N/A			
TZR 250 (1KT/2AW Japan - Eng/Frame # 1KT)	87	FA104		FA104V	FA104HH	MD2021	MD2021C	VR2021	
TZR 250 (2MA/2XW1/2XW2 Europe - Eng/Frame # 2MA -)	87-92	FA104		FA104V	FA104HH	MD2021	MD2021C	VR2021	
TZR 250 (3MA1 Reverse Cylinder - Eng/Frame # 3MA -)	89	FA104		FA104V	FA104HH	MD2021	MD2021C	VR2021	
TZR 250 (3MA3/3MA5 Reverse Cylinder - Eng/Frame # 3MA -0461058-)	90	FA104		FA104V	FA104HH	MD2021	MD2021C		
TZR 250 SP (3MA4 - Eng/Frame # 3MA 055)	90	FA104		FA104V	FA104HH	MD2021	MD2021C		
TZR 250 R (3XV1/3XV4/3XV6 V-Twin - Eng/Frame # 3XV 000101-08600)	91-93	FA104		FA104V	FA104HH	MD2021	MD2021C		

\*-2 Sets Required. ■ - Also available in MX-S race compound.

**SAFETY WARNING:** DO NOT USE HH PADS ON REAR UNLESS ALSO USED ON FRONT TO AVOID BRAKE IMBALANCE

**BRAKE APPLICATIONS**

**R** Suffix = High Durability Sintered Pad. **HH** Suffix = High Performance Sintered Pad. **G** Suffix = Grooved Shoe.  
**D** Suffix = Drilled Disc. **C** Suffix = Contoured Disc. **LS** Suffix = Left/Steel Disc. **RS** = Right/Steel Disc.

# JAPANESE Built Motorcycles



← FRONT / AVANT / VORN FRENTE / ANTERIORE →

## YAMAHA Contd.

Model	Year	DISC PAD CHOICES				BRAKE ROTOR CHOICES							
		NEW SFAC Scooter Carbon Pads	Semi-Sintered V-Pads™	Sintered/HH Pads/ Grooved shoes	Left/Gauche/Links	Right/Droite/Rechts	Contour Rotor Universal left and right fitment	NEW Vee-Rotors™ CONTOUR	NEW CX Extreme® ROTOR	Oversize 250/280mm Rotor Kit	Relocating Bracket for 250/280mm Rotor	Oversize 320mm Rotor Kit	Relocating Bracket for 320mm Rotor
TZR 250 RS (3XV8/3XV93XVA - V-Twin - Eng/Frame # 3XV 08080101-08200/088-)	92-94	FA252*		FA252HH*	TBA	TBA							
TZR 250 SPR (3XVC V-Twin 3XV 107101-)	95	FA252*		FA252HH*	TBA	TBA							
VP 250 X-City (5B2)	07-13	SFA196	SFAC196	SFA196HH	MD9130D								
WR 250 ZB/ZD/ZE/ZF/ZG/ZH/ZJ (2T)	91-97	FA135TT		FA135R ■	MD6028D		MD6028C	MD6028CX	OS6028EC	BRK035	NA	NA	
WR 250 ZK (5E/1) (2T)	98	FA185TT		FA185R ■	MD6028D		MD6028C	MD6028CX	OS6028C	BRK008	SM6028C	BRK009	
WR 250 FN (4T)	01	FA185TT		FA185R ■	MD6356D		MD6356C	MD6356CX	OS6028C	BRK008	SM6028C	BRK009	
WR 250 FP (4T)	02	FA185TT		FA185R ■	MD6356D		MD6356C	MD6356CX	OS6028C	BRK008	SM6028C	BRK009	
WR 250 FR/FS/FT/FFV (4T)	03-06	FA185TT		FA185R ■	MD6356D		MD6356C	MD6356CX	OS6028C	BRK008	SM6028C	BRK009	
WR 250 FW/FX/FY/FZ/FA/FB/FD (4T)	07-13	FA185TT		FA185R ■			MD6356C	MD6356CX	OS6028C	BRK008	SM6028C	BRK009	
WR 250 RX/RX (32D1/3)	08-10	FA185TT		FA185R ■			MD6320C						
WR 250 XX/XY (Supermoto) (32D2/4)	08-10	FA142		FA142HH			MD6323C						
X-City - See VP 250 X-City (5B2)	07-13												
XG 250 Tricker (5XT1)	04-06	FA275TT		FA275HH	MD6067D								
X-Max (Brembo F/Caliper/Non ABS/1C0) - See YP 250 R X-Max (Brembo F/Caliper/Non ABS/1C0)	05-09												
X-Max (37P1/Nissin F/Caliper/Non ABS) See YP 250 R X-Max (37P1/Nissin F/Caliper/Non ABS)	10-13												
X-Max (ABS) See -YP 250 R X-Max (ABS)	11-13												
X-Max Sport - See YP 250 X-Max Sport	11-12												
XS 250 C	78	FA034				MD2019RS							
XS 250 D/E	79-81	FA034				MD2019RS							
XS 250 SE/SF	79-81	FA041				MD2019RS							
XS 250 C	81	Y513											
XT 250	80	Y506		Y506G									
XT 250 X (5C1)	06-08	FA275TT		FA275HH	MD6067D								
XTZ 250 (4B4/2/3) Lander (Brasil)	07-09	FA135TT		FA135R	TBA								
XV 250 S Virago	95-00	FA199		FA199HH	MD2067LS								
XV 250 Virago	89-94	FA081				MD2019RS							
YBR 250 (5D11/3/4)	07-11	FA197		FA197HH		MD2106RS							
YFB 250 D/E/F Timberwolf	92-94	Y503*		Y503G*									
YFB 250 G/H/U/H/U/J/U/K/K Timberwolf	95-98	Y528*		Y528G*									
YFB 250 F/W/F/W/G/F/W/H/F/W/J/F/W/L/F/W/K Timberwolf	94-00	Y528*		Y528G*									
YFM 250 W/A/B	90-92	Y528*		Y528G*									
YFM 250 XLC/XL/X Bear Tracker	99-00	Y528*		Y528G*									
YFM 250 XN/XP/XR/XS Bear Tracker	01-04	FA054TT*		FA054R*	MD6054D	MD6054D							
YFM 250 BT/BV Bruin	05-06	FA054TT*		FA054R*	MD6054D	MD6054D							
YFM 250 BW/BX/BY Big Bear	07-10	FA054TT*		FA054R* ■	MD6054D	MD6054D							
YFM 250 RX/RV Raptor	Left 08-09	FA443TT		FA443R	MD6054D								
	Right	FA444TT		FA444R		MD6054D							
YFU1WYFUJ-T (230cc)	89-90	Y528*		Y528G*									
YP 250 Majesty	96-98	SFA199	SFAC199	SFA199HH		MD903D	MD903C	VR903					
YP 250 DX/A Majesty	98-99	SFA199	SFAC199	SFA199HH		MD903D	MD903C	VR903					
YP 250 Majesty	00-03	SFA199	SFAC199	SFA199HH		MD903D	MD903C	VR903					
YP 250 R X-Max (Brembo F/Caliper/Non ABS/1C0)	05-09	SFA430	SFAC430	SFA430HH		MD9102D		VR9102					
YP 250 R X-Max (37P1/Nissin F/Caliper/Non ABS)	10-13	SFA196	SFAC196	SFA196HH		MD9102D		VR9102					
YP 250 R X-Max (ABS)	11-13	SFA196	SFAC196	SFA196HH		MD9102D		VR9102					
YP 250 R X-Max Sport	11-12	SFA196	SFAC196	SFA196HH		MD9102D		VR9102					
YS 250 (1S41/2/3) Fazer (Brasil)	06-08	FA197		FA197HH		TBA							
YTZ 250 NS TR1-Z	85-86	FA101TT		FA101R ■	N/A	N/A							
YZ 250 D/E/F (2T)	77-79	Y507											
YZ 250 G (2T)	80	Y507		Y507G									
YZ 250 J/K/L (2T)	81-84	Y508		Y508G									
YZ 250 N (2T)	85	FA105TT		FA105R	MD6324D								
YZ 250 S/T (2T)	86-87	FA105TT		FA105R	MD6067D								
YZ 250 U (2T)	88	FA105TT		FA105R	MD6039D								
YZ 250 W/W/R/W (2T)	89	FA135TT		FA135R ■	MD6016D								
YZ 250 A/W/R/A/B (2T)	90-91	FA135TT		FA135R ■	MD6012D								
YZ 250 D/E/F/G/H/J (2T)	92-97	FA135TT		FA135R ■	MD6028D		MD6028C	MD6028CX	OS6028EC	BRK035	NA	NA	
YZ 250 K/L/M (2T)	98-00	FA185TT		FA185R ■	MD6028D		MD6028C	MD6028CX	OS6028C	BRK008	SM6028C	BRK009	

\*-2 Sets Required. ■ - Also available in MX-S race compound.

**SAFETY WARNING:** DO NOT USE HH PADS ON REAR UNLESS ALSO USED ON FRONT TO AVOID BRAKE IMBALANCE

APPLICATIONS  
BRAKE

R Suffix = High Durability Sintered Pad. HH Suffix = High Performance Sintered Pad. G Suffix = Grooved Shoe.

D Suffix = Drilled Disc. C Suffix = Contoured Disc. LS Suffix = Left/Steel Disc. RS = Right/Steel Disc.

# JAPANESE Built Motorcycles



## YAMAHA Contd.



← REAR / ARRIÈRE / HINTEN POSTERIOR / POSTERIORE →

		DISC PAD CHOICES			BRAKE ROTOR CHOICES			
		NEW SFAC Scooter Carbon Pads	Semi-Sintered V-Pads™	Sintered/HH Pads/ Grooved shoes	Contour Rotor Rear Fitment	NEW Vee-Rotors™ CONTOUR	NEW CX Extreme® ROTOR	
TZR 250 RS (3XV8/3XV93XVA - V-Twin - Eng/Frame # 3XV 08080101-08200/088-)	92-94	FA104		FA104V	FA104HH	MD2021	MD2021C	
TZR 250 SPR (3XVC V-Twin 3XV 107101-)	95	FA104		FA104V	FA104HH	MD2021	MD2021C	
VP 250 X-City (5B2)	07-13	SFA275	SFAC275		SFA275HH	MD9104D		
WR 250 ZBZD/ZEZFG/ZHZJ (2T)	91-97	FA152TT			FA152R ■	MD6011D		
WR 250 ZK (5EN1) (2T)	98	FA131TT			FA131R ■	MD6135D	MD6135C	MD6135C
WR 250 FN (4T)	01	FA131TT			FA131R ■	MD6135D	MD6135C	MD6135C
WR 250 FP (4T)	02	FA131TT			FA131R ■	MD6190D	MD6190C◆	MD6190CX◆
WR 250 FR/FS/FT/FV (4T)	03-06	FA367TT			FA367R ■	MD6190D	MD6190C◆	MD6190CX◆
WR 250 FW/FX/FY/FZ/FA/FB/FD (4T)	07-13	FA367TT			FA367R ■	MD6190D	MD6190C◆	MD6190CX◆
WR 250 RX/RY (32D1/3)	08-10	FA367TT			FA367R ■		MD6319C	
WR 250 XX/Y (Supermoto) (32D2/4)	08-10	FA367TT			FA367R ■		MD6319C	
XG 250 Tricker (5XT1)	04-06	FA152TT			FA152R ■	MD6244D		
XS 250 C	78	FA034				MD2019		
XS 250 D/E	79-81	Y516						
XS 250 SE/SF	79-81	Y516						
XS 250 C	81	Y516						
XT 250	80	Y506			Y506G			
XT 250 X (5C1)	06-08	FA152TT			FA152R	MD6244D		
XTZ 250 (4B41/2/3) Lander (Brasil)	07-09	FA152TT			FA152R	MD6244D		
XV 250 S Virago	95-00	Y527						
XV 250 Virago	89-94	Y527						
YBR 250 (5D11/3/4)	07-11	Y535						
YFB 250 D/E/F Timberwolf	92-94	Y528			Y528G			
YFB 250 G/H/U/H/U/U/UKK Timberwolf	95-98	Y528			Y528G			
YFB 250 F/W/F/W/G/F/W/H/F/W/J/F/W/K/F/W/L/F/W/K Timberwolf	94-00	Y528			Y528G			
YFM 250 W/A/B	90-92	FA021			FA021R	N/A		
YFM 250 XLC/XLX Bear Tracker	99-00	Y528			Y528G			
YFM 250 XNXP/XR/XS Bear Tracker	01-04	Y528			Y528G			
YFM 250 BT/BV Bruin	05-06	Y532			Y532G			
YFM 250 BW/BX/BY Big Bear	07-10	Y532			Y532G			
YFM 250 RX/RY Raptor	08-09	FA084TT			FA084R	MD6236D		
YFU1W/YFU1-T (230cc)	89-90	Y523*			Y523G*			
YP 250 Majesty	96-98	Y516						
YP 250 DX/A Majesty	98-99	SFA275	SFAC275		SFA275HH	MD927D	VR927	
YP 250 Majesty	00-03	SFA275	SFAC275		SFA275HH	MD953D	MD953C	VR953
YP 250 R X-Max (Brembo F/Caliper/Non ABS/1/CO)	05-09	SFA275	SFAC275		SFA275HH	MD9104D		VR9104
YP 250 R X-Max (37P1/Nissin F/Caliper/Non ABS)	10-13	SFA275	SFAC275		SFA275HH	MD9104D		VR9104
YP 250 R X-Max (ABS)	11-13	SFA275	SFAC275		SFA275HH	MD9108D		
YP 250 R X-Max Sport	11-12	SFA275	SFAC275		SFA275HH	MD9104D		VR9104
YS 250 (1S41/2/3) Fazer (Brasil)	06-08	Y531						
YZ 250 N/S TR1-Z	85-86	FA101TT			FA101R ■	N/A		
YZ 250 D/E/F (2T)	77-79	Y528			Y528G			
YZ 250 G (2T)	80	Y506			Y506G			
YZ 250 J/K/L (2T)	81-84	Y506			Y506G			
YZ 250 N (2T)	85	Y506			Y506G			
YZ 250 S/T (2T)	86-87	Y506			Y506G			
YZ 250 U (2T)	88	FA101TT			FA101R ■	MD6011D		
YZ 250 W/W/R/W (2T)	89	FA084/3TT			FA084/3R	MD6011D		
YZ 250 AWRAB (2T)	90-91	FA152TT			FA152R ■	MD6011D		
YZ 250 D/E/F/G/H/J (2T)	92-97	FA152/2TT			FA152/2R ■	MD6011D		
YZ 250 K/L/M (2T)	98-00	FA131TT			FA131R ■	MD6135D	MD6135C	MD6135CX

\*-2 Sets Required. ■ - Also available in MX-S race compound.

**SAFETY WARNING:** DO NOT USE HH PADS ON REAR UNLESS ALSO USED ON FRONT TO AVOID BRAKE IMBALANCE

**R** Suffix = High Durability Sintered Pad. **HH** Suffix = High Performance Sintered Pad. **G** Suffix = Grooved Shoe.  
**D** Suffix = Drilled Disc. **C** Suffix = Contoured Disc. **LS** Suffix = Left/Steel Disc. **RS** = Right/Steel Disc.

**BRAKE APPLICATIONS**

# JAPANESE Built Motorcycles



← FRONT / AVANT / VORN FRENTE / ANTERIORE →

## YAMAHA Contd.

### DISC PAD CHOICES

### BRAKE ROTOR CHOICES

Model	Year	Part No.	DISC PAD CHOICES		Left/Gauche/Links		Right/Droite/Rechts		BRAKE ROTOR CHOICES						
			NEW SFAC Scooter Carbon Pads	Semi-Sintered V-Pads™	Sintered/HH Pads/ Grooved shoes	Left/Gauche/Links	Right/Droite/Rechts	Contour Rotor Universal left and right fitment	NEW Vee-Rotors™ CONTOUR	NEW CX Extreme® ROTOR	Oversize 250/280mm Rotor Kit	Relocating Bracket for 250/280mm Rotor	Oversize 320mm Rotor Kit	Relocating Bracket for 320mm Rotor	
YZ 250 N (2T)	01	FA185TT			FA185R ■	MD6356D			MD6356C		MD6356CX	OS6028C	BRK008	SM6028C	BRK009
YZ 250 P (2T)	02	FA185TT			FA185R ■	MD6356D			MD6356C		MD6356CX	OS6028C	BRK008	SM6028C	BRK009
YZ 250 R/S/T/W (2T)	03-07	FA185TT			FA185R ■	MD6356D			MD6356C		MD6356CX	OS6028C	BRK008	SM6028C	BRK009
YZ 250 XY/Z/A/B/D (2T)	08-13	FA450TT			FA450R ■				MD6356C		MD6356CX	OS6728C	BRK002	SM6728C	BRK034
YZ 250 FN (4T)	01	FA185TT			FA185R ■	MD6356D			MD6356C		MD6356CX	OS6028C	BRK008	SM6028C	BRK009
YZ 250 FP (4T)	02	FA185TT			FA185R ■	MD6356D			MD6356C		MD6356CX	OS6028C	BRK008	SM6028C	BRK009
YZ 250 FR/FS/FT/FV (4T)	03-06	FA185TT			FA185R ■	MD6356D			MD6356C		MD6356CX	OS6028C	BRK008	SM6028C	BRK009
YZ 250 FW/FX/FY/FZ /FA/FB/FD (4T)	07-13	FA450TT			FA450R ■				MD6356C		MD6356CX	OS6728C	BRK002	SM6728C	BRK034
VP 300 Versity	03-05	SFA181	SFAC181		SFA181HH			MD995D			VR995				
XC 300 Versity	06	SFA196	SFAC196		SFA196HH			MD995D			VR995				
YFM 300 B/D Grizzly	12-13	FA083TT*			FA083R*	MD6283D	MD6283D								
RD 350 A/B	74-76	FA011						N/A							
RD 350 LC	80	FA084*				MD2019LS	MD2019RS								
RD 350 LC	81-82	FA070*				MD2019LS	MD2019RS								
RD 350 YPVS	83-84	FA081*				MD2011	MD2011	MD2011C*							
RD 350 FIF2	85-92	FA104*			FA104HH*	MD2011	MD2011	MD2011C*							
RD 350 N	85	FA104*			FA104HH*	MD2011	MD2011	MD2011C*							
RD 350 R	92-95	FA104*			FA104HH*	MD2011	MD2011	MD2011C*							
TT 350 A (3GJ)	90-95	FA105TT			FA105R	MD6039D									
TT 350 (1TJ)	85-89	FA105TT			FA105R	MD6039D									
XT 350	85-90	FA101TT			FA101R	MD6068D									
XT 350	91-95	FA101TT			FA101R	MD6068D									
YFM 350 FWT/FWJ Big Bear	87-88	Y520*			Y520G*										
YFM 350 FWW/FWA/FWB/FWD/FWE/FWF/FWG	89-95	Y524*			Y524G*										
YFM 350 FWH/FWJ/FWK Big Bear	96-98	Y524*			Y524G*										
YFM 350 XD/XE/XF/XG/XH/XJ/XK/XL/XM/XN/XP/XR/XS (Warrior)	92-04	FA054TT*			FA054R* ■	MD6054D	MD6054D								
YFM 350 ERD	92	Y528*			Y528G*										
YFM 350 ERE/ERF/ERG	93-95	Y528*			Y528G*										
YFM 350 FXG/FXJ/FXK/FXL/FXM/FXN/FXP/FXR/FXS Wolverine	95-04	FA054TT*			FA054R* ■	MD6123D	MD6123D								
YFM 350 UHU/UJK	96-98	Y524*			Y524G*										
YFM 350 L Big Bear	99	FA054TT*			FA054R* ■	MD6123D	MD6123D								
YFM 350 FAS/FAT/FAV Bruin 4x4	04-06	FA054TT*			FA054R* ■	MD6215D	MD6215D								
YFM 350 ANS/ANT/ANV Bruin 2x4	04-06	FA054TT*			FA054R* ■	MD6215D	MD6215D								
YFM 350 S/T/V/R/W/RW/RX/RV Raptor	04-09	FA084TT*			FA084R* ■	MD6054D	MD6054D								
YFM 350 XV/XW/XX/XY 2WD - Wolverine	06-09	FA054TT*			FA054R* ■	MD6215D	MD6215D								
YFM 350 GW/GX/GY/GZ Grizzly 2WD	08-10	FA054TT*			FA054R* ■	MD6215D	MD6215D								
YFM 350 FGW/FGX/FGY/FGZ/FGA/FGB Grizzly 4WD	07-12	FA054TT*			FA054R* ■	MD6215D	MD6215D								
YFM 350 FGIW/FGIX/FGIY/FGIZ Grizzly 4WD IRS	07-10	FA054TT*			FA054R* ■	MD6215D	MD6215D								
YZ 350 T/U/W Banshee	87-89	FA101TT			FA101R	MD6051D	MD6051D								
YZF 350 A/B/D/E/F/G/H/J/K/L/M/N/P/R/S/T Banshee	90-09	FA054TT*			FA054R* ■	MD6054D	MD6054D								
XS 360 B	75	FA011						N/A							
XS 360 C	76	FA034				MD2019RS									
DT 400 All models	75-77	Y528			Y528G										
FZ 400 N (IKF/46K/33M)	85	FA088*			FA088HH*	MD2011	MD2011								
FZ 400 (4YR1)	96	FA244*			FA244HH*	MD2001X	MD2001X	MD2001XC*	VR2001BLK*						
FZR 400 Genesis (1WG) F/No 1WG 000101-0305100	86	FA088*			FA088HH*	MD2020LS	MD2020RS								
FZR 400 RSP (2TK-EXUP) F/No 1WG 0305101-043100	87	FA123*			FA123HH*	MD2022LS	MD2022RS								
FZR 400 (3EN1) F/No 1WG 043101-080100	88	FA123*			FA123HH*	MD2022LS	MD2022RS								
FZR 400 R (3EN2) F/No 1WG 080101-	89	FA123*			FA123HH*	MD2001X	MD2001X	MD2001XC*	VR2001BLK*						
FZR 400 RR (3TJ1)		FA252*			FA252HH*	MD2001X	MD2001X	MD2001XC*	VR2001BLK*						
FZR 400 RRSP (3TJ2/67) (1TJ)		FA252*			FA252HH*	MD2001X	MD2001X	MD2001XC*	VR2001BLK*						
FZR 400 RR (4DX)	92	FA252*			FA252HH*	MD2001X	MD2001X	MD2001XC*	VR2001BLK*						
Majesty - See YP 400 Majesty	04														
Majesty - See YP 400 Majesty	05-12														
RD 400 C/D	76-77	FA011						N/A							
RD 400 E/F	78-79	FA041					MD2025RS								
SR 400 (3HT1)	88	Y526													
SR 400 (BC-RH01J)		FA179			FA179HH			TBA							
SRX 400 (1JL)	85	FA088			FA088HH			MD2011							
SRX 400 (3VN1/3VN2/3VN5)	90-96	FA123			FA123HH		MD2003X	MD2003XC	VR2003BLK*						

\*-2 Sets Required. ■ - Also available in MX-S race compound.

**SAFETY WARNING:** DO NOT USE HH PADS ON REAR UNLESS ALSO USED ON FRONT TO AVOID BRAKE IMBALANCE

# JAPANESE Built Motorcycles



## YAMAHA Contd.



← REAR / ARRIÈRE / HINTEN POSTERIOR / POSTERIORE →

			DISC PAD CHOICES			BRAKE ROTOR CHOICES			
			NEW SFAC Scooter Carbon Pads	Semi-Sintered V-Pads™	Sintered/HH Pads/ Grooved shoes	Contour Rotor Rear Fitment	NEW Vee-Rotors™ CONTOUR	NEW CX Extreme® ROTOR	
YZ 250 N (2T)	01	FA131TT			FA131R ■	MD6135D	MD6135C		MD6135CX
YZ 250 P (2T)	02	FA131TT			FA131R ■	MD6190D	MD6190C◆		MD6190CX◆
YZ 250 R/S/T/W/W (2T)	03-07	FA367TT			FA367R ■	MD6190D	MD6190C◆		MD6190CX◆
YZ 250 X/Y/Z/AB/D (2T)	08-13	FA367TT			FA367R ■		MD6190C◆		MD6190CX◆
YZ 250 FN (4T)	01	FA131TT			FA131R ■	MD6135D	MD6135C		MD6135CX
YZ 250 FP (4T)	02	FA131TT			FA131R ■	MD6190D	MD6190C◆		MD6190CX◆
YZ 250 FR/FS/FT/FV (4T)	03-06	FA367TT			FA367R ■	MD6190D	MD6190C◆		MD6190CX◆
YZ 250 FW/FX/FY/FZ /FA/FB/FD (4T)	07-13	FA367TT			FA367R ■		MD6190C◆		MD6190CX◆
VP 300 Versity	03-05	SFA181	SFAC181		SFA181HH	MD9104D		VR9104	
XC 300 Versity	06	SFA181	SFAC181		SFA181HH	MD9104D		VR9104	
YFM 300 B/D Grizzly	12-13	FA067TT			FA067R	MD6369D			
RD 350 A/B	74-76	Y514							
RD 350 LC	80	Y514							
RD 350 LC	81-82	Y514							
RD 350 YPVS	83-84	FA088				MD2011	MD2011C		
RD 350 F/F2	85-92	FA104		FA104V	FA104HH	MD2011	MD2011C		
RD 350 N	85	FA104		FA104V	FA104HH	MD2011	MD2011C		
RD 350 R	92-95	FA104		FA104V	FA104HH	MD2011	MD2011C		
TT 350 A (3GJ)	90-95	Y527			Y527G				
TT 350 (1TJ)	85-89	Y527			Y527G				
XT 350	85-90	Y506			Y506G				
XT 350	91-95	Y527			Y527G				
YFM 350 FWT/FWU Big Bear	87-88	FA021			FA021R	N/A			
YFM 350 FWW/FWA/FWB/FWD/FWE/FWF/FWG	89-95	FA021			FA021R	N/A			
YFM 350 FWH/FWJ/FWK Big Bear	96-98	Y516							
YFM 350 XD/XE/XF/XG/XH/XJ/XK/XL/XM/XN/XP/XR/XS (Warrior)	92-04	FA084TT			FA084R	MD6055D			
YFM 350 ERD	92	FA021			FA021R	N/A			
YFM 350 ERE/ERF/ERG	93-95	FA021			FA021R	N/A			
YFM 350 FXG/FXH/FXJ/FXK/FXL/FXM/FXN/FPX/RFX/S Wolverine	95-04	FA084TT			FA084R	MD6053D			
YFM 350 UH/UJ/UK	96-98	Y528			Y528G				
YFM 350 L Big Bear	99	Y516			516G				
YFM 350 FAS/FAT/FAV Bruin 4x4	04-06	Y532			Y532G				
YFM 350 ANS/ANT/ANV Bruin 2x4	04-06	Y532			Y532G				
YFM 350 S/T/V/RW/RV/RX/RY Raptor	04-09	FA084TT			FA084R ■	MD6236D			
YFM 350 XV/XW/XX/XY 2WD - Wolverine	06-09	Y532			Y532G				
YFM 350 GIW/GX/GY/GZ Grizzly -2WD	08-10	Y532			Y532G				
YFM 350 FGW/FGX/FGY/FGZ/FGA/FGB Grizzly 4WD	07-12	Y532			Y532G				
YFM 350 FGIW/FGIX/FGIY/FGIZ Grizzly 4WD IRS	07-10	N/A							
YZ 350 T/U/W Banshee	87-89	FA084TT			FA084R	MD6053D			
YZ 350 AB/D/EF/GH/J/K/L/M/N/P/R/S/T Banshee	90-09	FA084TT			FA084R ■	MD6237D			
XS 360 B	75	Y514							
XS 360 C	76	FA034				MD2019			
DT 400 All models	75-77	Y510			Y510G				
FZ 400 N (IKF/46K/33M)	85	FA104		FA104V	FA104HH	MD2002			
FZ 400 (4YR1)	96	FA104		FA104V	FA104HH	MD2002	MD2002C	VR2002	
FZR 400 Genesis (1WG) FNo 1WG 000101-0305100	86	FA104		FA104V	FA104HH	MD2021			
FZR 400 RSP (2TK-EX/UP) FNo 1WG 0305101-043100	87	FA104		FA104V	FA104HH	MD2021			
FZR 400 (3EN1) FNo 1WG 043101-080100	88	FA104		FA104V	FA104HH	MD2021			
FZR 400 R (3EN2) FNo 1WG 080101-	89	FA104		FA104V	FA104HH	MD2021	MD2021C	VR2021	
FZR 400 RR (3TJ1)		FA104		FA104V	FA104HH	MD2021	MD2021C	VR2021	
FZR 400 RRSF (3TJ2/6/7) (1TJ)		FA104		FA104V	FA104HH	MD2021	MD2021C	VR2021	
FZR 400 RR (4DX)	92	FA104		FA104V	FA104HH	MD2021	MD2021C	VR2021	
RD 400 C/D	76-77	FA011				N/A			
RD 400 E/F	78-79	FA041				MD2025RS			
SR 400 (3HT1)	88	Y510							
SR 400 (BC-RH01J)		Y510							
SRX 400 (1JL)	85	FA104		FA104V	FA104HH	MD2002			
SRX 400 (3VN1/3VN2/3VN5)	90-96	FA104		FA104V	FA104HH	MD2002	MD2002C	VR2002	

\*-2 Sets Required. ■ - Also available in MX-S race compound.

**SAFETY WARNING:** DO NOT USE HH PADS ON REAR UNLESS ALSO USED ON FRONT TO AVOID BRAKE IMBALANCE

**R** Suffix = High Durability Sintered Pad. **HH** Suffix = High Performance Sintered Pad. **G** Suffix = Grooved Shoe.  
**D** Suffix = Drilled Disc. **C** Suffix = Contoured Disc. **LS** Suffix = Left/Steel Disc. **RS** = Right/Steel Disc.

**BRAKE APPLICATIONS**



# JAPANESE Built Motorcycles



← FRONT / AVANT / VORN FRENTE / ANTERIORE →

## YAMAHA Contd.

Model	Year	Disc Pad	DISC PAD CHOICES				BRAKE ROTOR CHOICES								
			NEW SFAC Scooter Carbon Pads	Semi-Sintered V-Pads™	Sintered/HH Pads/ Grooved shoes	Left/Gauche/Links	Right/Droite/Rechts	Contour Rotor Universal left and right fitment	NEW Vee-Rotors™ CONTOUR	NEW CX Extreme® ROTOR	Oversize 250/280mm Rotor Kit	Relocating Bracket for 250/280mm Rotor	Oversize 320mm Rotor Kit	Relocating Bracket for 320mm Rotor	
XJR 400 (4HM1/4HM2/4HM4/4HM7)	93-96	FA199*			FA199HH*	MD2001X	MD2001X	MD2001XC*	VR2001BLK*						
XJR 400 (4HM3/4HM5/4HM6/4HM9/4HMA/4HMB)	95-99	FA244*			FA244HH*	MD2001X	MD2001X	MD2001XC*	VR2001BLK*						
XS 400 C	78	FA034					MD2019RS								
XS 400	79	FA034					MD2019RS								
XS 400 SE	80-81	FA041					MD2019RS								
XS 400	82	FA081					MD2011								
XVS 400	96	FA179			FA179HH		MD2076RS								
YFM 400 FWE/FWF/FWG/FWH/FWJ/FWK/FWL Kodiak	93-99	Y524*			Y524G*										
YFM 400 FAM/FAN	00-01	FA054TT*			FA054R* ■	MD6123D	MD6123D								
YFM 400 FWP Big Bear 4x4	02	FA084TT*			FA084R* ■	MD6123D	MD6123D								
YFM 400 FPP/FPS Big Bear	03-04	FA054TT*			FA054R* ■	MD6123D	MD6123D								
YFM 400 FAR/FAS Kodiak Auto	03-04	FA054TT*			FA054R* ■	MD6215D	MD6215D								
YFM 400 AR Kodiak (5VH3/4)	03	FA054TT*			FA054R* ■	MD6215D	MD6215D								
YFM 400 FAT/FAV (Big Bear)	05-06	FA054TT*			FA054R* ■	MD6215D	MD6215D								
YFM 400 FGW/FGX Grizzly	07-08	FA054TT*			FA054R* ■	MD6054D	MD6054D								
YP 400 Majesty (5RU1/3 - Non ABS)	04	SFA179	SFAC179		SFA179HH	MD9102D			VR9102						
YP 400 Majesty (5RU6/8 - Non ABS)	05-13	SFA199*	SFAC199*		SFA199HH*	MD9136D	MD9136D		VR9136						
YP 400 Majesty (ABS)	05-13	SFA199*	SFAC199*		SFA199HH*	MD9136D	MD9136D		VR9136						
YZ 400 DJEJF (2T)	77-79	Y507			Y507G										
YZ 400 FK (4T)	98	FA185TT			FA185R ■	MD6028D		MD6028C		MD6028CX	OS6028C	BRK008	SM6028C	BRK009	
YZ 400 FL (4T)	99	FA185TT			FA185R ■	MD6028D		MD6028C		MD6028CX	OS6028C	BRK008	SM6028C	BRK009	
WR 400 FK (4T)	98	FA185TT			FA185R ■	MD6028D		MD6028C		MD6028CX	OS6028C	BRK008	SM6028C	BRK009	
WR 400 FL/FM (4T)	99-00	FA185TT			FA185R ■	MD6028D		MD6028C		MD6028CX	OS6028C	BRK008	SM6028C	BRK009	
WR 400 FN (4T)	01	FA185TT			FA185R ■	MD6356D		MD6356C		MD6356CX	OS6028C	BRK008	SM6028C	BRK009	
IT 425 G	80	Y507			Y507G										
WR 426 FN (4T)	01	FA185TT			FA185R ■	MD6356D		MD6356C		MD6356CX	OS6028C	BRK008	SM6028C	BRK009	
WR 426 FP (4T)	02	FA185TT			FA185R ■	MD6356D		MD6356C		MD6356CX	OS6028C	BRK008	SM6028C	BRK009	
YZ 426 FM (4T)	00	FA185TT			FA185R ■	MD6028D		MD6028C		MD6028CX	OS6028C	BRK008	SM6028C	BRK009	
YZ 426 FN (4T)	01	FA185TT			FA185R ■	MD6356D		MD6356C		MD6356CX	OS6028C	BRK008	SM6028C	BRK009	
YZ 426 FP (4T)	02	FA185TT			FA185R ■	MD6356D		MD6356C		MD6356CX	OS6028C	BRK008	SM6028C	BRK009	
WR 450 FR/FS/FT/FV (4T)	03-06	FA185TT			FA185R ■	MD6356D		MD6356C		MD6356CX	OS6028C	BRK008	SM6028C	BRK009	
WR 450 FW/FX/FY/FZ/FA/FB/FD (4T)	07-13	FA185TT			FA185R ■			MD6356C		MD6356CX	OS6028C	BRK008	SM6028C	BRK009	
YFM 450 FAR/FAS Kodiak (5ND3/4)	03-04	FA054TT*			FA054R* ■	MD6215D	MD6215D								
YFM 450 FAT/FAHT/FAV (Kodiak)	05-06	FA054TT*			FA054R* ■	MD6215D	MD6215D								
YFM 450 FXV/FXW/FXX/FXY/FXZ Wolverine	06-10	FA054TT*			FA054R* ■	MD6215D	MD6215D								
YFM 450 FGJZFGIA/FGIB Grizzly IRS	10-12	FA054TT*			FA054R* ■	MD6215D	MD6215D								
YFM 450 FGW Grizzly	07	FA054TT*			FA054R* ■	MD6215D	MD6215D								
YFM 450 FGPA/FGPB Grizzly EPS	11-12	FA054TT*			FA054R* ■	MD6215D	MD6215D								
YFZ 450 S/TR (Quad)	Left 04-05	FA165TT			FA165R ■	MD6054D									
	Right	FA135TT			FA135R ■		MD6054D								
YFZ 450 VNW/X (Quad)	Left 06-08	FA165TT			FA165R ■	MD6054D									
	Right	FA135TT			FA135R ■		MD6054D								
YFZ 450 RY/RZ (Quad)	Left 09-10	FA165TT			FA165R ■	MD6054D									
	Right	FA135TT			FA135R ■		MD6054D								
YZ 450 FR/FS/FT/FV	03-06	FA185TT			FA185R ■	MD6356D		MD6356C		MD6356CX	OS6028C	BRK008	SM6028C	BRK009	
YZ 450 FW (4T)	07	FA185TT			FA185R ■			MD6356C		MD6356CX	OS6028C	BRK008	SM6028C	BRK009	
YZ 450 FX/FY/FZ/FA/FB/FD (4T)	08-13	FA450TT			FA450R ■			MD6356C		MD6356CX	OS6728C	BRK002	SM6728C	BRK034	
IT 465 HJ	81-82	Y508			Y508G										
YZ 465 G	80	Y508			Y508G										
YZ 465 H	81	Y508			Y508G										
IT 490 L	84	Y508			Y508G										
YZ 490 HJ	81-82	Y508			Y508G										
YZ 490 K	83	Y508			Y508G										
YZ 490 L	84	Y508			Y508G										
YZ 490 N	85	FA105TT			FA105R	MD6324D									
YZ 490 S/T	86-87	FA105TT			FA105R	MD6067D									
YZ 490 U	88	FA105TT			FA105R	MD6039D									
IT 500 GIH	80-81	Y507			Y507G										
RD 500 LC	84-86	FA088*			FA088HH*	MD2069	MD2069								
R/VZ 500R (51X)	85	FA088*			FA088HH*	MD2069	MD2069								

\*-2 Sets Required. ■ - Also available in MX-S race compound.

**SAFETY WARNING:** DO NOT USE HH PADS ON REAR UNLESS ALSO USED ON FRONT TO AVOID BRAKE IMBALANCE

APPLICTIONS  
BRAKE

R Suffix = High Durability Sintered Pad. HH Suffix = High Performance Sintered Pad. G Suffix = Grooved Shoe.  
D Suffix = Drilled Disc. C Suffix = Contoured Disc. LS Suffix = Left/Steel Disc. RS = Right/Steel Disc.

# JAPANESE Built Motorcycles



## YAMAHA Contd.



← REAR / ARRIÈRE / HINTEN POSTERIOR / POSTERIORE →

			DISC PAD CHOICES			BRAKE ROTOR CHOICES			
			NEW SFAC Scooter Carbon Pads	Semi-Sintered V-Pads™	Sintered/HH Pads/ Grooved shoes	Contour Rotor Rear Fitment	NEW Vee-Rotors™ CONTOUR	NEW CX Extreme® ROTOR	
XJR 400 (4HM1/4HM2/4HM4/4HM7)	93-96	FA104		FA104V	FA104HH	MD2002	MD2002C	VR2002	
XJR 400 (4HM3/4HM5/4HM6/4HM9/4HMA/4HMB) Brembo calipers	95-99	FA104		FA104V	FA104HH	MD2002	MD2002C	VR2002	
XS 400 C	78	FA034				MD2019			
XS 400	79	Y516							
XS 400 SE	80-81	Y516							
XS 400	82	Y516							
XVS 400	96	Y515							
YFM 400 FWE/FWF/FWG/FWH/FWJ/FWK/FVL Kodiak	93-99	Y516			Y516G				
YFM 400 FAM/FAN	00-01	FA307TT			FA307R	MD6174D			
YFM 400 FWP Big Bear 4x4	02	Y516			Y516G				
YFM 400 FPR/FPS Big Bear	03-04	Y516			Y516G				
YFM 400 FAR/FAS Kodiak Auto	03-04	Y516			Y516G				
YFM 400 AR Kodiak (5VH3/4)	03	Y532			Y532G				
YFM 400 FAT/FAV (Big Bear)	05-06	FA307TT			FA307R	MD6252D			
YFM 400 FGW/FGX Grizzly	07-08	FA307TT			FA307R	MD6252D			
YP 400 Majesty (5RU1/3 - Non ABS)	04	SFA408	SFAC408		SFA408HH	MD9103D		VR9103	
YP 400 Majesty (5RU6/8 - Non ABS)	05-13	SFA408	SFAC408		SFA408HH	MD9103D		VR9103	
YP 400 Majesty (ABS)	05-13	SFA408	SFAC408		SFA408HH	MD9103D		VR9103	
YZ 400 D/E/F (2T)	77-79	Y528			Y528G				
YZ 400 FK (4T)	98	FA1522TT			FA1522R ■	MD6011D			
YZ 400 FL (4T)	99	FA131TT			FA131R ■	MD6135D	MD6135C		MD6135CX
WR 400 FK (4T)	98	FA1522TT			FA1522R ■	MD6011D			
WR 400 FL/FM (4T)	99-00	FA131TT			FA131R ■	MD6135D	MD6135C		MD6135CX
WR 400 FN (4T)	01	FA131TT			FA131R ■	MD6135D	MD6135C		MD6135CX
IT 425 G	80	Y528			Y528G				
WR 426 FN (4T)	01	FA131TT			FA131R ■	MD6135D	MD6135C		MD6135CX
WR 426 FP (4T)	02	FA131TT			FA131R ■	MD6190D	MD6190C◆		MD6190CX◆
YZ 426 FM (4T)	00	FA131TT			FA131R ■	MD6135D	MD6135C		MD6135CX
YZ 426 FN (4T)	01	FA131TT			FA131R ■	MD6135D	MD6135C		MD6135CX
YZ 426 FP (4T)	02	FA131TT			FA131R ■	MD6190D	MD6190C◆		MD6190CX◆
WR 450 FR/FS/FT/FV (4T)	03-06	FA367TT			FA367R ■	MD6190D	MD6190C◆		MD6190CX◆
WR 450 FW/FX/FY/FZ/FA/FB/FD (4T)	07-13	FA367TT			FA367R ■		MD6190C◆		MD6190CX◆
YFM 450 FAR/FAS Kodiak (5ND3/4)	03-04	FA307TT			FA307R	MD6174D			
YFM 450 FAT/FAHT/FAV (Kodiak)	05-06	FA307TT			FA307R	MD6252D			
YFM 450 FXV/FXW/FXX/FXY/FXZ Wolverine	06-10	FA307TT			FA307R	MD6174D			
YFM 450 FGZ/FGA/FGIB Grizzly IRS	10-12	N/A							
YFM 450 FGW Grizzly	07	FA307TT			FA307R	MD6252D			
YFM 450 FGPA/FGPB Grizzly EPS	11-12	N/A							
YFZ 450 S/T/R (Quad)	04-05	FA084TT			FA084R	MD6236D			
YFZ 450 V/W/X (Quad)	06-08	FA323TT			FA323R	MD6263D			
YFZ 450 RY/RZ (Quad)	09-10	FA323TT			FA323R		MD6263C		
YZ 450 FR/FS/FT/FV	03-06	FA367TT			FA367R ■	MD6190D	MD6190C◆		MD6190CX◆
YZ 450 FW (4T)	07	FA367TT			FA367R ■		MD6190C◆		MD6190CX◆
YZ 450 FX/FY/FZ/FA/FB/FD (4T)	08-13	FA367TT			FA367R ■		MD6190C◆		MD6190CX◆
IT 465 HU	81-82	Y510			Y510G				
YZ 465 G	80	Y528			Y528G				
YZ 465 H	81	Y510			Y510G				
IT 490 L	84	Y510			Y510G				
YZ 490 HU	81-82	Y510			Y510G				
YZ 490 K	83	Y506			Y506G				
YZ 490 L	84	Y510			Y510G				
YZ 490 N	85	Y510			Y510G				
YZ 490 S/T	86-87	Y510			Y510G				
YZ 490 U	88	Y510			Y510G				
IT 500 GH	80-81	Y528			Y528G				
RD 500 LC	84-86	FA104		FA104V	FA104HH	MD2070			
RVZ 500R (51X)	85	FA104		FA104V	FA104HH	MD2070			

\*-2 Sets Required. ■ - Also available in MX-S race compound.

**SAFETY WARNING:** DO NOT USE HH PADS ON REAR UNLESS ALSO USED ON FRONT TO AVOID BRAKE IMBALANCE

**R** Suffix = High Durability Sintered Pad. **HH** Suffix = High Performance Sintered Pad. **G** Suffix = Grooved Shoe.  
**D** Suffix = Drilled Disc. **C** Suffix = Contoured Disc. **LS** Suffix = Left/Steel Disc. **RS** = Right/Steel Disc.

**BRAKE APPLICATIONS**

# JAPANESE Built Motorcycles



← FRONT / AVANT / VORN FRENTE / ANTERIORE →

## YAMAHA Contd.

### DISC PAD CHOICES

### BRAKE ROTOR CHOICES

Model	Year	FA Part	DISC PAD CHOICES		Left/Gauche/Links		Right/Droite/Rechts		Contour Rotor Universal left and right fitment	NEW Vee-Rotors™ CONTOUR	NEW CX Extreme® ROTOR	Oversize 250/280mm Rotor Kit	Relocating Bracket for 250/280mm Rotor	Oversize 320mm Rotor Kit	Relocating Bracket for 320mm Rotor
			NEW SFAC Scooter Carbon Pads	Semi- Sintered V-Pads™	Sintered/ HH Pads/ Grooved shoes	Left/Gauche/Links	Right/Droite/Rechts								
SR 500	78-82	FA034						MD2023LS							
SR 500 (3GW1/3/4/6/7)	96-98	Y526													
SR 500 S (3GW5)	98	Y526													
TXXS 500 B	75-77	FA011						N/A							
XP 500 N/P/R T-Max	01-03	SFA179	SFAC179		SFA179HH	MD2087LS									
XP 500 S/T/V T-Max (5VU1/2)	04-07	SFA199*	SFAC199*		SFA199HH*	MD2098	MD2098	MD2098C*							
XP 500 T-Max (Non ABS Models)	08-12	SFA252*	SFAC252*		SFA252HH*	MD2107	MD2107	MD2107C*							
XP 500 T-Max (ABS Models)	08-12	SFA252*	SFAC252*		SFA252HH*	MD2107	MD2107	MD2107C*							
XS 500 C/D	78-79	FA034						MD2024RS							
WR 500 ZD	92	FA135TT			FA135R ■	MD6016D									
XT 500	76-80	Y528			Y528G										
XP 530 - T-Max (Inc ABS Models)	12-13	SFA252*			SFA252HH*	MD2107	MD2107	MD2107C*							
Parking Brake	12-13	SFA621V													
XP 530 - Black Max	13	SFA252*			SFA252HH*	MD2107	MD2107	MD2107C*							
Parking Brake	13	SFA621V													
XV 535 Virago	88-94	FA136						MD2023RS							
XV 535/535 S Virago	95-03	FA179		FA179V	FA179HH		MD2076								
XJ 550	81-84	FA070*				MD2019LS	MD2019RS								
XJ 550 H/J/K Maxim	81-83	FA070					MD2023RS								
XJ 550 R/H/R/J/RK Seca	81-83	FA070					MD2023RS								
XT 550	82-83	Y510			Y510G										
XZ 550	82-84	FA081*				MD2011	MD2011	MD2011C*							
YFM 550 FGPV/FGPZ/FGPA/FGPB/FGPD Grizzly EPS	Left Right	09-13	FA443TT FA444TT		FA443R FA444R	MD6291D		MD6291D							
FZ 600	87-88	FA088*			FA088HH*	MD2011	MD2011	MD2011C*							
FZR 600	89	FA088*			FA088HH*	MD2001X	MD2001X	MD2001XC*	VR2001BLK*						
FZR 600	90-93	FA160*			FA160HH*	MD2001X	MD2001X	MD2001XC*	VR2001BLK*						
FZR 600 R	94-95	FA160*			FA160HH*	MD2001X	MD2001X	MD2001XC*	VR2001BLK*						
FZS 600 Fazer	98-03	FA252*			FA252HH*	MD2001X	MD2001X	MD2001XC*	VR2001BLK*						
FZ6 - Naked - Non-ABS/2 Piston Caliper (1B3/1B3D)	04-07	FA199*			FA199HH*	MD2082X	MD2082X	MD2082XC*	VR2082BLK*						
FZ6 - NS - Naked/Non-ABS/2 Piston Caliper (1B35/1B6)	05-06	FA199*			FA199HH*	MD2082X	MD2082X	MD2082XC*	VR2082BLK*						
FZ6 S2 - Naked/Non ABS/4 Piston Caliper (5S51/5S5)	07-09	FA252*			FA252HH*	MD2082X	MD2082X	MD2082XC*	VR2082BLK*						
FZ6 - Fazer - Half Fairing/Non ABS/2 Piston Caliper (5VX/5VXL)	04-07	FA199*			FA199HH*	MD2082X	MD2082X	MD2082XC*	VR2082BLK*						
FZ6 - Fazer - Half Fairing/ABS/2 Piston Caliper (4P5)	06-07	FA199*			FA199HH*	MD2082X	MD2082X	MD2082XC*	VR2082BLK*						
FZ6 Fazer S2 - Half Fairing/Non ABS/4 Piston Caliper (4S81/4S8)	07-09	FA252*			FA252HH*	MD2082X	MD2082X	MD2082XC*	VR2082BLK*						
FZ6 Fazer S2 - Half Fairing/ABS/4 Piston Caliper (5S2)	08	FA252*			FA252HH*	MD2082X	MD2082X	MD2082XC*	VR2082BLK*						
SRX 600 (1JK)	85	FA104*			FA104HH*	MD2011	MD2011	MD2011C*							
SRX 600 (3SX)	90	FA123			FA123HH		MD2003X	MD2003XC	VR2003BLK*						
SRX 600	86-87	FA104*			FA104HH*	MD2011	MD2011	MD2011C*							
TT 600 L	84	Y508			Y508G										
TT 600 N (59X) Frame # 59X 000101 - 007852	85-88	FA101TT			FA101R ■	MD6039D									
TT 600 W (2JT/3SW1) Frame # 59X 007853 Onwards	89-92	FA105TT			FA105R	MD6039D									
TT 600 E (4LW3/4LW4/4GV/4GV5)	94-01	FA181TT			FA181R ■	MD6182D									
TT 600 E (4GV2)	94-95	FA181TT			FA181R ■	MD6182D									
TT 600 K (4LW1/4GV1/4LW2) Up to 4GV 003403 (Nissin rear caliper)	93-95	FA181TT			FA181R ■	MD6182D									
TT 600 K From 4GV 003404 (Brembo rear caliper)	95-96	FA181TT			FA181R ■	MD6182D									
TT 600 R (5CH1)	97	FA181TT			FA181R ■	MD6182D									
TT 600 R (5CH2)	98-99	FA181TT			FA181R ■	MD6182D									
TT 600 R (5CH3)	00-02	FA181TT			FA181R ■	MD6182D									
TT 600 RE (5CH5)	04	FA181TT			FA181R ■	MD6182D									
XJ 600	84-91	FA088*			FA088HH*	MD2011	MD2011	MD2011C*							
XJ 600 S Diversion	92-97	FA179			FA179HH	MD2031LS									
XJ 600 S Diversion	98-03	FA199*			FA199HH*	MD2074X	MD2074X	MD2074XC*	VR2074BLK*						
XJ 600 N	95-97	FA179			FA179HH	MD2031LS									
XJ 600 N	98-03	FA199*			FA199HH*	MD2074X	MD2074X	MD2074XC*	VR2074BLK*						
XJ6-N Diversion 600 (Naked Diversion - Non ABS & ABS Models - 20S)	09-12	FA199*			FA199HH*	MD2082X	MD2082X	MD2082XC*	VR2082BLK*						
XJ6-N Diversion 600 (Naked Diversion - Non ABS & ABS Models)	13	FA199*			FA199HH*	MD2082X	MD2082X	MD2082XC*	VR2082BLK*						
XJ6-F Diversion 600 (Full Fairing Diversion - Non ABS & ABS Models - 1CW)	10-12	FA199*			FA199HH*	MD2082X	MD2082X	MD2082XC*	VR2082BLK*						
XJ6-F Diversion 600 (Full Fairing Diversion - Non ABS & ABS Models)	13	FA199*			FA199HH*	MD2082X	MD2082X	MD2082XC*	VR2082BLK*						

\*-2 Sets Required. ■ - Also available in MX-S race compound.

**SAFETY WARNING:** DO NOT USE HH PADS ON REAR UNLESS ALSO USED ON FRONT TO AVOID BRAKE IMBALANCE

APPLICATIONS  
BRAKE

R Suffix = High Durability Sintered Pad. HH Suffix = High Performance Sintered Pad. G Suffix = Grooved Shoe.  
D Suffix = Drilled Disc. C Suffix = Contoured Disc. LS Suffix = Left/Steel Disc. RS = Right/Steel Disc.

# JAPANESE Built Motorcycles



## YAMAHA Contd.



← REAR / ARRIÈRE / HINTEN POSTERIOR / POSTERIORE →

			DISC PAD CHOICES			BRAKE ROTOR CHOICES		
			NEW SFAC Scooter Carbon Pads	Semi-Sintered V-Pads™	Sintered/HH Pads/ Grooved shoes	Contour Rotor Rear Fitment	NEW Vee-Rotors™ CONTOUR	NEW CX Extreme® ROTOR
SR 500	78-82	Y510						
SR 500 (3GW1/3/4/6/7)	96-98	Y510						
SR 500 S (3GW5)	98	Y510						
TXS 500 B	75-77	Y512						
XP 500 N/P/R T-Max	01-03	SFA319	SFAC319		SFA319HH	MD2011	MD2011C	
XP 500 S/T/V T-Max (5VU1/2)	04-07	SFA408	SFAC408		SFA408HH	MD2011	MD2011C	
XP 500 T-Max (Non ABS Models)	08-12	SFA408	SFAC408		SFA408HH	MD2011	MD2011C	
XP 500 T-Max (ABS Models)	08-12	SFA408	SFAC408		SFA408HH	MD2011	MD2011C	
XS 500 C/D	78-79	FA034				MD2025RS		
WR 500 ZD	92	FA152TT			FA152R ■	MD6011D		
XT 500	76-80	Y510			Y510G			
XP 530 - T-Max (Inc ABS Models)	12-13	SFA319			SFA319HH	MD9143D	MD9143C	
XP 530 - Black Max	13	SFA319			SFA319HH	MD9143D	MD9143C	
XV 535 Virago	88-94	Y515						
XV 535/535 S Virago	95-03	Y515						
XJ 550	81-84	Y512						
XJ 550 H/J/K Maxim	81-83	Y512						
XJ 550 R/H/RJ/RK Seca	81-83	Y516						
XT 550	82-83	Y510			Y510G			
XZ 550	82-84	Y512						
YFM 550 FGPV/FGPZ/FGPA/FGPB/FGPD Grizzly EPS	Left 09-13	FA445TT			FA445R	MD6292D		
	Right	FA446TT			FA446R	MD6292D		
FZ 600	87-88	FA104		FA104V	FA104HH	MD2002	MD2002C	
FZR 600	89	FA088		FA088V	FA088HH	MD2002	MD2002C	VR2002
FZR 600	90-93	FA088		FA088V	FA088HH	MD2002	MD2002C	VR2002
FZR 600 R	94-95	FA088		FA088V	FA088HH	MD2002	MD2002C	VR2002
FZS 600 Fazer	98-03	FA104		FA104V	FA104HH	MD2002	MD2002C	VR2002
FZ6 - Naked - Non-ABS/2 Piston Caliper (1B3/1B3D)	04-07	FA174		FA174V	FA174HH	MD2093	MD2093C	VR2093
FZ6- NS - Naked/Non-ABS/2 Piston Caliper (1B35/1B6)	05-06	FA174		FA174V	FA174HH	MD2093	MD2093C	VR2093
FZ6 S2 - Naked/Non ABS/4 Piston Caliper (5S51/5S5)	07-09	FA174		FA174V	FA174HH	MD2093	MD2093C	VR2093
FZ6 - Fazer - Half Fairing/Non ABS/2 Piston Caliper (5VX/5VXL)	04-07	FA174		FA174V	FA174HH	MD2093	MD2093C	VR2093
FZ6 - Fazer - Half Fairing/ABS/2 Piston Caliper (4P5)	06-07	FA174		FA174V	FA174HH	MD2093	MD2093C	VR2093
FZ6 Fazer S2 - Half Fairing/Non ABS/4 Piston Caliper (4S81/4S8)	07-09	FA174		FA174V	FA174HH	MD2093	MD2093C	VR2093
FZ6 Fazer S2 - Half Fairing/ABS/4 Piston Caliper (5S2)	08	FA174		FA174V	FA174HH	MD2093	MD2093C	VR2093
SRX 600 (1JK)	85	FA104		FA104V	FA104HH	MD2002	MD2002C	
SRX 600 (3SX)	90	FA104		FA104V	FA104HH	MD2002	MD2002C	VR2002
SRX 600	86-87	FA104		FA104V	FA104HH	MD2002	MD2002C	
TT 600 L	84	Y506			Y506G			
TT 600 N (59X) Frame # 59X 000101 - 007852	85-88	Y527			Y527G			
TT 600 W (2JT/3SW1) Frame # 59X 007853 Onwards	89-92	Y527			Y527G			
TT 600 E (4LW3/4LW4/4GV4/4GV5)	94-01	FA208TT			FA208R ■	MD6183D		
TT 600 E (4GV2)	94-95	FA1522TT			FA1522R ■	MD6183D		
TT 600 K (4LW1/4G1/1/4LW2) Up to 4GV 003403 (Nissin rear caliper)	93-95	FA1522TT			FA1522R ■	MD6183D		
TT 600 K From 4GV 003404 (Brembo rear caliper)	95-96	FA208TT			FA208R ■	MD6183D		
TT 600 R (5CH1)	97	FA208TT			FA208R ■	MD6183D		
TT 600 R (5CH2)	98-99	FA208TT			FA208R ■	MD6183D		
TT 600 R (5CH3)	00-02	FA208TT			FA208R ■	MD6183D		
TT 600 RE (5CH5)	04	FA208TT			FA208R ■	MD6183D		
XJ 600	84-91	FA088		FA088V	FA088HH	MD2011	MD2011C	
XJ 600 S Diversion	92-97	FA104		FA104V	FA104HH	MD2002	MD2002C	
XJ 600 S Diversion	98-03	FA104		FA104V	FA104HH	MD2002	MD2002C	VR2002
XJ 600 N	95-97	FA104		FA104V	FA104HH	MD2002	MD2002C	VR2002
XJ 600 N	98-03	FA104		FA104V	FA104HH	MD2002	MD2002C	VR2002
XJ6-N Diversion 600 (Naked Diversion - Non ABS & ABS Models - 20S)	09-12	FA140		FA140V	FA140HH	MD2117		VR2117
XJ6-N Diversion 600 (Naked Diversion - Non ABS & ABS Models)	13	FA174		FA174V	FA174HH	MD2117		VR2117
XJ6-F Diversion 600 (Full Fairing Diversion - Non ABS & ABS Models - 1CW)	10-12	FA140		FA140V	FA140HH	MD2117		VR2117
XJ6-F Diversion 600 (Full Fairing Diversion - Non ABS & ABS Models)	13	FA174		FA174V	FA174HH	MD2117		VR2117

\*-2 Sets Required. ■ - Also available in MX-S race compound.

**SAFETY WARNING:** DO NOT USE HH PADS ON REAR UNLESS ALSO USED ON FRONT TO AVOID BRAKE IMBALANCE

**R** Suffix = High Durability Sintered Pad. **HH** Suffix = High Performance Sintered Pad. **G** Suffix = Grooved Shoe.  
**D** Suffix = Drilled Disc. **C** Suffix = Contoured Disc. **LS** Suffix = Left/Steel Disc. **RS** = Right/Steel Disc.

**BRAKE APPLICATIONS**

# JAPANESE Built Motorcycles



← FRONT / AVANT / VORN FRENTE / ANTERIORE →

## DISC PAD CHOICES

## BRAKE ROTOR CHOICES

### YAMAHA Contd.

Model	Year	FA Part	DISC PAD CHOICES		BRAKE ROTOR CHOICES									
			NEW SFAC Scooter Carbon Pads	Semi-Sintered V-Pads™	Sintered/HH Pads/ Grooved shoes	Left/Gauche/Links	Right/Droite/Rechts	Contour Rotor Universal left and right fitment	NEW Vee-Rotors™ CONTOUR	NEW CX Extreme® ROTOR	Oversize 250/280mm Rotor Kit	Relocating Bracket for 250/280mm Rotor	Oversize 320mm Rotor Kit	Relocating Bracket for 320mm Rotor
XJ6-S Diversion 600 (Top Fairing Diversion - Non ABS & ABS Models-36C)	09-12	FA199*			FA199HH*	MD2082X	MD2082X	MD2082XC*	VR2082BLK*					
XJ6-S Diversion 600 (Top Fairing Diversion - Non ABS & ABS Models)	13	FA199*			FA199HH*	MD2082X	MD2082X	MD2082XC*	VR2082BLK*					
XJ6-SP Diversion 600 (Non ABS & ABS Models)	13	FA199*			FA199HH*	MD2082X	MD2082X	MD2082XC*	VR2082BLK*					
XT 600	84-86	FA081			FA081R	MD6070D								
XT 600	87	FA118				MD6070D								
XT 600 Z.Tenere	84	FA081			FA081R	MD6070D								
XT 600 Z.Tenere	85-88	FA118				MD6070D								
XT 600/600 Z.Tenere	88-90	FA118				MD6070D								
XT 600 E	92-94	FA172TT			FA172R	MD6070D								
XT 600 E	95-03	FA172TT			FA172R	MD6116D X								
YFM 600 FWAK/FWAL/FWAM/FWAN Grizzly	98-01	FA084TT*			FA084R*	MD6140D	MD6140D							
YFM 600 HM Grizzly Hunting	00	FA084TT*			FA084R*	MD6140D	MD6140D							
YX 600 S/S/C/T/T/C/U/C/U/W/W/C/A/A/C Radian	86-90	FA088*			FA088HH*	MD2011	MD2011	MD2011C*						
YZF 600 R Thunder cat	96-03	FA252*			FA252HH*	MD2074X	MD2074X	MD2074XC*	VR2074BLK*					
YZF-R6	99-02	FA252*			FA252HH*	MD2074X	MD2074X	MD2074XC*	VR2074BLK*					
YZF R6	03-04	FA252*			FA252HH*	MD2082X	MD2082X	MD2082XC*	VR2082BLK*					
YZF R6	05-07				FA380HH*	MD2095X	MD2095X	MD2095XC*	VR2095BLK*					
YZF R6 (13S1)	08-12				FA380HH*	MD2105X	MD2105X	MD2105XC*	VR2105BLK*					
XJ 650 G/H/J/K Maxim	80-83	FA061		FA061V		MD2023LS								
XJ 650 LH Midnight	81	FA061		FA061V		MD2023LS								
XJ 650 RJ Seca	82	FA034*		FA034V*		MD2019LS	MD2019RS							
XJ 650 LK Seca	83	FA081*				MD2011	MD2011	MD2011C*						
XJ 650	80-84	FA034*		FA034V*		MD2019LS	MD2019RS							
XJ 650 Turbo	82	FA081*				MD2011	MD2011	MD2011C*						
XS 650	75	FA011*				N/A	N/A							
XS 650	77-81	FA034		FA034V			MD2025RS							
XS 650 SE	79-80	FA034		FA034V			MD2024RS							
XS 650 SE	81	FA034		FA034V			MD2024RS							
XVS 650 Drag Star	97-04	FA179		FA179V	FA179HH		MD2076							
XVS 650 A Drag Star Classic	98-07	FA179		FA179V	FA179HH		MD2076							
MT-03 (660cc)	06-12	FA199*		FA199V*	FA199HH*	MD2082X	MD2082X	MD2082XC*	VR2082BLK*					
SZR 660	96-97	FA095		FA095V	FA095HH		MD2003X	MD2003XC	VR2003BLK*					
XT 660 X Supermoto	04-13	FA244		FA244V	FA244HH	MD6226D								
XT 660 R	04-13	FA209/2		FA209/2V	FA209/2HH	MD6235D								
XT 660 Z.Tenere	08-13	FA181TT*			FA181R* ■	MD6235D	MD6235D							
XTZ 660 Tenere	91-98	FA172TT			FA172R	MD6116D X								
YFM 660 R/N/RP/R/RV/R/S/RT Raptor	01-05	FA084TT*			FA084R* ■	MD6054D	MD6054D							
YFM 660 FR/FS/FT Grizzly	03-05	FA084TT*			FA084R* ■	MD6189D	MD6189D							
YFM 660 FWAP/FWAPR/FWAS/FWAT/FWAV/FGW/FGX Grizzly	02-08	FA084TT*			FA084R* ■	MD6189D	MD6189D							
YXR 66 FAS/FAT/FAV Rhino 4x4 Side x Side	Left	04-06	FA135TT		FA135R ■	MD6241D								
	Right		FA165TT		FA165R ■	MD6241D								
FZX 700 S/S/C/T/C Fazer	86-87	FA088*		FA088V*	FA088HH*	MD2011	MD2011	MD2011C*						
YFM 700 R/V/RW/RX/R/Y/RA/RB - Raptor	Left	06-12	FA165TT		FA165R ■	MD6054D								
	Right		FA135TT		FA135R ■	MD6054D								
YFM 700 RD - Raptor	Left	13	FA165TT		FA165R ■	MD6054D								
	Right		FA135TT		FA135R ■	MD6054D								
YFM 700 FGPW/FGPX/FGPY/FGPZ/FGPA/FGPB /FGPD Grizzly EPS	Left	07-13	FA443TT		FA443R	MD6291D								
	Right		FA444TT		FA444R	MD6291D								
YXP 700 AS/AT/AV Pro Hauler 700 Side x Side		04-06	N/A											
YXR 700 Rhino 4x4 SE	Left	09	FA165TT		FA165R	MD6241D								
	Right		FA135TT		FA135R	MD6241D								
YXR 700 Rhino 4x4 SE Parking Brake		09	FA497TT			MD6333D								
YXR 700 FA/FB/FD Rhino Side x Side	Left	11-13	FA165TT		FA165R	MD6241D								
	Right		FA135TT		FA135R	MD6241D								
YXR 700 FA/FB/FD Rhino Side x Side Parking Brake		11-13	FA497TT			MD6333D								
FZ 750	85-86	FA088*			FA088HH*	MD2069	MD2069							
FZ 750	87-88	FA088			FA088HH	MD2011	MD2011	MD2011C*						
FZ 750	89-91	FA123*			FA123HH*	MD2001X	MD2001X	MD2001XC*	VR2001BLK*					
FZX 750	87	FA088*			FA088HH*	MD2011	MD2011	MD2011C*						
FZR 750 Genesis	87	FA123*			FA123HH*	MD2003X	MD2003X	MD2003XC*	VR2003BLK*					

\*-2 Sets Required. ■ - Also available in MX-S race compound.

**SAFETY WARNING:- DO NOT USE HH PADS ON REAR UNLESS ALSO USED ON FRONT TO AVOID BRAKE IMBALANCE**

**R** Suffix = High Durability Sintered Pad. **HH** Suffix = High Performance Sintered Pad. **G** Suffix = Grooved Shoe.  
**D** Suffix = Drilled Disc. **C** Suffix = Contoured Disc. **LS** Suffix = Left/Steel Disc. **RS** = Right/Steel Disc.



# JAPANESE Built Motorcycles



**YAMAHA** Contd.



← REAR / ARRIÈRE / HINTEN POSTERIOR / POSTERIORE →

			DISC PAD CHOICES			BRAKE ROTOR CHOICES		
			NEW SFAC Scooter Carbon Pads	Semi-Sintered V-Pads™	Sintered/HH Pads/ Grooved shoes	Contour Rotor Rear Fitment	NEW Vee-Rotors™ CONTOUR	NEW CX Extreme® ROTOR
XJ6-S Diversion 600 (Top Fairing Diversion - Non ABS & ABS Models-36C)	09-12	FA140		FA140V	FA140HH	MD2117		VR2117
XJ6-S Diversion 600 (Top Fairing Diversion - Non ABS & ABS Models)	13	FA174		FA174V	FA174HH	MD2117		VR2117
XJ6-SP Diversion 600 (Non ABS & ABS Models)	13	FA174		FA174V	FA174HH	MD2117		VR2117
XT 600	84-86	Y510			Y510G			
XT 600	87	FA101TT			FA101R	MD6072D		
XT 600 Z Tenere	84	Y510			Y510G			
XT 600 Z Tenere	85-88	Y510			Y510G			
XT 600/600 Z Tenere	88-90	FA101TT			FA101R	MD6072D		
XT 600 E	92-94	FA101TT			FA101R	MD6072D		
XT 600 E	95-03	FA101TT			FA101R	MD6072D		
YFM 600 FWAK/FWAL/FWAM/FWAN Grizzly	98-01	Y516			Y516G			
YFM 600 HM Grizzly Hunting	00	Y516			Y516G			
YX 600 S/SC/T/TC/CUC/U/W/WCA/IAC Radian	86-90	Y512						
YZF 600 R Thunder cat	96-03	FA088		FA088V	FA088HH	MD2002	MD2002C	VR2002
YZF-R6	99-02	FA275			FA275HH	MD2084	MD2084C	VR2084
YZF R6	03-04	FA174		FA174V	FA174HH	MD2091	MD2091C	VR2091
YZF R6	05-07	FA174		FA174V	FA174HH	MD2091	MD2091C	VR2091
YZF R6 (13S1)	08-12	FA174		FA174V	FA174HH	MD2091	MD2091C	VR2091
XJ 650 G/H/J/K Maxim	80-83	Y512						
XJ 650 LH Midnight	81	Y512						
XJ 650 RJ Seca	82	Y515						
XJ 650 LK Seca	83	Y515						
XJ 650	80-84	Y515						
XJ 650 Turbo	82	Y515						
XS 650	75	Y514						
XS 650	77-81	Y514						
XS 650 SE	79-80	FA034		FA034V		MD2025RS		
XS 650 SE	81	Y514						
XVS 650 Drag Star	97-04	Y515						
XVS 650 A Drag Star Classic	98-07	Y515						
MT-03 (660cc)	06-12	FA213		FA213V	FA213HH	MD2093	MD2093C	VR2093
SZR 660	96-97	FA047			FA047HH	MD2021	MD2021C	VR2021
XT 660 X Supermoto	04-13	FA213		FA213V	FA213HH	MD6234D		
XT 660 R	04-13	FA213		FA213V	FA213HH	MD6234D		
XT 660 Z Tenere	08-13	FA208TT			FA208R ■	MD6234D		
XTZ 660 Tenere	91-98	FA101TT			FA101R	MD6072D		
YFM 660 RV/RP/RR/RS/RT Raptor	01-05	FA084TT			FA084R	MD6237D		
YFM 660 FR/FS/FT Grizzly	03-05	FA344TT			FA344R	MD6197D		
YFM 660 FWAP/FWAR/FWAS/FWAT/FWAV/FGW/FGX Grizzly	02-08	FA344TT			FA344R	MD6197D		
YXR 66 FAS/FAT/FAV Rhino 4x4 Side x Side	04-06	FA428TT			FA428R	MD6242D		
FZX 700 S/SC/T/TC Fazer	86-87	FA088		FA088V	FA088HH	MD2069		
YFM 700 RV/RW/RX/RY/RA/RB - Raptor	06-12	FA428TT			FA428R	MD6263D		
YFM 700 RD - Raptor	13	FA323TT			FA323R	MD6236D		
YFM 700 FGPW/FGPX/FGPY/FGPZ/FGPA/FGPB/FGPD Grizzly EPS	07-13	FA445TT			FA445R	MD6292D		
		FA446TT			FA446R	MD6292D		
YXP 700 ASI/AT/AV Pro Hauler 700 Side x Side	04-06	Y534			Y534G			
YXR 700 Rhino 4x4 SE	09	FA165TT			FA165R	MD6332D		
		FA135TT			FA135R	MD6332D		
YXR 700 FA/FB/FD Rhino Side x Side	Left 11-13	FA165TT			FA165R	MD6332D		
	Right	FA135TT			FA135R	MD6332D		
FZ 750	85-86	FA088		FA088V	FA088HH	MD2069		
FZ 750	87-88	FA088		FA088V	FA088HH	MD2011	MD2011C	
FZ 750	89-91	FA088		FA088V	FA088HH	MD2011	MD2011C	VR2011
FZX 750	87	FA088		FA088V	FA088HH	MD2069		
FZR 750 Genesis	87	FA088		FA088V	FA088HH	MD2011	MD2011C	VR2011

\*-2 Sets Required. ■ - Also available in MX-S race compound.

**SAFETY WARNING:** DO NOT USE HH PADS ON REAR UNLESS ALSO USED ON FRONT TO AVOID BRAKE IMBALANCE

**R** Suffix = High Durability Sintered Pad. **HH** Suffix = High Performance Sintered Pad. **G** Suffix = Grooved Shoe.  
**D** Suffix = Drilled Disc. **C** Suffix = Contoured Disc. **LS** Suffix = Left/Steel Disc. **RS** = Right/Steel Disc.

**BRAKE APPLICATIONS**

# JAPANESE Built Motorcycles



← FRONT / AVANT / VORN FRENTE / ANTERIORE →

## YAMAHA Contd.

Model	Year	Side	DISC PAD CHOICES				BRAKE ROTOR CHOICES								
			NEW SFAC Scooter Carbon Pads	Semi-Sintered V-Pads™	Sintered/HH Pads/ Grooved shoes	Left/Gauche/Links	Right/Droite/Rechts	Contour Rotor Universal left and right fitment	NEW Vee-Rotors™ CONTOUR	NEW CX Extreme® ROTOR	Oversize 250/280mm Rotor Kit	Relocating Bracket for 250/280mm Rotor	Oversize 320mm Rotor Kit	Relocating Bracket for 320mm Rotor	
FZR 750 R OWO1	89-90		FA145*		FA145HH*	MD2009LS	MD2009RS								
XJ 750 RFR/JRK Seca	81-83		FA070*	FA070V*		MD2023LS	MD2023RS								
XJ 750	82-84		FA070*	FA070V*		MD2023LS	MD2023RS								
XS 750	77-79		FA034*	FA034V*		MD2025LS	MD2025RS								
XS 750 SE	79-80	Left	FA061	FA061V		MD2025LS									
		Right	FA041	FA041V			MD2025RS								
XTZ 750 Super Tenere	89-95	Left	FA135TT		FA135R ■	MD6118D									
		Right	FA165TT		FA165R ■		MD6118D								
XV 750 SE	81		FA061	FA061V		MD2024LS									
XV 750 Virago	92-93		FA088*	FA088V*	FA088HH*	MD2011	MD2011	MD2011C*							
XV 750 Virago	94-97		FA179*	FA179V*	FA179HH*	MD2067LS	MD2067RS								
YZF 750 R/SP	93-97		FA190*		FA190HH*	MD2003X	MD2003X	MD2003XC*	VR2003BLK*						
YZF-R7 750 OWO2 (Race Version)	99-01		FA424*		FA424HH*	N/A	N/A								
YZF-R7 750 OWO2 (Road Version) (5FL1)	99-01		FA252*		FA252HH*	MD2083	MD2083								
FZ 8 N-800cc (Naked/Single Headlight/Non ABS)	11-13				FA380HH*	MD2095X	MD2095X	MD2095XC*	VR2095BLK*						
FZ 8 NA-800cc (Naked/Single Headlight/ABS)	11-13				FA380HH*	MD2095X	MD2095X	MD2095XC*	VR2095BLK*						
Fazer 8 S-800cc (Top Fairing/Twin Headlight/Non ABS)	11-13				FA380HH*	MD2095X	MD2095X	MD2095XC*	VR2095BLK*						
Fazer 8 SA-800cc (Top Fairing/Twin Headlight/ABS)	11-13				FA380HH*	MD2095X	MD2095X	MD2095XC*	VR2095BLK*						
TDM 850	91-95		FA123*	FA123V*	FA123HH*	MD2001X	MD2001X	MD2001XC*	VR2001BLK*						
TDM 850	96-01		FA160*		FA160HH*	MD2001X	MD2001X	MD2001XC*	VR2001BLK*						
TRX 850	96-99		FA123*	FA123V*	FA123HH*	MD2001X	MD2001X	MD2001XC*	VR2001BLK*						
XS 850	80		FA034*	FA034V*		MD2024LS	MD2024RS								
TDM 900 (SPS/Non ABS)	02-13		FA252*		FA252HH*	MD2074X	MD2074X	MD2074XC*	VR2074BLK*						
TDM 900 A (2B0/ABS)	05-13		FA252*		FA252HH*	MD2074X	MD2074X	MD2074XC*	VR2074BLK*						
XJ 900/900 F	83-86		FA088*		FA088HH*	MD2069	MD2069								
XJ 900/900 F	87-94		FA088*		FA088HH*	MD2011	MD2011	MD2011C*							
XJ 900 S Diversion	95-03		FA179*		FA179HH*	MD2012	MD2012								
XVS 950 A Midnight Star	09-13		FA179	FA179V	FA179HH	MD2089X		MD2089XC	VR2089BLK*						
FZR 1000 Genesis	87-88		FA123*		FA123HH*	MD2003X	MD2003X	MD2003XC*	VR2003BLK*						
FZR 1000 EX UP (STD Forks)	89-90		FA160*		FA160HH*	MD2003X	MD2003X	MD2003XC*	VR2003BLK*						
FZR 1000 EX UP (USD Forks)	91-93		FA182*		FA182HH*	MD2003X	MD2003X	MD2003XC*	VR2003BLK*						
FZR 1000 EX UP (6 piston caliper)	94-95		FA190*		FA190HH*	MD2003X	MD2003X	MD2003XC*	VR2003BLK*						
FZS 1000 Fazer	01-05		FA252*		FA252HH*	MD2074X	MD2074X	MD2074XC*	VR2074BLK*						
FZ1 (Naked) (2D1) (1000cc)	06-09				FA380HH*	MD2101X	MD2101X	MD2101XC*	VR2101BLK*						
FZ1 NINA (Naked) (Non ABS & ABS)	10-13				FA380HH*	MD2101X	MD2101X	MD2101XC*	VR2101BLK*						
FZ1 Fazer (3C3) (Half fairing/Non ABS)	06-13				FA380HH*	MD2101X	MD2101X	MD2101XC*	VR2101BLK*						
FZ1 Fazer (Half fairing - ABS - 5D0)	08-13				FA380HH*	MD2101X	MD2101X	MD2101XC*	VR2101BLK*						
GTS 1000	93-99		FA191			N/A									
XV 1000 TR1	81		FA034*	FA034V*		MD2019LS	MD2019RS								
XV 1000 Virago	86		FA088*	FA088V*	FA088HH*	MD2011	MD2011	MD2011C*							
XV 1000 SE Virago	88		FA088*	FA088V*	FA088HH*	MD2011	MD2011	MD2011C*							
YZF 1000 R Thunderace	96-01		FA252*		FA252HH*	MD2074X	MD2074X	MD2074XC*	VR2074BLK*						
YZF R1	98-01		FA252*		FA252HH*	MD2074X	MD2074X	MD2074XC*	VR2074BLK*						
YZF R1	02-03		FA252*		FA252HH*	MD2074X	MD2074X	MD2074XC*	VR2074BLK*						
YZF R1	04-06				FA380HH*	MD2094X	MD2094X	MD2094XC*	VR2094BLK*						
YZF-R1 SP (4B1)	06				FA380HH*	MD2112X	MD2112X								
YZF R1 (6 piston radial caliper)	07-08		FA442/4*		FA442/4HH*	MD2102X	MD2102X	MD2102XC*	VR2102BLK*						
YZF R1	09-13		FA442/4*		FA442/4HH*	MD2105X	MD2105X	MD2105XC*	VR2105BLK*						
YXP 1000 ASI/AT Pro Hauler 1000 Side x Side	04-05		Y534*		Y534G*										
BT 1100 P/R/S/T/W Bulldog	02-06		FA252*		FA252HH*	MD2074X	MD2074X	MD2074XC*	VR2074BLK*						
FJ 1100	84-85		FA088*		FA088HH*	MD2068	MD2068								
XS 1100	78-80		FA034*			MD2024LS	MD2024RS								
XS 1100 S	81		FA070*			MD2024LS	MD2024RS								
XV 1100 Virago	89-93		FA088*	FA088V*	FA088HH*	MD2011	MD2011	MD2011C*							
XV 1100 Virago	94-98		FA179*	FA179V*	FA179HH*	MD2067LS	MD2067RS								
XV 1100 Virago	99		FA199*	FA199V*	FA199HH*	MD2067LS	MD2067RS								
XVS 1100 Drag Star	99-04		FA199*	FA199V*	FA199HH*	MD2076	MD2076								
XVS 1100 A Dragstar Classic	00-06		FA199*	FA199V*	FA199HH*	MD2076	MD2076								
FJ 1200 (ITX Type)	86-87		FA088*		FA088HH*	MD2068	MD2068								
FJ 1200 (3CV/3XW Type)	88-95		FA123*		FA123HH*	MD2001X	MD2001X	MD2001XC*	VR2001BLK*						

\*-2 Sets Required. ■ - Also available in MX-S race compound.

**SAFETY WARNING:** DO NOT USE HH PADS ON REAR UNLESS ALSO USED ON FRONT TO AVOID BRAKE IMBALANCE

APPLICATIONS  
BRAKE

R Suffix = High Durability Sintered Pad. HH Suffix = High Performance Sintered Pad. G Suffix = Grooved Shoe.  
D Suffix = Drilled Disc. C Suffix = Contoured Disc. LS Suffix = Left/Steel Disc. RS = Right/Steel Disc.

# JAPANESE Built Motorcycles



## YAMAHA Contd.



← REAR / ARRIÈRE / HINTEN POSTERIOR / POSTERIORE →

			DISC PAD CHOICES			BRAKE ROTOR CHOICES		
			NEW SFAC Scooter Carbon Pads	Semi-Sintered V-Pads™	Sintered/HH Pads/ Grooved shoes	Contour Rotor Rear Fitment	NEW Vee-Rotors™ CONTOUR	NEW CX Extreme® ROTOR
FZR 750 R OW01	89-90	FA088		FA088V	FA088HH	MD2008		
XJ 750 RF/RJ/RK Seca	81-83	Y515						
XJ 750	82-84	Y515						
XS 750	77-79	FA034		FA034V		MD2025RS		
XS 750 SE	79-80	FA034		FA034V		MD2025RS		
XTZ 750 Super Tenere	89-95	FA165/2TT			FA165/2R	MD6119D		
XV 750 SE	81	Y512						
XV 750 Virago	92-93	Y512						
XV 750 Virago	94-97	Y515						
YZF 750 R/SP	93-97	FA088		FA088V	FA088HH	MD2002	MD2002C	
YZF-R7 750 OW02 (Race Version)	99-01	TBA				MD2083		
YZF-R7 750 OW02 (Road Version) (5FL1)	99-01	FA267			FA267HH	MD2086		
FZ 8 N-800cc (Naked/Single Headlight/Non ABS)	11-13	FA174		FA174V	FA174HH	MD2116	MD2116C	VR2116
FZ 8 NA-800cc (Naked/Single Headlight/ABS)	11-13	FA174		FA174V	FA174HH	MD2116	MD2116C	VR2116
Fazer 8 S-800cc (Top Fairing/Twin Headlight/Non ABS)	11-13	FA174		FA174V	FA174HH	MD2116	MD2116C	VR2116
Fazer 8 SA-800cc (Top Fairing/Twin Headlight/ABS)	11-13	FA174		FA174V	FA174HH	MD2116	MD2116C	VR2116
TDM 850	91-95	FA088		FA088V	FA088HH	MD2002	MD2002C	VR2002
TDM 850	96-01	FA088		FA088V	FA088HH	MD2002	MD2002C	VR2002
TRX 850	96-99	FA088		FA088V	FA088HH	MD2002	MD2002C	VR2002
XS 850	80	FA034		FA034V		MD2024RS		
TDM 900 (SPS/Non ABS)	02-13	FA319/2		FA319/2V	FA319/2HH	MD2002	MD2002C	VR2002
TDM 900 A (2B0/ABS)	05-13	FA319/2		FA319/2V	FA319/2HH	MD2002	MD2002C	VR2002
XJ 900/900 F	83-86	FA088		FA088V	FA088HH	MD2069		
XJ 900/900 F	87-94	FA088		FA088V	FA088HH	MD2069		
XJ 900 S Diversion	95-03	FA088		FA088V	FA088HH	MD2011		
XVS 950 A Midnight Star	09-13	FA319/2		FA319/2V	FA319/2HH	MD2103	MD2103C	VR2103
FZR 1000 Genesis	87-88	FA088		FA088V	FA088HH	MD2011	MD2011C	VR2011
FZR 1000 EX UP (STD Forks)	89-90	FA088		FA088V	FA088HH	MD2011	MD2011C	VR2011
FZR 1000 EX UP (USD Forks)	91-93	FA088		FA088V	FA088HH	MD2011	MD2011C	VR2011
FZR 1000 EX UP (6 piston caliper)	94-95	FA088		FA088V	FA088HH	MD2011	MD2011C	VR2011
FZS 1000 Fazer	01-05	FA348			FA348HH	MD2011	MD2011C	VR2011
FZ1 (Naked) (2D1) (1000cc)	06-09	FA174		FA174V	FA174HH	MD2093	MD2093C	VR2093
FZ1 NNA (Naked) (Non ABS & ABS)	10-13	FA174		FA174V	FA174HH	MD2093	MD2093C	VR2093
FZ1 Fazer (3C3) (Half fairing/Non ABS)	06-13	FA174		FA174V	FA174HH	MD2093	MD2093C	VR2093
FZ1 Fazer (Half fairing - ABS - 5D0)	08-13	FA174		FA174V	FA174HH	MD2093	MD2093C	VR2093
GTS 1000	93-99	FA088		FA088V		MD2075		
XV 1000 TR1	81	Y515						
XV 1000 Virago	86	Y515						
XV 1000 SE Virago	88	Y515						
YZF 1000 R Thunderace	96-01	FA088		FA088V	FA088HH	MD2002	MD2002C	VR2002
YZF R1	98-01	FA267			FA267HH	MD2086	MD2086C	VR2086
YZF R1	02-03	FA275			FA275HH	MD2084	MD2084C	VR2084
YZF R1	04-06	FA174		FA174V	FA174HH	MD2091	MD2091C	VR2091
YZF-R1 SP (4B1)	06	FA174		FA174V	FA174HH	MD2091		
YZF R1 (6 piston radial caliper)	07-08	FA174		FA174V	FA174HH	MD2091	MD2091C	VR2091
YZF R1	09-13	FA174		FA174V	FA174HH	MD2091	MD2091C	VR2091
YXP 1000 AS/AT Pro Hauler 1000 Side x Side	04-05	Y534			Y534G			
BT 1100 P/R/S/T/V Bulldog	02-06	FA088		FA088V	FA088HH	MD2011	MD2011C	VR2011
FJ 1100	84-85	FA088		FA088V	FA088HH	MD2068		
XS 1100	78-80	FA034		FA034V		MD2024RS		
XS 1100 S	81	FA034		FA034V		MD2024RS		
XV 1100 Virago	89-93	Y515						
XV 1100 Virago	94-98	Y515						
XV 1100 Virago	99	FA088		FA088V	FA088HH	MD2011		
XVS 1100 Drag Star	99-04	FA088		FA088V	FA088HH	MD2092		
XVS 1100 A Dragstar Classic	00-06	FA088		FA088V	FA088HH	MD2092		
FJ 1200 (ITX Type)	86-87	FA088		FA088V	FA088HH	MD2068		
FJ 1200 (3CV/3XW Type)	88-95	FA088		FA088V	FA088HH	MD2068		

\*-2 Sets Required. ■ - Also available in MX-S race compound.

**SAFETY WARNING:** DO NOT USE HH PADS ON REAR UNLESS ALSO USED ON FRONT TO AVOID BRAKE IMBALANCE

**R** Suffix = High Durability Sintered Pad. **HH** Suffix = High Performance Sintered Pad. **G** Suffix = Grooved Shoe.  
**D** Suffix = Drilled Disc. **C** Suffix = Contoured Disc. **LS** Suffix = Left/Steel Disc. **RS** = Right/Steel Disc.

**BRAKE APPLICATIONS**

# JAPANESE Built Motorcycles



← FRONT / AVANT / VORN FRENTE / ANTERIORE →

## YAMAHA Contd.

Model	Year	DISC PAD CHOICES					BRAKE ROTOR CHOICES						
		NEW SFAC Scooter Carbon Pads	Semi-Sintered V-Pads™	Sintered/HH Pads/ Grooved shoes	Left/Gauche/Links	Right/Droite/Rechts	Contour Rotor Universal left and right fitment	NEW Vee-Rotors™ CONTOUR	NEW CX Extreme® ROTOR	Oversize 250/280mm Rotor Kit	Relocating Bracket for 250/280mm Rotor	Oversize 320mm Rotor Kit	Relocating Bracket for 320mm Rotor
FJ 1200 A (ABS Model)	91-95	FA160*		FA160HH*	MD2046	MD2046							
XJR 1200	95-98	FA123*		FA123HH*	MD2003X	MD2003X	MD2003XC*	VR2003BLK*					
XT 1200 Z Super Tenere (ABS/UBS Brake System)	11-13			FA380HH*			MD2095XC*	VR2095BLK*					
XVZ 12 TD	85	FA088*	FA088V*	FA088HH*	MD2081	MD2081							
V-Max 12	91-92	FA088*		FA088HH*	MD2068	MD2068							
V-Max 12	93-03	FA160*		FA160HH*	MD2074X	MD2074X	MD2074XC*	VR2074BLK*					
FJR 1300 (Non ABS/5JW)	01-04	FA252*		FA252HH*	MD2074X	MD2074X	MD2074XC*	VR2074BLK*					
FJR 1300 A (ABS/5VS)	03-05	FA252*		FA252HH*	MD2089X	MD2089X	MD2089XC*	VR2089BLK*					
FJR 1300 A (ABS/3P6)	06-09			FA423/4HH*	MD2089X	MD2089X	MD2089XC*	VR2089BLK*					
FJR 1300 A (ABS/1CY)	10-12			FA423/4HH*	MD2089X	MD2089X	MD2089XC*	VR2089BLK*					
FJR 1300 A (ABS/1MC)	13			FA423/4HH*	MD2089X	MD2089X	MD2089XC*	VR2089BLK*					
FJR 1300 AS (ABS - Electric G/Shift/2D2)	06-09			FA423/4HH*	MD2089X	MD2089X	MD2089XC*	VR2089BLK*					
FJR 1300 AS (ABS - Electric G/Shift)	13			FA423/4HH*	MD2089X	MD2089X	MD2089XC*	VR2089BLK*					
XJR 1300 L 5EA2/5EA3/5EA4	99	FA252*		FA252HH*	MD2074X	MD2074X	MD2074XC*	VR2074BLK*					
XJR 1300 M 5EAA/5EAB/5EAC	00	FA252*		FA252HH*	MD2074X	MD2074X	MD2074XC*	VR2074BLK*					
XJR 1300 (5EA1/5EA7) (320mm front discs) (Brembo calipers)	98-99	FA244*		FA244HH*	MD2003X	MD2003X	MD2003XC*	VR2003BLK*					
XJR 1300 (5EA9/5EAG) (298mm front disc)	00	FA252*		FA252HH*	MD2074X	MD2074X	MD2074XC*	VR2074BLK*					
XJR 1300 NP (5EAP/5EAR/5EAS/5EAT/5EAW/5EAV/5EAY (298mm front discs)	01-02	FA252*		FA252HH*	MD2074X	MD2074X	MD2074XC*	VR2074BLK*					
XJR 1300 R/S 5WM1/5WM3/5WM5/5WM6/5WM7/5WM9	03-04	FA252*		FA252HH*	MD2074X	MD2074X	MD2074XC*	VR2074BLK*					
XJR 1300 T/V/W/X 5WMA/5WMC/5WMD/5WME/Y	05-12	FA252*		FA252HH*	MD2074X	MD2074X	MD2074XC*	VR2074BLK*					
XJR 1300 SP (L) (5EA5/5EA6/5EA8)	99	FA252*		FA252HH*	MD2074X	MD2074X	MD2074XC*	VR2074BLK*					
XJR 1300 SP (M) (5EAD/5EAE/5EAF)	00	FA252*		FA252HH*	MD2074X	MD2074X	MD2074XC*	VR2074BLK*					
XJR 1300 SP (N) (5EAL/5EAM/5EAN)	01	FA252*		FA252HH*	MD2074X	MD2074X	MD2074XC*	VR2074BLK*					
XVS 1300 A Midnight Star	07-13	FA199*	FA199V*	FA199HH*	MD2074X	MD2074X	MD2074XC*	VR2074BLK*					
XVZ 13 AH/ATH Royal Star/Royal Star Tour Classic	96-01	FA123*	FA123V*	FA123HH*	MD2076	MD2076							
XVZ 1300 TF Venture Star	99-01	FA179*	FA179V*	FA179HH*	MD2076	MD2076							
XV 1600 A Wildstar	99-04	FA179*	FA179V*	FA179HH*	MD2076	MD2076							
MT-01 (1670cc) (4 piston caliper)	05-06			FA380HH*	MD2083	MD2083							
MT-01 (6 piston radial caliper)	07-09	FA442/4*		FA442/4HH*	MD2083	MD2083							
MT-01 S (6 piston radial caliper/5YUR)	09	FA442/4*		FA442/4HH*	MD2083	MD2083							
XV 1700 PCR Road Star Warrior	03-05	FA252*		FA252HH*	MD2074X	MD2074X	MD2074XC*	VR2074BLK*					
XV 1700 V-Max (2S3)	09-12	FA442/4*		FA442/4HH*			MD2109XC*						
XV 1900 A Midnight Star	06-12	FA252*		FA252HH*	MD2074X	MD2074X	MD2074XC*	VR2074BLK*					
XV 1900 A Midnight Star	13			FA423/4HH*	TBA	TBA							

NOTE - MD6190C◆ = MD6190CE Undrilled rear disc available for Enduro use

\*-2 Sets Required. ■ - Also available in MX-S race compound.

**SAFETY WARNING:** DO NOT USE HH PADS ON REAR UNLESS ALSO USED ON FRONT TO AVOID BRAKE IMBALANCE

**R** Suffix = High Durability Sintered Pad. **HH** Suffix = High Performance Sintered Pad. **G** Suffix = Grooved Shoe.  
**D** Suffix = Drilled Disc. **C** Suffix = Contoured Disc. **LS** Suffix = Left/Steel Disc. **RS** = Right/Steel Disc.





# ROAD RACING APPLICATIONS

Make & Model	Year	FRONT				REAR		
		Organic Pads or Shoes	Sintered/HH Pads Grooved shoes	Brake Rotor Left	Brake Rotor Right	Organic Pads or Shoes	Sintered Pads Grooved shoes	Brake Rotor
<b>HONDA</b>								
RS 125	88-89	FA124	FA124HH		N/A	FA151		MD713
RS 125	90-94	FA226	EPFA226HH		MD1003X	FA151		MD713
RS 125	95-03	FA239	EPFA239HH		MD1003X	FA151		MD713
RS 125 (Radial caliper)	04-07		GPFA347HH		MD1003X	FA151		MD713
NSF 250 R	12-13		GPFA347HH		N/A	FA151		N/A
RS 250	88-89	FA124*	FA124HH*	MD1003X	MD1003X	FA151		MD724
RS 250	90-94	FA226*	EPFA226HH*	MD1003X	MD1003X	FA151		MD724
RS 250	95-02	FA239*	EPFA239HH*	MD1003X	MD1003X	FA151		MD724
<b>MORIWAKI</b>								
MD250H	08-13		GPFA347HH		N/A	FA151		N/A
<b>YAMAHA</b>								
TZ 125	94-97	FA145	EPFA145HH		MD711RD	FA162		MD732
TZ 250	89-90	FA145*	EPFA145HH*	MD711LD	MD711RD	FA162		MD732
TZ 250	91	FA145*	EPFA145HH*	MD711LD	MD711RD	FA162		MD2021
TZ 250	92-96	FA145*	EPFA145HH*	MD711LD	MD711RD	FA162		MD732
TZ 250	97-01	FA145*	EPFA145HH*	MD730LD	MD730RD	FA162		MD732
TZ 250 (Radial Caliper)	02-10		GPFA347HH*	MD730LD	MD730RD	FA162		MD732

## PADS FOR AFTERMARKET CALIPERS

	Standard Organic Pad	Optional Organic Pad	Semi-Sintered Pad	Fully Sintered Pad	Fully Sintered Pad Track Day /Race Pad	Fully Sintered Race Pad
<b>AP LOCKHEED</b>						
2 Piston / 2 Pin (CP2195/CP2696 -38E0)	FA016	FA016S	N/A	FA016HH	EPFA016HH	GPFA016HH
2 Piston Sidecar caliper (CP2576/2577/3176/3177/3178)	N/A	N/A	N/A	N/A	N/A	N/A
2 Piston / 1 Pin (CP4226 - 2S0)	FA272	N/A	N/A	N/A	N/A	N/A
2 Piston / 1 Pin ( CP4227 - 2S0)	FA272	N/A	N/A	N/A	N/A	N/A
6 Piston / No Pins (CP3366/67)	FA217	N/A	N/A	N/A	N/A	N/A
6 Piston / 2 Pins (CP4466)	N/A	N/A	N/A	N/A	EPFA263HH	N/A
4 Piston (CP3086/CP3369/CP4484 D27)	FA107A (8mm pad)	N/A	N/A	N/A	N/A	N/A
4 Piston (CP4485/CP4679)	FA1072A (7mm pad)	N/A	N/A	N/A	N/A	N/A
4 Piston Radial 2 Piece (CP4488)	N/A	N/A	N/A	N/A	N/A	N/A
4 Piston (CP4680) 1 Piece Pad	N/A	N/A	N/A	N/A	N/A	N/A
4 Piston Radial Mount / 4 Seperate Pads (CP6688 - 8EOM/9EOM)	N/A	N/A	N/A	FA435/4HH	EPFA435/4HH	N/A
2 Piston / 1 Pin (CP7003-2S0) Radial mount	FA272	N/A	N/A	N/A	N/A	N/A
4 Piston Sidecar Caliper (CP7030-3S0 / 5S0)	N/A	N/A	N/A	N/A	N/A	N/A
4 Piston Radial Monobloc 1 Piece Pad (CP7853 D27 2E0/3E0)	N/A	N/A	N/A	N/A	N/A	N/A
<b>BEHRINGER</b>						
2 Piston Quad Caliper	N/A	N/A	N/A	N/A	N/A	N/A
4 Piston (Old Design)	FA158	N/A	N/A	FA158HH	EPFA158HH	N/A
4 Piston (Radial)	N/A	N/A	N/A	MXS405	N/A	N/A
6 Piston (Old Design)	FA249	N/A	N/A	FA249HH	EPFA249HH	N/A
6 Piston (Old design/2 piston)	FA047	FA047S	N/A	FA047HH	N/A	N/A
6 Piston (Old Design /Endurance)	FA249/2	N/A	N/A	N/A	N/A	N/A
6 Piston (New Design)	N/A	N/A	N/A	MXS406	N/A	N/A
<b>BREMBO</b>						
20 5161 43 or 81 - 2 Piston P 2/32 Rear caliper (Single Pad Fixing Pin / With Anti Rattle Shim)	FA047	FA047S	N/A	FA047HH	N/A	N/A
20 6950 51 - 2 Piston P2/32 Rear Caliper (Single Pad Fixing Pin / With Wire Clip)	FA266	N/A	FA266V	FA266HH	N/A	N/A
20 6951 12/50/63 - P2/34 Rear Caliper (Single Pad Fixing Pin / With Wire Clip)	FA266	N/A	FA266V	FA266HH	N/A	N/A
20 7850 11/21 - 4 Piston P4 /34 @ 65mm Spacing (Wire Clip Pad Retention Only)	N/A	N/A	N/A	FA322/4HH	EPFA322/4HH	N/A
20 8343 11/21 or 35/45 - 4 Piston P4 /34 @ 100mm Spacing (Wire Clip Pad Retention Only)	N/A	N/A	N/A	FA322/4HH	EPFA322/4HH	N/A
220B01010 - GP4-RX 4 Piston Radial Mount @ 108mm Spacing	N/A	N/A	N/A	FA447HH	EPFA447HH	GPFA447HH
X20-60-01 -2 Piston P2/24 Rear Caliper @ 64mm Spacing	N/A	N/A	N/A	N/A	N/A	N/A
X20-61-01 -4 Piston P4/24 Rear Caliper @ 64mm Spacing	N/A	N/A	N/A	N/A	N/A	N/A
X98-88-70 -2 Piston P2/34 Rear Caliper @ 64mm Spacing	N/A	N/A	N/A	N/A	N/A	N/A
X97.37.60/61 - 4 Piston Monobloc 32/36 Radial mount @ 108mm (Single Pin Fixing)	N/A	N/A	N/A	FA218HH	EPFA218HH	GPFA218HH
20 5165 55/68 - Goldline 4 piston P4 30/34 @ 40mm Spacing (Single Pin pad Fixing)	FA095	N/A	FA095V	FA095HH	EPFA095HH	N/A
20 6800 10/20 - Goldline4 piston P4 30/34 @ 65mm Spacing (Two Pin Pad Fixing)	FA244	N/A	FA244V	FA244HH	EPFA244HH	GPFA244HH
20 4756 52/62 - 4 Piston P4 30/34 @40mm Spacing (Single pin pad fixing)	FA095	N/A	FA095V	FA095HH	EPFA095HH	N/A
X99.C04 60/61 - 4 Piston P 34/34 Radial Mount Caliper @ 108mm Spacing (4 Pad Set)	N/A	N/A	N/A	N/A	EPFA435/4HH	N/A
XA3.B8.30/31 - 4 Piston P32/36 Radial Mount Caliper @ 108mm Spacing (Titanium Pistons)	N/A	N/A	N/A	N/A	EPFA218/2HH	GPFA218/2HH
XA3.B8.60/61 - 4 Piston P32/36 Radial Mount Caliper @ 108mm Spacing (Aluminium Pistons)	N/A	N/A	N/A	N/A	EPFA218/2HH	GPFA218/2HH
XA3.J7.50/51 - 4 Piston P 34/38 Radial Mount @ 108mm Spacing (Pinless Fixing)	N/A	N/A	N/A	N/A		GPFA611HH
XA3.J7.60/61 - 4 Piston P 34/38 Radial Mount @ 108mm Spacing (Pinless Fixing / Lithium Body)	N/A	N/A	N/A	N/A		GPFA611HH
XA8.Y3.310/11 - 4 Piston P 34/38 Radial Mount @ 130mm Spacing (Pinless Fixing)	N/A	N/A	N/A	N/A		GPFA611HH
XA9 .33.10/11 - 4 Piston P32/36 Radial Munt Monobloc @ 108mm Spacing (Single Pin Pad Fixing)	N/A	N/A	N/A		EPFA218/2HH	GPFA218/2HH
XA07680 - 2 Piston P2 34 Radial Mount) (Note Only Sold As Set Of 4 pads)	N/A	N/A	N/A	FA435/4HH	EPFA435/4HH	N/A
X1017.40/41 4 Piston / 40mm Axial Monobloc Caliper	N/A	N/A	N/A		EPFA218/2HH	GPFA218/2HH

# PADS FOR AFTERMARKET CALIPERS

	Standard Organic Pad	Optional Organic Pad	Semi-Sintered Pad	Fully Sintered Pad	Fully Sintered Pad Track Day /Race Pad	Fully Sintered Race Pad
<b>BREMBO</b>						
XA7G2.40/41 4 Piston / 100mm CNC Monobloc Caliper	N/A	N/A	N/A		EPFA218/2HH	GPFA218/2HH
XA32950 P4/34 Axial Radial Mount 65mm - 4 Pad Set	N/A	N/A	N/A	FA322/4HH	EPFA322/4HH	N/A
XA1K480 Motocross Radial Caliper	N/A	N/A	N/A	N/A	N/A	N/A
XQ21361 P2/28 Off Road Caliper	FA181TT	N/A	N/A	FA181R	EPFA181HH	N/A
122A99021 P2/24 Off Road Caliper	FA181TT	N/A	N/A	FA181R	EPFA181HH	N/A
XQ21390 PF 26 Off Road Rear Caliper	FA368TT	N/A	N/A	N/A	EPFA368HH	N/A
120A44110 P2/34 Supersport Rear Caliper	FA266	N/A	FA266V	FA266HH	N/A	N/A
206121 P4/24 Rear Caliper	N/A	N/A	N/A	N/A	N/A	N/A
XA1J040 P2/30 Rear Caliper	N/A	N/A	N/A	N/A	N/A	N/A
XA69510 P4 30/34 Motard Radial Mount 108mm 2 Pin Pad Fixing	FA244	N/A	FA244V	FA244HH	EPFA244HH	GPFA244HH
XA78910 P4 30/34 Motard Radial Caliper 100mm Mount 2 Pin Pad Fixing	FA244	N/A	FA244V	FA244HH	EPFA244HH	GPFA244HH
220A80310 P4 30/34 Radial Mount 100mm 2 Pin Pad Fixing	FA244	N/A	FA244V	FA244HH	EPFA244HH	GPFA244HH
220A16820 P30/34 Yamaha R1 07-10 Radial Mount	FA244	N/A	FA244V	FA244HH	EPFA244HH	GPFA244HH
XA7G2 10/11 P4 32/36 Radial Mount Caliper 100mm	N/A	N/A	N/A	N/A	EPFA218/2HH	GPFA218/2HH
X97C4 60/61 P4/34 Radial Monobloc 108mm 4 Pad Type Caliper	N/A	N/A	N/A	FA435/4HH	EPFA435/4HH	N/A
X9737 80/81 Radial Mount 108mm Endurance Caliper	N/A	N/A	N/A	N/A	EPFA295HH	N/A
220A39710 P4/34 Radial Mount 108mm Monobloc Caliper	N/A	N/A	N/A	FA447HH	EPFA447HH	GPFA447HH
220988530 P4/34 Radial Mount 100mm Monobloc Caliper	N/A	N/A	N/A	FA447HH	EPFA447HH	GPFA447HH
220A0610 P4 30/34 Radial Mount Caliper 108mm 2 Pin Pad Fixing	FA244	N/A	FA244V	FA244HH	EPFA244HH	GPFA244HH
220A80210 P4 30/34 Radial Mount Caliper 108mm 2 Pin Pad Fixing	FA244	N/A	FA244V	FA244HH	EPFA244HH	GPFA244HH
220A16810 P4 30/34 Radial Mount Caliper 100mm 2 Pin Pad Fixing	FA244	N/A	FA244V	FA244HH	EPFA244HH	GPFA244HH
20.9883 Radial Mount Caliper 100mm	N/A	N/A	N/A	FA447HH	EPFA447HH	GPFA447HH
<b>EBC</b>						
4 Piston	FA216/2	N/A	N/A	FA216/2HH	N/A	N/A
<b>FTE</b>						
4 Piston Radial Supermoto	N/A	N/A	N/A	MXS405	N/A	N/A
Piston Radial Supermoto	N/A	N/A	N/A	MXS406	N/A	N/A
<b>GMA</b>						
2 Piston rear (large) caliper model A (CCI #09-997)	FA036	N/A	FA036V	N/A	N/A	N/A
2 Piston (small) caliper model B (CCI # 09-996)	FA076	N/A	FA076V	FA076HH	N/A	N/A
4 Piston model F	FA115	N/A	FA115V	FA115HH	N/A	N/A
<b>HARRISON BILLET</b>						
Big 4 Piston (1296033)	FA047	FA047S	N/A	FA047HH	N/A	N/A
Big 6 Piston (1296033)	FA047	FA047S	N/A	FA047HH	N/A	N/A
2 Piston (1296040)	FA175		N/A	FA175HH	EPFA175HH	N/A
Slim Design	FA175		N/A	FA175HH	EPFA175HH	N/A
Min i6	FA175		N/A	FA175HH	EPFA175HH	N/A
<b>HHI - HAWG HALTERS</b>						
4 Piston - All Types	FA216/3	N/A	FA216/3V	FA216/3HH	N/A	N/A
4 Piston - Sprocket Brake	FA623	N/A	N/A	N/A	N/A	N/A
6 Piston - All Types	FA424	N/A	N/A	FA424HH	EPFA424HH	N/A
<b>IRON PEGASUS</b>						
Small caliper (Single Pin Fixing)	FA047	FA047S	N/A	FA047HH	N/A	N/A
Small caliper (2 Pin Fixing)	FA115	N/A	FA115V	FA115HH	N/A	N/A
<b>ISR</b>						
22-023-0A (2 Piston)	FA011	N/A	N/A	N/A	N/A	N/A
22-025-XX (4 Piston)	FA047	FA047S	N/A	FA047HH	N/A	N/A
22-026-0A (Sprocket Caliper)	FA011	N/A	N/A	N/A	N/A	N/A
22-027 (2 Piston Rear)	FA047	FA047S	N/A	FA047HH	N/A	N/A
22-028 (2 Piston)	FA047	FA047S	N/A	FA047HH	N/A	N/A
22-029 (Rear 2 Piston)	FA047	FA047S	N/A	FA047HH	N/A	N/A
22-030 (2 Piston Rear)	FA016	FA016S	N/A	FA016HH	EPFA016HH	GPFA016HH
22-032 (6 Piston Large)	FA175	N/A	N/A	FA175HH	N/A	N/A
22-033 (2 Piston HD)	FA016	FA016S	N/A	FA016HH	EPFA016HH	GPFA016HH
22-034 (6 Piston Small)	FA184	N/A	N/A	N/A	N/A	N/A
22-036 (2 Piston)	FA184	N/A	N/A	N/A	N/A	N/A
22-042 (6 Piston Racing)	FA175	N/A	N/A	FA175HH	N/A	N/A
22-043 (4 Piston)	FA184	N/A	N/A	N/A	N/A	N/A
Radial 6 Piston Monoblock	FA184	N/A	N/A	N/A	N/A	N/A
<b>JAYBRAKE</b>						
Dual 7 Quad (300-04) (2 & 4 Piston)	FA115	N/A	FA115V	FA115HH	N/A	N/A
J-Four (300-44) (4 Piston)	FA424	N/A	N/A	FA424HH	EPFA424HH	N/A
J-Six (300-64) (6 Piston)	FA243	N/A	N/A	FA243HH	N/A	N/A
6 PF-L (6 Piston)	N/A	N/A	N/A	FA455HH	N/A	N/A
Early Design 2 Piston	FA076	N/A	FA076V	FA076HH	N/A	N/A

# PADS FOR AFTERMARKET CALIPERS

## MAGURA

	Standard Organic Pad	Optional Organic Pad	Semi-Sintered Pad	Fully Sintered Pad	Fully Sintered Pad Track Day /Race Pad	Fully Sintered Race Pad
4 Piston Radial Supermoto Caliper	FA433/4	N/A	N/A	FA433/4HH	EPFA433/4HH	N/A

## MOTOMASTER

4 Piston	FA158	N/A	N/A	FA158HH	EPFA158HH	N/A
----------	-------	-----	-----	---------	-----------	-----

## NOVA/LEGENDS

4 Piston	FA216/3	N/A	FA216/3V	FA216/3HH	N/A	N/A
----------	---------	-----	----------	-----------	-----	-----

## OMP

4 Piston Caliper (Front or Rear)	FA095	N/A	FA095V	FA095HH	EPFA095HH	N/A
----------------------------------	-------	-----	--------	---------	-----------	-----

6 Piston	FA116	N/A	N/A	N/A	N/A	N/A
----------	-------	-----	-----	-----	-----	-----

Sprocket caliper	FA116	N/A	N/A	N/A	N/A	N/A
------------------	-------	-----	-----	-----	-----	-----

## PERFORMANCE MACHINE

112 X 6B	FA249	N/A	N/A	FA249HH	EPFA249HH	N/A
----------	-------	-----	-----	---------	-----------	-----

112 X 6QC	FA249	N/A	N/A	FA249HH	EPFA249HH	N/A
-----------	-------	-----	-----	---------	-----------	-----

112 X 6RSB	FA190	N/A	FA190V	FA190HH	EPFA190HH	N/A
------------	-------	-----	--------	---------	-----------	-----

112 X 6SSB	FA190	N/A	FA190V	FA190HH	EPFA190HH	N/A
------------	-------	-----	--------	---------	-----------	-----

124 X 4HR	FA216/2	N/A	N/A	FA216/2HH	N/A	N/A
-----------	---------	-----	-----	-----------	-----	-----

125 X 2	FA115	N/A	FA115V	FA115HH	N/A	N/A
---------	-------	-----	--------	---------	-----	-----

125 X 4R	FA216/3	N/A	FA216/3V	FA216/3HH	N/A	N/A
----------	---------	-----	----------	-----------	-----	-----

125 X 4RSPH	FA216/3	N/A	FA216/3V	FA216/3HH	N/A	N/A
-------------	---------	-----	----------	-----------	-----	-----

125 X 4S	FA115	N/A	FA115V	FA115HH	N/A	N/A
----------	-------	-----	--------	---------	-----	-----

125 X 4SL	FA115	N/A	FA115V	FA115HH	N/A	N/A
-----------	-------	-----	--------	---------	-----	-----

125 X 6	FA210	N/A	FA210V	N/A	N/A	N/A
---------	-------	-----	--------	-----	-----	-----

125 X 6QC	FA190	N/A	FA190V	FA190HH	N/A	N/A
-----------	-------	-----	--------	---------	-----	-----

137 X 4	FA216/2	N/A	N/A	FA216/2HH	N/A	N/A
---------	---------	-----	-----	-----------	-----	-----

137 X 4 (2006)	N/A	N/A	N/A	FA420HH	N/A	N/A
----------------	-----	-----	-----	---------	-----	-----

137 X 4B	FA216/3	N/A	FA216/3V	FA216/3HH	N/A	N/A
----------	---------	-----	----------	-----------	-----	-----

137 X 6	FA210	N/A	FA210V	N/A	N/A	N/A
---------	-------	-----	--------	-----	-----	-----

162 X 2	FA032	N/A	FA032V	N/A	N/A	N/A
---------	-------	-----	--------	-----	-----	-----

## PFM

6 Piston Superbike caliper	N/A	N/A	N/A	N/A	EPFA263HH	N/A
----------------------------	-----	-----	-----	-----	-----------	-----

## PRE TECH

4 Piston (Uni P401)	FA180	N/A	N/A	FA180HH	N/A	N/A
---------------------	-------	-----	-----	---------	-----	-----

4 Piston (P402) Lockheed Replacement Caliper	FA158	N/A	N/A	FA158HH	EPFA158HH	N/A
--	-------	-----	-----	---------	-----------	-----

6 Piston	FA190	N/A	FA190V	FA190HH	EPFA190HH	N/A
----------	-------	-----	--------	---------	-----------	-----

6 Piston (Radial Mount)	FA249	N/A	N/A	FA249HH	EPFA249HH	N/A
-------------------------	-------	-----	-----	---------	-----------	-----

## PRO-ONE

2 Piston	FA047	FA047S	N/A	FA047HH	N/A	N/A
----------	-------	--------	-----	---------	-----	-----

4 Piston	FA158	N/A	N/A	FA158HH	EPFA158HH	N/A
----------	-------	-----	-----	---------	-----------	-----

## P.V.M.

2 Piston Rear Caliper (Note Only 2 Pads Required)	N/A	N/A	N/A	FA435/4HH	EPFA435/4HH	N/A
---	-----	-----	-----	-----------	-------------	-----

4 Piston Radial Mount Caliper	N/A	N/A	N/A	FA435/4HH	EPFA435/4HH	N/A
-------------------------------	-----	-----	-----	-----------	-------------	-----

4 Piston race caliper (Old Design)	FA211/2	N/A	N/A	N/A	N/A	N/A
------------------------------------	---------	-----	-----	-----	-----	-----

6 Piston (old large design)	N/A	N/A	N/A	N/A	GFA183HH	N/A
-----------------------------	-----	-----	-----	-----	----------	-----

6 Piston (new small design)	N/A	N/A	N/A	N/A	GFA276HH	N/A
-----------------------------	-----	-----	-----	-----	----------	-----

## REVTECH

CCI Polished Caliper (Front/Rear)	FA095	N/A	FA095V	FA095HH	EPFA095HH	N/A
-----------------------------------	-------	-----	--------	---------	-----------	-----

New Black 4 Piston Caliper	FA216/3	N/A	FA216/3V	FA216/3HH	N/A	N/A
----------------------------	---------	-----	----------	-----------	-----	-----

6 Piston VR1000 Race Caliper	FA217	N/A	N/A	N/A	N/A	N/A
------------------------------	-------	-----	-----	-----	-----	-----

## SPONDON

4 Piston Caliper	FA107A (8mm)	N/A	N/A	N/A	N/A	N/A
------------------	--------------	-----	-----	-----	-----	-----

4 Piston Caliper	FA107/2A (7mm)	N/A	N/A	N/A	N/A	N/A
------------------	----------------	-----	-----	-----	-----	-----

## SPIEGLER

4 Piston Caliper S4B	N/A	N/A	N/A	N/A	N/A	N/A
----------------------	-----	-----	-----	-----	-----	-----

8 Piston Caliper S8B	N/A	N/A	N/A	N/A	N/A	N/A
----------------------	-----	-----	-----	-----	-----	-----

## THUNDERHEART

4 Piston Caliper	FA216/3	N/A	FA216/3V	FA216/3HH	N/A	N/A
------------------	---------	-----	----------	-----------	-----	-----

6 Piston Caliper	FA249	N/A	N/A	FA249HH	N/A	N/A
------------------	-------	-----	-----	---------	-----	-----

## WILWOOD

PS1 Caliper (Part # 150-4091K)	FA271TT	N/A	N/A	FA271R	N/A	N/A
--------------------------------	---------	-----	-----	--------	-----	-----

GP300/310 (Part # 150-8733-2)	FA095	N/A	FA095V	FA095HH	EPFA095HH	N/A
-------------------------------	-------	-----	--------	---------	-----------	-----

GP320 (Part # 154-8596K)	FA095/2	N/A	N/A	N/A	N/A	N/A
--------------------------	---------	-----	-----	-----	-----	-----



# Non-JAPANESE Built Motorcycles



← FRONT / AVANT / VORN FRENTE / ANTERIORE →

## ARCTIC CAT ATV

### DISC PAD CHOICES

### BRAKE ROTOR CHOICES

			NEW SFAC Scooter Carbon Pads	Semi-Sintered V-Pads™	Sintered/HH Pads/ Grooved shoes	Left/Gauche/Links	Right/Droite/Rechts	Contour Rotor Universal left and right fitment	NEW Vee-Rotors™ CONTOUR	NEW CX Extreme® ROTOR	Oversize 250/280mm Rotor Kit	Relocating Bracket for 250/280mm Rotor	Oversize 320mm Rotor Kit	Relocating Bracket for 320mm Rotor
50 2 x 4 Youth (2T)	04-06	H346*			H346G*									
50 DVX Sport (4T)	06-08	H346*			H346G*									
50 4 x 4 Auto Youth	06-08	H346*			H346G*									
90 2 x 4 Youth (2T) Rear Drum Model	02-04	H346*			H346G*									
90 2 x 4 Youth (4T) Rear Drum Model	04-05	H346*			H346G*									
90 2 x 4 Youth (4T) Rear Disc Model	06	H346*			H346G*									
90 DVX	06-12	H346*			H346G*									
90 DVX SE	09	H346*			H346G*									
90 DVX SE	09	H346*			H346G*									
90 Reverse Gear Model	10-12	H346*			H346G*									
150 Utility 2 x 4	09-12	H346*			H346G*									
250 2 x 4 Utility	99-04	FA271TT*			FA271R*	MD6173D	MD6173D							
250 2 x 4 Utility	05-09	FA395TT*			FA395R*	MD6173D	MD6173D							
250 4 x 4 Utility	01-04	FA271TT*			FA271R*	MD6173D	MD6173D							
250 4 x 4 Utility	05-08	FA395TT*			FA395R*	MD6173D	MD6173D							
250 DVX Sport	06-08	FA377TT*			FA377R*	MD6267D	MD6267D							
300 (4 x 4)	98-04	FA271TT*			FA271R*	MD6173D	MD6173D							
300 4 x 4 Utility	05	FA395TT*			FA395R*	MD6173D	MD6173D							
300 ATV	10-12	FA395TT*			FA395R*	MD6173D	MD6173D							
300 DVX	09-12	FA377TT*			FA377R*	MD6267D	MD6267D							
350 ATV	12	FA395TT*			FA395R*	MD6173D	MD6173D							
366 4 x 4 Auto Utility	08-09	FA395TT*			FA395R*	MD6173D	MD6173D							
366 SE	10	FA395TT*			FA395R*	MD6173D	MD6173D							
400 4 x 4 ACT	04	FA271TT*			FA271R*	MD6173D	MD6173D							
400 4 x 4 Auto ACT	04	FA271TT*			FA271R*	MD6173D	MD6173D							
400 2 x 4 Utility	98-04	FA271TT*			FA271R*	MD6173D	MD6173D							
400 2 x 4 Auto Utility	04	FA271TT*			FA271R*	MD6173D	MD6173D							
400 4 x 4 Utility	00-04	FA271TT*			FA271R*	MD6173D	MD6173D							
400 4 x 4 Utility	05-07	FA395TT*			FA395R*	MD6173D	MD6173D							
400 4 x 4 VP Utility	05-06	FA395TT*			FA395R*	MD6173D	MD6173D							
400 4 x 4 Auto Utility	04	FA271TT*			FA271R*	MD6173D	MD6173D							
400 4 x 4 Auto Utility	05-08	FA395TT*			FA395R*	MD6173D	MD6173D							
400 4 x 4 Auto LE Utility	05-07	FA395TT*			FA395R*	MD6173D	MD6173D							
400 4 x 4 Auto VP Utility	05-06	FA395TT*			FA395R*	MD6173D	MD6173D							
400 DVX Sport	04-08	FA084TT*			FA084R*	MD6210D	MD6210D							
400 DVX TS Sport	06-07	FA084TT*			FA084R*	MD6210D	MD6210D							
400 4 x 4 Auto TBX Utility	04	FA271TT*			FA271R*	MD6173D	MD6173D							
400 4 x 4 Auto TBX Utility	05-06	FA395TT*			FA395R*	MD6173D	MD6173D							
400 TRV	09	FA395TT*			FA395R*	MD6173D	MD6173D							
400 TRV H1	10	FA395TT*			FA395R*	MD6173D	MD6173D							
400 4X Auto TRV Multirider	06	FA395TT*			FA395R*	MD6173D	MD6173D							
400 4X Auto TRV Plus Multirider	07	FA395TT*			FA395R*	MD6173D	MD6173D							
425i	12	FA395TT*			FA395R*	MD6173D	MD6173D							
425i SE	12	FA395TT*			FA395R*	MD6173D	MD6173D							
450 H1 EFI	10	FA395TT*			FA395R*	MD6173D	MD6173D							
450i	11-12	FA395TT*			FA395R*	MD6173D	MD6173D							
450i GT	12	FA395TT*			FA395R*	MD6173D	MD6173D							
450 TRV	11-12	FA395TT*			FA395R*	MD6173D	MD6173D							
450i TRV	11	FA395TT*			FA395R*	MD6173D	MD6173D							
XC450i	11-12	FA395TT*			FA395R*	MD6173D	MD6173D							
454 Bearcat 2 x 4	97-98	FA271TT*			FA271R*	MD6173D	MD6173D							
454 Bearcat 4 x 4	96-98	FA271TT*			FA271R*	MD6173D	MD6173D							
500 4 x 4 Auto Utility	98-04	FA271TT*			FA271R*	MD6173D	MD6173D							
500 4 x 4 Auto Utility	05-08	FA395TT*			FA395R*	MD6173D	MD6173D							
500 4 x 4 Auto LE Utility	05-06	FA395TT*			FA395R*	MD6173D	MD6173D							
500 4 x 4 Manual G/Box Utility	98-04	FA271TT*			FA271R*	MD6173D	MD6173D							
500 4 x 4 Manual G/Box Utility	05-09	FA395TT*			FA395R*	MD6173D	MD6173D							
500 4 x 4 Auto TBX Utility	04	FA271TT*			FA271R*	MD6173D	MD6173D							
500 4 x 4 Auto TBX Utility	05-06	FA395TT*			FA395R*	MD6173D	MD6173D							
500 4 x 4 Auto TRV Utility	04	FA271TT*			FA271R*	MD6173D	MD6173D							

\*-2 Sets Required. ■ - Also available in MX-S race compound.

**SAFETY WARNING:** DO NOT USE HH PADS ON REAR UNLESS ALSO USED ON FRONT TO AVOID BRAKE IMBALANCE



# Non-JAPANESE Built Motorcycles



## ARCTIC CAT ATV



← REAR / ARRIÈRE / HINTEN  POSTERIOR / POSTERIORE →

		DISC PAD CHOICES				BRAKE ROTOR CHOICES			
		NEW SFAC Scooter Carbon Pads	Semi-Sintered V-Pads™	Sintered/HH Pads/ Grooved shoes		Contour Rotor Rear Fitment	NEW Vee-Rotors™ CONTOUR	NEW CX Extreme® ROTOR	
50 2 x 4 Youth (2T)	04-06	N/A							
50 DVX Sport (4T)	06-08	FA305		FA305R	MD6267D				
50 4 x 4 Auto Youth	06-08	FA305		FA305R	MD6267D				
90 2 x 4 Youth (2T) Rear Drum Model	02-04	H307		H307G					
90 2 x 4 Youth (4T) Rear Drum Model	04-05	H307		H307G					
90 2 x 4 Youth (4T) Rear Disc Model	06	FA305		FA305R					
90 DVX	06-12	FA305		FA305R	MD6267D				
90 DVX SE	09	FA305		FA305R	MD6267D				
90 DVX SE	09	FA305		FA305R	MD6267D				
90 Reverse Gear Model	10-12	FA305		FA305R	MD6267D				
150 Utility 2 x 4	09-12	FA305		FA305R	MD6267D				
250 2 x 4 Utility	99-04	FA271TT		FA271R	MD6173D				
250 2 x 4 Utility	05-09	FA395TT		FA395R	MD6173D				
250 4 x 4 Utility	01-04	FA271TT		FA271R	MD6173D				
250 4 x 4 Utility	05-08	FA395TT		FA395R	MD6173D				
250 DVX Sport	06-08	FA355TT*		FA355R*	MD6268D				
300 (4 x 4)	98-04	FA271TT		FA271R	MD6173D				
300 4 x 4 Utility	05	FA395TT		FA395R	MD6173D				
300 ATV	10-12	FA395TT		FA395R	MD6173D				
300 DVX	09-12	FA355TT*		FA355R*	MD6268D				
350 ATV	12	FA395TT		FA395R	MD6173D				
366 4 x 4 Auto Utility	08-09	FA395TT		FA395R	MD6173D				
366 SE	10	FA395TT		FA395R	MD6173D				
400 4 x 4 ACT	04	FA271TT		FA271R	MD6173D				
400 4 x 4 Auto ACT	04	FA271TT		FA271R	MD6173D				
400 2 x 4 Utility	98-04	FA271TT		FA271R	MD6173D				
400 2 x 4 Auto Utility	04	FA271TT		FA271R	MD6173D				
400 4 x 4 Utility	00-04	FA271TT		FA271R	MD6173D				
400 4 x 4 Utility	05-07	FA395TT		FA395R	MD6173D				
400 4 x 4 VP Utility	05-06	FA395TT		FA395R	MD6173D				
400 4 x 4 Auto Utility	04	FA271TT		FA271R	MD6173D				
400 4 x 4 Auto Utility	05-08	FA395TT		FA395R	MD6173D				
400 4 x 4 Auto LE Utility	05-07	FA395TT		FA395R	MD6173D				
400 4 x 4 Auto VP Utility	05-06	FA395TT		FA395R	MD6173D				
400 DVX Sport	04-08	FA137TT		FA137R	MD6211D				
400 DVX TS Sport	06-07	FA137TT		FA137R	MD6211D				
400 4 x 4 Auto TBX Utility	04	FA271TT		FA271R	MD6173D				
400 4 x 4 Auto TBX Utility	05-06	FA395TT		FA395R	MD6173D				
400 TRV	09	FA395TT		FA395R	MD6173D				
400 TRV H1	10	FA395TT		FA395R	MD6173D				
400 4X Auto TRV Multirider	06	FA395TT		FA395R	MD6173D				
400 4X Auto TRV Plus Multirider	07	FA395TT		FA395R	MD6173D				
425i	12	FA395TT		FA395R	MD6173D				
425i SE	12	FA395TT		FA395R	MD6173D				
450 H1 EFI	10	FA395TT		FA395R	MD6173D				
450i	11-12	FA395TT		FA395R	MD6173D				
450i GT	12	FA395TT		FA395R	MD6173D				
450 TRV	11-12	FA395TT		FA395R	MD6173D				
450i TRV	11	FA395TT		FA395R	MD6173D				
XC450i	11-12	FA395TT		FA395R	MD6173D				
454 Bearcat 2 x 4	97-98	FA271TT		FA271R	MD6173D				
454 Bearcat 4 x 4	96-98	FA271TT		FA271R	MD6173D				
500 4 x 4 Auto Utility	98-04	FA271TT		FA271R	MD6173D				
500 4 x 4 Auto Utility	05-08	FA395TT		FA395R	MD6173D				
500 4 x 4 Auto LE Utility	05-06	FA395TT		FA395R	MD6173D				
500 4 x 4 Manual G/Box Utility	98-04	FA271TT		FA271R	MD6173D				
500 4 x 4 Manual G/Box Utility	05-09	FA395TT		FA395R	MD6173D				
500 4 x 4 Auto TBX Utility	04	FA271TT		FA271R	MD6173D				
500 4 x 4 Auto TBX Utility	05-06	FA395TT		FA395R	MD6173D				
500 4 x 4 Auto TRV Utility	04	FA271TT		FA271R	MD6173D				

\*-2 Sets Required. ■ - Also available in MX-S race compound.

**SAFETY WARNING:** DO NOT USE HH PADS ON REAR UNLESS ALSO USED ON FRONT TO AVOID BRAKE IMBALANCE

**BRAKE APPLICATIONS**

**R** Suffix = High Durability Sintered Pad. **HH** Suffix = High Performance Sintered Pad. **G** Suffix = Grooved Shoe.  
**D** Suffix = Drilled Disc. **C** Suffix = Contoured Disc. **LS** Suffix = Left/Steel Disc. **RS** = Right/Steel Disc.

# Non-JAPANESE Built Motorcycles



← FRONT / AVANT / VORN FRENTE / ANTERIORE →

## ARCTIC CAT ATV

### DISC PAD CHOICES

### BRAKE ROTOR CHOICES

			NEW SFAC Scooter Carbon Pads	Semi-Sintered V-Pads™	Sintered/HH Pads/ Grooved shoes	Left/Gauche/Links	Right/Droite/Rechts	Contour Rotor Universal left and right fitment	NEW Vee-Rotors™ CONTOUR	NEW CX Extreme® ROTOR	Oversize 250/280mm Rotor Kit	Relocating Bracket for 250/280mm Rotor	Oversize 320mm Rotor Kit	Relocating Bracket for 320mm Rotor
550 HI EFI	09-10	FA395TT*			FA395R*	MD6173D	MD6173D							
500 4 x 4 Auto TRV Multirider	05-06/08	FA395TT*			FA395R*	MD6173D	MD6173D							
550 HI EFI LE	09-10	FA395TT*			FA395R*	MD6173D	MD6173D							
550 TRV	11	FA395TT*			FA395R*	MD6173D	MD6173D							
550 TRV Cruiser	11	FA395TT*			FA395R*	MD6173D	MD6173D							
550 TRV EFI	09-10	FA395TT*			FA395R*	MD6173D	MD6173D							
550 TRV EFI LE	09-10	FA395TT*			FA395R*	MD6173D	MD6173D							
550i	11-12	FA395TT*			FA395R*	MD6173D	MD6173D							
550i LTD	11-12	FA395TT*			FA395R*	MD6173D	MD6173D							
550i GT	11-12	FA395TT*			FA395R*	MD6173D	MD6173D							
550i GT TRV	11	FA395TT*			FA395R*	MD6173D	MD6173D							
550i TRV Cruiser	11	FA395TT*			FA395R*	MD6173D	MD6173D							
550 GT TRV	11-12	FA395TT*			FA395R*	MD6173D	MD6173D							
550 GT S TRV	10	FA395TT*			FA395R*	MD6173D	MD6173D							
550 S	10	FA395TT*			FA395R*	MD6173D	MD6173D							
550 S LTD	10	FA395TT*			FA395R*	MD6173D	MD6173D							
650 H1 4 x 4 Auto Utility	04	FA271TT*			FA271R*	MD6173D	MD6173D							
650 H1 4 x 4 Auto Utility	05/08	FA271TT*			FA271R*	MD6173D	MD6173D							
650 H1 4 x 4 Auto LE Utility	07	FA271TT*			FA271R*	MD6173D	MD6173D							
650 H1 4 x 4 SE Auto Utility	06	FA271TT*			FA271R*	MD6173D	MD6173D							
650 H1	10	FA395TT*			FA395R*	MD6173D	MD6173D							
650 Mudpro	10-11	FA395TT*			FA395R*	MD6173D	MD6173D							
650 H1 Mudpro	10	FA395TT*			FA395R*	MD6173D	MD6173D							
650 H1 TRV	09	FA395TT*			FA395R*	MD6173D	MD6173D							
650 HI TBX 4 x 4 Auto Utility	07	FA395TT*			FA395R*	MD6173D	MD6173D							
650 HI TRV 4 x 4 Auto Plus Multirider	07	FA395TT*			FA395R*	MD6173D	MD6173D							
650 HI TRV 4 x 4 Auto Plus LE Multirider	07	FA395TT*			FA395R*	MD6173D	MD6173D							
650 HI TRV 4 x 4 Auto	08	FA395TT*			FA395R*	MD6173D	MD6173D							
650 TBX	09	FA395TT*			FA395R*	MD6173D	MD6173D							
650 V2 4 x 4 Auto Utility	04-06	FA395TT*			FA395R*	MD6173D	MD6173D							
650 V2 4 x 4 Auto LE Utility	04-05	FA395TT*			FA395R*	MD6173D	MD6173D							
650 V2 4 x 4 Auto LE TS Utility	06	FA395TT*			FA395R*	MD6173D	MD6173D							
700 Diesel Utility	07-08	FA395TT*			FA395R*	MD6173D	MD6173D							
700i GT	11-12	FA395TT*			FA395R*	MD6173D	MD6173D							
700 TRV H2 EFI Cruiser	09-10	FA395TT*			FA395R*	MD6173D	MD6173D							
700 TRV	11-12	FA395TT*			FA395R*	MD6173D	MD6173D							
700 TRV Cruiser	11-12	FA395TT*			FA395R*	MD6173D	MD6173D							
700 TRV GT	11-12	FA395TT*			FA395R*	MD6173D	MD6173D							
700 EFI 4 x 4 Utility	07-08	FA395TT*			FA395R*	MD6173D	MD6173D							
700 EFI 4 x 4 LE Utility	06	FA395TT*			FA395R*	MD6173D	MD6173D							
700 EFI 4 x 4 SE Utility	06	FA395TT*			FA395R*	MD6173D	MD6173D							
700 EFI Cruiser	11	FA395TT*			FA395R*	MD6173D	MD6173D							
700 EFI 4 x 4 Auto M4	08	FA395TT*			FA395R*	MD6173D	MD6173D							
700 EFI 4 x 4 Auto TRV LE	08	FA395TT*			FA395R*	MD6173D	MD6173D							
700 H1 EFI	09-10	FA395TT*			FA395R*	MD6173D	MD6173D							
700 H1 EFI LE	09-10	FA395TT*			FA395R*	MD6173D	MD6173D							
700 H1 EFI 4 x 4 Auto SE	08-09	FA395TT*			FA395R*	MD6173D	MD6173D							
700 H1 TBX EFI	10	FA395TT*			FA395R*	MD6173D	MD6173D							
700 Super Duty Diesel	10-11	FA395TT*			FA395R*	MD6173D	MD6173D							
700 Mudpro	10-11	FA395TT*			FA395R*	MD6173D	MD6173D							
700 H1 EFI Mudpro	09-10	FA395TT*			FA395R*	MD6173D	MD6173D							
700i	11-12	FA395TT*			FA395R*	MD6173D	MD6173D							
700i LTD	11-12	FA395TT*			FA395R*	MD6173D	MD6173D							
700i Mudpro	11-12	FA395TT*			FA395R*	MD6173D	MD6173D							
700i Mudpro LTD	11	FA395TT*			FA395R*	MD6173D	MD6173D							
700 S	10	FA395TT*			FA395R*	MD6173D	MD6173D							
700 S LTD	10	FA395TT*			FA395R*	MD6173D	MD6173D							
700 TBX LTD	11	FA395TT*			FA395R*	MD6173D	MD6173D							
1000 GT	11-12	FA395TT*			FA395R*	MD6173D	MD6173D							
1000 Mudpro	10-11	FA395TT*			FA395R*	MD6173D	MD6173D							

\*-2 Sets Required. ■ - Also available in MX-S race compound.

**SAFETY WARNING:** DO NOT USE HH PADS ON REAR UNLESS ALSO USED ON FRONT TO AVOID BRAKE IMBALANCE

# Non-JAPANESE Built Motorcycles



## ARCTIC CAT ATV



← REAR / ARRIÈRE / HINTEN  POSTERIOR / POSTERIORE →

		DISC PAD CHOICES			BRAKE ROTOR CHOICES		
		NEW SFAC Scooter Carbon Pads	Semi-Sintered V-Pads™	Sintered/HH Pads/ Grooved shoes	Contour Rotor Rear Fitment	NEW Vee-Rotors™ CONTOUR	NEW CX Extreme® ROTOR
550 HI EFI	09-10	FA395TT		FA395R	MD6173D		
500 4 x 4 Auto TRV Multirider	05-06/08	FA395TT		FA395R	MD6173D		
550 HI EFI LE	09-10	FA395TT		FA395R	MD6173D		
550 TRV	11	FA395TT		FA395R	MD6173D		
550 TRV Cruiser	11	FA395TT		FA395R	MD6173D		
550 TRV EFI	09-10	FA395TT		FA395R	MD6173D		
550 TRV Efi LE	09-10	FA395TT		FA395R	MD6173D		
550i	11-12	FA395TT		FA395R	MD6173D		
550i LTD	11-12	FA395TT		FA395R	MD6173D		
550i GT	11-12	FA395TT		FA395R	MD6173D		
550i GT TRV	11	FA395TT		FA395R	MD6173D		
550i TRV Cruiser	11	FA395TT		FA395R	MD6173D		
550 GT TRV	11-12	FA395TT		FA395R	MD6173D		
550 GT S TRV	10	FA395TT		FA395R	MD6173D		
550 S	10	FA395TT		FA395R	MD6173D		
550 S LTD	10	FA395TT		FA395R	MD6173D		
650 H1 4 x 4 Auto Utility	04	FA271TT		FA271R	MD6173D		
650 H1 4 x 4 Auto Utility	05/08	FA271TT		FA271R	MD6173D		
650 H1 4 x 4 Auto LE Utility	07	FA271TT		FA271R	MD6173D		
650 H1 4 x 4 SE Auto Utility	06	FA271TT		FA271R	MD6173D		
650 H1	10	FA395TT		FA395R	MD6173D		
650 Mudpro	10-11	FA395TT		FA395R	MD6173D		
650 H1 Mudpro	10	FA395TT		FA395R	MD6173D		
650 H1 TRV	09	FA395TT		FA395R	MD6173D		
650 HI TBX 4 x 4 Auto Utility	07	FA395TT		FA395R	MD6173D		
650 HI TRV 4 x 4 Auto Plus Multirider	07	FA395TT		FA395R	MD6173D		
650 HI TRV 4 x 4 Auto Plus LE Multirider	07	FA395TT		FA395R	MD6173D		
650 HI TRV 4 x 4 Auto	08	FA395TT		FA395R	MD6173D		
650 TBX	09	FA395TT		FA395R	MD6173D		
650 V2 4 x 4 Auto Utility	04-06	FA395TT		FA395R	MD6173D		
650 V2 4 x 4 Auto LE Utility	04-05	FA395TT		FA395R	MD6173D		
650 V2 4 x 4 Auto LE TS Utility	06	FA395TT		FA395R	MD6173D		
700 Diesel Utility	07-08	FA395TT		FA395R	MD6173D		
700i GT	11-12	FA395TT		FA395R	MD6173D		
700 TRV H2 EFI Cruiser	09-10	FA395TT		FA395R	MD6173D		
700 TRV	11-12	FA395TT		FA395R	MD6173D		
700 TRV Cruiser	11-12	FA395TT		FA395R	MD6173D		
700 TRV GT	11-12	FA395TT		FA395R	MD6173D		
700 EFI 4 x 4 Utility	07-08	FA395TT		FA395R	MD6173D		
700 EFI 4 x 4 LE Utility	06	FA395TT		FA395R	MD6173D		
700 EFI 4 x 4 SE Utility	06	FA395TT		FA395R	MD6173D		
700 EFI Cruiser	11	FA395TT		FA395R	MD6173D		
700 EFI 4 x 4 Auto M4	08	FA395TT		FA395R	MD6173D		
700 EFI 4 x 4 Auto TRV LE	08	FA395TT		FA395R	MD6173D		
700 H1 EFI	09-10	FA395TT		FA395R	MD6173D		
700 H1 EFI LE	09-10	FA395TT		FA395R	MD6173D		
700 H1 EFI 4 x 4 Auto SE	08-09	FA395TT		FA395R	MD6173D		
700 H1 TBX EFI	10	FA395TT		FA395R	MD6173D		
700 Super Duty Diesel	10-11	FA395TT		FA395R	MD6173D		
700 Mudpro	10-11	FA395TT		FA395R	MD6173D		
700 H1 EFI Mudpro	09-10	FA395TT		FA395R	MD6173D		
700i	11-12	FA395TT		FA395R	MD6173D		
700i LTD	11-12	FA395TT		FA395R	MD6173D		
700i Mudpro	11-12	FA395TT		FA395R	MD6173D		
700i Mudpro LTD	11	FA395TT		FA395R	MD6173D		
700 S	10	FA395TT		FA395R	MD6173D		
700 S LTD	10	FA395TT		FA395R	MD6173D		
700 TBX LTD	11	FA395TT		FA395R	MD6173D		
1000 GT	11-12	FA395TT		FA395R	MD6173D		
1000 Mudpro	10-11	FA395TT		FA395R	MD6173D		

\*-2 Sets Required. ■ - Also available in MX-S race compound.

**SAFETY WARNING:** DO NOT USE HH PADS ON REAR UNLESS ALSO USED ON FRONT TO AVOID BRAKE IMBALANCE

**BRAKE APPLICATIONS**

**R** Suffix = High Durability Sintered Pad. **HH** Suffix = High Performance Sintered Pad. **G** Suffix = Grooved Shoe.  
**D** Suffix = Drilled Disc. **C** Suffix = Contoured Disc. **LS** Suffix = Left/Steel Disc. **RS** = Right/Steel Disc.

# Non-JAPANESE Built Motorcycles



← FRONT / AVANT / VORN FRENTE / ANTERIORE →

**APPLICATIONS**

**R** Suffix = High Durability Sintered Pad. **HH** Suffix = High Performance Sintered Pad. **G** Suffix = Grooved Shoe.  
**D** Suffix = Drilled Disc. **C** Suffix = Contoured Disc. **LS** Suffix = Left/Steel Disc. **RS** = Right/Steel Disc.

## ARCTIC CAT ATV

Model	Year	Disc Part	DISC PAD CHOICES				BRAKE ROTOR CHOICES							
			NEW SFAC Scooter Carbon Pads	Semi-Sintered V-Pads™	Sintered/HH Pads/ Grooved shoes	Left/Gauche/Links	Right/Droite/Rechts	Contour Rotor Universal left and right fitment	NEW Vee-Rotors™ CONTOUR	NEW CX Extreme® ROTOR	Oversize 250/280mm Rotor Kit	Relocating Bracket for 250/280mm Rotor	Oversize 320mm Rotor Kit	Relocating Bracket for 320mm Rotor
1000 H2 Mudpro EFI	10	FA395TT*			FA395R*	MD6173D	MD6173D							
1000i Mudpro	12	FA395TT*			FA395R*	MD6173D	MD6173D							
1000 TRV Cruiser	11	FA395TT*			FA395R*	MD6173D	MD6173D							
1000 TRV H2 EFI Cruiser	09-10	FA395TT*			FA395R*	MD6173D	MD6173D							
Thundercat 1000 H2	08-10	FA395TT*			FA395R*	MD6173D	MD6173D							
Thundercat 1000 H2 LE	10	FA395TT*			FA395R*	MD6173D	MD6173D							
1000 TRV H2 Efi	10	FA395TT*			FA395R*	MD6173D	MD6173D							

## ARCTIC CAT (SIDE X SIDE)

550 Hi EFI Prowler	09	FA395TT*			FA395R*	MD6271D	MD6271D							
XT 550	10-11	FA395TT*			FA395R*	MD6271D	MD6271D							
XT 550 i Prowler	11-12	FA395TT*			FA395R*	MD6271D	MD6271D							
XT 650 H1 Prowler	06-09	FA395TT*			FA395R*	MD6271D	MD6271D							
650 H1 Prowler	07	FA395TT*			FA395R*	MD6271D	MD6271D							
650 Prowler 4 x 4 / M4	08	FA395TT*			FA395R*	MD6271D	MD6271D							
XTX 700 Hi LE Prowler	08	FA395TT*			FA395R*	MD6271D	MD6271D							
XTX 700 Hi EFI Prowler	09	FA395TT*			FA395R*	MD6271D	MD6271D							
XTX 700	10-11	FA395TT*			FA395R*	MD6271D	MD6271D							
XTX 700 i Prowler	11-12	FA395TT*			FA395R*	MD6271D	MD6271D							
HDX 700 Prowler	11	FA395TT*			FA395R*	MD6271D	MD6271D							
HDX 700 i Prowler	11	FA395TT*			FA395R*	MD6271D	MD6271D							
Wildcat 1000i H.O.	12	FA395TT*			FA395R*	MD6271D	MD6271D							
XTZ 1000 H2 Prowler	09	FA395TT*			FA395R*	MD6271D	MD6271D							
XTZ 1000	10-11	FA395TT*			FA395R*	MD6271D	MD6271D							
XTZ 1000 i	11-12	FA395TT*			FA395R*	MD6271D	MD6271D							

Note - Hand Brake Pads And Disc Not Available For Any Models In This Range Of Quads.

## BOMARDIER/BRP (See Can-Am Section for 2007 models)

DS 50 (2 stroke)	02-06	H346*			H346G*									
Quest 50	03-04	H346*			H346G*									
DS 90 (2 stroke/4 stroke)	02-06	H346*			H346G*									
DS 250	06	FA377TT*			FA377R*	MD6283D	MD6283D							
Quest 90 (2 stroke/4 stroke)	03-04	H346*			H346G*									
Rally 200 (7550/7551/7552/7553)	03-04	FA083TT*			FA083R*	MD6220D	MD6220D							
Rally 200	05-07	FA083TT*			FA083R*	MD6220D	MD6220D							
Outlander 330 HO	Left 04-05	FA307TT			FA307R	MD6222D								
	Right	FA317TT			FA317R		MD6222D							
Outlander 400 (7535/7716)	Left 03-04	FA307TT			FA307R	MD6222D								
	Right	FA317TT			FA317R		MD6222D							
Outlander 400 Max HO	Left 03-06	FA307TT			FA307R	MD6222D								
	Right	FA317TT			FA317R		MD6222D							
Outlander 650 HO Efi 4 x 4/HO Efi XT 4 x 4	Left 06	FA307TT			FA307R	MD6222D								
	Right	FA317TT			FA317R		MD6222D							
Outlander Max 650 HO Efi 4 x 4/HO Efi XT 4 x 4	Left 06	FA307TT			FA307R	MD6222D								
	Right	FA317TT			FA317R		MD6222D							
Outlander 800 (All models)	Left 06	FA307TT			FA307R	MD6222D								
	Right	FA317TT			FA317R		MD6222D							
Traxter (4 x 4) (Model types 7400-7408/7413-7422/7425-7428/7453/7456)	99-00	FA266*			FA266R*	MD6229D	MD6229D							
Traxter (4 x 4) (Model types 7459/7460)	Left 01	FA307TT			FA307R	MD6229D								
	Right	FA317TT			FA317R		MD6229D							
Traxter XL (4 x 4) Up to SN V000708 (Model type 7448)	01	FA266*		FA266V*	FA266R*	MD6229D	MD6229D							
Traxter XL (4 x 4) (Model types 7448 from SN V000709/7458														
7477/7489/7565/7571)	Left 01-04	FA307TT			FA307R	MD6229D								
	Right	FA317TT			FA317R		MD6229D							
Traxter XT (4 x 4) (Model types 7423/7424)	00	FA266*		FA266V*	FA266R*	MD6229D	MD6229D							
Traxter XT (4 x 4) (Model types 7446/7452/7467/7468														
7472/7481/7493/7494)	Left 01	FA307TT			FA307R	MD6229D								
	Right	FA317TT			FA317R		MD6229D							
Traxter Autoshift (Model types 7431/7432/7433/7434)	01	FA266*		FA266V*	FA266R*	MD6229D	MD6229D							

\*-2 Sets Required. ■ - Also available in MX-S race compound.  
**SAFETY WARNING:** DO NOT USE HH PADS ON REAR UNLESS ALSO USED ON FRONT TO AVOID BRAKE IMBALANCE

# Non-JAPANESE Built Motorcycles



← REAR / ARRIÈRE / HINTEN POSTERIOR / POSTERIORE →

## ARCTIC CAT ATV



		DISC PAD CHOICES				BRAKE ROTOR CHOICES			
		NEW SFAC Scooter Carbon Pads	Semi-Sintered V-Pads™	Sintered/HH Pads/ Grooved shoes	Disc Pad	Contour Rotor Rear Fitment	NEW Vee-Rotors™ CONTOUR	NEW CX Extreme® ROTOR	
1000 H2 Mudpro EFI	10	FA395TT		FA395R		MD6173D			
1000i Mudpro	12	FA395TT		FA395R		MD6173D			
1000 TRV Cruiser	11	FA395TT		FA395R		MD6173D			
1000 TRV H2 EFI Cruiser	09-10	FA395TT		FA395R		MD6173D			
Thundercat 1000 H2	08-10	FA395TT		FA395R		MD6173D			
Thundercat 1000 H2 LE	10	FA395TT		FA395R		MD6173D			
1000 TRV H2 Efi	10	FA395TT		FA395R		MD6173D			

## ARCTIC CAT (SIDE X SIDE)

550 Hi EFI Prowler	09	FA395TT		FA395R	N/A			
XT 550	10-11	FA395TT		FA395R	N/A			
XT 550 i Prowler	11-12	FA395TT		FA395R	N/A			
XT 650 Hi Prowler	06-09	FA395TT		FA395R	N/A			
650 Hi Prowler	07	FA395TT		FA395R	N/A			
650 Prowler 4 x 4 / M4	08	FA395TT		FA395R	N/A			
XTX 700 Hi LE Prowler	08	FA395TT		FA395R	N/A			
XTX 700 Hi EFI Prowler	09	FA395TT		FA395R	N/A			
XTX 700	10-11	FA395TT		FA395R	N/A			
XTX 700 i Prowler	11-12	FA395TT		FA395R	N/A			
HDX 700 Prowler	11	FA395TT*		FA395R*	MD6173D*			
HDX 700 i Prowler	11	FA395TT*		FA395R*	MD6173D*			
Wildcat 1000i H.O.	12	FA395TT*		FA395R*	MD6271D	MD6271D		
XTZ 1000 H2 Prowler	09	FA395TT*		FA395R*	MD6271D*			
XTZ 1000	10-11	FA395TT*		FA395R*	MD6271D*			
XTZ 1000 i	11-12	FA395TT*		FA395R*	MD6271D*			

## BOMARDIER/BRP

DS 50 (2 stroke)	02-06	H330		H330G				
Quest 50	03-04	H330		H330G				
DS 90 (2 stroke/4 stroke)	02-06	H330		H330G				
DS 250	06	FA377TT		FA377R	MD6282D			
Quest 90 (2 stroke/4 stroke)	03-04	H330		H330G				
Rally 200 (7550/7551/7552/7553)	03-04	N/A			MD6221D			
Rally 200	05-07	FA165/2TT		FA165/2R	MD6285D			
Outlander 330 HO	04-05	FA307TT		FA307R	MD6223D			
Outlander 400 (7535/7716)	03-04	FA307TT		FA307R	MD6223D			
Outlander 400 Max HO	03-06	FA307TT		FA307R	MD6223D			
Outlander 650 HO Efi 4 x 4/HO Efi XT 4 x 4	06	FA307TT		FA307R	MD6223D			
Outlander Max 650 HO Efi 4 x 4/HO Efi XT 4 x 4	06	FA307TT		FA307R	MD6223D			
Outlander 800 (All models)	06	FA307TT		FA307R	MD6223D			
Traxter (4 x 4) (Model types 7400-7408/7413-7422/7425-7428/7455/7456)	99-00	FA266		FA266R	MD6230D			
Traxter (4 x 4) (Model types 7459/7460)	01	FA307TT		FA307R	MD6230D			
Traxter XL (4 x 4) Up to SN V000708 (Model type 7448)	01	FA266		FA266R	MD6230D			
Traxter XL (4 x 4) (Model types 7448 from SN V000709/7458 /74717/489/7565/7571)	01-04	FA317TT	FA266V	FA317R	MD6230D			
Traxter XT (4 x 4) (Model types 7423/7424)	00	FA266	FA266V	FA266R	MD6230D			
Traxter XT (4 x 4) (Model types 7448/7452/7457/7468 /7472/7481/7493/7494)	01	FA317TT		FA317R	MD6230D			
Traxter Autoshift (Model types 7431/7432/7433/7434)	01	FA266	FA266V	FA266R	MD6230D			

\*-2 Sets Required. ■ - Also available in MX-S race compound.

**SAFETY WARNING:** DO NOT USE HH PADS ON REAR UNLESS ALSO USED ON FRONT TO AVOID BRAKE IMBALANCE

**R** Suffix = High Durability Sintered Pad. **HH** Suffix = High Performance Sintered Pad. **G** Suffix = Grooved Shoe.  
**D** Suffix = Drilled Disc. **C** Suffix = Contoured Disc. **LS** Suffix = Left/Steel Disc. **RS** = Right/Steel Disc.

**BRAKE APPLICATIONS**



# Non-JAPANESE Built Motorcycles



← FRONT / AVANT / VORN FRENTE / ANTERIORE →

## DISC PAD CHOICES

## BRAKE ROTOR CHOICES

Model	Year	Side	DISC PAD CHOICES			BRAKE ROTOR CHOICES												
			NEW SFAC Scooter Carbon Pads	Semi-Sintered V-Pads™	Sintered/HH Pads/ Grooved shoes	Left/Gauche/Links	Right/Droite/Rechts	Contour Rotor Universal left and right fitment	NEW Vee-Rotors™ CONTOUR	NEW CX Extreme® ROTOR	Oversize 250/280mm Rotor Kit	Relocating Bracket for 250/280mm Rotor	Oversize 320mm Rotor Kit	Relocating Bracket for 320mm Rotor				
<b>BOMBARDIER/BRP</b>																		
Traxter Autoshift (Model types 7453/7454/7461/7462/7469/7470/7471/7475/7480/7495/7496/7497/7560/7561/7562/7563/7564/7566/7567/7568/7569/7570/7595/7596/7597/7598/7599)		Left	01-05	FA307TT		FA307R	MD6225D											
		Right		FA317TT		FA317R		MD6225D										
Traxter Footshift (Model types 7439/7440/7441/7442)			01	FA266*	FA266V*	FA266R*	MD6229D	MD6229D										
Traxter Footshift (Model types 7473/7474)		Left	01	FA307TT		FA307R	MD6229D											
		Right		FA317TT		FA317R		MD6229D										
Quest 500 (4 x 4) (Model types 7478/7515/7525/7539/7540/7546/7547/7583/7584/7713/7724/7725/7731)		Left	02-04	FA307TT		FA307R	MD6224D											
		Right		FA317TT		FA317R		MD6224D										
Traxter Max		Left	03-05	FA307TT		FA307R	MD6245D											
		Right		FA317TT		FA317R		MD6245D										
Quest 500 (2 x 4) (Model types 7541/7542/7548/7549/7585/7586/7714/7728)		Left	02	FA307TT		FA307R	MD6224D											
		Right		FA317TT		FA317R		MD6224D										
Quest 650 (2 x 4) (Model type 7582)		Left	02	FA307TT		FA307R	MD6224D											
		Right		FA317TT				MD6224D										
Quest 650 (4 x 4) (Model types 7443/7445/7516/7517/7523/7536/7537/7543/7544/7580/7581/7730)		Left	02-04	FA307TT		FA307R	MD6224D											
		Right		FA317TT		FA317R		MD6224D										
Quest 650 XT (4 x 4) (Model types 7522/7523/7534/7545/7715/7727/7728)		Left	02	FA307TT		FA307R	MD6224D											
		Right		FA317TT		FA317R		MD6224D										
Quest Max 650		Left	03-	FA307TT		FA307R	MD6224D											
		Right		FA317TT		FA317R		MD6224D										
DS 650 (Model types 7404/7409/7463/7482/7518/7519/7587/7588-7483)		Left	00-05	FA307TT		FA307R	MD6171D											
		Right		FA317TT		FA317R		MD6171D										
DS 650 Baja/X		Left	01-06	FA307TT		FA307R	MD6171D											
		Right		FA317TT		FA317R		MD6171D										
Traxter Max 650		Left	04-05	FA307TT		FA307R	MD6245D											
		Right		FA317TT		FA317R		MD6245D										
Sarasota 1000 Side x Side			05	N/A														
Traxter XL (7920/7921)		Left	04	FA307TT		FA307R	MD6245D											
		Right		FA317TT		FA317R		MD6245D										
Quest Max/STD/XT		Left	04-05	FA307TT		FA307R	MD6245D											
		Right		FA317TT		FA317R		MD6245D										
<b>CAN AM 4 WHEELER</b>																		
DS 70 (2 x 4 / 4T) Mini			08-12	H346*		H346G*												
DS 90 (2 x 4 / 4T)			07-12	H346*		H346G*												
DS 90 X (2 x 4 / 4T)			08-12	FA083TT*		FA083R*	MD6335D	MD6335D										
Rally 200 (4A7A/B/C/D/E/F)			07	FA083TT*		FA083R*	MD6220D	MD6220D										
DS 250 (3J7A/B/C)			07-12	FA377TT*		FA377R*	MD6283D	MD6283D										
Outlander 400 (4 x 4 STD) (2D7A/B/C/D/E/F/G/H)		Left	07-09	FA307TT		FA307R	MD6222D											
		Right		FA317TT		FA317R		MD6222D										
Outlander 400 (XT 4 x 4) (2E7A/B/C/D/E/F)		Left	07-09	FA307TT		FA307R	MD6222D											
		Right		FA317TT		FA317R		MD6222D										
Outlander 400 EFI		Left	09-13	FA307TT		FA307R	MD6222D											
		Right		FA317TT		FA317R		MD6222D										
Outlander Max 400 (STD 4 x 4) (2F7B/C/D/E/F/G/H/J)		Left	07-13	FA307TT		FA307R	MD6222D											
		Right		FA317TT		FA317R		MD6222D										
Outlander Max 400 (XT 4 x 4) (2G7A/B/C/D/E)		Left	07-13	FA307TT		FA307R	MD6222D											
		Right		FA317TT		FA317R		MD6222D										
DS 450 (2 x 4/EF)			08-12			FA468R*			MD6322C*									
DS 450 X (2 x 4/EF)			08-09			FA468R*			MD6322C*									
DS 450 Xxc/Xxm			09-12			FA468R*			MD6322C*									
Outlander 500 (STD 4 x 4) (2T7A/B/C/D)		Left	07-12	FA307TT		FA307R	MD6222D											
		Right		FA317TT		FA317R		MD6222D										

\*-2 Sets Required. ■ - Also available in MX-S race compound.

**SAFETY WARNING-** DO NOT USE HH PADS ON REAR UNLESS ALSO USED ON FRONT TO AVOID BRAKE IMBALANCE

APPLICATIONS  
BRAKE

R Suffix = High Durability Sintered Pad. HH Suffix = High Performance Sintered Pad. G Suffix = Grooved Shoe.  
D Suffix = Drilled Disc. C Suffix = Contoured Disc. LS Suffix = Left/Steel Disc. RS = Right/Steel Disc.

# Non-JAPANESE Built Motorcycles

**BRAKE APPLICATIONS**

**R** Suffix = High Durability Sintered Pad. **HH** Suffix = High Performance Sintered Pad. **G** Suffix = Grooved Shoe.  
**D** Suffix = Drilled Disc. **C** Suffix = Contoured Disc. **LS** Suffix = Left/Steel Disc. **RS** = Right/Steel Disc.



## BOMBARDIER/BRP



← REAR / ARRIÈRE / HINTEN POSTERIOR / POSTERIORE →

			DISC PAD CHOICES			BRAKE ROTOR CHOICES		
			NEW SFAC Scooter Carbon Pads	Semi-Sintered V-Pads™	Sintered/HH Pads/ Grooved shoes	Contour Rotor Rear Fitment	NEW Vee-Rotors™ CONTOUR	NEW CX Extreme® ROTOR
Traxler Autoshift (Model types 7453/7454/7461/7462/7469/7470/7471/7475/7480/7495/7496/7497/7560/7561/7562/7563/7564/7566/7567/7568/7569/7570/7595/7596/7597/7598/7599)	01-05	FA317TT			FA317R	MD6224D		
Traxler Footshift (Model types 7439/7440/7441/7442)	01	FA266		FA266V	FA266R	MD6230D		
Traxler Footshift (Model types 7473/7474)	01	FA317TT			FA317R	MD6230D		
Quest 500 (4 x 4) (Model types 7478/7515/7525/7539/7540/7546/7547/7583/7584/7713/7724/7725/7731)	02-04	FA317TT			FA317R	MD6225D		
Traxler Max	03-05	FA317TT			FA317R	MD6225D		
Quest 500 (2 x 4) (Model types 7541/7542/7548/7549/7585/7586/7714/7726)	02	FA317TT			FA317R	MD6225D		
Quest 650 (2 x 4) (Model type 7582)	02	FA317TT			FA317R	MD6225D		
Quest 650 (4 x 4) (Model types 7443/7445/7516/7517/7523/7536/7537/7543/7544/7580/7581/7730)	02-04	FA317TT			FA317R	MD6225D		
Quest 650 XT (4 x 4) (Model types 7522/7523/7534/7545/7715/7727/7728)	02	FA317TT			FA317R	MD6225D		
Quest Max 650	03-	FA317TT			FA317R	MD6225D		
DS 650 (Model types 7404/7409/7463/7482/7518/7519/7587/7588-7483)	00-05	FA307TT			FA307R	MD6172D		
DS 650 BajaX	01-06	FA307TT			FA307R	MD6172D		
Traxler Max 650	04-05	FA317TT			FA317R	MD6225D		
Sarasota 1000 Side x Side	05	N/A						
Traxler XL (7920/7921)	04	FA317TT			FA317R	MD6225D		
Quest Max/STD/XT	04-05	FA317TT			FA317R	MD6225D		
<b>CAN AM 4 WHEELER</b>								
DS 70 (2 x 4 / 4T) Mini	08-12	H307			H307G			
DS 90 (2 x 4 / 4T)	07-12	H307			H307G			
DS 90 X (2 x 4 / 4T)	08-12	FA083TT			FA083R	MD6334D		
Rally 200 (4A7A/B/C/D/E/F)	07	FA307TT			FA307R	MD6285D		
DS 250 (3J7A/B/C)	07-12	FA377TT			FA377R	MD6282D		
Outlander 400 (4 x 4 STD) (2D7A/B/C/D/E/F/G/H)	07-09	FA307TT			FA307R	MD6223D		
Outlander 400 (XT 4 x 4) (2E7A/B/C/D/E/F)	07-09	FA307TT			FA307R	MD6223D		
Outlander 400 EFI	09-13	FA307TT			FA307R	MD6223D		
Outlander Max 400 (STD 4 x 4) (2F7B/C/D/E/F/G/H/J)	07-13	FA307TT			FA307R	MD6223D		
Outlander Max 400 (XT 4 x 4) (2G7A/B/C/D/E)	07-13	FA307TT			FA307R	MD6223D		
DS 450 (2 x 4/EFI)	08-12				FA398R	MD6321C		
DS 450 X (2 x 4/EFI)	08-09				FA398R	MD6321C		
DS 450 Xxc/Xxm	09-12				FA398R	MD6321C		
Outlander 500 (STD 4 x 4) (2T7A/B/C/D)	07-12	FA307TT			FA307R	MD6223D		

\*-2 Sets Required. ■ - Also available in MX-S race compound.

**SAFETY WARNING:** DO NOT USE HH PADS ON REAR UNLESS ALSO USED ON FRONT TO AVOID BRAKE IMBALANCE

# Non-JAPANESE Built Motorcycles



← FRONT / AVANT / VORN FRENTE / ANTERIORE →

## CAN AM 4 WHEELER

### DISC PAD CHOICES

### BRAKE ROTOR CHOICES

Model	Side	Year	DISC PAD CHOICES			BRAKE ROTOR CHOICES									
			NEW SFAC Scooter Carbon Pads	Semi-Sintered V-Pads™	Sintered/HH Pads/ Grooved shoes	Left/Gauche/Links	Right/Droite/Rechts	Contour Rotor Universal left and right fitment	NEW Vee-Rotors™ CONTOUR	NEW CX Extreme® ROTOR	Oversize 250/280mm Rotor Kit	Relocating Bracket for 250/280mm Rotor	Oversize 320mm Rotor Kit	Relocating Bracket for 320mm Rotor	
Outlander 500 (XT 4 x 4) (2U7A/B/C/D)	Left	07-12	FA307TT		FA307R	MD6222D									
	Right		FA317TT		FA317R		MD6222D								
Outlander Max 500 (STD 4 x 4) (2N7A/B/C)	Left	07-12	FA307TT		FA307R	MD6222D									
	Right		FA317TT		FA317R		MD6222D								
Outlander Max 500 (XT 4 x 4) (2K7A/B/C)	Left	07-12	FA307TT		FA307R	MD6222D									
	Right		FA317TT		FA317R		MD6222D								
Outlander 500 4 x 4 (STD/DPS/XT)	Left	13	FA618TT		FA618R	MD6370D									
	Right		FA617TT		FA617R		MD6370D								
Outlander Max 500 4 x 4 (STD/DPS/XT)	Left	13	FA618TT		FA618R	MD6370D									
	Right		FA617TT		FA617R		MD6370D								
Renegade 500 (4 x 4/EFI)	Left	07-12	FA307TT		FA307R	MD6223D									
	Right		FA317TT		FA317R		MD6223D								
Renegade 500 (STD)	Left	12-13	FA618TT		FA618R	MD6370D									
	Right		FA617TT		FA617R		MD6370D								
DS 650 X (3B7A/B)	Left	07	FA307TT		FA307R	MD6171D									
	Right		FA317TT		FA317R		MD6171D								
Outlander 650 (4 x 4 STD) (2N7A/B/C/D/E/F/G/H)	Left	07-12	FA307TT		FA307R	MD6222D									
	Right		FA317TT		FA317R		MD6222D								
Outlander 650 (XT 4 x 4) (2P7A/B/C/D/E/F)	Left	07-12	FA307TT		FA307R	MD6222D									
	Right		FA317TT		FA317R		MD6222D								
Outlander 650 4 x 4 (STD/DPS/XT)	Left	13	FA618TT		FA618R	MD6370D									
	Right		FA617TT		FA617R		MD6370D								
Outlander Max 650 (STD 4 x 4) (2R7A/B/C/D/E/F/G/H/J/K)	Left	07-12	FA307TT		FA307R	MD6222D									
	Right		FA317TT		FA317R		MD6222D								
Outlander Max 650 (XT 4 x 4) (2S7A/B/C/D/E/F)	Left	07-12	FA307TT		FA307R	MD6222D									
	Right		FA317TT		FA317R		MD6222D								
Outlander Max 650 X-TP	Left	12	FA307TT		FA307R	MD6222D									
	Right		FA317TT		FA317R		MD6222D								
Outlander 800 (STD 4 x 4) (2H7A/B/C/D/E/F/G/H)	Left	07-08	FA307TT		FA307R	MD6222D									
	Right		FA317TT		FA317R		MD6222D								
Outlander 800 (XT 4 x 4) (2J7A/B/C/D/E/F)	Left	07-08	FA307TT		FA307R	MD6222D									
	Right		FA317TT		FA317R		MD6222D								
Outlander 800 R EFI	Left	09	FA307TT		FA307R	MD6222D									
	Right		FA317TT		FA317R		MD6222D								
Outlander 800 R XT	Left	09-10	FA307TT		FA307R	MD6222D									
	Right		FA317TT		FA317R		MD6222D								
Outlander 800 R STD	Left	12	FA618TT		FA618R	MD6370D									
	Right		FA617TT		FA617R		MD6370D								
Outlander 800 R 4 x 4 (STD/DPS/XT/XT-P)	Left	13	FA618TT		FA618R	MD6370D									
	Right		FA617TT		FA617R		MD6370D								
Outlander Max 800 R EFI	Left	09-12	FA307TT		FA307R	MD6222D									
	Right		FA317TT		FA317R		MD6222D								
Outlander Max 800 R XT	Left	09-12	FA307TT		FA307R	MD6222D									
	Right		FA317TT		FA317R		MD6222D								
Outlander 800 R XT	Left	12-13	FA618TT		FA618R	MD6370D									
	Right		FA617TT		FA617R		MD6370D								
Outlander Max 800 (Ltd 4 x 4)	Left	07-12	FA307TT		FA307R	MD6222D									
	Right		FA317TT		FA317R		MD6222D								
Outlander Max 800 (STD 4 x 4) (2K7A/B/C/D/E/F/G/H/J)	Left	07-12	FA307TT		FA307R	MD6222D									
	Right		FA317TT		FA317R		MD6222D								
Outlander Max 800 (XT 4 x 4) (2L7A/B/C/D/E/F)	Left	07-08	FA307TT		FA307R	MD6222D									
	Right		FA317TT		FA317R		MD6222D								
Outlander 800 R Xmr	Left	11-12	FA307TT		FA307R	MD6222D									
	Right		FA317TT		FA317R		MD6222D								
Outlander 800 R Xsc	Left	11	FA307TT		FA307R	MD6222D									
	Right		FA317TT		FA317R		MD6222D								
Outlander Max 800 R X-TP	Left	12	FA307TT		FA307R	MD6222D									
	Right		FA317TT		FA317R		MD6222D								
Renegade 800 X (4 x 4/EFI)	Left	08	FA307TT		FA307R	MD6223D									
	Right		FA317TT		FA317R		MD6223D								

\*-2 Sets Required. ■ - Also available in MX-S race compound.

**SAFETY WARNING:** DO NOT USE HH PADS ON REAR UNLESS ALSO USED ON FRONT TO AVOID BRAKE IMBALANCE

APPLICATIONS  
BRAKE

R Suffix = High Durability Sintered Pad. HH Suffix = High Performance Sintered Pad. G Suffix = Grooved Shoe.

D Suffix = Drilled Disc. C Suffix = Contoured Disc. LS Suffix = Left/Steel Disc. RS = Right/Steel Disc.

# Non-JAPANESE Built Motorcycles



## CAN AM 4 WHEELER



← REAR / ARRIÈRE / HINTEN POSTERIOR / POSTERIORE →

			DISC PAD CHOICES			BRAKE ROTOR CHOICES				
			NEW SFAC Scooter Carbon Pads	Semi-Sintered V-Pads™	Sintered/HH Pads/Grooved shoes	Contour Rotor Rear Fitment	NEW Vee-Rotors™ CONTOUR	NEW CX Extreme® ROTOR		
Outlander 500 (XT 4 x 4) (2U7A/B/C/D)	07-12		FA307TT		FA307R	MD6223D				
Outlander Max 500 (STD 4 x 4) (2W7A/B/C)	07-12		FA307TT		FA307R	MD6223D				
Outlander Max 500 (XT 4 x 4) (2X7A/B/C)	07-12		FA307TT		FA307R	MD6223D				
Outlander 500 4 x 4 (STD/DPS/XT)		Left								
		Right	FA617TT		FA617R	MD6370D				
Outlander Max 500 4 x 4 (STD/DPS/XT)		Left								
		Right	FA617TT		FA617R	MD6370D				
Renegade 500 (4 x 4/EFI)	07-12		FA307TT		FA307R	MD6223D				
Renegade 500 (STD)		Left								
		Right	FA617TT		FA617R	MD6370D				
DS 660 X (3B7A/B)	07		FA307TT		FA307R	MD6172D				
Outlander 650 (4 x 4 STD) (2N7A/B/C/D/E/F/G/H)	07-12		FA307TT		FA307R	MD6223D				
Outlander 650 (XT 4 x 4) (2P7A/B/C/D/E/F)	07-12		FA307TT		FA307R	MD6223D				
Outlander 650 4 x 4 (STD/DPS/XT)		Left								
		Right	FA617TT		FA617R	MD6370D				
Outlander Max 650 (STD 4 x 4) (2R7A/B/C/D/E/F/G/H/J/K)	07-12		FA307TT		FA307R	MD6223D				
Outlander Max 650 (XT 4 x 4) (2S7A/B/C/D/E/F)	07-12		FA307TT		FA307R	MD6223D				
Outlander Max 650 X-TP	12		FA307TT		FA317R	MD6223D				
Outlander 800 (STD 4 x 4) (2H7A/B/C/D/E/F/G/H)	07-08		FA307TT		FA307R	MD6223D				
Outlander 800 (XT 4 x 4) (2J7A/B/C/D/E/F)	07-08		FA307TT		FA307R	MD6223D				
Outlander 800 R EFI	09		FA307TT		FA307R	MD6223D				
Outlander 800 R XT	09-10		FA307TT		FA307R	MD6223D				
Outlander 800 R STD		Left				MD6370D				
		Right	FA617TT		FA617R	MD6370D				
Outlander 800 R 4 x 4 (STD/DPS/XT/XT-P)		Left				MD6370D				
		Right	FA617TT		FA617R	MD6370D				
Outlander Max 800 R EFI	09-12		FA307TT		FA307R	MD6223D				
Outlander Max 800 R XT	09-12		FA307TT		FA307R	MD6223D				
Outlander 800 R XT		Left								
		Right	FA617TT		FA617R	MD6370D				
Outlander Max 800 (Lid 4 x 4)	07-12		FA307TT		FA307R	MD6223D				
Outlander Max 800 (STD 4 x 4) (2K7A/B/C/D/E/F/G/H/J)	07-12		FA307TT		FA307R	MD6223D				
Outlander Max 800 (XT 4 x 4) (2L7A/B/C/D/E/F)	07-08		FA307TT		FA307R	MD6223D				
Outlander 800 R Xmr	11-12		FA307TT		FA307R	MD6223D				
Outlander 800 R Xxc	11		FA307TT		FA307R	MD6223D				
Outlander Max 800 R X-TP	12		FA307TT		FA317R	MD6223D				
Renegade 800 X (4 x 4/EFI)	08		FA307TT		FA307R	MD6223D				

\*-2 Sets Required. ■ - Also available in MX-S race compound.

**SAFETY WARNING:** DO NOT USE HH PADS ON REAR UNLESS ALSO USED ON FRONT TO AVOID BRAKE IMBALANCE

**BRAKE APPLICATIONS**

**R** Suffix = High Durability Sintered Pad. **HH** Suffix = High Performance Sintered Pad. **G** Suffix = Grooved Shoe.  
**D** Suffix = Drilled Disc. **C** Suffix = Contoured Disc. **LS** Suffix = Left/Steel Disc. **RS** = Right/Steel Disc.

# Non-JAPANESE Built Motorcycles



← FRONT / AVANT / VORN FRENTE / ANTERIORE →

## APPLICATIONS BRAKE

### CAN AM 4 WHEELER

Model	Side	Year	DISC PAD CHOICES				BRAKE ROTOR CHOICES							
			NEW SFAC Scooter Carbon Pads	Semi-Sintered V-Pads™	Sintered/HH Pads/ Grooved shoes	Left/Gauche/Links	Right/Droite/Rechts	Contour Rotor Universal left and right fitment	NEW Vee-Rotors™ CONTOUR	NEW CX Extreme® ROTOR	Oversize 250/280mm Rotor Kit	Relocating Bracket for 250/280mm Rotor	Oversize 320mm Rotor Kit	Relocating Bracket for 320mm Rotor
Renegade 800 (4 x 4 EFI)	Left	07-08	FA307TT		FA307R	MD6223D								
	Right		FA317TT		FA317R		MD6223D							
Renegade 800 R EFI	Left	09-11	FA307TT		FA307R	MD6222D								
	Right		FA317TT		FA317R		MD6222D							
Renegade 800 R STD	Left	12-13	FA618TT		FA618R	MD6370D								
	Right		FA617TT		FA617R		MD6370D							
Renegade 800 R X	Left	09-10	FA307TT		FA307R	MD6222D								
	Right		FA317TT		FA317R		MD6222D							
Renegade 800 R Xxc	Left	11	FA307TT		FA307R	MD6222D								
	Right		FA317TT		FA317R		MD6222D							
Renegade 800 R Xxc	Left	12-13	FA618TT		FA618R	MD6370D								
	Right		FA617TT		FA617R		MD6370D							
Outlander 1000 STD	Left	12	FA618TT		FA618R	MD6370D								
	Right		FA617TT		FA617R		MD6370D							
Outlander 1000 4 x 4 (DPS/XT/XT-P)	Left	13	FA618TT		FA618R	MD6370D								
	Right		FA617TT		FA617R		MD6370D							
Outlander 1000 4 x 4 (LTD)	Left	13	FA618TT		FA618R	MD6370D								
	Right		FA617TT		FA617R		MD6370D							
Outlander 1000 4 x 4 (XMR)	Left	13	FA618TT		FA618R	MD6370D								
	Right		FA617TT		FA617R		MD6370D							
Outlander 1000 XT	Left	12	FA618TT		FA618R	MD6370D								
	Right		FA617TT		FA617R		MD6370D							
Outlander Max 1000 4 x 4 (DPS/XT/XT-P)	Left	13	FA618TT		FA618R	MD6370D								
	Right		FA617TT		FA617R		MD6370D							
Renegade 1000 STD	Left	12-13	FA618TT		FA618R	MD6370D								
	Right		FA617TT		FA617R		MD6370D							
Renegade 1000 Xxc	Left	12-13	FA618TT		FA618R	MD6370D								
	Right		FA617TT		FA617R		MD6370D							

### CAN AM SIDE X SIDE

Commander 800 R (STD)	Left	11-13	FA165TT		FA165R	MD6366D								
	Right		FA135TT		FA135R		MD6366D							
Commander 800 (R XT)	Left	11-13	FA165TT		FA165R	MD6366D								
	Right		FA135TT		FA135R		MD6366D							
Commander 800 (XT/DPS)	Left	11-13	FA165TT		FA165R	MD6366D								
	Right		FA135TT		FA135R		MD6366D							
Commander 1000	Left	11-13	FA165TT		FA165R	MD6366D								
	Right		FA135TT		FA135R		MD6366D							
Commander 1000 (DPS)	Left	12	FA165TT		FA165R	MD6366D								
	Right		FA135TT		FA135R		MD6366D							
Commander 1000 (LTD)	Left	12-13	FA165TT		FA165R	MD6366D								
	Right		FA135TT		FA135R		MD6366D							
Commander 1000 X	Left	11-13	FA165TT		FA165R	MD6366D								
	Right		FA135TT		FA135R		MD6366D							
Commander 1000 XT	Left	11-13	FA165TT		FA165R	MD6366D								
	Right		FA135TT		FA135R		MD6366D							

### CANNONDALE

FX 400	Left	01	FA307TT		FA307R	N/A								
	Right		FA317TT		FA317R		N/A							
Cannibal 440	Left	02-03	FA307TT		FA307R	N/A								
	Right		FA317TT		FA317R		N/A							
Speed/Glamis 440	Left	02-03	FA307TT		FA307R	N/A								
	Right		FA317TT		FA317R		N/A							
Blaze 440	Left	02-03	FA307TT		FA307R	N/A								
	Right		FA317TT		FA317R		N/A							
Moto 440	Left	02-03	FA307TT		FA307R	N/A								
	Right		FA317TT		FA317R		N/A							

\*-2 Sets Required. ■ - Also available in MX-S race compound.

**SAFETY WARNING:** DO NOT USE HH PADS ON REAR UNLESS ALSO USED ON FRONT TO AVOID BRAKE IMBALANCE

R Suffix = High Durability Sintered Pad. HH Suffix = High Performance Sintered Pad. G Suffix = Grooved Shoe.  
 D Suffix = Drilled Disc. C Suffix = Contoured Disc. LS Suffix = Left/Steel Disc. RS = Right/Steel Disc.



# Non-JAPANESE Built Motorcycles

**BRAKE APPLICATIONS**



## CAN AM 4 WHEELER



← REAR / ARRIÈRE / HINTEN POSTERIOR / POSTERIORE →

			DISC PAD CHOICES			BRAKE ROTOR CHOICES		
			NEW SFAC Scooter Carbon Pads	Semi-Sintered V-Pads™	Sintered/HH Pads/ Grooved shoes	Contour Rotor Rear Fitment	NEW Vee-Rotors™ CONTOUR	NEW CX Extreme® ROTOR
Renegade 800 (4 x 4(EFI))	07-08		FA307TT		FA307R	MD6223D		
Renegade 800 R EFI	09-11		FA307TT		FA307R	MD6223D		
Renegade 800 R STD	Left 12-13							
	Right		FA617TT		FA617R	MD6370D		
Renegade 800 R X	09-10		FA307TT		FA307R	MD6223D		
Renegade 800 R Xxc	11		FA307TT		FA307R	MD6223D		
Renegade 800 R Xxc	Left 12-13		FA618TT		FA618R	MD6370D		
	Right		FA617TT		FA617R	MD6370D		
Outlander 1000 STD	Left 12		FA618TT		FA618R	MD6370D		
	Right		FA617TT		FA617R	MD6370D		
Outlander 1000 4 x 4 (DPS/XT/XT-P)	Left 13							
	Right		FA617TT		FA617R	MD6370D		
Outlander 1000 4 x 4 (LTD)	Left 13							
	Right		FA617TT		FA617R	MD6370D		
Outlander 1000 4 x 4 (XMR)	Left 13							
	Right		FA617TT		FA617R	MD6370D		
Outlander 1000 XT	Left 12		FA618TT		FA618R	MD6370D		
	Right		FA617TT		FA617R	MD6370D		
Outlander Max 1000 4 x 4 (DPS/XT/XT-P)	Left 13							
	Right		FA617TT		FA617R	MD6370D		
Renegade 1000 STD	Left 12-13		FA618TT		FA618R	MD6370D		
	Right		FA617TT		FA617R	MD6370D		
Renegade 1000 Xxc	Left 12-13		FA618TT		FA618R	MD6370D		
	Right		FA617TT		FA617R	MD6370D		
<b>CAN AM SIDE X SIDE</b>								
Commander 800 R (STD)	11-13		FA135TT		FA135R	MD6366D		
Commander 800 (R XT)	11-13		FA135TT		FA135R	MD6366D		
Commander 800 (XT/DPS)	11-13		FA135TT		FA135R	MD6366D		
Commander 1000	11-13		FA135TT		FA135R	MD6366D		
Commander 1000 (DPS)	12		FA135TT		FA135R	MD6366D		
Commander 1000 (LTD)	12-13		FA135TT		FA135R	MD6366D		
Commander 1000 X	11-13		FA135TT		FA135R	MD6366D		
Commander 1000 XT	11-13		FA135TT		FA135R	MD6366D		
<b>CANNONDALE</b>								
FX 400	01		FA307TT		FA307R	N/A		
Cannibal 440	02-03		FA307TT		FA307R	N/A		
Speed/Glamis 440	02-03		FA307TT		FA307R	N/A		
Blaze 440	02-03		FA307TT		FA307R	N/A		
Moto 440	02-03		FA307TT		FA307R	N/A		

**R** Suffix = High Durability Sintered Pad. **HH** Suffix = High Performance Sintered Pad. **G** Suffix = Grooved Shoe.  
**D** Suffix = Drilled Disc. **C** Suffix = Contoured Disc. **LS** Suffix = Left/Steel Disc. **RS** = Right/Steel Disc.

\*-2 Sets Required. ■ - Also available in MX-S race compound.  
**SAFETY WARNING:- DO NOT USE HH PADS ON REAR UNLESS ALSO USED ON FRONT TO AVOID BRAKE IMBALANCE**

# Non-JAPANESE Built Motorcycles



## JOHN DEERE (ATV & SIDE X SIDE)



← FRONT / AVANT / VORN FRENTE / ANTERIORE →

			DISC PAD CHOICES				BRAKE ROTOR CHOICES							
			NEW SFAC Scooter Carbon Pads	Semi-Sintered V-Pads™	Sintered/HH Pads/ Grooved shoes	Left/Gauche/Links	Right/Droite/Rechts	Contour Rotor Universal left and right fitment	NEW Vee-Rotors™ CONTOUR	NEW CX Extreme® ROTOR	Oversize 250/280mm Rotor Kit	Relocating Bracket for 250/280mm Rotor	Oversize 320mm Rotor Kit	Relocating Bracket for 320mm Rotor
Trail Buck 500/650 EX/EXT	Left	04-05	FA307TT		FA307R	MD6245D								
	Right		FA317TT		FA317R		MD6245D							
Buck 500/650 EX/EXT	Left	04-08	FA307TT		FA307R	MD6245D								
	Right		FA317TT		FA317R		MD6245D							
TX Gator Utility 9461		04-05			FA398R*	N/A	N/A							
TX Turf Gator 9462		04-05			FA398R*	N/A	N/A							
4PX Gator 4 x 2 / 4 x 4 Trail 9345		04-05			FA398R*	N/A	N/A							
HPX Gator 4 x 2 / 4 x 4 9446		04-08			FA398R*	N/A	N/A							
HPX 4 x 2 (Petrol) Gator		10-11			FA398R*	N/A	N/A							
HPX 4 x 4 / 4 x 4 Trail (Petrol) - Gator		10-11			FA398R*	N/A	N/A							
HPX 4 x 4 (Diesel) - Gator - (SN040000)		10			FA398R*	N/A	N/A							
HPX 4 x 4 (Diesel) - Gator - (SN040001 - 090000 / SN090001 -)		10-11			FA609R*	N/A	N/A							
XUV 620 i (Petrol) - Gator		10			FA609R*	N/A	N/A							
XUV 625 i (Petrol) - Gator		11			FA610R*	N/A	N/A							
XUV 825 i (Petrol) - Gator		11			FA610R*	N/A	N/A							
XUV 850 D (Diesel) - Gator		10			FA609R*	N/A	N/A							
XUV 855 D (Diesel) - Gator		11			FA610R*	N/A	N/A							
<b>POLARIS</b>														
50 Outlaw		08-12	H338*		H338G*									
50 Predator (2 stroke)		04-06	H338*		H338G*									
Scrambler (3 Wheeler)		85-86	Y503		Y503G									
50 Scrambler		01-03	H338*		H338G*									
90 Outlaw		07-12	H338*		H338G*									
90 Predator		03-06	H338*		H338G*									
90 Scrambler X		01-03	H338*		H338G*									
90 Sportsman		01-12	H338*		H338G*									
200 Phoenix (Rear drum model)		05	FA083TT*		FA083R*	MD6219D	MD6219D							
200 Phoenix (Rear drum model)		06-12	FA083TT*		FA083R*	MD6274D	MD6274D							
200 Phoenix (Rear disc model)		05-08	FA083TT*		FA083R*	MD6274D	MD6274D							
200 Sawtooth		06-07	FA083TT*		FA083R*	MD6274D	MD6274D							
200 Sawtooth Quad Rear disc model		06	FA083TT*		FA083R*	MD6274D	MD6274D							
250 2 x 4 / 4 x 4		90	FA159TT*		FA159R*	MD6149D	MD6149D							
250 2 x 4 / 4 x 4		93	FA159TT*		FA159R*	MD6150D	MD6150D							
250 Cyclone X		87	Y503*		Y503G*									
250 Big Boss 4 x 6		89-90	FA159TT*		FA159R*	MD6147D	MD6147D							
250 Big Boss 4 x 6 Middle Axle Brake		89-90	FA159TT*		FA159R*	MD6149D	MD6149D							
250 Big Boss 4 x 6		91-92	FA159TT*		FA159R*	MD6150D	MD6150D							
250 Big Boss 4 x 6 Middle Axle Brake		91-92	FA159TT*		FA159R*	MD6149D	MD6149D							
250 Big Boss 6 x 6		91	FA159TT*		FA159R*	MD6149D	MD6149D							
250 Big Boss 6 x 6 Middle Axle Brake		91	FA159TT		FA159R	MD6149D	MD6149D							
250 Big Boss 6 x 6		92-93	FA159TT*		FA159R*	MD6150D	MD6150D							
250 Big Boss 6 x 6 Middle Axle Brake		92-93	FA159TT*		FA159R*	MD6149D	MD6149D							
250 Trail Blazer		90	FA159TT*		FA159R*	MD6147D	MD6147D							
250 Trail Blazer		91-93	FA159TT*		FA159R*	MD6150D	MD6150D							
250 Trail Blazer		94-98	FA159TT*		FA159R*	MD6150D	MD6150D							
250 Trail Blazer		99-00	FA159TT*		FA159R*	MD6155D	MD6155D							
250 Trail Blazer (Freedom)		01-04	FA159TT*		FA159R*	MD6155D❖	MD6155D❖							
250 Trail Blazer		05-06	FA159TT*		FA159R*	MD6262D	MD6262D							
Trail Boss 2 x 4		85-87	Y503*		Y503G*									
Trail Boss		88-90	FA159TT*		FA159R*	MD6147D	MD6147D							
250 Trail Boss		91-99	FA159TT*		FA159R*	MD6150D	MD6150D							
Trail Boss 4 x 4		87	FA54*		FA54R*	MD6147D	MD6147D							
Trail Boss 2 x 4 / 4 x 4		88-89	FA159TT*		FA159R*	MD6147D	MD6147D							
250 Trail Boss 2 x 4 / 4 x 4		91-92	FA159TT*		FA159R*	MD6150D	MD6150D							
250 Xplorer (4 x 4)		00	FA159TT*		FA159R*	MD6155D❖	MD6155D❖							
300 2 x 4 / 4 x 4		94-95	FA159TT*		FA159R*	MD6150D	MD6150D							
300 Big Boss 6 x 6		94	FA159TT*		FA159R*	MD6150D	MD6150D							
300 Big Boss 6 x 6 Middle Axle Brake		94	FA159TT*		FA159R*	MD6149D	MD6149D							
300 Hawkeye 2 x 4		06	FA395TT*		FA395R*	MD6272D	MD6272D							

\*-2 Sets Required. ■ - Also available in MX-S race compound.

**SAFETY WARNING:** DO NOT USE HH PADS ON REAR UNLESS ALSO USED ON FRONT TO AVOID BRAKE IMBALANCE

APPLICATIONS  
BRAKE

R Suffix = High Durability Sintered Pad. HH Suffix = High Performance Sintered Pad. G Suffix = Grooved Shoe.  
D Suffix = Drilled Disc. C Suffix = Contoured Disc. LS Suffix = Left/Steel Disc. RS = Right/Steel Disc.

# Non-JAPANESE Built Motorcycles

**BRAKE APPLICATIONS**



**JOHN DEERE (ATV & SIDE X SIDE)**



← REAR / ARRIÈRE / HINTEN POSTERIOR / POSTERIORE →

		DISC PAD CHOICES				BRAKE ROTOR CHOICES			
		NEW SFAC Scooter Carbon Pads	Semi-Sintered V-Pads™	Sintered/HH Pads/ Grooved shoes	Contour Rotor Rear Fitment	NEW Vee-Rotors™ CONTOUR	NEW CX Extreme® ROTOR		
Trail Buck 500/650 EX/EXT	04-05	FA317TT		FA317R	MD6225D				
Buck 500/650 EX/EXT	04-08	FA317TT		FA317R	MD6225D				
TX Gator Utility 9461	04-05			FA398R*	N/A*				
TX Turf Gator 9462	04-05			FA398R*	N/A*				
4PX Gator 4 x 2 / 4 x 4 Trail 9345	04-05			FA398R*	N/A*				
HPX Gator 4 x 2 / 4 x 4 9446	04-08			FA398R*	N/A*				
HPX 4 x 2 (Petrol) Gator	10-11			FA398R*	N/A*				
HPX 4 x 4 / 4 x 4 Trail (Petrol) - Gator	10-11			FA398R*	N/A*				
HPX 4 x 4 (Diesel) - Gator - (SN040000)	10			FA398R*	N/A*				
HPX 4 x 4 (Diesel) - Gator - (SN040001 - 090000 / SN090001 - )	10-11			FA609R*	N/A*				
XUV 620 i (Petrol) - Gator	10			FA609R*	N/A*				
XUV 625 i (Petrol) - Gator	11			FA609R*	N/A*				
XUV 825 i (Petrol) - Gator	11			FA609R*	N/A*				
XUV 850 D (Diesel) - Gator	10			FA609R*	N/A*				
XUV 855 D (Diesel) - Gator	11			FA609R*	N/A*				
<b>POLARIS</b>									
50 Outlaw	08-12	H307		H307G					
50 Predator (2 stroke)	04-06	H307		H307G					
Scrambler (3 Wheeler)	85-86	FA040			N/A				
50 Scrambler	01-03	H307		H307G					
90 Outlaw	07-12	H307		H307G					
90 Predator	03-06	H307		H307G					
90 Scrambler X	01-03	H307		H307G					
90 Sportsman	01-12	H307		H307G					
200 Phoenix (Rear drum model)	05	H306		H306G					
200 Phoenix (Rear drum model)	06-12	H306		H306G					
200 Phoenix (Rear disc model)	05-08	FA083TT		FA083R	MD6311D				
200 Sawtooth	06-07	H306		H306G					
200 Sawtooth Quad Rear disc model	06	FA083TT		FA083R	MD6311D				
250 2 x 4 / 4 x 4	90	FA232TT		FA232R	N/A				
250 2 x 4 / 4 x 4	93	FA232TT		FA232R	N/A				
250 Cyclone X	87	FA040			N/A				
250 Big Boss 4 x 6	89-90	FA232TT		FA232R	N/A				
250 Big Boss 4 x 6 Middle Axle Brake	89-90								
250 Big Boss 4 x 6	91-92	FA232TT		FA232R	N/A				
250 Big Boss 4 x 6 Middle Axle Brake	91-92								
250 Big Boss 6 x 6	91	FA232TT		FA232R	N/A				
250 Big Boss 6 x 6 Middle Axle Brake	91								
250 Big Boss 6 x 6	92-93	FA232TT		FA232R	N/A				
250 Big Boss 6 x 6 Middle Axle Brake	92-93								
250 Trail Blazer	90	FA232TT		FA232R	N/A				
250 Trail Blazer	91-93	FA232TT		FA232R	N/A				
250 Trail Blazer	94-98	FA232TT		FA232R	N/A				
250 Trail Blazer	99-00	FA270TT		FA270R	MD6156D				
250 Trail Blazer (Freedom)	01-04	FA270TT		FA270R	MD6156D				
250 Trail Blazer	05-06	N/A		FA314R	MD6256D				
Trail Boss 2 x 4	85-87	FA040			N/A				
Trail Boss	88-90	FA232TT		FA232R	N/A				
250 Trail Boss	91-99	FA232TT		FA232R	N/A				
Trail Boss 4 x 4	87	FA232TT		FA232R	N/A				
Trail Boss 2 x 4 / 4 x 4	88-89	FA232TT		FA232R	N/A				
250 Trail Boss 2 x 4 / 4 x 4	91-92	FA232TT		FA232R	N/A				
250 Xplorer (4 x 4)	00	FA270TT		FA270R	N/A				
300 2 x 4 / 4 x 4	94-95	FA232TT		FA232R	N/A				
300 Big Boss 6 x 6	94	FA232TT		FA232R	N/A				
300 Big Boss 6 x 6 Middle Axle Brake	94								
300 Hawkeye 2 x 4	06	FA395TT*		FA395R*	MD6273D*				

\*-2 Sets Required. ■ - Also available in MX-S race compound.

**SAFETY WARNING:** DO NOT USE HH PADS ON REAR UNLESS ALSO USED ON FRONT TO AVOID BRAKE IMBALANCE

**R** Suffix = High Durability Sintered Pad. **HH** Suffix = High Performance Sintered Pad. **G** Suffix = Grooved Shoe.  
**D** Suffix = Drilled Disc. **C** Suffix = Contoured Disc. **LS** Suffix = Left/Steel Disc. **RS** = Right/Steel Disc.

# Non-JAPANESE Built Motorcycles



← FRONT / AVANT / VORN FRENTE / ANTERIORE →

## POLARIS

### DISC PAD CHOICES

### BRAKE ROTOR CHOICES

Model	Year	FA159TT*	DISC PAD CHOICES			Left/Gauche/Links		Right/Droite/Rechts		BRAKE ROTOR CHOICES					
			NEW SFAC Scooter Carbon Pads	Semi-Sintered V-Pads™	Sintered/HH Pads/ Grooved shoes	Universal left and right fitment	NEW Vee-Rotors™ CONTOUR	NEW CX Extreme® ROTOR	Oversize 250/280mm Rotor Kit	Relocating Bracket for 250/280mm Rotor	Oversize 320mm Rotor Kit	Relocating Bracket for 320mm Rotor			
300 Hawkeye 2 x 4	08-09	FA159TT*			FA159R*	MD6272D	MD6272D								
300 Hawkeye 4 x 4	06	FA395TT*			FA395R*	MD6272D	MD6272D								
Hawkeye 2 x 4/4 x 4	07	FA159TT*			FA159R*	MD6272D	MD6272D								
300 Sportsman (4 x 4)	08-10	FA159TT*			FA159R*	MD6272D	MD6272D								
300 Xplorer 4 x 4	96-00	FA159TT*			FA159R*	MD6150D	MD6150D								
300 / 400 Xpress L	96-97	FA159TT*			FA159R*	MD6150D	MD6150D								
300 Xpress 2 x 4	98-00	FA159TT*			FA159R*	MD6150D	MD6150D								
325 Magnum (4 x 4) (2 x 4)	00	FA159TT*			FA159R*	MD6149D	MD6149D								
325 Magnum 2 x 4/4 x 4 Mose	01	FA159TT*			FA159R*	MD6155D	MD6155D								
325 Magnum (2 x 4) HDS	02				FA159R*	MD6155D	MD6155D								
325 Magnum 4 x 4 (A02CD32AA/AB/AC)	02				FA159R*	MD6155D	MD6155D								
325 Magnum 4 x 4 HDS (A02CD32FB)	02				FA159R*	MD6202D	MD6202D								
325 Trail Boss	00	FA159TT*			FA159R*	MD6155D	MD6155D								
325 Trail Boss	01-02	FA159TT*			FA159R*	MD6155D	MD6155D								
325 Xpedition	00	FA159TT*			FA159R*	MD6155D	MD6155D								
325 Xpedition	02				FA159R*	MD6155D	MD6155D								
330 ATP (4 x 4)	04-05	FA159TT*			FA159R*	MD6202D	MD6202D								
330 Magnum (2 x 4)HDS	03-06				FA159R*	MD6149D	MD6149D								
330 Magnum (4 x 4)HDS	03-04				FA159R*	MD6202D	MD6202D								
330 Trail Boss	03-04	FA159TT*			FA159R*	MD6155D	MD6155D								
330 Trail Boss	05-09				FA159R*	MD6262D	MD6262D								
330 Trail Boss	10-12				FA159R*	MD6202D	MD6202D								
330 Trail Blazer	08-09				FA159R*	MD6262D	MD6262D								
330 Trail Blazer	10-12				FA159R*	MD6202D	MD6202D								
335 Sportsman 4 x 4	99-00	FA159TT*			FA159R*	MD6150D	MD6150D								
335 Sportsman/Worker 4 x 4	99-00	FA159TT*			FA159R*	MD6149D	MD6149D								
350 L 2 x 4	90	FA159TT*			FA159R*	MD6150D	MD6150D								
350 L 4 x 4	90	FA159TT*			FA159R*	MD6149D	MD6149D								
350 L 4 x 4	93	FA159TT*			FA159R*	MD6150D	MD6150D								
350 Big Boss L	93	FA159TT*			FA159R*	MD6149D	MD6149D								
350 Big Boss L Middle Axle Brake	93	FA159TT*			FA159R*	MD6149D	MD6149D								
350 Sportsman 4 x 4	93	FA159TT*			FA159R*	MD6149D	MD6149D								
350 Trail Boss L 2 x 4	91-93	FA159TT*			FA159R*	MD6150D	MD6150D								
350 Trail Boss L 4 x 4	91	FA159TT*			FA159R*	MD6149D	MD6149D								
400 L 2 x 4	94-95	FA159TT*			FA159R*	MD6150D	MD6150D								
400 L 4 x 4	94	FA159TT*			FA159R*	MD6149D	MD6149D								
400 Big Boss L 6 x 6	94-95	FA159TT*			FA159R*	MD6149D	MD6149D								
400 Big Boss L 6 x 6 Middle Axle Brake	94-95	FA159TT*			FA159R*	MD6149D	MD6149D								
400 Big Boss L 6 x 6	96	FA159TT*			FA159R*	MD6149D	MD6149D								
400 Big Boss L 6 x 6 Middle Axle Brake	96				FA273R*	MD6153D	MD6153D								
400 Big Boss L 6 x 6	97	FA159TT*			FA159R*	MD6149D	MD6149D								
400 Big Boss L 6 x 6 Middle Axle Brake	97	FA159TT*			FA159R*	MD6149D	MD6149D								
400 Scrambler L 4 x 4	95-97	FA159TT*			FA159R*	MD6150D	MD6150D								
400 Scrambler (2 x 4 / 4 x 4)	00	FA159TT*			FA159R*	MD6155D	MD6155D								
400 Scrambler 4 x 4	98-02	FA159TT*			FA159R*	MD6155D	MD6155D								
400 Scrambler 2 x 4	02	FA159TT*			FA159R*	MD6155D	MD6155D								
400 Sport L	94-98	FA159TT*			FA159R*	MD6150D	MD6150D								
400 Sport	99-00	FA159TT*			FA159R*	MD6150D	MD6150D								
400 Sportsman L 4 x 4	94-97	FA159TT*			FA159R*	MD6149D	MD6149D								
400 Sportsman	01-02	FA159TT*			FA159R*	MD6149D	MD6149D								
400 Sportsman 400	03-05				FA159R*	MD6149D	MD6149D								
400 Sportsman HO 4 x 4	08-10	FA159TT*			FA159R*	MD6272D	MD6272D								
400 Sportsman HO 4 x 4	11-12	FA159TT*			FA159R*	MD6202D	MD6202D								
400 Trail Blazer	03	FA159TT*			FA159R*	MD6155D	MD6155D								
400 Xplorer L 4 x 4	95-98	FA159TT*			FA159R*	MD6149D	MD6149D								
400 Xplorer L 4 x 4	99-00	FA159TT*			FA159R*	MD6149D	MD6149D								
400 Xplorer 4 x 4	01-02	FA159TT*			FA159R*	MD6155D	MD6155D								
400 Xplorer	01-02	FA159TT*			FA159R*	MD6149D	MD6149D								
425 Magnum 2 x 4	95-98	FA159TT*			FA159R*	MD6150D	MD6150D								
425 Magnum 4 x 4	95-98	FA159TT*			FA159R*	MD6149D	MD6149D								

\*-2 Sets Required. ■ - Also available in MX-S race compound.

**SAFETY WARNING:** DO NOT USE HH PADS ON REAR UNLESS ALSO USED ON FRONT TO AVOID BRAKE IMBALANCE

**R** Suffix = High Durability Sintered Pad. **HH** Suffix = High Performance Sintered Pad. **G** Suffix = Grooved Shoe.  
**D** Suffix = Drilled Disc. **C** Suffix = Contoured Disc. **LS** Suffix = Left/Steel Disc. **RS** = Right/Steel Disc.

**APPLICATIONS**  
**BRAKE**

# Non-JAPANESE Built Motorcycles



**POLARIS**



← REAR / ARRIÈRE / HINTEN POSTERIOR / POSTERIORE →

			DISC PAD CHOICES			BRAKE ROTOR CHOICES		
			NEW SFAC Scooter Carbon Pads	Semi-Sintered V-Pads™	Sintered/HH Pads/ Grooved shoes	Contour Rotor Rear Fitment	NEW Vee-Rotors™ CONTOUR	NEW CX Extreme® ROTOR
300 Hawkeye 2 x 4	08-09	FA159TT			FA159R	MD6273D		
300 Hawkeye 4 x 4	06	FA395TT*			FA395R*	MD6273D*		
Hawkeye 2 x 4/4 x 4	07	FA159TT*			FA159R*	MD6273D*		
300 Sportsman (4 x 4)	08-10	FA159TT			FA159R	MD6273D		
300 Xplorer 4 x 4	96-00	FA232TT			FA232R	N/A		
300 / 400 Xpress L	96-97	FA232TT			FA232R	N/A		
300 Xpress 2 x 4	98-00	FA232TT			FA232R	N/A		
325 Magnum (4 x 4) (2 x 4)	00	FA270TT			FA270R	MD6156D		
325 Magnum 2 x 4/4 x 4 Mose	01	FA270TT			FA270R	MD6156D		
325 Magnum (2 x 4) HDS	02	N/A			FA314R	MD6200D		
325 Magnum 4 x 4 (A02CD32AA/AB/AC)	02	N/A			FA314R	MD6200D		
325 Magnum 4 x 4 HDS (A02CD32FB)	02	N/A			FA314R	MD6200D		
325 Trail Boss	00	FA270TT			FA270R	MD6156D		
325 Trail Boss	01-02	FA270TT			FA270R	MD6156D		
325 Xpedition	00	FA270TT			FA270R	MD6156D		
325 Xpedition	02	N/A			FA314R	MD6200D		
330 ATP (4 x 4)	04-05	FA159TT*			FA159R*	MD6200D		
330 Magnum (2 x 4/HDS)	03-06	N/A			FA314R	MD6200D		
330 Magnum (4 x 4/HDS)	03-04	N/A			FA314R	MD6200D		
330 Trail Boss	03-04	FA270TT			FA270R	MD6156D		
330 Trail Boss	05-09	N/A			FA314R	MD6256D		
330 Trail Boss	10-12	N/A			FA314R	MD6256D		
330 Trail Blazer	08-09	N/A			FA314R	MD6256D		
330 Trail Blazer	10-12	N/A			FA314R	MD6256D		
335 Sportsman 4 x 4	99-00	FA270TT			FA270R	N/A		
335 Sportsman/Worker 4 x 4	99-00	FA270TT			FA270R	N/A		
350 L 2 x 4	90	FA232TT			FA232R	N/A		
350 L 4 x 4	90	FA232TT			FA232R	N/A		
350 L 4 x 4	93	FA232TT			FA232R	N/A		
350 Big Boss L	93	FA232TT			FA232R	N/A		
350 Big Boss L Middle Axle Brake	93							
350 Sportsman 4 x 4	93	FA232TT			FA232R	N/A		
350 Trail Boss L 2 x 4	91-93	FA232TT			FA232R	N/A		
350 Trail Boss L 4 x 4	91	FA232TT			FA232R	N/A		
400 L 2 x 4	94-95	FA232TT			FA232R	N/A		
400 L 4 x 4	94	FA232TT			FA232R	N/A		
400 Big Boss L 6 x 6	94-95	FA232TT			FA232R	N/A		
400 Big Boss L 6 x 6 Middle Axle Brake	94-95							
400 Big Boss L 6 x 6	96	FA232TT			FA232R	N/A		
400 Big Boss L 6 x 6 Middle Axle Brake	96							
400 Big Boss L 6 x 6	97	FA232TT			FA232R	N/A		
400 Big Boss L 6 x 6 Middle Axle Brake	97							
400 Scrambler L 4 x 4	95-97	FA232TT			FA232R	N/A		
400 Scrambler (2 x 4 / 4 x 4)	00	FA270TT			FA270R	MD6156D		
400 Scrambler 4 x 4	98-02	FA270TT			FA270R	MD6156D		
400 Scrambler 2 x 4	02	FA270TT			FA270R	MD6156D		
400 Sport L	94-98	FA232TT			FA232R	N/A		
400 Sport	99-00	FA270TT			FA270R	MD6156D		
400 Sportsman L 4 x 4	94-97	FA232TT			FA232R	N/A		
400 Sportsman	01-02	FA270TT			FA270R	N/A		
400 Sportsman 400	03-05	N/A			FA314R	N/A		
400 Sportsman HO 4 x 4	08-10	FA159TT			FA159R	MD6273D		
400 Sportsman HO 4 x 4	11-12	FA475TT			FA475R	MD6275D		
400 Trail Blazer	03	FA270TT			FA270R	MD6156D		
400 Xplorer L 4 x 4	95-98	FA232TT			FA232R	N/A		
400 Xplorer L 4 x 4	99-00	FA270TT			FA270R	MD6169D		
400 Xplorer 4 x 4	01-02	FA270TT			FA270R	MD6156D		
400 Xplorer	01-02	FA270TT			FA270R	MD6169D		
425 Magnum 2 x 4	95-98	FA232TT			FA232R	N/A		
425 Magnum 4 x 4	95-98	FA232TT			FA232R	N/A		

\*-2 Sets Required. ■ - Also available in MX-S race compound.

**SAFETY WARNING:** DO NOT USE HH PADS ON REAR UNLESS ALSO USED ON FRONT TO AVOID BRAKE IMBALANCE

**BRAKE APPLICATIONS**

**R** Suffix = High Durability Sintered Pad. **HH** Suffix = High Performance Sintered Pad. **G** Suffix = Grooved Shoe.  
**D** Suffix = Drilled Disc. **C** Suffix = Contoured Disc. **LS** Suffix = Left/Steel Disc. **RS** = Right/Steel Disc.



# Non-JAPANESE Built Motorcycles



← FRONT / AVANT / VORN FRENTE / ANTERIORE →

## POLARIS

### DISC PAD CHOICES

### BRAKE ROTOR CHOICES

				NEW SFAC Scooter Carbon Pads	Semi-Sintered V-Pads™	Sintered/HH Pads/ Grooved shoes	Left/Gauche/Links	Right/Droite/Rechts	Contour Rotor Universal left and right fitment	NEW Vee-Rotors™ CONTOUR	NEW CX Extreme® ROTOR	Oversize 250/280mm Rotor Kit	Relocating Bracket for 250/280mm Rotor	Oversize 320mm Rotor Kit	Relocating Bracket for 320mm Rotor
425 Magnum 6 x 6	96	FA159TT*				FA159R*	MD6149D	MD6149D							
425 Magnum 6 x 6 Middle Axle Brake	96					FA273R	MD6153D	MD6153D							
425 Magnum 6 x 6	97	FA159TT*				FA159R*	MD6149D	MD6149D							
425 Magnum 6 x 6 Middle Axle Brake	97	FA159TT*				FA159R*	MD6149D	MD6149D							
425 Xpedition (4 x 4)	00	FA159TT*				FA159R*	MD6149D	MD6149D							
450 S Outlaw	08					FA456R*	MD6219D	MD6219D							
450 Outlaw MXR	09-10					FA456R*	MD6219D	MD6219D							
450 Sportsman	06					FA159R*	MD6202D	MD6202D							
450 Sportsman	07					FA159R*	MD6202D	MD6202D							
455cc Diesel 4 x 4 EBS	99-00	FA159TT*				FA159R*	MD6149D	MD6149D							
455cc Diesel	01	FA159TT*				FA159R*	MD6149D	MD6149D							
500 ATP HO (4 x 4)	04-05	FA159TT*				FA159R*	MD6202D	MD6202D							
500 ATV Pro 4 x 4 PPS	02					FA159R*	MD6202D	MD6202D							
500 Big Boss 6 x 6	98-99	FA159TT*				FA159R*	MD6149D	MD6149D							
500 Big Boss 6 x 6 Middle Axle Brake	98-99	FA159TT*				FA159R*	MD6149D	MD6149D							
500 Magnum (4 x 4)	99-00	FA159TT*				FA159R*	MD6149D	MD6149D							
500 Magnum	01	FA159TT*				FA159R*	MD6149D	MD6149D							
500 Magnum (2 x 4/4 x 4 HDS)	02					FA159R*	MD6149D	MD6149D							
500 Magnum 4 x 4 HDS	02-03					FA159R*	MD6202D	MD6202D							
500 Outlaw	06-07	FA159TT*				FA159R*	MD6219D	MD6219D							
500 Predator/TLD	03-07	FA159TT*				FA159R*	MD6219D	MD6219D							
500 Scrambler 2 x 4	01-02	FA159TT*				FA159R*	MD6155D❖	MD6155D❖							
500 Scrambler 2 x 4	07-08					FA159R*	MD6262D	MD6262D							
500 Scrambler 4 x 4	97	FA159TT*				FA159R*	MD6150D	MD6150D							
500 Scrambler 4 x 4	98-04	FA159TT*				FA159R*	MD6155D❖	MD6155D❖							
500 Scrambler 4 x 4	05-09					FA159R	MD6155D❖	MD6155D❖							
500 Scrambler 4 x 4	10-12					FA159R*	MD6202D	MD6202D							
500 Sportsman 4 x 4	96	FA159TT*				FA159R*	MD6149D	MD6149D							
500 Sportsman 4 x 4	97	FA159TT*				FA159R*	MD6149D	MD6149D							
500 Sportsman/Worker 4 x 4 EBS /500 RSE	98-02	FA159TT*				FA159R*	MD6149D	MD6149D							
500 Sportsman HO/EFI	03-06					FA159R*	MD6202D	MD6202D							
500 Sportsman EFI/HO	07-08					FA159R*	MD6202D	MD6202D							
500 Sportsman HO (Built up to 15/12/2008)	08					FA159R*	MD6202D	MD6202D							
500 Sportsman HO (Built from 16/12/2008)	09-12					FA159R*	MD6202D	MD6202D							
500 Sportsman X2	06-08					FA159R*	MD6202D	MD6202D							
500 Sportsman 6 x 6	00-08					FA159R*	MD6149D	MD6149D							
500 Sportsman X 2 EFI	07-09	FA159TT*				FA159R*	MD6202D	MD6202D							
500 Sportsman Forest	12	FA159TT*				FA159R*	MD6202D	MD6202D							
500 Sportsman Touring H.O.	08-11	FA159TT*				FA159R*	MD6202D	MD6202D							
500 Sportsman Touring H.O.	11-12	FA159TT*				FA159R*	MD6202D	MD6202D							
500 Sportsman EFI Quad H.O.	08-11					FA159R*	MD6202D	MD6202D							
500 XP Sportsman	09	FA475TT*				FA475R*	MD6339D	MD6339D							
500 Xplorer 4 x 4	97	FA159TT*				FA159R*	MD6149D	MD6149D							
525 S Outlaw	08-10					FA456R*	MD6219D	MD6219D							
525 Outlaw IRS	08-11					FA456R*	MD6219D	MD6219D							
550 Sportsman	11-12	FA475TT*				FA475R*	MD6339D	MD6339D							
550 Sportsman EPS	10-12	FA475TT*				FA475R*	MD6339D	MD6339D							
550 Sportsman Forest	10-12	FA475TT*				FA475R*	MD6339D	MD6339D							
550 XP Sportsman EPS	09-11	FA475TT*				FA475R*	MD6339D	MD6339D							
550 Sportsman X2	10-11	FA475TT*				FA475R*	MD6339D	MD6339D							
550 Sportsman Touring EPS	10-12	FA475TT*				FA475R*	MD6339D	MD6339D							
600 Sportsman 4 x 4	03-05					FA159R*	MD6202D	MD6202D							
700 Sportsman (4 x 4)/EFI	02-06					FA159R*	MD6202D	MD6202D							
700 Sportsman MV	05-06					FA159R*	MD6202D	MD6202D							
700 Sportsman EFI	07					FA159R*	MD6202D	MD6202D							
700 Sportsman X 2	08	FA159TT*				FA159R*	MD6202D	MD6202D							
800 Sportsman EFI	05-06					FA159R*	MD6202D	MD6202D							
800 Sportsman EFI (Built up to 15/12/2008)	08					FA159R*	MD6202D	MD6202D							
800 Sportsman EFI (Built up after 16/12/2008)	09					FA159R*	MD6202D	MD6202D							
800 Sportsman EFI	10-12					FA159R*	MD6202D	MD6202D							

\*-2 Sets Required. ■ - Also available in MX-S race compound.

**SAFETY WARNING:** DO NOT USE HH PADS ON REAR UNLESS ALSO USED ON FRONT TO AVOID BRAKE IMBALANCE

APPLICATIONS  
BRAKE

R Suffix = High Durability Sintered Pad. HH Suffix = High Performance Sintered Pad. G Suffix = Grooved Shoe.

D Suffix = Drilled Disc. C Suffix = Contoured Disc. LS Suffix = Left/Steel Disc. RS = Right/Steel Disc.

# Non-JAPANESE Built Motorcycles



**POLARIS**



← REAR / ARRIÈRE / HINTEN POSTERIOR / POSTERIORE →

			DISC PAD CHOICES			BRAKE ROTOR CHOICES		
			NEW SFAC Scooter Carbon Pads	Semi-Sintered V-Pads™	Sintered/HH Pads/ Grooved shoes	Contour Rotor Rear Fitment	NEW Vee-Rotors™ CONTOUR	NEW CX Extreme® ROTOR
425 Magnum 6 x 6	96	FA232TT			FA232R	N/A		
425 Magnum 6 x 6 Middle Axle Brake	96							
425 Magnum 6 x 6	97	FA232TT			FA232R	N/A		
425 Magnum 6 x 6 Middle Axle Brake	97							
425 Xpedition (4 x 4)	00	FA270TT			FA270R	MD6156D		
450 S Outlaw	08	FA159TT			FA159R	MD6218D		
450 Outlaw MXR	09-10	FA159TT			FA159R	MD6290D		
450 Sportsman	06	N/A			FA314R	MD6201D		
450 Sportsman	07	N/A			FA314R	MD6275D		
455cc Diesel 4 x 4 EBS	99-00	FA270TT			FA270R	N/A		
455cc Diesel	01	FA270TT			FA270R	N/A		
500 ATP HO (4 x 4)	04-05	FA159TT*			FA159R*	MD6200D		
500 ATV Pro 4 x 4 PPS	02	N/A			FA314R	MD6200D		
500 Big Boss 6 x 6	98-99	FA232TT			FA232R	N/A		
500 Big Boss 6 x 6 Middle Axle Brake	98-99							
500 Magnum (4 x 4)	99-00	FA270TT			FA270R	MD6156D		
500 Magnum	01	FA270TT			FA270R	MD6156D		
500 Magnum (2 x 4/4 x 4 HDS)	02	N/A			FA314R	MD6200D		
500 Magnum 4 x 4 HDS	02-03	N/A			FA314R	MD6200D		
500 Outlaw	06-07	FA159TT			FA159R	MD6290D		
500 Predator/TLD	03-07	FA159TT			FA159R	MD6218D		
500 Scrambler 2 x 4	01-02	FA270TT			FA270R	MD6156D		
500 Scrambler 2 x 4	07-08	N/A			FA314R	MD6256D		
500 Scrambler 4 x 4	97	FA232TT			FA232R	N/A		
500 Scrambler 4 x 4	98-04	FA270TT			FA270R	MD6156D		
500 Scrambler 4 x 4	05-09	N/A			FA314R	MD6256D		
500 Scrambler 4 x 4	10-12	N/A			FA314R	MD6256D		
500 Sportsman 4 x 4	96	FA232TT			FA232R	MD6201D		
500 Sportsman 4 x 4	97	FA232TT			FA232R	MD6154D		
500 Sportsman/Worker 4 x 4 EBS /500 RSE	98-02	FA270TT			FA270R	N/A		
500 Sportsman HO/EFI	03-06	N/A			FA314R	MD6201D		
500 Sportsman EFI/HO	07-08	N/A			FA314R	MD6275D		
500 Sportsman HO (Built up to 15/12/2008)	08	N/A			FA314R	MD6275D		
500 Sportsman HO (Built from 16/12/2008)	09-12	FA475TT			FA475R	MD6275D		
500 Sportsman X2	06-08	N/A			FA314R	MD6275D*		
500 Sportsman 6 x 6	00-08	N/A			FA313R	MD6170D		
500 Sportsman X 2 EFI	07-09	FA159TT			FA159R	MD6275D		
500 Sportsman Forest	12	N/A			FA314R*	MD6275D*		
500 Sportsman Touring H.O.	08-11	FA159TT*			FA159R*	MD6275D*		
500 Sportsman Touring H.O.	11-12				FA354R*	MD6275D*		
500 Sportsman EFI Quad H.O.	08-11	N/A			FA314R*	MD6275D*		
500 XP Sportsman	09	FA475TT			FA475R	MD6339D		
500 Xplorer 4 x 4	97	FA232TT			FA232R	N/A		
525 S Outlaw	08-10	FA159TT			FA159R	MD6290D		
525 Outlaw IRS	08-11	FA159TT			FA159R	MD6290D		
550 Sportsman	11-12	FA475TT			FA475R	MD6339D		
550 Sportsman EPS	10-12	FA475TT			FA475R	MD6339D		
550 Sportsman Forest	10-12	FA475TT			FA475R	MD6339D		
550 XP Sportsman EPS	09-11	FA475TT			FA475R	MD6339D		
550 Sportsman X2	10-11	FA475TT			FA475R	MD6339D		
550 Sportsman Touring EPS	10-12	FA475TT			FA475R	MD6339D		
600 Sportsman 4 x 4	03-05	N/A			FA314R	MD6201D		
700 Sportsman (4 x 4)/EFI	02-06	N/A			FA314R	MD6201D		
700 Sportsman MV	05-06	N/A			FA314R	MD6201D		
700 Sportsman EFI	07	N/A			FA314R	MD6275D		
700 Sportsman X 2	08	FA159TT			FA159R	MD6275D		
800 Sportsman EFI	05-06	N/A			FA314R	MD6201D		
800 Sportsman EFI (Built up to 15/12/2008)	08	N/A			FA314R	MD6275D		
800 Sportsman EFI (Built up after 16/12/2008)	09	N/A			FA314R	MD6275D		
800 Sportsman EFI	10-12	N/A			FA475R	MD6275D		

\*-2 Sets Required. ■ - Also available in MX-S race compound.

**SAFETY WARNING:** DO NOT USE HH PADS ON REAR UNLESS ALSO USED ON FRONT TO AVOID BRAKE IMBALANCE

**BRAKE APPLICATIONS**

**R** Suffix = High Durability Sintered Pad. **HH** Suffix = High Performance Sintered Pad. **G** Suffix = Grooved Shoe.  
**D** Suffix = Drilled Disc. **C** Suffix = Contoured Disc. **LS** Suffix = Left/Steel Disc. **RS** = Right/Steel Disc.

# Non-JAPANESE Built Motorcycles



← FRONT / AVANT / VORN FRENTE / ANTERIORE →

## DISC PAD CHOICES

## BRAKE ROTOR CHOICES

### POLARIS

			NEW SFAC Scooter Carbon Pads	Semi-Sintered V-Pads™	Sintered/HH Pads/ Grooved shoes	Left/Gauche/Links	Right/Droite/Rechts	Contour Rotor Universal left and right fitment	NEW Vee-Rotors™ CONTOUR	NEW CX Extreme® ROTOR	Oversize 250/280mm Rotor Kit	Relocating Bracket for 250/280mm Rotor	Oversize 320mm Rotor Kit	Relocating Bracket for 320mm Rotor
800 Sportsman X 2 EFI	07-09		FA159TT*		FA159R*	MD6202D	MD6202D							
800 Sportsman EFI Int'l/HO	07-11		FA159TT*		FA159R*	MD6202D	MD6202D							
800 Sportsman Forest	12		FA475TT*		FA475R*	MD6339D	MD6339D							
800 Sportsman Touring/EFI	08-09		FA159TT*		FA159R*	MD6202D	MD6202D							
800 Sportsman "Big Boss" / EFI 6x6 / EFI	09-12		FA159TT*		FA159R*	MD6202D	MD6202D							
850 Sportsman Touring EPS	10-12		FA475TT*		FA475R*	MD6339D	MD6339D							
850 Sportsman Forest	12		FA475TT*		FA475R*	MD6339D	MD6339D							
850 XP Sportsman	09-12		FA475TT*		FA475R*	MD6339D	MD6339D							
850 XP EPS Sportsman	09-12		FA475TT*		FA475R*	MD6339D	MD6339D							

\*NOTE: Plain edged rotor will not allow fitment of optional speedo pick up.

▶ = Note 3 Sets Required

### POLARIS SIDE X SIDE

Ranger RZR 170	09-12		N/A		FA490R*	MD6353D	MD6353D							
PPS/PTV 4 x 4 Series 10			FA159TT*		FA159R*	MD6202D	MD6202D							
PPS/PTV 6 x 6 Series 10			FA159TT*		FA159R*	MD6149D	MD6149D							
PPS/UTV 2 x 4 Series 10			N/A		FA354R	MD6202D	MD6202D							
PPS/UTV 4 x 6 Series 10			N/A		FA354R*	MD6202D	MD6202D							
1500 PPS/UTV 2 x 4 Series 11			N/A		FA354R*	MD6202D	MD6202D							
PPS LUH 6 x 6	02		FA159TT*		FA159R*	MD6149D	MD6149D							
PPS Series 11 2 x 4/4 x 4			N/A		FA354R*	MD6202D	MD6202D							
PPS Series 11 6 x 6			N/A		FA354R*	MD6202D	MD6202D							
Ranger Series 10			N/A		FA354R*	MD6202D	MD6202D							
Ranger 2 x 4/4 x 4	04-05		N/A		FA354R	MD6202D	MD6202D							
Ranger Series 11			N/A		FA354R*	MD6202D	MD6202D							
Ranger 6 x 6	04-05		N/A		FA354R*	MD6202D	MD6202D							
Ranger TM	04-05		N/A		FA354R*	MD6202D	MD6202D							
Ranger TM	06		N/A		FA354R*	MD6202D	MD6202D							
Ranger XP	05		N/A		FA354R*	MD6202D	MD6202D							
500 Ranger Series 10 6 x 6			N/A		FA354R*	MD6202D	MD6202D							
Ranger (Note: Middle brake N/A)	99		FA159TT*		FA159R*	MD6149D	MD6149D							
For 6 x 6 model 4 rear discs required														
400 Ranger HO	10-11		FA452TT*		FA452R*	MD6202D	MD6202D							
500 Ranger (2 x 4/4 x 4)	06-07		N/A		FA354R*	MD6202D	MD6202D							
500 Ranger (4 x 4 EFI)	06-07		N/A		FA354R*	MD6202D	MD6202D							
500 Ranger (4 x 4 EFI)	08-10		FA452TT*		FA452R*	MD6202D	MD6202D							
500 Ranger (4 x 4 EFI)	11-12		N/A		FA354R*	MD6202D	MD6202D							
500 Ranger (Carb) 2 x 4	08-09		FA452TT*		FA452R*	MD6202D	MD6202D							
500 Ranger (EFI) 4 x 4 H.O.	09-11		FA452TT*		FA452R*	MD6338D	MD6338D							
500 Ranger Crew	11-12		FA452TT*		FA452R*	MD6202D	MD6202D							
550 Sportsman X2	10		FA475TT*		FA475R*	MD6339D*	MD6339D*							
570 Ranger RZR	12		N/A		TBA*	TBA	TBA							
700 Ranger 6x6 EFI	06-09		N/A		FA354R*	MD6202D	MD6202D							
700 Ranger XP 4 x 4	06		N/A		FA354R*	MD6202D	MD6202D							
700 Ranger 4 x 4 EFI/LE	07		N/A		FA354R*	MD6202D	MD6202D							
700 Ranger 4 x 4 EFI	09		FA452TT*		FA452R*	MD6338D	MD6338D							
700 Ranger Crew (EFI) 4 x 4	09		FA452TT*		FA452R*	MD6202D	MD6202D							
700 Ranger 6x4 EFI	08		FA452TT*		FA452R*	MD6202D	MD6202D							
700 Ranger XP 4 x 4	08		FA452TT*		FA452R*	MD6202D	MD6202D							
800 Ranger RZR	08-12		N/A		FA456R*	MD6312D	MD6312D							
800 Ranger RZR	12		N/A		TBA*	TBA	TBA							
800 Ranger RZR S EFI	09-12		N/A		FA456R*	MD6312D	MD6312D							
800 Ranger RZR-4	10-12		FA452TT*		FA452R*	MD6338D	MD6338D							
800 Ranger RZR-4 EPS	12		FA452TT*		FA452R*	MD6338D	MD6338D							
Ranger EV (Electric)	10-11		FA452TT*		FA452R*	MD6202D	MD6202D							
800 Ranger HD	10-11		FA452TT*		FA452R*	MD6338D	MD6338D							
800 Ranger XP	10-11		FA452TT*		FA452R*	MD6338D	MD6338D							
800 Ranger 6 x 6	10-11		FA452TT*		FA452R*	MD6338D	MD6338D							
800 Ranger Crew	10-12		FA452TT*		FA452R*	MD6338D	MD6338D							
800 Ranger Crew EPS	12		N/A		TBA*	TBA	TBA							

\*-2 Sets Required. ■ - Also available in MX-S race compound.

**SAFETY WARNING:** DO NOT USE HH PADS ON REAR UNLESS ALSO USED ON FRONT TO AVOID BRAKE IMBALANCE

# Non-JAPANESE Built Motorcycles



## POLARIS



← REAR / ARRIÈRE / HINTEN POSTERIOR / POSTERIORE →

			DISC PAD CHOICES			BRAKE ROTOR CHOICES		
			NEW SFAC Scooter Carbon Pads	Semi-Sintered V-Pads™	Sintered/HH Pads/ Grooved shoes	Contour Rotor Rear Fitment	NEW Vee-Rotors™ CONTOUR	NEW CX Extreme® ROTOR
800 Sportsman X 2 EFI	07-09	FA159TT*			FA159R*	MD6275D		
800 Sportsman EFI Inti/HO	07-11	N/A			FA314R	MD6275D		
800 Sportsman Forest	12	FA475TT			FA475R			
800 Sportsman Touring/EFI	08-09	FA159TT*			FA159R*	MD6275D		
800 Sportsman "Big Boss" / EFI 6x6 / EFI	09-12				FA314R <b>D</b>	MD6275D <b>D</b>		
850 Sportsman Touring EPS	10-12	FA475TT			FA475R	MD6339D		
850 Sportsman Forest	12	FA475TT*			FA475R*	MD6339D*		
850 XP Sportsman	09-12	FA475TT			FA475R	MD6339D		
850 XP EPS Sportsman	09-12	FA475TT			FA475R	MD6339D		

## POLARIS SIDE X SIDE

Ranger RZR 170	09-12	N/A			FA489R	MD6344D		
PPS/PTV 4 x 4 Series 10		N/A			FA314R	MD6200D		
PPS/PTV 6 x 6 Series 10		N/A			FA313R	MD6200D		
PPS/UTV 2 x 4 Series 10		N/A			FA354R	MD6201D		
PPS/UTV 4 x 6 Series 10		N/A			FA354R	MD6201D		
1500 PPS/UTV 2 x 4 Series 11		N/A			FA354R	MD6201D		
PPS LUH 6 x 6	02	N/A			FA313R	MD6170D		
PPS/Series 11 2 x 4/4 x 4		N/A			FA354R*	MD6201D*		
PPS/Series 11 6 x 6		N/A			FA354R*	MD6201D*		
Ranger Series 10		N/A			FA354R*	MD6201D*		
Ranger 2 x 4/4 x 4	04-05	N/A			FA354R*	MD6201D*		
Ranger Series 11		N/A			FA354R*	MD6201D*		
Ranger 6 x 6	04-05	N/A			FA354R*	MD6201D*		
Ranger TM	04-05	N/A			FA354R*	MD6201D*		
Ranger TM	06	N/A			FA354R*	MD6275D*		
Ranger XP	05	N/A			FA354R*	MD6201D*		
500 Ranger Series 10 6 x 6		N/A			FA354R*	MD6201D*		
Ranger (Note: Middle brake N/A)	99	N/A			FA273R	N/A		
400 Ranger HO	10-11	N/A			FA354R*	MD6275D*		
500 Ranger (2 x 4/4 x 4)	06-07	N/A			FA354R*	MD6275D*		
500 Ranger (4 x 4 EFI)	06-07	N/A			FA354R*	MD6275D*		
500 Ranger (4 x 4 EFI)	08-10	N/A			FA354R*	MD6275D*		
500 Ranger (4 x 4 EFI)	11-12	N/A			FA354R*	MD6275D*		
500 Ranger (Carb) 2 x 4	08-09	N/A			FA354R*	MD6275D*		
500 Ranger (EFI) 4 x 4 H.O.	09-11	N/A			FA354R*	MD6275D*		
500 Ranger Crew	11-12	N/A			FA354R*	MD6275D*		
550 Sportsman X2	10	FA475TT			FA475R	MD6339D		
570 Ranger RZR	12	N/A			TBA*	TBA*		
700 Ranger 6x6 EFI	06-09	N/A			FA354R*	MD6275D*		
700 Ranger XP 4 x 4	06	N/A			FA354R*	MD6275D*		
700 Ranger 4 x 4 EFI/LE	07	N/A			FA354R*	MD6275D*		
700 Ranger 4 x 4 EFI	09	N/A			FA354R*	MD6275D*		
700 Ranger Crew (EFI) 4 x 4	09	N/A		FA452TT*	FA452R*	MD6275D*		
700 Ranger 6x4 EFI	08	N/A			FA354R*	MD6275D*		
700 Ranger XP 4 x 4	08	N/A			FA354R*	MD6275D*		
800 Ranger RZR	08-12	FA159TT*			FA159R*	MD6275D*		
800 Ranger RZR	12	N/A			TBA*	TBA*		
800 Ranger RZR S EFI	09-12	FA159TT*			FA159R*	MD6275D*		
800 Ranger RZR-4	10-12				FA354R*	MD6275D*		
800 Ranger RZR-4 EPS	12				FA354R*	MD6275D*		
Ranger EV (Electric)	10-11	N/A			FA354R*	MD6275D*		
800 Ranger HD	10-11	N/A			FA354R*	MD6275D*		
800 Ranger XP	10-11	N/A			FA354R*	MD6275D*		
800 Ranger 6 x 6	10-11	N/A			FA354R*	MD6275D*		
800 Ranger Crew	10-12	N/A		FA452TT*	FA452R*	MD6275D*		
800 Ranger Crew EPS	12	N/A			TBA*	TBA*		

\*-2 Sets Required. ■ - Also available in MX-S race compound.

**SAFETY WARNING:** DO NOT USE HH PADS ON REAR UNLESS ALSO USED ON FRONT TO AVOID BRAKE IMBALANCE

**BRAKE APPLICATIONS**

**R** Suffix = High Durability Sintered Pad. **HH** Suffix = High Performance Sintered Pad. **G** Suffix = Grooved Shoe.  
**D** Suffix = Drilled Disc. **C** Suffix = Contoured Disc. **LS** Suffix = Left/Steel Disc. **RS** = Right/Steel Disc.

# Non-JAPANESE Built Motorcycles



← FRONT / AVANT / VORN FRENTE / ANTERIORE →

## DISC PAD CHOICES

## BRAKE ROTOR CHOICES

### POLARIS SIDE X SIDE

		NEW SFAC Scooter Carbon Pads	Semi-Sintered V-Pads™	Sintered/HH Pads/ Grooved shoes	Left/Gauche/Links	Right/Droite/Rechts	Contour Rotor Universal left and right fitment	NEW Vee-Rotors™ CONTOUR	NEW CX Extreme® ROTOR	Oversize 250/280mm Rotor Kit	Relocating Bracket for 250/280mm Rotor	Oversize 320mm Rotor Kit	Relocating Bracket for 320mm Rotor
900 D Crew Ranger Diesel	12	N/A		TBA*	TBA	TBA							
900 D Ranger 4 x 4 Diesel	11	FA452TT*		FA452R*	MD6338D	MD6338D							
900 Ranger RZR XP	11-12	FA452TT*		FA452R*	TBA	TBA							

### ACCOSSATO

50 Cross Mini	82-			926G									
50/80 Cross/Enduro	83-			841G									
C 50 Cross/Enduro/Compet.	84-			841G									
CE 80/125 Cross/Enduro H 20	84-			940G									
CE 50/80/KR 80	87-	FA047		FA047R	N/A								
Enduro Codice 50	89-	FA047		FA047R	N/A								

### ADIVA SCOOTERS

AD 125	09-11	SFA264	SFAC264	SFA264HH	N/A								
AD 200	09-11	SFA264	SFAC264	SFA264HH	N/A								
AD 400	09-11	SFA266*	SFAC266*	SFA266HH*	N/A	N/A							
AR 125	10-11	SFA264	SFAC264	SFA264HH	N/A								
AR 200	10-11	SFA264	SFAC264	SFA264HH	N/A								

### ADLY

AT 50 Air Tech 1	08-09	SFA083	SFAC083	SFA083HH	TBA								
50 RS Supersonic	06-08	SFA083*	SFAC083*	SFA083HH*	N/A	N/A							
Jet 50/100 (X-1)		SFA083	SFAC083	SFA083HH	MD904D		MD904C	VR904					
City Bird		SFA169	SFAC169	SFA169HH	TBA								
Predator 50/100		SFA083*	SFAC083*	SFA083HH*	MD923D	MD923D	MD923C*	VR923*					
Fox 50		SFA169	SFAC169	SFA169HH	MD904D		MD904C	VR904					
NB 50 Noble 50	08-10	SFA083	SFAC083	SFA083HH	N/A								
P50 Panther 50	02-09	SFA083	SFAC083	SFA083HH	TBA								
Cosy 50/80	02-06	SFA083	SFAC083	SFA083HH	TBA								
RT 50/100		SFA083	SFAC083	SFA083HH	TBA								
Road Tracer 50/90/100	04-06	SFA169	SFAC169	SFA169HH	MD904D		MD904C	VR904					
SF 50 Silver Fox 50	06-09	SFA083	SFAC083	SFA083HH	N/A								
SS 50 1/11 Supersonic	04-05	SFA083	SFAC083	SFA083HH	MD923D		MD923C	VR923					
TB 50 Thunderbike	08-09	SFA083	SFAC083	SFA083HH	N/A								
SS 100 1/11 Supersonic	04-05	SFA083	SFAC083	SFA083HH	MD923D		MD923C	VR923					
Thunderbike 125 (Rear Drum Model)		SFA083	SFAC083	SFA083HH	MD923D		MD923C	VR923					
Thunderbike 125 (Rear Disc Model)		SFA083	SFAC083	SFA083HH	MD923D		MD923C	VR923					
GK 125 Buggie	03-07	H346*		H346G*									
NB 125 B Noble 125 (Rear Drum Model)	08-09	SFA083	SFAC083	SFA83HH	N/A								
NB 125 D Noble 125 (Rear Disc Model)	08-10	SFA083	SFAC083	SFA83HH	N/A								
SS 125 B/D Supersonic	04-05	SFA083	SFAC083	FA083HH	MD923D		MD923C	VR923					
150 Crusader Quad	06	FA083TT*		FA083R*	N/A	N/A							
150 Interceptor	06	FA083TT*		FA083R*	N/A	N/A							
Crossroad 150 Quad	07-09	FA083TT*		FA083R*	N/A	N/A							
Sport 150 Quad	08-09	FA083TT*		FA083R*	N/A	N/A							
Crossroad 220 Sentinel Quad		FA377TT*		FA377R*	N/A	N/A							
Hurricane 280 Quad	08-09	FA377TT*		FA377R*	N/A	N/A							
Canyon 280 Quad	08-09	FA377TT*		FA377R*	N/A	N/A							
Canyon 300 Quad	08-09	FA377TT*		FA377R*	N/A	N/A							
Crossroad 300 Sentinel Quad	08-09	FA377TT*		FA377R*	N/A	N/A							
Hurricane 300 Quad	08-09	FA377TT*		FA377R*	N/A	N/A							
Interceptor 300	05-07	FA083TT*		FA083R*	N/A	N/A							
Interceptor 300 Quad		FA416TT*		FA416R*	N/A	N/A							
300 Crusader Quad	05-07	FA083TT*		FA083R*	N/A	N/A							
300 RS Quad	07-08	FA377TT*		FA377R*	TBA	TBA							
300 XS Quad	07-08	FA377TT*		FA377R*	TBA	TBA							
Utility 300	05-07	FA377TT*		FA377R*	N/A	N/A							
320 S Quad	08	FA377TT*		FA377R*	TBA	TBA							
Hurricane 320 Quad	08-09	FA377TT*		FA377R*	N/A	N/A							
500 S	08	FA377TT*		FA377R*	N/A	N/A							

\*-2 Sets Required. ■ - Also available in MX-S race compound.

**SAFETY WARNING:** DO NOT USE HH PADS ON REAR UNLESS ALSO USED ON FRONT TO AVOID BRAKE IMBALANCE

APPLICATIONS  
BRAKE

R Suffix = High Durability Sintered Pad. HH Suffix = High Performance Sintered Pad. G Suffix = Grooved Shoe.  
D Suffix = Drilled Disc. C Suffix = Contoured Disc. LS Suffix = Left/Steel Disc. RS = Right/Steel Disc.



# Non-JAPANESE Built Motorcycles

**BRAKE APPLICATIONS**



## POLARIS SIDE X SIDE



← REAR / ARRIÈRE / HINTEN POSTERIOR / POSTERIORE →

			DISC PAD CHOICES			BRAKE ROTOR CHOICES				
			NEW SFAC Scooter Carbon Pads	Semi-Sintered V-Pads™	Sintered/HH Pads/ Grooved shoes		Contour Rotor Rear Fitment	NEW Vee-Rotors™ CONTOUR	NEW CX Extreme® ROTOR	
900 D Crew Ranger Diesel	12	N/A			TBA*					
900 D Ranger 4 x 4 Diesel	11	N/A			FA354R*	MD6275D*				
900 Ranger RZR XP	11-12	N/A			FA354R*	TBA*				
<b>ACCOSSATO</b>										
50 Cross Mini	82-				926G					
50/80 Cross/Enduro	83-				841G					
C 50 Cross/Enduro/Compet.	84-				841G					
CE 80/125 Cross/Enduro H 20	84-				841G					
CE 50/80/KR 80	87-	FA116				N/A				
Enduro Codice 50	89-	FA116				N/A				
<b>ADIVA SCOOTERS</b>										
AD 125	09-11	SFA199	SFAC199		SFA199HH	N/A				
AD 200	09-11	SFA199	SFAC199		SFA199HH	N/A				
AD 400	09-11	SFA266	SFAC266		SFA266HH	N/A				
AR 125	10-11	SFA199	SFAC199		SFA199HH	N/A				
AR 200	10-11	SFA199	SFAC199		SFA199HH	N/A				
<b>ADLY</b>										
AT 50 Air Tech 1	08-09	TBA								
50 RS Supersonic	06-08	SFA083	SFAC083		SFA083HH	N/A				
Jet 50/100 (X-1)		Y503								
City Bird		Y503								
Predator 50/100		Y503								
Fox 50		Y503								
NB 50 Noble 50	08-10	TBA								
P50 Panther 50	02-09	Y503								
Cosy 50/80	02-06	Y503								
RT 50/100		897								
Road Tracer 50/90/100	04-06	Y503								
SF 50 Silver Fox 50	06-09	Y503								
SS 50 1/11 Supersonic	04-05	Y503								
TB 50 Thunderbike	08-09	TBA								
SS 100 1/11 Supersonic	04-05	Y503								
Thunderbike 125 (Rear Drum Model)		TBA								
Thunderbike 125 (Rear Disc Model)		SFA083	SFAC083		SFA083HH	MD982D				
GK 125 Buggie	03-07	FA083TT			FA083R	MD6354D				
NB 125 B Noble 125 (Rear Drum Model)	08-09	TBA								
NB 125 D Noble 125 (Rear Disc Model)	08-10	SFA083	SFAC083		SFA083HH	N/A				
SS 125 B/D Supersonic	04-05	SFA083	SFAC083		SFA083HH	MD982D				
150 Crusader Quad	06	FA083TT			FA083R	N/A				
150 Interceptor	06	FA083TT			FA083R	N/A				
Crossroad 150 Quad	07-09	FA083TT			FA083R	N/A				
Sport 150 Quad	08-09	FA083TT			FA083R	N/A				
Crossroad 220 Sentinel Quad		FA431TT			FA431R	N/A				
Hurricane 280 Quad	08-09	FA431TT			FA431R	N/A				
Canyon 280 Quad	08-09	FA431TT			FA431R	N/A				
Canyon 300 Quad	08-09	FA431TT			FA431R	N/A				
Crossroad 300 Sentinel Quad	08-09	FA431TT			FA431R	N/A				
Hurricane 300 Quad	08-09	FA431TT			FA431R	N/A				
Interceptor 300	05-07	FA083TT			FA083R	N/A				
Interceptor 300 Quad		FA431TT			FA431R	N/A				
300 Crusader Quad	05-07	FA083TT			FA083R	N/A				
300 RS Quad	07-08	FA431TT			FA431R	TBA				
300 XS Quad	07-08	FA431TT			FA431R	TBA				
Utility 300	05-07	FA431TT			FA431R	N/A				
320 S Quad	08	FA431TT			FA431R	TBA				
Hurricane 320 Quad	08-09	FA431TT			FA431R	N/A				
500 S	08	FA431TT			FA431R	N/A				

\*-2 Sets Required. ■ - Also available in MX-S race compound.

**SAFETY WARNING:** DO NOT USE HH PADS ON REAR UNLESS ALSO USED ON FRONT TO AVOID BRAKE IMBALANCE

**R** Suffix = High Durability Sintered Pad. **HH** Suffix = High Performance Sintered Pad. **G** Suffix = Grooved Shoe.  
**D** Suffix = Drilled Disc. **C** Suffix = Contoured Disc. **LS** Suffix = Left/Steel Disc. **RS** = Right/Steel Disc.

# Non-JAPANESE Built Motorcycles



← FRONT / AVANT / VORN FRENTE / ANTERIORE →

## DISC PAD CHOICES

## BRAKE ROTOR CHOICES

### AEON

			NEW SFAC Scooter Carbon Pads	Semi-Sintered V-Pads™	Sintered/HH Pads/ Grooved shoes	Left/Gauche/Links	Right/Droite/Rechts	Contour Rotor Universal left and right fitment	NEW Vee-Rotors™	NEW CX Extreme® ROTOR	Oversize 250/280mm Rotor Kit	Relocating Bracket for 250/280mm Rotor	Oversize 320mm Rotor Kit	Relocating Bracket for 320mm Rotor
Aero 50/100 (Scooter)	06		SFA083	SFAC083	SFA083HH	N/A								
Argon 50 (Scooter)	04-06		TBA			N/A								
Boy X 50 (Bike)	04-06		TBA											
Cobra 50			TBA*											
CO - IN ECO (Electric)	13		SFA384					N/A						
Echo 50 (Scooter)	04-06		TBA			N/A								
Minikoit 50 (AT06 Type) (Quad)	03-11		TBA*											
Nox 50/100/125/150 Scooter	06		SFA083	SFAC083	SFA083HH	N/A								
Regal 50/90 (Scooter)	06		SFA083	SFAC083	SFA083HH	N/A								
Revo R50 Cobra 2 (AT34 Type) (Quad)	04-06		TBA*											
X-Fast 50	06		TBA			N/A								
Cobra 60 (AT30 Type) (Quad)	04-11		H346*		H346G*									
Cobra 100 (AT30 Type) (Quad)	04-06		TBA*											
Pulsar 100/125/150 (Scooter)	06		SFA083	SFAC083	SFA083HH	N/A								
Revo R100 Cobra 2 (AT34 Type) (Quad)	04-11		TBA*											
X-Fast 110 (Bike)	06		TBA			N/A								
CO - IN 125 (4T)	13		SFA384					N/A						
Elite 125 (4T)	12-13		SFA228	SFAC228	SFA228HH	N/A								
MY 125	12-13		FA228		FA228HH	N/A								
Urban 125 (Scooter)	11		SFA228		SFA228HH	N/A								
Urban 125 (4T)	12-13		SFA228	SFAC228	SFA228HH	N/A								
Overland 125 (AT08) (Quad)	02-06		TBA											
OZ 125 (4T)	13		SFA384			N/A								
Sporty 125 (AT05 Type) (Quad)	01-05		TBA*											
OZ 150 (4T)	13		SFA384			N/A								
Cobra RS 180 (Quad)	06		TBA*											
Overland 180 (AT08) (Quad)	02-11		TBA*											
Sporty 180 (AT05 Type) (Quad)	04-05		TBA*											
Elite 200 i (Scooter)	11		SFA228		SFA228HH	N/A								
200 Two Hundred Quad	06		FA083TT*		FA083R*	N/A	N/A							
Cobra 220 (Quad)	06-11		FA083TT*		FA083R*	MD6274D	MD6274D							
Cube 300 - Side X Side	11		TBA*		TBA*	TBA	TBA							
Overland 300 (Quad) (AT20)	06-07		FA083TT*		FA083R*	MD6274D	MD6274D							
Cobra 350 (Quad)	10-11		FA083TT*		FA083R*	MD6274D	MD6274D							
Elite 350i (4T)	12-13		SFA228	SFAC228	SFA228HH	N/A								
Urban 350i (4T)	12-13		SFA228	SFAC228	SFA228HH	N/A								
Cube X4 400 - Side x Side	11-13		TBA*		TBA*	TBA	TBA							
Crossland RX 350	11		FA083TT*		FA083R*	TBA	TBA							
Crossland X4 350	11		TBA*		TBA*	TBA	TBA							
Urban 350 i (Scooter)	11		SFA228	SFAC228	SFA228HH	N/A								
Cobra 400 (Quad)	10-13		FA083TT*		FA083R*	MD6274D	MD6274D							
Crossland 400 (2 x 4)	12-13		FA083TT*		FA083R*	N/A	N/A							
Parking Brake			FA083TT*											
Crossland 400 (4 x 4)	12-13		FA083TT*		FA083R*	N/A	N/A							
Parking Brake			FA083TT*											
Overland 600 (Quad)	11		FA377TT*		FA377R*	N/A	N/A							
<b>AGRALE</b>														
Elefante 30.0			FA047		FA047R	N/A								
<b>AJP</b>														
PR3 125 Enduro	08-11		FA194		FA194HH	N/A								
PR3 125 Enduro Pro	08-11		FA194		FA194HH	N/A								
PR3 125 Supermoto	08-11		FA194		FA194HH	N/A								
PR3 125 Supermoto Pro	10-11		FA194		FA194HH	N/A								
PR4 Enduro 125	04-09		FA167		FA167HH	N/A								
PR4 Enduro 125	10-11		FA194		FA194HH	N/A								
PR4 Enduro Pro 125	10-11		FA194		FA194HH	N/A								
PR4 Supermoto 125	04-09		FA167		FA167HH	N/A								
PR4 Supermoto 125	10-11		FA194		FA194HH	N/A								

\*-2 Sets Required. ■ - Also available in MX-S race compound.

**SAFETY WARNING:** DO NOT USE HH PADS ON REAR UNLESS ALSO USED ON FRONT TO AVOID BRAKE IMBALANCE

APPLICATIONS  
BRAKE

R Suffix = High Durability Sintered Pad. HH Suffix = High Performance Sintered Pad. G Suffix = Grooved Shoe.  
D Suffix = Drilled Disc. C Suffix = Contoured Disc. LS Suffix = Left/Steel Disc. RS = Right/Steel Disc.

# Non-JAPANESE Built Motorcycles

**BRAKE APPLICATIONS**

**R** Suffix = High Durability Sintered Pad. **HH** Suffix = High Performance Sintered Pad. **G** Suffix = Grooved Shoe.  
**D** Suffix = Drilled Disc. **C** Suffix = Contoured Disc. **LS** Suffix = Left/Steel Disc. **RS** = Right/Steel Disc.



← REAR / ARRIÈRE / HINTEN POSTERIOR / POSTERIORE →

## AEON

			DISC PAD CHOICES			BRAKE ROTOR CHOICES			
			NEW SFAC Scooter Carbon Pads	Semi-Sintered V-Pads™	Sintered/HH Pads/ Grooved shoes	Contour Rotor Rear Fitment	NEW Vee-Rotors™ CONTOUR	NEW CX Extreme® ROTOR	
Aero 50/100 (Scooter)	06	TBA							
Argon 50 (Scooter)	04-06	TBA							
Boy X 50 (Bike)	04-06	TBA							
Cobra 50		TBA							
CO - IN ECO (Electric)	13	H303							
Echo 50 (Scooter)	04-06	TBA							
Mimikoh 50 (AT06 Type) (Quad)	03-11	TBA							
Nox 50/100/125/150 Scooter	06	TBA							
Regal 50/90 (Scooter)	06	TBA							
Revo R50 Cobra 2 (AT34 Type) (Quad)	04-06	FA083TT			FA083R	N/A			
X-Fast 50	06	TBA							
Cobra 60 (AT30 Type) (Quad)	04-11	FA083TT			FA083R	N/A			
Cobra 100 (AT30 Type) (Quad)	04-06	TBA							
Pulsar 100/125/150 (Scooter)	06	TBA							
Revo R100 Cobra 2 (AT34 Type) (Quad)	04-11	FA083TT			FA083R	N/A			
X-Fast 110 (Bike)	06	TBA							
CO - IN 125 (4T)	13	H303							
Elite 125 (4T)	12-13	SFA067	SFAC067		SFA067HH	N/A			
MY 125	12-13	FA067			FA067HH	N/A			
Urban 125 (Scooter)	11	SFA083			SFA083HH	N/A			
Urban 125 (4T)	12-13	SFA067	SFAC067		SFA067HH	N/A			
Overland 125 (AT08) (Quad)	02-06	FA165TT			FA165R	N/A			
OZ 125 (4T)	13	H303							
Sporty 125 (AT05 Type) (Quad)	01-05	FA083TT			FA083R	N/A			
OZ 150 (4T)	13	H303							
Cobra RS 180 (Quad)	06	FA165TT			FA165R	N/A			
Overland 180 (AT08) (Quad)	02-11	FA165TT			FA165R	N/A			
Sporty 180 (AT05 Type) (Quad)	04-05	FA083TT			FA083R	N/A			
Elite 200 i (Scooter)	11	SFA083			SFA083HH	N/A			
200 Two Hundred Quad	06	FA083TT			FA083R	N/A			
Cobra 220 (Quad)	06-11	FA067TT			FA067R	N/A			
Cube 300 - Side X Side	11	TBA			TBA	TBA			
Overland 300 (Quad) (AT20)	06-07	FA067TT			FA067R	N/A			
Cobra 350 (Quad)	10-11	FA067TT			FA067R	TBA			
Elite 350i (4T)	12-13	SFA067	SFAC067		SFA067HH	N/A			
Urban 350i (4T)	12-13	SFA067	SFAC067		SFA067HH	N/A			
Cube X4 400 - Side x Side	11-13	TBA			TBA	TBA			
Crossland RX 350	11	FA165TT			FA165R	TBA			
Crossland X4 350	11	TBA			TBA	TBA			
Urban 350 i (Scooter)	11	SFA083	SFAC083		SFA083HH	N/A			
Cobra 400 (Quad)	10-13	FA067TT			FA067R	TBA			
Crossland 400 (2 x 4)	12-13	FA135TT			FA135R	N/A			
Crossland 400 (4 x 4)	12-13	FA135TT			FA135R	N/A			
Overland 600 (Quad)	11	FA067TT			FA067R	N/A			

## AGRALE

Elefantre 30.0		845							
----------------	--	-----	--	--	--	--	--	--	--

## AJP

PR3 125 Enduro	08-11	FA303				N/A			
PR3 125 Enduro Pro	08-11	FA303				N/A			
PR3 125 Supermoto	08-11	FA303				N/A			
PR3 125 Supermoto Pro	10-11	FA303				N/A			
PR4 Enduro 125	04-09	FA303				N/A			
PR4 Enduro 125	10-11	FA093				N/A			
PR4 Enduro Pro 125	10-11	FA093				N/A			
PR4 Supermoto 125	04-09	FA303				N/A			
PR4 Supermoto 125	10-11	FA093				N/A			

\*-2 Sets Required. ■ - Also available in MX-S race compound.

**SAFETY WARNING:** DO NOT USE HH PADS ON REAR UNLESS ALSO USED ON FRONT TO AVOID BRAKE IMBALANCE

# Non-JAPANESE Built Motorcycles



← FRONT / AVANT / VORN FRENTE / ANTERIORE →

## DISC PAD CHOICES

## BRAKE ROTOR CHOICES

### AJP

		NEW SFAC Scooter Carbon Pads	Semi-Sintered V-Pads™	Sintered/HH Pads/ Grooved shoes	Left/Gauche/Links	Right/Droite/Rechts	Contour Rotor Universal left and right fitment	NEW Vee-Rotors™ CONTOUR	NEW CX Extreme® ROTOR	Oversize 250/280mm Rotor Kit	Relocating Bracket for 250/280mm Rotor	Oversize 320mm Rotor Kit	Relocating Bracket for 320mm Rotor
PR4 Supermoto Pro 125	10-11	FA194		FA194HH	N/A								
PR3 200 Enduro	08-11	FA194		FA194HH	N/A								
PR3 200 Enduro Pro	10-11	FA194		FA194HH	N/A								
PR3 200 MX	10-11	FA194		FA194HH	N/A								
PR3 200 MX Pro	10-11	FA194		FA194HH	N/A								
PR3 200 Supermoto	08-11	FA194		FA194HH	N/A								
PR3 200 Supermotard Pro	10-11	FA194		FA194HH	N/A								
PR4 200 Enduro	04-09	FA167		FA167HH	N/A								
PR4 Enduro 200	10-11	FA194		FA194HH	N/A								
PR4 Enduro Pro 200	10-11	FA194		FA194HH	N/A								
PR4 200 Supermoto	04-09	FA167		FA167HH	N/A								
PR4 200 Supermoto	10-11	FA194		FA194HH									
PR4 200 Supermoto Pro	10-11	FA194		FA194HH									
PR5 250 Enduro	09	FA185TT		FA185R ■	N/A								
PR5 250 Enduro	10-11	FA465TT		FA465R	N/A								
PR5 250 Supermoto	09	FA185TT		FA185R ■	N/A								
PR5 250 Supermoto	10-11	FA465TT		FA465R	N/A								

### AJS

Exactly 50 Scooter	08-11	SFA235	SFAC235					N/A					
Regal Raptor DD 50 E	04-06	SFA054	SFAC054	FA054HH									
Regal Raptor DD 100 E	04-06	TBA											
Bobber 125 (Custom)	10-11	FA086*		FA086HH*				N/A*					
Daytona 125 E	10	FA086		FA086HH				N/A					
EOS 125-Regal Raptor	09-10	FA086*		FA086HH*				N/A*					
Exactly 125 Scooter	08-11	SFA235	SFAC235					N/A					
JS 125-E (ECO 125)	07-09	SFA054	SFAC054	FA054HH		N/A							
JS 125-E (ECO-2 125)	09-11	SFA054	SFAC054	FA054HH		N/A							
JSM 125 Supermotard	10-11	FA086		FA086HH				N/A					
NAC 12 (125cc)	09-11	FA086*		FA086HH*				N/A*					
NKT 1-125 Naked	08-10	FA197		FA197HH		N/A							
Regal Raptor DD 125 E	04-06	FA197		FA197HH		N/A							
Regal Raptor DD 125 E (Cast Wheels)	09-10	FA086		FA086HH				N/A					
Regal Raptor CR3-125	06	FA375				MD644RS							
NKT 2-250 Naked	08-09	FA197		FA197HH		N/A							
Regal Raptor DD 250 E	04-09	FA197		FA197HH		N/A							

### ALFER

80 MC	87-	FA047TT		FA047R	N/A								
125 MC	87	FA047TT		FA047R	N/A								
125 MC	88-	FA126TT		FA126R	N/A								
VRE 125 4T	98-	FA181TT		FA181R	N/A								
AR 250	93-	FA185TT		FA185R	N/A								
Divertida 250 Super Motard	01-	FA181TT		FA181R	N/A								
Diferente Enduro	01-	FA181TT		FA181R	N/A								
250 MC	85-86	FA047TT		FA047R	N/A								
250 MC	87	FA047TT		FA047R	N/A								
250 MC	88-	FA126TT		FA126R	N/A								
250 GR/Enduro	85-87	FA047TT		FA047R	N/A								
250 GR/Enduro	88-	FA126TT		FA126R	N/A								
VR 250	98-	FA181TT		FA181R	N/A								
300 GR Enduro	85-87	FA047TT		FA047R	N/A								
300 GR Enduro	88-	FA126TT		FA126R	N/A								

### ANCILLOTTI

PS 80/PST 125 MX/GS	83-			841WG									
PSV 250 MX	83-			841WG									

\*-2 Sets Required. ■ - Also available in MX-S race compound.

**SAFETY WARNING:** DO NOT USE HH PADS ON REAR UNLESS ALSO USED ON FRONT TO AVOID BRAKE IMBALANCE

APPLICATIONS  
BRAKE

R Suffix = High Durability Sintered Pad. HH Suffix = High Performance Sintered Pad. G Suffix = Grooved Shoe.

D Suffix = Drilled Disc. C Suffix = Contoured Disc. LS Suffix = Left/Steel Disc. RS = Right/Steel Disc.

# Non-JAPANESE Built Motorcycles

**BRAKE APPLICATIONS**

**R** Suffix = High Durability Sintered Pad. **HH** Suffix = High Performance Sintered Pad. **G** Suffix = Grooved Shoe.  
**D** Suffix = Drilled Disc. **C** Suffix = Contoured Disc. **LS** Suffix = Left/Steel Disc. **RS** = Right/Steel Disc.



← REAR / ARRIÈRE / HINTEN POSTERIOR / POSTERIORE →

## AJP



			DISC PAD CHOICES			BRAKE ROTOR CHOICES		
			NEW SFAC Scooter Carbon Pads	Semi-Sintered V-Pads™	Sintered/HH Pads/ Grooved shoes	Contour Rotor Rear Fitment	NEW Vee-Rotors™ CONTOUR	NEW CX Extreme® ROTOR
PR4 Supermoto Pro 125	10-11	FA093				N/A		
PR3 200 Enduro	08-11	FA303				N/A		
PR3 200 Enduro Pro	10-11	FA303				N/A		
PR3 200 MX	10-11	FA303				N/A		
PR3 200 MX Pro	10-11	FA303				N/A		
PR3 200 Supermoto	08-11	FA303				N/A		
PR3 200 Supermotard Pro	10-11	FA303				N/A		
PR4 200 Enduro	04-09	FA303				N/A		
PR4 Enduro 200	10-11	FA093				N/A		
PR4 Enduro Pro 200	10-11	FA093				N/A		
PR4 200 Supermoto	04-09	FA303				N/A		
PR4 200 Supermoto	10-11	FA093				N/A		
PR4 200 Supermoto Pro	10-11	FA093				N/A		
PR5 250 Enduro	09	FA131TT			FA131R ■	N/A		
PR5 250 Enduro	10-11	FA131TT			FA131R ■	N/A		
PR5 250 Supermoto	09	FA131TT			FA131R ■	N/A		
PR5 250 Supermoto	10-11	FA131TT			FA131R ■	N/A		

## AJS

Exactly 50 Scooter	08-11	TBA						
Regal Raptor DD 50 E	04-06	TBA						
Regal Raptor DD 100 E	04-06	TBA						
Bobber 125 (Custom)	10-11	FA197			FA197HH	N/A		
Daytona 125 E	10	FA197			FA197HH	N/A		
EOS 125-Regal Raptor	09-10	FA197			FA197HH	N/A		
Exactly 125 Scooter	08-11	TBA						
JS 125-E (ECO 125)	07-09	TBA						
JS 125-E (ECO-2 125)	09-11	TBA						
JSM 125 Supermotard	10-11	FA054			FA054HH	N/A		
NAC 12 (125cc)	09-11	FA086			FA086HH	N/A		
NKT 1-125 Naked	08-10	FA197			FA197HH	N/A		
Regal Raptor DD 125 E	04-06	TBA						
Regal Raptor DD 125 E (Cast Wheels)	09-10	FA197			FA197HH	N/A		
Regal Raptor CR3-125	06	FA343				MD1151		
NKT 2-250 Naked	08-09	FA197			FA197HH	N/A		
Regal Raptor DD 250 E	04-09	TBA						

## ALFER

80 MC	87-	FA115TT			FA115R	N/A		
125 MC	87	N/A						
125 MC	88-	FA047TT			FA047R	N/A		
VRE 125 4T	98-	FA208TT			FA208R	N/A		
AR 250	93-	FA067TT			FA067R	N/A		
Diverdita 250 Super Motard	01-	FA208TT			FA208R	N/A		
Diferente Enduro	01-	FA208TT			FA208R	N/A		
250 MC	85-86	N/A						
250 MC	87	FA047TT			FA047R	N/A		
250 MC	88-	FA047TT			FA047R	N/A		
250 GRI/Enduro	85-87	N/A						
250 GRI/Enduro	88-	FA047TT			FA047R	N/A		
VR 250	98-	FA208TT			FA208R	N/A		
300 GR Enduro	85-87	N/A						
300 GR Enduro	88-	FA047TT			FA047R	N/A		

## ANCILLOTTI

PS 80/PST 125 MX/GS	83-				841WG			
PSV 250 MX	83-				843WG			

\*-2 Sets Required. ■ - Also available in MX-S race compound.  
**SAFETY WARNING:- DO NOT USE HH PADS ON REAR UNLESS ALSO USED ON FRONT TO AVOID BRAKE IMBALANCE**



# Non-JAPANESE Built Motorcycles



← FRONT / AVANT / VORN FRENTE / ANTERIORE →

## APACHE

Model	Year	DISC PAD CHOICES				BRAKE ROTOR CHOICES							
		NEW SFAC Scooter Carbon Pads	Semi-Sintered V-Pads™	Sintered/HH Pads/ Grooved shoes	Left/Gauche/Links	Right/Droite/Rechts	Contour Rotor Universal left and right fitment	NEW Vee-Rotors™ CONTOUR	NEW CX Extreme® ROTOR	Oversize 250/280mm Rotor Kit	Relocating Bracket for 250/280mm Rotor	Oversize 320mm Rotor Kit	Relocating Bracket for 320mm Rotor
Mini Tomahawk 50 (2T)	08-09	N/A											
Mini Tomahawk 50 (4T)	08-09	H346*		H346G*									
RLX 50		H346*		H346G*									
RLX 100		H346*		H346G*									
RLX 110		H346*		H346G*									
F 100		FA067TT*		FA067R*	N/A	N/A							
ZX 100		H346*		H346G*									
RLX 150 S		Y503*		Y503G*									
RLX 250 S (MK1) Rear Disc Model		FA067TT*		FA067R*	N/A	N/A							
RLX 250 SX (MK1) Rear Disc Model		FA067TT*		FA067R*	N/A	N/A							
RLX 320 S		FA067TT*		FA067R*	N/A	N/A							
RLX 320 Utility		FA067TT*		FA067R*	N/A	N/A							
RLX 450 S		FA067TT*		FA067R*	N/A	N/A							

## APRILIA (Inc Scarabeo models up to 2009. See separate section for 2010 upwards)

Model	Year	Disc Pad	Disc Pad	Disc Pad	Left/Gauche/Links	Right/Droite/Rechts	Contour Rotor	NEW Vee-Rotors™	NEW CX Extreme®	Oversize 250/280mm Rotor Kit	Relocating Bracket for 250/280mm Rotor	Oversize 320mm Rotor Kit	Relocating Bracket for 320mm Rotor
AF1 Futura 50	90-92	FA116			MD625LS								
Amico (All models)	96-98	SFA193	SFAC193	SFA193HH	MD904D		MD904C	VR904					
Area 51	98-02	SFA193	SFAC193	SFA193HH	MD936D			VR936					
Classic 50	92-01	FA116			N/A								
Europa 50	90-92	FA116			MD625LS								
Habana 50/Habana Custom	99-02	SFA193	SFAC193	SFA193HH	MD943D		MD943C	VR943					
Guliver (All models)	95-98	SFA193	SFAC193	SFA193HH	MD943D		MD943C	VR943					
Mini RX 50 Experience	04	FA351			N/A								
Mini RX 50 Challenge/Entry	04	TBA											
MX 50	03-05	FA194		FA194HH	MD6214D								
Mojito Custom 50 (120mm Diameter Rear Drum)	99-03	SFA193	SFAC193	SFA193HH	MD943D		MD943C	VR943					
Mojito Custom 50 (110mm Diameter Rear Drum)	04-12	SFA193	SFAC193	SFA193HH	MD943D		MD943C	VR943					
Mojito Retro 50 (120mm Diameter Rear Drum)	99-03	SFA193	SFAC193	SFA193HH	MD943D		MD943C	VR943					
Pegaso 50 (2 pads both same shape modification A)	92-94	FA256TT		FA256HH	MD6214D								
Pegaso 50 (Pad with hook on one side modification B)	92-94	FA194		FA194HH	MD6214D								
Quad 50 cc (2 stroke)	04	TBA*											
Rally (All models) A/C	95-02	SFA193	SFAC193	SFA193HH	MD943D		MD943C	VR943					
Rally 50 All models L/C	96-00	SFA193	SFAC193	SFA193HH	MD943D		MD943C	VR943					
RS 50 (6 bolt disc fixing front & rear)	93-98	FA047		FA047HH	MD639LS								
RS 50 (5 bolt fixing front & rear)	99-05	FA194		FA194HH	MD672LS								
RS 50 (Radial Caliper - 6 bolt fixing front & rear)	06-11	FA266		FA266HH	MD685LS								
RS4 50 (4T)	11-13	FA399			MD685LS								
RX 3-5 Marce (MN) (50cc)	91-92	FA167		FA167HH	MD6214D								
RX 3-5 Marce (P/R) (50cc)	93-94	FA167		FA167HH	MD6214D								
RX 50 C/CD	95-04	FA194		FA194HH	MD6214D								
RX 50 Racing	03-06	FA194		FA194HH	TBA								
RX 50	06-13	FA194		FA194HH	MD811								
Scarabeo 50 (2T) (HS/HL) Front drum model	93-97	805											
Scarabeo 50 (2T) (H2/HL) Front disc model	93-97	SFA193	SFAC193	SFA193HH	MD917D								
Scarabeo 50 (2T) (PFO100) (Rear drum model)	98-99	SFA193	SFAC193	SFA193HH	MD945D			VR945					
Scarabeo 50 (2T) (Rear disc model) (PFO100)	98-99	SFA193	SFAC193	SFA193HH	MD945D			VR945					
Scarabeo 50 (2T) (Rear drum model) (PFG00/TH000)	00-05	SFA193	SFAC193	SFA193HH	MD945D			VR945					
Scarabeo 50 (2T) (Rear disc model) (PFG00/TH000)	00-05	SFA193	SFAC193	SFA193HH	MD945D			VR945					
Scarabeo 50 Classic (2T) (PFO100) (Rear drum model)	98-99	SFA193	SFAC193	SFA193HH	MD990D			VR990					
Scarabeo Classic (2T) (PFO100) (Rear disc model)	98-99	SFA193	SFAC193	SFA193HH	MD990D			VR990					
Scarabeo 50 (Ditech) (2T) (SCA00)	02-06	SFA193	SFAC193	SFA193HH	MD945D			VR945					
Scarabeo 50 Street (2T) (TH00/TH00)	05-09	SFA193	SFAC193	SFA193HH	MD945D			VR945					
Scarabeo 50 (4T) (TG000)	02-06	SFA193	SFAC193	SFA193HH	MD945D			VR945					
Scarabeo 50 (4T) (TGA00/TGB00)	06-09	SFA193	SFAC193	SFA193HH	MD945D			VR945					
Sonic (All models)	98-08	SFA193	SFAC193	SFA193HH	MD935D								
Sport City One 50 (2T)	08-11	SFA353	SFAC353	SFA353HH	MD924D		MD924C	VR924					
Sport City One 50 (4T)	08-09	SFA353	SFAC353	SFA353HH	MD924D		MD924C	VR924					
SR 50 Ditch (LC) (RLD 100)	02-03	SFA193	SFAC193	SFA193HH	MD943D		MD943C	VR943					
SR 50 WWW (A/C) (LYH00)	97-01	SFA193	SFAC193	SFA193HH	MD943D		MD943C	VR943					

\*-2 Sets Required. ■ - Also available in MX-S race compound.

**SAFETY WARNING:** DO NOT USE HH PADS ON REAR UNLESS ALSO USED ON FRONT TO AVOID BRAKE IMBALANCE

APPLICATIONS  
BRAKE

R Suffix = High Durability Sintered Pad. HH Suffix = High Performance Sintered Pad. G Suffix = Grooved Shoe.  
D Suffix = Drilled Disc. C Suffix = Contoured Disc. LS Suffix = Left/Steel Disc. RS = Right/Steel Disc.

# Non-JAPANESE Built Motorcycles

**BRAKE APPLICATIONS**

**R** Suffix = High Durability Sintered Pad. **HH** Suffix = High Performance Sintered Pad. **G** Suffix = Grooved Shoe.  
**D** Suffix = Drilled Disc. **C** Suffix = Contoured Disc. **LS** Suffix = Left/Steel Disc. **RS** = Right/Steel Disc.



## APACHE



← REAR / ARRIÈRE / HINTEN POSTERIOR / POSTERIORE →

		DISC PAD CHOICES				BRAKE ROTOR CHOICES			
		NEW SFAC Scooter Carbon Pads	Semi-Sintered V-Pads™	Sintered/HH Pads/ Grooved shoes		Contour Rotor Rear Fitment	NEW Vee-Rotors™ CONTOUR	NEW CX Extreme® ROTOR	
Mini Tomahawk 50 (2T)	08-09	FA232TT			FA232R	N/A			
Mini Tomahawk 50 (4T)	08-09	H307			H307G				
RLX 50		FA083TT			FA083R	N/A			
RLX 100		FA083TT			FA083R	N/A			
RLX 110		FA083TT			FA083R	N/A			
F 100		FA067TT			FA067R	N/A			
ZX 100		FA067TT			FA067R	N/A			
RLX 150 S		FA165TT			FA165R	N/A			
RLX 250 S (MK1) Rear Disc Model		FA135TT			FA135R	N/A			
RLX 250 SX (MK1) Rear Disc Model		FA135TT			FA135R	N/A			
RLX 320 S		FA067TT			FA067R	N/A			
RLX 320 Utility		FA067TT			FA067R	N/A			
RLX 450 S		FA067TT			FA067R	N/A			
<b>APRILIA</b>									
AF1 Futura 50	90-92	FA060				N/A			
Amico (All models)	96-98	893							
Area 51	98-02	SFA193	SFAC193		SFA193HH	MD943D		VR943	
Classic 50	92-01	995							
Europa 50	90-92	FA060				N/A			
Habana 50/Habana Custom	99-02	817							
Gulliver (All models)	95-98	893							
Mini RX 50 Experience	04	TBA							
Mini RX 50 Challenge/Entry	04	TBA							
MX 50	03-05	FA060				MD6286D			
Mojito Custom 50 (120mm Diameter Rear Drum)	99-03	817							
Mojito Custom 50 (110mm Diameter Rear Drum)	04-12	899							
Mojito Retro 50 (120mm Diameter Rear Drum)	99-03	817							
Pegaso 50 (2 pads both same shape modification A)	92-94	FA337TT				MD6286D			
Pegaso 50 (Pad with hook on one side modification B)	92-94	FA337TT				MD6286D			
Quad 50 cc (2 stroke)	04	TBA							
Rally (All models) A/C	95-02	893							
Rally 50 All models L/C	96-00	SFA193	SFAC193		SFA193HH	MD943D	MD943C	VR943	
RS 50 (6 bolt disc fixing front & rear)	93-98	FA060				N/A			
RS 50 (5 bolt fixing front & rear)	99-05	FA060				MD664			
RS 50 (Radial Caliper - 6 bolt fixing front & rear)	06-11	FA115			FA115HH	MD686			
RS4 50 (4T)	11-13	FA093				MD833			
RX 3-5 Marce (M/N) (50cc)	91-92	FA060				MD6286D			
RX 3-5 Marce (P/R) (50cc)	93-94	FA060				MD6286D			
RX 50 C/C/D	95-04	FA060				MD6286D			
RX 50 Racing	03-06	FA060				MD6286D			
RX 50	06-13	FA115			FA115HH	MD6248D			
Scarabeo 50 (2T) (HS/HL) Front drum model	93-97	893							
Scarabeo 50 (2T) (H2/HL) Front disc model	93-97	893							
Scarabeo 50 (2T) (PFO100) (Rear drum model)	98-99	893							
Scarabeo 50 (2T) (Rear disc model) (PFO100)	98-99	SFA193	SFAC193		SFA193HH	MD943D		VR943	
Scarabeo 50 (2T) (Rear drum model) (PFG00/TH000)	00-05	893							
Scarabeo 50 (2T) (Rear disc model) (PFG00/TH000)	00-05	SFA193	SFAC193		SFA193HH	MD943D		VR943	
Scarabeo 50 Classic (2T) (PFO100) (Rear drum model)	98-99	893							
Scarabeo Classic (2T) (PFO100) (Rear disc model)	98-99	SFA193	SFAC193		SFA193HH	MD943D		VR943	
Scarabeo 50 (Ditech) (2T) (SCA00)	02-06	SFA298	SFAC298		SFA298HH	MD943D		VR943	
Scarabeo 50 Street (2T) (TH00/THE00)	05-09	816							
Scarabeo 50 (4T) (TG000)	02-06	816							
Scarabeo 50 (4T) (TGA00/TGB00)	06-09	816							
Sonic (All models)	98-08	893							
Sport City One 50 (2T)	08-11	816							
Sport City One 50 (4T)	08-09	816							
SR 50 Ditch (LC) (RLD 100)	02-03	SFA298	SFAC298		SFA298HH	MD943D	MD943C	VR943	
SR 50 WWW (A/C) (LYH00)	97-01	893							

\*-2 Sets Required. ■ - Also available in MX-S race compound.

**SAFETY WARNING:** DO NOT USE HH PADS ON REAR UNLESS ALSO USED ON FRONT TO AVOID BRAKE IMBALANCE

# Non-JAPANESE Built Motorcycles



← FRONT / AVANT / VORN FRENTE / ANTERIORE →

## DISC PAD CHOICES

## BRAKE ROTOR CHOICES

### APRILIA

				NEW SFAC Scooter Carbon Pads	Semi-Sintered V-Pads™	Sintered/HH Pads/ Grooved shoes	Left/Gauche/Links	Right/Droite/Rechts	Contour Rotor Universal left and right fitment	NEW Vee-Rotors™ CONTOUR	NEW CX Extreme® ROTOR	Oversize 250/280mm Rotor Kit	Relocating Bracket for 250/280mm Rotor	Oversize 320mm Rotor Kit	Relocating Bracket for 320mm Rotor
SR 50 Street (LC) (TE00/TEA00)															
Note - Rear disc mounts onto a spacer carrier hub	03-13	SFA193	SFAC193		SFA193HH	MD943D			MD943C	VR943					
SR 50 R/Factory (LC) (VFB00/VFD00)															
Note - Rear disc mounts onto a spacer carrier hub	04-13	SFA193	SFAC193		SFA193HH	MD943D			MD943C	VR943					
SR 50 R SBK/SBK Alitalia Replica (LC)	10-11	SFA193	SFAC193		SFA193HH				MD943C	VR943					
SR 50 H20 (Ditech) (RLA1/RLB1) (Rear disc model)	00-03	SFA193	SFAC193		SFA193HH	MD943D			MD943C	VR943					
SR 50 H20 (Ditech) (RLA1/RLB1) (Rear drum model)	00-03	SFA193	SFAC193		SFA193HH	MD943D			MD943C	VR943					
SR 50 (A/C) GPLBLF	93-96	SFA193	SFAC193		SFA193HH	MD943D			MD943C	VR943					
SR 50 (LC)	94-96	SFA193	SFAC193		SFA193HH	MD943D			MD943C	VR943					
SR 50 Motard	12-13	SFA353	SFAC353		SFA353HH	TBA									
SR 50 StealthRacing (LC) (Drum rear brake) (MZCO)	97-99	SFA193	SFAC193		SFA193HH	MD943D			MD943C	VR943					
SR 50 StealthRacing (LC) (Disc rear brake) (MZCO)	97-99	SFA193	SFAC193		SFA193HH	MD943D			MD943C	VR943					
SX 50	06-13	FA194			FA194HH	MD811									
Tuono 50	04	FA194			FA194HH	MD672LS									
Scarabeo 100 (2T) (Yamaha Engine - RE00)	00	SFA301	SFAC301		SFA301HH	MD945D				VR945					
Scarabeo 100 (2T) (Minarelli Engine - REA0)	00	SFA301	SFAC301		SFA301HH	MD945D				VR945					
Scarabeo 100 (4T) (SA000/VA000)	01-09	SFA301	SFAC301		SFA301HH	MD945D				VR945					
Quad 100cc (2 stroke)	04	TBA*													
AF1 125	87	FA134						MD635RS							
AF1 125	88-89	FA126			FA126HH			MD635RS							
AF1 125	90-91	FA126			FA126HH			MD612RS							
Atlantic 125	03-08	SFA324	SFAC324		SFA324HH	MD997D				VR997					
Atlantic 125	10	SFA324	SFAC324		SFA324HH	MD997D				VR997					
Classic 125	95-01	FA167			FA167HH			MD628RS							
ETX 125	99-01	FA194			FA194HH	N/A									
Habana 125/Habana Custom	00-02	SFA301	SFAC301		SFA301HH	MD943D			MD943C	VR943					
Leonardo 125/H150	96-98	SFA193	SFAC193		SFA193HH	MD942D				VR942					
Leonardo 125/H150 ST/SP	99-04	SFA301	SFAC301		SFA301HH	MD942D				VR942					
Leonardo 125	05-06	SFA301	SFAC301		SFA301HH	MD942D				VR942					
Mojito/Mojito Custom 125	03-12	SFA301	SFAC301		SFA301HH	MD943D			MD943C	VR943					
MX 125	04-06	FA181TT			FA181R	MD2003X					VR2003BLK				
RS 125 (6 bolt rear disc/2T)	92-98	FA126			FA126HH			MD2003X	MD2003XC		VR2003BLK				
RS 125 (5 bolt rear disc/2T)	99-05	FA126			FA126HH			MD2003X	MD2003XC		VR2003BLK				
RS 125 (Radial Caliper/2T)	06-12	FA432			FA432HH			MD621X	MD621XC		VR621BLK				
RS4 125 (4T) (AJP Rear Caliper)	11-13	FA399						MD686LS							
RS4 125 (4T) (J.Juan Rear Caliper)	11-13	FA399						MD686LS							
Scarabeo 125/H150	99-02	SFA256	SFAC256		SFA256HH	MD952D				VR952					
Scarabeo 125/200	03	SFA256	SFAC256		SFA256HH	MD952D				VR952					
Scarabeo 125/H150 GT	04-06	SFA324	SFAC324		SFA324HH	MD952D				VR952					
Scarabeo 125	07-10	SFA324	SFAC324		SFA324HH	MD952D				VR952					
Tuareg Rally 125 (N)	-93	FA167			FA167HH			N/A							
RX 125	92-99	FA194			FA194HH			N/A							
RX 125	00-01	FA181TT			FA181R	N/A									
RX 125 (Brembo Front & Grimeca Rear caliper)	08-12	FA181TT			FA181R ■	TBA									
RX 125 (AJP Calipers Front & Rear)	08-12	FA181TT			FA181R ■	TBA									
Pegaso 125	91	FA167			FA167HH			N/A							
Pegaso 125 Kat	94-95	FA194			FA194HH			N/A							
Red Rose 125 (Cast wheel)	87	FA256			FA256HH	N/A									
Red Rose 125 (Spoke wheel)	88-94	FA256			FA256HH			MD628RS							
Sport City 125	04-08	SFA256	SFAC256		SFA256HH	MD952D				VR952					
Sport City Cube 125	08-12	SFA256	SFAC256		SFA256HH	MD952D				VR952					
Sport City One - 125cc	08-11	SFA353	SFAC353		SFA353HH	MD924D			MD924C	VR924					
SR 125/H150	99-02	SFA301	SFAC301		SFA301HH	MD943D			MD943C	VR943					
SR 125 Motard	12-13	SFA353	SFAC353		SFA353HH	TBA									
SR 125 Max	11-13	SFA353	SFAC353		SFA353HH	MD983D				VR983					
SX 125	08-13	FA181TT			FA181R ■	TBA									
Tuareg Rally 125	89	FA163						N/A							
Tuareg Rally 125 (LM)	90-91	FA256TT			FA256HH	N/A									
Tuono 125	03-04	FA126			FA126HH			MD2003X	MD2003XC	VR2003BLK					
TX 125/240/311	86-88	FA115TT			FA115R			N/A							

\*-2 Sets Required. ■ - Also available in MX-S race compound.

**SAFETY WARNING:** DO NOT USE HH PADS ON REAR UNLESS ALSO USED ON FRONT TO AVOID BRAKE IMBALANCE

# Non-JAPANESE Built Motorcycles



## APRILIA



← REAR / ARRIÈRE / HINTEN  POSTERIOR / POSTERIORE →

		DISC PAD CHOICES				BRAKE ROTOR CHOICES			
		NEW SFAC Scooter Carbon Pads	Semi-Sintered V-Pads™	Sintered/HH Pads/ Grooved shoes		Contour Rotor Rear Fitment	NEW Vee-Rotors™ CONTOUR	NEW CX Extreme® ROTOR	
SR 50 Street (LC) (TE00/TEA00)									
Note - Rear disc mounts onto a spacer carrier hub	03-13	SFA298	SFAC298	SFA298HH	MD996D		VR996		
SR 50 R/Factory (LC) (VFB00/VFD00)									
Note - Rear disc mounts onto a spacer carrier hub	04-13	SFA298	SFAC298	SFA298HH	MD996D		VR996		
SR 50 R SBK/SBK Alitalia Replica (LC)	10-11	SFA298	SFAC298	SFA298HH		TBA			
SR 50 H20 (Ditech) (RLA1/RLB1) (Rear disc model)	00-03	SFA298	SFAC298	SFA298HH	MD943D	MD943C	VR943		
SR 50 H20 (Ditech) (RLA1/RLB1) (Rear drum model)	00-03	817							
SR 50 (A/C) GP/LBLF	93-96	893							
SR 50 (LC)	94-96	893							
SR 50 Motard	12-13	816							
SR 50 Stealth/Racing (LC) (Drum rear brake) (MZCO)	97-99	893							
SR 50 Stealth/Racing (LC) (Disc rear brake) (MZCO)	97-99	SFA193	SFAC193	SFA193HH	MD943D	MD943C	VR943		
SX 50	06-13	FA115		FA115HH	MD6248D				
Tuono 50	04	FA060			MD664				
Scarabeo 100 (2T) (Yamaha Engine - RE00)	00	Y527							
Scarabeo 100 (2T) (Minarelli Engine - REA0)	00	Y527							
Scarabeo 100 (4T) (SA000/VA000)	01-09	816							
Quad 100cc (2 stroke)	04	TBA							
AF1 125	87	FA047			MD658				
AF1 125	88-89	FA047		FA047HH	MD658				
AF1 125	90-91	FA047		FA047HH	MD658				
Atlantic 125	03-08	SFA298	SFAC298	SFA298HH	MD996D		VR996		
Atlantic 125	10	SFA298	SFAC298	SFA298HH	MD996D		VR996		
Classic 125	95-01	921							
ETX 125	99-01	FA173			N/A				
Habana 125/Habana Custom	00-02	816							
Leonardo 125/150	96-98	SFA193	SFAC193	SFA193HH	MD943D		VR943		
Leonardo 125/150 ST/SP	99-04	SFA301	SFAC301	SFA301HH	MD943D		VR943		
Leonardo 125	05-06	SFA301	SFAC301	SFA301HH	MD990D		VR990		
Mojito/Mojito Custom 125	03-12	816							
MX 125	04-06	FA382			MD6315D				
RS 125 (6 bolt rear disc/2T)	92-98	FA047		FA047HH	MD659				
RS 125 (5 bolt rear disc/2T)	99-05	FA047		FA047HH	MD664	MD664C			
RS 125 (Radial Caliper/2T)	06-12	FA298		SFA298HH	MD664	MD664C			
RS4 125 (4T) (AJP Rear Caliper)	11-13	FA093			MD833				
RS4 125 (4T) (J.Juan Rear Caliper)	11-13	FA083TT			MD833				
Scarabeo 125/150	99-02	SFA298	SFAC298	SFA298HH	MD942D		VR942		
Scarabeo 125/200	03	SFA298	SFAC298	SFA298HH	MD942D		VR942		
Scarabeo 125/150 GT	04-06	SFA298	SFAC298	SFA298HH	MD942D		VR942		
Scarabeo 125	07-10	SFA298	SFAC298	SFA298HH	TBA				
Tuareg Rally 125 (N)	-93	FA382			N/A				
RX 125	92-99	FA382			MD6315D				
RX 125	00-01	FA382			MD6315D				
RX 125 (Brembo Front & Grimeca Rear caliper)	08-12	FA067		FA067R	TBA				
RX 125 (AJP Calipers Front & Rear)	08-12	FA093			TBA				
Pegaso 125	91	FA382			N/A				
Pegaso 125 Kat	94-95	FA382			N/A				
Red Rose 125 (Cast wheel)	87	FA047		FA047HH					
Red Rose 125 (Spoke wheel)	88-94	921							
Sport City 125	04-08	SFA298	SFAC298	SFA298HH	MD942D		VR942		
Sport City Cube 125	08-12	SFA298	SFAC298	SFA298HH	MD942D		VR942		
Sport City One - 125cc	08-11	816							
SR 125/150	99-02	816							
SR 125 Motard	12-13	816							
SR 125 Max	11-13	SFA353	SFAC353	SFA353HH	MD960D		VR960		
SX 125	08-13	FA067		FA067R	TBA				
Tuareg Rally 125	89	FA382			MD6315D				
Tuareg Rally 125 (L/M)	90-91	FA382			MD6315D				
Tuono 125	03-04	FA047		FA047HH	MD664	MD664C			
TX 125/240/311	86-88			841G					

\*-2 Sets Required. ■ - Also available in MX-S race compound.

**SAFETY WARNING:** DO NOT USE HH PADS ON REAR UNLESS ALSO USED ON FRONT TO AVOID BRAKE IMBALANCE

**BRAKE APPLICATIONS**

**R** Suffix = High Durability Sintered Pad. **HH** Suffix = High Performance Sintered Pad. **G** Suffix = Grooved Shoe.  
**D** Suffix = Drilled Disc. **C** Suffix = Contoured Disc. **LS** Suffix = Left/Steel Disc. **RS** = Right/Steel Disc.

# Non-JAPANESE Built Motorcycles



← FRONT / AVANT / VORN FRENTE / ANTERIORE →

## DISC PAD CHOICES

## BRAKE ROTOR CHOICES

APRILIA	Year	Model	DISC PAD CHOICES		Left/Gauche/Links		Right/Droite/Rechts		Contour Rotor Universal left and right fitment	NEW Vee-Rotors™ CONTOUR	NEW CX Extreme® ROTOR	Oversize 250/280mm Rotor Kit	Relocating Bracket for 250/280mm Rotor	Oversize 320mm Rotor Kit	Relocating Bracket for 320mm Rotor
			NEW SFAC Scooter Carbon Pads	Semi- Sintered V-Pads™	Sintered/ HH Pads/ Grooved shoes	Left/Gauche/Links	Right/Droite/Rechts								
Quad 180 Sport (4 stroke)	04	TBA*													
Quad 180 Grip (4 stroke)	04	TBA*													
Atlantic 200	03-05	SFA324	SFAC324	SFA324HH	MD997D					VR997					
Scarabeo 200	07-09	SFA324	SFAC324	SFA324HH	MD952D					VR952					
Sport City 200	04-08	SFA256	SFAC256	SFA256HH	MD952D					VR952					
Sport City Cube 200	08-09	SFA256	SFAC256	SFA256HH	MD952D					VR952					
TRX 240 M	89	FA099		FA099R				N/A							
250	86	FA047		FA047R				N/A							
Atlantic 250 ie	06-08	SFA324	SFAC324	SFA324HH	MD997D					VR997					
Atlantic 250	03-05	SFA324	SFAC324	SFA324HH	MD997D					VR997					
Leonardo 250 SP/ST Models	00-04	SFA256	SFAC256	SFA256HH	MD942D					VR942					
RS 250	95-97	FA095*		FA095HH*	MD660LS			MD660RS							
RS 250	98-02	FA244*		FA244HH*	MD660LS			MD660RS							
Scarabeo 250 ie	07-10	SFA324	SFAC324	SFA324HH	MD952D					VR952					
Sport City 250 ie	06-08	SFA256*	SFAC256*	SFA256HH*	MD952D			MD952D		VR952*					
Sport City Cube 250	08-09	SFA256*	SFAC256*	SFA256HH*	MD952D			MD952D		VR952*					
280 R Climber	92-93	FA115TT		FA115R				N/A							
280 Climber	94-96	FA115TT		FA115R				N/A							
Scarabeo 250	06	SFA324	SFAC324	SFA324HH	MD952D					VR952					
Atlantic 300	10-11	SFA324	SFAC324	SFA324HH	MD997D					VR997					
Leonardo 300	05-06	SFA256	SFAC256	SFA256HH	MD942D					VR942					
Scarabeo 300 S	09-10	SFA324	SFAC324	SFA324HH	MD952D					VR952					
Sport City Cube 300	08-12	SFA256*	SFAC256*	SFA256HH*	MD952D			MD952D		VR952*					
Sport Cube 300 Blackline	11	SFA256*	SFAC256*	SFA256HH*	MD952D			MD952D		VR952*					
SR 300 Max	11-13	SFA353	SFAC353	SFA353HH	MD983D					VR983					
TX 311	88	FA115TT		FA115R				N/A							
Atlantic 400 Sprint	05-08	SFA324	SFAC324	SFA324HH	TBA										
Atlantic Sprint 400	05-08	SFA324	SFAC324	SFA324HH	TBA										
Scarabeo 400 ie	07-08	SFA256*	SFAC256*	SFA256HH*	MD952D			MD952D		VR952*					
MXV 450	09-13	FA185TT		FA185R ■					TBA						
RXV 450/550 Enduro	06-13	FA185TT		FA185R ■	TBA				TBA						
SXV 450/550 Supermoto	06-13			MXS405	TBA				TBA						
Atlantic 500	02-04	SFA256*	SFAC256*	SFA256HH*	MD952D			MD952D		VR952*					
Atlantic Sprint 500	05-08	SFA324	SFAC324	SFA324HH	TBA										
Scarabeo 500/500 ABS	03-06	SFA256*	SFAC256*	SFA256HH*	MD952D			MD952D		VR952*					
Scarabeo 500 Light	06	SFA256*	SFAC256*	SFA256HH*	MD952D			MD952D		VR952*					
Scarabeo 500 ie	07-09	SFA256*	SFAC256*	SFA256HH*	MD952D			MD952D		VR952*					
Pegaso 600	91	FA167		FA167HH				N/A							
Tuareg Wind 600	89	FA163			MD6180D										
Pegaso 650	91-96	FA177			MD6129D										
Pegaso 650	97-00	FA209/2		FA209/2V	FA209/2HH	MD6129D									
Pegaso 650 ie	01-04	FA209/2		FA209/2V	FA209/2HH	MD6129D									
Pegaso Strada 650	05-06	FA244		FA244V	FA244HH	MD621X			MD621XC	VR621BLK					
Pegaso 650 Trial	06-08	FA209/2		FA209/2V	FA209/2HH	MD6129D									
Pegaso 650	07-08	FA244			FA244HH	MD621X			MD621XC	VR621BLK					
Pegaso 650 Factory	06-08			FA244V	MXS405	MD621X			MD621XC	VR621BLK					
Moto 6.5	95-01	FA209/2		FA209/2V	FA209/2HH	MD673LS									
Shiver 750 (RA000)	07-10	FA432*			FA432HH*	MD621X		MD621X	MD621XC*	VR621BLK*					
Shiver 750 (RAE00STD & ABS)	10-13	FA432*			FA432HH*				MD621XC*	VR621BLK*					
Shiver 750 GT	09-10	FA432*			FA432HH*	MD621X		MD621X	MD621XC*	VR621BLK*					
Shiver 750 GT ABS	10-12	FA432*			FA432HH*				MD621XC*	VR621BLK*					
Dorsodura 750 (ABS)	08-13	FA432*			FA432HH*				TBA*						
Dorsodura Factory 750	10-13	FA244*		FA244V*	FA244HH*				TBA*						
Dorsodura Factory 750 (ABS)	10-12	FA244*		FA244V*	FA244HH*				TBA*						
NA 850 Mana (Non ABS)	08-11	FA432*			FA432HH*	MD621X		MD621X	MD621XC*	VR621BLK*					
NA 850 Mana Parking brake (Non ABS)	08-11	SFA257/2													
NA 850 Mana (ABS)	08-13	FA432*			FA432HH*	MD621X		MD621X	MD621XC*	VR621BLK*					
NA 850 Mana Parking brake (ABS)	08-13	SFA257/2													
NA 850 Mana GT (ABS Model)	09-13	FA432*			FA432HH*	MD621X		MD621X	MD621XC*	VR621BLK*					
NA 850 Mana GT Parking brake	09-13	SFA257/2													

\*-2 Sets Required. ■ - Also available in MX-S race compound.

**SAFETY WARNING:** DO NOT USE HH PADS ON REAR UNLESS ALSO USED ON FRONT TO AVOID BRAKE IMBALANCE



# Non-JAPANESE Built Motorcycles



## APRILIA



← REAR / ARRIÈRE / HINTEN  POSTERIOR / POSTERIORE →

		DISC PAD CHOICES				BRAKE ROTOR CHOICES			
		NEW SFAC Scooter Carbon Pads	Semi-Sintered V-Pads™	Sintered/HH Pads/ Grooved shoes		Contour Rotor Rear Fitment	NEW Vee-Rotors™ CONTOUR	NEW CX Extreme® ROTOR	
Quad 180 Sport (4 stroke)	04	TBA				TBA			
Quad 180 Grip (4 stroke)	04	TBA				TBA			
Atlantic 200	03-05	SFA298	SFAC298	SFA298HH	MD996D		VR996		
Scarabeo 200	07-09	SFA298	SFAC298	SFA298HH	TBA				
Sport City 200	04-08	SFA298	SFAC298	SFA298HH	MD942D		VR942		
Sport City Cube 200	08-09	SFA298	SFAC298	SFA298HH	MD942D		VR942		
TRX 240 M	89	FA099		FA099R	N/A				
250	86			841G					
Atlantic 250 ie	06-08	SFA298	SFAC298	SFA298HH	MD996D		VR996		
Atlantic 250	03-05	SFA298	SFAC298	SFA298HH	MD996D		VR996		
Leonardo 250 SP/ST Models	00-04	SFA298	SFAC298	SFA298HH	MD990D		VR990		
RS 250	95-97	FA047		FA047HH	MD665				
RS 250	98-02	FA047		FA047HH	MD665				
Scarabeo 250 ie	07-10	SFA298	SFAC298	SFA298HH	TBA				
Sport City 250 ie	06-08	SFA298	SFAC298	SFA298HH	MD942D		VR942		
Sport City Cube 250	08-09	SFA298	SFAC298	SFA298HH	MD942D		VR942		
280 R Climber	92-93	FA337TT		FA337R	N/A				
280 Climber	94-96	FA156			N/A				
Scarabeo 250	06	SFA298	SFAC298	SFA298HH	TBA				
Atlantic 300	10-11	SFA298	SFAC298	SFA298HH	MD996D		VR996		
Leonardo 300	05-06	SFA298	SFAC298	SFA298HH	MD990D		VR990		
Scarabeo 300 S	09-10	SFA298	SFAC298	SFA298HH	TBA				
Sport City Cube 300	08-12	SFA298	SFAC298	SFA298HH	MD942D		VR942		
Sport Cube 300 Blackline	11	SFA298	SFAC298	SFA298HH	MD942D		VR942		
SR 300 Max	11-13	SFA353	SFAC353	SFA353HH	MD960D		VR960		
TX 311	88	FA115TT		FA115R	N/A				
Atlantic 400 Sprint	05-08	SFA298	SFAC298	SFA298HH	MD990D				
Atlantic Sprint 400	05-08	SFA298	SFAC298	SFA298HH	MD990D				
Scarabeo 400 ie	07-08	SFA298	SFAC298	SFA298HH	TBA				
MXV 450	09-13	FA367TT		FA367R ■		TBA			
RXV 450/550 Enduro	06-13	FA367TT		FA367R ■		TBA			
SXV 450/550 Supermoto	06-13	FA367TT		FA367R ■		TBA			
Atlantic 500	02-04	SFA298	SFAC298	SFA298HH	MD990D		VR990		
Atlantic Sprint 500	05-08	SFA298	SFAC298	SFA298HH	MD990D				
Scarabeo 500/500 ABS	03-06	SFA298	SFAC298	SFA298HH	MD990D		VR990		
Scarabeo 500 Light	06	SFA298	SFAC298	SFA298HH	TBA				
Scarabeo 500 ie	07-09	SFA298	SFAC298	SFA298HH	TBA				
Pegaso 600	91	FA382			N/A				
Tuareg Wind 600	89	FA382			N/A				
Pegaso 650	91-96	FA173			MD6128D				
Pegaso 650	97-00	FA173			MD6128D				
Pegaso 650 ie	01-04	FA208TT		FA208R	TBA				
Pegaso Strada 650	05-06	FA213	FA213V	FA213HH	TBA				
Pegaso 650 Trial	06-08	FA213	FA213V	FA213HH	TBA				
Pegaso 650	07-08	FA213	FA213V	FA213HH	TBA				
Pegaso 650 Factory	06-08	FA213	FA213V	FA213HH	TBA				
Moto 6.5	95-01	FA173			MD674				
Shiver 750 (RA000)	07-10	FA213	FA213V	FA213HH	TBA				
Shiver 750 (RAE00/STD & ABS)	10-13	FA213	FA213V	FA213HH	TBA				
Shiver 750 GT	09-10	FA213	FA213V	FA213HH	TBA				
Shiver 750 GT ABS	10-12	FA213	FA213V	FA213HH	TBA				
Dorsodura 750 (ABS)	08-13	FA213	FA213V	FA213HH		TBA			
Dorsodura Factory 750	10-13	FA213	FA213V	FA213HH		TBA			
Dorsodura Factory 750 (ABS)	10-12	FA213	FA213V	FA213HH		TBA			
NA 850 Mana (Non ABS)	08-11	FA256		FA256HH	TBA				
NA 850 Mana (ABS)	08-13	FA256		FA256HH	TBA				
NA 850 Mana GT (ABS Model)	09-13	FA256		FA256HH	TBA				

\*-2 Sets Required. ■ - Also available in MX-S race compound.

**SAFETY WARNING:** DO NOT USE HH PADS ON REAR UNLESS ALSO USED ON FRONT TO AVOID BRAKE IMBALANCE

**BRAKE APPLICATIONS**

**R** Suffix = High Durability Sintered Pad. **HH** Suffix = High Performance Sintered Pad. **G** Suffix = Grooved Shoe.  
**D** Suffix = Drilled Disc. **C** Suffix = Contoured Disc. **LS** Suffix = Left/Steel Disc. **RS** = Right/Steel Disc.

# Non-JAPANESE Built Motorcycles



← FRONT / AVANT / VORN FRENTE / ANTERIORE →

## DISC PAD CHOICES

## BRAKE ROTOR CHOICES

### APRILIA

			NEW SFAC Scooter Carbon Pads	Semi-Sintered V-Pads™	Sintered/HH Pads/ Grooved shoes	Left/Gauche/Links	Right/Droite/Rechts	Contour Rotor Universal left and right fitment	NEW Vee-Rotors™ CONTOUR	NEW CX Extreme® ROTOR	Oversize 250/280mm Rotor Kit	Relocating Bracket for 250/280mm Rotor	Oversize 320mm Rotor Kit	Relocating Bracket for 320mm Rotor
SRV 850	12-13		SFA181*	SFAC181*	SFA181HH*	MD9125D	MD9125D							
SRV 850 Parking Brake			SFA257/2											
ETV 1000 Caponord/Rally (PS00/PSB0) (Non ABS models)	01-03		FA209/2*	FA209/2V*	FA209/2HH*	MD6307D	MD6307D							
ETV 1000 Caponord (PS004) (ABS Model)	04-08		FA209/2*	FA209/2V*	FA209/2HH*	TBA	TBA							
RST Futura 1000	01-04		FA244*		FA244HH*	MD2001X	MD2001X	MD2001XC*	VR2001BLK*					
RSV 1000 Mille	00		FA244*		FA244HH*	MD666X	MD666X	MD666XC*						
RSV 1000 Mille	01-02				FA322/4HH*	MD621X	MD621X	MD621XC*	VR621BLK*					
RSV 1000 Mille (Radial caliper)	03				FA322/4HH*	MD621X	MD621X	MD621XC*	VR621BLK*					
RSV 1000 Mille R	00		FA244*		FA244HH*	MD666X	MD666X	MD666XC*						
RSV 1000 R Mille	01-02				FA322/4HH*	MD621X	MD621X	MD621XC*	VR621BLK*					
RSV 1000 R Mille (Radial caliper)	03				FA322/4HH*	MD621X	MD621X	MD621XC*	VR621BLK*					
RSV 1000 R Racing/Factory (Radial caliper/4 pad)	04-08				FA322/4HH*	MD621X	MD621X	MD621XC*	VR621BLK*					
RSV 1000 R Tuono (Radial caliper/2 pin pad fixing)	07-08		FA244*		FA244HH*	MD621X	MD621X	MD621XC*	VR621BLK*					
RSV 1000 SP	99-00		FA244*		FA244HH*	MD621X	MD621X	MD621XC*	VR621BLK*					
RSV 1000 R Factory	04-08				FA322/4HH*	MD621X	MD621X	MD621XC*	VR621BLK*					
RSV 1000 R	04-08				FA322/4HH*	MD621X	MD621X	MD621XC*	VR621BLK*					
RSV 1000 R Tuono	02-06		FA244*		FA244HH*	MD621X	MD621X	MD621XC*	VR621BLK*					
RSV4 R	10				FA447HH*	MD2003X	MD2003X	MD2003XC*	VR2003BLK*					
RSV4 R APRC	11-13				FA447HH*	MD2003X	MD2003X	MD2003XC*	VR2003BLK*					
RSV4 Factory	09-10				FA447HH*	MD2003X	MD2003X	MD2003XC*	VR2003BLK*					
RSV4 Factory APRC	11-13				FA447HH*	MD2003X	MD2003X	MD2003XC*	VR2003BLK*					
SL 1000 Falco	00-04		FA244*		FA244HH*	MD666X	MD666X	MD666XC*						
Tuono R 1000 Radical caliper/4 pad type	02-05				FA322/4HH*	MD621X	MD621X	MD621XC*	VR621BLK*					
Tuono R Factory 1000 Radial caliper/4 pad type	06-10				FA322/4HH*	MD621X	MD621X	MD621XC*	VR621BLK*					
Tuono R 1000 Radial caliper/2 pad type	02-10		FA244*		FA244HH*	MD621X	MD621X	MD621XC*	VR621BLK*					
Tuono V4R	11-12		FA244*		FA244HH*	TBA	TBA	TBA*						
Tuono V4R - APRC	11-13		FA244*		FA244HH*	TBA	TBA	TBA*						
Caponord 1200	13		USE HH ONLY	USE HH ONLY	FA630HH*	TBA	TBA							
Dorsoduro 1200	11-12		FA244*		FA244HH*	TBA	TBA							
Dorsoduro 1200 ATC/ABS	11-13		FA244*		FA244HH*	TBA	TBA							

### ARMSTRONG

250 Trial/320 Trial					841G									
---------------------	--	--	--	--	------	--	--	--	--	--	--	--	--	--

### ASPES

50 Navaho					926G									
50 Sirio Hybrid	10-11		SFA228	SFAC228	SFA228HH	N/A								
CS 75 Navaho/125 Juma/Hopi					841G									
CM1 80					841G									
RCL 80			941											
125 Duma			FA076		FA076HH	N/A								
Vega 125 Hybrid	11		SFA086	SFAC086	SFA086HH		N/A							
Perseo Hybrid 150	11		SFA054	SFAC054	SFA054HH	N/A								

### ATALA

Hacker LC	97		SFA193	SFAC193	SFA193HH	MD901D		MD901C	VR901					
Hacker Racing	97		SFA193	SFAC193	SFA193HH	MD901D		MD901C	VR901					
Byte AT10	97		SFA193	SFAC193	SFA193HH	TBA								
Hacker	97		SFA193	SFAC193	SFA193HH	MD901D		MD901C	VR901					

### AUSA QUADS

M 50 Task - Side x Side			N/A*		FA266R*	N/A	N/A							
-------------------------	--	--	------	--	---------	-----	-----	--	--	--	--	--	--	--

### BAOTAIN

BT 49 QT-7	06-07		TBA			N/A								
BT 49 QT-9 (Speedy 50-4T)	10-11		SFA169	SFAC169	SFA169HH	N/A								
BT 50 QT-11 (Retro 50-4T)	06-11		SFA169	SFAC169	SFA169HH	N/A								
BT 49 QT-12 (Rebel-4T)	06-11		SFA235	SFAC235		N/A								
BT 49 QT-12 (Rocky-2T)	10-11		TBA			N/A								
Eagle 50	10-11		TBA			N/A								

\*-2 Sets Required. ■ - Also available in MX-S race compound.

**SAFETY WARNING:** DO NOT USE HH PADS ON REAR UNLESS ALSO USED ON FRONT TO AVOID BRAKE IMBALANCE

# Non-JAPANESE Built Motorcycles

**BRAKE APPLICATIONS**

**R** Suffix = High Durability Sintered Pad. **HH** Suffix = High Performance Sintered Pad. **G** Suffix = Grooved Shoe.  
**D** Suffix = Drilled Disc. **C** Suffix = Contoured Disc. **LS** Suffix = Left/Steel Disc. **RS** = Right/Steel Disc.



← REAR / ARRIÈRE / HINTEN POSTERIOR / POSTERIORE →

## APRILIA



		DISC PAD CHOICES				BRAKE ROTOR CHOICES			
		NEW SFAC Scooter Carbon Pads	Semi-Sintered V-Pads™	Sintered/HH Pads/ Grooved shoes	Contour Rotor Rear Fitment	NEW Vee-Rotors™ CONTOUR	NEW CX Extreme® ROTOR		
SRV 850	12-13	SFA353	SFAC353		SFA353HH	MD9124D			
ETV 1000 Caponord/Rally (PS00/PSB0) (Non ABS models)	01-03	FA266		FA266V	FA266HH	MD6308D			
ETV 1000 Caponord (PS004) (ABS Model)	04-08	FA266		FA266V	FA266HH	TBA			
RST Futura 1000	01-04	FA181TT			FA181HH	MD697	MD697C		
RSV 1000 Mille	00	FA266		FA266V	FA266HH	MD613	MD613C		
RSV 1000 Mille	01-02	FA266		FA266V	FA266HH	MD613	MD613C		
RSV 1000 Mille (Radial caliper)	03	FA266		FA266V	FA266HH	MD613	MD613C		
RSV 1000 Mille R	00	FA266		FA266V	FA266HH	MD613	MD613C		
RSV 1000 R Mille	01-02	FA266		FA266V	FA266HH	MD613	MD613C		
RSV 1000 R Mille (Radial caliper)	03	FA266		FA266V	FA266HH	MD613	MD613C		
RSV 1000 R Racing/Factory (Radial caliper/4 pad)	04-08	FA266		FA266V	FA266HH	MD613	MD613C		
RSV 1000 R Tuono (Radial caliper/2 pin pad fixing)	07-08	FA266		FA266V	FA266HH	MD613	MD613C		
RSV 1000 SP	99-00	FA266		FA266V	FA266HH	MD613	MD613C		
RSV 1000 R Factory	04-08	FA266		FA266V	FA266HH	MD613	MD613C		
RSV 1000 R	04-08	FA266		FA266V	FA266HH	MD613	MD613C		
RSV 1000 R Tuono	02-06	FA266		FA266V	FA266HH	MD613	MD613C		
RSV4 R	10	FA266		FA266V	FA266HH	MD613	MD613C		
RSV4 R APRC	11-13	FA266		FA266V	FA266HH	MD613	MD613C		
RSV4 Factory	09-10	FA266		FA266V	FA266HH	MD613	MD613C		
RSV4 Factory APRC	11-13	FA266		FA266V	FA266HH	MD613	MD613C		
SL 1000 Falco	00-04	FA266		FA266V	FA266HH	MD613	MD613C		
Tuono R 1000 Radical caliper/4 pad type	02-05	FA266		FA266V	FA266HH	MD613	MD613C		
Tuono R Factory 1000 Radial caliper/4 pad type	06-10	FA266		FA266V	FA266HH	MD613	MD613C		
Tuono R 1000 Radial caliper/2 pad type	02-10	FA266		FA266V	FA266HH	MD613	MD613C		
Tuono V4R	11-12	FA266		FA266V	FA266HH	MD613	TBA		
Tuono V4R - APRC	11-13	FA266		FA266V	FA266HH	MD613	TBA		
Caponord 1200	13	FA213		FA213V	FA213HH	TBA			
Dorsoduro 1200	11-12	FA213		FA213V	FA213HH	TBA			
Dorsoduro 1200 ATC/ABS	11-13	FA213		FA213V	FA213HH	TBA			

## ARMSTRONG

250 Trial/320 Trial					841G			
---------------------	--	--	--	--	------	--	--	--

## ASPES

50 Navaho					926G			
50 Siro Hybrid	10-11	TBA						
CS 75 Navaho/125 Juma/Hopi					843G			
CM1 80					841G			
RC1 80		941						
125 Duma		843						
Vega 125 Hybrid	11	TBA						
Perseo Hybrid 150	11	SFA086	SFAC086		SFA086HH	N/A		

## ATALA

Hacker LC	97	S624						
Hacker Racing	97	S624						
Byte AT10	97	S624						
Hacker	97	S624						

## AUSA QUADS

M 50 Task - Side x Side		FA266R*				N/A*		
-------------------------	--	---------	--	--	--	------	--	--

## BAOTAIN

BT 49 QT-7	06-07	H303				TBA		
BT 49 QT-9 (Speedy 50-4T)	10-11	H303						
BT 30 QT-11 (Retro 50-4T)	06-11	H303						
BT 49 QT-12 (Rebel-4T)	06-11	H303						
BT 49 QT-12 (Rocky-2T)	10-11	H303						
Eagle 50	10-11	H303						

\*-2 Sets Required. ■ - Also available in MX-S race compound.  
**SAFETY WARNING:** DO NOT USE HH PADS ON REAR UNLESS ALSO USED ON FRONT TO AVOID BRAKE IMBALANCE

# Non-JAPANESE Built Motorcycles



← FRONT / AVANT / VORN FRENTE / ANTERIORE →

## DISC PAD CHOICES

## BRAKE ROTOR CHOICES

### BAOTAIN

			NEW SFAC Scooter Carbon Pads	Semi-Sintered V-Pads™	Sintered/HH Pads/ Grooved shoes	Left/Gauche/Links	Right/Droite/Rechts	Contour Rotor Universal left and right fitment	NEW Vee-Rotors™ CONTOUR	NEW CX Extreme® ROTOR	Oversize 250/280mm Rotor Kit	Relocating Bracket for 250/280mm Rotor	Oversize 320mm Rotor Kit	Relocating Bracket for 320mm Rotor
Falcon 50 (2T)	10-11	TBA						N/A						
BT 50 QT-9N	06-07	TBA				N/A								
BT 110-2	06-07	TBA					N/A							
BT 125 T-2	06-07	TBA				N/A								
BT 125 T-7 (13" wheels)	06-07	TBA					N/A							
Citibike 125	10-11	TBA				N/A								
Tango 125	08-11	TBA				N/A								

### BAJAJ

Kristal 95cc DTS-i														
Platina 100cc (Cast wheel)	08	TBA				TBA								
XCD 125 (DTS-Si) (Cast wheel)	08	TBA				TBA								
Discover DTS-i (Cast wheel) (135cc 4T)	08	TBA				TBA								
Pulsar DTS-i (150/180/200cc 4T)	08	TBA				TBA								
Avenger DTS-i (180cc 4T)	08	TBA				TBA								
Pulsar DTS-Fi (220cc 4T)	08	TBA				TBA								

### BAROSSA

Mini 50/Python	03-05	TBA												
Mini 50/Python	03-05	TBA												
100 Sport/Python	03-05	TBA*												
XS 125 T-13	07-10	SFA264	SFAC264		SFA264HH	TBA								
170 Sport	03-04	TBA*												
170 Cheetah/Magna	03-05	TBA*												
170 Cheetah	03-06	Y503*			Y503G*									
250 Cheetah	03-06	Y503*			Y503G*									
Quarterback 250	05	TBA*												

### BEELINE

Veloce 50	08-10	SFA235	SFAC235			MD923C								
Veloce GT 50	08-10	SFA235	SFAC235			MD923C								

### BENELLI

49X Scooter	07	SFA235	SFAC235			TBA								
50 G2 Elle	79-	931												
S 50 Scooter	81-	945												
Devil 50	92-	FA126			FA126R	N/A								
Mala 50 (2T)	13	SFA193	SFAC193		SFA193HH	N/A								
Motorella	78-	908												
Naked 50	02-03	SFA193	SFAC193		SFA193HH	MD901D		MD901C	VR901					
Pepe 50/50 LX/Classic (7 Spoke Cast Wheel)	99-13	SFA193	SFAC193		SFA193HH	MD956D			VR956					
Pepe 50 (5 Spoke Cast Wheel/2T/4T)	10-13	SFA193	SFAC193		SFA193HH	MD956D			VR956					
Spring 50	93-	FA126			FA126R	N/A								
QuattroNove X (50cc/All Rear Drum Models)	08-12	SFA235	SFAC235			TBA								
QuattroNove X (50cc/All Rear Disc Models)	10-13	SFA235	SFAC235					TBA						
Devil 80	92-	FA126			FA126R	N/A								
491 (All drum rear models) 50cc	98-04	SFA193	SFAC193		SFA193HH	MD901D		MD901C	VR901					
491 (All rear disc models) 50cc	99-04	SFA193	SFAC193		SFA193HH	MD901D		MD901C	VR901					
K2 50	98-01	SFA193	SFAC193		SFA193HH	MD901D		MD901C	VR901					
K2 100	99-01	SFA193	SFAC193		SFA193HH	MD901D		MD901C	VR901					
Naked 100	02	SFA193	SFAC193		SFA193HH	MD901D		MD901C	VR901					
Pepe 100 LX	99-06	SFA193	SFAC193		SFA193HH	TBA								
125 T	83	FA047			FA047HH	N/A								
124/125 2C/126 2T/2CSE	76-	FA047			FA047R	N/A								
125 2C Twin Brake	-76	946												
Adiva 125 (12" front wheel/rear drum model)	00	SFA193	SFAC193		SFA193HH	MD924D		MD924C	VR924					
Adiva 125 (13" front wheel/rear disc model)	01-04	SFA193	SFAC193		SFA193HH	MD9101D								
Caffe Nero 125	11-13	SFA228	SFAC228		SFA228HH	N/A								
Hobby 125 (4T)	13	SFA228	SFAC228		SFA228HH	N/A								
Macis 125	10-13	SFA228	SFAC228		SFA228HH	TBA								

\*-2 Sets Required. ■ - Also available in MX-S race compound.

**SAFETY WARNING:** DO NOT USE HH PADS ON REAR UNLESS ALSO USED ON FRONT TO AVOID BRAKE IMBALANCE

# Non-JAPANESE Built Motorcycles

**BRAKE APPLICATIONS**

**R** Suffix = High Durability Sintered Pad. **HH** Suffix = High Performance Sintered Pad. **G** Suffix = Grooved Shoe.  
**D** Suffix = Drilled Disc. **C** Suffix = Contoured Disc. **LS** Suffix = Left/Steel Disc. **RS** = Right/Steel Disc.



## BAOTAIN



← REAR / ARRIÈRE / HINTEN POSTERIOR / POSTERIORE →

			DISC PAD CHOICES			BRAKE ROTOR CHOICES		
			NEW SFAC Scooter Carbon Pads	Semi-Sintered V-Pads™	Sintered/HH Pads/ Grooved shoes	Contour Rotor Rear Fitment	NEW Vee-Rotors™ CONTOUR	NEW CX Extreme® ROTOR
Falcon 50 (2T)	10-11	TBA				N/A		
BT 50 QT-9N	06-07	TBA						
BT 110-2	06-07	TBA						
BT 125 T-2	06-07	TBA				N/A		
BT 125 T-7 (13" wheels)	06-07	Y506						
Citibike 125	10-11	TBA				N/A		
Tango 125	08-11	TBA						

## BAJAJ

Kristal 95cc DTS-i								
Platina 100cc (Cast wheel)	08	TBA						
XCD 125 (DTS-S) (Cast wheel)	08	TBA						
Discover DTS-i (Cast wheel) (135cc 4T)	08	TBA						
Pulsar DTS-i (150/180/200cc 4T)	08	TBA						
Avenger DTS-i (180cc 4T)	08	TBA						
Pulsar DTS-Fi (220cc 4T)	08	TBA						

## BAROSSA

Mini 50/Python	03-05	H302			H302G			
Mini 50/Python	03-05	TBA						
100 Sport/Python	03-05	TBA						
XS 125 T-13	07-10	820						
170 Sport	03-04	FA135TT			FA135R	N/A		
170 Cheetah/Magna	03-05	FA135TT			FA135R	N/A		
170 Cheetah	03-06	FA067TT			FA067R	N/A		
250 Cheetah	03-06	FA067TT			FA067R	N/A		
Quarterback 250	05	FA135TT			FA135R	N/A		

## BEELINE

Veloce 50	08-10	Y503						
Veloce GT 50	08-10	Y503						

## BENELLI

49X Scooter	07	TBA						
50 G2 Elle	79-	931						
S 50 Scooter	81-	965						
Devil 50	92-	FA099			FA099R	N/A		
Mala 50 (2T)	13	816						
Motorella	78-	908						
Naked 50	02-03	893						
Pepe 50/50 LX/Classic (7 Spoke Cast Wheel)	99-13	893						
Pepe 50 (5 Spoke Cast Wheel/2T/4T)	10-13	893						
Spring 50	93-	FA099			FA099R	N/A		
QuattroNove X (50cc/All Rear Drum Models)	08-12	Y503						
QuattroNove X (50cc/All Rear Disc Models)	10-13	SFA235	SFAC235			TBA		
Devil 80	92-	FA099			FA099R	N/A		
491 (All drum rear models) 50cc	98-04	893						
491 (All rear disc models) 50cc	99-04	SFA193	SFAC193		SFA193HH	MD943D	MD943C	VR943
K2 50	98-01	893						
K2 100	99-01	Y527						
Naked 100	02	893						
Pepe 100 LX	99-06	893						
125 T	83	929						
124/125 2C/126 2T/2CSE	76-	929						
125 2C Twin Brake	-76	929						
Adiva 125 (12" front wheel/rear drum model)	00	816						
Adiva 125 (13" front wheel/rear disc model)	01-04	SFA321	SFAC321		SFA321HH	MD9106D		
Caffe Nero 125	11-13	SFA228	SFAC228		SFA228HH	N/A		
Hobby 125 (4T)	13	SFA228	SFAC228		SFA228HH	N/A		
Macis 125	10-13	SFA228	SFAC228		SFA228HH	TBA		

\*-2 Sets Required. ■ - Also available in MX-S race compound.

**SAFETY WARNING:** DO NOT USE HH PADS ON REAR UNLESS ALSO USED ON FRONT TO AVOID BRAKE IMBALANCE



# Non-JAPANESE Built Motorcycles



← FRONT / AVANT / VORN FRENTE / ANTERIORE →

## DISC PAD CHOICES

## BRAKE ROTOR CHOICES

### BENELLI

			NEW SFAC Scooter Carbon Pads	Semi-Sintered V-Pads™	Sintered/HH Pads/ Grooved shoes	Left/Gauche/Links	Right/Droite/Rechts	Contour Rotor Universal left and right fitment	NEW Vee-Rotors™ CONTOUR	NEW CX Extreme® ROTOR	Oversize 250/280mm Rotor Kit	Relocating Bracket for 250/280mm Rotor	Oversize 320mm Rotor Kit	Relocating Bracket for 320mm Rotor
Tarno 125	89-		FA126		FA126R		N/A							
X 125	12-13		SFA228	SFAC228	SFA228HH			N/A						
Velvet 125 (13" front wheel)	99-07		SFA193	SFAC193	SFA193HH	MD9101D								
Velvet 125 (13" front wheel/Touring)	08-12		SFA194	SFAC194	SFA194HH	MD9101D								
Adiva 150 (12" front wheel/rear drum model)	00		SFA193	SFAC193	SFA193HH	MD924D		MD924C	VR924					
Adiva 150 (13" front wheel/rear disc model)	01-04		SFA193	SFAC193	SFA193HH	MD9101D								
Caffe Nero 150	11-13		SFA228	SFAC228	SFA228HH	N/A								
Hobby 151 (4T)	13		SFA228	SFAC228	SFA228HH	N/A								
Macis 150	10-13		SFA228	SFAC228	SFA228HH	TBA								
UNO C 150 (Single Cyl)	13		FA244		FA244HH			N/A						
Velvet 150 (13" front wheel)	99-07		SFA193	SFAC193	SFA193HH	MD9101D								
Velvet 150 (13" front wheel/Touring)	08-12		SFA194	SFAC194	SFA194HH	MD9101D								
X 150	12-13		SFA228	SFAC228	SFA228HH			N/A						
BX Motard (250cc)	12		FA181TT		FA181TT ■			TBA						
Caffe Nero 250	Left	08-11	SFA197	SFAC197	SFA197HH	TBA								
	Right		SFA228	SFAC228	SFA228HH		TBA							
UNO C 250 (Single Cyl)	13		FA244		FA244HH			N/A						
Velvet 250	99-12		SFA194	SFAC194	SFA194HH	MD997D			VR997					
250 C/TS, 250I4	76-		FA047		FA047HH	N/A								
666 Scooter Born in Hell 125cc	98-99		FA095		FA095HH	N/A								
254	83		N/A			N/A								
304	83		FA047		FA047HH	N/A								
Zanzero 350	12-13		SFA228	SFAC228	SFA228HH	N/A								
354	-82		FA047*		FA047HH*	N/A	N/A							
354 Sport 2	83		FA047*		FA047HH*	N/A	N/A							
Velvet 400 Dusk	03-04		SFA194	SFAC194	SFA194HH	TBA								
BX Cross (449cc)	07-12		FA181TT		FA181TT ■			TBA						
500 04	76-		FA047*		FA047HH*	N/A	N/A							
BX Enduro (505cc)	08-12		FA181TT		FA181R ■	TBA								
BX 570 Motard	08-10				FA322/4HH	TBA								
BN 600 (4 Cyl)	13				FA322/4HH*	TBA	TBA							
654 Sport	83		FA047*		FA047HH*	N/A	N/A							
750 SEI (6 Cyl)	75-		FA018*	FA018V*	FA018HH*	MD837	MD837							
2 UE 750	09-10		FA244*		FA244HH*	MD614X	MD614X	MD614XC*	VR614BLK*					
Cafe Racer 899	10-12				FA322/4HH*			TBA*						
Century Racer 899	11-12				FA322/4HH*			TBA*						
TNT 899 Tornado Naked Tre	07-13		FA244*		FA244HH*	MD614X	MD614X	MD614XC*	VR614BLK*					
TNT 899 S Tornado Naked Tre	07-11		FA244*		FA244HH*	MD614X	MD614X	MD614XC*	VR614BLK*					
TRE-K 899	07-13		FA244		FA244HH	MD614X	MD614X	MD614XC*	VR614BLK*					
900 SEI (6 Cyl)	83		FA018*	FA018V*	FA018HH*	MD837	MD837							
Tornado 900	02		FA244*		FA244HH*	TBA	TBA							
Tornado Tre Novecento/LE/RS	03-05				FA322/4HH*	MD621X	MD621X	MD621XC*	VR621BLK*					
TNT 1130 Cafe Racer	05		FA244*		FA244HH*	MD621X	MD621X	MD621XC*	VR621BLK*					
TNT 1130 Cafe Racer	06-12				FA322/4HH*	MD621X	MD621X	MD621XC*	VR621BLK*					
TNT 1130 Sport/Sport Evo	04-09				FA322/4HH*	MD621X	MD621X	MD621XC*	VR621BLK*					
TNT 1130 Titanium	05		FA244*		FA244HH*	MD621X	MD621X	MD621XC*	VR621BLK*					
TNT 1130 Titanium	06				FA322/4HH*	MD621X	MD621X	MD621XC*	VR621BLK*					
Tornado TRE 1130 (Radial caliper)	06-10				FA322/4HH*	MD621X	MD621X	MD621XC*	VR621BLK*					
Tornado Naked TRE R 160	09-12				FA322/4HH*			TBA*						
Tornado Naked Tre TNT 1130	06-07		FA244*		FA244HH*	MD621X	MD621X	MD621XC*	VR621BLK*					
Tornado Naked Tre TNT 1130	13				FA447HH*			TBA*						
TRE-K 1130	06-13		FA244*		FA244HH*	MD614X	MD614X	MD614XC*	VR614BLK*					
TRE-K 1130 Amazonas	07-13		FA244*		FA244HH*			TBA*						

### BETA

Minicross Pro Race 12/10	04-06		FA351			N/A								
R 150 (Minicross 147/149cc)	10-13		FA086		FA086HH	N/A								
ARK (Air Cooled Models)	96-13		SFA193	SFAC193	SFA193HH	MD901D		MD901C	VR901					
ARK (LC Models)	97-13		SFA193	SFAC193	SFA193HH	MD901D		MD901C	VR901					
Pro Race 50	05		FA115		FA115HH	N/A								

\*-2 Sets Required. ■ - Also available in MX-S race compound.

**SAFETY WARNING:** DO NOT USE HH PADS ON REAR UNLESS ALSO USED ON FRONT TO AVOID BRAKE IMBALANCE

APPLICATIONS  
BRAKE

R Suffix = High Durability Sintered Pad. HH Suffix = High Performance Sintered Pad. G Suffix = Grooved Shoe.  
D Suffix = Drilled Disc. C Suffix = Contoured Disc. LS Suffix = Left/Steel Disc. RS = Right/Steel Disc.

# Non-JAPANESE Built Motorcycles



## BENELLI



← REAR / ARRIÈRE / HINTEN POSTERIOR / POSTERIORE →

		DISC PAD CHOICES				BRAKE ROTOR CHOICES			
		NEW SFAC Scooter Carbon Pads	Semi-Sintered V-Pads™	Sintered/HH Pads/ Grooved shoes		Contour Rotor Rear Fitment	NEW Vee-Rotors™ CONTOUR	NEW CX Extreme® ROTOR	
Tamo 125	89-	N/A							
X 125	12-13	SFA228	SFAC228		SFA228HH		N/A		
Velvet 125 (13" front wheel)	99-07	SFA193	SFAC193		SFA193HH	MD966D			
Velvet 125 (13" front wheel/Touring)	08-12	SFA298	SFAC298		SFA298HH	MD966D			
Adiva 150 (12" front wheel/rear drum model)	00	816							
Adiva 150 (13" front wheel/rear disc model)	01-04	SFA321	SFAC321		SFA321HH	MD9106D			
Caffe Nero 150	11-13	SFA228	SFAC228		SFA228HH	N/A			
Hobby 151 (4T)	13	SFA228	SFAC228		SFA228HH	N/A			
Macis 150	10-13	SFA228	SFAC228		SFA228HH	TBA			
UNO C 150 (Single Cyl)	13	FA047			FA047HH		N/A		
Velvet 150 (13" front wheel)	99-07	SFA193	SFAC193		SFA193HH	MD966D			
Velvet 150 (13" front wheel/Touring)	08-12	SFA298	SFAC298		SFA298HH	MD966D			
X 150	12-13	SFA228	SFAC298		SFA228HH		N/A		
BX Motard (250cc)	12	FA047TT			FA047R		TBA		
Caffe Nero 250	08-11	SFA413	SFAC413		SFA413HH	TBA			
UNO C 250 (Single Cyl)	13	FA047			FA047HH		N/A		
Velvet 250	99-12	SFA298	SFAC298		SFA298HH	MD966D	VR966		
250 C/TS, 250/4	76-	929							
666 Scooter Born in Hell 125cc	98-99	FA047			FA047HH	TBA			
254	83	929							
304	83	929							
Zanzero 350	12-13	SFA083	SFAC083		SFA083HH	N/A			
354	-82	FA018			FA018HH				
354 Sport 2	83	FA047			FA047HH	N/A			
Velvet 400 Dusk	03-04	SFA298	SFAC298		SFA298HH	TBA			
BX Cross (449cc)	07-12	FA208TT			FA208R ■		TBA		
500 04	76-	929							
BX Enduro (505cc)	08-12	FA208TT			FA208R ■	TBA			
BX 570 Motard	08-10	FA208TT			FA208R ■	TBA			
BN 600 (4 Cyl)	13	FA266		FA266V	FA266HH	TBA			
654 Sport	83	FA047			FA047HH	N/A			
750 SEI (6 Cyl)	75-	N/A							
2 UE 750	09-10	FA266		FA266V	FA266HH	TBA			
Cafe Racer 899	10-12	FA266		FA266V	FA266HH		TBA		
Century Racer 899	11-12	FA266		FA266V	FA266HH		TBA		
TNT 899 Tornado Naked Tre	07-13	FA266		FA266V	FA266HH	MD651			
TNT 899 S Tornado Naked Tre	07-11	FA266		FA266V	FA266HH	MD651			
TRE-K 899	07-13	FA266		FA266V	FA266HH	MD651			
900 SEI (6 Cyl)	83	FA077		FA077V		N/A			
Tomado 900	02	FA266		FA266V	FA266HH	MD651			
Tomado Tre Novecento/LE/RS	03-05	FA266		FA266V	FA266HH	MD651			
TNT 1130 Cafe Racer	05	FA266		FA266V	FA266HH	MD651			
TNT 1130 Cafe Racer	06-12	FA266		FA266V	FA266HH	MD651			
TNT 1130 Sport/Sport Evo	04-09	FA266		FA266V	FA266HH	MD651			
TNT 1130 Titanium	05	FA266		FA266V	FA266HH	MD651			
TNT 1130 Titanium	06	FA266		FA266V	FA266HH	MD651			
Tomado TRE 1130 (Radial caliper)	06-10	FA266		FA266V	FA266HH	MD651			
Tomado Naked TRE R 160	09-12	FA266		FA266V	FA266HH		TBA		
Tomado Naked Tre TNT 1130	06-07	FA266		FA266V	FA266HH	MD651			
Tomado Naked Tre TNT 1130	13	FA266		FA266V	FA266HH		TBA		
TRE-K 1130	06-13	FA266		FA266V	FA266HH	MD651			
TRE-K 1130 Amazonas	07-13	FA266		FA266V	FA266HH		TBA		

## BETA

Minicross Pro Race 12/10	04-06	FA351				N/A		
R 150 (Minicross /47/49cc)	10-13	FA337TT			FA337R	N/A		
ARK (Air Cooled Models)	96-13	893						
ARK (LC Models)	97-13	SFA193HH	SFAC193		SFA193HH	MD901D	MD901C	VR901
Pro Race 50	05	FA351				N/A		

\*-2 Sets Required. ■ - Also available in MX-S race compound.

**SAFETY WARNING:** DO NOT USE HH PADS ON REAR UNLESS ALSO USED ON FRONT TO AVOID BRAKE IMBALANCE

**R** Suffix = High Durability Sintered Pad. **HH** Suffix = High Performance Sintered Pad. **G** Suffix = Grooved Shoe.  
**D** Suffix = Drilled Disc. **C** Suffix = Contoured Disc. **LS** Suffix = Left/Steel Disc. **RS** = Right/Steel Disc.

**BRAKE APPLICATIONS**

# Non-JAPANESE Built Motorcycles



FRONT / AVANT / VORN FRENTE / ANTERIORE



## DISC PAD CHOICES

## BRAKE ROTOR CHOICES

### BETA

			NEW SFAC Scooter Carbon Pads	Semi-Sintered V-Pads™	Sintered/HH Pads/ Grooved shoes	Left/Gauche/Links	Right/Droite/Rechts	Contour Rotor Universal left and right fitment	NEW Vee-Rotors™ CONTOUR	NEW CX Extreme® ROTOR	Oversize 250/280mm Rotor Kit	Relocating Bracket for 250/280mm Rotor	Oversize 320mm Rotor Kit	Relocating Bracket for 320mm Rotor
Quadra 50	97-01	SFA193	SFAC193		SFA193HH	MD901D			VR901					
Rev 50	00-08	FA115			FA115R	N/A								
50 RR Supermoto/Enduro	99-05	FA115			FA115HH	N/A								
RR Enduro Alu 50/Motard Alu 50	04-08	FA194			FA194HH	N/A								
RR 50 Standard	05-08	FA194			FA194HH	N/A								
RR 50 Enduro Racing	09-11	FA194			FA194HH	N/A								
RR 50 Enduro	04-07	FA194			FA194HH	N/A								
RR 50 Enduro	08-13	FA194			FA194HH	N/A								
RR 50 Enduro Factory	12-13	FA194			FA194HH			N/A						
RR 50 Enduro Standard	09-13	FA115TT			FA115R	N/A								
RR 50 Motard Standard	09-12	FA115TT			FA115R	N/A								
RR 50 Motard (Spoke Wheel)	09-12	FA194			FA194HH	N/A								
RR 50 Motard Skull	11	FA194			FA194HH	N/A								
RR Motard 50 Track (Cast Wheels)	08-13	FA194			FA194HH	N/A								
RR 50 Motard Standard (5 Spoke Cast Wheel)	13	FA194			FA194HH			N/A						
RR 50 Motard 50 (Spoke Wheel)	12-13	FA194			FA194HH			N/A						
RK6	93-96	FA167			FA167HH	MD6296D								
Tempo 16	94-97	SFA116				N/A								
Eickon 50	99-06	FA115	SFAC115		FA115HH	MD901D		MD901C	VR901					
Mintrial 50	09-12	FA351				N/A								
RK6 50cc Enduro	97-02	FA167			FA167HH	N/A								
Tempo 50	98-02	SFA193	SFAC193		SFA193HH	MD901D		MD901C	VR901					
Evo 80	09-13	FA303				N/A								
Evo 80 Junior	09-13	FA115TT			FA115R	N/A								
Rev 80	00-07	FA115			FA115R	N/A								
Rev 80	08	FA303				N/A								
124 TR	80-83				841G									
ALP 125 4T	98-04	FA115TT			FA115R	N/A								
ALP 125 4T	05-13	FA194			FA194HH	N/A								
Evo 125 (2T)	09-13	FA303				N/A								
Rev 3 125/200	00-05	FA303				N/A								
Rev 3 125/200	06-08	FA303				N/A								
R 125 4T Mini Cross		SFA169	SFAC169		SFA169HH	N/A								
RE 125 4T Enduro	09-10	FA194			FA194HH	N/A								
RE 125 4T Enduro	10-12	FA115TT			FA115R	N/A								
RR 125 4T Enduro (A/C)	09-13	FA194			FA194HH	N/A								
RR 125 4T Enduro (L/C)	11-13	FA194			FA194HH	N/A								
RR 125 4T Motard (A/C - Spoke Wheel)	08-13	FA194			FA194HH	N/A								
RR 125 4T Motard (L/C - Cast Wheel)	11-12	FA194			FA194HH		N/A							
TR 125	80-83				841G									
TR 125 32/33	86-87	FA099			FA099R	N/A								
125 TR 34	88	FA115			FA115R	N/A								
125 TR 34	89	FA115			FA115R	N/A								
Eurotek/Techno 125/250	96-98	FA115			FA115R	N/A								
Urban 125	08-12	FA194			FA194HH	N/A								
Urban 125 Special	09-12	FA194			FA194HH		N/A							
Eikon 125/150	00-06	SFA047			SFA047HH	MD924D		MD924C	VR924					
Jonathan 125	00-01	FA095			FA095HH		MD813							
Jonathan 125	02-05	FA095			FA095HH		MD813							
ALP 200 4T	00-04	FA115TT			FA115R	N/A								
ALP 200 4T	05-13	FA194			FA194HH	N/A								
Evo 200 (2T)	09-13	FA303				N/A								
Urban 200	08-13	FA194			FA194HH	N/A								
Urban 200 Special	09-13	FA194			FA194HH		N/A							
240 TR	80-83				841G									
240 TR 32	84-85				939G									
240 TR 33	86	FA099			FA099R	N/A								
Evo 250 (2T)	09-13	FA303				N/A								
Evo 250 (4T)	09-13	FA303				N/A								
Rev 3 250/270	00-04	FA303			N/A	N/A								

\*-2 Sets Required. ■ - Also available in MX-S race compound.

**SAFETY WARNING:** DO NOT USE HH PADS ON REAR UNLESS ALSO USED ON FRONT TO AVOID BRAKE IMBALANCE

# Non-JAPANESE Built Motorcycles



**BETA**



← REAR / ARRIÈRE / HINTEN  POSTERIOR / POSTERIORE →

		DISC PAD CHOICES				BRAKE ROTOR CHOICES			
		NEW SFAC Scooter Carbon Pads	Semi-Sintered V-Pads™	Sintered/HH Pads/ Grooved shoes		Contour Rotor Rear Fitment	NEW Vee-Rotors™ CONTOUR	NEW CX Extreme® ROTOR	
Quadra 50	97-01			893					
Rev 50	00-08	FA115			FA115R	N/A			
50 RR Supermoto/Enduro	99-05	FA115			FA115HH	N/A			
RR Enduro Alu 50/Motard Alu 50	04-08	FA115			FA115HH	N/A			
RR 50 Standard	05-08	FA115			FA115HH	N/A			
RR 50 Enduro Racing	09-11	FA367/2TT			FA367/2R	N/A			
RR 50 Enduro	04-07	FA115			FA115HH	N/A			
RR 50 Enduro	08-13	FA367/2TT			FA367/2R	N/A			
RR 50 Enduro Factory	12-13	FA367/2TT			FA367/2R	N/A	N/A		
RR 50 Enduro Standard	09-13	FA367/2TT			FA367/2R	N/A			
RR 50 Motard Standard	09-12	FA367/2TT			FA367/2R	N/A			
RR 50 Motard (Spoke Wheel)	09-12	FA367/2TT			FA367/2R	N/A			
RR 50 Motard Skull	11	FA367/2TT			FA367/2R	N/A			
RR Motard 50 Track (Cast Wheels)	08-13	FA367/2TT			FA367/2R	N/A			
RR 50 Motard Standard (5 Spoke Cast Wheel)	13	FA367/2TT			FA367/2R	N/A	N/A		
RR 50 Motard 50 (Spoke Wheel)	12-13	FA367/2TT			FA367/2R	N/A	N/A		
RK6	93-96	FA116				N/A			
Tempo 16	94-97	893							
Eickon 50	99-06	FA115	SFAC115		FA115HH	MD901D	MD901C		
Minitrial 50	09-12	N/A				N/A			
RK6 50cc Enduro	97-02	FA115			FA115HH	N/A			
Tempo 50	98-02	893							
Evo 80	09-13	FA495				N/A			
Evo 80 Junior	09-13	FA115TT			FA115R	N/A			
Rev 80	00-07	FA115			FA115R	N/A			
Rev 80	08	FA403				N/A			
124 TR	80-83				841G				
ALP 125 4T	98-04	FA115TT			FA115R	N/A			
ALP 125 4T	05-13	FA367/2TT			FA367/2R	N/A			
Evo 125 (2T)	09-13	FA495				N/A			
Rev 3 125/200	00-05	FA303			N/A	N/A			
Rev 3 125/200	06-08	FA403				N/A			
R 125 4T Mini Cross		FA115			FA115HH	N/A			
RE 125 4T Enduro	09-10	FA367/2TT			FA367/2R	N/A			
RE 125 4T Enduro	10-12	FA367/2TT			FA367/2R	N/A			
RR 125 4T Enduro (A/C)	09-13	FA367/2TT			FA367/2R	N/A			
RR 125 4T Enduro (L/C)	11-13	FA367/2TT			FA367/2R	N/A			
RR 125 4T Motard (A/C - Spoke Wheel)	08-13	FA367/2TT			FA367/2R	N/A			
RR 125 4T Motard (L/C - Cast Wheel)	11-12	FA367/2TT			FA367/2R	N/A	N/A		
TR 125	80-83				841G				
TR 125 32/33	86-87				841G				
125 TR 34	88	FA116			N/A	N/A			
125 TR 34	89	FA115			FA115R				
Eurotek/Techno 125/250	96-98	FA115			FA115R	N/A			
Urban 125	08-12	FA367/2TT			FA367/2R	N/A			
Urban 125 Special	09-12	FA367/2TT			FA367/2R	N/A	N/A		
Eikon 125/150	00-06	SFA298			SFA298HH	MD909D			
Jonathan 125	00-01	FA213			FA213HH	N/A			
Jonathan 125	02-05	FA173				N/A			
ALP 200 4T	00-04	FA115TT			FA115R	N/A			
ALP 200 4T	05-13	FA367/2TT			FA367/2R	N/A			
Evo 200 (2T)	09-13	FA495				N/A			
Urban 200	08-13	FA367/2TT			FA367/2R	N/A			
Urban 200 Special	09-13	FA367/2TT			FA367/2R	N/A	N/A		
240 TR	80-83				841G				
240 TR 32	84-85				841G				
240 TR 33	86				841G				
Evo 250 (2T)	09-13	FA495				N/A			
Evo 250 (4T)	09-13	FA495				N/A			
Rev 3 250/270	00-04	FA303			N/A	N/A			

\*-2 Sets Required. ■ - Also available in MX-S race compound.

**SAFETY WARNING:** DO NOT USE HH PADS ON REAR UNLESS ALSO USED ON FRONT TO AVOID BRAKE IMBALANCE

**BRAKE APPLICATIONS**

**R** Suffix = High Durability Sintered Pad. **HH** Suffix = High Performance Sintered Pad. **G** Suffix = Grooved Shoe.  
**D** Suffix = Drilled Disc. **C** Suffix = Contoured Disc. **LS** Suffix = Left/Steel Disc. **RS** = Right/Steel Disc.

# Non-JAPANESE Built Motorcycles



← FRONT / AVANT / VORN FRENTE / ANTERIORE →

BETA	Year	Model	DISC PAD CHOICES			BRAKE ROTOR CHOICES									
			NEW SFAC Scooter Carbon Pads	Semi-Sintered V-Pads™	Sintered/HH Pads/ Grooved shoes	Left/Gauche/Links	Right/Droite/Rechts	Contour Rotor Universal left and right fitment	NEW Vee-Rotors™ CONTOUR	NEW CX Extreme® ROTOR	Oversize 250/280mm Rotor Kit	Relocating Bracket for 250/280mm Rotor	Oversize 320mm Rotor Kit	Relocating Bracket for 320mm Rotor	
Rev 3 250/270	05-08	FA303			N/A	N/A									
Rev 4T 250	07-08	FA303				N/A									
RR 250 4T Enduro	05-07	FA185TT			FA185R ■			MD6367C (1)							
RR 250 Enduro (2T)	13	FA185TT			FA185R ■			N/A							
TR 34	86-88	FA099			FA099R	N/A									
TR 34	86	FA099			FA099R	N/A									
TR 34 260	89-91	FA099			FA099R	N/A									
SYNT	92	FA115TT			FA115R	N/A									
Zero	92	FA115TT			FA115R	N/A									
SYNT/GARA	93-95	FA115TT			FA115R	N/A									
Super Trial ST	94	FA115TT			FA115R	N/A									
Techno	95	FA115TT			FA115R	N/A									
Evo 300 (2T)	09-13	FA303				N/A									
Evo 300 (4T)	09-13	FA303				N/A									
RR 300 Enduro (2T)	13	FA185TT			FA185R ■			N/A							
ALP 4.0 (4T/349cc)	05-13	FA194			FA194HH	N/A									
Euro 350	00-01	FA126			FA126HH		MD813								
Euro 350	02	FA126			FA126HH		MD813								
Euro 350	03-06	FA095			FA095HH		MD813								
Jonathan 350	03-06	FA095			FA095HH		N/A								
M4 350 Supermotard	04-06	FA426				N/A									
M4 350 Motard	07-13	FA426				N/A									
RR 350 4T Enduro	11	FA185TT			FA185R ■			MD6367C ①							
RR 350 4T Enduro	12-13	FA185TT			FA185R ■			N/A							
RR 400 4T Enduro	05-11	FA185TT			FA185R ■			MD6367C ①							
RR 400 4T Enduro	12-13	FA185TT			FA185R ■			N/A							
RR 450 4T Enduro	05-11	FA185TT			FA185R ■			MD6367C ①							
RR 450 4T Enduro	12-13	FA185TT			FA185R ■			N/A							
RR 450 4T Cross Country	12	FA185TT			FA185R ■			N/A							
RR 498 4T Enduro	12-13	FA185TT			FA185R ■			N/A							
RR 520 4T Enduro	10-11	FA185TT			FA185R ■			MD6367C ①							
RR 525 4T Enduro	05-09	FA185TT			FA185R ■			MD6367C ①							
① NOTE REMOVE OLD SPEEDO PICK UP MAGNET FROM OLD DISC AND REFIT TO NEW EBC DISC.															
<b>BETTER</b>															
BT 125-20	06-09	FA486					N/A								
<b>BIMOTA</b>															
All early models	-88	FA018*			FA018HH*	N/A	N/A								
All models (Single pin fixing)	89-	FA095*			FA095HH*	N/A	N/A								
Later models (Twin pin fixing)	98/99-	FA244*			FA244HH*	N/A	N/A								
Eliro	06				FA322/4HH*	N/A	N/A								
DB5 (All models)	06-07				FA322/4HH*	N/A	N/A								
DB5 Desiderio (1078cc)	12-13				FA322/4HH*	N/A	N/A								
DB5R	06-13				FA322/4HH*	TBA	TBA								
DB6 Delirio (992cc) Ducati engine	07				FA322/4HH*	TBA	TBA								
SB8K Gobert (Suzuki Engine) (996cc)	06	FA244*			FA244HH*	TBA	TBA								
SB8K Santamonica (Suzuki Engine) (996cc)					FA322/4HH*	MD621X	MD621X	MD621XC*	VR621BLK*						
Tesi 2D (Ducati) 992cc	04-06	FA095*			FA095HH*	N/A	N/A								
Tesi-3D (1078cc)	09-13				FA322/4HH*	N/A	N/A								
DB5R/S (1078cc)	08-09				FA322/4HH*	N/A	N/A								
DB6 (1078cc)	08-09				FA322/4HH*	N/A	N/A								
DB6 (1100cc)	08				FA322/4HH*	N/A	N/A								
DB6 (1100cc)	12-13				FA322/4HH*			N/A*							
DB6/R (1078cc)	08-09				FA322/4HH*	N/A	N/A								
DB7 (1098cc)	08				FA322/4HH*	TBA	TBA								
DB7 (1099cc)	09				FA447HH*	N/A	N/A								
DB6R Delirio (1100cc)	08				FA322/4HH*	TBA									
DB8 (1198cc)	10-13				FA447HH*	N/A	N/A								
DB8 SP (1198cc)	10-13				FA447HH*	N/A	N/A								

\*-2 Sets Required. ■ - Also available in MX-S race compound.

**SAFETY WARNING:** DO NOT USE HH PADS ON REAR UNLESS ALSO USED ON FRONT TO AVOID BRAKE IMBALANCE

APPLICATIONS  
BRAKE

R Suffix = High Durability Sintered Pad. HH Suffix = High Performance Sintered Pad. G Suffix = Grooved Shoe.

D Suffix = Drilled Disc. C Suffix = Contoured Disc. LS Suffix = Left/Steel Disc. RS = Right/Steel Disc.



# Non-JAPANESE Built Motorcycles





← REAR / ARRIÈRE / HINTEN  POSTERIOR / POSTERIORE →

**BRAKE  
APPLICATIONS**

## BETA



			DISC PAD CHOICES			BRAKE ROTOR CHOICES			
			NEW SFAC Scooter Carbon Pads	Semi-Sintered V-Pads™	Sintered/HH Pads/ Grooved shoes		Contour Rotor Rear Fitment	NEW Vee-Rotors™ CONTOUR	NEW CX Extreme® ROTOR
Rev 3 250/270	05-08	FA403			N/A	N/A			
Rev 4T 250	07-08	FA403				N/A			
RR 250 4T Enduro	05-07	FA367/2TT			FA367/2R		MD6368C		
RR 250 Enduro (2T)	13	FA367/2TT			FA367/2R		N/A		
TR 34	86-88	FA116			N/A	N/A			
TR 34	86	FA116			N/A	N/A			
TR 34 260	89-91	FA164			FA164R	N/A			
SYNT	92	FA164			FA164R	N/A			
Zero	92	FA164			FA164R	N/A			
SYNT/GARA	93-95	FA156			N/A	N/A			
Super Trial ST	94	FA164			FA164R	N/A			
Techno	95	FA156			N/A	N/A			
Evo 300 (2T)	09-13	FA495				N/A			
Evo 300 (4T)	09-13	FA495				N/A			
RR 300 Enduro (2T)	13	FA367/2TT			FA367/2R		N/A		
ALP 4.0 (4T/349cc)	05-13	FA367/2TT			FA367/2R	N/A			
Euro 350	00-01	FA213			FA213HH	N/A			
Euro 350	02	FA173				N/A			
Euro 350	03-06	FA101				N/A			
Jonathan 350	03-06	FA101				N/A			
M4 350 Supermotard	04-06	FA337TT				N/A			
M4 350 Motard	07-13	FA367/2TT				N/A			
RR 350 4T Enduro	11	FA367/2TT			FA367/2R		MD6368C		
RR 350 4T Enduro	12-13	FA367/2TT			FA367/2R		N/A		
RR 400 4T Enduro	05-11	FA367/2TT			FA367/2R		MD6368C		
RR 400 4T Enduro	12-13	FA367/2TT			FA367/2R		N/A		
RR 450 4T Enduro	05-11	FA367/2TT			FA367/2R		MD6368C		
RR 450 4T Enduro	12-13	FA367/2TT			FA367/2R		N/A		
RR 450 4T Cross Country	12	FA367/2TT			FA367/2R		N/A		
RR 498 4T Enduro	12-13	FA367/2TT			FA367/2R		N/A		
RR 520 4T Enduro	10-11	FA367/2TT			FA367/2R		MD6368C		
RR 525 4T Enduro	05-09	FA367/2TT			FA367/2R		MD6368C		

## BETTER

BT 125-20	06-09	TBA							
-----------	-------	-----	--	--	--	--	--	--	--

## BIMOTA

All early models	-88	FA018			FA018HH	N/A			
All models (Single pin fixing)	89-	FA047			FA047HH	N/A			
Later models (Twin pin fixing)	98/99-	FA047			FA047HH	N/A			
Elirio	06	FA266	FA266V	FA266HH	N/A				
DB5 (All models)	06-07	FA266	FA266V	FA266HH	N/A				
DB5 Desiderio (1078cc)	12-13	FA266	FA266V	FA266HH	N/A				
DB5R	06-13	FA266	FA266V	FA266HH	TBA				
DB6 Delirio (992cc) Ducati engine	07	FA266	FA266V	FA266HH	TBA				
SB8K Gobert (Suzuki Engine) (996cc)	06	FA047		FA047HH	TBA				
SB8K Santamonica (Suzuki Engine) (996cc)		FA047		FA047HH	TBA				
Tesi 2D (Ducati) 992cc	04-06	FA047		FA047HH	N/A				
Tesi 3D (1078cc)	09-13	FA047		FA047HH	N/A				
DB5F/S (1078cc)	08-09	FA047		FA047HH	N/A				
DB6 (1078cc)	08-09	FA047		FA047HH	N/A				
DB6 (1100cc)	08	FA266	FA266V	FA266HH	TBA				
DB6 (1100cc)	12-13	FA047		FA047HH		N/A			
DB6/R (1078cc)	08-09	FA047		FA047HH	N/A				
DB7 (1098cc)	08	FA266	FA266V	FA266HH	TBA				
DB7 (1099cc)	09	FA047		FA047HH	N/A				
DB6R Delirio (1100cc)	08	FA266	FA266V	FA266HH	TBA				
DB8 (1198cc)	10-13	FA266	FA266V	FA266HH	N/A				
DB8 SP (1198cc)	10-13	FA047		FA047HH	N/A				

\*-2 Sets Required. ■ - Also available in MX-S race compound.

**SAFETY WARNING:** DO NOT USE HH PADS ON REAR UNLESS ALSO USED ON FRONT TO AVOID BRAKE IMBALANCE

**R** Suffix = High Durability Sintered Pad. **HH** Suffix = High Performance Sintered Pad. **G** Suffix = Grooved Shoe.  
**D** Suffix = Drilled Disc. **C** Suffix = Contoured Disc. **LS** Suffix = Left/Steel Disc. **RS** = Right/Steel Disc.

# Non-JAPANESE Built Motorcycles



← FRONT / AVANT / VORN FRENTE / ANTERIORE →

## DISC PAD CHOICES

## BRAKE ROTOR CHOICES

### BIMOTA

			NEW SFAC Scooter Carbon Pads	Semi-Sintered V-Pads™	Sintered/HH Pads/ Grooved shoes	Left/Gauche/Links	Right/Droite/Rechts	Contour Rotor Universal left and right fitment	NEW Vee-Rotors™ CONTOUR	NEW CX Extreme® ROTOR	Oversize 250/280mm Rotor Kit	Relocating Bracket for 250/280mm Rotor	Oversize 320mm Rotor Kit	Relocating Bracket for 320mm Rotor
DB 9 Brivido (1198cc)	12-13				FA322/4HH*	N/A	N/A							
DB 9 Brivido S (6 Piston BCA Caliper/1198cc)	12-13				FA322/4HH*	N/A	N/A							
DB 10 Motard (1078cc)	12-13				FA322/4HH*			N/A*						
DB 11 VLX (1198cc)	12-13				FA322/4HH*	N/A	N/A							
DBX 1100	12-13	FA209/2*			FA209/2HH*	N/A	N/A							
DB 12 B. Tourist (1198cc)	12-13				FA322/4HH*	N/A	N/A							

### BLANEY (Quads)

FX 50	03-04	TBA*												
FX 90	03-04	TBA*												
XC 125 Trojan	03-04	TBA*												
XL 200 Trooper	03-04	TBA*												

### BLATA

Enduro 125	07-08	FA399				N/A								
Motard 125	07-08	FA399				N/A								

### BMW

C1 125	99-03	SFA209/2			FA209/2HH	MD968D		MD968C	VR968					
C1 200	01-03	SFA209/2			FA209/2HH	MD968D		MD968C	VR968					
G 450 X	08-11	FA181TT			FA181R ■			MD6343C			OS6343C	BRK011	SM6343C	BRK012
C 600 Sport Scooter	12-13	SFA142*	SFAC142*		SFA142HH*	TBA	TBA							
Parking Brake		SFA257/2												
C 600 Sport Highline Scooter	13	SFA142*	SFAC142*		SFA142HH*	TBA	TBA							
Parking Brake		SFA257/2												
C 650 GT Scooter	12-13	SFA142*	SFAC142*		SFA142HH*	TBA	TBA							
Parking Brake		SFA257/2												
C 650 GT Highline Scooter	13	SFA142*	SFAC142*		SFA142HH*	TBA	TBA							
Parking Brake		SFA257/2												
G 650 Xchallenge	07-09	FA209/2		FA209/2V	FA209/2HH			MD809C						
G 650 Xmoto (Cast wheel)	07-09	FA244		FA244V	FA244HH	MD621X		MD621XC	VR621BLK					
G 650 Xcountry	07-09	FA209/2		FA209/2V	FA209/2HH	MD809		MD809C						
G 650 GS (R131/Single cylinder/chain drive/Cast Wheels)	09-13	FA209/2		FA209/2V	FA209/2HH	MD834								
G 650 GS Sertao (Single cylinder/chain drive/Spoke Wheels)	12-13	FA209/2		FA209/2V	FA209/2HH	MD834								
F 650 (E169/0161/Standard)	09/93-96	FA209/2		FA209/2V	FA209/2HH	MD650 ☺								
F 650 (E169/0162/ Funduro/High Screen/19" Front Wheel)	97-00	FA209/2		FA209/2V	FA209/2HH	MD650 ☺								
F 650 CS/Scanner K14/0174/0184/Belt drive/17" Cast Wheels)	00-03	FA209/2		FA209/2V	FA209/2HH		MD834 ☺							
F 650 CS/Scanner K14/0177/0187/Belt drive/17" Cast Wheels)	04-07	FA209/2		FA209/2V	FA209/2HH		MD834 ☺							
F 650 GS (R130/172/0182/Single Cylinder/19" Front Wheel)	99-03	FA209/2		FA209/2V	FA209/2HH	MD834 ☺								
F 650 GS (R130/175/0185/Single Cylinder/19" Front Wheel)	04-07	FA209/2		FA209/2V	FA209/2HH	MD834 ☺								
F 650 GS (K72/0218/0228/Twin cylinder 798cc/Cast wheel)	07-12	FA209/2		FA209/2V	FA209/2HH		MD834 ☺							
F 650 GS (30 Years GS/Twin cylinder 798cc/Cast wheel)	11	FA209/2		FA209/2V	FA209/2HH		MD834 ☺							
F 650 GS Dakar (R130/173/0183/Single Cylinder/ 21" front wheel)	99-03	FA209/2		FA209/2V	FA209/2HH	MD834 ☺								
F 650 GS Dakar (R130/176/0186/Single Cylinder/ 21" front wheel)	04-07	FA209/2		FA209/2V	FA209/2HH	MD834 ☺								
F 650 ST (E169/0163/0168/Strada/Low Screen/18" Front Wheel)	97-00	FA209/2		FA209/2V	FA209/2HH	MD650 ☺								
F 700 GS	13	FA209/2*		FA209/2V*	FA209/2HH*	TBA	TBA							
F 800 GT	13	FA244*		FA244V*	FA244HH*	N/A	N/A							
F 800 GS	08-13	FA209/2*		FA209/2V*	FA209/2HH*	TBA	TBA							
F 800 GS (30 Years GS)	11	FA209/2*		FA209/2V*	FA209/2HH*	TBA	TBA							
F 800 GS Triple Black	12	FA209/2*		FA209/2V*	FA209/2HH*	TBA	TBA							
F 800 GS Trophy	12	FA209/2*		FA209/2V*	FA209/2HH*	TBA	TBA							
F 800 R (Disc has fixed bobbins)	09-13	FA244*		FA244V*	FA244HH*	N/A	N/A							
F 800 R Chris Pfeiffer Edition (Disc has fixed bobbins)	09-11	FA244*		FA244V*	FA244HH*	N/A	N/A							
F 800 S (Half fairing/Disc has loose bobbins)	06-08	FA244*		FA244V*	FA244HH*	MD803	MD803							
F 800 S (Half fairing/Disc has fixed bobbins)	08-10	FA244*		FA244V*	FA244HH*	N/A	N/A							
F 800 ST (Full fairing/Disc has loose bobbins)	06-08	FA244*		FA244V*	FA244HH*	MD803	MD803							
F 800 ST (Full fairing/Disc has fixed bobbins)	08-12	FA244*		FA244V*	FA244HH*	N/A	N/A							
F 800 ST (Touring/Disc has fixed bobbins)	10-12	FA244*		FA244V*	FA244HH*	N/A	N/A							
HP2 Enduro	05-09	FA209/2		FA209/2V	FA209/2HH	MD687								
HP2 Megamoto (Disc has fixed bobbins)	07-10				FA335HH*	N/A	N/A							

\*-2 Sets Required. ■ - Also available in MX-S race compound.

**SAFETY WARNING:** DO NOT USE HH PADS ON REAR UNLESS ALSO USED ON FRONT TO AVOID BRAKE IMBALANCE

# Non-JAPANESE Built Motorcycles



## BIMOTA



← REAR / ARRIÈRE / HINTEN POSTERIOR / POSTERIORE →

### DISC PAD CHOICES

### BRAKE ROTOR CHOICES

			NEW SFAC Scooter Carbon Pads	Semi-Sintered V-Pads™	Sintered/HH Pads/ Grooved shoes	Contour Rotor Rear Fitment	NEW Vee-Rotors™ CONTOUR	NEW CX Extreme® ROTOR
DB 9 Brivido (1198cc)	12-13		FA266	FA266V	FA266HH	N/A		
DB 9 Brivido S (6 Piston BCA Caliper/1198cc)	12-13		FA266	FA266V	FA266HH	N/A		
DB 10 Motard (1078cc)	12-13		FA047		FA047HH	N/A		
DB 11 VLX (1198cc)	12-13		FA266	FA266V	FA266HH	N/A		
DBX 1100	12-13		FA209/2		FA209/2HH	N/A		
DB 12 B. Tourist (1198cc)	12-13		FA266	FA266V	FA266HH	N/A		
<b>BLANEY (Quads)</b>								
FX 50	03-04		TBA					
FX 90	03-04		TBA					
XC 125 Trojan	03-04		FA083TT		FA083R	N/A		
XL 200 Trooper	03-04		FA165TT		FA165R	N/A		
<b>BLATA</b>								
Enduro 125	07-08		FA115			TBA		
Motard 125	07-08		FA115			TBA		
<b>BMW</b>								
C1 125	99-03		SFA213		SFA213HH	MD968D	MD968C	VR968
C1 200	01-03		SFA213		SFA213HH	MD968D	MD968C	VR968
G 450 X	08-11		FA368TT		FA368R	MD6342D	MD6342C	
C 600 Sport Scooter	12-13		SFA196	SFAC196	SFA196HH	TBA		
C 600 Sport Highline Scooter	13		SFA196	SFAC196	SFA196HH	TBA		
C 650 GT Scooter	12-13		SFA196	SFAC196	SFA196HH	TBA		
C 650 GT Highline Scooter	13		SFA196	SFAC196	SFA196HH	TBA		
G 650 Xchallenge	07-09		FA213	FA213V	FA213HH		MD810C	
G 650 Xmoto (Cast wheel)	07-09		FA213	FA213V	FA213HH	MD845		
G 650 Xcountry	07-09		FA213	FA213V	FA213HH	MD810	MD810C	
G 650 GS (R131/Single cylinder/chain drive/Cast Wheels)	09-13		FA213	FA213V	FA213HH	MD651		
G 650 GS Sertao (Single cylinder/chain drive/Spoke Wheels)	12-13		FA213	FA213V	FA213HH	MD651		
F 650 (E169/0161/Standard)	09/93-96		FA213	FA213V	FA213HH	MD651		
F 650 (E169/0162/ Funduro/High Screen/19" Front Wheel)	97-00		FA213	FA213V	FA213HH	MD651		
F 650 CS/Scanner K14/0174/0184/Belt drive/17" Cast Wheels)	00-03		FA213	FA213V	FA213HH	MD651		
F 650 CS/Scanner K14/0177/0187/Belt drive/17" Cast Wheels)	04-07		FA213	FA213V	FA213HH	MD651		
F 650 GS (R13/0172/0182/Single Cylinder/19" Front Wheel)	99-03		FA213	FA213V	FA213HH	MD651		
F 650 GS (R13/0175/0185/Single Cylinder/19" Front Wheel)	04-07		FA213	FA213V	FA213HH	MD651		
F 650 GS (K72/0218/0228/Twin cylinder 798cc/Cast wheel)	07-12		FA213	FA213V	FA213HH	MD671		
F 650 GS (30 Years GS/Twin cylinder 798cc/Cast wheel)	11		FA213	FA213V	FA213HH	MD671		
F 650 GS Dakar (R13/0173/0183/Single Cylinder/ 21" front wheel)	99-03		FA213	FA213V	FA213HH	MD651		
F 650 GS Dakar (R13/0176/0186/Single Cylinder/ 21" front wheel)	04-07		FA213	FA213V	FA213HH	MD651		
F 650 ST (E169/0163/0168/Strada/Low Screen/18" Front Wheel)	97-00		FA213	FA213V	FA213HH	MD651		
F 700 GS	13		FA213	FA213V	FA213HH	MD671		
F 800 GT	13		FA213	FA213V	FA213HH	MD671		
F 800 GS	08-13		FA213	FA213V	FA213HH	MD671		
F 800 GS (30 Years GS)	11		FA213	FA213V	FA213HH	MD671		
F 800 GS Triple Black	12		FA213	FA213V	FA213HH	MD671		
F 800 GS Trophy	12		FA213	FA213V	FA213HH	MD671		
F 800 R (Disc has fixed bobbins)	09-13		FA213	FA213V	FA213HH	MD671		
F 800 R Chris Pfeiffer Edition (Disc has fixed bobbins)	09-11		FA213	FA213V	FA213HH	MD671		
F 800 S (Half fairing/Disc has loose bobbins)	06-08		FA213	FA213V	FA213HH	MD671		
F 800 S (Half fairing/Disc has fixed bobbins)	08-10		FA213	FA213V	FA213HH	MD671		
F 800 ST (Full fairing/Disc has loose bobbins)	06-08		FA213	FA213V	FA213HH	MD671		
F 800 ST (Full fairing/Disc has fixed bobbins)	08-12		FA213	FA213V	FA213HH	MD671		
F 800 ST (Touring/Disc has fixed bobbins)	10-12		FA213	FA213V	FA213HH	MD671		
HP2 Enduro	05-09		FA363	FA363V	FA363HH	MD671		
HP2 Megamoto (Disc has fixed bobbins)	07-10		FA363	FA363V	FA363HH	MD671		

\*-2 Sets Required. ■ - Also available in MX-S race compound.

**SAFETY WARNING:** DO NOT USE HH PADS ON REAR UNLESS ALSO USED ON FRONT TO AVOID BRAKE IMBALANCE

**BRAKE APPLICATIONS**

**R** Suffix = High Durability Sintered Pad. **HH** Suffix = High Performance Sintered Pad. **G** Suffix = Grooved Shoe.  
**D** Suffix = Drilled Disc. **C** Suffix = Contoured Disc. **LS** Suffix = Left/Steel Disc. **RS** = Right/Steel Disc.

# Non-JAPANESE Built Motorcycles



← FRONT / AVANT / VORN FRENTE / ANTERIORE →

## DISC PAD CHOICES

## BRAKE ROTOR CHOICES

### BMW

				NEW SFAC Scooter Carbon Pads	Semi-Sintered V-Pads™	Sintered/HH Pads/ Grooved shoes	Left/Gauche/Links	Right/Droite/Rechts	Contour Rotor Universal left and right fitment	NEW Vee-Rotors™ CONTOUR	NEW CX Extreme® ROTOR	Oversize 250/280mm Rotor Kit	Relocating Bracket for 250/280mm Rotor	Oversize 320mm Rotor Kit	Relocating Bracket for 320mm Rotor
HP2 Sport (Disc has fixed bobbins)	08-11					FA447HH*	N/A	N/A							
HP4	13					FA447HH*	N/A	N/A							
HP4 Carbon	13					FA447HH*	N/A	N/A							
K 75/75-S (Non ABS)	84-08/88	FA018*		FA018V*	FA018HH*	MD604LS	MD604RS								
K 75/75-2 (Non ABS)	84-07/90	FA018*		FA018V*	FA018HH*	MD603LS	MD603RS								
K 75/75-2 (Non ABS)	09/88-96	FA171*		FA171V*	FA171HH*	MD604LS	MD604RS								
K 75/75-S (ABS Model)	08/90-96	FA171*		FA171V*	FA171HH*	MD603LS	MD603RS	Ⓜ							
K 75 C	85-08/88	FA018*		FA018V*	FA018HH*	MD604LS	MD604RS								
K 75 C	09/88-02/88	FA171*		FA171V*	FA171HH*	MD604LS	MD604RS								
K 75 RT (Non ABS)	89-96	FA171*		FA171V*	FA171HH*	MD604LS	MD604RS								
K 75 RT (ABS Model)	89-96	FA171*		FA171V*	FA171HH*	MD603LS	MD603RS	Ⓜ							
K 75 S (Non ABS)	85-09/88	FA018*		FA018V*	FA018HH*	MD604LS	MD604RS								
K 75 S (Non ABS Model)	09/88-95	FA171*		FA171V*	FA171HH*	MD604LS	MD604RS								
K 75 S (ABS Model)	85-09/88	FA018*		FA018V*	FA018HH*	MD603LS	MD603RS	Ⓜ							
K 75 S (ABS Model)	09/88-95	FA171*		FA171V*	FA171HH*	MD603LS	MD603RS	Ⓜ							
K 1000 (Non ABS - 8 valve model)	82-09/88	FA018*		FA018V*	FA018HH*	MD604LS	MD604RS								
K 100/2 (Non ABS - 8 valve model)	87-08/88	FA018*		FA018V*	FA018HH*	MD604LS	MD604RS								
K 100/2 (Non ABS - 8 valve model)	09/88-90	FA171*		FA171V*	FA171HH*	MD604LS	MD604RS								
K 100/2 (ABS - 8 valve model)	87-08/88	FA018*		FA018V*	FA018HH*	MD603LS	MD603RS	Ⓜ							
K 100/2 (ABS - 8 valve model)	09/88-90	FA171*		FA171V*	FA171HH*	MD603LS	MD603RS	Ⓜ							
K 100 LT (Non ABS - 8 valve model)	86-08/88	FA018*		FA018V*	FA018HH*	MD604LS	MD604RS								
K 100 LT (Non ABS - 8 valve model)	09/88-91	FA171*		FA171V*	FA171HH*	MD604LS	MD604RS								
K 100 LT (ABS - 8 valve model)	86/1-8/88	FA018*		FA018V*	FA018HH*	MD603LS	MD603RS	Ⓜ							
K 100 LT (ABS - 8 valve model)	09/88-91	FA171*		FA171V*	FA171HH*	MD603LS	MD603RS	Ⓜ							
K 100 RS (Non ABS - 8 valve)	83-09/88	FA018*		FA018V*	FA018HH*	MD604LS	MD604RS								
K 100 RS (Non ABS - 8 valve)	10/88-89	FA171*		FA171V*	FA171HH*	MD604LS	MD604RS								
K 100 RS (ABS Model - 8 valve)	83-09/88	FA018*		FA018V*	FA018HH*	MD603LS	MD603RS	Ⓜ							
K 100 RS (ABS Model - 8 valve)	10/88-89	FA171*		FA171V*	FA171HH*	MD603LS	MD603RS	Ⓜ							
K 100 RT (Non ABS - 8 valve)	83-09/88	FA018*		FA018V*	FA018HH*	MD604LS	MD604RS								
K 100 RT (Non ABS - 8 valve)	10/88-89	FA171*		FA171V*	FA171HH*	MD604LS	MD604RS								
K 100 RT (ABS - 8 valve)	83-09/88	FA018*		FA018V*	FA018HH*	MD603LS	MD603RS	Ⓜ							
K 100 RT (ABS - 8 valve)	10/88-89	FA171*		FA171V*	FA171HH*	MD603LS	MD603RS	Ⓜ							
K 100 RS (16 valve - Non ABS)	89-92	FA407*			FA407HH*	MD607LS	MD607RS								
K 100 RS (16 valve - ABS Models)	89-92	FA407*			FA407HH*	MD607LS	MD607RS	Ⓜ							
K1 (16 valve - Non ABS)	88-93	FA407*			FA407HH*	MD607LS	MD607RS								
K1 (16 valve - ABS models)	88-93	FA407*			FA407HH*	MD607LS	MD607RS	Ⓜ							
K 1100 LT (Non ABS)	89-07/93	FA407*			FA407HH*	MD607LS	MD607RS								
KL 1100 LT (ABS)	89-07/93	FA407*			FA407HH*	MD607LS	MD607RS	Ⓜ							
K 1100 LT (Non ABS)	08/93-99	FA407*			FA407HH*	MD607LS	MD607RS								
K 1100 LT (ABS Model)	08/93-99	FA407*			FA407HH*	MD607LS	MD607RS	Ⓜ							
K 1100 RS (Non ABS Model)	92-96	FA407*			FA407HH*	MD607LS	MD607RS								
K 1100 RS (ABS Model)	92-96	FA407*			FA407HH*	MD607LS	MD607RS	Ⓜ							
K 1200 RS (Non ABS & ABS Models)	96-00	FA407*			FA407HH*	MD652	MD652	Ⓜ	MD652C*						
K 1200 RS (With & Without Integral ABS)	01-04				FA335HH*	MD620	MD620	Ⓜ							
K 1200 LT (Integral ABS & STD ABS Models)	97-10/00	FA407*			FA407HH*	MD652	MD652	Ⓜ	MD652C*						
K 1200 LT (Evo-Integral ABS)	11/00-09				FA294HH*	MD616	MD616	Ⓜ							
K 1200 GT (2 pin rear pad K41) Disc has loose bobbins	03-06				FA335HH*	MD620	MD620								
K 1200 GT (K44) Disc has fixed bobbins	Left 06-08				FA335HH	N/A									
	Right				FA441HH***		N/A								
***Bike is fitted with pad wear sensors. These are not available separately from BMW. EBC part no. for these are as follows: (You will need to order 1 kit for the Front RH pad set, and 1 kit for the Rear pad set.)															
				MWL001											
K 1200 R (K27/0378/Tokico Caliper - Disc has loose bobbins)	11/05-11/07					FA294HH*	MD616	MD616							
K 1200 R (K27/0378/Tokico Caliper - Disc has fixed bobbins)	12/07-10					FA294HH*	N/A	N/A							
K 1200 S (K40)	05-08					FA335HH*	MD620	MD620							
K 1300 GT (Disc has fixed bobbins)	09-11					FA335HH*	N/A	N/A							
K 1300 GT EE (Disc has fixed bobbins)	10-11					FA335HH*	N/A	N/A							
K 1300 GT SE (Disc has fixed bobbins)	10-11					FA335HH*	N/A	N/A							
K 1300 R (Disc has fixed bobbins)	09-12					FA294HH*	N/A	N/A							

\*-2 Sets Required. ■ - Also available in MX-S race compound.

**SAFETY WARNING-** DO NOT USE HH PADS ON REAR UNLESS ALSO USED ON FRONT TO AVOID BRAKE IMBALANCE

APPLICTIONS  
BRAKE

R Suffix = High Durability Sintered Pad. HH Suffix = High Performance Sintered Pad. G Suffix = Grooved Shoe.

D Suffix = Drilled Disc. C Suffix = Contoured Disc. LS Suffix = Left/Steel Disc. RS = Right/Steel Disc.

# Non-JAPANESE Built Motorcycles



**BMW**



← REAR / ARRIÈRE / HINTEN POSTERIOR / POSTERIORE →

			DISC PAD CHOICES			BRAKE ROTOR CHOICES		
			NEW SFAC Scooter Carbon Pads	Semi-Sintered V-Pads™	Sintered/HH Pads/ Grooved shoes	Contour Rotor Rear Fitment	NEW Vee-Rotors™ CONTOUR	NEW CX Extreme® ROTOR
HP2 Sport (Disc has fixed bobbins)	08-11	FA363		FA363V	FA363HH	MD671		
HP4	13	FA213		FA213V	FA213HH	MD832		
HP4 Carbon	13	FA213		FA213V	FA213HH	MD832		
K 75/75-S (Non ABS)	84-08/88	863						
K 75/75-2 (Non ABS)	84-07/90	861						
K 75/75-2 (Non ABS)	09/88-96	861						
K 75/75-S (ABS Model)	08/90-96	FA018		FA018V	FA018HH	MD611		
K 75 C	85-08/88	861						
K 75 C	09/88-02/88	861						
K 75 RT (Non ABS)	89-96	FA018		FA018V	FA018HH	MD611		
K 75 RT (ABS Model)	89-96	FA018		FA018V	FA018HH	MD661		
K 75 S (Non ABS)	85-09/88	FA018		FA018V	FA018HH	MD611		
K 75 S (Non ABS Model)	09/88-95	FA018		FA018V	FA018HH	MD611		
K 75 S (ABS Model)	85-09/88	FA018		FA018V	FA018HH	MD611		
K 75 S (ABS Model)	09/88-95	FA018		FA018V	FA018HH	MD611		
K 1000 (Non ABS - 8 valve model)	82-09/88	FA018		FA018V	FA018HH	MD611		
K 100/2 (Non ABS - 8 valve model)	87-08/88	FA018		FA018V	FA018HH	MD611		
K 100/2 (Non ABS - 8 valve model)	09/88-90	FA018		FA018V	FA018HH	MD611		
K 100/2 (ABS - 8 valve model)	87-08/88	FA018		FA018V	FA018HH	MD661		
K 100/2 (ABS - 8 valve model)	09/88-90	FA018		FA018V	FA018HH	MD661		
K 100 LT (Non ABS - 8 valve model)	86-08/88	FA018		FA018V	FA018HH	MD611		
K 100 LT (Non ABS - 8 valve model)	09/88-91	FA018		FA018V	FA018HH	MD611		
K 100 LT (ABS - 8 valve model)	86-8/88	FA018		FA018V	FA018HH	MD661		
K 100 LT (ABS - 8 valve model)	09/88-91	FA018		FA018V	FA018HH	MD661		
K 100 RS (Non ABS - 8 valve)	83-09/88	FA018		FA018V	FA018HH	MD611		
K 100 RS (Non ABS - 8 valve)	10/88-89	FA018		FA018V	FA018HH	MD611		
K 100 RS (ABS Model - 8 valve)	83-09/88	FA018		FA018V	FA018HH	MD661		
K 100 RS (ABS Model - 8 valve)	10/88-89	FA018		FA018V	FA018HH	MD661		
K 100 RT (Non ABS - 8 valve)	83-09/88	FA018		FA018V	FA018HH	MD611		
K 100 RT (Non ABS - 8 valve)	10/88-89	FA018		FA018V	FA018HH	MD661		
K 100 RT (ABS - 8 valve)	83-09/88	FA018		FA018V	FA018HH	MD661		
K 100 RT (ABS - 8 valve)	10/88-89	FA018		FA018V	FA018HH	MD661		
K 100 RS (16 valve - Non ABS)	89-92	FA018		FA018V	FA018HH	MD611		
K 100 RS (16 valve - ABS Models)	89-92	FA018		FA018V	FA018HH	MD661		
K1 (16 valve - Non ABS)	88-93	FA018		FA018V	FA018HH	MD611		
K1 (16 valve - ABS models)	88-93	FA018		FA018V	FA018HH	MD661		
K 1100 LT (Non ABS)	89-07/93	FA018		FA018V	FA018HH	MD611		
KL 1100 LT (ABS)	89-07/93	FA018		FA018V	FA018HH	MD661		
K 1100 LT (Non ABS)	08/93-99	FA018		FA018V	FA018HH	MD661		
K 1100 LT (ABS Model)	08/93-99	FA018		FA018V	FA018HH	MD661		
K 1100 RS (Non ABS Model)	92-96	FA018		FA018V	FA018HH	MD661		
K 1100 RS (ABS Model)	92-96	FA018		FA018V	FA018HH	MD661		
K 1200 RS (Non ABS & ABS Models)	96-00	FA018		FA018V	FA018HH	MD661		
K 1200 RS (With & Without Integral ABS)	01-04	FA018		FA018V	FA018HH	MD661		
K 1200 LT (Integral ABS & STD ABS Models)	97-10/00	FA304		FA304V	FA304HH	MD615		
K 1200 LT (Evo-Integral ABS)	11/00-09	FA304		FA304V	FA304HH	MD615		
K 1200 GT (2 pin rear pad K41) Disc has loose bobbins	03-06	FA018		FA018V	FA018HH	MD661		
K 1200 GT (K44) Disc has fixed bobbins	06-08				FA438HH***	MD688		
***Bike is fitted with pad wear sensors. These are not available separately from BMW. EBC part no. for these are as follows: (You will need to order 1 kit for the Front R/H pad set, and 1 kit for the Rear pad set.)								
		MVL002						
K 1200 R (K27/0378/Tokico Caliper - Disc has loose bobbins)	11/05-11/07	FA363		FA363V	FA363HH	MD671		
K 1200 R (K27/0378/Tokico Caliper - Disc has fixed bobbins)	12/07-10	FA363		FA363V	FA363HH	MD671		
K 1200 S (K40)	05-08	FA363		FA363V	FA363HH	MD671		
K 1300 GT (Disc has fixed bobbins)	09-11	FA363		FA363V	FA363HH	MD688		
K 1300 GT EE (Disc has fixed bobbins)	10-11	FA363		FA363V	FA363HH	MD688		
K 1300 GT SE (Disc has fixed bobbins)	10-11	FA363		FA363V	FA363HH	MD688		
K 1300 R (Disc has fixed bobbins)	09-12	FA363		FA363V	FA363HH	MD671		

\*-2 Sets Required. ■ - Also available in MX-S race compound.

**SAFETY WARNING:** DO NOT USE HH PADS ON REAR UNLESS ALSO USED ON FRONT TO AVOID BRAKE IMBALANCE

**BRAKE APPLICATIONS**

**R** Suffix = High Durability Sintered Pad. **HH** Suffix = High Performance Sintered Pad. **G** Suffix = Grooved Shoe.  
**D** Suffix = Drilled Disc. **C** Suffix = Contoured Disc. **LS** Suffix = Left/Steel Disc. **RS** = Right/Steel Disc.



# Non-JAPANESE Built Motorcycles



FRONT / AVANT / VORN FRENTE / ANTERIORE



BMW	Year	DISC PAD CHOICES				BRAKE ROTOR CHOICES							
		NEW SFAC Scooter Carbon Pads	Semi-Sintered V-Pads™	Sintered/HH Pads/ Grooved shoes	Left/Gauche/Links	Right/Droite/Rechts	Contour Rotor Universal left and right fitment	NEW Vee-Rotors™ CONTOUR	NEW CX Extreme® ROTOR	Oversize 250/280mm Rotor Kit	Relocating Bracket for 250/280mm Rotor	Oversize 320mm Rotor Kit	Relocating Bracket for 320mm Rotor
K 1300 R Carbon (Disc has fixed bobbins)	12			FA294HH*	N/A	N/A							
K 1300 R Dynamic (Disc has fixed bobbins)	11-13			FA294HH*	N/A	N/A							
K 1300 S (Fixed bobbins - Non and ABS Models)	09-13			FA335HH*	N/A	N/A							
K 1300 S HP (Fixed bobbins - Non and ABS Models)	12			FA335HH*	N/A	N/A							
K 1300 S Sport (Fixed bobbins - Non and ABS Models)	12-13			FA335HH*	N/A	N/A							
K 1600 GT (Disc has fixed bobbins)	11-13			FA613HH*	N/A	N/A							
K 1600 GTSE (Disc has fixed bobbins)	12-13			FA613HH*	N/A	N/A							
K 1600 GTL (Disc has fixed bobbins)	11-13			FA613HH*	N/A	N/A							
K 1600 GTLE (Disc has fixed bobbins)	12-13			FA613HH*	N/A	N/A							
R 45/45 N (Single rotor with ATE caliper)	78-09/80	FA057	FA057V		MD606LS								
R 45/45 N (Twin rotor with ATE caliper)	8-09/80	FA057*	FA057V*		MD606LS	MD606RS							
R 45/45 N (Single rotor with ATE caliper)	10/80-85	FA057	FA057V		MD606LS								
R 45/45 N (Twin rotor with ATE caliper)	10/80-85	FA057*	FA057V*		MD606LS	MD606RS							
R 45/45 N (Single rotor with Brembo caliper)	78-90/80	FA018	FA018V	FA018HH	MD606LS								
R 45/45 N (Twin rotor with Brembo caliper)	78-90/80	FA018*	FA018V*	FA018HH*	MD606LS	MD606RS							
R 45/45 N (Single rotor with Brembo caliper)	10/80-85	FA018*	FA018V*	FA018HH*	MD606LS								
R 45/45 N (Twin rotor with Brembo calipers)	10/80-85	FA018*	FA018V*	FA018HH*	MD606LS	MD606RS							
R 45 T	80-85	FA057	FA057V		MD606LS								
R 50/5 / 60/5 / 60/6 / 75/5	69-76	864											
R 60/7 (Single rotor)	76-80	FA022	FA022V		MD602LS								
R 60/7 (Double rotor model)	76-80	FA022*	FA022V*		MD602LS	MD602RS							
R 60 TIC (Single rotor)	78-82	FA022	FA022V		MD602LS								
R 60 TIC (Double rotor model)	78-82	FA022*	FA022V*		MD602LS	MD602RS							
R 65 (Single rotor)	07/88-08/89	FA077	FA077V		MD605LS								
R 65 (Double rotor model)	07/88-08/89	FA018*	FA018V*	FA018HH*	MD605LS	MD605RS							
R 65 GS	87-92	FA018	FA018V	FA018HH		MD606RS							
R 65 LS (ATE caliper)	81-85	FA057*	FA057V*		MD606LS	MD606RS							
R 65 LS (Brembo Caliper)	81-85	FA018*	FA018V*	FA018HH*	MD606LS	MD606RS							
R 65 T (Brembo Caliper)	80-85	FA018	FA018V	FA018HH	MD606LS								
R 65 RT	85-88	FA018*	FA018V*	FA018HH*	MD605LS	MD605RS							
R 65 T (ATE caliper)	80-85	FA057	FA057V		MD606LS								
R 75/6 (Single rotor) 75/7	73-79	FA022	FA022V		MD602LS								
R 75/6 (Twin rotor) 75/7	73-79	FA022*	FA022V*		MD602LS	MD602RS							
R 80 (Single rotor)	77-09/80	FA022	FA022V		MD602LS								
R 80 (Double rotor)	77-09/80	FA022*	FA022V*		MD602LS	MD602RS							
R 80 (Single rotor)	10/80-84	FA022	FA022V		MD602LS								
R 80 (Double rotor)	10/80-84	FA022*	FA022V*		MD602LS	MD602RS							
R 80/R 80 RT (Single rotor)	84-07/90	FA077	FA077V		MD605LS								
R 80 RT (Double rotor)	82-84	FA018*	FA018V*	FA018HH*	MD602LS	MD602RS							
R 80/R 80 RT (Double rotor)	84-08/88	FA018*	FA018V*	FA018HH*	MD605LS	MD605RS							
R 80/R 80 RT (Single rotor)	08/90-95	FA077	FA077V			MD605RS							
R 80/R 80 RT (Double rotor)	09/88-95	FA171*	FA171V*	FA171HH*	MD605LS	MD605RS							
R 80 GS	80-87	FA018	FA018V	FA018HH		MD606RS							
R 80 GS	87-95	FA077	FA077V			MD605RS							
R 80 PD/CH	90-95	FA077	FA077V			MD605RS							
R 80 ST	82-84	FA018	FA018V	FA018HH		MD606RS							
R 80 TIC	78-08/80	FA022*	FA022V*		MD602LS	MD602RS							
R 80 TIC	09/80-85	FA018*	FA018V*	FA018HH*	MD602LS	MD602RS							
R 80 Mystic	94-95	FA077*		FA077HH*	MD605LS	MD605RS							
R 80 R	91-94	FA077*		FA077HH*	MD605LS	MD605RS							
R 850 C (Cast wheel/ABS)	97-00	FA077*		FA077HH*	MD652	MD652	MD652C*						
R 850 C (Spoke wheel/ABS)	97-00	FA077*		FA077HH*	MD652	MD652	MD652C*						
R 850 GS	96	FA077	FA077V			MD605RS							
R 850 GS (Std & ABS models)	96-00	FA077*		FA077HH*	MD652	MD652	MD652C*						
R 850 R (Cast wheel/ABS)	94-02	FA077*		FA077HH*	MD607LS	MD607RS							
R 850 R (Spoke wheel)	94-05/96	FA077*		FA077HH*	MD652	MD652	MD652C*						
R 850 R	04-06			FA294HH*	MD616	MD616							
R 850 RT (Cast wheel/ABS)	96-01	FA077*		FA077HH*	MD607LS	MD607RS							
R 850 RT (Spoke wheel)	96-01	FA077*		FA077HH*	MD652	MD652	MD652C*						
R 850 RT	06			FA335HH*	MD620	MD620							

\*-2 Sets Required. ■ - Also available in MX-S race compound.

**SAFETY WARNING:** DO NOT USE HH PADS ON REAR UNLESS ALSO USED ON FRONT TO AVOID BRAKE IMBALANCE

APPLICATIONS  
BRAKE

R Suffix = High Durability Sintered Pad. HH Suffix = High Performance Sintered Pad. G Suffix = Grooved Shoe.

D Suffix = Drilled Disc. C Suffix = Contoured Disc. LS Suffix = Left/Steel Disc. RS = Right/Steel Disc.

# Non-JAPANESE Built Motorcycles



**BMW**



← REAR / ARRIÈRE / HINTEN POSTERIOR / POSTERIORE →

			DISC PAD CHOICES			BRAKE ROTOR CHOICES		
			NEW SFAC Scooter Carbon Pads	Semi-Sintered V-Pads™	Sintered/HH Pads/ Grooved shoes	Contour Rotor Rear Fitment	NEW Vee-Rotors™ CONTOUR	NEW CX Extreme® ROTOR
K 1300 R Carbon (Disc has fixed bobbins)	12	FA363		FA363V	FA363HH	MD671		
K 1300 R Dynamic (Disc has fixed bobbins)	11-13	FA363		FA363V	FA363HH	MD671		
K 1300 S (Fixed bobbins - Non and ABS Models)	09-13	FA363		FA363V	FA363HH	MD671		
K 1300 S HP (Fixed bobbins - Non and ABS Models)	12	FA363		FA363V	FA363HH	MD671		
K 1300 S Sport (Fixed bobbins - Non and ABS Models)	12-13	FA363		FA363V	FA363HH	MD671		
K 1600 GT (Disc has fixed bobbins)	11-13	N/A		FA209/2V	FA209/2HH	TBA		
K 1600 GTSE (Disc has fixed bobbins)	12-13	N/A		FA209/2V	FA209/2HH	TBA		
K 1600 GTL (Disc has fixed bobbins)	11-13	N/A		FA209/2V	FA209/2HH	TBA		
K 1600 GTLE (Disc has fixed bobbins)	12-13	N/A		FA209/2V	FA209/2HH	TBA		
R 45/45 N (Single rotor with ATE caliper)	78-09/80	860						
R 45/45 N (Twin rotor with ATE caliper)	8-09/80	860						
R 45/45 N (Single rotor with ATE caliper)	10/80-85	861						
R 45/45 N (Twin rotor with ATE caliper)	10/80-85	861						
R 45/45 N (Single rotor with Brembo caliper)	78-90/80	860						
R 45/45 N (Twin rotor with Brembo caliper)	78-90/80	860						
R 45/45 N (Single rotor with Brembo caliper)	10/80-85	861						
R 45/45 N (Twin rotor with Brembo calipers)	10/80-85	861						
R 45 T	80-85	861						
R 50/5 / 60/5 / 60/6 / 75/5	69-76	860						
R 60/7 (Single rotor)	76-80	860						
R 60/7 (Double rotor model)	76-80	860						
R 60 TIC (Single rotor)	78-82	860						
R 60 TIC (Double rotor model)	78-82	860						
R 65 (Single rotor)	07/88-08/89	861						
R 65 (Double rotor model)	07/88-08/89	861						
R 65 GS	87-92	861						
R 65 LS (ATE caliper)	81-85	862						
R 65 LS (Brembo Caliper)	81-85	862						
R 65 T (Brembo Caliper)	80-85	861						
R 65 RT	85-88	861						
R 65 T (ATE caliper)	80-85	861						
R 75/6 (Single rotor) 75/7	73-79	860						
R 75/6 (Twin rotor) 75/7	73-79	860						
R 80 (Single rotor)	77-09/80	860						
R 80 (Double rotor)	77-09/80	860						
R 80 (Single rotor)	10/80-84	861						
R 80 (Double rotor)	10/80-84	861						
R 80/R 80 RT (Single rotor)	84-07/90	861						
R 80 RT (Double rotor)	82-84	861						
R 80/R 80 RT (Double rotor)	84-08/88	861						
R 80/R 80 RT (Single rotor)	08/90-95	861						
R 80/R 80 RT (Double rotor)	09/88-95	859						
R 80 GS	80-87	861						
R 80 GS	87-95	859						
R 80 PD/CH	90-95	859						
R 80 ST	82-84	861						
R 80 TIC	78-08/80	860						
R 80 TIC	09/80-85	861						
R 80 Mystic	94-95	859						
R 80 R	91-94	859						
R 850 C (Cast wheel/ABS)	97-00	FA363		FA363V	FA363HH	N/A		
R 850 C (Spoke wheel/ABS)	97-00	FA363		FA363V	FA363HH	N/A		
R 850 GS	96	859						
R 850 GS (Std & ABS models)	96-00	FA363		FA363V	FA363HH	MD653 ①	MD653C	
R 850 R (Cast wheel/ABS)	94-02	FA363		FA363V	FA363HH	MD653 ①		
R 850 R (Spoke wheel)	94-05/96	FA363		FA363V	FA363HH	MD653	MD653C	
R 850 R	04-06	FA363		FA363V	FA363HH	MD653		
R 850 RT (Cast wheel/ABS)	96-01	FA363		FA363V	FA363HH	MD653 ②		
R 850 RT (Spoke wheel)	96-01	FA363		FA363V	FA363HH	MD653	MD653C	
R 850 RT	06	FA363		FA363V	FA363HH	MD653		

\*-2 Sets Required. ■ - Also available in MX-S race compound.

**SAFETY WARNING:** DO NOT USE HH PADS ON REAR UNLESS ALSO USED ON FRONT TO AVOID BRAKE IMBALANCE

**R** Suffix = High Durability Sintered Pad. **HH** Suffix = High Performance Sintered Pad. **G** Suffix = Grooved Shoe.  
**D** Suffix = Drilled Disc. **C** Suffix = Contoured Disc. **LS** Suffix = Left/Steel Disc. **RS** = Right/Steel Disc.

**BRAKE APPLICATIONS**

# Non-JAPANESE Built Motorcycles



← FRONT / AVANT / VORN FRENTE / ANTERIORE →

## DISC PAD CHOICES

## BRAKE ROTOR CHOICES

### BMW

			NEW SFAC Scooter Carbon Pads	Semi-Sintered V-Pads™	Sintered/HH Pads/ Grooved shoes	Left/Gauche/Links	Right/Droite/Rechts	Contour Rotor Universal left and right fitment	NEW Vee-Rotors™ CONTOUR	NEW CX Extreme® ROTOR	Oversize 250/280mm Rotor Kit	Relocating Bracket for 250/280mm Rotor	Oversize 320mm Rotor Kit	Relocating Bracket for 320mm Rotor
R 90 S	73-76		FA022*	FA022V*		MD602LS	MD602RS							
R 90/6 (Single rotor)	73-76		FA022	FA022V		MD602LS								
R 90/6 (Twin rotor)	73-76		FA022*	FA022V*		MD602LS	MD602RS							
R 100 (Single rotor)	76-77		FA022	FA022V		MD602LS								
R 100 (Twin rotor)	76-77		FA022*	FA022V*		MD602LS	MD602RS							
R 100 GS	86-94		FA077	FA077V			MD605RS							
R 100 PD	89-96		FA077	FA077V			MD605RS							
R 100/7T (Single rotor)	77-09/80		FA022	FA022V		MD602LS								
R 100/7T (Twin rotor)	77-09/80		FA022*	FA022V*		MD602LS	MD602RS							
R 100/7T (Spoke wheel)	09/80-84		FA018*	FA018V*	FA018HH*	MD606LS	MD606RS							
R 100/7T (Cast wheel)	09/80-84		FA018*	FA018V*	FA018HH*	MD602LS	MD602RS							
R 100 S	76-08/80		FA022*	FA022V*		MD602LS	MD602RS							
R 100 S	09/80-80		FA018*	FA018V*	FA018HH*	MD602LS	MD602RS							
R 100 RS	76-09/80		FA022*	FA022V*		MD602LS	MD602RS							
R 100 RS	10/80-84		FA018*	FA018V*	FA018HH*	MD602LS	MD602RS							
R 100 RS	86-08/88		FA018*	FA018V*	FA018HH*	MD605LS	MD605RS							
R 100 RS	09/88-08/89		FA171*	FA171V*	FA171HH*	MD605LS	MD605RS							
R 100 RS	9/9-92		FA171*	FA171V*	FA171HH*	MD605LS	MD605RS							
R 100 RT	78-09/80		FA022*	FA022V*		MD602LS	MD602RS							
R 100 RT	10/80-84		FA018*	FA018V*	FA018HH*	MD602LS	MD602RS							
R 100 RT	87-08/88		FA018*	FA018V*	FA018HH*	MD605LS	MD605RS							
R 100 RT	09/88-08/89		FA171*	FA171V*	FA171HH*	MD605LS	MD605RS							
R 100 RT	09/89-95		FA171*	FA171V*	FA171HH*	MD605LS	MD605RS							
R 100 Mystic	93-96		FA407*		FA407HH*	MD605LS	MD605RS							
R 100 R	91-95		FA407*		FA407HH*	MD605LS	MD605RS							
R 1100 GS (STD & ABS)	93-99		FA407*		FA407HH*	MD652	MD652	MD652C*						
R 1100 R (Spoke wheel)	93-05/96		FA407*		FA407HH*	MD652	MD652	MD652C*						
R 1100 R (Spoke wheel)	06/96		FA407*		FA407HH*	MD652	MD652	MD652C*						
R 1100 R (Cast wheel)	93-01		FA407*		FA407HH*	MD607LS	MD607RS							
R 1100 RS	92-01		FA407*		FA407HH*	MD607LS	MD607RS							
R 1100 S	96-11/00		FA407*		FA407HH*	MD687	MD687							
R 1100 S (With integral ABS)	12/00-06				FA294HH*	MD616	MD616							
R 1100 S (Without integral ABS)	12/00-03				FA335HH*	MD803	MD803							
R 1100 RT (Cast wheel/ABS)	94-01	FA407*			FA407HH*	MD607LS	MD607RS							
R 1100 RT (Spoke wheel)	94-01	FA407*			FA407HH*	MD652	MD652	MD652C*						
R 1150 GS (R21/04/15/04/95)	98-10/01	FA407*			FA407HH*	MD652	MD652	MD652C*						
R 1150 GS (Evo R21/04/15/04/95)	11/01-03				FA335HH*	MD652	MD652	MD652C*						
R 1150 GS-Adventure (Evo R21A 0441/0492)	07/01-06				FA335HH*	MD652	MD652	MD652C*						
R 1150 R	01-06				FA294HH*	MD616	MD616							
R 1150 RS (Integral ABS)	01-04				FA294HH*	MD616	MD616							
R 1150 RT (Integral ABS)	00-06				FA335HH*	MD620	MD620							
R 1150 R Rockster	03-06				FA294HH*	MD616	MD616							
R 1150 R Rockster Edition 80	04				FA294HH*	MD616	MD616							
R 1200 (Independence/Cast Wheel)	00-02	FA407*			FA407HH*	MD652	MD652	MD652C*						
R 1200 (Independence/Spoke Wheel)	00-02	FA407*			FA407HH*	MD652	MD652	MD652C*						
R 1200 C (Cast Wheel/ABS)	96-02	FA407*			FA407HH*	MD652	MD652	MD652C*						
R 1200 C (Spoke Wheel/ABS)	96-02	FA407*			FA407HH*	MD652	MD652	MD652C*						
R 1200 C Independent (Cast Wheel)	03-04				FA294HH*	MD652	MD652	MD652C*						
R 1200 C Montauk	04				FA294HH*	MD652	MD652	MD652C*						
R 1200 C Classic	03-04				FA294HH*	MD652	MD652	MD652C*						
R 1200 CL	02-04				FA294HH*	MD652	MD652	MD652C*						
R 1200 GS (K25/0307) (Discs have loose bobbins)	02-11/07				FA335HH*	MD687	MD687							
R 1200 GS Adventure (K25/0382/Spoke Wheel) (Disc has fixed bobbins)	05-11/07				FA335HH*	N/A	N/A							
R 1200 GS Adventure/II (K25/0380/Spoke wheel) (Disc has fixed bobbins)	06-09				FA335HH*	N/A	N/A							
R 1200 GSM (K25/0303 Cast/Spoke wheel) (Disc has fixed bobbins)	06-09				FA335HH*	N/A	N/A							
R 1200 GS (Cast wheels/Disc has fixed bobbins)	10-11				FA335HH*	N/A	N/A							
R 1200 GS (30 Years GS/Spoke wheels/Disc has fixed bobbins)	11				FA335HH*	N/A	N/A							
R 1200 GS (Triple Black/Spoke wheels/Disc has fixed bobbins)	11-13				FA335HH*	N/A	N/A							
R 1200 GS Adventure (Spoke wheels/Disc has fixed bobbins)	10-13				FA335HH*	N/A	N/A							
R 1200 GS-Adventure (30 Years GS/Spoke wheels/Disc has fixed bobbins)	11				FA335HH*	N/A	N/A							

\*-2 Sets Required. ■ - Also available in MX-S race compound.

**SAFETY WARNING:- DO NOT USE HH PADS ON REAR UNLESS ALSO USED ON FRONT TO AVOID BRAKE IMBALANCE**

APPLICATIONS  
BRAKE

R Suffix = High Durability Sintered Pad. HH Suffix = High Performance Sintered Pad. G Suffix = Grooved Shoe.

D Suffix = Drilled Disc. C Suffix = Contoured Disc. LS Suffix = Left/Steel Disc. RS = Right/Steel Disc.

# Non-JAPANESE Built Motorcycles



**BMW**



← REAR / ARRIÈRE / HINTEN POSTERIOR / POSTERIORE →

			DISC PAD CHOICES			BRAKE ROTOR CHOICES			
			NEW SFAC Scooter Carbon Pads	Semi-Sintered V-Pads™	Sintered/HH Pads/ Grooved shoes	Contour Rotor Rear Fitment	NEW Vee-Rotors™ CONTOUR	NEW CX Extreme® ROTOR	
R 90 S	73-76	860							
R 90/6 (Single rotor)	73-76	860							
R 90/6 (Twin rotor)	73-76	860							
R 100 (Single rotor)	76-77	860							
R 100 (Twin rotor)	76-77	860							
R 100 GS	86-94	859							
R 100 PD	89-96	859							
R 100/7T (Single rotor)	77-09/80	860							
R 100/7T (Twin rotor)	77-09/80	860							
R 100/7T (Spoke wheel)	09/80-84	861							
R 100/7T (Cast wheel)	09/80-84	861							
R 100 S	76-08/80	860							
R 100 S	09/80-80	FA018		FA018V	FA018HH	MD602LS			
R 100 RS	76-09/80	860							
R 100 RS	10/80-84	FA018		FA018V	FA018HH	MD602LS			
R 100 RS	86-08/88	861							
R 100 RS	09/88-08/89	861							
R 100 RS	9/09-92	859							
R 100 RT	78-09/80	860							
R 100 RT	10/80-84	FA018		FA018V	FA018HH	MD602LS			
R 100 RT	87-08/88	861							
R 100 RT	09/88-08/89	861							
R 100 RT	09/89-95	859							
R 100 Mystic	93-96	859							
R 100 R	91-95	859							
R 1100 GS (STD & ABS)	93-99	FA363		FA363V	FA363HH	MD653	MD653C		
R 1100 R (Spoke wheel)	93-05/96	FA363		FA363V	FA363HH	MD653	MD653C		
R 1100 R (Spoke wheel)	06/96	FA363		FA363V	FA363HH	MD653	MD653C		
R 1100 R (Cast wheel)	93-01	FA363		FA363V	FA363HH	MD653			
R 1100 RS	92-01	FA018		FA018V	FA018HH	MD661			
R 1100 S	96-11/00	FA363		FA363V	FA363HH	MD653	MD653C		
R 1100 S (With integral ABS)	12/00-06	FA363		FA363V	FA363HH	MD653			
R 1100 S (Without integral ABS)	12/00-03	FA363		FA363V	FA363HH	MD653			
R 1100 RT (Cast wheel/ABS)	94-01	FA363		FA363V	FA363HH	MD653			
R 1100 RT (Spoke wheel)	94-01	FA363		FA363V	FA363HH	MD653	MD653C		
R 1150 GS (R21/0415/0495)	98-10/01	FA363		FA363V	FA363HH	MD653	MD653C		
R 1150 GS (Evo R21/0415/0495)	11/01-03	FA363		FA363V	FA363HH	MD653	MD653C		
R 1150 GS-Adventure (Evo R21A 0441/0492)	07/01-06	FA363		FA363V	FA363HH	MD653	MD653C		
R 1150 R	01-06	FA363		FA363V	FA363HH	MD653			
R 1150 RS (Integral ABS)	01-04	FA363		FA363V	FA363HH	MD653			
R 1150 RT (Integral ABS)	00-06	FA363		FA363V	FA363HH	MD653			
R 1150 R Rockster	03-06	FA363		FA363V	FA363HH	MD653			
R 1150 R Rockster Edition 80	04	FA363		FA363V	FA363HH	MD653			
R 1200 (Independence/Cast Wheel)	00-02	FA363		FA363V	FA363HH	N/A			
R 1200 (Independence/Spoke Wheel)	00-02	FA363		FA363V	FA363HH	N/A			
R 1200 C (Cast Wheel/ABS)	96-02	FA363		FA363V	FA363HH	N/A			
R 1200 C (Spoke Wheel/ABS)	96-02	FA363		FA363V	FA363HH	N/A			
R 1200 C Independent (Cast Wheel)	03-04	FA363		FA363V	FA363HH	N/A			
R 1200 C Montauk	04	FA363		FA363V	FA363HH	N/A			
R 1200 C Classic	03-04	FA363		FA363V	FA363HH	N/A			
R 1200 CL	02-04	FA304		FA304V	FA304HH	MD615			
R 1200 GS (K25/0307) (Discs have loose bobbins)	02-11/07	FA363		FA363V	FA363HH	MD671			
R 1200 GS Adventure (K25/0382/Spoke Wheel) (Disc has fixed bobbins)	05-11/07	FA363		FA363V	FA363HH	MD671			
R 1200 GS Adventure M (K25/0380/Spoke wheel) (Disc has fixed bobbins)	06-09	FA363		FA363V	FA363HH	MD671			
R 1200 GSM (K25/0303 Cast/Spoke wheel) (Disc has fixed bobbins)	06-09	FA363		FA363V	FA363HH	MD671			
R 1200 GS (Cast wheels/Disc has fixed bobbins)	10-11	FA363		FA363V	FA363HH	MD671			
R 1200 GS (30 Years GS/Spoke wheels/Disc has fixed bobbins)	11	FA363		FA363V	FA363HH	MD671			
R 1200 GS (Triple Black/Spoke wheels/Disc has fixed bobbins)	11-13	FA363		FA363V	FA363HH	MD671			
R 1200 GS Adventure (Spoke wheels/Disc has fixed bobbins)	10-13	FA363		FA363V	FA363HH	MD671			
R 1200 GS-Adventure (30 Years GS/Spoke wheels/Disc has fixed bobbins)	11	FA363		FA363V	FA363HH	MD671			

\*-2 Sets Required. ■ - Also available in MX-S race compound.

**SAFETY WARNING-** DO NOT USE HH PADS ON REAR UNLESS ALSO USED ON FRONT TO AVOID BRAKE IMBALANCE

**R** Suffix = High Durability Sintered Pad. **HH** Suffix = High Performance Sintered Pad. **G** Suffix = Grooved Shoe.  
**D** Suffix = Drilled Disc. **C** Suffix = Contoured Disc. **LS** Suffix = Left/Steel Disc. **RS** = Right/Steel Disc.

**BRAKE APPLICATIONS**

# Non-JAPANESE Built Motorcycles



FRONT / AVANT / VORN FRENTE / ANTERIORE

APPLICATIONS  
BRAKE

R Suffix = High Durability Sintered Pad. HH Suffix = High Performance Sintered Pad. G Suffix = Grooved Shoe.

D Suffix = Drilled Disc. C Suffix = Contoured Disc. LS Suffix = Left/Steel Disc. RS = Right/Steel Disc.

## BMW Contd.



		DISC PAD CHOICES				BRAKE ROTOR CHOICES							
		NEW SFAC Scooter Carbon Pads	Semi-Sintered V-Pads™	Sintered/HH Pads/ Grooved shoes	Left/Gauche/Links	Right/Droite/Rechts	Contour Rotor Universal left and right fitment	NEW Vee-Rotors™ CONTOUR	NEW CX Extreme® ROTOR	Oversize 250/280mm Rotor Kit	Relocating Bracket for 250/280mm Rotor	Oversize 320mm Rotor Kit	Relocating Bracket for 320mm Rotor
R 1200 GS Adventure (Triple Black /Disc has fixed bobbins)	12			FA335HH*	N/A	N/A							
R 1200 GS-Rallye (Disc has fixed bobbins)	12			FA335HH*	N/A	N/A							
R 1200 GS (Liquid Cooled / Radial Calipers)	13	USE HH ONLY	USE HH ONLY	FA630HH*	N/A	N/A							
R 1200 RT (K26/0368) (Brembo caliper/Disc has loose bobbins)	05-11/07			FA335HH*	MD803	MD803							
R 1200 RT (K26/0368) (Disc has fixed bobbins)	12/07-09			FA335HH*	N/A	N/A							
R 1200 RT (Disc has fixed bobbins)	10-13			FA335HH*	N/A	N/A							
R 1200 RT-SE (Disc has fixed bobbins)	10-13			FA335HH*	N/A	N/A							
R 1200 ST (K28/0328) (Disc has loose bobbins)	03-11/07			FA335HH*	MD803	MD803							
R 1200 ST (K28/0328) (Disc has fixed bobbins)	12/07-08			FA335HH*	N/A	N/A							
R 1200 S (K29/0366) (Disc has loose bobbins)	06-11/07			FA335HH*	MD803	MD803							
R 1200 S (K29/0366) (Disc has fixed bobbins)	12/07-08			FA335HH*	N/A	N/A							
R 1200 R (K27/0378) (Disc has loose bobbins)	06-07			FA294HH*	MD804	MD804							
R 1200 R (K27/0378) (Disc has fixed bobbins)	12/07-13			FA294HH*	N/A	N/A							
R 1200 R Classic (Disc has fixed bobbins)	11-13			FA294HH*	N/A	N/A							
R 1200 R SE (Disc has fixed bobbins)	10-11			FA294HH*	N/A	N/A							
S 1000 RR	10-13			FA604/4HH*	N/A	N/A							
S 1000 RR Sport	12-13			FA604/4HH*	N/A	N/A							

IMPORTANT NOTE ① - remove rotor outer ring from centre casting and refit.

② - remove ABS ring from old rotor and refit to new EBC rotor. Note: Ensure all mounting surfaces are clean and when refitting bolts use a thread lock cement to hold them in place.

## BORILE

B 500 CR	02-04	FA095		FA095HH	N/A								
B 500 MT	02	FA095		FA095HH	N/A								

## BRAMMO (ELECTRIC BIKES)

Empulse R	12-13	FA244*	FA244V*	FA244HH	MD614X	MD614X	MD614XC*	VR614BLK*					
Enerlia	12-13	FA209/2	FA209/2V	FA209/2HH	N/A								

## BRANSON

BS 50 Cuba	08	SFA235	SFAC235		MD923D		MD923C	VR923					
BS 50 Sting	08	SFA235	SFAC235		MD923D		MD923C	VR923					
BS 50 Snooker	08	TBA			TBA								
BC 125 Street Rider	08	TBA											
BM 125	08	SFA093			N/A								
BM 125 Retro	08	SFA093			N/A								
BM 125 Sport	08	FA093			N/A								
BS 125 Snooker	08	SFA257	SFAC257			N/A							
BS 125 Boulevard	08	SFA257	SFAC257			N/A							
BT 125 Ardennes	08	TBA			N/A								
Town Runner 125	08	TBA				N/A							
Andes 200	08	TBA			N/A								
BM 200	08	TBA			N/A								
BM 250 Cruiser	08	TBA			N/A								

## BSA

Bantam D7		858											
-----------	--	-----	--	--	--	--	--	--	--	--	--	--	--

## BSM

TB 100		SFA083*	SFAC083*	SFA083HH*	MD923D	MD923D	MD923C*	VR923*					
TB 125		SFA083*	SFAC083*	SFA083HH*	MD923D	MD923D	MD923C*	VR923*					
FT 125		FA056			N/A								

## BULTACO

Astro SM50		FA167		FA167HH	N/A								
Lobito 125 and 250 cc				831G									
Sherpa 250/350 N/A/I				831G									
Sherpa (91-250cc & 92-350cc)				831G									
Sherpa (124-250cc, 125-350cc), (150-250cc, 151)				831G									
Sherpa (198-250cc & 199-350cc)				831G									
Frontier 250/360/370 all models				833G									

\*-2 Sets Required. ■ - Also available in MX-S race compound.

**SAFETY WARNING:** DO NOT USE HH PADS ON REAR UNLESS ALSO USED ON FRONT TO AVOID BRAKE IMBALANCE



# Non-JAPANESE Built Motorcycles



← REAR / ARRIÈRE / HINTEN POSTERIOR / POSTERIORE →

## BMW Contd.



			DISC PAD CHOICES			BRAKE ROTOR CHOICES		
			NEW SFAC Scooter Carbon Pads	Semi-Sintered V-Pads™	Sintered/HH Pads/ Grooved shoes	Contour Rotor Rear Fitment	NEW Vee-Rotors™ CONTOUR	NEW CX Extreme® ROTOR
R 1200 GS Adventure (Triple Black /Disc has fixed bobbins)	12	FA363		FA363V	FA363HH	MD671		
R 1200 GS-Rallye (Disc has fixed bobbins)	12	FA363		FA363V	FA363HH	MD671		
R 1200 GS (Liquid Cooled / Radial Calipers)	13	FA363		FA363V	FA363HH	MD671		
R 1200 RT (K26/0368) (Brembo caliper/Disc has loose bobbins)	05-11/07	FA363		FA363V	FA363HH	MD671		
R 1200 RT (K26/0368) (Disc has fixed bobbins)	12/07-09	FA363		FA363V	FA363HH	MD671		
R 1200 RT (Disc has fixed bobbins)	10-13	FA363		FA363V	FA363HH	MD671		
R 1200 RT-SE (Disc has fixed bobbins)	10-13	FA363		FA363V	FA363HH	MD671		
R 1200 ST (K28/0328) (Disc has loose bobbins)	03-11/07	FA363		FA363V	FA363HH	MD671		
R 1200 ST (K28/0328) (Disc has fixed bobbins)	12/07-08	FA363		FA363V	FA363HH	MD671		
R 1200 S (K29/0366) (Disc has loose bobbins)	06-11/07	FA363		FA363V	FA363HH	MD671		
R 1200 S (K29/0366) (Disc has fixed bobbins)	12/07-08	FA363		FA363V	FA363HH	MD671		
R 1200 R (K27/0378) (Disc has loose bobbins)	06-07	FA363		FA363V	FA363HH	MD671		
R 1200 R (K27/0378) (Disc has fixed bobbins)	12/07-13	FA363		FA363V	FA363HH	MD671		
R 1200 R Classic (Disc has fixed bobbins)	11-13	FA363		FA363V	FA363HH	MD671		
R 1200 R SE (Disc has fixed bobbins)	10-11	FA363		FA363V	FA363HH	MD671		
S 1000 RR	10-13	FA213		FA213V	FA213HH	MD832		
S 1000 RR Sport	12-13	FA213		FA213V	FA213HH	MD832		
<b>BORILE</b>								
B 500 CR	02-04	FA213			FA213HH	N/A		
B 500 MT	02	FA213			FA213HH	N/A		
<b>BRAMMO (ELECTRIC BIKES)</b>								
Empulse R	12-13	FA266		FA266V	FA266HH	N/A		
Enerzia	12-13	FA266		FA266V	FA266HH	N/A		
<b>BRANSON</b>								
BS 50 Cuba	08	TBA						
BS 50 Sting	08	TBA						
BS 50 Snooker	08	TBA				N/A		
BC 125 Street Rider	08	TBA						
BM 125	08	TBA						
BM 125 Retro	08	TBA						
BM 125 Sport	08	TBA						
BS 125 Snooker	08	TBA						
BS 125 Boulevard	08	TBA				N/A		
BT 125 Ardennes	08	TBA				N/A		
Town Runner 125	08	TBA						
Andes 200	08	TBA				N/A		
BM 200	08	TBA				N/A		
BM 250 Cruiser	08	TBA						
<b>BSA</b>								
Bantam D7		858						
<b>BSM</b>								
TB 100		Y503						
TB 125		SFA083	SFAC083		FA083HH	MD923D	MD923C	VR923
FT 125		S602						
<b>BULTACO</b>								
Astro SM50		FA115			FA115HH	N/A		
Lobito 125 and 250 cc					831G			
Sherpa 250/350 N/A/I					831G			
Sherpa (91-250cc & 92-350cc)					N/A			
Sherpa (124-250cc, 125-350cc), (150-250cc, 151)					833G			
Sherpa (198-250cc & 199-350cc)					831G			
Frontier 250/360/370 all models					833G			

\*-2 Sets Required. ■ - Also available in MX-S race compound.

**SAFETY WARNING:- DO NOT USE HH PADS ON REAR UNLESS ALSO USED ON FRONT TO AVOID BRAKE IMBALANCE**

**BRAKE APPLICATIONS**

**R** Suffix = High Durability Sintered Pad. **HH** Suffix = High Performance Sintered Pad. **G** Suffix = Grooved Shoe.  
**D** Suffix = Drilled Disc. **C** Suffix = Contoured Disc. **LS** Suffix = Left/Steel Disc. **RS** = Right/Steel Disc.

# Non-JAPANESE Built Motorcycles



← FRONT / AVANT / VORN FRENTE / ANTERIORE →

## DISC PAD CHOICES

## BRAKE ROTOR CHOICES

### BULTACO

			NEW SFAC Scooter Carbon Pads	Semi-Sintered V-Pads™	Sintered/HH Pads/ Grooved shoes	Left/Gauche/Links	Right/Droite/Rechts	Contour Rotor Universal left and right fitment	NEW Vee-Rotors™ CONTOUR	NEW CX Extreme® ROTOR	Oversize 250/280mm Rotor Kit	Relocating Bracket for 250/280mm Rotor	Oversize 320mm Rotor Kit	Relocating Bracket for 320mm Rotor
Pursang MK6 125/175/200/250/350					831G									
Pursang MK7 and MK8 125/250/360					831G									
Pursang MK9 125/200					831G									
Pursang MK9 250/370					833G									
Pursang MK10 250cc					831G									
Pursang MK10 370cc					833G									
Pursang MK11 250cc					831G									
Pursang MK11 370cc					833G									
Pursang MK12 250cc					831G									
Pursang MK12 370cc					833G									

### CAGIVA

Cucciolo 50	98-99	SFA047			SFA047HH	TBA								
Stella 50	97	SFA264	SFAC264		SFA264HH	TBA								
Blues 50	93-95	FA156					N/A							
Mantis 50	99	SFA193	SFAC193		SFA193HH	TBA								
Nag 50 Scooter	08	SFA235	SFAC235											
Nuvola 50	00	SFA193	SFAC193		SFA193HH	TBA								
Progress 50	97-99	SFA115	SFAC115		SFA115HH	N/A								
Super City 50/80	93-95	FA156					N/A							
Prima 50	92-94	FA156					N/A							
W4 50	91-95	FA047			FA047HH	N/A								
City 50	91-94	SFA257	SFAC257			MD933D			VR933					
Mito 50	98-99	FA167			FA167HH	MD806LS								
Brillio 125	08	FA086				N/A								
Cruiser 125	87	FA134				N/A								
125 Elefant RE	87	FA047TT			FA047R	N/A								
Tamanaco 125	88-89	FA163				TBA								
WSXT 125 Aletta Rossa	83-84	FA060				N/A								
XSST 125	-80	N/A				N/A								
XSST 125	81-82	FA060				N/A								
SXT 125	82	FA060				N/A								
Blues 125	92-95	FA256			FA256HH	N/A								
Cucciolo 125	00	SFA047			SFA047HH	MD9110D			VR9110					
Mito 125	91-92	FA163					MD614X	MD614XC	VR614BLK					
Mito 125 All models	93-07	FA095			FA095HH		MD614X	MD614XC	VR614BLK					
Mito 125 (SP525)	08-10	FA095			FA095HH		MD614X	MD614XC	VR614BLK					
Passing 125	93-97	SFA264	SFAC264		SFA264HH	N/A								
Raptor 125	03-10	FA095			FA095HH		MD614X	MD614XC	VR614BLK					
Roadster 125	96-97	FA198					N/A							
Roadster 125	98-99	FA256					N/A							
Super City 125	92-00	FA163					MD614X	MD614XC	VR614BLK					
Freccia 125 SY	89	FA163					N/A							
Nuvola 125	00	SFA193	SFAC193		SFA193HH	N/A								
Planet 125 (3 Spoke Wheels Model / 6 Bolt Rear Disc)	99-03	FA095			FA095HH		MD614X	MD614XC	VR614BLK					
Planet 125 (6 Spoke Wheels Model - 1st Series / 3 Bolt Rear Disc)	99-03	FA095			FA095HH		MD614X	MD614XC	VR614BLK					
Planet 125 (6 Spoke Wheels Model - 2nd Series / Bolt Rear Disc)	99-03	FA095			FA095HH		MD614X	MD614XC	VR614BLK					
WMX 125 (Rimoldi Hub)	-85				944G									
WMX 125	86	FA047			FA047R	N/A								
WMX 125	87-88	FA134			FA134R	N/A								
WMX 125	89	FA134			FA134R	N/A								
W8 125	93-98	FA163					N/A							
N1 125	97	FA095			FA095HH		MD614X	MD614XC	VR614BLK					
SST 250	-80	N/A				N/A								
SST 250/350	80-82	FA047			FA047HH	N/A								
SX 250/350	-82				842G									
SX 250	82	FA047			FA047HH	N/A								
WMX 250	-85	FA047			FA047R	N/A								
WMX 250	86-88	FA134			FA134R	N/A								
WMX 250	89	FA134			FA134R	N/A								

\*-2 Sets Required. ■ - Also available in MX-S race compound.

**SAFETY WARNING:** DO NOT USE HH PADS ON REAR UNLESS ALSO USED ON FRONT TO AVOID BRAKE IMBALANCE

# Non-JAPANESE Built Motorcycles

**BRAKE APPLICATIONS**



← REAR / ARRIÈRE / HINTEN POSTERIOR / POSTERIORE →

## BULTACO



	DISC PAD CHOICES				BRAKE ROTOR CHOICES			
	NEW SFAC Scooter Carbon Pads	Semi-Sintered V-Pads™	Sintered/HH Pads/ Grooved shoes		Contour Rotor Rear Fitment	NEW Vee-Rotors™ CONTOUR	NEW CX Extreme® ROTOR	
Pursang MK6 125/175/200/250/350			N/A					
Pursang MK7 and MK8 125/250/360			833G					
Pursang MK9 125/200			831G					
Pursang MK9 250/370			833G					
Pursang MK10 250cc			833G					
Pursang MK10 370cc			833G					
Pursang MK11 250cc			833G					
Pursang MK11 370cc			833G					
Pursang MK12 250cc			833G					
Pursang MK12 370cc			833G					

## CAGIVA

Cucciolo 50	98-99	S624					
Stella 50	97	SFA264	SFAC264		TBA		
Blues 50	93-95	SFA186			N/A		
Mantis 50	99	TBA					
Nag 50 Scooter	08	TBA					
Nuvola 50	00	TBA					
Progress 50	97-99	S624					
Super City 50/80	93-95	SFA186			MD805		
Prima 50	92-94	SFA186			MD805		
W4 50	91-95	FA060			N/A		
City 50	91-94	893					
Mito 50	98-99	FA115		FA115HH	MD805		
Brillio 125	08	FA101			N/A		
Cruiser 125	87	FA060			N/A		
125 Elefant RE	87	953					
Tamanaco 125	88-89	FA060			TBA		
WSXT 125 Aletta Rossa	83-84	845					
XSST 125	-80	844					
XSST 125	81-82	844					
SXT 125	82			841WG			
Blues 125	92-95	FA047		FA047HH	N/A		
Cucciolo 125	00	816					
Mito 125	91-92	FA047			MD638		
Mito 125 All models	93-07	FA047		FA047HH	MD638		
Mito 125 (SP525)	08-10	FA047		FA047HH	MD638		
Passing 125	93-97	H303					
Raptor 125	03-10	FA047		FA047HH	MD638		
Roadster 125	96-97	949					
Roadster 125	98-99	949					
Super City 125	92-00	FA047			MD638		
Freccia 125 SY	89	FA047			N/A		
Nuvola 125	00	816					
Planet 125 (3 Spoke Wheels Model / 6 Bolt Rear Disc)	99-03	FA047		FA047HH	MD638		
Planet 125 (6 Spoke Wheels Model - 1st Series / 3 Bolt Rear Disc)	99-03	FA047		FA047HH	MD639		
Planet 125 (6 Spoke Wheels Model - 2nd Series / Bolt Rear Disc)	99-03	FA047		FA047HH	MD638		
WMX 125 (Fimoldi Hub)	-85			841G			
WMX 125	86			977G			
WMX 125	87-88			977G			
WMX 125	89	FA067		FA067R	N/A		
W8 125	93-98	FA060			N/A		
N1 125	97	FA047		FA047HH	TBA		
SST 250	-80	844					
SST 250/350	80-82			842G			
SX 250/350	-82			842G			
SX 250	82			842G			
WMX 250	-85			841G			
WMX 250	86-88			977G			
WMX 250	89	FA067		FA067R	N/A		

\*-2 Sets Required. ■ - Also available in MX-S race compound.  
**SAFETY WARNING:** DO NOT USE HH PADS ON REAR UNLESS ALSO USED ON FRONT TO AVOID BRAKE IMBALANCE

**R** Suffix = High Durability Sintered Pad. **HH** Suffix = High Performance Sintered Pad. **G** Suffix = Grooved Shoe.  
**D** Suffix = Drilled Disc. **C** Suffix = Contoured Disc. **LS** Suffix = Left/Steel Disc. **RS** = Right/Steel Disc.

# Non-JAPANESE Built Motorcycles



← FRONT / AVANT / VORN FRENTE / ANTERIORE →

## DISC PAD CHOICES

## BRAKE ROTOR CHOICES

CAGIVA	Year	FA Part	NEW SFAC Scooter Carbon Pads	Sintered/HH Pads/Grooved shoes	Left/Gauche/Links	Right/Droite/Rechts	Contour Rotor Universal left and right fitment	NEW Vee-Rotors™	NEW CX Extreme® ROTOR	Oversize 250/280mm Rotor Kit	Relocating Bracket for 250/280mm Rotor	Oversize 320mm Rotor Kit	Relocating Bracket for 320mm Rotor
WMX 500	84-86	FA047		FA047R	N/A								
W 12 350	93-95	FA163			N/A								
Canyon 500	96-00	FA124/2		FA124/2HH	MD6168D								
Mito 500 (4T)	07	FA095		FA095HH		MD614X	MD614XC	VR614BLK					
Mito 500 (4T)	08			FA322/4HH	MD614X		MD614XC	VR614BLK					
Excaliber 501 RLX	92	FA134			N/A								
W16 600	94-98	FA163			N/A								
River 600	95-99	FA095		FA095HH		MD614X	MD614XC	VR614BLK					
Canyon 600	96-99	FA124/2		FA124/2HH	MD6168D								
650 Elefant	85	FA120			N/A								
650 Elefant	88-89	FA120			MD6265D								
V-Raptor/Raptor 650	01-07	FA244*	FA244V*	FA244HH*	MD660LS	MD660RS							
750 Elefant	90-92	FA134			MD6265D								
E 750 Elefant	93-95	FA124/2		FA124/2HH	MD6168D								
900 IE Canyon/Gran Canyon	98-00	FA142*			MD6168D	MD6168D							
E 900 Elefant Dakar Rep (300mm front disc)	90	FA124/2		FA124/2HH	TBA								
E 900 ie Lucky Explorer (296mm front disc)	91-92	FA124/2		FA124/2HH	MD6168D								
E 900 ie GT (296mm front disc)	91-92	FA124/2		FA124/2HH	MD6168D								
E 900 C Elefant (282mm front discs/USD forks/Brembo front calipers/rear)	93-97	FA181TT*		FA181R	MD6303D	MD6303D							
E 900 C ie Lucky Explorer (282mm front discs)	95-97	TBA			MD6303D	MD6303D							
Navigator 1000	00-05	FA142*		FA142HH*	MD6168D	MD6168D							
Raptor/V-Raptor/X-tra	00-05	FA244*		FA244HH*	MD660LS	MD660RS							
Raptor X3 1000	03-04			FA322/4HH*	MD666X	MD666X	MD666XC*						
<b>CASAL</b>													
All disc models		FA050			N/A								
Mofas		875											
Boss		875											
Mofas drum dia. 110mm		894											
Mofas drum dia. 140mm		895											
50 Ciolomotori (140mm drum)		895											
<b>CCM</b>													
CR 40 S Cafe Racer (Full Fairing)	07-08	FA095		FA095HH	N/A								
CR 40 Cafe Racer (Handlebar Fairing)	07-08	FA095		FA095HH		MD813							
SR 40 Street Scrambler	07-09	FA194		FA194HH									
C-XR 125 M	07-09	FA086		FA086HH	TBA								
C-XR 125 E	08-09	FA086		FA086HH	TBA								
C-XR 125 S	08-09	FA086		FA086HH	TBA								
RL 125	08-09	FA197		FA197HH	N/A								
SM 125	08-09	FA197		FA197HH	TBA								
TL 125	08-09	FA086		FA086HH									
C-XR 230 E	07-09	FA086		FA086HH	TBA								
C-XR 230 S	07-09	FA086		FA086HH	TBA								
C-XR 230 M	07-09	FA086		FA086HH	TBA								
XTR 250	09	FA086		FA086HH	N/A								
LX 350-4A Quad	08-09	FA054TT*		FA054R*	TBA	TBA							
FT 35 S (400cc) (DRZ 400 Motor)	07-09	FA181TT		FA181R	TBA								
404 E	03-04	FA181TT		FA181R	MD6260D								
404 DS	03-04	FA181TT		FA181R	MD6260D								
404 DS Supermoto	03-04	FA181TT		FA181R	MD6209D								
404 DS Supermoto	07-09	FA181TT		FA181R	TBA								
404 DS Trail	07-09	FA181TT		FA181R	TBA								
CMX 450 (MX)	08	FA181TT		FA181R	N/A								
450 DS Trail	07-09	FA181TT		FA181R	TBA								
GP 450 (4T)	13	FA209/2	FA209/2V	FA209/2HH			N/A						
604 E DS (Dual Sport/Trail)	98-03	FA181TT		FA181R	MD6260D								
604E Supermoto	99-03	FA181TT		FA181R	MD6209D								
604 RS Roadster	00-03	FA181TT		FA181R	MD6209D								
644 DS Supermoto	04	FA181TT		FA181R	MD6209D								

\*-2 Sets Required. ■ - Also available in MX-S race compound.

**SAFETY WARNING:** DO NOT USE HH PADS ON REAR UNLESS ALSO USED ON FRONT TO AVOID BRAKE IMBALANCE

APPLICATIONS  
BRAKE

R Suffix = High Durability Sintered Pad. HH Suffix = High Performance Sintered Pad. G Suffix = Grooved Shoe.

D Suffix = Drilled Disc. C Suffix = Contoured Disc. LS Suffix = Left/Steel Disc. RS = Right/Steel Disc.

# Non-JAPANESE Built Motorcycles

**BRAKE APPLICATIONS**

**R** Suffix = High Durability Sintered Pad. **HH** Suffix = High Performance Sintered Pad. **G** Suffix = Grooved Shoe.  
**D** Suffix = Drilled Disc. **C** Suffix = Contoured Disc. **LS** Suffix = Left/Steel Disc. **RS** = Right/Steel Disc.



## CAGIVA



← REAR / ARRIÈRE / HINTEN POSTERIOR / POSTERIORE →

		DISC PAD CHOICES				BRAKE ROTOR CHOICES			
		NEW SFAC Scooter Carbon Pads	Semi-Sintered V-Pads™	Sintered/HH Pads/ Grooved shoes		Contour Rotor Rear Fitment	NEW Vee-Rotors™ CONTOUR	NEW CX Extreme® ROTOR	
WMX 500	84-86			982G					
W 12 350	93-95	FA173			N/A				
Canyon 500	96-00	FA165/2TT			MD6160D				
Mito 500 (4T)	07	FA047		FA047HH	MD638				
Mito 500 (4T)	08	FA047		FA047HH	MD638				
Excaliber 501 RLX	92	FA047			N/A				
W16 600	94-98	FA173			N/A				
River 600	95-99	FA047		FA047HH	MD638				
Canyon 600	96-99	FA165/2TT			MD6160D				
650 Elefant	85	FA047			N/A				
650 Elefant	88-89	FA047			MD6259D				
V-Raptor/Raptor 650	01-07	FA266	FA266V	FA266HH	MD617				
750 Elefant	90-92	FA163			MD6259D				
E 750 Elefant	93-95	FA181TT		FA181HH	TBA				
900 IE Canyon/Gran Canyon	98-00	FA165/2TT			MD6160D				
E 900 Elefant Dakar Rep (300mm front disc)	90	FA165/2TT			MD6160D				
E 900 ie Lucky Explorer (296mm front disc)	91-92	FA165/2TT			MD6160D				
E 900 ie GT (296mm front disc)	91-92	FA165/2TT			MD6160D				
E 900 C Elefant (282mm front discs/USD forks/Brembo front calipers/rear)	93-97	FA181TT		FA181R ■	MD6160D				
E 900 C ie Lucky Explorer (282mm front discs)	95-97	TBA			MD6160D				
Navigator 1000	00-05	FA165/2TT			MD6160D				
Raptor/V-Raptor/X-tra	00-05	FA266	FA266V	FA266HH	MD617				
Raptor X3 1000	03-04	FA266	FA266V	FA266HH	MD617				
<b>CASAL</b>									
All disc models		N/A							
Mofas		875							
Boss		875							
Mofas drum dia. 110mm		894							
Mofas drum dia. 140mm		895							
50 Ciclomotori (140mm drum)		895							
<b>CCM</b>									
CR 40 S Cafe Racer (Full Fairing)	07-08	FA213	FA213V	FA213HH	MD6276D				
CR 40 Cafe Racer (Handlebar Fairing)	07-08	FA213	FA213V	FA213HH	TBA				
SR 40 Street Scrambler	07-09	FA213	FA213V	FA213HH	TBA				
C-XR 125 M	07-09	FA054TT		FA054HH	TBA				
C-XR 125 E	08-09	FA054TT		FA054HH	TBA				
C-XR 125 S	08-09	FA054TT		FA054HH	TBA				
RL 125	08-09	TBA							
SM 125	08-09	FA197		FA197HH	TBA				
TL 125	08-09	FA197		FA197HH	TBA				
C-XR 230 E	07-09	FA054TT		FA054HH	TBA				
C-XR 230 S	07-09	FA054TT		FA054HH	TBA				
C-XR 230 M	07-09	FA054TT		FA054HH	TBA				
XTR 250	09	FA101			N/A				
LX 350-4A Quad	08-09	FA083TT		FA083R	TBA				
FT 35 S (400cc) (DRZ 400 Motor)	07-09	FA208TT		FA208R ■	TBA				
404 E	03-04	FA208TT		FA208R ■	MD6276D				
404 DS	03-04	FA208TT		FA208R ■	MD6276D				
404 DS Supemoto	03-04	FA208TT		FA208R ■	MD6276D				
404 DS Supemoto	07-09	FA208TT		FA208R ■	TBA				
404 DS Trail	07-09	FA208TT		FA208R ■	TBA				
CMX 450 (MX)	08	FA208TT		FA208R ■	N/A				
450 DS Trail	07-09	FA208TT		FA208R ■	TBA				
GP 450 (4T)	13	FA213	FA213V	FA213HH		N/A			
604 E DS (Dual Sport/Trail)	98-03	FA208TT		FA208R ■	MD6276D				
604E Supemoto	99-03	FA208TT		FA208R ■	MD6276D				
604 RS Roadster	00-03	FA208TT		FA208R ■	MD6276D				
644 DS Supemoto	04	FA208TT		FA208R ■	MD6276D				

\*-2 Sets Required. ■ - Also available in MX-S race compound.

**SAFETY WARNING:** DO NOT USE HH PADS ON REAR UNLESS ALSO USED ON FRONT TO AVOID BRAKE IMBALANCE



# Non-JAPANESE Built Motorcycles



FRONT / AVANT / VORN FRENTE / ANTERIORE

**APPLICATIONS**

**BRAKE**



		DISC PAD CHOICES				BRAKE ROTOR CHOICES							
		NEW SFAC Scooter Carbon Pads	Semi-Sintered V-Pads™	Sintered/HH Pads/ Grooved shoes	Left/Gauche/Links	Right/Droite/Rechts	Contour Rotor Universal left and right fitment	NEW Vee-Rotors™ CONTOUR	NEW CX Extreme® ROTOR	Oversize 250/280mm Rotor Kit	Relocating Bracket for 250/280mm Rotor	Oversize 320mm Rotor Kit	Relocating Bracket for 320mm Rotor
<b>CCM</b>													
644 DS	04	FA181TT		FA181R ■	MD6209D								
R 30 (Spoke wheel) (604/644)	02-04	FA181TT		FA181R ■	MD6209D								
R 30 (Mag wheel) (604/644)	02-04	FA181TT		FA181R ■	MD6306D								
R 35/R 35 S	07-09	FA181TT		FA181R ■	TBA								
R 45	07-09	FA181TT		FA181R ■	TBA								
FT 650	08	FA181TT		FA181R ■	TBA								
LX 700-4A Quad	08-09	FA054TT*		FA054R*	TBA	TBA							
FT 710 S Flat Tracker	08-09	FA181TT		FA181R ■	TBA								
Note: MD6260D = 260mm O/D MD6209D = 320mm O/D.													
<b>CECTEK</b>													
500 EFI King Cobra	09-10	FA484TT*		FA484R*	N/A	N/A							
500 EFI Gladiator	09-10	FA377TT*		FA377R*	N/A	N/A							
500 EFI Quadrit	09-10	FA484TT*		FA484R*	N/A	N/A							
500i Estoc	10	FA484TT*		FA484R*	N/A	N/A							
<b>C F MOTO</b>													
CF 125 T-22 Glory	10-11	SFA228	SFAC228	SFA228HH	N/A								
CF 125 T-21A E-Charm	10-12	SFA228	SFAC228	SFA228HH	N/A								
CF 150 - 20 V-Night	12	TBA					N/A						
CF 150 T-6A Glory	10-11	SFA228	SFAC228	SFA228HH	N/A								
CF 150 T-5i E-Charm	10-12	SFA228	SFAC228	SFA228HH	N/A								
CF 150 Leader	10-12	FA093			N/A								
CF 250 T - 5 Custom	11-12	FA179		FA179HH	N/A								
CF 250 T - 6A (Scooter)	12	SFA086*	SFAC086*	SFA086HH*	N/A	N/A							
CF 500-3 (Rancher 500 Side x Side)	Left 10-12	FA165TT		FA165R	N/A								
	Right	FA135TT		FA135R		N/A							
CF 500 (Terracross)	Left 11-12	FA165TT		FA165R	N/A								
	Right	FA135TT		FA135R		N/A							
CF 500-2 (Terranlander)	13	FA453TT*		FA453R*	N/A	N/A							
CF 625-3 (Z6 Terracross)	Left 11-13	FA165TT		FA165R	N/A								
	Right	FA135TT		FA135R		N/A							
CF 625 - B/C (X6 Terranlander)	11-13	FA453TT*		FA453R*	N/A	N/A							
650 NK	Left 12-13	FA229		FA231HH			N/A*						
	Right	FA231		FA231HH									
650 TR	Left 13	FA229		FA231HH			N/A*						
	Right	FA231		FA231HH									
CF 800-2 (Terranlander)	12-13	FA453TT*		FA453R*	N/A	N/A							
CF 800-3 (Tracker 800)	Left 13	FA165TT		FA165R	N/A								
	Right	FA135TT		FA135R		N/A							
<b>C H RACING</b>													
WXE 50 Enduro	05	FA167		FA167HH	N/A								
WSM 50 Motard	05	FA167		FA167HH	N/A								
WXE 125 Enduro	05	FA167		FA167HH	N/A								
WSM 125 Motard	05	FA167		FA167HH	N/A								
<b>CIMATTI</b>													
Gringo	-85	FA050			N/A								
Gringo	85-	FA099			N/A								
<b>CONTI</b>													
RX 356 V3 (12" wheels)	05-06	FA399			N/A								
RX 356 V3 (17" wheels)	05-06	FA399			N/A								
<b>CPI</b>													
Aragon 50	07-09	SFA235	SFAC235		TBA								
Aragon GP50	07-12	SFA235	SFAC235		TBA								
Aragon GP Paddock	08-12	SFA235	SFAC235		N/A								
Aragon Club 50	07-12	SFA235	SFAC235		TBA								

\*-2 Sets Required. ■ - Also available in MX-S race compound.

**SAFETY WARNING:** DO NOT USE HH PADS ON REAR UNLESS ALSO USED ON FRONT TO AVOID BRAKE IMBALANCE

**R** Suffix = High Durability Sintered Pad. **HH** Suffix = High Performance Sintered Pad. **G** Suffix = Grooved Shoe.  
**D** Suffix = Drilled Disc. **C** Suffix = Contoured Disc. **LS** Suffix = Left/Steel Disc. **RS** = Right/Steel Disc.

# Non-JAPANESE Built Motorcycles

**BRAKE APPLICATIONS**



← REAR / ARRIÈRE / HINTEN POSTERIOR / POSTERIORE →

## CCM



		DISC PAD CHOICES				BRAKE ROTOR CHOICES			
		NEW SFAC Scooter Carbon Pads	Semi-Sintered V-Pads™	Sintered/HH Pads/ Grooved shoes		Contour Rotor Rear Fitment	NEW Vee-Rotors™ CONTOUR	NEW CX Extreme® ROTOR	
644 DS	04	FA208TT			FA208R ■	MD6276D			
R 30 (Spoke wheel) (604/644)	02-04	FA208TT			FA208R ■	MD6276D			
R 30 (Mag wheel) (604/644)	02-04	FA208TT			FA208R ■	N/A			
R 35/R 35 S	07-09	FA208TT			FA208R ■	TBA			
R 45	07-09	FA208TT			FA208R ■	MD6276D			
FT 650	08	FA208TT			FA208R ■	TBA			
LX 700-4A Quad	08-09	FA344TT			FA344R	TBA			
FT 710 S Flat Tracker	08-09	FA208TT			FA208R ■	MD6276D			

## CECTEK

500 EFI King Cobra	09-10	FA083TT*			FA083R*	N/A*		
500 EFI Gladiator	09-10	FA083TT*			FA083R*	N/A*		
500 EFI QuadriFit	09-10	FA083TT*			FA083R*	N/A*		
500i Estoc	10	FA083TT*			FA083R*	N/A*		

## C F MOTO

CF 125 T-22 Glory	10-11	SFA266	SFAC266		SFA266HH	N/A		
CF 125 T-21A E-Charm	10-12	SFA266	SFAC266		SFA266HH	N/A		
CF 150 - 20 V-Night	12	TBA				N/A		
CF 150 T-6A Glory	10-11	SFA266	SFAC266		SFA266HH	N/A		
CF 150 T-5i E-Charm	10-12	SFA266	SFAC266		SFA266HH	N/A		
CF 150 Leader	10-12	S602						
CF 250 T - 5 Custom	11-12	FA101TT				N/A		
CF 250 T - 6A (Scooter)	12	SFA266	SFAC266		SFA266HH	N/A		
CF 500-3 (Rancher 500 Side x Side)	10-12	FA344TT			FA344R	N/A		
CF 500 (Terracross)	11-12	FA344TT			FA344R	N/A		
CF 500-2 (Terranlander)	13	FA344TT			FA344R	N/A		
CF 625-3 (Z6 Terracross)	11-13	FA344TT			FA344R	N/A		
CF 625 - B/C (X6 Terranlander)	11-13	FA344TT			FA344R	N/A		
650 NK	12-13	TBA				N/A		
650 TR	13							
CF 800-2 (Terranlander)	12-13	FA344TT			FA344R	N/A		
CF 800-3 (Tracker 800)	13	FA344TT			FA344R	N/A		

## C H RACING

WXE 50 Enduro	05	FA115			FA115HH	N/A		
WSM 50 Motard	05	FA115			FA115HH	N/A		
WXE 125 Enduro	05	FA115			FA115HH	N/A		
WSM 125 Motard	05	FA115			FA115HH	N/A		

## CIMATTI

Gingo	-85	N/A						
Gingo	85-	N/A						

## CONTI

RX 356 V3 (12" wheels)	05-06	FA115				N/A		
RX 356 V3 (17" wheels)	05-06	FA115				N/A		

## CPI

Aragon 50	07-09	Y503						
Aragon GP50	07-12	Y503						
Aragon GP Paddock	08-12	Y503						
Aragon Club 50	07-12	Y503						

\*-2 Sets Required. ■ - Also available in MX-S race compound.

**SAFETY WARNING:** DO NOT USE HH PADS ON REAR UNLESS ALSO USED ON FRONT TO AVOID BRAKE IMBALANCE

**R** Suffix = High Durability Sintered Pad. **HH** Suffix = High Performance Sintered Pad. **G** Suffix = Grooved Shoe.  
**D** Suffix = Drilled Disc. **C** Suffix = Contoured Disc. **LS** Suffix = Left/Steel Disc. **RS** = Right/Steel Disc.

# Non-JAPANESE Built Motorcycles



FRONT / AVANT / VORN ← → FRENTE / ANTERIORE



## DISC PAD CHOICES

## BRAKE ROTOR CHOICES

### CPI

		NEW SFAC Scooter Carbon Pads	Semi-Sintered V-Pads™	Sintered/HH Pads/ Grooved shoes	Left/Gauche/Links	Right/Droite/Rechts	Contour Rotor Universal left and right fitment	NEW Vee-Rotors™ CONTOUR	NEW CX Extreme® ROTOR	Oversize 250/280mm Rotor Kit	Relocating Bracket for 250/280mm Rotor	Oversize 320mm Rotor Kit	Relocating Bracket for 320mm Rotor
Aragon S-Line 50	07-12	SFA235	SFAC235			TBA							
Baby J 50	02	SFA083	SFAC083	SFA083HH	MD923D		MD923C	VR923					
Bravo 50	12	SFA086	SFAC086	SFA086HH									
Formula 50 Basic	07-08	SFA235	SFAC235			TBA							
Formula 50 R	07-08	SFA235	SFAC235			TBA							
Freaky 50	07	SFA235	SFAC235			TBA							
GTR 50/125/200	02	SFA194	SFAC194	SFA194HH	N/A								
GTS 50/125/200	02-03	SFA194	SFAC194	SFA194HH	N/A								
GTR 50	03-12	SFA266	SFAC266	SFA266HH	N/A								
50 Hussar	01-02	SFA083	SFAC083	SFA083HH	MD923D		MD923C	VR923					
Hussar 50	03-05	SFA235	SFAC235		MD923D		MD923C	VR923					
50 Mars	01-02	SFA083	SFAC083	SFA083HH	MD923D		MD923C	VR923					
Oliver 50 (All models)	03-12	SFA235	SFAC235		MD923D		MD923C	VR923					
Popcorn 50	02	SFA083	SFAC083	SFA083HH	MD923D		MD923C	VR923					
Popcorn 50	03-06	SFA235	SFAC235		MD923D		MD923C	VR923					
Quad 50/100cc (Crab)	03-04	H338*		H338G*									
Supermoto 50 SMX	03-08	FA115		FA115R	N/A								
Supermoto 50 (Low level exhaust)	06-09	FA115		FA115HH	N/A								
Supercross 50	03-09	FA115		FA115R	N/A								
SM 50	11-12	FA115TT		FA115R	N/A								
SM 50 Black Tiger	08-09	FA115		FA115HH	N/A								
SX 50	06-07	FA194		FA194HH	N/A								
SX 50	11-12	FA115TT		FA115R	N/A								
Vogue 50 EFI	12	TBA					N/A						
XT 50 Quad	06-09	Y503*		Y503G*									
Aragon S-Line 125	07-12	SFA235	SFAC235			TBA							
Aragon GP 125	07-08	SFA235	SFAC235			TBA							
Bravo 125	12	SFA086	SFAC086	SFA086HH			TBA						
125 Prince	01	FA197		FA197HH	N/A								
Oliver 125	06-12	SFA235	SFAC235			N/A							
SM 125	11-12	FA115TT		FA115R	N/A								
SX 125	11-12	FA115TT		FA115R	N/A								
Vogue 125 EFI	12	TBA					N/A						
X-Large 125/150/200	02-03	SFA266*	SFAC266*	SFA266HH*	N/A	N/A							
X-Large 125/300	11-12	SFA197	SFAC197	SFA197HH			N/A						
XR 125 Sprint	12	FA086		FA086HH	N/A								
Sauel 125		FA185TT		FA185R	MD6087D								
X-Large 250	11-12	SFA086	SFAC086	SFA086HH			N/A						
SM 250	11-12	FA115TT					N/A						
SX 250	11-12	FA115TT					N/A						
XR 250	12	FA086		FA086HH	N/A								
XS 250 Quad	06-09	FA377TT*		FA377R*	N/A	N/A							
X-Large 300	11-12	SFA197	SFAC197	SFA197HH			N/A						

### CQR

DN 50		TBA*											
DN 50 E		TBA*											
DN 50/50 E	05	TBA*											
Mini Adventure		TBA*											
DN 100	06	TBA*											
DN 100/100 E	05	TBA*											
DN 150		TBA*											
DN 150 Extreme		TBA*											
DN 150/150 E	05	TBA*											
DN 250/Hammel	06	FA083TT*		FA083R*	N/A	N/A							
DN 250 Dolphin	06	TBA*											
DN 250	05	TBA*											
Utility 250	06	FA083TT*		FA083R*	N/A	N/A							
RX 260	06	FA083TT*		FA083R*	N/A	N/A							

\*-2 Sets Required. ■ - Also available in MX-S race compound.

**SAFETY WARNING:** DO NOT USE HH PADS ON REAR UNLESS ALSO USED ON FRONT TO AVOID BRAKE IMBALANCE

# Non-JAPANESE Built Motorcycles

**BRAKE APPLICATIONS**



← REAR / ARRIÈRE / HINTEN POSTERIOR / POSTERIORE →

## CPI



		DISC PAD CHOICES				BRAKE ROTOR CHOICES			
		NEW SFAC Scooter Carbon Pads	Semi-Sintered V-Pads™	Sintered/HH Pads/ Grooved shoes		Contour Rotor Rear Fitment	NEW Vee-Rotors™ CONTOUR	NEW CX Extreme® ROTOR	
Aragon S-Line 50	07-12	Y503							
Baby J 50	02	Y503							
Bravo 50	12	Y503							
Formula 50 Basic	07-08	Y503							
Formula 50 R	07-08	Y503							
Freaky 50	07	Y503							
GTR 50/125/200	02	SFA260	SFAC260	SFA260HH	N/A				
GTS 50/125/200	02-03	SFA260	SFAC260	SFA260HH	N/A				
GTR 50	03-12	SFA260	SFAC260	SFA260HH	N/A				
50 Hussar	01-02	Y503							
Hussar 50	03-05	Y503							
50 Mars	01-02	Y503							
Oliver 50 (All models)	03-12	Y503							
Popcorn 50	02	Y503							
Popcorn 50	03-06	Y504							
Quad 50/100cc (Crab)	03-04	FA083TT		FA083R	N/A				
Supermoto 50 SMX	03-08	FA115		FA115R	N/A				
Supermoto 50 (Low level exhaust)	06-09	FA115		FA115HH	N/A				
Supercross 50	03-09	FA115		FA115R	N/A				
SM 50	11-12	FA115TT		FA115R	N/A				
SM 50 Black Tiger	08-09	FA115		FA115HH	N/A				
SX 50	06-07	FA115		FA115HH	N/A				
SX 50	11-12	FA115TT		FA115R	N/A				
Vogue 50 EFI	12	TBA			N/A				
XT 50 Quad	06-09	FA165TT		FA165R	N/A				
Aragon S-Line 125	07-12	Y503							
Aragon GP 125	07-08	Y527							
Bravo 125	12	Y503							
125 Prince	01	TBA							
Oliver 125	06-12	Y506							
SM 125	11-12	FA115TT		FA115R	N/A				
SX 125	11-12	FA115TT		FA115R	N/A				
Vogue 125 EFI	12	TBA			N/A				
X-Large 125/150/200	02-03	SFA266	SFAC266	SFA266HH	N/A				
X-Large 125/300	11-12	SFA197	SFAC197	SFA197HH	N/A				
XR 125 Sprint	12	TBA							
Sauel 125		FA131TT		FA131R ■	MD6013D				
X-Large 250	11-12	SFA086	SFAC086	SFA086HH	N/A				
SM 250	11-12	FA350TT				N/A			
SX 250	11-12	FA350TT				N/A			
XR 250	12	FA086		FA086HH	N/A				
XS 250 Quad	06-09	FA431TT		FA431R	N/A				
X-Large 300	11-12	SFA197	SFAC197	SFA197HH	N/A				

## CQR

DN 50		TBA						
DN 50 E		TBA				TBA		
DN 50/50 E	05	FA083TT		FA083R	N/A			
Mini Adventure		N/A				N/A		
DN 100	06	FA083TT		FA083R	TBA			
DN 100/100 E	05	FA083TT		FA083R	N/A			
DN 150		FA083TT		FA083R	N/A			
DN 150 Extreme		FA083TT		FA083R	TBA			
DN 150/150 E	05	FA083TT		FA083R	N/A			
DN 250/Hammel	06	FA083TT		FA083R	N/A			
DN 250 Dolphin	06	FA083TT		FA083R	TBA			
DN 250	05	FA083TT		FA083R	N/A			
Utility 250	06	FA083TT		FA083R	N/A			
RX 260	06	FA083TT		FA083R	N/A			

\*-2 Sets Required. ■ - Also available in MX-S race compound.  
**SAFETY WARNING:** DO NOT USE HH PADS ON REAR UNLESS ALSO USED ON FRONT TO AVOID BRAKE IMBALANCE

**R** Suffix = High Durability Sintered Pad. **HH** Suffix = High Performance Sintered Pad. **G** Suffix = Grooved Shoe.  
**D** Suffix = Drilled Disc. **C** Suffix = Contoured Disc. **LS** Suffix = Left/Steel Disc. **RS** = Right/Steel Disc.

# Non-JAPANESE Built Motorcycles



FRONT / AVANT / VORN ← FRENTE / ANTERIORE →

APPLICATIONS  
BRAKE



Model	Year	DISC PAD CHOICES				BRAKE ROTOR CHOICES						
		NEW SFAC Scooter Carbon Pads	Semi-Sintered V-Pads™	Sintered/HH Pads/ Grooved shoes	Left/Gauche/Links	Right/Droite/Rechts	Contour Rotor Universal left and right fitment	NEW Vee-Rotors™ CONTOUR	NEW CX Extreme® ROTOR	Oversize 250/280mm Rotor Kit	Relocating Bracket for 250/280mm Rotor	Oversize 320mm Rotor Kit
<b>CSR</b>												
Ona 125 (4T)	04-06	SFA235	SFAC235		N/A							
Scoo 125 (4T)	04-06	SFA235	SFAC235		N/A							
<b>C.Z./JAWA</b>												
Moped		804										
50 Minarelli	03-04	FA115		FA115HH		N/A						
50/100 Robby	03-04	FA115		FA115HH	N/A							
Scrambler Cross 125-380 (Single & twin port models)	65-76	950										
125 Sport	03-04	FA115		FA115HH		N/A						
125 Dandy	03-04	FA115		FA115HH		N/A						
125 Travel	03-04	FA115		FA115HH		N/A						
125 Chopper	03-04	FA198				N/A						
125/175/250/350	-74	949										
125/175/250/350	75-	951										
250/380 (Models 513/514) Full width front hub models	77-79	N/A										
Jawa 250/400 Cross	65-76	950										
350		FA198			N/A							
350 Chopper	03-04	FA198				N/A						
350 Tramp	03-04	FA198				N/A						
350 Californian	03-04	FA198				N/A						
350 Californian	09-10	FA142		FA142HH		TBA						
350 Classic	03-04	FA198				N/A						
<b>DAELIM</b>												
A-Four (50cc) (SJ 50 R)	06-09	SFA228	SFAC228	SFA228HH	N/A							
Bonita 50 (SE 50 C)	09-12	SFA257	SFAC257		N/A							
Cordi 50/SE 50 R	05-12	SFA257	SFAC257		N/A							
DX 50 D Camper	03	SFA169	SFAC169	SFA169HH	MD904D		MD904C	VR904				
GZ 50 Message	97-02	SFA257	SFAC257		TBA							
M 50 D/MD Milenium	03	SFA169	SFAC169	SFA169HH	MD904D		MD904C	VR904				
Tapo Message 50	04	SFA054	SFAC054	SFA054HH	N/A							
E-Five (SJ 50 A)	03-06	SFA257	SFAC257		N/A							
S- Four (ES 50)	10-12	SFA197	SFAC197	SFA197HH		N/A						
S- Five (SJ 50)	01-12	SFA257	SFAC257		TBA							
ST 90 Pro Monkey	03	SFA169	SFAC169	SFA169HH	MD904D			VR904				
Delfino 100 (SH100)	01-04	SFA257	SFAC257		TBA							
Citi Ace 110	03-11	SFA086	SFAC086	SFA086HH		N/A						
Allino 125/125 ES	01-04	SFA054	SFAC054	SFA054HH		N/A						
Besbi 125 (SC125)	08-13	SFA233				TBA						
B-Bone 125 (SN125)	09-13	SFA283*	SFAC283*	SFA283HH*	N/A	N/A						
History 125 (SL 125)	01-06	SFA054	SFAC054	SFA054HH		MD814						
History 125 (SL 125) Parking brake	01-06	H303										
Otello 125 (NS 125) DLX	00-02	SFA054	SFAC054	SFA054HH		N/A						
Roadwin (VJ 125)	04-13	FA196		FA196HH	N/A							
Roadwin R 125 Fi (VJF 125)	08-12	FA196		FA196HH	TBA							
SL 125 Otello Fi	07-09	SFA283*	SFAC283*	SFA283HH*	TBA							
SQ 125 S2 Freewing	07-09	SFA283*	SFAC283*	SFA283HH*	TBA							
ST 125	03	FA194		FA194HH	N/A							
SU 125 Delfino	07-11	SFA197	SFAC197	SFA197HH		N/A						
S1 125 (SL 125)	07-13	SFA283*	SFAC283*	SFA283HH*	N/A							
S3 125 (SV 125)	10-13	SFA283*	SFAC283*	SFA283HH*			N/A					
VL 125 Daystar/L	03-13	FA196		FA196HH		N/A						
VS 125 Evolution	01-04	FA196		FA196HH	N/A							
VT 125 Evolution	03	FA196		FA196HH	N/A							
NS 125 DLX/III Trans Eagle	03-07	SFA054	SFAC054	SFA054HH	N/A							
SQ 125 Freewing S2	06	SFA142	SFAC142	SFA142HH								
ET 250 Quad	05-08	FA083TT*		FA083R*	N/A	N/A						
Roadsport 250 (VJF 250)	10-13	FA142*		FA142HH*	N/A	N/A						
Roadwin R 250 Fi (VJF 250)	08-10	FA142*		FA142HH*	N/A	N/A						
SQ 250 Freeway S2	06	SFA142	SFAC142	SFA142HH	N/A							

\*-2 Sets Required. ■ - Also available in MX-S race compound.

**SAFETY WARNING:** DO NOT USE HH PADS ON REAR UNLESS ALSO USED ON FRONT TO AVOID BRAKE IMBALANCE



# Non-JAPANESE Built Motorcycles

**BRAKE APPLICATIONS**



← REAR / ARRIÈRE / HINTEN POSTERIOR / POSTERIORE →

## CSR



### DISC PAD CHOICES



### BRAKE ROTOR CHOICES



		NEW SFAC Scooter Carbon Pads	Semi-Sintered V-Pads™	Sintered/HH Pads/ Grooved shoes	Contour Rotor Rear Fitment	NEW Vee-Rotors™ CONTOUR	NEW CX Extreme® ROTOR
Ona 125 (4T)	04-06	SFA235	SFAC235		N/A		
Soco 125 (4T)	04-06	SFA235	SFAC235		N/A		
<b>C.Z./JAWA</b>							
Moped		TBA					
50 Minarelli	03-04	TBA					
50/100 Robby	03-04	TBA					
Scrambler Cross 125-300 (Single & twin port models)	65-76	950					
125 Sport	03-04	FA115		FA115HH	N/A		
125 Dandy	03-04	FA115		FA115HH	N/A		
125 Travel	03-04	FA115		FA115HH	N/A		
125 Chopper	03-04	949					
125/175/250/350	-74	949					
125/175/250/350	75-	949					
250/380 (Models 513/514) Full width front hub models	77-79	950					
Jawa 250/400 Cross	65-76	950					
350		949					
350 Chopper	03-04	949					
350 Tramp	03-04	949					
350 Californian	03-04	949					
350 Californian	09-10	949					
350 Classic	03-04	949					
<b>DAELIM</b>							
A-Four (50cc) (SJ 50 R)	06-09	H303					
Bonita 50 (SE 50 C)	09-12	TBA					
Cordi 50/SE 50 R	05-12	TBA					
DX 50 D Camper	03	Y503					
GZ 50 Message	97-02	TBA					
M 50 DIMD Millenium	03	Y503					
Tapo Message 50	04	TBA					
E-Five (SJ 50 A)	03-06	H303					
S-Four (ES 50)	10-12	TBA					
S-Five (SJ 50)	01-12	H303					
ST 90 Pro Monkey	03	Y503					
Delfino 100 (SH100)	01-04	H303					
Citi Ace 110	03-11	TBA					
Altino 125/125 ES	01-04	TBA					
Besbi 125 (SC125)	08-13	TBA					
B-Bone 125 (SN125)	09-13	SFA257			N/A		
History 125 (SL 125)	01-06	SFA054	SFAC054	SFA054HH	N/A		
Otello 125 (NS 125) DLX	00-02	H303					
Roadwin (VJ 125)	04-13	FA197		FA197HH	MD814		
Roadwin R 125 Fi (VJF 125)	08-12	FA197		FA197HH	MD814		
SL 125 Otello Fi	07-09	SFA054	SFAC054	SFA054HH	TBA		
SQ 125 S2 Freewing	07-09	SFA054	SFAC054	SFA054HH	TBA		
ST 125	03	FA115		FA115HH	N/A		
SU 125 Delfino	07-11	TBA					
S1 125 (SL 125)	07-13	SFA257	SFAC257		N/A		
S3 125 (SV 125)	10-13	SFA197	SFAC197	SFA197HH		N/A	
VL 125 Daystar/L	03-13	824					
VS 125 Evolution	01-04	H310					
VT 125 Evolution	03	TBA					
NS 125 DLX/III Trans Eagle	03-07	SFA054	SFAC054	SFA054HH	N/A		
SQ 125 Freewing S2	06	SFA197	SFAC197	SFA197HH	N/A		
ET 250 Quad	05-08	FA427T		FA427R	N/A		
Roadsport 250 (VJF 250)	10-13	FA197		FA197HH	N/A		
Roadwin R 250 Fi (VJF 250)	08-10	FA197		FA197HH	N/A		
SQ 250 Freeway S2	06	SFA197	SFAC197	SFA197HH	N/A		

\*-2 Sets Required. ■ - Also available in MX-S race compound.

**SAFETY WARNING:** DO NOT USE HH PADS ON REAR UNLESS ALSO USED ON FRONT TO AVOID BRAKE IMBALANCE

**R** Suffix = High Durability Sintered Pad. **HH** Suffix = High Performance Sintered Pad. **G** Suffix = Grooved Shoe.  
**D** Suffix = Drilled Disc. **C** Suffix = Contoured Disc. **LS** Suffix = Left/Steel Disc. **RS** = Right/Steel Disc.

# Non-JAPANESE Built Motorcycles



← FRONT / AVANT / VORN FRENTE / ANTERIORE →

## DISC PAD CHOICES

## BRAKE ROTOR CHOICES

### DAELIM

		NEW SFAC Scooter Carbon Pads	Semi-Sintered V-Pads™	Sintered/HH Pads/ Grooved shoes	Left/Gauche/Links	Right/Droite/Rechts	Contour Rotor Universal left and right fitment	NEW Vee-Rotors™ CONTOUR	NEW CX Extreme® ROTOR	Oversize 250/280mm Rotor Kit	Relocating Bracket for 250/280mm Rotor	Oversize 320mm Rotor Kit	Relocating Bracket for 320mm Rotor
ST 250 Sector Quad	05-06	FA083TT*		FA083R*	N/A	N/A							
ET 300 Quad	07-09	FA083TT*		FA083R*	TBA	TBA							

### DERBI

Atlantis 50 (AC/2T)	99-01	SFA115	SFAC115	SFA115HH	MD964D								
Atlantis 50 (AC/2T)	02	SFA115	SFAC115	SFA115HH	MD964D								
Atlantis 50 Bullet (AC/2T)	03-05	SFA115	SFAC115	SFA115HH	MD964D								
Atlantis 50 City (AC/2T)	03-06	SFA115	SFAC115	SFA115HH	MD964D								
Atlantis 50 Red Bullet (AC/2T)	03	SFA115	SFAC115	SFA115HH	MD964D								
Atlantis 50 Two Chic (AC/2T)	05	SFA115	SFAC115	SFA115HH	MD964D								
Atlantis 50 (4T) (13/13 spoke wheels)	04-06	SFA115	SFAC115	SFA115HH	MD991D								
Atlantis 50 (2T) Upto ref no. 8G253171 12/15 spoke wheels/ 190mm disc 3 bolt	07	SFA115	SFAC115	SFA115HH	MD964D								
Atlantis 50 (2T/AC) (12/15 spoke wheels/200mm disc From ref no. 8G253172/5 bolt)	07-11	SFA093			MD910D		MD910C	VR910					
Atlantis 50 (4T)	07-09	SFA093			MD910D		MD910C	VR910					
Atlantis 50 LC (4T)	99-01	SFA115	SFAC115	SFA115HH	MD964D								
Boulevard 50 (2T)	09-12	SFA353	SFAC353	SFA353HH	MD910D		MD910C	VR910					
Boulevard 50 (4T)	09	SFA353	SFAC353	SFA353HH	MD910D		MD910C	VR910					
Hunter	96-99	SFA115	SFAC115	SFA115HH	MD964D								
DFW 50 Quad	04-07	H338*		H338G*									
DRD 50 Supermoto/Racer	03-04	FA115TT*		FA115R*	N/A	N/A							
GP1 50cc	01-03												
GP1 50 Open	06-11	SFA194	SFAC194	SFA194HH	MD956D			VR956					
GP1 50 Euro 2 Chain driven/radial caliper/5 bolt fixing front disc	05	SFA266	SFAC266	SFA266HH	MD9113D								
GP1 50 Race Chain driven/radial caliper/5 bolt fixing front disc	05-07	SFA266	SFAC266	SFA266HH	MD9113D								
GP1 50cc	01-03	SFA115	SFAC115	SFA115HH	MD991D								
GPR 50 R (218mm Rear Disc)	97-01	FA167		FA167HH	MD806LS								
GPR 50 Replica Racing (218mm Rear Disc)	99-03	FA167		FA167HH	MD806LS								
GPR 50 (40mm Forks/180mm Rear Disc/Radial Caliper)	04-07	FA266		FA266HH	MD685LS								
GPR 50 Racing (40mm Forks/180mm Rear Disc/Radial Caliper)	08-10	FA266		FA266HH	MD685LS								
GPR 50 2T (41mm Forks/218mm Rear Disc/Radial Caliper)	09-11	FA399			MD685LS								
GPR 50 Nude (Radial caliper/180mm Rear Disc)	04-09	FA266		FA266HH	MD685LS								
Paddock 50 (AC/2T)	98-99	SFA115	SFAC115	SFA115HH	MD964D								
Predator 50 (AC/2T)	98-01	SFA115	SFAC115	SFA115HH	MD964D								
Predator 50 (LC/2T) 3 bolt front disc/USD Showa forks	98-03	SFA115	SFAC115	SFA115HH	MD964D								
Predator 50 (LC/2T) 5 bolt front disc/STD Paoili forks	98-03	SFA115	SFAC115	SFA115HH	MD991D								
Red Bullet 50	04-05	SFA115	SFAC115	SFA115HH	MD964D								
Sendia-R	96-99	FA115TT		FA115R	MD6175D								
Sendia-R	00-02	FA115TT		FA115R	MD6250D								
Sendia SM DRD 50 (Double disc model/SDR1DB)	02-03	FA167*		FA167HH*	MD6361D	MD6361D							
Sendia SM DRD 50 (Double disc model/SR3A1A)	05	FA115*		FA115HH*	MD6361D	MD6361D							
Sendia SM DRD 50 Black Edition	03	FA167		FA167HH	TBA								
Sendia SM DRD 50 Black Edition	05	FA115TT*		FA115R*	MD6361D	MD6361D							
Sendia SM DRD Racing LTD (SR2A2B Model / Cast Wheels)	05-07	FA115*		FA115HH*			MD836C*						
Sendia R DR	02	FA194		FA194HH	TBA								
Sendia DRD X Treme 50 R (21" Spoke Front Wheel/260mm disc)	11-12	FA083TT		FA083R	TBA								
Sendia DRD X Treme 50 SM (17" Cast Front Wheel/260mm disc)	11-12	FA266		FA266HH	TBA								
Sendia DRD Racing 50 SM (300mm disc /Std mounted caliper)	04-10	FA194		FA194HH	MD811								
Sendia DRD Racing 50 R (300mm disc/Std mounted caliper)	04-10	FA194		FA194HH	MD811								
Sendia DRD Racing 50 SM (260mm disc /Std mounted caliper)	11-12	FA194		FA194HH	MD811								
Sendia DRD Racing 50 R (260mm disc/Std mounted caliper)	11-12	FA194		FA194HH	MD811								
Sendia DRD Pro 50 R Radial Caliper/260mm disc	05-13	FA266		FA266HH	TBA								
Sendia DRD Pro 50 SM Radial Caliper/300mm disc	05-13	FA266		FA266HH	MD811								
Sendia DRD 50 Evo SM (Cast wheels)	08-11	FA266		FA266HH	N/A								
Sendia X-treme 50 R (240mm disc)	03-11	FA115		FA115HH	MD6250D								
Sendia X-treme 50 SM (260mm disc)	03-11	FA115		FA115HH	TBA								
Sendia X-Race 50 R (240mm disc)	05-11	FA115		FA115HH	MD6250D								
Sendia X-Race 50 SM (260mm disc)	06-11	FA115		FA115HH	TBA								
Sonar 50 (2T)	10-11	SFA260	SFAC260	SFA260HH	TBA								

\*-2 Sets Required. ■ - Also available in MX-S race compound.

**SAFETY WARNING:- DO NOT USE HH PADS ON REAR UNLESS ALSO USED ON FRONT TO AVOID BRAKE IMBALANCE**

APPLICATIONS  
BRAKE

R Suffix = High Durability Sintered Pad. HH Suffix = High Performance Sintered Pad. G Suffix = Grooved Shoe.  
D Suffix = Drilled Disc. C Suffix = Contoured Disc. LS Suffix = Left/Steel Disc. RS = Right/Steel Disc.

# Non-JAPANESE Built Motorcycles

**BRAKE APPLICATIONS**



**DAELIM**



← REAR / ARRIÈRE / HINTEN POSTERIOR / POSTERIORE →

		DISC PAD CHOICES				BRAKE ROTOR CHOICES			
		NEW SFAC Scooter Carbon Pads	Semi-Sintered V-Pads™	Sintered/HH Pads/ Grooved shoes	Contour Rotor Rear Fitment	NEW Vee-Rotors™ CONTOUR	NEW CX Extreme® ROTOR		
ST 250 Sector Quad	05-06	FA427TT			FA427R	N/A			
ET 300 Quad	07-09	FA427TT			FA427R	TBA			
<b>DERBI</b>									
Atlantis 50 (AC/2T)	99-01	S624							
Atlantis 50 (AC/2T)	02	899							
Atlantis 50 Bullet (AC/2T)	03-05	899							
Atlantis 50 City (AC/2T)	03-06	899							
Atlantis 50 Red Bullet (AC/2T)	03	899							
Atlantis 50 Two Chic (AC/2T)	05	899							
Atlantis 50 (4T) (13"/3 spoke wheels)	04-06	816							
Atlantis 50 (2T) Upto ref no. 8G253171 12"/5 spoke wheels/ 190mm disc 3 bolt	07	899							
Atlantis 50 (2T/AC) (12"/5 spoke wheels/200mm disc From ref no. 8G253172/5 bolt)	07-11	899							
Atlantis 50 (4T)	07-09	816							
Atlantis 50 LC (4T)	99-01	S624							
Boulevard 50 (2T)	09-12	816							
Boulevard 50 (4T)	09	816							
Hunter	96-99	S624							
DFW 50 Quad	04-07	H330			H330G				
DRD 50 Supermoto/Racer	03-04	FA115TT			FA115R	N/A			
GPI 50cc	01-03								
GPI 50 Open	06-11	SFA115	SFAC115		SFA115HH	MD932D		VR932	
GPI 50 Euro 2 Chain driven/radial caliper/5 bolt fixing front disc	05	SFA115	SFAC115		SFA115HH	MD9123D			
GPI 50 Race Chain driven/radial caliper/5 bolt fixing front disc	05-07	SFA115	SFAC115		SFA115HH	MD9123D			
GPI 50cc	01-03	SFA115	SFAC115		SFA115HH	MD932D			
GPR 50 R (218mm Rear Disc)	97-01	FA115			FA115HH	MD805			
GPR 50 Replica Racing (218mm Rear Disc)	99-03	FA115			FA115HH	MD805			
GPR 50 (40mm Forks/180mm Rear Disc/Radial Caliper)	04-07	FA115			FA115HH	MD686			
GPR 50 Racing (40mm Forks/180mm Rear Disc/Radial Caliper)	08-10	FA115			FA115HH	MD686			
GPR 50 2T (41mm Forks/218mm Rear Disc/Radial Caliper)	09-11	FA115			FA115HH	MD833			
GPR 50 Nude (Radial caliper/180mm Rear Disc)	04-09	FA115			FA115HH	MD686			
Paddock 50 (AC/2T)	98-99	S624							
Predator 50 (AC/2T)	98-01	S624							
Predator 50 (LC/2T) 3 bolt front disc/USD Showa forks	98-03	SFA115	SFAC115		SFA115HH	MD964D			
Predator 50 (LC/2T) 5 bolt front disc/STD Paioli forks	98-03	SFA115	SFAC115		SFA115HH	MD964D			
Red Bullet 50	04-05	S624							
Senda-R	96-99	FA115TT			FA115R	N/A			
Senda-R	00-02	FA115TT			FA115R	MD6248D			
Senda SM DRD 50 (Double disc model/SDR1DB)	02-03	FA115			FA115HH	MD6248D			
Senda SM DRD 50 (Double disc model/SR3A1A)	05	FA115			FA115HH	MD6248D			
Senda SM DRD 50 Black Edition	03	FA115			FA115HH	N/A			
Senda SM DRD 50 Black Edition	05	FA115TT			FA115R	TBA			
Senda SM DRD Racing LTD (SR2A2B Model / Cast Wheels)	05-07	FA115			FA115HH		MD805C		
Senda R DR	02	FA115			FA115HH	TBA			
Senda DRD X Treme 50 R (21" Spoke Front Wheel/260mm disc)	11-12	FA083TT			FA083R	TBA			
Senda DRD X Treme 50 SM (17" Cast Front Wheel/260mm disc)	11-12	FA083TT			FA083R	TBA			
Senda DRD Racing 50 SM (300mm disc /Std mounted caliper)	04-10	FA115			FA115HH	MD808			
Senda DRD Racing 50 R (300mm disc/Std mounted caliper)	04-10	FA115			FA115HH	MD808			
Senda DRD Racing 50 SM (260mm disc /Std mounted caliper)	11-12	FA083TT			FA083R	MD805			
Senda DRD Racing 50 R (260mm disc/Std mounted caliper)	11-12	FA083TT			FA083R	MD805			
Senda DRD Pro 50 R Radial Caliper/260mm disc	05-13	FA350			FA350HH	TBA			
Senda DRD Pro 50 SM Radial Caliper/300mm disc	05-13	FA350			FA350HH	MD808			
Senda DRD 50 Evo SM (Cast wheels)	08-11	FA350			FA350HH	N/A			
Senda X-treme 50 R (240mm disc)	03-11	FA115			FA115HH	MD6248D			
Senda X-treme 50 SM (260mm disc)	03-11	FA115			FA115HH	MD6248D			
Senda X Race 50 R (240mm disc)	05-11	FA115			FA115HH	MD6248D			
Senda X-Race 50 SM (260mm disc)	06-11	FA115			FA115HH	MD6248D			
Sonar 50 (2T)	10-11	816							

\*-2 Sets Required. ■ - Also available in MX-S race compound.

**SAFETY WARNING:- DO NOT USE HH PADS ON REAR UNLESS ALSO USED ON FRONT TO AVOID BRAKE IMBALANCE**

**R** Suffix = High Durability Sintered Pad. **HH** Suffix = High Performance Sintered Pad. **G** Suffix = Grooved Shoe.  
**D** Suffix = Drilled Disc. **C** Suffix = Contoured Disc. **LS** Suffix = Left/Steel Disc. **RS** = Right/Steel Disc.

# Non-JAPANESE Built Motorcycles



FRONT / AVANT / VORN FRENTE / ANTERIORE

## DISC PAD CHOICES

## BRAKE ROTOR CHOICES

### DERBI

		NEW SFAC Scooter Carbon Pads	Semi-Sintered V-Pads™	Sintered/HH Pads/ Grooved shoes	Left/Gauche/Links	Right/Droite/Rechts	Contour Rotor Universal left and right fitment	NEW Vee-Rotors™ CONTOUR	NEW CX Extreme® ROTOR	Oversize 250/280mm Rotor Kit	Relocating Bracket for 250/280mm Rotor	Oversize 320mm Rotor Kit	Relocating Bracket for 320mm Rotor
Vamos 50	93-95	S624											
Vamos/Vamos FL	96-99	SFA115	SFAC115	SFA115HH	N/A								
Variant Sport 50 (2T)	12	SFA353	SFAC353	SFA353HH	MD924D		MD924C	VR924					
X Race 50	06	FA115		FA115HH	TBA								
GPR 80 Cup Radial Caliper	04-05	FA266		FA266HH	N/A								
Atlantis 100 (AC2T)	00-01	SFA115	SFAC115	SFA115HH	MD964D								
Atlantis 100 (4T) (13/13 spoke wheels)	04-06	SFA115	SFAC115	SFA115HH	MD991D								
Boulevard 125	03-07	SFA350	SFAC350	SFA350HH	MD924D		MD924C	VR924					
Boulevard S 125	07	SFA256	SFAC256	SFA256HH	MD952D			VR952					
Boulevard 125 (4T)	08-12	SFA353	SFAC353	SFA353HH	MD910D		MD910C	VR910					
Cross City 125	07-08	FA194		FA194HH	MD807LS								
Cross City 125	09-13	FA465TT		FA465R	MD807LS								
GP1 125cc Scooter Full height seat/5 bolt fixing front disc	06	SFA266	SFAC266	SFA266HH	MD9113D								
GP1 125cc RACING Low Seat/Radial Caliper/6 bolt disc fixing	07-09	FA399			MD9122D								
GPR 125 RACING (Radial caliper) (2T)	04-07	FA399			MD685LS								
GPR 125 Nude (Radial caliper) (2T)	04-08	FA399			MD685LS								
GPR 125 (4T) 4V	09-12	FA399			MD685LS								
Mulhacen 125 (4T) Up to ref no.: 7N001790 Spoke wheel/2 pin pad fixing	07	FA194		FA194HH	MD807LS								
Mulhacen 125 (4T) From ref no.: 7N001791 Spoke wheel/Single pin fixing	07-10	FA465TT		FA465R	MD807LS								
Mulhacen 125 Cafe Cast wheel/radial caliper	08-11	FA266		FA266HH	MD685LS								
Rambla 125	08-12	SFA256	SFAC256	SFA256HH	MD952D			VR952					
Senda 125 R Vin # SCB1A	04	FA167		FA167HH	MD698LS								
Senda 125 R Vin # SCA1A	04	FA194		FA194HH	MD698LS								
Senda 125 SM (Twin headlight)	04-07	FA194		FA194HH	MD698LS								
Senda 125 Baja R (4T) (260mm disc)	06-12	FA194		FA194HH	TBA								
Senda 125 Baja SM (4T) (300mm disc)	06-12	FA194		FA194HH	MD698LS								
Senda DRD 125 R	10-12	FA266		FA266HH			TBA						
Senda DRD 125 SM	10-13	FA266		FA266HH	TBA								
Sonar 125 (4T)	10-11	SFA260	SFAC260	SFA260HH	TBA								
Terra 125 Adventure	07-13	FA465TT		FA465R	MD807LS								
Terra 125 Euro (Single pin pad fixing)	07-11	FA465TT		FA465R	MD807LS								
Variant Sport 125 (4T)	12	SFA353	SFAC353	SFA353HH	MD924D		MD924C	VR924					
Boulevard 150	03-07	SFA350	SFAC350	SFA350HH	MD924D		MD924C	VR924					
Sonar 150(4T)	09-10	SFA260	SFAC260	SFA260HH	TBA								
Boulevard 200	05	SFA350	SFAC350	SFA350HH	MD924D		MD924C	VR924					
DXR 200 Quad (Front drum model)	04	Y503*		Y503G*									
DXR 200 Quad (Front drum model)	04-05	Y503*		Y503G*									
DXR 200 Quad (Front disc model)	04-07	FA083TT*		FA083R*	MD6054D	MD6054D							
DXR 250 Quad (Front drum model)	04-05	Y503*		Y503G*									
DXR 250 Quad (Front disc model)	04-07	FA083TT*		FA083R*	MD6054D	MD6054D							
GP1 250cc Scooter	06-07	SFA266*	SFAC266*	SFA266HH*	MD9113D	MD9113D							
GP1 250cc RACING Low Seat/Radial Caliper/6 bolt disc fixing	07-09	FA399			MD9122D								
Rambla 250 i	08-09	SFA256*	SFAC256*	SFA256HH*	MD952D	MD952D		VR952*					
Rambla 300 i	10-12	SFA256*	SFAC256*	SFA256HH*	MD952D	MD952D		VR952*					
Mulhacen 659	06-08			FA322/4HH	TBA								

### DINLI

QZ 150 CUV (Front drum model)		Y503*		Y503G*									
QZ 150 CUV (Front disc model)		TBA*			N/A	N/A							
DL 450 RS (DL901)	06-09	FA067TT*		FA067R*	N/A	N/A							

### DUCATI

250/350/450 Desmo/Single	-76	928											
250/350/450 Desmo/Single (4 bolt disc fixing)	74-77	FA018		FA018HH	MD634LS								
Supersport 400 (Single disc)	93-97	FA095		FA095HH	MD2003X		MD2003XC	VR2003BLK					
Supersport 400 (Twin disc)	93-97	FA095*		FA095HH*	MD2003X	MD2003X	MD2003XC*	VR2003BLK*					
400 Monster	95-97	FA095		FA095HH	MD633X		MD633XC						
Monster 400 (Single disc)	00-02	FA244		FA244HH	MD614X		MD614XC	VR614BLK					
Monster 400 (Twin disc)	03-04	FA244*		FA244HH*	MD614X	MD614X	MD614XC*	VR614BLK*					
400 Monster (Japan)	00-04	FA244		FA244HH	MD614X		MD614XC	VR614BLK					

\*-2 Sets Required. ■ - Also available in MX-S race compound.

**SAFETY WARNING:** DO NOT USE HH PADS ON REAR UNLESS ALSO USED ON FRONT TO AVOID BRAKE IMBALANCE

APPLICATIONS  
BRAKE

R Suffix = High Durability Sintered Pad. HH Suffix = High Performance Sintered Pad. G Suffix = Grooved Shoe.

D Suffix = Drilled Disc. C Suffix = Contoured Disc. LS Suffix = Left/Steel Disc. RS = Right/Steel Disc.

# Non-JAPANESE Built Motorcycles



**DERBI**



← REAR / ARRIÈRE / HINTEN POSTERIOR / POSTERIORE →

		DISC PAD CHOICES				BRAKE ROTOR CHOICES			
		NEW SFAC Scooter Carbon Pads	Semi-Sintered V-Pads™	Sintered/HH Pads/ Grooved shoes	Contour Rotor Rear Fitment	NEW Vee-Rotors™ CONTOUR	NEW CX Extreme® ROTOR		
Vamos 50	93-95	S624							
Vamos/Vamos FL	96-99	S624							
Variant Sport 50 (2T)	12	816							
X Race 50	06	FA115		FA115HH	TBA				
GPR 80 Cup Radial Caliper	04-05	FA115		FA115HH	N/A				
Atlantis 100 (AC/2T)	00-01	S624							
Atlantis 100 (4T) (13/3 spoke wheels)	04-06	816							
Boulevard 125	03-07	816							
Boulevard S 125	07	SFA298	SFAC298	SFA298HH	MD942D		VR942		
Boulevard 125 (4T)	08-12	816							
Cross City 125	07-08	FA350		FA350HH	MD808				
Cross City 125	09-13	FA350TT			MD808				
GPI 125cc Scooter Full height seal/5 bolt fixing front disc	06	SFA266	SFAC266	SFA266HH	MD944D				
GPI 125cc Racing Low Seat/Radial Caliper/6 bolt disc fixing	07-09	SFA350			MD956D				
GPR 125 Racing (Radial caliper) (2T)	04-07	FA115			MD686				
GPR 125 Nude (Radial caliper) (2T)	04-08	FA115			MD686				
GPR 125 (4T) 4V	09-12	FA093			MD833				
Mulhacen 125 (4T) Up to ref no.: 7N001790 Spoke wheel/2 pin pad fixing	07	FA093			MD808				
Mulhacen 125 (4T) From ref no.: 7N001791 Spoke wheel/Single pin fixing	07-10	FA093			MD808				
Mulhacen 125 Cafe Cast wheel/radial caliper	08-11	FA093			MD833				
Rambla 125	08-12	SFA298	SFAC298	SFA298HH	MD942D		VR942		
Senda 125 R Vin # SCB1A	04	FA350		FA350HH	MD808				
Senda 125 R Vin # SCA1A	04	FA350		FA350HH	MD808				
Senda 125 SM (Twin headlight)	04-07	FA350		FA350HH	MD808				
Senda 125 Baja R (4T) (260mm disc)	06-12	FA350		FA350HH	MD808				
Senda 125 Baja SM (4T) (300mm disc)	06-12	FA350		FA350HH	MD808				
Senda DRD 125 R	10-12	FA093				TBA			
Senda DRD 125 SM	10-13	FA093				TBA			
Sonar 125 (4T)	10-11	816							
Terra 125 Adventure	07-13	FA093			MD808				
Terra 125 Euro (Single pin pad fixing)	07-11	FA093			MD808				
Variant Sport 125 (4T)	12	816							
Boulevard 150	03-07	816							
Sonar 150(4T)	09-10	816							
Boulevard 200	05	816							
DXR 200 Quad (Front drum model)	04	FA135TT		FA135R	N/A				
DXR 200 Quad (Front drum model)	04-05	FA067TT		FA067R	MD6053D				
DXR 200 Quad (Front disc model)	04-07	FA067TT		FA067R	MD6053D				
DXR 250 Quad (Front drum model)	04-05	FA135TT		FA135R	MD6053D				
DXR 250 Quad (Front disc model)	04-07	FA067TT		FA067R	MD6053D				
GPI 250cc Scooter	06-07	SFA266	SFAC266	SFA266HH	MD944D				
GPI 250cc Racing Low Seat/Radial Caliper/6 bolt disc fixing	07-09	SFA350	SFAC350		MD956D				
Rambla 250 i	08-09	SFA298	SFAC298	SFA298HH	MD942D		VR942		
Rambla 300 i	10-12	SFA298	SFAC298	SFA298HH	MD942D		VR942		
Mulhacen 659	06-08	FA266		FA266V FA266HH	TBA				
<b>DINLI</b>									
QZ 150 CUV (Front drum model)		TBA							
QZ 150 CUV (Front disc model)		TBA							
DL 450 RS (DL901)	06-09	FA067TT		FA067R	MD6348D				
<b>DUCATI</b>									
250/350/450 Desmo/Single	-76	929							
250/350/450 Desmo/Single (4 bolt disc fixing)	74-77	921							
Supersport 400 (Single disc)	93-97	FA047		FA047HH	MD2002	MD2002C	VR2002		
Supersport 400 (Twin disc)	93-97	FA047		FA047HH	MD2002	MD2002C	VR2002		
400 Monster	95-97	FA047		FA047HH	MD2002	MD2002C			
Monster 400 (Single disc)	00-02	FA047		FA047HH	MD2002	MD2002C	VR2002		
Monster 400 (Twin disc)	03-04	FA047		FA047HH	MD2002	MD2002C	VR2002		
400 Monster (Japan)	00-04	FA047		FA047HH	MD2002	MD2002C	VR2002		

\*-2 Sets Required. ■ - Also available in MX-S race compound.

**SAFETY WARNING:- DO NOT USE HH PADS ON REAR UNLESS ALSO USED ON FRONT TO AVOID BRAKE IMBALANCE**

**R** Suffix = High Durability Sintered Pad. **HH** Suffix = High Performance Sintered Pad. **G** Suffix = Grooved Shoe.  
**D** Suffix = Drilled Disc. **C** Suffix = Contoured Disc. **LS** Suffix = Left/Steel Disc. **RS** = Right/Steel Disc.

**BRAKE APPLICATIONS**



# Non-JAPANESE Built Motorcycles



← FRONT / AVANT / VORN FRENTE / ANTERIORE →

DUCATI	Year	DISC PAD CHOICES					BRAKE ROTOR CHOICES					
		NEW SFAC Scooter Carbon Pads	Semi-Sintered V-Pads™	Sintered/HH Pads/ Grooved shoes	Left/Gauche/Links	Right/Droite/Rechts	Contour Rotor Universal left and right fitment	NEW Vee-Rotors™ CONTOUR	NEW CX Extreme® ROTOR	Oversize 250/280mm Rotor Kit	Relocating Bracket for 250/280mm Rotor	Oversize 320mm Rotor Kit
Monster Dark ie 400 (Japan)	05-06	FA244*		FA244HH*	MD614X	MD614X	MD614XC*	VR614BLK*				
Monster Dark ie 400 (Single disc)	05	FA244		FA244HH	MD614X	MD614X	MD614XC*	VR614BLK*				
Monster 400 ie (Japan)	07-08	FA181TT*		FA181HH*	MD626X	MD626X	MD626XC*	VR626BLK*				
500 GTL	75	FA047*		FA047HH*	N/A	N/A						
500 GTV Pantah	77	FA047*		FA047HH*	N/A	N/A						
500 Sport Desmo	77	FA047*		FA047HH*	N/A	N/A						
500 Pantah	79	FA047*		FA047HH*	MD657LS	MD657RS						
(549cc) Supermono	93-95	FA095*		FA095HH*	N/A	N/A						
600 Pantah	81	FA018*		FA018HH*	MD657LS	MD657RS						
Monster 600 (Twin disc)	93-97	FA095*		FA095HH*	MD633X	MD633X	MD633XC*					
600 Monster (Single disc)	93-99	FA095		FA095HH	MD633X	MD633X	MD633XC					
600 Monster Dark	98-99	FA095		FA095HH	MD633X	MD633X	MD633XC					
600 Monster City/City Dark	99	FA095		FA095HH	MD614X	MD614X	MD614XC*	VR614BLK*				
600 Monster	00-01	FA244		FA244HH	MD614X	MD614X	MD614XC*	VR614BLK*				
600 Supersport (Single disc)	91-97	FA095		FA095HH	MD2003X	MD2003X	MD2003XC*	VR2003BLK*				
Monster 620 ie (Single disc)	03-04	FA244		FA244HH	MD614X	MD614X	MD614XC*	VR614BLK*				
620 IE Monster (First series)	02-05	FA244*		FA244HH*	MD614X	MD614X	MD614XC*	VR614BLK*				
620 IE Monster (Second series)	03-05	FA181TT*		FA181HH*	MD626X	MD626X	MD626XC*	VR626BLK*				
620 Sport	03	FA244*		FA244HH*	MD614X	MD614X	MD614XC*	VR614BLK*				
Monster 620	05-06	FA181TT*		FA181HH*	MD626X	MD626X	MD626XC*	VR626BLK*				
620 Multistrada (Twin Disc/Single Pin Pad Fixing)	06	FA181TT*		FA181HH*	MD626X	MD626X	MD626XC*	VR626BLK*				
620 Multistrada Dark (Single Disc/ Twin Pin Pad Fixing)	06	FA244	FA244V	FA244HH	MD2003X	MD2003X	MD2003XC*	VR2003BLK*				
650 Pantah	-84	FA018*		FA018HH*	N/A	N/A						
695 Monster	07-08	FA181TT*		FA181HH*	MD626X	MD626X	MD626XC*	VR626BLK*				
696 Monster	08-13	FA244*	FA244V*	FA244HH*	MD614X	MD614X	MD614XC*	VR614BLK*				
696+ Monster (Inc ABS Models)	09-12	FA244*	FA244V*	FA244HH*	MD614X	MD614X	MD614XC*	VR614BLK*				
748 R (2 pad caliper)	00	FA244*		FA244HH*	MD636X	MD636X	MD636XC*					
748 R (4 pad caliper)	01			FA322/4HH*	MD636X	MD636X	MD636XC*					
748 R (4 pad caliper)	02			FA322/4HH*	MD636X	MD636X	MD636XC*					
748 Biposto	95-98	FA095		FA095HH	MD2003X	MD2003X	MD2003XC*	VR2003BLK*				
748 Biposto	99-02	FA244*		FA244HH*	MD614X	MD614X	MD614XC*	VR614BLK*				
748 SP	95-97	FA095*		FA095HH*	TBA	TBA						
748 SP	98	FA095*		FA095HH*	MD633X	MD633X	MD633XC*					
748 SP/Monoposto	99-02	FA244*		FA244HH*	MD614X	MD614X	MD614XC*	VR614BLK*				
748 S (Biposto)	00-02	FA244*		FA244HH*	TBA	TBA						
748 S (Monoposto)	00-02	FA244*		FA244HH*	TBA	TBA						
748 SPS	98-99	FA244		FA244HH	MD633X	MD633X	MD633XC*					
748 Testa Bassa (Mono/Biposto)	01	FA244*		FA244HH*	MD614X	MD614X	MD614XC*	VR614BLK*				
749 Dark (Monoposto/Biposto)	04-06			FA322/4HH*	MD622X	MD622X	MD622XC*	VR622BLK*				
749 R (Radial caliper)	04-06			FA322/4HH*	MD622X	MD622X	MD622XC*	VR622BLK*				
749 S (Monoposto/Biposto)	03-06			FA322/4HH*	MD622X	MD622X	MD622XC*	VR622BLK*				
749 (Monoposto/Biposto)	03-06			FA322/4HH*	MD622X	MD622X	MD622XC*	VR622BLK*				
750 Sport (4 bolt disc fixing)	74	FA016		FA016HH	MD634LS	MD634RS						
750 SS (4 bolt disc fixing) (Note thinner pad version for shaved down caliper)	75-76	FA019*		FA019HH*	MD634LS	MD634RS						
751 F1	98	FA018*		FA018HH*	N/A	N/A						
750 Paso	87-90	FA018*		FA018HH*	MD630LS	MD630RS						
750 Sport	88-90	FA018*		FA018HH*	MD630LS	MD630RS						
750 Supersport (Single disc)	91-98	FA095		FA095HH	MD633X	MD633X	MD633XC*					
Supersport 750 (Twin disc)	91-98	FA095*		FA095HH*	MD633X	MD633X	MD633XC*					
750 Supersport	99	FA244*		FA244HH*	MD2003X	MD2003X	MD2003XC*	VR2003BLK*				
750 Supersport IE	00-02	FA244*		FA244HH*	MD614X	MD614X	MD614XC*	VR614BLK*				
750 Sport	01-02	FA244*		FA244HH*	MD614X	MD614X	MD614XC*	VR614BLK*				
750 Monster (Single disc)	96-97	FA095		FA095HH	MD2003X	MD2003X	MD2003XC*	VR2003BLK*				
750 Monster (Twin disc)	96-98	FA095*		FA095HH*	MD2003X	MD2003X	MD2003XC*	VR2003BLK*				
750 Monster City/City Dark	99	FA095*		FA095HH*	MD2003X	MD2003X	MD2003XC*	VR2003BLK*				
750 Monster/Monster Dark	99	FA095*		FA095HH*	MD2003X	MD2003X	MD2003XC*	VR2003BLK*				
750 Monster	00-01	FA244*		FA244HH*	MD614X	MD614X	MD614XC*	VR614BLK*				
750 ie Monster	02	FA244*		FA244HH*	MD614X	MD614X	MD614XC*	VR614BLK*				
796 Hypermotard	10-12	FA244*		FA244HH*	TBA	TBA						
796 Monster Inc ABS Models)	10-13	FA244*		FA244HH*	MD841X	MD841X	MD841XC*	VR841BLK*				

\*-2 Sets Required. ■ - Also available in MX-S race compound.

**SAFETY WARNING:** DO NOT USE HH PADS ON REAR UNLESS ALSO USED ON FRONT TO AVOID BRAKE IMBALANCE

APPLICATIONS  
BRAKE

R Suffix = High Durability Sintered Pad. HH Suffix = High Performance Sintered Pad. G Suffix = Grooved Shoe.  
D Suffix = Drilled Disc. C Suffix = Contoured Disc. LS Suffix = Left/Steel Disc. RS = Right/Steel Disc.

# Non-JAPANESE Built Motorcycles



**DUCATI**



← REAR / ARRIÈRE / HINTEN POSTERIOR / POSTERIORE →

		DISC PAD CHOICES				BRAKE ROTOR CHOICES			
		NEW SFAC Scooter Carbon Pads	Semi-Sintered V-Pads™	Sintered/HH Pads/ Grooved shoes		Contour Rotor Rear Fitment	NEW Vee-Rotors™ CONTOUR	NEW CX Extreme® ROTOR	
Monster Dark ie 400 (Japan)	05-06	FA047			FA047HH	MD2002	MD2002C	VR2002	
Monster Dark ie 400 (Single disc)	05	FA047			FA047HH	MD2002	MD2002C	VR2002	
Monster 400 ie (Japan)	07-08	FA047			FA047HH	MD2002	MD2002C	VR2002	
500 GTL	75	N/A							
500 GTV Pantah	77	FA047			FA047HH	N/A			
500 Sport Desmo	77	FA047			FA047HH				
500 Pantah	79	FA047			FA047HH	MD657RS			
(549cc) Supermono	93-95	FA115			FA115HH	N/A			
600 Pantah	81	FA047			FA047HH	N/A			
Monster 600 (Twin disc)	93-97	FA047			FA047HH	MD2002	MD2002C		
600 Monster (Single disc)	93-99	FA047			FA047HH	MD2002	MD2002C		
600 Monster Dark	98-99	FA047			FA047HH	MD2002	MD2002C		
600 Monster City/City Dark	99	FA047			FA047HH	MD2002	MD2002C	VR2002	
600 Monster	00-01	FA047			FA047HH	MD2002	MD2002C	VR2002	
600 Supersport (Single disc)	91-97	FA047			FA047HH	MD2002	MD2002C	VR2002	
Monster 620 ie (Single disc)	03-04	FA047			FA047HH	MD2002	MD2002C	VR2002	
620 IE Monster (First series)	02-05	FA047			FA047HH	MD2002	MD2002C	VR2002	
620 IE Monster (Second series)	03-05	FA047			FA047HH	MD2002	MD2002C	VR2002	
620 Sport	03	FA047			FA047HH	MD2002	MD2002C	VR2002	
Monster 620	05-06	FA047			FA047HH	MD2002	MD2002C	VR2002	
620 Multistrada (Twin Disc/Single Pin Pad Fixing)	06	FA266		FA266V	FA266HH	MD2002	MD2002C	VR2002	
620 Multistrada Dark (Single Disc/Twin Pin Pad Fixing)	06	FA266		FA266V	FA266HH	MD2002	MD2002C	VR2002	
650 Pantah	-84	FA018			FA018HH	N/A			
695 Monster	07-08	FA047			FA047HH	MD2002	MD2002C	VR2002	
696 Monster	08-13	FA266		FA266V	FA266HH	MD2002	MD2002C	VR2002	
696+ Monster (Inc ABS Models)	09-12	FA266		FA266V	FA266HH	MD2002	MD2002C	VR2002	
748 R (2 pad caliper)	00	FA047			FA047HH	MD632	MD632C		
748 R (4 pad caliper)	01	FA047			FA047HH	MD632	MD632C		
748 R (4 pad caliper)	02	FA047			FA047HH	MD632	MD632C		
748 Biposto	95-98	FA047			FA047HH	MD632	MD632C	VR632	
748 Biposto	99-02	FA047			FA047HH	MD2002	MD2002C	VR2002	
748 SP	95-97	FA047			FA047HH	MD632	MD632C		
748 SP	98	FA047			FA047HH	MD632	MD632C		
748 SP/Monoposto	99-02	FA047			FA047HH	MD2002	MD2002C	VR2002	
748 S (Biposto)	00-02	FA047			FA047HH	MD632			
748 S (Monoposto)	00-02	FA047			FA047HH	MD632			
748 SPS	98-99	FA047			FA047HH	MD632	MD632C		
748 Testa Bassa (Mono/Biposto)	01	FA047			FA047HH	MD632	MD632C	VR632	
749 Dark (Monoposto/Biposto)	04-06	FA266		FA266V	FA266HH	MD618		VR618	
749 R (Radial caliper)	04-06	FA266		FA266V	FA266HH	MD618		VR618	
749 S (Monoposto/Biposto)	03-06	FA266		FA266V	FA266HH	MD618		VR618	
749 (Monoposto/Biposto)	03-06	FA266		FA266V	FA266HH	MD618		VR618	
750 Sport (4 bolt disc fixing)	74	N/A							
750 SS (4 bolt disc fixing) (Note thinner pad version for shaved down caliper)	75-76	FA019			FA019HH	N/A			
751 F1	98	FA018			FA018HH	N/A			
750 Paso	87-90	FA047			FA047HH	MD631			
750 Sport	88-90	FA018			FA018HH	MD631			
750 Supersport (Single disc)	91-98	FA047			FA047HH	MD2002	MD2002C		
Supersport 750 (Twin disc)	91-98	FA047			FA047HH	MD2002	MD2002C		
750 Supersport	99	FA266		FA266V	FA266HH	MD2002	MD2002C	VR2002	
750 Supersport IE	00-02	FA266		FA266V	FA266HH	MD2002	MD2002C	VR2002	
750 Sport	01-02	FA266		FA266V	FA266HH	MD2002	MD2002C	VR2002	
750 Monster (Single disc)	96-97	FA047			FA047HH	MD2002	MD2002C	VR2002	
750 Monster (Twin disc)	96-98	FA047			FA047HH	MD2002	MD2002C	VR2002	
750 Monster City/City Dark	99	FA047			FA047HH	MD2002	MD2002C	VR2002	
750 Monster/Monster Dark	99	FA047			FA047HH	MD2002	MD2002C	VR2002	
750 Monster	00-01	FA047			FA047HH	MD2002	MD2002C	VR2002	
750 ie Monster	02	FA047			FA047HH	MD2002	MD2002C	VR2002	
796 Hypermotard	10-12	FA266		FA266V	FA266HH	MD627			
796 Monster Inc ABS Models	10-13	FA266		FA266V	FA266HH	MD627	MD627C	VR627	

\*-2 Sets Required. ■ - Also available in MX-S race compound.

**SAFETY WARNING:- DO NOT USE HH PADS ON REAR UNLESS ALSO USED ON FRONT TO AVOID BRAKE IMBALANCE**

**R** Suffix = High Durability Sintered Pad. **HH** Suffix = High Performance Sintered Pad. **G** Suffix = Grooved Shoe.  
**D** Suffix = Drilled Disc. **C** Suffix = Contoured Disc. **LS** Suffix = Left/Steel Disc. **RS** = Right/Steel Disc.

**BRAKE APPLICATIONS**

# Non-JAPANESE Built Motorcycles



← FRONT / AVANT / VORN FRENTE / ANTERIORE →

DUCATI		DISC PAD CHOICES						BRAKE ROTOR CHOICES					
		NEW SFAC Scooter Carbon Pads	Semi-Sintered V-Pads™	Sintered/HH Pads/ Grooved shoes	Left/Gauche/Links	Right/Droite/Rechts	Contour Rotor Universal left and right fitment	NEW Vee-Rotors™ CONTOUR	NEW CX Extreme® ROTOR	Oversize 250/280mm Rotor Kit	Relocating Bracket for 250/280mm Rotor	Oversize 320mm Rotor Kit	Relocating Bracket for 320mm Rotor
796 Monster 20th Anniversary Model	13	FA244*		FA244HH*	MD841X	MD841X	MD841XC*	VR841BLK*					
Monster 800	03-04	FA244*		FA244HH*	MD614X	MD614X	MD614XC*	VR614BLK*					
Monster S2R (803cc)	05-07	FA181TT*		FA181HH*	MD626X	MD626X	MD626XC*	VR626BLK*					
Monster S2R Dark (803cc)	05-06	FA181TT*		FA181HH*	MD626X	MD626X	MD626XC*	VR626BLK*					
800 Sport	03	FA244*		FA244HH*	MD614X	MD614X	MD614XC*	VR614BLK*					
800 Supersport	03-05	FA244*		FA244HH*	MD614X	MD614X	MD614XC*	VR614BLK*					
Hypermotard (821cc)	13	USE HH ONLY	USE HH ONLY	FA630HH*	TBA	TBA							
Hypermotard SP (821cc)	13	USE HH ONLY	USE HH ONLY	FA630HH*	TBA	TBA							
Hyperstrada (821cc)	13	USE HH ONLY	USE HH ONLY	FA630HH*	TBA	TBA							
848 (Radial 2 pad caliper)	08-10	FA244*		FA244HH*	MD843X	MD843X	MD843XC*	VR843BLK*					
848 Evo (Monobloc front calipers)	10-13			FA447HH*	MD843X	MD843X	MD843XC*	VR843BLK*					
848 Evo Corse SE	12-13			FA447HH*	MD694X	MD694X	MD694XC*	VR694BLK*					
848 Evo Dark	12			FA447HH*	MD843X	MD843X	MD843XC*						
848 Streetfighter	11-13	FA244*		FA244HH*	MD841X	MD841X	MD841XC*	VR841BLK*					
851 Superbike Biposto	89-92	FA095*		FA095HH*	MD633X	MD633X	MD633XC*						
860 GT/GTS	75-76	FA018*		FA018HH*	MD634LS	MD634RS							
888 SP4/SP5	92-93	FA095*		FA095HH*	MD633X	MD633X	MD633XC*						
888 Superbike Strada	94-95	FA095*		FA095HH*	MD633X	MD633X	MD633XC*						
900 GT/S (4 bolt disc fixing) (front & rear)	75-76	FA018*		FA018HH*	MD634LS	MD634RS							
900 Hallwood Replica (6 bolt disc fixing)	79	FA018*		FA018HH*	MD609LS	MD609RS							
900 SS (Note thinner pad version for shaved down caliper)	75-76	FA019*		FA019HH*	MD634LS	MD634RS							
900 Supersport	89-90	FA095*		FA095HH*	MD2001X	MD2001X	MD2001C*	VR2001BLK*					
900 Supersport/Superlight	91-97	FA095*		FA095HH*	MD633X	MD633X	MD633XC*						
900 Supersport	98-99	FA244*		FA244HH*	MD633X	MD633X	MD633XC*						
900 Supersport CR USA	98	FA095*		FA095HH*	MD633X	MD633X	MD633XC*						
900 Supersport FE	98	FA095*		FA095HH*	MD633X	MD633X	MD633XC*						
900 Supersport IE	00-01	FA244*		FA244HH*	MD614X	MD614X	MD614XC*	VR614BLK*					
900 Sport	02	FA244*		FA244HH*	MD614X	MD614X	MD614XC*	VR614BLK*					
900 Monster	93-99	FA095*		FA095HH*	MD633X	MD633X	MD633XC*						
900 Monster Cromo/Special	98	FA095*		FA095HH*	MD633X	MD633X	MD633XC*						
900 Monster City/City Dark	99	FA095*		FA095HH*	MD633X	MD633X	MD633XC*						
900 IE Monster	00-01	FA244*		FA244HH*	MD614X	MD614X	MD614XC*	VR614BLK*					
900 MH Evoluzione	00-01	FA244*		FA244HH*	MD614X	MD614X	MD614XC*	VR614BLK*					
900 SD Darmah (4 bolt front and rear disc fixing)	77	FA018*		FA018HH*	MD634LS	MD634RS							
900 SD Darmah (6 bolt front disc fixing/4 bolt rear disc fixing)	78	FA018*		FA018HH*	MD609LS	MD609RS							
900 SD Darmah (6 bolt disc fixing front & rear)	78	FA018*		FA018HH*	MD609LS	MD609RS							
906 Paso	88-89	FA018*		FA018HH*	TBA	TBA							
907 IE	90-91	FA095*		FA095HH*	MD2001X	MD2001X	MD2001XC*	VR2001BLK*					
907 IE	92-93	FA095*		FA095HH*	MD633X	MD633X	MD633XC*						
Monster S4 Foggy (916cc)	02	FA244*		FA244HH*	MD624	MD624		VR624BLK*					
Monster S4 (916cc)	01-02	FA244*		FA244HH*	MD624	MD624		VR624BLK*					
ST4 (916cc)	99	FA244*		FA244HH*	MD633X	MD633X	MD633XC*						
ST4 (916cc)	00	FA244*		FA244HH*	TBA	TBA							
ST4 (916cc)	01-02	FA244*		FA244HH*	MD614X	MD614X	MD614XC*	VR614BLK*					
916 (Biposto)	94-96	FA095*		FA095HH*	MD633X	MD633X	MD633XC*						
916 Senna	94-98	FA095*		FA095HH*	MD633X	MD633X	MD633XC*						
916 SP	94-96	FA095*		FA095HH*	MD633X	MD633X	MD633XC*						
ST2 (944cc)	97-99	FA244*		FA244HH*	MD633X	MD633X	MD633XC*						
ST2 (944cc)	00-03	FA244		FA244HH	MD614X	MD614X	MD614XC*	VR614BLK*					
ST3 (Non ABS) (992cc)	04-07	FA244*		FA244HH*	MD614X	MD614X	MD614XC*	VR614BLK*					
ST3 S (ABS Model) (992cc)	06-07	FA244*		FA244HH*	MD624	MD624		VR624BLK*					
916 SPS (996cc)	97-98	FA095*		FA095HH*	TBA	TBA							
Monster S4R (996cc) (2 pad caliper)	05-06	FA244*		FA244HH*	MD624	MD624		VR624BLK*					
996 SPS (996cc)	99	FA244*		FA244HH*	MD624	MD624		VR624BLK*					
996 (996cc) (Monoposto/Biposto)	99-01	FA244*		FA244HH*	MD624	MD624		VR624BLK*					
996 R	01			FA322/4HH*	MD636X	MD636X	MD636XC*						
996 S	01	FA244*		FA244HH*	MD624	MD624		VR624BLK*					
Monster S4R (996cc)	03-06	FA244*		FA244HH*	MD624	MD624		VR624BLK*					
S4RS Monster (998cc) (Radial 4 pad caliper)	06			FA322/4HH*	MD843X	MD843X	MD843XC*	VR843BLK*					
S4R Testastretta Monster (998cc) (Radial 4 pad caliper)	07-08			FA322/4HH*	MD843X	MD843X	MD843XC*	VR843BLK*					

\*-2 Sets Required. ■ - Also available in MX-S race compound.

**SAFETY WARNING:** DO NOT USE HH PADS ON REAR UNLESS ALSO USED ON FRONT TO AVOID BRAKE IMBALANCE

APPLICATIONS  
BRAKE

R Suffix = High Durability Sintered Pad. HH Suffix = High Performance Sintered Pad. G Suffix = Grooved Shoe.  
D Suffix = Drilled Disc. C Suffix = Contoured Disc. LS Suffix = Left/Steel Disc. RS = Right/Steel Disc.

# Non-JAPANESE Built Motorcycles



**DUCATI**



← REAR / ARRIÈRE / HINTEN POSTERIOR / POSTERIORE →

		DISC PAD CHOICES				BRAKE ROTOR CHOICES			
		NEW SFAC Scooter Carbon Pads	Semi-Sintered V-Pads™	Sintered/HH Pads/ Grooved shoes		Contour Rotor Rear Fitment	NEW Vee-Rotors™ CONTOUR	NEW CX Extreme® ROTOR	
796 Monster 20th Anniversary Model	13	FA266		FA266V	FA266HH	MD627	MD627C	VR627	
Monster 800	03-04	FA047			FA047HH	MD2002	MD2002C	VR2002	
Monster S2R (803cc)	05-07	FA047			FA047HH	MD627	MD627C	VR627	
Monster S2R Dark (803cc)	05-06	FA047			FA047HH	MD627	MD627C	VR627	
800 Sport	03	FA047			FA047HH	MD2002	MD2002C	VR2002	
800 Supersport	03-05	FA266		FA266V	FA266HH	MD2002	MD2002C	VR2002	
Hypermotard (821cc)	13	FA266		FA266V	FA266HH	MD627			
Hypermotard SP (821cc)	13	FA266		FA266V	FA266HH	MD627			
Hyperstrada (821cc)	13	FA266		FA266V	FA266HH	MD627			
848 (Radial 2 pad caliper)	08-10	FA266		FA266V	FA266HH	MD627	MD627C	VR627	
848 Evo (Monobloc front calipers)	10-13	FA266		FA266V	FA266HH	MD627	MD627C	VR627	
848 Evo Corse SE	12-13	FA266		FA266V	FA266HH	MD627	MD627C	VR627	
848 Evo Dark	12	FA266		FA266V	FA266HH	MD627	MD627C	VR627	
848 Streetfighter	11-13	FA266		FA266V	FA266HH	MD627	MD627C	VR627	
851 Superbike Biposto	89-92	FA047			FA047HH	MD2002	MD2002C		
860 GT/GTS	75-76	FA018			FA018HH	MD634LS			
888 SP4/SP5	92-93	FA047			FA047HH	MD2002	MD2002C		
888 Superbike Strada	94-95	FA047			FA047HH	MD2002	MD2002C		
900 GTS (4 bolt disc fixing) (front & rear)	75-76	FA018			FA018HH	MD634LS			
900 Hailwood Replica (6 bolt disc fixing)	79	FA018			FA018HH	MD609LS			
900 SS (Note thinner pad version for shaved down caliper)	75-76	FA019			FA019HH	N/A			
900 Supersport	89-90	FA047			FA047HH	MD2002	MD2002C	VR2002	
900 Supersport/Superlight	91-97	FA047			FA047HH	MD2002	MD2002C		
900 Supersport	98-99	FA266		FA266V	FA266HH	MD2002	MD2002C		
900 Supersport CR USA	98	FA047			FA047HH	MD2002	MD2002C		
900 Supersport FE	98	FA047			FA047HH	MD2002	MD2002C		
900 Supersport IE	00-01	FA266		FA266V	FA266HH	MD2002	MD2002C	VR2002	
900 Sport	02	FA266		FA266V	FA266HH	MD2002	MD2002C	VR2002	
900 Monster	93-99	FA047			FA047HH	MD2002	MD2002C		
900 Monster Cromo/Special	98	FA047			FA047HH	MD2002	MD2002C		
900 Monster City/City Dark	99	FA047			FA047HH	MD2002	MD2002C		
900 IE Monster	00-01	FA047			FA047HH	MD2002	MD2002C	VR2002	
900 MH Evoluzione	00-01	FA266		FA266V	FA266HH	MD632	MD632C	VR632	
900 SD Darmah (4 bolt front and rear disc fixing)	77	FA018			FA018HH	MD634LS			
900 SD Darmah (6 bolt front disc fixing/4 bolt rear disc fixing)	78	FA018			FA018HH	MD634LS			
900 SD Darmah (6 bolt disc fixing front & rear)	78	FA018			FA018HH	MD609LS			
906 Paso	88-89	FA018			FA018HH	MD631			
907 IE	90-91	FA047			FA047HH	MD2002	MD2002C	VR2002	
907 IE	92-93	FA047			FA047HH	MD2002	MD2002C		
Monster S4 Foggy (916cc)	02	FA047			FA047HH	MD2002		VR2002	
Monster S4 (916cc)	01-02	FA047			FA047HH	MD2002		VR2002	
ST4 (916cc)	99	FA266		FA266V		MD2002	MD2002C		
ST4 (916cc)	00	FA266		FA266V	FA266HH	MD2002			
ST4 (916cc)	01-02	FA266		FA266V	FA266HH	MD2002	MD2002C	VR2002	
916 (Biposto)	94-96	FA047			FA047HH	MD632	MD632C		
916 Senna	94-98	FA047			FA047HH	MD632			
916 SP	94-96	FA047			FA047HH	MD632	MD632C		
ST2 (944cc)	97-99	FA266		FA266V	FA266HH	MD2002	MD2002C		
ST2 (944cc)	00-03	FA266		FA266V	FA266HH	MD2002	MD2002C	VR2002	
ST3 (Non ABS) (992cc)	04-07	FA266		FA266V	FA266HH	MD2002	MD2002C	VR2002	
ST3 S (ABS Model) (992cc)	06-07	FA266		FA266V	FA266HH	MD2002		VR2002	
916 SPS (996cc)	97-98	FA047			FA047HH	MD632			
Monster S4R (996cc) (2 pad caliper)	05-06	FA047			FA047HH	MD627		VR627	
996 SPS (996cc)	99	FA047			FA047HH	MD632		VR632	
996 (996cc) (Monoposto/Biposto)	99-01	FA047			FA047HH	MD632		VR632	
996 R	01	FA047			FA047HH	MD632	MD632C		
996 S	01	FA047			FA047HH	MD632		VR632	
Monster S4R (996cc)	03-06	FA047			FA047HH	MD627		VR627	
S4RS Monster (996cc) (Radial 4 pad caliper)	06	FA047			FA047HH	MD627	MD627C	VR627	
S4R Testastretta Monster (996cc) (Radial 4 pad caliper)	07-08	FA047			FA047HH	MD627	MD627C	VR627	

\*-2 Sets Required. ■ - Also available in MX-S race compound.

**SAFETY WARNING:** DO NOT USE HH PADS ON REAR UNLESS ALSO USED ON FRONT TO AVOID BRAKE IMBALANCE

**BRAKE APPLICATIONS**

**R** Suffix = High Durability Sintered Pad. **HH** Suffix = High Performance Sintered Pad. **G** Suffix = Grooved Shoe.  
**D** Suffix = Drilled Disc. **C** Suffix = Contoured Disc. **LS** Suffix = Left/Steel Disc. **RS** = Right/Steel Disc.



# Non-JAPANESE Built Motorcycles



← FRONT / AVANT / VORN FRENTE / ANTERIORE →

## DUCATI

### DISC PAD CHOICES

### BRAKE ROTOR CHOICES

Model	Year	Disc Pad	DISC PAD CHOICES		BRAKE ROTOR CHOICES									
			NEW SFAC Scooter Carbon Pads	Semi-Sintered V-Pads™	Sintered/HH Pads/ Grooved shoes	Left/Gauche/Links	Right/Droite/Rechts	Contour Rotor Universal left and right fitment	NEW Vee-Rotors™ CONTOUR	NEW CX Extreme® ROTOR	Oversize 250/280mm Rotor Kit	Relocating Bracket for 250/280mm Rotor	Oversize 320mm Rotor Kit	Relocating Bracket for 320mm Rotor
S4RS Testastretta Monster (998cc) (Radial 4 pad caliper)	07-				FA322/4HH*	MD843X	MD843X	MD843XC*	VR843BLK*					
S4RS (Tricolore/Monster Testastretta) (998cc) (Radial 4 pad caliper)	08-				FA322/4HH*	MD843X	MD843X	MD843XC*	VR843BLK*					
ST4S (Non ABS/996cc)	01-05	FA244*			FA244HH*	MD624	MD624		VR624BLK*					
ST4S (ABS Model/996cc)	03-05	FA244*			FA244HH*	MD624	MD624		VR624BLK*					
Desmosedici RR (D16RR/989cc)	08				FA447HH*	MD694X	MD694X	MD694XC*	VR694BLK*					
998 Matrix (998cc)	04	FA244*			FA244HH*	MD633X	MD633X	MD633XC*						
998 R (998cc)	02				FA322/4HH*	TBA	TBA							
998 S Bayliss/Bostrom	02				FA322/4HH*	MD633X	MD633X	MD633XC*						
998 S (998cc) (4 pad caliper)	02-04				FA322/4HH*	MD633X	MD633X	MD633XC*						
998 (998cc) (2 pad caliper) (Monoposto/Biposto)	02-03	FA244			FA244HH	MD633X	MD633X	MD633XC*						
999 S (Std Caliper Mount) (Monoposto/Biposto)	03-04				FA322/4HH*	MD622X	MD622X	MD622XC*	VR622BLK*					
999 (Std mount caliper)	03-06				FA322/4HH*	MD622X	MD622X	MD622XC*	VR622BLK*					
999 R (Radial mount caliper)	03-06				FA322/4HH*	MD622X	MD622X	MD622XC*	VR622BLK*					
999 R Fila (Radial mount caliper)	03-				FA322/4HH*	MD622X	MD622X	MD622XC*	VR622BLK*					
999 R Xerox	06				FA322/4HH*	MD622X	MD622X	MD622XC*	VR622BLK*					
999 S (Radial caliper) Monoposto/Biposto	05-06				FA322/4HH*	MD622X	MD622X	MD622XC*	VR622BLK*					
1000 R1 Hailwood Replica (6 bolt disc)	84	FA018*			FA018HH*	MD609LS	MD609RS							
GT 1000 (992cc)	07-10	FA209/2*			FA209/2HH*	MD614X	MD614X	MD614XC*	VR614BLK*					
GT 1000 Touring (992cc)	09	FA209/2*			FA209/2HH*	MD614X	MD614X	MD614XC*	VR614BLK*					
Monster 1000 Dark	03	FA244*			FA244HH*	MD614X	MD614X	MD614XC*	VR614BLK*					
Monster 1000 ie (992cc)	04-05	FA244			FA244HH	MD614X	MD614X	MD614XC*	VR614BLK*					
Monster 1000 S ie (992cc)	03-05	FA244*			FA244HH*	MD614X	MD614X	MD614XC*	VR614BLK*					
Monster S2R 1000 (992cc)	06-08	FA244*			FA244HH*	MD614X	MD614X	MD614XC*	VR614BLK*					
Multistrada 1000 DS (992cc)	03-05	FA244*			FA244HH*	MD682	MD682							
Multistrada S 1000 DS (992cc)	05-06	FA244*			FA244HH*	MD682	MD682							
Paul Smart 1000 LE (992cc)	06	FA209/2*			FA209/2HH*	MD614X	MD614X	MD614XC*	VR614BLK*					
Sport 1000 S	07-09	FA209/2*			FA209/2HH*	MD614X	MD614X	MD614XC*	VR614BLK*					
Sport Classic 1000 (992cc) (Monoposto - Japan/Biposto - Europe)	06-08	FA209/2*			FA209/2HH*	MD614X	MD614X	MD614XC*	VR614BLK*					
Supersport 1000 DS (992cc)	03-06	FA244*			FA244HH*	MD614X	MD614X	MD614XC*	VR614BLK*					
1098	07-08				FA447HH*	MD694X	MD694X	MD694XC*	VR694BLK*					
1098 S Tricolore	07				FA447HH*	MD694X	MD694X	MD694XC*	VR694BLK*					
1098 S	07-08				FA447HH*	MD694X	MD694X	MD694XC*	VR694BLK*					
1098 R	08-09				FA447HH*	MD694X	MD694X	MD694XC*	VR694BLK*					
1100 Hypertard	07-09	FA244*			FA244HH*	TBA	TBA							
1100 S Hypertard	07-09				FA447HH*	TBA	TBA							
1100 EVO Hypertard	10-12	FA244*			FA244HH*	TBA	TBA							
1100 EVO SP Hypertard	10-12				FA447HH*	TBA	TBA							
1100 Monster	09-10	FA244*			FA244HH*	MD841X	MD841X	MD841XC*	VR841BLK*					
1100 S Monster	09-10	FA244*			FA244HH*	MD843X	MD843X	MD843XC*	VR843BLK*					
1100 Monster Evo	11-13	FA244*			FA244HH*	MD841X	MD841X	MD841XC*	VR841BLK*					
1100 Monster Evo 20th Anniversary Model	13	FA244*			FA244HH*	MD841X	MD841X	MD841XC*	VR841BLK*					
1100 Monster Diesel	13	FA244*			FA244HH*	MD841X	MD841X	MD841XC*	VR841BLK*					
1100 Multistrada (1078cc)	07-09	FA244*			FA244HH*	MD682	MD682							
1100 S Multistrada (1078cc)	07-09	FA244*			FA244HH*	MD682	MD682							
1100 Streetfighter (1099cc)	09-10				FA447HH*	MD694X	MD694X	MD694XC*	VR694BLK*					
1100 S Streetfighter (1099cc)	09-13				FA447HH*	MD694X	MD694X	MD694XC*	VR694BLK*					
1198	09-11				FA447HH*	MD694X	MD694X	MD694XC*	VR694BLK*					
1198 R Corse	10				FA447HH*	MD694X	MD694X	MD694XC*	VR694BLK*					
1198 S	09-10				FA447HH*	MD694X	MD694X	MD694XC*	VR694BLK*					
1198 S Corse	10				FA447HH*	MD694X	MD694X	MD694XC*	VR694BLK*					
1198 SP	11				FA447HH*	MD694X	MD694X	MD694XC*	VR694BLK*					
1199 Panigale	12-13				FA447HH*	MD694X	MD694X	MD694XC*	VR694BLK*					
1199 Panigale ABS	12-13				FA447HH*	MD694X	MD694X	MD694XC*	VR694BLK*					
1199 Panigale S ABS	12-13				FA447HH*	MD694X	MD694X	MD694XC*	VR694BLK*					
1199 Panigale S Tricolore	12-13				FA447HH*	MD694X	MD694X	MD694XC*	VR694BLK*					
1199 Panigale R	13				FA447HH*	MD694X	MD694X	MD694XC*	VR694BLK*					
Diavel ABS	11-13				FA447HH*	MD841X	MD841X	MD841XC*	VR841BLK*					
Diavel AMG	11-12				FA447HH*	MD841X	MD841X	MD841XC*	VR841BLK*					
Diavel Carbon ABS	11-13				FA447HH*	TBA	TBA							
Diavel Chromo ABS	12				FA447HH*	MD841X	MD841X	MD841XC*	VR841BLK*					

\*-2 Sets Required. ■ - Also available in MX-S race compound.

**SAFETY WARNING:** DO NOT USE HH PADS ON REAR UNLESS ALSO USED ON FRONT TO AVOID BRAKE IMBALANCE

APPLICATIONS  
BRAKE

R Suffix = High Durability Sintered Pad. HH Suffix = High Performance Sintered Pad. G Suffix = Grooved Shoe.  
D Suffix = Drilled Disc. C Suffix = Contoured Disc. LS Suffix = Left/Steel Disc. RS = Right/Steel Disc.



# Non-JAPANESE Built Motorcycles



**DUCATI**



← REAR / ARRIÈRE / HINTEN  POSTERIOR / POSTERIORE →

			DISC PAD CHOICES			BRAKE ROTOR CHOICES			
			NEW SFAC Scooter Carbon Pads	Semi-Sintered V-Pads™	Sintered/HH Pads/ Grooved shoes	 Contour Rotor Rear Fitment	NEW Vee-Rotors™ CONTOUR	NEW CX Extreme® ROTOR	
SARS Testastretta Monster (998cc) (Radial 4 pad caliper)	07	FA047			FA047HH	MD627	MD627C	VR627	
SARS (Tricolore/Monster Testastretta) (998cc) (Radial 4 pad caliper)	08	FA047			FA047HH	MD627	MD627C	VR627	
ST4S (Non ABS/996cc)	01-05	FA266		FA266V	FA266HH	MD2002		VR2002	
ST4S (ABS Model/996cc)	03-05	FA266		FA266V	FA266HH	MD2002		VR2002	
Desmosedici RR (D16RR/989cc)	08	FA266		FA266V	FA266HH	MD618	MD618C	VR618	
998 Matrix (998cc)	04	FA047			FA047HH	MD632	MD632C		
998 R (998cc)	02	FA047			FA047HH	MD632			
998 S Bayliss/Bostrom	02	FA047			FA047HH	MD632	MD632C		
998 S (998cc) (4 pad caliper)	02-04	FA047			FA047HH	MD632	MD632C		
998 (998cc) (2 pad caliper) (Monoposto/Biposto)	02-03	FA047			FA047HH	MD632	MD632C		
999 S (Std Caliper Mount) (Monoposto/Biposto)	03-04	FA266		FA266V	FA266HH	MD618		VR618	
999 (Std mount caliper)	03-06	FA266		FA266V	FA266HH	MD618		VR618	
999 R (Radial mount caliper)	03-06	FA266		FA266V	FA266HH	MD618		VR618	
999 R Fila (Radial mount caliper)	03-	FA266		FA266V	FA266HH	MD618		VR618	
999 R Xerox	06	FA266		FA266V	FA266HH	MD618		VR618	
999 S (Radial caliper) Monoposto/Biposto	05-06	FA266		FA266V	FA266HH	MD618		VR618	
1000 R1 Hailwood Replica (6 bolt disc)	84	FA018			FA018HH	MD609LS			
GT 1000 (992cc)	07-10	FA213		FA213V	FA213HH	MD2002	MD2002C	VR2002	
GT 1000 Touring (992cc)	09	FA213		FA213V	FA213HH	MD2002	MD2002C	VR2002	
Monster 1000 Dark	03	FA047			FA047HH	MD2002	MD2002C	VR2002	
Monster 1000 ie (992cc)	04-05	FA047			FA047HH	MD2002	MD2002C	VR2002	
Monster 1000 S ie (992cc)	03-05	FA047			FA047HH	MD2002	MD2002C	VR2002	
Monster S2R 1000 (992cc)	06-08	FA047			FA047HH	MD627	MD627C	VR627	
Multistrada 1000 DS (992cc)	03-05	FA266			FA266HH	MD627			
Multistrada S 1000 DS (992cc)	05-06	FA266			FA266HH	MD627			
Paul Smart 1000 LE (992cc)	06	FA213		FA213V	FA213HH	MD2002	MD2002C	VR2002	
Sport 1000 S	07-09	FA213		FA213V	FA213HH	MD2002	MD2002C	VR2002	
Sport Classic 1000 (992cc) (Monoposto - Japan/Biposto - Europe)	06-08	FA213		FA213V	FA213HH	MD2002	MD2002C	VR2002	
Supersport 1000 DS (992cc)	03-06	FA266		FA266V	FA266HH	MD2002	MD2002C	VR2002	
1098	07-08	FA266		FA266V	FA266HH	MD695	MD695C	VR695	
1098 S Tricolore	07	FA266		FA266V	FA266HH	MD695	MD695C	VR695	
1098 S	07-08	FA266		FA266V	FA266HH	MD695	MD695C	VR695	
1098 R	08-09	FA266		FA266V	FA266HH	MD695	MD695C	VR695	
1100 Hypermotard	07-09	FA266		FA266V	FA266HH	MD627			
1100 S Hypermotard	07-09	FA266		FA266V	FA266HH	MD627			
1100 EVO Hypermotard	10-12	FA266		FA266V	FA266HH	MD627			
1100 EVO SP Hypermotard	10-12	FA266		FA266V	FA266HH	MD627			
1100 Monster	09-10	FA266		FA266V	FA266HH	MD627	MD627C	VR627	
1100 S Monster	09-10	FA266		FA266V	FA266HH	MD627	MD627C	VR627	
1100 Monster Evo	11-13	FA266		FA266V	FA266HH	MD627	MD627C	VR627	
1100 Monster Evo 20th Anniversary Model	13	FA266		FA266V	FA266HH	MD627	MD627C	VR627	
1100 Monster Diesel	13	FA266		FA266V	FA266HH	MD627	MD627C	VR627	
1100 Multistrada (1078cc)	07-09	FA266		FA266V	FA266HH	MD627			
1100 S Multistrada (1078cc)	07-09	FA266		FA266V	FA266HH	MD627			
1100 Streetfighter (1099cc)	09-10	FA266		FA266V	FA266HH	MD695	MD695C	VR695	
1100 S Streetfighter (1099cc)	09-13	FA266		FA266V	FA266HH	MD695	MD695C	VR695	
1198	09-11	FA266		FA266V	FA266HH	MD695	MD695C	VR695	
1198 R Corse	10	FA266		FA266V	FA266HH	MD695	MD695C	VR695	
1198 S	09-10	FA266		FA266V	FA266HH	MD695	MD695C	VR695	
1198 S Corse	10	FA266		FA266V	FA266HH	MD695	MD695C	VR695	
1198 SP	11	FA266		FA266V	FA266HH	MD695	MD695C	VR695	
1199 Panigale	12-13	FA266		FA266V	FA266HH	TBA			
1199 Panigale ABS	12-13	FA266		FA266V	FA266HH	TBA			
1199 Panigale S ABS	12-13	FA266		FA266V	FA266HH	TBA			
1199 Panigale S Tricolore	12-13	FA266		FA266V	FA266HH	TBA			
1199 Panigale R	13	FA266		FA266V	FA266HH	TBA			
Diavel ABS	11-13	USE V OR HH		FA209/2V	FA209/2HH	TBA			
Diavel AMG	11-12	USE V OR HH		FA209/2V	FA209/2HH	TBA			
Diavel Carbon ABS	11-13	USE V OR HH		FA209/2V	FA209/2HH	TBA			
Diavel Chromo ABS	12	USE V OR HH		FA209/2V	FA209/2HH	TBA			

\*-2 Sets Required. ■ - Also available in MX-S race compound.

**SAFETY WARNING:- DO NOT USE HH PADS ON REAR UNLESS ALSO USED ON FRONT TO AVOID BRAKE IMBALANCE**

**BRAKE APPLICATIONS**

**R** Suffix = High Durability Sintered Pad. **HH** Suffix = High Performance Sintered Pad. **G** Suffix = Grooved Shoe.  
**D** Suffix = Drilled Disc. **C** Suffix = Contoured Disc. **LS** Suffix = Left/Steel Disc. **RS** = Right/Steel Disc.

# Non-JAPANESE Built Motorcycles



← FRONT / AVANT / VORN FRENTE / ANTERIORE →

**APPLICATIONS**  
**BRAKE**

**R** Suffix = High Durability Sintered Pad. **HH** Suffix = High Performance Sintered Pad. **G** Suffix = Grooved Shoe.

**D** Suffix = Drilled Disc. **C** Suffix = Contoured Disc. **LS** Suffix = Left/Steel Disc. **RS** = Right/Steel Disc.

## DUCATI

Model	Year	Disc	DISC PAD CHOICES				BRAKE ROTOR CHOICES							
			NEW SFAC Scooter Carbon Pads	Semi-Sintered V-Pads™	Sintered/HH Pads/ Grooved shoes	Left/Gauche/Links	Right/Droite/Rechts	Contour Rotor Universal left and right fitment	NEW Vee-Rotors™ CONTOUR	NEW CX Extreme® ROTOR	Oversize 250/280mm Rotor Kit	Relocating Bracket for 250/280mm Rotor	Oversize 320mm Rotor Kit	Relocating Bracket for 320mm Rotor
Diavel Dark	13				FA447HH*	MD841X	MD841X	MD841XC*	VR841BLK*					
Diavel Strada	13				FA447HH*	MD841X	MD841X	MD841XC*	VR841BLK*					
1200 Multistrada Standard Edition	10-11	FA244*			FA244HH*	MD841X	MD841X	MD841XC*	VR841BLK*					
1200 Multistrada ABS	10-13	FA244*			FA244HH*	MD841X	MD841X	MD841XC*	VR841BLK*					
1200 Multistrada GranTurismo	13	FA244*			FA244HH*	MD841X	MD841X	MD841XC*	VR841BLK*					
1200 S Multistrada Sports Edition	10-12	FA244*			FA244HH*	MD841X	MD841X	MD841XC*	VR841BLK*					
1200 S Multistrada Touring Edition	10-13	FA244*			FA244HH*	MD841X	MD841X	MD841XC*	VR841BLK*					
1200 S Multistrada Pikes Peak SE	11-13	FA244*			FA244HH*	MD841X	MD841X	MD841XC*	VR841BLK*					

## EASY RIDER

Model	Year	Disc	NEW SFAC Scooter Carbon Pads	Semi-Sintered V-Pads™	Sintered/HH Pads/ Grooved shoes	Left/Gauche/Links	Right/Droite/Rechts	Contour Rotor Universal left and right fitment	NEW Vee-Rotors™ CONTOUR	NEW CX Extreme® ROTOR	Oversize 250/280mm Rotor Kit	Relocating Bracket for 250/280mm Rotor	Oversize 320mm Rotor Kit	Relocating Bracket for 320mm Rotor
CJ 50 F	98	TBA												
Teeny Blazer/II	98	TBA												
QM 50 E	98	TBA												
M 50 Monkey/Monkey O.R	98	H303												
CJ 70 Holiday	98	TBA												
JH 125 L Trail Blazer	98	TBA												
JC 125/8 Dragon	98	FA093												

## ECO

Bushman 150 (LX 150 GY)		FA135TT												
-------------------------	--	---------	--	--	--	--	--	--	--	--	--	--	--	--

## ELSTARS

Various models (Check parts before fitting)		FA448												
---	--	-------	--	--	--	--	--	--	--	--	--	--	--	--

## E-MAX

90 S	08	TBA												
100 L	08	TBA												
110 S	08	TBA												
120 L	08	TBA												
140 L	08	TBA												
190 L	08	TBA												

## E-TON

IXL 40 Rascal	98-01	N/A												
RXL 40E Viper Junior	01-07	N/A												
Viper 40 E	99-00	N/A												
AXL 50 Lightning 50	99-00	H338*			H338G*									
BXL 50 Draco	05-06	H338*			H338G*									
EXL 50 Viper 50	907	H338*			H338G*									
NXL 50 Lightning 50	01-02	H338*			H338G*									
TXL 50 Wizz 50	98-99	H338*			H338G*									
Viper 50 Mini RXL 50M	03-07	N/A												
Viper 50 RXL 50	03-07	N/A												
Viper 70 RLX 70	05-07	H338			H338G									
AXL 90 Thunder	99-00	H338			H338G									
DXL 90 Sierra	99-03	S614*			S614G*									
NXL 90 Thunder	01-02	H338*			H338G*									
RXL 90 Viper 90	03-07	H338*			H338G*									
RXL 90 R Viper 90 R Reverse	03-07	H338*			H338G*									
BXL 100 Draco	05-06	H338*			H338G*									
CXL 150 Challenger (Rear disc)	02-07	H303*			H303G*									
CXL 150 Challenger (Drum brake model)	02-07	H303*			H303G*									
EXL 150 Yukon S.T. (Rear drum)	05-07	FA083TT*			FA083R*		N/A	N/A						
EXL 150 Yukon ST (Drum front/disc rear)	05-07	S614*			S614G*									
RXL 150 Viper	05-06	H303*			H303G*									
RXL 150 Viper	07	H303*			H303G*									
Viper EXL 150 ST Quad	05-07	FA083TT*			FA083R*		N/A	N/A						
YXL 150 Yukon	00-02	H303*			H303G*									
RXL 150 Viper R	05	H303*			H303G*									
VXL 250 ST Vector	06-07	FA083TT*			FA083R*		N/A	N/A						

\*-2 Sets Required. ■ - Also available in MX-S race compound.

**SAFETY WARNING:** DO NOT USE HH PADS ON REAR UNLESS ALSO USED ON FRONT TO AVOID BRAKE IMBALANCE

# Non-JAPANESE Built Motorcycles

**BRAKE  
APPLICATIONS**



## DUCATI



← REAR / ARRIÈRE / HINTEN POSTERIOR / POSTERIORE →

			DISC PAD CHOICES			BRAKE ROTOR CHOICES			
			NEW SFAC Scooter Carbon Pads	Semi-Sintered V-Pads™	Sintered/HH Pads/ Grooved shoes	Contour Rotor Rear Fitment	NEW Vee-Rotors™ CONTOUR	NEW CX Extreme® ROTOR	
Diavel Dark	13	USE V OR HH		FA209/2V	FA209/2HH	TBA			
Diavel Strada	13	USE V OR HH		FA209/2V	FA209/2HH	TBA			
1200 Multistrada Standard Edition	10-11	FA266		FA266V	FA266HH	TBA			
1200 Multistrada ABS	10-13	FA266		FA266V	FA266HH	TBA			
1200 Multistrada Granturismo	13	FA266		FA266V	FA266HH	TBA			
1200 S Multistrada Sports Edition	10-12	FA266		FA266V	FA266HH	TBA			
1200 S Multistrada Touring Edition	10-13	FA266		FA266V	FA266HH	TBA			
1200 S Multistrada Pikes Peak SE	11-13	FA266		FA266V	FA266HH	TBA			
<b>EASY RIDER</b>									
CJ 50 F	98	TBA							
Teeny Blazer/II	98	TBA							
QM 50 E	98	TBA							
M 50 Monkey/Monkey O.R	98	H303							
CJ 70 Holiday	98	TBA							
JH 125 L Trail Blazer	98	TBA							
JC 125/8 Dragon	98	TBA							
<b>ECO</b>									
Bushman 150 (LX 150 GY)		FA115TT				N/A			
<b>ELSTARS</b>									
Various models (Check parts before fitting)		FA448				N/A			
<b>E-MAX</b>									
90 S	08	TBA				N/A			
100 L	08	TBA				N/A			
110 S	08	TBA				N/A			
120 L	08	TBA				N/A			
140 L	08	TBA				N/A			
190 L	08	TBA				N/A			
<b>E-TON</b>									
IXL 40 Rascal	98-01	H330			H330G				
RXL 40E Viper Junior	01-07	H330			H330G				
Viper 40 E	99-00	H330			H330G				
AXL 50 Lightning 50	99-00								
BXL 50 Draco	05-06	FA083TT			FA083R	N/A			
EXL 50 Viper 50	907	FA083TT			FA083R	TBA			
NXL 50 Lightning 50	01-02	TBA							
TXL 50 Wizz 50	98-99	TBA							
Viper 50 Mini RXL 50M	03-07	FA083TT			FA083R	N/A			
Viper 50 RXL 50	03-07	FA083TT			FA083R	N/A			
Viper 70 RLX 70	05-07	FA083TT			FA083R	N/A			
AXL 90 Thunder	99-00	H330			H330G				
DXL 90 Sierra	99-03	H330			H330G				
NXL 90 Thunder	01-02	H330			H330G				
RXL 90 Viper 90	03-07	FA083TT			FA083R	N/A			
RXL 90 R Viper 90 R Reverse	03-07	FA083TT			FA083R	N/A			
BXL 100 Draco	05-06	FA083TT			FA083R	N/A			
CXL 150 Challenger (Rear disc)	02-07	FA165TT			FA165R	N/A			
CXL 150 Challenger (Drum brake model)	02-07	H330			H330G				
EXL 150 Yukon S.T. (Rear drum)	05-07	H330			H330G				
EXL 150 Eukon ST (Drum front/disc rear)	05-07	FA165TT			FA165R	TBA			
RXL 150 Viper	05-06	FA165TT			FA165R	N/A			
RXL 150 Viper	07	FA427			FA427R	TBA			
Viper EXL 150 ST Quad	05-07	H330			H330G				
YXL 150 Yukon	00-02	H330			H330G				
RXL 150 Viper R	05	FA165TT			FA165R	N/A			
VXL 250 ST Vector	06-07	FA427TT			FA427R	N/A			

\*-2 Sets Required. ■ - Also available in MX-S race compound.

**SAFETY WARNING:** DO NOT USE HH PADS ON REAR UNLESS ALSO USED ON FRONT TO AVOID BRAKE IMBALANCE

**R** Suffix = High Durability Sintered Pad. **HH** Suffix = High Performance Sintered Pad. **G** Suffix = Grooved Shoe.  
**D** Suffix = Drilled Disc. **C** Suffix = Contoured Disc. **LS** Suffix = Left/Steel Disc. **RS** = Right/Steel Disc.

# Non-JAPANESE Built Motorcycles



← FRONT / AVANT / VORN FRENTE / ANTERIORE →

## DISC PAD CHOICES

## BRAKE ROTOR CHOICES

### E-TON

		NEW SFAC Scooter Carbon Pads	Semi-Sintered V-Pads™	Sintered/HH Pads/ Grooved shoes	Left/Gauche/Links	Right/Droite/Rechts	Contour Rotor Universal left and right fitment	NEW Vee-Rotors™ CONTOUR	NEW CX Extreme® ROTOR	Oversize 250/280mm Rotor Kit	Relocating Bracket for 250/280mm Rotor	Oversize 320mm Rotor Kit	Relocating Bracket for 320mm Rotor
VXL Vector 250	06-07	FA083TT*		FA083R*	N/A	N/A							
VXL 300 Vector	07	FA083TT*		FA083R*	TBA	TBA							
VXL 300 ST Vector ST	07	FA083TT*		FA083R*	TBA	TBA							
VTX 300 Vortex	07	FA083TT*		FA083R*	TBA	TBA							
VTX 300 ST Vortex ST	07	FA083TT*		FA083R*	TBA	TBA							

### E-TROPOLIS (ELECTRIC SCOOTERS)

Bel-Air	13	SFA086	SFAC086			N/A							
Future	13	SFA086	SFAC086			N/A							
Miami	13	SFA086	SFAC086		N/A								
Retro	13	SFA086	SFAC086			N/A							

### EXPLORER

KBR 200	05	FA167		FA167HH	N/A								
Stinger 250	08-09	TBA*			N/A	N/A							
Ranger 300 2 x 4/4 x 4	08-09	FA416TT*		FA416R*	N/A	N/A							
Stinger 300	08-09	TBA*			N/A	N/A							
Taurus 300	08-09	TBA*			N/A	N/A							
Titan 300	08-09	TBA*			N/A	N/A							
Trasher 450	08-09	FA067TT*		FA067R*	N/A	N/A							
Atlas 500/4 x 4	08-09	FA453TT*		FA453R*	N/A	N/A							
Everest 500 L/4 x 4	08-09	FA453TT*		FA453R*	N/A	N/A							
Side x Side 500	08-09	TBA*			N/A	N/A							

### FACTORY

Chrono SM 50	04	FA194		FA194HH	N/A								
Phantom R14 Agua	04	FA351			N/A								
RP 50	05	FA194		FA194HH	N/A								
YM 50	05	FA194		FA194HH	N/A								
YR 50 Desert	02-03	FA115		FA115HH	N/A								
YR 50 Desert	04-05	FA194		FA194HH	N/A								
YR 125 4T	05	FA194		FA194HH	N/A								
YR 250 Desert	03	FA181TT		FA181R ■	N/A								

### FANTIC

50 Issimo spoke wheel		945											
50 Issimo Alu wheel		945											
50 Trial	-83			926G									
50 Strada Super Six	73-	FA050			N/A								
50 Strada	-82	841											
50 Strada	82-	FA067/2			N/A								
50 Repl./Enduro Repl.	-85			841G									
50 Enduro Competition	-82			841G									
50 Enduro	83-			922G									
50 Sprinter/3V.R	83-	909											
50 Casa/Competition	75-			841G									
50 Caballero	-83			922G									
50 Caballero/Caballero RC	91-	FA047		FA047R	N/A								
Caballero 50 Regolarita Competizione	06-09	FA181TT		FA181R ■	TBA								
Caballero Regolarita Competizione Mini 50	08-09	FA181TT		FA181R ■	N/A								
Caballero 50 Regolarita Casa	06-09	FA194		FA194HH	TBA								
Caballero 50 Supersel Competizione	07-08	FA181TT		FA181R ■	TBA								
Caballero 50 Supersel Motard	06-09	FA194		FA194HH	TBA								
50/50.1 Raider	81-	FA067/2			N/A								
50.1 Oasis	86-	FA116			N/A								
50.1 Oasis KS/Rally	86-	FA116			N/A								
50.1 Oasis E.S.	87-	FA116			N/A								
50.1 Oasis Kick	87-	FA099			N/A								
50.1 Trial	86-	FA099			N/A								
50.1 Trial H 20	87-	FA099			N/A								

\*-2 Sets Required. ■ - Also available in MX-S race compound.

**SAFETY WARNING:** DO NOT USE HH PADS ON REAR UNLESS ALSO USED ON FRONT TO AVOID BRAKE IMBALANCE

# Non-JAPANESE Built Motorcycles

**BRAKE APPLICATIONS**



← REAR / ARRIÈRE / HINTEN POSTERIOR / POSTERIORE →

## E-TON



		DISC PAD CHOICES			BRAKE ROTOR CHOICES			
		NEW SFAC Scooter Carbon Pads	Semi-Sintered V-Pads™	Sintered/HH Pads/ Grooved shoes	Contour Rotor Rear Fitment	NEW Vee-Rotors™ CONTOUR	NEW CX Extreme® ROTOR	
VXL Vector 250	06-07	FA427TT		FA427R	N/A			
VXL 300 Vector	07	FA427TT		FA427R	TBA			
VXL 300 ST Vector ST	07	FA427TT		FA427R	TBA			
VTX 300 Vortex	07	FA427TT		FA427R	TBA			
VTX 300 ST Vortex ST	07	FA427TT		FA427R	TBA			

## E-TROPOLIS (ELECTRIC SCOOTERS)

Bel-Air	13	SFA086	SFAC086		N/A			
Future	13	SFA086	SFAC086		N/A			
Miami	13	SFA086	SFAC086		N/A			
Retro	13	SFA086	SFAC086		N/A			

## EXPLORER

KBR 200	05	FA115		FA115HH	N/A			
Stinger 250	08-09	TBA			N/A			
Ranger 300 2 x 4/4 x 4	08-09	FA431TT		FA431R	N/A			
Stinger 300	08-09	TBA			N/A			
Taurus 300	08-09	TBA						
Titan 300	08-09	TBA			N/A			
Trasher 450	08-09	FA067TT		FA067R	N/A			
Atlas 500/4 x 4	08-09	FA344TT		FA344R	N/A			
Everest 500 L4 x 4	08-09	FA344TT		FA344R	N/A			
Side x Side 500	08-09	TBA			N/A			

## FACTORY

Chrono SM 50	04	FA115		FA115HH	N/A			
Phantom R14 Agua	04	FA115			N/A			
RP 50	05	FA115		FA115HH	N/A			
YM 50	05	FA115		FA115HH	N/A			
YR 50 Desert	02-03	FA115		FA115HH	N/A			
YR 50 Desert	04-05	FA115		FA115HH	N/A			
YR 125 4T	05	FA115		FA115HH	N/A			
YR 250 Desert	03	FA208TT		FA208R ■	N/A			

## FANTIC

50 Issimo spoke wheel		945						
50 Issimo Alu wheel		945						
50 Trial	-83			922G				
50 Strada Super Six	73-			843G				
50 Strada	-82			841G				
50 Strada	82-			843G				
50 Repl./Enduro Repl.	-85			841G				
50 Enduro Competition	-82			841G				
50 Enduro	83-			922G				
50 Sprinter/3V.R	83-	909						
50 Casa/Competition	75-			841G				
50 Caballero	-83			922G				
50 Caballero/Caballero RC	91-	FA060			N/A			
Caballero 50 Regolarita Competizione	06-09	FA367TT		FA367R ■	TBA			
Caballero Regolarita Competizione Mini 50	08-09	FA367TT		FA367R ■	N/A			
Caballero 50 Regolarita Casa	06-09	FA382			TBA			
Caballero 50 Supersei Competizione	07-08	FA367TT		FA367R ■	TBA			
Caballero 50 Supersei Motard	06-09	FA382			TBA			
50/50.1 Raider	81-	930						
50.1 Oasis	86-	FA060			N/A			
50.1 Oasis KS/Rally	86-			930G				
50.1 Oasis E.S.	87-	FA060			N/A			
50.1 Oasis Kick	87-			995G				
50.1 Trial	86-			930G				
50.1 Trial H 20	87-			995G				

\*-2 Sets Required. ■ - Also available in MX-S race compound.

**SAFETY WARNING:** DO NOT USE HH PADS ON REAR UNLESS ALSO USED ON FRONT TO AVOID BRAKE IMBALANCE

**R** Suffix = High Durability Sintered Pad. **HH** Suffix = High Performance Sintered Pad. **G** Suffix = Grooved Shoe.  
**D** Suffix = Drilled Disc. **C** Suffix = Contoured Disc. **LS** Suffix = Left/Steel Disc. **RS** = Right/Steel Disc.



# Non-JAPANESE Built Motorcycles



← FRONT / AVANT / VORN FRENTE / ANTERIORE →

## DISC PAD CHOICES

## BRAKE ROTOR CHOICES

Model	Year	Disc Pad	DISC PAD CHOICES		BRAKE ROTOR CHOICES									
			NEW SFAC Scooter Carbon Pads	Semi-Sintered V-Pads™	Sintered/HH Pads/ Grooved shoes	Left/Gauche/Links	Right/Droite/Rechts	Contour Rotor	NEW Vee-Rotors™ CONTOUR	NEW CX Extreme® ROTOR	Oversize 250/280mm Rotor Kit	Relocating Bracket for 250/280mm Rotor	Oversize 320mm Rotor Kit	Relocating Bracket for 320mm Rotor
50.5 Trial	89	FA115			FA115R	N/A								
50.7 Trial	90	FA115			FA115R	N/A								
50.9 Trial	91-	FA115			FA115R	N/A								
50 Fast	88-	FA116				N/A								
50 Joy	92-	945												
50 Koala		FA060				N/A								
50 Clubman	95-	FA115			FA115R	N/A								
Trial 50 Junior	87-				930G									
Trial 50	06	FA291				N/A								
TX 180 E (49cc/2T) Regularita Casa 50E	12-13	FA465TT			FA465R			N/A						
TX 180 ER (49cc/2T) Regularita Competizione 50ER	12-13	FA465TT			FA465R			N/A						
TX 180 ES (49cc/2T) Regularita Scuderia 50ES	12-13	FA465TT			FA465R			N/A						
TX 180 SM (49cc/2T) Motard Casa 50M	12-13	FA465TT			FA465R			N/A						
TX 180 MR (49cc/2T) Motard Competizione 50MR	12-13	FA465TT			FA465R			N/A						
80 Trial	-83				922G									
80 Trial	83-				930G									
80 Enduro	80-				841G									
80 Caballero/Caballero RC	91-	FA047			FA047R	N/A								
80 Cross Compet.	-81				841G									
80 Cross Compet.	81-				841G									
80 Kaloa		FA060				N/A								
80 Clubman	95-	FA115			FA115R	N/A								
Caballero 125 Regularita Competizione	07-09	FA181TT			FA181R ■	TBA								
Caballero 50 Regularita Casa	07-08	FA194			FA194HH	TBA								
Caballero 125 Supersai Motard	07-09	FA194			FA194HH	TBA								
Trial 125					841G									
Trial 125/2		FA099			FA099R	N/A								
Section 125/249 R	-95	FA115			FA115R	N/A								
TR 125 CR (2T) Cross Competizione	13	FA465TT			FA465R			N/A						
TR 125 MR (2T) Motard Competizione	13	FA465TT			FA465R			N/A						
TZ 125 CS (2T) Caballero Cross	11-12	FA465TT			FA465R			N/A						
TZ 125 ES (2T) Regularita Scuderia	11-12	FA465TT			FA465R			N/A						
TZ 125 SM (2T) Caballero Motard	11-12	FA095			FA095HH									
TZ 170 E (125 E / 4T) Regularita Casa	11-13	FA465TT			FA465R			N/A						
TZ 170 ER (125 ER / 4T) Caballero Regularita Competizione	11-13	FA465TT			FA465R			N/A						
TZ 170 SM (125 SM / 4T) Motard Casa	11-13	FA465TT			FA465R			N/A						
200					841G									
TZ 200 ER (200 ER / 4T) Caballero Regularita Competizione	11-13	FA465TT			FA465R			N/A						
TZ 200 MR (200 MR / 4T) Motard	11-13	FA465TT			FA465R			N/A						
201 Monoshock	86	FA099			FA099R	N/A								
240					841G									
Trial 243	87-	FA099			FA099R	N/A								
TF 250 ES (4T)	11-13	FA465TT			FA465R			N/A						
TR 250 ES (2T) Enduro Six Day	13	FA465TT			FA465R			N/A						
TR 300 ES (2T) Enduro Six Day	13	FA465TT			FA465R			N/A						
TZ 300 ES Regularita Scuderia	11-12	FA465TT			FA465R			N/A						
300 Trial					939G									
301 Monoshock	86	FA099			FA099R	N/A								
303 Monoshock	87	FA099			FA099R	N/A								
125.5/245/305	89	FA115			FA115R	N/A								
All series 7 models	90	FA115			FA115R	N/A								
309	92	FA115			FA115R	N/A								
K-R00 All Models	92-95	FA115			FA115R	N/A								
Section 125/249 R	95-	FA115			FA115R	N/A								

## FAST TOYS (SEE QUADZILLA)

## FB MINARELLI (SPAIN)

Rieju Marathon	74-	985												
MR 80		FA115			FA115R	N/A								

\*-2 Sets Required. ■ - Also available in MX-S race compound.

**SAFETY WARNING:** DO NOT USE HH PADS ON REAR UNLESS ALSO USED ON FRONT TO AVOID BRAKE IMBALANCE

APPLICATIONS  
BRAKE

R Suffix = High Durability Sintered Pad. HH Suffix = High Performance Sintered Pad. G Suffix = Grooved Shoe.

D Suffix = Drilled Disc. C Suffix = Contoured Disc. LS Suffix = Left/Steel Disc. RS = Right/Steel Disc.

# Non-JAPANESE Built Motorcycles



## FANTIC



← REAR / ARRIÈRE / HINTEN POSTERIOR / POSTERIORE →

		DISC PAD CHOICES				BRAKE ROTOR CHOICES			
		NEW SFAC Scooter Carbon Pads	Semi-Sintered V-Pads™	Sintered/HH Pads/ Grooved shoes	Contour Rotor Rear Fitment	NEW Vee-Rotors™ CONTOUR	NEW CX Extreme® ROTOR		
50.5 Trial	89	FA115		FA115R	N/A				
50.7 Trial	90	FA115		FA115R	N/A				
50.9 Trial	91-	FA115		FA115R	N/A				
50 Fast	88-			841G					
50 Joy	92-	945							
50 Koala		FA060			N/A				
50 Clubman	95-	FA115		FA115R	N/A				
Trial 50 Junior	87-			930G					
Trial 50	06	FA291			N/A				
TX 180 E (49cc/2T) Regolarita Casa 50E	12-13	FA346TT		FA346R	N/A				
TX 180 ER (49cc/2T) Regolarita Competizione 50ER	12-13	FA346TT		FA346R	N/A				
TX 180 ES (49cc/2T) Regolarita Scuderia 50ES	12-13	FA346TT		FA346R	N/A				
TX 180 SM (49cc/2T) Motard Casa 50M	12-13	FA346TT		FA346R	N/A				
TX 180 MR (49cc/2T) Motard Competizione 50MR	12-13	FA346TT		FA346R	N/A				
80 Trial	-83			922G					
80 Trial	83-			930G					
80 Enduro	80-			843G					
80 Caballero/Caballero RC	91-	FA060			N/A				
80 Cross Compet.	-81			841G					
80 Cross Compet.	81-			843G					
80 Kaloa		FA060							
80 Clubman	95-	FA115		FA115R					
Caballero 125 Regolarita Competizione	07-09	FA367TT		FA367R ■	TBA				
Caballero 50 Regolarita Casa	07-08	FA382			TBA				
Caballero 125 Supersei Motard	07-09	FA382			TBA				
Trial 125		841G							
Trial 125/2		FA099		FA099R	N/A				
Section 125/249 R	-95	FA115		FA115R	N/A				
TR 125 CR (2T) Cross Competizione	13	FA346TT		FA346R	N/A				
TR 125 MR (2T) Motard Competizione	13	FA346TT		FA346R	N/A				
TZ 125 CS (2T) Caballero Cross	11-12	FA346TT		FA346R	N/A				
TZ 125 ES (2T) Regolarita Scuderia	11-12	FA346TT		FA346R	N/A				
TZ 125 SM (2T) Caballero Motard	11-12	FA346TT		FA346R	N/A				
TZ 170 E (125 E / 4T) Regolarita Casa	11-13	FA346TT		FA346R	N/A				
TZ 170 ER (125 ER / 4T) Caballero Regolarita Competizione	11-13	FA346TT		FA346R	N/A				
TZ 170 SM (125 SM/ 4T) Motard Casa	11-13	FA346TT		FA346R	N/A				
200				841G					
TZ 200 ER (200 ER / 4T) Caballero Regolarita Competizione	11-13	FA346TT		FA346R	N/A				
TZ 200 MR (200 MR / 4T) Motard	11-13	FA346TT		FA346R	N/A				
201 Monoshock	86			841G					
240				841G					
Trial 243	87-	FA099		FA099R	N/A				
TF 250 ES (4T)	11-13	FA346TT		FA346R	N/A				
TR 250 ES (2T) Enduro Six Day	13	FA346TT		FA346R	N/A				
TR 300 ES (2T) Enduro Six Day	13	FA346TT		FA346R	N/A				
TZ 300 ES Regolarita Scuderia	11-12	FA346TT		FA346R	N/A				
300 Trial				841G					
301 Monoshock	86			841G					
303 Monoshock	87	FA099		FA099R	N/A				
125.5/245/305	89	FA115		FA115R	N/A				
All series 7 models	90	FA115		FA115R	N/A				
309	92	FA115		FA115R	N/A				
K-R00 All Models	92-95	FA115		FA115R	N/A				
Section 125/249 R	95-	FA115		FA115R	N/A				

## FAST TOYS (SEE QUADZILLA)

## FB MINARELLI (SPAIN)

Rieju Marathon	74-	985						
MR 80				936G				

\*-2 Sets Required. ■ - Also available in MX-S race compound.

**SAFETY WARNING:** DO NOT USE HH PADS ON REAR UNLESS ALSO USED ON FRONT TO AVOID BRAKE IMBALANCE

**BRAKE APPLICATIONS**

**R** Suffix = High Durability Sintered Pad. **HH** Suffix = High Performance Sintered Pad. **G** Suffix = Grooved Shoe.  
**D** Suffix = Drilled Disc. **C** Suffix = Contoured Disc. **LS** Suffix = Left/Steel Disc. **RS** = Right/Steel Disc.

# Non-JAPANESE Built Motorcycles



FRONT / AVANT / VORN FRENTE / ANTERIORE



## DISC PAD CHOICES

## BRAKE ROTOR CHOICES

### FONTA

		NEW SFAC Scooter Carbon Pads	Semi-Sintered V-Pads™	Sintered/HH Pads/ Grooved shoes	Left/Gauche/Links	Right/Droite/Rechts	Contour Rotor Universal left and right fitment	NEW Vee-Rotors™ CONTOUR	NEW CX Extreme® ROTOR	Oversize 250/280mm Rotor Kit	Relocating Bracket for 250/280mm Rotor	Oversize 320mm Rotor Kit	Relocating Bracket for 320mm Rotor
Hawk 50	06	TBA			TBA								
FK 125/17	06	TBA			TBA								
FT 125-T	06	TBA			TBA								

### FYM/X-SPORT

Mini-X RC 50 F	06	NA											
CR 90 E	06-07	SFA169	SFAC169	SFA169HH	N/A								
Xtreme CR90E Auto	06	TBA			N/A								
110 ES R X-Sport	06-07	SFA169	SFAC169	SFA169HH	N/A								
110 ES	06-07	SFA169	SFAC169	SFA169HH	N/A								
CR 110 X Sport 110	06-07	TBA			N/A								
CR 110	06-07	SFA169	SFAC169	SFA169HH	N/A								
CR 110 ESR	06-07	SFA169	SFAC169	SFA169HH	N/A								
X-Sport 110	06	TBA			N/A								
X-Sport CR3	06	TBA			N/A								
X-Sport Sand Blaster	06	TBA			N/A								
CR 125 Sand Bike	06-07	TBA											
CR 125 R	06-07	SFA169	SFAC169	SFA169HH	N/A								
CR 3 125	06-07	SFA169	SFAC169	SFA169HH	N/A								
FYM 125 EY-5 (X Sport CR3/CR125)	06-07	SFA169	SFAC169	SFA169HH	N/A								
X-Sport Typhoon 125 Quad	06-07	SFA169*	SFAC169*	SFA169HH*	N/A	N/A							
X-Trail 150	06-07	TBA			N/A								

### GARELLI

Queenie	95-	SFA083	SFAC083	SFA083HH	MD904D		MD904C	VR904					
Grinta	95-	SFA083	SFAC083	SFA083HH	MD904D		MD904C	VR904					
Capri 50 (DF50QT-7)	06	SFA169	SFAC169	SFA169HH	TBA								
Capri LX 50	06-08	SFA169	SFAC169	SFA169HH	TBA								
Ciclone 50	07	SFA169	SFAC169	SFA169HH	TBA								
Ciclone	08	TBA			N/A								
Flexi 50	09-12	SFA235	SFAC235		TBA								
FLO 50		SFA193	SFAC193	SFA193HH	MD916D								
FX 50		SFA169	SFAC169	SFA169HH	MD923D		MD923C	VR923					
GSP 50 (2T)	09-12	SFA235	SFAC235				TBA						
KRS 50		SFA264	SFAC264	SFA264HH	MD923D		MD923C	VR923					
Tesse 50 (2T)	08-10	SFA235	SFAC235		N/A								
Tesse 50 (4T)	08-10	SFA235	SFAC235		N/A								
VIP 50		TBA											
VIP 50	07	SFA235	SFAC235		TBA								
VIP 50	08	SFA169	SFAC169	SFA169HH	N/A								
XO 50	09	SFA235	SFAC235		TBA								
XO 50 (2T/4T - TM50QT-31)	10-12	SFA235	SFAC235		TBA								
XO 50'e (Electric)	12	SFA086	SFAC086	SFA086HH	TBA								
Comfort 125	07	SFA086	SFAC086	SFA086HH			N/A						
Freeland 125/150		SFA264	SFAC264	SFA264HH	MD923D		MD923C	VR923					
Joker 125/150	02	SFA264	SFAC264	SFA264HH	N/A								
Panther 125/150/250	02	SFA257	SFAC257		N/A								
Skyjet 250/400	02	SFA281		SFA281HH	N/A								
Eureka, Gulp		908											
50 Ciclone/KL50 SV				926G									
50 Vip/Noi/Basic spoke wheel		908											
50 Vip/Noi/Basic Alu Wheel		931											
Junior Turismo		909											
Gran Turismo				926G									
50 Tiger XLE	86-	FA256			N/A								
Formuno 50 till chassis no. 2701551	87-	N/A											
Formuno 50 from chassis no. 2701552	87-	N/A											
50 Team Matic	88-	877											
Sahel 50	91-	FA116			N/A								
Urka 50	91-	FA047		FA047R	N/A								

\*-2 Sets Required. ■ - Also available in MX-S race compound.

**SAFETY WARNING:** DO NOT USE HH PADS ON REAR UNLESS ALSO USED ON FRONT TO AVOID BRAKE IMBALANCE

# Non-JAPANESE Built Motorcycles

**BRAKE APPLICATIONS**

**R** Suffix = High Durability Sintered Pad. **HH** Suffix = High Performance Sintered Pad. **G** Suffix = Grooved Shoe.  
**D** Suffix = Drilled Disc. **C** Suffix = Contoured Disc. **LS** Suffix = Left/Steel Disc. **RS** = Right/Steel Disc.



← REAR / ARRIÈRE / HINTEN POSTERIOR / POSTERIORE →

## FONTA

		DISC PAD CHOICES				BRAKE ROTOR CHOICES			
		NEW SFAC Scooter Carbon Pads	Semi-Sintered V-Pads™	Sintered/HH Pads/ Grooved shoes		Contour Rotor Rear Fitment	NEW Vee-Rotors™ CONTOUR	NEW CX Extreme® ROTOR	
Hawk 50	06	TBA				TBA			
FK 125/17	06	TBA							
FT 125-T	06	TBA							

## FYM/X-SPORT

Mini-X RC 50 F	06	N/A						
CR 90 E	06-07	H338		H338G				
Xtreme CR90E Auto	06	N/A						
110 ES R X-Sport	06-07	SFA115	SFAC115	SFA115HH	N/A			
110 ES	06-07	H338		H338G				
CR 110 X Sport 110	06-07	TBA			N/A			
CR 110	06-07	SFA115	SFAC115	SFA115HH	N/A			
CR 110 ESR	06-07	SFA115	SFAC115	SFA115HH	N/A			
X-Sport 110	06	TBA			N/A			
X-Sport CR3	06	SFA115	SFAC115	SFA115HH	N/A			
X-Sport Sand Blaster	06	TBA			N/A			
CR 125 Sand Bike	06-07	TBA						
CR 125 R	06-07	SFA115	SFAC115	SFA115HH	N/A			
CR 3 125	06-07	SFA115	SFAC115	SFA115HH	N/A			
FYM 125 EY-5 (X Sport CR3/CR125)	06-07	SFA115	SFAC115	SFA115HH	N/A			
X-Sport Typhoon 125 Quad	06-07	SFA115	SFAC115	SFA115HH	N/A			
X-Trail 150	06-07	TBA			N/A			

## GARELLI

Queenie	95-	Y503						
Grinta	95-	Y503						
Capri 50 (DF50QT-7)	06	TBA						
Capri LX 50	06-08	TBA						
Ciclone 50	07	TBA						
Ciclone	08	TBA						
Flexi 50	09-12	TBA						
FLO 50		TBA						
FX 50		Y503						
GSP 50 (2T)	09-12	SFA115	SFAC115			TBA		
KRS 50		S624						
Tiesse 50 (2T)	08-10	Y503						
Tiesse 50 (4T)	08-10	Y503						
VIP 50		TBA						
VIP 50	07	TBA						
VIP 50	08	TBA						
XO 50	09	Y503						
XO 50 (2T/4T - TM50QT-31)	10-12	SFA235	SFAC235		N/A			
XO 50e (Electric)	12	SFA101	SFAC101	SFA101HH	N/A			
Comfort 125	07	TBA						
Freeland 125/150		S624						
Joker 125/150	02	TBA						
Panther 125/150/250	02	TBA						
Skyret 250/400	02	SFA193		SFA193HH	N/A			
Eureka, Gulp		908						
50 Ciclone/KL50 SV				926G				
50 Vip/Noi/Basic spoke wheel		908						
50 Vip/Noi/Basic Alu Wheel		931						
Junior Turismo		909						
Gran Turismo				926G				
50 Tiger XLE	86-	FA099			N/A			
Formuno 50 till chassis no. 2701551	87-	931						
Formuno 50 from chassis no. 2701552	87-	931						
50 Team Matic	88-	931						
Sahel 50	91-	FA115		FA115R	N/A			
Urka 50	91-	N/A						

\*-2 Sets Required. ■ - Also available in MX-S race compound.

**SAFETY WARNING:** DO NOT USE HH PADS ON REAR UNLESS ALSO USED ON FRONT TO AVOID BRAKE IMBALANCE

# Non-JAPANESE Built Motorcycles



← FRONT / AVANT / VORN FRENTE / ANTERIORE →

## GARELLI

Model	Year	DISC PAD CHOICES				BRAKE ROTOR CHOICES							
		NEW SFAC Scooter Carbon Pads	Semi-Sintered V-Pads™	Sintered/HH Pads/ Grooved shoes	Left/Gauche/Links	Right/Droite/Rechts	Contour Rotor Universal left and right fitment	NEW Vee-Rotors™ CONTOUR	NEW CX Extreme® ROTOR	Oversize 250/280mm Rotor Kit	Relocating Bracket for 250/280mm Rotor	Oversize 320mm Rotor Kit	Relocating Bracket for 320mm Rotor
Sahel 80	91-	FA116											
Flexi 125	09-12	SFA235	SFAC235			TBA							
RSX 125	81-			821G									
Strada/Sport 125		NA				N/A							
TSR 125	-83	FA076		FA076HH		N/A							
TSR 125	83-	NA				N/A							
125 XR/RD Tiger	83-	FA047		FA047R		N/A							
125 Tiger XLE	86-	FA256				N/A							
Tiger 125	07	FA197		FA197HH		N/A							
GTA 125	85	FA060*				N/A							
GTA 125	86-	FA060*				N/A							
XO 125i (TM 125 T)	09-12	SFA086	SFAC086*	SFA086HH		N/A							
Fashion 150	07	SFA054	SFAC054	FA054HH		N/A							
Mosquito 150	07	FA086		FA086HH		N/A							
XO 150i (TM 150 T)	09-12	SFA086	SFAC086	SFA086HH		N/A							
XO 200i (TM 200 T)	10-12	SFA086	SFAC086	SFA086HH		N/A							
Trial 320	-85			841G									
Trial 323	86-	FA115		FA115R		N/A							

## GAS-GAS

Cross MC 50	06	FA291				N/A							
EC 50 (Boy)	01-04	FA291				N/A							
EC 50 Boy (Air Cooled)	05	FA115		FA115HH ■		N/A							
EC 50 Boy (LC)	05-07	FA303				N/A							
EC 50 (Rookie)	01-04	FA167		FA167HH		N/A							
EC 50	05	FA194		FA194HH		N/A							
EC 50	06-07	FA115TT		FA115R		N/A							
K1 Quad	06	TBA*											
J50 Quad	06	TBA*											
Quad Wild HP 50	04-07	FA181TT*		FA181R ■		N/A							
SM 50 (Rookie)	01-04	FA167		FA167HH		N/A							
SM 50	05	FA194		FA194HH		N/A							
TXT 50 (Boy)	01	FA291				N/A							
TXT 50 (Boy)	04-10/13	FA115TT		FA115R ■		N/A							
TXT 50 (Rookie)	02-03	FA291				N/A							
TXT 50 (Rookie)	04-08	FA303				N/A							
TXT 50 (Cadet)	06-09	FA115TT		FA115R ■		N/A							
Cross MC 65	06	FA351				N/A							
MX 65 (MC)	05-08	FA351				N/A							
TXT 80 (Rookie)	02-03	FA291				N/A							
TXT 80 (Rookie)	04-09	FA303				N/A							
TXT 80 Cadet	06	FA351				N/A							
TXT 80 Cadet	07-09	FA303				N/A							
Enduro EC 125/200/250/300 (Brembo)	97-99	FA181TT		FA181R ■		N/A							
EC 125/200/250/300 (Nissin/2T)	00-08	FA185TT		FA185R ■	MD6289D		MD6289C						
EC 125/200/250/300 (Nissin/2T)	09-10	FA185TT		FA185R ■	MD6289D		MD6289C						
EC 125/200/250/300 (All Models/2T)	11-13	FA185TT		FA185R ■			MD6289C						
JTX 125/200/270/320	95-98	FA115TT		FA115R ■		N/A							
MX 125/250 (MC)	01-08	FA185TT		FA185R ■	MD6289D								
MX 125/250 (MC)	09-11	FA185TT		FA185R ■	MD6289D								
Pampera 125/250/370	96-97	FA115TT		FA115R ■		N/A							
Pampera 125/250/280	04	FA194		FA194HH		N/A							
Pampera 125 (2T)	05-08	FA194		FA194HH		TBA							
SM 125 (2T) Supermotard	03-06	FA095		FA095HH	MD6209D								
SM Halley 125cc	09	FA095		FA095HH		N/A							
Trail Halley 125cc	09	FA185TT		FA185R ■		N/A							
TX 125 Randomne (4T)	11/13	FA303				N/A							
TXT 125/200/249/280/321	00-03	FA291				N/A							
TXT 125/200/250/280/300 (TXT Pro)	04-11	FA303				N/A							
TXT 125/250/280/300 (For All models with AJP caliper/ 2 pin pad fixing)	12-13	FA303				N/A							

\*-2 Sets Required. ■ - Also available in MX-S race compound.

**SAFETY WARNING:** DO NOT USE HH PADS ON REAR UNLESS ALSO USED ON FRONT TO AVOID BRAKE IMBALANCE

APPLICATIONS  
BRAKE

R Suffix = High Durability Sintered Pad. HH Suffix = High Performance Sintered Pad. G Suffix = Grooved Shoe.

D Suffix = Drilled Disc. C Suffix = Contoured Disc. LS Suffix = Left/Steel Disc. RS = Right/Steel Disc.



# Non-JAPANESE Built Motorcycles

**BRAKE APPLICATIONS**



## GARELLI



← REAR / ARRIÈRE / HINTEN POSTERIOR / POSTERIORE →

			DISC PAD CHOICES			BRAKE ROTOR CHOICES		
			NEW SFAC Scooter Carbon Pads	Semi-Sintered V-Pads™	Sintered/HH Pads/ Grooved shoes	Contour Rotor Rear Fitment	NEW Vee-Rotors™ CONTOUR	NEW CX Extreme® ROTOR
Sahel 80	91-	FA115			FA115R	N/A		
Flexi 125	09-12	TBA						
RSX 125	81-				821G			
Strada/Sport 125		921						
TSR 125	-83	921						
TSR 125	83-	921						
125 XR/XRD Tiger	83-	952						
125 Tiger XLE	86-	FA060				N/A		
Tiger 125	07	FA197			FA197HH	N/A		
GTA 125	85	983						
GTA 125	86-	FA060				N/A		
XO 125i (TM 125 T)	09-12	SFA101	SFAC101		SFA101HH	N/A		
Fashion 150	07	TBA						
Mosquito 150	07	TBA						
XO 150i (TM 150 T)	09-12	SFA101	SFAC101		SFA101HH	N/A		
XO 200i (TM 200 T)	10-12	SFA101	SFAC101		SFA101HH	N/A		
Trial 320	-85				841G			
Trial 323	86-				930G			
<b>GAS-GAS</b>								
Cross MC 50	06	FA351				N/A		
EC 50 (Boy)	01-04	FA291				N/A		
EC 50 Boy (Air Cooled)	05	FA351				N/A		
EC 50 Boy (LC)	05-07	FA351				N/A		
EC 50 (Rookie)	01-04	FA291				N/A		
EC 50	05	FA291				N/A		
EC 50	06-07	FA351				N/A		
K1 Quad	06	TBA						
J50 Quad	06	FA115TT			FA115R	N/A		
Quad Wild HP 50	04-07	FA181TT			FA181R ■	N/A		
SM 50 (Rookie)	01-04	FA291				N/A		
SM 50	05	FA291				N/A		
TXT 50 (Boy)	01	FA291				N/A		
TXT 50 (Boy)	04-10/13	FA115TT			FA115R ■	N/A		
TXT 50 (Rookie)	02-03	FA291				N/A		
TXT 50 (Rookie)	04-08	FA351				N/A		
TXT 50 (Cadet)	06-09	FA351				N/A		
Cross MC 65	06	FA351				N/A		
MX 65 (MC)	05-08	FA115				N/A		
TXT 80 (Rookie)	02-03	FA291				N/A		
TXT 80 (Rookie)	04-09	FA351				N/A		
TXT 80 Cadet	06	FA351				N/A		
TXT 80 Cadet	07-09	FA351				N/A		
Enduro EC 125/200/250/300 (Brembo)	97-99	FA208TT			FA208R ■	MD6253D		
EC 125/200/250/300 (Nissin/2T)	00-08	FA131TT			FA131R ■	MD6253D	MD6253C	
EC 125/200/250/300 (Nissin/2T)	09-10	FA367TT			FA367R ■	MD6253D	MD6253C	
EC 125/200/250/300 (All Models/2T)	11-13	FA367TT			FA367R ■		MD6253C	
JTX 125/200/270/320	95-98	FA115TT			FA115R ■	N/A		
MX 125/250 (MC)	01-08	FA131TT			FA131R ■	MD6253D		
MX 125/250 (MC)	09-11	FA367TT			FA367R ■	MD6253D		
Pampera 125/250/370	96-97	FA115TT			FA115R ■	N/A		
Pampera 125/250/280	04	FA291				N/A		
Pampera 125 (2T)	05-08	FA131TT			FA131R ■	TBA		
SM 125 (2T) Supermotard	03-06	FA131TT			FA131R ■	MD6253D		
SM Halley 125cc	09	FA131TT			FA131R ■	N/A		
Trail Halley 125cc	09	FA131TT			FA131R ■	N/A		
TX 125 Plandonne (4T)	11/13	FA351				N/A		
TXT 125/200/249/280/321	00-03	FA291				N/A		
TXT 125/200/250/280/300 (TXT Pro)	04-11	FA351				N/A		
TXT 125/250/280/300 (For All models with AJP caliper/ 2 pin pad fixing)	12-13	FA351				N/A		

\*-2 Sets Required. ■ - Also available in MX-S race compound.

**SAFETY WARNING:** DO NOT USE HH PADS ON REAR UNLESS ALSO USED ON FRONT TO AVOID BRAKE IMBALANCE

**R** Suffix = High Durability Sintered Pad. **HH** Suffix = High Performance Sintered Pad. **G** Suffix = Grooved Shoe.  
**D** Suffix = Drilled Disc. **C** Suffix = Contoured Disc. **LS** Suffix = Left/Steel Disc. **RS** = Right/Steel Disc.

# Non-JAPANESE Built Motorcycles



← FRONT / AVANT / VORN FRENTE / ANTERIORE →

## GAS-GAS

### DISC PAD CHOICES

### BRAKE ROTOR CHOICES

Model	Year	Left/Right	NEW SFAC Scooter Carbon Pads	Sintered/HH Pads/Grooved shoes	Left/Gauche/Links	Right/Droite/Rechts	Contour Rotor Universal left and right fitment	NEW Vee-Rotors™	NEW CX Extreme® ROTOR	Oversize 250/280mm Rotor Kit	Relocating Bracket for 250/280mm Rotor	Oversize 320mm Rotor Kit	Relocating Bracket for 320mm Rotor
TXT 125/250/280/300 (For All models with Formula caliper/ 1 pin pad fixing)	12-13		FA612T	FA612R	N/A								
MX 200/250/300	99-00		FA185TT	FA185R ■	N/A								
TX 200/270/320	98		FA115TT	FA115R ■	N/A								
TXT 200/270/321	99		FA291		N/A								
Contact JT25 (238cc)	93-94		FA115TT	FA115R ■	N/A								
EC 250 F (4T)	12-13		FA185TT	FA185R ■			N/A						
Quad HP 240	04-06		FA181TT*	FA181R* ■	N/A								
KS 250 RV Quad		Left	06	FA135TT	FA135R	N/A							
		Right		FA165TT	FA165R		N/A						
Pampera 250/320	98-99		FA115TT	FA115R ■	N/A	N/A							
Pampera 250	02-03		FA194	FA194HH	N/A								
EC 300 F (4T)	13		FA185TT	FA185R ■			N/A						
Quad HP 300 RV	03-06		FA181TT*	FA181R* ■	N/A	N/A							
Pampera 400	06		FA181TT	FA181R ■	N/A								
SM 400 FSE (2T)	01-02		FA095	FA095HH	MD6209D								
EC 450 FSR (4T) Enduro/FSE	05-09		FA185TT	FA185R ■	MD6289D								
EC 450 F (4T)	13		FA185TT	FA185R ■			N/A						
Pampera 450 (4T)	07-08		FA185TT	FA185R ■	MD6289D								
SM 450 FSR (4T) Supermotard	07-09		FA095	FA095HH	MD6209D								
SM Halley 450cc	09		FA185TT	FA185R ■	N/A								
Trail Halley 450cc	09		FA185TT	FA185R ■	N/A								
Wild HP 450 Quad	04-09		FA181TT*	FA181R* ■	TBA	TBA							
EC 515 FSR/FSE (4T) Enduro	05-09		FA185TT	FA185R ■	MD6289D								
SM 515 FSR (4T) Supermotard	07-09		FA095	FA095HH	MD6209D								
Wild HP 515cc Quad	09		FA181TT	FA181R ■	N/A	N/A							

## GENERIC

Cracker 50 (2T/4T)	09-13		SFA235	SFAC235	MD923D		MD923C	VR923					
50 GT Race Explorer	09		SFA235	SFAC235	MD971D		MD971C	VR971					
Epico 50 (2T)	10-13		SFA235	SFAC235	TBA								
Epico Electric	12-13		SFA235	SFAC235	TBA								
Ideo 50	05-13		SFA235	SFAC235	MD923D		MD923C	VR923					
Mini Trigger SM 50	08-09		FA448		N/A								
Mini Trigger X 50	08-09		FA448		N/A								
Jump 50 (2T)	12-13		SFA083	SFAC083	SFA083HH	TBA							
Onyx 50 (2T/4T)	10-13		SFA193	SFAC193	SFA193HH	TBA							
Race 2 50 (2T/4T)	10-13		SFA235	SFAC235	TBA								
Roc 50	08-11		SFA235	SFAC235		MD923D	MD923C	VR923					
Simon 50 (2T/4T)	12-13		SFA235	SFAC235			MD923C	VR923					
Toxic 50	07-08		FA194		FA194HH	N/A							
Toxic 50 Sport (2T)	12		SFA235	SFAC235		TBA							
Trigger SM50 (All Models)	06-13		FA194		FA194HH	TBA							
Trigger X50 (All Models)	06-13		FA194		FA194HH	TBA							
Vendetta 50 (2T)	12-13		SFA264	SFAC264	SFA264HH	TBA							
Vertigo 50 (4T)	12-13		SFA086	SFAC086		N/A							
XOR 50 (2T)	05-13		SFA235	SFAC235		MD923D	MD923C	VR923					
Inox 125 (4T)	12-13		SFA228	SFAC228	SFA228HH		N/A						
Code S 125/150/200 (4T)	12-13		FA244		FA244HH		N/A						
Code X 125/150/200 (4T)	12-13		FA244		FA244HH		N/A						
Race 2 125 (4T)	10-13		SFA235	SFAC235		TBA							
Simon 125 (4T)	12-13		SFA235	SFAC235			MD923C	VR923					
Soho 125/150	06-13		SFA235	SFAC235		TBA							
TR 125 SM (4T)	12-13		FA228		FA228HH		N/A						
Trigger 125 SM	08-09		FA194		FA194HH	N/A							
Trigger 125 X	08-09		FA194		FA194HH	N/A							
Wox 125/150 (4T)	12-13		FA197		FA197HH		N/A						
XOR 125	05-11		SFA235	SFAC235		MD923D	MD923C	VR923					
Zion 125/150 (Rear Drum Model)	08-10		SFA228	SFAC228	SFA228HH	N/A							
Zion 125/150 (Rear Disc Model)	11-13		SFA228	SFAC228	SFA228HH	N/A							
Urano 275 Quad	07-08		TBA*		N/A	N/A							

\*-2 Sets Required. ■ - Also available in MX-S race compound.

**SAFETY WARNING:** DO NOT USE HH PADS ON REAR UNLESS ALSO USED ON FRONT TO AVOID BRAKE IMBALANCE

# Non-JAPANESE Built Motorcycles

**BRAKE APPLICATIONS**

**R** Suffix = High Durability Sintered Pad. **HH** Suffix = High Performance Sintered Pad. **G** Suffix = Grooved Shoe.  
**D** Suffix = Drilled Disc. **C** Suffix = Contoured Disc. **LS** Suffix = Left/Steel Disc. **RS** = Right/Steel Disc.



## GAS-GAS



← REAR / ARRIÈRE / HINTEN POSTERIOR / POSTERIORE →

		DISC PAD CHOICES				BRAKE ROTOR CHOICES			
		NEW SFAC Scooter Carbon Pads	Semi-Sintered V-Pads™	Sintered/HH Pads/ Grooved shoes	Contour Rotor Rear Fitment	NEW Vee-Rotors™ CONTOUR	NEW CX Extreme® ROTOR		
TXT 125/250/280/300 (For All models with Formula caliper/ 1 pin pad fixing)	12-13	FA351				N/A			
NX 200/250/300	99-00	FA131TT		FA131R ■	MD6253D				
TX 200/270/320	98	FA115TT		FA115R ■	N/A				
TXT 200/270/321	99	FA291			N/A				
Contact JT25 (238cc)	93-94	FA115TT		FA115R ■	N/A				
EC 250 F (4T)	12-13	FA367TT		FA367R ■		NA			
Quad HP 240	04-06	FA181TT		FA181R ■	N/A				
KS 250 RV Quad	06	TBA							
Pampera 250/320	98-99	FA115TT		FA115R ■	N/A				
Pampera 250	02-03	FA291			N/A				
EC 300 F (4T)	13	FA367TT		FA367R ■		NA			
Quad HP 300 RV	03-06	FA181TT		FA181R ■	N/A				
Pampera 400	06	FA131TT		FA131R ■	N/A				
SM 400 FSE (2T)	01-02	FA131TT		FA131R ■	MD6253D				
EC 450 FSR (4T) Enduro/FSE	05-09	FA131TT		FA131R ■	TBA				
EC 450 F (4T)	13	FA367TT		FA367R ■		NA			
Pampera 450 (4T)	07-08	FA131TT		FA131R ■	TBA				
SM 450 FSR (4T) Supermotard	07-09	FA131TT		FA131R ■	MD6253D				
SM Halley 450cc	09	FA131TT		FA131R ■	N/A				
Trail Halley 450cc	09	FA131TT		FA131R ■	N/A				
Wild HP 450 Quad	04-09	FA181TT		FA181R ■	TBA				
EC 515 FSR/FSE (4T) Enduro	05-09	FA131TT		FA131R ■	TBA				
SM 515 FSR (4T) Supermotard	07-09	FA131TT		FA131R ■	MD6253D				
Wild HP 515cc Quad	09	FA181TT		FA181R ■	N/A				
<b>GENERIC</b>									
Cracker 50 (2T/4T)	09-13	Y503							
50 GT Race Explorer	09	Y503							
Epico 50 (2T)	10-13	Y503							
Epico Electric	12-13	Y503							
Ideo 50	05-13	Y503							
Mini Trigger SM 50	08-09	FA448			N/A				
Mini Trigger X 50	08-09	FA448			N/A				
Jump 50 (2T)	12-13	Y503							
Onyx 50 (2T/4T)	10-13	Y503							
Race 2 50 (2T/4T)	10-13	Y503							
Roc 50	08-11	Y503							
Sinon 50 (2T/4T)	12-13	Y503							
Toxic 50	07-08	FA060			N/A				
Toxic 50 Sport (2T)	12	Y503			N/A				
Trigger SM50 (All Models)	06-13	FA060			TBA				
Trigger X50 (All Models)	06-13	FA060			TBA				
Vendetta 50 (2T)	12-13	Y503							
Vertigo 50 (4T)	12-13	Y503							
XOR 50 (2T)	05-13	Y503							
Inox 125 (4T)	12-13	TBA							
Code S 125/150/200 (4T)	12-13	FA298		FA298HH		NA			
Code X 125/150/200 (4T)	12-13	FA298		FA298HH		NA			
Race 2 125 (4T)	10-13	Y503							
Sinon 125 (4T)	12-13	Y503							
Soho 125/150	06-13	Y527							
TR 125 SM (4T)	12-13	FA298		SFA298HH		NA			
Trigger 125 SM	08-09	FA060			N/A				
Trigger 125 X	08-09	FA060			N/A				
Worx 125/150 (4T)	12-13			TBA					
XOR 125	05-11	Y527							
Zion 125/150 (Rear Drum Model)	08-10	Y527							
Zion 125/150 (Rear Disc Model)	11-13	TBA			N/A				
Urano 275 Quad	07-08	TBA			TBA				

\*-2 Sets Required. ■ - Also available in MX-S race compound.

**SAFETY WARNING:** DO NOT USE HH PADS ON REAR UNLESS ALSO USED ON FRONT TO AVOID BRAKE IMBALANCE

# Non-JAPANESE Built Motorcycles



← FRONT / AVANT / VORN FRENTE / ANTERIORE →

## GILERA

### DISC PAD CHOICES

### BRAKE ROTOR CHOICES

			NEW SFAC Scooter Carbon Pads	Semi-Sintered V-Pads™	Sintered/HH Pads/ Grooved shoes	Left/Gauche/Links	Right/Droite/Rechts	Contour Rotor Universal left and right fitment	NEW Vee-Rotors™ CONTOUR	NEW CX Extreme® ROTOR	Oversize 250/280mm Rotor Kit	Relocating Bracket for 250/280mm Rotor	Oversize 320mm Rotor Kit	Relocating Bracket for 320mm Rotor
Built 50	90-	FA099				N/A								
CBA 50		908												
ec1 50		908												
ECO 50		908												
503 50cc	91-	FA099				N/A								
50 CBA/ECO/EC 1		908												
50 GR 2		922												
50 GSA/Vale		909												
50 Rally	87-	FA047/2				N/A								
SMT 50 Supermotard	03-06	FA115			FA115HH	N/A								
R1/50	90-	FA047/2				N/A								
50 RC Top Rally	90-	FA173				N/A								
50 Trend	89-	909												
50 Trial/Enduro		909												
DNA 50 (Grimeca Caliper)	01-06	SFA194	SFAC194		SFA194HH	MD944D			VR944					
DNA 50 (Heng Tong Caliper)	01-05	SFA353	SFAC353		SFA353HH	MD944D			VR944					
Eaglet 50	96	FA099				N/A								
Easy Moving 50	95-96	SFA193	SFAC193		SFA193HH	MD904D		MD904C	VR904					
GSM 50	00-03	FA115			FA115HH	N/A								
H@K 50	00-02	FA115			FA115HH	N/A								
Zulu 50	01-02	FA115			FA115HH	N/A								
Ice 50cc	01-02	SFA193	SFAC193		SFA193HH	MD910D		MD910C	VR910					
Runner 50 (5 Bolt Fixing On Front Disc)	98	SFA193	SFAC193		SFA193HH	MD924D		MD924C	VR924					
Runner/Purejet 50 DD/SP (5 Bolt Fixing On Front Disc)	99-05	SFA193	SFAC193		SFA193HH	MD924D		MD924C	VR924					
Runner 50 P/JSP (6 Bolt Fixing On Front Disc)	06-13	SFA353	SFAC353		SFA353HH	MD956D			VR956					
Stalker 50 (Rear disc models) (Grimeca calipers)	97-06	SFA193	SFAC193		SFA193HH	MD9126D								
Stalker 50 (Rear drum model) (Grimeca calipers)	97-06	SFA193	SFAC193		SFA193HH	MD9126D								
Stalker 50 (Rear disc model) (Heng Tong caliper)	03-06	SFA083/2			SFA083/2HH	MD9126D								
Stalker 50 (Rear drum model) (Heng Tong caliper)	03-11	SFA083/2			SFA083/2HH	MD9126D								
RCR 50 Enduro	03-06	FA115			FA115HH	N/A								
RK 50 Cannibal	96-98	FA115			FA115HH	N/A								
RV 50 NGR	88	FA060*				N/A	NA							
SKP 50	98	SFA193	SFAC193		SFA193HH	MD943D		MD943C	VR943					
SKP 50	99-01	SFA193	SFAC193		SFA193HH	MD943D		MD943C	VR943					
SMT 50 Supermotard	03-06	FA115			FA115HH	N/A								
SMT 50	07	FA115			FA115HH	N/A								
Storm 50	94-95	SFA193	SFAC193		SFA193HH	MD943D		MD943C	VR943					
Typhoon 50, All models	93-95	SFA193	SFAC193		SFA193HH	MD901D		MD901C	VR901					
Typhoon 50	96-	SFA193	SFAC193		SFA193HH	MD901D		MD901C	VR901					
80 TG 1/2/3		FA076			FA076HH									
98 Giubileo					821G									
124 Giubileo					821G									
125 Apache	91-	FA134			FA134R	N/A								
125 Arcore					843WG									
125 CX	91-	FA126			FA126R	N/A								
125 GR 1		FA076			FA076HH	N/A								
125 E 1/E 1 Competition					841G									
125 TG 1/2/3		FA076			FA076HH									
125 HX LC	83-	FA047			FA047R	N/A								
125 RX	84-	FA047			FA047R	N/A								
125 MX1/MXR	89-	FA126			FA126R	N/A								
125 SP 01/SP 02	89-	FA126			FA126R	N/A								
125 XR1/XR2	89-	FA256			FA256HH	N/A								
DNA 125/180	01-03	SFA194	SFAC194		SFA194HH	MD944D			VR944					
DNA 125/180 (Heng Tong Caliper)	01-03	SFA353	SFAC353		SFA353HH	MD944D			VR944					
FX/FR 125/180 Runner (Rear drum brake model/Grimeca front caliper)	97-02	SFA194	SFAC194		SFA194HH	MD924D		MD924C	VR924					
FX/FR 125/180 Runner (Rear drum brake model/Heng Tong front caliper)	97-02	SFA353	SFAC353		SFA353HH	MD924D		MD924C	VR924					
GFR 125	94	FA126			FA126HH	N/A								
Nexus 125	07-12	SFA353	SFAC353		SFA353HH	MD983D			VR983					
RC 125 Rally	87-88	FA256			FA256HH	N/A								

\*-2 Sets Required. ■ - Also available in MX-S race compound.

**SAFETY WARNING:** DO NOT USE HH PADS ON REAR UNLESS ALSO USED ON FRONT TO AVOID BRAKE IMBALANCE

APPLICATIONS  
BRAKE

R Suffix = High Durability Sintered Pad. HH Suffix = High Performance Sintered Pad. G Suffix = Grooved Shoe.

D Suffix = Drilled Disc. C Suffix = Contoured Disc. LS Suffix = Left/Steel Disc. RS = Right/Steel Disc.

# Non-JAPANESE Built Motorcycles

**BRAKE APPLICATIONS**

**R** Suffix = High Durability Sintered Pad. **HH** Suffix = High Performance Sintered Pad. **G** Suffix = Grooved Shoe.  
**D** Suffix = Drilled Disc. **C** Suffix = Contoured Disc. **LS** Suffix = Left/Steel Disc. **RS** = Right/Steel Disc.



## GILERA



← REAR / ARRIÈRE / HINTEN POSTERIOR / POSTERIORE →

		DISC PAD CHOICES				BRAKE ROTOR CHOICES			
		NEW SFAC Scooter Carbon Pads	Semi-Sintered V-Pads™	Sintered/HH Pads/ Grooved shoes		Contour Rotor Rear Fitment	NEW Vee-Rotors™ CONTOUR	NEW CX Extreme® ROTOR	
Built 50	90-								
CBA 50									
ec1 50									
ECO 50									
503 50cc	91-	FA099				N/A			
50 CBA/ECO/EC 1		907							
50 GR 2		923							
50 GSA/Vale		924							
50 Rally	87-	845							
SMT 50 Supermotard	03-06	FA115		FA115HH	MD6248D				
R1.50	90-	N/A							
50 RC Top Rally	90-	FA173				N/A			
50 Trend	89-	909							
50 Trial/Enduro		909							
DNA 50 (Grimeca Caliper)	01-06	SFA260	SFAC260	SFA260HH	MD910D		VR910		
DNA 50 (Heng Tong Caliper)	01-05	SFA260	SFAC260		MD910D		VR910		
Eaglet 50	96	FA382				N/A			
Easy Moving 50	95-96	806							
GSM 50	00-03	FA115		FA115HH	N/A				
H@K 50	00-02	FA115		FA115HH	N/A				
Zulu 50	01-02	FA115		FA115HH	N/A				
Ice 50cc	01-02	899							
Runner 50 (5 Bolt Fixing On Front Disc)	98	899							
Runner/Purejet 50 DD/SP (5 Bolt Fixing On Front Disc)	99-05	SFA260	SFAC260	SFA260HH	MD932D	MD932C	VR932		
Runner 50 P/J/SP (6 Bolt Fixing On Front Disc)	06-13	SFA260	SFAC260	SFA260HH	MD932D		VR932		
Stalker 50 (Rear disc models) (Grimeca calipers)	97-06	SFA260	SFAC260	SFA260HH	MD932D				
Stalker 50 (Rear drum model) (Grimeca calipers)	97-06	899							
Stalker 50 (Rear disc model) (Heng Tong caliper)	03-06	SFA260		SFA260HH	MD932D				
Stalker 50 (Rear drum model) (Heng Tong caliper)	03-11	899							
RCR 50 Enduro	03-06	FA115		FA115HH	MD6248D				
RK 50 Cannibal	96-98	FA115		FA115HH	N/A				
RV 50 NGR	88	FA047				N/A			
SKP 50	98	899							
SKP 50	99-01	SFA260	SFAC260	SFA260HH	MD932D	MD932C	VR932		
SMT 50 Supermotard	03-06	FA115		FA115HH	MD6248D				
SMT 50	07	FA115		FA115HH	MD6248D				
Storm 50	94-95	806							
Typhoon 50, All models	93-95	886							
Typhoon 50	96-	806							
80 TG 1/2/3		843							
98 Giubileo		922							
124 Giubileo		922							
125 Apache	91-	FA101TT		FA101R	N/A				
125 Arcore		922							
125 CX	91-	FA047		FA047R	N/A				
125 GR 1		843							
125 E 1/E 1 Competition				843G					
125 TG 1/2/3		921							
125 HX LC	83-	952							
125 RX	84-	954							
125 MX1/MXR	89-	FA047		FA047R	N/A				
125 SP 01/SP 02	89-	FA047		FA047R	N/A				
125 XR1/XR2	89-	FA047			N/A				
DNA 125/180	01-03	SFA321 ★	SFAC321	SFA321HH	MD944D		VR944		
DNA 125/180 (Heng Tong Caliper)	01-03	SFA321 ★	SFAC321	SFA321HH	MD944D		VR944		
FX/FR 125/180 Runner (Rear drum brake model/Grimeca front caliper)	97-02	816							
FX/FR 125/180 Runner (Rear drum brake model/Heng Tong front caliper)	97-02	816							
GFR 125	94	FA047		FA047HH	N/A				
Nexus 125	07-12	SFA353	SFAC353	SFA353HH	MD960D		VR960		
RC 125 Rally	87-88	954							

\*-2 Sets Required. ■ - Also available in MX-S race compound.

**SAFETY WARNING:** DO NOT USE HH PADS ON REAR UNLESS ALSO USED ON FRONT TO AVOID BRAKE IMBALANCE



# Non-JAPANESE Built Motorcycles



← FRONT / AVANT / VORN FRENTE / ANTERIORE →

## DISC PAD CHOICES

## BRAKE ROTOR CHOICES

GILERA	Year	Model	DISC PAD CHOICES		Left/Gauche/Links		Right/Droite/Rechts		BRAKE ROTOR CHOICES		Relocating Bracket for 250/280mm Rotor	Oversize 320mm Rotor Kit	Relocating Bracket for 320mm Rotor
			NEW SFAC Scooter Carbon Pads	Semi-Sintered V-Pads™	Sintered/HH Pads/ Grooved shoes	Contour Rotor Universal left and right fitment	NEW Vee-Rotors™ CONTOUR	NEW CX Extreme® ROTOR	Oversize 250/280mm Rotor Kit				
RC 125 Top Rally	89-92	FA134			FA134R	N/A							
RV 125	88	N/A				N/A							
RX 125 Arizona	88	FA047			FA047R	N/A							
Coguar 125	99-02	FA256			FA256HH	MD983D			VR983				
Runner 125/180 FX/FXR/SP 2 stroke (Grimeca caliper)	99-02	SFA194	SFAC194		SFA194HH	MD924D		MD924C	VR924				
Runner 125/180 FX/FXR/SP 2 stroke (Heng Tong caliper)	99-02	SFA353	SFAC353		SFA353HH	MD924D		MD924C	VR924				
SC 125	06-07	FA399				MD688LS							
Typhoon 125	95-98	SFA193	SFAC193		SFA193HH	MD9126D							
Typhoon 125 X-XR	99-00	SFA193	SFAC193		SFA193HH	MD9126D							
125 VX4T/180 VXR4T Runner 4 stroke (Grimeca Caliper)	01-04	SFA194	SFAC194		SFA194HH	MD924D		MD924C	VR924				
125 VX4T/180 VXR4T Runner 4 stroke (Heng Tong Caliper)	01-04	SFA353	SFAC353		SFA353HH	MD924D		MD924C	VR924				
VX 125 Runner/ST (4T)	05-11	SFA353	SFAC353		SFA353HH	MD9112D			VR9112				
150 Aircore		925											
RX 200/Arizona/Enduro	85-	FA047			FA047R	N/A							
200 Arizona Hawk	85-	FA256			FA256HH	N/A							
200 RTX	85-	FA256			FA256HH	N/A							
200 T4/T4 C/T4 S		FA076			FA076HH	N/A							
200 ER	87-	FA256			FA256HH	N/A							
200 Fast Bike	87-	FA256			FA256HH	N/A							
RV 200	85-86	N/A				N/A							
RV 200 ES	87-	FA256			FA256HH	N/A							
VXR 200 Runner (4T) (6 bolt rear disc) Heng Tong caliper	02-04	SFA353	SFAC353		SFA353HH	MD924D		MD924C	VR924				
VXR 200 Runner (4T) (6 bolt rear disc) Grimeca caliper	02-04	SFA194	SFAC194		SFA194HH	MD924D		MD924C	VR924				
VX 200 Runner/ST (4T) (6 bolt rear disc) Heng Tong caliper	05-11	SFA353	SFAC353		SFA353HH	MD9112D			VR9112				
HX 250 LC	83-	FA047			FA047R	N/A							
Nexus 250 ie	07	SFA353	SFAC353		SFA353HH	MD961D			VR961				
NGR 250	85-	FA080*				N/A	N/A						
250 RX Arizona Rally	86-	FA047			FA047R	N/A							
Oregon 250 Quad	07	FA101TT*			FA101R*	TBA	TBA						
RC 250 Rally	87-88	FA256			FA256HH	N/A							
Nexus 300i	08-12	SFA353	SFAC353		SFA353HH	MD983D			VR983				
350 Dakota	85-	FA256			FA256HH	N/A							
ER 350	87-	FA256			FA256HH	N/A							
Satumo 350 Bialbero	90-	FA095			FA095HH	N/A							
XRT 350	90-	FA256			FA256HH	N/A							
Nord-West 350	94-	FA163				N/A							
Nord-West 350	94-	FA126*			FA126R*	N/A	N/A						
500 Dakota	87-	FA256			FA256HH	N/A							
ER 500	87-	FA256			FA256HH	N/A							
Fuoco 500 RC/ie	07-13	SFA260*	SFAC260*		SFA260HH*	MD9112D	MD9112D		VR9112*				
Fuoco 500 RC/ie Parking brake	07-13	SFA257/2											
Satumo 500 S/Bialbero/Piuma	90-	FA095			FA095HH	N/A							
Nordwest	94-96	FA126			FA126HH	N/A							
Nexus 500	03-12	SFA181*	SFAC181*		SFA181HH*	MD983D	MD983D		VR983*				
Nexus 500 SP	06-07	SFA181*	SFAC181*		SFA181HH*	MD983D	MD983D		VR983*				
RC 600	89-90	FA134				N/A							
R 600	91-92	FA134				N/A							
RC 600 Cobra	91-93	FA134				N/A							
XRT 600	88-	FA256			FA256HH	N/A							
GP 800 (Chain drive)	08-12	SFA181*	SFAC181*		SFA181HH*	MD9125D	MD9125D						
GP 800 (Chain drive) Parking brake	08-12	SFA257/2											
NOTE ★ See SFA459 if rear pad SFA321 is incorrect shape													
<b>GOCCIA (Electric Scooters)</b>													
E-Gora (Li/Si)	12-13	SFA086	SFAC086		SFA086HH		N/A						
Sunday (LA/Li)	12-13	SFA151	SFAC151			N/A							

\*-2 Sets Required. ■ - Also available in MX-S race compound.

**SAFETY WARNING:** DO NOT USE HH PADS ON REAR UNLESS ALSO USED ON FRONT TO AVOID BRAKE IMBALANCE

APPLICATIONS  
BRAKE

R Suffix = High Durability Sintered Pad. HH Suffix = High Performance Sintered Pad. G Suffix = Grooved Shoe.  
D Suffix = Drilled Disc. C Suffix = Contoured Disc. LS Suffix = Left/Steel Disc. RS = Right/Steel Disc.

# Non-JAPANESE Built Motorcycles



## GILERA



← REAR / ARRIÈRE / HINTEN POSTERIOR / POSTERIORE →

			DISC PAD CHOICES			BRAKE ROTOR CHOICES			
			NEW SFAC Scooter Carbon Pads	Semi-Sintered V-Pads™	Sintered/HH Pads/ Grooved shoes	Contour Rotor Rear Fitment	NEW Vee-Rotors™ CONTOUR	NEW CX Extreme® ROTOR	
RC 125 Top Rally	89-92	FA101TT			FA101R	MD6359D			
RV 125	88	921							
RX 125 Arizona	88	954							
Coguar 125	99-02	921							
Runner 125/180 FX/FXR/SP 2 stroke (Grimeca caliper)	99-02	SFA260	SFAC260		SFA260HH	MD944D		VR944	
Runner 125/180 FX/FXR/SP 2 stroke (Heng Tong caliper)	99-02	SFA260	SFAC260		SFA260HH	MD944D		VR944	
SC 125	06-07	FA115				MD686			
Typhoon 125	95-98	899							
Typhoon 125 X-XR	99-00	899							
125 VX4T/180 VXR4T Runner 4 stroke (Grimeca Caliper)	01-04	SFA321 ★	SFAC321		SFA321HH	MD910D	MD910C		
125 VX4T/180 VXR4T Runner 4 stroke (Heng Tong Caliper)	01-04	SFA321 ★	SFAC321		SFA321HH	MD910D			
VX 125 Runner/ST (4T)	05-11	SFA321 ★	SFAC321		SFA321HH	MD956D		VR956	
150 Arcore					843G				
RX 200/Arizona/Enduro	85-	954							
200 Arizona Hawk	85-	954							
200 RTX	85-	954							
200 T4/T4 C/T4 S		921							
200 ER	87-	954							
200 Fast Bike	87-	FA047				N/A			
RV 200	85-86	FA047				N/A			
RV 200 ES	87-	FA047				N/A			
VXR 200 Runner (4T) (6 bolt rear disc) Heng Tong caliper	02-04	SFA321 ★	SFAC321		SFA321HH	MD956D		VR956	
VXR 200 Runner (4T) (6 bolt rear disc) Grimeca caliper	02-04	SFA321 ★	SFAC321		SFA321HH	MD956D		VR956	
VX 200 Runner/ST (4T) (6 bolt rear disc) Heng Tong caliper	05-11	SFA321 ★	SFAC321		SFA321HH	MD956D		VR956	
HX 250 LC	83-	N/A							
Nexus 250 ie	07	SFA353	SFAC353		SFA353HH	MD960D		VR960	
NGR 250	85-	FA047				N/A			
250 RX Arizona Rally	86-				N/A				
Oregon 250 Quad	07	FA355*			FA355R*	TBA			
RC 250 Rally	87-88	FA047			FA047HH	N/A			
Nexus 300i	08-12	SFA353	SFAC353		SFA353HH	MD960D		VR960	
350 Dakota	85-	987							
ER 350	87-	987							
Saturno 350 Bialbero	90-	FA047			FA047HH	N/A			
XRT 350	90-	FA047			FA047HH	N/A			
Nord-West 350	94-	FA047				N/A			
Nord-West 350	94-								
500 Dakota	87-	987							
ER 500	87-	987							
Fuoco 500 RC/ie	07-13	SFA353	SFAC353		SFA353HH	MD960D		VR960	
Saturno 500 S/Bialbero/Piuma	90-	FA047			FA047R	N/A			
Nordwest	94-96	FA047			FA047HH	N/A			
Nexus 500	03-12	SFA266	SFAC266		SFA266HH	MD960D		VR960	
Nexus 500 SP	06-07	SFA266	SFAC266		SFA266HH	MD960D		VR960	
RC 600	89-90	FA101TT				N/A			
R 600	91-92	FA101TT				N/A			
RC 600 Cobra	91-93	FA101TT				N/A			
XRT 600	88-	FA047			FA047HH	N/A			
GP 800 (Chain drive)	08-12	SFA353	SFAC353		SFA353HH	MD9124D			

## GOCCIA (Electric Scooters)

E-Gora (Li/Si)	12-13	H303							
Sunday (LA/LI)	12-13	H303							

\*-2 Sets Required. ■ - Also available in MX-S race compound.

**SAFETY WARNING:** DO NOT USE HH PADS ON REAR UNLESS ALSO USED ON FRONT TO AVOID BRAKE IMBALANCE

**BRAKE APPLICATIONS**

**R** Suffix = High Durability Sintered Pad. **HH** Suffix = High Performance Sintered Pad. **G** Suffix = Grooved Shoe.  
**D** Suffix = Drilled Disc. **C** Suffix = Contoured Disc. **LS** Suffix = Left/Steel Disc. **RS** = Right/Steel Disc.

# Non-JAPANESE Built Motorcycles



FRONT / AVANT / VORN FRENTE / ANTERIORE



## DISC PAD CHOICES

## BRAKE ROTOR CHOICES

### GOES

			NEW SFAC Scooter Carbon Pads	Semi-Sintered V-Pads™	Sintered/HH Pads/ Grooved shoes	Left/Gauche/Links	Right/Droite/Rechts	Contour Rotor Universal left and right fitment	NEW Vee-Rotors™ CONTOUR	NEW CX Extreme® ROTOR	Oversize 250/280mm Rotor Kit	Relocating Bracket for 250/280mm Rotor	Oversize 320mm Rotor Kit	Relocating Bracket for 320mm Rotor
50 XS (Quad)	05-11	TBA*												
50 S (Quad)	07-11	TBA*												
GS 50 X	08-09	FA167			FA167HH	N/A								
SLAM 50 (Scooter)	10-12	SFA235	SFAC235					N/A						
G 55 R Scooter	08-12	SFA086	SFAC086		SFA086HH	N/A								
G 90 XS	10-13	TBA*												
G 125 M Big Wheel	08-09	FA086			FA086HH	N/A								
G 125 RT Retro (Scooter)	10-12	SFA235	SFAC235					N/A						
G 125 XM	08-09	FA185TT			FA185R ■	N/A								
G 125 X	08-09	FA086			FA086HH	N/A								
SP R 125 (Motorcycle)	10-12	FA086			FA086HH			N/A						
WIKI 125 (Scooter)	10-11	SFA235	SFAC235					N/A						
220 (Quad)	06-08	TBA*			TBA*	N/A	N/A							
G 225 S	12-13	FA083TT*			FA083R*	N/A	N/A							
G 250 XM	08-09	FA185TT			FA185R ■	N/A								
300 S (Quad)	07-08	TBA*				N/A	N/A							
320 Max (Quad)	07-08	TBA*			TBA*	N/A	N/A							
G 350 S (Quad)	08-13	FA083TT*			FA083R*	N/A	N/A							
360 Max (Quad)	08-12	FA453TT*			FA453R*	N/A	N/A							
Parking Brake		TBA												
450 X (Quad)	07-12	TBA*				N/A	N/A							
G 520 (Quad)	07-13	FA453TT*			FA453R*	N/A	N/A							
520 Max (Quad)	07-12	FA453TT*			FA453R*	N/A	N/A							
G 520 UTX (Side x Side)	Left	10-12	FA165TT		FA165R	N/A								
	Right		FA135TT		FA135R		N/A							
G 525 (4 x 4)	12-13	FA453TT*			FA453R*	N/A	N/A							
G 525 Max (4 x 4)	12-13	FA453TT*			FA453R*	N/A	N/A							
G 620 i	11-12	FA453TT*			FA453R*	N/A	N/A							
G 625i (4 x 4)	12-13	FA453TT*			FA453R*	N/A	N/A							
G 625i Max (4 x 4)	12-13	FA453TT*			FA453R*	N/A	N/A							
G 625i Max (4 x 4) UTX 4 x 4 (Side x Side)	12-13	FA453TT*			FA453R*	N/A	N/A							
G E - SSV Electric (Side x Side)	12-13	FA453TT*			FA453R*	N/A	N/A							

### GOVECES (Electric Scooters)

GO S 1.2	11-13	SFA193	SFAC193		SFA193HH			MD901C	VR901					
GO S 1.4	11-13	SFA193	SFAC193		SFA193HH			MD901C	VR901					
GO S 2.4	11-13	SFA193	SFAC193		SFA193HH			MD901C	VR901					
GO S 3.4	11-13	SFA193	SFAC193		SFA193HH			MD901C	VR901					
GOT 1.2	11-13	SFA193	SFAC193		SFA193HH	MD901D		MD901C	VR901					
GOT 2.4	11-13	SFA193	SFAC193		SFA193HH	MD901D		MD901C	VR901					
GOT 3.4	11-13	SFA193	SFAC193		SFA193HH	MD901D		MD901C	VR901					

### HAMMERHEAD BUGGIES

Mini (45cc)	08-09	N/A												
80 T	08-09	N/A												
150 Supersport ES 150 11 R	08-09	FA416TT*			FA416R*	N/A	N/A							

### HARTFORD/HRD

VR-125 Z Velo Sport	00-03	FA228			FA228HH	N/A								
VR-125 XH Velo-Cross	00-03	FA228			FA228HH	N/A								
VR 125/150 HX/Z	04	FA228			FA228HH	N/A								
HD 125 L/150 L	00-04	FA093				N/A								
Cabriolet 125	01	FA167			FA167HH	N/A								

### HERO HONDA

Nipster 50	06	SFA169	SFAC169		SFA169HH	TBA								
CD Dawn (100cc 4T) (Spoke wheel)	08	TBA												
CD Deluxe (100cc 4T) (Cast wheel)	08	TBA												
Passion Plus (100cc 4T) (Cast wheel)	08	TBA												
Passion Plus (100cc 4T) (Spoke wheel)	08	TBA												

\*-2 Sets Required. ■ - Also available in MX-S race compound.

**SAFETY WARNING:** DO NOT USE HH PADS ON REAR UNLESS ALSO USED ON FRONT TO AVOID BRAKE IMBALANCE

# Non-JAPANESE Built Motorcycles



← REAR / ARRIÈRE / HINTEN POSTERIOR / POSTERIORE →

## GOES



			DISC PAD CHOICES			BRAKE ROTOR CHOICES			
			NEW SFAC Scooter Carbon Pads	Semi-Sintered V-Pads™	Sintered/HH Pads/ Grooved shoes	Contour Rotor Rear Fitment	NEW Vee-Rotors™ CONTOUR	NEW CX Extreme® ROTOR	
50 XS (Quad)	05-11	TBA							
50 S (Quad)	07-11	TBA				TBA			
GS 50 X	08-09	FA167			FA167HH	N/A			
SLAM 50 (Scooter)	10-12	TBA							
G 55 R Scooter	08-12	TBA							
G 90 XS	10-13	FA083TT			FA083R	N/A			
G 125 M Big Wheel	08-09	FA197			FA197HH	N/A			
G 125 RT Retro (Scooter)	10-12	TBA				N/A			
G 125 XM	08-09	FA131TT			FA131R ■	N/A			
G 125 X	08-09	FA086			FA086HH	N/A			
SP R 125 (Motorcycle)	10-12	FA197			FA197HH		N/A		
W1KI 125 (Scooter)	10-11	TBA							
220 (Quad)	06-08	TBA			TBA	N/A			
G 225 S	12-13	FA067TT			FA067R	N/A			
G 250 XM	08-09	FA131TT			FA131R ■	N/A			
300 S (Quad)	07-08	TBA				N/A			
320 Max (Quad)	07-08	TBA			TBA	N/A			
G 350 S (Quad)	08-13	FA067TT			FA067R	N/A			
380 Max (Quad)	08-12					N/A			
450 X (Quad)	07-12	TBA				N/A			
G 520 (Quad)	07-13	FA344TT			FA344R	N/A			
520 Max (Quad)	07-12	FA344TT			FA344R	N/A			
G 520 UTX (Side x Side)	10-12	FA344TT			FA344R	N/A			
G 525 (4 x 4)	12-13	FA344TT			FA344R	N/A			
G 525 Max (4 x 4)	12-13	FA344TT			FA344R	N/A			
G 620 i	11-12	FA344TT			FA344R	N/A			
G 625i (4 x 4)	12-13	FA344TT			FA344R	N/A			
G 625i Max (4 x 4)	12-13	FA344TT			FA344R	N/A			
G 625i Max (4 x 4) UTX 4 x 4 (Side x Side)	12-13	FA344TT			FA344R	N/A			
G E - SSV Electric (Side x Side)	12-13	FA344TT			FA344R	N/A			
<b>GOVECES (Electric Scooters)</b>									
GO S 1.2	11-13	SFA083	SFAC083		SFA083HH		TBA		
GO S 1.4	11-13	SFA083	SFAC083		SFA083HH		TBA		
GO S 2.4	11-13	SFA083	SFAC083		SFA083HH		TBA		
GO S 3.4	11-13	SFA083	SFAC083		SFA083HH		TBA		
GO T 1.2	11-13	SFA083	SFAC083		SFA083HH	TBA	TBA		
GO T 2.4	11-13	SFA083	SFAC083		SFA083HH	TBA	TBA		
GO T 3.4	11-13	SFA083	SFAC083		SFA083HH	TBA	TBA		
<b>HAMMERHEAD BUGGIES</b>									
Mini (45cc)	08-09	FA485TT				N/A			
80 T	08-09	FA416TT			FA416R	N/A			
150 Supersport ES 150 11 R	08-09	FA431TT			FA431R	N/A			
<b>HARTFORD/HRD</b>									
VR-125 Z Velo Sport	00-03	H304							
VR-125 X/H Velo-Cross	00-03	H304							
VR 125/150 H/X/Z	04	FA197				N/A			
HD 125 L/150 L	00-04	S602							
Cabriolet 125	01	FA115				N/A			
<b>HERO HONDA</b>									
Nipster 50	06	TBA							
CD Dawn (100cc 4T) (Spoke wheel)	08	TBA							
CD Deluxe (100cc 4T) (Cast wheel)	08	TBA							
Passion Plus (100cc 4T) (Cast wheel)	08	TBA							
Passion Plus (100cc 4T) (Spoke wheel)	08	TBA							

\*-2 Sets Required. ■ - Also available in MX-S race compound.

**SAFETY WARNING:** DO NOT USE HH PADS ON REAR UNLESS ALSO USED ON FRONT TO AVOID BRAKE IMBALANCE

**BRAKE APPLICATIONS**

**R** Suffix = High Durability Sintered Pad. **HH** Suffix = High Performance Sintered Pad. **G** Suffix = Grooved Shoe.  
**D** Suffix = Drilled Disc. **C** Suffix = Contoured Disc. **LS** Suffix = Left/Steel Disc. **RS** = Right/Steel Disc.

# Non-JAPANESE Built Motorcycles



← FRONT / AVANT / VORN FRENTE / ANTERIORE →

## DISC PAD CHOICES

## BRAKE ROTOR CHOICES

### HERO HONDA

			NEW SFAC Scooter Carbon Pads	Semi-Sintered V-Pads™	Sintered/HH Pads/ Grooved shoes	Left/Gauche/Links	Right/Droite/Rechts	Contour Rotor Universal left and right fitment	NEW Vee-Rotors™ CONTOUR	NEW CX Extreme® ROTOR	Oversize 250/280mm Rotor Kit	Relocating Bracket for 250/280mm Rotor	Oversize 320mm Rotor Kit	Relocating Bracket for 320mm Rotor
Splendor NXG (100cc 4T) (Cast wheel)	08	TBA												
Splendor + (100cc 4T) (Front drum model)	08	TBA												
Splendor + (100cc 4T) (Front disc model)	08	TBA					TBA							
Pleasure (102cc 4T)	08	TBA						TBA						
Super Splendor (125cc 4T)	08	TBA						TBA						
Glamour PGM FI (125cc 4T) (Cast wheel)	08	TBA						TBA						
Glamour (125cc 4T) (Cast wheel)	08	TBA						TBA						
Magellan 125	06	FA197			FA197HH			N/A						
Punto 125	06	FA197			FA197HH			N/A						
Quickster 125	06	FA101						TBA						
Slickster 125	06	FA086			FA086HH			N/A						
Achiever (150cc 4T) (Cast Wheel)	08	TBA						TBA						
CBZ X-treme (Cast wheel)	08	TBA						TBA						
Hunk (150cc 4T) (Cast wheel)	08	TBA						TBA						
Karizma (223cc 4T)	08	TBA						TBA						

### HERO

Splendor NXG 100	11-12	H353												
Splendor Pro 100	11-12	H353												
Pleasure 102	11-12	H353												
Glamour 125 (PGM FI)	11-12	TBA						MD1030						
Super Splendor 125	11-12	TBA						MD1030						
Hunk 150	11-12	TBA						MD1030						
Karizma ZMR 230	11-12	FA375			NA									

### HIGHLAND

950 V2 Outback	00-04	FA181TT			FA181R ■		N/A							
950 V2 Motard	00-04	FA181TT			FA181R ■		N/A							

### HONDA DALL-ARA

XR 125 SM	04	FA185TT			FA185R ■		TBA							
XR 250 R	04	FA185TT			FA185R ■		MD6001D		MD6001C		MD6001CX			
XR 250 SM	04	FA185TT			FA185R ■		TBA							
XR 400/440 R	04	FA185TT			FA185R ■		MD6037D		MD6037C		MD6037CX			
XR 400/440 SM	04	FA185TT			FA185R ■		TBA							
XR 650 R	04	FA185TT			FA185R ■		MD6001D		MD6001C		MD6001CX			
XR 650 R	04	FA185TT			FA185R ■		TBA							

### HONDA-HM (ITALY)

Baja 10/10 JR & SR	99-07	FA351						N/A						
Baja 12/14 MX	99-09	FA351						N/A						
CRE 50 Six/Baja/Derapage Brembo caliper twin pin/41mm paioli forks	95-02	FA194			FA194HH			N/A						
① Note choice of 3 different pads on rear caliper - check shape in buyers guide - FA47/101/382														
CRE 50 Six/Baja/Derapage Brembo caliper single pin/Kayaba forks	95-02	FA134			FA134R			N/A						
① Note choice of 3 different pads on rear caliper - check shape in buyers guide - FA47/101/382														
CRE 50 Six/Baja/Derapage Grimeca caliper twin pin/Kayaba forks	95-02	FA166						N/A						
① Note choice of 3 different pads on rear caliper - check shape in buyers guide - FA47/101/382														
CRE 50 Six/Baja/Derapage Grimeca	95-02	FA382						N/A						
① Note choice of 3 different pads on rear caliper - check shape in buyers guide - FA47/101/382														
CRE 50 Six	01-02	FA181TT			FA181R ■			N/A						
CRE 50 Baja/Derapage	01-02	FA181TT			FA181R ■			N/A						
CRE 50 Baja/Six/Derapage	03-09	FA194			FA194HH			N/A						
CRE 50 Six Competition Magura Caliper	10-12				FA462R			N/A						
CRE 50 Baja RR Up to ZEN50XACEA7700324	07-09	FA194			FA194HH			N/A						
CRE 50 Baja RR From ZEN50XACEA7700325	07-09	FA194			FA194HH			N/A						
CRE 50 Baja RR	10-12	FA194			FA194HH			N/A						
CRE 50 Derapage RR Up to ZEN50XACMA7700384	07-09	FA194			FA194HH			N/A						
CRE 50 Derapage RR From ZEN50XACMA7700385	07-09	FA194			FA194HH			N/A						
CRE 50 Six Competition	07-08	FA194			FA194HH			N/A						
CRM 50 Derapage Competition	07-09	FA194			FA194HH			N/A						

\*-2 Sets Required. ■ - Also available in MX-S race compound.

**SAFETY WARNING:** DO NOT USE HH PADS ON REAR UNLESS ALSO USED ON FRONT TO AVOID BRAKE IMBALANCE

APPLICATIONS  
BRAKE

R Suffix = High Durability Sintered Pad. HH Suffix = High Performance Sintered Pad. G Suffix = Grooved Shoe.  
D Suffix = Drilled Disc. C Suffix = Contoured Disc. LS Suffix = Left/Steel Disc. RS = Right/Steel Disc.



# Non-JAPANESE Built Motorcycles

**BRAKE APPLICATIONS**



## HERO HONDA



← REAR / ARRIÈRE / HINTEN POSTERIOR / POSTERIORE →

			DISC PAD CHOICES			BRAKE ROTOR CHOICES		
			NEW SFAC Scooter Carbon Pads	Semi-Sintered V-Pads™	Sintered/HH Pads/ Grooved shoes	Contour Rotor Rear Fitment	NEW Vee-Rotors™ CONTOUR	NEW CX Extreme® ROTOR
Splendor NXG (100cc 4T) (Cast wheel)	08	TBA						
Splendor + (100cc 4T) (Front drum model)	08	TBA						
Splendor + (100cc 4T) (Front disc model)	08	TBA						
Pleasure (102cc 4T)	08	TBA						
Super Splendor (125cc 4T)	08	TBA						
Glamour PGM FI (125cc 4T) (Cast wheel)	08	TBA						
Glamour (125cc 4T) (Cast wheel)	08	TBA						
Magellan 125	06	TBA						
Punto 125	06	TBA						
Quickster 125	06	TBA						
Slikster 125	06	TBA						
Achiever (150cc 4T) (Cast Wheel)	08	TBA						
CBZ Xtreme (Cast wheel)	08	TBA						
Hunk (150cc 4T) (Cast wheel)	08	TBA						
Karizma (223cc 4T)	08	TBA						
<b>HERO</b>								
Splendor NXG 100	11-12	H353						
Splendor Pro 100	11-12	H353						
Pleasure 102	11-12	H353						
Glamour 125 (PGM FI)	11-12	H352						
Super Splendor 125	11-12	H352						
Hunk 150	11-12	H352						
Karizma ZMR 230	11-12	FA343			N/A			
<b>HIGHLAND</b>								
950 V2 Outback	00-04	FA208TT			FA208R ■	N/A		
950 V2 Motard	00-04	FA208TT			FA208R ■	N/A		
<b>HONDA DALL-ARA</b>								
XR 125 SM	04	FA115			FA115R ■	TBA		
XR 250 R	04	FA131TT			FA131R ■	MD6013D	MD6013C	MD6013CX
XR 250 SM	04	FA346TT			FA346R ■	MD6013D	MD6013C	
XR 400/440 R	04	FA346TT			FA346R ■	MD6013D	MD6013C	MD6013CX
XR 400/440 SM	04	FA346TT			FA346R ■	MD6013D	MD6013C	
XR 650 R	04	FA131TT			FA131R ■	MD6181D		MD6181CX
XR 650 R	04	FA131TT			FA131R ■	MD6181D		
<b>HONDA-HM (ITALY)</b>								
Baja 10/10 JR & SR	99-07	FA351				N/A		
Baja 12/14 MX	99-09	FA351				N/A		
CRE 50 Six/Baja/Derapage Brembo caliper twin pin/41mm paioli forks	95-02	FA101/047/382 ●				N/A		
CRE 50 Six/Baja/Derapage Brembo caliper single pin/Kayaba forks	95-02	FA101/047/382 ●				N/A		
CRE 50 Six/Baja/Derapage Grimeca caliper twin pin/Kayaba forks	95-02	FA101/047/382 ●				N/A		
CRE 50 Six/Baja/Derapage Grimeca	95-02	FA101/047/382 ●				N/A		
CRE 50 Six	01-02	FA382				N/A		
CRE 50 Baja/Derapage	01-02	FA115TT			FA115R ■	N/A		
CRE 50 Baja/Six/Derapage	03-09	FA350			FA350HH	N/A		
CRE 50 Six Competition Magura Caliper	10-12	FA346TT			FA346R	N/A		
CRE 50 Baja RR Up to ZEN50XACEA7700324	07-09	FA350			FA350HH	N/A		
CRE 50 Baja RR From ZEN50XACEA7700325	07-09	FA346TT			FA346R	N/A		
CRE 50 Baja RR	10-12	FA346TT			FA346R	N/A	N/A	
CRE 50 Derapage RR Up to ZEN50XACMA7700384	07-09	FA350			FA350HH	N/A		
CRE 50 Derapage RR From ZEN50XACMA7700385	07-09	FA346TT			FA346R	N/A		
CRE 50 Six Competition	07-08	FA346TT			FA346R	N/A		
CRM 50 Derapage Competition	07-09	FA346TT			FA346R	N/A		

\*-2 Sets Required. ■ - Also available in MX-S race compound.

**SAFETY WARNING:** DO NOT USE HH PADS ON REAR UNLESS ALSO USED ON FRONT TO AVOID BRAKE IMBALANCE

**R** Suffix = High Durability Sintered Pad. **HH** Suffix = High Performance Sintered Pad. **G** Suffix = Grooved Shoe.  
**D** Suffix = Drilled Disc. **C** Suffix = Contoured Disc. **LS** Suffix = Left/Steel Disc. **RS** = Right/Steel Disc.

# Non-JAPANESE Built Motorcycles



## HONDA-HM ITALY

← FRONT / AVANT / VORN FRENTE / ANTERIORE →

### DISC PAD CHOICES

### BRAKE ROTOR CHOICES

Model	Year	Disc Pad	DISC PAD CHOICES		BRAKE ROTOR CHOICES										
			NEW SFAC Scooter Carbon Pads	Semi-Sintered V-Pads™	Sintered/HH Pads/ Grooved shoes	Left/Gauche/Links	Right/Droite/Rechts	Contour Rotor Universal left and right fitment	NEW Vee-Rotors™ CONTOUR	NEW CX Extreme® ROTOR	Oversize 250/280mm Rotor Kit	Relocating Bracket for 250/280mm Rotor	Oversize 320mm Rotor Kit	Relocating Bracket for 320mm Rotor	
CRM 50 Derapage Competition	10-12				FA462R	N/A									
CRE 80	98-02	FA084TT			FA084R	■	MD6058D			MD6058C				MD6058CX	
CR 85 R/R2	03-07	FA084TT			FA084R	■	MD6058D			MD6058C				MD6058CX	
CRE 125	95-97	FA185TT			FA185R	■	MD6037D			MD6037C				MD6037CX	
CRE 125	98-01	FA185TT			FA185R	■	MD6037D			MD6037C				MD6037CX	
CRE 125 R Supermotard	02-06	FA185TT			FA185R	■	N/A			MD6037C				MD6037CX	
CRE 125 R Enduro	02-03	FA185TT			FA185R	■	MD6037D			MD6037C				MD6037CX	
CRE 125 R Enduro	04-07	FA185TT			FA185R	■	MD6037D			MD6037C				MD6037CX	
CRE 125 Baja RR 2T	11	FA465TT			FA465R				N/A						
CRE 125 (Six Competition 2T)	11	FA185TT			FA185R	■	N/A								
CRE F 125 X	09	FA194			FA194HH		N/A								
CR 125 Motard	04-06	FA185TT			FA185R	■	SM6437			MD6037C				MD6037CX	
CRM 125 R Supermoto	07	FA433/4			FA433/4HH		N/A								
CRM 125 (Derapage Competition 2T)	11	FA462R							N/A						
CRM 125 (Derapage RR 2T)	11								N/A						
CRM F 125 X	09	FA194			FA194HH		N/A								
CRF 150 R/R2	07-09	FA084TT			FA084R		MD6314D			MD6314C				MD6314CX	
CRF 230 Easy Trail	04-07	FA185TT			FA185R	■	MD6037D			MD6037C				MD6037CX	
CRF 230 Easy Enduro	04-07	FA185TT			FA185R	■	MD6037D			MD6037C				MD6037CX	
CRF 230 Easy Motard	04-07	FA185TT			FA185R	■	N/A			MD6037C				MD6037CX	
CRF 230 F Easy Trial (All models)	04-07	FA185TT			FA185R	■	MD6037D			MD6037C				MD6037CX	
CRE 250	97-01	FA185TT			FA185R	■	MD6037D			MD6037C				MD6037CX	
CRE 250	02	FA185TT			FA185R	■	MD6037D			MD6037C				MD6037CX	
CRE 250 R Supermotard	02-03	FA185TT			FA185R	■	N/A			MD6037C				MD6037CX	
CRE 250 R Enduro	02-07	FA185TT			FA185R	■	MD6037D			MD6037C				MD6037CX	
CR 250 R Moto	04	FA185TT			FA185R	■	MD6037D			MD6037C				MD6037CX	
CRE F 250 R	04-09	FA185TT			FA185R	■	MD6037D			MD6037C				MD6037CX	
CRE F 250 R	08-09	FA185TT			FA185R	■	MD6037D			MD6037C				MD6037CX	
CRE F 250 X	08-11	FA185TT			FA185R	■	MD6037D			MD6037C				MD6037CX	
CRE 250 R Enduro	04-07	FA185TT			FA185R	■	MD6037D			MD6037C				MD6037CX	
CRF 250 Motard	04-06	FA185TT			FA185R	■	MD6037D			MD6037C				MD6037CX	
CRF 250 F	04-08	FA185TT			FA185R	■	MD6037D			MD6037C				MD6037CX	
CRF 250 R	08-09	FA185TT			FA185R	■	MD6037D			MD6037C				MD6037CX	
CRM 250 X Supermoto	07	FA433/4			FA433/4HH		N/A								
CRE 260	95-96	FA185TT			FA185R	■	MD6001D			MD6001C				MD6001CX	
CRE 260	97-98	FA185TT			FA185R	■	MD6001D			MD6001C				MD6001CX	
CRE F 290 C	07	FA185TT			FA185R	■	MD6037D			MD6037C				MD6037CX	
CRE F 300 X	08-9	FA185TT			FA185R	■	MD6037D			MD6037C				MD6037CX	
CRE 450 F	02	FA185TT			FA185R	■	MD6037D			MD6037C				MD6037CX	
CRE 450 R Enduro	02-07	FA185TT			FA185R	■	MD6037D			MD6037C				MD6037CX	
CRE F 450 R Enduro	04-08	FA185TT			FA185R	■	MD6037D			MD6037C				MD6037CX	
CRE 450 F Supermoto	02-03	FA185TT			FA185R	■	N/A			MD6037C				MD6037CX	
CRE F 450 X	04-09	FA185TT			FA185R	■	MD6037D			MD6037C				MD6037CX	
CRF 450 Motard	04-06	FA185TT			FA185R	■	N/A			MD6037C				MD6037CX	
CRF 450 R	04-09	FA185TT			FA185R	■	MD6037D			MD6037C				MD6037CX	
CRM F 450 R Supermoto	07-08	FA433/4			FA433/4HH		N/A								
CRM F 450 X Supermoto	07-09	FA433/4			FA433/4HH		N/A								
CRE F 490 X	07	FA185TT			FA185R	■	MD6037D			MD6037C				MD6037CX	
CRM F 490 X Supermoto	07	FA433/4			FA433/4HH		N/A								
CRE F 500 X	08-09	FA185TT			FA185R	■	MD6037D			MD6037C				MD6037CX	
CRM F 500 X	11	FA433/4			FA433/4HH		N/A								
◆ PLAIN UNDRILLED DISC FOR ENDURO USE. REAR FITMENTS ONLY															
<b>HONGDOU</b>															
CTM 125 Chituma	04	FA086			FA086HH				N/A						
HD 125-7	05-07	FA486					TBA								
GY 125		TBA					N/A								

\*-2 Sets Required. ■ - Also available in MX-S race compound.

**SAFETY WARNING:** DO NOT USE HH PADS ON REAR UNLESS ALSO USED ON FRONT TO AVOID BRAKE IMBALANCE

APPLICATIONS  
BRAKE

R Suffix = High Durability Sintered Pad. HH Suffix = High Performance Sintered Pad. G Suffix = Grooved Shoe.

D Suffix = Drilled Disc. C Suffix = Contoured Disc. LS Suffix = Left/Steel Disc. RS = Right/Steel Disc.

# Non-JAPANESE Built Motorcycles



## HONDA-HM ITALY



← REAR / ARRIÈRE / HINTEN POSTERIOR / POSTERIORE →

			DISC PAD CHOICES			BRAKE ROTOR CHOICES		
			NEW SFAC Scooter Carbon Pads	Semi-Sintered V-Pads™	Sintered/HH Pads/ Grooved shoes	Contour Rotor Rear Fitment	NEW Vee-Rotors™ CONTOUR	NEW CX Extreme® ROTOR
CRM 50 Derapage Competition	10-12	FA346TT			FA346R	N/A		
CRE 80	98-02	FA131TT			FA131R ■	MD6005D	MD6005C	MD6005CX
CR 85 RR/2	03-07	FA131TT			FA131R ■	MD6005D	MD6005C	MD6005CX
CRE 125	95-97	FA131TT			FA131R ■	MD6002D		MD6002CX
CRE 125	98-01	FA131TT			FA131R ■	MD6124D	MD6124C	MD6124CX
CRE 125 R Supermotard	02-06	FA346TT			FA346R ■	MD6191D	MD6191C	MD6191CX
CRE 125 R Enduro	02-03	FA346TT			FA346R ■	MD6191D	MD6191C	MD6191CX
CRE 125 R Enduro	04-07	FA346TT			FA346R ■	MD6191D	MD6191C	MD6191CX
CRE 125 Baja RR 2T	11	FA346TT			FA346R		N/A	
CRE 125 (Six Competition 2T)	11	FA346TT			FA346R ■		N/A	
CRE F 125 X	09	FA346TT			FA346R	N/A		
CR 125 Motard	04-06	FA346TT			FA346R ■	MD6191D	MD6191C	MD6191CX
CRM 125 R Supermoto	07	FA346TT			FA346R	MD6191D	MD6191C	
CRM 125 (Derapage Competition 2T)	11	FA346TT			FA346R		N/A	
CRM 125 (Derapage RR 2T)	11	FA346TT			FA346R		N/A	
CRM F 125 X	09	FA346TT			FA346R	N/A		
CRF 150 RR/2	07-09	FA346TT			FA346R ■	MD6316D	MD6316C	MD6316CX
CRF 230 Easy Trail	04-07	FA346TT			FA346R ■	MD6191D	MD6191C	MD6191CX
CRF 230 Easy Enduro	04-07	FA346TT			FA346R ■	MD6191D	MD6191C	MD6191CX
CRF 230 Easy Motard	04-07	FA346TT			FA346R ■	MD6191D	MD6191C	MD6191CX
CRF 230 F Easy Trial (All models)	04-07	H304						
CRE 250	97-01	FA131TT			FA131R ■	MD6124D	MD6124C	MD6124CX
CRE 250	02	FA346TT			FA346R ■	MD6191D	MD6191C	MD6191CX
CRE 250 R Supermotard	02-03	FA346TT			FA346R ■	MD6191D	MD6191C	MD6191CX
CRE 250 R Enduro	02-07	FA346TT			FA346R ■	MD6191D	MD6191C	MD6191CX
CR 250 R Moto	04	FA346TT			FA346R ■	MD6191D	MD6191C	MD6191CX
CRE F 250 R	04-09	FA346TT			FA346R ■	MD6191D	MD6191C	MD6191CX
CRE F 250 R	08-09	FA131TT			FA131R ■	MD6191D	MD6191C	MD6191CX
CRE F 250 X	08-11	FA346TT			FA346R ■	MD6191D	MD6191C ◆	MD6191CX
CRE 250 R Enduro	04-07	FA346TT			FA346R ■	MD6191D	MD6191C	MD6191CX
CRF 250 Motard	04-06	FA346TT			FA346R ■	MD6191D	MD6191C	MD6191CX
CRF 250 F	04-08	FA346TT			FA346R ■	MD6191D	MD6191C	MD6191CX
CRF 250 R	08-09	FA346TT			FA346R ■	MD6191D	MD6191C	MD6191CX
CRM 250 X Supermoto	07	FA346TT			FA346R	MD6191D	MD6191C ◆	MD6191CX
CRE 260	95-96	FA131TT			FA131R ■	MD6002D		MD6002CX
CRE 260	97-98	FA131TT			FA131R ■	MD6124D	MD6124C	MD6124CX
CRE F 290 C	07	FA346TT			FA346R ■	MD6191D	MD6191C	MD6191CX
CRE F 300 X	08-9	FA346TT			FA346R ■	MD6191D	MD6191C ◆	MD6191CX
CRE 450 F	02	FA346TT			FA346R ■	MD6191D	MD6191C	MD6191CX
CRE 450 R Enduro	02-07	FA346TT			FA346R ■	MD6191D	MD6191C	MD6191CX
CRE F 450 R Enduro	04-08	FA346TT			FA346R ■	MD6191D	MD6191C	MD6191CX
CRE 450 F Supermoto	02-03	FA346TT			FA346R ■	MD6191D	MD6191C	MD6191CX
CRE F 450 X	04-09	FA346TT			FA346R ■	MD6191D	MD6191C ◆	MD6191CX
CRF 450 Motard	04-06	FA346TT			FA346R ■	MD6191D	MD6191C	MD6191CX
CRF 450 R	04-09	FA346TT			FA346R ■	MD6191D	MD6191C	MD6191CX
CRM F 450 R Supermoto	07-08	FA346TT			FA346R	MD6191D	MD6191C	
CRM F 450 X Supermoto	07-09	FA346TT			FA346R ■	MD6191D	MD6191C ◆	
CRE F 490 X	07	FA346TT			FA346R ■	MD6191D	MD6191C ◆	MD6191CX
CRM F 490 X Supermoto	07	FA346TT			FA346R ■	MD6191D	MD6191C ◆	
CRE F 500 X	08-09	FA346TT			FA346R ■	MD6191D	MD6191C ◆	MD6191CX
CRM F 500 X	11	FA346TT			FA346R	N/A		
<b>HONGDOU</b>								
CTM 125 Chituma	04	Y516						
HD 125-7	05-07	TBA						
GY 125		H304						

\*-2 Sets Required. ■ - Also available in MX-S race compound.

**SAFETY WARNING:** DO NOT USE HH PADS ON REAR UNLESS ALSO USED ON FRONT TO AVOID BRAKE IMBALANCE

**R** Suffix = High Durability Sintered Pad. **HH** Suffix = High Performance Sintered Pad. **G** Suffix = Grooved Shoe.  
**D** Suffix = Drilled Disc. **C** Suffix = Contoured Disc. **LS** Suffix = Left/Steel Disc. **RS** = Right/Steel Disc.

**BRAKE APPLICATIONS**

# Non-JAPANESE Built Motorcycles



← FRONT / AVANT / VORN FRENTE / ANTERIORE →

## DISC PAD CHOICES

## BRAKE ROTOR CHOICES

### HOEX

		NEW SFAC Scooter Carbon Pads	Semi-Sintered V-Pads™	Sintered/HH Pads/ Grooved shoes	Left/Gauche/Links	Right/Droite/Rechts	Contour Rotor Universal left and right fitment	NEW Vee-Rotors™ CONTOUR	NEW CX Extreme® ROTOR	Oversize 250/280mm Rotor Kit	Relocating Bracket for 250/280mm Rotor	Oversize 320mm Rotor Kit	Relocating Bracket for 320mm Rotor
Rebell 80 N		FA050			N/A								
Rebell 80 T		FA050*			N/A	N/A							
Sport 80 L		FA050*			N/A	N/A							
HRD 600	85	FA018*		FA018HH*	N/A	N/A							
500/600 Columbus	88-	FA018*		FA018HH*	N/A	N/A							
644 Osca	92-												
VR 6 Roadster	11-13	FA244*		FA244HH*			N/A*						

### H.P. POWER

Copper 50 (4T)	10-12	SFA086	SFAC086	SFA086HH		N/A							
Facile 50 (4T)	10-12	TBA											
Iron 50 (2T)	10-12	SFA047		SFA047HH			N/A						
Tin 50 (4T/4V)	10-12	SFA235	SFAC235		N/A								
Chromel 125 (4T/LC)	11-12	SFA086	SFAC086	SFA086HH		N/A							
Lithium 125 (2T/LC)	10-12	SFA086	SFAC086	SFA086HH	N/A								
Chromel 150 4T/LC)	11-12	SFA086	SFAC086	SFA086HH		N/A							
Lithium 150 (4T/2V/LC)	10-12	SFA086	SFAC086	SFA086HH	N/A								
Nickle 150 (4T/2V)	10-11	SFA086	SFAC086	SFA086HH		N/A							
Barum 280 (4T/2V/LC)	10-12	SFA197	SFAC197	SFA197HH		N/A							
Radium 300	11-12	SFA086	SFAC086	SFA086HH		N/A							
Pantera 600	11	FA231		FA231V FA231HH		N/A							

### HRD

GS 50		FA194			N/A								
RP 50 Cross				944G									
Sonic 2 Trail 50		FA167		FA167HH	N/A								
Sonic 2 Supermotard 50		FA167		FA167HH	N/A								
SX 50 Mini Cross		FA293			N/A								
RP 80 Cross	83-			944G									
Cabriollet Trail 125		FA167		FA167HH	N/A								
Cabriollet Supermotard 125		FA167		FA167HH	N/A								
WH 125 Road/Red Horse	85-	FA047		FA047R	N/A								

### HUSABERG

Enforcer Four	00-03	FA181TT*		FA181R* ■	N/A	N/A							
All models (central fixing pin in pad)	89-92	FA134		FA134R	N/A								
All models (fixing pin at end of brake pad)	93-94	FA181TT		FA181R ■	MD6125D				OS6125C	BRK010	SM6125C	BRK007	
All models (fixing pin at end of brake pad)	95-99	FA181TT		FA181R ■	MD6125D				OS6125C	BRK010	SM6125C	BRK007	
All MX/Enduro models (Brembo 2 piston caliper 260mm front disc)	00-05	FA181TT		FA181R ■	MD6032D		MD6032C		MD6032CX	OS6032C	BRK011	SM6032C	BRK012
All supermotard models (Beringer 4 piston caliper central in fixing 310mm front disc)	00-03	FA158		FA158HH	N/A								
TE 125 (2T)	12-13	FA181TT		FA181R ■			MD6032C		MD6032CX	OS6932C	BRK013	SM6932C	BRK014
TE 250 (2T)	11-13	FA181TT		FA181R ■			MD6032C		MD6032CX	OS6932C	BRK013	SM6932C	BRK014
TE 300 (2T)	11-13	FA181TT		FA181R ■			MD6032C		MD6032CX	OS6932C	BRK013	SM6932C	BRK014
FE 250 (4T)	13	FA181TT		FA181R ■			MD6032C		MD6032CX	OS6932C	BRK013	SM6932C	BRK014
FE 350 (4T)	13	FA181TT		FA181R ■			MD6032C		MD6032CX	OS6932C	BRK013	SM6932C	BRK014
FE 390 (New 70° Engine)	10-12	FA181TT		FA181R ■			MD6032C		MD6032CX	OS6932C	BRK013	SM6932C	BRK014
FE 450 E	06-08	FA181TT		FA181R ■	MD6032D		MD6032C		MD6032CX	OS6032C	BRK011	SM6032C	BRK012
FE 450 (New 70° Engine)	09-13	FA181TT		FA181R ■			MD6032C		MD6032CX	OS6932C	BRK013	SM6932C	BRK014
FS 450 C	06			MXS405	N/A								
FS 450 E	06-08			MXS405	N/A								
FX 450 (New 70° Engine)	10-11	FA181TT		FA181R ■			MD6032C		MD6032CX	OS6932C	BRK013	SM6932C	BRK014
FE 501 (4T)	13	FA181TT		FA181R ■			MD6032C		MD6032CX	OS6932C	BRK013	SM6932C	BRK014
FE 550 E	06-08	FA181TT		FA181R ■	MD6032D		MD6032C		MD6032CX	OS6032C	BRK011	SM6032C	BRK012
FS 550 E Supermoto	05-07			MXS405	MD6270D		MD6270C						
FE 570 (New 70° Engine)	09-12	FA181TT		FA181R ■			MD6032C		MD6032CX	OS6932C	BRK013	SM6932C	BRK014
FS 570 (Supermoto)	10-11	FA433/4		FA433/4HH			TBA						
FE 650 E	06-08	FA181TT		FA181R ■	MD6032D		MD6032C		MD6032CX	OS6032C	BRK011	SM6032C	BRK012
FS 650 C Supermoto	06-08			MXS405	MD6270D		MD6270C						
FS 650 E Supermoto	05-08			MXS405	MD6270D		MD6270C						

\*-2 Sets Required. ■ - Also available in MX-S race compound.

**SAFETY WARNING:** DO NOT USE HH PADS ON REAR UNLESS ALSO USED ON FRONT TO AVOID BRAKE IMBALANCE

# Non-JAPANESE Built Motorcycles

**BRAKE APPLICATIONS**



← REAR / ARRIÈRE / HINTEN POSTERIOR / POSTERIORE →

## HOREX



		DISC PAD CHOICES				BRAKE ROTOR CHOICES			
		NEW SFAC Scooter Carbon Pads	Semi-Sintered V-Pads™	Sintered/HH Pads/ Grooved shoes		Contour Rotor Rear Fitment	NEW Vee-Rotors™ CONTOUR	NEW CX Extreme® ROTOR	
Rebell 80 N		N/A							
Rebell 80 T		N/A							
Sport 80 L		N/A							
HRD 600	85	FA018		FA018HH	N/A				
500/600 Columbus	88-	FA018		FA018HH	N/A				
644 Osca	92-								
VR 6 Roadster	11-13	FA266		FA266HH		N/A			

## H.P. POWER

Copper 50 (4T)	10-12	SFA115		SFA115HH	N/A			
Facile 50 (4T)	10-12	TBA						
Iron 50 (2T)	10-12	SFA298		SFA298HH		N/A		
Tin 50 (4T/4V)	10-12	TBA						
Chromel 125 (4T/LC)	11-12	SFA086	SFAC086	SFA086HH	N/A			
Lithium 125 (2T/LC)	10-12	SFA086	SFAC086	SFA086HH	N/A			
Chromel 150 4T/LC)	11-12	SFA086	SFAC086	SFA086HH	N/A			
Lithium 150 (4T/2V/LC)	10-12	SFA086	SFAC086	SFA086HH	N/A			
Nickle 150 (4T/2V)	10-11	SFA197	SFAC197	SFA197HH	N/A			
Barum 260 (4T/2V/LC)	10-12	SFA427	SFAC427	SFA427HH	N/A			
Radium 300	11-12	SFA086	SFAC086	SFA086HH	N/A			
Pantera 600	11	FA213		FA213HH	N/A			

## HRD

GS 50		FA208TT			N/A			
RP 50 Cross				944G				
Sonic 2 Trail 50		FA115		FA115R	N/A			
Sonic 2 Supermotard 50		FA115		FA115R	N/A			
SX 50 Mini Cross		FA293			N/A			
RP 80 Cross	83-			944G				
Cabriollet Trail 125		FA115		FA115R	N/A			
Cabriollet Supermotard 125		FA115		FA115R	N/A			
WH 125 Road/Red Horse	85-							

## HUSABERG

Enforcer Four	00-03	FA181TT		FA181R ■	N/A			
All models (central fixing pin in pad)	89-92	FA067TT		FA067R	N/A			
All models (fixing pin at end of brake pad)	93-94	FA067TT		FA067R	MD6126D			
All models (fixing pin at end of brake pad)	95-99	FA208TT		FA208R ■	MD6126D			
All MX/Enduro models (Brembo 2 piston caliper 260mm front disc)	00-05	FA208TT		FA208R ■	MD6035D	MD6035C ◆		MD6035CX
All supermotard models (Beringer 4 piston caliper central in fixing 310mm front disc)	00-03	FA208TT		FA208R ■	MD6035D			
TE 125 (2T)	12-13	FA368TT		FA368R ■		MD6035C ◆		MD6035CX
TE 250 (2T)	11-13	FA368TT		FA368R ■		MD6035C ◆		MD6035CX
TE 300 (2T)	11-13	FA368TT		FA368R ■		MD6035C ◆		MD6035CX
FE 250 (4T)	13	FA368TT		FA368R ■		MD6035C ◆		MD6035CX
FE 350 (4T)	13	FA368TT		FA368R ■		MD6035C ◆		MD6035CX
FE 390 (New 70° Engine)	10-12	FA368TT		FA368R ■		MD6035C ◆		MD6035CX
FE 450 E	06-08	FA208TT		FA208R ■	MD6035D	MD6035C ◆		MD6035CX
FE 450 (New 70° Engine)	09-13	FA368TT		FA368R ■		MD6035C ◆		MD6035CX
FS 450 C	06	FA208TT		FA208R ■	MD6035D	MD6035C ◆		
FS 450 E	06-08	FA208TT		FA208R ■	MD6035D	MD6035C ◆		
FX 450 (New 70° Engine)	10-11	FA368TT		FA368R ■		MD6035C ◆		MD6035CX
FE 501 (4T)	13	FA368TT		FA368R ■		MD6035C ◆		MD6035CX
FE 550 E	06-08	FA208TT		FA208R ■	MD6035D	MD6035C ◆		MD6035CX
FS 550 E Supermoto	05-07	FA208TT		FA208R ■	MD6035D	MD6035C ◆		
FE 570 (New 70° Engine)	09-12	FA368TT		FA368R ■		MD6035C ◆		MD6035CX
FS 570 (Supermoto)	10-11	FA368TT		FA368R ■		MD6035C ◆		
FE 650 E	06-08	FA208TT		FA208R ■	MD6035D	MD6035C ◆		MD6035CX
FS 650 C Supermoto	06-08	FA208TT		FA208R ■	MD6035D	MD6035C ◆		
FS 650 E Supermoto	05-08	FA208TT		FA208R ■	MD6035D	MD6035C ◆		

\*-2 Sets Required. ■ - Also available in MX-S race compound.

**SAFETY WARNING:** DO NOT USE HH PADS ON REAR UNLESS ALSO USED ON FRONT TO AVOID BRAKE IMBALANCE

**R** Suffix = High Durability Sintered Pad. **HH** Suffix = High Performance Sintered Pad. **G** Suffix = Grooved Shoe.  
**D** Suffix = Drilled Disc. **C** Suffix = Contoured Disc. **LS** Suffix = Left/Steel Disc. **RS** = Right/Steel Disc.



# Non-JAPANESE Built Motorcycles



← FRONT / AVANT / VORN FRENTE / ANTERIORE →

## DISC PAD CHOICES

## BRAKE ROTOR CHOICES

### HUSABERG

		NEW SFAC Scooter Carbon Pads	Semi-Sintered V-Pads™	Sintered/HH Pads/ Grooved shoes	Left/Gauche/Links	Right/Droite/Rechts	Contour Rotor Universal left and right fitment	NEW Vee-Rotors™ CONTOUR	NEW CX Extreme® ROTOR	Overize 250/280mm Rotor Kit	Relocating Bracket for 250/280mm Rotor	Overize 320mm Rotor Kit	Relocating Bracket for 320mm Rotor
FS Supermotard Models (Beringer/FTE 6 piston caliper 310mm front disc)	04			MXS406	MD6270D		MD6270C						
FS Supermotard Models (FTE 4 piston radial caliper)	05			MXS405	MD6270D		MD6270C						
◆ PLAIN UNDRILLED DISC FOR ENDURO USE. REAR FITMENTS ONLY.													

### HUSQVARNA

Husky Boy	98-99			FA282R	N/A								
Husky Boy Racing S	00	984											
Husky Boy Drum front & rear	00-02	984											
Husky Boy Racing J	00	984											
Husky Boy J	01-02	FA115TT		FA115R ■	N/A								
Husky Boy R	01	FA115TT		FA115R ■	N/A								
Husky Boy S	01-02	FA115TT		FA115R ■	N/A								
CR 50 Junior	05	FA351			N/A								
CR 50 Junior Basic	05	TBA											
CR 50 Senior Pro	05	FA351			N/A								
CR 50	11-13	FA325TT		FA325R			N/A						
SM 50	02	FA167		FA167HH	TBA								
SM 50	11-13	FA325TT		FA325R			N/A						
TE 50 Boy	05	TBA											
WR 50	02	FA167		FA167HH	N/A								
WRS 50 Scooter	98-00	SFA115	SFAC115	SFA115HH	MD964D								
CR 65	11-13	FA357TT		FA357R			N/A						
TE 100	05	FA351			N/A								
CR 125	73-77	N/A											
CR 125	78			801G									
CR 125	79-81			801G									
CR 125	82-84			803G									
CR 125	85-86	FA047TT		FA047R	N/A								
CR 125	91	FA134		FA134R	N/A								
CR 125	92-94	FA135TT		FA135R ■	MD6125D					N/A	N/A	N/A	N/A
CR 125	95-99	FA181TT		FA181R ■	MD6125D					OS6125C	BRK010	SM6125C	BRK007
CR 125	00-01	FA181TT		FA181R ■	MD6184D		MD6184C			OS6184CHKC0	BRK0100110	SM6184CHKC0	BRK0070120
CR 125	02-04	FA181TT		FA181R ■	MD6184D		MD6184C			OS6184CHKC0	BRK0100110	SM6184CHKC0	BRK0070120
CR 125	05	FA181TT		FA181R ■	MD6184D		MD6184C			OS6184CHKC0	BRK0100110	SM6184CHKC0	BRK0070120
CR 125	06-08	FA181TT		FA181R ■	MD6184D		MD6184C			OS6184CHKC0	BRK0100110	SM6184CHKC0	BRK0070120
CR 125	09-13	FA181TT		FA181R ■	MD6184D		MD6184C			OS6184CHKC0	BRK0100110	SM6184CHKC0	BRK0070120
SC 125	73-74	N/A											
SM 125 (6 bolt fixing)	98-99	FA181TT		FA181R ■	MD6125D					OS6125C	BRK010	SM6125C	BRK007
SM 125 (4 bolt fixing)	00	FA181TT		FA181R ■	MD6184D		MD6184C			OS6184CHKC0	BRK0100110	SM6184CHKC0	BRK0070120
SM 125 S (4 bolt fixing/2T)	02-13	FA181TT		FA181R ■	MD6184D		MD6184C			OS6184CHKC0	BRK0100110	SM6184CHKC0	BRK0070120
SMS 4 125 (4T)	11	FA181TT		FA181R ■	MD6184D		MD6184C			OS6184CHKC0	BRK0100110	SM6184CHKC0	BRK0070120
TE 125 (4T)	11-13	FA181TT		FA181R ■	MD6184D		MD6184C			OS6184CHKC0	BRK0100110	SM6184CHKC0	BRK0070120
WR 125	73-74	N/A											
WR 125	79			801G									
WR 125	80-81			802G									
WR 125	82-84			803G									
WR 125	87-88	FA134		FA134R	N/A								
WR 125	91	FA134		FA134R	N/A								
WR 125	93-94	FA135TT		FA135R ■	MD6125D					N/A	N/A	N/A	N/A
WR 125	95-99	FA181TT		FA181R ■	MD6125D					OS6125C	BRK010	SM6125C	BRK007
WR 125	00-01	FA181TT		FA181R ■	MD6184D		MD6184C			OS6184CHKC0	BRK0100110	SM6184CHKC0	BRK0070120
WR 125	02-05	FA181TT		FA181R ■	MD6184D		MD6184C			OS6184CHKC0	BRK0100110	SM6184CHKC0	BRK0070120
WR 125	06-08	FA181TT		FA181R ■	MD6184D		MD6184C			OS6184CHKC0	BRK0100110	SM6184CHKC0	BRK0070120
WR 125	09-13	FA181TT		FA181R ■	MD6184D		MD6184C			OS6184CHKC0	BRK0100110	SM6184CHKC0	BRK0070120
WRE 125	93-99	FA181TT		FA181R ■	MD6125D					OS6125C	BRK010	SM6125C	BRK007
WRE 125	00	FA181TT		FA181R ■	MD6184D		MD6184C			OS6184CHKC0	BRK0100110	SM6184CHKC0	BRK0070120
WRE 125	02-13	FA181TT		FA181R ■	MD6184D		MD6184C			OS6184CHKC0	BRK0100110	SM6184CHKC0	BRK0070120
WXE 125	07	FA167		FA167HH	MD6184D		MD6184C			OS6184CHKC0	BRK0100110	SM6184CHKC0	BRK0070120
XC 125	82-84			803G									
XC 125	85-86	FA047TT		FA047R	N/A								

\*-2 Sets Required. ■ - Also available in MX-S race compound.

**SAFETY WARNING:** DO NOT USE HH PADS ON REAR UNLESS ALSO USED ON FRONT TO AVOID BRAKE IMBALANCE

# Non-JAPANESE Built Motorcycles

**BRAKE APPLICATIONS**



## HUSABERG



← REAR / ARRIÈRE / HINTEN POSTERIOR / POSTERIORE →

			DISC PAD CHOICES			BRAKE ROTOR CHOICES				
			NEW SFAC Scooter Carbon Pads	Semi-Sintered V-Pads™	Sintered/HH Pads/ Grooved shoes	Contour Rotor Rear Fitment	NEW Vee-Rotors™ CONTOUR	NEW CX Extreme® ROTOR		
FS Supermotard Models (Beringer/FTE 6 piston caliper 310mm front disc)	04	FA208TT			FA208R ■	MD6035D	MD6035C ◆			
FS Supermotard Models (FTE 4 piston radial caliper)	05	FA208TT			FA208R ■	MD6035D	MD6035C			
<b>HUSQVARNA</b>										
Husky Boy	98-99				FA282R	N/A				
Husky Boy Racing S	00	984								
Husky Boy Drum front & rear	00-02	984								
Husky Boy Racing J	00	984								
Husky Boy J	01-02	984								
Husky Boy R	01	984								
Husky Boy S	01-02	984								
CR 50 Junior	05	TBA								
CR 50 Junior Basic	05	TBA								
CR 50 Senior Pro	05	FA325TT				N/A				
CR 50	11-13	FA325TT			FA325R		N/A			
SM 50	02	FA115			FA115HH	TBA				
SM 50	11-13	FA325TT			FA325R					
TE 50 Boy	05	TBA								
WR 50	02	FA115			FA115HH	N/A				
WRS 50 Scooter	98-00	SR24								
CR 65	11-13	FA602TT			FA602R		N/A			
TE 100	05	TBA								
CR 125	73-77	N/A								
CR 125	78	N/A								
CR 125	79-81				801G					
CR 125	82-84				801G					
CR 125	85-86				802G					
CR 125	91	FA251				MD6126D				
CR 125	92-94	FA084TT			FA084R	MD6126D				
CR 125	95-99	FA208TT			FA208R ■	MD6126D				
CR 125	00-01	FA208TT			FA208R ■	MD6287D				
CR 125	02-04	FA208TT			FA208R ■	MD6295D				
CR 125	05	FA368TT			FA368R ■	MD6295D				
CR 125	06-08	FA368TT			FA368R ■	MD6288D				
CR 125	09-13	FA368TT			FA368R ■		TBA			
SC 125	73-74	N/A								
SM 125 (6 bolt fixing)	98-99	FA208TT			FA208R ■	MD6126D				
SM 125 (4 bolt fixing)	00	FA208TT			FA208R ■	MD6287D				
SM 125 S (4 bolt fixing/2T)	02-13	FA208TT			FA208R ■	MD6287D				
SMS 4 125 (4T)	11	FA208TT			FA208R ■	MD6287D				
TE 125 (4T)	11-13	FA208TT			FA208R ■	MD6287D				
WR 125	73-74	N/A								
WR 125	79				801G					
WR 125	80-81				802G					
WR 125	82-84				802G					
WR 125	87-88				802G					
WR 125	91	FA251				MD6126D				
WR 125	93-94	FA084TT			FA084R ■	MD6126D				
WR 125	95-99	FA208TT			FA208R ■	MD6126D				
WR 125	00-01	FA208TT			FA208R ■	MD6287D				
WR 125	02-05	FA208TT			FA208R ■	MD6295D				
WR 125	06-08	FA368TT			FA368R ■	MD6288D				
WR 125	09-13	FA368TT			FA368R ■		TBA			
WRE 125	93-99	FA208TT			FA208R ■	MD6126D				
WRE 125	00	FA208TT			FA208R ■	MD6287D				
WRE 125	02-13	FA208TT			FA208R ■	MD6287D				
VXE 125	07	FA131TT			FA131R ■	TBA				
XC 125	82-84				802G					
XC 125	85-86				801G					

\*-2 Sets Required. ■ - Also available in MX-S race compound.

**SAFETY WARNING:** DO NOT USE HH PADS ON REAR UNLESS ALSO USED ON FRONT TO AVOID BRAKE IMBALANCE

**R** Suffix = High Durability Sintered Pad. **HH** Suffix = High Performance Sintered Pad. **G** Suffix = Grooved Shoe.  
**D** Suffix = Drilled Disc. **C** Suffix = Contoured Disc. **LS** Suffix = Left/Steel Disc. **RS** = Right/Steel Disc.

# Non-JAPANESE Built Motorcycles



**HUSQVARNA**



		FRONT / AVANT / VORN						FRENTA / ANTERIORE					
		DISC PAD CHOICES				BRAKE ROTOR CHOICES							
		NEW SFAC Scooter Carbon Pads	Semi- Sintered V-Pads™	Sintered/ HH Pads/ Grooved shoes	Left/Gauche/Links	Right/Droite/Rechts	Contour Rotor Universal left and right fitment	NEW Vee-Rotors™ CONTOUR	NEW CX Extreme® ROTOR	Oversize 250/280mm Rotor Kit	Relocating Bracket for 250/280mm Rotor	Oversize 320mm Rotor Kit	Relocating Bracket for 320mm Rotor
CR 240	80-81			802G									
CR 240	82-84			803G									
CR 240	85-86	FA047TT		FA047R	N/A								
CR 240	87-88	FA134		FA134R	N/A								
WR 240	78			801G									
WR 240	80-81			802G									
WR 240	82-84			803G									
WR 240	87-88	FA134		FA134R	N/A								
WR 240	90-91	FA134		FA134R	N/A								
CR 250	71-74	N/A											
CR 250	75-79			801G									
CR 250	80-81			802G									
CR 250	82-84			803G									
CR 250	85-86	FA047TT		FA047R	N/A								
CR 250	87-88	FA134		FA134R	N/A								
CR 250	91	FA134		FA134R	N/A								
CR 250	92-94	FA135TT		FA135R ■	MD6125D					N/A	N/A	N/A	N/A
CR 250	95-99	FA181TT		FA181R ■	MD6125D					OS6125C	BRK010	SM6125C	BRK007
CR 250	00-01	FA181TT		FA181R ■	MD6184D		MD6184C			OS6184CHKC0	BRK0100110	SM6184CHKC0	BRK0070120
CR 250	02-04	FA181TT		FA181R ■	MD6184D		MD6184C			OS6184CHKC0	BRK0100110	SM6184CHKC0	BRK0070120
CR 250	05-07	FA181TT		FA181R ■	MD6184D		MD6184C			OS6184CHKC0	BRK0100110	SM6184CHKC0	BRK0070120
TC 250	02-03	FA181TT		FA181R ■	MD6184D		MD6184C			OS6184CHKC0	BRK0100110	SM6184CHKC0	BRK0070120
TC 250	05-08	FA181TT		FA181R ■	MD6184D		MD6184C			OS6184CHKC0	BRK0100110	SM6184CHKC0	BRK0070120
TC 250 (4T)	09-12	FA181TT		FA181R ■			MD6184C			OS6184CHKC0	BRK0100110	SM6184CHKC0	BRK0070120
TE 250 (4T)	02-05	FA181TT		FA181R ■	MD6184D		MD6184C			OS6184CHKC0	BRK0100110	SM6184CHKC0	BRK0070120
TE 250 (4T)	06-08	FA181TT		FA181R ■	MD6184D		MD6184C			OS6184CHKC0	BRK0100110	SM6184CHKC0	BRK0070120
TE 250 (4T)	09-13	FA181TT		FA181R ■			MD6184C			OS6184CHKC0	BRK0100110	SM6184CHKC0	BRK0070120
TE 250 Meo Replica (4T)	11	FA181TT		FA181R ■			MD6184C			OS6184CHKC0	BRK0100110	SM6184CHKC0	BRK0070120
TE 250 R (4T)	13	FA181TT		FA181R ■			MD6184C			OS6184CHKC0	BRK0100110	SM6184CHKC0	BRK0070120
WR 250	71-74	N/A											
WR 250	75-78			801G									
WR 250	80-81			802G									
WR 250	82-84			803G									
WR 250	87-88	FA134		FA134R	N/A								
WR 250	90-91	FA134		FA134R	N/A								
WR 250	92-94	FA135TT		FA135R ■	MD6125D					N/A	N/A	N/A	N/A
WR 250	95-99	FA181TT		FA181R ■	MD6125D					OS6125C	BRK010	SM6125C	BRK007
WR 250	00-01	FA181TT		FA181R ■	MD6184D		MD6184C			OS6184CHKC0	BRK0100110	SM6184CHKC0	BRK0070120
WR 250	02-05	FA181TT		FA181R ■	MD6184D		MD6184C			OS6184CHKC0	BRK0100110	SM6184CHKC0	BRK0070120
WR 250	06-08	FA181TT		FA181R ■	MD6184D		MD6184C			OS6184CHKC0	BRK0100110	SM6184CHKC0	BRK0070120
WR 250 (2T)	09-13	FA181TT		FA181R ■			MD6184C			OS6184CHKC0	BRK0100110	SM6184CHKC0	BRK0070120
XC 250	80-81			802G									
XC 250	82-84			803G									
XC 250	85-86	FA047TT		FA047R	N/A								
XC 250	87-88	FA134		FA134R	N/A								
WR 260	90-91	FA134		FA134R	N/A								
WR 300 (2T)	09-13	FA181TT		FA181R ■			MD6184C			OS6184CHKC0	BRK0100110	SM6184CHKC0	BRK0070120
TE 310 (4T)	09-11	FA181TT		FA181R ■			MD6184C			OS6184CHKC0	BRK0100110	SM6184CHKC0	BRK0070120
TE 310 R (4T)	13	FA181TT		FA181R ■			MD6184C			OS6184CHKC0	BRK0100110	SM6184CHKC0	BRK0070120
TE 350	90-91	FA134		FA134R	N/A								
TE 350	92-94	FA135TT		FA135R ■	MD6125D					N/A	N/A	N/A	N/A
TE 350	95-97	FA181TT		FA181R ■	MD6125D					OS6125C	BRK010	SM6125C	BRK007
360 Automatic	75-77	N/A											
CR 360	75-78			801G									
CR 360	92-94	FA135TT		FA135R ■	MD6125D					N/A	N/A	N/A	N/A
WR 360	75-78			801G									
WR 360	92-94	FA135TT		FA135R ■	MD6125D					N/A	N/A	N/A	N/A
WR 360	95-99	FA181TT		FA181R ■	MD6125D					OS6125C	BRK010	SM6125C	BRK007
WR 360	00-01	FA181TT		FA181R ■	MD6184D		MD6184C			OS6184CHKC0	BRK0100110	SM6184CHKC0	BRK0070120
WR 360	02	FA181TT		FA181R ■	MD6184D		MD6184C			OS6184CHKC0	BRK0100110	SM6184CHKC0	BRK0070120

\*-2 Sets Required. ■ - Also available in MX-S race compound.

**SAFETY WARNING:** DO NOT USE HH PADS ON REAR UNLESS ALSO USED ON FRONT TO AVOID BRAKE IMBALANCE

APPLICATIONS  
BRAKE

R Suffix = High Durability Sintered Pad. HH Suffix = High Performance Sintered Pad. G Suffix = Grooved Shoe.  
D Suffix = Drilled Disc. C Suffix = Contoured Disc. LS Suffix = Left/Steel Disc. RS = Right/Steel Disc.

# Non-JAPANESE Built Motorcycles

**BRAKE APPLICATIONS**



**HUSQVARNA**



← REAR / ARRIÈRE / HINTEN  POSTERIOR / POSTERIORE →

		DISC PAD CHOICES				BRAKE ROTOR CHOICES		
		NEW SFAC Scooter Carbon Pads	Semi-Sintered V-Pads™	Sintered/HH Pads/ Grooved shoes		Contour Rotor Rear Fitment	NEW Vee-Rotors™ CONTOUR	NEW CX Extreme® ROTOR
CR 240	80-81							
CR 240	82-84							
CR 240	85-86							
CR 240	87-88							
WR 240	78							
WR 240	80-81							
WR 240	82-84							
WR 240	87-88							
WR 240	90-91	FA251				MD6126D		
CR 250	71-74							
CR 250	75-79							
CR 250	80-81							
CR 250	82-84							
CR 250	85-86							
CR 250	87-88							
CR 250	91	FA251				MD6126D		
CR 250	92-94	FA084TT		FA084R		MD6126D		
CR 250	95-99	FA208TT		FA208R ■		MD6126D		
CR 250	00-01	FA208TT		FA208R ■		MD6287D		
CR 250	02-04	FA208TT		FA208R ■		MD6295D		
CR 250	05-07	FA368TT		FA368R ■		MD6295D		
TC 250	02-03	FA208TT		FA208R ■		MD6295D		
TC 250	05-08	FA368TT		FA368R ■		MD6288D		
TC 250 (4T)	09-12	FA368TT		FA368R ■			TBA	
TE 250 (4T)	02-05	FA208TT		FA208R ■		MD6295D		
TE 250 (4T)	06-08	FA368TT		FA368R ■		MD6288D		
TE 250 (4T)	09-13	FA368TT		FA368R ■			TBA	
TE 250 Meo Replica (4T)	11	FA368TT		FA368R ■			TBA	
TE 250 R (4T)	13	FA368TT		FA368R ■			TBA	
WR 250	71-74							
WR 250	75-78							
WR 250	80-81							
WR 250	82-84							
WR 250	87-88							
WR 250	90-91	FA251				MD6126D		
WR 250	92-94	FA084TT		FA084R ■		MD6126D		
WR 250	95-99	FA208TT		FA208R ■		MD6126D		
WR 250	00-01	FA208TT		FA208R ■		MD6287D		
WR 250	02-05	FA208TT		FA208R ■		MD6295D		
WR 250	06-08	FA208TT		FA208R ■		MD6295D		
WR 250 (2T)	09-13	FA208TT		FA208R ■		MD6295D		
XC 250	80-81							
XC 250	82-84							
XC 250	85-86							
XC 250	87-88							
WR 260	90-91	FA251				MD6126D		
WR 300 (2T)	09-13	FA208TT		FA208R ■		MD6295D		
TE 310 (4T)	09-11	FA208TT		FA208R ■		MD6295D		
TE 310 R (4T)	13	FA368TT		FA368R ■			TBA	
TE 350	90-91	FA251				MD6126D		
TE 350	92-94	FA084TT		FA084R ■		MD6126D		
TE 350	95-97	FA208TT		FA208R ■		MD6126D		
360 Automatic	75-77							
CR 360	75-78							
CR 360	92-94	FA084TT		FA084R ■		MD6126D		
WR 360	75-78							
WR 360	92-94	FA084TT		FA084R ■		MD6126D		
WR 360	95-99	FA208TT		FA208R ■		MD6126D		
WR 360	00-01	FA208TT		FA208R ■		MD6287D		
WR 360	02	FA208TT		FA208R ■		MD6295D		

\*-2 Sets Required. ■ - Also available in MX-S race compound.  
**SAFETY WARNING:** DO NOT USE HH PADS ON REAR UNLESS ALSO USED ON FRONT TO AVOID BRAKE IMBALANCE

**R** Suffix = High Durability Sintered Pad. **HH** Suffix = High Performance Sintered Pad. **G** Suffix = Grooved Shoe.  
**D** Suffix = Drilled Disc. **C** Suffix = Contoured Disc. **LS** Suffix = Left/Steel Disc. **RS** = Right/Steel Disc.

# Non-JAPANESE Built Motorcycles



← FRONT / AVANT / VORN FRENTE / ANTERIORE →

## HUSQVARNA

### DISC PAD CHOICES

### BRAKE ROTOR CHOICES

			NEW SFAC Scooter Carbon Pads	Semi-Sintered V-Pads™	Sintered/HH Pads/ Grooved shoes	Left/Gauche/Links	Right/Droite/Rechts	Contour Rotor Universal left and right fitment	NEW Vee-Rotors™ CONTOUR	NEW CX Extreme® ROTOR	Oversize 250/280mm Rotor Kit	Relocating Bracket for 250/280mm Rotor	Oversize 320mm Rotor Kit	Relocating Bracket for 320mm Rotor
ACC 390	80-81				801G									
ACCE 390	80-81				801G									
CR 390	75-79				801G									
CR 390	80-81				801G									
CR 390 Automatic	78				801G									
WR 390	78				801G									
CR 400	71-74				801G									
SM 400 R	02	FA095			FA095HH	MD6293D								
TE 400	02	FA181TT			FA181R ■	MD6184D		MD6184C			OS6184CCKC	BRK101011	SM6184CCKC	BRK007012
WR 400	75-78				801G									
WR 400	87-88	FA134			FA134R	N/A								
TE 410	95-99	FA181TT			FA181R ■	MD6125D					OS6125C	BRK1010	SM6125C	BRK007
TE 410	00	FA181TT			FA181R ■	MD6184D		MD6184C			OS6184CCKC	BRK101011	SM6184CCKC	BRK007012
TE 410	06	FA181TT			FA181R ■	MD6184D		MD6184C			OS6184CCKC	BRK101011	SM6184CCKC	BRK007012
TE 410 E	00	FA181TT			FA181R ■	MD6184D		MD6184C			OS6184CCKC	BRK101011	SM6184CCKC	BRK007012
430 Automatic	87-88	FA134			FA134R	N/A								
CR 430	80-81				802G									
CR 430	87-88	FA134			FA134R	N/A								
WR 430	80-81				802G									
WR 430	87-88	FA134			FA134R	N/A								
WR-E 430	80-81				802G									
WR-E 430	82-84				803G									
WRU 430	82-84				803G									
XC 430	80-81				802G									
XC 430	87-88	FA134			FA134R	N/A								
SMR 449 (4T)	11				FA322/4HH			TBA						
TC 449 (4T)	11-13	FA181TT			FA181R ■			MD6184C			OS6184CCKC	BRK101011	SM6184CCKC	BRK007012
TE 449 (4T)	11-13	FA181TT			FA181R ■			MD6184C			OS6184CCKC	BRK101011	SM6184CCKC	BRK007012
CR 450	71-74				801G									
SM 450 R	03-06	FA095			FA095HH	MD6293D								
SMR 450 RR (Radial caliper)	06-07				FA322/4HH	MD6293D								
SM 450 R (Radial caliper)	07-10				FA322/4HH	MD6293D								
SM 450 RR	08-10				FA322/4HH	N/A								
TC 450	03-04	FA181TT			FA181R ■	MD6184D		MD6184C			OS6184CCKC	BRK101011	SM6184CCKC	BRK007012
TC 450	05-08	FA181TT			FA181R ■	MD6184D		MD6184C			OS6184CCKC	BRK101011	SM6184CCKC	BRK007012
TC 450	09-10	FA181TT			FA181R ■	MD6184C		MD6184C			OS6184CCKC	BRK101011	SM6184CCKC	BRK007012
TE 450	03-05	FA181TT			FA181R ■	MD6184D		MD6184C			OS6184CCKC	BRK101011	SM6184CCKC	BRK007012
TE 450	06-08	FA181TT			FA181R ■	MD6184D		MD6184C			OS6184CCKC	BRK101011	SM6184CCKC	BRK007012
TE 450 (4T)	09-10	FA181TT			FA181R ■			MD6184C			OS6184CCKC	BRK101011	SM6184CCKC	BRK007012
WR 450	71-72				801G									
AE 500	82-84				803G									
CR 500	82-84				803G									
CR 500	85-86	FA047TT			FA047R	N/A								
CR 500	87-88	FA134			FA134R	N/A								
XC 500	82-84				803G									
XC 500	85-86	FA047TT			FA047R	N/A								
XC 500	87-88	FA134			FA134R	N/A								
SM 510 R	05	FA095			FA095HH	MD6293D								
SM 510 R (Radial caliper)	06-10				FA322/4HH	MD6293D								
TC 510	87-88	FA047TT			FA047R	N/A								
TC 510	89-	FA134			FA134R	N/A								
TC 510	90	FA134			FA134R	N/A								
TC 510	04	FA181TT			FA181R ■	MD6184D		MD6184C			OS6184CCKC	BRK101011	SM6184CCKC	BRK007012
TC 510	05-08	FA181TT			FA181R ■	MD6184D		MD6184C			OS6184CCKC	BRK101011	SM6184CCKC	BRK007012
TC 510	09	FA181TT			FA181R ■			TBA						
TE 510	87-88	FA047TT			FA047R	N/A								
TE 510	89-	FA134			FA134R	N/A								
TE 510	90	FA134			FA134R	N/A								
TE 510	04-05	FA181TT			FA181R ■	MD6184D		MD6184C			OS6184CCKC	BRK101011	SM6184CCKC	BRK007012
TE 510	06-08	FA181TT			FA181R ■	MD6184D		MD6184C			OS6184CCKC	BRK101011	SM6184CCKC	BRK007012

\*-2 Sets Required. ■ - Also available in MX-S race compound.

**SAFETY WARNING:** DO NOT USE HH PADS ON REAR UNLESS ALSO USED ON FRONT TO AVOID BRAKE IMBALANCE



# Non-JAPANESE Built Motorcycles



**BRAKE APPLICATIONS**



**HUSQVARNA**



← REAR / ARRIÈRE / HINTEN  POSTERIOR / POSTERIORE →

			DISC PAD CHOICES			BRAKE ROTOR CHOICES			
			NEW SFAC Scooter Carbon Pads	Semi-Sintered V-Pads™	Sintered/HH Pads/ Grooved shoes	 Contour Rotor Rear Fitment	NEW Vee-Rotors™ CONTOUR	NEW CX Extreme® ROTOR	
ACC 390	80-81				801G				
ACCE 390	80-81				801G				
CR 390	75-79				801G				
CR 390	80-81				801G				
CR 390 Automatic	78				801G				
WR 390	78				801G				
CR 400	71-74				801G				
SM 400 R	02	FA208TT			FA208R ■	MD6295D			
TE 400	02	FA208TT			FA208R ■	MD6295D			
WR 400	75-78				801G				
WR 400	87-88				802G				
TE 410	95-99	FA208TT			FA208R ■	MD6126D			
TE 410	00	FA208TT			FA208R ■	MD6287D			
TE 410	06	FA368TT			FA368R ■	MD6288D			
TE 410 E	00	FA208TT			FA208R ■	MD6126D			
430 Automatic	87-88				802G				
CR 430	80-81				801G				
CR 430	87-88				802G				
WR 430	80-81				802G				
WR 430	87-88				802G				
WR-E 430	80-81				802G				
WR-E 430	82-84				802G				
WRU 430	82-84				802G				
XC 430	80-81				802G				
XC 430	87-88				802G				
SMR 449 (4T)	11	FA368TT			FA368R ■		TBA		
TC 449 (4T)	11-13	FA368TT			FA368R ■		TBA		
TE 449 (4T)	11-13	FA368TT			FA368R ■		TBA		
CR 450	71-74				801G				
SM 450 R	03-06	FA208TT			FA208R ■	MD6295D			
SMR 450 RR (Radial caliper)	06-07	FA368TT			FA368R ■	MD6288D			
SM 450 R (Radial caliper)	07-10	FA368TT			FA368R ■	MD6288D			
SM 450 RR	08-10	FA368TT			FA368R ■	N/A			
TC 450	03-04	FA208TT			FA208R ■	MD6295D			
TC 450	05-08	FA368TT			FA368R ■	MD6288D			
TC 450	09-10	FA368TT			FA368R ■		TBA		
TE 450	03-05	FA208TT			FA208R ■	MD6295D			
TE 450	06-08	FA368TT			FA368R ■	MD6288D			
TE 450 (4T)	09-10	FA368TT			FA368R ■		TBA		
WR 450	71-72				801G				
AE 500	82-84				802G				
CR 500	82-84				801G				
CR 500	85-86				802G				
CR 500	87-88				802G				
XC 500	82-84				802G				
XC 500	85-86				801G				
XC 500	87-88				802G				
SM 510 R	05	FA208TT			FA208R ■	MD6295D			
SM 510 R (Radial caliper)	06-10	FA368TT			FA368R ■	MD6288D			
TC 510	87-88				801G				
TC 510	89-				801G				
TC 510	90	FA251				MD6126D			
TC 510	04	FA208TT			FA208R ■	MD6295D			
TC 510	05-08	FA368TT			FA368R ■	MD6288D			
TC 510	09	FA368TT			FA368R ■	TBA			
TE 510	87-88				801G				
TE 510	89-				801G				
TE 510	90	FA251				MD6126D			
TE 510	04-05	FA208TT			FA208R ■	MD6295D			
TE 510	06-08	FA368TT			FA368R ■	MD6288D			

\*-2 Sets Required. ■ - Also available in MX-S race compound.

**SAFETY WARNING:** DO NOT USE HH PADS ON REAR UNLESS ALSO USED ON FRONT TO AVOID BRAKE IMBALANCE

**R** Suffix = High Durability Sintered Pad. **HH** Suffix = High Performance Sintered Pad. **G** Suffix = Grooved Shoe.  
**D** Suffix = Drilled Disc. **C** Suffix = Contoured Disc. **LS** Suffix = Left/Steel Disc. **RS** = Right/Steel Disc.

# Non-JAPANESE Built Motorcycles



← FRONT / AVANT / VORN FRENTE / ANTERIORE →

## HUSQVARNA

Model	Year	DISC PAD CHOICES				BRAKE ROTOR CHOICES							
		NEW SFAC Scooter Carbon Pads	Semi-Sintered V-Pads™	Sintered/HH Pads/ Grooved shoes	Left/Gauche/Links	Right/Droite/Rechts	Contour Rotor Universal left and right fitment	NEW Vee-Rotors™ CONTOUR	NEW CX Extreme® ROTOR	Oversize 250/280mm Rotor Kit	Relocating Bracket for 250/280mm Rotor	Oversize 320mm Rotor Kit	Relocating Bracket for 320mm Rotor
TE510	09-10	FA181TT		FA181R ■						OS6184CCKC 0	BRK010/011 0	SM6184CCKC 0	BRK007/012 0
TX 510	87-88	FA047TT		FA047R	N/A								
WMX 510	89	FA134		FA134R	N/A								
WXE 510	89	FA134		FA134R	N/A								
SMR 511	11-13			FA322/4HH				TBA					
TE 511 (4T)	11-12	FA181TT		FA181R ■				TBA		OS6184CCKC 0	BRK010/011 0	SM6184CCKC 0	BRK007/012 0
SM 530 RR	08-10			FA322/4HH	MD6293D								
SM 570 R (4 bolt front disc)	01-	FA095		FA095HH	MD6293D								
SM 570 R	02-04	FA095		FA095HH	MD6293D								
TC 570	02-03	FA181TT		FA181R ■	MD6184D			MD6184C		OS6184CCKC 0	BRK010/011 0	SM6184CCKC 0	BRK007/012 0
TE 570	01	FA181TT		FA181R ■	MD6184D			MD6184C		OS6184CCKC 0	BRK010/011 0	SM6184CCKC 0	BRK007/012 0
TE 570	02-04	FA181TT		FA181R ■	MD6184D			MD6184C		OS6184CCKC 0	BRK010/011 0	SM6184CCKC 0	BRK007/012 0
LT 610 (6 bolt front disc)	00	FA244		FA244HH	MD6294D								
SM 610 (6 bolt front disc)	98-99	FA244		FA244HH	MD6294D								
SM 610 R	00	FA244		FA244HH	MD6184D			MD6184C		OS6184CCKC 0	BRK010/011 0	SM6184CCKC 0	BRK007/012 0
SM 610/S (4 bolt front disc)	02-06	FA244		FA244HH	MD6293D								
SM 610 S (Radial caliper)	06			FA322/4HH	MD6293D								
SM 610 IE	07-09			FA322/4HH	MD6293D								
TC 610	91	FA134		FA134R	N/A								
TC 610	92-94	FA135TT		FA135R ■	MD6125D					N/A	N/A	N/A	N/A
TC 610/E	95-99	FA181TT		FA181R ■	MD6125D					OS6125C	BRK010	SM6125C	BRK007
TC 610	00	FA181TT		FA181R ■	MD6184D			MD6184C		OS6184CCKC 0	BRK010/011 0	SM6184CCKC 0	BRK007/012 0
TE 610	91	FA134		FA134R	N/A								
TE 610	92-94	FA135TT		FA135R ■	MD6125D					N/A	N/A	N/A	N/A
TE 610 (6 bolt fixing)	00	FA181TT		FA181R ■	MD6125D					OS6125C	BRK010	SM6125C	BRK007
TE 610/E (6 bolt fixing)	95-99	FA181TT		FA181R ■	MD6125D					OS6125C	BRK010	SM6125C	BRK007
TE 610 E (6 bolt fixing)	00	FA181TT		FA181R ■	MD6125D					OS6125C	BRK010	SM6125C	BRK007
TE 610 E (6 bolt fixing)	03-04	FA181TT		FA181R ■	MD6125D					OS6125C	BRK010	SM6125C	BRK007
TE 610 IE	06-09	FA181TT		FA181R ■	MD6184D			MD6184C		OS6184CCKC 0	BRK010/011 0	SM6184CCKC 0	BRK007/012 0
SMR 630	06	FA095		FA095HH	MD6293D								
SMR 630 (4T)	10-12			FA322/4HH	MD6293D								
STR 650 CRC	07			FA322/4HH	MD6293D								
TE 630	10-12	FA181TT		FA181R ■	MD6184D			MD6184C		OS6184CCKC 0	BRK010/011 0	SM6184CCKC 0	BRK007/012 0
TR 650 Terra (Spoke Wheel)	12-13	FA209/2		FA209/2HH	MD834								
TR 650 Strada (Cast Wheel)	12-13	FA209/2		FA209/2HH	MD834								
Nuda 900 (Inc ABS)	12-13	FA244*		FA244HH*	N/A			N/A					
Nuda R 900 (Inc ABS)	12-13			FA447HH*	N/A			N/A					

0 NOTE - There could be a choice of forks on these models - disc will be correct by please select correct disc using info below.

BIKES WITH 45MM DIA MARZOCCHI FORKS - WITH 60MM CALIPER MOUNT CENTERS = OS/SM6184C AND BRK010/BRK007

BIKES WITH 48MM DIA MARZOCCHI FORKS OR 48MM DIA KAYABA - WITH 95MM CALIPER MOUNT CENTERS = OS/SM6184C AND BRK011/BRK012

## HYOSUNG

Eva Electric Scooter (ST-E3)	13	SFA083	SFAC083	SFA083HH	TBA								
Super Cab/Cab Plus/Sense 50/Prima Avanti	99-06	SFA083	SFAC083	SFA083HH	TBA								
SD 50	00-06	SFA083	SFAC083	SFA083HH	TBA								
SF 50 R Rally Prima/Racing	00-06	SFA083	SFAC083	SFA083HH	TBA								
ST E3 (Electric Scooter)	10-11	SFA083	SFAC083	SFA083HH	TBA								
TE 50	05-07	938*											
TE 90	05-07	938*											
EZ 100	99-05	SFA083	SFAC083	SFA083HH	TBA								
SF 100 R	05-06	SFA083	SFAC083	SFA083HH	N/A								
TE 100	05-07	938*											
FX 110 Midas - ECO/STD	99-02	S603											
FX 110 DLX Midas	99-04	SFA083	SFAC083	SFA083HH	TBA								
KR 110 Master	04-05	SFA083	SFAC083	SFA083HH	N/A								
GPS 125 Grand Prix/Hyper Rear drum model	99-04	SFA047		SFA047HH				N/A					
GPS 125 Grand Prix Plus Rear disc model	00-04	SFA047		SFA047HH				N/A					
Cruise II GA 125 F	99-06	FA056			N/A								
Boomer/Exceed 125	02-03	SFA047		SFA047HH				N/A					
Boomer/Exceed 125 Parking brake shoe	02-03	TBA											

\*-2 Sets Required. ■ - Also available in MX-S race compound.

**SAFETY WARNING:** DO NOT USE HH PADS ON REAR UNLESS ALSO USED ON FRONT TO AVOID BRAKE IMBALANCE

APPLICATIONS  
BRAKE

R Suffix = High Durability Sintered Pad. HH Suffix = High Performance Sintered Pad. G Suffix = Grooved Shoe.  
D Suffix = Drilled Disc. C Suffix = Contoured Disc. LS Suffix = Left/Steel Disc. RS = Right/Steel Disc.

# Non-JAPANESE Built Motorcycles

**BRAKE APPLICATIONS**

**R** Suffix = High Durability Sintered Pad. **HH** Suffix = High Performance Sintered Pad. **G** Suffix = Grooved Shoe.  
**D** Suffix = Drilled Disc. **C** Suffix = Contoured Disc. **LS** Suffix = Left/Steel Disc. **RS** = Right/Steel Disc.



## HUSQVARNA



← REAR / ARRIÈRE / HINTEN POSTERIOR / POSTERIORE →

		DISC PAD CHOICES				BRAKE ROTOR CHOICES		
		NEW SFAC Scooter Carbon Pads	Semi-Sintered V-Pads™	Sintered/HH Pads/ Grooved shoes		Contour Rotor Rear Fitment	NEW Vee-Rotors™ CONTOUR	NEW CX Extreme® ROTOR
TE510	09-10	FA368TT		FA368R ■		TBA		
TX 510	87-88			801G				
WMX 510	89			801G				
WXE 510	89			801G				
SMR 511	11-13	FA368TT		FA368R ■		TBA		
TE 511 (4T)	11-12	FA368TT		FA368R ■		TBA		
SM 530 RR	08-10	FA368TT		FA368R ■	N/A			
SM 570 R (4 bolt front disc)	01-	FA208TT		FA208R ■	MD6287D			
SM 570 R	02-04	FA208TT		FA208R ■	MD6295D			
TC 570	02-03	FA208TT		FA208R ■	MD6295D			
TE 570	01	FA208TT		FA208R ■	MD6287D			
TE 570	02-04	FA208TT		FA208R ■	MD6287D			
LT 610 (6 bolt front disc)	00	FA208TT		FA208R ■	MD6295D			
SM 610 (6 bolt front disc)	98-99	FA208TT		FA208R ■	MD6126D			
SM 610 R	00	FA208TT		FA208R ■	MD6287D			
SM 610/S (4 bolt front disc)	02-06	FA208TT		FA208R ■	MD6287D			
SM 610 S (Radial caliper)	06	FA208TT		FA208R ■	MD6288D			
SM 610 IE	07-09	FA208TT		FA208R ■	MD6295D			
TC 610	91	FA251			MD6126D			
TC 610	92-94	FA084TT		FA084R ■	MD6126D			
TC 610/E	95-99	FA208TT		FA208R ■	MD6126D			
TC 610	00	FA208TT		FA208R ■	MD6287D			
TE 610	91	FA251			MD6126D			
TE 610	92-94	FA084TT		FA084R ■	MD6126D			
TE 610 (6 bolt fixing)	00	FA208TT		FA208R ■	MD6287D			
TE 610/E (6 bolt fixing)	95-99	FA208TT		FA208R ■	MD6126D			
TE 610 E (6 bolt fixing)	00	FA208TT		FA208R ■	MD6126D			
TE 610 E (6 bolt fixing)	03-04	FA208TT		FA208R ■	MD6287D			
TE 610/E	06-09	FA208TT		FA208R ■	MD6295D			
SMR 630	06	FA208TT		FA208R ■	MD6295D			
SMR 630 (4T)	10-12	FA208TT		FA208R ■	MD6287D			
STR 650 CRC	07	FA208TT		FA208R ■	MD6295D			
TE 630	10-12	FA208TT		FA208R ■	MD6287D			
TR 650 Terra (Spoke Wheel)	12-13	FA213	FA213V	FA213HH	MD651			
TR 650 Strada (Cast Wheel)	12-13	FA213	FA213V	FA213HH	MD651			
Nuda 900 (Inc ABS)	12-13	FA213	FA213V	FA213HH	MD671			
Nuda R 900 (Inc ABS)	12-13	FA213	FA213V	FA213HH	MD671			
<b>HYOSUNG</b>								
Eva Electric Scooter (ST-E3)	13	SFA083	SFAC083	SFA083HH	TBA			
Super Cab/Cab Plus/Sense 50/Prima Avanti	99-06	TBA						
SD 50	00-06	TBA						
SF 50 R Rally Prima/Racing	00-06	TBA						
ST E3 (Electric Scooter)	10-11	N/A						
TE 50	05-07			FA282R	MD6301D			
TE 90	05-07			FA282R	MD6301D			
EZ 100	99-05	TBA						
SF 100 R	05-06	TBA						
TE 100	05-07			FA282R	MD6301D			
FX 110 Midas - ECO/STD	99-02	S603						
FX 110 DLX Midas	99-04	S603						
KR 110 Master	04-05	S603						
GPS 125 Grand Prix/Hyper Rear drum model	99-04	897						
GPS 125 Grand Prix Plus Rear disc model	00-04	SFA086		SFA086HH	N/A			
Cruise II GA 125 F	99-06	S602						
Boomer/Exceed 125	02-03	TBA			N/A			

\*-2 Sets Required. ■ - Also available in MX-S race compound.

**SAFETY WARNING:** DO NOT USE HH PADS ON REAR UNLESS ALSO USED ON FRONT TO AVOID BRAKE IMBALANCE

# Non-JAPANESE Built Motorcycles



## HYOSUNG



← FRONT / AVANT / VORN FRENTE / ANTERIORE →

### DISC PAD CHOICES

### BRAKE ROTOR CHOICES

Model	Year	Disc	DISC PAD CHOICES			BRAKE ROTOR CHOICES									
			NEW SFAC Scooter Carbon Pads	Semi-Sintered V-Pads™	Sintered/HH Pads/ Grooved shoes	Left/Gauche/Links	Right/Droite/Rechts	Contour Rotor Universal left and right fitment	NEW Vee-Rotors™ CONTOUR	NEW CX Extreme® ROTOR	Oversize 250/280mm Rotor Kit	Relocating Bracket for 250/280mm Rotor	Oversize 320mm Rotor Kit	Relocating Bracket for 320mm Rotor	
Comet 125/250	04		FA086		FA086HH	N/A									
Exceed 125 (MS1-125/150)	02-04		FA047		FA047HH	N/A									
Comet GT 125 (Naked)	04-06		FA086/2		FA086/2HH	MD690		MD690C							
GT 125 (Naked)	03-06		FA086/2		FA086/2HH	MD690		MD690C							
GT 125 (Naked)	07-12		FA086/2		FA086/2HH	MD690		MD690C							
GT 125 Pi (Naked)	13		FA086/2		FA086/2HH	N/A									
GT 125 R	06-13		FA086/2		FA086/2HH	MD690		MD690C							
GV 125 Aquila	01-06		FA086		FA086HH	N/A									
GV 125 C	07-13		FA086/2		FA086/2HH	N/A									
RT Karion 125	02-07		FA086		FA086HH	TBA									
RT 125 D Karion	08-13		FA086/2		FA086/2HH	TBA									
MS1 125/150	05		SFA047		SFA047HH	N/A									
MS3 (125cc)		Left	SFA228	SFAC228	SFA228HH	TBA									
		Right	SFA197	SFAC197	SFA197HH		TBA								
RX 125	01-07		FA086		FA086HH	N/A									
RX 125 D (XRX)	08-11		FA086/2		FA086/2HH	N/A									
RX 125 D (Karion)	07-11		FA086/2		FA086/2HH	N/A									
XRX 125 Enduro	00-06		FA086		FA086HH	N/A									
XRX 125 Supermoto	07-11		FA086/2		FA086/2HH	N/A									
Comet 250	02		FA129		FA129HH	N/A									
Comet GT 250 (Naked)	04-05		FA086		FA086HH	MD690		MD690C							
GT 250 (Naked)	06-12		FA086/2		FA086/2HH	MD690		MD690C							
GT 250 Pi (Naked)	13		FA086/2		FA086/2HH	N/A									
GT 250 R	07-13		FA086/2*		FA086/2HH*	MD690	MD690	MD690C*							
GV 250 Aquila	04-07		FA086		FA086HH	N/A									
GV 250 C	08-13		FA086/2		FA086/2HH	N/A									
MS3 250i		Left	SFA228	SFAC228	SFA228HH	N/A									
		Right	SFA197	SFAC197	SFA197HH		N/A								
RX 400	05		FA086		FA086HH	N/A									
TE 450 Quad Papier	06-09		FA054TT*		FA054R* ■	N/A	N/A								
Comet 600	02		FA129		FA129HH	N/A									
Comet GT 650 (Naked)	04-06		FA086*		FA086HH*	TBA	TBA								
Comet GT 650 (Naked)	07-08		FA086/2*		FA086/2HH*	MD690	MD690	MD690C*							
GT 650 (Naked)	09-11				FA296HH*	MD690	MD690	MD690C*							
GT 650 Pi (Naked)	13				FA296HH*	N/A	N/A								
GT 650 R	07-08		FA086/2*		FA086/2HH*	MD690	MD690	MD690C*							
GT 650 R	09-13				FA296HH*	MD690	MD690	MD690C*							
GT 650 X	07		FA086*		FA086HH*	TBA	TBA								
GT 650 S	05-06		FA086*		FA086HH*	TBA	TBA								
GT 650 S	05-08		FA086*		FA086HH*	MD690	MD690	MD690C*							
GV 650 Aquila (Carb)	04-06		FA086*		FA086HH*	TBA	TBA								
GV 650 (EFI)	07-12		FA086/2*		FA086/2HH*	MD691	MD691								
GV 650 Pi (Naked)	12-13		FA086/2*		FA086/2HH*	MD691	MD691								
GV 700 C	06-09		FA086/2		FA086/2HH	MD691									
ST 7 (GV 700 C)	10-13				FA296HH	MD691									
ST 7 Deluxe	12-13				FA296HH	MD691									
<b>ITALJET</b>															
Dragster 50 LC	98-12		SFA115	SFAC115	SFA115HH	MD941D		VR941							
Formula 50 LC	96-03		SFA115	SFAC115	SFA115HH	MD941D		VR941							
Formula Air 50	99-03		SFA115	SFAC115	SFA115HH	MD941D		VR941							
IT 50 (4T)	08		TBA				TBA								
50 it Scooter	09		SFA197	SFAC197	SFA197HH		N/A								
Jet Set 50cc 2T	02-03		SFA350	SFAC350	SFA350HH	TBA									
Pit Jet 50 (2T)	07-09		FA448			N/A									
Rollercoast 50 (4T)	07-08		TBA			N/A									
SX1 (50) 2T	08		TBA			N/A									
SX1 50 Scooter	09		SFA235	SFAC235		N/A									
Velocifero 50	98-02		H350												
Torpedo 50 (All models)	98-03		SFA115	SFAC115	SFA115HH	MD951D									

\*-2 Sets Required. ■ - Also available in MX-S race compound.

**SAFETY WARNING:** DO NOT USE HH PADS ON REAR UNLESS ALSO USED ON FRONT TO AVOID BRAKE IMBALANCE

# Non-JAPANESE Built Motorcycles



**HYOSUNG**



← REAR / ARRIÈRE / HINTEN POSTERIOR / POSTERIORE →

		DISC PAD CHOICES				BRAKE ROTOR CHOICES			
		NEW SFAC Scooter Carbon Pads	Semi-Sintered V-Pads™	Sintered/HH Pads/ Grooved shoes	Disc Pad	Contour Rotor Rear Fitment	NEW Vee-Rotors™ CONTOUR	NEW CX Extreme® ROTOR	
Comet 125/250	04	FA086			FA086HH	N/A			
Exceed 125 (MS1-125/150)	02-04	FA086			FA086HH	N/A			
Comet GT 125 (Naked)	04-06	FA086/2			FA086/2HH	MD689	MD689C		
GT 125 (Naked)	03-06	FA086/2			FA086/2HH	MD689	MD689C		
GT 125 (Naked)	07-12	FA086/2			FA086/2HH	MD689	MD689C		
GT 125 Pi (Naked)	13	FA086/2			FA086/2HH	N/A			
GT 125 R	06-13	FA086/2			FA086/2HH	MD689	MD689C		
GV 125 Aquila	01-06	S602							
GV 125 C	07-13	S602							
RT Karion 125	02-07	S602							
RT 125 D Karion	08-13	S602							
MS1 125/150	05	TBA							
MS3 (125cc)	07-09	SFA228	SFAC228		SFA228HH	TBA			
RX 125	01-07	S602							
RX 125 D (XRX)	08-11	S602							
RX 125 D (Karion)	07-11	S602							
XRX 125 Enduro	00-06	S602							
XRX 125 Supermoto	07-11	FA165/2TT			FA165/2R	N/A			
Comet 250	02	FA063			FA063HH	TBA			
Comet GT 250 (Naked)	04-05	FA086			FA086HH	MD689	MD689C		
GT 250 (Naked)	06-12	FA086/2			FA086/2HH	MD689	MD689C		
GT 250 Pi (Naked)	13	FA086/2			FA086/2HH	N/A			
GT 250 R	07-13	FA086/2			FA086/2HH	MD689	MD689C		
GV 250 Aquila	04-07	S606							
GV 250 C	08-13	S606							
MS3 250i	07-09	SFA228	SFAC228		FA228HH	N/A			
RX 400	05	FA131TT				N/A			
TE 450 Quad Rapier	06-09	FA054TT			FA054R ■	N/A			
Comet 600	02	FA063			FA063HH	TBA			
Comet GT 650 (Naked)	04-06	FA086			FA086HH	MD689			
Comet GT 650 (Naked)	07-08	FA086/2			FA086/2HH	MD689	MD689C		
GT 650 (Naked)	09-11	FA086/2			FA086/2HH	MD689	MD689C		
GT 650 Pi (Naked)	13	FA086/2			FA086/2HH	N/A			
GT 650 R	07-08	FA086/2			FA086/2HH	MD689	MD689C		
GT 650 R	09-13	FA086/2			FA086/2HH	MD689	MD689C		
GT 650 X	07	FA086			FA086HH	MD689	MD689C		
GT 650 S	05-06	FA086			FA086HH	MD689			
GT 650 S	05-08	FA086			FA086HH	MD689	MD689C		
GV 650 Aquila (Carb)	04-06	FA319/2			FA319/2HH	N/A			
GV 650 (EFI)	07-12	FA086/2			FA086/2HH	N/A			
GV 650 Pi (Naked)	12-13	FA086/2			FA086/2HH	N/A			
GV 700 C	06-09	FA086/2			FA086/2HH	TBA			
ST 7 (GV 700 C)	10-13	FA086/2			FA086/2HH	TBA			
ST 7 Deluxe	12-13	FA086/2			FA086/2HH	TBA			
<b>ITALJET</b>									
Dragster 50 LC	98-12	SFA115	SFAC115		SFA115HH	MD948D			
Formula 50 LC	96-03	SFA115	SFAC115		SFA115HH	MD950D			
Formula Air 50	99-03	S624							
IT 50 (4T)	08	TBA							
50 it Scooter	09	TBA							
Jet Set 50cc 2T	02-03	816							
Pit Jet 50 (2T)	07-09	FA448				N/A			
Rollercraft 50 (4T)	07-08	TBA							
SX1 (50) 2T	08	TBA							
SX1 50 Scooter	09	TBA							
Velocifero 50	98-02	S624							
Torpedo 50 (All models)	98-03	S624							

\*-2 Sets Required. ■ - Also available in MX-S race compound.

**SAFETY WARNING:** DO NOT USE HH PADS ON REAR UNLESS ALSO USED ON FRONT TO AVOID BRAKE IMBALANCE

**R** Suffix = High Durability Sintered Pad. **HH** Suffix = High Performance Sintered Pad. **G** Suffix = Grooved Shoe.  
**D** Suffix = Drilled Disc. **C** Suffix = Contoured Disc. **LS** Suffix = Left/Steel Disc. **RS** = Right/Steel Disc.

**BRAKE APPLICATIONS**



# Non-JAPANESE Built Motorcycles



← FRONT / AVANT / VORN FRENTE / ANTERIORE →

**APPLICATIONS**

**R** Suffix = High Durability Sintered Pad. **HH** Suffix = High Performance Sintered Pad. **G** Suffix = Grooved Shoe.

**D** Suffix = Drilled Disc. **C** Suffix = Contoured Disc. **LS** Suffix = Left/Steel Disc. **RS** = Right/Steel Disc.

## ITALJET

		DISC PAD CHOICES				BRAKE ROTOR CHOICES							
		NEW SFAC Scooter Carbon Pads	Semi-Sintered V-Pads™	Sintered/HH Pads/ Grooved shoes	Left/Gauche/Links	Right/Droite/Rechts	Contour Rotor Universal left and right fitment	NEW Vee-Rotors™ CONTOUR	NEW CX Extreme® ROTOR	Oversize 250/280mm Rotor Kit	Relocating Bracket for 250/280mm Rotor	Oversize 320mm Rotor Kit	Relocating Bracket for 320mm Rotor
(All models 125cc)		965		965G									
Dragster 125/180 LC	99	SFA115	SFAC115	SFA115HH	MD941D			VR941					
Dragster 125/180 LC	00-12	SFA115	SFAC115	SFA115HH	MD941D			VR941					
Formula 125 LC	96-03	SFA115	SFAC115	SFA115HH	MD941D			VR941					
Jack 125/150	07	SFA323	SFAC323	SFA323HH	TBA								
Jet Set 125/150 2T	02-03	SFA350	SFAC350	SFA350HH	TBA								
Jupiter 125/150	02	SFA199	SFAC199	SFA199HH		MD999D							
Millennium M 100/125/150 LC	00-01	SFA101	SFAC101	SFA101HH		MD9114D							
Millennium M 100/125/150 LC	02-04	SFA350	SFAC350	SFA350HH		MD9114D							
Pit Jet 125 4T	07-08	FA448			N/A								
Pit Jet 125 4T	07-09	FA448			N/A								
Torpedo 125 4T (Pro)	99-09	SFA115	SFAC115	SFA115HH	MD951D								
Torpedo 125	07-08	SFA323	SFAC323	SFA323HH	N/A								
Dragster 250	07-09	SFA115	SFAC115	SFA115HH	MD941D			VR941					
Jupiter 250	02-03	SFA199	SFAC199	SFA199HH		MD999D							
Marco Polo 400cc Scooter	07-09	SFA142*	SFAC142*	SFA142HH*	N/A	N/A							
Bazooka (650cc)	06	FA086*		FA086HH*	N/A	N/A							
Grifon #59 (650cc)	06	FA086*		FA086HH*	N/A	N/A							
Grifon #59	07	TBA*			TBA	TBA							

## JAWA - SEE CZ/JAWA

## JCB UTILITY VEHICLES

Groundhog 800D (4 x 4)	08-09	N/A		FA609R*	N/A	N/A							
Groundhog 1000D (4 x 4)	08-09	N/A		FA609R*	N/A	N/A							
Groundhog 1000D (6 x 4)	08-09	N/A		FA609R*	N/A	N/A							
Workmax 800D (4 x 4)	10-13	N/A		FA609R*	N/A	N/A							
Workmax 1000D (4 x 4)	10-13	N/A		FA609R*	N/A	N/A							
Workmax 1000D (6 x 4)	10-13	N/A		FA609R*	N/A	N/A							

## JIALING

JL 50 Stylish	98	TBA											
JH 50 III Street	98	TBA											
JL 70 Horizon	98	TBA											
JD 90 Freedom	98	TBA											
JH 125 Roadstar	98	TBA											
JH 125 B Roadstar	98	FA054TT						TBA					
JE 125 E Dragon	98	FA086		FA086HH		TBA							

## JCM

240 Europa	89	FA115		FA115R	N/A								
------------	----	-------	--	--------	-----	--	--	--	--	--	--	--	--

## J. J. COBAS

TR1	85-	FA095		FA095HH	N/A								
TRial	85-	FA115		FA115R	N/A								

## JONWAY

YY 50 QT-5 (2T) Neo	07-09	TBA											
YY 50 QT-5 (4T) Neo	07-09	TBA											
YY 50 QT-6 (2T) Agility	07-09	SFA086	SFAC086	SFA086HH	N/A								
YY 50 QT-6 (4T) Agility	07-09	SFA086	SFAC086	SFA086HH	N/A								
YY 50 QT-10 (2T) Viper	07-09	SFA086	SFAC086	SFA086HH	N/A								
YY 50 QT-10 (4T) Viper	07-09	SFA086	SFAC086	SFA086HH	N/A								
YY 50 QT-28 (2T) Raptor	07-09	SFA086	SFAC086	SFA086HH	N/A								
YY 50 QT-28 (4T) Raptor	07-09	SFA086	SFAC086	SFA086HH	N/A								
YY 80 QT-6 (4T) Agility	07-09	SFA086	SFAC086	SFA086HH	N/A								
YY 125	08-09	FA165TT		FA165R	N/A								
YY 150	08-09	FA165TT		FA165R	N/A								
YY 150 T-19	08-09	SFA086	SFAC086	SFA086HH		N/A							
YY 250/250 A	08-09	FA165TT		FA165R	N/A								

\*-2 Sets Required. ■ - Also available in MX-S race compound.

**SAFETY WARNING:** DO NOT USE HH PADS ON REAR UNLESS ALSO USED ON FRONT TO AVOID BRAKE IMBALANCE

# Non-JAPANESE Built Motorcycles

**BRAKE APPLICATIONS**

**R** Suffix = High Durability Sintered Pad. **HH** Suffix = High Performance Sintered Pad. **G** Suffix = Grooved Shoe.  
**D** Suffix = Drilled Disc. **C** Suffix = Contoured Disc. **LS** Suffix = Left/Steel Disc. **RS** = Right/Steel Disc.



← REAR / ARRIÈRE / HINTEN POSTERIOR / POSTERIORE →

## ITALJET

		DISC PAD CHOICES				BRAKE ROTOR CHOICES			
		NEW SFAC Scooter Carbon Pads	Semi-Sintered V-Pads™	Sintered/HH Pads/ Grooved shoes		Contour Rotor Rear Fitment	NEW Vee-Rotors™ CONTOUR	NEW CX Extreme® ROTOR	
(All models 125cc)		965			965G				
Dragster 125/180 LC	99	816							
Dragster 125/180 LC	00-12	SFA115	SFAC115	SFA115HH	MD949D				
Formula 125 LC	96-03	SFA115	SFAC115	SFA115HH	MD950D				
Jack 125/150	07	SFA323	SFAC323	SFA323HH	TBA				
Jet Set 125/150 2T	02-03	816							
Jupiter 125/150	02	SFA275	SFAC275	SFA275HH	MD953D				
Millennium M 100/125/150 LC	00-01	Y527							
Millennium M 100/125/150 LC	02-04	Y527							
Pit Jet 125 4T	07-08	FA448			N/A				
Pit Jet 125 4T	07-09	FA115			N/A				
Torpedo 125 4T (Pro)	99-09	816							
Torpedo 125	07-08	S624							
Dragster 250	07-09	SFA115	SFAC115	SFA115HH	MD949D				
Jupiter 250	02-03	SFA374			MD953D				
Marco Polo 400cc Scooter	07-09	SFA298	SFAC298	SFA298HH	N/A				
Bazooka (650cc)	06	FA086		FA086HH	N/A				
Grifon #59 (650cc)	06	FA086		FA086HH	N/A				
Grifon #59	07	FA209/2		FA209/2V	TBA				

## JAWA - SEE CZ/JAWA

## JCB UTILITY VEHICLES

Groundhog 800D (4 x 4)	08-09	N/A		FA609R*	N/A*			
Groundhog 1000D (4 x 4)	08-09	N/A		FA609R*	N/A*			
Groundhog 1000D (6 x 4)	08-09	N/A		FA609R*	N/A*			
Workmax 800D (4 x 4)	10-13	N/A		FA609R*	N/A*			
Workmax 1000D (4 x 4)	10-13	N/A		FA609R*	N/A*			
Workmax 1000D (6 x 4)	10-13	N/A		FA609R*	N/A*			

## JIALING

JL 50 Stylish	98	TBA						
JH 50 III Street	98	TBA						
JL 70 Horizon	98	TBA						
JD 90 Freedom	98	TBA						
JH 125 Roadstar	98	TBA						
JH 125 B Roadstar	98	TBA						
JE 125 E Dragon	98	TBA						

## JCM

240 Europa	89	FA337TT		FA337R	N/A			
------------	----	---------	--	--------	-----	--	--	--

## J. J. COBAS

TR1	85-	FA115		FA115R	N/A			
Trial	85-	N/A						

## JONWAY

YY 50 QT-5 (2T) Neo	07-09	TBA						
YY 50 QT-5 (4T) Neo	07-09	TBA						
YY 50 QT-6 (2T) Agility	07-09	TBA						
YY 50 QT-6 (4T) Agility	07-09	TBA						
YY 50 QT-10 (2T) Viper	07-09	TBA						
YY 50 QT-10 (4T) Viper	07-09	TBA						
YY 50 QT-28 (2T) Raptor	07-09	TBA						
YY 50 QT-28 (4T) Raptor	07-09	TBA						
YY 80 QT-6 (4T) Agility	07-09	TBA						
YY 125	08-09	FA165TT		FA165R	N/A			
YY 150	08-09	FA165TT		FA165R	N/A			
YY 150 T-19	08-09	SFA086	SFAC086	SFA086HH	N/A			
YY 250/250 A	08-09	FA165TT		FA165R	N/A			

\*-2 Sets Required. ■ - Also available in MX-S race compound.

**SAFETY WARNING:** DO NOT USE HH PADS ON REAR UNLESS ALSO USED ON FRONT TO AVOID BRAKE IMBALANCE

# Non-JAPANESE Built Motorcycles



← FRONT / AVANT / VORN FRENTE / ANTERIORE →

**APPLICATIONS**

**BRAKE**

## JONWAY

Model	Year	DISC PAD CHOICES				BRAKE ROTOR CHOICES							
		NEW SFAC Scooter Carbon Pads	Semi-Sintered V-Pads™	Sintered/HH Pads/ Grooved shoes	Left/Gauche/Links	Right/Droite/Rechts	Contour Rotor Universal left and right fitment	NEW Vee-Rotors™ CONTOUR	NEW CX Extreme® ROTOR	Oversize 250/280mm Rotor Kit	Relocating Bracket for 250/280mm Rotor	Oversize 320mm Rotor Kit	Relocating Bracket for 320mm Rotor
YY 250 T-19	08-09	SFA086	SFAC086	SFA086HH		N/A							
GTS 500		TBA			TBA								

## JORDAN

Easy 50/100	03-04	SFA169	SFAC169	SFA169HH	MD904D		MD904C	VR904					
Hipo/Mars/Bob 50/90/100 Anti Vibrate Model	03-04	H338*		H338G*									
Hipo/Mars/Bob 50/90/100 Street Model	03-04	H338*		H338G*									
Panther 125/150/250	03-04	TBA*			TBA	TBA							
Rino 125/150/250	03-04	TBA*			TBA	TBA							

## KAWATA

Fever 50/90	99-01	SFA169	SFAC169	SFA169HH	TBA	TBA							
Nightly 50	99-01	TBA			TBA	TBA							
Singer 90	99-01	SFA169	SFAC169	SFA169HH	TBA	TBA							
Falcon 125	99-01	TBA			TBA	TBA							

## KAZUMA QUADS

MF 90 Falcon		FA416TT*		FA416R*	N/A	N/A							
110 Falcon (Drum Brake Model)		TBA*		TBA*									

## KEEWAY

Agora 50 (2T/4T)	10-11	SFA086	SFAC086	SFA086HH		N/A							
ARN 50 (25/45)	10-11	SFA047		SFA047HH	TBA								
Easy/Hurricane 50 (25/45)	07-12	TBA			N/A								
Focus 50	06-07	SFA235	SFAC235		TBA								
F-Act 50	07-10	SFA235	SFAC235		TBA								
F-Act 50 EVO	11	SFA235	SFAC235		N/A								
F-Act NKD 50	09-11	SFA235	SFAC235		TBA								
F-Act 50 Racing (25/45)	10-12	SFA235	SFAC235		N/A								
F-Act 50 RS	10-11	SFA235	SFAC235		N/A								
Flash 50	07-09	SFA083	SFAC083	SFA083HH	TBA								
Flash 50 Electric	09-10	SFA235	SFAC235		TBA								
Goccia 50	08-11	SFA193	SFAC193	SFA193HH	N/A								
Hacker 50	08-09	SFA047		SFA047HH	N/A								
Hurricane 50	07-09	SFA083	SFAC083	SFA083HH	TBA								
Hurricane 50-Base	07	SFA083	SFAC083	SFA083HH	TBA								
Matrix 50 (2T)	06-12	SFA235	SFAC235		N/A								
Matrix V4 50 (25/45)	10-11	SFA235	SFAC235		N/A								
Milan 50	10-11	TBA											
Pixel 50	08-12	SFA083	SFAC083	SFA083HH	N/A								
RY6 50cc (25/45)	10-11	SFA235	SFAC235			N/A							
RY8 50cc (All models)	07-09	SFA235	SFAC235		TBA								
RY8 Racing 50cc (25/45)	10-11	SFA235	SFAC235			N/A							
RY8 SP 50cc (25/45)	10-11	SFA235	SFAC235			N/A							
Swan 50 (25/45)	10-11	SFA235	SFAC235		N/A								
TX50	10-12	FA194		FA194HH		N/A							
X-Ray 50 Supermoto	07-09	FA194		FA194HH	N/A								
Partner 110	06-07	SFA228	SFAC228	SFA228HH		N/A							
ARN 125	06-12	SFA047		SFA047HH	TBA								
F-Act 125	07-11	SFA235	SFAC235		N/A								
Focus 125	06-07	SFA235	SFAC235		TBA								
Hacker 125	08-10	SFA047		SFA047HH	N/A								
Hacker 125	11-12	TBA			N/A								
K2 125/150/250	07	SFA353	SFAC353	SFA353HH	TBA								
Matrix 125	06	SFA083	SFAC083	SFA083HH	N/A								
Matrix 125	07-10	SFA235	SFAC235		TBA								
Outlook 125/150	07-10	SFA228	SFAC228	SFA228HH	N/A								
Outlook Sport 125	10-11	TBA			N/A								
RKS 125	10-11	FA086		FA086HH		N/A							
RKV 125	10-13	FA244		FA244HH		N/A							

\*-2 Sets Required. ■ - Also available in MX-S race compound.

**SAFETY WARNING:** DO NOT USE HH PADS ON REAR UNLESS ALSO USED ON FRONT TO AVOID BRAKE IMBALANCE

# Non-JAPANESE Built Motorcycles



## JONWAY



← REAR / ARRIÈRE / HINTEN POSTERIOR / POSTERIORE →

### DISC PAD CHOICES

### BRAKE ROTOR CHOICES

			NEW SFAC Scooter Carbon Pads	Semi-Sintered V-Pads™	Sintered/HH Pads/ Grooved shoes		Contour Rotor Rear Fitment	NEW Vee-Rotors™ CONTOUR	NEW CX Extreme® ROTOR
YY 250 T-19	08-09	SFA086	SFAC086		SFA086HH	N/A			
GTS 500		TBA				TBA			
<b>JORDAN</b>									
Easy 50/100	03-04	Y503							
Hipo/Mars/Bob 50/90/100 Anti Vibrate Model	03-04	FA232TT			FA232R	N/A			
Hipo/Mars/Bob 50/90/100 Street Model	03-04	FA232TT			FA232R	N/A			
Panther 125/150/250	03-04	TBA				TBA			
Rino 125/150/250	03-04	TBA				TBA			
<b>KAWATA</b>									
Fever 50/90	99-01	TBA							
Nightfly 50	99-01	TBA							
Slinger 90	99-01	TBA							
Falcon 125	99-01	TBA							
<b>KAZUMA QUADS</b>									
MF 90 Falcon		FA416TT			FA416R	N/A			
110 Falcon (Drum Brake Model)		H330			H330G				
<b>KEEWAY</b>									
Agora 50 (2T/4T)	10-11	Y503							
ARN 50 (25/45)	10-11	Y503							
Easy/Hurricane 50 (25/45)	07-12	Y503							
Focus 50	06-07	Y503							
F-Act 50	07-10	Y503							
F-Act 50 EVO	11	TBA				TBA			
F-Act NKD 50	09-11	Y503							
F-Act 50 Racing (25/45)	10-12	Y503							
F-Act 50 RS	10-11	Y503							
Flash 50	07-09	Y503							
Flash 50 Electric	09-10	Y503							
Goccia 50	08-11	Y503							
Hacker 50	08-09	Y503							
Hurricane 50	07-09	Y503							
Hurricane 50-Base	07	Y503							
Matrix 50 (2T)	06-12	Y503							
Matrix V4 50 (25/45)	10-11	Y503							
Milan 50	10-11	TBA							
Pixel 50	08-12	Y503							
RV6 50cc (25/45)	10-11	Y503							
RV8 50cc (All models)	07-09	Y503							
RV8 Racing 50cc (25/45)	10-11	TBA					N/A		
RV8 SP 50cc (25/45)	10-11	Y503							
Swan 50 (25/45)	10-11	Y503							
TX50	10-12	FA060				N/A			
X-Ray 50 Supermoto	07-09	FA060				N/A			
Partner 110	06-07	TBA							
ARN 125	06-12	Y503							
F-Act 125	07-11	Y503							
Focus 125	06-07	Y506							
Hacker 125	08-10	TBA							
Hacker 125	11-12	TBA				TBA			
K2 125/150/250	07	SFA353	SFAC353		SFA353HH	TBA			
Matrix 125	06	Y506							
Matrix 125	07-10	Y506							
Outlook 125/150	07-10	SFA228	SFAC228		SFA228HH	N/A			
Outlook Sport 125	10-11	TBA				TBA			
RKS 125	10-11	TBA							
RKV 125	10-13	FA298			FA298HH		N/A		

\*-2 Sets Required. ■ - Also available in MX-S race compound.

**SAFETY WARNING:** DO NOT USE HH PADS ON REAR UNLESS ALSO USED ON FRONT TO AVOID BRAKE IMBALANCE

**R** Suffix = High Durability Sintered Pad. **HH** Suffix = High Performance Sintered Pad. **G** Suffix = Grooved Shoe.  
**D** Suffix = Drilled Disc. **C** Suffix = Contoured Disc. **LS** Suffix = Left/Steel Disc. **RS** = Right/Steel Disc.

**BRAKE APPLICATIONS**

# Non-JAPANESE Built Motorcycles

## APPLICATIONS BRAKE



← FRONT / AVANT / VORN FRENTE / ANTERIORE →

Model	Year	DISC PAD CHOICES				BRAKE ROTOR CHOICES						
		NEW SFAC Scooter Carbon Pads	Semi-Sintered V-Pads™	Sintered/HH Pads/ Grooved shoes	Left/Gauche/Links	Right/Droite/Rechts	Contour Rotor Universal left and right fitment	NEW Vee-Rotors™ CONTOUR	NEW CX Extreme® ROTOR	Oversize 250/280mm Rotor Kit	Relocating Bracket for 250/280mm Rotor	Oversize 320mm Rotor Kit
<b>KEEWAY</b>												
Silverblade 125/150/250	07	SFA181*	SFAC181*	SFA181HH*	TBA	TBA						
Silverblade 125	10-11	SFA197	SFAC197	SFA197HH		N/A						
Speed 125/150	07-12	SFA093			N/A							
Superlight 125	07-12	FA228		FA228HH	TBA							
TX125	10-12	FA194		FA194HH		N/A						
Am 150	06-09	SFA047		SFA047HH	N/A							
F-Act 150	07-10	SFA235	SFAC235		N/A							
Hacker 150	08-10	SFA047		SFA047HH	N/A							
Matrix 150	07-10	SFA235	SFAC235		N/A							
Superlight 150	07-12	FA228		FA228HH	TBA							
Cruiser 250	09-10	FA228		FA228HH	TBA							
Dragon 250 Quad	07-09	FA083TT*		FA083R*	N/A	N/A						
GTX300 Quad	10-11	FA483TT*		FA483R*	N/A	N/A						
<b>KIOTI/MECHRON (SIDE X SIDE)</b>												
2200 UTV (Side x Side)	09-12	FA622TT*		FA622R*	TBA	TBA						
2210 UTV (Side x Side)	11-12	FA622TT*		FA622R*	TBA	TBA						
<b>K.M. (KEEMOTORBIKES)</b>												
Badboy 50 CX	05	SFA235	SFAC235		N/A							
Badboy 100 CX	05	SFA235	SFAC235		N/A							
<b>KRAM-IT (KRAMER)</b>												
MC 125 LC												
EP 250/EC 250												
GS 250	00-	FA181TT		FA181R ■	N/A							
MC 250/MC 250 LC												
SM 250	00-	FA181TT		FA181R ■	N/A							
SMR 250	00-	TBA										
EC 450/MC 450												
MC 500												
ER 125/250/300 RV3	88-	FA134		FA134R	N/A							
ER 500/600	96-	FA134		FA134R	N/A							
<b>KREIDLER</b>												
50 MF2			H322									
50 MF4 Early Models			908									
50 MF4 Later Models			H322									
50 Flory MF 12/13			932									
50 Flory MF 20/22			H322									
50 Flory MF 23/24/25			932									
50 MP1 Early Models			908									
50 MP1 Later Models			H322									
50 PM			966									
50 LH/LF/LFF			932									
50 RMC/RMC-BG			932									
RS Typ K 54/53			N/A									
RSH Typ K54/53H			N/A									
50 RS-G/RSH-G and GS		FA056				N/A						
80 EL Florett		FA056				N/A						
Mustang 125		FA076		FA076HH	N/A							
125		967										
125 RS		FA056				N/A						
<b>KTM</b>												
50 Supermoto	06	FA325TT		FA325R	N/A							
50 SX/SXR Pro Junior/Senior/Adventure	96-03	H322										
50 SX Mini Adventure	04-07	H322										
50 SX Pro Senior LC	02-03	FA325TT		FA325R	N/A							
50 SX Senior Adventure	02-07	FA325TT		FA325R	N/A							

\*-2 Sets Required. ■ - Also available in MX-S race compound.

**SAFETY WARNING:** DO NOT USE HH PADS ON REAR UNLESS ALSO USED ON FRONT TO AVOID BRAKE IMBALANCE



# Non-JAPANESE Built Motorcycles

**BRAKE APPLICATIONS**



← REAR / ARRIÈRE / HINTEN POSTERIOR / POSTERIORE →

## KEEWAY



		DISC PAD CHOICES				BRAKE ROTOR CHOICES			
		NEW SFAC Scooter Carbon Pads	Semi-Sintered V-Pads™	Sintered/HH Pads/ Grooved shoes	Contour Rotor Rear Fitment	NEW Vee-Rotors™ CONTOUR	NEW CX Extreme® ROTOR		
Silverblade 125/150/250	07	SFA266	SFAC266		FA266HH	TBA			
Silverblade 125	10-11	SFA197	SFAC197		SFA197HH	N/A			
Speed 125/150	07-12	SFA093				N/A			
Superlight 125	07-12	TBA							
TX125	10-12	FA060				N/A			
Am 150	06-09	Y506							
F-Act 150	07-10	Y506							
Hacker 150	08-10	TBA							
Matrix 150	07-10	Y506							
Superlight 150	07-12	TBA							
Cruiser 250	09-10	TBA							
Dragon 250 Quad	07-09	FA054TT		FA054R	N/A				
GTX300 Quad	10-11	FA482TT		FA482R	N/A				

## KIOTI/MECHRON (SIDE X SIDE)

2200 UTV (Side x Side)	09-12	FA622TT*		FA622R*	TBA*			
2210 UTV (Side x Side)	11-12	FA622TT*		FA622R*	TBA*			

## K.M. (KEEMOTORBIKES)

Badboy 50 CX	05	H303						
Badboy 100 CX	05	H303						

## KRAM-IT (KRAMER)

MC 125 LC								
EP 250/EC 250				843G				
GS 250	00-	FA208TT		FA208R ■	N/A			
MC 250/MC 250 LC				843G				
SM 250	00-	FA208TT		FA208R ■	N/A			
SMR 250	00-	FA208TT		FA208R	N/A			
EC 450/MC 450				843G				
MC 500				843G				
ER 125/250/300 RV3	88-	FA067/3		FA067R	N/A			
ER 500/600	96-	FA067/3		FA067R	N/A			

## KREIDLER

50 MF2		H322						
50 MF4 Early Models		908						
50 MF4 Later Models		H322						
50 Flory MF 12/13		932						
50 Flory MF 20/22		H322						
50 Flory MF 23/24/25		932						
50 MP1 Early Models		908						
50 MP1 Later Models		H322						
50 RM		966						
50 LH/LF/LFF		932						
50 RMC/RMC-BG		932						
RS Typ K 54/53		N/A						
RSH Typ K54/53H		N/A						
50 RS-G/RSH-G and GS		TBA						
80 E/L Florett		966						
Mustang 125		932						
125		932						
125 RS		932						

## KTM

50 Supermoto	06	FA325TT		FA325R	N/A			
50 SX/SXR Pro Junior/Senior/Adventure	96-03	H322						
50 SX Mini Adventure	04-07	H322						
50 SX Pro Senior LC	02-03	H322						
50 SX Senior Adventure	02-07	H322						

\*-2 Sets Required. ■ - Also available in MX-S race compound.

**SAFETY WARNING:** DO NOT USE HH PADS ON REAR UNLESS ALSO USED ON FRONT TO AVOID BRAKE IMBALANCE

**R** Suffix = High Durability Sintered Pad. **HH** Suffix = High Performance Sintered Pad. **G** Suffix = Grooved Shoe.  
**D** Suffix = Drilled Disc. **C** Suffix = Contoured Disc. **LS** Suffix = Left/Steel Disc. **RS** = Right/Steel Disc.

# Non-JAPANESE Built Motorcycles



← FRONT / AVANT / VORN FRENTE / ANTERIORE →

KTM	Year	DISC PAD CHOICES				BRAKE ROTOR CHOICES								
		NEW SFAC Scooter Carbon Pads	Semi-Sintered V-Pads™	Sintered/HH Pads/ Grooved shoes	Left/Gauche/Links	Right/Droite/Rechts	Contour Rotor Universal left and right fitment	NEW Vee-Rotors™ CONTOUR	NEW CX Extreme® ROTOR	Oversize 250/280mm Rotor Kit	Relocating Bracket for 250/280mm Rotor	Oversize 320mm Rotor Kit	Relocating Bracket for 320mm Rotor	
50 SX Pro Senior LC (12" Front Wheel)	04-13	FA325TT		FA325R		N/A								
60 SX	98-99	FA115TT		FA115R		MD6192D		MD6192C						
60 SX	00	FA115TT		FA115R		MD6192D		MD6192C						
65 SX	00-01	FA115TT		FA115R		MD6192D		MD6192C						
65 SX	02-03	FA357TT		FA357R		MD6192D		MD6192C						
65 SX	04-08	FA357TT		FA357R		MD6243D		MD6243C		MD6243CX				
SX 65	09-13	FA357TT		FA357R				MD6243C		MD6243CX				
80 MX	86-92	FA047/2				N/A								
SX 85 (17"1/4" wheels)	03-10	FA357TT		FA357R				MD6258C		OS6258C	BRK028	N/A	N/A	
SX 85 (19"1/16" wheels)	03-10	FA357TT		FA357R				MD6258C		OS6258C	BRK028	N/A	N/A	
SX 85 (17"1/4" wheels)	11	FA357TT		FA357R				MD6258C		OS6258C	BRK028	N/A	N/A	
SX 85 (19"1/16" wheels)	11	FA357TT		FA357R				MD6258C		OS6258C	BRK028	N/A	N/A	
SX 85 (17"1/4" wheels)	12-13	FA612TT		FA612R				MD6258C		OS6258/12C	BRK027	N/A	N/A	
SX 85 (19"1/16" wheels)	12-13	FA612TT		FA612R				MD6258C		OS6258/12C	BRK027	N/A	N/A	
125/175	-84			812G										
125 GS	83			811G										
125 Duke	11-13	FA606		FA606HH		MD849								
D-XC/E-XC/E-GS 125	90-91	FA067TT		FA067R		MD6034D								
D-XC/E-XC/E-GS 125 Grimeca Calipers	90-91	FA132		FA132R		MD6034D								
D-XC/E-XC/E-GS 125 Brembo Calipers	92-93	FA181TT		FA181R	■	MD6034D								
D-XC/E-XC/E-GS 125 Grimeca Calipers	92-93	FA132		FA132R		MD6034D								
EXC 125	87	FA126TT		FA126R		N/A								
EXC 125	88	FA132		FA132R		N/A								
EXC 125 Brembo Calipers	89	FA067TT		FA067R		MD6034D								
EXC 125 Grimeca Calipers	89	FA132		FA132R		MD6034D								
EXC/EGS 125 (Standard forks)	94	FA181TT		FA181R	■	MD6032D		MD6032C		MD6032CX	OS6032EC	BRK015	SM6032EC	BRK016
EXC 125 (Standard forks)	95-99	FA181TT		FA181R	■	MD6032D		MD6032C		MD6032CX	OS6032EC	BRK015	SM6032EC	BRK016
EXC 125 (Upside down forks)	00-03	FA181TT		FA181R	■	MD6032D		MD6032C		MD6032CX	OS6032C	BRK011	SM6032C	BRK012
EXC 125 (Upside down forks)	04-08	FA181TT		FA181R	■	MD6032D		MD6032C		MD6032CX	OS6032C	BRK011	SM6032C	BRK012
EXC 125 (Upside down forks)	09-13	FA181TT		FA181R	■	MD6032D		MD6032C		MD6032CX	OS6932C	BRK013	SM6932C	BRK014
EXC 125 Six Days (Upside down forks)	11-13	FA181TT		FA181R	■	MD6032D		MD6032C		MD6032CX	OS6932C	BRK013	SM6932C	BRK014
EXE 125	00	FA181TT		FA181R	■	MD6032D		MD6032C		MD6032CX	OS6032C	BRK011	SM6032C	BRK012
GSXC/GS 125	85	FA047TT		FA047R		N/A								
LC2 125	96-98	FA181TT		FA181R	■	N/A								
Sting 125	97-99	FA095		FA095HH		N/A								
MX 125	83			811G										
MX 125	84			814G										
MX/MXC 125	85	FA047TT		FA047R		N/A								
MX/MXC/GS 125	86	FA047TT		FA047R		N/A								
MX 125	87	FA126TT		FA126R		N/A								
MX 125	88	FA132		FA132R		N/A								
MX 125 Brembo Calipers	89	FA067TT		FA067R		N/A								
MX 125 Grimeca Calipers	89	FA132		FA132R		N/A								
MX 125 Brembo Calipers	90-91	FA067TT		FA067R		N/A								
MX 125 Grimeca Calipers	90-91	FA132		FA132R		N/A								
MX 125 Brembo Calipers	92-93	FA181TT		FA181R	■	MD6032D		MD6032C		MD6032CX	OS6032EC	BRK015	SM6032EC	BRK016
MX 125 Grimeca Calipers	92-93	FA132		FA132R		MD6032D		MD6032C		MD6032CX	N/A	N/A	N/A	N/A
SM 125 Supermoto	00	FA181TT		FA181R	■	TBA								
SX 125 (Standard forks)	94-99	FA181TT		FA181R	■	MD6032D		MD6032C		MD6032CX	OS6032C	BRK011	SM6032C	BRK012
SX 125 (Upside down forks)	00-03	FA181TT		FA181R	■	MD6032D		MD6032C		MD6032CX	OS6032EC	BRK015	SM6032EC	BRK016
SX 125 (Upside down forks)	04-08	FA181TT		FA181R	■			MD6032C		MD6032CX	OS6032C	BRK011	SM6032C	BRK012
SX 125 (Upside down forks)	09-13	FA181TT		FA181R	■			MD6032C		MD6032CX	OS6932C	BRK013	SM6932C	BRK014
SX 150 (Upside down forks)	08	FA181TT		FA181R	■			MD6032C		MD6032CX	OS6032C	BRK011	SM6032C	BRK012
SX 150 (Upside down forks)	09-13	FA181TT		FA181R	■			MD6032C		MD6032CX	OS6932C	BRK013	SM6932C	BRK014
XC 150 (Upside down forks)	11-13	FA181TT		FA181R	■			MD6032C		MD6032CX	OS6932C	BRK013	SM6932C	BRK014
200 Duke	12-13	FA606		FA606HH		MD849								
EXC/EGS 200 (Standard forks)	98-99	FA181TT		FA181R	■	MD6032D		MD6032C		MD6032CX	OS6032EC	BRK015	SM6032EC	BRK016
EXC/EGS 200 (Upside down forks)	00-03	FA181TT		FA181R	■	MD6032D		MD6032C		MD6032CX	OS6032C	BRK011	SM6032C	BRK012
EXC 200 (Upside down forks)	04-08	FA181TT		FA181R	■	MD6032D		MD6032C		MD6032CX	OS6032C	BRK011	SM6032C	BRK012
EXC 200 (Upside down forks)	09-13	FA181TT		FA181R	■	MD6032D		MD6032C		MD6032CX	OS6932C	BRK013	SM6932C	BRK014

\*-2 Sets Required. ■ - Also available in MX-S race compound.

**SAFETY WARNING:** DO NOT USE HH PADS ON REAR UNLESS ALSO USED ON FRONT TO AVOID BRAKE IMBALANCE

APPLICATIONS

BRAKE

R Suffix = High Durability Sintered Pad. HH Suffix = High Performance Sintered Pad. G Suffix = Grooved Shoe.

D Suffix = Drilled Disc. C Suffix = Contoured Disc. LS Suffix = Left/Steel Disc. RS = Right/Steel Disc.

# Non-JAPANESE Built Motorcycles



**KTM**



← REAR / ARRIÈRE / HINTEN  POSTERIOR / POSTERIORE →

			DISC PAD CHOICES				BRAKE ROTOR CHOICES			
			NEW SFAC Scooter Carbon Pads	Semi-Sintered V-Pads™	Sintered/HH Pads/ Grooved shoes		Contour Rotor Rear Fitment	NEW Vee-Rotors™ CONTOUR	NEW CX Extreme® ROTOR	
50 SX Pro Senior LC (12" Front Wheel)	04-13	FA325TT			FA325R	N/A				
60 SX	98-99			815						
60 SX	00	FA337TT			FA337R	MD6216D				
65 SX	00-01	FA337TT			FA337R	MD6216D				
65 SX	02-03	FA337TT			FA337R	MD6216D				
65 SX	04-08	FA325TT			FA325R		MD6249C		MD6249CX	
SX 65	09-13	FA357TT			FA357R		MD6249C		MD6249CX	
80 MX	86-92	814G								
SX 85 (17"1/4" wheels)	03-10	FA357TT			FA357R		MD6257C			
SX 85 (19"1/6" wheels)	03-10	FA357TT			FA357R		MD6257C			
SX 85 (17"1/4" wheels)	11	FA602TT			FA602R		MD6360C			
SX 85 (19"1/6" wheels)	11	FA602TT			FA602R		MD6360C			
SX 85 (17"1/4" wheels)	12-13	FA602TT			FA602R		MD6360C			
SX 85 (19"1/6" wheels)	12-13	FA602TT			FA602R		MD6360C			
125/175	-84				812G					
125 GS	83				812G					
125 Duke	11-13	FA213			FA213HH	MD850				
D-XC/E-XC/E-GS 125	90-91	FA067TT			FA067R	N/A				
D-XC/E-XC/E-GS 125 Grimeca Calipers	90-91	FA132			FA132R	N/A				
D-XC/E-XC/E-GS 125 Brembo Calipers	92-93	FA067TT			FA067R	N/A				
D-XC/E-XC/E-GS 125 Grimeca Calipers	92-93	FA067TT			FA067R	N/A				
EXC 125	87	FA126TT			FA126R	N/A				
EXC 125	88	FA132			FA132R	MD6227D				
EXC 125 Brembo Calipers	89	FA067TT			FA067R	MD6227D				
EXC 125 Grimeca Calipers	89	FA132			FA132R	MD6227D				
EXC/EGS 125 (Standard forks)	94	FA208TT			FA208R ■	MD6035D	MD6035C ◆		MD6035CX	
EXC 125 (Standard forks)	95-99	FA208TT			FA208R ■	MD6035D	MD6035C ◆		MD6035CX	
EXC 125 (Upside down forks)	00-03	FA208TT			FA208R ■	MD6035D	MD6035C ◆		MD6035CX	
EXC 125 (Upside down forks)	04-08	FA368TT			FA368R ■	MD6035D	MD6035C ◆		MD6035CX	
EXC 125 (Upside down forks)	09-13	FA368TT			FA368R ■	MD6035D	MD6035C ◆		MD6035CX	
EXC 125 Six Days (Upside down forks)	11-13	FA368TT			FA368R ■	MD6035D	MD6035C ◆		MD6035CX	
EXC 125	00	FA208TT			FA208R ■	MD6035D	MD6035C ◆		MD6035CX	
GSXC/GS 125	85				814G					
LC2 125	96-98	FA208TT			FA208R ■	N/A				
Sting 125	97-99	FA208TT			FA208R	N/A				
MX 125	83				812G					
MX 125	84				814G					
MXMXC 125	85				814G					
MXMXC/GS 125	86	FA047TT			FA047R	MD6227D				
MX 125	87	FA126TT			FA126R	N/A				
MX 125	88	FA132			FA132R	MD6227D				
MX 125 Brembo Calipers	89	FA067TT			FA067R	MD6227D				
MX 125 Grimeca Calipers	89	FA132			FA132R	MD6227D				
MX 125 Brembo Calipers	90-91	FA067TT			FA067R	N/A				
MX 125 Grimeca Calipers	90-91	FA132			FA132R	N/A				
MX 125 Brembo Calipers	92-93	FA067TT			FA067R	N/A				
MX 125 Grimeca Calipers	92-93	FA067TT			FA067R	N/A				
SM 125 Supermoto	00	FA208TT			FA208R ■	MD6035D	MD6035C			
SX 125 (Standard forks)	94-99	FA208TT			FA208R ■	MD6035D	MD6035C		MD6035CX	
SX 125 (Upside down forks)	00-03	FA208TT			FA208R ■	MD6035D	MD6035C		MD6035CX	
SX 125 (Upside down forks)	04-08	FA368TT			FA368R ■		MD6035C		MD6035CX	
SX 125 (Upside down forks)	09-13	FA368TT			FA368R ■		MD6035C		MD6035CX	
SX 150 (Upside down forks)	08	FA368TT			FA368R ■		MD6035C		MD6035CX	
SX 150 (Upside down forks)	09-13	FA368TT			FA368R ■		MD6035C		MD6035CX	
XC 150 (Upside down forks)	11-13	FA368TT			FA368R ■		MD6035C		MD6035CX	
200 Duke	12-13	FA213			FA213HH	MD850				
EXC/EGS 200 (Standard forks)	98-99	FA208TT			FA208R ■	MD6035D	MD6035C ◆		MD6035CX	
EXC/EGS 200 (Upside down forks)	00-03	FA208TT			FA208R ■	MD6035D	MD6035C ◆		MD6035CX	
EXC 200 (Upside down forks)	04-08	FA368TT			FA368R ■	MD6035D	MD6035C ◆		MD6035CX	
EXC 200 (Upside down forks)	09-13	FA368TT			FA368R ■	MD6035D	MD6035C ◆		MD6035CX	

\*-2 Sets Required. ■ - Also available in MX-S race compound.

**SAFETY WARNING:** DO NOT USE HH PADS ON REAR UNLESS ALSO USED ON FRONT TO AVOID BRAKE IMBALANCE

**R** Suffix = High Durability Sintered Pad. **HH** Suffix = High Performance Sintered Pad. **G** Suffix = Grooved Shoe.  
**D** Suffix = Drilled Disc. **C** Suffix = Contoured Disc. **LS** Suffix = Left/Steel Disc. **RS** = Right/Steel Disc.

**BRAKE APPLICATIONS**

# Non-JAPANESE Built Motorcycles



← FRONT / AVANT / VORN FRENTE / ANTERIORE →

KTM	Year	DISC PAD CHOICES				BRAKE ROTOR CHOICES							
		NEW SFAC Scooter Carbon Pads	Semi-Sintered V-Pads™	Sintered/HH Pads/ Grooved shoes	Left/Gauche/Links	Right/Droite/Rechts	Contour Rotor Universal left and right fitment	NEW Vee-Rotors™ CONTOUR	NEW CX Extreme® ROTOR	Oversize 250/280mm Rotor Kit	Relocating Bracket for 250/280mm Rotor	Oversize 320mm Rotor Kit	Relocating Bracket for 320mm Rotor
250	-82			812G									
250 MX Leleu	82			811G									
250 MX	83			TBA									
250 XC/GS	83			811G									
DXC/EXC 250 Grimeca Calipers	90	FA132		FA132R	MD6034D								
D-XC/E-XC/E-GS 250 Brembo Calipers	91	FA067TT		FA067R	MD6034D								
D-XC/E-XC/E-GS 250	91	FA132		FA132R	MD6034D								
D-XC/E-XC/T-XC/E-GS 250 Grimeca Calipers	92-93	FA132		FA132R	MD6032D		MD6032C		MD6032CX	OS6032EC	BRK015	SM6032EC	BRK016
EXC/EGS 250	88	FA132		FA132R	N/A								
EXC/EGS 250 Brembo Calipers	89	FA067TT		FA067R	MD6034D								
EXC/EGS 250 Grimeca Calipers	89	FA132		FA132R	MD6034D								
EXC/EGS 250 (Standard forks)	94	FA181TT		FA181R ■	MD6032D		MD6032C		MD6032CX	OS6032EC	BRK015	SM6032EC	BRK016
EXC 250 (Standard forks)	95-99	FA181TT		FA181R ■	MD6032D		MD6032C		MD6032CX	OS6032EC	BRK015	SM6032EC	BRK016
EXC 250 (Upside down forks)	00-03	FA181TT		FA181R ■	MD6032D		MD6032C		MD6032CX	OS6032C	BRK011	SM6032C	BRK012
EXC 250 (Upside down forks) (2T)	04-08	FA181TT		FA181R ■	MD6032D		MD6032C		MD6032CX	OS6032C	BRK011	SM6032C	BRK012
EXC 250 (Upside down forks) (2T)	09-12	FA181TT		FA181R ■	MD6032D		MD6032C		MD6032CX	OS6932C	BRK013	SM6932C	BRK014
EXC 250 Six Days (Upside down forks) (2T)	11-13	FA181TT		FA181R ■	MD6032D		MD6032C		MD6032CX	OS6932C	BRK013	SM6932C	BRK014
EXC 250 Racing	06	FA181TT		FA181R ■	MD6032D		MD6032C		MD6032CX	OS6032C	BRK011	SM6032C	BRK012
EXC-F 250 (4T)	06-08	FA181TT		FA181R ■	MD6032D		MD6032C		MD6032CX	OS6032C	BRK011	SM6032C	BRK012
EXC-F 250 (4T)	09-13	FA181TT		FA181R ■	MD6032D		MD6032C		MD6032CX	OS6932C	BRK013	SM6932C	BRK014
EXC-F 250 Six Days (4T)	11-13	FA181TT		FA181R ■	MD6032D		MD6032C		MD6032CX	OS6932C	BRK013	SM6932C	BRK014
GS 250	86	FA047TT		FA047R	N/A								
GSXC/GS 250	85	FA047TT		FA047R	N/A								
MX 250	88	FA132		FA132R	N/A								
MX 250 Grimeca Calipers	89	FA132		FA132R	N/A								
MX 250 Brembo Calipers	89	FA067TT		FA067R	N/A								
MX 250 Brembo Calipers	90	FA067TT		FA067R	N/A								
MX 250 Brembo Calipers	91	FA067TT		FA067R	N/A								
MX 250 Grimeca Calipers	91	FA132		FA132R	N/A								
MX 250 Brembo Calipers	92-93	FA181TT		FA181R ■	MD6032D		MD6032C		MD6032CX	OS6032EC	BRK015	SM6032EC	BRK016
MX/EXC 250	87	FA126		FA126R	N/A								
MXMXC/GS 250	84			814G									
MXMXC 250	85	FA047TT		FA047R	N/A								
MXMXC 250	86	FA047TT		FA047R	N/A								
SX 250 (2T/Standard forks)	94-99	FA181TT		FA181R ■	MD6032D		MD6032C		MD6032CX	OS6032EC	BRK015	SM6032EC	BRK016
SX 250 (2T/Upside down forks)	00-02	FA181TT		FA181R ■			MD6032C		MD6032CX	OS6032C	BRK011	SM6032C	BRK012
SX 250 (2T/Upside down forks)	03-08	FA181TT		FA181R ■			MD6032C		MD6032CX	OS6032C	BRK011	SM6032C	BRK012
SX 250 (2T/Upside down forks)	09-13	FA181TT		FA181R ■			MD6032C		MD6032CX	OS6932C	BRK013	SM6932C	BRK014
SX-F 250 (4T/Upside down forks)	06-08	FA181TT		FA181R ■			MD6032C		MD6032CX	OS6032C	BRK011	SM6032C	BRK012
SX-F 250 (4T/Upside down forks)	09-13	FA181TT		FA181R ■			MD6032C		MD6032CX	OS6932C	BRK013	SM6932C	BRK014
SX-F 250 (Ken Roczen Edition)	12	FA181TT		FA181R ■			MD6032C		MD6032CX	OS6932C	BRK013	SM6932C	BRK014
XC 250 (2T/Upside down forks)	11-13	FA181TT		FA181R ■			MD6032C		MD6032CX	OS6932C	BRK013	SM6932C	BRK014
XC-F 250 (4T/Upside down forks)	11-13	FA181TT		FA181R ■			MD6032C		MD6032CX	OS6932C	BRK013	SM6932C	BRK014
EXC 300 (Upside down forks)	00-03	FA181TT		FA181R ■	MD6032D		MD6032C		MD6032CX	OS6032C	BRK011	SM6032C	BRK012
EXC 300 (Upside down forks)	04-08	FA181TT		FA181R ■	MD6032D		MD6032C		MD6032CX	OS6032C	BRK011	SM6032C	BRK012
EXC 300 (Upside down forks)	09-13	FA181TT		FA181R ■	MD6032D		MD6032C		MD6032CX	OS6932C	BRK013	SM6932C	BRK014
EXC 300 Six Days (Upside down forks)	11-13	FA181TT		FA181R ■	MD6032D		MD6032C		MD6032CX	OS6932C	BRK013	SM6932C	BRK014
EXC-E 300 (2T) (USD/Electric start)	08-09	FA181TT		FA181R ■	MD6032D		MD6032C		MD6032CX	OS6032C	BRK011	SM6032C	BRK012
XC 300 (2T)	11-13	FA181TT		FA181R ■	MD6032D		MD6032C		MD6032CX	OS6932C	BRK013	SM6932C	BRK014
GSXC/GS 300	85	FA047TT		FA047R	N/A								
MXMXC 300	85	FA047TT		FA047R	N/A								
MXMXC/GS 300	86	FA047TT		FA047R	N/A								
350	-82			812G									
350 Four Stroke	83	FA047TT		FA047R	N/A								
350 Freeride (4T)	12-13	FA612TT		FA612R				TBA					
350 Freeride (Electric)	12	FA612TT		FA612R				TBA					
DXC/EXC/EGS 350 Brembo Calipers	90-91	FA067TT		FA067R	MD6034D								
DXC/EXC/EGS 350 Grimeca Calipers	90-91	FA132		FA132R	MD6034D								
EXC 350 Brembo Calipers	89	FA067TT		FA067R	MD6034D								
EXC 350 Grimeca Calipers	89	FA132		FA132R	MD6034D								

\*-2 Sets Required. ■ - Also available in MX-S race compound.

**SAFETY WARNING:- DO NOT USE HH PADS ON REAR UNLESS ALSO USED ON FRONT TO AVOID BRAKE IMBALANCE**

# Non-JAPANESE Built Motorcycles



**KTM**



← REAR / ARRIÈRE / HINTEN POSTERIOR / POSTERIORE →

Model	Year	DISC PAD CHOICES				BRAKE ROTOR CHOICES			
		NEW SFAC Scooter Carbon Pads	Semi-Sintered V-Pads™	Sintered/HH Pads/ Grooved shoes	Disc Pad	Contour Rotor Rear Fitment	NEW Vee-Rotors™ CONTOUR	NEW CX Extreme® ROTOR	
250	82			813G					
250 MX Leleu	82			813G					
250 MX	83			TBA					
250 XC/GS	83			813G					
DXC/EXC 250 Grimeca Calipers	90	FA132		FA132R	N/A				
D-XC/E-XC/E-GS 250 Brembo Calipers	91	FA067		FA067R	N/A				
D-XC/E-XC/E-GS 250	91	FA132		FA132R	N/A				
D-XC/E-XC/T-XC/E-GS 250 Grimeca Calipers	92-93	FA067		FA067R	N/A				
EXC/EGS 250	88	FA132		FA132R	MD6227D				
EXC/EGS 250 Brembo Calipers	89	FA067		FA067R	MD6227D				
EXC/EGS 250 Grimeca Calipers	89	FA132		FA132R	MD6227D				
EXC/EGS 250 (Standard forks)	94	FA208TT		FA208R ■	MD6035D	MD6035C		MD6035CX	
EXC 250 (Standard forks)	95-99	FA208TT		FA208R ■	MD6035D	MD6035C ◆		MD6035CX	
EXC 250 (Upside down forks)	00-03	FA208TT		FA208R ■	MD6035D	MD6035C ◆		MD6035CX	
EXC 250 (Upside down forks) (2T)	04-08	FA368TT		FA368R ■	MD6035D	MD6035C ◆		MD6035CX	
EXC 250 (Upside down forks) (2T)	09-12	FA368TT		FA368R ■	MD6035D	MD6035C ◆		MD6035CX	
EXC 250 Six Days (Upside down forks) (2T)	11-13	FA368TT		FA368R ■	MD6035D	MD6035C ◆		MD6035CX	
EXC 250 Racing	06	FA368TT		FA368R ■	MD6035D	MD6035C ◆		MD6035CX	
EXC-F 250 (4T)	06-08	FA368TT		FA368R ■	MD6035D	MD6035C		MD6035CX	
EXC-F 250 (4T)	09-13	FA368TT		FA368R ■	MD6035D	MD6035C		MD6035CX	
EXC-F 250 Six Days (4T)	11-13	FA368TT		FA368R ■	MD6035D	MD6035C		MD6035CX	
GS 250	86	FA047TT		FA047R	MD6227D				
GSXC/GS 250	85			814G					
MX 250	88	FA132		FA132R	MD6227D				
MX 250 Grimeca Calipers	89	FA132		FA132R	MD6227D				
MX 250 Brembo Calipers	89	FA067TT		FA067R	MD6227D				
MX 250 Brembo Calipers	90	FA067TT		FA067R	N/A				
MX 250 Brembo Calipers	91	FA067TT		FA067R	N/A				
MX 250 Grimeca Calipers	91	FA132		FA132R	N/A				
MX 250 Brembo Calipers	92-93	FA067TT		FA067R	N/A				
MX/EXC 250	87	FA126		FA126R	N/A				
MX/MXC/GS 250	84			814G					
MX/MXC 250	85			814G					
MX/MXC 250	86	FA047TT		FA047R	MD6227D				
SX 250 (2T/Standard forks)	94-99	FA208TT		FA208R ■	MD6035D	MD6035C		MD6035CX	
SX 250 (2T/Upside down forks)	00-02	FA208TT		FA208R ■		MD6035C		MD6035CX	
SX 250 (2T/Upside down forks)	03-08	FA368TT		FA368R ■		MD6035C		MD6035CX	
SX 250 (2T/Upside down forks)	09-13	FA368TT		FA368R ■		MD6035C		MD6035CX	
SX-F 250 (4T/Upside down forks)	06-08	FA368TT		FA368R ■		MD6035C		MD6035CX	
SX-F 250 (4T/Upside down forks)	09-13	FA368TT		FA368R ■		MD6035C		MD6035CX	
SX-F 250 (Ken Roczen Edition)	12	FA368TT		FA368R ■		MD6035C		MD6035CX	
XC 250 (2T/Upside down forks)	11-13	FA368TT		FA368R ■		MD6035C ◆		MD6035CX	
XC-F 250 (4T/Upside down forks)	11-13	FA368TT		FA368R ■		MD6035C ◆		MD6035CX	
EXC 300 (Upside down forks)	00-03	FA208TT		FA208R ■	MD6035D	MD6035C ◆		MD6035CX	
EXC 300 (Upside down forks)	04-08	FA368TT		FA368R ■	MD6035D	MD6035C ◆		MD6035CX	
EXC 300 (Upside down forks)	09-13	FA368TT		FA368R ■	MD6035D	MD6035C ◆		MD6035CX	
EXC 300 Six Days (Upside down forks)	11-13	FA368TT		FA368R ■	MD6035D	MD6035C ◆		MD6035CX	
EXC-E 300 (2T) (USD/Electric start)	08-09	FA368TT		FA368R ■	MD6035D	MD6035C ◆		MD6035CX	
XC 300 (2T)	11-13	FA368TT		FA368R ■	MD6035D	MD6035C		MD6035CX	
GSXC/GS 300	85			814G					
MX/MXC 300	85			814G					
MX/MXC/GS 300	86	FA047TT		FA047R	MD6227D				
350	82			813G					
350 Four Stroke	83			813G					
350 Freeride (4T)	12-13	FA602TT		FA602R		MD6360C			
350 Freeride (Electric)	12	FA602TT		FA602R		MD6360C			
DXC/EXC/EGS 350 Brembo Calipers	90-91	FA067TT		FA067R	N/A				
DXC/EXC/EGS 350 Grimeca Calipers	90-91	FA132		FA132R	N/A				
EXC 350 Brembo Calipers	89	FA067TT		FA067R	MD6227D				
EXC 350 Grimeca Calipers	89	FA132		FA132R	MD6227D				

\*-2 Sets Required. ■ - Also available in MX-S race compound.

**SAFETY WARNING:** DO NOT USE HH PADS ON REAR UNLESS ALSO USED ON FRONT TO AVOID BRAKE IMBALANCE

**R** Suffix = High Durability Sintered Pad. **HH** Suffix = High Performance Sintered Pad. **G** Suffix = Grooved Shoe.  
**D** Suffix = Drilled Disc. **C** Suffix = Contoured Disc. **LS** Suffix = Left/Steel Disc. **RS** = Right/Steel Disc.

**BRAKE APPLICATIONS**



# Non-JAPANESE Built Motorcycles



← FRONT / AVANT / VORN FRENTE / ANTERIORE →

## DISC PAD CHOICES

## BRAKE ROTOR CHOICES

### KTM

		NEW SFAC Scooter Carbon Pads	Semi-Sintered V-Pads™	Sintered/HH Pads/ Grooved shoes	Left/Gauche/Links	Right/Droite/Rechts	Contour Rotor Universal left and right fitment	NEW Vee-Rotors™ CONTOUR	NEW CX Extreme® ROTOR	Oversize 250/280mm Rotor Kit	Relocating Bracket for 250/280mm Rotor	Oversize 320mm Rotor Kit	Relocating Bracket for 320mm Rotor
EXC 350 LC4 (Standard forks)	94-95	FA181TT		FA181R ■	MD6032D		MD6032C		MD6032CX	OS6032EC	BRK015	SM6032EC	BRK016
MX/MXC/GS 350	86	FA047TT		FA047R	N/A								
MX/EXC 350	87	FA126TT		FA126R	N/A								
MX/EXC/EGS 350	88	FA132		FA132R	N/A								
MX 350 Brembo Calipers	90-91	FA067TT		FA067R	N/A								
MX 350 Grimeca Calipers	90-91	FA132		FA132R	N/A								
MX 350 Brembo Calipers	89	FA067TT		FA067R	N/A								
MX 350 Grimeca Calipers	89	FA132		FA132R	N/A								
EXC 350 (Standard forks)	96-97	FA181TT		FA181R ■	MD6032D		MD6032C		MD6032CX	OS6032EC	BRK015	SM6032EC	BRK016
EXC-F 350 (4T/Upside down forks)	11-13	FA181TT		FA181R ■			MD6032C		MD6032CX	OS6932C	BRK013	SM6932C	BRK014
EXC-F 350 (4T/Six Days)	12-13	FA181TT		FA181R ■			MD6032C		MD6032CX	OS6932C	BRK013	SM6932C	BRK014
SX-F 350 (4T/Upside down forks)	11-13	FA181TT		FA181R ■			MD6032C		MD6032CX	OS6932C	BRK013	SM6932C	BRK014
SX-F 350 (Tony Cairoli Edition)	12	FA181TT		FA181R ■			MD6032C		MD6032CX	OS6932C	BRK013	SM6932C	BRK014
XC-F 350 (4T)	12-13	FA181TT		FA181R ■			MD6032C		MD6032CX	OS6932C	BRK013	SM6932C	BRK014
SX 360 (Standard forks)	96-97	FA181TT		FA181R ■	MD6032D		MD6032C		MD6032CX	OS6032EC	BRK015	SM6032EC	BRK016
EXC 380 (Standard forks)	98-99	FA181TT		FA181R ■	MD6032D		MD6032C		MD6032CX	OS6032EC	BRK015	SM6032EC	BRK016
EXC 380 (Upside down forks)	00-03	FA181TT		FA181R ■	MD6032D		MD6032C		MD6032CX	OS6032C	BRK011	SM6032C	BRK012
SX 380 (Standard forks)	98-99	FA181TT		FA181R ■	MD6032D		MD6032C		MD6032CX	OS6032EC	BRK015	SM6032EC	BRK016
SX 380 (Upside down forks)	00-03	FA181TT		FA181R ■	MD6032D		MD6032C		MD6032CX	OS6032C	BRK011	SM6032C	BRK012
390 Duke	13	FA606		FA606HH	MD849								
Duke 400 LC4	94-98	FA095		FA095HH	MD6199D		MD6199C			N/A	N/A	N/A	N/A
EGS 400/EGS-E/LSE (LC4 Enduro)	96-99	FA181TT		FA181R ■	MD6130D ¶					N/A	N/A	N/A	N/A
¶ = Choice of MD6130D = solid MD6130DF = Pro-lite MD6130CF = Contour Profile													
EXC/EGS 400 (USD)	00-03	FA181TT		FA181R ■	MD6032D		MD6032C		MD6032C	OS6032C	BRK011	SM6032C	BRK012
EXC 400 Racing (USD)	00	FA181TT		FA181R ■	MD6032D		MD6032C		MD6032C	OS6032C	BRK011	SM6032C	BRK012
EXC 400 Racing	04-07	FA181TT		FA181R ■	MD6032D		MD6032C		MD6032C	OS6032C	BRK011	SM6032C	BRK012
LC4-E 400 Enduro	00-01	FA181TT		FA181R ■	MD6130D ¶					N/A	N/A	N/A	N/A
¶ = Choice of MD6130D = solid MD6130DF = Pro-lite MD6130CF = Contour Profile													
SC 400 (Supercompetition LC4)	96-99	FA181TT		FA181R ■	MD6032D		MD6032C		MD6032CX	OS6032EC	BRK015	SM6032EC	BRK016
SX 400 (Upside down forks)	00-02	FA181TT		FA181R ■	MD6032D		MD6032C		MD6032CX	OS6032C	BRK011	SM6032C	BRK012
420 GS	85			812G									
EXC 440	94-95	FA181TT		FA181R ■	MD6032D		MD6032C		MD6032CX	OS6032C	BRK011	SM6032C	BRK012
SX 440	94-95	FA181TT		FA181R ■	MD6032D		MD6032C		MD6032CX	OS6032EC	BRK015	SM6032EC	BRK016
EXC 450 (4T)	03	FA181TT		FA181R ■	MD6032D		MD6032C		MD6032CX	OS6032C	BRK011	SM6032C	BRK012
EXC 450 (4T)	04-08	FA181TT		FA181R ■	MD6032D		MD6032C		MD6032CX	OS6032C	BRK011	SM6032C	BRK012
EXC 450 (4T)	09-13	FA181TT		FA181R ■	MD6032D		MD6032C		MD6032CX	OS6932C	BRK013	SM6932C	BRK014
EXC 450 Six Days (4T)	11-13	FA181TT		FA181R ■	MD6032D		MD6032C		MD6032CX	OS6932C	BRK013	SM6932C	BRK014
EXC 450 Racing	06-07	FA181TT		FA181R ■	MD6032D		MD6032C		MD6032CX	OS6032C	BRK011	SM6032C	BRK012
EXC-R 450 (4T)	08	FA181TT		FA181R ■	MD6032D		MD6032C		MD6032CX	OS6032C	BRK011	SM6032C	BRK012
SMR 450 (6 piston caliper)	04			MXS406	MD6270D								
SMR 450 (4 piston caliper)	05-06			MXS405	MD6270D		MD6270C						
SMR 450 (Magura caliper)	07-13	FA433/4		FA433/4HH			MD6313C						
SX 450 (4T)	03-06	FA181TT		FA181R ■			MD6032C		MD6032CX	OS6032C	BRK011	SM6032C	BRK012
SX-F 450 (4T)	07-08	FA181TT		FA181R ■			MD6032C		MD6032CX	OS6032C	BRK011	SM6032C	BRK012
SX-F 450 (4T)	09-13	FA181TT		FA181R ■			MD6032C		MD6032CX	OS6932C	BRK013	SM6932C	BRK014
450 SX-F (Quad)	09			FA462R*			MD6338C*						
XC 450 (Quad)	08-10			FA462R*			MD6338C*						
495	-82			812G									
495 MX Leleu	82			811G									
EXC 500 (4T)	12-13	FA181TT		FA181R ■	MD6032D		MD6032C		MD6032CX	OS6932C	BRK013	SM6932C	BRK014
EXC 500 Six Days (4T)	12-13	FA181TT		FA181R ■	MD6032D		MD6032C		MD6032CX	OS6932C	BRK013	SM6932C	BRK014
LC-4 MX/EXC 500	89	FA132		FA132R	MD6034D								
LC-4 MX 500 Brembo Calipers	90-91	FA067TT		FA067R	N/A								
LC-4 EXC 500 Brembo Calipers	90-91	FA067TT		FA067R	MD6034D								
LC-4 MX 500 Grimeca Calipers	90-91	FA132		FA132R	N/A								
LC-4 EXC 500 Grimeca Calipers	90-91	FA132		FA132R	MD6034D								
MX/MXC/XC-GS 500	85	FA047TT			N/A								
MX 500	92-94	FA181TT		FA181R ■	N/A								
MX 500	95	FA181TT		FA181R ■	N/A								
SX-F 505	07-08	FA181TT		FA181R ■	MD6032D		MD6032C		MD6032CX	OS6032C	BRK011	SM6032C	BRK012

\*-2 Sets Required. ■ - Also available in MX-S race compound.

**SAFETY WARNING:** DO NOT USE HH PADS ON REAR UNLESS ALSO USED ON FRONT TO AVOID BRAKE IMBALANCE

APPLICATIONS

BRAKE

R Suffix = High Durability Sintered Pad. HH Suffix = High Performance Sintered Pad. G Suffix = Grooved Shoe.

D Suffix = Drilled Disc. C Suffix = Contoured Disc. LS Suffix = Left/Steel Disc. RS = Right/Steel Disc.

# Non-JAPANESE Built Motorcycles



**KTM**



← REAR / ARRIÈRE / HINTEN POSTERIOR / POSTERIORE →

		DISC PAD CHOICES				BRAKE ROTOR CHOICES			
		NEW SFAC Scooter Carbon Pads	Semi-Sintered V-Pads™	Sintered/HH Pads/ Grooved shoes		Contour Rotor Rear Fitment	NEW Vee-Rotors™ CONTOUR	NEW CX Extreme® ROTOR	
EXC 350 LC4 (Standard forks)	94-95	FA208TT		FA208R ■	MD6035D	MD6035C ◆			
MX/MXC/GS 350	86	FA047TT		FA047R	MD6227D				
MX/EXC 350	87	FA126TT		FA126R	N/A				
MX/EXC/EGS 350	88	FA132		FA132R	MD6227D				
MX 350 Brembo Calipers	90-91	FA067TT		FA067R	N/A				
MX 350 Grimeca Calipers	90-91	FA132		FA132R	N/A				
MX 350 Brembo Calipers	89	FA067TT		FA067R	MD6227D				
MX 350 Grimeca Calipers	89	FA132		FA132R	MD6227D				
EXC 350 (Standard forks)	96-97	FA208TT		FA208R ■	MD6035D	MD6035C ◆		MD6035CX	
EXC-F 350 (4T/Upside down forks)	11-13	FA368TT		FA368R ■		MD6035C		MD6035CX	
EXC-F 350 (4T/Six Days)	12-13	FA368TT		FA368R ■		MD6035C		MD6035CX	
SX-F 350 (4T/Upside down forks)	11-13	FA368TT		FA368R ■		MD6035C		MD6035CX	
SX-F 350 (Tony Carroll Edition)	12	FA368TT		FA368R ■		MD6035C		MD6035CX	
XC-F 350 (4T)	12-13	FA368TT		FA368R ■		MD6035C		MD6035CX	
SX 360 (Standard forks)	96-97	FA208TT		FA208R ■	MD6035D	MD6035C		MD6035CX	
EXC 380 (Standard forks)	98-99	FA208TT		FA208R ■	MD6035D	MD6035C ◆		MD6035CX	
EXC 380 (Upside down forks)	00-03	FA208TT		FA208R ■	MD6035D	MD6035C ◆		MD6035CX	
SX 380 (Standard forks)	98-99	FA208TT		FA208R ■	MD6035D	MD6035C		MD6035CX	
SX 380 (Upside down forks)	00-03	FA208TT		FA208R ■	MD6035D	MD6035C		MD6035CX	
390 Duke	13	FA213		FA213HH	MD850				
Duke 400 LC4	94-98	FA208TT		FA208R ■	MD6371D	MD6371C			
EGS 400/EGS-ELSE (LC4 Enduro)	96-99	FA208TT		FA208R ■	MD6371D				
EXC/EGS 400 (USD)	00-03	FA208TT		FA208R ■	MD6371D	MD6371C			
EXC 400 Racing (USD)	00	FA208TT		FA208R ■	MD6035D	MD6035C ◆		MD6035CX	
EXC 400 Racing	04-07	FA368TT		FA368R ■	MD6035D	MD6035C		MD6035CX	
LC4-E 400 Enduro	00-01	FA208TT		FA208R ■	MD6035D	MD6035C		MD6035CX	
SC 400 (Supercompetition LC4)	96-99	FA208TT		FA208R ■	MD6371D	MD6371C			
SX 400 (Upside down forks)	00-02	FA208TT		FA208R ■	MD6035D	MD6035C		MD6035CX	
420 GS	85			812G					
EXC 440	94-95	FA208TT		FA208R ■	MD6035D	MD6035C		MD6035CX	
SX 440	94-95	FA208TT		FA208R ■	MD6035D	MD6035C		MD6035CX	
EXC 450 (4T)	03	FA208TT		FA208R ■	MD6035D	MD6035C ◆		MD6035CX	
EXC 450 (4T)	04-08	FA368TT		FA368R ■	MD6035D	MD6035C ◆		MD6035CX	
EXC 450 (4T)	09-13	FA368TT		FA368R ■	MD6035D	MD6035C ◆		MD6035CX	
EXC 450 Six Days (4T)	11-13	FA368TT		FA368R ■	MD6035D	MD6035C ◆		MD6035CX	
EXC 450 Racing	06-07	FA368TT		FA368R ■	MD6035D	MD6035C ◆		MD6035CX	
EXC-R 450 (4T)	08	FA368TT		FA368R ■	MD6035D	MD6035C ◆		MD6035CX	
SMR 450 (6 piston caliper)	04	FA368TT		FA368R ■	MD6035D	MD6035C			
SMR 450 (4 piston caliper)	05-06	FA368TT		FA368R ■	MD6035D	MD6035C			
SMR 450 (Magura caliper)	07-13	FA368TT		FA368R ■		MD6035C			
SX 450 (4T)	03-06	FA368TT		FA368R ■		MD6035C		MD6035CX	
SX-F 450 (4T)	07-08	FA368TT		FA368R ■		MD6035C		MD6035CX	
SX-F 450 (4T)	09-13	FA368TT		FA368R ■		MD6035C		MD6035CX	
450 SX-F (Quad)	09			FA463R	MD6337D				
XC 450 (Quad)	08-10			FA463R	MD6337D				
495	-82			813G					
495 MX Leleu	82			813G					
EXC 500 (4T)	12-13	FA368TT		FA368R ■	MD6035D	MD6035C ◆		MD6035CX	
EXC 500 Six Days (4T)	12-13	FA368TT		FA368R ■	MD6035D	MD6035C ◆		MD6035CX	
LC-4 MX/EXC 500	89	FA132		FA132R	N/A				
LC-4 MX 500 Brembo Calipers	90-91	FA067TT		FA067R	MD6035D	MD6035C			
LC-4 EXC 500 Brembo Calipers	90-91	FA067TT		FA067R	MD6035D	MD6035C ◆			
LC-4 MX 500 Grimeca Calipers	90-91	FA132		FA132R	MD6035D	MD6035C			
LC-4 EXC 500 Grimeca Calipers	90-91	FA132		FA132R	MD6035D	MD6035C ◆			
MX/MXC/XC-GS 500	85			814G					
MX 500	92-94	FA067TT		FA067R	N/A				
MX 500	95	FA208TT		FA208R ■	N/A				
SX-F 505	07-08	FA368TT		FA368R ■	MD6035D	MD6035C		MD6035CX	

\*-2 Sets Required. ■ - Also available in MX-S race compound.

**SAFETY WARNING:** DO NOT USE HH PADS ON REAR UNLESS ALSO USED ON FRONT TO AVOID BRAKE IMBALANCE

**R** Suffix = High Durability Sintered Pad. **HH** Suffix = High Performance Sintered Pad. **G** Suffix = Grooved Shoe.  
**D** Suffix = Drilled Disc. **C** Suffix = Contoured Disc. **LS** Suffix = Left/Steel Disc. **RS** = Right/Steel Disc.

**BRAKE APPLICATIONS**

# Non-JAPANESE Built Motorcycles



← FRONT / AVANT / VORN FRENTE / ANTERIORE →

KTM		DISC PAD CHOICES				BRAKE ROTOR CHOICES								
		NEW SFAC Scooter Carbon Pads	Semi-Sintered V-Pads™	Sintered/HH Pads/ Grooved shoes	Left/Gauche/Links	Right/Droite/Rechts	Contour Rotor Universal left and right fitment	NEW Vee-Rotors™ CONTOUR	NEW CX Extreme® ROTOR	Oversize 250/280mm Rotor Kit	Relocating Bracket for 250/280mm Rotor	Oversize 320mm Rotor Kit	Relocating Bracket for 320mm Rotor	
SX-F 505	09	FA181TT		FA181R ■		MD6032D		MD6032C		MD6032CX	OS6032C	BRK013	SM6032C	BRK014
505 SX-F (Quad)	09-12			FA462R*				MD6336C*						
EXC 520	01-03	FA181TT		FA181R ■		MD6032D		MD6032C		MD6032CX	OS6032C	BRK011	SM6032C	BRK012
SX 520	01-03	FA181TT		FA181R ■		MD6032D		MD6032C		MD6032CX	OS6032C	BRK011	SM6032C	BRK012
EXC 525	03	FA181TT		FA181R ■		MD6032D		MD6032C		MD6032CX	OS6032C	BRK011	SM6032C	BRK012
EXC 525	04-05	FA181TT		FA181R ■		MD6032D		MD6032C		MD6032CX	OS6032C	BRK011	SM6032C	BRK012
EXC 525 Racing	06	FA181TT		FA181R ■		MD6032D		MD6032C		MD6032CX	OS6032C	BRK011	SM6032C	BRK012
MXC 525 (Desert Racing)	03	FA181TT		FA181R ■		MD6032D		MD6032C		MD6032CX	OS6032C	BRK011	SM6032C	BRK012
MXC 525 (Desert Racing)	04	FA181TT		FA181R ■		MD6032D		MD6032C		MD6032CX	OS6032C	BRK011	SM6032C	BRK012
SMR 525 (6 piston caliper)	04			MXS406		MD6270D								
SMR 525 (4 piston caliper)	05			MXS405		MD6270D		MD6270C						
SX 525	03-06	FA181TT		FA181R ■		MD6032D		MD6032C		MD6032CX	OS6032C	BRK011	SM6032C	BRK012
XC 525 Racing	06-07	FA181TT		FA181R ■		MD6032D		MD6032C		MD6032CX	OS6032C	BRK011	SM6032C	BRK012
XC 525 (Quad)	08-12			FA462R*				MD6336C*						
EXC 530 (4T)	09-10	FA181TT		FA181R ■				MD6032C		MD6032CX	OS6032C	BRK013	SM6032C	BRK014
EXC 530 Six Days (4T)	11	FA181TT		FA181R ■				MD6032C		MD6032CX	OS6032C	BRK013	SM6032C	BRK014
EXC-R 530 (4T)	08	FA181TT		FA181R ■		MD6032D		MD6032C		MD6032CX	OS6032C	BRK011	SM6032C	BRK012
MXC 550	96	FA181TT		FA181R ■		MD6032D		MD6032C		MD6032CX	OS6032EC	BRK015	SM6032EC	BRK016
SMR 560 Supermoto	06			MXS405		N/A								
SMR 560	07	FA433/4		FA433/4HH		TBA								
LC4 MX/EXC 600	89	FA132		FA132R		MD6034D								
LC4 MX 600 Brembo Calipers	90-91	FA067TT		FA067R		N/A								
LC4 EXC 600 Brembo Calipers	90-91	FA067TT		FA067R		MD6034D								
LC4 MX 600 Grimeca Calipers	90-91	FA132		FA132R		N/A								
LC4 EXC 600 Grimeca Calipers	90-91	FA132		FA132R		MD6034D								
LC4 EXC 600	92-93	FA132		FA132R		MD6034D								
Duke 620 LC4	94-98	FA095		FA095HH		MD6199D		MD6199C			N/A	N/A	N/A	N/A
EGS 620 Enduro/EGS-E/LS	96-99	FA181TT		FA181R ■		MD6130D ¶								
¶ = Choice of MD6130D = solid MD6130DF = Pro-lite MD6130CF = Contour Profile														
EGS-E 620 Adventure/Rallye	99	FA181TT		FA181R ■		MD6032D		MD6032C		MD6032CX	OS6032EC	BRK015	SM6032EC	BRK016
LC4 620 SC Supermoto	00	FA181TT		FA181R ■		MD6199D		MD6199C			N/A	N/A	N/A	N/A
SC 620 Supercompetition	96-00	FA181TT		FA181R ■		MD6032D		MD6032C		MD6032CX	OS6032EC	BRK015	SM6032EC	BRK016
SX 620/EXC/EGS	94	FA181TT		FA181R ■		MD6032D		MD6032C		MD6032CX	OS6032EC	BRK015	SM6032EC	BRK016
SX EXC/EGS 620	95	FA181TT		FA181R ■		MD6032D		MD6032C		MD6032CX	OS6032EC	BRK015	SM6032EC	BRK016
SX 620	96-99	FA181TT		FA181R ■		MD6032D		MD6032C		MD6032CX	OS6032EC	BRK015	SM6032EC	BRK016
LC4 625 SC Supermoto	02	FA181TT		FA181R ■		MD6199D		MD6199C			N/A	N/A	N/A	N/A
LC4 625 SC Supercompetition	02	FA181TT		FA181R ■		MD6032D		MD6032C		MD6032CX	OS6032C	BRK011	SM6032C	BRK012
SMC 625	05-06	FA244	FA244V	FA244HH				MD6199C			N/A	N/A	N/A	N/A
SXC 625	03-04	FA181TT		FA181R ■		MD6032D		MD6032C		MD6032CX	OS6032C	BRK011	SM6032C	BRK012
SXC 625	05-06	FA181TT		FA181R ■		MD6032D		MD6032C		MD6032CX	OS6032C	BRK011	SM6032C	BRK012
Duke-E 640 (Single pin pad fixing/zero offset disc)	98	FA095	FA095V	FA095HH		MD6199D		MD6199C			N/A	N/A	N/A	N/A
Duke II 640 (2 pin pad fixing disc/zero offset)	99-07	FA244	FA244V	FA244HH		MD6199D		MD6199C			N/A	N/A	N/A	N/A
LC4-E 640 Enduro	00-04	FA181TT		FA181R ■		MD6130D ¶					N/A	N/A	N/A	N/A
¶ = Choice of MD6130D = solid MD6130DF = Pro-lite MD6130CF = Contour Profile														
LC4-E 640 Supermoto	00-06	FA181TT		FA181R ■		MD6199D		MD6199C			N/A	N/A	N/A	N/A
LC-4 640 Adventure	01-02	FA181TT		FA181R ■		MD6199D		MD6199C			N/A	N/A	N/A	N/A
LC-4 640 Adventure	03-07	FA181TT*		FA181R* ■		MD6266D								
LC-R 640 Adventure R	00	FA181TT		FA181R ■		MD6130D ¶					N/A	N/A	N/A	N/A
¶ = Choice of MD6130D = solid MD6130DF = Pro-lite MD6130CF = Contour Profile														
SMC 640 LC4	05	FA244	FA244V	FA244HH	TBA									
SMC 660 Supermoto	03-04	FA095	FA095V	FA095HH	TBA									
SMC 660 Supermoto	05-06	FA244	FA244V	FA244HH	TBA									
690 Duke	08-11			FA322/4HH		MD614X		MD614XC	VR614BLK					
690 Duke (2 Pin Pad Fixing)	12-13	FA244	FA244V	FA244HH		MD614X		MD614XC	VR614BLK					
690 Duke R	10-11			FA322/4HH		MD614X		MD614XC	VR614BLK					
690 Enduro	08-10	FA209/2	FA209/2V	FA209/2HH				MD6299C						
690 R Enduro	09-13	FA209/2	FA209/2V	FA209/2HH				MD6299C						
690 Rally Factory Replica	07-09	FA209/2	FA209/2V	FA209/2HH	MD6299D			MD6299C						
690 SM (2 pin pad fixing/spoke wheel)	07-09	FA244	FA244V	FA244HH	MD6199D			MD6199C						
690 SM -LE (Limited Edition)	10-11	FA244	FA244V	FA244HH	MD6199D			MD6199C						

\*-2 Sets Required. ■ - Also available in MX-S race compound.

**SAFETY WARNING:** DO NOT USE HH PADS ON REAR UNLESS ALSO USED ON FRONT TO AVOID BRAKE IMBALANCE

APPLICATIONS

BRAKE  
**R** Suffix = High Durability Sintered Pad. **HH** Suffix = High Performance Sintered Pad. **G** Suffix = Grooved Shoe.  
**D** Suffix = Drilled Disc. **C** Suffix = Contoured Disc. **LS** Suffix = Left/Steel Disc. **RS** = Right/Steel Disc.

# Non-JAPANESE Built Motorcycles



**KTM**



← REAR / ARRIÈRE / HINTEN  POSTERIOR / POSTERIORE →

		DISC PAD CHOICES				BRAKE ROTOR CHOICES			
		NEW SFAC Scooter Carbon Pads	Semi-Sintered V-Pads™	Sintered/HH Pads/ Grooved shoes		Contour Rotor Rear Fitment	NEW Vee-Rotors™ CONTOUR	NEW CX Extreme® ROTOR	
SX-F 505	09	FA368TT		FA368R ■	MD6035D	MD6035C		MD6035CX	
505 SX-F (Quad)	09-12			FA463R	MD6337D				
EXC 520	01-03	FA208TT		FA208R ■	MD6035D	MD6035C ◆		MD6035CX	
SX 520	01-03	FA208TT		FA208R ■	MD6035D	MD6035C		MD6035CX	
EXC 525	03	FA208TT		FA208R ■	MD6035D	MD6035C ◆		MD6035CX	
EXC 525	04-05	FA368TT		FA368R ■	MD6035D	MD6035C ◆		MD6035CX	
EXC 525 Racing	06	FA368TT		FA368R ■	MD6035D	MD6035C ◆		MD6035CX	
MXC 525 (Desert Racing)	03	FA208TT		FA208R ■	MD6035D	MD6035C		MD6035CX	
MXC 525 (Desert Racing)	04	FA208TT		FA208R ■	MD6035D	MD6035C		MD6035CX	
SMR 525 (6 piston caliper)	04	FA368TT		FA368R ■	MD6035D	MD6035C			
SMR 525 (4 piston caliper)	05	FA368TT		FA368R ■	MD6035D	MD6035C			
SX 525	03-06	FA368TT		FA368R ■	MD6035D	MD6035C		MD6035CX	
XC 525 Racing	06-07	FA368TT		FA368R ■	MD6035D	MD6035C		MD6035CX	
XC 525 (Quad)	08-12			FA463R	MD6337D				
EXC 530 (4T)	09-10	FA368TT		FA368R ■		MD6035C ◆		MD6035CX	
EXC 530 Six Days (4T)	11	FA368TT		FA368R ■		MD6035C ◆		MD6035CX	
EXC-R 530 (4T)	08	FA368TT		FA368R ■	MD6035D	MD6035C ◆		MD6035CX	
MXC 550	96	FA208TT		FA208R ■	MD6035D	MD6035C		MD6035CX	
SMR 560 Supermoto	06	FA368TT		FA368R ■	MD6035D	MD6035C			
SMR 560	07	FA368TT		FA368R ■	MD6035D	MD6035C			
LC4 MX/EXC 600	89	FA132		FA132R	N/A				
LC4 MX 600 Brembo Calipers	90-91	FA067TT		FA067R	MD6371D				
LC4 EXC 600 Brembo Calipers	90-91	FA067TT		FA067R	MD6371D				
LC4 MX 600 Grimeca Calipers	90-91	FA132		FA132R	MD6371D				
LC4 EXC 600 Grimeca Calipers	90-91	FA132		FA132R	MD6371D				
LC4 EXC 600	92-93	FA067TT		FA067R	MD6371D				
Duke 620 LC4	94-98	FA208TT		FA208R ■	MD6371D	MD6371C			
EGS 620 Enduro/EGS-ELSE	96-99	FA208TT		FA208R ■	MD6371D				
EGS-E 620 Adventure/Rallye	99	FA208TT		FA208R ■	MD6371D	MD6371C			
LC4 620 SC Supermoto	00	FA208TT		FA208R ■	MD6371D	MD6371C			
SC 620 Supercompetition	96-00	FA208TT		FA208R ■	MD6371D	MD6371C			
SX 620/EXC/EGS	94	FA067TT		FA067R	MD6371D	MD6371C			
SX EXC/EGS 620	95	FA208TT		FA208R ■	MD6371D	MD6371C			
SX 620	96-99	FA208TT		FA208R ■	MD6371D	MD6371C			
LC4 625 SC Supermoto	02	FA208TT		FA208R ■	MD6371D	MD6371C			
LC4 625 SC Supercompetition	02	FA208TT		FA208R ■	MD6371D	MD6371C			
SMC 625	05-06	FA208TT		FA208R ■	MD6371D	MD6371C			
SXC 625	03-04	FA208TT		FA208R ■	MD6371D	MD6371C			
SXC 625	05-06	FA368TT		FA368R ■	MD6371D	MD6371C			
Duke-E 640 (Single pin pad fixing/zero offset disc)	98	FA213	FA213V	FA213HH	MD6371D	MD6371C			
Duke II 640 (2 pin pad fixing disc/zero offset)	99-07	FA213	FA213V	FA213HH	MD6371D	MD6371C			
LC4-E 640 Enduro	00-04	FA208TT		FA208R ■	MD6371D				
LC4-E 640 Supermoto	00-06	FA208TT		FA208R ■	MD6371D	MD6371C			
LC-4 640 Adventure	01-02	FA208TT		FA208R ■	MD6371D	MD6371C			
LC-4 640 Adventure	03-07	FA208TT		FA208R ■	MD6371D				
LC-R 640 Adventure R	00	FA208TT		FA208R ■	MD6371D				
SMC 640 LC4	05	FA208TT		FA208R ■	MD6371D				
SMC 660 Supermoto	03-04	FA208TT		FA208R ■	MD6371D				
SMC 660 Supermoto	05-06	FA208TT		FA208R ■	MD6371D				
690 Duke	08-11	FA213	FA213V	FA213HH	MD681	MD681C	VR681		
690 Duke (2 Pin Pad Fixing)	12-13	FA213	FA213V	FA213HH	MD681	MD681C	VR681		
690 Duke R	10-11	FA213	FA213V	FA213HH	MD681	MD681C	VR681		
690 Enduro	08-10	FA208TT		FA208R ■		MD6269C			
690 R Enduro	09-13	FA208TT		FA208R ■		MD6269C			
690 Rally Factory Replica	07-09	FA213	FA213V	FA213HH	MD6269D	MD6269C			
690 SM (2 pin pad fixing/spoke wheel)	07-09	FA213	FA213V	FA213HH	MD6269D				
690 SM -LE (Limited Edition)	10-11	FA213	FA213V	FA213HH	MD6269D				

\*-2 Sets Required. ■ - Also available in MX-S race compound.

**SAFETY WARNING:** DO NOT USE HH PADS ON REAR UNLESS ALSO USED ON FRONT TO AVOID BRAKE IMBALANCE

**R** Suffix = High Durability Sintered Pad. **HH** Suffix = High Performance Sintered Pad. **G** Suffix = Grooved Shoe.  
**D** Suffix = Drilled Disc. **C** Suffix = Contoured Disc. **LS** Suffix = Left/Steel Disc. **RS** = Right/Steel Disc.

**BRAKE APPLICATIONS**



# Non-JAPANESE Built Motorcycles



← FRONT / AVANT / VORN FRENTE / ANTERIORE →

## DISC PAD CHOICES

NEW SFAC Scooter Carbon Pads    Semi-Sintered V-Pads™    Sintered/HH Pads/ Grooved shoes    Left/Gauche/Links    Right/Droite/Rechts    Contour Rotor Universal left and right fitment

## BRAKE ROTOR CHOICES

NEW Vee-Rotors™ CONTOUR    NEW CX Extreme® ROTOR    Oversize 250/280mm Rotor Kit    Relocating Bracket for 250/280mm Rotor    Oversize 320mm Rotor Kit    Relocating Bracket for 320mm Rotor

### KTM

690 SMC (4 pad type caliper/spoke wheel)	08-10			FA322/4HH	MD6199D		MD6199C						
690 SMC R	12-13			FA322/4HH	MD614X		MD614XC	VR614BLK					
690 SMR (4 pad type caliper/cast wheel)	07-11			FA322/4HH	MD614X		MD614XC	VR614BLK					
950 Adventure S	04-06	FA209/2*		FA209/2V*	FA209/2HH*	MD6266D	MD6266D						
950 R Superenduro	06-08	FA209/2		FA209/2V	FA209/2HH	MD6299D							
SMC 950 Supermoto	05-06			FA322/4HH*	MD680	MD680	MD680C*						
990 Adventure S (Non ABS)	06-08	FA209/2*		FA209/2V*	FA209/2HH*	MD6299D	MD6299D						
990 Adventure R (Non ABS)	09-12	FA209/2*		FA209/2V*	FA209/2HH*	MD6299D	MD6299D						
990 Adventure (ABS Model)	Left 07-12	FA209/2		FA209/2V	FA209/2HH	MD844X		MD844XC					
	Right	FA209/2		FA209/2V	FA209/2HH		MD848X	MD848XC					
990 Adventure Dakar Edition (ABS Model)	Left 11	FA209/2		FA209/2V	FA209/2HH	MD844X		MD844XC					
	Right	FA209/2		FA209/2V	FA209/2HH		MD848X	MD848XC					
990 Superduke	05-11			FA322/4HH*	MD633X	MD633X	MD633XC*						
990 Superduke R	07-13			FA322/4HH*	MD633X	MD633X	MD633XC*						
990 Supermoto T (SM-T)	09-13			FA322/4HH*	MD680	MD680	MD680C*						
990 Supermoto R (SM-R)	08-09			FA322/4HH*	MD680	MD680	MD680C*						
990 Supermoto R (SM-R)	10-13			FA447HH*	MD680	MD680	MD680C*						
RC8 (1190cc)	08-11			FA447HH*	MD633X	MD633X	MD633XC*						
RC8 R/Track (1190cc)	09-13			FA447HH*	MD633X	MD633X	MD633XC*						
1190 Adventure	13	FA244*		FA244HH	TBA	TBA							
1190 Adventure R	13	FA244*		FA244HH	TBA	TBA							

◆ PLAIN UNDRILLED DISC FOR ENDURO USE. REAR FITMENTS ONLY.

NOTE - Most KTM models changed the caliper bracket design in 2009.

O/E BRACKET REF 770 13 014 000 type is used in the OSISM6932C type disc.

### KYMCO

Activ 50	05-06	SFA197	SFAC197	SFA197HH		N/A							
Active SR 50cc	08-11	SFA086	SFAC086	SFA086HH		N/A							
Agility 50 (KG10SA)	05-08	SFA228	SFAC228	SFA228HH	MD971D		MD971C	VR971					
Agility 50 Basic	07	H303											
Agility 50 Carry (4T)	11-13	SFA305	SFAC305	SFA305HH			TBA						
Agility 50 R10 (4T) (CV 50 QT S) 10" wheels	06-12	SFA228	SFAC228	SFA228HH	MD971D		MD971C	VR971					
Agility 50 R12 (4T) (CX 50 QT S) 12" wheels	06-12	SFA228	SFAC228	SFA228HH	MD971D		MD971C	VR971					
Agility 50 R16 (2T/16" wheels)	08-12	SFA305	SFAC305	SFA305HH	MD9100D			VR9100					
Agility 50 R16 (4T/16" wheels)	08-13	SFA305	SFAC305	SFA305HH	TBA								
Agility RS 50 (2T/12" Wheels) Naked	10-12	SFA228	SFAC228	SFA228HH			MD971C	VR971					
Bet & Win 50/Dink Sports 50	02-06	SFA197	SFAC197	SFA197HH		MD973D		VR973					
Calyso 50/125	99	SFA235	SFAC235		TBA								
Cobra 50 Cross	00-06	SFA233			MD971D		MD971C	VR971					
Cobra Racer (SF10AG)	00-06	SFA233			MD971D		MD971C	VR971					
CX 50 (PR50AE)	93	H303											
CX 50 Super (PR50AC)	94-97	SFA233			MD933D			VR933					
Dink 50/Spacer 50/Yager 50 (SH10)	98-10	SFA197	SFAC197	SFA197HH		MD971D	MD971C	VR971					
Dink 50 (4T)	07-12	SFA197	SFAC197	SFA197HH		TBA							
Dink Classic Euro 2.50 (T8000)	03	SFA197	SFAC197	SFA197HH		MD973D		VR973					
DJ 50 S	12-13	SFA305	SFAC305	SFA305HH	TBA								
DJW 50 World (PR50AD)	95-97	SFA235	SFAC235		MD933D			VR933					
DJX 50 (KA50A)	91-92	H303											
DJY 50 Refined (PR50A)	93-06	H303											
Filly 50 (SD10AC)	98-00	H303											
Filly LX 50 (S210)	00-06	SFA228	SFAC228	SFA228HH	TBA								
Grand Dink 50 (2T)	04-07	SFA197	SFAC228	SFA197HH		MD973D		VR973					
Grand Dink 50 S	12-13	SFA197	SFAC228	SFA197HH		MD973D		VR973					
Heroism 50 (SE10BA)	95-97	SFA235	SFAC235		MD933D			VR933					
K-Pipe 50	12-13	FA197		FA197HH			N/A						
KB 50 (SE10CA)	95-00	SFA233			MD933D			VR933					
K12 Sport 50 (SE10CA)	95-00	SFA233			MD933D			VR933					
KXR 50 Mongoose	04-06	H346*		H346G*									
Kymco 50 i	13	SFA197	SFAC197	SFA197HH	TBA								
Like 50 (2T)	09	SFA305	SFAC305	SFA305HH									

\*-2 Sets Required. ■ - Also available in MX-S race compound.

**SAFETY WARNING:** DO NOT USE HH PADS ON REAR UNLESS ALSO USED ON FRONT TO AVOID BRAKE IMBALANCE



# Non-JAPANESE Built Motorcycles

**BRAKE APPLICATIONS**



← REAR / ARRIÈRE / HINTEN POSTERIOR / POSTERIORE →

## KTM



			DISC PAD CHOICES			BRAKE ROTOR CHOICES			
			NEW SFAC Scooter Carbon Pads	Semi-Sintered V-Pads™	Sintered/HH Pads/ Grooved shoes	Contour Rotor Rear Fitment	NEW Vee-Rotors™ CONTOUR	NEW CX Extreme® ROTOR	
690 SMC (4 pad type caliper/spoke wheel)	08-10	FA213		FA213V	FA213HH	MD6298D			
690 SMC R	12-13	FA213		FA213V	FA213HH	MD6298D			
690 SMR (4 pad type caliper/cast wheel)	07-11	FA213		FA213V	FA213HH	MD6299D			
950 Adventure/S	04-06	FA181TT			FA181HH	MD6299D			
950 R Superenduro	06-08	FA181TT			FA181HH	MD6298D			
SMC 950 Supermoto	05-06	FA181TT			FA181HH	MD681	MD681C	VR681	
990 Adventure S (Non ABS)	06-08	FA181TT			FA181HH	MD6298D			
990 Adventure R (Non ABS)	09-12	FA181TT			FA181HH	MD6298D			
990 Adventure (ABS Model)	07-12	FA181TT			FA181HH	MD6298D			
990 Adventure Dakar Edition (ABS Model)	11	FA181TT			FA181HH	MD6298D			
990 Superduke	05-11	FA213		FA213V	FA213HH	MD681	MD681C	VR681	
990 Superduke R	07-13	FA213		FA213V	FA213HH	MD681	MD681C	VR681	
990 Supermoto T (SM-T)	09-13	FA181TT			FA181HH	MD681	MD681C	VR681	
990 Supermoto R (SM-R)	08-09	FA181TT			FA181HH	MD681	MD681C	VR681	
990 Supermoto R (SM-R)	10-13	FA181TT			FA181HH	MD681	MD681C	VR681	
RC8 (1190cc)	08-11	FA266		FA266V	FA266HH	MD812			
RC8 R/Track (1190cc)	09-13	FA266		FA266V	FA266HH	MD812			
1190 Adventure	13	FA181TT			FA181HH	TBA			
1190 Adventure R	13	FA181TT			FA181HH	TBA			

## KYMCO

Activ 50	05-06	H303							
Active SR 50cc	08-11	H303							
Agility 50 (KG10SA)	05-08	H303							
Agility 50 Basic	07	H303							
Agility 50 Carry (4T)	11-13	H303							
Agility 50 R10 (4T) (CV 50 QT S) 10" wheels	06-12	H303							
Agility 50 R12 (4T) (CX 50 QT S) 12" wheels	06-12	H303							
Agility 50 R16 (2T/16" wheels)	08-12	818							
Agility 50 R16 (4T/16" wheels)	08-13	818							
Agility RS 50 (2T/12" Wheels) Naked	10-12	H303							
Bet & Win 50/Dink Sports 50	02-06	H303							
Calypto 50/125	99	H303							
Cobra 50 Cross	00-06	H303							
Cobra Racer (SF10AG)	00-06	H303							
CX 50 (PR50AE)	93	H333							
CX 50 Super (PR50AC)	94-97	H333							
Dink 50/Spacer 50/Yager 50 (SH10)	98-10	H303							
Dink 50 (4T)	07-12	H303							
Dink Classic Euro 2-50 (T8000)	03	H303							
DJ 50 S	12-13	H303							
DJW 50 World (PR50AD)	95-97	H303							
DJX 50 (KA50A)	91-92	H333							
DJY 50 Refined (PR50A)	93-06	H333							
Filly 50 (SD10AC)	98-00	H303							
Filly LX 50 (S210)	00-06	H303							
Grand Dink 50 (2T)	04-07	H303							
Grand Dink 50 S	12-13	H303							
Heroism 50 (SE10BA)	95-97	H303							
K-Pipe 50	12-13	H340							
KB 50 (SE10CA)	95-00	H303							
K12 Sport 50 (SE10CA)	95-00	H303							
KXR 50 Mongoose	04-06	H307			H307G				
Kymcovento 50 i	13	H303							
Like 50 (2T)	09	H303							

\*-2 Sets Required. ■ - Also available in MX-S race compound.

**SAFETY WARNING:** DO NOT USE HH PADS ON REAR UNLESS ALSO USED ON FRONT TO AVOID BRAKE IMBALANCE

**R** Suffix = High Durability Sintered Pad. **HH** Suffix = High Performance Sintered Pad. **G** Suffix = Grooved Shoe.  
**D** Suffix = Drilled Disc. **C** Suffix = Contoured Disc. **LS** Suffix = Left/Steel Disc. **RS** = Right/Steel Disc.

# Non-JAPANESE Built Motorcycles



← FRONT / AVANT / VORN FRENTE / ANTERIORE →

KYMCO	Year	DISC PAD CHOICES				BRAKE ROTOR CHOICES							
		NEW SFAC Scooter Carbon Pads	Semi-Sintered V-Pads™	Sintered/HH Pads/ Grooved shoes	Left/Gauche/Links	Right/Droite/Rechts	Contour Rotor Universal left and right fitment	NEW Vee-Rotors™ CONTOUR	NEW CX Extreme® ROTOR	Oversize 250/280mm Rotor Kit	Relocating Bracket for 250/280mm Rotor	Oversize 320mm Rotor Kit	Relocating Bracket for 320mm Rotor
Like 50 (2T)	10-13	SFA228	SFAC228										
Like 50 (4T)	09	SFA305	SFAC305										
Like 50 (4T)	10-13	SFA228	SFAC228										
Looker 50 (BA10AD) (JP)	07-08	SFA305	SFAC305										
Looping 50	98	SFA233											
Jetix 50	10	SFA086	SFAC086										
Newsento 50 i	13	SFA197	SFAC197										
Maxxer 50	05-13	H346*											
MXer 50 (Quad)	00-07	H303*											
MXU 50	05-13	H303*											
Nexxon 50	08-09	SFA086	SFAC086										
People S 50 2T (5 bolt fixing)	05-10	SFA305	SFAC305										
People S 50 (4T) (B91000) 5 Bolt fixing disc	06-13	SFA305	SFAC305										
People 50 (2T) (3 bolt fixing disc - BA10AD)	99-11	SFA305	SFAC305										
Sento 50	08-09	SFA228	SFAC228										
Sniper 50 (PR50B)	93	SFA233											
Sniper 50 DD (PR50BB)	94-96	SFA233											
Super 8 (50cc) 2T	07-13	SFA305	SFAC305										
Super 8 (50cc) 4T	07-12	SFA305	SFAC305										
Super 9 50 (LC) (SH10DA)	00-07	SFA197	SFAC197										
Super 9 (A/C)	00-07	SFA197	SFAC197										
Visa R 50	11-12	SFA067	SFAC067										
Vitality 50 (4T) (U31000)	04-09	SFA228	SFAC228										
Vitality 50 (2T) (SF10FA)	04-09	SFA228	SFAC228										
Yup 50	02-09	SFA228	SFAC228										
ZX 50 Super Fever/Scout (SC10AS) (ZX12)	99-06	SFA233											
Top Boy 50 (On road & off road models) (SF10GG)	97-06	SFA233											
Yager 50	07	SFA197	SFAC197										
KXR 90 Mongoose Quad	04-06	H338*											
Maxxer 90	05-06	H346*											
AS 100/125	99	TBA											
Cobra 100 Racer	99-03	SFA228	SFAC228										
KB 100 Manboy	97-00	SFA233											
Spike 100/125	00-06	SFA086	SFAC086										
Top Boy 100 (On road & off road models)	97	SFA233											
Activ 110/125	04-06	SFA197	SFAC197										
Visa R 110	11	SFA067	SFAC067										
Agility 125 Carry (4T)	11-12	SFA305	SFAC305										
Agility 125 4T (U62000/1 - 12" Wheels/3 Spoke)	06-12	SFA228	SFAC228										
Agility 125 (C20000 - 16" Wheels)	08-13	SFA305	SFAC305										
Agility RS 125 (2T-12" wheels/5 Spoke)	09-13	SFA305	SFAC305										
Agility RS 125 (4T-12" wheels/5 Spoke)	10-13	SFA228	SFAC228										
Bet & Win 125/150 (SH25CA/30C)	00-06	SFA197	SFAC197										
Cruiser 125	99	FA197											
Dink Classic 125/150 (SH25BB/30B)	02	SFA197	SFAC197										
Dink/Spacer 125/150 (SH25/30)	97-04	SFA197	SFAC197										
Dink LX 125/150 (SH25BA/30B)	98-00	SFA197	SFAC197										
Dink 125i (T90000)	06-12	SFA197	SFAC197										
Downtown 125 i/Super Dink (V21000)	09-13	SFA142	SFAC142										
DJ 125 S	12-13	SFA305	SFAC305										
Grand Dink/Miller 125/150 (S40000-00)	01-07	SFA197	SFAC197										
Grand Dink 125	12-13	SFA142	SFAC142										
Heroism 125 (SE25BA)	95-97	SFA235	SFAC235										
Heroism 150 (SE30AD)	95-97	SFA235	SFAC235										
Hipster 125/150	99-06	FA197											
K-Pipe 125	12-13	FA197											
K-XCT 125 i	12-13	SFA324	SFAC324										
KR 125 Quannon Naked	10-13	FA197											
KR 125 Quannon Sport	07-13	FA197											
Like 125	09	SFA305	SFAC305										

\*-2 Sets Required. ■ - Also available in MX-S race compound.

**SAFETY WARNING:** DO NOT USE HH PADS ON REAR UNLESS ALSO USED ON FRONT TO AVOID BRAKE IMBALANCE

APPLICATIONS  
BRAKE

R Suffix = High Durability Sintered Pad. HH Suffix = High Performance Sintered Pad. G Suffix = Grooved Shoe.  
D Suffix = Drilled Disc. C Suffix = Contoured Disc. LS Suffix = Left/Steel Disc. RS = Right/Steel Disc.

# Non-JAPANESE Built Motorcycles



**KYMCO**



← REAR / ARRIÈRE / HINTEN POSTERIOR / POSTERIORE →

		DISC PAD CHOICES				BRAKE ROTOR CHOICES			
		NEW SFAC Scooter Carbon Pads	Semi-Sintered V-Pads™	Sintered/HH Pads/ Grooved shoes		Contour Rotor Rear Fitment	NEW Vee-Rotors™ CONTOUR	NEW CX Extreme® ROTOR	
Like 50 (2T)	10-13	H303							
Like 50 (4T)	09	H303							
Like 50 (4T)	10-13	H303							
Looker 50 (BA10AD (JP))	07-08	818							
Looping 50	98	H303							
Jetix 50	10	SFA197		SFA197HH		NA			
Newsento 50 i	13	H303							
Maxver 50	05-13	H307		H307G					
MXer 50 (Quad)	00-07	FA305		FA305R	MD6267D				
MXU 50	05-13	FA305		FA305R	MD6267D				
Nexxon 50	08-09	SFA086		SFA086HH	N/A				
People S 50 2T (5 bolt fixing)	05-10	818							
People S 50 (4T) (B91000) 5 Bolt fixing disc	06-13	818							
People 50 (2T) (3 bolt fixing disc - BA10AD)	99-11	818							
Sento 50	08-09	H303							
Sniper 50 (PR50B)	93	H303							
Sniper 50 DD (PR50BB)	94-96	SFA234			MD926D				
Super 8 (50cc) 2T	07-13	818							
Super 8 (50cc) 4T	07-12	818							
Super 9 50 (LC) (SH10DA)	00-07	SFA305	SFAC305	SFA305HH	MD971D	VR971			
Super 9 (A/C)	00-07	H303							
Visa R 50	11-12	H303							
Vitality 50 (4T) (U31000)	04-09	H303							
Vitality 50 (2T) (SF10FA)	04-09	H303							
Yup 50	02-09	H303							
ZX 50 Super Fever/Scout (SC10AS) (ZX12)	99-06	H303							
Top Boy 50 (On road & off road models) (SF10GG)	97-06	H303							
Yager 50	07	H303							
KXR 90 Mongoose Quad	04-06	TBA							
Maxver 90	05-06	FA305		FA305R	MD6267D				
AS 100/125	99	TBA							
Cobra 100 Racer	99-03	H303							
KB 100 Marboy	97-00	H303							
Spike 100/125	00-06	TBA			N/A				
Top Boy 100 (On road & off road models)	97	H303							
Activ 110/125	04-06	H303							
Visa R 110	11	H303							
Agility 125 Carry (4T)	11-12	H303							
Agility 125 4T (U62000/1 - 12" Wheels/3 Spoke)	06-12	818							
Agility 125 (C20000 - 16" Wheels)	08-13	SFA067	SFAC067	SFA067HH	TBA				
Agility RS 125 (2T-12" wheels/5 Spoke)	09-13	818							
Agility RS 125 (4T-12" wheels/5 Spoke)	10-13	818							
Bet & Win 125/150 (SH25CA/30C)	00-06	SFA197	SFAC197	SFA197HH	MD974D	VR974			
Cruiser 125	99	TBA							
Dink Classic 125/150 (SH25BB/30B)	02	SFA197	SFAC197	SFA197HH	MD971D	VR971			
Dink/Spacer 125/150 (SH25/30)	97-04	SFA197	SFAC197	SFA197HH	MD971D	MD971C	VR971		
Dink LX 125/150 (SH25BA/30B)	98-00	SFA197	SFAC197	SFA197HH	MD971D	MD971C	VR971		
Dink 125i (T90000)	06-12	SFA197	SFAC197	SFA197HH	MD974D	VR974			
Downtown 125 i/Super Dink (V21000)	09-13	SFA498	SFAC498	SFA498HH	MD9129D				
DJ 125 S	12-13	H303							
Grand Dink/Miller 125/150 (S40000-00)	01-07	SFA197	SFAC197	SFA197HH	MD974D	VR974			
Grand Dink 125	12-13	SFA197	SFAC197	SFA197HH	TBA				
Heroism 125 (SE25BA)	95-97	H303							
Heroism 150 (SE30AD)	95-97	SFA234			MD926D				
Hipster 125/150	99-06	H340							
K-Pipe 125	12-13	H340							
K-XCT 125 i	12-13	SFA607		SFA607HH		NA			
KR 125 Quannon Naked	10-13	FA197		FA197HH	N/A				
KR 125 Quannon Sport	07-13	FA197		FA197HH	N/A				
Like 125	09	SFA197	SFAC197	SFA197HH	TBA				

\*-2 Sets Required. ■ - Also available in MX-S race compound.

**SAFETY WARNING:** DO NOT USE HH PADS ON REAR UNLESS ALSO USED ON FRONT TO AVOID BRAKE IMBALANCE

**R** Suffix = High Durability Sintered Pad. **HH** Suffix = High Performance Sintered Pad. **G** Suffix = Grooved Shoe.  
**D** Suffix = Drilled Disc. **C** Suffix = Contoured Disc. **LS** Suffix = Left/Steel Disc. **RS** = Right/Steel Disc.

**BRAKE APPLICATIONS**

# Non-JAPANESE Built Motorcycles



← FRONT / AVANT / VORN FRENTE / ANTERIORE →

## DISC PAD CHOICES

## BRAKE ROTOR CHOICES

### KYMCO

Model	Year	Disc Pad	DISC PAD CHOICES		Left/Gauche/Links		Right/Droite/Rechts		Contour Rotor Universal left and right fitment	NEW Vee-Rotors™ CONTOUR	NEW CX Extreme® ROTOR	Oversize 250/280mm Rotor Kit	Relocating Bracket for 250/280mm Rotor	Oversize 320mm Rotor Kit	Relocating Bracket for 320mm Rotor
			NEW SFAC Scooter Carbon Pads	Semi- Sintered V-Pads™	Sintered/ HH Pads/ Grooved shoes	Left/Gauche/Links	Right/Droite/Rechts								
Like 125	10-13	SFA228	SFAC228		SFA228HH	TBA									
Looker 125 S (BA25BA (JP))	07-08	SFA305	SFAC305		SFA305HH	MD989D									
Jetix 125	10	SFA086	SFAC086		SFA086HH			N/A							
Movie 125 (SL25AA)	99-00	SFA228	SFAC228		FA228HH	MD972D									
Movie XL 125/150 (S510/500)	01-09	SFA197	SFAC197		SFA197HH		MD973D		VR973						
Movie 125 i	12-13	SFA197	SFAC197		SFA197HH		TBA								
MXer 125/150 Quad (LA35AD/LA30AD)	02-07	H303*			H303G*										
Nexxon 125	07-08	SFA086	SFAC086		SFA086HH			N/A							
People GT 125 i	10-13	SFA324	SFAC324		SFA324HH			TBA							
People S125 (BA25BA) (5 bolt disc fixing)	05-06	SFA305	SFAC305		SFA305HH	MD9100D			VR9100						
People S 125 DD (D1000 rear disc model) (5 bolt fixing)	07-12	SFA305	SFAC305		SFA305HH	MD9100D			VR9100						
People 125 (B20000/10/11) (3 bolt disc fixing)	99-10	SFA305	SFAC305		SFA305HH	MD989D									
Pulsar 125/CK 125 (Luxe) (RJ25CB)	99-13	FA486				N/A									
Sector 125	98-01	FA197			FA197HH		N/A								
Spike 125 R	04-06	SFA197	SFAC197		SFA197HH	N/A									
Straight 125	05-06	FA197			FA197HH	N/A									
Stryker 125 (DA25BB) On Road/Off Road	01-06	FA228			FA228HH	N/A									
Super 8 4T (125cc)	08-13	SFA305	SFAC305		SFA305HH			TBA							
V-Link 125 SRC-V (SD125 LD (JP))	07-08	TBA				TBA									
V-Link 125 S (SD 25QA (JP))	07-08	TBA				TBA									
Yager 125	00	SFA197	SFAC197		SFA197HH	MD971D	MD971C	VR971							
Yager GT 125	07-13	SFA197	SFAC197		SFA197HH		TBA								
MXU 150	05-12	H303*			H303G*										
Stryker 150 (Off road)	00-06	FA228			FA228HH	N/A									
Vivio 125/150 (SL25BA/30AC)	00-03	SFA228	SFAC228		SFA228HH		MD972D								
Zing 125/150 Custom Style (RF25/30)	97-13	FA197			FA197HH		N/A								
Agility 150 R16 (C30000)	08-12	SFA305	SFAC305		SFA305HH	MD9100D			VR9100						
Jetix 150	10	SFA086	SFAC086		SFA086HH			N/A							
People 150 (B200001/20) (3 bolt disc fixing)	99-04	SFA305	SFAC305		SFA305HH	MD989D									
Agility 200 i R16	10-12	SFA305	SFAC305		SFA305HH	MD9100D			VR9100						
Dink 200i (T91000)	06-12	SFA197	SFAC197		SFA197HH		TBA								
Downtown 200 i	10-12	SFA142	SFAC142		SFA142HH			MD9128C	VR9128						
People GT 200 i	10-12	SFA324	SFAC324		SFA324HH		TBA								
Like 200i	09	SFA305	SFAC305		SFA305HH	TBA									
Like 200i	10-13	SFA228	SFAC228		SFA228HH	TBA									
People S 200 (D11000) (5 bolt fixing disc)	05-06	SFA305	SFAC305		SFA305HH	MD9100D			VR9100						
People S 200i DD (D12000) (5 bolt fixing disc F/Disc - Rear Disc Model)	07-12	SFA305	SFAC305		SFA305HH	MD9100D			VR9100						
Yager 200i	07-13	SFA197	SFAC197		SFA197HH		TBA								
Beit & Win 250 (S7000)	00-06	SFA197	SFAC197		SFA197HH		MD973D		VR973						
Grand Dink 250 (S400)	01-06	SFA355*	SFAC355*		SFA355HH*		MD973D		VR973						
KXR 250 Mongoose Quad	04-07	FA377TT*			FA377R*	MD6267D	MD6267D								
Maxxer 250	12-13	FA377TT*			FA377R*	MD6267D	MD6267D								
MXU 250	04-13	FA377TT*			FA377R*	MD6267D	MD6267D								
MXU 250 R	12-13	FA377TT*			FA377R*	MD6267D	MD6267D								
People 250 (BC50AA)	03-06	SFA197	SFAC197		SFA197HH	MD9100D			VR9100						
People 250 Si DD	Left 07-08	SFA228	SFAC228		SFA228HH	MD9100D			VR9100						
	Right	SFA197	SFAC197		SFA197HH		MD9100D		VR9100						
Urban Quad 250	06	FA377TT*			FA377R*	TBA	TBA								
Xciting 250 (T71000)	05	SFA142*	SFAC142*		SFA142HH*	TBA	TBA								
Xciting 250 i (T71010)	06-08	SFA142*	SFAC142*		SFA142HH*	TBA	TBA								
Venox 250 (R20010/RA50AA/Carb Model)	00-03	FA196			FA196HH	MD1101									
Venox 250 (RFBR20011/RA500AD/Carb Model)	04-06	FA196			FA196HH	MD1101									
Venox 250 (R20012/EFI Model)	00-12	FA196			FA196HH	MD1101									
Yup 250 (W2000)	03-06	SFA197	SFAC197		SFA197HH		MD973D		VR973						
Downtown 300 i/Super Dink (V20000)	09-12	SFA142	SFAC142		SFA142HH			MD9128C	VR9128						
Downtown 300i/ABS	10-13	SFA142	SFAC142		SFA142HH			MD9128C	VR9128						
Grand Dink 300i	12-13	SFA142	SFAC142		SFA142HH		MD973D								
K-XCT 300i	12-13	SFA324	SFAC324		SFA324HH			N/A							
Maxxer 300	06-13	FA377TT*			FA377R*	MD6267D	MD6267D								
MXU 300	06-11	FA377TT*			FA377R*	MD6267D	MD6267D								

\*-2 Sets Required. ■ - Also available in MX-S race compound.

**SAFETY WARNING:** DO NOT USE HH PADS ON REAR UNLESS ALSO USED ON FRONT TO AVOID BRAKE IMBALANCE







# Non-JAPANESE Built Motorcycles



**KYMCO**



← REAR / ARRIÈRE / HINTEN  POSTERIOR / POSTERIORE →

		DISC PAD CHOICES				BRAKE ROTOR CHOICES			
		 NEW SFAC Scooter Carbon Pads	 Semi-Sintered V-Pads™	 Sintered/HH Pads/ Grooved shoes		 Contour Rotor Rear Fitment	 NEW Vee-Rotors™ CONTOUR	 NEW CX Extreme® ROTOR	
Like 125	10-13	SFA197	SFAC197		SFA197HH	TBA			
Looker 125 S (BA25BA (JP))	07-08	818							
Jetix 125	10	SFA197	SFAC197		SFA197HH		NA		
Movie 125 (SL25AA)	99-00	818							
Movie XL 125/150 (S510/500)	01-09	818							
Movie 125 i	12-13	TBA							
MXer 125/150 Quad (LA35AD/LA30AD)	02-07	FA305			FA305R	MD6267D			
Nexon 125	07-08	SFA086	SFAC086		SFA086HH	N/A			
People GT 125 i	10-13	SFA498	SFAC498		SFA498HH	TBA			
People S125 (BA25BA) (5 bolt disc fixing)	05-06	818							
People S 125 DD (D1000 rear disc model) (5 bolt fixing)	07-12	SFA607			SFA607HH	MD9100D			
People 125 (B20000/10/11) (3 bolt disc fixing)	99-10	818							
Pulsar 125/CK 125 (Luxe) (RJ25CB)	99-13	H340							
Sector 125	98-01	TBA							
Spike 125 R	04-06	SFA197	SFAC197		SFA197HH	MD971D			
Straight 125	05-06	N/A							
Stryker 125 (DA25BB) On Road/Off Road	01-06	H340							
Super 8 4T (125cc)	08-13	818							
V-Link 125 SRC-V (SD125 LD (JP))	07-08	TBA							
V-Link 125 S (SD 25QA (JP))	07-08	TBA							
Yager 125	00	SFA197	SFAC197		SFA197HH	MD971D	MD971C	VR971	
Yager GT 125	07-13	SFA197	SFAC197		SFA197HH	MD974D			
MXU 130	05-12	FA305			FA305R	MD6267D			
Stryker 150 (Off road)	00-06	H340							
Vivio 125/150 (SL25BA/30AC)	00-03	818							
Zing 125/150 Custom Style (RF25/30)	97-13	H340							
Agility 150 R16 (C30000)	08-12	SFA197	SFAC197		SFA197HH	TBA			
Jetix 150	10	SFA197	SFAC197		SFA197HH		NA		
People 150 (B20000/120) (3 bolt disc fixing)	99-04	818							
Agility 200 i R16	10-12	SFA197	SFAC197		SFA197HH	TBA			
Dink 200i (T71000)	06-12	SFA197	SFAC197		SFA197HH	MD974D			
Downtown 200 i	10-12	SFA498	SFAC498		SFA498HH	MD9129D			
People GT 200 i	10-12	SFA498	SFAC498		SFA498HH	TBA			
Like 200i	09	SFA197	SFAC197		SFA197HH	TBA			
Like 200i	10-13	SFA197	SFAC197		SFA197HH	TBA			
People S 200 (D11000) (5 bolt fixing disc)	05-06	818							
People S 200i DD (D12000) (5 bolt fixing disc FIDisc - Rear Disc Model)	07-12	SFA607			SFA607HH	MD9100D			
Yager 200i	07-13	SFA197	SFAC197		SFA197HH	MD974D			
Bet & Win 250 (S7000)	00-06	SFA197	SFAC197		SFA197HH	MD974D		VR974	
Grand Dink 250 (S400)	01-06	SFA356				MD974D		VR974	
KXR 250 Mongoose Quad	04-07	FA355*			FA355R*	MD6268D			
Maxver 250	12-13	FA377TT			FA377R	MD6267D			
MXU 250	04-13	FA355*			FA355R*	MD6268D			
MXU 250 R	12-13	FA377TT			FA377R	MD6267D			
People 250 (BC50AA)	03-06	SFA197	SFAC197		SFA197HH	MD9100D			
People 250 Si DD	07-08	SFA607			SFA607HH	MD9100D			
Urban Quad 250	06	FA355			FA355R	TBA			
Xoiting 250 (T71000)	05	SFA607			SFA607HH	TBA			
Xoiting 250 i (T71010)	06-08	SFA607			SFA607HH	TBA			
Venox 250 (R20010/RA50AA/Carb Model)	00-03	H321							
Venox 250 (RFBR20011/RA500AD/Carb Model)	04-06	H321							
Venox 250 (R20012/EFI Model)	00-12	H321							
Yup 250 (W2000)	03-06	SFA197	SFAC197		SFA197HH	MD974D		VR974	
Downtown 300 i/Super Dink (V20000)	09-12	SFA498	SFAC498		SFA498HH	MD9129D			
Downtown 300i/ABS	10-13	SFA498	SFAC498		SFA498HH	MD9129D			
Grand Dink 300i	12-13	SFA608			SFA608HH		N/A		
K-XCT 300i	12-13	SFA607			SFA607HH		N/A		
Maxver 300	06-13	FA355*			FA355R*	MD6268D			
MXU 300	06-11	FA377TT*			FA377R*	MD6267D			

\*-2 Sets Required. ■ - Also available in MX-S race compound.

**SAFETY WARNING:** DO NOT USE HH PADS ON REAR UNLESS ALSO USED ON FRONT TO AVOID BRAKE IMBALANCE

**R** Suffix = High Durability Sintered Pad. **HH** Suffix = High Performance Sintered Pad. **G** Suffix = Grooved Shoe.  
**D** Suffix = Drilled Disc. **C** Suffix = Contoured Disc. **LS** Suffix = Left/Steel Disc. **RS** = Right/Steel Disc.

**BRAKE APPLICATIONS**



# Non-JAPANESE Built Motorcycles



← FRONT / AVANT / VORN FRENTE / ANTERIORE →

## DISC PAD CHOICES

## BRAKE ROTOR CHOICES

KYMCO			DISC PAD CHOICES			BRAKE ROTOR CHOICES									
			NEW SFAC Scooter Carbon Pads	Semi-Sintered V-Pads™	Sintered/HH Pads/ Grooved shoes	Left/Gauche/Links	Right/Droite/Rechts	Contour Rotor Universal left and right fitment	NEW Vee-Rotors™ CONTOUR	NEW CX Extreme® ROTOR	Oversize 250/280mm Rotor Kit	Relocating Bracket for 250/280mm Rotor	Oversize 320mm Rotor Kit	Relocating Bracket for 320mm Rotor	
MXU 300 R	10-13		FA377T*		FA377R*	MD6267D	MD6267D								
People GT 300i	10-13		SFA324	SFAC324	SFA324HH		TBA								
People S 300i	08-10	Left	SFA228	SFAC228	SFA228HH	MD9100D				VR9100					
		Right	SFA197	SFAC197	SFA197HH			MD9100D		VR9100					
Xciting 300i (T72000 - EFI Model)	08		SFA142*	SFAC142*	SFA142HH*	TBA	TBA								
Xciting 300i R (T72001/T72011)	09-12		SFA142*	SFAC142*	SFA142HH*			TBA*							
Maxxer 400	09-10		FA395TT*		FA395R*	MD6173D	MD6173D								
Maxxer 400 (Parking brake)	09-10		SFA257/2												
MXU 400 (A40000)	08-11		FA395TT*		FA395R*	MD6173D	MD6173D								
MXU 400 (Parking brake)	08-11		SFA257/2												
Xciting 400i	12		SFA627*		SFA627HH*			TBA*							
Maxxer 450 i (On & Off Road Models)	10-13		FA395TT*		FA395R*	MD6173D	MD6173D								
Maxxer 450 i (Parking brake)	10-13		SFA257/2												
MXU 450 i IRS	11-12		FA395TT*		FA395R*	MD6173D	MD6173D								
MXU 450 i	13		FA395TT*		FA395R*	TBA	TBA								
Parking Brake	13		SFA257/2												
MXU 500 (L70000 /Carb Model/4 x 4)	05-13		FA377T*		FA377R*	MD6195D	MD6195D								
MXU 500 i DX	12-13		FA600T*		FA600R*	MD6173D	MD6173D								
MXU 500 i DX Parking Brake	12-13		FA377												
MXU 500 i IRS (4 x 4 - IRS) (LAA0CD/CM)	09-13		FA600T*		FA600R*	MD6173D	MD6173D								
MXU 500 i IRS (4 x 4 - IRS) (LAA0CD/CM) Parking brake	09-13		FA377TT		FA377R										
UXV 500 (Side x Side/4 x 4/U10000)	08-09		FA377T*		FA377R*	TBA	TBA								
UXV 500 i (Side x Side/4 x 4/U10100)	10-13		FA377T*		FA377R*	TBA	TBA								
MXU 550 i	12		FA600T*		FA600R*	MD6173D	MD6173D								
MXU 550 i Parking Brake			FA377TT												
MXU 550 i (4 x 4 LoF)	13		FA600T*		FA600R*	MD6173D	MD6173D								
MXU 550 i Parking Brake			FA377TT												
Xciting 500 (T70000 - Carb Model)	05		SFA142*	SFAC142*	SFA142HH*	TBA	TBA								
Xciting 500 i (T70020 - EFI Model)	06-08		SFA142*	SFAC142*	SFA142HH*	TBA	TBA								
Xciting 500i R (T70030 - EFI Model)	07-09		SFA142*	SFAC142*	SFA142HH*	TBA	TBA								
Xciting 500i R (T70021 - EFI Model)	07-12		SFA142*	SFAC142*	SFA142HH*			TBA*							
Xciting Evo 500i ABS	13		SFA142*	SFAC142*	SFA142HH*			N/A*							
My Road 700 i	11-12		SFA142*	SFAC142*	SFA142HH*	N/A	N/A								
MXU 700 i (4 x 4 LoF)	13		FA600T*		FA600R*	N/A	N/A								
MXU 700 i Parking Brake			FA377TT												
<b>LAMBRETTA</b>															
LJ 50	Dec-13		SFA264	SFAC264	SFA264HH	TBA									
LT 50	Dec-13		SFA264	SFAC264	SFA264HH	TBA									
50 N Pato	08-10		SFA086	SFAC086	SFA086HH	TBA									
125 N Pato	08-10		SFA086	SFAC086	SFA086HH	TBA									
125/150/175 L1			958												
125/150/200 DL			959												
125/150 D-LD			N/A												
LN 125 (4T)	11-13		SFA264	SFAC0264	SFA264HH	TBA									
LN 151 (4T)	11-13		SFA264	SFAC264	SFA264HH	TBA									
151 N Pato	08-10		SFA086	SFAC086	SFA086HH	TBA									
175 TV II			FA100			N/A									
<b>LAVERDA</b>															
CR 50 Atlas	87-		FA047		FA047HH	N/A									
Quasar 50	02-04		H338*		H338G*										
Quasar 100	02-04		H338*		H338G*										
Mini Quasar	02-04		TBA*												
GS 125 Lesmo	86-89		FA047*		FA047HH*	N/A	N/A								
LB 125 Custom/Sabbia Strada/Sport	85-87		FA060			N/A									
LZ 125 Sport Brembo Caliper	80-82		FA047		FA047HH	N/A									
LZ 125 Sport Grimeca Caliper	80-82		FA076		FA076HH	N/A									
Phoenix 125/150/200	01-04		SFA306	SFAC306		N/A									
Quasar 125 HP Grip	02-04		TBA*												

\*-2 Sets Required. ■ - Also available in MX-S race compound.

**SAFETY WARNING:** DO NOT USE HH PADS ON REAR UNLESS ALSO USED ON FRONT TO AVOID BRAKE IMBALANCE

APPLICATIONS  
BRAKE

R Suffix = High Durability Sintered Pad. HH Suffix = High Performance Sintered Pad. G Suffix = Grooved Shoe.  
D Suffix = Drilled Disc. C Suffix = Contoured Disc. LS Suffix = Left/Steel Disc. RS = Right/Steel Disc.

# Non-JAPANESE Built Motorcycles

**BRAKE APPLICATIONS**

**R** Suffix = High Durability Sintered Pad. **HH** Suffix = High Performance Sintered Pad. **G** Suffix = Grooved Shoe.  
**D** Suffix = Drilled Disc. **C** Suffix = Contoured Disc. **LS** Suffix = Left/Steel Disc. **RS** = Right/Steel Disc.



**KYMCO**



← REAR / ARRIÈRE / HINTEN POSTERIOR / POSTERIORE →

		DISC PAD CHOICES				BRAKE ROTOR CHOICES			
		NEW SFAC Scooter Carbon Pads	Semi-Sintered V-Pads™	Sintered/HH Pads/ Grooved shoes	Contour Rotor Rear Fitment	NEW Vee-Rotors™ CONTOUR	NEW CX Extreme® ROTOR		
MXU 300 R	10-13	FA377TT		FA377R	MD6267D				
People GT 300i	10-13	SFA498	SFAC498	SFA498HH	TBA				
People S 300i	08-10	SFA197	SFAC197	SFA197HH	MD9100D				
Xciting 300i (T72000 - EFI Model)	08	SFA607		SFA607HH	TBA				
Xciting 300i R (T72001/T72011)	09-12	SFA607		SFA607HH		NA			
Maxxer 400	09-10	FA395TT		FA395R	MD6173D				
MXU 400 (A40000)	08-11	FA395TT		FA395R	MD6173D				
Xciting 400i	12	SFA608		SFA608HH		NA			
Maxxer 450 i (On & Off Road Models)	10-13	FA395TT		FA395R	MD6173D				
MXU 450 i IRS	11-12	FA395TT		FA395R	MD6173D				
MXU 450 i	13	FA395TT		FA395R	TBA				
MXU 500 (L70000 /Carb Model/4 x 4)	05-13	FA377TT*		FA377R*	MD6376D				
MXU 500 i DX	12-13	FA6002TT		FA6002R	TBA				
MXU 500 i IRS (4 x 4 - IRS) (LAACD/CM)	09-13	FA6002TT		FA6002R	TBA				
UXV 500 (Side x Side/4 x 4/U10000)	08-09	FA377TT		FA377R	MD6376D				
UXV 500 i (Side x Side/4 x 4/U10100)	10-13	FA377TT		FA377R	MD6376D				
MXU 550 i	12	FA6002TT		FA6002R	TBA				
MXU 550 I (4 x 4 LoF)	13	FA6002TT		FA6002R	TBA				
Xciting 500 (T70000 - Carb Model)	05	SFA608		SFA608HH	TBA				
Xciting 500 i (T70020 - EFI Model)	06-08	SFA608		SFA608HH	TBA				
Xciting 500i R (T70030 - EFI Model)	07-09	SFA608		SFA608HH	TBA				
Xciting 500i R (T70021 - EFI Model)	07-12	SFA608		SFA608HH		TBA			
Xciting Evo 500i ABS	13	SFA608		SFA608HH		NA			
My Road 700 i	11-12	SFA608		SFA608HH		NA			
MXU 700 i (4 x 4 LoF)	13	FA6002TT*		FA6002R*	N/A*				
<b>LAMBRETTA</b>									
LJ 50	Dec-13	TBA							
LT 50	Dec-13	TBA							
50 N Pato	08-10	SFA086	SFAC086	SFA086HH	TBA				
125 N Pato	08-10	SFA086	SFAC086	SFA086HH	TBA				
125/150/175 L1		958							
125/150/200 DL		959							
125/150 D-LD		957							
LN 125 (4T)	11-13	TBA							
LN 151 (4T)	11-13	TBA							
151 N Pato	08-10	SFA086	SFAC086	SFA086HH	TBA				
175 TV II		958							
<b>LAVERDA</b>									
CR 50 Atlas	87-	FA047		FA047HH	N/A				
Quasar 50	02-04	H330		H330G					
Quasar 100	02-04	H330		H330G					
Mini Quasar	02-04	TBA							
GS 125 Lesmo	86-89								
LB 125 Custom/Sabbia Strada/Sport	85-87	921							
LZ 125 Sport Brembo Caliper	80-82	921							
LZ 125 Sport Grimeca Caliper	80-82	921							
Phoenix 125/150/200	01-04	SFA305	SFAC305		TBA				
Quasar 125 HP Grip	02-04	TBA							

\*-2 Sets Required. ■ - Also available in MX-S race compound.

**SAFETY WARNING:** DO NOT USE HH PADS ON REAR UNLESS ALSO USED ON FRONT TO AVOID BRAKE IMBALANCE

# Non-JAPANESE Built Motorcycles



← FRONT / AVANT / VORN FRENTE / ANTERIORE →

## LAVERDA

		DISC PAD CHOICES					BRAKE ROTOR CHOICES						
		NEW SFAC Scooter Carbon Pads	Semi-Sintered V-Pads™	Sintered/HH Pads/ Grooved shoes	Left/Gauche/Links	Right/Droite/Rechts	Contour Rotor Universal left and right fitment	NEW Vee-Rotors™ CONTOUR	NEW CX Extreme® ROTOR	Oversize 250/280mm Rotor Kit	Relocating Bracket for 250/280mm Rotor	Oversize 320mm Rotor Kit	Relocating Bracket for 320mm Rotor
Quasar 125 HP	02-04	TBA*											
Quasar 180 HP Grip	04	TBA*											
Quasar 180 HP	04	TBA*											
Quasar 4 x 4 400	04	FA271TT*		FA271R*	MD6173D	MD6173D							
Montjuic	76	FA047*		FA047HH*	N/A	N/A							
Alpino 500	76	FA047*		FA047HH*	N/A	N/A							
Quasar 4 x 4 500C	04	FA271TT*		FA271R*	MD6173D	MD6173D							
Quasar 4 x 4 500	04	FA271TT*		FA271R*	MD6173D	MD6173D							
650 All models	94-95	FA095*	FA095V*	FA095HH*	MD2003X	MD2003X	MD2003XC*	VR2003BLK*					
668 All models	96-98	FA095*	FA095V*	FA095HH*	MD2003X	MD2003X	MD2003XC*	VR2003BLK*					
750 SF2	74	FA018*	FA018V*	FA018HH*	MD609LS	MD609RS							
750 SFC	74	FA018*	FA018V*	FA018HH*	MD609LS	MD609RS							
750 SF3	76-77	FA018*	FA018V*	FA018HH*	MD609LS	MD609RS							
750 All models	98-01	FA095*	FA095V*	FA095HH*	MD2003X	MD2003X	MD2003XC*	VR2003BLK*					
1000 3C	74-75	FA018*	FA018V*	FA018HH*	MD609LS	MD609RS							
1000 3CL	76-78	FA018*	FA018V*	FA018HH*	MD609LS	MD609RS							
1000 3CL Jarama/Jota	79-81	FA018*	FA018V*	FA018HH*	MD609LS	MD609RS							
1000 RGS	82	FA018*	FA018V*	FA018HH*	MD609LS	MD609RS							
1000 RGA/RGS Exec	83	FA018*	FA018V*	FA018HH*	MD609LS	MD609RS							
1000 RGS Corsa	84	FA077*	FA077V*		MD609ALS	MD609ARS							
1000 SFC	85-86	FA018*	FA018V*	FA018HH*	MD668LS	MD668RS							
SFC 1000	03-04			FA322/4HH*	MD621X	MD621X	MD621XC*	VR621BLK*					
1200	78-79	FA018*	FA018V*	FA018HH*	MD609LS	MD609RS							
1200 TSMirage	81	FA018*	FA018V*	FA018HH*	MD609LS	MD609RS							
MD670 - Bolt on - Ring only													
Note: Disc ring only for early 280mm disc													
9 bolt fixing @ 6.5mm thickness													

## LEM

R2/R3 (Hydraulic System)	03-05			FA325R	N/A								
Four X Pro		SFA169	SFAC169	SFA169HH	N/A								
RX 65		FA325TT		FA325R	N/A								
RX 2/3		FA325TT		FA325R	N/A								
CX 2/3		FA325TT		FA325R	N/A								

## LEONART

Daytona 125	13	FA086*	FA086V*	FA086HH*			N/A*						
Spyder 125	13	FA086*	FA086V*	FA086HH*			N/A*						

## LIFAN

LF 50 QGY		SFA169	SFAC169	SFA169HH	N/A								
LF 50 QGY 1/2		H303/H304 †											
Smart 50/125		FA375											
LF-100 5		S603											
LF-100 A		FA086		FA086HH	N/A								
LF 125 Off Road	07	FA448			N/A								
LT-125 T-2D		TBA											
LT-125-3A		FA056				N/A							

† Check old shoe against drawings in buyers guide to select correct shoe.

## LINHAI

LH 50 Prince (Scooter)	07-09	SFA101	SFAC101	SFA101HH	N/A								
ATV 80	13	N/A*											
Drive-in City Walker 125/150 Scooter	08-09	TBA			N/A								
Eggy 125cc (Scooter)	07-09	SFA101	SFAC101	SFA101HH	N/A								
Monarch 125/150 T	06-07	SFA199	SFAC199	SFA199HH		TBA							
ATV 150	13	N/A*											
Goon 260cc (ATV) 2 x 4/4 x 4	07-09	FA453TT*		FA453R*	N/A	N/A							
Goon 260 ATV (2 x 4/4 x 4)	07-09	FA453TT*		FA453R*	N/A	N/A							
Goon 260 ATV (2 x 4/4 x 4) Parking brake	07-09	FA270TT											

\*-2 Sets Required. ■ - Also available in MX-S race compound.

**SAFETY WARNING:** DO NOT USE HH PADS ON REAR UNLESS ALSO USED ON FRONT TO AVOID BRAKE IMBALANCE

# Non-JAPANESE Built Motorcycles

**BRAKE APPLICATIONS**

**R** Suffix = High Durability Sintered Pad. **HH** Suffix = High Performance Sintered Pad. **G** Suffix = Grooved Shoe.  
**D** Suffix = Drilled Disc. **C** Suffix = Contoured Disc. **LS** Suffix = Left/Steel Disc. **RS** = Right/Steel Disc.



## LAVERDA



← REAR / ARRIÈRE / HINTEN POSTERIOR / POSTERIORE →

			DISC PAD CHOICES			BRAKE ROTOR CHOICES		
			NEW SFAC Scooter Carbon Pads	Semi-Sintered V-Pads™	Sintered/HH Pads/ Grooved shoes	Contour Rotor Rear Fitment	NEW Vee-Rotors™ CONTOUR	NEW CX Extreme® ROTOR
Quasar 125 HP	02-04	TBA						
Quasar 180 HP Grip	04	TBA						
Quasar 180 HP	04	TBA						
Quasar 4 x 4 400	04	FA271TT			FA271R	MD6173D		
Montjuic	76	FA047			FA047HH	N/A		
Alpino 500	76	FA047			FA047HH	N/A		
Quasar 4 x 4 500C	04	FA271TT			FA271R	MD6173D		
Quasar 4 x 4 500	04	FA271TT			FA271R	MD6173D		
650 All models	94-95	FA047			FA047HH	MD2002	MD2002C	
668 All models	96-98	FA047			FA047HH	MD2002	MD2002C	
750 SF2	74	N/A						
750 SFC	74	FA018		FA018V	FA018HH	MD609LS		
750 SF3	76-77	FA018		FA018V	FA018HH	MD609LS		
750 All models	98-01	FA047			FA047HH	MD2002	MD2002C	
1000 3C	74-75	FA018		FA018V	FA018HH	MD609LS		
1000 3CL	76-78	FA018		FA018V	FA018HH	MD609LS		
1000 3CL Jarama/Jota	79-81	FA018		FA018V	FA018HH	MD609LS		
1000 RGS	82	FA018		FA018V	FA018HH	MD609LS		
1000 RGA/RGS Exec	83	FA018		FA018V	FA018HH	MD609LS		
1000 RGS Corsa	84	FA018		FA018V		MD609ALS		
1000 SFC	85-86	FA018		FA018V	FA018HH	MD609LS		
SFC 1000	03-04	FA266		FA266V	FA266HH	MD613	MD613C	
1200	78-79	FA018		FA018V	FA018HH	MD609LS		
1200 TSMirage	81	FA018		FA018V	FA018HH	MD609LS		
<b>LEM</b>								
R2/R3 (Hydraulic System)	03-05				FA325R		N/A	
Four X Pro		FA115			FA115HH	N/A		
RX 65		FA325TT			FA325R	N/A		
RX 2/3		FA325TT			FA325R	N/A		
CX 2/3		FA325TT			FA325R	N/A		
<b>LEONART</b>								
Daytona 125	13	FA197		FA197V	FA197HH		N/A	
Spyder 125	13	FA197		FA197V	FA197HH		N/A	
<b>LIFAN</b>								
LF 50 QGY		H303/H304 †						
LF 50 QGY 1/2		H303/H304 †						
Smart 50/125		H304						
LF-100 5		S603						
LF 100 A		H304						
LF 125 Off Road	07	FA480				N/A		
LT-125 T-2D		TBA						
LT-125-3A		S602						
<b>LINHAI</b>								
LH 50 Prince (Scooter)	07-09	TBA						
ATV 80	13	FA067TT			FA067R	N/A		
Drive-in City Walker 125/150 Scooter	08-09	TBA				TBA		
Eggy 125cc (Scooter)	07-09	TBA						
Monarch 125/150 T	06-07	SFA275	SFAC275		SFA275HH	N/A		
ATV 150	13	FA067TT			FA067R	N/A		
Goon 260cc (ATV) 2 x 4/4 x 4	07-09	FA270TT			FA270R	N/A		
Goon 260 ATV (2 x 4/4 x 4)	07-09	FA453TT			FA453R	N/A		

\*-2 Sets Required. ■ - Also available in MX-S race compound.  
**SAFETY WARNING:** DO NOT USE HH PADS ON REAR UNLESS ALSO USED ON FRONT TO AVOID BRAKE IMBALANCE

# Non-JAPANESE Built Motorcycles



← FRONT / AVANT / VORN FRENTE / ANTERIORE →

## DISC PAD CHOICES

## BRAKE ROTOR CHOICES

### LINHAI

			NEW SFAC Scooter Carbon Pads	Semi-Sintered V-Pads™	Sintered/HH Pads/ Grooved shoes	Left/Gauche/Links	Right/Droite/Rechts	Contour Rotor Universal left and right fitment	NEW Vee-Rotors™ CONTOUR	NEW CX Extreme® ROTOR	Oversize 250/280mm Rotor Kit	Relocating Bracket for 250/280mm Rotor	Oversize 320mm Rotor Kit	Relocating Bracket for 320mm Rotor
CUV Carry 300 (ATV)	07-09	FA453TT*			FA453R*	N/A	N/A							
Main Street 300cc (Scooter)	07-09	SFA199	SFAC199		SFA199HH		TBA							
Mainstreet 300cc Scooter	08-09	TBA					TBA							
Muddy 300 4 x 4 (ATV)	07-09	FA453TT*			FA453R*	N/A	N/A							
Muddy 300 4 x 4 (ATV) Parking brake	07-09													
Muddy 300 4 x 4 (ATV)	07-09	FA453TT*			FA453R*	N/A	N/A							
Muddy 300 4 x 4 (ATV) Parking brake	07-09	FA270TT												
ATV 310 (4 x 2)	13	FA453TT*			FA453R*	N/A	N/A							
ATV 320 (4 x 4 / Carrier)	13	FA453TT*			FA453R*	N/A	N/A							
ATV 420 (4 x 2/LoF)	13	FA453TT*			FA453R*	N/A	N/A							
ATV 420 (4 x 4/LoF)	13	FA453TT*			FA453R*	N/A	N/A							
ATV 420 (4 x 4 / Carrier LoF)	13	FA453TT*			FA453R*	N/A	N/A							
CUV Jobber 4 x 4	13	FA482TT*			FA482R*	N/A	N/A							
520 Quad	08-09	TBA*				N/A	N/A							
ATV 600 Efi 4 x 4 /LoF	13	TBA*				N/A	N/A							

### LML

Star Deluxe 125 (2T/Drum model)	01-03	V903												
Star Deluxe 125 (2T/Disc model)	01-03	SFA186	SFAC186			MD910D		MD910C	VR910					
Star Deluxe 150 (2T/Drum model)	01-03	V903												
Star Deluxe 150 (2T/Disc model)	01-03	SFA186	SFAC186			MD910D		MD910C	VR910					
Star 125 (2T) All Models	10-13	SFA186	SFAC186			MD910D		MD910C	VR910					
Star 125 (4T) All Models	10-13	SFA186	SFAC186			MD910D		MD910C	VR910					
Star 150 (2T) All Models	10-13	SFA186	SFAC186			MD910D		MD910C	VR910					
Star 150 (4T) All Models	10-13	SFA186	SFAC186			MD910D		MD910C	VR910					
Star 151 (4T) All Models	10-13	SFA186	SFAC186			MD910D		MD910C	VR910					
Star 200 (4T) All Models	10-13	SFA186	SFAC186			MD910D		MD910C	VR910					

### MAGNI

Sport 1200 S	01	FA244*			FA244HH*	N/A	N/A							
--------------	----	--------	--	--	----------	-----	-----	--	--	--	--	--	--	--

### MAICO

All models	-84				821G									
All models	85	FA047			FA047R	N/A								
All models	86-88	FA106TT			FA106R	N/A								
All models	89-93	FA132			FA132R	N/A								
250 MX	94-98	FA132			FA132R	N/A								
500 MX	94-98	FA132			FA132R	N/A								
500 MX/Enduro	99	FA181TT			FA181R ■		N/A							

### MALAGUTI

Chopper 25/40	-82	FA050				N/A								
50 LX Sport	-82	FA050				N/A								
50 Ronco RCW	-82	FA050				N/A								
50 Fifty HF	-82	FA050				N/A								
VA Olympique	-82	FA050				N/A								
50 Watercooled	-82	FA050				N/A								
50 Enduro RCX-W/Sahib	83-	FA099				N/A								
50 Fifty Full/CX	83-	FA099				N/A								
50 RGT Strada	83-	FA099				N/A								
50 Enduro Dune	87-	FA099				N/A								
50 MDX Gold Enduro	87-	FA067/2				N/A								
50 Enduro MEX	85-86	FA047			FA047R	N/A								
50 Enduro MEX	87-	FA067/2				N/A								
50 Enduro MGX	87-				922G									
50 Enduro MLX	87-	FA116				N/A								
50 Enduro MSX	85-	FA067/2				N/A								
50 Fifty Top	85-	FA099				N/A								
50 RGT Sport	85-	FA099				N/A								
50 Custom Fox	87-	931												

\*-2 Sets Required. ■ - Also available in MX-S race compound.

**SAFETY WARNING:** DO NOT USE HH PADS ON REAR UNLESS ALSO USED ON FRONT TO AVOID BRAKE IMBALANCE

APPLICATIONS  
BRAKE

R Suffix = High Durability Sintered Pad. HH Suffix = High Performance Sintered Pad. G Suffix = Grooved Shoe.

D Suffix = Drilled Disc. C Suffix = Contoured Disc. LS Suffix = Left/Steel Disc. RS = Right/Steel Disc.



# Non-JAPANESE Built Motorcycles

**BRAKE APPLICATIONS**

**R** Suffix = High Durability Sintered Pad. **HH** Suffix = High Performance Sintered Pad. **G** Suffix = Grooved Shoe.  
**D** Suffix = Drilled Disc. **C** Suffix = Contoured Disc. **LS** Suffix = Left/Steel Disc. **RS** = Right/Steel Disc.



← REAR / ARRIÈRE / HINTEN POSTERIOR / POSTERIORE →

## LINHAI

		DISC PAD CHOICES				BRAKE ROTOR CHOICES			
		NEW SFAC Scooter Carbon Pads	Semi-Sintered V-Pads™	Sintered/HH Pads/ Grooved shoes	Contour Rotor Rear Fitment	NEW Vee-Rotors™ CONTOUR	NEW CX Extreme® ROTOR		
CUV Carry 300 (ATV)	07-09	FA453TT*		FA453R*	N/A*				
Main Street 300cc (Scooter)	07-09	SFA275	SFAC275	SFA275HH	TBA				
Mainstreet 300cc Scooter	08-09	TBA			TBA				
Muddy 300 4 x 4 (ATV)	07-09	FA453TT		FA453R	N/A				
Muddy 300 4 x 4 (ATV) Parking brake	07-09	FA270TT		FA270R	N/A				
Muddy 300 4 x 4 (ATV)	07-09	FA453TT		FA453R	N/A				
ATV 310 (4 x 2)	13	FA453TT		FA453R	N/A				
ATV 320 (4 x 4 / Carrier)	13	FA453TT		FA453R	N/A				
ATV 420 (4 x 2/LoF)	13	FA453TT		FA453R	N/A				
ATV 420 (4 x 4/LoF)	13	FA453TT		FA453R	N/A				
ATV 420 (4 x 4 / Carrier LoF)	13	FA453TT		FA453R	N/A				
CUV Jobber 4 x 4	13	FA453TT*		FA453R*	N/A*				
520 Quad	08-09	TBA*			N/A*				
ATV 600 Efi 4 x 4 /LoF	13	FA453TT*		FA453R*	N/A*				

## LML

Star Deluxe 125 (2T/Drum model)	01-03	V903							
Star Deluxe 125 (2T/Disc model)	01-03	V903							
Star Deluxe 150 (2T/Drum model)	01-03	V903							
Star Deluxe 150 (2T/Disc model)	01-03	V903							
Star 125 (2T) All Models	10-13	V903							
Star 125 (4T) All Models	10-13	V903							
Star 150 (2T) All Models	10-13	V903							
Star 150 (4T) All Models	10-13	V903							
Star 151 (4T) All Models	10-13	V903							
Star 200 (4T) All Models	10-13	V903							

## MAGNI

Sport 1200 S	01	FA063		FA063HH	N/A				
--------------	----	-------	--	---------	-----	--	--	--	--

## MAICO

All models	-84			822G					
All models	85			822G					
All models	86-88	FA106TT		FA106R	N/A				
All models	89-93	FA132		FA132R	N/A				
250 MX	94-98	FA132		FA132R	N/A				
500 MX	94-98	FA067		FA067R	N/A				
500 MX/Enduro	99	FA208TT		FA208R ■	N/A				

## MALAGUTI

Chopper 25/40	-82	908							
50 LX Sport	-82	908							
50 Ronco RCW	-82	908							
50 Fitty HF	-82			926G					
VA Olympique	-82	908							
50 Watercooled	-82			926G					
50 Enduro RCX-W/Sahib	83-			930G					
50 Fitty Full/CX	83-			926G					
50 RGT Strada	83-	931							
50 Enduro Dune	87-	FA099			N/A				
50 MDX Gold Enduro	87-			922G					
50 Enduro MEX	85-86			922G					
50 Enduro MEX	87-			922G					
50 Enduro MGX	87-			922G					
50 Enduro MLX	87-			922G					
50 Enduro MSX	85-			922G					
50 Fitty Top	85-	926							
50 RGT Sport	85-			922G					
50 Custom Fox	87-	931							

\*-2 Sets Required. ■ - Also available in MX-S race compound.

**SAFETY WARNING:** DO NOT USE HH PADS ON REAR UNLESS ALSO USED ON FRONT TO AVOID BRAKE IMBALANCE

# Non-JAPANESE Built Motorcycles



← FRONT / AVANT / VORN FRENTE / ANTERIORE →

## MALAGUTI

### DISC PAD CHOICES

### BRAKE ROTOR CHOICES

		NEW SFAC Scooter Carbon Pads	Semi-Sintered V-Pads™	Sintered/HH Pads/ Grooved shoes	Left/Gauche/Links	Right/Droite/Rechts	Contour Rotor Universal left and right fitment	NEW Vee-Rotors™ CONTOUR	NEW CX Extreme® ROTOR	Oversize 250/280mm Rotor Kit	Relocating Bracket for 250/280mm Rotor	Oversize 320mm Rotor Kit	Relocating Bracket for 320mm Rotor
50 Dribbling	87-	931											
50 Fifty HF/NL 4 gears	87-			922G									
50 Fifty RV	90-00	931											
50 Grizzly RCX 10 (Round pad with tag)	90-00	N/A			N/A								
50 Grizzly RCX 12	90-00	931											
Grizzly RCW4	01-07	N/A			N/A								
Grizzly 10 (50) (Round pad with tag)	08-09	N/A			N/A								
Grizzly 10 CE (50) (Round pad with tag)	01-07	931											
Grizzly 12	08-09	931											
Grizzly 12 CE		N/A											
Grizzly Quad	87-	FA050			N/A								
50 Ranocchio 3 Wheels	87-	931											
50 RST Sport	87-	FA099			N/A								
50 MXR	89-	FA060			N/A								
50 America	91-	SFA173			N/A								
50 Evolution	91-	FA099			N/A								
50 Raid	91-	FA099			N/A								
Centro SL/SL Cat 50	94-00	SFA116				MD902D		VR902					
Centro Base 50 (Drum front model)	93-94			926G									
Centro Base (Front disc model)		SFA116				MD902D		VR902					
Centro 50/SL (4T)	08-11	SFA083	SFAC083	SFA083HH	TBA								
Ciak 50	00-04	SFA193	SFAC193	SFA193HH		MD965D							
Ciak 50 Twin Disc	00-03	SFA193	SFAC193	SFA193HH	MD965D								
Ciak 50 (4T) Master	04-08	SFA193	SFAC193	SFA193HH	MD965D								
Drakon S	06	FA266		FA266HH		N/A							
F10 Jetline 50	91-93	SFA173			MD915D			VR915					
F10 Jet Line 50	94-07	SFA193	SFAC193	SFA193HH	MD915D			VR915					
F10 Tribal	08-10	SFA193	SFAC193	SFA193HH	MD915D			VR915					
F10 Jetline WAP	06-10	SFA193	SFAC193	SFA193HH	MD915D			VR915					
F10 WAP	10-11	SFA083	SFAC083	SFA083HH	TBA								
Phantom F12 ***	94-98	SFA099			MD901D		MD901C	VR901					
***Note - Pads with two pin holes													
F12 Phantom 50 **	94-03	SFA116											
**Note - Pads with one pin hole													
F12 50 Phantom	98	SFA116			MD901D		MD901C	VR901					
F12 50 Phantom	99-03	SFA116			MD946D								
F12 Phantom (Air cooled) all models	02-08	SFA193	SFAC193	SFA193HH	MD946D								
F12 Phantom All liquid cooled models	00-08	SFA193	SFAC193	SFA193HH	MD946D								
Phantom F12R 50 A/C (All air cooled models)	07-11	SFA193	SFAC193	SFA193HH	TBA		TBA						
Phantom F12R 50 L/C (All liquid cooled models)	07-11	SFA193	SFAC193	SFA193HH	TBA		TBA						
Malbo Line DVD	10-11	SFA169	SFAC169	SFA169HH	MD904D			VR904					
NKD 50 Drakon	05-09	FA266		FA266HH		N/A							
XSM 50 Super Motard	03-11	FA194		FA194HH	MD8279D								
XTM 50	03-11	FA115		FA115HH	N/A								
Chopper 80	-82	FA050											
Enduro MDX 80	84-	FA047		FA047R									
Ciak 100	99-03	SFA193	SFAC193	SFA193HH	MD965D								
Phantom 100 F12	99-03	SFA193	SFAC193	SFA193HH	MD946D								
Firefox F15 50	96-98	SFA116			MD901D		MD901C	VR901					
F15 50 Firefox	98-00	SFA116			MD901D		MD901C	VR901					
F15 Firefox (All liquid cooled models)	01-08	SFA193	SFAC193	SFA193HH	MD946D								
Firefox F15 (Air cooled models)	99-08	SFA193	SFAC193	SFA193HH	MD946D								
F69 Phantom 70cc	98	SFA193	SFAC193	SFA193HH	MD936D			VR936					
Crosser CR1 ***	95-98	SFA099			MD901D		MD901C	VR901					
***Note - Pads with two pin holes													
Crosser CR1	95-98	SFA116			MD901D		MD901C	VR901					
Yesterday	98-03	SFA116			MD915D			VR915					
Blog 125 ie	09-11	SFA228	SFAC228	SFA228HH	TBA								
Ciak 125/150	01-08	SFA047		SFA047HH	MD965D								
Centro 125 ie/SL	07-11	SFA228	SFAC228	SFA228HH	TBA								

\*-2 Sets Required. ■ - Also available in MX-S race compound.

**SAFETY WARNING:** DO NOT USE HH PADS ON REAR UNLESS ALSO USED ON FRONT TO AVOID BRAKE IMBALANCE

APPLICATIONS  
BRAKE

R Suffix = High Durability Sintered Pad. HH Suffix = High Performance Sintered Pad. G Suffix = Grooved Shoe.

D Suffix = Drilled Disc. C Suffix = Contoured Disc. LS Suffix = Left/Steel Disc. RS = Right/Steel Disc.

# Non-JAPANESE Built Motorcycles



**MALAGUTI**



← REAR / ARRIÈRE / HINTEN POSTERIOR / POSTERIORE →

			DISC PAD CHOICES			BRAKE ROTOR CHOICES		
			NEW SFAC Scooter Carbon Pads	Semi-Sintered V-Pads™	Sintered/HH Pads/ Grooved shoes	Contour Rotor Rear Fitment	NEW Vee-Rotors™ CONTOUR	NEW CX Extreme® ROTOR
50 Dribbling	87-	931						
50 Fitty HF/NL 4 gears	87-				922G			
50 Fitty RV	90-00	931						
50 Grizzly RCX 10 (Round pad with tag)	90-00	931						
50 Grizzly RCX 12	90-00	931						
Grizzly RCW4	01-07	931						
Grizzly 10 (50) (Round pad with tag)	08-09	931						
Grizzly 10 CE (50) (Round pad with tag)	01-07	931						
Grizzly 12	08-09	931						
Grizzly 12 CE		TBA						
Grizzly Quad	87-	931						
50 Ranocchio 3 Wheels	87-	931						
50 RST Sport	87-	FA099				N/A		
50 MXR	89-							
50 America	91-	893						
50 Evolution	91-	N/A						
50 Raid	91-	893						
Centro SL/SL Cat 50	94-00	893						
Centro Base 50 (Drum front model)	93-94			893				
Centro Base (Front disc model)		893						
Centro 50/SL (4T)	08-11	816						
Ciak 50	00-04	893						
Ciak 50 Twin Disc	00-03	SFA193	SFAC193		SFA193HH	MD901D		
Ciak 50 (4T) Master	04-08	816						
Drakon S	06	FA115			FA115HH	N/A		
F10 Jetline 50	91-93	893						
F10 Jet Line 50	94-07	893						
F10 Tribal	08-10	893						
F10 Jetline WAP	06-10	893						
F10 WAP	10-11	893						
Phantom F12 ***	94-98	893						
F12 Phantom 50 **	94-03	893						
F12 50 Phantom	98	SFA193				MD901D	MD901C	
F12 50 Phantom	99-03	SFA193				MD901D		
F12 Phantom (Air cooled) all models	02-08	893						
F12 Phantom All liquid cooled models	00-08	SFA193	SFAC193		SFA193HH	MD901D		
Phantom F12R 50 A/C (All air cooled models)	07-11	893						
Phantom F12R 50 L/C (All liquid cooled models)	07-11	SFA193	SFAC193		SFA193HH	TBA		
Malbo Line DVD	10-11	Y503						
NKD 50 Drakon	05-09	FA115			FA115HH	N/A		
XSM 50 Super Motard	03-11	FA115			FA115HH	N/A		
XTM 50	03-11	FA115			FA115HH	N/A		
Chopper 80	-82	908						
Enduro MDX 80	84-							
Ciak 100	99-03	SFA193	SFAC193		SFA193HH	MD901D		
Phantom 100 F12	99-03	SFA193	SFAC193		SFA193HH	MD901D		
Firefox F15 50	96-98	893						
F15 50 Firefox	98-00	SFA193				MD901D	MD901C	
F15 Firefox (All liquid cooled models)	01-08	SFA193	SFAC193		SFA193HH	MD901D		
Firefox F15 (Air cooled models)	99-08	893			SFA193HH			
F69 Phantom 70cc	98	893						
Crosser CR1 ***	95-98	807						
Crosser CR1	95-98	807						
Yesterday	98-03	893						
Blog 125 ie	09-11	SFA101	SFAC101		SFA101HH	TBA		
Ciak 125/150	01-08	818						
Centro 125 ie/SL	07-11	SFA101	SFAC101		SFA101HH	TBA		

\*-2 Sets Required. ■ - Also available in MX-S race compound.

**SAFETY WARNING:- DO NOT USE HH PADS ON REAR UNLESS ALSO USED ON FRONT TO AVOID BRAKE IMBALANCE**

**R** Suffix = High Durability Sintered Pad. **HH** Suffix = High Performance Sintered Pad. **G** Suffix = Grooved Shoe.  
**D** Suffix = Drilled Disc. **C** Suffix = Contoured Disc. **LS** Suffix = Left/Steel Disc. **RS** = Right/Steel Disc.

**BRAKE APPLICATIONS**

# Non-JAPANESE Built Motorcycles



← FRONT / AVANT / VORN FRENTE / ANTERIORE →

## MALAGUTI

		DISC PAD CHOICES				BRAKE ROTOR CHOICES							
		NEW SFAC Scooter Carbon Pads	Semi-Sintered V-Pads™	Sintered/HH Pads/ Grooved shoes	Left/Gauche/Links	Right/Droite/Rechts	Contour Rotor Universal left and right fitment	NEW Vee-Rotors™ CONTOUR	NEW CX Extreme® ROTOR	Oversize 250/280mm Rotor Kit	Relocating Bracket for 250/280mm Rotor	Oversize 320mm Rotor Kit	Relocating Bracket for 320mm Rotor
Madison T 125/150/180	99-03	SFA194	SFAC194										
Madison 125-3	06-09	SFA194	SFAC194										
Phantom Max 125/200	04-08	SFA194	SFAC194										
R 125 Madison	03-07	SFA194	SFAC194										
X3M Enduro (Spoke wheel) 125	08-10	FA350											
X3M Motard (Cast wheels) 125	08-10	FA194											
Blog 160 ie	09-11	SFA228	SFAC228										
Centro 160 ie/SL	07-11	SFA228	SFAC228										
Ciak 200	06-08	SFA047											
Madison S 200	04	SFA194	SFAC194										
Madison S 250	99-03	SFA324	SFAC324										
Madison 250ie 3	06-10	SFA194	SFAC194										
Password 250	05-11	SFA194	SFAC194										
RS 250 Madison	04-07	SFA194	SFAC194										
Phantom Max 250	04-08	SFA194	SFAC194										
F18 Warrior 125/150	00-03	SFA047											
Madison K 400	02-06	SFA324	SFAC324										
Spider Max GT 500	04-10	SFA256*	SFAC256*										
Spider Max RS 500	04-11	SFA256*	SFAC256*										
Ciak (Electric Power)	00-05	SFA193	SFAC193										

## MALANCA

E2 C80/CS		FA047*											
125 GTI		FA047*											
125 Mark Enduro	-84	FA047											
125/ST 54/GT 5		FA050											
125 ob one M6	85-	FA060											
125 ob one M6 Racing	85-	FA060*											
125 Mark Enduro	85-	FA060											

## MASAI

K50	05-07	TBA*											
L50	05-07	TBA*											
L100	05-07	TBA*											
L150	05-07	TBA*											
110/125 Dirt Bike	06	TBA*											
A300 Quad	05-07	FA083TT*											
A450 Quad	05-07	FA083TT*											

## MASSEY-FERGUSON (ATV)

MF 250 (2WD/4WD)	04	FA271TT*											
MF 300 (2WD/4WD)	04	FA271TT*											
MF 400 (4WD)	04	FA271TT*											
MF 400 (Auto 4WD)	04	FA271TT*											
MF 400/4WD Auto (376cc)	05-09	FA395TT*											
MF 500 (4WD)	04	FA271TT*											
MF 500 (Auto)	04	FA271TT*											
MF 500 (Auto TBX 4WD)	04	FA271TT*											
MF 500/4WD Auto (493cc)	05-09	FA395TT*											
MF 650 2 cy/4WD Auto (633cc)	05-09	FA395TT*											
MF 650/4WD Auto (641cc)	05-09	FA395TT*											
MF 700 2 D/4WD Auto (686cc Diesel)	05-08	FA395TT*											

## MBK

CR 50 Z Target	91-95	SFA169	SFAC169										
CS 50 Mach G AC (Air cooled)	02-05	SFA193	SFAC193										
CS 50 Mach G AC (Air cooled)	06-10	SFA193	SFAC193										
CS 50 Mach G LC (Liquid cooled)	03-05	SFA193	SFAC193										
CS 50 Mach G LC (Liquid cooled)	06-10	SFA193	SFAC193										
CT 50 S Sorriso	91-92	Y503											

\*-2 Sets Required. ■ - Also available in MX-S race compound.

**SAFETY WARNING:** DO NOT USE HH PADS ON REAR UNLESS ALSO USED ON FRONT TO AVOID BRAKE IMBALANCE

APPLICATIONS  
BRAKE

R Suffix = High Durability Sintered Pad. HH Suffix = High Performance Sintered Pad. G Suffix = Grooved Shoe.

D Suffix = Drilled Disc. C Suffix = Contoured Disc. LS Suffix = Left/Steel Disc. RS = Right/Steel Disc.

# Non-JAPANESE Built Motorcycles



← REAR / ARRIÈRE / HINTEN  POSTERIOR / POSTERIORE →

## MALAGUTI



		DISC PAD CHOICES				BRAKE ROTOR CHOICES			
		NEW SFAC Scooter Carbon Pads	Semi-Sintered V-Pads™	Sintered/HH Pads/ Grooved shoes		Contour Rotor Rear Fitment	NEW Vee-Rotors™ CONTOUR	NEW CX Extreme® ROTOR	
Madison T 125/150/180	99-03	SFA298	SFAC298		SFA298HH	MD966D		VR966	
Madison 125-3	06-09	SFA266	SFAC266		SFA266HH	TBA			
Phantom Max 125/200	04-08	SFA298	SFAC298		SFA298HH	MD966D		VR966	
R 125 Madison	03-07	SFA298	SFAC298		SFA298HH	MD966D		VR966	
X3M Enduro (Spoke wheel) 125	08-10	FA115			FA115HH	N/A			
X3M Motard (Cast wheels) 125	08-10	FA115			FA115HH	N/A			
Blog 160 ie	09-11	SFA101	SFAC101		SFA101HH	TBA			
Centro 160 ie/SL	07-11	SFA101	SFAC101		SFA101HH	TBA			
Ciak 200	06-08	818							
Madison S 200	04	SFA298	SFAC298		SFA298HH	MD966D		VR966	
Madison S 250	99-03	SFA298	SFAC298		SFA298HH	MD966D			
Madison 250ie 3	06-10	SFA266	SFAC266		SFA266HH	TBA			
Password 250	05-11	SFA298	SFAC298		SFA298HH	TBA			
RS 250 Madison	04-07	SFA298	SFAC298		SFA298HH	MD966D		VR966	
Phantom Max 250	04-08	SFA298	SFAC298		SFA298HH	MD966D		VR966	
F18 Warrior 125/150	00-03	SFA298	SFAC298		SFA298HH	MD946D			
Madison K 400	02-06	SFA298	SFAC298		SFA298HH	MD967D			
Spider Max GT 500	04-10	SFA266	SFAC266		SFA266HH	TBA			
Spider Max RS 500	04-11	SFA266	SFAC266		SFA266HH	TBA			
Ciak (Electric Power)	00-05	TBA							

## MALANCA

E2 C80/CS		FA047			FA047R	N/A			
125 GTI		FA047			FA047R	N/A			
125 Mark Enduro	-84	N/A							
125ST 54/GT 5		N/A							
125 ob one M6	85-	FA060				N/A			
125 ob one M6 Racing	85-	FA060				N/A			
125 Mark Enduro	85-				841G				

## MASAI

K50	05-07	FA232TT			FA232R	N/A			
L50	05-07	FA232TT			FA232R	N/A			
L100	05-07	TBA				N/A			
L150	05-07	FA083TT			FA083R	N/A			
110/125 Dirt Bike	06	TBA				N/A			
A300 Quad	05-07	FA355*			FA355R*	N/A			
A450 Quad	05-07	FA355*			FA355R*	N/A			

## MASSEY-FERGUSON (ATV)

MF 250 (2WD/4WD)	04	FA271TT			FA271R	MD6173D			
MF 300 (2WD/4WD)	04	FA271TT			FA271R	MD6173D			
MF 400 (4WD)	04	FA271TT			FA271R	MD6173D			
MF 400 (Auto 4WD)	04	FA271TT			FA271R	MD6173D			
MF 400/4WD Auto (376cc)	05-09	FA395TT			FA395R	MD6173D			
MF 500 (4WD)	04	FA271TT			FA271R	MD6173D			
MF 500 (Auto)	04	FA271TT			FA271R	MD6173D			
MF 500 (Auto TBX 4WD)	04	FA271TT			FA271R	MD6173D			
MF 500/4WD Auto (493cc)	05-09	FA395TT			FA395R	MD6173D			
MF 650 2 cy/4WD Auto (633cc)	05-09	FA395TT			FA395R	MD6173D			
MF 650/4WD Auto (641cc)	05-09	FA395TT			FA395R	MD6173D			
MF 700 2 D/4WD Auto (686cc Diesel)	05-08	FA395TT			FA395R	MD6173D			

## MBK

CR 50 Z Target	91-95	Y503							
CS 50 Mach G AC (Air cooled)	02-05	Y503							
CS 50 Mach G AC (Air cooled)	06-10	Y530							
CS 50 Mach G LC (Liquid cooled)	03-05	Y503							
CS 50 Mach G LC (Liquid cooled)	06-10	Y530							
CT 50 S Sorriso	91-92	Y503							

\*-2 Sets Required. ■ - Also available in MX-S race compound.

**SAFETY WARNING:** DO NOT USE HH PADS ON REAR UNLESS ALSO USED ON FRONT TO AVOID BRAKE IMBALANCE

**BRAKE APPLICATIONS**

**R** Suffix = High Durability Sintered Pad. **HH** Suffix = High Performance Sintered Pad. **G** Suffix = Grooved Shoe.  
**D** Suffix = Drilled Disc. **C** Suffix = Contoured Disc. **LS** Suffix = Left/Steel Disc. **RS** = Right/Steel Disc.



# Non-JAPANESE Built Motorcycles



FRONT / AVANT / VORN      FRETE / ANTERIORE



## DISC PAD CHOICES

## BRAKE ROTOR CHOICES

**MBK**

		NEW SFAC Scooter Carbon Pads	Semi-Sintered V-Pads™	Sintered/HH Pads/ Grooved shoes	Left/Gauche/Links	Right/Droite/Rechts	Contour Rotor Universal left and right fitment	NEW Vee-Rotors™ CONTOUR	NEW CX Extreme® ROTOR	Oversize 250/280mm Rotor Kit	Relocating Bracket for 250/280mm Rotor	Oversize 320mm Rotor Kit	Relocating Bracket for 320mm Rotor
CT 50 SS Sorriso	93-95	Y503											
CV 50 Evolis	97	SFA193	SFAC193	SFA193HH	MD904D		MD904C	VR904					
CW 50 Fizz 50	93-97	SFA193	SFAC193	SFA193HH	MD916D								
CW 50 Booster	90-91	Y503											
CW 50 Booster	92-94	Y503											
CW 50 Booster (10" Wheels)	09-10	SFA193	SFAC193	SFA193HH	MD916D								
CW 50 R Booster Road	94-95	SFA193	SFAC193	SFA193HH	MD904D		MD904C	VR904					
CW 50 RS Booster NG	95-98	SFA193	SFAC193	SFA193HH	MD916D								
CW 50 RSX Booster Track	96-98	SFA193	SFAC193	SFA193HH	MD916D								
CW 50 Booster Spirit	96-98	SFA193	SFAC193	SFA193HH	MD916D								
CW 50 RS Booster Spirit	99-06	SFA193	SFAC193	SFA193HH	MD916D								
CW 50 RSP Rocket	97-98	SFA193	SFAC193	SFA193HH	MD916D								
CW 50 RS Booster NG	01-06	SFA193	SFAC193	SFA193HH	MD923D		MD923C	VR923					
CW 50 RS Booster Naked	05-06	SFA193	SFAC193	SFA193HH	MD916D								
CW 50 Booster Naked (10" Wheels)	06-10	SFA193	SFAC193	SFA193HH	MD916D								
CW 50 Power Rocket	06	SFA193	SFAC193	SFA193HH	MD916D								
CW 50 Booster (12" wheels)	06-10	SFA193	SFAC193	SFA193HH	MD916D								
CW 50 Booster Spirit	09	SFA193	SFAC193	SFA193HH	MD916D								
CW 50 Naked Booster (12" Wheels)	09	SFA193	SFAC193	SFA193HH	MD916D								
CY 50 Forte/Forte Mufa	96-97	SFA169	SFAC169	SFA169HH	MD904D		MD904C	VR904					
EW 50 Stunt	00-06	SFA268	SFAC268	SFA268HH	MD923D		MD923C	VR923					
EW 50 Stunt Naked	05-10	SFA268	SFAC268	SFA268HH	MD923D		MD923C	VR923					
TZR 50 X-Power	00	FA165TT		FA165HH		MD2067RS							
TZR 50 X Power	03-10	FA194		FA194HH	MD672LS								
X Limit Enduro 50cc	03-10	FA350		FA350HH	MD6297D								
X Limit Supermoto 50cc	03-10	FA194		FA194HH	MD6297D								
XF 50 Booster X	07-10	Y530											
YA 50 R Forte	94-95	SFA193	SFAC193	SFA193HH	MD904D		MD904C	VR904					
YA 50 TA Sorriso	95-96	Y503											
YE 50 Evolis	92-95	SFA193	SFAC193	SFA193HH	MD904D		MD904C	VR904					
YH 50 Flipper	98-10	SFA193	SFAC193	SFA193HH	MD928D								
YM 50 Fizz	94-95	SFA193	SFAC193	SFA193HH	MD904D		MD904C	VR904					
YN 50 R Ovetto (2T)	98-10	SFA193	SFAC193	SFA193HH	MD943D		MD943C	VR943					
YN 50 Ovetto (4T)	09-10	SFA193	SFAC193	SFA193HH	MD943D		MD943C	VR943					
YQ 50 Nitro	97-10	SFA193	SFAC193	SFA193HH	MD923D		MD923C	VR923					
YQ 50 Nitro Naked	06-10	SFA193	SFAC193	SFA193HH	MD923D		MD923C	VR923					
YV 80 Evolis	97	SFA193	SFAC193	SFA193HH	MD904D		MD904C	VR904					
YN 100 Ovetto	99-02	SFA193	SFAC193	SFA193HH	MD943D		MD943C	VR943					
YQ 100 Nitro	01-03	SFA193	SFAC193	SFA193HH	MD923D		MD923C	VR923					
YW 100 Booster 100	99-02	SFA169	SFAC169	SFA169HH	N/A								
XC 125 T Flame	95-96	Y527											
XC 125 Flame 125	96-03	SFA101	SFAC101	SFA101HH	N/A								
XC 125 WAAP	08-10	SFA464				MD9127D		VR9127					
XN 125/150 Doo Do	00-05	SFA193	SFAC193	SFA193HH	MD907D		MD907C	VR907					
XQ 125/150 Thunder	01-03	SFA181	SFAC181	SFA181HH	MD957D			VR957					
YP 125 D Skyliner	98-00	SFA181	SFAC181	SFA181HH	MD907D		MD907C	VR907					
YP 125 D Skyliner	01-10	SFA181	SFAC181	SFA181HH	MD907D		MD907C	VR907					
YP 125 Skycruiser	06-10	SFA430	SFAC430	SFA430HH		MD9102D							
VP 125 Cityliner	08-10	SFA196	SFAC196	SFA196HH	MD9130D								
YW 125 Z X-Over	10	SFA492			MD986D			VR986					
NXC 125 Flame X (220mm Front Disc)	04-06	SFA393	SFAC393			MD986D		VR986					
NXC 125 Flame X (240mm Front Disc)	07-12	SFA393	SFAC393			MD9133D		VR9133					
XC 150 Vertex	97	SFA181	SFAC181	SFA181HH	N/A								
YP 250 Skyliner	96-98	SFA199	SFAC199	SFA199HH		MD903D	MD903C	VR903					
YP 250 Skyliner	98-99	SFA199	SFAC199	SFA199HH		MD903D	MD903C	VR903					
YP 250 Skyliner 250	00-02	SFA199	SFAC199	SFA199HH		MD903D	MD903C	VR903					
VP 300 R Killbre	03-04	SFA181	SFAC181	SFA181HH		MD985D		VR985					
YP 400 Skyliner	04	SFA199	SFAC199	SFA199HH	MD9102D			VR9102					

## MECHRON - SEE KIOTI

\*-2 Sets Required. ■ - Also available in MX-S race compound.

**SAFETY WARNING:** DO NOT USE HH PADS ON REAR UNLESS ALSO USED ON FRONT TO AVOID BRAKE IMBALANCE

**R** Suffix = High Durability Sintered Pad. **HH** Suffix = High Performance Sintered Pad. **G** Suffix = Grooved Shoe.  
**D** Suffix = Drilled Disc. **C** Suffix = Contoured Disc. **LS** Suffix = Left/Steel Disc. **RS** = Right/Steel Disc.

**APPLICATIONS**  
**BRAKE**

# Non-JAPANESE Built Motorcycles

**BRAKE APPLICATIONS**

**R** Suffix = High Durability Sintered Pad. **HH** Suffix = High Performance Sintered Pad. **G** Suffix = Grooved Shoe.  
**D** Suffix = Drilled Disc. **C** Suffix = Contoured Disc. **LS** Suffix = Left/Steel Disc. **RS** = Right/Steel Disc.



**MBK**



← REAR / ARRIÈRE / HINTEN POSTERIOR / POSTERIORE →

			DISC PAD CHOICES			BRAKE ROTOR CHOICES		
			NEW SFAC Scooter Carbon Pads	Semi-Sintered V-Pads™	Sintered/HH Pads/ Grooved shoes	Contour Rotor Rear Fitment	NEW Vee-Rotors™ CONTOUR	NEW CX Extreme® ROTOR
CT 50 SS Sorriso	93-95	Y503						
CV 50 Evolis	97	Y503						
CW 50 Fizz 50	93-97	Y503						
CW 50 Booster	90-91	Y503						
CW 50 Booster	92-94	Y503						
CW 50 Booster (10" Wheels)	09-10	Y503						
CW 50 R Booster Road	94-95	Y503						
CW 50 RS Booster NG	95-98	Y503						
CW 50 RSX Booster Track	96-98	Y503						
CW 50 Booster Spirit	96-98	Y503						
CW 50 RS Booster Spirit	99-06	Y503						
CW 50 RSP Rocket	97-98	Y503						
CW 50 RS Booster NG	01-06	Y503						
CW 50 RS Booster Naked	05-06	Y503						
CW 50 Booster Naked (10" Wheels)	06-10	Y503						
CW 50 Power Rocket	06	Y503						
CW 50 Booster (12" wheels)	06-10	Y503						
CW 50 Booster Spirit	09	Y503						
CW 50 Naked Booster (12" Wheels)	09	Y503						
CY 50 Forte/Forte Mufa	96-97	Y503						
EW 50 Stunt	00-06	Y503						
EW 50 Stunt Naked	05-10	Y503						
TZR 50 X-Power	00	FA101TT				MD2077		
TZR 50 X Power	03-10	FA115			FA115HH	MD2113		
X Limit Enduro 50cc	03-10	FA350			FA350HH	MD6280D		
X Limit Supermoto 50cc	03-10	FA350			FA350HH	MD6280D		
XF 50 Booster X	07-10	Y530						
YA 50 R Forte	94-95	Y503						
YA 50 TA Sorriso	95-96	Y503						
YE 50 Evolis	92-95	Y503						
YH 50 Flipper	98-10	Y503						
YM 50 Fizz	94-95	Y503						
YN 50 R Ovetto (2T)	98-10	Y503						
YN 50 Ovetto (4T)	09-10	Y503						
YQ 50 Nitro	97-10	SFA268	SFAC268		SFA268HH	MD923D	MD923C	VR923
YQ 50 Nitro Naked	06-10	SFA268	SFAC268		SFA268HH	MD923D	MD923C	VR923
CV 80 Evolis	97	Y503						
YN 100 Ovetto	99-02	Y527						
YQ 100 Nitro	01-03	Y527						
YW 100 Booster 100	99-02	Y527						
XC 125 T Flame	95-96	Y503						
XC 125 Flame 125	96-03	Y503						
XC 125 WAAP	08-10	Y530						
XN 125/150 Doo Do	00-05	Y527						
XQ 125/150 Thunder	01-03	SFA266	SFAC266		SFA266HH	MD958D		VR958
YP 125 D Skyliner	98-00	Y527						
YP 125 D Skyliner	01-10	SFA266	SFAC266		SFA266HH	MD962D		VR962
YP 125 Skyruiser	06-10	SFA266	SFAC266		SFA266HH	MD9104D		VR9104
VP 125 Cityliner	08-10	SFA275	SFAC275		SFA275HH	MD9104D		VR9104
YW 125 Z X-Over	10	Y533						
NXC 125 Flame X (220mm Front Disc)	04-06	Y533						
NXC 125 Flame X (240mm Front Disc)	07-12	Y533						
XC 150 Vertex	97	Y527						
YP 250 Skyliner	96-98	Y516						
YP 250 Skyliner	98-99	SFA275	SFAC275		SFA275HH	MD927D		VR927
YP 250 Skyliner 250	00-02	SFA275	SFAC275		SFA275HH	MD953D	MD953C	VR953
VP 300 R Kilibre	03-04	SFA181	SFAC181		SFA181HH	MD9104D		VR9104
YP 400 Skyliner	04	SFA408	SFAC408		SFA408HH	MD9103D		VR9103

## MECHRON - SEE KIOTI

\*-2 Sets Required. ■ - Also available in MX-S race compound.

**SAFETY WARNING:** DO NOT USE HH PADS ON REAR UNLESS ALSO USED ON FRONT TO AVOID BRAKE IMBALANCE

# Non-JAPANESE Built Motorcycles



← FRONT / AVANT / VORN FRENTE / ANTERIORE →

## DISC PAD CHOICES

## BRAKE ROTOR CHOICES

### MEGELLI

		NEW SFAC Scooter Carbon Pads	Semi-Sintered V-Pads™	Sintered/HH Pads/ Grooved shoes	Left/Gauche/Links	Right/Droite/Rechts	Contour Rotor Universal left and right fitment	NEW Vee-Rotors™ CONTOUR	NEW CX Extreme® ROTOR	Oversize 250/280mm Rotor Kit	Relocating Bracket for 250/280mm Rotor	Oversize 320mm Rotor Kit	Relocating Bracket for 320mm Rotor
125 M (Supermoto)	08-10	FA086		FA086HH	TBA								
125 R (Sportbike)	08-10	FA086		FA086HH	TBA								
125 S (Naked Sport Bike)	08-10	FA086		FA086HH	TBA								

### METRAKIT

XL 80 Mini GP	09	TBA			N/A								
Pre GP 125	09	FA399			N/A								

### MH/MOTOR HISPANIA

Kn2 50 (50cc)	12-13	FA399					N/A						
MH 10 50 Enduro	13	FA416TT					N/A						
MH 10 50 Pro Enduro	13	FA416TT					N/A						
MH 10 50 SM	13	FA416TT					N/A						
MH 10 50 Pro SM	13	FA416TT					N/A						
RX 50 Super Racing	06-07	FA167		FA167HH	MD6318D								
RX 50 R	08-13	FA399					N/A						
Furia Max Supermoto	07-10	FA115		FA115HH	N/A								
Furia Max Enduro 50	06-10	FA115		FA115HH	N/A								
RYZ 50 Enduro	06-10	FA115		FA115HH	N/A								
RYZ 50 Enduro	13	FA416TT					N/A						
RYZ 50 Supermotard	06-10	FA194		FA194HH	N/A								
RYZ SM 50	06-10	FA416TT					N/A						
RYZ 50 Pro Racing Supermotard	06-10	FA194		FA194HH	N/A		TBA						
RYZ Pro SM 50	06-10	FA416TT					N/A						
RYZ 50 Urban Bike	06-10	FA167		FA167HH	MD6318D								
RYZ 50 Pro Racing Urban Bike	06-10	FA194		FA194HH	N/A		TBA						
RYZ 50 Pro Racing Enduro	06-10	FA167		FA167HH	N/A		TBA						
Custom 125	12	FA093			N/A								
Duna 125 Hard Road Enduro (21" front wheel/18" rear wheel)	08-12	FA093			N/A								
Duna 125 Dual Plus Trail (19" wheels)	08-10	FA194		FA194HH	N/A								
Duna 125 Sports City Supermotard (17" wheels)	08-10	FA194		FA194HH	N/A								
Duna 125	13	FA416TT			N/A								
Duna 125 Pro	13	FA416TT			N/A								
Kn1 125 (125cc)	09-10	FA399					N/A						
Kn2 125 (125cc)	12-13	FA399					N/A						
RX 125 R	08-13	FA399					N/A						
MH7 Naked (125cc/Air cooled)	08-10	FA399			N/A								
MH7 Naked (125cc/Liquid cooled)	08-13	FA399					N/A						
MH 10 125 Enduro	13	FA416TT					N/A						
MH 10 125 SM	13	FA416TT					N/A						
125 LC Hard Road SM	12	FA399					N/A						

### MINI MOTO

Polini/Pasini/GRC Callipers (Round Type)		FA293			N/A								
Polini/Pasini/GRC Callipers (Square Two Pin Type)		FA352			N/A								

### MODENAS

Kriss 110	00-02	S603											
Kriss 115		FA165TT			N/A								

### MONDIAL

Piega 1000	02	FA424*		FA424HH*	N/A	N/A							
Piega 1000	03-04			FA322/4HH*	MD621X	MD621X	MD621XC*	VR621BLK*					
Evo	04			FA322/4HH*	MD621X	MD621X	MD621XC*	VR621BLK*					

### MONTESA/HONDA

Old Models		N/A											
Cota 123/230/349	-83			933G									
Cota 123/200/242/349	84			937G									
250 4RT Cota	05-10	FA303			N/A								

\*-2 Sets Required. ■ - Also available in MX-S race compound.

**SAFETY WARNING:** DO NOT USE HH PADS ON REAR UNLESS ALSO USED ON FRONT TO AVOID BRAKE IMBALANCE

APPLICATIONS  
BRAKE

R Suffix = High Durability Sintered Pad. G Suffix = Grooved Shoe.

HH Suffix = High Performance Sintered Pad. H Suffix = High Performance Sintered Pad.

D Suffix = Drilled Disc. C Suffix = Contoured Disc. LS Suffix = Left/Steel Disc. RS Suffix = Right/Steel Disc.

# Non-JAPANESE Built Motorcycles



← REAR / ARRIÈRE / HINTEN  POSTERIOR / POSTERIORE →

**BRAKE  
APPLICATIONS**

## MEGELLI



DISC PAD CHOICES				BRAKE ROTOR CHOICES			
NEW SFAC Scooter Carbon Pads	Semi-Sintered V-Pads™	Sintered/HH Pads/ Grooved shoes		Contour Rotor Rear Fitment	NEW Vee-Rotors™ CONTOUR	NEW CX Extreme® ROTOR	

125 M (Supermoto)	08-10	FA346TT		FA346R	TBA	
125 R (Sportbike)	08-10	FA346TT		FA346R	TBA	
125 S (Naked Sport Bike)	08-10	FA346TT		FA346R	TBA	

## METRAKIT

XL 80 Mini GP	09	FA351			N/A	
Pre GP 125	09	FA351			N/A	

## MH/MOTOR HISPANIA

Kr2 50 (50cc)	12-13	FA416TT			N/A	
MH 10 50 Enduro	13	FA083TT			N/A	
MH 10 50 Pro Enduro	13	FA083TT			N/A	
MH 10 50 SM	13	FA083TT			N/A	
MH 10 50 Pro SM	13	FA083TT			N/A	
RX 50 Super Racing	06-07	FA115		FA115HH	N/A	
RX 50 R	08-13	FA093			N/A	
Furia Max Supermoto	07-10	FA115		FA115HH	N/A	
Furia Max Enduro 50	06-10	FA115		FA115HH	N/A	
RYZ 50 Enduro	06-10	FA115		FA115HH	N/A	
RYZ 50 Enduro	13	FA083TT			N/A	
RYZ 50 Supermotard	06-10	FA115		FA115HH	N/A	
RYZ SM 50	06-10	FA083TT			N/A	
RYZ 50 Pro Racing Supermotard	06-10	FA115		FA115HH	N/A	TBA
RYZ Pro SM 50	06-10	FA083TT			N/A	
RYZ 50 Urban Bike	06-10	FA115		FA115HH	N/A	
RYZ 50 Pro Racing Urban Bike	06-10	FA115		FA115HH	N/A	TBA
RYZ 50 Pro Racing Enduro	06-10	FA115		FA115HH	N/A	TBA
Custom 125	12	TBA				
Duna 125 Hard Road Enduro (21" front wheel/18" rear wheel)	08-12	FA115		FA115HH	N/A	
Duna 125 Dual Plus Trail (19" wheels)	08-10	FA115		FA115HH	N/A	
Duna 125 Sports City Supermotard (17" wheels)	08-10	FA093			N/A	
Duna 125	13	FA083TT			N/A	
Duna 125 Pro	13	FA083TT			N/A	
Kr1 125 (125cc)	09-10	FA093			N/A	
Kr2 125 (125cc)	12-13	FA416TT			N/A	
RX 125 R	08-13	FA093			N/A	
MH7 Naked (125cc/Air cooled)	08-10	FA093			N/A	
MH7 Naked (125cc/Liquid cooled)	08-13	FA093			N/A	
MH 10 125 Enduro	13	FA083TT			N/A	
MH 10 125 SM	13	FA083TT			N/A	
125 LC Hard Road SM	12	FA416TT			N/A	

## MINI MOTO

Polini/Pasini/GRC Calipers (Round Type)		FA293			N/A	
Polini/Pasini/GRC Calipers (Square Two Pin Type)		FA352			N/A	

## MODENAS

Kriss 110	00-02	S603				
Kriss 115		S603				

## MONDIAL

Piega 1000	02	FA095	FA095V	FA095HH	N/A	
Piega 1000	03-04	FA266	FA266V	FA266HH	TBA	
Evo	04	FA266	FA266V	FA266HH	TBA	

## MONTESA/HONDA

Old Models		889				
Cota 123/290/349	-83			933G		
Cota 123/200/242/349	84			933G		
250 4RT Cota	05-10	FA351			N/A	

\*-2 Sets Required. ■ - Also available in MX-S race compound.

**SAFETY WARNING:** DO NOT USE HH PADS ON REAR UNLESS ALSO USED ON FRONT TO AVOID BRAKE IMBALANCE

**R** Suffix = High Durability Sintered Pad. **HH** Suffix = High Performance Sintered Pad. **G** Suffix = Grooved Shoe.  
**D** Suffix = Drilled Disc. **C** Suffix = Contoured Disc. **LS** Suffix = Left/Steel Disc. **RS** = Right/Steel Disc.

# Non-JAPANESE Built Motorcycles



FRONT / AVANT / VORN FRENTE / ANTERIORE

APPLICATIONS  
BRAKE

## MONTESA/HONDA



Model	Year	DISC PAD CHOICES				BRAKE ROTOR CHOICES						
		NEW SFAC Scooter Carbon Pads	Semi-Sintered V-Pads™	Sintered/HH Pads/ Grooved shoes	Left/Gauche/Links	Right/Droite/Rechts	Contour Rotor Universal left and right fitment	NEW Vee-Rotors™ CONTOUR	NEW CX Extreme® ROTOR	Oversize 250/280mm Rotor Kit	Relocating Bracket for 250/280mm Rotor	Oversize 320mm Rotor Kit

Cota 307/335	88	FA115TT		FA115R	N/A								
348 Trial Enduro				933G									
Honda 311 260cc	92-93	FA115TT		FA115R	N/A								
Honda 314 R	94-96	FA115TT		FA115R	N/A								
Honda 315R	97-00	FA115TT		FA115R	N/A								
Honda 315 R	01-04	FA303			N/A								

## MOTOBECANE

40 AE/41 AE		878											
50 all mod. Atom hub	88-	H322											
50 all mod. Leleu hub	88-	H322											
50 AE/AE		878											
51 SA/SAE/SV/SVE		878											
51 SUE		877											
51 VLM		878											
or 51 VLM		878											
Rock/Rock A		877											
Magnum/A/Racing		877											

## MOTO GUZZI

350 - V 35 (12 Spoke Cast Wheels/Electronic Ignition)	77-79	FA047*		FA047V*	FA047HH*	N/A	N/A						
350 - V 35 II (12 Spoke Cast Wheels)	80-85	FA047*		FA047V*	FA047HH*	N/A	N/A						
350 - V 35 III (10 Spoke Cast Wheels)	85-87	FA047*		FA047V*	FA047HH*	N/A	N/A						
350 - V 35 C Custom (10 Spoke Cast Wheel/Points Ignition)	82-86	FA047*		FA047V*	FA047HH*	N/A	N/A						
350 - V 35 Florida	86-90	FA047*		FA047V*	FA047HH*	N/A	N/A						
350 - NTX 350	87-90	FA047*		FA047V*	FA047HH*	N/A	N/A						
350 - Nevada	92-97	FA047*		FA047V*	FA047HH*	N/A	N/A						
350 - Nevada Club	98-99	FA047*		FA047V*	FA047HH*	N/A	N/A						
500 - V 50 (12 Spoke Cast Wheels/Electronic Ignition)	77-79	FA047*		FA047V*	FA047HH*	N/A	N/A						
500 - V 50 III (12 Spoke Cast Wheels)	85-87	FA047*		FA047V*	FA047HH*	N/A	N/A						
500 - V 50 C Custom (10 Spoke Cast Wheel/Points Ignition)	82-86	FA047*		FA047V*	FA047HH*	N/A	N/A						
650 - 65 GT	88-89	FA047*		FA047V*	FA047HH*	N/A	N/A						
650 - NTX 650	87-90	FA047		FA047V*	FA047HH*	N/A	N/A						
650 - V 65 C Custom (10 Spoke Cast Wheel)	83-86	FA047*		FA047V*	FA047HH*	N/A	N/A						
650 - V 65 Florida (Spoke & Cast Wheel Models)	85-92	FA047*		FA047V*	FA047HH*	N/A	N/A						
750 - Brevia ie (3 Spoke Cast Wheel)	03-11	FA244		FA244V	FA244HH	MD614X		MD614XC	VR614BLK				
750 - SP (10 Spoke Cast Wheels)	90-92	FA047*		FA047V*	FA047HH*	MD693LS	MD693RS						
750 - Targa	90-93	FA047*		FA047V*	FA047HH*	N/A	N/A						
750 - Nevada 750	91-01	FA047		FA047V	FA047HH	MD693LS							
750 - Nevada 750	02-11	FA047		FA047V	FA047HH	MD693LS							
750 - Nevada Club (Up To LK112433)	98-00	FA047*		FA047V*	FA047HH*	N/A	N/A						
750 - Nevada Club (From LK112434)	98-00	FA047*		FA047V*	FA047HH*	N/A	N/A						
750 - Nevada Classic 750 ie (Spoke Wheels)	04-13	FA244		FA244V	FA244HH	MD614X		MD614XC	VR614BLK				
750 - Strada / T Roadster	93-95	FA047*		FA047V*	FA047HH*	N/A	N/A						
750 - V 75 (10 Spoke Cast Wheels/Solid front discs)	92-96	FA047*		FA047V*	FA047HH*	N/A	N/A						
750 - V 75 (10 Spoke Cast Wheels/Solid floating discs)	96-01	FA047*		FA047V*	FA047HH*	N/A	N/A						
750 - V7 Classic	08-12	FA244		FA244V	FA244HH	MD614X		MD614XC	VR614BLK				
750 - V7 Cafe Classic	09-12	FA244		FA244V	FA244HH	MD614X		MD614XC	VR614BLK				
750 - V7 Racer	10-11	FA244		FA244V	FA244HH	MD614X		MD614XC	VR614BLK				
850 - Le Mans I	76-77	FA018*		FA018V*	FA018HH*	N/A	N/A						
850 - Le Mans II	78-80	FA018*		FA018V*	FA018HH*	N/A	N/A						
850 - Le Mans III	81-84	FA018*		FA018V*	FA018HH*	N/A	N/A						
850 - T	74	FA018		FA018V	FA018HH	N/A	N/A						
850 - T3	75-79	FA018*		FA018V*	FA018HH*	N/A	N/A						
850 - T3 California (With Screen/Panniers)	75-79	FA018*		FA018V*	FA018HH*	N/A	N/A						
850 - T4	80-82	FA018*		FA018V*	FA018HH*	N/A	N/A						
850 - T5	83-85	FA018*		FA018V*	FA018HH*	N/A	N/A						
850 - T5 California (With Screen/Panniers)	83-85	FA018*		FA018V*	FA018HH*	N/A	N/A						
850 - Brevia ie	06-07	FA244*		FA244V*	FA244HH*	MD624	MD624		VR624BLK*				
850 - Griso	06-07	FA244*		FA244V*	FA244HH*	MD621X	MD621X	MD621XC*	VR621BLK*				

\*-2 Sets Required. ■ - Also available in MX-S race compound.

**SAFETY WARNING:** DO NOT USE HH PADS ON REAR UNLESS ALSO USED ON FRONT TO AVOID BRAKE IMBALANCE

R Suffix = High Durability Sintered Pad. HH Suffix = High Performance Sintered Pad. G Suffix = Grooved Shoe.  
D Suffix = Drilled Disc. C Suffix = Contoured Disc. LS Suffix = Left/Steel Disc. RS = Right/Steel Disc.



# Non-JAPANESE Built Motorcycles



## MONTESA/HONDA



← REAR / ARRIÈRE / HINTEN POSTERIOR / POSTERIORE →

		DISC PAD CHOICES			BRAKE ROTOR CHOICES				
		NEW SFAC Scooter Carbon Pads	Semi-Sintered V-Pads™	Sintered/HH Pads/Grooved shoes	Contour Rotor Rear Fitment	NEW Vee-Rotors™ CONTOUR	NEW CX Extreme® ROTOR		
Cota 307/335	88	FA115TT		FA115R	N/A				
348 Trial Enduro				933G					
Honda 311 260cc	92-93	FA047TT		FA047R	N/A				
Honda 314 R	94-96	FA047TT		FA047R	N/A				
Honda 315R	97-00	FA047TT		FA047R	N/A				
Honda 315 R	01-04	FA351			N/A				
<b>MOTOBECANE</b>									
40 AE/41 AE		878							
50 all mod. Atom hub	88-	873							
50 all mod. Leleu hub	88-	873							
50 A/E/AE		878							
51 SA/SAE/SV/SVE		878							
51 SUE		877							
51 VLM		878							
or 51 VLM		H322							
Rock/Rock A		877							
Magnum/A/Racing		877							
<b>MOTO GUZZI</b>									
350 - V 35 (12 Spoke Cast Wheels/Electronic Ignition)	77-79	FA047	FA047V	FA047HH	N/A				
350 - V 35 II (12 Spoke Cast Wheels)	80-85	FA047	FA047V	FA047HH	N/A				
350 - V 35 III (10 Spoke Cast Wheels)	85-87	FA047	FA047V	FA047HH	N/A				
350 - V 35 C Custom (10 Spoke Cast Wheel/Points Ignition)	82-86	FA047	FA047V	FA047HH	N/A				
350 - V 35 Florida	86-90	FA047	FA047V	FA047HH	N/A				
350 - NTX 350	87-90	FA047	FA047V	FA047HH	N/A				
350 - Nevada	92-97	FA047	FA047V	FA047HH	N/A				
350 - Nevada Club	98-99	FA047	FA047V	FA047HH	N/A				
500 - V 50 (12 Spoke Cast Wheels/Electronic Ignition)	77-79	FA047	FA047V	FA047HH	N/A				
500 - V 50 III (12 Spoke Cast Wheels)	85-87	FA047	FA047V	FA047HH	N/A				
500 - V 50 C Custom (10 Spoke Cast Wheel/Points Ignition)	82-86	FA047	FA047V	FA047HH	N/A				
650 - 65 GT	88-89	FA047	FA047V	FA047HH	N/A				
650 - NTX 650	87-90	FA047	FA047V	FA047HH	N/A				
650 - V 65 C Custom (10 Spoke Cast Wheel)	83-86	FA047	FA047V	FA047HH	N/A				
650 - V 65 Florida (Spoke & Cast Wheel Models)	85-92	FA047	FA047V	FA047HH	N/A				
750 - Brevia ie (3 Spoke Cast Wheel)	03-11	FA266	FA266V	FA266HH	N/A				
750 - SP (10 Spoke Cast Wheels)	90-92	FA047	FA047V	FA047HH	N/A				
750 - Targa	90-93	FA047	FA047V	FA047HH	N/A				
750 - Nevada 750	91-01	FA047	FA047V	FA047HH	N/A				
750 - Nevada 750	02-11	FA266	FA266V	FA266HH	N/A				
750 - Nevada Club (Up To LK112433)	98-00	FA047	FA047V	FA047HH	N/A				
750 - Nevada Club (From LK112434)	98-00	FA266	FA266V	FA266HH	N/A				
750 - Nevada Classic 750 ie (Spoke Wheels)	04-13	FA266	FA266V	FA266HH	N/A				
750 - Strada / T Roadster	93-95	FA047	FA047V	FA047HH	N/A				
750 - V 75 (10 Spoke Cast Wheels/Solid front discs)	92-96	FA047	FA047V	FA047HH	N/A				
750 - V 75 (10 Spoke Cast Wheels/Solid floating discs)	96-01	FA047	FA047V	FA047HH	N/A				
750 - V7 Classic	08-12	FA266	FA266V	FA266HH	N/A				
750 - V7 Cafe Classic	09-12	FA266	FA266V	FA266HH	N/A				
750 - V7 Racer	10-11	FA266	FA266V	FA266HH	N/A				
850 - Le Mans I	76-77	FA018	FA018V	FA018HH	N/A				
850 - Le Mans II	78-80	FA018	FA018V	FA018HH	N/A				
850 - Le Mans III	81-84	FA077	FA077V		N/A				
850 - T	74	N/A							
850 - T3	75-79	FA018	FA018V	FA018HH	N/A				
850 - T3 California (With Screen/Panniers)	75-79	FA018	FA018V	FA018HH	N/A				
850 - T4	80-82	FA018	FA018V	FA018HH	N/A				
850 - T5	83-85	FA018	FA018V	FA018HH	N/A				
850 - T5 California (With Screen/Panniers)	83-85	FA018	FA018V	FA018HH	N/A				
850 - Brevia ie	06-07	FA181TT		FA181HH	MD840				
850 - Griso	06-07	FA181TT		FA181HH	MD840	MD840C			

\*-2 Sets Required. ■ - Also available in MX-S race compound.

**SAFETY WARNING:** DO NOT USE HH PADS ON REAR UNLESS ALSO USED ON FRONT TO AVOID BRAKE IMBALANCE

**BRAKE APPLICATIONS**

**R** Suffix = High Durability Sintered Pad. **HH** Suffix = High Performance Sintered Pad. **G** Suffix = Grooved Shoe.  
**D** Suffix = Drilled Disc. **C** Suffix = Contoured Disc. **LS** Suffix = Left/Steel Disc. **RS** = Right/Steel Disc.

# Non-JAPANESE Built Motorcycles



← FRONT / AVANT / VORN FRENTA / ANTERIORE →

## MOTO GUZZI

### DISC PAD CHOICES

### BRAKE ROTOR CHOICES

			NEW SFAC Scooter Carbon Pads	Semi-Sintered V-Pads™	Sintered/HH Pads/ Grooved shoes	Left/Gauche/Links	Right/Droite/Rechts	Contour Rotor Universal left and right fitment	NEW Vee-Rotors™ CONTOUR	NEW CX Extreme® ROTOR	Oversize 250/280mm Rotor Kit	Relocating Bracket for 250/280mm Rotor	Oversize 320mm Rotor Kit	Relocating Bracket for 320mm Rotor
850 - Norge	07		FA244*		FA244H*	MD624	MD624		VR624BLK*					
940 - Bellagio	07-13		FA209/2*		FA209/2HH*	MD614X	MD614X	MD614XC*	VR614BLK*					
1000 - Daytona 1000	92-95		FA095*		FA095HH*	MD667	MD667							
1000 - Daytona 1000 RS	97-98		FA095*		FA095HH*	N/A	N/A							
1000 - MGS-01 Corsa	03-11				FA322/4HH*	MD621X	MD621X	MD621XC*	VR621BLK*					
1000 - GT (1st Series Cast & Spoke Wheels)	87-91		FA018*		FA018HH*	N/A	N/A							
1000 - GT (2nd Series Cast & Spoke Wheels)	87-91		FA018*		FA018HH*	N/A	N/A							
1000 - 1000 S (Cast & Spoke Wheel Models)	84-93		FA018*		FA018HH*	MD693LS	MD693RS							
1000 - 1000 SP (12 Spoke Cast Wheels/Dished Front Discs)	83-94		FA018*		FA018HH*	N/A	N/A							
1000 - 1000 SP II (10 Spoke Cast Wheels/Flat Solid Front Discs)	83-94		FA018*		FA018HH*	N/A	N/A							
1000 - 1000 SP III (10 Spoke Cast Wheels/Flat Floating Front Discs)	84-88		FA018*		FA018HH*	N/A	N/A							
1000 - California 1000 II (12 Spoke Cast Wheels/Screen + Luggage)	81-87		FA018*		FA018HH*	N/A	N/A							
1000 - California 1000 III - Carbs (VY Chassis Code/Full Faring /Cast & Spoke Wheels)	88-90		FA018*		FA018HH*	MD835	MD835							
1000 - California 1000 III - Carbs (VW Chassis Code/Screen Only)	87-93		FA018*		FA018HH*	MD835	MD835							
1000 - California 1000 III - EFI (VY Chassis Code/Full Faring / Cast & Spoke Wheels)	90-93		FA018*		FA018HH*	MD835	MD835							
1000 - Le-Mans IVV (10 Spoke Cast Wheels)	84-93		FA018*		FA018HH*	MD693LS	MD693RS							
1000 - Strada	93-94		FA018*		FA018HH*	N/A	N/A							
1000 - Quota 1000 Efi	92-97		FA126*		FA126HH*	MD846X	MD846X							
1000 - V10 Centauro GT	97-99		FA095*		FA095HH*	MD614X	MD614X	MD614XC*	VR614BLK*					
1000 - V10 Centauro Sport	97-99		FA095*		FA095HH*	MD614X	MD614X	MD614XC*	VR614BLK*					
1100 - Brevia 1100 (Std & ABS Models)	05-07		FA244*		FA244HH*	MD624	MD624		VR624BLK*					
1100 - California Carbs (KC/KD Chassis Codes)	94-97		FA018*		FA018HH*	MD835	MD835							
1100 - California 1100 Aluminium	02-05		FA244*		FA244HH*	MD614X	MD614X	MD614XC*	VR614BLK*					
1100 - California 1100 Aquila Nera	09-11		FA244*		FA244HH*	MD614X	MD614X	MD614XC*	VR614BLK*					
1100 - California 1100 Classic Touring	06-08		FA244*		FA244HH*	MD614X	MD614X	MD614XC*	VR614BLK*					
1100 - California 1100 EV (Single pin pad fixing/Up To KD115426)	97-00		FA095*		FA095HH*	MD614X	MD614X	MD614XC*	VR614BLK*					
1100 - California 1100 EV (2 pad pin fixing/From KD115427)	97-02		FA244*		FA244HH*	MD614X	MD614X	MD614XC*	VR614BLK*					
1100 - California 1100 EV Touring	03-05		FA244*		FA244HH*	MD614X	MD614X	MD614XC*	VR614BLK*					
1100 - California 1100 Jackal (Single pin pad fixing/Up To KD152328)	94-01		FA095*		FA095HH*	MD614X	MD614X	MD614XC*	VR614BLK*					
1100 - California 1100 Jackal (2 pad pin fixing/From KD152329)	94-01		FA244*		FA244HH*	MD614X	MD614X	MD614XC*	VR614BLK*					
1100 - California 1100 Special (Single pin pad fixing/Up To KD131644)	99-00		FA095*		FA095HH*	MD614X	MD614X	MD614XC*	VR614BLK*					
1100 - California 1100 Special (2 pad pin fixing/From KD1131645)	99-00		FA244*		FA244HH*	MD614X	MD614X	MD614XC*	VR614BLK*					
1100 - California 1100 Sport	01-02		FA244*		FA244HH*	MD614X	MD614X	MD614XC*	VR614BLK*					
1100 - California 1100 Stone	01-05		FA244		FA244HH	MD614X		MD614XC	VR614BLK					
1100 - California 1100 Stone Metal	02-03		FA244		FA244HH	MD614X		MD614XC	VR614BLK					
1100 - California 1100 Titanium With Top Faring)	04-05		FA244*		FA244HH*	MD614X	MD614X	MD614XC*	VR614BLK*					
1100 - California 1100 Vintage	06-12		FA244*		FA244HH*	MD614X	MD614X	MD614XC*	VR614BLK*					
1100 - California 1100 90	12		FA244*		FA244HH*	MD621X	MD621X	MD621XC*	VR621BLK*					
1100 - Griso 1100	05-08		FA244*		FA244HH*	MD621X	MD621X	MD621XC*	VR621BLK*					
1100 - Sport Carbs	94-96		FA095*		FA095HH*	MD614X	MD614X	MD614XC*	VR614BLK*					
1100 - Sport EFI	96-99		FA095*		FA095HH*	MD614X	MD614X	MD614XC*	VR614BLK*					
1100 - Sport Corsa	98-99		FA095*		FA095HH*	N/A	N/A							
1100 - Quota ES	99-01		FA209/2*		FA209/2HH*	N/A	N/A							
1100 - V11 Ballabio	03-05		FA244*		FA244HH*	MD614X	MD614X	MD614XC*	VR614BLK*					
1100 - V11 Le Mans	01-05		FA244*		FA244HH*	MD614X	MD614X	MD614XC*	VR614BLK*					
1100 - V11 Naked	02-03		FA244*		FA244HH*	MD614X	MD614X	MD614XC*	VR614BLK*					
1100 - V11 Scura	01-03		FA244*		FA244HH*	MD614X	MD614X	MD614XC*	VR614BLK*					
1100 - V11 Sport	99-01		FA244*		FA244HH*	MD614X	MD614X	MD614XC*	VR614BLK*					
1200 - Brevia	08-09		FA244*		FA244HH*	MD624	MD624		VR624BLK*					
1200 - Griso 8V (Standard/Cast Wheel/Radial Caliper)	07-12		FA244*		FA244HH*			MD614XC*	VR614BLK*					
1200 - Griso 8V (Special Edition /Spoke Wheel/Radial Caliper)	07-12		FA244*		FA244HH*	MD614X	MD614X	MD614XC*	VR614BLK*					
1200 - Norge 1200	06-07		FA244*		FA244HH*	MD624	MD624		VR624BLK*					
1200 - Norge GT 8V (ABS)	08-13		FA244*		FA244HH*	TBA	TBA		VR624BLK*					
1200 - Sport (4V)	06-07		FA244*		FA244HH*	MD624	MD624		VR624BLK*					
1200 - Sport (8V)	08-13		FA244*		FA244HH*	TBA	TBA		VR624BLK*					
1200 - Stelvio	08-11		FA244*		FA244HH*	MD624	MD624		VR624BLK*					
1200 - Stelvio 8V (ABS)	11-13		FA244*		FA244HH*	TBA	TBA		VR624BLK*					
1200 - Stelvio NTX ABS	09-10		FA244*		FA244HH*	MD624	MD624		VR624BLK*					

\*-2 Sets Required. ■ - Also available in MX-S race compound.

**SAFETY WARNING:** DO NOT USE HH PADS ON REAR UNLESS ALSO USED ON FRONT TO AVOID BRAKE IMBALANCE

APPLICATIONS

BRAKE

R Suffix = High Durability Sintered Pad. HH Suffix = High Performance Sintered Pad. G Suffix = Grooved Shoe.

D Suffix = Drilled Disc. C Suffix = Contoured Disc. LS Suffix = Left/Steel Disc. RS = Right/Steel Disc.

# Non-JAPANESE Built Motorcycles



**MOTO GUZZI**



← REAR / ARRIÈRE / HINTEN POSTERIOR / POSTERIORE →

			DISC PAD CHOICES			BRAKE ROTOR CHOICES		
			NEW SFAC Scooter Carbon Pads	Semi-Sintered V-Pads™	Sintered/HH Pads/ Grooved shoes	Contour Rotor Rear Fitment	NEW Vee-Rotors™ CONTOUR	NEW CX Extreme® ROTOR
850 - Norge	07	FA181TT			FA181HH	MD840		
940 - Bellagio	07-13	FA181TT			FA181HH	MD840	MD840C	
1000 - Daytona 1000	92-95	FA047		FA047V	FA047HH	N/A		
1000 - Daytona 1000 RS	97-98	FA047		FA047V	FA047HH	MD692		
1000 - MGS-01 Corsa	03-11	N/A				N/A		
1000 - GT (1st Series Cast & Spoke Wheels)	87-91	FA018		FA018V	FA018HH	N/A		
1000 - GT (2nd Series Cast & Spoke Wheels)	87-91	FA018		FA018V	FA018HH	N/A		
1000 - 1000 S (Cast & Spoke Wheel Models)	84-93	FA018		FA018V	FA018HH	MD693LS		
1000 - 1000 SP (12 Spoke Cast Wheels/Dished Front Discs)	83-94	FA077		FA077V		N/A		
1000 - 1000 SP II (10 Spoke Cast Wheels/Flat Solid Front Discs)	83-94	FA077		FA077V		N/A		
1000 - 1000 SP III (10 Spoke Cast Wheels/Flat Floating Front Discs)84-88		FA077		FA077V		MD693LS		
1000 - California 1000 II (12 Spoke Cast Wheels/Screen + Luggage)81-87		FA018		FA018V	FA018HH	N/A		
1000 - California 1000 III - Carbs (VY Chassis Code/Full Faring /Cast & Spoke Wheels)	88-90	FA018		FA018V	FA018HH	MD693LS		
1000 - California 1000 III - Carbs (VW Chassis Code/Screen Only)	87-93	FA018		FA018V	FA018HH	MD693LS		
1000 - California 1000 III - EFI (VY Chassis Code/Full Faring / Cast & Spoke Wheels)	90-93	FA018		FA018V	FA018HH	MD693LS		
1000 - Le-Mans IVV (10 Spoke Cast Wheels)	84-93	FA018		FA018V	FA018HH	MD693LS		
1000 - Strada	93-94	FA018		FA018V	FA018HH	MD693LS		
1000 - Quota 1000 Efi	92-97	FA163				N/A		
1000 - V10 Centauro GT	97-99	FA047		FA047V	FA047HH	MD692	MD692C	
1000 - V10 Centauro Sport	97-99	FA047		FA047V	FA047HH	MD692	MD692C	
1100 - Brevia 1100 (Std &ABS Models)	05-07	FA181TT			FA181HH	MD840		
1100 - California Carbs (KC/KD Chassis Codes)	94-97	FA018			FA018HH	MD693		
1100 - California 1100 Aluminium	02-05	FA209/2		FA209/2V	FA209/2HH	MD692	MD692C	
1100 - California 1100 Aquila Nera	09-11	FA209/2		FA209/2V	FA209/2HH	MD692	MD692C	
1100 - California 1100 Classic Touring	06-08	FA209/2		FA209/2V	FA209/2HH	MD692	MD692C	
1100 - California 1100 EV (Single pin pad fixing/Up To KD115426)	97-00	FA209/2		FA209/2V	FA209/2HH	MD692	MD692C	
1100 - California 1100 EV (2 pad pin fixing/From KD115427)	97-02	FA209/2		FA209/2V	FA209/2HH	MD692	MD692C	
1100 - California 1100 EV Touring	03-05	FA209/2		FA209/2V	FA209/2HH	MD692	MD692C	
1100 - California 1100 Jackal (Single pin pad fixing/Up To KD152328)	94-01	FA209/2		FA209/2V	FA209/2HH	MD692	MD692C	
1100 - California 1100 Jackal (2 pad pin fixing/From KD152329)	94-01	FA209/2		FA209/2V	FA209/2HH	MD692	MD692C	
1100 - California 1100 Special (Single pin pad fixing/Up To KD131644)	99-00	FA209/2		FA209/2V	FA209/2HH	MD692	MD692C	
1100 - California 1100 Special (2 pad pin fixing/From KD1131645)	99-00	FA209/2		FA209/2V	FA209/2HH	MD692	MD692C	
1100 - California 1100 Sport	01-02	FA209/2		FA209/2V	FA209/2HH	MD692	MD692C	
1100 - California 1100 Stone	01-05	FA209/2		FA209/2V	FA209/2HH	MD692	MD692C	
1100 - California 1100 Stone Metal	02-03	FA209/2		FA209/2V	FA209/2HH	MD692	MD692C	
1100 - California 1100 Titanium With Top Faring)	04-05	FA209/2		FA209/2V	FA209/2HH	MD692	MD692C	
1100 - California 1100 Vintage	06-12	FA209/2		FA209/2V	FA209/2HH	MD692	MD692C	
1100 - California 1100 90	12	FA209/2		FA209/2V	FA209/2HH	MD692	MD692C	
1100 - Griso 1100	05-08	FA181TT			FA181HH	MD840	MD840C	
1100 - Sport Carbs	94-96	FA047		FA047V	FA047HH	N/A		
1100 - Sport EFI	96-99	FA047		FA047V	FA047HH	N/A		
1100 - Sport Corsa	98-99	FA047		FA047V	FA047HH	N/A		
1100 - Quota ES	99-01	FA181TT			FA181HH	N/A		
1100 - V11 Ballabio	03-05	FA047		FA047V	FA047HH	MD692	MD692C	
1100 - V11 Le Mans	01-05	FA047		FA047V	FA047HH	MD692	MD692C	
1100 - V11 Naked	02-03	FA047		FA047V	FA047HH	MD692	MD692C	
1100 - V11 Scura	01-03	FA047		FA047V	FA047HH	MD692	MD692C	
1100 - V11 Sport	99-01	FA047		FA047V	FA047HH	MD692	MD692C	
1200 - Brevia	08-09	FA181TT			FA181HH	MD840		
1200 - Griso 8V (Standard/Cast Wheel/Radial Caliper)	07-12	FA181TT			FA181HH	MD840	MD840C	
1200 - Griso 8V (Special Edition /Spoke Wheel/Radial Caliper)	07-12	FA181TT			FA181HH	MD840	MD840C	
1200 - Norge 1200	06-07	FA181TT			FA181HH	MD840		
1200 - Norge GT 8V (ABS)	08-13	FA181TT			FA181HH	MD840		
1200 - Sport (4V)	06-07	FA181TT			FA181HH	MD840		
1200 - Sport (8V)	08-13	FA181TT			FA181HH	MD840		
1200 - Stelvio	08-11	FA181TT			FA181HH	MD840		
1200 - Stelvio 8V (ABS)	11-13	FA181TT			FA181HH	MD840		
1200 - Stelvio NTX ABS	09-10	FA181TT			FA181HH	MD840		

\*-2 Sets Required. ■ - Also available in MX-S race compound.

**SAFETY WARNING:** DO NOT USE HH PADS ON REAR UNLESS ALSO USED ON FRONT TO AVOID BRAKE IMBALANCE

**R** Suffix = High Durability Sintered Pad. **HH** Suffix = High Performance Sintered Pad. **G** Suffix = Grooved Shoe.  
**D** Suffix = Drilled Disc. **C** Suffix = Contoured Disc. **LS** Suffix = Left/Steel Disc. **RS** = Right/Steel Disc.

**BRAKE APPLICATIONS**

# Non-JAPANESE Built Motorcycles



← FRONT / AVANT / VORN FRENTE / ANTERIORE →

**APPLICATIONS**

**BRAKE**

## MOTO GUZZI

Model	Year	DISC PAD CHOICES				BRAKE ROTOR CHOICES							
		NEW SFAC Scooter Carbon Pads	Semi-Sintered V-Pads™	Sintered/HH Pads/ Grooved shoes	Left/Gauche/Links	Right/Droite/Rechts	Contour Rotor Universal left and right fitment	NEW Vee-Rotors™ CONTOUR	NEW CX Extreme® ROTOR	Oversize 250/280mm Rotor Kit	Relocating Bracket for 250/280mm Rotor	Oversize 320mm Rotor Kit	Relocating Bracket for 320mm Rotor
1200 - Stelvio 8V NTX	11-13	FA244*		FA244HH*	TBA	TBA		VR624BLK*					
1400 - California Custom	13	FA244*		FA244HH*	TBA	TBA							
1400 - California Touring	13	FA244*		FA244HH*	TBA	TBA							

## MOTOM

Ana 50	08-09	SFA086	SFAC086	SFA086HH		N/A							
Gypsy 50	08-09	SFA235	SFAC235		TBA								
Spasso 50	08-09	FA448			TBA								
Dolcevita 125/151	08-09	SFA235	SFAC235		TBA								
Transcity 125/250	08-09	SFA179	SFAC179	SFA179HH	N/A								
Ana 151	08-09	SFA086	SFAC086	SFA086HH		N/A							

## MOTO MORINI

125 Monocilindro	79-	FA076		FA076HH	N/A								
125 KJ/TK/Kanguro	84-	N/A			N/A								
250 All Models	71-	FA076		FA076HH	N/A								
350 Coguaro	90-	FA134		FA134R	N/A								
350 Sport	-79	FA076*		FA076HH*	N/A								
350 Sport	80	FA076		FA076HH	N/A								
350 Sport	81	FA076		FA076HH	N/A								
350 Sport	82-	N/A			N/A								
350 FT/Turismo	80-	FA076		FA076HH	N/A								
350 Kanguro	-83			927G									
350 Kanguro	84-86	N/A			N/A								
350 Kanguro	87	FA256		FA256HH	N/A								
Excaliber 350/501 RLX	93	FA134			N/A								
Dart 350	87	FA134			N/A								
350 K2		N/A*			N/A	N/A							
9 1/2 (998cc)	06-10	FA244*		FA244HH*	MD636X	MD636X	MD636XC*						
MM3 (1187cc)	07	FA244*		FA244HH*	MD636X	MD636X	MD636XC*						
Corsaro 1200	05-10	FA244*		FA244HH*	MD636X	MD636X	MD636XC*						
Corsaro 1200 Veloce	07-09	FA244*		FA244HH*	MD636X	MD636X	MD636XC*						
Granpasso 1200	08-10	FA209/2V*	FA209/2V*	FA209/2HH*	N/A	N/A							
Corsaro Avio	08-09	FA244		FA244HH	MD636X	MD636X	MD636XC*						
1200 Sport	08-10	FA244*		FA244HH*	MD636X	MD636X	MD636XC*						
Scrambler 1200	08-09	FA244*		FA244HH*	N/A	N/A							
Scrambler 1200	10-13	FA209/2V*	FA209/2V*	FA209/2HH*	N/A	N/A							
Rebello 1200 Giubileo	12-13			FA322/4HH*	N/A	N/A							

## MOTO ROMA

Bee 50	04-05	SFA169	SFAC169	SFA169HH	TBA								
Blazer 50/100/110 Quad	99-04	H338*		H338G*									
Wasp 50	99-05	TBA			TBA								
G10 (50cc/2T)	11-12	SFA235	SFAC235				N/A						
Go-Go 50	97-05	SFA169	SFAC169	SFA169HH	MD904D		MD904C	VR904					
Stinger 50	99-05	SFA169	SFAC169	SFA169HH	MD904D		MD904C	VR904					
Scrambler 50	01	SFA169	SFAC169	SFA169HH	MD904D		MD904C	VR904					
Road Runner 50/100	01-02	SFA169	SFAC169	SFA169HH	MD904D		MD904C	VR904					
Grand Prix 50/100	99-03	SFA083*	SFAC083*	SFA083HH*	MD923D	MD923D	MD923C*	VR923*					
Sport 90 Quad	01-03	H338*		H338G*									
Quad Roadrunner 100	04	H338*		H338G*									
Go-Go 110	01-02	SFA169	SFAC169	SFA169HH		N/A							
Grand Prix 125	01	SFA169	SFAC169	SFA169HH	TBA								
Grand Prix 125	02	SFA083	SFAC083	SFA083HH	MD923D		MD923C	VR923					
Lazer 125 Buggy	03-07	H346*		H346G*									
Lambros 125 (4T)	11-12	SFA235	SFAC235		N/A								
MXR 125	03	FA056			N/A								
MXR 125 B	04	TBA			N/A								
Road Runner 125	02-04	FA135TT			TBA								
SK 125 (Cast Wheel)	10-12	FA093					N/A						

\*-2 Sets Required. ■ - Also available in MX-S race compound.

**SAFETY WARNING:** DO NOT USE HH PADS ON REAR UNLESS ALSO USED ON FRONT TO AVOID BRAKE IMBALANCE

**R** Suffix = High Durability Sintered Pad. **HH** Suffix = High Performance Sintered Pad. **G** Suffix = Grooved Shoe.  
**D** Suffix = Drilled Disc. **C** Suffix = Contoured Disc. **LS** Suffix = Left/Steel Disc. **RS** = Right/Steel Disc.

# Non-JAPANESE Built Motorcycles

**BRAKE APPLICATIONS**



← REAR / ARRIÈRE / HINTEN POSTERIOR / POSTERIORE →

## MOTO GUZZI



		DISC PAD CHOICES			BRAKE ROTOR CHOICES			
		NEW SFAC Scooter Carbon Pads	Semi-Sintered V-Pads™	Sintered/HH Pads/ Grooved shoes	Contour Rotor Rear Fitment	NEW Vee-Rotors™ CONTOUR	NEW CX Extreme® ROTOR	
1200 - Stevio 8V NTX	11-13	FA181TT		FA181HH	MD840			
1400 - California Custom	13	FA181TT		FA181HH	TBA			
1400 - California Touring	13	FA181TT		FA181HH	TBA			

## MOTOM

Ana 50	08-09	SFA197	SFAC197	FA197HH	N/A			
Gypsy 50	08-09	TBA						
Spasso 50	08-09	TBA						
Dolcevit 125/151	08-09	SFA086	SFAC086		N/A			
Transcity 125/250	08-09	SFA086	SFAC086	SFA086HH	N/A			
Ana 151	08-09	SFA197	SFAC197	SFA197HH	N/A			

## MOTO MORINI

125 Monocilindro	79-			821G				
125 KJ/TK/Kanguro	84-			821G				
250 All Models	71-	921						
350 Coguaro	90-	FA047		FA047HH	N/A			
350 Sport	-79	FA076			N/A			
350 Sport	80	921						
350 Sport	81	N/A						
350 Sport	82-	N/A			N/A			
350 FT/Turismo	80-	921						
350 Kanguro	-83			927G				
350 Kanguro	84-86			927G				
350 Kanguro	87	FA047			N/A			
Excaltiber 350/501 RLX	93	FA047			N/A			
Dart 350	87	FA047			N/A			
350 K2		FA047			N/A			
9 1/2 (998cc)	06-10	FA266	FA266V	FA266HH	N/A			
MM3 (1187cc)	07	FA266	FA266V	FA266HH	N/A			
Corsaro 1200	06-10	FA266	FA266V	FA266HH	N/A			
Corsaro 1200 Veloce	07-09	FA266	FA266V	FA266HH	N/A			
Granpasso 1200	08-10	FA181TT		FA181HH	N/A			
Corsaro Avio	08-09	FA266	FA266V	FA266HH	N/A			
1200 Sport	08-10	FA266	FA266V	FA266HH	N/A			
Scrambler 1200	08-09	FA266	FA266V	FA266HH	N/A			
Scrambler 1200	10-13	FA181TT	FA266V	FA181HH	N/A			
Rebello 1200 Giubileo	12-13	FA266		FA266HH	N/A			

## MOTO ROMA

Bee 50	04-05	TBA						
Blazer 50/100/110 Quad	99-04	H330		H330G				
Wasp 50	99-05	Y503						
G10 (50cc/2T)	11-12	Y503						
Go-Go 50	97-05	Y503						
Stinger 50	99-05	Y503						
Scrambler 50	01	Y503						
Road Runner 50/100	01-02	Y503						
Grand Prix 50/100	99-03	Y503						
Sport 90 Quad	01-03	H330		H330G				
Quad Roadrunner 100	04	H330		H330G				
Go-Go 110	01-02	S603						
Grand Prix 125	01	TBA						
Grand Prix 125	02	SFA083	SFAC083	SFA083HH	MD982D			
Lazer 125 Buggy	03-07	FA083TT		FA083R	MD6354D			
Lambros 125 (4T)	11-12	Y503						
MXR 125	03	S602						
MXR 125 B	04	TBA			N/A			
Road Runner 125	02-04	TBA						
SK 125 (Cast Wheel)	10-12	S602						

\*-2 Sets Required. ■ - Also available in MX-S race compound.  
**SAFETY WARNING:** DO NOT USE HH PADS ON REAR UNLESS ALSO USED ON FRONT TO AVOID BRAKE IMBALANCE

**R** Suffix = High Durability Sintered Pad. **HH** Suffix = High Performance Sintered Pad. **G** Suffix = Grooved Shoe.  
**D** Suffix = Drilled Disc. **C** Suffix = Contoured Disc. **LS** Suffix = Left/Steel Disc. **RS** = Right/Steel Disc.



# Non-JAPANESE Built Motorcycles



← FRONT / AVANT / VORN FRENTE / ANTERIORE →

## MOTO ROMA

Model	Year	Disc Pad Choices	BRAKE ROTOR CHOICES											
			NEW SFAC Scooter Carbon Pads	Semi-Sintered V-Pads™	Sintered/HH Pads/ Grooved shoes	Left/Gauche/Links	Right/Droite/Rechts	Contour Rotor Universal left and right fitment	NEW Vee-Rotors™ CONTOUR	NEW CX Extreme® ROTOR	Oversize 250/280mm Rotor Kit	Relocating Bracket for 250/280mm Rotor	Oversize 320mm Rotor Kit	Relocating Bracket for 320mm Rotor
SMX 125	04-06	FA167			FA167HH	N/A								
Virage 125	01	FA093				N/A								
Geko 300 Quad	04-06	FA083TT*			FA083R*	N/A	N/A							

## MOTRON

50 Sting	98	SFA193	SFAC193	SFA193HH	TBA									
50 Synoro	98	SFA193	SFAC193	SFA193HH	TBA									
50 Thunder	98	SFA193	SFAC193	SFA193HH	TBA									

## MV

675 - Brutale	Dec-13	FA244*		FA244HH*	TBA	TBA								
675 - F3	Dec-13	FA244*		FA244HH*	TBA	TBA								
675 - F3 Serie Oro	12			FA447HH*	TBA	TBA								
750 - Brutale S F4	03-05			FA424HH*	TBA	TBA								
750 - Brutale Oro F4	03-05			FA322/4HH*	TBA	TBA								
750 - F4 S (Mono Posto)	99-04			FA424HH*	MD675LS	MD675RS								
750 - F4 S 1+1 (Bi Posto)	01-04			FA424HH*	TBA	TBA								
750 - F4 SPR	01-04			FA424HH*	TBA	TBA								
750 - F4 SPR Senna	01-03			FA424HH*	TBA	TBA								
800 - Brutale	12-13	FA244*		FA244HH*	N/A	N/A								
800 - Rivale	13			FA630HH*	N/A	N/A								
910 - Brutale S (Nissin Calipers)	06-08			FA424HH*	TBA	TBA								
910 - Brutale R (Brembo Calipers/4 Pads)	06-08			FA322/4HH*	TBA	TBA								
920 - Brutale	11-12			FA244HH*	TBA	TBA								
989 - Brutale	08-09			FA244HH*	TBA	TBA								
990 - Brutale R	10-11			FA244HH*	TBA	TBA								
998 - Frece Tricolori	10			FA447HH*	TBA	TBA								
998 - F4	10-13			FA447HH*	TBA	TBA								
998 - F4 R	12-13			FA447HH*	TBA	TBA								
998 - F4 RR	10-13			FA447HH*	TBA	TBA								
998 - F4 RR Corsa Corta	12			FA447HH*	TBA	TBA								
1000 - F4 Ago	05			FA424HH*	TBA	TBA								
1000 - F4 S (Mono Posto)	04-06			FA424HH*	TBA	TBA								
1000 - F4 Ss 1+1 (Bi Posto)	04-06			FA424HH*	TBA	TBA								
1000 - F4 Tamburini	05			FA424HH*	TBA	TBA								
1000 - F4 R	06-07			FA322/4HH*	TBA	TBA								
1000 - F4 R 312 (Brembo 4 Pad Caliper Up To VIN # 008064)	07			FA322/4HH*	TBA	TBA								
1000 - F4 R 312 (Brembo 4 Pad Caliper From VIN # 008065)	08-09			FA447HH*	TBA	TBA								
1000 - F4 R 312 1+1	07-08			FA322/4HH*	TBA	TBA								
1078 - Brutale RR	08-09			FA447HH*	TBA	TBA								
1078 - F4 100 CC Claudio Castioni	07-08			FA435/4HH*	N/A	N/A								
1078 - F4 RR 312	09			FA447HH*	TBA	TBA								
1090 - Brutale	13			FA244HH*	TBA	TBA								
1090 - Brutale R	12-13			FA244HH*	TBA	TBA								
1090 - Brutale RR	10-13			FA447HH*	TBA	TBA								

## MZ/MUZ

Simpson	80-94	980												
Moskito 50	02	SFA083	SFAC083	SFA083HH	N/A									
Moskito FB 50	97-03	SFA169	SFAC169	SFA169HH	MD904D		MD904C	VR904						
Moskito SX JP50	00-03	SFA169	SFAC169	SFA169HH	MD904D		MD904C	VR904						
VRS 50	05	TBA*												
VRS 100	05	TBA*												
Saxon 125	93-97	FA018		FA018HH		MD623RS								
ETZ 125/150	85-92	FA018		FA018HH		N/A								
Mantizz 125 S	05-07	SFA323	SFAC323	SFA323HH		TBA								
Moskito 125	02	SFA083	SFAC083	SFA083HH	N/A									
RT 125 (All models)	02-07	FA197		FA197HH	N/A									
SM 125 (All models)	02-07	FA228		FA228HH	N/A									
SX 125 (All models)	02-07	FA228		FA228HH	N/A									

\*-2 Sets Required. ■ - Also available in MX-S race compound.

**SAFETY WARNING:** DO NOT USE HH PADS ON REAR UNLESS ALSO USED ON FRONT TO AVOID BRAKE IMBALANCE

APPLICATIONS  
BRAKE

R Suffix = High Durability Sintered Pad. HH Suffix = High Performance Sintered Pad. G Suffix = Grooved Shoe.  
D Suffix = Drilled Disc. C Suffix = Contoured Disc. LS Suffix = Left/Steel Disc. RS = Right/Steel Disc.

# Non-JAPANESE Built Motorcycles

**BRAKE APPLICATIONS**

**R** Suffix = High Durability Sintered Pad. **HH** Suffix = High Performance Sintered Pad. **G** Suffix = Grooved Shoe.  
**D** Suffix = Drilled Disc. **C** Suffix = Contoured Disc. **LS** Suffix = Left/Steel Disc. **RS** = Right/Steel Disc.



## MOTO ROMA



← REAR / ARRIÈRE / HINTEN POSTERIOR / POSTERIORE →

			DISC PAD CHOICES			BRAKE ROTOR CHOICES				
			NEW SFAC Scooter Carbon Pads	Semi-Sintered V-Pads™	Sintered/HH Pads/ Grooved shoes	Contour Rotor Rear Fitment	NEW Vee-Rotors™ CONTOUR	NEW CX Extreme® ROTOR		
SMX 125	04-06	FA115			FA115HH	N/A				
Virage 125	01	S602								
Geko 300 Quad	04-06	FA165TT			FA165R	N/A				
<b>MOTRON</b>										
50 Sting	98	TBA								
50 Syncro	98	TBA								
50 Thunder	98	TBA								
<b>MV</b>										
675 - Brutale	Dec-13	FA266		FA266V	FA266HH	TBA				
675 - F3	Dec-13	FA266		FA266V	FA266HH	TBA				
675 - F3 Serie Oro	12	FA266		FA266V	FA266HH	TBA				
750 - Brutale S F4	03-05				FA320HH	MD696				
750 - Brutale Oro F4	03-05				FA320HH	MD696				
750 - F4 S (Mono Posto)	99-04				FA320HH	MD696				
750 - F4 S 1+1 (Bi Posto)	01-04				FA320HH	MD696				
750 - F4 SPR	01-04				FA320HH	MD696				
750 - F4 SPR Senna	01-03				FA320HH	MD696				
800 - Brutale	12-13	FA266			FA266HH	N/A				
800 - Rivale	13	FA266			FA266HH	N/A				
910 - Brutale S (Nissin Calipers)	06-08				FA320HH	MD696				
910 - Brutale R (Brembo Calipers/4 Pads)	06-08				FA320HH	MD696				
920 - Brutale	11-12				FA320HH	MD696				
989 - Brutale	08-09				FA320HH	MD696				
990 - Brutale R	10-11				FA320HH	MD696				
998 - Frece Tricolori	10				FA320HH	MD696				
998 - F4	10-13				FA320HH	MD696				
998 - F4 R	12-13				FA320HH	MD696				
998 - F4 RR	10-13				FA320HH	MD696				
998 - F4 RR Corsa Corta	12				FA320HH	MD696				
1000 - F4 Ago	05				FA320HH	MD696				
1000 - F4 S (Mono Posto)	04-06				FA320HH	MD696				
1000 - F4 Ss 1+1 (Bi Posto)	04-06				FA320HH	MD696				
1000 - F4 Tamburini	05				FA320HH	MD696				
1000 - F4 R	06-07				FA320HH	MD696				
1000 - F4 R 312 (Brembo 4 Pad Caliper Up To VIN # 008064)	07				FA320HH	MD696				
1000 - F4 R 312 (Brembo 4 Pad Caliper From VIN # 008065)	08-09				FA320HH	MD696				
1000 - F4 R 312 1+1	07-08				FA320HH	MD696				
1078 - Brutale RR	08-09				FA320HH	MD696				
1078 - F4 100 CC Claudio Castioni	07-08				FA320HH	MD696				
1078 - F4 RR 312	09				FA320HH	MD696				
1090 - Brutale	13				FA320HH	MD696				
1090 - Brutale R	12-13				FA320HH	MD696				
1090 - Brutale RR	10-13				FA320HH	MD696				
<b>MZ/MUZ</b>										
Simpson	80-94	980								
Moskito 50	02	TBA								
Moskito FB 50	97-03	Y503								
Moskito SX JP50	00-03	Y503								
VRS 50	05	TBA								
VRS 100	05	TBA								
Saxon 125	93-97	979								
ETZ 125/150	85-92	979								
Manizz 125 S	05-07	TBA								
Moskito 125	02	TBA								
RT 125 (All models)	02-07	FA197			FA197HH	N/A				
SM 125 (All models)	02-07	FA197			FA197HH	N/A				
SX 125 (All models)	02-07	FA197			FA197HH	N/A				

\*-2 Sets Required. ■ - Also available in MX-S race compound.

**SAFETY WARNING:** DO NOT USE HH PADS ON REAR UNLESS ALSO USED ON FRONT TO AVOID BRAKE IMBALANCE

# Non-JAPANESE Built Motorcycles



← FRONT / AVANT / VORN FRENTE / ANTERIORE →

## DISC PAD CHOICES

## BRAKE ROTOR CHOICES

### MZ/MUZ

		NEW SFAC Scooter Carbon Pads	Semi-Sintered V-Pads™	Sintered/HH Pads/ Grooved shoes	Left/Gauche/Links	Right/Droite/Rechts	Contour Rotor Universal left and right fitment	NEW Vee-Rotors™ CONTOUR	NEW CX Extreme® ROTOR	Oversize 250/280mm Rotor Kit	Relocating Bracket for 250/280mm Rotor	Oversize 320mm Rotor Kit	Relocating Bracket for 320mm Rotor
TS 125/150		978											
VRT 125 Quad	05	TBA*											
Saxon 150	95	FA018		FA018HH			MD623RS						
VRS 150 Quad	05	TBA*											
VRT 175 Quad	05	TBA*											
TS 250		978											
251 Fun	95-96	FA018		FA018HH			MD623RS						
ETZ 250/300	85-92	FA018		FA018HH			N/A						
Saxon Tour 251/301	93-98	FA018		FA018HH			MD623RS						
Saxon 500 All models	93-98	FA018		FA018HH			MD623RS						
Skorpion Tour/Traveller	95-02	FA095		FA095HH			MD619RS						
Skorpion Sport/Cup	95-01	FA095		FA095HH			MD619RS						
Skorpion Replica	95-01	FA095*		FA095HH*	TBA	TBA							
Baghira - Black Panther - 17" Front wheel/Spoke wheel	96-03	FA177				TBA							
Baghira - Forest/ Forest.HR - 21" Front wheel/Spoke wheel	96-05	FA177				N/A							
Baghira - Street Moto 17" Front wheel/Spoke wheel	96-05	FA177				TBA							
Baghira - 21" Front wheel/Spoke wheel	99-05	FA177				N/A							
Mastiff - 21" Front wheel/Spoke wheel	96-05	FA177				TBA							
Mastiff - 17" Front wheel/Cast wheel	99-05	FA095		FA095HH		TBA							
1000 S	03-07	FA145*		FA145HH*	TBA	TBA							
1000 SF	05-07	FA145*		FA145HH*	TBA	TBA							
1000 SFX	07	FA145*		FA145HH*	TBA	TBA							
1000 ST	07	FA145*		FA145HH*	TBA	TBA							

### NEW FORCE QUADS

Most models		FA453TT*		FA453R*	N/A	N/A							
(Check Shape Of Old Pad Against Picture In The Pad Buyers)													

### NIPPONIA

Brio 50 (4T)	12-13	SFA086	SFAC086	SFA086HH			N/A						
Ezio 50 (4T)	12-13	SFA086	SFAC086	SFA086HH			N/A						
Neon 50 (2T)	12-13	TBA				N/A							
Miro 100 (4T)	12-13	SFA101	SFA101	SFA101HH			N/A						
Arte 125 (4T)	12-13	SFA197	SFAC197	SFA197HH	N/A								
Brio 125 (4T)	12-13	SFA086	SFAC086	SFA086HH			N/A						
Duel 125 (4T)	12-13	FA228		FA228HH	N/A								
Eclipse 125 (4T)	12-13	TBA											
Ezio 125 (4T)	12-13	SFA086	SFAC086	SFA086HH			N/A						
Inter 125 (4T)	12-13	TBA					TBA						
Miro 125 (4T)	12-13	SFA101	SFA101	SFA101HH			N/A						
U2L 125 (4T)	12-13	TBA					N/A						
Vorrei 125 (4T)	12-13	TBA				N/A							
Miro 130 (4T)	12-13	SFA101	SFA101	SFA101HH			N/A						
Arte 150 (4T)	12-13	SFA197	SFAC197	SFA197HH	N/A								
Inter 150 (4T)	12-13	TBA					TBA						
Vorrei 150 (4T)	12-13	TBA				N/A							
Eclipse 180 (4T)	12-13	TBA					N/A						

### NORTON

Commando (Drum Brake Models)	68-70	852											
750 MK V Commando Roadster/Interstate	73	FA027				N/A							
850 MK 1 Commando Hi Rider/Interstate	73	FA027				N/A							
850 MK 1A Commando Roadster/Interstate	73	FA027				N/A							
850 MK 11/11A Commando Roadster/Hi Rider/Interstate	74	FA027				N/A							
850 MK 111 Commando Roadster/Hi Rider/Interstate	75	FA027				N/A							
Classic (Rotary)	89	FA018*		FA018V*	FA018HH*	N/A	N/A						
Interpol 2 (Rotary)	89	FA018*		FA018V*	FA018HH*	N/A	N/A						
Commander (Rotary)	90	FA088*		FA088V*	FA088HH*	MD2011	MD2011	MD2011C*	VR2011*				
F1 (Rotary) P55 Model	90	FA095*		FA095V*	FA095HH*	MD684	MD684						
F1 (Rotary) P55 B Model	90-91	FA095*		FA095V*	FA095HH*	MD684	MD684						

\*-2 Sets Required. ■ - Also available in MX-S race compound.

**SAFETY WARNING:- DO NOT USE HH PADS ON REAR UNLESS ALSO USED ON FRONT TO AVOID BRAKE IMBALANCE**

APPLICATIONS  
BRAKE

R Suffix = High Durability Sintered Pad. HH Suffix = High Performance Sintered Pad. G Suffix = Grooved Shoe.

D Suffix = Drilled Disc. C Suffix = Contoured Disc. LS Suffix = Left/Steel Disc. RS = Right/Steel Disc.

# Non-JAPANESE Built Motorcycles



**MZ/MUZ**



← REAR / ARRIÈRE / HINTEN POSTERIOR / POSTERIORE →

			DISC PAD CHOICES			BRAKE ROTOR CHOICES		
			NEW SFAC Scooter Carbon Pads	Semi-Sintered V-Pads™	Sintered/HH Pads/ Grooved shoes	Contour Rotor Rear Fitment	NEW Vee-Rotors™ CONTOUR	NEW CX Extreme® ROTOR
TS 125/150				979				
VRT 125 Quad	05	FA165/2TT			FA165/2R	N/A		
Saxon 150	95			979				
VPS 150 Quad	05	FA083TT			FA083R	N/A		
VRT 175 Quad	05	FA165/2TT			FA165/2R	N/A		
TS 250				978				
251 Fun	95-96			979				
ETZ 250/300	85-92			979				
Saxon Tour 251/301	93-98			979				
Saxon 500 All models	93-98			979				
Skorpion Tour/Traveller	95-02	FA047			FA047HH	MD637		
Skorpion Sport/Cup	95-01	FA047			FA047HH	MD637		
Skorpion Replica	95-01	FA047			FA047HH	MD637		
Baghira - Black Panther - 17" Front wheel/Spoke wheel	96-03	FA173				MD6284D		
Baghira - Forest/ Forest HR - 21" Front wheel/Spoke wheel	96-05	FA173				MD6284D		
Baghira - Street Moto 17" Front wheel/Spoke wheel	96-05	FA173				MD6284D		
Baghira - 21" Front wheel/Spoke wheel	99-05	FA173				MD6284D		
Mastiff - 21" Front wheel/Spoke wheel	96-05	FA173				MD6284D		
Mastiff - 17" Front wheel/Cast wheel	99-05	FA047			FA047HH	TBA		
1000 S	03-07	FA254			FA254HH	N/A		
1000 SF	05-07	FA254			FA254HH	TBA		
1000 SFX	07	FA254			FA254HH	TBA		
1000 ST	07	FA254			FA254HH	TBA		

## NEW FORCE QUADS

Most models		FA453			FA453R	N/A		
-------------	--	-------	--	--	--------	-----	--	--

## NIPPONIA

Brio 50 (4T)	12-13	TBA						
Ezio 50 (4T)	12-13	TBA						
Neon 50 (2T)	12-13	TBA						
Miro 100 (4T)	12-13	TBA						
Arte 125 (4T)	12-13	SFA197	SFAC197		SFA197HH	N/A		
Brio 125 (4T)	12-13	TBA						
Duel 125 (4T)	12-13	TBA						
Eclipse 125 (4T)	12-13	TBA						
Ezio 125 (4T)	12-13	TBA						
Inter 125 (4T)	12-13	TBA						
Miro 125 (4T)	12-13	TBA						
U2L 125 (4T)	12-13	TBA						
Vorrei 125 (4T)	12-13	TBA						
Miro 130 (4T)	12-13	TBA						
Arte 150 (4T)	12-13	SFA197	SFAC197		SFA197HH	N/A		
Inter 150 (4T)	12-13	TBA						
Vorrei 150 (4T)	12-13	TBA						
Eclipse 180 (4T)	12-13	TBA						

## NORTON

Commando (Drum Brake Models)	68-70	851						
750 MK V Commando Roadster/Interstate	73	FA027				N/A		
850 MK 1 Commando Hi Rider/Interstate	73	FA027				N/A		
850 MK 1A Commando Roadster/Interstate	73	FA027				N/A		
850 MK 11/11A Commando Roadster/Hi Rider/Interstate	74	FA027				N/A		
850 MK 111 Commando Roadster/Hi Rider/Interstate	75	FA027				N/A		
Classic (Rotary)	89	FA018		FA018V	FA018HH	N/A		
Interpol 2 (Rotary)	89	FA018		FA018V	FA018HH	N/A		
Commander (Rotary)	90	FA088		FA088V	FA088HH	MD2069		
F1 (Rotary) P55 Model	90	FA047			FA047HH	MD816		
F1 (Rotary) P55 B Model	90-91	FA095			FA095HH	MD816		

\*-2 Sets Required. ■ - Also available in MX-S race compound.

**SAFETY WARNING:** DO NOT USE HH PADS ON REAR UNLESS ALSO USED ON FRONT TO AVOID BRAKE IMBALANCE

**R** Suffix = High Durability Sintered Pad. **HH** Suffix = High Performance Sintered Pad. **G** Suffix = Grooved Shoe.  
**D** Suffix = Drilled Disc. **C** Suffix = Contoured Disc. **LS** Suffix = Left/Steel Disc. **RS** = Right/Steel Disc.

**BRAKE APPLICATIONS**

# Non-JAPANESE Built Motorcycles



← FRONT / AVANT / VORN FRENTE / ANTERIORE →

NORTON	Year	DISC PAD CHOICES						BRAKE ROTOR CHOICES					
		NEW SFAC Scooter Carbon Pads	Semi-Sintered V-Pads™	Sintered/HH Pads/ Grooved shoes	Left/Gauche/Links	Right/Droite/Rechts	Contour Rotor Universal left and right fitment	NEW Vee-Rotors™ CONTOUR	NEW CX Extreme® ROTOR	Oversize 250/280mm Rotor Kit	Relocating Bracket for 250/280mm Rotor	Oversize 320mm Rotor Kit	Relocating Bracket for 320mm Rotor
Commando Sport (961CC)	10-13	FA244*		FA244HH*	MD614X	MD614X	MD614XC*	VR614BLK*					
Commando Cafe Racer (961CC)	10-13			FA322/4HH*	MD614X	MD614X	MD614XC*	VR614BLK*					
Commando SE (961CC)	10-11			FA322/4HH*	MD614X	MD614X	MD614XC*	VR614BLK*					
Commando SF (961CC)	13			FA322/4HH*	MD614X	MD614X	MD614XC*	VR614BLK*					
<b>NVT</b>													
Easy Rider		908											
125/175 Rambler		FA076		FA076HH	N/A								
<b>OSSA</b>													
125 Cross	74-			934G									
TR 125	13	FA303				N/A							
250 Cross-Fuego/Super Pioneer	74-			934G									
Enduro 250i	12	FA181TT		FA181R ■			N/A						
Explorer 280i	12	FA303				N/A							
TR 280i	10-13	FA303				N/A							
Enduro 300i	12	FA181TT		FA181R ■			N/A						
350 Tu-Yo		FA050			N/A								
pre 1980 models				934G									
81 onwards				935G									
500	92	FA132		FA132R	N/A								
560	92	FA067		FA067R	N/A								
<b>PEUGEOT</b>													
Most Mofas/Mopeds		H322											
Fox/Fox L 50	94-98	H322											
103 Pro, SP 3		H322											
Buxy M/Buxy RM (50cc)	94-97	SFA193②	SFAC193②	SFA193HH②	MD901/909①		MD901C	VR901					
Blaster RS 12 50 (2T)	10-11	SFA115	SFAC115	SFA115HH			MD9105C						
Blaster Iceblade 50 (2T/12" Wheels)	10-12	SFA115	SFAC115	SFA115HH			MD9105C						
Elyseo 50	98-02	SFA193②	SFAC193②	SFA115HH②	MD901D		MD901C	VR901					
Elyseo 50	03	SFA115	SFAC115	SFA115HH	MD901D		MD901C	VR901					
Elystar 50 TSDi	02-07	SFA115	SFAC115	SFA115HH	MD947D			VR947					
Elystar 50 Advantage	02-07	SFA115	SFAC115	SFA115HH	MD947D			VR947					
Jet Force 50/Jet-C (All models)	03-10	SFA115	SFAC115	SFA115HH	MD985D			VR985					
Jet C Tech 50	11-12	SFA115	SFAC115	SFA115HH	MD985D			VR985					
Jet Darkside 50 (2T)	11-13	SFA115	SFAC115	SFA115HH	MD985D			VR985					
Jet Iceblade 50 (2T)	11-13	SFA115	SFAC115	SFA115HH	MD985D			VR985					
Jet H2i 50 (2T-Air Cooled)	11-12	SFA115	SFAC115	SFA115HH			N/A						
Jet H2i 50 (2T-LJC)	11-12	SFA115	SFAC115	SFA115HH			N/A						
Kisbee 50 (4T)	10-12	SFA083	SFAC083	SFA083HH	TBA								
Kisbee RS 50 (4T)	10-12	SFA083	SFAC083	SFA083HH	TBA								
LooXoR 50 (AJP Caliper/ Rear Drum)	01-06	SFA115	SFAC115	SFA115HH	MD954D			VR954					
LooXoR 50 (Heng Tong Caliper/ Rear Drum)	01-06	SFA083	SFAC083	SFA083HH	MD954D			VR954					
LooXoR 50 TSDi (Rear disc)	06	SFA115	SFAC115	SFA115HH	MD954D			VR954					
Ludix One (10" wheels) 50cc	04-12	H303											
Ludix Snake (10" wheels) 50cc	04-09	SFA115	SFAC115	SFA115HH	MD992D			VR992					
Ludix Bullet (10" wheels) 50cc	04	SFA115	SFAC115	SFA115HH	MD992D			VR992					
Ludix Trend (10" wheels) 50cc	04-07	SFA115	SFAC115	SFA115HH	MD992D			VR992					
Ludix Elegance (14" wheels) 50cc	04-09	SFA115	SFAC115	SFA115HH	MD993D								
Ludix Classic (14" wheels)	04-05	H303											
Ludix Urban Track	06-07	SFA115	SFAC115	SFA115HH	MD992D			VR992					
Ludix Red Zone	06	SFA115	SFAC115	SFA115HH	MD992D			VR992					
Ludix Acid	06	SFA115	SFAC115	SFA115HH	MD992D			VR992					
Ludix Blaster (10" Wheels)	05-09	SFA115	SFAC115	SFA115HH			MD9105C						
Ludix 2 Trend 50cc (2T/12" wheels)	07-12	SFA115	SFAC115	SFA115HH			MD9105C						
Ludix Pro (4T/14" Wheels/AJP Caliper)	11-13	SFA115	SFAC115	SFA115HH			MD901C	VR901					
Ludix Pro (4T/14" Wheels/Juan Caliper)	11-13	SFA193	SFAC193	SFA193HH			MD901C	VR901					
Ludix 2 Bispoto 50cc (2T/10" wheels)	07-09	H303											
Ludix 2 One Bispoto (2T/10" Wheels)	10-12	H303											

\*-2 Sets Required. ■ - Also available in MX-S race compound.

**SAFETY WARNING:- DO NOT USE HH PADS ON REAR UNLESS ALSO USED ON FRONT TO AVOID BRAKE IMBALANCE**

**R** Suffix = High Durability Sintered Pad. **HH** Suffix = High Performance Sintered Pad. **G** Suffix = Grooved Shoe.  
**D** Suffix = Drilled Disc. **C** Suffix = Contoured Disc. **LS** Suffix = Left/Steel Disc. **RS** = Right/Steel Disc.

**APPLICATIONS**  
**BRAKE**



# Non-JAPANESE Built Motorcycles

**BRAKE APPLICATIONS**

**R** Suffix = High Durability Sintered Pad. **HH** Suffix = High Performance Sintered Pad. **G** Suffix = Grooved Shoe.  
**D** Suffix = Drilled Disc. **C** Suffix = Contoured Disc. **LS** Suffix = Left/Steel Disc. **RS** = Right/Steel Disc.



## NORTON



← REAR / ARRIÈRE / HINTEN POSTERIOR / POSTERIORE →

		DISC PAD CHOICES				BRAKE ROTOR CHOICES			
		NEW SFAC Scooter Carbon Pads	Semi-Sintered V-Pads™	Sintered/HH Pads/ Grooved shoes		Contour Rotor Rear Fitment	NEW Vee-Rotors™ CONTOUR	NEW CX Extreme® ROTOR	
Commando Sport (961CC)	10-13	FA266		FA266V	FA266HH	TBA			
Commando Cafe Racer (961CC)	10-13	FA266		FA266V	FA266HH	TBA			
Commando SE (961CC)	10-11	FA266		FA266V	FA266HH	TBA			
Commando SF (961CC)	13	FA266		FA266V	FA266HH	TBA			
<b>NVT</b>									
Easy Rider		908							
125/175 Rambler				821G					
<b>OSSA</b>									
125 Cross	74-			990G					
TR 125	13	FA351			N/A				
250 Cross/Fuego/Super Pioneer	74-			990G					
Enduro 250i	12	FA368TT		FA368R ■		N/A			
Explorer 280i	12	FA351			N/A				
TR 280i	10-13	FA351			N/A				
Enduro 300i	12	FA368TT		FA368R ■		N/A			
350 Tu-Yo		FA050			N/A				
pre 1980 models				934G					
81 onwards				936G					
500	92	FA067		FA067R	N/A				
560	92	FA067		FA067R	N/A				
<b>PEUGEOT</b>									
Most Moias/Mopeds		H322							
Fox/Fox L 50	94-98	H303							
103 Pro, SP 3		H322							
Buxy M/Buxy RM (50cc)	94-97	H303							
Blaster RS 12.50 (2T)	10-11	SFA115	SFAC115	SFA115HH		N/A			
Blaster Iceblade 50 (2T/12" Wheels)	10-12	SFA115	SFAC115	SFA115HH		N/A			
Elyseo 50	98-02	H303							
Elyseo 50	03	SFA115	SFAC115	SFA115HH	MD925D	MD925C	VR925		
Elystar 50 TSDi	02-07	SFA350	SFAC350	SFA350HH	MD978D		VR978		
Elystar 50 Advantage	02-07	SFA115	SFAC115	SFA115HH	MD925D		VR925		
Jet Force 50/Jet-C (All models)	03-10	SFA115	SFAC115	SFA115HH	MD984D		VR984		
Jet C Tech 50	11-12	SFA115	SFAC115	SFA115HH	MD984D		VR984		
Jet Darkside 50 (2T)	11-13	SFA115	SFAC115	SFA115HH	MD984D		VR984		
Jet Iceblade 50 (2T)	11-13	SFA115	SFAC115	SFA115HH	MD984D		VR984		
Jet H2i 50 (2T -Air Cooled)	11-12	H303							
Jet H2i 50 (2T-L/C)	11-12	SFA115	SFAC115	SFA115HH		N/A			
Kisbee 50 (4T)	10-12	H303							
Kisbee RS 50 (4T)	10-12	H303							
LooXoR 50 (AJP Caliper/ Rear Drum)	01-06	H303							
LooXoR 50 (Heng Tong Caliper/ Rear Drum)	01-06	H303							
LooXoR 50 TSDi (Rear disc)	06	SFA115	SFAC115	SFA115HH	MD901D		VR901		
Ludix One (10" wheels) 50cc	04-12	H303							
Ludix Snake (10" wheels) 50cc	04-09	H303							
Ludix Bullet (10" wheels) 50cc	04	H303							
Ludix Trend (10" wheels) 50cc	04-07	H303							
Ludix Elegance (14" wheels) 50cc	04-09	H303							
Ludix Classic (14" wheels)	04-05	H303							
Ludix Urban Track	06-07	H303							
Ludix Red Zone	06	H303							
Ludix Acid	06	H303							
Ludix Blaster (10" Wheels)	05-09	H303							
Ludix 2 Trend 50cc (2T/12" wheels)	07-12	H303							
Ludix Pro (47/14" Wheels/AJP Caliper)	11-13	H303							
Ludix Pro (47/14" Wheels/Juan Caliper)	11-13	H303							
Ludix 2 Bipoposto 50cc (2T/10" wheels)	07-09	H303							
Ludix 2 One Bipoposto (2T/10" Wheels)	10-12	H303							

\*-2 Sets Required. ■ - Also available in MX-S race compound.

**SAFETY WARNING:** DO NOT USE HH PADS ON REAR UNLESS ALSO USED ON FRONT TO AVOID BRAKE IMBALANCE

# Non-JAPANESE Built Motorcycles



← FRONT / AVANT / VORN FRENTE / ANTERIORE →

## PEUGEOT

		DISC PAD CHOICES				BRAKE ROTOR CHOICES							
		NEW SFAC Scooter Carbon Pads	Semi-Sintered V-Pads™	Sintered/HH Pads/ Grooved shoes	Left/Gauche/Links	Right/Droite/Rechts	Contour Rotor Universal left and right fitment	NEW Vee-Rotors™ CONTOUR	NEW CX Extreme® ROTOR	Oversize 250/280mm Rotor Kit	Relocating Bracket for 250/280mm Rotor	Oversize 320mm Rotor Kit	Relocating Bracket for 320mm Rotor
Ludix 2 One Monoposto (271/2" Wheels)	10-11	H303											
Metal-X 50 (All models)	04-06	SFA115	SFAC115	SFA115HH	MD984D			VR984					
Vivacity 50 (AJP Caliper/12" Wheels/190mm Disc)	92-07	SFA115	SFAC115	SFA115HH	MD901D		MD901C	VR901					
Vivacity 50 (Heng Tong Caliper/12" Wheels/190mm Disc)	92-07	SFA083	SFAC083	SFA083HH	MD901D		MD901C	VR901					
Vivacity 2.50 (AJP Caliper/10" Wheels/190mm Disc)	08-11	SFA115	SFAC115	SFA115HH	MD901D		MD901C	VR901					
Vivacity 2.50 (Heng Tong Caliper/10" Wheels/190mm Disc)	08-11	SFA083	SFAC083	SFA083HH	MD901D		MD901C	VR901					
E-Vivacity (Electric)	10	SFA235	SFAC235		TBA								
E-Vivacity (Electric)	11-13	SFA228	SFAC228	SFA228HH	MD9141D			VR9141					
New Vivacity (50cc/271/2" Wheels/200mm Disc)	08-13	SFA054	SFAC054	SFA054HH	MD9141D			VR9141					
New Vivacity (50cc/471/2" Wheels/200mm Disc)	08-13	SFA054	SFAC054	SFA054HH	MD9141D			VR9141					
New Vivacity Sixties (50cc/471/2" Wheels/200mm Disc)	10-13	SFA054	SFAC054	SFA054HH	MD9141D			VR9141					
Speedake 50cc	95-01	SFA115	SFAC115	SFA115HH	MD901/909		MD901C	VR901					
Speedlight 50 1 / 2 (Air Cooled) - Rear Drum Models - AJP Calipers	97-08	SFA115	SFAC115	SFA115HH	MD925D		MD925C	VR925					
Speedlight 50 1 / 2 (Air Cooled) - Rear Drum Models - Heng Tong Calipers	97-08	SFA083	SFAC083	SFA083HH	MD925D		MD925C	VR925					
Speedlight 50 1 / 2 (LC) - Front & Rear Disc Models - AJP Calipers	97-08	SFA115	SFAC115	SFA115HH	MD925D		MD925C	VR925					
Speedlight 50 1 / 2 (LC) - Front & Rear Disc Models - Heng Tong Calipers	97-08	SFA083	SFAC083	SFA083HH	MD925D		MD925C	VR925					
Speedlight 3 (50cc A/C - 2T)	09-12	SFA086	SFAC086	SFA086HH			N/A						
Speedlight 3 (50cc L/C - 2T)	09-12	SFA086	SFAC086	SFA086HH			N/A						
Speedlight 3 - RS (50cc A/C - 2T)	10-12	SFA086	SFAC086	SFA086HH			N/A						
Speedlight 3 - RS (50cc L/C - 2T)	09-12	SFA086	SFAC086	SFA086HH			N/A						
Speedlight Darkside (50cc L/C - 2T)	13	SFA086	SFAC086	SFA086HH			N/A						
Speedlight Furious (50cc L/C - 2T)	13	SFA086	SFAC086	SFA086HH			N/A						
Squab 50cc	95-01	SFA115	SFAC115	SFA115HH	MD901/909		MD901C	VR901					
SV 50/80/125 (Geo)	91-92	SFA131/2V		SFA131/2HHV	MD901/909		MD901C	VR901					
SV 50/80/125 (Geo)	93-	SFA131/3V		SFA131/3HHV	MD901/909		MD901C	VR901					
SV 50 J (Front drum model) (Geo)	91-95	H303											
Trekker (2T) AJP Caliper	98-00	SFA115	SFAC115	SFA115HH	MD901D		MD901C	VR901					
Trekker (2T) Heng Tong Caliper	98-00	SFA083	SFAC083	SFA083HH	MD901D		MD901C	VR901					
TRK2 WRC 50 (2T)	99-08	SFA115	SFAC115	SFA115HH	MD901D		MD901C	VR901					
TRK 50 (271/10" Wheels)	09-12	SFA115	SFAC115	SFA115HH	MD901D		MD901C	VR901					
TRK 50 12 (271/12" Wheels)	09-12	SFA115	SFAC115	SFA115HH	MD901D		MD901C	VR901					
Tweet 50 (4T/Rear Drum Model)	10-13	SFA264	SFAC264	SFA264HH	TBA								
Tweet 50 RS (4T/Rear Disc Model)	10-13	SFA264	SFAC264	SFA264HH			TBA						
V-Clic 50 (4T) (155mm F/disc)	08-13	SFA169	SFAC169	SFA169HH	MD904D			VR904					
V-Clic 50 (4T) (160mm F/disc)	08-11	SFA169	SFAC169	SFA169HH	TBA								
Vogue 50 (2T)	08-09	TBA											
XP6 Enduro/Top Road 21" front wheel	03-10	FA115		FA115HH	N/A								
XP6 Supermoto (17" front wheel/240mm disc)	03-09	FA115		FA115HH	N/A								
XR6 (2T) 50	03-07	FA167		FA167HH	MD6318D								
XPS 50 SM	09	FA093			N/A								
XPS Enduro	03-09	FA115		FA115HH	N/A								
XPS Supermoto (17" front wheel/260mm disc)	03-10	FA194		FA194HH	N/A								
XPS Street (17" front wheel/280mm disc)	03-09	FA194		FA194HH	N/A								
XPS 50 Track (21" F/Wheel)	11-12	FA093			N/A								
XPS 50 Top Road (17" F/Wheel)	10-12	FA093			N/A								
NK7 (50cc) Naked	09-12	FA399			N/A								
XR7 (50cc) Full Fairing	08-12	FA399			N/A								
Zenith LS 50cc	96-99	SFA115	SFAC115	SFA115HH			MD904C	VR904					
Zenith MN 50cc	96-00	H303											
Elyseo 100	98-02	SFA115	SFAC115	SFA115HH	MD947D			VR947					
Elyseo 100	03	SFA115	SFAC115	SFA115HH	MD947D			VR947					
LooXoR 100 (All models)	01-04	SFA115	SFAC115	SFA115HH	MD954D			VR954					
Speedlight 100 1/2 (AJP Calipers Front & Rear All models)	97-07	SFA115	SFAC115	SFA115HH	MD925D		MD925C	VR925					
SV 100 L		SFA116			MD901D		MD901C	VR901					
Trekker 100 (2T) AJP Caliper	98-00	SFA115	SFAC115	SFA115HH	MD901D		MD901C	VR901					
VOX 110 (4T)	12-13	SFA635					N/A						
City Star 125 i	11-13	SFA228	SFAC228	SFA228HH	TBA								
City Star 125 i Active	13	SFA228	SFAC228	SFA228HH	TBA								
Elyseo 125/150 (Drum Rear model)	98-01	SFA115	SFAC115	SFA115HH	MD947D			VR947					
Elyseo 125/150 Rear Disc Model	03	SFA194	SFAC194	SFA194HH	MD977D								

\*-2 Sets Required. ■ - Also available in MX-S race compound.

**SAFETY WARNING:** DO NOT USE HH PADS ON REAR UNLESS ALSO USED ON FRONT TO AVOID BRAKE IMBALANCE

**R** Suffix = High Durability Sintered Pad. **HH** Suffix = High Performance Sintered Pad. **G** Suffix = Grooved Shoe.  
**D** Suffix = Drilled Disc. **C** Suffix = Contoured Disc. **LS** Suffix = Left/Steel Disc. **RS** = Right/Steel Disc.

# Non-JAPANESE Built Motorcycles

**BRAKE APPLICATIONS**

**R** Suffix = High Durability Sintered Pad. **HH** Suffix = High Performance Sintered Pad. **G** Suffix = Grooved Shoe.  
**D** Suffix = Drilled Disc. **C** Suffix = Contoured Disc. **LS** Suffix = Left/Steel Disc. **RS** = Right/Steel Disc.



**PEUGEOT**



← REAR / ARRIÈRE / HINTEN POSTERIOR / POSTERIORE →

			DISC PAD CHOICES			BRAKE ROTOR CHOICES			
			NEW SFAC Scooter Carbon Pads	Semi-Sintered V-Pads™	Sintered/HH Pads/ Grooved shoes	Contour Rotor Rear Fitment	NEW Vee-Rotors™ CONTOUR	NEW CX Extreme® ROTOR	
Ludix 2 One Mono-posto (27/12" Wheels)	10-11	H303							
Metal-X 50 (All models)	04-06	H303							
Vivacity 50 (AJP Caliper/12" Wheels/190mm Disc)	92-07	H303							
Vivacity 50 (Heng Tong Caliper/12" Wheels/190mm Disc)	92-07	H303							
Vivacity 250 (AJP Caliper/10" Wheels/190mm Disc)	08-11	H303							
Vivacity 250 (Heng Tong Caliper/10" Wheels/190mm Disc)	08-11	H303							
E-Vivacity (Electric)	10	H303							
E-Vivacity (Electric)	11-13	H303							
New Vivacity (50cc/27/12" Wheels/200mm Disc)	08-13	H303							
New Vivacity (50cc/47/12" Wheels/200mm Disc)	08-13	H303							
New Vivacity Sixties (50cc/47/12" Wheels/200mm Disc)	10-13	H303							
Speedake 50cc	95-01	H303							
Speedfight 50 1 / 2 (Air Cooled) - Rear Drum Models - AJP Calipers	97-08	H303							
Speedfight 50 1 / 2 (Air Cooled) - Rear Drum Models - Heng Tong Calipers	97-08	SFA260	SFAC260		SFA260HH	MD925D	MD925C	VR925	
Speedfight 50 1 / 2 (LC) - Front & Rear Disc Models - AJP Calipers	97-08	SFA115	SFAC115		SFA115HH	MD925D	MD925C	VR925	
Speedfight 50 1 / 2 (LC) - Front & Rear Disc Models - Heng Tong Calipers	97-08	SFA260	SFAC260		SFA260HH	MD925D	MD925C	VR925	
Speedfight 3 (50cc A/C - 2T)	09-12	H303							
Speedfight 3 (50cc L/C - 2T)	09-12	SFA266	SFAC266		SFA266HH		N/A		
Speedfight 3 - RS (50cc A/C - 2T)	10-12	SFA266	SFAC266		SFA266HH		N/A		
Speedfight 3 - RS (50cc L/C - 2T)	09-12	SFA266	SFAC266		SFA266HH		N/A		
Speedfight Darkside (50cc L/C - 2T)	13	SFA266	SFAC266		SFA266HH		N/A		
Speedfight Furious (50cc L/C - 2T)	13	SFA266	SFAC266		SFA266HH		N/A		
Squab 50cc	95-01	H303							
SV 50/80/125 (Geo)	91-92	H303							
SV 50/80/125 (Geo)	93-	H303							
SV 50 J (Front drum model) (Geo)	91-95	H303							
Trekker (2T) AJP Caliper	98-00	H303							
Trekker (2T) Heng Tong Caliper	98-00	H303							
TRK2 WRC 50 (2T)	99-08	H303							
TRK 50 (2T/10" Wheels)	09-12	H303							
TRK 50 12 (2T/12" Wheels)	09-12	H303							
Tweet 50 (47/Rear Drum Model)	10-13	H307							
Tweet 50 RS (47/Rear Disc Model)	10-13	SFA260	SFAC260		SFA260HH		TBA		
V-Clic 50 (4T) (155mm F/disc)	08-13	H303							
V-Clic 50 (4T) (160mm F/disc)	08-11	H303							
Vogue 50 (2T)	08-09	TBA							
XP6 Enduro/Top Road 21" front wheel	03-10	FA115			FA115HH	N/A			
XP6 Supermoto (17" front wheel/240mm disc)	03-09	FA115			FA115HH	N/A			
XR6 (2T) 50	03-07	FA115			FA115HH	N/A			
XPS 50 SM	09	FA093				N/A			
XPS Enduro	03-09	FA115			FA115HH	N/A			
XPS Supermoto (17" front wheel/260mm disc)	03-10	FA115			FA115HH	N/A			
XPS Street (17" front wheel/280mm disc)	03-09	FA115			FA115HH	N/A			
XPS 50 Track (21" F/Wheel)	11-12	FA115				N/A			
XPS 50 Top Road (17" F/Wheel)	10-12	FA115				N/A			
NK7 (50cc) Naked	09-12	FA093				N/A			
XR7 (50cc) Full Fairing	08-12	FA093				N/A			
Zenith LS 50cc	96-99	H303							
Zenith MN 50cc	96-00	H303							
Elyseo 100	98-02	H303							
Elyseo 100	03	SFA115	SFAC115		SFA115HH	MD925D		VR925	
LooxoR 100 (All models)	01-04	SFA115	SFAC115		SFA115HH	MD901D		VR901	
Speedfight 100 1/2 (AJP Calipers Front & Rear All models)	97-07	SFA115	SFAC115		SFA115HH	MD925D	MD925C	VR925	
SV 100 L		H303							
Trekker 100 (2T) AJP Caliper	98-00	H303							
VOX 110 (4T)	12-13	H303							
City Star 125 1	11-13	SFA260	SFAC260		SFA260HH	TBA			
City Star 125 1 Active	13	SFA260	SFAC260		SFA260HH	TBA			
Elyseo 125/150 (Drum Rear model)	98-01	857							
Elyseo 125/150 Rear Disc Model	03	SFA350	SFAC350		SFA350HH	MD978D			

\*-2 Sets Required. ■ - Also available in MX-S race compound.

**SAFETY WARNING:** DO NOT USE HH PADS ON REAR UNLESS ALSO USED ON FRONT TO AVOID BRAKE IMBALANCE

# Non-JAPANESE Built Motorcycles



← FRONT / AVANT / VORN  FRENTE / ANTERIORE →

PEUGEOT		DISC PAD CHOICES				BRAKE ROTOR CHOICES								
		NEW SFAC Scooter Carbon Pads	Semi-Sintered V-Pads™	Sintered/HH Pads/ Grooved shoes	Left/Gauche/Links	Right/Droite/Rechts	Contour Rotor Universal left and right fitment	NEW Vee-Rotors™ CONTOUR	NEW CX Extreme® ROTOR	Oversize 250/280mm Rotor Kit	Relocating Bracket for 250/280mm Rotor	Oversize 320mm Rotor Kit	Relocating Bracket for 320mm Rotor	
Elystar 125/150 (3 bolt fixing front disc)	02-05	SFA194	SFAC194		SFA194HH	MD977D								
Elystar 125/150 (5 bolt fixing front disc)	06-07	SFA194	SFAC194		SFA194HH	MD980D								
Geo RS 125 (Nissin Calipers)	07-12	SFA228	SFAC228		SFA228HH	MD9111D				VR9111				
Geopolis 125 Executive (AJP Caliper/Non ABS)	07-12	SFA194	SFAC194		SFA194HH	MD9111D				VR9111				
Geopolis 125 Premium (Nissin Caliper/Non ABS)	07-12	SFA228	SFAC228		SFA228HH	MD9111D				VR9111				
Geopolis 125 Urban (AJP Caliper/ ABS)	07-12	SFA194	SFAC194		SFA194HH	TBA								
Geopolis 125 (AJP Caliper/ABS)	07-12	SFA194	SFAC194		SFA194HH	MD9111D				VR9111				
Jet Force 125 (All models)	03-07	SFA194	SFAC194		SFA194HH	MD980D								
LooXoR 125/150	03-06	SFA324	SFAC324		SFA324HH	MD954D				VR954				
Ludix Ambition (14" wheels) 125cc	04	SFA115	SFAC115		SFA115HH	MD901909		MD901C		VR901				
LXR 125 (4T)	10-13	SFA264	SFAC264		SFA264HH	TBA								
E-Vivacity (Electric)	10	SFA235	SFAC235			TBA								
e - Satelis	11-13	SFA228	SFAC228		SFA228HH	TBA								
Satelis 125 4V Executive/Premium/City (4 stroke/4 valve)	06-09	SFA194	SFAC194		SFA194HH	MD9111D				VR9111				
Satelis 125 Blacksat (AJP Calipers)	10-11	SFA194	SFAC194		SFA194HH	N/A								
Satelis 125 Compressor (4T)	06-11	SFA194	SFAC194		SFA194HH	MD9111D				VR9111				
Satelis 125 Urban (AJP Caliper/ABS)	07-11	SFA194	SFAC194		SFA194HH	N/A								
Satelis 125 RS (AJP Caliper)	07-13	SFA194	SFAC194		SFA194HH	N/A								
Satelis 125 Whitesat (AJP Calipers)	10-11	SFA194	SFAC194		SFA194HH	N/A								
Satelis 125 Avenue (Nissin Calipers)	08-09	SFA228	SFAC228		SFA228HH	TBA								
Satelis 125	13	SFA603			SFA603HH	N/A								
Satelis 125 RS (4T)	13	SFA228	SFAC228		SFA228HH	TBA								
Sum-Up (125cc)	08-11	SFA054	SFAC054		SFA054HH		N/A							
Tweet 125 (4T/Rear Drum Model)	10-12	SFA264	SFAC264		SFA264HH	MD9137D				VR9137				
Tweet 125 (4T/Rear Disc Model)	12-12	SFA264	SFAC264		SFA264HH			TBA						
Tweet 125 RS (4T/Rear Disc Model)	10-13	SFA264	SFAC264		SFA264HH			TBA						
WTR 125	08	FA197			FA197HH		TBA							
XPS 125 CT	05-07	FA115			FA115HH	N/A								
XP 125 Street Evo 2	05	FA167			FA167HH	N/A								
Vivacity 125 (4T)	10-12	SFA228	SFAC228		SFA228HH	MD9141D				VR9141				
Vivacity Sixties 125 (4T)	11-12	SFA228	SFAC228		SFA228HH	MD9141D				VR9141				
Tweet 150 (4T/Rear Drum Model)	10-12	SFA264	SFAC264		SFA264HH	MD9137D				VR9137				
Tweet 150 RS (4T/Rear Disc Model)	10-12	SFA264	SFAC264		SFA264HH			TBA						
City Star 200 i	12-13	SFA228	SFAC228		SFA228HH	TBA								
LXR 200i (4T)	10-11	SFA264	SFAC264		SFA264HH	TBA								
Geo 250 (Nissin Caliper)	07-11	SFA228	SFAC228		SFA228HH	MD9111D				VR9111				
Geopolis 250 Executive (AJP Caliper/Non ABS)	07-11	SFA194	SFAC194		SFA194HH	MD9111D				VR9111				
Geopolis 250 Premium (Nissin Caliper/Non ABS)	07-11	SFA228	SFAC228		SFA228HH	MD9111D				VR9111				
Geopolis 250 Urban (AJP Caliper/ABS)	07-11	SFA194	SFAC194		SFA194HH	MD9111D				VR9111				
Satelis 250 Premium (Nissin Calipers)	07-12	SFA228	SFAC228		SFA228HH	TBA								
Satelis 250 Urban (AJP Caliper/ABS)	07-12	SFA194	SFAC194		SFA194HH	N/A								
Satelis 250 RS (Nissin Calipers)	07-12	SFA228	SFAC228		SFA228HH	TBA								
SV 250	01-02	SFA281			SFA281HH	MD922D		MD922C		VR922				
SV 250 (Parking brake)	01-02	H351												
Geo RS 300 (Nissin Calipers)	10-12	SFA228	SFAC228		SFA228HH	MD9111D				VR9111				
Geopolis 300 Premium (Nissin Calipers/Non ABS)	10-12	SFA228	SFAC228		SFA228HH	MD9111D				VR9111				
Geostyle 300 (Nissin Calipers)	10-12	SFA228	SFAC228		SFA228HH	MD9111D				VR9111				
Satalis 300 (4t)	13	SFA228	SFAC228		SFA228HH	N/A								
Geo RS 400 (Nissin Calipers)	08-12	SFA228	SFAC228		SFA228HH	MD9111D				VR9111				
Geopolis 400 Premium (Nissin Caliper/Non ABS)	07-12	SFA228	SFAC228		SFA228HH	MD9111D				VR9111				
Geopolis 400 Urban (AJP Caliper/ABS)	07-12	SFA194	SFAC194		SFA194HH	MD9111D				VR9111				
Metropolis 400 (3 Wheel Model)	13	FA453TT*				N/A	N/A							
Parking Brake		SFA083												
Satelis 400 Premium (Nissin Calipers)	08-11	SFA142*	SFAC142*		SFA142HH*	N/A	N/A							
Satelis 400 Urban (Nissin Calipers)	08-12	SFA142*	SFAC142*		SFA142HH*	N/A	N/A							
Satelis 400 RS (Nissin Calipers)	08-12	SFA142*	SFAC142*		SFA142HH*	N/A	N/A							
Geopolis 500	08-11	SFA142*	SFAC142*		SFA142HH*	MD9111D	MD9111D			VR9111*				
Satelis 500	07-12	SFA142*	SFAC142*		SFA142HH*	TBA	TBA							
Satelis 500 RS (Nissin Calipers)	08-12	SFA142*	SFAC142*		SFA142HH*	TBA	TBA							

\*-2 Sets Required. ■ - Also available in MX-S race compound.

**SAFETY WARNING:- DO NOT USE HH PADS ON REAR UNLESS ALSO USED ON FRONT TO AVOID BRAKE IMBALANCE**

APPLICATIONS  
BRAKE

R Suffix = High Durability Sintered Pad. HH Suffix = High Performance Sintered Pad. G Suffix = Grooved Shoe.  
D Suffix = Drilled Disc. C Suffix = Contoured Disc. LS Suffix = Left/Steel Disc. RS = Right/Steel Disc.

# Non-JAPANESE Built Motorcycles



PEUGEOT



← REAR / ARRIÈRE / HINTEN POSTERIOR / POSTERIORE →

		DISC PAD CHOICES				BRAKE ROTOR CHOICES			
		NEW SFAC Scooter Carbon Pads	Semi-Sintered V-Pads™	Sintered/HH Pads/ Grooved shoes	Contour Rotor Rear Fitment	NEW Vee-Rotors™ CONTOUR	NEW CX Extreme® ROTOR		
Elystar 125/150 (3 bolt fixing front disc)	02-05	SFA350	SFAC350		SFA350HH	MD978D			
Elystar 125/150 (5 bolt fixing front disc)	06-07	SFA350	SFAC350		SFA350HH	MD978D			
Geo RS 125 (Nissin Calipers)	07-12	SFA228	SFAC228		SFA228HH	N/A			
Geopolis 125 Executive (AJP Caliper/Non ABS)	07-12	SFA350	SFAC350		SFA350HH	TBA			
Geopolis 125 Premium (Nissin Caliper/Non ABS)	07-12	SFA228	SFAC228		SFA228HH	TBA			
Geopolis 125 Urban (AJP Caliper/ABS)	07-12	SFA350	SFAC350		SFA350HH	TBA			
Geopolis 125 (AJP Caliper/ABS)	07-12	SFA350	SFAC350		SFA350HH	TBA			
Jet Force 125 (All models)	03-07	SFA350	SFAC350		SFA350HH	MD978D			
LooXoR 125/150	03-06	SFA115	SFAC115		SFA115HH	MD9121D			
Ludix Ambition (14" wheels) 125cc	04	H303							
LXR 125 (4T)	10-13	SFA427	SFAC427		SFA427HH	TBA			
E-Vivacity (Electric)	10	H303							
e-Satelis	11-13	SFA228	SFAC228		SFA228HH	TBA			
Satelis 125 4V Executive/Premium/City (4 stroke/4 valve)	06-09	SFA350	SFAC350		SFA350HH	MD978D		VR978	
Satelis 125 Blacksat (AJP Calipers)	10-11	SFA350	SFAC350		SFA350HH	MD978D			
Satelis 125 Compressor (4T)	06-11	SFA350	SFAC350		SFA350HH	MD978D		VR978	
Satelis 125 Urban (AJP Caliper/ABS)	07-11	SFA350	SFAC350		SFA350HH	MD978D			
Satelis 125 RS (AJP Caliper)	07-13	SFA350	SFAC350		SFA350HH	MD978D			
Satelis 125 Whitesat (AJP Calipers)	10-11	SFA350	SFAC350		SFA350HH	MD978D			
Satelis 125 Avenue (Nissin Calipers)	08-09	SFA228	SFAC228		SFA228HH	MD978D			
Satelis 125	13	SFA260			SFA260HH	N/A			
Satelis 125 RS (4T)	13	SFA260			SFA260HH	N/A			
Sum-Up (125cc)	08-11	Y506							
Tweet 125 (4T/Rear Drum Model)	10-12	Y506							
Tweet 125 (4T/Rear Disc Model)	12-12	SFA260	SFAC260		SFA260HH	TBA	TBA		
Tweet 125 RS (4T/Rear Disc Model)	10-13	SFA260	SFAC260		SFA260HH	TBA	TBA		
WTR 125	08	TBA							
XPS 125 CT	05-07	FA115			FA115HH	N/A			
XP 125 Street Evo 2	05	FA115			FA115HH	N/A			
Vivacity 125 (4T)	10-12	Y506							
Vivacity Sixties 125 (4T)	11-12	Y506							
Tweet 150 (4T/Rear Drum Model)	10-12	Y506							
Tweet 150 RS (4T/Rear Disc Model)	10-12	SFA260	SFAC260		SFA260HH	TBA	TBA		
City Star 200 i	12-13	SFA260	SFAC260		SFA260HH	TBA			
LXR 200i (4T)	10-11	SFA427	SFAC427		SFA427HH	TBA			
Geo 250 (Nissin Caliper)	07-11	SFA228	SFAC228		SFA228HH	N/A			
Geopolis 250 Executive (AJP Caliper/Non ABS)	07-11	SFA350	SFAC350		SFA350HH	N/A			
Geopolis 250 Premium (Nissin Caliper/Non ABS)	07-11	SFA228	SFAC228		SFA228HH	N/A			
Geopolis 250 Urban (AJP Caliper/ABS)	07-11	SFA350	SFAC350		SFA350HH	N/A			
Satelis 250 Premium (Nissin Calipers)	07-12	SFA228	SFAC228		SFA228HH	N/A			
Satelis 250 Urban (AJP Caliper/ABS)	07-12	SFA350	SFAC350		SFA350HH	N/A			
Satelis 250 RS (Nissin Calipers)	07-12	SFA228	SFAC228		SFA228HH	N/A			
SV 250	01-02	SFA140			SFA140HH	MD1004		VR1004	
Geo RS 300 (Nissin Calipers)	10-12	SFA228	SFAC228		SFA228HH	N/A			
Geopolis 300 Premium (Nissin Calipers/Non ABS)	10-12	SFA228	SFAC228		SFA228HH	N/A			
Geostyle 300 (Nissin Calipers)	10-12	SFA228	SFAC228		SFA228HH	N/A			
Satelis 300 (4t)	13	SFA228	SFAC228		SFA228HH	N/A			
Geo RS 400 (Nissin Calipers)	08-12	SFA228	SFAC228		SFA228HH	N/A			
Geopolis 400 Premium (Nissin Caliper/Non ABS)	07-12	SFA228	SFAC228		SFA228HH	N/A			
Geopolis 400 Urban (AJP Caliper/ABS)	07-12	SFA350	SFAC350		SFA350HH	N/A			
Metropolis 400 (3 Wheel Model)	13	FA453TT*				N/A*			
Satelis 400 Premium (Nissin Calipers)	08-11	SFA228	SFAC228		SFA228HH	N/A			
Satelis 400 Urban (Nissin Calipers)	08-12	SFA228	SFAC228		SFA228HH	N/A			
Satelis 400 RS (Nissin Calipers)	08-12	SFA228	SFAC228		SFA228HH	N/A			
Geopolis 500	08-11	SFA228	SFAC228		SFA228HH	TBA			
Satelis 500	07-12	SFA228	SFAC228		SFA228HH	TBA			
Satelis 500 RS (Nissin Calipers)	08-12	SFA228	SFAC228		SFA228HH	TBA			

\*-2 Sets Required. ■ - Also available in MX-S race compound.

**SAFETY WARNING:** DO NOT USE HH PADS ON REAR UNLESS ALSO USED ON FRONT TO AVOID BRAKE IMBALANCE

**BRAKE APPLICATIONS**

**R** Suffix = High Durability Sintered Pad. **HH** Suffix = High Performance Sintered Pad. **G** Suffix = Grooved Shoe.  
**D** Suffix = Drilled Disc. **C** Suffix = Contoured Disc. **LS** Suffix = Left/Steel Disc. **RS** = Right/Steel Disc.



# Non-JAPANESE Built Motorcycles



FRONT / AVANT / VORN ← → FRENTE / ANTERIORE



## DISC PAD CHOICES

NEW SFAC Scooter Carbon Pads  
Semi-Sintered V-Pads™  
Sintered/HH Pads/ Grooved shoes



## BRAKE ROTOR CHOICES

Contour Rotor Universal left and right fitment  
NEW Vee-Rotors™  
NEW CX Extreme® ROTOR  
Oversize 250/280mm Rotor Kit  
Relocating Bracket for 250/280mm Rotor  
Oversize 320mm Rotor Kit  
Relocating Bracket for 320mm Rotor

## PEUGEOT

1 - Check if discs are either - counterbored (Leleu wheels) disc = MD909D or countersunk (Grimeca wheels) disc = MD901D														
2 - Caliper manufacture may vary - check old pad shape to select correct type. Hengtong = SFA83 AJP = SFA115														
3 - Check if discs are either - counterbored (Leleu wheels) disc = MD904D or countersunk (Grimeca wheels) disc = MD914D														
4 - Check caliper manufacturer Hengtong = FA083TT Nissin = SFA131/2 or SFA131/3														

## PETRONAS

FP1	05			FA322/4HH*	TBA	TBA								
-----	----	--	--	------------	-----	-----	--	--	--	--	--	--	--	--

## PHB

500	92	FA132		FA132R	N/A									
560	92	FA067		FA067R	N/A									

## PGO

i-Dep Electric Scooter	09	SFA264	SFAC264	SFA264HH	N/A									
Big Max 50	94-06	SFA169	SFAC169	SFA169HH	MD904D		MD904C	VR904						
Big Max 50 S	03-04	SFA264	SFAC264	SFA264HH	TBA									
Big Max 50 (Front wave disc)	07-09	SFA264	SFAC264	SFA264HH			N/A							
Big Max 50 Naked (Round disc/No cover on handlebars)	07-09	SFA264	SFAC264	SFA264HH	N/A									
Bugrider 50 (Buggie)	06	FA416TT*		FA416R*	N/A	N/A								
EPS	97	SFA169	SFAC169	SFA169HH	MD904D		MD904C	VR904						
Galaxy 50	94-	SFA083	SFAC083	SFA083HH	MD939D									
G-Max 50	05-07	SFA264	SFAC264	SFA264HH	N/A									
G-Max 50 Naked (Wave disc)	09	SFA264	SFAC264	SFA264HH			N/A							
G-Max 50 (Wave disc)	08-12	SFA264	SFAC264	SFA264HH			N/A							
Libra 50 (2T)	09	SFA264	SFAC264	SFA264HH	N/A									
Ligero 50 (2T)	08-12	SFA264	SFAC264	SFA264HH	N/A									
Mega 50	94-	SFA083	SFAC083	SFA083HH	TBA									
My Bubu 50	03	SFA193	SFAC193	SFA193HH	MD904D		MD904C	VR904						
PMX 50	00-07	SFA264	SFAC264	SFA264HH	MD923D		MD923C	VR923						
PMX 50 Naked		SFA264	SFAC264	SFA264HH	TBA									
Rodo Show 50	00-09	SFA193	SFAC193	SFA193HH	TBA									
T-Rex 50	99-12	SFA264	SFAC264	SFA264HH	MD923D		MD923C	VR923						
T-Rex 3 (50cc) (3 wheeler)	03-04	SFA264	SFAC264	SFA264HH	TBA									
Tornado 50/125	97	SFA169	SFAC169	SFA169HH	MD904D		MD904C	VR904						
X Rider 50/90/110	04-05	TBA*												
XL-Rider 50	07-08	TBA*												
XL-Rider	07-08	TBA*												
Bubu 100/125	03-08	SFA264	SFAC264	SFA264HH	MD923D		MD923C	VR923						
My Bubu 100/125	03-05	SFA264	SFAC264	SFA264HH	N/A									
PMX 110	00-07	SFA264	SFAC264	SFA264HH	MD923D		MD923C	VR923						
T-Rex 110	99-06	SFA264	SFAC264	SFA264HH	MD923D		MD923C	VR923						
Charge 125 A/B	01-02	SFA264	SFAC264	SFA264HH	MD923D		MD923C	VR923						
G-Max 125	06-08	FA095		FA095HH	N/A									
G-Max 125 (Wave disc)	09-12	FA095		FA095HH			N/A							
i-Charge 125	03-05	SFA264	SFAC264	SFA264HH	N/A									
Libra 125 EFI (4T)	09-12	SFA264	SFAC264	SFA264HH	N/A									
Ligero 125	06-08	SFA264	SFAC264	SFA264HH	MD923D		MD923C	VR923						
Ligero 125 (4T)	08-12	SFA264	SFAC264	SFA264HH	N/A									
Tigra 125 (4T/4V)	12	SFA264	SFAC264	SFA264HH			N/A							
T-Rex 125	99-07	SFA264	SFAC264	SFA264HH	MD923D		MD923C	VR923						
T-Rex 125 (Wave disc)	08-12	SFA264	SFAC264	SFA264HH			N/A							
Bugrider 150		FA416TT*		FA416R*	N/A	N/A								
Bugxter BR150 A	05-07	FA416TT*		FA416R*	N/A	N/A								
Libra 150 (4T)	09	SFA264	SFAC264	SFA264HH	N/A									
TR-3 150cc (3 wheeler)	03-09	SFA264	SFAC264	SFA264HH	N/A									
X Rider 150	04-05	H338*		H338G*										
BR-200 Bug Rider	07-12	FA416TT*		FA416R*	TBA	TBA								
250 Bug		FA416TT*		FA416R*	N/A	N/A								
BR 250 Bugrider E	05-12	FA416TT*		FA416R*	TBA	TBA								
Bugrider 250 SS (Single seat)		FA416TT		FA416R	N/A	N/A								

\*-2 Sets Required. ■ - Also available in MX-S race compound.

**SAFETY WARNING:** DO NOT USE HH PADS ON REAR UNLESS ALSO USED ON FRONT TO AVOID BRAKE IMBALANCE

APPLICATIONS  
BRAKE

R Suffix = High Durability Sintered Pad. HH Suffix = High Performance Sintered Pad. G Suffix = Grooved Shoe.  
D Suffix = Drilled Disc. C Suffix = Contoured Disc. LS Suffix = Left/Steel Disc. RS = Right/Steel Disc.

# Non-JAPANESE Built Motorcycles

**BRAKE APPLICATIONS**

**R** Suffix = High Durability Sintered Pad. **HH** Suffix = High Performance Sintered Pad. **G** Suffix = Grooved Shoe.  
**D** Suffix = Drilled Disc. **C** Suffix = Contoured Disc. **LS** Suffix = Left/Steel Disc. **RS** = Right/Steel Disc.



**PEUGEOT**



← REAR / ARRIÈRE / HINTEN POSTERIOR / POSTERIORE →

		DISC PAD CHOICES			BRAKE ROTOR CHOICES		
		NEW SFAC Scooter Carbon Pads	Semi-Sintered V-Pads™	Sintered/HH Pads/ Grooved shoes	Contour Rotor Rear Fitment	NEW Vee-Rotors™ CONTOUR	NEW CX Extreme® ROTOR
<b>PETRONAS</b>							
FP1	05	FA266	FA266V	FA266HH	TBA		
<b>PHB</b>							
500	92	FA067		FA067R	N/A		
580	92	FA067		FA067R	N/A		
<b>PGO</b>							
i-Dep Electric Scooter	09	SFA264	SFAC264		N/A		
Big Max 50	94-06	897					
Big Max 50 S	03-04	897					
Big Max 50 (Front wave disc)	07-09	897					
Big Max 50 Naked (Round disc/No cover on handlebars)	07-09	897					
Bugrider 50 (Buggie)	06	FA054TT		FA054R	N/A		
EPS	97	897					
Galaxy 50	94-	897					
G-Max 50	05-07	897					
G-Max 50 Naked (Wave disc)	09	897					
G-Max 50 (Wave disc)	08-12	897					
Libra 50 (2T)	09	TBA					
Ligero 50 (2T)	08-12	897					
Mega 50	94-	897					
My Bubu 50	03	Y503					
PMX 50	00-07	897					
PMX 50 Naked		897					
Rodo Show 50	00-09	897					
T-Rex 50	99-12	897					
T-Rex 3 (50cc) (3 wheeler)	03-04	TBA*					
Tornado 50/125	97	897					
X Rider 50/90/110	04-05	FA083TT		FA083R	N/A		
XL-Rider 50	07-08	FA083TT		FA083R	N/A		
XL-Rider	07-08	FA083TT		FA083R	N/A		
Bubu 100/125	03-08	S602					
My Bubu 100/125	03-05	S602					
PMX 110	00-07	897					
T-Rex 110	99-06	897					
Charge 125 AB	01-02	S624					
G-Max 125	06-08	FA197		FA197HH	N/A		
G-Max 125 (Wave disc)	09-12	FA197		FA197HH	N/A		
i-Charge 125	03-05	S602					
Libra 125 EFI (4T)	09-12	TBA					
Ligero 125	06-08	S624					
Ligero 125 (4T)	08-12	S624					
Tigra 125 (4T/4V)	12	SFA260		SFA260HH	N/A		
T-Rex 125	99-07	S602					
T-Rex 125 (Wave disc)	08-12	S602					
Bugrider 150		FA054TT		FA054R	N/A		
Bugxter BR150 A	05-07	FA054TT		FA054R	N/A		
Libra 150 (4T)	09	TBA					
TR-3 150cc (3 wheeler)	03-09	TBA*					
X Rider 150	04-05	FA083TT		FA083R	N/A		
BR-200 Bug Rider	07-12	FA431TT		FA431R	TBA		
250 Bug		FA431TT		FA431R	N/A		
BR 250 Bugrider E	05-12	FA431TT		FA431R	TBA		
Bugrider 250 SS (Single seat)		FA054TT		FA054R	N/A		

\*-2 Sets Required. ■ - Also available in MX-S race compound.

**SAFETY WARNING:** DO NOT USE HH PADS ON REAR UNLESS ALSO USED ON FRONT TO AVOID BRAKE IMBALANCE

# Non-JAPANESE Built Motorcycles



← FRONT / AVANT / VORN FRENTE / ANTERIORE →

## DISC PAD CHOICES

## BRAKE ROTOR CHOICES

### PGO

			NEW SFAC Scooter Carbon Pads	Semi-Sintered V-Pads™	Sintered/HH Pads/ Grooved shoes	Left/Gauche/Links	Right/Droite/Rechts	Contour Rotor Universal left and right fitment	NEW Vee-Rotors™ CONTOUR	NEW CX Extreme® ROTOR	Oversize 250/280mm Rotor Kit	Relocating Bracket for 250/280mm Rotor	Oversize 320mm Rotor Kit	Relocating Bracket for 320mm Rotor
Bugrider 250			FA416TT		FA416R	N/A	N/A							
G-Max 250	06-08		FA095		FA095HH	N/A								
500 Bug	08-09		FA484TT*		FA484R*		N/A							
Parking brake	08-09		FA232TT		FA232R									
BR 600i Racer	07-09		FA484TT*		FA484R*	TBA	TBA							
BR 600i Racer	12		FA484TT*		FA484R*	TBA	TBA							

### PIAGGIO

Boss 50	88-89		909											
Bravo 50 Alloy Wheels	73-81		909											
Bravo 50 Spoke Wheels	73-81		N/A											
Bravo 3	87-90		909											
Ciao - All models	71-99		909											
Ciao Mix Teen 50	96-01		808											
Ciao 50 Catalitico	99-05		909											
Diesis 50	01-05	SFA115	SFAC115		SFA115HH	MD943D		MD943C	VR943					
FL2 50 HP	91-97		V903											
Fly 50 (2T)	05-13	SFA353	SFAC353		SFA353HH	MD910D		MD910C	VR910					
Fly 50 (4T)	05-12	SFA353	SFAC353		SFA353HH	MD910D		MD910C	VR910					
Free 50	92-00		908											
Free 50 (Disc model)	95-00	SFA116					MD910D	MD910C	VR910					
Free Delivery 50	00-01	SFA116				MD910D		MD910C	VR910					
Free 50	02	SFA193	SFAC193		SFA193HH	MD910D		MD910C	VR910					
Grillo 50	89-93		909											
Liberty 50 (Grimeca Caliper) (2T/5 Spoke Wheels)	97-08	SFA260	SFAC260		SFA260HH	MD956D			VR956					
Liberty 50 (Heng Tong Caliper) (2T/5 Spoke Wheels)	97-08	SFA260	SFAC260		SFA260HH	MD956D			VR956					
Liberty 50 4T (Grimeca Caliper/5 Spoke Wheels)	00-08	SFA260	SFAC260		SFA260HH	MD956D			VR956					
Liberty 50 4T (Heng Tong Caliper/5 Spoke Wheels)	00-08	SFA260	SFAC260		SFA260HH	MD956D			VR956					
Liberty 50 (2T/10 Spoke Cast Wheels)	09-13	SFA353	SFAC353		SFA353HH	MD959D			VR959					
Liberty 50 (4T/10 Spoke Cast Wheels)	09-13	SFA353	SFAC353		SFA353HH	MD959D			VR959					
Liberty S 50 (2T)	07-08	SFA260	SFAC260		SFA260HH	MD956D			VR956					
Liberty S 50 (4T)	07-08	SFA260	SFAC260		SFA260HH	MD956D			VR956					
Liberty Elettrico	11-12	SFA260	SFAC260		SFA260HH	MD956D			VR956					
New Fly 50 (4T/4V)	12-13	SFA353	SFAC353		SFA353HH	MD9126D								
NRG 50	94-96	SFA193	SFAC193		SFA193HH	MD943D		MD943C	VR943					
NRG 50 RST (DT/DD) MC2 (Rear drum)	96-97	SFA193	SFAC193		SFA193HH	MD943D		MD943C	VR943					
NRG 50 RST (DD/DT) MC2 (Rear drum)	98	SFA193	SFAC193		SFA193HH	MD943D		MD943C	VR943					
NRG 50 RST (DD/DT) MC2 (Rear disc)	98	SFA193	SFAC193		SFA193HH	MD943D		MD943C	VR943					
NRG 50 Extreme (Rear Drum Model)	99-01	SFA193	SFAC193		SFA193HH	MD924D		MD924C	VR924					
NRG 50 Extreme (Rear Disc Model)	99-01	SFA193	SFAC193		SFA193HH	MD924D		MD924C	VR924					
NRG 50 DT MC3 (Rear Drum Model)	01-05	SFA193	SFAC193		SFA193HH	MD924D		MD924C	VR924					
NRG 50 MC3 DD (Rear Disc Model)	01-05	SFA193	SFAC193		SFA193HH	MD924D		MD924C	VR924					
NRG 50 Power DD	05-13	SFA083/2			SFA083/2HH	MD956D			VR956					
NRG 50 Power Pure Jet	04-10	SFA083/2			SFA083/2HH	MD956D			VR956					
NRG 50 Power DT	05-13	SFA083/2			SFA083/2HH	MD956D			VR956					
NRG 50 Silver Bullet	10	SFA083/2			SFA083/2HH	MD956D			VR956					
NTT 50	95-96	SFA193	SFAC193		SFA193HH	MD943D			VR943					
Quartz 50	92-96	SFA186	SFAC186			MD902D			VR902					
S1 50 Alloy Wheels	79-88		909											
S1 50 Spoke Wheels	79-88		N/A											
S1 50 FL2	91-97		909											
S1 Mix 50	96-99		808											
Scatto 50	92-93		890											
Sefera Base 50	91-93		885											
Sefera 50 Maquillage 2	94		885											
Sefera 50 RST	95-97	SFA255				MD910D		MD910C	VR910					
Superbravo 50	85-90		896											
Typhoon	94-97	SFA193	SFAC193		SFA193HH	MD9126D								
Typhoon 50 X	98-99	SFA193	SFAC193		SFA193HH	MD9126D								
Typhoon 50 XR	00	SFA193	SFAC193		SFA193HH	MD9126D								

\*-2 Sets Required. ■ - Also available in MX-S race compound.

**SAFETY WARNING:** DO NOT USE HH PADS ON REAR UNLESS ALSO USED ON FRONT TO AVOID BRAKE IMBALANCE

APPLICATIONS  
BRAKE

R Suffix = High Durability Sintered Pad. HH Suffix = High Performance Sintered Pad. G Suffix = Grooved Shoe.  
D Suffix = Drilled Disc. C Suffix = Contoured Disc. LS Suffix = Left/Steel Disc. RS = Right/Steel Disc.

# Non-JAPANESE Built Motorcycles

**BRAKE APPLICATIONS**



**PGO**



← REAR / ARRIÈRE / HINTEN POSTERIOR / POSTERIORE →

		DISC PAD CHOICES				BRAKE ROTOR CHOICES			
		NEW SFAC Scooter Carbon Pads	Semi-Sintered V-Pads™	Sintered/HH Pads/ Grooved shoes	Contour Rotor Rear Fitment	NEW Vee-Rotors™ CONTOUR	NEW CX Extreme® ROTOR		
Bugrider 250		FA054TT			FA054R	N/A			
G-Max 250	06-08	SFA197			FA197HH	N/A			
500 Bug	08-09	FA377TT							
BR 500i Racer	07-09	FA377TT*			FA377R*	TBA*			
BR 600i Racer	12	FA377TT*			FA377R*	TBA*			
<b>PIAGGIO</b>									
Boss 50	88-89	V907							
Bravo 50 Alloy Wheels	73-81	V907							
Bravo 50 Spoke Wheels	73-81	V907							
Bravo 3	87-90	N/A							
Ciao - All models	71-99	V907							
Ciao Mix Teen 50	96-01	V907							
Ciao 50 Catalitico	99-05	V907							
Diesis 50	01-05	899							
FL2 50 HP	91-97	V903							
Fly 50 (2T)	05-13	816							
Fly 50 (4T)	05-12	816							
Free 50	92-00	806							
Free 50 (Disc model)	95-00	806							
Free Delivery 50	00-01	899							
Free 50	02	899							
Gillo 50	89-93	V907							
Liberty 50 (Girmecca Caliper) (2T/5 Spoke Wheels)	97-08	816							
Liberty 50 (Heng Tong Caliper) (2T/5 Spoke Wheels)	97-08	816							
Liberty 50 4T (Girmecca Caliper/5 Spoke Wheels)	00-08	816							
Liberty 50 4T (Heng Tong Caliper/5 Spoke Wheels)	00-08	816							
Liberty 50 (2T/10 Spoke Cast Wheels)	09-13	816							
Liberty 50 (4T/10 Spoke Cast Wheels)	09-13	816							
Liberty S 50 (2T)	07-08	816							
Liberty S 50 (4T)	07-08	816							
Liberty Elettrico	11-12	816							
New Fly 50 (4T/4V)	12-13	816							
NRG 50	94-96	806							
NRG 50 RST (DT/DD) MC2 (Rear drum)	96-97	806							
NRG 50 RST (DD/DT) MC2 (Rear drum)	98	899							
NRG 50 RST (DD/DT) MC2 (Rear disc)	98	SFA260	SFAC260		SFA260HH	MD932D	MD932C	VR932	
NRG 50 Extreme (Rear Drum Model)	99-01	899							
NRG 50 Extreme (Rear Disc Model)	99-01	SFA260	SFAC260		SFA260HH	MD932D	MD932C	VR932	
NRG 50 DT MC3 (Rear Drum Model)	01-05	899							
NRG 50 MC3 DD (Rear Disc Model)	01-05	SFA260	SFAC260		SFA260HH	MD932D	MD932C	VR932	
NRG 50 Power DD	05-13	SFA260			SFA260HH	MD932D		VR932	
NRG 50 Power Pure Jet	04-10	SFA260			SFA260HH	MD932D		VR932	
NRG 50 Power DT	05-13	899							
NRG 50 Silver Bullet	10	SFA260			SFA260HH	MD932D		VR932	
NTT 50	95-96	806							
Quartz 50	92-96	886							
S1 50 Alloy Wheels	79-88	V907							
S1 50 Spoke Wheels	79-88	V907							
S1 50 FL2	91-97	V907							
S1 Mix 50	96-99	V907							
Scatto 50	92-93	890							
Sefera Base 50	91-93	806							
Sefera 50 Maquillage 2	94	806							
Sefera 50 RST	95-97	806							
Superbravo 50	85-90	V907							
Typhoon	94-97	806							
Typhoon 50 X	98-99	806							
Typhoon 50 XR	00	899							

\*-2 Sets Required. ■ - Also available in MX-S race compound.

**SAFETY WARNING:** DO NOT USE HH PADS ON REAR UNLESS ALSO USED ON FRONT TO AVOID BRAKE IMBALANCE

**R** Suffix = High Durability Sintered Pad. **HH** Suffix = High Performance Sintered Pad. **G** Suffix = Grooved Shoe.  
**D** Suffix = Drilled Disc. **C** Suffix = Contoured Disc. **LS** Suffix = Left/Steel Disc. **RS** = Right/Steel Disc.

# Non-JAPANESE Built Motorcycles



**PIAGGIO**



← FRONT / AVANT / VORN FRENTE / ANTERIORE →

		DISC PAD CHOICES				BRAKE ROTOR CHOICES							
		NEW SFAC Scooter Carbon Pads	Semi-Sintered V-Pads™	Sintered/HH Pads/ Grooved shoes	Left/Gauche/Links	Right/Droite/Rechts	Contour Rotor Universal left and right fitment	NEW Vee-Rotors™ CONTOUR	NEW CX Extreme® ROTOR	Oversize 250/280mm Rotor Kit	Relocating Bracket for 250/280mm Rotor	Oversize 320mm Rotor Kit	Relocating Bracket for 320mm Rotor
Typhoon 50 (2T) (Heng Tong Caliper/10" Wheels)	01-09	SFA193	SFAC193	SFA193HH	MD9126D								
Typhoon 50 (2T) (Grimeca Caliper/10" wheels)	00-04	SFA193	SFAC193	SFA193HH	MD9126D								
Typhoon 50 (2T/12" Wheels)	10-13	SFA353	SFAC353	SFA353HH	MD9126D								
Velofax 50	96-99	899											
Zip 50 Base (Drum Model)	92-96	909											
Zip Fast Rider	93-97	SFA193	SFAC193	SFA193HH	MD904D		MD904C	VR904					
Zip & Zip 50 Bimodale	94-97	896											
Zip 50 Base (Disc model)	95-96	SFA193	SFAC193	SFA193HH	MD904D		MD904C	VR904					
Zip 50 RST	96-99	808											
Zip 50 RST	96-99	SFA260	SFAC193	SFA260HH	MD904D		MD904C	VR904					
Zip 50 (Grimeca Caliper) (Heng Tong Caliper) (A/C) 4T	00-09	SFA260	SFAC193	SFA260HH	MD932D		MD932C	VR932					
Zip 50 SP (Liquid Cooled)	96-12	SFA260	SFAC193	SFA260HH	MD910D		MD910C	VR910					
Zip 50 Elettrico	02	SFA193	SFAC193	SFA193HH	MD904D		MD904C	VR904					
Zip 50 (2T)	00-12	SFA260	SFAC193	SFA260HH	MD932D		MD932C	VR932					
Zip 50 SP (2T)	13	SFA260	SFAC193	SFA260HH	MD932D		MD932C	VR932					
Zip 50 (4T)	00-12	SFA260	SFAC193	SFA260HH	MD932D		MD932C	VR932					
SKR 80 City	99	885											
Diesis 100	01-03	SFA115	SFAC115	SFA115HH	MD943D		MD943C	VR943					
Fly 100 (4T)	07-12	SFA353	SFAC353	SFA353HH	MD910D		MD910C	VR910					
Free 100	02	SFA193	SFAC193	SFA193HH	MD910D		MD910C	VR910					
Zip 100	06-10	SFA260	SFAC260	SFA260HH	MD932D		MD932C	VR932					
125 GTR (VNL2)	74	V901											
Beverly B 125/200 (Heng Tong Caliper)	02-06	SFA353	SFAC353	SFA353HH	MD961D			VR961					
Beverly B 125/200 (Grimeca Caliper)	02-06	SFA194	SFAC194	SFA194HH	MD961D			VR961					
Beverly 125	07	SFA353	SFAC353	SFA353HH	MD961D			VR961					
Beverly S 125	07	SFA353	SFAC353	SFA353HH	MD961D			VR961					
Beverly Tourer 125	08-09	SFA353	SFAC353	SFA353HH	MD961D			VR961					
Beverly 125 (Multi Spoke Cast Type Wheels/ 4T)	11-12	SFA353	SFAC353	SFA353HH	TBA			VR961					
Carnaby 125	07-09	SFA353	SFAC353	SFA353HH	MD961D			VR961					
Cosa CL/CLX 125/200	88-91	882											
Cosa 2 125	91-97	882											
Fly 125	05-12	SFA353	SFAC353	SFA353HH	MD910D		MD910C	VR910					
Hexagon 125/150	94-97	SFA193	SFAC193	SFA193HH	MD905D								
Hexagon LX4 125	98-99	SFA194	SFAC194	SFA194HH	MD910D		MD910C	VR910					
Liberty 125 (5 Spoke Wheels)	98-08	SFA260	SFAC260	SFA260HH	MD956D			VR956					
Liberty 125 (4T/10 Spoke Cast Wheels)	09-13	SFA260	SFAC260	SFA260HH	MD956D			VR956					
Liberty 125 (Full Optional/4T/10 Spoke Cast Wheels)	13	SFA260	SFAC260	SFA260HH	MD956D			VR956					
Liberty S 125	07-08	SFA260	SFAC260	SFA260HH	MD956D			VR956					
MP3 125 (Carb models) (12" rear wheel)	06-08	SFA260*	SFAC260*	SFA260HH*	MD9112D	MD9112D		VR9112*					
MP3 125 (Carb models) (12" rear wheel) Parking brake	06-08	SFA257/2											
MP3 125 ie (EFI models) (14" rear wheel)	08-11	SFA260*	SFAC260*	SFA260HH*	MD9112D	MD9112D		VR9112*					
MP3 125 ie (EFI models) (14" rear wheel) Parking brake	08-11	SFA257/2											
MP3 125 (Hybrid/125cc) (14" rear wheel)	09-12	SFA260*	SFAC260*	SFA260HH*	MD9112D	MD9112D		VR9112*					
MP3 125 (Hybrid/125cc) (14" rear wheel) Parking brake	09-12	SFA257/2											
125 ie MP3 Yourban	11-12	SFA260*	SFAC260*	SFA260HH*	MD9112D	MD9112D		VR9112*					
125 ie MP3 Yourban - Parking Brake	11-12	SFA257/2											
New Fly 125 ie (3V)	12-13	SFA353	SFAC353	SFA353HH	MD9126D								
Skipper LX 125/150	98-99	SFA194	SFAC194	SFA194HH	MD924D		MD924C	VR924					
Skipper 125/150	94-97	SFA186	SFAC186		MD902D			VR902					
Skipper ST 125/150 4T (Grimeca Caliper)	00-04	SFA194	SFAC194	SFA194HH	MD924D		MD924C	VR924					
Skipper ST 125/150 4T (Heng Tong Caliper)	00-04	SFA353	SFAC353	SFA353HH	MD924D		MD924C	VR924					
Sefera 125	95-97	SFA255			MD910D		MD910C	VR910					
Super Hexagon GTX 125/180 (11" wheels) (Grimeca calipers)	00	SFA194	SFAC194	SFA194HH	MD910D		MD910C	VR910					
Super Hexagon GTX 125/180 (11" wheels) (Heng Tong Calipers)	00	SFA353	SFAC353	SFA353HH	MD910D		MD910C	VR910					
Super Hexagon GTX 125/180 (12" wheels)	01-03	SFA353	SFAC353	SFA353HH	MD960D			VR960					
Typhoon 125	99-03	SFA193	SFAC193	SFA193HH	MD9126D								
Typhoon 125 (4T/12" Wheels)	10-13	SFA353	SFAC353	SFA353HH	MD9126D								
Xevo 125	07-13	SFA353	SFAC353	SFA353HH	MD983D			VR983					
X7 125cc	08-09	SFA353	SFAC353	SFA353HH	MD983D			VR983					
X7 Evo 125 ie (EFI)	09-12	SFA353	SFAC353	SFA353HH	MD983D			VR983					

\*-2 Sets Required. ■ - Also available in MX-S race compound.

**SAFETY WARNING:** DO NOT USE HH PADS ON REAR UNLESS ALSO USED ON FRONT TO AVOID BRAKE IMBALANCE

**APPLICATIONS**

**BRAKE**  
**R** Suffix = High Durability Sintered Pad. **HH** Suffix = High Performance Sintered Pad. **G** Suffix = Grooved Shoe.  
**D** Suffix = Drilled Disc. **C** Suffix = Contoured Disc. **LS** Suffix = Left/Steel Disc. **RS** = Right/Steel Disc.



# Non-JAPANESE Built Motorcycles

**BRAKE  
APPLICATIONS**

**R** Suffix = High Durability Sintered Pad. **HH** Suffix = High Performance Sintered Pad. **G** Suffix = Grooved Shoe.  
**D** Suffix = Drilled Disc. **C** Suffix = Contoured Disc. **LS** Suffix = Left/Steel Disc. **RS** = Right/Steel Disc.



**PIAGGIO**



← REAR / ARRIÈRE / HINTEN POSTERIOR / POSTERIORE →

			DISC PAD CHOICES			BRAKE ROTOR CHOICES				
			NEW SFAC Scooter Carbon Pads	Semi-Sintered V-Pads™	Sintered/HH Pads/ Grooved shoes	Contour Rotor Rear Fitment	NEW Vee-Rotors™ CONTOUR	NEW CX Extreme® ROTOR		
Typhoon 50 (2T) (Heng Tong Caliper/10" Wheels)	01-09	899								
Typhoon 50 (2T) (Grimeca Caliper/10" wheels)	00-04	899								
Typhoon 50 (2T/12" Wheels)	10-13	816								
Velofox 50	96-99	809								
Zip 50 Base (Drum Model)	92-96	806								
Zip Fast Rider	93-97	806								
Zip & Zip 50 Bimodale	94-97	806								
Zip 50 Base (Disc model)	95-96	806								
Zip 50 RST	96-99	899								
Zip 50 RST	96-99	899								
Zip 50 (Grimeca Caliper) (Heng Tong Caliper) (A/C) 4T	00-09	899								
Zip 50 SP (Liquid Cooled)	96-12	899								
Zip 50 Elettrico	02	806								
Zip 50 (2T)	00-12	899								
Zip 50 SP (2T)	13	899								
Zip 50 (4T)	00-12	899								
SKR 80 City	99	806								
Diesis 100	01-03	S624								
Fly 100 (4T)	07-12	816								
Free 100	02	816								
Zip 100	06-10	899								
125 GTR (VNL2)	74	V903								
Beverly B 125/200 (Heng Tong Caliper)	02-06	SFA353	SFAC353		SFA353HH	MD961D		VR961		
Beverly B 125/200 (Grimeca Caliper)	02-06	SFA194	SFAC194		SFA194HH	MD961D		VR961		
Beverly 125	07					MD961D		VR961		
Beverly S 125	07	SFA353	SFAC353		SFA353HH	MD961D		VR961		
Beverly Tourer 125	08-09	SFA353	SFAC353		SFA353HH	MD961D		VR961		
Beverly 125 (Multi Spoke Cast Type Wheels/ 4T)	11-12	SFA418	SFAC418		SFA418HH	TBA				
Carnaby 125	07-09	SFA353	SFAC353		SFA353HH	MD961D		VR961		
Cosa CL/CLX 125/200	88-91	881								
Cosa 2 125	91-97	881								
Fly 125	05-12	816								
Hexagon 125/150	94-97	899								
Hexagon LX4 125	98-99	816								
Liberty 125 (5 Spoke Wheels)	98-08	816								
Liberty 125 (4T/10 Spoke Cast Wheels)	09-13	816								
Liberty 125 (Full Optional/4T/10 Spoke Cast Wheels)	13	816								
Liberty S 125	07-08	816								
MP3 125 (Carb models) (12" rear wheel)	06-08	SFA425	SFAC425		SFA425HH	MD960D		VR960		
MP3 125 ie (EFI models) (14" rear wheel)	08-11	SFA418	SFAC418		SFA418HH	MD960D		VR960		
MP3 125 (Hybrid/125cc) (14" rear wheel)	09-12	SFA418	SFAC418		SFA418HH	MD960D		VR960		
125 ie MP3 Yourban	11-12	SFA418	SFAC418		SFA418HH	MD960D		VR960		
New Fly 125 ie (3V)	12-13	SFA321	SFAC321		SFA321HH	MD956D				
Skipper LX 125/150	98-99	816								
Skipper 125/150	94-97	899								
Skipper ST 125/150 4T (Grimeca Caliper)	00-04	816								
Skipper ST 125/150 4T (Heng Tong Caliper)	00-04	816								
Setera 125	95-97	899								
Super Hexagon GTX 125/180 (11" wheels) (Grimeca calipers)	00	SFA321	SFAC321		SFA321HH	MD910D	MD910C	VR910		
Super Hexagon GTX 125/180 (11" wheels) (Heng Tong Calipers)	00	SFA321	SFAC321		SFA321HH	MD910D	MD910C	VR910		
Super Hexagon GTX 125/180 (12" wheels)	01-03	SFA321	SFAC321		SFA321HH	MD956D		VR956		
Typhoon 125	99-03	816								
Typhoon 125 (4T/12" Wheels)	10-13	816								
Xevo 125	07-13	SFA418	SFAC418		SFA418HH	MD960D		VR960		
X7 125cc	08-09	SFA418	SFAC418		SFA418HH	MD960D		VR960		
X7 Evo 125 ie (EFI)	09-12	SFA418	SFAC418		SFA418HH	MD960D		VR960		

\*-2 Sets Required. ■ - Also available in MX-S race compound.

**SAFETY WARNING:** DO NOT USE HH PADS ON REAR UNLESS ALSO USED ON FRONT TO AVOID BRAKE IMBALANCE

# Non-JAPANESE Built Motorcycles



← FRONT / AVANT / VORN FRENTE / ANTERIORE →

**PIAGGIO**

**DISC PAD CHOICES**

**BRAKE ROTOR CHOICES**

Model	Year	Disc Pad	DISC PAD CHOICES			BRAKE ROTOR CHOICES								
			NEW SFAC Scooter Carbon Pads	Semi-Sintered V-Pads™	Sintered/HH Pads/ Grooved shoes	Left/Gauche/Links	Right/Droite/Rechts	Contour Rotor Universal left and right fitment	NEW Vee-Rotors™ CONTOUR	NEW CX Extreme® ROTOR	Oversize 250/280mm Rotor Kit	Relocating Bracket for 250/280mm Rotor	Oversize 320mm Rotor Kit	Relocating Bracket for 320mm Rotor
X8 125	04-05	SFA353	SFAC353		SFA353HH	MD983D				VR983				
X8 125	05-06	SFA353	SFAC353		SFA353HH	MD983D				VR983				
X8 125 ie	07	SFA353	SFAC353		SFA353HH	MD961D				VR961				
X8 125 Street	06-07	SFA353	SFAC353		SFA353HH	MD961D				VR961				
X9 125	00-02	SFA266*	SFAC266*		SFA266HH*	MD959D	MD959D	MD959C*		VR959*				
X9 125 Evolution (Brembo/Single pin fixing)	03-04	SFA266*	SFAC266*		SFA266HH*	MD959D	MD959D	MD959C*		VR959*				
X9 125 Evolution (Henglong/2 Pin Fixing)	Left 05-07	SFA353	SFAC353		SFA353HH	MD959D		MD959C		VR959				
		Right	SFA418	SFAC418		SFA418HH		MD959D	MD959C	VR959				
X 10 125 (4V/4T/EF)	Left 12-13	SFA353	SFAC353		SFA353HH	TBA								
		Right	SFA418	SFAC418		SFA418HH		TBA						
Zip 125 (4T-200mm F/Disc)	00-01	SFA260	SFAC260		SFA260HH	MD910D		MD910C		VR910				
Zip 125 (4T-175mm F/Disc)	02-04	SFA260	SFAC260		SFA260HH	MD932D		MD932C		VR932				
Fly 150 (4T)	05-12	SFA353	SFAC353		SFA353HH	MD910D		MD910C		VR910				
150 Sprint Veloce (VLB1)	74	V901												
Cosa CL/CLX 150	88-91	882												
Cosa 2 150	91-97	882												
150 Super (VBC1)	74	V905												
Liberty 150 (5 Spoke Wheels)	08	SFA260	SFAC260		SFA260HH	MD956D				VR956				
Liberty 150 (4T / 10 Spoke Cast Wheels)	09-12	SFA260	SFAC260		SFA260HH	MD956D				VR956				
X8 150 Street	06-08	SFA353	SFAC353		SFA353HH	MD961D				VR961				
Hexagon LX 180	98-99	SFA194	SFAC194		SFA194HH	MD910D		MD910C		VR910				
Hexagon LXT 180	98-99	SFA194	SFAC194		SFA194HH	MD910D		MD910C		VR910				
X9 180 Amalfi	00-03	SFA266*	SFAC266*		SFA266HH*	MD959D	MD959D	MD959C*		VR959*				
Carnaby 200	07-09	SFA353	SFAC353		SFA353HH	MD961D				VR961				
Cosa CL/CLX 200	88-91	882												
Cosa 2 200	91-97	882												
Liberty 200	98-07	SFA260	SFAC260		SFA260HH	MD956D				VR956				
Liberty S 200	07-08	SFA260	SFAC260		SFA260HH	MD956D				VR956				
Rally 200 (VSE1)	74	V901												
X8 200	04-05	SFA353	SFAC353		SFA353HH	MD983D				VR983				
X9 200	02-03	SFA266*	SFAC266*		SFA266HH*	MD959D	MD959D	MD959C*		VR959*				
X9 200 Evolution	03-04	SFA266*	SFAC266*		SFA266HH*	MD959D	MD959D	MD959C*		VR959*				
Beverley 250 (Carb Model)	04-07	SFA353	SFAC353		SFA353HH	MD961D				VR961				
Beverley 250 ie	06-07	SFA353	SFAC353		SFA353HH	MD961D				VR961				
Beverley S 250 ie	07	SFA353	SFAC353		SFA353HH	MD961D				VR961				
Beverley Cruiser 250 ie	07-08	SFA353	SFAC353		SFA353HH	MD961D				VR961				
Beverley Tourer 250 ie	08-09	SFA353	SFAC353		SFA353HH	MD961D				VR961				
Carnaby 250 ie	08-09	SFA353	SFAC353		SFA353HH	MD961D				VR961				
Hexagon GT 250	98-99	SFA194	SFAC194		SFA194HH	MD910D		MD910C		VR910				
MP3 250 EFI (12" rear wheel)	06-08	SFA260*	SFAC260*		SFA260HH*	MD9112D	MD9112D			VR9112*				
MP3 250 EFI (12" rear wheel) Parking brake	06-08	SFA257/2												
MP3 250 MIC/EFI (14" rear wheel)	08-09	SFA260*	SFAC260*		SFA260HH*	MD9112D	MD9112D			VR9112*				
MP3 250 MIC/EFI (14" rear wheel) Parking brake	08-09	SFA257/2												
MP3 LT 250 ie (14" rear wheel)	09	SFA260*	SFAC260*		SFA260HH*	MD9112D	MD9112D			VR9112*				
MP3 LT 250 ie (14" rear wheel) Parking brake	09	SFA257/2												
Super Hexagon GTX 250	00-02	SFA194	SFAC194		SFA194HH	MD910D		MD910C		VR910				
Xevo 250 ie	07-10	SFA353	SFAC353		SFA353HH	MD983D				VR983				
X7 250 ie	08-09	SFA353	SFAC353		SFA353HH	MD983D				VR983				
X8 250 ie	05-06	SFA353	SFAC353		SFA353HH	MD983D				VR983				
X8 250 ie	07	SFA353	SFAC353		SFA353HH	MD961D								
X9 250 (13" rear wheel)	00-04	SFA266*	SFAC266*		SFA266HH*	MD959D	MD959D	MD959C*		VR959*				
X9 250 (Linked brake F & R wheel 14" dia)	04	SFA181*	SFAC181*		SFA181HH*	MD983D	MD983D			VR983*				
X9 250	Left 05-06	SFA353	SFAC353		SFA353HH	MD959D		MD959C		VR959				
		Right	SFA418	SFAC418		SFA418HH		MD959D	MD959C	VR959				
Beverly 300 (278cc/4T/5 Spoke Wheel)	10-13	SFA353	SFAC353		SFA353HH	TBA								
Beverly 300 Sport Touring (330cc/4T/Multi Spoke Wheel)	11-13	SFA324	SFAC324		SFA324HH	TBA								
Carnaby Cruiser 300	08-11	SFA353	SFAC353		SFA353HH	MD961D				VR961				
Carnaby 300 ie	12	SFA353	SFAC353		SFA353HH	MD961D				VR961				
MP3 LT 300 ie	10	SFA260*	SFAC260*		SFA260HH*	MD9112D	MD9112D			VR9112*				
MP3 LT 300 ie Parking brake	10	SFA257/2												

\*-2 Sets Required. ■ - Also available in MX-S race compound.

**SAFETY WARNING:** DO NOT USE HH PADS ON REAR UNLESS ALSO USED ON FRONT TO AVOID BRAKE IMBALANCE

APPLICATIONS

**BRAKE**  
**R** Suffix = High Durability Sintered Pad. **HH** Suffix = High Performance Sintered Pad. **G** Suffix = Grooved Shoe.  
**D** Suffix = Drilled Disc. **C** Suffix = Contoured Disc. **LS** Suffix = Left/Steel Disc. **RS** = Right/Steel Disc.

# Non-JAPANESE Built Motorcycles



**PIAGGIO**



← REAR / ARRIÈRE / HINTEN POSTERIOR / POSTERIORE →

		DISC PAD CHOICES				BRAKE ROTOR CHOICES			
		NEW SFAC Scooter Carbon Pads	Semi-Sintered V-Pads™	Sintered/HH Pads/ Grooved shoes		Contour Rotor Rear Fitment	NEW Vee-Rotors™ CONTOUR	NEW CX Extreme® ROTOR	
X8 125	04-05	SFA266	SFAC266			MD960D		VR960	
X8 125	05-06	SFA425	SFAC425			MD960D		VR960	
X8 125 ie	07	SFA425	SFAC425			SFA425HH		VR960	
X8 125/Street	06-07	816							
X9 125	00-02	SFA266	SFAC266			MD959D	MD959C	VR959	
X9 125 Evolution (Brembo/Single pin fixing)	03-04	SFA266	SFAC266			SFA266HH	MD959D	MD959C	VR959
X9 125 Evolution (Hengtong/2 Pin Fixing)	05-07	SFA266	SFAC266			SFA266HH	MD959D	MD959C	VR959
X 10 125 (4V/4T/EF)	12-13	SFA418	SFAC418			SFA418HH	TBA		
Zip 125 (4T-200mm F/Disc)	00-01	899							
Zip 125 (4T-175mm F/Disc)	02-04	899							
Fly 150 (4T)	05-12	816							
150 Sprint Veloce (VLB1)	74	V903							
Cosa CL/CLX 150	88-91	881							
Cosa 2 150	91-97	881							
150 Super (VBC1)	74	V902							
Liberty 150 (5 Spoke Wheels)	08	816							
Liberty 150 (4T / 10 Spoke Cast Wheels)	09-12	816							
X8 150 Street	06-08	816							
Hexagon LX 180	98-99	816							
Hexagon LXT 180	98-99	816							
X9 180 Amalfi	00-03	SFA266	SFAC266			SFA266HH	MD959D	MD959C	VR959
Carnaby 200	07-09	SFA353	SFAC353			SFA353HH	MD961D		VR961
Cosa CL/CLX 200	88-91	881							
Cosa 2 200	91-97	881							
Liberty 200	98-07	816							
Liberty S 200	07-08	816							
Rally 200 (VSE1)	74	V903							
X8 200	04-05	SFA266	SFAC266			SFA266HH	MD960D		VR960
X9 200	02-03	SFA266	SFAC266			SFA266HH	MD959D	MD959C	VR959
X9 200 Evolution	03-04	SFA266	SFAC266			SFA266HH	MD959D	MD959C	VR959
Beverley 250 (Carb Model)	04-07	SFA353	SFAC353			SFA353HH	MD961D		VR961
Beverley 250 ie	06-07	SFA353	SFAC353			SFA353HH	MD961D		VR961
Beverley S 250 ie	07	SFA353	SFAC353			SFA353HH	MD961D		VR961
Beverley Cruiser 250 ie	07-08	SFA353	SFAC353			SFA353HH	MD961D		VR961
Beverley Tourer 250 ie	08-09	SFA353	SFAC353			SFA353HH	MD961D		VR961
Carnaby 250 ie	08-09	SFA353	SFAC353			SFA353HH	MD961D		VR961
Hexagon GT 250	98-99	H350							
MP3 250 EFI (12" rear wheel)	06-08	SFA425	SFAC425			SFA425HH	MD960D		VR960
MP3 250 MIC/EFI (14" rear wheel)	08-09	SFA418	SFAC418			SFA418HH	MD960D		VR960
MP3 LT 250 ie (14" rear wheel)	09	SFA418	SFAC418			SFA418HH	MD960D		VR960
Super Hexagon GTX 250	00-02	SFA321	SFAC321			SFA321HH	MD910D	MD910C	VR910
Xevo 250 ie	07-10	SFA418	SFAC418			SFA418HH	MD960D		VR960
X7 250 ie	08-09	SFA418	SFAC418			SFA418HH	MD960D		VR960
X8 250 ie	05-06	SFA425	SFAC425			SFA425HH	MD960D		VR960
X8 250 ie	07	SFA425	SFAC425			SFA425HH	MD960D		VR960
X9 250 (13" rear wheel)	00-04	SFA266	SFAC266			SFA266HH	MD959D	MD959C	VR959
X9 250 (Linked brake F & R wheel 14" dia)	04	SFA266	SFAC266			SFA266HH	MD960D		VR960
X9 250	05-06	SFA425	SFAC425			SFA425HH	MD959D	MD959C	VR959
Beverly 300 (278cc/4T/5 Spoke Wheel)	10-13	SFA418	SFAC418			SFA418HH	TBA		
Beverly 300 Sport Touring (330cc/4T/Multi Spoke Wheel)	11-13	SFA418	SFAC418			SFA418HH	TBA		
Carnaby Cruiser 300	08-11	SFA353	SFAC356			SFA353HH	MD961D		VR961
Carnaby 300 ie	12	SFA353	SFAC353			SFA353HH	MD961D		VR961
MP3 LT 300 ie	10	SFA418	SFAC418			SFA418HH	MD960D		VR960

\*-2 Sets Required. ■ - Also available in MX-S race compound.

**SAFETY WARNING:** DO NOT USE HH PADS ON REAR UNLESS ALSO USED ON FRONT TO AVOID BRAKE IMBALANCE

**BRAKE APPLICATIONS**

**R** Suffix = High Durability Sintered Pad. **HH** Suffix = High Performance Sintered Pad. **G** Suffix = Grooved Shoe.  
**D** Suffix = Drilled Disc. **C** Suffix = Contoured Disc. **LS** Suffix = Left/Steel Disc. **RS** = Right/Steel Disc.

# Non-JAPANESE Built Motorcycles



← FRONT / AVANT / VORN FRENTE / ANTERIORE →

Model	Year	Disc Pad Choices	BRAKE ROTOR CHOICES									
			NEW SFAC Scooter Carbon Pads	Semi-Sintered V-Pads™	Sintered/HH Pads/ Grooved shoes	Left/Gauche/Links Right/Droite/Rechts	Contour Rotor Universal left and right fitment	NEW Vee-Rotors™ CONTOUR	NEW CX Extreme® ROTOR	Oversize 250/280mm Rotor Kit	Relocating Bracket for 250/280mm Rotor	Oversize 320mm Rotor Kit
MP3 Business LT 300 ie	13	SFA260*	SFAC260*	SFA260HH*	MD9112D	MD9112D		VR9112*				
MP3 Business LT 300 ie Parking brake		SFA257/2										
MP3 Hybrid 300 ie	11-13	SFA260*	SFAC260*	SFA260HH*	MD9112D	MD9112D		VR9112*				
MP3 Hybrid 300 ie Parking brake		SFA257/2										
MP3 Hybrid LT 300 ie	11-12	SFA260*	SFAC260*	SFA260HH*	MD9112D	MD9112D		VR9112*				
MP3 Hybrid LT 300 ie Parking brake		SFA257/2										
MP3 Touring 300 ie	11-12	SFA260*	SFAC260*	SFA260HH*	MD9112D	MD9112D		VR9112*				
MP3 Touring 300 ie Parking brake		SFA257/2										
MP3 Touring LT 300 ie	11-12	SFA260*	SFAC260*	SFA260HH*	MD9112D	MD9112D		VR9112*				
MP3 Touring LT 300 ie Parking brake		SFA257/2										
MP3 Sport LT 300 ie	13	SFA260*	SFAC260*	SFA260HH*	MD9112D	MD9112D		VR9112*				
MP3 Sport LT 300 ie Parking brake		SFA257/2										
300 ie MP3 Yourban	11-13	SFA260*	SFAC260*	SFA260HH*	MD9112D	MD9112D		VR9112*				
300 ie MP3 Yourban - Parking Brake		SFA257/2										
300 ie MP3 Yourban LT	11-13	SFA260*	SFAC260*	SFA260HH*	MD9112D	MD9112D		VR9112*				
300 ie MP3 Yourban LT - Parking Brake		SFA257/2										
300 ie MP3 Yourban LT	13	SFA260*	SFAC260*	SFA260HH*	MD9112D	MD9112D		VR9112*				
300 ie MP3 Yourban LT - Parking Brake	13	SFA257/2										
X7 EVO 300 ie	10-12	SFA353	SFAC353	SFA353HH	MD983D			VR983				
X 10 350 (4V/4T/EFI)	Left 12-13	SFA353	SFAC353	SFA353HH	TBA							
	Right	SFA418	SFAC418	SFA418HH		TBA						
Parking Brake		SFA257/2										
Beverley 400 ie	07	SFA181	SFAC181*	SFA181HH	MD961D	MD961D		VR961*				
Beverley Tourer 400 ie	08-09	SFA266	SFAC266*	SFA266HH	MD961D	MD961D		VR961*				
Trackmaster 400 Quad	06	FA395TT*		FA395R*	MD6173D	MD6173D						
Trackmaster 400 Quad Parking brake	06	FA271TT		FA271R								
MP3 400 ie	07-10	SFA260*	SFAC260*	SFA260HH*	MD9112D	MD9112D		VR9112*				
MP3 400 ie Parking brake	07-10	SFA257/2										
MP3-LT 400 ie	09-10	SFA260*	SFAC260*	SFA260HH*	MD9112D	MD9112D		VR9112*				
MP3-LT 400 ie Parking brake	09-10	SFA257/2										
MP3 Touring 400 ie	11-12	SFA260*	SFAC260*	SFA260HH*	MD9112D	MD9112D		VR9112*				
MP3 Touring 400 ie - Parking brake	11-12	SFA257/2										
MP3 Touring LT 400 ie	11-12	SFA260*	SFAC260*	SFA260HH*	MD9112D	MD9112D		VR9112*				
MP3 Touring LT 400 ie - Parking brake	11-12	SFA257/2										
Xevo 400 ie	Left 07-10	SFA353	SFAC353	SFA353HH	MD959D		MD959C	VR959				
	Right	SFA418	SFAC418	SFA418HH		MD959D	MD959C	VR959				
X8 400 ie	Left 06-08	SFA353	SFAC353	SFA353HH	MD961D			VR961				
	Right	SFA418	SFAC418	SFA418HH		MD961D		VR961				
Beverley B 500	02-05	SFA266*	SFAC266*	SFA266HH*	MD961D	MD961D		VR961				
Beverley 500	06	SFA266*	SFAC266*	SFA266HH*	MD961D	MD961D		VR961				
Beverley Cruiser 500 ie	07-11	SFA266*	SFAC266*	SFA266HH*	MD961D	MD961D		VR961				
Beverley 500 ie	12	SFA266*	SFAC266*	SFA266HH*	MD961D	MD961D		VR961				
MP3 500 EFI	09-10	SFA260*	SFAC260*	SFA260HH*	MD9112D	MD9112D		VR9112*				
MP3 500 EFI Parking brake	09-10	SFA257/2										
MP3 Touring Business 500 ie	11-12	SFA260*	SFAC260*	SFA260HH*	MD9112D	MD9112D		VR9112*				
MP3 Touring Business 500 ie - Parking Brake		SFA257/2										
MP3 Touring Business LT 500 ie	11-13	SFA260*	SFAC260*	SFA260HH*	MD9112D	MD9112D		VR9112*				
MP3 Touring Business LT 500 ie - Parking Brake		SFA257/2										
MP3 Touring Sport 500 ie	11-12	SFA260*	SFAC260*	SFA260HH*	MD9112D	MD9112D		VR9112*				
MP3 Touring Sport 500 ie - Parking Brake		SFA257/2										
MP3 Touring Sport LT 500 ie	11-13	SFA260*	SFAC260*	SFA260HH*	MD9112D	MD9112D		VR9112*				
MP3 Touring Sport LT 500 ie - Parking Brake		SFA257/2										
X9 500/500 SL	00-02	SFA266*	SFAC266*	SFA266HH*	MD961D	MD961D		VR961*				
X9 500 cc Evolution (inc ABS)	03-06	SFA181*	SFAC181*	SFA181HH*	MD983D	MD983D		VR983*				
X9 500 ie	07	SFA181*	SFAC181*	SFA181HH*	MD961D	MD961D		VR961*				
X 10 - 500 i (4V/4T/EFI)	Left 12-13	SFA353	SFAC353	SFA353HH	MD959D		MD959C	VR959				
	Right	SFA418	SFAC418	SFA418HH		TBA	MD959C	VR959				
X 10 - 500 i (4V/4T/EFI) Parking Brake	12-13	SFA257/2										

\*-2 Sets Required. ■ - Also available in MX-S race compound.

**SAFETY WARNING:** DO NOT USE HH PADS ON REAR UNLESS ALSO USED ON FRONT TO AVOID BRAKE IMBALANCE

APPLICATIONS  
BRAKE

R Suffix = High Durability Sintered Pad. HH Suffix = High Performance Sintered Pad. G Suffix = Grooved Shoe.

D Suffix = Drilled Disc. C Suffix = Contoured Disc. LS Suffix = Left/Steel Disc. RS = Right/Steel Disc.

# Non-JAPANESE Built Motorcycles

**BRAKE APPLICATIONS**

**R** Suffix = High Durability Sintered Pad. **HH** Suffix = High Performance Sintered Pad. **G** Suffix = Grooved Shoe.  
**D** Suffix = Drilled Disc. **C** Suffix = Contoured Disc. **LS** Suffix = Left/Steel Disc. **RS** = Right/Steel Disc.



**PIAGGIO**



← REAR / ARRIÈRE / HINTEN POSTERIOR / POSTERIORE →

		DISC PAD CHOICES				BRAKE ROTOR CHOICES			
		NEW SFAC Scooter Carbon Pads	Semi-Sintered V-Pads™	Sintered/HH Pads/ Grooved shoes		Contour Rotor Rear Fitment	NEW Vee-Rotors™ CONTOUR	NEW CX Extreme® ROTOR	
MP3 Business LT 300 ie	13	SFA418	SFAC418		SFA418HH	MD960D		VR960	
MP3 Hybrid 300 ie	11-13	SFA418	SFAC418		SFA418HH	MD960D		VR960	
MP3 Hybrid LT 300 ie	11-12	SFA418	SFAC418		SFA418HH	MD960D		VR960	
MP3 Touring 300 ie	11-12	SFA418	SFAC418		SFA418HH	MD960D		VR960	
MP3 Touring LT 300 ie	11-12	SFA418	SFAC418		SFA418HH	MD960D		VR960	
MP3 Sport LT 300 ie	13	SFA418	SFAC418		SFA418HH	MD960D		VR960	
300 ie MP3 Yourban	11-13	SFA418	SFAC418		SFA418HH	MD960D		VR960	
300 ie MP3 Yourban LT	11-13	SFA418	SFAC418		SFA418HH	MD960D		VR960	
300 ie MP3 Yourban LT	13	SFA418	SFAC418		SFA418HH	MD960D		VR960	
X7 EVO 300 ie	10-12	SFA418	SFAC418		SFA418HH	MD960D		VR960	
X 10 350 (4V/4T/EF)	12-13	SFA418			SFA418HH	TBA			
Beverley 400 ie	07	SFA353	SFAC353		SFA353HH	MD960D		VR960	
Beverley Tourer 400 ie	08-09	SFA266	SFAC266		SFA266HH	MD959D		VR959	
Trackmaster 400 Quad	06	FA395TT			FA395R	MD6173D			
MP3 400 ie	07-10	SFA353	SFAC353		SFA353HH	MD960D		VR960	
MP3-LT 400 ie	09-10	SFA353	SFAC353		SFA353HH	MD960D		VR960	
MP3 Touring 400 ie	11-12	SFA353	SFAC353		SFA353HH	MD960D		VR960	
MP3 Touring LT 400 ie	11-12	SFA353	SFAC353		SFA353HH	MD960D		VR960	
Xevo 400 ie	07-10	SFA353	SFAC353		SFA353HH	MD960D		VR960	
X8 400 ie	06-08	SFA353	SFAC353		SFA353HH	MD960D		VR960	
Beverley B 500	02-05	SFA266	SFAC266		SFA266HH	MD960D		VR960	
Beverley 500	06	SFA425	SFAC425		SFA425HH	MD960D		VR960	
Beverley Cruiser 500 ie	07-11	SFA266	SFAC266		SFA266HH	MD960D		VR960	
Beverley 500 ie	12	SFA266	SFAC266		SFA266HH	MD960D		VR960	
MP3 500 EFI	09-10	SFA418	SFAC418		SFA418HH	MD960D		VR960	
MP3 Touring Business 500 ie	11-12	SFA353	SFAC353		SFA353HH	MD960D		VR960	
MP3 Touring Business LT 500 ie	11-13	SFA353	SFAC353		SFA353HH	MD960D		VR960	
MP3 Touring Sport 500 ie	11-12	SFA353	SFAC353		SFA353HH	MD960D		VR960	
MP3 Touring Sport LT 500 ie	11-13	SFA353	SFAC353		SFA353HH	MD960D		VR960	
X9 500/500 SL	00-02	SFA266	SFAC266		SFA266HH	MD960D		VR960	
X9 500 cc Evolution (inc ABS)	03-06	SFA266	SFAC266		SFA266HH	MD960D		VR960	
X9 500 ie	07	SFA266	SFAC266		SFA266HH	MD960D		VR960	
X 10 - 500 i (4V/4T/EF)	12-13	SFA418	SFAC418		SFA418HH	MD959D	MD959C	VR959	

\*-2 Sets Required. ■ - Also available in MX-S race compound.

**SAFETY WARNING:** DO NOT USE HH PADS ON REAR UNLESS ALSO USED ON FRONT TO AVOID BRAKE IMBALANCE



# Non-JAPANESE Built Motorcycles



FRONT / AVANT / VORN FRENTE / ANTERIORE

APPLICATIONS  
BRAKE

R Suffix = High Durability Sintered Pad. HH Suffix = High Performance Sintered Pad. G Suffix = Grooved Shoe.

D Suffix = Drilled Disc. C Suffix = Contoured Disc. LS Suffix = Left/Steel Disc. RS = Right/Steel Disc.

## POLINI



		DISC PAD CHOICES				BRAKE ROTOR CHOICES							
		NEW SFAC Scooter Carbon Pads	Semi-Sintered V-Pads™	Sintered/HH Pads/ Grooved shoes	Left/Gauche/Links	Right/Droite/Rechts	Contour Rotor Universal left and right fitment	NEW Vee-Rotors™ CONTOUR	NEW CX Extreme® ROTOR	Oversize 250/280mm Rotor Kit	Relocating Bracket for 250/280mm Rotor	Oversize 320mm Rotor Kit	Relocating Bracket for 320mm Rotor
Mini Motard 110cc 10" wheels (2 pin fixing)		FA352											
Mini Bikes (With round type pad with threaded pin/mechanical caliper)		FA293/293S											
X1R/X3R H20 50cc Formula Hydraulic Caliper		FA325TT		FA325R									
XP4 Street 50 10" wheels, single pin fixing		FA351											
XP 65 R Single pin fixing		FA351											
XP4T 110cc Cross 14" front/12" rear wheel, 2 pin fixing		FA352											
XP4T 110 Cross 12" front/10" rear wheel, 2 pin fixing		FA352											
XP4 Street 125 10" wheels, single pin fixing		FA351											
XP4 Off Road 125 14" front/12" rear wheel, single pin fixing		FA351											

## PRAGA

250 Enduro	03	FA181TT		FA181R ■		N/A							
610 Enduro	03	FA181TT		FA181R ■		N/A							
610 Supermotard	03	FA095		FA095HH		N/A							

## PUCH

Magnum 50cc Automatic Kids Bike	78-80	931											
Maxi 50 (N/NK) Spoke Wheels/1 Speed automatic/Solid rear frame	73-80	H322											
Maxi 50 (S/W/SKW) Spoke Wheels/1 Speed automatic/with rear suspension	73-80	H322											
Maxi 50 Spoke Wheels/2 Speed automatic/with rear suspension	73-80	H322											
Maxi 50 Executive (Cast Wheels/1 Speed automatic)		931											
Maxi S 50 Sport (Cast Wheels/1 Speed automatic)		931											
Maxi 50 Super (Cast Wheels/2 Speed automatic)		931											
Maxi 50 Executive (Cast Wheels with screwed in hub/1 speed automatic)		H322											
Maxi S 50 Sport (Cast Wheels with screwed in hub/1 speed automatic)		H322											
Maxi 50 Super (Cast Wheels with screwed in hub/2 Speed automatic)		H322											
M2 50cc Sport	74	856											
M3 50cc Sport	75	856											
MS 50/50 L		970											
M50 Sport	73-74	843G											
M50 Grand Prix	74-77	932											
M50 SDP Spoke Wheel/Grand Prix Special	75-77	FA050						N/A					
M50 SDP Cast Wheel/Grand Prix Supreme	75-77	FA050						N/A					
VS/DS/DZS/DSK 50		856											
50 KAK2/K25/K3T/MSP		972											
Monza 4 SLJGP		932											
Imola X/GX		FA050				N/A							
Cobra 80/80-8/80-6 GT/GTL		FA050				N/A							

## PUZEY

MTD 300 (4T/4V)	11-12	FA135TT		FA135R ■		N/A							
MX 300 (4T/4V)	11-12	FA135TT		FA135R ■									

## QUADRO

350 D	11-13	SFA193*	SFAC193*	SFA193HH*		N/A							
Parking Brake		TBA											
350 S	12-13	SFA193*	SFAC193*	SFA193HH*		N/A							
Parking Brake		TBA											
350 Off Road 4D	12-13	SFA193*	SFAC193*	SFA193HH*		N/A							
Parking Brake		TBA											
4 D	11-13	SFA193*	SFAC193*	SFA193HH*		N/A							
Parking Brake		TBA											

## QUADZILLA (inc White Knuckle Models)

Buzz 50	03-07	N/A											
Micro Buggy MK11/111 (RV 50)	05-09	H346*		H346G*									
R 50 (Rear disc model)	03-06	S614*		S614G*									
R 50 (Rear drum model)		S614*		S614G*									
WK 50 White Knuckle (Pit Bike)	06-08	S614		S614G									
WK One 50	10-11	TBA				TBA							

\*-2 Sets Required. ■ - Also available in MX-S race compound.

**SAFETY WARNING:** DO NOT USE HH PADS ON REAR UNLESS ALSO USED ON FRONT TO AVOID BRAKE IMBALANCE

# Non-JAPANESE Built Motorcycles



← REAR / ARRIÈRE / HINTEN POSTERIOR / POSTERIORE →

## POLINI



DISC PAD CHOICES				BRAKE ROTOR CHOICES			
NEW SFAC Scooter Carbon Pads	Semi-Sintered V-Pads™	Sintered/HH Pads/Grooved shoes		Contour Rotor Rear Fitment	NEW Vee-Rotors™ CONTOUR	NEW CX Extreme® ROTOR	

Mini Motard 110cc 10" wheels (2 pin fixing)		FA352					N/A
Mini Bikes (With round type pad with threaded pin/mechanical caliper)		FA293/293S					N/A
X1R/X3R H20 50cc Formula Hydraulic Caliper		FA325TT		FA325R			N/A
XP4 Street 50 10" wheels, single pin fixing"		FA351					N/A
XP 65 R Single pin fixing		FA351					N/A
XP4T 110cc Cross 14" front/12" rear wheel, 2 pin fixing		FA352					N/A
XP4T 110 Cross 12" front/10" rear wheel, 2 pin fixing"		FA352					N/A
XP4 Street 125 10" wheels, single pin fixing		FA351					N/A
XP4 Off Road 125 14" front/12" rear wheel, single pin fixing		FA351					N/A

## PRAGA

250 Enduro	03	FA208TT		FA208R ■			N/A
610 Enduro	03	FA208TT		FA208R ■			N/A
610 Supermotard	03	FA208TT					N/A

## PUCH

Magnum 50cc Automatic Kids Bike	78-80	931					
Maxi 50 (NWK) Spoke Wheels/1 Speed automatic/Solid rear frame	73-80	H322					
Maxi 50 (SW/SKW) Spoke Wheels/1 Speed automatic/with rear suspension	73-80	H322					
Maxi 50 Spoke Wheels/2 Speed automatic/with rear suspension	73-80	H322					
Maxi 50 Executive (Cast Wheels/1 Speed automatic)		931	945				
Maxi S 50 Sport (Cast Wheels/1 Speed automatic)		931	945				
Maxi 50 Super (Cast Wheels/2 Speed automatic)		931	945				
Maxi 50 Executive (Cast Wheels with screwed in hub/1 speed automatic)		H322					
Maxi S 50 Sport (Cast Wheels with screwed in hub/1 speed automatic)		H322					
Maxi 50 Super (Cast Wheels with screwed in hub/2 Speed automatic)		H322					
M2 50cc Sport	74	856					
M3 50cc Sport	75	856					
MS 50/50 L		970					
M50 Sport	73-74	843G					
M50 Grand Prix	74-77	932					
M50 SDP Spoke Wheel/Grand Prix Special	75-77	932					
M50 SDP Cast Wheel/Grand Prix Supreme	75-77	843G					
VS/DS/DZS/DSK 50		856					
50 KAK/2K25/K3T/MSP		972					
Monza 4 SLGP		932					
Imola X/GX		932					
Cobra 80/80-8/80-6 GT/GTL		932					

## PUZEY

MTD 300 (4T/4V)	11-12	FA346TT		FA346R ■			
MX 300 (4T/4V)	11-12	FA346TT		FA346R ■			

## QUADRO

350 D	11-13	TBA		N/A			
350 S	12-13	TBA		N/A			
350 Off Road 4D	12-13	TBA		N/A			
4 D	11-13	TBA		N/A			

## QUADZILLA (inc White Knuckle Models)

Buzz 50	03-07	H302		H302G			
Micro Buggy MK11/111 (RV 50)	05-09	FA485TT			N/A		
R 50 (Rear disc model)	03-06	FA232TT		FA232R	N/A		
R 50 (Rear drum model)		Y527		Y527G			
WK 50 White Knuckle (Pit Bike)	06-08	S614		S614G			
WK One 50	10-11	TBA					

\*-2 Sets Required. ■ - Also available in MX-S race compound.

**SAFETY WARNING:** DO NOT USE HH PADS ON REAR UNLESS ALSO USED ON FRONT TO AVOID BRAKE IMBALANCE

**R** Suffix = High Durability Sintered Pad. **HH** Suffix = High Performance Sintered Pad. **G** Suffix = Grooved Shoe.  
**D** Suffix = Drilled Disc. **C** Suffix = Contoured Disc. **LS** Suffix = Left/Steel Disc. **RS** = Right/Steel Disc.

**BRAKE APPLICATIONS**

# Non-JAPANESE Built Motorcycles



← FRONT / AVANT / VORN FRENTE / ANTERIORE →

## QUADZILLA

### DISC PAD CHOICES

### BRAKE ROTOR CHOICES

			NEW SFAC Scooter Carbon Pads	Semi-Sintered V-Pads™	Sintered/HH Pads/ Grooved shoes	Left/Gauche/Links	Right/Droite/Rechts	Contour Rotor Universal left and right fitment	NEW Vee-Rotors™ CONTOUR	NEW CX Extreme® ROTOR	Oversize 250/280mm Rotor Kit	Relocating Bracket for 250/280mm Rotor	Oversize 320mm Rotor Kit	Relocating Bracket for 320mm Rotor
WK GP 50	10-11	TBA				TBA								
WK GTR 50	10-11	TBA				TBA								
X50		H346*			H346G*									
ZR 50	07-09	H346			H346G									
WK 70 White Knuckle (Pit Bike) (Front drum model)	06-09	S614			S614G									
WK 70 White Knuckle (Pit Bike) (Front disc model)	06-09	SFA169	SFAC169		SFA169HH	N/A								
Black Max M100 (S.E.)	06	Y503*			Y503G*									
Pro Shark 100 (RMX) (Front disc models)		FA067*			FA067R*	N/A	N/A							
Pro Shark (Double A Arms)		Y503*			Y503G*									
Pro Shark 100 (Single A Arms)		H346*			H346G*									
Ram R100	03-05	TBA*												
Ram R100 E	03-05	TBA*												
R 100 (Rear disc model)	06-09	S614*			S614G*									
R 100 (Rear drum model)		S614*			S614G*									
Magmax	03-05	TBA*												
Magmax		H346*			H346G*									
X 100 E (XLC)	06-07	Y503*			Y503G*									
X 100		H346*			H346G*									
WK 110 White Knuckle (Pit Bike)	06-08	SFA169	SFAC169		SFA169HH									
RV 125 Midi RV Bug		FA416TT*			FA416R*	N/A	N/A							
WK 125 White Knuckle (Pit Bike)	06-09	SFA169	SFAC169		SFA169HH	N/A								
WK125 S - Efi	10-11	TBA												
WK125 SC - Efi	10-11	TBA												
WK125 R	10-11	TBA				N/A								
WK 140 White Knuckle (Pit Bike)	06-08	FA448				N/A								
BR 150 E Bugrider	04-06	FA416TT*			FA416R*	N/A	N/A							
CVT 150 E	10-11	FA453TT*			FA453R*	N/A	N/A							
RV 150 Midi RV Buggie		FA416TT*			FA416R*	N/A	N/A							
Ram R170	03-05	Y503*			Y503G*									
Ram R170 E Stinger	03-05	Y503*			Y503G*									
Stinger R170E	06	Y503*			Y503G*									
4 Cross 200 E SUV	06-07	FA083TT*			FA083R*	N/A	N/A							
4 Cross 200cc		H307*			H307G*									
BR 200	07-08	FA416TT*			FA416R*	N/A	N/A							
QZ 200 (Front disc model)		FA067TT*			FA067R*	N/A	N/A							
R 200 E Stinger	06-07	TBA*				N/A	N/A							
ST 200 E (Automatic)	06-07	Y503*			Y503G*									
ST 200 E (5 speed manual)	06-07	FA083TT*			FA083R*	N/A	N/A							
250 e	06-11	FA067TT*			FA067R*	N/A	N/A							
BR 250 E Bugrider	05-08	FA416TT*			FA416R*	N/A	N/A							
BR 250		FA416TT*			FA416R*	N/A	N/A							
QZ 250 (Front disc model)		FA067TT*			FA067R*	N/A	N/A							
Ram R250	03-05	Y503*			Y503G*									
Ram R250E Stinger	03-05	Y503*			Y503G*									
Stinger R250 E	06	FA083TT*			FA083R*	N/A	N/A							
XRV 250 (Off Road)	06	FA416TT*			FA416R*	N/A	N/A							
XRV 250 E	06-07	FA416TT*			FA416R*	N/A	N/A							
XRV 250		FA416TT			FA416R	N/A	N/A							
QZ 270		FA067TT*			FA067R*	N/A	N/A							
300 e XLC Stinger	07-08	FA067TT*			FA067R*	N/A	N/A							
300 e XLC	07-08	FA067TT*			FA067R*	N/A	N/A							
300 E Stinger	09-11	FA067TT*			FA067R*	N/A	N/A							
300 E SUV (Automatic)	06	FA453TT*			FA453R*	N/A	N/A							
300 E (4 x 4) (Auto)	06-07	FA453TT*			FA453R*	N/A	N/A							
300 E XLC	06-07	FA083TT*			FA083R*	N/A	N/A							
300 SE 4 Valve	06-07	FA083TT*			FA083R*	N/A	N/A							
300 E SUV (Manual)	06-07	FA453TT*			FA453R*	N/A	N/A							
CUV 300 (4 x 4 Super Utility Side x Side)	08	FA482TT*			FA482R*	N/A	N/A							
CUV 300 E 4 x 4 Side x Side	08-09	FA482TT*			FA482R*	N/A	N/A							
CUV 300 E 4 x 4 Side x Side Parking brake	08-09	FA481												

\*-2 Sets Required. ■ - Also available in MX-S race compound.

**SAFETY WARNING:** DO NOT USE HH PADS ON REAR UNLESS ALSO USED ON FRONT TO AVOID BRAKE IMBALANCE

APPLICATIONS  
BRAKE

R Suffix = High Durability Sintered Pad. HH Suffix = High Performance Sintered Pad. G Suffix = Grooved Shoe.

D Suffix = Drilled Disc. C Suffix = Contoured Disc. LS Suffix = Left/Steel Disc. RS = Right/Steel Disc.

# Non-JAPANESE Built Motorcycles

**BRAKE APPLICATIONS**

**R** Suffix = High Durability Sintered Pad. **HH** Suffix = High Performance Sintered Pad. **G** Suffix = Grooved Shoe.  
**D** Suffix = Drilled Disc. **C** Suffix = Contoured Disc. **LS** Suffix = Left/Steel Disc. **RS** = Right/Steel Disc.



## QUADZILLA



← REAR / ARRIÈRE / HINTEN POSTERIOR / POSTERIORE →

			DISC PAD CHOICES			BRAKE ROTOR CHOICES		
			NEW SFAC Scooter Carbon Pads	Semi-Sintered V-Pads™	Sintered/HH Pads/ Grooved shoes	Contour Rotor Rear Fitment	NEW Vee-Rotors™ CONTOUR	NEW CX Extreme® ROTOR
WK GP 50	10-11	TBA						
WK GTR 50	10-11	TBA						
X50		FA083TT			FA083R	N/A		
ZR 50	07-09	FA083TT			FA083R	N/A		
WK 70 White Knuckle (Pit Bike) (Front drum model)	06-09	S614			S614G			
WK 70 White Knuckle (Pit Bike) (Front disc model)	06-09	S614			S614G			
Black Max M100 (S.E.)	06	FA083TT			FA083R	N/A		
Pro Shark 100 (RMX) (Front disc models)		FA083TT			FA083R	N/A		
Pro Shark (Double A Arms)		FA083TT			FA083R	N/A		
Pro Shark 100 (Single A Arms)		FA083TT			FA083R	N/A		
Ram R100	03-05	FA083TT			FA083R	N/A		
Ram R100 E	03-05	FA083TT			FA083R	N/A		
R 100 (Rear disc model)	06-09	FA083TT			FA083R	N/A		
R 100 (Rear drum model)		Y527			Y527G			
Magmax	03-05	FA083TT			FA083R	N/A		
Magmax		FA083TT			FA083R	N/A		
X 100 E (XLC)	06-07	FA083TT			FA083R	N/A		
X 100		FA083TT			FA083R	N/A		
WK 110 White Knuckle (Pit Bike)	06-08	FA086			FA086HH	N/A		
RV 125 Midi RV Bug		FA054TT			FA054R	N/A		
WK 125 White Knuckle (Pit Bike)	06-09	FA086			FA086HH	N/A		
WK125 S - Efi	10-11							
WK125 SC - Efi	10-11							
WK125 R	10-11	TBA			TBA	N/A		
WK 140 White Knuckle (Pit Bike)	06-08	FA480				N/A		
BR 150 E Bugrider	04-06	FA054TT			FA054R	N/A		
CVT 150 E	10-11	FA431TT			FA431R	N/A		
RV 150 Midi RV Buggie		FA054TT			FA054R	N/A		
Ram R170	03-05	FA135TT			FA135R	N/A		
Ram R170 E Stinger	03-05	FA135TT			FA135R	N/A		
Stinger R170E	06	FA135TT			FA135R	N/A		
4 Cross 200 E SUV	06-07	FA067TT			FA067R	N/A		
4 Cross 200cc		FA165TT			FA165R	N/A		
BR 200	07-08	FA054TT			FA054R	N/A		
QZ 200 (Front disc model)		FA067TT			FA067R	N/A		
R 200 E Stinger	06-07	TBA				N/A		
ST 200 E (Automatic)	06-07	FA135TT			FA135R	N/A		
ST 200 E (5 speed manual)	06-07	FA067TT			FA067R	N/A		
250 e	06-11	FA067TT			FA067R	N/A		
BR 250 E Bugrider	05-08	FA431TT			FA431R	N/A		
BR 250		FA054TT			FA054R	N/A		
QZ 250 (Front disc model)		FA067TT			FA067R	N/A		
Ram R250	03-05	FA135TT			FA135R	N/A		
Ram R250E Stinger	03-05	FA135TT			FA135R	N/A		
Stinger R250 E	06	FA067TT			FA067R	N/A		
XRV 250 (Off Road)	06	FA431TT			FA431R	N/A		
XRV 250 E	06-07	FA431TT			FA431R	N/A		
XRV 250		FA054TT			FA054R	N/A		
QZ 270		FA067TT			FA067R	N/A		
300 e XLC Stinger	07-08	FA067TT			FA067R	N/A		
300 e XLC	07-08	FA067TT			FA067R	N/A		
300 E Stinger	09-11	FA067TT			FA067R	N/A		
300 E SUV (Automatic)	06	FA270TT			FA270R	N/A		
300 E (4 x 4) (Auto)	06-07	FA270TT			FA270R	N/A		
300 E XLC	06-07	FA067TT			FA067R	N/A		
300 SE 4 Valve	06-07	FA067TT			FA067R	N/A		
300 E SUV (Manual)	06-07	FA270TT			FA270R	N/A		
CUV 300 (4 x 4 Super Utility Side x Side)	08	FA453TT*			FA453R*	N/A*		
CUV 300 E 4 x 4 Side x Side	08-09	FA270TT			FA270R	N/A		

\*-2 Sets Required. ■ - Also available in MX-S race compound.

**SAFETY WARNING:** DO NOT USE HH PADS ON REAR UNLESS ALSO USED ON FRONT TO AVOID BRAKE IMBALANCE

# Non-JAPANESE Built Motorcycles



← FRONT / AVANT / VORN FRENTE / ANTERIORE →

## QUADZILLA

### DISC PAD CHOICES

### BRAKE ROTOR CHOICES

Model	Year	Disc Pad Part	NEW SFAC Scooter Carbon Pads	Sintered/HH Pads/Grooved shoes	Left/Gauche/Links	Right/Droite/Rechts	Contour Rotor Universal left and right fitment	NEW Vee-Rotors™ CONTOUR	NEW CX Extreme® ROTOR	Oversize 250/280mm Rotor Kit	Relocating Bracket for 250/280mm Rotor	Oversize 320mm Rotor Kit	Relocating Bracket for 320mm Rotor
Jow 300	07-08	FA067TT*		FA067R*	N/A	N/A							
Quadzilla 300	04-05	FA453TT*		FA453R*	N/A	N/A							
QZ 300 XLC		FA067TT*		FA067R*	N/A	N/A							
QZ 300 E 4 x 4		FA483TT*		FA483R*	N/A	N/A							
QZ 300 E 4 x 4 Parking brake		FA431TT		FA431R									
RL 300 Buggy	07-08	FA416TT*		FA416R*	N/A	N/A							
RL 300 Buggy	09-11	FA067TT*		FA067R*	N/A	N/A							
WK 300 White Knuckle (Pit Bike)	06-08	FA228		FA228HH	N/A								
XL 300		FA416TT*		FA416R*	N/A	N/A							
320 e 4 x 4	07-08	FA453TT*		FA453R*	N/A	N/A							
320 e 4 x 4 Parking brake	07-08	FA270TT		FA270R									
320 CUV		FA067TT*		FA067R*	N/A	N/A							
CVT 320 e	07-11	FA453TT*		FA453R*	N/A	N/A							
CVT 320 e Parking brake	07-11												
QZ 320 E 4 x 4	09	FA483TT		FA483R	N/A	N/A							
QZ 320 E 4 x 4 Parking brake	09	FA431TT		FA431R									
325 4 x 4 Quad	10-11	FA483TT*		FA483R*	N/A	N/A							
QZ 450 RS	06-09	FA067TT*		FA067R*	N/A	N/A							
QZ 450 Sport	08-09	FA067TT*		FA067R*	N/A	N/A							
500 4 x 4	06-07	FA453TT*		FA453R*	N/A	N/A							
CUV 500 Side x Side	10-11	FA453TT*		FA453R*	N/A								
CUV 500 Side x Side Parking Brake	10-11					N/A							
QZ 500 E/ES 4 x 4	09-11	FA453TT*		FA453R*	N/A	N/A							
QZ 500 E/ES 4 x 4 Parking brake	09-11	FA232TT		FA232R									
RL 500 Buggy	08-09	FA171*		FA171HH*	N/A	N/A							
RL 500 MK 11 Buggy	10-11	FA453TT*		FA453R*	N/A	N/A							
RS 5 4WD	10-11	FA453TT*		FA453R*	N/A	N/A							
Parking Brake	10-11	FA232TT		FA232R									
XLC 500	10-13	FA067TT*		FA067R*	N/A	N/A							
RS 6 4WD	Left	10-11	FA135TT*	FA135R*	N/A								
	Right		FA165TT	FA165R		N/A							
RS 7 4WD	10-11	FA377TT*		FA377R*	N/A	N/A							
X7 R	10-11	FA377TT*		FA377R*	N/A	N/A							
RS 8	10-11	FA377TT*		FA377R*	N/A	N/A							
Z 6 4 x 4	10-13	FA453TT*		FA453R*	N/A	N/A							
X 8 (4 x 4/Efi)	12-13	FA453TT*		FA453R*	N/A	N/A							
<b>RIEJU</b>													
MIUS - Electric	12-13	TBA			N/A								
MRT 50 (Single piston caliper)	09-13	FA093			N/A		N/A						
MRT-Pro 50 (Radial/double piston caliper)	09-13	FA266		FA266HH			N/A						
MRT Supermotard 50 (Cast wheel/single piston caliper)	09-13	FA093			N/A								
MRT-Pro Supermotard (Radial caliper/cast wheel)	09-13	FA266		FA266HH			N/A						
MTR 50 Competizione (Spoke Wheel)	11-13	FA465TT		FA465R			N/A						
MRX 50 Castrol	01-02	FA167		FA167HH	N/A								
MRX 50	03-08	FA115		FA115R	N/A								
MRX 50 Pro/Top	04-08	FA194		FA194HH	N/A								
RS2 NKD	05	FA194		FA194HH		N/A							
NKD 50	07	FA374			N/A								
NKD 50	08-10	FA375				N/A							
Pacific 50 (4T)	08	FA235			N/A								
RS1 50cc	97-00	FA115		FA115HH	N/A								
RS1 50cc	01-04	FA167		FA167HH	N/A								
RR 50cc Thunderfire	97-02	FA115		FA115HH	N/A								
RR 50 Castrol	00-02	FA167		FA167HH	N/A								
RR 50 Sport	03-06	FA115		FA115HH	N/A								
RRX 50 Spike (17" wheel/spoke wheel)	03-08	FA115		FA115HH	N/A								
RRX 50 Spike (17" cast wheel)	06-09	FA115		FA115HH	N/A								
RRX 50	06-09	FA115		FA115HH	N/A								
RS2 50 FR	09-10	FA375				N/A							

\*-2 Sets Required. ■ - Also available in MX-S race compound.

**SAFETY WARNING:** DO NOT USE HH PADS ON REAR UNLESS ALSO USED ON FRONT TO AVOID BRAKE IMBALANCE

APPLICATIONS  
BRAKE

R Suffix = High Durability Sintered Pad. HH Suffix = High Performance Sintered Pad. G Suffix = Grooved Shoe.

D Suffix = Drilled Disc. C Suffix = Contoured Disc. LS Suffix = Left/Steel Disc. RS = Right/Steel Disc.



# Non-JAPANESE Built Motorcycles

**BRAKE APPLICATIONS**



## QUADZILLA



← REAR / ARRIÈRE / HINTEN POSTERIOR / POSTERIORE →

		DISC PAD CHOICES				BRAKE ROTOR CHOICES			
		NEW SFAC Scooter Carbon Pads	Semi-Sintered V-Pads™	Sintered/HH Pads/ Grooved shoes	Contour Rotor Rear Fitment	NEW Vee-Rotors™ CONTOUR	NEW CX Extreme® ROTOR		
Jow 300	07-08	FA067TT		FA067R	N/A				
Quadzilla 300	04-05	FA270TT		FA270R	N/A				
QZ 300 XLC		FA067TT		FA067R	N/A				
QZ 300 E 4 x 4		FA270TT		FA270R	N/A				
RL 300 Buggie	07-08	FA431TT		FA431R	N/A				
RL 300 Buggie	09-11	FA067TT		FA067R	N/A				
WK 300 White Knuckle (Pit Bike)	06-08	FA197TT		FA197HH	N/A				
XL 300		FA054TT		FA054R	N/A				
320 e 4 x 4	07-08	FA431TT		FA431R	N/A				
320 CUV		FA067TT		FA067R	N/A				
CVT 320 e	07-11	FA431TT		FA431R	N/A				
CVT 320 e Parking brake	07-11	FA270TT		FA270R					
QZ 320 E 4 x 4	09	FA270TT		FA270R	N/A				
325 4 x 4 Quad	10-11	FA482TT		FA482R	N/A				
QZ 450 RS	06-09	FA067TT		FA067R	MD6348D				
QZ 450 Sport	08-09	FA067TT		FA067R	MD6348D				
500 4 x 4	06-07	FA270TT		FA270R	N/A				
CUV 500 Side x Side	10-11	FA344TT		FA344R	N/A				
CUV 500 Side x Side Parking Brake	10-11	FA232TT		FA232R					
QZ 500 E/ES 4 x 4	09-11	FA344TT		FA344R	N/A				
RL 500 Buggie	08-09	FA171*		FA171HH*	N/A*				
RL 500 MK 11 Buggie	10-11	FA344TT		FA344R	N/A				
RS 5 4WD	10-11	FA344TT		FA344R	N/A				
XLC 500	10-13	FA067TT		FA067R	N/A				
RS 6 4WD	10-11	TBA*		TBA*	N/A*				
RS 7 4WD	10-11	FA067TT		FA067R	N/A				
X7 R	10-11	FA067TT		FA067R	N/A				
RS 8	10-11	FA067TT		FA067R	N/A				
Z 6 4 x 4	10-13	FA344TT		FA344R	N/A				
X 8 (4 x 4/Ef)	12-13	FA344TT		FA344R	N/A				
<b>RIEJU</b>									
MIUS - Electric	12-13	TBA		N/A					
MRT 50 (Single piston caliper)	09-13	FA093			N/A				
MRT-Pro 50 (Radial/double piston caliper)	09-13	FA093				N/A			
MRT Supermotard 50 (Cast wheels/single piston caliper)	09-13	FA093			N/A				
MRT-Pro Supermotard (Radial caliper/cast wheel)	09-13	FA093		N/A		N/A			
MTR 50 Competizione (Spoke Wheel)	11-13	FA367/2TT		FA367/2R		N/A			
MRX 50 Castrol	01-02	FA115		FA115HH	N/A				
MRX 50	03-08	FA115		FA115R	N/A				
MRX 50 Pro/Top	04-08	FA115		FA115HH	N/A				
RS2 NKD	05	FA115		FA115HH	N/A				
NKD 50	07	FA115		FA115HH	TBA				
NKD 50	08-10	FA093			N/A				
Pacific 50 (4T)	08	TBA							
RS1 50cc	97-00	FA115		FA115HH	N/A				
RS1 50cc	01-04	FA115		FA115HH	N/A				
RR 50cc Thunderfire	97-02	FA115		FA115HH	N/A				
RR 50 Castrol	00-02	FA115		FA115HH	N/A				
RR 50 Sport	03-06	FA115		FA115HH	N/A				
RRX 50 Spike (17" wheel/spoke wheel)	03-08	FA115		FA115HH	N/A				
RRX 50 Spike (17" cast wheel)	06-09	FA115		FA115HH	N/A				
RRX 50	06-09	FA115		FA115HH	N/A				
RS2 50 FR	09-10	FA093			N/A				

\*-2 Sets Required. ■ - Also available in MX-S race compound.

**SAFETY WARNING:** DO NOT USE HH PADS ON REAR UNLESS ALSO USED ON FRONT TO AVOID BRAKE IMBALANCE

**R** Suffix = High Durability Sintered Pad. **HH** Suffix = High Performance Sintered Pad. **G** Suffix = Grooved Shoe.  
**D** Suffix = Drilled Disc. **C** Suffix = Contoured Disc. **LS** Suffix = Left/Steel Disc. **RS** = Right/Steel Disc.

# Non-JAPANESE Built Motorcycles



← FRONT / AVANT / VORN FRENTE / ANTERIORE →

## DISC PAD CHOICES

## BRAKE ROTOR CHOICES

### RIEJU

			NEW SFAC Scooter Carbon Pads	Semi-Sintered V-Pads™	Sintered/HH Pads/ Grooved shoes	Left/Gauche/Links	Right/Droite/Rechts	Contour Rotor Universal left and right fitment	NEW Vee-Rotors™ CONTOUR	NEW CX Extreme® ROTOR	Oversize 250/280mm Rotor Kit	Relocating Bracket for 250/280mm Rotor	Oversize 320mm Rotor Kit	Relocating Bracket for 320mm Rotor
RS2 Matrix (50CC) (AJP Caliper)	02-08	FA374					N/A							
RS2 50cc Matrix (J. Juan Caliper)	07-09	FA375					N/A							
RS2 50cc Pro (J. Juan Caliper)	07-10	FA375						N/A						
RS2 50cc Pro (AJP Caliper)	06-10	FA194			FA194HH			N/A						
RS3 50cc	11-13	FA374					N/A							
RS3 Pro 50cc	11-13	FA086			FA086HH		N/A							
RS Sport 50 (Scooter)	12-13	SFA083	SFAC083		SFA083HH			N/A						
SMX 50	02-06	FA115			FA115R	N/A								
SMX 50 Pro Supermotard/Top	04-07	FA194			FA194HH	N/A								
SMX 50 Pro Street (Cast wheel)	06-08	FA194			FA194HH	N/A								
SMX 50 (Cast Wheel)	07-08	FA115			FA115HH	N/A								
Spike 50	04-06	FA115			FA115HH	N/A								
Spike 50 Pro	04	FA167			FA167HH	N/A								
Spike X50	06-07	FA115			FA115HH	N/A								
Tango 50 (Spoke Wheel)	11	FA093				N/A								
Tango 50 Motard	09-10	FA093				N/A								
Tango 50 Motard (Cast Wheel)	11	FA093				N/A								
Tango 50 (2T)	07-12	FA266			FA266HH	N/A								
Toreo 50 (4T)	07-08	SFA235	SFAC235			N/A								
Marathon 125 (Air Cooled)	10-13	FA093						N/A						
Marathon 125 SM (Air Cooled)	10-13	FA093						N/A						
Marathon Pro 125 (Radial/double piston caliper/Spoke Wheel)	09-13	FA266			FA266HH			N/A						
Marathon Pro 125 Competizione (Spoke Wheel)	11-13	FA465TT			FA465R			N/A						
Marathon Pro Supermotard 125 (Cast wheel/radial caliper)	09-13	FA266			FA266HH			N/A						
MRX 125	02-08	FA167			FA167HH	N/A								
NKD 125	06-07	FA374					N/A							
NKD 125	08-10	FA375					N/A							
Pacific 125 (4T)	08	SFA235	SFAC235			N/A								
Pacific 125 Scooter	09	SFA235	SFAC235			TBA								
RS2 125 (AJP Caliper)	06-10	FA374					N/A							
RS2 125 (J. Juan Caliper)	07-10	FA375					N/A							
RS2 125 Pro (J. Juan Caliper)	07-10	FA375						N/A						
RS3 125cc	11-12	FA086			FA086HH		N/A							
SMX 125	02-07	FA167			FA167HH	N/A								
SMX 125 (Cast wheel)	07-08	FA266			FA266HH	N/A								
Tango 125	06-10	FA266			FA266HH	N/A								
Tango 125	11-13	FA465TT			FA465R	N/A								
Tango 125 Motard (Cast wheel)	08-09	FA266			FA266HH	N/A								
Tango Pro 125	07-10	FA266			FA266HH			N/A						
Marathon 250	09-10	FA181TT			FA181R ■			N/A						
Tango 250	08-11	FA266			FA266HH	N/A								
Tango 250	12-13	FA465TT			FA465R	N/A								
Marathon 450	09-10	FA181TT			FA181R ■			N/A						
<b>ROXON</b>														
Duel 50 SM	06	FA115			FA115HH	N/A								
Duel 50 SM	06	FA115			FA115HH	N/A								
Duel 50 TT	06	FA115			FA115HH	N/A								
Fox 50 (Quad)	04-06	H338*			H338G*									
Go-Kart Enfant X-Cube	06	N/A												
Silver Fox 50 (Quad)	04-06	TBA*												
Fox 100 (Quad)	04-06	TBA*												
RX 150 (Quad)	04-06	TBA*												
Sport Spirit NFS150 (Quad)	04-06	TBA*												
<b>ROVIGO</b>														
Spoletto 50cc	04-05	TBA				N/A								
Tempesta 50cc	04-05	TBA				N/A								
Tempesta 90cc	04-05	TBA				N/A								

\*-2 Sets Required. ■ - Also available in MX-S race compound.

**SAFETY WARNING:** DO NOT USE HH PADS ON REAR UNLESS ALSO USED ON FRONT TO AVOID BRAKE IMBALANCE

APPLICATIONS  
BRAKE

R Suffix = High Durability Sintered Pad. HH Suffix = High Performance Sintered Pad. G Suffix = Grooved Shoe.  
D Suffix = Drilled Disc. C Suffix = Contoured Disc. LS Suffix = Left/Steel Disc. RS = Right/Steel Disc.

# Non-JAPANESE Built Motorcycles



## RIEJU



← REAR / ARRIÈRE / HINTEN POSTERIOR / POSTERIORE →

		DISC PAD CHOICES				BRAKE ROTOR CHOICES			
		NEW SFAC Scooter Carbon Pads	Semi-Sintered V-Pads™	Sintered/HH Pads/ Grooved shoes	Contour Rotor Rear Fitment	NEW Vee-Rotors™ CONTOUR	NEW CX Extreme® ROTOR		
RS2 Matrix (50CC) (AJP Caliper)	02-08	FA115		FA115HH	N/A				
RS2 50cc Matrix (J. Juan Caliper)	07-09	FA093			N/A				
RS2 50cc Pro (J. Juan Caliper)	07-10	FA093				N/A			
RS2 50cc Pro (AJP Caliper)	06-10	FA115		FA115HH		N/A			
RS3 50cc	11-13	FA093			N/A				
RS3 Pro 50cc	11-13	FA093			N/A				
RS Sport 50 (Scooter)	12-13	SFA193	SFAC193	SFA193HH		N/A			
SMX 50	02-06	FA115		FA115R	N/A				
SMX 50 Pro Supermotard/Top	04-07	FA115		FA115HH	N/A				
SMX 50 Pro Street (Cast wheel)	06-08	FA115		FA115HH	N/A				
SMX 50 (Cast Wheel)	07-08	FA115		FA115HH	N/A				
Spike 50	04-06	FA115		FA115HH	N/A				
Spike 50 Pro	04	FA115		FA115HH	N/A				
Spike X50	06-07	FA115		FA115HH	N/A				
Tango 50 (Spoke Wheel)	11	FA093			N/A				
Tango 50 Motard	09-10	FA115		FA115HH	N/A				
Tango 50 Motard (Cast Wheel)	11	FA115		FA115HH	N/A				
Tango 50 (2T)	07-12	FA115		FA115HH	N/A				
Toreo 50 (4T)	07-08	TBA							
Marathon 125 (Air Cooled)	10-13	FA093				N/A			
Marathon 125 SM (Air Cooled)	10-13	FA093				N/A			
Marathon Pro 125 (Radial/double piston caliper/Spoke Wheel)	09-13	FA093				N/A			
Marathon Pro 125 Competizione (Spoke Wheel)	11-13	FA367/2TT		FA367/2R		N/A			
Marathon Pro Supermotard 125 (Cast wheel/radial caliper)	09-13	FA093				N/A			
MRX 125	02-08	FA115		FA115HH	N/A				
NKD 125	06-07	FA115		FA115HH	N/A				
NKD 125	08-10	FA093			N/A				
Pacific 125 (4T)	08	TBA							
Pacific 125 Scooter	09	TBA							
RS2 125 (AJP Caliper)	06-10	FA115		FA115HH	N/A				
RS2 125 (J. Juan Caliper)	07-10	FA093			N/A				
RS2 125 Pro (J. Juan Caliper)	07-10	FA093				N/A			
RS3 125cc	11-12	FA083		FA083HH	N/A				
SMX 125	02-07	FA115		FA115HH	N/A				
SMX 125 (Cast wheel)	07-08	FA115		FA115HH	N/A				
Tango 125	06-10	FA115		FA115HH	N/A				
Tango 125	11-13	FA115TT		FA115R	N/A				
Tango 125 Motard (Cast wheel)	08-09	FA093			N/A				
Tango Pro 125	07-10	FA115		FA115HH		N/A			
Marathon 250	09-10	FA368TT		FA368 ■		N/A			
Tango 250	08-11	FA115		FA115HH	N/A				
Tango 250	12-13	FA115TT		FA367/2R	N/A				
Marathon 450	09-10	FA368TT		FA368 ■		N/A			
<b>ROXON</b>									
Duel 50 SM	06	FA115		FA115HH	N/A				
Duel 50 SM	06	FA115		FA115HH	N/A				
Duel 50 TT	06	FA115		FA115HH	N/A				
Fox 50 (Quad)	04-06	H307		H307G					
Go-Kart Enfant X-Cube	06	TBA*			N/A*				
Silver Fox 50 (Quad)	04-06	TBA							
Fox 100 (Quad)	04-06	TBA							
RX 150 (Quad)	04-06	FA083TT		FA083R	N/A				
Sport Spirit NFS150 (Quad)	04-06	FA083TT		FA083R	N/A				
<b>ROVIGO</b>									
Spoletto 50cc	04-05	TBA							
Tempesta 50cc	04-05	TBA							
Tempesta 90cc	04-05	TBA							

\*-2 Sets Required. ■ - Also available in MX-S race compound.

**SAFETY WARNING:** DO NOT USE HH PADS ON REAR UNLESS ALSO USED ON FRONT TO AVOID BRAKE IMBALANCE

**R** Suffix = High Durability Sintered Pad. **HH** Suffix = High Performance Sintered Pad. **G** Suffix = Grooved Shoe.  
**D** Suffix = Drilled Disc. **C** Suffix = Contoured Disc. **LS** Suffix = Left/Steel Disc. **RS** = Right/Steel Disc.

**BRAKE APPLICATIONS**

# Non-JAPANESE Built Motorcycles



← FRONT / AVANT / VORN FRENTE / ANTERIORE →

## DISC PAD CHOICES

## BRAKE ROTOR CHOICES

### ROYAL ENFIELD

		NEW SFAC Scooter Carbon Pads	Semi-Sintered V-Pads™	Sintered/HH Pads/ Grooved shoes	Left/Gauche/Links	Right/Droite/Rechts	Contour Rotor Universal left and right fitment	NEW Vee-Rotors™ CONTOUR	NEW CX Extreme® ROTOR	Oversize 250/280mm Rotor Kit	Relocating Bracket for 250/280mm Rotor	Oversize 320mm Rotor Kit	Relocating Bracket for 320mm Rotor
Bullet 500 (Eli / Dual Seat)	09-13	FA228	FA228V	FA228HH	MD847								
Bullet Electra X (All disc models/Dual Seat)	05-13	FA228	FA228V	FA228HH	MD847								
Bullet Classic 500 (Eli / Single Seat)	09-13	FA228	FA228V	FA228HH	MD847								
Bullet Classic Chrome 500 (Eli / Single Seat)	09-13	FA228	FA228V	FA228HH	MD847								
Bullet Battle Green 500 (Eli / Single Seat)	09-12	FA228	FA228V	FA228HH	MD847								
Bullet Desert Storm 500 (Eli / Single Seat)	12	FA228	FA228V	FA228HH	MD847								
Clubman 500 EFI	09-12	FA228	FA228V	FA228HH	MD847								
Electra 500 EFI	09-13	FA228	FA228V	FA228HH	MD847								
Fury 500 EFI	11-12	FA228	FA228V	FA228HH	MD847								
Trials 500 EFI	09-12	FA228	FA228V	FA228HH	MD847								
Woodsman 500 EFI	09-12	FA228	FA228V	FA228HH	MD847								

### SACHS (HERCULES)

Diff. older models with disc brake		FA050			N/A								
49 ER 10	07	SFA233			TBA								
50 KX 5		FA050			N/A								
50 Supra Enduro		922											
50 Supra 4 GP		FA067/2			N/A								
50 Ultra, RS Ultra		FA050			N/A								
Bee 50	08-10	SFA101	SFAC101	SFA101HH		TBA							
Madass 50 (2 stroke) (Hydraulic rear brake)	04-05	FA086		FA086HH	MD806LS								
Madass 50 (4 stroke) (Mechanical rear brake)	04-05	FA086		FA086HH	MD806LS								
Mad Ass 50 (4T)	06-09	FA086		FA086HH	MD806LS								
Speedforce 50 (2T)	08	SFA235	SFAC235		TBA								
Speedjet 50(2T)	08	SFA235	SFAC235		TBA								
49ER 12	08	SFA235	SFAC235		TBA								
SX-1 50 (2T)	08-09	SFA235	SFAC235		TBA								
80 CV		Y503											
80 Ultra, F Ultra, RS Ultra		FA050			N/A								
80 Ultra Chopper		FA050			N/A								
80 Ultra AC		FA050			N/A								
80 Ultra AC Chopper		FA050			N/A								
80 XE 9		FA050			N/A								
Bee 125	08-09	SFA101	SFAC101	SFA101HH		TBA							
Dirty Devil 125	08	FA351			N/A								
Eagle 125	08	TBA				TBA							
Mad Ass 125	05	FA086		FA086HH	MD806LS								
Mad Ass 125 (4T)	06-09	FA086		FA086HH	MD806LS								
Speedjet RS 125	10	SFA235	SFAC235				N/A						
Roadster 125 V2	00-03	FA167		FA167HH	TBA								
125 Roadster	03-04	TBA			N/A								
X Road 125	06	FA095				N/A							
X Road 125	07	FA095		FA095HH		N/A							
X Road 125	08	FA244		FA244HH		TBA							
XTC 125 Supersport	00-07	FA095		FA095HH		MD619RS							
XTC 125	08	FA244		FA244HH		TBA							
ZX 125 Enduro	01-02	FA194		FA194HH	N/A	N/A							
ZZ 125 Funbike	02	SFA193	SFAC193	SFA193HH	N/A								
Eagle 150	08	TBA				TBA							
Quattrocento 400	08	FA142*		FA142HH*	TBA	TBA							
Roadster 650	01-04	FA095		FA095HH		MD683RS							
Roadster 650	05	FA095		FA095HH		MD683RS							
Roadster 800	02-05	FA095*		FA095HH*	MD819	MD819							
B-805	03-04	FA095*		FA095HH*	MD819	MD819							

### SCARABEO - See Aprilia Section for pre-2010 models

50 (2T/ Street)	10-13	SFA083/2		SFA083/2HH	MD945D			VR945					
50 Net 4T(4V)	10-11	SFA083/2		SFA083/2HH	MD945D			VR945					
50 4T(4V)	10-13	SFA083/2		SFA083/2HH	MD945D			VR945					
50 YourZ (4T/4V)	10-11	SFA083/2		SFA083/2HH	MD945D			VR945					

\*-2 Sets Required. ■ - Also available in MX-S race compound.

**SAFETY WARNING:** DO NOT USE HH PADS ON REAR UNLESS ALSO USED ON FRONT TO AVOID BRAKE IMBALANCE

# Non-JAPANESE Built Motorcycles



## ROYAL ENFIELD



← REAR / ARRIÈRE / HINTEN POSTERIOR / POSTERIORE →

### DISC PAD CHOICES

### BRAKE ROTOR CHOICES

			NEW SFAC Scooter Carbon Pads	Semi-Sintered V-Pads™	Sintered/HH Pads/ Grooved shoes		Contour Rotor Rear Fitment	NEW Vee-Rotors™ CONTOUR	NEW CX Extreme® ROTOR
Bullet 500 (Efi / Dual Seat)	09-13		N/A						
Bullet Electra X (All disc models/Dual Seat)	05-13		N/A						
Bullet Classic 500 (Efi / Single Seat)	09-13		N/A						
Bullet Classic Chrome 500 (Efi / Single Seat)	09-13		N/A						
Bullet Battle Green 500 (Efi / Single Seat)	09-12		N/A						
Bullet Desert Storm 500 (Efi / Single Seat)	12		N/A						
Clubman 500 EFI	09-12		N/A						
Electra 500 EFI	09-13		N/A						
Fury 500 EFI	11-12		N/A						
Trials 500 EFI	09-12		N/A						
Woodsman 500 EFI	09-12		N/A						

## SACHS (HERCULES)

Diff. older models with disc brake			N/A						
49 ER 10	07		TBA						
50 KX 5			N/A						
50 Supra Enduro			922						
50 Supra 4 GP			N/A						
50 Ultra, RS Ultra			921						
Bee 50	08-10		TBA						
Madass 50 (2 stroke) (Hydraulic rear brake)	04-05		FA115		FA115HH	N/A			
Madass 50 (4 stroke) (Mechanical rear brake)	04-05		N/A			N/A			
Mad Ass 50 (4T)	06-09		FA054TT		FA054HH	N/A			
Speedforce 50 (2T)	08		TBA						
Speedjet 50(2T)	08		TBA						
49ER 12	08		TBA						
SX-1 50 (2T)	08-09		TBA						
80 CV			Y503						
80 Ultra, F Ultra, RS Ultra			921						
80 Ultra Chopper			921						
80 Ultra AC			922						
80 Ultra AC Chopper			922						
80 XE 9									
Bee 125	08-09		Y506						
Dirty Devil 125	08		FA351			N/A			
Eagle 125	08		TBA						
Mad Ass 125	05		FA086		FA086HH	N/A			
Mad Ass 125 (4T)	06-09		FA054TT		FA054HH	N/A			
Speedjet RS 125	10		SFA260	SFAC260			N/A		
Roadster 125 V2	00-03		Y506						
125 Roadster	03-04		TBA						
X Road 125	06		FA382			N/A			
X Road 125	07		FA054TT		FA054HH	N/A			
X Road 125	08		FA054TT		FA054HH	TBA			
XTC 125 Supersport	00-07		FA382			MD659			
XTC 125	08		FA054TT		FA054HH	MD659			
ZX 125 Enduro	01-02		FA382			N/A			
ZZ 125 Furbike	02		FA382			N/A			
Eagle 150	08		TBA						
Quattrocento 400	08		SFA260		SFA260HH	TBA			
Roadster 650	01-04		FA382			N/A			
Roadster 650	05		FA101			N/A			
Roadster 800	02-05		S626						
B-805	03-04		S626						

## SCARABEO - See Aprilia Section for pre-2010 models

50 (2T/ Street)	10-13		816						
50 Net 4T(4V)	10-11		816						
50 4T(4V)	10-13		816						
50 YourZ (4T/4V)	10-11		816						

\*-2 Sets Required. ■ - Also available in MX-S race compound.

**SAFETY WARNING:** DO NOT USE HH PADS ON REAR UNLESS ALSO USED ON FRONT TO AVOID BRAKE IMBALANCE

**BRAKE APPLICATIONS**

**R** Suffix = High Durability Sintered Pad. **HH** Suffix = High Performance Sintered Pad. **G** Suffix = Grooved Shoe.  
**D** Suffix = Drilled Disc. **C** Suffix = Contoured Disc. **LS** Suffix = Left/Steel Disc. **RS** = Right/Steel Disc.



# Non-JAPANESE Built Motorcycles



← FRONT / AVANT / VORN FRENTE / ANTERIORE →

## SCARABEO

Model	Year	Disc	DISC PAD CHOICES				BRAKE ROTOR CHOICES								
			NEW SFAC Scooter Carbon Pads	Semi-Sintered V-Pads™	Sintered/HH Pads/ Grooved shoes	Left/Gauche/Links	Right/Droite/Rechts	Contour Rotor Universal left and right fitment	NEW Vee-Rotors™ CONTOUR	NEW CX Extreme® ROTOR	Oversize 250/280mm Rotor Kit	Relocating Bracket for 250/280mm Rotor	Oversize 320mm Rotor Kit	Relocating Bracket for 320mm Rotor	
100 (4T)	10-13		SFA083/2		SFA083/2HH	MD945D				VR945					
125 ie	10-13		SFA324	SFAC324	SFA324HH	MD960D				VR960					
125 Net	10-11		SFA324	SFAC324	SFA324HH	MD960D				VR960					
200 ie	10-13		SFA324	SFAC324	SFA324HH	MD960D				VR960					
200 Net	10-11		SFA324	SFAC324	SFA324HH	MD960D				VR960					
300 S ie	09-12		SFA324	SFAC324	SFA324HH	MD952D				VR952					
500 ie	10-12		SFA256*	SFAC256*	SFA256HH*	MD952D	MD952D			VR952*					

## SCORPA

SR 125 (2T)	10-13		FA303			N/A									
SR 125 Long Ride (2T)	10-11		FA303			N/A									
SY 125 F (4T)	03-10		FA303			N/A									
SY 125 FR (4T)	03-11		FA303			N/A									
SY 125 (4T) Long Ride	09-10		FA303			N/A									
T-Ride 125 F (Enduro)	10		FA465TT		FA465R	N/A									
T-Ride 125 (2T) Enduro	12-13		FA083TT		FA083R				N/A						
TY 125 (4T)	11-13		FA303			N/A									
TV-S 125 F Enduro	03-05		FA115TT		FA115R ■	N/A									
TV-S 125 F	06-07		FA115TT		FA115R ■	N/A									
TV-S 125 F Long Ride	06-08		FA115TT		FA115R ■	N/A									
SY 175 F	06		FA303			N/A									
TV-S 175 F	06		FA115TT		FA115R ■	N/A									
SY 200 F (4T) (163cc)	08		FA303			N/A									
250 Easy	96-99		FA115TT		FA115R ■	N/A									
SY 250 (2T)	00-05		FA303			N/A									
SY 250 R (2T)	00-05		FA303			N/A									
SY 250 (2T)	06-09		FA303			N/A									
SY 250 R (2T)	06-09		FA303			N/A									
SY 250 Long Ride (2T)	04-06		FA303			N/A									
SY 250 F (4T)	06-10		FA303			N/A									
SY 250 FR (4T)	06-10		FA303			N/A									
SY 250 F (4T) Long Ride	07-08		FA303			N/A									
SY 250 FR (4T) Long Ride	10		FA303			N/A									
SR 280 (2T)	09-13		FA303			N/A									
SR 280 (2T) Long Ride	09-11		FA303			N/A									
T-Ride 250 F (Enduro)	08-11		FA465TT			N/A									
T-Ride 280 (2T) Enduro	12-13		FA083TT		FA083R				N/A						
Raidster 660	07		FA244		FA244HH	TBA									

\* - Note check drawings in buyers guide to confirm rear pad friction area i.e. FA351 = Large friction area FA471 = Small friction area

## SFM

SFM 125 Roadster	13		FA228		FA228V	FA228HH	N/A								
ZZX 125 Enduro	13		FA086		FA086V	FA086HH			N/A						
ZZX 125 Sport	13		FA086		FA086V	FA086HH			N/A						
ZZX 125 Trail	13		FA086		FA086V	FA086HH			N/A						
ZZR 125 SM (Cast Wheel)	13														

## SHERCO

Trials 0.5 (50cc 2T)	02		TBA												
Enduro 50cc (2T)	02-07		FA167			FA167HH	N/A								
Enduro 50c (2T) Urban/SU - Spoke wheel models)	08-13		FA194			FA194HH	N/A								
Supermotard 50cc (2T)	02-07		FA167			FA167HH	N/A								
Supermotard 50cc (2T)	08-13		FA194			FA194HH	N/A								
SU 50 (2T) Urban Base - Cast wheel model)	10		FA093						N/A						
SM 0.5cc Black Panther	08-10		FA194			FA194HH			N/A						
Trials 0.8 (2T)	01-04		FA115TT			FA115R ■	N/A								
Trials 0.8 (2T)	05-10		FA303				N/A								
ST 80 (2T)	13		FA612TT			FA612R			N/A						
City Corp 125 (All models)	03-07		FA167			FA167HH	N/A								
City Corp 125 (All models)	08		FA194			FA194HH	N/A								

\*-2 Sets Required. ■ - Also available in MX-S race compound.

**SAFETY WARNING:- DO NOT USE HH PADS ON REAR UNLESS ALSO USED ON FRONT TO AVOID BRAKE IMBALANCE**

APPLICATIONS  
BRAKE

R Suffix = High Durability Sintered Pad. HH Suffix = High Performance Sintered Pad. G Suffix = Grooved Shoe.  
D Suffix = Drilled Disc. C Suffix = Contoured Disc. LS Suffix = Left/Steel Disc. RS = Right/Steel Disc.

# Non-JAPANESE Built Motorcycles



## SCARABEO



← REAR / ARRIÈRE / HINTEN POSTERIOR / POSTERIORE →

			DISC PAD CHOICES			BRAKE ROTOR CHOICES		
			NEW SFAC Scooter Carbon Pads	Semi-Sintered V-Pads™	Sintered/HH Pads/ Grooved shoes	Contour Rotor Rear Fitment	NEW Vee-Rotors™ CONTOUR	NEW CX Extreme® ROTOR
100 (4T)	10-13	816						
125 ie	10-13	SFA298	SFAC298		SFA298HH	TBA		
125 Net	10-11	SFA298	SFAC298		SFA298HH	TBA		
200 ie	10-13	SFA298	SFAC298		SFA298HH	TBA		
200 Net	10-11	SFA298	SFAC298		SFA298HH	TBA		
300 S ie	09-12	SFA298	SFAC298		SFA298HH	TBA		
500 ie	10-12	SFA298	SFAC298		SFA298HH	TBA		

## SCORPA

SR 125 (2T)	10-13	FA351/471 *				N/A		
SR 125 Long Ride (2T)	10-11	FA351/471 *				N/A		
SY 125 F (4T)	03-10	FA351/471 *				N/A		
SY 125 FR (4T)	03-11	FA351/471 *				N/A		
SY 125 (4T) Long Ride	09-10	FA351/471 *				N/A		
T-Ride 125 F (Enduro)	10	FA350TT				N/A		
T-Ride 125 (2T/Enduro)	12-13	FA083TT			FA083R		N/A	
TY 125 (4T)	11-13	FA351/471 *				N/A		
TYS 125 F Enduro	03-05	FA115TT			FA115R ■	N/A		
TYS 125 F	06-07	FA351/471 *				N/A		
TYS 125 F Long Ride	06-08	FA351/471 *				N/A		
SY 175 F	06	FA351/471 *				N/A		
TVS 175 F	06	FA351/471 *				N/A		
SY 200 F (4T) (163cc)	08	FA351/471 *				N/A		
250 Easy	96-99	FA115TT			FA115R ■	N/A		
SY 250 (2T)	00-05	FA351/471 *				N/A		
SY 250 R (2T)	00-05	FA351/471 *				N/A		
SY 250 (2T)	06-09	FA351/471 *				N/A		
SY 250 R (2T)	06-09	FA351/471 *				N/A		
SY 250 Long Ride (2T)	04-06	FA351/471 *				N/A		
SY 250 F (4T)	06-10	FA351/471 *				N/A		
SY 250 FR (4T)	06-10	FA351/471 *				N/A		
SY 250 F (4T) Long Ride	07-08	FA351/471 *				N/A		
SY 250 FR (4T) Long Ride	10	FA351/471 *				N/A		
SR 280 (2T)	09-13	FA351/471 *				N/A		
SR 280 (2T) Long Ride	09-11	FA351/471 *				N/A		
T-Ride 250 F (Enduro)	08-11	FA350TT				N/A		
T-Ride 280 (2T/Enduro)	12-13	FA083TT			FA083R		N/A	
Raidster 660	07	FA351/471 *				TBA		

## SFM

SFM 125 Roadster	13	TBA						
ZZX 125 Enduro	13	FA086		FA086V	FA086HH		N/A	
ZZX 125 Sport	13	FA086		FA086V	FA086HH		N/A	
ZZX 125 Trail	13	FA086		FA086V	FA086HH		N/A	
ZZR 125 SM (Cast Wheel)	13	FA086		FA086V	FA086HH		N/A	

## SHERCO

Trials 0.5 (50cc 2T)	02	TBA						
Enduro 50cc (2T)	02-07	FA115			FA115HH		N/A	
Enduro 50c (2T)/Urban/SU - Spoke wheel models)	08-13	FA350			FA350HH		N/A	
Supermotard 50cc (2T)	02-07	FA115			FA115HH		N/A	
Supermotard 50cc (2T)	08-13	FA350			FA350HH		N/A	
SU 50 (2T) Urban Base - Cast wheel model)	10	FA350					N/A	
SM 0.5cc Black Panther	08-10	FA350			FA350HH		N/A	
Trials 0.8 (2T)	01-04	FA351					N/A	
Trials 0.8 (2T)	05-10	FA351					N/A	
ST 80 (2T)	13	FA351					N/A	
City Corp 125 (All models)	03-07	FA115			FA115HH		N/A	
City Corp 125 (All models)	08	FA350			FA350HH		N/A	

\*-2 Sets Required. ■ - Also available in MX-S race compound.

**SAFETY WARNING:** DO NOT USE HH PADS ON REAR UNLESS ALSO USED ON FRONT TO AVOID BRAKE IMBALANCE

**R** Suffix = High Durability Sintered Pad. **HH** Suffix = High Performance Sintered Pad. **G** Suffix = Grooved Shoe.  
**D** Suffix = Drilled Disc. **C** Suffix = Contoured Disc. **LS** Suffix = Left/Steel Disc. **RS** = Right/Steel Disc.

**BRAKE APPLICATIONS**

# Non-JAPANESE Built Motorcycles

## APPLICATIONS BRAKE



← FRONT / AVANT / VORN FRENTE / ANTERIORE →

## SHERCO

		DISC PAD CHOICES				BRAKE ROTOR CHOICES							
		NEW SFAC Scooter Carbon Pads	Semi-Sintered V-Pads™	Sintered/HH Pads/ Grooved shoes	Left/Gauche/Links	Right/Droite/Rechts	Contour Rotor Universal left and right fitment	NEW Vee-Rotors™ CONTOUR	NEW CX Extreme® ROTOR	Oversize 250/280mm Rotor Kit	Relocating Bracket for 250/280mm Rotor	Oversize 320mm Rotor Kit	Relocating Bracket for 320mm Rotor
Trials 1.25cc (2T)	99-05	FA115TT		FA115R ■	N/A								
Trials 1.25cc (2T)/AJP Calipers	06-12	FA303			N/A								
SE 1.25 F Enduro (4T)	10-12	FA194		FA194HH	N/A								
SM 1.25 i F Black Panther (4T)	10-12	FA194		FA194HH	N/A								
ST 125 (2T)	13	FA612TT		FA612R			N/A						
Trials 2.0cc (2T)	99-05	FA115TT		FA115R ■	N/A								
Trials 2.5 (2T)	99-05	FA115TT		FA115R ■	N/A								
Trials 2.5 (2T)/AJP Calipers	06-12	FA303			N/A								
Enduro 2.5i (4T) Inc. SE Models	08-11	FA181TT		FA181R ■	N/A		N/A						
SE 250 i R (Brembo Rear Caliper)	12-13	FA181TT		FA181R ■			N/A						
SM 2.5i Supermotard (4T)	08	FA181TT		FA181R ■	N/A								
ST 250 (2T)	13	FA612TT		FA612R			N/A						
SX 2.5i F Moto Cross	10	FA181TT		FA181R ■			N/A						
ST 290 (2T)	13	FA612TT		FA612R			N/A						
Trials 2.9 (2T)	99-05	FA115TT		FA115R ■	N/A								
Trials 2.9 (2T)/AJP Calipers	06-12	FA303			N/A								
X-Ride 290	12	FA083TT		FA083R			N/A						
Enduro SE 3.0i (4T)	10-11	FA181TT		FA181R ■			N/A						
SE 300 i R (Brembo Rear Caliper)	12-13	FA181TT		FA181R ■			N/A						
ST 305 (2T)	13	FA612TT		FA612R			N/A						
Trials 3.2cc (4T)/AJP Calipers	05-12	FA303			N/A								
Enduro 4.5i (4T) Inc SE Models	04-11	FA181TT		FA181R ■	N/A		N/A						
SE 450 i R (Nissin Rear Caliper)	12-13	FA181TT		FA181R ■			N/A						
SM 4.5i F (Supermotard)	04-10	FA181TT		FA181R ■	N/A								
SM 4.5i F (Black Panther)	08-12			FA322/4HH			N/A						
Enduro 5.1i F Inc SE Models	07-11	FA181TT		FA181R ■			N/A						
SE 510 i R (Nissin Rear Caliper)	12-13	FA181TT		FA181R ■			N/A						
SM 5.1i F Supermotard	07	FA181TT		FA181R ■			N/A						
SM 5.1i F Black Panther	08-12			FA322/4HH			N/A						

## SIAMOTO

Birdie 50	02-04	SFA169	SFAC169	SFA169HH	TBA								
Mat 50	97-01	TBA			TBA								
Scross 50	97-01	TBA			TBA								
TR 50		TBA			TBA								
Mat 100	97-01	TBA			TBA								
Capri Quattro	00-01	TBA			TBA								
Columbus 125	01-02	TBA			TBA								
KD 125	00-04	FA101TT			TBA								
Favorite 125	02-04	SFA169	SFAC169	SFA169HH	TBA								
SX1 125	04	FA194		FA194HH	N/A								
Geco 250	04	FA106TT			N/A								

## SINNIS

Strike 50 (2T)	09-10	SFA086	SFAC086	SFA086HH		MD971D	VR971C	VR971					
Pioneer 50 (2T)	09-10	SFA235	SFAC235			MD923D	MD923C	VR923					
Nitro 50 (2T)	09-10	SFA086	SFAC086	SFA086HH			MD971C						
QM 50 T-10R Eagle 50	10-12	SFA228	SFAC228	SFA228HH		TBA							
QM 50 QT-2T Falcon	08-10	SFA169	SFAC169	SFA169HH	MD904D			VR904					
QM 50 QT-6A Jet 50	08-10	SFA169	SFAC169	SFA169HH	MD904D			VR904					
QM 50 10A (B) Hawk	08-10	SFA228	SFAC228	SFA228HH	MD9131D								
WY 50 QT-39A Ghost	06-10	SFA235	SFAC235			MD923D	MD923C	VR923					
i25 T-8G Ecocity 125	07-09	SFA054	SFAC054	SFA054HH									
QM 125-2 C Vista 125	08-10	FA093			MD828								
QM 125- 2 D Stealth 125	08-10	FA228		FA228HH		N/A							
		FA197		FA197HH									
QM 125 T- Matrix	10	SFA054	SFAC054	SFA054HH									
QM 125 T-10H Matrix II	10	SFA054	SFAC054	SFA054HH									
QM 125 T-10R Eagle 125	10	SFA054	SFAC054	SFA054HH									
QM 125-2 V Max 125	08-10	FA199		FA199HH		MD829							

\*-2 Sets Required. ■ - Also available in MX-S race compound.

**SAFETY WARNING:** DO NOT USE HH PADS ON REAR UNLESS ALSO USED ON FRONT TO AVOID BRAKE IMBALANCE

# Non-JAPANESE Built Motorcycles



## SHERCO



← REAR / ARRIÈRE / HINTEN POSTERIOR / POSTERIORE →

			DISC PAD CHOICES			BRAKE ROTOR CHOICES			
			NEW SFAC Scooter Carbon Pads	Semi-Sintered V-Pads™	Sintered/HH Pads/ Grooved shoes	Contour Rotor Rear Fitment	NEW Vee-Rotors™ CONTOUR	NEW CX Extreme® ROTOR	
Trials 1.25cc (2T)	99-05	FA115TT			FA115R ■	N/A			
Trials 1.25cc (2T/AJP Calipers)	06-12	FA351				N/A			
SE 1.25 F Enduro (4T)	10-12	FA350			FA350HH	N/A			
SM 1.25 i F Black Panther (4T)	10-12	FA350			FA350HH	N/A			
ST 125 (2T)	13	FA351					N/A		
Trials 2.0cc (2T)	99-05	FA115TT			FA115R ■	N/A			
Trials 2.5 (2T)	99-05	FA115TT			FA115R ■	N/A			
Trials 2.5 (2T/AJP Calipers)	06-12	FA351				N/A			
Enduro 2.5i (4T) Inc. SE Models	08-11	FA367TT			FA367R ■	N/A	N/A		
SE 250 i R (Brembo Rear Caliper)	12-13	FA368TT			FA368R ■		N/A		
SM 2.5i Supermotard (4T)	08	FA367TT			FA367R ■	N/A			
ST 250 (2T)	13	FA351					N/A		
SX 2.5i F Moto Cross	10	FA367TT			FA367R ■		N/A		
ST 290 (2T)	13	FA351					N/A		
Trials 2.9 (2T)	99-05	FA115TT			FA115R ■	N/A			
Trials 2.9 (2T/AJP Calipers)	06-12	FA351				N/A			
X-Ride 290	12	FA083TT			FA083R		N/A		
Enduro SE 3.0i (4T)	10-11	FA367TT			FA367R ■		N/A		
SE 300 i R (Brembo Rear Caliper)	12-13	FA368TT			FA368R ■		N/A		
ST 305 (2T)	13	FA351					N/A		
Trials 3.2cc (4T/AJP Calipers)	05-12	FA351					N/A		
Enduro 4.5i (4T) Inc SE Models	04-11	FA367TT			FA367R ■	N/A	N/A		
SE 450 i R (Nissin Rear Caliper)	12-13	FA367TT			FA367R ■		N/A		
SM 4.5i F (Supermotard)	04-10	FA367TT			FA367R ■	N/A			
SM 4.5i F (Black Panther)	08-12	FA367TT			FA367R ■		N/A		
Enduro 5.1iF Inc SE Models	07-11	FA367TT			FA367R ■		N/A		
SE 510 i R (Nissin Rear Caliper)	12-13	FA367TT			FA367R ■		N/A		
SM 5.1i F Supermotard	07	FA367TT			FA367R ■		N/A		
SM 5.1i F Black Panther	08-12	FA367TT			FA367R ■		N/A		
<b>SIAMOTO</b>									
Birdie 50	02-04	TBA							
Mat 50	97-01	TBA							
Scross 50	97-01	TBA							
TR 50		TBA							
Mat 100	97-01	TBA							
Capri Quattro	00-01	TBA							
Columbus 125	01-02	TBA							
KD 125	00-04	TBA							
Favorite 125	02-04	TBA							
SX1 125	04	FA115			FA115HH	N/A			
Geo 250	04	S602							
<b>SINNIS</b>									
Strike 50 (2T)	09-10	H303							
Pioneer 50 (2T)	09-10	H303							
Nitro 50 (2T)	09-10	H303							
QM 50 T-10R Eagle 50	10-12	897							
QM 50 QT-2T Falcon	08-10	H303							
QM 50 QT-6A Jet 50	08-10	H303							
QM 50 10A (B) Hawk	08-10	897							
WY 50 QT-39A Ghost	06-10	H303							
125 T-8G Ecocity 125	07-09	SFA266	SFAC266		SFA266HH	MD9132D			
QM 125-2 C Vista 125	08-10	Y516							
QM 125-2 D Stealth 125	08-10	FA140			FA140HH	MD827			
QM 125 T- Matrix	10	Y506							
QM 125 T-10H Matrix II	10	Y506							
QM 125 T-10R Eagle 125	10	Y506							
QM 125-2 V Max 125	08-10	Y506							

\*-2 Sets Required. ■ - Also available in MX-S race compound.

**SAFETY WARNING:** DO NOT USE HH PADS ON REAR UNLESS ALSO USED ON FRONT TO AVOID BRAKE IMBALANCE

**BRAKE APPLICATIONS**

**R** Suffix = High Durability Sintered Pad. **HH** Suffix = High Performance Sintered Pad. **G** Suffix = Grooved Shoe.  
**D** Suffix = Drilled Disc. **C** Suffix = Contoured Disc. **LS** Suffix = Left/Steel Disc. **RS** = Right/Steel Disc.

# Non-JAPANESE Built Motorcycles



FRONT / AVANT / VORN      FRENTE / ANTERIORE



Model	Year	DISC PAD CHOICES				BRAKE ROTOR CHOICES						
		NEW SFAC Scooter Carbon Pads	Semi-Sintered V-Pads™	Sintered/HH Pads/ Grooved shoes	Left/Gauche/Links	Right/Droite/Rechts	Contour Rotor Universal left and right fitment	NEW Vee-Rotors™ CONTOUR	NEW CX Extreme® ROTOR	Oversize 250/280mm Rotor Kit	Relocating Bracket for 250/280mm Rotor	Oversize 320mm Rotor Kit
<b>SINNIS</b>												
QM 125 GY Apache 125 (Rear drum model)	09-10	FA135TT		FA135R			N/A					
QM 125 GY-2B (A) Apache 125 (Rear disc model)	09-10	FA135TT		FA135R			MD6357C					
QM 125 GY-2B Blade 125	09-10	FA135TT		FA135R			N/A					
WY 125 T-56A Nitro 125	09-10	SFA086	SFAC086	SFA086HH			MD971C	VR971				
Trackstar 125 (4T)	10-12	FA093				N/A						
Sublime 125	09-10	SFA101	SFAC101									
Pioneer 125	09-10	SFA235	SFAC235			MD923D	MD923C	VR923				
Grampus 250	10	SFA197	SFAC197	SFA197HH			TBA					
<b>SMC</b>												
YB 125	09	FA086		FA086HH			N/A					
YB 150	09	FA086		FA086HH			N/A					
YB 250	09	FA086		FA086HH			N/A					
<b>SUPERBYKE</b>												
Ape Byke 50		TBA										
CQ 50 Road Classic		FA375										
M-Ped 50 Road Classic		SFA169	SFAC169	SFA169HH	MD904D		MD904C	VR904				
RFX 50 Road Trail		FA093				N/A						
CU 125 Road Classic		FA375										
M-Ped 125 Road Classic		FA086		FA086HH			MD904D	MD904C	VR904			
Powerband 125	07-08	TBA				N/A						
RFX 125 Road Trail		FA093				N/A						
RMR 125	07-09	FA135TT		FA135R								
R-MX 125 4V	05-07	TBA				N/A						
RMX 125	07-08	FA086		FA086HH								
R-SR 125 4V		FA056										
SB 125-4		FA086		FA086HH								
SBS 125	07-08	TBA				N/A						
RFX 200	05-07	TBA				N/A						
RMR 200 SM	07-08	TBA				N/A						
R-SR 250		FA086		FA086HH	MD690		MD690C					
ZS 250-5	07-08	TBA				TBA						
<b>STOMP - MINI MOTO</b>												
125 Elite	07-09	FA448					N/A					
<b>SVM (SWM)</b>												
50/80 TR/TL Trial	-83			926G								
50/80 MK/GS/RBS Enduro	83-			841G								
50/80 MK/MC Cross	83-			841G								
125/175/250/347/440 Enduro	-83			843G								
125/250/440 Cross	-83			843G								
125/240/320/350 HMM/WTL Trial	-83			841G								
125/250 S1/S2	83-	FA047		FA047R		N/A						
323 Trial	85-			841G								
323 Trial	85-	FA047		FA047R		N/A						
350 XP Sahara	83-	FA018		FA018HH		N/A						
XN 506 Enduro	84-			849G								
<b>SYM</b>												
Allo 50 (4T)	11-13	SFA264	SFAC264	SFA264HH				VR923				
Cinderella 50/100	99-00	SFA151	SFAC151			MD933D		VR933				
City Hopper 50	99-02	SFA257	SFAC257			MD933D		VR933				
DD 50 (2T)	02-12	SFA151	SFAC151			MD9138D		VR9138				
Evie (Electric Scooter)	10	H303										
E Woo (Electric)	11	SFA151	SFAC151			MD933D		VR933				
Symmetry (Electric)	11	H303										
E-Symmetry (Electric)	12-13	SFA151	SFAC151			MD933D						
E-Vivid (Electric)	12-13	H303										

\*-2 Sets Required. ■ - Also available in MX-S race compound.

**SAFETY WARNING:** DO NOT USE HH PADS ON REAR UNLESS ALSO USED ON FRONT TO AVOID BRAKE IMBALANCE

APPLICATIONS  
BRAKE

R Suffix = High Durability Sintered Pad. HH Suffix = High Performance Sintered Pad. G Suffix = Grooved Shoe.  
D Suffix = Drilled Disc. C Suffix = Contoured Disc. LS Suffix = Left/Steel Disc. RS = Right/Steel Disc.



# Non-JAPANESE Built Motorcycles

**BRAKE APPLICATIONS**



← REAR / ARRIÈRE / HINTEN POSTERIOR / POSTERIORE →

## SINNIS



		DISC PAD CHOICES			BRAKE ROTOR CHOICES		
		NEW SFAC Scooter Carbon Pads	Semi-Sintered V-Pads™	Sintered/HH Pads/ Grooved shoes	Contour Rotor Rear Fitment	NEW Vee-Rotors™ CONTOUR	NEW CX Extreme® ROTOR
QM 125 GY Apache 125 (Rear drum model)	09-10		S602				
QM 125 GY-2B (A) Apache 125 (Rear disc model)	09-10		FA054		FA054R	MD6358C	
QM 125 GY-2B Blade 125	09-10		FA054		FA054R	N/A	
WY 125 T-56A Nitro 125	09-10		Y506				
Trackstar 125 (4T)	10-12		H310				
Sublime 125	09-10		Y506				
Pioneer 125	09-10		Y506				
Grampus 250	10	SFA266	SFAC266	SFA266HH	TBA		

## SMC

YB 125	09		FA086		FA086HH	N/A	
YB 150	09		FA086		FA086HH	N/A	
YB 250	09		FA086		FA086HH	N/A	

## SUPERBYKE

Ape Byke 50			TBA				
CQ 50 Road Classic			FA086			N/A	
M-Ped 50 Road Classic			TBA				
RFX 50 Road Trail			TBA				
CU 125 Road Classic			FA086			N/A	
M-Ped 125 Road Classic			TBA				
Powerband 125	07-08		TBA				
RFX 125 Road Trail			TBA				
RMR 125	07-09		FA054TT		FA054R	N/A	
R-MX 125 4V	05-07		TBA				
RMX 125	07-08		FA086		FA086HH	N/A	
R-SR 125 4V			TBA				
SB 125-4			H303				
SBS 125	07-08		TBA				
RFX 200	05-07		TBA			N/A	
RMR 200 SM	07-08		TBA				
R-SR 250			FA086		FA086HH	MD689	MD689C
ZS 250-5	07-08		TBA				

## STOMP - MINI MOTO

125 Elite	07-09		FA480			N/A	
-----------	-------	--	-------	--	--	-----	--

## SVM (SWM)

50/80 TR/TL Trial	-83				926G		
50/80 MK/GS/RBS Enduro	83-				841G		
50/80 MK/MC Cross	83-				841G		
125/175/250/347/440 Enduro	-83				843G		
125/250/440 Cross	-83				843G		
125/240/320/350 HMMW/TL Trial	-83				841G		
125/250 S1/S2	83-				841G		
323 Trial	85-				841G		
323 Trial	85-				841G		
350 XP Sahara	83-				841G		
XN 506 Enduro	84-				843G		

## SYM

Allo 50 (4T)	11-13		820				
Cinderella 50/100	99-00		H303				
City Hopper 50	99-02		H303				
DD 50 (2T)	02-12		H333				
Evie (Electric Scooter)	10		H303				
E Woo (Electric)	11		H303				
Symmetry (Electric)	11		H303				
E-Symmetry (Electric)	12-13		H303				
E-Vivid (Electric)	12-13		H303				

\*-2 Sets Required. ■ - Also available in MX-S race compound.  
**SAFETY WARNING:** DO NOT USE HH PADS ON REAR UNLESS ALSO USED ON FRONT TO AVOID BRAKE IMBALANCE

**R** Suffix = High Durability Sintered Pad. **HH** Suffix = High Performance Sintered Pad. **G** Suffix = Grooved Shoe.  
**D** Suffix = Drilled Disc. **C** Suffix = Contoured Disc. **LS** Suffix = Left/Steel Disc. **RS** = Right/Steel Disc.

# Non-JAPANESE Built Motorcycles



← FRONT / AVANT / VORN FRENTE / ANTERIORE →

SYM		DISC PAD CHOICES				BRAKE ROTOR CHOICES							
		NEW SFAC Scooter Carbon Pads	Semi-Sintered V-Pads™	Sintered/HH Pads/ Grooved shoes	Left/Gauche/Links	Right/Droite/Rechts	Contour Rotor Universal left and right fitment	NEW Vee-Rotors™ CONTOUR	NEW CX Extreme® ROTOR	Oversize 250/280mm Rotor Kit	Relocating Bracket for 250/280mm Rotor	Oversize 320mm Rotor Kit	Relocating Bracket for 320mm Rotor
E-Vivid Deluxe (Electric)	12-13	SFA151	SFAC151			MD933D							
Fiddle 50	99-05	H303											
Fiddle II 50	08-13	SFA264	SFAC264			MD923D		MD923C	VR923				
Jet Basix 50	06-09	SFA264	SFAC264			SFA264HH	MD9116D		VR9116				
Jet 50/Euro X S	99-05	SFA264	SFAC264			SFA264HH	MD9116D		VR9116				
Jet Euro X 50	06-12	SFA264	SFAC264			SFA264HH	MD9116D		VR9116				
Jet Sport X 50 SR	06-13	SFA264	SFAC264			SFA264HH		TBA					
Jet 4 (50cc/4T)	10-13	SFA264	SFAC264			SFA264HH	TBA						
Jet 4 R (50cc/2T)	11-13	SFA264	SFAC264			SFA264HH		MD9137C	VR9137				
Jungle 50/100	99-02	SFA264	SFAC264			SFA264HH	MD9116D		VR9116				
Mask 50	00-05	SFA264	SFAC264			SFA264HH	MD9116D		VR9116				
Mio 50	05-13	SFA151	SFAC151			MD933D			VR933				
Orbit 50	08-09	SFA257	SFAC257			MD923D		MD923C	VR923				
Orbit 11 50 (4T)	12-13	SFA197	SFAC197			SFA197HH	N/A						
Orbit 11 50 Naked (4T)	12-13	SFA197	SFAC197			SFA197HH	N/A						
Orbit 11 50 TS (4T)	12-13	SFA197	SFAC197			SFA197HH	N/A						
Red Devil 50	99-09	SFA264	SFAC264			SFA264HH	MD9116D		VR9116				
RS 50	04-09	SFA306	SFAC306				N/A						
Shark 50	99-03	SFA306	SFAC306				N/A						
Super Fancy 50	96-06	SFA257	SFAC257			MD933D			VR933				
Symphony 50 (4T/Rear drum model)	09	SFA264	SFAC264			SFA264HH	MD9137D	MD9137C	VR9137				
Symphony S 50 (4T/Rear disc model)	10-13	SFA264	SFAC264			SFA264HH	MD9137D	MD9137C	VR9137				
Symphony 50 SR (4T/Rear disc model)	10-13	SFA264	SFAC264			SFA264HH		MD9137C	VR9137				
Symply 50	07-08	SFA264	SFAC264			SFA264HH	MD923D	MD923C	VR923				
Symply 11 50	09-13	SFA264	SFAC264			SFA264HH	MD923D	MD923C	VR923				
Tonic 50 (4T)	11-13	SFA151	SFAC151				TBA						
XPro 50	13	SFA197	SFAC197			SFA197HH	N/A						
Jet 100 (G100P-6)	99-00	SFA264	SFAC264			SFA264HH	MD9116D		VR9116				
Mio 100	05-13	SFA151	SFAC151			MD933D			VR933				
SR 100 Sunrise	97	SFA1312				SFA1312HH	N/A						
Symba 100	11-12	H303											
Tonic 110 (4T)	11-13	SFA151	SFAC151				N/A						
Allo 125 (4T)	11-13	SFA264	SFAC264			SFA264HH	N/A		VR923				
Attila 125	99-00	SFA264	SFAC264			SFA264HH	MD933D		VR933				
Cevalo B9A (125cc -4T)	10	FA196				FA196HH		N/A					
City Com 125	08-13	SFA264	SFAC264			SFA264HH	N/A						
ComBiz 125	11-13	SFA067	SFAC067			SFA067HH	N/A						
CT 125	03-04	FA297						N/A					
Euro MX 125 (HF12-W6 Euro 1) (Rear drum model)	02-07	SFA306	SFAC306				N/A						
Euro MX 125 (HF12W3-6 Euro 2) (Rear disc model)	06-09	SFA306	SFAC306				N/A						
Fiddle II 125	08-13	SFA264	SFAC264			SFA264HH	MD923D	MD923C	VR923				
GTS 125 Joymax/Voyager	06-09	SFA427	SFAC427			SFA427HH	N/A						
GTS 125 i Joymax/Voyager EVO 125 i	10-12	SFA355*	SFAC355*			SFA355HH*	TBA						
HD 125/200	04-07	SFA305	SFAC305			SFA305HH	N/A						
HD 125 S Evo	07	SFA264	SFAC264			SFA264HH	N/A						
HD Evo 125 (Carb & EFI Models/4T/Single Headlight)	03-13	SFA264	SFAC264			SFA264HH	TBA						
HD2- 125i (4T)	10-13	SFA264	SFAC264			SFA264HH	N/A						
Huskey 125/150	99-05	FA297					N/A						
JET 4 (125cc/4T)	10-13	SFA264	SFAC264			SFA264HH	MD9137D	MD9137C	VR9137				
JET V (125cc/4T)	12-13	SFA067	SFAC067			SFA067HH		MD9137C	VR9137				
Joyride 125	01-06	SFA306	SFAC306				N/A						
Joyride 125 i	07-09	SFA306	SFAC306				N/A						
Joyride EVO 125 i (Twin Headlights)	09-13	SFA306	SFAC306				N/A						
Megalo 125	00-07	SFA264	SFAC264			SFA264HH	MD933D		VR933				
Orbit 125	08-09	SFA257	SFAC257				TBA						
RS 125	04-06	SFA306	SFAC306				N/A						
SB 125 N - Wolf (Carb Model/Drum Rear Brake)	11-13	FA179				FA179HH		TBA					
SB 125 Ni - Wolf (EFI Model)	11-13	FA427TT						TBA					
Shark 125/150 (Drum rear model)	99-02	SFA306	SFAC306				N/A						
Shark 4VR 125/150 R (Rear disc model)	00-02	SFA306	SFAC306				N/A						

\*-2 Sets Required. ■ - Also available in MX-S race compound.

**SAFETY WARNING:** DO NOT USE HH PADS ON REAR UNLESS ALSO USED ON FRONT TO AVOID BRAKE IMBALANCE

APPLICATIONS  
BRAKE

R Suffix = High Durability Sintered Pad. HH Suffix = High Performance Sintered Pad. G Suffix = Grooved Shoe.

D Suffix = Drilled Disc. C Suffix = Contoured Disc. LS Suffix = Left/Steel Disc. RS = Right/Steel Disc.

# Non-JAPANESE Built Motorcycles



**SYM**



← REAR / ARRIÈRE / HINTEN POSTERIOR / POSTERIORE →

			DISC PAD CHOICES			BRAKE ROTOR CHOICES			
			NEW SFAC Scooter Carbon Pads	Semi-Sintered V-Pads™	Sintered/HH Pads/ Grooved shoes		Contour Rotor Rear Fitment	NEW Vee-Rotors™ CONTOUR	NEW CX Extreme® ROTOR
E-Vivid Deluxe (Electric)	12-13	H303							
Fiddle 50	99-05	H302							
Fiddle II 50	08-13	H303							
Jet Basic 50	06-09	H303							
Jet 50/Euro X S	99-05	H303							
Jet Euro X 50	06-12	H303							
Jet Sport X 50 SR	06-13	SFA234					TBA		
Jet 4 (50cc/4T)	10-13	H303							
Jet 4 R (50cc/2T)	11-13	H303							
Jungle 50/100	99-02	H303							
Mask 50	00-05	H303							
Mio 50	05-13	H303							
Orbit 50	08-09	H303							
Orbit 11 50 (4T)	12-13	H307							
Orbit 11 50 Naked (4T)	12-13	H307							
Orbit 11 50 TS (4T)	12-13	H303							
Red Devil 50	99-09	H303							
RS 50	04-09	H303							
Shark 50	99-03	820							
Super Fancy 50	96-06	H303							
Symphony 50 (4T/Rear drum model)	09	H307							
Symphony S 50 (4T/Rear disc model)	10-13	SFA260	SFAC260		SFA260HH	TBA			
Symphony 50 SR (4T/Rear disc model)	10-13	SFA260	SFAC260		SFA260HH	TBA			
Symply 50	07-08	H303							
Symply 11 50	09-13	H303							
Tonic 50 (4T)	11-13	H303							
XPro 50	13	H303							
Jet 100 (G100P-6)	99-00	H303							
Mio 100	05-13	H303							
SR 100 Sunrise	97								
Symba 100	11-12	H303							
Tonic 110 (4T)	11-13	H307							
Allo 125 (4T)	11-13	820							
Attila 125	99-00	H307							
Cevalo B9A (125cc-4T)	10	TBA							
City Com 125	08-13	SFA427	SFAC427		SFA427HH	N/A			
ComBiz 125	11-13	820							
CT 125	03-04	819							
Euro MX 125 (HF12-W6 Euro 1) (Rear drum model)	02-07	820							
Euro MX 125 (HF12W3-6 Euro 2) (Rear disc model)	06-09	SFA197	SFAC197			TBA			
Fiddle II 125	08-13	H307							
GTS 125 Joymax/Voyager	06-09	SFA427	SFAC427		SFA427HH	N/A			
GTS 125 i Joymax/Voyager EVO 125 i	10-12	SFA427	SFAC427		SFA427HH	TBA			
HD 125/200	04-07	820							
HD 125 S Evo	07	820							
HD Evo 125 (Carb & EFI Models/4T/Single Headlight)	03-13	SFA427	SFAC427		SFA427HH	TBA			
HD2- 125i (4T)	10-13	SFA427	SFAC427		SFA427HH	TBA			
Huskey 125/150	99-05	819							
JET 4 (125cc/4T)	10-13	H307							
JET V (125cc/4T)	12-13	H307							
Joyride 125	01-06	SFA305	SFAC305			N/A			
Joyride 125 i	07-09	SFA427	SFAC427			TBA			
Joyride EVO 125 i (Twin Headlights)	09-13	SFA427	SFAC427			TBA			
Megalo 125	00-07	820							
Orbit 125	08-09	820							
RS 125	04-06	TBA							
SB 125 N - Wolf (Carb Model/Drum Rear Brake)	11-13	TBA							
SB 125 Ni - Wolf (EFI Model)	11-13	FA377TT				TBA			
Shark 125/150 (Drum rear model)	99-02	820							
Shark 4VR 125/150 R (Rear disc model)	00-02	SFA197	SFAC197			N/A			

\*-2 Sets Required. ■ - Also available in MX-S race compound.

**SAFETY WARNING:** DO NOT USE HH PADS ON REAR UNLESS ALSO USED ON FRONT TO AVOID BRAKE IMBALANCE

**R** Suffix = High Durability Sintered Pad. **HH** Suffix = High Performance Sintered Pad. **G** Suffix = Grooved Shoe.  
**D** Suffix = Drilled Disc. **C** Suffix = Contoured Disc. **LS** Suffix = Left/Steel Disc. **RS** = Right/Steel Disc.

**BRAKE APPLICATIONS**

# Non-JAPANESE Built Motorcycles



← FRONT / AVANT / VORN FRENTE / ANTERIORE →

SYM		DISC PAD CHOICES				BRAKE ROTOR CHOICES							
		NEW SFAC Scooter Carbon Pads	Semi-Sintered V-Pads™	Sintered/HH Pads/ Grooved shoes	Left/Gauche/Links	Right/Droite/Rechts	Contour Rotor Universal left and right fitment	NEW Vee-Rotors™ CONTOUR	NEW CX Extreme® ROTOR	Oversize 250/280mm Rotor Kit	Relocating Bracket for 250/280mm Rotor	Oversize 320mm Rotor Kit	Relocating Bracket for 320mm Rotor
SK 125	03-04	SFA306	SFAC306			N/A							
Super Duke 125/150	99-02	SFA264	SFAC264			SFA264HH	MD933D			VR933			
Symphony 125 (4T/Rear drum)	09	SFA264	SFAC264			SFA264HH	MD9137D			MD9137C	VR9137		
Symphony S 125 (4T/Rear disc model)	10-13	SFA264	SFAC264			SFA264HH	MD9137D			MD9137C	VR9137		
Symphony 125 SR (4T/Rear disc model)	10-13	SFA264	SFAC264			SFA264HH				MD9137C	VR9137		
Simply 125	07-08	SFA264	SFAC264			SFA264HH	MD923D			MD923C	VR923		
Simply 11 125	09-13	SFA264	SFAC264			SFA264HH	MD923D			MD923C	VR923		
VS 125	06-13	SFA306	SFAC306				N/A						
Wolf Legend	04-05	FA086				FA086HH		N/A					
Wolf 125/150 Scooter (Type 125M/P125M/P150M)	00	H306											
XS 125 K	07-13	FA197				FA197HH		N/A					
XPro 125	13	SFA197	SFAC197			SFA197HH	N/A						
Allo 150 (4T)	11-13	SFA264	SFAC264			SFA264HH		N/A					
Joyride 150	01-06	SFA306	SFAC306				N/A						
RS 150	06	SFA306	SFAC306				N/A						
Fiddle II 151	08-13	SFA264	SFAC264			SFA264HH	TBA						
Symphony S 151 (4T/Rear disc model)	10-13	SFA264	SFAC264			SFA264HH	MD9137D			MD9137C	VR9137		
Symphony 151 SR (4T/Rear disc model)	10-13	SFA264	SFAC264			SFA264HH				MD9137C	VR9137		
VS 150	06-13	SFA306	SFAC306				N/A						
H 200 SE	06	SFA264	SFAC264			SFA264HH	TBA						
HD 200 S Evo	07	SFA264	SFAC264			SFA264HH	TBA						
HD Evo 200 (Carb & EFI Models/4T/Single Headlight)	03-13	SFA264	SFAC264			SFA264HH	TBA						
HD2-200i (4T)	10-13	SFA264	SFAC264			SFA264HH	N/A						
Joyride 200	03-07	SFA306	SFAC306				N/A						
Joyride 200 i	07-09	SFA306	SFAC306				N/A						
Joyride EVO 200 i	09-13	SFA306	SFAC306				N/A						
Trackrunner 200 Quad	05-09	FA377TT*				FA377R*	N/A	N/A					
Quadlander 200	12-13	FA377TT*				FA377R*	N/A	N/A					
GTS 250	07-08	SFA355*	SFAC355*			SFA355HH*	N/A						
Joymax 250	06	SFA355*	SFAC355*			SFA355HH*	N/A						
Joymax 250 i	07-08	SFA355*	SFAC355*			SFA355HH*	TBA						
Quadlander 250	05-09	FA377TT*				FA377R*	N/A	N/A					
SB 250 Ni	12-13	SFA627				SFA627HH			N/A				
Voyager 250	05	SFA355*	SFAC355*			SFA355HH*	N/A						
GTS 300/Joymax	08-13	SFA355*	SFAC355*			SFA355HH*	N/A						
GTS /Joymax Evo 300i	10-13	SFA355*	SFAC355*			SFA355HH*	TBA						
City Com 300 i	08-13	SFA264	SFAC264			SFA264HH	N/A						
Citymax 300 Quad	06	FA377*				FA377R*	TBA	TBA					
Outlander 300	08-10	FA377TT*				FA377R*	TBA	TBA					
Outlander 300 S	07-13	FA377TT*				FA377R*	TBA	TBA					
Max Sym 400i	11-12	SFA627*				SFA627HH*	TBA	TBA					
GT 500	04	SFA283*	SFAC283*			SFA283HH*	N/A						
XP 500	04	TBA					N/A						
Quadraider 600	06-07	FA054TT*				FA054R* ■	TBA	TBA					
Quadraider 600	08-13	FA377TT*				FA377R*	N/A	N/A					
Quadraider 600LE	10-13	FA377*				FA377R*	N/A	N/A					
<b>TAISHAN (Project Quads)</b>													
Commuter 50	03-05	S632											
XT 50	03-04	FA054TT				FA054HH	N/A						
Sport 50 (Drum front)	03-05	S632					N/A						
Panther 50 Quad	03-04	FA054TT				FA054HH	N/A						
Desert Cat 100	04-05	TBA*											
Desert Cat Extreme 100	04-05	TBA*											
Hurricane 125 Quad	04-05	TBA*											
XT 125 Sport	04-05	FA054TT				FA054HH	N/A						
Explorer 150 Quad	04-05	TBA*											
Tornado 200 Quad	04	TBA*											

\*-2 Sets Required. ■ - Also available in MX-S race compound.

**SAFETY WARNING:** DO NOT USE HH PADS ON REAR UNLESS ALSO USED ON FRONT TO AVOID BRAKE IMBALANCE

APPLICATIONS  
BRAKE

R Suffix = High Durability Sintered Pad. HH Suffix = High Performance Sintered Pad. G Suffix = Grooved Shoe.  
D Suffix = Drilled Disc. C Suffix = Contoured Disc. LS Suffix = Left/Steel Disc. RS = Right/Steel Disc.

# Non-JAPANESE Built Motorcycles



**SYM**



← REAR / ARRIÈRE / HINTEN POSTERIOR / POSTERIORE →

		DISC PAD CHOICES				BRAKE ROTOR CHOICES			
		NEW SFAC Scooter Carbon Pads	Semi-Sintered V-Pads™	Sintered/HH Pads/ Grooved shoes		Contour Rotor Rear Fitment	NEW Vee-Rotors™ CONTOUR	NEW CX Extreme® ROTOR	
SK 125	03-04	SFA305	SFAC305			N/A			
Super Duke 125/150	99-02	H303							
Symphony 125 (4T/Rear drum)	09	H307							
Symphony S 125 (4T/Rear disc model)	10-13	SFA260	SFAC260		SFA260HH	TBA			
Symphony 125 SR (4T/Rear disc model)	10-13	SFA260	SFAC260		SFA260HH		TBA		
Symply 125	07-08	H307							
Symply 11 125	09-13	H307							
VS 125	06-13	820							
Wolf Legend	04-05	819							
Wolf 125/150 Scooter (Type 125M/P125M/P150M)	00	H307							
XS 125 K	07-13	H310							
XPro 125	13	H303							
Allo 150 (4T)	11-13	820							
Joyride 150	01-06	SFA305	SFAC305			N/A			
RS 150	06	SFA228	SFAC228			N/A			
Fiddle II 151	08-13	H307							
Symphony S 151 (4T/Rear disc model)	10-13	SFA260	SFAC260		SFA260HH	TBA			
Symphony 151 SR (4T/Rear disc model)	10-13	SFA260	SFAC260		SFA260HH		TBA		
VS 150	06-13	820							
H 200 SE	06	SFA427	SFAC427		SFA427HH	TBA			
HD 200 S Evo	07	SFA427	SFAC427		SFA427HH	TBA			
HD Evo 200 (Carb & EFI Models/4T/Single Headlight)	03-13	SFA427	SFAC427		SFA427HH	TBA			
HD2-200i (4T)	10-13	SFA427	SFAC427		SFA427HH	TBA			
Joyride 200	03-07	SFA305	SFAC305			N/A			
Joyride 200 i	07-09	SFA427	SFAC427			TBA			
Joyride EVO 200 i	09-13	SFA427	SFAC427			TBA			
Trackrunner 200 Quad	05-09	FA427TT			FA427R	N/A			
Quadlander 200	12-13	FA427TT			FA427R	N/A			
GTS 250	07-08	SFA427	SFAC427		SFA427HH	N/A			
Joymax 250	06	SFA427	SFAC427		SFA427HH	N/A			
Joymax 250 i	07-08	SFA427	SFAC427		SFA427HH	TBA			
Quadlander 250	05-09	FA427TT			FA427R	N/A			
SB 250 Ni	12-13	FA377				N/A			
Voyager 250	05	SFA319			SFA319HH	N/A			
GTS 300/Joymax	08-13	SFA427	SFAC427		SFA427HH	N/A			
GTS /Joymax Evo 300i	10-13	SFA427	SFAC427		SFA427HH	TBA			
City Com 300 i	08-13	SFA264	SFAC264		SFA264HH	N/A			
Citymax 300 Quad	06	FA427TT			FA427R	TBA			
Outlander 300	08-10	FA377TT			FA377R	TBA			
Outlander 300 S	07-13	FA377TT			FA377R	TBA			
Max Sym 400i	11-12	SFA628			SFA628HH	TBA			
GT 500	04	SFA305	SFAC305		SFA305HH	N/A			
XP 500	04	TBA				N/A			
Quadraider 600	06-07	FA377TT			FA377R	TBA			
Quadraider 600	08-13	FA377TT			FA377R	N/A			
Quadraider 600LE	10-13	FA377TT			FA377R	N/A			
<b>TAISHAN (Project Quads)</b>									
Commuter 50	03-05	H303							
XT 50	03-04	TBA							
Sport 50 (Drum front)	03-05	H303							
Panther 50 Quad	03-04	TBA							
Desert Cat 100	04-05	TBA				TBA			
Desert Cat Extreme 100	04-05	TBA				TBA			
Hurricane 125 Quad	04-05	FA165TT			FA165R	N/A			
XT 125 Sport	04-05	TBA							
Explorer 150 Quad	04-05	FA165TT			FA165R	N/A			
Tornado 200 Quad	04	FA165TT			FA165R	N/A			

\*-2 Sets Required. ■ - Also available in MX-S race compound.

**SAFETY WARNING:** DO NOT USE HH PADS ON REAR UNLESS ALSO USED ON FRONT TO AVOID BRAKE IMBALANCE

**R** Suffix = High Durability Sintered Pad. **HH** Suffix = High Performance Sintered Pad. **G** Suffix = Grooved Shoe.  
**D** Suffix = Drilled Disc. **C** Suffix = Contoured Disc. **LS** Suffix = Left/Steel Disc. **RS** = Right/Steel Disc.

**BRAKE APPLICATIONS**



# Non-JAPANESE Built Motorcycles



← FRONT / AVANT / VORN FRENTE / ANTERIORE →

## DISC PAD CHOICES

## BRAKE ROTOR CHOICES

Model	Year	Disc	DISC PAD CHOICES			BRAKE ROTOR CHOICES								
			NEW SFAC Scooter Carbon Pads	Semi-Sintered V-Pads™	Sintered/HH Pads/ Grooved shoes	Left/Gauche/Links	Right/Droite/Rechts	Contour Rotor Universal left and right fitment	NEW Vee-Rotors™ CONTOUR	NEW CX Extreme® ROTOR	Oversize 250/280mm Rotor Kit	Relocating Bracket for 250/280mm Rotor	Oversize 320mm Rotor Kit	Relocating Bracket for 320mm Rotor
<b>TAMORETTI</b>														
Retro 50			SFA086	SFAC086	SFA086HH	MD901D		MD901C	VR901					
Retro 125			SFA086	SFAC086	SFA086HH	MD901D		MD901C	VR901					
Stealth 125			SFA235	SFAC235		MD901D		MD901C	VR901					
<b>TERRA MOTO</b>														
TDX 125 F	07		SFA169	SFAC169	SFA169HH	N/A								
TDX 125 F Krusha	07		SFA169	SFAC169	SFA169HH	N/A								
TDX 125 F Street Ripa	07		SFA169	SFAC169	SFA169HH	N/A								
<b>TGB</b>														
Bullet 250 (2T)	11-12		SFA083	SFAC083	SFA083HH			N/A						
Bull & T 50 RS (2T)	11-12		SFA083	SFAC083	SFA083HH			N/A						
Bull & T 50 RR (2T)	11-12		SFA083	SFAC083	SFA083HH			N/A						
City 50cc (2T)	07-08		SFA083	SFAC083	SFA083HH	MD923D		MD923C	VR923					
City 50cc (4T)	07-11		SFA083	SFAC083	SFA083HH	MD923D		MD923C	VR923					
Delivery 50 Scooter (Up to E/F no 609099)	04-06		SFA264	SFAC264	SFA264HH	MD923D		MD923C	VR923					
Delivery/Express 50 (From F/E No 609100)	06-12		SFA083	SFAC083	SFA083HH	MD923D		MD923C	VR923					
Akros Tec (50)	03-04		SFA264	SFAC264	SFA264HH	MD923D		MD923C	VR923					
High Wheel 50	02-03		SFA083	SFAC083	SFA083HH	MD923D		MD923C	VR923					
Hornet 50/90 Quad	04-05		H338*		H338G*									
R 50 X Bullet	06-10		SFA093			MD9115D								
R 50 X Bullet	10-11		SFA093					N/A						
Tapo RS 50 (2T)	10-12		SFA083	SFAC083	SFA083HH			N/A						
Tapo RR 50 (2T)	10-12		SFA083	SFAC083	SFA083HH			N/A						
Trigger 50	02-03		SFA083	SFAC083	SFA083HH	MD923D		MD923C	VR923					
X Race 50 (2T)	11-12		SFA083	SFAC083	SFA083HH									
i01 R (50cc)	04-09		SFA264	SFAC264	SFA264HH	MD923D		MD923C	VR923					
Bellavita 125 i (4T)	12		SFA264	SFAC264	SFA264HH		N/A							
Delivery/Express (125cc)	04-12		SFA093			MD9115D								
X-Motion 125	08-12		SFA484			N/A								
X-Motion 125 R i	11-12		SFA484			N/A								
R 125 X Bullet	08-09		SFA093			MD9115D								
R 125 X Bullet	10-11		SFA093					N/A						
202 Classic (50cc)	03-09		SFA264	SFAC264	SFA264HH	MD923D		MD923C	VR923					
204 Classic (125cc)	03-04		SFA083	SFAC083	SFA083HH	TBA								
250 Blade/Congo ATV	06-07		FA067TT*		FA067R*	N/A	N/A							
X-Motion 250i	08-10		SFA484			N/A								
302 Sport (50cc)	03-09		SFA093			MD9115D								
303R Hawk/Laser (50cc)	04-11		SFA083	SFAC083	SFA083HH	MD923D		MD923C	VR923					
303R Hawk/Laser (125/150cc)	04-08		SFA093			MD9115D								
303R Hawk/Laser (125/150cc)	09-11		SFA093					N/A						
303 Revolution (50/125cc)	02-03		SFA083		SFA083HH	MD923D		MD923C	VR923					
304 Sport (125cc)	03-09		SFA093			MD9115D								
F409 Cruise 50/125	02-05		SFA083	SFAC083	SFA083HH	MD923D		MD923C	VR923					
309 RS 50	02-03		SFA093			MD923D		MD923C	VR923					
Bellavita 300 i (4T)	12		SFA264	SFAC264	SFA264HH		N/A							
X-Motion 300 Efi	10-12		SFA484			N/A								
Blade 325 Quad (4 x 2)	07-11		FA083TT*		FA083R*	TBA	TBA							
Blade 325 LE Quad (4 x 2)	08-10		FA083TT*		FA083R*	TBA	TBA							
Blade 325 SL Quad (4 x 2)	11-12		FA083TT*		FA083R*	TBA	TBA							
Target 325 (4 x 2)	09-12		FA083TT*		FA083R*	N/A	N/A							
Avenger 400 Quad (4 x 2)	07-09		FA377TT*		FA377R*	TBA	TBA							
Avenger 400 LE Quad (4 x 2)	09-10		FA377TT*		FA377R*	TBA	TBA							
Target 400 (4 x 2)	09-10		FA083TT*		FA083R*	N/A	N/A							
404 Executive	03-04		SFA093			TBA								
Blade (4 x 4) 425 Quad	07-09		FA377TT*		FA377R*	N/A	N/A							
Blade SE (4 x 4) 425 Quad	09-10		FA377TT*		FA377R*	N/A	N/A							
Target 425 (4 x 4)	09-11		FA083TT*		FA083R*	N/A	N/A							
Blade 450 SE (4 x 4)	10-11		FA377TT*		FA377R*	N/A	N/A							
Blade 460 R Target	12		FA083TT*		FA083R*	N/A	N/A							

\*-2 Sets Required. ■ - Also available in MX-S race compound.

**SAFETY WARNING:** DO NOT USE HH PADS ON REAR UNLESS ALSO USED ON FRONT TO AVOID BRAKE IMBALANCE

# Non-JAPANESE Built Motorcycles



## TAMORETTI



← REAR / ARRIÈRE / HINTEN POSTERIOR / POSTERIORE →

		DISC PAD CHOICES			BRAKE ROTOR CHOICES			
		NEW SFAC Scooter Carbon Pads	Semi-Sintered V-Pads™	Sintered/HH Pads/ Grooved shoes	Contour Rotor Rear Fitment	NEW Vee-Rotors™ CONTOUR	NEW CX Extreme® ROTOR	
Retro 50		H303						
Retro 125		H303						
Stealth 125		H307						
<b>TERRA MOTO</b>								
TDX 125 F	07	SFA169	SFAC169	SFA169HH	N/A			
TDX 125 F Krusha	07	SFA169	SFAC169	SFA169HH	N/A			
TDX 125 F Street Ripa	07	SFA169	SFAC169	SFA169HH	N/A			
<b>TGB</b>								
Bullet 250 (2T)	11-12	897						
Bull & T 50 RS (2T)	11-12	SFA083	SFAC083	SFA083HH	N/A			
Bull & T 50 RR (2T)	11-12	SFA083	SFAC083	SFA083HH	N/A			
City 50cc (2T)	07-08	897						
City 50cc (4T)	07-11	897						
Delivery 50 Scooter (Up to E/F no 609099)	04-06	897						
Delivery/Express 50 (From F/E No 609100)	06-12	897						
Akros Tec (50)	03-04	897						
High Wheel 50	02-03	897						
Hornet 50/90 Quad	04-05	FA083TT		FA083R	N/A			
R 50 X Bullet	06-10	SFA083			MD9115D			
R 50 X Bullet	10-11	SFA083				N/A		
Tapo RS 50 (2T)	10-12	897						
Tapo RR 50 (2T)	10-12	897						
Trigger 50	02-03	897						
X Race 50 (2T)	11-12	897						
101 R (50cc)	04-09	897						
Bellavita 125 i (4T)	12	SFA298	SFAC298	SFA298HH	N/A			
Delivery/Express (125cc)	04-12	820						
X-Motion 125	08-12	SFA427			N/A			
X-Motion 125 R i	11-12	SFA427			N/A			
R 125 X Bullet	08-09	SFA083			MD9115D			
R 125 X Bullet	10-11	SFA083				N/A		
202 Classic (50cc)	03-09	897						
204 Classic (125cc)	03-04	TBA						
250 Blade/Congo ATV	06-07	FA083TT		FA083R	N/A			
X-Motion 250i	08-10	SFA427			N/A			
302 Sport (50cc)	03-09	897						
303R Hawk/Laser (50cc)	04-11	897						
303R Hawk/Laser (125/150cc)	04-08	820						
303R Hawk/Laser (125/150cc)	09-11	820						
303 Revolution (50/125cc)	02-03	897						
304 Sport (125cc)	03-09	897						
F409 Cruise 50/125	02-05	897						
309 RS 50	02-03	897						
Bellavita 300 i (4T)	12	SFA298	SFAC298	SFA298HH	N/A			
X-Motion 300 Effi	10-12	SFA427			N/A			
Blade 325 Quad (4 x 2)	07-11	FA067TT		FA067R	TBA			
Blade 325 LE Quad (4 x 2)	08-10	FA067TT		FA067R	TBA			
Blade 325 SL Quad (4 x 2)	11-12	FA067TT		FA067R	TBA			
Target 325 (4 x 2)	09-12	FA067TT		FA067R	N/A			
Avenger 400 Quad (4 x 2)	07-09	FA377TT*		FA377R*	TBA*			
Avenger 400 LE Quad (4 x 2)	09-10	FA377TT*		FA377R*	TBA*			
Target 400 (4 x 2)	09-10	FA067TT		FA067R	N/A			
404 Executive	03-04	TBA						
Blade (4 x 4) 425 Quad	07-09	FA377TT*		FA377R*	N/A*			
Blade SE (4 x 4) 425 Quad	09-10	FA377TT*		FA377R*	N/A*			
Target 425 (4 x 4)	09-11	FA067TT		FA067R	N/A			
Blade 450 SE (4 x 4)	10-11	FA067TT		FA067R	N/A			
Blade 460 R Target	12	FA067TT		FA067R	N/A			

\*-2 Sets Required. ■ - Also available in MX-S race compound.

**SAFETY WARNING:** DO NOT USE HH PADS ON REAR UNLESS ALSO USED ON FRONT TO AVOID BRAKE IMBALANCE

**BRAKE APPLICATIONS**

**R** Suffix = High Durability Sintered Pad. **HH** Suffix = High Performance Sintered Pad. **G** Suffix = Grooved Shoe.  
**D** Suffix = Drilled Disc. **C** Suffix = Contoured Disc. **LS** Suffix = Left/Steel Disc. **RS** = Right/Steel Disc.

# Non-JAPANESE Built Motorcycles



← FRONT / AVANT / VORN FRENTE / ANTERIORE →

## DISC PAD CHOICES

## BRAKE ROTOR CHOICES

### TGB

		NEW SFAC Scooter Carbon Pads	Semi-Sintered V-Pads™	Sintered/HH Pads/ Grooved shoes	Left/Gauche/Links	Right/Droite/Rechts	Contour Rotor Universal left and right fitment	NEW Vee-Rotors™ CONTOUR	NEW CX Extreme® ROTOR	Oversize 250/280mm Rotor Kit	Relocating Bracket for 250/280mm Rotor	Oversize 320mm Rotor Kit	Relocating Bracket for 320mm Rotor
Blade 460 R Target	12	FA083TT*		FA083R*	N/A	N/A							
Blade 460 SL IRS 4 x 4	12	FA377TT*		FA377R*	N/A	N/A							
Avenger 500 R Quad (4 x 2)	09-10	FA377TT*		FA377R*	TBA	TBA							
Target 500 (4 x 2)	09-10	FA083TT*		FA083R*	N/A	N/A							
Blade 510 LE	11-12	FA377TT*		FA377R*	N/A	N/A							
Blade 525 SE 4 x 4	09-10	FA377TT*		FA377R*	N/A	N/A							
Blade 525 SL 4 x 4	09-10	FA377TT*		FA377R*	N/A	N/A							
525 SE 4 x 4	09	FA377TT*		FA377R*	N/A	N/A							
Target 525 (4 x 4)	09-11	FA083TT*		FA083R*	N/A	N/A							
Blade 550 LT 4 x 4	10-11	FA377TT*		FA377R*	N/A	N/A							
Blade 550 SE 4 x 4	09-11	FA377TT*		FA377R*	N/A	N/A							
Blade 550 SL 4 x 4	09-10	FA377TT*		FA377R*	N/A	N/A							
Gunner 550 4 x 4 Target	10-12	FA377TT*		FA377R*	N/A	N/A							
Blade 550 IRS Target	11-12	FA377TT*		FA377R*	N/A	N/A							
550 IRS Blade LT	10-12	FA377TT*		FA377R*	N/A	N/A							

### THUMPSTAR

Thumpstar Junior 90cc	04-06	SFA169	SFAC169	SFA169HH	N/A								
Thumpstar Supa 110cc	04-06	SFA169	SFAC169	SFA169HH	N/A								
Thumpstar Expert 125	06	SFA169	SFAC169	SFA169HH	N/A								
Thumpstar Pro 125	05-06	SFA169	SFAC169	SFA169HH	N/A								
Thumpstar 125 Road Ripper	06	SFA169	SFAC169	SFA169HH	N/A								

### T.M.

Junior 80/85/100 Cross (Small wheel)	02-04	FA181TT		FA181R ■	N/A								
Junior 80/85/100	05-07	FA181TT		FA181R ■	N/A								
80/85/100 (Big wheel)	02-04	FA181TT		FA181R ■	N/A								
80 Enduro	96-00	FA181TT		FA181R ■	N/A								
80/85 Minicross/Junior	96-00	FA083TT		FA083R	N/A								
80/85 Cross	96-01	FA181TT		FA181R ■	N/A								
MX 85 JR (Small Wheel)	02-04	FA181TT		FA181R ■			MD6349C						
MX 85 JR (Small Wheel)	05-13	FA181TT		FA181R ■			MD6349C						
MX 85 (Big Wheel)	02-04	FA181TT		FA181R ■			MD6349C						
MX 85 (Big Wheel)	05-13	FA181TT		FA181R ■			MD6349C						
125 Cross	95-00	FA181TT		FA181R ■	N/A								
MX 125 (2T)	01-04	FA181TT		FA181R ■			MD6349C						
MX 125 (2T)	05-12	FA181TT		FA181R ■			MD6349C						
125 Enduro	95-00	FA181TT		FA181R ■	N/A								
Enduro EN 125 (2T)	01-04	FA181TT		FA181R ■			MD6349C						
Enduro EN 125 (2T)	05-13	FA181TT		FA181R ■			MD6349C						
SMM 125 Black Dream (Rim brake)	04-07	NA			N/A								
SMM 125 (2T) Black Dream (320mm front disc)	08-13			FA3224HH	N/A								
SMR 125 (2T)	05-13	FA095		FA095HH	N/A								
EN 144 (2T)	08-13	FA181TT		FA181R ■			MD6349C						
MX 144 (2T)	08-13	FA181TT		FA181R ■			MD6349C						
250 Enduro	95-00	FA181TT		FA181R ■	N/A								
EN 250 F (4T) Enduro	04	FA181TT		FA181R ■			MD6349C						
EN 250 F (4T) Enduro	05-13	FA181TT		FA181R ■			MD6349C						
Enduro EN 250 (2T)	01-04	FA181TT		FA181R ■			MD6349C						
Enduro EN 250 (2T)	05-13	FA181TT		FA181R ■			MD6349C						
EN 250 FI	10-13	FA181TT		FA181R ■			MD6349C						
SME 250 (4T)	04	FA095		FA095HH	N/A								
250 Cross	95-00	FA181TT		FA181R ■	N/A								
MX 250 (2T)	01-04	FA181TT		FA181R ■			MD6349C						
MX 250 (2T)	05-13	FA181TT		FA181R ■			MD6349C						
MX 250 (4T) Cross	02-10	FA181TT		FA181R ■			MD6349C						
MX 250 (4T) Cross	05-12	FA181TT		FA181R ■			MD6349C						
MX 250 FI (4T)	10-13	FA181TT		FA181R ■			MD6349C						
SM 250	02	FA095		FA095HH	N/A								
SMM 250 (2T)	05-13	FA095		FA095HH	N/A								

\*-2 Sets Required. ■ - Also available in MX-S race compound.

**SAFETY WARNING:** DO NOT USE HH PADS ON REAR UNLESS ALSO USED ON FRONT TO AVOID BRAKE IMBALANCE

APPLICATIONS  
BRAKE

R Suffix = High Durability Sintered Pad. HH Suffix = High Performance Sintered Pad. G Suffix = Grooved Shoe.  
D Suffix = Drilled Disc. C Suffix = Contoured Disc. RS = Right/Steel Disc. LS Suffix = Left/Steel Disc.

# Non-JAPANESE Built Motorcycles

**BRAKE APPLICATIONS**



← REAR / ARRIÈRE / HINTEN POSTERIOR / POSTERIORE →

## TGB



		DISC PAD CHOICES				BRAKE ROTOR CHOICES			
		NEW SFAC Scooter Carbon Pads	Semi-Sintered V-Pads™	Sintered/HH Pads/ Grooved shoes	Contour Rotor Rear Fitment	NEW Vee-Rotors™ CONTOUR	NEW CX Extreme® ROTOR		
Blade 460 R Target	12	FA067TT			FA067R	N/A			
Blade 460 SL IRS 4 x 4	12	FA067TT			FA067R	N/A			
Avenger 500 R Quad (4 x 2)	09-10	FA377TT*			FA377R*	TBA*			
Target 500 (4 x 2)	09-10	FA067TT			FA067R	N/A			
Blade 510 LE	11-12	FA067TT			FA067R	N/A			
Blade 525 SE 4 x 4	09-10	FA377TT*			FA377R*	N/A*			
Blade 525 SL 4 x 4	09-10	FA067TT			FA067R	N/A			
525 SE 4 x 4	09	FA067TT			FA067R	N/A			
Target 525 (4 x 4)	09-11	FA067TT			FA067R	N/A			
Blade 550 LT 4 x 4	10-11	FA067TT			FA067R	N/A			
Blade 550 SE 4 x 4	09-11	FA067TT			FA067R	N/A			
Blade 550 SL 4 x 4	09-10	FA067TT			FA067R	N/A			
Gunner 550 4 x 4 Target	10-12	FA377TT*			FA377R*	N/A*			
Blade 550 IRS Target	11-12	FA067TT			FA067R	N/A			
550 IRS Blade LT	10-12	FA067TT			FA067R	N/A			

## THUMPSTAR

Thumpstar Junior 90cc	04-06	SFA169	SFAC169		SFA169HH	N/A		
Thumpstar Supa 110cc	04-06	SFA169	SFAC169		SFA169HH	N/A		
Thumpstar Expert 125	06	SFA169	SFAC169		SFA169HH	N/A		
Thumpstar Pro 125	05-06	SFA169	SFAC169		SFA169HH	N/A		
Thumpstar 125 Road Ripper	06	SFA169	SFAC169		SFA169HH	N/A		

## T.M.

Junior 80/85/100 Cross (Small wheel)	02-04	FA208TT			FA208R ■	N/A		
Junior 80/85/100	05-07	FA367TT			FA367R ■	N/A		
80/85/100 (Big wheel)	02-04	FA208TT			FA208R ■	N/A		
80 Enduro	96-00	FA208TT			FA208R ■	N/A		
80/85 Minicross/Junior	96-00	FA0843TT			FA0843R	N/A		
80/85 Cross	96-01	FA208TT			FA208R ■	N/A		
MX 85 JR (Small Wheel)	02-04	FA131TT			FA131R ■		MD6350C	
MX 85 JR (Small Wheel)	05-13	FA367TT			FA367R ■		MD6350C	
MX 85 (Big Wheel)	02-04	FA131TT			FA131R ■		MD6350C	
MX 85 (Big Wheel)	05-13	FA367TT			FA367R ■		MD6350C	
125 Cross	95-00	FA208TT			FA208R ■	N/A		
MX 125 (2T)	01-04	FA131TT			FA131R ■		MD6350C	
MX 125 (2T)	05-12	FA367TT			FA367R ■		MD6350C	
125 Enduro	95-00	FA208TT			FA208R ■	N/A		
Enduro EN 125 (2T)	01-04	FA131TT			FA131R ■		MD6350C	
Enduro EN 125 (2T)	05-13	FA131TT			FA131R ■		MD6350C	
SMM 125 Black Dream (Rim brake)	04-07	FA047			FA047HH	N/A		
SMM 125 (2T) Black Dream (320mm front disc)	08-13	FA047			FA047HH	N/A		
SMR 125 (2T)	05-13	FA367TT			FA367R ■	N/A		
EN 144 (2T)	08-13	FA367TT			FA367R ■		MD6350C	
MX 144 (2T)	08-13	FA367TT			FA367R ■		MD6350C	
250 Enduro	95-00	FA208TT			FA208R ■	N/A		
EN 250 F (4T) Enduro	04	FA131TT			FA131R ■		MD6350C	
EN 250 F (4T) Enduro	05-13	FA367TT			FA367R ■		MD6350C	
Enduro EN 250 (2T)	01-04	FA131TT			FA131R ■		MD6350C	
Enduro EN 250 (2T)	05-13	FA367TT			FA367R ■		MD6350C	
EN 250 Fi	10-13	FA367TT			FA367R ■		MD6350C	
SME 250 (4T)	04	FA131TT			FA131R ■	N/A		
250 Cross	95-00	FA208TT			FA208R ■	N/A		
MX 250 (2T)	01-04	FA131TT			FA131R ■		MD6350C	
MX 250 (2T)	05-13	FA367TT			FA367R ■		MD6350C	
MX 250 (4T) Cross	02-10	FA131TT			FA131R ■		MD6350C	
MX 250 (4T) Cross	05-12	FA367TT			FA367R ■		MD6350C	
MX 250 Fi (4T)	10-13	FA367TT			FA367R ■		MD6350C	
SM 250	02	FA131TT			FA131R ■	N/A		
SMM 250 (2T)	05-13	FA047			FA047HH	N/A		

\*-2 Sets Required. ■ - Also available in MX-S race compound.

**SAFETY WARNING:** DO NOT USE HH PADS ON REAR UNLESS ALSO USED ON FRONT TO AVOID BRAKE IMBALANCE

**R** Suffix = High Durability Sintered Pad. **HH** Suffix = High Performance Sintered Pad. **G** Suffix = Grooved Shoe.  
**D** Suffix = Drilled Disc. **C** Suffix = Contoured Disc. **LS** Suffix = Left/Steel Disc. **RS** = Right/Steel Disc.

# Non-JAPANESE Built Motorcycles



FRONT / AVANT / VORN      FRENTE / ANTERIORE

APPLICATIONS  
BRAKE

R Suffix = High Durability Sintered Pad.    HH Suffix = High Performance Sintered Pad.    G Suffix = Grooved Shoe.

D Suffix = Drilled Disc.    C Suffix = Contoured Disc.    LS Suffix = Left/Steel Disc.    RS = Right/Steel Disc.

T.M.	Year	Disc Pad Choices	BRAKE ROTOR CHOICES											
			NEW SFAC Scooter Carbon Pads	Semi-Sintered V-Pads™	Sintered/HH Pads/ Grooved shoes	Left/Gauche/Links	Right/Droite/Rechts	Contour Rotor Universal left and right fitment	NEW Vee-Rotors™ CONTOUR	NEW CX Extreme® ROTOR	Oversize 250/280mm Rotor Kit	Relocating Bracket for 250/280mm Rotor	Oversize 320mm Rotor Kit	Relocating Bracket for 320mm Rotor
SMM 250 F (4T)	10-13				FA322/4HH	N/A								
SMR 250 (2T)	05-13	FA095			FA095HH	N/A								
SMR 250 F (4T)	10-13				FA322/4HH	N/A								
SMX 250 F (4T)	12-13				FA322/4HH	N/A								
300 Enduro (2T)	95-00	FA181TT			FA181R ■	N/A								
Enduro EN 300 (2T)	01-04	FA181TT			FA181R ■			MD6349C						
Enduro EN 300 (2T)	05-13	FA181TT			FA181R ■			MD6349C						
300 Cross	95-00	FA181TT			FA181R ■	N/A								
MX 300 (2T)	01-04	FA181TT			FA181R ■			MD6349C						
MX 300 (2T)	05-13	FA181TT			FA181R ■			MD6349C						
SMM 300 (2T)	05-13	FA095			FA095HH	N/A								
SMR 300 (2T)	05-13	FA095			FA095HH	N/A								
400 (4T) MX Cross	02-03	FA181TT			FA181R ■	N/A								
400 Cross (4T)	95-00	FA181TT			FA181R ■	N/A								
SME 400 (4T)	04	FA095			FA095HH	N/A								
SMM 400 (4T) (Rim brake)	04	N/A				N/A								
SM 400	02-03	FA095			FA095HH	N/A								
EN 450 F (4T)	04	FA181TT			FA181R ■			MD6349C						
EN 450 F (4T)	05-13	FA181TT			FA181R ■			MD6349C						
MX 450 F (4T)	04	FA181TT			FA181R ■			MD6349C						
MX 450 F (4T)	05-13	FA181TT			FA181R ■			MD6349C						
SMM 450 F Black Dream ES (320mm front disc)	08-10				FA322/4HH	N/A								
SMM 450 F	11-13				FA322/4HH	N/A								
SMR 450 FES	05-09	FA095			FA095HH	N/A								
SMR 450 F (4T)	10-13				FA322/4HH	N/A								
SMX 450 F	05-13				FA322/4HH	N/A								
530 Cross (4T)	98-00	FA181TT			FA181R ■	N/A								
EN 530 F (4T)	04	FA181TT			FA181R ■			MD6349C						
EN 530 F (4T)	05-12	FA181TT			FA181R ■			MD6349C						
530 (4T) Cross	02-03	FA095			FA095HH	N/A								
MX 530 F	05-13	FA181TT			FA181R ■			MD6349C						
SMM 530 F Black Dream (Rim brake)	04-07	N/A				N/A								
SM 530	02-03	FA095			FA095HH	N/A								
SME 530 (4T)	04	FA095			FA095HH	N/A								
SMM 530 F Black Dream ES (320mm front disc)	08-10				FA322/4HH	N/A								
SMR 530 F	10-13				FA322/4HH	N/A								
SMR 530 F ES	05-09	FA095			FA095HH	N/A								
SMX 530 F	05-13				FA322/4HH	N/A								
SMX 660 F	04	FA095			FA095HH	N/A								
SMX 660 F	05-10				FA322/4HH	N/A								
<b>TOMOS</b>														
Moped with spoke wheels		908												
Moped with cast wheels		931												
Alpino 45 (Drum Brakes)		909												
Alpino 45 (Front Disc Brake)		SFA115	SFAC115		SFA115HH	N/A								
APN6		SFA115	SFAC115		SFA115HH	N/A								
Classic XL		909												
Flexer EX 25		909												
Flexer XL		909												
Funsport R 25		909												
Funtastic 25		SFA115	SFAC115		SFA115HH	N/A								
Hip Hop		SFA115	SFAC115		SFA115HH	N/A								
Luxe		909												
Luxe EX 25		909												
Nitro 50		TBA												
Revival TS	03-04	SFA116				N/A								
Revival TS		SFA115	SFAC115		SFA115HH	N/A								
Standard		909												
Standard XL		909												

\*-2 Sets Required.    ■ - Also available in MX-S race compound.

**SAFETY WARNING:** DO NOT USE HH PADS ON REAR UNLESS ALSO USED ON FRONT TO AVOID BRAKE IMBALANCE



# Non-JAPANESE Built Motorcycles



← REAR / ARRIÈRE / HINTEN POSTERIOR / POSTERIORE →

## T.M.



			DISC PAD CHOICES			BRAKE ROTOR CHOICES			
			NEW SFAC Scooter Carbon Pads	Semi-Sintered V-Pads™	Sintered/HH Pads/ Grooved shoes	Contour Rotor Rear Fitment	NEW Vee-Rotors™ CONTOUR	NEW CX Extreme® ROTOR	
SMM 250 F (4T)	10-13	FA367TT			FA367R ■	N/A			
SMR 250 (2T)	05-13	FA367TT			FA367R ■	N/A			
SMR 250 F (4T)	10-13	FA367TT			FA367R ■	N/A			
SMX 250 F (4T)	12-13	FA367TT			FA367R ■	N/A			
300 Enduro (2T)	95-00	FA208TT			FA208R ■	N/A			
Enduro EN 300 (2T)	01-04	FA131TT			FA131R ■		MD6350C		
Enduro EN 300 (2T)	05-13	FA367TT			FA367R ■		MD6350C		
300 Cross	95-00	FA208TT			FA208R ■	N/A			
MX 300 (2T)	01-04	FA131TT			FA131R ■		MD6350C		
MX 300 (2T)	05-13	FA367TT			FA367R ■		MD6350C		
SMM 300 (2T)	05-13	FA047			FA047HH	N/A			
SMR 300 (2T)	05-13	FA367TT			FA367R ■	N/A			
400 (4T) MX Cross	02-03	FA131TT			FA131R ■	N/A			
400 Cross (4T)	95-00	FA208TT			FA208R ■	N/A			
SME 400 (4T)	04	FA131TT			FA131R ■	N/A			
SMM 400 (4T) (Rim brake)	04	FA047			FA047HH	N/A			
SM 400	02-03	FA131TT			FA131R ■	N/A			
EN 450 F (4T)	04	FA131TT			FA131R ■		MD6350C		
EN 450 F (4T)	05-13	FA367TT			FA367R ■		MD6350C		
MX 450 F (4T)	04	FA131TT			FA131R ■		MD6350C		
MX 450 F (4T)	05-13	FA367TT			FA367R ■		MD6350C		
SMM 450 F Black Dream ES (320mm front disc)	08-10	FA047			FA047HH	N/A			
SMM 450 F	11-13	FA047			FA047HH	N/A			
SMR 450 FES	05-09	FA367TT			FA367R ■	N/A			
SMR 450 F (4T)	10-13	FA367TT			FA367R ■	N/A			
SMX 450 F	05-13	FA367TT			FA367R ■	N/A			
530 Cross (4T)	98-00	FA208TT			FA208R ■	N/A			
EN 530 F (4T)	04	FA131TT			FA131R ■		MD6350C		
EN 530 F (4T)	05-12	FA367TT			FA367R ■		MD6350C		
530 (4T) Cross	02-03	FA131TT			FA131R ■	N/A			
MX 530 F	05-13	FA367TT			FA367R ■		MD6350C		
SMM 530 F Black Dream (Rim brake)	04-07	FA047			FA047HH	N/A			
SM 530	02-03	FA131TT			FA131R ■	N/A			
SME 530 (4T)	04	FA131TT			FA131R ■	N/A			
SMM 530 F Black Dream ES (320mm front disc)	08-10	FA047			FA047HH	N/A			
SMR 530 F	10-13	FA367TT			FA367R ■	N/A			
SMR 530 F ES	05-09	FA367TT			FA367R ■	N/A			
SMX 530 F	05-13	FA367TT			FA367R ■	N/A			
SMX 660 F	04	FA131TT			FA131R ■	N/A			
SMX 660 F	05-10	FA367TT			FA367R ■	N/A			

## TOMOS

Moped with spoke wheels		908						
Moped with cast wheels		931						
Alpino 45 (Drum Brakes)		909						
Alpino 45 (Front Disc Brake)		909						
APN6		909						
Classic XL		909						
Flexer EX 25		909						
Flexer XL		909						
Funsport R 25		909						
Funtastic 25		909						
Hip Hop		909						
Luxe		909						
Luxe EX 25		909						
Nitro 50		TBA						
Revival TS	03-04	TBA						
Revival TS		909						
Standard		909						
Standard XL		909						

\*-2 Sets Required. ■ - Also available in MX-S race compound.

**SAFETY WARNING:** DO NOT USE HH PADS ON REAR UNLESS ALSO USED ON FRONT TO AVOID BRAKE IMBALANCE

**BRAKE APPLICATIONS**

**R** Suffix = High Durability Sintered Pad. **HH** Suffix = High Performance Sintered Pad. **G** Suffix = Grooved Shoe.  
**D** Suffix = Drilled Disc. **C** Suffix = Contoured Disc. **LS** Suffix = Left/Steel Disc. **RS** = Right/Steel Disc.

# Non-JAPANESE Built Motorcycles



← FRONT / AVANT / VORN FRENTE / ANTERIORE →

## DISC PAD CHOICES

## BRAKE ROTOR CHOICES

TOMOS	Year	Model	DISC PAD CHOICES			BRAKE ROTOR CHOICES								
			NEW SFAC Scooter Carbon Pads	Semi-Sintered V-Pads™	Sintered/HH Pads/ Grooved shoes	Left/Gauche/Links	Right/Droite/Rechts	Contour Rotor Universal left and right fitment	NEW Vee-Rotors™ CONTOUR	NEW CX Extreme® ROTOR	Oversize 250/280mm Rotor Kit	Relocating Bracket for 250/280mm Rotor	Oversize 320mm Rotor Kit	Relocating Bracket for 320mm Rotor
Streetmate		SFA116				N/A								
Streetmate R		SFA116				N/A								
Twister 50		SFA264	SFAC264		SFA264HH	N/A								
MC 36	05-07	TBA												
MC 50 Junior	05-07	TBA												
MC 50 Senior	05	FA325TT			FA325R	N/A								
MC 50 Senior	05-07	TBA												
MC 50 Senior Pro	05-07	FA351				N/A								
Pack'R EX		909												
Quadro		909												
Quadro EX		909												
Racing		SFA115	SFAC115		SFA115HH	N/A								
Youngst'R 50		SFA115	SFAC115		SFA115HH	N/A								
MC 80	05-07	TBA												
SE 125 F	05-08	FA167			FA167HH	N/A								
SM 125 F	05-08	FA266			FA266HH	N/A								
Nitro 125		TBA												
Twister 125		SFA264	SFAC264		SFA264HH	N/A								
Nitro 150		TBA												

## TRIUMPH (MERIDEN PRODUCED MACHINES)

Cub 500		858												
T 120 (650cc/Twin Leading Shoe)	66-70	854												
T 140V Bonneville (Drum rear brake/5 Speed G/Box)	73-74	FA016			FA016HH	MD656LS	NOTE							
T 140V Bonneville (Discs all round/5 Speed G/Box)	75-78	FA016			FA016HH	MD656LS	NOTE							
T 140 Silver Jubilee Bonneville	77	FA016			FA016HH	MD656LS	NOTE							
T 140E Bonneville	78-83	FA016			FA016HH	MD656LS	NOTE							
T 140D Bonneville (Lester Alloy Wheels)	79-81	FA016			FA016HH	MD838	NOTE							
T 140 ES (Electric Start)	80-81	FA016			FA016HH	MD656LS	NOTE							
T 140 E/ES (Executive/Morris Alloy Wheels)	81-83	FA016			FA016HH	MD656LS	NOTE							
TSS 750 (8 Valve)	83	FA016			FA016HH	MD656LS	NOTE							
TSX 750 (8 Valve)	83	FA016			FA016HH	MD656LS	NOTE							
T 140 Bonneville (L.F. Harris Production Bike/Brembo Calipers)	85-88	FA018*		FA018V*	FA018HH*	N/A	N/A							

Note = MD656LS/RS = 4 BOLT FIXING / MD838 = 6 BOLT FIXING, listing should be correct but please check quantity of bolts on the original disc and order accordingly.

## TRIUMPH (HINCKLEY PRODUCED MACHINES)

Adventurer	96-01	FA196		FA196V	FA196HH	MD642LS	①							
NOTE ① Floating conversion available order MD629														
America (6 Spoke Cast wheel)	07-09	FA196		FA196V	FA196HH	MD649	②			MD649CX				
NOTE ② Floating conversion available order MD601LS														
America (12 Spoke Cast wheel-865cc)	10-13	FA196		FA196V	FA196HH	MD821	③							
NOTE ③ Floating conversion available order MD821X/XC														
Bonneville America (Spoke wheel)	02-06	FA196		FA196V	FA196HH	MD649	②			MD649CX				
NOTE ④ Floating conversion available order MD601LS														
Bonneville 800 (790cc)	01-06	FA196		FA196V	FA196HH	MD649	②			MD649CX				
NOTE ⑤ Floating conversion available order MD601LS														
Bonneville T100 (790cc)	02-04	FA196		FA196V	FA196HH	MD649	②			MD649CX				
NOTE ⑥ Floating conversion available order MD601LS														
Bonneville T100 (865cc)	05-09	FA196		FA196V	FA196HH	MD649	②			MD649CX				
NOTE ⑦ Floating conversion available order MD601LS														
Bonneville T100 (865cc/Spoke Wheel)	10-13	FA196		FA196V	FA196HH	MD822								
Bonneville Steve McQueen SE (865cc/Spoke Wheel)	12	FA196		FA196V	FA196HH	MD822								
Bonneville/Bonneville Black (865cc)	07-08	FA196		FA196V	FA196HH	MD649	②			MD649CX				
NOTE ⑧ Floating conversion available order MD601LS														
Bonneville (865cc/Cast Wheels)	09-13	FA196		FA196V	FA196HH	MD821	③							
NOTE ⑨ Floating conversion available order MD821X/XC														
Bonneville SE (865cc/Cast Wheels)	09-11	FA196		FA196V	FA196HH	MD821	③							
NOTE ⑩ Floating conversion available order MD821X/XC														
Daytona 600	03-04	FA236*			FA236HH*	MD662X	MD662X	MD662XC*	VR662BLK*					
TT 600	00-03	FA236*			FA236HH*	MD662X	MD662X	MD662XC*	VR662BLK*					

\*-2 Sets Required. ■ - Also available in MX-S race compound.

**SAFETY WARNING:** DO NOT USE HH PADS ON REAR UNLESS ALSO USED ON FRONT TO AVOID BRAKE IMBALANCE

APPLICATIONS  
BRAKE

R Suffix = High Durability Sintered Pad. HH Suffix = High Performance Sintered Pad. G Suffix = Grooved Shoe.  
D Suffix = Drilled Disc. C Suffix = Contoured Disc. RS Suffix = Right/Steel Disc. LS Suffix = Left/Steel Disc.

# Non-JAPANESE Built Motorcycles

**BRAKE APPLICATIONS**

**R** Suffix = High Durability Sintered Pad. **HH** Suffix = High Performance Sintered Pad. **G** Suffix = Grooved Shoe.  
**D** Suffix = Drilled Disc. **C** Suffix = Contoured Disc. **LS** Suffix = Left/Steel Disc. **RS** = Right/Steel Disc.



**TOMOS**



← REAR / ARRIÈRE / HINTEN POSTERIOR / POSTERIORE →

		DISC PAD CHOICES			BRAKE ROTOR CHOICES		
		NEW SFAC Scooter Carbon Pads	Semi-Sintered V-Pads™	Sintered/HH Pads/ Grooved shoes	Contour Rotor Rear Fitment	NEW Vee-Rotors™ CONTOUR	NEW CX Extreme® ROTOR
Streetmate		TBA					
Streetmate R		909					
Twister 50		H307					
MC 36	05-07	TBA					
MC 50 Junior	05-07	TBA					
MC 50 Senior	05	FA325TT		FA325R	N/A		
MC 50 Senior	05-07	TBA					
MC 50 Senior Pro	05-07	FA351			N/A		
Pack'R EX		909					
Quadro		909					
Quadro EX		909					
Racing		909					
Youngst'R 50		909					
MC 80	05-07	TBA					
SE 125 F	05-08	FA115		FA115HH	N/A		
SM 125 F	05-08	FA115		FA115HH	N/A		
Nitro 125		TBA					
Twister 125		H307					
Nitro 150		TBA					

## TRIUMPH (MERIDEN PRODUCED MACHINES)

Cub 500		858					
T 120 (650cc/Twin Leading Shoe)	66-70	853					
T 140V Bonneville (Drum rear brake/5 Speed G/Box)	73-74	N/A					
T 140V Bonneville (Discs all round/5 Speed G/Box)	75-78	FA016		FA016HH	MD656RS	NOTE	
T 140 Silver Jubilee Bonneville	77	FA016		FA016HH	MD656RS	NOTE	
T 140E Bonneville	78-83	FA016		FA016HH	MD656RS	NOTE	
T 140D Bonneville (Lester Alloy Wheels)	79-81	FA016		FA016HH	MD838	NOTE	
T 140 ES (Electric Start)	80-81	FA016		FA016HH	MD656RS	NOTE	
T 140 E/ES (Executive/Morris Alloy Wheels)	81-83	FA016		FA016HH	MD656RS	NOTE	
TSS 750 (8 Valve)	83	FA016		FA016HH	MD656RS	NOTE	
TSX 750 (8 Valve)	83	FA016		FA016HH	MD656RS	NOTE	
T 140 Bonneville (L.F. Harris Production Bike/Brembo Calipers)	85-88	FA018	FA018V	FA018HH	N/A		

## TRIUMPH (HINCKLEY PRODUCED MACHINES)

Adventurer	96-01	FA196		FA196V	FA196HH	MD643	
America (6 Spoke Cast wheel)	07-09	FA214/2			FA214/2HH	MD643	VR643
America (12 Spoke Cast wheel-865cc)	10-13	FA214/2			FA214/2HH	MD643	
Bonneville America (Spoke wheel)	02-06	FA214/2			FA214/2HH	MD643	VR643
Bonneville 800 (790cc)	01-06	FA214/2			FA214/2HH	MD663	VR643
Bonneville T100 (790cc)	02-04	FA214/2			FA214/2HH	MD663	VR643
Bonneville T100 (865cc)	05-09	FA214/2			FA214/2HH	MD663	VR663
Bonneville T100 (865cc/Spoke Wheel)	10-13	FA214/2			FA214/2HH	MD663	
Bonneville Steve McQueen SE (865cc/Spoke Wheel)	12	FA214/2			FA214/2HH	MD663	
Bonneville/Bonneville Black (865cc)	07-08	FA214/2			FA214/2HH	MD663	VR666
Bonneville (865cc/Cast Wheels)	09-13	FA214/2			FA214/2HH	MD663	MD663C
Bonneville SE (865cc/Cast Wheels)	09-11	FA214/2			FA214/2HH	MD663	MD663C
Daytona 600	03-04	FA140	FA140V	FA140HH	MD648	MD648C	VR648
TT 600	00-03	FA140	FA140V	FA140HH	MD648	MD648C	VR648

\*-2 Sets Required. ■ - Also available in MX-S race compound.

**SAFETY WARNING:- DO NOT USE HH PADS ON REAR UNLESS ALSO USED ON FRONT TO AVOID BRAKE IMBALANCE**

# Non-JAPANESE Built Motorcycles



← FRONT / AVANT / VORN  FRENTE / ANTERIORE →

## TRIUMPH

		DISC PAD CHOICES				BRAKE ROTOR CHOICES							
		NEW SFAC Scooter Carbon Pads	Semi-Sintered V-Pads™	Sintered/HH Pads/ Grooved shoes	Left/Gauche/Links	Right/Droite/Rechts	Contour Rotor Universal left and right fitment	NEW Vee-Rotors™ CONTOUR	NEW CX Extreme® ROTOR	Oversize 250/280mm Rotor Kit	Relocating Bracket for 250/280mm Rotor	Oversize 320mm Rotor Kit	Relocating Bracket for 320mm Rotor
Daytona 650	05	FA236*		FA236HH*	MD662X	MD662X	MD662XC*	VR662BLK*					
Daytona 675	06-08			FA437HH*	MD800X	MD800X	MD800XC*	VR800BLK*					
Daytona 675 Black Monobloc radial caliper - flat look to outer body	09-12			FA491HH*	MD800X	MD800X	MD800XC*	VR800BLK*					
Daytona 675 (Nissin F / Brembo R Calipers)	13			FA491HH*	MD852X	MD852X	MD852XC*						
Daytona 675 R (Brembo Calipers)	11-12			FA447HH*	TBA	TBA							
Daytona 675 R (Brembo Calipers)	13			FA447HH*	TBA	TBA							
T595 Daytona (6 bolt) Front disc	97	FA236*		FA236HH*	MD647X	MD647X	MD647XC*	VR647BLK*					
Daytona 955i (6 bolt) Front disc (single sided swinging arm)	98-00	FA236*		FA236HH*	MD647X	MD647X	MD647XC*	VR647BLK*					
Daytona 955i (from VIN132513) (5 bolt Front disc) (Single sided slarm)	01-04	FA236*		FA236HH*	MD669X	MD669X	MD669XC*	VR669BLK*					
Daytona 955i (from VIN132513) (5 bolt Front disc) (Double sided slarm)	01-04	FA236*		FA236HH*	MD669X	MD669X	MD669XC*	VR669BLK*					
Daytona 955i	05-06	FA236*		FA236HH*	MD669X	MD669X	MD669XC*	VR669BLK*					
Daytona 750 (3 cyl)	92	FA236*		FA236HH*	MD640	MD640		VR640BLK*					
Daytona 1000 (4 cyl)	92	FA236*		FA236HH*	MD640	MD640		VR640BLK*					
Daytona 900 (3 cyl)	93-96	FA236*		FA236HH*	MD640	MD640		VR640BLK*					
Daytona Super III (3 cyl)	94-97	FA190*		FA190HH*	MD640	MD640		VR640BLK*					
Daytona 1200 (4 cyl)	93-98	FA236*		FA236HH*	MD640	MD640		VR640BLK*					
Legend TT	98-01	FA196	FA196V	FA196HH	MD642LS								
NOTE ● Floating conversion available order MD629													
Rocket III 2300cc	04-09			FA236HH*	MD669X	MD669X	MD669XC*	VR669BLK*					
Rocket III Classic	07-09			FA236HH*	MD669X	MD669X	MD669XC*	VR669BLK*					
Rocket III Roadster ABS	10-13			FA236HH*	MD669X	MD669X	MD669XC*	VR669BLK*					
Rocket III Touring	08-13			FA236HH*	TBA	TBA							
Scrambler (865cc)	06-09	FA196	FA196V	FA196HH	MD649				MD649CX				
NOTE ● Floating conversion available order MD601LS													
Scrambler (865cc)	10-13	FA196	FA196V	FA196HH	MD822								
Speed Triple (carb models)	94-96	FA236*		FA236HH*	MD640	MD640		VR640BLK*					
Speed Triple (EFI) T509 - 885cc & 955cc (up to VIN 141871) (6 bolt front disc)	97-01	FA236*		FA236HH*	MD647X	MD647X	MD647XC*	VR647BLK*					
Speedtriple 955cc (from VIN 141872) (5 bolt front disc)	02-04	FA236*		FA236HH*	MD669X	MD669X	MD669XC*	VR669BLK*					
Speed Triple (1050cc) Nissin Radial caliper	05-07			FA347HH*	MD679X	MD679X	MD679XC*	VR679BLK*					
Speed Triple (1050cc) Brembo 4 Pad Radial caliper													
/10 Spoke Cast Wheels	08-12			FA3224HH*	MD817X	MD817X	MD817XC*	VR817BLK*					
Speed Triple R (1050cc) Brembo Monobloc Radial caliper													
/5 Spoke Cast Wheels	12			FA447HH*	MD817X	MD817X	MD817XC*	VR817BLK*					
Speedfour 600	02-05	FA236*		FA236HH*	MD662X	MD662X	MD662XC*	VR662BLK*					
Speedmaster (790cc/ Carbs)	03-04	FA142*	FA142V*	FA142HH*	MD649	MD649			MD649CX*				
NOTE ● Floating conversion available order MD601LS/RS													
Speedmaster (865cc/Carbs)	05-07	FA142*	FA142V*	FA142HH*	MD649	MD649			MD649CX				
NOTE ● Floating conversion available order MD601LS/RS													
Speedmaster (865cc/EFI)	08-10	FA142*	FA142V*	FA142HH*	MD649	MD649			MD649CX				
NOTE ● Floating conversion available order MD601LS/RS													
Speedmaster (865cc/EFI)	10-13	FA196	FA196V	FA196HH	MD821								
NOTE ● Floating conversion available order MD821X/XC													
Sprint (All carb models) Up to VIN 9082	Left	93	FA214	FA214HH	MD646LS			VR646BLK					
	Right		FA215	FA215HH		MD646RS		VR646BLK					
Sprint (All carb models from VIN 9083)	94-98	FA236*		FA236HH*	MD640	MD640		VR640BLK*					
Sprint RS (up to VIN 139276) (6 bolt front disc) (double sided swinging arm)	99-01	FA236*		FA236HH*	MD647X	MD647X	MD647XC*	VR647BLK*					
Sprint RS (from VIN 139277) (6 bolt front disc)													
Note: up to VIN 161317 double sided swinging arm	02	FA236*		FA236HH*	MD647X	MD647X	MD647XC*	VR647BLK*					
Sprint RS (from VIN 139277) (Single sided swing arm up to VIN 161317)													
(6 bolt front disc) Note: from VIN 161318 double sided swinging arm	03-04	FA236*		FA236HH*	MD647X	MD647X	MD647XC*	VR647BLK*					
Sprint ST 955i (Front Disc With Offset / 6 Bolt Fixing)	99-04	FA236*		FA236HH*	MD647X	MD647X	MD647XC*	VR647BLK*					
Sprint ST 1050 (5 Spoke wheel / Non ABS/F Disc With Offset / 5 Bolt Fixing) Vin 208167>	05-10	FA236*		FA236HH*	MD669X	MD669X	MD669XC*	VR669BLK*					
Sprint ST 1050 (5 Spoke wheel / ABS/F Disc With Offset / 5 Bolt Fixing)	05-10	FA236*		FA236HH*	MD669X	MD669X	MD669XC*	VR669BLK*					
Sprint ST 1050i (Non ABS / Front Disc With Zero Offset / 5 Bolt Fixing)	11-12	FA236*		FA236HH*	MD817X	MD817X	MD817XC*	VR817BLK*					
Sprint ST 1050i (ABS / Front Disc With Zero Offset / 5 Bolt Fixing)	11-12	FA236*		FA236HH*	MD817X	MD817X	MD817XC*	VR817BLK*					
Sprint GT 1050 (ABS)	10-13	FA236*		FA236HH*	MD817X	MD817X	MD817XC*	VR817BLK*					
Street Triple 675 (Naked)	07-12	FA226*		FA226HH*	MD800X	MD800X	MD800XC*	VR800BLK*					

\*-2 Sets Required. ■ - Also available in MX-S race compound.

**SAFETY WARNING:** DO NOT USE HH PADS ON REAR UNLESS ALSO USED ON FRONT TO AVOID BRAKE IMBALANCE

APPLICATIONS  
BRAKE

R Suffix = High Durability Sintered Pad. HH Suffix = High Performance Sintered Pad. G Suffix = Grooved Shoe.  
D Suffix = Drilled Disc. C Suffix = Contoured Disc. LS Suffix = Left/Steel Disc. RS = Right/Steel Disc.

# Non-JAPANESE Built Motorcycles



**TRIUMPH**



← REAR / ARRIÈRE / HINTEN POSTERIOR / POSTERIORE →

		DISC PAD CHOICES				BRAKE ROTOR CHOICES			
		NEW SFAC Scooter Carbon Pads	Semi-Sintered V-Pads™	Sintered/HH Pads/ Grooved shoes	Contour Rotor Rear Fitment	NEW Vee-Rotors™ CONTOUR	NEW CX Extreme® ROTOR		
Daytona 650	05	FA140	FA140V	FA140HH	MD648	MD648C	VR648		
Daytona 675	06-08	FA140	FA140V	FA140HH	MD648	MD648C	VR648		
Daytona 675 Black Monoblock radial caliper - flat look to outer body	09-12	FA140	FA140V	FA140HH	MD648	MD648C	VR648		
Daytona 675 (Nissin F / Brembo R Calipers)	13	FA140	FA140V	FA140HH	MD851	MD851C			
Daytona 675 R (Brembo Calipers)	11-12	FA140	FA140V	FA140HH	MD648				
Daytona 675 R (Brembo Calipers)	13	FA140	FA140V	FA140HH	MD851	MD851C			
T595 Daytona (6 bolt) Front disc	97	FA214/2		FA214/2HH	MD648	MD648C	VR648		
Daytona 955i (6 bolt) Front disc (single sided swinging arm)	98-00	FA214/2		FA214/2HH	MD648	MD648C	VR648		
Daytona 955i (from VIN132513) (5 bolt Front disc) (Single sided slarm)	01-04	FA214/2		FA214/2HH	MD648	MD648C	VR648		
Daytona 955i (from VIN132513) (5 bolt Front disc) (Double sided slarm)	01-04	FA140	FA140V	FA140HH	MD648	MD648C	VR648		
Daytona 955i	05-06	FA214/2		FA214/2HH	MD648	MD648C	VR648		
Daytona 750 (3 cyl)	92	FA215/2		FA215/2HH	MD641		VR641		
Daytona 1000 (4 cyl)	92	FA215/2		FA215/2HH	MD641		VR641		
Daytona 900 (3 cyl)	93-96	FA215/2		FA215/2HH	MD641		VR641		
Daytona Super III (3 cyl)	94-97	FA215/2		FA215/2HH	MD641		VR641		
Daytona 1200 (4 cyl)	93-98	FA215/2		FA215/2HH	MD641		VR641		
Legend TT	98-01	FA196	FA196V	FA196HH	MD643				
Rocket III 2300cc	04-09	USE V OR HH	FA209/2V	FA209/2HH	MD699				
Rocket III Classic	07-09	USE V OR HH	FA209/2V	FA209/2HH	MD699				
Rocket III Roadster ABS	10-13	USE V OR HH	FA209/2V	FA209/2HH	MD699				
Rocket III Touring	08-13	USE V OR HH	FA209/2V	FA209/2HH	MD699				
Scrambler (865cc)	06-09	FA214/2		FA214/2HH	MD663		VR663		
Scrambler (865cc)	10-13	FA214/2		FA214/2HH	MD663				
Speed Triple (carb models)	94-96	FA215/2		FA215/2HH	MD641		VR641		
Speed Triple (EFI) T509 - 885cc & 955cc (up to VIN 141871) (6 bolt front disc)	97-01	FA214/2		FA214/2HH	MD648	MD648C	VR648		
Speedtriple 955cc (from VIN 141872) (5 bolt front disc)	02-04	FA214/2		FA214/2HH	MD648	MD648C	VR648		
Speed Triple (1050cc) Nissin Radial caliper	05-07	FA214/2		FA214/2HH	MD648	MD648C	VR648		
Speed Triple (1050cc) Brembo 4 Pad Radial caliper									
/10 Spoke Cast Wheels	08-12	FA214/2		FA214/2HH	MD648	MD648C	VR648		
Speed Triple R (1050cc) Brembo Monobloc Radial caliper									
/5 Spoke Cast Wheels	12	FA214/2		FA214/2HH	MD648	MD648C	VR648		
Speedfour 600	02-05	FA140	FA140V	FA140HH	MD648	MD648C	VR648		
Speedmaster (790cc/ Carbs)	03-04	FA214/2		FA214/2HH	MD643		VR643		
Speedmaster (865cc/Carbs)	05-07	FA214/2		FA214/2HH	MD643		VR643		
Speedmaster (865cc/EFI)	08-10	FA214/2		FA214/2HH	MD643		VR643		
Speedmaster (865cc/EFI)	10-13	FA214/2		FA214/2HH	MD643				
Sprint (All carb models) Up to VIN 9082	93	FA215/2		FA215/2HH	MD641		VR641		
Sprint (All carb models from VIN 9083)	94-98	FA215/2		FA215/2HH	MD641		VR641		
Sprint RS (up to VIN 139276) (6 bolt front disc) (double sided swinging arm)	99-01	FA215/2		FA215/2HH	MD663	MD663C	VR663		
Sprint RS (from VIN 139277) (6 bolt front disc)									
Note: up to VIN 161317 double sided swinging arm	02	FA215/2		FA215/2HH	MD663	MD663C	VR663		
Sprint RS (from VIN 139277) (Single sided swing arm up to VIN 161317) (6 bolt front disc) Note: from VIN 161318 double sided swinging arm	03-04	FA214/2		FA214/2HH	MD663	MD663C	VR663		
Sprint ST 955i (Front Disc With Offset / 6 Bolt Fixing)	99-04	FA214/2		FA214/2HH	MD663	MD663C	VR663		
Sprint ST 1050 (5 Spoke wheel / Non ABS/F Disc With Offset / 5 Bolt Fixing) Vin 208167>	05-10	FA214/2		FA214/2HH	MD663	MD663C	VR663		
Sprint ST 1050 (5 Spoke wheel / ABS/F Disc With Offset / 5 Bolt Fixing)	05-10	FA214/2		FA214/2HH	MD820	MD820C			
Sprint ST 1050i (Non ABS / Front Disc With Zero Offset / 5 Bolt Fixing)	11-12	FA214/2		FA214/2HH	MD663	MD663C	VR663		
Sprint ST 1050i (ABS / Front Disc With Zero Offset / 5 Bolt Fixing)	11-12	FA214/2		FA214/2HH	MD820	MD820C			
Sprint GT 1050 (ABS)	10-13	FA214/2		FA214/2HH	MD820	MD820C			
Street Triple 675 (Naked)	07-12	FA140	FA140V	FA140HH	MD648	MD648C	VR648		

\*-2 Sets Required. ■ - Also available in MX-S race compound.

**SAFETY WARNING:** DO NOT USE HH PADS ON REAR UNLESS ALSO USED ON FRONT TO AVOID BRAKE IMBALANCE

**R** Suffix = High Durability Sintered Pad. **HH** Suffix = High Performance Sintered Pad. **G** Suffix = Grooved Shoe.  
**D** Suffix = Drilled Disc. **C** Suffix = Contoured Disc. **LS** Suffix = Left/Steel Disc. **RS** = Right/Steel Disc.

**BRAKE APPLICATIONS**



# Non-JAPANESE Built Motorcycles



← FRONT / AVANT / VORN FRENTE / ANTERIORE →

## DISC PAD CHOICES

## BRAKE ROTOR CHOICES

### TRIUMPH

			NEW SFAC Scooter Carbon Pads	Semi-Sintered V-Pads™	Sintered/HH Pads/ Grooved shoes	Left/Gauche/Links	Right/Droite/Rechts	Contour Rotor Universal left and right fitment	NEW Vee-Rotors™ CONTOUR	NEW CX Extreme® ROTOR	Oversize 250/280mm Rotor Kit	Relocating Bracket for 250/280mm Rotor	Oversize 320mm Rotor Kit	Relocating Bracket for 320mm Rotor
Street Triple 675 (Nissin F/R Calipers)	13		FA226*		FA226HH*	MD852X	MD852X	MD852XC*						
Street Triple R 675	09-12				FA347HH*	MD800X	MD800X	MD800XC*	VR800BLK*					
Street Triple 675 R (Nissin F/Brembo R Calipers)	13				FA347HH*	MD852X	MD852X	MD852XC*						
Thunderbird	95-03		FA196	FA196V	FA196HH	MD642LS								
NOTE ● Floating conversion available order MD629						MD642LS ●								
Thunderbird Sport	98-04		FA196*	FA196V*	FA196HH*	MD649 ●	MD649 ●			MD649CX*				
NOTE ● Floating conversion available order MD601LS/RS														
Thunderbird (1597cc)	09-13		FA236*		FA236HH*	MD825	MD825							
Thunderbird Storm (1699cc)	11-13		FA236*		FA236HH*	MD825	MD825							
ThruXton 900	04-13		FA142		FA142HH	MD629			VR629					
Tiger 800 (Non ABS)	11-13		FA226*		FA226HH*	MD842X	MD842X	MD842XC*	VR842BLK*					
Tiger 800 (With ABS)	11-13		FA226*		FA226HH*	MD842X	MD842X	MD842XC*	VR842BLK*					
Tiger 800 XC (Non ABS)	11-13		FA226*		FA226HH*	MD842X	MD842X	MD842XC*	VR842BLK*					
Tiger 800 XC (With ABS)	11-13		FA226*		FA226HH*	MD842X	MD842X	MD842XC*	VR842BLK*					
Tiger 885cc (Carbs) (Up to VIN 71698)	Left 92-97		FA214		FA214HH	MD644LS								
	Right		FA215		FA215HH		MD644RS							
Tiger 885i (From VIN 71699)	98-99		FA196*		FA196HH*	MD649 ●	MD649 ●			MD649CX*				
NOTE ● Floating conversion available order MD601LS/RS														
Tiger 955cc (Spoke wheel) up to VIN 198874	00-04		FA196*		FA196HH*	MD649 ●	MD649 ●			MD649CX*				
NOTE ● Floating conversion available order MD601LS/RS														
Tiger 955 (Cast wheel) from VIN 198875	04-06		FA196*	FA196V*	FA196HH*	MD676	MD676							
Tiger 1050 (Radial caliper)	07-11				FA347HH*	MD679X	MD679X	MD679XC*	VR679BLK*					
Tiger Sport (ABS) 1050cc	13				FA347HH*	TBA	TBA							
Tiger SE (ABS) 1050cc	10-13				FA347HH*	TBA	TBA							
Tiger Explorer 1200	12-13		FA236*		FA236HH*	MD842X	MD842X	MD842XC*	VR842BLK*					
Tiger Explorer XC 1200	13		FA236*		FA236HH*	MD842X	MD842X	MD842XC*	VR842BLK*					
Trident 750	Left 92-98		FA214		FA214HH	MD646LS			VR646BLK					
	Right		FA215		FA215HH		MD646RS		VR646BLK					
Trident 900	Left 92-98		FA214		FA214HH	MD646LS			VR646BLK					
	Right		FA215		FA215HH		MD646RS		VR646BLK					
Trophy 900 (3 cyl) (up to VIN 9082)	Left 92-93		FA214		FA214HH	MD646LS			VR646BLK					
	Right		FA215		FA215HH		MD646RS		VR646BLK					
Trophy 900 (3 cyl) From VIN 9083	94-01		FA236*		FA236HH*	MD640	MD640		VR640BLK*					
Trophy 1200 (4 cyl) (up to VIN 4901)	Left 92-93		FA214		FA214HH	MD646LS			VR646BLK					
	Right		FA215		FA215HH		MD646RS		VR646BLK					
Trophy 1200 (4 cyl) From VIN 4902	94-01		FA236*		FA236HH*	MD640	MD640		VR640BLK*					
Trophy 1215					FA4234HH*	MD817X	MD817X	MD817XC*	VR817BLK*					
Trophy SE 1215					FA4234HH*	MD817X	MD817X	MD817XC*	VR817BLK*					
NOTE ● Floating conversion available order MD629														
NOTE ● Floating conversion available order MD601LS/RS														
<b>TVS SUZUKI</b>														
XL Super (70cc 2T)			TBA											
Scooty 90cc 4T	08		TBA			TBA								
Star Sport (100cc 4T)	08		TBA											
Star (100cc 4T) (Spoke wheel)	08		TBA											
Star City (100cc 4T) (Cast wheel)	08		TBA											
Flame 125	08		TBA				TBA							
Fiero 150cc FX (Disc model)	08		TBA			TBA								
Fiero 150 FX (Drum model)	08		TBA											
Fiero 150cc F2 (Disc model)	08		TBA			TBA								
Fiero 150cc F2 (Drum model)	08		TBA											
Apache RTR 160	08		TBA					TBA						
<b>URAL</b>														
Cross With Sidecar (Brembo 2 Pin Pad Fixing)	11-12		FA244		FA244HH		N/A							
Ranger With Sidecar (Brembo 2 Pin Pad Fixing)	11-12		FA244		FA244HH		N/A							
Retro With Sidecar (Brembo 2 Pin Pad Fixing)	11-12		FA244		FA244HH		N/A							
Sportsman With Sidecar (Brembo 2 Pin Pad Fixing)	11-12		FA244		FA244HH		N/A							
Tourist With Sidecar (Brembo 2 Pin Pad Fixing)	11-12		FA244		FA244HH		N/A							

\*-2 Sets Required. ■ - Also available in MX-S race compound.

**SAFETY WARNING:- DO NOT USE HH PADS ON REAR UNLESS ALSO USED ON FRONT TO AVOID BRAKE IMBALANCE**

APPLICATIONS  
BRAKE

R Suffix = High Durability Sintered Pad. HH Suffix = High Performance Sintered Pad. G Suffix = Grooved Shoe.  
D Suffix = Drilled Disc. C Suffix = Contoured Disc. LS Suffix = Left/Steel Disc. RS = Right/Steel Disc.

# Non-JAPANESE Built Motorcycles

**BRAKE APPLICATIONS**



## TRIUMPH



← REAR / ARRIÈRE / HINTEN POSTERIOR / POSTERIORE →

		DISC PAD CHOICES				BRAKE ROTOR CHOICES			
		NEW SFAC Scooter Carbon Pads	Semi-Sintered V-Pads™	Sintered/HH Pads/ Grooved shoes	Contour Rotor Rear Fitment	NEW Vee-Rotors™ CONTOUR	NEW CX Extreme® ROTOR		
Street Triple 675 (Nissin F/ R Calipers)	13	FA140		FA140V	FA140HH	MD851	MD851		
Street Triple R 675	09-12	FA140		FA140V	FA140HH	MD648	MD648C	VR648	
Street Triple 675 R (Nissin F/Brembo R Calipers)	13	FA140		FA140V	FA140HH	MD851	MD851		
Thunderbird	95-03	FA196		FA196V	FA196HH	MD643			
Thunderbird Sport	98-04	FA196		FA196V	FA196HH	MD643		VR643	
Thunderbird (1597cc)	09-13	FA209/2		FA209/2V	FA209/2HH	MD831			
Thunderbird Storm (1699cc)	11-13	FA209/2		FA209/2V	FA209/2HH	MD831			
Thruxton 900	04-13	FA214/2			FA214/2HH	MD663		VR663	
Tiger 800 (Non ABS)	11-13	FA140		FA140V	FA140HH	MD663	MD663C	VR663	
Tiger 800 (With ABS)	11-13	FA140		FA140V	FA140HH	MD820	MD820C		
Tiger 800 XC (Non ABS)	11-13	FA140		FA140V	FA140HH	MD663	MD663C	VR663	
Tiger 800 XC (With ABS)	11-13	FA140		FA140V	FA140HH	MD820	MD820C		
Tiger 885cc (Carbs) (Up to VIN 71698)	92-97	FA215/2			FA215/2HH	MD645			
Tiger 885i (From VIN 71699)	98-99	FA196		FA196V	FA196HH	MD643		VR643	
Tiger 955cc (Spoke wheel) up to VIN 198874	00-04	FA196		FA196V	FA196HH	MD643		VR643	
Tiger 955 (Cast wheel) from VIN 198875	04-06	FA215/2			FA215/2HH	MD677			
Tiger 1050 (Radial caliper)	07-11	FA215/2			FA215/2HH	MD663	MD663C	VR663	
Tiger Sport (ABS) 1050cc	13	FA214/2			FA214/2HH	MD820			
Tiger SE (ABS) 1050cc	10-13	FA215/2			FA215/2HH	MD663			
Tiger Explorer 1200	12-13	FA214/2			FA214/2HH	TBA			
Tiger Explorer XC 1200	13	FA214/2			FA214/2HH	TBA			
Trident 750	92-98	FA215/2			FA215/2HH	MD641		VR641	
Trident 900	92-98	FA215/2			FA215/2HH	MD641		VR641	
Trophy 900 (3 cyl) (up to VIN 9082)	92-93	FA215/2			FA215/2HH	MD641		VR641	
Trophy 900 (3 cyl) From VIN 9083	94-01	FA215/2			FA215/2HH	MD641		VR641	
Trophy 1200 (4 cyl) (up to VIN 4901)	92-93	FA215/2			FA215/2HH	MD641		VR641	
Trophy 1200 (4 cyl) From VIN 4902	94-01	FA215/2			FA215/2HH	MD641		VR641	
Trophy 1215		FA214/2			FA214/2HH	TBA			
Trophy SE 1215		FA214/2			FA214/2HH	TBA			

## TVS SUZUKI

XL Super (70cc 2T)		TBA						
Scooty 90cc 4T	08	TBA						
Star Sport (100cc 4T)	08	TBA						
Star (100cc 4T) (Spoke wheel)	08	TBA						
Star City (100cc 4T) (Cast wheel)	08	TBA						
Flame 125	08	TBA						
Fiero 150cc FX (Disc model)	08	TBA						
Fiero 150 FX (Drum model)	08	TBA						
Fiero 150cc F2 (Disc model)	08	TBA						
Fiero 150cc F2 (Drum model)	08	TBA						
Apache RTR 160	08	TBA						

## URAL

Cross With Sidecar (Brembo 2 Pin Pad Fixing)	11-12	N/A						
Ranger With Sidecar (Brembo 2 Pin Pad Fixing)	11-12	N/A						
Retro With Sidecar (Brembo 2 Pin Pad Fixing)	11-12	N/A						
Sportsman With Sidecar (Brembo 2 Pin Pad Fixing)	11-12	N/A						
Tourist With Sidecar (Brembo 2 Pin Pad Fixing)	11-12	N/A						

\*-2 Sets Required. ■ - Also available in MX-S race compound.

**SAFETY WARNING:** DO NOT USE HH PADS ON REAR UNLESS ALSO USED ON FRONT TO AVOID BRAKE IMBALANCE

**R** Suffix = High Durability Sintered Pad. **HH** Suffix = High Performance Sintered Pad. **G** Suffix = Grooved Shoe.  
**D** Suffix = Drilled Disc. **C** Suffix = Contoured Disc. **LS** Suffix = Left/Steel Disc. **RS** = Right/Steel Disc.

# Non-JAPANESE Built Motorcycles



← FRONT / AVANT / VORN FRENTE / ANTERIORE →

## URAL

Model	Year	DISC PAD CHOICES				BRAKE ROTOR CHOICES							
		NEW SFAC Scooter Carbon Pads	Semi-Sintered V-Pads™	Sintered/HH Pads/ Grooved shoes	Left/Gauche/Links	Right/Droite/Rechts	Contour Rotor Universal left and right fitment	NEW Vee-Rotors™ CONTOUR	NEW CX Extreme® ROTOR	Oversize 250/280mm Rotor Kit	Relocating Bracket for 250/280mm Rotor	Oversize 320mm Rotor Kit	Relocating Bracket for 320mm Rotor
Ural T With Sidecar (Brembo 2 Pin Pad Fixing)	11-12	FA244		FA244HH		N/A							
All Sidecar Models With Drum Brakes	All Years												
Retro Solo (Brembo 2 Pin Pad Fixing)	11-12	FA244		FA244HH		N/A							
Solo ST (Brembo 2 Pin Pad Fixing)	11-12	FA244		FA244HH		N/A							
Wolf Solo (Brembo 2 Pin Pad Fixing)	11-12	FA244		FA244HH		N/A							

## VECTRIX

VX-1 (LiLi+)	07-13	SFA181	SFAC181	SFA181HH		N/A							
VX-2	12-13	SFA086	SFAC086	SFA086HH		N/A							
VX-3 (3 Wheel Model)	12-13	SFA266*	SFAC266*	SFA266HH*	N/A	N/A							
Parking Brake		SFA257/2											

## VERTEMATI

All models with 2 piston Brembo calipers	99-04	FA181TT		FA181R ■		N/A							
All models with 4 piston Beringher/Ergal calipers	99-04	FA158		FA158HH		N/A							

## VESPA

S 50 (2T)	07-13	SFA260	SFAC260	SFA260HH	MD910D		MD910C	VR910					
S 50 (4T/4V)	08-13	SFA260	SFAC260	SFA260HH	MD910D		MD910C	VR910					
S 50 Sport (2T)	11-13	SFA260	SFAC260	SFA260HH	MD910D		MD910C	VR910					
S 50 Sport (4T/4V)	11-13	SFA260	SFAC260	SFA260HH	MD910D		MD910C	VR910					
50 R	70-83	V905											
50 S	75-83	V905											
50 Special Edition	91	V905											
50 S	68	V905											
LX 50 (2T)	05-13	SFA260	SFAC260	SFA260HH	MD910D		MD910C	VR910					
LX 50 (4T/4V)	05-13	SFA260	SFAC260	SFA260HH	MD910D		MD910C	VR910					
LXV 50	07-09	SFA260	SFAC260	SFA260HH	MD956D			VR956					
PK 50	82-85	V905											
PK 50 S	82-85	V905											
PK 50 SS	83-85	V905											
PK 50 S Automatica	84-89	V905											
PK 50 XL	85-88	V905											
PK 50 XL	88-89	V903											
50 N	89-90	V903											
FL 50	90	V903											
FL2 Automatica	90-91	V903											
ET2 50	97-05	SFA260	SFAC260	SFA260HH	MD910D		MD910C	VR910					
ET4 50 (Grimeca Caliper)	00-04	SFA260	SFAC260	SFA260HH	MD910D		MD910C	VR910					
ET4 50 (Heng Tong Caliper)	00-04	SFA260	SFAC260	SFA260HH	MD910D		MD910C	VR910					
GT 60 (Special Anniversary Model) (GTV 250)	06	SFA353	SFAC353	SFA353HH	MD956D			VR956					
LX 60 (Special Anniversary Model)	06	SFA186	SFAC186		MD910D		MD910C	VR910					
PK 100 XL	78-83	V905											
FL 125	89-00	V903											
GT 125 Granturismo (Grimeca caliper)	03-06	SFA194	SFAC194	SFA194HH	MD956D			VR956					
GT 125 Granturismo (Heng Tong caliper)	03-06	SFA353	SFAC353	SFA353HH	MD956D			VR956					
GTS 125	07-11	SFA353	SFAC353	SFA353HH	MD956D			VR956					
GTS 125 Super	10-13	SFA353	SFAC353	SFA353HH	MD956D			VR956					
GTS 125 Supersport	13	SFA353	SFAC353	SFA353HH	MD956D			VR956					
GTV 125	07-09	SFA353	SFAC353	SFA353HH	MD956D			VR956					
LXV 125	07-12	SFA260	SFAC260	SFA260HH	MD956D			VR956					
S 125 (4T/3V)	07-13	SFA260	SFAC260	SFA260HH	MD910D		MD910C	VR910					
S 125 Sport (4T/3V)	11-13	SFA260	SFAC260	SFA260HH	MD910D		MD910C	VR910					
ET4 125	96-99	SFA260	SFAC260	SFA260HH	MD910D		MD910C	VR910					
ET4 125/150	99-05	SFA260	SFAC260	SFA260HH	MD910D		MD910C	VR910					
125 Primavera	67-83	V905											
125 ET3	76-83	V905											
LX 125 (4T/3V)	05-13	SFA260	SFAC260	SFA260HH	MD910D		MD910C	VR910					
LX 125 (Serie Speciali/4T)	12	SFA260	SFAC260	SFA260HH	MD910D		MD910C	VR910					
PX 125 E/EFL	81-97	V903											

\*-2 Sets Required. ■ - Also available in MX-S race compound.

**SAFETY WARNING:** DO NOT USE HH PADS ON REAR UNLESS ALSO USED ON FRONT TO AVOID BRAKE IMBALANCE

**R** Suffix = High Durability Sintered Pad. **HH** Suffix = High Performance Sintered Pad. **G** Suffix = Grooved Shoe.  
**D** Suffix = Drilled Disc. **C** Suffix = Contoured Disc. **LS** Suffix = Left/Steel Disc. **RS** = Right/Steel Disc.

**APPLICATIONS**  
**BRAKE**

# Non-JAPANESE Built Motorcycles

**BRAKE APPLICATIONS**



← REAR / ARRIÈRE / HINTEN POSTERIOR / POSTERIORE →

## URAL



		DISC PAD CHOICES			BRAKE ROTOR CHOICES		
		NEW SFAC Scooter Carbon Pads	Semi-Sintered V-Pads™	Sintered/HH Pads/ Grooved shoes	Contour Rotor Rear Fitment	NEW Vee-Rotors™ CONTOUR	NEW CX Extreme® ROTOR

Ural T With Sidecar (Brembo 2 Pin Pad Fixing)	11-12	N/A					
All Sidecar Models With Drum Brakes	All Years	N/A					
Retro Solo (Brembo 2 Pin Pad Fixing)	11-12	N/A					
Solo ST (Brembo 2 Pin Pad Fixing)	11-12	N/A					
Wolf Solo (Brembo 2 Pin Pad Fixing)	11-12	N/A					

## VECTRIX

VX-1 (LiLi+)	07-13	SFA181	SFAC181	SFA181HH	N/A		
VX-2	12-13	SFA083	SFAC083	SFA083HH	N/A		
VX-3 (3 Wheel Model)	12-13	SFA181	SFAC180	SFA181HH	N/A		

## VERTEMATI

All models with 2 piston Brembo calipers	99-04	FA208TT		FA208R ■	N/A		
All models with 4 piston Beringher/Ergal calipers	99-04	FA208TT		FA208R ■	N/A		

## VESPA

S 50 (2T)	07-13	899					
S 50 (4T/4V)	08-13	899					
S 50 Sport (2T)	11-13	899					
S 50 Sport (4T/4V)	11-13	899					
50 R	70-83	V906					
50 S	75-83	V904					
50 Special Edition	91	V906					
50 S	68	V906					
LX 50 (2T)	05-13	899					
LX 50 (4T/4V)	05-13	899					
LXV 50	07-09	899					
PK 50	82-85	V903					
PK 50 S	82-85	V903					
PK 50 SS	83-85	V903					
PK 50 S Automatica	84-89	V942					
PK 50 XL	85-88	V903					
PK 50 XL	88-89	V903					
50 N	89-90	V903					
FL 50	90	V903					
FL2 Automatica	90-91	V942					
ET2 50	97-05	899					
ET4 50 (Grimeca Caliper)	00-04	899					
ET4 50 (Heng Tong Caliper)	00-04	899					
GT 60 (Special Anniversary Model) (GTV 250)	06	SFA321	SFAC321	SFA321HH	MD956D	VR956	
LX 60 (Special Anniversary Model)	06	V903					
PK 100 XL	78-83	V906					
FL 125	89-00	V903					
GT 125 Granturismo (Grimeca caliper)	03-06	SFA321	SFAC321	SFA321HH	MD956D	VR956	
GT 125 Granturismo (Heng Tong caliper)	03-06	SFA321	SFAC321	SFA321HH	MD956D	VR956	
GTS 125	07-11	SFA321	SFAC321	SFA321HH	MD956D	VR956	
GTS 125 Super	10-13	SFA321	SFAC321	SFA321HH	MD956D	VR956	
GTS 125 Supersport	13	SFA321	SFAC321	SFA321HH	MD956D	VR956	
GTV 125	07-09	SFA321	SFAC321	SFA321HH	MD956D	VR956	
LXV 125	07-12	899					
S 125 (4T/3V)	07-13	899					
S 125 Sport (4T/3V)	11-13	899					
ET4 125	96-99	899					
ET4 125/150	99-05	899					
125 Primavera	67-83	V904					
125 ET3	76-83	V904					
LX 125 (4T/3V)	05-13	899					
LX 125 (Serie Special/4T)	12	899					
PX 125 E/EFL	81-97	V903					

\*-2 Sets Required. ■ - Also available in MX-S race compound.

**SAFETY WARNING:** DO NOT USE HH PADS ON REAR UNLESS ALSO USED ON FRONT TO AVOID BRAKE IMBALANCE

**R** Suffix = High Durability Sintered Pad. **HH** Suffix = High Performance Sintered Pad. **G** Suffix = Grooved Shoe.  
**D** Suffix = Drilled Disc. **C** Suffix = Contoured Disc. **LS** Suffix = Left/Steel Disc. **RS** = Right/Steel Disc.

# Non-JAPANESE Built Motorcycles



← FRONT / AVANT / VORN FRENTE / ANTERIORE →

## DISC PAD CHOICES

## BRAKE ROTOR CHOICES

VESPA	Year	Model	DISC PAD CHOICES		Left/Gauche/Links		Right/Droite/Rechts		BRAKE ROTOR CHOICES		Relocating Bracket for 250/280mm Rotor	Oversize 320mm Rotor Kit	Relocating Bracket for 320mm Rotor
			NEW SFAC Scooter Carbon Pads	Semi-Sintered V-Pads™	Sintered/HH Pads/ Grooved shoes	Left/Gauche/Links	Right/Droite/Rechts	Contour Rotor Universal left and right fitment	NEW Vee-Rotors™ CONTOUR	NEW CX Extreme® ROTOR			
PK 125	82-85	V903											
PK 125 S	82-85	V903											
PK 125 S Automatica	84-89	V903											
PX 125 T5	85-00	V903											
PX 125 (Disc Brake Model)	98-13	SFA186	SFAC186				MD910D	MD910C	VR910				
946 Special - 125cc/4T/4V	13	SFA353	SFAC353	SFA353HH	TBA								
LX 150 (4T/3V)	05-13	SFA260	SFAC260	SFA260HH	MD910D			MD910C	VR910				
LX 150 (Serie Special/4T)	12	SFA260	SFAC260	SFA260HH	MD910D			MD910C	VR910				
PX 150 E/EFL	81-97	V903											
PX 150 (Disc Brake Model)	98-13	SFA186	SFAC186				MD910D	MD910C	VR910				
S 150 (4T)	07-12	SFA260	SFAC260	SFA260HH	MD910D			MD910C	VR910				
S 150 Sport (4T)	11-12	SFA260	SFAC260	SFA260HH	MD910D			MD910C	VR910				
GT 200 L Granturismo (Grimeca Caliper)	03-06	SFA194	SFAC194	SFA194HH	MD956D				VR956				
GT 200 L Granturismo (Heng Tong Caliper)	03-06	SFA353	SFAC353	SFA353HH	MD956D				VR956				
PX 200 E/EFL	81-97	V903											
PX 200 (Disc Brake Model)	98-07	SFA186	SFAC186				MD910D	MD910C	VR910				
GTS 250 ie/ABS	05-11	SFA353	SFAC353	SFA353HH	MD956D				VR956				
GTV 250 ie	07-09	SFA353	SFAC353	SFA353HH	MD956D				VR956				
GTS 300	11-13	SFA353	SFAC353	SFA353HH	MD956D				VR956				
GTS 300 ie	08-12	SFA353	SFAC353	SFA353HH	MD956D				VR956				
GTS 300 Super	10-13	SFA353	SFAC353	SFA353HH	MD956D				VR956				
GTS 300 Super Sport	10-13	SFA353	SFAC353	SFA353HH	MD956D				VR956				
GTS 300 ie Touring	11-13	SFA353	SFAC353	SFA353HH	MD956D				VR956				
GTV 300 (4T/4V)	10-13	SFA353	SFAC353	SFA353HH	MD956D				VR956				
<b>VIALLI</b>													
Cargo 50	06	SFA169	SFAC169	SFA169HH	TBA								
DXB 50	06	SFA228	SFAC228	SFA228HH	TBA								
Fireforce 50	06	SFA228	SFAC228	SFA228HH	TBA								
FXR Sport 50	06	SFA169	SFAC169	SFA169HH	TBA								
Jupiter 50	06	SFA169	SFAC169	SFA169HH	TBA								
RX Sport 50	06	SFA083	SFAC083	SFA083HH	TBA								
Truro 50	06	SFA086	SFAC086	SFA086HH			TBA						
<b>VOR</b>													
All models with 2 piston Brembo calipers	99-02	FA181TT		FA181R ■	N/A								
All models with 4 piston Ergal calipers	02	TBA		TBA	N/A								
EN 450/530 Enduro	03-04	FA181TT		FA181R ■	N/A								
EN-E 450/530 Enduro	03-04	FA181TT		FA181R ■	N/A								
SM-E 450/530	03-04	FA095		FA095HH	N/A								
MX 450/530	03-04	FA181TT		FA181R ■	N/A								
<b>VOXAN</b>													
Black Magic	04-08	FA244*		FA244HH*	MD614X	MD614X	MD614XC*	VR614BLK*					
Street Scrambler	03-05	FA095*		FA095HH*	MD614X	MD614X	MD614XC*	VR614BLK*					
Street Scrambler	07-08	FA244		FA244HH	MD614X	MD614X	MD614XC*	VR614BLK*					
VB1-Evo	03-04	FA244*		FA244HH*	MD614X	MD614X	MD614XC*	VR614BLK*					
Cyclope 1000	02	FA095*		FA095HH*	N/A	N/A							
Scrambler 1000	06	FA142*		FA142HH*	N/A	N/A							
Cafe Racer 1000	02-05	FA095*		FA095HH*	MD614X	MD614X	MD614XC*	VR614BLK*					
Cafe Racer	06-08	FA244*		FA244HH*	MD614X	MD614X	MD614XC*	VR614BLK*					
Roadster 1000	02-05	FA095*		FA095HH*	MD614X	MD614X	MD614XC*	VR614BLK*					
Roadster	06-08	FA244*		FA244HH*	MD614X	MD614X	MD614XC*	VR614BLK*					
Charade Racing	06			FA322/4HH*	N/A	N/A							
Charade Racing (Behringer Caliper)	07-08	TBA*			N/A	N/A							
GTV 1200	08			FA322/4HH	TBA	TBA							

\*-2 Sets Required. ■ - Also available in MX-S race compound.

**SAFETY WARNING:** DO NOT USE HH PADS ON REAR UNLESS ALSO USED ON FRONT TO AVOID BRAKE IMBALANCE

APPLICATIONS  
BRAKE

R Suffix = High Durability Sintered Pad. HH Suffix = High Performance Sintered Pad. G Suffix = Grooved Shoe.

D Suffix = Drilled Disc. C Suffix = Contoured Disc. LS Suffix = Left/Steel Disc. RS = Right/Steel Disc.



# Non-JAPANESE Built Motorcycles

**BRAKE APPLICATIONS**

**R** Suffix = High Durability Sintered Pad. **HH** Suffix = High Performance Sintered Pad. **G** Suffix = Grooved Shoe.  
**D** Suffix = Drilled Disc. **C** Suffix = Contoured Disc. **LS** Suffix = Left/Steel Disc. **RS** = Right/Steel Disc.



## VESPA



← REAR / ARRIÈRE / HINTEN POSTERIOR / POSTERIORE →

			DISC PAD CHOICES			BRAKE ROTOR CHOICES		
			NEW SFAC Scooter Carbon Pads	Semi-Sintered V-Pads™	Sintered/HH Pads/ Grooved shoes	Contour Rotor Rear Fitment	NEW Vee-Rotors™ CONTOUR	NEW CX Extreme® ROTOR
PK 125	82-85	V903						
PK 125 S	82-85	V903						
PK 125 S Automatica	84-89	V942						
PX 125 T5	85-00	V903						
PX 125 (Disc Brake Model)	98-13	V903						
946 Special - 125cc/4T/4V	13	SFA321	SFAC321		SFA321HH	TBA		
LX 150 (4T/3V)	05-13	899						
LX 150 (Serie Special/4T)	12	899						
PX 150 E/EFL	81-97	V903						
PX 150 (Disc Brake Model)	98-13	V903						
S 150 (4T)	07-12	899						
S 150 Sport (4T)	11-12	899						
GT 200 L Granturismo (Grimeca Caliper)	03-06	SFA321	SFAC321		SFA321HH	MD956D	VR956	
GT 200 L Granturismo (Heng Tong Caliper)	03-06	SFA321	SFAC321		SFA321HH	MD956D	VR956	
PX 200 E/EFL	81-97	V903						
PX 200 (Disc Brake Model)	98-07	V903						
GTS 250 ie/ABS	05-11	SFA321	SFAC321		SFA321HH	MD956D	VR956	
GTV 250 ie	07-09	SFA321	SFAC321		SFA321HH	MD956D	VR956	
GTS 300	11-13	SFA321	SFAC321		SFA321HH	MD956D	VR956	
GTS 300 ie	08-12	SFA321	SFAC321		SFA321HH	MD956D	VR956	
GTS 300 Super	10-13	SFA321	SFAC321		SFA321HH	MD956D	VR956	
GTS 300 Super Sport	10-13	SFA321	SFAC321		SFA321HH	MD956D	VR956	
GTS 300 ie Touring	11-13	SFA321	SFAC321		SFA321HH	MD956D	VR956	
GTV 300 (4T/4V)	10-13	SFA321	SFAC321		SFA321HH	MD956D	VR956	
<b>VIALLI</b>								
Cargo 50	06	TBA						
DXB 50	06	TBA						
Fireforce 50	06	TBA						
FXR Sport 50	06	TBA						
Jupiter 50	06	TBA						
RX Sport 50	06	TBA						
Truro 50	06	TBA						
<b>VOR</b>								
All models with 2 piston Brembo calipers	99-02	FA208TT			FA208R ■	N/A		
All models with 4 piston Ergal calipers	02	FA208TT			FA208R ■	N/A		
EN 450/530 Enduro	03-04	FA208TT			FA208R ■	N/A		
EN-E 450/530 Enduro	03-04	FA208TT			FA208R ■	N/A		
SM-E 450/530	03-04	FA208TT			FA208R ■	N/A		
MX 450/530	03-04	FA208TT			FA208R ■■	N/A		
<b>VOXAN</b>								
Black Magic	04-08	FA266		FA266V	FA266HH	MD2002	MD2002C	VR2002
Street Scrambler	03-05	FA266		FA266V	FA266HH	MD2002	MD2002C	VR2002
Street Scrambler	07-08	FA266		FA266V	FA266HH	MD2002	MD2002C	VR2002
VB1-Evo	03-04	FA266		FA266V	FA266HH	MD2002	MD2002C	VR2002
Cyclope 1000	02	FA266		FA266V	FA266HH	N/A		
Scrambler 1000	06	FA165/2TT				N/A		
Cafe Racer 1000	02-05	FA266		FA266V	FA266HH	MD2002	MD2002C	VR2002
Cafe Racer	06-08	FA266		FA266V	FA266HH	MD2002	MD2002C	VR2002
Roadster 1000	02-05	FA266		FA266V	FA266HH	MD2002	MD2002C	VR2002
Roadster	06-08	FA266		FA266V	FA266HH	MD2002	MD2002C	VR2002
Charade Racing	06	FA047			FA047HH	N/A		
Charade Racing (Behringer Caliper)	07-08	TBA				N/A		
GTV 1200	08	FA266		FA266V	FA266HH	TBA		

\*-2 Sets Required. ■ - Also available in MX-S race compound.

**SAFETY WARNING:- DO NOT USE HH PADS ON REAR UNLESS ALSO USED ON FRONT TO AVOID BRAKE IMBALANCE**

# Non-JAPANESE Built Motorcycles



← FRONT / AVANT / VORN FRENTE / ANTERIORE →

## W K BIKES

Model	Year	Disc	DISC PAD CHOICES				BRAKE ROTOR CHOICES							
			NEW SFAC Scooter Carbon Pads	Semi-Sintered V-Pads™	Sintered/HH Pads/ Grooved shoes	Left/Gauche/Links	Right/Droite/Rechts	Contour Rotor Universal left and right fitment	NEW Vee-Rotors™ CONTOUR	NEW CX Extreme® ROTOR	Oversize 250/280mm Rotor Kit	Relocating Bracket for 250/280mm Rotor	Oversize 320mm Rotor Kit	Relocating Bracket for 320mm Rotor
Mit 50 (4T)	13		TBA						N/A					
SM 50	11-12		FA115		FA115HH				N/A					
SP 50 (4T)	13		TBA						N/A					
WK Go 50 (4T)	11-13		SFA235	SFA235					N/A					
WK One 50 (2T)	10-12		SFA235	SFA235					N/A					
WK GP 2 (2T/50cc)	10-13		SFA235	SFA235					N/A					
WK GTR 50 (2T)	10-11		SFA266	SFAC266	SFA266HH	N/A								
VS 50 (4T/Scooter)	13		TBA			N/A								
Wasp 50 (2T)	13		TBA						N/A					
Trial 125	11-13		FA323TT		FA323R				N/A					
GP 125 (4T/Scooter)	13		TBA			N/A								
VS 125 (4T/Scooter)	13		TBA			N/A								
WK 125 C (4T/16" Wheels)	10-13		SFA228	SFAC228	SFA228HH	N/A								
WK 125 SC (4T/14" Wheels)	10-12		SFA228	SFAC228	SFA228HH	N/A								
WK 125 R (4T)	10-13		FA196		FA196HH	N/A								
WK 125 Sport (4T)	11-13		FA196		FA196HH	N/A								
125 RR	12-13		TBA*						N/A*					
SP 125 (4T)	13		TBA						N/A					
WK Jetmax 250 (4T)	10-13	Left	SFA228	SFAC228	SFA228HH	N/A								
		Right	SFA197	SFAC197	SFA197HH		N/A							
GTR 300 (Scooter)	13		TBA			N/A								
650 i (Naked)	13	Left	FA229		FA229HH				N/A*					
		Right	FA231		FA231HH									
650 TR (Touring)	13	Left	FA229		FA229HH				N/A*					
		Right	FA231		FA231HH									

## W.T. MOTORS

Bilbao 50 (4T)	08-09		SFA086	SFAC086	SFA086HH	N/A								
WT 500 Alaska Quad	08-09		FA453TT*		FA453R*	N/A	N/A							

## WUYANG

WY 50 QT	06-07		SFA169	SFAC169	SFA169HH	N/A								
WY 125-12	06-07		SFA093			N/A								
WY 125-16C	06-07		SFA093			N/A								
WY 125-24B	06-07		SFA197	SFAC197	SFA197HH	N/A								
WY 125-GY2	06-07		TBA											

## XISPA

X 125 R	08-09		FA303			N/A								
X 250 R	08-09		FA303			N/A								
X 280 R	08-09		FA303			N/A								

## ZERO (ELECTRIC MOTORCYCLES)

Zero DS (ZF8.5/ZF11.4)	10-13		FA142		FA142HH				N/A					
Zero MX (ZF2.8/ZF5.7)	10-13		FA142		FA142HH				N/A					
Zero S (ZF8.5/ZF11.4)	10-13		FA142		FA142HH				N/A					
Zero XU	10-13		FA142		FA142HH				N/A					
Zero FX	10-13		FA142		FA142HH				N/A					

## ZING BIKES

Vogue 150 (3 wheeler)	08-09		FA486				N/A							
-----------------------	-------	--	-------	--	--	--	-----	--	--	--	--	--	--	--

## ZUNDAPP

CS 25 Mofa Bj (Type 448-140)	80-82		976											
CS 25 Mofa Bj (Type 448-141)	82		976											
CX 25 Mofa Bj (Type 448-151)	82		976											
CX 25 Mofa Bj	83-84		976											
CB 50 Mokick Bj (Type 448-011)	80		976											
CS 50 Mokick Bj (Type 448-010)	79-80		976											
CS 50 Mokick Bj (Type 448-013)	80-82		976											

\*-2 Sets Required. ■ - Also available in MX-S race compound.

**SAFETY WARNING:** DO NOT USE HH PADS ON REAR UNLESS ALSO USED ON FRONT TO AVOID BRAKE IMBALANCE

APPLICATIONS  
BRAKE

R Suffix = High Durability Sintered Pad. HH Suffix = High Performance Sintered Pad. G Suffix = Grooved Shoe.

D Suffix = Drilled Disc. C Suffix = Contoured Disc. LS Suffix = Left/Steel Disc. RS = Right/Steel Disc.

# Non-JAPANESE Built Motorcycles

**BRAKE  
APPLICATIONS**

**R** Suffix = High Durability Sintered Pad. **HH** Suffix = High Performance Sintered Pad. **G** Suffix = Grooved Shoe.  
**D** Suffix = Drilled Disc. **C** Suffix = Contoured Disc. **LS** Suffix = Left/Steel Disc. **RS** = Right/Steel Disc.



## W K BIKES



← REAR / ARRIÈRE / HINTEN POSTERIOR / POSTERIORE →

			DISC PAD CHOICES			BRAKE ROTOR CHOICES		
			NEW SFAC Scooter Carbon Pads	Semi-Sintered V-Pads™	Sintered/HH Pads/ Grooved shoes	Contour Rotor Rear Fitment	NEW Vee-Rotors™ CONTOUR	NEW CX Extreme® ROTOR
Mii 50 (4T)	13	TBA						
SM 50	11-12	FA115			FA115HH		N/A	
SP 50 (4T)	13	TBA					N/A	
WK Go 50 (4T)	11-13	Y503						
WK One 50 (2T)	10-12	Y503						
WK GP 2 (2T/50cc)	10-13	Y503						
WK GTR 50 (2T)	10-11	SFA260	SFAC260		SFA260HH	N/A		
VS 50 (4T/Scooter)	13	TBA						
Wasp 50 (2T)	13	TBA						
Trial 125	11-13	FA367TT			FA367R		N/A	
GP 125 (4T/Scooter)	13	TBA						
VS 125 (4T/Scooter)	13	TBA						
WK 125 C (4T/16" Wheels)	10-13	SFA101	SFAC101		SFA101HH	N/A		
WK 125 SC (4T/14" Wheels)	10-12	SFA266	SFAC266		SFA266HH	N/A		
WK 125 R (4T)	10-13	FA197			FA197HH	N/A		
WK 125 Sport (4T)	11-13	FA197			FA197HH	N/A		
125 RR	12-13	FA256			FA256HH		N/A	
SP 125 (4T)	13	TBA					N/A	
WK Jetmax 250 (4T)	10-13	SFA266	SFAC266		SFA266HH	N/A		
GTR 300 (Scooter)	13	TBA					N/A	
650 i (Naked)	13	FA192		FA192V	FA192HH		N/A	
650 TR (Touring)	13	FA192		FA192V	FA192HH		N/A	
<b>W.T. MOTORS</b>								
Bilbao 50 (4T)	08-09	TBA						
WT 500 Alaska Quad	08-09	FA344TT			FA344R	N/A		
<b>WUYANG</b>								
WY 50 QT	06-07	TBA						
WY 125-12	06-07	TBA						
WY 125-16C	06-07	TBA						
WY 125-24B	06-07	TBA						
WY 125-GY2	06-07	TBA						
<b>XISPA</b>								
X 125 R	08-09	FA351					N/A	
X 250 R	08-09	FA351					N/A	
X 280 R	08-09	FA351					N/A	
<b>ZERO (ELECTRIC MOTORCYCLES)</b>								
Zero DS (ZF8.5/ZF11.4)	10-13	FA367TT			FA367R		N/A	
Zero MX (ZF2.8/ZF5.7)	10-13	FA367TT			FA367R		N/A	
Zero S (ZF8.5/ZF11.4)	10-13	FA367TT			FA367R		N/A	
Zero XU	10-13	FA367TT			FA367R		N/A	
Zero FX	10-13	FA367TT			FA367R		N/A	
<b>ZING BIKES</b>								
Vogue 150 (3 wheeler)	08-09	TBA*						
<b>ZUNDAPP</b>								
CS 25 Mofa Bj (Type 448-140)	80-82	976						
CS 25 Mofa Bj (Type 448-141)	82	976						
CX 25 Mofa Bj (Type 448-151)	82	976						
CX 25 Mofa Bj	83-84	976						
CB 50 Mokick Bj (Type 448-011)	80	976						
CS 50 Mokick Bj (Type 448-010)	79-80	976						
CS 50 Mokick Bj (Type 448-013)	80-82	976						

\*-2 Sets Required. ■ - Also available in MX-S race compound.

**SAFETY WARNING:** DO NOT USE HH PADS ON REAR UNLESS ALSO USED ON FRONT TO AVOID BRAKE IMBALANCE







# DISC PAD BUYERS GUIDE

## FA011 48 x 9mm

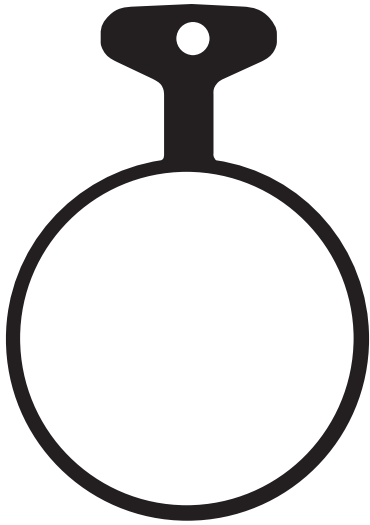

### YAMAHA

RD 250 A/B/C	75-77	F
RD 250 D	77	F&R
RD 350 A/B	74-76	F
XS 360 B	75	F
RD 400 C/D	76-77	F&R
TX/XS 500 B	75-77	F
XS 650	75	F

### ISR

22-023-0A (2 Piston)  
22-026-0A (Sprocket caliper)

### Competitor X Ref

Dunlop	Ferodo	SBS	Vesrah
DP400	FDB157	504	VD-201

### Equivalents OE #

1A1 W0045 00	306 25811 03	409 W0045 00
306 25811 00	306 25811 04	409 25811 00
306 25811 01	306 25811 05	409 25811 01
306 25811 02	306 25811 06	

### MATERIAL AVAILABILITY AND PART NO.

STD	OPTIONS			
FA	HH	R	MXS	EPFA
FA011	-	-	-	-

## FA012 50 x 13/20mm

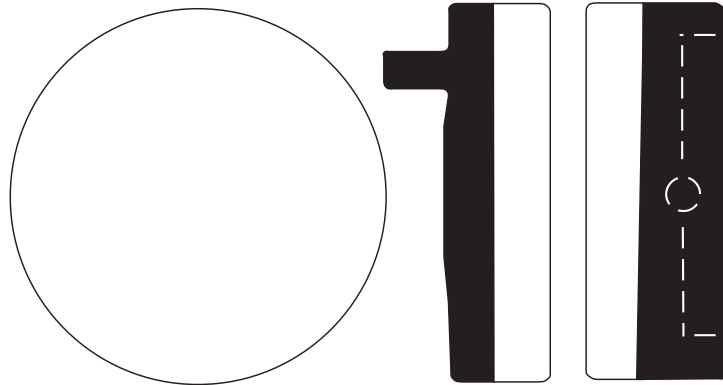

**HONDA** CB 750 K0-K6 69-77 F

### Equivalents OE #

45105 300 040	45106 341 000
45105 341 000	45106 341 003
45105 341 003	45106 300 004
45105 341 305	45106 341 305

### Competitor X Ref

Dunlop	Ferodo	SBS	Vesrah
-	-	502	VD-101

### MATERIAL AVAILABILITY AND PART NO.

STD	OPTIONS				
FA	V	HH	R	MXS	EPFA
FA012	FA012V	-	-	-	-

## FA013 52 x 13/20mm

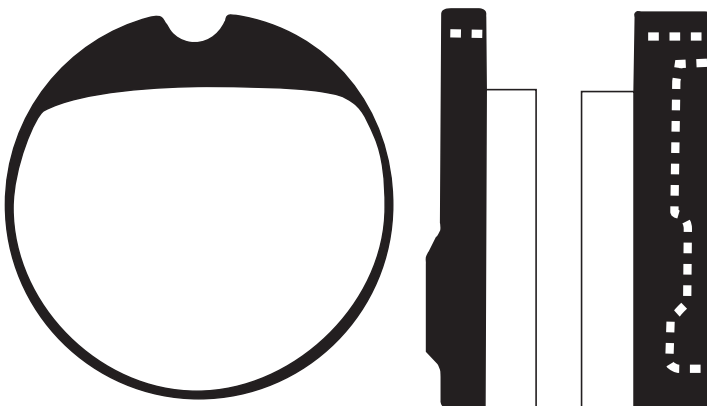

### HONDA

CB 250 G5	75	F
CJ 250 T	77	F
CB 360 G5	75	F
CJ 360 T	78	F
CB 400 F/F1/F2	75-79	F
CB 500 T	75-77	F
CB 500 K1/K2/F	75-77	F
CB 550 F/F1/F2/F3	78-80	F
CB 750 F/F1	76-77	F
CB 750 K7	78	F

### Equivalents OE #

45102 393 700	45105 323 043	45106 323 023
45105 323 006	45105 390 003	45106 323 036
45105 323 013	45105 390 006	45106 323 043
45105 323 016	45105 390 305	45106 390 003
45105 323 023	45106 323 013	45106 390 006
45105 323 036	45106 323 016	45106 390 305

### Competitor X Ref

Dunlop	Ferodo	SBS	Vesrah
-	FDB119	501	VD102-106

### MATERIAL AVAILABILITY AND PART NO.

STD	OPTIONS				
FA	V	HH	R	MXS	EPFA
FA013	FA013V	-	-	-	-

# FA016 59.7 x 51.6 x 10mm



**Equivalents OE #**

4741 537

**Competitor X Ref**

<b>Dunlop</b> DP500	<b>Ferodo</b> FDB342R	<b>SBS</b> 698	<b>Vesrah</b> VD-906
------------------------	--------------------------	-------------------	-------------------------

## AP/LOCKHEED

2 Piston / 2 Pin (CP2195/CP2696 - 38EO)  
220-30 (2 Piston Rear)  
22-033 (2 Piston HD)

## DUCATI

750 Sport 74 F

## TRIUMPH (MERIDEN MODELS)

T 140 V Bonneville 5 Speed Gearbox /Drum Rear Brake 73-74 F  
T 140 V Bonneville Disc All Round /5 Speed Gearbox 75-78 F&R  
T 140 Silver Jubilee Bonneville 77 F&R  
T 140 E Bonneville 78-83 F&R  
T 140 D Bonneville (Lester Alloy wheels) 79-81 F&R  
T 140 ES (750cc) (Electric Start) 80-81 F&R  
T 140 E/ES (750cc) (Executive/Alloy Wheels) 81-83 F&R  
T 150V (Trident 3 cyl) 73-74 F&R  
T 160V (Trident 3 cyl) 75 F&R  
TSS 750 (8 valve) 83 F&R  
TSX 750 83 F&R

### MATERIAL AVAILABILITY AND PART NO.

STD	OPTIONS				
FA	HH	R	MXS	EPFA	GPFA
FA016	FA016HH	-	-	EPFA016HH	GPFA016HH
FA016'S' (Green)					

# FA018 55.7 x 55 x 9mm

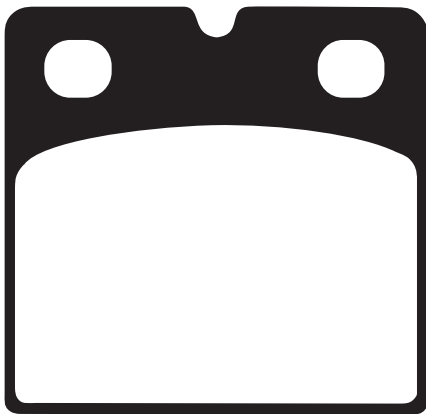

## BENELLI

354 -82 R  
750 SEi (6 cyl) 75- F  
900 SEi (6 cyl) 83 F

## BIMOTA

All early models -83 F&R

## BMW

K 75/75-S 84-90 F  
K 75/75-S 08/90-96 R  
K 75 C 85-08/88 F  
K 75 RT 89-96 R  
K 75 S 85-09/88 F&R  
K 75 S 09/88-95 R  
K 75 S 85-09/88 F&R  
K 75 S 09/88-85 R  
K 1000 82-09/88 F&R  
K 100/2 87-08/88 F&R  
K 100/2 09/88-90 R  
K 100/2 87-08/88 F&R  
K 100/2 09/88-90 R  
K 100 LT 86-08/88 F&R  
K 100 LT 09/88-91 R  
K 100 LT 86/08-88 F&R  
K 100 LT 09/88-91 R  
K 100 RS 83-09/88 F&R  
K 100 RS 10/88-89 R  
K 100 RS 83-09/88 F&R  
K 100 RS 10/88-89 R  
K 100 RT 83-09/88 F&R  
K 100 RT 10/88-89 R  
K 100 RT 83-09/88 F&R  
K 100 RT 10/88-89 R  
K 100 RS 89-92 R  
K 100 RS 89-92 R  
K1 88-93 R  
K 1100 LT 89-07/93 R

## BMW Contd.

KL 1100 LT 89-07/93 R  
KL 1100 LT 08/93-99 R  
KL 1100 LT 08/93-99 R  
K 1100 RS 92-96 R  
K 1100 RS 92-96 R  
K 1200 RS 96-00 R  
K 1200 RS 01-04 R  
K 1200 GT 03-06 R  
R 45/45N 78-85 F  
R 65 07/88-92 F  
R 65 T (Brembo Caliper) 80-85 F  
R 65 LS (Brembo Caliper) 81-85 F  
R 65 GS 87-92 F  
R 65 RT 85-88 F  
R 80 RT 82-84 F  
R 80 GS 80-87 F  
R 80 ST 82-84 F  
R 80 TIC 09/80-85 F  
R 100/7T 09/80-84 F  
R 100 S 09/80-90 F&R  
R 100 RS 10/80-84 F&R  
R 100 RS 86-08/88 F  
R 100 RT 10/80-84 F&R  
R 100 RT 87-08/88 F  
R 100 RS 92-01 R  
250/350/450 Desmo -76 F  
600 Pantah 81 F&R  
650 Pantah -84 F&R  
751 F1 98 F&R  
750 Paso 87-90 F  
750 Sport 88-90 F&R  
860 GT/GTS 75-76 F&R  
900 GTS 75-76 F&R

## DUCATI Contd.

900 Hailwood Replica 79 F&R  
900 SD Darmah (4 bolt front and rear disc fixing) 77 F&R  
900 SD Darmah (6 bolt front disc fixing/4 bolt rear disc fixing) 78 F&R  
900 SD Darmah (6 bolt disc fixing front & rear) 78 F&R  
906 Paso 88-89 F&R  
1000 R1 Hailwood Replica 84 F&R  
**HOREX**  
HRD 600 85 F&R  
500/600 Columbus 88- F&R  
**INDIAN**  
Chief Standard (Brembo calipers) 09-11 R  
Chief Blackhawk 11 R  
Chief Blackhawk Dark 11 R  
Chief Classic 11-12 R  
Chief Deluxe (Brembo calipers) 09 R  
Chief Roadmaster (Brembo calipers) 09-11 R  
Chief Vintage (Brembo calipers) 09-12 R  
Dark Horse (Brembo calipers) 10-12 R  
Bomber (Brembo calipers) 10-11 R  
**LAVERDA**  
750 SF2 74 F  
750 SFC 74 F&R  
750 SF3 76-77 F&R  
1000 3C 74-75 F&R  
1000 3CL 76-78 F&R  
1000 3CL Jarama/Jota 79-81 F&R  
1000 RGS 82 F&R  
1000 RGA/RGS Exec 83 F&R  
1000 RGS Corsa 84 R  
1000 SFC 85-86 F&R  
1200 78-79 F&R  
1200 TS/Mirage 81 F&R

# FA018 Contd.

## MOTO GUZZI

850 Le Mans I	76-77	F&R
850 Le Mans II	78-80	F&R
850 Le Mans III (12 spoke cast wheel)	81-84	F
850 T	74	F
850 T3	75-79	F&R
850 T3 California (with screen/panniers)	75-79	F&R
850 T4	80-82	F&R
850 T5	83-85	F&R
850 T5 California (with screen/panniers)	83-85	F&R
1000 GT 1st Series Alloy Wheels & Cast	87-91	F&R
1000 GT 2nd Series Alloy Wheels & Cast	87-91	F&R
1000 - 1000 S	89-94	F&R
1000 - 1000 SP (12 spoke cast wheels/dished front discs)	79-83	F

1000 - 1000 SP II (10 spoke cast wheels/solid front discs)	84-87	F&R
1000 - 1000 SP III (No spoke cast wheels/flat floating front discs)	89-94	F&R
1000 California II (12 spoke cast wheels/screen & luggage)	81-87	F&R
1000 California III Carbs (VY Chassis code/full fairing /cast & spoke wheels)	88-90	F&R
1000 California III Carbs (VW Chassis code/screen only)	87-93	F&R
1000 California III - EFI (VY Chassis Code/Full fairing /cast & spoke wheels)	90-93	F&R
1000 Le Mans 1V/V (10 spoke cast wheel)	84-93	F&R
1000 Strada	93-94	F&R
1100 California - Carbs (KC/KD Chassis codes)	94-97	F&R

## MZ

ETZ 125/150/250/300	85-92	F
Saxon 125/251/301/500	93-97	F
Saxon 150	95	F
Saxon Tour 251/301	93-98	F
251 Fun	95-96	F
Saxon 500 All models	93-98	F

## NORTON

Classic (Rotary)	89	F&R
Interpol 2 (Rotary)	89	F&R

## TRIUMPH (MERIDEN MODELS)

T 140 Bonneville (L.F. Harris Made Machine/Brembo Calipers)	85-88	F&R
--	-------	-----

### Equivalents OE #

34 11 1 451 995	14654650
34 11 1 454 724	0795 39 856
34 11 1 458 388	0979 39 856
34 1 2 301 360	0960 39 656
34 21 7 657 025	61654630
34 21 1 236 221	00 1865 4660
34 21 2 332 988	00 2865 4601
14654601	

### Competitor X Ref

Dunlop	Ferodo	SBS	Vesrah
DP600	FDB108/148	506	VD-907

### MATERIAL AVAILABILITY AND PART NO.

STD	OPTIONS				
FA	V	HH	R	MXS	EPFA
FA018	FA018V	FA018HH	-	-	-

# FA019 55.7 x 55 x 7.5mm

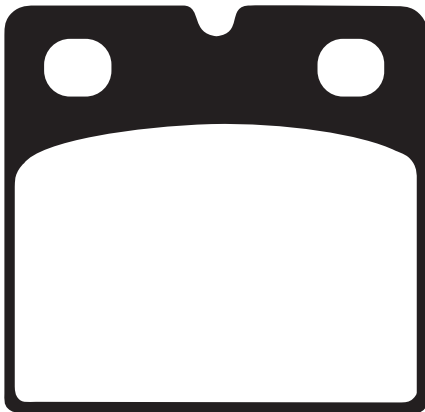

## DUCATI

750 SS (4 bolt disc fixing) Note thinner pad version for shaved down caliper	75-76	F&R
900 SS Note thinner pad version for shaved down caliper	75-76	F&R

### Equivalents OE #

0797 39656

### Competitor X Ref

Dunlop	Ferodo	SBS	Vesrah
-	-	-	VD907/2

### MATERIAL AVAILABILITY AND PART NO.

STD	OPTIONS				
FA	HH	R	MXS	EPFA	
FA019	FA019HH	-	-	-	

# FA021 47 x 16.2mm

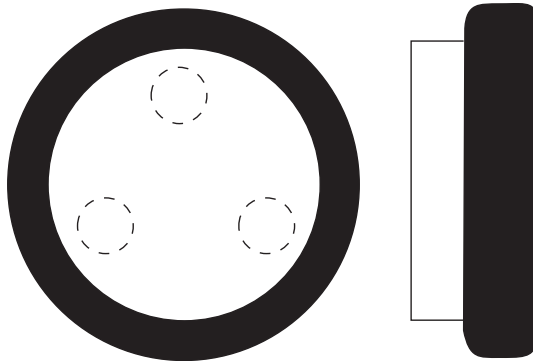

## YAMAHA

YFM 200 N/DXW/DX/DXA	85-90	R
YTM 200 EL/DX	89	R
YTM 225 DRN	85	R
YFM 225 S/T/U	86-89	R
YFM 250 W/A/B	90-92	R
YFM 350 FWT/FWU/FWW/FWA FWB/FWD/FWE/FWF/ FWG "Big Bear"	87-95	R
YFM 350 ERD/ERE/ERF/ERG	92-95	R

### Competitor X Ref

Dunlop	Ferodo	SBS	Vesrah
-	-	576	VD234

### Equivalents OE #

2HR W0045 00	5V6 W0045 01
5V6 W0045 00	

### MATERIAL AVAILABILITY AND PART NO.

STD	OPTIONS				
FA	HH	R	MXS	EPFA	
FA021	-	FA021R	-	-	

# FA022 71.8 x 35mm

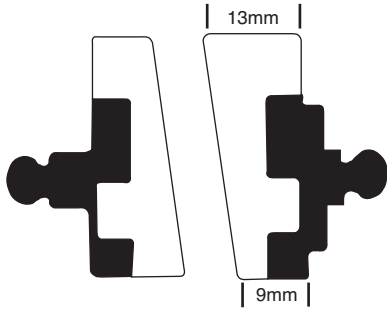

**Note: 1 pad left  
1 pad right  
Tapered finish**

**BMW**

R 60/7	76-80	F
R 60 TIC	78-82	F
R 75/6/75/7	73-79	F
R 80	77-84	F
R 80 TIC	78-08/80	F
R 90 S	73-76	F
R 90/6	73-76	F
R 100	76-77	F
R 100/7T	77-09/80	F
R 100 S	76/08/80	F
R 100 RS	76-09/80	F
R 100 RT	78-09/80	F

**Competitor X Ref**

Dunlop	Ferodo	SBS	Vesrah
-	FDB155	520	VD910

**Equivalents OE #**

34 11 2 301 358	34 11 1 233 319
-----------------	-----------------

MATERIAL AVAILABILITY AND PART NO.					
STD	OPTIONS				
FA	V	HH	R	MXS	EPFA
FA022	FA022V	-	-	-	-

# FA024/2 113.8 x 66.8 x 7mm

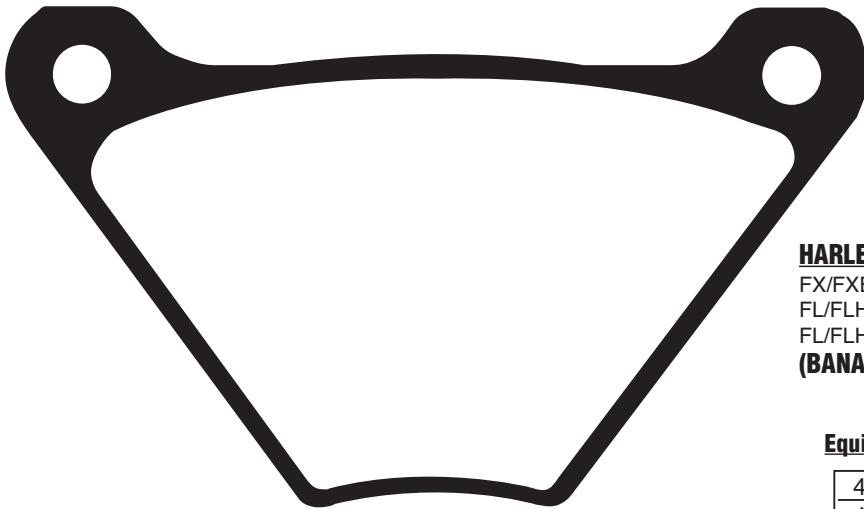

**HARLEY DAVIDSON**

FX/FXE/FXEF/FXWG/FXS	73-83	R
FL/FLH	72-84	F
FL/FLH	72-84	R

**(BANANA CALIPER)**

**Equivalents OE #**

44005 74
44135 74A
44005-78

**Competitor X Ref**

Dunlop	Ferodo	SBS	Vesrah
DP906	FDB185/R	513	VD902/915

MATERIAL AVAILABILITY AND PART NO.					
STD	OPTIONS				
FA	V	HH	R	MXS	EPFA
FA024/2	FA024/2V	-	-	-	-

# FA026 78 x 52.5 x 6.3mm

## HARLEY DAVIDSON

FX, FXE  
XLH, XLCH

73-77 F  
F

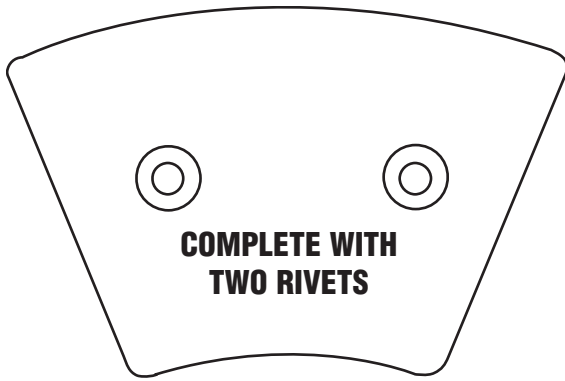

### Equivalents OE #

44281-74

### Competitor X Ref

Dunlop	Ferodo	SBS	Vesrah
-	-	679	VD901

### MATERIAL AVAILABILITY AND PART NO.

STD	OPTIONS			
	HH	R	MXS	EPFA
FA026	-	-	-	-

# FA027 44.4 x 55.4 x 9.5mm

## NORTON

750 Mk V Commando / Roadster / Interstate 73 F&R  
850 Mk I Commando / Hi Rider / Interstate 73 F&R  
850 Mk I A Commando Roadster / Interstate 73 F&R  
850 Mk II / II A Commando Roadster / Hi Rider / Interstate 74 F&R  
850 Mk III Commando Roadster / Hi Rider / Interstate 75 F&R

### Equivalents OE #

06 6005	06 6186
06 1894	

### Competitor X Ref

Dunlop	Ferodo	SBS	Vesrah
-	FDB88	505	VD904

### MATERIAL AVAILABILITY AND PART NO.

STD	OPTIONS			
	HH	R	MXS	EPFA
FA027	-	-	-	-



# FA028 45.3 x 12/15.5mm

## YAMAHA

FSIE DX 77-79 F  
RD 50 M 78 F  
RS 100 DX 77-80 F  
RS 100 (IY8 Europe) 77-78 F  
RS 100 DX (IY8 Europe) 79 F  
RD 125 DX 75-77 F  
RS 125 DX 76-80 F  
RD 200 DX 75-78 F

### Equivalents OE #

1V1 W0045 00	404 W0045 12
404 2000 11	464 20000 11
404 2000 12	464 20000 12

### Competitor X Ref

Dunlop	Ferodo	SBS	Vesrah
-	-	500	VD202/203

### MATERIAL AVAILABILITY AND PART NO.

STD	OPTIONS			
	HH	R	MXS	EPFA
FA028	-	-	-	-

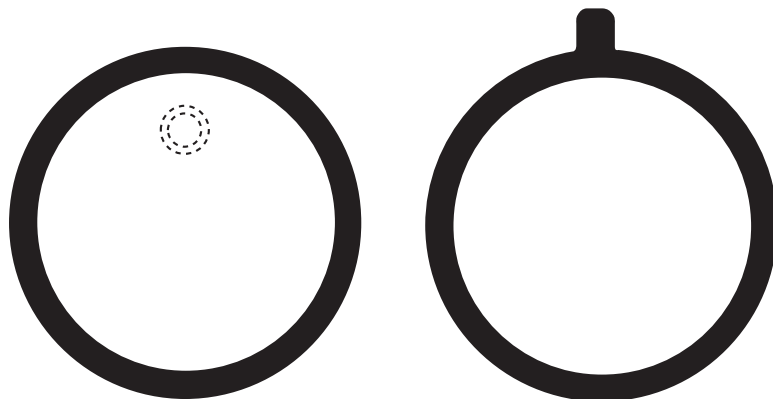



# FA029 67 x 49.2 x 11mm

# FA030 67 x 49.2 x 10mm

# FA031 67 x 49.2 x 9mm

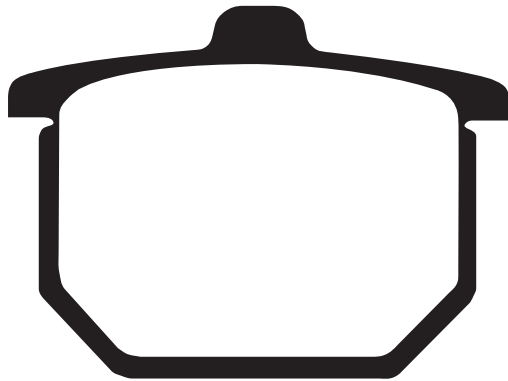

### Competitor X Ref

	<b>Dunlop</b>	<b>Ferodo</b>	<b>SBS</b>	<b>Vesrah</b>
<b>FA29</b>	DP102	-	508	VD112/2
<b>FA30</b>	DP101	FDB182	-	VD112/3
<b>FA31</b>	-	-	517	VD112

### Equivalents OE #

#### FA31

43105 461 770	06435 761 405
45105 371 000	06455 371 405

### FA29 - HONDA

CX 500 CA/CB/Z/A/B	79-81	F
GL 1000 K3/KZ "Goldwing"	78-79	F

### FA30 - HONDA

CB 400 N/NA/NB	78-81	F
CB 750 F2	79	R
CBX 1000 Z	79-80	R
GL 1000 K/K1/K2/KZ 'Goldwing'	75-77	F
GL 1100 A/DA/B/DB (SC02)	80-81	F&R

### FA31 - HONDA

CB 750 F2	79	F
CB 750 FZ/FA/FB	78-82	F&R
CB 900 FZ/FA	80-81	F&R
CBX 1000 Z	79-80	F&R

### Equivalents OE #

#### FA29

43105 461 305	45105 415 772	45105 410 026
43105 461 771	45105 410 004	45105 410 305
43105 461 772	45105 410 006	45105 415 004
45105 415 006	45105 410 007	45105 415 305
45105 415 770	45105 410 016	

### Equivalents OE #

#### FA30

45105 461 771	45105 438 000	45105 438 008
45105 461 772	45105 438 004	
45105 415 006	45105 438 007	

### MATERIAL AVAILABILITY AND PART NO.

STD	OPTIONS				
FA	V	HH	R	MXS	EPFA
<b>FA029</b>	<b>FA029V</b>	-	-	-	-

### MATERIAL AVAILABILITY AND PART NO.

STD	OPTIONS				
FA	V	HH	R	MXS	EPFA
<b>FA030</b>	<b>FA030V</b>	-	-	-	-

### MATERIAL AVAILABILITY AND PART NO.

STD	OPTIONS				
FA	V	HH	R	MXS	EPFA
<b>FA031</b>	<b>FA031V</b>	-	-	-	-

# FA032 57.8 x 65.3 x 11mm

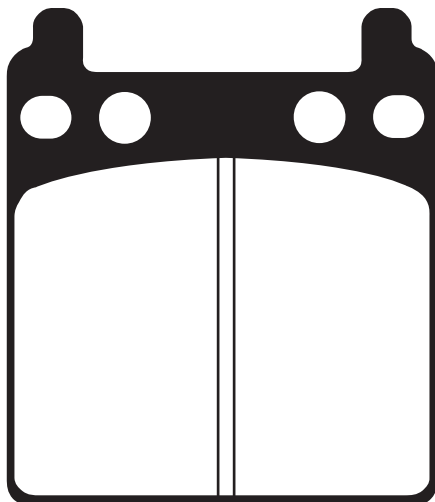

### HONDA

CB 750 F/F1	76-77	R
GL 1000 K/K1/K2/K3/KZ 'Goldwing'	75-79	R

### Equivalents OE #

431A0 431 673	43211 431 671
43211 371 006	43211 431 672
43211 392 006	43211 431 673
43211 392 016	

### Competitor X Ref

<b>Dunlop</b>	<b>Ferodo</b>	<b>SBS</b>	<b>Vesrah</b>
-	FDB134R	509	VD108/116

### MATERIAL AVAILABILITY AND PART NO.

STD	OPTIONS				
FA	V	HH	R	MXS	EPFA
<b>FA032</b>	<b>FA032V</b>	-	-	-	-

# FA033 A = 51.3 x 12.3mm B = 50 x 12.5mm

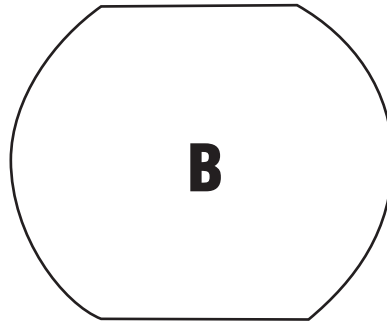
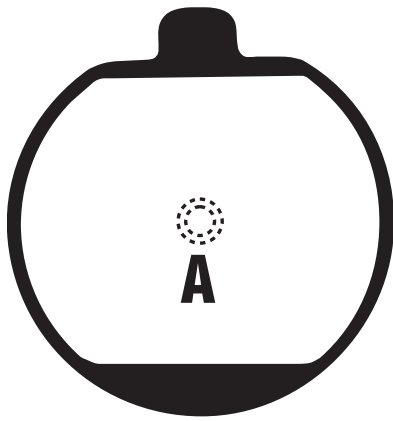

### Equivalents OE #

43050 002	43050 1006	43051 007
43050 005	43050 1021	43051 008
43050 006	43050 5001	43051 011
43050 007	43050 5002	43082 001
43050 008	43050 5003	43082 1001
43050 009	43051 001	43082 1005
43050 011	43051 006	

### Competitor X Ref

Dunlop	Ferodo	SBS	Vesrah
DP300	FDB132	510	VD404/408/ 409/411

### KAWASAKI

KH 250 B1-B5	77-82	F
S2-A (350cc)	72-73	F
KH 400 A3/A4/A5	76-78	F
S3/S3-A (400cc)	74-75	F
Z 400 G1	79	F
KH 500 A8	76	F
Z 650 B1/B2/B3	79-81	F
Z 650 C1/C2	76-78	F
Z 750 B1/B2/D1	76-78	F
Z 900 A4	77-78	F
Z 1000 A1-A2	74-82	F
Z 1000 D1 (Z1-R)	78-	F
Z 1000 H1	80	F

### MATERIAL AVAILABILITY AND PART NO.

STD	OPTIONS			
FA	HH	R	MXS	EPFA
FA033	-	-	-	-

# FA034 57.8 x 65.3 x 11mm

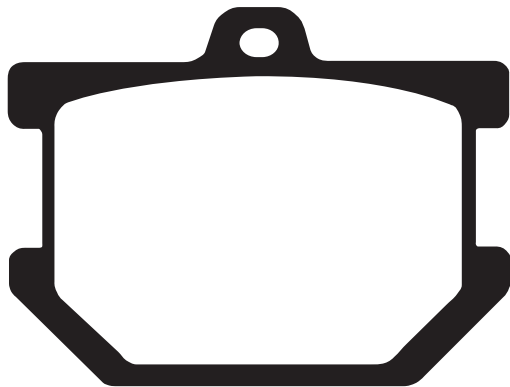

### YAMAHA

XS 250 C	78	F&R
XS 250 D/E	79-81	F
XS 360 C	76	F&R
XS 400 C	78	F&R
XS 400	79	F
SR 500	78-82	F
XS 500 C/D	78-79	F&R
XJ 650	80-84	F
XJ 650 LH Midnight	81	F
XJ 650 RJ 'Seca'	82	F
XS 650	77-81	F
XS 650 SE	79-80	F&R
XS 650 SE	81	F
XS 750	77-79	F&R
XS 750 SE	79-80	R
XS 850	80	F&R
XV 1000 TRI	81	F
XS 1100	78-80	F&R
XS 1100 S	81	R

### Equivalents OE #

1J3 20000 11	1J3 W0046 00	2J2 W0046 00	3H5 W0045 01
1J3 20000 13	1J9 20000 02	2J2 W0046 01	4K0 W0045 00
1J3 20000 63	1L9 W0045 00	2M0 W0046 00	4K0 W0045 01
1J3 20000 64	1L9 W0046 00	2M0 W0046 01	4K0 W0045 02
1J3 20000 70	1U4 W0046 01	3G1 W0046 00	
1J3 W0045 00	1U4 W0046 02	3H5 W0045 00	

### Competitor X Ref

Dunlop	Ferodo	SBS	Vesrah
DP401	FDB177R	507	VD205-212

### MATERIAL AVAILABILITY AND PART NO.

STD	OPTIONS				
FA	V	HH	R	MXS	EPFA
FA034	FA034V	-	-	-	-

# FA035 51 x 11/12mm

## SUZUKI

GS 400 B/C	77-78	F
GS 425 EN	78-80	F
GS 750 B/DB/DC/EC/EN	77-80	F

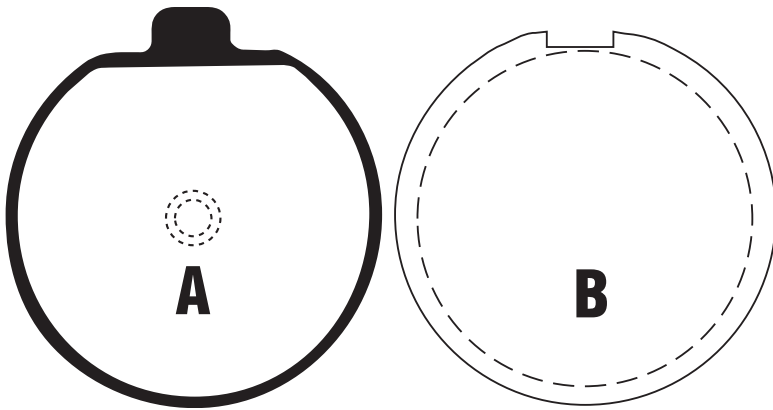

### Equivalents OE #

59100 45820	59300 44822
59100 45821	59300 44860
59300 44810	59300 45890
59300 44820	59300 45891
59300 44821	59302 45830

### Competitor X Ref

Dunlop	Ferodo	SBS	Vesrah
-	FDB150	511	VD305

### MATERIAL AVAILABILITY AND PART NO.

STD	OPTIONS			
FA	HH	R	MXS	EPFA
FA035	-	-	-	-

# FA036 57.6 x 52.8 x 9mm

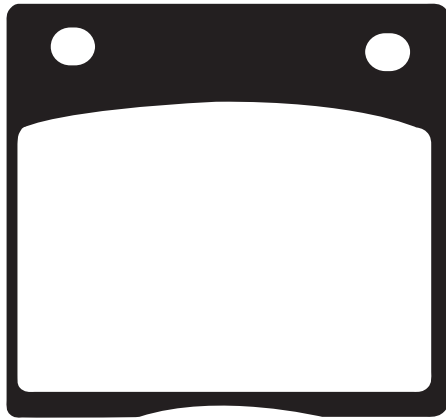

## KAWASAKI

Z 500 B1/B2	79-80	R
Z 650 C3	79	R
Z 650 D2/D3 (SR)	79-80	R
Z 1000 D1/D3 (Z1R)	78-79	R
Z 1000 A1-A4	77-80	R
Z 1000 ST (E1-E2 shaft)	79-82	R
Z 1000 H1	80	R
Z 1300 A1-A5	79-83	R
ZG 1300 A1-A3	84-86	R

## SUZUKI

GSX 400 FX/FZ/FD	81-83	R
GS 550 EC/EN	78-79	R
GS 550 ET/EX/EZ/LT/LX/MX/MZ	80-84	R
XN 85 Turbo	83	R
GS 650 GTX/GTZ/GTD/GX/GZ	81-83	R
GS 700 EF/ESF	85	R
GS 750 B/DB/DC/EC/EN	77-80	R
GSX 750 ET/EX/ESD/EFE/ESG /ESE/ESH/ESF	82-86	R
GSX 750 SE Katana	85	R
GSX 750 S/SS (G57SX-106815-) Katana	84	R
GSX 750 S-2/S-2C (G575X-114747-) Katana	84	R
GS 850 GN/GT/GX/GZ/GE/GG	79-85	R
GS 1000 HC/EC/EN/SN	78-80	R
GS 1000 ET/GT/GX	81-82	R
GSX 1000 SZ "Katana"	82	R
GSX 1100 ET/EX/EZ/ESD	80-83	R
GS 1100 GZ	82	R
GSX 1100 SZ/SD Katana	82-83	R
GV 1200 GLF/GLF2/GLG Madura	85-86	R

## GMA

2 Piston Rear (Large) Caliper model A (CCI # 09-997)

### Equivalents OE #

43050 010	69130 45010	69101 45820
43050 1013	69130 45020	69101 45830
43082 1059	69130 45021	69101 45840
69130 34220	69130 45100	69101 45850 XNA
69130 34240	69130 45101	69101 45860 XNA
69130 45000	69130 45990	69130 45030
69130 45001	69100 34870	

### Competitor X Ref

Dunlop	Ferodo	SBS	Vesrah
DP203	FDB151R	512	VD306

### MATERIAL AVAILABILITY AND PART NO.

STD	OPTIONS				
FA	V	HH	R	MXS	EPFA
FA036	FA036V	-	-	-	-

# FA037 51.5 x 13/12mm

## KAWASAKI

Z 650 C1/C2  
Z 750 B1/B2  
Z 750 D1

77-78 R  
77-78 R  
76 R

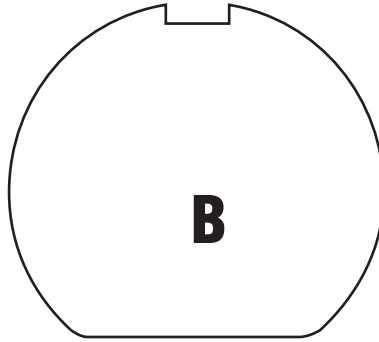
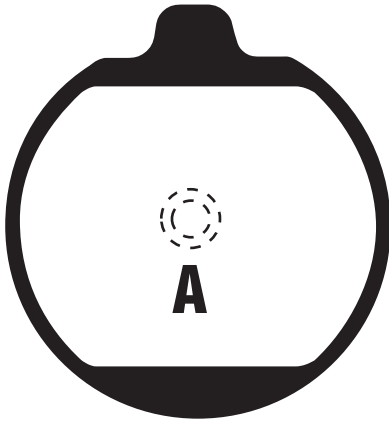

### Competitor X Ref

Dunlop	Ferodo	SBS	Vesrah
-	FDB181R	514	VD405/412

### Equivalents OE #

43051 009	43050 1006
43050 1008	43050 5002

### MATERIAL AVAILABILITY AND PART NO.

STD FA	OPTIONS			
	HH	R	MXS	EPFA
FA037	-	-	-	-

# FA038 A. 50 x 12mm B. 50 x 11.9mm

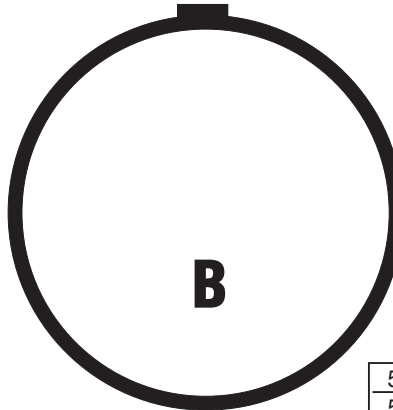
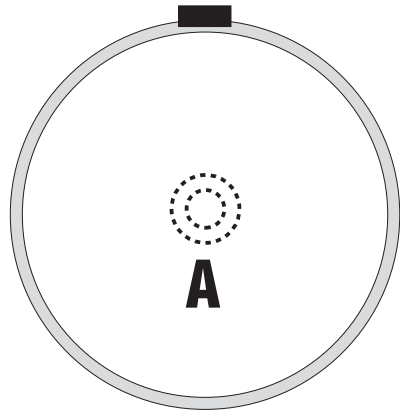

## SUZUKI

GT 125 C/EC/EN 78-79 F  
GT 200 EN/EX "X5" 79-82 F  
GT 250 EN/ET/EX "X7" 78-81 F  
GS 550 DB/DC/EC/EN 77-79 F  
GS 850 GN/GT/GX 79-81 F  
GS 1000 HC/EC/EN/SN 78-80 F

### Competitor X Ref

Dunlop	Ferodo	SBS	Vesrah
-	FDB181R	515	VD307/308 310/315/ 316/320

### Equivalents OE #

59100 11850	59300 47830
59100 34820	59300 47840
59300 45820	59300 47850
59300 47810	59300 47870
59300 47820	59300 47880

### MATERIAL AVAILABILITY AND PART NO.

STD FA	OPTIONS			
	HH	R	MXS	EPFA
FA038	-	-	-	-

# FA039 43.50ø x 12/10mm

## KAWASAKI

KH 125 A1-A4  
Z 200 A1-A5

77-81 F  
77-82 F

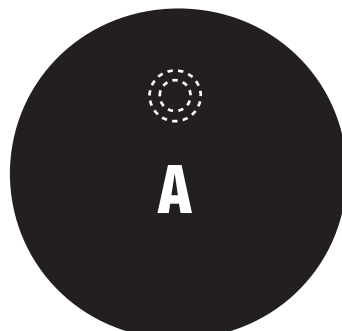
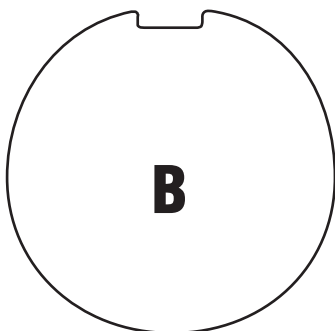

## SUZUKI

GT 50 KB/KEN 77-80 F  
ZR 50 KEN/KEX "X1" 79-83 F

### Competitor X Ref

Dunlop	Ferodo	SBS	Vesrah
-	-	516	VD309/410

### Equivalents OE #

43050 1009	59300 46811
43050 1010	59300 46820
59300 46810	

### MATERIAL AVAILABILITY AND PART NO.

STD FA	OPTIONS			
	HH	R	MXS	EPFA
FA039	-	-	-	-

# FA040 41 x 21/11mm

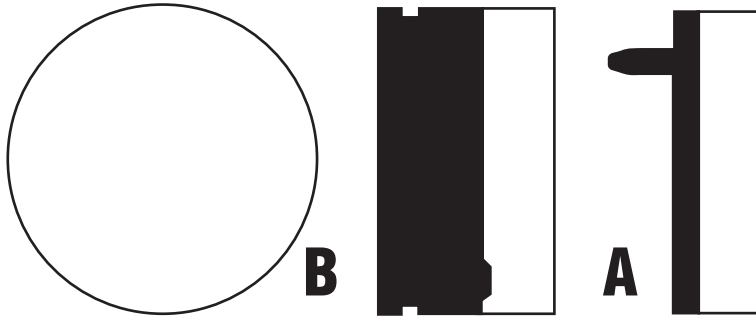

### HONDA

CB 50 J	81	F
SS 50 ZB2	77-80	F
CB 125 J/T	78-79	F
FL 250 Odyssey	77-84	R

### POLARIS

Trail Boss 2 x 4	85-87	R
Scrambler 3 wheeler	85-86	R
Cyclone '250 X'	87	R

#### Equivalents OE #

45340 107 720 A	45340 149 003 A	45345 107 720 B	45345 149 003 B	45350 950 000
45340 107 721 A	45340 149 720 A	45345 107 721 B	45345 149 720 B	
45340 107 722 A	45340 950 000 A	45345 107 722 B	45350 107 720	
45340 149 000 A	45345 950 000 B	45345 149 000 B	45350 107 720 B	

#### Competitor X Ref

Dunlop	Ferodo	SBS	Vesrah
-	-	525	VD109/111

#### MATERIAL AVAILABILITY AND PART NO.

STD	OPTIONS			
FA	HH	R	MXS	EPFA
FA040	-	-	-	-

# FA041 94.5 x 56mm

**MARKED WITH BLUE TAG TO AVOID  
CONFUSION WITH FA061**

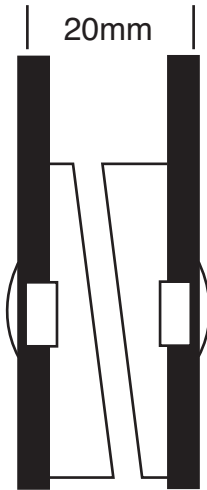

### YAMAHA

RD 250 E/F	78-79	F&R
XS 250 SE/SF	79-81	F
RD 400 E/F	78-79	F&R
XS 400 SE	80-81	F
XS 750 SE	79-80	F (Right)

#### Equivalents OE #

2G2 W0045 00	3J6 W0045 01
2R8 W0045 003	4W1 W0046 00
3H6 W0045 00	

#### Competitor X Ref

Dunlop	Ferodo	SBS	Vesrah
-	FDB184	528	VD215

#### MATERIAL AVAILABILITY AND PART NO.

STD	OPTIONS				
FA	V	HH	R	MXS	EPFA
FA041	FA041V	-	-	-	-

# FA042 45 x 45 x 10/16mm

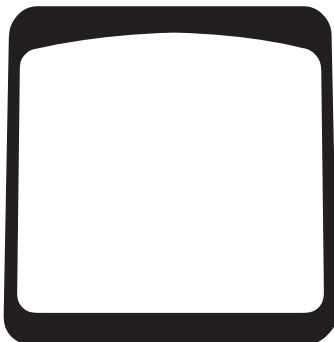

### YAMAHA

FS 1 DX	79-80	F
RD 50 M	79-80	F
RS 100 (IY8 Europe)	80-82	F
RD 125 DX	78-81	F
RS 125 DX	81	F
RD 200 DX	78-80	F

#### Equivalents OE #

2R6 W0045 00	2R6 W0045 11
2R6 W0045 10	2R6 W0045 12

#### Competitor X Ref

Dunlop	Ferodo	SBS	Vesrah
-	FDB248	531	VD-213

#### MATERIAL AVAILABILITY AND PART NO.

STD	OPTIONS			
FA	HH	R	MXS	EPFA
FA042	-	-	-	-



# FA043 46 x 21/11mm

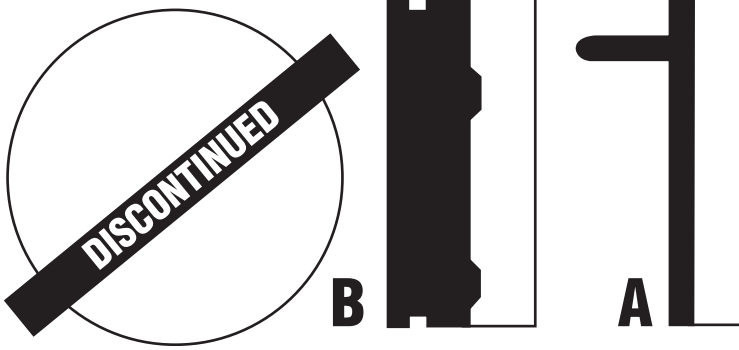

## HONDA

CB 125 K6/S2 76 F  
CB 200 B 76-79 F

### Equivalents OE #

45340 351 305
45340 351 700 A
45345 351 700 B
45345 351 305

### Competitor X Ref

Dunlop	Ferodo	SBS	Vesrah
-	-	521/194	VD-110

MATERIAL AVAILABILITY AND PART NO.					
STD	OPTIONS				
FA	HH	R	MXS	EPFA	
-	-	-	-	-	

# FA045 54 x 53 x 11mm

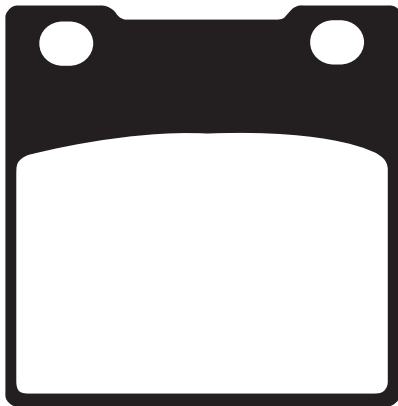

## HONDA

CB 250 T/N/NA/NB/NDB/NDC 78-82 F  
CB 250 RSA/RSD 81-84 F  
CM 250 TB 81 F  
CB 400 A 'Honda-matic' 79 F  
CB 400 T 78 F  
CB 650 Z/B 79-81 F  
CB 750 KZ 80 F

### Equivalents OE #

45105 413 003	45105 425 003	45105 MA5 671
45105 413 305	45105 425 006	06455 425 405
45105 413 871	45105 471 006	

### Competitor X Ref

Dunlop	Ferodo	SBS	Vesrah
DP103	FDB183	526	VD113/117

MATERIAL AVAILABILITY AND PART NO.					
STD	OPTIONS				
FA	V	HH	R	MXS	EPFA
FA045	FA045V	-	-	-	-

# FA046 44 x 11.5/13mm

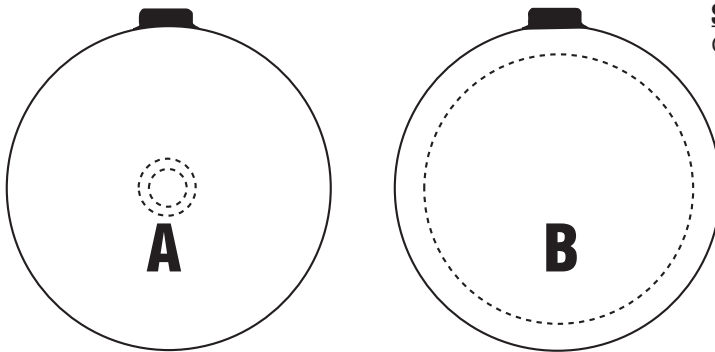

## SUZUKI

GP 100 C/N/X/DED 78-87 F

### Equivalents OE #

59300 39840
-------------

### Competitor X Ref

Dunlop	Ferodo	SBS	Vesrah
-	-	538	VD-314

MATERIAL AVAILABILITY AND PART NO.					
STD	OPTIONS				
FA	HH	R	MXS	EPFA	
FA046	-	-	-	-	

# FA047 40 x 50 x 7mm

# FA047/2 40 x 50 x 5.5mm

# FA047/3 40 x 50 x 9.3mm

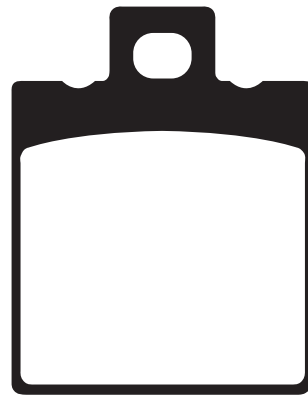

## FA047

### ACCOSSATO

CE 50/80/KR 80	87-	F
Enduro Codice 50	89-	F

### AGRALE

Elefantre 30.0		F
----------------	--	---

### ALFER

80 MC	87-	F
125 MC	87	F
125 MC	88-	R
250 MC	85-86	F
250 MC	87	F&R
250 MC	88-	R
250 GR/Enduro	85-87	F
250 GR/Enduro	88-	R
300 GR Enduro	88-	R

### APRILIA

RS 50	93-98	F
AF1 125	87-89	R
RS 125 (All models)	92-05	R
AF 125	90-91	R
Red Rose 125	87	R
Tuono 125	03-04	R
250	86	F
RS 250 (All models)	95-02	R

### BENELLI

124/125 2C/125 2T/2CSE	76-	F
125 T	83	F
250 C/TS, 250/4	76-	F
BX 250 Motard	12-13	R
Uno C 250 (Single)	13	R
304	83	F
354	-82	F
354 Sport 2	83	F&R
500/4	76-	F
654 Sport	83	F&R
666 Scooter "Born in Hell"	98-99	R

### BEHRINGER

6 Piston (Old design / 2 piston)		
----------------------------------	--	--

### BETA

Eikon 125/150	00-06	F
---------------	-------	---

### BIMOTA

All models	89-03	R
DB5R/S (1078cc)	08-09	R
DB6 (1078cc)	08-09	R
DB6/R (1078cc)	08-09	R
DB6 Delirio (1078cc)	12-13	R
DB7 (1099cc)	09	R
DB8 SP (1078cc)	12-13	R
DB10 Motard (1078cc)	12-13	R
Tesi 2D	04-06	R
Tesi 3D (1078cc)	09-13	R
SB8K Gobert (996cc Suzuki engine)	06	R
SB8K Santamonica (992cc Suzuki engine)		R

### BREMBO

20 5161 43 or 81 - 2 Piston P 2/32 Rear caliper (Single pad fixing pin / with anti rattle shim)		
---	--	--

### CAGIVA

Cucciolo 50	97	F
W4 50	91-95	F
Blues 125	92-95	R
Cucciolo 125	00	F
125 Elefant RE	87	F
Frecia 125 SY	89	R
NI 125	97	R
Supercity 125	92	R
Mito 125 (all models)	91-10	R
Planet 125 (3 Spoke Wheels)	98-03	R
Planet 125 (6 Spoke Wheels/ST Series)	98-03	R
Planet 125 (6 Spoke Wheels 2nd Series)	98-03	R
Raptor 125	03-10	R
SST 250/350	80-82	F
SX 250	82	F
WMX 125	86	F
WMX 250	-85	F
Mito 500	91-92	R
Mito 500 (4T)	08	R
WMX 500	84-86	F
Excaliber 501 RX	92-	R

River 600	95-99	R
650 Elephant	85-	R
650 Elefant	88-89	R

### DERBI

GPI 250	05	R
---------	----	---

### DUCATI

Supersport 400	93-97	R
400 Monster/Dark	95-04	R
Monster 400 ie (Japan)	07-08	R
Monster Dark ie 400 (Japan)	05-06	R
Monster Darkie 400 (Single disc)	05	R
Monster 400 (Single disc)	00-02	R
Monster 400 (Twin disc)	03-04	R
Supersport 400 (Twin disc)	93-97	R
500 GTL	75	F
500 GTV Pantah	77	F&R
500 Sport Desmo	77	F&R
500 Pantah	79	F&R

Monster 600 (Twin disc)	93-97	R
600 Monster	93-99	R
600 Monster Dark	98-99	R
600 Monster City/City Dark	99	R
600 Monster	00-01	R
600 Supersport	91-97	R
620/IE/SIE Monster	02-04	R
620 Sport	03	R
Monster 620 ie (Single disc)	03-04	R
Monster 620	05-06	R
S4RS (998cc)	06	R
Monster 620 Dark	03-06	R
695 Monster	07-08	R
748 S (Biposto)	00-02	R
748 S (Monoposto)	00-02	R
748 SPS	98-99	R

748 Testa Bassa (Mono/Biposto)	07	R
748 Biposto	95-02	R
748 SP/Monoposto	99-02	R
748 SP	95-98	R
748 R (2 pad caliper)	00	R
748 R (4 pad caliper)	01-02	R
750 Paso	87-90	R
750 Supersport	91-98	R
750 Monster	96-98	R
750 Monster City/City Dark	99	R
750 Monster/Monster Dark	99	R
750 Monster	00-01	R
Monster ie 750	02	R
Supersport 750 (Twin disc)	91-98	R
Monster 800	03-04	R
800 Supersport	03-05	R
851 Superbike Biposto	89-92	R
888 SP4/SP5	92-93	R
888 Superbike Strada	94-95	R
900 Supersport	89-90	R
900 Supersport/Superlight	91-97	R
900 Supersport CR USA	98	R
900 Supersport FE	98	R
900 Monster	93-99	R
900 Monster Cromo/Special	98	R
900 Monster City/City Dark	99	R
900 IE Monster	00-01	R
907 IE	90-93	R
916 SPS (996cc)	97-98	R
Monster S2R Dark (803cc)	05-06	R
Monster S4 Foggy (916cc)	02	R
Monster S4 (916cc)	01-02	R
916 (Biposto)	94-98	R
916 Senna	94-98	R
916 SP	94-96	R

S4 RS Monster (998cc)		
(Radial 4 pad caliper)	06	R
S4R Monster Testastretta (998cc)		
(Radial 4 pad caliper)	07-08	R
S4RS Monster Testastretta (998cc)		
(Radial 4 pad caliper)	07	R
S4RS (Tricolore/Monster Testastretta)		
(998cc) Radial 4 pad caliper	08	R
Monster S4R (996cc) (2 pad caliper)	05-06	R
996 SPS (996cc)	99	R
996 (996cc) (Monoposto/Biposto)	99-01	R

### DUCATI Contd.

Monster S4R (996cc)	03-06	R
996 R	01	R
996 S	01	R
998 Matrix (998cc)	04	R
998 R (998cc)	02	R
998 S Baylis/Bostrom	02	R
998 S (998cc) 4 pad caliper	02-04	R
998 (998cc) (2 pad caliper)		
(Monoposto/biposto)	02-03	R
Monster 1000 Dark	03	R
Monster 1000 ie (92cc)	04-05	R
Monster 1000 S ie (992cc)	03-05	R
Monster S2R 1000 (992cc)	06-08	R

### FANTIC

50 Caballero/Caballero RC	91-	F
80 Caballero/Caballero RC	91-	F

### GILERA

RV 50 NGR	88-	R
125 HX LC	83-	F
125 RX	84-	F
RX 125 Arizona	88-	F
GFR 125	94	R
Nordwest	94	R
125 CX	91-	R
125 MX1/MXR	89-	R
125 SP 01/SP 02	89-	R
125 XR1/XR2	89-	R
RX 200/Arizona/Enduro	85-	F
200 Fast Bike	87-	R
RV 200	85-86	R
RV 200 ES	87-	R
HX 250 LC	83-	F
NGR 250	85-	R
250 RX Arizona Rally	86-	F
RC 250 Rally	87-	R
Saturno 350 Bialbero	90-	R
XRT 350	90-	R
Nord-West 350	94-	R
Saturno 500 S/Bialbero/Piuma	90-	R
XRT 600	88-	R

### HARRISON BILLET

Big 4 Piston (1296033)		
Big 6 Piston (1296033)		

### HRD

WH 125 Road/Red Horse	85-	F
-----------------------	-----	---

### HONDA HM (Italy)

CRE 50 Six/Baja/Derapage	95-02	R
--------------------------	-------	---

### H P POWER

Iron 50 (2T)	10-11	F
--------------	-------	---

### HYOSUNG

Grand Prix 125	99-04	F
Exceed 125 (MS1 125/150)	02-04	F
Boomer/Exceed 125	02-03	F
GPS 125 Grand Prix/Hyper Rear drum model	99-04	F
GPS 125 Grand Prix Plus Rear disc model	00-04	F
MSI 125/150	05	F

### HUSQVARNA

XC 125	85-86	F
CR 240	85-86	F
CR 250	85-86	F
XC 250	85-86	F
CR 500	85-86	F
XC 500	85-86	F
TC 510	87-88	F
TE 510	87-88	F
TX 510	87-88	F

# FA047 Contd. 40 x 50 x 7mm

## FA047/2 Contd. 40 x 50 x 5.5mm

## FA047/3 Contd. 40 x 50 x 9.3mm

### FA047 Contd.

#### INDIAN

See application page for details

#### IRON PEGASUS

Small caliper (Single pin fixing)

#### ISR CALIPERS

22-025-XX (4 piston)

22-027 (2 piston rear)

22-028 (2 piston)

22-029 (Rear 2 piston)

#### KEEWAY

ARN 50 (25/45)

Hacker 50

ARN 125

Hacker 125

ARN 150

Hacker 150

#### KTM

MX/MXC 125

GSXC/GS 125

MX/MXC/GS 125

MX/MXC 250

GSXC/GS 250

MX/MXC/GS 250

MX/MXC 300

GSXC/GS 300

MX/MXC/GS 300

MX/MXC/GS 350

350 Four Stroke

MX/MXC/XC-GS 500

#### LAVERDA

OR 50 Atlas

GS 125 Lesmo

LZ 125 Sport Brembo caliper

Montjuic

Alpino 500

650 All models

668 All Models

750 All Models

#### MAICO

All Models

#### MALAGUTI

50 Enduro MEX

Enduro MDX 80

Ciak 125/150/200

F18 125/150 Warrior

#### MALANCA

E2 C80/CS

125 GTI

125 Mark Enduro

Ciak 200

#### MONTESA

311 (Honda) 260cc

314R (Honda)

315R (Honda)

#### MOTO GUZZI

(350) V35 Florida

350 V35 II (12 spoke cast wheels)

350 V35 III (10 spoke cast wheels)

350 V35C Custom (10 spoke

cast wheels/points ignition)

350 V35 (12 spoke cast wheels/

electronic ignition)

NTX 350

350 Nevada

350 Nevada Club

500 V50 (12 spoke cast wheels/

electronic ignition)

500 V50 C Custom (10 spoke

cast wheels/points ignition)

500 V50 III (12 spoke cast wheel)

650 65 GT

650 V65 C Custom (10 spoke

cast wheels)

650 V65 Florida

(Spoke/cast wheel models)

NTX 650

750 Nevada Club (Up to LK112433)

750 Nevada Club (From LK112433)

750 SP (10 spoke cast wheels)

750 Strada/T Roadster

750 Targa

750 Nevada

750 V75 (10 spoke cast wheel/

solid front disc)

750 V75 (10 spoke cast wheel/

floating front discs)

1000 Daytona

1000 Daytona RS

1000 V10 Centauro GT

1000 V10 Centauro Sport

1100 Sport Carbs

1100 Sport EFI

1100 Sport Corsa

1100 V11 Ballabio

F&R

F&R

F

F

F

F

F

F

F

F

F

F

F

F

F

F

F

F

F

F

F

F

F

F

F

F

F

F

F

F

F

F

F

F

F

F

F

F

F

F

F

F

F

R

R

R

R

R

R

R

R

R

1100 V11 Le Mans

1100 V11 Sport

1100 V11 Scura

1100 V11 Naked

#### MOTO MORINI

Dart 350

350 Kanguro

Excaliber 350/501 RLX

#### MZ/MUZ

Mastiff - 17" front wheel/cast wheel

Tour/Traveller

Skorpion Sport/Replica/Cup

#### PRO-ONE

2 Piston

#### TM

SMM 125 Black Dream (Rim brake)

SMM 250 (2T)

SMM 250 F (4T)

SMM 300 (2T)

SMM 400 (4T) Rim brake

SMM 450 F Black Dream E-S

SMM 530 F Black Dream Rim brake

#### VOXAN

Charade Racing

#### YAMAHA

TDR 125 R Lightburner (3SH2/3XE2)

TZR 125 R

TZR 125 R Brembo Caliper (4DL1/4DL2)

SZR 660

#### FA047/2

#### GARELLI

Urka 50

125 XR/XRD Tiger

#### GILERA

50 Rally

R1/50

#### KTM

80 MX

#### FA047/3

#### HONDA

CRM 125 RL/RM/RN/RR/RV/RX

NSR 125 FJ/FK/FL/FM/FN

NSR 125 RK/RL/RM/RN/RR/RS/RV/RW

/RX/RV/R1

### Equivalents OE #- FA47

8103662	8113638	8000 39730	3SH F5811 20	8A00 46147	9021035000	00276546100	GU27654610
8113016	8113651	323 627	613 4008 1A	8000 46147	252524000	107 28 86 30	211021022
8113064	8113662	326 446	613 4007 71A	03613 9666	000276546100	107 5365 13	211082010
8113118	8213197	341 170	43105 NN2 600	61340 311A	613 4 0541A	KA3496535	
8113196	8213200	19654600	8000 46147	61340 281A	2547/F/S	9021038000	
8113222	19654600	19654601	8000 90156	04700 2000037	211082010	12906040	
8113323	8000 29070	491 13 409 044	2525 242000	119 52200	000316546650	1296006	

### Equivalents OE #- FA47/3

43105 KBS 405	43105 KY4 902
43105 KBS W00	43105 NW2 610
43105 KY4 901	

### Competitor X Ref - FA47

Dunlop	Ferodo	SBS	Vesrah
DP601	FDB207/R /FDB705	519/138 /164	VD911

### Competitor X Ref - FA47/2

Dunlop	Ferodo	SBS	Vesrah
-	-	583/131	-

### Competitor X Ref - FA47/3

Dunlop	Ferodo	SBS	Vesrah
-	-	646	VD911/2

### MATERIAL AVAILABILITY AND PART NO.

STD	OPTIONS						
FA	SFA	TT	HH	SFA-HH	R	MXS	EPFA
FA047	SFA047	FA047TT	FA047HH	SFA047HH	FA047R	-	-

### MATERIAL AVAILABILITY AND PART NO.

STD	OPTIONS			
FA	HH	R	MXS	EPFA
FA047/2	-	FA047/2R	-	-

### MATERIAL AVAILABILITY AND PART NO.

STD	OPTIONS			
FA	HH	R	MXS	EPFA
FA047/3	-	-	-	-

# FA048 46 x 44 x 16/11mm

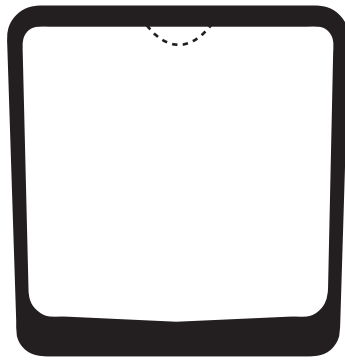

## KAWASAKI

KH 100 G2/G3 81-83 F  
Z 400 B1/B2 78-80 F

### Equivalents OE #

43050 1007 A	43050 5004
43050 1007 B	

### Competitor X Ref

Dunlop	Ferodo	SBS	Vesrah
-	FDB248	522	VD-413

### MATERIAL AVAILABILITY AND PART NO.

STD	OPTIONS				
	FA	HH	R	MXS	EPFA
FA048	-	-	-	-	-

# FA050 31.5 x 49 x 5.5mm



### Equivalents OE #

359 1 40 280 0
359 1 40 283 1

### Competitor X Ref

Dunlop	Ferodo	SBS	Vesrah
-	FDB213	532	VD-912

### MATERIAL AVAILABILITY AND PART NO.

STD	OPTIONS				
	FA	HH	R	MXS	EPFA
FA050	-	-	-	-	-

## CASAL

All disc models F

## CIMATTI

Gringo -85 F

## FANTIC

50 Strada Super Six 73- F

## HERCULES (SACHS)

Diff. older models with disc brake F

50 KX 5 F

50 Ultra, RS Ultra F

80 Ultra, F Ultra, RS Ultra F

80 Ultra Chopper F

80 Ultra AC F

80 Ultra AC Chopper F

80 XE 9 F

## HOREX

Rebell 80 N F

Rebell 80 T F

Sport 80 L F

## MALAGUTI

Chopper 25/40 -82 F

50 LX Sport -82 F

50 Ronco RCW -82 F

50 Fity HF -82 F

VA Olympique -82 F

50 Watercooled -82 F

Chopper 80 -82 F

## MALANCA

125/ST 54/GT 5 F

## PUCH

M 50 SDP Spoke Wheel/Grand Prix Special 75-77 F

M 50 SDP Cast Wheel/Grand Prix Supreme 75-77 F

# FA051 78 x 50 x 11.5mm



## SUZUKI

GN 250 F/J/M/R/T 85-97 F

GS 250 TT/TX 80-81 F

GSX 250 ET/EX/EZ 80-82 F

GN 400 TT 80 F

GSX 400 ET/EX/EZ 81-83 F

GSX 400 LX/TX 81 F

GS 450 ET/EG/EJ 80-88 F

GS 700 EF/ESF 85 F

GSX 750 ESD/EFE/ESG/ESE/ESH/EFF 82-86 F

GSX 750 ET/EX 80-81 F

GS 850 GZ/GE/GG 82-85 F

GS 1000 GT/GX 81-82 F

GS 1100 GZ 82 F

GV 1200 GLF/GLF2/GLG Madura 85-86 F

### Equivalents OE #

59130 45230	59301 45850	59330 38310
59301 45810	59300 05810	
59301 45811	59330 38300	

### Competitor X Ref

Dunlop	Ferodo	SBS	Vesrah
DP205	FDB218	532	VD-912

### MATERIAL AVAILABILITY AND PART NO.

STD	OPTIONS				
	V	HH	R	MXS	EPFA
FA051	FA051V	-	-	-	-

# FA052 41 x 21/11mm

## HONDA

CB 100 N	78-80	F
CB 125 T2	79	F



### Equivalents OE #

45340 399 700	45345 399 700
45340 399 701	45345 399 701
45340 399 702	45345 399 702

### Competitor X Ref

Dunlop	Ferodo	SBS	Vesrah
-	-	529	VD119

MATERIAL AVAILABILITY AND PART NO.				
STD	OPTIONS			
FA	HH	R	MXS	EPFA
FA052	-	-	-	-

# FA054 39.5 x 45 x 7.5mm

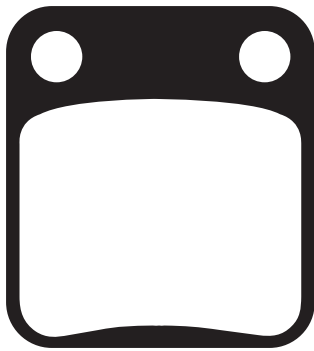

### Equivalents OE #

43082 1241	45112 GC4 601	59340 22A00	59101 38850
43082 0043	45112 GC4 831	59340 42A10	59101 38860
43235-FYBQ-300	800070854	59340 44A00	K4308 21241
45105 166 007	43082 1028	3GD W0045 00	06455 KEH 900
45105 GE3 601	43082 1201	06455 GBF J01	06455 GBZ 701
45105 GE3 602	54074-10000	5LP W0045 00	06455 KRM 861
45105 GC4 601	59300 44870	59100 38870	55100 23044 08
45105 GC4 602/603	59300 42810	59100 38880	PE774896
45105 GW6 004	59300 42850	59101 38810	
45105 GBF 405	59340 13A00	59101 38820	

### AJS

Regal Raptor DD 50 E/E2	04-10	F
JS 125-E/E2 (Eco 125)	07-10	F
JS 125-E (Eco-2 125)	09-11	F
JSM 125 Supermotard	10-11	R

### ASPES

Perseo Hybrid 150	11	F
-------------------	----	---

### HONDA

MB 5 S	80-82	F
MG 50 S/X/1/3 Magna 50	95-03	F
MRX 50	88-	F
MBX 80 FWDD/FWDF	83-86	F
CB 125 RS	83	F
CBX 125 TS Custom	82	F
CG 125 ES4-ES8	04-08	F
CG 150 ESD Titan	04-05	F
CG 150 KS/ES Titan	04-05	F
CBX 200 Strada	97-01	F
ATC 250 RB	81	F

### HYOSUNG

TE 450 Quad Rapier	06-09	F&R
--------------------	-------	-----

### KAWASAKI

KX 65 A1/A2/A3/A4/A5/A6/A6F/A7F/A8F/A9F/AAF /ABF/ACF/ADF	00-13	R
KH 125 K1	83	F
BN 125 A1/A2 'Eliminator'	98-99	F
KLX 125 CAF/CBF/CCF/CDF	10-13	R
KLX 125 DAF/DBF/DCF/DDF D-Tracker	10-13	R
KVF 300 A1/A2/A3/A4/B1/B2/B3/B4 (Prairie 4x4/2x4)	99-02	F
KVF 360 A1-A3/A6F/A7F/A8F/A9F/AAF/ABF /ACF/ADF Prairie	03-13	F
KVF 360 B1-B3/B6F/B7F/B8F/B9F	03-09	F
KVF 360 C1-C3/C6F/C7F/C8F Prairie All models	03-08	F
KVF 400 A1/A2/B1 'Prairie'	97-98	F
KVF 400 C1/C2/C3/C4/D1/D2/D3/D4 (Prairie 4x4/2x4)	99-02	F

### KEEWAY

Dragon 250 Quad	07-09	R
-----------------	-------	---

### KREIDLER

125 DD Supermoto	12-13	R
------------------	-------	---

### SUZUKI

RM 65 K3/K4/K5	03-05	R
DF 125		F
DR 125 SF/SH/SJ	85-94	F
DR 125 SEX/SEY	99-01	F
TS 125 XUF/XUG/XUH/XUJ	86-90	F
DF 200 EV/EW/EY (SH42A)	98-00	F
DR 200 G/H/J	86-89	F
DR 200 SEP/SER/SES/SEV/SEW/SEX/SEY Djebel (SH42A)	93-00	F
DR 200 SE Trojan		F
DR 200 SEK1-SEK9	01-09	F
SX 200 R/R2/RJ/RM	90-91	F

LT-F 250 K2/K3/K4/K5/K6/K7/K8/K9/L2 Ozark	02-12	F
TS 250 XE/XG/XH/XJ/XK	85-89	F
LT-A 400 FK2/FK3/FK4/FK5/FK6/FK7 Eiger 4WD	02-07	F
LT-A 400 K2/K3/K4 Eiger	02-04	F
LT-F 400 FK2/FK3/FK4/FK5/FK6/FK7 (Eiger 4WD)	02-07	F
LT-F 400 FK5/FK6/FK7 Eiger	02-04	F
LT-F 400 K2-K7	02-07	F
LT-A 500 FK2/FK3/FK4 Vinson 4WD Auto	02-07	F
LT-F 500 FK3/FK4/FK5/FK6/FK7 Vinson	03-07	F
<b>YAMAHA</b>		
YFS 200 R/S/T/V Blaster	03-06	F
YFM 250 XN/XP/XR/XS	01-04	F
YFM 250 BT/BV Bruin	05-06	F
YFM 250 BW/BX/BY Big Bear	05-10	F
YFM 350 XD/XE/XF/XG/XH/XJ/XK/XL/XM/XN/XP/XR	92-03	F
YFZ 350 U/B/D/E/F/G/H/J/K/L/M/N/P/R/S/T/V Banshee	88-09	F
YFM 350 FXG/FXH/FXJ/FXK/FXL/FXM/FXN /FXP/FXR/FXS Wolverine	95-04	F
YFM 350 FGW/FGX/FGY/FGZ/FGA/FGB Grizzly 4WD	07-12	F
YFM 350 FGIW/FGIX/FGIY/FGIZ Grizzly 4WD IRS	07-10	F
YFM 350 L Big Bear	99	F
YFM 350 FAS/FAT/FAV Bruin 4x4	04-06	F
YFM 350 ANS/ANT/ANV Bruin 2x4	04-06	F
YFM 350 XV/XXW/XXXY 2WD Wolverine	06-09	F
YFM 350 GW/GX/GY/GZ Grizzly 2WD	08-10	F
YFM 400 FAM/FAN	00-01	F
YFM 400 FPR/FPS	03-04	F
YFM 400 FWT (Big Bear)	05	F
YFM 400 FGW/FGX Grizzly	07-08	F
YFM 450 FAR/FAS	03-04	F
YFM 450 FAT/FAHT/FAV (Kodiak)	05-06	F
YFM 450 FGW/FGX/FGY Grizzly/IRS	07-09	F
YFM 450 FXV/FXW/FXX/FXY/FXZ Wolverine	06-10	F
YFM 450 FGIZ/FGIA/FGIB Grizzly IRS	10-12	F
YFM 450 Grizzly EPS FGPA/FPGB	11-12	f

### CCM

C-XR 125 E	08-09	R
C-XR 125 M	07-09	R
C-XR 125 S	08-09	R
C-XR 230 E	07-09	R
C-XR 230 M	07-09	R
C-XR 230 S	07-09	R
LX 350-4A Quad	08-09	F
LX 700-4A Quad	08-09	F
<b>DAELIM</b>		
Altino 125	01-04	F
Otello 125 (NS 125 DLX)	00-02	F
NS 125 DLX/III	03-07	F&R
History 125	01-06	F&R
SL 125 Otello Fi	07-09	R
SQ 125 S2 Freewing	07-09	R
Tapo Message 50	04	F



# FA054 Contd.

## GARELLI

Fashion F150

## HUSQVARNA

TC/TE 610

## JIALING

JH 125 B Roadstar

## TAISHAN

XT 50

Sport 50

CT 125

## PEUGEOT

New Vivacity 50 (2T)

New Vivacity (50cc/2T) (12" wheels/200mm dia disc)

New Vivacity 50 (4T)

New Vivacity (50cc/4T) (12" wheels/200mm dia disc)

New Vivacity Sixties (50cc/4T) 12" wheels/200mm disc

Sixties Vivacity/50 (4T)

Sum-up (125cc)

## PGO

BR 150 A Bugxter

Bugrider 50 (Buggie)

Bugrider 150

Bugrider 250 SS (Single seat)

Bugrider 250

07 F

92-94 R

98 F

03-04 F

03-04 F

04 F

08-11 F

08-12 F

08-11 F

08-12 F

10-12 F

10-11 F

08-11 F

04-06 R

06 R

R

R

R

## POLARIS

Trail Boss 4x4

## QUADZILLA

RV 125 Midi RV Bug

RV 150 Midi RV Buggie

BR 200

BR 250

XRV 250

XL 300

## SACHS

X Road

Mad Ass 50 (4T)

Mad Ass 125 (4T)

X-Road 125

XTC 125

## SINNIS

Apache 125 QM 125 GY-2B(A) (Rear disc model)

Blade 125 QM 125 GY-2B

Eagle 125 QM 125 T-10R

Matrix II 125 QM 125 T-10H

Matrix 125

Ecocity 125 (125T-86)

## SUPERBYKE

RMR 125

## SYM

Quadraider 600

87 F

R

R

07-08 R

R

R

R

07 R

06-09 R

06-09 R

08 R

08 R

09-10 R

08-10 R

10 F

10 F

07-09 F

07-09 F

07-09 R

07-09 R

06-07 F

### Competitor X Ref

MATERIAL AVAILABILITY AND PART NO.								Competitor X Ref			
STD	OPTIONS							Dunlop	Ferodo	SBS	Vesrah
FA	SFA	SFAC	HH	SFA-HH	R	MXS	EPFA	DP107	FDB250	536	VD120/333
FA054TT	SFA054	SFAC054	FA054HH	SFA054HH	FA054R	MXS54	-				

# FA055 50 x 12/9mm

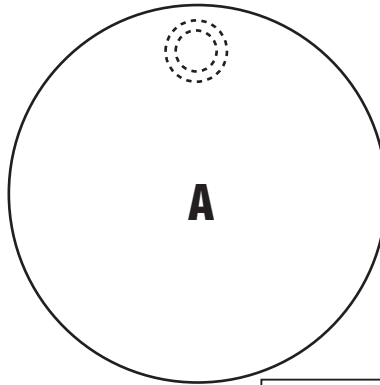
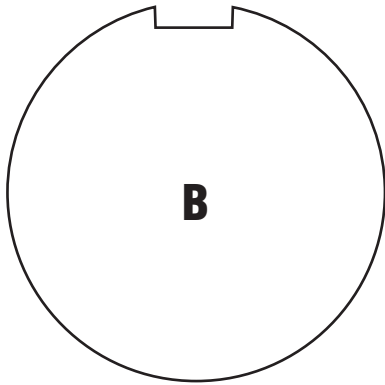

## KAWASAKI

HI-D/E/F 500

H2/H20A Mach IV (750cc)

H2-B/H2-C Mach IV (750cc)

Z 900 ZIA/ZIB

## SUZUKI

GT 125 L/M/A/B

GT 185 L/M/A/B

GT 250 L/M/A/B

GT 380 L/M/A/B

RE5 M/A

GT 500 A/B

GT 550 K/L/M/A/B

GT 750 K/L/M/A/B

73-75 F

72-73 F

74-75 F

74-76 F

74-77 F

74-79 F

74-79 F

74-79 F

75-77 F

75-77 F

73-77 F

73-77 F

### Competitor X Ref

Dunlop	Ferodo	SBS	Vesrah
DP200/201	-	503	VD301/302 /303/304/ 401/402

### Equivalents OE #

59100 18840	59100 31831	43082 001
59100 18841	43050 001	59300 18810
59100 36830/1	43050 002	59300 36840
59100 39810	43051 001	
59100 31830	43071 001	

### MATERIAL AVAILABILITY AND PART NO.

STD	OPTIONS			
FA	HH	R	MXS	EPFA
FA055	FA055HH	-	-	-

# FA056 43.5 x 8mm

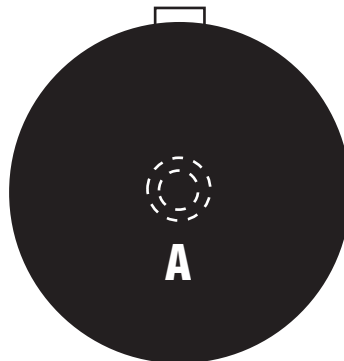
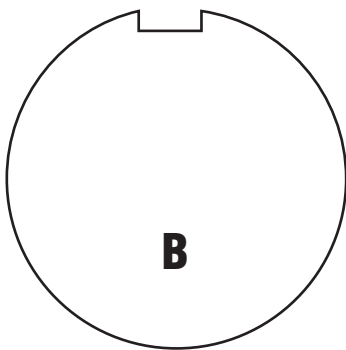

## SUZUKI

GP 125 C/N/X/D

## HYOSUNG

GF/A 125 'Speed'

Cruise II GA 125 F

## KREIDLER

50 RS-G/RSH-G and GS

80 E/L Florett

125 RS

## LIFAN

LT 125-3A

## MOTO ROMA

MXR 125

## SUPERBYKE

R-SR125 4V

78-84 F

99-06 F

99-04 F

F

F

F

F

F

03 F

F

F

### Competitor X Ref

Dunlop	Ferodo	SBS	Vesrah
-	-	524	VD-312

### Equivalents OE #

59300 39820	59340 39100
59300 39821	59330 39100
59302 39870	

### MATERIAL AVAILABILITY AND PART NO.

STD	OPTIONS			
FA	HH	R	MXS	EPFA
FA056	-	-	-	-

# FA057 55.7 x 53 x 9mm

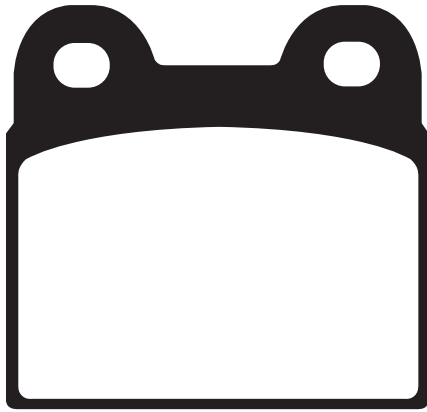

### BMW

R 45/45 N	78-85	F
R 45 T	80-85	F
R 65 LS	81-85	F
R 65 T	80-85	F

### Equivalents OE #

34 71 2 301 359
34 11 1 238 083

### Competitor X Ref

Dunlop	Ferodo	SBS	Vesrah
-	-	527	VD-935

MATERIAL AVAILABILITY AND PART NO.					
STD	OPTIONS				
FA	V	HH	R	MXS	EPFA
FA057	FA057V	-	-	-	-

# FA058 USE FA161

# FA059 32 x 18.8mm



### BENELLI

254	83	F
-----	----	---

### CAGIVA

XSST 125	-80	F
SST 250	-80	F

### Competitor X Ref

Dunlop	Ferodo	SBS	Vesrah
-	-	-	-

### Equivalents OE #

N/A
-----

MATERIAL AVAILABILITY AND PART NO.				
STD	OPTIONS			
FA	HH	R	MXS	EPFA
-	-	-	-	-

# FA060 35.2 x 51.5 x 6mm

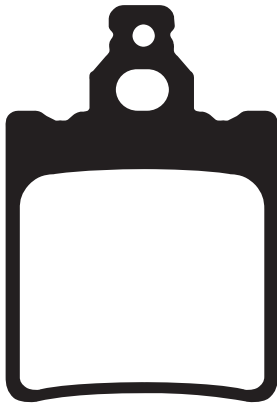

### Competitor X Ref

<b>Dunlop</b> DP611	<b>Ferodo</b> FDB694	<b>SBS</b> 574	<b>Vesrah</b> VD-920/937
------------------------	-------------------------	-------------------	-----------------------------

### Equivalents OE #

8113104	8213051	326 478
8000 33545	8213104	8000 40413
8000 37009	238 076570	
8000 40413	245 07 6340	

MATERIAL AVAILABILITY AND PART NO.					
STD	OPTIONS				
FA	HH	R	MXS	EPFA	
FA060	-	-	-	-	

### APRILIA

Europa 50	90-92	R
AF1 Futura 50	90-92	R
MX 50	03-05	R
RS 50	93-06	R
RX 50 C/CD	93-04	R
Tuorno 50	03-04	R
RX 50 Raing	03-06	R
RX3-5 Marce (M/N/P/R)	91-94	R

### KEEWAY

X Ray 50 Supermoto	07-09	R
TX 50	10-12	R
TX 125	10-12	R

### MOTO GUZZI

250 (All Models)	75-	F
------------------	-----	---

### CAGIVA

W4 50	91-95	R
Cruiser 125	87	R
WSXT 125 "Aletta Rossa"	83-84	F
XSST 125	81-82	F
SXT 125	82-	F
Tamanaco 125	88-89	R
W8 125	93-98	R

### FANTIC

50 Caballero/Caballero RC	91-	R
50.1 Oasis	86-	R
50.1 Oasis E.S.	87-	R

50 Kaloa		F&R
80 Caballero/Caballero RC	91-	R
80 Kaloa		F&R

### GARELLI

125 Tiger XLE	86-	R
GTA 125	85	F
GTA 125	86-	F&R

### GENERIC

Toxic 50	07-08	R
Trigger X50	06-13	R
Trigger SM 50	06-13	R
Trigger 125 SM	08-09	R
Trigger 125 X	08-09	R

### GILERA

RV 50 NGR	88-	F
NGR 250	85-	F

### LAVERDA

LB 125 Custom/Sarbia/Strada Sport	85-87	F
-----------------------------------	-------	---

### MALAGUTI

50 MXR	89-	F
--------	-----	---

### MALANCA

125 ob one M6	85-	F&R
125 ob one M6 Racing	85-	F&R
125 Mark Enduro	85-	F

# FA061 94.5 x 56mm Tapered 1 Left/1Right



**MARKED WITH GREEN TAG TO AVOID CONFUSION WITH FA041**

### Equivalents OE #

2G2 W0045 01	3J6 W0045 11	4H7 W0045 12
2G2 W0045 10	4H7 W0045 00	4W5 W0045 00
3J6 W0045 10	4H7 W0045 10	

### Competitor X Ref

<b>Dunlop</b> -	<b>Ferodo</b> FDB247	<b>SBS</b> 545	<b>Vesrah</b> VD-216
--------------------	-------------------------	-------------------	-------------------------

### YAMAHA

XJ 650 G/H/J/K Maxim	80-83	F
XJ 650 LH Midnight	81	F
XS 750 SE	79-80	F(left)
XV 750 SE	81	F

MATERIAL AVAILABILITY AND PART NO.					
STD	OPTIONS				
FA	V	HH	R	MXS	EPFA
FA061	FA061V	-	-	-	-

# FA062 51.3 x 11mm

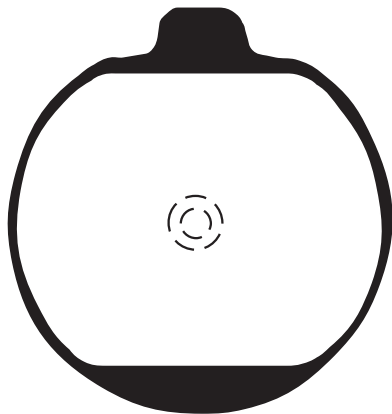

## KAWASAKI

Z 1000 ST (E1/E2 shaft)	79-82	F
Z 1300 A1-A5	79-83	F
ZG 1300 A1-A3	84-86	F

### Competitor X Ref

Dunlop	Ferodo	SBS	Vesrah
DP303	FDB220	530	VD-423

### Equivalents OE #

43082 1004
43082 1058

### MATERIAL AVAILABILITY AND PART NO.

STD	OPTIONS			
FA	HH	R	MXS	EPFA
FA062	-	-	-	-

# FA063 52.6 x 53 x 9mm

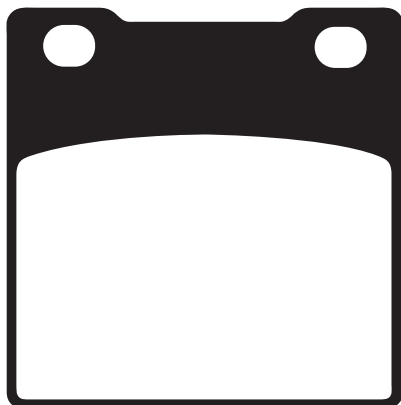

### Equivalents OE #

59100 16820	69100 05870	69130 27A10
59130 16700	69130 16700	69130 30B21
59130 16720	69130 16740	69130 33C00
59130 16730	69130 20A10	69130 21820
59130 16740	69130 21E00	69130 34C00
59130 16750	69100 05830	69100 34860
59130 16810	69100 05860	69101 05820
59130 30B00	69100 05890	69100 05890
59130 30B10	69100 06810	69100 0BE00
59130 30B20	69100 20810	
59130 30B21	69100 21820	

## HYOSUNG

Comet 250/600	02	R
<b>MAGNI</b>		
Sport 1200 'S'	01	R
<b>SUZUKI</b>		
GSF 250 N/ZM/P/NP/ZP/N/NR	92-96	R
GSF 250 VS/VT/VV/VZ/VW/VX/VY Bandit (GJ77)	95-00	R
GSX 250 R CH/H (GJ72A)		R
GSX 250 SSM Katana (GJ76A)	91	R
GSX 250 FL/FM/FN/FP/FR/FS/FT/FV/FW Across	90-98	R
GSXR 250 J (GJ72A)		R
GSXR 250 CK		R
GSXR 250 RK (GJ73A)	89	R
RG 250 WD 'Gamma'	83	F&R
RG 250 WE/FG/CH/FCH/FH 'Gamma'	84-88	R
RGV 250 J/K/L	88-90	R
TV 250 J/K/AK/L (VJ21A) Wolf	88-90	R
SG 350 N 'Goose'	92	R
GSXR 400 H	87	R
GSXR 400 J/RR/RAK (GK73A)	88-90	R
GSXR 400 RL/RM/RN/RS (GK76A)	90-95	R
GSF 400 All models (Bandit)	89-97	R
GSX 400 R2/RG (GK71B/F)		R
GSX 400 X/XA/XS Impulse		R
GSX 400 FJ/FK/FAK/FL (GK74A)	88-90	R
GSX 400 R/S/T/ZR/ZS/ZT/X Impulse Type S	94-99	R
GSX 400 FW/FWS/FWS-2		F&R
GSX 400 SSN (GK77A) Katana	92	R
GSX 400 FSV/FSK1 (GK7B) Inazuma	00	R
RF 400 RP/RR/VR/RT/RVT/RV-V (GK78A)	93-97	R
RG 400 EWF/EW-2G/EWH Walter Wolf (Type 1&2)	85-87	R
SV 400 N (VK53A)	98	R
SV 400 SV (VK53A)	98	R
SV 400 X/Y/K1/K2	00-02	R
SV 400 SX/SY/SK1/SK2	00-02	R
GS 500 EK/EL/EM/EN/EP/ER/ES/ET/EV/EW/EX/EY /K1/K2/K3/FK4/K4/FK5/K5/FK6/K6/K7/FK7/K8/FK8	89-08	R
RG 500 G/CH	85-87	R
GSX 550 ESD/ESE/EFE/EFF/ESH/EFG	84-87	F&R
GSF 600 Y/K1/K2/K3/K4 (Naked Bandit)	00-04	R

GSF 600 SY/SK1/SK2/SK3/SK4 (Faired Bandit)	00-04	R
GSX 600 FJ/FK/FL/FM/FN/FP/FR/FS/FT/FV	88-97	R
GSX 600 FW/FX/FY/FK1/FK2/FK3/FK4/FK5/FK6	98-06	R
RF 600 RP/RR/RS/RT/RV	93-97	R
GSXR 600 V/W/X/Y/K1/K2/K3/ZK3	97-03	R
GSF 650 S/T/V/W/X Naked Bandit	95-99	R
GSX 650 ST/SV/SW/SX Faired Bandit	95-99	R
SV 650 A/Y/K1/K2 Naked - Non ABS	99-02	R
SV 650 SX/SY/SK1/SK2 Top Fairing Non ABS	99-02	R
GSX 750 SE "Katana"	85	F
GSX 750 FK/FL/FM/FN/FP/FR/FS/FT/FV	89-97	R
GSX 750 RG	89	R
GSX 750 FW/FX/FY/FK1/FK2/FK3/FK4/FK5/FK6	98-06	R
GSX 750 W/X/Y/K1	98-03	R
GSXR 750 F/G/H/J/K/L/M/WN/WP/WR/WS /T/V/W/X/Y/K1/K2/K3		
GSXR 750 RG	85-00	R
RF 900 RT/RV/RW	86	R
TL 1000 SV/SW/SX/RW/RX/SY/SY/SK1/RK1	96-98	R
GSXR 1100 G/H/J/K/L/M/N	97-02	R
GSXR 1100 WP/WR/WS/WT	86-92	R
GSF 1200 T/ST/V/SV/S/SW/X/SX/SY/SK1/K1 /K2/SK2/K3/SK3/K4/SK4/K5/SK5 'Bandit'	93-96	R
GSF 1200 SAV ABS-Bandit	96-05	R
GSF 1200 K1/K2/K3/K4/K5 (Naked Bandit - 6 piston caliper)	97	R
GSF 1200 SK1/SK2/SK3/SK4/SK5 (Faired Bandit - 6 piston caliper)	01-05	R
GSF 1200 T/V/W/X/Y (Naked Bandit) 4 Piston Caliper	01-05	R
GSF 1200 ST/SV/SW/SX/SY (Faired Bandit) 4 Piston Caliper	96-00	R
GSX 1200 FSW/FSX 'Inazuma'	96-00	R
GSX 1300 RX/RY/RK1/RK2/RZK3/RK3 /RK4/RK5/K6/K7 'Hayabusa'	98-99	R
	99-07	R

### Competitor X Ref

Dunlop	Ferodo	SBS	Vesrah
DP207	FDB338/R	556	VD-327

### MATERIAL AVAILABILITY AND PART NO.

STD	OPTIONS				
FA	V	HH	R	MXS	EPFA
FA063	FA063V	FA063HH	-	-	-

# FA064 65.3 x 59 x 10mm

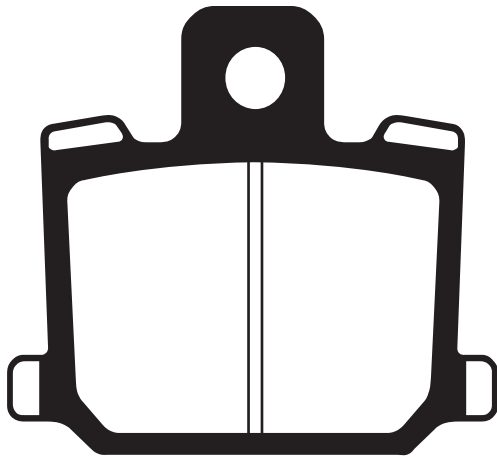

## YAMAHA

RD 250/350 LC

80 F

### Equivalents OE #

4LO W0045 00	4KO W0045 00
4LO W0045 10	4KO W0045 10

### Competitor X Ref

Dunlop	Ferodo	SBS	Vesrah
-	-	535	VD-221

### MATERIAL AVAILABILITY AND PART NO.

STD	OPTIONS			
FA	HH	R	MXS	EPFA
FA064	-	-	-	-

# FA065 71.6 x 45.2 x 11.5mm

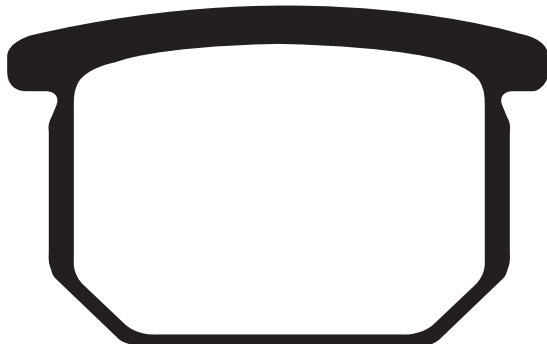

## SUZUKI

GS 550 ET/EX/EZ/LT/LX/MX/MZ	80-84	F
GR 650 D/XD Tempter	83	F
GS 650 GTX/GTZ/GTD/GX/GZ	81-83	F
GSX 750 S/SS (G57SX-106815-) Katana	84	F
GSX 750 S-2/S-2C		
(GS75X-114747-) Katana	84	F
XN 85 Turbo	83	F
GS 1000 ET	81	F
GSX 1000 SZ 'Katana'	82	F
GSX 1100 ET/EX/EZ/ESD	80-83	F
GSX 1100 SZ/SD 'Katana'	82-83	F

### Equivalents OE #

59300 49820	59300 49850
59300 49821	

### Competitor X Ref

Dunlop	Ferodo	SBS	Vesrah
DP206	FDB217	534	VD-324

### MATERIAL AVAILABILITY AND PART NO.

STD	OPTIONS				
FA	V	HH	R	MXS	EPFA
FA065	FA065V	-	-	-	-

# FA066 USE FA068



**FA067 B. 85 x 43 x 8mm A. 55.5 x 37 x 10mm**  
**FA067/2 B. 85 x 43 x 6.2mm A. 55.5 x 37 x 8.5mm**  
**FA067/3 B. 85 x 43 x 7mm A. 55.5 x 37 x 9mm**

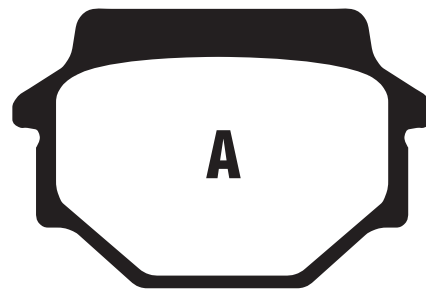
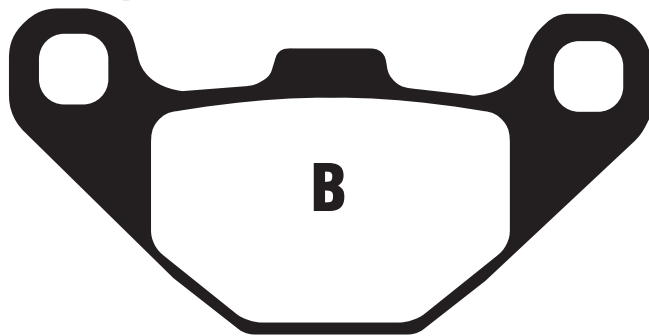

**FA067**

**AEON**

MY 125		R
Cobra 220 Quad	06-11	R
Overland 300 (Quad) (AT20)	06-07	R
Cobra 350 (Quad)	10-11	R
Cobra 400 (Quad)	10-13	R
Overland 600 (Quad)	10-11	R

**ALFER**

AR 250	93-	R
--------	-----	---

**APACHE**

F 100		F&R
ZX 100		R
RLX 250 S/SX (Mk1)		
Rear disc model		F
170 Cheetah	03-06	R
250 Cheetah	03-06	R
RLX 320 S		F&R
RLX 320 Utility		F&R
RLX 450 S		F&R

**APRILIA**

RX 125 (Grimeca Caliper)	08-13	R
SXC 125 (Grimeca Caliper)	08-12	R

**CAGIVA**

WMX 125/250	89	R
-------------	----	---

**DERBI**

DXR 200	04-07	R
---------	-------	---

**DINLI**

DL 450 RS (DL901)	06-09	F&R
-------------------	-------	-----

**EXPLORER**

Trasher 450	08-09	F&R
-------------	-------	-----

**GAS-GAS**

80/125 Enduro	94-95	R
MX 80	96	R

**GOES**

G 225 S	12-13	R
C 350 S (Quad)	08-13	R

**KTM**

125/250/350/500 MX	89-91	F&R
125/250/300/500 MX	92-93	R
125/250/300/600 Enduro	92-93	R

**KTM Contd.**

250/300 E/XC/GS	90-91	R
EXC/020/EGS/620 SX	94-95	R

**KAWASAKI**

KSR 1 (KMX50 B1/B2)	90-91	R
KSR 11 (KMX80 B1/B2)	90-91	R
KH 100 G4-G8 (EX)	83-87	F
AR 125 A1-A7/B1-B8	82-94	F
KH 125 K2-K10	82-98	F
KH 125 L1 (EX)	84	F
KMX 125 A1-A5/B1-B12	86-03	R
KX 125 B2/C1/D1	83-85	F
KX 125 E1	86	F&R
KX 125 E2/F1	87-88	R
KMX 200 A2/A3	88-92	R
KDX 200 C1-C3/E1-E4	86-92	F
Z 200 A6	83	F
BJ 250 B1-B7A 'Estrella'	92-99	F&R
BJ 250 C1-C7 Estrella RS	95-01	F&R
KL 250 J1-J3 Stockman	00-02	F
KLX 250 G1/G1A Super Sherpa	97	R
KR 250 A1/A2	84-86	F
KX 250 C1/C2/D1	83-85	F

**KAWASAKI Contd.**

KX 250 D2	86	F&R
KX 250 E1/F1	87-88	R
KXT 250 A2/B1 Tecate		
3 Wheel Model	85-86	F&R
KXT 250 B2 Tecate		
3 Wheel Model	87	F
KLR 250 D2-D22	84-05	F
KLX 250 H1 'Super Sherpa'	98	R
ZR 250 B6 Balius-II	02	R
KLF 300 B1-B17 "Bayou"	88-04	F
GPZ 305 B1-B10/A1	83-96	F
ZR 400 A1/B1 (Z 400F)	83-84	F
Z 400 C2/C3 (Z400 F2)	85-87	F
ZL 400 B 'Eliminator' 400 SE	88	F
FX 400 R (ZX 400 E1-E3)	86-88	F
GPZ 400 R (ZX 400 D/D3/D3A)	85-87	F
GPZ 500 S (EX 500 B1-B5)	88-93	F
GPZ 500 S (EX 500 E1-E10)	94-03	R
KX 500 A1/A2/B1	83-85	F
KX 500 B2	86	F&R
KX 500 C1/D1	87-88	R
ZR 550 A1/A2 (Z 550F)	83-84	F
GT 550 G1-G9	83-01	F
KLR 600 A1/A2/B1-B4/86-89	84-94	F
KL 650 B1/B2/B3 "Tengai"	89-92	R
KLR 650 C1-C10	95-04	R

**KTM**

MX 125	89-91	F&R
MX 125	92-93	R
EXC 125	89	F&R
D-XC/E-XC/E-GS 125	90-91	F&R
D-XC/E-XC/E-GS 125	92-93	R
MX 250	89-91	F&R
MX 250	92-93	R
EXC/EGS 250	89	F&R
D-XC/E-XC/E-GS 250	91	F&R
D-XC/E-XC/T-XC/E-GS 250	92-93	R
MX 350	89-91	F&R
DXC/EXC/EGS 350	90-91	F&R
EXC 350	89	F&R
MX 500	92-94	R
LC-4 MX 500	90-91	F&R
LC-4 EXC 500	90-91	F&R
LC-4 MX/EXC 600	90-91	F&R
LC-4 EXC 600	92-93	R
SX/EXC/EGS 620	94-	R

**LINHAI**

ATV 80	13	R
ATV 150	13	R

**MAICO**

500 MX	94-98	R
--------	-------	---

**OSSA**

560	92	F&R
500	92	R

**P.B.H**

500	92	R
-----	----	---

**QUADZILLA**

Pro Shark 100 (RMX)		
Front disc model)		F
Pro Shark 200 RMX	07-08	F
QZ 200 (Front disc model)		F&R
250 e	06-11	F&R
QZ 250 (Front disc model)		F&R

**QUADZILLA Contd.**

QZ 270			F&R
300 E XLC	06-07	R	
300 e XLC Stinger	07-08	F&R	
Jow 300	07-08	F&R	
QZ 300 XLC			F&R
300 e XLC	07-08	F&R	
RL 300 Buggie	09-11	F&R	
300 E Stinger	09-11	F&R	
320 CUV			F&R
450 R	06-07	R	
RS7 4WD	10-11	R	
RS8	10-11	R	
QZ 450 RS	06-09	F&R	
QZ 450 Sport	08-11	F&R	
X7R	10-11	R	
XLC 500	10-13	F&R	

**SUZUKI**

RB 50 H 'GSXR 50'	87	F
RG 50 EW		F
OR 50 ET	80	F
ZR 50 SLKX	81	F
ZR 50 SKX/SKE/SKH	83-87	F
GN 125 Z/M/R/V/W/X/Y/K1	94-01	F
GN 125 HS (LC6PCJB1)		
(Chinese production)	00-11	F
GN 125 ER/EV/EW/EX/EY/EK1		
(NF41A/Black cast wheel)	94-01	F
GS 125 ESZ	82	F
GS 125 ESR/ESX	95-00	F
X4 125		F
GSX 400 FX/FZ/FD	81-83	F

**TGB**

250 Blade/Congo ATV	06-07	F
Blade 325 Quad (4x2)	07-10	R
Blade 325 LE (4x2)	09-10	R
Blade 325 SL 4x4	11-12	R
Target 325 (4x2)	09-12	R
Avenger 400 LE (4x2)	09-10	R
Target 400 (4x2)	09-10	R
Blade 425 SE (4x4)	09-10	R
Target 425 (4x4)	09-11	R
Blade 450 SE 4x4	10-11	R
Blade 460 R Target	12	R
Blade 460 IRS Target	12	R
Blade 460 SL IRS 4x4	12	R
500 Avenger R (4x2)	09-10	R
Target 500 (4x2)	09-10	R
Blade 510 LE	11-12	R
Target 525 (4x4)	09-11	R
550 SL 4x4	09-10	R
550 SE 4x4	09-11	R
Blade 525 SE	09-10	R
Blade 525 SL	09-10	R
Blade 550 LT 4x4	10-11	R
Blade LT 550 IRS	10-12	R
Blade 550 4x4 IRS Target	11-12	R

**YAMAHA**

YFM 90 RZ/RA/RB Raptor	10-12	R
YFM 300 B/D	12-13	F

**SFA067**

<b>AEON</b>			
Elite 125 (4T)	12-13	R	
Urban 125 (4T)	13	R	

# FA067 / FA067/2 / FA067/3 Contd.

Elite 350i (4T)	12-13	R	<b>HERCULES (SACHS)</b>		ZR 250 A1-A5	91-95	R
Urban 350i (4T)	13	R	50 Supra 4 GP	F	ZR 400 D1/D3/D4 'Xanthus'	92-95	R
<b>KYMCO</b>			<b>MALAGUTI</b>		GPZ 500 S (EX 500 D1-D7)	94-01	R
Visa R50	11	F	50 MDX Gold Enduro	87- F	KLE 500 A1-A12	91-04	R
Visa R110	11	F	50 Enduro MEX	87- F	KLE 500 B1P/B6F/B7F	05-07	R
Agility 125 R16 (C20000) (16" wheels)	08-10	R	50 Enduro MSX	85- F	KLR 650 A1-A10	87-89	R
<b>SYM</b>			<b>FA067/3</b>		<b>SUZUKI</b>		
Combiz 125	11-13	F	<b>KAWASAKI</b>		GSX 250 FXK2/K3/K4/K5	02-05	R
Jet V 125 (4T)	12-13	F	KLE 250 A2 (Anhelu)	95 R	<b>KRAM-IT (KRAMER)</b>		
<b>FA067/2</b>			KLE 250 A3/A5/A6	97/00-01 R	ER 125/250/300 RV3	88-	R
<b>FANTIC</b>			ZZR 250 (EX 250 H1-H13)	90-03 R	ER 500/600	96-	R
50 Strada	82-	F	ZXR 250 C1-C3	91-93 R			
50/50.1 Raider	81-	F	ZXR 250 R/SP/D1	91 R			

### Equivalents OE #- FA067/2

238 07 6340    240 07 6340

### Equivalents OE #- FA067/3

43082 1116

### Equivalents OE #- FA067

43050 1063	43082 1063	43082 1163	59100 33812	59300 36811	59301 33810
43050 1064	43082 1064	43082 1191	59100 33820	59300 36820	545 13209 044
43050 1073	43082 1070	43082 1204	59130 26820	59300 36821	K4308 21204
43050 1082	43082 1073	43082 120	59300 04830	59300 36822	513506
43082 1027	43082 1084	45105 LFC3 305	59300 04831	59300 36871	00Q25001198
430821031	43082 1086	45815 RAM 000	59300 26820	59301 39810	890304
43082 1051	43082 1092	45815 RAM 01	59300 33810	59301 39811	1SC F5806 00
43082 1056	43082 1096	59100 33810	59300 36810	59301 39812	43D F5906 01

### Competitor X Ref

<b>Dunlop</b>	<b>Ferodo</b>	<b>SBS</b>	<b>Vesrah</b>
DP310	FDB314	586/546 /102/113 /118/135	VD-325

### MATERIAL AVAILABILITY AND PART NO.

STD		OPTIONS						
FA	SFA	SFAC	TT	SFA-HH	HH	R	MXS	EPFA
FA067	SFA067	SFAC067	FA067TT	SFA067HH	FA067HH	FA067R	-	-

STD		OPTIONS			
FA	HH	R	MXS	EPFA	
FA067/2	-	-	-	-	

STD		OPTIONS			
FA	HH	R	MXS	EPFA	
FA067/3	-	-	-	-	

# FA068 67.8 x 40.7 x 9.5mm



### KAWASAKI

Z 250 A3	81	F
Z 400 J2/J3	81-83	F
Z 440 C2	81	F
Z 440 D5/D6 (LTD)	83-84	F
Z 440 H1/H2	82-83	F
GPZ 550 H1/H2	82-83	F&R
GPZ 550 D1	82	F&R
Z 550 A2/A3/C1/C2/LTD	81-84	F
Z 650 F2/F3/F4	80-83	F
Z 700 A1 'Ltd'	84	F&R
Z 750 E1	80	F&R
Z 750 H1/H2/LTD	80-81	F&R
Z 750 L1/L2/L3/L4	81-84	F&R
Z 750 N1/N2 'Spectre'	82-83	F&R
GT 750 P1-P9	82-96	F&R
GPz 750 R1	82	F&R
Z 750 Y1 (LTD)	82	F
Z 1000 R1/R2 (Eddie Lawson Replica)	82-83	F&R
Z 1000 J1/J2/J3	81-83	F&R
Z 1000 K1/K2 LTD	81-82	F&R
Z 1100 A1-A3	81-83	F&R
GPz 1100 B1/B2	82-83	F&R
Z 1100 D1/D2 'Spectre'	82-83	F&R

### Competitor X Ref

<b>Dunlop</b>	<b>Ferodo</b>	<b>SBS</b>	<b>Vesrah</b>
DP308/309	FDB298/R	539/540	VD-420/421

### Equivalents OE #

43082 1007	43082 1021	43082 1025
43082 1008	43082 1022	43082 1026

### MATERIAL AVAILABILITY AND PART NO.

STD		OPTIONS			
FA	V	HH	R	MXS	EPFA
FA068	FA068V	FA068HH	-	-	-

# FA069 90 x 49 x 10mm

# FA069/2 90 x 49 x 9mm

# FA069/3 90 x 49 x 11.3mm

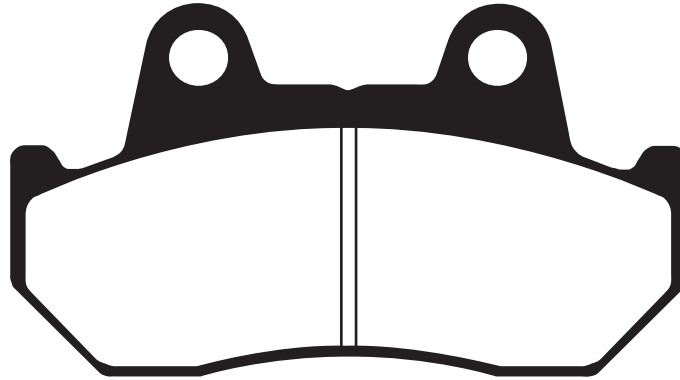

### FA069 - HONDA

CB 125 TDC/TDE/TDJ	83-89	F
CBX 125 F	84-	F
CBX 250 RSE	84	F
NS 400 RF/RG	85-87	F&R
CMX 450 CH/CJ Rebel	87-88	F
CX 500 CC	82	F
CX 500 EC	82	F&R
CX 500 TCC 'Turbo'	83	F&R
FT 500 C	82	F&R
GL 500 DC	82	F
VF 500 FE/F2E/FF/F2F	84-85	F&R
XBR 500 F/G/H/SJ	85-89	F
XL 600 LMF/RMG/RMH	85-87	F
XL 600 VH/VJ/VK 'Transalp'	87-90	F
CX 650 ED	83	R
CB 750 FC/F2C/FD/F2D	83-84	R
CBX 750 FE	84	F
VF 750 C Shadow	83	F
VF 750 FD/FE	83-84	F
VF 750 SC (V45 Sabre)	82	F
XLV 750 R (RD/RF)	83-88	R
CB 900 FB/F2B	82-85	R
CB 900 FC/F2C/FD/F2D	84-85	F&R
CBX 1000 B/C	81-82	R
VF 1000 FE/FF/FG/F2F/F2G	84-86	F
VF 1000 RE/RF/RG	84-86	F
CB 1100 RBII/RCII/RDII	80-83	F&R
GL 1100 C/DC/AD 'Goldwing'	82-83	R

NSR 250 RG (MC16-100)	86	R
CBR 400 RG/RHYA (NC23)	86-87	R
VFR 400 ZG/ZH/RG-YA (NC21)	85-87	R
CBR 500 FH/FJ/FK/FL	87-90	R
CBR 600 FH/FJ/FK/FL	87-90	R
CBR 750 FH Superaero	87	R
CBX 750 FE	84	R
VF 750 FD/FE	83-84	R
VF 750 CH	87	F
VFR 750 FG/FH	86-87	R
VF 1000 FE/FF/FG/F2F/F2G	84-86	R
CBR 1000 FH/FJ	87-88	R
CB 1100 RB2/RC2/RD2	80-83	R
VT 1100 CH/CJ/CN/CP Shadow	87-93	F
GL 1200 DE/DF/DG/AE/AF/AG	84-86	F&R
GL 1500 J/K/L/SEM/SEN/SEP/SER /SES/SEV/SEW/SEX/SEY "Goldwing"	88-00	R

### Equivalents OE #- FA069

06435 MT8 405	43105 MC7 004/007/024	45105 MB1 702
06455 MA3 405	43105 MC7 014	45105 MC4 004
451A0 MM9 670	43105 MJ6 004	45105 MF2 670
431A0 MC7 024	43105 MJ6 007	45105 MJ1 672
431A0 MC7 305	43105 MJ6 014	45105 MK4 004
451A0 MM9 670	45105 MA6 671	45105 MK6 671
43105 KE7 702	45105 MB0 007	45105 MK7 671
43105 MA3 004	45105 MB0 008	45105 MK7 672
43105 MA3 007	45105 MB1 701	

### Equivalents OE #- FA069/2

06455 443 405	45105 443 761	45105 KN8 712
06455 KN8 405	45105 443 762	45105 MC7 004
431A0 MC7 024	45105 KL8 004	45105 MC7 007
45105 KL8 405	45105 KL8 007	45105 MC7 014
45105 KL8 405	45105 KL8 014	45105 MC7 024
43105 KN8 007	45105 KL8 712	45105 MM9 670
43105 MJ6 721/722/723	45105 KN8 007	45105 MM9 781
43105 MJ6 724	45105 006/016/026	45105 MM9 782

### Equivalents OE #- FA069/3

06435 MT8 405	43105 MB6 018/008	43105 MN5 008
06435 ML7 405	43105 MG9 007/017	43105 MT8 008
06435 ML7 415	43105 ML7 006	431A0 MN5 670
43105 MB4 007/017	43105 ML7 007	451A0 MM8 670
43105 MB4 008	43105 ML7 017	
43105 MB4 305	43105 ML7 027	

### FA069/2 - HONDA

CN 250 H/J/L/M/P/R/S/T/V/X SPAZIO/Helix	87-98	F
GB 250 E/H 'Clubman'	84-87	F
NS 250 FE/RE (MC11-100)	84	F
NS 250 RG (MC11-102)	86	F
CB 400 NC	82	F
CX 650 TD 'Turbo'	83	F
CX 650 ED	83	F
GL 650 D2-E	84	F
CB 750 FC/F2C/FD/F2D	83-84	F
CB 900 FB/F2B	82-88	F
CBX 1000 B/C	81-82	F
GL 1100 C/DC/1C Interstate 'Goldwing'	82	F
GL 1100 AC Aspencade 'Goldwing'	82	F
GL 1100 C/DC/AD	82	F

### FA069/3 - HONDA

NS 250 FE/RE (MC11-100)	84	R
NS 250 RG (MC11-102)	86	R

### Competitor X Ref

Dunlop	Ferodo	SBS	Vesrah
DP104/105	FDB244/R	542/572/127 /160	VD-123/132

### MATERIAL AVAILABILITY AND PART NO.

STD	OPTIONS				
FA	V	HH	R	MXS	EPFA
FA069	FA069V	FA069HH	-	-	-

### MATERIAL AVAILABILITY AND PART NO.

STD	OPTIONS				
FA	V	HH	R	MXS	EPFA
FA069/2	FA069/2V	-	-	-	-

### MATERIAL AVAILABILITY AND PART NO.

STD	OPTIONS				
FA	V	HH	R	MXS	EPFA
FA069/3	FA069/3V	FA069/3HH	-	-	-

# FA070 66.5 x 59 x 10mm

## YAMAHA

RD 50 MX/RD 50	81-87	F
RD 80 (Air Cooled)	82	F
RD 250	80-83	F
RZ 250 (4L3)		F
RD 350 LX	81-82	F
XJ 550	81-84	F
XJ 550 H/J/K Maxim	81-83	F
XJ 550 RH/RJ/RK Seca	81-83	F
XJ 750	82-84	F
XJ 750 RF/RJ/RK Seca	81-83	F
XS 1100 S	81	F

### Equivalents OE #

23W W0045 01	4W1 W0045 00
23W W0045 10	4W1 W0045 00
4L3 W0045 00	4W1 W0045 20
4L3 W0045 10	4W1 W0045 30

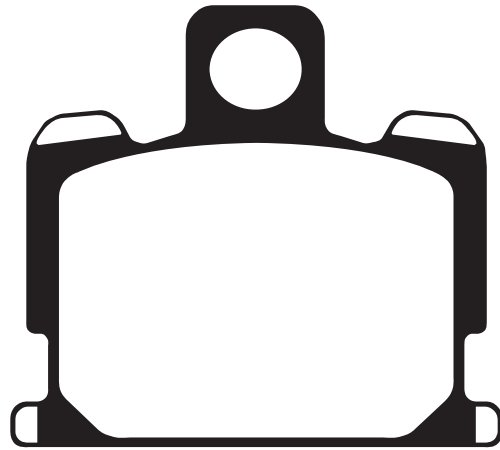

### Competitor X Ref

Dunlop	Ferodo	SBS	Vesrah
DP402	FDB277	547	VD-228

### MATERIAL AVAILABILITY AND PART NO.

STD	OPTIONS				
FA	V	HH	R	MXS	EPFA
FA070	FA070V	-	-	-	-
FA070S (Green)					

# FA071 69.5 x 53.8 x 6.5mm



## HARLEY DAVIDSON

FX/FXE/FXEF/FXWG/FXS	Late 78-83	F
XL/XLH/XLCH/XLS/XLX	79-83	F
FXD, FXDL, FXDWG, FXR, FXRS, FXRT, FXRD, FXLR	82-83	F

### Equivalents OE #

44032 77
44032 79
44098-77

### Competitor X Ref

Dunlop	Ferodo	SBS	Vesrah
DP907	FDB333	537	VD-903/908

### MATERIAL AVAILABILITY AND PART NO.

STD	OPTIONS				
FA	V	HH	R	MXS	EPFA
FA071	FA071V	-	-	-	-

# FA072 89 x 71.2 x 6.5mm

## HARLEY DAVIDSON

XL/XLH/XLCH	73-81	R
FLT/FLHT/FHTCI	80-83	F

### Equivalents OE #

43395 80
44099 77

### Competitor X Ref

Dunlop	Ferodo	SBS	Vesrah
DP908	FDB334/R	543	VD-909

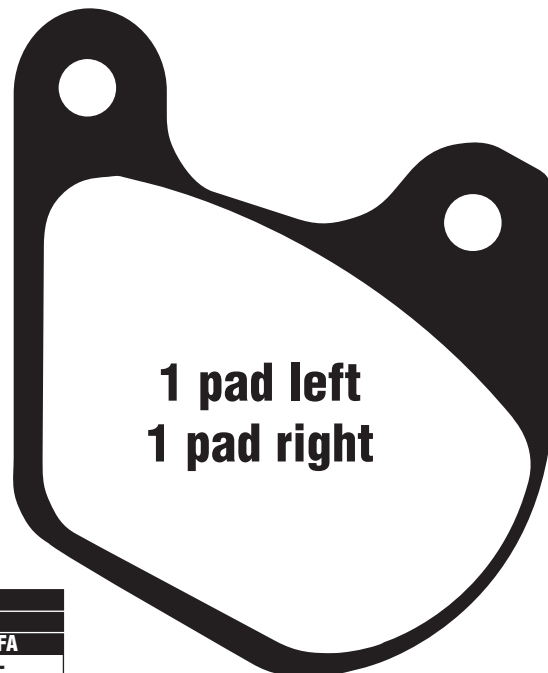

### MATERIAL AVAILABILITY AND PART NO.

STD	OPTIONS				
FA	V	HH	R	MXS	EPFA
FA072	FA072V	-	-	-	-

# FA073 A. 51.3 x 9.4mm B. 50 x 8mm

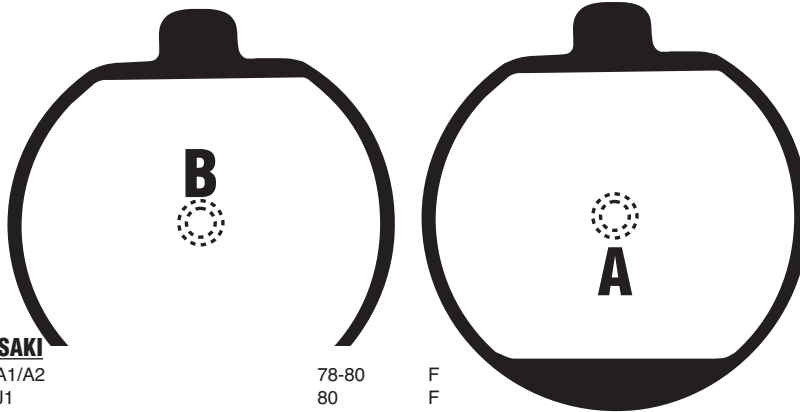

### Equivalents OE #

43082 1001
43082 1005

### KAWASAKI

Z 250 A1/A2	78-80	F
Z 400 J1	80	F
Z 440 A2/C1	79-80	F
Z 440 D4 (LTD)	82	F
Z 500 B1/B2	79-80	F
Z 550 A1	80	F
Z 650 (D2/D-SR)	79-80	F
Z 650 C3	79	F
Z 650 F1	80	F
Z 650 D2/D3 (SR)	79-80	F
Z 1000 A3/A4	79-80	F
Z 1000 H1/H2	74-75	F
Z 1000 D3 (ZIR)	79	F

### Competitor X Ref

Dunlop	Ferodo	SBS	Vesrah
DP302/305	FDB132	510	VD-403/417

### MATERIAL AVAILABILITY AND PART NO.

STD	OPTIONS			
FA	HH	R	MXS	EPFA
FA073	-	-	-	-

# FA074 38 x 51.5 x 7mm

### Equivalents OE #

430963

### Competitor X Ref

Dunlop	Ferodo	SBS	Vesrah
N/A	N/A	N/A	N/A

### MATERIAL AVAILABILITY AND PART NO.

STD	OPTIONS			
FA	HH	R	MXS	EPFA
FA074	-	-	-	-



# FA076 49 x 59 x 7.1mm

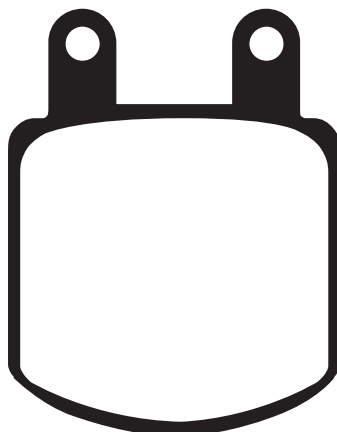

### Competitor X Ref

Dunlop	Ferodo	SBS	Vesrah
-	FDB205	560	VD-928

### ASPES

125 Duma F

### GARELLI

TSR 125 -83 F

### GILERA

80 TG 1/2/3 F

125 GR 1 F

125 TG 1/2/3 F

200 T4/T4 C/T4 S F

### GMA

2 Piston (Small) Caliper model B (CCI # 09-996)

### JAYBRAKE

Early Design 2 Piston

### KREIDLER

Mustang 125 F

### LAVERDA

LZ 125 Sport (Grimeca Caliper) 80-82 F

### MOTO MORINI

125 Monocilindro 79- F

250 All models 71- F

350 Sport -79 F&R

350 Sport 80-81 F

350 FT/Turismo 80- F

### NVT

125/175 Rambler F

### Equivalents OE #

310 292  
430 09 11

### MATERIAL AVAILABILITY AND PART NO.

STD	OPTIONS				
FA	V	HH	R	MXS	EPFA
FA076	FA076V	FA076HH	-	-	-



# FA077 60 x 58 x 9mm

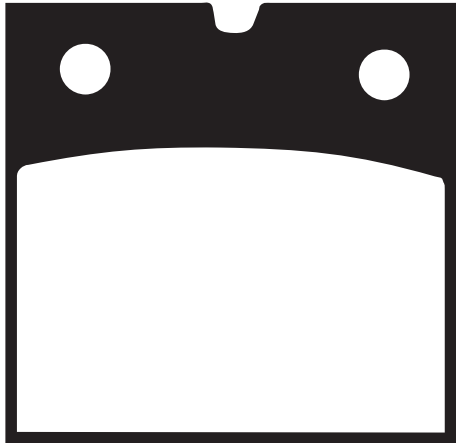

## **BENELLI**

900 SE1 (6 cyl) 83 R

## **BMW**

R 65 07/88-08/89F  
 R 80/R 80 RT 84-07/95 F  
 R 80 GS 87-95 F  
 R 80 PD/CH 90-95 F  
 R 850 GS 96 F  
 R 100 GS 86-94 F  
 R 100 PD 89-96 F

## **LAVERDA**

1000 RGS Corsa 84 F

## **MOTO GUZZI**

850 Le Mans III (12 spoke cast wheel) 81-84 R  
 1000 - 1000 SP (12 spoke cast wheels /dished front discs) 79-83 R

### **Equivalents OE #**

34 11 1 354 720	34 11 2 310 601
34 11 2 331 177	18654660
34 11 2 314 545	GV18654660

### **Competitor X Ref**

<b>Dunlop</b>	<b>Ferodo</b>	<b>SBS</b>	<b>Vesrah</b>
DP620	FDB204/R	554	VD-933

<b>MATERIAL AVAILABILITY AND PART NO.</b>					
<b>STD</b>	<b>OPTIONS</b>				
<b>FA</b>	<b>V</b>	<b>HH</b>	<b>R</b>	<b>MXS</b>	<b>EPFA</b>
<b>FA077</b>	<b>FA077V</b>	-	-	-	-

# FA078 74.2 x 49 x 12mm

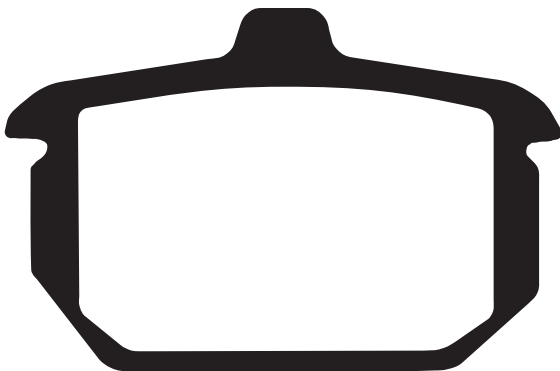

## **HARLEY DAVIDSON**

FX/FXE/FXEF/FXWG/FXS 84-86 R  
 FXWG/FXSB 83 R  
 XL/XLH/XLCH/XLS/XLX 82-Early 87 R  
 FXD, FXDL, FXDWG, FXR, FXRS, FXRT,  
 FXRD, FXLR 82-early 87 R  
 FXST, FXSTB, FXSTC, FXSTS, FLST,  
 FLSTC, FLSTF, FLSTS, FLSTN 84-early 87 R

**NOW INCLUDES  
 SHIMS x 2**

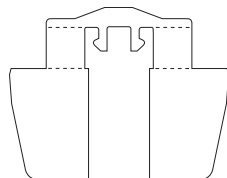

### **Equivalents OE #**

44209 82
44209 82A

### **Competitor X Ref**

<b>Dunlop</b>	<b>Ferodo</b>	<b>SBS</b>	<b>Vesrah</b>
DP901	FDB335/R	549	VD918

<b>MATERIAL AVAILABILITY AND PART NO.</b>					
<b>STD</b>	<b>OPTIONS</b>				
<b>FA</b>	<b>V</b>	<b>HH</b>	<b>R</b>	<b>MXS</b>	<b>EPFA</b>
<b>FA078</b>	<b>FA078V</b>	<b>FA078HH</b>	-	-	-

# FA079 174 x 73.2 x 9.3mm

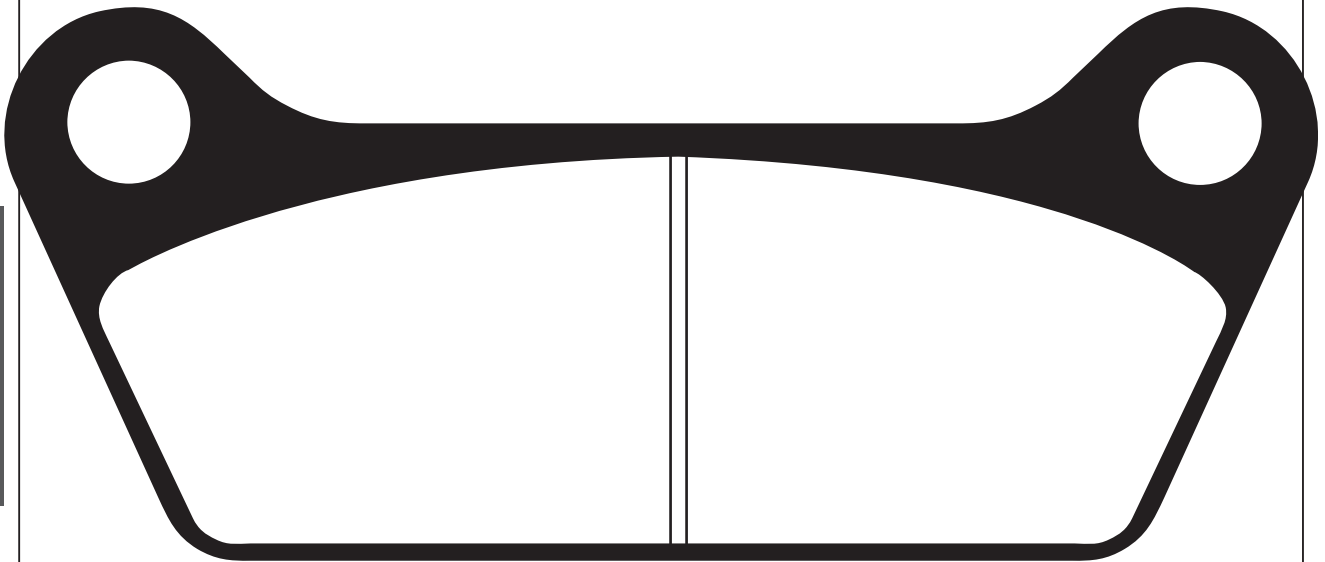

DISC PADS  
BUYERS GUIDE

### HARLEY DAVIDSON

FL/FLH 81-84 R  
FLT/FLHT/FLHTCI 80-85 R

### Competitor X Ref

Dunlop	Ferodo	SBS	Vesrah
-	-	553	VD-917

### MATERIAL AVAILABILITY AND PART NO.

STD	OPTIONS				
FA	V	HH	R	MXS	EPFA
FA079	FA079V	-	-	-	-

### Equivalents OE #

43957 80

# FA080 92 x 53 x 8mm

# FA080/2 92 x 53 x 9.5mm

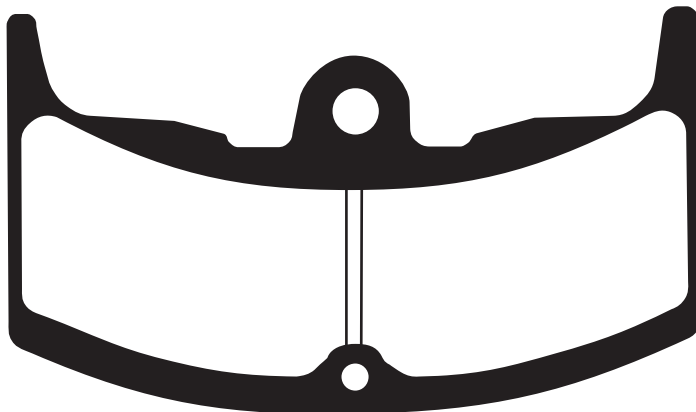

### FA080 - HONDA

CBX 550 FC/F2C/FD/F2D 82-84 F

### FA080/2 - HONDA

MXV 250 F (MC92) 83-88 F  
VT 250 FD 83 F  
VF 400 FD 83-85 F&R  
VT 500 ED/EF 83-85 F  
CBX 550 FC/F2C/F2D/FD 82-84 R

### Equivalents OE #FA080

45105 MA7 007	45105 MA7 305
45105 MA7 004	

### Equivalents OE #FA080/2

45105 MA6 004	45105 MA6 305
45105 MA6 007	

### Competitor X Ref

Dunlop	Ferodo	SBS	Vesrah
DP106	FDB310/R	552/571	VD-129/129/2

### MATERIAL AVAILABILITY AND PART NO.

STD	OPTIONS			
FA	HH	R	MXS	EPFA
FA080	-	-	-	-

### MATERIAL AVAILABILITY AND PART NO.

STD	OPTIONS			
FA	HH	R	MXS	EPFA
FA080/2	-	-	-	-

# FA081 68 x 60 x 10.5mm

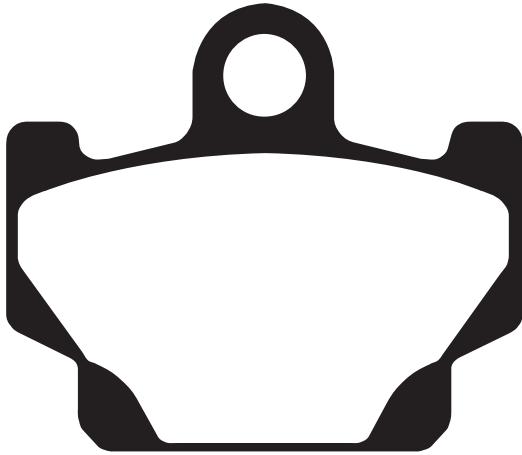

## YAMAHA

DT 80 LC (37A)	81-84	F
RD 80 LC	82	F
RX 115 (5FS3)	99	F
RD 125 LC	82-84	F
SR 125 SE	92-96	F
RX 135 (13X)	81	F
RZ 250 R (29L)		F
SR 250 Classic (21L)	96-00	F
XV 250 Virago	89-94	F
RD 350 YPVS	83-84	F
XS 400	82	F
XZ 550	82-84	F
XT 600	84-86	F
XT 600 (Z Tenere)	84	F
XJ 650 Turbo	82	F
XJ 650 LK 'Seca'	83	F

## Equivalents OE #

11H W0045 00	11U W0045 10	2UJ W0045 00	4X8 W0045 00
11H W0045 01	22U W0045 10	2UJ W0045 01	52R W0045 00
11H W0045 11	29L W0045 00	34L W0045 10	5R2 W0045 00
11L W0045 00	29L W0045 10	43F W0045 00	3XL W0045 00
11U W0045 00	2KJ W0045 00	43F W0045 01	

## Competitor X Ref

Dunlop	Ferodo	SBS	Vesrah
DP403	FDB311	550	VD-235

MATERIAL AVAILABILITY AND PART NO.				
STD	OPTIONS			
FA	HH	R	MXS	EPFA
FA081	-	FA081R	-	-

# FA083TT A. 47.5 x 37 x 9mm B. 85 x 42.5 x 7mm

# FA083/2TT A. 47.5 x 37 x 10mm B. 85 x 42.5 x 7.8mm

# SFA083/2 A. 47.5 x 37 x 10mm B. 85 x 42.5 x 7.8mm

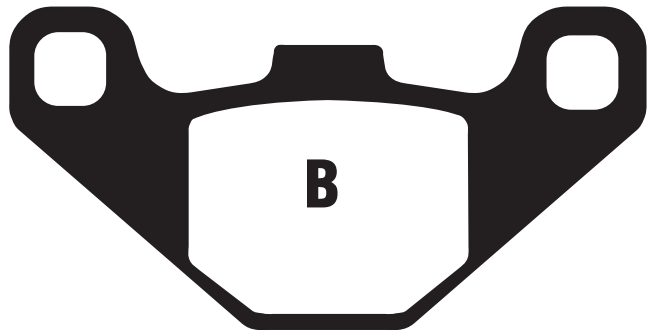
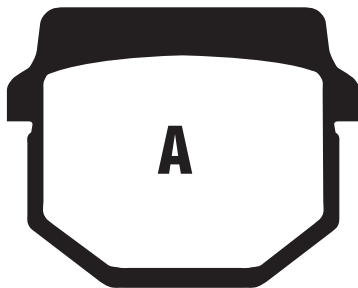

## FA083

### KAWASAKI

AR 50 A1/C2-C10	81-97	F
AH 80 Address	92-94	F
AR 80 A1/C1-C8	81-91	F
KX 80 E2/E3/G1/G2/J1/J2/L1-L3/N2/N3/ R1-R6/T1-T6	84-96	F
AH 100 Address	92-94	F
KX 100 A1/A2/B1-B6	89-96	F
KMX 125 A1-A5/B1-B9	86-98	F
KX 125 B1	82	F
KDX 125 A1/A2/B1/B2	90-94	F
KMX 200 A2/A3	88-92	F
KX 250 B1	82	F
KXT 250 A1 Tecate	84	R
KXF 250 A1/A2 'Tecate 4'	87-88	R

### ADLY

50 RS Supersonic	06-08	F&R
AT 50 Air Tech 1	08-09	F
Silver Fox 50/SF50	06-09	F
Thunderbike 125		F&R
Jet 50/100		F
NB 50 Noble 50	08-10	F
Predator 50/100		F
Panther 50/P50	02-09	F
Cosy 50/80	02-06	F
TB 50 Thunderbike	08-10	F
RT 50/100		F
SS 50 1/11 Supersonic	04-05	F
SS 100 1/11 Supersonic	04-05	F

GK 125 Buggie	03-07	R
NB 125 Noble 125	08-09	F&R
Noble 125 B (Rear drum model)	08-10	F
TB 125 B (Rear drum model)		F
SS 125 B/D Supersonic	04-05	F&R
150 Crusader Quad	06	F&R
150 Interceptor	06	F&R
Crossroad 150 Quad	07-09	F&R
Sport 150 Quad	08-09	F&R
Interceptor 300	05-07	F&R
300 Crusader Quad	05-07	F&R

### AEON

Aero 50/100 (Scooter)	06	F
Nox 50/100/125/150 Scooter	06	F
Regal 50/90 (Scooter)	06	F
Revo R50 Cobra 2 (AT34 Type) (Quad)	04-06	R
Cobra 60 (AT30 Type) (Quad)	04-11	R
Revo R100 Cobra 2 (AT34 Type) (Quad)	04-11	R
Pulsar 100/125/150 (Scooter)	06	F
Sporty 125 (AT05 type) (Quad)	01-05	R
Urban 125 (Scooter)	11	R
Sporty 180 (AT05 type) (Quad)	04-05	R
200 Two Hundred Quad	05	F&R
Elite 200 i (Scooter)	11	R
Cobra 220 (Quad)	06-11	F
Overland 300 (Quad) (AT20)	06-07	F
Cobra 350	10-11	F
Crossland RX 350	11	F
Urban 350i (Scooter)	11	R
Cobra 400 (Quad)	10-13	F

# FA083TT / FA083/2TT / SFA083/2 Contd.

Crossland 440 (2x4)	12-13	F	<b>GOES</b>		
Crossland 440 (4x4)	12-13	F	G 350 S (Quad)	08-13	F
<b>ALFER</b>			<b>HYOSUNG</b>		
VR 125 Raider	12-13	R	Super Cab/Cab Plus/Sense 50/Prima 50/Avanti	99-06	F
VX 125 Explorer	12-13	R	SF 50 R Rally Prima	00-06	F
VX 200 Explorer	12-13	R	SD 50	00-06	F
<b>APACHE</b>			EZ 100	99-02	F
RLX 50		R	SF 100 R	05-06	F
RLX 100		R	FX 110 DLX Midas	99-04	F
RLX 110		R	Krillo Master	04	F
<b>APRILIA</b>			ST E3 (Electric Scooter)	10-11	F
RS4 125 (4T)	11-13	R	<b>KEEWAY</b>		
<b>BENELLI</b>			Focus 50	06-07	F
Zenzero 350	12-13	R	Flash 50	07-10	F
<b>BLANEY (Quads)</b>			Hurricane 50	07-10	F
XC 125 Trojan	03-04	R	Hurricane 50-Base	07	F
<b>BOMBARDIER</b>			Pixel 50	08-12	F
Rally 200	03-06	F	Focus 125	06-07	F
<b>BSM</b>			Dragon 250 Quad	07-09	F
TB 100		F	<b>MALAGUTI</b>		
TB 125		F&R	Centro 50 (4T)/SL	08-11	F
<b>CAN-AM</b>			F10 WAP	10-11	F
DS 90 X (4T)	08-12	F&R	<b>MASAI</b>		
Rally 200 (4A7A/B/C/D/E/F)	07	F	L 150	05-07	R
<b>CCM</b>			A 300 Quad	05-07	F
LX 350-4A Quad	08-09	R	A 450 Quad	05-07	F
<b>CECTEK</b>			<b>MH</b>		
500 EFI King Cobra	09-10	R	MH10 50 Enduro	13	R
500 EFI Gladiator	09-10	R	MH10 50 SM	13	R
500 EFI Quadrift	09-10	R	MH10 Pro 50 Enduro	13	R
500i Estoc	10	R	MH10 Pro 50 SM	13	R
<b>CF MOTO</b>			RYZ 50 Enduro	13	R
CF 800-3 (Tracker 800 Side x Side)	13	R	RYZ SM 50	13	R
<b>COR QUADS</b>			RYZ Pro SM 50	13	R
DN 50/50 E	05	R	Duna 125	13	R
DN 100/100 E	05	R	Duna Pro 125	13	R
DN 150/150 E	05	R	MH10 125 Enduro	13	R
DN 250	05	R	MH10 125 SM	13	R
<b>CPI</b>			<b>MOTO-ROMA</b>		
50 Hussar	01-03	F	Grand Prix 50/100	99-03	F
50 Mars	01	F	Grand Prix 125	02	F&R
Baby J 50	02	F	Lazer 125 Buggie	03-07	R
Quad	03	R	Geko 300 Quad	04-06	F
Popcorn 50	02-03	F	<b>MZ/MUZ</b>		
ST 250 Sector Quad	05-06	F	Moskito 50/50 SX	02	F
<b>CQR</b>			Moskito 125	02	F
DN 250/Hammel	06	F&R	VRS 150 Quad	05	R
DN 100	06	R	<b>PEUGEOT (Heng Tong calipers)</b>		
DN 250 Dolphin	06	R	Various Scooter models (Check pad shape)		F
RX 260	06	F&R	Kisbee 50 (4T)	10-13	F
Utility 250	06	F&R	Kisbee RS 50	10-13	F
DN 150		R	Looxo 50 (Heng Tong Caliper/Drum rear)	01-06	F
DN 150 Extreme		R	Trekker 50 (2T) Heng Tong Caliper	98-00	F
<b>DAELIM</b>			Speedfight 50 LC Darkside	13	R
ET 250 Quad	05-08	F	Speedfight 50 1/2	97-08	F
ET 300 Quad	07-09	F	Vivacity 50 (12" wheels/190mm disc)	92-07	F
<b>DERBI</b>			Vivacity 2 (50cc) (10" wheels/190mm disc)	08-11	F
Senda DRD Racing 50 R (Spoke wheel/260mm F/disc)	11-12	R	<b>PGO</b>		
Senda DRD Racing 50 SM (Cast wheel/260mm f/disc)	11-12	R	Galaxy 50	93-00	F
Senda DRD X-Treme 50R (Spoke wheel/ 260mm f disc/21" front wheel)	11-13	F&R	Mega 50	94-	F
Senda DRD X-Treme 50 SM (Cast Wheel/ 260mm F disc/17" front wheel)	11-13	R	XL Rider 50	07-08	R
DXR 200	04-07	F	XL Rider	07-08	R
DXR 250	04-07	F	Rider 150 50/90/110	04-05	R
<b>E-TON QUADS</b>			<b>POLARIS</b>		
BXL-50 Draco	05-06	R	Phoenix 200	05-11	F
EXL 50 Viper 50	07	R	200 Phoenix (Rear disc model)	05-08	F&R
Viper 50 Mini RXL 50 M	03-07	R	200 Sawtooth	06-07	F
Viper 50 RXL 50	03-06	R	200 Sawtooth Quad Rear Disc Model	06	F&R
Viper 70 RLX 70	05-07	R	<b>QUADZILLA</b>		
BXL 100 Draco	05-06	R	ZR 50	07-09	R
RXL 90 Viper 90	03-07	R	X 50		R
RXL 90 R Viper 90 R Reverse	03-07	R	R 100 (Rear disc model)	06-09	R
Viper EXL 150 ST Quad	05-07	F	X 100		R
EXL 150 Yukon ST	05-06	F	Magmax		R
VXL 250 Vector	06	F&R	Black Max M100 (SE)	06	R
Vector VXL 250 ST Quad	06-07	F&R	Pro Shark 100 (RMX) (Front disc model)		R
VXL 300 Vector	07	F	Pro Shark 100 (Single 4 Arms)		R
VXL 300 ST Vector ST	07	F	Pro Shark (Double 4 arms)		R
VTX 300 Vortex	07	F	Stinger R 250 E	06	R
VTX 300 ST Vortex ST	07	F	300 E XLC	06-07	F
<b>GARELLI</b>			300 SE 4 Valve	06-07	F
Queenie	95-	F	4 Cross 200 E SUV	06-07	F
Grinta	95-	F	X 100 E (XLC)	06-07	R
<b>GENERIC</b>			ST Shark-E	06	R
Epico 50 (2T)	10-13	F	ST 200 E (5 Speed Manual)	06-07	F
Jump 50	12-13	F	<b>RIEJU</b>		
			RS Sport 50 (Scooter)	12-13	F
			RS3 125	11-13	R
			<b>ROXON</b>		
			RX 150 (Quad)	04-06	R
			Sport Spirit NFS 150 (Quad)	04-06	R

# FA083 Contd.

## FA083/2 Contd.

### SCARABEO

50 Yourz (4T) 12 F

### SCORPA

T-Ride 125 (2T) 12-13 F&R

T-Ride 280 (2T) 12-13 F&R

### SHERCO

X-Ride 290 12-13 F&R

### SUZUKI

AD 50 T/Tune/V-Tune 88 F

AE 50 R F

AJ 50 ZZ/RS Sepia 92- F

CP 50 C F

CR 50 DC F

RM 80 XG/XH/XJ/XK 86-89 F

RM 80 XL/XM/XN/XP/XR/XS 90-95 F&R

RM 80 T/V/W/X/Y/K1 96-01 R

RM 85 K2/LK2/K3/LK3/K4/LK4 02-04 R

AH 100 P Address 95-96 F

UE 125 CTK1 01-03 F

UE 150 CTK1 01 F

### TGB

Bullet 2 50 (2T) 11-12 F

Bullet 50 RS (2T) 11-12 F&R

Bullet 50 RR 11-12 F&R

City 50cc (2T) 07-08 F

City 50cc (4T) 07-11 F

Delivery 50 (From FE no 609100) 06-12 F

Hornet 50/90 Quad 04-05 R

Tapo RR 50 2T 10-12 F

Tapo RS 50 (2T) 10-12 F

Trigger 50 02-03 F

X Race 50 (2T) 11-12 F

High Wheel 50 02-03 F

F409 Cruise 50/125 02-05 F

R 125 X Bullet 08-09 R

250 Blade/Congo ATV 06-07 R

303 Revolution (50/125cc) 02-03 F

303 R Hawk/Laser (50cc) 04-11 F

204 Classic (125cc) 03-04 F

R 50 X Bullet 06-10 F

R 50 X Bullet 10-11 R

R 125 X Bullet 10-11 R

Blade 325 Quad (4x2) 07-11 F

Blade 325 SL 4x2 11-12 F

Target 325 (4x2) 09-11 F

Target 400 (4x2) 09-10 F

Target 425 (4x4) 09-11 F

Blade 460 R Target 12 F

Blade 460 IRS Target 12 F

Target 500 (4x2) 09-10 F

Target 525 (4x4) 09-11 F

### TM

80/85 Minicross/Junior 96-00 F

### VECTRIX

VX2 12-13 F

### VIALLI

RX Sport 50 06 F

### YAMAHA

YFM 90 RY 09 R

YFM 300 B/D Grizzly 12-13 F

### ZERO

Zero DS ZF6 10-12 R

Zero DS ZF9 10-12 R

Zero S ZF6 10-12 R

Zero S ZF9 10-12 R

Zero XU 10-12 R

Zero X 10-12 R

Zero MX 10-12 R

### FA083/2TT

### GOES

G 90 XS 10-13 R

G 225 S 12-13 F

### KAWASAKI

KSR1 (KMX50 B1/B2) 90-91 F

KSR11 (KMX80 B1/B2) 90-91 F

### HONDA

MB 80 (MB8) 80- F

MCX 80 82- F

### SFA083

### GOVECS (ELECTRIC SCOOTERS)

GO S 1-2 11-13 R

GO S 1-4 11-13 R

GO S 2-4 11-13 R

GO T 2-4 11-13 R

GO S 3-4 11-13 R

GO T 3-4 11-13 R

### HYOSUNG

Eva Electric Scooter (ST-E3) 13 F&R

### PEUGEOT

Metropolis 400 3 Wheel Model Parking brake 13

### SFA083/2

### SUZUKI

AN 125 HKK5 06-08 F

### GILERA

Stalker 50 03-11 F

### PIAGGIO

NRG 50 DD 06-13 F

NRG 50 Pure Jet 06-09 F

NRG 50 Power DT 05-13 F

NRG 50 Silver Bullet 10 F

### SCARABEO

50 (2T) Street 10-13 F

50 Net (4T/4V) 10-11 F

50 (4T/4V) 10-13 F

100 (4T) 10-13 F

### Equivalents OE #- FA083

43050 1040	43082 1164	59340 46F00	610143
43050 1043	4312016900B	736502	45110 JHFT 000
43050 1044	45120 119 00	752426	45120 168000
43050 1048	45815 NAF00	752818	45120 169000
43050 1051	69100 02821	GF5359902	G71315EE00000
43050 1126	59100 02820	705 600 285	0453036
43050 1169	59100 02821	45815RAM00/01	PE802452
43082 1065	59100 02830	610113 497417	ISC F5805 00
43082 1079	59300 09810	514069	B044223
43082 1081	59300 09811	67131 5EE0 0000	B044224
43082 1083	59300 03870	59300 03860	4084 43D F5906 00
43082 1115	59330 46F00	45110 B20T 000	

### Equivalents OE #- FA083/2

497417	59300 37810
647171	59302 20820

### Competitor X Ref

Dunlop	Ferodo	SBS	Vesrah
DP312	FDB313	544	VD-339/342/442

### MATERIAL AVAILABILITY AND PART NO.

STD	OPTIONS						
FA	SFA	SFAC	HH	SFA-HH	R	MXS	EPFA
FA083TT	SFA083	SFAC083	FA083HH	SFA083HH	FA083R	-	-

### MATERIAL AVAILABILITY AND PART NO.

STD	OPTIONS					
FA	SFA	HH	SFA-HH	R	MXS	EPFA
FA083/2TT	SFA083/2	-	SFA083/2HH	-	-	-



# FA084 46 x 45 x 7.8mm

# FA084/2 46 x 45 x 6.5/7.8mm (1 piece each size per set)

# FA084/3 46 x 45 x 6.5mm

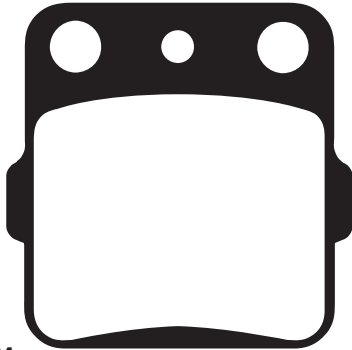

### FA084

#### ARCTIC CAT

400 DVX (2x4) Sport  
400 DVX TS Sport

#### HONDA

CR 80 RG/RH/RJ/RK/RL/RM/RN/RO/RR/RS/RT/RBT/RV  
/RBV/RW/RBW/RX/RB/R1/RB1/RB2/R2

CR 85 R3/RB3/R4/RB4/R5/RB5/R6/RB6/R7/RS7

CRF 150 RB7/R7/RB8/R8/RB9/R9/RC/RBC/RD/RBD

ATC 250 RD

ATC 250 RC

TRX 250 EX1/2/3/4/5/6/7/8

TRX 250 X9/XA/XB

TRX 300 EX P/R/S/T/V/W/X/Y/1/2/3/4/5/6/7/8

TRX 300 X9

TRX 400 EXX/EXY/EX1/EX8

TRX 400 X9

TRX 420 FE7/FE8/FE9/FEA/FEB 4WD Fourtrax ES

TRX 420 FA9/FAA/FAB Fourtrax - Auto 4WD

TRX 420 FM7/FM8/FM9/FMA/FMB 4WD Fourtrax

TRX 420 FPA9/FPA4/FPA8 Fourtrax Auto Power Steering

TRX 420 FPM9/FPMA/FPMB Fourtrax 4WW Power Steering

TRX 420 TE7/TE8/TE9 Fourtrax ES 2WD

TRX 420 TM7/TM8/TM9/TMA/TMB Fourtrax 2WD

TRX 500 FEC Fourtrax Foreman ES 2x4 HD

TRX 500 FMC Fourtrax Foreman S 2/4WD

TRX 500 FPC Fourtrax Foreman 2/4WD

TRX 500 FAC Fourtrax Foreman AT 2/4WD

#### HONDA HM (Italy)

CR 85 R/R2

CR 150 R/R2

#### HUSQVARNA

CR 125

WR 125

CR 250

WR 250

04-08 F

06-07 F

86-02 F

03-07 F

07-13 F

83-84 F&R

82 F

01-08 F

09-11 F

93-08 F&R

09 F&R

99-08 F&R

09 F&R

07-11 F

09-11 F

07-11 F

09-11 F

09-11 F

07-09 F

07-10 F

12 F

12 F

12 F

12 F

03-07 F

07-09 F

92-94 R

93-94 R

92-94 R

92-94 R

#### HUSQVARNA Contd.

TE 350

CR 360

WR 360

TC 610

TE 610

#### KAWASAKI

KX 80 L1-L3/N2/N3/R1-R7/T1-T6/W1/W2/W3

KX 85 A1-A5/A6F/A7F/A8F/A9F/AAF/ABF/ACF/ADF  
(17" front wheel/14" rear wheel)

KX 8511 B1-B5/B6F/B7F/B8F/B9F/BAF/BBF/BCF/BDF  
(19" front wheel/16" rear wheel)

KX 100 A1/A2/B1-B7/C1/C2/C3

KSF 250 A1-A18

KXT 250 B2 Tecate 3 Wheel Model

KEF 300 B1/B2/B3 Lakota Sport

KVF 400 A1/A2/A3 (KFX 400)

KFX 450 R Quad (KSF 450 B8F/B9F/BAF)

#### SUZUKI

RM 100 K3

LT-Z 250 K4/K5/K6/K7/K8/K9/L0 QuadSport

LT-Z 400 K3/K4/K5/K6/K7/K8/K9/L0/L1

#### YAMAHA

YFS 200 R/S/T/V Blaster

YFM 250 RX/RV Raptor

YFZ 350 T/U/W/A/B/D/E/F/G/H/J/K/L/M/N/P/R/S/T/V Banshee

YFM 350 XD/XE/XF/XG/XH/XJ/XK/XL/XM/XN

/XP/XR/XS

YFM 350 FXG/FXH/FXJ/FXK/FXL/FXM

/FXN/FXP/FXR/FXS Wolverine

YFM 350 S/T/V/R-WV/RW/RX/RY/RZ Raptor

YFM 400 FWP Big Bear 4x4

YFZ 450 S/T

YFM 600 FWAK/FWAL/FWAM/FWAN 'Grizzly'

YFM 600 HM "Grizzly Hunting"

YFM 660 RN/RP/RR/RS Raptor

YFM 660 FWAP/FWAR/FWAS/FWAT/FWAV/FGW/FGX Grizzly

YFM 660 FR/FS/FT Grizzly

#### FA084/2

#### HONDA

ATC 200 XD

#### FA084/3

#### SUZUKI

RM 125 J

RM 250 H/J

#### TM

80/85 Minicross/Junior

#### YAMAHA

YZ 80 E/F/LWF/LWG/G/LWH/H

/LWJ/J/LWK/K/L/LWL/LWM/M/LWN/N

YZ 85 P/LWP/R/LWR/S/LWS/T/LWT/V/LWW/W/LWX/LWY

/LWY/Y/Z/LWZ/LWA/LWB/LWD

YZ 125 W

YZ 250 W/WRW

92-94 R

92-94 R

92-94 R

92-94 R

92-94 R

88-00 R

01-13 R

01-13 R

89-00 R

87-04 R

87 R

01-03 R

03-05 F

08-10 R

03 R

04-12 F

03-12 F

03-06 R

08-09 R

87-09 R

92-04 R

95-04 R

04-10 F&R

02 F

04-05 R

98-01 F

00 F

01-04 F&R

02-08 F

03-05 F

83 F&R

88 R

87-88 R

96-00 R

93-01 R

02-13 R

89 R

89 R

#### Equivalents OE # - FA084

#### Equivalents OE # - FA084/2

431A0 965 000	45105 961 006
431A0 965 670	43120 965 000
43120 HC0 007	

#### Equivalents OE # - FA084/3

69140 26C00	3JD W0046 00
3JD W0046 01	4ES W0046 00
3JD W0046 10	5PA W0046 00

#### Competitor X Ref - FA084

Dunlop	Ferodo	SBS	Vesrah
DP811	FDB381	592	VD-128

#### Competitor X Ref - FA084/2

Dunlop	Ferodo	SBS	Vesrah
-	-	562	VD-127/2

#### Competitor X Ref - FA084/3

Dunlop	Ferodo	SBS	Vesrah
DP816	FDB661	584	VD-127

06435 HA5 405	43120 HA5 670	5LP W0046 50
06435 HA5 670	69140 19A00	K4308 21205
1UY W0046 00	69140 19A01	59300 42850
43082 5006	69140 19A11	3406 031
43082 1205	69140 19A10	3406 032
43106 961 006	4WV W0045 00	59300 42860
45105 961 000	45105 GC4 601	59300 42870
45110 HB7 007	45105 GC4 602/603	800070854
451A0 HB5 670	45105 GBF 405	800071451
43082 1066	45112 GC4 601	06435 HP5602
43082 1082	45112 GC4 831	06455 KSE 006
431A0 HA5 670	06455 GBF J01	06455 KSE 016
43120 HA5 305	5LP W0046 00	

#### MATERIAL AVAILABILITY AND PART NO.

STD	OPTIONS			
FA	HH	R	MXS	EPFA
FA084TT	-	FA084R	MXS84	-

#### MATERIAL AVAILABILITY AND PART NO.

STD	OPTIONS			
FA	HH	R	MXS	EPFA
FA084/2TT	-	FA084/2R	-	-

#### MATERIAL AVAILABILITY AND PART NO.

STD	OPTIONS			
FA	HH	R	MXS	EPFA
FA084/3TT	-	FA084/3R	MXS84/3	-

# FA085 A. 111 x 50 x 9.5mm B. 69x 43.5x 9.8mm

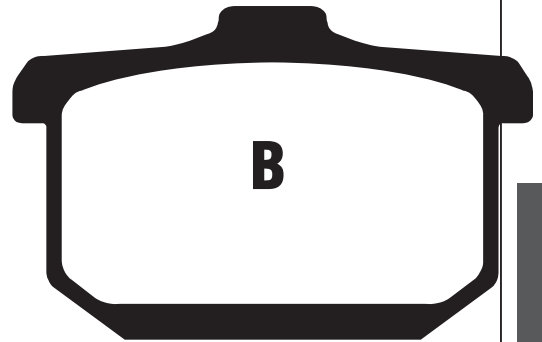
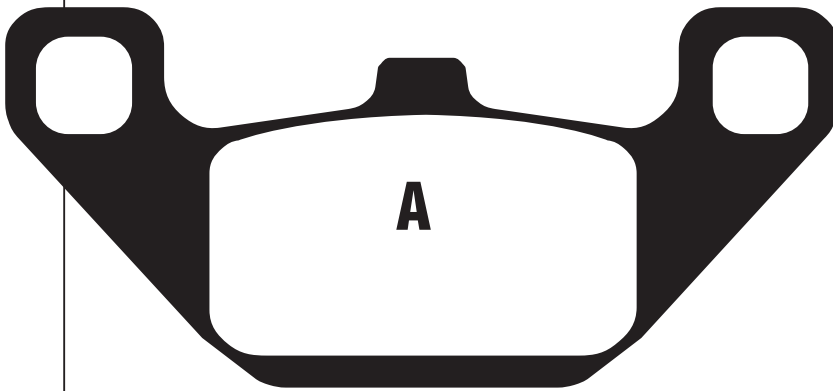

DISC PADS  
BUYERS GUIDE

### GENERIC

Vertigo 125 (4T)	12-13	F
<b>KAWASAKI</b>		
EL 250 'Eliminator'	87-89	F
EL 250 D1-D5	90-94	F
EL 252 (EL 250 F2/F3/F5/F6)	96-03	F
ER 250 B1-B3 (Z250T Scorpion)	83-88	F
GPZ 250 R (EX 250 E)	86	F&R
KR 250 A1/A2	84-86	R
Z 400 C2/C3 (Z 400 F2)	85-87	R
ZL 400 A 'Eliminator'	86-87	F
FX 400 R (ZX400 E1-E3)	86-88	R
GPX 400 R (ZX 400 D1/D3/D3A)	85-87	R
LTD 454 (EN 450 A1-A5)	86-89	F
EN 500 A1-A3/B1-B2/C1-C9	90-04	F
GPz 550 A1-A4 (ZX 550 A1-A4)	84-87	F&R
GPz 600 R A1-A5A	85-89	F&R
VN 700 A1 'Vulcan'	85	F

ZN 700 A1/A2 'Ltd'	84-85	F&R
GPz 750 A1-A5	83-87	F&R
GPz 750 E1-E2 (Turbo)	84-87	F&R
GPz 750 R G2/G3	85-86	F&R
VN 750 A2-A5/A10	86-94	F
VN 800 A1-A3	95-99	F
GPz 900 R (A1-A6)	84-89	F&R
ZL 900 A1/A2 'Eliminator'	85-86	F&R
GPz 1000 RX (A1-A3)	86-88	F&R
ZL 1000 A1	87	F&R
1000 GTR (ZG 1000 A1-A7)	86-93	F&R
1000 GTR (ZR 1000 A9-A14)	94-99	R
GPz 1100 A1-A3	83-85	F&R
Z 1100 R1	84	F
VN 1500 B2-B6 (VN15SE)	88-92	F&R
VN 1500 A6 (VN15)	92	F&R
VN 1500 C1/C2 (VN15)	94-95	F&R
VN 1500 D1/D2/E1/E2 'Classic'	96-99	R
VN 1500 G1/G2 'Classic Tourer'	98-99	R

### Competitor X Ref

Dunlop	Ferodo	SBS	Vesrah
DP311	FDB339/R	557	VD-424/ 426

### Equivalents OE #

43082 1029	43082 1061	43082 1167
43082 1031	43082 1062	43082 1194
43082 1057	43082 1080	

### MATERIAL AVAILABILITY AND PART NO.

STD	OPTIONS				
	V	HH	R	MXS	EPFA
FA085	FA085V	FA085HH	-	-	-

# FA086 77.3 x 42.2 x 7.2mm

## FA086/2 77.3 x 42.2 x 8.4mm

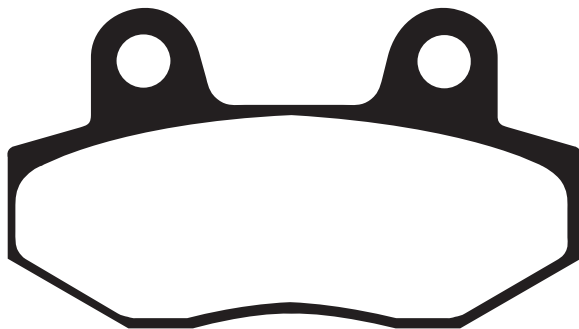

### Competitor X Ref

Dunlop	Ferodo	SBS	Vesrah
DP111	FDB312	551/103 /200	VD-131

### Equivalents OE # FA086

451A0 KR3 603	45105 KR3 004	46630 FYBQ 000
45105 GE2 004	45105 KR3 007	P4064905001002640
45105 GE2 006	45105 KR3 014	251 0037 A
45105 GE2 305	45105 KR3 601	59300 HG5 800
45105 KK4 004	45105 KR3 602	59301 HP9 500
45105 KK4 007	45105 KR3 603	PE776170
45105 KK4 014	45105 KW7 405	

### Equivalents OE #- FA086/2

59301 HP9 500

### MATERIAL AVAILABILITY AND PART NO.

STD	OPTIONS						
	SFA	SFAC	SFA-HH	HH	R	MXS	EPFA
FA086	SFA086	SFAC086	SFA086HH	FA086HH	-	-	-
FA086/2	-	-	-	FA086/2HH	-	-	-

# FA086 / FA086/2 Contd.

## FA086

### AJS

DD 125 E Mk2 Regal Raptor (Cast wheels)	10-11	F
EOS 125 Regal Raptor	09-10	F
NAC 12 (125cc)	09-11	F&R
Bobber 125 (Custom)	10-11	F
JSM 125 Supermotard	10-11	F

### ASPES

Vega 125 Hybrid	11	F
Perseo Hybrid 150	11	R

### BETA

R150 (Minicross/4T/49cc)	10-13	F
--------------------------	-------	---

### CCM

C-XR 125 E	08-09	F
C-XR 125 M	07-09	F
C-XR 125 S	08-09	F
TL 125	08-09	F
C-XR 230 E	07-09	F
C-XR 230 M	07-09	F
C-XR 230 S	07-09	F
XTR 250	09	F

### CAGIVA

Brillio 125	08	F
-------------	----	---

### CF MOTO

CF 250 T - 6A (Scooter)	12	F
-------------------------	----	---

### CPI

Bravo 50	12	F
Bravo 125	12	F
SUV 125	11-12	F
XR 125 Sprint	11-12	F
X-Large 250	11-12	F&R
XR 250	11-12	F&R

### DAELIM

Citi Ace 110	03-11	F
--------------	-------	---

### GARELLI

Comfort 125	07	F
XO 125i (TM 125 T)	09-12	F
Mosquito 150	07	F
XO 150i (TM 150 T)	09-12	F
XO 200i (TM 200 T)	10-12	F
XO'E (Electric)	12	F

### GENERIC

Vertigo 50 (4T)	12-13	F
-----------------	-------	---

### GOES

G 55 R Scooter	08-12	F
G 125 M Big Wheel	08-09	F
G 125 X	08-09	F&R
SP R 125 (Motorcycle)	10-12	F

### HERO HONDA

Slickster 125	06	F
---------------	----	---

### HONDA

MBX 50 SD/SF	83-85	F
NSR 50 FP/FR/FS	93-95	F
NSR 50 SK/SP/SR/SS	89-95	F
NSR 80 J-2/K/L/N (HC06)	88-92	F
CBX 125 Custom	88-	F
FS 125 Sonic	03-04	F
LS 125 RY	00-	F
MBX 125 FE	84-86	F
CBX 250	84-98	F

### HONGDOU

CTM 125 Chituma	04	F
-----------------	----	---

### HP POWER

Copper 50 (4T)	10-12	F
Chromel 125 (4T/LC)	11-12	F&R
Lithium 125 (2T/LC)	10-12	F&R
Chromel 150 (4T/LC)	11-12	F&R
Lithium 150 (4T/2V/LC)	10-12	F&R
Nickel 150 (4T/2V)	10-12	F
Radium 300 (4T/4V)	11-12	F&R

### HYOSUNG

Comet GT 125 (Naked)	04-06	F&R
RX 125	01-02	F
RT Karion 125	02-06	F
Exceed 125 (MS 125/150)	02-04	R
GPS 125 Grand Prix Plus Rear disc model	00-04	R
XRX 125 Enduro	00-06	F
GV 125 Aquilla	01-06	F
Comet GT 250	04-05	F&R
Comet GT 250 (Naked)	04-06	F&R
GV 250 Aquilla	01-09	F
RX 400	05	F
Comet GT 650 (Naked)	04-06	F&R
Comet GT 650 R	04-06	F&R
Comet GT 650 S	05-06	F&R
GV 650 Aquilla	04-06	F&R
GT 650 S	05-08	F&R
GT 650	06-08	F&R
GT 650 X	07	F&R

### ITALJET

Grifon #59 (650cc)	06	F&R
Bazooka (650cc)	06	F&R

### JIALING

JE 125 E Dragon	98	F
-----------------	----	---

### JONWAY

YY 50 QT-6 (2T) Agility	07-09	F
YY 50 QT-6 (4T) Agility	07-09	F
YY 50 QT-10 (2T) Viper	07-09	F
YY 50 QT-10 (4T) Viper	07-09	F
YY 50 QT-28 (2T) Raptor	07-09	F
YY 50 QT-28 (4T) Raptor	07-09	F
YY 80 QT-6 (4T) Agility	07-09	F
YY 150 T-19	08-09	F&R
YY 250 T-19	08-09	F&R

### KEEWAY

Agora 50 (2T/4T)	10-11	F
RKS 125	10-11	F

### KYMCO

Active SR 50cc	08-11	F
Jetix 50	10	F
Nexxon 50	08-09	F&R
Jetix 125	10	F
Nexxon 125	07-08	F&R
Pulsar 125 (Luxe)/CK 125 (RJ 25 CB)	99-06	F
Spike 100/125	00-06	F
Jetix 150	10	F

### LAMBRETTA

50 N Pato	08-10	F&R
125 N Pato	08-10	F&R
151 N Pato	08-10	F&R

### LEONART

Daytona 125	13	F
Spyder 125		F

### LIFAN

LF 100 A		F
----------	--	---

### MEGELLI

125 M	08-10	F
-------	-------	---

### MOTOM

ANA 50	08-09	F
ANA 151	08-09	F
Dolcevita 125/151	08-09	R
Transcity 125/250	08-09	R

### NIPPONIA

Brio 50 (4T)	12-13	F
EZ10 50 (4T)		F
Brio 125 (4T)	12-13	F
Dion 125 (4T)		F
EZ10 125 (4T)		F
Dion 150 (4T)		F

### PEUGEOT

Speedfight 3 50cc (A/C 2T)	09-13	F
Speedfight 3 50cc (LC 2T)	09-13	F
Speedfight 3-RS (50cc-L 2T)	09-12	F
Speedfight 3 RS (50cc AC)	10-12	F
Speedfight 50 LC Furious	13	F

### QUADZILLA

WK 110	06-08	R
WK 125	06-09	R

### RIEJU

RS3 50 Pro	11-13	F
RS3 125	11-13	F

### SAGHS

Madass 50 (4 stroke)	04-05	F
Madass 50 (2 stroke)	04-05	F
Mad Ass 50 (4T)	06-09	F
Madass 125	05	F&R
Mad Ass 125 (4T)	06-09	F

### SFM

ZZX 125 Enduro	13	F&R
ZZX 125 Trail		F&R
ZZX 125 SM (Cast Wheels)	13	F&R

### SINNIS

Nitro 50 (2T)		F
Strike 50 (2T)	09-10	F
Nitro 125 (WY 125 T-56A)	09-10	F

### SMC

YB 125	09	F&R
YB 150	09	F&R
YB 250	09	F&R

### SUPERBYKE

CQ 50 Road Classic		R
CU 125 Road Classic		R
M-Ped 125 Road Classic		F
RMX 125	07-08	F&R
R-SR 250		F&R

### SYM

Wolf Legend	04-05	F
-------------	-------	---

### VECTRIX

VX2	12-13	F
-----	-------	---

### VIALLI

Truro 50	06	F
----------	----	---

### W.T. MOTORS

Bilbao 50 (4T)	08-09	F
----------------	-------	---

# FA086 / FA086/2 Contd.

## SFA086

### E-TROPOLIS (ELECTRIC SCOOTERS)

Bel Air	13	F&R
Future	13	F&R
Miami	13	F&R
Retro	13	F&R

### GO CCIA (ELECTRIC SCOOTERS)

E-Gura (Li/Si)	12-13	F
<b>KREIDLER</b>		
50 Flory Classic	12-13	F
50 Supermoto DD	12-13	F&R

### TAMORETTI

Retro 50		F
Retro 125		F

## FA086/2

### HYOSUNG

GT 125 Naked	07-12	F&R
GT 125 P (Naked)	13	F&R
GT 125 R	06-13	F&R

GV 125 C	07-13	F
RT 125 D KARION	07-13	F
RX 125 D (XRX)	08-11	F
XRX 125 Supermoto	07-11	F
GV 150 C	08-11	F
GT 250 P (Naked)	13	F&R
GT 250 R	07-13	F&R
GT 250 (Naked)	06-12	F&R
GT 650 R	07-08	F&R
GT 650 Naked	07-08	F&R
GT 650 (Naked)	09-12	R
GT 650 R	09-13	R
GT 650 Pi (Naked)	12-13	R
GV 650 (EFI)	07-12	F&R
GV 650 Pi Pro Cruiser	12-13	F&R
GV 700 C	06-09	F&R
ST7	10-13	R
ST7 Deluxe Cruiser	12-13	R

# FA088 64 x 55 x 9mm



### Equivalent OE #

1FK W0045 00	26H W0045 11	3HE W0045 11
1FK W0045 10	29L W0045 10	3XF W0045 00
1FK W0046 02	29L W0046 01	43F W0045 00
1FK W0046 01	31A W0046 00	47X W0045 00
1UF W0045 00	31A W0046 10	47X W0045 01
1UF W0045 01	33M W0045 01	4FM W0046 00
26H W0045 00	33M W0045 10	4FM W0045 10
26H W0045 01	36H W0046 01	4FM W0045 20
26H W0045 10	37A W0045 00	4FM W0045 30
26H W0046 00	38A W0045 01	4SV W0045 50
26H W0046 01	3HE W0045 00	

### Competitor X Ref

Dunlop	Ferodo	SBS	Vesrah
DP404	FDB337/R	555	VD-236

## NORTON

Commander (Rotary)	90	F&R
--------------------	----	-----

## YAMAHA

TZR 125	90-92	F
RD 350 YPVS	83-84	R
FZ 400 N (IFK/46X/33M)	85	F
FZR 400 Genesis (1WG)	86	F
SRX 400 (1JL)	85	F
XJR 400	95-	R
RD 500 LC	84-86	F
RZV 500 R (SIX)	85	F
FZ 600	87-88	F
FZR 600	89	F&R
FZR 600	90-93	R
FZR 600 R	94-95	R
YZF 600 R "Thundercat"	96-03	R
XJ 600	84-91	F&R
YX 600 S/SC/T/TC/UC/UW/WC		
/A/AC 'Radian'	86-90	F
FZX 700 S/SC/T/TC Fazer	86-87	F&R
FZ 750	85-88	F&R
FZ 750	89-91	R
FZX 750	87	F&R
FZR 750 'Genesis'	87	R
FZR 750 R "OWOI"	89-90	R
XV 750 Virago	92-93	F
YZF 750 R/SP	93-97	R
TDM 850	91-01	R
TRX 850	96-99	R
XJ 900/900 F	83-92	F&R
XJ 900 S "Diversion"	95-03	R
GTS 1000	93-99	R
FZR 1000 Genesis	87-88	R
FZR 1000 'EX UP'	89-95	R
YZF 1000 R "Thunderace"	96-02	R
XV 1000/1000 SE "Virago"	86-88	F
BT 1100 P/R/S/T/V Bulldog	02-06	R
FJ 1100	84-85	F&R
XV 1100 Virago	89-93	F
XV 1100 Virago	99	R
XVS 1100 Dragstar	99-04	R
XVS 1100 A "Dragstar Classic"	00-07	R
FJ 1200 (ITX Type)	86-87	F&R
FJ1200 (3CV/3XW Type)	88-95	R
FJ 1200 A (ABS model)	91-95	R
XVZ 12 TD	85	F&R
V-MAX 12	91-92	F&R
V-MAX 12	93-03	R
XJR 1200	95-98	R
XJR 1300 (5EA1/5EA7) Brembo calipers (320mm front discs)	98-99	R
XJR 1300 L 5EA2/5EA3/5EA4	99	R
XJR 1300 M 5EAA/5EAB/5EAC	00	R
XJR 1300/1300 SP	99-01	R
XJR 1300 SP (L) 5EA5/5EA6/5EA8	99	R
XJR 1300 SP (M) 5EAD/5EAE/5EAF	00	R
XJR 1300 SP (N) 5EAL/5EAM/5EAN	01	R

### MATERIAL AVAILABILITY AND PART NO.

STD	OPTIONS				
FA	V	HH	R	MXS	EPFA
FA088	FA088V	FA088HH	-	-	-

# FA090 91 x 51 x 10mm

**HONDA**

CB 650 SCC "Nighthawk"

82

F

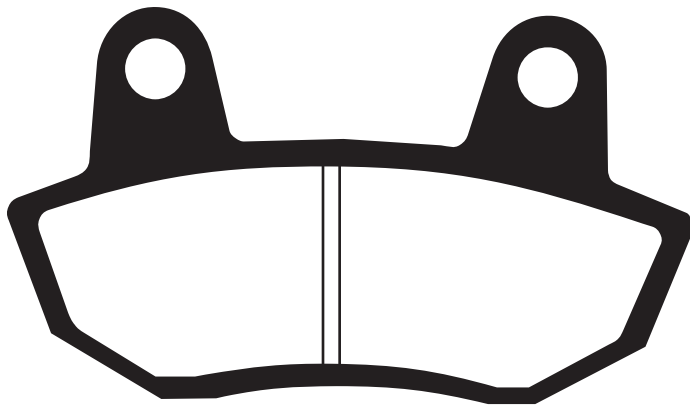

**Equivalents OE #**

45105 MA5 771
45105 MA5 772
45105 MC9 305

**Competitor X Ref**

MATERIAL AVAILABILITY AND PART NO.					
OPTIONS					
STD	V	HH	R	MXS	EPFA
FA					
FA090	FA090V	-	-	-	-

Dunlop	Ferodo	SBS	Vesrah
-	FDB2020	561	VD-130

# FA092 81 x 42 x 7.5mm

**FA092/2 Use SFA323/2**

**FA092/3 Use SFA323/3**

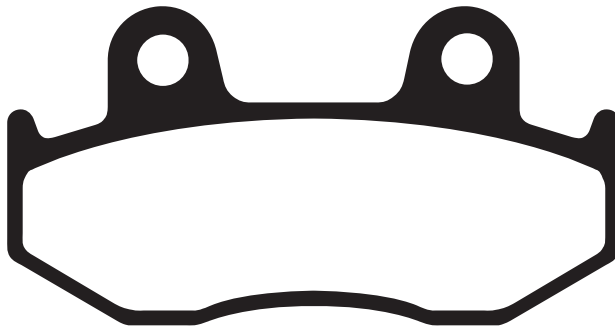

**HONDA**

CR 125 RE/RF/RG	84-86	F
MTX 125 RWE/RWF/RWH/RWL	85-95	F
XL 125 RF/RH	85-86	F
XL 200 R	85	F
MTX 200 RWF	85	F
FTR 223 (MC34) Y/2/A2	00-02	F
ATC 250 RF/RG	85-86	F&R
CR 250 RE/RF/RG	84-86	F
XR 250 RE/RF/RG/RH	84-87	F
XLR 250 R (MD22)	88-90	F
TRX 250 RG/RH/RJ/RK	86-89	R
XR 350 RE	84	F
CR 500 RE/RF/RG	84-86	F
XR 500 RD/RE	84-85	F
XL 600 RD/LD/RE/LE/RF/RG/RH	83-87	F
XR 600 RF-RH	85-87	F

**Competitor X Ref**

Dunlop	Ferodo	SBS	Vesrah
DP812/114	FDB382	558	VD-134/ 136

**Equivalents OE #- FA092**

43105 HB9 008	45105 HA2 671	45105 KE1 744
431A0 HB9 008	45105 HB9 008	45105 KS5 004
451A0 MG3 670	45105 KA3 731	45105 KS5 006
451A0 KA3 731	45105 KE1 742	45105 MG3 006
45105 G04 601	45105 KE1 743	06455 KPM 006

MATERIAL AVAILABILITY AND PART NO.				
OPTIONS				
STD	HH	R	MXS	EPFA
FA				
FA092TT	-	FA092R	-	-



# FA093 A. 88 x 48 x 7.8mm B. 56 x 36.6 x 10.2mm

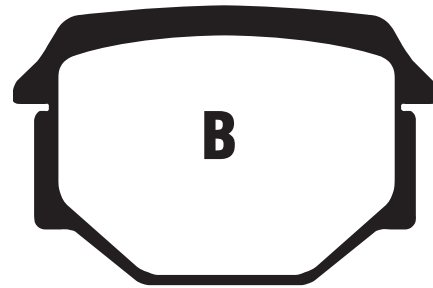
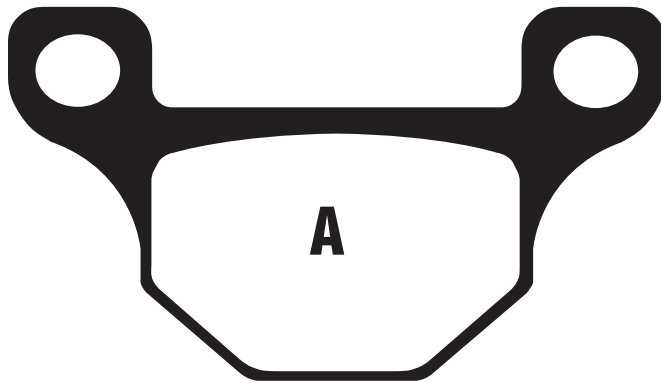

## SUZUKI

GN 125 Z/D/K Gold Coloured Cast Wheels /Aisin Caliper	82-90	F
GS 125 ESD/ESF/ESK/ESM	83-94	F
GX 125 (SJ 125)	03	F

## AJP

PR4 125 Enduro	10-11	R
PR4 125 Enduro Pro	10-11	R
PR4 125 Supermoto	10-11	R
PR4 125 Supermoto Pro	10-11	R
PR4 200 Enduro Pro	10-11	R
PR4 200 Supermoto	10-11	R
PR4 200 SM Pro	10-11	R

## APRILIA

RS4 50 (4T) (AJP Rear Caliper)	11-13	R
RX 125 (AJP Rear Caliper)	08-12	R
RS4 125 (4T)	11-13	R

## BRANSON

BM 125 Retro	08	F
BM 125	08	F
BM 125 Sport	08	F

## CF MOTO

CF 150 Leader	10-11	F
---------------	-------	---

## DERBI

Atlantis 50 (4T)	07-09	F
Atlantis 50 (2T/AC) 12"/5 spoke wheels/200mm disc /5 bolt From Ref No8G253172	07-11	F
GPR 50 (2T) 41mm Forks (218mm rear disc)	09-12	R
Terra 125 Euro (Single pin pad fixing)	07-11	R
Terra 125 Adventure	07-12	R
GPR 125 (4T) 4V	09-12	R
Mulhacen 125 (4T) Up to ref no. 7N001790 Spoke wheel/2 pin pad fixing	07	R
Mulhacen 125 (4T) From Ref no. 7N001791 Spoke wheel/single pin fixing	07-11	R
Mulhacen 125 Cafe Cast wheel/radial caliper	08-11	R
Senda DRD 125 R	10-12	R
Senda DRD 125 SM	10-13	R

## EASY RIDER

JC 125/8 Dragon	98	F
-----------------	----	---

## HARTFORD

HD 125 L/150 L	00-04	F
----------------	-------	---

## KEEWAY

Speed 125/150	07-12	F&R
---------------	-------	-----

## MH/MOTORHISPANIA

RX 50 R	08-13	R
125 Custom	12	F
RX 125 R	08-13	R
MH7 Naked (125cc/Air cooled)	08-10	R
MH7 Naked (125cc/Liquid Cooled)	08-13	R
Duna 125 Hard Road Enduro	08-12	F
Duna 125 Sports City Supermotard	08-09	R
KN1 (125cc)	09-10	R

## MOTO-ROMA

SK 125 (Cast Wheel)	10-12	F
Virage 125	01	F

## PEUGEOT

XR7 (50cc)	08-12	R
NK7 "Naked" 50cc	09-12	R
XPS 50 SM	09	F&R
XPS 50 Track (21" front wheel)	11-12	F
XPS 50 Top Road (17" front wheel)	10-12	F

## RIEJU

MRT 50 (Single piston caliper)	09-13	F&R
MRT Pro Supermotard (Radial caliper/cast wheel)	09-13	R
MRT Supermotard 50 (Cast wheel/single piston caliper)	09-13	F&R
MRT-Pro 50 (Radial/double piston caliper)	09-13	R
NKD 50	08-10	R
RS2 50cc Matrix/Pro	07-10	R
RS3 50	11-13	R
RS3 50 Pro	11-13	R
TS2 50 FR	09-10	R
Tango 50 Motard	09-10	F
Tango 50 (Spoke Wheel)	11	F
Tango 50 Motard (Cast Wheel)	11	F
Marathon Pro Supermotard 125 (Cast wheel/radial caliper)	09-13	R
Marathon Pro 125 (Radial/double piston caliper)	09-13	R
Marathon 125	10-11	F&R
Marathon 125 SM (Air Cooled/Cast Wheel)	10-13	F&R
NKD 125	08-10	R
RS2 125/Pro	07-10	R
Tango 125 Motard (Cast wheel)	08-10	R

## SHERCO

SE 0.5	11	F
SM 0.5	11	F
SU 50cc (2T) Urban Base (Cast Wheels)	10	F
SE 1.25 F	11	F
SM 1.25 F Black Panther	11	F

## SINNIS

Trackstar 125 (4T)	10-12	F
Vista 125 QM 125 2C	08-10	F

## SUPERBYKE

RFX 50 Road Trail		F
RFX 125 Road Trail		F

## TGB

R 50 X Bullet	06-11	F
Delivery/Express 125cc	04-12	F
R 125 X Bullet	08-11	F
302 Sport (50cc)	03-08	F
303R Hawk/Laser (125/150cc)	04-08	F
303R Hawk/Laser (125/150)	09-11	F
304 Sport (125cc)	03-04	F
309 RS 50	02-03	F
404 Executive	03-08	F

## WUYANG

WY 125-12	06-07	F
WY 125 16C	06-07	F

### Equivalents OE #

59301 39841	413610
59300 29820	45110 J00 P001
45120 128 000	00TRS01A0068
864121	B044221
864428	K01310073
866692	0/000 930 0090
894051	

### Competitor X Ref

Dunlop	Ferodo	SBS	Vesrah
-	FDB384	585/203	VD-346

### MATERIAL AVAILABILITY AND PART NO.

STD	OPTIONS				
FA	SFA	HH	R	MXS	EPFA
FA093	SFA093	-	-	-	-

# FA094 60 x 63 x 13mm

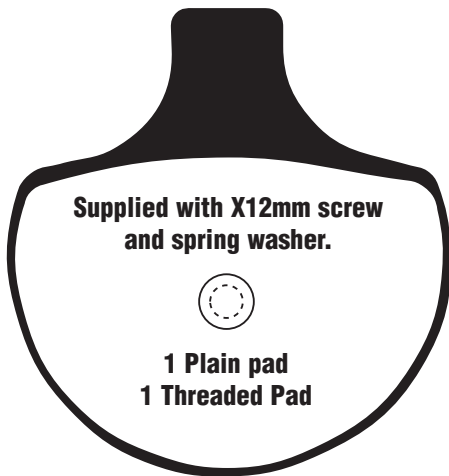

## HARLEY DAVIDSON

FXD/FXDL/FXDWG/FXR/FXRS/FXRT/FXRD/FXLR	84-99	F
FXST/FXSTB/FXSTC/FXSTS/FLST/FLSTC/FLSTF/FLSTS/FLSTN	84-99	F
FX/FXE/FXEF/FXWG/FXS	84-86	F
XL/XLH/XLCH/XLS/XLX	84-99	F
FLT/FLHT/FLHTCI	84-99	F
FLHR/FLHRCI	94-99	F
FXSTS/FXSTSi	00-05	F
FLSTS Heritage Springer	00-03	F
FLSTSC/FLSTSCi Springer Classic	05-07	F
FLSTSC/FLSTSCi Springer Softail Classic	06-07	F
FLSTSB Softail Cross Bones	08-11	F

### Competitor X Ref

Dunlop	Ferodo	SBS	Vesrah
DP900	FDB352/R	579	VD-919

### Equivalents OE #

43063 83	44063 839	44247-98A
44063 83A	44063 83C	

### MATERIAL AVAILABILITY AND PART NO.

STD	OPTIONS				
FA	V	HH	R	MXS	EPFA
FA094	FA094V	FA094HH	-	-	EPF094HH

# FA095 69.2 x 51 x 8.2mm

## FA095/2 69.2 x 51 x 11.2mm

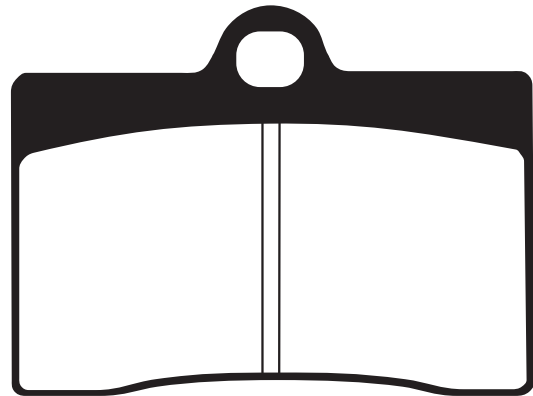

### FA095 - APRILIA

RS 250 All models	95-97	F
B 500 CR	02	F
B 500 MT	02	F

### BENELLI

666 Scooter "Born in Hell"	98-99	F
----------------------------	-------	---

### BETA

Jonathan 125	00-05	F
Euro 350	03-06	F
Jonathan 350	03-06	F

### BIMOTA

Various models	89-03	F
Tesi 2D	05-06	F

### BORILE

B 500 CR	02-04	F
B 500 MT	02	F

### BREMBO

20 5165 55/68 Goldline 4 Piston P4 30/34 @ 40mm Spacing (Single pin pad fixing)		
20 4756 52/62 - 4 Piston P4 30/34 @ 40mm Spacing (Single pin pad fixing)		

### CAGIVA

Mito 125/SP525	93-10	F
N1 125	97	F
Planet 125 (3 Spoke Wheels)	98-03	F
Planet 125 (6 Spoke Wheels/ST Series)	98-03	F
Planet 125 (6 Spoke Wheels 2nd Series)	98-03	F
Raptor 125	03-10	F
Mito 500	07	F
River 600	95-99	F

### CCM

CR 40 S Cafe Racer (Full Fairing)	07-09	F
CR 40 Cafe Racer (Handlebar Fairing)	07-08	F

### DUCATI

Supersport 400	93-97	F
400 Monster	95-97	F
(549cc) Supermono	93-95	F
600 Monster	93-99	F
600 Monster Dark	98-99	F
600 Monster City/City Dark	99	F
600 Supersport	91-97	F
748 SP	95-98	F

749 Biposto	95-98	F
750 Supersport	91-98	F
Supersport 750 (Twin disc)	91-98	F
750 Monster	96-98	F
750 Monster City/City Dark	99	F
750 Monster/Monster Dark	99	F
851 Superbike Biposto	89-92	F
884 SP4/SP5	92-93	F
888 Superbike Strada	94-95	F
900 Supersport	89-90	F
900 Supersport/Superlight	91-97	F
900 Supersport CR USA	98	F
900 Supersport FE	98	F
900 Monster	93-99	F
900 Monster Cromo/Special	98	F
900 Monster City/City Dark	99	F
907 IE	90-93	F
916 SPS (996cc)	97-98	F
916 Biposto	94-98	F
916 Senna	94-98	F
916 SP	94-96	F

### FANTIC

TZ 125 SM Caballero Motard (2T)	11-12	F
TZ 125 MR (2T) Motard Competizione	13	F

### GAS GAS

SM 125/250/400 FSE	02	F
SM 125/250 (2T)	01-06	F
SM 125 (2T) Supermotard	03-06	F
SM Halley 125cc	09	F
SM 400 FSE (2T)	01-04	F
SM 450 FSR (4T) Supermotard	07-09	F
SM 515 FSR (4T) Supermotard	07-09	F

### GILERA

Saturno 350 Bialbero	90-	F
Saturno 500 S/Bialbero/Piuma	90-	F

### HONDA

CBR 900 'Evolution Blade'	99	F
---------------------------	----	---

### HUSQVARNA

SM 400 R	02	F
SM 450 R	03-06	F
SM 510 R	05	F
SM 570 R	01-04	F
SMR 630	06	F

# FA095 / FA095/2 Contd.

## INDIAN

See application pages for details

## KTM

Sting 125	97-99	F
Duke 400 LC4	94-98	F
Duke 620 LC4	94-98	F
Duke-E 640 (Single pin pad fixing/zero offset disc)	98	F
SMC 660 Supermoto	03-04	F

## LAVERDA

650 All models	94-95	F
668 All models	96-98	F
750 All models	98-01	F

## MONDIAL

Piega 1000	02	F
------------	----	---

## MOTO GUZZI

1000 Daytona	92-95	F
1000 Daytona RS	97-98	F
1000 V10 Centauro GT	97-99	F
1000 V10 Centauro Sport	97-99	F
Sport V11	98-99	F
California 1100 EV (Single pad pin fixing)	97-00	F
California 1100 Jackal (Single pin pad fixing)	99-01	F
California 1100 Special (Single pin pad fixing)	99-00	F
1100 California EV (Up to KD115426/ Single pin pad fixing)	97-00	F
1100 California Jackal (Up to KD152328 Single pin pad fixing)	94-01	F
1100 California Special (Up to KD131644/ single pin pad fixing)	99-00	F
1100 Sport Carbs	94-96	F
1100 Sport EFi	96-99	F
1100 Sport Corsa	98-99	F

## MZ/MUZ

Skorpion/Tour/Sport/Traveller/Cup	95-02	F
Mastiff -17" front wheel/cast wheel	99-05	F

## OMP

4 Piston		F&R
----------	--	-----

## PGO

G Max 125	06-08	F
G Max 125 (Wave disc)	09-12	F
G Max 250	06-08	F

## REVTECH

CCI Polished Caliper (Front/Rear)

## TM

SMR 125	05-13	F
SM 250	02	F
SME 250 (4T)	04-	F
SMM 250 (2T)	05-13	F
SMR 250 (2T)	05-13	F
SMM 300 (2T)	05-13	F
SMR 300 (2T)	05-13	F
SME 400 (4T)	04	F
SM 400	02-03	F

SMR 450/530 FAE	05	F
SMR 450 FES	05-09	F
EN 530 F-ES	03-04	F
SM 530	02-03	F
SME 530 (4T)	04	F
SMR 530 FES	05-09	F
530 (4T) Cross	02-03	F
SMR 125/250/250 (4T)/300	06	R
SMX 660 F	04	F

## YAMAHA

TZR 125 R Brembo Caliper (4DL1/4DL2)	91-93	F
TZR 125 RR	96-	F
SZR 660	96-97	F

## SACHS

XTC 125 Supersport	00-07	F
X Road 125	06-07	F
Roadster 650	05	F
Roadster 800	01-05	F
B-805	03-04	F

## VOR

SM-E 450/530	03-04	F
--------------	-------	---

## VOXAN

Cyclope 1000	02	F
Cafe Racer 1000	02-05	F
Roadster 1000	02-05	F
Street Scrambler	03-05	F

## WILWOOD

GP300/310 (Part # 150-8733-2)

## FA095/2

## WILWOOD

GP320 (Part # 154-8596K)

### Equivalent OE #

4SU F5811 00	573 V3 030 000	GU30654600
613 4 004 24	90210 55000	GU30654602
613 4 009 1A	BE250122065SM	107 A486 53
613 4 0041 A	800094411	211021021
8113585	211041010	211082009
8000 78331	27 69173	07009R
047 00 2000036	800078331	

### Competitor X Ref

Dunlop	Ferodo	SBS	Vesrah
DP614	FR 408	566	VD-945

MATERIAL AVAILABILITY AND PART NO.					
STD	OPTIONS				
FA	V	HH	R	MXS	EPFA
FA095	FA095V	FA095HH	-	-	EPFA095HH

MATERIAL AVAILABILITY AND PART NO.					
STD	OPTIONS				
FA	V	HH	R	MXS	EPFA
FA095/2	-	-	-	-	-

# FA098 43.5 x 64.5 x 6.5mm

### Equivalents OE #

323 628
400 07 6340

### Competitor X Ref

Dunlop	Ferodo	SBS	Vesrah
-	FDB696	606	VD930

MATERIAL AVAILABILITY AND PART NO.				
STD	OPTIONS			
FA	HH	R	MXS	EPFA
FA098	-	-	-	-



# FA099 31.5 x 52 x 5.5mm

### Competitor X Ref

Dunlop	Ferodo	SBS	Vesrah
DP602	FDB436	595/132	VD-932

### Equivalents OE #

266 07 6340
510 362 4 282
464143
11933400

MATERIAL AVAILABILITY AND PART NO.				
STD	OPTIONS			
FA	HH	R	MXS	EPFA
FA099	-	FA099R	-	-



### APRILIA

TRX 240 M 89 F&R

### BENELLI

Devil 50 92- R  
Spring 50 93- R  
Devil 80 92- R

### BETA

TR 32/33 125 86-87 F  
TR 33 240 86 F  
TR 34 260 89-91 F  
TR 34 86-88 F

### CIMATTI

Gringo 85- F

### FANTIC

50.1 Oasis Kick 87- F  
50.1 Trial 86- F  
50.1 Trial H 20 87- F  
Trial 125/2 F&R  
201/301 Monoshock 86 F  
243 Trial 87- F&R  
303 Monoshock 87 F&R

### GARELLI

50 Tiger XLE 86- R

### GILERA

Eaglet 50 96 F  
BUILT 50 90- F  
503 50cc 91- F&R

### MALAGUTI

Phantom F12 94-98 F  
Crosser CR1 97 F  
50 Enduro RCX-W/Sahib 83- F  
50 Fifty Full/CX 83- F  
50 RGT Strada 83- F  
50 Enduro Dune 87- F&R  
50 Fifty Top 85- F  
50 RGT Sport 85- F  
50 RST Sport 87- F&R  
50 Evolution 91- F  
50 Raid 91- F

# FA100 39 x 9mm

### LAMBRETTA

175 TV II F

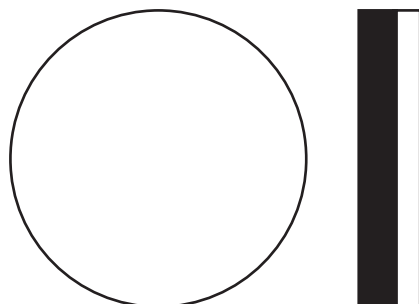

### Equivalents OE #

14744200
----------

### Competitor X Ref

Dunlop	Ferodo	SBS	Vesrah
-	-	-	-

MATERIAL AVAILABILITY AND PART NO.				
STD	OPTIONS			
FA	HH	R	MXS	EPFA
FA100	-	-	-	-

# FA101 71 x 36 x 9.2mm

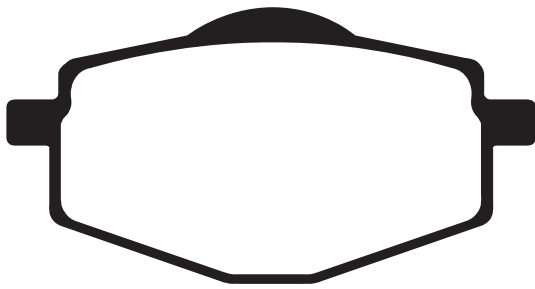

## BETA

Euro 350 03-06 R  
Jonathan 350 03-06 R

## CCM

XTR 250 09 R

## CF MOTO

CF 125 T-21A E-Charm 10-11 R  
CF 150 T-Si 10-11 R  
CF 250 T-5 V5 Custom 11-12 R

## GARELLI

XO 125i (TM 125 T) 09-12 R  
XO 150i (TM 150 T) 09-12 R  
XO 200i (TM 200 T) 10-12 R  
XO'E Electric 12 R

## HERO HONDA

Quickster 125 06 F

## HONDA HM (Italy)

CRE 50 Six/Baja/Derapage 95-02 R

## LINHAI

Eggy 125cc (Scooter) 07-09 F  
LH50 Police (Scooter) 07-09 F

## MALAGUTI

Blog 125 ie 09-11 R  
Centro 125 ie/SL 07-11 R  
Blog 160 ie 09-11 R  
Centro 160 ie/SL 07-11 R

## MBK

TZR 50 X-Power 00 R  
XC 125 Flame 125 96-03 F  
XC 150 Vertex 97 F

## MZ

660 SSR 95 R

## YAMAHA

TZR 50 'Thunderkid' (5DU1/3) 97-00 R  
YSR 50 T 87 F  
DT 80 LC-2 (53V) 85-92 F  
DT 125 LC 86-87 F  
DT 125 R 88-03 F&R  
DT 125 RE 04 F&R  
DT 125 RE 05-07 F  
TDR 125 (4GW/GX 1/2/3/4) 93-03 R  
YBR 125 ED (3D91) 05-06 F  
YZ 125 U 88 R  
XC 125 TR "Cygnus" 96-03 F  
DT 200 (2LR) 87 F  
XT 225 (2LN) Serrow (1KH 020101-) 86-87 F  
XT 225 (3RW1-5 Serrow) (1KH 034101-132000) 89-93 F

## YAMAHA Contd.

XT 225 W (4JG1/2/3/4) Serrow 93-96 F  
XT 225 (4VW1/3/5/7/9) (4VWA/B/D/G/J/L) (Brasil) 97-06 F  
YZ 250 U 88 R  
YTZ 250 N/S "TRI-Z" 85-86 F&R  
YFZ 350 T/U/W 87-89 F  
XT 350 85-95 F  
TT 600 N (59X) Frame #59X000101-59X007852 85-88 F  
XT 600 87 R  
XT 600 Z "Tenere" 88-90 R  
XT 600 E 92-03 R  
XTZ 660 E "Tenere" 91-98 R

## GILERA

125 Apache 91- R  
RC 125 Top Rally 89-92 R  
Oregon 250 Quad 07 F  
RC 600 89-90 R

## ITALJET

Millennium 100/125/150 00-01 F

## NIPPONIA

Miro 100 (4T) F  
Miro 125 (4T) F  
Miro 130 (4T) F

## SACHS

Bee 50 08-10 F  
Bee 125 08-09 F  
Roadster 650 05 R

## SIAMOTO

KD 125 00-04 F

## SINNIS

Sublime 125 09-10 F

## W.K. BIKES

WK 125 C (4T) (16" wheel) 10-13 R

### Equivalents OE #

1UY W0045 00	34X W0046 02	3JH W0045 00
1UY W0045 01	38W W0045 00	3UH W0045 00
1UY W0045 02	38W W0045 01	344 840
1UY W0045 03	3BN W0045 00	48 7100 7
2VN W0046 00	3BN W0045 01	4KL F5811 00
2VN W0046 01	3FY W0045 00	KA3495506
34X W0046 00	3XP W0045 00	11969900
34X W0046 01	3XP W0046 00	605 08 02 50

### Competitor X Ref

Dunlop	Ferodo	SBS	Vesrah
DP406	FDB383	575/619/107	VD-239

### MATERIAL AVAILABILITY AND PART NO.

STD	OPTIONS							
FA	SFA	SFAC	TT	SFA-HH	HH	R	MXS	EPFA
FA101	SFA101	SFAC101	FA101TT	SFA101HH	-	FA101R	MXS101	-



# FA102 58 x 48 x 8.7mm

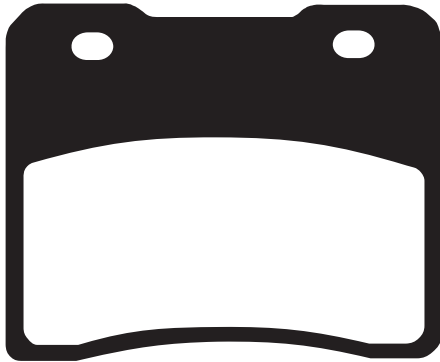

## SUZUKI

RG 250 WE/FG/CH/FCH/FH 'Gamma' 84-88 F  
GSX 400 R2 (GK71B) F

### Equivalents OE #

59130 04A00	59100 04830
59130 04A10	

### Competitor X Ref

Dunlop	Ferodo	SBS	Vesrah
-	FDB390	578	VD-328

MATERIAL AVAILABILITY AND PART NO.					
STD	OPTIONS				
FA	HH	R	MXS	EPFA	
FA102	-	-	-	-	

# FA103 58 x 53.5 x 8.7mm

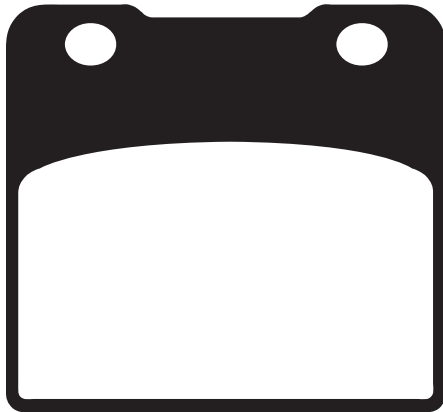

## SUZUKI

GSX 250 R CH/H (GJ72A) F  
GSXR 250 J (GJ72A) F  
GSXR 250 CK F  
GSXR 400 H 87 F  
GSX 400 X/XA/XS "Impulse" F  
GSX 400 R3 (GK71F) F  
RG 400 F  
RG 400 EWF/EW-2G/EWH Walter Wolf (Type 1&2) 85-87 F  
VS 400 VR/FR/VTR/FTR/V-T/F-T 94- F  
RG 500 G/CH 85-87 F  
VS 600 GLS/GLT/GLV 95-97 F  
VS 700 GLEFG/GLEPG/GLEFH/GLEPH 86-87 F  
VS 700 GLFH/GLPH/GLFG/GLPG 86-87 F  
GSXR 750 F/G/H 85-87 F  
VS 750 All models 85-91 F  
VS 800 GLN/GLP/GLR/GLT/GLS/GLV/GLW/GLX 92-99 F  
GSX 1100 EFE/EFF/ESF 84-86 F&R  
GSX 1100 FJ/FK/FL/FM/FN/FP/FR 88-94 F  
GSXR 1100 G/H/J 86-88 F  
GV 1400 GDG/GTG Cavalcade 86 F&R  
VS 1400 GLPH/GLFH/GLPJ/GLFJ/GLPR/GLPT  
/GLPV/GLPW/GLPX/GLPY/GLPK1  
/GLPK2 Intruder 87-03 F&R  
VL 1500 W/X/Y/K1 98-01 F&R

### Equivalents OE #

59100 10810	59130 06B20	69100 38840
59100 20810	59130 00810	69100 38860
59100 20820	59130 24A00	69100 38870
59100 30810	59130 27A00	69100 48810
59100 06820	59130 27A10	69130 38B10
59100 30820	59130 30B00	69130 38B00
59100 38820	59130 30B01	69130 48B00
59130 00A00	59130 30B21	69130 38820
59130 00A10	69100 38810	69130 48810
59130 06B10	69100 38820	

### Competitor X Ref

Dunlop	Ferodo	SBS	Vesrah
DP210	FDB389/R	577	VD-330/ 331/338

MATERIAL AVAILABILITY AND PART NO.					
STD	OPTIONS				
FA	V	HH	R	MXS	EPFA
FA103	FA103V	FA103HH	-	-	-

# FA104 68 x 56.2 x 8.8mm

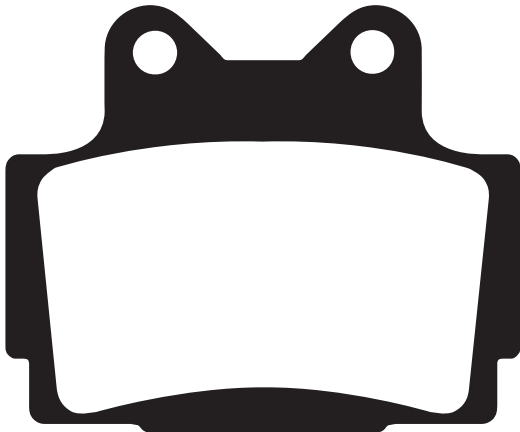

## YAMAHA

RD 125 LC (MK 2-3)	85-87	F
RZ 125 (1GV 030101-)	85	F
TZR 125	87-89	F
TZR 125	90-92	R
TZR 125 R	93-	R
TZR 150 R (4AP2)	00	R
SDR 200 (2TV)	87-89	F&R
FZR 250 R		R
FZR 250	87	R
FZX 250 Zeal (3YX1/2/4)	91-92	R
RZ 250 R (1AR/1XG)		F&R
RZ 250 R (29L)		R
RZ 250 RR (51L)		F&R
R1-Z (250CC/3XC)	90-92	R
SRX 250		F
TDR 250 (3CK1/3CK2 Europe)		
(Eng Frame # 3CK-)	88-92	R
TZR 250 (2MA/2XW1/2XW2 Europe)		
(Eng Frame # 2MA-)	87-92	R
TZR 250 (1KT/2AW Japan)		
(Eng Frame # 1KT-000/056)	87	R
TZR 250 (2XT1 Japan)		
(Eng Frame 1KT-09)	88	R
TZR 250 (3MA1 - Reverse Cylinders)		
(Eng Frame # 3MA-0001)	89	R
TZR 250 (3MA3/3MA5)		
(Eng Frame # 3MA-046/058)	90	R
TZR 250 SP (3MA4)		
(Eng Frame # 3MA055)	90	R
TZR 250 R (3XV1/3X4/3XV6) V-Twin		
(Eng Frame # 3XV000101-08600)	91-93	R
TZR 250 RS (3XV8/3XV9/3XVA) V-Twin		
(Eng Frame # 3XV080101		
/08200 088-)	92-94	R
TZR 250 SPR (3XVC) V-Twin		
(Eng Frame # 3XV 107101-)	95	R
RD 350 N	85	F&R
RD 350 F/F2	85-92	F&R
RD 350 R	92-95	F&R
FZ 400 (4YR1)	96	R
FZ 400 N (IFK 146X 133M)	85	R
FZR 400 RR (4DX)	92	R
FZR 400 (3TJ1/2/6/7)		R
FZR 400 Genesis (1WG)	86	R
FZR 400 RSP (2TK EX-UP)	87	R
FZR 400 (3EN1/2)	88-89	R
SRX 400 (1JL)	85	R
SRX 400 (3VN1/3VN2/3VN5)	90-96	R
XJR 400 (4HM1/4HM2/4HM4/4HM7)	93-96	R
XJR 400 (4HM3/4HM5/4HM6/4HM9		
/4HMA/4HMB) Brembo caliper	95-99	R
RD 500 LC	84-86	R
RZV 500 R(SIX)	85	R
FZ 600	87-88	R
FZS 600 Fazer	98-03	R
SRX 600	86-87	F&R
SRX 600 (1JK)	85	F&R
SRX 600 (3SX)	90-91	R
XJ 600 N	95-03	R
XJ 600 S "Diversion"	92-03	R

### Equivalents OE #

1KT W0046 50	1KT W0046 52	51L W0046 00	51L W0046 02
1KT W0046 51	3TJ W0046 00	51L W0046 01	4AP W0046 00

### Competitor X Ref

Dunlop	Ferodo	SBS	Vesrah
DP407	FDB386/R	570	VD-240

### MATERIAL AVAILABILITY AND PART NO.

STD	OPTIONS				
FA	V	HH	R	MXS	EPFA
FA104	FA104V	FA104HH	-	-	-

# FA105 91 x 30.4 x 8mm



## YAMAHA

YZ 125 N/S/T/U	85-88	F
TT 250	90	F
YZ 250 N/S/T/U	85-88	F
TT 350 (ITJ)	85-89	F
TT 350 A (3GJ)	90-95	F
YZ 490 N/S/T/U	85-88	F
TT 600 W (2JT/3SW1)		
(Frame # 59X007853-)	89-92	F

### Equivalents OE #

56A W0046 00	2HH W0045 00
1LN W0045 01	2HH W0045 01
1LX W0045 00	

### Competitor X Ref

Dunlop	Ferodo	SBS	Vesrah
DP405	FDB411	580	VD-241

### MATERIAL AVAILABILITY AND PART NO.

STD	OPTIONS			
FA	HH	R	MXS	EPFA
FA105TT	-	FA105R	-	-

# FA106 77 x 54 x 7mm

# FA106/2 77 x 54 x 9.5mm

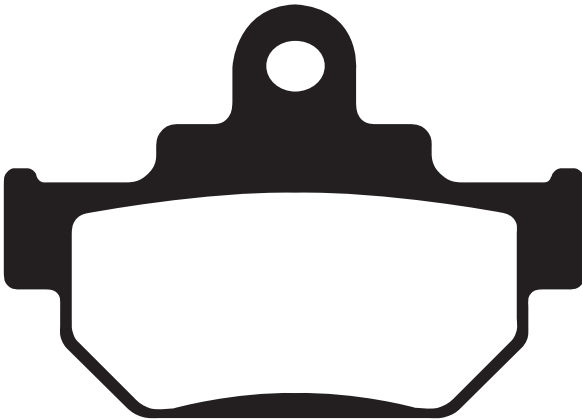

### SUZUKI

GZ 125 W/X/Y/K1-K9 'Marauder'	98-10	F
RM 125/250 F/G	85-86	F
TU 125 X Super Classic	99	F
VL 125 Y/K1/K2/K3/K4/K5/K6/K7 Intruder	00-08	F
GZ 250 K2-K8 Marauder	02-08	F
GZ 250 X/Y/K1	99-01	F
TU 250 XV/XW	97-00	F
TU 250 S/T/XS/XT/X-ST/XSV		
/XT-W (NJ47A 10001-115972)	92-97	F
VL 250 Y/K1/K5/K6/K7 Intruder	00-01/05-07	F
LS 650 "Savage" FG/PK/PM/PR/PG/PT/PV/PW/PX	87-99	F

### SIAMOTO

Geco 250	04	F
----------	----	---

### MAICO

All Models	86-88	F&R
------------	-------	-----

### FA106/2 - SUZUKI

DR 600 RG/RH/RJ (SN41A) (Rear drum model)	86-88	F
DR 600 RK (SN41A) (Rear disc model)	89	F
DR 600 SF/SG/SH/SJ/SK (SN41A)	85-89	F

### Competitor X Ref

Dunlop	Ferodo	SBS	Vesrah
DP405	FDB404/673	581/582	VD-329/ 329/2

### Equivalents OE #- FA106

59300 24830
59340 14600
59340 24B00
59340 24B10

MATERIAL AVAILABILITY AND PART NO.					
STD	OPTIONS				
FA	V	HH	R	MXS	EPFA
FA106TT	FA106V	-	FA106R	-	-

### Equivalents OE #- FA106/2

59300 14830
59340 14500
59340 14501
59340 14510

MATERIAL AVAILABILITY AND PART NO.				
STD	OPTIONS			
FA	HH	R	MXS	EPFA
FA106/2TT	-	FA106/2R	-	-

# FA107A 82 x 54 x 8mm

# FA107/2A 82 x 54 x 7mm

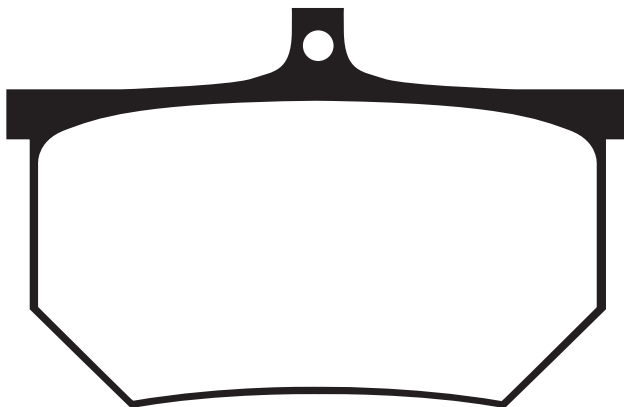

### FA107A - AP/LOCKHEED

4 Piston Caliper (CP3086/CP3369/CP4484 D27)

### SPONDON

4 Piston Caliper

### FA107/2A - AP/LOCKHEED

4 Piston Caliper (CP4485/CP4679)

### SPONDON

4 Piston Caliper

### Competitor X Ref

Dunlop	Ferodo	SBS	Vesrah
DP624	FRP410	661	-

MATERIAL AVAILABILITY AND PART NO.				
STD	OPTIONS			
FA	HH	R	MXS	EPFA
FA107A	-	-	-	-

MATERIAL AVAILABILITY AND PART NO.				
STD	OPTIONS			
FA	HH	R	MXS	EPFA
FA107/2A	-	-	-	-

# FA109 50 x 55 x 11.3mm

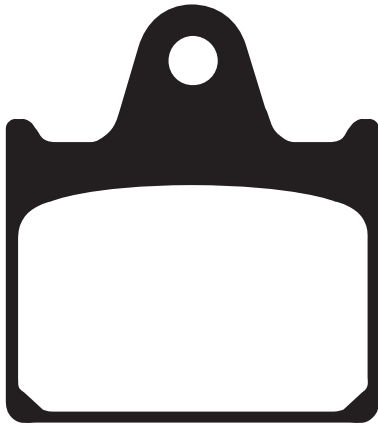

**HONDA**

VF 1000 RE/RF/RG

84-86 R

**Equivalents OE #**

43105 MJ4 007
43105 MJ4 008

**Competitor X Ref**

Dunlop	Ferodo	SBS	Vesrah
-	-	573	VD-258

MATERIAL AVAILABILITY AND PART NO.				
STD	OPTIONS			
FA	HH	R	MXS	EPFA
FA109	-	-	-	-

DISC PADS  
BUYERS GUIDE

# FA110 52.5 x 44.5 x 7.2mm

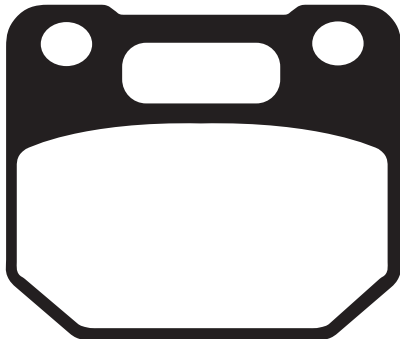

**Equivalents OE #**

59100 36850
59130 36A00
59130 36A01

**Competitor X Ref**

Dunlop	Ferodo	SBS	Vesrah
-	FDB437	587	VD-335

**SUZUKI**

RG 125 CG/CH/J (NF12A) Gamma/  
Rear drum brake model 86-90 F  
RG 125 UCG/UCH/UJ/UAJ/BUJ (NF12B)  
Gamma/Rear drum model 86-90 F

MATERIAL AVAILABILITY AND PART NO.				
STD	OPTIONS			
FA	HH	R	MXS	EPFA
FA110	-	-	-	-

# FA111 64 x 57 x 9mm

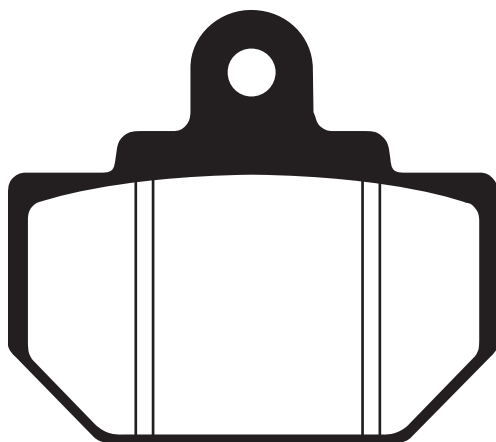

**HONDA**

FL 350 R Odyssey 85-87 R  
FL 400 R/RK/RL "Pilot" 89-93 R

**Equivalents OE #**

43105 HE0 305	431A0 HE0 670
43105 VM0 008	431A0 VM0 008
43105 VM0 771	

**Competitor X Ref**

Dunlop	Ferodo	SBS	Vesrah
DP813	-	610	VD-931

MATERIAL AVAILABILITY AND PART NO.				
STD	OPTIONS			
FA	HH	R	MXS	EPFA
FA111	-	FA111R	-	-

# FA113 78.7 x 47 x 7.4mm

# USE FA256





# FA115 Contd.

## JAYBRAKE

Dual 7 Quad (300-04) (2 & 4 Piston)

## JCM

240 Europa 89 F

## KTM

60 SX 98-00 F

65 SX 00-01 F

## LEM

Four X Pro R

## MALAGUTI

NDK 50 Drakon 05-09 R

XTM 50 03-11 F&R

XSM 50 03-11 R

Drakon S 06 R

X3M Enduro (Cast wheel) 08-10 R

X3M Motard (Cast wheels) 08-10 R

## MBK

TZR 50 X Power 03-09 R

## MH/MOTORHISPANIA

Furia Max Supermoto 07-10 F&R

Furia Max Enduro 50 06-10 F&R

RYZ 50 Enduro 06-10 F&R

RYZ 50 Pro Racing Enduro 06-10 R

RYZ 50 Pro Racing Supermotard 06-10 R

RYZ 50 Pro Racing Urban Bike 06-10 R

RYZ 50 Supermotard 06-10 R

RYZ 50 Urban Bike 06-10 R

RX 50 Super Racing 06-07 R

Duna 125 Hard Road Enduro 08-12 R

Duna 125 Dual Plus Trail 08-10 R

## MONTESA

Cota 307/335 88 F&R

311 (Honda) 92-93 F

314 R (Honda) 94-96 F

315 R (Honda) 97-00 F

## MOTO ROMA

SMX 125 04-06 R

## SUZUKI

RMX 50 F&R

AY 50 WRX/WX/WRY/WY

/WRK1-WRK4 "Katana" 99-04 R

AY 50 WRK1/WRK2/K3/WRK3

/WRK4/AK5 (AJP Caliper) 01-05 F

UF 50 Y "Estilite" 00-02 F

## PERFORMANCE MACHINE

125 X 2

125 X 4S

125 X 4SL

## PEUGEOT (AJP CALIPER)

Blaster RS12 50 (2T) 10-11 F

Blaster Ice Blade 50 (2T/12" wheels) 10-12 F&R

Elyseo 50 98-02 F

Elyseo 50 03 F&R

Elystar 50 TSDi 02-07 F

Elystar 50 Advantage 02-07 F&R

Jet C Tech 50 11-12 F&R

Jet Darkside 50 (2T) 11-13 F&R

Jet Force 50 H2i (2T/Air Cooled) 11-12 F

Jet Iceblade 50 (2T) 11-13 F&R

Jet H2i 50 (L/C) 11-12 F&R

Looxor 50 01-06 F

Ludix Blaster (10" wheels) 05-09 F

Ludix 2 Trend 50cc (2T) 07-11 F

Ludix Snake 50cc 04-09 F

Ludix Bullet 50cc 04 F

Ludix Trend 50cc 04-07 F

Ludix Elegance 50cc

Ludix Pro (14" wheels/4T)

(AJP caliper) 11-13 F

Speedfight 50 1/2 97-08 F&R

TRK 50 (2T) (10" wheels) 09-12 F

TRK2 WRC 50 (2T) 04-06 F

Trekker 50 (2T) AJP Caliper 98-00 F

TRK 50 (2T/12" wheels) 09-12 F

Vivacity 50 (12" wheels/190mm

disc) (AJP Caliper) 92-07 F

Vivacity 2 (50cc) AJP Caliper

(10" wheels/190mm disc) 08-11 F

XP6 Track 03-08 F&R

XR6 (2T) 50 03-07 R

XPS 50 Track (21" front wheel) 11-12 R

XPS 50 Top Road (17" front wheel) 10-12 R

Elyseo 100 98-02 F

Speedfight 100 1/2 97-09 F&R

Trekker 100 (2T) 98 F

Elyseo 125/150 98-02 F

Ludix Ambition 125cc 04 F

Squab F

Vivacity 50/100 (All models) 99-07 F

LOOXOR 100 01-04 F&R

Metal X 50 02-03 F

Elyseo 100 03 F&R

LOOXOR 125/150 03-06 R

Elystar 50 TSDI 02-05 F

Jet Force 50/Jet-C 03-10 F&R

Ludix Urban Track 06-07 F

Ludix Red Zone 06 F

Ludix Acid 06 F

Looxor 50 TSDI (Rear disc) 06 F&R

XPS 125 CT 05-07 F&R

Ludix Blaster 05-09 F

XP 125 Street Evo 2 05 R

XP6 Enduro/Top Road 21" front wheel 03-10 F&R

XPS Enduro 03-09 F&R

XP6 Supermoto (17" front wheel

/240mm disc) 03-09 F&R

XPS Supermoto (17" front wheel

/260mm disc) 03-10 R

XPS Street (17" front wheel

/280mm disc) 03-09 R

## PIAGGIO

Diesis 50 01-05 F

Diesis 100 01-03 F

## RIEJU

MRX 50 03-08 F&R

NKD 50 07 R

RS1 50cc 97-00 F&R

RS2 NKD 05 R

RR 50 cc Thunderfire 97-02 F&R

RR 50 Castrol 00-02 R

RR 50 Sport 03-06 F&R

RRX 50 Spike (17" wheel

/spoke wheel) 03-08 F&R

RRX 50 Spike (17" cast wheel) 06-09 F&R

RS2 50cc Pro 06-10 R

MRX 50 Pro 04-08 R

Spike 50 04-06 F&R

Spike 50 Pro 04 R

SMX 50 Pro Supermotard/Top 04-07 R

RS1 50cc 01-04 R

SMX 50 02-06 F&R

SMX 50 Pro Street 06-08 R

SMX 50 (Cast wheel) 07-08 F&R

04-09 F

MRX 50 Castrol/SMX 50

RRX 50 01-02 R

RRX 50 06-09 F&R

Spike X50 06-08 F&R

Tango 50 06-07 F&R

Tango 50 (Spoke wheel) 07-12 R

Tango 50 Motard 11 R

Tango 50 Motard (Cast wheel) 09-10 R

Tango 50 (4T) 11 R

RS2 125 07-08 R

125 NKD 06-10 R

SMX 125 06-07 R

MRX 125 02-08 R

Tango Pro 125 07-10 R

Tango 125 06-12 R

RS2 Matrix 02-08 R

Tango 250 08-13 R

**ROXON**

Duel 50 SM 06 F&R

Duel 50 TT 06 F&R

**SACHS**

Madass 50 (2 stroke) (Hydraulic

rear brake) 04-05 R

**SCORPA**

250 Easy 96 F&R

TY-S 125 F Enduro 03-05 F&R

TYS 125 F 06-08 F

TY-S 175 F 06 F

**SHERCO**

All models 0.5-2.0 01-05 F

All models 1.2-2.0 01-05 R

SM 50 Supermotard 03-07 R

SE 0.5 11 R

SM 0.5 11 R

Supermotard 50cc (2T) 02-07 R

Enduro 50 (EN 50) 03-07 R

Enduro 50cc (2T) 02-07 R

SE 1.25 F 11 R

SM 1.25 F Black Panther 11 R

SM 125/125 City Corp 03-06 R

City Corp 125 (All models) 03-07 R

0.8 01-05 F

Trials 0.8 (2T) 01-04 F

Trials 1.25 (2T) 99-05 F&R

Trials 2.0 (2T) 99-05 F&R

Trials 2.5 (2T) 99-05 F&R

Trials 2.9 (2T) 99-05 F&R

**SIAMOTO**

SX1 125 04 R

**TOMOS**

Alpino (Front Disc) F

APN6 F

Fantastic 25 F

Hip Hop F

Racing F

Revival TS F

SM 125 F 05-08 R

SE 125 F 05-08 R

Youngstr 50 05-08 F

**WK**

SM 50 11-12 F&R

**YAMAHA**

TZR 50 (5WX1) 03-08 R

TY 250 R 91-92 F

TY 250 R 93-94 F&R

TYZ 250 R 93-96 F&R

## Competitor X Ref

Dunopad	Ferodo	SBS	Vesrah
DP607	FRP405	559/105 /188	VD-254/ 925

## Equivalents OE #

3380925	752816	812732	P150442	R051	K00996315
3380928	753092	2525241000	2525350000	460 13 016 000	00H01303551
3499074	753200	2525350000	2525241000	00009300060	R051
8113181	757215	00G04700141	59300 06E00	0009307001	11966900
510 015 4 282	59330 06E00	00H01301931	KA3497506	EJ29099074	61340051A
4AJ W0045 00	45105 NN2 900	00D01210221	K00996315	11955600	R235000
737786	0DN00G04700141	213307100003	5WX W0045 10	21330710000019	GA121001T

## MATERIAL AVAILABILITY AND PART NO.

STD	OPTIONS								
FA	V	SFA	SFAC	TT	SFA-HH	HH	R	MXS	EPFA
FA115	FA115V	SFA115	SFAC115	FA115TT	SFA115HH	FA115HH	FA115R	MXS115	-

# FA116 31.5 x 57.2 x 5.5mm

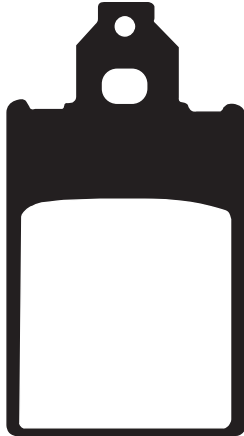

### Competitor X Ref

Dunlop	Ferodo	SBS	Vesrah
DP610	FDB697	607/106/109	VD-937

### Equivalents OE #

119 363 00	119 468 000	8213145
5BK F5811 00	119 419 000	07010R
821 3145	752817	
498840	2525250000	

### ACCOSSATO

CE 50/80/KR 80 87- R  
Enduro Codice 50 89- R

### APRILIA

Classic 50 92-01 F  
AF1 Futura 50 90-92 F  
Europa 50 90-92 F

### BETA

TR34 86-88 R  
TR34 125 86- R  
Tempo 16" 94-97 F  
Tempo 98 F  
RK6 93-96 R

### CAGIVA

W4 50 91-95 F

### FANTIC

50.1 Oasis 86- F  
50.1 Oasis KS/Rally 86- F  
50.1 Oasis E.S. 87- F  
50 Fast 88- F

### GARELLI

Sahel 50 91- F  
Sahel 80 91- F

### MALAGUTI

50 Enduro MLX 87- F  
Yesterday 98-03 F  
F15 Firefox 96-00 F  
Centro SL/SL Cat 94-00 F  
CRI Crosser 95-98 F  
Centro Base F  
F12 Phantom 50 94-03 F

### OMP

6 Piston Sprocket Brake

### PEUGEOT

SV 100 L F

### PIAGGIO

Free 50 (Disc Model) 95-00 F  
Free Delivery 50 00-01 F

### TOMOS

Streetmate 03-04 F  
Streetmate R F  
Revival/Revival TS 03-04 F

### YAMAHA

DT 50 R 97-01 F  
DR 50 R-L (SM-5VB1/VG55BK) 02-03 F

### MATERIAL AVAILABILITY AND PART NO.

STD	OPTIONS				
FA	SFA	HH	R	MXS	EPFA
FA116	SFA116	-	-	-	-

# FA118 71 x 38.8 x 10mm



### ALFER

VRE 125 4T 98- F  
Divertida 250 Super Motard 01- F  
Diferente Enduro 01- F  
VR 250 98- F

### YAMAHA

XT 600 87 F  
XT 600 (Z Tenere) 85-90 F

### Equivalents OE #

55W W0045 00
55W W0045 01

### Competitor X Ref

Dunlop	Ferodo	SBS	Vesrah
-	FDB583	596	VD-245

### MATERIAL AVAILABILITY AND PART NO.

STD	OPTIONS			
FA	HH	R	MXS	EPFA
FA118	-	-	-	-

# FA119 82.6 x 21.8 x 7.1mm

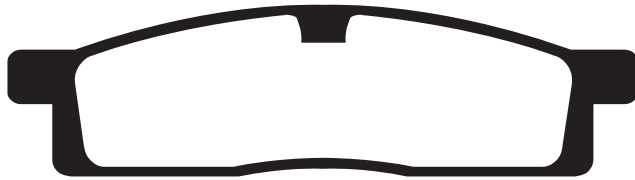

### Equivalents OE #

1LR W0046 00	3UN W0045 00
2HF W0046 00	4ES W0045 00
2HF W0046 02	4P1 W0045 00

### YAMAHA

DT 50 LC	98-	F
YZ 80 S/T/U/W/E/F/LWF/LWG/G/LWH/H/LWJ /J/LWK/K/L/LWL/LWM/M/N/LWN	86-01	F
YZ 85 P/LWP/R/LWR/S/LWS/T/LWT/V/LWV /LWW/W/LWX/X/LWY/Z/LWZ/LWA/LWB/LWD	02-12	F
TT-R 125 LWM/LWN/LWP/LWR/LWES/LWS/LWET /LWT/LV/LEV/LEW/LEX/LEY/LWEZ/LWEA/LWED	00-12	F

### Competitor X Ref

Dunlop	Ferodo	SBS	Vesrah
DP408	FDB453	589/136	VD-244

### MATERIAL AVAILABILITY AND PART NO.

STD	OPTIONS			
FA	HH	R	MXS	EPFA
FA119TT	-	FA119R	-	-

# FA120 119.8 x 52 x 8mm

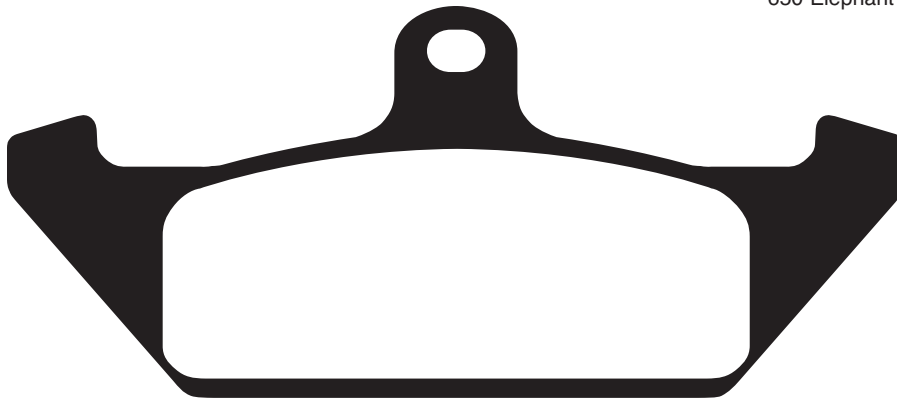

### CAGIVA

Elefant 650	85	F
650 Elephant	88-89	F

### Equivalents OE #

8000 45453
------------

### Competitor X Ref

Dunlop	Ferodo	SBS	Vesrah
-	FDB592	594	VD-924

### MATERIAL AVAILABILITY AND PART NO.

STD	OPTIONS			
FA	HH	R	MXS	EPFA
FA120	-	-	-	-

# FA121 81.2 x 42 x 8mm

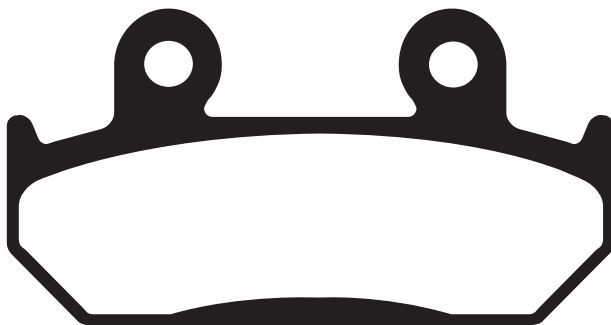

### HONDA

CBR 250 FG/FGYA (MC14)	86	F
CBR 250 RH (MC17)	87	F
NSR 250 RG (MC16-100)	86	F
CB 350 SG/SJ	86-90	F
CBR 400 RG (NC23)	86	F
CBR 400 RHYA (NC23)	87	F
CB 450 SG/SJ	86-88	F
CBR 500 FH/FJ/FK/FL	87-90	F
CBR 600 FH/FJ/FK/FL	87-90	F
VFR 400 ZG/ZH/RG/RG-YA (NC21)	85-87	F
VFR 400 RH2/RJ (NC24)	87-88	F
XRV 750 L/M/N 'Africa Twin'	90-93	F

## SAME AS FA203 EXCEPT REDUCED THICKNESS

### Equivalents OE #

06455 ML4 P00	45105 ML4 000	45105 ML7 017
06455 ML7 P10	45105 ML4 004	45105 ML0 007
451A0 MN4 670	45105 ML4 006	45105 MN4 007
45105 KT7 751	45105 ML4 008	45105 MN4 008
45105 KT7 761	45105 ML4 014	
45105 KT8 004	45105 ML4 024	

### MATERIAL AVAILABILITY AND PART NO.

STD	OPTIONS			
FA	HH	R	MXS	EPFA
FA121	FA121HH	-	-	-

### Competitor X Ref

Dunlop	Ferodo	SBS	Vesrah
DP110	FDB462	593	VD-141/142

# FA122 55 x 52.6 x 9.4mm

**HONDA**

CB 450 DX-K

89-92 F&R

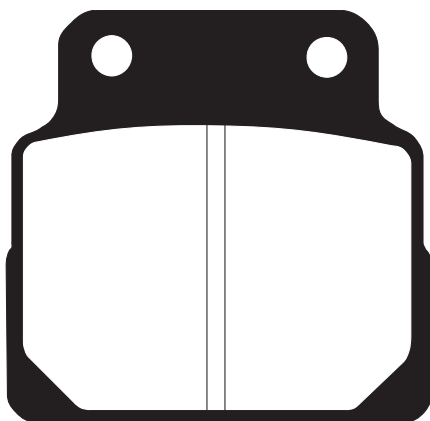

**Equivalents OE #**

43105 KK9 691

**Competitor X Ref**

Dunlop	Ferodo	SBS	Vesrah
-	-	598	VD-146

**MATERIAL AVAILABILITY AND PART NO.**

STD	OPTIONS			
	HH	R	MXS	EPFA
FA122	-	-	-	-

DISC PADS  
BUYERS GUIDE

# FA123 74.8 x 54 x 10mm

**YAMAHA**

FZR 250	87	F
TDR 250 (3CK1/3CK2 Europe) (Eng Frame # 3CK-)	88-92	F
TZR 250 (2MA/2XW1/2XW2 Europe)		
(Eng Frame # 2MA-)	87-92	F
TZR 250 (1KT/2AW Japan)		
(Eng Frame # 1KT-000/056)	87	F
TZR 250 (2XT1 Japan) (Eng Frame 1KT-09)	88	F
FZR 400 (3EN1/3EN2)	88-89	F
FZR 400 RSP (2TK-EX-UP)	87	F
SRX 400 (3VN1/3VN2/3VN5)	90-96	F
SRX 600 (3SX)	90-91	F
FZ 750	89-91	F
FZR 750 'Genesis'	87	F
TDM 850	91-95	F
TRX 850	96-99	F
FZR 1000 Genesis	87-88	F
FJ 1200 (3CV/3XW type)	88-95	F
FJ 1200 A (ABS model)	91-95	F
XJR 1200	95-98	F
XVZ 13 AH/ATH "Royal Star"		
Royal Star Classic	96-00	F&R
XVZ 1300 TF Venture Star	99-01	R
XV 1600 Wildstar	99-04	R

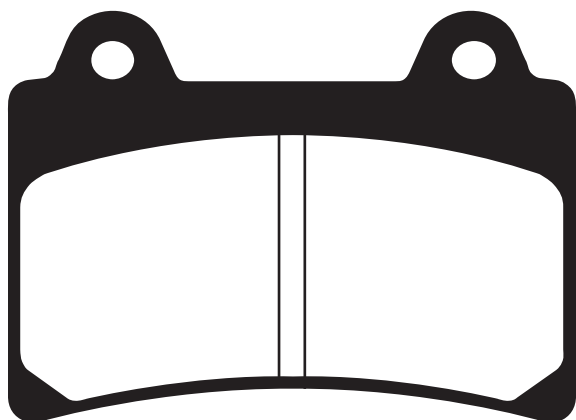

**Equivalents OE #**

1NL W0045 00	2GH W0045 01
1NL W0045 01	3EN W0045 00
1RK W0045 00	4KG W0045 00
1RK W0045 50	4NK W0046 00
1RK W0046 00	4NK W0045 00
2GH W0045 00	4WM W0046 00

**Competitor X Ref**

Dunlop	Ferodo	SBS	Vesrah
DP409	FDB662	590	VD-242/ 242/2

**MATERIAL AVAILABILITY AND PART NO.**

STD	OPTIONS				
	V	HH	R	MXS	EPFA
FA123	FA123V	FA123HH	-	-	-

# FA124 87.9 x 41.1 x 8.8mm

# FA124/2 87.9 x 41.1 x 9.8mm

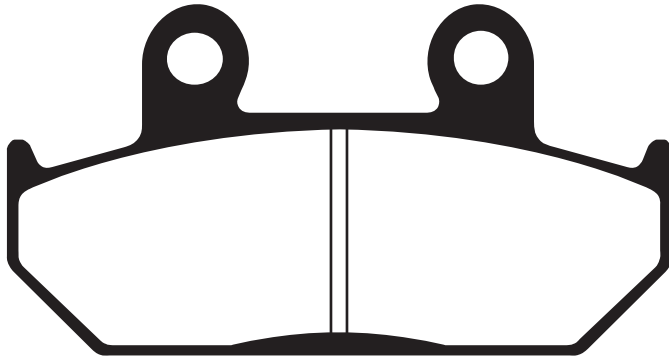

### Competitor X Ref

Dunlop	Ferodo	SBS	Vesrah
DP109/116	FDB452R/663	600	VD-143/143/2

### Equivalents OE #- FA124

45105 ML7 006	45105 NF4 000
45105 ML7 007	451A0 ML7 670
45105 MM5 007	45105 MM5 017
45105 MM5 008	06455 MM5 P00

### Equivalents OE #- FA124/2

06455 MT8 405	45105 MN5 018	45105 MT8 008
06455 MS8 405	45105 MN9 008	45106 MW3 671
06455 MV4	45105 MR1 671	451A0 MT8 670
06455 MS8 405	45105 MS6 901	451A0 MT2 670
06455 MS6 P00	45105 MS8 008	8000 66796
45105 KV0 701	45105 MT2 007	
45105 MN5 008	45105 MT2 008	

### FA124

#### HONDA

RS 125/250	88-89	F
CBR 750 FH Superaero	87-88	F
VFR 750 FG/FH	86-87	F
CBR 1000 FH/FJ	87-88	F

### FA124/2

#### CAGIVA

Canyon 500	96-00	F
Canyon 600	96-99	F
E 750 Elefant	93-95	F
E 900 Elefant Dakar Rep (300mm front disc)	90	F
E 900 ie Lucky Explorer (296mm front disc)	90	F
E 900 ie GT (296mm front disc)	91-92	F

#### HONDA

CD 250 UJ	88-92	F
GB 250 J/L/P/S/V 'Clubman'	89-97	F
VTZ 250 H/J/K	86-88	F
NV 400 C/J/CK 'Steed'	92-93	F
NX 500 J/K/L/M/N/P/R/S/T Dominator	92-96	F
XL 600 VM/VN/VP Trans Alp	91-93	F
VT 600 C/N "Shadow Custom"	93	F
NX 650 J/K/L/LII/M/N/P/R/S/T "Dominator"	88-96	F
XR 650 J Africa Twin	88-89	F
GL1500 J/K/SEM/SEN/SEP/SER/SES/SEV/SEW/SEX/SEY "Goldwing"	88-00	F

### MATERIAL AVAILABILITY AND PART NO.

STD	OPTIONS			
FA	HH	R	MXS	EPFA
FA124	FA124HH	-	-	-

### MATERIAL AVAILABILITY AND PART NO.

STD	OPTIONS				
FA	V	HH	R	MXS	EPFA
FA124/2	FA124/2V	FA124/2HH	-	-	-

# FA125 94.2 x 32 x 7.3mm



### Competitor X Ref

Dunlop	Ferodo	SBS	Vesrah
DP814	FDB495	603/139	VD-139

### Equivalents OE #

45105 HA5 671A	45106 HA5 671B
45105 HA5 672A	45106 HA5 672B
45105 HA5 672B	45106 KS6 701A
45105 KS6 831A	45106 KS6 701B
45105 KT0 405	45106 KS6 831B
45105 KZ1 405	45106 KY7 008
45105 KW3 405	45106 KW3 681
45105 KW3 681	451A0 HB9 670
45105 KY7 008	

### ALSO SEE FA185 FOR OVERSIZE PAD

#### HONDA

CRM 50 RN/RP/RR/RT	93-96	F
CRM 75 RK/RL/RM/RP/RR	89-94	F
CR 125 RH/RJ/RK/RL/RM/RN/RP/RR	87-94	F
AX-1 (NX 250 J/K/R/R3)	89-94	F
CR 250 RH/RJ/RK/RL/RM/RN/RP/RR	87-94	F
CRM 250 R (RK) MK1/MD24 (100001-1008385)	89-90	F
CRM 250 R (RM) MK2/MD24 (1200001-1211634)	91-92	F
CRM 250 R (RP-RP-11) MK2/2 MD24 (1300001-)	93	F
NX 250 J/K/L/ZL/M/P/2P	87-93	F
TRX 250 RG/RH/RJ/RK	86-89	F
XL 250 RL	90	F
XR 250 RJ/RK/RL/RM/RN/RP/RR/RS	88-95	F
CR 500 RH/RJ/RK/RL/RM/RN/RP/RR	87-94	F
XR 600 RJ/RK/RL/RM/RN	88-92	F

### MATERIAL AVAILABILITY AND PART NO.

STD	OPTIONS			
FA	HH	R	MXS	EPFA
FA125TT	-	FA125R	-	-



# FA126 67.5 x 51 x 7mm



## ALFER

125 MC	88-	F
250 MC	88-	F
250 GR/Enduro	88-	F
300 GR/Enduro	88-	F

## APRILIA

AF-1 125	88-91	F
RS 125 All models	92-05	F
Tuono 125	03-04	F

## BENELLI

Devil 50	92-	F
Spring 50	93-	F
Devil 80	92-	F
Tarno 125	89-	F

## GILERA

GFR 125	94	F
Nordwest	94-96	F
125 CX	91-	F
125 MX1/MXR	89-	F
125 SP 01/SP 02	89-	F
Nord-West 350	94-	F

## KTM

Most Models	87	F&R
-------------	----	-----

## MALAGUTI

Madison 125	99	R
-------------	----	---

## MOTO GUZZI

Quota 100 D	93-95	F
1000 Quota	92-97	F

## MZ

Skorpion replica	95-96	F
------------------	-------	---

### Equivalents OE #

8113489	90214 01000
000306546310	GU30654631

### Competitor X Ref

MATERIAL AVAILABILITY AND PART NO.					
STD	OPTIONS				
FA	TT	HH	R	MXS	EPFA
FA126	FA126TT	FA126HH	FA126R	-	-

Dunlop	Ferodo	SBS	Vesrah
DP604	FDB498	591	VD-943

# FA128 A. 35 x 85 x 8mm B. 37 x 55.5 x 9.8mm

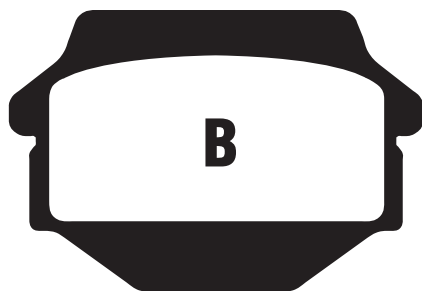
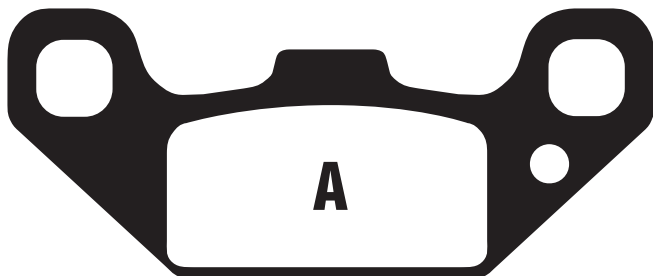

## KAWASAKI

KXF 250 A1/A2 Tecate 4	87-88	F
KSF 250 A1-A18	87-04	F
KEF 300 B1/B2 Lakota Sport	01-02	F

## SUZUKI

LT 250 RH/RJ/RK/RL	87-90	F
LT 500 RL	90	F

### Equivalents OE #

43082 1067	59300 03840
59100 43810	

### Competitor X Ref

Dunlop	Ferodo	SBS	Vesrah
DP821	FDB2013	591	VD332

MATERIAL AVAILABILITY AND PART NO.				
STD	OPTIONS			
FA	HH	R	MXS	EPFA
FA128TT	-	FA128R	-	-

# FA129 A. 141 x 41.5 x 9.7mm B. 95 x 34.5 x 9.7mm

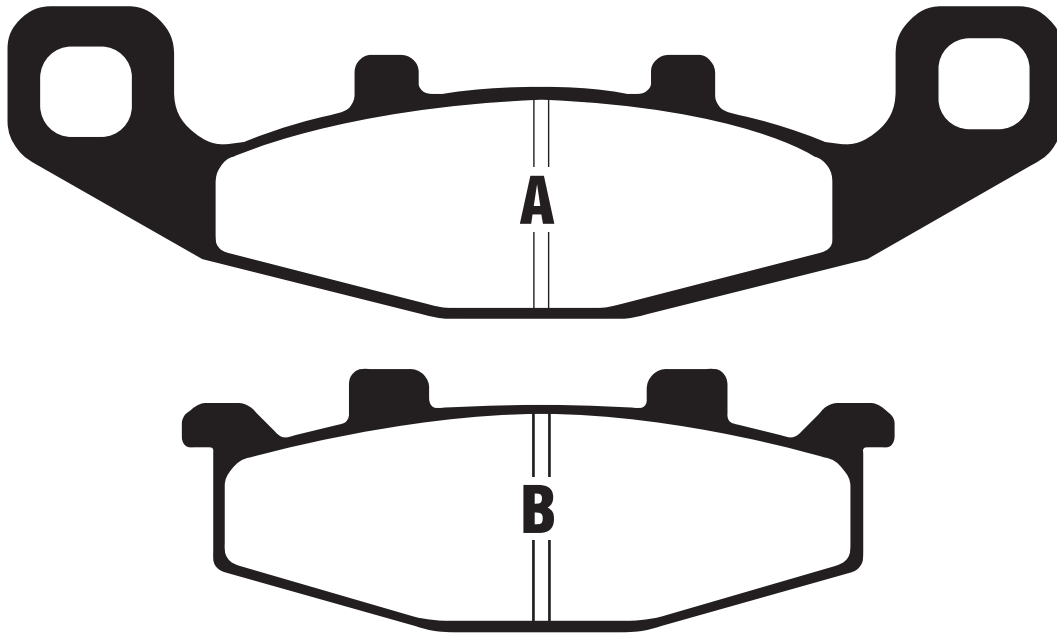

### HYOSUNG

Comet 250/600

02 F

### KAWASAKI

GPX 250 R (ZX 250 F2-F9)

88-95 F

GPX 250 R (EX 250 F)

87 F

KLE 250 A2 (Anhelo)

95 F

KLE 250 A3/A5/A6

97/00-01 F

ZZR 250 (EX 250 H1-H13)

90-03 F

ZR 250 A1-A5

91-95 F

GPX 400 R (ZX 400 F1)

87 R

GPZ 400 R 'D4'

88 R

ZL 400 D1/D2

94-95 F

ZRX 400 (ZR 400 E1/E2)

94-95 F

ZZR 400 (ZX 400 K1/K2/K3)

90-92 R

ER-5 (ER500 A1/A2/A3/A4)

97-00 F

GPz 500 S (EX 500 A1-A6/D1-D7)

87-01 F

KLE 500 A1-A12

91-04 F

KLE 500 B1P/B6F/B7F

05-07 F

ZR 550 B2-B6 "Zephyr"

91-99 F

GPx 600 R (ZX 600 C1-C7)

88-96 F&R

ZL 600 B1 "Eliminator"

95-97 F

ZZ-R 600 (ZX 600 D1-D3)

90-93 R

KL 650 B1-B3 "Tengai"

89-92 F

GPX 750 R (ZX 750 F1-F3)

87-89 F&R

ZR 750 C1-C5 'Zephyr'

91-95 F&R

ZR 750 D1 'Zephyr'

96- R

GPz 900R A7-A8

90-96 R

GPZ 900 R (ZX 900 A11)

98 R

GPZ 900 R (ZX 900 A12-15)

99-02 R

ZX 100 B1-B3 (ZX-10)

88-90 F&R

ZG 1000 A9-A18 (1000 GTR)

94-03 F

ZZR 1100 (ZX 1100 C1-C3)

90-92 R

ZR 1100 A1-A4 'Zephyr'

92-95 R

ZR 1100 B1 'Zephyr'

96-97 R

ZR 1100 B5 (Zephyr 1100 RS)

02 R

### SUZUKI

RG 125 UN 'Wolf'

92-94 F

RG 125 UN "Wolf" (NF13E) Naked

92-94 F

GSF 250 N/ZM/P/NP/ZP/N/NR

92-96 F

GSX 250 SSM Katana (GJ76A)

91 F

GSX 250 FL/FM/FN/FP/FR/FS/FT/FV/FW Across

90-98 F

SW-1 250 (NJ45A)

92 F

GSF 400 M/N/P Bandit

91-95 F

GS 500 EK/EL/EM/EN/EP/ER/ES

89-95 F

DR 800 SM/SN/SP

91-93 F

VX 800 L/M/N/P/R

90-95 F

GSX 1100 GM/GN

91-94 F

### Equivalents OE #

43082 1068	43082 1095	43082 1134	59100 26810
43082 1069	43082 1104	43082 1139	59100 45860
43082 1074	43082 1114	43082 1161	59301 45860
43082 1077	43082 1123	43082 1189	59302 45810
43082 1088	43082 1124	59100 01820	

### Competitor X Ref

Dunlop	Ferodo	SBS	Vesrah
DP314	FDB481/R	597	VD-427

### MATERIAL AVAILABILITY AND PART NO.

STD	OPTIONS				
FA	V	HH	R	MXS	EPFA
FA129	FA129V	FA129HH	FA129R	-	EPFA129HH

# FA130 A. 73.3 x 49.3 x 7mm

# B. 60.8 x 62.8 x 9mm

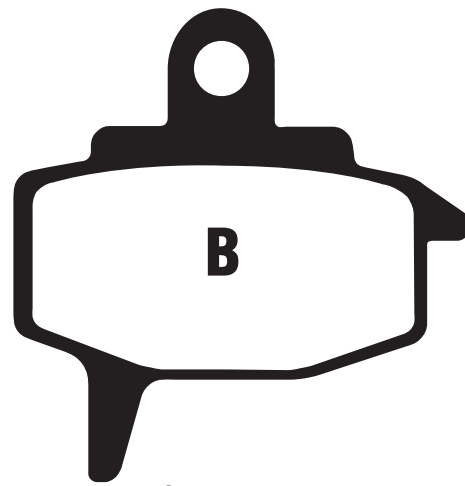
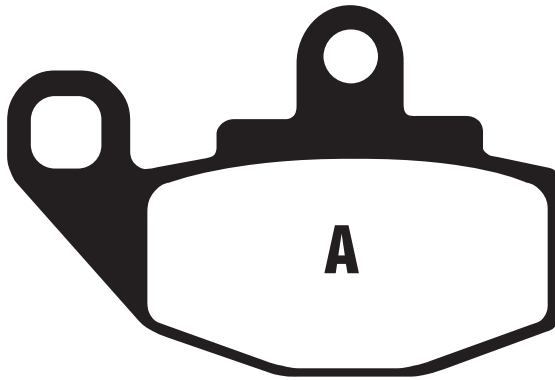

### KAWASAKI

KX 125 E2/F1	87-88	F
KX 250 E1/F1	87-88	F
KX 500 C1/D1	87-88	F
KLR 650 A1-A3	87-89	F

### Competitor X Ref

Dunlop	Ferodo	SBS	Vesrah
DP313	FDB494	602	VD-126

### Equivalents OE #

43082 1072
43082 1078

### MATERIAL AVAILABILITY AND PART NO.

STD	OPTIONS				
FA	V	HH	R	MXS	EPFA
FA130TT	FA130V	-	FA130R	-	-

# FA131 75 x 36 x 10.5mm

# \*FA131R/MXS 75 x 36 x 9.5mm

# FA131/2 75 x 36 x 7.5mm

# FA131/3 75 x 36 x 9.5mm



\* This pad is made to a thinner dimension to allow fitting of radiator shims to the back of pads if required.

### FA131TT

<b>AJP</b>			
PR5 Supermoto 250cc	09	R	
PR5 Enduro 250cc	09	R	
PR5 250 Enduro	10-11	R	
PR5 250 Supermoto	10-11	R	
<b>CPI</b>			
Sauel 125		R	
<b>GAS-GAS</b>			
EC 125/200/250/300	00-08	R	
Pampera 125 (2T)	05-08	R	
Enduro EC 200/250/300	99-00	R	
MX 125/250 (MC)	01-08	R	
MX 200/250/300	99-00	R	
SM 125/250/400 FSE	02	R	
SM 125/250 (2T)	01-06	R	
SM 125 (2T) Supermotard	03-06	R	
SM Halley 125cc	09	R	
Trail Halley 125cc	09	R	
Pampera 400	06	R	
SM 400 FSE (2T)	01-02	R	
EC 450 FSR/FSE Enduro (4T)	05-09	R	
Pampera 450 (4T)	07-08	R	
SM 450 FSR (4T) Supermotard	07-09	R	
SM Halley 450cc	09	R	
Trail Halley 450cc	09	R	
EC 515 FSR/FSE Enduro (4T)	05-09	R	
SM 515 FSR (4T) Supermotard	07-09	R	
<b>GOES</b>			
G 125 XM	08-09	R	
G 250 XM	08-09	R	
<b>HONDA</b>			
CB 50 V/W Dream 50	97-98	R	
XR 50 M5 (AD14) Motard	05	R	
CR 80 RN/RP/RR/RS/RT/RBT/RV/RBV/RW/RBWX/RBX/RBY/RB1/RB1/R2/RB2	92-02	R	
CR 85 R3/RB3/R4/RB4/R5/RB5/R6/RB6/R7/RB7	03-07	R	
NH 90 M/P/R Yuppy	95-97	F	

XR 100 MS (HD13) Motard	05	R
CR 125/250/500 RH/RJ/RK/RL/RM/RN/RP/RR/RS/RT/RV/RW/RX/RY/R1	87-01	R
CRF 230 L	08-10	R
CRF 230 M Supermoto	09-10	R
SL 230 'Free Landsports' (MD33) V/W/X/1	97-01	R
CRM 250 R (RM) MK2/MD24 (120001-1211634)	91-92	R
CRM 250 R (RP-RP-11) MK2/2 (MD 24 1300001-)	93	R
CRM 250 'Active Radial' (MD32) ARV/ARW	97-98	R
XL 250 RL	90	R
XLR 250 RM/R3N/RP/RR/R3R (MD22)	91-	R
XR 250 RL/RM/RN/RP/RR/RS	90-95	R
XR 250 RT/RV/RW/RX/RY/R1/R2/R3/R4	96-04	R
XR 250 Y/3 (MD30)	00-03	R
XR 250 3/5 (MD30) Motard	03-05	R
XR 250 III Y/3 Baja	00-03	R
XR 300 R10	10	R
NX4 Falcon	02-05	R
XR 400 RT/RV/RW/RX/RY/R1-R5	96-05	R
XR 400 M (ND08/NC38E) Supermotard	06-08	R
XR 600 RM/RP/RR/RS/RT/RV/RW/RX/RY	91-00	R
XR 650 RY/R1-R6	00-06	R
XR 650 L	93-12	R
<b>HONDA DALL'ARA</b>		
XR 250 R	04	R
XR 650 R	04	R
<b>HONDA HM (Italy)</b>		
CR 85 R/R2	03-07	R
CRE F 250 R	08-09	R
<b>HYOSUNG</b>		
RX 400	05	R
<b>HUSQVARNA</b>		
WXE 125	07	R
<b>KAWASAKI</b>		
KX 125 K2-K5/L1/L2/L3/L4/M1/M2/M3/M6F-M8F	95-08	R
KLX 250 J1-J6 D-Tracker	98-03	R
KLX 250 H6F/H7F	06-07	R
KLX 250 S9F/SAF/SBF/SCF/SDF	09-13	R

# FA131 Contd.

## \*FA131R/MXS Contd.

## SFA131/2 Contd.

## SFA131/3 Contd.

KX 250 K2-K5/L1/L2/L3/L4/M1/M2/R1/R6F-R8F	95-08	R
KLX 300 A2/A3/A4/A5/A6/A7/A8/A9/A10/A6F/A7F	97-07	R
KLX 400 R (KLX 400 B1/B2)	03-04	R
KX 500 E8-A16	96-04	R
<b>SUZUKI</b>		
DR 125 SMK8/SMK9/SML0	08-12	R
RM 125 T/V/W/X/Y/K1-K9	96-12	R
RM 125 XCK8	09	R
RM 250 T/V/W/X/Y/K1-K9	96-12	R
RM 250 XCK8	09	R
RMX 250 ST/SV/SW/SX (SJ14A)	96-99	R
250 SBK2 (LX 250 L)	02	R
DR-Z 400 SEY/EY/Y/SEK1/EK1/K2/SEK2/EK2/K3		
/SEK3/EK3/K4/SEK4/EK4/EK5/SK5/SK6/K6		
/SK7/K7/EK7/SK8/SK9	00-09	R
DR-Z 400 SMK5/SMK6/SMK7/SMK8/SMK9	05-09	R
<b>TM</b>		
MX 85 JR	02-04	R
MX 85 (Big Wheel)	02-04	R
MX 125 (2T)	01-04	R
Enduro EN 125 (2T)	01-04	R
MX 250 (2T)	01-04	R
Enduro EN 250 (2T)	01-04	R
EN 250 F (4T) Enduro	04	R
SM 250	02	R
SME 250 (4T)	04	R
MX 250 (4T) Cross	02-04	R
MX 300 (2T)	01-04	R
Enduro EN 300 (2T)	01-04	R
400 (4T) MX Cross	02-03	R
SM 400	02-03	R
SME 400 (4T)	04	R
EN 450 F (4T)	04-	R
MX 450 F (4T)	04-	R
530 (4T) Cross	02-03	R
EN 530 F (4T)	04-	R
SM 530	02-03	R
SME 530 (4T)	04	R
<b>YAMAHA</b>		
YZ 125 K/L/M/N/P	98-02	R
YZ 250 K/L/M/N/P/R/S/T/V/W	98-02	R
YZ 250 FN/FP (4T)	01-02	R
WR 250 ZK	98	R
WR 250 FN/FP (4T)	01-02	R
WR 400 FL/FM/FN	99-01	R
YZ 400 FL	99	R
WR 426 FN/FP	01-02	R
YZ 426 FM/FN/FP	00-02	R

## SFA131/2

### PEUGEOT

SV 50 80/125 Geo

91-92 F

### SYM (SANYANG)

SR 100 Sunrise

97- F

### HONDA

NSR 50 X (AC10-190)

99 R

NS-1 75

92- R

## SFA131/3

### HONDA

NSR 50 RV/RW/RX/RV

97-00 R

NSR 50 V (AC10-180)

97 R

SRX 50 T/W/X 'Joker/Shadow'

97-99 F

NSR 75 N/P/R/X/Y (NS-1/NSR 80)

92-00 R

NSR 80 J-2/K/L/N/P/R/S (HC06)

88-93 R

NSR 80 V (HC06-170)

97 R

NSR 80 X (HC06-180)

99 R

Lead 90

88- F

NH 90 M/P/R

91-94 F

SRX 90 T/W/X 'Shadow'

97-99 F

### PEUGEOT

SV 50 80/125 Geo

93- F

### Equivalents OE # - FA131

06435 KCZ 000	43106 KS6 701B	43082 1267
06455 6CK 006	43106 KS6 702B	5MV W0046 00
43082 0090	43082 1173	43082 5010
43082 1228	5DH WD0046 00	43082 5012
43105 GT4 004A	5ET W0046 00	43082 1292
43105 GW2 004A	5GR W0046 00	69100 37810
43105 KS6 701A	69100 36820	BE2500 22068
43105 KS6 702A	69100 36830	69400 37820
43105 KZ1 405	69100 36840	69100 37830
43105 MY6 415	69100 36850	69095
43106 GT4 004B	69100 36860	69096
43106 GW2 004B	69100 36870	00TRS01A0075

### Equivalents OE # - SFA131/2

752394	752391
752071	

### Equivalents OE # - SFA131/3

06435 GT4 405	06431 GW2 405
---------------	---------------

### Competitor X Ref

Dunlop	Ferodo	SBS	Vesrah
DP815/621	FDB539	604/116/121	VD-144

MATERIAL AVAILABILITY AND PART NO.				
STD	OPTIONS			
FA	HH	R	MXS	EPFA
FA131	-	FA131R	MXS131	EPFA131HH

MATERIAL AVAILABILITY AND PART NO.				
STD	OPTIONS			
FA	HH	R	MXS	EPFA
SFA131/2	SFA131/2HH	-	-	-

MATERIAL AVAILABILITY AND PART NO.				
STD	OPTIONS			
FA	HH	R	MXS	EPFA
SFA131/3	SFA131/3HH	-	-	-

# FA132 79.6 x 46.5 x 9mm

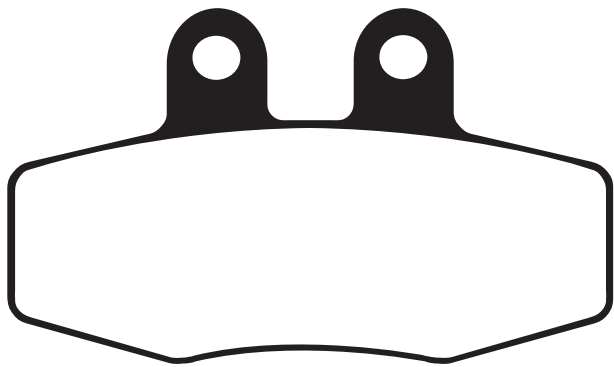

### Equivalents OE #

565 13209544
565 13209323

### Competitor X Ref

Dunlop	Ferodo	SBS	Vesrah
DP606	FDB561	621	VD-936

MATERIAL AVAILABILITY AND PART NO.				
STD	OPTIONS			
FA	HH	R	MXS	EPFA
FA132	-	FA132R	-	-

### KTM

Most 1988 Models	88	F&R
Enduro Models	89-91	F&R
250/300 E/XC/GS	90-91	F
125/350 E/XL/GS	90-91	F&R
125/250/300/600 Enduro	92-93	F
125/250/400/600 LC Models	89-91	F&R
MX 125	89-91	F&R
MX 125	92-93	F
EXC 125	89	F&R
D-XC/E-XC/E-GS 125	90-91	F&R
D-XC/E-XC/E-GS 125	92-93	F
MX 250	88-91	F&R
EXC/EGS 250	88-89	F&R
DXC/EXC 5-0	90	F&R
D-XC/EXC/E-GS 250	91	F&R
D-XC/E-XC/T-XC/E-GS 250	92-93	F
MX/EXC/EGS 350	88	F&R
MX 350	89-91	F&R
DXC/EXC/EGS 350	90-91	F&R
EXC 350	89	F&R
LC-4 MX/EXC 500	89-91	F&R
LC-4 MX/EXC 600	89-91	F&R
LC-4 EXC 600	92-93	F

### MAICO

All Models	89-93	F&R
250 MX	94-98	F&R
500 MX	94-98	F

### OSSA

500	92	F
-----	----	---

### PHB

500	92	F
-----	----	---

# FA134 99.8 x 46.7 x 8.5mm

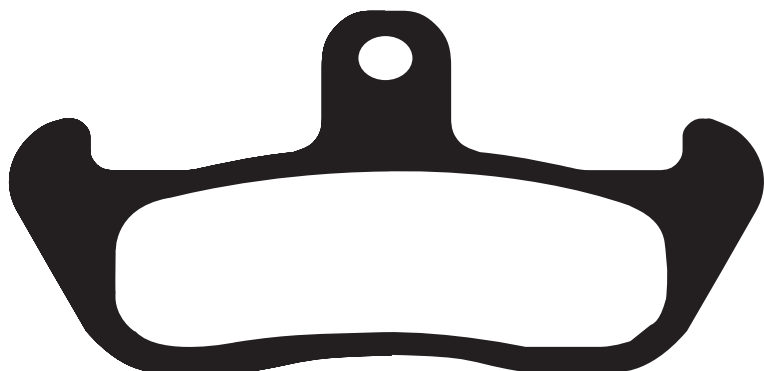

### NOTE

EBC pads are supplied with close tolerance slider pin holes and do not therefore require use of original anti-rattle clip slider pin hole.

### Equivalents OE #

341878
2VW F0047 00
K00946315

### APRILIA

AF1 125 87 F

### CAGIVA

Cruiser 125 87 F  
 WMX 125 89 F  
 Excaltiber 501 RLX 92 F  
 WMX 250 86-89 F  
 WM 125 87-88 F  
 750 Elefant 90-92 F

### GILERA

125 Apache 91 F  
 RC 125 Top Rally 89-92 F  
 RC 600 89-90 F

### HONDA HM (Italy)

CRE 50 Six/Baja/Derapage Brembo caliper/Kayaba forks 95-02 F

### HUSQVARNA

CR 125 91 F  
 WR 125 87-88/91 F  
 CR 240 87-88 F  
 WR 240 87-88/90-91 F  
 CR 250 87-88/91 F  
 WR 250 87-88/90-91 F  
 XC 250 87-88 F  
 WR 260 90-91 F  
 TE 350 90-91 F  
 WR 400 87-88 F  
 CR 430 87-88 F  
 WR 430 87-88 F  
 XC 430 87-88 F

430 Automatic 87-88 F  
 CR 500 87-88 F  
 XC 500 87-88 F  
 TC 510 89-90 F  
 TE 510 89-90 F  
 WMX 510 89 F  
 WXE 510 89 F  
 TC 610 91 F  
 TE 610 91 F

### KRAM-IT (KRAMER)

ER 125/250/300 RV3 88- F  
 ER 500/600 96- F

### MOTO MORINI

Excaltiber 350/501 RLX 93- F  
 Dart 350 87 F

### YAMAHA

TDR 125 (3HS1/3XDO/3HS3/3XD01) 89-93 F  
 TDR 125 R Lightburner (3SH2/3XE2) 93-94 F

### Competitor X Ref

Dunlop	Ferodo	SBS	Vesrah
DP605	FDB499	608	VD-929/ 942

MATERIAL AVAILABILITY AND PART NO.				
STD	OPTIONS			
FA	HH	R	MXS	EPFA
FA134	-	FA134R	-	-



# FA135 A. 96.7 x 42.7 x 7.4mm B. 77 x 42.2 x 7.4mm

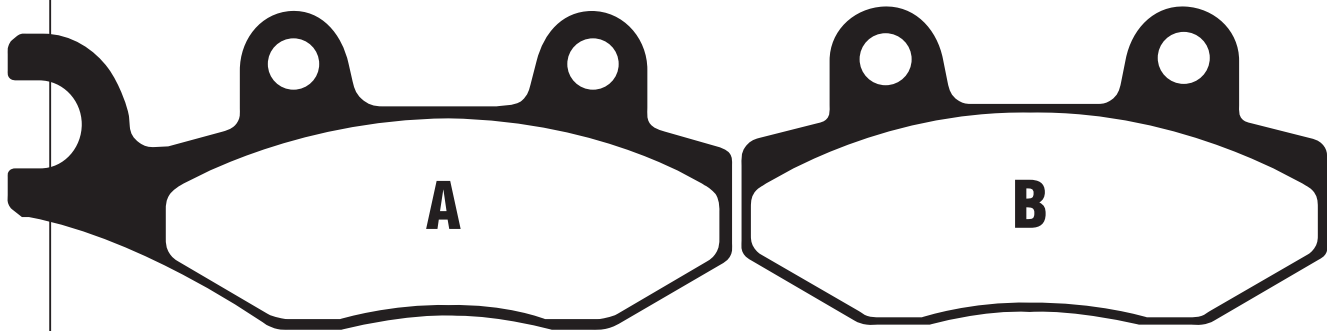

DISC PADS  
BUYERS GUIDE

## AEON

Crossland 400 (2x4) 12-13 R  
Crossland 400 (4x4) 12-13 R

## APACHE

RLX 250 S/SX (Mk1) Rear disc model R

## BAROSSA QUADS

170 Sport 03-04 R  
170 Cheetah/Magna 03-05 R  
Quarterback 250 05 R

## CAN AM (SIDE X SIDE)

Commander 800 (XT/DPS) 11-13 F(right)&R  
Commander 800 R 11-13 F(right)&R  
Commander 800 R XT 11-13 F(right)&R  
Commander 1000 11-13 F(right)&R  
Commander 1000 X 11-13 F(right)&R  
Commander 1000 XT 11-13 F(right)&R  
Commander 1000 (DPS) 12 F(right)&R  
Commander 1000 LTD 12-13 F(right)&R

## CF MOTO

CF 500-3 (Rancher 500 Side x Side) 10-11 F(right)  
CF-500 (Z6 Terra Cross) 12 F(right)&R(right)  
CF-625-3 (Z6 Terra Cross) 11-12 F(right)&R(right)  
CF 800-3 (Tracker 800 Side x Side) 13 F(right)

## ECO

Bushman 150 (LX 150 GY) F

## GAS GAS

KZ 250 RV Quad 06 F(left)

## GOES

G 520 UTX (Side x Side) 10-11 F(right)

## HUSQVARNA

CR 125 92-94 F  
WR 125 93-94 F  
CR 250 92-94 F  
WR 250 92-94 F  
TE 350 92-94 F  
CR 360 92-94 F  
WR 360 92-94 F  
TE 610 92-94 F  
TC 610 92-94 F

## KAWASAKI

KLX 125 CAF/CBF/CCF/CDF 10-13 F  
KLX 125 DAF/DBF/DCF/DDF D-Tracker 10-13 F  
KX 125 G1/H1/H2/J1/J2 89-93 F  
KDX 200 E5/E6 93-94 F  
KDX 200 SR (DX200G) F  
KX 250 G1/H1/H2/J1/J2 89-93 F  
KDX 250 SR (KDX 250 F1) 91 F  
KDX 250 D1 91-93 F  
KLX 250 S9F/SAF/SBF/SCF/SDF 09-13 F  
KLF 300 C1-C17 "Bayou" 89-05 F(right)  
KLF 400 B1-B7 Bayou 93-99 F(right)  
KX 500 E1-E5 89-93 F  
KVF 650 F7F/F8F Brute Force 4x4  
Hardwoods Green 07-08 F(right)  
KVF 650 H7F/H8F Brute Force 4x4  
Hardwoods Green 07-08 F(right)  
KVF 650 67F/68F Brute Force 4x4  
Hardwoods Green 07-08 F(right)  
KVF 750 A1/B1/A2/B2 Brute Force 4x4  
Hardwoods Green HD 05-06 F(right)  
KVF 750 E8FA Brute Force 4x4  
Hardwoods Green HD 08 F(right)  
KVF 750 D8F/D9F/DAF/DBF 08-11 F(right)  
KRF 750 Teryx 750 4x4 (RUV) A8F/B8F 08 F(right)  
KRF 750 Teryx 750 4x4 LE (RUV) C8F/D8F 08 F(right)  
KRF 750 TAF/VBP Teryx 750 Fi 4x4 SGO 10-11 F(right)  
KRF 750 G9F/NAF/NBF/NCS/NDF Teryx 750 Fi 4x4 09-12 F(right)  
KRF 750 J9FA/K9F/PAF/RAF/PBF/RBF/RCS  
/PDF/RDF Teryx 750 Fi 4x4 LE 09-13 F(right)  
KRF 750 L9F Teryx 750 Fi 4x4 LE Sport 09 F(right)

KRF 750 M9F Teryx 750 Fi 4x4 NRA Outdoors 09 F(right)  
KRF 750 SAF/SAFA/SBF/SBFA/SCS/SCSA  
Teryx 750 Fi 4x4 Sport LE 10-12 F(right)  
Teryx 750 4x4 NRA Outdoors (RUV)  
KRF 750 F8F 08 F(right)

## KREIDLER

125 DD Supermoto 12-13 F

## MOTO ROMA

Road Runner 125 04-05 F

## PUZEY

MTD 300 (4T/4V) (Motard model) 11-12 F  
MX 300 (4T/4V) (Enduro model) 11-12 F

## QUADZILLA

Stingr R170E 06 R  
ST 200 E (Automatic) 06 R

## SINNIS

Apache 125 QM 125 GY-2B(A)  
(Rear disc model) 09-10 F  
Apache (Rear drum model) 09-10 F  
Blade 125 QM 125 GY-2B 08-10 F

## SUPERBYKE

RMR 125 07-09 F

## SUZUKI

EN 125-2/125-2A 05 F  
TS 125 RK/RL/RM/RN/RP/RR 90-96 F  
RM 125/250 H/J/K/L/M/N/P/R/S 87-95 F  
TS 200 RK/RL/RM/RN/RP/RR 89-94 F  
DR 250 SL/SM/SN/SEP/SER/SES (SJ448) 90-95 F  
RMX 250 K/M/N/P/R/S 89-95 F  
RMX 250 SN/SR/SS (SJ13A) 95-97 F  
LT-F 300 FK2 02 F(right)  
DR 350 SL/SM/SN/SP 4 bolt front disc/kick start 90-93 F  
DR 350 SER/SES (Electric start  
/4 bolt front disc) 94-95 F  
DR 350 SET/SEV (Electric start  
/4 bolt front disc) 96-97 F  
LT-R 450 K6/K7/K8/K9/L0/L1 06-12 F(right)  
LT-A 500 FY/FK1 00-01 F(right)  
LT-F 500 FW/FX/FY/FK1/FK2 98-02 F(right)

## YAMAHA

XTZ 125 K/E 05-10 F  
XTZ 125 (5RM) 03-10 F  
YZ 125 W/A/B/D/E/F/G/H/J 89-97 F  
DT 200 WR (3XP) 92-93 F  
WR 200 D/E/F 92-94 F  
DT 230 (4TP1/2) Lanza 91-98 F  
TT 250 R (4GY) Raid/4MR2 96 F  
TT 250 R RL/RM/RN/RP/RR/RS 99-04 F  
TT 250 R (4GY1 Japan) 93-94 F  
TT 250 R (4RR1/2 Japan) 95-97 F  
TT 250 RL (4PX5) 99 F  
TT 250 RM (4PX6) 00 F  
TT 250 R (4GY3/4GY5/4WA1) Raid 94-96 F  
WR 250 ZB/ZD/ZE/ZF/ZG/ZH/ZJ 91-97 F  
XTZ 250 Lander (Brasil) (4B41/2/3) 07-09 F  
YZ 250 D/E/F/G/H/J 92-97 F  
YZ 250 W/WRW 89 F  
YZ 250 A/WRA/B 90-91 F  
YZ 250 A/WRA/B 90-91 F  
YFZ 450 S/T/V/W/X 04-08 F(right)  
YFZ 450 RY/RZ (Quad) 09-10 F(right)  
WR 500 ZD 92 F  
YXR 66 FAS/FAT Rhino 4x4 Side x Side 04-05 F(right)  
YFM 700 RV/RW/RX/RV/RA/RB Raptor 06-12 F(right)  
YFM 700 RD Raptor 13 F(right)  
YXR 700 Rhino 4x4 SE 09 F(right)&R  
YXR 700 FA/FB/FS Rhino Side x Side 11-13 F&R(right)  
XTZ 750 "Super Tenere" 89-95 F(right)

# FA135 Contd.

### Equivalents OE #

43082 0082	59300 27850	800071450
43082 0087	59300 27860	59100 09840
43082 0099	3JD W0045 00	59100 09850
43082 0100	3SP W0045 00	59100 09870
43082 1089	3XP W0045 00	59100 09890
43082 1093	4EW W0045 00	IS3 W0045 00
43082 1117	4EW W0045 01	5RM W0045 10
43082 1129	4GY W0045 01	800070858
59100 39850	4MX W0045 00	903 08 08 70
59300 08810	4TP W0045 00	903 08 08 80
59300 26830	5B4 W0045 10	153 W0045 10
59300 27830	5GF W0045 00	715500336
59300 27810	800070888	

### Competitor X Ref

Dunlop	Ferodo	SBS	Vesrah
DP411	FDB497	611	VD-340

### MATERIAL AVAILABILITY AND PART NO.

STD	OPTIONS			
FA	HH	R	MXS	EPFA
FA135TT	-	FA135R	MXS135	-

# FA136 80 x 40 x 9.8mm

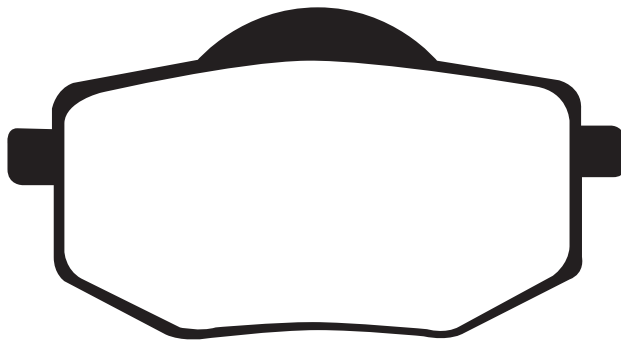

### YAMAHA

XV 535 Virago

88-94 F

### Equivalents OE #

3JB W0045 00

### MATERIAL AVAILABILITY AND PART NO.

STD	OPTIONS			
FA	HH	R	MXS	EPFA
FA136	-	-	-	-

### Competitor X Ref

Dunlop	Ferodo	SBS	Vesrah
DP417	FDB591	616	VD246

# FA137 47 x 45.1 x 7.5mm

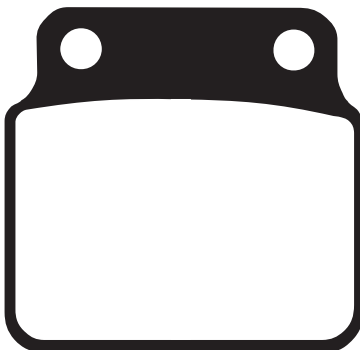

### Equivalents OE #

43082 S007
69100 07810
69140 35B00
69140 43B00
69140 43B10
3406-075
69100 01810

### ARCTIC CAT

400 DVX (2x4) Sport

04-08 R

400 DVX TS Sport

06-07 R

### KAWASAKI

KSF 400 A1/A2/A3 (KFX 400)

03-05 R

### SUZUKI

LT 250 RH/RJ/RK/RL

87-90 R

LT-Z 400 K3/K4/K5/K6/K7/K8/K9/L0/L1

03-12 R

LT-R 450 K6/K7/K8/K9/L0/L1

06-12 R

LT 500 RL

90 R

### MATERIAL AVAILABILITY AND PART NO.

STD	OPTIONS			
FA	HH	R	MXS	EPFA
FA137TT	-	FA137R	-	-

### Competitor X Ref

Dunlop	Ferodo	SBS	Vesrah
DP817	FDB2016	649	VD-341

# FA138 104.3 x 62.3 x 12 mm

## REFERRED TO FA201

# FA139 104.3 x 62 x 11mm

## REFERRED TO FA200

# FA140 86 x 40 x 10.2mm

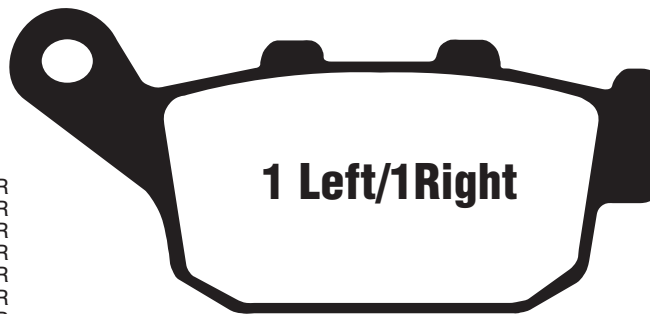

DISC PADS  
BUYERS GUIDE

### HONDA

FES 125 3/4/5 Pantheon	03-06	R
FES 150 3/4/5 Phantom	03-06	R
CB 250 FT/FV/FX/FY/F1 'Hornet'	96-01	R
CBR 250 RH (MC17)	87	R
CBR 250 RJ/RK/RK2 (MC19)	88-89	R
FES 250 Y/1/2/5 Foreight	00-05	R
NSR 250 R6K/R6K-2 (MC18-110)	89	R
NSR 250 R7L/R7N (MC21-100/106)	90	R
NSR 250 R8L-3/R9L/R8N/R8N-3 (MC21-101/102/106)	90-92	R
NSR 250 R9N (MC21-106)	92	R
NSR 250 R2J (MC18-100)/R4J (MC18-100)	88	R
NSR 250 R5K/R5K-2 (MC18-110)	89	R
VT 250 FL Spada/Castec	88-90	R
VTR 250 W/Y/1-7 (MC33)	98-07	R
VTR 250-9	09-10	R
CB-1 (CB 400 F)	89-90	R
NT 400 'Bros' NC25		R
CB 400 SF (F2N/F2R) "Superfour" (NC31)	92-	R
CB 400 SF (F2V/F3T) Superfour (NC31)	96-97	R
CB 400 SF (F3V) Superfour (NC31)	97	R
CB 400 Four V/V-II/W/W-II (NC36)	97-98	R
CBR 400 RRJ/K (NC23 Tri-arm)	92-93	R
CBR 400 RRL/RRN/RRR (NC29 Gull-arm)	90-94	R
VFR 400 RH2/RJ (NC24)	87-88	R
CB 500 FAD (Twin)	13	R
CB 500 RD (Twin)	13	R
CB 500 XD (Twin)	13	R
NX 500 J/K/L/M/N/P/R/S/T Dominator	92-96	R
NTV 600 J/K/M Revere	88-92	R
XL 600 VM/VN/VP/VR/VT/VV/VW/VX "Trans Alp"	91-00	R
FMX 650 5/6	05-08	R
NT 650 J/K/L 'Bros'	88-92	R
NT 650 V/W	98	R
NTV 650 J/K/L/M/P/S/T/V	88-97	R
NX 650 J/K/L/LII/M/N/P/R/S/T "Dominator"	88-	R
NT 650 VW/VX/VY/V1 "Deauville"	98-01	R
XL 650 VY/V1-V7 Transalp	00-07	R
XR7 650 J Africa Twin	88-89	R
NC 700 SC/SD (Manual Gearbox)	12-13	R
NC 700 XC/XD (Manual Gearbox)	12-13	R
XL 700 V8/V9/VA (Transalp/2 piston front caliper /ABS on rear disc)	08-11	R
XR7 750 L/M/N/P/R/S/T/V/W/X/Y "Africa Twin"	90-03	R
Z 800 E (Z 800 CDS - Non ABS)	13	R
Z 800 E (Z 800 DDS - ABS Model)	13	R
Z 800 (Z 800 ADS - Non ABS)	13	R
Z 800 (Z 800 BDS - ABS Model)	13	R

### KAWASAKI

Z 750 R Non ABS (ZR 750 NBF/NCF)	11-12	R
X 750 R ABS (ZR 750 PBF/PCF)	11-12	R

### KREIDLER

125 Street DD	12-13	R
---------------	-------	---

### BUELL

X1 Lightning	98-05	R
M2 Cyclone	00-05	R
Blast	00-07	R
Firebolt XB9R	02-07	R
XB9S Lightning	03-04	R
XB9SX Lightning CityX	05-09	R
XB9SX Lightning	08-10	R
XB12R Firebolt	04-10	R
XB12S Lightning	04-08	R
XB12SS Lightning	09-10	R
XB12X Ulysses	06-10	R
XB12XT Ulysses	08-10	R
XB12 SCG Lightning	06-08	R
XB12SS Lightning Long	06-09	R
XB12STT Lightning	08	R
XB12SCG Lightning	09-10	R

### PEUGEOT

SV 250	01-02	R
--------	-------	---

### SINNIS

Stealth 125 QM125-2D	08-10	R
----------------------	-------	---

### SUZUKI

XF 650 V/W/X/Y Freewind	97-02	R
-------------------------	-------	---

### TRIUMPH

Daytona 600	03-04	R
Speedfour 600	02-05	R
TT 600	00-03	R
Daytona 650	05	R
Daytona 675	06-12	R
Daytona 675 R (Brembo calipers)	11-12	R
Street Triple 675 (Naked)	07-12	R
Street Triple 675	13	R
Street Triple R 675	09-12	R
Tiger 800	11-13	R
Tiger 800 XC	11-13	R
Daytona 955i	01-04	R

### YAMAHA

XJ6-N (600cc) (Naked - 20S) ABS		
/Non ABS	09-12	R
XJ6-S Diversion (600cc) (Top fairing - 36C)		
ABS and Non ABS version	09-12	R
XJ6-F Diversion (600cc) (Full Fairing - 1CW)		
(Non ABS/ABS)	10-12	R

### Equivalents OE #

06435 KFG J21	43105 KT7 762A	T2020602
06435 KFK 016	43106 KT7 761B	06435 KFG J21
06435 KT7 405	43105 KV3 831	754804
06435 KV3 405	43105 MN8 006	H0301 T
06435 MGZ 501	43106 KV3 831	06435 MY9 405
06435 MGS D31	43106 MN8 006	06435 KFK 006
42385 98Y	43105 MY1 405	06435 MFF D01
43082 0117	43106 KT7 762B	20S W0046 00
43105 KT7 761A	69100 04830	

### Competitor X Ref

Dunlop	Ferodo	SBS	Vesrah
DP115	FDB531	614	VD-147

### MATERIAL AVAILABILITY AND PART NO.

STD		OPTIONS						
FA	V	SFA	SFAC	HH	SFA-HH	R	MXS	EPFA
FA140	FA140V	SFA140	SFAC140	FA140HH	SFA140HH	-	-	-

# FA141 A. 106 x 38.2 x 9mm B. 76.4 x 27 x 10.7mm

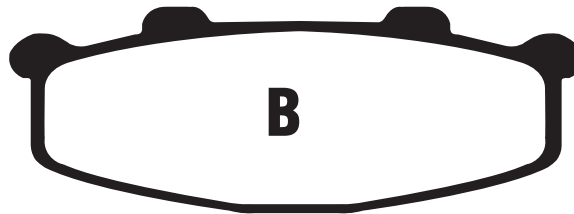

## KAWASAKI

KR-1 (KR 250 B2)	89	F&R
KR1S (KR 250C2/C3)	90-92	R
GPX 250 R (ZX 250 F2-F9)	88-95	R
GPX 250 R (EX 250 F)	87	R
GPX 250 R II (EX 250 G)	88	F&R
ZXR 250 C1-C5 (ZX 250 C1-C5)	91-95	F
ZXR 250 R (ZX 250 D1)	91	F
ZXR 250 (ZX 250 A1/A2)	89/90	F&R
ZXR 250 R (ZX 250 B1/B2)	89-90	F&R
GPX 400 R (ZX 400 F1)	87	F
GPZ 400 R 'D4'	88	F
ZR 400 D1/D3/D4 'Zanhus'	92-95	F
ZX-4 (ZX 400 G1/G1A/G1B)	88	F&R
GPZ 500 S (EX 500 E1-E10)	94-04	F
ZR 550 B2/B3 'Zephyr'	91-93	R

## SUZUKI

RGV 250 M/N/P/R/S/T	91-96	R
RGV 250 T (RGVR 250 SP VJ23A)	96	R

## Equivalents OE #

43082 1075	43082 1144
43082 1076	43082 1147
43082 1085	43082 1162
43082 1087	69100 22820
43082 1101	69100 22830
43082 1125	69100 22850
43082 1127	

## Competitor X Ref

Dunlop	Ferodo	SBS	Vesrah
DP204	FDB508	615	VD-430

## MATERIAL AVAILABILITY AND PART NO.

STD	OPTIONS			
FA	HH	R	MXS	EPFA
FA141	-	-	-	-

# FA142 102 x 38 x 9mm

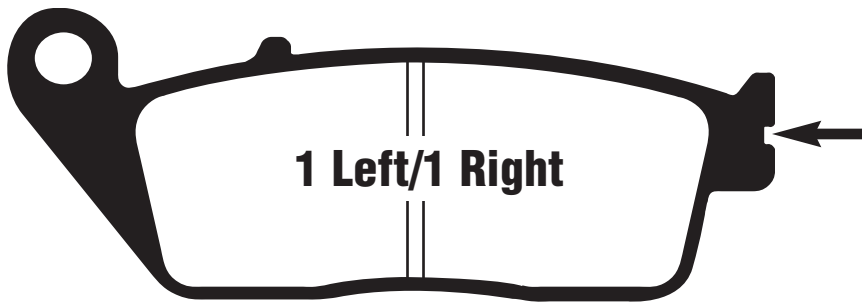

## NOTE

Later supplies have clip notch. Both designs ok for front brake use

### BMW

C 600 Sport Scooter	12	F
C 600 Sport Highline	13	F
C 650 GT Scooter	12	F
C 650 GT Highline	13	F

### CAGIVA

900 IE Canyon/Gran Canyon	98-00	F
Navigator 1000	00-05	F

### DAELIM

SQ 125 Freewing S2	06	F
Roadwin R 250 Fi (VJF 250)	08-11	F
Roadsport 250 (VJF 250)	10-13	F
SQ 250 Freeway S2	06	F

### HONDA

CBR 250 RB/RC (Non ABS)	11-13	F
CBR 250 RJ/RK/RK2 (MC19)	88-89	F
CBR 250 RRL/RRN/RRR (MC22)	90-94	F
VT 250 FL Spada/Castec	88-90	F
CB-1 (CB 400 F)	89-90	F
CB 400 SF "Superfour" (NC31) (F2N/F2R/F2S/F2T/F3S)	92-95	F
CB 400 Four V/V-II/W/W-II (NC36)	97-98	F
CBR 400 RR/JK (NC23 Tri-Arm)	92-93	F
CBR 400 RRL/RRN/RRR (NC29 Gull Arm)	90-94	F
NV 400 CS/CV 'Steed'	95-97	F
XR 400 M (ND08/NC38E) Supermotard	06-08	F
NTV 600 J/K/M Revere	88-92	F
VT 600 CR/CS/CT/CV/CW/CX 'Shadow Custom'	94-99	F
NTV 650 J/K/L/M/P/S/T/V	88-97	F
NX 650 J/K/L/LII/M/N/P/R/S/T/V	88-97	R
CBR 750 FJ "Superaero"	88	F
VFR 750 FJ/FK/FL/FM/FN/FP/FR/FS/FT/FV	88-97	F
CB 750 F2N/F2R/F2S/F2T/F2V/F2W/F2X		
/F2Y/F21 'CB Seven fifty'	92-02	F
PC 800 'Pacific Coast'	89-97	F
Z 800 E (Z 800 CDS - Non ABS)	13	F
CBR 1000 FK/FL/FM/FN	89-92	F
ST 1100 AN/AP/AR/AS Pan European (ABS Model)	92-95	F
ST 1100 L/M/N/P/R/S/T/V/W/X/Y/1/2 Pan European - Non ABS	90-02	F
GL 1500 'CV/CW/CX/CY/C1/C2' (F6C)	97-03	F

### ITALJET

Marco Polo 400xx Scooter	07-09	F
--------------------------	-------	---

### JAWA

350 Classic		F
-------------	--	---

### KAWASAKI

Z 750 (ZR 750 L7F/L8F/L9F/LAF/LBF)	07-11	F
Z 750 ABS (ZR 750 M7F/M8F/M9F/MAF/MBF)	07-11	F

### KYMCO

Downtown/Super Dink 125i (C21000)	09-13	F
Grand Dink 125	12-13	F
Downtown 200i	10-12	F
Xciting 250/250i	05-07	F
Xciting 250	05	F
Xciting 250i	06-08	F
Downtown/Super Dink 300i (V20000)	09-12	F
Downtown 300i (ABS/C20010)	10-13	F

### Competitor X Ref

Dunlop	Ferodo	SBS	Vesrah
DP117	FDB570	627/183/184	VD-156

Grand Dink 300i	12-13	F
Xciting 300i (T72000) (EFi Model)	08	F
Xciting 300i R (T72001/72011)	08-12	F
Xciting 500 Ri (T70021) (EFi Model)	09-12	F
Xciting 500i (T70020) (EFi Model)	06-08	F
Xciting 500 (T70000) (Carb Model)	05	F
Xciting Evo 500i ABS	13	F
MX Road 700i	12	F

### PEUGEOT

Satelis 400 Premium (Nissin Calipers)	08-11	F
Satelis 400 Urban (Nissin Calipers/ABS)	08-12	F
Satellis 400 RS (Nissin Calipers)	08-12	F
Geopolis 500	08-11	F
Satelis 500	07-12	F
Satelis 500 RS (Nissin Calipers)	08-12	F

### SACHS

Quattrocento 400	08	F
------------------	----	---

### SUZUKI

GSX 400 R/S/T/ZR/ZS/ZT "Impulse Type"	94-96	F
RF 400 RP/RR/VR/RT/RVT/RV-V (GK78A)	93-97	F
RF 600 RP/RR/RS/RT/RV	93-97	F
AN 650 K3/K4/K5/K6/K7/K8/K9/L0 Burgman/Non ABS	04-11	F
AN 650 AK4/AK5/AK6/AK7/AK8/AZK8/AK8/AK9/ALO Burgman/ABS/Executive	04-12	F
AN 650 ZL3 Burgman ABS Executive	13	F
AN 650 L3 Burgman Non ABS	13	F
GSF 650 S/T/V/W/X Naked Bandit	95-99	F
GSX 650 ST/SV/SW/SX Faired Bandit	95-99	F

### TRIUMPH

Speedmaster (765cc/Carb)	03-04	F
Speedmaster (865cc/Carb)	05-07	F
Speedmaster (865cc/EFi)	08-10	F
Thruxton 900	04-13	F

### VOXAN

Scrambler 1000	06	F
----------------	----	---

### YAMAHA

WR 125 X	09-13	F
WR 125 R	09-12	F
WR 250 XX/XY (Supermoto) (32D2/4)	08-10	F

### Equivalents OE #

06455 MR1 405	45106 ML7 922B
06455 MR4 405	45106 MR4 901
06455 MW3 405	45106 MS9 612
06455 MV4 405	45106 MT4 651/405
06455 MZ0 760	59300 21820
43082 0079	59300 21840
451A0 MT4 670	59300 21850
45105 ML7 921/922	8000 88482
45105 MS9 612	06455 MBE 006
45105 MT4 651/405	59100 21860
45105 KAZ 004	59100 21870
45105 MV4 008	06455 KFR7 701
45105 ML7 405	T2020543
45105 ML7 P10	3D7 W0045 10
45105 LBA2 305	22B FS811 00
45105 LEA7 305	5AP W0045 00
45106 ML7 922	59301 48811

### MATERIAL AVAILABILITY AND PART NO.

STD	OPTIONS						
FA	SFA	SFAC	HH	SFA-HH	R	MXS	EPFA
FA142	SFA142	SFAC142	FA142HH	SFA142HH	-	-	-



# FA143 94.2 x 32 x 10mm



1 Left/1 Right

### HONDA

NSR 250 R2R/R3R (MC28-110)	94	R
R2T/R3T (MC28-120)	94	R
NSR 250 RR (MC28-100)	94-96	R
RVF 400 RR/RR-II/RT/RT-II (NC35)	89-92	R
VFR 400 RK/R3L/R3M/R3N (NC30)	92	R
NR 750 N	88-90	R
VFR 750 RJ/RK/RL (RC30)	94-98	R
RVF 750 RR/RS 'RC45'		

### Equivalents OE #

06435 MR7 P00	43105 MT7 405
43105 MR7 007A	43106 MR7 007B
43105 MR7 017A	43106 MR7 017B

### Competitor X Ref

Dunlop	Ferodo	SBS	Vesrah
DP113	FDB496	623	VD-139/2

### MATERIAL AVAILABILITY AND PART NO.

STD	OPTIONS			
	HH	R	MXS	EPFA
FA143	-	-	-	-

## FA144 use FA187

# FA145 70 x 55.5 x 8mm

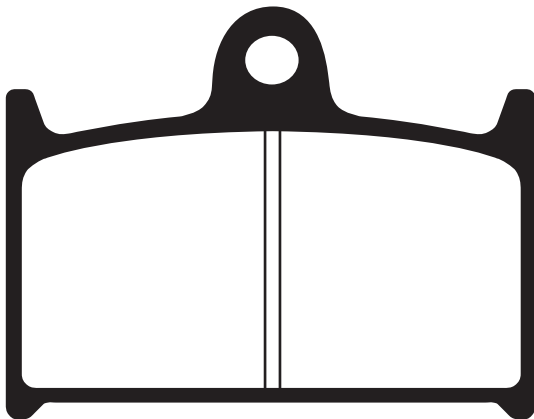

### SUZUKI

GSXR 400 RL/RM/RN/RP/RS (GK76A)	90-95	F
GSXR 750 J/K/L/M/WN/WP	88-93	F
GSXR 750 RG	86	F
RF 900 RR/RS/RS2/RT/RV/RW	94-98	F
GSXR 1100 K/L/M/N	89-92	F
GSF 1200 T/ST/V/SV/W/SW/X/SX/S/SY 'Bandit'	96-00	F
GSF 1200 SAV ABS Bandit	97	F

### YAMAHA

TZ 125	94-97	F
TZ 250	89-02	F
FZR 750 R "OWO"	89-90	F

### MZ/MUZ

1000 S	03-07	F
1000 SF	05-07	F
1000 SFX	07	F
1000 ST	07	F

### Equivalents OE #

59100 33830	59300 17811
59100 40810	3FV W0045 00
59130 17C00	3LC 25811 00
59130 33C00	3MW W0045 00
59130 33C10	3TC W0045 00
59130 40C00	9024020000
59300 17810	

### Competitor X Ref

Dunlop	Ferodo	SBS	Vesrah
DP213	FDB557	624	VD343

### MATERIAL AVAILABILITY AND PART NO.

STD	OPTIONS			
	HH	R	MXS	EPFA
FA145	FA145HH	-	-	EPFA145HH

# FA146 58.8 x 57.1 x 9mm

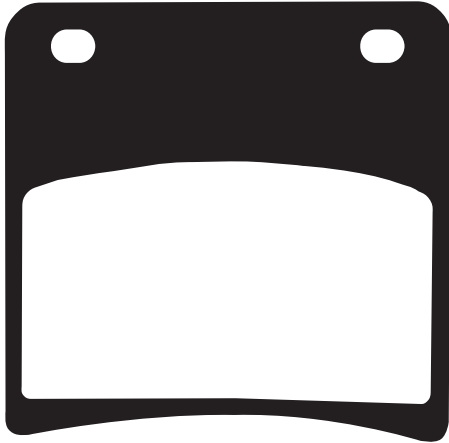

## SUZUKI

GW 250 L3 Inazuma	13	F
GSX 400 FJ/FK/FAK/FL (GK74A)	88-90	F
GSX 600 FJ/FK/FL/FM/FN/FP/FR/FS/FT/FV	88-97	F
GSX 750 FK/FL/FM/FN/FP/FR/FS/FT/FV	89-97	F
VX 800 L/M/N/P/R/T	90-96	R
GSX 1100 FJ/FK/FL/FM/FN/FP/FR	88-94	F
GSX 1100 GM/GN	91-94	R
GV 1400 GDG/GCG/GDH/GDJ "Cavalcade"	86-88	F

### Equivalents OE #

59100 19820	69100 34860
59100 24810	69100 45890
59130 19C00	69130 34C00
59130 20C00	69130 45C00
59130 24A10	69130 45C10
59130 26D00	69130 26D00
59130 45C10	69100 26810
59130 48B00	

### Competitor X Ref

Dunlop	Ferodo	SBS	Vesrah
DP212	FDB569	620	VD-345/2

MATERIAL AVAILABILITY AND PART NO.					
STD	OPTIONS				
FA	V	HH	R	MXS	EPFA
FA146	FA146V	FA146HH	-	-	-

# FA147 A. 118 x 48 x 8.6mm B. 97.5 x 57 x 10.8mm

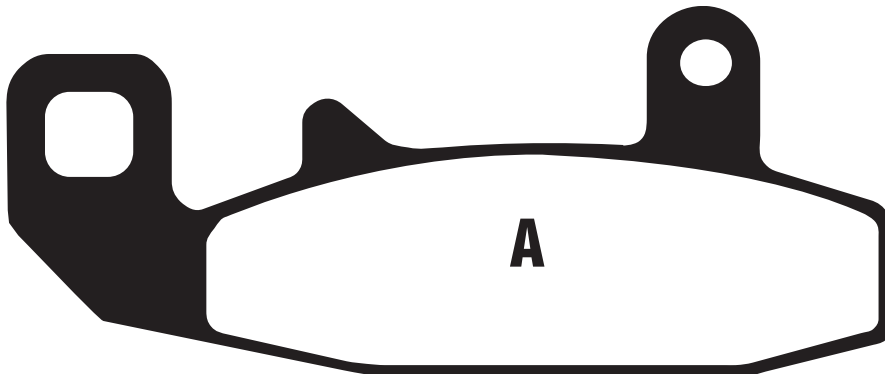

## SUZUKI

DR 650 RER/RES (SP45A/B)	94-95	F
DR 650 RSEM/RSEN/RSEP (SP43A/B)	91-93	F
DR 650 RL/RM (SP41A)	90-91	F
DR 650 RSL/RSM (SP42A)	90-91	F
DR 650 RUN/RN/RUP/RP (SP44A/B)	92-93	F
DR 750 SJ/SK	88-89	F
DR 800 SL	90	F

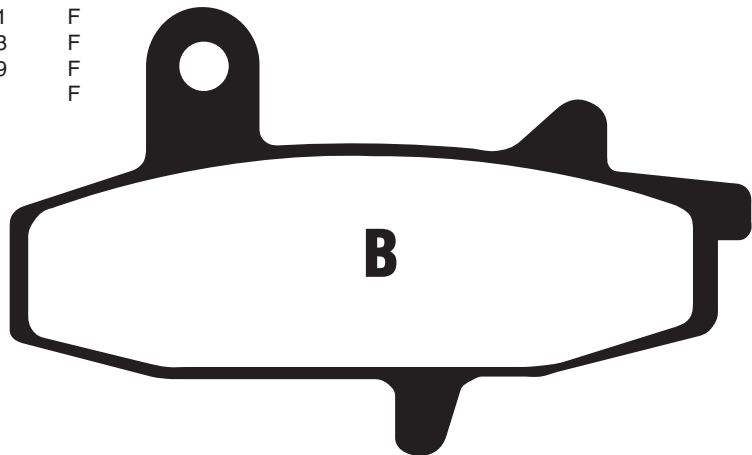

### Equivalents OE #

59300 44850
-------------

### Competitor X Ref

MATERIAL AVAILABILITY AND PART NO.				
STD	OPTIONS			
FA	HH	R	MXS	EPFA
FA147	-	FA147R	-	-

Dunlop	Ferodo	SBS	Vesrah
DP214	FDB606	626	VD-347

# FA150 57.3 x 59 x 9mm

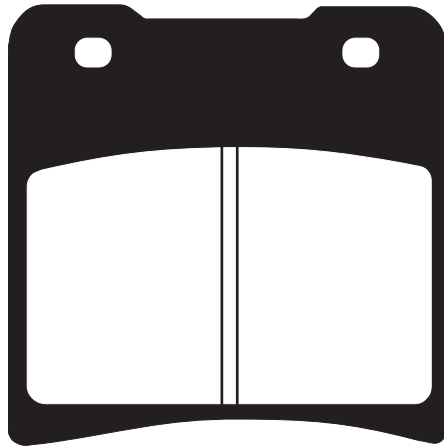

## SUZUKI

GV 1400 GDG/GCG/GDH/GDJ/GCH

'Cavalcade' (from f.no -103765)

86-88 R

### Equivalents OE #

69100 24860	69130 24A03
69130 24A02	69130 24A04

### Competitor X Ref

Dunlop	Ferodo	SBS	Vesrah
-	FDB831	-	VD331/2

### MATERIAL AVAILABILITY AND PART NO.

STD	OPTIONS				
FA	V	HH	R	MXS	EPFA
FA150	FA0150V	FA150HH	-	-	-

# FA151 51 x 36.5 x 8.3mm



## FA151

### HONDA

RS 125/250

88-07 R

NSF 250 R

12-13 R

### MORIWAKI/HONDA

MD 250 H/S

08-13 R

### SFA151

### GO CCIA (ELECTRIC SCOOTER)

Sunday (LA/Li)

12-13 F

### SYM

Cinderella 50/100

99-00 F

DD 50 (2T)

02-12 F

Mio 50

05-13 F

Tonik 50 (4T)

11-13 F

Mio 100

05-13 F

E W00 Electrico

11 F

Tonik 110 (4T)

11-13 F

E-Virid (Electric) Deluxe

12-13 F

E-Symmetry

12-13 F

### Equivalents OE #

43105 NF5 611	45105 GM9 742
43105 NF5 612	45105 GM9 743
45105 GH9 710	45105 GM9 743A
45105 GM9 741	

### Competitor X Ref

Dunlop	Ferodo	SBS	Vesrah
DP119	FDB2192	618/110	VD-150

### MATERIAL AVAILABILITY AND PART NO.

STD	OPTIONS					
FA	SFA	SFAC	HH	R	MXS	EPFA
FA151	SFA151	SFAC151	-	-	-	-

# FA152 62 x 40.8 x 9mm

# FA152/2 62 x 40.8 x 11mm



**NOTE:**  
**ANTI RATTLE SHIMS MUST BE  
DISCARDED TO USE THICKER PAD**

## FA152

### CANNONDALE

MX 400 00 R

### KAWASAKI

KX 125 G1/H1/H2/J1/J2/K1 89-94 R  
 KDX 125 A1/A2/B1/B2 90-94 R  
 KDX 200 E1-E6 89-94 R  
 KDX 200 H1-H5 95-99 R  
 KDX 200 SR (DX 200 G) R  
 KDX 220 R A4-A12/A6F 97-06 R  
 KDX 220 SR (DX 220 B) R  
 KDX 250 SR (KDX 250 F1) 91 R  
 KX 250 G1/H1/H2/J1/J2/K1 89-94 R  
 KDX 250 D1 91-93 R  
 KLX 250 R D1/D2/G1 93-97 R  
 KLX 250 F1-F4 94-97 R  
 KX 500 E1-E7 89-95 R  
 KLX 650 C1-C3 93-97 R

### SUZUKI

TS 125 RK/RL/RM/RN/RR 90-96 R  
 RM 125/250 K/L/M 89-91 R  
 TS 200 RK/RL/RM/RN/RR 89-94 R  
 DR 250 RS/RLS/RT/RV/RLV/RLW/RW/RX  
 (SJ45A/DOHC) 95-00 R  
 DR 250 RXT/RXLT/RXV/RXLV/RXW/RXLW  
 /RXGW/RXGLW/RXY/RXGY R  
 (Dejbel 250 XC/GPS Ver (SJ45A) R  
 DR 250 SL/SM/SN/SEP/SER/SES (SJ44A) 90-95 R  
 RMX 250 K/M/N/P 89-93 R  
 RMX 250 T/V/W 96-98 R  
 DR 350 SL/SM/SN/SP 4 bolt front disc  
 /kick start 90-93 R  
 DR 350 SER/SES (Electric start/4 bolt front disc) 94-95 R  
 DR 350 SET/SEV (Electric start/4 bolt front disc) 96-97 R  
 DR 350 SEW/SEX (Electric start/6 bolt front disc) 98-99 R  
 DR 650 SET/SEV 96-97 R

### YAMAHA

DT 125 RE 05-07 R  
 DT 125 X 05-06 R  
 YZ 125 A/B 90-91 R  
 TT 250 RL/RM/RN/RR/RS 99-04 R  
 XG 250 Tricker (5XT1) 04-06 R

XT 250 X (5C1) 06-08 R  
 XTZ 250 Lander (Brasil) (4B41/2) 07-08 R  
 YZ 250 A/WRA/B 90-91 R  
 WR 200 D/E/F 92-94 R  
 WR 250 ZB/ZD/ZE/ZF/ZG/ZH/ZJ 91-97 R  
 YZ 400 FK 98 R  
 WR 500 ZD 92 R  
 TT 600 RES 04 R

## FA152/2

### SUZUKI

RM 125 N/P/R/S 92-95 R  
 DR-Z 250 K1-K7 (DJ43A) 01-07 R  
 RM 250 N/P/R/S 92-95 R  
 RMX 250 R/S 94-95 R  
 RMX 250 SN/SR/SS (SJ13A) 95-97 R

### YAMAHA

YZ 125 D/E/F/G/H/J 92-97 R  
 DT 200 WR (3XP) 92-93 R  
 XT 225 WE (4JG5/6) Serrow 97-98 R  
 DT 230 (4TP1/2) Lanza 97-96 R  
 TT 250 R (4GY) Raid/4MR2 96 R  
 TT 250 R (4GY1 Japan) 93-94 R  
 TT 250 R (4RR1/2 Japan) 95-97 R  
 TT 250 RL (4PX5) 99 R  
 TT 250 RM (4PX6) 00 R  
 TT 250 R (4GY3/4GY5/4WA1) Raid 94-96 R  
 YZ 250 D/E/F/G/H/J 92-97 R  
 YZ 400 FK/WR 400 FK 98 R  
 WR 400 FK 98 R  
 TT 600 E (4GV2) 94-95 R  
 TT 600 K (4LW1/4GV1/4LW2) R  
 Up to 4GV 003403 (Nissin rear caliper) 93-95 R

### Equivalents OE #-FA152

43082 1090	43082 1151	69140 28C00
43082 1118	69100 15810	5XT W0046 50
43082 1131	69140 03D00	
43082 1137	69140 15D00	

### Competitor X Ref

Dunlop	Ferodo	SBS	Vesrah
DP315	FDB659	632/648	VD-432/2

### Equivalents OE #-FA152/2

69100 43820	69140 05D00	69140 27C20	3SP W0046 00	4GV FS811 00
69100 43840	69140 26C00	69140 43D00	3XP W0046 00	4GY W0046 00
69100 43850	69140 27C10	69140 43840	4DA W0046 00	5GF W0046 00

MATERIAL AVAILABILITY AND PART NO.				
STD	OPTIONS			
FA	HH	R	MXS	EPFA
FA152TT	-	FA152R	MXS152	-

MATERIAL AVAILABILITY AND PART NO.				
STD	OPTIONS			
FA	HH	R	MXS	EPFA
FA152/2TT	-	FA152/2R	MXS152/2	-

# FA153 75 x 40 x 8mm

## HONDA

AX-1 (NX 250 J/K/R/R3)	89-94	R
CRM 250 R (RK) MK1 MD24 (100001-1008385)	89-90	R
RTL 250 S	88-89	R
XLR 250 R (MD22)	88-90	R
XLR 250 Baja MK2 (MD22)		R
TLM 260	89-93	R



### Equivalents OE #

43106 KW3 006B
43106 KZ9 006B

### Competitor X Ref

Dunlop	Ferodo	SBS	Vesrah
DP120	FDB568	629	VD-153

### MATERIAL AVAILABILITY AND PART NO.

STD	OPTIONS			
FA	HH	R	MXS	EPFA
FA153	-	-	-	-

# FA155 40 x 23/7.8mm

## YAMAHA

YFS 200 B/F/G/H/J/K/L/M/N/P "Blaster"	91-02	R
---------------------------------------	-------	---

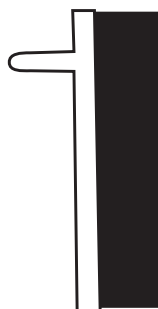
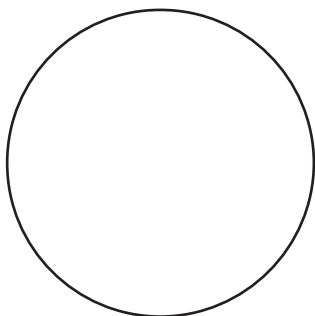

### Equivalents OE #

2XJ 25811 00
--------------

### Competitor X Ref

Dunlop	Ferodo	SBS	Vesrah
DP843	FDB2017	637	VD261

### MATERIAL AVAILABILITY AND PART NO.

STD	OPTIONS			
FA	HH	R	MXS	EPFA
FA155	-	FA155R	-	-

# FA156 55.8 x 45.5 x 6mm



## APRILIA

280 Climber	94-96	R
-------------	-------	---

## BETA

Synt/Gara	93-95	R
Techno	95	R

## CAGIVA

Blues 50	93-95	F
Super City 50/80	93-95	F
Prima 50	92-94	F

### Competitor X Ref

Dunlop	Ferodo	SBS	Vesrah
-	FDB886	672/126	VD-943

### Equivalents OE #

800066937
-----------

### MATERIAL AVAILABILITY AND PART NO.

STD	OPTIONS			
FA	HH	R	MXS	EPFA
FA156	-	-	-	-



# FA157 A. 99.3 x 44 x 7.4mm B. 47.7 x 83.3 x 9.7mm

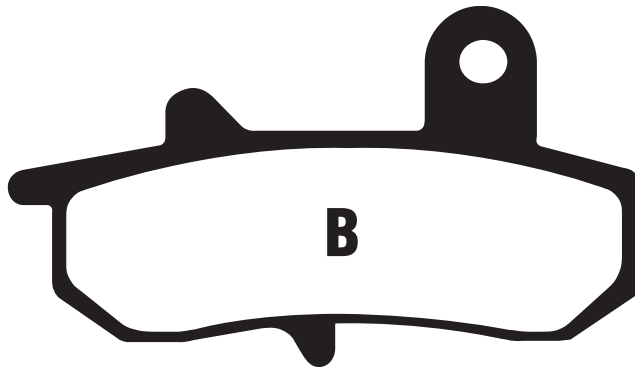
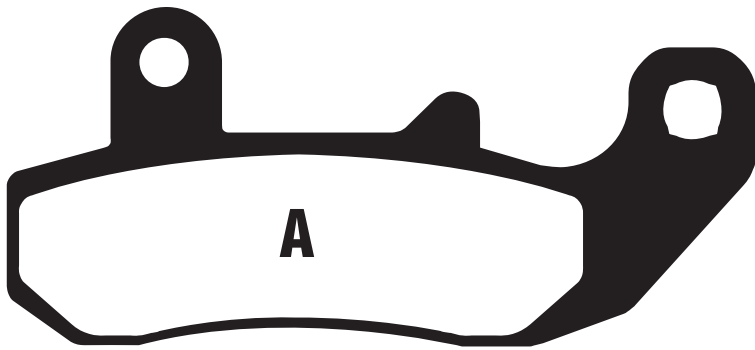

### SUZUKI

RG 125 FN/FP/FR (NF13A) Gamma		
/Rear Disc Model	92-94	R
RG 125 FUN/FUP/FUR (NF13B) Gamma		
/Rear Disc Model	92-94	R
RG 125 UN "Wolf" (ND13E) Naked	92-94	R
DR 600 RK (SN41A) (Rear disc model)	89	R
DR 650 RL/RM (SP41A)	90-91	R
DR 650 RSL/RSM (SP42A)	90-91	R
DR 650 RUN/RN/RUP/RP (SP44A/B)	92-93	R
DR 650 RER/RES (SPA45A/B)	94-95	R
DR 650RSEM/RSEN/RSEP (SP43A/B)	91-93	R
DR 750 SK	89	R
DR 800 SL	90	R

### YAMAHA

DTZ 125 Tenere/Tenere	89-90	R
DT 125 Chesterfield Scout	89-90	R

### Equivalents OE #

69100 44860
69100 12810

### Competitor X Ref

Dunlop	Ferodo	SBS	Vesrah
DP215	FDB607	635	VD-348/ 940

MATERIAL AVAILABILITY AND PART NO.				
STD	OPTIONS			
FA	HH	R	MXS	EPFA
FA157	-	FA157R	-	-

# FA158 46.7 x 69.8 x 8mm

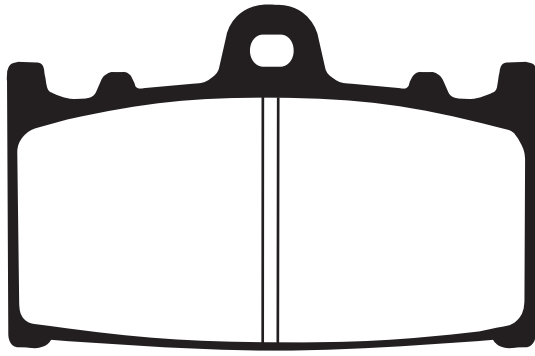

### KAWASAKI

KRIS (KR 250 C2/C3)	90-92	F
ZR 400 Zephyr (G2/G3/G3A/G4/G5)	97-01	F
ZXR 400 H1/H2	89-90	F
ZXR 400 J1/J2	89-90	F
ZXR 400 R (ZX 400 M1-M4)	91-94	F
ZZR 400 (ZX 400 K1/K2/K3)	90-92	F
ZZR 400 (ZX 400 N1/N2/N3/N4/N5/N6/N7)	93-99	F
ZZR 600 (ZX 600 D1-D3)(E1-E13)	90-05	F
ZZR 600 (ZX 600 E6F)	06-07	F
ZX6 R (ZX 600 F1/F2/F3)	95-97	F
ZXR 750 H1/H2/J1/J2/K1/K2/L1/L2 L3/M1/M2	89-95	F
GPz 900 R A7/A8	90-96	F
GPZ 900 R (ZX 900 A11)	98	F
ZX9 R (ZX 900 B1/B2)	94-95	F
KLZ 1000 ACF/ADF Versys	12-13	F
ZZR 1100 (ZX 1100 C1-C3) (D1-D9)	90-01	F
ZR 1100 A1-A4 'Zephyr'	92-95	F
ZZR 1200 C1H/C2H	02-04	F
VN 1700 B9F/BAF/BBF/BCF/BDF Voyager ABS	09-13	F
VN 1700 KBF/KCF/KDF Voyager Custom	11-13	F
VN 2000 A1/A2/A6F	04-08	F
VN 2000 H8F/H9F Classic	08-09	F
<b>SUZUKI</b>		
RG 125 FN/FP/FR (NF13A) Gamma/Rear disc	92-94	F
RG 125 FUN/FUP/FUR (NF13B) Gamma/Rear disc	92-94	F
GSXR 250 RK (GJ73A)		F
RGV 250 J/K/L/M/N/P/R/S	88-95	F
TV 250 J/K/AK/L (VJ21A) Wolf	88-90	F
SG 350 N 'Goose'	92	F
GSF 400 K/NK/Z/VM/VZM/P/NP/VP /VZP/VR (GK75A) "Bandit"	89-94	F
GSF 400 S/VS/V-V/VZ-V Bandit (GK7AA)	95-97	F
GSXR 400 J/RR/RAK (GK73A)	88-90	F
GSXR 400 K6/K7/K8	06-08	F
GSX 400 SSN (GK77A) Katana	92	F
GSR 600 K6/K7/K8	06-10	F

### SUZUKI Contd.

GSXR 600 V/W/X/Y/K1/K2/K3/ZK3	97-03	F
GSF 650 AK7/AK8/AK9 Naked Bandit - ABS	07-09	F
GSF 650 SAK7/SAK8/SAK9 Faired Bandit - ABS	07-10	F
GSF 650 K7/K8/K9/OL0 (Naked Bandit/Non ABS)	07-11	F
GSX 650 FK8/FK9/FL0/FL1/FL2	08-13	F
GSX 650 SK7/SK8/SK9 (Faired Bandit/Non ABS)	07-09	F
GSX 650 FAK8/FAK9/FAL0/FAL1/FAL2 (ABS Model)	08-13	F
GSXR 750 Y/K1/K2/K3	00-02	F
SV 1000 K3/K4/K5/K6/K7	03-07	F
SV 1000 SK3/SK4/SK5/SK6/SK7 (Faired model)	03-07	F
TL 1000 SV/SW/SX/SY/SK1	97-01	F
GSF 1200 SK6/SAK6 ABS & Non ABS Faired Bandit 4 Piston Caliper	06	F
GSF 1200 SK7/SK8/SK9/SL0 Faired Bandit - Non ABS 4 Piston Caliper	07-10	F
GSF 1250 K6/AK6 ABS & Non ABS Naked Bandit 4 Piston Caliper	06	F
GSF 1250 K7/K8/K9/OL0 Non ABS Naked Bandit 4 Piston Caliper	07-11	F
GSF 1250 AK7/AK8 ABS Model Naked Bandit 4 Piston Caliper	07-08	F
GSF 1250 SAK7/SAK8/SAK9/SAZK9/SAL0 ABS Model Faired Bandit 4 Piston Caliper	07-12	F
GSX 1250 FAL0/FAL1/FAL2	10-13	F
GSX 1250 FAL0ST/FST Sports Touring	10-12	F
<b>BEHRINGER</b>		
4 Piston (Old Design)		
<b>MOTOMASTER</b>		
4 Piston		
<b>PRE TECH</b>		
4 Piston (P402) Lockheed Replacement Caliper		
<b>PRO ONE</b>		
4 Piston		
<b>VERTEMATI</b>		
4 Piston Caliper	99-04	F

### Equivalents OE #

43082 1097	59100 32820	59130 32C20
43082 1102	59100 34830	59130 38C00
43082 1110	59100 35880	59300 34830
43082 1111	59101 35810	59100 35830
43082 1113	59130 06C00	59100 35850
43082 1120	59130 22D00	43082 0015
43082 1142	59130 32000	43082 1169
43082 1208	59130 32020	2654F/S/R2
43082 1288	59130 32C00	
59100 22810	59130 32C10	

### Competitor X Ref

Dunlop	Ferodo	SBS	Vesrah
DP317	FDB574	631	VD-343/344

### MATERIAL AVAILABILITY AND PART NO.

STD	OPTIONS			
FA	HH	R	MXS	EPFA
FA158	FA158HH	-	-	EPFA158HH

# FA159 97 x 40 x 7mm

**POLARIS**  
All Models

89- F&R



**DANGER MUST BE FITTED IN COMPLETE FRONT AXLE SETS TO AVOID PULLING LEFT OR RIGHT**

**Equivalents OE #**

1910036	1930731	2202412
1910042	1930815	2203452
1910129	2200465	2203792
1910333	2200901	2201149
1930643	2201398	1911171

**Competitor X Ref**

<b>Dunlop</b>	<b>Ferodo</b>	<b>SBS</b>	<b>Vesrah</b>
DP902/502	FDB2055	642	VD-940

MATERIAL AVAILABILITY AND PART NO.				
STD	OPTIONS			
FA	HH	R	MXS	EPFA
FA159TT	-	FA159R	-	-

DISC PADS BUYERS GUIDE

# FA160 74.8 x 53.9 x 10mm

**MZ**  
850 KBT 95 F

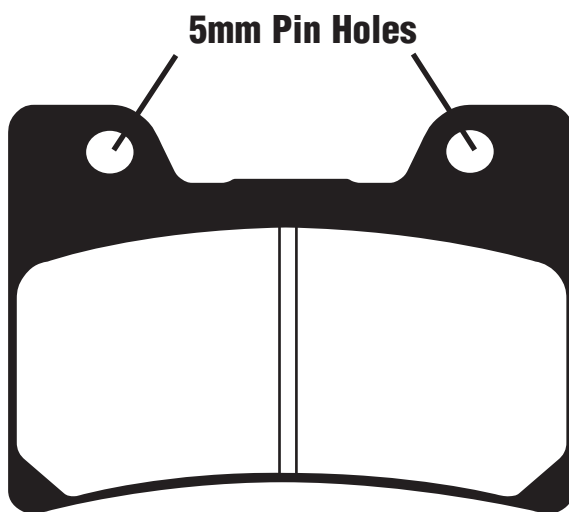

**YAMAHA**  
FZR 600 90-93 F  
FZR 600 R 94-95 F  
TDM 850 96-01 F  
FZR 1000 EX UP (Std Forks) 89-90 F  
V-MAX 12 93-03 F  
FJ 1200 A (ABS Model) 91-95 F

**Equivalents OE #**

3GM W0045 00	3GM W0045 11
3GM W0045 01	

**Competitor X Ref**

<b>Dunlop</b>	<b>Ferodo</b>	<b>SBS</b>	<b>Vesrah</b>
DP410	FDB666	645	VD-251

**For later pad FZR 1000 92-93 with 6mm pin holes use FA182**

MATERIAL AVAILABILITY AND PART NO.				
STD	OPTIONS			
FA	HH	R	MXS	EPFA
FA160	FA160HH	-	-	-

# FA161 52.6 x 52.7 x 8mm

**KAWASAKI**  
Z 250 A1/A2/A3 78-81 R  
ZXR 400 (L1-L9) 91-03 R  
ZXR 400 H1/H2 89-90 R  
ZXR 400 J1/J2 89-90 R  
ZXR 400 R (ZX 400 M1-M4) 91-94 R  
ZXR 750 H1/H2/J1/J2/K1/K2/L1/L2L3/M1/M2 89-95 R  
ZX-7R (ZX 750 P1/P2/P3/P4/P5/P6/P7) 96-03 R  
ZZR 1100 D1-D9 93-01 R  
ZRX 1100 (ZR 1100 C1/C2/C3/C4) 97-00 R  
ZX12R (ZX 1200 A1/A2/B1/B2) 00-03 R  
ZRX 1200 R(A1/A2/A3/A4/A5/A6F) 01-08 R  
ZRX 1200 5 (B1-B3) 01-04 R  
ZZR 1200 C1H/C2H 02-04 R  
ZX 12R (ZX 1200 B3/B4/B6F) 04-06 R

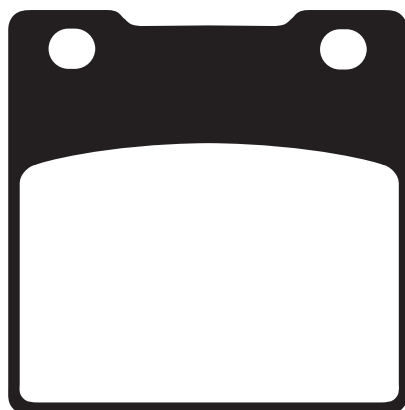

**Competitor X Ref**

<b>Dunlop</b>	<b>Ferodo</b>	<b>SBS</b>	<b>Vesrah</b>
DP318	FDB338	556	VD-416

**Equivalents OE #**

43082 1003	43082 1141	43082 1257
43082 1098	43082 1180	43082 1291
43082 1103	43082 1200	

MATERIAL AVAILABILITY AND PART NO.					
STD	OPTIONS				
FA	V	HH	R	MXS	EPFA
FA161	FA161V	FA161HH	-	-	-

# FA162 47.8 x 48.6 x 7.2mm

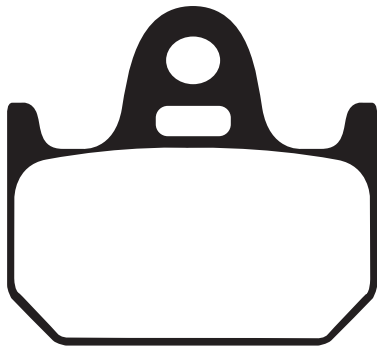

### YAMAHA

TZ 125	94-97	R
TZ 250	89-01	R
TZ 250 (Radial Caliper)	02-10	R

### Equivalents OE #

3CL W0046 00	3LC W0046 00
3LC 25811 50	4TW W0046 00

### Competitor X Ref

Dunlop	Ferodo	SBS	Vesrah
-	FDB2194	659	-

### MATERIAL AVAILABILITY AND PART NO.

STD	OPTIONS			
FA	HH	R	MXS	EPFA
FA162	-	-	-	-

# FA163 99.5 x 52 x 7.8mm

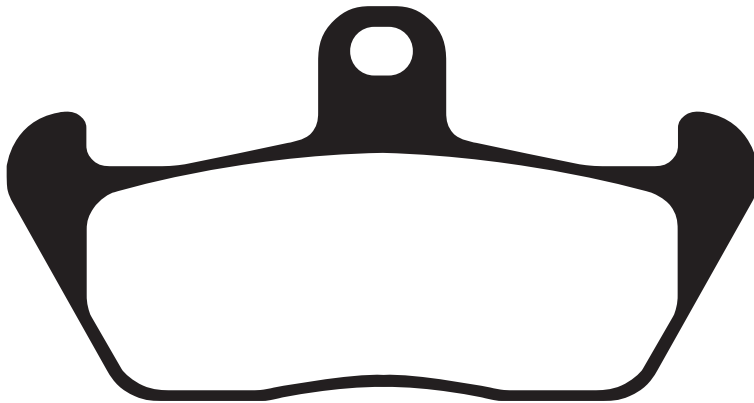

### CAGIVA

Mito 125	91-92	F
W8 125	93-98	F
Freccia 125 SY	89	F
Supercity 125	92-	F
Tamanaco 125	88-89	F
W12 "350"	93-95	F
W16 "600"	94-98	F
750 Elefant	90-92	R

### APRILIA

Tuareg Rally 215	89	F
Tuareg Wind 600	89	F

### GILERA

Nord-West 350	94-	F
---------------	-----	---

### MOTO GUZZI

1000 Quota	92-97	R
------------	-------	---

### Equivalents OE #

8000 59214
000306546300
8113283
GU30654630

### Competitor X Ref

Dunlop	Ferodo	SBS	Vesrah
DP618	FDB529	641	VD-927

### MATERIAL AVAILABILITY AND PART NO.

STD	OPTIONS			
FA	HH	R	MXS	EPFA
FA163	-	-	-	-

# FA164 74.2 x 40.5 x 6.7mm



### BETA

TR34 260	89-91	R
Synt	92	R
Zero	92	R
Supertrial ST	94	R

### Equivalents OE #

N/A
-----

### Competitor X Ref

Dunlop	Ferodo	SBS	Vesrah
DP609	-	636	VD-938

### MATERIAL AVAILABILITY AND PART NO.

STD	OPTIONS			
FA	HH	R	MXS	EPFA
FA164	-	FA164R	-	-

**FA165 A. 96.7 x 42 x 7.4mm B. 77.3 x 42 x 7.4mm**

**FA165/2 A. 96.7 x 42 x 9.7mm B. 77.3 x 42 x 8mm**

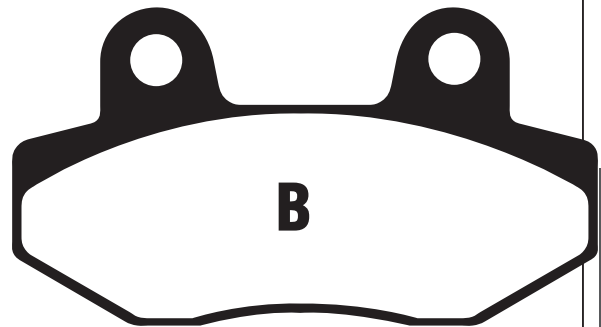
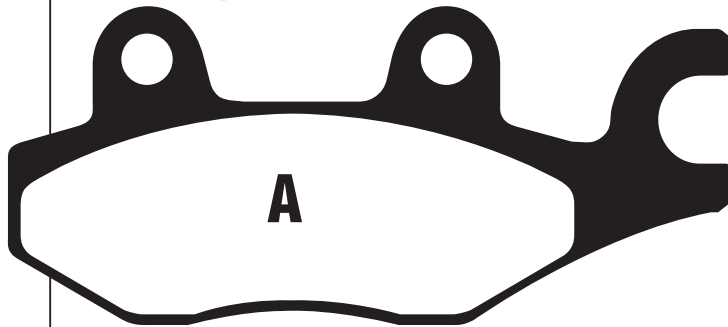

**FA165**

**AEON**

Cobra RS 180 (Quad)	06	R
Overland 125 (AT08) (Quad)	02-06	R
Overland 180 (AT08) (Quad)	02-11	R
Crossland RX 350	11	R

**APACHE**

RLX 150 S		R
-----------	--	---

**BLANEY (Quads)**

XL 200 Trooper	03-04	R
----------------	-------	---

**CAN AM (SIDE X SIDE)**

Commander 800 R	11-13	F (Left)
Commander 800 R XT	11-13	F (Left)
Commander 800 (XT/DPS)	11-13	F (Left)
Commander 1000	11-13	F (Left)
Commander 1000 LTD	12-13	F (Left)
Commander 1000 X	11-13	F (Left)
Commander 1000 XT	11-13	F (Left)
Commander 1000 (DPS)	12	F (Left)

**CF MOTO**

CF 500-3 (Rancher 500 Side x Side)	10-11	F (Left)
CF 500 (Terra Cross)	12	F(left)&R(left)
CF 625-3 (Z6 Terra Cross)	11-12	F(left)&R(left)
CF 800-3 (Tracker 800 Side x Side)	13	F (Left)

**CPI**

XT 50 Quad	06-09	R
------------	-------	---

**E-TON QUADS**

RXL 150 Viper R	05	R
CXL 150 Yukon II/Challenger	02-	R
EXL 150 Eukon St	05-07	R
RXL 150 Viper	05-06	R

**GOES**

G 520 UTX (Side x Side)	10-11	F(Left)
-------------------------	-------	---------

**JONWAY**

YY 125	08-09	F&R
YY 150	08-09	F&R
YY 250/250 A	08-09	F&R

**KAWASAKI**

Kazer 115		F
KLF 300 C1-C17 "Bayou"	89-05	F(left)
KLF 400 B1-B7 Bayou	93-99	F(left)
KVF 650 F7F/F8F Brute Force 4x4i		
Hardwoods Green	07-08	F(left)
KVF 650 H7F/H8F Brute Force 4x4i	07-08	F(left)
KVF 650 G7F/G8F Brute Force 4x4i		
Hardwoods Green	07-08	F(left)
KVF 750 A1/A6F/B1/B6F Brute Force 4x4	05-06	F(left)
KVF 750 E8FA Brute Force 4x4		
Hardwoods Green HD	08	F(left)
KRF 750 TAF Teryx 750 Fi 4x4 SGE	10-11	F(left)
KRF 750 G9F/NAF/NBF/NCS/NDF Teryx 750 Fi 4x4	09-13	F(right)
KRF 750 J9FA/K9F/PAF/RAF/PBF/RBF/RCS/		
PDF/RDF Teryx 750 Fi 4x4 LE	09-13	F(right)
KRF 750 L9F Teryx 750 Fi 4x4 LE Sport	09	F(right)
KRF 750 M9F Teryx 750 Fi 4x4 NRA Outdoors	09	F(right)
KRF 750 SAF/SAFA/SBF/SBFA/SCS/SCSA		
/SDF Teryx 750 Fi 4x4 Sport LE	10-13	F(right)
Teryx 750 4x4 (RUV) KRF 750 A8F/B8F	08	F(left)
Teryx 750 4x4 LE (RUV) KRF 750 C8F/D8F	08	F(left)
Teryx 750 4x4 NRA Outdoors (RUV)		
KRF 750 F8F	08	F(left)

**MBK**

TZR 50 'X-Blazer'	00	F
-------------------	----	---

**MOTO-ROMA**

Go-Go 110	02	F
Geko 300 Quad	04-06	R

**QUADZILLA**

4 Cross 200cc		R
---------------	--	---

**SUZUKI**

LT-F 300 FK2	02	R(left)
LT-R 450 K6/K7/K8/K9/L0/L1	06-12	F(left)
LTA 500 FY/FK1	00-01	F(left)
LT-F 500 FW/FX/FY/FK1/FK2	98-02	F(left)

**TAISHAN**

Panther 90 Quad	04	R
Hurricane 125 Quad	04	R
Explorer 150 Quad	04	R
Tornado 200 Quad	04	R

**YAMAHA**

YZF 450 S/T/V/W/X	04-08	F(left)
YZF 450 RY/RZ (Quad)	09-10	F(left)
YXR 66 FAS/FAT Rhino 4x4 Side x Side	04-05	F(left)
YFM 700 RV/RW/RX/RY/RA/RB Raptor	06-12	F(left)
YFM 700 RD Raptor	13	F(left)
YXR 700 Rhino 4x4 SE	09	F(left)
YXR 700 FA/FB/FD Rhino Side x Side	11-13	F&R(left)
XTZ 750 "Super Tenere"	89-95	F&R(left)

**FA165/2**

**BOMBARDIER**

Rally 200	05-06	R
-----------	-------	---

**CAGIVA**

Canyon 600 E	96-99	R
Canyon 500	96-00	R
900 IE Canyon/Gran Canyon	97-00	R
E 900 Elefant Dakar Rep (300mm front disc)	90	R
E 900 ie Lucky Explorer (296mm front disc)	90	R
E 900 ie GT (296mm front disc)	91-92	R
Navigator 1000	00-05	R

**HYOSUNG**

XRX 125 Supermoto	07-11	R
-------------------	-------	---

**MZ/MUZ**

VRT 125 Quad	05	R
VRT 175 Quad	05	R

**SUZUKI**

DR 800 SM/SN/SP	91-93	R
-----------------	-------	---

**YAMAHA**

XTZ 750 "Super Tenere"	89-95	R
------------------------	-------	---

**VOXAN**

Scrambler 1000	02-06	R
----------------	-------	---

**Competitor X Ref**

Dunlop	Ferodo	SBS	Vesrah
DP412	FDB631	638	VD-250

**Equivalents OE # - FA165**

43020 CEK 000	7 020 016	5B4 W0045 00
43082 0069	IS3 W0046 10	59300 09840
43082 0080	59100 09860	59300 09850
43082 1094	59100 09880	715500325
3JD W0045 10	810183	903 08 08 80
59100 09840	67131 BCAA 0000	903 08 08 90

**Equivalents OE # - FA165/2**

69100 31820	59312 HP7 600
3LD W0046 01	59400 HP7 600
8000 66785	59401 HP7 600
A45120 168 000	

MATERIAL AVAILABILITY AND PART NO.				
STD	OPTIONS			
FA	HH	R	MXS	EPFA
FA165TT	FA165HH	FA165R	MXS165	-

MATERIAL AVAILABILITY AND PART NO.				
STD	OPTIONS			
FA	HH	R	MXS	EPFA
FA165/2TT	-	FA165/2R	-	-



# FA166 100 x 46.7 x 7.5mm

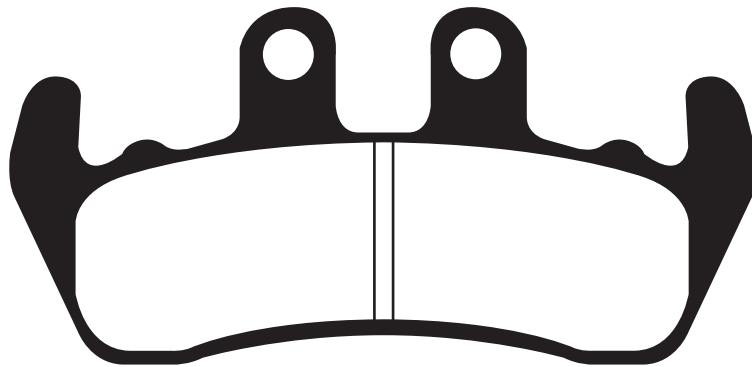

### HONDA HM (Italy)

CRE 50 Six/Baja/Derapage Grimeca  
caliper twin pin Kayaba forks 95-02 F

### YAMAHA

DT-Z 125 'Tenere/Tenere Scout' 89-90 F  
DT 125 Chesterfield Scout 89-90 F

### Equivalents OE #

K009463415

### Competitor X Ref

Dunlop	Ferodo	SBS	Vesrah
-	-	-	-

MATERIAL AVAILABILITY AND PART NO.				
STD	OPTIONS			
FA	HH	R	MXS	EPFA
FA166	-	-	-	-

# FA167 77 x 42 x 7.5mm

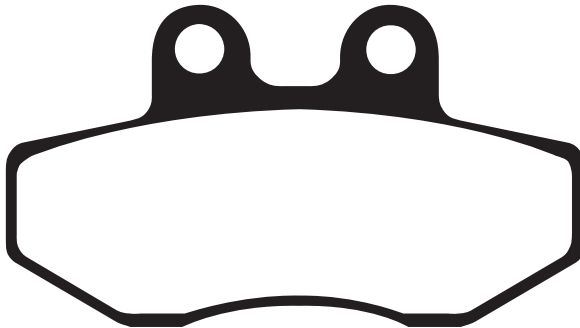

### EXPLORER

KBR 200 05 F

### GAS-GAS

EC 50 Rookie 01-04 F

SM 50 Rookie 01-04 F

### GOES

G 50 X 08-09 F&R

### HRD

Cabriolett 125 01 F

Sonic 2 Trail 50 F

Sonic 2 Supermotard 50 F

Cabriolett Trail 125 F

Cabriolett Supermotard 125 F

### HUSQVARNA

SM 50 02 F

WR 50 02 F

WXE 125 07 F

### MH/MOTORHISPANIA

RX 50 Super Racing 06-07 F

RYZ 50 Urban Bike 06-10 F

RYZ 50 Pro Racing Enduro 06-10 F

### MOTO ROMA

SMX 125 04-06 F

### PEUGEOT

XP 125 Street Evo 2 05 F

XR6 (2T) 50 03-07 F

### RIEJU

RR 50 Castrol 50 00-02 F

RS1 50cc 01-04 F

MRX 50 Castrol/SMX 50 01-02 F

Spike 50 Pro 04 F

SMX 125 02-07 F

MRX 125 02-08 F

### SACHS

Roadster 125 00-03 F

### SHERCO

SM 50 Supermotard 03-07 F

Enduro 50 (50 EN) 03-07 F

Enduro 50cc (2T) 02-07 F

Supermotard 50cc (2T) 02-07 F

City Corp 125 (All models) 03-07 F

SM 125/125 City Corp 03-06 F

### TOMOS

SE 125 F 05-08 F

### AJP

PR4-Enduro 125 04-09 F

PR4-Supermotard 125 04-09 F

PR4 Enduro 200 04-09 F

PR4 Supermotard 200 04-09 F

### APRILIA

RX3-5 Marce (M/N/P/R) 91-94 F

Classic 125 96-01 F

Tuareg Rally 125 (N) 93 F

Pegaso 125 91 F

Pegaso 600 91 F

Classic 125 99 F

### BETA

RK6 93-96 F

RK6 50cc Enduro 97-02 F

### BULTACO

Astro SM50 F

### CH RACING

WXE 50 Enduro 05 F

WSM 50 Motard 05 F

WXE 125 Enduro 05 F

WSM 125 Motard 05 F

### DERBI

GPR 50 R 97-01 F

GPR 50 Replica Racing 99-03 F

Senda SM DRD 50 (Double disc model) (SDR1DB) 02-03 F

Senda 50 Black Edition 03 F

Senda R 125 Vin# SCB1A 04 F

### Competitor X Ref

Dunlop	Ferodo	SBS	Vesrah
DP613	FDB706	652/148	-

MATERIAL AVAILABILITY AND PART NO.				
STD	OPTIONS			
FA	HH	R	MXS	EPFA
FA167	FA167HH	-	-	-

### Equivalents OE #

8113373	00009300065
8113478	00RTS01A0015
8113604	2525230000
P00 927 020 64 07 000	R351
214 007 1000002	00H04702141

# FA168 Use FA252

# SFA169 61.1 x 27.1 x 7.3mm

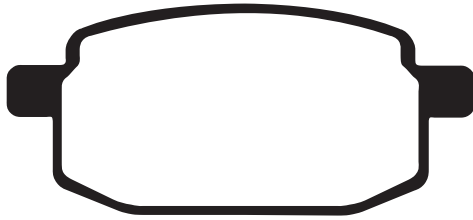

## ADLY

City Bird F  
 Fox 50 F  
 Road Tracer 50/90/100 04-06 F

## BAOTIAN

BT49 QT-9 Speedy 50 (4T) 10-11 F  
 BT49 QT-11 Retro 50 (4T) 06-11 F

## BETA

R 125 4T Mini Cross F

## DAELIM

M 50 D/MD Millenium 03 F  
 DX 50 D Camper 03 F  
 ST 90 Pro Monkey 03 F

## FYM/X-Sport

CR 90 E 06-07 F  
 110 ES 06-07 F  
 CR 110 06-07 F  
 CR 110 ESR 06-07 F  
 X-Sport Typhoon 125 Quad 06-07 F  
 CR 3 125 06-07 F  
 CR 125 R 06-07 F

## GARELLI

FX 50 F  
 Capri LX 50 06-08 F  
 Capri (DF 50 QT-7) 06 F  
 Ciclone 50 07 F  
 Vip 50 08 F

## HERO HONDA

Nipster 50 06 F

## JORDAN

Easy 50/100 03-04 F

## KAWARA

Fever 50/90 99 F  
 Stinger 90 99 F

## LEM

Four X Pro F

## LIFAN

LF 50 QGY F

## MALAGUTI

Malbo Line - DVD 50 (2T) 10-11 F

## MOTO-ROMA

Bee 50 04-05 F  
 Go-Go 50/110 97-05 F  
 Stinger 50 01-05 F  
 Scrambler 50 01 F  
 Road Runner 50/100 01-02 F  
 Grand Prix 125 01 F

## MBK

CY 50 Forte/Forte Mufa 96-97 F  
 CR 50 Z Target 91-95 F

## MZ/MUZ

Moskito FB50 97-03 F  
 Moskito SX/JP50 00-03 F

## PEUGEOT

V-Clic 50 (4T) (155mm dia. disc) 08-13 F  
 V-Clic 50 (4T) (160mm dia. disc) 08-11 F

## P.G.O

Big Max 50 94-06 F  
 EPS 97 F  
 Tornado 50/125 97 F

## QUADZILLA

WK 70 (Front disc model) 06-09 F  
 WK 110 06-08 F  
 WK 125 06-09 F

## SIAMOTO

Birdie 50 02-04 F  
 Favorite 02-04 F

## SINNIS

Falcon 50 QM 50 QT-2T 08-10 F  
 Jet 50 QM 50 QT-6A 08-10 F

## SUPERBYKE

M-Ped 50 Road Classic F

## TERRA MOTO

TDX 125 F 07 F&R  
 TDX 125 F Krusha 07 F&R  
 TDX 125 F Street Ripa 07 F&R

## THUMPSTAR

Thumpstar Junior 90cc 04-06 F  
 Thumpstar Supa 110cc 04-06 F  
 Thumpstar Expert 125 06 F  
 Thumpstar Pro 125 05-06 F  
 Thumpstar 125 Road Ripper 06 F&R

## VIALLI

Cargo 50 06 F  
 FXR Sport 50 06 F  
 Jupiter 50 06 F

## WUYANG

WY 50 QT 06-07 F

## YAMAHA

CR-Z 50 (3WN) 91-95 F  
 CY 50 RS Jog R 96- F  
 YA 50 ZA Jog Z (4SC1) 95 F  
 YW 100 T Booster BWs 96 F

### Competitor X Ref

Dunlop	Ferodo	SBS	Vesrah
N/A	FDB636	619/111	VD253

### Equivalent OE #

2NA W0045 01	802 567 1000
5CP W0045 00	T01H000101
45120 107 000	64098800
3XG W0045 00	140330
5JU W0045 00	

### MATERIAL AVAILABILITY AND PART NO.

STD	OPTIONS						
	SFA	SFAC	HH	SFA-HH	R	MXS	EPFA
-	SFA169	SFAC169	-	SFA169HH	-	-	-

# FA170 99.8 x 55.8 x 9.3mm

**USE  
FA407**

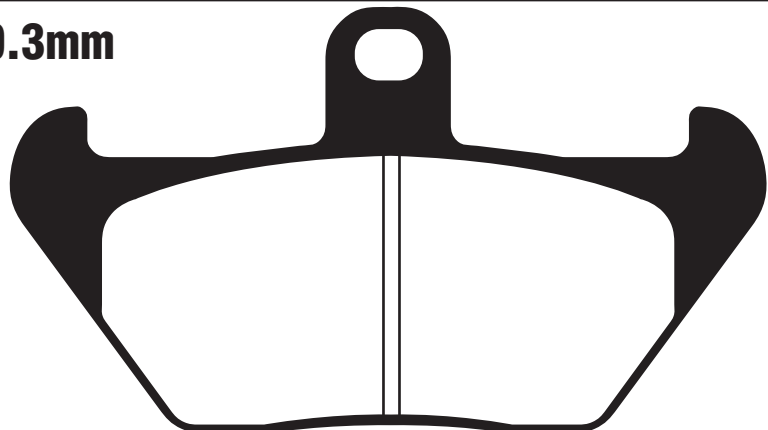

# FA171 57.7 x 53.7 x 8.9mm

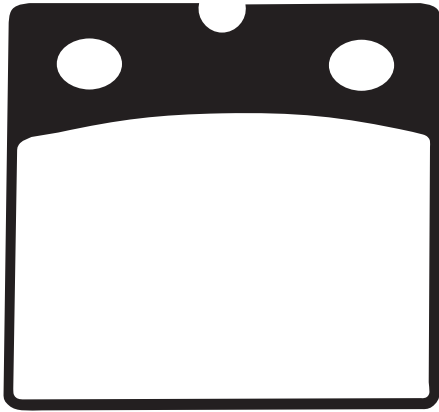

## BMW

K 75/75-2	09/88-96	F
K 75/75-S	08/90-96	F
K 75 C	09/88-02/88	F
K 75 RT	89-96	F
K 75 RT	89-96	F
K 75 S	09/88-95	F
K 75 S	09/88-95	F
K 100/2	09/88-90	F
K 100 LT	09/88-91	F
K 100 RS	10/88-89	F
K 100 RT	10/88-89	F
R 80/R 80 RT	09/88-95	F
R 100 RS	9/9-92	F
R 100 RT	09/88-95	F
<b>QUADZILLA</b>		
RL 500 Buggie	08-09	F&R

### Equivalents OE #

34 11 2 310 494	34 11 2 331 175
34 11 2 311 175	34 11 2 314 546

### Competitor X Ref

Dunlop	Ferodo	SBS	Vesrah
DP608	FDB736	640	VD-933

### MATERIAL AVAILABILITY AND PART NO.

STD	OPTIONS				
FA	V	HH	R	MXS	EPFA
FA171	FA171V	FA171HH	-	-	-

# FA172 A. 104 x 45.6 x 9.8mm B. 88 x 42 x 9.8mm

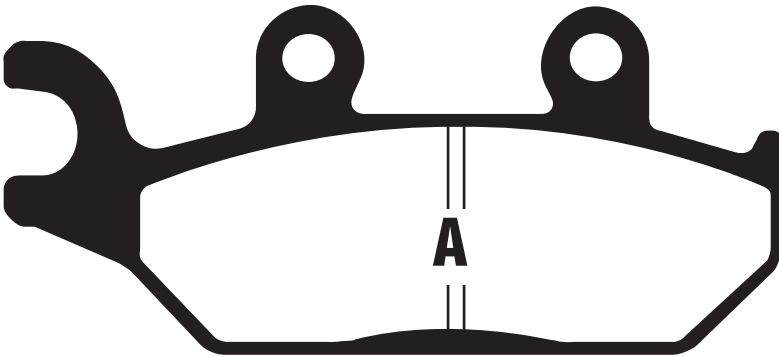

**A**

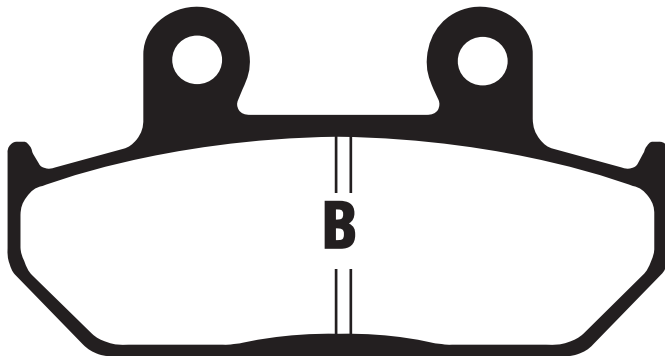

**B**

## YAMAHA

XT 600 E	92-03	F
XTZ 660 "Tenere"	91-98	F

### Equivalents OE #

3YF W0045 00	4PT W0045 00
3TB W0045 00	

### Competitor X Ref

Dunlop	Ferodo	SBS	Vesrah
DP413	FDB737	650/137	VD-252

### MATERIAL AVAILABILITY AND PART NO.

STD	OPTIONS			
FA	HH	R	MXS	EPFA
FA172TT	-	FA172R	-	-

# FA173 A. 85 x 42.5 x 7.3mm

# B. 56 x 35 x 9.7mm

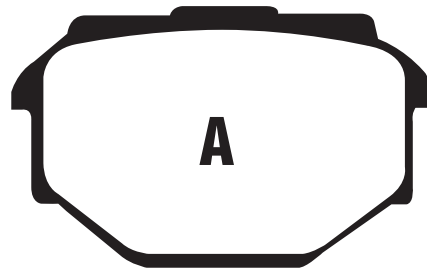
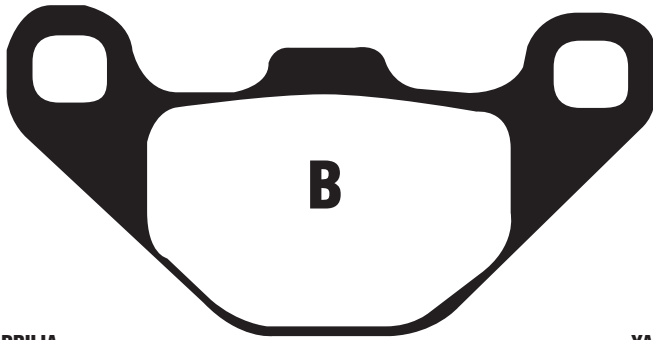

### APRILIA

ETX 125	99-01	R
Moto 6.5	95-01	R
Pegaso 650	91-00	R

### BETA

Jonathan 125	02-05	R
--------------	-------	---

### CAGIVA

W12 "350"	93-95	R
W16 "600"	94-98	R

### GILERA

Eaglet 50	96	R
50 RC Top Rally	90-	F&R

### MALAGUTI

F10 Jetline	91-93	F
50 America	91-	F

### MBK

X-Limit 50	02	R
------------	----	---

### MZ/MUZ

Baghira - Forest/Forest HR		
- 21" front wheel/spoke wheel	96-05	R
Baghira - Street Moto		
- 17" front wheel/spoke wheel	96-05	R
Baghira - 21" front wheel/spoke wheel	99-05	R
Baghira - Black Panther		
- 17" front wheel/spoke wheel	96-03	R
Mastiff - 21" front wheel/spoke wheel	96-05	R

### YAMAHA

TDR 125 (3HS1/3XD0/3SH3/3XD01)	89-93	R
--------------------------------	-------	---

### Equivalents OE #

34 11 2 310 494	902203100
8113595	3SH F5811 00
8000 68794	5VB W0045 00
11940100	

### Competitor X Ref

Dunlop	Ferodo	SBS	Vesrah
DP310	FDB828	684	VD-425

### MATERIAL AVAILABILITY AND PART NO.

STD		OPTIONS			
FA	SFA	HH	R	MXS	EPFA
FA173	SFA173	-	-	-	-

# FA174 86.3 x 41.4 x 10.2mm



### HONDA

CB 400 SF4/5/S5 (NC39)	04-05	R
VRX 400 T (NC33)	96	R
CB 500 A4/A5/A6/A7	04-07	R
CBF 500 4 (Non ABS Model)	04-	R
CB 600 FW/FX/ "Hornet"	98-00	R
CB 600 FY/F2Y/F1/F21/F2/F22/F3/F4/F5/F6		
/FA7/FA8/FA9/FAA/FAB Hornet	00-12	R
CBF 600 N8/N9 (Non ABS)	08-09	R
CBF 600 S4/S5/S6/S8/S9 (Non ABS)	04-06/08-09	R
CBF 600 SA4/SA5/SA6/SA8/SA9/SAA (ABS)	04-06/08-12	R
CBF 600 NA8/NA9 (ABS)	08-09	R
CBF 600 N4/N5/N6 (Non ABS)	04-06	R
CBF 600 NA4/NA5/NA6 (ABS)	04-06	R
CBR 600 FM/FN/FP/FR/FS/FT/FV/FW/FX/FY	91-00	R
CBR 600 F1/F2/ CBR 600 FS1/FS2 'Sport'	01-02	R
CBR 600 F3/F4/F5/F6	03-06	R
CBR 600 RR3/RR4/RR5/RR6	03-06	R
CBR 600 FAB/FAC (ABS Model)	11-13	R
700 Integra Scooter NC 700 DC	12-13	R
NC 700 XAC/XAD-DCT (Auto G/box)	12-13	R
NC 700 SAC/SAD DCT Auto Gearbox	12-13	R
XL 700 VA8/VA9/VAA (Transalp/3 piston front caliper		
/ABS front & rear wheels)	08-11	R
CB 750 F2N/F2R/F2S/F2T/F2V/F2W/F2X/F2Y/F2I		
CB Seven Fifty	92-02	R

CBR 900 RRN/RRP/RRR/RRS/RRT/RRV		
/RRW/RRX/RRY/RR1/RR2/RR3 Fireblade	92-03	R
CB 900 F2/F3/F4/F5/F6/F7 Hornet	02-07	R
CB 1000 FP/FR/FS/FT/FV	93-97	R
CBF 1000 6/7/8/9/A (Non ABS Model)	06-10	R
CBF 1000 F (FA) (2 piston front calipers/non ABS)	10-11	R
CBF 1000 6/7/8/9/A (2 piston front caliper/Non ABS)	06-11	R
CBR 1000 RR4/RR5 Fireblade	04-05	R
KLZ 1000 ACF-Versys	12	R
VTR 1000 FV/FW/FX/FY/F1-F6 'Firestorm'	97-06	R
VT-R 1000 SPY/SP1 (SC45)	00-01	R
VTR 1000 SP2/SP3/SP4/SP5/SP6	02-07	R
CB 1100 D	13	R
VT 1100 C2 (W/X/Y/1/2/3/4/5)	98-05	R
VT 1100 C2 (S/T/V)	95-97	R
VT 1100 C3 (W/X/Y)	98-00	R
CB 1300 F3/F13	03-04	R
CB 1300 5/6/7/8/9 (Superfour)	05-09	R
CB 1300 A5/A6/A7/A8/A9 (Superfour ABS)	05-09	R
CB 1300 SA5/SA6/SA7/SA8/SA9/SAA	05-12	R
CB 1300 S5/S6/S7/S8/S9	05-09	R
VT 1300 CXA Chopper (9 spoke cast wheel/non ABS)	10-12	R
VT 1300 CXAA "Chopper"		
(9 spoke cast wheel/ABS model)	10-11	R
VTX 1300 S3/S4/S5/S6/S7/S8	03-08	R

# FA174 Contd.

## KAWASAKI

Z 750 (ZR 750 L7F/L8F/L9F/LAF/LBF)	07-11	R
Z 750 ABS (ZR 750 M7F/M8F/M9F/MAF/MBF)	07-11	R
KLX 1000 (LV 1000 A1H/A2H)	04-05	R
KLZ 1000 ACF/ADF Versys	12-13	R
Z 1000 (ZR 1000 B7F/B8F)	07-08	R
Z 1000 ABS (ZR 1000 C7F/C8F/C9F)	07-09	R

## SUZUKI

SV 400 K3/K4/K5	03-05	R
SV 400 SK3/SK4/SK5	03-05	R
DL 650 AK9 GT V-Strom Traveller ABS	09-11	R
DL 650 K4/K5/K6 V-Strom	04-06	R
DL 650 XK7/XK8/XK9/XL0 V-Strom X	07-11	R
DL 650 AK7/AK8/AK9/ALO V-Strom ABS	07-11	R
DL 650 AL1 XP V-Strom Xpedition	11	R
DL 650 AL2/AL3 V-Strom	12-13	R
GSF 650 AK5/AK6 Naked Bandit ABS	05-06	R
GSF 650 AK7/AK8/AK9 Naked Bandit ABS	07-09	R
GSF 650 K7/K8/K9/OL0 Naked Bandit/Non ABS	07-11	R
GSF 650 SAK5/SAK6 Faired Bandit ABS	05-06	R
GSF 650 SAK7/SAK8/SAK9/SAL0 Faired Bandit ABS	07-11	R
GSX 650 FK8/FK9/FL0/FL1/FL2	08-13	R
GSX 650 SK7/SK8/SK9 Faired Bandit/Non ABS	07-09	R
GSX 650 FAK8/FAK9/FAL0/FAL1/FAL2 (ABS Model)	08-13	R
SV 650 K3/K4/K5/K6/K7/K8/K9/LO Naked - Non ABS	03-10	R
SV 650 SK3/SK4/SK5/SK6/SK7/SK8/SK9/SLO Top Fairing Non ABS	03-13	R
SV 650 AK7/AK8/AK9/ALO Naked - ABS	07-10	R
SV 650 SAK7/SAK8/SAK9/SAL0	07-12	R
GSR 750 L1/L2/L3	11-13	R
DL 1000 K2/K3/K4/K5/K6/K7/K8/K9/LO V-Strom	02-10	R
SV 1000 K3/K4/K5/K6/K7	03-07	R
SV 1000 SK3/SK4/SK5/SK6/SK7 Faired Model	03-07	R
GSF 1250 SK6/SAK6 ABS & Non ABS Faired Bandit 4 Piston Caliper	06	R
GSF 1250 K6/AK6 ABS & Non ABS Naked Bandit 4 Piston Caliper	06	R
GSF 1250 K7/K8/K9/OL0 Non ABS Naked Bandit 4 Piston Caliper	07-11	R
GSF 1250 SK7/SK8/SK9/SLO Faired Bandit Non ABS 4 Piston Caliper	07-10	R
GSF 1250 SAK7/SAK8/SAK9/SAZK9/SAL0 ABS Faired Bandit 4 Piston Caliper	07-12	R
GSF 1250 AK7/AK8 ABS Model Naked Bandit 4 Piston Caliper	07-08	R
GSX 1250 FAL0/FAL1/FAL2	10-13	R
GSX 1250 FAL0ST Sports Tourer	10-12	R

## YAMAHA

XJ6-F Diversion 600 (Full Fairing - Non & ABS Models)	13	R
XJ6-S Diversion 600 (Top fairing model - Non & ABS Models)	13	R
XJ6-N Diversion Naked	13	R
XJ6 SP	13	R
FZ1 N/NA Naked (Non ABS/ABS)	10-13	R
YZF-R6	03-07	R
YZF R6 (13S1)	08-12	R
FZ6 Fazer	04-07	R
FZ6 (Naked version)	04-07	R
FZ6 Naked/Non ABS 2 Piston Caliper (1B3/1B3D)	04-07	R
FZ6-NS Naked/Non ABS/2 Piston Caliper (1B35/6)	05-06	R
FZ6 S2 ABS (Naked)	07-09	R
FZ6 Fazer S2 (ABS) (4 piston caliper)	07-09	R
FZ6 Fazer (Half Fairing/Non ABS/2 Piston Caliper) (5VX/5VXL)	04-07	R
FZ6 Fazer (ABS/Half Fairing/2 Piston Caliper) (4P5)	06-07	R
FZ6 Fazer S2 (ABS/Half Fairing/4 Piston Caliper) (5S2)	08	R
FZ6 Fazer S2 (Non ABS/Half Fairing/4 Piston Caliper) (4S81/4S8)	07-09	R
FZ6 S2 (Naked/Non ABS) (4 Piston Caliper) (5S51/5S5)	07-09	R
FZ8 N-Naked/Single Headlight/Non ABS (800cc) (RN255/39P1)	11-13	R
FZ8 NA-Naked/Single Headlight/ABS (800cc) (RN256/59P1)	11-13	R
Fazer 8 - FZ8-S (800cc) (Top fairing /Twin headlight/Non ABS) (RN251/42P1)	11-13	R
Fazer 8 - FZ8-SA (800cc) (Top fairing /Twin headlight/ABS) (RN252/1BD1)	11-13	R
FZ1 Fazer (Half Fairing - ABS - 5D0)	08-13	R
FZ1 (Naked) (1000cc) (2D1)	06-09	R
YZF-R1SP	06	R
YZF R1	04-06	R
YZF R1 (6 piston radial caliper)	07-13	R

### Competitor X Ref

Dunlop	Ferodo	SBS	Vesrah
DP121	FDB754	670/161	VD-162

### Equivalents OE #

43105 MW0 405	69100 06820	69100 16851
T2020602	69100 08850	43082 0073
5SL W0046 00	06435 MEJ 006	5VX 25806 00
06435 KV3 405	06435 MEJ 016	
69100 06830	5VX W0045 00	
06435 MEE 006	43020 S020	

### MATERIAL AVAILABILITY AND PART NO.

STD	OPTIONS				
FA	V	HH	R	MXS	EPFA
FA174	FA174V	FA174HH	-	-	-

# FA175 33.7 x 50.5 x 7mm

## CFK175

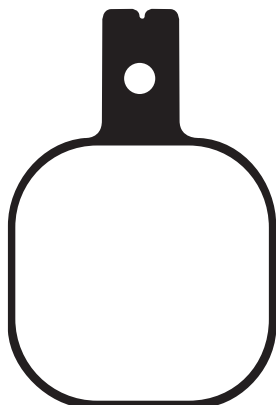

### Equivalents OE #

29-001
1296033
1296007

### HARRISON BILLET

2 Piston (1296040)  
Slim Design  
Mini 6

### ISR

22-032 (6 Piston Large)  
22-042 (6 Piston Racing)

### Competitor X Ref

Dunlop	Ferodo	SBS	Vesrah
-	FRP415	656	-

### MATERIAL AVAILABILITY AND PART NO.

STD	OPTIONS				
FA	HH	R	MXS	EPFA	
FA175	FA175HH	-	-	EPFA175HH	
FA175S (Green)					



# SFA176 87 x 53 x 7.5mm

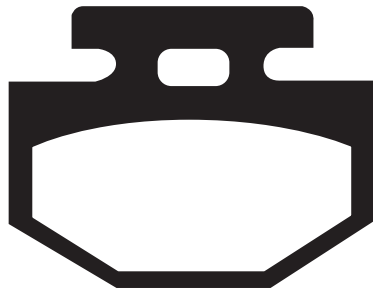

## HONDA

NH 50 Lead 50 SS	84	F
NH 50 Lead AF01/d716	84-85	F
NH 80 Lead 80/SS	85	F
NH 125 Lead 125	86-87	F

### Equivalents OE #

45105 GM9 711	45105 GN3 701
45105 GM9 712	45105 GN3 704

### Competitor X Ref

Dunlop	Ferodo	SBS	Vesrah
-	-	112	VD137

### MATERIAL AVAILABILITY AND PART NO.

STD	OPTIONS			
FA	HH	R	MXS	EPFA
SFA176	-	-	-	-

# FA177 87 x 53 x 7.5mm

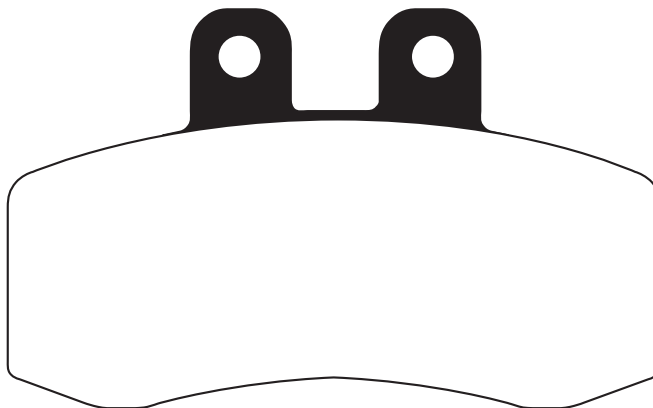

## APRILIA

Pegaso 650	91-96	F
<b>MZ/MUZ</b>		
Baghira - Forest/Forest HR - 21" front wheel/spoke wheel	96-05	F
Baghira - Street Moto - 17" front wheel/spoke wheel	96-05	F
Baghira - 21" front wheel /spoke wheel	99-05	F
Baghira - Black Panther - 17" front wheel/spoke wheel	96-03	F
Mastiff - 21" front wheel/spoke wheel	96-05	F

### Equivalents OE #

9022001000

### Competitor X Ref

Dunlop	Ferodo	SBS	Vesrah
DP615	FDB782	681	-

### MATERIAL AVAILABILITY AND PART NO.

STD	OPTIONS			
FA	HH	R	MXS	EPFA
FA177	-	-	-	-

# FA178 41.1 x 43 x 7.7mm



Use  
SFA257

# FA179 102 x 41 x 10mm

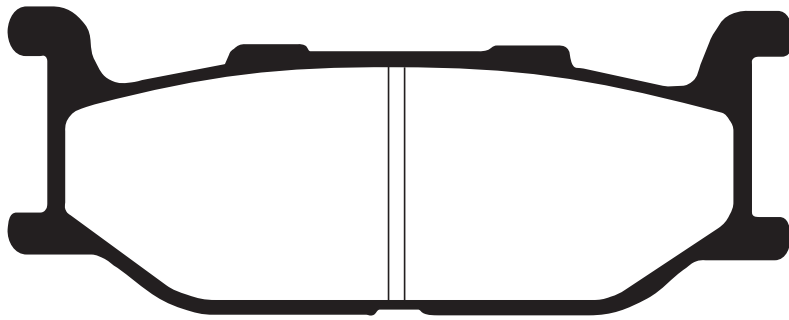

### CF MOTO

CF 250 T-5 V5 Custom 11-12 F

### MOTOM

Transcity 125/250 08-09 F

### SYM

SB 125 N (Carb) Wolf (Drum Rear) 11-13 F

### YAMAHA

FZX 250 Zeal (3YX1/2/4) 91-92 F

SRV 250 'Soulfullwin/Renaissa' (4DN1-6) 92-97 F

SR 400 (BC-RU01J) F

XP 400 Majesty 04 F

XVS 400 96 F

XP 500 N/P/R T-Max 01-03 F

XV 535/535 S 'Virago' 95-03 F

XJ 600 N 95-97 F

XJ 600 S "Diversion" 92-97 F

XVS 650 Drag Star 97-04 F

XVS 650 A Dragstar classic 98-07 F

XV 750 Virago 94-97 F

XJ 900 S "Diversion" 95-03 F

XVS 950 A Midnight Star 09-13 F

XV 1100 Virago 94-98 F

XVZ 1300 TF 'Venture Star' 99-01 F

XV 1600 A 'Wildstar' 99-04 F

### Equivalents OE #

3YX W0045 00	5BN W0045 00
4BP W0045 00	5RU W0045 10
4FU W0045 00	5S7 10045 00
4KM W0045 00	803.08.01.60
4TR W0045 00	43108 HMA 000A
4WM W0045 00	

### Competitor X Ref

Dunlop	Ferodo	SBS	Vesrah
DP414	FDB781	663/170	VD-255

### MATERIAL AVAILABILITY AND PART NO.

STD	OPTIONS							
FA	V	SFA	SFAC	HH	SFA-HH	R	MXS	EPFA
FA179	FA179V	SFA179	SFAC179	FA179HH	SFA179HH	-	-	-

# FA180 58.9 x 40 x 8mm

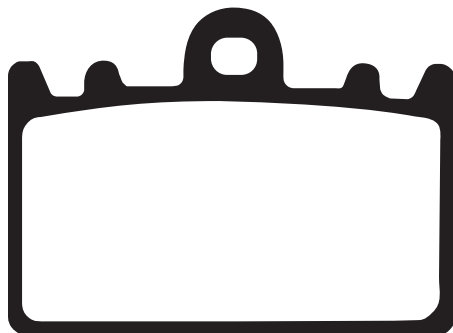

### KAWASAKI

ZXR 400 L1-L9 91-03 F

### SUZUKI

RGV 250 T (RGVR 250 SP VJ23A) 96 F

### Equivalents OE #

43082 1130
59300 42840

### Competitor X Ref

Dunlop	Ferodo	SBS	Vesrah
DP319	FDB741	666	VD-433

### MATERIAL AVAILABILITY AND PART NO.

STD	OPTIONS			
FA	HH	R	MXS	EPFA
FA180	FA180HH	-	-	-

# FA181 94 x 37.3 x 7.5mm



DISC PADS  
BUYERS GUIDE

<b>ALFER</b>						
VR 250	98-13	F				
<b>APRILIA</b>						
RX 125	00-01	F				
RX 125	08-12	F				
MX 125	04-06	F				
SX 125	08-13	F				
SXV 4.5 Supermoto	04	F				
SRV 850	12-13	F				
RST 1000 Futura	01-04	R				
<b>BENELLI</b>						
BX 250 Motard	12-13	F				
BX Cross (449cc)	07-12	F				
BX Enduro (505cc)	08-12	F				
<b>BMW</b>						
GX 450 X	08-11	F				
<b>BREMBO</b>						
XQ 21361 P2/28 Off Road Caliper						
122A99021 P2 24 Off Road Caliper						
<b>CAGIVA</b>						
E 750 Elefant	93-95	R				
E 900 C Elefant (282mm front discs/USD forks /Brembo front/rear calipers)	93-97	F&R				
<b>CCM</b>						
R30 (Spoke & Mag Wheel)	02-04	F				
R35/R 35 S	06-09	F				
FT 35 S (400cc) (DRZ 400 motor)	07-09	F				
R 45	07-09	F				
404E	03-04	F				
404 DS	03-04	F				
404 DS Supermoto	03-04	F				
404 DS Supermoto	07-09	F				
404 DS Trail	07-09	F				
CMX 450 (MX)	08	F				
450 DS Trail	07-09	F				
604E Supermotard/RS/Dual Sport	98-03	F				
644 DS Supermoto	04	F				
644 DS	04	F				
FT 650	08	F				
FT 710 S Flat Tracker	08-09	F				
<b>DUCATI</b>						
Monster 400 ie (Japan)	07-08	F				
Monster S2R (803cc)	05-07	F				
Monster Dark 620	05-06	F				
Monster 620	05-06	F				
620 Multistrada (Twin disc/Single pin pad fixing)	06	F				
695 Monster	07-08	F				
<b>FACTORY</b>						
YR 250	03	R				
<b>FANTIC</b>						
Caballero 50 Regularita Competizione	06-09	F				
Caballero 50 Supersei Competizione	07-08	F				
Caballero 125 Regularita Competizione	07-09	F				
Caballero Regularita Competizione Mini 50	08-09	F				
<b>GAS GAS</b>						
Quad Wild HP 50	04-07	F&R				
80/125 Enduro	94-95	F				
MX 80	96	F				
80/125/250/200/300 Enduro	95-99	F				
Enduro EC 125/200/250/300	97-99	F				
Wild HP 240/300	03-06	F&R				
Pampera 400	06	F				
Wild HP 450 Quad	04-09	F&R				
Wild HP 515cc Quad	09	F&R				
<b>GILERA</b>						
Nexus 500	03-12	F				
GP 800 (Chain drive)	08-12	F				
<b>HIGHLAND</b>						
950 V2 Outback	00-04	F				
950 V2 Motard	00-04	F				
<b>HONDA HM (Italy)</b>						
CRE 50 Six	01-02	F				
CRE 50 Baja/Derapage	01-02	F				
<b>HUSABERG</b>						
TE 125 2T	12-13	F				
FE 250 (4T)	13	F				
TE 250 (2T)	11-13	F				
TE 300 (2T)	11-13	F				
FE 350 (4T)	13	F				
FE 390 (New 70° Engine)	10-12	F				
Enforcer Four	00-03	F&R				
FE 450 E	06-08	F				
FE 450 (New 70° Engine)	08-13	F				
FX 450	10-12	F				
FE 501 (4T)	13	F				
FE 550 E	06-08	F				
FE 570	09-12	F				
FE 650 E	06-08	F				
<b>HUSQVARNA</b>						
CR 125	95-13	F				
SM 125	98-00	F				
SM 125 S	02-13	F				
SMR 125 (4T)	11-13	F				
SMS 4-125cc (4T)	11	F				
TE 125 (4T)	11-13	F				
WR 125	05-13	F				
WRE 125	93-13	F				
CR 250	95-05	F				
TC 250 (4T)	02-13	F				
TE 250 (4T)	02-12	F				
TE 250 Meo Replica (4T)	11	F				
TE 250 R (4T)	13	F				
WR 250 (2T)	95-13	F				
WR 300 (2T)	09-12	F				
TE 310 (4T)	09-12	F				
TE 310 R (4T)	13	F				
TE 350	95-97	F				
WR 360	95-02	F				
TE 400	02	F				
TE 410	95-00/06	F				
TE 410 E	00	F				
TC 449 (4T)	11-13	F				
TE 449 (4T)	11-13	F				
TC 450	03-10	F				
TE 450	03-10	F				
TC 510	04-09	F				
TE 510	04-10	F				
TE 511 (4T)	11-13	F				
TC 570	02-03	F				
TE 570	01-04	F				
TC 610	00	F				
TC 610 E	95-99	F				
TE 610	00	F				
TE 610 E	95-00/02-03	F				
TE 610/IE	06-09	F				
TE 630	10-12	F				
<b>KEEWAY</b>						
Silverblade 125/150/250	07	F				
<b>KRAM-IT (KRAMER)</b>						
GS 250	00-	F				
SM 250	00-	F				
<b>KTM</b>						
LC2 125	96-98	F				
MX 125	92-93	F				
D-XC/E-XC/E-GS 125	92-93	F				
EXC/EGS 125	94	F				
EXC 125	95-13	F				
EXC 125 (2T) Six Days	11-13	F				
SM 125 Supermoto	94-13	F				
EXE 125	00	F				
SX 150	00	F				
XC 150 (USD)	08-13	F				
EXC 200/EGS	11-13	F				
EXC 200	94-03	F				
EXC 250 Racing	04-12	F				
EXC-F 250	06	F				
MX 250	06-11	F				
SX 250 (2T/Std Forks)	92-93	F				
SX 250 (2T) (Upside Down Forks)	94-99	F				
SX-F 250 (4T)	09-13	F				
SX-F 250 Ken Roczen Edition	06-13	F				
EXC/EGS 250	12	F				
EXC 250	94	F				
EXC 250 (2T) Six Days	95-12	F				
EXC-F 250 (4T) Six Days	11-12	F				
XC 250 (USD)	11-12	F				
XC-F 250 (USD)	11-13	F				
EXC 300 (Upside Down Forks)	11-13	F				
EXC 300 (2T) Six Days	00-12	F				
XC 300 (2T)	11-12	F				
EXC 350 LC4	11-13	F				
SX-F 350 (Upside down forks)	94-95	F				
SX-F 350 Tony Cairoli Edition	11-13	F				
EXC-F 350 (USD)	12	F				
EXC-F 350 Six Days Diaphragm Spring	11-12	F				
XC-F 350	12	F				
SX 360	12-13	F				
EXC 360	96-97	F				
SX 380	96-97	F				
EXC 380	98-03	F				
EXC 400 Racing	98-03	F				
EXC 400 (4T)	04-07	F				
EXC 450 Racing	09-11	F				
EXC-R 450 (4T)	06-07	F				
EXC 450 (4T) Six Days	08	F				
SC 400	11	F				
EGS/EGS-E/LSE 400 (LC4 Enduro)	96-99	F				
SX 400	96-99	F				
EXC/EGS 400 (USD)	00-02	F				
EXC 400 Racing (USD)	00-03	F				
EXC 400	00	F				
LC4-E 400 Enduro	04-11	F				
SX 440	00-01	F				
EXC 440	94-95	F				
SX 450 (4T)	94-95	F				
SX-F 450 (4T)	03-07	F				
EXC 450 (HT)	07-13	F				
EXC 450 (4T) Six Days	03-12	F				
EXC 500 (4T)	11-12	F				
EXC 500 (4T) Six Days	12	F				
MX 500	12	F				
SX-F 505	92-95	F				
SX 520	07-09	F				
EXC 520	01-03	F				
EXC 525	01-03	F				
SX 525	03	F				
EXC 525	03-06	F				
MXC 525	04-05	F				
XC 525 Racing	03-04	F				
EXC-R 530 (4T)	06-07	F				
	08	F				

# FA181 Contd.

EXC 530	09-11	F	450 SM	04-08	F
EXC530 (4T) Six Days	11	F	2.5i Enduro (4T)	06-09	F
MXC 550	96	F	Enduro 2.5iF (4T) (inc SE models)	08-10	F
SX/EXC/EGS 620	94-95	F	SM 2.5i Supermotard	08	F
SX 620	96-98	F	SX 2.5iF Moto Cross	10	F
SC 620 Supercompetition	96-00	R	Enduro SE 3.0i (4T)	10	F
EGS/EGS-E/LSE 620 Enduro	96-99	F	SE 300 iR Enduro (Brembo rear caliper)	12	F
EGS-E 620 Adventure/Rallye	99	F	SE 300 i Enduro (Brembo rear caliper)	12	F
LC4 620 SC Supermoto	00	F	4.5i (Enduro)	04-09	F
SXC 625	05-06	F	Enduro 4.5i	04-10	F
LC4-E 640 Enduro	00-04	F	SE 450 iR Enduro (Nissin rear caliper)	12	F
LC4-E 640 Supermoto	00-06	F	SE 510 iR (Nissin rear caliper)	12	F
LC4 640 Adventure R	00	F	5.1i Enduro (4T)	06-09	F
640 LC4 Adventure	03-07	F	Enduro 5.1iF	07-10	F
LC4 625 SC Supermoto	02	F	5.1i Supermotard	06-09	F
LC4 625 SC Supercompetition	02	F	SM 5.1iF Supermotard	07	F
SXC 625	03-04	F	<b>SUZUKI</b>		
LC4 640 Adventure	01-06	F	UH 125 K2/K3/K4/K5/K6 Burgman	02-06	F
SM 950	05-06	R	<b>TM</b>		
950 R Superenduro	06-08	R	80 Enduro	96-00	F
990 Adventure	06-08	R	80/85 Cross	96-01	F
990 Adventure R	09-12	R	80/85/100 (Big wheel)	02-04	F
990 T (SM-T)	09-13	R	Junior 80/85/100 Cross (Small wheel)	02-04	F
990 Supermoto R (SM-R)	08-13	R	Junior 80/85/100	05-08	F
1190 Adventure	13	R	MX 85 JR	02-13	F
1190 Adventure R	13	R	MX 85 (Big Wheel)	02-13	F
<b>MAICO</b>			125 Cross	95-00	F
500 MX/Enduro	99	F	MX 125 (2T)	01-13	F
<b>MBK</b>			125 Enduro	95-00	F
XQ 125/150 Thunder	01-03	F	Enduro EN 125 (2T)	01-13	F
YP 125 D Skyliner	98-10	F	MX 125 (2T)	05-13	F
VP 300 R Kilibre	03-04	F&R	EN 144 (2T)	08-13	F
<b>MOTO GUZZI</b>			MX 144 (2T)	08-13	F
850 Brevia ie	06-07	R	250 Cross	95-00	F
850 Griso	06-07	R	250 (4T) Cross MX	02-13	F
940 Bellagio	07-13	R	EN 250 Fi (4T)	10-13	F
Brevia V1100	05	R	EN 250 F (4T) Enduro	05-13	F
Brevia 1100 (ABS)	07	R	MX 250 (2T)	01-13	F
Brevia 1100	05-06	R	MX 250 Fi (4T)	10-13	F
1100 Brevia (Std/ABS Models)	05-07	R	MX 250 (4T)	05-13	F
Quota 1100 ES	99-01	R	250 Enduro	95-00	F
1100 Griso 4V (1064cc)	05-08	R	Enduro EN 250 (2T)	01-13	F
1100 Griso	05-08	R	EN 250 F (4T) Enduro	04-10	F
1100 Quota ES	99-01	R	300 Cross	95-00	F
Brevia 1200	08-09	R	MX 300 (2T)	01-13	F
Norge 1200	06-09	R	Enduro EN 300 (2T)	01-13	F
1200 Notge GT 8v	08-12	R	300 Enduro (2T)	95-00	F
1200 Griso 8v Spedal Edition			400 (4T) MX Cross	02-03	F
(1151cc/Spoke Wheel/Radial Caliper)	09-11	R	400 Cross (4T)	95-00	F
1200 Griso 8v (Std - Cast wheel/radial caliper)	07-12	R	EN 450 F (4T)	04-13	F
1200 Griso 8v (1151cc/Cast Wheel/Radial Caliper)	09-11	R	MX 450 F (4T)	04-13	F
1200 Sport	06-07	R	MX 450 Fi	05-13	F
1200 Sport (2V)	06-09	R	530 Cross (4T)	98-00	F
1200 Sport 4 Valve	08-12	R	EN 530 F (4T)	04-13	F
Stelvio 1200	08-11	R	MX 530 F	05-13	F
1200 Stelvio NTX ABS	09-10	R	<b>VECTRIX</b>		
1200 Stelvio 8v NTX	11-12	R	Vectrix Electric Std Scooter VX-1	07-13	F&R
1200 Stelvio 8v	11-12	R	VX-3 Li+ (3 wheeler model)	12-13	R
Stelvio NTX1200 (4 valve) (Radial caliper/ABS)	09-11	R	<b>VERTEMATI</b>		
Norge GT 8V (1200cc)	10-11	R	All models (2 piston Brembo)	99-04	F
1400 California Custom	13	R	<b>VOR</b>		
1400 California Touring	13	R	All models (2 piston Brembo)	03-04	F
<b>MOTO MORINI</b>			<b>YAMAHA</b>		
Granpasso 1200	08-13	R	YBA 125 Enticer (3P01/3P41)	05-06	F
Scrambler 1200	10-13	R	YP 125 Majesty	98-09	F
<b>PEUGEOT</b>			XQ 125/150 N Maxster	01-03	F
Enduro 250 i	12	F	YZF-R 125	08-13	F
Enduro 300 i	12	F	VP 300 Versity	03-05	F&R
<b>PIAGGIO</b>			XC 300 Versity	06	R
X9 250 Linked brake f&r wheel 14"dia	04	F	TT 600 R (5CH1/5CH2/5CH3)	97-02	F
Beverley 400ie	07	F	TT 600 RE (5CH5)	04	F
X9 500cc Evolution	03-06	F	TT 600 E (4LW3/4LW4/4GV4/4GV5)	94-01	F
X9 500ie	07	F	TT 600 E (4GV2)	94-95	F
<b>RIEJU</b>			TT 600 K (4LW1/4GV1/4LW2) Up to 4GV 003403	93-95	F
Marathon 250	09-10	F	TT 600 K From 4GV 003404	95-96	F
Marathon 450	09-10	F	XT 660 Z Tenere	08-13	F
<b>SHERCO</b>					
SE 250 iR Enduro (Brembo rear caliper)	12	F			
SE 250 i Enduro (Brembo rear caliper)	12	F			

## Equivalents OE #

546 13 209 044	8B0074181	497396	BQ300222068	34 11 7 717 292	1679
5CH F5911 00	8C0074181	800074181	K00976315	34 11 7 717 308	647074
5DS F5811 00	800074181	503 13 030 100	80009634	5D7 FS811 00	894047
4GV F5911 00	AB024	8113593	BQ300222065	11D FS811 00	3710
8000 88482	AB024 S	0624	56325 R	770 13 020 000	07849312/27
5NR F5811 00	59330 49F00	59330 49F00	GU05654630	69107	5SU W0045 00
5SE F5811 00	5SE F5811 10	00306546250	GU30654675	69116	107 861750
8A0074181	K00976315	613 4 072 1A	8133516	860883	M9467Z04

## Competitor X Ref

Dunlop	Ferodo	SBS	Vesrah
DP617	FDB2018	671	VD-947

## MATERIAL AVAILABILITY AND PART NO.

STD	OPTIONS						
FA	SFA	SFAC	HH	SFA-HH	R	MXS	EPFA
FA181TT	SFA181	SFAC181	FA181HH	SFA181HH	FA181R	MXS181	EPFA181HH

# FA182 74.8 x 53.9 x 10mm

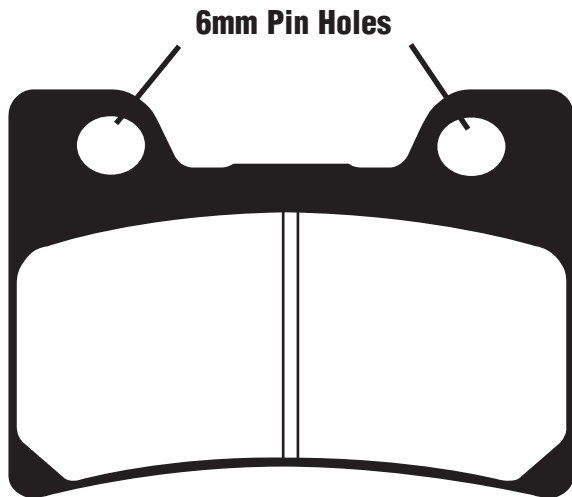

## YAMAHA

FZR 1000 EX UP (USD Forks) 91-93 F

### Equivalents OE #

3GM W0045 50

### Competitor X Ref

Dunlop	Ferodo	SBS	Vesrah
DP415	FDB637	665	VD-257

### MATERIAL AVAILABILITY AND PART NO.

STD	OPTIONS			
FA	HH	R	MXS	EPFA
FA182	FA182HH	-	-	-

# GFA183HH 102.40 x 55.25 x 8mm

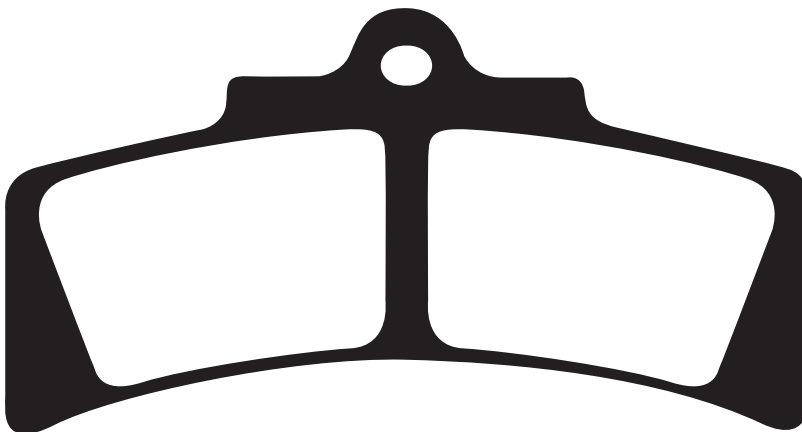

### Equivalents OE #

N/A

### Competitor X Ref

Dunlop	Ferodo	SBS	Vesrah
-	-	677	9027

### MATERIAL AVAILABILITY AND PART NO.

STD	OPTIONS			
FA	HH	R	MXS	GFA
-	-	-	-	GFA183HH

# FA184 28.5 x 45.8 x 7mm

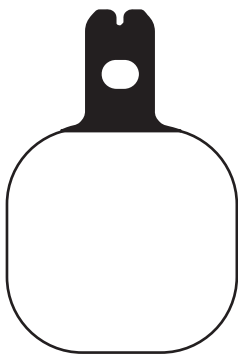

## ISR

22-034 (6 Piston Small)  
22-036 (2 Piston)  
22-043 (4 Piston)  
Radial 6 Piston Monoblock

### Competitor X Ref

Dunlop	Ferodo	SBS	Vesrah
-	-	655	-

### Equivalents OE #

ISR29-002

### MATERIAL AVAILABILITY AND PART NO.

STD	OPTIONS			
FA	HH	R	MXS	EPFA
FA184	-	-	-	-



# FA185 94 x 34.2 x 7.5mm



<b>AJP</b>			XL 600 VV/VW/VX Transalp	97-00	F
PR5 Supermoto 250cc	09	F	XL 650 VY/V1/V2/V3/V4/V5/V6/V7 Transalp	00-07	F
PR5 Enduro 250cc	09	F	XR 650 RY/R1-R7	00-07	F
<b>ALFER</b>			XR 650 L	93-12	F
AR 250	93-	F	TRX 700 XX8/XX9/XXB	08-11	F
<b>APRILIA</b>			XL 700 V8/V9/VA (Transalp/2 piston front caliper /ABS on rear disc)	08-11	F
MXV 450	09-13	F	XRV 750 P/R/S/T/V/W/X/Y 'Africa Twin'	94-03	F
RXV 450/550 Enduro	06-13	F	<b>HONDA DALL'ARA</b>		
<b>BETA</b>			XR 125 SM	04	F
RR 250 2T	13	F	XR 250 R	04	F
RR 250 4T Enduro	05-07	F	XR 250 SM	04	F
RR 300 Enduro 2T	13	F	XR 400/440 R	04	F
RR 350 4T Enduro	11-13	F	XR 400/440 SM	04	F
RR 400 4T Enduro	05-13	F	XR 650 R	04	F
RR 450 4T Enduro	05-13	F	<b>HONDA-HM (ITALY)</b>		
RR 450 4T Cross Country	12	F	CR 125 Motard	04	F
RR 498 4T Enduro	12-13	F	CRE 125 R Supermotard	02-03	F
RR 520 Enduro	05-11	F	CRE 125 R Enduro	02-06	F
RR 525 4T Enduro	05-09	F	CRE 125 (Six Competition 2T)	11	F
<b>CANNONDALE</b>			CRM 125 (Derapage RR 2T)	11	F
MX 400	00	F	CRF 230 Easy Trail	04	F
<b>CPI</b>			CRF 230 Easy Enduro	04	F
Sauel 125		F	CRF 230 Easy Motard	04	F
<b>GAS-GAS</b>			CRF 230 F Easy Trial (All models)	04-07	F
EC 125/200/250/300 (2T)	00-13	F	CRE 250 R Supermotard	02-03	F
MX 125/250 (MC)	01-09	F	CRE 250 R Enduro	02-06	F
Trail Halley 125cc	09	F	CRE 250 R Moto	04	F
MX 200/250/300	99-00	F	CRE 250 F Enduro	04-06	F
EC 250 F (4T)	12-13	F	CRE 250 X		F
EC 300 F (4T)	13	F	CRE F 250 X	08-11	F
EC 450 FSR/FSE (4T) Enduro	05-09	F	CRF 250 Motard	04	F
EC 450 F (4T)	13	F	CRF 250 F	04-08	F
Pampera 450 (4T)	07-08	F	CRF 250 R	08-09	F
SM Halley 450cc	09	F	CRE F 250 R	08-09	F
Trail Halley 450cc	09	F	CRE F 290 X	07	F
EC 515 FSR/FSE (4T) Enduro	05-09	F	CRE F 300 X	08-09	F
<b>GOES</b>			CRE 450 F Enduro	02-04	F
G 125 XM	08-09	F	CRF 450 Motard	04	F
G 250 XM	08-09	F	CRE 450 Supermoto	02-03	F
<b>HONDA</b>			CRE 450 X		F
CR 125/250 RS/RT/RV/RW/RX/R1			CRF 450 R	04-08	F
/R1/R2/R3/R4/R5/R6/R7	95-07	F	CRE F 490 X	07	F
XLR 125 RW	98-01	F	CRE F 500 X	08-09	F
XR 125 L3/L4/L5/L6/L7/L8	03-08	F	<b>KAWASAKI</b>		
CRF 150 F3/F4/F5/F6/F7	03-07	F	KX 125 K1/K2/K3/K4/K5/L1		
CTX 200/CTX 200 A Bushlander	04-05	F	/L2/L3/L4/M1/M2/M3/M6F/M7F/M8F	94-08	F
CRF 230 F4/F5/F6/F7/F8/F9	04-09	F	KDX 200 H1/H2/H3/H4/H5	95-99	F
CRF 230 L	08-10	F	RM 125 K6/K7/K8	06-08	F
CRF 230 M	09-10	F	KDX 220 R A4/A5/A6/A7/A8/A9		
SL 230 'Free Landsports' (MD33)			/A10/A11/A12/A6F	97-06	F
VW/X/1	97-01	F	KDX 220 SR (DX 220 B)		F
CRM 250 RR/RR11 (MD24 140) MK3	94-96	F	KLX 250 F1-F4	94-97	F
CRM 250 'Active Radial' (MD32)			KLX 250 R D1/D2	93-94	F
ARV/ARW	97-98	F	KLX 250 G1	94	F
CRF 250 R4/R5/R6/R7/R8/R9/RA/RB/RC/RD	04-13	F	KLX 250 J1-J6 D-Tracker	98-03	F
CRF 250 X4/X5/X6/X7/X8/X9/XB/XC/XD	04-13	F	KLX 250 H6F/H7F	06-07	F
CRF 250 XRLD	13	F	KX 250 F (KX 250 N1/N2)	04-05	F
XR 250 RT/RV/RW/RX/R1/R2/R3/R4	96-04	F	KX 250 K1-K5/L1-L4/M1-M2/R1/R6F/R7F/R8F	94-08	F
XL 250 Degree (MD26)	94-96	F	KX 250 F (T6F/T7F/T8F)	06-08	F
XLR 250 RM/R3N/RP/RR/R3R (MD22)	91-	F	KX 250 W9F/XAFB/YBF/YCF/ZDF	09-13	F
XLR 250 Baja MK2 (MD22)		F	KLX 300 A2-A10/A6F/A7F	97-07	F
XR 250 Y/3 (MD30)	00-03	F	KLX 400 R (KLX 400 B1/B2)	03-04	F
XR 250 3/S (MD30) Motard	03-05	F	KLX 450 R (A8F/A9F/AAF/ABF/ACF)	08-12	F
XR 250 III Y/3 Baja	00-03	F	KX 450 F (D6F/D7F/D8F/E9F/EA/EBF/FCF/FDF)	06-13	F
XR 300 R10	10	F	KX 500 E6-E16	94-04	F
NX4 Falcon	02-05	F	KLX 650 C1/C2/C3	93-97	F
XR 400 RT/RV/RW/RX/R1-R5	96-05	F	<b>SUZUKI</b>		
CRF 450 R2-R9/RA/RB/RC/RD	02-13	F	DR 125 SMK8/SMK9/SML0	08-12	F
CRF 450 X5/X6/X7/X8/X9/XB/XC/XD	05-13	F	RM 125 T/V/W/X/K1-K9	96-12	F
CRF 450 XRLD	13	F	RM 125 XCK8	09	F
TRX 450 R4/R5/R6/ER6/R7/ER7/R8/ER8			250 SBK2 (LX 250 L)	02	F
/R9/ER9	04-09	F	DR 250 RLV/RL/RLY/RS/RLS/RT/RV/RL/RL		
CR 500 RS/RT/RV/RW/RX/R1	95-01	F	/RLW/RW/R1 (SJ45A/DOHC)	95-00	F
XR 600 RP/RR/RS/RT/RV/RW/RX/R1	93-00	F			

# FA185 Contd.

DR 250 RXT/RXLT/RTV/RXLV/RXW/RXLW  
/RXGW/RXGLW/RXY/RXGY  
(Dejbel 250 XC/GPS Ver (SJ45A)

DR-Z 250 K1-K7 (DJ43A)	01-07	F
RM 250 T/V/W/X/K1-K9	96-12	F
RM 250 XCK8	09	F
RMX 250 T/V/W	96-98	F
RMX 250 ST/SV/SW/SX (SJ14A)	96-99	F
RM-Z 250 K4/K5/K6/K7/K8/K9/L0/L1/L2/L3	04-13	F
DR 350 SEW/SEX Electric Start/6 bolt front disc	98-99	F
DR-Z 400 SEY/EY/Y/SEK1/EK1/K1/K2/SEK2/EK2 /K3/SEK3/EK3/K4/SEK4/EK4/SK5/EK5/K5/SK6 /K6/EK7/SK7/K7/SK8/SK9	00-09	F
DR-Z 400 SMK5/SMK6/SMK7/SMK8/SMK9	05-09	F
RMX 450 ZL0	10-12	F
RM-Z 450 K5/K6/K7/K8/K9/L0/L1/L2/L3	05-13	F
DR 650 SET/SEV	96-97	F

## YAMAHA

YZ 125 K/L/M/N/P/R/S/T/V/W (2T)	98-07	F
WR 250 FN/FP/FR/FS/FT/FV/FW/FX/FY/FZ /FA/FB/FD (4T)	01-13	F
WR 250 ZK	98	F
WR 250 RX/RV (32D1/3)	08-10	F
YZ 250 K/L/M/N/P/R/S/T/V/W	98-07	F
YZ 250 FN/FP/FR/FS/FT/FV (4T)	01-06	F
YZ 400 FK/FL	98-99	F
WR 400 FL/FM/FN	99-01	F
WR 426 FN/FP	01-02	F
YZ 426 FM/FN/FP	00-02	F
WR 450 FR/FS/FT/FV/FW/FX/FY/FA/FB/FD (4T)	03-13	F
YZ 450 FR/FS/FT/FV/FW	03-07	F

### Equivalents OE #

06455 GZ8 405	06455 HP1 006	45106 KV6 701	43082 1286	59300 36860	9100788
06455 KCZ 000	06455 HP1 016	43082 0132	45105 KTO 405	59300 36870	43082 0049
06455 KHA 941	06456 MCB 611	43082 1149	45105 KZI 405	59300 3K880	BE250022065
06455 MY1 405	06456 MCB 612	43082 1152	45105 KAS 415	59301 36810	32D W0045 00
06455 MAY 000	43082 124	43082 1172	5DH W0045 00	K4308 21225	252536200
06455 KBR 731	45105 KT0 405	43082 1193	5DH W0045 10	K4308 21286	9100788
06455 KHA 941	45105 KZ1 405	43082 1218	5MV W0045 00	BE 2500 22065	
06455 MAW 761	45105 MY6 405	43082 1266	59300 13830	BC 2500 22065	
06456 MAW 761	45105 MY6 415	43082 S011	59300 13860	59300 29860	
06455 MCB 611	45105 KV6 701	43082 S009	59300 36850	43082 0026	

### Competitor X Ref

Dunlop	Ferodo	SBS	Vesrah
DP321	FDB892	694	VD-161

### MATERIAL AVAILABILITY AND PART NO.

STD	OPTIONS			
FA	HH	R	MXS	EPFA
FA185TT	-	FA185R	MXS185	EPFA185HH

# SFA186 31.5 x 51 x 5.5mm

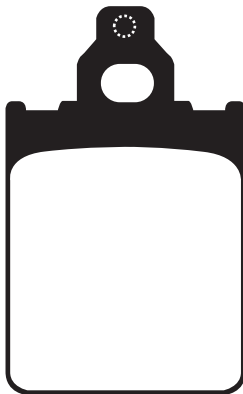

## CAGIVA

Blues 50	93-95	R
Supercity 50/80	93-95	R
Prima 50	92-94	R

## LML

Star 125i (4T)	10-11	F
Star 125 (2T)	10-11	F
Star 125 Deluxe (2T) (Front disc)	01-03	F
Star 150 (2T)	10-11	F
Star 150 Deluxe (2T) (Front disc)	01-03	F
Star 151i (4T)	10-11	F
Star 151 (4T) All models	10-12	F
Star 200i (4T)	10-11	F

## PIAGGIO

Quartz 50	92-96	F
Sfera 50 RST	95-97	F
Skipper 125/150	94-97	F
LX 60 (Special Anniversary Model)	06	F

## VESPA

PX 125 (Disc brake model)	98-12	F
PX 150 (Disc brake model)	98-12	F
PX 200 (Disc brake model)	98-07	F

### Equivalents OE #

494762
498414
800067127
C-4721834

### Competitor X Ref

Dunlop	Ferodo	SBS	Vesrah
-	FDB784	680/117	VD949

### MATERIAL AVAILABILITY AND PART NO.

STD	OPTIONS				
SFA	SFAC	HH	R	MXS	EPFA
SFA186	SFAC186	-	-	-	-

# FA187 68 x 54 x 8mm

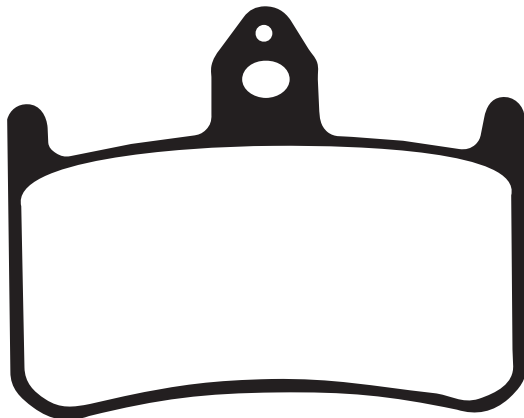

## HONDA

CB 250 FT/FV/FX/FY/F1 'Hornet'	96-01	F
NSR 250 R6K/R6K-2 (MC18-110)	89	F
NSR 250 R7L (MC21-100) R7N (MC21-106)	90	F
NSR 250 R8L-3 (MC21-101) R9L (MC21-102)		
R8N/R89N-3 (MC21-106)	90-92	F
NSR 250 R2R/R3R (MC28-110) R2T/R3T (MC28-120)	94	F
NSR 250 R9N (MC21-106)	92	F
NSR 250 RR (MC28-100)	94	F
NSR 250 R2J (MC18-100) R4J (MC18-100)	88	F
NSR 250 R5K/R5K-2 (MC18-110)	89	F
CB 400 SF (F2V/F3T) Superfour (NC31)	96-97	F
NT 400 'Bros' NC25		F
VFR 400 R3K/R3L/R3M/R3N (NC30)	89-92	F
RVF 400 RR/RRII/RT/RT-II (NC35)	94-96	F
Bros Product One 650		
NT 650 J/K/L 'Bros'	88-92	F
NR 750 N	92	F
VFR 750 RJ/RK/RL (RC30)	88-90	F
RVF 750 RR/RS 'RC45'	94-98	F
CBR 900 RRN/RRP/RRR/RRS/RRT/RRV Fireblade	92-97	F
CB 900 F2/F3/F4/F5/F6/F7 Hornet	02-07	F
CB 1000 FP/FR/FS/FT/FV	93-97	F
VTR 1000 FV/FW/FX/FY/F1/F2/F3/F4/F5/F6 Firestorm	97-06	F
'X4' CB 1300 DCV/DCW/DCX/DCY (SC38)	97-00	F

### Equivalents OE #

06455 MAS 305	45105 MR7 612
06455 MBB 006	45105 MR7 681
06455 MCZ 006	45105 MW0 405
06455 MZ1 405	45105 MW0 415
45105 MN8 006	45106 KV3 701
45105 MR7 006	

### Competitor X Ref

Dunlop	Ferodo	SBS	Vesrah
DP112	FDB858	622	VD-154

### MATERIAL AVAILABILITY AND PART NO.

OPTIONS				
STD	HH	R	MXS	EPFA
FA	FA187HH	-	-	EPFA187HH

# FA188 89 x 53 x 8.3mm

(inc fitted shim on HH pad)

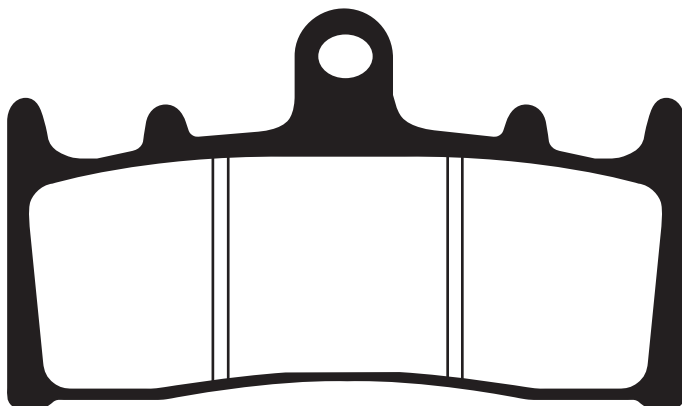

## KAWASAKI

ZX-6R (ZX 600 G1/G2/J1/J2)	98-01	F
ZX6R (ZX 636 A1P) '636cc'	02	F
ZX-7R (ZX 750 P1-P7)	96-03	F
GPZ 900 R (ZX 900 A12-15)	99-02	F
ZX-9R (ZX 900 B3/B4/C1/C2/E1/E2)	96-01	F
ZRX 1100 C1/C2/C3/C4	97-00	F
ZX12R (ZX 1200 A1/A2/B1/B2)	00-03	F
ZRX 1200 R(A1/A2/A3/A4/A5/A6F)	01-08	F
ZRX 1200 S (B1/B2/B3)	01-04	F
VN 1500 Mean Streak P1/P2	02-04	F
VN 1600 B1 Mean Streak	04	F

## SUZUKI

GSXR 750 WR/WS	94-95	F
GSXR 750 T/V/W/X	96-99	F
GSXR 1000 K1/K2	01-02	F
TL 1000 RW/RX/RV/RK1	98-02	F
GSXR 1100 WP/WR/WS/WT	93-96	F
GS 1200 SSK1/ZK1 (GV78A)	02	F
GSF 1200 SK1/K1/K2/SK2/K3/SK3/K4		
/SK4/K5/SK5	01-05	F
GSX 1300 RX/RV/RK1/RK2/RZK3/RK3/		
RK4/RK5/K6/K7 'Hayabusa'	99-07	F
GSX 1400 K1/K2/K3/K4/K5/K6/K7/FE	01-07	F
M 1600 (VZ 1600 K4 Intruder)	04	F
VZ 1600 K4 Marauder	04	F

### Competitor X Ref

Dunlop	Ferodo	SBS	Vesrah
DP216	FDB873 FDB2144	686	VD-349

### Equivalents OE #

43082 1199	43082 1179	43082 1274
43082 1224	43082 1227	59301 33870
59130 46E00	43082 1230	59100 46820
59300 33870	43082 1250	43082 1251
59300 33890	43082 1253	59100 40830
59300 46840/830	43082 1259	K4308-21274
59300 46820	43082 1272	

### MATERIAL AVAILABILITY AND PART NO.

OPTIONS				
STD	HH	R	MXS	EPFA
FA	FA188HH	-	-	EPFA188HH

# FA189 125.5 x 45.1 x 9mm

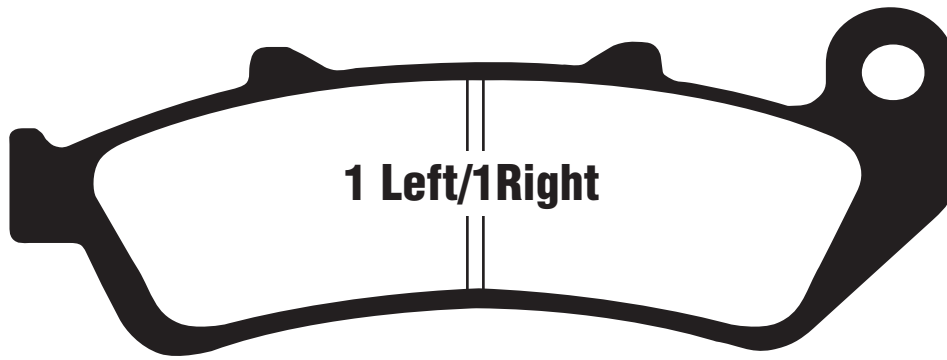

**HONDA**

CBR 1000 FP/FR/FS/FT/FV/FW/FX 93-99 F&R

**Equivalents OE #**

06455 MZ2 405
06455 MAJ G41
06435 MAJ G41
06435 MAT 006
06455 MZ2 405

**LINKED BRAKE**

**FIT ALL THREE SETS AT PAD CHANGE**

**Competitor X Ref**

Dunlop	Ferodo	SBS	Vesrah
DP122	FDB2002	685	VD-164

MATERIAL AVAILABILITY AND PART NO.				
STD	OPTIONS			
FA	HH	R	MXS	EPFA
FA189	FA189HH	-	-	-

# FA190 98.9 x 49.5 x 9.5mm

# FA190HH 98.9 x 49.5 x 8.5mm

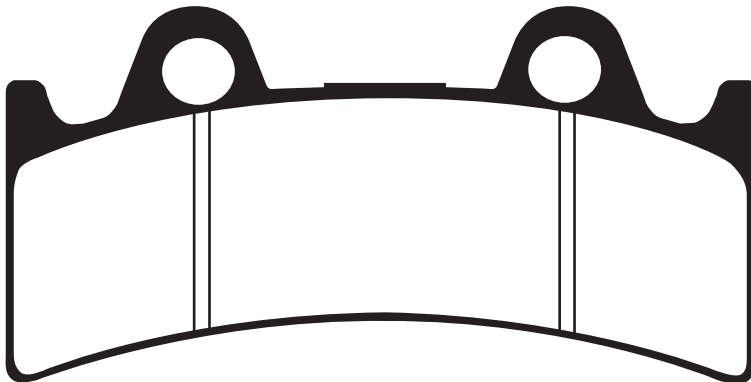

**TRIUMPH**

Daytona Super III (3 cyl) 94-97 F

**YAMAHA**

YZF 750 R/SP 93-97 F

FZR 1000 EX UP (6 piston caliper) 94-95 F

**Equivalents OE #**

4FM W0045 00	T2020221
4FM W0045 10	T2020218
T2020211	

**Competitor X Ref**

Dunlop	Ferodo	SBS	Vesrah
DP416	FDB864	683	VD-258

MATERIAL AVAILABILITY AND PART NO.					
STD	OPTIONS				
FA	V	HH	R	MXS	EPFA
FA190	FA190V	FA190HH	-	-	EPFA190HH

# FA191 131.9 x 80 x 9.5mm

**YAMAHA**  
GTS 1000

93-99 F

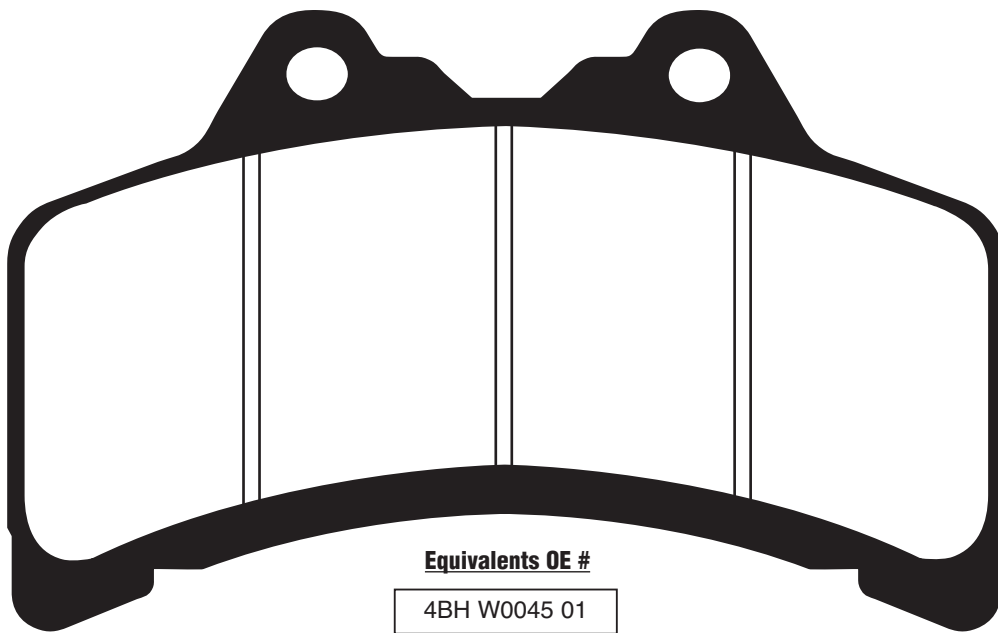

**Equivalents OE #**

4BH W0045 01

**Competitor X Ref**

Dunlop	Ferodo	SBS	Vesrah
-	FDB865	682	VD-259

MATERIAL AVAILABILITY AND PART NO.					
STD	OPTIONS				
FA	HH	R	MXS	EPFA	
FA191	-	-	-	-	

# FA192 A. 90 x 51 x 8.5mm B. 68 x 52 x 9.5mm

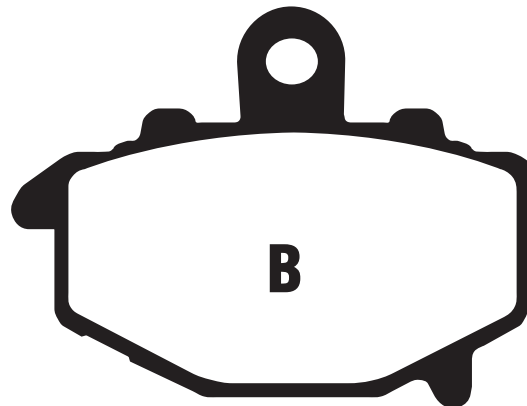
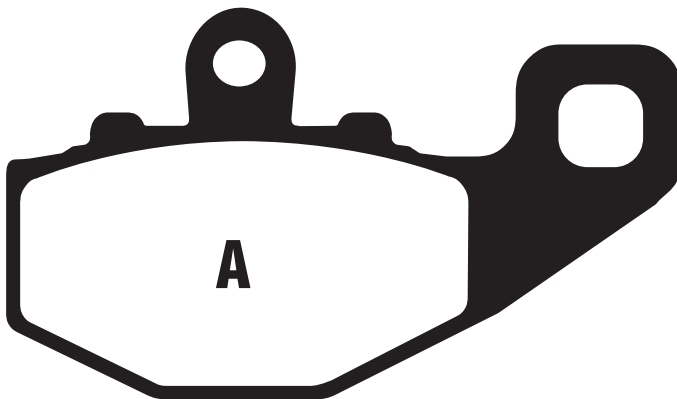

**CF MOTO**

650 NK 12-13 R  
650 TR 13 R

**KAWASAKI**

ZR 400 Zephyr (G2/G3/G3A/G4/G5) 97-01 R  
ZRX 400 (ZR 400 E1-E7) 95-01 R  
ZZR 400 (ZX 400 N1/N2/N3/N4/N5/N6/N7) 93-99 R  
ZR 550 B4/B5/B6 "Zephyr" 94-99 R  
ZZR 600 (ZX 600 E1-E13) 93-05 R  
ZZR 600 (ZX 600 E6F) 06-07 R  
ZX-6R (ZX 600) F1/F2/F3/G1/G2/J1/J2) 95-01 R  
ZX6R (ZX 636 A1P/B1/B2/C1) 636cc 02-05 R  
ZX6R (ZX 600 P7F/P8F) 07-08 R  
ZX-6R (ZX 600 R9F/RAF/RBF/RCF/RDF 599cc) 09-13 R  
ZX6RR (ZX 600 K1/M1/N1) 03-05 R  
ER-6f (EX 650 A6F/A7F/A8F/C9F/CAF/CBF) 06-11 R  
ER-6f (EX 650 B6F/B7F/B8F/D9F/DAF/CBF) ABS 06-11 R  
ER-6f (FCF/FDF) (Double pipe type frame/with ABS) 12-13 R  
ER-6f (ECF/EDF) (Double pipe type frame/non ABS) 12-13 R  
ER-6n (ER 650 A6F/A7F/A8F/C9F/CAF/CBF) 06-11 R  
ER-6n (ER 650 B6F/B7F/B8F/D9F) 06-10 R  
ER-6n (FCF/FDF) (Double pipe type frame/with ABS) 12-13 R  
ER-6n (ECF/EDF) (Double pipe type frame/non ABS) 12-13 R  
650 (KLE 650 CBF/CCF) Versys Non ABS 12 R  
KLE 650 A7F/A8F/A9F/CAF/CBF/CCF/CDF Versys 07-13 R  
KLE 650 B7F/B8F/B9F/DAF/DBF/DCF/DDF Versys ABS 07-13 R  
Z 750 (ZR 750 J1/J2) 04-05 R  
Z 750 S (ZR 750 K1/K6F) 05-07 R

ZX-9R (ZX 900 B1/B2/B3/B4/C1/C2/E1/E2) 94-01 R  
ZX9R (ZX 900 F1/F2) 02-04 R  
Z 1000 (ZR 1000 A1/A2/A3) 03-05 R  
ZX 10 R (ZX 1000 C1/C2/D6F/D7F) 04-07 R  
ZX 10 R (ZX 1000 E8F/E9F/FAF) 08-10 R  
Z 1000 SX (ZR 1000 HBF/HCF/HDF) (ABS) 11-13 R  
Z 1000 SX (ZR 1000 GBF/GCF/GDF) (Non ABS) 11-13 R  
Z 1000 Black Edition (ZR 1000 DCFA/DDFA) 12-13 R  
ZR 1000 DAF/DBF/DCF/DDF (Z1000) 10-13 R  
GPZ 1100 E1/E2/F1 95-98 R  
**WK**  
650i (Naked) 13 R  
650 TR (Touring) 12-13 R

**Equivalents OE #**

43082 0111	43082 1171
43082 1148	43082 1213
43082 1157	43082 0004
43082 1160	

**Competitor X Ref**

Dunlop	Ferodo	SBS	Vesrah
DP320	FDB2012R	687	VD-434

**MATERIAL AVAILABILITY AND PART NO.**

STD	OPTIONS				
FA	V	HH	R	MXS	EPFA
FA192	FA192V	FA192HH	-	-	-

# SFA193 39.8 x 51.2 x 7mm

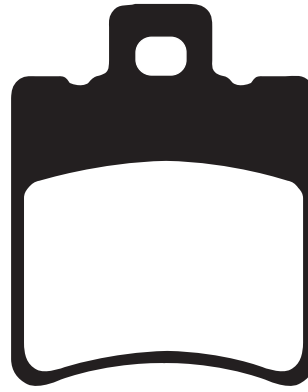

**AJP**

PR3 125 Supermoto Pro 10-11 F

**APRILIA**

Habana 50/Habana Custom 99-02 F  
 Mojito Custom 50 (120mm Ø rear drum) 99-02 F  
 Mojito Custom 50 (110mm Ø rear drum) 04-12 F  
 Mojito Retro 50 (120mm Ø rear drum) 99-03 F  
 Scarabeo 50 Street (2T) (TH00/THE00) 05-09 F  
 Scarabeo 50 (4T) (TGA00/TGB00) 06-09 F  
 Scarabeo 50 (2T) (Rear disc model) (PF0100) 98-99 F  
 Scarabeo 50 (2T) (Rear drum model) (PFG00/TH000) 00-05 F  
 Scarabeo 50 (2T) (Rear disc model) (PFG00/TH000) 00-05 F&R  
 Scarabeo 50 (Ditech) (2T) (SCA00) 02-06 F  
 Scarabeo 50 (4T) (TG000) 02-06 F  
 Scarabeo 50 (2T) (H2/HL) Front disc model 93-97 F  
 Scarabeo 50 Classic 2T (PF0100) (Rear drum model) 98-99 F

Scarabeo 50 (2T) (PF0100) (Rear drum model) 98-99 F&R  
 Scarabeo Classic (2T) (PF0100) (Rear disc model) 98-99 F

SR 50 Ditech (LC) (RLD 100) 02-03 F  
 SR 50 WWW (A/C) (LYH00) 97-01 F  
 SR 50 Street (LC) (TE00/TEA00) 03-13 F  
 SR 50 R/Factory (LC) (VFB00/VFD00) 04-13 F  
 SR 50 H20 (Ditech) (RLA1/RLB1) 00-03 F  
 SR 50 (A/C)(GP/LB/LF) 93-96 F  
 SR 50 (LC) 94-96 F  
 SR 50 Stealth/Racing (LC) (MZCO) 97-99 F  
 SR 50 R SBK Alitalia (Replica) (LC) 10-11 F  
 Area 51 98-02 F&R  
 Amico (All models) 96-98 F  
 Gulliver (All models) 95-98 F  
 Rally A/C (All models) 95-02 F  
 Rally L/C (All models) 96-00 F&R  
 Sonic (All models) 98-08 F  
 SR 125 99 F  
 Leonardo 125/150 96-98 F&R

**ATALA**

Hacker LC 97 F  
 Hacker Racing 97 F  
 Byte RT10 97 F  
 Hacker 97 F

**BENELLI**

491 All rear drum models 98-04 F  
 491 Scooter All rear disc models 99-04 F&R  
 Mala 50 (2T) 13 F  
 Naked 50 02-03 F  
 Naked 100 02 F  
 Pepe 50/50 LX/Classic (7 Spoke Wheel) 99-13 F  
 Pepe 50 (5 spoke cast wheel) 10-13 F  
 K2 Scooter 98-01 F  
 K2 100 99-01 F  
 Pepe 100 LX 99-02 F  
 Velvet 125/150 99-07 F&R  
 Adiva 125/150 00-04 F

**BETA**

Ark (LC models) 97-13 F&R  
 Ark (A/C models) 96-13 F  
 Quadra 50 97-02 F  
 Tempo 50 98-02 F

**CAGIVA**

Nuvola 50 00 F  
 Nuvola 125 00 F

**GARELLI**

Flo 50 F  
 Skynet 250/40 02 R

**GENERIC**

Onyx 50 (2T/4T) 10-13 F

**GILERA**

Stalker 50 97-06 F  
 50 DD/SP Runner/Purejet 99-04 F  
 Ice 50 01-03 F  
 Runner 50 98 F  
 SKP 50 98-01 F  
 Storm 50 94-95 F  
 Easy Moving 50 95-96 F  
 Stalker 50 (Rear drum model) 97-02 F  
 Typhoon 125 95-98 F  
 Typhoon 125 X-XR 99-00 F

**GOVECS (ELECTRIC SCOOTERS)**

GO S 1-2 11-13 F  
 GO T 1-2 11-13 F  
 GO S 1-4 11-13 F  
 GO S 2-4 11-13 F  
 GO T 2-4 11-13 F  
 GO S 3-4 11-13 F  
 GO T 3-4 11-13 F

**HONDA**

SFX 50 S/T/V/W/X/Y/1 95-04 F  
 SGX 50 V/W/X/Y/1 "Sky deluxe" 97-03 F  
 SH 50 T Fifty/Scoopy W/X/Y/1 97-03 F  
 SRX 50 W/SW/X/SX 98-99 F  
 SZX 50 (X8R) SW/SX/SY/S1 'Supersport Scooter' 98-04 F  
 SZX 50 (X8R) XW/XX/X/Y/X1 'Cross Sport' 98-04 F  
 SH 100 T/W/X/Y/1 Scoopy 96-01 F

**ITALJET**

50 Formula 98-00 F&R

**KEEWAY**

Goccia 50 08-11 F

**MALAGUTI**

F18 Warrior 125/150 00-03 F  
 Ciak 50/100 00-04 F  
 Ciak 50 00-03 F&R  
 Ciak 50 (4T) Master 04-08 F  
 Ciak 100 99-03 F&R  
 Ciak (electrical power) 00-05 F  
 F10 Jetline/ 94-07 F  
 F10 Jetline WAP 06-10 F  
 F10 Tribal 08-10 F  
 F12 50 Phantom 98-02 R  
 F12 Phantom (All liquid cooled models) 99-07 F&R  
 Phantom F12R 50 A/C 07-11 F  
 Phantom F12R 50 L/C 07-11 F&R  
 F15 RR 99-01 R  
 F12 Phantom (A/C) 02-08 F  
 F15 Firefox (Liquid cooled models) 01-08 F&R  
 Firefox F15 (Air cooled models) 99-08 F  
 F69 Phantom 70 98 F

**MBK**

CS 50 Mach G AC (Air Cooled) 02-10 F  
 CS 50 Mach G LC (Liquid Cooled) 03-10 F  
 CW 50 R Booster Road 94-95 F  
 CW 50 Booster Spirit 96-98/09 F  
 CW 50 Booster Naked (10" wheels) 06-10 F  
 CW 50 Naked Booster (12" wheels) 09-10 F  
 CW 50 RS Booster NG 95-98 F  
 CW 50 RS Booster NG 01-06 F  
 CW 50 RS Booster Naked 04-08 F  
 CW 50 RSX Booster Track 96-98 F  
 CW 50 RS Booster Spirit 99-06 F  
 CW 50 RSP Rocket 97-00 F  
 CW 50 Fizz 50 93-97 F  
 CW 50 Evolis 97 F  
 CW 50 Power Rocket 06 F  
 CW 50 Booster (12" wheels) 06-10 F  
 CW 50 Booster (10" wheels) 09-10 F  
 YA 50 R Forte 94-95 F  
 YE 50 Evolis 92-95 F  
 YH 50 Flipper 98-10 F  
 YM 50 Fizz 94-95 F  
 YN 50 R Ovetto (2T) 98-10 F  
 YN 50 Ovetto (4T) 09-10 F  
 YQ 50 Nitro 97-10 F  
 YQ 50 Nitro Naked 06-10 F  
 CV 80 Evolis 97 F  
 YN 100 Ovetto 99-03 F  
 YQ 100 Nitro 01-02 F  
 XN 125/150 Doo Do 00-05 F

**MOTRON**

50 Sting 98 F  
 50 Syncro 98 F  
 50 Thunder 98 F

**PEUGEOT**

Buxy/Buxy RS 94-97 F  
 Zenith L (All models) 96-99 F  
 Ludix Pro (14" wheels/4T) (J. Juan Caliper) 11-13 F

**PGO**

Rodo Show 50 00-09 F





# FA194 Contd.

<b>BENELLI</b>			<b>HONDA HM (Italy)</b>		
Velvet 125/150 (Touring)	08-12	F	CRE 50 Six/Baja/Derapage Brembo caliper		
Velvet 250	99-12	F	twin pin/41mm Paioli forks	95-02	F
Velvet 400 Dusk	03-04	F	CRE 50 Baja/Derapage	01-02	F
<b>BETA</b>			CRE 50 Baja RR Up to ZEN50XACEA7700324	07-09	F
RR Enduro Alu 50/Motard Alu 50	04-08	F	CRE 50 Baja/Six/Derapage	03-09	F
RR Enduro 50	04-07	F	CRE 50 Baja RR From ZEN50XACEA7700325	07-09	F
RR 50 Enduro Racing	09-11	F	CRE 50 Baja RR	10-12	F
RR 50 Enduro Factory	12-13	F	CRE 50 Derapage RR Up to ZEN50XACMA7700384	07-09	F
RR 50 Motard (Spoke wheel)	09-13	F	CRE 50 Derapage RR From ZEN50XACMA7700385	07-09	F
RR 50 Enduro	08-13	F	CRE 50 Six Competition	07-08	F
RR 50 Enduro Standard	09-13	F	CRM 50 Derapage Competition	07-08	F
RR Motard 50 Track (Cast Wheels)	08-13	F	CRE 125 X	09	F
RR Motard 50 Skull	11	F	CRM F 125 X	09	F
RR Motard 50 Standard (Cast wheel 5 spoke)	13	F	<b>HRD</b>		
RR 50 Standard	05-08	F	GS 50		F
Alp 125 (4T)	05-13	F	<b>KEEWAY</b>		
RE 125 4T Enduro	08-09	F	X Ray 50 Supermoto	07-09	F
RR 125 4T Enduro (A/C)	09-13	F	TX 50	10-12	F
RR 125 4T Enduro (LC)	11-13	F	TX 125	10-12	F
RR 125 Motard (4T) (A/C - Spoke Wheel)	08-13	F	<b>MALAGUTI</b>		
RR Motard 125 4T (LC) (Cast wheels)	11-12	F	XSM 50 Supermotard	03-11	F
Urban 125	08-13	F	Madison 125/150/180	99-03	F
Urban 125 Special	09-13	F	Madison 125-3	06-09	F
Alp 200 (4T)	05-13	F	Madison R125	03-07	F
Alp 4.0 (4T/349cc)	05-12	F	Phantom Max 125/200	04-08	F
Urban 200	08-13	F	Madison 250 ie 3	06-10	F
Urban 200 Special	09-13	F	Phantom Max 250	04-08	F
<b>CCM</b>			Madison S200	04	F
SR 40 Street Scrambler	07-09	F	R 125 Madison	03-06	F
<b>GPI</b>			250 Madison	04-07	F
GTS 50/125/200	02-03	F	Password 250	05-11	F
GTR 50/125/200	02	F	X3M Motard (Cast wheels)	08-10	F
SX 50	06-07	F	<b>MBK</b>		
<b>DAELIM</b>			TZR 50 X Power	03-09	F
ST 125	03	F	X-Limit Supermoto	03-09	F
<b>DERBI</b>			<b>MH/MOTORHISPANIA</b>		
GP1 50 Open	06-11	F	RYZ 50 Pro Racing Supermotard	06-10	F
Mulhacen 125 (4T) Upto Ref No 7N001790			RYZ 50 Pro Racing Urban Bike	06-10	F
Spoke wheel/2 pinpadfixing	07	F	RYZ 50 Supermotard	06-10	F
Senda R DRD	02	F	Duna 125 Dual Plus Trail	08-10	F
Senda 125 Baja R (4T) (260mm disc)	06-12	F	Duna 125 Sports City Supermotard	08-10	F
Senda 125 Baja SM (4T) (360mm disc)	06-12	F	<b>PEUGEOT</b>		
Senda DRD Racing 50 SM (300mm disc			Elyseo 125/150 Rear Disc Model	03	F
/Std caliper mounted)	04-11	F	Elystar 125/150 (3 bolt fixing - front disc)	02-05	F
Senda DRD Racing 50 R (260mm disc/			Elystar 125/150 (5 bolt fixing - front disc)	06-07	F
Std mounted caliper)	04-11	F	Geopolis 125 Executive/Non ABS (AJP Calipers)	07-12	F
Senda DRD Racing 50 R (Spoke Wheel/			Geopolis 125 Urban/ABS (AJP Calipers)	07-12	F
260mm F/disc)	11-12	F	Jet Force 125 (All models)	03-07	F
Senda DRD Racing 50 SM (Cast Wheel/			Satelis 125 Compressor (4T)	06-11	F
260mm F/disc)	11-12	F	Satelis 125 RS	07-12	F
Senda 125 SM (Twin headlight)	04-07	F	Satelis RS 125 (AJP Caliper)	07-12	F
Senda R 125 Vin# SCIAIA	04	F	Satelis 125 Blacksats (AJP Caliper)	10-12	F
Cross City 125	07-08	F	Satelis Urban 125 (AJP Caliper/ABS)	07-12	F
<b>FACTORY</b>			Satelis 125 Whitesat (AJP Caliper)	10-12	F
RP 50	05	F	XPS Supermoto (17" front wheel/260mm disc)	03-10	F
YM 50	05	F	XPS Street (17" front wheel/280mm disc)	03-09	F
YR 50 Desert	04-05	F	Geopolis 250 (Urban/ABS/AJP Calipers)	07-10	F
Chrono SM 50	04	F	Geopolis 250 (Executive/AJP Calipers/Non ABS)	07-10	F
YR 125 4T	05	F	Satelis 250 Urban (AJP Caliper/ABS)	07-12	F
<b>FANTIC</b>			Geopolis 400 (Urban/AJP Calipers/ABS)	07-11	F
Caballero 50 Regularita Casa	06-09	F	<b>PIAGGIO/VESPA (Grimeca Calipers)</b>		
Caballero 50 Supersei Motard	06-09	F	Beverley B 125	03-06	F&R
Caballero 125 Regularita Casa	07-08	F	Beverley 200	03-05	F&R
Caballero 125 Supersei Motard	07-09	F	Hexagon GT 250	98-99	F
<b>GAS GAS</b>			Hexagon LX 180	98-99	F
EC 50	05	F	Hexagon LXT 180	98-99	F
SM 50	05	F	Hexagon LX4 125	98-99	F
Pampera 250	02	F	Skipper LX 125/150	98-99	F
Pampera 125/250/280	04	F	Super Hexagon GTX 125/180		
Pampera 125 (2T)	05-08	F	(11" wheels)	00	F
Pampera 250	02-03	F	Skipper ST 125/150 4T		
<b>GENERIC</b>			Grimeca Caliper	00-04	F
Toxic 50	07-08	F	Super Hexagon GTX 250	00-02	F
Trigger X50	06-13	F	GT 125 L Granturismo	03-06	F
Trigger SM 50	06-13	F	GT 200 L Granturismo	03-06	F
Trigger 125 SM	08-09	F	<b>RIEJU</b>		
Trigger 125 X	08-09	F	MRX 50 Pro/Top	04-08	F
<b>GILERA (Grimeca Calipers)</b>			SMX 50 Pro Supermotard/Top	04-07	F
DNA 50	01-06	F	RS2 NKD	05	F
DNA 125/180	01-05	F	RS2 50cc Pro	06-09	F
125 VX 4T/180 VXR 4T	01-04	F	SMX 50 Pro Street	06-08	F
FX/FXR 125/180 Runner (Rear drum brake			<b>SACHS</b>		
model/Grimeca front caliper)	97-02	F	ZX 125 Enduro	01	F
Coguar	00-01	F	ZZ 125 Funbike	02	F
VXR 200 Runner (4T)	02-04	F			

# FA194 Contd.

## SHERCO

EN 50 Champion Replica	08	F
Replica Cup SM 50	08	F
Enduro 50 (EN50)	08-09	F
Enduro/Urban/SU 50cc(2T) (Spoke wheel)	08-13	F

## SHERCO Contd.

Black Panther SM 50	08-09	F
Supermotard 50	08-12	F
Supermotard SM 50	08-13	F
SM 0.5 Black Panther	08-10	F
City Corp 125 (All models)	08	F

### Equivalents OE #

8113478	5WX W0045 00	11967800
8113523	R290063110000	13D FS811 00
119 493 00	00009300080	1677
119 495 00	1D5 F5811 00	R050371008000
494628	00H04703141	PE757231
R43440 311A0	K00976315	K01309079
754605	11955700	014360258000
756020	2525340000	

SM 1.25 F Black Panther (4T)	10-12	F
SE 1.25 F Enduro (4T)	10-12	F
<b>SIAMOTO</b>		
SX1 125	04	F
<b>YAMAHA</b>		
DT 50 X (Supermotard)	04-08	F
TZR 50 (5WX1)	03-08	F
XT 125 X (3D62/3D64)	05-06	F
XT 125 X (13D2)	07	F
XT 125 X (13D4/13D6)	07-11	F

### Competitor X Ref

Dunlop	Ferodo	SBS	Vesrah
-	FDB677	689/120/168 /177	VD9015

### MATERIAL AVAILABILITY AND PART NO.

STD	OPTIONS						
FA	SFA	SFAC	HH	SFA-HH	R	MXS	EPFA
FA194	SFA194	SFAC149	FA194HH	SFA194HH	-	-	-

# FA196 102 x 38 x 9.8mm

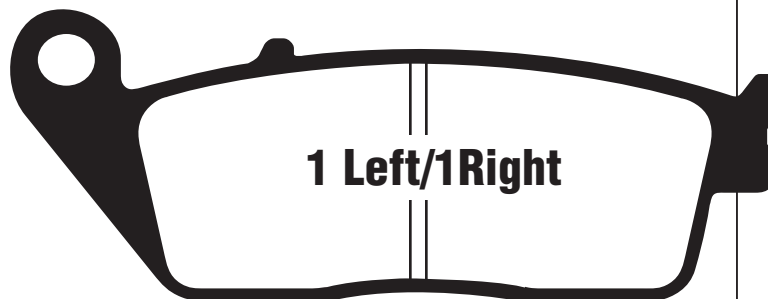

## BMW

C 600 Sport Scooter	12	R
C 600 Sport Highline	13	R
C 650 GT Scooter	12	R
C 650 GT Highline	13	R

## BUELL

Blast	00-07	F
-------	-------	---

## DAELIM

Roadwin R 125 (VJF 125)	08-12	F
Roadtwin (VJ 125)	04-13	F
VL 125 Daystar/125 L	03-13	F
VT 125 Evolution	03	F
VS 125 Evolution	01-04	F
(VJ 125) Roadwin	04-11	F

## HONDA

CB 250 N/T/W/X/Y/1/4 "Two Fifty"	92-05	F
CN 250 3 (MF02) Fusion/Fusion X/ Fusion X Special	03	F
VT 250 Spada	89-	F
VT 250 CR/CT/CV 'Magna'	95-97	F
VTR 250 W/Y/1-7 (MC33)	98-07	F
VTR 250-9	09-10	F
CB 400 SS (SS2-N41)	01-05	F
CL 400 (NC38)	98-03	F
FJS 400 D6/D7/D8	06-08	R
NV 400 DCY/DC1/DC2 (NC40) Shadow Slasher	00-02	F
SW-T 400 (FJS 400 D9)	09	R
SW-T 400 (FJS 400 A9/AB) (ABS)	09-13	R
VRX 400 T (NC33)	96	F
CBF 500 4 (Non ABS Model)	04	F
CB 500 R/T	94-96	F
CB 500 FAD (Twin)	13	F
CB 500 XD (Twin)	13	F
CBR 500 RD (Twin)	13	F
FJS 600 1/2/D3/D4/D5/D6/D7/A3-A7 Silverwing	01-09	R
SW-T 600 (FJS 600 AB) (ABS)	11-13	R
XL 600 VR/VT "Transalp"	94-96	F
FMX 650 5/6	05-08	F
DN-01 (680cc) (NSA700 A8/A9)	08-11	R
CBR 750 FJ 'Superaero'	-88	R
VF 750 CP/CR/CS/CT/CV/CW/CX	93-99	F
VFR 750 FJ/FK/FL/FM/FN/FP/FR/FS/FT/FV	88-97	R
VT 750 CV/C2V/CW/C2W/CX/C2X/CY/C2Y C1/C21/C31/C4/C5/C6/C7/C8 'Shadow'	97-09	F
VT 750 C2BA/C2BB/C2BC Shadow Black Spirit (Rear drum) 21" front wheel	10-13	F
VT 750 DC1/DC2 Black Widow	01-04	F
VT 750 DC7/DC8 Shadow Spirit	07-09	F

VT 750 S (VT 750 SA/SB)	10-12	F
CBR 1000 FK/FL/FM/FN	89-92	R
ST 1100 AN/AP/AR/AS Pan European (ABS Model)	92-95	R
ST 1100 L/M/N/P/R/S/T/V/W/X/Y/1/2 Pan European - Non ABS	90-02	R
VT 1100 CR/CS/CT/CV/CW Shadow	94-98	F
VT 1100 C2 (S/T/V/W/X/Y/1/2/3/4/5)	95-05	F
VT 1100 C3 (W/X/Y)	98-00	F
VT 1300 CXA Chopper (9 spoke cast wheel/non ABS)	10-12	F
VTX 1300 S3/S4/S5/S6/S7/S8	03-08	F
GL 1500 'CV/CW/CX/CY/C1/C2 (F6C)'	97-03	R
<b>KYMCO</b>		
Venox 250 (R20010/RA50AA/Carb Model)	00-03	F
Venox 250 (RFBR20011/RA50AD/Carb Model)	04-06	F
Venox 250 (R20012/EFi Model)	07-12	F
<b>MBK</b>		
VP 125 Cityliner	08-10	F
<b>SUZUKI</b>		
VL 1500 L3 (CT 1500 T Intruder)	13	F
<b>SYM</b>		
Cevalo B9A (125cc 4T)	10	F
<b>TRIUMPH</b>		
Adventurer	96-01	F&R
America (6 spoke cast wheel)	07-09	F
America (12 spoke cast wheel - 865cc)	10-13	F
Bonneville America	02-06	F
Bonneville 800	01-06	F
Bonneville/Bonneville Black (865cc)	07-08	F
Bonneville (865cc)	09-13	F
Bonneville SE (865cc)	09-13	F
Bonneville T100	02-13	F
Bonneville Steve McQueen SE	12	F
Legend TT	98-01	F&R
Speedmaster (865cc/EFi)	11-13F	
Thunderbird	95-03	F&R
Thunderbird Sport	98-03	F&R
Tiger 885cc	92-99	F&R
Tiger 955cc Up to VIN 198874	00-04	F&R
Tiger 955 (Cast wheel model) from VIN 198875	05-06	F
Scrambler (865cc)	06-13	F
Tiger 855i (From VIN 71699)	98-99	F&R
<b>VICTORY</b>		
Arlen Ness Victory Vision	09-12	R
Cory Ness Jackpot	08-10	R
Cory Ness Victory Cross Country	11-12	R
Cross Country	10-12	R
Cross Country Tour	12	R
Cross Roads	10-11	R

# FA196 Contd.

Hammer	08-11	R	<b>W.K. BIKES</b>		
Hammer S	08-12	R	WK 125 R (4T)	10-13	F
Hammer 8 Ball	10-11	R	WK 125 Sport	11-13	F
Hard Ball	12-13	R	<b>YAMAHA</b>		
Highball	12	R	VP 125 X-City (16P)	08-11	F
Jackpot	10-11	R	YP 125 Majesty DX (Taiwan Production)	02	F
Judge	12-13	R	YP 125 R (X-Max - ABS) (39D2)	11-13	F
Kingpin Tour	08-09	R	YP 125 R (X-Max - Non ABS) (39D1/5) Nissin F/Caliper	10-13	F
King Pin	08-09	R	YP 125 X-Max Business (ABS)	11	F
Kingpin 8-Ball	08-12	R	YP 125 R X-Max Sport	11-12	F
Kingpin-Low	09	R	VP 250 X City (5B2)	07-13	F
Vegas 8-Ball	08-12	R	XP 250 R X-Max (37P) (Nissin front caliper/Non ABS)	10-13	F
Vegas	08-12	R	YP 250 R X-Max Sport	11	F
Vegas Low	08-09	R	YP 250 R X-Max ABS	11-13	F
Vegas Jackpot	08-09	R	XC 300 Versity	06	F
Vision Street	08-09	R	MT-01 (1670cc)	05-10	R
Vision Tour (All models)	08-12	R	MT-01S (5YUR)	09	R
Vision 8 Ball	10-12	R			
Zach Ness Vegas	11-12	R			

### Equivalents OE #

06435 MCT 405	06455 MZO 760	06455 MEA 671	43105 MT3/6 007	45106 MW3 671	06455 MCK A01
06435 ML7 P01	06455 MAW 621	06455 MGS D31	43105 MT4 007A	T2020077	45105 BA5 RB10M1
06435 ML7 415	06455 MAB 405	431A0 MT4 670	43105 MY7 405	T2020194	45106 BA5 RB10M1
06435 MS2 P00	06455 MAH 405	43105 ML7 921A	43106 ML7 921B	T2020537	1S6 W0045 00
06435 MT3 405	06455 KCR 405	43105 ML7 922A	45105 LEA7 305	06455 KFR 701	37P F5811 00
06435 MS9 405	06455 MAA 405	43105 MS2 007A	45106 MN8 671B	45105 KED9 305	H0300T
06435 MZO 006	06455 MBK 751	43105 MS9 612A	45106 MS9 612B	5YU W0046 00	

### Competitor X Ref

<b>Dunlop</b>	<b>Ferodo</b>	<b>SBS</b>	<b>Vesrah</b>
DP118	FDB664	700/181	VD-156/2/3

### MATERIAL AVAILABILITY AND PART NO.

STD	OPTIONS							
FA	V	SFA	SFAC	HH	SFA-HH	R	MXS	EPFA
FA196	FA196V	SFA196	SFAC196	FA196HH	SFA196HH	-	-	-

# FA197 A. 96.7 x 42 x 9mm B. 77.3 x 42 x 9mm

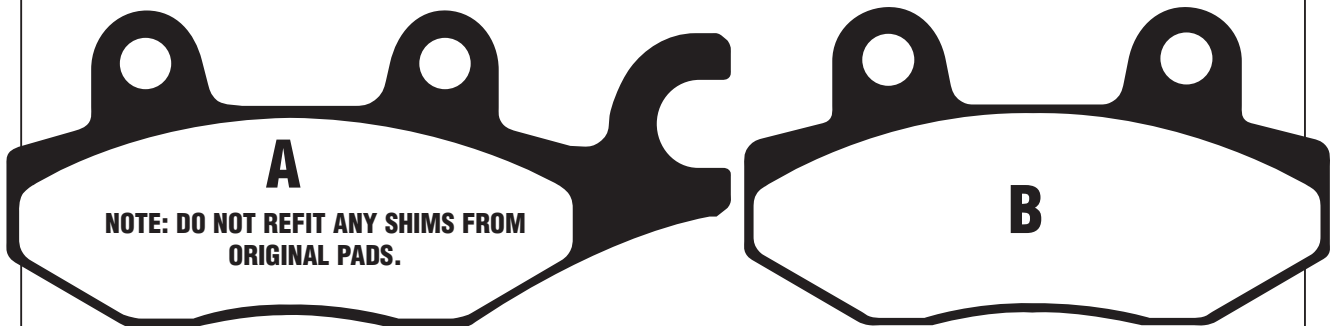

### AJS

Crazy Naked 50	10-11	F
Bobber 125 (Custom)	10-11	R
DD 125 E Mk2 Regal Raptor (Cast Wheels)	10-11	R
EOS 125 Regal Raptor	09-10	R
NKT 1-125 Naked	08-09	F&R
NKT 2-250 Naked	08-09	F&R
Regal Raptor DD 125 E	04-06	F
Regal Raptor DD 250 E	04-09	F

### HONDA

CB 50 V/W Dream 50	97-98	F
NSR 50 RV/RW/RX/RV	97-00	F
NSR 50 V (AC10-180)	97	F
NSR 50 X (AC10-190)	99	F
XR 50 M5 (AD14) Motard	05	F
NSR 75 N/P/R/X/Y (N5-1/NSR 80)	92-00	F
NSR 80 P/R/S (HC06)	93-95	F
NSR 80 V (HC06-170)	97	F
NSR 80 X (HC06-180)	99	F
Astra Supra NF 100	99	F
XR 100 M5 (HD13) Motard	05	F
LS 125 RY	00-	R
VT 125 CX/CY/C1/C21/C2Y /C3/C4/C7/C8 'Shadow'	99-08	F
XL 125 V1/V2/V3/V4/V5/V6/V7/V8 /V9/VA 'Varadero'	01-11	F
NSR 150 RR (Malaysian market)		F&R
TA 200 (TA Shadow)	02-05	F&R
CBF 250 4/7	04-07	F
CB 300 R10	10	F

### ARCTIC CAT

DVX 50 (Y6)	06	R
DVX 90 (Y12 4 Stroke)	06	R
<b>BENELLI</b>		
Caffe Nero 250	08-13	F(left)
<b>CCM</b>		
RL 125	08-09	F
SM 125	08-09	F&R
TL 125	08-09	R

### CP

125 Prince	01	F
X Large 125	11-12	F&R
X Large 300	11-12	F&R

### DAELIM

S-Four 50cc ES 50	10-12	F
Roadwin (VJ125)	04-13	R
Roadsport R 125 (NJF 125)	08-12	R
SQ 125 Freewing A2	06	R
SU 125 Delfino	07-11	F
SQ 250 Freeway S2	06	R
Roadwin R 250 Fi (VJF 250)	08-11	R
Roadsport 250 (VJF 250)	10-13	R
S3 125 (SV 125)	10-13	R

### GARELLI

Tiger 125	07	F&R
-----------	----	-----

### GENERIC

Worx 125/150 (4T)	12-13	F
-------------------	-------	---

### GOES

G 125 M Big Wheel	08-09	R
SP R 125 (Motorcycle)	10-12	R



# FA197 Contd.

## HARTFORD

VR 125/150 H/X/Z 04 R

## HERO HONDA

Magellan 125 06 F

Pluto 125 06 F

## HP POWER

Nickel 150 (4T/2V) 10-11 R

Barum260 (4T/2V/LC) 10-11 F

## HYOSUNG

MS3 (125cc) 07-09 F(right)

MS3 250i 07-09 F(right)

## ITALJET

50 it Scooter 09 F

## MODENAS

Kriss 115 F

Dynamic 125 08-09 F&R

Kristar 125 08-11 F&R

X-Cite 135 09-10 F&R

## YAMAHA

TZR 50 Thunderkid (5DU1/3) 97-00 F

Crypton-R New 110cc 04 F

YS 250 Fazer (Brasil) (1S41/2/3) 06-08 F

## KAWASAKI

BN 125 A3/A4/A5/A6F/A7F Eliminator 00-07 F

Kaze-R New 112cc 04 F

ZX 130 R Kaze 08-10 F

EX 250 K8F/K9F/KAF/KBF 08-12 F&R

/KBFA/KCF Ninja 250 R F&R

EX 300 ADF Ninja (Non ABS) F&R

EX 300 BDF Ninja ABS Model 13 F&R

KLR 650 (KL 650 E8F/E9F) 08-09 R

## KEEWAY

Silverblade 125 10-11 F&R

## KREIDLER

Galactica 2.0 Electro 12-13 R

Hiker 20 Electro 12-13 R

125 Street DD 12-13 F(left)

## KYMCO

Activ 50/110/125 04-06 F

Bet & Win 50/Dink Sports 50 02-06 F

Dink 50/Spacer 50/Yager 50 98-06 F

Dink Classic 50 Euro 2 03 F

Dink 50 (4T) 07-12 F

Grand Dink 50 (2T) 04-07 F

Grand Dink 50 S 12-13 F

Jetix 50 10 R

K-Pipe 50 12 F

Kymcosento 50i 13 F

Newsento 50i 13 F

Super 9 50 (LC) 00-07 F

Super 9 (A/C) 50 00-07 F

Yager 50 07 F

Bet & Win 125/150 00-06 F&R

Cruiser 125 99 F

Dink 125/150/Spacer 97-04 F&R

Dink Classic 125/150 02 F&R

Dink LX 125/150 98-00 F&R

Dink 125 i 06-12 F&R

Grand Dink/Miler 125/150 01-07 F&R

Grand Dink 125 12-13 R

Hipster 125/150 99-06 F

Jetix 125 10 R

KR 125 Sport Quannon 07-08 F&R

K-Pipe 125 12-13 F

Movie XL 125/150 01-09 F

KR 125 Quannon 07-13 F&R

KR 125 Quannon Naked 10-13 F&R

Like 125 (D20000) 09 R

Like 125 10-13 R

Movie 125i 12-13 F

Sector 125 99-01 F

Sector 125 98-01 F

Spike 125 R 04-06 F&R

Straight 125 05-06 F

Yager 125 00 F&R

Yager GT 125 07-13 F&R

Zing 125/150 Custom 97-13 F

Agility 150 R16 (C30000) (16" wheels) 08-12 R

Jetix 150 10 R

Activity 200i R16 10-12 R

Dink 200 i 06-12 F&R

Like 200 i 09-13 R

Yager 200i 07-13 F&R

Bet & Win 250 00-06 F&R

People 250 03-06 F&R

People 250 S 06-08 F(right)

Yup 250 03-06 F

Yup 250 04-06 R

Grand Dink 300i 12-13 F

People S 300 i 08-10 F(right)&R

## LEONART

Daytona 125 13 R

Spyder 125 R

## MOTOM

ANA 50 08-09 R

ANA 151 08-09 R

## MZ/MUZ

RT 125 02-07 F&R

SM 125 02-07 R

SX 125 02-07 R

## NIPPONIA

Brio 50 (4T) 12-13 R

Arte 125 (4T) F&R

Brio 125 (4T) 12-13 R

Dion 125 (4T) R

Arte 150 (4T) F&R

Dion 150 (4T) R

## PEUGEOT

WTR 125 08 F

## PGO

G Max 125 06-08 R

G Max 125 (Wave disc) 08-12 R

G Max 250 06-08 R

## QUADZILLA

WK 300 06-08 R

## SINNIS

Stealth 125 QM125-2D 08-10 F(right)

Grampus 250 10 F

## SYM

Orbit II 50cc (4T) 12-13 F

Orbit II 50 Naked (4T) 12-13 F

Orbit II 50 TS (4T) 12-13 F

X-Pro 50 13 F

Euro MX 125 (Rear disc model) 06-09 R

(HF12 W3-6 Euro 2) 01-02 R

Shark 4VR-125 07-13 F

## SUZUKI

FL 125 SDWK7/SDWK8 Address 07-10 F

/Underbone F

FX 125 F

Shogun-R FD-112 04 F

AN 250 Skywave Type M (BA-CJ45SA) 07-08 F(right)

AN 250 Skywave/Type D (BA-CK44A) 07-08 F(right)

AN 250 8 Skywave SS (CJ46A) 08 F(right)

AN 400 K7/ZK7/K8/ZK8/K9/L0/L1/L2/L3 07-13 F(right)

Burgman/Non ABS/Skywave F(right)

AN 400 AK9/ZAK9/AL0/ZAL0/AL1/ZAL1 09-13 F(right)

/AL2/AL3 Skywave/Burgman/ABS F(right)

## W.K. BIKES

WK 125 R (4T) 10-13 R

WK 125 Sport 11-13 F

WK Jetmax 250 (4T) 10-13 F(right)

## WUYANG

WY 125 24B 06-07 F

## YAMAHA

YBR 250 (5D11/3/4) 07-11 F

### Competitor X Ref

Dunlop	Ferodo	SBS	Vesrah
DP129	FDB2087	638/119/134	

### Equivalents OE #

06455 KPC 641	43082 1238	4510A KW6 9000	45150 LLB5 3050	252 0033A	45106 SEA 0000
06455 GCR 006	43105 LDH1 E00	4510A KFW6 900	4510A KFW6 900	43150 LEA5 306	5HH W0045 10
3LD W0045 10	43105 LFC4 305	45105 KBE 3050 M2	06455 KTK 006	59301 HP7 600	PE802576
3LD W0045 30	43105 SABR Z00M1	43150 KBE 3060	4310A BA4 000M1	45105 DE3 A00	
06455 KR3 000	43106 SABR Z00M1	43150 LDHIE 00	59100 07810	06455 KW6 843	
06455 KR3 405	43108 H3C 000A	43150 LLS 3050	59100 05820	06455 KW6 844	
43082 0081	45105 KR3 871	902 300 1000	1S4 W0045 00	43082 0080	
43082 0128	45106 KR3 871	45105 KW6 405	59401 HP7 600	45105 SEA 0000	

### MATERIAL AVAILABILITY AND PART NO.

STD		OPTIONS					
FA	SFA	SFAC	HH	SFA-HH	R	MXS	EPFA
FA197	SFA197	SFAC197	FA197HH	SFA197HH	-	-	EPFA197HH

# FA198 106 x 31.7 x 6mm

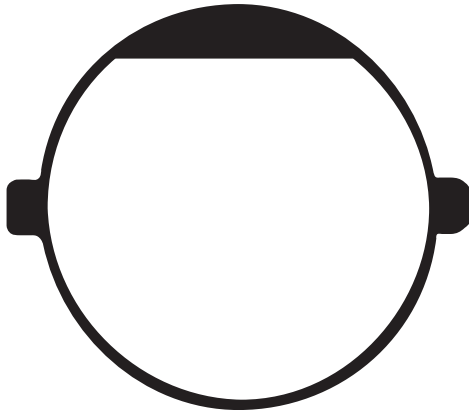

## CAGIVA

Roadster 125 96-97 F

## CZ / JAWA

All Disc Models F  
 125 Travel 03-04 F  
 125 Chopper 03-04 F  
 350 Chopper 03-04 F  
 350 Tramp 03-04 F  
 350 Californian 03-04 F

### Equivalents OE #

639 41 054

### Competitor X Ref

Dunlop	Ferodo	SBS	Vesrah
-	-	699	-

### MATERIAL AVAILABILITY AND PART NO.

STD	OPTIONS			
FA	HH	R	MXS	EPFA
FA198	-	-	-	-

# FA199 93.8 x 40.3 x 9.8mm

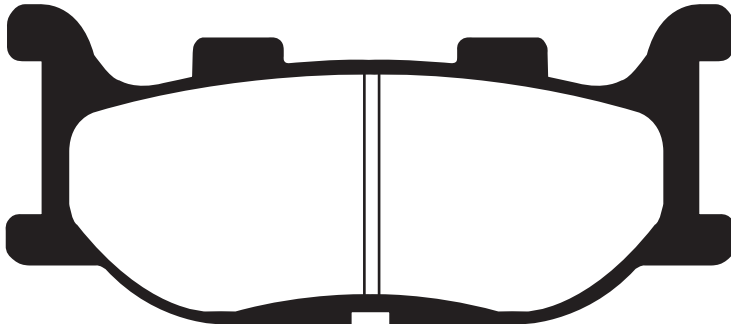

## YAMAHA

TDR 125 (4GW/GX 1/2/3/4) 93-03 F  
 XV 125 'Virago' 97-00 F  
 XVS 125 Dragstar 00-03 F  
 SR 125 97-03 F  
 TZR 150 R (4AP2) 00 F  
 CP 250 (EB71) Maxam/Morphus 05-08 F  
 XV 250 S 'Virago' 95-00 F  
 XVS 250 Dragstar 01-04 F  
 YP 250 DX/A/Majesty 98-03 F  
 XJR 400 (4HM3/4HM5/4HM6/4HM9/4HMA/4HMB) Brembo calipers 95-99 F  
 YP 400 Majesty (Non ABS) 05-13 F  
 YP 400 Majesty (ABS) 07-13 F  
 XP 500 T-Max (5VU1/2) 04-07 F  
 FZ6 Naked/Non ABS 2 Piston Caliper (1B3/1B3D) 04-07 F  
 FZ6-NS Naked/Non ABS/2 Piston Caliper 05-06 F  
 FZ6-Fazer (Half Fairing/Non ABS/2 Piston Caliper) (5VX/5VXL) 04-07 F  
 FZ6 - Fazer (ABS/Half Fairing/2 Piston Caliper) 06-07 F  
 XJ 600 S/N 98-03 F  
 XJ6-F Diversion (600cc) (Full Fairing- 1CW) (Non ABS/ABS) 10-12 F  
 XJ6-F Diversion 600 (Full Fairing Model - Non & ABS Models) 13 F  
 XJ6-N (600cc) (Naked 20S) Non ABS/ABS 09-12 F

XJ6-N Diversion Naked 13 F  
 XJ6-S Diversion (600cc) (Top Fairing - 36C) ABS and Non ABS Version 09-12 F  
 XJ6-S Diversion 600 (Top Fairing Model - Non & ABS Models) 13 F  
 XJ6 SP 13 F  
 MT-03 (660cc) 06-12 F  
 XV 1100 Virago 99 F  
 XVS 1100 Dragstar 99-04 F  
 XVS 1100 A Dragstar Classic 00-07 F  
 XVS 1300 A Midnight Star 07-13 F

## ADIVA SCOOTERS

AD 125 09-11 R  
 AR 125 10-11 R  
 AD 200 09-11 R  
 AR 200 10-11 R

## ITALJET

Jupiter 125/150 02 F  
 Jupiter 250 02-03 F

## LINHAI

Monarch 125/150 T 06-07 F  
 Main Street 300cc (Scooter) 07-08 F

## MBK

YP 250 Skyliner 96-99 F  
 YP 250 Skyliner 250 (+ABS) 00-02 F  
 YP 400 Skyliner 04 F

## SINNIS

Max 125 QM 125-2V 08-09 F

### Equivalents OE #

1B7 W0045 00	5VX W0045 00
4GA W0045 00	5VH W0045 00
4HM W0045 00	5RU W0045 00
4EB W0045 00	5VU W0045 10
4716630	

### Competitor X Ref

Dunlop	Ferodo	SBS	Vesrah
DP421	FDB2003	691/128	VD-260

### MATERIAL AVAILABILITY AND PART NO.

STD	OPTIONS							
FA	V	SFA	SFAC	HH	SFA-HH	R	MXS	EPFA
FA199	FA199V	SFA199	SFAC199	FA199HH	SFA199HH	-	-	-



# FA200 104 x 62.4 x 11.2mm

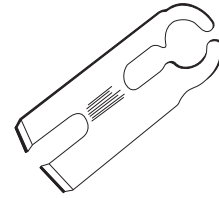
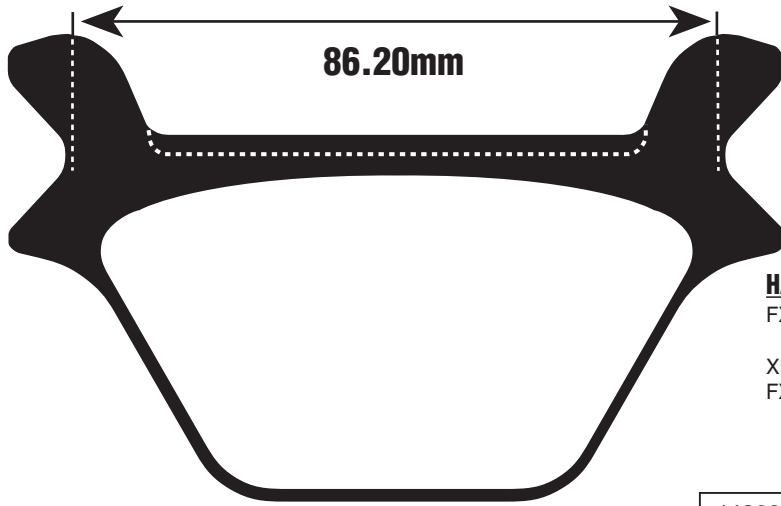

**Abutment Shims  
(2 per set)  
Ref. Pt. No. SHFA200/201**

**HARLEY DAVIDSON**

FXST/FXSTB/FXSTC/FXSTS/FLST/  
FLSTC/FLSTF/FLSTS/FLSTN Late 87-99 R  
XL/XLH/XLCH/XLS/XLX Late 87-99 R  
FXD/FXDL/FXDWG/FXR/FXRS/FXRT  
/FXRD/FXLR Late 87-99 R

**Equivalents OE #**

44209 87B	44209 87C	44213 87
-----------	-----------	----------

**Competitor X Ref**

<b>Dunlop</b> DP905	<b>Ferodo</b> FDB521/2001	<b>SBS</b> 669	<b>Vesrah</b> VD-923
------------------------	------------------------------	-------------------	-------------------------

**MATERIAL AVAILABILITY AND PART NO.**

STD	OPTIONS				
FA	V	HH	R	MXS	EPFA
FA200	FA200V	FA200HH	-	-	EPFA200HH

# FA201 104 x 62.4 x 11.4mm

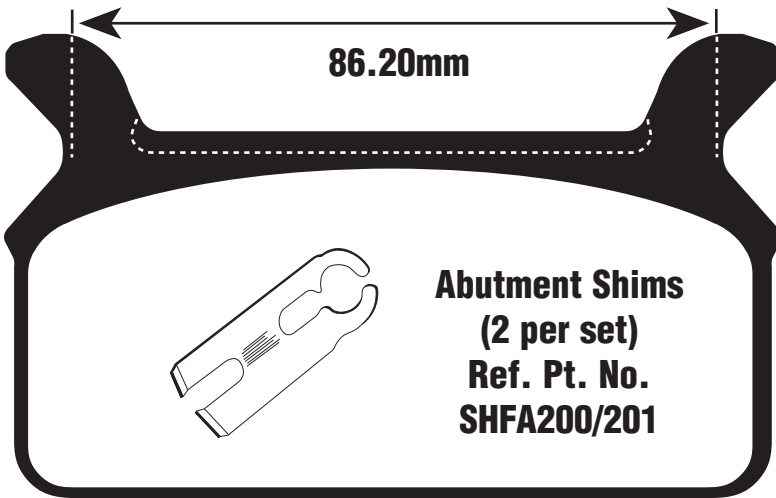

**HARLEY DAVIDSON**

FLT/FLHT/FLHTCI 86-99 R  
FLHR/FLHRCI 94-99 R

**Equivalents OE #**

43957 86	43957 86B
43957 86A	43957 86D

**Competitor X Ref**

<b>Dunlop</b> DP904	<b>Ferodo</b> FDB485	<b>SBS</b> 668	<b>Vesrah</b> VD-922
------------------------	-------------------------	-------------------	-------------------------

**Abutment Shims  
(2 per set)  
Ref. Pt. No.  
SHFA200/201**

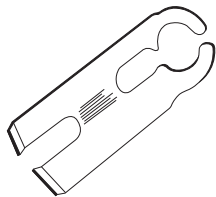

**MATERIAL AVAILABILITY AND PART NO.**

STD	OPTIONS				
FA	V	HH	R	MXS	EPFA
FA201	FA201V	FA201HH	-	-	-

# FA202 A. 96.7 x 43.4 x 7.6mm B. 77 x 43.4 x 8mm



DISC PADS BUYERS GUIDE

**Equivalents OE #**

N/A

**Competitor X Ref**

Dunlop	Ferodo	SBS	Vesrah
-	-	-	-

MATERIAL AVAILABILITY AND PART NO.				
STD	OPTIONS			
FA	HH	R	MXS	EPFA
FA202	-	FA202R	-	-

# FA203 81.2 x 42 x 9.5mm

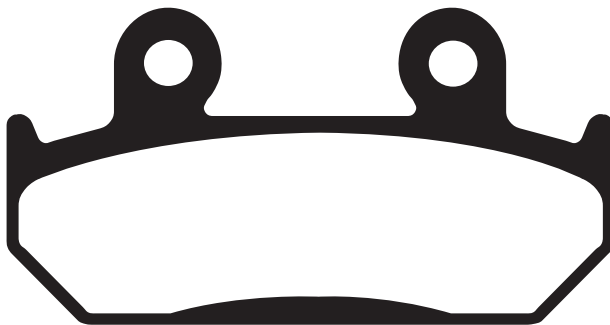

**HONDA**

CBR 600 FM/FN/FP/FR

91-94 F

**Equivalents OE #**

45105 MV1 008  
45105 MV1 405

**Competitor X Ref**

Dunlop	Ferodo	SBS	Vesrah
DP110	FDB462	593	VD142

MATERIAL AVAILABILITY AND PART NO.				
STD	OPTIONS			
FA	HH	R	MXS	EPFA
FA203	FA203HH	-	-	-

# FA206 39.8 x 53.7 x 6.4mm





# FA208 Contd.

Junior 80/85/100 Cross (Small wheel)	02-04	R
125 Cross	95-00	R
125 Enduro	95-00	R
250 Cross	95-00	R
250 Enduro	95-00	R
300 Cross	95-00	R
300 Enduro (2T)	95-00	R
400 Cross (4T)	95-00	R
530 Cross (4T)	98-00	R
<b>VERTEMATI</b>		
All models	99-04	R

<b>VOR</b>		
All models		99-04 R
<b>YAMAHA</b>		
TT 600 R (5CH1/5CH2/5CH3)		97-02 R
TT 600 RE (5CH5)		04 R
TT 600 E (4LW3/4LW4/4GV4/4GV5)		94-01 R
TT 600 K From 4GV 003404 (Brembo rear caliper)		95-96 R
XT 660 Z Tenere		08-13 R

### Competitor X Ref

Equivalents OE #		
800079072	546 13 309 200	750 13 090 000
8A0079072	546 13 309 300	5VK W0046 00
8113538	546 13 309 400	8000A9231
AB040	211021038	
AB040 S	4GV FS811 00	

Dunlop	Ferodo	SBS	Vesrah
DP622	FDB2019	675	VD-953

MATERIAL AVAILABILITY AND PART NO.				
STD	OPTIONS			
FA	HH	R	MXS	EPFA
FA208TT	-	FA208R	MXS208	EPFA208HH

## FA209 Use FA209/2 FA209/2 108.9 x 41.3 x 7.6mm

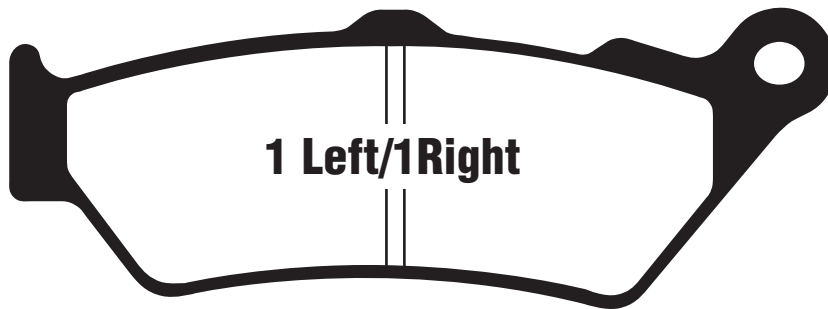

<b>APRILIA</b>			K 1600 GT SE	12-13	R
Moto 6.5	95-01	F	K 1600 GTL	11-13	R
Pegaso 650/650 IE	97-04	F	K 1600 GTL E	12-13	R
Pegaso 650 Trial	06-08	F	<b>BRAMMO</b>		
ETV 1000 Caponord/Rally (PS00/PSB0) (Non ABS)	01-03	F	Enertia	12-13	F
ETV 1000 Caponord (PS004) (ABS model)	04-08	F	<b>CCM</b>		
<b>BIMOTA</b>			GP 450 (4T)		F
DBX 1100 (MX)	12-13	F&R	<b>DUCATI</b>		
<b>BMW</b>			Diavel ABS	11-13	R
C1 125	99-03	F	Diavel Carbon ABS	11-13	R
C1 200	01-03	F	Diavel Chromo ABS	12	R
F 650 (E169/0161) Standard	09/93-96	F	Diavel AMG	11-12	R
F 650 (E169/0162) (Funduro/High Screen) (19" front wheel)	97-00	F	Diavel Strada	13	R
F 650 CS Scarver (K14/0174/0184 Belt Drive /17" wheels cast)	00-03	F	Diavel Dark	13	R
F 650 CS Scarver (K14/0177/0187 Belt Drive /17" wheels cast)	04-07	F	Paul Smart 1000 Limited	06	F
F 650 GS (R13/0172/0182) 19" front wheel	99-03	F	Paul Smart 1000 LE (992cc)	06	F
F 650 GS Dakar (R13/0173/0183) 21" front wheel	99-03	F	Classic Sport Biposto (992cc)	07	F
F 650 GS (R13/0175/0185) Single Cylinder 19" front wheel	04-07	F	GT 1000 (992cc)	07-10	F
F 650 GS Dakar (R13/0176/0186) 21" front wheel	04-07	F	GT 1000 Touring (992cc)	09	F
F 650 GS (K72/0218/0228) (798cc Twin Cylinder/Cast Wheels)	07-12	F	Sport 1000 S (992cc)	07	F
F 650 GS (30 Years GS) (Twin Cylinder 798cc/Cast Wheel)	11	F	Sport 1000 S	07-09	F
F 650 ST (E169/0163/168) Strada (18" front wheel/low screen)	97-00	F	Sport Classic 1000 (992cc) (Monoposto - Japan/Biposto - Europe)	06-08	F
G 650 GS (R131) (Single cylinder/chain drive/cast wheel)	09-12	F	<b>HONDA</b>		
G 650 GS Sertao (Spoke wheels)	12	F	CB 500 V/W/SW/X/SX/Y/SY/2/S2	97-03	F
G 650 Xchallenge	07-08	F	NX 500 V/W/X Dominator	97-99	F
G 650 Xcountry	07-08	F	SRL 650 V/W	97-98	F
F 700 GS	13	F	NT 650 VW/XV/XY/V1 'Deauville'	98-01	F
F 800 GS	08-13	F	NX 650 V/W/X Dominator	97-02	F
F 800 GS (30 Years GS)	11	F	FX 650 X/Y 'Vigor'	99-03	F
F 800 GS Triple Black	12	F	<b>HUSQVARNA</b>		
F 800 GS Trophy	12	F	TR 650 Terra (Spoke wheel)	12-13	F
HP2 1200 Enduro	05-09	F	TR 650 Strada (Cast wheel)	12-13	F
K 1600 GT	11-13	R	<b>ITALJET</b>		
			Griffon #59	07	R
			<b>KTM</b>		
			690 Enduro R	09-13	F
			690 Enduro	08-10	F
			690 Rally Factory Replica	07-09	F
			950 Adventure/S	04-06	F
			950 R Superenduro	06-08	F
			990 Adventure S (Non ABS)	06-08	F
			990 Adventure R (Non ABS)	09-12	F

# FA209/2 Contd.

## MOTO GUZZI

940 Belagio	07-13	F
1100 California Aluminium	02-05	R
1100 California Titanium (With top fairing)	04-05	R
1100 California Aquila Nera	09-11	R
1100 California Classic Touring	06-08	R
1100 California EV (Up to KD115426/ Single pin pad fixing)	97-00	R
1100 California EV Touring	03-05	R
1100 California Jackal (Up to KD142328/ Single pin pad fixing)	94-01	R
1100 California Jackal (Up to KD152328 /2 pin pad fixing)	94-01	R
1100 California Special (Up to KD131644/ single pin pad fixing)	99-00	R
1100 California Special (From KD131645/ 2 pin pad fixing)	99-00	R
1100 California Sport	01-02	R
1100 California Stone	01-05	R
1100 California Stone Metal	02-03	R
1100 California Vintage	06-12	R
1100 California 1100 190	12	R
1100 Quota ES	99-01	F
1200 Griso 8v Special Edition /Spoke wheels/radial caliper	07-12	R
<b>MOTO MORINI</b>		
Granpasso 1200	08-13	F
Scrambler 1200	10-13	F

## TRIUMPH

**Note - Use FA209/2HH only on this Triumph fitment**

Rocket III 2300cc	04-09	R
Rocket III Classic	07-09	R
Rocket III Touring	08-13	R
Rocket III Road- ABS	10-13	R
Thunderbird (1597cc)	09-13	R
Thunderbird Storm (1699cc)	11-13	R

## VICTORY

Victory All models	98-07	R
--------------------	-------	---

## YAMAHA

DT 125 X	05-06	F
XT 660 R	04-13	F

### Equivalents OE # - FA209/2

06455 MAK 000	34 11 7 711 498	GU30654626
06455 MAN 911	34 21 7 724 609	61340751A
06455 MY5 731	2202491	61340941A
06455 MAK 003	5VK W0045 00	T2020692
0000 365 46000	600 13 030 000	T202048
34 11 2 345 445	2C8 W0045 00	AP8113627
8113533	8113627	M1340001400
34 11 7 660 340	8133906	8532279
34 11 7 651 958	000306546260	
34 11 7 697 086	GU03654600	

### Competitor X Ref

Dunlop	Ferodo	SBS	Vesrah
DP623	FDB2006	674/176	VD958

### MATERIAL AVAILABILITY AND PART NO.

STD	OPTIONS						
FA	V	SFA	HH	SFA-HH	R	MXS	EPFA
FA209/2	FA209/2V	SFA209/2	FA209/2HH	-	-	-	-

# FA210 112.1 x 56.3 x 10mm

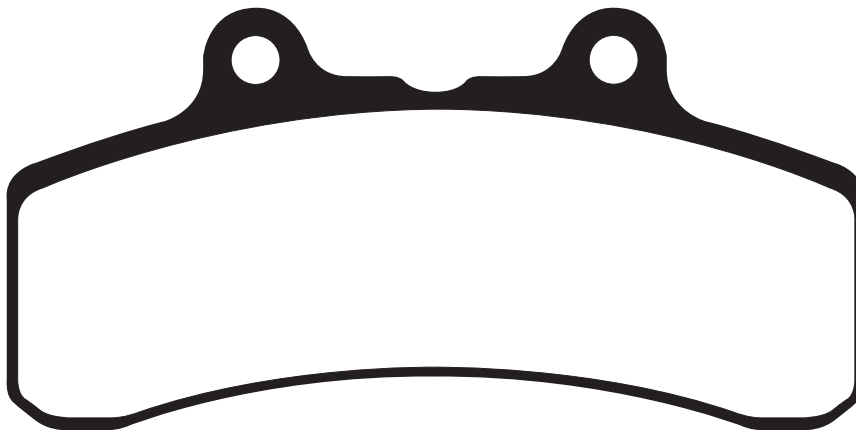

## BUELL

M2 Cyclone	94-97	F
S2 "Thunderbolt"	94-97	F
S1 Lightning	94-97	F
S3 Thunderbolt	94-97	F

### Competitor X Ref

Dunlop	Ferodo	SBS	Vesrah
DP912	FDB847	658	-

### Equivalents OE #

42386 84Y
0053 1604
H0300 8A

### MATERIAL AVAILABILITY AND PART NO.

STD	OPTIONS					
FA	V	HH	R	MXS	EPFA	
FA210	FA210V	-	-	-	-	

# FA211 77.8 x 45.4 x 8.5mm

# FA211/2 77.8 x 45.4 x 10.4mm

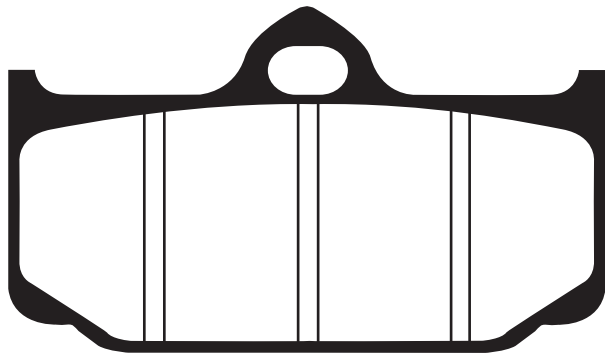

### Equivalents OE #

N/A

MATERIAL AVAILABILITY AND PART NO.				
STD	OPTIONS			
FA	HH	R	MXS	EPFA
FA211	-	-	-	-

### Competitor X Ref

Dunlop	Ferodo	SBS	Vesrah
-	FDB 2008	-	-

MATERIAL AVAILABILITY AND PART NO.				
STD	OPTIONS			
FA	HH	R	MXS	EPFA
FA211/2	-	-	-	-

# FA213 78.13 x 41.2 x 9mm



1 Left/1Right

### APRILIA

Pegaso Strada 650	05-06	R
Pegaso 650 Trial	06-08	R
Pegaso 650	07-08	R
Pegaso 650 Factory	06-08	R
Dorsoduro Factory 750	10-13	R
Dorsoduro 750 ABS	08-13	R
Shiver 750 GT	09-10	R
Shiver 750	07-10	R
Shiver 750 (RAE00) (Std & ABS)	10-13	R
Shiver 750 GT ABS	10-12	R
Caponard 1200	13	R
Dorsoduro 1200	11-12	R
Dorsoduro 1200 ATC/ABS	11-13	R

### BETA

Jonathan 125	00-01	R
Euro 350	00-01	R

### BMW

C1 125	99-03	R
C1 200	01-03	R
F 650 (E169/0161) Standard	09/93-96	R
F 650 (E169/0162) (Funduro/High Screen /19" front wheel)	97-00	R
F 650 CS Scarver (K14/0174/0184 - Belt Drive/ 17" cast wheels)	00-03	R
F 650 CS Scarver (K14/0177/0187 - Belt Drive/ 17" cast wheels)	04-07	R
F 650 ST (E169/0163/168) Strada (18" front wheel/low screen)	97-00	R
F 650 GS (R13/0172/0182) (19" front wheel)	99-03	R
F 650 GS Dakar (R13/0173/0183) (21" front wheel)	99-03	R
F 650 GS (R13/0175/0185) Single cylinder	04-07	R
F 650 GS Dakar (R13/0176/0186) (21" front wheel)	04-07	R
F 650 GS (K72/0218/0228) (798cc Twin Cylinder/cast wheels)	07-12	R
F 650 GS (30 Years GS) (Twin Cylinder 798cc/cast wheel)	11	R
G 650 Xchallenge	07-09	R
G 650 Xmoto	07-09	R
G 650 Xcountry	07-09	R

G 650 GS (R131) (Single cylinder/chain drive)	09-11	R
G 650 GS Sertao (Spoke Wheels)	12	R
F 700 GS	13	R
F 800 GS	08-13	R
F 800 GS (30 Years GS)	11	R
F 800 GS Triple Black	12	R
F 800 GS Trophy	12	R
F 800 GT	13	R
F 800 R	09-13	R
F 800 R Chris Pfeiffer Edition	09-11	R
F 800 S (Half Fairing)	06-10	R
F 800 ST (Full Fairing)	06-12	R
F 800 ST Touring	10-12	R
S 1000 RR	10-13	R
S 1000 RR Sport	12-13	R
HP4	13	R
HP4 Carbon	13	R

### BORILE

B 500 CR	02-04	R
B 500 MT	02	R

### CCM

CR 40 S Cafe Racer (Full fairing)	07-09	R
CR 40 Cafe Racer (Handlebar fairing)	07-08	R
SR 40 Street Scrambler	07-09	R
GP 450 (4T)		R

### DUCATI

Paul Smart 1000 Limited	06-07	R
Paul Smart 1000 LE (992cc)	06	R
1000 Sport (992cc)	06-07	R
Classic Sport Biposto (992cc)	07	R
GT 1000 (992cc)	07-10	R
GT 1000 Touring (992cc)	09	R
Sport 1000 S (992cc)	07	R
Sport 1000 S	07-09	R
Sport Classic 1000 (992cc) (Monoposto - Japan/Biposto - Europe)	06-08	R

### HONDA

CB 500 V/W/SW/X/SX/Y/SY/2/S2	97-03	R
NX 500 V/W/X Dominator	97-99	R
FLX 650 X/Y "Vigor"	99-03	R
SLR 650 V/W	97-98	R
NX 650 V/W/X Dominator	97-99	R



# FA213 Contd.

## H P POWER

Pantera 600 11 R

## HUSQVARNA

TR 650 Terra (Spoke wheel) 12-13 R

TR 650 Strada (Cast wheel) 12-13 R

Nuda 900 12-13 R

Nuda 900 R 12-13 R

## KTM

Duke 125 (4T) 11-13 R

Duke 200 (4T) 12-13 R

Duke 390 13 R

Duke-E 640 (Single pin pad fixing

/zero offset disc) 98 R

Duke II 640 (2 pin pad fixing/zero offset disc) 99-07 R

690 Duke 08-11 R

690 Duke (2 pin pad fixing) 12-13 R

690 Duke R 10-11 R

690 R Duke 13 R

690 Rally Factory Replica 07-09 R

690 SM 07-09 R

690 SMR 07-11 R

690 SMC 07-11 R

690 SMC R 12-13 R

690 SM-LE (Limited Edition) 10-11 R

990 Superduke 05-11 R

990 Superduke R 07-13 R

Daytona 675 R

Daytona 675 R 13 R

Street Triple 675R 13 R

## YAMAHA

WR 125 X 09-13 R

WR 125 R 09-12 R

WR 250 XX/XY (Supermoto) (32D2/4) 08-10 R

WR 250 RX/RX (32D1/3) 08-10 R

XT 660 X Supermoto 04-13 R

XT 660 R 04-13 R

MT-03 (660cc) 06-12 R

### Equivalents OE #

06435 MAK 003	8133825	34 21 7 722 884
34 21 7 660 343	61340761A	897119
34 21 7 660 253	8133911	7707809
34 21 7 664 983	503 13 090 000	901 13 090 000
34 21 2 345 449	6130761A	T2024901
34 21 7 707 908	858200	546 13 309 200
5VK W0046 00	22BF591100	8539283

### Competitor X Ref

Dunlop	Ferodo	SBS	Vesrah
-	-	175	-

### MATERIAL AVAILABILITY AND PART NO.

STD	OPTIONS						
FA	V	SFA	HH	SFA-HH	R	MXS	EPFA
FA213	FA213V	SFA213	FA213HH	-	-	-	-

**FA214 A. 96.7 x 42 x 7.6mm B. 77.3 x 42 x 8mm**

**FA214/2 A. 96.7 x 42 x 9.7mm B. 77.3 x 42 x 8mm**

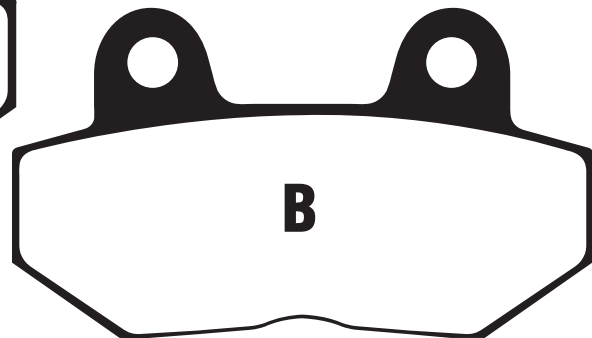
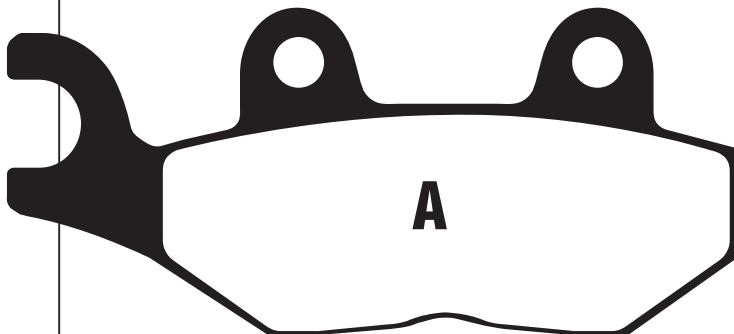

### Equivalents OE #

FA214 = T 2020071 T301

### Equivalents OE #

FA214/2 = T 2020 555	FA214/2 = T 2020 556
FA214/2 = T 2020 072 T31	FA214/2 = T 2020 191

### MATERIAL AVAILABILITY AND PART NO.

STD	OPTIONS			
FA	HH	R	MXS	EPFA
FA214	FA214HH	-	-	-

### Competitor X Ref

Dunlop	Ferodo	SBS	Vesrah
DP411	FDB497	638	VD340

### MATERIAL AVAILABILITY AND PART NO.

STD	OPTIONS			
FA	HH	R	MXS	EPFA
FA214/2	FA214/2HH	-	-	-

# FA214 Contd.

## FA214/2 Contd.

### FA214 TRIUMPH

Sprint (All carb models)	93	F(Left)
Tiger 885cc	92-97	F(Left)
Trident 750	92-98	F(Left)
Trident 900	92-98	F(Left)
Trophy 900	92-93	F(Left)
Trophy 1200	92-93	F(Left)

### FA214/2 TRIUMPH

America (6 spoke cast wheel)	07-09	R
America (12 spoke cast wheel - 865cc)	10-13	R
Bonneville America	02-06	R
Bonneville 800	01-06	R
Bonneville T100	02-13	R
Bonneville (865cc)	09-13	R
Bonneville SE (865cc)	09-11	R
Bonneville/Bonneville Black (865cc)	07-08	R
Bonneville Steve McQueen SE	12	R
T595 Daytona	97	R
Daytona 955i	98-00	R
Daytona 955i (From VIN 132513)		
(5 bolt front disc single sided s/arm)	01-04	R
Daytona 955i	05-06	R
Speed Triple	97-01	R
Speed Triple 955cc	02-04	R

Sprint RS	99-04	R
Thruxton 900	04-13	R
Scrambler (865cc)	06-13	R
Speedmaster (765cc/Carb)	03-04	R
Speedmaster (865cc/Carb)	05-07	R
Speedmaster (865cc/EFI)	08-13	R
Speed Triple (1050cc)	05-13	R
Speed Triple R 1050 (Brembo monobloc radial caliper/5 spoke cast wheel)	12-13	R
Sprint 955i ST Front Disc with offset /6 bolt fixing)	99-04	R
Sprint GT 1050 (ABS)	10-13	R
Sprint 1050i GT Front disc with offset /5 bolt fixing	05-06	R
Sprint 1050i Sprint ST (Non ABS) front disc with zero offset	11-12	R
Sprint 1050i ST (ABS) Front disc with zero offset	11-12	R
Sprint 1050 ST (5 spoke wheel/ Non ABS Model/5 bolt disc with offset)	05-10	R
Sprint 1050 ST (5 spoke wheel/ ABS Model/5 bolt disc with offset)	05-10	R
Tiger Explorer 1200	12-13	R
Tiger Explorer 1200 XC	13	R
Tiger Sport 1050cc	13	R
Trophy 1215cc	12-13	R
Trophy 1215cc SE	12-13	R

## FA215 A. 96.7 x 42 x 7.6mm B. 77.3 x 42 x 8mm

## FA215/2 A. 96.7 x 42 x 9.7mm B. 77.3 x 42 x 8mm

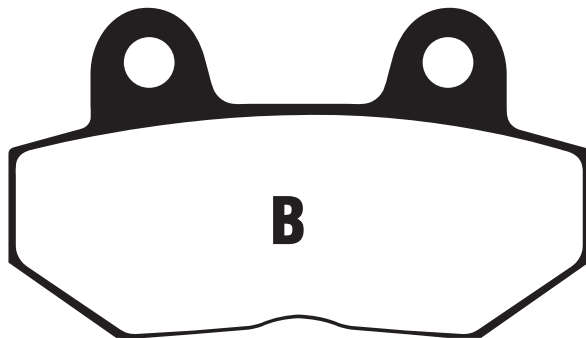
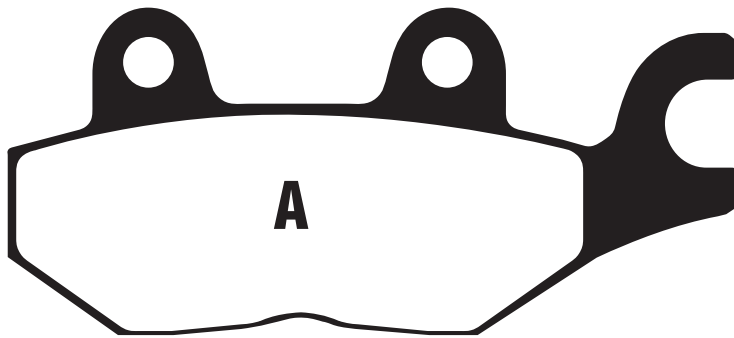

### FA215 - TRIUMPH

Sprint	93	F(Right)
Trident 750	92-98	F(Right)
Tiger 885cc	92-97	F(Right)
Trident 900	92-98	F(Right)
Trophy 900	92-93	F(Right)
Trophy 1200	92-93	F(Right)

### FA215/2 - TRIUMPH

Daytona 750	92	R
Daytona 1000	92	R
Daytona 900	93-96	R
Daytona Super III	94-97	R
Daytona 1200	93-98	R
Speed Triple	94-97	R
Sprint	93-98	R
Sprint RS	99-02	R
Trident 750	92-98	R
Tiger 885cc	92-97	R
Trident 900	92-98	R
Trophy 900	92-01	R
Tiger 955 (from VIN198875)	04-06	R
Tiger 1050 (Radial caliper)	07-12	R
Tiger 1050 SE - ABS (1050cc)	10-13	R
Trophy 1200	92-01	R

### Equivalents OE #

FA215 = T 2020072-T301	FA215/2 = T 2020561
FA215/2 = T 2020560	

### Competitor X Ref

Dunlop	Ferodo	SBS	Vesrah
DP412	FDB631	611	VD250/250/2

MATERIAL AVAILABILITY AND PART NO.				
STD	OPTIONS			
FA	HH	R	MXS	EPFA
FA215	FA215HH	-	-	-

MATERIAL AVAILABILITY AND PART NO.				
STD	OPTIONS			
FA	HH	R	MXS	EPFA
FA215/2	FA215/2HH	-	-	-

**FA216 USE FA216/3**  
**FA216/2 69.2 x 48.8 x 10.5mm**  
**FA216/3 69.2 x 48.8 x 7.8mm**

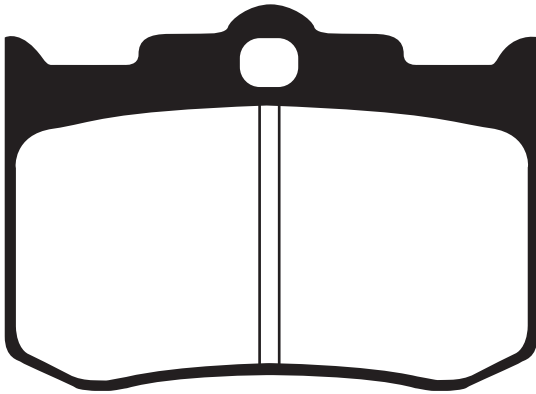

**Competitor X Ref**

<u>Dunlop</u>	<u>Ferodo</u>	<u>SBS</u>	<u>Vesrah</u>
DP911	FDB2040/H	678/662	-

**FA216/2**  
**EBC**  
 4 Piston  
**PERFORMANCE MACHINE**  
 124 X 4HR  
 137 X 4  
**FA216/3**  
**HHI - (Hawg Halters)**  
 4 Piston - All types  
**INDIAN** - See page for application details  
 Nova  
 Legends  
 Thunderheart  
**NOVA/LEGENDS**  
 4 Piston  
**PERFORMANCE MACHINE**  
 125 X 4R  
 137 X 4B  
**REVTECH**  
 New Black 4 Piston Caliper  
**THUNDERHEART**  
 4 Piston Caliper

<b>MATERIAL AVAILABILITY AND PART NO.</b>				
STD	OPTIONS			
FA	HH	R	MXS	EPFA
FA216/2	-	-	-	-

<b>MATERIAL AVAILABILITY AND PART NO.</b>					
STD	OPTIONS				
FA	V	HH	R	MXS	EPFA
FA216/3	FA216/3V	FA216/3HH	-	-	-

**FA217 106 x 31.7 x 8.5mm**

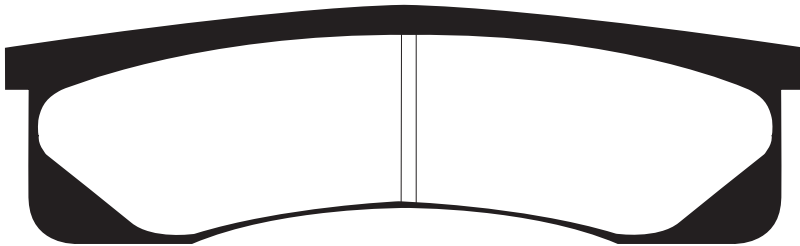

**RACE USE ONLY**

**AP/LOCKHEED**  
 6 Piston / No Pins (CP3366/67)  
**REVTECH**  
 6 Piston VR1000 Race Caliper

**Equivalents OE #**

N/A

**Competitor X Ref**

<u>Dunlop</u>	<u>Ferodo</u>	<u>SBS</u>	<u>Vesrah</u>
-	FRP418	660	-

<b>MATERIAL AVAILABILITY AND PART NO.</b>				
STD	OPTIONS			
FA	HH	R	MXS	EPFA
FA217	-	-	-	-

# FA218 77.65 x 40.50 x 9.3mm

# FA218/2 77.65 x 40.50 x 8mm

**RACE USE ONLY**

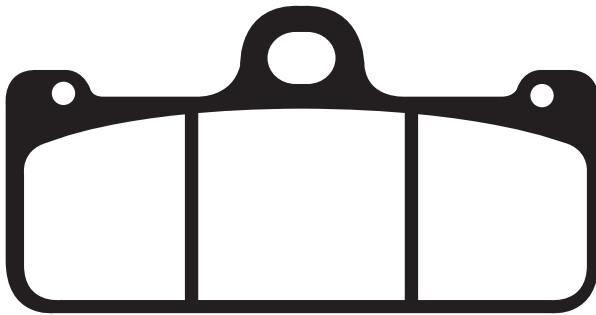

### FA218 - BREMBO

XA9.33.10/11 - 4 Piston P32/36 Radial mount monobloc @ 108mm spacing (single pin pad fixing)  
 X97.37.60/61 - 4 Piston Monobloc 32/36 Radial Mount @ 108mm (Single pin fixing)

### TM

MX 660 06 F

### FA218/2 - BREMBO

XA3.B8.30/31 - 4 Piston P32/36 Radial Mount Caliper @ 108mm Spacing (Titanium Pistons)  
 XA3.B8.60/61 - 4 Piston P32/36 Radial Mount Caliper @ 108mm Spacing (Aluminium Pistons)  
 X1017.40/41 - 4 Piston/40mm Axial Monobloc  
 XA7G2.40/41 - 4 Piston 100mm CNC Monobloc Race Caliper  
 XA7G2.10/11 P4 32/36 Radial monobloc 100mm spacing

### Equivalents OE # - FA218

107 A486 02
07 684831

### Equivalents OE # - FA218/2

107 A486 03
107 684830
M028Z04

### Competitor X Ref - FA218

Dunlop	Ferodo	SBS	Vesrah
DP626	FDB2007	695	VD969/2

MATERIAL AVAILABILITY AND PART NO.				
STD	OPTIONS			
FA	HH	R	MXS	EPFA
FA218	FA218HH	-	-	EPFA218HH

### Competitor X Ref - FA218/2

Dunlop	Ferodo	SBS	Vesrah
-	-	711	VD969

MATERIAL AVAILABILITY AND PART NO.				
STD	OPTIONS			
FA	HH	R	MXS	EPFA
-	-	-	-	EPFA218/2HH

# FA220 69 x 50.4 x 8.7 mm

### PIN HOLE

Right to left 5.8mm

Top to bottom 5.0mm

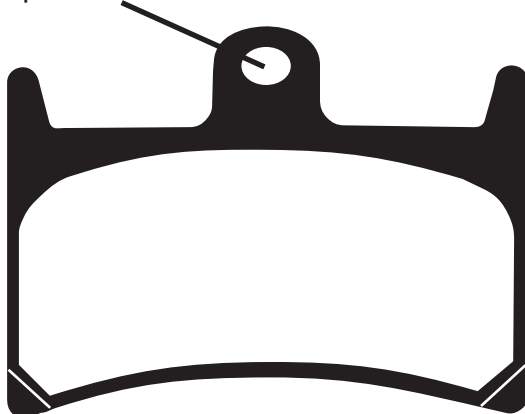

### YAMAHA

FZR 250 R F  
 R1-Z (250CC/3XC) 90-92 F

### Equivalents OE #

3LN W0045 00

### Competitor X Ref

Dunlop	Ferodo	SBS	Vesrah
-	-	639	VD-249

MATERIAL AVAILABILITY AND PART NO.				
STD	OPTIONS			
FA	HH	R	MXS	EPFA
FA220	-	-	-	-

# FA222 52.60 x 56.30 x 9mm

**SUZUKI**

RF 900 RR/RS/RS2

94-95 R

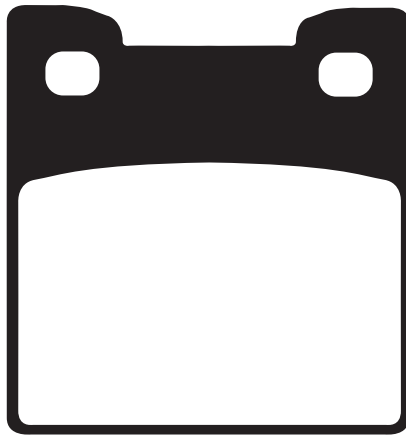

**Equivalents OE #**

69100 31830
69130 31E00

**Competitor X Ref**

Dunlop	Ferodo	SBS	Vesrah
DP217	FDB2058	701	VD-350

**MATERIAL AVAILABILITY AND PART NO.**

STD	OPTIONS			
FA	HH	R	MXS	EPFA
FA222	-	-	-	-

DISC PADS BUYERS GUIDE

# FA226 102 x 38 x 9.0mm

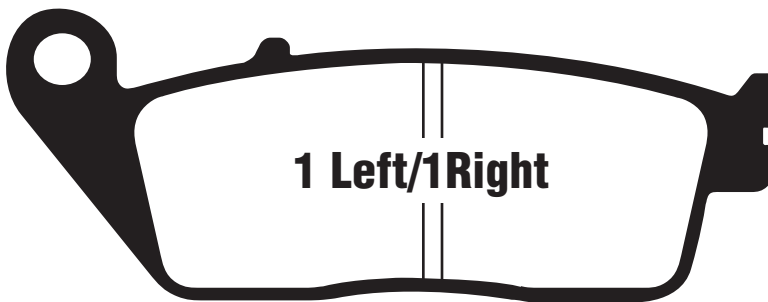

**HONDA**

RS 125	90-94	F
RS 250	90-94	F
CB 600 FW/FX/FY/F2-Y/F1/F21/F2/F22/F3/F4/F5/F6 /F7/F8/F9/FA/FB/FC Hornet	98-13	F
CBF 600 N4/NA4/S4/SA4/N5/NA5/S5/SA5	04-05	F
CBF 600 N8/N9/NA (Non ABS)	08-11	F
CBF 600 NA4/NA5/NA6 (ABS Model)	04-06	F
CBF 600 S4/S5/S6 (Non ABS)	04-06	F
CBF 600 SA4/SA5/SA6 (ABS Model)	04-06	F
CBF 600 S8/S9 (Non ABS)	08-09	F
CBF 600 N4/N5/N6 (Non ABS)	04-06	F
CBF 600 NA4/NA5/NA6 (ABS)	04-06	F
CBR 600 FS/FT/FV/FW	95-98	F
CBR 600 FB/FC	11-13	F
CBF 1000 677/8/9/A (2 piston front calipers/Non ABS Model)	06-11	F
CBF 1000 F (FA) (2 piston front calipers/Non ABS)	10-11	F

**TRIUMPH**

Street Triple 675 (Naked)	07-12	F
Street Triple 675	13	F
Tiger 800 (Non ABS)	11-13	F
Tiger 800 XC (Non ABS)	11-13	F

**Equivalents OE #**

06455 MV4 405
06455 MR4 405
06455 MAL G01

**Competitor X Ref**

Dunlop	Ferodo	SBS	Vesrah
DP117	FDB570	627	VD156/2

**MATERIAL AVAILABILITY AND PART NO.**

STD	OPTIONS			
FA	HH	R	MXS	EPFA
FA226	FA226HH	-	-	EPFA226HH

# FA228 A. 96.7 x 42 x 9mm B. 77.3 x 42 x 9mm

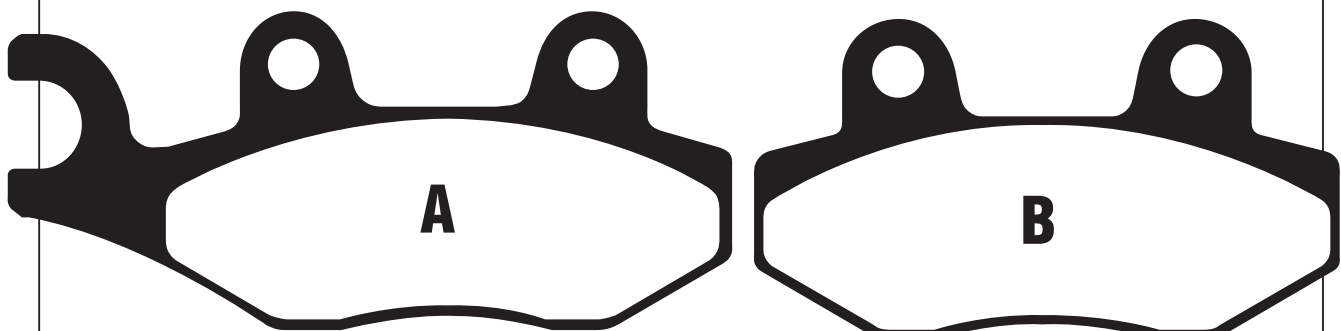

**NOTE: Do not refit any shims from original pads**

# FA228 Contd.

DISC PADS  
BUYERS GUIDE

## AEON

Elite 125 (4T)	12-13	F
MY 125		F
OZ 125 (4T)	13	F
Urban 125 (Scooter)	11	F
Urban 125 (4T)	13	F
OZ 150 (4T)	13	F
Elite 200i (Scooter)	11	F
Elite 350i (4T)	12-13	F
Urban 350i (Scooter)	11	F
Urban 350i (4T)	13	F

## ASPES

50 Sirio Hybrid	11	F
-----------------	----	---

## BENELLI

Caffe Nero 125/150	11-13	F&R
Hobby 125 (4T)	13	F&R
Macis 125/150	10-13	F&R
X 125	12-13	F
X 150	12-13	F
Hobby 151 (4T)	13	F&R
Caffe Nero 250	08-13	F(right)
Zenzero 350	12-13	F

## CF MOTO

CF 125 T-22 Glory	10-11	F
CF 125 T-21A E-Charm	10-11	F
CF 150 T-6A Glory	10-11	F
CF 150 T-Si	10-11	F

## DAELIM

SJ 50 R A-Four (50cc)	06-09	F
-----------------------	-------	---

## GENERIC

Zion 125/150 (Rear drum model)	08-10	F
Inox 125 (2T)	12-13	F

## HARTFORD

VR-125 Z Velo Sport	00-03	F
VR-125 X/H Velo-Cross	00-03	F
CR 125/150 H/X/Z	04	F

## HONDA

CA125 S/T 'Rebel'	95-97	F
CMX 250 CT 'Rebel'	96-97	F

## HYOSUNG

MS3 (125cc)	07-09	F (Left)&R
MS3 250i	07-09	F (Left)&R

## KAWASAKI

KLR 650 (KL 650 E8F/E9F)	08-09	F
--------------------------	-------	---

## KEEWAY

Partner 110	06-07	F
Outlook 125/150	07-10	F&R
Superlight 125	07-12	F
Superlight 150	07-10	F
Cruiser 250	09-10	F

## KREIDLER

50 Florett (RS 50 DD)	12-13	F
50 Galactica 2.0 (RS 50 DD)	12-13	F
50 Galactica 2.0 (50 DD)	12-13	F
50 Galactica 2.0 (50 DD City)	12-13	F
50 Galactica 2.0 (RC 50)	12-13	F
125 DD Street	12-13	F(right)
Hiker 2.0 Electro	12-13	F
Galactica 2.0 Electro	12-13	F

## KYMCO

Agility 50	05-08	F
Agility 50 R10 (4T) (CK 50 QT S)	06-12	F
Agility 50 R12 (4T) (CK 50 QT S)	06-12	F
Agility RS 50 Naked (2T/12" wheels)	10-12	F
Filly 50 LX (S210)	00-06	F
Like 50 (2T/4T)	10-13	F
Sento 50	08-09	F
Vitality 50 (2T) (SF10FA)	04-09	F
Vitality 50 (4T) (U31000)	04-09	F
Yup 50	01-09	F
Cobra 100 Racer	99-03	F
Agility 125	06-10	F
Agility RS 125 (4T 12" wheels)	10-13	F
Stryker 125	01-06	F
Like 125	10-13	F
Movie 125	99-00	F
Vivio 125/150	00-03	F
Stryker 150 (Off road)	00-06	F
Like 200i	10-13	F
People 250 S	06-08	F(left)
People S 300 i	08-10	F(left)

## MALAGUTI

Blog 125 ie	09-11	F
Centro 125 ie/SL	07-11	F
Blog 160 ie	09-11	F
Centro 160 ie/SL	07-11	F

## MZ/MUZ

SX 125	02-07	F
SM 125	02-07	F

## NIPPONIA

Duel 125 (4T)		F
---------------	--	---

## PEUGEOT

Citystar 125 i	11-13	F
Citystar 125 Active	13	F
Geopolis 125 (Premium/Non ABS) (Nissin Calipers)		
Geo RS 125 (Nissin Caliper)	07-12	F&R
Satelis 125 Avenue (Nissin calipers)	07-12	F&R
Satelis 125 (4T)	08-09	F&R
Satelis 125 RS (4T)	13	R
E-Satelis (Electric)	13	F
E-Vivacity (Electric)	11	F&R
Vivacity 125	11-12	F
Vivacity Sixties 125 (4T)	10-12	F
Citystar 200i	11-12	F
Geo RS 250 (Nissin Caliper)	12	F
Geopolis 250 (Premium/Nissin Calipers 'Non ABS)	07-12	F&R
Satelis RS 250 (Nissin Calipers)	07-12	F&R
Satelis 250 Premium (Nissin Calipers)	07-12	F&R
Geopolis 300 (Premium/Nissin Calipers 'Non ABS)		
Geostyle 300 (Nissin Calipers)	10-12	F&R
Geo RS 300 (Nissin Calipers)	10-12	F&R
Satelis 300 (4T)	13	F&R
Geopolis 400 (Premium/Nissin Calipers/Non ABS)	07-12	F&R
Geo RS 400 (Nissin Calipers)	08-12	F&R
Satelis 400 Premium (Nissin Calipers)	08-12	R
Satelis 400 Urban (Nissin Calipers/ABS)	08-12	R
Satelis 400 RS (Nissin Calipers)	08-12	R
Geopolis 500	08-11	R
Satelis 500	07-12	R
Satelis 500 RS (Nissin Calipers)	08-12	R

## QUADZILLA

WK 300	06-08	F
--------	-------	---

## ROYAL ENFIELD

Bullet Electra (All disc models) (Dual Seat)	05-13	F
Clubman 500 EFI (Single Seat)	09-12	F
Bullet Battle Green 500 EFI (Single Seat)	09-12	F
Bullet Classic 500 EFI (Single Seat)	09-13	F
Bullet Classic Chrome 500 EFI (Single seat)	09-13	F
Bullet Desert Storm 500 (EFI/Single Seat)	12	F
Bullet 500 EFI (Dual Seat)	09-12	F
Electra 500 EFI (Dual Seat)	09-12	F
Fury 500	11-12	F
Trails 500 EFI	09-12	F
Woodsmen 500cc EFI	10-12	F

## SINNIS

Hawk 50 QM 50 10A-(C)	08-10	F
Stealth 125 QM125-2D	08-10	F(left)
QM 50 T-10R Eagle 50	10-12	F

## SUZUKI

AN 250 Skywave Type M (BA-CJ45A)	07-08	F(left)
AN 250 Skywave/Type S (BA-CJ44A)	07-08	F(left)
AN 250 8 (CJ46A) Skywave SS	08	F(left)
AN 400 K7/ZK7/K8/ZK8/K9/L0/L1/L2/L3 Burgman /Non ABS/Skywave	07-13	F(left)
AN 400 AK9/ZAK9/AL0/ZAL0/AL1/ZAL1/AL2/AL3 Skywave/Burgman/ABS	09-13	F(left)

## SFM

SFM 25 Roadster	13	F
-----------------	----	---

## SYM

XPro 125	11-13	F
RS 150	06	R

## VIALLI

DXB 50	06	F
Fireforce 50	06	F

## W.K. BIKES

WK 125 C (2T) (16" wheel)	10-13	F
WK 125 SC (4T) (14" wheels)	10-12	F
WK Jetmax 250 (4T)	10-13	F(left)

## YAMAHA

YBR 125 ED (5HHB/F/H) Brasil (Disc front)	06-08	F
---	-------	---

### Equivalent OE #

06455 KEB 900	59401 HP7 600
45105 KCE 3050 M2	119 69800
45105 KKD 6305	45105 SB3 0001M1
45150 KEC8 3050	45106 SB3 0001M1
902 3002000	43082 0060
59100 05830	560583
45110 K2GP 000	PE 758935
5HH W0045 00	45105 LDC8 305
5RM W0045 10	R1700 7208 0000
45130T40 000	

### Competitor X Ref

Dunlop	Ferodo	SBS	Vesrah
DP211	FDB497	713/163/197	VD340/2

### MATERIAL AVAILABILITY AND PART NO.

STD		OPTIONS					
FA	SFA	SFAC	HH	SFA-HH	R	MXS	EPFA
FA228	SFA228	SFAC228	FA228HH	SFA228HH	-	-	-



# FA229 A. 133.5 x 36.8 x 8.4mm B. 109.6 x 44.4 x 8.5mm

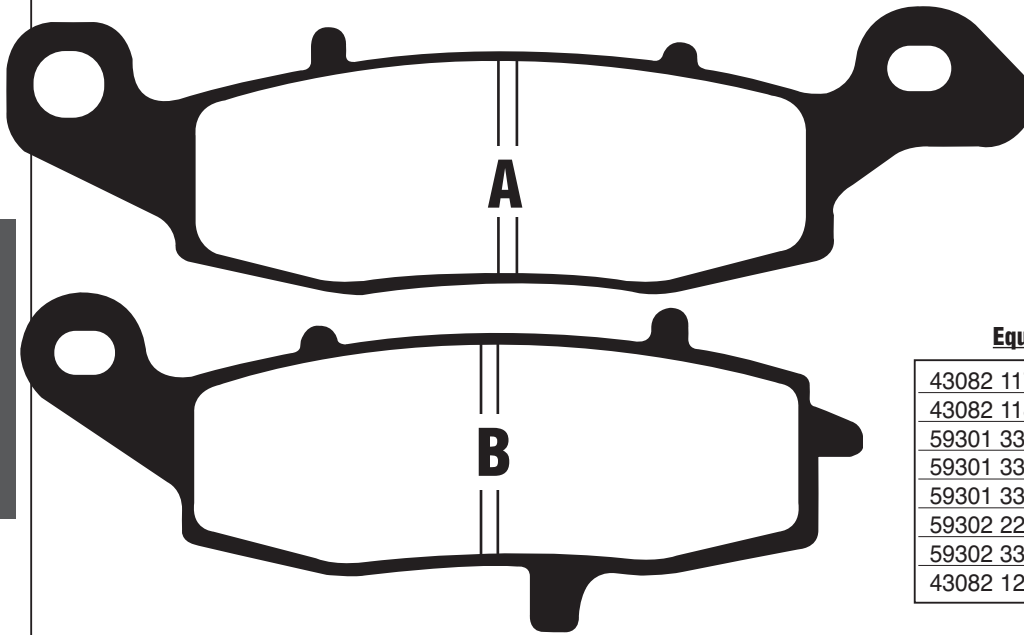

### Equivalents OE #

43082 1177	43082 1234
43082 1187	43082 1244
59301 33820	43082 1282
59301 33830	43082 S019
59301 33840	59300 33850
59302 22850	59302 33830
59302 33810	59303 33810
43082 1223	

### CF MOTO

650 NK 12-13 F(left)  
650 TR 13 F(left)

### KAWASAKI

ZR-X 400 E3 (ZR 400 E3) 96 F(left)  
ER-5 ER 500 C1-C5P 01-07 F  
ER-6f (EX 650 A6F/A7F/A8F/C9F/CAF/CBF) 06-11 F(left)  
ER-6f (EX 650 B6F/B7F/B8F/D9F/DAF/DBF) ABS 06-11 F(left)  
ER-6f (FCF/FDF) (Double pipe type frame/with ABS) 12-13 F(left)  
ER-6f (ECF/EDF) (Double pipe type frame/non ABS) 12-13 F(left)  
ER-6n (ER 650 A6F/A7F/A8F/C9F/CAF/CBF) 06-11 F(left)  
ER-6n (ER 650 B6F/B7F/B8F/D9F/DAF) 06-10 F(left)  
ER-6n (FCF/FDF) (Double pipe type frame/with ABS) 12-13 F(left)  
ER-6n (ECF/EDF) (Double pipe type frame /non ABS) 12-13 F(left)  
KLE 650 A7F/A8F/A9F/CAF/CBF Versys 07-13 F(left)  
KLE 650 B7F/B8F/B9F/DAF/DBF/DCF/DDF Versys ABS 07-13 F(left)  
KLR 650 C1-C10 95-04 F  
650 (KLE 650 Versys) (Non ABS) 12 F(left)  
650 (KLE 650 DCF Versys) (ABS Model) 12 F(left)  
ZR 750 D1 "Zephyr" 96- F(left)  
ZR-7 (ZR 750 F1/F3/F5) 99-04 F(left)  
ZR-7S (ZR 750 H1/H2) 01-04 F(left)  
Z 750 (ZR 750 J1/J2) 04-05 F(left)  
Z 750 S (ZR 750 K1/K6F) 05-07 F(left)  
VN 800 C1/C2/E1/E2/E3 "Drifter" 99-04 F  
VN 800 B1-B10/B6F/BDF "Classic" 96-06 F  
VN 900 A6F Classic 06 F  
VN 900 B7F/B8F/B9F/BAF/BBF/BCF Classic (Spoke wheel) 07-13 F  
VN 900 C7F/C8F/C9F/CAF/CBF/CCF/CDF Custom (Cast wheel) 07-13 F  
VN 900 BBFA/BCFA/BDFA Classic Special Edition/ White Wall Tyres/Spoke Wheel 11-12 F  
KLV 1000 (LV 1000 A1H/A2H) 04-05 F(left)  
GPZ 1100 E1/E2/F1 95-98 F(left)  
ZR 1100 B1 "Zephyr" 96-97 F(left)  
ZR 1100 B5 (Zephyr 1100 RS) 02 F(left)  
VN 1500 D1/D2/E1/E2 "Classic" 96-99 F  
VN 1500 G1/G2 Classic Tourer 98-00 F(left)  
VN 1500 J1/J2/R1/R2/R3 Drifter 99-04 F  
VN 1500 L1/L2/L3/L4 "Nomad Fi" 00-03 F(left)  
VN 1500 N1/N2/N3 Classic Fi 00-04 F  
VN 1600 A1/A2/A3/A6F 03-08 F(left)  
VN 1600 D1H/D6F Classic Tourer 05-08 F(left)  
VN 1700 C9F Classic Tourer 09 F(left)  
VN 1700 E9F Classic 09 F(left)  
VN 1700 DAF/DBF/DCF/DDF Classic Tourer ABS 10-13 F(left)  
VN 1700 FAF/BBF/FCF/FDF Classic ABS 10-13 F(left)

### SUZUKI

GSF 250 VS/VT/VV/VVZ/VW/VX/VY (GJ77) Bandit 95-00 F  
TU 250 GY/GBK1 Grass Tracker/ Big Boy NJ47A-117/123) 00-01 F  
TU 250 XTX/XTY (NJ47A/115) Volty 99-00 F  
SV 400 X/Y/K1/K2 00-02 F(left)  
SV 400 SX/SY/SK1/SK2 00-02 F(left)  
SV 400 K3/K4/K5 03-05 F(left)  
SV 400 SK3/SK4/SK5 03-05 F(left)  
GSX 600 FW/FX/FY/FK1/FK2/FK3 /FK4/FK5/FK6 98-06 F(left)  
GSF 600 Y/SY/K1/SK1/K2/SK2/K3/SK3 K4/SK4 Bandit 00-04 F(left)  
DL 650 K4/K5/K6 V-Strom 04-06 F(left)  
DL 650 XK7/XK8/XK9/XL0 V-Strom X 07-11 F(left)  
DL 650 AK7/AK8/AK9/AL0 V-Strom ABS 07-11 F(left)  
DL 650 AL1 XP V-Strom Expedition 11 F(left)  
DL 650 AL2/AL3 V-Strom 12-13 F(left)  
DL 650 AK9 GT V-Strom Traveller ABS 09-11 F(left)  
GSF 650 SK5/SK6 Faired Bandit Non ABS 05-06 F(left)  
GSF 650 K5/K6 Naked Bandit Non ABS 05-06 F(left)  
GSF 650 AK5/AK6 Naked Bandit - ABS 05-06 F(left)  
GSF 650 SAK5/SAK6 Faired Bandit - ABS 05-06 F(left)  
SFV 650 K9/L0/L1 Gladius 09-12 F(left)  
SFV 650 AK9/AL0/AL1/AL3 (ABS) 09-13 F(left)  
SV 650 K3/K4/K5/K6/K7/K8/K9/L0 Naked Non ABS 03-10 F(left)  
SV 650 AK7/AK8/AK9/AL0 Naked ABS 07-10 F(left)  
SV 650 SAK7/SAK8/SAK9/SAL0 07-12 F(left)  
SV 650 SK3/SK4/SK5/SK6/SK7/SK8/SK9/SL0 Top Fairing Non ABS 03-13 F(left)  
SV 650 X/Y/K1/K2 Naked - Non ABS 99-02 F(left)  
SV 650 SX/SY/SK1/SK2 Top Fairing - Non ABS 99-02 F(left)  
GSR 750 L1/L2/L3 11-13 F(left)  
GSX 750 FW/FX/FY/FK1/FK2/FK3/FK4/FK5/FK6 98-06 F(left)  
GSX 750 W/X/Y 98-03 F(left)  
VX 800 T 96 F  
DL 1000 K2/K3/K4/K5/K6/K7/K8/K9/L0 V-Strom 02-10 F(left)  
M 1500 (VZ 1500 K9/L0/L1 Intruder) 09-13 F(left)  
VL 1500 K2/K3 02-03 F(left)  
VL 1500 K5/K6/K7/K8 (C1500 Intruder) 05-08 F(left)

### WK

650i (Naked) 13 F(left)  
650 TR (Touring) 12-13 F(left)

### Competitor X Ref

Dunlop	Ferodo	SBS	Vesrah
DP322	FDB2048	705	VD-352

### MATERIAL AVAILABILITY AND PART NO.

STD	OPTIONS				
FA	V	HH	R	MXS	EPFA
FA229	FA229V	FA229HH	-	-	EPFA229HH

# FA230 A. 99 x 44.1 x 7.56mm B. 75.50 x 37.90 x 8.26

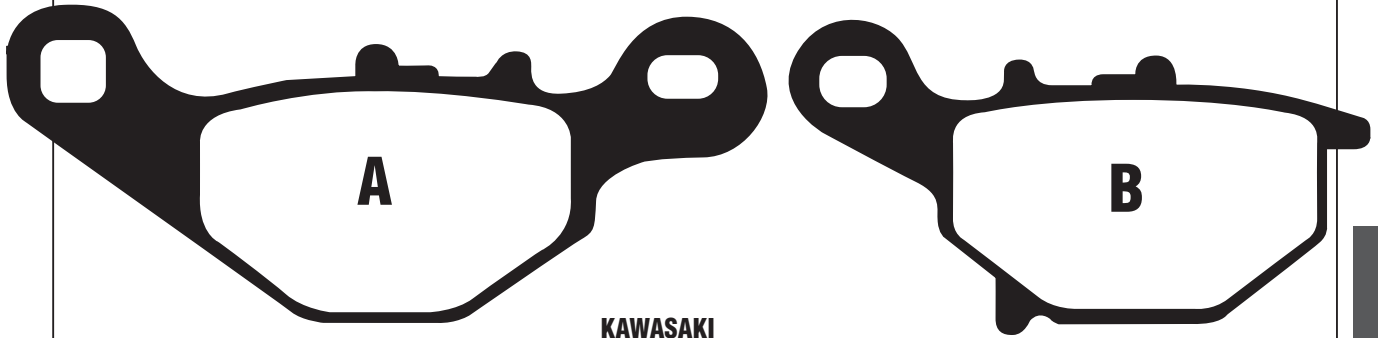

### Equivalents OE #

59300 03880	43082 S005
59300 03891	43082 S015

### KAWASAKI

KLX 125 L (B1/B2/B3/B6F)  
KMX 125 B10/B11/B12

03-06 F  
99-03 F

### SUZUKI

RM 80 T/V/W/X/Y/K1  
RM 85 K2/LK2/K3/LK3/LK4/K4  
DR-Z 125 LK3/LK4/LK5/LK6/LK7/LK8/LK9

96-01 F  
02-04 F  
03-13 F

### Competitor X Ref

Dunlop	Ferodo	SBS	Vesrah
DP218	-	702	VD-351

MATERIAL AVAILABILITY AND PART NO.					
STD	OPTIONS				
FA	HH	R	MXS	EPFA	
FA230TT	-	FA230R	-	-	

# FA231 A. 133.5 x 36.8 x 8.4mm B. 109.6 x 44.4 x 8.5mm

# FA231/2 A. 133.5 x 36.8 x 10.7mm B. 109.6 x 44.4 x 10.7mm

# FA231/3 A. 133.5 x 36.8 x 11.4mm B. 109.6 x 44.4 x 11.4mm

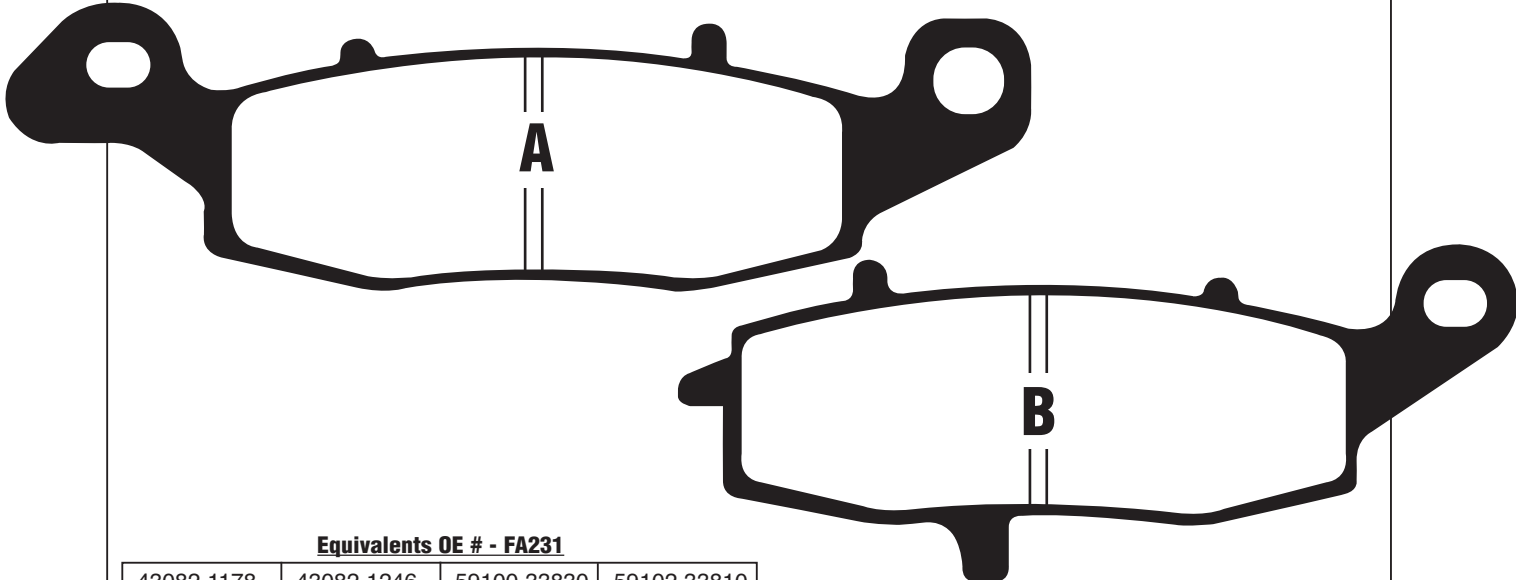

### Equivalents OE # - FA231

43082 1178	43082 1246	59100 33830	59102 33810
43082 1188	43082 1248	59100 33850	59102 33840
43082 1203	43082 1260	59100 33870	K4308-21203
43082 1226	43082 1265	59101 33810	59103 33810
43082 1232	43082 1280	59101 33820	
43082 1235	43082 1283	59101 33830	
43082 1243	43082 S018	59101 33850	

### Competitor X Ref - FA231

Dunlop	Ferodo	SBS	Vesrah
DP323	FDB2049	704	VD-435

### Competitor X Ref - FA231/2

Dunlop	Ferodo	SBS	Vesrah
DP323	FDB2049	886	VD-435

MATERIAL AVAILABILITY AND PART NO.					
STD	OPTIONS				
FA	V	HH	R	MXS	EPFA
FA231	FA231V	FA231HH	-	-	EPFA231HH

MATERIAL AVAILABILITY AND PART NO.					
STD	OPTIONS				
FA	V	HH	R	MXS	EPFA
-	FA231/2V	-	-	-	-

MATERIAL AVAILABILITY AND PART NO.					
STD	OPTIONS				
FA	V	HH	R	MXS	EPFA
-	FA231/3V	-	-	-	-

### Equivalents OE # - FA231/2

43082 0015	43082 0105
43082 0052	69100 01880
43082 0063	69100 01810

### Equivalents OE # - FA231/3

43082 1264	69100 01870
K4308-21264	

# FA231 Contd.

## CF MOTO

650 NK 12-13 F(right)  
650 TR 13 F(right)

## KAWASAKI

BJ 250 F1/F2 (250 TR) 02-03 F  
ZR 250 B6 (Balius II) 02 F  
ZR-X 400 E3 (ZR 400 E3) 96 F(right)  
650 (KLE 650 Versys CBF/CCF) (Non ABS) 12 F(right)  
ER-6f (EX 650 A6F/A7F/A8F/C9F/CAF/CBF) 06-11 F(right)  
ER-6n (ER 650 A6F/A7F/A8F/C9F/CAF/CBF) 06-11 F(right)  
ER-6f (EX 650 B6F/B7F/B8F/D9F/DAF/DBF) ABS 06-11 F(right)  
ER-6f (FCF/FDF) (Double pipe type frame/with ABS) 12-13 F(right)  
ER-6n (ER 650 B6F/B7F/B8F/D9F/DAF) 06-10 F(right)  
ER-6n (FCF/FDF) (Double pipe type frame/with ABS) 12-13 F(right)  
ER-6n (ECF/EDF) (Double pipe type frame/non ABS) 12-13 F(right)  
KLE 650 A7F/A8F/A9F/CAF/CBF/CCF/CDF Versys 07-13 F(right)  
KLE 650 B7F/B8F/B9F/DAF/DBF/DCF Versys ABS 07-13 F(right)  
W 650 (EJ 650-A1/C3/C4/C5/C6/C7) 99-05 F  
650 (KLE 650 DCF/DDF Versys) ABS Model 12-13 F(right)  
Z 750 (ZR 750 J1/J2) 04-05 F(right)  
Z 750 S (ZR 750 K1/K6F) 05-07 F(right)  
ZR 750 D1 'Zephyr' 96- F(right)  
ZR-7 (ZR 750 F1/F3/F5) 99-04 F(right)&R  
ZR-7S (ZR 750 H1/H2) 01-04 F(right)&R  
EJ 800 ABF/ACF (W 800/Solid F/Disc) 11-12 F  
EJ 800 (W 800 Cafe Style/Cockpit Fairing) 11 F  
EJ 800 ACFA (W 800 Special Edition  
Black Exhaust/Gold rims) 12 F  
EJ 800 ADF (W 800) 13 F  
VN 800 C1/C2/E1/E2/E3 'Drifter' 99-03 R  
W 800 ABF 11 F  
VN 900 A6F Classic 06 R  
VN 900 C7F/C8F/C9F/CAF/CBF/CCF/CDF  
Custom (Cast wheel) 07-13 R  
VN 900 B7F/B8F/B9F/BAF/BBF/BCF/DBF  
Classic (Spoke wheel) 07-13 R  
VN 900 BBFA/BCFA/BDFA Classic Special Edition  
/White Wall Tyres/Spoke Wheel 11-13 R  
KLV 1000 (LV 1000 A1H/A2H) 04-05 F(right)  
GPz 1100 E1/E2/F1 95-98 F(right)  
ZR 1100 B1 'Zephyr' 96-97 F(right)  
ZR 1100 B5 (Zephyr 1100 RS) 02 F(right)  
VN 1500 G1/G2 Classic Tourer 98-99 F(right)  
VN 1500 J1/J2/R1/R2/R3 Drifter 99-04 R  
VN 1500 L1/L2/L3/L4 "Nomad Fi" 00-03 F(right)&R  
VN 1500 N1/N2/N3 "Classic Fi" 00-04 R  
VN 1500 P1/P2 Mean Streak 02-04 R  
VN 1600 A1/A2/A3/A6F 03-08 F(right)&R  
VN 1600 B1 Mean Streak 04 R  
VN 1600 B2H/B6F/B7F (Mean Streak) 05-08 R  
VN 1600 D1H/D6H Classic Tourer 05-08 F(right)&R  
VN 1700 B9F/BAF/BBF/BCF Voyager ABS 09-12 R  
VN 1700 C9F Classic Tourer 09 F(right)&R  
VN 1700 E9F Classic 09 F(right)&R  
VN 1700 DAF/DBF/DCF/DDF Classic Tourer ABS 10-13 F(right)&R  
VN 1700 FAF/FBF/FCF/FDF Classic ABS 10-13 F(right)&R  
VN 1700 KBF/KCF/KDF Voyager Custom 11-13 R  
VN 2000 A1/A2/A6F 04-08 R  
VN 2000 H8F/H9F Classic 08-09 R

## SUZUKI

RV 125 K2/K3/K4/K5/K6/K7/K8/K9/L0 Van-van 02-13 F  
RV 200 K2/K3 02-03 F  
GSX 250 FXK2/K3/K4/K5 02-05 F  
SV 400 N (VK53A) 98 F  
SV 400 SV (VK53A) 98 F  
SV 400 X/Y/K1/K2 00-02 F(right)  
SV 400 SX/SY/SK1/SK2 00-02 F(right)  
SV 400 K3/K4/K5 03-05 F(right)  
SV 400 SK3/SK4/SK5 03-05 F(right)  
GS 500 ET/EV/EW/EX/EY/K1/K2/K3/FK4  
/FK5/K5/FK6/K6/K7/FK7/K8/FK8 96-08 F  
GSF 600 Y/SY/K1/SY1/K2/SK2/SK3/K3  
/K4/SK4 Bandit 00-04 F(right)  
GSF 600 Y/K1/K2/K3/K4 (Naked Bandit) 00-04 F(right)  
GSF 600 SY/SK1/SK2/SK3/SK4 (Faired Bandit) 00-04 F(right)  
GSX 600 FW/FX/FY/FK1/FK2/FK3/FK4/FK5/FK6 98-06 F(right)  
DL 650 K4/K5/K6 V-Strom 04-06 F(right)  
DL 650 XK7/XK8/XK9/XL0 V-Strom X 07-11 F(right)  
DL 650 AK7/AK8/AK9/AL0 V-Strom ABS 07-11 F(right)  
DL 650 AL1XP V-Strom Xpedition 11 F(right)

DL 650 AL2/AL3 V-Strom 12-13 F(right)  
GSF 650 SK5/SK6 Faired Bandit Non ABS 05-06 F(right)  
GSF 650 AK5/AK6 Naked Bandit - ABS 05-06 F(right)  
GSF 650 SAK5/AK6 Faired Bandit - ABS 05-06 F(right)  
GSF 650 K5/K6 Naked Bandit - Non ABS 05-06 F(right)  
SFV 650 K9/L0/L1 Gladius 09-12 F(right)  
SFV 650 AK9/AL0/AL1/AL3 (ABS) 09-13 F(right)  
SV 650 K3/K4/K5/K6/K7/K8/K9/L0  
Naked - Non ABS 03-10 F(right)  
SV 650 SK3/SK4/SK5/SK6/SK7/SK8/SK9  
/SL0 Top Fairing - Non ABS 03-13 F(right)  
SV 650 X/Y/K1/K2 Naked - Non ABS 99-02 F(right)  
SV 650 SX/SY/SK1/SK2 Top Fairing Non ABS 99-02 F(right)  
SV 650 AK7/AK8/AK9/AL0 Naked - ABS 07-10 F(right)  
SV 650 SAK7/AK8/AK9/SAL0 07-12 F(right)  
XF 650 V/W/X/Y Freewind 97-02 F  
GSX 750 FW/FX/FY/FK1/FK2/FK3/FK4/FK5/FK6 98-06 F(right)  
GSX 750 W/X/Y 98-03 F(right)  
GSR 750 L1/L2/L3 11-13 F(right)  
C 800 (VL 800 K6/K7/K8/K9/L0/L1/L2/L3)  
Intruder (Spoke wheel model) 06-13 F  
C 800 C (VL 800 CK7/CK8/CK9/CL0/CL1/CL2/CL3)  
Intruder (Cast wheel model) 07-13 F  
VL 800 K1/K2/K3/K4/K5 'Intruder Volusia' 01-05 F  
VZ 800 V/W/X/Y/K1/K2 Marauder 97-03 F  
M 800 Z (VZ 800 K5-K9/L0/L1/L3 Intruder) 5-13 F  
M 800 Z (VZ 800 K9Z Intruder) 09-10 F  
DL 1000 K2/K3/K4/K5/K6/K7/K8/K9/L0 V-strom 02-10 F(right)  
M 1500 (VZ 1500 K9/L0 Intruder) 09-13 F(right)&R  
VL 1500 K2/K3 02-03 F(right)  
VL 1500 K5/K6/K7/K8 (C1500 Intruder) 05-08 F(right)  
VL 1500 L3 (CT 1500 T Intruder) 13 R  
M 1600 (VZ 1600 K4 Intruder) 04 R  
M 1600 (VZ 1600 K5 Intruder) 05 R  
C 1800 R (VLR 1800 K8/K9/L0/L1)  
(C 1800 R Intruder) 08-13 R  
C 1800 RT (VLR 1800 K8RT/K9RT)  
Touring Intruder 08-10 R  
M 1800 R (VZR 1800 K6/K7/K8/K9)  
Intruder - Handlebar Cowling 06-09 R  
M 1800 R2 (VZR 1800 NK8/NK9) Intruder  
- No Handlebar Cowling 08-09 R  
M 1800 RZ (VZR 1800 ZK7/ZK8/ZL1/ZL2 Intruder)  
With Handlebar Cowling 07-13 R

## H P POWER

Pantera 600 11 F

## WK

650i (Naked) 13 F(right)  
650 TR (Touring) 12-13 F(right)

# FA232 72.5 x 43.7 x 7mm

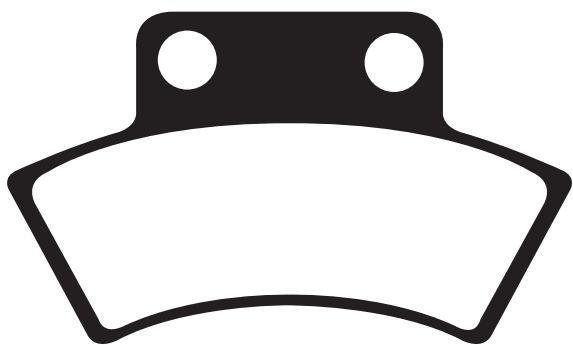

**Equivalents OE #**

1910032	1930644	2200418	B840F660000
1910051	1930741	2200464	
1930626	2200899	901 08 03 22	

**Competitor X Ref**

Dunlop	Ferodo	SBS	Vesrah
DP909	FDB2054	717	VD950

**APACHE**

Mini Tomahawk 50 (2T) 08-09 R

**POLARIS**

Rear pad most models 89-00

See main application list for full details.

This pad has increased friction area. Can be fitted in place of FA178 to improve wear life on Polaris ATV's

**JORDAN**

HIPO/MARS/BOB 50/90/100 03-04 R

**QUADZILLA**

R 50 (Rear disc model) 03-06 R

CUV 500 Side x Side (Parking brake) 10-11

QZ 500 E/ES 4x4 (Parking brake) 09-11 R

RS5 4WD (Parking brake) 10-11

RS6 EFI 4WD (Parking brake) 10-11

**MATERIAL AVAILABILITY AND PART NO.**

STD	OPTIONS			
FA	HH	R	MXS	EPFA
FA232TT	-	FA232R	-	-

# SFA233 75.1 x 37.2 x 9.5mm



**Equivalents OE #**

45105 KCX E050
45105 KCX 3050 MZ
45105 KCU 3050
46350 SA50 000

**Competitor X Ref**

Dunlop	Ferodo	SBS	Vesrah
N/A	N/A	144	N/A

**DAELIM**

BESB1 125 (SC125) 08-13 F

**KYMCO**

Cobra 50 Cross 00-06 F

Cobra Racer (SF10AG) 00-06 F

CX 50 Super (PR50AC) 94-97 F

K12 Sport 50 (SE10CA) 95-00 F

KB 50 (SE10CA) 95-00 F

Looping 50 98 F

Top Boy 50 (SF10GG) 97-06 F

ZX 50 Super Fever/Scout 99-06 F

KB 50 Scout 97 F

Filly 50 LX 00-02 F

Sniper 50 (PR 50 B) 93 F

Sniper 50 DD (PR50BB) 94-96 F

KB 100 Manboy 97-00 F

Top Boy 100 97 F

**SACHS**

49 ER 10" 07 F

**MATERIAL AVAILABILITY AND PART NO.**

STD	OPTIONS			
FA	HH	R	MXS	EPFA
SFA233	-	-	-	-

# SFA234 58.9 x 44.6 x 9.4mm

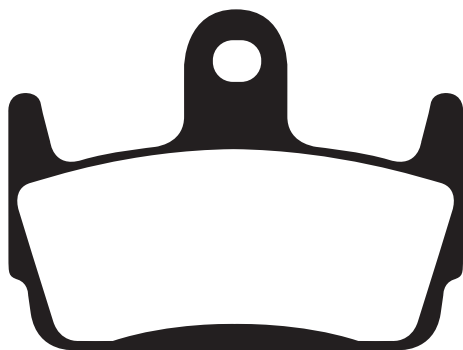

**Competitor X Ref**

Dunlop	Ferodo	SBS	Vesrah
DP014	N/A	710/129	N/A

**HONDA**

SZX 50 X8R-SW/SX/SY/S1 "Supersport Scooter" 98-04 R

SZX 50 X8R-XW/XX/XY/X1 "Cross Sport" 98-04 R

**KYMCO**

Sniper 50 DD (PR50BB) 94-96 R

Heroism 150 95-97 R

**SYM**

Jet Sport X 50 SR 06-11 R

**Equivalents OE #**

06435 GCM 900
06435 GCM 902
43105 KBF 3050 MZ
43105 KBF 9000
45105 TFA 000 A

**MATERIAL AVAILABILITY AND PART NO.**

STD	OPTIONS			
FA	HH	R	MXS	EPFA
SFA234	-	-	-	-

# SFA235 59.5 x 44.5 x 9mm



### Equivalents OE #

45150 KBK 9000 MZ
45110 J4FT 000
R0200710080
GA023463 1T
404210 TAC 000

DISC PADS  
BUYERS GUIDE

#### AJS

Exactly 50 08-11 F  
Exactly 125 Scooter 08-11 F

#### BAOTAIN

BT49 QT-12 Rebel (4T) 06-11 F

#### BEELINE

Veloce 50 08-10 F  
Veloce GT 50 08-10 F

#### BENELLI

49X-Scooter 07 F  
Quattro Nove X (50cc) (All rear drum models) 08-09 F  
Quattro Nove X (50cc all rear disc models) 10-13 F&R

#### BRANSON

BS 50 Cuba 08 F  
BS 50 Sting 08 F

#### CAGIVA

Nag 50 Scooter 08 F

#### CPI

Aragon 50 07-09 F  
Aragon GP50 07-12 F  
Aragon GP Paddock 08-12 F  
Aragon Club 50 07-12 F  
Aragon S-Line 50 07-12 F  
Formula 50 Basic 07-08 F  
Formula 50 R 07-12 F  
Freaky 50 07 F  
Oliver 50 (All models) 03-12 F  
Hussar 50 03-05 F  
Popcorn 50 03-05 F  
Aragon GP 125 07-12 F  
Aragon S Line 125 07-12 F  
Oliver 125 06-12 F

#### CSR

ONA 125 (4T) 04-06 F&R  
Scoo 125 (4T) 04-06 F&R

#### GARELLI

GP 50 (2T) 09-10 F  
Flexi 50 09-12 F  
Tesse 50 (2T/4T) 08-10 F  
VIP 50 07 F  
XO 50 09 F  
XO 50 (TM 50 QT-31) (2T/4T) 10-12 F&R  
Flexi 125 09-12 F

#### GENERIC

Cracker 50 (2T/4T) 09-13 F  
50 GT Race Explorer 09 F  
Epico 50 (2T) 10-13 F  
Epico Electric 12-13 F  
Evolution 50 (2T) 10-11 F  
XOR 50 05-13 F  
Ideo 50 05-13 F  
Race 2 50 (2T/4T) 10-13 F  
Roc 50 08-11 F  
Sirion 50 (2T/4T) 12-13 F  
Toxic 50 Sport 12 F  
Race 2 125 (4T) 10-13 F  
Soho 125/150 06-13 F  
Sirion 125 (4T) 12-13 F  
XOR 125 05-11 F

#### GOES

Slam 50 (Scooter) 10-12 F  
Wiki 125 (Scooter) 10-12 F  
G 125 RT Retro (Scooter) 10-12 F

#### H P POWER

Tin 50 (4T/4V) 10-12 F

#### ITALJET

SX1 50 Scooter 09 F

#### KEEWAY

F-Act 50 07-10 F  
F-Act 50 Evo 11 F  
F-Act 50 RS 10-11 F  
F-Act Nkd 50 09-11 F  
F-Act Racing 50 (25/45) 10-12 F  
Flash 50 Electric 09-10 F  
Focus 50 06-07 F  
Matrix 50 06-12 F  
Matrix V4 50 (25/50) 10-11 F  
RY6 50 (25/45) 10-11 F  
RY8 SP 50 (25/45) 10-11 F  
RY8 Racing 50 (25/45) 10-11 F  
Swan 50 (25/45) 10-11 F  
F-Act 100 08-10 F  
F-Act 125 07-11 F  
Matrix 125 07-10 F  
F-Act 150 07-10 F  
Matrix 150 07-10 F  
RY8 50cc (All models) 07-09 F  
Matrix Electric 09-10 F

#### KM (KEEN MOTORBIKES)

Badboy 50 CX 05 F  
Badboy 100 CX 05 F

#### KREIDLER

50 Florett 2 (RS 50) 12-13 F  
50 Florett 50 City 12-13 F  
50 Vabene 12-13 F

#### KYMCO

DJW 50 World (PR50AD) 95-97 R  
Matrix 25/50 06-08 F  
Heroism 125 (SE25BA) 95-97 F  
Matrix 125 06-08 F  
Heroism 50 (SE10BA) 95-97 F  
Heroism 150 (SE30AD) 95-97 F

#### MOTOM

Gypsy 50 08-09 F  
Dolcevita 125/151 08-09 F

#### MOTO ROMA

G10 (50cc/2T) 11-12 F  
Lambros 125/4T 11-12 F

#### RIEJU

Pacific 50 (4T) 08 F  
Toreo 50 (4T) 07-08 F  
Pacific 125 (4T) 08 F  
Pacific 125 Scooter 09 F

#### SACHS

SX-1 50 (2T) 08-09 F  
Speedforce50 (2T) 08 F  
Speedjet 50 (2T) 08 F  
49ER 12" 08 F  
Speedjet RS 125 10 F

#### SINNIS

Pioneer 50 (2T) F  
WY 50 T-39A Ghost 06-10 F  
Pioneer 125 F

#### TAMORETTI

Stealth 125 F

#### W K BIKES

WK One 50 (2T) 10-12 F  
WK GP 2 (50/2T) 10-13 F  
WK GO 50 (4T) 11-13 F

#### Competitor X Ref

Dunlop	Ferodo	SBS	Vesrah
-	FDB2191	723/141	-

#### MATERIAL AVAILABILITY AND PART NO.

STD	OPTIONS				
FA	SFAC	HH	R	MXS	EPFA
SFA235	SFAC235	-	-	-	-

# FA236 70 x 55.5 x 8.3mm

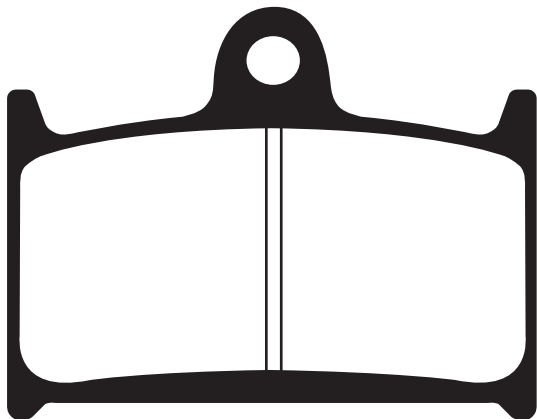

## TRIUMPH

T595 Daytona	97	F
Daytona 600	03-04	F
Daytona 650	05	F
Speedfour 600	02-05	F
TT 600	00-03	F
Daytona 750	92	F
Daytona 900	93-96	F
Trophy 900	94-01	F
Daytona 955i	98-04	F
Daytona 955i (From VIN 132513) (5 bolt front disc single sided s/arm)	01-04	F
Speed Triple	94-01	F
Speed Triple 955cc	02-04	F
Sprint 955i ST Front disc with offset/6 bolt fixing	99-04	F
Sprint 1050i ST (Non ABS) Front disc with zero offset	11-12	F
Sprint 1050 ST (5 spoke wheel/non ABS model /5 bolt disc with offset)	05-10	F
Sprint 1050 ST (5 spoke wheel/ABS model 5 bolt fixing disc with offset)	05-10	F
Daytona 1000	92	F
Daytona 1200	93-98	F
Trophy 1200	94-01	F
Rocket III (2300cc)	04-09	F
Rocket III Classic	07-09	F
Rocket III Touring	08-13	F
Rocket III Roadster - ABS	10-13	F
Sprint	94-98	F
Sprint GT 1050 (ABS)	10-13	F
Sprint RS	99-04	F
Tiger Explorer 1200	12-13	F
Tiger Explorer 1200 XC	13	F
Thunderbird (1597cc)	09-13	F
Thunderbird Storm (1699cc)	11-13	F

### Equivalents OE #

2020073 T0301	T2020245
T2020193	T2020246

### Competitor X Ref

Dunlop	Ferodo	SBS	Vesrah
DP213/503	FDB557	624	VD343

### MATERIAL AVAILABILITY AND PART NO.

STD	OPTIONS			
FA	HH	R	MXS	EPFA
FA236	FA236HH	-	-	-

# FA237 USE FA229

# FA239 69.65 x 51.85 x 8.5mm

# EPFA239HH 69.65 x 51.85 x 8.5mm Race use only

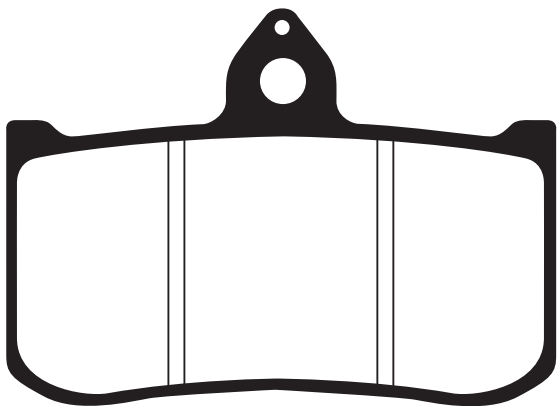

## HONDA (RACE BIKES)

RS 125	95-03	F
RS 250	93-02	F

### Equivalents OE #

45105 NX4 770

### Competitor X Ref

Dunlop	Ferodo	SBS	Vesrah
RDP123	FDB858	-	-

### MATERIAL AVAILABILITY AND PART NO.

STD	OPTIONS			
FA	HH	R	MXS	EPFA
FA239	-	-	-	EPFA239HH



# FA243 98.9 x 49.5 x 8.5mm

Similar to FA190 with difference in pad pin diameter and thickness

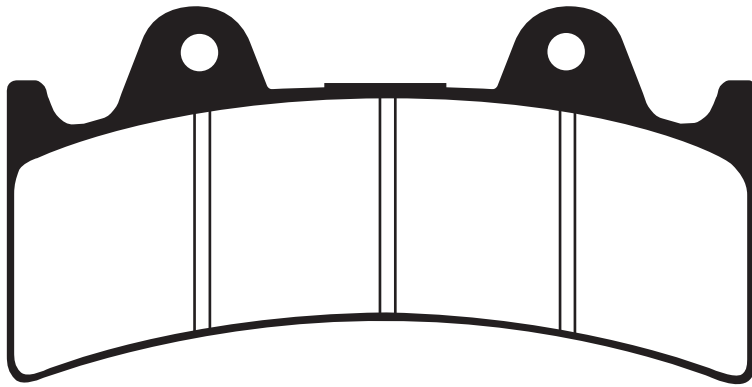

**JAYBRAKE**  
J-Six (300-64) (6 Piston)

**Equivalents OE #**

N/A

**Competitor X Ref**

Dunlop	Ferodo	SBS	Vesrah
DP627	FDB2031	-	-

MATERIAL AVAILABILITY AND PART NO.				
STD	OPTIONS			
FA	HH	R	MXS	EPFA
FA243	FA243HH	-	-	EPFA243HH

# FA244 75 x 55 x 8.70mm

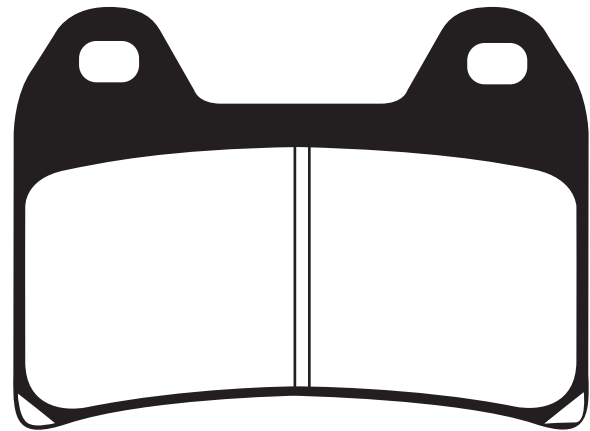

**APRILIA**

RS 250	98-02	F
Pegaso Strada 650	05-06	F
Pegaso 650	07-08	F
Dorsodura Factory 750	10-13	F
Dorsoduro 750 ABS	08-12	F
ETV 1000 Caponord	01-02	F
SL 1000 Falco	00-04	F
RST Futura 1000	01-04	F
RSV 1000 R Tuono (Radial caliper /2 pin pad fixing)	07-08	F
RSV 1000 SP	99-00	F
RSV 1000 Mille	00	F
RSV 1000 Mille R	00	F
RSV 1000 R Tuono	02-06	F
Tuono R 1000 Radial caliper/2 pad type	02-10	F
Tuono V4R-APRC	11-13	F
Tuono V4R	11-12	F
Dorsoduro 1200	11-12	F
Dorsoduro 1200 ATC/ABS	11-13	F

**BIMOTA**

Later models	98/99-	F
SB8K Gobert (996cc Suzuki engine)	06	F

**BENELLI**

Uno C 150	13	F
Uno C 250 (Single)	13	F
2 UE 750	09-10	F
TNT 899 Tornado Naked Tre	07-13	F
TNT 899 S Tornado Naked Tre	07-11	F
Trek 899	07-13	F
Tornado 900	02	F
TNT 1130 Cafe Racer	05	F
TNT 1130 Titanium	05	F
TNT 1130 Tornado Naked Tre	06-07	F
TRE-K 1130	06-13	F
Trek 1130 Amazonas	07-12	F

**BMW**

G 650 Xmoto	07-09	F
F 800 GT	13	R
F 800 R	09-13	F
F 800 R Chris Pfeiffer Edition	09-11	F
F 800 S (Half Fairing)	06-10	F
F 800 ST (Full Fairing)	06-12	F
F 800 ST Touring	10-12	F

**BRAMMO**

Empulse R	12-13	F
-----------	-------	---

**BREMBO**

20 6800 10/20 - Goldline 4 piston P4 30/34 @ 65mm Spacing (Two pin pad fixing)		
XA69510 P4 30/34 Motard radial 108mm mount 2 pin fixing		
XZ78910 P4 30/34 Motard radial 100mm mount 2 pin fixing		
220A80310 P4 30/34 2 pin pad fixing 100mm radial mount		
220A16820 P30/34 Yamaha R1 Radial mount	07-10	
220A01610 P4 30/34 2 pin pad fixing 108mm radial mount		
220A80210 P4 30/34 2 pin pad fixing 108mm radial mount		
220A16810 P4 30/34 2 pin pad fixing 100mm radial mount		

**CAGIVA**

Raptor 650	00-07	F
1000 Raptor/V-Raptor	00-05	F

**DUCATI**

400 Monster/Dark	00-04	F
Monster Dark ie 400 (Japan)	05-06	F
Monster Dark ie 400 (Single disc)	05	F
Monster 400 (Single disc)	00-02	F
Monster 400 (Twin disc)	03-04	F
600 Monster	00-01	F
620/IE Monster	02-04	F
620 Sport	03	F
620 Monster ie	03-04	F
620 Monster Dark	03-04	F
620 Multistrada Dark (Single disc/twin pin pad fixing)	06	F
696 Monster	08-13	F
696 + Monster (inc ABS models)	09-12	F
Monster 696 20th Anniversary Model	13	F
748 S (Biposto/Monoposto)	00-02	F
748 SPS	98-99	F
748 Testa Bassa (Mono/Biposto)	07	F
748 Biposto	99-02	F
748 SP/Monoposto	99-02	F
748 R (2 pad caliper)	00	F
750 Supersport	99	F
750 Supersport IE	00-02	F
750 Sport	01-02	F
750 Monster	00-01	F
Monster ie 750	02	F
796 Hypermotard	10-13	F
796 Monster (inc ABS models)	10-12	F
Monster 796 20th Anniversary Model	13	F
Monster 800	03-04	F
800 Sport	03	F
800 Supersport	03-05	F
848 (Radial 2 pad caliper)	08-10	F
848 Streetfighter	11-13	F
900 Supersport	98-99	F
900 Supersport IE	00-01	F
900 Sport	02	F
900 IE Monster	00-01	F
900 MH Evoluzione	00-01	F
ST2 (944cc)	97-03	F
ST3 (Non ABS) (992cc)	04-07	F
ST3S (ABS Model) (992cc)	06-07	F
Monster S4R (996cc) (2 pad caliper)	05-06	F
Monster S4R (996cc)	03-06	F
Monster S4 Foggy (916cc)	02	F
Monster S4 (916cc)	01-02	F
ST4S (ABS Model) (996cc)	03-05	F

# FA244 Contd.

DISC PADS  
BUYERS GUIDE

ST4S (Non ABS/996cc)	01-05	F
ST4 (916cc)	99-02	F
996 SPS (996cc)	99	F
996 (996cc) (Monoposto/Biposto)	99-01	F
996 S	01	F
998 Matrix (998cc)	04	F
998 (Monoposto/Biposto) (998cc)		
(2 pad caliper)	02-03	F
Monster 1000 Dark	03	F
Monster 1000 ie (992cc)	04-05	F
Monster 1000 S ie (992cc)	03-05	F
Monster S2R 1000 (992cc)	06-08	F
Multistrada 1000 DS (992cc)	03-06	F
Multistrada S 1000 DS (992cc)	05-06	F
Supersport 1000 DS (992cc)	03-06	F
Hypermotard 1100	07-09	F
Multistrada 1100/1100 S (1078cc)	07-09	F
1100 Monster	09-10	F
1100 S Monster	09-10	F
1100 Evo Hypermotard	10-11	F
1100 Monster Evo	11-13	F
Monster 1100 Evo 20th Anniversary Model	13	F
Monster Diesel 1100	13	F
1200 Multistrada Standard	10-11	F
1200 Multistrada ABS	10-13	F
1200 Multistrada 1200 S Pikes Peak SE	11-13	F
1200 S Multistrada Sport Edition	10-13	F
1200 S Multistrada Touring Edition	10-13	F
Multistrada 1200 S Granturismo	13	F
<b>GENERIC</b>		
Code S 125/150/200 (4T)	12-13	F
Code X 125/150/200 (4T)	12-13	F
<b>HONDA</b>		
CB 400 SF (F3V) Superfour (NC31)	97	F
<b>HOREX</b>		
VR6 Roadster	11-13	F
<b>HUSQVARNA</b>		
SM 610 (6 bolt front disc)	98-00	F
SM 610/S (4 bolt front disc)	02-06	F
SM 610 R	00	F
LT 610 (6 bolt front disc)	00	F
Nuda 900	12-13	F
<b>KEEWAY</b>		
RKV 125	10-12	F
<b>KTM</b>		
SMC 625	05-06	F
Duke II 640 (2 pin pad fixing/zero offset disc)	99-07	F
SMC 640 LC4	05	F
SMC 660	05-06	F
690 Duke (2 pin pad fixing)	12-13	F
690 SM	07-09	F
690 SM-LE (Limited Edition)	10-11	F
1190 Adventure	13	F
1190 Adventure R	13	F
<b>MAGNI</b>		
Sport 1200 'S'	01	F
<b>MOTO GUZZI</b>		
750 Brevia ie (3 spoke cast wheels)	03-07	F
750 Nevada Classic ie (spoke wheels)	04-13	F
750 Nevada	02-11	F
750 V7 Classic	08-12	F
750 V7 Cafe Classic	09-12	F
750 V7 Racer	10-11	F
V7 Racer 750 (Spoke)	12-13	F
V7 Special 750 (Spoke wheel)	13	F
V7 Stone (Cast wheel)	12-13	F
850 Brevia ie	06-07	F
850 Griso	06-07	F
940 Bellagio	07-12	F
1100 Brevia (Std/ABS Models)	05-07	F
1100 California Aluminium	02-05	F
1100 California Titanium (with top fairing)	04-05	F
1100 California Aquila Nera	09-11	F
1100 California Classic Touring	06-08	F
1100 California EV		
(From KD115427/2 pin pad fixing)	97-02	F
1100 California EV Touring	03-05	F
1100 California Jackal		
(From KD152329/2 pin pad fixing)	94-01	F
1100 California Special		
(From KD131645/2 pin pad fixing)	99-00	F
1100 California Sport	01-02	F
1100 California Stone	01-05	F
1100 California Stone Metal	02-03	F
1100 California Vintage	06-12	F
1100 California 1100 190	12	F
1100 Griso	05-08	F
1100 V11 Ballabio	03-05	F
1100 V11 Le Mans	01-05	F
1100 V11 Sport	99-01	F
1100 V11 Scura	01-03	F
1100 V11 Naked	02-03	F
1200 Brevia	08-09	F
1200 Griso 8v (Std Cast Wheel)		
Radial caliper	07-13	F

1200 Griso 8v Special Edition		
Spoke wheels/radial caliper	07-12	F
1200 Norge	06-07	F
1200 Norge GT 8v	08-13	F
1200 Sport 4v	06-07	F
1200 Sport 8v	08-13	F
1200 Stelvio	08	F
1200 Stelvio NTX ABS	09-10	F
1200 Stelvio 8v NTX	11-13	F
1200 Stelvio 8v	11-13	F
1400 California Custom	13	F
1400 California Touring	13	F
<b>MOTO MORINI</b>		
Corsaro 1200	05-10	F
Corsaro 1200 Veloce	07-08	F
MM3 (1187cc)	07	F
9 1/2 (998cc)	06-10	F
Corsaro Avio	08	F
Scrambler 1200	08-09	F
1200 Sport	08-10	F
<b>MV (AGUSTA)</b>		
675 F3	12-13	F
675 Brutale	12-13	F
Brutale 800	12-13	F
920 Brutale	11-12	F
989 Brutale	08-09	F
990 Brutale R	10-11	F
1090 Brutale R	12-13	F
Brutale 1090	13	F
<b>NORTON</b>		
Commando Sport(961cc)	10-13	F
<b>SACHS</b>		
X-Road 125	08	F
XTC 125	08	F
<b>SCORPA</b>		
Raidster 660	07	F
<b>SUZUKI</b>		
GSX 400 X Impulse	99	F
GSX 400 FSV/FSK1 (GK7B) Inazuma	00	F
GSX 1200 FSW/FSX 'Inazuma'	98-99	F
<b>URAL</b>		
Tourist with Sidecar (Brembo 2 pin pad fixing)	11-12	F
Cross with Sidecar (Brembo 2 pin pad fixing)	11-12	F
Sportsman with Sidecar (Brembo 2 pin pad fixing)	11-12	F
Ranger with Sidecar (Brembo 2 pin pad fixing)	11-12	F
Retro with Sidecar (Brembo 2 pin pad fixing)	11-12	F
Solo ST (Brembo 2 pin pad fixing)	11-12	F
Wolf Solo (Brembo 2 pin pad fixing)	11-12	F
Ural T (Brembo 2 pin pad fixing)	11-12	F
<b>VICTORY</b>		
Victory All models	98-07	F
Judge	12-13	F
<b>VOXAN</b>		
Black Magic	04-08	F
VB1-Evo	03-04	F
Cafe Racer	06-08	F
Roadster	06-08	F
<b>YAMAHA</b>		
FZ 400 (4YR1)	96	F
XJR 400 (4HM3/4HM5/4HM6/4HM9/ 4HMA/4HMB) Brembo calipers)	95-99	F
XT 660 X Supermoto	04-13	F
XJR 1300 (5EA1/5EA7 Brembo calipers (320mm front discs)	98-99	F

**Equivalent OE #**

06455 MY9 871	000016546300	750 13 030 000
4HM W0045 00	587 13 030 000	883673
4HM W0045 50	R30000126000	8000B1593
59100 03860	2202492	8000B6714
613 4 0201 A	1D2 W0045 00	8537246
613 4 0211 B	211082018	GU32654610
613 4 0411 A	4KG W045 10	07BB19RC
8113754	107 6708 21	107670823
8113720	34 11 7 69 65 93	07BB1950
8133614	34 11 7 711 498	45120 580 000
8000 88772	M13400001400	
8000 95542	GU01654630	

**Competitor X Ref**

<b>Dunlop</b>	<b>Ferodo</b>	<b>SBS</b>	<b>Vesrah</b>
DP630	FDB2042	706/727	VD262

**MATERIAL AVAILABILITY AND PART NO.**

STD	OPTIONS					
FA	V	GPFA	HH	R	MXS	EPFA
FA244	FA244V	GPFA244HH	FA244HH	-	-	EPFA244HH

# FA245 USE FA181TT

# FA246 USE FA407

## FA249 91.6 x 51.5 x 10mm

## FA249/2 91.6 x 51.5 x 12mm

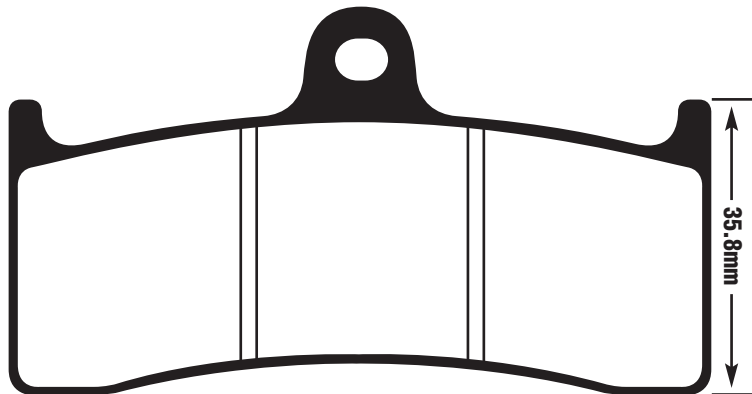

### FA249 - BEHRINGER

6 Piston (Old Design)  
**PERFORMANCE MACHINE**

112 x 6B  
112 x 6QC

### PRE TECH

6 Piston (Radial Mount)

### THUNDERHEART

6 Piston Caliper

### FA249/2 - BEHRINGER

6 Piston (Old Design/Endurance)

### Competitor X Ref - FA249

<b>Dunlop</b> DP324	<b>Ferodo</b> FDB2036	<b>SBS</b> 779	<b>Vesrah</b> VD437
------------------------	--------------------------	-------------------	------------------------

MATERIAL AVAILABILITY AND PART NO.				
STD	OPTIONS			
FA	HH	R	MXS	EPFA
FA249	FA249HH	-	-	EPFA249HH

MATERIAL AVAILABILITY AND PART NO.				
STD	OPTIONS			
FA	HH	R	MXS	EPFA
FA249/2	-	-	-	-

# FA251 A. 55.5 x 37 x 10mm B. 85 x 43 x 8mm

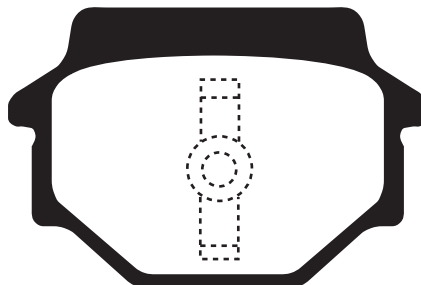
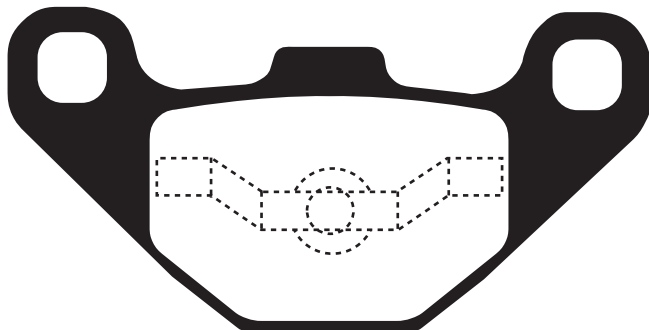

### BUELL

S2 "Thunderbolt" 94-97 R  
S3 "Thunderbolt" 94-97 R  
M2 Cyclone 94-97 R  
S1 Lightning 94-97 R

### HUSABERG

Enforcer four 400/501/600 & Quad 99 R

### HUSQVARNA

CR 125 91 R  
WR 125 91 R  
WR 240 90-91 R  
CR 250 91 R  
WR 250 90-91 R  
WR 260 90-91 R  
TE 350 90-91 R  
TE 510 90 R  
TC 510 90 R  
TC 610 91 R  
TE 610 91 R

### Equivalents OE #

42385 94Y
8000 60195

### Competitor X Ref

<b>Dunlop</b> DP310	<b>Ferodo</b> FDB314	<b>SBS</b> 692	<b>Vesrah</b> -
------------------------	-------------------------	-------------------	--------------------

MATERIAL AVAILABILITY AND PART NO.				
STD	OPTIONS			
FA	HH	R	MXS	EPFA
FA251	-	-	-	-

# FA252 50.4 x 69 x 8.7mm

### Competitor X Ref

Dunlop	Ferodo	SBS	Vesrah
DP418	FDB605	634/198	VD-249

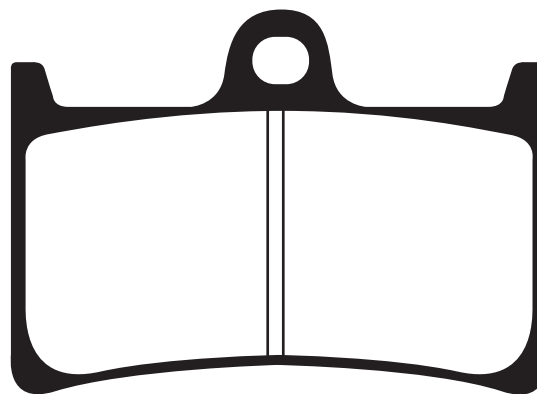

DISC PADS  
BUYERS GUIDE

### YAMAHA

TZR 125 R	93-	F
FZR 400 RR (4DX)	92	F
FZR 400 RR (3TJ1/2/6/7)		F
TZR 250 (3MA1-Reverse Cylinder) (Eng Frame # 3MA-0001)	89	F
TZR 250 (3MA3/3MA5 Reverse Cylinder) (Eng Frame # 3MA-046/058)	90	F
TZR 250 SP (3MA4) (Eng Frame # 3MA 055)	90	F
TZR 250 R (3XV1/3X4/3XV6) V-Twin (Eng Frame # 3XV000101-08600)	91-93	F
TZR 250 RS (3XV8/3XV9/3XVA) V-Twin (Eng Frame # 3XV008D101/08200 088-)	92-94	F
XP 500 T-Max (Non ABS Models)	08-11	F
TZR 250 SPR (3XVC) V-Twin (Eng Frame # 3XV107101-)	95	F
X 500 T-Max (ABS Models)	08-11	F
T-Max 530	12	F
XP 530 Black Max (59CE)	13	F
FZS 600 Fazer	98-03	F
FZ6 Fazer S2 (ABS/Half Fairing 1/4 Piston Caliper) (5S2)	08	F
FZ6 Fazer S2 (Non ABS/Half Fairing 1/4 Piston Caliper) (4S81/4S8)	07-09	F
FZ6 S2 (Naked/Non ABS/4 Piston Caliper) (5S51/5S5)	07-09	F
YZF 600 R "Thundercat"	96-03	F
YZF 'R6'	99-04	F

YZF-R7 750 '0W02' (Road version)	99-01	F
TDM 900 (5PS/Non ABS)	02-13	F
TDM 900 (2BO/ABS)	05-13	F
FZS 1000 Fazer	01-05	F
YZF 1000 R "Thunderace"	96-02	F
YZF R1	98-03	F
BT 1100 P/R/S/T/V Bulldog	02-06	F
FJR 1300 A (ABS) (5VS-)	03-05	F
FJR 1300 (Non ABS) (5JW)	01-04	F
XJR 1300 L 5EA2/5EA3/5EA4	99	F
XJR 1300 M 5EAA/5EAB/5EAC	00	F
XJR 1300 5EA9/5EAG (298mm front disc)	00	F
XJR 1300 N/P 5EAP/5EAR/5EAS/5EAT /5EAW/5EAV/5EAY (298mm front disc)	01-02	F
XJR 1300 R/S 5WMA/5WM3/5WM5/5WM6 /5WM7/5WM9	03-04	F
XJR 1300 T/V/W/X/Y 5WMA/5WMC/5WMD/5WMF	05-12	F
XJR 1300 SP (L) 5EA5/5EA6/5EA8	99	F
XJR 1300 SP (M) 5EAD/5EAE/5EAF	00	F
XJR 1300 SP (N) 5EAL/5EAM/5EAN	01	F
XV 1700 PCR	03-05	F
XV 1900 A Midnight Star	06-12	F

### Equivalents OE #

3JD W0046 00	4B5 W0045 00	5JJ W0045 00
3MA W0045 00	4SV W0045 00	5SL W0045 00
3TJ W0045 00	4XV W0045 00	

### MATERIAL AVAILABILITY AND PART NO.

STD	OPTIONS						
FA	SFA	SFAC	HH	SFA-HH	R	MXS	EPFA
FA252	SFA252	SFAC252	FA252HH	SFA252HH	-	-	EPFA252HH

# FA254 59.75 x 57 x 8.0mm

**NOTE: Refit O/E shim & insulator)**

**PIN HOLE**  
Right to left 7.3mm  
Top to bottom 6.2mm

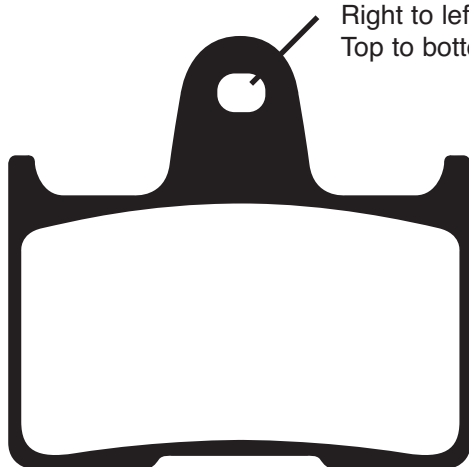

### HONDA

CB 400 SFX/SFY/SF1/SF2/SF3 Super Four	99-03	F
VT 750 C2SA/C25B Shadow (Rear disc model/ABS) 17" front wheel	10-12	R
'X4' CB 1300 DCV (5C38)	97-	R
CB 1300 FW/FX/FY/F1 (SC40)	98-01	R

### KAWASAKI

ZX-7RR (ZX750 N1/N2)	96-99	R
GTR 1400 (ZG 1400 A8F/A9F/CAF/CBF/CCF/CDF)	08-13	R
ZZR 1400 (ZX 1400 A6F/A7F)	06-07	R
ZZR 1400 ABS (ZX 1400 B7F)	07	R
ZZR 1400 ABS (ZX 1400 D8F/D9F/DAF/DBF/FCF/FDF)	08-13	R

### MZ/MUZ

1000 S	03-07	R
1000 SF	05-07	R
1000 SFX	07	R
1000 ST	07	R

### SUZUKI

GSXR 600 K4/K5	04-05	R
GSF 650 SK5/SK6 Faired Bandit Non ABS	05-06	R
GSF 650 K5/K6 Naked Bandit Non ABS	05-06	R
GSXR 750 K4/K5	04-05	R
GSXR 1000 K1/K2/K3/K4/K5/K6	01-06	R
GSF 1200 SSK1/ZK1 (GV78A)	02	R
GSX 1400 K1/K2/K3/K4/K5/K6/K7/FE	01-07	R

### Equivalents OE #

43082 1182	69100 40820	69100 29810
43082 0055	69100 40840	06435 MCE 006
06435 MAZ 006	69100 18810	9024030000

### Competitor X Ref

Dunlop	Ferodo	SBS	Vesrah
DP220	FDB211	715/765	VD436

### MATERIAL AVAILABILITY AND PART NO.

STD	OPTIONS				
FA	HH	R	MXS	EPFA	
FA254	FA254HH	-	-	-	

# SFA255 30.5 x 49 x 7.0mm

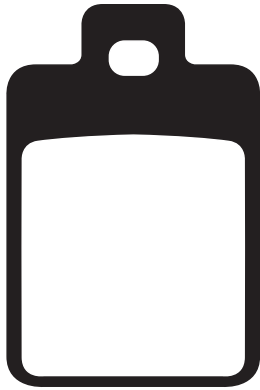

## PIAGGIO

Sfera RST 50  
Sfera 125

95-97 F  
95-97 F

### Equivalents OE #

498846

### Competitor X Ref

Dunlop	Ferodo	SBS	Vesrah
-	FDB2037	712/130	VD955

### MATERIAL AVAILABILITY AND PART NO.

STD	OPTIONS			
FA	HH	R	MXS	EPFA
SFA255	-	-	-	-

# FA256 78.7 x 47 x 7.4mm

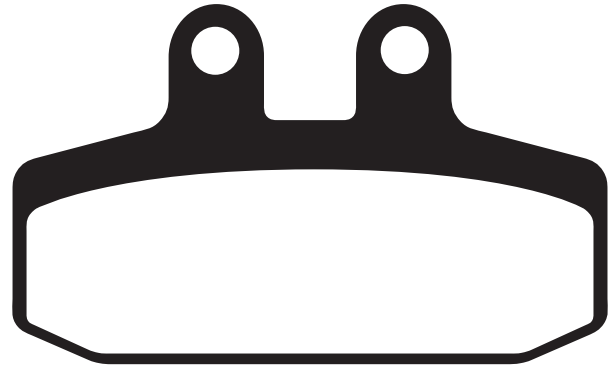

## APRILIA

Pegaso 50	92-94	F
Scarabeo 125/150/200	99-02	F
Red Rose 125	87-94	F
Sport City 125	04-08	F
Sport City Cube 125	08-12	F
Tuareg Rally 125 (L/M)	90-91	F
Sport City 200	04-08	F
Sport City Cube 200	08-10	F
Leonardo 250 ST/SP	00-04	F
Sport City 250 ie	06-08	F
Sport City Cube 250	08-09	F
Leonardo 300	05-06	F
Sport City Cube 300	08-12	F
Sport Cube 300 Blackline	11	F
Scarabeo 400 ie	07-08	F
Atlantic 500	02-04	F
Scarabeo 500/500 AB3	03-06	F
Scarabeo 500 Light	06	F
Scarabeo 500 ie	07-09	F
Scarabeo 125/200	03	F
Mana 850	08-11	R
Mana 850 GT (ABS Model)	09-13	R
Mana 850 ABS	08-13	R

## CAGIVA

Blues 125	92-95	F
Roadster 125	98-99	F

## DERBI

Boulevard S125	07	F
Rambla 125	08-12	F
Rambla 250 i	08-09	F
Rambla 300 i	10-12	F

## GARELLI

50 Tiger XLE	86-	F
125 Tiger XLE	86-	F

## GILERA

Cougar 125	99-02	F
125 XR1/XR2	89-	F
RC 125 Rally	87-88	F
200 Arizona Hawk	85-	F
200 RTX	85-	F
200 ER	87-	F
200 Fast Bike	87-	F
RV 200 ES	87-	F
RC 250 Rally	87-	F
350 Dakota	85-	F
ER 350	87-	F

XRT 350	90-	F
500 Dakota	87-	F
ER 500	87-	F
XRT 600	88-	F
<b>HONDA</b>		
SJ 50 P/R/S/T/V/W/X 'Bali'	93-99	F
SJ 100 T/V/W/X 'Bali-Ex	96-99	F
CA 125 V/W/X 'Rebel'	98-00	F
CLR 125 W 'City Fly'	98-03	F
CRM 125 RL/RM/RN/RR/RV/RX	90-99	F
NS 125 FG/FH/RH	86-87	F
NSR 125 FJ/FK/FL/FM/FN	88-92	F
NSR 125 RK/RL/RM/RN/RR/RS/RV/RW/RX/RY/R1	89-01	F
NX 125 K/S/F Transcity	89-97	F
XL 125 L Paris-Dakar	85	F
XL 200 L	85	F
CMX 250 CV/CW/CX 'Rebel'	97-00	F

## MALAGUTI

Spidermax RS 500	04-11	F
Spidermax GT 500	04-10	F

## MOTO GUZZI

V7 Racer 750 (Spoke)	12-13	R
V7 Special 750 (Spoke wheel)	13	R
V7 Stone (Cast wheel)	12-13	R

## MOTO MORINI

350 'Kanguro'	87	F
---------------	----	---

## SCARABEO

500 ie	10-12	F
--------	-------	---

## WK

125 RR	12-13	R
--------	-------	---

### Equivalents OE #

159 07 6340	45105 KR1 862	45105 KBS 405	06435 KBS W00
238 070 5 6340	45105 KR1 863	8000 88725	8113431
326 814	45105 KS3 901	8113865	06455 GAV 405
344839	45105 KS3 902	8133540	8133798
45105 KB9 960	45105 KY4 901	8133724	
45105 KR1 861	45105 KY4 902	8133725	

### Competitor X Ref

Dunlop	Ferodo	SBS	Vesrah
DP108	FDB438/2146	588/793/108 /124/179	VD152

### MATERIAL AVAILABILITY AND PART NO.

STD	OPTIONS							
FA	SFA	SFAC	TT	HH	SFA-HH	R	MXS	EPFA
FA256	SFA256	SFAC256	FA256TT	FA256HH	SFA256HH	-	-	-

# SFA257 41.1 x 43 x 7.7mm

# SFA257/2 41.1 x 43 x 5.3mm



### SFA257

#### BRANSON

BS 125 Snooker	08	F
BS 125 Boulevard	08	F

#### CAGIVA

City 50	91-94	F
---------	-------	---

#### DAELIM

Bonita 50 (SE 50 C)	09-12	F
Cordi 50/SE 50 R	04-12	F
'S' Five (SJ50)	01-12	F
E-Five (SJ50A)	03-06	F
GZ 50 Message	97-02	F
Delfino 100 (SH100)	01-04	F
B-Bone 125 (SN 125)	09-13	R
S1 125 (SL 125)	07-13	R

#### GARELLI

Panther 125/150/250	02	F
---------------------	----	---

#### HONDA

Tact 50		F
SK 50 MM-II/MM-YD/MM-II/MP-II (AF28) Dio SR		F
SK 50 MN-III/MP-III/MP-IV (AF28) Dio-ZX		F
SK 50 MMR-II/MMT-II (AF28) Dio-XR		F

#### SYM

Super Fancy 50	96-02	F
City Hopper 50	99-02	F
Orbit 50	08-09	F
Orbit 125	08-09	F

### SFA257/2

#### HONDA

FJS 400 Silverwing D6/D7/D8 Non ABS 256mm front disc Parking brake	06-08	
SW-T 400 (FJS 400 A9/AB)	09-13	
SW-T 600 (FJS 600 AB)	11-13	
FJS 600 1/2/B3/B4/D5/D6/D7/D8 Silverwing Parking brake	01-08	
DN-01 (680cc) (NSA 700 A8/A9) Parking brake	08-11	
NC 700 XAC/XAD-DCT (Auto G/box) Parking brake	12-13	
NC 700 SAC/SAD DCT Auto Gearbox Parking brake	12-13	
NC 700 - 700 Integra (Parking brake)	12	

#### APRILIA

NA 850 Mana (Non ABS)	08-11	
NA 850 Mana GT (ABS)	09-13	
SRV 850 Parking brake	12-13	
Mana 850 ABS Parking brake	08-13	

### BMW

C 600 Sport Scooter Parking brake	12
C 600 Sport Highline Parking brake	12
C 650 GT Scooter Parking brake	12
C 650 GT Highline Parking brake	12

### GILERA

Fuoco 500 IE (Parking brake)	07-13
GP 800 (Parking brake)	08-12

### KYMCO

Maxxer 400 (Parking brake)	09-10
MXU 400 (A40000) (Parking brake)	08-11
Maxxer 450i (Parking brake)	10-13
MXU 450 i (4x4 LOF) (Parking brake)	12-13

### PIAGGIO

MP3 125/250/400 (Parking brake)	07-08
MP3 - Hybrid (125cc) (Parking brake)	09-10
MP3 125 ie (EFi Models) Parking brake	08-11
MP3 250cc (EFi) Parking brake	06-08
MP3 250 LT (EFi) Parking brake	09
MP3 LT 300 ie Parking brake	10-11
MP3 300 ie (Hybrid) Parking brake	11-13
MP3 300 ie (Hybrid) LT Parking brake	10-12
MP3 Business LT 300 ie Parking brake	13
MP3 Sport LT 300ie Parking brake	13
MP3 Touring 300 ie Parking brake	11-12
MP3 Touring LT 300 ie Parking brake	11-12
300 ie MP3 Yourban Parking brake	11-13
MP3 Yourban LT 300 ie Parking brake	11-13
MP3 Yourban Sport 300ie Parking brake	13
MP3 Yourban Sport LT 300i Parking brake	13
X10 ie 350 (4V/4T/EFI) Parking brake	12-13
MP3 400 ie Parking Brake	07-11
MP3 400 Touring ie Parking brake	11-12
MP3 Touring Business 500 ie Parking brake	11-12
MP3 Touring Business 500 ie LT Parking brake	11-13
MP3 Touring Sport 500 ie Parking brake	11-12
MP3 Touring Sport 500 ie LT Parking brake	11-13
X10 500ie (4V/4T/EFI) Parking brake	12-13

### VECTRIX

VX-3 Li+ (3 wheeler model) Parking brake	12-13
--	-------

#### Equivalents OE

##### # SFA257

45105 GZ0 ACA	45105 SE5 5001E
45112 GZ0 315	45105 GAZ 5000 EU
Y00 FA0112	45105 GAZ 9800
45105 G22 000 AC	45105 SE5R 00M4
45105 G02 000	

#### Equivalents OE

##### # SFA257/2

06436 MCT 006	668541
648476	890490
649830	

#### Competitor X Ref - SFA257

Dunlop	Ferodo	SBS	Vesrah
-	-	670/879/100/115	VD162

#### Competitor X Ref - SFA257/2

Dunlop	Ferodo	SBS	Vesrah
-	-	209	-

#### MATERIAL AVAILABILITY AND PART NO.

STD	OPTIONS				
SFA	SFAC	HH	R	MXS	EPFA
SFA257	SFAC257	-	-	-	-
SFA257/2	-	-	-	-	-



# FA258 A. 26.10 x 119.55 x 7.1mm B. 35.60 x 94.54 x 7.80mm

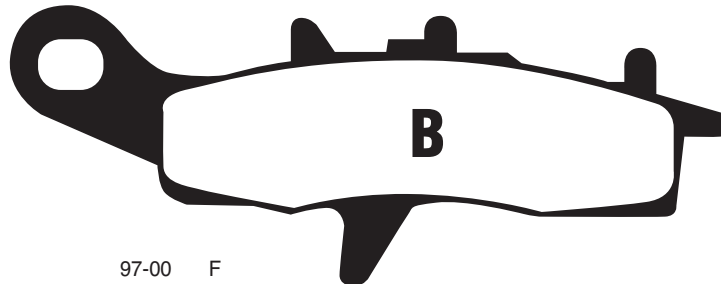
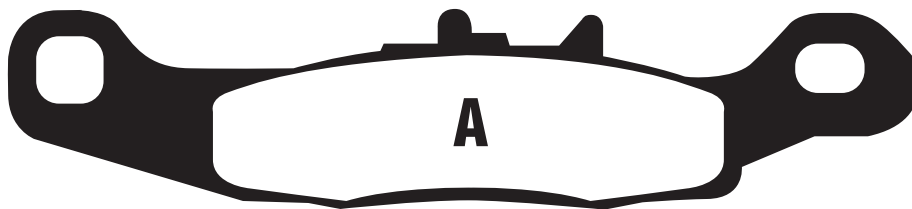

### KAWASAKI

KX 80 R7/W1/W2/W3	97-00	F
KX 85 A1-A5/A6F/A7F/A8F/A9F/AAF/ABF/ACF/ADF (17" front wheel/14" rear wheel)	01-13	F
KX 85 11 B1-B5/B6F/B7F/B8F/B9F/BAF/BBF/BCF/BDF (19" front wheel/16" rear wheel)	01-13	F
KX 100 B7/C1/C2/C3	97-00	F
KL 250 G1/G1A Super Sherpa	97	F
KL 250 J1-J3 Stockman	00-02	F
KLX 250 H1 'Super Sherpa'	98	F

### SUZUKI

RM 85 K5/K6/K7/K8/K9/L0/L2 Small 17" wheel	05-12	F
RM 85 LK5/LK6/LK7/LK8/LK9/LL0/LL2 Large 19" wheel	05-13	F
RM 100 K3	03	F

### Equivalents OE #

43082 1196
43082 1206
K4308-21196
59301 03820

### Competitor X Ref

Dunlop	Ferodo	SBS	Vesrah
DP326	-	726	VD438

MATERIAL AVAILABILITY AND PART NO.				
STD	OPTIONS			
FA	HH	R	MXS	EPFA
FA258TT	-	FA258R	-	-

## FA259 USE FA231

# SFA260 35.86 x 49 x 7.0mm

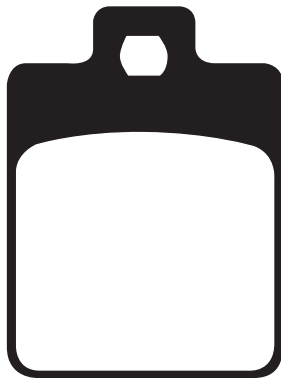

## Competitor X Ref

Dunlop	Ferodo	SBS	Vesrah
DP635	FDB2057	724/142 /202	N/A

## Equivalents OE #

494097	647157	43105 ARB 000A
494938	647073	PE 802219
498846	647170	PE756676
494938	651356	PE757243

### BENELLI

X 150 Street 12 R

### CPI

GTR 50 03-12 R

GTS 50/125/200 02-03 R

GTR 50/125/200 02 R

### DERBI

Sonar 50 2S (2T) 10-11 F

Sonar 125 4S (4T) 10-11 F

Sonar 150 (4T) 09-10 F

### GILERA

DNA 50 01-06 R

50 DD/SP Runner/Purejet 99-05 R

Runner 50 PJ/SP 06-13 R

SKP 50 99-01 R

Stalker 50 97-03 R

Stalker 50 03-06 R

125/180 Runner All models 99-04 R

Fuoco 500 RC/ie 07-13 F

### KREIDLER

50 Florett (RS 50 DD) 12-13 R

50 Galactica 2.0 (RS 50 DD) 12-13 R

50 Galactica 2.0 (50 DD) 12-13 R

50 Galactica 2.0 (50 DD City) 12-13 R

50 Galactica 2.0 (RC 50) 12-13 R

### PEUGEOT

Speedfight 50 1/2 (L/C) 97-08 R

Tweet 50 RS (4T/Rear disc model) 10-12 R

Citystar 125 i 11-12 R

Citystar 125 Active 13 R

Satelis 125 RS (4T) 13 R

Tweet 125 (4T) 10-11 R

Tweet 125 RS (4T/Rear disc model) 10-12 R

Tweet 125 (Rear disc) 12-13 R

Tweet 150 (4T) 10-11 R

Tweet 151 RS (4T/Rear disc model) 10-12 R

Citystar 200i 12 R

### PGO

Tigra 125 (4V/4T) 12 R

### PIAGGIO

NRG 50 RST "MC2" 98 R

Zip 50 RST 96-99 F

Liberty 50 2T (Grimeca Caliper) 97-08 F

Liberty 50 (Heng Tong Caliper) (2T) 97-08 F

NRG 50 Extreme 99-01 R

NRG 50 MC3 DD 01-05 R

NRG 50 DD 06-13 R

NRG 50 Pure Jet 06-09 R

NRG 50 Silver Bullet 10 R

NRG 50 Power DD 05-12 R

Zip 50 Grimeca caliper (A/C 4T) 00-08 F

Zip 50 SP (Liquid Cooled) 96-12 F

Zip 50 (2T) 00-12 F

Zip 50 (4T) 00-12 F

Zip 50 SP (2T) 13 F

Liberty 50 4T (Grimeca caliper) 00-08 F

Liberty 50 4T (Heng Tong caliper) 00-08 F

Liberty S 50 (2T/4T) 07-08 F

Zip 100 06-13 F

125 ie MP3 Yourban 11-12 F

Liberty Elettrico 11-12 F

Liberty 125 98-08 F

Liberty 125 (Full optional/10 spoke wheel) 13 F

Liberty S125 07-08 F

MP3-Hybrid (125cc) 09-12 F

MP3-125ie (EFI models) 08-11 F

MP3 125 Carb models 06-08 F

Zip 125 00-01 F

Liberty 150 08 F

Liberty 200 98-07 F

Liberty S 200 07-08 F

MP3 250 MIC/EFI 08-09 F

MP3 250cc (EFI) 06-08 F

MP3 250 LT (EFI) 09 F

MP3 300 LT (EFI) 10-11 F

MP3 300 ie (Hybrid) 11-13 F

MP3 300 ie (Hybrid LT) 11-13 F

MP3 Business LT 300 ie 13 F

MP3 Sport LT 300 ie 13 F

MP3 Touring 300 ie 11-12 F

MP3 Touring LT 300 ie 11-12 F

300 ie MP3 Yourban 11-13 F

MP3 Yourban LT 300 ie 11-13 F

MP3 Yourban Sport 300ie 13 F

MP3 Yourban Sport LT 300ie 13 F

MP3 400 ie 07-11 F

MP3 Touring 400 ie 11-12 F

MP3 Touring 400 ie LT 11-12 F

MP3-LT 400 ie 09-10 F

MP3 500 EFI 09-10 F

MP3 Touring Business 500 ie 11-12 F

MP3 Touring Business 500 ie LT 11-13 F

MP3 Touring Sport 500 ie 11-12 F

MP3 Touring Sport 500 ie LT 11-13 F

**QUADRO**

4D 11 F&R

**SACHS**

Speedjet RS 125 10 R

**SYM**

Symphony S 50 (4T) Rear Disc Model 10-13 R

Symphony SR 50 10-13 R

Symphony S 151 (4T) Rear Disc Model 09-13 R

Symphony SR 151 10-13 R

**VESPA**

ET2 50 97-05 F

ET4 50 (Grimeca caliper) 00-04 F

ET4 125 96-99 F

ET4 125/150 99-05 F

ET4 (Heng Tong Caliper) 00-04 F

LX 50 (2T) 05-13 F

LX 50 (4T/4V) 05-13 F

LXV 50 07-09 F

S 50 (2T) 07-13 F

S 50 (4T/4V) 09-13 F

S 50 Sport (2T) 11-13 F

S 50 Sport (4T/4V) 11-13 F

LX 125/150 (4T) 05-11 F

LX 125 (4T/Serie Speciali) 12 F

LXV 125 07-13 F

S 125 (4T) 07-13 F

S 125 Sport (4T) 11-13 F

LX 150 (4T) 05-12 F

LX 150 (4T/Serie Special) 12 F

S 150 Sport (4T) 11-12 F

S 150 (4T) 07-12 F

**WK**

WK GTR 50 (2T) 10-12 R

Symphony S 125 (4T) Rear Disc Model 10-12 R

Symphony SR 125 10-12 R

## MATERIAL AVAILABILITY AND PART NO.

STD	OPTIONS				
SFA	SFAC	HH	R	MXS	EPFA
SFA260	SFAC260	SFA260HH	-	-	-

# FA261HH 115.60 x 41 x 8.30mm (& shim)

Linked Brake - fit all three sets at pad change

# FA261/2HH 115.60 x 41 x 10.40mm (Refit OE shim)

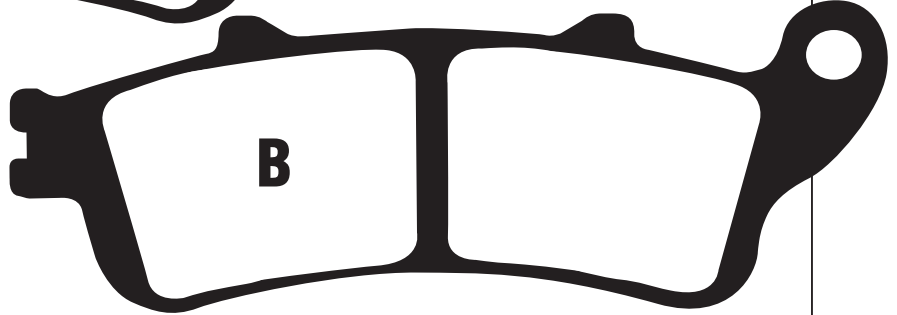

**IMPORTANT NOTE:**  
Remove old Honda shim and insulator from original pads and fit on backplate side of new EBC pads on FA261/2HH only.

DISC PADS BUYERS GUIDE

### HONDA - FA261HH

FJS 400 D6/D7/D8	06-08	F
FJS 400 A9/D9	09	F
FJS 600 1/2/D3/D4/D5/D6/A3-A7/D7 Silverwing	01-09	F
NT 650 V2/V3/V4/V5	02-05	F&R
NT 700 V6/VA6/VA7/V7/VA8/V8/VA/VAA Deauville	06-13	R
VFR 800 FiW/FiX/FiY/Fi1/2/3/4/5/A2/A3/A4/A5	98-05	F&R
VFR 800 6/8/9	06-09	R
VFR 800 A6/A8/A9	06-13	R
XL 1000 VX/VY/V1/V2 Varadero - Non ABS Model	99-02	F&R
XL 1000 V3/V4/V5/V6 Varadero Non ABS	03-06	F&R
XL 1000 V7/V8/V9/VA/VB Varadero - Non ABS	07-11	R
XL 1000 VA4/VA5/VA6/VA7/VA8/VA9/VAA/VAB		
Varadero ABS	04-11	R
CB 1100 SFY/SF1 "XII"	00-04	F&R
CBR 1100 XXV/XXW/XXX/XXY/XX1/XX2/XX3		
/XX4/XX5/XX6 "Blackbird"	97-08	F&R
ST 1100 AT/AV/AW/AX/AY/A1/A2 Pan European (ABS)	96-02	F&R
ST 1300 2/3/4/6 Pan European (Non ABS)	02-07	F&R
S 1300 A2/A3/A4/A6 Pan European (ABS Model)	02-07	F&R
ST 1300 8/9 Pan European (Non ABS)	08-09	R
ST 1300 A8/A9/AA Pan European - ABS Model	08-13	R
GL 1800 A1/A2/A3/A4/A5 "Goldwing"	01-05	F
GL 1800 6/7/8/9/A Goldwing	06-13	F
VTX 1800 C2/C3/C4/C15/C16/C17	02-08	F&R
F6B Goldwing	13	R

### VICTORY

Vision Street	08-09	F
Vision Tour (All models)	08-12	F
Vision 8 Ball	10-12	F
Arlen Ness Victory Vision	10-12	F

### HONDA - FA261/2HH

GL 1800 A1-A5	02-09	R
GL 1800 6/7/8/9/A Goldwing	06-13	R
F6B Goldwing	13	R

### Competitor X Ref

Dunlop	Ferodo	SBS	Vesrah
DP124/5/6	FDB2073	721/722	VD165
DP128		735/880	

### Equivalents OE #FA261/2HH

06435 MCA 006

### Equivalents OE #FA261HH

06435 MAJ G41	06455 MAT 006	06455 MCS G01
06435 MAT 006	06455 MAT E21	06455 MCS G02
06435 MCC 006	06455 MCA 006	06455 MCT 691
06435 MCH 006	06455 MCC 006	06456 MCA 006
06435 MBL D01	06455 MCH 006	06456 MCC 006
06435 MCS G01	06455 MBG 005	
06455 MAJ G41	06455 MBT 611	

MATERIAL AVAILABILITY AND PART NO.				
STD	OPTIONS			
FA	HH	R	MXS	EPFA
-	FA261HH	-	-	EPFA261HH

MATERIAL AVAILABILITY AND PART NO.				
STD	OPTIONS			
FA	HH	R	MXS	EPFA
-	FA261/2HH	-	-	EPFA261/2HH

# EPFA263HH 100.5 x 34 x 9mm

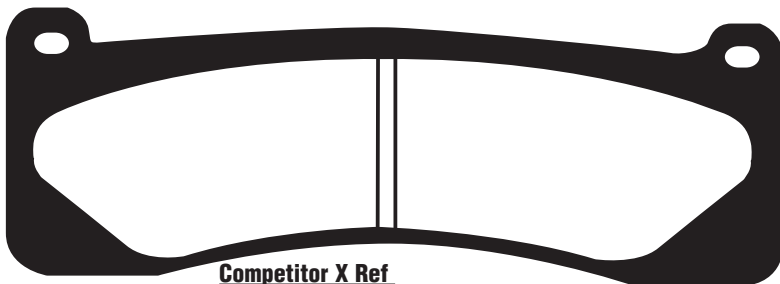

**RACE USE ONLY**

### AP/LOCKHEED

6 Piston / 2 Pins (CP4466)

### Equivalents OE #

4466 / 4477

Dunlop	Ferodo	SBS	Vesrah
RDP629	FDB2043 FDB2167	707	-

MATERIAL AVAILABILITY AND PART NO.				
STD	OPTIONS			
FA	HH	R	MXS	EPFA
-	-	-	-	EPFA263HH

# SFA264 A. 85.1 x 42.9 x 8.2mm B. 69.8 x 41 x 8.2mm

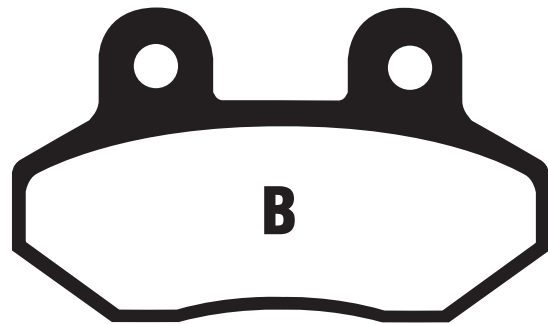
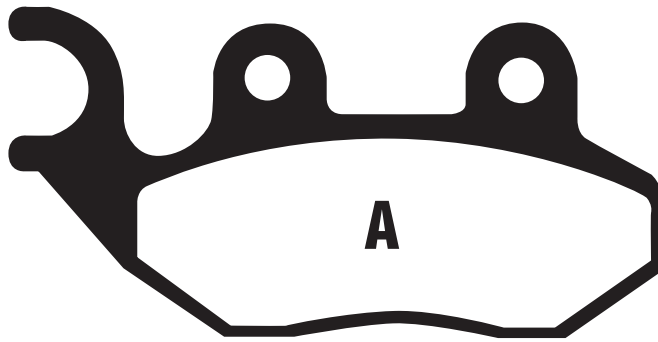

DISC PADS  
BUYERS GUIDE

**ADIVA SCOOTERS**

AD 125	09-11	F
AR 125	10-11	F
AD 200	09-11	F
AR 200	10-11	F

**BAROSSA**

XS 125 T-13	07-10	F
-------------	-------	---

**CAGIVA**

Stella 50	97	F&R
Passing 125	93-97	F

**GARELLI**

KRS 50		F
Joker 125/150	02	F
Freeland 125/150		F

**GENERIC**

Vendetta 50 (2T)	12-13	F
------------------	-------	---

**LAMBRETTA**

LJ 50	12-13	F
LT 50	12-13	F
LN 125 (4T)	10-13	F
LN 151 (4T)	10-13	F

**PEUGEOT**

Tweet 50 (4T)	10-11	F
Tweet 50 (4T/Rear drum model)	10-13	F
Tweet 50 RS (4T/Rear disc model)	10-13	F
LXR 125 (4T)	10-13	F
Tweet 125 (4T)	10-11	F
Tweet 125 (4T/Rear drum model)	10-12	F
Tweet 125 RS (4T/Rear disc model)	10-12	F
Tweet 125 (Rear Disc)	12-13	F
Tweet 150 (4T)	10-11	F
Tweet 151 (4T/Rear drum model)	10-12	F
Tweet 151 RS (4T/Rear disc model)	10-12	F
LXR 200i (4T)	10-12	F

**PGO**

i-Dep Electric Scooter	09	F&R
Big Max 50 S	03-04	F
Big Max 50 (Front wave disc)	07-09	F
Big Max 50 Naked (Round disc/no cover on H/bars)	07-09	F

G-Max 50	05-07	F
G-Max 50 (Wave disc)	08-09	F
G-Max 50 Naked (Wave disc)	09	F
Libra 50 (2T)	09	F
Ligero 50 (2T)	08-12	F
T-Rex 3 (50cc) (3 wheeler)	03-04	F
Bubu 100/125	03-08	F
T/Rex 50	99-12	F
Charge 125 A/B	00-02	F
i-Charge 125	03-05	F
PMX 50	00-07	F
PMX 50 Naked		F
PMX 110	00-07	F
T-Rex 110	99-06	F
Libra 125 EFi (4T)	09-12	F
Ligero 125	06-08	F
Ligero 125 (4T)	08-12	F
T-Rex 125 (Wave disc)	08-12	F
Tigra 125 (4V/4T)	12	F
Libra 150 (4T)	09	F
TR-3 150cc (3 wheeler)	03-09	F

**SYM**

Allo 50 (4T)	11-13	F
Fiddle II 50	08-13	F
Mask 50	00-05	F

Jet 4 (50cc 4T)	10-13	F
Jet 4 R50 (2T)	11-13	F
Jet Basix 50	06-09	F
Jet 50/Euro XS	99-05	F
Jet Euro X 50	06-13	F
Jet Sport X 50 SR	06-13	F
Red Devil 50	99-09	F
Symply 50	07-08	F
Symphony 50 (4T)	09	F
Symphony 50 S (4T) Rear disc model	10-13	F
Symphony SR 50	10-13	F
Symply 11 50	09-13	F
Jungle 50	99-02	F
Jet 100 (G100P-6)	99-00	F
Allo 125 (4T)	11-13	F
City Com 125	08-10	F
Fiddle II 125	08-13	F
Attila 125	99-00	F
HD 125 S Evo	07	F
HD Evo 125 (Carb & EFi models/4T /Single Headlamp)	03-13	F
H2-125i (4T)	10-13	F
Jet 4 (125cc 4T)	10-13	F
Megalo 125	00-06	F
Super Duke 125/150	99-02	F
Symply 125	07-08	F
Symply 11 125	09-13	F
Symphony 125 S (4T)	09	F
Symphony 125 (4T) Rear disc model	10-13	F
Symphony SR 125	10-13	F
Allo 150 (4T)	11-13	F
Fiddle 11 S 151	11-13	F
Symphony 151 (4T/Rear disc model)	09-13	F
Symphony SR 151	10-13	F
H 200 SE	06	F
HD 200 S Evo	07	F
HD2-200i (4T)	10-13	F
HD Evo 200 (Carb & EFi models/4T /Single Headlamp)	03-13	F
City Com 300i	08-13	F&R

**TGB**

Akros Tec (50)	03-04	F
Delivery 50 Scooter (Up to E/F No 609099)	04-05	F
101 R (50cc)	04-08	F
202 Classic (50cc)	03-07	F
Bellavita 125i (4T)	12	F
Bellavita 300i (4T)	12	F

**TOMOS**

Twister 50		F
Twister 125		F

**ZERO (ELECTRIC MOTORCYCLES)**

Zero DS ZF6	10-12	F
Zero DS ZF9	10-12	F
Zero S ZF6	10-12	F
Zero S ZF9	10-12	F
Zero XU	10-12	F
Zero X	10-12	F
Zero MX	10-12	F

**Equivalents OE #**

45105 H13 000 AC	Y00FA1409
45105 G22 000 AC	PE801968
45105 G02 000 AS	45105 HHA 000A
45105 APA000A	

**Competitor X Ref**

Dunlop	Ferodo	SBS	Vesrah
-	FDB2190	708/140	VD9012

**MATERIAL AVAILABILITY AND PART NO.**

STD	OPTIONS				
FA	SFAC	HH	R	MXS	EPFA
SFA264	SFAC264	SFA264HH	-	-	-

# FA265HH 74.75 x 55.4 x 8.1mm (with fitted shim)

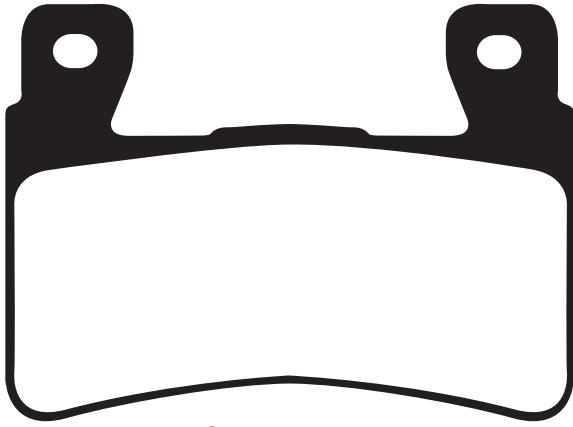

Competitor X Ref

## HONDA

CBR 900 RRW/RRX/RRY/RR1/RR2/RR3 'Fireblade'	98-03	F
VTR 1000 SPY/SP1 (SC45)	00-01	F
VTR 1000 SP-2/SP-3/SP-4/SP-5/SP-6	02-06	F
CB 1300 F1 (SC40)	01	F

## Equivalents OE #

06455 MAS E01	06455 MBW E11
06455 MCF 006	06455 MFA D11
06455 MCS 016	

Dunlop	Ferodo	SBS	Vesrah
DP127	FDB2079	734	VD166/2

MATERIAL AVAILABILITY AND PART NO.				
STD	OPTIONS			
FA	HH	R	MXS	EPFA
-	FA265HH	-	-	EPFA265HH

# FA266 54.05 x 50.90 x 7.50mm

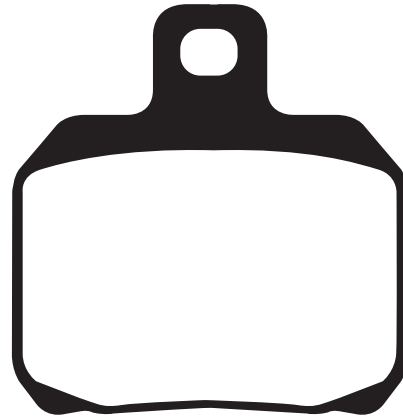

## ADIVA SCOOTERS

AD 400 09-11 F&R

## APRILIA

RS 50	06-11	F
ETV 1000 Caponord/Rally (PS00/PSB0) (Non ABS)	01-03	R
ETV 1000 Caponord (PS004) (ABS Model)	04-08	R
RSV 1000 Mille	01-02	R
RSV 1000 R Mille	01-02	R
RSV 1000 Mille (Radial caliper)	03	R
RSV 1000 R Mille (Radial caliper)	03	R
RSV 1000 R Racing/Factory (Radial caliper/4 pad)	04-08	R
RSV 1000 R Tuono (Radial caliper/2 pin pad fixing)	07-08	R
RSV 1000 SP	99-00	R
RSV 1000 Mille	00	R
RSV 1000 Mille R	00	R
RSV 100 R Factory	04-08	R
RSV 1000 R	04-08	R
RSV 1000 R Tuono	02-06	R
SL 1000 Falco	00-04	R
Tuono R Factory 1000 Radial caliper/4 pad type	06-10	R
Tuono R 1000 Radial caliper/2 pad type	02-10	R
Tuono R 1000 Radial caliper/4 pad type	02-05	R
Tuono 4VR-APRC	11-13	R
Tuono V4R	11-12	R
RSV4 R	10	R
RSV4 R APRC	11-13	R
RSV4 Factory	09-10	R
RSV4 Factory APRC	11-13	R

## AUSA QUADS

M 50 Task Side x Side F&R

## BENELLI

BN 600 (4 Cyl)	13	R
2 UE 750	09-10	R
Cafe 899 Racer	10-12	R
Century Racer 899	11-12	R
Trek 899	07-13	R
Tornado 900	02	R
Tornado LE/Tre Novecento/RS	03-05	R
Century 1130 Racer	11-12	R
TNT 1130 Sport/Sport Evo	04-09	R
TNT 1130 Cafe Racer	05-12	R
TNT 1130 Titanium	05-06	R
TRE-K 1130	06-13	R
Trek 1130 Amazonas	07-13	R
Tornado TRE1130 (Radial caliper)	06-10	R
Tornado Naked Tre 1130 TNT	13	R
Tornado Naked TRE TNT 1130	06-07	R
Tornado Naked TRE R 160	09-12	R

## BIMOTA

Elirio	06	R
DB5 (All models)	06-07	R
DB5R	06-13	R
DB5 Desiderio (1078cc)	12-13	R
DB6 Delirio 992cc Ducati engine)	07	R
DB6 (1100cc)	08	R
DB6R Delirio (1100cc)	08	R
DB7 (1098cc)	08	R
DB8 (1198cc)	10-12	R
DB9 Brivido (1198cc)	12-13	R
DB9 Brivido S (1198cc) (with BCA 6 piston caliper)	12-13	R
DB11 VLX (1198cc)	12-13	R
DB12B Tourist (1198cc)	12-13	R

## BOMBARDIER

Traxter (4x4) 99-01 F&R

## BREMBO

20 6950 51 - 2 Piston P2/32 Rear Caliper  
(Single pad fixing pin / with wire clip)

20 6951 12/50/63 - P2/34 Rear caliper  
(Single pad fixing pin / with wire clip)  
120A44110 P2/34 Supersport rear caliper

## CAGIVA

Raptor/V-Raptor 650 00-07 R  
1000 Raptor/V-Raptor 00-05 R

## BRAMMO

Empulse R 12-13 R  
Enertia 12-13 R

## CF MOTO

CF 125 T-22 Glory 10-11 R  
CF 150 T-6A Glory 10-11 R  
CF 250 T-6A (Scooter) 12 R

## CPI

GTR 50 03-12 F  
GTR 50/15-/18/300 03-12 F  
X-Large 125/150/200 02-03 F&R

## DERBI

GP1 50 Euro 2 ChainDriven/Radial caliper  
5 bolt fixing front disc 05 F  
GP1 50 Race Chain driven/radial caliper

5 bolt fixing front disc 05-07 F  
GPR 50 Nude (Radial caliper) 04-09 F  
GPR 50 Racing 40mm forks/180mm rear disc  
/radial caliper 08-10 F

GPR 50 40mm forks/180mm rear disc  
/radial caliper 04-07 F  
Senda DRD Pro 50 R Radial caliper/260mm disc 05-13 F

Senda DRD Pro 50 SM Radial caliper/300mm disc 05-13 F  
Senda DRD 50 Evo SM (Cast wheels) 08-11 F  
Senda DRD X-Treme 50 SM (Cast Wheel/  
260mm F disc/17" front wheel) 11-13 F

GRP 80 Cup (Radial Caliper) 04-05 F  
GP1 125cc Scooter Full height seat/  
5 bolt fixing front disc 06 F&R

Mulhacen 125 Cafe Cast wheel/radial caliper 08-10 F  
Senda DRD 125 R 10-12 F  
Senda DRD 125 SM 10-13 F

GP1 250cc Scooter 06-07 F&R  
Mulhacen 659 06-08 R

## DUCATI

620 Multistrada (Twin disc/single pin pad fixing) 06 R  
620 Multistrada Dark (Single disc/twin pin pad fixing) 06 R  
696 Monster 08-13 R

696 + Monster (inc ABS Models) 09-12 R  
Monster 696 20th Anniversary Model 13 R  
749 Dark (Monoposto/Biposto) 04-06 R

749 R (Radial caliper) 04-06 R  
749 S (Monoposto/Biposto) 03-06 R

# FA266 contd.

749 (Monoposto/Biposto)	03-06	R	1000 MGS-01 Corsa	04-07	R
750 Supersport	99	R	1100 California EV	98-00	R
750 Supersport IE	00-02	R	V 1100 Brevia	04	R
750 Sport	01-02	R	Fionda 1100	05	R
796 Hypermotard	10-12	R	<b>MOTO MORINI</b>		
796 Monster (inc ABS models)	10-13	R	Corsaro 1200	05-10	R
Monster 796 20th Anniversary Model	13	R	Corsaro 1200 Veloce	07-08	R
800 Supersport	03-04	R	9 1/2 (998cc)	06-10	R
Hypermotard (821cc)	13	R	MM3 (1187cc)	07	R
Hypermotard SP (821cc)	13	R	Corsaro Avio	08	R
Hyperstrada (821cc)	13	R	Rebello 1200 Giubileo	12-13	R
848	08-10	R	Scrambler 1200	08-09	R
848 Evo (Monobloc front calipers)	10-13	R	1200 Sport	08-10	R
848 Streetfighter	11-13	R	<b>MV</b>		
848 Evo Corse SE	12-13	R	675 F3 Serie Oro	12-13	R
848 Evo Dark	12	R	675 F3	12-13	R
900 Supersport	98-99	R	675 Brutale	12-13	R
900 Supersport IE	00-01	R	Brutale 800	12-13	R
900 Sport	02	R	Rivale 800	13	R
900 MH Evoluzione	00-01	R	Brutale 1090	13	R
ST2 (944cc)	97-03	R	<b>NORTON</b>		
ST3 (Non ABS) (992cc)	04-07	R	Commando Sport (961cc)	10-13	R
ST3 S (ABS Model) (992cc)	06-07	R	Commando Cafe Racer (961cc)	10-13	R
ST4S (ABS Model/996cc)	03-05	R	Commando SE (961cc)	10-11	R
ST4S (Non ABS/996cc)	01-05	R	Commander 961 SF	13	R
ST4 (916cc)	99-02	R	<b>PETRONAS</b>		
Desmosedici RR (D16RR/989cc)	08	R	FP1	05	R
999 S (Std caliper mount monoposto/biposto)	03-04	R	<b>PEUGEOT</b>		
999 (Std mount caliper)	03-06	R	Speedfight 3 50cc (L/C 2T)	09-12	R
999 R (Radial mount caliper)	03-06	R	Speedfight 3-RS (50cc-L/C 2T)	09-12	R
999 R Fila (Radial mount caliper)	03-	R	Speedfight 3 RS (50cc AC)	10-12	R
999 S (Radial caliper Monoposto/biposto)	05-06	R	Speedfight 50 LC Furious	13	R
999 R Xerox	06	R	Speedfight 50LC Darkside	13	F
Multistrada 1000 DS (992cc)	02-06	R	<b>PIAGGIO</b>		
Multistrada S 1000 DS (992cc)	05-06	R	X8 125	04-05	R
Supersport 1000 DS (992cc)	03-06	R	X9 125	00-02	F&R
1098	07-08	R	X9 125 Evolution (Brembo single pin fixing)	03-04	F&R
1098 S	07-08	R	X9 125 Evolution	05-07	R
1098 S Tricolore	07	R	X9 180 Amalfi	00-03	F&R
1098 R	08-09	R	X8 200	04-05	R
Hypermotard 1100/1100 S	07-09	R	X9 200	02-03	F&R
Multistrada 1100/1100 S (1078cc)	07-09	R	X9 200 Evolution	03-04	F&R
1100 Monster	09-10	R	X9 250/250 SL	00-04	F&R
1100 S Monster	09-12	R	X9 250 Linked brake f&r wheel 14" dia	04	R
Monster Diesel 1100	13	R	Beverley Tourer 400 ie	08-09	F&R
Streetfighter 1100 (1099cc)	09-11	R	Beverley B500	02-04	F&R
Streetfighter 1100 S (1099cc)	09-13	R	Beverley 500	06	F
1100 Evo Hypermotard	10-12	R	Beverley Cruiser 500 ie	07-11	F&R
1100 Evo SP Hypermotard	10-12	R	Beverly 500 ie	12	F&R
1100 Monster Evo	11-13	R	X9 500/500 SL	00-02	F&R
Monster 1100 Evo 20th Anniversary Model	13	R	X9 500cc Evolution (inc ABS)	03-06	R
1198	09-11	R	X9 500 ie	07	R
1198 S	09-10	R	<b>RIEJU</b>		
1198 R Corse	10	R	Tango 50 (2T)	07-13	F
1198 S Corse	10	R	MRT-Pro 50 (Radial/double piston caliper)	09-13	F
1198 SP	11	R	MRT Pro Supermotard (Radial caliper/cast wheel)	09-13	F
1199 Panigale	12-13	R	Marathon Pro Supermotard 125 (Cast wheel/radial caliper)	09-13	F
1199 Panigale ABS	12-13	R	Marathon Pro 125 (Radial/double piston caliper)	09-13	F
1199 Panigale S ABS	12-13	R	SMX 125	07-08	F
1199 Panigale S Tricolore	12-13	R	Tango 125	06-10	F
1199 Panigale R	13	R	Tango 125 Motard (Cast wheel)	08-10	F
1200 Multistrada Standard	10-11	R	Tango Pro 125	07-10	F
1200 Multistrada ABS	10-13	R	Tango 250	08-11	F
1200 Multistrada 1200 S Pikes Peak SE	11-13	R	<b>SINNIS</b>		
1200 S Multistrada Sport Edition	10-12	R	Ecocity 125 (125T-8G)	07-09	R
1200 S Multistrada Touring Edition	10-13	R	Grampus 250	10	R
Multistrada 1200 S Granturismo	13	R	<b>SUZUKI</b>		
<b>GENERIC</b>			UH 125 K2/K3/K4/K5/K6 Burgman	02-06	R
GRS 600	13	R	<b>TOMOS</b>		
<b>GILERA</b>			SM 125 F	05-08	F
Nexus 500	03-11	R	<b>VECTRIX</b>		
<b>HOREX</b>			VX-3 Li+ (3 wheeler model)	12-13	F
VR6 Roadster	11-13	R	<b>VOXON</b>		
<b>KEEWAY</b>			Cafe Racer	06	R
Silverblade 125/150/250	07	R	Roadster	06	R
<b>KTM</b>			<b>W.K. BIKES</b>		
RC8 (1190cc)	08-11	R	WK GTR 50 (2T)	10-11	F
RC8 R (1190cc)/Track	09-12	R	WK 125 SC (4T) (14" wheels)	10-13	R
<b>LAVERDA</b>			WK Jetmax 250 (4T)	10-13	R
SFC 1000	03-04	R	<b>YAMAHA</b>		
<b>MALAGUTI</b>			XQ 125/150 Maxster	01-03	R
NKD 50 Drakon	05-09	F	VP 125 X-City (16P)	08-11	R
Drakon S	06	F	YP 125 Majesty	01-09	R
<b>MBK</b>			YP 125 R X-Max	06-10	R
VP 125 Cityliner	08-10	R	YP 125 R (X-Max - Non ABS) (39D1/5)		
XQ 125/150 Thunder	01-03	R	Nissin F/Caliper	10-13	R
YP 125 D Skyliner	00-08	R	YP 125 R X-Max Sport	11-12	R
YP 125 D Skyliner	06-10	R	YP 180 Majesty	06	R
YP 125 Skycruiser	06-10	R	<b>VOXAN</b>		
<b>MONDIAL</b>			Cyclope 1000	02	R
Piega 1000	03-04	R	Cafe Racer 1000	02-08	R
EVO	04	R	Roadster 1000	02-08	R
<b>MOTO GUZZI</b>			Black Magic	04-08	R
750 Brevia ie (3 spoke cast wheels)	03-07	R	Street Scrambler	03-05	R
750 Nevada	02-11	R	Street Scrambler	07-08	R
750 Nevada Classic ie (spoke wheels)	04-13	R	VB1-Evo	03-04	R
750 Nevada Club (From LK112434-)	00-01	R	GTV 1200	08	R
750 V7 Classic	08-12	R			
750 V7 Cafe Classic	09-12	R			
750 V7 Racer	10-11	R			



# FA266 Contd.

## Equivalents OE #

613 4 021 1A	R44422001A	497394
8113751	8133542	690 13 090 000
8113898	107 694 936	690 13 190 000
494966	862489	606 08 02 70
613 403 81A	862698	PE776171
5NR F5811 00	861760	GU31654681
8000 95280	647077	8000B59975
497083	5NR F5811 10	861760
69130 49F00	00H04704141	M1300001500
R180100127000	613 4 038 1A	07BB2010
497394	00009308000	07BB2050
09130 07E00	M13400004400	

### Competitor X Ref

Dunlop	Ferodo	SBS	Vesrah
DP631	FDB2074	730/157	-

### MATERIAL AVAILABILITY AND PART NO.

STD	OPTIONS							
FA	V	SFA	SFAC	HH	SFA-HH	R	MXS	EPFA
FA266	FA266V	SFA266	SFAC266	FA266HH	SFA266HH	FA266R	-	-

# FA267 51.85 x 59.75 x 8.90mm



### YAMAHA

YZF 1000 R1	98-00	R
YZF R7 750 'OWO2' Road version	99-00	R
XJR 1300 (5EA9/5EAG) (298mm front disc)	00	R

### Equivalents OE #

4XV W0046 00
4XV W0046 10
5EA W0046 50
5FL W0046 50

### Competitor X Ref

Dunlop	Ferodo	SBS	Vesrah
DP419	FDB2084	733	VD264

### MATERIAL AVAILABILITY AND PART NO.

STD	OPTIONS			
FA	HH	R	MXS	EPFA
FA267	FA267HH	-	-	-

# SFA268 45.80 x 52.80 x 6.50mm

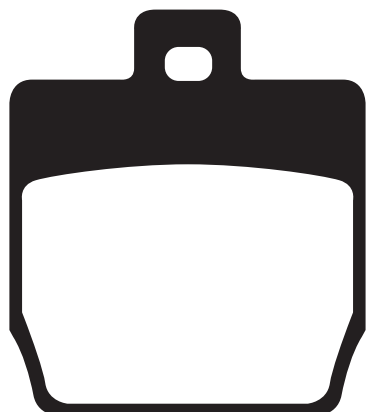

### YAMAHA

NS 50 Aerox R (1PH1)	13	R
NS 50 Aerox R Naked (1PL1)	13	R
YQ 50 Aerox R/Aerox	97-13	R
EW 50 Slider	00-05	F
<b>MBK</b>		
EW 50 Stunt	00-06	F
EW 50 Stunt Naked	05-10	F
YQ 50 Nitro	97-10	R
YQ 50 Nitro Naked	06-10	R

### Equivalents OE #

5BR F5811 00
5BR FS811 10
1PH F5806 00

### Competitor X Ref

Dunlop	Ferodo	SBS	Vesrah
DP013 DP422	FDB2062	731/145	-

### MATERIAL AVAILABILITY AND PART NO.

STD	OPTIONS				
FA	SFAC	HH	R	MXS	EPFA
SFA268	SFAC268	SFA268HH	-	-	-

# FA269 use SFA234

# FA270 73.85 x 52.8 x 6.82mm

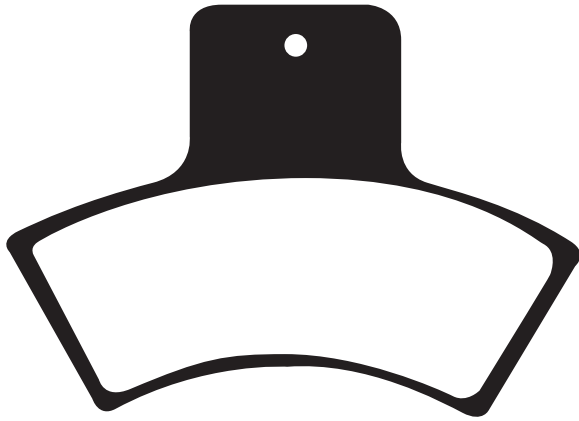

## **POLARIS**

Most models 98 onwards. Check application pages for fitment details.

## **QUADZILLA**

CVT 150 E (Parking brake)	10-11	
Quadzilla 300 "Utility"	04-06	R
300 E SUV	06	R
300 E (4x4) (Auto)	06-07	R
CUV 300 E 4x4 Side by Side	08-09	R
QZ 300 E 4x4		R
320 e4x4	07-08	R
CVT 320 e	07-11	R
QZ 320 E 4x4	09	R
400 4x4	06-07	R

### Equivalents OE #

1910339	2201399
1930860	2202411
2201093	2202412
2201189	

### Competitor X Ref

Dunlop	Ferodo	SBS	Vesrah
DP915	FDB2121	755	-

### MATERIAL AVAILABILITY AND PART NO.

STD	OPTIONS			
FA	HH	R	MXS	EPFA
FA270TT	-	FA270R	-	-

# FA271 67.6 x 43.95 x 7.7mm

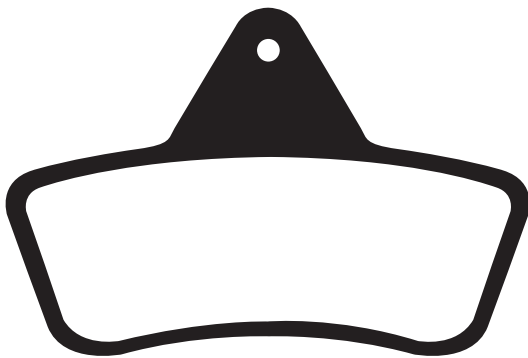

## **ARCTIC CAT**

Most models 96-04 F&R  
Check application fitment details

## **LAVERDA**

Quasar 4x4 500c	04	F&R
Quasar 4x4 500	04	F&R
Quasar 4x4 400	04	F&R

## **MASSEY FERGUSON (ATV)**

MF 250 (2WD/4WD)	04	F&R
MF 300 (2WD/4WD)	04	F&R
MF 400 4WD	04	F&R
MF 400 Auto 4WD	04	F&R
MF 500 (Auto 4WD) TBX Auto	04	F&R

## **WILWOOD**

PS1 Caliper (Part # 150-4091K)

### Equivalents OE #

0502 019	0402 096	0402 494	0402 882
----------	----------	----------	----------

### Competitor X Ref

Dunlop	Ferodo	SBS	Vesrah
DP914	FDB2175	758	-

### MATERIAL AVAILABILITY AND PART NO.

STD	OPTIONS			
FA	HH	R	MXS	EPFA
FA271TT	-	FA271R	-	-

# FA272 39.6 x 44.4 x 7mm

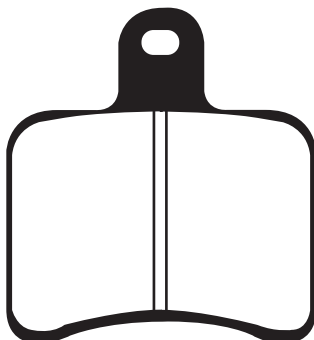

## **AP/LOCKHEED**

2 Piston / 1 Pin (CP4226-2S0)  
2 Piston / 1 Pin (CP4227-2S0)  
2 Piston / 1 Pin (CP7003-2S0) Radial mount

### Equivalents OE #

CP4226-4

### Competitor X Ref

Dunlop	Ferodo	SBS	Vesrah
-	-	719	-

### MATERIAL AVAILABILITY AND PART NO.

STD	OPTIONS			
FA	HH	R	MXS	EPFA
FA272	-	-	-	-

# FA273R 60.7 x 50.3 x 12.3mm

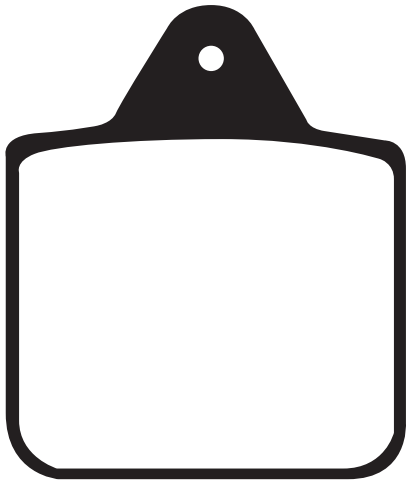

## POLARIS

Big Boss 400 L 6x6	96	
400 Big Boss L 6x6	96	Middle Axle Brake
Big Boss 425 6x6	96	Middle Axle Brake
425 Magnum 6x6	96	Middle Axle Brake
Ranger	99	R

### Equivalents OE #

2200807

### Competitor X Ref

Dunlop	Ferodo	SBS	Vesrah
SDP844	FDB2135	756	-

### MATERIAL AVAILABILITY AND PART NO.

STD	OPTIONS			
FA	HH	R	MXS	EPFA
-	-	FA273R	-	-

# FA275 99.77 x 30.2 x 9mm

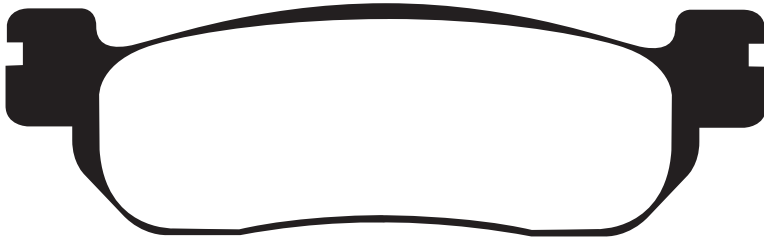

### Equivalents OE #

4730480	5EK W0045 10
4JG W0045 00	5EB W0046 00
4US W0045 00	5GM W0046 00
3 YR W0045 00	5PW W0046 50
37P W0046 00	5LB W0045 00
5CG W0046 00	5XT W0045 00
5CG W0046 20	

## YAMAHA

RZ 50 (5FC1/2)	02	F
T 105 E (5ER1/2) Crypton-R	99	F
T 105 SE Crypton (5EA3)	02	F
V 110 ZE/ZK/ZHE/ZHK FIZR/FIZR Sport	96	F
AT 115 Neo (Brasil) (2B81/2/3)	05-07	F
AT 115 (Neo CVT/Brasil) (15S1)	08	F
TW 125 (5EK/5RS)	99-04	F
YP 125 R (X-Max ABS) (39D2)	11-13	R
YP 125 X-Max Business (ABS)	11	R
TW 200 (2JL/4CS1/2/3/5)	91-98	F
TW 200 E (4CS4/6/5LB1/2)	98-01	F
ST 225 (5BT) Bronco	97	F
TW 225 E (5VC1/2)	02-03	F
XT 225 WE (4JG5/6) Serrow	97-98	F
Serrow 250 (3C51/52)	05	F
VP XG 250 Tricker (5XT1)	04-06	F
XT 250 X (5C1)	06-08	F
VP 250 X-City	07-13	R
XP 250 R X-Max (ICO) (Brembo Front Caliper/Non ABS)	05-09	R

XP 250 R X-Max (37P) (Nissin front caliper/Non ABS)	10-13	R
YP 250 R (X-Max)	05-09	R
YP 250 DX/A Majesty	98-03	R
YP 250 R X-Max (ABS)	11-13	R
YP 250 R X-Max Sport	11-12	R
YZF 600 R 'R6'	99-02	R
YZF 1000 R1	02-03	R

## LINHAI

Monarch 125/150 T	06-07	R
Main Street 300cc (Scooter)	07-08	R

## MBK

YP 250 Skyliner 250 (+ABS)	98-02	R
----------------------------	-------	---

## ITALJET

Jupiter 125/150	02	R
-----------------	----	---

### Competitor X Ref

Dunlop	Ferodo	SBS	Vesrah
DP420	FDB2083	728/155	VD265

### MATERIAL AVAILABILITY AND PART NO.

STD	OPTIONS							
FA	TT	SFA	HH	SFAC	SFA-HH	R	MXS	EPFA
FA275	FA275TT	SFA275	FA275HH	SFAC275	SFA275HH	-	-	-

# GFA276HH 95.8 x 47.5 x 8.4mm



**Race use  
only**

## PVM

6 Piston (new small design)

### Equivalents OE #

-

### Competitor X Ref

Dunlop	Ferodo	SBS	Vesrah
-	-	-	VD9027

### MATERIAL AVAILABILITY AND PART NO.

STD	OPTIONS			
FA	HH	R	MXS	EPFA
-	-	-	-	GFA276HH

# SFA281 115.6 x 41 x 9.3mm

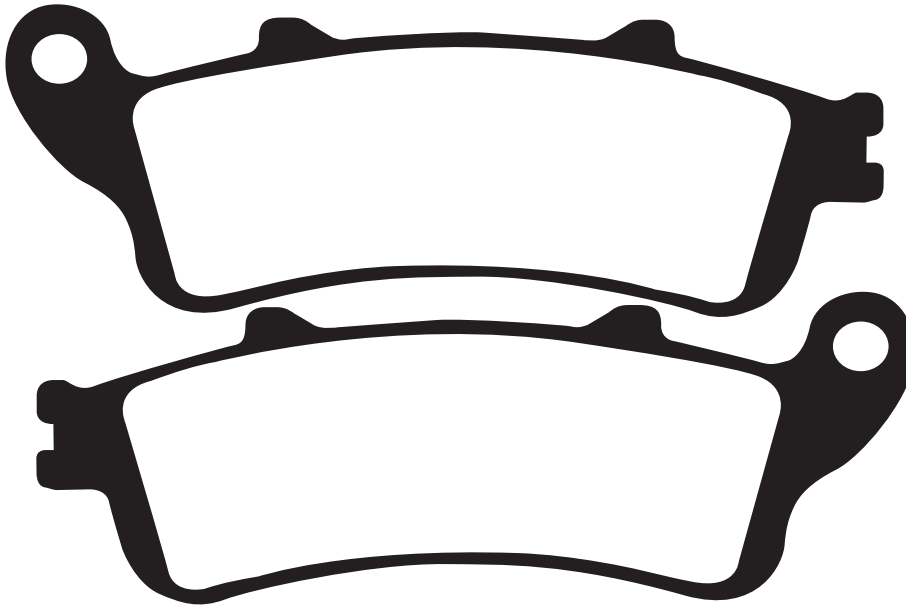

### Equivalents OE #

06455 KFG 016
06455 KFG 641
06455 KPB 406
06455 KPB 416
119 481 00
754808

### GARELLI

Skynet 250/400

02 F

### HONDA

FES 125 W/Y/1/2/3/4/5 Pantheon

98-06 F

FES 150 W/Y/1/2/3/4/5 Pantheon

98-06 F

FES 250 W/X/Y/1/2/5 Foresight

98-05 F

NSS 250 Y/AY/1/A1/A3/3 Forza/Forza-S/Forza-T/Forza-ST/Jazz/Reflex (MF04/MF06)

00-04 F

FJS 400 Silverwing D6/D7/D8 Non ABS 256mm front disc

06-08 F

FJS 600 1/2/D3/D4/D5/D6/D7/A3-A7 Silverwing

01-08 F

### PEUGEOT

SV 250

01-02 F

### Competitor X Ref

Dunlop	Ferodo	SBS	Vesrah
DP124	FDB2075	722/147/156	-

MATERIAL AVAILABILITY AND PART NO.				
STD	OPTIONS			
SFA	SFA-HH	R	MXS	EPFA
SFA281	SFA281HH	-	-	-

# FA282R 31.25 x 35.85 x 5.12mm

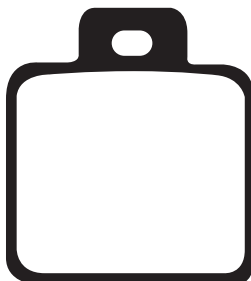

### HUSQVARNA

Husky Boy 50

98-99 F&R

### HYOSUNG

TE 50

05-07 R

TE 90

05-07 R

TE 100

05-07 R

### Equivalents OE #

59300 21000

### Competitor X Ref

MATERIAL AVAILABILITY AND PART NO.				
STD	OPTIONS			
FA	HH	R	MXS	EPFA
-	-	FA282R	-	-

Dunlop	Ferodo	SBS	Vesrah
-	-	-	-

# SFA283 53.5 x 44.7 x 8.6mm

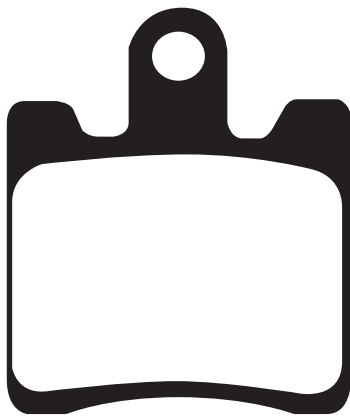

**NOTE: 2 sets required to replace one caliper set**

**Competitor X Ref**

Dunlop	Ferodo	SBS	Vesrah
DP219	FDB2085	740/146	VD353

**DAELIM**

B-Bone 125 (SN 125)	09-13	F
S1 125 (SL 125)	07-13	F
S3 125 (SV 125)	10-13	F
SL 125 Otello F1	07-09	F
SQ 125 S2 Freewing	07-09	F

**KAWASAKI**

SC 250 A1 Epsilon	02-03	F
-------------------	-------	---

**SUZUKI**

AN 250 W/X/Y Burgman/Skywave	98-00	F
AN 250 K1/K2 Burgman/Skywave	01-02	F
AN 250 K3-K6 Burgman (CJ43A)	03-06	F
AN 400 X/Y/K1/K2 Burgman/Skywave	99-02	F
AN 400 K3-K6 Burgman/Skywave	03-06	F

**SYM**

GT 500	04	F
--------	----	---

**Equivalents OE #**

59300 14870	59301 14810
59300 14880	59301 14820
43082 S002	45105 SZ1 0100

**MATERIAL AVAILABILITY AND PART NO.**

STD	OPTIONS				
SFA	SFAC	SFA-HH	R	MXS	EPFA
SFA283	SFAC283	SFA283HH	-	-	-

# FA291 43.8 x 56.8 x 6.45mm

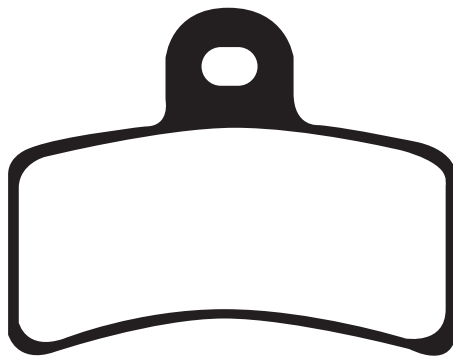

**Equivalents OE #**

BT-27922065
BT-280022065

**Competitor X Ref**

Dunlop	Ferodo	SBS	Vesrah
DP640	FDB2103	815	-

**GAS GAS**

Cross MC 50	06	F
125/200/249/270/280/321 TXT	99-03	F&R
50/80 TXT	01-02	F&R
50 EC Rookie	01-02	R
50 EC Boy	01	F&R
TXT Boy 50/280	01	F&R
EC Boy 50	01	F&R
EC 50 (Boy)	01-04	F&R
EC 50 (Rookie)	01-04	R
EC 50	05	R
TXT 50 (Boy)	01	F&R
TXT 50 (Rookie)	02-03	F&R
SM 50 (Rookie)	01-04	R
SM 50	05	R
TXT 80 (Rookie)	02-03	F&R
Pampera 125/250/280	04	R
Pampera 250	02	R
SM 50 Rookie	01-02	R
TXT 200/270/321	99	F&R
TXT 125/200/249/280/321	00-03	F&R
Pampera 250	02-03	R

**MATERIAL AVAILABILITY AND PART NO.**

STD	OPTIONS				
FA	HH	R	MXS	EPFA	
FA291	-	-	-	-	

# FA293S = Green FA293 = Blue

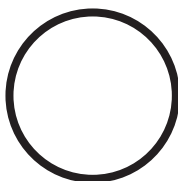

- A. 22Ø x 5.95mm (Plain pin)
- B. 22Ø x 5.95mm (Thread pin)

**MINI MOTO**

Pasini/GRC	
<b>HRD</b>	
SX 50 Mini Cross	F&R

**POLINI**

Mini Bikes	F&R
------------	-----

**Equivalents OE #**

143 750 009
-------------

**Competitor X Ref**

Dunlop	Ferodo	SBS	Vesrah
-	-	-	-

**MATERIAL AVAILABILITY AND PART NO.**

STD	OPTIONS				
FA	HH	R	MXS	EPFA	
FA293	-	-	-	-	
FA293S (Green)					

# FA294HH 81 x 45.9 x 7.7mm

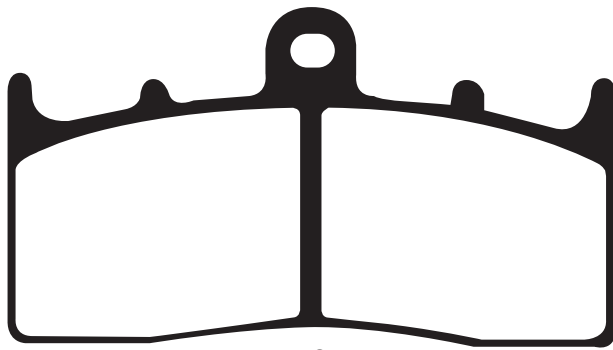

**Equivalents OE #**

34 11 7 658 386	34 117 69 0 169
34 11 7 655 898	43082 1217
34 11 7 690 170	

**Competitor X Ref**

Dunlop	Ferodo	SBS	Vesrah
DP639	FDB2124	743/778	VD439

**BMW**

R 850 R	04-06	F
R 1100 S (with integral ABS)	12/00-06	F
R 1150 R/R/S	01-06	F
R 1150 R Rockster	03-06	F
R 1150 Rockster Edition 80	04	F
K 1200 LT	11/00-09	F
K 1200 R (Urban)	05-08	F
K 1200 R (K27/0378) Tokico Caliper	06-11	F
R 1200 CL	02-04	F
R 1200 C Independent (Cast wheel)	03-04	F
R 1200 C Montauk	04	F
R 1200 C Classic	03-04	F
R 1200 R SE	10-11	F
R 1200 R Classic	11-12	F
R 1200 R	12/07-13	F
K 1200 R Sport	07	F
K 1300 R	09-12	F
K 1300 R Dynamic	11-13	F
K 1300 R Carbon	12	F

**KAWASAKI**

ZRX 400 (ZR 400 E4-E7)	98-01	F
------------------------	-------	---

MATERIAL AVAILABILITY AND PART NO.				
STD	OPTIONS			
FA	HH	R	MXS	EPFA
-	FA294HH	-	-	EPFA294HH

# EPFA295HH 77.6 x 44 x 10.4mm

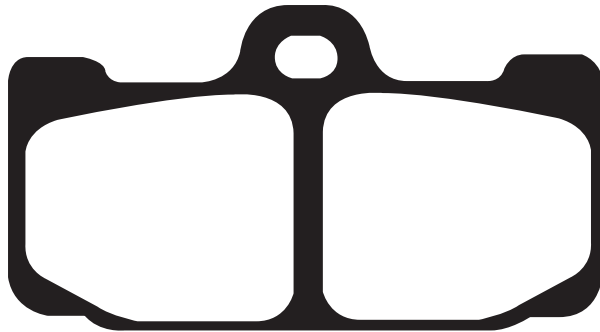

**Race use only**

**BREMBO**

X9737 80/81 Radial mount endurance caliper 108mm spacing

**Equivalents OE #**

107 684612
------------

**Competitor X Ref**

Dunlop	Ferodo	SBS	Vesrah
-	-	741	VD9021

MATERIAL AVAILABILITY AND PART NO.				
STD	OPTIONS			
FA	HH	R	MXS	EPFA
-	-	-	-	EPFA295HH

# FA296HH 74.75 x 55.4 x 7.6mm (No shim fitted)

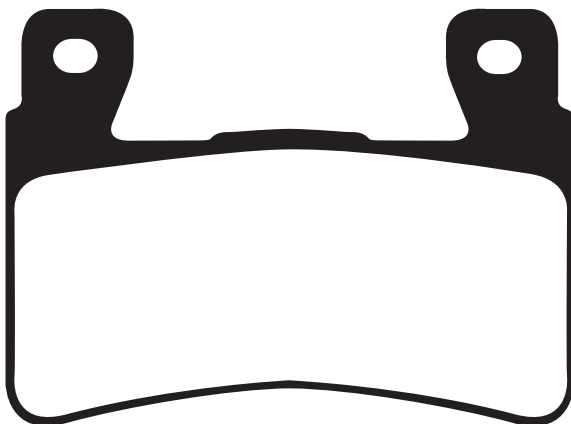

**Equivalents OE #**

06455 MBW 006	59330 H99 700
06455 MBW E11	43082 0131
42739 008	

**Competitor X Ref**

Dunlop	Ferodo	SBS	Vesrah
DP127	FDB2079	734/895	VD166

**HARLEY-DAVIDSON**

XR 1200	08-10	F
XR 1200 X	10-12	F

**HONDA**

CB 400 SFX/SFY/SF1/SF2/SF3 Super Four	99-03	F
CB 400 SF4/5/S5 (NC39)	04-05	F
CBR 600 FX/FY	99-00	F
CBR 600 F1/F2/600 FS1/FS2 'Sport'	01-02	F
CBR 600 F3/F4/F5/F6	03-06	F
CBR 600 RR3/RR4	03-04	F
CB 1300 F3/F13	03-04	F
CB 1300 5/6/7/8/9 (Superfour)	05-09	F
CB 1300 A5/A6/A7/A8/A9 (Superfour ABS)	05-09	F
CB 1300 SA5/SA6/SA7/SA8/SA9/SAA	05-12	F
CB 1300 S5/S6/S7/S8/S9	05-09	F

**HYOSUNG**

GT 650 (Naked)	09-12	F
GT 650 R	09-13	F
GT 650 Pi (Naked)	12-13	F
ST7	10-13	F
ST7 Deluxe Cruiser	12-13	R

**KAWASAKI**

ZX-6R EDF (Non ABS/636cc)	13	F
ZX-6R FDF (ABS Model/636cc)	13	F

MATERIAL AVAILABILITY AND PART NO.					
STD	OPTIONS				
FA	GPFA	HH	R	MXS	EPFA
-	GPFA296HH	FA296HH	-	-	EPFA296HH



# FA297 A. 105 x 43.6 x 7.84mm B. 66 x 36.5 x 12.7mm

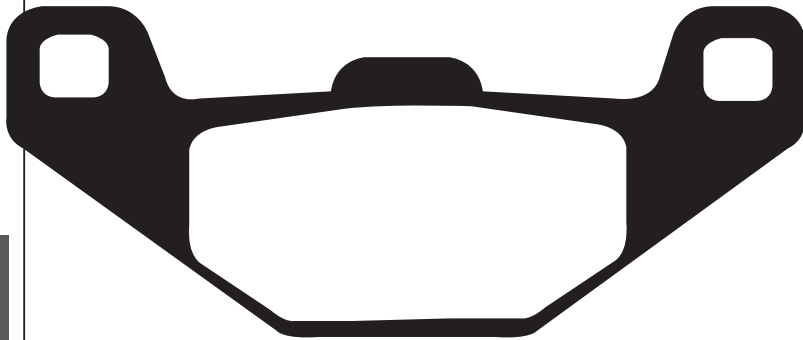

**SYM**

Huskey 125/150 99-05 F  
CT 125 03-04 F

**Equivalents OE #**

45105 N02 001 A

**Competitor X Ref**

Dunlop	Ferodo	SBS	Vesrah
-	FDB2129	745/150	VD9019

MATERIAL AVAILABILITY AND PART NO.				
STD	OPTIONS			
FA	HH	R	MXS	EPFA
FA297	-	-	-	-

# FA298 50.96 x 53.40 x 9.5mm



**Equivalents OE #**

811 3869	8213506	8133946
119 491 00	8133539	666397
2525371000	8133946	R050372080000
R44440161A0	8213577	55120 J41 000
11948600	8133726	

**Competitor X Ref**

Dunlop	Ferodo	SBS	Vesrah
-	FDB2090	747/152	-

MATERIAL AVAILABILITY AND PART NO.						
STD	OPTIONS					
FA	SFA	SFAC	HH	R	MXS	EPFA
FA298	SFA298	SFAC298	SFA298HH	-	-	-

**APRILIA**

Scarabeo 50 (Ditech) (2T) (SCA00)	01-04	R
SR 50 Ditech (LC) (RLD100)	02-03	R
SR 50 Street (LC) (TE00/TEA00)	03-13	R
SR 50 R/Factory (LC) (VFB00/VFD00)	04-13	R
SR 50 H20 (ditech) (RLA1/RLB1)	00-03	R
SR 50 R SBK Aprilia (Replica) (LC)	10-11	R
Atlantic 125/200/250	03-06	R
Atlantic 125	03-08	R
Atlantic 125	10	R
RS 125 (Radial Caliper model) 2T	06-13	R
Scarabeo 125/150/200	99-02	R
Scarabeo 125/200	03	R
Scarabeo 125/150/250 GT	04-06	R
Scarabeo 125/200	07-09	R
Sport City 125	04-08	R
Sport City Cube 125	08-12	R
Atlantic 200	03-05	R
Sport City 200	04-08	R
Sport City Cube 200	08-10	R
Atlantic 250 ie	06-08	R
Atlantic 250	03-05	R
Leonardo 250 ST/SP	00-04	R
Scarabeo 250	06	R
Scarabeo 250 ie	07-10	R
Sport City 250 ie	06-08	R
Sport City Cube 250	08-09	R
Atlantic 300	10-11	R
Sport Cube 300 Blackline	11	R
Leonardo 300	05-06	R
Sport City Cube 300	08-12	R
Atlantic Sprint 400	05-08	R
Scarabeo 400 ie	07-08	R
Atlantic 500	02-04	R
Atlantic Sprint 500	05-08	R
Scarabeo 500	03-06	R
Scarabeo 500 ie	07-09	R
Scarabeo 500 Light	07	R

**BENELLI**

Velvet 125/150 (13" front wheel/touring)	08-12	R
X 125	12-13	R
X 150	12-13	R
Velvet 250	99-12	R
Velvet 400	03-04	R

**BETA**

Eikon 125/150	00-06	R
<b>DERBI</b>		
Boulevard S125	07	R
Rambla 125	08-12	R
Rambla 250 i	08-09	R
Rambla 300 i	10-12	R
<b>GENERIC</b>		
Code S 125/150/200 (4T)	12-13	R
Code X 125/150/200 (4T)	12-13	R
<b>H P POWER</b>		
Iron 50 (2T)	10-12	R
<b>ITALJET</b>		
Marco Polo 400cc Scooter	07-09	R
<b>KEEWAY</b>		
RKV 125	10-12	R
<b>MALAGUTI</b>		
Madison T125/150/R180/S250	99-03	R
Madison 125-3	06-09	R
F18 Warrior 125/150	00-03	R
Phantom Max 125/200	04-08	R
R 125 Madison	03-07	R
Madison S 200	04	R
Madison 250 ie 3	06-10	R
Password 250	05-11	R
Phantom Max 250	04-08	R
250 Madison	04-07	R
Scarabeo 300 S	09-10	R
Madison K 400	02-06	R
Spidermax RS 500	04-11	R
Spidermax GT 500	04-10	R
<b>SCARABEO</b>		
125 ie	10-13	R
125 Net	10-11	R
200 ie	10-13	R
200 Net	10-11	R
300 S	09-11	R
500 ie	10-11	R
<b>TGB</b>		
Bellavita 125i (4T)	12	R
Bellavita 300i (4T)	12	R

# FA299 A. 92.9 x 65.15 x 7.5mm B. 92.9 x 65.15 x 7.5mm

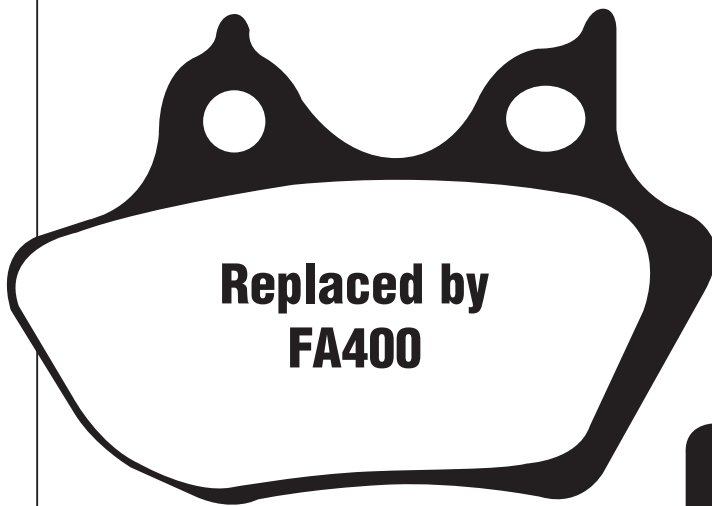

**Replaced by  
FA400**

**All production is now FA400  
version only.**

**HARLEY DAVIDSON**

New 4 piston caliper 2000-2004 models F&R  
Check page 39/40 for application details.

**IMPORTANT NOTE:**  
This pad fits 04 and prior models only.  
See also FA400 which has similar shape but  
larger friction area.  
**DO NOT ATTEMPT TO FIT THIS PAD IN MODELS  
AFTER 05.**  
Always compare old pad shape.



**Note:**  
If you still have stock  
of FA299/299HH refer to note  
opposite

**Equivalents OE #**

44082-00

**Competitor X Ref**

Dunlop	Ferodo	SBS	Vesrah
DP918	FDB2097	750	VD971

MATERIAL AVAILABILITY AND PART NO.				
STD	OPTIONS			
FA	HH	R	MXS	EPFA
FA299	FA299HH	-	-	-

# SFA301 53.90 x 50.75 x 8.00mm

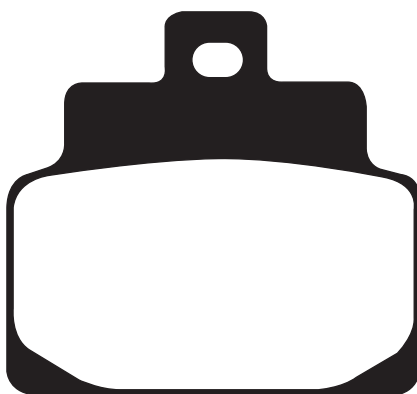

**APRILIA**

Scarabeo 100 (2T)	00	F
Scarabeo 100 (4T) (SA000/VA000)	01-09	F
Habana 125	00-02	F
Leonardo 125/150 ST/SP	99-04	F&R
Leonardo 125	05-06	F&R
SR 125/150	99-02	F
Mojito/Mojito Custom 125	03-12	F

**Equivalents OE #**

8213460  
8213462

**Competitor X Ref**

Dunlop	Ferodo	SBS	Vesrah
-	FDB2095	748/153	-

MATERIAL AVAILABILITY AND PART NO.					
STD	OPTIONS				
FA	SFAC	HH	R	MXS	EPFA
SFA301	SFAC310	SFA301HH	-	-	-

# FA302 A. 67.65 x 36.52 x 7.58mm B. 51.90 x 40.10 x 7.62mm

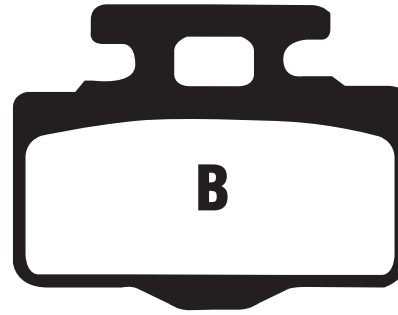
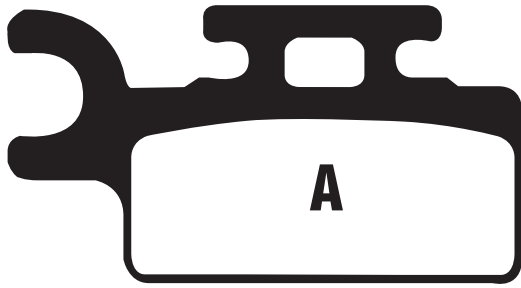

## KAWASAKI

KX 65 A1/A2/A3/A4/A5/A6/A6F/A7F/A8F/A9F/AAF/ABF/ACF/ADF

00-13 F

## SUZUKI

RM 65 K3/K4/K5

03-05 F

## Equivalents OE #

43082-1242	K4308-21242
43082-0042	

## Competitor X Ref

Dunlop	Ferodo	SBS	Vesrah
DP328	FDB2110	752	VD440

## MATERIAL AVAILABILITY AND PART NO.

STD	OPTIONS			
FA	HH	R	MXS	EPFA
FA302TT	-	FA302R	-	-

# FA303 49.95 x 43.85 x 5.9mm

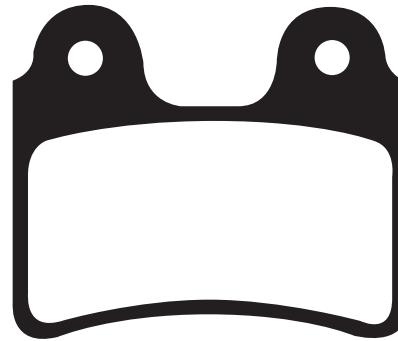

## AJP

PR3 125 Enduro	08-11	R
PR3 125 Supermoto	08-11	R
PR3 125 Enduro Pro	10-11	R
PR3 125 Supermoto Pro	10-11	R
PR4-Enduro 125	04-09	R
PR4-Supermoto 125/200	04-11	R
PR3 200 Enduro	08-11	R
PR3 200 Supermoto	08-11	R
PR3 200 Supermotard Pro	10-11	R
PR3 200 M/X	10-11	R
PR3 200 M/X Pro	10-11	R
PR4 Enduro 200	04-09	R
MX 200	09	R

## BETA

Evo 80	09-13	F
Rev 80	08	F
Evo 125 (2T)	09-13	F
Rev 3 125/200	00-06	F&R
Rev 3 125/200	06-08	F
Evo 200 (2T)	09-13	F
Rev 3 250/270	00-04	F&R
Rev 3 250/270	05-08	F
Evo 250 (4T/2T)	09-13	F
Rev 4T 250	07-08	F
Evo 300 (2T)	09-13	F
Evo 300 (4T)	09-13	F

## GAS-GAS

TXT 125/200/250/280/300 (TXT PRO)	04-11	F
TXT 125/250/280/300 (For models with AJP caliper with 2 pin pad fixing)	12	F
TXT 125 Randonne (4T)	11/13	F
EC 50 Boy (LC)	05	F
TXT 50 Rookie	04-09	F
TXT 80 Rookie	04-09	F
TXT 80 (Cadet)	07-09	F

## HONDA/MONTESA

315R	01-04	F
250 4RT Cota	05-10	F

## Competitor X Ref

Dunlop	Ferodo	SBS	Vesrah
-	FDB2109	802	-

## OSSA

TR 125	13	F
TR 280 i	10-12	F
280 i Explorer	12-13	F

## SCORPA

SR 125 (2T)	09-13	F
SR 125 Long Ride (2T)	09-11	F
SY 125 F	03-08	F
SY 125 4T Long Ride	09-10	F
SY 125 FR (4T)	03-11	F
TY 125 (4T)	11-13	F
SY 175 F	06	F
SY 200 F (4T) (163cc)	08	F
SY 250 F	06-10	F
SY 250 Long Ride (2T)	04-06	F
SY 250 (2T)	00-05	F
SY 250 F (4T) Long Ride	07-08	F
SY 250 R (2T)	00-09	F
SY 250 FR Long Ride	10	F
SY 250 FR	06-10	F
SR 280 (2T)	09-13	F
SR 280 (2T) Long Ride	09-11	F

## SHERCO

Trials 0.8 (2T)	05-10	F
Trials 1.25 (2T) AJP Caliper	06-12	F
Trials 2.5 (2T) AJP Caliper	06-12	F
Trials 2.9 (2T) AJP Caliper	06-12	F
Trials 3.2 (4T) AJP Caliper	05-12	F

## XISPA

X 125 R	08-09	F
X 250 R	08-09	F
X 280 R	08-09	F

## Equivalents OE #

45105 NN3 830	25-25352	00TRS01A0027
6211	C389	2525352000

## MATERIAL AVAILABILITY AND PART NO.

STD	OPTIONS			
FA	HH	R	MXS	EPFA
FA303	-	-	-	-

# FA304 75.05 x 54.90 x 8.97mm



## BMW

R 1200 CL	02-04	R
K 1200 LT (All models)	97-09	R

## Equivalents OE #

34 21 7 671 246
34 21 7 657 492
34 21 7 680 374
34 21 7 680 375
34 21 2 333 337

## Competitor X Ref

Dunlop	Ferodo	SBS	Vesrah
DP637	FDB2102	746	-

## MATERIAL AVAILABILITY AND PART NO.

STD	OPTIONS				
FA	V	HH	R	MXS	EPFA
FA304	FA304V	FA304HH	-	-	-

# FA305 A 84.95 x 43.5 x 8.60mm B 63.95 x 36 x 10.96mm

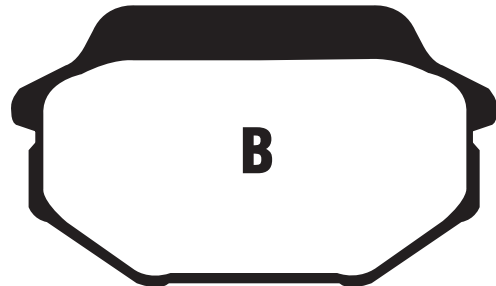
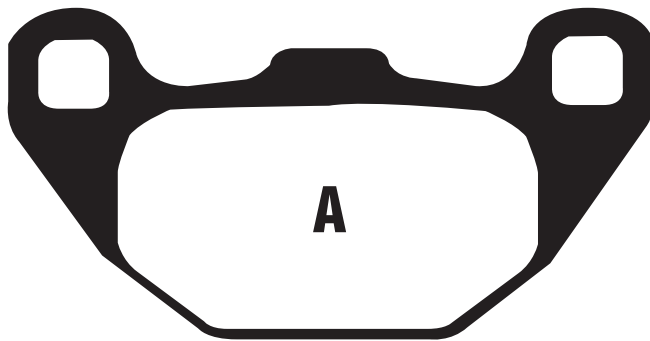

## ARCTIC CAT

50 DVX (4T) Sport	06/08	R
50 4x4 Auto Youth	08	R
90 DVX	06-12	R
90 DVX SE	09	R
90 2x4 (4T) Youth (Rear disc model)	06	R
90 SE	09	R
90 (Reverse gear model)	10-12	R
150 Utility	09-12	R

## KAWASAKI

KXF 50 (KSF 50 B7F/B8F/B9F)	07-09	R
KXF 90 (KSF 90 A7F/A8F/A9F/AAF/ABF/ACF)	07-12	R

## LAVERDA

Phoenix 125/150/200	01-04	R
---------------------	-------	---

## KYMCO

Agility 50 R16 (2T/16" wheels)	08-12	F
Agility 50 R16 (4T/16" wheels)	08-13	F
Agility 50 Carry (4T)	11-13	F
DJ 50 S	12-13	F
Like 50 (4T)	09	F
Look er50	07-08	F
People S 50 2T (5 bolt fixing)	05-10	F
People S 50 (4T) (B91000)	06-13	F
People 50 (2T)	99-11	F
Super 8 (50cc) (2T)	07-13	F
Super 8 (50cc) (4T)	07-12	F
Super 9 50 (LC)	01-07	R
MXU 50 (Quad)	05-13	R
Maxxer 90	05-06	R
Agility 125 R16 (C20000) (16" wheels)	08-13	F
Agility RS125 (2T/12" wheels)	09-13	F
Agility RS125 (4T/12" wheels)	09-13	F
Agility 125 Carry (4T)	11-12	F
DJ 125 S	12-13	F
Like 125 (D20000)	09	F
Looker 125 S	07-08	F
People S 125 DD	07-11	F

People S 125	05-06	F
People 125	99-10	F
Super 8 (125cc) (4T)	08-13	F
Agility 150 R16 (C30000) (16" wheels)	08-10	F
Like 150 (2T)	09	F
Mxer 150 Quad	02-07	R
MXU 150	05-12	R
People 150	99-04	F
Agility 200i R16	10-12	F
Like 200 i	09	F
People S 200 (D11000)	05-06	F
People S 200i DD (D12000)	07-12	F

## SYM

HD 125/200	04-07	F
Joyride 125/200	01-07	R
SK 125	03-04	R
Joyride 150	01-06	R
GT 500	04	R

## Equivalents OE #

8900539	3303-446
45105 KFA6 3050	3305-139
43082 Y001	45105 LDC8 305
45105 LEJ2 305	45105 KFA6 305
3304-567	

## Competitor X Ref

Dunlop	Ferodo	SBS	Vesrah
-	FDB2096	749/154	-

## MATERIAL AVAILABILITY AND PART NO.

STD	OPTIONS					
FA	SFA	SFAC	HH	R	MXS	EPFA
FA305	SFA305	SFAC305	SFA305HH	FA305R	-	-

# SFA306 70.13 x 41.85 x 8.07mm

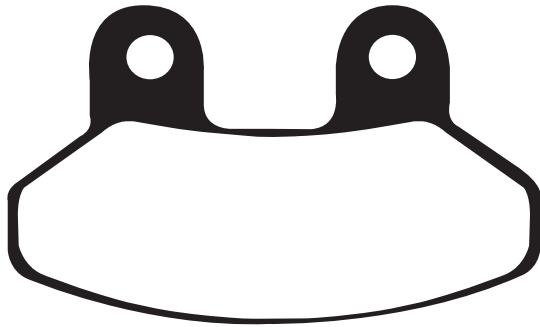

**Equivalents OE #**

45105 HA3A 000
45105 H3A 900A
8900239

**LAVERDA**

Phoenix 125/150/200	01-04	F
<b>SYM</b>		
RS 50	04-09	F
Shark 50	99-03	F
Euro MX 125 (Rear drum model) (HF12-W6 Euro 1)	02-07	F
Euro MX 125 (Rear disc model) (HF12 W3-6 Euro 2)	06-09	F
RS 125	04-06	F
SK 125	03-04	F
Shark 125/150	99-02	F
Shark 4VR 125	01-02	F
Joyride 125/150/200	01-07	F
Joyride 125 i	07-09	F
Joyride Evo 125i	09-13	F
VS 125	06-13	F
RS 150	06	F
VS 150	06-13	F
Joyride 200 i	07-09	F
Joyride Evo 200i	09-12	F

**Competitor X Ref**

Dunlop	Ferodo	SBS	Vesrah
-	FDB2108	792/178	-

**MATERIAL AVAILABILITY AND PART NO.**

STD	OPTIONS				
SFA	SFAC	HH	R	MXS	EPFA
SFA306	SFAC306	-	-	-	-

# FA307 A 82.08 x 40.85 x 9.46mm B 62.03 x 40.80 x 9.46mm

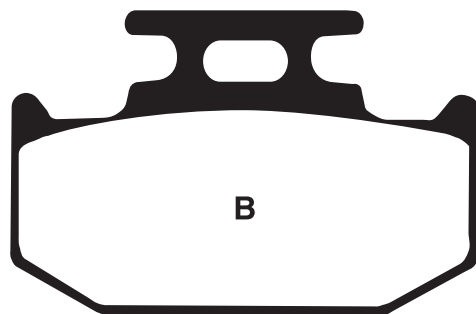
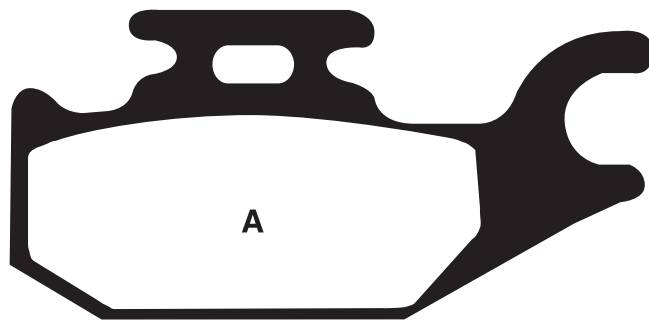

**FA307TT**

**YAMAHA**

YFM 400 FAM/FAN	00-01	R
YFM 400 FWT (Big Bear)	05	R
YFM 400 FGW/FGX Grizzly	07-08	R
YFM 450 FAR/FAS	03-04	R
YFM 450 FAT/FAHT/FAV (Kodiak)	05-06	R
YFM 450 FGW/FGX/FGY Grizzly	07-09	R
YFM 450 FXV/FXW/FXX/FXY/FXZ Wolverine	06-10	R

**BOMBARDIER**

Most models (see application pages)	01-06	F(left)&R
-------------------------------------	-------	-----------

**CAN AM**

Most models (see application pages)	07-13	F(left)&R
-------------------------------------	-------	-----------

**CANNONDALE**

All quads (check main application pages for fitments)	01-04	F(left)&R
---	-------	-----------

**JOHN DEERE ATV**

Most models (see application pages)	04-05	F(left)&R
-------------------------------------	-------	-----------

**SFA307**

**SUZUKI**

UX 125 K8/K9/L0/L1 SIXteen	08-11	R
UX 150 K8/K9/L0/L1 SIXteen	08-11	R

**Equivalents OE #**

5GH W0046 00	705 600 349
5GH W0046 10	69100 03890
705 600 014	69101 03810
ID9 W0046 00	1P1 W0046 00
705 600 398	

**Competitor X Ref**

Dunlop	Ferodo	SBS	Vesrah
DP327	FDB2148	754	VD266

**MATERIAL AVAILABILITY AND PART NO.**

STD	OPTIONS				
FA	HH	R	MXS	EPFA	
FA307TT	-	FA307R	-	-	
SFA307	SFA307HH				

# FA313R 123.5 x 55 x 9.25mm

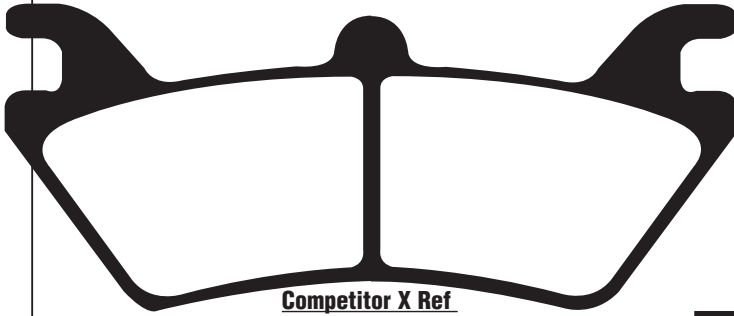

**Competitor X Ref**

Dunlop	Ferodo	SBS	Vesrah
-	FDB2177	757	-

## POLARIS

Sportsman 6x6	00-03	R
500 Sportsman 6x6	00-08	R
PTV (6x6)	03	R
PPS/PTV 6x6/Series 10		R
PPS LUH 6x6	02	R

## Equivalents OE #

2201685
2201749
1910450V

## MATERIAL AVAILABILITY AND PART NO.

STD	OPTIONS			
FA	HH	R	MXS	EPFA
-	-	FA313R	-	-

# FA314R 90.3 x 41.05 x 8.2mm

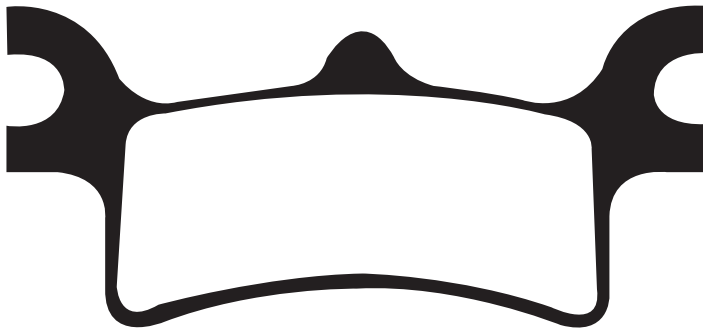

## Equivalents OE #

2201871
2202414
1910683

## Competitor X Ref

Dunlop	Ferodo	SBS	Vesrah
DP932	FDB2176	787	-

## MATERIAL AVAILABILITY AND PART NO.

STD	OPTIONS			
FA	HH	R	MXS	EPFA
-	-	FA314R	-	-

## POLARIS

250 Trail Blazer	05-06	R
Magnum 325/500	02-03	R
325 Magnum (2x4) HDS	02	R
325 Magnum 4x4 (A02CD32AA/AB/AC)	02	R
325 Magnum 4X4 GDS (A02CD32FB)	02	R
Xpedition 325	02	R
Magnum 330 (2x4/HDS)	03-06	R
Magnum 330 (4x4/HDS)	03-04	R
330 Trial Boss	05-11	R
330 Trial Blazer	08-11	R
Sportsman 400	03	R
400 Sportsman 400	03-05	R
400 Sportsman	03-04	R
450 Sportsman	06-07	R
ATV Pro 500 4x4 TPS	02	R
500 ATV Pro 4x4 PPS	02	R
Magnum 500 HDS	02-03	R
Magnum 500 (2x4/4x4 HDS)	02	R
500 Scrambler 4x4	05-11	R
500 Scrambler 2x4	07-08	R
500 Sportsman HO/EFI	03-06	R
500 Sportsman HO (Up to 15/12/2008)	08	R
500 Sportsman EFI/HO	07-08	R
500 Sportsman EFI Quad	08-11	R
500 Sportsman X2	06-08	R
500 Sportsman Forest	12	R
Sportsman 500 HP	03-04	R
Sportsman 600 4x4	03-05	R
Sportsman 700 (4x4)	02-04	R
700 Sportsman (4x4)/EFI	02-06	R
700 Sportsman EFI	07	R
Sportsman MV 700	05-06	R
Sportsman 800	05	R
800 Sportsman EFI	05-07	R
800 Sportsman EFI Intl/HO	07-11	R
800 Sportsman Big Boss/6x6/EDi	09-12	R
800 Sportsman HO/EFI (Up to 15/12/2008)	08	R
PPS/PTV 4x4/Series 10		R

# FA317 A 82.08 x 40.85 x 9.46mm B 62.03 x 40.80 x 9.46mm

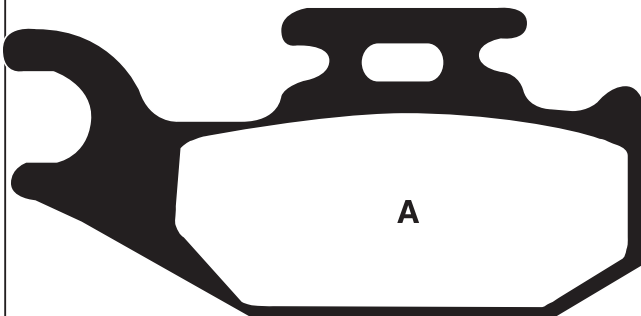

A

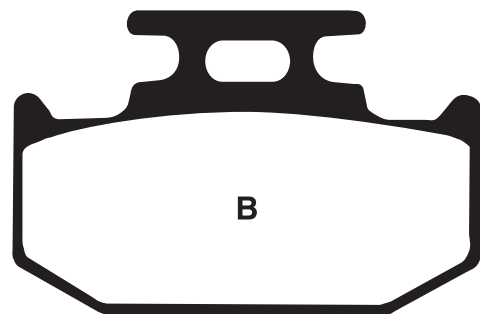

B

## Equivalents OE #

705 600 004	5UG W0045 00
69100 03840	705 600 350
705 600 150	1S3 W0046 00

## Competitor X Ref

Dunlop	Ferodo	SBS	Vesrah
DP920	FDB2149	767	-

## MATERIAL AVAILABILITY AND PART NO.

STD	OPTIONS			
FA	HH	R	MXS	EPFA
FA317TT	-	FA317R	-	-

## SUZUKI

LT-A 500 FK2 Vision 4WD 02 R

## BOMBARDIER

Most models (see application pages) 01-06 F(right)&R

## CAN-AM

Most models (see application pages) 07-13 F(right)&R

## CANNONDALE

All quads (check main application pages for fitments) 01-04 F(Right)

## JOHN DEERE ATV

Most models (see application pages) 01-05 F(right)&R



# SFA319 99.95 x 36.25 x 11.95mm

# FA319/2 99.95 x 36.25 x 9.5mm

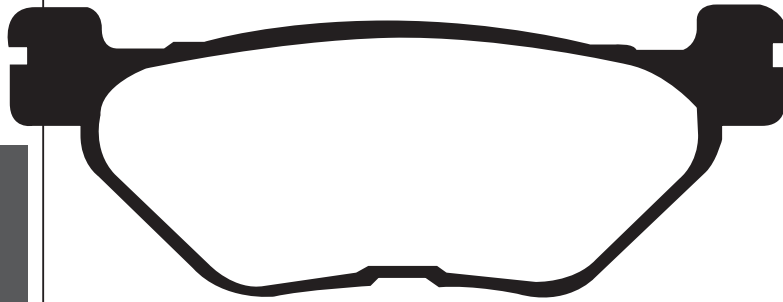

### SFA319 - YAMAHA

XP 500 N/P/R T-Max	01-03	R
T-Max 530	12	R
XP 530 Black Max (59CE)	13	R

### SYM

Voyager 250	05	R
-------------	----	---

### FA319/2 - YAMAHA

TDM 900 (5PS/Non ABS)	02-13	R
TDM 900 (2B0/ABS)	05-13	R
XVS 950 A Midnight Star	09-13	R
XT 1200 Z Super Tenere ABS		
/JBS Brake system	11-13	R
FJR 1300 A (ABS) (5VS-)	03-05	R
FJR 1300 A (ABS) (3P6-Model)	06-09	R
FJR 1300 A (ABS) (1CY-)	10-12	R
FJR 1300 A (1MC)		
(ABS/Manual G/shift)	13	R
FJR 1300 AS (ABS/Electric Shift) (2D2-)	06-09	R
FJR 1300 AS (ABS/Electric Shift)	13	R
FJR 1300 (Non ABS) (5JW)	01-04	R
XVS 1300 A Midnight Star	07-13	R
XV 1700 PCR	03-05	R
XV 1700 (2S3) V-Max	09-11	R
XV 1900 A Midnight Star	06-12	R
XVS 1900 A (Midnight Star)		
3 spring clutch	13	R

### Equivalents OE #SFA319

5GJ W0045 00

### Competitor X Ref FA319

Dunlop	Ferodo	SBS	Vesrah
DP423	FB2126	768/169	VD269

### MATERIAL AVAILABILITY AND PART NO.

STD	OPTIONS				
SFA	SFAC	SFA-HH	R	MXS	EPFA
SFA319	SFAC319	SFA319HH	-	-	-

### Equivalents OE #FA319/2

5JW W0046 00	3P6 W0046 50
5PS W0046 00	1D7 W0046 00

### Competitor X Ref FA319/2

Dunlop	Ferodo	SBS	Vesrah
DP423	FB2156	769	VD269/2

### MATERIAL AVAILABILITY AND PART NO.

STD	OPTIONS				
FA	V	HH	R	MXS	EPFA
FA319/2	FA319/2V	FA319/2HH	-	-	-

# FA320HH 69.75 x 42.6 x 7.45mm

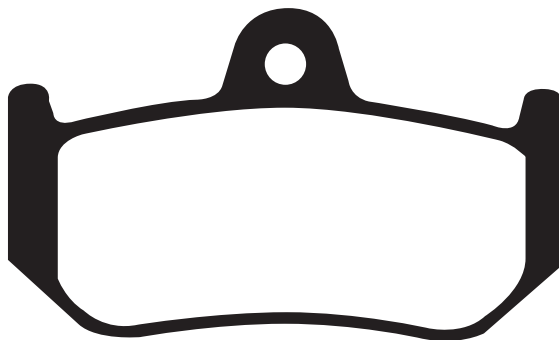

### FA320 - MV

750 Brutale S F4	03-05	R
750 Brutale Oro F4	03-05	R
750 F4S (Mono Posto)	99-04	R
750 F4S 1+1 (Bi-Posto)	01-04	R
750 F4 SPR	01-04	R
750 F4 SPR Senna	01-03	R
910 Brutale S (Nissin Calipers)	06-08	R
910 Brutale R (Brembo calipers/4 pads)	06-08	R
920 Brutale	11-12	R
990 Brutale R	10-11	R
998 Freccie Tricolori	10	R
998 F4RR	10-11	R
998 F4 RR Corsa Corta	12	R
998 F4R	12	R
F4 998cc	10-13	R
1000 F4 Ago	05	R
1000 F4 S (Mono Posto)	04-06	R
1000 F4 S 1+1 (Bi-Posto)	04-06	R
1000 F4 Tamburini	05	R
1000 F4 R	06-07	R
1000 F4 R 312 (Brembo 4 pad caliper up to VIN 008064)	07	R
1000 F4 R 312 (From VIN 008065 Brembo 2 pad caliper)	08-09	R
1000 F4 R 312 1+1	07-08	R
1078 F4 RR 312	09	R
1078 Brutale RR	08-09	R
1078 F4100cc Claudio Castiglioni	07-08	R
1090 Brutale RR	10-12	R
1090 Brutale R	12	R

### Equivalents OE #

8000 82748

### Competitor X Ref

Dunlop	Ferodo	SBS	Vesrah
DP958	FDB2198	763	-

### MATERIAL AVAILABILITY AND PART NO.

STD	OPTIONS			
FA	HH	R	MXS	EPFA
-	FA320HH	-	-	-

# SFA321 55.5 x 49 x 7.5mm

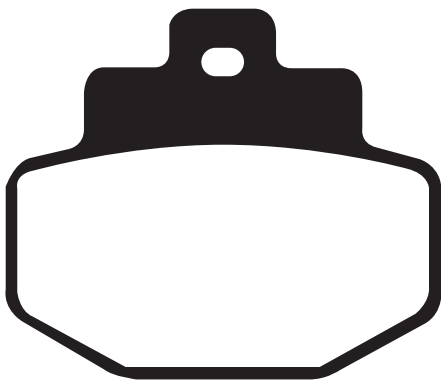

### Equivalents OE #

497002	R44440181A0
497348	647161

### Competitor X Ref

Dunlop	Ferodo	SBS	Vesrah
DP327	-	772/166	-

### BENELLI

Adiva 125/150 01-04 R

### GILERA

**Also see SFA459 if pad is a different shape to SFA321.**

125 VX 4T/180/VXR 200 4T 01-05 R

DNA 125/180 01-03 R

VX 125 Runner/ST (4T) 05-11 R

VXR/VX 200 Runner/ST (4T) 02-11 R

### PIAGGIO

New Fly 125ie (3V) 12-13 R

Super Hexagon GTX 125/180 12" wheels 01-03 R

Super Hexagon GTX 250 00-02 R

### VESPA

GT 125 L Granturismo 03-06 R

GTS 125 07-11 R

GTS 125 Super 10-13 R

GTS 125 Supersport 13 R

GTV 125 07-08 R

946 Special (4T/3V) (125cc) 13 R

GT 200 L Granturismo 03-06 R

GTS 250 ie/ABS 05-10 R

GTS 250 ie/ABS 05-11 R

GT 60 (Special Anniversary Model) (GTV 250) 06 R

GTV 250 ie 07-08 R

GTS 300 ie 08-13 R

GTS 300 ie Touring 11-13 R

GTS 300 Supersport 10-13 R

GTS 300 11-13 R

GTS 300 Super 10-13 R

### MATERIAL AVAILABILITY AND PART NO.

STD	OPTIONS				
SFA	SFAC	SFA-HH	R	MXS	EPFA
SFA321	SFAC321	SFA321HH	-	-	-

# FA322/4HH 35 x 40.53mm x 7.4mm



**NOTE:- Pads are sold as 4pcs - i.e. one caliper set 3.0mm backplate**

**NOTE:- Do not use for BMW S 1000 RR 10-11 F For this application, FA604/4HH must be used.**

### APRILIA

RSV 1000 Mille 01-02 F

RSV 1000 R Mille 01-02 F

RSV 1000 Mille (Radial caliper) 03 F

RSV 1000 R Mille (Radial caliper) 03 F

RSV 1000 R Racing/Factory (Radial caliper/4 Pad) 04-08 F

RSV 1000 R Factory 04-08 F

RSV 1000 R 04-08 F

Tuono R Factory 1000 Radial caliper /4 pad type 06-10 F

Tuono R 1000 Radial caliper/4 pad type 02-05 F

**BENELLI**

BX 570 Motard 08-10 F

BN 600 (4 Cyl) 13 F

Cafe 899 Racer 10-12 F

Century Racer 899 11-12 F

Century 1130 Racer 11-12 F

TNT 1130 Sport/Sport Evo 04-09 F

TNT 1130 Cafe Racer 06-12 F

TNT 1130 Titanium 06-08 F

Tornado LE/Tornado TRE Novecento/RS 03-05 F

Tornado Tre 1130 06-10 F

Tornado Naked Tre R160 1130cc 09-12 F

**BIMOTA**

Elirio 06 F

DB5 (All models) 06-07 F

DB5R 06-13 F

DB5R/S (1078cc) 08-09 F

DB5 Desiderio (1078cc) 12-13 F

DB6 Delirio (992cc Ducati engine) 07 F

DB6 (1078cc) 08-09 F

DB6/R (1078cc) 08-09 F

DB6 (1100cc) 08 F

DB6R Delirio (1100cc) 08 F

DB6 Delirio (1078cc) 12-13 F

DB7 (1098cc) 08 F

DB9 Brivido (1198cc) 12-13 F

DB10 Motard (1078cc) 12-13 F

DB12 B Tourist (1198cc) 12-13 F

SB8K Santamonica (996cc Suzuki engine) F

Tesi-3D (1078cc) 09-13 F

**BREMBO**

20 7850 11/21 - 4 Piston P4/34 @ 65mm Spacing (Wire clip pad retention only)

20 8343 11/21 or 35/45 - 4 piston P4/34 @ 100mm Spacing (wire clip pad retention only)

XA 32950 P4/34 Motard Avial Mount 65mm 4 pad set

**CAGIVA**

Mito 500 (4T) 08 F

Raptor X3 1000 03-04 F

**DERBI**

Mulhacen 659 06-08 F

**DUCATI**

748 R (4 pad caliper) 01 F

748 R (4 pad caliper) 02 F

749 Dark (Monoposto/Biposto) 04-06 F

749 R (Radial caliper) 04-06 F

749 S (Monoposto/Biposto) 03-06 F

749 (Monoposto/Biposto) 03-06 F

S4 RS Monster (998cc) (Radial 4 pad caliper) 06 F

S4R Monster Testastretta (998cc) (Radial 4 pad caliper) 07-08 F

S4RS Monster Testastretta (998cc) (Radial 4 pad caliper) 07 F

S4RS (Tricolore/Monster Testastretta) (998cc) Radial 4 pad caliper 08 F

996 R 01 F

# FA322/4HH Contd.

998 R (998cc)	02	F
998 S Baylis/Bostrom	02	F
998 S (998cc) (4 pad caliper)	02-04	F
999 S (Std Caliper Mount Monoposto/Biposto)	03-04	F
999 (Std mountcaliper)	03-06	F
999 R (Radial mount caliper)	03-06	F
999 R Fila (Radial mount caliper)	03	F
999 S (Radial caliper monoposto/biposto)	05-06	F
999 R Xerox	06	F
<b>GENERIC</b>		
GRS 600	13	F
<b>HUSQVARNA</b>		
SMR 449	11	F
SMR 450 RR Radial caliper	06-07	F
SM 450 R Radial caliper	07-10	F
SM 450 RR	08-10	F
SM 510 R (Radial caliper)	06-10	F
SMR 511	11-13	F
SM 530 RR	08-10	F
SM 610 S (Radial caliper)	06	F
SM 610 ie	07-09	F
SMR 630 (4T)	10-12	F
STR 650 CRC	07	F
<b>KTM</b>		
690 Duke	08-11	F
690 Duke R	10-11	F
690 SM Prestige	07	F
690 SMR (4 pad type caliper/cast wheel)	07-11	F
690 SMC (4 pad type caliper/spoke wheel)	08-11	F
690 SMC R	12-13	F
SM 950 Supermoto	05-06	F
990 Superduke	05-11	F
990 Superduke R	07-13	F
990 Supermoto T (SM-T)	09-13	F
990 Supermoto R (SM-R)	08-09	F
<b>LAVERDA</b>		
SFC 1000	03-04	F
<b>MONDIAL</b>		
Piega 1000	03-04	F
EVO	04	F
<b>MOTO GUZZI</b>		
Griso	04	F
1000 MGS-01 Corsa	04-07	F
Fionda 1100	05	F
<b>MOTO MORINI</b>		
Rebello 1200 Giubileo	12-13	F

<b>M.V. AGUSTA</b>		
Brutale 910 R	05-08	F
910 Brutale R (Brembo calipers/4 pads)	06-08	F
F4R 1000	06-07	F
1000 F4R	06-07	F
1000 F4R 312 (Brembo 4 pad caliper		
Up to VIN 008064)	07	F
1000 F4 R 312 1+1	07-08	F
F4RR 312R 1000	07	F
<b>NORTON</b>		
Commando Cafe Racer (961cc)	10-13	F
Commando SE (961cc)	10-11	F
Commando 961 SF	13	F
<b>PETRONAS</b>		
FP1	05	F
<b>SHERCO</b>		
SM 4.5iF Supermoto	04-07	F
SM 4.5iF Black Panther Supermotard	08-10	F
SM 5.1iF Black Panther	08-10	F
<b>TM</b>		
SMM 125 (2T) Black Dream ES	08-10	F
SMM 250 F (4T)	10-13	F
SMR 250 F (4T)	10-13	F
SMX 250 F	12-13	F
SMM 450 F Black Dream ES	08-11	F
SMM 450 F	11-13	F
SMR 450 F (4T)	10-13	F
SMX 450 F	05-13	F
SMM 530 F Black Dream ES	08-11	F
SMR 530 F (4T)	10-13	F
SMX 530 F	05-13	F
SMX 660 F	05-10	F
<b>TRIUMPH</b>		
Speedtriple (1050cc) (Radial Brembo caliper)	08-13	F
<b>VOXAN</b>		
Charade Racing	06	F
GTV 1200	08	F

### Equivalents OE #

613 403 01A	69177	1679
613 40391 A	862486	AP8133592
8223972	862697	107 A48647
R 180 100 12600	8000A7417	07BB0510
610 13 030 000	8000A6416	07BB05RC
8000A2040	610 13 030 100	M478Z04

### Competitor X Ref

Dunlop	Ferodo	SBS	Vesrah
DP638	FDB2120	762	VD986

MATERIAL AVAILABILITY AND PART NO.				
STD	OPTIONS			
FA	HH	R	MXS	EPFA
-	FA322/4HH	-	-	EPFA322/4HH

**FA323TT** 81 x 42 x 9mm

**SFA323** 81 x 42 x 9mm

**SFA323/2** 81 x 42 x 6.9mm

**SFA323/3** 81 x 42 x 8.2mm

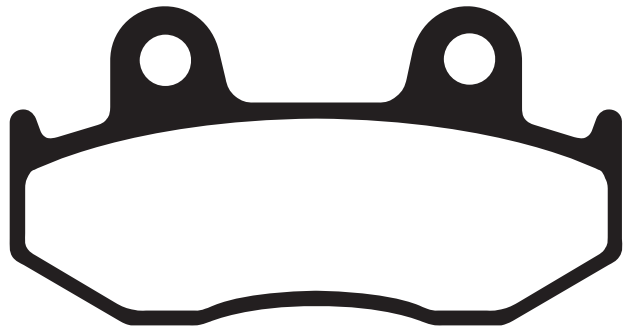

**FA323TT**

**YAMAHA**

YFZ 450 V/W/X	06-08	R
YFZ 450 RY/RZ (Quad)	09-10	R
YFM 700 RD Raptor	13	R

**WK**

Triá 125	11-13	F
----------	-------	---

**SFA323**

**HONDA**

SCV 110 Lead (NHX 110 WH8 - 3 bolt disc fixing)	08-09	F
NES 125 Y/1/2/3/4/5/6 (@ 125 Scooter)	00-06	F
PES 125 6/7/8/9/A (PS 125)	06-10	F
PES 125 R8/R9/RA (PS 125) ABS	08-12	F
SH 125 i 4/5/6/7/8/R8/S7/S8/D9 Fuel Injection	04-09	F
SH 125 1/3 Carb/Rear drum model	01-03	F
NES 150 Y/1/2/3/4/5/6 "@150 Scooter"	01-06	F
SH 150 1/3 Carb/Rear drum model	01-03	F
SH 150i 4/5/6/7/8/S7/S8/R8/D9 Fuel Injection	04-09	F
PES 150 6/7/8/9 (PS 150)/A	06-10	F
PES 150 R8/R9/RA ABS	08-12	F
SES 125/150 2/3/4 Dylan	02-07	F

**ITALJET**

Torpedo 125/150	07-09	F
Jack 125/150	07	F&R

**MZ**

Mantizz 125 S	05-07	F
---------------	-------	---

**SFA323/2**

**HONDA**

CH 250 F/G "Spacy"	85-86	F
--------------------	-------	---

**SFA323/3**

**SUZUKI**

AN 250 W/X/Y 'Burgman'	98-00	R
AN 400 X/Y 'Burgman'	99-00	R

**KAWASAKI**

SC 250 A1 (Epsilon 250)	02-03	R
-------------------------	-------	---

**Competitor X Ref FA323**

Dunlop	Ferodo	SBS	Vesrah
-	FDB2119	125	-

**Competitor X Ref FA323/2**

Dunlop	Ferodo	SBS	Vesrah
-	FDB2119	104	-

**Competitor X Ref FA323/3**

Dunlop	Ferodo	SBS	Vesrah
-	FDB2119	781	-

**Equivalents OE # - SFA323/FA323**

06455 GCS 006	06455 GCS 016
5TG W0046 10	06455 GCC B52
06455 GCS 026	

MATERIAL AVAILABILITY AND PART NO.						
STD	OPTIONS					
FA	SFA	SFAC	SFA-HH	R	MXS	EPFA
FA323TT	SFA323	SFAC323	SFA323HH	FA323R		

**Equivalents OE #- SFA323/2**

45105 KM1 004	45105 KM1 712
45105 KM1 007	45105 KM1 710
45105 KM1 711	

MATERIAL AVAILABILITY AND PART NO.				
STD	OPTIONS			
FA	HH	R	MXS	EPFA
SFA323/2	SFA323/2HH	-	-	-

**Equivalents OE #- SFA323/3**

69100 14840
69100 14860
43082 S003

MATERIAL AVAILABILITY AND PART NO.				
STD	OPTIONS			
FA	HH	R	MXS	EPFA
SFA323/3	SFA323/3HH	-	-	-

# SFA324 117.5 x 41.3 x 8.6mm

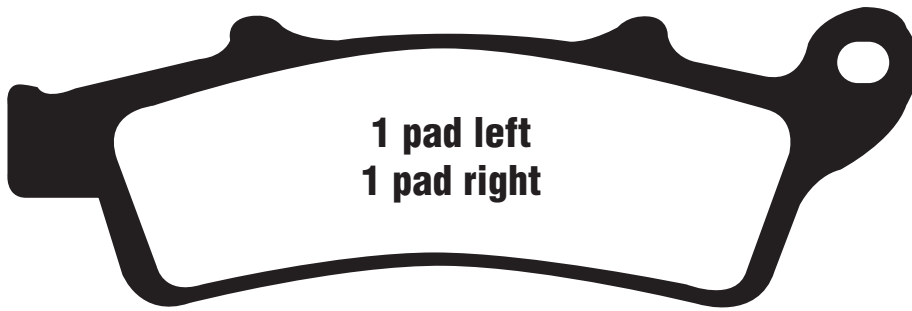

## APRILIA

Atlantic 125	03-08	F
Atlantic 125	10	F
Scarabeo 125/150/250 GT	04-06	F
Scarabeo 125/200	07-09	F
Atlantic 200	03-05	F
Atlantic 250	03-05	F
Atlantic 250 ie	06-08	F
Scarabeo 250 ie	07-10	F
Atlantic 300	10-11	F
Atlantic Sprint 400	05-08	F
Atlantic Sprint 500	05-08	F

## KYMCO

K-XCT 125	12-13	F
People GTi 125	10-11	F
People GTi 200	10-11	F
K-XCT 300 i	12-13	F
People GTi 300	10-11	F

## MALAGUTI

Madison S 250	99-03	F
Madison K 400	02-06	F

## PEUGEOT

LOOXOR 125/150	03-06	F
----------------	-------	---

## PIAGGIO

Beverly 300 Sport Touring (330cc/4T) (5 spoke cast wheel)	11-13	F
--	-------	---

## SCARABEO

125 ie	10-13	F
125 Net	10-11	F
200 ie	10-13	F
200 Net	10-11	F
300 S ie	09-12	F

### Equivalents OE #

119 481 00	8213648
81133603	45105 LGE5 305
8133761	666935
8133815	

### Competitor X Ref

Dunlop	Ferodo	SBS	Vesrah
-	FDB2105	761/159	VD9017

### MATERIAL AVAILABILITY AND PART NO.

STD	OPTIONS				
SFA	SFAC	SFA-HH	R	MXS	EPFA
SFA324	SFAC324	SFA324HH	-	-	-

# FA325TT 43.45 x 25.2 x 5mm



### Equivalents OE #

451 13 030 000
8000H4667

### Competitor X Ref

Dunlop	Ferodo	SBS	Vesrah
DP923	FDB2183	794	-

## HUSQVARNA

CR 50 Senior Pro	05	R
CR 50	11-13	F&R
SM 50	11-13	F&R

## LEM

R2/R3 (Hydraulic System)	03-05	F&R
RX 65		F&R
RX 2/3		F&R
CX 2/3		F&R

## KTM

CR 50 Senior Pro	05	R
50 SX Pro Senior LC	02-03	F
50 SX Senior Adventure	02-07	F
50 SX Pro Senior LC (12" F/wheel)	04-12	F&R
50 Supermoto	06	F&R
65 SX	04-08	R

## POLINI

X1R/X3R H20 50cc		F&R
------------------	--	-----

## TOMOS

MC 50 Senior	05	F&R
--------------	----	-----

### MATERIAL AVAILABILITY AND PART NO.

STD	OPTIONS			
FA	HH	R	MXS	EPFA
FA325TT	-	FA325R	-	-

# FA335HH 77.25 x 51.45 x 8.55mm

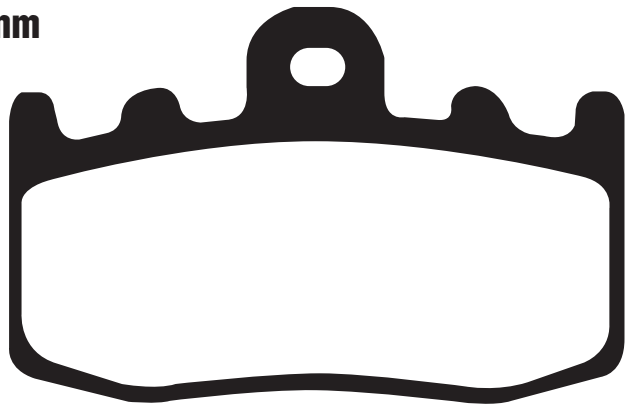

## BMW

R 850 RT	06	F	R 1200 GS (30 years GS)	11	F
R 1100 S (Non ABS)	12/00-03	F	R 1200 RT K26/0368		
R 1150 GS (EVO - R21/0415/0495)	11/01-03	F	Brembo caliper	05-09	F
R 1150 GS Adventure	07/01-06	F	R 1200 RT	10-13	F
R 1150 RT (Integral ABS)	00-06	F	R 1200 RT-SE	10-13	F
K 1200 RS/R/S	01-05	F	R 1200 ST K28/0328	03-08	F
K 1200 GT (K41)	03-06	F	R 1200 S K29/0366 Brembo caliper	06-08	F
K 1200 GT (K44)	06-08	F(left)	R 1200 GS Rallye (Spoke wheels)	12	F
K 1200 S (K40)	05-08	F	R 1200 GS Adventure Triple Black	12	F
R 1200 GS (K25/0307/			HP2 Megamoto	07-09	F
Cast/Spoke wheel)	02-11/07	F	HP2 Megamoto (K25)	07-10	F
R 1200 GS Adventure			K 1300 GT	09-11	F
(K25/0382/Spoke wheel)	05-11/07	F	K 1300 GT EE	10-11	F
R 1200 GS/Adventure			K 1300 GT SE	10-11	F
(Spoke wheels)	10-12	F	K 1300 S (Non & ABS Models)	09-13	F
R 1200 GS Adventure/M			K 1300 S Sport	12-13	F
(K25/0380/Spoke wheel)	06-09	F	K 1300 S HP	12	F
R 1200 GS/M (K25/0303/Cast wheel)	06-09	F			
R 1200 GS (Cast wheels)	10-12	F			
R 1200 GS Adventure (30 years GS)	11	F			
R 1200 GS Triple Black (Spoke wheels)	11-13	F			

### Equivalents OE #

34 11 7 660 448	34 11 7 683 064
34 11 7 671 780	

### Competitor X Ref

Dunlop	Ferodo	SBS	Vesrah
DP641	FDB2125	796	-

MATERIAL AVAILABILITY AND PART NO.				
STD	OPTIONS			
FA	HH	R	MXS	EPFA
-	FA335HH	-	-	EPFA335HH



# SFA336 77.85 x 46.5 x 7.05mm

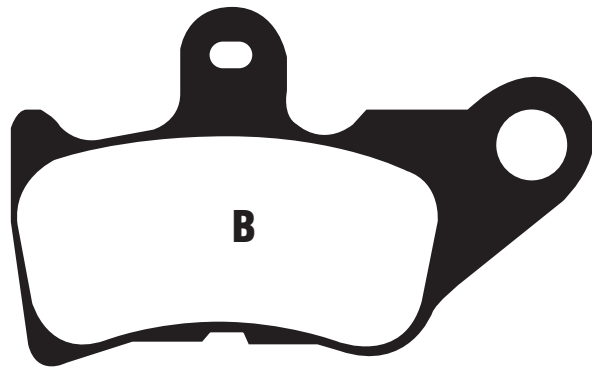
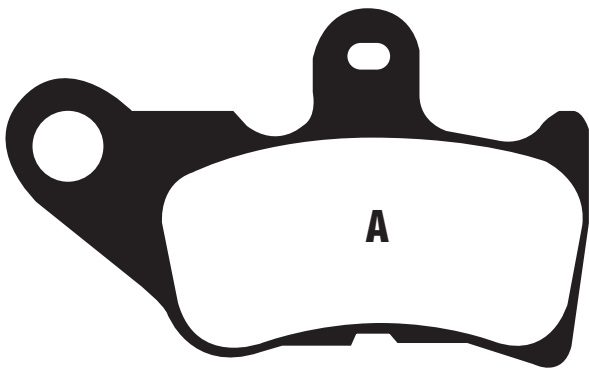

## YAMAHA

CV 50 ZR (5PT1) Evolution	01-02	F
CV 50 (5KN1/2) Jog-Cool Style	00-02	F
MIO (113cc)	05-07	F
MIO Sporty (113cc)	05-07	F
Nuovo-Z (113cc)	06-07	F

### Equivalents OE #

5KN W0045 00

### Competitor X Ref

Dunlop	Ferodo	SBS	Vesrah
-	764	764/165	VD267

### MATERIAL AVAILABILITY AND PART NO.

STD	OPTIONS			
	HH	R	MXS	EPFA
FA SFA336	-	-	-	-

# FA337 35.2 x 51.5 x 6mm

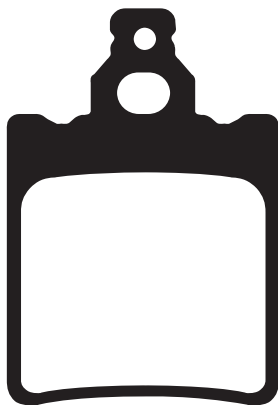

## APRILIA

Pegaso 50	92-94	R
280 R Climber	92-93	R

## BETA

R150 (Minicross/4T/49cc)	10-13	R
M4 350 Supermotard	04-06	R

## JCM

240 Europa	89-	R
------------	-----	---

## KTM

60 SX	00	R
65 SX	00-03	R

### Equivalents OE #

460 13 090 000

### Competitor X Ref

Dunlop	Ferodo	SBS	Vesrah
-	-	-	-

### MATERIAL AVAILABILITY AND PART NO.

STD	OPTIONS			
	HH	R	MXS	EPFA
FA FA337TT	-	FA337R	-	-

# FA342R A. 26.1 x 119.55 x 7.1mm B. 35.6 x 94.54 x 7.8mm

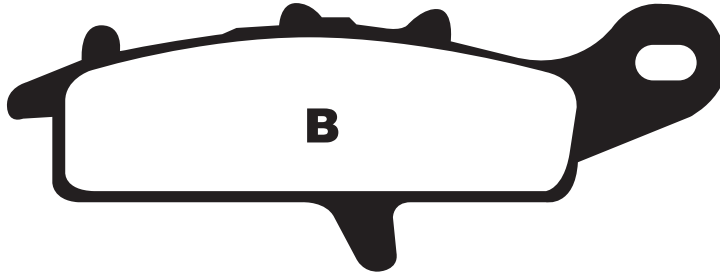
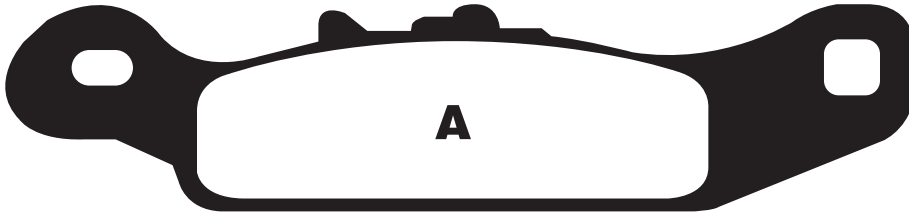

**Equivalents OE #**

43082 1255

**KAWASAKI**

KFX 450 R Quad(KSF 450 B8F/B9F/BAF/BBF)	08-11	F(Left)
KVF 650 A1/A2 Prairie	02-03	F(Left)
KVF 650 D1/D6F/D7F/D8F/D9F/DAF/DBF Brute Force 4x4	05-11	F(Left)
KVF 650 E1/E6F/E7F/E8F/E9F Brute Force 4x4 Hardwoods Green HD	05-09	F(Left)
KVF 700 A1/B1/A2/A6F/B2/B6F/A7F/A8F 4x4 (Prairie)	04-08	F(Left)
KVF 700 D1 Team Green	05	F(Left)

**SUZUKI**

LT-V 700 FK4/FK5 Twin Peaks	04-05	F(Left)
-----------------------------	-------	---------

**Competitor X Ref**

Dunlop	Ferodo	SBS	Vesrah
DP929	FDB2188	801	VD441

**MATERIAL AVAILABILITY AND PART NO.**

STD	OPTIONS			
FA	HH	R	MXS	EPFA
-	-	FA342R	-	-

# FA343 A. 107 x 41 x 10mm B. 91.6 x 40.6 x 10mm

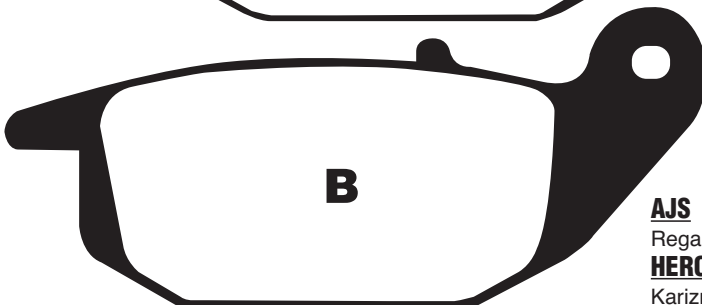
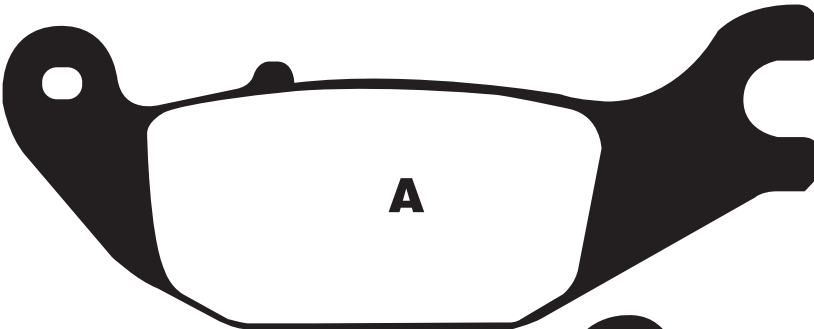

**Equivalents OE #**

06435 KPC 641  
06435 KPP 901  
06435 KPP 902

**AJS**

Regal Raptor CR3-125	06	R
----------------------	----	---

**HERO**

Karizma ZMR 230	11-12	R
-----------------	-------	---

**HONDA**

CBR 125 R4/R5/RS5/RS6	04-06	R
CBR 125 RW5/RW6/RW7/RW8/RW9/RWA	05-10	R
XL 125 V1/V2/V3/V4/V5/V6/V7/V8/V9/VA Varadero	01-11	R
CBR 150 R	00-03	R

**Competitor X Ref**

Dunlop	Ferodo	SBS	Vesrah
DP129	FDB2143	784	-

**MATERIAL AVAILABILITY AND PART NO.**

STD	OPTIONS			
FA	HH	R	MXS	EPFA
FA343	-	-	-	-

# FA344 65.5 x 44.75 x 11.65mm

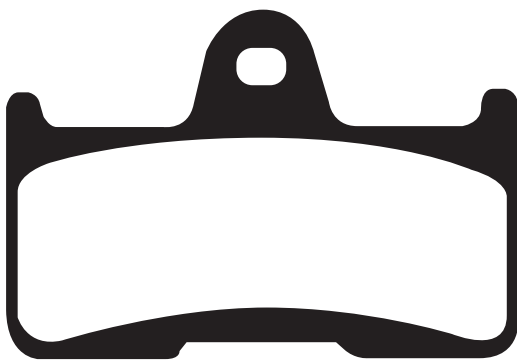

### Equivalents OE #

5KM W0046 00
901 08 05 01
901 08 05 10

### YAMAHA

YFM 660 FWAP/FWAR/FWAS/FWAT /FWAW/FGW/FGX Grizzly	02-08	R
YFM 660 FR/FS/FT Grizzly	03-05	R
LX 700-4A Quad	08-09	R

### CCM

LX 700-4A Quad	08-09	R
----------------	-------	---

### C F MOTO

CF 500-2 Terralander 500	13	R
CF 500-3 (Rancher 500 Side x Side)	10-11	R
CF 625-B/C X6 Terralander	11-13	R
CF 800-2 Terralander	12-13	R

### EXPLORER

Atlas 500/4x4	08-09	R
Everest 500 L/4x4	08-09	R

### GOES

G 520 F (Quad)	07-13	R
520 Max (Quad)	07-12	R
G 520 UTX (Side x Side)	10-12	R
G 525 (4x4)	12-13	R
G 525 4x4 Max	12-13	R
G 625i (All models)	12	R
G 625i (4x4)	12-13	R
G 625i 4x4 Max	12-13	R

G 625i UTX 4x4 (Side x Side)	12-13	R
G E-SSV Electric (Side x Side)	12-13	R

### QUADZILLA

CUV 500 Side x Side	10-11	R
QZ 500 E/ES 4x4	09-11	R
RL 500 MKII Buggy	10-11	R
RS5 4WD	10-11	R
RS6 EFI 4WD	10-11	R
X8 (4x4/EFi)	12-13	R
Z6 4x4	10-13	R

### WT MOTORS

WT 500 Alaska Quad	08-09	R
--------------------	-------	---

### Competitor X Ref

Dunlop	Ferodo	SBS	Vesrah
DP930	FDB2193	799	VD270

### MATERIAL AVAILABILITY AND PART NO.

STD	OPTIONS			
FA	HH	R	MXS	EPFA
FA344TT	-	FA344R	-	-

# FA345HH 91.7 x 49.3 x 8.1mm

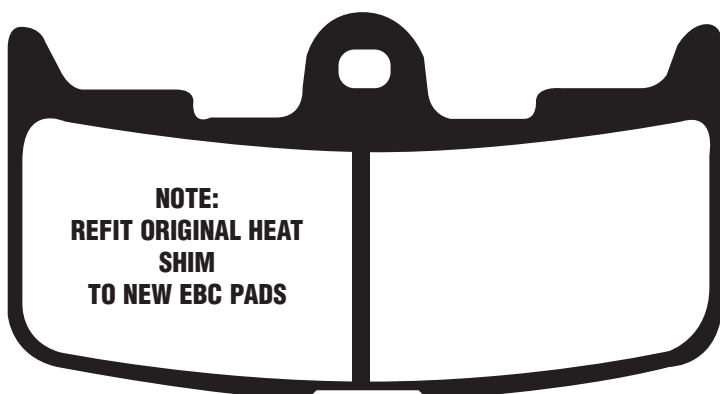

**NOTE:  
REFIT ORIGINAL HEAT  
SHIM  
TO NEW EBC PADS**

### BUELL

Firebolt XB9R	02-07	F
XB9S Lightning	03-04	F
XB9SX Lightning City X	05-09	F
XB9 SX Lightning	08-10	F
XB 12 S Lightning	04-08	F
XB 12 R Firebolt	04-08	F
XB 12 SS Lightning Long	06-08	F
XB 12 SCG Lightning	06-08	F
XB 12 X Ulysses	06-10	F
XB 12 XT Ulysses	08-10	F
XB12 STT Lightning	08	F

### Equivalents OE #

H0300-02A8

### Competitor X Ref

Dunlop	Ferodo	SBS	Vesrah
DP926	FDB2145	795	-

### MATERIAL AVAILABILITY AND PART NO.

STD	OPTIONS			
FA	HH	R	MXS	EPFA
-	FA345HH	-	-	EPFA345HH

# FA346 60 x 44.8 x 11mm



## ALFER

EVX 400 Electric 12-13 R

## FANTIC

TR 125 CR (2T) Cross Competizione 13 R  
 TR 125 MR (2T) Motard Competizione 13 R  
 TZ 125 CS Caballero Cross (2T) 11-12 R  
 TZ 125 ES Regularita Scuderia (2T) 11-12 R  
 TZ 125 SM Caballero Motard (2T) 11-13 R  
 TZ 170 E Regularita Casa (125E/4T) 11-13 R  
 TZ 170 ER Caballero Regularita 11-13 R  
 TZ 170 SM Motard Casa (125SM/4T) 11-12 R  
 Competizione (125ER/4T) 11-13 R  
 TZ 170 MR Motard (125 MR 4T) 11-13 R  
 TX 180 E Regularita Casa 50E (49cc/2T) 11-13 R  
 TX 180 ER Regularita Competizione (49cc/2T) 50ER 11-13 R  
 TX 180 ES Regularita Scuderia (49cc/2T) 50ES 11-13 R  
 TX 180 SM Motard Casa (49cc/2T) 11-13 R  
 TZ 180 MR Motard Competizione (49cc/2T) 50MR 11-13 R  
 TZ 200 ER Caballero Regularita Competizione (200ER/4T) 11-13 R  
 TZ 200 SMR Motard (200 SMR 4T) 11-12 R  
 TZ 250 ES Regularita (2T) 11-12 R  
 TF 250 ES Regularita (4T) 11-13 R  
 TR 250 ES (2T) Enduro Six Days 13 R  
 TR 300 ES (2T) Enduro Six Days 13 R  
 TZ 300 ES Regularita Scuderia 11-12 R

## HONDA

CR 125 R2/R3/R4/R5/R6/R7 02-07 R  
 CRF 150 RB7/R7/RB8/R8/RB9/R9/RC/RBC/RD/RBD 07-13 R  
 CR 250 R2/R3/R4/R5/R6/R7 02-07 R  
 CRF 250 R4/R5/R6/R7/R8/R9/RA/RB/RC/RD 04-13 R  
 CRF 250 X4/X5/X6/X7/X8/X9/XB/XC/XD 04-13 R  
 CRF 250 XRLD 13 R  
 CRF 450 R2-R9/RA/RB/RC/RD 02-13 R  
 CRF 450 X5/X6/X7/X8/X9/XB/XC/XD 05-13 R  
 CRF 450 XRLD 13 R

## HONDA-DALL'ARA

XR 250 SM 04 R  
 XR 400/440 R 04 R  
 XR 400/440 SM 04 R

## HONDA-HM (ITALY)

CR 50 Derapage RR  
 From ZEN50XACMA7700385 07-09 R  
 CRE 50 Baja RR  
 From ZEN0XACEA7700325 07-09 R  
 CRE 50 Six Competition 07-08 R  
 CRE 50 Six Competition 10-12 R  
 CRM 50 Derapage Competition 07-08 R  
 CRM 50 Derapage Competition 09 R  
 CRE 125 R Supermotard 02-03 R  
 CRE 125 R Enduro 04-06 R

CR 125 Motard 04 R  
 CRE 125 R Enduro 02-03 R  
 CRE 125 (Six Competitin 2T) 11 R  
 CRE 125 (Baja RR 2T) 11 R  
 CREF 125 X 09 R  
 CRM 125 R Supermoto 07 R  
 CRM F 125 X 09 R  
 CRM 125 (Derapage Competition 2T) 11 R  
 CRM 125 (Derapage RR 2T) 11 R  
 CR 150 R/R2 07-09 R  
 CR 230 Easy Trail 04 R  
 CRF 230 Easy Enduro 04 R  
 CRF 230 Easy Motard 04 R  
 CRE 250 02 R  
 CRE 250 R Supermotard 02-03 R  
 CRE 250 R Enduro 02-06 R  
 CRE 250 X R  
 CRE F 250 X 08-11 R  
 CRM 250 X Supermoto 07 R  
 CR 250 R Moto 04 R  
 CRE 250 F Enduro 04 R  
 CRF 250 Motard 04 R  
 CRF 250 F 04-08 R  
 CRF 250 R 08-09 R  
 CRE F 290 X 07 R  
 CRE F 300 X 08-09 R  
 CRE 450 F Enduro 02-06 R  
 CRE 450 F 02 R  
 CRF 450 Motard 04 R  
 CRE 450 F Supermoto 02-03 R  
 CRE 450 X R  
 CRF 450 R 04-08 R  
 CRM F 450 R/X Supermoto 07 R  
 CRE F 490 X 07 R  
 CRM F 490 X Supermoto 07 R  
 CRE F 500 X 08-09 R  
 CRMF500 X 11 R

## MEGELLI

125 M 08-10 R

## PUZEY

MTD 300 (4T/4V) (Motard model) 11-12 R  
 MX 300 (4T/4V) (Enduro model) 11-12 R

### Competitor X Ref

Dunlop	Ferodo	SBS	Vesrah
DP921	FDB2139	777	VD168

### Equivalents OE #

06435 KZ4 J41	06435 KRN 712
06435 KRN 711	K01306075

MATERIAL AVAILABILITY AND PART NO.				
STD	OPTIONS			
FA	HH	R	MXS	EPFA
FA346TT	-	FA346R	MXS346	EPFA346HH

# FA347HH 69.5 x 49.55 x 7mm

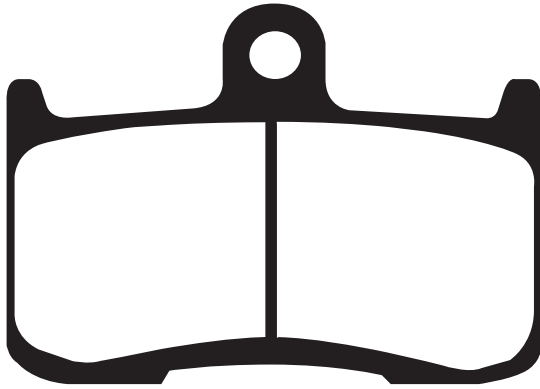

**NOTE: Early gold coloured caliper with staggered piston diameters/caliper body shows curved shape**

**HONDA**

RS 125 (Radial caliper)	04-07	F
NSF 250 R	12-13	F

**KAWASAKI**

Z 800 E (Z 800 DDS - ABS Model)	13	F
Z 800 (Z 800 ADS - Non ABS)	13	F
Z 800 (Z 800 BDS ABS Model)	13	F
ZX9R (ZX 900 F1/F2)	02-04	F
Z 1000 (ZR 1000 A1/A2/A3)	03-05	F

**SUZUKI**

GSX 1300 BKK8/BKK9/BKL0/BKL1 B-King	08-12	F
-------------------------------------	-------	---

**YAMAHA**

TZ 250 (Radial Caliper)	02-10	F
-------------------------	-------	---

**MORIWAKI/HONDA**

MD 250 H/S	08-13	F
------------	-------	---

**TRIUMPH**

Daytona 675	06-08	F
Street Triple 675 R	09-13	F
Speed Triple (1050cc) (Nissin Radial caliper)	05-07	F
Tiger 1050 (radial caliper)	07-12	F
Tiger SE - ABS (1050cc)	10-13	F
Triple Sport 1050cc	13	F

**VICTORY**

Hammer	08-11	F
Hammer S	08-12	F
Cory Ness Jackpot	08-10	F
Cory Ness Victory Cross Country	11-12	F
Cross Country	10-12	F

Cross Country Tour	12	F
Cross Roads	10-12	F
Hammer 8 Ball	10-11	F
Hard Bil	12-13	F
Highball	12	F
Jackpot	10-11	F
King Pin	08-12	F
Kingpin Tour	08-09	F
Kingpin 8-Ball	08-11	F
Kingpin Low	09	F
Vegas 8-Ball	08-12	F
Vegas	08-12	F
Vegas Low	08-09	F
Vegas Jackpot	08-09	F
Zach Ness Vegas	11-12	F

**Equivalents OE #**

43082 1290	T 2020 475	45105 NX7 006
43082 0002	59100 23830	06455 NX7 006
5KE W0045 00	06455 NX4 860	43082 0129
T 2020 329	59100 23840	

**Competitor X Ref**

Dunlop	Ferodo	SBS	Vesrah
DP922	FDB2158	782	VD443

**MATERIAL AVAILABILITY AND PART NO.**

STD	OPTIONS				
FA	HH	R	MXS	EPFA	GPFA
-	FA347HH	-	-	EPFA347HH	GPFA347HH

# FA348 63.35 x 60.32 x 8.9mm



**YAMAHA**

FZS 1000 Fazer	01-05	R
XJR 1300 N/P (5EAP/5EAR/5EAS/5EAT/5EAW /5EAV/5EAY) (298mm front disc)	01-02	R
XJR 1300 R/S 5WM1/5WM3/5WM5 /5WM6/5WM7/5WM9	03-04	R
XJR 1300 T/V/W/X/Y 5WMA/5WMC /5WMD/5WMF	05-12	R

**Equivalents OE #**

5LV W0046 50

**Competitor X Ref**

Dunlop	Ferodo	SBS	Vesrah
-	FDB2150	770	VD268

**MATERIAL AVAILABILITY AND PART NO.**

STD	OPTIONS				
FA	HH	R	MXS	EPFA	GPFA
FA348	FA348HH	-	-	-	-

# FA349R A. 26.1 x 119.55 x 7.1mm B. 35.6 x 94.54 x 7.8mm

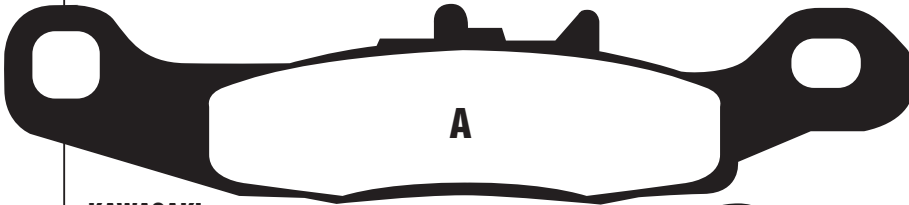

### Equivalents OE #

43082 1273
43082 0078

### KAWASAKI

KFX 450 R Quad (KSF 450 B8F/B9F/BAF/BBF)	08-11	F(right)
KVF 650 A1/A2 Prairie	02-03	F(right)
KVF 650 D1/D6F/D7F/D8F/D9F/DAF/DBF		
Brute Force 4x4	05-11	F(right)
KVF 650 E1/E6F/E7F/E8F/E9F Brute Force 4x4		
Hardwoods Green HD	05-09	F(right)
KVF 700 A1/B1/A2/A6F/B2/B6F/A7F/A8F		
4x4 (Prairie)	04-08	F(right)
KVF 700 D1 Team Green	05	F(right)

### SUZUKI

LT-V 700 FK4/FK5 Twin Peaks	04-05	F(right)
-----------------------------	-------	----------

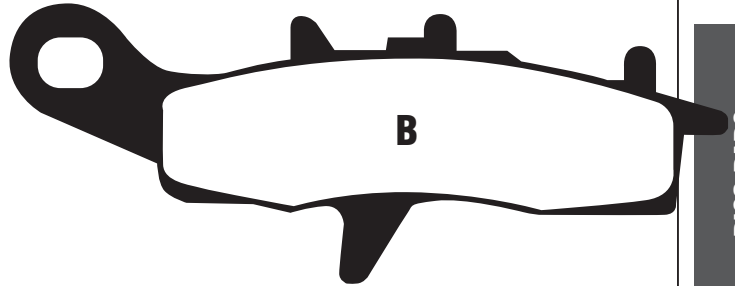

### Competitor X Ref

Dunlop	Ferodo	SBS	Vesrah
-	-	798	VD442

### MATERIAL AVAILABILITY AND PART NO.

STD	OPTIONS			
FA	HH	R	MXS	EPFA
-	-	FA349R	-	-

# FA350 50.1 x 47.4 x 6.8mm

### CPI

SM 250	11-12	R
SX 250	11-12	R

### DERBI

Senda DRD Pro 50 R Radial caliper		
/260mm disc	05-13	R
Senda DRD Pro 50 SM Radial caliper		
/300mm disc	05-13	R
Senda DRD 50 Evo SM (Cast wheels)	08-11	R
Boulevard 125	03-07	F
Cross City 125	07-13	R
GP1 125cc Racing Low seat/radial caliper		
6 bolt disc fixing	07-09	R
Senda 125 SM (Twin headlight)	04-07	R
Senda R 125 SM	04-07	R
Senda R 125	04	R
Senda R Euro 2 125	04-07	R
Senda 125 Baja (4T) (260mm disc)	06-12	R
Senda 125 Baja SM (4T) (300mm disc)	06-12	R
Boulevard 150	03-07	F
Boulevard 200	05	F
GP1 250cc Racing Low seat/radial caliper		
6 bolt disc fixing	07-09	R

### HONDA HM (Italy)

CRE 50 Baja/Six/Derapage	03-09	R
CRE 50 Baja RR		
Up to ZEN50XACEA7700324	07-09	R
CRE 50 Derapage RR		
Up to ZEN50XACMA7700384	07-09	R

### PEUGEOT

Elystar 50 TSDi	02-07	R
Elyseo 125/150	01-03	R
Elystar 125/150 (3 bolt fixing - front disc)	02-05	R
Elystar 125/150 (5 bolt fixing - front disc)	06-07	R
Jet Force 125 (All models)	03-07	R
Satelis 125 Compressor (4T)	06-11	R
Satelis 125 RS	07-11	R
Satelis 250 (AJP Calipers)	07-10	R

### ITALJET

Jet Set 50/125/150	02-03	F
Millenium 100/125/150	02-04	F

### MALAGUTI

X3M Enduro (Spoke wheel)	08-10	F
--------------------------	-------	---

### MBK

X-Limit Enduro	03-09	F&R
X-Limit Supermoto	03-09	R

### PEUGEOT

Geopolis 125 Executive/Non ABS (AJP calipers)	07-12	R
Geopolis 125 Urban/ABS (AJP Calipers)	07-12	R
Satelis 125 Blacksat (AJP Calipers)	10-12	R
Satelis 125 Whitesat (AJP Caliper)	10-12	R
Satelis RS 125 (AJP Calipers)	07-12	R
Satelis Urban 125 (AJP Caliper/ABS)	07-12	R
Geopolis 250 Urban/ABS (AJP Calipers)	07-10	R

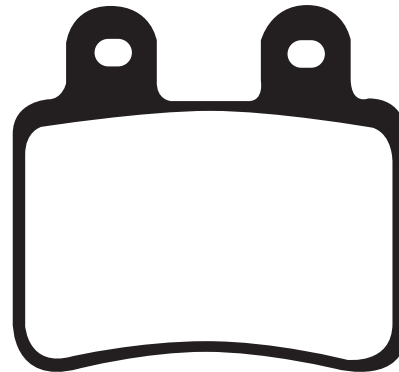

### Competitor X Ref

Dunlop	Ferodo	SBS	Vesrah
-	FDB2128	773/167	-

### Equivalents OE #

745658	1D4 F5742 00	862900
4722090	00H01304931	S11D 40202 00
755981 1160	K01303070	11967300
00G01202221	7588626	1160
3D6 F5811 00	00H01302551	PE 745658

Geopolis 250 Executive(AJP Calipers/Non ABS)	07-10	R
Satelis 250 Urban (AJP Calipers/ABS)	07-12	R
Geopolis 400 Urban (AJP Calipers/ABS)	07-12	R

### SCORPA

T-Ride 125 F	10	R
T-Ride 250 F (Enduro)	08-10	R

### SHERCO

Enduro/Urban/SU 50cc (2T) (Spoke wheel)	08-13	R
SU 50cc (2T) Urban Base (Cast Wheels)	10	R
SM 0.5 "Black Panther"	08-10	R
Supermotard SM50	08-13	R
City Corp 125 (All models)	08	R
SM 1.25 F Black Panther (4T)	10-12	R
SE1.25 F Enduro (4T)	10-12	R

### YAMAHA

DT 50 R	02-08	F&R
DT 50 X	04-08	R
XT 125 R (3D61/3D63)	05-06	F&R
XT 125 R (13D1)	07	F&R
XT 125 R (13D3/13D5)	07-12	F&R
XT 125 X (3D62/3D64)		
XT 125 X (13D2)	07	R
XT 125 X (13D4/13D6)	07-11	R

### MATERIAL AVAILABILITY AND PART NO.

STD	OPTIONS						
FA	TT	SFA	SFAC	HH	R	MXS	EPFA
FA350	FA350TT	SFA350	SFAC350	SFA350HH	-	-	-



# FA351 36 x 39 x 6mm

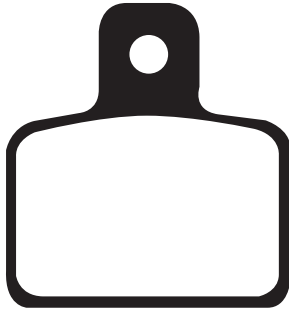

**NOTE Same shape as FA471  
but has larger friction area.**

**Equivalents OE #**

43105 NN3 820	KM0961320
7040	810K0209
C390	S10B-40202-00-00
BT280222068	

**APRILIA**

Mini RX 50 Experience 04 F

**BETA**

Minicross Pro Race 12/10 04-06 F&R

Minitrial 50 09-12 F

Pro Race 50 05 R

**FACTORY**

Phantom R14 Agua 04 F

**GAS-GAS**

Cross MC 50 06 R

TXT 50 Cadet 06-09 F

TXT 50 Rookie 04-09 R

Cross MC 65 06 F&R

TXT Cadet 80 06 F&R

TXT 80 Rookie 04-09 R

TXT 80 (Cadet) 07-09 R

TX 125 Randonne (4T) 11/13 R

TXT 125/200/250/280/300 (TXT PRO) 04-11 R

TXT 125/250/280/300 (For models with Formula front caliper/single pin pad fixing) 12 R

TXT 125/250/280/300 (For models with AJP caliper/2 pin pad fixing) 12 R

EC 50 Boy (Air cooled) 05 R

EC 50 Boy (LC) 05-07 R

MX 65 05-08 F

**HONDA HM (Italy)**

Baja 10/10 JR & SR 99-07 F&R

Baja 12/14 MX 99-09 F&R

**HUSQVARNA**

CR 50 Senior Pro 05 F

CR 50 Junior 05 F

TE 100 05 F

**METRAKIT**

XL 80 Mini GP 09 R

Pre GP 125 09 R

**MONTESA/HONDA**

Honda 315 R 01-04 R

250 4RT Cota 05-10 R

**OSSA**

TR 125 13 R

TR 280 i 10-13 R

280 i Explorer 12 R

**POLINI**

XP4 Street 50 10" wheels F&R

XP 65 R

XP4 Street 125 10" wheels F&R

XP4 Off Road 125 14" front/12" rear wheel F&R

**SAGHS**

Dirty Devil 125 08 F&R

**SCORPA**

\*SR 125 (2T) 09-13 R

\*SR 125 Long Ride (2T) 09-11 R

\*SY 125 F 03-08 R

\*Note: Check friction shape with FA471 to get correct pad

SY 125 4T Long Ride 09-10 R

SY 125 FR (4T) 03-11 R

TY 125 (4T) 11-13 R

TYS 125 F 06-08 R

SY 175 F 06 R

TY-S 175 F 06 R

SY 250 (2T) 00-05 R

SY 250 Long Ride (2T) 04-06 R

SY 200 F (4T) (163cc) 08 R

SY 250 F (4T) Long Ride 07-08 R

SY 250 F 06-10 R

SY 250 FR Long Ride 10 R

SY 250 FR 06-10 R

SY 250 R (2T) 00-09 R

SR 280 (2T) 09-13 R

SR 280 (2T) Long Ride 09-11 R

Roadster 660 07 R

**SHERCO**

Trials 0.8 (2T) 01-10 R

Trials 1.25 (2T/AJP Caliper) 06-12 R

Trials 2.5 (2T/AJP Caliper) 06-12 R

Trials 2.9 (2T/AJP Caliper) 06-12 R

Trials 3.2 (4T/AJP Caliper) 05-12 R

ST 80 (2T) 13 R

ST 125 (2T) 13 R

ST 250 (2T) 13 R

ST 290 (2T) 13 R

ST 305 (2T) 13 R

**TOMOS**

MC 50 Senior Pro 05-07 F&R

**XISPA**

X 125 R 08-09 R

X 250 R 08-09 R

X 280 R 08-09 R

**Competitor X Ref**

Dunlop	Ferodo	SBS	Vesrah
-	FDB2127	803	-

**MATERIAL AVAILABILITY AND PART NO.**

STD	OPTIONS				
	FA	HH	R	MXS	EPFA
FA351	-	-	-	-	-

# FA352 37.55 x 31.3 x 5.55mm

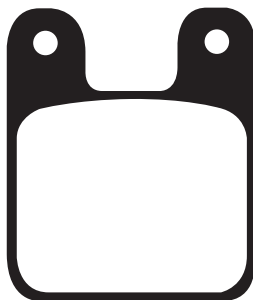

**MINI MOTO**

Pasini/GRC Calipers (Square 2 pin type) F&R

**POLINI**

Mini Motard 110cc 10" wheels (2 pin fixing) F&R

XP4T 110cc Cross 14" front/12" rear wheel F&R

XP4T 110cc Cross 12" front/10" rear wheel F&R

**Equivalents OE #**

144 750 008
-------------

**Competitor X Ref**

Dunlop	Ferodo	SBS	Vesrah
DP951	-	-	-

**MATERIAL AVAILABILITY AND PART NO.**

STD	OPTIONS				
	FA	HH	R	MXS	EPFA
FA352	-	-	-	-	-

# SFA353 A. 96.8 x 39.35 x 9.3mm B. 77 x 42 x 9.3mm

Equivalents OE #

497072
497116
647078
56012R
650983
651253
668017

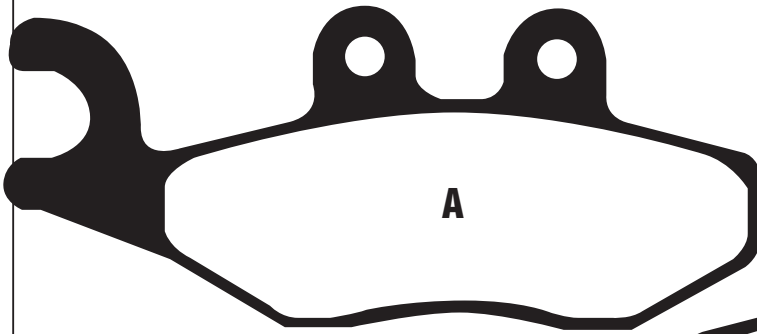

A

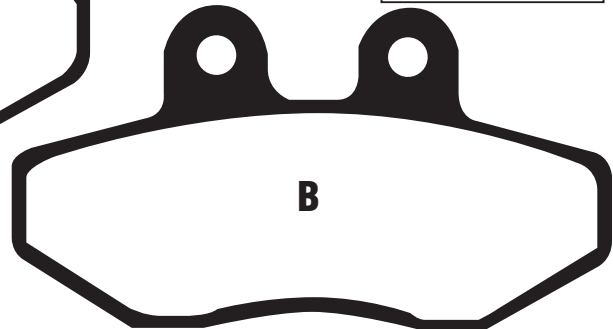

B

**NOTE: HENG TONG CALIPER**

DISC PADS BUYERS GUIDE

## APRILIA

Sport City One 50 (2T)	08-11	F
Sport City One 50 (4T)	08-10	F
SR 50 Motard	12-13	F
Sport City One 125cc	08-11	F
SR 125 Max	11-13	F&R
SR 125 Motard	12-13	F
SR 300 Max	11-13	F&R
SRV 850	12-13	R

## DERBI

Boulevard 50 (2T)	09-12	F
Boulevard 50 (4T)	09	F
Vibrant Sport 50 (2T)	12	F
Boulevard 125 (4T)	08-12	F
Vibrant Sport 125 (4T)	12	F

## GILERA

DNA 50 (Heng Tong Caliper)	01-05	F
Runner 50 PJ/SP	06-13	F
125 VX/180 VXR (4T)	01-04	F
DNA 125/180 (Heng Tong Caliper)	01-03	F
FX/FXR 125/180 Runner (Rear drum brake model/Heng Tong front caliper)	97-02	F
Runner 125/180 FX/FXR/SP (2T)	99-02	F
VXR 200 Runner (4T)	02-04	F
Nexus 125	07-12	F&R
Nexus 250 ie	07-08	F&R
VX 125 Runner/ST (4T)	05-12	F
VX 200 Runner/ST (4T)	05-11	F
Nexus 300 i	08-12	F&R
Fuoco 500 RC/ie	07-13	R
GP 800 (Chain drive)	08-12	R

## KEEWAY

K2 125/150/250	07	F&R
----------------	----	-----

## PIAGGIO

Fly 50 (2T)	05-13	F
Fly 50 (4T)	05-12	F
Liberty 50 (2T) (10 spoke cast wheels)	09-13	F
Liberty 50 (4T) (10 spoke cast wheels)	09-13	F
New Fly 50 (4T/4V)	12-13	F
Typhoon 50 (2T) (12" wheels)	10-13	F
Fly 100 (4T)	07-13	F
Beverley 125	07	F
Beverly B125	02-06	F&R
Beverley S 125	07	F&R
Beverley Tourer 125	08-09	F&R
Beverly 125 (4T) (Multi spoke cast wheel)	11-13	F
Carnaby 125	07-09	F&R
Fly 125 (4T)	05-12	F
Liberty 125 (4T) 10 spoke cast wheels	09-12	F
New Fly 125 ie (3V)	12-13	F
Skipper ST 125/150 4T	00-04	F
Super Hexagon GTX 125/180 (11" wheels)	00	F
Super Hexagon 125/180 (12" wheels)	01-03	F
Typhoon 125 (4T) (12" wheels)	10-13	F
Xevo 125	07-13	F
X7 125cc	08-09	F
X7 Evo 125 ie (EFI)	09-12	F
X8 125	04-06	F
X8 125 ie	07	F
X8 125/Street	07	F
X9 125 Evolution	05-07	F(left)

X10 125ie (4V/4T/EFI)	12-13	F(left)
Fly 150 (4T)	05-12	F
Liberty 150 (4T) 10 spoke cast wheels	09-12	F
X8 150 Street	07	F
Beverly B 200	02-05	F&R
Carnaby 200	07-09	F&R
GT 200 L Granturismo Heng Tong Caliper	03-06	F
X8 200	04-05	F
Beverly 250 (Carb)	04-07	F&R
Beverley 250 ie	06-07	F&R
Beverley S 250 ie	07	F&R
Beverley Tourer 250 ie	08-09	F&R
Beverley Cruiser 250 ie	07-08	F&R
Carnaby 250 ie	08-09	F&R
X7 250cc ie	08-09	F
X8 250 ie	05-07	F
X9 250	05-06	F(left)
Xevo 250 ie	07-10	F
Beverly 300 (278cc/4T) Multi spoke cast wheel	10-13	F
Carnaby 300 ie	12	F&R
Carnaby Cruiser 300	08-11	F&R
MP3 Sport LT 300 ie	13	R
MP3 Business LT 300 ie	13	R
X7 300 Evo	09-12	F
X10 ie 350 (4V/4T/EFI)	12-13	F(left)
Beverley 400 ie	07	R
Xevo 400 ie	07-11	F(left)&R
MP3 400 ie	07-09	R
MP3-LT 400 ie	09-10	R
X8 400 ie	06-08	F(left)&R
MP3 Touring Business 500 ie	11-12	R
MP3 Touring Business 500 ie LT	11-13	R
MP3 Touring Sport 500 ie	11-12	R
MP3 Touring Sport 500 ie LT	11-13	R
X10 500ie (4V/4T/EFI)	12-13	F(left)

## VESPA

GT 125 L Granturismo Heng Tong Caliper	03-06	F
GTS 125	07-11	F
GTS 125 Super	10-13	F
GTS 125 Supersport	13	F
GTV 125	07-09	F
946 Special (4T/3V) (125cc)	13	F
GTS 250 ie/ABS	05-11	F
GTS 250 ie/ABS	05-10	F
GTV 250 ie	07-09	F
GT 60 (Special Anniversary Model) (GTV 250)	06	F
GTS 300	08-09	F
GTS 300	11-13	F
GTS 300 Super	10-12	F
GTS 300 Super Sport	10-13	F
GTS 300 ie Touring	11-13	F
GTV 300 ie	10-13	F

## Competitor X Ref.

Dunlop	Ferodo	SBS	Vesrah
-	-	786	-

MATERIAL AVAILABILITY AND PART NO.					
STD	OPTIONS				
SFA	SFAC	HH	R	MXS	EPFA
SFA353	SFAC353	SFA353HH	-	-	-

# FA354R 97 x 51.7 x 6.95mm

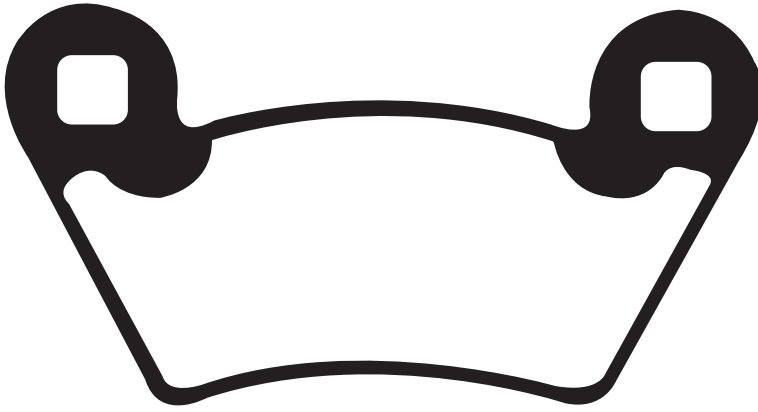

### Equivalents OE #

1910514
2202413
2202097

### Competitor X Ref

Dunlop	Ferodo	SBS	Vesrah
DP997	FDB 2236	800	VD9024

MATERIAL AVAILABILITY AND PART NO.				
STD	OPTIONS			
FA	HH	R	MXS	EPFA
-	-	FA354R	-	-

### POLARIS

Ranger (2x4/4x4)	02-05	F&R
UTV 2x4 (Utility task vehicle series 10)	03	F&R
PPS/UTV/Series 10 2x4		F&R
PPS/UTV/Series 10 4x6		F&R
PPS/Series II UTV 1500 2x4		F&R
Ranger Series 10 "500 6x6"		F&R
Ranger Series 11		F&R
PPS/Series 11 2x4/4x4		F&R
PPS/Series 11 6x6		F&R
Ranger 6x6	04-05	F&R
Ranger TM	04-06	F&R
Ranger XP	05	F&R
Ranger 2x4/4x4	04-06	R
400 Ranger	10-11	R
400 Ranger 4x4	12	F&R
Ranger EV (Electric)	10-11	R
Ranger 500 (2x4/4x4)	06-07	F&R
Ranger 500 (4x4 EFI)	06-07	F&R
500 Ranger 4x4 EFI	08	R
500 Ranger 2x4	08	R
500 Ranger (Carb) 2x4	09	R
500 Ranger (EFI) 4x4 HO	09-11	R
500 Ranger Series 10 6x6		F&R
500 Ranger Crew	11	R
500 Ranger 4x4 EFI	11-12	F&R
500 Sportsman Touring HO	11-12	R
Ranger 6x6 EFI 700	06-09	F&R
Ranger XP 700 4x4	06/08	F&R
700 Ranger 4x4 EFI/LE	07	F&R
700 Ranger 4x4 EFI	09	R
700 Ranger 6x4 EFI	08	R
Ranger TM	06	F&R
800 Ranger HD	10-11	R
800 Ranger XP	10-11	R
800 Ranger 6x6	10-11	R
800 Ranger Crew (RGR 4x4)	10-11	R
800 Ranger RZR 4 EPS	12	R
900 D Ranger 4x4 Diesel	11	R
Ranger RZR XP 900	11	R
Ranger RZR XP 900 White Lightning LE	11	R
900 Ranger RZR XP EFI	12	R
900 Ranger RZR XP	12	R

# FA355 44.9 x 50.75 x 7mm

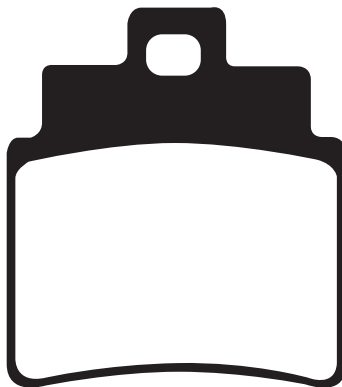

### ARCTIC CAT

250 DVX Sport	06-08	R
300 DVX	09-12	R

### KYMCO

Grand Dink 250	01-06	F
KXR 250 Mongoose Quad	04-07	R
MXU 250	04-13	R
Urban Quad 250	06	R
Maxxer 300	06-13	R

### GILERA

Oregon 250 Quad	07	R
-----------------	----	---

### KYMCO

Maxxer 250	12-13	R
------------	-------	---

### MASAI

A 300 Quad	05-07	R
A 450 Quad	05-07	R

### SYM

GTS/Joymax Evo 125i	10-13	F
GTS 250	07-08	f
Joymax 250	06	F
Joymax 250 i	07-08	F
Voyager 250	05	F
Voymax 250	06	F
GTS 300/Joymax	08-13	F
GTS/Joymax Evo 300i	10-13	F

### Competitor X Ref

Dunlop	Ferodo	SBS	Vesrah
-	-	775/171	-

MATERIAL AVAILABILITY AND PART NO.						
STD	OPTIONS					
FA	SFA	SFAC	HH	R	MXS	EPFA
FA355	SFA355	SFAC355	SFA355HH	FA355R	-	-

### Equivalents OE #

45105 HMA 000A	00156924
45106 KKC4 9000	

# SFA356 55.5 x 46 x 7.1mm

## KYMCO

Grand Dink 250

01-06 R

### Equivalents OE #

43105 KKC4 9000



### Competitor X Ref

MATERIAL AVAILABILITY AND PART NO.				
STD	OPTIONS			
SFA	HH	R	MXS	EPFA
SFA356	SFA356HH	-	-	-

Dunlop	Ferodo	SBS	Vesrah
-	-	776/172	-

# FA357 62.1 x 31.4 x 6.55mm

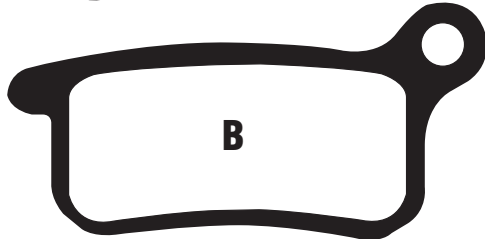
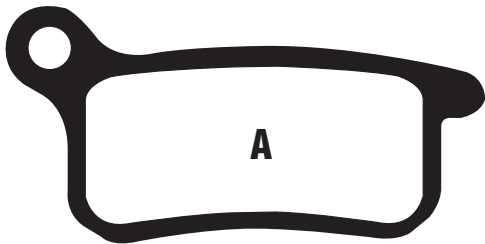

## HUSQVARNA

CR 65

11-13 F

## KTM

SX 65

02-08 F

SX 65

09-13 F&R

SX 85

03-10 F&R

SX 85 (17"/14" wheels)

11 F

SX 85 (19"/16" wheels)

03-10 F&R

SX 85 (19"/16" wheels)

11 F

### Equivalents OE #

461 13 030 000
462 13 030 000
470 13 090 000
470 13 090 200
8000H7132

### Competitor X Ref

MATERIAL AVAILABILITY AND PART NO.				
STD	OPTIONS			
FA	HH	R	MXS	EPFA
FA357TT	-	FA357R	-	-

Dunlop	Ferodo	SBS	Vesrah
DP924	FDB2157	783	-

# SFA358 A. 86.1 x 40 x 8.9mm B. 86.1 x 40 x 8.9mm

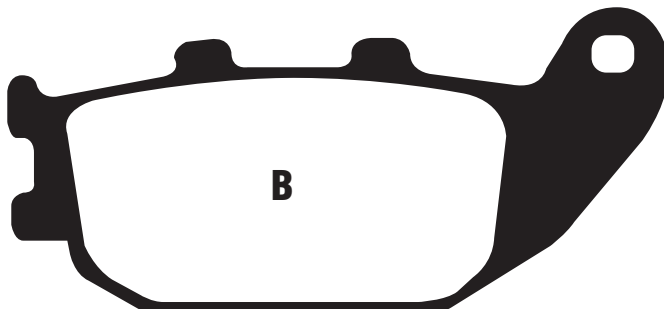
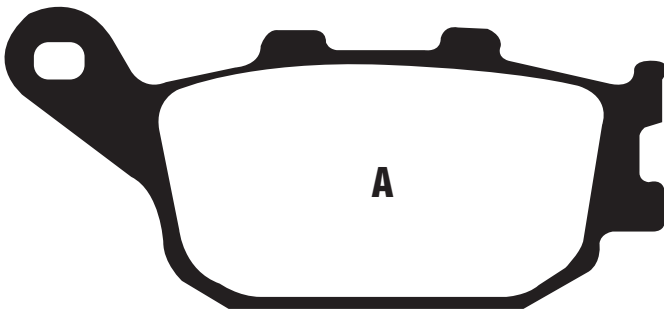

## HONDA

NSS 250 Y/AY/1/A1/A3/3 Forza/Forza-S  
/Forza-T/Forza-ST/Jazz/Reflex  
(MF04/MF06)

00-04 R

### Equivalents OE #

06435 KPB 016

### Competitor X Ref

MATERIAL AVAILABILITY AND PART NO.				
STD	OPTIONS			
FA	HH	R	MXS	EPFA
SFA358	SFA358HH	-	-	-

Dunlop	Ferodo	SBS	Vesrah
DP928	-	753/158	VD169

# FA363 A. 94 x 37.3 x 8.6mm B. 94 x 37.3 x 10.1mm

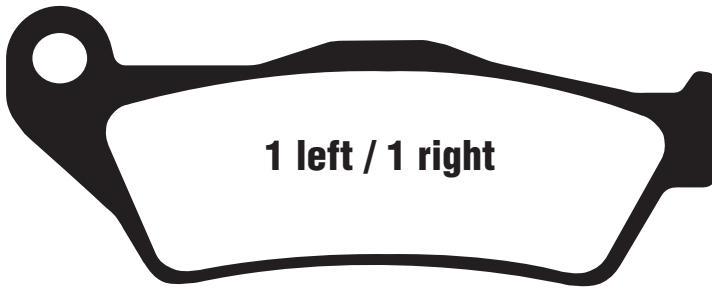

1 left / 1 right

### Equivalents OE #

34 21 2 314 947
34 21 2 335 465
34 21 2 330 633
34 21 7 660 281

DISC PADS  
BUYERS GUIDE

### BMW

F 800 R	09-10	R
R 850 C	97-00	R
R 850 GS	96-00	R
R 850 R	94-06	R
R 850 RT	96-01	R
R 850 RT	06	R
R 1100 GS	93-99	R
R 1100 R	93-01	R
R 1100 S	96-06	R
R 1100 RT	94-01	R
R 1150 R	01-06	R
R 1150 RS	01-04	R
R 1150 RT	00-06	R
R 1150 R Rockster	03-06	R
R 1150 GS (EVO R21/0415/0495)	11/01-03	R
R 1150 GS (R21/0415/0495)	98-10/01	R
R 1150 GS Adventure	07/01-06	R
HP2 Enduro	05-08	R
HP2 Megamoto (K25)	07-10	R
HP2 Sport (K29)	08-11	R
R 1200	00-02	R
R 1200 C	96-04	R
R 1200 RT K26/0368 Brembo Caliper	05-09	R
R 1200 RT	10-12	R
R 1200 RT-SE	10-12	R
R 1200 ST K28/0328	03-08	R
R 1200 S K29/0366 Brembo Caliper	06-07	R
R 1200 GS (K25/0307/Cast/Spoke Wheel)	02-11/07	R

R 1200 GS Adventure (K25/0382/Spoke wheel)	05-11/07	R
R 1200 GS Adventure/M (K25/0380/Spoke wheel)	06-09	R
R 1200 GS/M (K25/0303/Cast/Spoke Wheel)	06-09	R
R 1200 GS (Cast wheels)	10-12	R
R 1200 GS Adventure (Spoke wheels)	10-12	R
R 1200 GS Adventure (30 Years GS)	11	R
R 1200 GS Adventure Triple Black	12-13	R
R 1200 GS Triple Black	11-12	R
R 1200 GS (30 Years GS)	11	R
R 1200 GS Rallye (Spoke wheels)	12	R
R 1200 GS (Liquid Cooled/Radial Mount Caliper)	13	R
R 1200 R SE	10-11	R
R 1200 R Classic	11-12	R
K 1200 S (K40)	05-08	R
K 1200 R (Urban)	05-08	R
K 1200 R Sport	07-08	R
K 1200 R (K27/0378) Tokico Caliper	06-11	R
R 1200 R	12/07-13	R
K 1300 GT	09-11	R
K 1300 GT EE	10-11	R
K 1300 GT SE	10-11	R
K 1300 R	09-12	R
K 1300 R Dynamic	11-13	R
K 1300 R Carbon	12	R
K 1300 S (Non & ABS Models)	09-13	R
K 1300 S Sport	12-13	R
K 1300 S HP	12	R

### Competitor X Ref

Dunlop	Ferodo	SBS	Vesrah
-	FDB2039	742	-

### MATERIAL AVAILABILITY AND PART NO.

STD	OPTIONS				
FA	V	HH	R	MXS	EPFA
FA363	FA363V	FA363HH	-	-	-

# FA366 69.8 x 46.7 x 13.05mm

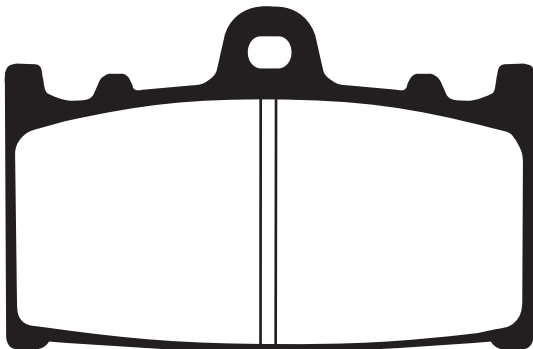

### SUZUKI

VL 1500 K2/K3 Intruder	02-03	R
VL 1500 K5/K6/K7/K8 (C 1500 Intruder)	05-08	R

### Equivalents OE #

69100 10820

### Competitor X Ref

Dunlop	Ferodo	SBS	Vesrah
-	FDB2163	789	-

### MATERIAL AVAILABILITY AND PART NO.

STD	OPTIONS				
FA	V	HH	R	MXS	EPFA
FA366TT	FA366V	FA366HH	-	-	-

# FA367TT 66.9 x 36.1 x 10.75mm

# FA367/2TT 66.9 x 36.1 x 8.5mm



## FA367TT

### APRILIA

MXV 450	09-13	R
RXV 450/550 Enduro	06-13	R
SXV 450/550 Supermotard	06-13	R

### BETA

RR 125 4T Enduro (LC)	11	R
-----------------------	----	---

### FANTIC

Caballero 50 Regularita Competizione	06-09	R
Caballero 50 Supersei Competizione	07-08	R
Caballero 125 Regularita Competizione	07-09	R
Caballero Regularita Competizione Mini 50	08-09	R

### GAS GAS

EC 125/200/250/300 (2T)	09-13	R
MX 125/250	09-11	R
EC 250 F (4T)	12-13	R
EC 300 F (4T)	13	R
EC 450 F (4T)	13	R

### KAWASAKI

KX 250 F (KX 250 N1/N2)	04-05	R
KX 250 F (T6F/T7F/T8F)	06-08	R
KX 250 W9F/XAFB/YBF/YCF/ZDF	09-13	R
KX 450 F (D6F/D7F/D8F/E9F/EAF/EBF/FCF/FDF)	06-13	R
KLX 450 R (A8F/A9F/AAF/ABF/ACF)	08-12	R

### SHERCO

Enduro 2.5i F (4T) (inc SE models)	08-11	R
SM 2.5i Supermotard	08	R
SX 2.5i F Moto Cross	10	R
Enduro SE 3.0i (4T)	10-11	R
SE 450 iR Enduro (Nissin rear caliper)	12	R
SM 450i	04-09	R
Enduro 4.5i	04-10	R
SM 4.5i F Supermoto	04-07	R
SM 4.5i F Black Panther	08-12	R
4.5i Enduro (4T)	06-09	R
5.1i Enduro	06-09	R
Enduro 5.1iF	07-11	R
5.1i Supermotard	06-09	R
SM 5.1iF Supermotard	07	R
SM 5.1iF Black Panther	08-12	R
SE 510 iR (Rear Nissin Caliper)	12	R

### SUZUKI

RM-Z 250 K4/K5/K6/K7/K8/K9/L0/L1/L2/L3	04-13	R
RMX 450 ZL0	10-11	R
RM-Z 450 K5/K6/K7/K8/K9/L0/L1/L2/L3	05-13	R

### TM

MX 85 JR (Small wheel)	05-13	R
MX 85 (Big Wheel)	05-13	R
Enduro EN 125 (2T)	05-13	R
MX 125 (2T)	05-13	R
SMR 125 (2T)	05-13	R
EN 144 (2T)	08-13	R
MX 144 (2T)	08-13	R
EN 250 Fi	10-13	R
EN 250 F (4T) Enduro	05-13	R
Enduro EN 250 (2T)	05-13	R
MX 250 Fi (4T)	10-13	R
MX 250 (2T)	05-12	R
MX 250 (4T)	05-13	R
SMM 250 F (4T)	10-13	R
SMR 250 (2T)	05-13	R
SMR 250 F (2T)	10-13	R
SMX 250 F	12-13	R
Enduro EN 300 (2T)	05-13	R
MX 300 (2T)	05-13	R
SMR 300 (2T)	05-13	R

SMR 250 F (4T)	10-13	R
MX 450 Fi	05-13	R
SMM 450 F	11-13	R
SMR 450 FES	05-11	R
SMR 450 F (4T)	10-13	R
SMX 450 F	05-13	R
EN 530 F (4T)	05-13	R
MX 530 F	05-10	R
SMR 530 F	10-13	R
SMR 530 FES	05-09	R
SMR 530 F (4T)	10-13	R
SMX 530 F	05-13	R
SMX 660 F	05-10	R

### WK

Trial 125	11-12	R
-----------	-------	---

### YAMAHA

YZ 125 R/S/T/V/W/X/Y/Z/A/B/D (2T)	03-13	R
WR 250 FR/FS/FT/FV/FW/FX/FY/FZ/FA/FB/FD (4T)	03-13	R
YZ 250 R/S/T/V/W/X/Y/Z/A/B (2T)	03-12	R
YZ 250 FR/FS/FT/FV/FW/FX/FY/FZ/FA/FB (4T)	03-12	R
WR 450 FR/FS/FT/FV/FW/FX/FY/FA/FB/FD (4T)	03-13	R
YZ 450 FR/FS/FT/FV/FW/FX/FY/FZ/FA/FB (4T)	03-12	R

### FA367/2TT

### BETA

RR 50 Motard (Spoke wheel)	09-12	R
RR Motard 50 Track (Cast wheels)	08-13	R
RR Motard 50 Standard (Cast wheel/5 spoke)	13	R
RR Motard 50 (Spoke wheel)	12-13	R
RR Enduro 50 Standard	09-13	R
RR 50 Enduro Racing	09-11	R
RR Enduro 50	08-13	R
RR 50 Enduro Factory	12-13	R
RR Motard 50 Standard	09-12	R
RR Motard 50 Skull	11	R
Alp 125 (4T)	05-13	R
RR 125 4T Enduro (A/C)	09-13	R
RE 125 4T Enduro	08-12	R
RR 125 Motard (4T) (A/C - Spoke Wheel)	08-13	R
RR Motard 125 4T (LC) (Cast wheels)	11-12	R
Urban 125	08-13	R
Urban 125 Special	09-13	R
Alp 200 (4T)	05-13	R
RR 250 4T Enduro	05-07	R
Alp 4.0 (4T/349cc)	05-13	R
Urban 200	08-13	R
Urban 200 Special	09-13	R
RR 250 Enduro (2T)	13	R
RR 300 Enduro (2T)	13	R
M4 350 Motard	07-13	R
RR 350 4T Enduro	11-13	R
RR 400 4T Enduro	05-13	R
RR 450 4T Enduro	05-13	R
RR 450 4T Cross Country	12	R
RR 498 4T Enduro	12-13	R
RR 520 Enduro	05-11	R
RR 525 4T Enduro	05-09	R

### RIEJU

MTR 50 Pro Competizione (Spoke Wheel)	11-12	R
Marathon Pro 125 Competizione	11-12	R

### Equivalents OE # - FA367

5UN W0046 00	IC3 W0046 50	9100797
5UN W0046 50	25.25362	69096-05
5UN W0046 51	0631	BE 675002509
43082 0006	69100 35810	43082 0107
K4308 0006	69100 28820	855852
IC3 W0046 10	43082 0048	

### Equivalents OE # - FA367/2TT

2525345000
2525362000

### Competitor X Ref

<b>Dunlop</b> DP940	<b>Ferodo</b> FDB2162	<b>SBS</b> 790/199	<b>Vesrah</b> VD271
------------------------	--------------------------	-----------------------	------------------------

MATERIAL AVAILABILITY AND PART NO.				
STD	OPTIONS			
FA	HH	R	MXS	EPFA
FA367TT	-	FA367R	MXS367	EPFA367HH
FA367/2TT		FA367/2R		



# FA368 A. 64 x 41.6 x 9.25mm B. 64 x 41.6 x 9.25mm



### Equivalents OE #

548 13 090 000
548 13 090 100
8000A2790
548 13 090 300
34 21 7 717 324
3711
07849312/27

### BMW

G 450 X 08-11 R

### BREMBO

Xq 21390 PF 26 Off Road Rear Caliper

### HUSABERG

TE 125 2T 12-13 R  
 FE 250 (4T) 13 R  
 TE 250 (2T) 11-13 R  
 TE 300 (2T) 11-13 R  
 FE 350 (4T) 13 R  
 FE 390 (New 70° Engine) 10-12 R  
 FE 450 (New 70° Engine) 08-13 R  
 FX 450 10-12 R  
 FE 501 (4T) 13 R  
 FS 570 Supermoto 10-12 R  
 FE 570 09-12 R  
 TE 570 09 R

### HUSQVARNA

CR 125 05-13 R  
 SMS 4 125 (4T) 11 R  
 WR 125 06-13 R  
 CR 250 05 R  
 TC 250 (4T) 02-13 R  
 TE 250 (4T) 06-12 R  
 TE 250 Meo Replica (4T) 11 R  
 TE 250 R (4T) 13 R  
 TE 310 (4T) 09-12 R  
 TE 310 R (4T) 13 R  
 TE 410 06 R  
 SMR 449 11 R  
 TC 449 (4T) 11-13 R  
 TE 449 (4T) 11-13 R  
 SMR 450 RR (Radial caliper) 06-07 R  
 SM 450 R Radial Caliper 07-10 R  
 SM 450 RR 08-10 R  
 TC 450 05-10 R  
 TE 450 06-10 R  
 SM 510 R (Radial caliper) 06-09 R  
 TC 510 05-09 R  
 TE 510 06-10 R  
 SMR 511 11-13 R  
 TE 511 (4T) 11-13 R  
 SM 530 RR 08-10 R  
 SM 630 (4T) 10 R

### KTM

SX 125 (Upside Down Forks) 04-13 R  
 EXC 125 04-13 R  
 EXC 125 (2T) Six Days 11-13 R  
 SX 150 08 R  
 SX 150 (Upside Down Forks) 09-13 R  
 XC 150 (USD) 11-13 R  
 EXC 200 04-12 R  
 SX 250 (2T) (Upside Down Forks) 03-13 R  
 SX-F 250 (4T) 06-13 R

EXC 250 (2T) 04-12 R  
 EXC 250 Racing 06 R  
 EXC 250 (2T) Six Days 11-12 R  
 EXC-F 250 06-12 R  
 EXC-F 250 (4T) Six Days 11-12 R  
 SX-F 250 Ken Roczen Edition 12 R  
 XC 250 (USD) 11-13 R  
 XC-F 250 (USD) 11-13 R  
 EXC 300 (2T) 04-12 R  
 EXC 300 (2T) Six Days 11-12 R  
 XC 300 (2T) 11-13 R  
 EXC-F 350 (USD) 11-12 R  
 EXC-F 350 Six Days 12 R  
 SX-F 350 (Upside Down Forks) 11-13 R  
 SX-F 350 Tony Cairoli Edition 12 R  
 XC-F 350 12-13 R  
 EXC 400 Racing 04-07 R  
 EXC 400 (4T) 09-11 R  
 EXC 450 Racing 06-07 R  
 EXC 450 (4T) Six Days 11-12 R  
 SMR 450 04-13 R  
 SX 450 (4T) 03-06 R  
 SX-F 450 (4T) 07-13 R  
 EXC 450 (4T) 04-12 R  
 EXC-R 450 (4T) 08 R  
 EXC 500 (4T) 12 R  
 EXC 500 (4T) Six Days 12 R  
 SX-F 505 07-09 R  
 SMR 525 04-05 R  
 SX 525 03-06 R  
 EXC 525 04-05 R  
 XC 525 Racing 06-07 R  
 EXC-R 530 (4T) 08 R  
 EXC 530 09-11 R  
 EXC 530 (4T) Six Days 11 R  
 SMR 560 07 R  
 SXC 625 05-06 R  
 SMR 650 Supermoto 06 R  
 SMR 525 05 R

**OSSA**  
 Enduro 250 i 12 R  
 Enduro 300 i 12 R

**RIEJU**  
 Marathon 250 09-10 R  
 Marathon 450 09-10 R

**SHERCO**  
 SE 250 i Enduro (Brembo rear caliper) 12 R  
 SE 250 iR Enduro (Brembo rear caliper) 12 R  
 SE 300 i Enduro (Brembo rear caliper) 12 R  
 SE 300 iR Enduro (Brembo rear caliper) 12 R

### Competitor X Ref

Dunlop	Ferodo	SBS	Vesrah
DP935	FDB2165	791	-

MATERIAL AVAILABILITY AND PART NO.				
STD	OPTIONS			
FA	HH	R	MXS	EPFA
FA368TT	-	FA368R	MXS368	EPFA368HH

# FA369/4HH 49.2 x 38.6 x 8mm

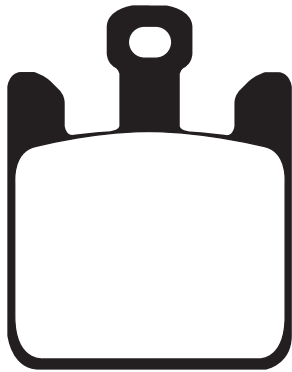

## KAWASAKI

ZX-6RR (ZX 600 K1/M1/N1/N6F)	03-06	F
ZX6R (ZX 636 B1/B2/C1/C6F)	03-06	F
ZX 10 R (ZX 1000 C1/C2/D6F/D7F)	04-07	F
ZX 12 R (ZX 1200 B3/B4/B6F)	04-06	F
VN 1600 B2H/B6F/B7F (Mean Streak)	05-08	F

## SUZUKI

GSXR 1000 K3	03	F
M 1600 (VZ 1600 K5 Intruder)	05	F
VZ 1600 K5 (M 1600 Intruder)	05	F

### Equivalents OE #

59100 18851	43082 0019	43082 0037
43082 1293	43082 0021	
43082 0018	43082 0031	

### Competitor X Ref

Dunlop	Ferodo	SBS	Vesrah
DP942	FDB2164 FDB2203	788	VD354

MATERIAL AVAILABILITY AND PART NO.				
STD	OPTIONS			
FA	HH	R	MXS	EPFA
-	FA369/4HH	-	-	EPFA369/4HH

# FA372R A. 37 x 55.5 x 10.94mm B. 85 x 43 x 8.7mm

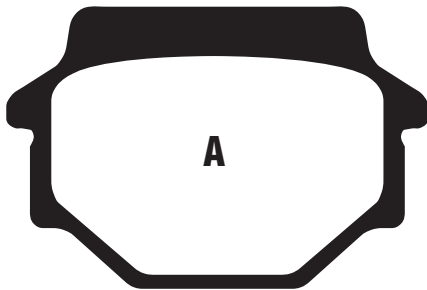

## SUZUKI

LT-A 500 FK3/FK4/FK5/FK6/FK7 Vinson 4WD Auto	03-07	R
LT-F 500 FK3/FK4/FK5/FK6/FK7	03-07	R

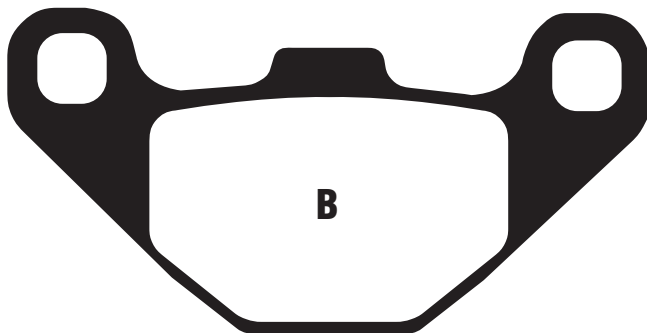

### Equivalents OE #

69100 03850
69100 03860

MATERIAL AVAILABILITY AND PART NO.				
STD	OPTIONS			
FA	HH	R	MXS	EPFA
FA372TT	-	FA372R	-	-

### Competitor X Ref

Dunlop	Ferodo	SBS	Vesrah
-	-	-	-

# FA373 75.35 x 39.35 x 11.75mm

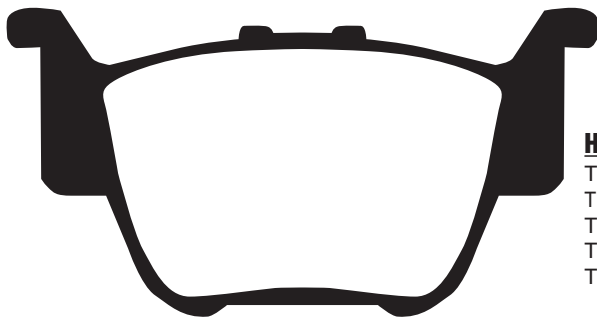

### Equivalents OE #

06435 HN8 006
06435 HP1 006

### HONDA

TRX 420 FA9/FAA/FBB Fourtrax Auto 4WD	09-11	R
TRX 420 FPA9/FPAA/FPBA Fourtrax Auto Power Steering	09-11	R
TRX 450 R4/R5/R6/ER6/R7/ER7/R8/ER8/R9/ER9	04-09	R
TRX 650 FA3/FA4/FA5 Rincon 4x4 Auto	03-05	R
TRX 680 FA6/FA7/FA8/FA9/FAA/FAB Rincon 4x4 Auto	06-11	R

### Competitor X Ref

MATERIAL AVAILABILITY AND PART NO.					
STD	OPTIONS				
FA	HH	R	MXS	EPFA	
FA373TT	-	FA373R	-	-	

Dunlop	Ferodo	SBS	Vesrah
DP944	FDB2182	813	VD171

# FA374 A. 95.5 x 42 x 8mm B. 77 x 42 x 8mm

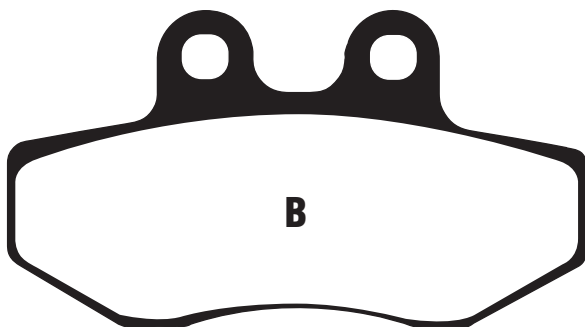
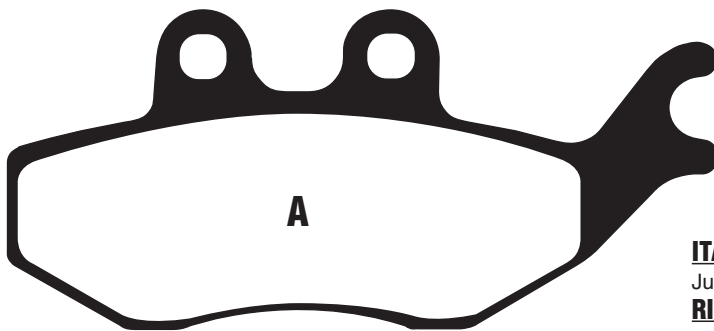

### ITALJET

Jupiter 250 02-03 R

### RIEJU

NKD 50	07	F
RS2 Matrix (50cc)	02-08	F
RS3 50	11-13	F
RS2 125	06-08	F
125 NKD	06-07	F

### Equivalents OE #

4716610
00009307000

### Competitor X Ref

Dunlop	Ferodo	SBS	Vesrah
-	FDB2147	780/173/187	VD9013

MATERIAL AVAILABILITY AND PART NO.					
STD	OPTIONS				
FA	SFA	HH	R	MXS	EPFA
FA374	SFA374	-	-	-	-

# FA375 A. 110.6 x 34.6 x 7.6mm B. 98.7 x 33.5 x 7.5mm

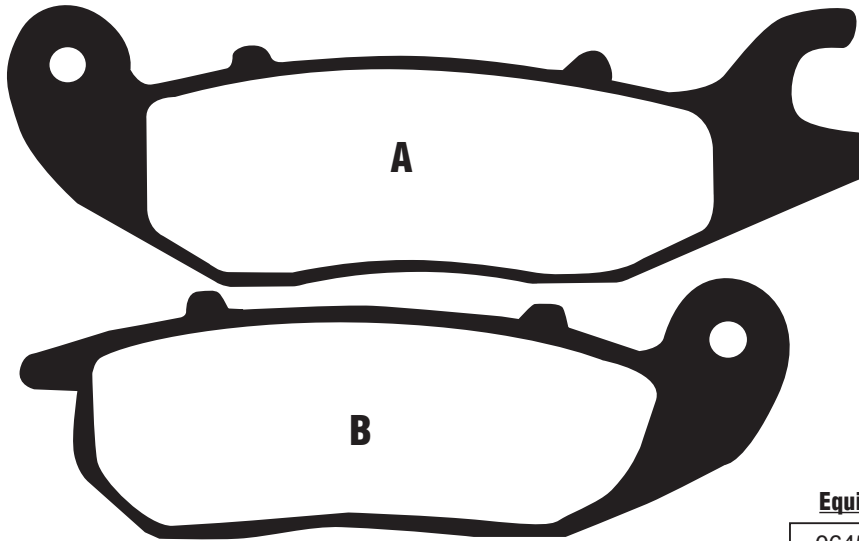

**AJS**

Regal Raptor CR3-125

06 F

**HERO**

Karizma ZMR 230

11-12 F

**HONDA**

ANF 125 3/5/T5/6/T6/7/A Innova

03-11 F

CBF 125 M9/MA/MB

09-13 F

CBR 125 R4/R5/RS5/RS6

04-06 F

CBR 125 RW5/RW6/RW7/RW8

05-13 F

/RW9/RWA/RWB

FS 125 Sonic

03-04 R

CBR 150 R

00-03 F

**LIFAN**

Smart 50/125

F

**RIEJU**

NKD 50

08-09 F

RS2 50cc Matrix/Pro

07-09 F

RS2 50 FR

09-10 F

NKD 125

08-09 F

RS2 125/Pro

07-09 F

**SUPERBYKE**

CQ 50 Road Classic

F

CU 125 Road Classic

F

**Equivalents OE #**

06455 KPH 951
06455 KPP 901
06455 KWF 951
0000 640 7210

**Competitor X Ref**

Dunlop	Ferodo	SBS	Vesrah
-	FDB2169	797/180	VD177

**MATERIAL AVAILABILITY AND PART NO.**

STD	OPTIONS				
FA	SFA	HH	R	MXS	EPFA
FA375	SFA375	-	-	-	-

# FA377 A. 94 x 46 x 8.5mm B. 73 x 46 x 11mm

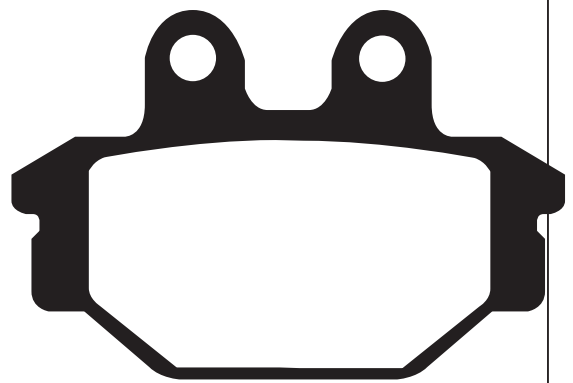
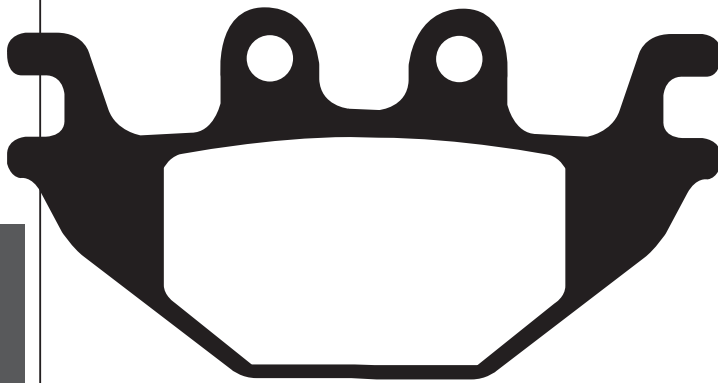

DISC PADS  
BUYERS GUIDE

## ADLY

Crossroad 220 Sentinal Quad		F
Canyon 280 Quad	08-09	F
Hurricane 280 Quad	08-09	F
Canyon 300 Quad	08-09	F
Crossroad 300 Sentinal Quad	08-09	F
Utility 300	05-07	F
Hurricane 300 Quad	08-09	F
300 RS Quad	07-08	F
300 XS Quad	07-08	F
320 S Quad	08	F
Hurricane 320 Quad	08-09	F
500 S	08	F

## AEON

Overland 600 (Quad)	10-11	F
---------------------	-------	---

## ARCTIC CAT

250 DVX Sport	06-08	F
300 DVX	09-12	F

## BOMBARDIER

DS 250	06	F&R
--------	----	-----

## CAN-AM

DS 250 (3J7A/B)	07-11	F&R
-----------------	-------	-----

## CECTEK

500 EFI Gladiator	09-10	F
-------------------	-------	---

## CPI

XS 250 Quad	06-09	F
-------------	-------	---

## KAWASAKI

KVF 300 CCF/CDF (2x4)	13	F&R
-----------------------	----	-----

## KYMCO

KXR 250 Mongoose Quad	04-07	F
Maxxer 250	12-13	F
MXU 250	04-13	F
MXU 250 R	12-13	F&R
Urban Quad 250	06	F
MXU 300	06-11	F&R
MXU 300 R	10-13	F&R
Maxxer 300	06-13	F

MXU 500i (4x4 IRS) (LAA0CD/CM) (Parking brake)	09-13	
---	-------	--

MXU 500 4x4/Carb Model	05-13	F&R
------------------------	-------	-----

UXV 500 4x4 (Side x Side) (U10000)	08-09	F&R
------------------------------------	-------	-----

UXV 500i (Side x Side/4x4) U10100	10-13	F&R
-----------------------------------	-------	-----

MXU 550i (4x4 LOF) Parking Brake	13	
----------------------------------	----	--

MXU 700i (4x4 LOF) Parking Brake	13	
----------------------------------	----	--

## PGO

BR-500i Racer	07-09	R
---------------	-------	---

500 Bug	08-09	R
---------	-------	---

BR 600 I Bug Racer	12	R
--------------------	----	---

## QUADZILLA

RS7 4WD	10-11	F
---------	-------	---

RS8	10-11	F
-----	-------	---

X7R	10-11	F
-----	-------	---

## SYM

SB 125 Ni-Wolf	11-13	R
Quadlander 200	12-13	F
Trackrunner 200 Quad	05-07	F
Quadlander 250	05-13	F
SB 250 Ni	12-13	R
Outlander 300 S	07-13	F&R
Citymax 300 Quad	06	F
Quadlander 300	08-10	F&R
Quadraider 600	06-07	R
Quadraider 600	08-13	F&R
Quadraider 600 LE (Quad)	10-13	F&R

## TGB

Blade 325 LE (4x2)	09-10	F
Avenger 400 Quad (4x2)	07-08	F&R
Avenger 400 LE (4x2)	09-10	F
Blade 425 Quad (4x4)	07-08	F&R
Blade 425 SE (4x4)	09-10	F
Blade 450 SE 4x4	10-11	F
Blade 460 SL IRS 4x4	12	F
500 Avenger R (4x2)	09-10	F
Blade 510 LE	11-12	F
Blade 525 SE	09-10	F
Blade 525 SL	09-10	F
Blade 525 SE 4x4	09-10	F&R
Blade 550 LT 4x4	10-11	F
Blade 550 SL 4x4	09-10	F
Blade 550 SE 4x4	09-11	F
Blade 550 4x4 IRS Target	11-12	F
Gunner 550 4x4 Target	10-12	F&R
Target 550 IRS Blade LT	10-12	F

## YAMAHA

YZF-R 125	08-12	R
-----------	-------	---

### Equivalents OE #

45105 LB17 3050	00157056	B840F64-6500000
45105 LBA7 3050	S4511ARCA000	FZ10176
45105 LEE 8305	S4311ARCA000	45105 PWA 1305
45113 REA 300A	515049	43082 Y003
4511A RAI 000	515050	43082 Y004
45120 256 000	5D7 F5911 00	3303-908

### Competitor X Ref

Dunlop	Ferodo	SBS	Vesrah
DP967	FDB2184	810	VD9026

### MATERIAL AVAILABILITY AND PART NO.

STD	OPTIONS				
FA	TT	HH	R	MXS	EPFA
FA377	FA377TT	FA377R			

# FA379HH 71.45 x 49.9 x 7.76mm

## KAWASAKI

ZX10R (ZX 1000 E8F/E9F/FAF)	08-10	F
ZX10R ABS (ZX 1000 KBF/KCF/KDF)	11-13	F
ZX10R (ZX 1000 JBF/JCF/JDF)	11-13	F
ZR 1000 DAF/DBF/DCF/DDF (Z1000)	10-13	F
Z 1000 SX (ZR 1000 HBF/HCF/HDF) (ABS)	11-13	F
Z 1000 SX (ZR 1000 GBF/GCF/GDF) (Non ABS)	11-13	F
Z 1000 Black Edition (ZR 1000 DCFA/DDFA)	12-13	F

## SUZUKI

GSXR 600 K4/K5/K6/K7/K8/K9/L0	04-10	F
GSXR 750 K4/K5/K6/K7/K8/K9/L0	04-10	F
GSXR 1000 K4/K5/K6/K7/K8/K9/L0/L1	04-11	F
GSX 1300 RK8/RK9/K9/RL0/RL1/RL2 Hayabusa	08-12	F
M 1800 R (VZR 1800 K6/K7/K8/K9)		
Intruder - Handlebar Cowling	06-09	F
M 1800 R2 (VZR 1800 NK8/NK9)		
Intruder - No Handlebar Cowling	08-09	F
M 1800 RZ (VZR 1800 ZK7/ZK8/ZL1/ZL2)		
Intruder - With Handlebar Cowling	07-13	F
VZR 1800 K6/K7/K8 (M 1800 R Intruder)	06-09	F
VZR 1800 RZK8 Intruder M1800 R2/M109 R2	08-09	F

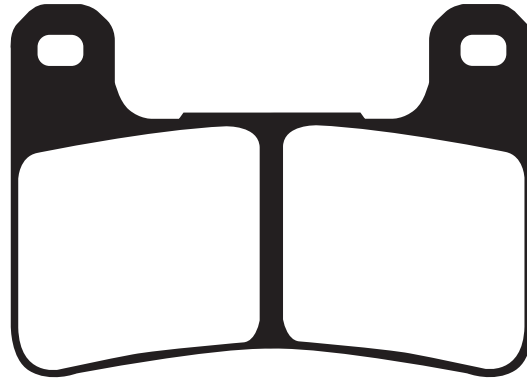

### Equivalents OE #

43082 0091	59100 47890
59100-29820	43082 0113
59100-29840	107 A486 51
59100 29850	

### Competitor X Ref

Dunlop	Ferodo	SBS	Vesrah
DP947	FDB2178 FDB2204	306	VD355

### MATERIAL AVAILABILITY AND PART NO.

STD	OPTIONS				
FA	GPFA	HH	R	MXS	EPFA
-	GPFA379HH	FA379HH	-	-	EPFA379HH

# FA380HH 50.4 x 69 x 8.7mm

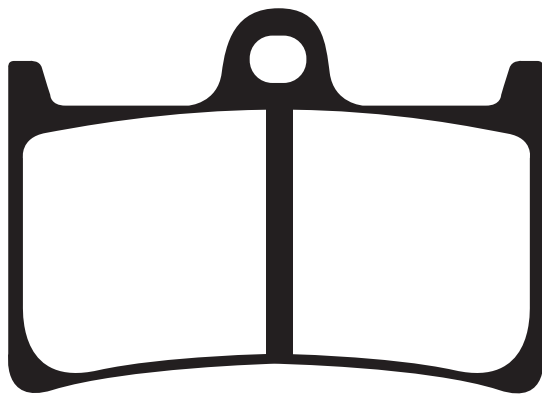

## YAMAHA

FZ1-N (Naked/Non ABS/1EC)	11-12	F
FZ1-NA (Naked/ABS/ZZC)	11-12	F
FZ1 N/NA Naked (Non ABS/ABS)	10-13	F
FZ6 Fazer S2 (ABS) (4 piston caliper)	07-09	F
FZ8N-Naked/Single Headlight		
Non ABS (RN255/39P1) (800cc)	11-13	F
FZ8NA-Naked/Single Headlight/ABS		
(RN256/59P1) (800cc)	11-13	F
Fazer 8-FZ8-S (800cc) (Top Fairing		
/Twin Headlight/Non ABS) (RN251/42P1)	11-13	F
Fazer 8-FZ8-SA (800cc) (Top Fairing		
/Twin Headlight/ABS) (RN252/1BD1)	11-13	F
YZF R6	04-07	F
YZF R6 (13S1)	08-12	F
YZF R1	04-06	F
FZ1 (Naked) (1000cc) (2D1)	06-09	F
FZ1 Fazer (Half Fairing - ABS - 5D0)	08-13	F
FZ1 Fazer (3C3) Non ABS) Half Fairing	06-13	F
MT-01 (1670cc)	05-06	F
YZF-R1SP	06	F
XT 1200 Z Super Tenere		
(ABS/UBS Brake system)	11-13	F

### Equivalents OE #

5VN W0045 00
5VY W0045 00
39P W0045 00

### Competitor X Ref

Dunlop	Ferodo	SBS	Vesrah
DP418	FDB605	634	VD248/274

### MATERIAL AVAILABILITY AND PART NO.

STD	OPTIONS				
FA	GPFA	HH	R	MXS	EPFA
-	GPFA380HH	FA380HH	-	-	EPFA380HH



# FA381 103 x 48 x 10.9mm

Total thickness with refitted O/E shim & insulator (size of pad on its own 8.9mm)

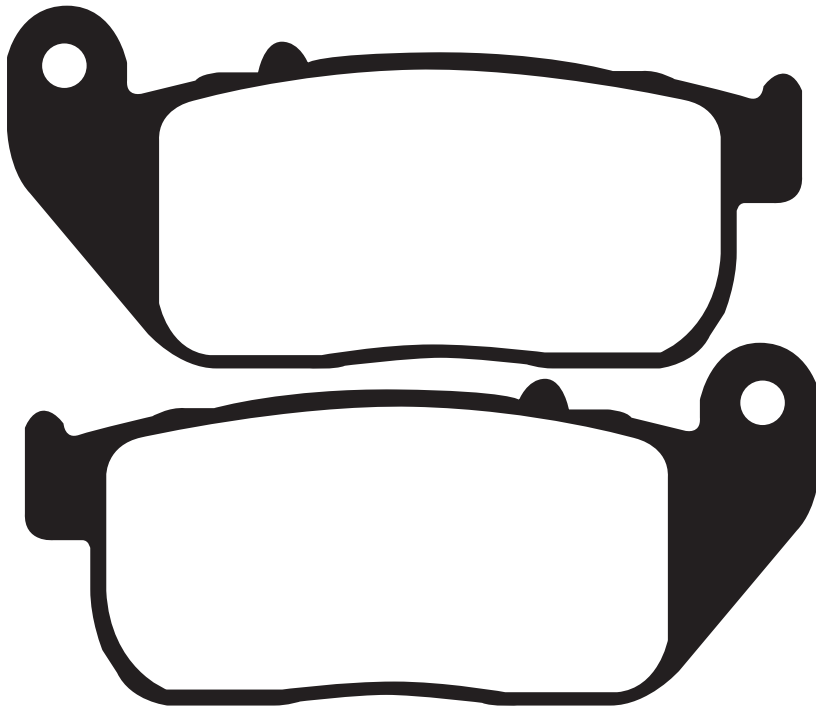

**NOTE: Only refit shim & insulator to HH pads**

DISC PADS  
BUYERS GUIDE

### HARLEY DAVIDSON

XL 50 50th Anniversary Sportster	07	F
XL 883 Sportster STD	04-08	F
XL 883C Sportster Custom	04-10	F
XL 883 L (883 Low)	04-10	F
XL 883 R Sportster R	05-13	F
XL 883 R Roadster	10	F
XL 883 N Iron	09-13	F
XL 883 L Superlow	11-13	F
XL 1200 C Sportster Custom	04-13	F
XL 1200 R Sportster Roadster	04-08	F
XL 1200 L Sportster Low	07-11	F
XL 1200 N Nightster (Spoke Wheel)	08-12	F
XL 1200 X Sportster Forty-Eight	10-13	F
XL 1200 V Seventy Two	12-13	F

### Equivalents OE #

42831-04

### Competitor X Ref

Dunlop	Ferodo	SBS	Vesrah
DP948	FDB2179	807	VD9009JL

### MATERIAL AVAILABILITY AND PART NO.

STD	OPTIONS				
FA	V	HH	R	MXS	EPFA
FA381	FA381V	FA381HH	-	-	EPFA381HH

# FA382 A. 85.12 x 42.70 x 7.4mm B. 56 x 34.75 x 9.6mm

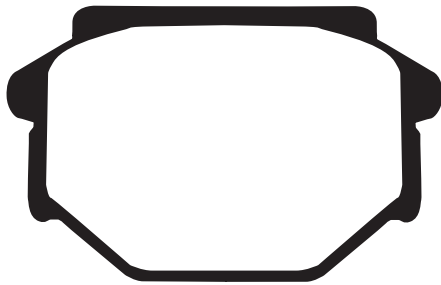
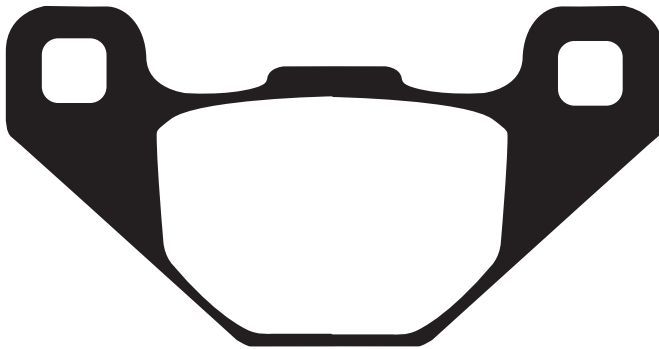

### APRILIA

MX 125	04-06	R
Tuareg Rally 125	89-93	R
Tuareg Rally 125 (L/M)	90-91	R
RX 125	92-01	R
Pegaso 125	91	R
Pegaso 125 KAT	94-95	R
Pegaso 600	91	R
Tuareg Wind 600	89	R

### FANTIC

Caballero 50 Regularita Casa	06-09	R
Caballero 50 Supersei Motard	06-09	R
Caballero 125 Regularita Casa	07-08	R
Caballero 125 Supersei Motard	07-09	R

### HONDA HM (Italy)

CRE 50 Six	01-02	R
CRE 50 Six/Baja/Derapae	95-02	R
CRE 50 Six/Baja/Derapage		
Grimeca caliper	95-02	F&R

### SACHS

XTC 125 Supersport	00-07	R
X Road 125	06	R
Roadster 650	01-04	R

### YAMAHA

DT 50 R-L (SM-5VB1/VG55BK)	02-03	F
----------------------------	-------	---

#### Equivalents OE #

5VB W0045 00
8113375
KA3497506

#### Competitor X Ref

Dunlop	Ferodo	SBS	Vesrah
-	-	682	-

#### MATERIAL AVAILABILITY AND PART NO.

STD	OPTIONS			
FA	HH	R	MXS	EPFA
FA382				

# SFA384 A. 99 x 42.5 x 8mm B. 77.1 x 40.8 x 8.95mm

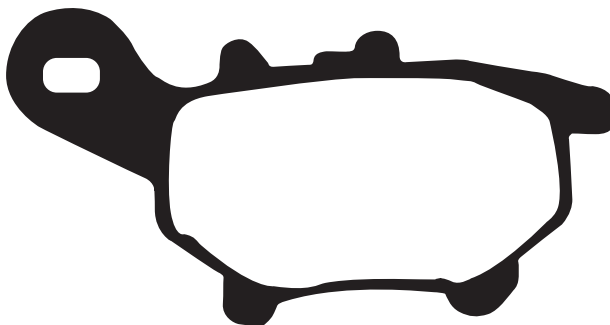
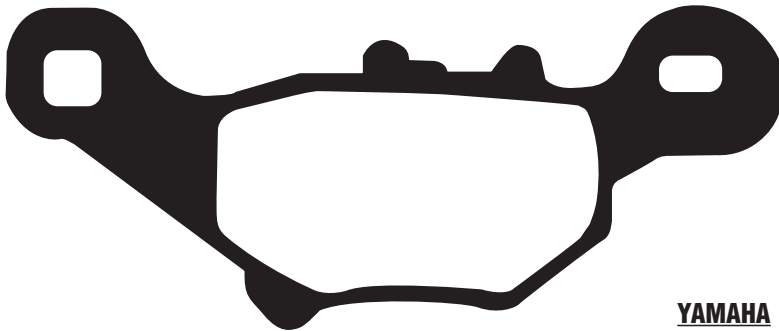

### YAMAHA

CV 50 A/R Jog (5SU1/2/SA16J)	03-08	F
------------------------------	-------	---

### AEON

CO IN Eco (Electric)	13	F
CO IN 125 (4T)	13	F

#### Equivalents OE #

5SU W0045 00
5SU W0045 02

#### Competitor X Ref

Dunlop	Ferodo	SBS	Vesrah
-	-	206	-

#### MATERIAL AVAILABILITY AND PART NO.

STD	OPTIONS			
FA	HH	R	MXS	EPFA
SFA384				

# FA387 87 x 50 x 10.4mm (Note refit o/e shim to HH pads only)



**Equivalents OE #**

42836-04
----------

**HARLEY DAVIDSON**

XL 50 50th Anniversary Sportster	07	R
XL 883 Sportster STD	04-08	R
XL 883C Sportster Custom	04-10	R
XL 883 L (883 Low)	04-10	R
XL 883 R Sportster R	05-13	R
XL 883 R Roadster	10	R
XL 883 N Iron	09-13	R
XL 883 L Superlow	11-13	R
XL 1200 C Sportster Custom	04-13	R
XL 1200 R Sportster Roadster	04-08	R
XL 1200 L Sportster Low	07-11	R
XL 1200 N Nightster (spoke wheel)	08-12	R
XL 1200 V Seventy Two	12-13	R
XL 1200 X Sportster - Forty-Eight	10-13	R
XR 1200	08-10	R
XR 1200 X	10-12	R

**Competitor X Ref**

Dunlop	Ferodo	SBS	Vesrah
DP949	FDB2180	808	VD9010JL

**MATERIAL AVAILABILITY AND PART NO.**

STD	OPTIONS				
FA	V	HH	R	MXS	EPFA
FA387	FA387V	FA387HH	-	-	EPFA387HH

DISC PADS BUYERS GUIDE

# FA388 118 x 47 x 8.3mm (Refit O/E shim)

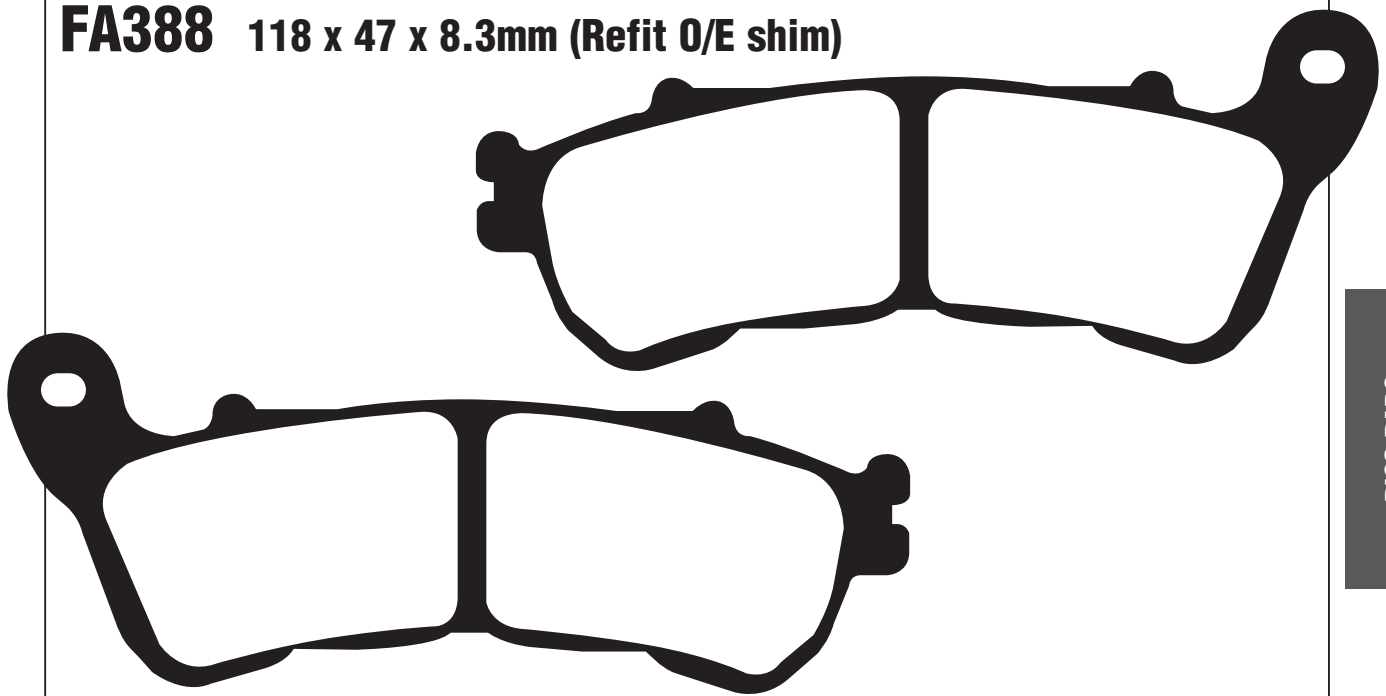

## HONDA

FES 125 A7/A9/AA S-Wing	07-13	F
FES 125 7/9/A S-Wing (Non ABS Model)	07-13	F
SH 125i 9/A/B Fuel Injection	09-12	F
SH 125i RA (Fuel injection/rear disc model)	10-13	F
FES 150 7/9/A S-Wing	07-13	F
FES 150 A7/A9/A (S-Wing) ABS Model	07-13	F
SH 150i 9/A/B Fuel Injection	09-12	F
SH 150 RA Fuel Injection (Rear disc)	10-13	F
CBR 250 RAB/RAC (ABS)	11-13	F
NSS 250 EX5/EX7/EX8 (ABS) Forza EX	05-08	F
NSS 250 AX5/AX6/A7 (ABS) Forza Z	05-07	F
NSS 250 X5/X7/X8 Forza	05-08	F
PS 250 5/6 Big Ruckus	05-06	F
NSS 300 AD Forza	13	F
SH 300i 7/8/9/A/B (Non ABS)	07-12	F
SH 300i A7/A8/A9/AA/AB/AC (ABS Model)	07-13	F
SH 300i R8/R9/RA (Non ABS)	08-10	F
SH 300i AR8/AR9/ARA (ABS Model)	08-10	F
SW-T 400 (FJS 400 D9)	09	F
SW-T 400 (FJS 400 A9/AB ABS Model)	09-13	F
CBF 500 A4/A5/A6 (ABS)	04-07	F
CB 600 FA7/FA8/FA9/FAA/FAB Hornet (ABS)	07-13	F
CBF 600 NA8/NA9/NAA (ABS)	08-11	F
CBF 600 SA8/SA9/SAA (ABS)	08-12	F
CBR 600 FAB/FAC (ABS Model)	11-13	F
SW-T 600 (FJS 600 AB) (ABS Model)	11-13	F
MC 700 D DC 700 Integra Scooter	12-13	F
DN-01 (680cc) NSA 700 A8/A9	08-11	F
NC 700 XAC/XAD-DCT (Auto G/box)	12-13	F
NC 700 XC/XD (Manual G/box)	12-13	F
NC 700 SC/SD	12-13	F
NC 700 SAC/SAD-DCT Auto Gearbox	12-13	F
NT 700 V6/VA6/VA7/V7/V8/VA8/VA/VAA Deauville	06-13	F
XL 700 VA8/VA9/VAA (Transalp/3 piston front caliper/ ABS front & rear wheels)	08-11	F
VT 750 CS2A Shadow (3 piston caliper/rear disc /17" front wheel)	10-12	F
VFR 800 6/8/9	06-09	F
VFR 800 A6/A8/A9	06-13	F
VFR 800 XC Crossrunner 800	12-13	F
CB 1000 RA9/RAA/RAB/RAC (ABS Model)	09-13	F
CBF 1000 A6/A7/A8/A9/AA (ABS Model)	06-10	F&R
CBF 1000 FA (FAA/FAB) (3 piston front caliper/ABS)	10-13	F&R
CBF 1000 FS (FSA) (3 piston front caliper/ABS)	10-11	F&R
CBF 1000 FT (FTA) (3 piston front caliper/ABS)	10-11	F&R

CBF 1000 A (A6/A7/A8/A9/AA) (3 piston front caliper/ABS)	06-10	F&R
CBF 1000 S (S7/S8/S9/SA) (3 piston front caliper/ABS)	07-11	F&R
CBF 1000 T (T7/T8/T9/TA) (3 piston front caliper/ABS)	07-12	F&R
XL 1000 VA4/VA5/VA6/VA7/VA8/VA9/VAA/VAB Varadero - ABS Model	04-11	F
XL 1000 V7/V8/V9/VA/VB Varadero Non ABS Model	07-11	F
CB 1100 D	13	F
VFR 1200 XDC Crosstourer (Automatic Transmission Model)	12-13	F
VFR 1200 XC (Manual Gearbox)	12-13	F
ST 1300 8/9 Pan European (Non ABS)	08-09	F
ST 1300 A8/A9/AA Pan European - ABS Model	08-13	F
VT 1300 CXAA "Chopper" (9 spoke cast wheel /ABS model)	10-11	F

**SUZUKI**

UH 125 K7/K8/K9/L0/L1/L3 Burgman	07-13	F
UX 125 K8/K9/L0/L1 SIXteen	08-11	F
UX 150 K8/K9/L0/L1 SIXteen	08-11	F
UH 200 K7/K8/K9/L0/L1/L3 Burgman	07-13	F
C 1800 R (VLR 1800 K8/K9/L0/L1 C 1800 R Intruder)	08-13	F
C 1800 RT VLR 1800 K8RT/K9RT C 1800 RT Touring Intruder	08-10	F

### Equivalents OE #

06455 MBT D51	06456 MFF D01
06455 MET 651	59101 03810
06455 KSV J03	59100 22830
06455 KSV J41	59300 22830
06455 KSV J01	06455 MEH 006
06455 MCS R01	06456 MEH 006
06455 MCW H01	06455 MC5 R01
06456 MCW H01	06455 MFR A01
06455 MFA D11	59101 03820
06455 KTW 901	

### Competitor X Ref

Dunlop	Ferodo	SBS	Vesrah
DP954	FDB2196	828/192	VD172

### MATERIAL AVAILABILITY AND PART NO.

STD	OPTIONS						
FA	SFA	SFAC	HH	SFA-HH	R	MXS	EPFA
FA388	SFA388	SFAC388	FA388HH	SFA388HH	-	-	EPFA388HH

# FA389 USE FA185TT

# FA390 75 x 48 x 8mm

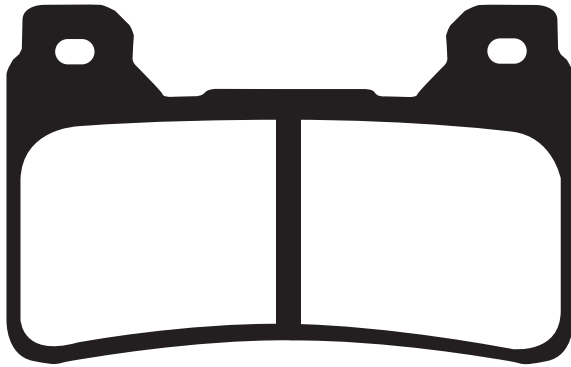

## HONDA

CBR 600 RR5/RR6/RR7/RR8/RR9/RAA/RRB/RRC/RRD (Radial Caliper)	05-13	F
CBR 600 RA9/RAA/RAB/RAC/RAD (C-ABS)	09-13	F
CBR 600 RR Hannspree	08	F
CBR 1000 RR4/RR5/RR6/RR7/RR8/RR9 /RRA/RRB/RRC/RRD Fireblade	04-13	F
CBR 1000 RA9/RAA/RAB/RAC/RAD (C-ABS) Fireblade	09-13	F
CB 1000 R9/RA/RB/RC Non ABS Model	09-13	F

### Equivalents OE #

06455 MEL 003	06455 MEL D22
06455 MEL 013	06455 MJF D02
06455 MFJ D01	107 A486 48

### Competitor X Ref

Dunlop	Ferodo	SBS	Vesrah
DP950	FDB2181 FDB2205	809	VD170

### MATERIAL AVAILABILITY AND PART NO.

STD	OPTIONS				
FA	GPFA	HH	R	MXS	EPFA
-	GPFA390HH	FA390HH	-	-	EPFA390HH

# SFA393 77 x 42 x 9.3mm

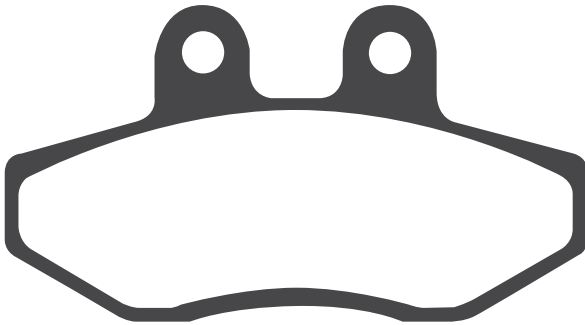

## MBK

NXC 125 Flame X (240mm H disc O/D)	07-12	F
YP 125 Flame X	04-10	F

## YAMAHA

NXC 125-Cygnus X - 220mm Disc (5ML)	04-06	F
NXC 125-Cygnus X - 240mm Disc (4P9)	07-13	F

### Equivalents OE #

5NW W0045 00

### Competitor X Ref

Dunlop	Ferodo	SBS	Vesrah
-	FDB 2225	823/186/190	VD273

### MATERIAL AVAILABILITY AND PART NO.

STD	OPTIONS				
SFA	SFAC	HH	R	MXS	EPFA
SFA393	SFAC393	-	-	-	-

# FA395 95 x 48 x 7mm

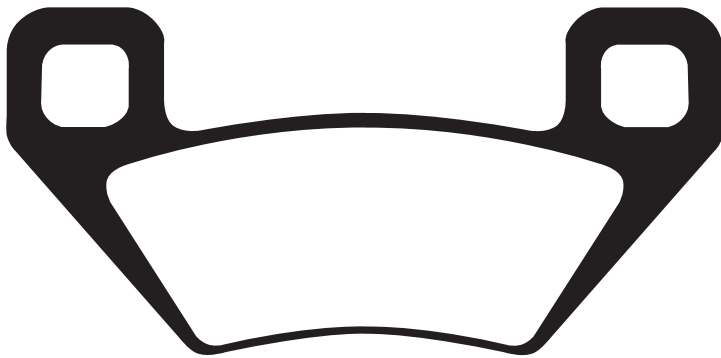

## ARCTIC CAT

250 (2X4) (Utility)	05-09	F&R
250 (4X4) (Utility)	05/08	F&R
300 (2X4) (Utility)	05	F&R
300 ATV	10-12	F&R
350 ATV	12	F&R
366 4x4 Auto Utility	08-09	F&R
366 SE	10	F&R
400 4x4 Auto Utility	05-08	F&R
400 4x4 Auto VP Utility	05-06	F&R
400 4x4 Auto LE Utility	05-07	F&R
400 4x4 Auto TBX Utility	05-06	F&R
400 4x4 VP Utility	05-06	F&R
400 4x4 Utility	05-07	F&R
400 4x4 Auto TRV Multirider	06	F&R
400 4x4 Auto TRV Plus Multirider	07	F&R
400 TRV	09	F&R
400 TRV H1	10	F&R
425i	12	F&R
425i SE	12	F&R
450 H1 EFI	10	F&R
450 TRV	11-12	F&R
450i	11-12	F&R
450i GT	12	F&R
450i TRV	11	F&R
XC 450i	11-12	F&R
500 4x4 Auto TRV Multirider	05-06/08	F&R
500 4x4 Auto TBX Utility	05-06	F&R
500 4x4 Auto LE Utility	05-06	F&R
500 4x4 Auto Utility	05-08	F&R
500 4x4 Utility (Manual G/box)	05-09	F&R
550 GT TRV	11-12	F&R
550 H1 EFI	09-10	F&R
550 H1 EFI LE	09-10	F&R
550i	11-12	F&R
550i GT	11-12	F&R
550i GT TRV	11	F&R
550i LTD	11-12	F&R
550i TRV Cruiser	11	F&R
550 S	10	F&R
550 S Ltd	10	F&R
550 TRV EFI	09-10	F&R
550 TRV Hi EFI LE	09-10	F&R
550 TRV S GT	10	F&R
550 TRV	11	F&R
550 TRV Cruiser	11	F&R
650 H1 4X4 Auto Utility	05/08	F&R
650 H1 4x4 Auto TBX Utility	07	F&R
650 H1 4x4 Auto LE Utility	07	F&R
650 H1 4x4 SE Utility	06	F&R
650 H1 4x4 Auto Utility	07	F&R
650 H1 4x4 Auto TRV Plus Multirider	07	F&R
650 H1 4x4 TRV Plus LE Multirider	07	F&R
650 H1 4x4 Auto TRV	08	F&R
650 H1 TRV	09	F&R
650 H1	10	F&R
650 H1 Mudpro	10	F&R
650 Mudpro	10-11	F&R
650 V2 4x4 LE TS Utility	06	F&R
650 V2 4x4 Auto LE Utility	04-05	F&R
650 V2 4x4 Auto Utility	04-06	F&R
TBX 650	09	F&R
700 EFI 4x4 Auto Utility	07-08	F&R
700 EFI 4x4 Auto LE Utility	07	F&R
700 EFI 4x4 SE Utility	06	F&R
700 EFI 4x4 Auto M4	08	F&R

700 H1 EFI 4x4 Auto SE	08-09	F&R
700 H1 EFI Mudpro	09-10	F&R
700 H1 EFI	09-10	F&R
700 H1 EFI LE	09-10	F&R
700i	11-12	F&R
700i GT	11-12	F&R
700i Ltd	11-12	F&R
700i Mudpro	11-12	F&R
700 EFI Cruiser	08	F&R
700 EFI 4x4 Auto TRV LE	08	F&R
700 Diesel Utility	07-08	F&R
700 Mudpro	10-11	F&R
700 Mudpro i Ltd	11	F&R
700 S	10	F&R
700 S Ltd	10	F&R
700 TBX H1 EFI	10	F&R
700 TRV	11	F&R
700 TRV GT	11	F&R
700 TRV H1 EFI Cruiser	09-10	F&R
700 TRV Cruiser	11	F&R
700 Super Duty Diesel	10-11	F&R
700 TBX Ltd	11	F&R
1000 GT	11-12	F&R
Thundercat 1000 H2	08-10	F&R
Thundercat 1000 H2 LE	10	F&R
1000 Mudpro H2 EFI	10	F&R
1000 Mudpro	10-11	F&R
1000 Mudpro i	12	F&R
1000 TRV H2 EFI Cruiser 2 Up	09-10	F&R
1000 TRV H2 EFI	10	F&R
1000 TRV Cruiser	11	F&R

## KYMCO

Maxxer 400	09-10	F&R
MXU 400 (A40000)	08-11	F&R
Maxxer 450i	10-13	F&R
MXU 450 i IRS	11-12	F&R
MXU 450 i (4x4 Lof)	12-13	F&R

## ARCTIC CAT SIDE X SIDE

550 H1 EFI Prowler	09	F&R
XT 550	10-11	F&R
XT 550i Prowler	11-12	F&R
XT 650 H1 Prowler	06-09	F&R
650 H1 Prowler	07	F&R
650 Prowler 4x4 Auto/M4	08	F&R
HDX 700 Prowler	11	F&R
HDX 700i Prowler	11-12	F&R
XTX 700 Hi LE Prowler	08	F&R
XTX 700 Hi EFI Prowler	09	F&R
XTX 700	10-11	F&R
XTX 700i Prowler	11-12	F&R
Wildcat 1000i HO	12	F&R
XTZ 1000 H2 EFI Prowler	09	F&R
XTZ 1000	10-11	F&R
XTZ 1000 i Prowler	11-12	F&R

## MASSEY FERGUSON

MF 400/4WD Auto (386cc)	05-09	F&R
MF 500/4WD Auto (493cc)	05-09	F&R
MF 650 2 cyl/4WD Auto (633cc)	05-09	F&R
MF 650/4WD Auto (641cc)	05-09	F&R
MF 700 D/4WD Auto (686cc Diesel)	05-08	F&R

## PIAGGIO

Trackmaster 400 Quad	06	F&R
----------------------	----	-----

**POLARIS**  
300 Hawkeye 2x4/4x4 06 F&R

## Competitor X Ref

Dunlop	Ferodo	SBS	Vesrah
DP956/512	-	822	VD9023

## Equivalents OE #

0502-604	45105 PWB 1305
0502-875	1436-420
2203045	1502-694
1436-165	

## MATERIAL AVAILABILITY AND PART NO.

STD	OPTIONS			
FA	HH	R	MXS	EPFA
FA395TT		FA395R		



# SFA396 A. 99.00 x 44.10 x 7.56mm B. 75.50 x 37.90 x 8.26

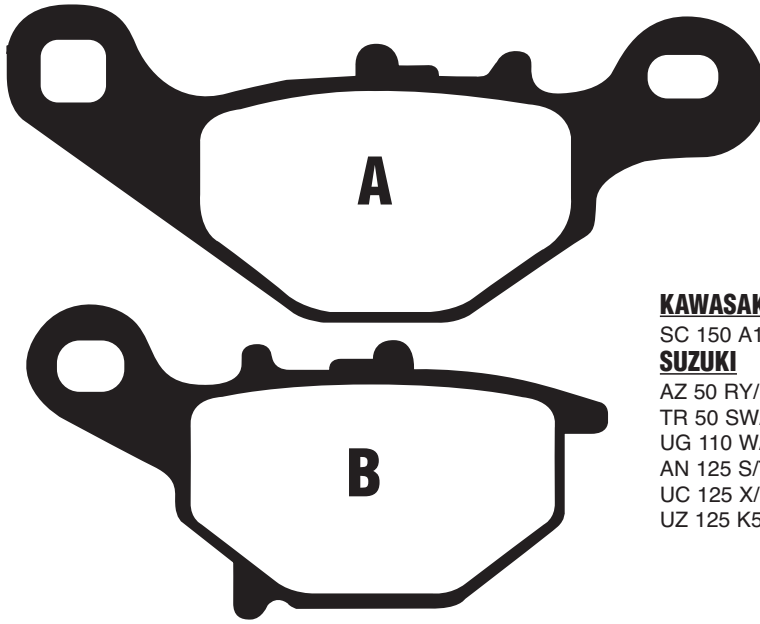

### KAWASAKI

SC 150 A1 (Epsilon 150) 02-03 F

### SUZUKI

AZ 50 RY/RK2 (ZZ Inch Up Sport) 00-02 F  
 TR 50 SW/SX 98-00 F  
 UG 110 W/SW/Y/SY/SK1 Hokuto/Address 98-02 F  
 AN 125 S/T/V/W/XX 95-00 F  
 UC 125 X/Y 'Epicuro' 99-02 F  
 UZ 125 K5/GK5 (CF46A) (V126G) 05 F

### Equivalents OE #

43082 S001	59300 20830
59300 20841	59300 20880
59300 20890	59300 20890

### Competitor X Ref

Dunlop	Ferodo	SBS	Vesrah
DP218	-	702/122	-

### MATERIAL AVAILABILITY AND PART NO.

STD	OPTIONS			
FA	HH	R	MXS	EPFA
SFA396	SFA396HH			

# FA398R 95.4 x 39.55 x 6.85mm

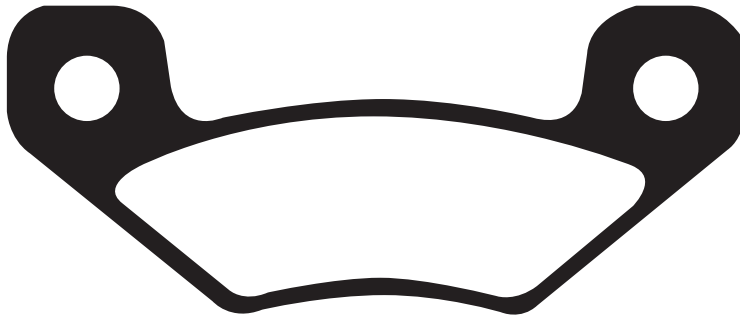

### JOHN DEERE

Gator HPX All models 04-05 F&R  
 HPX 4x4 Gator (Petrol) 10-11 F&R  
 HPX 4x4 Gator (Petrol) Parking brake 10-11  
 HPX 4x4/4x4 Trail Gator (Petrol) 10-11 F&R  
 HPX 4x4 Gator (Diesel) 10 F&R

### CAN AM

DS 450 (2x4/EFi) 08-12 R  
 DS 450 X (2x4/EFi) 08-09 R  
 DS 450 XXC/XXM 10-12 R

### Equivalents OE #

VGA 12182
VGA12183
705600485
Z150-9261
705600 711

### Competitor X Ref

Dunlop	Ferodo	SBS	Vesrah
-	-	-	-

### MATERIAL AVAILABILITY AND PART NO.

STD	OPTIONS			
FA	HH	R	MXS	EPFA
-	-	FA398R	-	-

# FA399 69.65 x 51.55 x 7.25mm

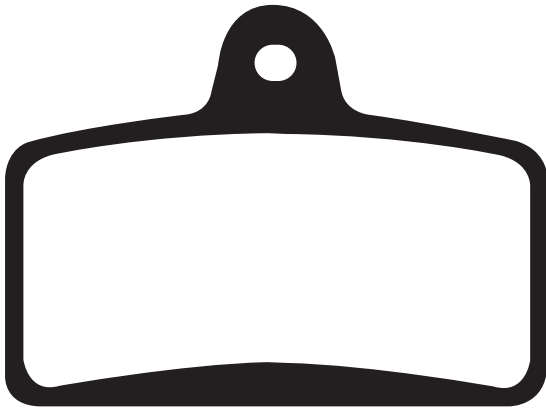

### Equivalents OE #

00H01201221	8044220
810K5804	864580
866687	

### Competitor X Ref

Dunlop	Ferodo	SBS	Vesrah
-	FDB2201	821/189	VD9004

### APRILIA

RS4 50 (4T) 11-13 F  
RS4 125 (4T) 11-13 F

### BLATA

Enduro 125 07-08 F  
Motard 125 07-08 F

### CONTI

RX 356 V3 (12" wheels) 05-06 F  
RX 356 V3 (17" wheels) 05-06 F

### DERBI

GPR 50 (2T) 41mm forks/218mm rear disc 09-12 F  
GP1 125cc Racing Low seat/radial caliper /6 bolt disc fixing 07-09 F  
GPR 125 Racing (Radial caliper) 04-07 F  
GPR 125 Nude (Radial caliper) 04-08 F  
GPR 125 (4T) 4V 09-12 F  
GP1 250i cc Racing Low seat/radial caliper /6 bolt disc fixing 07-09 F

### GILERA

SC 125 06-07 F

### METRAKIT

Pre GP 125 09 F

### MH/MOTORHISPANIA

KN2 50 12-13 F  
RX 50 R 08-13 F  
125 LC Hard Road SM 12 F  
KN1 (125cc) 09-10 F  
KN2 (125/4T) 12-13 F  
RX 125 R 08-13 F  
MH7 Naked (125cc/Air Cooled) 08-10 F  
MH7 Naked (125cc/Liquid Cooled) 08-13 F

### PEUGEOT

XR7 (50cc) 08-12 F  
NK7 "Naked" 50cc 09-12 F

### MATERIAL AVAILABILITY AND PART NO.

STD	OPTIONS				
	FA	HH	R	MXS	EPFA
FA399	-	-	-	-	-

# FA400 A. 97.54 x 64.2 x 8.1mm B. 97.54 x 64.2 x 8.1mm FA400HH/V A. 97.54 x 64.2 x 7.5mm B. 97.54 x 64.2 x 7.5mm

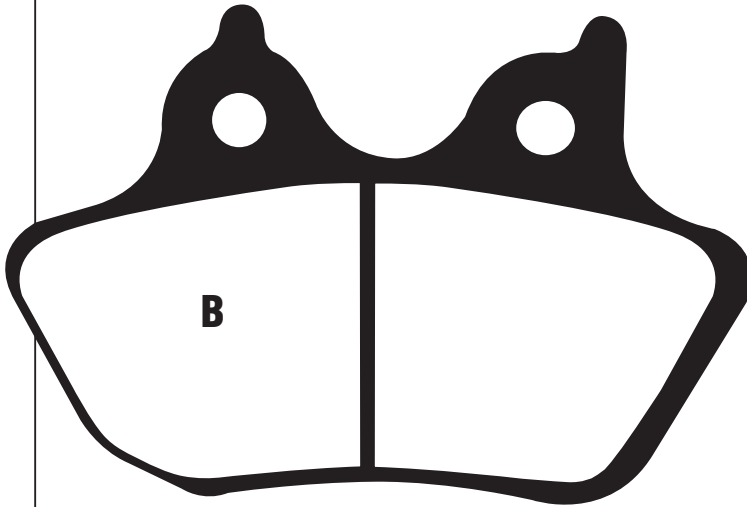

**NOTE: THIS PAD REPLACES  
FA299/FA299HH**

### HARLEY DAVIDSON

Most models 03-11 F&R  
Check application listings for details

### Equivalents OE #

44082 00C
44082 00D

### Competitor X Ref

Dunlop	Ferodo	SBS	Vesrah
DP957	-	826	VD9022

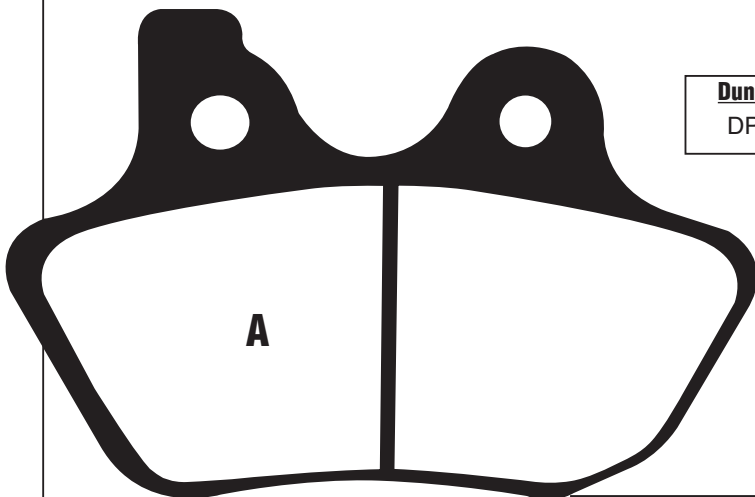

**CHECK PAD SHAPE TO CONFIRM  
CORRECT PAD HAS BEEN  
SELECTED**

### MATERIAL AVAILABILITY AND PART NO.

STD	OPTIONS				
	V	HH	R	MXS	EPFA
FA400	FA400V	FA400HH	-	-	EPFA400HH

# FA401 A. 99 x 40.1 x 7.56mm B. 75.5 x 37.9 x 8.26mm

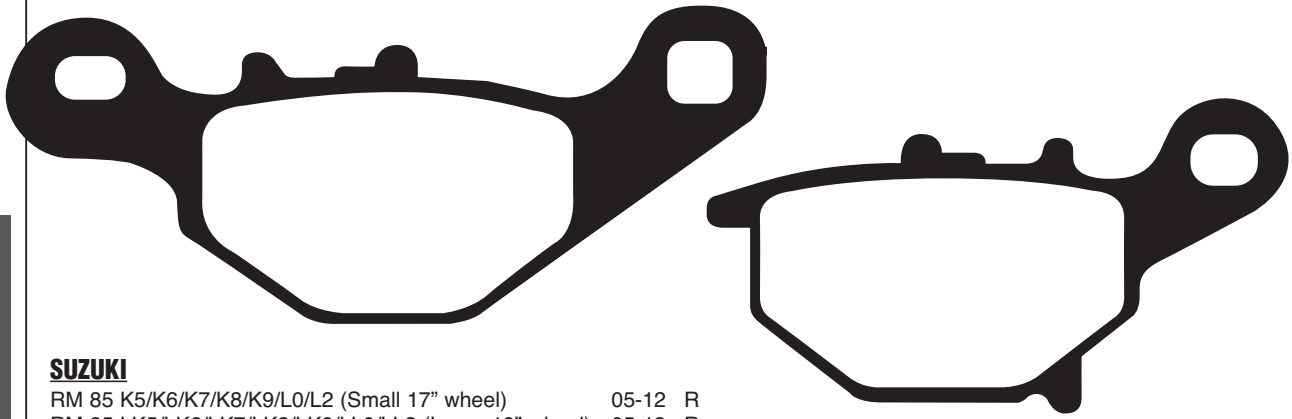

**SUZUKI**

RM 85 K5/K6/K7/K8/K9/L0/L2 (Small 17" wheel) 05-12 R  
 RM 85 LK5/LK6/LK7/LK8/LK9/LL0/LL2 (Large 19" wheel) 05-13 R

**Competitor X Ref**

Dunlop	Ferodo	SBS	Vesrah
DP953	FDB2197	820	VD358

**Equivalents OE #**

69100 03880

MATERIAL AVAILABILITY AND PART NO.				
STD	OPTIONS			
FA	HH	R	MXS	EPFA
FA401TT	-	FA401R	-	-

# FA403 41.1 x 44.7 x 6.45mm



**BETA**

REV 80 08 R  
 REV 3 125/200 06-08 R  
 REV 3 250/270 05-08 R  
 REV 4T 250 07-08 R

**Equivalents OE #**

25-25363  
 25-25373

**Competitor X Ref**

MATERIAL AVAILABILITY AND PART NO.				
STD	OPTIONS			
FA	HH	R	MXS	EPFA
FA403	-	-	-	-

Dunlop	Ferodo	SBS	Vesrah
-	-	896	-

# MXS405 76.35 x 49.4 x 7.9mm

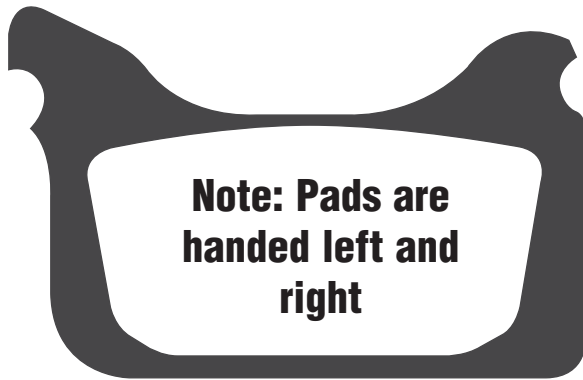

**APRILIA**

SXV 450/550 Supermotard 06-13 F  
 Pegaso 650 Factory 06-08 F

**BEHRINGER**

4 Piston (Radial)

**FTE**

4 Piston Radial Supermoto

**HUSABERG**

FS 450 C 06 F  
 FS 450 E 06-08 F  
 FS 550 E Supermoto 05-07 F  
 FS 650 C 06-08 F  
 FS 650 E Supermoto 05-08 F

**KTM**

SMR 450 05-06 F  
 SMR 525 05  
 SMR 650 Supermoto 06 F

**Note: Pads are handed left and right**

**Equivalents OE #**

586 13 030 100	586 13030 200
9100906	586 13 030 300
1200 S/R2	586 13 030 000

**Competitor X Ref**

MATERIAL AVAILABILITY AND PART NO.				
STD	OPTIONS			
FA	HH	R	MXS	EPFA
-	-	-	MXS405	EPFA405HH

Dunlop	Ferodo	SBS	Vesrah
-	-	-	VD9030

# MXS406 102.2 x 47.8 x 7.9mm

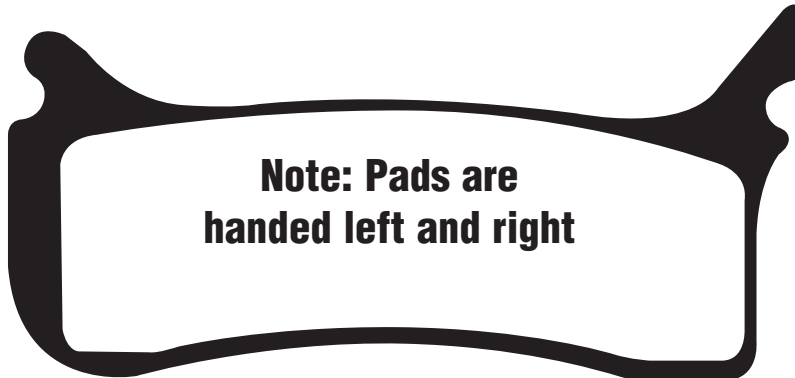

**Note: Pads are handed left and right**

**Equivalents OE #**

800 13 030 000
1100 S/R2

**BEHRINGER**

6 Piston (New Design)

**FTE**

Piston Radial Supermoto

**HUSABERG**

FS Supermotard Models 04- F

**KTM**

SMR 450/525 04 F

**Competitor X Ref**

MATERIAL AVAILABILITY AND PART NO.				
STD	OPTIONS			
FA	HH	R	MXS	EPFA
-	-	-	MXS406	EPFA406HH

Dunlop	Ferodo	SBS	Vesrah
-	-	-	-

# FA407 100.10 x 57.20 x 8.40mm

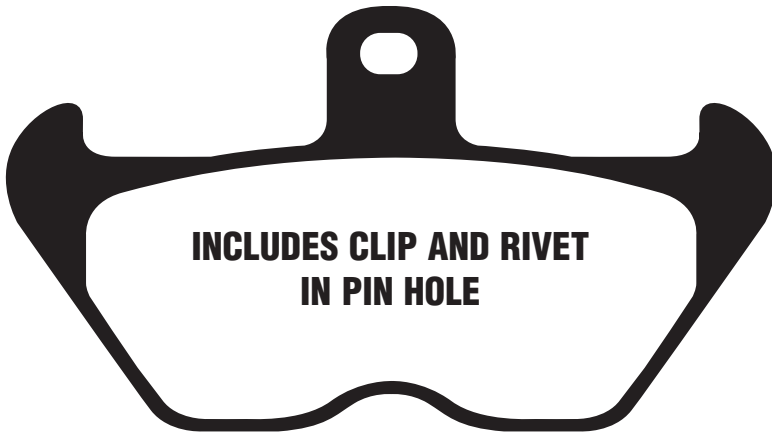

**INCLUDES CLIP AND RIVET  
IN PIN HOLE**

## BMW

K 100 RS	89-92	F
K 1	88-93	F
K 1100 LT	89-07/93	F
KL 1100 LT	89-99	F
K 1100 RS	92-96	F
K 1200 RS	96-00	F
K 1200 LT	97-10/00	F
R 80 Mystic	94-95	F
R 80 R	91-94	F
R 850 C	97-00	F
R 850 GS	96-00	F
R 850 R	94-02	F
R 850 RT	96-01	F
R 100 Mystic	93-96	F
R 100 R	91-95	F
R 1100 GS	93-99	F
R 1100 R	93-01	F
R 1100 RS	92-01	F
R 1100 S	96-11/00	F
R 1100 RT	94-01	F
R 1150 GS (R21/0415/0495)	98-10/01	F
R 1200	00-02	F
R 1200 C	96-02	F

## Equivalents OE #

34 11 2 314 996	34 11 7 655 687	34 11 7 658 156
34 11 2 310 983	34 11 2 331 173	34 11 2 333 045
34 11 7 663 764	34 11 2 314 512	

**NOTE: THIS PAD REPLACES FA246**

## Competitor X Ref

Dunlop	Ferodo	SBS	Vesrah
DP625	FDB2050	703	VD959

MATERIAL AVAILABILITY AND PART NO.				
STD	OPTIONS			
FA	HH	R	MXS	EPFA
FA407	FA407HH	-	-	EPFA407HH

# SFA408 99.84 x 38.52 x 11.8mm

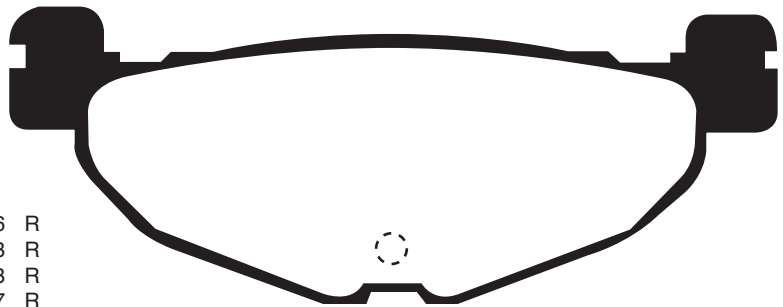

## YAMAHA

CP 250 (1B71) Maxam/Morphus	05-06	R
YP 400 Majesty (Non ABS)	04-13	R
YP 400 Majesty (ABS)	07-13	R
XP 500 T-Max (5VU1/2/4BS)	04-07	R
XP 500 T-Max Non ABS Models	08-11	R
XP 500 T-Max (ABS Models)	08-11	R

## MBK

YP 400 Skyliner	04	R
-----------------	----	---

## Equivalents OE #

5VU W0046 01	1B7 W0046 00	5RU W0046 00
--------------	--------------	--------------

## Competitor X Ref

Dunlop	Ferodo	SBS	Vesrah
-	FDB2200	812/185	VD275

MATERIAL AVAILABILITY AND PART NO.				
STD	OPTIONS			
SFA	SFAC	HH	R	EPFA
SFA408	SFAC408	SFA408HH	-	-

# FA409HH 91.95 x 56 x 7.05mm

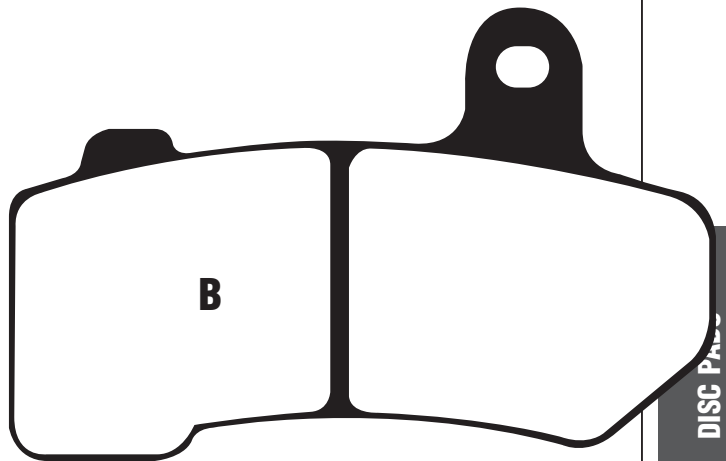
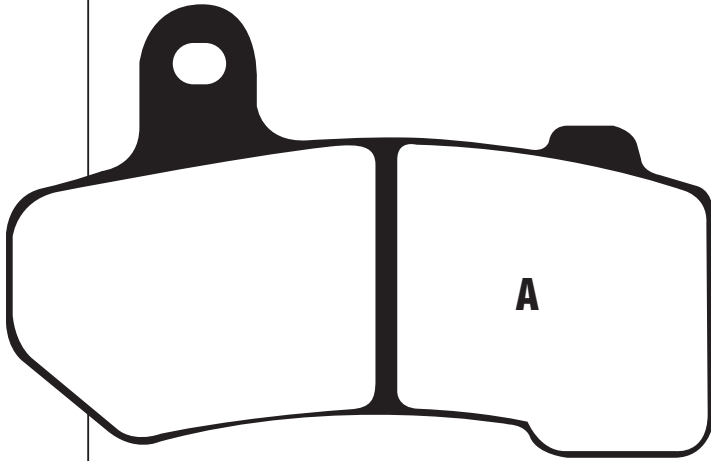

DISC PARTS BUYERS GUIDE

**VRSCA/VRSCB**

V-Rod	06	F&R
VRSCR Street Rod	06-07	F&R
VRSCD Night Rod (Cast Wheel)	06-08	F&R
VRSCAW V-Rod	07-10	F&R
VRSCDX Night Rod Special (Cast wheel)	07-11	F&R
VRSCX VRod	07	F&R
VRSCF V-Rod Muscle	09-12	F&R
VRSC Night Rod Special		F&R
VRSC 10th Anniversary V-Rod	12	F&R

**FLHR/FLHRCI**

FLHR Road King	08-12	F&R
FLHRC Road King Classic	08-13	F&R
FLTR Road Glide	08-09	F&R
FLHTC Electra Glide Classic	08-11	F&R
FLHTCU Ultra Classic Electra Glide	08-13	F&R
FLHT Electra Glide Standard	08-10	F&R
FLHTK Electra Glide Ultra Ltd	10-13	F&R

FLTRX Road Glide Custom	10-13	F&R
FLHX Street Glide	08-12	F&R
FLHTCUTG Tri Glide Ultra Classic Trike	09-13	F
FLTRU Road Glide Ultra	11-12	F&R
FLHXXX Street Glide Trike	10-11	F

**Equivalents OE #**

41852-08	42850-06B
41854-08	42897-06A
42850-06A	42897-08

**Competitor X Ref**

Dunlop	Ferodo	SBS	Vesrah
DP962	-	830	VD9025

**MATERIAL AVAILABILITY AND PART NO.**

STD	OPTIONS				
FA	V	HH	R	MXS	EPFA
FA409	FA409V	FA409HH	-	-	EPFA409HH

# FA410 81.8 x 38.45 x 10.15mm

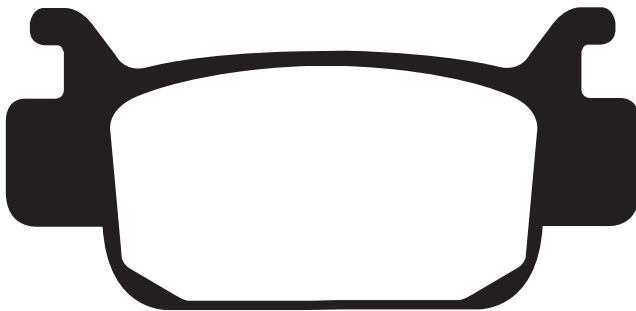

**HONDA**

TRX 500 FA5/FA6/FA7/FA8/FA9/FAA/FAB	05-11	F
TRX 500 FE5/FE6/FE7/FE8/FE9/FEA/FEB Fourtrax Foreman 4WD ES	05-11	F
TRX 500 FM5/FM6/FM7/FM8/FM9/FMA/FMB Fourtrax Foreman 4WD	05-11	F
TRX 500 FPE8/FPE9/FPEA Fourtrax Foreman Power Steering	08-11	F
TRX 500 TM5/TM6 Fourtrax Foreman	05-06	F
TRX 680 FGA6/FGA7/FGA8/FGA9/FA6/7/8/9 Fourtrack Rincon	06-09	F
TRX 680 FA6/FA7/FA8/FA9/FAA/FAB Rincon 4x4 Auto	06-11	F
TRX 700 XX8/XX9/XXB	08-11	R

**Equivalents OE #**

06451 HPO A01	06435 HP6 A01
06452 HPO A01	

**Competitor X Ref**

Dunlop	Ferodo	SBS	Vesrah
959	-	829/193	VD175

**MATERIAL AVAILABILITY AND PART NO.**

STD	OPTIONS			
FA	HH	R	MXS	EPFA
FA410TT	-	FA410R	-	-



# SFA411 81 x 42 x 8.3mm

## SUZUKI

AN 250 K1/K2 Burgman 01-02 R  
 AN 400 K1-K6 Burgman/Skywave 01-06 R

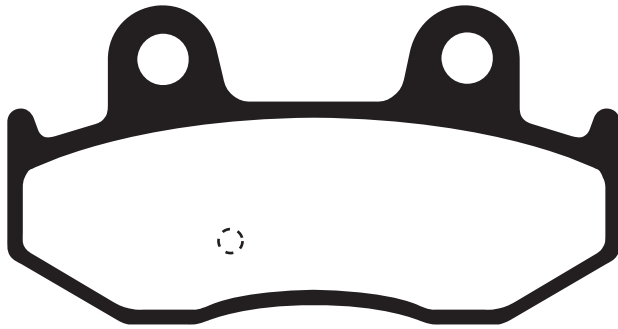

### Equivalents OE #

69100 14860
69100 14890

### Competitor X Ref

Dunlop	Ferodo	SBS	Vesrah
-	-	781/174	VD356

MATERIAL AVAILABILITY AND PART NO.					
STD	OPTIONS				
SFA	SFAC	HH	R	MXS	EPFA
SFA411	SFAC411	SFA411HH	-	-	-

DISC PADS BUYERS GUIDE

# SFA412 87.9 x 41.1 x 8.4mm

## SUZUKI

AN 250 Skywave Type M (BA-CJ4SA) 07-08 R  
 AN 250 Skywave/Type S (BA-CJ44A) 07-08 R  
 AN 250 8 Skywave SS (CJ46A) 08 R  
 AN 400 K7/ZK7/K8/ZK8/K9/L0/L1/L2/L3  
 Burgman/Non ABS/Skywave 07-13 R  
 AN 400 AK9/ZAK9/AL0/ZAL0/AL1/ZAL1/AL2/AL3  
 Skywave/Burgman/ABS 09-13 R  
 AN 650 K3/K4/K5/K6/K7/K8/K9/L0 Burgman/Non ABS 04-11 R  
 AN 650 ZL3 Burgman ABS Executive 13 R  
 AN 650 L3 Burgman Non ABS 13 R  
 AN 650 AK4/AK5/AK6/AK7/AZK8/AK8/AK9/AL0  
 Burgman/ABS Executive 04-12 R

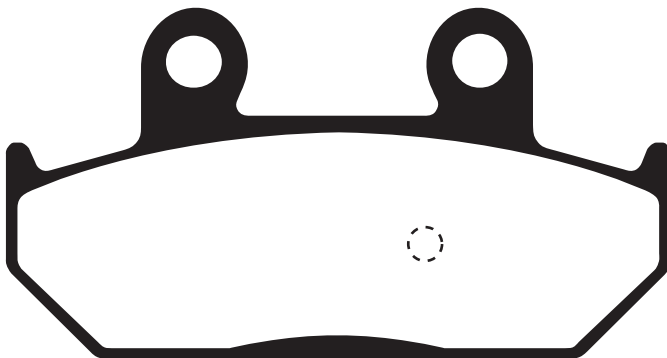

### Equivalents OE #

69100 10840
69100 10860

### Competitor X Ref

Dunlop	Ferodo	SBS	Vesrah
DP968	FDB2173	804/182	VD357

MATERIAL AVAILABILITY AND PART NO.					
STD	OPTIONS				
SFA	SFAC	HH	R	MXS	EPFA
SFA412	SFAC412	SFA412HH	-	-	-

# FA413 A. 82 x 40.85 x 8.22mm B. 62 x 40.8 x 8.6mm

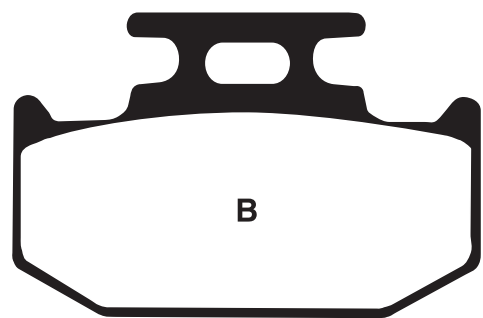
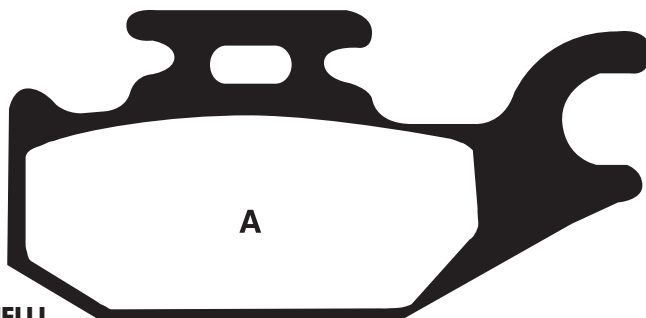

## BENELLI

Caffe Nero 250 08-13 R

## SUZUKI

UH 125 K7/K8/K9/L0/L1/L3 Burgman 07-13 R  
 UH 200 K7/K8/K9/L0/L1/L3 Burgman 07-13 R  
 LT-A 400 FK8/FK9/FL0/FL1 King Quad 4WD 08-12 F(left)  
 LT-F 400 FK8/FK9/FL0/FL1 King Quad 4WD 08-12 F(left)  
 LT-A 450 XK7/XK8/XK9 King Quad 07-10 F(left)  
 LT-A 500 XPK9/XPZK9/XPL1/XPL0 King Quad  
 (Power Steering) 09-10 F(left)  
 LT-A 700 XK5/XCK6/XK6/XK7 Kingquad 05-07 F(left)  
 LT-A 750 XZK8/XK8/XK9/XZK9/L0 King Quad 08-10 F(left)  
 LT-A 750 XPK9/XPZK9/XPL0/XPL1 King Quad Power Steering 09-12 F(left)

### Equivalents OE #

59100 31860
-------------

### Competitor X Ref

Dunlop	Ferodo	SBS	Vesrah
DP920	-	835/196	VD266/2

MATERIAL AVAILABILITY AND PART NO.							
STD	OPTIONS						
FA	SFA	SFAC	HH	SFAC-HH	R	MXS	EPFA
FA413TT	SFA413	SFAC413	-	SFA413HH	FA413R	-	-

# FA414 A. 82 x 40.85 x 8.22mm B. 62 x 40.8 x 8.6mm

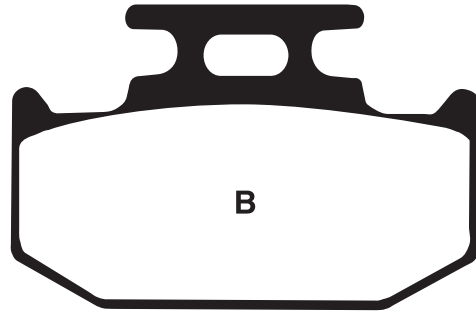
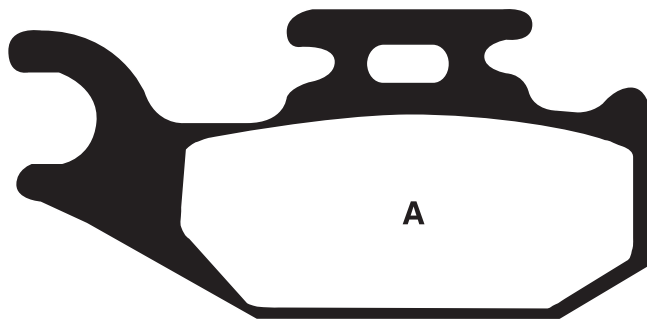

## SUZUKI

LT-A 400 FK8/FK9/FL0/FL1 King Quad Auto 4WD	08-12	F(right)
LT-F 400 FK8/FK9/FL0/FL1 King Quad 4WD	08-12	F(right)
LT-A 450 XK7/XK8/XK9 King Quad	07-10	F(right)
LT-A 500 XPLO/XPK9/XPZK9/XPL1 King Quad (Power steering)	09-12	F(right)
LT-A 700 XK5/XCK6/XK6/XK7 Kingquad	05-07	F(right)
LT-A 750 XK8/XK9/XZK9/XL0 King Quad	08-10	F(right)
LT-A 750 XPK9/XPZK9/XPLO/XPL1/XZK8 King Quad (Power Steering)	09-12	F(right)

### Equivalents OE #

59100 31850

MATERIAL AVAILABILITY AND PART NO.					
STD	OPTIONS				
FA	HH	R	MXS	EPFA	
FA414TT	-	FA414R	-	-	

### Competitor X Ref

Dunlop	Ferodo	SBS	Vesrah
DP919	-	836	VD979/2

# SFA415 81.7 x 37.35 x 8.95mm - Refit O/E shim



## HONDA

FES 125 A7/A9/AA S-Wing	07-13	R
FES 125 7/9/A S-Wing (Non ABS Model)	07-13	R
SH 125i 9/A/B Fuel Injection	09-12	R
SH 125i RA Fuel Injection (Rear disc model)	10-13	R
FES 150 7/9/A S-Wing	07-13	R
FES 150 A7/A9/AA (S-Wing) ABS Model	07-13	R
SH 150i 9/A/B Fuel Injection	09-12	R
SH 150 RA Fuel Injection (Rear disc)	10-13	R
NSS 250 EX5/EX7/EX8 Forza EX	05-08	R
NSS 250 AX5/AX6 (ABS) Forza Z	05-06	R
NSS 250 X5/X7/X8 Forza	05-08	R
NSS 300 AD Forza	13	R
SH 300i 7/8/9/A/B (Non ABS)	07-12	R
SH 300i A7/A8/A9/AA/AB/AC (ABS model)	07-13	R
SH 300i R8/R9/RA (Non ABS)	08-10	R
SH 300i AR8/AR9/ARA (ABS Model)	08-10	R

### Equivalents OE #

06435 KSV J01  
06435 KSV J02  
43251 KTW 901

### Competitor X Ref

Dunlop	Ferodo	SBS	Vesrah
-	-	832	VD173

MATERIAL AVAILABILITY AND PART NO.					
STD	OPTIONS				
SFA	SFAC	HH	R	MXS	EPFA
SFA415	SFAC415	SFA415HH	-	-	-

# FA416 A. 85 x 37 x 7.9mm B. 31.8 x 48.1 x 10.2mm

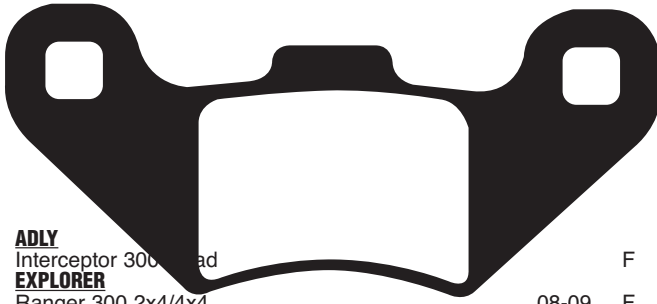

<b>ADLY</b>			
Interceptor 300			F
<b>EXPLORER</b>			
Ranger 300 2x4/4x4	08-09		F
<b>HAMMERHEAD BUGGIES</b>			
80T	08-09		R
150 Supersport ES 150 11 R	08-09		F
<b>KAZUMA</b>			
MF 90 Falcon			F&R
<b>MH</b>			
KN2 50	12-13		R
MH 10 50 Enduro	13		F
MH 10 50 SM	13		F
MH10 Pro 50 Enduro	13		F
MH10 Pro 50 SM	13		F
RYZ 50 Enduro	13		F
RYZ SM 50	13		F
RYZ Pro SM 50	13		F
Duna 125	13		F
Duna Pro 125	13		F
KN2 (125/4T)	12-13		R
125 LC Hard Road SM	12		R
MH10 125 Enduro	13		F
MH10 125 SM	13		F
<b>PGO</b>			
BR 150 E Bugrider	04-07		F
Bugrider 150			F
BR-200 Bugrider	07-12		F
BR 250 Bugrider E	05-12		F
Bugrider 250 SS (Single seat)			F
Bugrider 250			F
250 Bug			F
Bugrider 50 (Buggie)	06		F
<b>QUADZILLA</b>			
RV 125 Midi RV Bug			F
RV 150 Midi RV Bug			F
BR 200	07-08		F

**Equivalents OE #**

07-020-016
B54033 10000

**Competitor X Ref**

<b>Dunlop</b>	<b>Ferodo</b>	<b>SBS</b>	<b>Vesrah</b>
-	-	-	-

MATERIAL AVAILABILITY AND PART NO.				
STD	OPTIONS			
FA	HH	R	MXS	EPFA
FA416TT	-	FA416R	-	-

# FA417/4HH 49.85 x 37.75 x 7.78mm

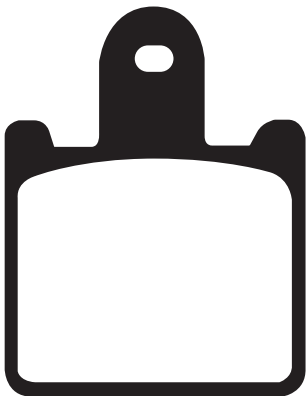

**KAWASAKI**

ZX6R (ZX 600 P7F/P8G/R9F/RAF/RBF/RCF/RDF)	07-13	F
Z 750 R Non ABS (ZR750 NBF/NCF)	11-12	F
Z 750 R ABS (ZR 750 PBF/PCF)	11-12	F
Z 1000 (ZR 1000 B7F/B8F)	07-08	F
Z 1000 ABS (ZR 1000 C7F/C8F/C9F)	07-09	F
GTR 1400 (ZG 1400 A8F/A9F/CAF/CBF/CCF)	08-13	F
ZZR 1400 (ZX 1400 A6F/A7F)	06-11	F
ZZR 1400 ABS (ZX 1400 B6F/B7F/D8F/D9F/DAF/DBF/FCF/FDF)	06-13	F

**Equivalents OE #**

43082 0053
43082 0071
43082 0072
43082 0118

**Competitor X Ref**

MATERIAL AVAILABILITY AND PART NO.					
STD	OPTIONS				
FA	GPFA	HH	R	MXS	EPFA
-	GPFA417/4HH	FA417/4HH	-	-	EPFA417/4HH

<b>Dunlop</b>	<b>Ferodo</b>	<b>SBS</b>	<b>Vesrah</b>
DP964	FDB 2220	838	VD354

# SFA418 A. 96.8 x 39.35 x 9.3mm B. 77 x 42 x 9.3mm

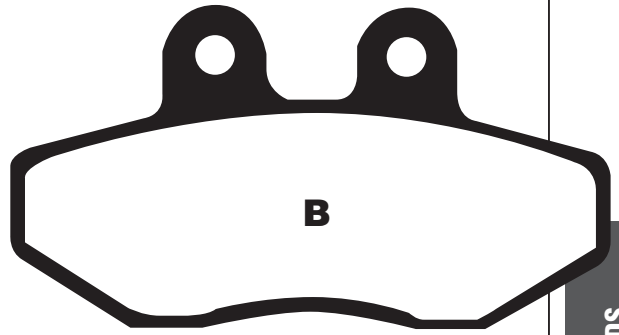
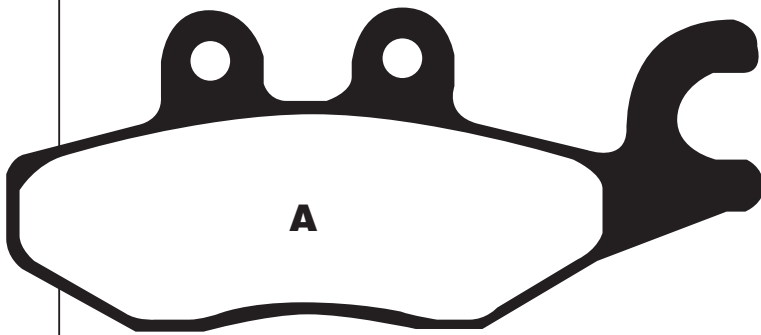

DISC PADS  
BUYERS GUIDE

## PIAGGIO

Beverly 125 (4T) (Multi spoke cast wheel)	11-13	R
MP3 Hybrid (125cc) (14" rear wheel)	09-12	R
MP3 125 ie (EFI Models)	08-11	R
125 ie MP3 Yourban	11-12	R
X7 125cc	08-09	R
X7 Evo 125 ie (EFi)	09-12	R
X9 125 Evolution	05-07	F(right)
X10 125ie (4V/4T/EFI)	12-13	F(right)&R
Xevo 125	07-13	R
Xevo 125 IE (EFi)	09-12	F
MP3 250 MIC/EFi (14" rear wheel)	08-09	R
MP3 250 LT (EFi) (14" rear wheel)	09	R
X7 250 ie	08-09	R
X9 250	05-06	F(right)
Xevo 250 ie	07-10	R
Beverly 300 Sport Touring (330cc/4T) (5 spoke cast wheel)	11-13	R
Beverly 300 (278cc/4T) (Multi spoke cast wheel)	10-13	R
300 ie MP3 Yourban	11-12	R
MP3 300 LT(EFi)	10-11	R
MP3 300 ie (Hybrid)	10-12	R
MP3 300 ie (Hybrid LT)	10-12	R
MP3 Touring 300 ie	11-12	R
MP3 Touring LT 300 ie	11-12	R

MP3 Yourban LT 300ie	11-12	R
MP3 Yourban Sport 300ie	13	R
MP3 Yourban Sport LT 300ie	13	R
X7 300 Evo	09-12	R
X10 ie 350 (4v/4t/efi)	12-13	F(right)&R
400 ie (MP3 Touring)	11-12	R
MP3 Touring 400 ie LT	11-12	R
Xevo 400 ie	07-10	F(right)
X8 400 ie	06-08	F(right)
MP3 500 EFi	09-10	R
X10 500ie (4V/4T/EFI)	12-13	F(right)&R

### Equivalents OE #

497395
647079
665842
668021

### Competitor X Ref

Dunlop	Ferodo	SBS	Vesrah
-	-	818	-

### MATERIAL AVAILABILITY AND PART NO.

STD	OPTIONS				
SFA	SFAC	HH	R	MXS	EPFA
SFA418	SFAC418	SFA418HH	-	-	-

# FA419 A. 89.25 x 40.65 x 9.75mm B. 89.25 x 40.65 x 9.75mm

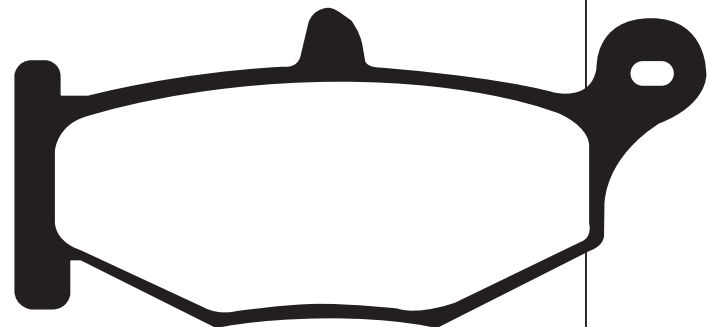
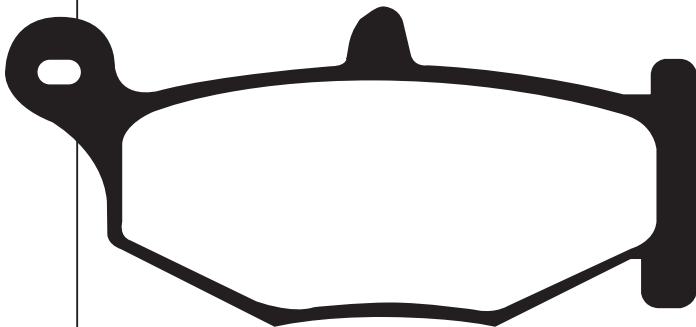

## SUZUKI

GSR 400 K6/K7/K8	06-08	R
GSR 600 K6/K7/K8	06-10	R
GSXR 600 K6/K7/K8/K9/L0	06-10	R
GSXR 750 K6/K7/K8/K9/L0	06-10	R
GSXR 1000 K7/K8	07-10	R
GSX 1300 RK8/RK9/RL0/RL1/RL2 Hayabusa	08-12	R
GSX 1300 BKK8/BKK9/BKL0/BKL1 B-King	08-12	R
GSX 1300 RL3 Hayabusa (Brembo calipers)	13	R

### Equivalents OE #

69101 44810
69100 15830

### Competitor X Ref

Dunlop	Ferodo	SBS	Vesrah
DP963	-	833	SD359

### MATERIAL AVAILABILITY AND PART NO.

STD	OPTIONS				
FA	V	HH	R	MXS	EPFA
FA419	FA419V	FA419HH	-	-	-

# FA420HH 69.28 x 54.48 x 7.9mm

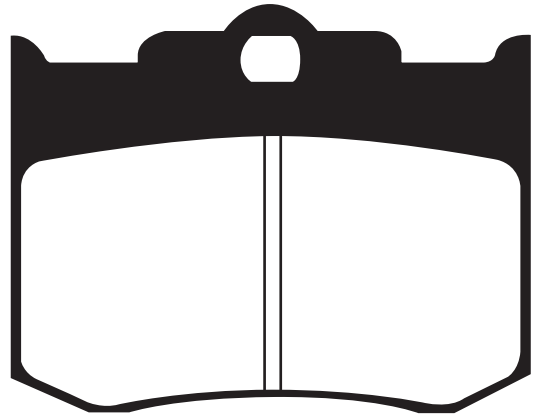

**Equivalents OE #**

137 X 4

**Competitor X Ref**

Dunlop	Ferodo	SBS	Vesrah
-	-	-	-

MATERIAL AVAILABILITY AND PART NO.				
STD	OPTIONS			
FA	HH	R	MXS	EPFA
-	FA420HH	-	-	-

# FA423/4HH 44.7 x 53.5 x 8.45mm

**YAMAHA**

FJR 1300 A (ABS) (3P6- Model)	06-09	F
FJR 1300 A (ABS) (ICY-)	10-12	F
FJR 1300 A (1MC) (ABS/Manua G/shift)	13	F
FJR 1300 AS (ABS - Electric Shift)	13	F
FJR 1300 AS (ABS/Electric Shift) (2D2-)	06-09	F
XVS 1900 A (Midnight Star 3 spring clutch)	13	F

**TRIUMPH**

Trophy 1215cc	12-13	F
Trophy 1215cc SE	12-13	F

**Equivalents OE #**

3P6 W0045 00  
1CR W0045 00

**Competitor X Ref**

Dunlop	Ferodo	SBS	Vesrah
DP965	-	740	VD353

MATERIAL AVAILABILITY AND PART NO.				
STD	OPTIONS			
FA	HH	R	MXS	EPFA
-	FA423/4HH	-	-	-

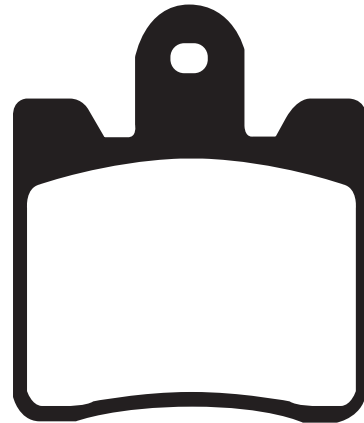

# FA424 91.6 x 51.5 x 8.2mm

**HONDA**

CB 1300 FW/FX/FY (SC40)	98-00	F
-------------------------	-------	---

**KAWASAKI**

ZX-7RR (ZX750 N1/N2)	96-99	F
----------------------	-------	---

**YAMAHA**

YZF-R7 750 '0W02' (Race version)	99-01	F
----------------------------------	-------	---

**BUELL**

X1 Lightning	98-05	F
M2 Cyclone	98-05	F

**HHI (Hawg Halters)**

6 Piston - All types

**JAYBRAKE**

J-Four (300-44) (4 Piston)

**MV**

750 Brutale S F4	03-05	F
750 Brutale Oro F4	03-05	F
750 F4S (Mono Posto)	99-04	F
750 F4S 1+1 (Bi-Posto)	01-04	F
750 F4 SPR	01-04	F
750 F4 SPR Senna	01-03	F
910 Brutale S (Nissin Calipers)	06-08	F
1000 F4 AGO	05	F
1000 F4 S (Mono Posto)	04-06	F
1000 F4 S 1+1 (Bi Posto)	04-06	F
1000 F4 Tamburini	05	F

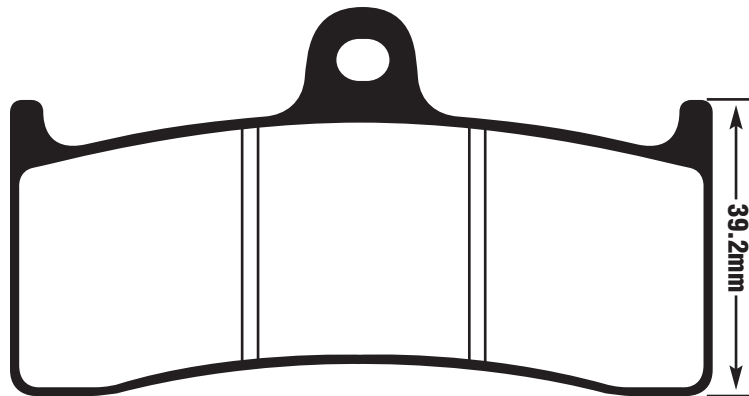

**Equivalents OE #**

43082 1181  
800094024  
80009870  
H0300F  
06455 MBR 006

**Competitor X Ref**

Dunlop	Ferodo	SBS	Vesrah
-	-	-	-

MATERIAL AVAILABILITY AND PART NO.				
STD	OPTIONS			
FA	HH	R	MXS	EPFA
FA424	FA424HH	-	-	EPFA424HH

# SFA425 55.5 x 54.5 x 8mm

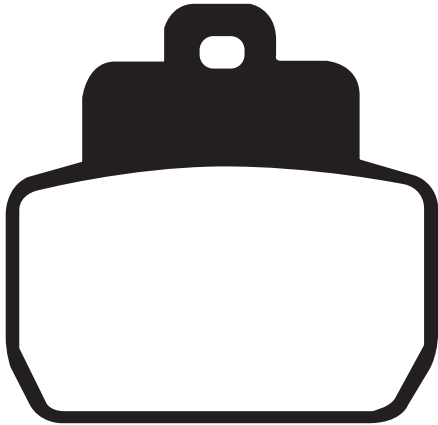

## PIAGGIO

MP3 125 (Carb models) (12" rear wheel)	06-08	R
X8 125	05-06	R
X8 125 ie	07	R
X8 150 Street	07	R
MP3 250cc (EFi) (12" rear wheel)	06-08	R
X8 250 ie	05-07	R
X9 250	05-07	R
Beverley 500	06	R

### Equivalents OE #

497429
647080
647400

### Competitor X Ref

Dunlop	Ferodo	SBS	Vesrah
-	-	831/191	VD9041

MATERIAL AVAILABILITY AND PART NO.					
STD	OPTIONS				
SFA	SFAC	HH	R	MXS	EPFA
SFA425	SFAC425	SFA425HH	-	-	-

# FA426 64 x 48 x 7.8mm

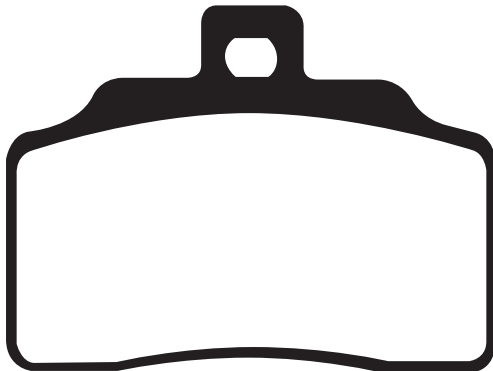

## BETA

M4 350 Supermotard	04-13	F
--------------------	-------	---

### Equivalents OE #

252524600
-----------

### Competitor X Ref

Dunlop	Ferodo	SBS	Vesrah
-	-	-	-

MATERIAL AVAILABILITY AND PART NO.					
STD	OPTIONS				
FA	HH	R	MXS	EPFA	
FA426	-	-	-	-	



# FA427 94 x 36.1 x 10.3mm

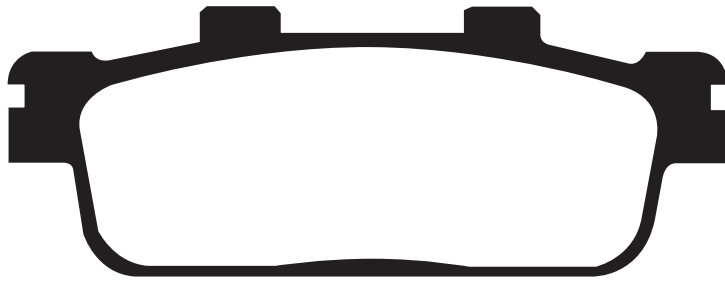

DISC PADS  
BUYERS GUIDE

### DAELIM

ET 250 Quad	05-08	R
ET 300 Quad	07-09	R
ST 250 Sector Quad	05-06	R

### E-TON

RXL 150 Vector	07	R
XVL 250 ST Vector	06-07	R
VXL 250 Vector	06-07	R
VXL 300 Vector	07	R
VXL 300 ST Vector ST	07	R
VTX 300 Vortex	07	R
VTX 300 ST Vortex ST	07	R

### H P POWER

Barum 260 (4T/2V/LC)	10-11	R
----------------------	-------	---

### KYMCO

People S 125 DD	07-11	R
People S 200i DD	07-11	R
Xciting 250 i	06-08	R
Xciting 250	05	R
Xciting 300i (T72000) (EFi Model)	08	R
Xciting 300i R (T72001/72011)	08-10	R

### PEUGEOT

LXR 125 (4T)	10-12	R
LXR 200i (4T)	10-12	R

### SYM

City Com 125	08-13	R
GTS 125 Joymax/Voyager	06-09	F&R
GTS/Joymax Evo 125i	10-13	R
HD2-125i (4T)	10-13	R
HD Evo 125 (Carb & EFi models /4T/Single headlamp)	03-13	R
Joyride 125 i	07-09	R
Joyride Evo 125i	09-13	R
SB 125 Ni-Wolf	11-13	F

HD 200 S Evo	07	R
Quadlander 200	12-13	R
Trackrunner 200 Quad	05-08	R
GTS 250	07-08	R
Quadlander 250	05-07	R
H200SE	06	R
HD2-200i (4T)	10-13	R
HD Evo 200 (Carb & EFi models /4T/Single headlamp)	03-13	R
Joyride 200i	07-09	R
Joyride Evo 200i	09-13	R
Joymax 250 GTS	06-07	R
Joymax 250i	07-08	R
Citymax 300 Quad	06	R
GTS 300/Joymax	08-09	R
GTS/Joymax Evo 300i	10-13	R
<b>TGB</b>		
X-Motion 125	08-11	R
X-Motion 125 Ri	11-12	R
X-Motion 250 i	08-10	R
X-Motion 300 EFi	10-11	R

### Equivalents OE #

G7131 LRAO 000	43108 HWW 000A
812111	43105 HMA 00DA
43105 LDH 1E00	

### Competitor X Ref

Dunlop	Ferodo	SBS	Vesrah
-	FDB 2226	847	VD9045

### MATERIAL AVAILABILITY AND PART NO.

STD	OPTIONS					
FA	SFA	SFAC	HH	R	MXS	EPFA
FA427TT	SFA427	SFAC427	SFA427HH	FA427R	-	-

# FA428 A. 82.08 x 40.85 x 9.5mm B. 62.03 x 40.8 x 9.5mm

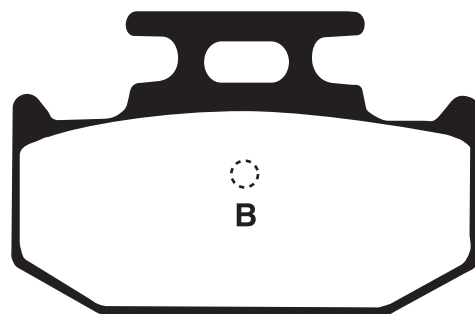
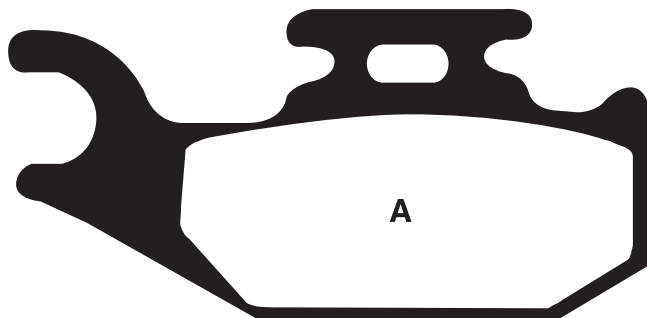

### YAMAHA

YXR 66 FAS/FAT/FAV Rhino 4x4 Side x Side	04-06	R
YFM 700 RV/RW/RX/RV/RA/RB Raptor	06-12	R

### Equivalents OE #

1S3 W0046 00
5UG W0046 00

### Competitor X Ref

Dunlop	Ferodo	SBS	Vesrah
DP988	FDB 2235	816	VD276

### MATERIAL AVAILABILITY AND PART NO.

STD	OPTIONS			
FA	HH	R	MXS	EPFA
FA428TT	-	FA428R	-	-

# SFA430 A. 94.5 x 40 x 7.5mm B. 94.5 x 40 x 7.5mm



### MBK

YP 125 Skycruiser 06-10 F

### YAMAHA

YP 125 R (X-Max) 06-09 F  
 XP 250 R-X-Max (ICO) (Brembo Front Caliper/Non ABS) 05-09 F

### Competitor X Ref

Dunlop	Ferodo	SBS	Vesrah
DP995	FDB 2208	837/151	-

### Equivalents OE #

1B9 W0045 00

MATERIAL AVAILABILITY AND PART NO.					
STD	OPTIONS				
SFA	SFAC	HH	R	MXS	EPFA
SFA430	SFAC430	SFA430HH	-	-	-

# FA431 A. 103.5 x 42.6 x 9mm B. 62.95 x 34.5 x 11mm

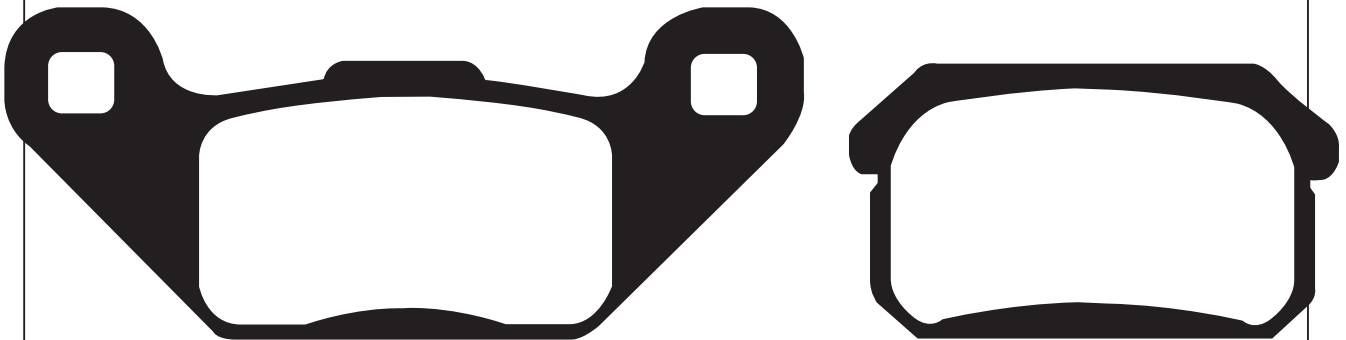

### ADLY

Crossroad 220 Sentinal Quad R  
 Canyon 280 Quad 08-09 R  
 Hurricane 280 Quad 08-09 R  
 Canyon 300 Quad 08-09 R  
 Crossroad 300 Sentinal Quad 08-09 R  
 Interceptor 300 Quad R  
 Utility 300 05-07 R  
 Hurricane 300 Quad 08-09 R  
 300 RS Quad 07-08 R  
 300 XS Quad 07-08 R  
 Hurricane 320 Quad 08-09 R  
 320 S Quad 08 R  
 500 S 08 R

### CPI

XS 250 06-09 R

### EXPLORER

Ranger 300 2x4/4x4 08-09 R

### HAMMERHEAD BUGGIES

150 Supersport ES 150 11 R 08-09 R

### QUADZILLA

CVT 150 E 10-11 R  
 XRV 250 (Off road) 06-07 R  
 XRV 250 E 06-07 R  
 QZ 300 E 4x4 (Parking brake)  
 RL 300 Buggie 07-08 R  
 320 e 4x4 07-08 R(left)  
 CVT 320 e 07-11 R(left)  
 QZ 320 E 4x4 (Parking brake) 09 R

### PGO

BR-200 Bugrider 07-12 R  
 BR 250 E Bugrider 05-12 R  
 250 Bug R

### Equivalents OE #

7-020-022	32176F	B74074-100000
43120 256 000	32176G	

### Competitor X Ref

Dunlop	Ferodo	SBS	Vesrah
-	-	848	-

MATERIAL AVAILABILITY AND PART NO.				
STD	OPTIONS			
FA	HH	R	MXS	EPFA
FA431TT	-	FA431R	-	-

# FA432 68 x 55 x 9mm

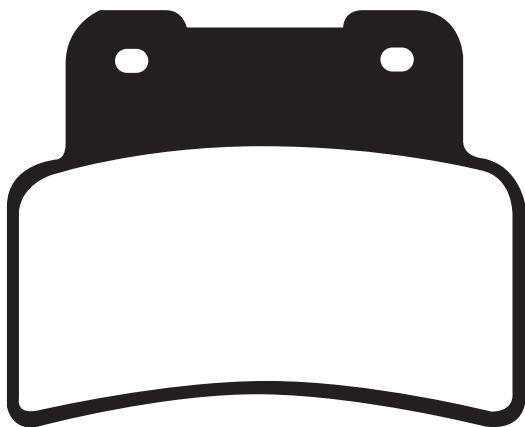

## APRILIA

RS 125 (Radial Caliper) 2T  
 Shiver 750 GT  
 Shiver 750  
 Shiver 750 (RAE00) (Std & ABS)  
 Shiver 750 GT ABS  
 Dorsoduro 750 (ABS)  
 Mana 850  
 Mana 850 GT (ABS Model)  
 Mana 850 ABS

06-13 F  
 09-10 F  
 07-10 F  
 10-13 F  
 10-12 F  
 08-13 F  
 08-11 F  
 09-13 F  
 08-13 F

### Equivalents OE #

8133943
897118

### Competitor X Ref

Dunlop	Ferodo	SBS	Vesrah
-	FDB 2216	844/214	-

### MATERIAL AVAILABILITY AND PART NO.

STD	OPTIONS					
FA	SFA	HH	SFA HH	R	MXS	EPFA
FA432	SFA432	FA432HH	SFA432HH	-	-	-

# FA433/4 45.96 x 34.97 x 7.42mm

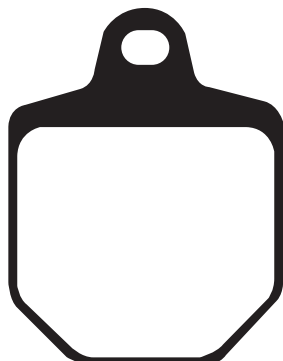

## HONDA HM (Italy)

CRM 125 R Supermoto  
 CRM 250 X Supermoto  
 CRM 450 R/X Supermoto  
 CRM F 490 X Supermoto  
 CRM F 500 X

07 F  
 07 F  
 07-09 F  
 07 F  
 11 F

## HUSABERG

FS 570 Supermoto

10-11 F

## KTM

SMR 450 (Magura caliper)  
 SMR 560

07-13 F  
 07 F

## MAGURA

4 Piston Radial Supermoto Caliper

### Equivalents OE #

0722189	594 13 030 000
072223	SM 27300

### Competitor X Ref

Dunlop	Ferodo	SBS	Vesrah
-	-	843	-

### MATERIAL AVAILABILITY AND PART NO.

STD	OPTIONS			
FA	HH	R	MXS	EPFA
FA433/4	FA433/4HH	-	-	EPFA433/4HH

# FA434 A. 97.54 x 64.2 x 8mm B. 97.54 x 64.2 x 8mm

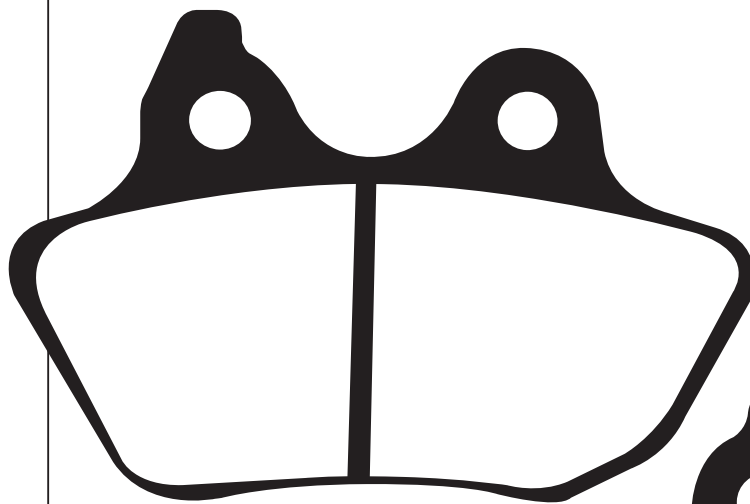

**NOTE:  
DOUBLE CHECK PAD SHAPE.  
DO NOT CONFUSE WITH  
FA400.**



**Equivalents OE #**

46721-06
----------

**HARLEY DAVIDSON**

FXST/FXSTi Softail Standard  
 FXSTB/FXSTBi Night Train Softail  
 FLSTSC/FLSTSCi Springer Softail Classic  
 FLSTF/FLSTFi Fat Boy

06-07 R  
 06-07 R  
 06-07 R  
 07 R

**Competitor X Ref**

Dunlop	Ferodo	SBS	Vesrah
DP971	-	846	VD9033

MATERIAL AVAILABILITY AND PART NO.					
STD	OPTIONS				
FA	V	HH	R	MXS	EPFA
FA434	FA434V	FA434HH	-	-	EPFA434HH

# FA435/4HH 43.5 x 49 x 9.5mm

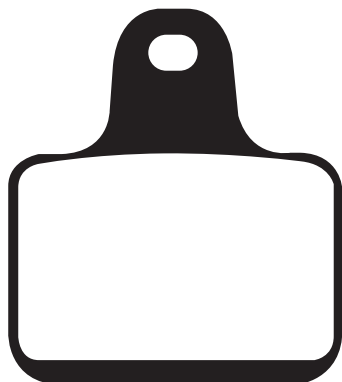

**AP/LOCKHEED**

4 Piston Radial Mount / 4 Separate Pads (CP6688 - 8EOM/9EOM)

**BREMBO**

X00.C04 60/61 - 4 Piston P 34/34 RadialMount Caliper  
 @ 108mm spacing (4 pad set)

XA07680 - 2 Piston P2 34 Radial Mount (Note only sold as set of 4 pads)

X99C4 60/61 P4/34 Radial monobloc 4 pad 108mm spacing

**MV AUGUSTA**

F4 100cc (1078cc) (Claudio Castiglioni)

07-08 F

**PVM**

2 Piston Rear Caliper (Note only 2 pads required)

4 Piston Radial Mount Caliper

**Equivalents OE #**

07 7874 24
8000B1421
CP6688D29
107 A486 04
M049Z04

**Competitor X Ref**

Dunlop	Ferodo	SBS	Vesrah
-	-	805	-

MATERIAL AVAILABILITY AND PART NO.				
STD	OPTIONS			
FA	HH	R	MXS	EPFA
-	FA435/4HH	-	-	EPFA435/4HH

# FA436 77.5 x 42.5 x 8.8mm

Note - refit any O/E shims fitted to original pads



### HONDA

CB 600 F7/F8/F9/FA/FB/FC	07-13	R
CBR 600 FB/FC	11-13	R
CBR 600 RR7/RR8/RR9/RRA/RRB/RRC/RRD	07-13	R
CBR 600 RA9/RAA/RAB/RAC/RAD (C-ABS)	09-13	R
CBR 600 RR Hannspree	08	R
CBR 1000 RR6/RR7/RR8/RR9/RRA/RRB/RRC/RRD	06-13	R
CBR 1000 RA9/RAA/RAB/RAC/RAD (C-ABS) Fireblade	09-13	R

### KAWASAKI

ZX-6R EDF (Non ABS/636cc)	13	R
ZX-6R FDF (ABS Model/636cc)	13	R
ZX 10 R ABS (ZX 1000 KBF/KCF/KDF)	11-13	R
ZX 10 R (ZX 1000 JBF/JCF/JDF)	11-13	R

### SUZUKI

GSXR 600 L1/L2/L3	11-13	R
GSXR 750 L1/L2/L3	11-13	R
GSXR 1000 K9/L0/L1/L2/L3	09-13	R

### Equivalents OE #

06435 MEL D21
06435 MFG D02
06435 MEL D22
69100 47820
43082 0115

### Competitor X Ref

Dunlop	Ferodo	SBS	Vesrah
DP973	FDB 2221	834	359

### MATERIAL AVAILABILITY AND PART NO.

STD	OPTIONS				
FA	V	HH	R	MXS	EPFA
FA436	FA436V	FA436HH	-	-	-

# FA438HH A. 102.9 x 37.3 x 8.52mm B. 102.9 x 37.3 x 8.45mm

NOTE: Need to order new wear lead Part no. MWL002

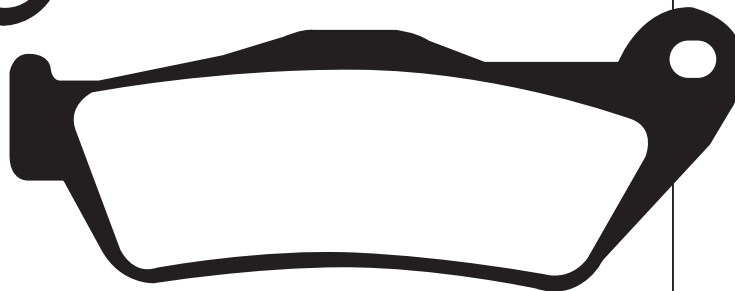
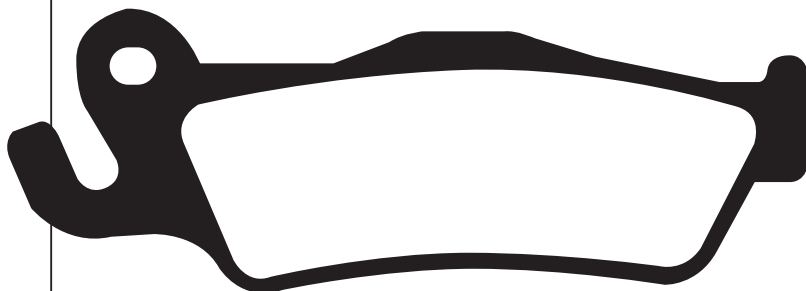

### BMW

K 1200 GT (K44)	06-08	R
-----------------	-------	---

### Equivalents OE #

34-21-7-690-262
-----------------

### Competitor X Ref

Dunlop	Ferodo	SBS	Vesrah
-	-	-	-

### MATERIAL AVAILABILITY AND PART NO.

STD	OPTIONS				
FA	HH	R	MXS	EPFA	
-	FA438HH	-	-	-	

# FA441HH A. 77.3 x 51.45 x 8.55mm B. 77.3 x 51.45 x 8.55mm



**NOTE: Need to order new wear lead Part no. MWL001**

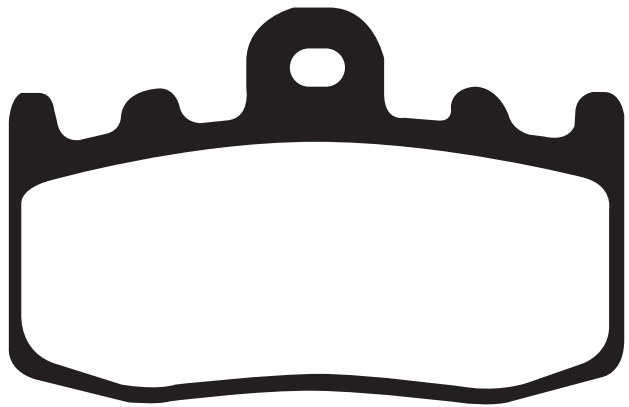

**Equivalents OE #**

34-11-7-690-259
34-11-7-712-948
34-11-7-704-614

**BMW**

K 1200 GT (K44)

06-08 F(right)

**Competitor X Ref**

MATERIAL AVAILABILITY AND PART NO.					
STD	OPTIONS				
FA	HH	R	MXS	EPFA	
-	FA441HH	-	-	-	

Dunlop	Ferodo	SBS	Vesrah
-	-	-	-

# FA442/4 A. 61.85 x 44.25 x 8.1mm B. 48 x 30.8 x 8.1mm

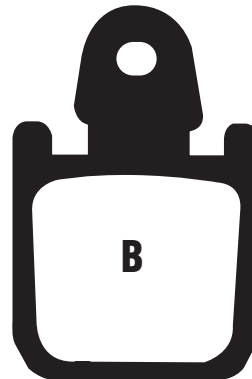
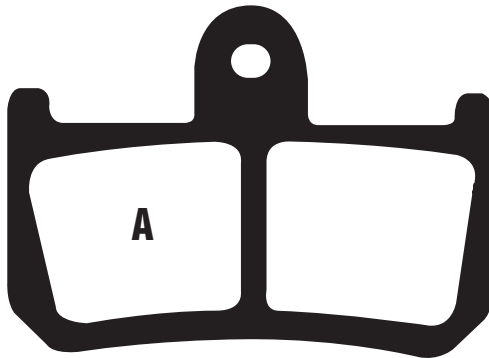

**YAMAHA**

YZF R1 (6 piston radial caliper)  
 MT-01 (6 piston radial caliper)  
 XV 1700 V-Max (2S3)  
 MT-01S (5YUR)

07-13 F  
 07-10 F  
 09-12 F  
 09 F

**Equivalents OE #**

4C8 W0045 00
107 A225 40

**Competitor X Ref**

MATERIAL AVAILABILITY AND PART NO.					
STD	OPTIONS				
FA	GPFA	HH	R	MXS	EPFA
FA442/4	GPFA442/4HH	FA442/4HH	-	-	EPFA442/4HH

Dunlop	Ferodo	SBS	Vesrah
DP977	FDB 2217	839	-



# FA443TT A. 107 x 33.75 x 8mm B. 91.66 x 38.2 x 8mm

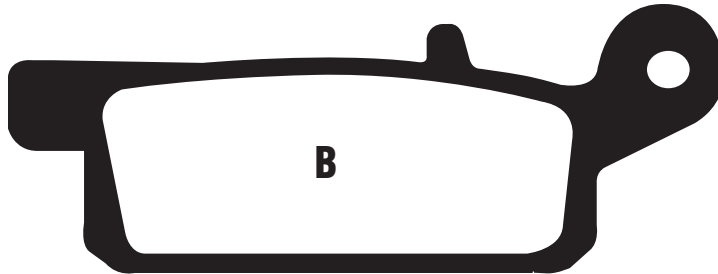
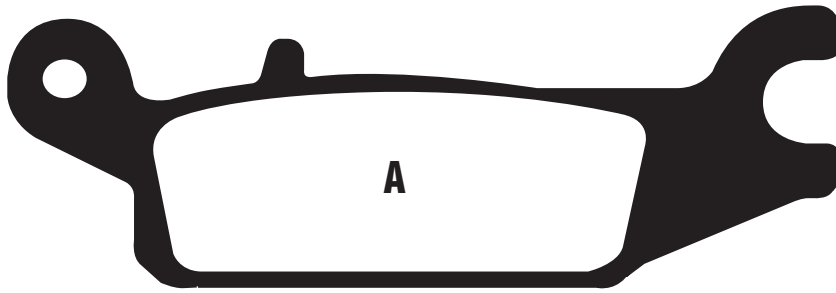

### YAMAHA

YFM 250 RX/RV Raptor	08-09	F(left)
YFM 550 Grizzly FGAY/FGPY/FGPA/FGPB/FGPD	09-13	F(left)
YFM 700 FGPW/FGPX/FGPY/FGPZ/FGPA/FGPB/FGPD Grizzly	07-13	F(left)

### Equivalents OE #

3B4 W0045 00
4D3 W0045 00

MATERIAL AVAILABILITY AND PART NO.				
STD	OPTIONS			
FA	HH	R	MXS	EPFA
FA443TT	-	FA443R	-	-

### Competitor X Ref

Dunlop	Ferodo	SBS	Vesrah
DP979	FDB 2231	850	VD279/2

# FA444TT A. 107 x 33.75 x 8mm B. 91.66 x 38.2 x 8mm

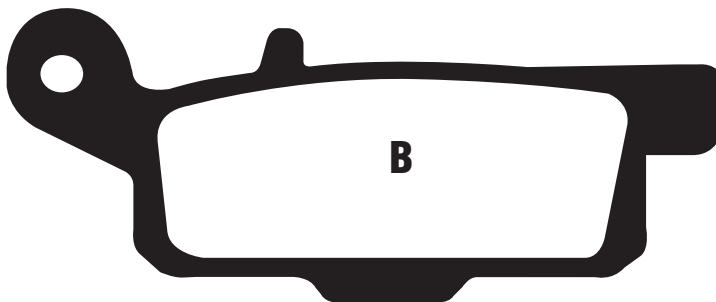
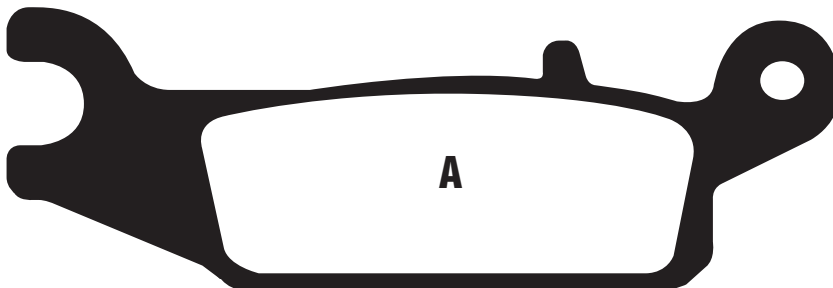

### YAMAHA

YFM 250 RX/RV Raptor	08-09	F(right)
YFM 550 Grizzly FPHY/FGPY/FGPA/FGPB/FGPD	09-13	F(right)
YFM 700 FGPW/FGPX/FGPY/FGPZ/FGPA/FGPB/FGPD Grizzly	07-13	F(right)

### Equivalents OE #

3B4 W0045 10
4D3 W0045 10

MATERIAL AVAILABILITY AND PART NO.				
STD	OPTIONS			
FA	HH	R	MXS	EPFA
FA444TT	-	FA444R	-	-

### Competitor X Ref

Dunlop	Ferodo	SBS	Vesrah
DP980	FDB 2230	849	VD278/2

# FA445TT A. 107 x 33.75 x 8mm B. 91.66 x 38.2 x 9mm

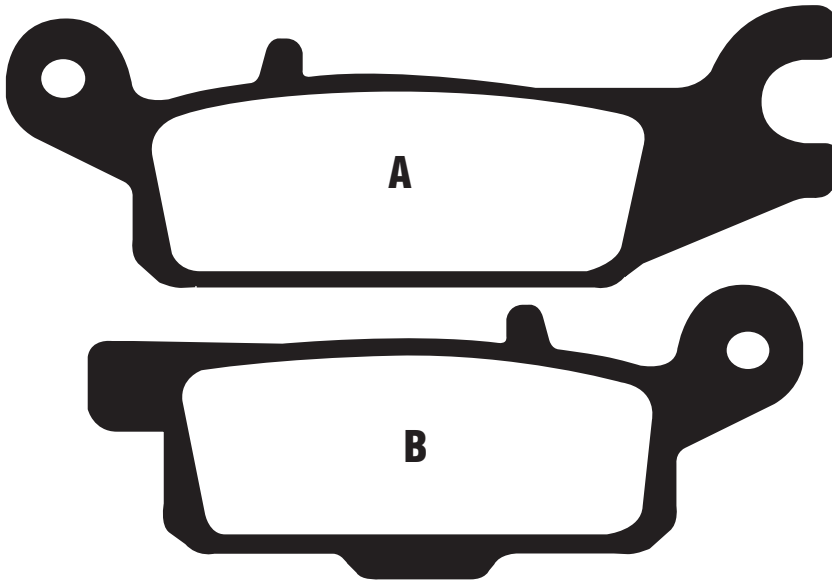

**YAMAHA**

YFM 550 Grizzly FGPY/FGPY/FGPA/FGPB/FGPD 09-13 R(left)  
 YFM 700 FGPW/FGPX/FGPY/FGPZ/FGPA/FGPB/FGPD Grizzly 07-13 R(left)

**Equivalents OE #**

3B4 W0046 00

MATERIAL AVAILABILITY AND PART NO.				
STD	OPTIONS			
FA	HH	R	MXS	EPFA
FA445TT	-	FA445R	-	-

**Competitor X Ref**

Dunlop	Ferodo	SBS	Vesrah
DP981	FDB 2233	852	VD279

# FA446TT A. 107 x 33.75 x 8mm B. 91.66 x 38.2 x 9mm

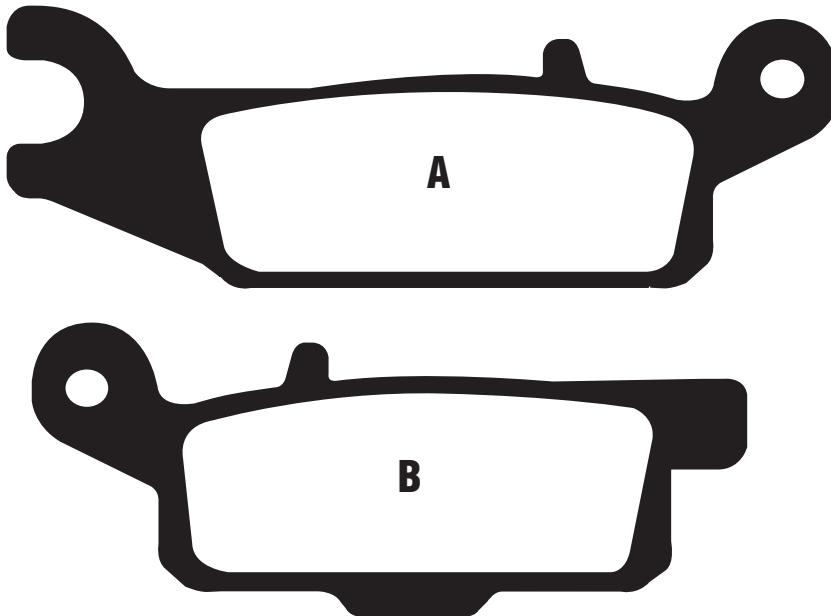

**YAMAHA**

YFM 550 Grizzly FGPY/FGPY/FGPA/FGPB/FGPD 09-13 R(right)  
 YFM 700 FGPW/FGPX/FGPY/FGPZ/FGPA/FGPB/FGPD Grizzly 07-13 R(right)

**Equivalents OE #**

3B4 W0046 10

MATERIAL AVAILABILITY AND PART NO.				
STD	OPTIONS			
FA	HH	R	MXS	EPFA
FA446TT	-	FA446R	-	-

**Competitor X Ref**

Dunlop	Ferodo	SBS	Vesrah
DP982	FDB 2232	851	VD278

# FA447HH 102.25 x 42.25 x 7.5mm

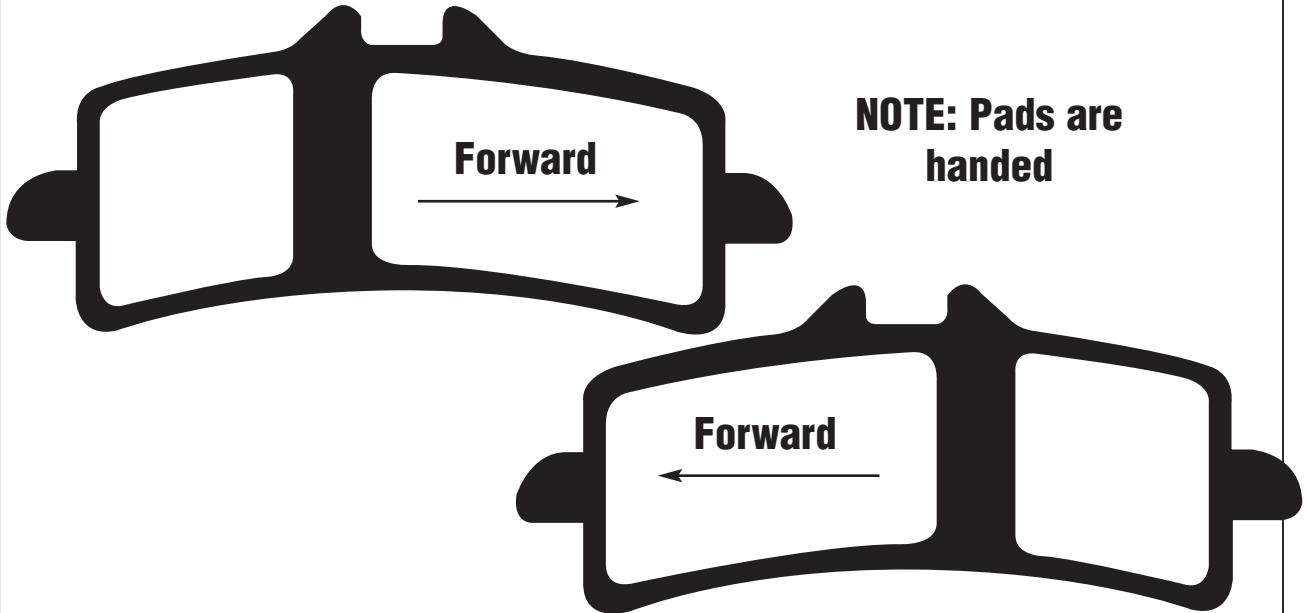

### APRILIA

RSV4 R	10	F
RSV4R APRC	11-13	F
RSV4 Factory	09-10	F
RSV4 Factory APRC	11-13	F

### BENELLI

Tornado Naked Tre 1130 TNT	13	F
----------------------------	----	---

### BIMOTA

DB7 (1099cc)	09	F
DB8 (1198cc)	10-13	F
DB8 SP (1078cc)	12-13	F
DB11 VLX (1198cc)	12-13	F

### BMW

HP2 Sport (K29)	08-11	F
HP4	13	F
HP4 Carbon	13	F

### BREMO

220B01010 - GP4-RX 4 Piston Radial Mount @ 108mm Spacing  
 220A39710 P4/34 108mm Mount monobloc radial  
 220988530 P4/34 100mm Mount monobloc radial  
 20 9883 Radial monobloc 100mm centres

### DUCATI

848 Evo (Monobloc front calipers)	10-13	F
848 Evo Dark	12	F
848 Evo Corse SE	12-13	F
Diavel - ABS	11-12	F
Diavel Carbon - ABS	11-12	F
Diavel Chromo ABS	12	F
Diavel AMG	11-12	F
Diavel Strada	13	F
Diavel Dark	13	F
990 Supermoto R (SM-R)	10-11	F
1098	07-08	F
1098 S	07-08	F
1098 R	08-09	F
1098 S Tricolore	07	F
Hypermotard 1100 S	07-09	F
Desmosedici RR (D16RR/989cc)	08	F
Streetfighter 1100 (1099cc)	09-11	F
Streetfighter 1100 S (1099cc)	09-13	F
1100 Evo SP Hypermotard	10-12	F
1198	09-11	F

1198 S	09-10	F
1198 R Corse	10	F
1198 S Corse	10	F
1198 SP	11	F
1199 Panigale	12-13	F
1199 Panigale ABS	12-13	F
1199 Panigale S ABS	12-13	F
1199 Panigale S Tricolore	12-13	F
1199 Panigale R	13	F

### HUSQVARNA

Nuda 900 R	12-13	F
------------	-------	---

### KTM

690 R Duke	13	F
990 Supermoto R (SMR)	10-13	F
RC8 (1190cc)	08-11	F
RC8 R (1190CC)/Track	09-13	F

### MV AGUSTA

675 F3 Serie Oro	12-13	F
998 Freccce Tricolori	10	F
998 F4R	12-13	F
998 F4RR	10-13	F
998 F4RR Corsa Corta	12	F
F4 998cc	10-13	F
F4 1000 CC	07	F
1000 F4R 312 (From VIN 008065 Brembo 2 pad caliper)		
1078 Brutale RR	08-09	F
F4RR 1078cc 312	08-09	F
1078 F4 RR 312	09	F
Brutale 1090 RR	10-13	F

### SUZUKI

GSXR 600 L1/L2/L3	11-13	F
GSXR 750 L1/L2/L3	11-13	F
GSXR 1000 L2/L3/ZL3	12-13	F
GSX 1300 RL3 Hayabusa (Brembo calipers)	13	F

### TRIUMPH STREET

Daytona 675R (Brembo calipers)	11-13	F
Speed Triple R 1050 (Brembo monobloc radial caliper/5 spoke cast wheel)	12-13	F

### Equivalents OE #

61340791A	59100 14830	07BB30RC
07 9882 10	107 A486 49	M497Z04
690 13 030 000	8000B1601	107988210
34 11 710 743	8000B6714	07BB3050
8000B1663	8537251	61340961A
T2021451	8538735	59100 14850

### Competitor X Ref

Dunlop	Ferodo	SBS	Vesrah
DP978	FDB 2218/2260	841	VD9031

### MATERIAL AVAILABILITY AND PART NO.

STD	OPTIONS				
FA	GPFA	HH	R	MXS	EPFA
-	GPFA447HH	FA447HH	-	-	EPFA447HH

# FA448 58.1 x 33.35 x 6mm

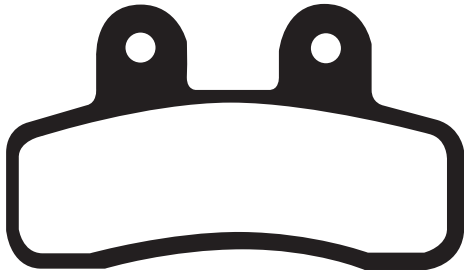

**Equivalents OE #**

1-290025
3-290055

**ELSTARS (PIT BIKES)**

Various models (Check parts before fitting)

F&R

**ITALJET**

Pit Jet 50 (2T)

07-09 F&R

Pit Jet 125 4T (Pro)

07-09 F&R

**GENERIC**

Mini Trigger X50

08-09 F&R

Mini Trigger SM 50

08-09 F&R

**LIFAN**

LF 125 Off Road

07 F

**MOTOM**

Spasso 50

08-09 F

**QUADZILLA**

WK 140

06-08 F

**STOMP MINI MOTO**

125cc Elite

07-09 F

MATERIAL AVAILABILITY AND PART NO.				
STD	OPTIONS			
FA	HH	R	MXS	EPFA
FA448	-	-	-	-

**Competitor X Ref**

Dunlop	Ferodo	SBS	Vesrah
-	-	211	-

# FA450 94.2 x 31.8 x 7.2mm

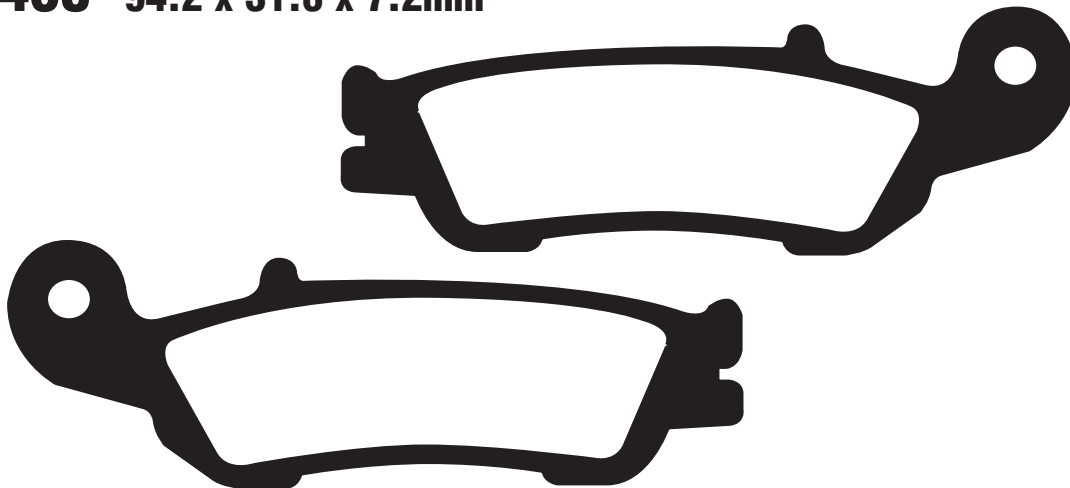

**YAMAHA**

YZ 125 X/Y/Z/A/B/D (2T)

08-13 F

YZ 250 X/Y/Z/A/B (2T)

08-12 F

YZ 250 FW/FX/FY/FZ/FA/FB (4T)

07-12 F

YZ 450 FX/FY/FZ/FA/FB

08-12 F

**Equivalents OE #**

5XC W0045 00

MATERIAL AVAILABILITY AND PART NO.				
STD	OPTIONS			
FA	HH	R	MXS	EPFA
FA450TT	-	FA450R	MXS450	EPFA450HH

**Competitor X Ref**

Dunlop	Ferodo	SBS	Vesrah
DP983	FDB 2219	840	VD280

# FA452R 120.65 x 57.35 x 6.9mm

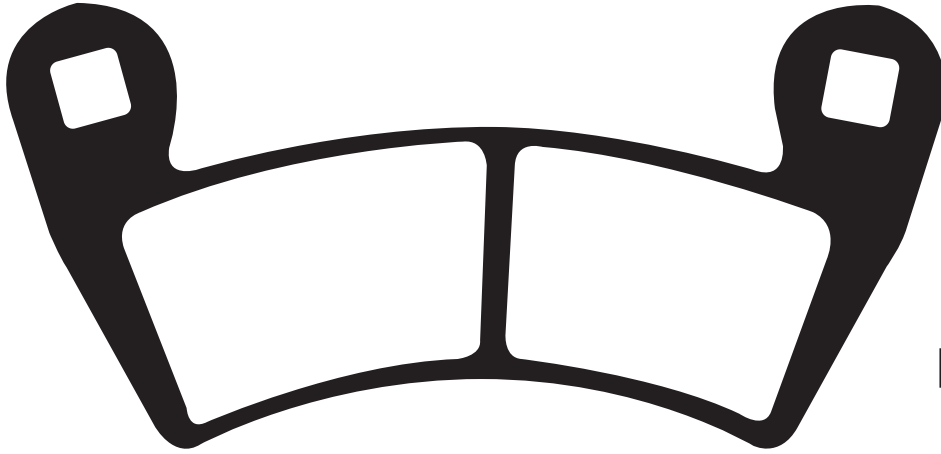

### Equivalents OE #

2203747

### POLARIS

400 Ranger	10-11	F
Ranger 500 4x4 EFI	08-11	F
500 Ranger (EFI) 4x4 HO	09-11	F
Ranger 500 2x4	08	F
500 Ranger Crew	11	F
500 Ranger (Carb) 2x4	09	F
Ranger 700 6x4 EFI	08	F
Ranger XP 700 4x4	08	F
700 Ranger 4x4 EFI	09	F
700 Ranger Crew (EFI) 4x4	09	F&R
Ranger EV (Electric)	10-11	F
800 Ranger HD	10-11	F
800 Ranger XP	10-11	F
800 Ranger 6x6	10-11	F
800 Ranger Crew (RGR 4x4)	10-11	F

800 Ranger RZR-4	10-12	F
800 Ranger RZR 4 EPS	12	F
900 D Ranger 4x4 Diesel	11	F
Ranger RZR XP 900	11	F
Ranger RZR XP 900 White Lightning LE	11	F
900 Ranger RZR XP EFI	12	F
900 Ranger RZR XP	12	F

### Competitor X Ref

Dunlop	Ferodo	SBS	Vesrah
DP996	FDB2263	897	-

MATERIAL AVAILABILITY AND PART NO.				
STD	OPTIONS			
FA	HH	R	MXS	EPFA
FA452TT	-	FA452R	-	-

# FA453 96.96 x 37.25 x 7.15mm

### Equivalents OE #

901 08 08 01	322050A
901 08 08 10	3220505A
45815 RAM 01	

### Competitor X Ref

Dunlop	Ferodo	SBS	Vesrah
DP511	-	-	-

MATERIAL AVAILABILITY AND PART NO.				
STD	OPTIONS			
FA	HH	R	MXS	EPFA
FA453TT	-	FA453R	-	-

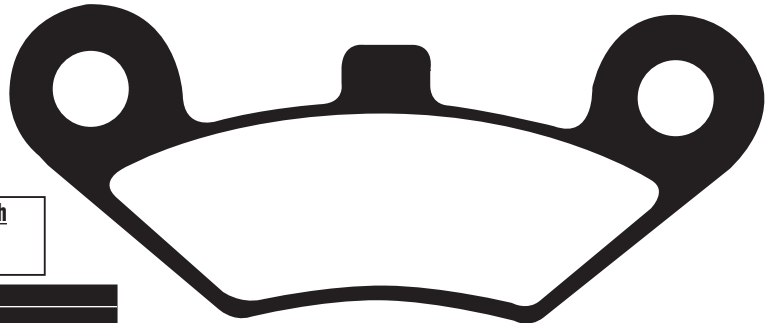

### AJS

Crazy Naked 50 10-11 R

### C F MOTO

CF 500-2 Terralander 500 13 F  
 CF 625-B/C X6 Terralander 11-13 F  
 CF 800-2 Terralander 12-13 F

### EXPLORER

Atlas 500/4x4 08-09 F  
 Everest 500 L/4x4 08-09 F

### GOES

360 Max (Quad) 08-12 F  
 G 520 F (Quad) 07-13 F  
 520 Max (Quad) 07-12 F  
 G 525 (4x4) 12-13 F  
 G 525 4x4 Max 12-13 F  
 G 625i (All models) 12 F  
 G 625i (4x4) 12-13 F  
 G 625i 4x4 Max 12-13 F  
 G 625i UTX 4x4 (Side x Side) 12-13 F  
 G E-SSV Electric (Side x Side) 12-13 F

### LINHAI

Goon 260 ATV (2x4/4x4) 07-09 F&R  
 CUV Carry 300 (ATV) 07-09 F&R  
 Muddy 300 4x4 (ATV) 07-09 F&R  
 ATV 310 (4x2) 13 F&R  
 ATV 320 4x4 Carrier 13 F&R  
 ATV 420 4x2/LOF 13 F&R

ATV 420 4x4/LOF 13 F&R  
 ATV 420 4x4 Carrier/LOF 13 F&R  
 ATV 600 EFI 4x4/LOF 13 R  
 CUV Jobber 4x4 13 R

### NEW FORCE QUADS

Most models (Check shape of old pad) F&R

### PEUGEOT

Metropolis 400 3 Wheel Model 13 F&R

### QUADZILLA

CVT 150 E 10-11 F  
 CUV 300 (4x4 Super Utility Side x Side) 08 R  
 Quadzilla 300 Utility 04-06 F  
 300 E SUV (Manual) 06-07 F  
 300 E SUV (Automatic) 06 F  
 300 E (4x4) (Auto) 06 F  
 320 e 4x4 07-11 F  
 CVT 320 e 07-11 F  
 500 4x4 09-11 F  
 CUV 500 Side x Side 10-11 F  
 RL 500 MKII Buggie 10-11 F  
 QZ 500 E/ES 4x4 F  
 RS5 4WD 10-11 F  
 RS6 EFI 4WD 10-11 F  
 X8 (4x4/EFI) 12-13 F  
 ZX6 4x4 10-13 F

### W.T. MOTORS

WT 500 Alaska Quad 08-09 F

# FA454/4HH 61.5 x 46.83 x 7.35mm (inc shims)

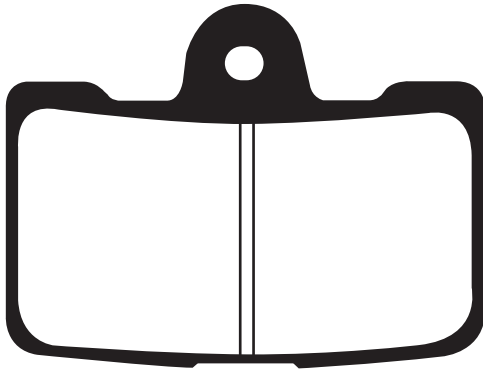

**BUELL**

1125 R  
 1125 CR  
 XB12 SCG Lightning  
 XB12 R Firebolt  
 XB12 SS Lightning

08-10 F  
 09-10 F  
 09-10 F  
 09-10 F  
 09-10 F

**8 piston caliper**

**Equivalents OE #**

H0300 1AMA

**Competitor X Ref**

MATERIAL AVAILABILITY AND PART NO.				
STD	OPTIONS			
FA	HH	R	MXS	EPFA
-	FA454/4HH	-	-	EPFA454/4HH

<u>Dunlop</u>	<u>Ferodo</u>	<u>SBS</u>	<u>Vesrah</u>
-	FDB 2240	856	VD9038

# FA455HH 98.8 x 55 x 8.8mm

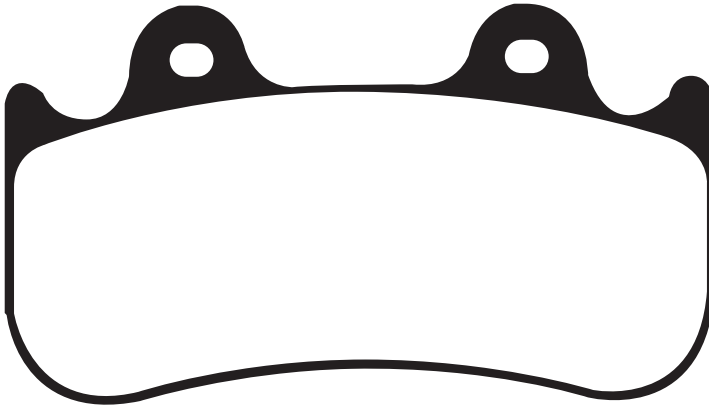

**JAYBRAKE**

6 PF-L (6 Piston)

**Equivalents OE #**

[Empty box for OE #]

**Competitor X Ref**

MATERIAL AVAILABILITY AND PART NO.				
STD	OPTIONS			
FA	HH	R	MXS	EPFA
FA455V	FA455HH	-	-	-

<u>Dunlop</u>	<u>Ferodo</u>	<u>SBS</u>	<u>Vesrah</u>
-	-	-	-

# FA456R 97.1 x 46.8 x 6.85mm



**POLARIS**

450 S Outlaw  
 450 Outlaw MXR  
 525 S Outlaw  
 525 Outlaw IRS  
 800 Ranger RZR  
 800 Ranger RZR S EFI

08 F  
 09-10 F  
 08-10 F  
 08-11 F  
 08-11 F  
 09-12 F

**Equivalents OE #**

1911197
2203318
2203930

**Competitor X Ref**

MATERIAL AVAILABILITY AND PART NO.				
STD	OPTIONS			
FA	HH	R	MXS	EPFA
-	-	FA456R	-	-

<u>Dunlop</u>	<u>Ferodo</u>	<u>SBS</u>	<u>Vesrah</u>
DP984	-	898	-



# FA457HH A. 90.6 x 62.1 x 8.1mm B. 90.6 x 62.1 x 8.1mm

**NOTE**  
Do not refit any original insulator shims from old original pads.

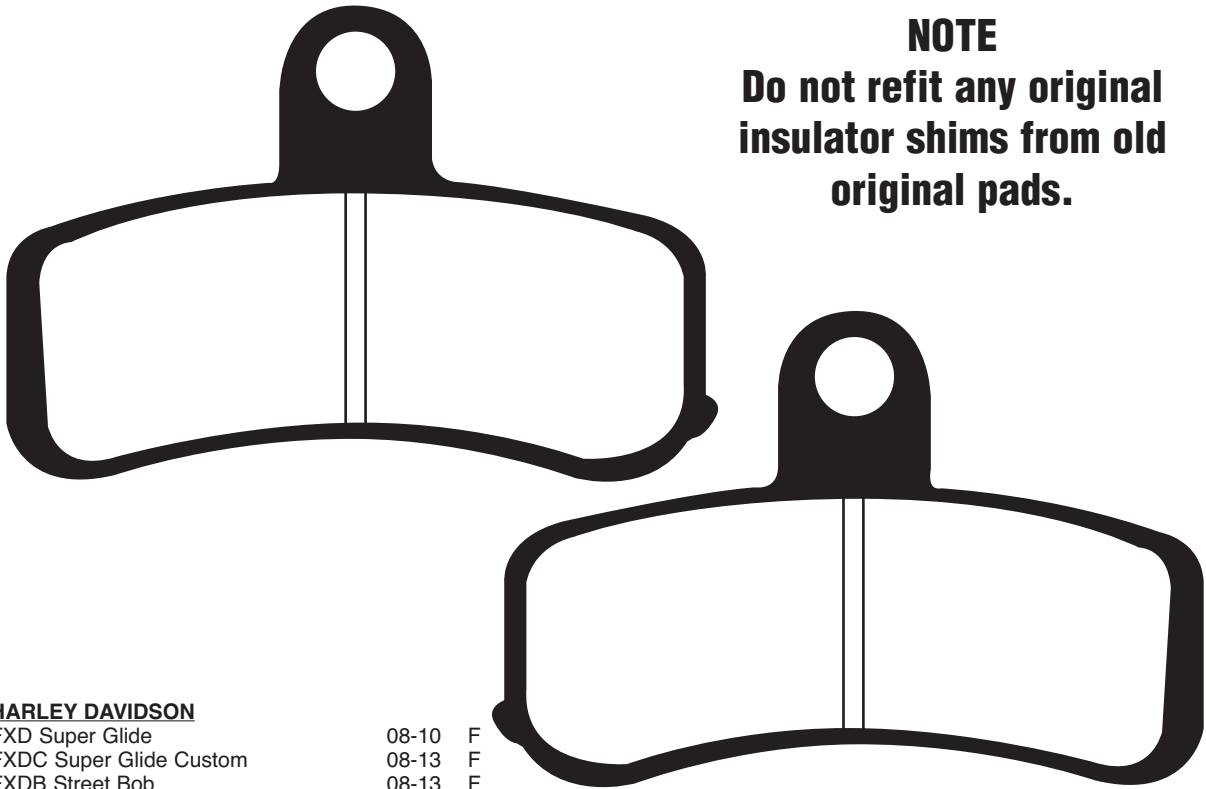

DISC PADS  
BUYERS GUIDE

**HARLEY DAVIDSON**

FXD Super Glide	08-10	F
FXDC Super Glide Custom	08-13	F
FXDB Street Bob	08-13	F
FDXL Low Rider	08-09	F
FXDF Fat Bob	08-13	F
FXDWG	08-13	F
Dyna Wide Glide (Spoke wheels)	10-12	F
FXSTB Night Train	08-09	F
FXSTC Softail Custom	08-10	F
FLS Softail Slim	12	F
FLSTF Fat Boy	08-12	F
FLSTFB Fat Boy Special	10-13	F
FLSTN Softail Deluxe	08-13	F
FLSTC Heritage Softail Classic	08-13	F
FXCW Rocker	08-09	F
FXCWC Rocker C	08-11	F
FLD Switchback	12-13	F
FLSTFB Fat Boy Lo Softail	10-13	F
Softail FXS Blackline	11-13	F

**Equivalents OE #**

44082-08
46363-11

**Competitor X Ref**

<b>Dunlop</b>	<b>Ferodo</b>	<b>SBS</b>	<b>Vesrah</b>
DP986	FDB 2250	853	VD9034

**MATERIAL AVAILABILITY AND PART NO.**

STD	OPTIONS				
FA	V	HH	R	MXS	EPFA
-	FA457V	FA457HH	-	-	EPFA457HH

**FA458V** A. 130 x 56.5 x 8mm B. 130 x 56.5 x 8mm  
**FA458HH** A. 130 x 56.5 x 7.45mm B. 130 x 56.5 x 7.45mm

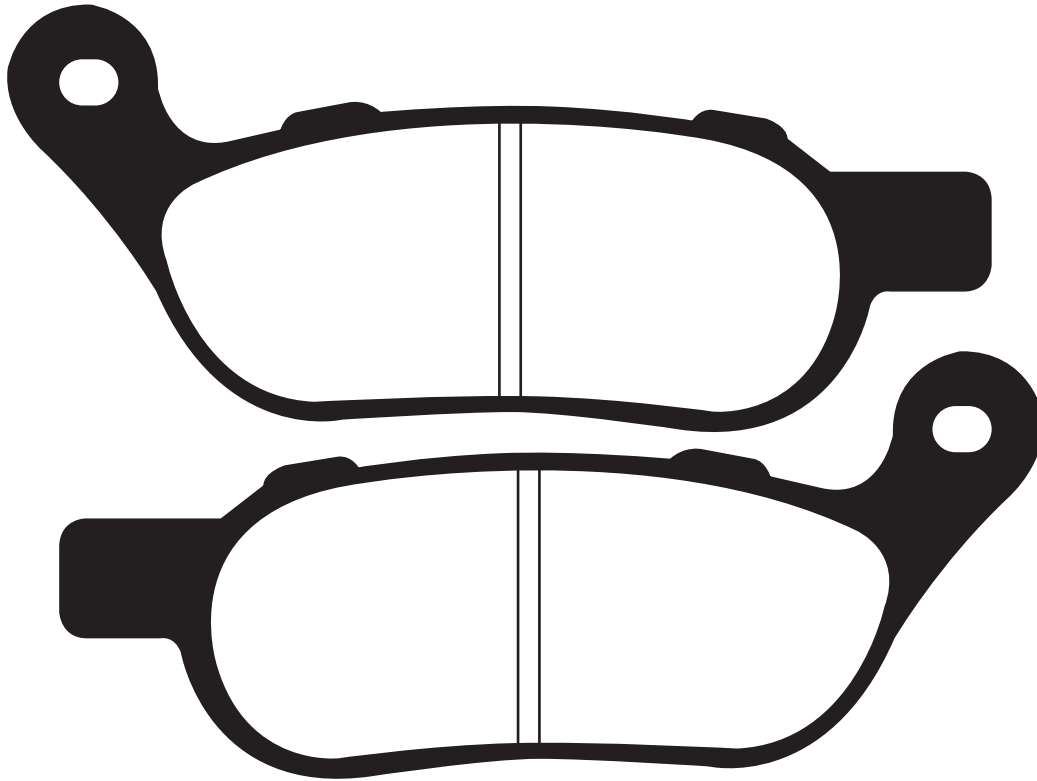

**HARLEY DAVIDSON**

FXD Super Glide	08-10	R
FXDC Super Glide Custom	08-13	R
FXDB Street Bob	08-13	R
FDXL Low Rider	08-09	R
FXDF Fat Bob	08-13	R
FXDWG Dyna Wide Glide (Spoke wheels)	08-13	R
FXSTB Night Train	08-09	R
FXSTC Softail Custom	08-10	R
FLS Softail Slim	12-13	R
FLSTF Fat Boy	08-13	R
FLSTFB Fat Boy Special	10-13	R
FLSTN Softail Deluxe	08-13	R
FLSTC Heritage Softail Classic	08-13	R
FLSTSB Softail Cross Bones	08-11	R
FLSTFB Fat Boy Lo Softail	10-13	R
FXCW Rocker	08-09	R
FXCWC Rocker C	08-11	R
Softail FXS Blackline	11-13	R

**Equivalents OE #**

42298-08

**Refit on HH pads only, the  
OE shim to non piston side**

**Competitor X Ref**

Dunlop	Ferodo	SBS	Vesrah
DP987	FDB 2251	854	VD9035

MATERIAL AVAILABILITY AND PART NO.					
STD	OPTIONS				
FA	V	HH	R	MXS	EPFA
-	FA458V	FA458HH	-	-	EPFA458HH

**SFA459** 55.5 x 49 x 7.5mm

**GILERA**

Various models. Check old pad shape between this pad and SFA321.

**Equivalents OE #**

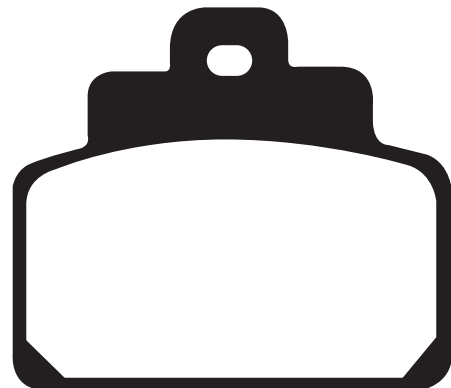

**Competitor X Ref**

Dunlop	Ferodo	SBS	Vesrah
-	-	-	-

MATERIAL AVAILABILITY AND PART NO.					
STD	OPTIONS				
FA	HH	R	MXS	EPFA	
SFA459	-	-	-	-	-

# FA460HH 46.43 x 49.23 x 6.9mm

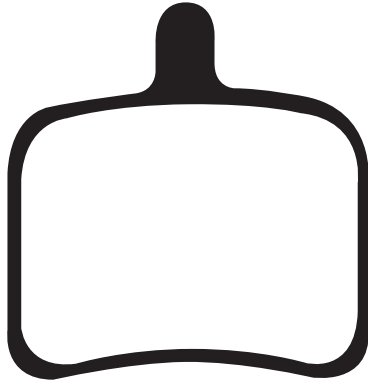

**BUELL**

1125 R  
1125 CR

08-10 R  
09-10 R

**Equivalents OE #**

H301 1AM

**Competitor X Ref**

MATERIAL AVAILABILITY AND PART NO.				
STD	OPTIONS			
FA	HH	R	MXS	EPFA
-	FA460HH	-	-	-

Dunlop	Ferodo	SBS	Vesrah
-	-	857	-

# FA462R 75 x 37 x 7.5mm

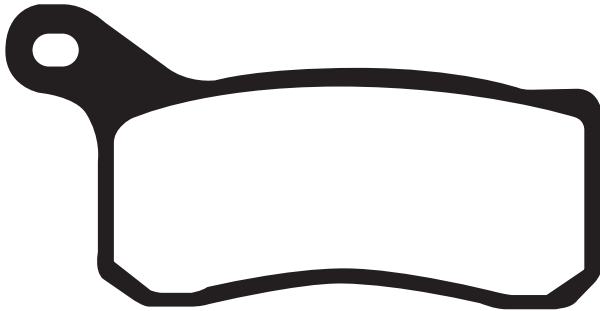

**HM**

CRE 50 Six Competition  
CRM 50 Derapage Competition  
CRM 125 (Derapage Competition 2T)

10-12 F  
09 F  
11 F

**KTM**

450 SX-F (Quad)  
505 SX-F (Quad)  
XC 450 Quad  
XC 525 Quad

09-11 F  
09-12 F  
08-10 F  
08-12 F

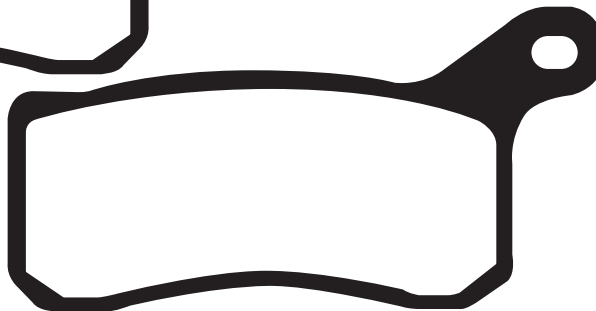

**Equivalents OE #**

830 13 030 100  
K00979315

**Competitor X Ref**

MATERIAL AVAILABILITY AND PART NO.				
STD	OPTIONS			
FA	HH	R	MXS	EPFA
-	-	FA462R	-	-

Dunlop	Ferodo	SBS	Vesrah
DP989	-	866	-

# FA463R 58.72 x 35.35 x 8.5mm

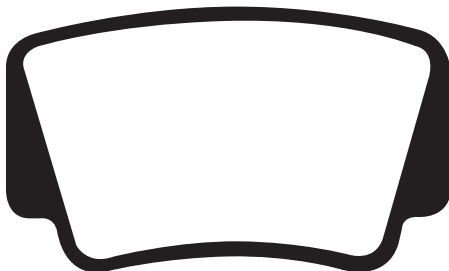

**KTM**

450 SX-F (Quad)  
505 SX-F (Quad)  
XC 450 Quad  
XC 525 Quad

09-11 R  
09-12 R  
08-10 R  
08-12 R

**Equivalents OE #**

830 13 090 100

**Competitor X Ref**

MATERIAL AVAILABILITY AND PART NO.				
STD	OPTIONS			
FA	HH	R	MXS	EPFA
-	-	FA463R	-	-

Dunlop	Ferodo	SBS	Vesrah
DP990	-	867	-

# FA464 A. 109.6 x 50.6 x 8.4mm B. 95.6 x 36.9 x 8.45mm

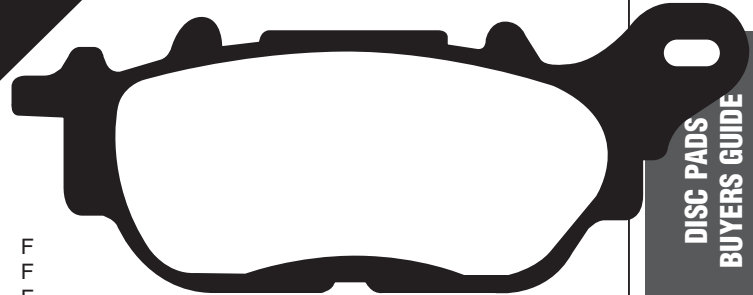
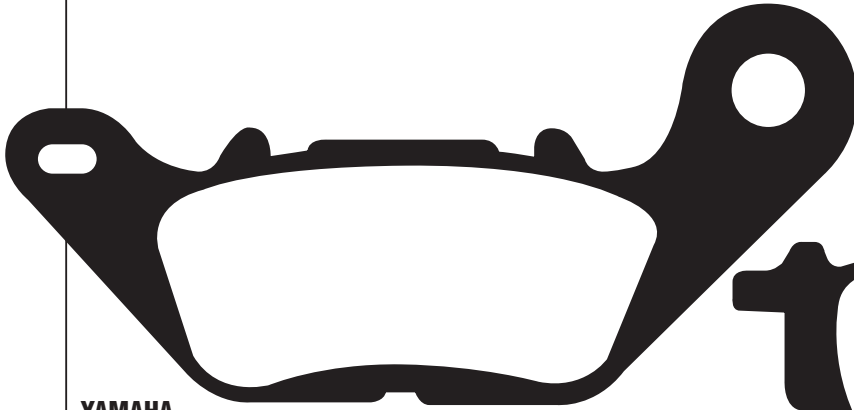

DISC PADS  
BUYERS GUIDE

## YAMAHA

XC 125 Vity (4P7)	08-13	F
YBR 125 (3D92/9)	07-09	F
YBR 125 Custom	08-13	F
YBR 125 (51D1/2) (4 plate clutch)	10-13	F
T 135 HC/S (2S61) Cypton X/Jupiter MX/Spark 135 /Exciter/135 LC/Sniper	06-08	F
T 135-SE (1S71) (Automatic Clutch) Cypton X /Jupiter MX/Spark 135/Exciter/135 LC/Sniper	06-08	F

## MBK

XC 125 WAAP	08-10	F
-------------	-------	---

### Equivalents OE #

4S5 W0045 00
4C9 W0045 00
5D9 W0045 01
3C1 W0045 10

### Competitor X Ref

MATERIAL AVAILABILITY AND PART NO.					
STD	OPTIONS				
FA	SFA	HH	R	MXS	EPFA
FA464	SFA464	-	-	-	-

Dunlop	Ferodo	SBS	Vesrah
-	-	858	VD282

# FA465TT A. 110.6 x 34.6 x 7.42mm B. 98.7 x 33.5 x 7.46mm

### Equivalents OE #

864342
865527
00TRS01A0074
06451 KZZ 901

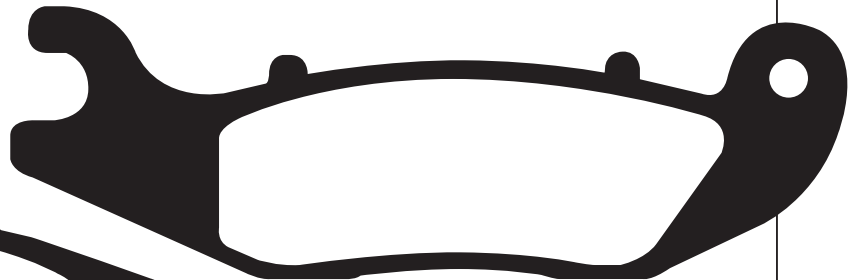

## AJP

PR5 250 Enduro	10-11	F
PR5 250 Supermoto	10-11	F

## DERBI

Cross City 125	09-13	F
Mulhacen 125 (4T) From Ref No. 7N001791		
Spoke wheel/single pin fixing	07-11	F
Terra 125 Euro (Single pin pad fixing)	07-11	F
Terra 125 Adventure	07-13	F

## FANTIC

TR 125 CR (2T) Cross Competizione	13	F
TZ 125 CS Caballero Cross (2T)	11-12	F
TZ 125 ES Regularita Scuderia (2T)	11-12	F
TZ 170 E Regularita (125E/4T)	11-12	F
TZ 170 ER Caballero Regularita Competizione (125ER/4T)	11-12	F
TZ 170 SM Motard (125SM/4T)	11-12	F
TZ 170 SMR Motard (125 SMR 4T)	11-12	F
TX 180 E Regularita Casa 50 E (49cc/2T)	11-13	F
TX 180 ER Regularita Competizione 50 ER (49cc/2T)	11-13	F
TX 180 ES Regularita Scuderia 50 ES (49cc/2T)	11-13	F
TX 180 SM Motard Casa 50M (49cc/2T)	11-13	F

TZ 180 MR Motard Competizione 50 MR (49cc/2T)	11-13	F
TZ 200 ER Caballero Regularita Competizione (200ER/4T)	11-13	F
TZ 200 MR Motard (200 MR/4T)	11-13	F
TZ 250 ES Regularita (2T)	11-13	F
TF 250 ES Regularita (4T)	11-13	F
TR 250 ES (2T) Enduro Six Days	13	F
TR 300 ES (2T) Enduro Six Days	13	F
TZ 300 ES Regularita Scuderia	11-12	F

## HONDA

CRF 250 LD	13	F
------------	----	---

## HONDA H-M

CRE 125 (Baja RR 2T)	11	F
----------------------	----	---

## RIEJU

MTR 50 Pro Competizione (Spoke wheel)	11-13	F
Marathon Pro 125 Competizione	11-13	F
Tango 125	11-13	F
Tango 250	12-13	F

## SCORPA

T-Ride 125 F	10	F
T-Ride 250 F (Enduro)	08-10	F

### Competitor X Ref

MATERIAL AVAILABILITY AND PART NO.				
STD	OPTIONS			
FA	HH	R	MXS	EPFA
FA465TT	-	FA465R	-	-

Dunlop	Ferodo	SBS	Vesrah
-	-	859	-

# FA468R 67.2 x 52 x 7.6mm

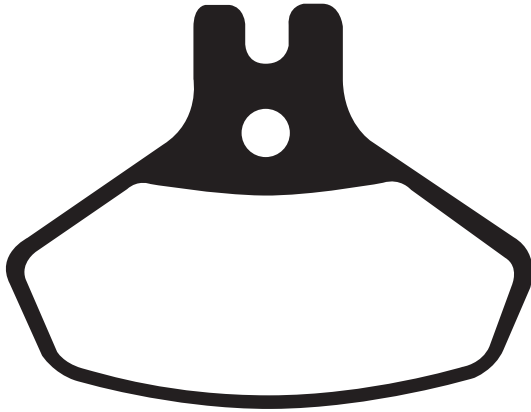

### Equivalents OE #

705600402
Z 150 9260

### CAN-AM

DS 450 (2x4/EFi)	08-12	F
DS 450 X (2x4/EFi)	08-09	F
DS 450 XXC/XXM	10-12	F

### Competitor X Ref

Dunlop	Ferodo	SBS	Vesrah
DP991	-	-	-

### MATERIAL AVAILABILITY AND PART NO.

STD	OPTIONS			
FA	HH	R	MXS	EPFA
-	-	FA468R	-	-

# FA471 36 x 39.1 x 6mm



**NOTE Shape same as FA351 but has smaller friction area**

### SCORPA

SR 125 (2T)	09-13	R
SR 125 Long Ride (2T)	09-11	R
SY 125 FR (4T)	03-11	R
SY 125 (4T) Long Ride	09-10	R
TY 125 (4T)	11-13	R
SY 250 R (2T)	00-09	R
SY 250 FR Long Ride	10	R
SY 250 FR	06-10	R
SR 280 (2T)	09-13	R
SR 280 (2T) Long Ride	09-11	R

### Equivalents OE #

S1A 40202 00 00
-----------------

### MATERIAL AVAILABILITY AND PART NO.

STD	OPTIONS			
FA	HH	R	MXS	EPFA
FA471	-	-	-	-

### Competitor X Ref

Dunlop	Ferodo	SBS	Vesrah
-	-	-	-

# FA473 110.65 x 54.5 x 7.92mm

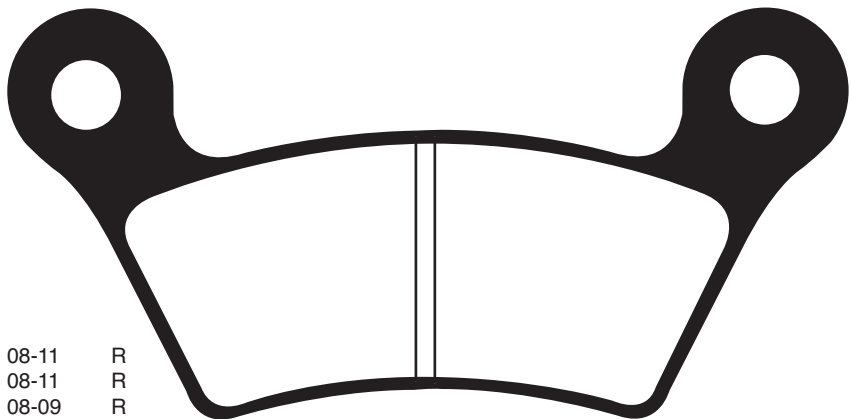

### CAN-AM

Spyder SM5 GS990 (3 wheeler)	08-11	R
Spyder SE5 GS990 (3 wheeler)	08-11	R
Spyder RS SES 990cc	08-09	R
Spyder RS SMS 990cc	08-09	R
Spyder RS Phantom Black	09	R
Spyder RT-S	10-12	R
Spyder RT	10-12	R
Spyder RS-S	10-12	R
Spyder RS	10-12	R
Spyder RT LTD	11-12	R

### Equivalents OE #

219800031
219800165

### Competitor X Ref

Dunlop	Ferodo	SBS	Vesrah
-	-	-	-

### MATERIAL AVAILABILITY AND PART NO.

STD	OPTIONS				
FA	V	HH	R	MXS	EPFA
FA473	FA473V	-	-	-	-

# FA474 A. 75.6 x 31.95 x 8mm B. 75.6 x 31.95 x 8mm

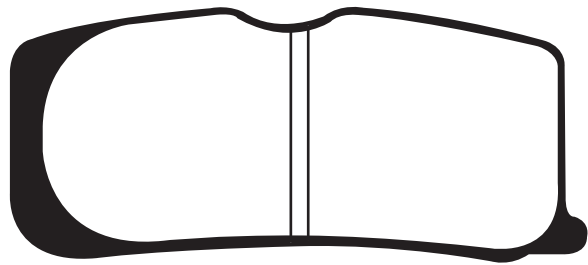
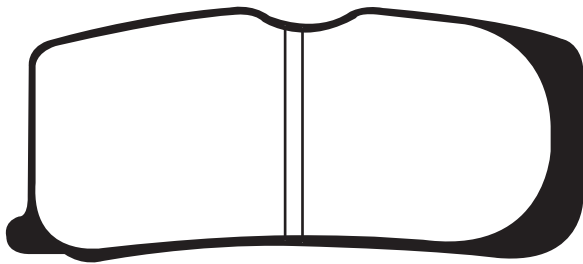

## CAN-AM

Spyder SM5 GS990 (3 wheeler)	08-11	F
Spyder SE5 GS990 (3 wheeler)	08-11	F
Spyder RS SES 990cc	08-09	F
Spyder RS SMS 990cc	08-09	F
Spyder RS Phantom Black	09	F
Spyder RT-S	10-12	F
Spyder RT	10-12	F
Spyder RS-S	10-12	F
Spyder RS	10-12	F
Spyder RT LTD	11-12	F

### Equivalents OE #

219800038
219800164

### Competitor X Ref

Dunlop	Ferodo	SBS	Vesrah
-	-	-	-

### MATERIAL AVAILABILITY AND PART NO.

STD	OPTIONS				
FA	V	HH	R	MXS	EPFA
FA474	FA474V	-	-	-	-

# FA475 96.88 x 42.45 x 6.87mm

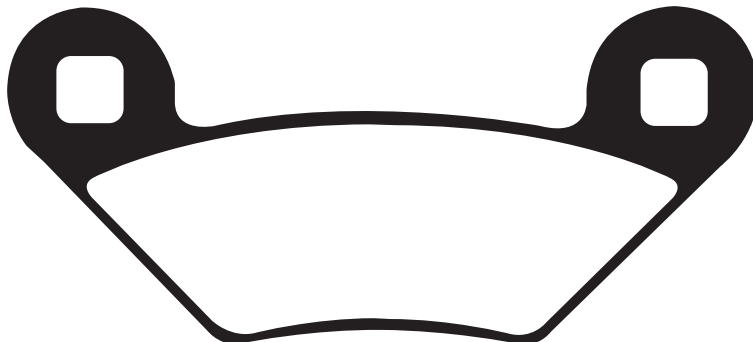

### Equivalents OE #

2203628
2204088

## POLARIS

400 Sportsman HO 4x4	11-12	R
500 XP Sportsman	09	F&R
500 Sportsman HO (After 16/12/2008)	09-12	R
500 Sportsman Forest	12	F&R
550 Sportsman XP EPS	09-11	F&R
550 Sportsman X2	10-11	F&R
550 XP Sportsman	09-11	F&R
550 Sportsman Touring EFI	10-12	F&R
550 Sportsman EPS	10-12	F&R
800 Sportsman HO/EFI (After 16/12/2008)	09	R
800 Sportsman EFI	10-12	R
800 Sportsman Forest	12	R
800 Sportsman Forest Tractor	12	R
850 XP Sportsman	09-11	F&R
850 XP EPS Sportsman	09-11	F&R
850 Sportsman Touring EPS	10-12	F&R
850 Sportsman Forest	12	F&R

### Competitor X Ref

Dunlop	Ferodo	SBS	Vesrah
DP992	-	899	-

### MATERIAL AVAILABILITY AND PART NO.

STD	OPTIONS			
FA	HH	R	MXS	EPFA
FA475TT	-	FA475R	-	-



**FA476TT** A. 103.85 x 43.55 x 12.8mm (Screech clip fitted)  
 B. 103.85 x 43.55 x 12.8mm

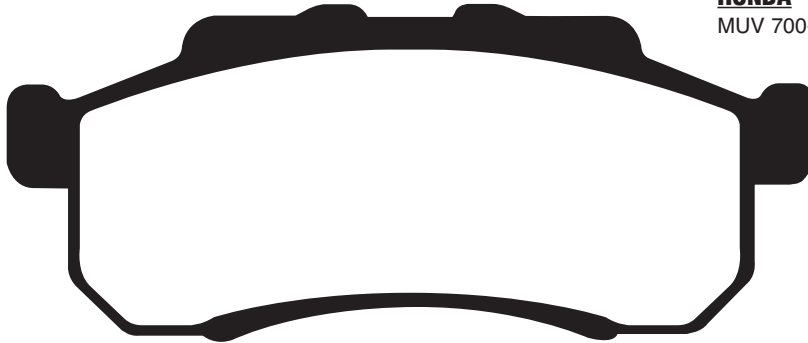
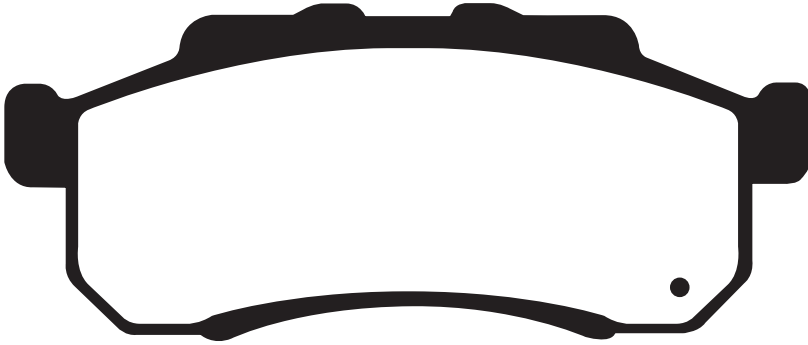

**HONDA**  
 MUV 700-9 Big Red Side x Side 09 F Left

**Equivalents OE #**

06451 HL1 A01

**Competitor X Ref**

Dunlop	Ferodo	SBS	Vesrah
-	-	-	-

MATERIAL AVAILABILITY AND PART NO.				
STD	OPTIONS			
FA	HH	R	MXS	EPFA
FA476TT	-	-	-	-

**FA477TT** A. 103.85 x 43.55 x 12.8mm (Screech clip fitted)  
 B. 103.85 x 43.55 x 12.8mm

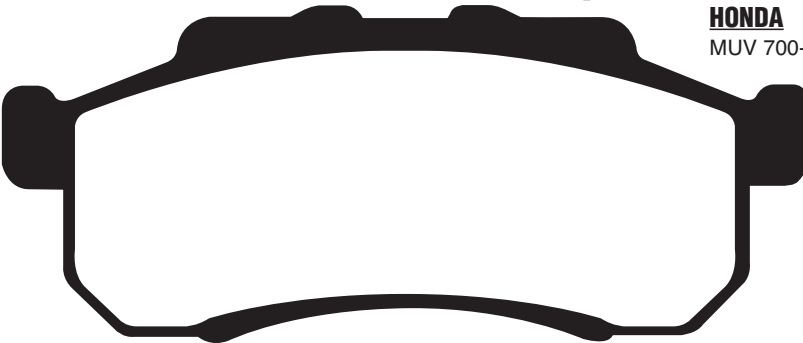
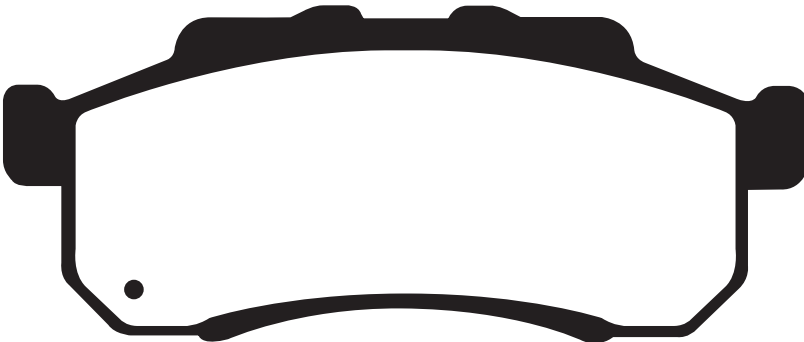

**HONDA**  
 MUV 700-9 Big Red Side x Side 09 F Right

**Equivalents OE #**

06452 HL1 A01

**Competitor X Ref**

MATERIAL AVAILABILITY AND PART NO.				
STD	OPTIONS			
FA	HH	R	MXS	EPFA
FA477TT	-	-	-	-

Dunlop	Ferodo	SBS	Vesrah
-	-	-	-

**FA478TT** A. 88.95 x 36.5 x 13.8mm (Screech clip fitted)  
B. 88.95 x 36.5 x 13.8mm

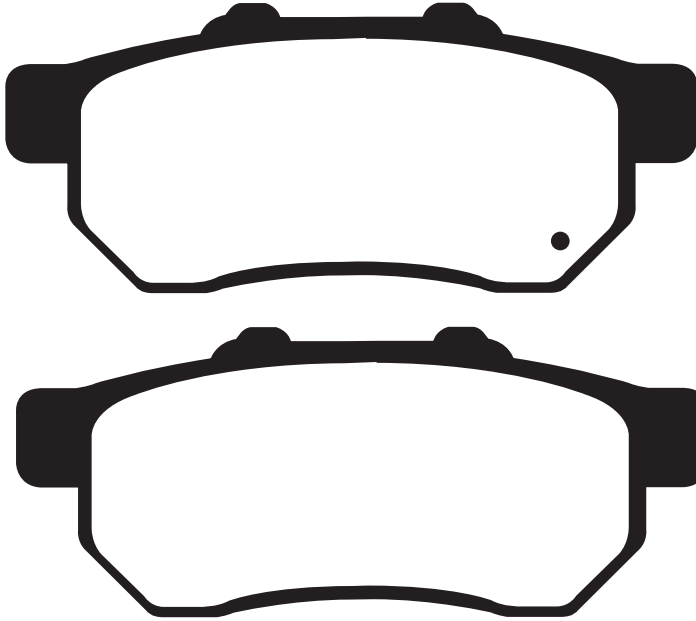

**Equivalents OE #**

06454 HL1 A01

**HONDA**

MUV 700-9 Big Red Side x Side

09 R Left

**Competitor X Ref**

MATERIAL AVAILABILITY AND PART NO.				
STD	OPTIONS			
FA	HH	R	MXS	EPFA
FA478TT	-	-	-	-

Dunlop	Ferodo	SBS	Vesrah
-	-	-	-

**FA479TT** A. 88.95 x 36.5 x 13.8mm (Screech clip fitted)  
B. 88.95 x 36.5 x 13.8mm

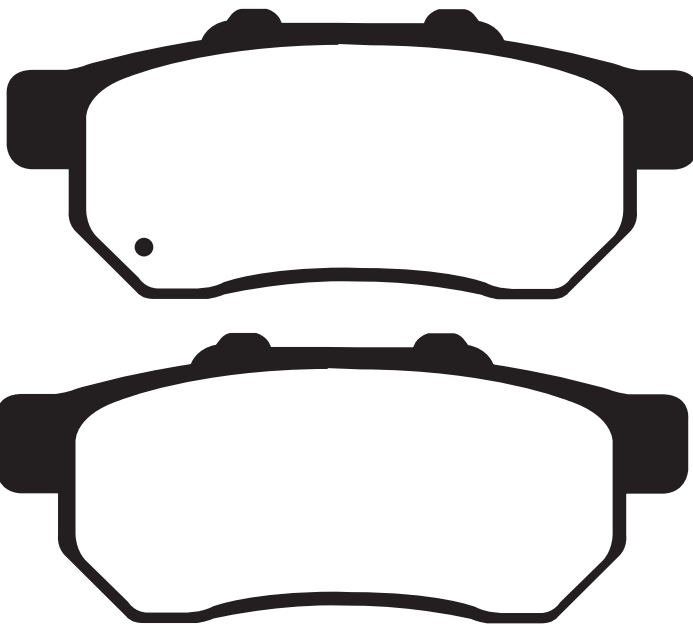

**Equivalents OE #**

06455 HL1 A01

**HONDA**

MUV 700-9 Big Red Side x Side

09 R Right

**Competitor X Ref**

MATERIAL AVAILABILITY AND PART NO.				
STD	OPTIONS			
FA	HH	R	MXS	EPFA
FA479TT	-	-	-	-

Dunlop	Ferodo	SBS	Vesrah
-	-	-	-

# FA480 A. 74.05 x 36.4 x 7mm B. 38 x 27.1 x 9mm

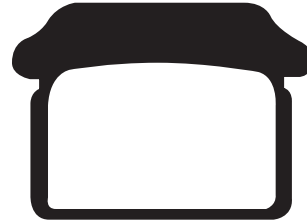
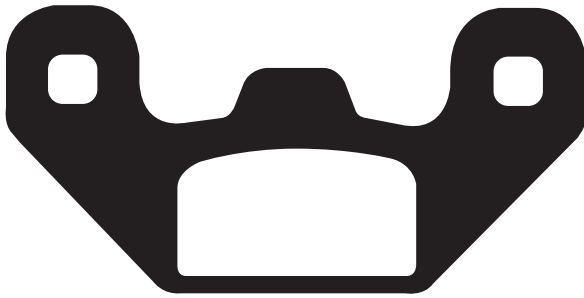

**LIFAN**

LF 125 Off Road 07 R

**QUADZILLA**

WK 140 06-08 R

**STOMP MINI MOTO**

125cc Elite 07-09 R

**Equivalents OE #**

**Competitor X Ref**

MATERIAL AVAILABILITY AND PART NO.				
STD	OPTIONS			
FA	HH	R	MXS	EPFA
FA480	-	-	-	-

Dunlop	Ferodo	SBS	Vesrah
-	-	213	-

# FA481 88 x 48 x 7.8mm

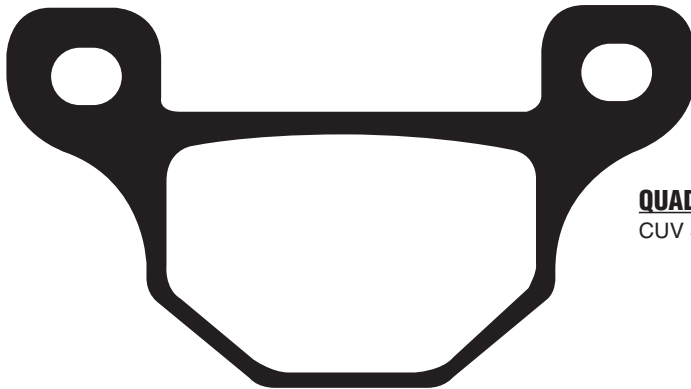

**QUADZILLA**

CUV 300 E 4x4 Side by Side (Parking brake) 08-09

**Equivalents OE #**

**Competitor X Ref**

MATERIAL AVAILABILITY AND PART NO.				
STD	OPTIONS			
FA	HH	R	MXS	EPFA
FA481	-	-	-	-

Dunlop	Ferodo	SBS	Vesrah
-	-	-	-

# FA482TT 110.1 x 49.25 x 8mm

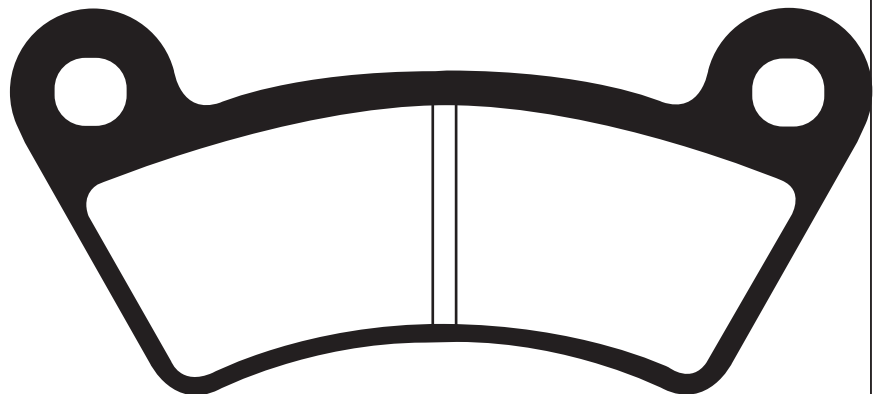

**KEEWAY**

GTX 300 Quad 10-11 R

**LINHAI**

CUV Jobber 4x4 13 F

**QUADZILLA**

CUV 300 (4x4 Super Utility Side x Side) 08 F

CUV 300 4x4 "Side x Side" 08-09 F

325 4x4 10-11 R

**Equivalents OE #**

26825
4 3 01 3370

**Competitor X Ref**

MATERIAL AVAILABILITY AND PART NO.				
STD	OPTIONS			
FA	HH	R	MXS	EPFA
FA482TT	-	FA482R	-	-

Dunlop	Ferodo	SBS	Vesrah
-	-	-	-

# FA483TT 96.65 x 40.75 x 7.2mm

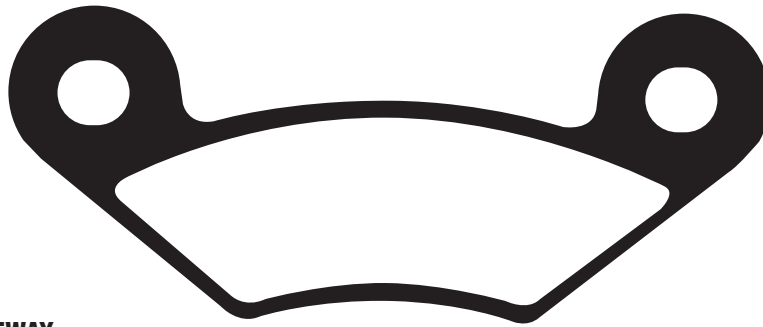

### KEEWAY

GTX 300 Quad	10	F
<b>QUADZILLA</b>		
QZ 300 E 4x4		F
QZ 320 E 4x4	09	F
325 4x4	10-11	F

### Equivalents OE #

26826
22245
4 3 01 3350

### Competitor X Ref

MATERIAL AVAILABILITY AND PART NO.				
STD	OPTIONS			
FA	HH	R	MXS	EPFA
FA483TT	-	FA483R	-	-

Dunlop	Ferodo	SBS	Vesrah
-	-	-	-

# FA484TT A. 116.35 x 42.15 x 9.25mm B. 76.96 x 42.15 x 9.3mm

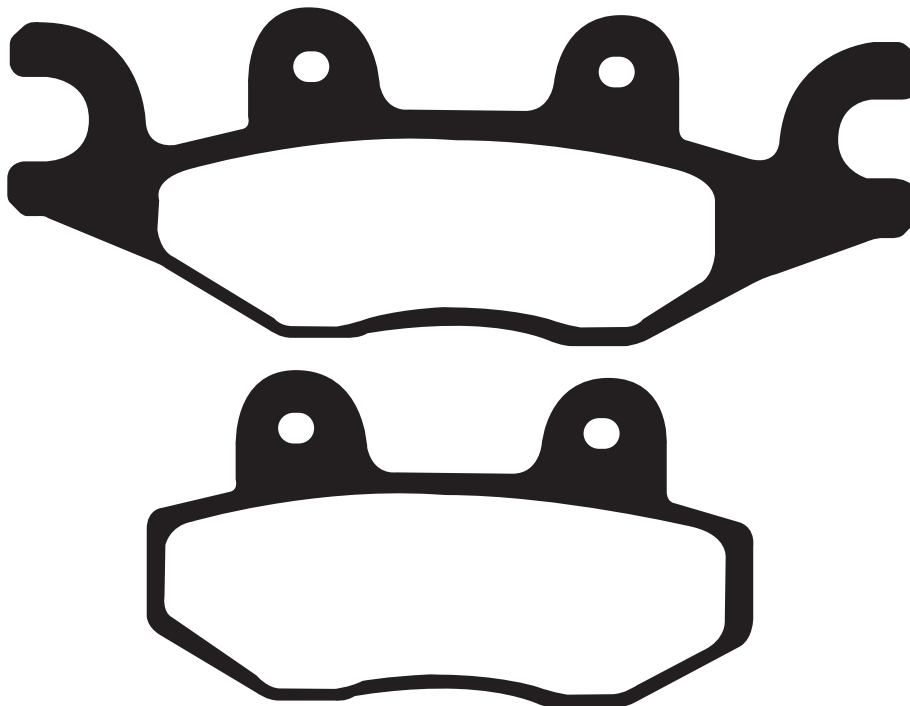

### CECTEK

500 EFI King Cobra	09-10	F
500 EDI Quadrif	09-10	F
500i Estoc	10	F

### PGO

BR 500i Racer	07-09	F
500 Bug	08-09	F
BR 600 I BUG RACER	12	F

### TGB

X-Motion 125	08-12	F
X-Motion 125 Ri	11-12	F
X-Motion 250 i	08-10	F
X-Motion 300 EFI	10-12	F

### Equivalents OE #

B840C34
3500000
414220

MATERIAL AVAILABILITY AND PART NO.				
STD	OPTIONS			
FA	HH	R	MXS	EPFA
FA484TT	-	FA484R	-	-
SFA484				

### Competitor X Ref

Dunlop	Ferodo	SBS	Vesrah
-	-	210/878	-

# FA485TT A. 32.1 x 39.08 x 5.04mm

## B. 35.17 x 31.6 x 5.1mm

### Equivalents OE #

3050005036400
7-020-060

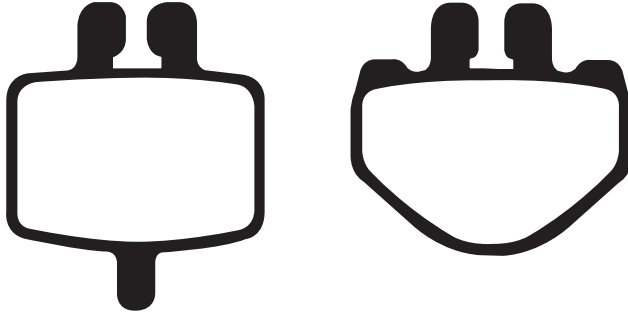

### HAMMERHEAD BUGGIES

Mini (45cc) 08-09 R

### QUADZILLA

Micro Buggy MKII/III (RV50) 05-09 R

### Competitor X Ref

MATERIAL AVAILABILITY AND PART NO.				
STD	OPTIONS			
FA	HH	R	MXS	EPFA
FA485TT	-	-	-	-

Dunlop	Ferodo	SBS	Vesrah
-	-	-	-

# FA486 49.5 x 46.85 x 9mm

### Equivalents OE #

45105 KBH E000 GM
-------------------

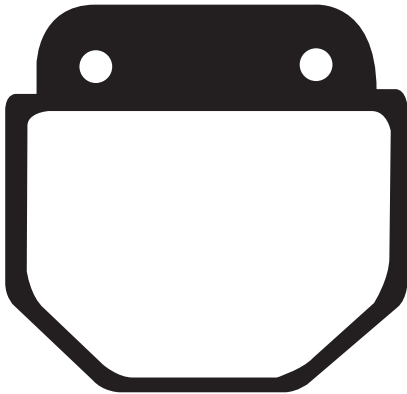

### BETTER

BT 125-20 06-09 F

### HONGDOU

GHD 125-7 05-07 F

### KYMCO

Pulsar 125/CK 125 (Luxe) (RJ25CB) 99-13 F

### ZING BIKES

Vogue 150 (3 wheeler) 08-09 F

### Competitor X Ref

MATERIAL AVAILABILITY AND PART NO.				
STD	OPTIONS			
FA	HH	R	MXS	EPFA
FA486	-	-	-	-

Dunlop	Ferodo	SBS	Vesrah
-	-	-	-

# FA488HH 99.35 x 38.65 x 8.9mm

### Equivalents OE #

06435 MFN D01
06435 MFN D11



### HONDA

VFR 800 XC Crossrunner 800 12-13 R

CB 1000 R9/RA/RB/RC Non ABS Model 09-13 R

CB 1000 RA9/RAA/RAB/RAC (ABS Model) 09-13 R

VFR 1200 FA/FB 10-13 R

### Competitor X Ref

MATERIAL AVAILABILITY AND PART NO.				
STD	OPTIONS			
FA	HH	R	MXS	EPFA
-	FA488HH	-	-	-

Dunlop	Ferodo	SBS	Vesrah
DP506	FDB2253	862	VD178

# FA489R 88.6 x 46.65 x 7.8mm



### Equivalents OE #

43120 214 00 AEON 0454444
------------------------------

### POLARIS

Ranger RZR 170

09-11 R

### Competitor X Ref

MATERIAL AVAILABILITY AND PART NO.				
STD	OPTIONS			
FA	HH	R	MXS	EPFA
-	-	FA489R	-	-

Dunlop	Ferodo	SBS	Vesrah
-	-	-	-

# FA490R 87.1 x 42.65 x 7.8mm



### Equivalents OE #

43121 205 001 AEON 0454440
-------------------------------

### POLARIS

Ranger RZR 170

09-11 F

### Competitor X Ref

MATERIAL AVAILABILITY AND PART NO.				
STD	OPTIONS			
FA	HH	R	MXS	EPFA
-	-	FA490R	-	-

Dunlop	Ferodo	SBS	Vesrah
-	-	-	VD9050

# FA491HH 78.1 x 46.2 x 7.6mm

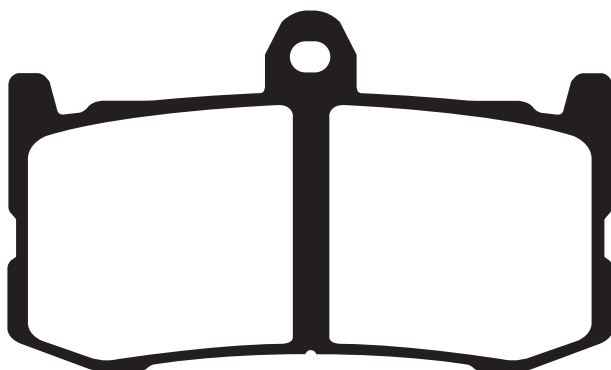

**Note: Refit original shim**

### Equivalents OE #

T2021221 107 A486 55
-------------------------

### TRIUMPH

Daytona 675

09-12 F

### Competitor X Ref

MATERIAL AVAILABILITY AND PART NO.					
STD	OPTIONS				
FA	HH	R	MXS	EPFA	GPFA
-	FA491HH	-	-	EPFA491HH	GPFA491HH

Dunlop	Ferodo	SBS	Vesrah
DP999	FDB2252	864	VD9048



# SFA492 A. 109.6 x 51.1 x 9.7mm B. 113.8 x 41.5 x 8.9mm

DISC PADS  
BUYERS GUIDE

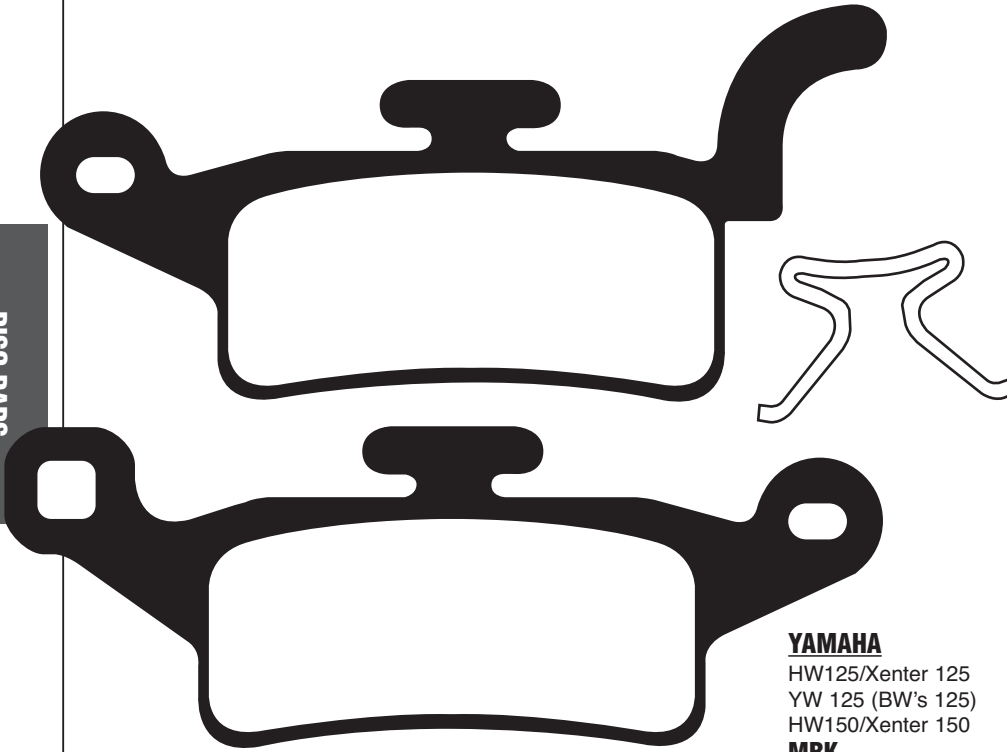

**Including 2  
new clips**

**Equivalents OE #**

5S9 W0045 00
52S F5811 00

**YAMAHA**

HW125/Xenter 125	12-13	F
YW 125 (BW's 125)	10-13	F
HW150/Xenter 150	12-13	F

**MBK**

YW 125 Z X-Over	10	F
-----------------	----	---

**MATERIAL AVAILABILITY AND PART NO.**

STD	OPTIONS			
SFA	HH	R	MXS	EPFA
SFA492	-	-	-	-

**Competitor X Ref**

Dunlop	Ferodo	SBS	Vesrah
-	-	208	VD283

# FA495 35.7 x 42.2 x 5.6mm

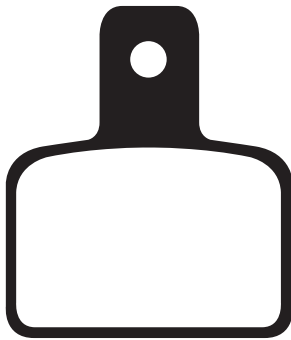

**BETA**

Evo 80	09-13	R
Evo 125 (2T)	09-13	R
Evo 200 (2T)	09-13	R
Evo 250 (4T/2T)	09-13	R
Evo 2300 (2T)	09-13	R
Evo 300 (4T)	09-13	R

**Equivalents OE #**

00736071800
-------------

**MATERIAL AVAILABILITY AND PART NO.**

STD	OPTIONS			
FA	HH	R	MXS	EPFA
FA495	-	-	-	-

**Competitor X Ref**

Dunlop	Ferodo	SBS	Vesrah
-	-	895	-

# FA496 86 x 40 x 8.95mm

## Equivalents OE #

69101 44850
06435 KYJ 901
69100 48820

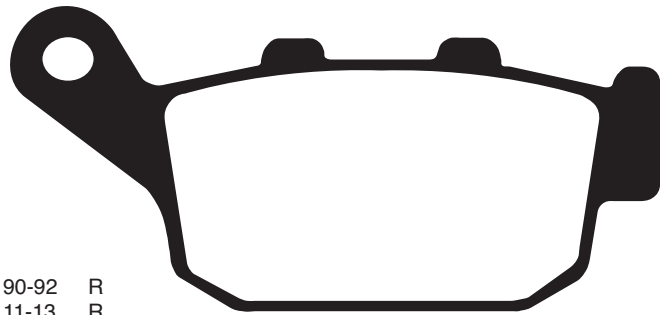

### HONDA

CBR 250 RRL/RRN/RRR (MC22)	90-92	R
CBR 250 RB (Non ABS)	11-13	R
CBR 250 RAB/RAC (ABS)	11-13	R

### SUZUKI

GW 250 L3 Inazuma	13	R
SFV 650 K9/L0/L1 Gladius	09-12	R
SFV 650 AK9/AL0/AL1/AL3 (ABS)	09-13	R

## Competitor X Ref

MATERIAL AVAILABILITY AND PART NO.					
STD	OPTIONS				
FA	HH	R	MXS	EPFA	
FA496	FA496HH	-	-	-	

Dunlop	Ferodo	SBS	Vesrah
DP513	FDB2258	881	-

# FA497TT 62 x 40.8 x 7.1mm

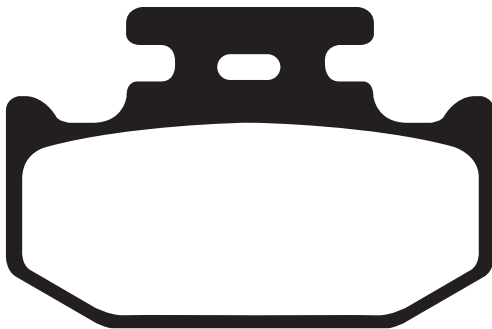

### YAMAHA

YXR 700 Rhino 4x4 SE (Parking brake)	09	
YXR 700 FA/FB/FD Rhine Side x Side (Parking brake)	11-13	

## Equivalents OE #

5B4 W0046 00

## Competitor X Ref

MATERIAL AVAILABILITY AND PART NO.					
STD	OPTIONS				
FA	HH	R	MXS	EPFA	
FA497TT	-	-	-	-	

Dunlop	Ferodo	SBS	Vesrah
-	-	-	-

# SFA498 90 x 33.3 x 9.8mm

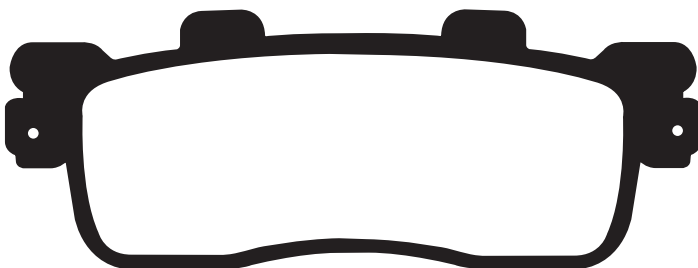

### BENELLI

Velvet 125/150 (Touring)	08-11	R
--------------------------	-------	---

### KYMCO

Downtown/Superdink 125i (V21000)	09-13	R
People GT 125i	10-13	R
Downtown 200i	10-12	R
People GT 200i	10-12	R
Downtown/Superdink 300i (V20000)	09-12	R
Downtown 300i (ABS/V20010)	10-13	R
People GT 300i	10-13	R

## Equivalents OE #

43105 LEA7 305

## Competitor X Ref

MATERIAL AVAILABILITY AND PART NO.					
STD	OPTIONS				
SFA	SFAC	HH	R	MXS	EPFA
SFA498	SFAC498	SFA498HH	-	-	-

Dunlop	Ferodo	SBS	Vesrah
-	-	204	VD9044

# FA499/4HH A. 69.2 x 51.55 x 8.9mm B. 33 x 51.55 x 8.9mm

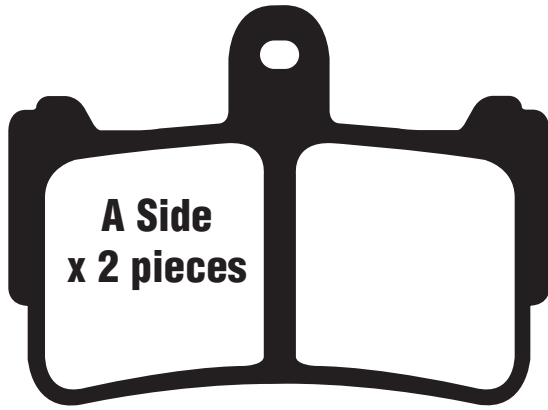

**2 Pieces A Side**  
**Fitted to lower end of caliper**

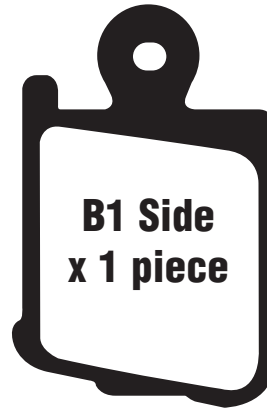

**Fitted to top inside of caliper**

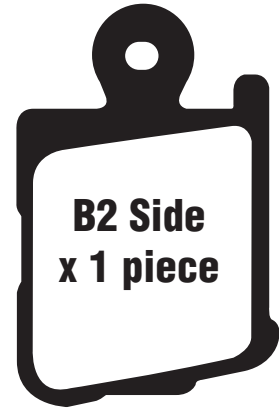

**Fitted to top outside of caliper**

**Refit original shims**

**HONDA**

VFR 1200 FA/FB 10-13 F  
VFS 1200 FDA/FDB (Automatic transmission) 10-13 F

**Equivalents OE #**

06435 MGE 006

**Competitor X Ref**

MATERIAL AVAILABILITY AND PART NO.				
STD	OPTIONS			
FA	HH	R	MXS	EPFA
-	FA499/4HH	-	-	-

Dunlop	Ferodo	SBS	Vesrah
DP504	FDB2259	869	VD179

# FA600TT 102.3 x 42.7 x 7.85mm

# FA600/2TT 102.3 x 42.7 x 7.1mm

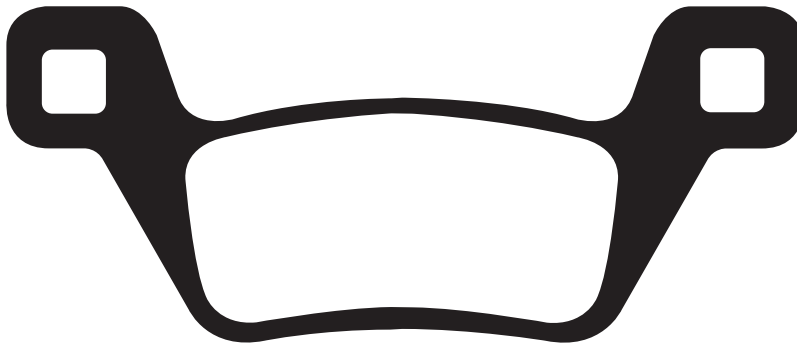

**FA600TT - KYMCO**

MXU 500i (4x4 IRS) (LAAOCD/CM) 09-13 F  
MXU 500i DX 11-13 F  
MXU 550i 12 F  
MXU 550i (4x4 LOF) 13 F  
MXU 700i (4x4 LOF) 13 F

**FA600/2TT - KYMCO**

MXU 500i (4x4 IRS) (LAAOCD/CM) 09-13 R  
MXU 500i DX 11-13 R  
MXU 550i 12 R  
MXU 550i (4x4 LOF) 13 R  
MXU 700i (4x4 LOF) 13 R

**Equivalents OE # FA600**

45105 LFE9 305

**Equivalents OE # FA600/2**

43105 LFE9 305

MATERIAL AVAILABILITY AND PART NO.				
STD	OPTIONS			
FA	HH	R	MXS	EPFA
FA600TT	-	FA600R	-	-

MATERIAL AVAILABILITY AND PART NO.				
STD	OPTIONS			
FA	HH	R	MXS	EPFA
FA600/2TT	-	FA600/2R	-	-

**Competitor X Ref**

Dunlop	Ferodo	SBS	Vesrah
-	-	-	-

# FA602TT 40.95 x 42.35 x 7.3mm

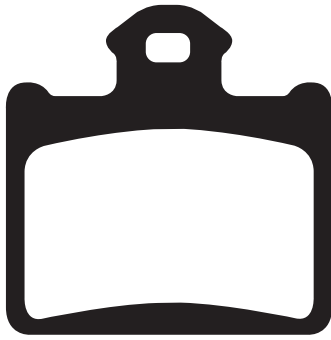

### HUSQVARNA

CR 65	11-13	R
<b>KTM</b>		
SX 85 (17"/14" wheels)	11-13	R
SX 85 (19"/16" wheels)	11-13	R
350 Freeride (4T)	12-13	R
Freeride E (Electric)	12	R

### Equivalents OE #

470 130 90 300
8000H7138

### Competitor X Ref

MATERIAL AVAILABILITY AND PART NO.				
STD	OPTIONS			
FA	HH	R	MXS	EPFA
FA602	-	FA602R	-	-

Dunlop	Ferodo	SBS	Vesrah
DP508	FDB2257	872	-

# SFA603 A. 111.6 x 43.01 x 8.05mm B. 109.6 x 43.01 x 8.05mm

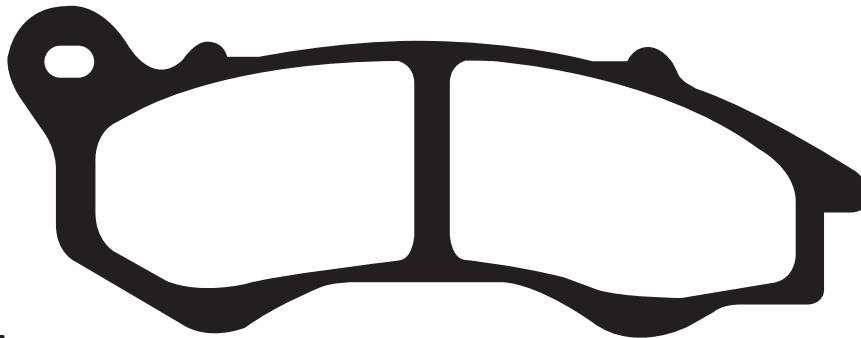
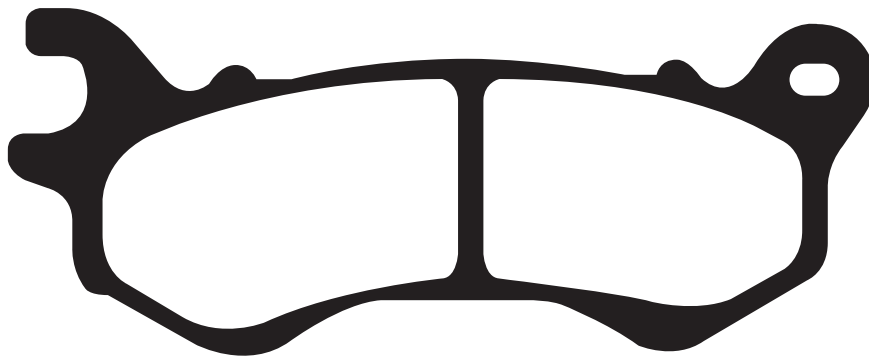

### HONDA

NSC 50 AC Vision 50 (4T) (16" wheels)	12-13	F
NSC 50 C Vision 50 (4T) (14" wheels)	12-13	F
NSC 50 R (14" wheels)	13	F
NSC 110 Vision 110 (4T) WHB	11-13	F
NSC 110 AC Vision 110 (4T)	12	F
SCV 110 (NHX 110 WHA) 4 bolt lead disc fixing)	10-11	F
PCX 125 (WW 125 EXZA-10)	10-13	F
Satelis 125 (4T)	13	F

### Equivalents OE #

06455 KWN 641
06455 GFM D31
06455 KZL 861

### Competitor X Ref

MATERIAL AVAILABILITY AND PART NO.				
STD	OPTIONS			
SFA	HH	R	MXS	EPFA
SFA603	SFA603HH	-	-	-

Dunlop	Ferodo	SBS	Vesrah
-	FDB2256	205	VD180

# FA604/4HH 34.9 x 40.5 x 9mm



**4.5mm  
backplate**

**BMW**

S 1000 RR  
S 1000 RR Sport

10-13 F  
12-13 F

**Please refer to original BMW workshop manual for correct fitting information.**

**Equivalents OE #**

34 11 7 714 800

**Competitor X Ref**

MATERIAL AVAILABILITY AND PART NO.					
STD	OPTIONS				
FA	GPFA	HH	R	MXS	EPFA
-	GPFA604/4HH	FA604/4HH	-	-	EPFA604/4HH

Dunlop	Ferodo	SBS	Vesrah
DP509	FDB2255	870	-

# FA605/4HH 97.95 x 46.95 x 7.8mm

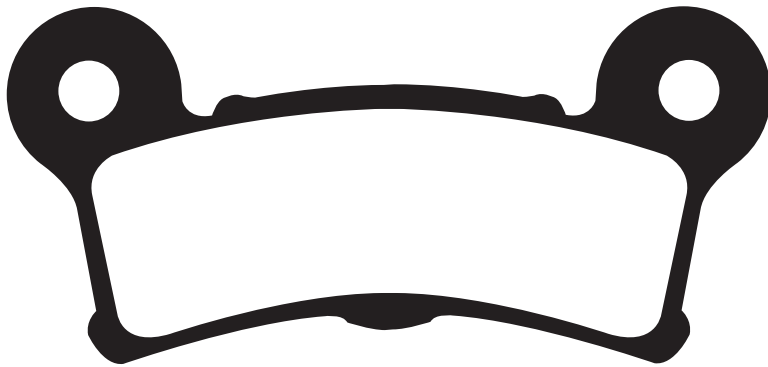

**Equivalents OE #**

83911-09  
83911-09B

**HARLEY DAVIDSON**

FLHTCUTG Tri Glide Ultra Classic Trike 09-12 R  
FLHXXX Street Glide Trike 10-11 R

**Competitor X Ref**

MATERIAL AVAILABILITY AND PART NO.					
STD	OPTIONS				
FA	V	HH	R	MXS	EPFA
-	FA605/4V	FA605/4HH	-	-	-

Dunlop	Ferodo	SBS	Vesrah
-	-	-	-

# FA606 69.4 x 45 x 8.6mm

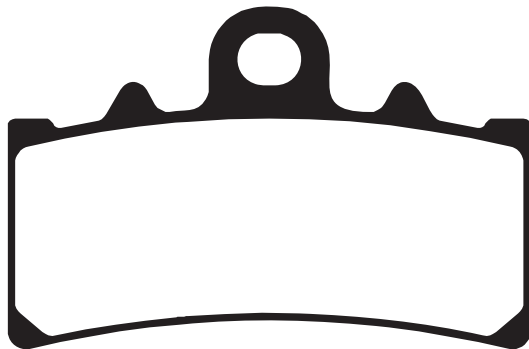

**KTM**

Duke 125 (4T) 11-13 F  
Duke 200 (4T) 12-13 F  
Duke 390 13 F

**Equivalents OE #**

901-13-030-000

**Competitor X Ref**

MATERIAL AVAILABILITY AND PART NO.					
STD	OPTIONS				
FA	HH	R	MXS	EPFA	
FA606	FA606HH	-	-	-	

Dunlop	Ferodo	SBS	Vesrah
-	-	877	-

# SFA607 94 x 36.15 x 10.45mm

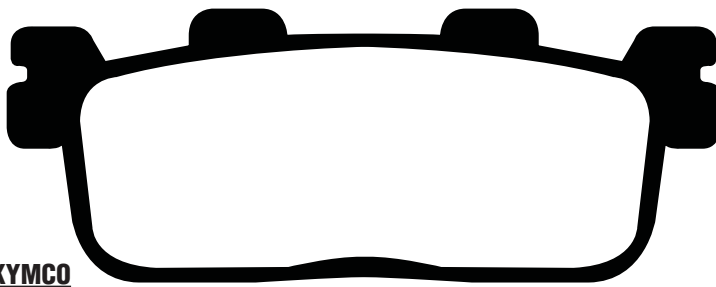

**Equivalents OE #**

43105 LDH1 E00

**KYMCO**

K-XCT 125	12-13	R
People S125 DD (D1000 rear disc model)	07-12	R
People S200i DD (D12000) (5 bolt fixing disc)	07-12	R
People 250 Si DD	07-08	R
Xciting 250 (T71000)	05	R
Xciting 250 i (T71010)	06-08	R
K-XCT 300i	12-13	R
Xciting 300i (T72000 - EFI Model)	08	R
Xciting 300i R (T72001/T72011)	09-12	R

**Competitor X Ref**

MATERIAL AVAILABILITY AND PART NO.					
STD	OPTIONS				
SFA	HH	R	MXS	EPFA	
SFA607	SFA607HH	-	-	-	

Dunlop	Ferodo	SBS	Vesrah
-	FDB2254	195/863	-

# SFA608 102 x 38 x 10.45mm



**Equivalents OE #**

43105 LBA2 305

**KYMCO**

X-Citing 400i	12	R
X-Citing 500 Ri (T70021) (EFI Model)	09-12	R
X-Citing 500i (T70020) (EFI Model)	06-08	R
X-Citing 500 (T70000) (Carb Model)	05	R
Xciting Evo 500i ABS	13	R
MX Road 700i	12	R

**Competitor X Ref**

MATERIAL AVAILABILITY AND PART NO.					
STD	OPTIONS				
SFA	HH	R	MXS	EPFA	
SFA608	SFA608HH	-	-	-	

Dunlop	Ferodo	SBS	Vesrah
-	-	877/212	-

# FA609 97.8 x 42.4 x 7.5mm

**Equivalents OE #**

AM141182

**JCB (UTILITY VEHICLES)**

Groundhog 800 D (4x4)	08-09	F&R
Workmax 800 D (4x4)	10-13	F&R
Groundhog 1000 D (4x4)	08-09	F&R
Groundhog 6x4 1000 D	08-09	F&R
Workmax 1000 D (4x4)	10-13	F&R
Workmax 6x4 1000 D	10-13	F&R

**JOHN DEERE (SIDE X SIDE)**

HPX 4X4 Gator (Diesel)	10-11	F&R
XUV 620i Gator (Petrol)	10	F&R
XUV 625i Gator (Petrol)	11	R
XUV 825i Gator (Petrol)	11	R
XUV 850 D Gator (Diesel)	10	F&R
XUV 855 D Gator (Diesel)	11	R

**DO NOT REFIT O/E SHIM**

**Competitor X Ref**

MATERIAL AVAILABILITY AND PART NO.					
STD	OPTIONS				
FA	GPFA	HH	R	MXS	EPFA
FA609R	-	-	-	-	-

Dunlop	Ferodo	SBS	Vesrah
-	-	-	-



# FA610 135.6 x 55 x 8mm

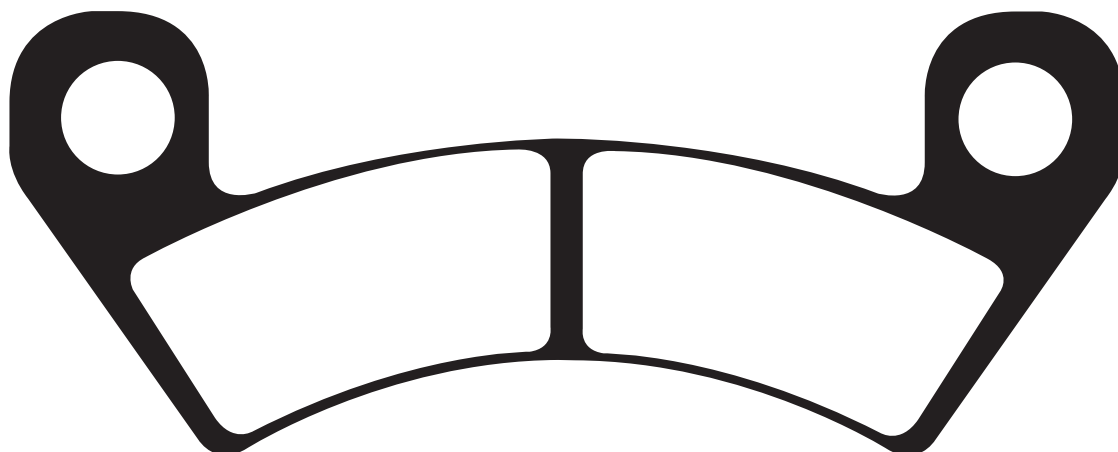

### JOHN DEERE (SIDE X SIDE)

XUV 625i Gator (Petrol)	11	F
XUV 825i Gator (Petrol)	11	F
XUV 855 D Gator (Diesel)	11	F

### Equivalents OE #

AM140607
----------

### Competitor X Ref

MATERIAL AVAILABILITY AND PART NO.					
STD	OPTIONS				
FA	GPFA	HH	R	MXS	EPFA
FA610R	-	-	-	-	-

Dunlop	Ferodo	SBS	Vesrah
-	-	-	-

# GFA611HH 82.15 x 28.8 x 9.5mm



### Equivalents OE #

07 8354 24
------------

### BREMBO

- XA3.J7.50/51 - 4 Piston P34/38 Radial Mount @ 108mm Spacing (Pinless Fixing)
- XA3.J7.60/61 - 4 Piston P 34/38 Radial Mount @ 108mm Spacing (Pinless Fixing/Lithium Body)
- XA8.Y3.310/11 - 4 Piston P34/38 Radial Mount @ 130mm Spacing (Pinless Fixing)

### Competitor X Ref

MATERIAL AVAILABILITY AND PART NO.					
STD	OPTIONS				
FA	GPFA	HH	R	MXS	EPFA
-	GPFA611HH	-	-	-	-

Dunlop	Ferodo	SBS	Vesrah
-	-	-	-

# FA612 59 x 40.18 x 7.45mm

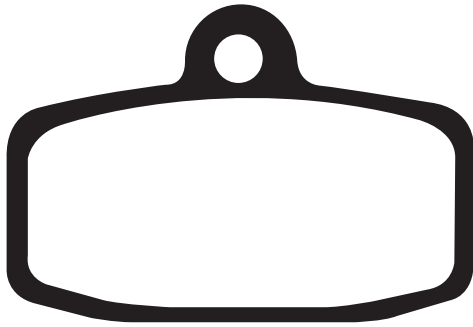

### GAS-GAS

TXT 125/250/280/300 (For models with formula front caliper/single pin pad fixing) 12 F

### KTM

SX 85 17/14" wheels 12-13 F  
 SX 85 19/16" wheels 12-13 F  
 350 Freeride (4T) 12-13 F  
 Freeride E (Electric) 12 F

### SHERCO

ST 80 (2T) 13 F  
 ST 125 (2T) 13 F  
 ST 250 (2T) 13 F  
 ST 290 (2T) 13 F  
 ST 305 (2T) 13 F

### Equivalents OE #

470 13 030 000
BT 6000063012
4252

### MATERIAL AVAILABILITY AND PART NO.

STD	OPTIONS				
FA	GPFA	HH	R	MXS	EPFA
FA612TT	-	-	FA612R	-	-

### Competitor X Ref

Dunlop	Ferodo	SBS	Vesrah
DP514	FDB2262	885	-

# FA613 81 x 45.9 x 9.4mm

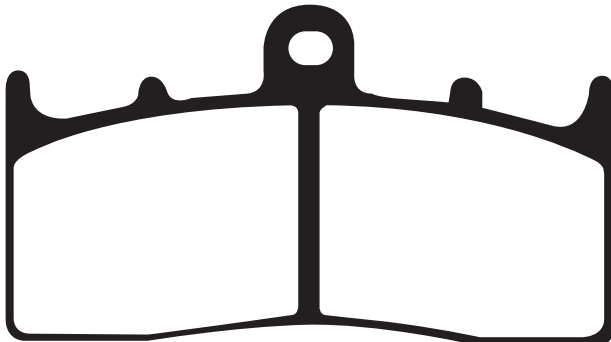

### Equivalents OE #

34 11 7 728 945
-----------------

### BMW

K 1600 GT 11-13 F  
 K 1600 GT SE 12-13 F  
 K 1600 GTL 11-13 F  
 K 1600 GTL E 12-13 F

### MATERIAL AVAILABILITY AND PART NO.

STD	OPTIONS				
FA	GPFA	HH	R	MXS	EPFA
-	-	FA613HH	-	-	-

### Competitor X Ref

Dunlop	Ferodo	SBS	Vesrah
-	-	-	-

# FA617 A. 109.15 x 39.2 x 7.65mm B. 96.3 x 36.5 x 7.6mm

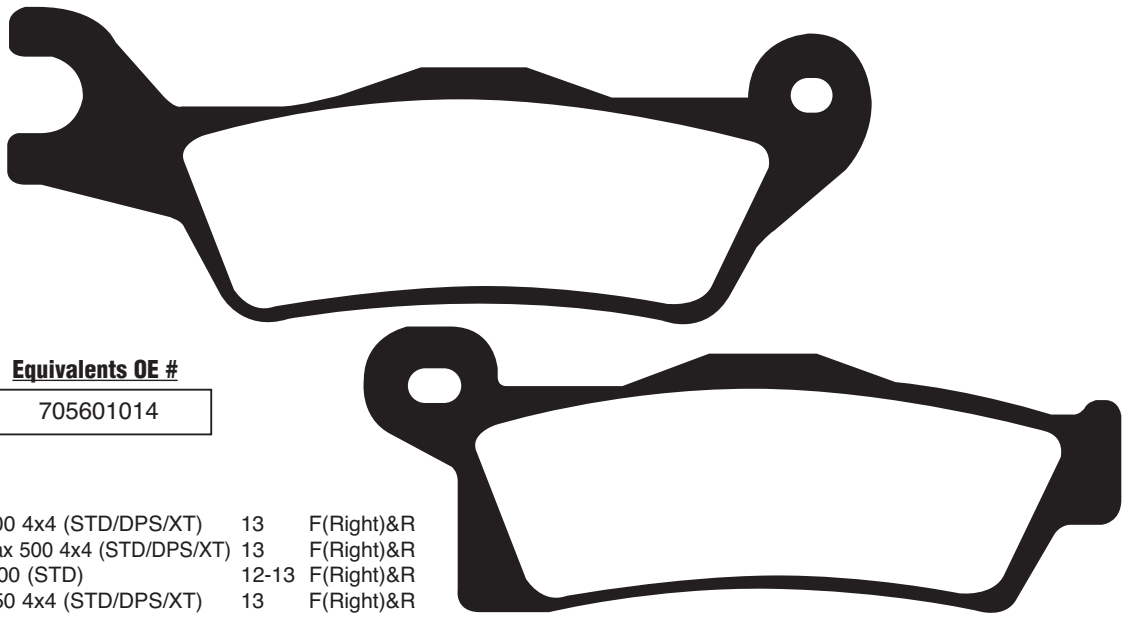

**Equivalents OE #**

705601014

**CAN AM**

Outlander 500 4x4 (STD/DPS/XT)	13	F(Right)&R
Outlander Max 500 4x4 (STD/DPS/XT)	13	F(Right)&R
Renegade 500 (STD)	12-13	F(Right)&R
Outlander 650 4x4 (STD/DPS/XT)	13	F(Right)&R
Outlander 800 R STD	12-13	F(Right)&R
Outlander 800 R XT	12-13	F(Right)&R
Outlander 800 R 4x4 9STD/DPS/XT/XT-P)	13	F(Right)&R
Renegade 800 R STD	12-13	F(Right)&R
Renegade 800 R XXC	12-13	F(Right)&R
Outlander 1000 STD	12	F(Right)&R
Outlander 1000 XT	12-13	F(Right)&R
Outlander 1000 4x4 (DPS) XT/XT-P1	13	F(Right)&R
Outlander 1000 4x4 (LTD)	13	F(Right)&R
Outlander 1000 4x4 (XMR)	13	F(Right)&R
Outlander Max 1000 4x4 (DPS/XT/XT-P)	13	F(Right)&R
Renegade 1000 STD	12-13	F(Right)&R
Renegade 1000 XXC	12-13	F(Right)&R

**Competitor X Ref**

MATERIAL AVAILABILITY AND PART NO.					
STD	OPTIONS				
FA	GPFA	HH	R	MXS	EPFA
FA617TT	-	-	FA617R	-	-

Dunlop	Ferodo	SBS	Vesrah
-	-	-	-

# FA618 A. 109.15 x 39.2 x 7.65mm B. 96.3 x 36.5 x 7.6mm

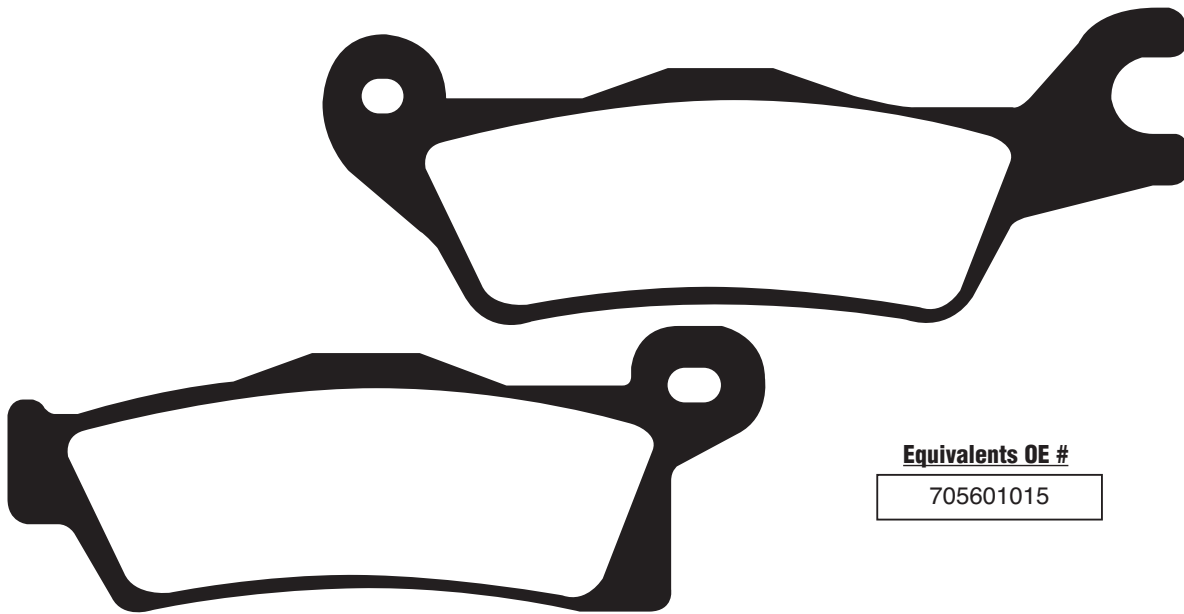

**Equivalents OE #**

705601015

**CAN AM**

Outlander 500 4x4 (STD/DPS/XT)	13	F(Left)&R(Left)
Outlander Max 500 4x4 (STD/DPS/XT)	13	F(Left)&R(Left)
Renegade 500 (STD)	12-13	F(Left)&R(Left)
Outlander 650 4x4 (STD/DPS/XT)	13	F(Left)&R(Left)
Outlander 800 R STD	12-13	F(Left)&R(Left)
Outlander 800 R XT	12-13	F(Left)&R(Left)
Outlander 800 R 4x4 9STD/DPS/XT/XT-P)	13	F(Left)&R(Left)
Renegade 800 R STD	12-13	F(Left)&R(Left)
Renegade 800 R XXC	12-13	F(Left)&R(Left)
Outlander 1000 STD	12	F(Left)&R(Left)
Outlander 1000 XT	12-13	F(Left)&R(Left)
Outlander 1000 4x4 (DPS) XT/XT-P1	13	F(Left)&R(Left)
Outlander 1000 4x4 (LTD)	13	F(Left)&R(Left)
Outlander 1000 4x4 (XMR)	13	F(Left)&R(Left)
Outlander Max 1000 4x4 (DPS/XT/XT-P)	13	F(Left)&R(Left)
Renegade 1000 STD	12-13	F(Left)&R(Left)
Renegade 1000 XXC	12-13	F(Left)&R(Left)

**Competitor X Ref**

Dunlop	Ferodo	SBS	Vesrah
-	-	-	-

MATERIAL AVAILABILITY AND PART NO.					
STD	OPTIONS				
FA	GPFA	HH	R	MXS	EPFA
FA618TT	-	-	FA618R	-	-

# FA621V 27.8mm Ø

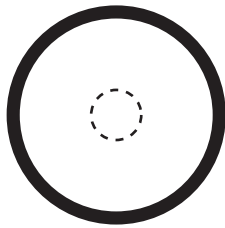

## YAMAHA

T-Max 530 Parking brake 12  
 XP 530 Black Max (59CE) Parking brake 13

### Equivalents OE #

59C 25805 50

### Competitor X Ref

MATERIAL AVAILABILITY AND PART NO.					
STD	OPTIONS				
FA	GPFA	HH	R	MXS	EPFA
SFA621V	-	-	-	-	-

Dunlop	Ferodo	SBS	Vesrah
-	-	-	-

DISC PADS BUYERS GUIDE

# FA623 84.4 x 59.7 x 10.2mm

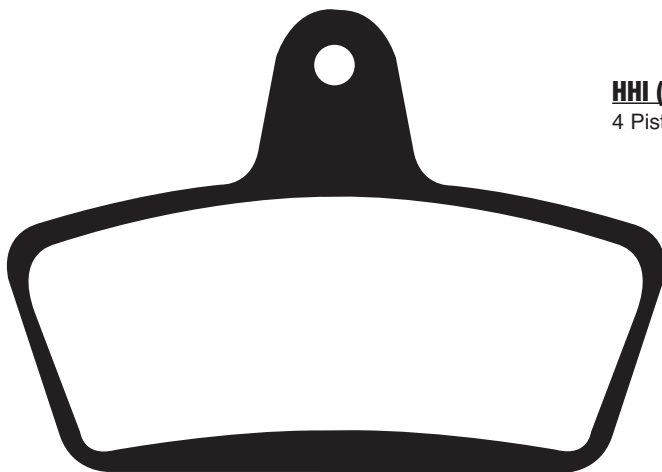

## HHI (Hawg Halters)

4 Piston - Sprocket Brake

### Equivalents OE #

-

### Competitor X Ref

MATERIAL AVAILABILITY AND PART NO.					
STD	OPTIONS				
FA	GPFA	HH	R	MXS	EPFA
FA623	-	-	-	-	-

Dunlop	Ferodo	SBS	Vesrah
-	-	-	-

# FA624TT 41.95 x 49.9 x 6.5mm

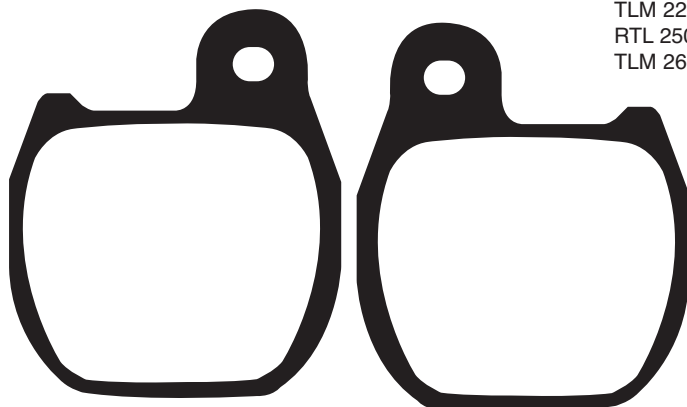

## HONDA

TLM 220 R 88-92 F  
 RTL 250 S 88-89 F  
 TLM 260 89-93 F

### Equivalents OE #

-

### Competitor X Ref

MATERIAL AVAILABILITY AND PART NO.					
STD	OPTIONS				
FA	GPFA	HH	R	MXS	EPFA
FA624TT	-	-	-	-	-

Dunlop	Ferodo	SBS	Vesrah
-	-	-	-

# SFA625 A. 84.9 x 44.05 x 6.85mm B. 84.9 x 40.58 x 6.85mm

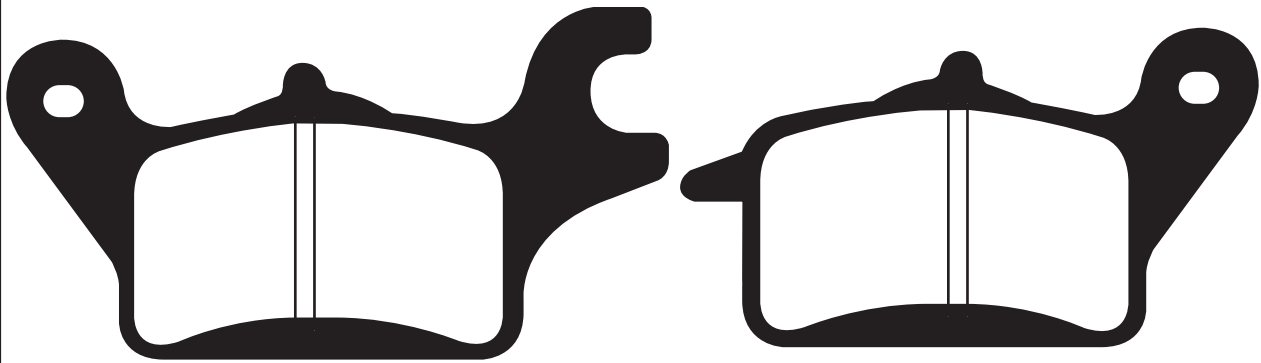

**HONDA**

AFS 110 25HC Wave

12-13 F

**Equivalents OE #**

06455 KWW 951

**Competitor X Ref**

MATERIAL AVAILABILITY AND PART NO.						
STD	OPTIONS					
FA	GPFA	HH	R	MXS	EPFA	
SFA625	-	-	-	-	-	

Dunlop	Ferodo	SBS	Vesrah
-	-	-	-

# SFA627 72.6 x 53.3 x 7.95mm

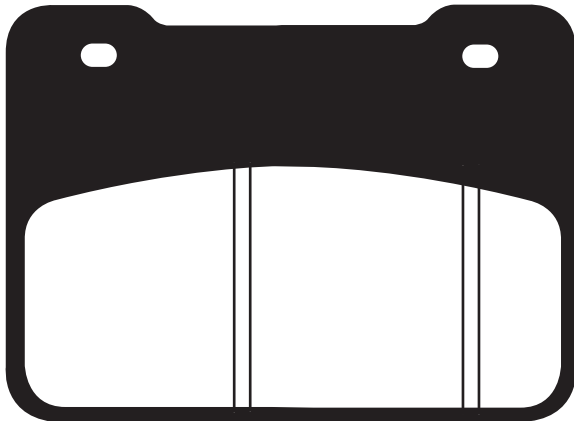

**KYMCO**

Xciting 400i

12 F

**SYM**

Max Sym 400i (Inc ABS)

11-13 F

**Equivalents OE #**

45130 L4A 300  
45135 L4A 300

**Competitor X Ref**

MATERIAL AVAILABILITY AND PART NO.						
STD	OPTIONS					
FA	GPFA	HH	R	MXS	EPFA	
SFA627	-	SFA627HH	-	-	-	

Dunlop	Ferodo	SBS	Vesrah
-	-	-	-

# SFA628 83.35 x 47.55 x 11.9mm

**Equivalents OE #**

43140 L4A 300

**SYM**

Max Sym 400i (Inc ABS)

11-13 R



**Competitor X Ref**

MATERIAL AVAILABILITY AND PART NO.						
STD	OPTIONS					
FA	GPFA	HH	R	MXS	EPFA	
SFA628	-	SFA628HH	-	-	-	

Dunlop	Ferodo	SBS	Vesrah
-	-	-	-



# FA629TT 88 x 39.6 x 10mm



### HONDA

CBR 125 RWB  
CRF 250 LD

11-13 R  
13 R

### Equivalents OE #

06435 KZZ 901

### MATERIAL AVAILABILITY AND PART NO.

STD	OPTIONS					
FA	TT	GPFA	HH	R	MXS	EPFA
FA629	FA629TT	-	-	FA629R	-	-

### Competitor X Ref

Dunlop	Ferodo	SBS	Vesrah
-	-	-	-

# FA630 85.06 x 50.6 x 8mm

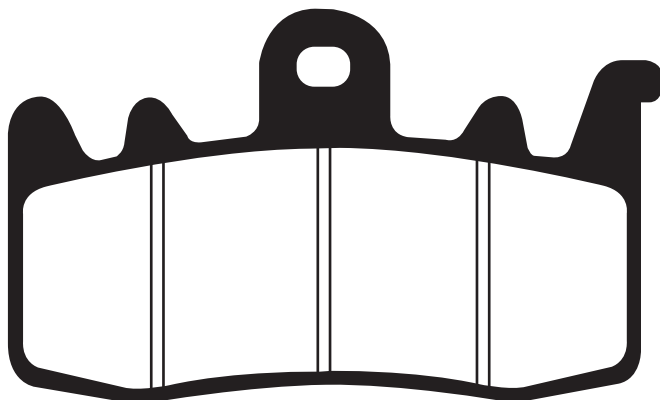

**NOTE - USE  
V VERSION ON  
CAN AM MODELS ONLY**

### APRILIA

Caponard 1200 13 F

### BMW

R 1200 GS (Liquid Cooled/radial mount caliper) 13 F

### CAN AM

Spyder RT Brembo calipers 13 F

Spyder RT-S Brembo calipers 13 F

Spyder RT Ltd Brembo calipers 13 F

Spyder ST Brembo calipers 13 F

Spyder ST-S Brembo calipers 13 F

Spyder ST Ltd Brembo calipers 13 F

Spyder RS Brembo calipers 13 F

Spyder RS-S Brembo calipers 13 F

### DUCATI

Hypermotard (821cc) 13 F

Hypermotard SP (821cc) 13 F

Hyperstrada (821cc) 13 F

### MV

Rivale 800 13 F

### Equivalents OE #

219800237

### MATERIAL AVAILABILITY AND PART NO.

STD	OPTIONS					
FA	GPFA	HH	R	MXS	EPFA	
FA630V	-	FA630HH	-	-	-	

### Competitor X Ref

Dunlop	Ferodo	SBS	Vesrah
-	-	-	-

# FA631V 96.42 x 43.6 x 8.05mm

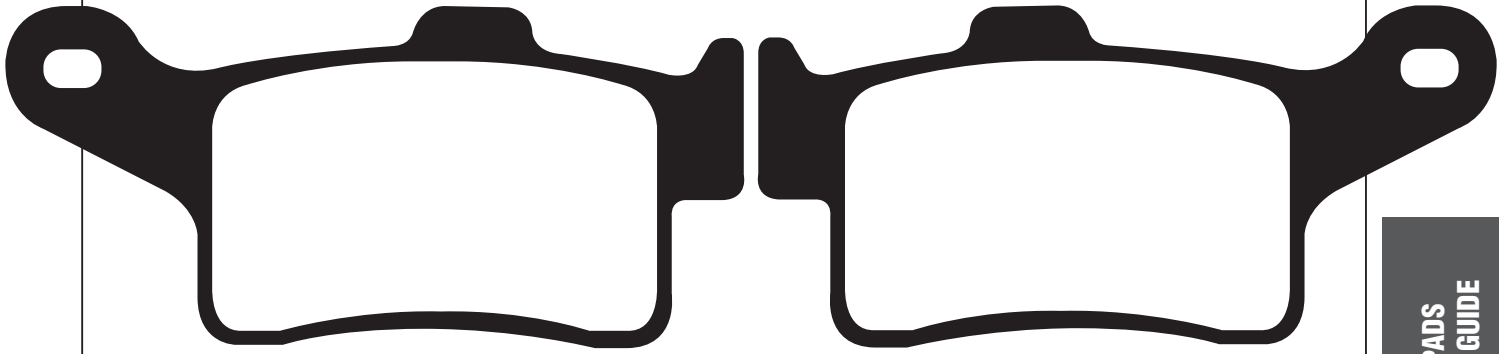

### CAN AM

Spyder RT Brembo calipers	13	R
Spyder RT-S Brembo calipers	13	R
Spyder RT Ltd Brembo calipers	13	R
Spyder ST Brembo calipers	13	R
Spyder ST-S Brembo calipers	13	R
Spyder ST Ltd Brembo calipers	13	R
Spyder RS Brembo calipers	13	R
Spyder RS-S Brembo calipers	13	R

### Equivalents OE #

219800239
-----------

### Competitor X Ref

MATERIAL AVAILABILITY AND PART NO.					
STD	OPTIONS				
FA	GPFA	HH	R	MXS	EPFA
FA631V	-	FA631HH	-	-	-

Dunlop	Ferodo	SBS	Vesrah
-	-	-	-

# SFA632 90 x 39.6 x 10.8mm

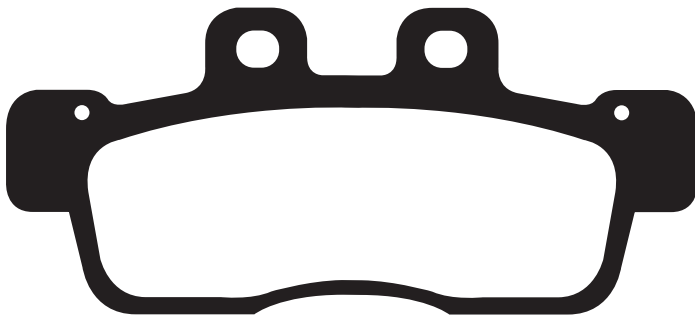

### YAMAHA

NCX 125 K "Cygnus X Cab" (HC6-1)	07-10	F
NCX 125 L Cygnus X Injection (4C6-2)	07-10	F
YW 125 X (1DN1/2)	10-13	F

### SYM

SB 250 Ni	12-13	F
-----------	-------	---

### Equivalents OE #

17C W0045 00
4C6 W0045 00

### Competitor X Ref

MATERIAL AVAILABILITY AND PART NO.					
STD	OPTIONS				
FA	GPFA	HH	R	MXS	EPFA
SFA632	-	-	-	-	-

Dunlop	Ferodo	SBS	Vesrah
-	-	-	-

DISC PADS  
BUYERS GUIDE

# SFA635 A. 96.53 x 42.85 x 7.25mm B. 76.9 x 42 x 7.25mm

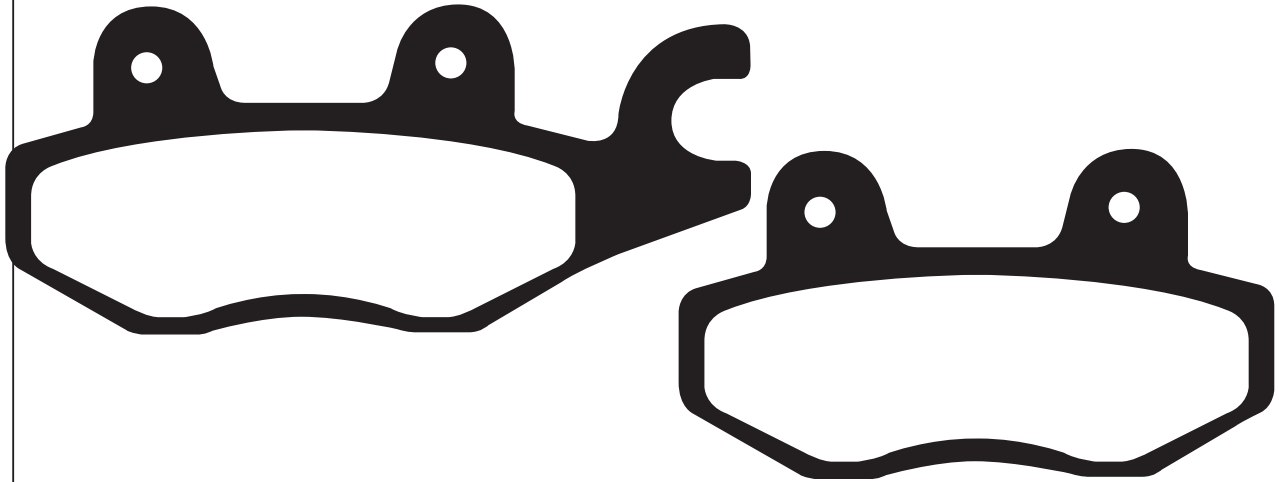

**PEUGEOT**

VOX 110

12-13 F

**Equivalents OE #**

PE802576

**MATERIAL AVAILABILITY AND PART NO.**

STD	OPTIONS				
FA	GPFA	HH	R	MXS	EPFA
SFA635	-	-	-	-	-

**Competitor X Ref**

Dunlop	Ferodo	SBS	Vesrah
-	-	-	-

# FA636HH 101.95 x 39.9 x 9.4mm

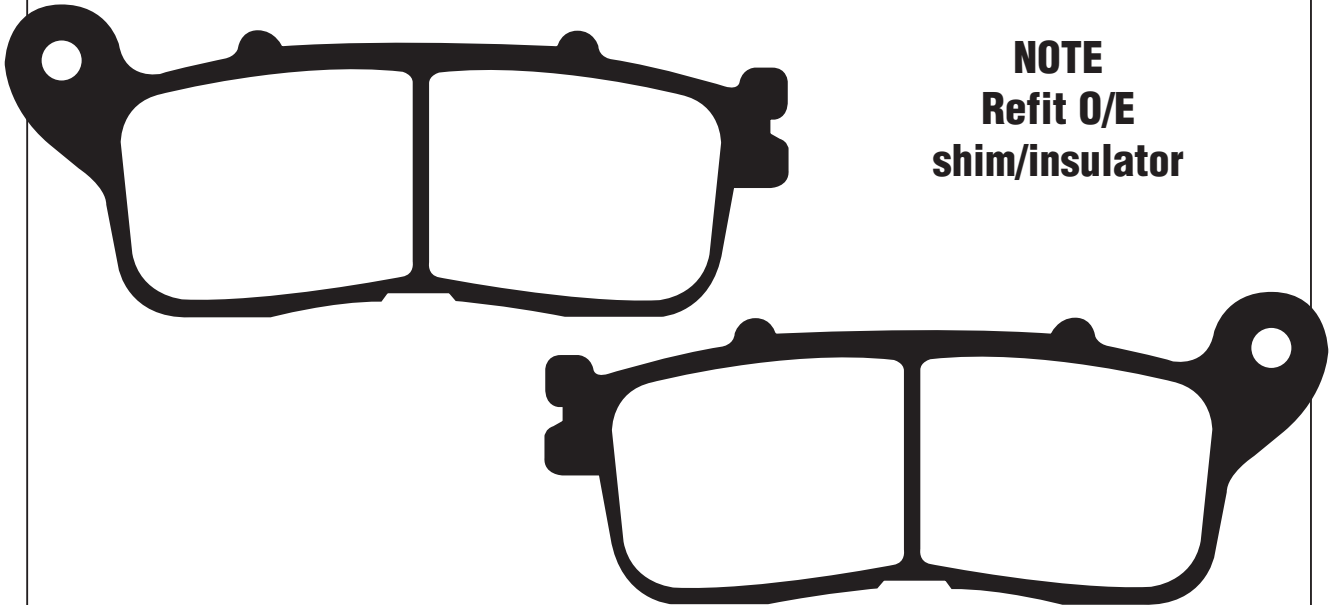

**NOTE**  
Refit O/E  
shim/insulator

**HONDA**

- VFR 1200 XC Crosstourer (Manual G/Box) 12-13 R
- VFR 1200 XDC - DCT Crosstourer (Automatic Transmission Model) 12-13 R
- VFR 1200 XDC Crosstourer (Automatic transmission model) 12-13 R
- VFR 1200 XC (Manual Gearbox) 12-13 R

**Equivalents OE #**

06435 MGE D01

**MATERIAL AVAILABILITY AND PART NO.**

STD	OPTIONS				
FA	GPFA	HH	R	MXS	EPFA
SFA635	-	-	-	-	-

**Competitor X Ref**

Dunlop	Ferodo	SBS	Vesrah
-	-	-	-

# DISC BRAKE PAD COMPETITOR INTERCHANGE LIST

BREMBO	EBC	BREMBO	EBC	BREMBO	EBC	BREMBO	EBC
07BB0106	FA47	07BB24SA	FA407HH	07HD16SA	FA400HH	07HO31SP	FA196HH
07BB0109	FA47/3	07BB2507	FA304	07HD16SP	FA400HH	07HO3405	FA196
07BB0110	FA47	07BB2607	FA335HH	07HO0130	FA13	07HO34SP	FA196HH
07BB0111	FA47	07BB26SA	FA335HH	07HO0229	FA12	07HO3509	FA124
07BB01SP	FA47HH	07BB2750	FA368	07HO0307	FA30	07HO35SA	FA124HH
07BB0210	FA208/213	07BB27SD	FA368R	07HO0411	FA32	07HO3607	FA174
07BB0250	FA208R/213HH	07BB27SX	FA368R	07HO0531	FA43	07HO36SP	FA174HH
07BB-2SD	FA208/213	07GR0101	FA50	07HO0631	FA40	07HO3907	FA189
07BB02SX	FA208R/213HH	07GR0204	FA76	07HO0712	FA45	07HO39SA	FA189HH
07BB02TT	FA208/213	07GR1001	FA98	07HO0831	FA52	07HO39SP	FA189HH
07BB0306	FA209/2	07GR1406	FA167	07HO0906	FA54	07HO4008	FA197
07BB0310	FA209/2	07GR1506	FA166	07HO09SD	FA54HH	07HO4108	FA196
07BB0311	FA209/2	07GR1705	FA156	07HO09SX	FA54R	07HO41SA	FA196HH
07BB0350	FA209/2HH	07GR2106	FA177	07HO09TT	FA54TT	07HO4206	FA281
07BB03SA	FA209/2HH	07GR35SP	FA320HH	07HO1010	FA69/3	07HO42SA	FA261HH
07BB0410	FA181	07GR4804	FA351	07HO10SA	FA69/3HH	07HO4308	FA281
07BB0450	FA181HH/R	07GR49SD	FA307TT	07HO10SP	FA69/3HH	07HO43SA	FA261HH
07BB04SA	FA245HH	07GR49SX	FA307R	07HO1118	FA83	07HO43SP	FA261HH
07BB04SD	FA245HH	07GR50SD	FA317TT	07HO1212	FA29	07HO4507	FA296HH
07BB04SP	FA363HH	07GR50SX	FA317R	07HO1406	FA80	07HO45RC	FA296HH
07BB04SX	FA245HH	07GR5105	FA291	07HO1505	FA92TT	07HO45SA	FA296HH
07BB04TT	FA245	07GR5209	FA377	07HO15SD	FA92R	07HO45SC	FA296HH
07BB0510	FA322/4HH	07GR52SD	FA377R	07HO15SX	FA92R	07HO4607	FA153
07BB05RC	FA322/4HH	07GR52SX	FA377R	07HO15TT	FA92TT	07HO48SD	FA346R
07BB05SA	FA322/4HH	07GR53SD	FA395R	07HO1609	FA90	07HO48SX	FA346R
07BB05SC	FA322/4HH	07GR54SD	FA271R	07HO1708	FA80/2	07HO48TT	FA346TT
07BB0606	FA120	07GR54SX	FA271R	07HO1807	FA69/2	07HO4905	FA343
07BB0708	FA251	07GR55SD	N/A	07HO018SP	N/A	07HO50RC	FA390HH
07BB0810	FA268	07GR5605	FA126	07HO1912	FA109	07HO50SA	FA390HH
07BB0907	FA134	07GR56SC	FA126HH	07HO20SD	FA84/3R	07HO50SC	FA390HH
07BB1205	FA115	07GR5705	FA164	07HO20TT	FA84TT	07HO55SD	FA373R
07BB12TT	FA115	07GR5804	FA303	07HO2107	FA121	07HO5606	FA375
07BB1305	FA60	07GR5915	FA22	07HO21SA	FA121HH	07HO57SA	FA388HH
07BB1310	FA60	07GR6007	FA57	07HO21SC	FA121HH	07HO58SD	FA410R
07BB13SD	FA337R	07GR6207	FA188	07HO2205	FA84/3TT	07KA0122	FA73
07BB1408	FA18	07GR62SA	FA188HH	07HO22SD	FA84/3R	07KA0223	FA55
07BB1410	FA18	07GR6319	FA56	07HO22SX	FA84/3R	07KA0328	N/A
07BB14SP	FA18HH	07GR6407	FA132	07HO22TT	FA84/3TT	07KA0414	FA62
07BB1507	FA95	07GR64TT	FA132	07HO2307	FA124	07KA0506	FA68
07BB1510	FA95	07GR6527	FA48	07HO23SA	FA124HH	07KA0608	FA68
07BB1511	FA95	07GR6610	FA16	07HO23SP	FA124HH	07KA0717	FA83TT
07BB15RC	FA95	07GR6706	FA107A	07HO2408	FA122	07KA07SD	FA83HH
07BB15SA	FA95HH	07GR68SA	FA345HH	07HO2506	FA125TT	07KA07SX	FA83R
07BB15SC	FA95HH	07GR69SD	FA357R	07HO25SD	FA125R	07KA0808	FA85
07BB1606	FA163	07GR69SX	FA357R	07HO25SX	FA125R	07KA08SA	FA85HH
07BB1710	FA193	07GR70SD	FA325R	07HO25TT	FA125TT	07KA08SP	FA85HH
07BB1750	FA193HH	07GR70SX	FA325R	07HO2608	FA131TT	07KA0933	FA129
07BB1810	FA193	07GR71SD	FA355R	07HO26SD	FA131R	07KA09SA	FA129HH
07BB1811	FA193	07GR71SX	FA355R	07HO26SX	FA131R	07KA09SP	FA129HH
07BB1907	FA244	07HD0105	FA24/2	07HO26TT	FA131TT	07KA10TT	FA130
07BB1910	FA244	07HD0202	FA71	07HO2711	FA140	07KA1117	FA141
07BB1950	FA244HH	07HD0303	FA72	07HO27SP	FA140HH	07KA11SA	N/A
07BB19RC	FA244	07HD0413	FA78	07HO2807	FA187	07KA11SP	N/A
07BB19SA	FA244	07HD0507	FA79	07HO28RC	FA187	07KA12SD	FA152R
07BB19SC	FA244HH	07HD0614	FA94	07HO28SA	FA187HH	07KA12SX	FA152R
07BB2010	FA266	07HD0910	FA201	07HO28SC	FA187HH	07KA12TT	FA152TT
07BB2050	FA266HH	07HD1011	FA200	07HO2911	FA143	07KA1306	FA158
07BB2107	FA171	07HD1109	FA210	07HO29SP	N/A	07KA13RC	FA158
07BB21SA	FA171HH	07HD1210	FA400	07HO3005	FA142	07KA13SA	FA158HH
07BB2207	FA407	07HD12SA	FA400HH	07HO30RC	FA142	07KA13SC	FA158HH
07BB22SA	FA407HH	07HD12SP	FA400HH	07HO30SA	FA142HH	07KA1406	FA180
07BB2307	FA77	07HD13SA	FA381HH	07HO30SC	FA142HH	07KA14SA	FA180HH
07BB2407	FA407	07HD14SP	FA387HH	07HO3109	FA196	07KA14SC	FA180HH

# DISC BRAKE PAD COMPETITOR INTERCHANGE LIST

BREMBO	EBC	BREMBO	EBC	BREMBO	EBC	BREMBO	EBC
07KA1617	FA192	07SU1121	FA128TT	07YA16SX	FA119R	07008	FA99
07KA16SP	FA192HH	07SU11SD	FA128R	07YA1711	FA123	07009	FA116
07KA1705	FA185TT	07SU11SX	FA128R	07YA17SA	FA123HH	07010	FA131/2
07KA17SD	FA185R	07SU1215	FA228	07YA17SP	FA123HH	07011	FA131/3
07KA17SX	FA185R	07SU12SD	FA228HH	07YA1809	FA118	07012	FA194
07KA17TT	FA185TT	07SU12SX	FA135R	07YA18SA	N/A	07012ST	FA194HH
07KA1807	FA231	07SU12TT	FA135TT	07YA1909	FA136	07013	FA186
07KA18RC	FA231	07SU1407	FA236	07YA2008	FA215/2	07013ST	N/A
07KA18SA	FA231HH	07SU14RC	FA236	07YA20SP	FA215/2HH	07014	FA382
07KA18SC	FA231HH	07SU14SA	FA236HH	07YA2106	FA197	07015	FA382
07KA1907	FA229	07SU14SC	FA236HH	07YA21SA	FA197HH	07016	FA234
07KA19RC	FA229	07SU1509	FA147	07YA21SD	FA197HH	07017	FA255
07KA19SA	FA229HH	07SU15SA	FA147R	07YA21SX	FA135R	07018	FA235
07KA19SC	FA229HH	07SU15TT	FA147	07YA21TT	FA135TT	07018ST	N/A
07KA2009	FA424	07SU1718	FA157	07YA2206	FA228	07019	FA260
07KA20RC	FA424	07SU17SP	FA157R	07YA22SA	FA228HH	07019ST	FA260HH
07KA20SA	FA424HH	07SU17TT	FA157	07YA22SD	FA228HH	07020	FA298
07KA20SC	FA424HH	07SU18SD	FA152/2R	07YA22TT	FA165TT	07020ST	N/A
07KA2107	FA254	07SU18TT	FA152/2TT	07YA2307	FA252	07021	FA321
07KA22SD	FA258TT	07SU1907	FA188	07YA23RC	FA252	07021ST	N/A
07KA2305	N/A	07SU19RC	FA188	07YA23SA	FA252HH	07022	FA305
07KA23RC	N/A	07SU19SA	FA188HH	07YA23SC	FA252HH	07022ST	FA305R
07KA23A	FA347HH	07SU19SC	FA188HH	07YA2409	FA160	07023	FA297
07KA23SC	FA347HH	07SU2007	FA222	07YA24SA	FA160HH	07024	FA257
07KA24SD	FA342R	07SU20SP	N/A	07YA24SC	FA160HH	07024ST	N/A
07KA25SX	FA349R	07SU22SA	FA236HH	07YA2508	FA172TT	07025	FA69/3
07KA26SA	FA294HH	07SU25SP	FA254HH	07YA25SA	FA172R	07025ST	FA69/3HH
07KA27SD	FA302TT	07SU26RC	N/A	07YA25SC	FA172R	07026	FA83TT
07KA27SX	FA302R	07SU26SA	FA369/4HH	07YA2609	FA182	07027	FA167
07KS0124	FA55	07SU26SC	FA369/4HH	07YA26SA	FA182HH	07028	FA131/3
07KS0207	FA36	07SU27RC	N/A	07YA26SC	FA182HH	07028ST	N/A
07KS0321	FA39	07SU27SA	FA379HH	07YA2709	FA179	07029	FA140
07KS0432	FA67	07SU27SC	FA379HH	07YA27SA	FA179HH	07029ST	FA140HH
07KS04SD	FA67HH	07SU2906	FA137TT	07YA3108	FA191	07030	FA174
07KS04SX	FA67R	07SU29SD	FA137R	07YA3208	FA190	07031	FA151
07KS04TT	FA67TT	07SU29SX	FA137R	07YA32SA	FA190HH	07032	FA257
07KS0507	FA63	07SU31SD	FA401R	07YA32SC	FA190HH	07033	FA197
07KS05RC	FA63	07SU32SP	FA419HH	07YA3408	FA199	07033ST	FA197HH
07KS05SP	FA63HH	07YA0113	FA28	07YA34SA	FA199HH	07034	FA281
07PO0106	FA159TT	07YA0207	FA11	07YA3509	FA123	07034ST	FA261HH
07PO01SD	FA159R	07YA0309	FA34	07YA35SA	FA123HH	07035	FA228
07PO01SX	FA159R	07YA0413	FA41	07YA3707	FA275	07035ST	FA228HH
07PO02SD	FA159R	07YA0527	FA42	07YA37SP	FA275HH	07036	FA396
07PO03SD	FA232R	07YA0609	FA64	07YA3807	FA267	07036ST	N/A
07PO03SX	FA232R	07YA0713	FA61	07YA38SP	FA267HH	07037	FA283
07PO04SD	FA270R	07YA0809	FA70	07YA3908	FA319/2	07037ST	FA283HH
07PO04SX	FA270R	07YA1011	FA81	07YA39SP	FA319/2HH	07038	FA323
07PO05SX	FA313R	07YA1107	FA88	07YA4007	FA348	07038ST	FA323HH
07PO06SD	FA314R	07YA11SA	FA88HH	07YA40SP	FA348HH	07039	FA101
07PO06SX	FA314R	07YA11SP	FA88HH	07YA41SD	FA367R	07039ST	N/A
07PO07SD	FA354R	07YA1207	FA104	07YA41SX	FA367R	07041	FA169
07PO08SD	FA237R	07YA12SA	FA104HH	07YA44SD	FA155R	07041ST	FA169HH
07SU0125	FA35	07YA12SP	FA104HH	07YA45SD	FA344R	07042	FA199
07SU0220	FA38	07YA13SD	FA105R	07001ST	FA181TT	07042ST	FA199HH
07SU0312	FA51	07YA13SX	FA105R	0700S	FA193	07043	FA275
07SU0412	FA65	07YA13TT	FA105TT	07002ST	FA193HH	07043ST	FA275HH
07SU0526	FA46	07YA1407	FA101	07003ST	FA193HH	07045	FA324
07SU0607	FA103	07YA14SD	FA101R	07004	FA266	07045ST	FA336
07SU0707	FA102	07YA14SX	FA101R	07004ST	FA266HH	07047	FA321
07SU0808	FA106/2TT	07YA14TT	FA101TT	07005	FA264	07048	FA350
07SU08TT	FA106/2TT	07YA1519	FA21	07006	FA256	07049	FA194
07SU0904	FA106TT	07YA1605	FA119TT	07006ST	FA256HH	07050	FA355
07SU1005	FA110	07YA16SD	FA119R	07007	FA256	07051	FA356

# DISC BRAKE PAD COMPETITOR INTERCHANGE LIST

BREMBO	EBC	CARBONE LORRAINE	EBC	CARBONE LORRAINE	EBC	CARBONE LORRAINE	EBC
07052	FA319	1033	FA322/4	2255	FA188	2424	FA119
07052ST	FA319HH	1034	FA302	2256	FA142	2430	FA407
07053	FA358	1066	FA348	2257	FA189	2451	FA092
07054	FA374	1067	FA343	2260	FA116	2466	FA067/3
07055	FA411	1075	FA435/4	2269	FA162	2469	FA083
07056	FA353	1076	FA346	2280	FA103	2472	FA067/2
07057	FA256	1078	FA357	2281	FA146	2539	FA244
07058	FA412	1083	FA347	2282	FA063	2546	FA199
07059	FA408	1084	FA319/2	2283	FA088	2584	FA183
07059ST	N/A	1089	FA060	2284	FA101	2586	N/A
07060	FA418	1101	FA335	2285	FA085	2589	FA024/2
07061	FA425	1102	FA317	2287	FA151	2601	FA156
07061ST	N/A	1103	FA367	2288	FA135	2602	FA261
07062	FA306	1108	FA368	2289	FA069/3	2621	FA323/3
07063	FA388	1110	FA369/4	2296	FA174	2694	FA051
07064	FA415	1123	FA305	2298	FA140	2696	FA169
		1128	FA325	2299	FA152	2699	FA094
		1129	FA433/4	2300	FA185	2700	FA071
		1133	FA379	2301	FA104	2701	FA078
		1134	FA390	2302	FA125	2702	FA079
		1139	FA345	2304	FA129	2711	FA265
		1140	FA373	2305	FA123	2713	FA267
		1141	FA349	2306	FA067	2718	FA072
		1142	FA342	2307	FA193	2720	FA263
		1144	FA167	2308	FA147	2750	FA258
		1145	FA158	2309	FA182	2792	FA105
		1146	FA194	2310	FA124	2794	FA256
		1147	FA377	2311	FA160	2799	FA128
		1148	FA375	2313	FA196	2801	FA120
		1149	FA381	2314	FA131	2802	FA081
		1150	FA387	2326	FA165	2807	FA070
		1151	FA355	2328	FA084	2813	FA254
		1152	FA401	2329	FA218	2814	FA030
		1157	FA239	2332	FA018	2827	FA266
		1159	FA388	2342	FA201	2828	FA275
		1163	FA419	2352	FA181	2840	FA077
		1164	FA323	2353	FA208	2847	FA034
		1165	FA314	2360	FA172	2899	FA424
		1167	FA047	2361	FA252	2900	FA363
		1171	FA395	2362	FA191	2914	FA230
		1172	FA409	2363	FA180	2919	N/A
		1174	FA436	2369	FA210	2920	N/A
		1175	FA423/4	2370	FA200	2922	N/A
		1177	FA417/4	2377	FA115	2923	FA307
		1180	FA442/2	2381	FA192	2924	FA232
		1183	FA450	2382	FA069/2	2925	FA270
		1184	FA427	2383	FA229	2926	FA271
		1185	FA447	2384	FA231	2927	FA159
		1187	FA432	2385	FA143	2931	FA190
		1192	FA444	2386	FA106/2	2933	FA211/2
		1193	FA443	2387	FA106	2950	FA016
		1194	FA445	2388	FA157	2958	FA400
		1195	FA446	2389	FA141	2960	FA294
		1203	FA320	2390	FA222	2961	FA145
		2245	FA187	2391	FA179	2984	N/A
		2246	FA236	2392	FA136	2987	FA304
		2247	FA095	2393	FA118	3001	FA047
		2248	FA124/2	2396	FA209/2	3003	FA142
		2249	FA047	2398	FA126	3004	FA116
		2251	FA158	2399	FA132	3006	FA131/3
		2252	FA121	2400	FA134	3008	FA101
		2253	FA123	2404	N/A	3009	FA151
		2254	FA190	2408	FA054	3011	FA069/3



# DISC BRAKE PAD COMPETITOR INTERCHANGE LIST

CARBONE LORRAINE	EBC	DUNLOPAD/DP	EBC	DUNLOPAD/DP	EBC	DUNLOPAD/DP	EBC
3012	FA067	DP101	FA30	DP315	FA152	DP613	FA167
3013	FA193	DP102	FA29	DP316	FA141	DP614	FA95
3014	FA233	DP103	FA45	DP317	FA158	DP615	FA170
3015	FA115	DP104	FA69/2	DP318	FA161	DP617	FA181
3017	FA069/2	DP105	FA69	DP319	FA180	DP618	FA163
3018	FA054	DP106	FA80	DP320	FA192	DP620	FA77
3019	FA323	DP107	FA54	DP321	FA185	DP621	FA131/2
3020	FA256	DP108	FA113	DP322	FA229	DP622	FA208
3021	FA256	DP109	FA124	DP323	FA231	DP623	FA209
3022	FA083	DP110	FA121	DP324	FA249	DP624	FA107A
3024	FA067/2	DP111	FA86	DP326	FA258	DP625	FA246
3025	FA199	DP112	FA187	DP327	FA307	DP626	FA218
3026	FA281	DP113	FA143	DP328	FA302	DP627	FA243
3027	FA268	DP114	FA92/2	DP400	FA11	DP628	FA363
3028	FA181	DP115	FA140	DP401	FA34	DP629	FA263
3029	FA169	DP116	FA124/2	DP402	FA70	DP630	FA244
3031	FA194	DP117	FA142	DP403	FA81	DP631	FA266
3033	FA275	DP118	FA196	DP404	FA88	DP633	FA193
3034	FA099	DP119	FA151	DP405	FA105	DP634	FA206
3036	FA197	DP120	FA153	DP406	FA101	DP635	FA260
3037	FA060	DP121	FA174	DP407	FA104	DP637	FA304
3038	FA257	DP122	FA189	DP408	FA119	DP638	FA322
3039	FA264	DP123	EPFA239	DP409	FA123	DP639	FA294
3041	FA234	DP124	FA281	DP410	FA160	DP640	FA291
3043	FA260	DP125	FA261	DP411	FA135	DP641	FA335
3045	FA255	DP126	FA261	DP412	FA165/2	DP701	FA18
3047	FA235	DP127	FA265	DP413	FA172	DP811	FA84
3049	FA283	DP128	FA261	DP414	FA179	DP812	FA92
3051	FA396	DP129	FA343	DP415	FA182	DP813	FA111
3053	FA186	DP200	FA55	DP416	FA190	DP814	FA125
3054	FA321	DP201	FA55	DP417	FA136	DP815	FA131
3055	FA298	DP203	FA36	DP418	FA252	DP816	FA84/3
3056	FA324	DP204	FA141	DP419	FA267	DP817	FA137
3057	FA266	DP205	FA51	DP420	FA275	DP821	FA67/2
3058	FA179	DP206	FA65	DP421	FA199	DP841	FA21
3059	FA196	DP207	FA63	DP422	FA268	DP842	FA20
3060	FA194	DP208	FA106	DP423	FA319	DP843	FA155
3061	FA319	DP209	FA106/2	DP424	FA275	DP900	FA94
3068	FA305	DP210	FA103	DP500	FA16	DP901	FA78
3069	FA167	DP211	FA135	DP501	FA196	DP902	FA159
3070	FA355	DP212	FA146	DP502	FA159	DP903	FA54/2
3071	FA356	DP213	FA145	DP503	FA236	DP904	FA201
3072	FA256	DP214	FA147	DP504	FA499/4	DP905	FA200
3073	FA323	DP215	FA157	DP506	FA488	DP906	FA24/2
3074	FA411	DP216	FA188	DP508	FA602	DP907	FA71
3075	FA408	DP217	FA222	DP509	FA604/4HH	DP908	FA72
3076	FA140	DP218	FA230	DP510	FA605/4HH	DP909	FA232
3077	FA418	DP219	FA283	DP511	FA453	DP911	FA216
3078	FA228	DP220	FA254	DP512	FA395	DP912	FA210
3079	FA174	DP300	FA33	DP513	FA496	DP913	FA216
3080	FA375	DP302	FA73	SDP844	FA273R	DP914	FA271R
3081	FA374	DP303	FA62	DP600	FA18	DP915	FA270R
3082	FA388	DP304	FA36	DP601	FA47	DP916	FA32
3083	FA415	DP305	FA73	DP602	FA99	DP917	FA76
3084	FA425	DP307	FA58	DP604	FA126	DP918	FA400
3085	FA430	DP308	FA68	DP605	FA134	DP919	FA307
3086	FA197	DP309	FA68	DP606	FA132	DP920	FA317
3087	FA228	DP310	FA67	DP607	FA115	DP921	FA346
3089	FA427	DP310-C	FA67	DP608	FA171	DP922	FA347
3090	FA413	DP311	FA85	DP609	FA164	DP923	FA357
3091	FA252	DP312	FA83	DP610	FA116	DP924	FA325R
3092	FA427	DP313	FA130	DP611	FA60	DP926	FA345
		DP314	FA129	DP612	FA166	DP927	FA323/3

# DISC BRAKE PAD COMPETITOR INTERCHANGE LIST

DUNLOPAD/DP	EBC	FERODO	EBC	FERODO	EBC	FERODO	EBC
DP928	FA358	FDB 88	FA27	FDB 384	FA93	FDB 665	FA69/3
DP929	FA342R	FDB 108	FA18	FDB 386	FA104	FDB 666	FA160
DP930	FA344	FDB 108R	FA18	FDB 386R	FA104	FDB 672	FA131/3
DP931	FA348	FDB 119	FA13	FDB 389	FA103	FDB 673	FA106/2
DP932	FA314R	FDB 132	FA33	FDB 389R	FA103	FDB 677	FA194
DP935	FA368	FDB 134R	FA32	FDB 390	FA102	FDB 680	FA193
DP936	FA351	FDB 148	FA18	FRP 403	FA11	FDB 694	FA60
DP937	FA303	FDB 148R	FA18	FDB 404	FA106	FDB 695	FA74
DP940	FA367	FDB 150	FA35	FRP 405	FA115	FDB 696	FA98
DP942	FA369/4HH	FDB 151R	FA36	FRP 408	FA95	FDB 697	FA116
DP944	FA373R	FDB 155	FA22	FRP 410	FA107A	FDB 698	N/A
DP946	FA366	FDB 157	FA11	FDB 411	FA105	FDB 699	FA166
DP947	FA379HH	FDB 177	FA34	FRP 415	FA175	FDB 705	FA47
DP948	FA381	FDB 177R	FA34	FRP 418	FA217	FDB 706	FA167
DP949	FA381	FDB 178	FA38	FRP 419	FA95/2	FDB 731	FA67/2
DP950	FA379HH	FDB 181R	FA37	FDB 436	FA99	FDB 736	FA171
DP951	FA352	FDB 182	FA30	FDB 437	FA110	FDB 737	FA172
DP952	FA194	FDB 183	FA45	FDB 438	FA113	FDB 741	FA180
DP953	FA401	FDB 184	FA41	FDB 449	FA123	FDB 754	FA174
DP954	FA388	FDB 185	FA24/2	FDB 449R	FA123	FDB 781	FA179
DP956	FA395	FDB 185R	FA24/2	FDB 452	FA124	FDB 782	FA177
DP957	FA400	FDB 204	FA77	FDB 452R	FA124	FDB 783	FA131/2
DP958	FA320	FDB 204R	FA77	FDB 453	FA119	FDB 784	FA186
DP959	FA410	FDB 207	FA47	FDB 462	FA121	FDB 828	FA173
DP961	FA373	FDB 207R	FA47	FDB 475	FA101	FDB 831	FA150
DP962	FA409	FDB 213	FA76	FDB 481	FA129	FDB 847	FA210
DP963	FA419	FRP 213	FA16	FDB 481R	FA129	FDB 851	FA142
DP964	FA417	FDB 217	FA65	FDB 485	FA201	FDB 858	FA187
DP965	FA423/4	FDB 218	FA51	FDB 494	FA130	FDB 864	FA190
DP966	FA411	FDB 220	FA62	FDB 495	FA125	FDB 865	FA191
DP967	FA377	FDB 244	FA69	FDB 496	FA143	FDB 866	FA156
DP968	FA412	FDB 244R	FA69	FDB 497	FA135	FDB 873	FA188
DP971	FA434	FDB 247	FA61	FDB 498	FA126	FDB 889	FA206
DP973	FA436	FDB 248	FA42	FDB 499	FA134	FDB 892	FA185
DP976	FA442	FDB 250	FA54	FDB 508	FA141	FDB 2001	FA200
DP977	FA435	FDB 277	FA70	FDB 521	FA200	FDB 2002	FA189
DP978	FA447	FDB 298	FA68	FDB 529	FA163	FDB 2003	FA199
DP979	FA443	FDB 298R	FA68	FDB 531	FA140	FDB 2005	FA208
DP980	FA444	FDB 299	FA68	FDB 533	FA187	FDB 2006	FA209
DP981	FA445	FDB 310	FA80	FDB 538	FA69/2	FDB 2007	FA218
DP982	FA446	FDB 310R	FA80	FDB 539	FA131	FDB 2008	FA211
DP983	FA450	FDB 311	FA81	FDB 557	FA145	FDB 2012	FA192
DP984	FA456	FDB 312	FA86	FDB 561	FA132	FDB 2013	FA128
DP986	FA457	FDB 313	FA83	FDB 568	FA153	FDB 2014	FA21
DP987	FA458	FDB 314	FA67	FDB 569	FA146	FDB 2015	FA119
DP988	FA428	FDB 333	FA71	FDB 570	FA142	FDB 2016	FA137
DP989	FA462	FDB 334	FA72	FDB 574	FA158	FDB 2017	FA155
DP990	FA463	FDB 334R	FA72	FDB 583	FA118	FDB 2018	FA181
DP991	FA468	FDB 335	FA78	FDB 591	FA136	FDB 2019	FA208
DP992	FA475	FDB 335R	FA78	FDB 592	FA120	FDB 2022	FA196
DP993	FA454/4	FDB 337	FA88	FDB 605	FA252	FDB 2031	FA243
DP994	N/A	FDB 337R	FA88	FDB 606	FA147	FDB 2033	N/A
DP995	FA430	FDB 338	FA63	FDB 607	FA157	FDB 2034	N/A
DP996	FA452	FDB 338R	FA63	FDB 625	FA178	FDB 2036	FA249
DP997	FA354	FDB 339	FA85	FDB 631	FA165	FDB 2037	FA255
DP999	FA491	FDB 339R	FA85	FDB 636	FA169	FDB 2039	FA245
		FDB 342	FA16	FDB 637	FA182	FDB 2040	FA216
		FDB 342R	FA16	FDB 657	FA170	FDB 2041	FA216/2
		FDB 352	FA94	FDB 659	FA152	FDB 2042	FA244
		FDB 352R	FA94	FDB 661	FA84/3	FDB 2043	FA263
		FDB 381	FA84	FDB 662	FA123	FDB 2044	FA107A
		FDB 382	FA92	FDB 663	FA124/2	FDB 2048	FA231
		FDB 383	FA101	FDB 664	FA196	FDB 2049	FA229

# DISC BRAKE PAD COMPETITOR INTERCHANGE LIST

FERODO	EBC	FERODO	EBC	FERODO	EBC	LOCKHEED	EBC
FDB 2050	FA246	FDB 2142	FA353	FDB 2226	FA427	LMP100	FA28
FDB 2053	FA201	FDB 2143	FA343	FDB 2230	FA444	LMP101	FA13
FDB 2054	FA232	FDB 2144	FA188	FDB 2231	FA443	LMP102	FA12
FDB 2055	FA159	FDB 2145	FA345	FDB 2232	FA446	LMP103	FA55
FDB 2056	FA255	FDB 2146	FA256	FDB 2233	FA445	LMP104	FA11
FDB 2057	FA260	FDB 2147	FA374	FDB 2235	FA428	LMP105	FA27
FDB 2058	FA222	FDB 2148	FA307	FDB 2236	FA354	LMP106	FA18
FDB 2059	FA196	FDB 2149	FA317	FDB 2240	FA454/4	LMP107	FA34
FDB 2060	FA256	FDB 2150	FA348	FDB 2241	N/A	LMP108	FA29
FDB 2062	FA268	FDB 2153	N/A	FDB 2250	FA457	LMP109	FA32
FDB 2073	FA261	FDB 2155	N/A	FDB 2251	FA458	LMP110	*FA33/ FA73
FDB 2074	FA266	FDB 2156	FA319/2	FDB 2252	FA491		FA35
FDB 2075	FA261	FDB 2157	FA357	FDB 2253	FA488	LMP111	FA36
FDB 2079	FA265	FDB 2158	FA347	FDB 2254	SFA607	LMP112	FA24
FDB 2080	FA258	FDB 2162	FA367	FDB 2255	FA604/4	LMP113	FA37
FDB 2081	FA47	FDB 2163	FA366	FDB 2256	SFA603	LMP114	FA38
FDB 2083	FA275	FDB 2164	FA369/4	FDB 2257	FA602	LMP115	FA39
FDB 2084	FA267	FDB 2165	FA368	FDB 2258	FA496	LMP116	*FA30/ FA31
FDB 2085	FA283	FDB 2166	EPFA435/4	FDB 2259	FA499/4	LMP117	NONE
FDB 2086	FA323/3	FDB 2167	GF263	FDB 2260	FA447		FA47
FDB 2087	FA197	FDB 2168	N/A	FDB 2262	FA612	LMP118	FA22
FDB 2090	FA298	FDB 2169	FA375	FDB 2263	FA452	LMP119	FA43
FDB 2091	FA515	FDB 2170	N/A			LMP120	FA48
FDB 2095	FA301	FDB 2171	N/A	FRP 213	FA16	LMP121	FA16
FDB 2096	FA305	FDB 2173	FA412	FRP 219	FA95/2	LMP122	FA56
FDB 2097	FA400	FDB 2175	FA271	FRP 405	FA115	LMP123	FA40
FDB 2098	FA261	FDB 2176	FA314	FRP 408	FA95	LMP124	FA45
FDB 2099	FA244	FDB 2177	FA313	FRP 410	FA107A	LMP125	FA57
FDB 2100	FA186	FDB 2178	FA379	FRP 415	FA175	LMP126	FA41
FDB 2101	FA234	FDB 2179	FA381	FRP 416	FA47/3	LMP127	FA52
FDB 2102	FA304	FDB 2180	FA387	FRP 417	FA183	LMP128	FA62
FDB 2103	FA291	FDB 2181	FA390	FRP 419	FA95	LMP129	FA42
FDB 2105	FA324	FDB 2182	FA373			LMP130	FA50
FDB 2106	FA194	FDB 2183	FA325			LMP131	FA51
FDB 2107	FA115	FDB 2184	FA377			LMP132	FA65
FDB 2108	FA306	FDB 2185	FA426			LMP133	FA64
FDB 2109	FA303	FDB 2186	FA418			LMP134	FA54
FDB 2110	FA302	FDB 2187	FA142			LMP135	FA71
FDB 2111	FA254	FDB 2188	FA342			LMP136	FA46
FDB 2113	FA203	FDB 2189	N/A			LMP137	FA68
FDB 2114	FA296	FDB 2190	FA264			LMP138	FA68
FDB 2115	FA321	FDB 2191	FA235			LMP139	FA67/2
FDB 2116	FA323	FDB 2192	FA151			LMP140	FA69
FDB 2120	FA322HH	FDB 2193	FA344			LMP141	FA72
FDB 2121	FA270R	FDB 2194	FA162			LMP142	FA83
FDB 2122	N/A	FDB 2196	FA388			LMP143	FA61
FDB 2123	FA295	FDB 2197	FA401			LMP144	FA67
FDB 2124	FA294HH	FDB 2198	FA320			LMP145	FA70
FDB 2125	FA335HH	FDB 2200	FA408			LMP146	FA83/2
FDB 2126	FA319	FDB 2201	FA399			LMP147	FA78
FDB 2127	FA351	FDB 2203	FA369/4			LMP148	FA81
FDB 2128	FA350	FDB 2204	FA379			LMP149	FA86
FDB 2129	FA297	FDB 2205	FA390			LMP150	FA80
FDB 2130	FA358	FDB 2208	FA430			LMP151	FA79
FDB 2131	FA196	FDB 2214	N/A			LMP152	FA77
FDB 2132	FA323/3	FDB 2215	N/A			LMP153	FA88
FDB 2133	FA230	FDB 2216	FA432			LMP154	FA63
FDB 2134	FA227	FDB 2217	FA442/4			LMP155	FA85
FDB 2135	N/A	FDB 2218	FA447			LMP156	FA92
FDB 2136	N/A	FDB 2219	FA450			LMP157	FA115
FDB 2139	FA346	FDB 2220	FA417/4			LMP158	FA76
FDB 2140	FA356	FDB 2221	FA436			LMP159	
FDB 2141	FA357	FDB 2225	FA393			LMP160	

# DISC BRAKE PAD COMPETITOR INTERCHANGE LIST

LOCKHEED	EBC	LOCKHEED	EBC	SBS	EBC	SBS	EBC
LMP161	FA90	LMP231	FA158	100	SFA257	164	SFA047
LMP162	FA84	LMP232	FA152	101	FA083	165	SFA336
LMP166	FA95	LMP233	FA165	102	SFA067	166	SFA321
LMP170	FA104	LMP234	FA252	103	SFA086	167	SFA350
LMP171	FA80/2	LMP235	FA157	104	SFA323/2	168	SFA194
LMP172	FA69/2	LMP236	FA164	105	SFA115	169	SFA319
LMP173	FA109	LMP238	FA165	106	FA116	170	SFA179
LMP174	FA60	LMP239	FA220	107	SFA101	171	SFA355
LMP175	FA101	LMP240	FA171	108	SFA256	172	SFA356
LMP176	FA21	LMP242	FA159	109	SFA116	173	SFA374
LMP177	FA103	LMP243	FA178	110	SFA151	174	SFA411
LMP178	FA102	LMP244	FA170	111	SFA169	175	SFA213
LMP179	FA94	LMP245	FA160	112	SFA176	176	SFA209/2
LMP180	FA105	LMP246	FA47/3	113	FA067/2	177	SFA194
LMP181	FA106	LMP247	FA124/2	114	SFA193	178	SFA306
LMP182	FA106/2	LMP248	FA152	115	SFA257	179	SFA256
LMP183	FA47/2	LMP296	FA113	116	SFA131/2	180	SFA375
LMP184	FA84/2	LMP297	FA193	117	SFA186	181	SFA196
LMP185	FA93	LMP298	FA16	118	SFA067	182	SFA412
LMP187	FA110	LMP299	FA198	119	SFA197	183	SFA142
LMP188	FA113	LMP300	FA196	120	SFA194	184	SFA142
LMP189	FA119	LMP301	FA222	121	SFA131/3	185	SFA408
LMP190	FA123	LMP302	FA230	122	SFA396	186	SFA393
LMP191	FA67/2	LMP303	FA246	123	SFA193	187	SFA374
LMP192	FA84	LMP304	FA231	124	SFA256	188	SFA115
LMP193	FA121	LMP305	FA229	125	SFA323	189	FA399
LMP194	FA120	LMP306	FA244	126	FA156	190	SFA393
LMP195	FA99	LMP307	FA263	127	FA069/2	191	SFA425
LMP196	FA118	LMP308	FA264	128	SFA199	192	FA388
LMP197	FA129	LMP309	FA92/3	129	SFA234	193	FA410
LMP198	FA122	LMP310	FA234	130	SFA255	194	SFA43
LMP199	RFA107	LMP311	FA218/2	131	FA047/2	195	SFA607
LMP200	FA124	LMP312	FA255	132	FA099	196	FA413
LMP201	FA126	LMP313	FA228	133	N/A	197	FA228
LMP202	FA130	LMP314	FA145	134	FA197	198	FA252
LMP203	FA125	LMP315	FA254	135	FA067/2	199	FA367/2
LMP204	FA131	LMP316	FA159	136	FA119	200	FA086
LMP205	FA98	LMP317	FA232	137	FA172	201	FA427
LMP206	FA111	LMP318	FA47	138	FA047	202	SFA260
LMP207	FA116	LMP319	N/A	139	FA125	203	FA093
LMP208	FA134	LMP320	N/A	140	SFA264	204	SFA498
LMP209	FA201	LMP321	FA261	141	SFA235	205	SFA603
LMP210	FA111	LMP322	FA261	142	SFA260	206	SFA384
LMP211	FA135			143	SFA193	207	N/A
LMP212	FA200			144	SFA233	208	SFA492
LMP213	FA123			145	SFA268	209	SFA257/2
LMP214	FA140			146	SFA283	210	SFA484
LMP215	FA141			147	SFA281	211	FA448
LMP216	FA136			148	SFA167	212	SFA608
LMP217	FA20			149	SFA193	213	FA480
LMP218	FA151			150	FA297	214	FA432
LMP219	FA169			151	SFA430	215	SFA627
LMP220	FA146			152	SFA298	500	FA28
LMP221	FA132			153	SFA301	501	FA13
LMP222	FA144			154	SFA305	502	FA12
LMP223	FA143			155	SFA275	503	FA55
LMP224	FA145			156	SFA281	504	FA11
LMP225	FA204			157	SFA266	505	FA27
LMP226	FA147			158	SFA358	506	FA18
LMP227	FA142			159	SFA324	507	FA34
LMP228	FA151			166	FA069/3	508	FA29
LMP229	FA153			161	FA174	509	FA32
LMP230	FA196			163	SFA228	510	FA33

# DISC BRAKE PAD COMPETITOR INTERCHANGE LIST

SBS	EBC	SBS	EBC	SBS	EBC	SBS	EBC
511	FA35	576	FA21	639	FA220	705	FA229
512	FA36	577	FA103	640	FA171	706	FA244
513	FA24/2	578	FA102	641	FA163	707	FA263
514	FA37	579	FA94	642	FA159	708	FA264
515	FA38	580	FA105	643	FA54	709	FA92/3
516	FA39	581	FA106	644	FA170	710	FA234
517	FA31	582	FA106/2	645	FA123	711	FA255
519	FA47	583	FA47/2	646	FA47/3	712	FA255
520	FA22	584	FA84/2	647	FA124/2	713	FA228
521	FA43	585	FA93	648	FA152	714	FA145
522	FA48	586	FA67	649	FA137	715	FA254
523	FA16	587	FA110	650	FA172	716	FA159
524	FA56	588	FA113	651	FA173	717	FA232
525	FA40	589	FA119	652	FA167	718	FA47
526	FA45	590	FA123	653	FA166	719	FA272
527	FA57	591	FA128	654	FA196	720	N/A
528	FA41	592	FA84	655	FA184	721	FA261
529	FA52	593	FA121	656	FA175	722	FA261
530	FA62	594	FA120	657	FA174	723	FA235
531	FA48	595	FA99	658	FA210	724	FA260
532	FA50	596	FA118	659	FA162	725	FA193
533	FA51	597	FA129	660	EPFA217	726	FA258
534	FA65	598	FA122	661	FA107A	727	FA244
535	FA64	599	FA107	662	FA95	728	FA275
536	FA54	600	FA124	663	FA179	729	FA249
537	FA71	601	FA126	664	N/A	730	FA266
538	FA46	602	FA130	665	FA182	731	FA258
539	FA66	603	FA125	666	FA180	732	N/A
540	FA68	604	FA131	667	FA193	733	FA267
541	FA67/2	605	FA98	668	FA201	734	FA265
542	FA69	606	FA111	669	FA200	735	FA261
543	FA72	607	FA116	670	FA257	736	FA261
544	FA83	608	FA134	671	FA181	737	FA47
545	FA61	609	FA201	672	FA156	738	FA196
546	FA67	610	FA117	673	FA131/2	740	FA283
547	FA70	611	FA135	676	FA249	741	FA295
548	FA83/2	612	FA200	677	FA183	742	FA363
549	FA78	613	FA123	678	FA95	743	FA294
550	FA81	614	FA140	679	FA26	744	FA206
551	FA86	615	FA141	680	FA116	745	FA297
552	FA80	616	FA136	681	FA177	746	FA304
553	FA79	617	FA20	682	FA191	747	FA298
554	FA77	618	FA151	683	FA190	748	FA301
555	FA88	619	FA169	684	FA173	749	FA305
556	FA63	620	FA146	685	FA189	750	FA400
557	FA85	621	FA132	686	FA188	751	N/A
558	FA92	622	FA187	687	FA192	752	FA302
559	FA115	623	FA143	688	FA197	753	FA174
560	FA76	624	FA145	689	FA194	754	FA307
561	FA90	625	N/A	690	FA131/3	755	FA270R
562	FA84	626	FA147	691	FA199	756	FA273R
563	FA75	627	FA142	692	FA67	757	FA313R
563	FA75/2	628	FA151	694	FA185	758	FA271R
565	FA89	629	FA153	695	FA218	760	N/A
566	FA95	630	FA196	696	FA113	761	FA324
568	FA96	631	FA158	697	FA193	762	FA322HH
569	FA149/2	632	FA152	698	FA16	763	FA320
570	FA104	633	FA165	699	FA198	764	FA336
571	FA80/2	634	FA252	700	FA196	765	FA254
572	FA69/2	635	FA157	701	FA222	766	N/A
573	FA109	636	FA164	702	FA230	767	FA317
574	FA60	637	FA155	703	FA246	768	FA319
575	FA101	638	FA165	704	FA231	769	FA319/2



# DISC BRAKE PAD COMPETITOR INTERCHANGE LIST

SBS	EBC	SBS	EBC	VESRAH	EBC	VESRAH	EBC
770	FA348	838	FA417/4	VD-101	FA12	VD-156/2	FA196
771	FA193	839	FA442/4	VD-102	FA13	VD-160	N/A
772	FA321	840	FA450	VD-103	FA13	VD-161	FA185
773	FA350	841	FA447	VD-104	FA13	VD-162	FA257
774	FA194	842	FA405	VD-105	FA13	VD-163	FA174
775	FA355	843	FA433/4	VD-106	FA13	VD-164	FA189
776	FA356	844	FA432	VD-107	FA29	VD-165	FA261
777	FA346	845	N/A	VD-108	FA32	VD-166	FA265
778	FA294	846	FA434	VD-109	FA40	VD-166/2	FA265
779	FA249/2	847	FA427	VD-110	FA43	VD-168	FA346
781	FA411	848	FA431	VD-111	FA40	VD-169	FA358
782	FA347	849	FA444	VD-112	FA31	VD-170	FA390
783	FA357	850	FA443	VD-112/2	FA29	VD-171	FA373
785	N/A	851	FA446	VD-112/3	FA30	VD-172	FA388
786	FA353	852	FA445	VD-113	FA45	VD-173	FA415
787	FA314	853	FA457	VD-114	FA29	VD-174	FA436
788	FA369	854	FA458	VD-115	FA30	VD-175	FA410
789	FA366	856	FA454/4	VD-116	FA32	VD-177	FA375
790	FA367	857	FA460	VD-117	FA45	VD-178	FA488
791	FA368	858	FA464	VD-118	FA30	VD-179	FA499/4
792	FA306	859	FA465	VD-119	FA52	VD-180	SFA603
793	FA256	860	FA296	VD-120	FA54	VD-201	FA11
794	FA325R	861	FA367	VD-122	FA83/2	VD-202	FA28
795	FA345	862	FA488	VD-123	FA69	VD-203	FA28
796	FA335	863	SFA607	VD-123/2	FA69/2	VD-204	FA11
797	FA375	864	FA491	VD-123/3	FA69/3	VD-205	FA34
798	FA349	866	FA462	VD-123/4	FA69/3	VD-206	FA34
799	FA344	867	FA463	VD-124	FA69/2	VD-207	FA34
800	FA354	868	FA260	VD-125	FA29	VD-208	FA34
801	FA342	869	FA499/4	VD-126	FA130	VD-209	FA34
802	FA303	870	FA604/4	VD-127	FA84/3	VD-210	FA34
803	FA351	872	FA602TT	VD-127/2	FA84	VD-211	FA34
804	FA412	877	FA606	VD-127/3	FA84/2	VD-212	FA34
805	EPFA435/4	878	SFA484	VD-128	FA84	VD-213	FA42
806	FA379	879	SFA257/2	VD-129	FA80/2	VD-214	FA34
807	FA381	880	FA261/2HH	VD-129	FA197	VD-215	FA41
808	FA387	881	FA496	VD-129/2	FA80	VD-216	FA61
809	FA390	885	FA612	VD-130	FA90	VD-221	FA64
810	FA377	886	FA231/2	VD-131	FA86	VD-222	FA20
812	FA408	887	FA435/4	VD-132	FA69	VD-228	FA70
813	FA373	894	FA296	VD-133	FA69/3	VD-231	FA81
814	FA86	895	FA495	VD-134	FA92	VD-234	FA21
815	FA291	896	FA403	VD-135	FA80	VD-235	FA81
816	FA428	897	FA452	VD-136	FA92/2	VD-236	FA88
817	FA167	898	FA456	VD-137	FA176	VD-237	FA38A
818	FA418	899	FA475	VD-138	FA111	VD-238	FA89
819	FA115	900	FA630	VD-138/2	FA111/2	VD-239	FA101
820	FA401			VD-139	FA125	VD-240	FA104
821	FA399			VD-139/2	FA143	VD-241	FA105
822	FA395			VD-140	FA109	VD-242	FA123
823	FA393			VD-141	FA121	VD-242/2	FA123
824	FA47/2			VD-142	FA121	VD-244	FA119
825	N/A			VD-143	FA124	VD-245	FA118
826	FA400			VD-143/2	FA124/2	VD-246	FA136
829	FA410			VD-144	FA131	VD-247	FA169
830	FA409			VD-144/2	FA131	VD-248	FA252
831	FA425			VD-146	FA122	VD-249	FA220
832	FA415			VD-147	FA140	VD-250	FA214
833	FA419			VD-150	FA151	VD-250/2	FA215/2
834	FA436			VD-152	FA113	VD-251	FA160
835	FA413			VD-153	FA153	VD-252	FA172
836	FA414			VD-154	FA187	VD-253	FA169
837	FA430			VD-156	FA142	VD-254	FA115



# DISC BRAKE PAD COMPETITOR INTERCHANGE LIST

DISC PADS  
BUYERS GUIDE

VESRAH	EBC	VESRAH	EBC	VESRAH	EBC	VESRAH	EBC
VD-255	FA179	VD-331/2	FA150	VD-432/2	FA152/2	VD-958	FA209
VD-256	FA206	VD-332	FA67/2R	VD-433	FA180	VD-959	FA246
VD-257	FA182	VD-333	FA54	VD-434	FA192	VD-960	FA268
VD-258	FA190	VD-334	FA84/2	VD-435	FA231	VD-961	EPFA263
VD-259	FA199	VD-335	FA110	VD-437	FA249	VD-962	FA234
VD-260	FA199	VD-336	FA84	VD-438	FA258	VD-963	FA270
VD-261	FA155	VD-337	FA106/2	VD-439	FA294	VD-964	FA266
VD-262	FA244	VD-338	FA103	VD-440	FA302	VD-965	FA271
VD-263	N/A	VD-339	FA83	VD-441	FA342	VD-967	FA194
VD-264	FA267	VD-340	FA214	VD-442	FA349	VD-968	FA260
VD-265	FA275	VD-341	FA137	VD-443	FA347	VD-967	FA194
VD-266	FA307	VD-342	FA83	VD-444	FA417/4	VD-968	FA260
VD-266/2	FA413	VD-342/2	FA83/2	VD-901	FA26	VD-969/2	FA295
VD-267	FA336	VD-343	FA158	VD-902	FA24/2	VD-971	FA400
VD-268	FA348	VD-344	FA158	VD-903	FA71	VD-972	FA304
VD-269	FA319	VD-344/2	FA158	VD-904	FA27	VD-973	FA313
VD-269/2	FA319/2	VD-345	FA146	VD-906	FA16	VD-974	FA298
VD-270	FA344	VD-345/2	FA146	VD-907	FA18	VD-975	FA210
VD-271	FA367	VD-346	FA93	VD-907/2	FA19	VD-976	FA301
VD-272	FA384	VD-347	FA147	VD-908	FA71	VD-977	-
VD-273	FA393	VD-348	FA157	VD-909	FA72	VD-978	-
VD-274	FA380	VD-349	FA188	VD-910	FA22	VD-979/2	FA414
VD-275	FA408	VD-350	FA222	VD-911	FA47	VD-981	FA321
VD-276	FA428	VD-351	FA230	VD-911/2	FA47/3	VD-982	FA177
VD-277	FA442/4	VD-352	FA229	VD-912	FA50	VD-983	FA353
VD-278	FA446	VD-353	FA283	VD-913	FA18	VD-984	-
VD-278/2	FA444	VD-354	FA369/4	VD-915	FA24/2	VD-986	FA322/4
VD-279	FA445	VD-354	FA423/4	VD-916	N/A	VD-987	FA355
VD-279/2	FA443	VD-355	FA379	VD-917	FA79	VD-988	FA356
VD-280	FA450	VD-356	FA411	VD-918	FA78	VD-991	FA325
VD-282	FA464	VD-357	FA412	VD-919	FA94	VD-992	FA314
VD-285	SFA626	VD-358	FA401	VD-920	FA60	VD-993	FA345
VD-283	SFA492	VD-359	FA419	VD-921	N/A	VD-994	FA306
VD-301	FA55	VD-360	N/A	VD-922	FA201	VD-995	FA305
VD-302	FA55	VD-401	FA55	VD-923	FA200	VD-996	FA235
VD-303	FA55	VD-402	FA55	VD-924	FA120	VD-997	FA368
VD-304	FA55	VD-403	N/A	VD-925	FA115	VD-998	FA320
VD-305	FA35	VD-404	FA33	VD-926	FA204	VD-999	FA350
VD-306	FA36	VD-405	FA37	VD-927	FA163	VD-9000	FA335
VD-306/2	RFA36/2	VD-406	FA36	VD-928	FA76	VD-9001	FA303
VD-307	FA38	VD-408	FA33	VD-929	FA134	VD-9002	FA352
VD-308	FA38	VD-409	FA33	VD-930	FA98	VD-9003	FA351
VD-309	FA39	VD-410	FA39	VD-931	FA111	VD-9004	FA399
VD-310	FA38	VD-411	FA33	VD-932	FA99	VD-9005	N/A
VD-311	FA36	VD-412	FA37	VD-933	FA77	VD-9006	FA357
VD-312	FA56	VD-413	FA48	VD-934	FA171	VD-9007	FA167
VD-313	FA35	VD-414	FA33	VD-935	FA57	VD-9009	FA381
VD-314	FA46	VD-415	FA36/2	VD-936	FA132	VD-9010	FA387
VD-315	FA38	VD-416	FA161	VD-937	FA116	VD-9011	FA435/4
VD-316	FA38	VD-417	FA73	VD-938	FA164	VD-9012	FA264
VD-318	FA35	VD-419	N/A	VD-939	FA54/2	VD-9013	FA374
VD-320	FA38	VD-420	FA68	VD-940	FA159	VD-9015	FA194
VD-322	FA51	VD-420/2	FA68	VD-941	FA170	VD-9017	FA324
VD-323	FA51	VD-421	FA68	VD-942	FA134	VD-9018	N/A
VD-324	FA65	VD-422	FA83	VD-943	FA126	VD-9019	FA297
VD-325	FA67	VD-423	FA62	VD-945	FA95	VD-9020	FA294
VD-327	FA63	VD-424	FA85	VD-947	FA245	VD-9021	FA295
VD-327/2	FA161	VD-425	FA173	VD-948	FA193	VD-9022	FA400
VD-328	FA102	VD-426	FA85	VD-950	FA232	VD-9023	FA395
VD-329	FA106	VD-427	FA129	VD-953	FA208	VD-9024	FA354
VD-329/2	FA106/2	VD-428	FA130	VD-955	FA255	VD-9025	FA409
VD-330	FA103	VD-430	FA141	VD-956	FA201	VD-9026	FA377
VD-331	FA103	VD-432	FA152	VD-957	FA200	VD-9027	GFA183HH

# ***DISC BRAKE PAD COMPETITOR INTERCHANGE LIST***

<b>VESRAH</b>	<b>EBC</b>	<b>VESRAH</b>	<b>EBC</b>	<b>VESRAH</b>	<b>EBC</b>	<b>VESRAH</b>	<b>EBC</b>
VD-9030	MXS405						
VD-9031	FA447						
VD-9033	FA434						
VD-9034	FA457						
VD-9035	FA458						
VD-9036	FA452						
VD-9038	FA454/4						
VD-9039	N/A						
VD-9041	SFA425						
VD-9044	SFA498						
VD-9045	FA427						
VD-9048	FA491						
VD-9050	FA490						
VD-9051							
VD-9052							

**DISC PADS  
BUYERS GUIDE**



Part No.	Make/Model	Year		Part No.	Make/Model	Year	
<b>H303 Contd.</b>	<b>PEUGEOT Contd.</b>			<b>H303 Contd.</b>	<b>KYMCO Contd.</b>		
	Ludix 50cc One	04-10	F&R		DJY 50 Refined	93-06	F
	Ludix Snake 50cc	04-09	R		K12 Sport 50	95-00	R
	Ludix Bullet 50cc	04	R		KB 50	95-00	R
	Ludix Trend 50cc	04-07	R		Sniper 50	93	R
	Ludix Elegance 50c	04-09	R		CX 50	93	F
	Ludix Ambition 125cc	04	R		Heroism 50	95-97	R
	Ludix Classic (14" wheels)	04-05	F&R		Grand King 125/150		F&R
	Ludix Urban Track	06-07	R		Filly 50	98-00	F&R
	Ludix Red Zone	06	R		Filly LX 50	00-06	R
	Ludix Acid	06	R		KB 50 Scout	97	R
	Ludix Blaster (10" wheels)	05-09	R		Looping 50	98	R
	Ludix 2 Trend 50cc (2T)	07-12	R		MXU 50	05-12	F
	Ludix 2 Biposto 50cc (2T)	07-09	F&R		Mxer 50/150 (Quad)	00-07	F
	Ludix 2-One Biposto (2T)				Spacer 50	99-06	R
	(10" wheels)	10-12	F&R		Top Boy 50	97-06	R
	Ludix 2-One Monoposto				Yager 50	07	R
	(10" wheels)	10-11	F&R		Agility 50 Basic	07	F&R
	TRK 50 (2T) (10" wheels)	09-12	R		Yup 50	01-09	R
	TRK 50 (2T/12" wheels)	09-12	R		ZX 50 Super Fever/Scout	99-06	R
	New Vivacity 50 (4T)	08-11	R		Cobra 100 Racer	99-03	R
	Sixties Vivacity (Old model) 50 (4T)	10-11	R		KB 100 Manboy	97-00	R
	Vivacity 50/100	04-07	R		Top Boy 100	97	R
	Vivacity 2 (50cc) (10" wheels				Activ 50/110/125	04-06	R
	/190mm disc)	08-11	R		Visa R 50	11	R
	Vivacity 50 12" wheels/190mm disc	92-07	R		Visa R 110	11-12	R
	New Vivacity (50cc/2T)				Agility 125 Carry (4T)	11-12	R
	(12" wheels/200mm dia disc)	08-12	R		Heroism 125	95-99	R
	New Vivacity Sixties (50cc/4T)				MXU 150 Quad	05-12	F
	(12" wheels/200mm disc)	10-12	R		<b>LIFAN</b>		
	E-Vivacity (Electric)	11-12	R		LF 50 QGY		R
	Metal X 50	02-03	R		LF 50 QGY 1/2		F&R
	SV 50 J (Fromt drum model)	91-95	F&R		<b>SINNIS</b>		
	Elyseo 50/100	98-02	R		WY 50 QT-39A Ghost	06-10	R
	Jet Force 50 H2i (2T/Air Cooled)	11-12	R		Falcon 50 QM 50 QT-2T	08-10	R
	V-Clic 50 (4T)	08-11	R		Jet 50 QM 50 QT-6A	08-10	R
	SV 50/80/125	91-95	R		Nitro 50 (2T)		R
	Trekker 50 (2T) AJP Caliper	98-00	R		Pioneer 50 (2T)		R
	Trekker 50 (2T) Heng Tong Caliper	98-00	R		Strike 50 (2T)	09-10	R
	Tweet 50	10	R		<b>SUPERBYKE</b>		
	Trekker 100 (2T)	98	R		SB 125-4		R
	TRK2 WRC 50 (2T)	04-06	R		<b>SYM</b>		
	Buxy/M/RM	94-97	R		Cinderella 50/100	99-00	R
	Speedake	95-97	R		Red Devil	99-09	R
	Speedfight 3 50cc (AC)	09-12	R		Jungle 50	99-02	R
	Squab	95-97	R		Jet 4 (50cc 4T)	10-13	R
	Zenith LS	96-99	R		Jet 4 R 50 (2T)	11-13	R
	Zenith M/N	96-00	F&R		Jet 50/Euro XS	99-05	R
	Vivacity 50/100 (All models)	99-07	R		Jet 50 Basix 50	06-09	R
	SV 100 L				Jet Euro X 50	06-13	R
	Fox/Fox L 50	94-98	F&R		Mio 50	05-13	R
	V-Clic 50 (4T)	08-11	R		Fiddle 50	99-05	F
	E-Vivacity (Electric)	11	R		Fiddle II 50	08-13	R
	Ludix Pro (14" wheels/4T)	11	R		City Hopper 50	99-02	R
	Vox 110	12-13	R		Mask 50	00-05	R
	<b>KYMCO</b>				Orbit 50	08-09	R
	Active SR 50cc	08-11	R		Orbit II 50 TS (4T)	12-13	R
	Agility 50	05-08	R		Super Fancy 50	96-02	R
	Agility 50 Carry (4T)	11-13	R		Simply 50	07-08	R
	Agility 50 R10 (4T)	06-12	R		Symply II 50	09-13	R
	Agility 50 R12 (4T)	06-12	R		Tonik 50	11-13	R
	Agility RS 50 Naked (2T/12" wheels)	10-13	R		Tonik 50 (4T)	11-13	R
	Bet & Win 50/Dink Sports 50	02-06	R		Jet 100 (G100P-6)	99-00	R
	Calypso 50/125	99	R		Mio 100	05-13	R
	Super 9 (A/C)	00-07	R		Symba 100	11-12	F&R
	Cobra Racer	00-06	R		Evie (Electric Scooter)	10	F&R
	Cobra 50 Cross	00-06	R		Symmetry-Electric	11	F&R
	Grand Dink 50 (2T)	04-07	R		E W00 Elettrico	11	R
	Like 50 (2T)	09-13	R		<b>TAMORETTI</b>		
	Like 50 (4T)	09-13	R		Retro 50		R
	Sento 50	08-09	R		Retro 125		R
	Vitality 50 (2T/4T)	04-09	R				
	Cobra 100 Racer	99-03	R				
	Fever ZX 50/Scout	99-03	R	<b>H304</b>	<b>HONDA</b>		
	Dink 50/Spacer 50/Yager 50	98-06	R	06430 GBJ J10	C 50 N (Single seat model)	95	R
	Dink 50 (4T)	07-12	R	06430 GCE 900	C 50 P/S/V/X/Y/1/2 (Single seat)	96-02	R
	Dink Classic Euro 2 50	03	R	06430 KK0 405	CB 50 J	81	R
	DJW 50 World	95-97	F	06430 365 305	CD 50 ST/SV/SW/SX Benley 50 S	96-99	F&R
	DJX 50	91-92	F	06430 365 306	CL 50 V/X Benley CL50	97-99	R
				06430 365 405	CRM 50 RN/RP/RR/RT	93-96	R
				06430 365 674			
				06430 MN1 671			

45120 E60 000  
45120 096 6520 M2  
43121 A F01 000  
45120 GC8 000  
43120 KXC 9000  
4312A LAB4 90B  
5312A KXCX900



Part No.	Make/Model	Year		Part No.	Make/Model	Year	
<b>H304 Contd.</b>	<b>HONDA Contd.</b>			<b>H305</b>	<b>use H333</b>		
06430 KB9 005	MB 5 S	80-82	R	<b>H306</b>	<b>HONDA</b>		
06430 KB9 405	MBX 50 SD/SF	83-85	R	06430 968 681	TRX 90 Fourtrax/Sportrax (All models)	93-06	R
06430 KT0 305	MG 50 S/X/1/3 Magna 50	95-03	R	06430 HF1 911	TRX 90 EX	07-08	R
06450 121 630	MP 50 3/DX3 (AC17) Solo	03	F&R	06430 HF7 000	TRX 90 X9/XB	09-11	R
06450 121 730	MRX 50	88-	R	06430 HF7 A30	ATC 110 (All models)	79-84	R
43120 110 670	MT 50 SA/SE/SG/SJ/SL	80-93	F&R	06430 HF7 D00	TRX 125 J	88	R
43120 121 751	MTX 50 SC	83-84	F&R	431A2 968 681	ATC 125 ME/MG	84-85	R
43120 167 892	NSR 50 FP/FR/FS	93-95	R	43120 283 010	Wolf 125/150 Scooter	00	F
43120 331 670	NSR 50 SK/SP/SR/SS	89-95	R	43120 942 000	CD 175 (All models)	71-78	F
43120 331 671	TC 50 Y/2 Gyro Canopy	00-02	F	43120 961 000	ATC 185 A/SB	80-81	R
43120 365 671	XZ 50 1/2 APE-AC16	01-02	F&R	43120 961 010	ATC 200 B/ESE/ESF/SE	81-84	R
43120 365 672	CRM 75 RK/RL/RM/RP/RR	89-94	R	43120 968 405	TRX 200 L/M/DM/DN	90-93	R
43120 365 673	XR 75 K4	75-78	F&R	43120 968 681	TRX 200 D	91-97	R
43120 365 647	CR 80 RA/RB	80-81	F&R	43120 968 682	TRX 200 L/M Fourtrax	90-91	R
43120 365 307	CR 80 RC	82	F	45120 230 000	TRX 200 SX	86-87	R
43120 KB9 005	CR 80 R2F/R2G	85-86	F&R	45120 303 690	ATC 250 RB/RC	81-82	R
43120 KB9 015	CR 80 R2F/R2G	80-	R	45120 HAO 003	ATC 250 ESF/ESG/ESH/ESJ	85-88	F
43120 KF0 005	MB 80 (MB8)	83-86	R	45120 HAO 006	FL 250 Odyssey	77-84	R
43120 MN1 641	MBX 80 FWDD/FEDF	82-	R	0452705	<b>POLARIS</b>		
43120 MN1 642	MCX 80	83-84	F&R		Phoenix 200	05-11	R
43120 MN1 643	MTX 80 RFD/RFF	86	R		200 Sawtooth	06-07	R
43120 MN1 671	NSR 80	80-81	F&R				
431A2 365 672	XR 80 Z/A/B	80-81	F&R				
45120 365 671	C 90 All models	93-03	F&R				
45120 365 672	CB 100 N	78-80	R				
45120 365 673	XL 100 (All Models)	78-82	F&R				
45120 KB9 005	XZ 100 2 APE-HC07	02	F&R	<b>H307</b>	<b>HONDA</b>		
45120 KB9 015	CT 1100 A/B/C/D/K/M	80-88	R	0450434	Wolf 125/150 Scooter	00	R
45120 KK0 005	CT 110 X	05-09	F	04500442	CD 175 (All models)	71-78	R
451A2 KK0 305	CB 125 J	79	R	43120 230 000	<b>APACHE</b>		
	CBX 125 Custom	88-	R	43120 303 690	Mini Tomahawk 50 (4T)	08-09	R
	CG 125 S/T/W/M1	98-02	R	43120 303 305	<b>ARCTIC CAT</b>		
	CLR 125 W 'City Fly'	98-02	R	4312A B06 000	50 Y-6 Youths (2x4)	04-05	F
	CLR 125 X/W/Y	99-	R	3301-183	90 Y-12 Youths (2T & 4T Models)	02-05	F
	CR 125 M2/M4	76-78	F&R	4312A LBD4 900	90 2x4 (4T) Youth		
	CT 125 C	85	F&R	V43121 MAA00	Rear Drum Model	04-05	R
	MBX 125 FE	84-86	R	45120 MAA 000	90 2x4 (2T) Youth	02-04	R
	MTX 125 RWD	83-84	F&R	4312A HIA 000	<b>CAN-AM</b>		
	MTX 125 RWE/RWF/RWH/RWL	85-95	R		DS 70	08-12	R
	SL 125 K1D/E/F/G/K2A	76-80	F&R		<b>KYMCO</b>		
	TL 125	76	F&R		Maxxer 50	05-13	R
	XL 125 K2	78	F&R		<b>POLARIS</b>		
	XL 125 K3/K4	79	R		50 Outlaw	08-11	R
	XL 125 SZ/SA/SB/SC/RC	79-82	F&R		Predator 50 (2 stroke)	04-06	R
	XL 125 RF/RH	85-86	R		Scrambler 50	01-03	R
	XLR 125 RW	98-99	R		90 Outlaw	07-11	R
	XR 125 L3/L4/L5/L6/L7/L8	03-08	R		Predator 90	03-06	R
	CRF 150 F3/F4/F5/F6/F7	03-07	R		Scrambler 90 X	01-03	R
	XL 185 SZ/SA/SB	80-82	F&R		Sportsman 90	01-11	R
	CTX 200/CTA 200 A Bushlander	04-05	R		<b>QUADZILLA</b>		
	MTX 200 RWD	83-84	F&R		4-Cross 200cc		F
	MTX 200 RWF	85	R		<b>ROXON</b>		
	TL 200 J/Y 'Colin Seeley'	76-78	F&R		Fox 50 (Quad)	04-06	R
	TLR 200 G/H	86-87	F		<b>SYM</b>		
	XR 200 R	81-02	F&R		E-Virid (Electric) Deluxe	12-13	R
	XR 200	80-84	F&R		E-Virid (Electric)	12-13	F&R
	TLM 220 R	88-92	R		Orbit II 50 Naked (4T)	12-13	R
	CRF 230 F4/F5/F6/F7/F8/F9	04-09	R		X'Pro 50	13	R
	CBX 250	84-98	R		Symphony 50 (4T)	09-10	R
	RTL 250 SG	86	F&R		Tonik 110 (4T)	11-13	R
	TL 250 K1	79	F&R		Fiddle II 125	08-13	R
	TLM 250 RJ	89	F&R		Jet 4 (125cc 4T)	10-12	R
	TLR 250 F	85	F&R		Simply 125	07-08	R
	XR 250 RE/RF/RG/RH/RJ/RK	84-89	R		Symply II 125	09-13	R
	XR 350 RD/RE	83-84	R		Symphony 125 (4T)	09	R
	XR 500 RD/RE	84-85	R		125 Attila	99-00	R
	XR 600 RF/RG/RH/RJ/RK/RL	85-90	R		Super Duke 125/150	99-02	R
	<b>HARTFORD</b>				X'Pro 125	11-13	R
	VR 125 Z Velo Sport	00-03	R		Fiddle II 151	11	R
	VR 125 X/H Velo Cross	00-03	R		KXR 50/90 Mongoose	04-06	R
	<b>HONDA HM (ITALY)</b>				<b>TAMORETTI</b>		
	CRF 230 F Easy Trial (All models)	04-07	R		Stealth 125		R
	<b>HONGDOU</b>				<b>TOMOS</b>		
	GY 125	06-08	R		Twister 50		R
	<b>LIFAN</b>				Twister 125		R
	LF 50 QGY		R	<b>H308</b>	<b>HONDA</b>		
	LF 50 QGY 1/2		F&R	45120 235 000	CB 125 K1 to K5	72-76	F
	Smart 50/125		R	45120 354 670	CB 175 (All models)	74-76	F
	LF 100 A		R				















Part No.	Make/Model	Year		Part No.	Make/Model	Year	
<b>Y503 Cont.</b>	<b>CPI Contd.</b>			<b>Y503 Cont.</b>	<b>KRIEDLER Contd.</b>		
	Aragon S-Line 50/125	07-12	R		50 Florett 50 City	12-13	R
	Baby J 50	02	R		<b>MALAGUTI</b>		
	Bravo 50	12	R		Malbo Line - DVD 50 (2T)	10-11	R
	Formula 50 Basic	07-08	R		<b>MBK</b>		
	Formula 50 R	07-12	R		CR 50 Z Target	91-95	R
	Freaky 50	07	R		CS 50 Mach G AC (Air cooled)	02-05	R
	Oliver 50 (All models)	03-12	R		CS 50 Mach G LC		
	Popcorn 50	02	R		(Liquid Cooled)	03-05	R
	50 Hussar	01-05	R		CT 50 S 50RR 150	91-92	F&R
	Aragon 50	07-09	R		CT 50 SS Sorriso	93-95	F&R
	Aragon GP50	07-12	R		CV 50 Evolis	97	R
	Aragon S Line 125	07-12	R		CW 50 Booster Naked		
	Bravo 125	12	R		(10" wheels)	06-10	R
	<b>DAELIM</b>				CW 50 Booster 10" wheels	09-10	R
	M 50 D/MD Millenium	03	R		CW 50 RS 'Booster' 'Spirit'	99-06	R
	DX 50 D Camper	03	R		CW 50 RSP "Rocket"	97-98	R
	ST 90 Pro Monkey	03	R		CW 50 Fizz 50	93-97	R
	<b>DERBI</b>				CW 50 RS Booster NG	95-06	R
	DXR 200 Quad	04-05	F		CW 50 RSX Booster Track	96-98	R
	DXR 250 Quad	04-05	F		CW 50 Booster	90-91	F&R
	<b>DINLI</b>				CW 50 Booster	92-94	F&R
	QZ 125 CUV		F		CW 50 Booster (12" wheels)	06-10	R
	<b>GARELLI</b>				CW 50 Power Rocket	06	R
	Queenie	95-	R		CW 50 Booster Spirit	96-98	R
	Grinta	95-	R		CW 50 Booster Spirit	09	R
	FX 50		R		CW 50 Naked Booster 12" wheels	09-10	R
	XO 50	09-	R		CY 50 Forte/Forte Mufa	96-97	R
	<b>GENERIC</b>				EW 50 'Stunt'	00-06	R
	Cracker 50 (2T/4T)	09-13	R		EW 50 Stunt Naked	05-10	R
	50 GT Race Explorer	09	R		YA 50 R Forte	94-95	R
	Epico 50 (2T)	10-13	R		YA 50 TA Sorriso	95-96	F&R
	Onyx 50 (2T/4T)	10-13	R		YE 50 Evolis	92-95	R
	XOR 50	05-12	R		YH 50 'Flipper'	98-10	R
	Ideo 50	05-13	R		YM 50 Fizz	94-95	R
	Jump 50 (2T)	12-13	R		YN 50 Ovetto (4T)	09-10	R
	Race 2 50 (2T/4T)	10-13	R		YN 50 R Ovetto (2T)	98-10	R
	Roc 50	08-11	R		CV 80 Evolis	97	R
	Sirion 50 (2T/4T)	12-13	R		XC 125 Flame 125	96-03	R
	Toxic 50 Sport	12	R		XC 125 T Flame	95-96	R
	Vertigo 50 (4T)	12	R		<b>MOTO ROMA</b>		
	Race 2 125 (4T)	10-13	R		G10 (50cc/2T)	11-12	R
	Sirion 125 (4T)	12-13	R		Go-Go 50	97-05	R
	Vertigo 125 (4T)	12-13	R		Stinger 50	99-05	R
	<b>HERCULES (SACHS)</b>				Wasp 50	99-05	R
	80 CV		F&R		Grand Prix 50/110	99-03	R
	<b>JORDAN</b>				Roadrunner 50/100	01-02	R
	Easy 50/100	03-04	R		Scrambler 50	01	R
	<b>KEEWAY</b>				Lambros 125 (4T)	11-12	R
	Agora 50 (2T/4T)	10-11	R		<b>MUZ</b>		
	ARN 50 (25/45)	10-11	R		Moskito FB 50	97-03	R
	Flash 50 Electric	09-10	R		Moskito SX UP50	00-03	R
	Hurricane 50	07-10	R		<b>POLARIS</b>		
	Hurricane 50-Base	07	R		250 Cyclone X	87	F
	RY6 50 (25/45)	10-11	R		Scrambler (3 wheeler)	85-86	F
	RY8	07	R		Trail Boss 2x4	85-87	F
	RY8 SP 50 (25/45)	10-11	R		<b>QUADZILLA</b>		
	Focus 50	06-09	R		Black Max M100 (SE)	06	F
	Matrix 50	06-12	R		Pro Shark (Double A Arms)		F
	Easy Hurricane 50 (25/45)	07-12	R		X 100 E (XLC)	06	F
	F-Act 50	07-10	R		Pro Shark	06	F
	F-Act 50 RS	10-11	R		Pro Shark 100 R MX	07	F
	F-Act-NKD 50	09-11	R		Stinger R 170 E	06	F
	F-Act Racing 50 (25/45)	10-12	R		ST 200 E (Automatic)	06	F
	Flash 50	07-10	R		<b>PGO</b>		
	Goccia 50	08-11	R		My Bubu 50	03	R
	Hacker 50	08-09	R		<b>WK BIKES</b>		
	Pixel 50	08-12	R		WK One 50 (2T)	10-11	R
	Swan 50 (25/45)	10-11	R		WK GP2 (50/2T)	10-13	R
	F-Act 100	08-10	R		WK GO 50 (4T)	11-13	R
	Matrix Electric	09-10	R				
	Matrix V4 50 (25/50)	10-11	R				
	Matrix 50	06-11	R				
	ARN 125	06-12	R				
	F-Act 125	07-11	R				
	<b>KRIEDLER</b>						
	50 Vabene	12-13	R				
	50 Flory (RS 50 DD)	12-13	R				
	50 Florett 2 (RS50)	12-13	R				





Part No.	Make/Model	Year		Part No.	Make/Model	Year	
<b>Y512</b> 371 25330 00 4H7 25330 00 4H7 25330 01 4H7 W2536 00 3LT W2536 00 3LT 4253E 00	<b>YAMAHA</b> TX 500/XS 500 B XJ 550 XJ 550 H/J/K "Maxim" XZ 550 YX 600 S/S/C/T/TC/U/UC/W/WC A/AC Radian XJ 650 G/H/J/K "Maxim" XJ 650 LH "Midnight" XV 750 SE XV 750 Virago	75-77 81-84 81-83 82-84 86-90 80-83 81 81 92-93	R R R R R R R R R	<b>Y518</b> 18A 25330 00 18A W2534 00 36R 25330 00 36R W2536 00 2JN W2535 00 23T F5330 00 3LS W253E 00	<b>YAMAHA</b> FS1 T 50 'Townmate' V 50 M CW 50 T 'BWS' 'Bi-Wizz' CY 50 'Jog-in' DT 50 MX YZ 50 Zest YT 60 'Tri Zinger' YF 60 S DT 80 MX '36N type' MXS PW 80 K/S/91 T 80 'Townmate' V 80 DL RXS 100 T 105/105 E Crypton T 105 (5ER1/2) Crypton-R T 105 SE (SER3) Crypton-R New 110cc V 110 ZE/ZK/ZHE/ZHK 'FIZR/FIZR Sporty' RX 115 (5FS3) SR 125 SE SR 125 (3MW2)	87-90 86 83 90-94 91-95 87-91 93-95 83 88 83-85 83-91 83-97 83 83-97 96 99 02 04 96 99 92-96 89-91	F&R F&R F&R F&R R F&R R R F&R R F&R F&R R R R R R R R R R
<b>Y513</b> 168 25130 00 152 25130 00 168 W2535 00 1JN W2535 00 3HT W2535 00 256 25130 00	<b>YAMAHA</b> YDS-7 XS 250 C	73-75 81	F F	<b>Y519</b> 451 25130 00 451 W2535 00 4K5 25130 00 3EP W2536 00 27V W2536 00 4FB W2535 00 4JP W2535 00	<b>YAMAHA</b> CG 50 'Jog' CY 50 'Jog-in' CA 50 'Salient' LC 50 M 'Bop' MS 50 SA 50 M/ME 'Passola' YJ 50 R (5AU1-3) Vino YV 50 (5BM2) Jog Space Innovation	88-92 91-95 83-85 80 85-86 80-84 98- 97-	R F R F&R R R R F F
<b>Y514</b> 148 25330 00 156 25330 00 168 25330 00 152 25330 00 4L0 W2536 00 447 25330 00 447 25330 01 256 25330 00 5R3 W253E 00 5R3 W253G 00	<b>YAMAHA</b> YDS-7 RD 250 A/B/C RD 250 LC RZ 250 (4L3) RD 350 A/B RD 350 LC XS 360 B XS 650 XS 650 SE	73-75 75-77 80-83 80-83 74-76 80-82 75 75-81 81	R R R R R R R R R	<b>Y520</b> 2HR W2535 00 2HR W2535 10	<b>YAMAHA</b> YFM 350 FWT/FWU Big Bear	87-88	F
<b>Y515</b> 16G 25330 00 5A8 25330 00 5A8 W2536 00 4K0 25330 00 3DR W2536 00	<b>YAMAHA</b> XVS 400 XV 535 'Virago' XV 535 S 'Virago' XJ 650 XJ 650 'Turbo' XJ 650 RJ "Seca" XJ 650 LK "Seca" XVS 650 'Drag Star' XVS 650 A "Dragstar Classic" XJ 750 XJ 750 RF/RJ/RK "Seca" XV 750 Virago XV 1000 TRI XV 1000/1000 SE 'Virago' XV 1100 'Virago' XVS 1100 Dragstar	96 88-94 95-03 80-84 82 82 83 97-04 98-07 82-84 81-83 94-97 81 86-88 89-99 99-00	R R R R R R R R R R R R R R R	<b>Y521</b> 25G 25130 00 3TE W2535 00 25G W2535 00	<b>YAMAHA</b> BL 125 XC 125	85 92-95	F F
<b>Y516</b> 1L9 25330 00 1L9 25330 01 4G0 W2536 00 4G0 25330 00 1HX W2536 00 4HC W2536 00 4GB W2536 00 4WV W2536 00 5FU WF536 00	<b>YAMAHA</b> XS 250 D/E XS 250 SE/SF XS 250 C YP 250 Majesty YFM 350 FWH/FWJ/FWK 'Big Bear' YFM 350 L 'Big Bear' XS 400 YFM 400 FWE/FWF/FWG/FWH /FWJ/FWK Kodiak YFM 400 FWP/FPR/FPS Big Bear 4x4 YFM 400 FAR/FAS XJ 550 RH/RJ/RK "Seca" YFM 600 FWAK/FWAM/FWAN 'Grizzly' YFM 600 HM "Grizzly Hunting" <b>HONGDOU</b> CTM 125 Chituma <b>MBK</b> YP 250 Skyliner <b>SINNIS</b> Vista 125 QM 125 2C	79-81 79-81 81 96-99 96-98 99 79-82 93-98 02-04 03-04 81-83 98-01 00 04 96-98 08-10	R R R R R R R R R R R R R R R R R	<b>Y522</b> 431 25330 00 431 25330 01 431 25330 02 431 25330 10 431 W2536 00 4GR W2536 00 4GR W253E 00	<b>YAMAHA</b> SR 250 (3Y8) US Custom SR 250 (4GR1/2/3/4) SR 250 SE Special (3Y8)	80-81 94-96 81-83	F F F
<b>Y517</b> 24X 25330 00 39W 25330 00 39W W2536 00 39W W2536 10	<b>YAMAHA</b> YZ 125 K/L/N/S IT 200 L TY 250 S/R	83-86 84 84-90	R F&R F	<b>Y523</b> 2NL W2536 00 2NL W253E 00 3JN W2536 00	<b>YAMAHA</b> YFU1W/YFU1T (230cc)	89-90	R
				<b>Y524</b> 3HN W2535 00 3HN W2535 10	<b>YAMAHA</b> YFM 350 (All models) YFM 400 FWE/F/G/H /J/K/L/M Kodiak	89-98 93-00	F F
				<b>Y526</b> 3HT W2535 00 1JN W2535 00	<b>YAMAHA</b> SR 400 (3HT1) SR 500 (3GW1/3/4/6/7)	88 96-98	F F
				<b>Y527</b> 3LS W2536 00 3LS W2536 10 3FA W2536 00 3KG W2536 00 3KG W253E 00 3LS W253E 00 4WX X2533 00 3UH X25330 00 3FA W253A 00 3LS W2534 00 5HH F5330 00 29M F5330 00 5CP X2533 00 36L WF536 00 5VL W25330 20	<b>YAMAHA</b> YFM 50 S/T/RV/RV/RW/RX Raptor YFM 80 D/E/F/G/H/J/K/L/M /N Badger YFM 80 WP/WR/WS/RT/RV /RW/RX Raptor YFM 80 GT/GV/GW/GX Grizzly AG 100 J (3HAA) AG 100 E 'Farm Bike' YN 100 "Neos 100" YQ 100 "Aerox 100" DT 125 (3TT4) SR 125 (3MW2) XC 125 XC 125 T Cygnus XN 125 Teo's XTZ 125 (5RM)	04-09 92-01 02-08 05-08 82 93 99-03 00-04 96 89-91 93-95 95-98 00-03 03-10	R R R F R R R R R F R R R R

Part No.	Make/Model	Year		Part No.	Make/Model	Year			
<b>Y527 Contd.</b>	<b>YAMAHA Contd.</b>			<b>Y530</b>	<b>MBK</b>				
	YBR 125 ED (3D91)	05-06	R		CS 50 Mach G AC (Air cooled)	06-10	R		
	YBR 125 E/K (Brasil)	00-08	F&R		CS 50 Mach G LC				
	YBR 125 ED (Brasil)	06-08	R		(Liquid Cooled)	06-10	R		
	YFM 125 S/GT/GV/GW/GX				XF 50 X Booster	07-10	F&R		
	/GY/GZ/GA/GB/GD Grizzly	04-13	R		XC 125 WAAP	08-10	R		
	YP 125 'Majesty'	98-00	R		<b>YAMAHA</b>				
	YP 125 Majesty DX				BA 50 S/V (UA03J)	08	R		
	(Taiwan Production)	02	R		BW's 50 (5WW4/6/8/9/B/D/F/H/K/M/P)	05-13	R		
	YFA1D/F/G/H/J/K/L/M/N/P/R Breeze	92-03	R		BW's 50 Naked (2B7B/D/F/H)	09-13	R		
	XTZ 125 K/E	05-10	R		CS 50 Jog R	06-11	R		
	XV 125 Virago	97-00	R		CS 50 Z (Jog RR)	06-12	R		
	XVS 125 Dragstar	00-04	R		CV 50 ZR (5PT1)	01-02	R		
	DT 175 (3TS4)	96	F&R		CV 50 (5KN1/2)	00-02	R		
	AG 200 E (3GX6)	93	R		CV 50 A/R Jog (5SU1/2/SA165)	03-08	R		
	XT 225	97-06	R		CW 50 (5WW4/BWS)	04-07	R		
	SR 250 (4GR1/2/3/4)	94-96	R		BA 50 C (4KNH) Gear-C	04	R		
	SR 250 Classic (2IL)	96-00	R		XC 50 X Vino Classic (SA26J)	08	F&R		
	SRV 250 'Soulful Twin/Renaissa'	92-97	R		XF 50 Giggle/Vox	07-12	F&R		
	XV 250 Virago	89-94	R		YN 50 Neos (4T) (5C3)	09-13	R		
	XV 250 'S' Virago	95-00	R		YN 50 Neos (2T) (1F5C2/1H5C2)	07-13	R		
	XVS 250 Dragstar	01-04	R		T90 D (4NM4/5/7)	97-99	F&R		
	TT 350 A (3GJ)	90-95	R		T90 D 4NM8/UB02J	00-08	F&R		
	TT 350 (ITJ)	85-89	R		T90 N (4NM1/2/3/6)	94-99	F&R		
	XT 350 'S'	91-95	R		T90 N 4NM9/UB02J	00-08	F&R		
	TT 600 N (59X)	85-88	R		XC 125 Vity (4P7)	08-13	R		
	TT 600 W (2JT/3SW1)	89-92	R						
	<b>APRILIA</b>				<b>Y531</b>	<b>YAMAHA</b>			
	8510601 8113913	Scarabeo 100 (2T)	00		R	5DV W2534 00	YB-1 (50cc) 5JE1/3	01-02	F&R
		<b>BENELLI</b>				5DV W253E 01/02	BA 50 C (4KNH) Gear-C	04	R
		K2 100	99-01		R	5DV W253G 01	BA 50 S/N (UA03J0)	08	F
		<b>CPI Argon GP125</b>	07-12		R	4AT W253G 01	AT 115 (2B81/2/3) Neo (Brasil)	05-07	R
		<b>ITALJET</b>				4AT W253E 01	AT 115 (15S1) (Neo CVT/Brasil)	08	R
	48 7026 00	Millennium 100/125/150	00-04		R	5MX F530K 00	TW 125 (5RS)	03-04	R
		<b>MBK</b>				4S9 WF530 00	YBR 125 (3D92)	07-09	R
		YN 100 Ovetto	99-03		R		T 135 HC/S (2S61)	06-08	R
		YQ 100 Nitro	01-02		R		T135-SE (1S71)	06-08	R
		YW 100 T Booster 100	96		R		TW 225 E (5VC1/2)	03	R
		XC 125 T Flame	95-96		F		YBR 250	07-08	R
		XN 125/150 Doo Do	00-05		R		YS 250 Fazer (Brasil) (1S41/2/3)	06-08	R
	YP 125 D Skyliner	98-00	R						
	XC 150 Vertex	97	R						
	<b>QUADZILLA</b>			<b>Y532</b>	<b>YAMAHA</b>				
32345-SK900	R50 (Rear drum model)		R	5VH WF536 00	YFM 250 BT/BV Bruin	05-06	R		
	R100 (Rear drum model)		R		YFM 250 BW/BX/BY Big Bear	07-10	R		
	<b>GENERIC</b>				YFM 350 FAS/FAT/FAV Bruin 4x4	04-06	R		
	Soho 125/150	06-13	R		YFM 350 ANS/ANT/ANV Bruin 2x4	04-06	R		
	XOR 125	05-11	R		YFM 350 XV/XW/XX/XY				
	Zion 125/150	08-09	R		2WD Wolverine	06-09	R		
					YFM 350 FGW/FGX/FGY/FGZ				
					/FGA/FGB Grizzly 4WD	07-12	R		
					YFM 350 GW/GX/GY/GZ				
					Grizzly 2WD	08-10	R		
					YFM 400 AR 2WD Kodiak	03	R		
					<b>MBK</b>				
					YX 125 Z X-Over	10	R		
<b>Y528</b>	<b>YAMAHA</b>			<b>Y533</b>	<b>YAMAHA</b>				
4BD W2536 00	DT 250 All models	75-80	F	5ML X2533 00	NXC 125 - Cygnus X - (5ML)	04-06	R		
2NL W2535 00	IT 250 G	80	R		NXC 125 - Cygnus X - (4P9)	07-13	R		
4WV W2536 00	YFB 250 D/E/F Timberwolf	92-94	R		NCX 125 K Cygnus X Cab (4C6-1)	07-10	R		
4XE WF531 00	YFB 250 G/H/UH/J/UJ/UK/K				NCX 125 L Cygnus X Injection (4C6-2)	07-10	R		
1W4 25330 00	Timberwolf	95-98	F&R		HW 125 Xenter 125	12-13	R		
1W4 25330 01	YFB 250 FWF/FWG/FWH/FWJ				YW 125 (BW's 125)	10-13	R		
1W4 W2536 00	/FWK/FWL/FWM Timberwolf	94-00	F&R		YW 125 X (1DN1/2)	10-13	R		
2X4 25330 00	YFM 250 XLC/XL/X Bear Tracker	99-00	F&R		HW 150 Xenter 150	12-13	R		
2X4 W2536 00	YFM 250 W/A/B	90-92	F		<b>MBK</b>				
3BH W2536 00	YFM 250 XN/XP/XR/XS	01-04	R		NXC 125 Flame X	04-12	R		
3BH W253E 00	YFU1W/YFU1T (230cc)	89-90	F						
4GR W2536 00	YFM 350 ERD/ERE/ERF/ERG	92-95	F						
4BD W2536 01	YFM 350 UH/UJ/UK	96-98	R						
4WV W2536 01	YZ 250 D/E/F	77-79	R						
3UR W253E 00	DT 400 All models	75-77	F						
4HC W253E 00	YZ 400 D/E/F	77-79	R						
431 W253600	IT 425 G	80	R						
	YZ 465 G	80	R						
	IT 500 G/H	80-81	R						
	XT 500	76-80	F						
<b>Y529</b>	<b>USE Y516</b>			<b>Y534</b>	<b>YAMAHA</b>				
				JN6 F5331 01	YXP 700 AS/AV Pro Hauler 700				
				JN6 F5341 01	Side x Side	04-06	R		
				5D1 WF53A 00	YXP 1000 AS/AT Pro Hauler 1000				
					Side x Side	04-05	F&R		
				<b>Y535</b>	<b>YAMAHA</b>				
				5D1 WF53A 00	YBR 125 Custom	08-13	R		
				3D9 W2533 00	YBR 125 (3D92/9)	07-13	R		
					YBR 125 (51D1/2)	10-13	R		
					YBR 250 (5D11/3/4)	08-11	R		



Part No.	Make/Model	Year		Part No.	Make/Model	Year	
<b>S603</b>	<b>HYOSUNG</b>			<b>S604 Contd.</b>	<b>SUZUKI</b>		
41048 002	FX 110 Midas Eco/Std	99-02	F&R		RM 80 XT/XX	80-81	F&R
41048 017	FX 110 DXL	99-02	R		RM 80 HD/HF	83-85	R
41048 1052	KR 110 Master	04	R		LT-Z 90 K7/K8/K9/L0 QuadSport	07-12	F
41048 1085	<b>KAWASAKI</b>				TS 100 ERZ/ERH	82-87	R
41048 1125	AE 50 A1/A2	81-82	F&R		DR-Z 125 K3/K4/K5/K6/K7/K8/K9	03-12	F&R
41048 1141	AR 50 A1/C2-C10	81-97	R		DR-Z 125 LK3/LK4/LK5/LK6		
K4104-81141	AR 80 A1/C1-C8	81-91	R		/LK7/LK8/LK9	03-13	R
	AE 80 A1/B1	81-82	F&R		TS 125 ERZ	82	R
	KC 100 C1-C4	80-83	F&R		<b>KAWASAKI</b>		
	KE 100 A7-A10/B1-B15	79-98	F&R		KFX 50 (KSF 50 A1/A2/A3)	03-05	R
	KH 100 A2-A4	78-81	R		KLX 125 A1/A2/A3/A6F	03-06	F&R
	KH 100 G2-G4	81-83	R		KLX 125 L (B1/B2/B3/B6F)	03-06	R
	KM 100 A4-A6	78-81	F&R				
	Max 100		F&R	<b>S605</b>	<b>KAWASAKI</b>		
	KLF 110 B1/B2 'Mojave'	87-88	F	41048 1018	KDX 250 B1	79	R
	KLX 110 R (KLX 110 A1-A4/A6F			41048 1107	KL 250 A1/A2	78-79	R
	/A7F/A8F/A9F/CAF/CBF/CCF			42019 002	KX 250	74	R
	/CDF)	02-13	R	42019 011	KX 250 A/A3/A4/A5/A6/A7	75-81	R
	Kaze-r New 112cc	04	R		KX 420 A1/A2	80-81	R
	Kazer 115		R		<b>SUZUKI</b>		
	ZX 130 R Kaze	08-10	R	54400 32810	LT 125 E	84	R
	KLT 200 C1/C2/A1/A4A	81-84	F	54410 08000	LT 160 EK/EL/EM/EN	89-92	R
	KLT 250 C1/C2/C3 'Prairie'	83-85	F	54410 08001	LT-F 160 L/M/N/P/R/S/T/V/W/X/Y/K1-K4	90-04	R
	<b>LIFAN</b>			54410 08002	LT 185 E/F	84-85	R
	LF-100 5		F&R	54410 32400	SB 200 N/X	79-81	F
	<b>MODENAS</b>			54410 37200	SX 200 R/R-2/RJ/RM	90-91	R
	Kriss 110	00-01	F&R	54410 41410	LT 230 GEF/GEG	85-86	R
	Kriss 115	00-01	R	64400 02830	LT-F 230 G/H	86-87	R
	<b>MOTO-ROMA</b>			64410 02C00	PE 250 B/C/T/X/Z	77-82	F&R
	Go-Go 110	02	R		RM 250 A/B/C	76-78	R
	<b>SUZUKI</b>				RM 250 N	79	F
	A 50	71-76	F&R		TS 250 L/M/A/B/C/ERN/ERT/ERX	74-82	F&R
	AP 50	75-78	F&R		SP 370 C/N	77-80	F&R
	F 50	71-73	F&R		DR 400 ST/SX	79-81	F&R
	FR 50	74-81	F&R		PE 400 T/X	79-81	R
	GT 50 KB/KEN	77-80	R		RM 400 C	78	R
	RM 50 C/N/T	78-80	F&R		RM 400 N	79	F
	TS 50 KN	79	F&R		SP 400 T	80	F&R
	TS 50 ERKT/X/Z/D	80-83	F		DR 500 X/Z/D	81-83	R
	ZR 50 KEN/KEX 'X1'	79-83	R				
	FR 70	74-76	F&R	<b>S606</b>	<b>SUZUKI</b>		
	FR 80 M/B/N/X/Z/D	76-83	F&R	64400 11830	SW-1 (250) (NJ45A)	92	R
	RM 80 B/C/N	77-79	F&R	64400 11860	GT 250 EN/ET/EX 'X7'	78-81	R
	TS 90 R/J	71-73	F	64400 44810	GS 250 TT/TX/ET/EX/EZ	80-82	R
	ASS 100	69-71	R	64410 11300	GV 250 C	08-11	R
	A100 (All models)	74-80	F&R	64410 11301	GN 400 TT	80	R
	GP 100 C/N/X/DED	78-87	R	64410 44B00	GSX 400 ET/EX/EZ	81-83	R
	GP 100 UN/UX/UD/UL	79-92	R	64410 44B10	GS 400 LX	81	R
	RM 100 A/B/C/N/T/X	76-81	F	64410 11320	LT-A 400 FK2-FK7 Eiger 4WD	02-07	R
	TS 100 K/L/M	73-75	F	64400 38830	LT-A 400 K2/K3/K4 Eiger	02-04	R
	FX 110 Shogun		F&R	64400 7830	LT-F 400 FK2-FK7 (Eiger 4WD)	02-07	R
	DR-Z 110 K3/K4/K5	03-05	R	64400 SJ8200	LT-F 400 K2-K7 Eiger (2WD)	02-07	R
	Smash 110cc	03	F&R		ST 400 Tempter V/W/X/Y/K1/K2/K3	97-03	R
	Shogun-R FD-112	04	R		GS 425 EN	78-80	R
	CS 125 D	83	F&R		GS 450 ET/EG/EJ	80-88	R
	FX 125		R		GR 650 D/XD "Tempter"	83	R
	RV 125 K	73	F		LS 650 FG/PK/PM/PR/PG/PT/PV		
	RV 125 K2-K9/L0	02-13	R		/PW/PX 'Savage'	87-99	R
	TS 125 K	72	F		DR 750 SJ	88	R
	TS 185 K	73	F		<b>HYOSUNG</b>		
	RV 200 K2/K3/K4	02-04	R		GV 250 Aquilia	04-07	R
	RL 250 L/M	74-75	F				
	RL 250 Beamish Model Reed			<b>S608</b>	<b>SUZUKI</b>		
	Valve Engine	78-82	F	54400 11000 54410 11002	T 20 Super Six/T 250II/R/J	66-72	F
	RL 325 Beamish Model			54400 11820 54410 11020	T 350 1/2/R/J	69-72	F
	Reed Valve Engine	78-82	F	54400 11830 54410 11900	GT 380 J	72	F
				54410 11000 54410 11910			
				54410 11001			
<b>S604</b>	<b>SUZUKI</b>			<b>S609</b>	<b>SUZUKI</b>		
54400 43820	GS 50 K5 (NA41A)	05	F&R	64400 11870	GT 250 K/L/M/N/A/B/C	73-78	R
54400 43880	LT-A 50 K2-K5 Quadmaster	02-05	R	64410 11001	T 20 Super Six/T 250 II/R/J	66-72	R
54401 43810	LT-Z 50 K6/K7/K8/K9	06-12	R	64410 11002	T 350 1/2/R/J	69-72	R
54410 43010	OR 50 ET	80	R		GT 380 J/K/L/M/A/B	72-77	R
54410 43020	RB 50 H 'GSXR 50'	87	R		GS 400 B/C	77-78	R
54410 43021	RM 50 X/Z	81-82	F&R		GS 400 TX	81	R
54410 43030	ZR 50 SLKX/SKX/SKE/SKH	81-87	R		T 500 1/2/3/R/J/K/L/M	68-75	R
54401 43820	DS 80 T/X/Z/D/F/G/H/J/K/L/M/				GT 500 A/B	76-77	R
54401 43840	N/P/R/S/T/V/W/X/Y	80-00	F&R		GT 550 J/K/L/M	72-75	R
41048 S005	JR 80 K1-K7	01-07	F&R				
41048 S003							
54400 08810							











Part No.	Make/Model	Year		Part No.	Make/Model	Year		
<b>801G Contd.</b>	<b>HUSQVARNA Contd.</b>			<b>804</b>	<b>CZ/JAWA</b>			
	WR 250	71-74	R	8213220	Mope		F	
	WR 250	75-78	F&R					
	XC 250	85-86	R	<b>805</b>	<b>APRILIA</b>			
	360 Automatic	75-77	R	Scarabeo	93-97	F		
	CR 360	75-78	F&R					
	WR 360	75-78	F&R	<b>806</b>	<b>GILERA</b>			
	ACC 390	80-81	F&R	2691885	Storm 50	94-95	R	
	ACCE 390	80-81	F&R	272709	Easy moving 50	95-96	R	
	CR 390	75-79	F&R	272711	<b>PIAGGIO</b>			
	CR 390	80-81	F&R	272714	Sefera Base 50	91-93	R	
	CR 390 Automatic	78	F&R	272715	Sefera 50 RST	95-97	R	
	WR 390	78	F&R	274904	Free 50	92-00	R	
	CR 400	71-74	F&R	277599	Zip 50 Base (Drum Model)	92-96	R	
	WR 400	75-78	F&R		Zip Fast Raider	93-97	R	
	CR 430	80-81	R		Sefera 50 Maquillage 2	94	R	
	CR 450	71-74	F&R		NRG 50	94-96	R	
	WR 450	71-72	F&R		Zip & Zip 50 Bimodale	94-97	R	
	CR 500	82-84	R		NTT 50	95-96	R	
	XC 500	85-86	R		Typhoon 50	94-97	R	
	TC 510	87-88	R		Typhoon 50 X	98-99	R	
	TC 510	89	R		Zip 50 Base (Disc Model)	95-96	R	
	TX 510	87-88	R		Zip 50 Elettrico	02	R	
	TE 510	87-88	R		Free 50 (Disc Model)	95-00	R	
	TE 510	89	R		NRG 50 RST (DT/DD) "MC2"	96-97	R	
	WMX 510	89	R		SKR 80 City	99	R	
	WXE 510	89	R					
					119 445 00			
	<b>802G</b> 1516-77801 1516-77802 1516-78801 1516 78802	<b>HUSQVARNA</b>			<b>807</b>	<b>MALAGUTI</b>		
		CR 125	85-86	R	272727	Crosser CR1	97-01	R
		WR 125	80-81	F&R	272718			
WR 125		82-84/87-88	R	<b>808</b>	<b>PIAGGIO</b>			
XC 125		82-84	R	S1 Mix 50	96-99	F		
CR 240		80-81	F	Zip 50 RST	96-99	F		
CR 240		85-86	R	Ciao Mix Teen 50	96-01	F		
CR 240		87-88	R					
WR 240		80-81	F&R	273430				
WR 240		82-84	R	<b>809</b>	<b>PIAGGIO</b>			
WR 240		87-88	R	Velofax 50	96-99	R		
CR 250		80-81	F					
CR 250		85-86	R	<b>811G</b>	<b>KTM</b>			
CR 250		87-88	R	542 09 035 000	MX 125	83	F	
WR 250		80-81	F&R		125 GS	83	F	
WR 250		82-84	R		250 MX Leleu	82	F	
WR 250		87-88	R		250 XC/GS	83	F	
XC 250		80-81	F&R		495 MX Leleu	82	F	
XC 250		82-84	R					
XC 250		87-88	R	<b>812G</b>	<b>KTM</b>			
WR 400		87-88	R	550 09 035 000	MX 125	83	R	
430 Automatic		87-88	R		125/175	-84	F&R	
CR 430		87-88	R		125 GS	83	R	
CR 430		80-81	F		250	-82	F	
CR 430		87-88	R		350	-82	F	
WR 430		80-81	F&R		420 GS	85	F&R	
WR 430		87-88	R		495	-82	F	
WRE 430		82-84	R					
WR-E 430		80-81	F&R	<b>813G</b>	<b>KTM</b>			
WRU 430		82-84	R	520 10 035 560	250	-82	R	
XC 430		80-81	F&R		250 MX Leleu	82	R	
XC 430	87-88	R		250 XC/GS	83	R		
AE 500	82-84	R		350	-82	R		
CR 500	85-86	R		350 Four Stroke	83	R		
CR 500	87-88	R		495	-82	R		
XC 500	82-84	R		495 MX Leleu	82	R		
XC 500	87-88	R						
<b>803G</b> 1516-27801	<b>HUSQVARNA</b>			<b>814G</b>	<b>KTM</b>			
	CR 125	82-84	F	543 09 035 000	80 MX	86-92	R	
	WR 125	82-84	F		MX 125	84	F&R	
	XC 125	82-84	F		MX/MXC 125	85	R	
	CR 240	82-84	F		GSXC/GS 125	85	R	
	CR 250	82-84	F		MX/MXC/GS 250	84	F&R	
	WR 240	82-84	F		MX/MXC 250	85	R	
	WR 250	82-84	F		GSXC/GS 250	85	R	
	XC 250	82-84	F		MX/MXC 300	85	R	
	WRE 430	82-84	F		GSXC/GS 300	85	R	
	WRU 430	82-84	F		MX/MXC/XC-GS 500	85	R	
	AE 500	82-84	F					
	CR 500	82-84	F	<b>815</b>	<b>KTM</b>			
	XC 500	82-84	F	490 10 035 000	60 SX	98-99	R	





Part No.	Make/Model	Year		Part No.	Make/Model	Year	
<b>858</b>	<b>BSA</b> Bantam D7 <b>TRIUMPH</b> Cub 500		F&R F&R	<b>877</b>	<b>GARELLI</b> 50 Team Matic <b>MOTO BECANE</b> 51 SUE Rock/Rock A Magnum/A/racing	88-	F F&R F&R F&R
<b>859</b> 34-21-2-311-519 34-21-2-310-474	<b>BMW</b> R 80/R 80 RT R 80 GS R 80 PD/CH R 80 Mystic R 80 R R 850 GS R 100 GS R 100 PD R 100 RS R 100 RT R 100 Mystic R 100 R	09/88-95 87-95 90-95 94-95 91-94 96 86-94 89-96 9/09-92 09/89-95 93-96 91-95	R R R R R R R R R R R R	<b>878</b>	<b>MOTOBECANE</b> 40 AE/41 AE 50 A/E/AE 51 SA/SAE/SV/SVE 51 VLM		F&R F&R F&R F&R
<b>860</b> 34-21-2-311-080 34-21-2-311-081	<b>BMW</b> R 45/45 N R 50/5 / 60/5 / 75/5 R 60/7 R 60 TIC R 75/6 / 75/7 R 80 R 80 TIC R 90 S R 90/6 R 100 R 100/7T R 100 S R 100 RS R 100 RT	78-80 69-76 76-80 78-82 73-79 77-09/80 78-08/80 73-76 73-76 76-77 77-09/80 76-08/80 76-09/80 78-09/80	R R R R R R R R R R R R R R	<b>881</b> 414437	<b>PIAGGIO</b> Cosa CL/CLX 125 Cosa 2 125 Cosa CL/CLX 150 Cosa 2 50 Cosa CL/CLX 200 Cosa 2 200	88-91 91-97 88-91 91-97 88-91 91-97	R R R R R R
<b>861</b> 34-21-2-310-523	<b>BMW</b> K 75/7-2 K 75 C R 45/45 N R 45 T R 65 R 65 GS R 65 RT R 65 T R 80 R 80/R 80 RT R 80 RT R 80/R 80 RT R 80 GS R 80 ST R 80 TIC R 100/7T R 100 RS R 100 RT	84-96 85-02/88 10/80-85 80-85 07/88-08/89 87-92 85-88 80-85 10/80-84 84-07/90 82-84 84-95 80-87 82-84 09/80-85 09/80-84 86-08/89 87-08/89	R R R R R R R R R R R R R R R R R R	<b>882</b> 414429	<b>PIAGGIO</b> Cosa CL/CLX 125 Cosa 2 50/125 Cosa CL/CLX 150 Cosa CL/CLX 200 Cosa 2 200	88-91 91-97 88-91 88-91 91-97	F F F F F
<b>862</b> 34 21 1 242 603 34 21 1 242 604	<b>BMW</b> R 65 LS	81-85	R	<b>883</b>	<b>GILERA</b> Bullit 50	90-	R
<b>863</b>	<b>BMW</b> K 75/75-S	84-08/88	R	<b>885</b> 2691825	<b>PIAGGIO</b> Sefera Base 50 Sefera 50 Maquillage 2 SXR 80 City	91-93 94 99	F F F
<b>864</b> 34 11 2 311 079	<b>BMW</b> R 50/5 / 60/5 / 60/6 / 75/5	69-76	F	<b>886</b> 272714	<b>PIAGGIO</b> Quartz 50	92-96	R
<b>869</b>	<b>KREIDLER</b> <b>DISCONTINUED</b>		F&R	<b>889</b>	<b>MONTESA</b> Old models		R
<b>873</b>	<b>MOTO BECANE</b> 50 all mod. Atom hub 50 all mod. Leleu hub	88- 88-	R R	<b>890</b> 499124	<b>PIAGGIO</b> Scatto 50	92-93	F&R
<b>875</b>	<b>CASAL</b> Mofas Boss		F&R F&R	<b>893</b> 8213133	<b>APRILIA</b> Amico 'All models' Rally Scooter 'All air cooled models' Gulliver 'All models' Sonic (All models) Scarabeo 50 (2T) SR 50 WWW (LYH00) (A/C) SR 50 GP/LB/LF (A/C) SR 50 (L/C) SR 50 Stealth/Racing (LC)	96-98 95-02 95-98 98-08 93-05 97-01 93-96 94-96 97-99	R R R R R R R R R
				1242150000	<b>BETA</b> Tempo Quadra 50 Ark (Air Cooled)	94-02 97-00 96-12	R R R
				44790031A0	<b>BENELLI</b> K2 Scooter 50 Naked 50 Naked 100 Pepe 50/50 LX/Classic (7 spoke cast wheels) Pepe 50 (5 spoke cast wheel) 491 (All drum rear models) Pepe 100 LX	98-01 02-03 02 99-13 10-13 98-04 99-02	R R R R R R R
				Y00FA0152	<b>CAGIVA</b> City 50	91-94	R
				11940300 11946300 11971000	<b>MALAGUTI</b> Ciak 50/100 Centro SL/SL Cat Centro Base 50 F10 Jet Line F10 Jet Line WAP F10 Tribal F10 WAP Firefox F15 (Air cooled models) F15 RR	00-04 94-00 93-94 96-07 06-10 08-10 100-11 99-08 99-00	R R R R R R R R R



Part No.	Make/Model	Year		Part No.	Make/Model	Year		
<b>893 Contd.</b>	<b>MALAGUTI Contd.</b>			<b>899</b>	<b>PIAGGIO</b>			
	Phantom F12 (A/C)	94-08	R		273623	Diesis 50	01-05	R
	Phantom F12R 50 A/C	07-11	R		2736235	Free 50	02	R
	Phantom F69 (70cc)	98	R		560442	NRG 50 RST (DD/DT) "MC2"	98	R
	Yesterday	98-03	R		2721845	NRG 50 DT "MC3"	01-06	R
50 America	91-	R	56292R	NRG 50 Power DT	05-12	R		
50 Raid	91-	R	82907R	Zip 50 RST	96-99	R		
<b>894</b>	<b>CASAL</b>			Zip 50 RST	96-99	R		
	Mofas drum dia. 110mm		F&R	Zip 50 SP (L/C)	96-12	R		
<b>895</b>	<b>CASAL</b>			Typhoon 50 (2T) (Grimeca)	00-04	R		
	50 Ciclomotori		F&R	Zip 50 (2T)	00-13	R		
<b>896</b>	<b>CASAL - Mofas drum dia. 140mm</b>			Zip 50 (4T)	00-13	R		
498117	<b>PIAGGIO</b>			Zip 50 SP (2T)	13	R		
	Superbrand 50	85-90	F	Vespa ET2 50	97-05	R		
	Zip 7 Zip 50 Bimodale	94-97	F	Vespa ET4 50 Grimeca Caliper	00-04	R		
<b>897</b>	<b>ADLY</b>			Vespa ET4 50 Heng Tong Caliper	00-04	R		
64400 41820	RT 50/100		R	Vespa LX 50 (2T & 4T)	05-08	R		
64400 41840	<b>HYOSUNG</b>			Vespa LX 125/150 (4T)	05-09	R		
64400 41850	Grand Prix 125	99-04	R	NRG 50 Extreme	99-01	R		
	GPS 125 Grand Prix/Hyper	99-04	R	Typhoon 50 XR	00	R		
	<b>PGO</b>			Typhoon 50 (2T) Heng Tong				
	G-Max 50	05-07		Caliper/10" whels	01-09	R		
	Rodo Show 50	00-09	R	Typhoon 50 (2T) Grimeca				
	PMX 50	00-07	R	Caliper/10" whels	00-04	R		
	Mega 50	94-	R	Zip 50 A/C (4T)	00-09	R		
	Big Max 50	94-06	R	Free Delivery 50	00-01	R		
	Big Max 50 (Front wave disc)	07-09	R	Zip 100	06-10	R		
	Big Max 50 Naked (Round disc			Hexagon 125/150	94-97	R		
	/no cover on H/bars)	07-09	R	Skipper 125/150	94-97	R		
	EPS	97	R	Sefera 125	95-97	R		
	Tornado 50/125	97	R	Zip 125	00-01	R		
	Galaxy 50	93-00	R	<b>APRILIA</b>				
	G-Max 50 Naked (Wave disc)	09	R	Mojito Custom 50				
	G-Max 50 (Wave disc)	08-12	R	(110mmØ rear drum)	04-12	R		
	Ligero 50 (2T)	08-12	R	<b>DERBI</b>				
	PMX 50 Naked			Atlantis 50 Bullet (AC/2T)	03-05	R		
	T-Rex 50	99-12	R	Atlantis 50 City (AC/2T)	03-06	R		
	T-Rex 110	99-06	R	Atlantis 50 Red Bullet (AC/2T)	03	R		
	PMX 110	00-07	R	Atlantis 50 Two Chic (AC/2T)	05	R		
	<b>SINNIS</b>			Atlantis 50 (AC/2T)	02	R		
	Eagle 50 QM 50 T-10R		R	Atlantis 50 (2T) Up to Ref No				
	Hawk 50 QM50 10A-(B)	08-10	R	8G253171 12"/5 spoke wheels				
	<b>SUZUKI</b>			/190mm disc 3 bolt	07	R		
	TR 50 SW/SX	98-00	R	Atlantis 50 (2T/AC) 12"/5 spoke				
	UG 110 W/SW/Y/SY/SK1			wheels 5 bolt/200mm disc				
	Address/Yokuto	98-02	R	From Ref no. 8G253172	07-11	R		
	<b>TGB</b>			<b>GILERA</b>				
GA5580012	Bullet 2 50 (2T)	11-12	R	Ice 50	01-03	R		
	City 50cc (2T)	07-08	R	Runner 50	98	R		
	City 50cc (4T)	07-11	R	SKP 50	98	R		
	101 R (50cc)	04-09	R	Stalker 50 (Rear drum models)	97-11	R		
	303 Revolution (50/125cc)	02-03	R	Typhoon 125	95-98	R		
	309 RS50	02-03	R	Typhoon 125 X-XR	99-00	R		
	F409 Cruise 50-125	02-05	R	<b>VESPA</b>				
	Delivery/Express 50	04-12	R	LX 50 (4T/2T)	05-13	R		
	202 Classic (50cc)	03-09	R	LXV 50	07-09	R		
	303R Hawk/Laser (50cc/125/150cc)	04-10	R	S 50 (2T)	07-13	R		
	Tapo RS 50 (2T)	10-12	R	S 50 (4T/4V)	08-13	R		
	Tapo RR 50 2T	10-12	R	S 50 Sport (2T)	11-13	R		
	Trigger 50	02-03	R	S 50 Sport (4T/4V)	11-13	R		
	Akros Tec 50	03-04	R	ET4 125	96-99	R		
	High Wheel 50	02-03	R	ET4 125/150	99-05	R		
	X Race 50 (2T)	11-12	R	LX 125 (4T)	05-13	R		
	302 Sport (50cc)	03-09	R	LX 125 (4T/Serie Speciali)	12	R		
	304 Sport (125cc)	03-09	R	LXV 125	07-13	R		
	309 RS 50	02-03	R	S 125 (4T)	07-13	R		
	F409 Cruise 50/125	02-05	R	S 125 Sport (4T)	11-13	R		
				LX 150 (4T)	05-13	R		
				LX 150 (4T/Serie Special)	12	R		
				S 150 Sport (4T)	11-12	R		
				S 150 (4T)	07-12	R		
				<b>V901</b>				
				26832	<b>PIAGGIO (VESPA)</b>			
				C4721957	125 GTR (VNL2)	74	F	
					150 Sprint Veloce (VLB1)	74	F	
					Rally 200 (VSE1)	74	F	





Part No.	Make/Model	Year		Part No.	Make/Model	Year					
921 8135159	<b>APRILIA</b> Classic 125 Red Rose 125 (Spoke wheel)	95-01 87	R R	928	<b>DUCATI</b> 250/350/450 Desmo	-76	F				
	<b>DUCATI</b> 250/350/450 Desmo	74-77	R		929	<b>BENELLI</b> 124/125 2C/125 2T/2CSE 125 2C twin brake 125 T 250 C/TS, 250/4 254/304 500-4	76- 76 83 76- 83 76-	R R R R R			
967211	<b>GILERA</b> RV 125 125 Cougar Strada/Sport 125 125 TG 1/2/3 TSR 125 TSR 125 200 T4/T4 C/T4 S	88 99-02    -83 83-	R R R R R R R	930G		<b>FANTIC</b> 50/50.1 Raider 50.1 Oasis KS/Rally 50.1 Trial Trial 50 Junior 80 Trial	81- 86- 86- 87- 83-	R R R F&R F&R			
	<b>HERCULES (SACHS)</b> 50 Ultra, RS Ultra 80 Ultra, F Ultra, RS Ultra 80 Ultra Chopper		R R R		<b>GARELLI</b> Trial 323	86-	R				
	<b>LAVERDA</b> LB 125 Custom/Sarbia LZ 125 Sport LZ 125 Sport	85-87 80-82 80-82	R R R		<b>MALAGUTI</b> 50 Enduro RCW-X/Sahib	83-	R				
	<b>MOTO MORINI</b> 250 all models 350 Sport 350 FT/Turismo	71- 80 80-	R R R		931 931G 349.2.40.715.9	<b>TOMOS</b> Moped with cast wheels		F&R			
	922 922G	<b>FANTIC</b> 50 Trial 50 Enduro 50 Caballero 80 Trial	-83 83- -83 -83			R F&R F&R F&R	<b>BENELLI</b> 50 G2 Elle	79-	F&R		
		<b>GILERA</b> 50 GR 2 98 Giubileo 124 Giubileo 125 Arcore				F R R R	<b>GARELLI</b> 50 Vip/Noi/Basic Alu wheel Formuno 50 50 Team Matic	87- 88-	R R		
		<b>HERCULES (SACHS)</b> 50 Supra Enduro 80 Ultra AC 80 Ultra AC Chopper				F&R R R	<b>MALAGUTI</b> 50 RGT Strada 50 Custom Fox 50 Dribbling 50 Fifty RV 50 Ranocchio 3 wheels Grizzly 10 CE (50cc) Grizzly 10 (50cc) Grizzly 12 CE Grizzly 12 Grizzly RCW4 Grizzly RCX 10 Grizzly RCX 12	83- 87- 87- 87- 87- 08-09 01-07 08-09 01-07 90-94 90-00 90-00	R F&R F&R F&R F&R R R F&R F&R R F&R		
		<b>MALAGUTI</b> 50 MDX Gold Enduro 50 Enduro MEX 50 Enduro MEX 50 Enduro MGX 50 Enduro MLX 50 Enduro MXS 50 RGT Sport 50 Fifty HF/NL 4 gears	87- 85-86 87- 87- 87- 87- 85- 85- 87-			R R R F&R R R R F&R	<b>PUCH</b> Maxi 50 Executive Cast Wheels /1 Speed Automotive Maxi S 50 Sport Cast Wheel 1 Speed Automatic Maxi 50 Super Cast Wheel /2 Speed Automatic Magnum 50 Automatic Kids Bike		F F F F&R		
		923	<b>GILERA</b> 50 GR 2				F	932 359.1.40.015.0	<b>KREIDLER</b> 50 Flory MF 12/13 50 Flory MF 23/24/25 50 LH/LF/LFF 50 RMC/RMC-BG Mustang 125 125 125 RS		F&R F&R F&R F&R R R R
			924			<b>GILERA</b> 50 GSA/Vale			R	<b>PUCH</b> Monza 4 SL/GP Imola X/GX Cobra 80/80-6/80-6 GT/GTL	
		925				<b>GILERA</b> 150 Arcore		F	933 933G MC2855 0650	<b>MONTESA/HONDA</b> Cota 123/290/349 Cota 123/200/242/349 348 Trial Enduro	-83 84
			926 926G 8213179 11907700			<b>ACCOSSATO</b> 50 Cross Mini	82-	F&R		934G	<b>OSSA</b> Pre 1980 Models 125 Cross 250 Cross/Fuego/Super Pioneer
<b>ASPES</b> 50 Navaho				F&R		935G	<b>OSSA</b> 81 Onwards		F		
927G		<b>FANTIC</b> 50 Trial	-83	F							
		<b>GARELLI</b> 50 Ciclone/KL 50 SV Gran Turismo		F&R F&R							
927G		<b>MALAGUTI</b> Centro Base 50 50 Fifty HF 50 Watercooled 50 Fifty Full/CX 50 Fifty Top	93-94 -82 -82 83- 85-	F R R R R							
	<b>SWM (SWM)</b> 50/80 TR/TL Trial	-83	F&R								
927G	<b>MOTO MORINI</b> 350 Kanguro 350 Kanguro	-83 84-86	F&R R								

Part No.	Make/Model	Year		Part No.	Make/Model	Year	
936G	<b>OSSA</b> 81 Onwards <b>FB MINARELLI (SPAIN)</b> MR 80		R R	954	<b>GILERA</b> 125 RX RX 200/Arizona/Enduro 200 Arizona Hawk 200 RTX 200 ER RX 125 Arizona	84- 85- 85- 85- 87- 88	R R R R R R
937G	<b>MONTESA/HONDA</b> Cota 123/200/242/349	84	F	957	<b>LAMBRETTA</b> 125/150 D-LD		R
938 64400 HK3100	<b>HYOSUNG</b> TE 50 TE 90 TE 100	05-07 05-07 05-07	F F F	958	<b>LAMBRETTA</b> 175 TV-1 125/150/175 L1		R F&R
939G	<b>FANTIC</b> 300 Trial <b>BETA</b> 240 TR 32		F F	959	<b>LAMBRETTA</b> 125/150/200 DL		F&R
940G	<b>ACCOSSATO</b> CE 80/120 Cross/Enduro H 20	84-	F	965 965G	<b>ITALJET</b> (All Models 125cc) <b>BENELLI</b> S 50 Scooter		F&R R
941	<b>ASPES</b> RCL 80		F&R	966	<b>KREIDLER</b> 50 RM 80 E/L Florett		F&R R
V942 266509	<b>PIAGGIO (VESPA)</b> Vespa PK 50 S Automatica Vespa FL2 Automatica Vespa PK 125 S Automatica	84-89 90-91 84-89	R R R	967	<b>KREIDLER</b> 125		F
944 944G	<b>CAGIVA</b> WMX 125 (Rimoldi Hub) <b>HRD</b> RP 50 Cross RP 80 Cross	-85 83-	F&R F&R	970	<b>PUCH</b> MS 50/50 L		F&R
945 349.1.40.715.9	<b>BENELLI</b> S 50 Scooter <b>FANTIC</b> 50 Issimo spoke wheel 50 Joy <b>PUCH</b> Maxi 50 Executive Cast Wheels /1 Speed Automotive Maxi S 50 Sport Cast wheel /1 Speed Automatic Maxi 50 Super Cast wheel /2 Speed Automatic	81- 92-	F F&R F&R R R R	972	<b>PUCH</b> 50 KA/K2/K25/K3T/MSP		F&R
946	<b>BENELLI</b> 125 2C twin brake	-76	F	976	<b>ZUNDAPP</b> CS 25 Mofa BJ (Type 448-140) CS 25 Mofa BJ (Type 448-141) CX 25 Mofa BJ (Type 448-151) CX 25 Mofa BJ CS 50 Mokick BJ (Type 448-010) CS 50 Mokick BJ (Type 448-011) CS 50 Mokick BJ (Type 448-013) Hai 25 25 Mofa BJ (Type 448-150) Hai 50 50 Mokick Enduro (Type 448-150) Hai 50 50 Mokick Enduro (Type 448-111)	80-82 82 82 83-84 79-80 80 80-82 80-82 80-82 80 80-82	F&R F&R F&R F&R F&R F&R F&R F&R F&R F&R
949	<b>CAGIVA</b> Roadster 125 <b>CZ / JAWA</b> 125/175/250/350 125/175/250/350 350 Classic	96-99 -74 75-	R F&R R R	977G	<b>CAGIVA</b> WMX 125 WM 125 WMX 250	86 87-88 86-88	R R R
950	<b>CZ / JAWA</b> Scrambler Cross 125 x 300 Jawa 250/400 Cross 250/380 (Models 513/514)	65-76 65-76 77-79	F&R F&R R	978	<b>MZ</b> TS 125/150 TS 250		F F&R
951	<b>CZ / JAWA</b> 125/175/250/350	75-	F	979	<b>MZ</b> Saxon 125 Saxon 150 TS 125/150 ETZ 125/150 ETZ 250/300 251 Fun Saxon 'Tour' 251/301 Saxon 500 'All models'	93-97 95 95-92 85-92 95-96 93-98 93-98	R R R R R R R
952	<b>GARELLI</b> 125 XR/XRD Tiger <b>GILERA</b> 125 HX LC	83- 83-	R R	980 11 34519 502R	<b>MZ</b> Simpson	80-94	F&R
953	<b>CAGIVA</b> 125 Elefant RE	87	R	982G	<b>CAGIVA</b> WMX 500	84-86	R
				983	<b>GARELLI</b> GTA 125	85	R



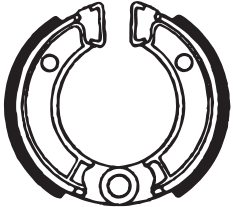
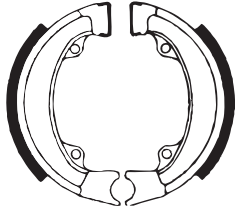
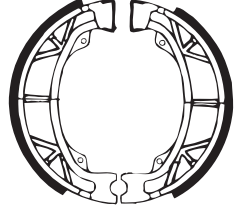
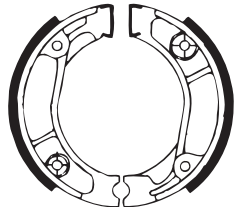
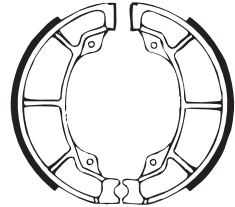
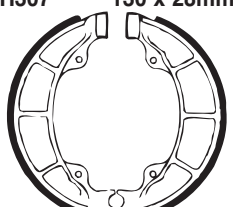
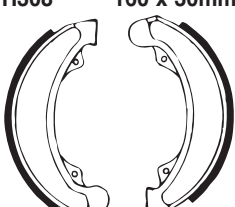
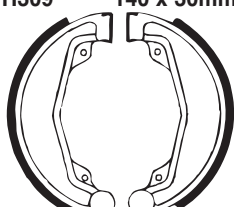
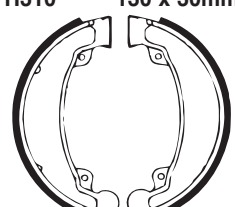
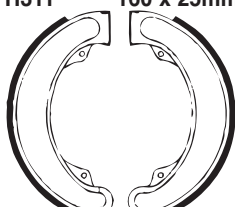
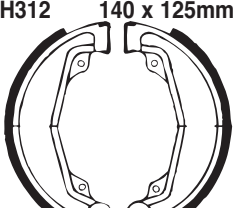
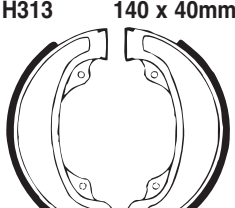
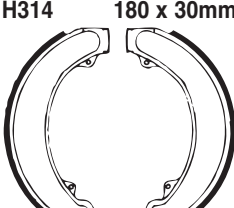
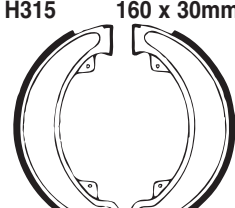
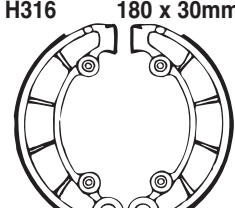
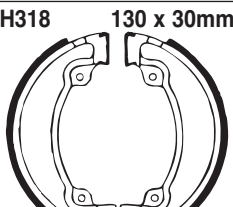
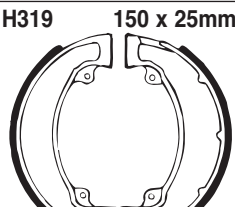
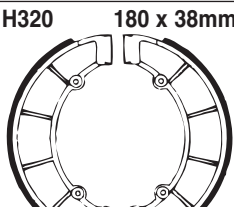
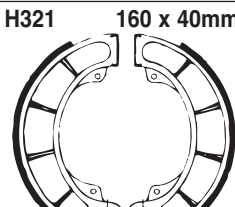
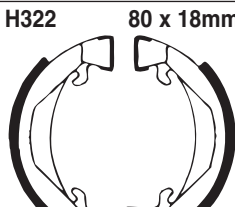
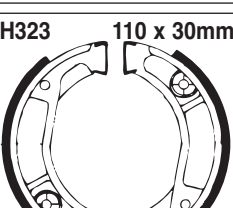
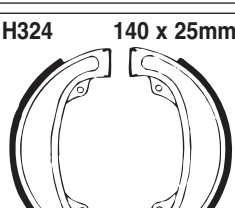
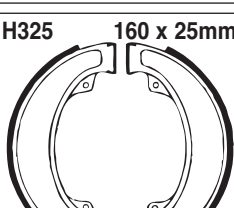
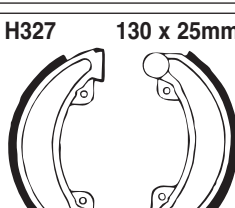
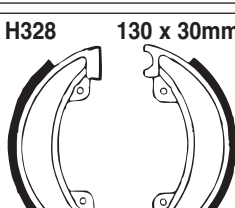
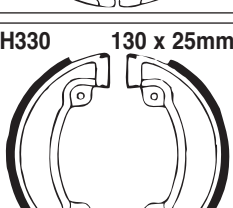
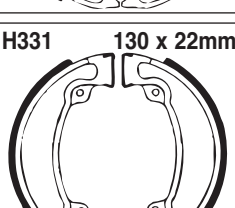
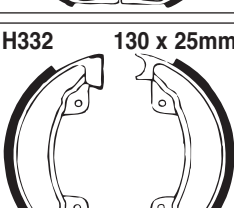
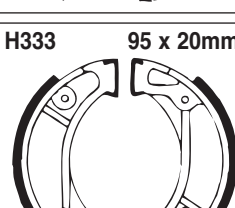
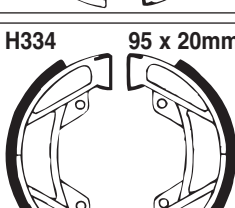
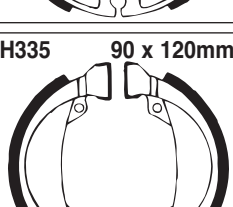
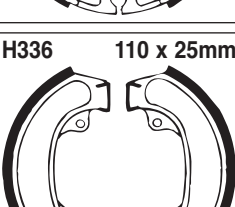
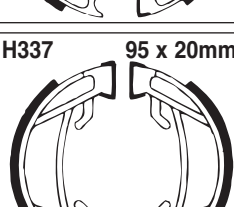
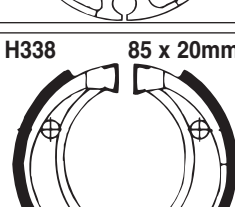
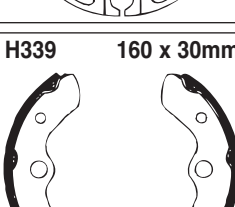
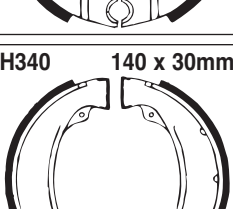
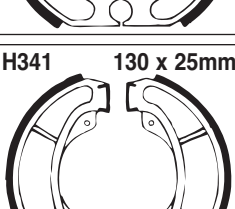
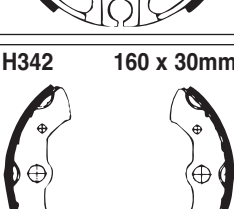
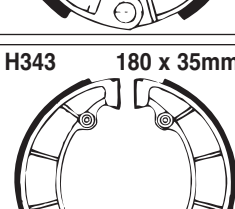
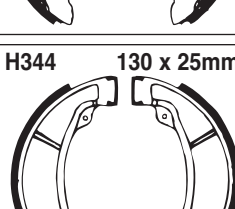

Part No.	Make/Model	Year		Part No.	Make/Model	Year	
984 XH295500	<b>HUSQVARNA</b> Husky Boy J Husky Boy R Husky Boy S	01-02 01 01-02	R R R				
985	<b>FB MINARELLI (SPAIN)</b> Rieju Marathon	74-	F&R				
987	<b>GILERA</b> 350 Dakota ER 350 500 Dakota ER 500	85- 87- 87- 87-	R R R R				
990G	<b>OSSA</b> 125 Cross 250 Cross/Fuego/Super Pioneer	74- 74-	R R				
991	<b>use S624</b>						
995 8213179	<b>APRILIA</b> Classic 50 <b>FANTIC</b> 50.1 Oasis Kick 50.1 Trial H 20	92-01 87- 87-	R R R				

# BRAKE SHOE ILLUSTRATIONS

H301 80 x 18mm 	H302 95 x 20mm 	H303 110 x 25mm 	H304 110 X 25mm 	H306 140 x 28mm 
H307 130 x 28mm 	H308 160 x 30mm 	H309 140 x 30mm 	H310 130 x 30mm 	H311 160 x 25mm 
H312 140 x 125mm 	H313 140 x 40mm 	H314 180 x 30mm 	H315 160 x 30mm 	H316 180 x 30mm 
H318 130 x 30mm 	H319 150 x 25mm 	H320 180 x 38mm 	H321 160 x 40mm 	H322 80 x 18mm 
H323 110 x 30mm 	H324 140 x 25mm 	H325 160 x 25mm 	H327 130 x 25mm 	H328 130 x 30mm 
H330 130 x 25mm 	H331 130 x 22mm 	H332 130 x 25mm 	H333 95 x 20mm 	H334 95 x 20mm 
H335 90 x 120mm 	H336 110 x 25mm 	H337 95 x 20mm 	H338 85 x 20mm 	H339 160 x 30mm 
H340 140 x 30mm 	H341 130 x 25mm 	H342 160 x 30mm 	H343 180 x 35mm 	H344 130 x 25mm 

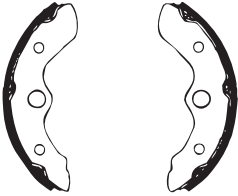
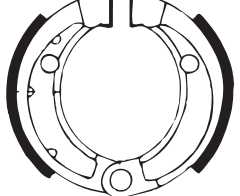
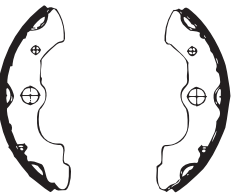
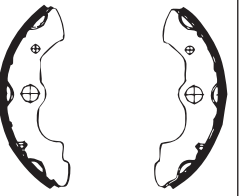
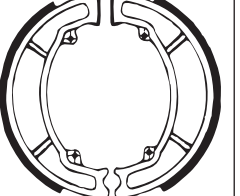
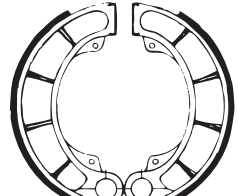
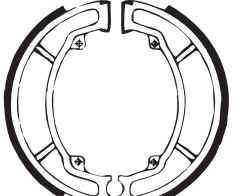
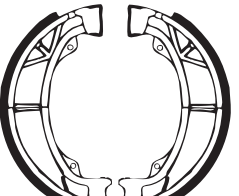
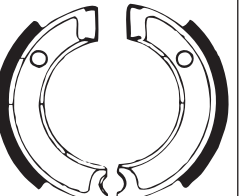
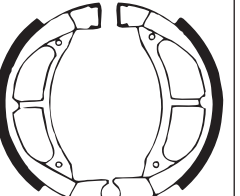
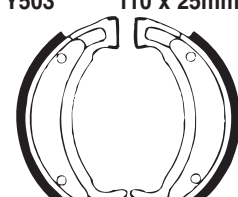
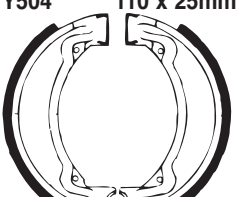
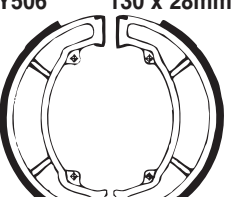
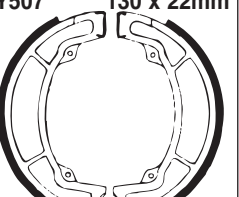
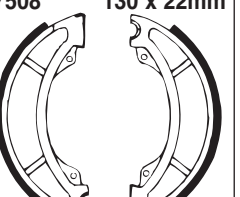
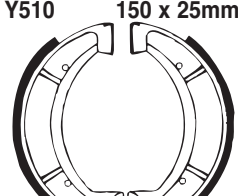

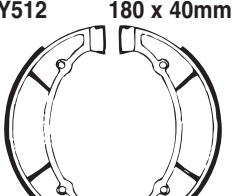
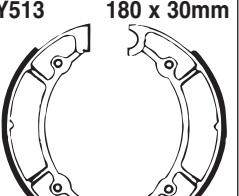
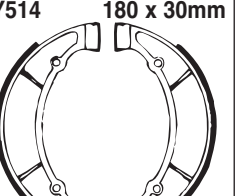
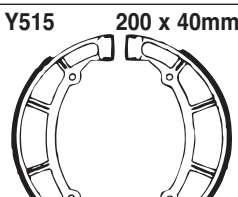
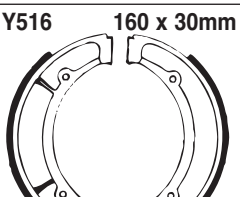
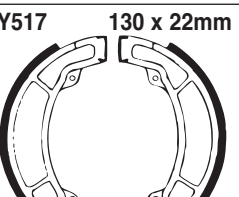
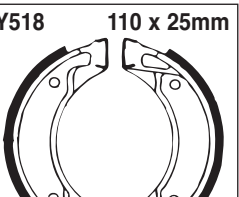
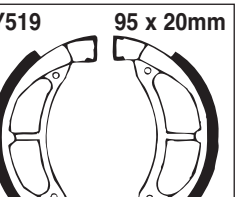
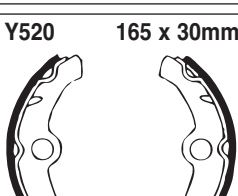
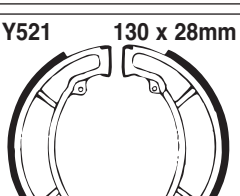
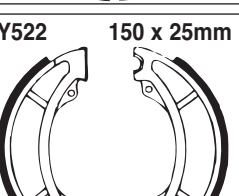
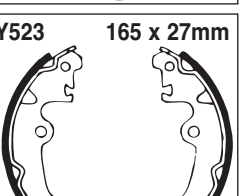
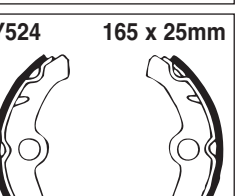
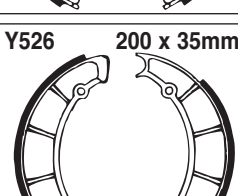
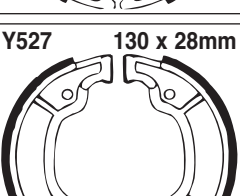
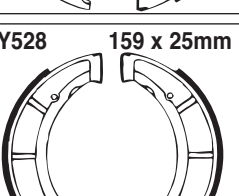
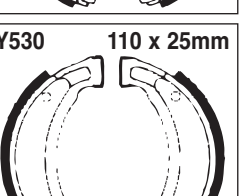
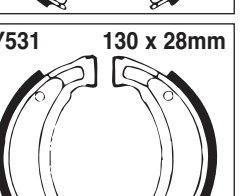
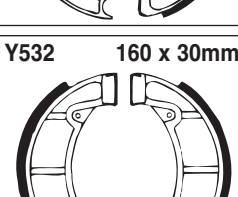
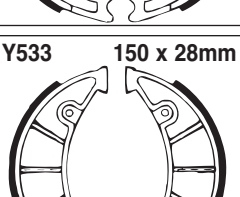
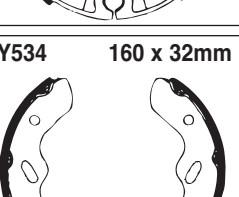



# BRAKE SHOE ILLUSTRATIONS

H345 130 x 25mm 	H346 87 x 20mm 	H347 160 x 20mm 	H347S 160 x 20mm 	H350 130 x 25mm 
H351 160 x 30mm 	H352 130 x 25mm 	H353 110 x 25mm 	Y501 80 x 17mm 	Y502 95 x 20mm 
Y503 110 x 25mm 	Y504 110 x 25mm 	Y506 130 x 28mm 	Y507 130 x 22mm 	Y508 130 x 22mm 
Y510 150 x 25mm 	Y511 160 x 25mm 	Y512 180 x 40mm 	Y513 180 x 30mm 	Y514 180 x 30mm 
Y515 200 x 40mm 	Y516 160 x 30mm 	Y517 130 x 22mm 	Y518 110 x 25mm 	Y519 95 x 20mm 
Y520 165 x 30mm 	Y521 130 x 28mm 	Y522 150 x 25mm 	Y523 165 x 27mm 	Y524 165 x 25mm 
Y526 200 x 35mm 	Y527 130 x 28mm 	Y528 159 x 25mm 	Y530 110 x 25mm 	Y531 130 x 28mm 
Y532 160 x 30mm 	Y533 150 x 28mm 	Y534 160 x 32mm 	Y535 130 x 28mm 	Y536 100 x 20mm 

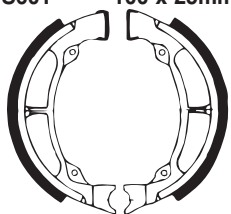
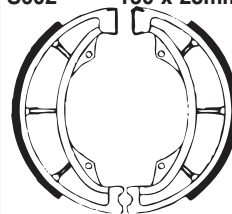
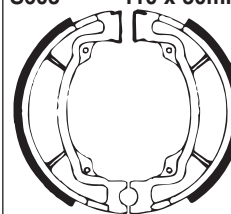
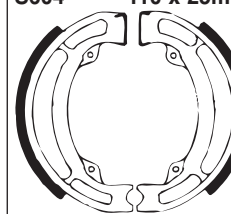
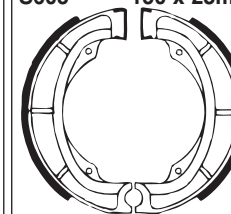
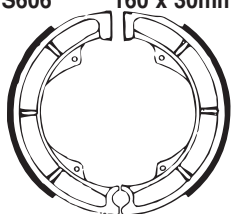
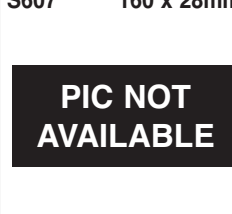
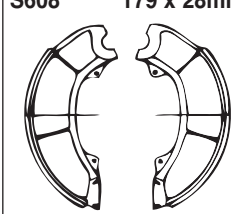
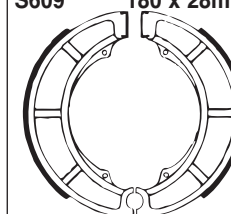

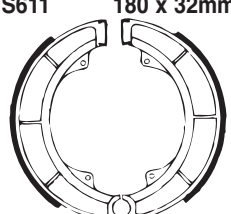
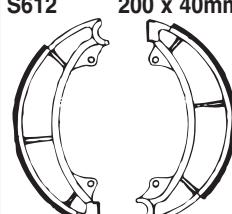
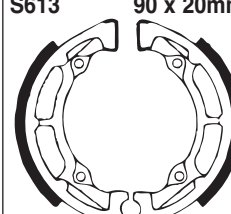
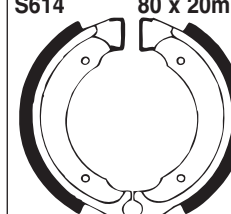
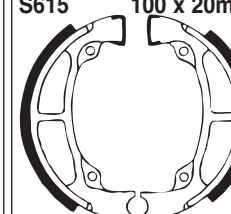
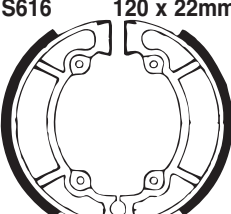
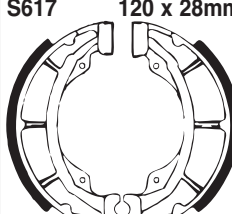
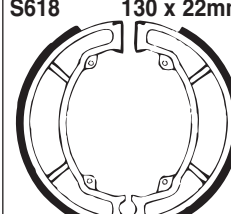
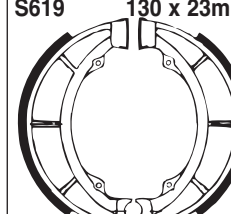
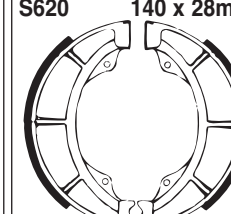
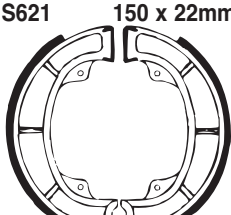
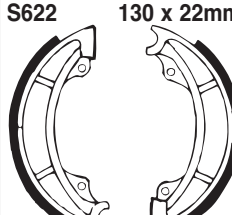
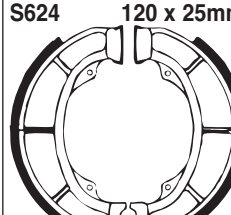
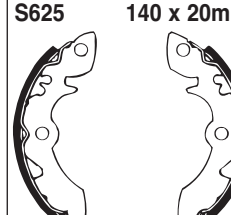
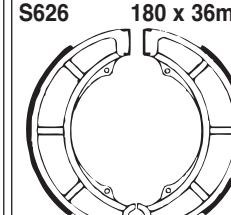
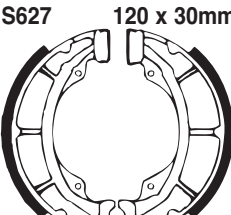
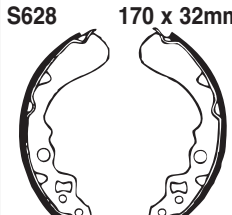
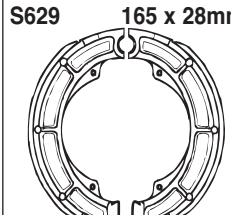
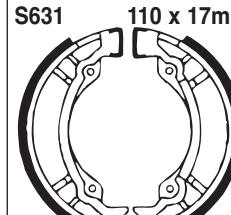
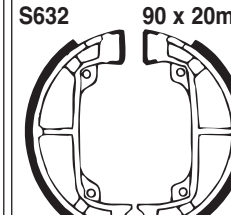
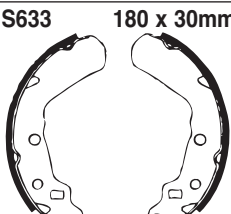
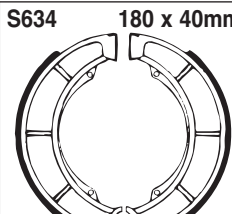
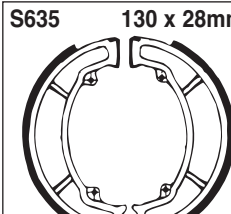
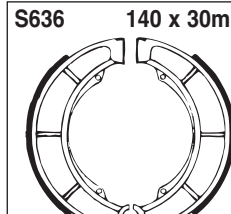

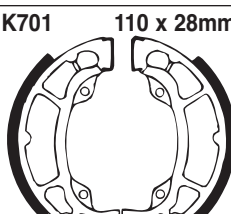
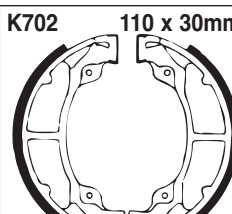
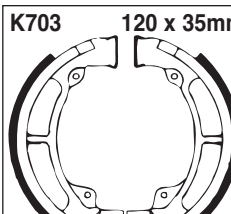
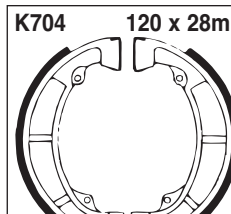
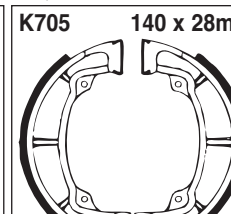



# BRAKE SHOE ILLUSTRATIONS

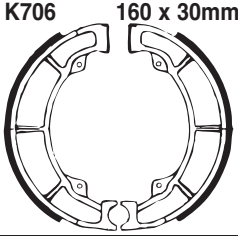
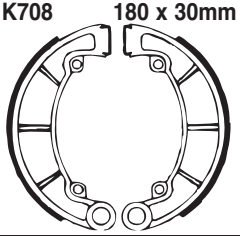
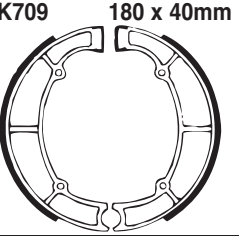
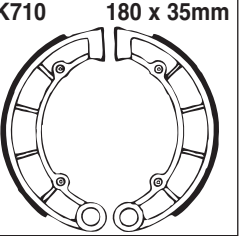
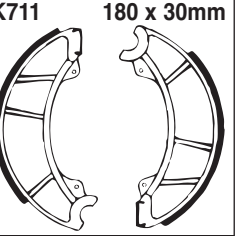
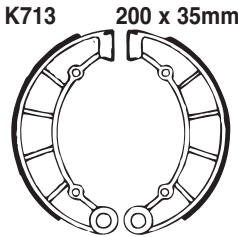
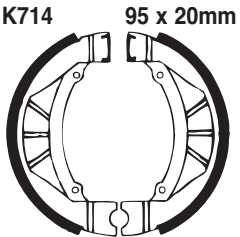
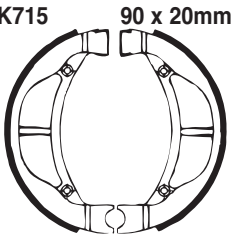
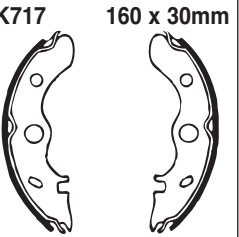
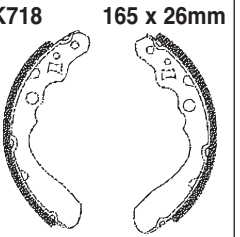
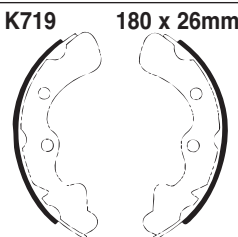
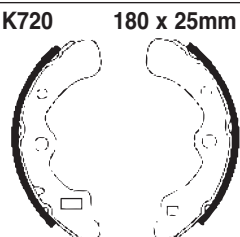
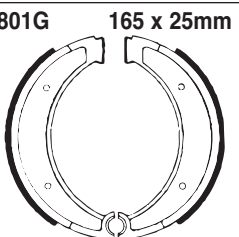
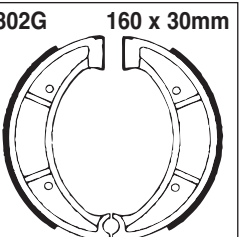
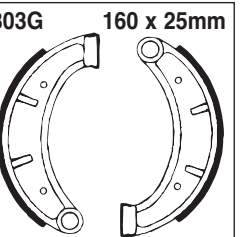
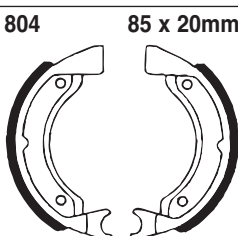
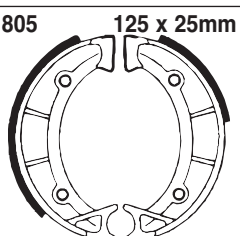
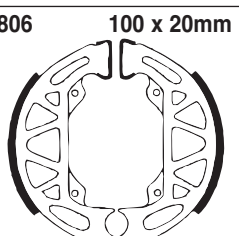
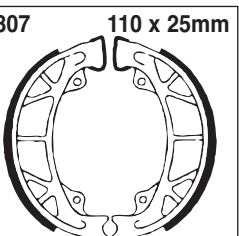

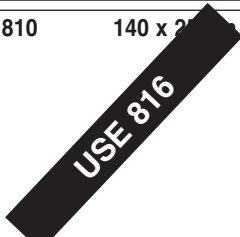
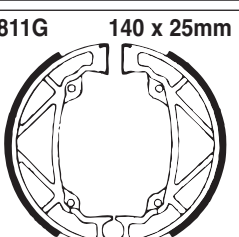
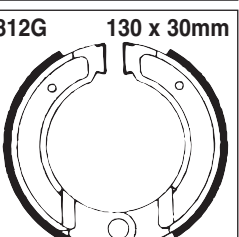
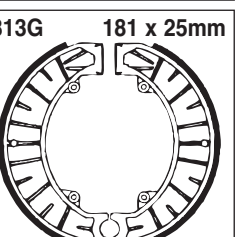
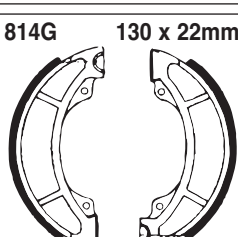
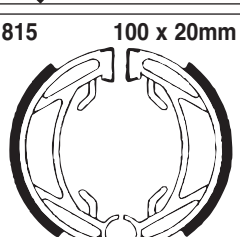
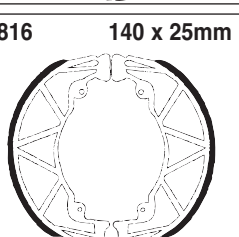
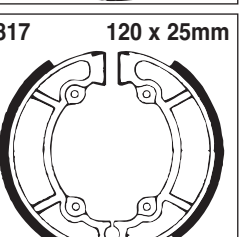
S601 100 x 25mm 	S602 130 x 28mm 	S603 110 x 30mm 	S604 110 x 25mm 	S605 150 x 28mm 
S606 160 x 30mm 	S607 160 x 28mm 	S608 179 x 28mm 	S609 180 x 28mm 	S610 180 x 28mm 
S611 180 x 32mm 	S612 200 x 40mm 	S613 90 x 20mm 	S614 80 x 20mm 	S615 100 x 20mm 
S616 120 x 22mm 	S617 120 x 28mm 	S618 130 x 22mm 	S619 130 x 23mm 	S620 140 x 28mm 
S621 150 x 22mm 	S622 130 x 22mm 	S624 120 x 25mm 	S625 140 x 20mm 	S626 180 x 36mm 
S627 120 x 30mm 	S628 170 x 32mm 	S629 165 x 28mm 	S631 110 x 17mm 	S632 90 x 20mm 
S633 180 x 30mm 	S634 180 x 40mm 	S635 130 x 28mm 	S636 140 x 30mm 	S638 80 x 28mm 
K701 110 x 28mm 	K702 110 x 30mm 	K703 120 x 35mm 	K704 120 x 28mm 	K705 140 x 28mm 

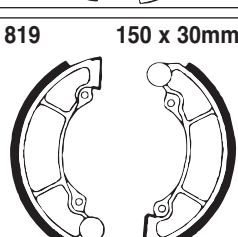
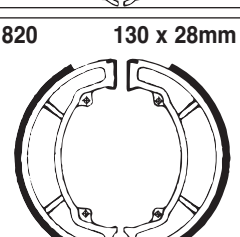
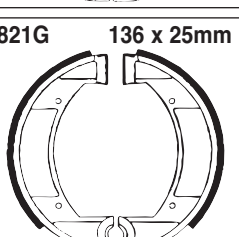
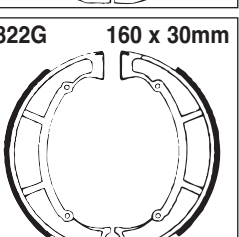
SHOE  
BUYERS GUIDE

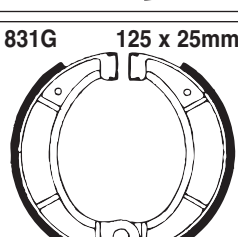
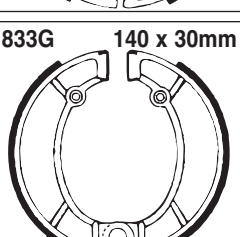
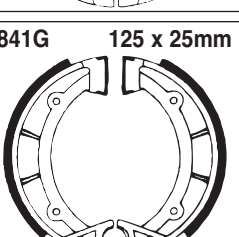
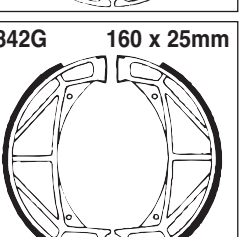
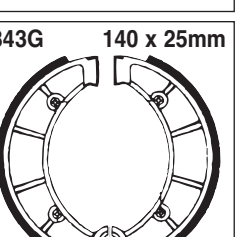
# BRAKE SHOE ILLUSTRATIONS

K706 160 x 30mm 	K708 180 x 30mm 	K709 180 x 40mm 	K710 180 x 35mm 	K711 180 x 30mm 
K713 200 x 35mm 	K714 95 x 20mm 	K715 90 x 20mm 	K717 160 x 30mm 	K718 165 x 26mm 
K719 180 x 26mm 	K720 180 x 25mm 	801G 165 x 25mm 	802G 160 x 30mm 	803G 160 x 25mm 
804 85 x 20mm 	805 125 x 25mm 	806 100 x 20mm 	807 110 x 25mm 	808 100 x 22mm 
809 150 x 24mm 	810 140 x 25mm 	811G 140 x 25mm 	812G 130 x 30mm 	813G 181 x 25mm 
814G 130 x 22mm 	815 100 x 20mm 	816 140 x 25mm 	817 120 x 25mm 	818 130 x 25mm 
819 150 x 30mm 	820 130 x 28mm 	821G 136 x 25mm 	822G 160 x 30mm 	824 130 x 28mm 
831G 125 x 25mm 	833G 140 x 30mm 	841G 125 x 25mm 	842G 160 x 25mm 	843G 140 x 25mm 

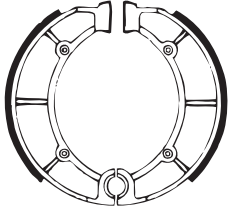
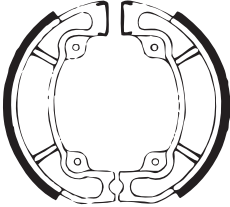
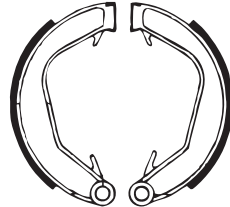
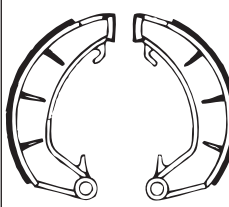
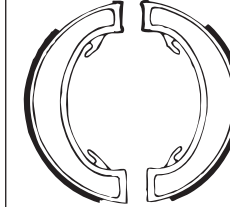
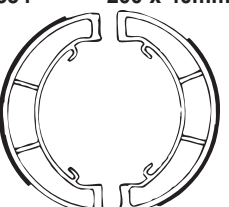
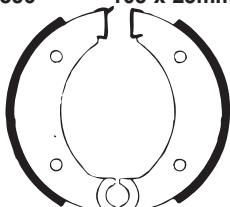
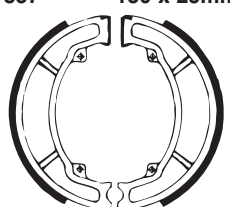
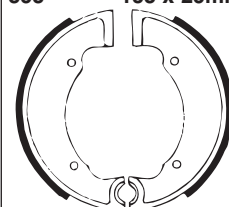
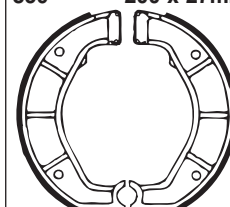
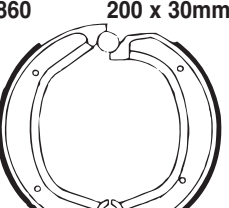
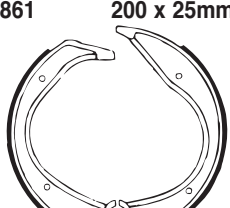
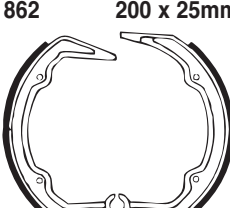
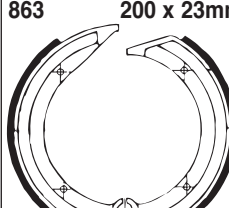
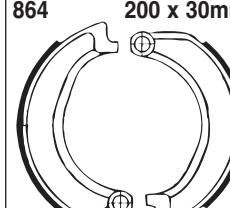

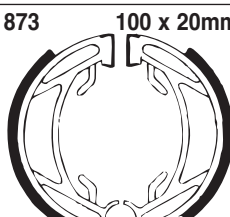
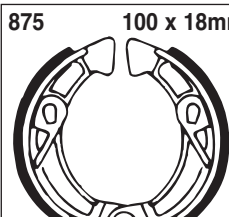
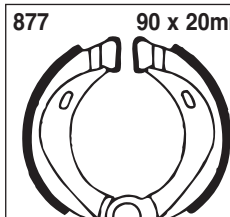
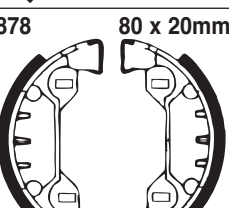
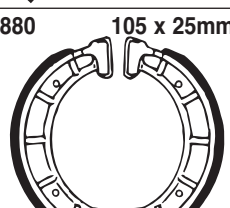
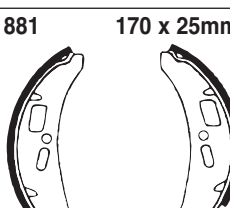
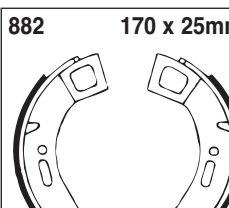
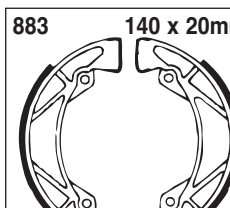
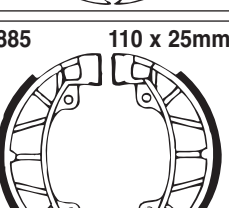
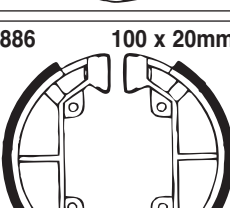
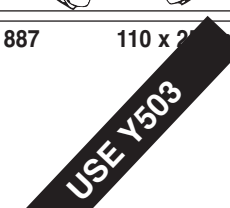
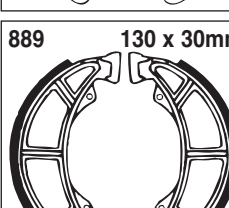
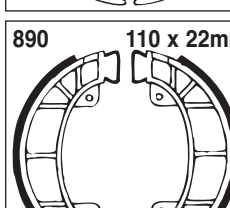
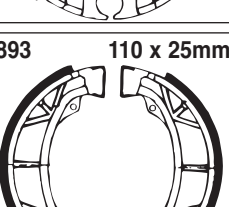
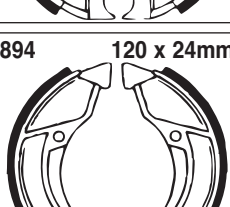
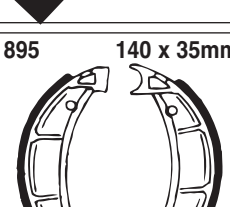
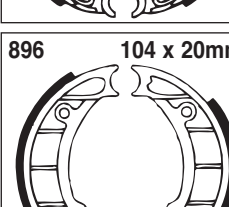
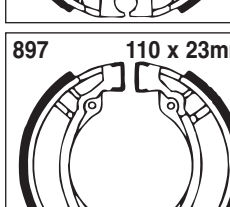
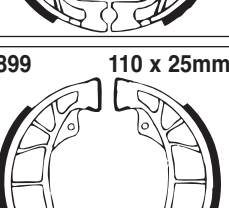
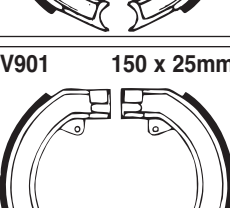
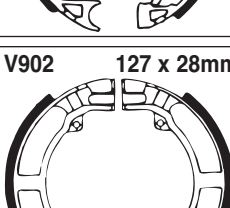
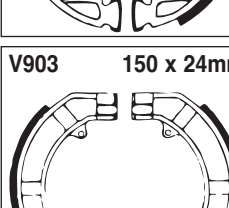
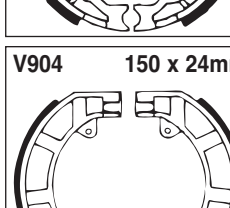



# BRAKE SHOE ILLUSTRATIONS

844 135 x 25mm 	845 125 x 22mm 	851 180 x 30mm 	852 200 x 30mm 	853 180 x 25mm 
854 200 x 40mm 	856 105 x 25mm 	857 130 x 25mm 	858 138 x 25mm 	859 200 x 27mm 
860 200 x 30mm 	861 200 x 25mm 	862 200 x 25mm 	863 200 x 23mm 	864 200 x 30mm 
869 <b>DISCONTINUED</b> 	872 140 x 25mm <b>DISCONTINUED</b> 	873 100 x 20mm 	875 100 x 18mm 	877 90 x 20mm 
878 80 x 20mm 	880 105 x 25mm 	881 170 x 25mm 	882 170 x 25mm 	883 140 x 20mm 
885 110 x 25mm 	886 100 x 20mm 	887 110 x 25mm <b>USE Y503</b> 	889 130 x 30mm 	890 110 x 22mm 
893 110 x 25mm 	894 120 x 24mm 	895 140 x 35mm 	896 104 x 20mm 	897 110 x 23mm 
899 110 x 25mm 	V901 150 x 25mm 	V902 127 x 28mm 	V903 150 x 24mm 	V904 150 x 24mm 

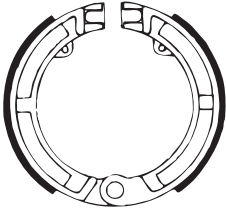
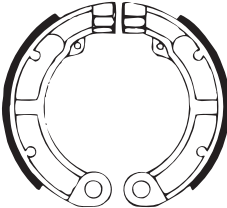
SHOE  
BUYERS GUIDE

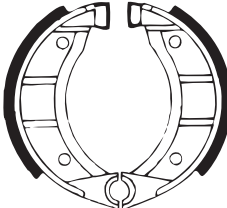
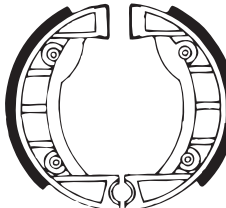
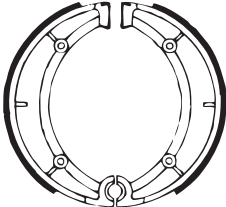
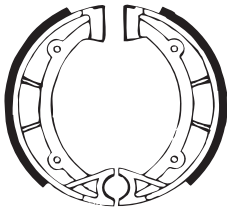

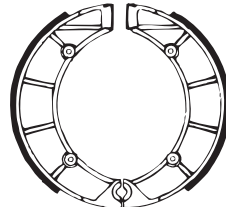
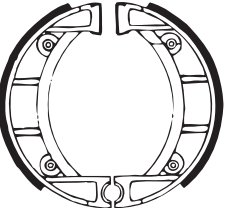
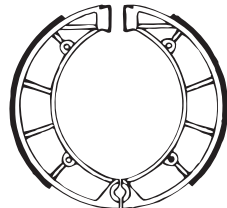
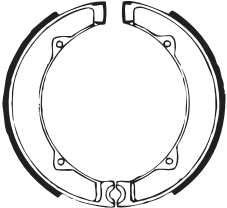
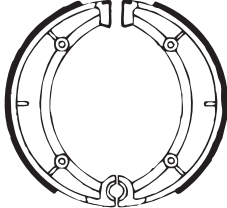
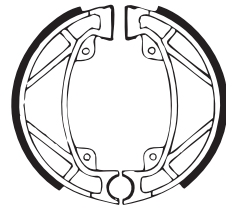
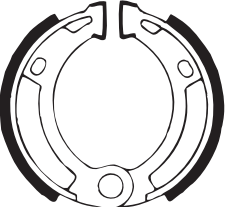
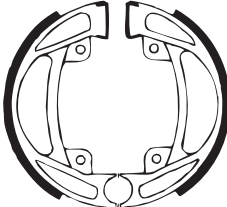
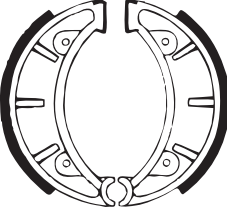
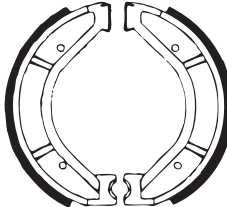
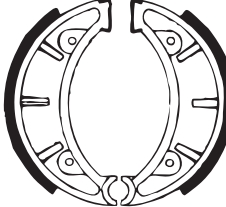
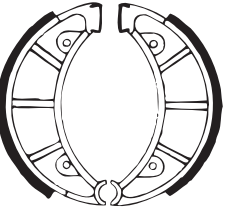
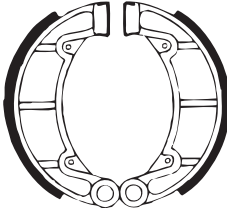
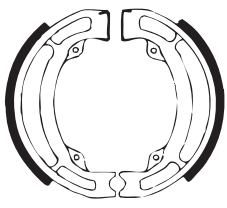
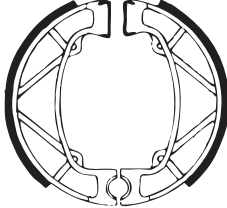
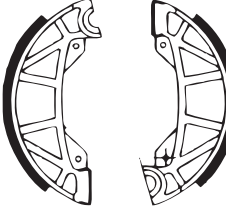
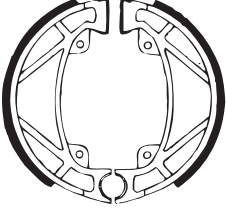
# BRAKE SHOE ILLUSTRATIONS

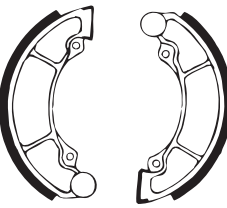
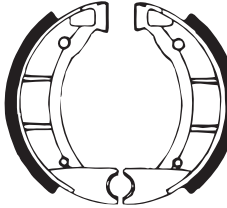
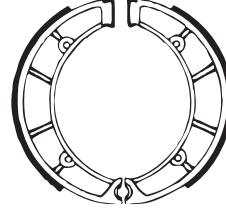
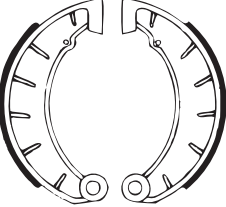
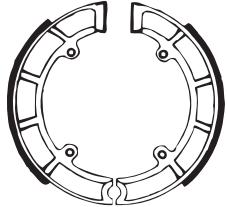
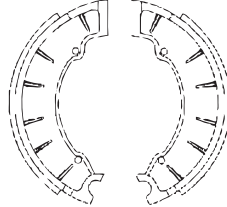
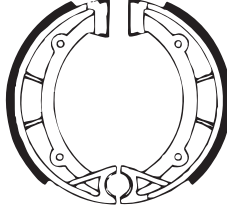
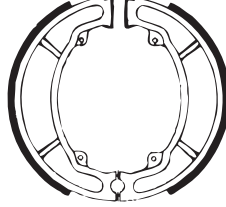
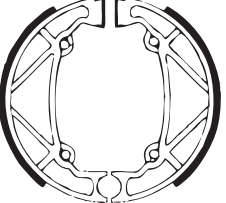
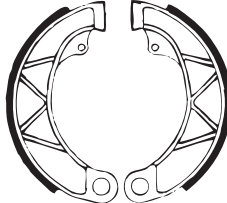
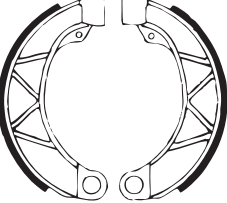
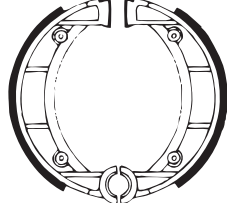
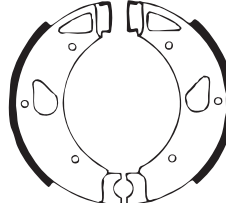
V905 125 x 17mm 	V906 125 x 20mm 	V907 135 x 16mm 	908 90 x 18mm 	909 105 x 20mm 
921 160 x 30mm 	922 123 x 25mm 	923 <b>DISCONTINUED</b> 	924 150 x 18mm 	925 160 x 30mm 
926 118 x 20mm 	927G 160 x 25mm 	928 182 x 35mm 	929 158 x 30mm 	930G 118 x 24mm 
931 90 x 18mm 	932 120 x 20mm 	933 110 x 30mm 	934G 122 x 30mm 	935G 110 x 25mm 
936G 120 x 25mm 	937G 125 x 28mm 	938 110 x 22mm 	939G 125 x 25mm 	940G 125 x 25mm 
941 118 x 24mm 	V942 150 x 24mm 	944 124 x 28mm 	945 90 x 18mm 	946 180 x 30mm 
949 160 x 35mm 	950 180 x 25mm 	951 160 x 35mm 	952 125 x 25mm 	953 130 x 30mm 
954 140 x 25mm 	958 152 x 25mm 	959 152 x 25mm 	965 124 x 25mm 	966 116 x 20mm 

# BRAKE SHOE ILLUSTRATIONS

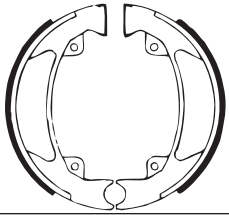
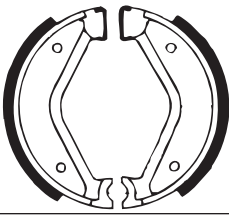
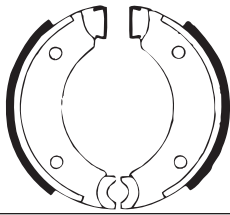
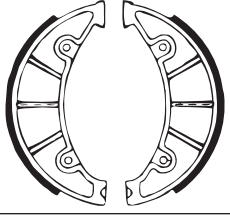
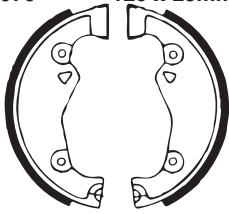
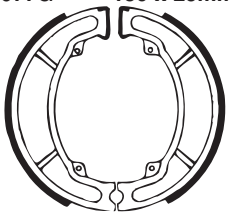
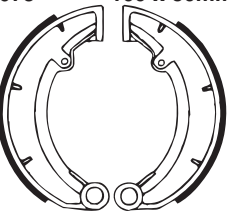
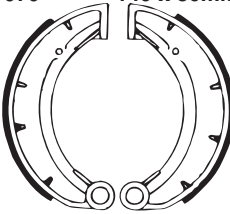
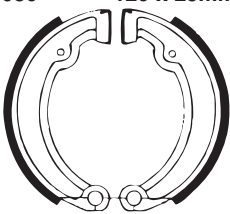
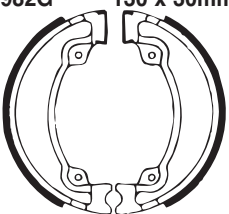
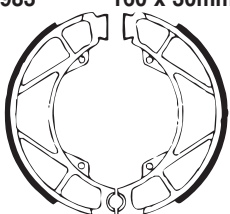
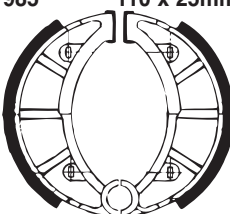
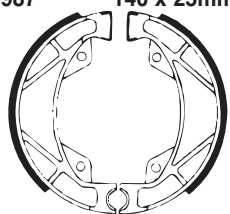
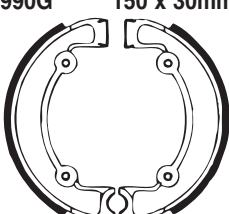
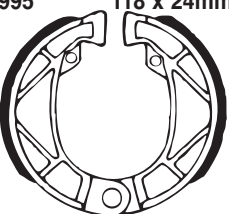
967 160 x 25mm 	968 80 x 25mm <b>USE H322</b>	970 90 x 20mm 	972 105 x 25mm 	975 150 x 25mm 
976 120 x 25mm 	977G 130 x 25mm 	978 160 x 30mm 	979 140 x 30mm 	980 120 x 25mm 
982G 130 x 30mm 	983 160 x 30mm 	984 90 x 20mm <b>PIC NOT AVAILABLE</b>	985 110 x 25mm 	987 140 x 25mm 
990G 150 x 30mm 	991 120 x 25mm <b>USE S624</b>	995 118 x 24mm 	999 105 x 25mm <b>PIC NOT AVAILABLE</b>	

SHOE  
BUYERS GUIDE

# BRAKE SHOE COMPETITOR INTERCHANGE

FERODO	EBC	FERODO	EBC	FERODO	EBC	FERODO	EBC	VESRAH	EBC
FSB700	860	FSB771	Y525	FSB842	989	FSB913	Y507	VB101	H303
FSB701	861	FSB772	Y521	FSB843	959	FSB914	892	VB110	H303
FSB702	H301	FSB773	S609	FSB844	845	FSB915	896	VB117	H317
FDB703	H302	FSB774	N/A	FSB845	982	FSB916	858	VB119	H314
FSB704	H303	FSB775	S619	FSB846	943	FSB917	N/A	VB123	H307
FSB705	H304	FSB776	S618	FSB847	821G	FSB918	N/A	VB124	H311
FSB706	H310	FSB777	S624	FSB848	953	FSB919	853	VB125	H312
FSB707	H312	FSB778	S622	FSB849	842	FSB920	852	VB126	H304
FSB708	H313	FSB779	S621	FSB850	801G	FSB921	854	VB127	H315
FSB709	H318	FSB780	S611	FSB851	865	FSB922	851	VB128	H316
FSB710	H320	FSB781	983	FSB852	927	FSB923	N/A	VB129	H320
FSB711	H321	FSB782	S634	FSB853	948	FSB924	N/A	VB130	H310
FSB712	H322	FSB783	S615	FSB854	949	FSB925	H339	VB132	H313
FSB713	H330	FSB784	S626	FSB855	951	FSB926	H345	VB133	H321
FSB714	H333	FSB785	S620	FSB856	992	FSB927	S625	VB134	H301
FSB715	H336	FSB786	S616	FSB857	833G	FSB928	Y520	VB135	H306
FSB716	K702	FSB787	S602	FSB858	844	FSB929	S633	VB136	H318
FSB717	K703	FSB788	893	FSB859	947	FSB930	N/A	VB137	H324
FSB718	K706	FSB789	S629	FSB860	894	FSB931	H347	VB138	H325
FSB719	K709	FSB790	S606	FSB861	895	FSB932	K717	VB139	H309
FSB720	S601	FSB791	S631	FSB862	887	FSB933	Y524	VB140	H323
FSB721	S602	FSB792	S632	FSB863	859	FSB934	S628	VB141	H302
FSB722	S603	FSB793	K708	FSB864	873	FSB935	N/A	VB142	H330
FSB723	S604	FSB794	K710	FSB865	876	FSB936	804	VB143	H331
FSB724	S605	FSB795	K713	FSB866	888	FSB937	900	VB144	H328
FSB725	S606	FSB796	N/A	FSB867	880	FSB938	899	VB146	H343
FSB726	S613	FSB797	K704	FSB868	N/A	FSB939	805	VB147	H339
FSB727	S614	FSB798	K701	FSB869	V901	FSB940	806	VB148	H332
FSB728	S617	FSB799	K705	FSB870	877	FSB941	807	VB149	H327
FSB729	S627	FSB800	K711	FSB871	867	FSB942	H311	VB150	H333
FSB730	Y501	FSB801	K714	FSB872	N/A	FSB943	H314	VB151	H341
FSB731	Y503	FSB802	K715	FSB873	911	FSB944	H342	VB152	H345
FSB732	Y504	FSB803	930	FSB874	V903	FSB945	H345	VB153	H342
FSB733	Y506	FSB804	862	FSB875	910	FSB946	H351	VB154	H331
FSB734	Y510	FSB805	863	FSB876	921	FSB947	Y527	VB156	H347
FSB735	Y514	FSB806	864	FSB877	945	FSB948	Y528	VB157	H351
FSB736	Y516	FSB807	831G	FSB878	N/A	FSB949	N/A	VB158	H340
FSB737	Y517	FSB808	999	FSB879	V902	FSB950	S612	VB159	H330
FSB738	Y518	FSB809	986	FSB880	N/A	FSB951	809	VB206	Y513
FSB739	Y519	FSB810	997	FSB881	N/A	FSB952	N/A	VB208	Y510
FSB740	H323	FSB811	866	FSB882	N/A	FSB953	816	VB210	Y510
FSB741	H316	FSB812	802G	FSB883	897	FSB954	846	VB212	Y504
FSB742	H315	FSB813	803G	FSB884	914	FSB955	N/A	VB219	Y507
FSB743	H325	FSB814	812G	FSB885	V906	FSB956	817	VB220	Y511
FSB744	H327	FSB815	813G	FSB886	912	FSB957	S635	VB223	Y506
FSB745	H328	FSB816	814G	FSB887	942	FSB958	818	VB224	Y501
FSB746	H331	FSB817	811G	FSB888	868	FSB959	819	VB225	Y514
FSB747	H324	FSB818	929	FSB889	V907	FSB960	820	VB226	Y502
FSB748	H341	FSB819	822G	FSB890	V905	FSB961	Y511	VB227	Y512
FSB749	H309	FSB820	933	FSB891	V904	FSB962	N/A	VB228	Y510
FSB750	H319	FSB821	937	FSB892	881	FSB963	H352	VB229	Y503
FSB751	H332	FSB822	878	FSB893	882	FSB964	820	VB230	Y515
FSB752	H337	FSB823	978	FSB894	885			VB231	Y516
FSB753	H346	FSB824	979	FSB895	886			VB233	Y517
FSB754	H334	FSB825	934	FSB896	890			VB234	Y508
FSB755	H340	FSB826	935	FSB897	922			VB235	Y506
FSB756	H338	FSB827	936	FSB898	841G			VB238	Y520
FSB757	H344	FSB828	990	FSB899	939			VB239	Y527
FSB758	H335	FSB829	883	FSB900	995			VB240	Y524
FSB759	987	FSB830	N/A	FSB901	843G			VB241	Y526
FSB760	H306	FSB831	998	FSB902	908			VB242	Y531
FSB761	H343	FSB832	985	FSB903	988			VB243	Y530
FSB762	H350	FSB833	944	FSB904	940			VB244	Y533
FSB763	Y508	FSB834	955	FSB905	N/A			VB302	K/S602
FSB764	Y502	FSB835	975	FSB906	996			VB304	S608
FSB765	Y515	FSB836	976	FSB907	926			VB305	S609
FSB766	Y522	FSB837	965	FSB908	931			VB306	S610
FSB767	Y511	FSB838	954	FSB909	981			VB307	S611
FSB768	941	FSB839	958	FSB910	909			VB308	S606
FSB769	Y512	FSB840	N/A	FSB911	952			VB309	K/S605
FSB770	Y513	FSB841	977	FSB912	924			VB310	S604



# BRAKE SHOE COMPETITOR INTERCHANGE







VESRAH	EBC	DP	EBC	DP	EBC	SBS	EBC	SBS	EBC
VB311	S617	9100	H303	9172	H350	SBS2010	H301	SBS2098	S634
VB312	K/S603	9101	H304	9173	806	SBS2011	H302	SBS2099	S611
VB313	S613	9102	H310	9174	810	SBS2012	H303	SBS2101	S614
VB314	S618	9103	H313	9175	816	SBS2013	H304	SBS2102	S616
VB315	S621	9104	H322	9176	886	SBS2014	S602	SBS2103	S617
VB316	S616	9105	H301	9177	-	SBS2015	S603	SBS2104	S618
VB318	S620	9106	H302	9178	899	SBS2016	S605	SBS2107	S621
VB319	S/Y502	9107	Y504	9179	V903	SBS2017	S604	SBS2108	S622
VB320	S625	9108	Y506	9180	-	SBS2018	S606	SBS2110	S629
VB321	S626	9109	Y501	9181	-	SBS2019	H306	SBS2111	S606
VB322	S601	9110	Y502	9182	-	SBS2020	S613	SBS2112	Y501
VB323	S614	9111	Y503	9184	908	SBS2021	Y519	SBS2113	Y513
VB324	S631	9112	S602	9185	885	SBS2022	S615	SBS2114	Y520
VB325	S632	9113	S603	9186	H340	SBS2023	H312	SBS2115	Y521
VB326	S633	9114	S613	9187	S634	SBS2024	H315	SBS2116	801
VB327	S628	9115	S601	9188	860	SBS2025	K703	SBS2117	802
VB328	S624	9116	S606	9189	861	SBS2026	H318	SBS2118	803
VB329	S629	9117	K706	9190	H321	SBS2027	H320	SBS2120	812
VB330	897	9118	K709	9191	815	SBS2028	Y503	SBS2121	813
VB404	K708	9119	H315	9192	H338	SBS2029	H323	SBS2122	814
VB405	K713	9120	H316	9193	816	SBS2030	H332	SBS2139	860
VB406	K/S603	9121	H320	9194	897	SBS2031	H324	SBS2140	861
VB407	K/S605	9122	H306	9195	Y528	SBS2032	Y504	SBS2141	862
VB408	K704	9123	H309	9196	S635	SBS2033	Y507	SBS2143	859
VB409	K602A	9124	H324	9197	817	SBS2034	Y506	SBS2146	V903
VB410	K/S602	9125	H330	9198	857	SBS2035	Y511	SB2171	978
VB411	K705	9126	H333	9199	H352	SBS2036	Y508	SBS2172	979
VB412	K709	9127	Y511	9200	H346	SBS2037	Y510	SBS2177	Y523
VB413	K706	9128	Y514	9201	H307	SBS2038	K706	SBS2178	Y524
VB414	K701	9129	Y512	9202	K718	SBS2039	K704	SBS2181	S624
VB415	K714	9130	Y510	9203	K719	SBS2040	K705	SBS2182	Y502
VB416	K703	9131	Y515	9204	K720	SBS2041	H330	SBS2183	K602A
VB417	K715	9132	Y516	9205	864	SBS2042	H331	SBS2184	882
VB418	K717	9133	S605	9206	S636	SBS2043	H338	SBS2185	881
VB419	K710	9134	S604			SBS2044	H339	SBS2186	885
		9135	S617			SBS2045	H342	SBS2187	886
		9136	K704			SBS2046	H343	SBS2188	897
		9137	S627			SBS2047	H344	SBS2189	H350
		9138	S614			SBS2048	H346	SBS2190	Y526
		9139	H318			SBS2049	Y517	SBS2191	Y525
		9140	Y518			SBS2050	Y518	SBS2182	Y522
		9141	Y519			SBS2051	S625	SBS2193	H335
		9142	K702			SBS2052	S626	SBS2194	H334
		9143	K703			SBS2053	S628	SBS2195	899
		9144	K602A			SBS2054	K717	SBS2196	909
		9145	K710			SBS2056	K703	SBS2197	K710
		9146	H339			SBS2057	H333	SBS2198	H351
		9147	H342			SBS2058	H313	SBS2199	Y527
		9148	H343			SBS2059	H321	SBS2200	806
		9149	H345			SBS2060	K709	SBS2201	817
		9150	H347			SBS2063	Y512	SBS2202	S635
		9151	Y527			SBS2064	Y514	SBS2203	818
		9152	Y528			SBS2065	Y515	SBS2204	810
		9153	S610			SBS2066	Y516	SBS2205	816
		9154	-			SBS2069	H310	SBS2207	H351
		9155	S624			SBS2070	H325		
		9156	S625			SBS2071	H314		
		9157	S626			SBS2072	H316		
		9158	S628			SBS2074	H322		
		9159	S629			SBS2075	H325		
		9160	S633			SBS2077	H332		
		9161	K705			SBS2080	H336		
		9162	K717			SBS2082	H341		
		9163	Y520			SBS2085	H347		
		9165	Y524			SBS2087	K701		
		9166	Y523			SBS2088	K708		
		9167	H351			SBS2091	K713		
		9168	807			SBS2092	K714		
		9169	893			SBS2093	K715		
		9170	K715			SBS2094	S601		
		9171	-			SBS2097	S609		

# BRAKE SHOE COMPETITOR INTERCHANGE

LUCAS	EBC	LUCAS	EBC			
MCS800	H303	MCS963	Y519			
MCS802	H315	MCS964	Y517			
MCS803	H312	MCS967	Y526			
MCS804	H304	MCS968	Y527			
MCS805	H318	MCS969	Y521			
MCS806	H321	MCS980	V903			
MCS807	H313	MCS981	V905			
MCS808	H320	MCS982	882			
MCS809	H316	MCS983	881			
MCS810	N/A	MCS984	889			
MCS811	H309	MCS985	896			
MCS812	H323	MCS986	V904			
MCS813	H302	MCS987	885			
MCS815	H332	MCS988	908			
MCS816	H327	MCS989	806			
MCS817	H310	MCS990	897			
MCS819	H330	MCS991	S632			
MCS820	H336	MCS993	S615			
MCS821	H340	MCS994	816			
MCS822	H343	MCS995	H351			
MCS824	H344	MCS996	N/A			
MCS825	H333					
MCS827	H301					
MCS828	H322					
MCS831	H350					
MCS832	H338					
MCS833	Y511					
MCS834	Y512					
MCS850	H316					
MCS851	K713					
MCS852	K709					
MCS853	K706					
MCS854	S603					
MCS855	S602					
MCS856	S617					
MCS857	K715					
MCS858	K711					
MCS861	K703					
MCS890	978					
MCS891	979					
MCS892	H320					
MCS901	S604					
MCS902	S605					
MCS904	S609					
MCS905	S634					
MCS906	S611					
MCS907	S606					
MCS915	S616					
MCS918	S627					
MCS919	S606					
MCS920	804					
MCS921	S624					
MCS940	860					
MCS941	861					
MCS942	862					
MCS943	863					
MCS944	864					
MCS945	859					
MCS950	Y512					
MCS951	Y504					
MCS952	Y511					
MCS953	Y506					
MCS954	Y513					
MCS955	Y510					
MCS956	Y518					
MCS957	Y515					
MCS958	Y516					
MCS959	N/A					
MCS960	Y501					
MCS961	Y502					
MCS962	Y503					







# STREETBIKE DISC BUYERS GUIDE

DISC No.	FRONT/ REAR	TYPE	MODELS	DIA (MM)	DISC No.	FRONT/ REAR	TYPE	MODELS	DIA (MM)
<b>MD609LS</b> <b>MD609RS</b>  6 bolt fixing 27.2mm Offset	FRONT / REAR	D	<b>DUCATI</b> 900 Hailwood Replica 79 900 SD Darmah (6 bolt front disc fixing/4 bolt rear disc fixing) 78 900 SD Darmah (6 bolt front & rear disc fixing) 78 1000 R1 Hailwood Replica (6 bolt disc) 84 <b>LAVERDA</b> 750 SF2 74 750 SFC 74 750 SF3 76-77 1000 3C 74-75 1000 3CL 76-81 1000 RGS 82 1000 RGA/RGS Exec 83 1200 78-79 1200 TS/Mirage 81	280	<b>MD614X</b> <b>MD614XC</b> Contd. 	FRONT	F	<b>DUCATI</b> 750 Supersport IE 00-02 750 Sport 01-02 750 Monster 00-01 Monster ie750 02 Monster 800 03-04 Supersport 800 03-05 900 Supersport IE 00-01 900 IE Monster 00-01 900 MH Evoluzione 00-01 900 Sport 02 ST2 (944cc) 00-03 ST4 (916cc) 01-02 GT 1000 (992cc) 07-10 GT 1000 Touring (992cc) 09 Monster 1000 Dark 03 Monster 1000 ie (992cc) 04-05 Monster 1000 S ie (992cc) 03-05 Monster S2R 1000 (992cc) 06-08 Paul Smart 1000 LE (992cc) 06 Sport Classic 1000 (992cc) 06-08 Sport 1000 S 07-08 <b>GENERIC</b> GRS 600 13 <b>KTM</b> 690 Duke 08-13 690 Duke R 10-11 690 SMC R 12 690 SMR 07-11 <b>MOTO GUZZI</b> 750 Brevia ie (3 spoke cast wheels) 03-07 750 Nevada Classic ie (spoke wheels) 04-13 750 Nevada 02-11 750 V7 Classic 08-12 750 V7 Cafe Classic 09-12 750 V7 Racer 10-11 940 Bellagio 07-13 1000 V10 Centauro GT 97-99 1000 V10 Centauro Sport 97-99 1100 California Aluminium 02-05 1100 California Titanium (with top fairing) 04-05 1100 California Aquila Nera 09-11 1100 California Classic Touring 06-08 1100 California EV (Up to KD115426/ Single pin pad fixing) 97-00 1100 California EV (From KD115427/ 2 pin pad fixing) 97-02 1100 California EV Touring 03-05 1100 California Jackal 94-01 1100 California Special 99-00 1100 California Sport 01-02 1100 California Stone 01-05 1100 California Stone Metal 02-03 1100 California Vintage 06-12 1100 Sport Carbs 94-96 1100 Sport EFI 96-99 1100 Sport Corsa 98-99 1100 - V11 Ballabio 03-05 1100 - V11 Le Mans 01-05 1100 - V11 Sport 99-01 1100 - V11 Scura 01-03 1100 - V11 Naked 02-03 1200 Griso 8v 07-12 <b>NORTON</b> Commando Sport (961cc) 10-11 Commando Cafe Racer (961cc) 10-11 Commando SE (961cc) 10-11 Commando 961 SF 13 <b>VOXAN</b> Black Magic 04-08 Street Scrambler 03-06 VB1-Evo 03-04 Cafe Racer 1000 02-08 Roadster 1000 02-08	320
			<b>MD609ALS</b> <b>MD609ARS</b> 6 bolt fixing 26mm off set					FRONT / REAR	
<b>MD611</b> 	REAR	F	<b>BMW</b> K 75/75-S 90-96 K 75 RT 89-96 K 75 S 85-95 K 100 82-88 K 100/2 87-90 K 100 LT 86-91 K 100 RS 83-89 K 100 RT 83-88 K 100 RS 89-92 K1 88-93 K 1100 LT 89-93	285	<b>MD612RS</b> 	FRONT	F	<b>APRILIA</b> AF 125 90-91	320
			<b>MD613</b> <b>MD613C</b>					REAR	
<b>MD614X</b> <b>MD614XC</b> <b>VR614BLK</b> <b>VR614BLU</b> <b>VR614RED</b> <b>VR614GLD</b> 	FRONT	F	<b>BENELLI</b> TRE-K 1130 06-12 TRE-K 899 07-12 2UE 750 08-09 TNT 899 S Tornado Naked Tre 07-11 TNT 899 Tornado Naked Tre 07-10 <b>BRAMMO (Electric Bikes)</b> Empulse R 12-13 <b>CAGIVA</b> Mito 125 (SP525) 91-10 N1 125 97 Planet 125 (3 spoke wheels) 98-03 Planet 125 (6 spoke wheels) 98-03 Raptor 125 03-10 Supercity 125 92-00 Mito 500 07-08 River 600 94- <b>DUCATI</b> Monster Dark ie 400 05-06 Monster 400 00-04 600 Monster City/City Dark 99 600 Monster 00-01 620 IE Monster 02-04 620 Monster Dark 03-04 696 Monster 08-13 696 + Monster (inc ABS) 09-12 Monster 696 20th Anniversary Model 13 748 Testa Bassa 01 748 Biposto 99-02 748 SP/Monoposto 99-02	320	<b>MD615</b> 	REAR	F	<b>BMW</b> K 1200 LT 97-09 R 1200 CL 02-04	285

D = Dished Solid Original (We replace with floating rotor conversion unit) F = Floating Rotor S = Solid Rotor  
 SF = Solid Flat Original Disc which we replace with fully floating unit - fits direct no mods required.



# STREETBIKE DISC BUYERS GUIDE

DISC No.	FRONT/ REAR	TYPE	MODELS	DIA (MM)	DISC No.	FRONT/ REAR	TYPE	MODELS	DIA (MM)
<b>MD616</b> Loose bobbins	FRONT	S	<b>BMW</b> R 850 R 04-06 R 1100 S 00-06 R 1150 R 01-06 R 1150 RS 01-04 R 1150 R Rockster 03-06 K 1200 LT 00-09 K 1200 R (K27/0378) Tokico Caliper Disc with loose buttons 11/05-11/07 K 1200 R 05-08	320	<b>MD622X</b> <b>MD622XC</b> <b>VR622BLK</b> <b>VR622BLU</b> <b>VR622RED</b> <b>VR622GLD</b> 	FRONT	F	<b>DUCATI</b> 749 Dark 04-06 749 R 04-06 749 S 03-06 999 S 03-06 999 03-06 999 R 03-06 999 R Flla 03 999 R Xerox 06 1100 S Monster 09-10	320
<b>MD617</b>	REAR	S	<b>CAGIVA</b> 650 Raptor 01-07 1000 Raptor/V-Raptor 00-06 1000 Raptor/V-Raptor 00-05	220	<b>MD623RS</b>	FRONT	S	<b>MZ/MUZ</b> Saxon 125 93-97 Saxon 150 95 251 Fun 95-96 Saxon "Tour" 251/301 93-98 Saxon 500 All models 93-98	280
<b>MD618</b> <b>MD618C</b> <b>VR618</b>	REAR	S	<b>DUCATI</b> 749 Dark 04-06 749 R 04-06 749 S 03-06 749 Monoposto/Biposto 03-06 Desmosedici RR (D16RR/989cc) 08 999 S 03-04 999 03-06 999 R 03-06 999 R Flla 03 999 R Xerox 06	240	<b>MD624</b> <b>VR624BLK</b> <b>VR624BLU</b> <b>VR624RED</b> <b>VR624GLD</b> 	FRONT	F	<b>DUCATI</b> 996 S 01 Monster S4R (994cc) 03-06 Monster S4 Foggy (916cc) 02 Monster S4 (916cc) 01-02 ST3S (ABS Model) 06-07 ST4S (ABS) 03-05 ST4S (Non ABS) 01-05 996 SPS 99 996 Monoposto/Biposto 99-01 <b>MOTO GUZZI</b> 850 Brevia ie 06-07 1100 Brevia (STD/ABS models) 05-07 Brevia 1200 08-09 Norge 1200 (ABS) All models 06-09 1200 Sport (ABS) 06-07 Stelvio 1200/ABS 08-10 1200 Stelvio NTX ABS 09-10	320
<b>MD619RS</b> 	FRONT	F	<b>MZ/MUZ</b> Skorpion Tour/Traveller 95-02 Skorpion Sport/Cup 95-01	316	<b>MD625LS</b>	FRONT	S	<b>APRILIA</b> Europa 50 90-92 AF1 Futura 50 90-92	290
<b>MD620</b> Loose bobbins	FRONT	S	<b>BMW</b> R 850 RT 06 K 1200 RS 01-04 K 1200 S (K40) 05-08 R 1150 RT 00-06 K 1200 GT (K41) 03-06	320	<b>MD626X</b> <b>MD626XC</b> <b>VR626BLK</b> <b>VR626BLU</b> <b>VR626RED</b> <b>VR626GLD</b> 	FRONT	F	<b>DUCATI</b> Monster S2R (803cc) 05-07 Monster S2R Dark (803cc) 05-06 Monster 400 ie 07-08 Monster 620 05-06 Monster Dark 620 05-06 620 Multistrada 06 695 Monster 07-08	300
<b>MD621X</b> <b>MD621XC</b> <b>VR621BLK</b> <b>VR621BLU</b> <b>VR621RED</b> <b>VR621GLD</b> 	FRONT	F	<b>APRILIA</b> RS 125 (Radial Caliper) 2T 06-13 Pegaso Strada 650 05-06 Pegaso 650 07-08 Pegaso 650 Factory 06-08 Shiver 750 07-10 Shiver 750 (RAE00/STD & ABS) 10-13 Shiver 750 GT 09-10 Shiver 750 GT ABS 10-12 Mana 850 08-11 Mana 850 ABS 08-13 Mana 850 GT ABS Model 09-13 RSV 1000 Mille 01-08 RSV 1000 R Mille 01-08 Tuono R Factory 1000 06-10 Tuono R 1000 02-10 <b>BENELLI</b> 2 UE 756 09-10 Tornado Tre Novecento LE/RS 03-05 Cafe Racer 899 10-12 Century 1130 Racer 11-12 Tornado TRE 1130 06 TNT 1130 Cafe Racer 06-12 TNT 1130 Titanium 06 TNT 1130 Sport/Sport Evo 04-09 Tornado Naked TRE 06-07 Tornado Tre 1130 06-10 <b>BIMOTA</b> SB8K Santamonica <b>BMW</b> G 650 X Moto 07-09 <b>MONDIAL</b> Piega 1000 03-04 Evo 04 <b>LAVERDA</b> SFC 1000 03-04 <b>MOTO GUZZI</b> 850 Griso 06-07 940 Bellagio 07-12 1000 MGS-01 Corsa 04-07 1100 Griso 05-08 1100 california 1000 190 12	320	<b>MD627</b> <b>MD627C</b> <b>VR627</b>	REAR	S	<b>DUCATI</b> 796 Hypermotard 10-12 796 Monster (inc ABS) 10-13 Monster 796 20th Anniversary Model 13 Monster S2R Dark (803cc) 05-06 Hypermotard (821cc) 13 Hypermotard SP (821cc) 13 Hyperstrada (821cc) 13 848 (Radial 2 pad caliper) 08-10 848 Evo (Monobloc front calipers) 10-13 848 Evo Corse SE 12-13 848 Evo Dark 12 848 Streetfighter 11-13 S4RS Monster (998cc) 06 S4R Monster Testastretta (998cc) 07-08 S4RS Monster Testastretta (998cc) 07 S4RS Tricolore/Monster Testastretta 08 Monster S4R (994cc) 03-06 Monster S2R 1000 (992cc) 06-08 Multistrada 1000 DS 03-06 Multistrada S DS 1000 05-06 1100 Evo Hypermotard 10-12 1100 Evo SP Hypermotard 10-12 Hypermotard 1100 07-09 Hypermotard 1100 S 07-09 Multistrada 1100 (1078c) 07-09 Multistrada 1100 S (1078cc) 07-09 1100 Monster 09-10 1100 Monster Evo 11-13 1100 S Monster 09-10 Monster Diesel 1100 13 1199 Panigale R 13	245

**D = Dished Solid Original (We replace with floating rotor conversion unit) F = Floating Rotor S = Solid Rotor SF = Solid Flat Original Disc which we replace with fully floating unit - fits direct no mods required.**





# STREETBIKE DISC BUYERS GUIDE

DISC No.	FRONT/ REAR	TYPE	MODELS	DIA (MM)	DISC No.	FRONT/ REAR	TYPE	MODELS	DIA (MM)
MD628RS	FRONT	S	<b>APRILIA</b> Classic 125 95-01 Red Rose 125 (Spoke wheel) 88-94	260	MD634LS MD634RS	FRONT /REAR	F	<b>DUCATI</b> 250/350/450 Desmo 74-77 750 Sport 74 750 SS (4 bolt disc fixing) 75-76 860 GT/GTS 75-76 900 GTS 75-76 900 SS Desmo (4 bolt fixing front disc) 76 900 SD Darmah (4 bolt front and rear disc fixing) 77 900 SD Darmah (6 bolt front disc fixing 4 bolt rear disc fixing) 78	280
MD629 VR629BLK VR629BLU VR629RED VR629GLD	FRONT	F	<b>TRIUMPH</b> Thruxton 04-12	320					
MD630LS/RS	FRONT	S	<b>DUCATI</b> 750 Paso 87-90 750 Sport 88	280	MD635RS	FRONT	F	<b>APRILIA</b> AF1 125 87-89	320
MD631	REAR	S	<b>DUCATI</b> 750 Paso 87-90 750 Sport 88 906 Paso 88-89	270	MD636X MD636XC	FRONT	F	<b>DUCATI</b> 748 R 00-02 996 R 01 <b>MOTO MORINI</b> 9 1/2 (998cc) 06-10 MM3 (1187cc) 07 Corsaro 1200 05-10 Corsaro 1200 Veloce 07-09 Corsaro Avio 08-09 1200 Sport 08-10	320
MD632 MD632C VR632	REAR	S	<b>DUCATI</b> 748 Biposto 95-98 748 SP 95-98 748 S Biposto 00-02 748 S Monoposto 00-02 748 SPS 98-99 748 Testa Bassa 01 748 R 00-02 900 MH Evoluzione 00-01 916 SPS (996cc) 97-98 916 Biposto 94-98 916 Senna 94-98 916 SP 94-96 996 SPS (996cc) 99 996 (996cc) 99-01 996 R/S 01 998 R 02 998 Matrix 04 998 S Bayliss/Bostrom 02 998 S (998cc) 02-04 998 (998cc) Monoposto/Biposto 02-03	220					
MD633X MD633XC With Counterbore	FRONT	F	<b>DUCATI</b> 400 Monster 95-97 600 Monster 93-99 600 Monster Dark 98-99 748 Biposto 95-98 748 SP 98 748 SPS 98-99 750 Supersport 91-99 750 Monster 96-98 750 Monster City/City Dark 99 750 Monster/Monster Dark 99 Supersport 750 91-98 851 Superbike Biposto 89-92 888 Superbike Strada 94-95 900 Supersport/Superlight 91-97 900 Supersport 98-99 900 Supersport CR USA 98 900 Supersport FE 98 907 IE 92-93 916 Biposto 94-98 916 SP 94-96 ST2 (944cc) 97-99 ST4 (916cc) 99 STS3 ABS 06-07 998 Matrix 04 998 S Bayliss/Bostrom 02 998 S (998cc) 02-04 998 (998cc) Monoposto/Biposto 02-03 900 Monster 93-99 900 Monster Cromo/Special 98 900 Monster City/City Dark 99 <b>KTM</b> 990 Adventure R 09-10 990 Adventure (ABS) 07-10 990 Superduke 05-11 990 Superduke R 07-13 RC8/Track (1190cc) 08-11 RC8 R (1190cc) 09-12 <b>MOTO GUZZI</b> V 1100 Brevia 04-05	320	MD637	REAR	S	<b>MZ</b> Skorpion Tour/Traveller 95-02 Skorpion Sport/Cup 95-01 Skorpion Replica 95-01	240
					MD638 (6 bolt fixing)	REAR	S	Raptor 125 03-10 Super City 125 92-00 Mito 125 (SP525) 91-10 Planet 125 (3 spoke wheels) 98-03 Planet 125 (6 spoke wheel 2nd series) 98-03 Mito 500 07-08	230
					MD639LS	FRONT	S	RS 50 (6 bolt fixing)	290
					MD640 310mm disc VR640BLK VR640BLU VR640RED VR640GLD	FRONT	F	<b>TRIUMPH</b> Daytona 750 92 Daytona 900 93-96 Daytona Super 3 94-97 Speed Triple (Carbs) 94-96 Sprint 900 94-98 Trophy 900 94-01 Daytona 1000 92 Trophy 1200 94-01 Daytona 1200 93-98	310
									
					MD641 VR641	REAR	S	<b>TRIUMPH</b> Daytona 750 92 Trident 750 92-98 Tiger 885cc 92-96 Daytona 900 93-96 Daytona Super 3 94-97 Speed Triple 94-97 Sprint 900 93-98 Trident 900 92-98 Trophy 900 92-01 Daytona 1000 92 Trophy 1200 92-02 Daytona 200 93-98	255
					MD642LS Note: Floating conversion kit available MD629	FRONT	S	<b>TRIUMPH</b> Adventurer 96-01 Thunderbird 95-02 Legend TT 98-01	320

D = Dished Solid Original (We replace with floating rotor conversion unit) F = Floating Rotor S = Solid Rotor  
SF = Solid Flat Original Disc which we replace with fully floating unit - fits direct no mods required.











# STREETBIKE DISC BUYERS GUIDE

DISC No.	FRONT/ REAR	TYPE	MODELS	DIA (MM)	DISC No.	FRONT/ REAR	TYPE	MODELS	DIA (MM)
<b>MD643</b> <b>VR643</b>	REAR	S	<b>TRIUMPH</b> America (6 Spoke Cast wheel) 07-09 America (12 Spoke Cast wheel 865cc) 10-13 Bonneville America 02-06 Adventurer 96-01 Thunderbird 95-02 Thunderbird Sport 98-00 Legend TT 98-01 Speedmaster (790cc/Carb) 03-04 Speedmaster (865cc/EFI) 05-13 Tiger 885i (From VIN 71699) 98-99 Tiger 900 885cc 97-99 Tiger 955cc (Spoke wheel) 99-04	285	<b>MD651</b>	REAR	S	<b>BMW</b> F 650 (E169/0161)/Standard 09/93-96 F 650 (E169/0162) (Funduro /HighScreen) (19" front wheel) 97-00 F 650 CS Scarver (K14/0174 /0184 Belt Drive) 00-03 F 650 CS Scarver (K17/0177 /0187 Belt Drive) 04-07 F 650 GS (R13/0172/0182) (19" front wheel) 99-03 F 650 GS Dakar (R13/0173/0183) (21" front wheel) 99-03 F 650 ST (E169/0163/168) Strada (18" front wheel/low screen) 97-00 F 650 GS Dakar (R13/0173/0183) (21" front wheel) 99-03 F 650 GS Dakar (R13/0176/0186) 04-07 F 650 GS (R13/0175/0185) 04-07 <b>BENELLI</b> TRE-K 1130 06-12 TNT 1130 Cafe Racer 05-12 TNT 1130 Sport/Sport Evo 04-09 TNT 1130 Titanium 05-06 Tornado TRE 1130 (Radial caliper) 06-10 Tornado Naked Tre TNT 1130 06-07 <b>HUSQVARNA</b> TR 650 Terra (Spoke Wheel) 12-13 TR 650 Strada (Cast Wheel) 12-13	240
<b>MD644LS</b> <b>MD644RS</b>	FRONT	S	<b>TRIUMPH</b> Tiger 900 885cc 92-97 <b>HONDA</b> CBR 125 R4/R5/RS5/RS6 04-06 CBR 125 RW5/RW6/RW7/RW8 /RW9/RWA 05-10 CBR 150 R 00-03	276					
<b>MD645</b>	REAR	S	<b>TRIUMPH</b> Tiger 900 885cc 92-97	255					
<b>MD646LS</b> <b>MD646RS</b> 296mm Disc <b>VR646BLK</b> <b>VR646RBLU</b> <b>VR646RED</b> <b>VR646GLD</b>	FRONT 	F	<b>TRIUMPH</b> Trident 750 92-98 Sprint 900 93 Trident 900 92-98 Trophy 900 92-93 Trophy 1200 92-93	296	<b>MD652</b> <b>MD652C</b>	FRONT	S	<b>BMW</b> K 1200 RS 96-00 K 1200 LT 97-00 R 850 C 97-00 R 850 GS 96-00 R 850 R 94-96 R 850 RT 96-01 R 1100 GS 93-99 R 1100 R 93-96 R 1100 RT 94-01 R 1150 GS (Evo - R21/0415/0495)11-01-03 R 1150 GS (R21/0415/0495) 98-10/01 R 1150 GS Adventure 07/01-06 R 1200 00-02 R 1200 C 96-04 R 1200 CL 02-04	305
<b>MD647X</b> <b>MD647XC</b> (6 bolt disc) <b>VR647BLK</b> <b>VR647BLU</b> <b>VR647RED</b> <b>VR647GLD</b>	FRONT 	F	<b>TRIUMPH</b> Sprint ST 99-04 T509 Speed Triple 885/955cc 97-01 T595 Daytona/955i 97-00 Sprint RS 99-04	320					
<b>MD648</b> <b>MD648C</b> <b>VR648</b>	REAR	S	<b>TRIUMPH</b> Daytona 600 03-04 TT 600 00-03 Speed Four 600 02-05 Daytona 650 05 Daytona 675 06-12 Daytona 675 R (Brembo calipers) 11-12 Street Triple 675 (Naked) 07-12 Street Triple R 675 09-12 T509 Speed Triple 885/955c 97- Speed Triple 02-04 T595 Daytona/955i 97-00 Daytona 955i 01-06 Speed Triple 1050 05-13 Speed Triple R 1050 12-13	220	<b>MD653</b> <b>MD653C</b>	REAR	S	<b>BMW</b> R 850 GS 96-00 R 850 R 94-02/06 R 850 RT 96-01 R 850 RT 06 R 1100 GS 93-99 R 1100 R 93-01 R 1100 S 96-06 R 1100 RT 94-01 R 1150 GS (Evo - R21/0415/0495)11-01-03 R 1150 GS (R21/0415/0495) 98-10/01 R 1150 GS Adventure 07/01-06 R 1150 R 01-06 R 1150 RS 01-06 R 1150 RT 00-06 R 1150 R Rockster 03-06	276
<b>MD649</b> Note: Floating conversion kit available MD601LS/RS	FRONT	S	<b>TRIUMPH</b> America (Cast wheels) 07-09 Bonneville 800 01-06 Bonneville T100 02-09 Bonneville America 02-06 Bonneville/Bonneville Black 07-08 Scrambler (865cc) 06-09 Speedmaster (790cc) (Carb) 03-04 Speedmaster (865cc) 05-07 Speedmaster (865cc/EFI) 08-10 Thunderbird Sport 98-00 Tiger 885i (From VIN 71699) 98-99 Tiger 900 885cc 97-99 Tiger 955cc Spoke wheel 99-04	310	<b>MD656LS</b> <b>MD656RS</b> 4 bolt fixing	FRONT /REAR	F	<b>TRIUMPH</b> T 140 V Bonneville Drum Rear Brake / 5 Speed Gearbox 73-74 T 140 V Bonneville Disc All Round / 5 Speed Gearbox 75-78 T 140 Silver Jubilee Bonneville 77 T 140 E Bonneville 78-83 T 140 D Bonneville (Lester Alloy wheels) 79-81 T 140 ES (750cc) (Electric Start) 80-81 T 140 E/ES (750cc) (Executive /Alloy Wheels) 81-83 T 150 V (Trident 3 cyl) 73-74 T 150 V (Trident 3 cyl) 73-74 T 160 V (Trident 3 cyl) 75 TSS 750 (8 valve) 83 TSX 750 83	250
<b>MD650</b>	FRONT	S	<b>BMW</b> F 650 (E169/0161)/Standard 09/93-96 F 650 (E169/0162) (Funduro /HighScreen) (19" front wheel) 97-00 F 650 ST (E169/0163/168) Strada (18" front wheel/low screen) 97-00	300					

**D = Dished Solid Original (We replace with floating rotor conversion unit) F = Floating Rotor S = Solid Rotor SF = Solid Flat Original Disc which we replace with fully floating unit - fits direct no mods required.**







# STREETBIKE DISC BUYERS GUIDE

DISC No.	FRONT/ REAR	TYPE	MODELS	DIA (MM)	DISC No.	FRONT/ REAR	TYPE	MODELS	DIA (MM)
MD657LS MD657RS 	FRONT	D	<b>DUCATI</b> 500 Pantah 79 600 Pantah 81	260	MD669X MD669XC (5 bolt fixing) VR669BLK VR669BLU VR669RED VR669GLD 	FRONT	F	<b>TRIUMPH</b> Speed Triple 02-04 Daytona 955i 01-04 Sprint 1050 ST 05-10 Rocket III 2300 04-09 Rocket III Classic 07-09 Rocket III Roadster - ABS 10-13 Rocket III Touring 08-13	320
	REAR	D	<b>DUCATI</b> 500 Pantah 79	260		REAR	S	<b>LAVERDA</b> Bolt On - Ring Only	280
MD658	REAR	S	<b>APRILIA</b> AF1 125 87-91	240	MD659 (6 bolt fixing)	FRONT/REAR	S		
MD659	REAR	S	<b>APRILIA</b> RS 125 92-95	220	MD670	FRONT/REAR	S		
MD660LS MD660RS 	FRONT	F	<b>APRILIA</b> RS 250 All models 95-02 <b>CAGIVA</b> 650 Raptor 00-07 1000 Raptor 00-05	298	MD671	REAR	S	<b>BMW</b> F 650 GS (K72/0218/0228) (798cc twin cylinder/cast wheels) 07-12 F 650 GS (30 Years GS) 11 F 700 GS 13 F 800 GS 08-13 F 800 GS (30 Years GS) 11 F 800 GS Triple Black 12 F 800 GS Trophy 12 F 800 GT 13 F 800 R (Disc has fixed bobbins) 09-13 F 800 R Chris Pfeiffer Edition 09-11 F 800 ST (Full fairing) 06-12 F 800 ST Touring 10-12 F 800 S (Half fairing) 06-10 HP 2 Enduro 05-08 HP2 Megamoto (K25) (Disc has fixed bobbins) 07-10 HP2 Sport (K29) (Disc has fixed bobbins) 08-11 K 1200 S (K40) 05-08 K 1200 R Sport 07-08 K 1200 R (K27/0378) Tokico Caliper Disc with fixed buttons 12/07-10 K 1200 R (K27/0378) Tokico Caliper Disc with loose buttons 11/05-11/07 R 1200 GS (K25/0307/Cast/Spoke wheel) Disc with loose bobbins 02-11/07 R 1200 GS/M (K25/0303/Cast/ /Spoke wheel) Disc has fixed bobbins 06-09 R 1200 GS Adventure (K25/0382 /Spoke wheel) Disc has loose bobbins 05-11/07 R 1200 GS Adventure/M (K25/0380 /Spoke wheel) Disc has fixed bobbins 06-09 R 1200 GS Adventure (Spoke wheels) (Disc has fixed bobbins) 10-12 R 1200 GS (Cast wheels) (Disc has fixed bobbins) 10-12 R 1200 GS Adventure (30 Years GS) (Disc has fixed bobbins) 11 R 1200 GS Triple Black 11-13 R 1200 GS (30 Years GS) 11 R 1200 GS Rallye (Spoke wheels) 12 R 1200 GS Adventure Triple Black 12 R 1200 GS (Liquid Cooled /Radial front caliper) 13 R 1200 RSE (Disc has fixed bobbins) 10-11 R 1200 RT K26/0368 Brembo Caliper Disc has loose bobbins 05-11/07 R 1200 RT (Disc has fixed bobbins) 10-13 R 1200 RT-SE (Disc has fixed bobbins) 10-13 R 1200 R Classic 11-13 R 1200 R 12/07-13 R 1200 ST K28/0328 Disc has loose bobbins 03-11/07 R 1200 S K29/0366 - Brembo caliper Disc with loose bobbins 06-11/07 R 1200 S K29/0366 - Brembo caliper Disc with fixed bobbins 12/07-08 R 1200 RT K26/0368 Brembo caliper Disc has fixed bobbins 12/07-09 R 1200 ST K28/0328 (Disc has fixed bobbins) 12/07-08 K 1300 R 09-12 K 1300 R Dynamic 11-13 K 1300 R Carbon 12 K 1300 S (Non & ABS Models) 09-13 K 1300 S Sport 13	265
MD661 	REAR	F	<b>BMW</b> K 75 S ABS 85-95 K 75 RT (ABS) 89-96 R 1100 RS 92-01 K 100/2 (ABS 8 valve model) 87-90 K 100 LT (ABS 8 valve model) 86-91 K 100 RS (ABS 8 valve model) 83-89 K 100 RT (non-ABS 8 valve) 10/88-89 K 100 RT (ABS 8 valve) 83-89 K 100 RS (16 valve ABS) 89-92 K1 (16 valve ABS model) 88-93 KL 1100 LT (ABS) 89-07/93 KL 1100 LT (Non ABS) 08/93-99 KL 1100 (ABS Model) 08/93-99 K 1100 RS (All models) 92-96 K 1200 RS (All models) 96-04 K 1200 GT 03-06	285	MD662X MD662XC VR662BLK VR662BLU VR662RED VR662GLD 	FRONT	F	<b>TRIUMPH</b> Daytona 600 03-04 TT 600 00-03 Speed Four 600 02-05 Daytona 650 05	310
MD663 MD663C VR663	REAR	S	<b>TRIUMPH</b> Daytona 650 05 Bonneville 800 01-06 Bonneville 865cc (Cast wheels) 09-13 Bonneville SE 865cc (Cast wheels) 09-12 Bonneville T100 02-13 Bonneville/Bonneville Black 07-08 Bonneville Steve McQueen SE 12 Scrambler (865cc) 06-13 Sprint RS 99-04 Tiger 800 11-12 Tiger 800 XC 11-12 Thrupton 900 04-12 Sprint 1050 ST 05-10 Tiger 1050 07-12 Tiger 1050 SE-ABS (1050cc) 10-13	255	MD664 MD664C (6 bolt fixing)	REAR	S	<b>APRILIA</b> RS 50 99-06 Tuono 50 03-04 RS 125 (2T) 96-13 Tuono 125 03-04	220
MD665	REAR	S	<b>APRILIA</b> RS 250 95-02	220	MD666X MD666XC 	FRONT	F	<b>APRILIA</b> RSV 1000 Mille / Mille R 00 SL 1000 'Falco' 00-04 <b>CAGIVA</b> Raptor X3 1000 03-04	320
MD667 	FRONT	F	<b>MOTO GUZZI</b> 1000 Daytona 92-95	299	MD668LS/RS 	FRONT	F	<b>LAVERDA</b> 1000 SFC 85-86	299

DISC BUYERS GUIDE

D = Dished Solid Original (We replace with floating rotor conversion unit) F = Floating Rotor S = Solid Rotor  
SF = Solid Flat Original Disc which we replace with fully floating unit - fits direct no mods required.

# STREETBIKE DISC BUYERS GUIDE

DISC No.	FRONT/ REAR	TYPE	MODELS	DIA (MM)	DISC No.	FRONT/ REAR	TYPE	MODELS	DIA (MM)
MD671 Contd.	REAR	S	<b>BMW</b> K 1300 S HP 12 <b>HUSQVARNA</b> Nuda 900 (inc ABS) 12-13 Nuda 900 R (inc ABS) 12-13	265	MD685LS	FRONT	S	<b>APRILIA</b> RS 50 (Radial Caliper) 06-11 RS4 50 (4T) 11-13 RS4 125 (4T) 11-13 <b>DERBI</b> GPR 50 Nude 04-09 GPR 50 (2T) 09-12 GPR 50 Racing 08-10 GPR 50 04-07 GPR 125 Nude 04-08 GPR 125 Racing 04-07 Mulhacen 125 Cafe Cast wheel/radial caliper 08-10 <b>GILERA</b> SC 125 06-07	300
MD672LS	FRONT	S	<b>APRILIA</b> RS 50 (5 bolt fixing) 99-06 Tuono 50 04 <b>MBK</b> TZR 50 X Power 03-10 <b>YAMAHA</b> TZR 50 03-13	280	MD686	REAR	S	<b>APRILIA</b> RS 50 (Radial Caliper) 06-11 <b>DERBI</b> GPR 50 (40mm Forks/180mm Rear Disc/Radial Caliper) 04-07 GPR 50 Racing (40mm Forks/180mm Rear Disc/Radial Caliper) 08-10 GPR 50 2T (41mm Forks/218mm Rear Disc/Radial Caliper) 09-11 GPR 50 Nude (Radial Caliper) 04-07 GPR 125 Racing (Radial caliper) (2T) 04-09 GPR 125 Nude (Radial caliper) (2T) 04-08 <b>GILERA</b> SC 125 06-07	180
MD673LS 	FRONT	F	<b>APRILIA</b> Moto 6.5 95-01	296	MD687	FRONT	S	HP2 "Enduro" 05-09 R 1100 S 96-00 R 1200 GS (K25/0307/317/Cast/Spoke wheel) Disc with loose bobbins 02-11/07	305
MD674	REAR	S	<b>APRILIA</b> Moto 6.5 95-01	220	MD688	REAR	S	K 1200 GT (K44) 06-08 K 1300 GT 09-11 K 1300 GT EE (Disc has fixed bobbins) 10-11 K 1300 GT SE (Disc has fixed bobbins) 10-11	294
MD675LS MD675RS 	FRONT	F	<b>MV AGUSTA</b> 750 F4S (Mono Posto) 99-04	310	MD689 MD689C	REAR	S	<b>HYOSUNG</b> Comet GT 125 (Naked) 04-06 GT 125 Naked 06-12 GT 125 R 06-13 Comet GT 250 04-05 Comet GT 250 (Naked) 04-06 GT 250 (Naked) 06-12 GT 650 Naked 07-12 GT 650 R 07-13 GT 650 S 05-08 GT 650 X 07 Comet GT 650 (Naked) 04-06 Comet GT 650 R 04-06 Comet GT 650 S 05-06 <b>SUPERBYKE</b> R-SR 250	230
MD676 Black Hub	FRONT	F	<b>TRIUMPH</b> Tiger 955 From VIN 198875 04-06	310	MD690 MD690C	FRONT	F	<b>HYOSUNG</b> GT 125 Naked 06-12 GT 125 R 06-12 GT 250 (Naked) 06-12 GT 250 R 07-12 Comet GT 250 04-05 GT 650 Naked 07-12 GT 650 R 07-12 GT 650 S 05-08 GT 650 X 07 <b>SUPERBYKE</b> R-SR 250	300
MD677	REAR	S	<b>TRIUMPH</b> Tiger 955 From VIN 198875 04-06	285	MD691	FRONT	F	<b>HYOSUNG</b> GV 650 (EFI) 07-12 GV 700 C 06-09 S7 06-13	300
MD678 	FRONT	F	<b>VICTORY</b> Victory Models 03-13	300					
MD678	REAR	F	<b>VICTORY</b> Victory Models 03-13	300					
MD679X MD679XC VR679BLK VR679BLU VR679RED VR679GLD 	FRONT	F	<b>TRIUMPH</b> Speed Triple 1050cc 06-07 Tiger 1050 07-12 Tiger 1050 SE 10-12	320					
MD680 MD680C 	FRONT	F	<b>KTM</b> SMC 950 Supermoto 05-06 990 Supermoto T (SM-T) 08-13 990 Supermoto R SM-R 08-13	305					
MD681 VR681	REAR	S	<b>KTM</b> 690 Duke 08-13 690 Duke R 10-11 SMC 950 Supermoto 05-06 990 Adventure R 09-10 990 Adventure (ABS) 07-10 990 Superduke 05-11 990 Superduke R 07-13 990 Supermoto T (SM-T) 08-13 990 SM-R Supermoto R 08-13	240					
MD682	FRONT	S	<b>DUCATI</b> Multistrada 1000 DS 03-06 Multistrada S DS 1000 05-06 Multistrada 1100 (1078cc) 07-09 Multistrada 1100 S (1078cc) 07-09	320					
MD683RS 	FRONT	F	<b>SACHS HERCULES</b> Roadster 650 01-05	316					
MD684LS	FRONT	F	<b>NORTON</b> F1 (Rotary) P55 Model 90 F1 (Rotary) P55 B Model 90-91	320					

D = Dished Solid Original (We replace with floating rotor conversion unit) F = Floating Rotor S = Solid Rotor  
SF = Solid Flat Original Disc which we replace with fully floating unit - fits direct no mods required.

# STREETBIKE DISC BUYERS GUIDE

DISC No.	FRONT/ REAR	TYPE	MODELS	DIA (MM)	DISC No.	FRONT/ REAR	TYPE	MODELS	DIA (MM)
MD692 MD692C	REAR	S	<b>MOTO GUZZI</b> 1000 Daytona RS 97-98 1000 V10 Centauro GT 97-99 1000 V10 Centauro Sport 97-99 California 1100 Aluminium 02-05 California 1100 Classic 06-09 California 1100 EV 01- California 1100 Jackall 99-01 California 1100 Metal 02-03 California 1100 Special 99-00 California 1100 Sport 01-02 California 1100 Stone 01-05 California 1100 Titanium 04-05 California 1100 Touring 06-07 California 1100 Vintage 06-10 1100 California Aquila Nera 09-11 1100 California Classic Touring 06-08 1100 California EV 97-02 1100 California EV Touring 03-05 1100 California Jackal 94-01 1100 California Special 99-00 1100 California Sport 01-02 1100 California Stone 01-05 1100 California Stone Metal 02-03 1100 California Vintage 06-12 1100 California 1100 190 12 1100 V11 Ballabio 03-05 1100 V11 Le Mans 01-05 1100 V11 Sport 99-01 1100 V11 Scuro 01-03 1100 V11 Naked 02-03 V11 (All models) 99-06 Le Mans (All models) 01-04 Brevia 1200 08-09 Norge 1200 (ABS) All models 06-09 Stelvio 1200 08-11 Stelvio NTX 1200 (4 Valve) (Radial Caliper/ABS) 09-11	282	MD695 MD695C VR695	REAR	S	<b>DUCATI</b> 1098 07-08 1098 S 07-08 1098 R 08-09 Monster 1100 Evo 20th Anniversary Model 13 Streetfighter 1100 (1099cc) 09-11 Streetfighter 1100 S (1099cc) 09-13 1198 09-11 1198 S 09-10 1198 R Corse 10 1198 S Corse 10 1198 SP Corse 11	245
MD693LS MD693RS	FRONT/ REAR	F	<b>MOTO GUZZI</b> 750 SP 90-92 750 Nevada 91-01 1000-1000 SP111 (No spoke cast wheels/flat floating front discs) 89-94 1000 - California III - Carbs (VY Chassis Code/Full fairing/Cast & spoke wheels) 88-90 1000 - California III - Carbs (VW Chassis Code/Screen only) 87-93 1000 - California III - EFI (VY Chassis Code /Full fairing/cast & spoke wheels) 90-93 1000 - Le Mans 1V/V (10 spoke cast wheel) 84-93 1100 - California - Carbs (KC/KD Chassis codes) 94-97	270	MD697 MD697C	REAR	S	<b>APRILIA</b> RST Futura 1000 01-04	255
					MD698LS	FRONT	S	<b>DERBI</b> Senda 125 Baja SM (4T) (300mm disc) 06-12 Senda 125 SM (Twin headlight) 04-07 Senda R 125 04	300
MD694X MD694XC VR694BLK VR694BLU VR694RED VR694GLD	FRONT	F	<b>DUCATI</b> 848 Evo Corse SE 12-13 Desmosedici RR (D16RR/989cc) 08 1098 07-08 1098 S 07-08 1098 R 08-09 1098 S Tricolore 07 Streetfighter 1100 (1099cc) 09-11 Streetfighter 1100 S (1099cc) 09-13 1198 09-11 1198 S 09-10 1198 R Corse 10 1198 S Corse 10 1198 SP Corse 11 1199 Panigale 12-13 1199 Panigale ABS 12-13 1199 Panigale S ABS 12-13 1199 Panigale S Tricolore 12-13 1199 Panigale R 13	330	MD711LD MD711RD	FRONT	F	<b>YAMAHA</b> TZ 125 94-97 TZ 250 89-96	282
					MD713	REAR	S	<b>HONDA</b> RS 125 88-07 MD 250 H 08-11 MD 250 S 08-11	185
					MD719LS/RS	FRONT	F	<b>BUELL</b> All models (Countersunk fixing)	94- 340
					MD724	REAR	S	<b>HONDA</b> RS 250 88-02	198
					MD727	FRONT	F	<b>VICTORY</b> Victory Models 98-04	300
					MD727	REAR	F	Victory Models 98-04	
					MD730LD MD730RD	FRONT	F	<b>YAMAHA</b> TZ 250 97-01 TZ 250 (Radial Calipers) 02-10	298

DISC BUYERS GUIDE

**D = Dished Solid Original (We replace with floating rotor conversion unit) F = Floating Rotor S = Solid Rotor**  
**SF = Solid Flat Original Disc which we replace with fully floating unit - fits direct no mods required.**



# STREETBIKE DISC BUYERS GUIDE

DISC No.	FRONT/ REAR	TYPE	MODELS	DIA (MM)	DISC No.	FRONT/ REAR	TYPE	MODELS	DIA (MM)
MD732	REAR	S	<b>YAMAHA</b> TZ 125 94-97 TZ 250 89-90/92-01 TZ 250 (Radial Calipers) 02-10	185	MD806LS	FRONT	S	<b>CAGIVA</b> Mito 50 98-99 <b>DERBI</b> GPR 50 Replica Racing 99-03 GPR 50 R 97-01 <b>SACHS (HERCULES)</b> Madass 50 (2 stroke) (Hydraulic rear brake) 04-05 Madass 50 (4 stroke mechanical rear brake) 04-05 Madass 50 (4T) 06-09 Madass 125 05 Madass 125 (4T) 06-09	260
MD733RD	FRONT	F	<b>DISCONTINUED</b>	276					
MD734RS	FRONT	F	<b>HARLEY DAVIDSON</b> M2 Cyclone, X1 Lightning 00-05	340					
MD735RS	FRONT	S	<b>BUELL</b> See application pages for fitments	375					
MD800X MD800XC VR800BLK VR800BLU VR800RED VR800GLD	FRONT	F	<b>TRIUMPH</b> Daytona 675 06-12 Street Triple 675 (Naked) 07-12 Street Triple R 675 09-12	308	MD807LS	FRONT	F	<b>DERBI</b> Cross City 125 07-13 Mulhacen 125 (4T) Up to Ref No. 7N001790 Spoke wheel /2 pin pad fixing 07 Mulhacen 125 (4T) From Ref No. 7N001791 Spoke wheel /single pin fixing 07-11 Terra 125 Adventure 09-13 Terra 125 Euro (Single pin pad fixing) 07-11	280
MD801	FRONT	S	<b>CAN-AM</b> Spyder RS SES 990cc 08-09 Spyder RS SMS 990cc 08-09 Spyder RS Phantom Black 09 Spyder RS-S 10-12 Spyder RS 10-12 Spyder RT-S 10-12 Spyder RT 10-12 Spyder RT Ltd 10-12 Spyder SM5 GS990 (3 wheeler) 08-11 Spyder SE5 GS990 (3 wheeler) 08-11	250	MD808	REAR	S	<b>DERBI</b> Senda DRD Racing 50 SM (300mm disc/std mounted caliper) 04-11 Senda DRD Racing 50 R (300mm disc/std mounted caliper) 04-11 Senda DRD Racing 50 SM (300mm disc/radial caliper) 05-13 Cross City 125 07-13 Mulhacen 125 (4T) Up to Ref No. 7N001790 Spoke wheel /2 pin pad fixing 07 Mulhacen 125 (4T) From Ref No. 7N001791 Spoke wheel/single pin fixing 07-11 Senda 125 Baja R (4T) (260mm disc) 06-12 Senda 125 Baja SM (4T) (300mm disc) 06-12 Senda 125 SM (Twin headlight) 04-07 Senda R 125 04 Terra 125 Euro (Single pin pad fixing) 07-11 Terra 125 Adventure 07-13	218
MD802	REAR	S	<b>CAN-AM</b> Spyder RS SES 990cc 08-09 Spyder RS SMS 990cc 08-09 Spyder RS Phantom Black 09 Spyder RS-S 10-12 Spyder RS 10-12 Spyder RT-S 10-12 Spyder RT 10-12 Spyder RT Ltd 10-12 Spyder SM5 GS990 (3 wheeler) 08-11 Spyder SE5 GS990 (3 wheeler) 08-11	250	MD809 MD809C	FRONT	S	<b>BMW</b> G 650 Xchallenge 07-09 G 650 Xcountry 07-09	300
MD803	FRONT	S	<b>BMW</b> F 800 ST (Full fairing) (Disc has loose bobbins) 06-08 F 800 S (Half fairing) (Disc has loose bobbins) 06-08 R 1100 S (Non ABS) 12/00-03 R 1200 RT K26/0368 Brembo Caliper Disc has loose bobbins 05-11/07 R 1200 ST K28/0328 Disc has loose bobbins 03-11/07 R 1200 S K29/0366 - Brembo caliper Disc with loose bobbins 06-11/07	320	MD810 MD810C	REAR	S	<b>BMW</b> G 650 Xchallenge 07-09 G 650 Xcountry 07-09	240
MD804	FRONT	S	<b>BMW</b> K 1200 R Sport 07-08	320	MD811	FRONT	F	<b>APRILIA</b> RX 50 06-13 SX 50 06-13 <b>DERBI</b> Senda DRD Racing 50 SM (300mm disc/std mounted caliper) 04-11 Senda DRD Racing 50 R (300mm disc/std mounted caliper) 04-11 Senda DRD Racing 50 SM (300mm disc/radial caliper) 05-13	300
MD805	REAR	S	<b>CAGIVA</b> Super City 50/80 93-95 Prima 50 92-94 Mito 50 98-99 <b>DERBI</b> GPR 50 Replica Racing 99-03 GPR 50 R 97-01 Senda DRD Racing 50 R (Spoke wheel) 11-12 Senda DRD Racing 50 SM (Cast wheel) 11-12 Senda DRD X-treme 50 R (Spoke wheel/21" front wheel) 11-12 Senda DRD X-treme 50 SM (Cast wheel/17" front wheel) 11-12	220	MD812	REAR	S	<b>KTM</b> RC8 (1190cc) 08-11 RC8 R/Track (1190cc) 09-12	220
					MD813	FRONT	F	<b>CCM</b> CR 40 Cafe Racer (Handlebar fairing) 07-08	300
					MD814	FRONT /REAR	S	<b>DAELIM</b> History 125 (SL 125) 01-06 Roadwin (VJ125) 04-13 Roadsport R 125 Fi (VJF 125) 08-12	220
					MD815	REAR	S	<b>SACHS (HERCULES)</b> XTC 125 Supersport 00-07 XTC 125 08	220
					MD816	REAR	S	<b>NORTON</b> F1 (Rotary) P55 Model 90 F1 (Rotary) P55 B Model 90-91	230

**D = Dished Solid Original (We replace with floating rotor conversion unit) F = Floating Rotor S = Solid Rotor SF = Solid Flat Original Disc which we replace with fully floating unit - fits direct no mods required.**



# STREETBIKE DISC BUYERS GUIDE

DISC No.	FRONT/ REAR	TYPE	MODELS	DIA (MM)	DISC No.	FRONT/ REAR	TYPE	MODELS	DIA (MM)
<b>MD817X</b> <b>MD817XC</b> <b>VR817BLK</b> <b>VR817BLU</b> <b>VR817RED</b> <b>VR817GLD</b> <b>VR817GLD</b>	FRONT	F	<b>TRIUMPH</b> Speed Triple (1050cc) Brembo Radial Caliper 08-13 Sprint GT 1050i ST (ABS/Non ABS)10-13 Speed Triple R 1050 12-13 Trophy 1215cc 12-13 Trophy 1215cc SE 12-13	320	<b>MD837</b>	FRONT	S	750 SEi (6 Cyl) 75- 900 SEi (6 Cyl) 83	300
<b>MD818</b>	FRONT	F	DISCONTINUED	305	<b>MD838</b>	FRONT /REAR	F	Various Meriden Triumphs 6 bolt fixing. See application pages	250
<b>MD819</b>	FRONT	F	<b>SACHS HERCULES</b> Roadster 800 02-05 B-805 03-04	320	<b>MD839</b>	FRONT	S	Planet 125 (6 spoke wheels) 98-03	230
<b>MD820</b> <b>MD820C</b>	REAR	S	Sprint GT 1050 (ABS) 10-13 Sprint 1050 ST 05-10 Tiger Sport 1050cc 13	255	<b>MD840</b>	REAR	S	850 Brevia ie 06-07 850 Griso 06-07 940 Bellagio 07-13 1100 Brevia (STD/ABS Models) 05-07 1100 Griso 05-08 1200 Brevia 08-09 1200 Griso 8V 07-12 1200 Norge 06-07 1200 Norge GT 8V 08-12 1200 Sport 06-07 1200 Sport 4V 08-12 1200 Stelvio 08 1200 Stelvio NTX ABS 09-10 1200 Stelvio 8V NTX 11-12 1200 Stelvio 8V 11-12	282
<b>MD821</b> <b>MD821X/XC</b> Floating conversion	FRONT	S	America (12 spoke Cast Wheel 865cc) 10-13 Bonneville 865cc (Cast wheels) 09-13 Bonneville SE 865cc (Cast wheels) 09-11 Speedmaster (865cc/EFi) 11-13	310	<b>MD841X/XC</b> <b>VR841BLK</b> <b>VR841BLU</b> <b>VR841RED</b> <b>VR841GLD</b>	FRONT	F	<b>DUCATI</b> Diavel Chromo ABS 12 Diavel AMG 11-12 Diavel Strada 13 Diavel Dark 13 749 Monoposto/Biposto 03-06 796 Monster (inc ABS) 10-13 Monster 796 20th Anniversary Model 13 848 Streetfighter 11-13 Monster Diesel 1100 13 1100 Monster 09-10 1100 Monster Evo 11-13 Monster 1100 Evo 20th Anniversary Model 13 1200 Multistrada ABS 10-12 1200 Multistrada 1200 S Pikes Peak SE 11-12 Multistrada 1200 S Granturismo 13	320
<b>MD822</b>	FRONT	S	Scrambler (865cc) 10-13 Bonneville T100 (Spoke wheel) 10-13 Bonneville Steve McQueen SE 12	310					
<b>MD823</b>	FRONT	F	DISCONTINUED	320	<b>MD842X</b> <b>VR842BLK</b> <b>VR842BLU</b> <b>VR842RED</b> <b>VR842GLD</b>	FRONT	F	<b>TRIUMPH</b> Tiger 800 XC 11-13 Tiger Explorer 1200 12 Tiger Explorer 1200 XC 13	305
<b>MD824</b>	FRONT	F	DISCONTINUED	320					
<b>MD825</b>	FRONT	F	Thunderbird (1597cc) 09-13 Thunderbird Storm (1699cc) 11-13	310	<b>MD843X</b> <b>MD843XC</b> <b>VR843BLK</b> <b>VR843BLU</b> <b>VR843RED</b> <b>VR843GLD</b>	FRONT	F	<b>DUCATI</b> 848 (Radial 2 pad caliper) 08-10 848 Evo (Monobloc front calipers) 10-13 848 Evo Dark 12 S4RS Monster (998cc) (Radial 4 pad caliper)06 S4R Testastretta Monster (998cc) (Radial 4 pad caliper) 07-08 S4RS Testastretta Monster (998cc) (Radial 4 pad caliper) 07- S4RS (Tricolore Monster/Testastretta) (998cc) (Radial 4 pad caliper)07-08	320
<b>MD826</b>	FRONT	F	DISCONTINUED	320	<b>MD850</b>	REAR	S	<b>KTM</b> Duke 390 13	230
<b>MD827</b>	REAR	S	<b>SINNIS</b> Stealth 125 QM125-2D 08-10	240	<b>MD851</b>	REAR	S	<b>TRIUMPH</b> Street Triple 675R 13 Daytona 675	220
<b>MD828</b>	FRONT	S	<b>SINNIS</b> Vista 125 QM125 2C 08-10	276	<b>MD852X</b> <b>MD852XC</b>	FRONT	F	<b>TRIUMPH</b> Street Triple 675R 13 Daytona 675 Daytona 675 R 13	310
<b>MD829</b>	FRONT	S	<b>SINNIS</b> Max 125 QM125-2V 08-09	267	<b>MD853</b>	FRONT	S	<b>CAN-AM</b> Spyder RT Brembo calipers 13 Spyder RT-S Brembo calipers 13 Spyder RT Ltd Brembo calipers 13 Spyder ST Brembo calipers 13 Spyder ST-S Brembo calipers 13 Spyder ST Ltd Brembo calipers 13 Spyder RS Brembo calipers 13 Spyder RS-S Brembo calipers 13	270
<b>MD830</b>	FRONT	F	DISCONTINUED	320					
<b>MD831</b>	REAR	S	Thunderbird (1597cc) 09-13 Thunderbird Storm (1699cc) 11-13	310					
<b>MD832</b>	REAR	S	HP4 13 HP4 Carbon 13 S 1000 RR 10-13 S 1000 RR Sport 12-13	220					
<b>MD833</b>	REAR	S	GPR 50 (2T) 09-11 RS4 50 (4T) 11-13 RS4 125 (4T) 11-13	218					
<b>MD834</b>	FRONT	F	F 650 CS Scarver (K14/0174 /0184 Belt Drive) 00-03 F 650 CS Scarver (K17/0177 /0187 Belt Drive) 04-07 F 650 GS (R13/0172/0182) (19" front wheel) 99-03 F 650 GS Dakar (R13/0173/0183) (21" front wheel) 99-03 F 650 GS Dakar (R13/0176/0186) 04-07 F 650 GS (R13/0175/0185) 04-07 F 650 GS (K72/0218/0228) (798cc twin cylinder/cast wheels) 07-12 F 650 GS (30 Years GS) 11 G 650 GS (R131) 09-13 <b>HUSQVARNA</b> TR 650 Terra (Spoke Wheel) 12-13 TR 650 Strada (Cast Wheel) 12-13	300					
<b>MD835</b>	FRONT	F	1000 - California III - Carbs 88-90 1000 - California III - EFi 90-93 1100 - California Carbs 94-97	300					
<b>MD836C</b>	FRONT	S	Senda SM DRD Racing Ltd (SR2A2B Model/Cast Wheels)	240					

DISC BUYERS GUIDE

**D = Dished Solid Original (We replace with floating rotor conversion unit) F = Floating Rotor S = Solid Rotor SF = Solid Flat Original Disc which we replace with fully floating unit - fits direct no mods required.**



# STREETBIKE DISC BUYERS GUIDE

DISC No.	FRONT/ REAR	TYPE	MODELS	DIA (MM)	DISC No.	FRONT/ REAR	TYPE	MODELS	DIA (MM)
MD854	REAR	S	<b>CAN-AM</b>	270	MD904D MD904C VR904	FRONT	S	<b>ADLY</b>	155
			Spyder RT-S Brembo calipers 13 Spyder RT Ltd Brembo calipers 13 Spyder ST Brembo calipers 13 Spyder ST-S Brembo calipers 13 Spyder ST Ltd Brembo calipers 13 Spyder RS Brembo calipers 13 Spyder RS-S Brembo calipers 13					Road Tracker 50/90/100 04-06 <b>APRILIA</b> Amico (All models) 93- <b>GARELLI</b> Queenie 95- Grinta 95- <b>GILERA</b> Easy Moving 50 95-96 <b>JORDAN</b> Easy 50/100 03-04 <b>MALAGUTI</b> Malbo Line - DVD 50 (2T) 10-11 <b>MBK</b> CR 50 Z Target 91-95 CW 50 R Booster Road 94-95 CV 50 Evolis 97 CY 50 Forte/Forte Mufa 96-97 YA 50 R Forte 94-95 YE 50 Evolis 92-95 YM 50 Fizz 94-95 CV 80 Evolis 97 <b>MOTO-ROMA</b> Go-Go 50 97-05 Stinger 50 99-05 Scrambler 50 01 Roadrunner 50/100 01-02 <b>MUZ</b> Moskito FB50 97-03 Moskito SX JP50 00-03 <b>PIAGGIO</b> Zip Fast Raider 93-97 Zip 50 Base 95-96 Zip 50 RST 96-99 Zip 50 Elettrico 02 <b>PEUGEOT</b> Scooters with Leleu wheels disc attached with counterbored bolts Ludix Snake/Bullet/Trend 50cc 04 <b>P.G.O.</b> Big max 50 94-06 EPS 97 Tornado 50/125 97 <b>SINNIS</b> Jet 50 QM50QT-6A 08-10 M-Ped 50 Road Classic <b>SUPERBYKE</b> Falcon 50 QM50QT-2T 08-10 <b>YAMAHA</b> CR-Z 50 (3WN) 91-95 YA 50 R Axis (4pc) 95-96 YE 50 Zest 93-95 YM 50 Breeze (4KH) 94-95 Jog 'R' 91-	
MD901D MD901C VR901 With counter sunk bolt holes	FRONT & REAR	S	<b>ATALA</b> Hacker (LC) 97 Hacker (Racing) 97 Hacker 97 <b>BETA</b> Eickon 50 99-06 Quadra 50 97-00 Tempo 50 98-02 ARK LC/AC 97-13 <b>GOVECS (Electric Scooters)</b> GO S 1.2 11-13 GO T 1.2 11-13 GO S 1.4 11-13 GO S 2.4 11-13 GO T 2.4 11-13 GO S 3.4 11-13 GO T 3.4 11-13 <b>MALAGUTI</b> Ciak 50 Twin Disc 00-03 Ciak 100 99-01 Ciak 50/100 00-03 Phantom F12 50 (LC) 94-08 F12 50 Phantom 98 Firefox F15 96-03 CROSSER CR1 97-01 F15 RR 99-01 F15 Firefox (LC) 01-08 F15 Firefox Kat 98-00 <b>PEUGEOT</b> Scooters with Grimeca Wheels Disc attached with countersunk bolts Elyseo 50 98-02 Looxor 50 TSDi 06 Ludix Elegance 50cc 04 Ludix Pro (14" wheels/4T) 11 Metal-X 50 02-03 TRK 50 (2T) (10" wheels) 09-12 TRK 50 (2T/12" wheels) 09-12 Trekker 50 (2T) AJP Caliper 98-00 Trekker 50 (2T) Heng Tong Caliper 98-00 Vivacity 50 (12" wheels) 92-07 Vivacity 2 (50cc) (10" wheels) 08-11 Vivacity 50/100 (All models) 99-07 SV 100 L Looxor 100 01-04 Trekker 100 (2T) 98 Ludix Ambition 125cc 04-05 <b>PIAGGIO</b> Quartz 50 92-96 <b>TAMORETTI</b> Retro 50 Retro 125 Stealth 125	190	MD905D	FRONT	S	<b>PIAGGIO</b> Hexagon 125/150 94-97	175
			MD902D VR902					FRONT	
MD903D MD903C VR903	FRONT	S	<b>YAMAHA</b> YP 250 DX/A 'Majesty' 98-00 YP 250 Majesty 96-02 YP 250 Skyliner 96-98 YP 250 Skyliner 250 (+ABS) 00-03 <b>MBK</b> YP 250 Skyliner 96-00	245	MD907D MD907C VR907	FRONT	S	<b>YAMAHA</b> YP 125 Majesty 98-09 XN 125 N Teo's 00-03 <b>MBK</b> XN 125/150 Doo Do 00-05 YP 125 D Skyliner 98-09	220
			MD908D VR908					FRONT	
					MD909D With counterbored holes	FRONT REAR	S	<b>BENELLI</b> 491 98-04 K2 50/100 98-01 Naked 50/100 02-03 <b>PEUGEOT</b> Scooter with Leleu wheels discs attached with counterbored bolts Ludix Elegance 50cc 04 Ludix Ambition 125cc 04	190

D = Dished Solid Original (We replace with floating rotor conversion unit) F = Floating Rotor S = Solid Rotor  
SF = Solid Flat Original Disc which we replace with fully floating unit - fits direct no mods required.

# STREETBIKE DISC BUYERS GUIDE

DISC No.	FRONT/ REAR	TYPE	MODELS	DIA (MM)	DISC No.	FRONT/ REAR	TYPE	MODELS	DIA (MM)						
MD910D MD910C VR910	FRONT	S	<b>PIAGGIO</b>	200	MD915D VR915	FRONT	S	<b>MALAGUTI</b>	155						
			Fly 50 (2T) 05-13 Fly 50 (4T) 05-13 Free 50 95-02 LX 50 (4T) 05-10 Sfera 50 RST 95-97 Zip 50 SP (L/C) 96-12 Free Delivery 50 00-02 Fly 100 (4T) 07-12 Free 100 02 Fly 125 (4T) 05-12 Sfera 125 95-97 Vespa ET4 125 96-99 Fly 150 (4T) 05-09 LX 150 (4T) 05-09 Hexagon LX 180 98-99 Hexagon LXT 180 98-99 Hexagon LX4 125 98-99 Super Hexagon GTX 125/180 00 Zip 125 00-01 Hexagon GT 250 98-99 Super Hexagon GTX 250 00-02 <b>GILERA</b> Ice 50 01-03 <b>DERBI</b> Atlantis 50 (4T) 07-09 Atlantis 50 (2T/AC) 12 7/5 spoke wheels/200mm disc/5 bolt From ref. 8G253172 07-11 Boulevard 50 (2T) 09-12 Boulevard 50 (4T) 09 Boulevard 125 (4T) 08-12 <b>LML</b> Star 125 (2T) 10-13 Star 125i (4T) 10-13 Star 125 Deluxe (2T) (Front disc) 01-03 Star 150 (2T) 10-13 Star 150 Deluxe (2T) (Front disc) 01-03 Star 151i (4T) 10-13 Star 151 (4T) All models 10-13 Star 200i (4T) 10-13 <b>VESPA</b> LX 50 (2T/4T) 05-13 S 50 (2T) 07-13 S 50 (4T/4V) 08-13 S 50 Sport (2T) 11-13 S 50 Sport (4T/4V) 11-13 ET2 50 97-05 ET4 50 00-04 LX 60 (Special Anniversary Model) 06 LX 125 (4T) 05-13 LX 125 (4T/Serie Speciali) 12 S 125 (4T) 07-13 S 125 Sport (4T) 11-13 ET4 125/150 99-05 PX 125 (Disc brake model) 98-13 LX 150 (4T/Serie Speciali) 12 PX 150 (Disc brake model) 98-13 S 150 Sport (4T) 11-12 S 150 (4T) 07-12 PX 200 (Disc brake model) 98-07	F10 Jet Line 96-07 F10 Jet Line WAP 06-10 F10 Tribal 08-10 Yesterday 98-03											
MD910D MD910C	REAR	S	<b>GILERA</b>		MD916D	FRONT	S	<b>YAMAHA</b>	180						
			DNA 50 01-06 Runner VX 125/180 01-04 <b>PIAGGIO</b> Super Hexagon GTX 125/180 00	BWS 50 Original 99-02 BW's 50 Naked (1D11/2B71) 03-04 BW's 50 Naked (2B7B/D/F/H) 09-13 BW's 50 (5WW1) 04 BW's 50 (5WW4/6/8/9/B/D/F/H/K/M/P) 05-13 BWs 50 (5WWB-K) 08-11 CW 50 RS (4YA1/2/BWS) 96-97 CW 50 RS (4YA4/BWS NG) 98 CW 50 (5WW4/BWS) 04-07 CW 50 RSP (5CC1/3/4YA BWS Spy) 97-98 <b>GARELLI</b> FLO 50 <b>MBK</b> CW 50 RS Booster (All models) 95-06 CW 50 Booster Naked (10" wheels) 06-10 CW 50 Booster 10" wheels 09-10 CW 50 Fizz 50 93-97 CW 50 Booster (12" wheels) 06-10 CW 50 Booster Spirit 09 CW 50 Naked Booster (12" wheels) 09-10 CW 50 Power Rocket 06											
				<b>APRILIA</b> Scarabeo 50 93-97				220							
				<b>HONDA</b> SH 50 T/X/W/X/Y/1 'Fifty /Scoopy' 97-03 SH 100 T/W/X/Y/1 Scoopy 96-01 UX 125 K8/K9 SIXteen 08-10 UX 150 K8/K9 SIXteen 08-10				220							
				<b>HONDA</b> SK 50 MM-II/MM-YD/MN-II /MP-II (AF28) Dio SR SK 50 MN-III/MP-III/MP-IV (AF28) Dio ZX SK 50 MMR-II/MMT-II (AF28) Dio XR				160							
				<b>HONDA</b> SZX 50 Super Sport Scooter X8R-SW/SX/SY/S1 98-04 SZX 50 XW Cross Sport X8R-XW/XX/XY/X1 98-04				220							
				<b>HONDA</b> SZX 50 SW X8R-SW/SX/SY/S1 'Super Sport Scooter' 98-04 SZX 50 XW X8R-XW/XX/XY/X1 'Cross Sport' 98-04				190							
				<b>HONDA</b> FES 125/150 W/Y/1-5 'Pantheon' 98-06 FES 125 7/9/A S-Wing (Non ABS) 07-13 FES 125 A7/A9/AA S-Wing (ABS) 07-13 SH 125 1/3 Carb 01-03 SH 125i 9 A/B Fuel Injection 09-12 SH 125i D9 Fuel Injection 09 SH 125i R8 Fuel Injection 08 SH 125i RA 10-13 SH 125i S7/S8 Fuel Injection 07-08 FES 150 W/Y/1/2/3/4/5 Pantheon 98-06 FES 150 A7/A9/A (S-Wing) ABS 07-13 FES 150 7/9/AA S-Wing 07-13 SH 150 1/3 Carb 01-03 SH 150i 9/A/B Fuel Injection 09-12 SH 150i D9 Fuel Injection 09 SH 150i R8 Fuel Injection 08 SH 150i S7/S8 Fuel Injection 07-08 SH 150 RA 10-13 FES 250 W/X/Y/1/2/5 'Foresight' 98-05 NSS 250 Y/AY/1/A1/A3/3 Forza /Forza-S/Forza-T/Forza-ST/Jazz /Reflex (MF04/MF06) 00-04 NSS 250 EX5/EX6/EX8 Forza EX (ABS) 05-06 NSS 250 AX5/AX6 (Forza Z) (ABS) 05-08 NSS 250 X5/X7/X8 Forza 05-08 PS 250 5/6 Big Ruckus 05-06 <b>PEUGEOT</b> SV 250 01-02				240							
			MD911D MD911C VR911	FRONT				S	<b>SUZUKI</b>	180					
									TR 50 SW/SX 98-00 UG 110 W/SW/Y/SY/SK1 Hokuto/Address 98-02 AN 125 S/T/V/W/X 95-00 AN 125 HKK5 06-08 UE 125 CTK1 01-03						
MD912D	FRONT	S	<b>SUZUKI</b>	161											
			AH 100 P Address 95-96												
MD913D	FRONT	S	<b>HONDA</b>	170											
			CH 250 F/G Spacy 85-86												
MD914D	FRONT	S	<b>PEUGEOT</b>	155											
			Scooter with Grimeca wheels discs attached with countersunk bolts Ludix Snake/Bullet/Trend 50cc 04												

DISC BUYERS GUIDE

**D = Dished Solid Original (We replace with floating rotor conversion unit) F = Floating Rotor S = Solid Rotor SF = Solid Flat Original Disc which we replace with fully floating unit - fits direct no mods required.**

# STREETBIKE DISC BUYERS GUIDE

DISC No.	FRONT/ REAR	TYPE	MODELS	DIA (MM)	DISC No.	FRONT/ REAR	TYPE	MODELS	DIA (MM)
MD923D MD923C VR923	FRONT /REAR	S	<b>YAMAHA</b> NS 50 Aerox R (1PH1) 13 NS 50 Aerox R Naked (1PL1) 13 YQ 50 'Aerox' R/Aerox 97-13 YQ 100 "Aerox 100" 00-04 EW 50 "Slider" 00-05 BWS 50 Next Generation 99-07 <b>ADLY</b> Thunderbike 125 Predator 50/100 SS 50/100 1/11 Supersonic 04-05 SS 125 B/D Supersonic 04-05 <b>BEELINE</b> Veloce 50 08-10 Veloce GT 50 08-10 <b>BSM</b> TB 100 TB 125 FT 125 <b>CPI</b> Baby J 50 02 Popcorn 50 02-06 Oliver 50 (All models) 03-12 Hussar 50 03-06 <b>GARELLI</b> FX 50 KRS 50 Freeland 125/150 <b>GENERIC</b> Cracker 50 (2T/4T) 09-13 Roc50 08-11 XOR 50 05-13 Ideo 50 05-13 Sirion 50 (2T/4T) 12-13 Sirion 125 (4T) 12-13 XOR 125 05-11 <b>HONDA</b> SJ 50 P/R/S/T/W/X 'Bali' 93-99 SJ 100 T/W/X 'Bali Ex' 96-99 SCV 110 Lead (NHX 110 WHB 3 bolt disc fixing) 08-09 <b>MBK</b> Nitro 98-01 CW 50 RS Booster NG 01-06 EW 50 Stunt 00-06 EW 50 Stunt Naked 05-09 YQ 50 Nitro 97-09 YQ 50 Nitro Naked 06-09 YQ 100 Nitro 01-03 <b>MOTO ROMA</b> Grand Prix 50/100 99-03 Grand Prix 125 02 <b>TGB</b> Akros Tec (50) 03-04 City 50cc (2T) 07-08 City 50cc (4T) 07-11 Delivery/Express 50 04-12 Trigger 50 02-03 High Wheel 50 02-03 101 R (50cc) 04-09 202 Classic (50cc) 03-09 303R Revolution (50/125cc) 02-03 303R Hawk/Laser (50cc) 04-10 309 RS 50 02-03 F409 Cruise (50/125cc) 02-03 <b>P.G.O.</b> T-Rex 50 99-12 PMX 50 00-03 Bubo 100/125 06-08 PMX 110 00-07 T-Rex 110 99-06 Charge 125 A/B 01-02 Ligero 125 06-08 T-Rex 125 99-07 <b>SINNIS</b> Pioneer 50 (2T) WY 50 QT-39A Ghost 06-10 Pioneer 125 <b>YAMAHA</b> CW 50 RS (5FXA/VG5SA BWS) 99 CW 50 RS (5FXJ/VG5SA BWS) 00 CW 50 RS (5FXM/VG5SA BWS) 01-05 CW 50 (5MS2/4G54R) 02 YQ 50 'Aerox' R/Aerox 97-13	190	MD923D MD923C VR923 Contd.	FRONT /REAR	S	<b>BSM</b> TB 125 <b>MBK</b> YQ 50 Nitro 97-10 YQ 50 Nitro Naked 06-10 <b>SYM</b> Symply II 50 09-13 Symply II 125 09-13	190
					MD924D MD924C VR924	FRONT	S	<b>PIAGGIO</b> NRG 50 Extreme 99-01 NRG 50 DT MC3 01-05 NRG 50 MC3 DD 01-04 Skipper LX 125/150 98-99 Skipper ST 125/150 4T 00-04 <b>BENELLI</b> Adiva 125/150 00 <b>APRILIA</b> Sport City 50 (4T) 08-10 Sport City One 50 (2T) 08-11 SR 50 Motard 12 Sport City One 125cc 08-11 SR 125 Motard 12 <b>DERBI</b> Vibrant Sport 50 (2T) 12 Boulevard 125 03-07 Vibrant Sport 125 (4T) 12 Boulevard 150 03-09 Boulevard 200 05 <b>GILERA</b> 50 DD/SP Runner/Purejet 98-05 125 VX 4T/180 VXR 4T 01-04 FX/FXR 125/180 Runner 97-02 VXR 200 Runner (4T) 02-04	220
					MD925D MD925C VR925	FRONT/ REAR	S	<b>PEUGEOT</b> Elyseo 50 03 Elystar 50 Advantage 02-07 Speedfight 50 1/2 (L/C) 97-08 Speedfight 50 1/2 (Air Cooled) 97-08 Elyseo 100 03 Speedfight 100 1/2 (L/C) 97-09	180
					MD926D	REAR	S	<b>KYMCO</b> Sniper 50 DD 94-96 Heroism 150 (SE30AD) 95-97	160
					MD927D VR927	REAR	S	<b>YAMAHA</b> YP 250 Majesty 98-99 <b>MBK</b> YP 250 Skyliner 98-99	230
					MD928D	FRONT	S	<b>YAMAHA</b> YH 50 'Why' 98-09 <b>MBK</b> YH 50 Flipper 98-09	220
					MD929D MD929C VR929	FRONT	S	<b>SUZUKI</b> AN 250 K1/K2 Burgman/Skywave 01-02 AN 250 W/X/Y Burgman/Skywave 98-03 AN 400 X/Y/K1/K2 Burgman/Skywave 99-02 <b>KAWASAKI</b> SC 250 A1 (Epsilon 250) 02	260
					MD930D MD930C VR930	REAR	S	<b>SUZUKI</b> AN 250 K1/K2 Burgman/Skywave 01-02 AN 250 W/X/Y Burgman/Skywave 98-03 AN 400 X/Y/K1/K2 Burgman/Skywave 99-02 <b>KAWASAKI</b> SC 250 A1 (Epsilon 250) 02	210
					MD931D VR931	FRONT	S	<b>HONDA</b> SGX 50 V/W/X/Y/1 'Sky' 97-03 SRX 50 T/W/X 97-99 SRX 90 T/W/X 97-99	190

D = Dished Solid Original (We replace with floating rotor conversion unit) F = Floating Rotor S = Solid Rotor  
SF = Solid Flat Original Disc which we replace with fully floating unit - fits direct no mods required.

# STREETBIKE DISC BUYERS GUIDE

DISC No.	FRONT/ REAR	TYPE	MODELS	DIA (MM)	DISC No.	FRONT/ REAR	TYPE	MODELS	DIA (MM)
MD932D MD932C VR932	FRONT/ REAR	S	<b>GILERA</b>	175	MD941D Contd.	FRONT	S	<b>PEUGEOT</b>	175
			50 DD/SP 'Runner/Purejet' 98-05 Runner 50 PJ/SP 06-13 Stalker 50 97-06 <b>DERBI</b> GP1 50 Open 06-11 GP1 50cc 01-03 <b>PIAGGIO</b> NRG 50 RST (DD/DT) MC2 98 NRG 50 Extreme 99-01 NRG 50 MC3 DD 01-05 NRG 50 DD 06-13 NRG 50 Pure Jet 06-09 NRG 50 Silver Bullet 10 Zip 50 (2T) 00-13 Zip 50 SP (2T) 13 Zip 50 (4T) 00-13 Zip 100 06-10					Vivacity 125 (4T) 10-12 Vivacity Sixties 125 (4T) 11-12	
MD933D VR933	FRONT	S	<b>CAGIVA</b>	160	MD942D VR942	FRONT	S	Leonardo 125/150 ST/SP 96-04 Leonardo 125 05-06 Leonardo 250 ST/SP 00-04 Scarabeo 125/150/GT 99-04 Leonardo 300 05-06	220
			<b>KYMCO</b> Agility 50 R10 (4T) 06-07 CX 50 Super (PR 50 AC) 94-97 Heroism 50 95-00 Sniper 50 (PR 50 B) 93 Sniper 50 DD (PR 50 BB) 94-96 KB 100 Manboy 97-00 Heroism 125 (SE25BA) 95-97 Heroism 150 (SE30AD) 95-97 <b>SYM</b> City Hopper 60 96-06 Mio 50/100 05-13 Super Fancy 50 96-06 Attila 125 99-00 Megalo 125 00-07 Superduke 125/150 99-02 E-Virid (Electric) Deluxe 11-13 E WOO Elettrico 11					Scarabeo 125/250/G6 04-06 Scarabeo 125/200 03 Sport City 125/200 04-08 Sport City Cube 125 08-12 Sport City Cube 200 08-10 Sport City 250 ie 06-08 Sport City Cube 250 08-09 Sport City Cube 300 08-12 Sport Cube 300 Blackline 11 <b>DERBI</b> Boulevard S125 07 Rambla 125 08-12 Rambla 250 i 08-09 Rambla 300i 10-12	
MD934D	FRONT	S	<b>SUZUKI</b> UC 125 99-02 <b>KAWASAKI</b> SC 150 A1 (Epsilon 150) 02-03	220	MD943D MD943C VR943	FRONT	S	<b>APRILIA</b> Rally A/C & L/C 95-02 Gulliver (All models) 95-98 Habana 50 (All models) 99-02 Mojito Custom 50 99-12 Mojito Retro 50 99-03 SR 50 Ditech (LC) (RLD100) 02-03 SR 50 WWW (A/C) (LYHoo) 97-01 SR 50 Street (LC) (TE00/TEA00) 03-13 SR 50 R/Factory (LC) 04-13 SR 50 H20 (Ditech) 00-03 SR 50 (A/C / L/C) 93-96 SR 50 Stealth/Racing (LC) 97-99 SR 50 R (SBK Alitalia (Replica) (LC) 10-11 Habana 125 (All models) 00-02 SR 125/150 99-02 Mojito/Mojito Custom 125 03-12 <b>GILERA</b> Storm 50 94-95 <b>MBK</b> CS 50 Mach G AC (Air cooled) 02-10 CS 50 Mach G LC (Liquid cooled) 03-10 YN 50 R Ovetto (2T) 98-10 YN 50 Ovetto (4T) 09-10 YN 100 Ovetto 99-03 <b>PIAGGIO</b> Diesis 50 01-05 NRG 50 94-96 NTT 50 95-96 NRG 50 RST (DT/DD) MC2 96-98 Diesis 100 01-03 <b>YAMAHA</b> CS 50 Jog R 02-11 CS 50 Z Jog RR 03-12 YN 50 Neos 02-06 YN 50 Neos (4T) (5C3) 09-13 YN 50 Neos (2T) (IF5C2/IH5C2) 07-13 YN 50 R Neos 97-02 YN 100 "Neos 100" 99-03	190
MD935D	FRONT	S	<b>APRILIA</b> Sonic (All models) 98-08	155					
MD936D VR936	FRONT	S	<b>APRILIA</b> Area 51 98-02	190	MD943D MD943C VR943	REAR	S	<b>APRILIA</b> SR 50 Ditech (LC) (RLD100) 02-03 SR 50 H20 (Ditech) 00-03 Scarabeo 50 (2T) 98-05 Scarabeo Classic (2T) 98-99 Area 51 98-01 Rally 50 L/C 96-01 SR 50 Stealth/Racing (LC) 97-99 Leonardo 125/150 ST/SP 96-04	240
MD936D	REAR		<b>MALAGUTI</b> F12 50 Phantom 98-03 Phantom F69 (70cc) 98						
MD937D	FRONT	S	<b>SUZUKI</b> AP 50 R/S/T/V/W 96-02	180	MD944D VR944	FRONT	S	<b>GILERA</b> DNA 50 01-06 DNA 125/180 01-05 <b>DERBI</b> GP1 125cc Scooter Full height seat/ 5 bolt fixing front disc 06 GP2 250cc Scooter 06-07 <b>GILERA</b> Runner 125/180 All models 99-04 DNA 125/180 01-03	240
MD938D VR938	FRONT	S	<b>SUZUKI</b> AY 50 V/W/WV/WX/WY/WRW /WRX/WRY/WRK1/WRK2/WRK3 /K1/K2/K3/K4/WRK4/AK5 'Katana' 97-05 UF 50 Y 00-02 UX 50 WX/WY 99-02	180					
MD939D	FRONT	S	<b>SUZUKI</b> AH 80 Address 92-94 AH 100 Address 92-94 <b>PGO</b> Galaxy 50 94-	146	MD944D	REAR	S		
MD940D VR940	REAR	S	<b>SUZUKI</b> AY 50 WRX/WX/WRY/WY/WRK1/WRK3 /WRK4/AK5 'Katana' 99-05	190					
MD941D VR941	FRONT	S	<b>ITALJET</b> Dragster 50LC 98-12 Formula 50/125 LC 96-02 Formula 50 Air 99-02 Dragster 125/180 LC 99-12 Dragster 250 07-08 Formula 50/125 LC 96-02	175					

D = Dished Solid Original (We replace with floating rotor conversion unit) F = Floating Rotor S = Solid Rotor  
SF = Solid Flat Original Disc which we replace with fully floating unit - fits direct no mods required.









# STREETBIKE DISC BUYERS GUIDE

DISC No.	FRONT/ REAR	TYPE	MODELS	DIA (MM)	DISC No.	FRONT/ REAR	TYPE	MODELS	DIA (MM)
MD964D Contd.	FRONT	S	<b>DERBI Contd.</b> Atlantis 100 (AC/2T) 00-01 <b>HUSQVARNA</b> WRS 50 Scooter 98-00	190	MD972D	FRONT	S	<b>KYMCO</b> Movie XL 125/150 99-00 Vivio 125/150 00-03	200
MD964D	REAR	S	<b>DERBI</b> Predator 50 (LC/2T) (5 bolt front disc/STD Paioli Forks) 98-03	190	MD973D VR973	FRONT	S	<b>KYMCO</b> Bet & Win 50/Dink Sport 50 02-06 Grand Dink 50 (2T) 04-07 Grand Dink 50 S 12-13 Bet & Win 125/150 00-06 Grand Dink/Miler 125/150 01-07 Dink Classic 125/150 02 Dink Classic Euro 2 50 03 Grand Dink 250 01-06 Bet & Win 250 00-06 Yup 250 03-06 Grand Dink 300i 12-13	220
MD965D	FRONT	S	<b>YAMAHA</b> CV 50 ZR (5PT1) Evolution 01-02 CV 50 (5KN1/2) Jog-Cool Style 00-02 CV 50 A/R Jog (SSU2/1/SA165) 03-08	155	MD974D VR974	REAR	S	<b>KYMCO</b> Bet & Win 125/150 00-06 Dink 125i 06-12 Grand Dink/Miler 125/150 01-07 Yager GT 125 07-13 Dink 200 i 06-12 Yager 200 i 07-13 Grand Dink 250 01-06 Bet & Win 250 00-06 Yup 250 03-06	200
MD966D VR966	FRONT	S	<b>MALAGUTI</b> 125/150/180 99-02 Phantom Max 125/200 04-08 R 125 Madison 03-07 Madison S 200 04 250 Madison 04-07 Phantom Max 250 04-08	220	MD975D VR975	REAR	S	<b>SUZUKI</b> UH 125 K2-K6 Burgman 02-06	220
MD966D VR966	REAR	S	<b>BENELLI</b> Velvet 125/150/250 99-12 <b>MALAGUTI</b> 250 S 99-03 Phantom Max 125/200 04-08 R 125 Madison 03-07 Madison S 200 04 250 Madison 05-07 Phantom Max 250 04-08	220	MD976D MD976C VR976	FRONT	S	<b>SUZUKI</b> UH 125 K2-K6 Burgman 02-06	220
MD967D	FRONT/ REAR	S	<b>MALAGUTI</b> Madison S 250 99-03 Madison K400 02-06	240	MD977D	FRONT	S	<b>PEUGEOT</b> Elyseo 125/150 Rear Disc Model 03 Elystar 125/150 (3 bolt fixing - front disc) 02-05	226
MD968D MD968C VR968	FRONT/ REAR	S	<b>BMW</b> C1 125/200 99-03	220	MD978D MD978C VR978	REAR	S	<b>PEUGEOT</b> Elyseo 125/150 Rear Disc Model 03 Elystar 50 TDSI 02-07 Elystar 125/150 (All models) 02-07 Elystar 125/150 (3 bolt fixing - front disc) 02-05 Elystar 125/150 (5 bolt fixing - front disc) 06-07 Jet Force 125 (All models) 03-07 Satelis 125 4V Executive/ Premium/City 06-09 Satelis 125 Compressor (4T) 06-11 Satelis 125 RS 07-11 Satelis 125 Avenue (Nissin calipers) 08-09 Satelis 125 Blacksat (AJP Calipers) 10-11 Satelis RS 125 (AJP Calipers) 07-11 Satelis Urban 125 (AJP Calipers/ABS) 07-11	210
MD969D	FRONT	S	<b>MALAGUTI</b> K 400 Madison 02-06	270	MD979D	FRONT	S	<b>YAMAHA</b> YP 125 Majesty DX Taiwan Production 02	245
MD970D MD970C VR970	FRONT	S	<b>HONDA</b> NES 125 Y1/2/3/4/5/6 00-06 PES 125 6/7/8/9/A (PS 125) 06-10 PES 125 R8/R9/RA (PS 125) 08-12 SES 125 2/3/4 Dylan 02-07 SH 125i 4/5/6/7/8 Fuel Injection (Rear drum) 04-08 NES 150 Y1/2/3/4/5/6 00-06 PES 150 6/7/8/9 (PS 150) 06-09 PES 150 R8/R9 (PS 150) 08-09 SES 150 2/3/4 Dylan 02-06 SH 150i 4/5/6/7/8 04-08 SH 150i R8 08	220	MD980D	FRONT	S	<b>PEUGEOT</b> Jet Force 125 (All models) 03-07 Elystar 125/150 (5 bolt fixing - front disc) 06-07	226
MD971D MD971C VR971	FRONT/ REAR	S	<b>GENERIC</b> 50 GT Race Explorer 09 <b>KYMCO</b> Agility 50 (KG 105A) 05-08 Agility 50 R10 (4T) 06-12 Agility 50 R12 (4T) 06-12 Agility RS 50 (2T/12" wheels) Naked 10-13 Cobra 50 Cross/Racer 00-06 Dink 50/Spacer 50/Yager 50 98-06 Super 9 50 (L/C) 00-06 Top Boy 50 (On road /off road models) 97-05 Vitality 50 (2T/4T) 04-09 Yager 50 07 Yup 50 02-09 ZX 50 Super Fever/Scout (SC10AS) 99-06 Maxxer 90 05-06 Agility 125 06-10 Grand Dink 125/150 01-02 Dink Classic 125/150 02 Dink LX 125/150 98-00 Dink 125/150/Spacer 97-04 Spike 125 R 04-06 Yager 125 00 <b>SINNIS</b> Nitro 50 (2T) 09-10 Strike 50 (2T) 09-10 Nitro 125 (WY 125 T-56A) 09-10	180	MD981D VR981	FRONT	S	<b>KYMCO</b> Super 9 50 (AC/LC) 00-07	210
					MD982D	REAR	S	<b>ADLY</b> 125 Thunderbike	165
					MD983D VR983	FRONT /REAR	S	<b>GILERA</b> Coguar 125 99-02 Nexus 125 07-12 Nexus 300 i 08-12 Nexus 500 03-12 <b>APRILIA</b> SR 125 Max 11-13 SR 300 Max 11-13 <b>PIAGGIO</b> X7 125cc 08-09 X7 Evo 125 ie (EFI) 09-12	260

D = Dished Solid Original (We replace with floating rotor conversion unit) F = Floating Rotor S = Solid Rotor  
SF = Solid Flat Original Disc which we replace with fully floating unit - fits direct no mods required.

# STREETBIKE DISC BUYERS GUIDE

DISC No.	FRONT/ REAR	TYPE	MODELS	DIA (MM)	DISC No.	FRONT/ REAR	TYPE	MODELS	DIA (MM)
<b>MD983D</b> <b>Contd.</b>	FRONT /REAR	S	<b>PIAGGIO Contd.</b> X8 125 04-06 Xevo 125 07-13 X8 200 04-05 Xevo 250 ie 07-10 X7 250 ie 08-09 X8 250 ie 05-06 X9 250 04 X7 300 Evo 09-12 X9 500cc Evolution 03-06	260	<b>MD994D</b> (5 bolt fixing) <b>VR994</b>	FRONT	S	<b>SUZUKI</b> AN 250 Skywave Type M/S 07-08 AN 250 8 Skywave SS 08 SN 250 K3-K6 Burgman (CJ43A) 03-06 AN 400 K7/ZK7/K8/ZK8/K9/L0/L1/L2/L3 Burgman/Non ABS/Skywave 07-13 AN 400 AK9/ZAK9/AL0/ZAL0/AL1/ZAL1/ AL2/AL3 Skywave/Burgman/ABS 09-13 AN 650 K4/K5/K6/K7/K8/K9/L0 Burgman/Non ABS 04-11 AN 650 AK4/AK5/AK6/AK7/AZK8/AK8 /AK9/AL0 Burgman/ABS/Executive 04-12	260
<b>MD984D</b> <b>VR984</b>	REAR	S	<b>PEUGEOT</b> Jet C Tech 50 11-12 Jet Darkside 50 (2T) 11 Jet Iceblade 50 (2T) 11 Jet Force 50/Jet-C (All models) 03-10 TRK2 WRC 50 (2T) 04-06 Satelis 125 Whitesat (AJP Caliper) 10-11	190	<b>MD995D</b> <b>VR995</b>	FRONT	S	<b>YAMAHA</b> VP 300 Versity 03-05 XC 300 Versity 06 XC 300 V Versity 06	270
<b>MD985D</b> <b>VR985</b>	FRONT	S	<b>PEUGEOT</b> Jet C Tech 50 11-12 Jet Darkside 50 (2T) 11 Jet Iceblade 50 (2T) 11 JetForce 50/Jet-C (All models) 03-10	226	<b>MD996D</b> <b>VR996</b>	REAR	S	<b>APRILIA</b> SR 50 Street (LC) 03-13 SR 50 R/Factory (LC) 04-13 Atlantic 125 03-08/10 Atlantic 200 03-05 Atlantic 250 03-05 Atlantic 250 ie 06-08 Atlantic 300 10-11	190
<b>MD986D</b> <b>VR986</b>	FRONT	S	NXC 125 Flame X 04-06 NXC 125 Cygnus X - (5ML) 04-06 YW 125 (BW's 125) 10-13 YW 125 Z X-Over 10	220	<b>MD997D</b> <b>VR997</b>	FRONT	S	<b>APRILIA</b> Atlantic 125 03-08/10 Atlantic 200 03-05 Atlantic 250 03-05 Atlantic 250 ie 06-08 Atlantic 300 10-11 <b>BENELLI</b> Velvet 250 99-12	240
<b>MD987D</b> (4 bolt fixing) <b>VR987</b>	FRONT	S	<b>SUZUKI</b> AN 650 K3 Burgman/Skywave 03	260	<b>MD998D</b> <b>VR998</b>	REAR	S	<b>SUZUKI</b> AN 650 K4/K5/K6/K7/K8/K9/L0 Burgman/Non ABS 04-11 AN 650 AK4/AK5/AK6/AK7/AZK8/AK8 /AK9/AL0 Burgman/ABS/Executive 04-12	250
<b>MD988D</b> <b>VR988</b>	REAR	S	<b>SUZUKI</b> AN 650 K3 Burgman/Skywave 03	250	<b>MD999D</b>	FRONT	S	<b>ITALJET</b> Jupiter 125/150 02 Jupiter 250 02-03	250
<b>MD989D</b>	FRONT	S	<b>KYMCO</b> Looker 50 07-08 People 50 (2T) 99-11 Looker 125 S 07-08 People 125 99-11 People 150 99-04	226	<b>MD9100D</b> <b>VR9100</b>	FRONT /REAR	S	<b>KYMCO</b> Agility 50 R16 (4T/16" wheels) 08-12 People 50 (2T) 05-09 People S 50 2T (5 bolt fixing) 05-10 People S 50 (4T) 06-13 Agility 125 R16 (C20000) (16" wheels) 08-13 People S 125 DD 07-12 People S 125 05-06 Agility 150 R16 (C30000) (16" wheels) 08-12 Agility 200i R16 10-12 People S 200 05-06 People S 200i DD 07-12 People 250 S 06-08 People 250 (BC 50 AA) 03-06 People S 300 i 08-10	260
<b>MD990D</b> <b>VR990</b>	REAR	S	<b>APRILIA</b> Scarabeo 50 (2T) 93-97 Scarabeo 50 Classic (2T) 98-99 Leonardo 125 05-06 Leonardo 250 99-04 Leonardo 300 05-06 Atlantic 400 07 Atlantic Sprint 400 05-08 Atlantic 500 01-06 Atlantic Sprint 500 05-08 Scarabeo 500 03-05	220	<b>MD9101D</b>	FRONT	S	<b>BENELLI</b> Adiva 125/150 (13" front wheel) 01-04 Velvet 125/150 99-07 Velvet 125/150 (Touring) 08-12	220
<b>MD991D</b> 5 Bolt Fixing	FRONT	S	<b>PEUGEOT</b> Ludix Bullet 04-07 Ludix Trend 04-07 <b>DERBI</b> Atlantis 50 (4T) (13"/ 3 spoke wheels) 04-06 GP1 50cc 01-03 Predator 50 (LC/2T) (5 bolt front disc/STD Paioli Forks) 98-03 Atlantis 100 (4T) (13" /3 spoke wheels) 04-06	190	<b>MD9102D</b> <b>VR9102</b>	FRONT	S	<b>YAMAHA</b> YP 125 R X-Max 06-10 YP 125 R (X-Max ABS) (39D2) 11-13 YP 125 R (X-Max Non ABS) (39D1/5) 10-13 YP 125 X-Max Business (ABS) 11 YP 125 R X-Max Sport 11-12 YP 250 R XMax Sport 11-12 YP 250 R XMax ABS 11-13 XP 250 R XMax (ICO) Non ABS 05-09 XP 250 R XMax (37P) Non ABS 10-13 YP 400 Majesty 04 <b>MBK</b> YP 125 Skycruiser 06-10 YP 400 Skyliner 04	267
<b>MD992D</b> <b>VR992</b>	FRONT	S	<b>PEUGEOT</b> Ludix Snake 04-09 Ludix Acid 06 Ludix Red Zone 06 Ludix Urban Track 06-07	155					
<b>MD993D</b>	FRONT	S	<b>PEUGEOT</b> Ludix Elegance 04-09	190					

DISC BUYERS GUIDE

**D = Dished Solid Original (We replace with floating rotor conversion unit) F = Floating Rotor S = Solid Rotor**  
**SF = Solid Flat Original Disc which we replace with fully floating unit - fits direct no mods required.**

# STREETBIKE DISC BUYERS GUIDE

DISC No.	FRONT/ REAR	TYPE	MODELS	DIA (MM)	DISC No.	FRONT/ REAR	TYPE	MODELS	DIA (MM)
MD9103D VR9103	REAR	S	<b>MBK</b> YP 400 Skyliner 04 <b>YAMAHA</b> YP 400 Majesty (Non ABS) 04-13 YP 400 Majesty (ABS) 07-13	267	MD9112D Contd.	FRONT	S	<b>PIAGGIO Contd.</b> MP3 125 ie (EFI Models) 08-11 MP3 Hybrid (125cc) 09-12 MP3 250 MIC/EFI 08-09 MP3 250cc (EFI) 06-08 MP3 250 LT (EFI) 09 300 ie MP3 Yourban 11-13 MP3 Business LT 300 ie 13 MP3 Yourban Sport 300 ie 13 MP3 Yourban Sport LT 300 ie 13 MP3 Sport LT 300 ie 13 MP3 300 LT (EFI) 10-11 MP3 300 ie (Hybrid) 11-13 MP3 300 ie (Hybrid LT) 11-13 MP3 Yourban LT 300 ie 11-13 MP3 Touring 300 ie 11-12 MP3 Touring LT 300 ie 11-12 MP3 400 ie 07-11 MP3 LT 400 IE 09-10 MP3 Touring 400 ie 11-12 MP3 Touring LT 400 ie 11-12 MP3 500 EFI 09-10 MP3 Touring Business 500 ie 11-12 MP3 Touring Business LT 500 ie 11-13 MP3 Touring Sport 500 ie 11-12 MP3 Touring Sport LT 500 ie 11-13	240
MD9104D VR9104	REAR	S	<b>YAMAHA</b> YP 125 R X-Max 06-09 YP 125 R (X-Max Non ABS) (39D1/5) 10-13 VP 125 X-City (16P) 08-13 YP 125 R X-Max Sport 11-12 VP 250 X-City (5B2) 07-13 YP 250 R XMax Sport 11 XP 250 R XMax (ICO) Non ABS 05-09 XP 250 R XMax (37P) Non ABS 10-11 VP 300 R/S/T Varsity 03-05 XC 300 Varsity 06 <b>MBK</b> VP 300 R Kilibre 03-04 YP 125 Skycruiser 06-10 VP 125 City Liner 08-10	240	MD9113D	FRONT	S	<b>DERBI</b> GP1 50 Euro 2 Chain driven/radial caliper/5 bolt fixing front disc 05 GP1 50 Race Chain driven/radial caliper/5 bolt fixing front disc 05-07 GP1 125cc Scooter Full height seat/ 5 bolt fixing front disc 06 GP1 250cc Scooter 06-07	245
MD9105C	FRONT	S	<b>PEUGEOT</b> Ludix Blaster (10" wheels) 05-09 Ludix 2 Trend 50 (2T/12" wheels) 07-12 Blaster Ice Blade 50 (2T/12" wheels) 10-12	170	MD9114D	FRONT	S	<b>ITALJET</b> Millenium M100/125/150 LC 00-04	218
MD9106D	REAR	S	<b>BENELLI</b> Adiva 125/150 01-04	220	MD9115D	FRONT /REAR	S	<b>TGB</b> Delivery/Express (125cc) 04-11 R 50 X Bullet 06-10 R 125 X Bullet 08-09 302 Sport (50cc) 03-09 303 R Hawk/Laser (125/150cc) 04-08 304 Sport (125cc) 03-09	220
MD9107D	FRONT	S	CP 250 V (IB71) Maxam/Morphus 05-08	245	MD9116D VR9116	FRONT	S	<b>SYM</b> Jet Basix 50 06-09 Jet 50/Euro X S 99-05 Jet Euro X 50 06-12 Jungle 50/100 99-02 Mask 50 00-05 Red Devil 50 99-09 Jet 100 G100P-6) 99-00	190
MD9108D	REAR	S	CP 250 V (IB71) Maxam/Morphus 05-08 YP 125 R (X-Max ABS) (39D2) 11-13 YP 125 X-Max Business (ABS) 11 YP 250 R XMax ABS 11-13	245	MD9117D VR9117	FRONT/ REAR	S	<b>SUZUKI</b> UH 125 K7/K8/K9/L0/L1/L3 07-13 UH 200 K7/K8/K9/L0/L1/L3 07-13	240
MD9109D VR9109	REAR	S	AN 250 Skywave Type M/S 07-08 AN 250 8 Skywave SS 08 AN 400 K7/ZK7/K8/ZK8/K9/L0/L1/L2/L3 Burgman/Non ABS/Skywave 07-13 AN 400 AK9/ZAK9/AL0/ZAL0/AL1/ZAL1/ZAL2 /ZAL3 Skywave/Burgman/ABS 09-13	210	MD9118D VR9118	FRONT	S	<b>HONDA</b> SH 300 i 7/8/9/A/B/AB (Non ABS) 07-12 SH 300 i A7/A8/A9/AA/AB/AC (ABS) 07-13 SH 300 i R8/R9/RA (Non ABS) 08-10 SH 300 i AR8/AR9/ARA (ABS) 08-10	256
MD9110D VR9110	FRONT	S	Cucciolo 125 00	240	MD9119D VR9119	REAR	S	<b>HONDA</b> SH 300 i 7/8/9/A/B (Non ABS) 07-12 SH 300 i A7/A8/A9/AA/AB/AC (ABS) 07-13 SH 300 i R8/R9/RA (Non ABS) 08-10 SH 300 i AR8/AR9/ARA (ABS) 08-10	256
MD9111D VR9111	FRONT	S	<b>PEUGEOT</b> Geopolis 125 Executive/Non ABS (AJP Calipers) 07-11 Geopolis 125 Premium/Non ABS (Nissin Calipers) 07-11 Geopolis 125 Urban/ABS (AJP Calipers) 07-11 Geo RS 125 (Nissin Calipers) 07-11 Sateelis 125 Compressor 06-11 Sateelis 125 RS 07-11 Geo RS 250 (Nissin Caliper) 07-11 Geopolis 250 (Premium /Nissin Calipers/Non ABS) 07-11 Geopolis 250 (Urban /AJP Calipers/ABS) 07-10 Geopolis 250 (Executive /AJP Calipers/Non ABS) 07-10 Geopolis 300 (Premium /Nissin Calipers/Non ABS) 10-11 Geostyle 300 (Nissin Calipers) 10-11 Geo RS 300 (Nissin Calipers) 10-11 Geopolis 400 (Premium/ Nissin Calipers/Non ABS) 07-11 Geopolis 400 (Urban/ AJP Calipers/ABS) 07-11 Geo RS 400 (Nissin Calipers) 08-11 Geopolis 500 08-11	263	MD9120D	FRONT	S	<b>SUZUKI</b> FL 125 SDWK7/SDWK8 Address/Underbone 07-10	220
MD9112D VR9112	FRONT	S	<b>GILERA</b> VX 125 Runner ST (4T) 05-12 VX 200 Runner ST (4T) 05-11 Fuoco 500 RC/ie 07-13 <b>PIAGGIO</b> 125 ie MP3 Yourban 11-12 MP3 125 (Carb models) 06-08	240	MD9121D	REAR	S	<b>PEUGEOT</b> LooXor 125/150 03-06	198
					MD9122D	FRONT	S	<b>DERBI</b> GP1 125cc Racing Low seat/ Radial caliper/6 bolt disc fixing 07-09 GP1 250cc Racing Low seat/ Radial caliper/6 bolt disc fixing 07-09	245

**D = Dished Solid Original (We replace with floating rotor conversion unit) F = Floating Rotor S = Solid Rotor SF = Solid Flat Original Disc which we replace with fully floating unit - fits direct no mods required.**















# STREETBIKE DISC BUYERS GUIDE

DISC No.	FRONT/ REAR	TYPE	MODELS	DIA (MM)	DISC No.	FRONT/ REAR	TYPE	MODELS	DIA (MM)
MD9123D	REAR	S	<b>DERBI</b> GP1 50 Euro 2 Chain driven/radial caliper/5 bolt fixing front disc 05 GP1 50 Race Chain driven/radial caliper/5 bolt fixing front disc 05-07	180	MD9137D VR9137	FRONT	S	<b>SYM</b> Jet 4 R 50 (2T) 11-13 Symphony S 50 (4T/Rear disc model) 10-13 Symphony SR 50 10-13 Jet V 125 (4T) 12-13 Symphony S 125 (4T/Rear disc model) 10-13 Symphony SR 125 10-13 Symphony S 151 (4T/Rear disc model) 09-13	225
MD9124D	REAR	S	<b>GILERA</b> GP 800 (Chain drive) 08-12 <b>APRILIA</b> SRV 850 12-13	280					
MD9125D	FRONT	S	<b>GILERA</b> GP 800 (Chain drive) 08-12 <b>APRILIA</b> SRV 850 12-13	300					
MD9126D	FRONT	S	<b>GILERA</b> Typhoon 50 94-97 Typhoon 50 X 98-99 Typhoon 125 95-03 Typhoon 125 X-XR 99-00 <b>PIAGGIO</b> New Fly 50 (4T/4V) 12-13 Stalker 50 (All models) 97-11 Typhoon 50 (2T) Heng Tong Caliper/10" wheels 01-09 Typhoon 50 (2T) Grimeca Caliper/10" wheels 00-04 New Fly 125 ie (3V) 12-13	190					
MD9127D VR9127	FRONT	S	<b>YAMAHA</b> XC 125 Vity 08-13 <b>MBK</b> XC 125 WAAP 08-10	180	MD9138D VR9138	FRONT	S	<b>SYM</b> DD 50 (2T) 02-12	160
MD9128C VR9128	FRONT	F	<b>KYMCO</b> Downtown/Superdink 125i (V21000) 09-13 Downtown 200i 10-12 Downtown/Superdink 300i (V20000) 09-12 Downtown 300i (ABS/V20010) 10-13	260	MD9139D VR9139	REAR	S	<b>HONDA</b> SH 125i 9/A/B 09-12 SH 125i RA 10-13 SH 125i 9/A/B 09-12 SH 150i RA 10-13	240
MD9129D	REAR	S	<b>KYMCO</b> Downtown/Superdink 125i (V21000) 09-13 Downtown 200i 10-12 Downtown/Superdink 300i (V20000) 09-13	240	MD9140D VR9140	FRONT	S	<b>HONDA</b> NSC 50 C Vision 50 (4T) (14" wheels) 12-13 NSC 50 AC Vision 50 (4T) (16" wheels) 12-13 NSC 50 R (14" wheels) 13 NSC 110 WHB-Vision 110 (4T) (14" wheels) 11-13 NSC 110 AC-Vision 110 (4T) 12-13 SCV 110 (NHX 110 WHA 4 bolt lead disc fixing) 10-11	190
MD9130D	FRONT	S	<b>YAMAHA</b> VP 125 X-City (16P) 08-13 VP 250 X-City (5B2) 07-13 <b>MBK</b> VP 125 Cylinder 08-10	270	MD9141D VR9141	FRONT	S	<b>PEUGEOT</b> New Vivacity (50cc/2T) (12" wheels) 08-12 New Vivacity Sixties (50cc/4T) (12" wheels) 10-12 E-Vivacity (Electric) 11-12	200
MD9131D	FRONT	S	<b>YAMAHA</b> VP 125 X-City (16P) 08-09	186	MD9142D	FRONT /REAR	S	<b>SUZUKI</b> UX 125 K8/K9/L0/L1 Sixteen 08-11 UX 150 K8/K9/L0/L1 Sixteen 08-11	220
MD9132D	REAR	S	<b>SINNIS</b> Ecocity 125 (125T-8G) 07-09	195	MD9143D	REAR	S	<b>YAMAHA</b> T-Max 530 12 XP 530 Black Max (59CE) 13	282
MD9133D MD9133C VR9133	FRONT	S	<b>YAMAHA</b> NXC 125 Cygnus X (4P9) 07-13 NCX 125 K Cygnus X Cab (4C6-1) 07-10 NCX 125 L Cygnus X Injection (4C6-2) 07-10 NXC 125 Flame X 07-12 YW 125 X (1DN1/2) 10-13	240	MD1001	FRONT	S	CBR 400 RG/RH-YA (NC23) 86-87 VFR 400 RH2/RJ (NC24) 87-88 XBR 500 F/G/H/SJ 85-89 CBR 600 FH/FJ/FK/FLFM/FN/FP/FR 87-94 CBX 750 FE 84 CBR 750 FH Superaero 87 VF 750 SC (V45 Sabre) 82 VFR 750 FG/FH 86-87 CBR 400 RG/RH-YA (NC23) 86-87 PC 800 Pacific Coast 89-97 VF 1000 FE/FF/F2F/FG /F2G 84-86 CBR 1000 FH/FJ 87-88	276
MD9134D VR9134	FRONT	S	<b>HONDA</b> NFS 110 25HC Wave 12-13 PCX 125 (WW125EXZA) 10-13 PCX 150 12-13	240	MD1001	REAR	S	"X4"-CB 1300 DCV/DCW/DCX /DCY (SC38) 97-00	276
MD9135D	REAR	S	FES 125/150 3/4/5/6/7 Pantheon 03-07 FES 250 Y/1/2/5 00-05 NSS 250 Y/AY/1/A1/A3/3 Forza /Forza-S/Forza-T/Forza-ST/Jazz /Reflex (MF04/MF06) 00-04	220	MD1002	REAR	S	CBR 250 RH (MC17) 87 CBR 250 RJ/RK/RK2 (MC19) 88-89 NSR 250 RG (MC16-100) 86 NSR 250 R2J (MC18-100) /R4J (MC18-100) 88 NSR 250 RSP/RSK/RSP (MC18) 89 NSR 250 RL/RN/RSP (MC21) 95- NSR 250 R5K/R5K-2 (MC18-110) 89 NSR 250 R6K/R6K-2 (MC18-110) 89 NSR 250 R7L (MC21-100) /R7N (MC21-106) 90 NSR 250 R8L-3 (MC21-100) /R9L (MC21-102)/R8N/R8N-3 (MC21-106) 90 NSR 250 R9N (MC21-106) 92 NS 250 FE (MCII) 84 NS 250 RE/RG (MCII) 84-86 NS 250 FE/RE (MC11-100) 84 NS 250 RG (MC11-102) 86	220
MD9136D	FRONT	S	<b>YAMAHA</b> HW 125 Xenter 125 12-13 HW 150 Xenter 150 12-13 YP 400 Majesty (Non ABS) 05-13 YP 400 Majesty (ABS) 07-13	267					

D = Dished Solid Original (We replace with floating rotor conversion unit) F = Floating Rotor S = Solid Rotor  
SF = Solid Flat Original Disc which we replace with fully floating unit - fits direct no mods required.











# STREETBIKE DISC BUYERS GUIDE

DISC No.	FRONT/ REAR	TYPE	MODELS	DIA (MM)	DISC No.	FRONT/ REAR	TYPE	MODELS	DIA (MM)
<b>MD1002 Contd.</b>	REAR	S	VT 250 FL Spada/Castec 88-90	220	<b>MD1008</b>	FRONT	S	NV 400 DCY/DC1/DC2 (NC40)	296
			CBR 400 RG/RGYA (NC23) 86					CB 500 RT/VN/SW/SX/SY/SZ/S2 94-02	
<b>MD1003X MD1003XC MD1003CC VR1003BLK VR1003BLU VR1003RED</b>	FRONT	F	CBR 400 RRJ/RRK (NC23) 92-93	296		FRONT	F	CBF 600 N4/N5/N6 (Non ABS) 04-06	310
			(NC23 Tri arm) 92-93					CBF 600 NA4/NA5/NA6 (ABS) 04-06	
			NS 400 RF/RG 85-87					CBF 600 S4/S5/S6 (Non ABS) 04-06	
			VFR 400 ZG/ZH/RG/RH-YA (NC21) 85-87					CBF 600 SA4/SA5/SA6 (ABS) 04-06	
			CBR 600 FH/FJ/FK/FL 87-90					NT 650 VVVV/VY/V1 Deauville 98-01	
								NT 650 V2-V5 Deauville 02-05	
								NT 700 V6/V7/V8/VA Deauville 06-12	
								NT 700 VA6/VA7/VA8/VAA 07-13	
								CB 750 F2N/F2R/F2S/F2T/F2V/F2W /F2X/F2Y/F21 CB 'Seven Fifty' 92-02	
								VFR 750 FJ/FK/FL/FM/FN/FP 88-93	
								CBR 1000 FH/FJ/FK/FL/FM/FN /FP/FR/FS/FT/FV/FW/FX 87-99	
								ST 1100 AT/AV/AW/AX/AY/A1/A2 Pan European (ABS) 96-02	
<b>MD1004 MD1004C VR1004</b>	REAR	S	RS 125 90-07	220		FRONT	F	VFR 750 RJ/RK/RL (RC30) 88-90	220
			MD 250 H 08-11						
			MD 250 S 08-11						
			RS 250 90-02						
			CBR 400 RRJ/RRK (NC23) Tri-Arm 81-89						
			CBR 400 RRL/RRN/RRR (NC30) Gull-Arm 90-94						
			RVF 400 RR/RR-II/RT/RT-II (NC35) 94-96						
			VFR 400 R3L/R3N (NC30) 89-92						
			VFR 400 R3L/R3M (NC30) 90-91						
			CBR 600 FS/FT/FV/FW 95-98						
			VFR 750 FR/FS/FT/FV/ 94-97						
			CBR 900 RRR/RRS/RRT/RRV VTR 1000 FV/FW/FX/FY /F1/F2/F3/F4/F5/F6 Firestorm 97-06						
<b>MD1005LS MD1005RS</b>	FRONT	S	CBR 250 RRL/RRN/RRR 90-94	256		FRONT	F	RVF 750 RR/RS (RC45) 94-98	310
			CBR 250 RB/RC (Non ABS) 11-13						
			CB 250 FT/FV/FX/FY/F1 'Hornet' 96-01						
			VTR 250 W/Y/1-7 (MC33) 98-07						
			CBR 400 RRL/RRN/RRR (NC29) Gull-Arm 90-94						
			NX 4 Falcon 02-05						
			CB 600 'Hornet' FW/FX/FY /F2Y/F1/F2Y/F2/F3/F4/F5/F6 98-06						
			CBR 600 FM/FN/FP/FR/FS/FT/FV/FW/FX/FY/F1 /FS1/F2/FS2/F3/RR3/F3/F4/RR4/F5/F6 91-06						
			CBR 600 RR5-RR9/RAA/RRB/RRC 05-12						
			CBR 600 RR Hannspree 08						
			CBR 900 RRN/RRP/RRR/RRS/RRT/RRV /RRW/RRX/RRY/RR1/RR2/RR3 92-03						
			CB 1000 R8 08-09						
CBR 1000 RR4/RR5/RR6/RR7/RR8/RR9 /RAA/RRB/RRC/RRD Fireblade 04-13									
CBR 1000 RA9/RAA/RAB/RAC/RAD Fireblade (C-ABS) 09-13									
VTR 1000 SPY/SP1 00-01									
VTR 1000 SP2/SP3/SP4/SP5/SP6 02-07									
VTR 1000 FV/FW/FX/FY/F1 /F2/F3/F4/F5/F6 Firestorm 97-06									
<b>PEUGEOT SV 250</b> 01-02									
<b>MD1006 MD1006C VR1006</b>	FRONT	S	CB 350 SG/SJ 86-90	256		REAR	S	NSS 250 EX5/EX7/EX8 (ABS) Forza EX 05-08	240
			CB 450 SG/SJ 86-88					NSS 250 AX5/AX6 (Forza Z) (ABS) 05-06	
								NSS 250 X5/X7/X8 Forza 05-08	
								CB-1 (CB 400 F) 89-90	
								CB 400 SF (F2N/F2R/F2V/F3T /F3V) Superfour (NC31) 92-97	
								CB 500 VNV/SW/SX/SY/SZ/S2 97-03	
	REAR	S	CB 750 SG/SJ 84-85			CB 750 F2N/F2R/F2S/F2T/F2V/F2W/F2X /F2Y/F21 'CB Seven Fifty' 92-02		CB 900 F2/F3/F4/F5/F6/F7 02-07	
			FJS 600 1/2/D3/D4/D5/D6 Silverwing 01-06						
			VF 500 FE/F2E/FF/F2F 84-85						
			CBR 750 FH/FJ Superaero 87-88						
			VFR 750 FG/FH/FJ/FK 86-89						
			CBR 1000 FP/FR/FS/FT/FV/FW/FX XL 1000 V3/V4/V5/V6/V7/V8 /V9/VAB Vardero 03-11						
XL 1000 VA4/VA5/VA6/VA7/VA8/VA9 /VAA/VAB Vardero - ABS 04-11									
CB 1100 SFY/SF1 "XII" 00-03									
CBR 1100 XXV/XXW/XXX/XXY/XX1/XX2 /XX3/XX4/XX5/XX6 Blackbird 97-08									
CB 1300 F3/F13 03-04									
<b>MD1007 MD1007C</b>	REAR	S	VFR 750 FL/FM/FN/FP FR/FS/FT/FV 94-97	256		REAR	S	VTR 1000 SP2/SP3/SP4/SP5/SP6 02-07	276
<b>MD1010LS/RS</b>	FRONT	F		296		FRONT	F	VTR 1000 SP2/SP3/SP4/SP5/SP6 02-07	310
<b>MD1011</b>	REAR	S	VFR 750 RJ/RK/RL (RC30) 88-90	220		REAR	S	VFR 750 RJ/RK/RL (RC30) 88-90	220
<b>MD1012LS/RS</b>	FRONT	F		310		FRONT	F	RVF 750 RR/RS (RC45) 94-98	310
<b>MD1013</b>	REAR	S		220		REAR	S	RVF 750 RR/RS (RC45) 94-98	220
<b>MD1014X MD1014XC MD1014CC VR1014BLK VR1014BLU VR1014RED</b>	FRONT	F	CB 600 FX/FY 99-00	296		FRONT	F	CBR 600 FX/FY 99-00	296
			VFR 800 FIW/FIX 98-99					VFR 800 FIW/FIX 98-99	
			VFR 800 FIY/F1/2/3/4/5 00-05					VFR 800 FIY/F1/2/3/4/5 00-05	
			CBR 900 RRN/RRP 92-93					CBR 900 RRN/RRP 92-93	
			XL 1000 VX/VY/V1/V2 Varadero Non ABS Model 99-02					XL 1000 VX/VY/V1/V2 Varadero Non ABS Model 99-02	
			XL 1000 V3/V4/V5/V6/V7/V8/V9/VAA/VB Varadero - Non ABS 03-11					XL 1000 V3/V4/V5/V6/V7/V8/V9/VAA/VB Varadero - Non ABS 03-11	
GL 1500 CV/CW/CX/CY /C1/C2 (F6C) 97-03	GL 1500 CV/CW/CX/CY /C1/C2 (F6C) 97-03								
GL 1800 6/7/8/9/A Goldwing 06-13	GL 1800 6/7/8/9/A Goldwing 06-13								
GL 1800 A1-A5 01-05	GL 1800 A1-A5 01-05								
F6B Goldwing 13	F6B Goldwing 13								
<b>MD1016</b>	REAR	S	NT 650 VVVV/VY/V1-V5 'Deauville' 98-05	276		REAR	S	NT 650 VVVV/VY/V1-V5 'Deauville' 98-05	276
			NT 700 V6/V7/V8/VAA Deauville 06-12					NT 700 V6/V7/V8/VAA Deauville 06-12	
<b>MD1020 MD1020C VR1020</b>	REAR	S	NT 700 VA6/VA7/VA8/VAA 07-13	240		REAR	S	NT 1000 FP/FR/FS/FT/FV 93-97	240
			CBR 1000 FK/FL/FM/FN 89-92					CBR 1000 FK/FL/FM/FN 89-92	
			VT 1100 C2 (W/X/Y/1/2/3/4/5) 98-05					VT 1100 C2 (W/X/Y/1/2/3/4/5) 98-05	
			VT 1100 C2 (S/T/V) 95-97					VT 1100 C2 (S/T/V) 95-97	
			VT 1100 C3 (W/X/Y) 98-00					VT 1100 C3 (W/X/Y) 98-00	
<b>MD1021LS MD1021RS</b>	FRONT	SF	VT 250 CR/CT/CV 'Magna' 95-97	316		FRONT	SF	VT 250 CR/CT/CV 'Magna' 95-97	316
			NTV 600 J/K/M Revere 88-92					NTV 600 J/K/M Revere 88-92	
<b>MD1022</b>	REAR	S	NTV 650 J/K/L/M/P/S/T/V 88-97	240		REAR	S	VFR 400 RH2/RJ (NC24) 87-88	240
			VF 750 CP/CR/CS/CT/CV 93-97					NT 400 'Bros' NC25 88-92	
<b>MD1024LS/RS</b>	FRONT	SF	VT 1100 C2 (S/T/V) 95-97	240		FRONT	SF	VT 1100 C2 (S/T/V) 95-97	240
<b>MD1025</b>	REAR	S	VFR 400 RH2/RJ (NC24) 87-88	240		REAR	S	VFR 400 RH2/RJ (NC24) 87-88	240
			NT 400 'Bros' NC25 88-92					NT 400 'Bros' NC25 88-92	
<b>MD1026RS</b>	FRONT	SF	NT 650 J/K/L (Bros) (NC31) 88-92	240		FRONT	SF	NT 650 J/K/L (Bros) (NC31) 88-92	240
<b>MD1024LS/RS</b>	FRONT	SF		276		FRONT	SF	<b>USE MD1001LS/RS</b>	276
<b>MD1025</b>	REAR	S		276		REAR	S	NTV 600 J/K/M Revere 89-92	276
<b>MD1026RS</b>	FRONT	SF		276		FRONT	SF	NTV 650 J/K/L/M/P/S/T/V 88-97	276
<b>MD1026RS</b>	FRONT	SF		276		FRONT	SF	<b>NOT BEING MADE</b>	276

**D = Dished Solid Original (We replace with floating rotor conversion unit) F = Floating Rotor S = Solid Rotor SF = Solid Flat Original Disc which we replace with fully floating unit - fits direct no mods required.**

# STREETBIKE DISC BUYERS GUIDE











DISC No.	FRONT/ REAR	TYPE	MODELS	DIA (MM)	DISC No.	FRONT/ REAR	TYPE	MODELS	DIA (MM)
MD1030	FRONT	S	CA 125 S/T/V/W/X Rebel 95-00	240	MD1076LS/RS	FRONT	D	USE MD1036LS/RS	276
			CBF 125 M9/MA/MB 09-13		MD1077	REAR	S	ST 1100 AN/AP/AR/AS Pan European (ABS) 92-95	
			VT 125 CX/CY/C2Y/C1/C21/C3/C4/C7 /C8 'Shadow' 99-08				ST 1100 L/M/N/P/R/S/T/V/W/X/Y /1/2 Pan European Non ABS 90-02		
			CBX 250 84-98				GL 1500 L/SEM/SEN/SEP/SER/SES SEV/SEW/SEX/SEY Goldwing 88-00		
			CMX 250 CT/CV/CW 'Rebel' 96-00				GL 1500 CV/CW/CX 97-99		
			<b>HERO</b>						
			Glamour 125 (PGM F1) 11-12						
			Hunk 150 11-12						
MD1035LS/RS			<b>NOT BEING MADE</b>		MD1079	REAR	S	CBX 750 FE 84	276
								VF 1000 FE/FF/F2F/FG/F2G 84-86	
MD1036LS MD1036RS 5 Bolt Fixing	FRONT	D	CB 250 N/NA/NB/NDB/NDC 78-82	276	MD1080RS	FRONT	F	VT 1100 CH/CJ/CN/CP Shadow 87-93	336
			CM 250 TB 81						
			CX 500 EC 82						
			CB 650 SCC Nighthawk 82						
			CX 650 ED 83						
			CB 750 KZ 80						
			CB 750 FZ/FA/FB/FC/F2C/FD/F2D 78-84						
			CB 900 FZ/FA/FB/F2B 80-83						
			CB 900 FC/F2C/FD/F2D 84-85						
			CBX 1000 Z 79-80						
			GL 1000 K3/KZ Goldwing 77-78						
			GL 1000 Z 79						
			GL 1100 A/DA/B/DB Goldwing 80-81						
			GL 1100 1A/1B Interstate Goldwing 80-81						
			GL 1100 C/DC 82						
MD1037LS/RS			<b>NOT BEING MADE</b>		MD1083LS/RS	FRONT	D	VF 750 FD/FE 83-84	276
								GL 1200 DE/DF/DG 84-86	
MD1038 RS	FRONT	F	CB-1 (CB 400 F) 89-90	310	MD1084LS	FRONT	S	NS 125 FG/FH/RH 86-87	240
									
MD1040LS/RS	FRONT	S	GL 650 D2E 84	276	MD1088LS	FRONT	F	NSR 125 FM/RK/RL/RM/RN 91-92	316
								NSR 125 FJ/K/FL/FM/FN 88-92	
MD1041LS	FRONT	S	CMX 450 CH/CJ Rebel 87-88	276				NSR 125 RK/RL/RM/RN 89-92	
MD1045LS			<b>NOT BEING MADE</b>		MD1089LS	FRONT	S	CB 250 N/T/W/X/Y/1/4 (CB Two Fifty) 92-05	240
MD1046			<b>USE MD1082</b>		MD1090LS	FRONT	S	CBX 250 RSE 84	240
								CD 250 UJ 88-92	
MD1047LS	FRONT	S	FT 500 C 82	296	MD1092LS/RS			<b>USE MD1003X</b>	
			VT 600 CN/CR/CS/CT/CV/CW/CX 'Shadow custom' 93-00		MD1093LS/RS			<b>USE MD1003X</b>	
			VF 750 C Shadow 83		MD1095LS/RS			<b>USE MD1083LS/RS</b>	
MD1048	REAR	F	FT 500 C 82	276	MD1100LS/RS			<b>USE MD1133X</b>	
					MD1101	FRONT	S	<b>HONDA</b>	316
MD1051LS			<b>USE MD1047LS</b>					ST 1100 AN/AP/AR/AS Pan European (ABS) 92-95	
MD1056	FRONT	F	CB 1000 FP/FR/FS/FT/FV 93-97	310				ST 1100 L/M/N/P/R/S/T/V/W/X/Y/1/2 Pan European (Non ABS) 90-02	
								<b>KYMCO</b>	
MD1059LS	FRONT	S	VF 750 CH 87	316				Venox 250 (R20010/RA50AA /Carb Model) 00-03	
								Venox 250 (RFBR20011/RA50AD /Carb Model) 04-06	
MD1062LS	FRONT	D	CB 750 K6-K7 76-78	296				Venox 250 (R20012/EFi Model) 07-12	
			CB 750 KZ 80		MD1102			<b>USE MD1077</b>	
MD1064	REAR	F	CB 750 F/F1/F2 76-78	296	MD1103LS			<b>USE MD1047LS</b>	
			GL 1000 2 Goldwing 79		MD1109LS	FRONT	F	NSR 125 FP/RR/RR/RV/RW/RX/R1 93-04	316
			GL 1000 K/K1/K2/K3 Goldwing 75-					NSR 125 RR/RS/RV/RW/RX/R1 93-01	
MD1065			<b>USE MD1071</b>		MD1110			N/A	
MD1068	REAR	S	VF 750 FD/FE 83-84	296	MD1111	REAR	S	NSR 250 R2R/R3R/ (MC28-110) R2T/R3T (MC28-120) 94	220
								NSR 250 RR (MC28-100) 94	
MD1071	REAR	D	CB 750 FZ/FA/FB 78-82	296				VFR 400 RK3/R3L/R3M /R3N (NC30) 89-92	
			CB 900 FZ/FA 80-81					RVF 400 RR/RR-II/RT/RT-II (NC35) 94-96	
			CBX 1000 Z 79-80		MD1112LS/RS			<b>NOT BEING MADE</b>	
			CBX 1000 B/C 81-82		MD1113			<b>NOT BEING MADE</b>	
			GL 1000 K/K1-K3/KZ 75-79						
			GL 1100 A/DA/B/DB Goldwing 80-81						
			GL 1100 1A/1B Interstate Goldwing 80-81						
			GL 1100 C/DC 82						
MD1074LS/RS	FRONT	D	GL 1000 K/K1/K2 75-77	276					
6 Bolt Fixing									

DISC BUYERS GUIDE

D = Dished Solid Original (We replace with floating rotor conversion unit) F = Floating Rotor S = Solid Rotor  
SF = Solid Flat Original Disc which we replace with fully floating unit - fits direct no mods required.



# STREETBIKE DISC BUYERS GUIDE

DISC No.	FRONT/ REAR	TYPE	MODELS	DIA (MM)	DISC No.	FRONT/ REAR	TYPE	MODELS	DIA (MM)
MD1114LS			USE MD1001		MD1138X MD1138XC MD1138CC	FRONT	F	VTR 1000 SPY/SP1 (SC45) 00-01 VTR 1000 SP2/SP3/SP4/SP5/SP6 02-07	320
MD1116 	REAR	D	CB 1100 RB11/RC11/RD11 80-83	296					
MD1117LS/RS 	FRONT	F	NSR 250 R6K/R6K-2 89 NSR 250 R7L (MC21-100)/R7N (MC21-106) 90 NSR 250 R8L-3 (MC21-101)/R9L (MC21-102)/R8N/R8N-3 (MC21-106) 90-92 NSR 250 R9N (MC21-106) 92 NSR 250 RR (MC28-100) 94 NSR 250 R2R/R3R (MC28-110) /R2T/R3T (MC28-120) 94 NSR 250 R2J (MC18-100) /R4J(MC18-100) 88 NSR 250 R5K/R5K-2 (MC18-110) 89	276	MD1139 MD1139C 17" wheel	FRONT	F	CB 600 FY/F2Y/F1/F21/F22/F2/F3 /F4/F5/F6 00-06	296
					MD1140RS 	FRONT	F	CBR 250 RJ/RK/R2K MC19 88-89	310
					MD1141X MD1141XC MD1141CC VR1141BLK VR1141BLU VR1141RED	FRONT	F	CBR 600 F1/F2/F3/F4/F5/F6 01-06 CBR 600 FS1/FS2 'Sport' 01-02 CB 900 F2-F7 Hornet 02-07 VTX 1800 C2/C3/C4/C15/C16/C17 02-08	296
MD1118			USE MD1077		MD1142RS	FRONT	S	NSR 75 N/P/R/X/Y (NS-1) 92-00	256
MD1120 VR1120BLK VR1120BLU VR1120RED	FRONT	F	CBR 1100 XXV/XXW Blackbird 97-98	310	MD1143	REAR	S	NSR 75 N/P/R/X/Y (NS-1) 92-00	220
					MD1144RS 	FRONT	F	CB 250 FT/FV/FX/FY/F1 Hornet VTR 250 W/Y/1-7 (MC33) 96-01 98-07	296
MD1124LS 	FRONT	F	NT 400 BROS NC25 NT 650 J/K/L (Bros) (NC31) 88-92	320	MD1145LS/RS 	FRONT	F	CBR 250 RRL/RRN/RRR (MC22) 90-94	276
MD1125 	FRONT	D	GL 1200 AE/AF/AG Goldwing 84-86	276	MD1146	FRONT	S	VF 1000 RE/RF/RG 84-86	276
MD1126	FRONT	S	GL 1500 J/K/L/SEM/SEN/SEP/SER /SES/SEV/SEW/SEX/SEY Goldwing 88-00	296	MD1147LS	FRONT	S	CLR 125 W 'City Fly' 99-03 NX 125 K/S/T 89-97 CRM 125 RL/RM/R/PP/RR/RV/RX 90-99	240
MD1127	REAR	S	GL 1500 J/K Goldwing 88-89	296	MD1148	REAR	S	GL 1500 CY/C1/C2 (F6C) 00-03 VTX 1800 C2/C3/C4/C15/C16/C17 02-08	316
MD1129LS/RS 	FRONT	F	NSR 250 RG (MC16-100) 86	256	MD1149 MD1149C	REAR	S	FJS 400 Silverwing D6/D7/D8 06-08 SW-T 400 (FJS 400 D9) 09 SW-T 400 (FJS 400 A9/AB) (ABS) 09-12 FJS 600 1/2/D3/D4/D5/D6 Silverwing 01-06 FJS 600 A3-A7/D7 Silverwing 03-09 SW-T 600 (FJS 600 AB) (ABS) 11-13	240
MD1130			NOT BEING MADE		MD1150RS	FRONT	S	XL 125 V1-VA Varadero 01-11	276
MD1131LS 	FRONT	F	FT 500 C 82	296	MD1151	REAR	S	XL 125 V1-VA Varadero 01-11 CBR 125 R4/R5/RS5/RS6 04-06 CBR 125 RW5-RW9/RWA/RWB 05-13 CBR 150 R 00-03	220
MD1132 MD1132C 16" wheel	FRONT	F	CB 400 SF (F2N/F2R/F2V/F3T/F3V) Superfour (NC31) 92-97 CB 600 FW/FX 98-99	296	MD1152X MD1152XC MD1152CC VR1152BLK VR1152BLU VR1152RED	FRONT	F	CBR 600 RR3/RR4/RR5/RR6/RR7 /RR8/RR9/RAA/RRB/RRC 03-13 CBR 600 RR Hannspree 08 CBR 600 RA9/RAA/RAB/RAC/RAD 09-13 CB 1000 R9/RA/RB (Non ABS) 09-12 CB 1000 RA9/RAA/RAB/RAC (ABS Model) 09-12 CB 1300 5/6/7/8/9 (Superfour) 05-09 CB 1300 A5-A9 (Superfour ABS) 05-09 CB 1300 S5/S6/S7/S8/S9 05-09 CB 1300 SA5/SA6/SA7/SA8/SA9/SA 05-12	310
MD1133 	FRONT	F	GL 1100 AD GL 1100 AC Aspencade Goldwing 83 82	296	MD1153X MD1153XC MD1153CC VR1153BLK VR1153BLU VR1153RED	FRONT	F	CBR 1000 RR4/RR5 04-05	310
MD1134 MD1134X MD1134XC MD1134CC VR1134BLK VR1134BLU VR1134RED	FRONT	F	CBR 900 RRW/RRX 98-99	310					
MD1135	REAR	S	ST 1100 AT/AV/AW/AX/AY/A1/A2 Pan European (ABS) 96-02	296	MD1154X MD1154XC	FRONT	F	ST 1300 2/3/4/6 Pan European (Non ABS) 02-07 S 1300 A2/A3/A4/A6/A8/A9/AA Pan European (ABS Model) 02-13 ST 1300 8/9 Pan European (Non ABS) 08-09	310
MD1136 MD1136C VR1136BLK VR1136BLU VR1136RED	FRONT	F	CBR 1100 XXX/XXY/XX1-XX6 Blackbird 99-08 CB 1100 SFY/SF1 "XII" 00-03	310	MD1155RS	FRONT	S	CBF 500 4 (Non ABS Model) 04 CBF 500 A4/A5/A6/A7 ABS Model 04-07	296
MD1137X MD1137XC MD1137CC VR1137BLK VR1137BLU VR1137RED	FRONT	F	CBR 900 RRY/RR1 "929cc Fireblade" 00-01 CBR 900 RR2/RR3 954cc 02-03	330					

D = Dished Solid Original (We replace with floating rotor conversion unit) F = Floating Rotor S = Solid Rotor  
SF = Solid Flat Original Disc which we replace with fully floating unit - fits direct no mods required.

# STREETBIKE DISC BUYERS GUIDE

DISC No.	FRONT/ REAR	TYPE	MODELS	DIA (MM)	DISC No.	FRONT/ REAR	TYPE	MODELS	DIA (MM)
MD1156	REAR	S	CBF 500 4 (Non ABS Model) 04-05	240	MD1168X MD1168XC	FRONT	F	CB 600 F7/F8/F9/FA/FB/FC Hornet 07-13	296
			CBF 500 A4/A5/A6/A7 ABS Model 04-07					CB 600 FA7/FA8/FA9/FAA /FAB/FAC Hornet (ABS) 07-13	
			CB 600 F7/F8/F9/FA/FB/FC Hornet (ABS) 07-13					CBR 600 FB/FC/FAB/FAC (ABS Model) 11-13	
			CBF 600 N4/N5/N6/N8/N9/NA (Non ABS) 04-06/08-11						
			CBF 600 NA4/NA5/NA6/NA8/NA9 (ABS) 04-06/08-09						
			CBF 600 S4/S5/S6/S8/S9 (Non ABS) 04-06/08-09						
			CBF 600 SA4/SA5/SA6/SA8/SA9/SA (ABS) 04-06/08-12						
			CBR 600 FB/FC (Non ABS Model) 11-13						
			CBR 600 FAB/FAC (ABS Model) 11-13						
			CBF 1000 6/7/8/9/A (Non ABS) 06-11						
CBF 1000 F (FA) (Non ABS) 10-11									
MD1157X MD1157XC	FRONT	F	VFR 800 A2/A3/A4/A5 (ABS) 02-05	296	MD1169C MD1169CF	FRONT	S/F	NSR 50 V (AC10-180) 97	220
			VFR 800 6/8/9 06-09					NSR 50 X (AC10-190) 99	
	FRONT	F	VFR 800 A6/A7/A8/A9 (ABS) 06-13	296	MD1170C	REAR	S	NSR 80 V (HC06-170) 97	160
			VFR 800 XC Crossrunner 800 11-13					NSR 80 X (HC06-180) 99	
MD1158RS	FRONT	F	VTX 1300 S3/S4/S5/S6/S7/S8 03-08	336	MD1171X MD1171XC VR1171BLK VR1171BLU VR1171RED	FRONT	F	CBR 1000 RR8/RR9/RRA/RRB/RRC /RRD Fireblade 08-13	320
								CBR 1000 RA9/RAA/RAB/RAC/RAD Fireblade (ABS) 09-13	
MD1159	FRONT	S	NV 400 DCY/DC1/DC2 (NC40) Shadow Slasher 00-02	296	MD1172LS	FRONT	S	SW-T 400 (FJS 400 D9) 09	276
			VT 750 CV/C2V/CW/C2W/CX/C2X/CY/C2Y /C1/C21/C4/C5/C6/C7/C8 Shadow97-09					SW-T 400 (FJS 400 A9/AB) (ABS) 09-12	
MD1159	REAR	S	VT 750 DC1/DC2 'Black Widow' 01-04	296	MD1173 MD1173C VR1173	REAR	S	FJS 600 Silverwing A3-A7/D7 03-09	220
			VT 750 DC7/DC8 Shadow Spirit 07-09					SW-T 600 (FJS 600 AB) (ABS) 11-13	
MD1159	REAR	S	VT 750 C2BA/C2BB/C2BC Shadow Black Spirit 10-13	296	MD1174 MD1174C	REAR	S	CB 1300 5/6/7/8/9 (Superfour) 05-09	256
			VT 750 S (VT750SA/SB) 10-12					CB 1300 A5/A6/A7/A8/A9 (Superfour ABS) 05-09	
MD1160	FRONT	F	VTX 1300 S3/S4/S5/S6/S7/S8 03-08	336	MD1175	REAR	S	CB 1300 SA5/SA6/SA76/SA8/SA9 /SAA 05-12	276
								VFR 1200 FA/FB 10-13	
MD1161X MD1161XC MD1161CC VR1161BLK VR1161BLU VR1161RED	FRONT	F	CBF 600 N8/N9/NA (Non ABS) 08-11	296	MD1176X	FRONT	F	VFR 1200 FDA/FDB 10-13	320
			CBF 600 NA8/NA9/NA (ABS) 08-11						
			CBF 600 S8/S9 (Non ABS) 08-09						
			CBF 600 SA8/SA9/SA (ABS) 08-12						
			CBF 1000 6/7/8/9/A (Non ABS) 06-10						
			CBF 1000 A6/A7/A8/A9/AA (ABS) 06-10						
			CBF 1000 F (FA) (Non ABS) 10-11						
			CBF 1000 FA (FAA/FAB) (ABS) 10-13						
			CBF 1000 FS (FSA) (ABS) 10-11						
			CBF 1000 FT (FTA) (ABS) 10-11						
MD1162LS/RS	FRONT	F	CBF 1000 S (S7/S8/S9/SA) (ABS) 07-11	296	MD1177 MD1177C	REAR	S	CB 1000 R9/RA/RB (Non ABS) 09-12	256
			CBF 1000 T (T7/T8/T9/TA) (ABS) 07-12					CB 1000 RA9/RAA/RAB (ABS) 09-12	
MD1161X MD1161XC MD1161CC VR1161BLK VR1161BLU VR1161RED	FRONT	F	CBR 1000 RR6/RR7 06-07	320	MD1178	REAR	S	CBF 1000 A6/A7/A8/A9/AA (ABS) 06-10	240
								CBF 1000 (FAA/FAB) (ABS) 10-13	
MD1162LS/RS	FRONT	F	CBR 750 FJ 88	296	MD1179	FRONT	S	CBF 1000 FS (FSA) (ABS) 10-11	316
								VT 1100 C2 (W/X/Y/1/2/3/4/5) 98-05	
MD1163	REAR	S	ST 1300 2/3/4/6 Pan European (Non ABS) 02-07	316	MD1180X MD1180XC	FRONT	F	VT 1100 C3 (W/X/Y) 98-00	296
			S 1300 A2/A3/A4/A6/A8/A9/AA Pan European (ABS Model) 02-13					CBR 250 RB/RC (Non ABS) 11-13	
MD1164 MD1164C	REAR	S	ST 1300 8/9 Pan European (Non ABS) 08-09	256	MD1181	REAR	S	CBR 250 RAB/RAC (ABS) 11-13	240
								CBR 250 RAB/RAC (ABS) 11-13	
MD1164 MD1164C	REAR	S	VFR 800 FiY/Fi1/2/3/4/5 00-05	256	MD2001X MD2001XC MD2001CC VR2001BLK VR2001BLU VR2001RED	FRONT	F	TZR 250 (3MA1 Reverse Cylinders) 89	298
			VFR 800 A2/A3/A4/A5 (ABS) 02-05					FZR 400 RR (4DX) 92	
VFR 800 6/8/9 06-09	FZ 400 (4YR1) 96								
VFR 800 A6/A7/A8/A9 (ABS) 06-13	FZR 400 (3TJ/2/6/7) 89								
	FZR 400 (3ENZ) 89								
	XJR 400 4HM1/4HM2/4HM4/4HM7 93-96								
	XJR 400 4HM3/4HM5/4HM6/4HM9 /4HMA/4HMB 95-99								
	FZR 600 89-93								
	FZR 600 R 94-95								
	FZS 600 Fazer 98-03								
MD1165 MD1165C	REAR	S	VFR 800 FiW/FIX 98-99	256	MD1181	REAR	S	FZ 750 89-91	256
								TDM 850 91-01	
MD1166RS	FRONT	S	CBR 125 RWB 11-13	276	MD1181	REAR	S	TRX 850 96-99	256
			CBF 250 4/6 04-06					FJ 1200 (3CV/3XW Type) 88-95	
MD1166RS	FRONT	S	CB 300 R10 10	276	MD1181	REAR	S	APRILIA RST Futura 1000 01-04	276
								DUCATI 900 Supersport 89-90	
MD1167RS	FRONT	S	VT 1100 CR/CS/CT/CV/CW Shadow 94-98	330	MD1181	REAR	S	907 IE 90-91	330

DISC BUYERS GUIDE

D = Dished Solid Original (We replace with floating rotor conversion unit) F = Floating Rotor S = Solid Rotor  
SF = Solid Flat Original Disc which we replace with fully floating unit - fits direct no mods required.







# STREETBIKE DISC BUYERS GUIDE

DISC No.	FRONT/ REAR	TYPE	MODELS	DIA (MM)	DISC No.	FRONT/ REAR	TYPE	MODELS	DIA (MM)
MD2067LS MD2067RS	FRONT	S	TZR 50 'Thunderkid' (SDU1/3) 97-00 TZR 50 X-Power 00 XV 125 Virago 97-00 XVS 125 Dragstar 00-04 SRV 250 'Soulfultwin /Renaissa' 92-97 XV 250 S Virago 95-00 XVS 250 Dragstar 01-04 XV 750 Virago 94-97 XV 1100 Virago 94-99	280	MD2077	REAR	S	TZR 50 'Thunderkid' (5DU1/3) 97-00 TZR 50 X-Power 00	203
			MZ/MUZ Baghira - Forest/Forest HR 21" Front Wheel/Spoke Wheel 96-05 Baghira 21" Front Wheel /Spoke Wheel 99-05 <b>ROYAL ENFIELD</b> Electra 500 05-11 Clubman 500 EFI 09-11 Bullet Classic 500 EFI 09-11 Woodsman 500cc EFI 10-11 Trails 50 EFI 09-11		MD2078	REAR	S	XVZ 13 AH/ATH Royal Star 96-00 XVZ 1300 TF 'Venture Star' 99-01	320
MD2068 MD2068	FRONT	S	FJ 1100 84-85 FJ 1200 (ITX) 86-87 FJ 1100 84-85 FJ 1200 (ITX/3CV/3XW) 86-95 FJ 1200 A (ABS Model) 91-95 V MAX 12 'All models' 91-02	282	MD2081	FRONT /REAR	S	XVZ 12 TD 85 XVZ 12 TD 85	298
	REAR	S		282	MD2082X MD2082XC MD2082CC VR2082BLK VR2082BLU VR2082RED	FRONT	F	YZF R6 03-04 MT-03 (660cc) 06-12 FZ6 Naked/Non ABS 2 Piston Caliper (IB3/IB3D) 04-07 FZ6-NS Naked/Non ABS/ 2 Piston Caliper (IB35/6) 05-06 FZ6-Fazer (Half Fairing/Non ABS /2 Piston Caliper) (5VX/5VXL) 04-07 FZ6 Fazer (ABS/Half Fairing /2 Piston Caliper) 06-07 FZ6 Fazer S2 (ABS/Half Fairing /4 Piston Caliper) 08 FZ6 Fazer S2 (Non ABS/Half Fairing /4 Piston Caliper) (4S81/4S8) 07-09 FZ6 S2 (Non ABS/Half Fairing /4 Piston Caliper) (5S51/5S5) 07-09 XJ6-N (600cc) (Naked - 20S ABS /NonABS) 09-12 XJ6-N Diversion Naked 13 XJ6-S Diversion (600cc) (Top Fairing - 36C ABS/NonABS) 09-13 XJ6-SP 13 XJ6-F Diversion (600cc) (Full Fairing - 1CW1 ABS/NonABS) 10-13	298
MD2069	FRONT	S	RD 500 LC 84-86 RZV 500 R (SIX) 85 FZ 750 85-86 XJ 900/900F 83-86	267		MD2083LS/RS	FRONT	F	YZF-R7 750 'OWO2' 99-00 MT-01 (1670cc) 05-10 MT-01S (5YUR) 09
MD2069	REAR		FZX 700 S/SC/T/TC 'Fazer' 86-87 FZ 750 85-86 FZX 750 87 <b>NORTON</b> Commander (Rotary) 90		MD2084 MD2084C VR2084	REAR	S	YZF 600 R 'R6' 99-02 YZR 1000 R1 02-03	220
MD2070	REAR	S	RD 500 LC 84-86 RZV 500 R (SIX) 85	245		MD2085LS	FRONT	S	SR 125 97-03
MD2073RS			<b>USE MD2022RS</b>		MD2086 MD2086C VR2086	REAR	S	YZF R7 OWO2 (Road version) 99-01 YZF R1 98-01	245
MD2074X MD2074XC MD2074CC VR2074BLK VR2074BLU VR2074RED	FRONT	F	YZF 600 R Thunder Cat 96-03 XJ 600 S 'Diversion' 98-03 XJ 600 N 98-03 YZF 600 R 'R6' 99-02 TDM 900 (SPS) (Non ABS) 02-12 TDM 900 (2BO) (ABS) 05-07 FZS 1000 Fazer 01-04 YZF 1000 R Thunder Ace 96-02 YZF 1000 R1 98-03 BT 1100 P/R/S/T/V Bulldog 02-06 V-Max 12 93-03 FJR 1300 (Non ABS) (5JW) 01-04 XJR 1300 L 5EA2/5EA3/5EA4 99 XJR 1300 M 5EAA/5EAB/5EAC 00 XJR 1300 (5EA9/5EAG) 00 XJR 1300 N/P (5EAP/5EAR/5EAS /5EAT/5EAW/5EAW/5EAY) 01-02 XJR 1300 R/S 5WM1/5WM3/5WM5 /5WM6/5WM7/5WM9 03-04 XJR 1300 T/V/W/X/Y SWMA/5WMC/ /5WMD/5WMF 05-12 XJR 1300 SP (L) 5EA5/5EA6/5EA8 99 XJR 1300 SP (M) 5EAD/5EAE/5EAF 00 XJR 1300 SP (N) 5EAL/5EAM/5EAN 01 XVS 1300 A Midnight Star 07-13 XV 1700 PCR Road Star Warrior 03-05 XV 1900 A 06-12	298	MD2087LS	FRONT	S	XP 500 N/P/R/S T-Max 01-04	282
					MD2088	REAR	S	XV 1600 A Wildstar 99-04	320
MD2075	REAR	S	GTS 1000 93-99	282	MD2089X MD2089XC MD2089CC (Black hub) VR2089BLK VR2089BLU VR2089RED	FRONT	F	XVS 950 A Midnight Star 09-12 FJR 1300 A (ABS) (3P6 Model) 06-09 FJR 1300 A (ABS) (ICY) 10-12 FJR 1300 A (ABS) (5VS) 03-05 FJR 1300 A (1MC/ABS/Manual G/Shift) 13 FJR 1300 AS (ABS/Electric Shift) (2D2) 06-09 FJR 1300 AS (ABS - Electric Shift) 13	320
	MD2076	FRONT	S	XVS 400 96 XV 535/535 S Virago 95-03 XVS 650 Drag star 97-04 XVS 650 A Dragstar Classic 98-07 XVS 1100 Dragstar 99-04 XVS 1100 A Dragstar Classic 00-07 XVZ 13 AH/ATH Royal Star 96-00 XVZ 1300 TF 'Venture Star' 99-01 XV 1600 A 'Wildstar' 99-04	298	MD2090LS/RS	FRONT		<b>USE MD2074</b>
					MD2091 MD2091C VR2091	REAR	S	YZF R6 03-12 YZF R1 04-12	220
					MD2092 MD2092C VR2092	REAR	S	XVS 1100 Dragstar 99-04 XVS 1100 A Dragstar Classic 00-07 FJR 1300 A (ABS) (5VS) 03-05 FJR 1300 (Non ABS) (5JW) 01-04 XV 1700 PCR Road Star Warrior 03-05	282
					MD2093 MD2093C VR2093	REAR	S	FZ1 (2D1) (Naked) Non ABS 06-09 FZ1 Fazer (3C3) (Half fairing) 06-13 FZ1 Fazer (Half Fairing - ABS - 5DO) 08-13 FZ1 N/A Naked (Non ABS/ABS) 10-13 FZ6 Naked/Non ABS 2 Piston Caliper (IB3/IB3D) 04-07 FZ6-NS Naked/Non ABS/ 2 Piston Caliper (IB35/6) 05-06	245

D = Dished Solid Original (We replace with floating rotor conversion unit) F = Floating Rotor S = Solid Rotor  
SF = Solid Flat Original Disc which we replace with fully floating unit - fits direct no mods required.









# STREETBIKE DISC BUYERS GUIDE

DISC No.	FRONT/ REAR	TYPE	MODELS	DIA (MM)	DISC No.	FRONT/ REAR	TYPE	MODELS	DIA (MM)	
MD2093 MD2093C VR2093 Contd.	REAR	S	FZ6-Fazer (Half Fairing/Non ABS /2 Piston Caliper) (5VX/5VXL) 04-07	245	MD2112X	FRONT	F	YZF-R1 SP (4B1)	06 320	
			FZ6 Fazer (ABS/Half Fairing /2 Piston Caliper) 06-07		MD2113	REAR	S	TZR 50 X Power 03-10 TZR 50 03-13	220	
			FZ6 Fazer S2 (ABS/Half Fairing /4 Piston Caliper) 08		MD2114	REAR	S	USA ONLY	310	
			FZ6 Fazer S2 (Non ABS/Half Fairing /4 Piston Caliper) (4S81/4S8) 07-09		MD2115C	REAR	S	XT 1200 Z Super Tenere (ABS/UBS Brake System) 11-13	280	
			FZ6 S2 (Non ABS/Half Fairing /4 Piston Caliper) (5S51/5S5) 07-09 MT-03 (660cc) 06-12		MD2116 MD2116C VR2116	REAR	S	FZ 8 N-800cc (Naked/Single Headlight/Non ABS) 11-13 FZ 8 NA-800cc (Naked/Single Headlight/ABS) 11-13 Fazer 8 S-800cc (Top Fairing/ Twin Headlight/Non ABS) 11-13 Fazer 8 S-800cc (Top Fairing/ Twin Headlight/ABS) 11-13	267	
MD2094X MD2094XC MD2094CC VR2094BLK VR2094BLU VR2094RED	FRONT	F	YZF R1 04-06	320						
MD2095X MD2095XC MD2095CC VR2095BLK VR2095BLU VR2095RED	FRONT	F	YZF R6 05-07	310	MD2117 VR2117	REAR	S	XJ6-N Diversion 600 (Naked Diversion - Non ABS & ABS Models - 20S) 09-12 XJ6-N Diversion Naked 13 XJ6-F Diversion 600 (Full Fairing Diversion - Non ABS & ABS Models - 1CW) 10-13 XJ6-S Diversion 600 (Top Fairing Diversion - Non ABS & ABS Models - 36C) 09-13 XJ6-SP 13	245	
			FZ 8 N-800cc (Naked/Single Headlight/Non ABS) 11-13		MD2118	REAR	S	YZF-R1SP	06 220	
			FZ 8 NA-800cc (Naked/Single Headlight/ABS) 11-13			MD3001LS MD3001RS	FRONT	S	GSXR 400 H 87 GSX 400 RS (GK71F) 290 GSX 400 X/XA/XS 88 GSX 600 FJ 88	
			Fazer 8 S-800cc (Top Fairing/ Twin Headlight/Non ABS) 11-13				MD3002 MD3002C VR3002	REAR	S	GSF 250 N/ZM/P/NP/ZP/R/NR 92-96 GSX 250 SSM Katana 91 GSX 250 FL/FM/FN/FP/FR/FS/FT /FV/FW Across 90-98 GSF 400 M/N/P Bandit 91-95 GSX 400 FJ/FK/FAK/FL (GK74A) 88-90 GSX 400 R/S/T/X/ZR/ZS/ZT Impulse Type S 94-99 GSX 400 SSN Katana 92 GSF 400 K/NK/Z/V/M/VZM/P/NP /N/P/VZP/VR Bandit (GK75A) 89-94 GS 500 EK/EL/EM/EN/EP/ER/ES /ET/EV/EW/EX/EY/K1/K2/K3/K4/FK4 /FK5/K5/K6/FK6/K7/FK7/K8/FK8 89-08 GSX 600 FJ/FK/FL/FM/FN/FP/FR/FS/FT/FV88-97 GSX 750 FK/FL/FM/FN/FP/FR/FS/FT/FV 89-96
			XT 1200 Z Super Tenere (ABS/UBS Brake System) 11-13					FRONT	F	MD3003X MD3003XC MD3003CC VR3003BLK VR3003BLU VR3003RED
MD2097RS	FRONT	S	YBR 125 ED (3D91) 05-06	245						
MD2098 MD2098C	FRONT	F	T-Max XP 500 04-07	267						
MD2099	REAR	S	XV 1900 A Midnight Star 06-13	320						
MD2100 VR2100	REAR	S	FJR 1300 A (ABS) (3P6 Model) 06-09 FJR 1300 A (ABS) (ICY) 10-12 FJR 1300 A (1MC/ABS/Manual G/Shift) 13 FJR 1300 AS (ABS/Electric Shift) (2D2) 06-09 FJR 1300 AS (ABS - Electric Shift) 13	282						
MD2101X MD2101XC VR2101BLK	FRONT	F	FZ1 (2D1) (Naked) 06-09 FZ1 Fazer (3C3) Half fairing (Non ABS) 06-13 FZ1 Fazer (Half Fairing - ABS - 5D0) 08-13 FZ1 N/NA Naked (Non ABS/ABS) 10-13	320						
MD2102X/XC MD2102CC VR2102BLK VR2102BLU VR2102RED	FRONT	F	YZF R1 07-08	310						
MD2103 MD2103C VR2103	REAR	S	XVS 950 A Midnight Star 09-13 XVS 1300 A Midnight Star 07-13	298						
MD2104RS	FRONT	S	YBR 125 Custom 07-13 YBR 125 (3D92/9) 07-09 YBR 125 (51D1/2) 10-13	245						
MD2105X MD2105XC VR2105BLK VR2105BLU VR2105RED	FRONT	F	YZF R1 09-12 YZF R6 (13S1) 08-12	310						
MD2106RS	FRONT	S	YBR 250 (5D11/3/4) 07-11	280						
MD2107 MD2107C (Black Hub)	FRONT	F	XP 500 T-Max (Non ABS Models) 08-11 XP 500 T-Max (ABS Models) 08-11 T-Max 530 12 XP 530 Black Max (59CE) 13	267						
MD2108C	REAR	F	XV 1700 V-Max (2S3) 09-12	298						
MD2109XC	FRONT	F	XV 1700 V-Max (2S3) 09-12	320						
MD2110LS	FRONT	S	YZF-R 125 08-12	290						
MD2111	REAR	S	YZF-R 125 08-12	230						
					MD3004	FRONT	F	GSXR 1100 G/H/J 86-88	310	

D = Dished Solid Original (We replace with floating rotor conversion unit) F = Floating Rotor S = Solid Rotor  
SF = Solid Flat Original Disc which we replace with fully floating unit - fits direct no mods required.



# STREETBIKE DISC BUYERS GUIDE

DISC No.	FRONT/ REAR	TYPE	MODELS	DIA (MM)	DISC No.	FRONT/ REAR	TYPE	MODELS	DIA (MM)		
<b>MD3005</b> 	FRONT	F	GSXR 750 F/G/H/RG	85-87	300	<b>MD3010LS</b>	FRONT	S	RB 50 H 'GSXR 50'	87	162
<b>MD3006X</b> <b>MD3006XC</b> <b>MD3006CC</b> <b>VR3006BLK</b> <b>VR3006BLU</b> <b>VR3006RED</b>	FRONT	F	GSF 250 N/Z/M/P/NP/ZP/R/NR 92-96 GSF 250 VS/VT/VV/VVZ/VW/VX/VY (GJ77) Bandit 95-00 GSX 250 SSM Katana 91 GSX 250 FL/FM/FN/FP/FR/FS/FT /FV/FW Across 90-98 GSF 400 M/N/P Bandit 91-95 GSR 400 K6 06 SV 400 N (VK53A) 98 SV 400 SN (VK53A) 98 GS 500 EK/EL/EM/EN/EP/ER/ES/ET/EV /E/W/EX/EY/K1/K2/K3/K4/FK4/FK5/K5 /K6/FK6/K7/FK7/K8/FK8 89-08 GSR 600 K6/K7/K8 06-08 RF 900 RR/RS/RS2/RT/RV/RW 94-98 GSF 1200 T/V/W/X/Y (Naked Bandit) 4 Piston Caliper 96-00 GSF 1200 ST/SV/SW/SX/SY (Faired Bandit) 4 Piston Caliper 96-00 GSF 1200 K1-K5 (Naked Bandit) - 6 Piston Caliper 01-05 GSF 1200 SK1-SK5 (Faired Bandit) - 6 Piston Caliper 01-05 GSX 1200 FSW/FSX 'Inazuma' 98-99	310	<b>MD3014LS</b> <b>MD3014RS</b> 	FRONT	D	GN 250 F/J/M/R/T 87-97 GT 250 K/L/M/N/A/B/C 73-78 GSX 250 ET/EX/EZ 80-82 GS 250 TT/TX 80-81 RG 250 WD/WE 83-84 GT 380 K/L/M/A/B 73-77 GS 400 B/C 77-78 GSX 400 ET/EX/EZ 81-83 GN 400 TT 80 GSX 400 LX/TX 81 GS 425 EN 78-80 GS 450 ET/EG/EJ 80-88 GS 550 DB/DC/EC/EN 77-79 GS 650 GTX/GTZ/GTD/GX/GZ 81-83 GR 650 D/XD Tempter 83 GS 750 DB/DC/EC/EN 77-80 GSX 750 ET/EX 80-81 GSX 750 SE Katana 85 GSX 750 SE 85 GS 850 GN/GT/GX 79-81 GS 850 GZ/GE/GG 82-85 GS 1000 HC/EC/EN/SN/ET 78-81 GS 1000 GT/GX 81-82 GSX 1000 SZ Katana 82 GS 1100 GZ 82 GSX 1100 ET/EX/EZ/ESD 80-83 GSX 1100 SZ/SD 82-83	276		
<b>MD3007</b>  <b>MD3007C</b> <b>VR3007BLK</b> <b>VR3007BLU</b> <b>VR3007RED</b> 	FRONT	F	TV 250 J/K/AK/L Wolf 88-90 GSXR 750 J/K/L/M/WN/WP/WR/WS 88-95 GSXR 1100 K/L/M/N/WP/WR/WS/WT 89-96	310	<b>MD3014RS</b>	REAR	D	GS 550 EC/EN/ET/EX/EZ /LT/LX/MX/MZ 78-84 XN 85 Turbo 83 GS 750 B/DB/DC/EC/EN 77-80 GSX 750 ET/EX 80-81 GSX 750 S/SS Katana 84 GSX 750 S-2/S-2C Katana 84 GS 850 GN/GT/GX 79-81 GS 1000 GT/GX 81-82 GS 1000 HC/EC/EN/SN/ET 78-81 GSX 1000 SZ Katana 82 GSX 1100 ET/EX/EZ/ESD 80-83 GSX 1100 SZ/SD 'Katana' 82-83	276		
<b>MD3008</b> <b>MD3008C</b> <b>VR3008</b>	REAR	S	RF 400 RP/RR/VR/RT/RVT/RV-V 93-97 GSX 400 FSV/FSK1 Inazuma 00 SV 400 N (VK53A) 98 SV 400 SN (VK53A) 98 SV 400 X/Y/K1/K2 00-02 SV 400 SX/SY/SK1/SK2 00-02 GSF 600 Y/K1/K2/K3/K4 (Naked Bandit) 00-04 GSF 600 SY/SK1/SK2/SK3/SK4 (Faired Bandit) 00-04 RF 600 RP/RR/RS/RT/RV 93-97 GSX 600 FW/FX/FY/FK1/FK2/FK3/FK4 98-04 GSF 650 K5/K6 Naked Bandit - Non ABS 05-06 GSF 650 SK5/SK6 Faired Bandit Non ABS 05-06 GSF 650 S/T/V/W/X Naked Bandit 95-99 GSX 650 ST/SV/SW/SX Faired Bandit 96-99 SV 650 X/Y/K1/K2 Naked - Non ABS 99-02 SV 650 SX/SY/SK1/SK2 Top Fairing - Non ABS 99-02 GSX 750 FW/FX/FY/FK1/FK2/FK3 /FK4/FK5/FK6 98-06 GSXR 750 J/K/L/M/WN/ WP/WR/WS 88-95 GSX 750 W/X/Y/K1 98-03 GSX 750 FK3/FK4/FK5/FK6 03-06 RF 900 RR/RS/RS2/RT/RV/RW 94-99 GSX 1100 K/L/M/N/WP/ WR/WS/WT 89-96 GSF 1200 FSW/FSX 'Inazuma' 98-99 GS 1200 SSK1/ZK1 01 GSF 1200 T/V/W/X/Y (Naked Bandit) 4 Piston Caliper 96-00 GSF 1200 ST/SV/SW/SX/SY (Faired Bandit) 4 Piston Caliper 96-00 GSF 1200 K1-K5 (Naked Bandit) - 6 Piston Caliper 01-05 GSF 1200 SK1-SK5 (Faired Bandit) - 6 Piston Caliper 01-05 GSX 1300 RX/RV/RK1/RK2/RK3 /RZK3/RK4/RK5/K6 99-06	240	<b>MD3015LS</b>			<b>USE MD3014LS/RS</b>			
					<b>MD3015</b>			<b>USE MD3014</b>			
					<b>MD3017LS</b>	FRONT	S	LS 650 FG/PK/PM/PR/PG /PT/PV/PW/PX Savage 87-99	260		
					<b>MD3019LS</b> <b>MD3019RS</b> 	FRONT	D	GT 500 A/B 75-78 RE5 M/A 75-77 GT 550 K/L/M/A/B 73-77 GT 750 K/L/M/A/B 73-77 GT 750 B 77	296		
					<b>MD3023LS/RS</b>			<b>Use MD3014LS/RS</b>			
					<b>MD3024LS/RS</b> 	FRONT	D	GSX 400 FW/FWS/FWS-2 GSX 550 ESD/ESE/EFE/ESH/ESG 84-87	260		
					<b>MD3025</b>	REAR	S	GSX 400 FW/FWS/FWS-2 GSX 550 ESD/ESE/EFE/ESH/ESG 84-87 GSX 400 FX/FZ/FD 81-83	250		
					<b>MD3027</b>	REAR	S	GS 650 GTX/GTZ/GTD//GX/GZ 81-83 GS 850 GZ/GE/GG 82-85 GS 1100 GZ 82	275		
					<b>MD3028LS</b> <b>MD3028RS</b> 	FRONT	D	XN 85 Turbo 83 GS 700 EF/ESF 85 GSX 750 ESD/ESE/EFE/ESH/ESG/EFF 82-86 GSX 750 S/SS Katana 84 GSX 750 S-2/S-2C Katana 84	260		
					<b>MD3029</b> 	REAR	D	GS 700 EF/ESF 85 GSX 750 SE Katana 85 GSX 750 ESD/ESE/EFE/ESH ESG/EFF 82-86	260		
<b>MD3009</b>	REAR	S	GSXR 750 F/G/H/RG 85-87 GSXR 1100 G/H/J 86-88	220							

**D = Dished Solid Original (We replace with floating rotor conversion unit) F = Floating Rotor S = Solid Rotor SF = Solid Flat Original Disc which we replace with fully floating unit - fits direct no mods required.**







# STREETBIKE DISC BUYERS GUIDE

DISC No.	FRONT/ REAR	TYPE	MODELS	DIA (MM)	DISC No.	FRONT/ REAR	TYPE	MODELS	DIA (MM)
MD3030LS MD3030RS	FRONT	S	GV 1200 GLF/GLF2/GLG Madura 85-86	276	MD3060 MD3060C VR3060	REAR	S	SV 400 K3/K4/K5 03-05 SV 400 SK3/SK4/SK5 03-05 GSXR 600 V/W/X/Y/K1/K2/K3/ZK3/K4 /K5/K6/K7/K8/K9/L0/L1/L2/L3 97-13 SV 650 K3-K9/L0 Naked Non ABS 03-10 SV 650 SK3-SK9/SLO Top Fairing Non ABS 03-13 GSXR 750 T/V/W/X/Y/K1-K9 /L0/L1/L2/L3 96-13 GSXR 1000 K1-K9/L0/L1/L2/L3 01-13 SV 1000 K3/K4/K5/K6/K7 Naked 03-07 SV 1000 SK3-SK7 Faired Model 03-07 TL 1000 SV/SW/RW/SX/RX SY/RY/RK1/SK1 97-02	220
MD3031LS (5 bolt)	FRONT	S	VS 700 GLFG/GLPG 86-87 VS 750 GLF/GLPG/GLFG 85-90	296	MD3061	REAR	S	VX 800 L/M/N/P/R/T 90-96	250
MD3032LS MD3032RS (6 bolt)	FRONT	SF	VS 400 VR/FR/VTR/FTR/ V-T/F-T Intruder 94- VS 600 GLS/GLT/GLV 95-97 VS 700 GLFH/GLPH 86-87 VS 750 GLFH/GLPH 'Intruder' Spoke Wheel 87 VS 750 GLPK/GLPL/GLPM 'Intruder' 'Spoke wheel' 88-91 VS 800 GLN/GLP/GLR/GLS/GLT /GLV/GLW/GLX 'Intruder' 92-99 VS 1400 GLPH/GLFH/GLPJ/GLFJ /GLPR/GLPT/GLPV/GLPW/GLPX /GLPY/GLPK1 Intruder 87-02	296	MD3063			USE MD3059	
MD3033LS	FRONT	S	VX 800 L/M/N/P/R/T 90-96	310	MD3064	REAR	S	RG 250 WD/WE 83-84 RG 250 FG/CH/FCH/FH Gamma 85-88 GSX 250 R CH/H (GJ72A) GSX 400 R2 (GK71B) GSX 400 R3 (GK71F) GSX 400 X/XA/XS Impulse RG 400 EWF/EW-2G/EWH Walter Wolf 85-87 RG 500 G/CH 85-87 GSXR 400 H 87	210
MD3034LS/RS			USE MD3014LS/RS		MD3065LS/RS			NOT BEING MADE	
MD3036	REAR	S	GSX 1100 FJ/FK/FL/FN/FM/FP/FR 89-94	276	MD3066LS/RS	FRONT	D	GSX 400 FX/FZ/FD 81-83	276
MD3037LS/RS	FRONT	S	GSX 1100 GM/GN 91-94	310	MD3067			USE MD3025	
MD3038	REAR	S	GSX 1100 GM/GN 91-94	295	MD3068LS/RS			USE MD3001LS/RS	
MD3039LS MD3039RS	FRONT	F	GSX 1100 EFE/EFF/ESE 84-86 GSX 1100 FJ/FK/FL/FN/FM/FP/FR 89-94	276	MD3069			USE MD3064	
MD3039	REAR	F	GSX 1100 EFE/EFF/ESE 84-86	276	MD3070LS/RS	FRONT	F	RG 500 G/CH 85-87 RG 400 EWF/EW-2G/EWH Walter Wolf 85-87	260
MD3041	REAR	D	GV 1200 GLF/GLF2/GLG Madura 85-86	275	MD3071			USE MD3064	
MD3042LS MD3042RS	FRONT	S	GV 1400 Cavalcade All models 85-88	275	MD3072RS			USE MD3045	
MD3043	REAR	S	GV 1400 Cavalcade All models 85-88	295	MD3073LS	FRONT	SF	VS 700 GLEFG/GLEPG /GLEFH/GLEPH 86-87 VS 750 GLEFH/GLEPH 'Intruder' 'Cast wheel' 87	296
MD3044	REAR	S	VS 1400 GLPH/GLFH/GLPJ/GLFJ /GLPR/GLPT/GLPV/GLPW/GLPX /GLPY/GLPK1/GLPK2 Intruder 87-03	278	MD3074	FRONT	S	GSX 250 R CH/H (GJ72A) GSXR 250 J (GJ72A) GSXR 250 CK	275
MD3045	FRONT	F	RG 125 FN/FP/FR (NF13A) Gamma 92-94 RG 125 FUN/FUP/FUR (NF13B) Gamma 92-94 RG 125 UN Wolf (NF13E) Naked 92-94 RGV 250 M/N/P/R/S 91-95 GSXR 400 RL/RM/RN/RP /RS (GK76A) 90-95 GSX 750 W/X/Y/K1 98-03 VZ 800 V/W/X/Y/K1/K2 'Marauder' 97-03	300	MD3075LS MD3075RS	FRONT	F	GSF 1200 SAV ABS Bandit 97	310
MD3048LS	FRONT	S	RG 125 CG/CH/J Gamma (NF12A) 86-90 RG 125 UCG/UCH/UJ/UAJ/BUJ (NF12B) Gamma 86-90	260	MD3076	REAR	S	GSF 1200 SAV ABS Bandit 97	276
MD3051			USE MD3059		MD3077LS/RS			USE MD3045	
MD3058X MD3058XC MD3058CC VR3058BLK VR3058BLU VR3058RED	FRONT	F	GSXR 600 V/W/X/Y/SY/K1-K3/ZK3 97-03 GSXR 750 T/V/W/X/Y/K1-K3 96-03 GSXR 1000 K1/K2 01-02 TL 1000 SV/SW/RW/SX/RX/RY/K1/SK1 97-02 GS 1200 SSK1/ZK1 01 GSX 1300 RX/RY/RK1/RK3/RZK3/RK3 /RK4/RK5/K6 'Hayabusa' 99-06 GSX 1400 K1-K7/FE 01-07	320	MD3078RS	FRONT	S	VL 1500 W/X/Y/K1 'Intruder Legendary Classic' 98-01	300
MD3059	REAR	S	RG 125 FN/FP/FR (NF13A) Gamma 92-94 RG 125 FUN/FUP/FUR (NF13B) Gamma 92-94 RG 125 UN Wolf (NF13E) Naked 92-94 RGV 250 M/N/P/R/S/T 91-96 GSXR 250 J (GJ72A) GSXR 250 CK	210	MD3079	REAR	F	VL 1500 W/X 'Intruder Legendary Classic' 98-99	276
					MD3080RS	FRONT	F	SG 350 N 'Goose' 92	299
					MD3081	REAR	S	RGV 250 J/K/L 88-90 TV 250 J/K/AK/L Wolf 88-90 SG 350 N 'Goose' 92 GSXR 400 RL/RM/RN/RP /RS (GK76A) 90-95 GSXR 400 J/R/RAK (GK73A) 88-90	210

DISC BUYERS GUIDE



D = Dished Solid Original (We replace with floating rotor conversion unit) F = Floating Rotor S = Solid Rotor  
SF = Solid Flat Original Disc which we replace with fully floating unit - fits direct no mods required.

# STREETBIKE DISC BUYERS GUIDE

DISC No.	FRONT/ REAR	TYPE	MODELS	DIA (MM)	DISC No.	FRONT/ REAR	TYPE	MODELS	DIA (MM)	
<b>MD3082LS/RS</b> 	FRONT	F	RGV 250 T (RGVR 250 SP) 96	290	<b>MD3092X</b> <b>MD3092XC</b> <b>MD3092CC</b> <b>VR3092BLK</b> <b>VR3092BLU</b> <b>VR3092RED</b> Contd.	FRONT	F	GSF 1250 K6/AK6 Naked Bandit ABS & Non ABS 4 Piston 06 GSF 1250 AK7/AK8 Naked Bandit ABS 4 Piston 07-08 GSF 1250 K7/K8/K9/0L0 Naked Bandit Non ABS 4 Piston 07-11 GSF 1250 SK6/SAK6 Faired Bandit ABS & Non ABS 4 Piston 06 GSF 1250 SK7/SK8/SK9/SLO Faired Bandit Non ABS 4 Piston 07-12 GSF 1250 SAK7/SAK8/SAK9/SAZK9 /SALO ABS Model Faired Bandit 4 Piston 07-12 GSX 1250 FAL0/FAL1 11-12 GSX 1250 FAL0ST/FAL1ST Sports Touring 10-12	310	
<b>MD3083/C</b>	REAR	S	GSX 1400 K1-K7/FE 01-07	260		REAR	S	GW 250 L3 Inazuma 13 GSR 400 K6/K7/K8 06-08 GSR 600 K6/K7/K8 06-09 GSF 650 SAK5/SAK6 Faired Bandit - ABS 05-06 GSF 650 K7/K8/K9/0L0 Naked Bandit - Non ABS 07-11 GSF 650 SK7/SK8 Faired Bandit - Non ABS 07-08 GSF 650 AK5/AK6 Naked Bandit - ABS 05-06 GSF 650 AK7/AK8/AK9 Naked Bandit - ABS 07-09 GSF 650 SAK7/SAK8/SAK9/SALO Faired Bandit - ABS 07-11 GSF 650 SK7/SK8/SK9 (Faired Bandit/Non ABS) 07-09 GSF 650 K7/K8/K9/0L0 (Naked Bandit/Non ABS) 07-11 GSX 650 FK8/FK9/FL0/FL1/FL2 Non ABS 08-13 GSX 650 FAK8/FAK9/FAL0/FAL1 /FAL2 (ABS Model) 08-13 SFV 650 K9/L0/L1 Gladius 09-12 SFV 650 AK9/AL0/AL1/AL3 (ABS) 09-13 SV 650 AK7/AK8/AK9/AL0 Naked - ABS 07-10 SV 650 SAK7/SAK8/SAK9/SALO 07-12 GSR 750 L1/L2/L3 11-13 GSF 1250 K6/AK6 Naked Bandit ABS & Non ABS 4 Piston 06 GSF 1250 AK7/AK8 Naked Bandit ABS 4 Piston 07-08 GSF 1250 K7/K8/K9/0L0 Naked Bandit Non ABS 4 Piston 07-11 GSF 1250 SK6/SAK6 Faired Bandit ABS & Non ABS 4 Piston 06 GSF 1250 SAK7/SAK8/SAK9/SAZK9 /SALO ABS Model Faired Bandit 4 Piston 07-12 GSF 1250 SK7/SK8/SK9/SLO Faired Bandit Non ABS 4 Piston 07-10 GSX 1250 FAL0/FAL1 10-12 GSX 1250 FAL0ST Sports Touring 10-12	240	
<b>MD3084</b>	REAR	S	GSF 250 VS/VT/VV/VVZ/VV/VX/VY (GJ77) Bandit 95-00 GSF 400 S/V/S/V-VVZ-V Bandit 95-97	240		<b>MD3093</b> <b>MD3093C</b> <b>VR3093</b>	FRONT	F	DL 650 K4/K5/K6 04-06 DL 1000 K2-K9/L0 02-10 SV 1000 K3-K8 Naked 03-07 SV 1000 SK3-SK7 Faired Model 03-07	310
<b>MD3086</b> 	REAR	F	VL 1500 Y/K1/K2/K3/K5-K8 Intruder Legendary Classic 00-03/05-08	276						
<b>MD3087LS</b> <b>MD3087RS</b>	FRONT	S	VL 1500 K2/K3/K5/K6/K7/K8 Intruder Legendary Classic 02-03/05-08	290						
<b>MD3088X</b> <b>MD3088XC</b> <b>MD3088CC</b> <b>VR3088BLK</b> <b>VR3088BLU</b> <b>VR3088RED</b> 	FRONT	F	DL 650 K4/K5/K6 04-06 DL 1000 K2-K9/L0 02-10 SV 1000 K3-K8 Naked 03-07 SV 1000 SK3-SK7 Faired Model 03-07	310						
<b>MD3089X</b> <b>MD3089XC</b> <b>MD3089CC</b> <b>VR3089BLK</b> <b>VR3089BLU</b> <b>VR3089RED</b> 	FRONT	F	GSXR 1000 K3 03	300						
<b>MD3090X</b> <b>MD3090XC</b> <b>MD3090CC</b> <b>VR3090BLK</b> <b>VR3090BLU</b> <b>VR3090RED</b> 	FRONT	F	SV 400 K3/K4/K5 03-05 SV 400 SK3/SK4/SK5 03-05 GSX 600 FK3/FK4/FK5/FK6 03-06 GSF 650 K5/K6 Naked Bandit - Non ABS 05-06 GSF 650 SK5/SK6 Faired Bandit Non ABS 05-06 SV 650 K3-K9/L0 Naked - Non ABS 03-10 SV 650 SK3-SK9/SLO Top Fairing - Non ABS 03-13 GSX 750 FK3/FK4/FK5/FK6 03-06 M 1500 (VZ 1500 K9/L0 - Intruder) 09-13 C 1800 R (VLR 1800 K8/K9/L0/L1) (C 1800 R Intruder) 08-13 (C 1800 RT) VLR 1800 K8RT/K9RT - Touring Intruder 08-10	290						
<b>MD3091X</b> <b>MD3091XC</b> <b>MD3091CC</b> <b>VR3091BLK</b> <b>VR3091BLU</b> <b>VR3091RED</b> 	FRONT	F	GSXR 600 K6/K7 06-07 GSXR 750 K6/K7 06-07 GSXR 1000 K5/K6/K7/K8 05-08 M 1800 R (VZR 1800 K6/K7/K8/K9 Intruder Handlebar Cowling) 06-09 M 1800 R2 (VZR 1800 NK8/NK9 Intruder - No Handlebar Cowling) 08-09 M 1800 RZ (VZR 1800 ZK7/ZK8/ZL1/ZL2 Intruder - With Handlebar Cowling with central tape strip) 07-13	310						
<b>MD3092X</b> <b>MD3092XC</b> <b>MD3092CC</b> <b>VR3092BLK</b> <b>VR3092BLU</b> <b>VR3092RED</b> 	FRONT	F	GSR 400 K6/K7/K8 06-10 GSR 600 K6/K7/K8 06-09 DL 650 XK7/XK8/XK9/XL0 V-Strom X 07-11 DL 650 AK7/AK8/AK9/AL0 V-Strom ABS 07-11 DL 650 AL1XP V-Strom Xpedition 11 DL 650 AK9 GT V-Strom Traveller ABS 09-11 DL 650 AL2/AL3 V-Strom 12-13 GSF 650 AK7/AK8/AK9 Naked Bandit - ABS 07-09 GSF 650 SAK7/SAK8/SAK9/SALO Faired Bandit - ABS 07-10 GSF 650 SK7/SK8/SK9 (Faired Bandit/Non ABS) 07-09 GSF 650 K7/K8/K9/0L0 (Naked Bandit/Non ABS) 07-11 GSX 650 FK8/FK9/FL0/FL1/FL2 Non ABS 08-12 GSX 650 FAK8/FAK9/FAL0/FAL1 /FAL2 (ABS Model) 08-13 GSR 750 L1/L2/L3 11-13	310						
<b>MD3094X</b> <b>MD3094XC</b>	FRONT	F	<b>USE MD3101X/XC</b>	290						
<b>MD3095RS</b>	FRONT	S	Intruder Volusia VL 800 K1-K5/L0 01-05 C 800 C (VL 800 CK7/CK8/CK9/CL0/ CL1/CL2/CL3) Intruder (Cast wheel) 07-13	300						
<b>MD3096RS</b>	FRONT	F	M 800 (VZ 800 K5-K9/L0/L1/L3 Intruder M800) 05-13 M 800 Z (VZ 800 K9Z - Intruder) 09-10	300						
<b>MD3097</b>	REAR	F	VL 1500 K5/K6/K7/K8 (C 1500 Intruder) 05-08 M 1500 (VZ 1500 K9/L0 - Intruder) 09-13 C 1800 R (VLR 1800 K8/K9/L0/L1) (C 1800 R Intruder) 08-13 (C 1800 RT) VLR 1800 K8RT/K9RT - Touring Intruder 08-10	275						

**D = Dished Solid Original (We replace with floating rotor conversion unit) F = Floating Rotor S = Solid Rotor**  
**SF = Solid Flat Original Disc which we replace with fully floating unit - fits direct no mods required.**

# STREETBIKE DISC BUYERS GUIDE

DISC No.	FRONT/ REAR	TYPE	MODELS	DIA (MM)	DISC No.	FRONT/ REAR	TYPE	MODELS	DIA (MM)
<b>MD3097</b> Contd.	REAR	F	M 1800 R (VZR 1800 K6/K7/K8/K9 Intruder Handlebar Cowling) 06-09 M 1800 R2 (VZR 1800 NK8/NK9 Intruder - No Handlebar Cowling) 08-09 M 1800 RZ (VZR 1800 ZK7/ZK8/ZL1/ZL2 Intruder - With Handlebar Cowling) 07-13	275	<b>MD4008</b> <b>VR4008BLK</b> <b>VR4008GRN</b> <b>MD4008C</b> <b>MD4008CC</b> Contd.			ZL 400 D1/D2 94-95 ZRX 400 (ZR 400 E1-E7) 94-01 ZXR 400 H1/H2 89-90 ZXR 400 J1/J2 89-90 ZZR 400 (ZX 400 K1-K3/N1-N7) 90-99 ZR 550 B2-B6 91-99 ZX6-R F1-F3 95-97 ZL 600 B1 95-97 EJ 650 A1/C3-C7 (E650) 00-05 ZR 750 C1-C5/D1 Zephyr 92-95 EJ 800 (W 800 Cafe Style/ Cockpit Fairing) 11 EJ 800 ACFA (W 800 Special Edition Black Exhaust/Gold Rims) 12 EJ 800 ADF (W800) 13 GPZ 900 A7/A8 90-96 GPZ 900 R (ZX 900 A11) 98 ZG 1000 A9-A18 94-03 GPZ 1100 E1/E2/F1 95-98	300
<b>MD3098X</b> <b>MD3098XC</b> <b>MD3098CC</b> <b>VR3098BLK</b> <b>VR3098BLU</b> <b>VR3098RED</b>	FRONT	F	GSX 1300 RK8/RK9/RL0/RL1/RL2/RL3 Hayabusa 08-13 GSX 1300 BKK8/BKK9/BKLO /BKLL1 B-King 08-12	310					
<b>MD3099</b> <b>MD3099C</b> <b>VR3099</b>	REAR	S	GSX 1300 RK8/RK9/RL0/RL1/RL2/RL3 Hayabusa 08-13 GSX 1300 BKK8/BKK9/BKLO /BKLL1 B-King 08-12	260					
<b>MD3100X</b> <b>MD3100XC</b> <b>VR3100BLK</b> <b>VR3100BLU</b> <b>VR3100RED</b>	FRONT	F	GSXR 600 K8/K9/L0/L1/L2/L3 08-13 GSXR 750 K8/K9/L0/L1/L2/L3 08-13 GSXR 1000 L2/L3 12-13	310					
<b>MD3101X</b> <b>MD3101XC</b>	FRONT	F	GSF 650 AK5/AK6 05-06 GSF 650 SAK5/SAK6 05-06	290					
<b>MD3102X</b> <b>MD3102XC</b> <b>VR3102BLK</b> <b>VR3102BLU</b> <b>VR3102RED</b>	FRONT	F	GSXR 1000 K9/L0/L1 09-11	310					
<b>MD3103X</b> <b>MD3103XC</b>	FRONT	F	SFV 650 K9/L0/L1 Gladius 09-11 SFV 650 AK9/AL0/AL1/AL3 (ABS) 09-13 SV 650 AK7/AK8/AK9/AL0 Naked - ABS 07-10 SV 650 SAK7/SAK8/SAK9/SAL0 07-12	290					
<b>MD3104X</b> <b>MD3104XC</b> <b>VR3104BLK</b> <b>VR3104BLU</b> <b>VR3104RED</b>	FRONT	F	GSXR 600 K4/K5 04-05 GSXR 750 K4/K5 04-05 GSXR 1000 K4 04	300					
<b>MD3105RS</b>	FRONT	S	GW 250 L3 Inazuma 13	290					
<b>MD4001</b>	REAR	S	Z 400 C2/C3 (Z 400 F2) 85-87 GPZ 550 A1-A4 84-87	260					
<b>MD4002LS</b> <b>MD4002RS</b>	FRONT	S	EL 252 F2 (EL 250 F2/F5/F6) 96-03 EL 250 D1-D5 90-94 EL 250 'Eliminator' 87-89 GPX 250 R (EX 250 E) 86 GPZ 550 A1-A4 84-87	260					
<b>MD4004LS/RS</b>			<b>USE MD4099LS/RS</b>						
<b>MD4005</b> 	FRONT	F	ZXR 400 L1-L9 91-03 ZXR 400 R (ZX 400 M1-M4) 91-94	310					
<b>MD4006LS</b> <b>MD4006RS</b>	FRONT	S	EN 450 A1-A5 (LTD 454) 86-89 EN 500 A1-A3 90-93 GT 550 G1-G9 83-01 Z 1000 J1/J2 81-82 Z 1000 K1/K2 LTD 81-82 Z 1000 K1 'Ltd' 83 GPZ 1100 B1 82 Z 1100 D1/D2 'Spectre' 82-83 Z 1100 A1-A3 81-83	270					
<b>MD4007</b> <b>VR4007</b>	REAR	S	ZZR 400 (ZX 400 K1/2/3) 90-92 ZZR 600 D1-D3 90-93 GPX 750 R F1-F3 87-89 ZR 750 C1-C5/D1 Zephyr 92-95	230					
<b>MD4008</b> <b>VR4008BLK</b> <b>VR4008GRN</b> 	FRONT	F	GSX 250 FXK2/K3-K5 (ZR 250 C) 02-05 KR-1S (KR 250 C2/C3) 90-92 ZR 250 A1-A5 91-95 ZR 250 B6 (Balius-II) 02 ZXR 250 A1/A2/B1/B2 89-90 ZZR 250 (EX 250 H1-H13) 90-03	300					
								ZXR 400 L1-L9 91-03 ZXR 400 H1/H2 89-90 ZXR 400 J1/J2 89-90 ZXR 400 (M1-M4) 91-94 ZX-4 (ZX 400 G1/G1A/G1B) 88 ZR 400 Zephyr 97-01 ZR 400 Zephyr (G2/G3/G3A/G4/G5) 97-01 ZZR 400 (ZX 400 N1-N7) 93-99 ZR 550 B2-B6 91-98 ZZR 600 E1-E13 93-05 ZZR 600 (ZX 600 E6F) 06-07	240
								Z 250 A3 81 Z 400 J2-J3 81-83 Z 440 D5-D6 'Ltd' 83-84 Z 440 C2/H1-H2 81-83 Z 550 A2-A3 81-82 Z 550 C1-C2 Ltd 82-84 GPZ 550 D1 82 Z 650 F2-F4 81-83 VN 700 A1 'Vulcan' 85 Z 700 A1 Ltd 84 Z 750 E1 80 GPZ 750 R1 82 GT 750 P1-P9 82-96 Z 750 H1-H2 Ltd 80-81 Z 750 N1/N2 Spectre 82-83 Z 750 L1-L4 81-84 VN 750 A2-A5/10 86-94	260
								GPZ 550 D1 82 Z 700 A1 Ltd 84 GPZ 750 R1 82 GT 750 P1-P9 82-96 Z 750 E1 80 Z 750 H1-H2 Ltd 80-81 Z 750 N1/N2 Spectre 82-83 Z 750 L1-L4 81-84	260
								ZXR 750 H1-H2 89-90 ZX9R (ZX 900 E1/E2) 00-01 ZR 1100 A1-A4 'Zephyr' 92-95 ZR 1100 B1 'Zephyr' 96-97 ZZR 1100 C1-C3 90-92 ZRX 1100 C1-C4 97-00 ZR 1100 B5 02 ZX 1200 A1-A5/A6F/B1-B3 01-08	310
								ZXR 750 H1/H2/K1/K2/J1/J2 /M1/M2/L1-L3/P1-P7/N1/N2 89-03 ZX 9R (ZX 900 B1-B4) 94-97	230
								ZZR 1100 D1-D9 93-01	250
								FX 400 R (ZX 400 E1-E3) 86-88 GPZ 400 R (ZX 400 D1/D3/D3A) 85-87 GPZ 600 R A1-A5A 85-89 GPZ 900 A7-A8 90-96 GPZ 900 R (ZX 900 A11) 98 GPZ 900 R (ZX 900 A12-15) 99-02 ZX 1000 B1-B3 (ZX10) 88-90 ZZR 1100 C1-C3 90-92	250

**D = Dished Solid Original (We replace with floating rotor conversion unit) F = Floating Rotor S = Solid Rotor**  
**SF = Solid Flat Original Disc which we replace with fully floating unit - fits direct no mods required.**













# STREETBIKE DISC BUYERS GUIDE

DISC No.	FRONT/ REAR	TYPE	MODELS	DIA (MM)	DISC No.	FRONT/ REAR	TYPE	MODELS	DIA (MM)								
MD4016	FRONT	S	ZL 400 A 'Eliminator' 86-87	280	MD4041RS	FRONT	S	GPX 250 R (EX250 F) 87	260								
			ER-5 (ER 500 A1/A2/A3/A4/C1-C5P) 97-07					GPX 250 R 88-95									
			GPZ 500 'S' (EX 500 A1-A6) 87-93					MD4042		REAR	S	GPX 250 R 88-95	230				
			GPZ 500 'S' (EX 500 D1-D9) 94-02									GPX 250 R (EX 250 F/G) 87-88					
			GPZ 750 R G2-G3 85-86					MD4043LS/RS		FRONT	F	Z 750 Y1 Ltd 82	260				
			GPZ 750 E1/E2 Turbo 84-87														
			GPZ 900 R A1-A6 84-89									MD4047LS MD4047RS		FRONT	D	Z 400 J1 80	278
			ZL 900 A1/A2 'Eliminator' 85-86													Z 440 A2 'Ltd' 79	
			GPZ 1000 RX (A1-A3) 86-88													Z 440 D4 'Ltd' 82	
			ZL 1000 A1 87													Z 500 B1-B2 79-80	
GPZ 1100 A1-A3 83-85	MD4048LS			USE MD4006LS													
MD4017	REAR	S	GPZ 750 E1/E2 Turbo 84-87	270	MD4051 MD4051C	REAR	S	GSX 250 FXK2/K3-K5 (ZR 250 C) 02-05	230								
			GPZ 750 R G2-G3 85-86					ZXR 250 A1/A2/B1/B2 89-90									
			GPZ 900 R A1-A6 84-89					ZR 250 A1-A5 91-95									
			ZL 900 A1/A2 'Eliminator' 85-86					ZR 250 B6 Balius-II 02									
			ZL 1000 A1 87					ZXR 250 C1-C3/D1 91-95									
			GPZ 1100 A1-A3 83-85					GPZ 500 'S' (EX 500 D1-D7) 94-01									
								GPZ 500 S (EX 500 E1-E10) 94-04									
MD4018LS/RS			USE MD4016														
MD4019	REAR	S	GPZ 750 A1-A5 83-87	260	MD4052LS MD4052RS	FRONT	D	Z 650 B1/B2/B3 79-81	296								
			GPZ 1000 RX A1-A3 86-88					Z 650 F1 80									
MD4020LS/RS			USE MD4016					Z 900 A4 77									
MD4021	FRONT	S	ZX 1000 B1-B3 (ZX10) 88-90	300	MD4054LS			USE MD4006									
MD4022X MD4022XC MD4022CC VR4022BLK VR4022GRN	FRONT	F	ZXR 750 K1/K2/J1/J2/M1/M2 91-03	320	MD4054	REAR	S	Z 1000 J1-J3 81-83	270								
			L1-L3/P1-P7/N1/N2 94-97					Z 1000 R1/R2 (Eddie Lawson Replica) 82-83									
			ZX-9R B1-B4 94-97					Z 1000 K1/K2 LTD 81-82									
			ZX9R (ZX 900 F1/F2) 02-04					GPZ 1100 B1-B2 82-83									
			ZZR 1100 D1-D9 93-01					Z 1100 A1-A3 81-83									
			ZX12R (A1/A2/B1/B2/B3) 00-04					Z 1100 D1/D2 'Spectre' 82-83									
			ZZR 1200 C1H/C2H 02-04					Z 1100 R1 84									
			VN 1500 P1/P2 Mean Streak 02-04					VN 1500 A6 92									
			M 1600 (VZ 1600 K4/K5 Intruder) 04-05					VN 1500 B2-B6 88-92									
			VN 1600 B1/B2/B2H/B6F/B7F Mean Streak 04-08														
MD4023	REAR	S	ZX-6R F1-F3 95-97	230	MD4059LS/RS	FRONT	D	Z 650 C1/C2/C3 77-79	276								
MD4023C VR4023			ZX12R (A1/A2/B1/B2/B3/B4/B6F) 00-06					Z 650 D2/D3 79-80									
MD4024	REAR	S	GPZ 550 H1-H2 82-83	260	MD4060LS/RS			USE MD4006LS/RS									
MD4025LS/RS			USE MD4012														
MD4026LS MD4026RS	FRONT	S	GPX 600 R C1-C7 88-96	260	MD4062	REAR	D	Z 650 C1/C2 77-78	276								
MD4027 MD4027C VR4027	REAR	S	GPX 400 R (ZX 400 F1) 87	240	MD4063	REAR	D	Z 650 (D2/D3-SR) 79-80	276								
			GPX 600 R C1-C7 88-96														
			ZR 1100 A1-A4 Zephyr 92-95														
			ZR 1100 B1 96-97		MD4064LS/RS	FRONT	D	Z 1000 A1-A4 77-80	296								
			ZR 1100 B5 02					Z 1000 H1 80									
MD4028	FRONT	S	Z 400 C2/C3 (Z 400 F2) 85-87	270	MD4067LS MD4067RS	FRONT	S	ZN 700 A1/A2 'Ltd' 84-85	270								
			GPZ 600 R A1-A5A 85-89					ZN 700 A1/A2 'Ltd' 84-85									
			GPZ 750 A1-A5A 83-87		MD4068	REAR	S	ZN 700 A1/A2 'Ltd' 84-85	260								
			ZG 1000 A1-A7 86-93		MD4069LS/RS	FRONT	D	Z 900 Z1A/Z1B 74-76	296								
MD4029			USE MD4015								H2/H2-A Mach IV (750cc) 72-73						
MD4031LS			USE MD4002LS								H2-B/H2C Mach IV (750cc) 74-75						
MD4032	REAR	S	GPX 250 R (EX 250 E) 86	240	MD4071LS MD4071RS	FRONT	S	GPX 750 R F1-F3 87-89	270								
MD4033LS/RS			USE MD4028LS/RS								HI D/E/F 500 73-75						
MD4034			USE MD4019														
MD4035LS/RS			USE MD4016					USE MD4077									
MD4036			USE MD4017														
MD4038	FRONT	S	Z 1000 J3 83	280	MD4076LS/RS	FRONT	D	Z 1000 D1-D3 (ZIR) 78-79	298								
			Z 1000 R1/R2 (Eddie Lawson Replica) 82-83														
			GPZ 1100 B2 83														
			Z 1100 R1 84														
MD4040LS	FRONT	S	AR 50 A1/C2-C10 81-97	210	MD4077	REAR	D	Z 1000 D1-D3 (ZIR) 78-79	290								
			AR 80 A1/C1-C8 81-91					Z 1000 A1-A4 77-80									
								Z 1000 H1 80									

D = Dished Solid Original (We replace with floating rotor conversion unit) F = Floating Rotor S = Solid Rotor  
SF = Solid Flat Original Disc which we replace with fully floating unit - fits direct no mods required.

# STREETBIKE DISC BUYERS GUIDE

DISC No.	FRONT/ REAR	TYPE	MODELS	DIA (MM)	DISC No.	FRONT/ REAR	TYPE	MODELS	DIA (MM)
MD4078LS/RS	FRONT	D	Z 1000 ST E1-E2 79-82	286	MD4132C VR4132BLK VR4132GRN	FRONT 	F	GPZ 1100 F1 96-98	300
MD4082 MD4082C	REAR	S	ZG 1000 A1-A7 86-93 ZG 1000 A9-A18 94-03	280	MD4133 MD4133C VR4133	REAR	S	ZRX 1100 C1/C2/C3/C4 97-00 ZRX 1200 A1-A5/A6F 01-07 ZRX 1200 B1-B3 01-03 ZZR 1200 C1H/C2H 02-04	250
MD4085	REAR	S	VN 900 A6F Classic 06 VN 900 C7F/C8F/C9F/CAF/CBF/CCF /CDF Custom (Cast wheel) 07-13 VN 900 B7F/B8F/B9F/BAF/BBF/BCF Classic (Spoke wheel) 07-13 VN 900 BBFA/BCFA/BDFA Classic Special Edition White Wall Tyres/ Spoke Wheel 11-13	270	MD4134 	FRONT	F	ZX-4 (ZX 400 G1/G1A/G1B) 88	300
MD4089LS/RS 	FRONT	D	Z 1300 A1-A5 79-83 ZG 1300 A1-A3 84-86	299	MD4135LS MD4135RS	FRONT	S	GPZ 400 R (ZX 400 D/D3/D3A) 85-87 ZL 400 B 'Eliminator 400 SE' 88 FX 400 R (ZX 400 E1-E3) 86-88	270
MD4090	REAR	S	Z 1000 ST E1-E2 79-82 Z 1300 A1-A5 79-83 ZG 1300 A1-A3 84-86	290	MD4136X MD4136XC MD4136CC VR4136BLK VR4136GRN	FRONT 	F	ZX6R (ZX 600 G1/G2/J1/J2) 98-01 ZX6R (ZX 636 A1P) 636cc 02 ZX9R (ZX 900 C1/C2) 98-99	300
MD4093LS			USE MD4124LS		MD4137RS	FRONT	S	BN 125 A1-A5/A6F/A7F Eliminator 98-07	260
MD4094LS 	FRONT	SF	VN 1500 B2-B6 88-92	300	MD4138 MD4138C VR4138	REAR	S	ZX6R (ZX 600 G1/G2/J1/J2) 98-01 ZX6R (ZX 636 A1P/B1/B2) 636cc 02-04 ZX-6R (ZX 636 C1/C6F) 05-06 ZX6R (ZX 600 P7F/P8F) 07-08 ZX6R (ZX 600 R9F/RAF/RBF /RCF/RDF (599cc)) 09-13 ZX6RR (ZX 600 K1/M1) 03-04 ZX-6RR (ER6-f ZX 600 N1/N6F) 05-06 ER-6f (ECF/FDF) (Double pipe type frame Non ABS) 12-13 ER-6n (ER 650 A6F/A7F/A8F/ C9F/CAF/CBF) 06-11 ER-6n (ECF/EDF) (Double pipe type frame Non ABS) 12-13 KLE 650 A7F/A8F/A9F/CAF Versys 07-10 650 (KLE 650 CBF/CCF/CDF) Versys Non ABS 11 Z 750 (ZR 750 J1/J2/J6F) 04-06 Z 750 S (ZR 750 K1/K6F) 05-06 ZX9R (ZX 900 C1/C2/E1/E2) 98-01 ZX9R (ZX 900 F1/F2) 02-04 ZX10R (ZX 1000 C1/C2/D6F) 04-06 ZX10R (ZX 1000 E8F/E9F/FAF) 08-10 Z 1000 (ZR 1000 A1/A2/A3/A6F) 03-06	220
MD4095LS/RS 	FRONT	F	KR-1 (KR 250 B2) 89	280					
MD4096	REAR	S	KR-1 (KR 250 B2) 89 KR-1S (KR 250 C2-C3) 90-92	210					
MD4099	FRONT	S	AR 125 A1-A7/B1-B8 82-94 ER 250 B1-B3 83-88 GPZ 550 H1-H2 82-83	260					
MD4105LS MD4105RS	FRONT	S	KH 100 G5-G8 (EX) 84-87 KH 125 L1 (EX) 84 GPZ 305 A1/B1-B10 83-96	240					
MD4108LS MD4108RS	FRONT	S	ZR 400 A1/B1 83-84 ZR 550 A1-A2 (Z 550 F) 83-84	270					
MD4115LS			USE MD4124LS						
MD4116LS	FRONT	S	KH 100 G2-G4 81-83	240					
MD4117	REAR	S	ZZR 250 (EX 250 H1-H13) 90-03	220	MD4140LS MD4140RS	FRONT	S	GPX 400 R (ZX 400 F1) 87	270
MD4122LS MD4122RS			USE MD4008		MD4141X MD4141XC MD4141CC	FRONT 	F	ZR-7 (ZR 750 F1/F3/F5) 99-04 ZR-7S (ZR 750 H1/H3) 01-04 ZZR 600 D1-D3 90-93 Z 750 S K1/K6F/J1/J2/J6F Naked	300
MD4124LS 	FRONT	F	EN 500 B1-B2/C1-C9 94-04 VN 800 A1-A3 95-99 VN 1500 C1-C2 94-95 VN 1500 A6 92 VN 1500 N1/N2/N3 00-02	299	MD4142 MD4142C	REAR	S	ZR-7 (ZR 750 F1/F3/F5) 99-04 ZR-7S (ZR 750 H1/H3) 01-04	240
MD4125LS	FRONT	S	VN 800 B1-B10/B6F Classic 96-06 VN 800 C1/C2/E1/E2/E3 Drifter 99-04 VN 1500 J1/J2/R1/R2/R3 /N1/N2/N3 99-04	300	MD4143LS MD4143RS	FRONT	S	GPZ 400 R D4 88	280
MD4126LS/RS			USE MD4038		MD4144	FRONT	S	GPZ 500 S (EX 500 B1-B5) 88-93 GPZ 500 S (EX 500 E1-E10) 94-04	270
MD4127			USE MD4054		MD4146 MD4146C	REAR	S	VN 1500 P1/P2 03-04 VN 1600 A1/A2/A3/A6F 03-08 VN 1600 B1/B2H/B6F/B7F (Mean Streak) 04-08 VN 1600 D1H/D6F Classic Tourer 05-08 M 1600 (VZ 1600 K4/K5 Intruder) 04-05	300
MD4128	REAR	S	VN 1500 C1-C2 94-95 VN 1500 D1/D2/E1/F2 96-99	270	MD4147	REAR	S	VN 1500 G1/G2/L1/L2/L3/L4 98-03	320
MD4129LS/RS			USE MD4008		MD4148	FRONT	S	VN 800 C1/C2/E1/E2/E3 99-04 VN 1500 J1/J2/R1/R2/R3 /N1/N2/N3 99-04	270
MD4130 MD4130C VR4130	REAR	S	GPZ 1100 E1/E2/F1 95-98	250	MD4149LS/RS 	FRONT	F	ZXR 250 C1/C2/C3/D1 91-95	300
MD4131LS 	FRONT	F	VN 1500 D1/D2/E1/E2 96-99	299					

D = Dished Solid Original (We replace with floating rotor conversion unit) F = Floating Rotor S = Solid Rotor  
SF = Solid Flat Original Disc which we replace with fully floating unit - fits direct no mods required.



# STREETBIKE DISC BUYERS GUIDE

DISC No.	FRONT/ REAR	TYPE	MODELS	DIA (MM)	DISC No.	FRONT/ REAR	TYPE	MODELS	DIA (MM)	
MD4150	FRONT	S	VN 1500 G1/G2 VN 1500 L1/L2/L3/L4	98-99 00-03	280	MD4157C VR4157 Contd.	REAR	S	ZZR 1400 ABS (ZX 1400 B6F/B7F /D8F/D9F/DAF/DBF/FCF) 06-12 ZZR 1400 FCF/FDF (ABS) 12-13	250
MD4151X MD4151XC	FRONT	F	ZX6RR (ZX 600 K1/M1) ZX6R (ZX 636 B1/B2)	03-04 03-04	280	MD4158	FRONT	S	EJ 800 ABF/ACF (W 800 /Solid F Disc) 11-12 W 800 ABF 11 VN 900 A6F Classic 06 VN 900 C7F/C8F/C9F/CAF/CBF/CCF /CDF Custom (Cast wheel) 07-13 VN 900 B7F/B8F/B9F/BAF/BBF/BCF /BDF Classic (Spoke wheel) 07-13 VN 900 BBFA/BCFA/BDFA Classic Special Edition/White Wall Tyres /Spoke Wheel 11-13 VN 1600 A1/A2/A3/A6F 03-08 VN 1600 D1H/D6F 05-08 VN 1700 B9F/BAF/BBF/BCF/BDF Voyager ABS 09-13 VN 1700 C9F Classic Tourer 09 VN 1700 DAF/DBF/DCF/DDF Classic Tourer ABS 10-13 VN 1700 KBF/KCF/KDF Voyager Custom 11-13 VN 1700 E9F Classic 09 VN 1700 FAF/FBF/FCF/FDF Classic ABS 10-13 VN 2000 A1/A2/A6F 04-07 VN 2000 H8F/H9F Classic 08-09	300
MD4152XC MD4152CC VR4152BLK VR4152GRN	FRONT	F	ZX-6RR (ZX 600 N1/N6F) 05-06 ZX-6R (ZX 636 C1/C6F) 05-06 ZX-6R (ZX 600 P7F/P8F) 07-08 ZX-6R (ZX 600 R9F/RAF/RBF/RCF) 09-13 Z 750 R Non ABS (ZR 750 NBF/NCF) 11-12 Z 750 R ABS (ZR 750 PBF/PCF) 11-12 ZX10R (ZX 1000 C1/C2/D6F/D7F) 04-07 Z 1000 (ZR 1000 B7F/B8F) 07-08 Z 1000 ABS (ZR 1000 C7F/C8F/C9F) 07-09 Z 1000 Black Edition (ZR 1000 DCFA/DDFA) 12-13 ZR 1000 DAF/DBF/DCF/DDF 10-13	05-06 05-06 07-08 09-13 11-12 11-12 04-07 07-08 07-09 12-13 10-13	300	MD4159XC VR4159BLK VR4159GRN	FRONT	F	ER-6f (EX 650 A6F-A8F/C9F /CAF/CBF) 06-11 ER-6f (ECF/EDF) (Double pipe type frame/non ABS) 12-13 ER-6n (ER 650 A6F-A8F/C9F /CAF/CBF) 06-11 ER-6n (ECF/EDF) (Double pipe type frame/non ABS) 12-13 KLE 650 A7F-A9F/CAF Versys 07-10 KLE 650 A7F/A8F/B8F/B9F Versys 07-09 650 (KLE 650 CBF/CCF/CDF) Versys Non ABS 11-13 Z 750 (ZR 750 L7F/L8F/L9F/LAF/LBF) 07-11	300
MD4153X MD4153XC MD4153CC VR4153BLK VR4153GRN	FRONT	F	ZZR 600 E1-E13 ZZR 600 (ZX 600 E6F)	93-05 06-07	300	MD4160C VR4160	REAR	S	GTR 1400 (ZG 1400 A8F/A9F/CAF /CBF/CCF/CDF) 08-13	270
MD4154X MD4154XC MD4154CC VR4154BLK VR4154GRN	FRONT	F	Z 1000 (ZR 1000 A1-A3/A6F) 03-06 ZX12R B3/B4/B6F 04-06	03-06 04-06	300	MD4161XC VR4161BLK VR4161GRN	FRONT	F	ZX10R (ZX 1000 E8F/E9F/FAF) 08-10 ZX10R ABS (ZX 1000 KBF/KCF/KDF) 11-13 ZX10R (ZX 1000 JBF/JCF/JDF) 11-13	310
MD4155XC MD4155CC VR4155BLK VR4155GRN	FRONT	F	GTR 1400 (ZG 1400 A8F/A9F/CAF/CBF/CCF/CDF) 08-13 ZZR 1400 (ZX 1400 A6F/A7F) 06-07 ZZR 1400 ABS (ZX 1400 B6F/B7F D8F/D9F/DAF/DBF) 06-11 ZZR 1400 FCF/FDF (ABS) 12-13	08-13 06-07 06-11 12-13	310	MD4162C	FRONT	S	EX 250 K8F/K9F/KAF/KBF/KBFA /KCF Ninja 250 R 08-12	290
MD4156XC	FRONT	F	ER-6f (ABS Model) (EX 650 B6F/B7F B8F/D9F/DAF) 06-10 ER-6n (ABS Model) (ER 650 B6F/B7F/B8F/D9F/DAF) 06-10 KLE 650 B7F-B9F/DAF Versys ABS 07-10 Z 750 ABS (ZR 750 M7F/M8F/M9F /MAF/MBF) 07-11	06-10 06-10 07-10 07-11	300	MD4163C	REAR	S	EX 250 K8F/K9F/KAF/KBF/KBFA /KCF Ninja 250 R 08-12 EX 300 ADF Ninja (Non ABS) EX 300 BDF Ninja ABS Model 13	220
MD4156AXC (With ABS ring fitted)	FRONT	F	ER-6F (ABS Model) (EX 650 B6F/B7F B8F/D9F/DAF/DBF) 06-11 ER-6F (FCF/FDF) (Double pipe type frame/with ABS) 12-13 ER-6N (ABS Model) (ER 650 B6F/B7F/B8F/D9F/DAF) 06-10 ER-6n (FCF/FDF) (Double pipe type frame/with ABS) 12-13 KLE 650 B7F-B9F/DAF/DBF Versys ABS 07-11 650 Versys (KLE 650 DBF/DCF/DDF ABS Model) 11-13	06-11 12-13 06-10 12-13 07-11 11-13	300	MD4164AC (With ABS Ring)	REAR	S	ER-6f (ABS Model) (EX 650 B6F/B7F /B8F/D9F/DAF/DBF) 06-11 ER-6f (FCF/FDS) (Double pipe type frame/with ABS) 12-13 ER-6n (ABS Model) (ER 650 B6F/B7F /B8F/D9F/DAF) 06-10 ER-6n (FCF/FDS) (Double pipe type frame/with ABS) 12-13 KLE 650 B7F/B8F/B9F/DAF/DBF Versys ABS 07-11 650 (KLE 650 DBF/DCF/DDF) Versys ABS Model 11-13	220
MD4157C VR4157	REAR	S	Z 750 (ZR 750 L7F/L8F/L9F/LAF /LBF) 07-11 Z 750 ABS (ZR 750 M7F/M8F/M9F /MAF/MBF) 07-11 Z 750 R Non ABS (ZR 750 NBF/NCF) 11-12 Z 750 R ABS (ZR 750 PBF/PCF) 11-12 KIZ 1000 ACF/ADF Versys 12-13 Z 1000 (ZR 1000 B7F/B8F) 07-08 Z 1000 ABS (ZR 1000 C7F/C8F/C9F /CAF/CBF) 07-11 Z 1000 SX (ZR 1000 GBF/GCF/GDF) Non ABS Model 11-13 Z 1000 SX (ZR 1000 HBF/HCF/HDF) (ABS) 11-13 Z 1000 Black Edition (ZR 1000 DCFA/DDFA) 12-13 ZR 1000 DAF/DBF/DCF/DDF 10-13 ZZR 1400 (ZX 1400 A6F/A7F) 06-07	07-11 07-11 11-12 11-12 12-13 07-08 07-11 11-13 11-13 12-13 10-13 06-07	250	MD4165C VR4165	REAR	S	ZX 6R EDF (Non ABS/636cc) 13 ZX 6R FDF (ABS Model/636cc) 13 ZX 10 R (ZX 1000 JBF/JCF) 11-13 ZX 10 R ABS (ZX 1000 KBF/KCF/KDF) 11-13	220
						MD4166C	FRONT		EX 300 ADF Ninja (Non ABS) EX 300 BDF Ninja ABS Model 13	13

D = Dished Solid Original (We replace with floating rotor conversion unit) F = Floating Rotor S = Solid Rotor  
SF = Solid Flat Original Disc which we replace with fully floating unit - fits direct no mods required.

# OFF ROAD DISC BUYERS GUIDE

DISC No.	FRONT/ REAR	TYPE	MODELS	DIA (MM)	DISC No.	FRONT/ REAR	TYPE	MODELS	DIA (MM)
MD6001D MD6001C OS6001C OS6001EC SM6001C MD6001CX	FRONT	S	CRM 50 RN/RP/RR/RT 93-96	240	MD6010D MD6010CX SM6010C	FRONT	S	XR 300 R10 10	256
			CRM 75 RK/RL/RN/RP/RR 89-94					NX 500 J/K/L/M/N/P/R/S/T/V/W/X 88-99	
			CR 125 RN/RP/RR* 92-94					XR 600 RF/RG/RH 85-87	
			XLR 125 RW 98-01					XL 600 VV/VW/WX Transalp 97-99	
			CTX 200/CTX 200 A Bushlander 04-05					NX 650 J/K/L/M/N/P/R/S T/V/W/X 'Dominator' 88-02	
			CRF 230 F4/F5/F6/F7/F8/F9 04-09					XR 650 L 93-12	
			CRF 230 F Easy Trial 04-07						
			CRF 230 L 08-10						
			CRF 230 M 09-10						
			SL 230 V/W/X/1 97-01						
CRM 250 ARV/ARW (MD32) 97-98									
CRM 250 R (RM) MK2 MD24 (1200001-1211634) 91-92									
CRM 250 R (RP/RP-II) MK2/2 MD24 (1300001-) 93									
AX-1 (NX 250 J/K/R/R3) 89-94									
XLR 250 Baja Mk 1									
XLR 250 Baja Mk 2									
XL 250 Degree									
CRM 250 RR/RRII MK 3 (MD24) 94-96									
CR 250 RN/RP/RR 92-94									
NX 250 L/2L/M/P/2P 90-93									
XLR 250 RM/R3N/RP/RR/R3R (MD22) 91-94									
XR 250 RE/RF 84-85									
XR 250 RM/RN/RP/RR/RS/RT/ RV/RW/RX/R1/R2/R3/R4 96-04									
XR 250 Y/3 (MD30) 00-03									
XR 250 3/5 (MD30) Motard 03-05									
XR 250 III Y/3 Baja 00-03									
XL 250 RL 90									
CRE 260 95-98									
XR 400 RT/RV/RW/RX/R1-R5 96-05									
CR 500 RN/RP/RR 92-94									
XR 500 RD/RE 84-85									
XR 600 RM/RP/RR/RS RT/RV/RW/RX/R1-R7 91-00									
XR 650 RY/R1-R7 00-07									
<b>HONDA-DALL-ARA</b>									
XR 250 R/650 R 04									
MD6002D MD6002CX	REAR	S	CR 125 RK/RL/RM/RN/RP/ RR/RS/RT/RV 89-97	220					
			CR 250 RK/RL/RM/RN/RP/RR/RS/RT 89-96						
			CR 500 RK/RL/RM/RN/RP/RR /RS/RT/RV/RW/RX/R1 89-00						
MD6003D	FRONT	S	CR 125 RL/RM 90-91	240					
			CR 250 RL/RM 90-91						
			XR 250 RL 90						
			CR 500 RL/RM 90-91						
			XR 600 RJ/RK/RL 88-90						
MD6004D	FRONT	S	CR 80 RG/RH/RJ/RK/RL /RM/RN/RP/RR/RS 86-95	215					
MD6005D MD6005C MD6005CX	REAR	S	CR 80 RN/RP/RR/RS/RT/RBT /RV/RB/RW/RB/RX/RB /RY/RBY/R1/RB1/R2/RB2 92-02	190	MD6014D MD6014C MD6014CX	REAR	S	DR 125 SMK8/SMK9/SML0 08-12	220
			CR 85 R/R2 03-07					RM 125 J/K/L/M/N/P/R/S/T/V/W 88-98	
			CR 85 R3/RB3/R4/RB4/R5/RB5 /R6/RB6/R7/RB7 03-07					RM 250 H/J/K/L/M/N/P/R/S/T/V 87-98	
								RMX 250 P/R/S/T/V/W 94-98	
								RMX 250 SN/SR/SS 95-97	
								RMX 250 ST/SV/SW/SX (SJ14A) 96-99	
								DR-Z 400 SEY/EY/SEK1/EK1/K1 /SK2/EK2/K2/SK3/EK3/K3/K4/SK4 /EK4/SK5/EK5/K6/EK6/SK6/SK7 /EK7/K7/SK8/SK9 00-09	
								KLX 400 R (KLX 400 B1/B2) 03-04	
MD6006D	FRONT	S	ATC 250 RF/RG 85-86	174	MD6015D OS6015C MD6015C SM6015C MD6015CX	FRONT	S	KX 125 G1/H1/H2/J1/J2/ K1-K5/L1/L2/L3/L4 89-02	250
			TRX 250 RJ/RK 88-89					KDX 200 E5-E6 93-94	
			TRX 250 EX1/2/3/4/5/6/7/8 01-08					KLX 250 R D1-D2 93-94	
			TRX 250 X9/XA/XB 09-11					KX 250 G1/H1/H2/J1/J2 K1-K5/L1/L2/L3/L4 89-02	
			TRX 300 EX P/R/S/T/V/W /X/Y/1/2/3/4/5/6/7/8 93-08					KLX 300 A2-A10/A6F/A7F 97-07	
			TRX 300 X9 09					KX 500 E1-E16 89-04	
			TRX 400 EXX/EXY/EX1-EX8 99-08						
			TRX 400 X9 09						
			TRX 450 R4/R5/R6/ER6/R7 /ER7/R8/ER8/R9/ER9 04-09						
			TRX 700 XX8/XX9/XXB 08-11						
MD6007D	REAR	S	TRX 250 RG/RH/RJ/RK 86-89	186	MD6016D	FRONT	S	YZ 125 W 89	230
MD6008D	FRONT	S	CR 125 RK 89	240				YZ 250 W/WRW 89	
			CR 250 RK 89					WR 500 ZD 92	
			NX 250 J/K 87-89						
			XR 250 RG/RH/RJ/RK/RL 86-90						
			XLR 250 R 91-94						
			CR 500 RK 89						
			XR 600 RJ/RK/RL 88-90						
MD6009D	REAR	S	CR 125 RH/RJ 87-88	220					
			CR 250 RH/RJ 87-88						
			CR 500 RH/RJ 87-88						

# OFF ROAD DISC BUYERS GUIDE



DISC No.	FRONT/ REAR	TYPE	MODELS	DIA (MM)	DISC No.	FRONT/ REAR	TYPE	MODELS	DIA (MM)
<b>MD6017D</b> <b>OS6017C</b> <b>OS6017EC</b> <b>SM6017C</b> <b>MD6017C</b> <b>MD6017CX</b>	FRONT	S	<b>SUZUKI</b> DR 125 SMK8/SMK9/SML0 08-12 RM 125 K/L/M/N/P/R/S /T/V/W/X/Y/K1-K9 89-12 RM 125 XCK8 09 DR 250 RS/RLS/RT/RV/RLV /RW/RLW/RY 95-00 DR 250 RXT/RXLT/RXV/RXLV/RXW /RXLW/RXGW/RXGLW/RXY/RXGY (Dejbel 250 XC/GPS SJ45A) 96-98 DR-Z 250 K1-K7 (DJ43A) 01-07 RM 250 K/L/M/N/P/R/S /T/V/W/X/Y/K1-K9 89-12 RM 250 XCK8 09 RMX 250 P/R/S/T/V/W 94-98 RMX 250 ST/SV/SW/SX (SJ14A) 96-99 RMX 250 SN/SR/SS 95-97 DR 350 SEW/SEX Electric Start /6 bolt front disc (USA Only) 98-99 DR-Z 400 EY/SY/EK1/K1/SEK1/EK2 /SEK2/K2/K3/SK2/EK2/K2/SK3/EK3 /K3/SK4/EK4/K4/SK5/EK5/K6/EK6 /SK6/SK7/EK7/K7/SK8/SK9 00-09 <b>KAWASAKI</b> KLX 400 R (KLX 400 B1/B2) 03-04 <b>YAMAHA</b> WR 250 FP/FR/FS/FT/FV/FW/FX/FY 02-09 WR 250 FW 07 YZ 250 FW 07 YZ 250 FN/FP/FR/FS/FT/FV/FW/FX 01-09 YZ 250 X/Y 08-09 WR 400 FN 01 WR 426 FN/FP 01-02 YZ 426 FN/FP 01-02 YZ 450 FR/FS/FT/FV/FW/FX 03-09 WR 450 FR/FS/FT/FV/FW/FX/FY 03-09	250	<b>MD6030D</b> <b>MD6030C</b> <b>OSS6030C</b> <b>OSY6030C</b> <b>MD6030CX</b>	FRONT	S	<b>YAMAHA</b> YZ 80 E/F/LWF/LWG/G/LWH/H/LWJ /J/LWK/K/LWL/M/LWM/N/LWN 93-01 YZ 85 P/LWP/R/LWR/S/LWS/T/LWT /N/LWV/W/LWX/X/LWX/LWY/Y /LWZ/Z/LWA/LWB/LWD 02-13	220
					<b>MD6030D</b> <b>MD6030C</b> <b>OSS6030C</b> <b>OSY6030C</b> <b>MD6030CX</b>	FRONT	S	<b>SUZUKI</b> RM 85 K5/LK5/K6/LK6/K7/LK7/LK8 /K8/LK9/K9/LLO/L0/L1/L2 05-12	220
					<b>MD6031D</b> <b>MD6031C</b> <b>MD6031CX</b>	REAR	S	YZ 80 E/F/LWF/LWG/G/LWH /H/LWJ/J/LWK/K/L/LWL M/LWM/N/LWN 93-01 YZ 85 P/LWP/R/LWR/S/LWS/T/LWT /N/LWV/W/LWX/X/LWX/LWY/Y Z/LWZ/Z/LWA/LWB/LWD 02-13	190
					<b>MD6032D</b> <b>OS6032C</b> <b>OS6032EC</b> <b>MD6032C</b> <b>SM6032C</b> <b>OS6932C</b> <b>SM6932C</b> <b>MD6032CX</b>	FRONT	S	<b>KTM</b> MX 125 92-93 SX 125 94-13 EXC/EGS 125 94 EXC 125 95-13 EXC 125 (2T) Six Days 11-13 EXE 125 00 SX 150 08-13 XC 150 (USD) 11-13 EXC/EGS 200 98-99 EXC 200 04-13 MX 250 92-93 SX 250 (2T) 94-13 SX-F 250 06-13 EXC/EGS 250 94 EXC 250 95-13 EXC 250 (2T) Six Days 11-12 EXC-F 250 06-13 EXC-F 250 (4T) Six Days 11-12 EXC 250 Racing 06 SX-F 250 Ken Roczen Edition 12 XC 250 (USD) 11-13 XC-F 250 (USD) 11-13 EXC 300 (2T) 00-13 EXC 300 (2T) Six Days 11-12 XC 300 (2T) 11-13 EXC 350 94-95 SX-F 350 11-12 EXC-F 350 (USD) 11-12 EXC-F 350 Six Days 12 SX-F 350 Tony Cairoli Edition 12 XC-F 350 12-13 SX 360 96-97 EXC 360 96-97 SX 380 98-03 EXC 380 98-03 SC 400 96-99 SX 400 00-02 EXC/EGS 400 (USD) 00-03 EXC 400 Racing (USD) 00 EXC 400 Racing 04-07 EXC 400 (4T) 09-11 SX 440 94-95 EXC 440 94-95 SX-F 450 03-13 EXC 450 (4T) 03-13 EXC 450 Racing 06-07 EXC 450 (4T) Six Days 11-12 EXC-R 450 08 SMR 450 05 EXC 500 (4T) 12-13 EXC 500 (4T) Six Days 12 SXF 505 07-09 SX 520 01-03 EXC 520 01-03 EXC 525 03-05 XC 525 Racing 06-07 MXC 525 03-04 SX 525 03-06 XC 525 Racing 06 EXC-R 530 08 EXC 530 09-11 EXC 530 (4T) Six Days 11 MXC 550 96 SX/EXC/EGS 620 94-95 EGS-E 620 Adventure/Rallye 99	260
<b>MD6018D</b> <b>MD6018C</b> <b>OS6018C</b>	FRONT	S	RM 80 XG/XH/XJ/XK/XL/XM/XN /XP/XR/XS/T/V/W/X/Y/K1 86-01 RM 85 K2/LK2/K3/LK3/LK4/K4 02-04	200					
<b>MD6019D</b>			<b>USE MD6025D</b>						
<b>MD6020D</b>	FRONT	S	LT 250 RH/RJ/RK/RL 87-90	160					
<b>MD6021D</b>	REAR	S	LT 250 RH/RJ/RK/RL 87-90	220					
<b>MD6022D</b>	FRONT	S	LT 500 RL 90	170					
<b>MD6023D</b>	REAR	S	LT 500 RL 90	240					
<b>MD6024D</b> <b>MD6024C</b> <b>MD6024CX</b>	REAR	S	KX 125 G1/H1/H2/J1/J2/ K1-K5/L1/L2/L3 89-01 KDX 200 E1-E6 89-94 KX 250 G1/H1/H2/J1/J2 K1-K5/L1/L2/L3 89-01 KX 500 E1-E16 89-04	220					
<b>MD6025D</b> <b>MD6025C</b>	REAR	S	KX 80 L1/L2/N2/L3/N3 R1/T1 88-91 KX 80 R2-R7/T2-T6/W1-W3 92-00 KX 100 A1/A2/B1-B7/C1-C3 89-00 <b>SUZUKI</b> RM 80 XL/XM/XN/XP/ XR/XS/T/V/W/X/Y/K1 90-01 RM 85 K2/LK2/K3/LK3/LK4/K4 02-04	185					
<b>MD6026D</b>	FRONT	S	KX 80 R2-R7/T2-T6/W1-W3 92-00 KX 85/85 II A1/B1 01 KX 100 B2-B7/C1/C2/C3 91-00	220					
<b>MD6027D</b>	FRONT	S	KX 80 E2/E3/G1/G2/J1/J2 84-87 KX 80 L1-L3/N2/N3/R1/T1 88-91 KX 100 A1/A2/B1 89-91	200					
<b>MD6028D</b> <b>OS6028</b> <b>OS6028E</b> <b>MD6028C</b> <b>MD6028CX</b>	FRONT	S	YZ 125 D/E/F/G/H/J/K/L/M 92-00 YZ 250 D/E/F/G/H/J/K/L/M 92-00 WR 250 ZB/ZD/ZE/ZF/ZG/ZH/ZJ/ZK 91-98 WR 400 FL/FM 99-00 YZ 400 FK/FL/WR 400 FK/FL/FM 98-00 YZ 426 FM 00	245					
<b>MD6029D</b>	FRONT	S	YZ 80 S/T/U/W 86-89	190					

# OFF ROAD DISC BUYERS GUIDE

DISC No.	FRONT/ REAR	TYPE	MODELS	DIA (MM)	DISC No.	FRONT/ REAR	TYPE	MODELS	DIA (MM)
<b>MD6032D</b> <b>OS6032C</b> <b>OS6032EC</b> <b>MD6032C</b> <b>SM6032C</b> <b>OS6932C</b> <b>SM6932C</b> <b>MD6032CX</b> <b>Contd.</b>	FRONT	S	<b>KTM</b> SX 620 96-99 SC 620 Supercompetition 96-00 SXC 625 03-06 LC4 625 SC Supercompetition 02 <b>HUSABERG</b> All MX/Enduro Models See Main Catalogue 00-13	260	<b>MD6035D</b> <b>MD6035C</b> <b>MD6035CE</b> (Undrilled Enduro Disc Contd.)	REAR	S	<b>HUSABERG</b> All MX/Enduro Models 00-13 See Main Catalogue	220
<b>MD6033D</b>			<b>USE MD6035</b>		<b>MD6036D</b>	FRONT	S	KX 125 D1/E1/E2/F1 85-88 KDX 200 C1-C3 86-88 KDX 200 E1-E4 89-92 KDX 200 SR (DX 200 G) 85-88 KX 250 D1-D2/E1/F1 85-88 KX 500 B1-B2/C1/D1 85-88	250
<b>MD6034D</b>	FRONT	S	<b>KTM</b> EXC 125 89 D-XC/E-XC/E-GS 125 90-93 EXC/EGS 250 89 DXC/EXC 250 90 DXC/EXC/EGS 250 91 DXC/EXC/EGS 350 90-91 EXC 350 89 LC-4 MX/EXC 500 89 LC-4 MX 500 (Brembo) 90-91 LC-4 EXC 500 (Grimeca) 90-91 LC-4 MX/EXC 600 89 LC-4 EXC 600 90-93	240	<b>MD6037D</b> <b>OS6037</b> <b>MD6037C</b> <b>SM6037C</b> <b>OS6437C</b> <b>SM6437C</b> <b>MD6037CX</b> Note: For HM models check application pages	FRONT	S	CR 125 RS/RT/RV/RW/RX/RY/R1-R795-07 CR 250 RS/RT/RV/RW/RX/RY/R1-R795-07 CRE F 250 R 08-09 CRE F 250 X 08-11 CRF 250 R4/R5/R6/R7/R8/R9 /RA/RB/RC/RD 04-13 CRF 250 R 08-09 CRF 250 X4/X5/X6/X7/X8/X9 /XB/XC/XD 04-13 CRF 250 XRLD 13 CRE F 300 X 08-09 CRF 450 X5/X6/X7/X8/X9 /XB/XC/XD 05-13 CRF 450 R2-R9/RA/RB/RC/RD 02-13 CRF 450 R 04-09 CRF 450 XRLD 13 CR 500 RS/RT/RV/RW/RX/RY/R1 95-01 CRE F500 X 08-09	240
<b>MD6035D</b> <b>MD6035C</b> <b>MD6035CE</b> (Undrilled Enduro Disc)	REAR	S	<b>KTM</b> SX 125 94-13 EXC/EGS 125 94 EXC 125 95-13 EXC 125 (2T) Six Days 11-13 EXE 125 00 SM 125 Supermoto 00 SX 150 08-13 XC 150 (USD) 11-13 EXC/EGS 200 98-03 EXC 200 04-13 D-XC/E-XC/T-XC/E-GS 250 92-93 SX 250 (2T) 94-13 EXC/EGS 250 94 EXC-F 250 06-13 EXC-F 250 (4T) Six Days 11-12 EXC 250 95-13 EXC 250 (2T) Six Days 11-12 EXC 250 Racing 06 SX-F 250 06-13 SX-F 250 Ken Roczen Edition 12 XC 250 (USD) 11-13 XC-F 250 (USD) 11-13 EXC 300 00-13 EXC 300 (2T) Six Days 11-12 XC 300 (2T) 12-13 EXC 350 LC4 94-95 SX-F 350 11-13 EXC-F 350 (USD) 11-13 EXC-F 350 Six Days 12 SX-F 350 Tony Cairoli Edition 12 XC-F 350 12-13 SX/EXC 360 96-97 SX 380 98-03 EXC 380 98-99 EXC 400 (4T) 09-11 SX 400 00-02 EXC/EGS 400 (USD) 00-03 EXC 400 Racing 00/04-07 SX/EXC 440 94-95 SX-F 450 03-13 EXC 450 03-13 EXC 450 Racing 06-07 EXC 450 (4T) Six Days 11-12 EXC-R 450 08 SMR 450 04-13 EXC 500 (4T) 12-23 EXC 500 (4T) Six Days 12 SX-F 505 07-09 EXC 525 03 SX 525 03-06 LC-4 MX 500 90-91 LC-4 EXC 500 90-91 EXC 520 01-03 SX 520 01-03 EXC 525 04-05 EXC 525 Racing 06-07 MXC 525 03-04 SMR 525 04-05 EXC 530 09-11 EXC 530 (4T) Six Days 11 MXC 550 96 SMR 560 Supermoto 06-07	220	<b>MD6038D</b> <b>MD6038CX</b>	REAR	S	TS 125 RK/RL/RM/RN/RR 90-96 TS 200 RK/RL/RM/RN/RR89-94 DR 250 SL/SM/SN/SEP/SER /SES (SJ44A) 90-95 DR 350 SL/SM/SN/SP 4 Bolt front disc/Kick start 90-93 DR 350 SER/SES (Electric street /4 bolt front disc) 94-95	220
					<b>MD6039D</b>	FRONT	S	DT 125 R 88-03 DT 125 RE 04-07 YZ 125/250 U 88 TT 350 (ITJ) 85-89 YZ 490 U 88 TT 600 N (59X) Frame # 59X00101- 59X007852 85-88 TT 600 W (2JT/3SW1) (Frame # 59X007853-) 89-92	230
					<b>MD6040D</b> <b>OS6040C</b> <b>MD6040CX</b>	FRONT	S	DR 250 SL/SM/SN/SEP/SER /SES (SJ44A) 90-95 DR 350 SL/SM/SN/SP 4 bolt front disc/Kick start 90-93 DR 350 SER/SES (Electric start/ 4 bolt front disc) 94-95 DR 350 SET/SEV/SEW/SEX (Electric start/4 bolt front disc) (UK/Europe) 96-97	250
					<b>MD6041D</b>			<b>USE MD6082D</b>	
					<b>MD6042D</b> <b>SM6042C</b> <b>MD6042CX</b>	FRONT	S	KLR 650 A1-A3 87-89	260
					<b>MD6043D</b>			<b>USE MD6067D</b>	
					<b>MD6044D</b>	FRONT	S	XL 600 VH/VJ/VK/VM/VN VP/VR/VT Transalp 87-96 FX 650 X/Y 'Vigor' 99-03 SLR 650 V/W 97-98 XLV 750 R (RD/RF) 83-88	276
					<b>MD6045D</b> <b>MD6045CX</b>	REAR	S	XR 650 L 93-12	
					<b>MD6046D</b>	FRONT	S	TRX 250 RG/RH 86-87	166
					<b>MD6050D</b>	REAR	S	YFS 200 B/F/G/H/J/K/L/M/N/P Blaster 91-02	220
					<b>MD6051D</b>	FRONT	S	YFZ 350 T/U/W 87-89	161



# OFF ROAD DISC BUYERS GUIDE

DISC No.	FRONT/ REAR	TYPE	MODELS	DIA (MM)	DISC No.	FRONT/ REAR	TYPE	MODELS	DIA (MM)							
MD6053D	REAR	S	YFM 350 FXG/FXH/FXJ/FXK/FXL/FXM /FXN/FXP/FXR/FXS Wolverine 95-04	220	MD6068D	FRONT	S	XT 350	85-95	245						
			<b>DERBI</b> DXR 200 04-07 DXR 200 Quad (Front disc model) 04-07 DXR 250 04-06		MD6070D	FRONT	S	XT 600 84-87 XT 600 Z Tenere 84-90 XT 600 E 92-94	267							
MD6054D	FRONT	S	YFS 200 R/S/T/V 03-06	161	MD6072D	REAR	S	XT 600 87 XT 600/600 Z Tenere 88-90 XT 600 E 92-03 XT 660 'Tenere' 91-98	220							
			YFM 250 XN/XP/XR/XS 01-04		MD6073D	FRONT	S	DF 125 85-94 DR 125 SF/SH/SJ 99-01 TS 125 XUF/XUG/XUH/XUJ 86-90 DF 200 EV/EW/EY (SH42A) 86-89 DR 200 G/H/J 86-89 DR 200 SEP/SER/SES/SEV/SEW /SEX/SEY (SH42A) Djebel 93-00 DR 200 SEK1-SEK9 01-09	230							
			YFM 250 BT/BV Bruin 05-06			MD6075D	FRONT	S	TS 250 XE/XG/XH/XJ/XK 85-89 DR 600 RG/RH/RJ (SN41A) 86-88 DR 600 RK 89 DR 600 SF/SG/SH/SJ/SK (SN41A) 85-89	240						
			YFM 250 BW/BX/BY Big Bear 07-10				MD6076D	FRONT	S	DR 650 RL/RM 90-91 DR 650 RSL/RSM (SP42A) 90-91 DR 750 SJ/SK 88-89 DR 800 SL 90	280					
			YFM 250 RX/RV Raptor 08-09					MD6077D	REAR	S	DR 600 RK (SN41A) 89 DR 650 RL/RM 90-91 DR 650 RSL/RSM (SP42A) 90-91 DR 650 RUN/RN/RUP/RP (SP44A/B) 92-93 DR 650 RER/RES (SP45A/B) 94-95 DR 650 RSEM/RSEN/RSEP (SP43A/B) 91-93 DR 750 SK 89 DR 800 SL/SM/SN/SP 90-93	250				
			YFM 350 XD/XE/XF/XG/XH/XJ XK/XL/XM/XN/XP/XR/XS 92-04						MD6078D	FRONT	S	DR 650 RUN/RN/RUP/RP (SP44A/B) 92-93 DR 650 RER/RES (SP45A/B) 94-95 DR 650 RSEM/RSEN/RSEP (SP43A/B) 91-93	300			
			YFM 350 S/T/V/R-WV/RW/RX /RY/RZ Raptor 04-10							MD6080D	FRONT	S	KLR 600 A1/A3 B1-B4/B6-B9 84-94	250		
			YFZ 350 A/D/E/F/G/H/J/K/L M/N/P/R/S/T/V Banshee 90-09								MD6081D	FRONT	S	KL 650 B1-B3 'Tengai' 89-92 KLR 650 C1-C10 95-04	280	
			YFM 400 FGW/FGX Grizzly 07-08									MD6082D MD6082CX	REAR	S	KLE 500 A1-A12/B1 91-05 KLE 500 B1P/B6F/B7F 05-07 KL 650 B1-B3 'Tengai' 89-92 KLR 650 A1-A3 87-89 KLR 650 C1-C10 95-04	230
			YFZ 450 S/T/W/X 04-08										MD6083D MD6083CX	FRONT	S	KDX 125 A1/A2/B1/B2 90-94 KDX 200 H1/H2/H3/H4/H5 95-99 KDX 220 R A4-A12/A6F 97-06 KDX 220 SR (DX220B) 91 KDX 250 SR 91-93 KDX 250 D1 91-93
YFZ 450 RY/RZ (Quad) 09-10	MD6084D			<b>USE MD6105D</b>												
YFM 660 RN/RP/RR/RS/RT Raptor 01-05		MD6085D	REAR	S	KLX 250 R D1-D2 93-94 KLX 250 G1 94- KLX 650 C1-C3 93-97									230		
YFM 700 RV/RW/RX/RY /RA/RB Raptor 06-12			MD6086D	FRONT	F	KLX 650 C1-C3 93-97								290		
YFM 700 RD Raptor 13																
<b>DERBI</b> DXR 200 04-07 DXR 250 04-07																
MD6055D					REAR	S	YFM 350 XD/XE/XF/XG/XH/XJ /XK/XL/XM/XN/XP/XR/XS 92-04	245								
MD6056D							<b>USE MD6008D</b>									
MD6057D					FRONT	S	KMX 200 A2/A3 89-92 KLR 250 D2-D22 84-05	240								
MD6058D MD6058C OS6058C MD6058CX					FRONT	S	CR 80 RT/RBT/RBV/RV/RBW /RW/RX/RBX/RY/RBY/R1/RB1 R21/RB2 96-02 CR 85 R/R2 03-07 CR 85 R3/RB3/R4/RB4/R5/RB5 /R6/RB6/R7/RB7 03-07	220								
MD6059D					FRONT	S	ATC 200 XD 83 ATC 250 RD 83-84 ATC 250 RF/RG 85-86	206								
MD6059D	REAR				S	ATC 200 XD 83 ATC 250 RD 83-84	206									
MD6060D	FRONT	S			ATC 250 RB/RC 81-82	156										
MD6064D	REAR	S	TRX 300 EX P/R/S/T/V/W/X/Y/1-8 93-08 TRX 300 X9 09		220											
MD6065D			<b>USE MD6039</b>													
MD6066D	FRONT	S	WR 200 D/E/F 92-94 DT 200 WR 92-93 DT 230 Lanza (LTP1/2) 97-98 TT 250 R (4GY1 Japan) 93-94 TT 250 R (4RR1/2 Japan) 95-96 TT 250 RL (4PX5) 99 TT 250 RM (4PX6) 00 TT 250 R (4GY3/4GY5/4WA1) Raid94-96	245												
MD6067D	FRONT	S	DT 125 LC 86-87	220	MD6084D			<b>USE MD6105D</b>								
			TW 125 (5EK/5RS) 99-04		MD6085D	REAR	S	KLX 250 R D1-D2 93-94 KLX 250 G1 94- KLX 650 C1-C3 93-97	230							
			XYZ 125 (5RM) 03-10			MD6086D	FRONT	F	KLX 650 C1-C3 93-97	290						
			YZ 125/250 S/T 86-87													
			DT 200 (2LR) 87													
			TW 200 (2JL/4CS1/2/3/5) 91-98													
			TW 200 E (4CS4/6/5LB1/2) 98-01													
			ST 225 (5BT) Bronco 97													
			TW 225 E (5VC1/2) 02-03													
			XT 225 Serrow (4JG) MK1-2													
			XT 225 WE (4JG5/6) Serrow 97-98													
			XT 225 (2LN) Serrow (1KH 020101-) 86-87													
			XT 225 (3RW1-5 Serrow) (1KH 034101-13200) 89-93													
			XT 225 97-06													
			XT 225 S (3RW3) (1KH 102101-109000) 92													
XG 250 Tricker (5TX1) 04-06																
XT 250 X (5C1) 06-08																
YZ 490 N/S/T 85-87																





# OFF ROAD DISC BUYERS GUIDE

DISC No.	FRONT/ REAR	TYPE	MODELS	DIA (MM)	DISC No.	FRONT/ REAR	TYPE	MODELS	DIA (MM)
MD6126D	FRONT	S	<b>HUSQVARNA</b> CR 125 95-99 WR 125 95-99 TC 610 92-94	220	MD6144D	REAR	S	<b>HONDA</b> FL 400 R Pilot RK/RL 89-90	256
	REAR	S	<b>HUSABERG</b> All Models 93-99 <b>HUSQVARNA</b> CR 125 91-99 SM 125 98-99 WR 125 91/93-99 WRE 125 93-99 WR 240 90-91 CR 250 91-99 WR 250 90-99 WR 260 90-91 TE 350 90-97 CR 360 92-94 WR 360 92-99 TE 410 95-99 TE 410 E 00 TE 510 90 TC 510 90 LT 610 00 SM 610 98-00 SM 610 R 00 TE 610 91-94 TE 610/E 95-00 TC 610 91-94 TC 610/E 95-99	220	MD6145D	FRONT	S	LT-F 500 FW/FX/FY/FK1/FK2 98-02	206
MD6127D			<b>USE MD6095D</b>		MD6147D	FRONT	S	<b>POLARIS</b> Big Boss 250 4x6 89-90 Trail Boss 88-90 Trail Boss 4x4 87 Trail Boss 2x4/4x4 88-89 Trail Blazer 90	165
					MD6148D			USE MD6214D	
MD6128D	REAR	S	Pegaso 650 91-00	220	MD6149D	FRONT	S	<b>POLARIS</b> Big Boss 250 4x6 Middle Axle 89-92 Big Boss 250 6x6 91-92 Big Boss 350 L 93 Big Boss 300 6x6 Middle Axle 94 Big Boss 400 L 6x6 94-97 Big Boss 500 6x6 98-99 350 L 4x4 90 250 2x4/4x4 90 400 L 4x4 94 Magnum 325 4x4/2x4 00 Magnum 330 (2x4/HDS) 03-04 Magnum 425 4x4 95-98 Magnum 425 6x6 96-97 Magnum 500 4x4 99-00 Magnum 500 01 Magnum 500 (2x4/4x4 HDS) 02 Sportsman 350 4x4 93 Sportsman 400 L 4x4 94-97 Sportsman 400 01-04 Sportsman 500 4x4 96- Sportsman/Worker 500 4x4 EBS/500 RSE 98-02 Sportsman/Worker 335 4x4 99-00 Sportsman 6x6 (500) Big Boss 00-01 Trail Boss 350 L 4x4 91 Xpedition 425 (4x4) 00 Xplorer 400 L 4x4 95-00 Xplorer 500 4x4 97 Xplorer 400 01-02 Diesel 455cc 4x4 EBS 99-00 Diesel 01 Ranger 99 PPS LUH 6x6 02	228
MD6129D	FRONT	S	<b>APRILIA</b> Pegaso 650/650 ie 91-04 Pegaso 650 Trail 06-08	300					
MD6130D MD6130CF MD6130DF	FRONT	S F F	<b>KTM</b> EGS 400/EGS-E/LSE (LC4 Enduro) 96-99 LC4-E 400 Enduro 00-01 EGS/EGS-E/LSE 620 Enduro 96-99 LC-E 640 Enduro 00-04 LC4 640 Adventure R 00	300	MD6150D	FRONT	S	<b>POLARIS</b> Big Boss 250 4x6 91-92 Big Boss 250 6x6 92-93 Big Boss 300 6x6 94 350 L 2x4 90 250 2x4/4x4 93 350 L 4x4 93 300 2x4/4x4 94-95 400 L 2x4 94-95 Magnum 425 2x4 95-98 Scrambler 400 L 4x4 95-97 Scrambler 500 4x4 97 Sport 400 L 94-98 Sport 400 99-00 Sportsman 335 4x4 99-00 Trail Boss 250 91-99 Trail Boss 250 2x4/4x4 91-92 Trail Boss 350 L 2x4 91-93 Trail Blazer 91-93 Trail Blazer 250 94-98 Xpedition 300/400 L 96-97 Xpress 300 2x4 98-00 Xplorer 300 4x4 96-00	175
MD6131D	FRONT	S	KLF 300 C1-C17 89-05 KVF 300 A1-A4/B1-B4 (Prairie 4x4) 99-02 KLF 400 B1-B7 93-99 KVF 400 A1/A2/B1/C1-C4/D1-D4 97-02	200					
MD6132D	REAR	S	KSF 250 A1-A18 87-04 KEF 300 B1/B2/B3 01-03	220	MD6153D	FRONT	S	<b>POLARIS</b> Big Boss 400 L 6x6 Middle Axle 96 Magnum 425 6x6 Middle Axle 96	253
MD6133D	FRONT	S	KSF 250 A1-A18 87-04 KXF 250 A1/A2 87-88 KEF 300 B1/B2/B3 01-03 KLF 300 B1-B17 'Bayou' 88-04	168					
MD6134D	REAR	S	KXT 250 B2 (Tecate - 3 wheel) 87	220	MD6154D	REAR	S	<b>POLARIS</b> Sportsman 500 97	150
MD6135D MD6135C MD6135CX	REAR	S	YZ 125 N (2T) 01 WR 250 ZK (5EN1) 98 WR 250 FN/FP (4T) 01-02 YZ 250 N (2T) 01 YZ 250 FN (4T) 01 YZ 400 FL 99 WR 400 FL/FM/FN 99-01 WR 426 FN (4T) 01 YZ 426 FN (4T) 01	240					
MD6136D	REAR	S	KXF 250 A1/A2 87-88	231					
MD6137D	FRONT	S	KFX 450 R (KSF 450 B8F /B9F/BAF/BBF/BCS) 08-12	163					
MD6138D	FRONT /REAR	S	KXT 250 B1 (Tecate - 3 wheel) 86 KXT 250 B2 (Tecate - 3 wheel) 87	206					
MD6140D	FRONT	S	YFM 600 FWAK/FWAL/FWAM/FWAN 'Grizzly' 98-00 YFM 600HM "Grizzly Hunting" 00	220					
MD6141D	FRONT	S	<b>HUSABERG</b>	260					
MD6142D	REAR	S	<b>HUSABERG</b>	220					

# OFF ROAD DISC BUYERS GUIDE

DISC No.	FRONT/ REAR	TYPE	MODELS	DIA (MM)	DISC No.	FRONT/ REAR	TYPE	MODELS	DIA (MM)
MD6155D	FRONT	S	<b>POLARIS</b>	182	MD6169D	FRONT	S	<b>POLARIS</b> Sportsman 6x6 02-04	203
			Magnum 325 2X4/4X4 Mose 01		MD6169D	REAR	S	<b>POLARIS</b> Xplorer 400 L (4x4) 99-02	203
			Magnum 325 (2x4) HDS 02		MD6170D	FRONT	S	<b>POLARIS</b> Sportsman 6x6 (500) 00-04 PPS LUH 6x6 02	228
			Magnum 325 4x4 02		MD6171D	FRONT	S	<b>BOMBARDIER</b> DS 650 00-04 <b>CAN AM</b> DS 650 X 07	166
Scrambler 400 (2x4/4x4) 00	MD6156	REAR	S	175	MD6172D	REAR	S	<b>BOMBARDIER</b> DS 650 00-04 <b>CAN AM</b> DS 650 X 07	196
Scrambler 400 4x4/2x4 98-02									
Scrambler 500 4x4 98-00									
Scrambler 500 2x4/4x4 01-02									
Trail Boss 325 00-02									
Trail Blazer 250 99-00									
Trail Blazer 250 Freedom 01-02									
Xpedition 325 00/02									
Xplorer 250 4x4 00									
Xplorer 4x4 400 01-02									
Magnum 325 (4x4) (2x4) 00									
Magnum 325 2x4/4x4 Mose 01									
Magnum 500 4x4 99-00									
Magnum 500 01									
Scrambler 400 (2x4/4x4) 00									
Scrambler 400 4x4 98-02									
Scrambler 400 2x4 02									
Scrambler 500 4x4 98-00									
Scrambler 500 2x4/4x4 01-02									
Sport 400 99-00									
Trail Boss 325 00-02									
Trail Blazer 250 99-00									
Trail Blazer 250 Freedom 01-02									
Trail Boss 330 03-04									
Xpedition 425 4x4 00									
Xpedition 325 00									
Xplorer 4x4 400 01-02									
MD6157D/C MD6157CX	REAR	S	RM 125/250 X/Y/K1-K5 99-05 DR-Z 400 SMK5/K6/K7/K8/K905-09	240	MD6173D	FRONT /REAR	S	<b>MASSEY FERGUSON</b> MF 250/300/400/500/650/700 (2WD/4WD)04-09 <b>ARCTIC CAT</b> Most models 98-12 <b>KYMCO</b> MXU 400 (A40000) 08-11 Maxxer 450 i 10-13 MXU 450i IRS 11-12 MXU 500i (4x4 -IRS) 09-12 <b>LAVERDA</b> Quasar 4x4 400 04 Quasar 4x4 500 C 04 Quasar 4x4 500 04 <b>PIAGGIO</b> Trackmaster 400 Quad 06	202
MD6158D MD6158C	FRONT	S	DT 50 LC 98- TT-R 125 LWM/LWN/LWP/LWR/LWES/LWS /LWET/LWT/LV/LVEV/LWEV/LWEX /LWX/LEY/LEWZ/LWEA/LWED 00-13	220	MD6174D	REAR	S	<b>YAMAHA</b> YFM 400 FAM/FAN 00-01 YFM 450 FAR/FAS 03-04 YFM 450 FXV/FXW/FXX/FXY/FXZ Wolverine 06-10	220
MD6159D	FRONT		<b>USE MD6149D</b>		MD6175D	FRONT	S	<b>DERBI</b> Senda-R 96-99	218
MD6160D	REAR	S	Canyon 500 96-00 900 IE Canyon/Gran Canyon 98-00 E 900 Elephant 90-99 Navigator 1000 00-05	240	MD6176D	REAR	S	<b>N/A</b>	
MD6161D	REAR	S	KX 125 E/E2/F1 86-88 KX 250 D2 86- KX 250 E1/F1 87-88 KX 500 B2/C1/D1 86-88	220	MD6180D	FRONT	S	<b>APRILIA</b> Tuareg Wind 600 89	260
MD6162D			<b>USE MD6014D</b>		MD6181D MD6181C MD6181CX	REAR	S	XR 650 RY/R1-R7 00-07 <b>HONDA-DALL'ARA</b> XR 650 R 04	240
MD6163D	FRONT	S	<b>SUZUKI</b> RM 125/250 F/G/H/J 85-88	240	MD6182D	FRONT	S	TT 600 E (4LW3/4LW4/4GV4/4GV5) 94-01 TT 600 E (4GV2) 94-95 TT 600 K (4LW1/4GV1/4LW2) 93-96 TT 600 R (5CH1/5CH2/5CH3) 97-02 TT 600 RE (5CH5) 04	267
MD6164D	REAR	S	TRX 400 EXX/EXY/EX1-EX8 99-08 TRX 400 X9 09	220	MD6183D	REAR	S	TT 600 E (4LW3/4LW4/4GV4/4GV5) 94-01 TT 600 E (4GV2) 94-95 TT 600 K (4LW1/4GV1/4LW2) 93-96 TT 600 R (5CH1/5CH2/5CH3) 97-02 TT 600 RE (5CH5) 04	220
MD6165D	REAR	S	CRM 250-1 (RK) M1/MD24 (10001-1008385) 89-90	220	MD6184D MD6184C OS6184HC OS6184KC SM6184HC SM6184KC	FRONT	S	<b>HUSQVARNA</b> CR 125 00-13 SM 125 00 SM 125 S 02-13 SMR 125 (4T) 11-13 SMS 4-125cc (4T) 11 TE 125 (4T) 11-13 WR 125 00-13 WRE 125 00/02-13 WXE 125 07 CR 250 (4T) 00-05 TC 250 02-03/05-13 TE 250 (4T) 02-13 TE 250 Meo replica (4T) 11 TE 250 R (4T) 13 WR 250 00-13 WR 300 (2T) 09-13 TE 310 R (4T) 13 TZ 310 (4T) 09-12 WR 360 00-02 TE 400 02 TE 410 00/06 TE 410 E 00 SMR 449 11 TC 449 (4T) 11-13	260
MD6166D MD6166CX	FRONT	S	KX 65 A1/A2/A3/A4/A5/A6/A6F/A7F /A8F/A9F/AAF/ABF/ACF/ADF 00-13 <b>SUZUKI</b> RM 65 K3/K4/K5 03-05	180					
MD6166D MD6166CX	REAR	S	KX 65 A1/A2/A3/A4/A5/A6/A6F/A7F /A8F/A9F/AAF/ABF/ACF/ADF 00-13 <b>SUZUKI</b> RM 65 K3/K4/K5 03-05	180					
MD6168D	FRONT	S	<b>HONDA</b> XRV 650 J Africa Twin 88-89 <b>CAGIVA</b> Canyon 500 96-00 Canyon 600 96-99 E 750 Elephant 93-95 900 IE Canyon/Gran Canyon 98-00 E 900 ie Lucky Explorer 90-92 E 900 ie GT 91-92 Navigator 1000 00-05 Canyon 500 96-00 Canyon 600 96-99	296					

# OFF ROAD DISC BUYERS GUIDE

DISC No.	FRONT/ REAR	TYPE	MODELS	DIA (MM)	DISC No.	FRONT/ REAR	TYPE	MODELS	DIA (MM)
<b>MD6184D</b> <b>MD6184C</b> <b>OS6184HC</b> <b>OS6184KC</b> <b>SM6184HC</b> <b>SM6184KC</b> Contd.	FRONT	S	<b>HUSQVARNA</b> TE 449 (4T) 11-13 TC 450 03-07 TE 450 03-07 TC 510 04-07 TE 510 04-07 TE 511 (4T) 11-13 TC 570 02-03 TE 570 01-04 TC 610 00 TE 610/IE 06-09 TE 630 10-11	260	<b>MD6192D</b> <b>MD6192C</b>	FRONT	S	<b>KTM</b> 60 SX 98-00 65 SX 00-03	198
<b>MD6186D</b> <b>MD6186C</b> <b>OS6186C</b> <b>MD6186CX</b>	FRONT	S	<b>SUZUKI</b> KX 85 A1-A5/A6F/A7F/A8F/A9F/AAF /ABF/ACF/ADF (17" front wheel /14" rear wheel) 01-13 KX 85 B1-B5/B6F/B7F/B8F/B9F/BAF /BBF/BCF/BDF (19" front wheel/ 16" rear wheel) 01-13 RM 100 K3 03	220	<b>MD6195D</b>	FRONT	S	LT-A 400 FK2/K2/FK3/K3/K4/FK4 /FK5/FK6/FK7/FK8 Eiger 4WD 02-09 LT-A 400 FK8/FK9/FL0/FL1 King Quad Auto 4WD 08-12 LT-F 400 FK2/FK3/FK4 /FK5/FK6/FK7 Eiger 02-10 LT-F 400 FK8/FK9/FL0/FL1 08-12 LT-F 400 K2/K3/K4/K5/K6/K7 02-07 LT-A 500 FK2/FK3/FK4/FK5/FK6/FK7 Vinson 4WD 02-07 LT-F 500 FK3/FK4/FK5/FK6/FK7 03-07 MXU 500 (L70000/Carb Model) 05-09 MXU 500 4x4/Carb Model 05-13	190
<b>MD6187D</b> <b>MD6187C</b> <b>MD6187CX</b>	REAR	S	<b>SUZUKI</b> KX 85 A1-A5/A6F/A7F/A8F/A9F/AAF /ABF/ACF/ADF (17" front wheel /14" rear wheel) 01-13 KX 85 B1-B5/B6F/B7F/B8F/B9F/BAF /BBF/BCF/BDF (19" front wheel/ 16" rear wheel) 01-13 RM 100 K3 03	185	<b>MD6196D</b>	REAR	S	LT-A 500 FK2/FK3/FK4/FK5/FK6/FK7 Vinson 4WD 02-07 LT-F 500 FK3/FK4/FK5/FK6/FK7 03-07	216
<b>MD6188D</b>	FRONT	S	KVF 360 A1-A3/A6F/A7F/A8F/ /A9F/AAF/ABF/ACF/ADF 03-13 KVF 360 B1-B3/B6F/B7F/B8F/B9F 03-09 KVF 360 C1-C3/C6F/C7F/C8F Prairie All Models 03-08 KVF 650 A1/A2 02-03 KVF 650 D1/D6F/D7F/D8F/D9F /DAF/DBF Brute Force 4x4 05-11 KVF 650 E1/E6F/E7F/E8F/E9F Brute Force 4x4 Hardwoods Green HD 05-09 KVF 650 F7F/F8F/H7F/H8F/ /G7F/G8F 07-08 KVF 700 A1/B1/B6F/B7F/A2/B2/A6F /A7F/A8F 4x4 (Prairie) 04-08 KVF 700 D1 Team Green 05 KVF 750 D8F/D9F/DAF/DBF 08-11 KVF 750 E8FA 08	200	<b>MD6197D</b>	REAR	S	YFM 660 FWAP/FWAR/FWAS/FWAT /FWAV/FGW/FGX Grizzly 02-08 YFM 660 FR/FS/FT Grizzly 03-05	148
<b>MD6189D</b>	FRONT	S	YFM 660 FWAP/FWAR/FWAS/FWAT /FWAV/FGW/FGX Grizzly 02-08 YFM 660 FR/FS/FT Grizzly 03-05	220	<b>MD6198D</b>	REAR	S	AX-1 (NX 250 J/K/R/R3) 89-94	220
<b>MD6190D</b> <b>MD6190C</b> <b>MD6190CE</b> <b>MD6190CX</b> (Undrilled Enduro Disc)	REAR	S	YZ 125 P/R/S/T/V/W/X/Y/Z/A/B/D (2T) 02-13 YZ 250 P (2T) 02 YZ 250 P/R/S/T/V/W/X/Y/Z /A/B (2T) 02-12 YZ 250 FP/FR/FS/FT/FV/FW FX/FY/FZ/FA/FB (4T) 02-12 WR 250 FR/FS/FT/FV/FW FX/FY/FZ/FA/FB/FD (4T) 03-13 WR 426 FP (4T) 02 YZ 426 FP (4T) 02 WR 450 FR/FS/FT/FV/FW /FX/FY/FA/FB/FD (4T) 03-13 YZ 450 FR/FS/FT/FV/FW/FX/FY /FZ/FA/FB (4T) 03-12	245	<b>MD6199D</b>	FRONT	F	<b>KTM</b> Duke 400 LC4 94-98 Duke 620 LC4 LC4 620 SC Supermoto 00 LC4 625 SC Supermoto 02 SMC 625 05-06 Duke II 640 01-06 Duke-E 640 (Single pin pad fixing /zero offset disc) 98 Duke II 640 (2 pin pad fixing /zero offset disc) 99-07 LC4-E 640 Supermoto 00-06 LC4 640 Adventure 01-02 690 SM 07-09 690 SMC 08-11 690 SM-LE (Limited Edition) 10-11	320
<b>MD6191D</b> <b>MD6191C</b> <b>MD6191CE</b> (Undrilled Enduro Disc) Note: For HM models check application page <b>MD6191CX</b>	REAR	S	CR 125 R2/R3/R4/R5/R6/R7 02-07 CR 250 R2/R3/R4/R5/R6/R7/R8/R9 02-09 CRE F 250 R 08-09 CRE F 250 X 08-11 CRF 250 R4-R9/RA/RB/RC/RD 04-13 CRF 250 R 08-09 CRF 250 X4/X5/X6/X7/X8/X9 /XB/XC/XD 04-13 CRF 250 XRLD 13 CRE F 300 X 08-09 CRF 450 R2-R9/RA/RB/RC/RD 02-13 CRF 450 R 04-09 CRF 450 X5/X6/X7/X8/X9 /XB/XC/XD 05-13 CRF 450 XRLD 13 CRE F 500 X 08-09	240	<b>MD6200D</b>	REAR	S	<b>POLARIS</b> Magnum 325 2x4 HDS 02 Magnum 325 4x4 02 Magnum 325 4x4 HDS 02 Magnum 330 (4x4/HDS) 03-04 Magnum 500 (2x4/4x4 HDS) 02-03 Xpedition 325 02 PPS/PTV 4x4/Series 10 PPS/PTV 6x6/Series 10	206
					<b>MD6201D</b>	REAR	S	400 Sportsman 03-04 Sportsman 500 X2 06 Sportsman 600 (4x4) 03-04 Sportsman 700 4x4 02-04 Sportsman MV 700 05 Sportsman 800 05 PPS/Series 10 UTV 2x4/4x6 PPS/Series II UTV 1500 2x4 PPS/Series 11 2x4/4x4/6x6 Ranger 6x6 04-05 Ranger TM 04-05 Ranger XP 05 Ranger 2x4/4x4 04-06 Ranger Series 10 Ranger Series 10 500 6x6 Ranger Series 11	218
					<b>MD6202D</b>	FRONT /REAR	S	<b>POLARIS</b> Magnum 325 4x4 HDS 02 ATP 330 (4x4) 04 Magnum 330 (4x4/HDS) 03-04 330 Trail Boss 10-11 330 Trail Blazer 10-11 400 Ranger 4x4 12 400 Sportsman (Code A04CH42 AQ/AR/AS/AT/AV) 04 400 Sportsman HO 4x4 11-12 ATP 500 HO (4x4) 04 Magnum 500 HDS 02-03 500 Scrambler 4x4 10-11 Sportsman 500 HO 03-04 500 Sportsman HO Up to 15/12/08 500 Sportsman HO After 16/12/08 500 Sportsman Touring HO 11-12	228

DISC BUYERS GUIDE



# OFF ROAD DISC BUYERS GUIDE

DISC No.	FRONT/ REAR	TYPE	MODELS	DIA (MM)	DISC No.	FRONT/ REAR	TYPE	MODELS	DIA (MM)				
<b>MD6202D Contd.</b>	FRONT /REAR	S	<b>POLARIS</b>	228	<b>MD6215D</b>	FRONT	S	YFM 350 FAS/FAT/FAV Bruin 4x4	200				
			500 Sportsman Forest					12		YFM 350 ANS/ANT Bruin 2x4	04-06		
			Sportsman 700 (4x4)					02-04		YFM 350 XV/XW/XX 2WD			
			Sportsman MV 700					05		Wolverine IRS	06-09		
			Sportsman 800					05		YFM 350 FGW/FGX/FGY/FGZ/FGA			
			800 Sportsman Big Boss/6/6/EFI					09-12		/FGB Grizzly 4WD	07-12		
			800 Sportsman HO/EFI					Up to 15/12/08		YFM 350 FGIW/FGIX/FGIY/FGIZ			
			800 Sportsman HO/EFI					After 16/12/08		Grizzly 4WD IRS	07-10		
			800 Sportsman EFI					10-12		YFM 350 GW/GX/GY/GZ Grizzly			
			800 Sportsman Forest					12		2WD	08-10		
800 Sportsman Forest Tractor	12	YFM 400 FAR/FAS Kodiak Auto	03-04										
PPS/PTV 4x4/Series 10		YFM 400 AR Kodiak (5VH3/4)	03										
PPS/Series 10 UTV 2x4/4x6		YFM 400 FAT/FAV (Big Bear)	05-06										
PPS/Series II UTV 1500 2x4		YFM 450 FAR/FAS Kodiak (5ND3/4)	03-04										
PPS/Series 11 2x4/4x4/6x6		YFM 450 FAT/FAHT/FAV (Kodiak)	05-06										
Ranger 6x6	04-05	YFM 450 FGW Grizzly	07-09										
Ranger TM	04-06	YFM 450 FXV/FXW/FXX/FXY/FXZ											
Ranger XP	05	Wolverine	06-10										
Ranger 2x4/4x4	04-06	YFM 450 FGIZ/FGIA/FGIB											
Ranger 500 (2x4/4x4/4x4 EFI)	06	Grizzly IRS	10-12										
500 Ranger Crew	11	YFM 450 Grizzly EPS FGPA/FGPB	11-12										
500 Ranger 4x4 EFI	11-12												
Ranger 6x6 EFI 700	06												
Ranger XP 700 4x4	06												
<b>MD6203D</b>			<b>USE MD6188D</b>		<b>MD6216D</b>	REAR	S	<b>KTM</b>	160				
<b>MD6206D</b>	FRONT	S	LT-F 300 FK2	02	168			60/65 SX	00-01				
<b>MD6207D</b>	FRONT	S	LT-F 250 K2-K9 Ozark	02-12	160			65 SX	00-03				
<b>MD6208D MD6208C MD6208CE MD6208CX</b>	REAR	S	KX 125 M1/M2/M3/M6F/M7F/M8F	03-08	<b>MD6217D</b>	REAR	F	<b>HONDA</b>	170				
			KX 250 F (KX 250 N1/N2)	04-05				TRX 420 FA9/FAA/FAB Fourtrax					
			KX 250 M1/M2/R1/R6F/R7F/R8F	03-08				Auto 4WD		09-11			
			KX 250 F (T6F/T7F/T8F)	06-08				TRX 420 FPA9/FPA4/FPA8					
			KX 250 W9F/XAFB/YBF/YCF/ZDF	09-13				Fourtrax Auto Power Steering		09-11			
KX 450 F (D6F/D7F/D8F		TRX 650 FA3/FA4/FA5 Rincon											
/E9F/EAF/EBF/FCF)	06-13	4x4 Auto	03-05										
KLX 450 R (A8F/A9F/AAF		TRX 680 FA6/FA7/FA8/FA9/FAA/FAB											
/ABF/ACF)	08-12	Rincon 4x4 Auto	06-11										
<b>SUZUKI</b>													
RM-Z 250 K4/K5/K6	04-06												
<b>MD6209D</b>	FRONT	F	SM 125 (2T)	03-06	<b>MD6218D</b>	REAR	S	Predator 500	196				
			404 DS Supermoto	03-04									
			SM 450 ER (4T)	07-08				<b>MD6219D</b>		FRONT	S	Predator 500	03-04
			SM 515 FSR (4T)	07-08				Phoenix 200		05			
			604 E Supermoto	99-03				<b>MD6220D</b>		FRONT	S	<b>BOMBARDIER</b>	
			604 RS "Roadster"	00-03				Rally 200		03-06			
			644 DS Supermoto	04				<b>CAN AM</b>					
			644 DS	04				Rally 200		07			
			R 30 (Spoke wheel)	02-04				<b>MD6221D</b>		REAR	S	<b>BOMBARDIER</b>	
								Rally 200		03-04			
<b>MD6210D</b>	FRONT	S	LT-Z 250 K4-K9/L0 QuadSport	04-12	<b>MD6222D</b>	FRONT	S	<b>BOMBARDIER</b>	205				
			LT-Z 400 K3-K9/L0/L1	03-12				See main application pages					
			KSF 400 A1/A2/A3	03-05				for fitments					
			DVX 400	04-08				<b>CAN AM</b>					
400 DVX (2x4) Sport	04-08	See main application pages											
<b>MD6211D</b>	REAR	S	LT-Z 400 K3-K9/L0/L1	03-12	<b>MD6223D</b>	REAR	S	<b>BOMBARDIER</b>	180				
			KSF 400 A1/A2/A3	03-05				See main application pages					
			DVX 400	04-08				for fitments					
			400 DVX (2x4) Sport	04-08				<b>CAN AM</b>					
400 DVX TS Sport	06-07	See main application pages											
<b>MD6212D</b>	FRONT	S	DR-Z 125 LK3/LK4/LK5/LK6/LK7		<b>MD6224D</b>	FRONT /REAR	S	<b>BOMBARDIER</b>	203				
			/LK8/LK9	03-13				Traxter		01-04			
			KLX 125 L (B1/B2/B3/A6F)	03-06				Quest 500/650		02-04			
<b>MD6213D MD6213C OS6213C SM6213C MD6213CX</b>	FRONT	S	KX 125 M1/M2/M3	03-04	<b>MD6225D</b>	FRONT /REAR	S	<b>BOMBARDIER</b>	218				
			KX 250 N1/N2	04-05				Traxter		01-04			
			KX 250 M1/M2/R1	03-05				Quest 500/650		02-04			
			RM-Z 250 K4/K5/K6	04-06				Traxter Max 650		04-05			
								Traxter XL (7920/7921)		04			
		Quest Max/STD/XT	04-05										
<b>MD6214D</b>	FRONT	S	DT 50 R-L	97-03	<b>MD6226D</b>	FRONT	F	<b>JOHN DEERE ATV</b>	320				
			MX 50	03-05				Trail Buck 500 Utility		04-05			
			Pegaso 50	92-94				Trail Buck 650/650 EX/EXT		04-05			
			RX 3-5 Marce (M/N/P/R)	91-94				Buck 500/500 EX/EXT		04-05			
			RX 50 C/CD	95-04									

DISC BUYERS GUIDE

# OFF ROAD DISC BUYERS GUIDE

DISC No.	FRONT/ REAR	TYPE	MODELS	DIA (MM)	DISC No.	FRONT/ REAR	TYPE	MODELS	DIA (MM)	
MD6227D	REAR	S	KTM MX/MXC/GS 125	86	MD6245D	FRONT	S	Traxter Max 650	04-05	
			MX 125	88-89				Traxter XL (7920/7921)	04	
			EXC 125	88-89				Quest Max/STD/XT	04-05	
			MX/MXC 250	86				<b>JOHN DEERE ATV</b>		
			GS 250	86				Trail Buck 500 Utility	04-05	
			MX 250	88-89				Trail Buck 650/650 EX/EXT	04-05	
			EXC/EGS 250	88-89				Buck 500/500 EX/EXT	04-05	
			MX/MXC/GS 300	86						
			MX/MXC/GS 350	86/88						
			MX 350	89						
EXC 350	89									
MD6228D	FRONT	S	Use MD6229D		MD6246D	REAR	S	RM 85 LK5/K5/LK6/K6/LK7/K7/LK8 /K8/K9/LK9/LO/LL0/L2/LL2	05-12	
MD6229D	FRONT	S	<b>BOMBARDIER</b> Traxter	99-04	205	MD6247D MD6247C	FRONT	F	DRZ 400 SMK5/SMK6/SMK7 /SMK8/SMK9	05-09
MD6230D	REAR	S	<b>BOMBARDIER</b> Traxter	99-04	220	MD6248D	REAR	S	<b>DERBI</b> Senda X Race 50 R Senda X-treme 50 R Senda X-treme 50 SM Senda SM DRD 50 Senda SM DRD 50	05-11 03-11 03-11 02-03 05
MD6231D	FRONT	F	Use MD3088LS/RS							
MD6232D MD6232CX	REAR	S	<b>SUZUKI</b>		MD6249C MD6249CX	REAR	S	<b>KTM</b>		
			DL 650 XK7/XK8/XK9/XL0 V-Strom X	07-11				SX 65	04-13	
			DL 650 AK7/AK8/AK9/ALO							
			V-Strom ABS	07-11						
			DL 650 AK9 GT V-Strom							
			Traveller ABS	09-11						
			DL 650 AL1XP V-Strom Xpedition	11						
			DL 650 AL2/AL3 V-Strom	12-13						
			DL 1000 K2-K9/L0 V-Strom	02-11						
			<b>KAWASAKI</b>							
KLX 1000 (LV 1000 A1H/A2H)	04-05									
MD6233D	REAR	S	TRX 450 R4/R5/R6/ER6/R7/ER7 /R8/ER8/R9/ER9	04-09	190	MD6250D	FRONT	S	<b>DERBI</b> Senda X Race 50 R Senda X-treme 50 R	05-11 03-11
MD6234D	REAR	S	XT 660 X Supermoto XT 660 R XT 660 Z Tenere	04-13 04-13 08-13	245	MD6251D	FRONT	S	<b>HONDA</b> TRX 500 FE5/FE6/FE7/FE8/FE9/FEA/FEB Fourtrax Foreman 4WD-ES TRX 500 FA5/FA6/FA7/FA8/FA9/FAA /FAB TRX 500 FM5/FM6/FM7/FM8/FM9/FMA /FMB Fourtrax Foreman 4WD TRX 500 FPE8/FPE9/FPEA/FPEB Fourtrax Foreman - Power Steering TRX 500 TM5/TM6 Fourtrax Foreman TRX 680 FA6/FA7/FA8/FA9/FAA/FAB Rincon 4x4 Auto	05-11 03-11
MD6235D	FRONT	F	DT 125 X	04-06	298	MD6252D	REAR	S	YFM 400 FAT/FAV (Big Bear)	05-06
			WR 125 X (Supermoto)	09-13					YFM 400 FGW/FGX Grizzly IRS	07-08
			XT 660 R	04-13					YFM 450 FGW Grizzly	07
			XT 660 Z Tenere	08-13					YFM 450 FAT/FAHT/FAV (Kodiak)	05-06
MD6236D	REAR	S	YFM 250 RX/RV Raptor	08-09	200	MD6253D MD6253C	REAR	S	<b>GAS-GAS</b>	
			YFM 350 S/T/V/R-VV/RW/ RX/RV/RZ Raptor	04-10					See application pages	
			YFZ 450 S/T	04-05						
			YFM 700 RD Raptor	13						
MD6237D	REAR	S	YFS 200 R/S/T/V	03-06	220	MD6254D MD6254C OS/SM6254C	FRONT	S	RM-Z 250 K8/K9/L0/L1/L2/L3	08-13
			YZF 350 U/B/D/E/F/G/H/J/K/L /M/N/P/R/S/T/V Banshee	88-09					RM-X 450 L0	10-12
			YFM 660 RN/RP/RR						RM-Z 450 K5/K6/K7/L0/L1/L2/L3	05-13
			/RS/RT Raptor	01-05						
MD6238D	FRONT	S	<b>USE MD6215D</b>							
MD6239D	FRONT	S	KLX 250 G1/G1A/H1 Super Sherpa	97-98	240	MD6255D MD6255C MD6255CE (Plain) MD6255CX	REAR	S	RM-Z 250 K8/K9/L0/L1/L2/L3	08-13
			KL 250 J1-J3	00-02					RM-Z 450 K5/K6/K7/K8/K9/L0 /L1/L2/L3	05-13
MD6240D MD6240C	FRONT	S	250 SBK2 (LX 250 L)	02	250	MD6256D	REAR	S	330 Trail Boss	10-11
			KLX 250 J1-J6 D-Tracker	98-03					330 Trail Blazer	10-11
MD6241D	FRONT	S	YXR 66 FAS Rhino 4x4		200	MD6257C	REAR	S	<b>KTM</b> SX85	03-10
			Side x Side	04						
			YXR 700 Rhino 4x4 SE	09						
YXR 700 FA/FB/FD Rhino Side x Side	11-13									
MD6242D OS6242	REAR	S	YXR 66 FAS Rhino 4x4 Side x Side	04	165	MD6258C OS6258C	FRONT	S	<b>KTM</b> SX85 (17"/14" wheels) SX85 (19"/16" wheels)	03-13 03-13
MD6243C/D MD6243CX	FRONT	S	<b>KTM</b>	198	203	MD6259D	REAR	S	650 Elephant	88-89
			SX 65	04-13					750 Elephant	90-92
MD6244D	REAR	S	XT 225 WE (4JG5/6) Sorrow	97-98	203	MD6260D	FRONT	S	<b>CCM</b>	
			XT 250 Tricker (5XT1)	04-06					404 E	03-04
			XT 250 X (5C1)	06-08					404 DS	03-04
			XTZ 250	07-08					604 E DS	98-03



# OFF ROAD DISC BUYERS GUIDE

DISC No.	FRONT/ REAR	TYPE	MODELS	DIA (MM)	DISC No.	FRONT/ REAR	TYPE	MODELS	DIA (MM)					
MD6261D	FRONT	S	<b>SUZUKI</b> LT-A 700 XK5/XCK6/XK6/XK7 05-07 LT-A 750 XZK8/XK8/XK9/XZK9/XL0 King Quad 08-10	200	MD6271D	FRONT	S	<b>ARCTIC CAT</b> 550 Hi Efi Prowler 09 XT 550 10-11 XT 550 i Prowler 11-12 XT 650 H1 Prowler 06 650 H1 Prowler 07 650 Prowler 4x4 Auto/M4 08 HDX 700 Prowler 11 HDX 700 i Prowler 11-12 XTX 700 i Prowler 11-12 XTX 700 Hi Le Prowler 08 XTX 700 Hi Efi Prowler 09 XTZ 1000 H2 Efi Prowler 09 XTZ 1000 i Prowler 11-12 XTX 700 10-11 Wildcat 1000 i HO 12 ZTZ 1000 10-11	252					
MD6262D	FRONT	S	<b>POLARIS</b> Trail Blazer 250 05-06 Trail Boss 330 05-06	182				REAR	S	<b>ARCTIC CAT</b> XTZ 1000 H2 Efi Prowler 09 XTZ 1000 i Prowler 11-12 Wildcat 1000 i HO 12 <b>KAWASAKI</b> KVF 300 CCF/CDF (2x4) 13	252			
MD6263D	REAR	S	YFZ 450 V/W/X 06-09 YFZ 450 RY/RZ (Quad) 09-10 YFM 700 RV/RW/RX/RY/RA /RB Raptor 06-12	200						MD6272D	FRONT	S	<b>POLARIS</b> Hawkeye 300 2x4/4x4 06	198
MD6264D MD6264C OS6264C SM6264C MD6264CX	FRONT	F	KX 125 M6F/M7F/M8F 06-08 KX 250 R6F/R7F/R8F 06-08 KX 250 F (T6F/T7F/T8F) 06-08 KX 250 W9F/XAFB/YBF/YCF/ZDF 09-13 KX 450 F (D6F/D7F/D8F/E9F /EAF/EBF/FCF/FDF) 06-13 KLX 450 R (A8F/A9F/AAF /ABF/ACF) 08-12	250						MD6273D	REAR	S	<b>POLARIS</b> Hawkeye 300 2x4/4x4 06	202
MD6265D	FRONT	F	650 Elefant 88-89 750 Elefant 90-92	260						MD6274D	FRONT	S	Cobra 220 (Quad) 06-11 Overland 300 (Quad) (AT20) 06-07 Cobra 350 10-11 Cobra 400 (Quad) 10-13	173
MD6266D	FRONT	S	250 DVX Sport 06-08 LC-4 640 Adventure 03-07 950 Adventure/S 04-06	300		MD6275D	REAR			S	400 Ranger 10 400 Ranger 4x4 12 400 Sportsman HO 4x4 11-12 Sportsman 500 X2 06 500 Sportsman Touring HO 11-12 Ranger 500 (2x4/4x4) 06 Ranger 500 (4x4 Efi) 09-10 500 Ranger 4x4 Efi 11-12 500 Ranger Crew 11 500 Sportsman HO Up to 15/12/08 500 Sportsman HO After 16/12/08 500 Sportsman Forest 12 Ranger 6x6 Efi 700 06 Ranger XP 700 4x4 06 Ranger TM 06 Ranger EV (Electric) 10 800 Ranger HD 10 800 Ranger XP 10 800 Ranger 6x6 10 800 Ranger Crew 10 800 Ranger RZR 08-10 800 Ranger RZR S Efi 09-12 800 Ranger RZR-4 10-12 800 Ranger RZR 4 EPS 12 800 Sportsman Big Boss/6/6/Efi 09-12 800 Sportsman HO/Efi Up to 15/12/08 800 Sportsman HO/Efi After 16/12/08 800 Sportsman Efi 10-12 800 Sportsman Forest 12 800 Sportsman Forest Tractor 12 900 D Ranger 4x4 Diesel 11 900 Ranger RZR XP 12	218		
MD6267D	FRONT /REAR	S	<b>KYMCO</b> Mxer 50 (Quad) 00-07 MXU 50 05-13 50 DVX (4T) Sport 06/08 50 4x4 Auto Youth 08 90 2x4 (4T) Youth 06 90 DVX 06-12 90 DVX SE 09 90 (Reverse gear model) 10-12 90 SE 09 150 Utility 09-12 MXU 150 05-13 250 DVX Sport 06-08 KXR 250 04-06 Maxxer 250 12-13 MXU 250 04-13 MXU 250 R 12-13 300 DVX 09-12 Maxxer 300 06-12 MXU 300 06-11 MXU 300 R 10-13 <b>KAWASAKI</b> KXF 50 (KSF 50 B7F/B8F/B9F)07-09 KXF 90 (KSF 90 A7F/A8F/A9F/AAF/ ABF/ACF) 07-12 KVF 300 CCF/CDF (2x4) 13	180		MD6276D	REAR	S	<b>CCM</b> CR 40 S Cafe Racer (Full fairing)07-08 SR 40 Street Scrambler 07-09 R 45 07-09 404 E 03-04 404 DS 03-04 404 DS Supermoto 03-04 604 E DS 98-03 604 E Supermoro 99-03 604 RS 00-03 644 DS/SM 04 FT 710 S Fiat Tracker 08-09 R30 (Spoke Wheel) 02-04	220				
MD6268D	REAR	S	<b>KYMCO</b> KXR 250 04-06 Maxxer 250 12-13 MXU 250 04-13 MXU 250 R 12-13 300 DVX 09-12 Maxxer 300 06-13	220		MD6277D	FRONT	S	LTR 450 K6/K7/K8/K9/L0/L1 06-12	160				
MD6269D/C	REAR	S	690 Rally Factory Replica 07-09 690 SM 07-09 690 SM-LE (Limited Edition) 10-11 690 SMR 07-09 690 Enduro R 09-13 690 Enduro 08-11 950 Adventure/S 04-06	240		MD6278D	REAR	S	LTR 450 K6/K7/K8/K9/L0/L1 06-12	190				
MD6270D/C	FRONT	F	<b>KTM</b> SMR 450/525 04-07 <b>HUSABERG</b> FS 650 E Supermoto 05-07	310										

DISC  
BUYERS GUIDE



# OFF ROAD DISC BUYERS GUIDE

DISC No.	FRONT/ REAR	TYPE	MODELS	DIA (MM)	DISC No.	FRONT/ REAR	TYPE	MODELS	DIA (MM)
<b>MD6279D</b>	FRONT	S	<b>MALAGUTI</b> XSM 50 Supermotard 03-07 <b>YAMAHA</b> DT 50 X (Supermotard) 04-08 XT 125 X 07-11	260	<b>MD6289D</b> <b>MD6289C</b>	FRONT	S	EC 125/200/250/300 (Nissin) 00-10 EC 125/200/250/300 (All models/2T) 11-13 MX 125/250 (MC) 01-09 EC 450 FSR (4T) Enduro/FSE 05-09 Pampera 450 (4T) 07-08 EC 515 FSR/FSE (4T) Enduro 05-09	260
<b>MD6280D</b>	REAR	S	DT 50 R 02-08 DT 50 X Supermotard 02-08 XT 125 R (3D61/ED63) 05-06 XT 125 R (13D1) 07 XT 125 R (13D3/13D5) 07-12 XT 125 X (3D62/3D64) 05-06 <b>MBK</b> X Limit Enduro 50cc 03-09 X Limit Supermoto 50cc 03-09	220	<b>MD6291D</b>	FRONT	S	YFM 550 Grizzly FGAY/FGPY/FGPZ FGPA/FGPB/FGPD 09-13 YFM 700 FGPW/FGPX/FGPY/FGPZ /FGPA/FGPB/FGPD Grizzly 07-13	220
<b>MD6281D</b>	FRONT	S	RV 125 K2-K9/L0 02-13 RV 200 K2/K3 02-03	220	<b>MD6292D</b>	REAR	S	YFM 550 Grizzly FGAY/FGPY/FGPZ FGPA/FGPB/FGPD 09-13 YFM 700 FGPW/FGPX/FGPY/FGPZ /FGPA/FGPB/FGPD Grizzly 07-13	203
<b>MD6282D</b>	REAR	S	YFM 90 RY/RZ/RA/RB/RD Raptor 09-13 DS 250 06-12	190	<b>MD6293D</b>	FRONT	F	<b>HUSQVARNA</b> SM 400 R 02 SM 450 R 03-10 SM 450 RR 07-10 SMR 450 R 06-07 SM 510 R 06-10 SM 550 RR 08-10 SM 570 R 01-04 SM 610/S 02-06 SM 610 ie 07-09 SMR 630 (4T) 10-11 SMR 630 06/10-12 STR 650 CRC 07	320
<b>MD6283D</b>	FRONT	S	DS 250 06-12 <b>YAMAHA</b> YFM 300 B/D Grizzly 12-13	175					
<b>MD6284D</b>	REAR	S	<b>MZ/MUZ</b> Baghira Forest/Forest HR 21" front /spoke wheel 96-05 Baghira Street Moto 17" front spoke wheel 96-05 Baghira 21" front spoke wheel 99-05 Baghira Black Panther 17" front spoke wheel 96-03 Mastiff 21" front spoke wheel 96-05	245	<b>MD6294D</b>	FRONT	F	<b>HUSQVARNA</b> LT 610 00 SM 610 R 00 SM 610 98-00	320
<b>MD6285D</b>	REAR	S	Rally 200 05-07	200	<b>MD6295D</b>	REAR	F	<b>HUSQVARNA</b> CR 125 02-05 WR 125 02-05 CR 250 02-05 TC 250 02-03 TE 250 02-05 WR 250 02-05 WR 300 09-12 WR 360 02 SM 400 R 02 TE 400 02 SM 450 R 03-06 TC 450 03-04 TE 450 03-05 SM 510 R 06 TC 510 04 TE 510 04-05 SM 570 R 02-04 TC 570 02-03 TE 570 02-04 SM 610 ie 07-09 TE 610 / IE 06-09 SMR 630 06 STR 650 CRC 07	220
<b>MD6286D</b>	REAR	S	DT 50 R-L (SM) 02-03 MX 50 03-05 Pegaso 50 92-94 RX 3-5 Marce (M/N/P/R) 91-94 RX 50 C/CD 95-04 RX 50 Racing 03-06	220	<b>MD6296D</b>	FRONT	S	RK6 93-96	240
<b>MD6287D</b>	REAR	S	<b>HUSQVARNA</b> CR 125 00-01 SM 125 00 SM 125 S 02-13 SMR 125 (4T) 11-13 SMS 4-125cc (4T) 11 TE 125 (4T) 11-13 WR 125 00-01 WRE 125 00/02-13 CR 250 00-01 WR 360 00-01 TE 410 00 SM 570 R 01 TE 570 01 SM 610 S 02-06 TC 610 00 TE 610 00 SMR 620 10-12	220	<b>MD6297D</b>	FRONT	S	<b>YAMAHA</b> DT 50 R 02-08 XT 125 R (3D61/ED63) 05-06 XT 125 R (13D1) 07 XT 125 R (13D3/13D5) 07-10 <b>MBK</b> X Limit Enduro 50cc 03-09 X Limit Supermoto 50cc 03-09	240
<b>MD6288D</b>	REAR	F	<b>HUSQVARNA</b> CR 125 06-08 WR 125 06-08 TC 250 05-08 TE 250 06-08 WR 250 00-01 WR 250 06-08 TE 410 06 EC 450 FSR Enduro (4T) 05-08 Pampera 450 (4T) 07-08 SM 450 R 07-10 SMR 450 RR 06-07 TC 450 05-08 TE 450 06-08 SM 510 R 06-10 TC 510 05-08 TE 510 06-08 EC 515 FSR/FSE (4T) 05-08 SM 610 S 06	240	<b>MD6298D</b>	REAR	F	690 SMC 08-11 690 SMC R 12 950 R Superenduro 06-08 990 Adventure S 06-08 990 Adventure R 09-12	240
					<b>MD6299D</b> <b>MD6299C</b>	FRONT	F	690 Enduro R 09-13 690 Enduro 08-10 690 Rally Factory Replica 07-09 950 R Superenduro 06-08 990 Adventure S (Non) 06-08 990 Adventure R (ABS) 09-12	300
					<b>MD6300D</b>	FRONT	S	<b>HONDA</b> FMX 650 5/6 05-08	296

# OFF ROAD DISC BUYERS GUIDE

DISC No.	FRONT/ REAR	TYPE	MODELS	DIA (MM)	DISC No.	FRONT/ REAR	TYPE	MODELS	DIA (MM)
MD6301D	REAR	S	<b>HYOSUNG</b> TE 50 05-07 TE 90 05-07 TE 100 05-07	160	MD6322C	FRONT	S	DS 450 (2x4/EFi) 08-12 DS 450 X (2x4/EFi) 08-09 DS 450 XXC/XXM 10-12	190
MD6302D	FRONT	S	<b>HONDA</b> TRX 420 FE7/FE8/FE9/FEA/FEB 4WD Fourtrax ES 07-11 TRX 420 FA9/FAA/FAB Fourtrax Auto 4WD 09-11 TRX 420 FM7/FM8/FM9/FMA/FMB 4WD Fourtrax 07-11 TRX 420 FPA9/FPAA/FPAB Fourtrax Auto Power Steering 09-11 TRX 420 FPM9/FPMA/FPMB Fourtrax 4WW - Power Steering 09-11 TRX 420 TE7/TE8/TE9 Fourtrax ES - 2WD 07-09 TRX 420 TM7/TM8/TM9/TMA/TMB 2WD Fourtrax 07-11	185	MD6323C SM6323C	FRONT	F	WR 250 XX/XY 08-10	298
MD6303D	FRONT	S	E 900 C Elefant 93-97 E 900 C IE Lucky Explorer 95-97	282	MD6324D	FRONT	S	YZ 125/250/490 N 85	240
MD6304C	REAR	S	KSF 450 B8F/B9F/BAF/BBF/BCS (KFX 450 R) 08-12	200	MD6325D	FRONT	S	KRF 750 A8F/B8F Teryx 750 4x4 (RUV) 08 KRF 750 C8F/D8F Teryx 750 4x4 LE (RUV) 08 (RUV) KRF 750 F8F Teryx 750 4x4 NRA Outdoors 08 KRF 750 TAF/PDF/RDF/VBP Teryx 750i 4x4 SGE 10-11 KRF 750 G9F/NAF/NBF/NCS/NDF Teryx 750 Fi 4x4 09-13 KRF 750 J9FA/K9F/PAF/RAF/PBF/RBF /RCS Teryx 750 Fi 4x4 LE 09-12 KRF 750 L9F Teryx 750 Fi 4x4 Le Sport 09 KRF 750 M9F Teryx 750 Fi 4x4 NRA Outdoors 09 KRF 750 SAF/SAFA/SBF/SBFA/SCS/SCSA /SDF Teryx 750 Fi 4x4 Sport LE 10-13	220
MD6305D/C MD6305CX	REAR	S	RM 125 K6/K7/K8/K9 06-12 RM 125 XCK8 09 RM 250 K6/K7/K8/K9 06-12 RM 250 XCK8 09	240	MD6326C	REAR	S	KLX 250 S9F/SAF/SBF/SCF/SDF 09-13	240
MD6306D	FRONT	F	R30 (604/644) (Mag wheel) 02-04	320	MD6327C	REAR	S	USA ONLY	186
MD6307D	FRONT	S	ETV 1000 Caponord/Rally 01-03	300	MD6328C	FRONT	S	USA ONLY	220
MD6308D	REAR	S	ETV 1000 Caponord/Rally 01-03	270	MD6329C OS6329C SM6329C	FRONT	F	KLX 250 (KLX 250 S9F/SAF/SBF /SCF/SDF) 09-13	250
MD6309C MD6309CX	FRONT	S	KLR 650 (KL 650 E8F/E9F) 08-09	280	MD6330D OS6330C SM6330C MD6330CX	FRONT	F	KLX 250 H6F/H7F 06-07	250
MD6310C MD6310CX	REAR	S	KLR 650 (KL 650 E8F/E9F) 08-09	240	MD6331D	REAR	S	TRX 700 XX8/XX9/XXB 08-11	200
MD6311D	REAR	S	200 Phoenix (Rear disc model) 05-08 200 Sawtooth Quad Rear disc model 06	220	MD6332D	REAR	S	YXR 700 Rhino 4x4 SE 09 YXR 700 FA/FB/FD Rhino Side x Side 11-13	185
MD6312D	FRONT	S	400 Ranger 10 Ranger EV (Electric) 10 800 Ranger HD 10 800 Ranger XP 10 800 Ranger 6x6 10 800 Ranger Crew 10 800 Ranger RZR 08-10 800 Ranger RZR S EFI 09-12	235	MD6333D	REAR	S	YXR 700 Rhino 4x4 SE 09 (Parking brake) YXR 700 FA/FB/FD Rhino Side x Side Parking brake 11-13	165
MD6313C	FRONT	F	SMR 450 07-13	310	MD6334D	REAR	S	DS 90 X (2x4/4T) 08-11	180
MD6314D/C OS6314C MD6314CX	FRONT	S	CRF 150 RB7/R7/RB8/R8/RB9 /R9/RC/RBC/RB/RBD 07-13	220	MD6335D	FRONT	S	DS 90 X (2x4/4T) 08-11	165
MD6315D	REAR	S	RX 125 92-01 Tuareg Rally 125 89 Tuareg Rally 125 (L/M) 90-91	220	MD6336C	FRONT	F	450 SX-F (Quad) 09-11 505 SX-F (Quad) 09-12 XC 450 Quad 08-10 XC 525 Quad 08-12	180
MD6316D/C MD6316CX	REAR	S	CRF 150 RB7/R7/RB8/R8/RB9 /R9/RC/RBC/RB/RBD 07-13	190	MD6337D	REAR	S	450 SX-F (Quad) 09-11 505 SX-F (Quad) 09-12 XC 450 Quad 08-10 XC 525 Quad 08-12	200
MD6317D OS6317C SM6317C	FRONT	S	CRF 150 F3/F4/F5/F6/F7 03-07	240	MD6338D	FRONT	S	500 Ranger (EFI) 4x4 09-10 700 Ranger 4x4 EFI 09 800 Ranger RZR-4 10-12 800 Ranger RZR 4 EPS 12 900 D Ranger 4x4 Diesel 11 900 Ranger RZR XP 12	225
MD6318D	FRONT	S	RX 50 Super Racing 06-07 RYZ 50 Urban Bike 06-10 XR6 (2T) 50 03-07	260	MD6339D	FRONT/ REAR	S	500 XP Sportsman 09 550 Sportsman XP EPS 09 550 XP Sportsman 09 550 Sportsman XP 10 550 Sportsman X2 10 550 Sportsman EPS 10-12 550 Sportsman Touring EPS 10-12 550 Sportsman Forest 12 850 Sportsman Forest 12 850 Sportsman Touring EPS 10-12 850 XP Sportsman 09 850 XP ES Sportsman 09	246
MD6319C	REAR	S	WR 250 RX/RX 08-10 WR 250 XX/XY 08-10	230					
MD6320C OS/SM6320C	FRONT	F	WR 250 RX/RX 08-10	250					
MD6321C	REAR	S	DS 450 (2x4/EFi) 08-12 DS 450 X (2x4/EFi) 08-09 DS 450 XXC/XXM 10-12	198					

# OFF ROAD DISC BUYERS GUIDE

DISC No.	FRONT/ REAR	TYPE	MODELS	DIA (MM)	DISC No.	FRONT/ REAR	TYPE	MODELS	DIA (MM)	
<b>MD6340D</b>			<b>USE MD6217D</b>		<b>MD6363C</b>	FRONT	S	KLX 125 CAF/CBF/CCF/CDF 10-13 KLX 125 DAF/DBF/DCF/DDF (D-Tracker) 10-13	190	
<b>MD6341D</b>	FRONT /REAR	S	MUV 700-9 Big Red Side x Side 09	200	<b>MD6365D</b>	FRONT	S	TRX 500 FEC Fourtrax Foreman ES 2/4 WD 12 TRX 500 FMC Fourtrax Foreman S 2/4WD 12 TRX 500 FPEC Fourtrax Foreman 2/4 WD 12 TRX 500 FAC Fourtrax Foreman AT 2/4 WD 12	196	
<b>MD6342D/C</b>	REAR	S	G 450 X 08-11	220	<b>MD6366D</b>	FRONT /REAR	S	<b>CAN AM</b> See main application pages	215	
<b>MD6343C SM/OS6343C</b>	FRONT	S	G 450 X 08-11	260	<b>MD6367C</b>	FRONT	F	RR 250 4T Enduro 05-07 RR 350 4T Enduro 11 RR 400 4T Enduro 05-11 RR 450 4T Enduro 05-11 RR 520 4T Enduro 05-11 RR 525 4T Enduro 05-09	260	
<b>MD6344D</b>	REAR	S	Ranger RZR 170 09-10	220	<b>MD6368C</b>	REAR	S	RR 250 4T Enduro 05-07 RR 350 4T Enduro 11 RR 400 4T Enduro 05-11 RR 450 4T Enduro 05-11 RR 520 4T Enduro 05-11 RR 525 4T Enduro 05-09	240	
<b>MD6345D</b>	REAR	S	XL 700 V8/V9/VA Transalp 08-11 XL 700 VA8/VA9/VAA Transalp 08-11	240	<b>MD6369D</b>	REAR	S	YFM 350 B/D Grizzly 12-13	220	
<b>MD6346D</b>	FRONT	S	XL 650 VY/V1-V7 Transalp 00-07 XL 700 V8/V9/VA Transalp 08-11 XL 700 VA8/VA9/VAA Transalp 08-11	256	<b>MD6370D</b>	FRONT /REAR	S	<b>CAN AM</b> See main application pages	215	
<b>MD6347C</b>	FRONT	S	WR 125 R 09-13	240	<b>MD6371D MD6371C</b>	REAR	S	SC 400 96-99 EGS 400/EGS-E/LSE (LC4 Enduro) 96-99 LC4-E 400 Enduro 00-01 LC4 MX 600 90-91 LC4 EXC 600 90-93 SX EXC/EGS 620 95 SX 620 96-99 SC 620 Supercompetition 96-00 EGS/EGS-E/LSE 620 Enduro 96-99 EGS-E 620 Adventure/Rallye 99 LC4 620 SC Supermoto 00 LC4 625 SC Supermoto 02 LC4 625 SC Supercompetition 02 SMC 625 05-06 SXC 625 03-04 Duke-E 640 (Single pin pad fixing /zero offset disc) 98 Duke II 640 (2 pin pad fixing/ zero offset) 99-07 LC4-E 640 Enduro 00-04 LC4-E 640 Supermoto 00-04 LC4 640 Adventure R 00 LC4 640 Adventure 01-05 640 LC4 Adventure 03-07 SMC 660 Supermoto 03-04	220	
<b>MD6348D</b>	REAR	S	DL 450 RS (DL901) 06-09 QZ 450 RS 06-09 QZ 450 Sport 08-11	220	<b>MD6372C MD6372CX</b>	FRONT	S	<b>HONDA</b> CRF 250 LD 13	256	
<b>MD6349C</b>	FRONT	F	<b>TM</b> Most models 01-13	270	<b>MD6373C MD6373CX</b>	REAR	S	<b>HONDA</b> CRF 250 LD 13	220	
<b>MD6350C</b>	REAR	S	<b>TM</b> Most models 01-13	220	<b>MD6374D</b>	REAR	S	TBA	200	
<b>MD6351C</b>	FRONT	F	No fitment	300	<b>MD6375D</b>	FRONT	S	TBA	200	
<b>MD6352C</b>	REAR	S	No fitment	240	<b>MD6376D</b>	REAR	S	UXV 500 (Side x Side) 08-09 UXV 500 i (Side x Side) 10-13 MXU 500 4x4/Carb Model 05-13	200	
<b>MD6353D</b>	FRONT	S	<b>POLARIS</b> Ranger RZR 170 09-10	125						
<b>MD6354D</b>	REAR	S	<b>ADLY</b> GK 125 Buggy 03-07 <b>MOTOROMA</b> Lazer 125 Buggy 03-07	200						
<b>MD6355D</b>	FRONT	S	LT-A 500 XPK9/XPZK9 /XPL0/XPL1 09-12 LT-A 750 XPK9/XPZK9/XPL0 /XPL1 09-12	190						
<b>MD6356D MD6356C MD6356CX</b>	FRONT	F	YZ 125 N/P/R/S/T/V/W/X/Y /Z/A/B/D (2T) 01-13 YZ 250 N/P/R/S/T/V/W/X/Y /Z/A/B (2T) 01-12 YZ 250 FN/FP/FR/FS/FT/FV/FW /FX/FY/FZ/FA/FB (4T) 01-12 WR 250 FN/FP/FR/FS/FT/FV/FW /FX/FY/FZ/FA/FB/FD (4T) 01-13 WR 400 FN (4T) 01 WR 426 FN/FP 01-02 YZ 426 FN/FP (4T) 01-02 WR 450 FR/FS/FT/FV/FW /FX/FY/FA/FB/FD (4T) 03-13 YZ 450 FR/FS/FT/FV/FW /FX/FY/FZ/FA/FB (4T) 03-12	250						
<b>MD6357C</b>	FRONT	S	<b>SINNIS</b> Apache 125 QM 125 GY-2B(A) 09-10 Apache (Rear drum model) 09-10	240						
<b>MD6358C</b>	REAR	S	<b>SINNIS</b> Apache 125 QM 125 GY-2B(A) 09-10	210						
<b>MD6359D</b>	FRONT	S	RC 125 Top Rally 89-92	240						
<b>MD6360C</b>	REAR	S	<b>KTM</b> SX 85 (17/14" wheels) 11-13 SX 85 (19/16" wheels) 11-13 350 Freeride (4T) 12 350 Freeride (Electric) 12	210						
<b>MD6361D</b>	FRONT	S	Senda SM DRD 50 02-03 Senda SM DRD 50 05 Senda 50 SM DRD Black Edition 05	240						
<b>MD6362C</b>	REAR	S	KLX 125 CAF/CBF/CCF/CDF 10-13 KLX 125 DAF/DBF/DCF/DDF (D-Tracker) 10-13	240						

# CLUTCH KITS FOR STREET/DIRT/ATV

## STREET - 3 choices

### 1. Standard - CK Series

Almost identical to original equipment clutch plates the CK series are a cork based product impregnated with aluminum particles to increase wear life and heat resistance. Material is highly compressed to avoid swell and clutch drag and is an ideal general purpose replacement material for all grades and sizes of motorcycle. Kit includes a complete "engine set" of friction plates only.



### 2. Race/Sport SRC Kevlar Series

A Kevlar paper lined plate set complete with heavy duty clutch springs (for bikes fitted with diaphragm type springs we cannot supply a heavy duty spring kit), the SRC kit is ideal for heavy sport bikes, faster riders and production based race use. Advantages of the SRC Kevlar series are longer life, higher heat resistance, although this clutch has a more aggressive/faster take up than the CK cork series.



### 3. Race/Sport SRK Series

SRK complete kits include Kevlar® fiber lined friction plates, steel separator plates and springs to provide a streetgoing kit for high performance street and road race use much similar to the DRC program for off road. Some of the kits will now feature new **DIAPHRAGM** springs as used in many larger new bikes to provide a complete clutch rebuild kit for every sportbike possible.



## CSK CLUTCH SPRING SETS



DIAPHRAGM TYPE SPRING

Always fit new springs which get tired after miles of heat and use. EBC spring kits are 8-10% stiffer than standard and are sold in engine sets. As stated in general fitting/safety instructions, advise customers that lever will feel slightly "heavier" when uprating springs, and to test ride/acquaint themselves with this change in control.



COIL TYPE SPRING



## DIRT/ATV - 2 choices



### 2. Standard - CK Series

Cork based replacement clutch exactly the same as used on the street series CK clutch plates described above. A general all purpose replacement unit.

EBC only sell complete kits as replacing single plates is deemed unwise. The object is to reset the clutch to its original stack height and just replacing one plate will not achieve that and promote clutch slip.

Many off road clutches use aluminium separator plates which wear quickly and muddy the oil. If this has happened in your engine, flush the drive case, change the oil and rebuild the clutch with a complete DRC kit which includes STEEL separator plates that not only prevent wear but increase flywheel effect of the engine and improve performance.

### 1. Full Kit - DRC Series

The US #1 selling off road clutch

Why are these the best???

- Anti-swell, alloy impregnated heavy duty cork based facings provide smooth clutch take up and allow modulation, unlike paper clutches which tend to snatch.
- Complete engine set of friction plates, HD springs and STEEL SEPARATOR PLATES prevent premature driven plate wear, oil muddying and loss of stack height.
- EBC DRC kits are built with swaged aluminum carriers which spread the load on the clutch basket and prevent clutch basket "dogging".

What makes EBC the BEST!!!

Unique wide ear soft alloy drive body eliminates basket damage and delivers smooth clutch operation.

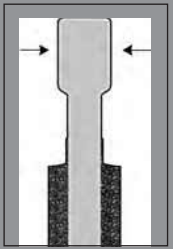

CLUTCH APPLICATIONS



# EBC Coil Spring Kits

Full engine sets of heat treated and tempered spring steel coil springs with a guaranteed tension of 15% above standard. Clutch springs are an extremely important part of a motorcycle transmission system and we take very seriously the accuracy of spring tension in the EBC range of CSK kits. See application pages for part numbers.



## Spring Tension Measuring Machine



You simply cannot engineer coil springs correctly without such a device as shown here. EBC have one of these digital clutch spring tension calibration machines at each of its locations to guarantee the accuracy and consistency of spring batches. The machine is calibrated based on the nominal spring deformation and then a tight tolerance of variation is achieved within the target and then a tight tolerance of variation is achieved within the target 15% upgrade range. EBC have tested many original and aftermarket clutch springs and the variation in tension is enormous and varies so dramatically, that we took the decision to measure and calibrate every clutch spring in-house to be sure of their accuracy.

## EBC Diaphragm Clutch Springs

EBC SRK clutch kits, shown on the following pages, include the new diaphragm spring range. Full engine sets of heat treated and tempered spring steel diaphragm springs with a guaranteed 15% tension upgrade.

The picture opposite shows a typical aftermarket billet clutch and how the assembly looks. It is essential when replacing the diaphragm spring that the anti-scuff plate is in good condition. This is a rather flimsy steel pressing and can become bent or distorted in which case it must be replaced, this is a genuine part available from your main dealer only.

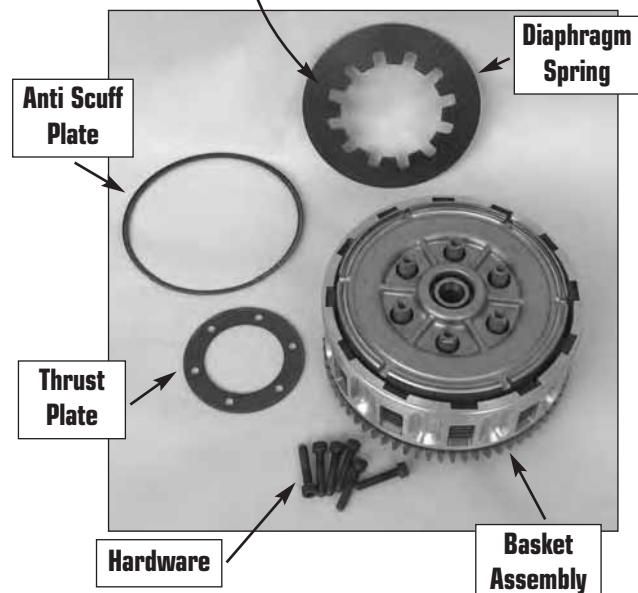
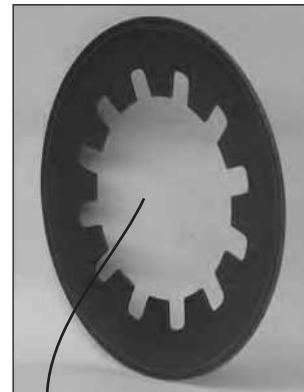

CLUTCH APPLICATIONS

# CKF Clutch Kits



See application pages for availability and fitments.

CKF is the name of the new EBC carbon fibre impregnated motocross and ATV clutches and they are built tough to last longer, grip better, feel better and drive better than stock cork based units.

PLUS the high heat ability of these CKF Carbon Fiber clutch plates handles much higher stresses and temperatures encountered in racing yet feel gentle and smooth in everyday riding.

One day all motocross bikes and ATV will be built using a clutch like this but for now the only way to get the best clutch in the game is to step up to an EBC CKF plate set or go the whole hog and invest in the DRCF clutch kits which are sold as an assembly with a stack height measured to precisely reset your bike to the original sizing.

## DRC-F Clutch Kits

The toughest off road clutch yet.

**Tested for 12 months in the toughest moto-x applications, these new heavy duty kits are ideal for fast off road use especially on modern 4 stroke engines.**



More added for 2013, the ultimate moto-x and ATV heavy duty clutch kit designed for race use. These new kits feature carbon fiber lined clutch plates plus a full set of steel plates and heavy duty springs.

### Available Part Numbers

DRCF25	DRCF46	DRCF88	DRCF108	DRCF128	DRCF155	DRCF189	DRCF230	DRCF259
DRCF33	DRCF49	DRCF98	DRCF109	DRCF129	DRCF158	DRCF195	DRCF241	DRCF261
DRCF42	DRCF54	DRCF100	DRCF111	DRCF130	DRCF159	DRCF200	DRCF244	DRCF262
DRCF43	DRCF58	DRCF101	DRCF113	DRCF131	DRCF163	DRCF201	DRCF254	DRCF269
DRCF44	DRCF70	DRCF105	DRCF119	DRCF137	DRCF164	DRCF208	DRCF255	DRCF276
DRCF45	DRCF79	DRCF107	DRCF123	DRCF148	DRCF182	DRCF227	DRCF256	

See application pages for fitments.

# Clutch Removal Tools



More added for 2013, a range of clutch tools to allow easy install of all EBC clutch kits. Range covers 95% of US market motorcycles and ATVs and allow positive holding of the clutch basket or center boss to allow untightening and retightening of securing nuts.

Clutch application pages show appropriate tool and below is a list of the available 2013 programme.

### PART NUMBERS AVAILABLE AT TIME OF PRINT

CT001	CT012SP	CT024	CT037SP	CT051
CT002	CT013	CT024SP	CT038SP	CT052
CT003	CT013SP	CT025	CT039	CT053SP
CT004	CT014	CT026	CT040SP	CT054SP
CT005	CT014SP	CT027	CT041	CT055SP
CT006	CT015	CT028	CT042	CT056SP
CT007	CT016	CT029	CT043SP	CT057SP
CT008	CT017	CT029SP	CT044	CT058
CT009	CT018SP	CT030	CT045	CT060
CT009SP	CT019	CT031	CT046	CT061
CT010	CT020	CT032	CT047SP	
CT010SP	CT021	CT033SP	CT048SP	
CT011	CT022	CT035SP	CT049	
CT012	CT023	CT036SP	CT050SP	



Costing far less than OE manufacturer tools, EBC strongly recommend selling a clutch tool for every clutch sold.

Many dealers have already ordered one of each tool and loan these to customers with a deposit to gain tool loan income.



# EBC CLUTCH KITS



# EBC<sup>®</sup> HEAVY DUTY CLUTCHES & SPRINGS



EBC Clutches are totally Asbestos Free made from a cork based "anti-swell" facing impregnated with aluminium particles to reduce wear & heat fade. Kits are sold in pre-measured engine sets and should always be replaced in engine sets. **USE ONLY MANUFACTURERS Drive case oils and avoid lead or other anti-friction additives.**

**SOAK PLATES** in drive case oil before installing. EBC Clutch Springs are 10-15% stiffer than stock springs to avoid slip. Always check lever operating pressure for ease of clutch disengagement before riding or releasing motorcycle for use.

### CAUTION – SAFETY WARNINGS FOR CONSUMERS

The following warnings now appear on the underside of our clutch packaging. For stocks in older packaging that do not display these safety warnings, we strongly recommend you photocopy these essential points and advise customers.

Never start a motorcycle whilst in gear with clutch depressed. Never reverse a motorcycle with the engine running, the machine in gear and clutch depressed. Hold front brake lever on when selecting gears from standstill.

Never engage gears from a standstill with engine revs above 1500 rpm. Check oil levels regularly.

When fitting heavy duty clutch springs acquaint yourself with increased hand pressure required to depress clutch before riding motorcycle. Assemble the clutch as per the original manufacturers workshop manual.

CLUTCH APPLICATIONS

Make & Model	Year	CK Series #	CKF Series #	Spring Kit #	DRC Series #	DRCF Series #	SRC Series #	SRK Series #	CT Tool #
<b>HONDA</b>									
C 50 M/C 50	-78	CK1107		CSK044					
C 50 Z2/ZZ/ZA	78-81	CK1148		CSK044					
C 50 All models	82-93	CK1148		N/A					
C 50 (Single seat model)	95	CK1148		N/A					
C 50 P/S/N/X/Y/1/2	96-02	CK1148		N/A					
CB 50 J	81	CK1150		CSK003					CT012SP
CB 50 V/W Dream 50	97-98	CK1150		CSK048					CT012SP
CD 50 ST/SV/SW/SX Benley 50 S	96-99	CK1105		N/A					
CF 50/CF 50 K2	77-78	CK1148		CSK044					
CL 50 V/X Benley CL 50	97-99	CK1105		N/A					
CR 50 RE-RF	84-85	CK1151	CKF1151	CSK003					CT012SP
CRF 50 F4/F5/F6/F7/F8/F9/FA/FB/FC/FD	04-13	CK1148		N/A			SRC090	SRK090	
CRM 50 RN/RP/RR/RT	93-96	CK1150		CSK003					CT012SP
MB 50	80-82	CK1150		CSK003					CT012SP
MTX 50 SC	83-87	CK1150		CSK003					CT012SP
MBX 50 SD/SF	83-85	CK1150		CSK003					CT012SP
MP 50 3/DX3 (AC17) Solo	03	CK1148		N/A					
MT 50 SA/SE/SG/SJ/SL	80-93	CK1150		CSK003					CT012SP
NSR 50 FP/FR/FS	93-95	CK1150		CSK003					CT012SP
NSR 50 RV/RW/RX/RY	97-00	CK1150		CSK003					CT012SP
NSR 50 SK/SP/SR/SS	89-95	CK1150		CSK003					CT012SP
NSR 50 V (AC10-180)	97	CK1151	CKF1151	CSK003					CT012SP
NSR 50 X (AC10-190)	99	CK1151	CKF1151	CSK003					CT012SP
SS 50 ZK2/ZB2	75-80	CK1105		N/A					
ST 50 J/K DAX	78-93	CK1148		N/A					
TLM 50 F	85	CK1150		CSK031					CT012SP
XR 50 R1/R2/R3	01-03	CK1148		N/A					
XR 50 M5 (AD14) Motard	06	CK1150		CSK048					CT012SP
XZ 50 1/2 APE-AC16	01-02	CK1150		CSK048					CT012SP
Z 50 RZ/RA-RD	79-86	CK1107		CSK044					
CR 60 RF/RG	85-86	CK1151	CKF1151	CSK003					CT012SP
ATC 70 all Models	78-85	CK1148		CSK018					
C 70/C 70 M	-78	CK1107		N/A					
C 70 Z2/ZZ/C/D/DMC	78-85	CK1148		CSK018					
CF 70 C	77-78	CK1148		CSK018					
CRF 70 F4/F5/F6/F7/F8/F9/FA/FB/FC/FD	04-13	CK1148		CSK018					
XR 70 RV/RW/RX/RY/R1/RY/R1-R3	97-03	CK1148		CSK018					
CRM 75 RK/RL/RM/RP/RR	89-94	CK1151	CKF1151	CSK003					CT012SP
NSR 75 N/P/R/X/Y (NS-1)	92-00	CK1151	CKF1151	CSK003					CT012SP
XR 75 K4/K5	78-79	CK1150		CSK022					CT012SP
CR 80 RA/RB/RC	80-82	CK1151	CKF1151	CSK003					CT012SP

# EBC CLUTCH KITS

Make & Model	Year	CK Series #	CKF Series #	Spring Kit #	DRC Series #	DRCF Series #	SRC Series #	SRK Series #	CT Tool #
<b>HONDA Contd.</b>									
CR 80 RD	83	CK1151	CKF1151	CSK23					CT012SP
CR 80 RE	84	CK1119		CSK23					CT012SP
CR 80 RF/R2F	85	CK1119		CSK173	DRC001				CT012SP
CR 80 RG/R2G	86	CK1119		CSK173	DRC001				CT012SP
CR 80 RH/RJ/RK/RL/RM/RN/RP/RR/RS/RT/RBT/RV/RBV /RW/RBW/RX/RBX/RY/RBY/R1/RB1/R2/RB2	87-02	CK1119		CSK173	DRC001				CT012SP
CRF 80 F4/F5/F6/F7/F8/F9/FB/FC	04-12	CK1150		CSK48					CT012SP
MBX 80 FWDD/FWDF	83-86	CK1151	CKF1151	CSK003					CT012SP
MTX 80 RFD/RFF	83-84	CK1151	CKF1151	CSK003					CT012SP
NSR 80 J-2/K/L/N/P/R/S (HC06)	88-	CK1151	CKF1151	CSK003					CT012SP
NSR 80 V (HC06-170)	97	CK1151	CKF1151	CSK003					CT012SP
NSR 80 X (HC06-180)	99	CK1151	CKF1151	CSK003					CT012SP
XR 80 Z/A/B	80-81	CK1150		CSK022					CT012SP
XR 80 R	87-88	CK1150		CSK008					CT012SP
CR 85 R3/RB3/R4/RB4/R5/RB5/R6/RB6/R7/RB7	03-07	CK1119		CSK173	DRC001				CT012SP
C 90 (from frame no A073285/Z2/ZZ)	75-81	CK1156		N/A					
C 90 C/E/G/MF/P/MP/MG/N/MN/P/MP/T/MT	82-03	CK1148		N/A					
TRX 90 P/R/S/T/V/W/X/Y/1-6	93-06	CK1151	CKF1151	N/A					CT012SP
TRX 90 EX	07-08	CK1151	CKF1151	N/A					CT012SP
TRX 90 X9/XB	09-11	CK1151	CKF1151	N/A					CT012SP
Astrea Supra NF100	99	CK1151	CKF1151	N/A					CT012SP
Astrea Grand/Supra (Drum model)	97-98	CK1151	CKF1151	N/A					CT012SP
CB 100 N	78-80	CK1119		CSK004					CT012SP
CRF 100 F4/F5/F6/R7/F8/F9/FA/FB/RC	04-12	CK1151	CKF1151	CSK023	DRC049	DRCF049			CT012SP
H 100 A/SD/SG/SJ	84-92	CK1151	CKF1151	CSK003					CT012SP
XL 100 SZ/SA	78-80	CK1151	CKF1151	CSK048					CT012SP
XL 100 SB	81-82	CK1151	CKF1151	CSK022					CT012SP
XR 100 RP/RR/RS/RT/RV/RW/RX/RY/R1/R2/R3	93-03	CK1151	CKF1151	CSK023	DRC049	DRCF049			CT012SP
XR 100 M5 (HD13) Motard	06	CK1151	CKF1151	TBA					CT012SP
XZ 100 2 APE-HC07	02	CK1151	CKF1151	N/A					CT012SP
ATC 110 All models	79-84	CK1156		CSK018					
CRF 110 FD	13	TBA		N/A					
CT 110 A/B/C/D/K/M	80-88	CK1156		N/A					
CT 110 P	89-04	CK1156		N/A					
CT 110 X	05-09	CK1156		N/A					
ANF 125 3/5/T5/6/7/A Innova	03-11	CK1307		N/A					
ATC 125 ME	84	CK1156		CSK021					
ATC 125 MG	86	CK1151	CKF1151	CSK048					CT012SP
CA 125 S/T	95-96	CK1252		CSK167					CT012SP
CA 125 Rebel VW/X	98-00	CK1119		CSK167					CT012SP
CB 125 S/J	75-79	CK1119		CSK041					CT012SP
CB 125 T/T2	78-80	CK1119		CSK167					CT012SP
CB 125 TDC/TDE	83-86	CK1119		CSK167					CT012SP
CB 125 TDJ	87-89	CK1252		CSK167					CT012SP
CB 125 RS	83	CK1119		CSK041					CT012SP
CBF 125 M9/MA/MB	09-13	CK1119		CSK166					CT012SP
CBR 125 R4/R5/RS5/RW5/RS6/RW6	04-06	CK1252		CSK105					CT012SP
CBR 125 RW7/RW8/RW9/RWA/RWB	07-13	CK1119		CSK105					CT012SP
CD 125 TC	78	CK1119		CSK167					CT012SP
CG 125 Cargo	10	TBA		TBA					
CG 125 K1/B/C/E/BR/BR-K/BR-KJ/S/T/W	77-00	CK1119		CSK041					CT012SP
CG 125 M1/1	01-03	CK1252		CSK041					CT012SP
CG 125 ES4-ES8	04-08	CK1252		CSK041					CT012SP
CG 125 Job	05	TBA		TBA					
CLR 125 W City Fly	98-03	CK1119		CSK167					CT012SP
CM 125 CC/CF	82-85	CK1119		CSK009					CT012SP
CT 125 C	85	CK1119		CSK041					CT012SP
CR 125 M2-M4	76-78	CK1144		CSK036					CT002
CR 125 RZ/RA	79-80	CK1199		CSK031					
CR 125 RB	81	CK1191	CKF1191	CSK031					CT002
CR 125 RC	82	CK1186		CSK031					CT002
CR 125 RD/RE	83-84	CK1190	CKF1190	CSK024	DRC067				CT013
CR 125 RF	85	CK1200		CSK024	DRC068				CT001
CR 125 RG/RH/RJ/RK/RL/RM/RN/RP/RR/RS/RT/RV/RW/RX	86-99	CK1222		CSK024	DRC002				CT001
CR 125 RY/R1/R2/R3	00-03	CK1293	CKF1293	CSK176	DRC262	DRCF262			CT001
CR 125 R4/R5/R6/R7	04-07	CK1293	CKF1293	CSK077	DRC101	DRCF101			CT001
CRM 125 RL/RM/RN/RP/RR/RV/RX	90-99	CK1160		CSK004					CT013SP
LS 125 R	00-	CK1252		CSK105					CT012SP
MBX 125 FE	84-86	CK1180		CSK009					CT013SP
MSX 125	13	TBA		TBA					
MTX 125 RWD/E/F/H/L	83-95	CK1180		CSK004					CT013SP
NS 125 FG/FH/RH (5 Plate Clutch)	86-87	CK1153		CSK159					CT013SP
NSR 125 FJ/FK/FL/FM/FN (6 Plate Clutch)	88-92	CK1160		CSK004					CT013SP

# EBC CLUTCH KITS

Make & Model	Year	CK Series #	CKF Series #	Spring Kit #	DRC Series #	DRCF Series #	SRC Series #	SRK Series #	CT Tool #
<b>HONDA Contd.</b>									
NSR 125 RK/RL/RM/RN (6 Plate Clutch)	89-92	CK1160		CSK004					CT013SP
NSR 125 RR/RS/RV/RW/RX/RY/R1 (6 Plate Clutch)	93-01	CK1160		CSK004					CT013SP
NX 125 K/S/F Transcity	89-97	CK1119		CSK167					CT012SP
NXR 125 Bros ES/KS	05	TBA		TBA					
TL 125 S	76	CK1119		CSK004					CT012SP
TRX 125 J	88	CK1151	CKF1151	CSK048					CT012SP
VT 125 CX/CY/C2Y/C1/C21/C3/C4/C7/C8 Shadow	99-08	CK1292		CSK033					
XL 125 K2-K4/SZ/SA	78-79	CK1119		CSK004					CT012SP
XL 125 SB/SC/SZ/SA	79-82	CK1119		CSK031					CT012SP
XL 125 RC/RF/RH	83-86	CK1119		CSK009					CT012SP
XL 125 V1-VA Varadero	01-11	CK1292		CSK033					
XLR 125 RW	98-99	CK1119		CSK166					CT012SP
XR 125 L3/L4/L5/L6/L7/L8	03-08	CK1119		CSK041					CT012SP
CBR 150 R	00-	CK1252		CSK105					CT012SP
CRF 150 F3/F4/F5	03-05	CK1304		CSK077	DRC180				CT012SP
CRF 150 F6/F7	06-07	CK1119		CSK006	DRC181				CT012SP
CRF 150 RB7/R7/RB8/R8/RB9/R9/RC/RBC/RD/RBD	07-13	CK1191	CKF1191	CSK134	DRC182	DRCF182			CT002
CB 175 All Models		CK1134		CSK008					
CD 175 All Models		CK1134		CSK008					
CD 185 T	78	CK1119		CSK009					CT012SP
ATC 185 A/SB/SC/SD	80-83	CK1151	CKF1151	CSK022					CT012SP
XL 185 SZ/SA/SB	80-81	CK1119		CSK041					CT012SP
XL 185 SB	82	CK1119		CSK065					CT012SP
ATC 200 B/ESE/ESF/SE	81-84	CK1151	CKF1151	CSK022					CT012SP
ATC 200 XD	84	CK1119		CSK024					CT012SP
CB 200/CB 200 B	76-78	CK1134		CSK008					
CBX 200 Strada	97-01	TBA		TBA					
CD 200 TA	79-80	CK1119		CSK024					CT012SP
CM 200 TA/TB	79-80	CK1119		CSK024					CT012SP
CTX 200/CTX 200 A Bushlander	04-05	CK1119		CSK105	DRC091				CT012SP
MTX 200 RWD	83-84	CK1217		CSK004					CT013SP
MTX 200 RWF	85	CK1180		CSK106					CT013SP
TA 200 (TA Shadow)	02-05	CK1252		TBA					CT012SP
TL 200 J/Y	76-78	CK1119		CSK004					CT012SP
TLR 200 D/E/G/H	83-87	CK1119		CSK009					CT012SP
TRX 200 L/M	90-91	CK1119		CSK172	DRC004				CT012SP
TRX 200 D	91-97	CK1119		CSK172	DRC004				CT012SP
TRX 200 SX	86-87	CK1119		CSK172	DRC004				CT012SP
XR 200 R	81-83	CK1119		CSK105	DRC091				CT012SP
XR 200 R	84-85	CK1180		CSK004	DRC060				CT013SP
XR 200 R	86-02	CK1119		CSK105	DRC091				CT012SP
XR 200	80-84	CK1119		CSK105	DRC091				CT012SP
FTR 223 Y/2/A2 (MCS4)	00-02	CK1252		TBA					CT012SP
CRF 230 F4/F5/F6/F7/F8/F9	04-09	CK1304		CSK024	DRC136				CT012SP
CRF 230 L	08-10	CK1252		CSK009					CT012SP
CRF 230 M (Supermoto)	09-10	CK1252		CSK009					CT012SP
SL 230 V/W/X/1	97-01	CK1252		TBA					CT012SP
XL 230 2 (MC36)	02	CK1252		TBA					CT012SP
ATC 250 RB/RC/RD	81-83	CK1163		CSK031					
ATC 250 RF	85	CK1193	CKF1193	CSK015					CT013SP
ATC 250 RG	86	CK1193	CKF1193	CSK032					CT013SP
ATC 250 ESF/ESG/ESH/ESJ	85-88	CK1194		CSK004					CT013SP
AX-1 (NX 250 J/K/R/R3)	89-94	CK1190	CKF1190	CSK030	DRC051				CT013SP
CB 250 K3-K5	73-75	CK1132		CSK004					CT009
CB 250 G5	75-76	CK1132		CSK004					CT009
CB 250 T/N/NA/NB/NDB/NDC	78-82	CK1140		CSK006					CT013SP
CB 250 RSA/RSD	81-84	CK1153		CSK009					CT013SP
CB 250 N/T/W/X/Y/1/4 Two Fifty	93-05	CK1191	CKF1191	CSK024					CT012SP
CB 250 FT/FV/FX/FY/F1 (MC31) Hornet	96-01	CK1235		CSK172			SRC047	SRK047	CT012SP
CBF 250 4/6	04-06	CK1190	CFK1190	CSK168					CT013SP
CBR 250 FG/RH/RJ/RK/RK2 (MC14/17/19)	86-89	CK1235		CSK172			SRC047	SRK047	CT012SP
CBR 250 RRL/RRN/RRR (MC22 -100/105/110)	90-94	CK1235		CSK172			SRC047	SRK047	CT012SP
CBR 250 RB/RC (Non ABS Model)	11-13	CK1313		CSK188					
CBR 250 RAB/RAC (ABS Model)	11-13	CK1313		CSK188					
CBX 250 RSE	84	CK1217		CSK007					CT013SP
CBX 250 Twister		CK1217		CSK007					CT013SP
CBX 250	84-98	TBA		CSK106					
CD 250 UJ/UK	88-92	CK1191	CKF1191	CSK024					CT012SP
CJ 250 T/T2	77	CK1132		CSK031					CT009
CL 250 SC	81	CK1153		CSK009					CT013SP
CM 250 TB	81	CK1140		CSK016					CT013SP
CMX 250 CT/CV/CW/CX	96-00	CK1191	CKF1191	CSK024					CT012SP
CR 250 R/RZ/RA	78-80	CK1163		CSK031					

# EBC CLUTCH KITS

Make & Model	Year	CK Series #	CKF Series #	Spring Kit #	DRC Series #	DRCF Series #	SRC Series #	SRK Series #	CT Tool #
<b>HONDA Contd.</b>									
CR 250 RB/RC	81-82	CK1131		CSK041					CT009
CR 250 RD/RE/RF/RG/RH/RJ/RK	83-89	CK1170	CKF1170	CSK028	DRC003				CT009
CR 250 RL/RM/RN/RP	90-93	CK1247	CKF1247	CSK028	DRC075				CT009
CR 250 RR/RS/RT/RV/RW/RX/R1-R7	94-07	CK1247	CKF1247	CSK178	DRC079	DRCF079			CT009
CRF 250 LD	13	CK1314		CSK188	DRC277				
CRF 250 R4/R5/R6/R7	04-07	CK1293	CKF1293	CSK176	DRC129	DRCF129			CT001
CRF 250 R8-R9	08-09	CK1305	CKF1305	CSK176	DRC208	DRCF208			CT001
CRF 250 RA	10	CK1293	CKF1293	CSK164	DRC256	DRCF256			CT001
CRF 250 RB/RC/RD	11-13	CK1305	CKF1305	CSK164	DRC261	DRCF261			CT001
CRF 250 X4/X5/X6/X7/X8/X9/XB/XC/XD	04-13	CK1305	CKF1305	CSK176	DRC208	DRCF208			CT001
CRF 250 XLRD	13	CK1305	CKF1305	CSK176	DRC208	DRCF208			CT001
CRM 250 R (RK) MK1 MD24 (100001-1008385)	89-90	CK1193	CKF1193	CSK028	DRC093				CT013
CRM 250 R (RM) MK2 MD24 (1200001-1211634)	91-92	CK1193	CKF1193	CSK028	DRC093				CT013
CRM 250 R (RP/RP-11) MK2/2MD24 (1300001-)	93	CK1193	CKF1193	CSK028	DRC093				CT013
CRM 250 MK3 RR/RR2 (MD24-10)	94-96	CK1181		CSK028					CT013
CRM 250 Active Radial ARV/ARW (MD32)	97-98	CK1181		TBA					CT013
GB 250 E/H/J/L/P/S/V Custom	84-97	CK1217		CSK007					CT013SP
MXV 250 F (MC92)	83-88	N/A		N/A					
NS 250 FE/RE (MC11-100)	84	CK1218		CSK020					CT013
NS 250 RG (MC11-102)	86	CK1218		CSK020					CT013
NSR 250 RG (MC16-100)- Wet Clutch	86	CK1181		CSK024					CT013
NSR 250 R2J (MC18-100)/R4J (MC18-100) - Wet Clutch	88	CK1181		CSK024					CT013
NSR 250 R5K/R5K-2 (MC18-110) - Wet Clutch	89	CK1181		CSK024					CT013
NSR 250 R6K/R6K-2 (MC18-110) - Dry Clutch	89	CK1288		CSK009					CT013
NSR 250 R7L (MC21-100)/R7N (MC21-106) - Wet Clutch	90	CK1181		CSK024					CT013
NSR 250 R8L-3 (MC21-101)/NSR 250 R9L (MC21-102)									
/NSR 250 R8N/R8N-3 (MC21-106)	90-92	CK1288		CSK167					
NSR250R9N(MC21-106) - Dry Clutch	92	CK1288		CSK167					
NSR 250 RR (MC28-100) - Wet Clutch	94	CK1181		CSK024					CT013
NSR 250 R2R/R3R(MC28-100)/R3S (MC28-110)									
/R2T/R3T(MC28-120) - Dry Clutch	94	CK1288		CSK167					
NX 250 J/K/L (MD21)	87-90	CK1190	CKF1190	CSK065					CT013SP
NX 250 2L/M/P/2P	90-93	CK1190	CKF1190	CSK065					CT013SP
TL 250/TL 250 K1	78-79	CK1131		CSK004					CT009
TLR 250 F	85-	CK1119		CSK105	DRC091				CT012SP
TRX 250 F/G/H	85-87	CK1194		CSK004					CT013SP
TRX 250 RG/RH	86-87	CK1193	CKF1193	CSK032	DRC005				CT013
TRX 250 RJ/RK	88-89	CK1193	CKF1193	CSK045	DRC081				CT013
TRX 250 V/W/X/Y/1/TE2-9/TEA/TEB/TEC/TM2-9/TMA									
/TMB/TMC Recon/ES	97-12	CK1119		CSK172	DRC004				CT012SP
TRX 250 X9/XA/XB	09-11	CK1119		CSK172	DRC004				CT012SP
TRX 250 EX1/2/3/4/5/6/7/8	01-08	CK1119		CSK172	DRC004				CT012SP
VT 250 CR Magna		CK1235		CSK172			SRC047	SRK047	CT012SP
VT 250 FD	83	CK1191	CKF1191	CSK023					CT002
VT 250 FL Spada/Castec	88-90	CK1235		CSK172					CT012SP
VTZ 250 H/J/K	86-88	CK1235		CSK172			SRC047	SRK047	CT012SP
VTR 250 W/Y (MC33)/1-7	98-07	CK1235		CSK172			SRC047	SRK047	CT012SP
VTR 250 9	09-10	CK1235		CSK004					CT012SP
XL 250 K3/K4	78-79	CK1131		CSK004					CT009
XL 250 S/SZ/SA	78-80	CK1152		CSK009					CT013SP
XL 250 SB/RC	81-82	CK1153		CSK009					CT013SP
XL 250 RE/RF	84-85	CK1180		CSK004	DRC060				CT013SP
XL 250 Degree		CK1190	CFK1190	CSK009					CT013SP
XLR 250 R Baja (5 Plate) (MD22)		CK1180		CSK004	DRC060				CT013SP
XLR 250 R Baja (6 Plate) (MD22)		CK1190	CFK1190	CSK004					CT013SP
XR 250 SZ/SA	79-80	CK1152		CSK009					CT013SP
XR 250 RB/RC/RD	81-83	CK1153		CSK009					CT013SP
XR 250 RE/RF	84-85	CK1180		CSK004	DRC060				CT013SP
XR 250 RG/RH/RJ/RK/RL/RM/RN/RP/RR/RS	86-95	CK1190	CKF1190	CSK004	DRC044	DRCF044			CT013SP
XR 250 RT/RV/RW/RX/R1/R2/R3/R4	96-04	CK1190	CKF1190	CSK065	DRC084				CT013SP
XR 250 Tornado	05	TBA		TBA					
XR 250 Y/3 (MD30)	00-03	CK1190	CKF1190	CSK065					CT013SP
XR 250 3/5 (MD30) Motard	03-05	CK1190	CKF1190	CSK065					CT013SP
XR 250 III Y/3 Baja	00-03	CK1190	CKF1190	CSK065					CT013SP
CB 300 R10	10	TBA		TBA					
TRX 300 FWJ/K/L/T/V/W/X/Y/J/K/L/T/V/W/X/Y	88-00	CK1196		CSK023	DRC006				CT013SP
TRX 300 EX P/R/S/T/V/W/X/Y/1-8	93-08	CK1190	CKF1190	CSK004	DRC044	DRCF044			CT013SP
TRX 300 X9	09	CK1190	CKF1190	CSK004	DRC044	DRCF044			CT013SP
XR 300 R10	10	TBA		TBA					
TRX 350 G/H/J/K/L/M/N	86-93	CK1196		CSK012	DRC006				CT013SP
TRX 350 FMY/1-5 Fourtrax Rancher/4x4	00-05	CK1196		CSK048	DRC126				CT013SP
TRX 350 TE/FE Fourtrax Rancher ES/ES 4x4 FEY/1-5	00-05	CK1160		CSK048	DRC127				CT013SP
CB 350 SG/SJ	86-88	CK1140		CSK015					CT013SP

# EBC CLUTCH KITS

Make & Model	Year	CK Series #	CKF Series #	Spring Kit #	DRC Series #	DRCF Series #	SRC Series #	SRK Series #	CT Tool #
<b>HONDA Contd.</b>									
CB 350 K4		CK1132		CSK003					CT009
XR 350 RD/RE	83-84	CK1190	CKF1190	CSK004	DRC044	DRCF044			CT013SP
CB/CJ 360 all models		CK1132		CSK082					CT009
CB 400 F/F1/F2	75-79	CK1140		CSK082					CT013SP
CB 400 T/N/NA/NB/NC	78-82	CK1140		CSK047					CT013SP
CB-1 (CB400F)	89-90	CK1228		CSK006					CT009SP
CB 400 SF (F2N/F2R) (Super Four) (NC31)	92-95	CK1228		CSK006					CT009SP
CB 400 SF (F2V/F3T) Superfour (NC31)	96-97	CK1228		CSK006					CT009SP
CB 400 SF (F3V) Superfour (NC31)	97	CK1228		CSK006					CT009SP
CB 400 Four V/V-II/W/W-II (NC36)	97-98	CK1228		TBA					CT009SP
CB 400 SFX/SFY/SF1/SF2/SF3/SF4/S5 (NC39) Super Four	99-05	CK1265		TBA					CT009SP
CB 400 SS (SS2-NC41)	01-05	CK1181		CSK032					CT013
CBR 400 RG/RHYA (NC23 100/101)	86	CK1228		TBA					CT009SP
CBR 400 RRJ/RRK (NC23 102/109)	92-93	CK1228		CSK006					CT009SP
CBR 400 RRL/RRN/RRR (NC29)	90-94	CK1181		CSK033			SRC049	SRK049	CT013SP
CL 400 (NC38)	97-03	CK1181		CSK032					CT013
FL 400 R/RK/RL Pilot	89-93	CK1234		TBA					
NS 400 RF/RG	85-87	CK1218		CSK167					CT013
NT 400 Bros NC 25		CK1160		CSK028			SRC061	SRK061	CT013SP
NV 400 CJ/CK (Steed)	92-93	CK1160		CSK028			SRC061	SRK061	CT013SP
NV 400 CS/CV (Steed)	95-97	CK1160		CSK028			SRC061	SRK061	CT013SP
NV 400 DCY/DC1/DC2 (NC40) Shadow Slasher	00-02	CK1160		CSK028			SRC061	SRK061	CT013SP
TRX 400 FWS/T/V/W/X/Y	95-00	CK1196		CSK023	DRC006				CT013SP
TRX 400 EX/EY/EXX/EYX/EX1-EX8	99-08	CK1193	CKF1193	CSK073	DRC100	DRCF100			CT013
TRX 400 X9	09	CK1193	CKF1193	CSK073	DRC100	DRCF100			CT013
RVF 400 RR/RT/RR-II/RT-II (NC35 -100/110)	94-96	CK1289		N/A					CT002
VF 400 FD	83-85	CK1165		CSK009					CT002
VFR 400 R3K/R3L/R3M/R3N (NC30)	89-92	CK1250		CSK904			SRC063	SRK063	CT002
VFR 400 ZG/ZH/RG/RG-YA (NC21)	85-86	CK1177		CSK006					CT002
VFR 400 RH2/RJ (NC24)	87-88	CK1177		CSK009					CT002
XL 400 R	82	N/A		N/A					
XR 400 RT	96	CK1193	CKF1193	CSK028	DRC093				CT013
XR 400 RV/RW/RX/RY/R1-R5	97-05	CK1193	CKF1193	CSK033	DRC106				CT013
VRX 400 T (NC33)	96	CK1160		CSK033					CT013SP
XR 400 R5/R6 Motard (NC38E)	05-06	CK1181		CSK178	DRC266				CT013
XR 400 M Supermotard (ND08/NC38E)	06-08	CK1181		CSK178	DRC266				CT013
TRX 420 TM7/TM8/TM9/TMA/TMB	07-11	CK1154		CSK154	DRC239				CT013SP
TRX 420 FE7/FE8/FE9/FEA/FEB 4WD - Fourtrax ES	07-11	CK1196		CSK155	DRC238				CT013SP
TRX 420 FM7/FM8/FM9/FMA/FMB 4WD - Fourtrax	07-11	CK1154		CSK154	DRC239				CT013SP
TRX 420 FPMP/FPMA/FPMB Fourtrax 4WD - Power Steering	09-11	CK1154		CSK154	DRC239				CT013SP
TRX 420 TE7/TE8/TE9 Fourtrax ES - 2WD	07-09	CK1196		CSK155	DRC238				CT013SP
CB 450 DX-K	89	CK1140		CSK047					CT013SP
CR 450 RB	81	CK1131		CSK041					CT009
CRF 450 R2/R3	02-03	CK1247	CKF1247	CSK178	DRC112				CT009
CRF 450 R4/R5 (6 Spring Type)	04-05	CK1247	CKF1247	CSK120	DRC148	DRCF148			CT009
CRF 450 R6/R7/R8 (6 Spring Type)	06-08	CK1247	CKF1247	CSK178	DRC112				CT009
CRF450 R9/RA (4 Spring type)	09-10	CK1247	CKF1247	CSK157	DRC244	DRCF244			CT009
CRF 450 RB/RC	11-12	CK3433	CKF3433	CSK174	DRC259	DRCF259			CT009
CRF 450 RD (6 Spring Type)	13	CK3433	CKF3433	CSK201	DRC276	DRCF276			CT009
CRF 450 X5/X6/X7/X8/X9/XB/XC/XD	05-13	CK1247	CKF1247	CSK120	DRC148	DRCF148			CT009
CRF 450 XLRD	13	CK1247	CKF1247	CSK120	DRC148	DRCF148			CT009
CMX 450 CH/CJ Rebel	02	CK1140		CSK015					CT013SP
TRX 450 ESW/ESX/ESY/ES1	98-01	CK1196		CSK023	DRC006				CT013SP
TRX 450 R4/R5/R6/ER6/R7/ER7/R8/ER8/R9/ER9	04-09	CK1302	CKF1302	CSK178	DRC131	DRCF131			CT009
CR 480 RC	82	CK1131		CSK024					CT009
CR 480 RD	83	CK1170	CKF1170	CSK028	DRC003				CT009
CB 500 F (Four)		CK1146		CSK009					
CB 500 FAD (Twin)	13	TBA		CSK033					
CB 500/K1/K2 (Four)	75-77	CK1135		CSK003					CT009
CB 500 K3 (Four)		CK1146		CSK009					
CB 500 T (Twin)	75-77	CK1130		CSK015					CT031
CB 500 R/T/V/W/SW/X/SX/Y/SY/2/S2 (Twin)	94-03	CK1181		CSK033					CT013SP
CB 500 XD (Twin)	13	TBA		CSK033					
CBF 500 4/A4/A5/A6/A7	04-07	CK1181		CSK033					CT013SP
CBR 500 FH/FJ/FK/FL (Four)	87-90	CK1228		CSK012			SRC016	SRK016	CT009SP
CBR 500 RD (Twin)	13	TBA		CSK033					
CR 500 RE/RG/RH/RJ/RK	84-89	CK1170	CKF1170	CSK028	DRC003				CT009
CR 500 RL/RM/RN/RP/RR/RS/RT/RV/RW/RX/RY/R1	90-01	CK1247	CKF1247	CSK028	DRC075				CT009
CX 500 CA/CB/Z/A/B/EC	79-85	CK1146		CSK041					
CX 500 Turbo	82	CK1159		CSK010					CT053SP
FT 500 C	82	CK1154		CSK015					CT013SP
GL 500 DC	82	CK1146		CSK041					
NX 500 J/K/L/M/N/P/R/S/T/V/W/X Dominator	88-99	CK1170	CKF1170	CSK016	DRC054	DRCF054			CT009



# EBC CLUTCH KITS

Make & Model	Year	CK Series #	CKF Series #	Spring Kit #	DRC Series #	DRCF Series #	SRC Series #	SRK Series #	CT Tool #
<b>HONDA Contd.</b>									
TRX 500 FE5/FE6/FE7/FE8/FE9/FEA/FAB									
Fourtrax Foreman 4WD/ES	05-11	CK1154		CSK117	DRC236				CT013SP
TRX 500 FEC Fourtrax Foreman ES 2/4 WD	12	CK1154		CSK029	DRC270				CT013SP
TRX 500 FM5/FM6/FM7/FM8/FM9/FMA/FMB									
Fourtrax Foreman 4x4	05-11	CK1154		CSK153	DRC237				CT013SP
TRX 500 FMC Fourtrax Foreman S 2/4 WD	12	CK1154		CSK079	DRC271				CT013SP
TRX 500 TM5/TM6 Fourtrax Foreman	05-06	CK1154		CSK153	DRC237				CT013SP
TRX 500 FPE8/FPE9/FPEA/FPEB									
Fourtrax Foreman 4x4 ES/EP5	08-11	CK1154		CSK117	DRC236				CT013SP
TRX 500 FPEC Fourtrax Foreman S 2/4 WD	12	CK1154		CSK029	DRC270				CT013SP
VF 500 FE/F2E/FF/F2F	84-85	CK1177		CSK009					CT002
VT 500 ED/EF	83-85	CK1160		N/A					CT013SP
XBR 500 F/G/H/SH/SJ	85-89	CK1219		CSK016					CT009
XL 500 SZ/SB/RC	80-82	CK1140		CSK015					CT013SP
XR 500 SZ/SA/RB/RC	79-82	CK1154		CSK015					CT013SP
XR 500 RD/RE	84-85	CK1170	CKF1170	CSK015					CT009
CB 550 F/F1/F2/K3	78-80	CK1146		CSK009					
CBX 550 FC/F2C/FD/F2D	82-85	CK1228		CSK026			SRC048	SRK048	CT009SP
CB 600 Hornet FW/FX/FY/F2-Y/F1/F21/F2/F22/F3/F4/F5/F6	98-06	CK1206		CSK045			SRC019	SRK019	CT014SP
CB 600 F7/F8/F9/FA/FB/FC Hornet	07-13	CK1218		CSK101			SRC075	SRK075	CT014
CB 600 FA7/FA8/FA9/FAA/FAB/FAC Hornet (ABS)	07-13	CK1218		CSK101			SRC075	SRK075	CT014
CBF 600 N4/N5/N6	04-06	CK1206		CSK045			SRC019	SRK019	CT014SP
CBF 600 N8/N9/NA	08-11	CK1218		CSK101			SRC075	SRK075	CT014
CBF 600 NA4/NA5/NA6	04-06	CK1206		CSK045			SRC019	SRK019	CT014SP
CBF 600 NA8/NA9/NAA	08-11	CK1218		CSK101			SRC075	SRK075	CT014
CBF 600 S4/S5/S6	04-06	CK1206		CSK045			SRC019	SRK019	CT014SP
CBF 600 S8/S9	08-09	CK1218		CSK101			SRC075	SRK075	CT014
CBF 600 SA4/SA5/SA6	04-06	CK1206		CSK045			SRC019	SRK019	CT014SP
CBF 600 SA8/SA9/SAA	08-12	CK1218		CSK101			SRC075	SRK075	CT014
CBR 600 FH/FJ	87-88	CK1228		CSK012			SRC016	SRK016	CT009SP
CBR 600 FK/FL	89-90	CK1228		CSK047			SRC042	SRK042	CT009SP
CBR 600 FM/FN/FP/FR/FS/FT/FV/FW	91-98	CK1206		CSK045			SRC019	SRK019	CT014SP
CBR 600 FX/FY/F1/F2/F3/F4/F5/F6	99-06	CK1193	CKF1193	CSK029			SRC066	SRK066	CT014
CBR 600 FS1/FS2 Sport	01-02	CK1218		CSK045			SRC057	SRK057	CT014
CBR 600 FB/FC	11-13	CK1218		CSK045			SRC057	SRK057	CT014
CBR 600 FAB/FAC	11-13	CK1218		CSK045			SRC057	SRK057	CT014
CBR 600 RR3/RR4/RR5/RR6/RR7/RR8/RR9/RAA									
/RRB/RRC/RRD	03-13	CK1218		CSK101			SRC075	SRK075	CT014
CBR 600 RR Hannspree	08	CK1218		CSK101			SRC075	SRK075	CT014
CBR 600 RA9/RAA/RAB/RAC/RAD(C-ABS)	09-13	CK1218		CSK101			SRC075	SRK075	CT014
NTV 600 J/K/M	88-91	CK1230		CSK032					CT013SP
VT 600 CN/CR/CS/CT/CV/CW/CX	92-00	CK1181		CSK033					CT013SP
XL 600 RD/LD/RE/LE/RF/RG/RH	83-87	CK1170	CKF1170	CSK015	DRC092				CT009
XL 600 LMF/RMG/LMH	85-87	CK1170	CKF1170	CSK016	DRC054	DRCF054			CT009
XL 600 VHV/JVK/VMN/VNP/VR/VT/VV/VW/VX Transalp	87-99	CK1181		CSK033	DRC053				CT013SP
XR 600 RF/RG/RH/RJ/RK/RL/RM/RP/RR/RS/RT/RV/RW/RX/RZ	84-00	CK1170	CKF1170	CSK016	DRC054	DRCF054			CT009
FMX 650 5/6	05-08	CK1170	CKF1170	CSK016	DRC054	DRCF054			CT009
FX 650 X/Y Vigor	99-03	CK1170	CKF1170	CSK016	DRC054	DRCF054			CT009
NT 650 J/K/L (BROS)	88-92	CK1230		CSK028			SRC064	SRK064	CT013SP
NTV 650 J/K/L/M/P/S/T/V	88-97	CK1230		CSK033			SRC062	SRK062	CT013SP
NT 650 VV/VX/VY/V1-V5 Deauville	98-05	CK1230		CSK033			SRC062	SRK062	CT013SP
NX 650 J/K/L/M/N/P/R/S/T/V/W/X	88-02	CK1170	CKF1170	CSK016	DRC054	DRCF054			CT009
CB 650 Z/B/SCC	79-82	CK1147		CSK167					
CX 650 ED	83-85	CK1147		CSK012					
CX 650 TD Turbo	83	CK1159		CSK010					CT053SP
GL 650 D2-E	84	CK1147		CSK012					
SLR 650 V/W	97-98	CK1170	CKF1170	CSK016	DRC054	DRCF054			CT009
XL 650 VY/V1/V2/V3/V4/V5/V6/V7	00-07	CK1230		CSK028					CT013SP
XR 650 L	93-12	CK1170	CKF1170	CSK016	DRC054	DRCF054			CT009
XR 650 RY/R1-R7	00-07	CK1295		CSK045	DRC179				CT009
XRV 650 J/K Africa Twin	88-89	CK1230		CSK028					CT013SP
NC 700 SC/SD (Manual Gearbox)	12-13	CK1230		CSK033			SRC062	SRK062	CT013SP
NC 700 XC/XD (Manual Gearbox)	12-13	CK1230		CSK033			SRC062	SRK062	CT013SP
NT 700 V6/VA7/V7/V8/VA8/VA/VAA Deauville	06-13	CK1230		CSK033			SRC062	SRK062	CT013SP
TRX 700 XX8/XX9/XXB	08-11	CK1302	CKF1302	CSK178	DRC240	DRCF240			CT009
XL 700 V8/V9/VA (Transalp/2 Piston Front Caliper									
/ABS on Rear Disc)	08-11	CK1230		CSK009					CT013SP
XL 700 VA8/VA9/VAA (Transalp/3 Piston Front Caliper									
/ABS Front & Rear Wheels)	08-11	CK1230		CSK009					CT013SP
CB 750/CB 750 K1 (Up to E.No.:1056079)	69-70	CK1223		CSK009					
CB 750 K1 (From E.No.:1056080)	70-71	CK1133		CSK009					
CB 750 K2/K3/K4/K5	71-75	CK1133		CSK004					
CB 750 KZ	80	CK1149		CSK041					CT021



# EBC CLUTCH KITS

Make & Model	Year	CK Series #	CKF Series #	Spring Kit #	DRC Series #	DRCF Series #	SRC Series #	SRK Series #	CT Tool #
<b>HONDA Contd.</b>									
CB 750 F/F1	76-77	CK1220		CSK082					
CB 750 K6/K7/F2	76-78	CK1145		CSK082					
CB 750 FA/FB/F2C	79-82	CK1149		CSK041					CT021
CB 750 F2N/F2R/F2S/F2T/F2W/F2X/F2Y/F21	92-02	CK1265		CSK006					CT009SP
CBR 750 FH/FJ (Superaero)	87-88	CK1287		CSK027					
CBX 750 FE	84-85	CK1166		N/A					CT031
NR 750 N	92	CK1257		N/A					
VF 750 FD/FE	83-85	CK1167		CSK900			SRC002	SRK002	CT031
VF 750 SC (V45 Sabre)	82	CK1166		CSK077					CT031
VF 750 CH	87	CK1166		CSK077					CT031
VF 750 CP/CR/CS/CT/CV	93-97	CK1206		CSK028					CT014
VFR 750 FG/FH/FJ/FK/FL/FMFN/FP/FR/FS/FT/FV	86-97	CK1206		CSK028			SRC003	SRK003	CT014
VFR 750 RJ/RK/RL (RC30)	88-92	CK1229		CSK901			SRC005	SRK005	CT014
VT 750 C Shadow	83	CK1166		N/A					CT031
VT 750 CV/C2V/CW/C2W/CX/C2X/CY/C2Y/C1/C1Y/C4 /C5/C6/C7/C8	97-09	CK1230		CSK028			SRC064	SRK064	CT013SP
VT 750 C2BA/C2BB/C2BC Shadow Black Spirit (21" Front Wheel/Rear Drum Model)	10-13	CK1230		TBA					CT013SP
VT 750 C2SA/C2SB Shadow (3 Piston Caliper/17" Front Wheel/Rear disc)	10-12	CK1230		TBA					CT013SP
VT 750 DC1/DC2 Black Widow	01-04	CK1230		CSK028					CT013SP
VT 750 DC7/DC8 Shadow Spirit	07-09	CK1230		CSK028					CT013SP
VT 750 S (VT 750 SA/SB)	10-12	CK1230		CSK028			SRC064	SRK064	CT013SP
RVF 750 RR-R/RR-S	94-98	CK1257		N/A					
XLV 750 R (RD/RF)	83-88	CK1166		CSK077					CT031
XRV 750 L/M/N/P/R/S/T/V/W/X/Y	90-03	CK1167		CSK006					CT009
PC 800 Pacific Coast	89-97	CK1167		CSK030					CT009
VFR 800 Fi-W/Fi-X	98-99	CK1206		CSK029					CT014
VFR 800 Fi-Y/Fi-1	00-02	CK1253		CSK029					CT014
VFR 800 2/3/4/5/6/8/9	02-09	CK1218		CSK029					CT014
VFR 800 A2/A3/A4/A5/A6/A8/A9	02-13	CK1218		CSK029					CT014
VFR 800 XC (Crossrunner)	12-13	TBA		TBA					
CB 900 FZ/FA/FB/F2B/F2C/FD/F2D	80-85	CK1149		CSK167					CT021
CB 900 F2/F3/F4/F5/F6/F7 Hornet	02-07	CK1218		CSK045			SRC057	SRK057	CT014
CBR 900 RRN/RRP/RRR (893cc)	92-94	CK1206		CSK028			SRC094	SRK094	CT014
CBR 900 RRS (918cc)	95	CK1206		CSK028			SRC094	SRK094	CT014
CBR 900 RRT/RRV (918cc)	96-97	CK1284		CSK045			SRC055	SRK055	CT014
CBR 900 RRW/RRX (918cc)	98-99	CK1218		CSK045			SRC057	SRK057	CT014
CBR 900 RRY/RR1 (929cc Fireblade)	00-01	CK1206		CSK045			SRC019	SRK100	CT014
CBR 900 RR2/RR3 (954cc Fireblade)	02-03	CK1206		CSK045			SRC019	SRK100	CT014
CB 1000 FP/FR/FS/FT/FV	93-97	CK1248		CSK029			SRC004	SRK004	CT009
CB 1000 R9/RA/RB/RC (Non ABS Model)	09-13	CK1303		CSK112			SRC80	SRK80	CT009SP
CB 1000 RA9/RAA/RAB/RAC (ABS Model)	09-13	CK1303		CSK112			SRC80	SRK80	CT009SP
CBF 1000 6/7/8/9/A (2 Piston Front Caliper/Non ABS)	06-11	CK1303		CSK090					CT009SP
CBF 1000 A A6/A7/A8/A9/AA (3 Piston Front Caliper/ABS)	06-11	CK1303		CSK090					CT009SP
CBF 1000 S S7/S8/S9/SA (3 Piston Front Caliper/ABS)	07-10	CK1303		CSK090					CT009SP
CBF 1000 T T7/T8/T9/TA (3 Piston Front Caliper/ABS)	07-12	CK1303		CSK090					CT009SP
CBF 1000 F FA (2 Piston Front Caliper/Non ABS)	10-11	CK1303		CSK090					CT009SP
CBF 1000 FA FAA (3 Piston Front Caliper/ABS)	10-13	CK1303		CSK090					CT009SP
CBF 1000 FS FSA (3 Piston Front Caliper/ABS)	10-11	CK1303		CSK090					CT009SP
CBF 1000 FT FTA (3 Piston Front Caliper/ABS)	10-11	CK1303		CSK090					CT009SP
CBR 1000 FH/FJ/FK/FL/FM/FN/FP/FR/FS/FT/FV/FW/FX	87-99	CK1248		CSK029			SRC004	SRK004	CT009
CBR 1000 RR4/RR5/RR6/RR7 Fireblade (Coil Spring Type Clutch)	04-07	CK1303		CSK112			SRC080	SRK080	CT009SP
CBR 1000 RR8/RR9/RRA/RRB/RRC/RA9/RAA/RAB /RAC Fireblade (Diaphragm Type Clutch)	08-12	CK1312		CSK905			SRC095	SRK095	CT043SP
CBX 1000 Z	79	CK1183		CSK167					
CBX 1000 B/C	80-81	CK1183		CSK010					
GL 1000 K1 (Up to E.No:-2002383)	77	CK1221		CSK010					
GL 1000 K1/K2 (From E.No:-2002384)	77-78	CK1143		CSK010					
VF 1000 FE/FF/RE/RF/RG/F2F	84-86	CK1176		N/A					CT031
VTR 1000 FV/FW/FX/FY/F1-F6 Firestorm	97-06	CK1290		CSK066			SRC060	SRK060	CT009
VTR 1000 SPY/SP1 (SC45)	00-01	CK1291		CSK043					CT021
VTR 1000 SP-2/SP-3/SP-4/SP-5/SP-6	02-07	CK1300		CSK043					
XL 1000 VX/VY/V1/V2 Varadero - Non ABS Model /10 Plate Kit	99-02	CK1290		CSK066	DRC267				CT009
XL 1000 V3/V4/V5/V6/V7/V8/V9/VA/VB Varadero - Non ABS Model/8 Plate Kit	03-11	CK1257		CSK138	DRC268				CT009
XL 1000 V6/VA6/VA7/VA8/VA9VAA/VAB Varadero - ABS Model/8 Plate Kit	06-11	CK1257		CSK138	DRC268				CT009
CB 1100 RB2/RC2	80-81	CK1149		CSK009					CT021
CB 1100 RD2	82	CK1149		CSK046					CT021
CB 1100 SFY/SF1 X11	00-03	CK1291		CSK043					CT021

CLUTCH APPLICATIONS

# EBC CLUTCH KITS

Make & Model	Year	CK Series #	CKF Series #	Spring Kit #	DRC Series #	DRCF Series #	SRC Series #	SRK Series #	CT Tool #
<b>HONDA Contd.</b>									
CB 1100 D	13	TBA		TBA					
CBR 1100 XXV/XXW Blackbird	97-98	CK1286		CSK070					CT021
CBR 1100 XXX/XXY/XX1-XX6 Blackbird	99-08	CK1291		CSK043					CT021
GL 1100 A/DA/B/IB/DB (SC02)	80-81	CK1159		CSK010					
ST 1100 L/M/N/P/R/S/T/V/W/X/Y/1/2 (Pan European - Non ABS Model)	90-02	CK1264		CSK033			SRC070	SRK070	CT056SP
ST 1100 AN/AP/AR/AS (Pan European ABS Model)	92-95	CK1264		CSK033			SRC070	SRK070	CT056SP
ST 1100 AT/AV/AW/AX/AY/A1/A2 (Pan European ABS Model)	96-02	CK1264		CSK033			SRC070	SRK070	CT056SP
VT 1100 CH/CJ/CN/CP Shadow	87-93	CK1239		N/A					CT031
VT 1100 CR/CS/CT/CV/CW Shadow	94-98	CK1239		N/A					CT031
VT 1100 C2 (S/T/V)	95-97	CK1176		TBA					CT031
VT 1100 C2 (W/X/Y/1/2/3/4/5)	98-05	CK1176		TBA					CT031
VT 1100 C3 (W/X/Y)	98-00	CK1176		TBA					CT031
GL 1200 AE/DE/AF	84-85	CK1210		N/A					CT053SP
GL 1200 DH/AH/AG/DG	86-87	CK1224		N/A					
VFR 1200 FA/FB (Manual Gearbox Model)	10-13	CK1312		CSK907			SRC103	SRK103	CT043SP
VFR 1200 XC Crosstourer (Manual G/Box)	12-13	N/A		N/A	N/A		N/A	N/A	
CB 1300 FW/FX/FY/F1 (SC40)	98-01	CK1299		TBA					CT009
CB 1300 DCV/DCW/DCX/DCY (SC38)	97-00	CK1290		CSK070					CT009
CB 1300 F3/F13	03-04	CK1257		CSK113					CT009
CB 1300 5/6/7/8/9 (Superfour)	05-09	CK1257		CSK113					CT009
CB 1300 A5-A8 (Superfour ABS)	05-08	CK1257		CSK113					CT009
CB 1300 SA5/SA6/SA7/SA8 Super Bol-Dor	05-08	CK1257		CSK113					CT009
ST 1300 2/3/4/6/8/9 Pan European-Non ABS	02-09	CK1297		CSK175					CT021
ST 1300 A2/A3/A4/A6/A8/A9/AA Pan European - ABS Model	02-13	CK1297		CSK175					CT021
VT 1300 CXA (Fury/Chopper/Non ABS/9 Spoke Cast Wheel)	10-12	CK1298		CSK090					CT021
VT 1300 CXAA (Fury/Chopper/ABS/9 Spoke Cast Wheel)	10-11	CK1298		CSK090					CT021
VTX 1300 S3/S4/S5/S6/S7/S8	03-08	CK1298		CSK090					CT021
GL 1500 J/K/L/SEM/SEN/SEP/SER/SES/SEX Goldwing	88-96	CK1285		N/A					CT021
GL 1500 CV/CW/CX/CY/C1/C2 F6C	97-03	CK1285		N/A					CT021
GL 1500 SEV/SEW/SEX/SEY Goldwing	97-00	CK1285		N/A					CT021
F6B Goldwing	13	CK1297		N/A					CT021
GL 1800 A1-A5 Goldwing	01-05	CK1297		N/A					CT021
GL 1800 5-9/A Goldwing	06-13	CK1297		N/A					CT021
VTX 1800 C2/C3/C4/C15/C16/C17	02-08	CK1298		CSK090					CT021
<b>HONDA-DALL ARA</b>									
XR 125 SM	04	CK1119		CSK004					CT012SP
XR 250 R	04	CK1190	CKF1190	CSK065	DRC084				CT013SP
XR 250 RM	04	CK1190	CKF1190	CSK065	DRC084				CT013SP
XR 400/440 R	04	CK1193	CKF1193	CSK033	DRC106				CT013
XR 400/440 SM	04	CK1193	CKF1193	CSK033	DRC106				CT013
XR 650 R	04	CK1295		CSK045					CT009
<b>KAWASAKI</b>									
AE 50 A1/A2	81-84	CK4442		CSK018					
AR 50 A1/C2-C10	81-97	CK4442		CSK018					
KDX 50 A1/A2/A3/A6F	03-06	CK3366		N/A					
KSR I (KMX50 B1/B2)	90-91	CK4442		CSK044					
KX 60 A1/A2/B1-B19	83-03	CK4438	CKF4438	CSK018	DRC007				
KX 65 A1/A2/A3/A4/A5/A6/A6F/A7F/A8F/A9F/AAF/ABF/ACF/ADF	00-13	CK4438	CKF4438	CSK040	DRC098	DRCF098			
AE 80 A1/B1	81-83	CK4440		CSK018					
AR 80 A1/C1-C8	81-91	CK4440		CSK018					
KSR II (KMX 80 B1/B2)	90-91	CK4440		CSK044					
KX 80 E1/E2	83-84	CK4438	CKF4438	CSK040					
KX 80 E3/G1/G2/J1/J2	85-87	CK4468		CSK034	DRC008		DRC008		
KX 80 L1	88	CK4477		CSK035	DRC009				
KX 80 L2/L3/R1-R7	89-97	CK4478		CSK035	DRC010				
KX 80 W1/W2/W3	98-00	CK4453	CKF4453	CSK041	DRC045	DRCF045			CT002
KX 85 A1-A5/A6F/A7F/A8F/A9F/AAF/ABF/ACF/ADF (17" Front/14" Rear Wheel)	01-13	CK4453	CKF4453	CSK041	DRC045	DRCF045			CT002
KX 85 II B1-B5/B6F/B7F/B8F/B9F/BAF/BBF/BCF/BDF (19" Front/14" Rear Wheel)	01-13	CK4453	CKF4453	CSK041	DRC045	DRCF045			CT002
KC 100 C1-C4	81-83	CK4440		CSK019					
KE 100 A8-A10	79-81	CK4440		CSK019					
KE 100 B1-B15	82-98	CK4440		CSK040					
KH 100 A2-A4/G2-G8	78-87	CK4440		CSK019					
KM 100 A4/A6	79-80	CK4440		CSK019					
KX 100 N1	88	CK4477		CSK035	DRC009				
KX 100 A1/A2/B1-B7	89-97	CK4478		CSK035	DRC010				
KX 100 C1/C2/C3	98-00	CK4453	CKF4453	CSK041	DRC045	DRCF045			CT002
KLF 110 B1/B2	87-88	CK4463		N/A					
KLX 110 R (KLX 110 A1-A4/A6FA7F/A8F/A9F/CAF/CBF/CCF/CDF)	02-13	CK4438	CKF4438	CSK040					

# EBC CLUTCH KITS

Make & Model	Year	CK Series #	CKF Series #	Spring Kit #	DRC Series #	DRCF Series #	SRC Series #	SRK Series #	CT Tool #
<b>KAWASAKI Contd.</b>									
AR 125 A1/A1-A7/B1-B8	83-94	CK4453	CKF4453	CSK041					CT002
BN 125 A1-A5/A6F/A7F Eliminator	98-07	CK4511		CSK041					
KDX 125 A1/A2/B1/B2	90-94	CK4489		CSK001					CT042
KE 125 A7-A12	80-85	CK4411		CSK001					CT058
KH 125 A1-A4	77-81	CK4411		CSK001					CT058
KH 125 K1	82	CK4440		CSK040					
KH 125 K2-K10	82-98	CK4438	CKF4438	CSK040					
KH 125 L1 (KH 125 EX)	83	CK4438	CKF4438	CSK040					
KLX 125 A1/A2/A3/A6F	03-06	CK3318	CKF3318	CSK034					CT011
KLX 125 L (B1/B2/B3/B6F)	03-06	CK3318	CKF3318	CSK034					CT011
KLX 125 CAF/CBF/CCF	10-13	CK4522		CSK142	DRC211				CT012SP
KLX 125 DAF/DBF/DCF (D-Tracker)	10-13	CK4522		CSK142	DRC211				CT012SP
KMX 125 A1/A2	86-87	CK4453	CKF4453	CSK031					CT002
KMX 125 A3/A4/A5	88-89	CK4486		CSK031					
KMX 125 B1/B2 (From E.No.- MX 125 AE 000001-013436)	86-87	CK4453	CKF4453	CSK031					CT002
KMX 125 B2-B12 (From E.No. MX AE 013437)	87-03	CK4486		CSK031					
KX 125 B1	82	CK4436		CSK001					CT058
KX 125 B2	83	CK4457		CSK036					CT058
KX 125 C1	84	CK4457		CSK001					CT058
KX 125 D1/E1/E2	85-87	CK4469		CSK001	DRC011				CT042
KX 125 F1/G1	88-89	CK4482		CSK006	DRC013				CT042
KX 125 H1/H2	90-91	CK4485		CSK116	DRC036				CT042
KX 125 J1	92	CK4485		CSK116	DRC083				CT042
KX 125 J2	93	CK4498		CSK116	DRC069				CT042
KX 125 K1/K2/K3	94-96	CK4425		CSK007					CT004
KX 125 K4/K5/L1-L4	97-02	CK4425		CSK065	DRC073				CT004
KX 125 M1/M2/M3/M6F/M7F/M8F	03-08	CK4425		CSK097	DRC122				CT004
KDX 175 A1-A3	80-82	CK4436		CSK001					CT058
KE 175 D1-D5	79-83	CK4411		CSK039					CT058
KLF 185 A3	87	CK1119		CSK003					CT012SP
KDX 200 A1/A2	83-84	CK4457		CSK036					CT058
KDX 200 A3	85	CK4457		CSK001					CT058
KDX 200 C1/C2	86-87	CK4469		CSK001	DRC074				CT042
KDX 200 C3	88	CK4469		CSK001	DRC011				CT042
KDX 200 E1/E2/E3/E4/E5/E6	89-94	CK4482		CSK010	DRC061				CT042
KDX 200 H1/H2/H3/H4/H5	95-99	CK4505		CSK030	DRC062				
KMX 200 A2/A3	88-92	CK4486		CSK009					
Z 200 A1 (Up to E.No.-005062)	77	CK4446		CSK148					CT004
Z 200 A1 (From E.No.-005063)	78	CK4425		CSK148					CT004
Z 200 A2-A6	79-83	CK4425		CSK148					CT004
KDX 220 R A4-A12/A6F	97-06	CK4505		CSK030	DRC062				
KDX 220 SR		CK4505		CSK030	DRC062				
KLF 220 A1-A15	88-02	CK1180		CSK116	DRC224				CT013SP
BJ 250 B1-B7A Estrella	92-99	CK4508		CSK004					
BJ 250 E1-EA Estrella-RS Custom	96-99	CK4508		CSK004					
BJ 250 C1-C7 Estrella-RS	95-01	CK4508		CSK004					
BJ 250 D1-D7 Estrella Custom	96-02	CK4508		CSK004					
BJ 250 F1/F2 (250 TR)	02-03	CK4508		CSK007					
EL 250 B1/B2/B3 Eliminator	87-89	CK4473		CSK004					CT016
ER 250 B1/B2/B3 Scorpion	83-88	CK4433		CSK007					CT006
EL 250 D1-D5	90-94	CK4473		CSK004					CT016
EL 252 (EL 250 F2/F3F5/F6)	96-03	CK4473		CSK004					CT016
EX 250 K8F/K9F/KAF/KBF/KBFA/KCF Ninja 250R	08-12	CK4521		CSK142					CT014
GPX 250 R (ZX 250 F2/F3/F6-F9)	88-95	CK4473		CSK004					CT016
GPZ 250 R (EX 250 E)	86	CK4473		CSK004					CT016
GPX 250 R II (EX 250 G)	88	CK4473		CSK004					CT016
KDX 250 B1	81	CK4439		CSK006					CT006
KDX 250 B2/B3	82-83	CK4433		CSK006					CT006
KDX 250 D1	91-93	CK4475		CSK030	DRC041				CT006
KDX 250 SR (KDX 250 F1)	91	CK4509		CSK030					
KH 250 B4/B5	79-80	CK4436		CSK001					CT058
KL 250 A1-A4/C1/C2	78-84	CK4425		CSK007					CT004
KL 250 H1 Super Sherpa	98	CK4469		CSK074					CT042
KL 250 J1 Stockman		CK4469		CSK074					CT042
KLE 250 A1/A1A/A2 (Anhelo)		CK4473		CSK007					CT016
KLE 250 A2	95	TBA		TBA					
KLE 250 A3	97	TBA		TBA					
KLE 250 A5/A6	00-01	TBA		TBA					
KLF 250 A1/A2/A3/A6F/A7F/A8F/A9F/AAF/ABF (Bayou 250)	03-11	CK1180		CSK116	DRC224				CT013SP
KLR 250 D2-D22	84-05	CK4446		CSK148	DRC063				CT004
KLT 250 C1-C3	83-85	CK4425		CSK148					CT004
KLX 250 D1/D2	93-95	CK4469		CSK001					CT042
KLX 250 F1-F4 (KLX 250 E)	94-97	CK4469		CSK001					CT042

CLUTCH APPLICATIONS

# EBC CLUTCH KITS

Make & Model	Year	CK Series #	CKF Series #	Spring Kit #	DRC Series #	DRCF Series #	SRC Series #	SRK Series #	CT Tool #
<b>KAWASAKI Contd.</b>									
KLX 250 G1	94-	CK4469		CSK001					CT042
KLX 250 J1-J6 D-Tracker	98-03	CK4469		CSK001					CT042
KLX 250 S H6F/H7F	06-07	CK4469		CSK144	DRC212				CT042
KLX 250 (KLX 250 S9F/SAF/SBF/SCF/SDF)	09-13	CK4469		CSK144	DRC212				CT042
KR 250 A1/A2	84-86	CK4517		CSK010					CT016
KR-1 (KR 250 B2)	89	CK4484		CSK010					CT016
KR-1S (KR 250 C2/C3)	90-92	CK4484		CSK010					CT016
KSF 250 A1-A18 (KXF 250 Mojave)	87-04	CK4425		CSK148	DRC225				CT004
KT 250 A/A2	75-76	CK4411		CSK001					CT058
KX 250	74	CK4419		CSK007					CT006
KX 250 A/A3/A4/A5	75-79	CK4419		CSK007					CT006
KX 250 A6/A7	80-81	CK4439		CSK007					CT006
KX 250 B1/C1	82-83	CK4465		CSK010					CT006
KX 250 C2	84	CK4465		CSK010					CT006
KX 250 D1/D2	85-86	CK4459		CSK010					CT006
KX 250 E1/F1/G1	87-89	CK4475		CSK007	DRC015				CT006
KX 250 H1	90	CK4475		CSK006	DRC017				CT006
KX 250 H2	91	CK4475		CSK030	DRC041				CT006
KX 250 J1/J2/K1-K5/L1-L4	92-02	CK4435	CKF4435	CSK007	DRC046	DRCF046			CT016
KX 250 M1/M2/R1/R6F/R7F/R8F (2T)	03-08	CK4435	CKF4435	CSK007	DRC046	DRCF046			CT016
KX 250 F (KX 250 N1/N2/T6F/T7F/T8F) (4T)	04-08	CK4514	CKF4514	CSK097	DRC123	DRCF123			CT004
KX 250 F (KX 250 W9F/XAFB/YBF/YCF/ZDF) (4T)	09-13	CK4514	CKF4514	CSK097	DRC123	DRCF123			CT004
KXF 250 A1/A2	87-88	CK4475		CSK010					CT006
KXT 250 A1 Tecate	84	CK4433		CSK007					CT006
KXT 250 A2 Tecate	85	CK4465		CSK010					CT006
KXT 250 B1 Tecate	86	CK4459		CSK010	DRC038				CT006
KXT 250 B2 Tecate	87	CK4459		CSK010	DRC038				CT006
Z 250 A1-A3/B1/B2	79-81	CK4433		CSK006					CT006
Z 250 C1/C2/G1/G2	80-83	CK4425		CSK007					CT004
ZR 250 A1-A5 Balius	91-95	CK4508		CSK007					
ZR 250 B6 (Balius-II)	02	CK4508		CSK007					
ZZ-R 250 (EX 250 H1-H13)	90-03	CK4473		CSK004					CT016
ZXR 250 (ZX 250 A1/A2)	89-90	CK4508		CSK007					
ZXR 250 C1-C5 (ZX 250 C1-C5)	91-95	CK4508		CSK007					
ZXR 250 R (ZX 250 D1)	91	CK4508		CSK007					
ZXR 250 R (ZX 250 B1/B2)	89-90	CK4509		CSK007					
EX 300 ADF Ninja (Non ABS)	13	CK4524		CSK203			SRC118	SRK118	CT009
EX 300 BDF Ninja (ABS)	13	CK4524		CSK203			SRC118	SRK118	CT009
KEF 300 B1/B2 Lakota Sport	01-02	CK4419		CSK151	DRC233				CT006
KLF 300 A1/A2/B1-B17/C1-C17	87-05	CK4419		CSK151	DRC233				CT006
KLX 300 A2	97	CK4469		CSK001					CT042
KLX 300 A3-A10/A6F	98-06	CK4469		CSK144					CT042
GPz 305 A1/B2-B10	83-96	CK4433		CSK010					CT006
S2/S2A (350cc)	72-73	CK4457		CSK192					CT058
FX 400 R (ZX 400 E1/E2/E3)	86-88	CK4424		CSK023					CT016
GPZ 400 R (ZX 400 D1/D2/D3/D3A)	85-87	CK4424		CSK023					CT016
GPZ 400 R (ZX 400 F1)	87	CK4424		CSK023					CT016
S3/S3A (400cc)	74-75	CK4457		CSK192					CT058
KH 400 A3-A5	76-78	CK4457		CSK192					CT058
KLF 400 B1-B7	93-98	CK4439		N/A					CT006
KLX 400 R (KLX 400 B1/B2)	03-04	CK3433	CKF3433	CSK079	DRC105	DRCF105			CT006
KSF 400 A1/A2 (KFX 400)	03-04	CK3433	CKF3433	CSK079	DRC105	DRCF105			CT006
KSF 400 A3/A6F (KFX 400)	05-06	CK3447	CKF3447	CSK079	DRC137	DRCF137			CT006
Z 400 B1/B2	78-80	CK4421		CSK010					
Z 400 G1	79	CK4421		CSK010					
Z 400 J1-J3	80-83	CK4424		CSK010			SRC011	SRK011	CT016
ZL 400 A Eliminator	86-87	CK4424		CSK007			SRC022	SRK022	CT016
ZL 400 B Eliminator 400 SE	88	CK4424		CSK007			SRC022	SRK022	CT016
ZL 400 D1/D2	94-95	CK4424		CSK148					
ZR 400 A1/B1 (Z 400 F)	83-84	CK4424		CSK010			SRC011	SRK011	CT016
ZR 400 D1/D3/D4 Xanthus	92-95	CK4446		CSK007					CT004
ZRX 400 (ZR 400 E1-E7)	94-01	CK4424		TBA					CT016
ZR 400 Zephyr (G2/G3/G3A/G4/G5)	97-01	CK4424		CSK010			SRC044	SRK044	CT016
ZX 400 C2 (Z 400 F 11)	85	CK4424		CSK010			SRC011	SRK011	CT016
ZXR 400 H1/H2	89	CK4446		CSK007					CT004
ZXR 400 (ZX 400 L1-L5/L8/L9)	91-02	CK4446		CSK006			SRC021	SRK021	CT004
ZXR 400 R (ZX 400 M1-M4)	91-94	CK4446		CSK006					CT004
ZX 400 J1/J2	89-90	CK4446		CSK007					CT004
ZZR 400 (ZX 400 K1/K2/K3)	90-92	CK4424		CSK007					CT016
ZZR 400 (ZX 400 N1-N7)	93-99	CK4424		CSK043					CT016
Z 440 A2	80-81	CK4421		CSK004					
Z 440 C1/C2	80-81	CK4421		CSK004					
Z 440 D4-D6 (Lid)	82-84	CK4421		CSK004					

# EBC CLUTCH KITS

Make & Model	Year	CK Series #	CKF Series #	Spring Kit #	DRC Series #	DRCF Series #	SRC Series #	SRK Series #	CT Tool #
<b>KAWASAKI Contd.</b>									
Z 440 H1/H2	82-83	CK4421		CSK004					
KX 420 A1/A2	80-81	CK4439		CSK006					CT006
EN 450 A1-A5 (LTD 454)	86-89	CK4424		CSK010			SRC011	SRK011	CT016
KFX 450 R Quad (KSF 450 B8F/B9F/BAF/BBF/BCS)	08-12	CK4519		CSK177	DRC185				CT006
KLX 450 R (A8F/A9F/AAF/ABF)	08-12	CK1247	CKF1247	CSK180	DRC158	DRCF158			CT006
KX 450 F (D6F/D7F/D8F/E9F/EAF/EBF)	06-11	CK1247	CKF1247	CSK180	DRC158	DRCF158			CT006
KX 450 F (FCF/FDF)	12-13	CK1247	CKF1247	CSK029	DRC269	DRCF269			CT006
EN 500 A1-A4/B1/B2/C1-C9	90-04	CK4424		CSK010			SRC011	SRK011	CT016
ER-5 (ER 500 A1/A2/A3/A4/C1-C5P)	97-07	CK4424		CSK010			SRC011	SRK011	CT016
EX 500 A1-A6/D1-D7 (GPz 500 S)	87-02	CK4424		CSK010			SRC011	SRK011	CT016
GPZ 500 (S) (EX 500 B1-B5)	88-93	CK4424		CSK010			SRC011	SRK011	CT016
GPZ 500 (S) (EX 500 E1-E10)	94-04	CK4424		CSK010			SRC011	SRK011	CT016
H1 500 Mach 111	69-70	CK4425		CSK007					CT004
H1-A 500 S Mach 111	71	CK4425		CSK007					CT004
H1-B/C 500 Mach 111	72	CK4425		CSK007					CT004
H1-D/E/F 500	73-75	CK4425		CSK007					CT004
KH 500 A8	76	CK4425		CSK007					CT004
KX 500 A1/A2	83-84	CK4433		CSK010					CT006
KX 500 B1/B2	85-86	CK4459		CSK010	DRC038				
KX 500 C1/D1	87-88	CK4475		CSK010	DRC016				CT006
KX 500 E1-E16	89-04	CK4475		CSK010	DRC016				CT006
KLE 500 A1-A12	91-04	CK4424		CSK010	DRC064				CT016
KLE 500 B1P/B6F/B7F	05-07	CK4424		CSK010	DRC064				CT016
Z 500 A1-A3/B1/B2	79-81	CK4424		CSK010			SRC011	SRK011	CT016
GT 550 G1-G9	83-01	CK4424		CSK010			SRC011	SRK011	CT016
GPz 550 D1/H1/H2/A1-A4	81-87	CK4424		CSK010			SRC011	SRK011	CT016
ZR 550 A1/A2 (Z 550 F)	83-84	CK4424		CSK010			SRC011	SRK011	CT016
ZR 550 B2-B6 Zephyr	91-99	CK4424		CSK010			SRC044	SRK044	CT016
Z 550 C1/C2 (Ltd)	80-81	CK4424		CSK010			SRC011	SRK011	CT016
KL 600 A1 (KLR 600)	84	CK4424		CSK010			SRC011	SRK011	CT016
KLR 600 B1/B2/B4/B6-B9	85-94	CK4424		CSK010			SRC011	SRK011	CT016
GPz 600 R A1-A6	85-89	CK4424		CSK010			SRC011	SRK011	CT016
GPX 600 R (C1-C3/C6-C7)	88-96	CK4424		CSK010			SRC044	SRK044	CT016
ZL 600 B1	95-97	CK4424		CSK023			SRC044	SRK044	CT016
ZZR 600 D1/D2/D2A/D3	90-92	CK4424		CSK010			SRC022	SRK022	CT016
ZZR 600 (ZX 600 E1-E13)	93-05	CK4424		CSK043			SRC043	SRK043	CT016
ZZR 600 (ZX 600 E6F)	06-07	CK4424		CSK043			SRC043	SRK043	CT016
ZX 6 R F1/F2/F3/G1/G2	95-99	CK4503		CSK056			SRC038	SRK108	CT004
ZX 6 R (ZX 600 J1/J2)	00-01	CK4503		CSK056			SRC038	SRK038	CT004
ZX 6 R (ZX 600 P7F/P8F/RF9/RAF/RBF/RCF/RDF 599cc)	07-13	CK4514	CKF4514	CSK165			SRC101	SRK101	CT004
ZX 6 R (ZX 636 A1P) 636cc	02	CK4503		CSK056			SRC038	SRK038	CT004
ZX 6 R (ZX 636 B1/B2)	03-04	CK4503		CSK056			SRC038	SRK038	CT004
ZX 6 R (ZX 636 C1/C6F)	05-06	CK4514	CKF4514	CSK117			SRC084	SRK084	CT004
ZX 6 R (ZX 636 EDF - Non ABS - 636cc)	13	CK4514	CKF4514	CSK202					CT004
ZX 6 R (ZX 636 FDF - ABS - 636cc)	13	CK4514	CKF4514	CSK202					CT004
ZX 6 RR (ZX 600 K1)	03	CK4503		CSK099			SRC076	SRK076	CT004
ZX 6 RR (ZX 600 M1)	04	CK4514	CKF4514	CSK099			SRC083	SRK083	CT004
ZX 6 RR (ZX 600 N1/N6F)	05-06	CK4514	CKF4514	CSK117				SRK107	CT004
ER-6f (EX 650 A6F/A7F/A8F/C9F/CAF/CBF)	06-11	CK4424		CSK010			SRC022	SRK102	CT016
ER-6f (ABS Model) (EX 650 B6F/B7F/B8F/D9F/DAF/DBF)	06-11	CK4424		CSK010			SRC022	SRK102	CT016
ER-6f - FCF/FDF (Double Pipe Type Frame/ABS Model)	12-13	CK4424		CSK010			SRC022	SRK102	CT016
ER-6f - ECF/EDF (Double Pipe Type Frame/Non ABS Model)	12-13	CK4424		CSK010			SRC022	SRK102	CT016
ER-6n (ER 650 A6F/A7F/A8F/C9F/CAF/CBF)	06-11	CK4424		CSK010			SRC022	SRK102	CT016
ER-6n (ABS) ER 650 B6F/B7F/B8F/D9F)	06-09	CK4424		CSK010			SRC022	SRK102	CT016
ER-6n - FCF/FDF (Double Pipe Type Frame/ABS Model)	12-13	CK4424		CSK010			SRC022	SRK102	CT016
ER-6n - ECF/EDF (Double Pipe Type Frame/Non ABS Model)	12-13	CK4424		CSK010			SRC022	SRK102	CT016
KLE 650 A7F/A8F/A9F/CAF (Versys)	07-10	CK4424		CSK010			SRC022	SRK102	CT016
KLE 650 B7F/B8F/B9F/DAF (Versys ABS)	07-10	CK4424		CSK010			SRC022	SRK102	CT016
KLE 650 CBF/CCF/CDF (Versys / Non ABS)	11-13	CK4424		CSK010					CT016
KLE 650 DBF/DCF/DDF (Versys / ABS)	11-13	CK4424		CSK010					CT016
KLR 650 A1-A3	87-89	CK4424		CSK007	DRC065				CT016
KLR 650 (KL 650 E8F/E9F)	08-09	CK4435	CKF4435	CSK010	DRC168				CT016
KL 650 B1/B2/B3 Tengai	89-92	CK4424		CSK007	DRC065				CT016
KLX 650 C1/C2/C3	93-97	CK4424		CSK007	DRC065				CT016
KLR 650 C1-C10	95-04	CK4435	CKF4435	CSK030	DRC168				CT016
W 650 (EJ 650 A1/C3-C7)	99-05	CK4435	CKF4435	CSK010			SRC046	SRK046	CT016
Z 650 B/B2/B3	77-79	CK4413		CSK007					CT019
Z 650 C1/C2/C3 Custom	77-79	CK4413		CSK010					CT019
Z 650 D2/D3	79-80	CK4413		CSK010					CT019
Z 650 F1/F2/F3/F4	80-83	CK4413		CSK010					CT019
Z 700 A1 Ltd	84	CK4413		CSK007					CT019
ZN 700 A1/A2 Ltd	84-85	CK4413		CSK007					CT019
VN 700 A1 Vulcan	85	CK4435	CKF4435	CSK007			SRC053	SRK053	CT016

CLUTCH APPLICATIONS



# EBC CLUTCH KITS

Make & Model	Year	CK Series #	CKF Series #	Spring Kit #	DRC Series #	DRCF Series #	SRC Series #	SRK Series #	CT Tool #
<b>KAWASAKI Contd.</b>									
GPX 750 F1/F2/F2A/F3	87-89	CK4435	CKF4435	CSK007			SRC053	SRK053	CT016
GPz 750 R1	82	CK4413		CSK010					CT019
GPz 750 A1-A5	83-87	CK4413		CSK010					CT019
GPz 750 R G2/G3	85-86	CK4435	CKF4435	CSK010					CT016
GT 750 P1-P5	82-90	CK4413		CSK007					CT019
GT 750 P7/P9	92-96	CK4493		CSK023					CT019
H2/H2-A Mach IV (750cc)	72-73	CK4415		CSK023					CT004
H2-B/H2-C Mach IV (750cc)	74-75	CK4523		CSK023					CT004
VN 750 A2/A3/A4/A5/A10	86-94	CK4435	CKF4435	CSK007			SRC053	SRK053	CT016
Z 750 B1/B2	77-78	CK4435	CKF4435	CSK010			SRC046	SRK046	CT016
Z 750 D1	76	CK4435	CKF4435	CSK007			SRC053	SRK053	CT016
Z 750 N1/N2 Spectre	82-83	CK4413		CSK007					CT019
Z 750 (ZR 750 J1/J2/J6F)	04-06	CK4503		CSK056			SRC038	SRK038	CT004
ZR 750 C1/C2/C3/C4 Zephyr	91-95	CK4493		CSK010					CT019
ZR 750 C5/D1 Zephyr	95-98	CK4493		CSK038					CT019
ZR7 (ZR 750 F1/F3/F5)	99-04	CK4493		CSK038					CT019
ZR-7S (ZR 750 H1/H2)	01-04	CK4493		CSK038					CT019
Z 750 E1/H1/H2/L1-L4	80-84	CK4413		CSK007					CT019
Z 750 Y1 (Ltd)	82	CK4435	CKF4435	CSK007			SRC053	SRK053	CT016
Z 750 S (ZR 750 K1/K6)	05-07	CK4503		CSK056			SRC038	SRK038	CT004
Z 750 (ZR 750 L7F/L8F/L9FLAF)	07-10	CK4503		CSK056			SRC038	SRK038	CT004
Z 750 ABS (ZR 750 M7F/M8F/M9F)	07-09	CK4503		CSK056			SRC038	SRK038	CT004
Z 750 R Non ABS (ZR 750 NBF/NCF)	11-12	CK4503		CSK056			SRC038	SRK038	CT004
Z 750 R Black Edition (ZR 750 NBFA)	12	CK4503		CSK056			SRC038	SRK038	CT004
Z 750 R ABS (ZR 750 PBF/PCF)	11-12	CK4503		CSK056			SRC038	SRK038	CT004
ZX 750 E1/E2 (Turbo)	84-87	CK4443		CSK010					CT019
ZXR 750 H1/H2	89-90	CK4424		CSK023					CT016
ZXR 750 J1/J2/L1-L3/P1-P7	91-03	CK4435	CKF4435	CSK088			SRC024	SRK024	CT016
ZXR 750 R (ZX 750 K1/K2/M1/M2)	91-94	CK4435	CKF4435	CSK088			SRC024	SRK024	CT016
ZX7 RR (ZX 750 N1/N2)	96-99	CK4435	CKF4435	CSK038			SRC041	SRK041	CT016
VN 800 A1-A3/B1-B10/B6F	95-06	CK4435	CKF4435	CSK010			SRC046	SRK046	CT016
VN 800 C1/C2/E1/E2/E3 Drifter	99-04	CK4435	CKF4435	CSK007			SRC053	SRK053	CT016
EJ 800 ABF/ACF (W800 Solid Front Disc)	11-12	CK4435	CKF4435	CSK010			SRC046	SRK046	CT016
EJ 800 W 800 Cafe Style/Cockpit Fairing)	11	CK4435	CKF4435	CSK010			SRC046	SRK046	CT016
EJ 800 ACF/AW 800 Special Edition (Black Exhaust/Gold Rims)	12	CK4435	CKF4435	CSK010			SRC046	SRK046	CT016
EJ 800 ADF (W800)	13	CK4435	CKF4435	CSK010			SRC046	SRK046	CT016
Z1/Z1 A/Z1 B	74-76	CK4409		CSK010					CT019
Z 900 A4/A5	76-77	CK4409		CSK010					CT019
ZL 900 A1/A2 Eliminator	85-86	CK4434		CSK023			SRC020	SRK020	CT016
GPz 900 R A1-A8	84-96	CK4435	CKF4435	CSK010			SRC046	SRK046	CT016
GPZ 900 R (ZX 900 A11)	98	CK4435	CKF4435	CSK010			SRC046	SRK046	CT016
GPZ 900 R (ZX 900 A12-15)	99-02	CK4435	CKF4435	CSK010			SRC046	SRK046	CT016
VN 900 A6F Classic	06	CK4435	CKF4435	CSK010			SRC046	SRK046	CT016
VN 900 B7F/B8F/B9F/BAF/BBF/BCF/BDF (Classic) (Spoke wheel)	07-13	CK4435	CKF4435	CSK010			SRC046	SRK046	CT016
VN 900 BBFA/BCFA/BDFA (Classic Special Edition /White Wall Tyres) (Spoke wheel)	11-13	CK4435	CKF4435	CSK010			SRC046	SRK046	CT016
VN 900 C7F/C8F/C9F/CAF/CBF/CCF/CDF (Custom) (Cast wheel)	07-13	CK4435	CKF4435	CSK010			SRC046	SRK046	CT016
ZX-9 R (ZX 900 B1-B4)	94-97	CK4435	CKF4435	CSK038			SRC041	SRK041	CT016
ZX 9 R (ZX 900 C1/C2/E1/E2/F1/F2)	98-04	CK4510		CSK067			SRC059	SRK059	CT004
KLZ 1000 ACF/ADF - Versys	12-13	CK4510		TBA					CT004
KLV 1000 (LV 1000 A1H/A2H)	04-05	CK3443		CSK043					CT021
Z 1000 D1-D3 Z1R	78-80	CK4409		CSK007					CT019
Z 1000 E1/E2 (ST-Shaft)	79-80	CK4434		CSK023			SRC020	SRK020	CT016
Z 1000 A1/A2/A3/A4	77-80	CK4409		CSK010					CT019
Z 1000 H1	80	CK4409		CSK010					CT019
Z 1000 K1/K2 (Ltd)	81-82	CK4434		CSK010			SRC054	SRK054	CT016
Z 1000 J1/J2/J3	81-83	CK4434		CSK010			SRC054	SRK054	CT016
Z 1000 R1/R2 (Eddie Lawson Replica)	83	CK4434		CSK010			SRC054	SRK054	CT016
Z 1000 (ZR 1000 A1/A2/A3/A6F)	03-06	CK4510		CSK067			SRC059	SRK059	CT004
GPz 1000 RX A1-A3	86-88	CK4434		CSK023			SRC020	SRK020	CT016
1000 GTR (ZG 1000 A1-A18)	86-03	CK4434		CSK023			SRC020	SRK020	CT016
Z 1000 (ZR 1000 B7F/B8F)	07-08	CK4510		CSK110					CT004
Z 1000 ABS (ZR 1000 C7F/C8F/C9F)	07-09	CK4510		CSK110					CT004
Z 1000 (ZR 1000 DAF/DBF/DCF/DDF)	10-13	CK4510		CSK169					CT004
Z 1000 Black Edition (ZR 1000 DCF/DDFA)	12-13	CK4510		CSK169					CT004
Z 1000 SX ABS Model (ZR 1000 HBF/HCF/HDF)	11-13	CK4510		CSK169					CT004
Z 1000 SX Non ABS Model (ZR 1000 GBF/GCF/GDF)	11-13	CK4510		CSK169					CT004
ZX 10 B1/B2/B3	88-90	CK4434		CSK023			SRC020		CT016
ZX 10R (ZX 1000 C1/C2)	04-05	CK4510		CSK111			SRC079	SRK079	CT004
ZX 10R (ZX 1000 D6F/D7F/E8F/E9F/FAF)	06-10	CK4510		CSK111			SRC079	TBA	CT004
ZX 10R ABS (ZX 1000 KBF/KCF/KDF)	11-13	CK4510		CSK111			SRC079	TBA	CT004



# EBC CLUTCH KITS

Make & Model	Year	CK Series #	CKF Series #	Spring Kit #	DRC Series #	DRCF Series #	SRC Series #	SRK Series #	CT Tool #
<b>KAWASAKI Contd.</b>									
ZX 10R (ZX 1000 JBF/JCF/JDF)	11-13	CK4510		CSK111			SRC079	TBA	CT004
ZL 1000 A1	87	CK4434		CSK023			SRC020	SRK020	CT016
GPz 1100 B1/B2	81-82	CK4434		CSK010			SRC054	SRK054	CT016
GPz 1100 A1-A3	82-85	CK4434		CSK023			SRC020	SRK020	CT016
Z 1100 R1	84	CK4434		CSK023			SRC020	SRK020	CT016
Z 1100 A1-A3	81-83	CK4434		CSK023			SRC020	SRK020	CT016
Z 1100 D1/D2 Spectre	82-83	CK4434		CSK023			SRC020	SRK020	CT016
ZR 1100 A1/A2/A3/A4/B1	92-97	CK4434		CSK023			SRC020	SRK020	CT016
ZR 1100 B5 (Zephyr 1100 RS)	02	CK4434		CSK023					CT016
ZRX 1100 (ZX 1100 C1/C2/C3/C4)	97-00	CK4434		CSK023			SRC020	SRK020	CT016
ZZ-R 1100 C1/C2/C2A/C3/D1-D9	90-01	CK4488		CSK029			SRC025	SRK025	CT021
ZX 1100 E1/E2/F1	95-98	CK4488		CSK029			SRC025	SRK025	CT021
ZRX 1200 R A1/A2/A3/A4/A5/A6F	01-08	CK4434		CSK038					CT016
ZRX 1200 S B1/B2/B3 (ZR 1200)	01-03	CK4434		CSK038					CT016
ZX 12R (ZX 1200 A1)	00	CK4513		CSK109					CT009
ZX 12 R (ZX 1200 A2/A3/A4/B1-B4/B6F)	01-06	CK4515		CSK109					CT009
ZZR 1200 C1H/C2H	02-04	CK4488		CSK029			SRC025	SRK025	CT021
Z 1300 A1-A3	79-81	CK4452		CSK010					
Z 1300 A4/A5	82-83	CK4458		CSK010					
ZG 1300 A1-A3	84-86	CK4455		CSK007					CT032
GTR 1400 (ZG 1400 A8F/A9F/CAF/CBF) ABS	08-11	CK4520		CSK023					CT021
GTR 1400 ABS (ZG 1400 CCF/CDF)	12-13	CK4520		CSK023					CT021
ZZR 1400 (ZX 1400 A6F/A7F)	06-07	CK4518		CSK124					CT021
ZZR 1400 ABS (ZX 1400 B6F/B7F)	06-07	CK4518		CSK124					CT021
ZZR 1400 ABS (ZX 1400 D8F/D9F/DAF/DBF)	08-11	CK4518		CSK124					CT021
ZZR 1400 FCF/FDF ABS	12-13	CK4518		CSK124					CT021
VN 1500 B2/C1/C2/D1	88-96	CK4455		N/A					CT032
VN 1500 B2-B6	88-92	CK4455		N/A					CT032
VN 1500 C1/C2	94-95	CK4455		N/A					CT032
VN 1500 D1/D2	96-98	CK4455		N/A					CT032
VN 1500 G1/G2	98-99	CK4455		N/A					CT032
VN 1500 E1/E2 Classic	98-99	CK4455		N/A					CT032
VN 1500 J1/J2/R1/R2/R3 Drifter	99-04	CK4455		N/A					CT032
VN 1500 N1/N2/N3 Classic Fi	00-04	CK4455		N/A					CT032
VN 1500 L1/L2/L3/L4 Nomad Fi	00-03	CK4455		N/A					CT032
VN 1500 P1/P2 Mean Streak	02-04	CK4455		N/A					CT032
VN 1600 A1/A2/A3/A6F Classic	03-08	CK4455		N/A					CT032
VN 1600 B1 Mean Streak	04	CK4455		N/A					CT032
VN 1600 B2H/B6F/B7F (Mean Streak)	05-08	CK4455		N/A					CT032
VN 1600 D1H/D6F Classic Tourer	05-08	CK4455		N/A					CT032
VN 1700 B9F/BAFBBF/BCF/BDF Voyager ABS	09-13	CK4516		CSK170					CT032
VN 1700 C9F Classic Tourer	09	CK4516		CSK170					CT032
VN 1700 DAF/DBF/DCF/DDF Classic Tourer ABS	10-13	CK4516		CSK170					CT032
VN 1700 E9F Classic	09	CK4516		CSK170					CT032
VN 1700 FAF/FBF/FCF/FDF Classic ABS	10-13	CK4516		CSK170					CT032
VN 1700 KBF/KCF/KDF Voyager Custom	11-13	CK4516		CSK170					CT032
VN 2000 A1/A2/A6F	04-07	CK4516		CSK110					CT032
VN 2000 H8F/H9F Classic	08-09	CK4516		CSK110					CT032
<b>SUZUKI</b>									
AP 50	-78	CK3311		CSK025					CT051
FR 50	81-	CK3393		N/A					
GS 50 K5 (NA41A)	05	CK3328		CSK013					CT011
GT 50 KB/KEN	77-80	CK3328		CSK001					CT011
JR 50 (All models)	78-07	CK3366		CSK002					
RM 50 C/N/T/X/Z	78-82	CK3328		CSK001					
OR 50 ET	80	CK3328		CSK001					CT011
RB 50 H	87	CK3380		CSK001					CT051
RG 50 EW		CK3349		CSK001					CT011
TS 50 KN/ERKT/ERKX/ERKZ/ERKD	79-83	CK3328		CSK001					CT011
TS 50 XKE/XKG/XKH/XKJ/XKM/XKR	84-02	CK3349		CSK001					CT011
TS 50 W		CK3349		CSK001					CT011
ZR 50 KEN/KEX	79-81	CK3328		CSK001					CT011
ZR 50 SLKX/SKX	81	CK3328		CSK001					CT011
ZR 50 SKE/SKH	84-87	CK3328		CSK001					CT011
RM 60 K3	03	CK4438	CKF4438	CSK018	DRC007				
RM 65 K3/K4/K5	03-05	CK4438	CKF4438	CSK040	DRC098	DRCF098			
DR-70 K8/K9/L0	08-12	CK3458		N/A					
DS 80 T/X/Z/D/F/G/H/J/K/L/M/N/P/R/S/T/V/W/X/Y	80-00	CK3340		CSK001					CT011
FR 80 M/B/N/X/Z/D	76-83	CK3378		N/A					
JR 80 K1/K2/K3/K4/K5/K6/K7	01-07	CK3340		CSK001					CT011
RM 80 B	77	CK3318	CKF3318	CSK001					CT011
RM 80 C/N/XT/XX	78-81	CK3318	CKF3318	CSK001					CT011

CLUTCH APPLICATIONS

# EBC CLUTCH KITS

Make & Model	Year	CK Series #	CKF Series #	Spring Kit #	DRC Series #	DRCF Series #	SRC Series #	SRK Series #	CT Tool #
<b>SUZUKI Contd.</b>									
RM 80 XZ	-82	CK3340		CSK036					CT011
RM 80 XD/HD	83	CK3340		CSK034					CT011
RM 80 XE/XF/HF	84-85	CK3318	CKF3318	CSK034					CT011
RM 80 XG	86	CK3367		CSK034					
RM 80 XH/XJ	87-88	CK3367		CSK055	DRC019				
RM 80 K/L	89-90	CK3318	CKF3318	CSK001	DRC020				CT011
RM 80 M/N/P/R/S/T/V/W/X/Y/K1	91-01	CK3318	CKF3318	CSK014	DRC025	DRCF025			CT011
RM 85 K2/LK2/K3/LK3/K4/LK4	02-04	CK3318	CKF3318	CSK014	DRC025	DRCF025			CT011
RM 85 K5/K6/K7/K8/K9/L0/L2 (Small 17" Front Wheel)	05-12	CK3318	CKF3318	CSK014	DRC025	DRCF025			CT011
RM 85 LK5/LK6/LK7/LK8/LK9/L0/L2 (Large 21" Front Wheel)	05-13	CK3318	CKF3318	CSK014	DRC025	DRCF025			CT011
FB 90 K1	01	N/A		N/A					
A 100 L/M/N	74-80	CK3312		CSK025					CT051
GP 100 C/UC	78	CK3319		CSK025					CT011
GP 100 N/UN	79	CK3318	CKF3318	CSK025					CT011
GP 100 X/UX/D/UD/UL	81-92	CK3339		CSK025					CT011
RM 100 A	76	CK3319		CSK025					CT011
RM 100 B/C	77-78	CK3329		CSK025					CT011
RM 100 N/T/X	79-81	CK3319		CSK025					CT011
RM 100 K3	03	CK4453	CKF4453	CSK041	DRC045	DRCF045			CT002
TS 100 K/L/M/A/B	73-77	CK3326		CSK025					CT051
TS 100 C	78	CK3318		CSK025					CT011
TS 100 ERN Upto F 300563	79	CK3318	CKF3318	CSK025					CT011
TS 100 ERN/ERT/ERX From F 300564	80-81	CK3337		CSK025					CT011
TS 100 ERZ/ERH	82	CK3318	CKF3318	CSK025					CT011
DR-Z 110 K3/K4/K5	03-05	CK4438	CKF4438	CSK040					
110cc Smash	03	CK4438	CKF4438	CSK010					
B 120		CK3306		CSK001					CT052
DF 125		CK3318	CKF3318	CSK034					CT011
DR 125 SZ/SD/SE/SF/SH/SJ	82-94	CK3318	CKF3318	CSK034					CT011
DR 125 SEX/SEY	99-01	CK3318	CKF3318	CSK034					CT011
DR 125 SMK8/SMK9/SML0	08-12	CK3337		CSK034					CT011
DR-Z 125 K3/K4/K5/K6/K7/K8/K9	03-12	CK3318	CKF3318	CSK034					CT011
DR-Z 125 LK3/LK4/LK5/LK6/LK7/LK8/LK9	03-13	CK3318	CKF3318	CSK034					CT011
FX 125		CK3318	CKF3318	CSK034					CT011
GN 125 R/V/W/X/Y/K1 (NF41A)	94-01	CK3318	CKF3318	CSK034					CT011
GN 125 ER/EV/EW/EX/EY/EK1 (NF41A)	94-01	CK3318	CKF3318	CSK034					CT011
GN 125 Z/D/K (Gold cast wheel/Aisin caliper)	82-90	CK3318	CKF3318	CSK034					CT011
GN 125 HS (LC6PCJB1/Chinese Production)	00-11	CK3318	CKF3318	CSK034					CT011
GP 125 C/N	78-79	CK3319		CSK025					CT011
GP 125 X/XD	81-84	CK3338		CSK025					CT011
GS 125 Z/D/ESZ/ESD/ESF/ESK/ESM/ESR/ESX	82-00	CK3318	CKF3318	CSK034					CT011
GT 125 L/M/A/B/C/EC	74-78	CK3318	CKF3318	CSK025					CT011
GT 125 EN	79	CK3337		CSK025					CT011
GZ 125 W/X/Y/K1-K9 Marauder	98-11	CK3318	CKF3318	CSK034					CT011
LT 125 D/E/F/G/H	84-86	CK3328		N/A					CT011
RG 125 CG/CH/J (NF12A)									
(Gamma/Rear Drum Brake Model)	86-90	CK3319		CSK025					CT011
RG 125 UCG/UCH/UCJ/BUJ (NF12B)									
(Gamma/Rear Drum Model)	86-90	CK3319		CSK025					CT011
RG 125 FN/FP/FR Gamma (NF13A/Rear Disc Model)	92-94	CK3319		CSK146					CT011
RG 125 FUN/FUP/FUR Gamma (NF13B/Rear Disc Model)	92-94	CK3319		CSK146					CT011
RG 125 UN - Wolf (NF13E/Naked)	92-94	CK3319		CSK146					CT011
RM 125 A/B/C	76-78	CK3329		CSK025					CT011
RM 125 N/T	79-80	CK3319		CSK025					CT011
RM 125 X/Z	81-82	CK3329		CSK036					CT011
RM 125 D	83	CK3329		CSK034					CT011
RM 125 E	84	CK3356		CSK034					CT011
RM 125 F	85	CK3329		CSK034					CT011
RM 125 G/H	86-87	CK3319		CSK001	DRC021				CT011
RM 125 J/K/L/M	88-91	CK3356		CSK053	DRC022				CT011
RM 125 N	92	CK3401		CSK032	DRC114				CT003
RM 125 P/R/S/T/V/W	93-96	CK3401		CSK027	DRC076S				CT003
RM 125 X/Y/K1	97-01	CK3401		CSK091	DRC115				CT003
RM 125 K2/K3/K4/K5/K6/K7/K8/K9	02-12	CK4514	CKF4514	CSK091	DRC130	DRCF130			CT003
RM 125 XCK8	09	CK4514	CKF4514	CSK091	DRC130	DRCF130			CT003
RV 125 K2/K3/K4/K5/K6/K7/K8/K9/L0 Van-Van	02-13	CK3318	CKF3318	CSK034					CT011
T 125/125-11/R Stinger	69-71	CK3306		CSK025					CT052
TF 125 Farm Bike (All models)	78-05	CK3318	CKF3318	CSK025					CT011
TS 125 K/L/M/A/B/C/C2	73-78	CK3318	CKF3318	CSK025					CT011
TS 125 ERN Up to F No 302345	79	CK3318	CKF3318	CSK025					CT011
TS 125 ERN From F No 302346	79	CK3337		CSK025					CT011
TS 125 ERT/ERX	80-81	CK3337		CSK025					CT011
TS 125 ERZ	82	CK3318	CKF3318	CSK025					CT011

# EBC CLUTCH KITS

Make & Model	Year	CK Series #	CKF Series #	Spring Kit #	DRC Series #	DRCF Series #	SRC Series #	SRK Series #	CT Tool #
<b>SUZUKI Contd.</b>									
TS 125 N to Frame No.178871	84	CK3318	CKF3318	CSK025					CT011
TS 125 N from Frame No.178872	84	CK3337		CSK025					CT011
TS 125 XUE/XUF/XUG/XUH/XUJ	84-90	CK3319		CSK025					CT011
TS 125 RK/RL/RM/RN/RR	90-94	CK3319		CSK146					CT011
TU 125 X Super Classic	99	TBA		TBA					
VL 125 Y/K1-K7 Intruder	00-08	CK3432		CSK006					CT029
X4 125		TBA		TBA					
LT 160 EK/EL/EM/EN	89-92	CK3364		CSK048	DRC218				CT011
LT-F 160 L/M/N/P/R/S/T/V/W/X/Y/K1-K3	90-03	CK3364		CSK048	DRC218				CT011
LT 160 K3/K4 QuadSport	03-04	CK3364		CSK048	DRC218				CT011
PE 175 C/N/T/X/Z	78-82	CK3329		CSK025					CT011
GT 185 K/L/M/A/B/C/EC	73-79	CK3319		CSK025					CT011
LT 185 E/F	84-85	CK3328		N/A					CT011
TS 185 K/L/M	73-75	CK3319		CSK025					CT011
TS 185 B/C	77-78	CK3319		CSK025					CT011
TS 185 ERN/ERT/ERX	79-81	CK3319		CSK025					CT011
DF 200 EV/EW/EY (SH42A)	98-99	CK3319		CSK034	DRC274				CT011
DR 200 G/H/J	86-89	CK3319		CSK034	DRC094				CT011
DR 200 SEP/SER/SES/SEV/SEW/SEX/SEY (SH42A) Djebel	93-00	CK3319		CSK034	DRC274				CT011
DR 200 SE Trojan		CK3319		CSK034	DRC274				CT011
DR 200 SEK1-SEK9	01-09	CK3319		CSK034	DRC274				CT011
GT 200 EN/EX X5	79-80	CK3319		CSK025					CT011
RV 200 K2/K3	02-03	CK3319		CSK034	DRC274				CT011
SB 200 N/X	79-80	CK3319		CSK025					CT011
SX 200 R/R-Z/RJ/RM	90-91	CK3319		CSK034					CT011
TS 200 RK/RL/RM/RN/RR	89-94	CK3329		CSK034					CT011
LT 230 GEF/GEG	85-86	CK3364		CSK048	DRC218				CT011
LT-F 230 G/H	86-87	CK3364		CSK048	DRC218				CT011
DR 250 RS/RLS/RT/RV/RLV/RW/RLW/RY (SJ45A/DOHC)	95-00	CK1181		CSK046					CT013
DR 250 RXT/RXL/RXV/RXLV/RXW/RXLW/RXGW/RXGLW /RXY/RXGY Djebel 250 XC/GPS Ver (SJ45A)		CK1181		CSK046					CT013
DR 250 SL/SM/SN/SEP/SER/SES (SJ 44 A)	90-95	CK3399	CKF3399	CSK034	DRC058	DRCF058			CT022
DR-Z 250 K1-K7 (DJ 43 A)	01-07	CK1181		CSK046					CT013
GS 250 TT/TX	80-81	CK3329		CSK036					CT011
GSF 250 N/ZM/P/NP/ZP/RN (GJ74A)	92-96	CK3319		CSK036					CT011
GSF 250 VS/VT/VV/VVZ/VW/VX/VY Bandit (GJ77A)	95-00	TBA		TBA					
GSX 250 ET/EX/EZ	80-82	CK3329		CSK036					CT011
GSX 250 FL/FM/FN/FP/FR/FS/FT/FV/FW - Across	90-98	TBA		TBA					
GSX 250 RCH/RH (GJ72A)		CK3319		CSK036					CT011
GSX 250 SSM Katana (GJ76A)	91	CK3339		CSK036					CT011
GSX 250 FXK2/F3/F4/F5 (ZR 250C)	02-05	CK4508		CSK007					
GSXR 250 CJ (GJ72A)		CK3319		CSK036					CT011
GSXR 250 CK (GJ72A)		CK3319		CSK036					CT011
GSXR 250 RK (GJ73A)	89	CK3339		CSK036					CT011
GN 250 F/J/M/R/T (NJ41A)	85-97	CK3358		CSK006					CT029
GT 250 K/L	73-74	CK3313		CSK006					CT046
GT 250 M/A-C	75-78	CK3315		CSK006					CT022
GT 250 EN/ET/EX X7	79-81	CK3315		CSK006					CT022
GW 250 L3 Inazuma	13	CK3358		CSK204					
GZ 250 X/Y/K1-K8 Marauder	99-08	CK3358		CSK068					CT029
LT-F 250 J/K/L/M/N/P/R/S/T/V/W/Y/K1	89-01	CK3390		CSK048	DRC089				CT011
LT-F4WD H/J/K/L/M/N/P/R/S/T/V/W	87-98	CK4523		CSK048	DRC089				
LT 250 RH/RJ/RK	87-90	CK3372		CSK034	DRC023				CT022
LT 250 EFF/EFG	85-86	CK3390		CSK048	DRC089				CT011
LT-F 250 FX/FY/FK1/FK2	99-02	CK3390		CSK048	DRC089				CT011
LT-F 250 K2 Ozark (Up to F/No JSAAJ51A22100696)	02	CK3364		CSK048	DRC220				CT011
LT-F 250 K2 Ozark (From F/No JSAAJ51A22100697-)	02	CK3364		CSK147	DRC213				CT011
LT-F 250 K3 Ozark	03	CK3390		CSK147	DRC221				CT011
LT-F 250 K4 Ozark	04	CK3448		CSK148	DRC222				
LT-F 250 K5/K6/K7/K8/K9/L2 Ozark	05-12	CK3390		CSK147	DRC221				CT011
LT-Z 250 K4/K5/K6/K7/K8/K9/L0 QuadSport	04-12	CK3448		CSK048	DRC222				
250 SBK2 (LX 250 L)	02	CK4469		CSK001					CT042
PE 250 B/C/N	77-79	CK3334		CSK006					CT022
PE 250 T/X/Z	80-82	CK3331		CSK006					CT022
RG 250 WD	83	CK3384		CSK006					CT022
RG 250 WE	84	CK3351		CSK006					CT022
RG 250 FG/FH/CH/FCH	85-88	CK3351		CSK006					CT022
RGV 250 J	88	CK3351		CSK007					CT022
RGV 250 K/L (VJ21A)	89-90	CK3351		CSK007					CT022
RGV 250 M/N/P/R/S (VJ22A)	91-95	CK3333		CSK007					CT022
RGV 250 T (RGVR 250 SP) VJ23A - Dry Clutch	96	CK1288		CSK167					
RL 250 L/M	74-75	CK3315		N/A					CT022
RL 250 Beamish Model Reed Valve Engine	78-82	CK3343		CSK006					CT018SP

# EBC CLUTCH KITS

Make & Model	Year	CK Series #	CKF Series #	Spring Kit #	DRC Series #	DRCF Series #	SRC Series #	SRK Series #	CT Tool #
<b>SUZUKI Contd.</b>									
RM 250 A/B/C	76-78	CK3334		CSK006					CT022
RM 250 N/T/X/Z/D/E/F	79-85	CK3331		CSK006					CT022
RM 250 G	86	CK3372		CSK034					CT022
RM 250 H	87	CK3372		CSK055	DRC052				CT022
RM 250 J/K/L	88-90	CK3374		CSK027	DRC024				CT022
RM 250 M	91	CK3374		CSK045	DRC040				CT022
RM 250 N/P	92-93	CK3400		CSK032	DRC048				CT022
RM 250 R/S	94-95	CK3374		CSK032	DRC072				CT022
RM 250 T	96	CK4435	CKF4435	CSK032	DRC080				CT016
RM 250 V/W/X/Y/K1/K2	97-02	CK4435	CKF4435	CSK091	DRC095				CT016
RM 250 K3/K4/K5	03-05	CK3454		CSK091	DRC161				CT016
RM 250 K6/K7/K8/K9	06-12	CK3453		CSK119	DRC160				CT016
RM 250 XCK8	09	CK3453		CSK119	DRC160				CT016
RMX 250 K/L	89-90	CK3374		CSK027					CT022
RMX 250 M	91	CK3374		CSK045					CT022
RMX 250 N/P	92-93	CK3400		CSK032					CT022
RMX 250 R/S/T/V/W	94-98	CK3374		CSK032	DRC072				CT022
RMX 250 SN/SR/S-S (SJ13A)	95-97	CK3437		N/A					CT022
RMX 250 ST/SV/SW/SX (SJ14A)	96-99	CK3374		CSK032	DRC072				CT022
RM-Z 250 K4/K5/K6	04-06	CK4514	CKF4514	CSK097	DRC123	DRCF123			CT004
RM-Z 250 K7/K8/K9	07-09	CK4514	CKF4514	CSK141	DRC189	DRCF189			CT004
RM-Z 250 L0/L1/L2/L3	10-13	CK4514	CKF4514	CSK164	DRC255	DRCF255			CT004
SW-1 (NJ45A)	92	CK3358		CSK006					CT029
T 20 Super Six	66-68	CK3310		CSK076					CT038SP
T 250 II/R/J	70-72	CK3313		CSK006					CT046
TS 250 K/L/M/A/B/C/ERN/ERT/ERX	73-81	CK3315		CSK006					CT022
TS 250 XE/XG/XH/XJ/XK	85-89	CK3319		CSK034					CT011
TU 250 T/XS/XT/X-ST/XSV Volty	92-97	CK3358		CSK006					CT029
TU 250 XT/X/XTY (NJ45A-115-) Volty	99-00	CK3358		CSK068					CT029
TU 250 GY/GBK1 Grass Tracker Big Boy (NJ47A-117/123)	00-01	CK3358		CSK068					CT029
TV 250 J/K/RK/L (VJ21A) Wolf	88-90	CK3351		CSK007					CT022
VL 250 Y/K1/K5/K6/K7 Intruder	00-01/05-07	CK3358		CSK068					CT029
LT-F 300 J/K	88-89	CK3390		CSK048	DRC089				CT011
LT-F4WDX M/N/P/R/S/T/V/W 300 Quadrunner	91-98	CK3356		CSK048	DRC103				CT011
TU 250 XV/XW	97-00	CK3358		CSK006					CT029
LT-F 300 FX/FY/FK1	99-01	CK3356		CSK048	DRC103				CT011
RL 325 Beamish Model Reed Valve Engine	78-82	CK3343		CSK006					CT018SP
DR 350 SL/SM/SN/SP/SER/SES/SET/SEV/SEW/SEX	90-99	CK3399	CKF3399	CSK034	DRC058	DRCF058			CT022
SG 350 N Goose	92	CK3399	CKF3399	CSK034					CT022
T 350 1/2/R/J	69-72	CK3313		CSK006					CT046
SP 370 C/N	78-79	CK3334		CSK006					CT022
GT 380 K-M/A/B	73-77	CK3315		CSK006					CT022
DR 400 ST/SX	80-81	CK3332		CSK006					CT022
DR-Z 400 SY/EY/YSK1/EK1/K1/SK2/EK2/K2/SK3/EK3/K3/SK4									
/EK4/K4/EK5/SK5/K6/SK6/EK6/SK7/EK7/K7/SK8/SK9	00-09	CK3433	CKF3433	CSK079	DRC105	DRCF105			CT006
DR-Z 400 SMK5/SMK6/SMK7/SMK8/SMK9	05-09	CK3433	CKF3433	CSK079	DRC105	DRCF105			CT006
GN 400 TT	80	CK3332		CSK006					CT022
GS 400 B/C	77-78	CK3343		CSK006					CT018SP
GSF 400 M/N/P	91-95	CK3397		CSK034					CT011
GSF 400 K/NK/Z/V/M/VZM/P/NP/VPVZR/VR Bandit (GK75A)	89-94	CK3397		CSK034					CT011
GSF 400 V/V/S/V-V/VZ-V Bandit (GK7AA)		CK3397		CSK034					CT011
GSX 400 ET/EX/EZ	80-82	CK3333		CSK006					CT022
GSX 400 FEX/FZ/FD	81-83	CK3332		CSK006					CT022
GSX 400 FW/FWS/FWS-2		CK3332		CSK006					CT022
GSX 400 R2 (GK71B)		CK3385		CSK034					CT011
GSX 400 R3 (GK71F)		CK3385		CSK034					CT011
GSX 400 FJ/FK/FAK/FL (GK74A)	88-90	CK3397		CSK034					CT011
GSX 400 X/XA/XS Impulse		CK3385		CSK034					CT011
GSX 400 R/S/T/X/ZR/ZS/ZT Impulse Type S	94-99	CK1177		CSK006					CT002
GSX 400 TX/LX	81	CK3333		CSK006					CT022
GSX 400 FSV/FSK1 (GK7BA) Inazuma	00	CK3359		CSK006					CT047SP
GSX 400 SSN (GK77A) Katana	92	CK3441		TBA					
GSX R 400 H	87	CK3385		CSK034					CT011
GSXR 400 J/RR/RAK (GK73A)	88-90	CK3397		CSK034					CT011
GSXR 400 RL/RM/RN/RS (GK76A)	90-95	CK3397		CSK034					CT011
GSR 400 K6/K7/K8	06	CK1218		CSK075					CT014
LT-F 400 K2 (Eiger)	02	CK4439		CSK098	DRC223				CT006
LT-F 400 FK2-FK7 (Eiger 4WD)	02-07	CK4439		CSK098	DRC120				CT006
LT-F 400 FK8/FK9/FL0/FL1 King Quad 4WD	08-12	CK4439		CSK098	DRC120				CT006
LT-F 400 K3-K7 Eiger 2WD	03-07	CK4439		CSK098	DRC120				CT006
LT-Z 400 K3/K4	03-04	CK3433	CKF3433	CSK079	DRC105	DRCF105			CT006
LT-Z 400 K5/K6/K7/K8/K9/L0L1 QuadSport	05-12	CK3447	CKF3447	CSK079	DRC137	DRCF137			CT006
PE 400 T/X	80-81	CK3332		CSK006					CT022

# EBC CLUTCH KITS

Make & Model	Year	CK Series #	CKF Series #	Spring Kit #	DRC Series #	DRCF Series #	SRC Series #	SRK Series #	CT Tool #
<b>SUZUKI Contd.</b>									
RF 400 RP/RR/VR/RT/RVT/RV-V (GK78A)		CK1177		CSK006					CT002
RG 400 EWF/EW-2G/EWH Walter Wolf	85-87	CK4503		CSK007					CT037SP
RM 400 C	78	CK3315		CSK006					CT022
RM 400 N/T	79-80	CK3332		CSK006					CT022
RV 400 RP/RR	93-	CK1177		CSK006					CT002
SP 400 T	80	CK3332		CSK006					CT022
ST 400 VW/X/Y/K1/K2/K3 Tempter	97-03	CK3359		CSK026					CT029SP
SV 400 N (VK53A)	98	CK3377		CSK069			SRC081	SRK081	CT033SP
SV 400 X/Y/K1/K2	99-02	CK3377		CSK069			SRC081	SRK081	CT033SP
SV 400 K3/K4/K5	03-05	CK1219		CSK133			SRC082	SRK082	CT033SP
SV 400 SN (VK53A)	98	CK3377		CSK069			SRC081	SRK081	CT033SP
SV 400 SX/SY/SK1/SK2	99-02	CK3377		CSK069			SRC081	SRK081	CT033SP
SV 400 SK3/SK4/SK5	03-05	CK1219		CSK133			SRC082	SRK082	CT033SP
VS 400 VR/FR/VTR/FTR/VT/FT Intruder	94-	CK3377		CSK026					CT029
GS 425 EN	79	CK3343		CSK006					CT018SP
GS 450 ET/EG/EJ	80-88	CK3333		CSK006					CT022
LT-R 450 K6/K7/K8/K9/L0/L1	06-12	CK3450	CKF3450	CSK125	DRC164	DRCF164			CT045
RM-X 450 ZL0	10-12	CK3450	CKF3450	CSK186	DRC155	DRCF155			CT045
RM-Z 450 K5/K6/K7	05-07	CK3450	CKF3450	CSK164	DRC254	DRCF254			CT045
RM-Z 450 K8/K9/L0/L1/L2/L3	08-13	CK3450	CKF3450	CSK186	DRC155	DRCF155			CT045
RM 465 X/Z	81-82	CK3348		CSK006					CT022
DR 500 X/Z/D	81-83	CK3359		CSK026					CT029SP
LT 500 RL/RM	90-91	CK3374		CSK034	DRC026				CT022
LT-F 500 FW/FX/FY/FK1/FK2	98-02	CK4439		CSK007	DRC217				CT006
LT-F 500 FK3-FK7	03-07	CK3452		CSK007					CT006
GS 500 EK/EL/EM/EN/EP/ER/ES/ET/EV/EW/EX/EY/K1/K2									
/K3/K4/FK4/F5/FK5/K6/FK6/K7/FK7/K8/FK8	89-08	CK3333		CSK061					CT022
GT 500 A/B	76-77	CK3316		CSK006					CT022
RE 5 M/A	75-76	CK3373		CSK006					CT035SP
RG 500 G/CH	85-87	CK4503		CSK098					CT037SP
RM 500 D/E	83-84	CK3348		CSK006					CT022
T 500 1/2/3 (18 ears)	68-70	CK3314		CSK006					CT046
T 500 R/J/K/L/M (12 ears)	71-75	CK3316		CSK006					CT022
GT 550 J/K/L/M/A/B	72-77	CK3321		CSK158					CT035SP
GS 550 DB/DC/EC/EN/ET/EX/EZ	77-82	CK3344		CSK006					CT018SP
GS 550 MX/MZ Katana	81-82	CK3344		CSK006					CT018SP
GS 550 LT/LX	80-81	CK3344		CSK006					CT018SP
GSX 550 ESD/ESE/EFF/EFE/ESH/EFG (GN71D)	84-87	CK3344		CSK006					CT018SP
DR 600 RG/RH/RJ/RK (SN41A)	86-89	CK3359		CSK098					CT029SP
DR 600 SF (SN41A)	85	CK3359		CSK115					CT029SP
DR 600 SG/SH/SJ/SK (SN41A)	86-89	CK3359		CSK098					CT029SP
GSF 600 S/T/V/W/X (Naked Bandit)	95-99	CK3348		CSK045					CT047SP
GSF 600 ST/SV/SW/SX (Faired Bandit)	96-99	CK3348		CSK045					CT047SP
GSF 600 Y/K1/K2/K3/K4 (Naked Bandit)	00-04	CK3348		CSK045					CT047SP
GSF 600 SY/SK1/SK2/SK3/SK4 (Faired Bandit)	00-04	CK3348		CSK045					CT047SP
GSR 600 K6/K7/K8	06-10	CK1218		CSK075					CT014
GSX 600 FJ/FK/FL/FM	88-91	CK3348		CSK026			SRC013	SRK013	CT047SP
GSX 600 FN/FP/FR/FS/FT/FV	92-97	CK3387		CSK045			SRC017	SRK017	CT036SP
GSX 600 FW/FX/FY/FK1/FK2/FK3/FK4/FK5/FK6	98-06	CK3357		CSK045					CT047SP
GSXR 600 V/W (SRAD)	97-98	CK1206		CSK902			SRC058	SRK106	CT055SP
GSXR 600 X/Y (SRAD)	99-00	CK1206		CSK902			SRC058	SRK058	CT055SP
GSXR 600 K1/K2/K3/ZK3	01-03	CK3466		CSK156			SRC112	SRK112	CT014
GSXR 600 K4/K5	04-05	CK1206		CSK156			SRC078	SRK078	CT014
GSXR 600 K6/K7	06-07	CK3455		CSK069			SRC086	SRK086	CT015
GSXR 600 K8/K9/L0	08-10	CK3456		CSK069			SRC088	SRK109	CT015
GSXR 600 L1/L2/L3	11-13	CK3456		CSK183			SRC110	SRK110	CT015
RF 600 RP/RR/RS/RT	93-96	CK3408		CSK045			SRC045	SRK045	CT036SP
VS 600 GLS/GLT/GLV	95-97	CK3377		CSK115					CT029
DL 650 K4-K6 V-Strom	04-06	CK1219		CSK133			SRC082	SRK082	CT033SP
DL 650 AK7/AK8/AK9/AL0 V-Strom ABS	07-11	CK1219		CSK133			SRC082	SRK082	CT033SP
DL 650 AL2/AL3 V-Strom ABS	12-13	CK1219		CSK133			SRC082	SRK082	CT033SP
DL 650 AL1XP V-Strom Xpedition - ABS	11	CK1219		CSK133			SRC082	SRK082	CT033SP
DL 650 AK9GT V-Strom Traveller - ABS	09-10	CK1219		CSK133			SRC082	SRK082	CT033SP
DL 650 XK7/XK8/XK9/XL0 V-Strom	04-11	CK1219		CSK133			SRC082	SRK082	CT033SP
DR 650 RL/RM (SP41A)	90-91	CK3402		CSK115	DRC059				CT029SP
DR 650 RSL/RSM (SP42A)	90-91	CK3402		CSK115	DRC059				CT029SP
DR 650 RUN/RN/RUP/RP (SP44A/B)	92-93	CK3402		CSK115	DRC059				CT029SP
DR 650 RSEM/RSEN/RSEP (SP43A/B)	91-93	CK3402		CSK115	DRC059				CT029SP
DR 650 RER/RES (SP45A/B)	94-95	CK3402		CSK115	DRC142				CT029SP
DR 650 SET/SEV	96-97	CK3386		CSK026	DRC087				CT024
GR 650 D/XD	83	CK3357		CSK026					CT029
GS 650 GX/GZ Katana	81-82	CK3330		CSK006					CT018SP
GS 650 GTX/GTZ/GTD	81-83	CK3330		CSK006					CT018SP

CLUTCH APPLICATIONS



# EBC CLUTCH KITS

Make & Model	Year	CK Series #	CKF Series #	Spring Kit #	DRC Series #	DRCF Series #	SRC Series #	SRK Series #	CT Tool #
<b>SUZUKI Contd.</b>									
GSF 650 K5/K6 Naked Bandit - Non ABS	05-06	CK3357		CSK122					CT047SP
GSF 650 SK5/SK6 Faired Bandit - Non ABS	05-06	CK3357		CSK122					CT047SP
GSF 650 AK5/AK6 Naked Bandit - ABS Model	05-06	CK3357		CSK122					CT047SP
GSF 650 SAK5/AK6 Faired Bandit - ABS Model	05-06	CK3357		CSK122					CT047SP
GSF 650 K7/K8/K9/OL0 Naked Bandit - Non ABS	07-11	CK1218		CSK122					CT014
GSF 650 SK7/SK8 Faired Bandit - Non ABS	07-08	CK1218		CSK122					CT014
GSF 650 AK7/AK8/AK9 Naked Bandit - ABS	07-09	CK1218		CSK122					CT014
GSF 650 SAK7/AK8/AK9/SAK0 Faired Bandit - ABS	07-11	CK1218		CSK122					CT014
GSX 650 FK8/FK9/FL0/FL1/FL2 (Non ABS)	08-13	CK1218		CSK122					CT014
GSX 650 FAK8/FAK9/FAL0/FAL1/FAL2 (ABS)	08-13	CK1218		CSK122					CT014
LS 650 Savage FG/PK/PM/PR/PG/PT/PV	87-97	CK3359		CSK026					CT029SP
SFV 650 K9/L0/L1 Gladius (Non ABS)	09-12	CK1219		CSK133			SRC082	SRK082	CT0033SP
SFV 650 AK9/AL0/AL1/AL3 Gladius (ABS)	09-13	CK1219		CSK133			SRC082	SRK082	CT0033SP
SV 650 X/Y/K1/K2 (Naked - Non ABS)	99-02	CK3377		CSK069			SRC081	SRK081	CT022
SV 650 SX/SY/SK1/SK2 (Faired - Non ABS)	99-02	CK3377		CSK069			SRC081	SRK081	CT022
SV 650 K3/K4/K5/K6/K7/K8/K9/L0 (Naked - Non ABS)	03-10	CK1219		CSK133			SRC082	SRK082	CT033SP
SV 650 SK3/SK4/SK5/SK6/SK7/SK8/SK9/SLO (Top Fairing - Non ABS)	03-12	CK1219		CSK133			SRC082	SRK082	CT033SP
SV 650 AK7/AK8/AK9/AL0 (Naked ABS Model)	03-10	CK1219		CSK133			SRC082	SRK082	CT033SP
SV 650 SAK7/AK8/AK9/SAL0 (Top Fairing - ABS Model)	03-13	CK1219		CSK133			SRC082	SRK082	CT033SP
XF 650 V/W/X/Y Freewind	97-02	CK3386		CSK026	DRC087				CT024
XN 85 D Turbo	83	CK3347		CSK006					CT018SP
GS 700 EF/ESF	85	CK3330		CSK115					CT018SP
VS 700 GLFG/GLEFG/GLPH/GLEPH	86-87	CK3377		CSK115					CT029
DR 750 S/J/SK	88-89	CK3386		CSK115					CT024
GT 750 J/K/L/M/A/B	72-77	CK3324		CSK158					CT018SP
GS 750 B/DB/DC/EC/EN	77-79	CK3324		CSK006					CT018SP
GSR 750 L1/L2/L3	11-13	CK3417		CSK067					CT014
GSX 750 ET/EX	80-81	CK3330		CSK006					CT018SP
GSX 750 ESD/EFE/ESG/ESE/EFF	83-86	CK3330		CSK115					CT018SP
GSX 750 SE Katana	84	CK3330		CSK026					CT018SP
GSX 750 FK/FL/FM/FN/FP/FR/FS/FT/FV	89-97	CK3387		CSK012					CT036SP
GSX 750 FW/FX/FY/FK1-FK6	98-06	CK3357		CSK045					CT047SP
GSX 750 W/X/Y/K1	98-03	CK3357		CSK045					CT047SP
GSX 750 S/SS (GS75X-106815-)		CK3330		CSK006					CT018SP
GSX 750 S-2/S-2C (GS75X-114747-) Katana		CK3330		CSK006					CT018SP
GSXR 750 F/G/H (GR75A)	85-87	CK3348		CSK115			SRC013	SRK013	CT047SP
GSXR 750 RG (Dry Clutch)	86	CK3376		TBA					
GSXR 750 J/K	88-89	CK3387		CSK012			SRC014	SRK014	CT036SP
GSXR 750 L/M/WN	90-92	CK3387		CSK045			SRC017	SRK017	CT036SP
GSXR 750 WP/WR/WS	93-95	CK3387		CSK045			SRC017	SRK104	CT036SP
GSXR 750 T/V/W/X (SRAD)	96-99	CK3417		CSK902			SRC040	SRK040	CT055SP
GSXR 750 Y	00	CK1229		CSK156			SRC071	SRK071	CT014
GSXR 750 K1/ K2/K3	01-03	CK3465		CSK156			SRC111	SRK111	CT014
GSXR 750 K4/K5	04-05	CK3417		CSK075					CT014
GSXR 750 K6/K7	06-07	CK3456		CSK069			SRC088	SRK088	CT015
GSXR 750 K8/K9/L0	08-10	CK3456		CSK069			SRC088	SRK109	CT015
GSXR 750 L1/L2/L3	11-13	CK3456		CSK183			SRC110	SRK110	CT015
VS 750 GLF/GLFG/GLFH/GLPG/GLPK/GLPL/GLPM/GLPH /GLEFH/GLEPH (VR51A)	85-91	CK3377		CSK115					CT029
DR 800 SL (SR43A)/SM/SN/SP (SR43B)	90-93	CK3386		CSK115					CT024
VS 800 GLN/GLP/GLR/GLS/GLT/GLV	92-97	CK3377		CSK115					CT029
VL 800 K1-K5 Intruder Volusia	01-05	CK3377		CSK066					CT029
C 800 Intruder - Spoke Wheels (VL 800 K6/K7/K8/K9/L0/L1/L2/L3)	06-13	CK3377		CSK066					CT029
C 800 C Intruder - Cast Wheels (VL 800 CK7/CK8/CK9/CL0/CL1/CL2/CL3)	07-13	CK3377		CSK066					CT029
VX 800 L/M/N/P/R/T (8 Spring CSK Kit)	90-96	CK3377		CSK162					CT029
VZ 800 V/W/X/Y/K1/K2 Marauder (8 Spring CSK Kit)	97-02	CK3377		CSK162					CT029
M 800 (VZ 800 K5-K9/L0/L1/L3) Intruder M800	05-13	CK3377		CSK066					CT029
M 800 Z (VZ 800 K9Z Intruder M800Z)	09-10	CK3377		CSK066					CT029
GS 850 GN/GT/GX/GZ/GF/GG	79-85	CK3330		CSK006					CT018SP
RF 900 RR	94	CK3418		CSK902			SRC039	SRK039	CT055SP
RF 900 RS/R2S/RT/RV/RW	95-98	CK3417		CSK029					CT014
DL 1000 K2-K9/L0 V-Strom	02-10	CK3443		CSK043					CT021
GS 1000 HC/EC/EN/SN/ET	78-80	CK3345		CSK006			SRC115	SRK115	CT035SP
GS 1000 GT/GX	80-81	CK3335		CSK006			SRC050	SRK050	CT024SP
GSX 1000 SZ	82	CK3335		CSK006			SRC050	SRK050	CT024SP
GSXR 1000 K1/K2/K3/K4	01-04	CK4510		CSK128			SRC089	SRK089	CT004
GSXR 1000 K5/K6/K7/K8	05-08	CK3451		CSK145			SRC085	SRK085	CT015
GSXR 1000 K9/L0/L1	09-11	CK3462		CSK160			SRC097	SRK097	CT009
GSXR 1000 L2/L3/ZL3	12-13	CK3462		TBA			TBA	TBA	CT009
SV 1000 K3K4/K5/K6/K7 (Naked)	03-07	CK3443		CSK114					CT021



# EBC CLUTCH KITS

Make & Model	Year	CK Series #	CKF Series #	Spring Kit #	DRC Series #	DRCF Series #	SRC Series #	SRK Series #	CT Tool #
<b>SUZUKI Contd.</b>									
SV 1000 SK3/SK4/SK5/SK6/SK7 (Faired)	03-07	CK3443		CSK114					CT021
TL 1000 SV/SW	97-98	CK3417		CSK078					CT014
TL 1000 RW/RX/RY	98-00	CK3428		CSK071			SRC068	SRK068	CT009
TL 1000 SX/SY	99-00	CK3428		CSK071			SRC068	SRK068	CT009
TL 1000 SK1	01-02	CK3435		CSK071					CT009
TL 1000 RK1	01-02	CK3435		CSK071					CT009
GS 1100 GZ	82	CK3335		CSK006			SRC050	SRK050	CT024SP
GSX 1100 ET/EX/EZ	80-82	CK3335		CSK006			SRC050	SRK050	CT024SP
GSX 1100 SZ	82	CK3335		CSK006			SRC050	SRK050	CT024SP
GSX 1100 SD	83	CK3346		CSK006					
GSX 1100 ESD	83	CK3346		CSK006					
GSX 1100 EFE/EFG/ESF	84-86	CK3335		CSK006			SRC050	SRK050	CT024SP
GSX 1100 FJ/FK/FL/FM/FN/FP/FR	88-94	CK3381		CSK012					CT048SP
GSX 1100 GM/GN	91-94	CK3392		CSK902			SRC010	SRK010	CT055SP
GSX R 1100 G/H/J	86-88	CK3381		CSK026			SRC015	SRK015	CT048SP
GSXR 1100 K/L/M/N	89-92	CK3392		CSK902			SRC010	SRK010	CT055SP
GSXR 1100 WP/WR/WS/WT	93-96	CK3418		CSK902			SRC039	SRK039	CT055SP
GS 1200 SSK/ZK1 (GV78A)	01	CK3417		CSK902			SRC040	SRK040	CT055SP
GSF 1200 T/V/W/X/Y (Naked Bandit 4 Piston Caliper)	96-00	CK3417		CSK902			SRC040	SRK040	CT055SP
GSF 1200 K1/K2/K3/K4/K5 (Naked Bandit 6 Piston caliper)	01-05	CK3417		CSK902			SRC040	SRK040	CT055SP
GSF 1200 ST/SV/SW/SX/SY (Faired Bandit 4 Piston Caliper)	96-00	CK3417		CSK902			SRC040	SRK040	CT055SP
GSF 1200 SAV ABS Bandit	97	CK3417		CSK902			SRC040	SRK040	CT055SP
GSF 1200 SK1/SK2/SK3/SK4/SK5 (Faired Bandit 6 Piston caliper)	01-05	CK3417		CSK902			SRC040	SRK040	CT055SP
GSF 1200 K6/AK6 (Naked Bandit - Non & ABS Version - 4 Piston caliper)	06	CK3417		CSK902			SRC040	SRK040	CT055SP
GSF 1200 SK6/SAK6 (Faired Bandit - Non & ABS Version - 4 Piston caliper)	06	CK3417		CSK902			SRC040	SRK040	CT055SP
GSF 1200 SFK7 Bandit Streetfighter	07-09	CK3459		CSK124					CT021
GSX 1200 FSW/FSX Inazuma (GV76A)	98-99	CK3417		CSK902			SRC040	SRK040	CT055SP
GV 1200 GLF/GLF2/GLG Madura	85-86	CK3375		CSK115					CT029
GSF 1250 K7/K8/K9 (Naked Bandit - Non ABS - 4 Piston caliper)	07-10	CK3459		CSK124					CT021
GSF 1250 AK7/AK8 (Naked Bandit - ABS Model - 4 Piston caliper)	07-10	CK3459		CSK124					CT021
GSF 1250 SK7/SK8/SK9/SLO (Faired Bandit - ABS Model - 4 Piston Caliper)	07-10	CK3459		CSK124					CT021
GSF 1250 SAK7/SAK8/SAK9/SAZK9/SALO (Faired Bandit - ABS Model - 4 Piston Caliper)	07-12	CK3459		CSK124					CT021
GSX 1250 FAL0/FAL1/FAL2	10-13	CK3459		CSK124					CT021
GSX 1250 FAL0ST Sports Touring	10-12	CK3459		CSK124					CT021
GSX 1300 RX Hayabusa	99	CK3430		CSK072			SRC067	SRK067	CT021
GSX 1300 RY/RK1 Hayabusa	00-01	CK3430		CSK171					CT021
GSX 1300 RK2/RZK3/RK3/RK4/RK5/K6/K7	02-07	CK3443		CSK171					CT021
GSX 1300 RK8/RK9/RL0/RL1/RL2 Hayabusa	08-12	CK3443		CSK139					CT021
GSX 1300 RL3 Hayabusa (Brembo Calipers)	13	TBA		TBA					
GSX 1300 BKK8/BBK9/BKL0/BKL1 B-King	08-12	CK3443		CSK139					CT021
GSX 1400 K1	01	CK3445		CSK089					CT009
GSX 1400 K2/K3/K4/K5/K6/K7	02-07	CK3439		CSK089					CT009
GV 1400 Cavalcade (All models)	85-88	CK3388		CSK115					CT029
VS 1400 GLPH/GLPJ/GLFH/GLFJ/GLPR/GLPT/GLPV /GLPW/GLPY/GLPK1/GLPK2	87-03	CK3382		N/A					CT029
VL 1500 W/X/Y/K1/K2/K3 Intruder Legendary Classic	98-03	CK3335		CSK031					CT024SP
VL 1500 K5/K6/K7/K8/K9 (C 1500 Intruder)	05-09	CK3335		CSK031					CT024SP
VL 1500 L3 (C 1500T Intruder)	13	CK3459		TBA					CT021
M 1500 (VZ 1500 K9/L0 (M 1500 Intruder)	09-13	CK3459		TBA					
M 1600 (VZ 1600 K4/K5 (M 1600 Marauder)	04-05	CK4455		N/A					CT032
C 1800 R Intruder (VLR 1800 K8/K9/L0/L1)	08-13	CK3463		CSK075					
C 1800 RT Intruder (VLR 1800 K8RT/K9RT)	08-09	CK3463		CSK075					
M 1800 R (VZR 1800 K6/K7/K8/K9 - M 1800 R Intruder with handlebar cowlng)	06-09	CK3457		CSK122					
M 1800 R2 (VZR 1800 NK8/NK9 Intruder - M1800R2 - No handlebar cowlng)	08-09	CK3457		CSK122					
M 1800 RZ (VZR1800 ZK7/ZK8/ZL1/ZL2 - M1800RZ - with handlebar cowlng )	07-13	CK3457		CSK122					
<b>YAMAHA</b>									
FS 1 E/FS 1 DX	74-80	CK2205		CSK042					CT044
FS 1	87-90	CK2205		CSK042					CT044
FS 1 SE	81-82	CK2205		CSK042					CT044
DT 50 M	78-79	CK2206		CSK042					CT044
DT 50 M/MX	80-95	CK2205		CSK042					CT044
DT 50 LC	98	CK2206		CSK042					CT044

CLUTCH APPLICATIONS

# EBC CLUTCH KITS

Make & Model	Year	CK Series #	CKF Series #	Spring Kit #	DRC Series #	DRCF Series #	SRC Series #	SRK Series #	CT Tool #
<b>YAMAHA Contd.</b>									
DT 50 R	97-08	CK2348		N/A					
DT 50 X (Supermotard)	04-08	CK2348		N/A					
RD 50 M	78-79	CK2206		CSK042					CT044
RD 50 M/MX	80-83	CK2205		CSK042					CT044
RD 50	86-87	CK2205		CSK042					CT044
RZ 50 (5FC1/2)	02	CK2238		CSK042					CT044
TT 50 EV/EW/EX/EY/EZ/EA/EB/ED	06-13	TBA		N/A					
TY 50/TY 50 M (1F4/1G7)	77-78	CK2206		CSK042					CT044
TY 50 M (2K0)	80	CK2205		CSK042					CT044
T 50	86	CK2302		N/A					
TZR 50 (5 Plate Kit)	97-03	CK2349		N/A					
TZR 50 (4 Plate Kit)	04-13	CK2348		N/A					
V 50 M/P	75-77	CK2303		N/A					
YFM 50 S/T/RV/RW/RX Raptor	04-08	CK2303		N/A					
YZ 50 G/H/J/K	80-83	CK2206		CSK042					CT044
DT 80 LC1 (37A) - 4 Plate Clutch	81-84	CK2238		CSK042					CT044
DT 80 LC2 (53A) - 5 Plate Clutch	85-92	CK2254	CKF2254	CSK042					CT044
DT 80 MX Type 5J2	81-82	CK2206		CSK042					CT044
DT 80 MX Type 12X	83	CK2206		CSK042					CT044
DT 80 MX Type 36N	83-85	CK2238		CSK001					CT044
DT 80 MXS	84	CK2238		CSK042					CT044
PW 80 (All models)	83-06	CK2303		N/A					
RD 80	82	CK2206		CSK042					CT044
RD 80 LC	82	CK2238		CSK042					CT044
T 80	83-97	CK2303		N/A					
TY 80	77-83	CK2206		CSK042					CT044
V 80	79-83	CK2303		N/A					
YFM 80 D/E/F/G/H/J/K/L/M/N Badger	91-01	CK2303		N/A					
YFM 80 WP/WR/WS/RT/RV/RW/RX Raptor	02-08	CK2303		N/A					
YFM 80 GT/GV/GW/GX Grizzly	05-08	CK2303		N/A					
YZ 80 D	77	CK2238		CSK042					CT044
YZ 80 E/F	78-79	CK2254	CKF2254	CSK042					CT044
YZ 80 G	80	CK2238		CSK042					CT044
YZ 80 H/J/K/L/N	81-85	CK2287		CSK042					CT010
YZ 80 S/T/U/W	86-89	CK2304		CSK042	DRC027				CT010
YZ 80 E/LC/LW/F	93-94	CK2304		CSK039	DRC066				CT010
YZ 80 G/H/J/K/L/M/N	95-01	CK2335	CKF2335	CSK042	DRC078				CT010
YZ 85 P/LWP/R/LWR/S/LWS/T/LWT/V/LWV/W/LWW/X /LWX/Y/LWY/Z/LWZ/LWA/LWB/LWD	02-13	CK2335	CKF2335	CSK042	DRC111	DRCF111			CT010
TT-R 90 M/N/P/R/ES/S/ET/T/EV/EW	00-07	CK2354		N/A					
T 90 N/D (4NM1-9) Mate	00-	CK2354		N/A					
AG 100 E Farm Bike	93	CK2208		CSK001					CT039
AG 100 J (3HAA)	82	CK2208		CSK001					CT039
DT 100	76-80	CK2236		CSK042					CT039
RS 100 (478)	75-76	CK2208		CSK042					CT039
RS 100 (1Y8 Europe)	77-78	CK2254	CKF2254	CSK042					CT044
RS 100 S (1Y8 UK)	77-78	CK2254	CKF2254	CSK042					CT044
RS 100 DX (1Y8 Europe)	79	CK2254	CKF2254	CSK042					CT044
RS 100 (1Y9 UK)	79-81	CK2254	CKF2254	CSK042					CT044
RS 100 (1Y8 Europe)	80-82	CK2254	CKF2254	CSK042					CT044
RT 100 E/F/K	93-03	CK2254	CKF2254	CSK001					CT044
RX S 100	83-97	CK2254	CKF2254	CSK001					CT044
YB 100	78-92	CK2207		N/A					CT044
YZ 100 E/F/G/H/J/K	78-83	CK2234		CSK039					CT039
T 105/105 E Crypton	96	CK2354		N/A					
T 105 E (5ER1/2)	99	CK2354		N/A					
V 110 ZE/ZK/ZHE/ZHK/FIZR/FIZR Sporty		CK2354		N/A					
TT-R 110 EX/EY	08-09	CK2375		CSK150					
RX 115 (5FS3)	99	CK2254	CKF2254	CSK042					CT044
DT 125	74	CK2209		CSK042					CT039
DT 125/125 F	76-77	CK2236		CSK039					CT039
DT 125 E	78-79	CK2236		CSK001					CT039
DT 125 MX	80-81	CK2236		CSK042					CT039
DT 125 LC Type 10V	82	CK2281		CSK042					
DT 125 LC Type 12W	82	CK2281		CSK042					
DT 125 LC Type 26G	83	CK2281		CSK042					
DT 125 LC Type 35A	85-87	CK2283		CSK042					CT044
DT 125 R	88-03	CK2313	CKF2313	CSK042	DRC042	DRCF042			CT010
DT 125 RE	04-07	CK2313	CKF2313	CSK042	DRC042	DRCF042			CT010
DT 125 (3TT4)	96	CK2283		CSK042					CT044
DT 125 X	05-06	CK2313	CKF2313	CSK042	DRC042	DRCF042			CT010
IT 125 G/H/J	80-82	CK2234		CSK042					CT044
RD 125 DX	75-76	CK2236		CSK042					CT039

# EBC CLUTCH KITS

Make & Model	Year	CK Series #	CKF Series #	Spring Kit #	DRC Series #	DRCF Series #	SRC Series #	SRK Series #	CT Tool #
<b>YAMAHA Contd.</b>									
RD 125 DX	78-81	CK2254	CKF2254	CSK042					CT044
RD 125 LC (MK1-MK3)	82-87	CK2283		CSK042					CT044
RZ 125 (1GV 030101-)	85	CK2283		CSK042					CT044
RS 125/RS 125 DX	75-76	CK2236		CSK042					CT039
RS 125	77-81	CK2254	CKF2254	CSK042					CT044
SR 125 SE	81-83	CK2256		CSK052					CT039
SR 125	89-03	CK2256		CSK052					CT039
TDR 125 (3HS1/3XD0/3HS3/3XD1)	89-93	CK2313		CSK042					CT010
TDR 125 (4GH/GX 1/2/3/4)	93-03	CK2313	CKF2313	CSK042	DRC042	DRCF042			CT010
TDR 125R (3HS2/3XE2) Lightburner	93-94	CK2313	CKF2313	CSK042					CT010
TT-R 125 M/LWM/N/LWN/P/LWP/R/LWR/LWES/LWS/S/ES /T/ET/LWT/LWET/EV/LV/LEV/EW/LEW/LWEW/LWEX /LWX/LEY/EX/EY/LWEZ/LWEA/LWED	00-13	CK2254	CKF2254	CSK042	DRC230	DRCF230			CT044
TW 125 (5EK) 4 Friction Plate Type	99-02	CK2256		CSK052					CT039
TW 125 (5RS) 5 Friction Plate Type	03-04	CK2234		CSK052					CT039
TZR 125 (2RK/3PC1/2/3)	87-92	CK2304		CSK042					CT010
TZR 125 (3JB/4JB/4HW/4HX)	93-95	CK2313	CKF2313	CSK042					CT010
TZR 125 R (4DL1/4DL2)	91-93	CK2313	CKF2313	CSK042					CT010
TZR 125 RR (4DL3)	94-95	CK2313	CKF2313	CSK042	DRC042	DRCF042			CT010
TY 125	80-82	CK2234		CSK042					CT039
WR 125 R	09-13	CK2292		CSK024					CT061
WR 125 X	09-13	CK2292		CSK024					CT061
XV 125 Virago	97-00	CK2316		CSK002					CT008
XVS 125 Drag Star	00-03	CK2316		CSK002					CT008
XT 125	82-83	CK2256		CSK052					CT039
XT 125 R (3D61/3D63) - 5 Friction plate type	05-06	CK2254	CKF2254	CSK042					CT044
XT 125 R (13D1) - 5 Friction plate type	07	CK2254	CKF2254	CSK042					CT044
XT 125 R (13D3/13D5) - 4 Friction plate type	07-11	CK1151	CKF1151	CSK042					CT012
XT 125 X (3D62/3D64) - 5 Friction plate type	05-06	CK2254	CKF2254	CSK042					CT044
XT 125 X (13D2) - 5 Friction plate type	07	CK2254	CKF2254	CSK042					CT044
XT 125 X (13D4/13D6) - 4 Friction plate type	07-11	CK1151	CKF1151	CSK042					CT012
XTZ 125 (5RM) (5 plate clutch)	03-10	CK2254	CKF2254	CSK042					CT044
YBA 125 Enticer (3P01/3P41)	05-06	TBA		TBA					
YBR 125 ED (3D91/3D92/3D9) - 4 Plate type	06-09	CK1151	CKF1151	N/A					CT012
YBR 125 ED (51D1/2) - 4 Plate type	10-13	CK1151	CKF1151	N/A					CT012
YBR 125 E/K (5HH1/2/G/G/J/5LX/5LX9) (Drum Front/Brazil) - 5 Friction plate type	00-06	CK2254	CKF2254	CSK042					CT044
YBR 125 ED (5HHB/F/H) (Disc front/Brazil) - 5 Friction plate type	06-08	CK2254	CKF2254	CSK042					CT044
YBR 125 Custom - 4 Friction plate type	08-13	CK1151	CKF1151	N/A					CT012
YZ 125 C (2T)	76	CK2234		CSK039					CT039
YZ 125 D/E (2T)	77-78	CK2235		CSK039					CT039
YZ 125 F (2T)	79	CK2234		CSK042					CT039
YZ 125 G (2T)	80	CK2234		CSK039					CT039
YZ 125 H (2T)	81	CK2235		CSK039					CT039
YZ 125 J (2T)	82	CK2276		CSK039					
YZ 125 K/L/N (2T)	83-85	CK2278		CSK039					CT054SP
YZ 125 S/T (2T)	86-87	CK2278		CSK002	DRC028				CT054SP
YZ 125 U (2T)	88	CK2312		CSK002	DRC029				CT054SP
YZ 125 W/A (2T)	89-90	CK2311		CSK002	DRC030				CT054SP
YZ 125 B/D (2T)	91-92	CK2319		CSK081	DRC039				CT005
YZ 125 E/F/G/H/J/K/L/M/N (2T)	93-01	CK2325	CKF2325	CSK081	DRC070	DRCF070			CT005
YZ 125 P/R/S (2T)	02-04	CK2325	CKF2325	CSK014	DRC085				CT005
YZ 125 T/V/W/X/Y/Z/A/B/D (2T)	05-13	CK2325	CKF2325	CSK081	DRC070	DRCF070			CT005
YZF-R 125	08-13	CK2292		CSK024					CT061
RX 135 (13X)	81	CK2283		CSK042					CT044
T 135 HC/S (2S61) Crypton X/Jupiter MX/Spark 135 /Exciter/135LC Sniper	06-08	TBA		TBA					
T 135-SE (1S71) Crypton X/Jupiter MX/Spark 135 /Exciter/135LC Sniper	06-08	TBA		TBA					
TZR 150 R (4AP2)	00	CK2313	CKF2313	CSK042					CT010
DT 175	74-75	CK2236		CSK042					CT039
DT 175	76-77	CK2236		CSK039					CT039
DT 175 MX	78-81	CK2245		CSK042					CT039
DT 175 (3TS4)	96	CK2365		CSK042					CT044
IT 175 G/H/J	80-82	CK2235		CSK039					CT039
TY 175	77-80	CK2234		CSK042					CT039
AG 200 E (3GX6)	93	CK2292		CSK149	DRC055				CT039
DT 200 (2LR)	87	CK2313	CKF2313	CSK042					CT010
DT 200 WR 3XP	92-93	CK2313	CKF2313	CSK042					CT010
IT 200 L	84	CK2235		CSK001					CT039
RD 200 DX	76-81	CK2209		CSK042					CT039
RS 200	79-80	CK2209		CSK042					CT039

CLUTCH APPLICATIONS

# EBC CLUTCH KITS

Make & Model	Year	CK Series #	CKF Series #	Spring Kit #	DRC Series #	DRCF Series #	SRC Series #	SRK Series #	CT Tool #
<b>YAMAHA Contd.</b>									
SDR 200 (2TV)	87-89	CK2313	CKF2313	CSK042	DRC042	DRCF042			CT010
TW 200 (2JL/4CS1/2/3/5)	91-98	CK2234		CSK149	DRC231				CT039
TW 200 (4CS4/6/5LB1/2)	98-01	CK2234		CSK149	DRC231				CT039
WR 200 D/E/F	92-94	CK2313	CKF2313	CSK042	DRC042	DRCF042			CT010
YFM 200 DKW/DX/DXA	86-90	CK2287		CSK149	DRC232				CT010SP
YFS 200 B/F/G/H/J/K/L/M/N/P/R/S/T/V Blaster	91-06	CK2313	CKF2313	CSK042	DRC042	DRCF042			CT010
YTM 200 EL/DX	89	CK2304		N/A					CT010
ST 225 (5BT) Bronco	97	CK2324		CSK149	DRC229				CT039
TDM 225	05	TBA		TBA					
TW 225 E (5VC1/2)	02-03	CK2234		CSK149	DRC229				CT039
XT 225 (2LN) Serrow (1KH 020101-)	86-87	CK2324		CSK149	DRC229				CT039
XT 225 (3RW1/2/4/5 Serrow) (1KH 034101-132000)	89-93	CK2324		CSK149	DRC229				CT039
XT 225 S (3RW3 Serrow) (1KH 034101-132000)	92	CK2324		CSK149	DRC229				CT039
XT 225 (3RW4 Serrow) (1KH 080101-)	92	CK2324		CSK149	DRC229				CT039
XT 225 W (4JG1/2/3/4) Serrow	93-95	CK2324		CSK149	DRC229				CT039
XT 225 WE (4JG5/6) Serrow	97-98	CK2324		CSK149	DRC229				CT039
XT 225 (4VW1/3/5/7/9) (4VVA/B/D/G/J/L) (Brasil)	97-06	CK2324		CSK149	DRC229				CT039
YFM 225 N/S/T/U	85-89	CK2287		N/A					CT010SP
YTM 225 DRN	85	CK2287		CSK052	DRC104				CT010SP
DT 230 R Lanza (4TP1/2)	97-98	CK2313	CKF2313	CSK042	DRC042	DRCF042			CT010
DT 250	75-76	CK2240		CSK002					CT008
DT 250 MX	77-80	CK2223		CSK002					
FZR 250	87	CK2331		CSK034			SRC034	SRK034	CT010
FZR 250 R (3LN1/3/5/6/7)		CK2331		CSK034			SRC034	SRK034	CT010
FZX 250 Zeal (3YX1/2/4)	91-92	CK2331		CSK034			SRC034	SRK034	CT010
IT 250 G	80	CK2250		CSK002					CT008
IT 250 H/J	81-82	CK2279	CKF2279	CSK002					CT008
IT 250 L	84	CK2280		CSK002					CT060
RD250 A/B	74-75	CK2240		CSK039					CT008
RD 250 C/D/E/F	76-79	CK2240		CSK002					CT008
RD 250 LC	80-82	CK2240		CSK002					CT008
RZ 250 R (1AR/1XG)		CK2240		CSK002					CT008
RZ 250 R (29L)		CK2240		CSK002					CT008
RZ 250 RR (51L)		CK2240		CSK002					CT008
RZ 250 (4L3)		CK2240		CSK002					CT008
Ri-Z (250cc/3XC)	90-92	CK2319		CSK052					CT005
Serrow 250 (3C51/52)	06	CK2370	CKF2370	CSK081					CT005
SR 250 (US Custom/3Y8/6 Plate Clutch)	80-81	CK2267		CSK002					CT008
SR 250 SE (Special/3Y8/5 Plate Clutch)	81-83	CK2261		CSK002					CT008
SR 250 (4GR1/2/3/4/5 Plate Clutch)	94-96	CK2261		CSK002					CT008
SR 250 (Classic/21L/5 Plate Clutch)	96-00	CK2261		CSK002					CT008
SRV 250 Soulful Twin/Renaissa (4DN1-6)	92-97	CK2316		N/A					CT008
SRX 250		CK2261		CSK049					CT008
TDR 250 (3CK1/3CK2 Europe - Eng/Frame # 3CK)	88-92	CK2319		CSK052					CT025
TT 250 R (4GY1 Japan - 6 Plate Clutch)	93-94	CK2370	CKF2370	CSK049					CT005
TT 250 R (4RR1/2 Japan - 6 Plate Clutch)	95-97	CK2370	CKF2370	CSK049					CT005
TT 250 R (4GY3/4GY5/4WA1 - Raid - Japan - 6 Plate Clutch)	94-96	CK2370	CKF2370	CSK049					CT005
TT 250 R (4MR2 - UK - 6 Plate Clutch)	96	CK2370	CKF2370	CSK049					CT005
TT 250 RL (4PX5 - 6 Plate Clutch)	99	CK2370	CKF2370	CSK049					CT005
TT 250 RM (4PX6 - 7 Plate Clutch)	00	CK2319		CSK014	DRC226				CT005
TYR 250 D/E	77-78	CK2240		CSK002					CT008
TY 250 S/R	84-90	CK2295		CSK059					CT060
TY 250 R	91-92	CK2295		CSK059					CT060
TY 250 Z	93-96	CK2319		CSK002					CT005
TZR 250 (2MA/2XW1/2XW2 Europe - Eng/Frame # 2MA -)	87-92	CK2319		CSK052					CT025
TZR 250 (1KT/2AW Japan - Eng/Frame # 1KT - 000/056-)	87	CK2319		CSK052					CT025
TZR 250 (2XT1 Japan - Eng/Frame # 1KT - 09-)	88	CK2319		CSK052					CT025
TZR 250 (3MA1 - Reverse Cylinder - Eng/Frame # 3MA 0001-)	89	CK2342		CSK081					CT008
TZR 250 (3MA3/3MA5 - Reverse Cylinder - Eng/Frame # 3MA -046/058 -)	89-90	CK2342		CSK081					CT008
TZR 250 SP (3MA4 - Eng/Frame # 3MA 055 -)	90	N/A		CSK002					
TZR 250 R (3XV1/3XV4/3XV6 - V-Twin - Eng/Frame # 3XV 000101-08600)	91-93	CK2319		CSK014					CT005
TZR 250 RS (3XV8/3XV9/3XVA - V-Twin - Eng/Frame # 3XV 080101-08200/088-)	92-94	N/A		N/A					
TZR 250 SPR (3XVC - V-Twin - Eng/Frame # 3XV 107101-)	95	N/A		N/A					
WR 250 ZB/ZD/ZE (2T)	91-93	CK2309		CSK081					CT020
WR 250 ZF/ZG/ZH/ZJ/ZK (2T)	94-98	CK2274	CKF2274	CSK081					CT020
WR 250 FN/FP/FR/FS/FT/FV/FW/FX/FY/FZ/FA/FB/FD (4T)	01-13	CK2355	CKF2355	CSK002	DRC119	DRCF119			CT005
WR 250 RX/RV (32D1/3)	08-10	CK2319		CSK081	DRC039				CT005
WR 250 XX/XY (Supermoto) (32D2/4)	08-10	CK2319		CSK081	DRC039				CT005
XG 250 Tricker (5XT1)	04-06	CK2370	CKF2370	CSK081					CT005
XT 250 X	06	CK2370	CKF2370	CSK081					CT005

# EBC CLUTCH KITS

Make & Model	Year	CK Series #	CKF Series #	Spring Kit #	DRC Series #	DRCF Series #	SRC Series #	SRK Series #	CT Tool #
<b>YAMAHA Contd.</b>									
XV 250 Virago	89-94	CK2316		CSK002					CT008
YBR 250 (5D11/3/4)	07-11	CK1217		CSK132					CT014
YFB 250 D/E/F/G/H/J/K/FWF/FWG/FWH/FWJ/FWK/FWL/FWM	92-00	CK2287		CSK052	DRC104				CT010SP
YFM 250 W/A/B	90-92	CK2287		CSK052	DRC104				CT010SP
YFM 250 XN/XP/XR/XS Bear Tracker	00-04	CK2287		CSK052	DRC104				CT010SP
YFM 250 FN	01	CK2287		CSK052	DRC104				CT010SP
YFM 250 BT/BV Bruin	05-06	CK2287		CSK052	DRC104				CT010SP
YFM 250 BW/BX/BY Big Bear	07-10	CK2287		CSK052	DRC104				CT010SP
YFM 250 RX/RV Raptor	08-09	CK2370	CKF2370	CSK058	DRC200	DRCF200			CT005
YFU1WT (230cc)	89-90	CK2287		CSK052	DRC104				CT010SP
YTZ 250 N/S (TRI Z)	85-86	CK2280		CSK002	DRC032				CT060
YS 250 Fazer (Brasil) (1S41/2/3)	06-08	CK1217		CSK132					CT014
XS 250 C/D/E	78-80	CK2279	CKF2279	CSK002					CT008
XS 250 SE/C	80-81	CK2250		CSK049					CT008
XTZ 250 Lander (Brasil) (4B41/2/3)	07-09	CK1217		CSK132					CT014
XV 250 S Virago	95-00	CK2316		CSK002					CT008
XVS 250 Dragstar	01-04	CK2250		CSK002					CT008
XT 250	80	CK2267		CSK001					CT008
YZ 250 D/E (2T)	77-78	CK2244		CSK002					CT008
YZ 250 F (2T)	79	CK2250		CSK002					CT008
YZ 250 G (2T)	80	CK2244		CSK002					CT008
YZ 250 H (2T)	81	CK2279	CKF2279	CSK002					CT008
YZ 250 J/K/L (2T)	82-84	CK2280		CSK002					CT060
YZ 250 N/S/T (2T)	85-87	CK2280		CSK103	DRC035				CT060
YZ 250 U/W/A/B/D (2T)	88-92	CK2309		CSK081	DRC031				CT020
YZ 250 E/F/G/H/J/L (2T)	93-99	CK2274	CKF2274	CSK081	DRC071				CT020
YZ 250 M/N (2T)	00-01	CK2274	CKF2274	CSK049	DRC097				CT020
YZ 250 P/R/S/T/V/W/X/Y/Z/A/B/D (2T)	02-13	CK2274	CKF2274	CSK092	DRC113	DRCF113			CT020
YZ 250 FN/FP/FR/FS/FT/FV/FW (4T)	01-07	CK2355	CKF2355	CSK191	DRC109	DRCF109			CT005
YZ 250 FX/FY/FZ/FA/FB/FD (4T)	08-13	CK2355	CKF2355	CSK137	DRC227	DRCF227			CT005
YZ 250 WRW/WRA (2T)	89-90	CK2309		CSK024					CT020
RD 350 A/B	74-75	CK2240		CSK039					CT008
RD 350 LC/YPVS	80-84	CK2240		CSK002					CT008
RD 350 N/F/F2/R	85-95	CK2240		CSK002					CT008
TT 350 A (3GJ)	90-95	CK2240		CSK014	DRC056				CT008
TT 350 (ITJ)	85-89	CK2240		CSK014	DRC056				CT008
XT 350	85-95	CK2240		CSK014	DRC056				CT008
YFM 350 FWT/FWU/FWW/FWA/FWE Big Bear	86-93	CK2290	CKF2290	CSK058	DRC033	DRCF033			CT008
YFM 350 FWF/FWG/FWH/FWJ	94-97	CK2290	CKF2290	CSK049	DRC082				CT008
YFM 350 XD/XE/XF/XG/XH/XJ/XK/XL/XM/XN/XP/XR/XS	92-04	CK2290	CKF2290	CSK058	DRC033	DRCF033			CT008
YFM 350 ERD/ERE/ERF	92-94	CK2290	CKF2290	CSK058	DRC033	DRCF033			CT008
YFM 350 ERG	95	CK2290	CKF2290	CSK049	DRC082				CT008
YFM 350 FX Wolverine All models	95-04	CK2240		CSK081	DRC228				CT008
YFM 350 UH/UJ	96-97	CK2290	CKF2290	CSK049	DRC082				CT008
YFM 350 S/T/V/R-WV/RW/RX/RV Raptor	04-09	CK2290	CKF2290	CSK058	DRC033	DRCF033			CT008
YFZ 350 T/U/W/A/B/D/E/F/G/H/J/K/L/M/N/P/R/S/T/V Banshee	87-09	CK2279	CKF2279	CSK002	DRC043	DRCF043			CT008
DT 400	75-76	CK2240		CSK002					CT008
DT 400 MX	77-79	CK2290	CKF2290	CSK002					CT008
FZ 400 N (1FK/33M/46X)	85	CK2255		CSK014					CT008
FZ 400 (4YR1)	96	CK2371		CSK035					CT010
FZR 400 RR (4DX)	92	CK2317		CSK185			SRC006	SRK006	CT010
FZR 400 Genesis (1WG)	86	CK2317		CSK185			SRC006	SRK006	CT010
FZR 400 RSP (2TK-EXUP)	87	CK2315		CSK185			SRC007	SRK007	CT010
FZR 400 (3EN1/3EN2)	88-89	CK2317		CSK185			SRC006	SRK006	CT010
FZR 400 RR (3TJ)		CK2317		CSK185			SRC006	SRK006	CT010
FZR 400 RRS (3TJ2/6/7)		CK2315		CSK185			SRC007	SRK007	CT010
RD 400 C/D/E/F	76-79	CK2240		CSK002					CT008
SR 400		CK2296		CSK014					CT008
SRX 400 (1JL)		CK2297	CKF2297	CSK081					CT008
SRX 400 (3VN1/3VN2/3VN5)	90-96	CK2297	CKF2297	CSK081					CT008
XJR 400 (4HM1/4HM2/4HM4/4HM7)	93-96	CK2255		CSK081					CT008
XJR 400 (4HM3/4HM5/4HM6/4HM9/4HMA/4HMB)	95-99	CK2255		CSK081					CT008
XS 400	78-79	CK2279	CKF2279	CSK002					CT008
XS 400	82	CK2262		CSK002					CT017
XS 400 SE	80	CK2279	CKF2279	CSK002					CT008
XVS 400	96	CK2299		CSK091					CT020
YFM 400 FWE/FWF/FWG/FWH/FWJ/FWK Kodiak	93-00	CK2290	CKF2290	CSK049	DRC082				CT010
YFM 400 FPR/FPS Big Bear	03-04	CK2290	CKF2290	CSK049	DRC082				CT010
YZ 400 D/E/F (2T)	77-79	CK2279	CKF2279	CSK002					CT008
YZ 400 FK/FL (4T)	98-99	CK2310		CSK181	DRC265				CT008
WR 400 FK/FL/FM/FN (4T)	98-01	CK2310		CSK049	DRC099				CT008
IT 425 G	80	CK2279	CKF2279	CSK002					CT008
WR 426 FN/FP (4T)	01-02	CK2356		CSK062	DRC110				CT020

CLUTCH APPLICATIONS



# EBC CLUTCH KITS

Make & Model	Year	CK Series #	CKF Series #	Spring Kit #	DRC Series #	DRCF Series #	SRC Series #	SRK Series #	CT Tool #
<b>YAMAHA Contd.</b>									
YZ 426 FM (4T)	00	CK2352		CSK181	DRC102				CT020
YZ 426 FN/FP (4T)	01-02	CK2356		CSK092	DRC116				CT020
WR 450 FR (4T)	03	CK2356		CSK062	DRC110				CT020
WR 450 FS (4T)	04	CK2352		CSK062	DRC263				CT020
WR 450 FT/FV/FW/FX/FY/FZ/FA/FB/FD(4T)	05-13	CK2274	CFK2274	CSK092	DRC194				CT020
YZ 450 FR/FS (4T)	03-04	CK2352		CSK092	DRC121				CT020
YZ 450 FT/FV (4T)	05-06	CK2352		CSK058	DRC162				CT020
YZ 450 FW/FX/FY/FZ/FA/FB/FD (4T)	07-13	CK2274	CKF2274	CSK037	DRC195	DRCF195			CT020
YFZ 450 S/T/V Quad	04-06	CK2364	CKF2364	CSK187	DRC159	DRCF159			CT020
YFZ 450 W/X Quad	07-09	CK2364	CKF2364	CSK058	DRC201	DRCF201			CT020
YFZ 450 RX/RY Quad	09-10	CK2364	CKF2364	CSK058	DRC201	DRCF201			CT020
IT 465 H/J	81-82	CK2279	CKF2279	CSK002					CT008
YZ 465 G/H	80-81	CK2279	CKF2279	CSK002					CT008
IT 490 L	84	CK2280		CSK002	DRC032				CT060
YZ 490 J/K/L/N/S/T/U	82-88	CK2280		CSK002	DRC032				CT060
RD 500 LC	84-86	CK2305		CSK014					CT017
RZV 500 R (51X)	85	CK2305		CSK014					CT017
SR 500	78-82	CK2296		CSK014					CT008
SR 500 S (3GWS)	98	CK2296		CSK014					CT008
SR 500 (3GW1/4/6/7)	96-98	CK2296		CSK014					CT008
WR 500 ZD	92-93	CK2280		CSK002					CT060
TT 500 G/H	80-81	CK2296		CSK014					CT008
XP 500 (T-Max Scooter - All models)	01-11	CK2378		CSK189			SRC099	SRK099	
XT 500 C	76	CK2334		CSK014					CT008
XT 500	77-81	CK2296		CSK014					CT008
XS 500 B	77	CK2255		CSK014					CT008
XS 500 C/D	78-79	CK2255		CSK014					CT008
XV 535/535 S Virago	88-03	CK2299		CSK091					CT008
XJ 550	81	CK2306		CSK014					CT008SP
XJ 550 H/J/K Maxim	81-83	CK2306		CSK014					CT008SP
XJ 550 RH/RJ/RK Seca	81-83	CK2306		CSK014					CT008SP
XT 550	82	CK2310		CSK014					CT008
XT 550	83	CK2297	CKF2297	CSK014			SRC072	SRK072	CT008
XZ 550	82	CK2296		CSK014					CT008
FZ 600	87-88	CK2255		CSK014					CT008SP
FZR 600	89-93	CK2315		CSK185			SRC007	SRK007	CT010
FZR 600 R (4JH1/4)	94-95	CK2332		CSK081					CT054SP
FZ6 - Naked - Non-ABS/2 Piston Caliper (1B3/1B3D)	04-07	CK2255		CSK017			SRC051	SRK051	CT008SP
FZ6 - NS - Naked/Non-ABS /2 Piston Caliper (1B35/1B6)	05-06	CK2255		CSK017			SRC051	SRK051	CT008SP
FZ6 S2 - Naked/Non ABS/4 Piston Caliper (5S51/5S5)	07-09	CK2255		CSK017			SRC051	SRK051	CT008SP
FZ6 - Fazer - Half Fairing/Non ABS/2 Piston Caliper (5VX/5VXL)	04-07	CK2255		CSK017			SRC051	SRK051	CT008SP
FZ6 - Fazer - Half Fairing/ABS/2 Piston Caliper (4P5)	06-07	CK2255		CSK017			SRC051	SRK051	CT008SP
FZ6 Fazer S2 - Half Fairing/Non ABS/4 Piston Caliper (4S81/4S8)	07-09	CK2255		CSK017			SRC051	SRK051	CT008SP
FZ6 Fazer S2 - Half Fairing/ABS/4 Piston Caliper (5S2)	08	CK2255		CSK017			SRC051	SRK051	CT008SP
FZS 600 Fazer	98-99	CK2347		CSK002					CT054SP
FZS 600 Fazer/ SP	00-03	CK2347		CSK081					CT054SP
SRX 600	86-87	CK2297	CKF2297	CSK014			SRC072	SRK072	CT008
SRX 600 (1JK/3SX)	85-91	CK2297	CKF2297	CSK014			SRC072	SRK072	CT008
TT 600 L	84	CK2297	CKF2297	CSK002	DRC057				CT008
TT 600 N (59X) Frame # 59X 000101-7852	85-88	CK2297	CKF2297	CSK002	DRC057				CT008
TT 600 W (2JT/3SU1) Frame # 59X 007853 Onwards	89-92	CK2297	CKF2297	CSK002	DRC057				CT008
TT 600 R (5CH2)	98-99	CK2297	CKF2297	CSK002	DRC057				CT008
TT 600 R (5CH3)	00-02	CK2297	CKF2297	CSK002	DRC057				CT008
TT 600 RE (5CH5)	04	CK2296		CSK002					CT008
TT 600 R (5CH1)	97	CK2297	CKF2297	CSK002	DRC057				CT008
TT 600 E	94-01	CK2297	CKF2297	CSK002	DRC057				CT008
TT 600 K	93-96	CK2297	CKF2297	CSK002	DRC057				CT008
XJ 600	84-92	CK2255		CSK014					CT008SP
XJ 600 S Diversion	92-03	CK2255		CSK014					CT008SP
XJ 600 N	95-03	CK2255		CSK014					CT008SP
XJ6-N Diversion 600 (Naked Diversion - Non ABS & ABS Model - 20S)	09-13	CK2306		CSK017					CT008SP
XJ6-F Diversion 600 (Full Fairing Diversion - Non ABS & ABS Models - 1CW)	10-13	CK2306		CSK017					CT008SP
XJ6-S Diversion 600 (Top Fairing Diversion - Non ABS & ABS Models - 36C)	09-13	CK2306		CSK017					CT008SP
XJ6-SP Diversion 600 (Non ABS & ABS Models)	13	CK2306		CSK017					CT008SP
XT 600	84-87	CK2297	CKF2297	CSK002	DRC057				CT008
XT 600 Z	84-85	CK2297	CKF2297	CSK002	DRC057				CT008
XT 600 Z	86-90	CK2297	CKF2297	CSK014	DRC088	DRCF088			CT008
XT 600 E/ZE	90-03	CK2297	CKF2297	CSK014	DRC088	DRCF088			CT008
YX 600 S/SC/T/TC/UC/UW/WC/A/AC Radian	86-90	CK2255		CSK014					
YZF 600 Thunder Cat	96-03	CK2332		CSK102			SRC033	SRK033	CT054SP



# EBC CLUTCH KITS

Make & Model	Year	CK Series #	CKF Series #	Spring Kit #	DRC Series #	DRCF Series #	SRC Series #	SRK Series #	CT Tool #
<b>YAMAHA Contd.</b>									
YZF 600 R R6 (8 plate)	99-02	CK2255		CSK017			SRC051	SRK051	CT008SP
YZF-R6 (8 plate)	03-05	CK2255		CSK092			SRC074	SRK074	CT008SP
YZF R6 (9 plate)	06-07	CK2318		CSK126			SRC087	SRK087	CT008SP
YZF R6 (13S1) (9 plate)	08-11	CK2318		CSK126			SRC087	SRK087	CT008SP
XJ 650	80-84	CK2255		CSK081					CT008SP
XJ 650 Turbo	82	CK2255		CSK014					CT008SP
XJ 650 G/H/J/K Maxim	80-83	CK2255		CSK081					CT008SP
XJ 650 LH Midnight	81	CK2255		CSK081					CT008SP
XJ 650 R/LK Seca	82-83	CK2255		CSK014					CT008SP
XS 650	75-76	CK2226		CSK014					
XS 650	77-79	CK2226		CSK002					
XS 650	80-81	CK2242		CSK014					
XS 650 SE	79-81	CK2242		CSK014					
XVS 650 Dragstar	97-04	CK2309		CSK091					CT020
XVS 650 A Dragstar Classic	98-07	CK2309		CSK091					CT020
MT-03 (660cc)	06-12	CK2368		CSK123					CT020
SZR 660	96-97	CK2297	CKF2297	CSK014	DRC088	DRCF088			CT008
XTZ 660 Tenere	91-97	CK2297	CKF2297	CSK014	DRC088	DRCF088			CT008
XT 660 X Supermoto (1D21/1D23/1D24/1D26/3S72/10S1/11B1)	04-09	CK2368		CSK123					CT020
XT 660 X Supermoto (10S7)	10-13	CK2368		CSK123					CT020
XT 660 R (Model Code 5VK1/3/4/6/8/3S62/3S63)	04-07	CK2368		CSK123					CT020
XT 660 R (Model Code 5VKA/5VKC)	08-09	CK2368		CSK123					CT020
XT 660 R (Model Code 5VKE)	10-13	CK2368		CSK123					CT020
XT 660 Z Tenere	08-13	CK2368		CSK123					CT020
YFM 660 RN/RP/RR/RS/RT Raptor	01-05	CK2297	CKF2297	CSK014	DRC088	DRCF088			CT008
FZX 700 S/SC/T/C Fazer	86-87	CK2255		CSK017			SRC051	SRK051	CT008SP
YFM 700 RV/RW/RX Raptor	06-08	CK2364	CKF2364	CSK037	DRC128	DRCF128			CT020
YFM 700 RY/RA/RB Raptor	09-12	CK2364	CKF2364	CSK037	DRC128	DRCF128			CT020
YFM 700 RD Raptor	13	CK2364	CKF2364	CSK037	DRC128	DRCF128			CT020
FZ 750	85-86	CK2255		CSK017			SRC051	SRK051	CT008SP
FZ 750	87-92	CK2306		CSK017					CT008SP
FZX 750	87	CK2306		CSK017					CT008SP
FZR 750	87	CK2308		CSK017			SRC008	SRK008	CT008SP
FZR 750 R OWO1	89-90	CK2318		CSK017			SRC009	SRK009	CT008SP
XJ 750	82-83	CK2255		CSK014					CT008SP
XJ 750 RF/RJ/RK Seca	81-83	CK2255		CSK014					CT008SP
XS 750	77-79	CK2279	CKF2279	CSK014					CT008SP
XS 750 SE	79-80	CK2279	CKF2279	CSK014					CT008SP
XTZ 750	89-95	CK2255		CSK187					CT008
XV 750 SE	81	CK2274	CKF2274	CSK081					CT020
XV 750 Virago	92-97	CK2274	CKF2274	CSK081					CT020
YZF 750 R/SP	93-97	CK2318		CSK017			SRC009	SRK009	CT008SP
YZF 7R OWO2	99-00	CK2353		N/A					CT020
FZ 8 N-800cc (Naked/Single Headlight/Non ABS)	11-13	CK2364	CKF2364	CSK119					CT020
FZ 8 NA-800cc (Naked/Single Headlight/ABS)	11-13	CK2364	CKF2364	CSK119					CT020
Fazer 8 S-800cc (Top Fairing/Twin Headlight/Non ABS)	11-13	CK2364	CKF2364	CSK119					CT020
Fazer 8 SA-800cc (Top Fairing/Twin Headlight/ ABS)	11-13	CK2364	CKF2364	CSK119					CT020
TDM 850	91-95	CK2255		CSK017					CT008
TDM 850	96-98	CK2318		CSK017			SRC009	SRK009	CT008
TDM 850	99-01	CK2318		CSK092					CT008
TRX 850	96-98	CK2318		CSK017			SRC009	SRK009	CT008
XS 850	80	CK2273		CSK014					CT008SP
TDM 900 (5PS/Non ABS)	02-13	CK2318		CSK037					CT008
TDM 900 A (2B0/ABS)	05-13	CK2318		CSK037					CT008
XJ 900	83/90	CK2255		CSK049					CT008SP
XJ 900 F	85-92	CK2255		CSK017					CT008SP
XJ 900 S Diversion	95-03	CK2255		CSK187					CT008SP
XVS 950 A Midnight Star	09-13	CK2379		TBA					CT017
FZ1 (Naked) (1000cc) (2D11)	06-09	CK2356		CSK119			SRC077	SRK077	CT020
FZ1-N/NA (Naked / Non ABS& ABS)	10-13	CK2356		CSK119			SRC077	SRK077	CT020
FZ1 Fazer (1000cc) (3C3)	06-13	CK2356		CSK119			SRC077	SRK077	CT020
FZ1 Fazer (Half Fairing - ABS - 5D0)	08-13	CK2356		CSK119			SRC077	SRK077	CT020
FZR 1000 (2RG - Genesis Non EX-UP)	87-88	CK2308		CSK017			SRC008	SRK008	CT008SP
FZR 1000 (3GM1/3/5/7/8-3LG1/2/3/4 -3LH1/2/3/4-3LE1/2/3/4 - EX-UP Models)	89-92	CK2321		CSK037			SRC031	SRK031	CT008SP
FZR 1000 (3GME/F-3LG5/6-3LH5/6-3LE/5 -3LG6-3LJ6-4PM1 - EX-UP Models)	93-95	CK2327		CSK037			SRC029	SRK029	CT008SP
FZS 1000 Fazer	01-05	CK2358		CSK037					CT008SP
GTS 1000	93-96	CK2327		CSK037			SRC029	SRK029	CT008SP
XV 1000 TR1	81	CK2274	CKF2274	CSK014					CT020
XV 1000	86	CK2274	CKF2274	CSK014					CT020
YZF 1000 Thunder Ace	96-02	CK2327		CSK037			SRC029	SRK029	CT008SP
YZF R1 (4XV1/2)	98	CK2226		CSK903			SRC056	SRK056	CT017

CLUTCH APPLICATIONS

# EBC CLUTCH KITS

Make & Model	Year	CK Series #	CKF Series #	Spring Kit #	DRC Series #	DRCF Series #	SRC Series #	SRK Series #	CT Tool #
<b>YAMAHA Contd.</b>									
YZF R1 (4XV7/8 5JJ1/8 5PW1/7)	99-03	CK2350		CSK903			SRC065	SRK065	CT017
YZF R1	04-06	CK2356		CSK119			SRC077	SRK077	CT020
YZF R1 SP (4B1)	06	CK2356		CSK120			SRC093	SRK093	CT020
YZF R1	07-08	CK2356		CSK120			SRC093	SRK093	CT020
YZF R1	09-13	CK2352		CSK120			SRC096	SRK096	CT020
BT 1100 Bulldog P/R/S/T/V	02-06	CK2274	CKF2274	N/A					CT020
XS 1100/1100 S	78-81	CK2230		CSK014					CT017
XV 1100 Virago	89-00	CK2274	CKF2274	N/A					CT020
XVS 1100 A Dragstar Classic	00-07	CK2274	CKF2274	N/A					CT020
XVS 1100 Dragstar	99-04	CK2274	CKF2274	N/A					CT020
FJ 1100	84-85	CK2285		CSK903					CT017
FJ 1200/1200 A	86-95	CK2285		CSK903					CT017
XT 1200 Z Super Tenere (ABS/UBS Brake System)	11-13	CK2362		CSK903					CT017
XVZ 12 TD	85	CK2300		CSK906					CT050SP
V-MAX All models	91-03	CK2300		CSK906					CT050SP
XJR 1200	95-98	CK2285		CSK903					CT017
FJR 1300 N/P	01-02	CK2362		CSK903					CT017
FJR 1300 R/AR/S/AS/AT (ABS)	03-05	CK2362		CSK903					CT017
FJR 1300 A (3P6)	06-09	CK2362		CSK903					CT017
FJR 1300 A (1CY/Manual G/Shift)	10-12	CK2362		CSK903					CT017
FJR 1300 A (1MC/Manual G/Shift)	13	CK2362		CSK903					CT017
FJR 1300 AS (2D2/Electric G/Shift)	06-09	CK2362		N/A					CT017
FJR 1300 AS (Electric G/Shift)	13	CK2362		N/A					CT017
XJR 1300 L 5EA2/5EA3/5EA4	99	CK2285		CSK903					CT017
XJR 1300 M 5EAA/5EAB/5EAC	00	CK2285		CSK903					CT017
XJR 1300 (5EA1/5EA7)	98-99	CK2285		CSK903					CT017
XJR 1300 (5EA9/5EAG)	00	CK2285		CSK903					CT017
XJR 1300 N/P (5EAP/5EAS/5EAT/5EAW/5EAV/5EAY)	01-02	CK2285		CSK903					CT017
XJR 1300 R/S 5WM1/5WM3/5WM5/5WM6/5WM7/5WM9	03-04	CK2285		CSK903					CT017
XJR 1300 T/V/W/X/Y 5WMA/5WMC/5WMD/5WMF	05-11	CK2285		CSK903					CT017
XJR 1300 SP (L) (5EA5/5EA6/5EA8)	99	CK2285		CSK903					CT017
XJR 1300 SP (M) (5EAD/5EAE/5EAF)	00	CK2285		CSK903					CT017
XJR 1300 SP (N) (5EAL/5EAM/5EAN)	01	CK2285		CSK903					CT017
XVZ 13 Royal Star All models	96-01	CK2300		CSK906					CT050SP
XVS 1300 A Midnight Star	07-13	CK2362		CSK903					CT017
XV 1600 A Wild Star	99-04	CK2351		CSK906					CT050SP
MT-01 (1670cc)	05-09	CK2366		CSK903					
MT-01 S (1670cc)	09	CK2366		CSK903					
XV 1700 PCR Road Star Warrior	03-05	CK2363		CSK906					CT050SP
XV 1700 V-Max (2S3)	09-12	CK2380		CSK903					CT017
XV 1900 A Midnight Star	06-12	CK2367		CSK903					CT017
XV 1900 A Midnight Star (3 Spring Clutch)	13	TBA		TBA					
<b>ARCTIC CAT ATV 4 WHEELERS</b>									
250 (2 x 4/4 x 4)	01-04	CK3390		CSK048	DRC089				CT011
250 (2 x 4/4 x 4)	05	CK3390		CSK048	DRC089				CT011
300 (2 x 4/4 x 4)	98-04	CK3356		CSK048	DRC103				CT011
300 (4 x 4)	05	CK3356		CSK048	DRC103				CT011
400 (2 x 4/4 x 4)	98-	CK4439		CSK088	DRC215				CT006
400 (2 x 4)	98	CK4439		CSK088	DRC214				CT006
400 (2 x 4/4 x 4)	00-02	CK4419		CSK088	DRC215				CT006
400 (2 x 4/4 x 4)	03-04	CK4439		CSK098	DRC120				CT006
400 (4 x 4 Manual)	05-08	CK4439		CSK098	DRC120				CT006
400 DVX	04-06	CK3433	CKF3433	CSK079	DRC105	DRCF105			CT006
400 DVX	07-08	CK3447	CKF3447	CSK079	DRC137	DRCF137			CT006
Bearcat 454 (4 x 4)	96-98	CK4439		CSK088	DRC216				CT006
Bearcat 454 (2 x 4)	97-98	CK4439		CSK088	DRC216				CT006
500 (4 x 4)	98-02	CK4439		CSK088	DRC214				CT006
500 (4 x 4 Manual)	03-04	CK3452		CSK007	DRC216				CT006
500 (Manual 4x4)	05-09	CK3452		CSK007	DRC216				CT006
<b>APRILIA</b>									
AF1 Futura 50	90-92	CK2348		N/A					
Classic 50	92-01	CK2348		N/A					
Europa 50	90-92	CK2348		N/A					
MX 50	03-05	CK2348		N/A					
Pegaso 50	92-94	CK2348		N/A					
RS 50	93-05	CK2348		N/A					
RS 50	06-10	CK5604		CSK143					CT026
RX3-5 Marce	91-94	CK2348		N/A					
RX 50 All models	91-05	CK2348		N/A					
RX 50	06-09	CK5604		CSK143					CT026
SX 50	06-09	CK5604		CSK143					

# EBC CLUTCH KITS

Make & Model	Year	CK Series #	CKF Series #	Spring Kit #	DRC Series #	DRCF Series #	SRC Series #	SRK Series #	CT Tool #
<b>APRILIA Contd.</b>									
Tuono 50	03-04	CK2348		N/A					
AF1 125	87-91	CK5598		CSK190	DRC247				CT034SP
Classic 125	95-01	CK5598		CSK190	DRC247				CT034SP
MX 125	04-06	CK5598		CSK190	DRC247				CT034SP
Pegaso 125	91-95	CK5598		CSK190	DRC247				CT034SP
Red Rose 125 (Cast Wheel)	87	CK5598		CSK190	DRC247				CT034SP
Red Rose 125 (Spoke Wheel)	88-94	CK5598		CSK190	DRC247				CT034SP
RS 125 (2T)	92-13	CK5598		CSK190	DRC247				CT034SP
RX 125	92-98	CK5598		CSK190	DRC247				CT034SP
Tuono 125	03-04	CK5598		CSK190	DRC247				CT034SP
RS 250	95-02	CK3333		CSK007					CT022
Pegaso Strada/Trial	05-06	CK2368		CSK123					CT020
ETV 1000 Caponord/Rally (PS00/PSB0) (Non ABS Models)	01-03	CK4434		CSK200			SRC117	SRK117	
ETV Caponord (PS004) (ABS Model)	04-08	CK4434		CSK200			SRC117	SRK117	
RST 1000 Futura	01-04	CK4434		CSK200			SRC117	SRK117	
RSV 1000 Mille	01-02	CK6680		CSK200					
RSV 1000 R Mille	01-02	CK6680		CSK200					
RSV 1000 Mille (Radial caliper)	03	TBA		CSK200					
RSV 1000 R Mille (Radial caliper)	03	TBA		CSK200					
RSV 1000 R Racing/Factory (Radial caliper/4 pad)	04-08	TBA		CSK200					
RSV 1000 R Tuono (Radial caliper/2 pin pad fixing)	07-08	TBA		CSK200					
RSV 1000 SP	99-00	CK6680		CSK200					
RSV 1000 Mille	00	CK6680		CSK200					
RSV 1000 Mille R	00	CK6680		CSK200					
RSV 1000 R Factory	04-08	CK6680		CSK200					
RSV 1000 R	04-08	CK6680		CSK200					
RSV 1000 R Tuono	02-06	CK6680		CSK200					
SL 1000 Falco	00-04	CK6680		CSK200					
RSV4 Factory SBK Racing	09-10	CK6681		CSK184			SRC113	SRK113	
RSV4 Factory APRC	11-13	CK6681		CSK184			SRC113	SRK113	
RSV4 R	10	CK6681		CSK184			SRC113	SRK113	
RSV4 R APRC	11-13	CK6681		CSK184			SRC113		
Tuono V4R	11	TBA		TBA					
Tuono V4R -APRC	11	TBA		TBA					
<b>BMW</b>									
R 45/R 45 N	81-	CK6601		N/A					
R 65 All models	81-	CK6601		N/A					
R 80 All models	80-	CK6601		N/A					
R 100 All models	80-	CK6601		N/A					
R 45/R 45 N	78-80	CK6602		N/A					
R 65	78-80	CK6602		N/A					
R 50/5	69-72	CK6603		N/A					
R 60/5-7	69-80	CK6603		N/A					
R 75 All models	69-	CK6603		N/A					
R 80/7 N-S	77-80	CK6603		N/A					
R 90/6, S	73-76	CK6603		N/A					
R 100/7 T, S, RT, RS	76-80	CK6603		N/A					
K 75 All models	85-	CK6604		N/A					
K 100 All models	83-	CK6605		N/A					
K1	89-	CK6605		N/A					
R 100 RS	86-92	CK6601		N/A					
R 100 RT	87-95	CK6601		N/A					
R 45	09/80-85	CK6601		N/A					
R 45/N	09/80-85	CK6601		N/A					
R 45 T	09/80-85	CK6601		N/A					
R 45 T/N	09/80-85	CK6601		N/A					
R 65	09/80-85	CK6601		N/A					
R 65 LS	81-85	CK6601		N/A					
R 65 T	80-85	CK6601		N/A					
R 65 GS	87-92	CK6601		N/A					
R 80 GS	80-87	CK6601		N/A					
R 80 ST	82-84	CK6601		N/A					
R 80	09/80-84	CK6601		N/A					
R 80 RT	82-84	CK6601		N/A					
R 80 TIC	09/80-85	CK6601		N/A					
R 100/7 T	09/80-84	CK6601		N/A					
R 100 CS	80-84	CK6601		N/A					
R 100 RS	09/80-84	CK6601		N/A					
R 100 RT	09/80-84	CK6601		N/A					
R 100 TIC	80-84	CK6601		N/A					
R 65/20	85-93	CK6601		N/A					
R 65/35	85-88	CK6601		N/A					

CLUTCH APPLICATIONS

# EBC CLUTCH KITS

Make & Model	Year	CK Series #	CKF Series #	Spring Kit #	DRC Series #	DRCF Series #	SRC Series #	SRK Series #	CT Tool #
<b>BMW Contd.</b>									
R 65 RT	85-88	CK6601		N/A					
R 80	84-95	CK6601		N/A					
R 80 RT	84-95	CK6601		N/A					
R 100 GS	86-90	CK6601		N/A					
R 100 PD	89-90	CK6601		N/A					
R 80 GS	87-90	CK6601		N/A					
R 80 PD/CH	90	CK6601		N/A					
R 100 MYS	93-96	CK6601		N/A					
R 100 R	91-95	CK6601		N/A					
R 80 MYS	94-95	CK6601		N/A					
R 80 R	91-94	CK6601		N/A					
R 80 GS	96	CK6601		N/A					
R 45	78-09/80	CK6602		N/A					
R 45 N	78-09/80	CK6602		N/A					
R 65	78-09/80	CK6602		N/A					
R 50/5	69-73	CK6603		N/A					
R 60/5	69-73	CK6603		N/A					
R 60/6	73-76	CK6603		N/A					
R 75/5	69-73/80	CK6603		N/A					
R 75/6	73-76	CK6603		N/A					
R 90/6	73-79	CK6603		N/A					
R 90 S	73-76	CK6603		N/A					
R 60/7	76-09/80	CK6603		N/A					
R 60 TIC	78-09/80	CK6603		N/A					
R 75/7	76-79	CK6603		N/A					
R 80	77-09/80	CK6603		N/A					
R 80 TIC	78-09/80	CK6603		N/A					
R 100	76-77	CK6603		N/A					
R 100/7T	77-09/80	CK6603		N/A					
R 100 RS	76-09/80	CK6603		N/A					
R 100 RT	78-09/80	CK6603		N/A					
R 100 S	76-80	CK6603		N/A					
K 75	84-96	CK6604		N/A					
K 75/2	84-96	CK6604		N/A					
K 75 C	85-88	CK6604		N/A					
K 75 RT	89-96	CK6604		N/A					
K 75 S	85-95	CK6604		N/A					
K 100	82-88	CK6605		N/A					
K 100/2	87-90	CK6605		N/A					
K 100 LT	86-91	CK6605		N/A					
K 100 RT	83-89	CK6605		N/A					
K1	88-93	CK6605		N/A					
K 100 RS	89-92	CK6605		N/A					
K 1100 LT	89-99	CK6605		N/A					
K 1100 RS	92-96	CK6605		N/A					
F 650 (E169/0161/Standard)	09/93-96	CK5605		CSK104					
F 650 (E169/0162/ Funduro/High Screen/19" Front Wheel)	97-00	CK5605		CSK104					
F 650 CS/Scarver K14/0174/0184/Belt drive/17" Cast Wheels)	00-03	CK5636		CSK104					
F 650 CS/Scarver K14/0177/0187/Belt drive/17" Cast Wheels)	04-07	CK5635		CSK104					
F 650 GS (R13/0172/0182/Single Cylinder/19" Front Wheel)	99-03	CK5636		CSK104					
F 650 GS (R13/0175/0185/Single Cylinder/19" Front Wheel)	04-07	CK5635		CSK104					
F 650 GS Dakar (R13/0173/0183/Single Cylinder/21" front wheel)	99-03	CK5636		CSK104					
F 650 GS Dakar (R13/0176/0186/Single Cylinder/21" front wheel)	04-07	CK5635		CSK104					
F 650 ST (E169/0163/0168/Strada/Low Screen/18" Front Wheel)	97-00	CK5605		CSK104					
<b>CCM</b>									
R30 (644 Suzuki Engine)	02-04	CK3386		CSK004	DRC087				CT024
R35/R35S	06-07	CK3433	CKF3433	CSK079	DRC105	DRCF105			CT006
404 E/DS/Supermoto	03-04	CK3433	CKF3433	CSK079	DRC105	DRCF105			CT006
604 Trial/SM/RS/R30 (Rotax Engine)	98-03	CK5628		CSK127	DRC165				CT040SP
644 DS/Supermoto	04	CK3386		CSK004	DRC087				CT024
CR 40 S Cafe Racer	07	CK3433	CKF3433	CSK079	DRC105	DRCF105			CT006
CR 40 Street	07	CK3433	CKF3433	CSK079	DRC105	DRCF105			CT006
SR 40 Street Scrambler	07	CK3433	CKF3433	CSK079	DRC105	DRCF105			CT006
<b>DERBI</b>									
GPR 50 Nude	04-05	CK5604		CSK143					CT026
GPR 50 R	97-00	CK5604		CSK143					CT026
GPR 50 Raing	04-05	CK5604		CSK143					CT026
GPR 50 Replica	99-05	CK5604		CSK143					CT026
Senda 50 (4 Plate Clutch)	99-05	CK5604		CSK143					CT026
Mulhacen 659	06-07	CK2297	CKF2297	CSK014					CT008

# EBC CLUTCH KITS

Make & Model	Year	CK Series #	CKF Series #	Spring Kit #	DRC Series #	DRCF Series #	SRC Series #	SRK Series #	CT Tool #
<b>ELSTARS (Pit Bikes)</b>									
Various models (Check parts before fitting)		CK1308		N/A			SRC091	SRK091	
<b>GAS-GAS</b>									
EC 125 (2T)	00-08	CK1293	CKF1293	CSK024	DRC206				CT001
SM 125 (2T) Supermotard	03-06	CK1293	CKF1293	CSK024	DRC206				CT001
EC 200/250/300 (2T)	00-08	CK5643		CSK141	DRC207				CT009
EC 450 FSR/FSE (4T) Enduro	05-08	CK5643		CSK141	DRC207				CT009
SM 450 FSR (4T) Supermotard	07-08	CK5643		CSK141	DRC207				CT009
Wild HP 450 Quad	04-08	CK5643		CSK141	DRC207				CT009
EC 515 FSR/FSE (4T) Enduro	05-08	CK5643		CSK141	DRC207				CT009
SM 515 FSR (4T) Supermotard	07-08	CK5643		CSK141	DRC207				CT009
<b>HUSQVARNA</b>									
CR 125	00-11	CK1222		CSK182	DRC264				CT001
WR 125	00-11	CK1222		CSK182	DRC264				CT001
WRE 125	00-11	CK1222		CSK182	DRC264				CT001
SM S 125	00-11	CK1222		CSK182	DRC264				CT001
<b>KTM</b>									
SX 60	98-00	CK5594	CKF5594	CSK064	DRC107	DRCF107			CT027
SX 65	98-08	CK5594	CKF5594	CSK064	DRC107	DRCF107			CT027
SX 65	09-13	CK5594	CKF5594	CSK021	DRC241	DRCF241			CT057/SP
SX 85 (17"/14" Wheels)	03-10	CK5610		CSK042	DRC139				CT028
SX 85 (19"/16" Wheels)	03-10	CK5610		CSK042	DRC139				CT028
SX 85 (17"/14" Wheels)	11-13	CK5610		CSK042	DRC139				CT028
SX 85 (19"/16" Wheels)	11-13	CK5610		CSK042	DRC139				CT028
125 EGS	94-97	N/A		CSK011	N/A		N/A		
125 EGS	98-99	CK5611		CSK024	DRC145				CT001
125 EXE	00-01	CK5611		CSK024	DRC145				CT001
125 LC 2 Sting	96-98	N/A		N/A	N/A		N/A		
125 Supermoto	00-01	CK5611		CSK024	DRC145				CT001
Duke 125	11-13	CK4522		CSK199					
EXC 125	98-06	CK5611		CSK024	DRC145				CT001
EXC 125	07-13	CK5611		CSK132	DRC174				CT001
EXC 125 Six Days	11-13	CK5611		CSK132	DRC174				CT001
SX 125	98-07	CK5611		CSK024	DRC145				CT001
SX 125	08	CK5611		CSK132	DRC174				CT001
SX 125	09-13	CK5611		CSK024	DRC145				CT001
125 SXS	01-02	CK5611		CSK024	DRC145				CT001
XC 150	11-13	CK5611		CSK091	DRC144				CT001
SX 150	08-13	CK5611		CSK091	DRC144				CT001
Duke 200	12-13	CK4486		CSK195					
200 EGS	98-99	CK5611		CSK091	DRC144				CT001
200 EXC	97-12	CK5611		CSK091	DRC144				CT001
200 MXC	98-03	CK5611		CSK091	DRC144				CT001
SX 200	03/06-07	CK5611		CSK091	DRC144				CT001
SX 250 (2T)	94-12	CK5595	CKF5595	CSK080	DRC108	DRCF108			CT007
SX 250 (2T/Diaphragm Spring)	13	CK5651		CSK910	DRC275				CT023
SX-F 250 (4T)	05-12	CK1293	CKF1293	CSK179	DRC163	DRCF163			CT001
SX-F 250 (4T/Coil Spring)	13	CK5651		CSK091	DRC260				CT023
250 EGS	94-99	CK5595	CKF5595	CSK080	DRC108	DRCF108			CT007
EXC 250 (2T)	94-12	CK5595	CKF5595	CSK080	DRC108	DRCF108			CT007
EXC 250 Six Days (2T)	11-13	CK5595	CKF5595	CSK080	DRC108	DRCF108			CT007
EXC 250 Six Days (2T/Diaphragm Spring)	13	CK5651		CSK910	DRC275				CT023
250 EXC-G Racing	03	CK5612		CSK120	DRC171				CT023
250 MXC	98-99	CK5595	CKF5595	CSK080	DRC108	DRCF108			CT007
250 SXS	01-03	CK5595	CKF5595	CSK080	DRC108	DRCF108			CT007
250 EXC Racing	02-03	CK5612		CSK120	DRC171				CT023
250 EXC Racing	04	CK5602		CSK120	DRC117				
250 EXC Racing (2T)	05	CK5612		CSK120	DRC154				CT023
250 EXC-G Racing	04	CK5602		CSK120	DRC117				
EXC-F 250 (4T)	06-13	CK1293	CKF1293	CSK179	DRC163	DRCF163			CT001
EXC-F 250 Six Days (4T)	11-13	CK1293	CKF1293	CSK179	DRC163	DRCF163			CT001
XC 250 (2T)	11-12	CK5595	CKF5595	CSK080	DRC108	DRCF108			CT007
XC 250 (2T/Diaphragm Spring)	13	CK5651		CSK910	DRC275				CT023
XC-F 250 (4T)	11-12	CK1293	CKF1293	CSK179	DRC163	DRCF163			CT001
XC-F 250 (4T/Coil Spring)	13	CK5651		CSK091	DRC260				CT023
300 EGS	94-99	CK5595	CKF5595	CSK080	DRC108	DRCF108			CT007
EXC 300 (2T)	00-12	CK5595	CKF5595	CSK080	DRC108	DRCF108			CT007
EXC 300 (2T/Diaphragm Spring)	13	CK5651		CSK910	DRC275				CT023
EXC 300 Six Days (2T)	11-12	CK5595	CKF5595	CSK080	DRC108	DRCF108			CT007
EXC 300 Six Days (2T/Diaphragm Spring)	13	CK5651		CSK910	DRC275				CT023
300 EXC	94-07	CK5595	CKF5595	CSK080	DRC108	DRCF108			CT007

CLUTCH APPLICATIONS



# EBC CLUTCH KITS

Make & Model	Year	CK Series #	CKF Series #	Spring Kit #	DRC Series #	DRCF Series #	SRC Series #	SRK Series #	CT Tool #
<b>KTM Contd.</b>									
300 MXC	94-03	CK5595	CKF5595	CSK080	DRC108	DRCF108			CT007
300 MXC	04-05	CK5595	CKF5595	CSK080	DRC108	DRCF108			CT007
XC 300 (2T)	11-12	CK5595	CKF5595	CSK080	DRC108	DRCF108			CT007
SX 300	94	CK5595	CKF5595	CSK080	DRC108	DRCF108			CT007
300 Six Days	96	CK5595	CKF5595	CSK080	DRC108	DRCF108			CT007
350 Enduro (2T)	89	CK5596		CSK084	DRC173				
350 EXC	94	CK5631		CSK080	DRC169				CT030
350 Freeride (4T)	12-13	CK5651		CSK910	DRC273				CT023
350 MX (2T)	89	CK5596		CSK084	DRC173				
350 Super Comp	94-95	CK5631		CSK080	DRC169				CT030
EXC-F 350 (Coil Spring)	11	CK5651		CSK091	DRC260				CT023
EXC-F 350 (4T/Diaphragm Spring)	12-13	CK5651		CSK910	DRC273				CT023
EXC-F 350 (4T/Six Days/Diaphragm Spring)	12-13	CK5651		CSK910	DRC273				CT023
SX-F 350 (USD Forks/Coil Spring)	11-13	CK5651		CSK091	DRC260				CT023
XC-F 350	12	CK5651		CSK091	DRC260				CT023
360 EGS	96-97	CK5595	CKF5595	CSK080	DRC108	DRCF108			CT007
360 EXC	96-97	CK5595	CKF5595	CSK080	DRC108	DRCF108			CT007
360 MXC	96-97	CK5595	CKF5595	CSK080	DRC108	DRCF108			CT007
360 SX	96-97	CK5595	CKF5595	CSK080	DRC108	DRCF108			CT007
360 Six Days	96	CK5595	CKF5595	CSK080	DRC108	DRCF108			CT007
380 EGS	98-99	CK5631		CSK129	DRC170				CT030
380 EXC	98-02	CK5595	CKF5595	CSK080	DRC108	DRCF108			CT007
380 MXC	98-01	CK5595	CKF5595	CSK080	DRC108	DRCF108			CT007
SX 380	98-02	CK5595	CKF5595	CSK080	DRC108	DRCF108			CT007
400 Duke	94-95	CK5631		CSK080	DRC169				CT030
400 EGS-E	97	CK5631		CSK129	DRC170				CT030
400 EGS	94	CK5631		CSK080	DRC169				CT030
400 EGS	96-97	CK5631		CSK129	DRC170				CT030
400 EXC (LC4 Engine)	93-95	CK5632		CSK011	DRC178				
400 EXC	94	CK5631		CSK080	DRC169				CT030
400 EXC	96	CK5631		CSK129	DRC170				CT030
400 EXC	00-01	CK5602		CSK120	DRC117				
400 EXC Racing	02	CK5612		CSK120	DRC171				CT023
400 EXC-G Racing	02	CK5612		CSK120	DRC171				CT023
400 EXC Racing	05	CK5612		CSK120	DRC154				CT023
400 EXC	07-09	CK5612		CSK120	DRC171				CT023
400 EXC-G Racing	05	CK5612		CSK120	DRC154				CT023
400 EXC-G Racing	06	CK5612		CSK120	DRC171				CT023
EXC 400 (4T)	09-11	CK5648		CSK140	DRC252				CT041
400 LC-4	98	CK5631		CSK129	DRC170				CT030
400 LC4-E	00-01	CK5631		CSK129	DRC170				CT030
LC4 R 400	99	CK5631		CSK129	DRC170				CT030
400 LSE	97	CK5631		CSK129	DRC170				CT030
400 LS-E	04	CK5631		CSK129	DRC170				CT030
400 MXC	01	CK5602		CSK120	DRC117				
400 MXC	02	CK5612		CSK120	DRC171				CT023
400 Super Comp	95	CK5631		CSK080	DRC169				CT030
400 Super Comp/EXC	96-99	CK5631		CSK129	DRC170				CT030
RXC-E 400	95	CK5595	CKF5595	CSK011	DRC108	DRCF108			CT007
400 RXC-E	95	CK5632		CSK011	DRC178				
400 RXC-E	96-97	CK5631		CSK129	DRC170				CT030
SC 400 (LC4 Engine)	95	CK5632		CSK011	DRC178				
SXC 400	97	CK5631		CSK129	DRC170				CT030
400 SX-X	98	CK5631		CSK129	DRC170				CT030
400 SX	99	CK5631		CSK129	DRC170				CT030
SX 400	00-01	CK5602		CSK120	DRC117				
400 SX Racing	02	CK5612		CSK120	DRC171				CT023
400 SXC	00	CK5631		CSK129	DRC170				CT030
400 TXC	98	CK5631		CSK129	DRC170				CT030
SX 440	94	N/A		N/A	N/A		N/A		
MXC 440	94	N/A		N/A	N/A		N/A		
EXC 440	94-95	N/A		N/A	N/A		N/A		
450 EXC Racing	03	CK5612		CSK120	DRC171				CT023
450 EXC-G Racing	03	CK5612		CSK120	DRC171				CT023
450 EXC-G Racing	04	CK5602		CSK120	DRC117				
450 EXC-G Racing	05	CK5612		CSK120	DRC154				CT023
450 EXC Racing	04	CK5602		CSK120	DRC117				
450 EXC Racing	05	CK5612		CSK120	DRC154				CT023
450 EXC	04-05	CK5612		CSK120	DRC154				CT023
450 EXC	06-09	CK5612		CSK120	DRC171				CT023
EXC 450 (4T/Coil Spring)	09-11	CK5648		CSK140	DRC252				CT041
EXC 450 (4T/Diaphragm Spring)	12	CK5651		CSK910	DRC273				CT023
EXC-F 450 (4T/Diaphragm Spring)	13	CK5651		CSK910	DRC275				CT023

CLUTCH APPLICATIONS



# EBC CLUTCH KITS

Make & Model	Year	CK Series #	CKF Series #	Spring Kit #	DRC Series #	DRCF Series #	SRC Series #	SRK Series #	CT Tool #
<b>KTM Contd.</b>									
EXC 450 Six Days (4T)	11	CK5648		CSK140	DRC252				CT041
EXC 450 Six Days (4T /Diaphragm Spring)	12	CK5651		CSK910	DRC273				CT023
EXC 450 Six Days (4T/Diaphragm Spring)	13	CK5651		CSK910	DRC275				CT023
EXC-R 450 (4T)	08-10	CK5648		CSK140	DRC252				CT041
450 MXC-G Racing	03	CK5612		CSK120	DRC171				CT023
450 MXC-G Racing	04	CK5602		CSK120	DRC117				
450 MXC-G Racing	05	CK5612		CSK120	DRC154				CT023
MXC 450	06	CK5612		CSK120	DRC171				CT023
450 SMR	04-05	CK5612		CSK120	DRC154				CT023
SMR 450	06-07	CK5612		CSK120	DRC171				CT023
SMR 450 (Slipper Clutch)	08-13	N/A		N/A					
450 SMS	04	CK5612		CSK120	DRC172				CT023
SX 450 (4T)	03	CK5612		CSK120	DRC171				CT023
SX 450 (4T)	04-05	CK5612		CSK120	DRC154				CT023
SX 450 (4T)	06	CK5612		CSK120	DRC171				CT023
SX-F 450 (4T/Coil Spring)	07-11	CK5638		CSK136	DRC184				CT009
SX-F 450 (4T/Diaphragm Spring)	12	CK5651		CSK910	DRC273				CT023
SX-F 450 (4T/Diaphragm Spring)	13	CK5651		CSK910	DRC275				CT023
450 SX (Quad)	09-11	CK5638		CSK136	DRC184				CT009
XC 450 Quad (4T)	08-09	CK5612		CSK120	DRC171				CT023
500 Enduro (2T)	89	CK5596		CSK084	DRC173				
500 Enduro (4T)	89	CK5596		CSK084	DRC173				
EXC 500 (4T/Diaphragm Spring)	12	CK5651		CSK910	DRC273				CT023
EXC 500 Six Days (4T/Diaphragm Spring)	12	CK5651		CSK910	DRC273				CT023
EXC 500 Six Days (4T/Diaphragm Spring)	13	CK5651		CSK910	DRC275				CT023
500 MX (2T)	89	CK5596		CSK084	DRC173				
500 MX (4T) LC	89	CK5596		CSK084	DRC173				
SX-F 505	07-09	CK5638		CSK136	DRC184				CT009
505 SX-F (Quad)	09-12	CK5638		CSK136	DRC184				CT009
520 EXC	00-01	CK5602		CSK120	DRC117				
SX 520	00-01	CK5602		CSK120	DRC117				
520 SX Racing	02	CK5612		CSK120	DRC171				CT023
525 EXC-G Racing	03	CK5612		CSK120	DRC171				CT023
525 EXC	03	CK5612		CSK120	DRC171				CT023
525 EXC Racing	04	CK5602		CSK120	DRC117				
525 EXC-G Racing	04	CK5602		CSK120	DRC117				
525 EXC Racing	05	CK5612		CSK120	DRC154				CT023
525 EXC-G Racing	05	CK5612		CSK120	DRC154				CT023
525 MXC Desert Racing	03	CK5612		CSK120	DRC171				CT023
525 MXC Desert Racing	04	CK5602		CSK120	DRC117				
525 MXC Desert Racing	05	CK5612		CSK120	DRC154				CT023
MXC 525	06	CK5612		CSK120	DRC171				CT023
525 MXC-G Racing	04	CK5602		CSK120	DRC117				
525 SMR	04-05	CK5612		CSK120	DRC154				CT023
525 SX Racing	03	CK5612		CSK120	DRC171				CT023
525 SX Racing	04	CK5602		CSK120	DRC117				
525 SX Racing	05	CK5602		CSK120	DRC154				CT023
SX 525	06	CK5612		CSK120	DRC171				CT023
XC 525 (Quad)	08-12	CK5612		CSK120	DRC171				CT023
EXC-R 530 (4T) - (7 Friction plate type)	08	CK5640		CSK140	DRC198				CT041
EXC 530 - (7 Friction Plate Type)	08	CK5640		CSK140	DRC198				CT041
EXC 530 - (9 Friction Plate Type)	09-11	CK5648		CSK140	DRC252				CT041
540 SX-C	98-99	CK5639		CSK129	DRC196				CT030
540 SXS Racing	02	CK5612		CSK120	DRC171				CT023
MXC 550	94-96	N/A		N/A	N/A		N/A		
SMR 560	06-07	CK5612		CSK120	DRC171				CT023
600 Enduro (4T) LC	89	CK5596		CSK084	DRC173				
600 MX (4T) LC	89	CK5596		CSK084	DRC173				
620 Duke	94	CK5631		CSK080	DRC169				CT030
620 Duke	97	CK5631		CSK129	DRC170				CT030
620 EGS	94-95	CK5631		CSK080	DRC169				CT030
620 EGS/Adventure	96-97	CK5631		CSK129	DRC170				CT030
620 EGS-E	97	CK5631		CSK129	DRC170				CT030
620 Enduro Ltd	97	CK5631		CSK129	DRC170				CT030
620 EXC	94-95	CK5631		CSK080	DRC169				CT030
620 LC-4	98	CK5631		CSK129	DRC170				CT030
620 LC4 Competition	99	CK5639		CSK129	DRC196				CT030
620 LC4 Super Moto	99	CK5639		CSK129	DRC196				CT030
620 LSE	97	CK5631		CSK129	DRC170				CT030
620 RXC-E	96-97	CK5631		CSK129	DRC170				CT030
620 Six Days	96	CK5631		CSK129	DRC170				CT030
620 Super Comp	94-95	CK5631		CSK080	DRC169				CT030
620 Super Comp	96-99	CK5639		CSK129	DRC196				CT030

CLUTCH APPLICATIONS

# EBC CLUTCH KITS

Make & Model	Year	CK Series #	CKF Series #	Spring Kit #	DRC Series #	DRCF Series #	SRC Series #	SRK Series #	CT Tool #
<b>KTM Contd.</b>									
RXC-E 620	95	CK5595	CKF5595	CSK011	DRC108				CT007
620 RXC-E	95	CK5632		CSK011	DRC178				
620 SC	00-01	CK5631		CSK129	DRC170				CT030
SX 620	94	CK5631		CSK080	DRC169				CT030
SX 620	97-99	CK5639		CSK129	DRC196				CT030
SXC 620	97	CK5631		CSK129	DRC170				CT030
620 Supermoto	98	CK5639		CSK129	DRC196				CT030
620 TXC	98	CK5639		CSK129	DRC196				CT030
625 SC	02	CK5639		CSK129	DRC196				CT030
625 SMC	04/06	CK5639		CSK129	DRC196				CT030
625 SXC	03-04	CK5639		CSK129	DRC196				CT030
640 Adventure-R	98-02	CK5639		CSK129	DRC196				CT030
640 Duke-E	98	CK5639		CSK129	DRC196				CT030
Duke-E 640	98	CK5639		CSK129	DRC196				CT030
Duke II 640	99-02	CK5639		CSK129	DRC196				CT030
Duke II 640	03-07	CK5639		CSK129	DRC196				CT030
640 LC Rallye Dakar	97	CK5631		CSK129	DRC170				CT030
640 LC4	99	CK5639		CSK129	DRC196				CT030
640 LC4	99-00	CK5639		CSK129	DRC196				CT030
640 LC4 Six Days	99	CK5639		CSK129	DRC196				CT030
640 LC4-E	00-02	CK5639		CSK129	DRC196				CT030
640 LC4 Adventure	03-06	CK5639		CSK129	DRC196				CT030
640 LC4 Supermoto	03-04	CK5639		CSK129	DRC196				CT030
660 LC4	97	CK5631		CSK129	DRC170				CT030
660 LC4 Rallye	99-00	CK5639		CSK131	DRC175				CT030
660 Rallye	01-03	CK5633		CSK129	DRC176				CT030
660 Rallye Factory	04	CK5633		CSK129	DRC176				CT030
660 SM Factory Replica	02-03	CK5639		CSK131	DRC175				CT030
660 SMC	03-04	CK5639		CSK131	DRC175				CT030
660 SMS	04	CK5631		CSK131					CT030
690 Enduro	08-10	CK5642		CSK131	DRC205				
690 Duke	08-13	CK5642		CSK131	DRC205				
690 Duke R	10-11	CK5642		CSK131	DRC205				
690 Duke R	13	TBA		TBA	TBA				
690 R Enduro	09-13	CK5642		CSK131	DRC205				
690 Rally Factory Replica	07-09	CK5641		CSK131	DRC199				CT030
690 SM	07-09	CK5642		CSK129					
690 SM - LE (Limited Edition)	10-11	CK5642		CSK131	DRC205				
690 SMC	08-11	CK5642		CSK131	DRC205				
690 SMR	07-11	CK5642		CSK131	DRC205				
690 SMC R	12-13	CK5642		CSK131	DRC205				
950 Adventure S	03-04	CK5634		CSK130	DRC177				CT015
950 Adventure	06	CK5634		CSK130	DRC177				CT015
950 Superenduro R	07-08	CK5634		CSK130	DRC177				CT015
990 Adventure S	06-08	CK5634		CSK130	DRC177				CT015
990 Adventure R	09-12	CK5634		CSK130	DRC177				CT015
990 Adventure	09-12	CK5634		CSK130	DRC177				CT015
990 Adventure Dakar Edition	11	CK5634		CSK130	DRC177				CT015
990 Superduke	05-11	CK5634		CSK130	DRC177				CT015
990 Superduke R	07-13	CK5634		CSK130	DRC177				CT015
990 Supermoto T (SM-T)	08-13	CK5634		CSK130	DRC177				CT015
990 Supermoto R (SM-R)	08-09	CK5634		CSK130	DRC177				CT015
990 Supermoto R (SM-R)	10-13	CK5634		CSK130	DRC177				CT015
RC8 (1190cc)	08-11	CK5644		CSK161			SRC098	SRK098	CT021
RC8 R/Track (1190cc)	10-13	CK5644		CSK161			SRC098	SRK098	CT021
1190 Adventure	13	TBA		TBA					
1190 Adventure R	13	TBA		TBA					
Reklus After Market Clutch for EXC 250/300 (2T Models/24 Tooth Steel Plate)	03-11	CK5595	CKF5595	N/A	N/A	N/A			CT049
Reklus After Market Clutch for SX 250/300 (2T Models/24 Tooth Steel Plate)	03-11	CK5595	CKF5595	N/A	N/A	N/A			CT049
<b>MODENAS</b>									
Kriss 110/115		CK4438	CKF4438	CSK40					
<b>MONTESA-HONDA</b>									
315R (2T)	97-04	CK1170	CKF1170	CSK163	DRC250				CT009
4RT 250cc (4T)	05-09	CK1171		TBA					
<b>MORIWAKI/HONDA</b>									
MD 250 H	08-11	CK1305	CKF1305	CSK176					CT001
MD 250 S	08-11	CK1305	CKF1305	CSK176					CT001

# EBC CLUTCH KITS

Make & Model	Year	CK Series #	CKF Series #	Spring Kit #	DRC Series #	DRCF Series #	SRC Series #	SRK Series #	CT Tool #
<b>MOTO ROMA</b>									
Geko 300 Quad	04-06	CK1190	CKF1190	N/A					CT013SP
<b>QUADZILLA</b>									
WK 300	06	CK3399	CKF3399	CSK034	DRC058	DRCF058			CT022
<b>SACHS</b>									
XTC 125	00-07	CK3318	CKF3318	CSK034					CT011
X Road 125	06-07	CK3318	CKF3318	CSK034					CT011
<b>TRIUMPH</b>									
Adventurer	96-01	CK5588		CSK068					CT021
America (Cast Wheel)	07-09	CK5608		CSK015					
Bonneville 800 (790cc) Up to Engine no. 211132	01-04	CK5597		CSK015					CT009SP
Bonneville 800 From Engine no. 211133	01-04	CK5608		CSK015					
Bonneville America	02-06	CK5608		CSK015					
Bonneville/Bonneville Black (865cc)	07-08	CK5608		CSK015					
Bonneville (865cc)	09	TBA		TBA					
Bonneville SE (865cc)	09	TBA		TBA					
Bonneville T-100 (790cc) Up to Engine no. 211132	02-04	CK5597		CSK015					CT009SP
Bonneville T-100 From Engine No. 211133	02-04	CK5608		CSK015					
Bonneville T100 (865cc)	05-09	CK5608		CSK015					
Bonneville - Steve McQueen SE	12	CK5608		CSK015					
Daytona 600	02-05	CK1206		CSK083					CT013SP
Daytona 650	05	CK1181		CSK015					CT014
Daytona 675	06-12	CK1206		CSK135					CT014
Daytona 675 R	11-12	TBA		TBA					
Daytona 750 (3cyl)	92	CK5588		CSK068					CT021
Daytona 900 (3cyl)	93-96	CK5588		CSK068					CT021
Daytona 955i	98-00	CK5589		CSK029					CT009
Daytona 955i (From VIN 132513)	01-06	CK5599		CSK029					CT009
Daytona 1000 (4cyl)	92	CK5588		CSK015					CT021
Daytona Super III (3cyl)	94-97	CK5588		CSK068					CT021
Daytona 1200 (4cyl)	93-98	CK5588		CSK045					CT021
Legend TT	98-01	CK5588		CSK068					CT021
Rocket III 2300cc	04-09	CK5624		CSK118					CT021
Rocket III Classic	07-09	CK5624		CSK118					CT021
Rocket III Roadster ABS	10-12	CK5624		CSK118					CT021
Rocket III Touring	08-12	CK5624		CSK118					CT021
Speedmaster 800 (790cc) Up to VIN 210261	03-04	CK5608		CSK015					
Speedmaster From VIN 210262	03-04	CK5608		CSK015					
Scrambler (865cc)	06-09	CK5608		CSK015					
Speedmaster (865cc)	05-09	CK5608		CSK015					
Speed Triple (Carb models)	94-97	CK5588		CSK068					CT021
Speed Triple (EFI)	97-01	CK5589		CSK029					CT009
Street Triple 675 (Naked)	07-08	TBA		TBA					
Speed Triple 955cc (From VIN 141872 to 210444)	02-04	CK5599		CSK029					CT009
Speed Triple (1050cc)	05-08	CK5599		CSK029					CT009
Speed Triple R (1050cc)	12	TBA		TBA					
Sprint GT1050	10-12	TBA		TBA					
Sprint ST (1050cc) (From VIN 208167)	05-09	CK5599		CSK029					CT009
Rocket III 2300cc (All models)	04-09	CK5624		CSK118					CT021
Sprint (All carb models up to VIN 9082)	93	CK5588		CSK068					CT021
Sprint (All carb models from VIN9083)	94-98	CK5588		CSK068					CT021
Sprint RS (Up to VIN139276)	99-01	CK5589		CSK029					CT009
Sprint RS (From VIN 139277)	02-04	CK5599		CSK029					CT009
Sprint ST (Up to VIN 139276)	99-01	CK5589		CSK029					CT009
Sprint ST (From VIN139277 to 208166)	02-04	CK5599		CSK029					CT009
T595 Daytona	97	CK5589		CSK029					CT009
TT600	00-03	CK1206		CSK083					CT013SP
Thunderbird	95-03	CK5588		CSK068					CT021
Thunderbird Sport	98-04	CK5588		CSK068					CT021
Thunderbird (1597cc)	09-12	TBA		TBA					
Thunderbird Storm (1699cc)	11-12	TBA		TBA					
Thruxton 900	04-12	CK5608		CSK015					
Tiger 800	11-12	TBA		TBA					
Tiger 800 XC	11-12	TBA		TBA					
Tiger 900cc (Up to VIN71698)	93-96	CK5588		CSK068					CT021
Tiger 900cc (From VIN71699)	97-98	CK5589		CSK029					CT009
Tiger 955cc (Up to VIN 198874)	99-04	CK5589		CSK029					CT009
Tiger 955 (From VIN 198875)	04-06	CK5589		CSK029					CT009
Tiger 1050	07-12	CK5599		CSK029					CT009
Tiger 1050 SE	10-12	CK5599		CSK029					CT009
Tiger Explorer 1200	12	TBA		TBA					

CLUTCH APPLICATIONS



# CLUTCH KIT BUYERS GUIDE

CK1101	<b>HONDA</b> No fitment		CK1119 ■=CT012SP	<b>HONDA Cont.</b> TRX 200 SX XR 200 RB/RC/RD XR 200 XR 200 R XR 200 R TLR 250 F TRX 250 V/W/X/Y/1/TE2/TEA /TEB/TEC/TM2/TMA/TMB/TMC TRX 250 EX1/2/3/4/5/6/7/8 TRX 250 X9/XA/XB <b>HONDA-DALL'ARA</b> XR 125 SM <b>KAWASAKI</b> KLF 185 A3	86-87 ■ 81-83 ■ 80-84 ■ 81-83 ■ 86-02 ■ 85- ■ 97-12 ■ 01-07 ■ 09-11 ■ 04 ■ 87 ■	
CK1102	No fitment		CK1120	<b>HONDA</b> No fitment		
CK1103	No fitment		CK1121	No fitment		
CK1104	Use CK1276		CK1122	No fitment		
CK1105	SS 50 ZK2/ZB2 CD 50 ST/SV/SW/SX Benley 50 S CL 50 V/X Benley CL 50	75-80 96-99 97-99	CK1123	No fitment		
CK1106	Use CK1107		CK1124	No fitment		
CK1107	Z50 RZ-RD C 70/C70M	79-86 -78	CK1125	No fitment		
CK1108	Use CK1156		CK1126	No fitment		
CK1109	Use CK1105		CK1127	No fitment		
CK1110	Use CK1107		CK1128	No fitment		
CK1111	No fitment		CK1129	No fitment		
CK1112	Use CK1107		CK1130	CB500 T ▲=CT031	75-77 ▲	
CK1113	Use CK1107		CK1131	CR 250 RB/RC TL 250/TL250 K1 XL 250 K3/K4 CR 450 RB CR 480 RC	81-82 78-79 78-79 81 82	
CK1114	Use CK1111		CK1132	CB 250 K3-K5/G5 ▲=CT009 CJ 250 T/T2 CB 350 K4 CB 360/CJ 360 (All models)	73-76 ▲ 77 ▲ ▲ ▲	
CK1115	No fitment		CK1133	CB 750/K1/K2/K3/K4/K5 (From E/No.:1056080)	69-75	
CK1116	Use CK1156		CK1134	CB 175 (All models) CD 175 (All models) CB 200/CB 200 B	76-78	
CK1117	Use CK1150		CK1135	CB 500/K1/K2 ▲=CT009	75-77 ▲	
CK1118	Use CK1151		CK1136	Use CK1140		
CK1119	CR 80 RE ■=CT012SP CR 80 RF/R2F/RG/R2G/RH/RJ /RK/RL/RM/RP/RR/RS/RT/RBT /RV/RBV/RW/RBW/RX/RBX/RY /RBY/R1/RB1/R2/RB2 CR 85 R3/RB3/R4/RB4/R5/RB5/R6 /RB6/R7/RB7 CB 100 N CA 125 V/W/X CB 125 S/J CB 125 T/T2 CB 125 TDC/TDE CB 125 RS CBF 125 M9/MA/MB CBR 125 RW7/RW8/RW9/RWA/RWB CD 125 TC CG 125 K1/B/C/E/BR/BR-K/BR-J/S/T/W CLR 125 W 'City Fly' CM 125 CC/CF CT 125 C TL 125 S NX 125 K/S/F Transcity XL 125 K2-K4/SZ/SA XL 125 SB/SC/SZ/SA/RC/RF/RH XLR 125 RW XR 125 L3/L4/L5/L6/L7/L8 CRF 150 F6/F7 CD 185 T XL 185 SZ/SA/SB ATC 200 XD CD 200 TA CM 200 TA/TB CTX 200/CTX 200 A Bushlander TL 200 J/Y TLR 200 D/E/G/H TRX 200 D TRX 200 L/M Fourtrax	84 ■ 85-02 ■ 03-07 ■ 78-80 ■ 98-00 ■ 75-79 ■ 78-80 ■ 83-86 ■ 83 ■ 09-13 ■ 05-13 ■ 78 ■ 77-00 ■ 98-03 ■ 82-85 ■ 85 ■ 76 ■ 89-97 ■ 78-79 ■ 79-86 ■ 98-99 ■ 03-08 ■ 06-07 ■ 78 ■ 80-82 ■ 84 ■ 79-80 ■ 79-80 ■ 04-05 ■ 76-78 ■ 83-87 ■ 91-97 ■ 90-91 ■	84 ■ 85-02 ■ 03-07 ■ 78-80 ■ 98-00 ■ 75-79 ■ 78-80 ■ 83-86 ■ 83 ■ 09-13 ■ 05-13 ■ 78 ■ 77-00 ■ 98-03 ■ 82-85 ■ 85 ■ 76 ■ 89-97 ■ 78-79 ■ 79-86 ■ 98-99 ■ 03-08 ■ 06-07 ■ 78 ■ 80-82 ■ 84 ■ 79-80 ■ 79-80 ■ 04-05 ■ 76-78 ■ 83-87 ■ 91-97 ■ 90-91 ■	CK1140 ■=CT013SP	CB 250 T/N/NA/NB/ND/NBD/NDC CM 250 TB CB 350 SG/SJ CB 400 F/F1/F2 CB 400 T/N/NA/NB/NC CB 450 DX-K CMX 450 CH/CJ Rebel XL 500 SZ/SB/RC	78-82 ■ 81 ■ 86-88 ■ 75-79 ■ 78-82 ■ 89 ■ 02 ■ 80-82 ■

Part No.	Make/Model	Year	Part No.	Make/Model	Year						
CK1141	<b>HONDA Cont.</b> Use CK1146		CK1151 CKF1151 Contd. ■=CT012SP ▲=CT012	<b>HONDA Cont.</b> XR 100 RP/RR/RS/RT/RV/RW/RX /RY/R1/R2/R3	93-03 ■						
CK1142	Use CK1145			XR 100 M5 (HD13) Motard	05 ■						
CK1143	GL 1000 K1/K2 'Goldwing' (From E/No.:2002384)	77-78		XZ 100 2 APE-HC07	02 ■						
CK1144 ▲=CT002	CR 125 M2-M4	76-78 ▲		ATC 125 MG	86 ■						
CK1145	CB 750 F2 CB 750 K6/K7	78 76-77		H 100 A/SD/SG/SJ	84-92 ■						
CK1146	CB 500 F/K3 CX 500 CA/CB/Z/A/B/EC GL 500 DC CB 550 F/F1/F2/K3	79-85 82 78-80		TRX 125 J	88 ■						
				ATC 185 A/SB/SC/SD	80-83 ■						
				ATC 200 B/ESE/ESF/SE	81-84 ■						
				<b>YAMAHA</b> XT 125 R (13D3/13D5) (4 friction plate clutch)	07-11 ▲						
CK1147	CB 650 Z/B/SCC CX 650 ED GL 650 D2-E	79-82 83-85 84		XT 125 X (13D4/13D6) (4 friction plate clutch)	07-11 ▲						
			YBR 125 ED (3D91/3D92)	05-12 ▲							
CK1148	C 50 Z2/ZZ/ZA C 50 All Models C 50 N (Single seat model) C 50 P/S/N/X/Y/1/2 CF 50/CF 50 K2 CRF 50 F4/F5/F6/F7/F8/F9/FA/FB/FC/FD MP 50 3/DX3 Solo (AC17) ST 50 J/K Dax XR 50 1/2/3 ATC 70 All Models C 70 Z2/ZZ/C/D/DMC CRF 70 F4/F5/F6/F7/F8/F9/FA/FB/FC/FD XR 70 RV/RW/RX/RY/R1/R2/R3 C 90 C/E/G/MF/P/MP/MG/N/MN P/MP/T/MT	78-81 82-93 95 96-02 77-78 04-13 03 78-93 01-03 79-85 77-85 04-13 97-03 82-03	YBR 125 Custom	08-13 ▲							
			CK1152 ■=CT013SP	XL 250 S/SZ/SA XR 250 SZ/SA	78-80 ■ 78-80 ■						
			CK1153 ■=CT013SP	NS 125 FG/FH/RH CB 250 RSA/RSD CL 250 SC XL 250 RB/RC/RD XL 250 SB/RC	86-87 ■ 81-84 ■ 81 ■ 81-83 ■ 81-82 ■						
			CK1154 ■=CT013SP	TRX 420 FM7/FM8/FM9/FMA/FMB 4WD - Fourtrax TRX 420 FPM9/FPMA/FPMB Fourtrax - 4WW - Power Steering TRX 420 TM7/TM8/TM9/TMA/TMB Fourtrax 2WD FT 500C TRX 500 FE5/FE6/FE7/FE8/FE9 /FEA Fourtrax Foreman 4WD-ES TRX 500 FM5/FM6/FM7/FM8/FM9 /FMA Fourtrax Foreman 4WD TRX 500 FPE8/FPE9/FPEA Fourtrax Foreman - Power Steering TRX 500 TM5/TM6 Fourtrax Foreman TRX 500 FEC Fourtrax Foreman ES 2/4 WD TRX 500 FMC Fourtrax Foreman 2/4 WD TRX 500 FPEC Fourtrax Foreman 2/4 WD XR 500 SZ/SA/RB/RC	07-11 ■ 09-11 ■ 07-12 ■ 82 ■ 05-10 ■ 05-10 ■ 08-10 ■ 05-06 ■ 12 ■ 12 ■ 12 ■ 79-82 ■						
						CK1155	Use CK1119				
						CK1156	C 90 Z2/ZZ (From E/No.:A073285) ATC 110 All Models CT 110 A/B/C/D/K/M/P/X ATC 125 ME	75-81 79-84 80-09 84			
									CK1157	Use CK1163	
									CK1158	Use CK1191	
						CK1159 ▲=CT053SP	CX 500 TC 'Turbo' CX 650 TD 'Turbo' GL 1100 A/DA/BI/B/DB	82 ▲ 83 ▲			
									CK1160 ■=CT013SP	CRM 125 RL/RM/RN/RP/RR/RV/RX NSR 125 FJ/FK/FL/FM/FN NSR 125 RK/RL/RM/RN NSR 125 RR/RS/RV/RW/RX/RY/R1 TRX 350 TE/FE Fourtrax Rancher ES/ES 4x4 (FEY/1-5) NT 400 Bros (NC25) NV 400 CJ/CK (Steed) NV 400 CS/CV Steed NV 400 DCY/DC1/DC2 (NC40) Shadow Slasher VRX 400 T (NC33) VT 500 ED/EF	90-99 ■ 88-92 ■ 89-92 ■ 93-01 ■ 00-05 ■ 92-93 ■ 95-97 ■ 00-02 ■ 96 ■ 83-85 ■
CK1151 CKF1151 ■=CT012SP	CR 50 RE/RF NSR 50 V (AC10-180) NSR 50 X (AC10-190) CR 60 RF/RG CRM 75 RK/RL/RM/RP/RR NSR 75 N/P/R/X/Y (NS-1) CR 80 RA/RB/RC/RD MBX 80 FWDD/FWDF MTX 80 RFD/RFF NSR 80 J-2/K/L/N/P/R/S (HC06) NSR 80 V (HC06-170) NSR 80 X (HC06-180) TRX 90 P/R/S/T/V/W/XY/1-6 TRX 90 EX TRX 90 X9/XB Astrea Supra NF 100 Astrea Grand/Supra CRF 100 F4/F5/F6/F7/F8/F9/FA/FB/FC XL 100 SZ/SA/SB	84-85 ■ 97 ■ 99 ■ 85-86 ■ 89-94 ■ 92-00 ■ 80-83 ■ 83-86 ■ 83-84 ■ 88- ■ 97 ■ 99 ■ 93-06 ■ 07-08 ■ 09-11 ■ 99 ■ 97-98 ■ 04-12 ■ 78-82 ■									





Part No.	Make/Model	Year	Part No.	Make/Model	Year
CK1191 CKF1191 ▲=CT012 ■=CT012SP	<b>HONDA Cont.</b> CR 125 RB CRF 150 RB7/R7/RB8/R8/RB9/R9 /RC/RBC/RD/RBD CB 250 N/T/W/X/Y/1/4 "Two Fifty" VT 250 FD CD250 UJ/UK CMX 250 CT/CV/CW/CX	81 07-13 ▲ 93-05 ■ 83 ▲ 88-92 ■ 96-00 ■	CK1206 ▲=CT014 ●=CT014SP ■=CT055SP Contd.	<b>TRIUMPH</b> TT 600 Daytona 600 Daytona 675	00-03 ● 02-05 ● 06-12 ▲
CK1192	Use CK1191		CK1207	Use CK1149	
CK1193 CKF1193 ▲=CT013 ★=CT014 ■=CT013SP	ATC 250 RF/RG CRM 250 R (RK) MK1/MD 24 (100001-1008385) CRM 250 R (RM) MK2/MD24 (1200001-1211634) CRM 250 R (RP/RP-II) MK2/2 MD24 (1300001-) TRX 250 RG/RH/RJ/RK TRX 400 EXX/EXY/EX1-EX8 TRX 400 X9 XR 400 RT/RV/RW/RX/RY/R1-R5 CBR 600 FX/FY/F1 <b>HONDA-DALL'ARA</b> XR 400/440 R XR 400/440 SM	85-86 ■ 89-90 ▲ 91-92 ▲ 93 ▲ 86-89 ▲ 99-08 ▲ 09 ▲ 96-05 ▲ 99-01 ★ 04 ▲ 04 ▲	CK1208	Use CK1209	
CK1194 ▲=CT013SP	TRX 250 F/G/H ATC 250 ESF/ESG/ESH/ESJ	85-87 ▲ 85-88 ▲	CK1209	No Fitment	
CK1195	Use CK1193		CK1210 ▲=CT053SP	GL 1200 AE/DE/AF	84-85 ▲
CK1196 ■=CT013SP	TRX 300 FWJ/FWK/FWL/FWT/FWV /FWW/FWX/J/K/L/T/V/W/X/Y TRX 350 G/H/J/K/L/M/N TRX 350 FMY/1-5 Fourtrax Rancher/4x4 TRX 400 FWS/T/V/W/X/Y TRX 420 FE7/FE8/FE9/FEA/FEB 4WD - Fourtrax ES TRX 420 TE7/TE8/TE9 Fourtrax ES-2WD TRX 450 ESW/ESX/ESY/ES1	88-00 ■ 86-93 ■ 00-05 ■ 95-00 ■ 07-11 ■ 07-09 ■ 98-01 ■	CK1211	Use CK1224	
CK1197	Use CK1151		CK1212	Use CK1119	
CK1198	Use CK1119		CK1213	Use CK1148	
CK1199	CR 125 RZ/RA	79-80	CK1214	Use CK1153	
CK1200 ▲=CT001	CR 125 RF	85 ▲	CK1215	Use CK1217	
CK1201	Use CK1222		CK1216	Use CK1119	
CK1202	Use CK1131		CK1217 ■=CT013SP ▲=CT014	MTX 200 RWD CBX 250 Twister CBX 250 RSE GB 250 E/H/J/L/P/S/V 'Custom' <b>YAMAHA</b> XTZ 250 Lander (Brasil) YBR 250 (5D11/3/4) YS 250 Fazer (Brasil)	83-84 ■ 84 ■ 84-97 ■ 07-09 ▲ 07-11 ▲ 06-08 ▲
CK1203	Use CK1190		CK1218 ▲=CT014	<b>HONDA</b> NS 250 FE (MC11) NS 250 RE/RG (MC11) NS 400 RF/RG CB 600 F7/F8/F9/FA/FB/FAC CB 600 FA7/FA8/FA9/FAA/FAB/FAC Hornet (ABS) CBF 600 N8/N9/NA (Non ABS) CBF 600 NA8/NA9/NAA (ABS) CBF 600 S8/S9 (Non ABS) CBF 600 SA8/SA9/SA (ABS) CBR 600 F2/F3/F4/F5/F6/F7 CBR 600 FS1/2 CBR 600 RR3/RR4/RR5/RR6/RR7/RR8 /RR9/RA9/RAA/RAA/RAB/RRB/RAC /RRC/RAD/RRD CBR 600 RR Hannspree CBR 600 FAB/FAC (ABS Model) CBR 600 FB/FC VFR 800 2/3/4/5/6/8/9 VFR 800 A2/A3/A4/A5/A6/A8/A9 CB 900 F2/F3/F4/F5/F6/F7 Hornet CBR 900 RRW/RRX/RRY	84 84-86 85-87 07-13 ▲ 07-13 ▲ 08-11 ▲ 08-11 ▲ 08-09 ▲ 08-12 ▲ 02-07 ▲ 01-02 ▲ 03-13 ▲ 08 ▲ 11-13 ▲ 11-13 ▲ 02-09 ▲ 02-13 ▲ 02-07 ▲ 98-00 ▲
CK1204	Use CK1140		<b>SUZUKI</b> GSR 600 K6/K7/K8 GSF 650 K7/K8/K9/0L0 Naked Bandit - Non ABS GSF 650 SK7/SK8/SK9 Faired Bandit - Non ABS GSF 650 AK7/AK8/AK9 Naked Bandit - ABS GSF 650 SAK7/SAK8/SAK9/SAL0 Faired Bandit - ABS GSX 650 FK8/FK9/FL0/FL1/FL2 (Non ABS) GSX 650 FAK8/FAK9/FAL0/FAL1 /FAL2 (ABS Model)	06-10 ▲ 07-11 ▲ 07-09 ▲ 07-09 ▲ 07-11 ▲ 08-13 ▲ 08-13 ▲	
CK1205	Use CK1147				
CK1206 ▲=CT014 ●=CT014SP ■=CT055SP	CBR 600 FM/FN/FP/FR/FS/FT/FV/FW CB 600 FW/FX/FY/FSY/F2Y/F21 /F1/F2/F22/F3/F4/F5/F6 Hornet CBF 600 N4/N5/N6 (Non ABS) CBF 600 NA4/NA5/NA6 (ABS) CBF 600 S4/S5/S6 (Non ABS) CBF 600 SA4/SA5/SA6 (ABS) VFR 750 FG/FH/FJ/FL/FM/FN/FP/ FR/FS/FT/FV VF 750 CP/CR/CS/CT/CV VFR 800 Fi-W/Fi-X CBR 900 RRN/RRP/RRR (893cc) CBR 900 RRS (918cc) CBR 900 RRY/RR1 (929cc Fireblade) CBR 900 RR2/RR3 954cc Fireblade <b>SUZUKI</b> GSXR 600 V/W/X/Y GSXR 600 K4/K5	91-98 ● 98-06 ● 04-06 ● 04-06 ● 04-06 ● 04-06 ● 86-97 ▲ 93-97 ▲ 98-99 ▲ 92-94 ▲ 95 ▲ 00-01 ▲ 02-03 ▲ 97-00 ■ 04-05 ▲			

Part No.	Make/Model	Year	Part No.	Make/Model	Year
CK1219 ▲=CT009 ■=CT033SP	<b>HONDA</b> GB 500 TT XBR 500 F/G/H/SH/SJ <b>SUZUKI</b> SV 400 K3/K4/K5 SV 400 SK3/SK4/SK5 DL 650 K4/K5/K6 DL 650 AK7/AK8/AK9/AL0 V-Strom ABS DL 650 AL1XP V-Strom Xpedition DL 650 AL2/AL3 V-Strom DL 650 AK9 GT V-Strom Traveller ABS SFV 650 K9/L0/L1 SFV 650 AK9/AL0/AL1/AL3 (ABS) SV 650 K3/K4/K5/K6/K7/K8/K9/L0 Naked - Non ABS SV 650 AK7/AK8/AK9/AL0 Naked - ABS SV 650 SAK7/SAK8/SAK9/SAL0 SV 650 SK3/SK4/SK5/SK6/SK7/SK8 /SK9/SLO Top Fairing - Non ABS	85-89 ▲  03-05 ■ 03-05 ■ 04-06 ■ 07-11 ■ 11 ■ 12-13 ■ 09-11 ■ 09-12 ■ 09-13 ■  03-10 ■ 07-10 ■ 07-12 ■  03-13 ■	CK1231	<b>HONDA Cont.</b> Use CK1228	
			CK1232	Use CK1233	
			CK1233	USE CK1285	
			CK1234	FL 400 R/RK/RL 'Pilot'	89-93
			CK1235 ■=CT012SP	CB 250 FT/FV/FX/FY/F1 CBR 250 FG/RH/RJ/RK/RK2 (MC14/17/19) CBR 250 RRL/RRN/RRR (MC22-100/105/110) VTZ 250 H/J/K VT 250 CR/CT/CV 'Magna' MC29 VT 250 FL Spada/Castec VTR 250 W/Y/1-7 (MC33) VTR 250-9	96-01 ■ 86-89 ■ 90-94 ■ 86-88 ■ 95-97 ■ 88-90 ■ 98-07 ■ 09-10 ■
CK1220	CB 750 F/F1	76-77	CK1236	Use CK1181	
CK1221 ▲=CT053SP	GL 1000 K1 (Up to E/No.2002383)	77 ▲	CK1237	Use CK1230	
CK1222 ▲=CT001	CR 125 RG/RH/RJ/RK/RL/RM/RN/ RP/RR/RS/RT/RV/RW/RX CR 125 SMS 125 WR 125 WRE 125	86-99 ▲ 00-11 ▲ 00-11 ▲ 00-11 ▲ 00-11 ▲	CK1238	Use CK1167	
			CK1239 ▲=CT031	VT 1100 CH/CJ/CN/CP Shadow VT 1100 CR/CS/CT/CV/CW Shadow	87-93 ▲ 94-98 ▲
CK1223	CB 750/CB 750 K1 (Up to E/No.:1056079)	69-70	CK1240	Use CK1252	
CK1224	GL 1200 DH/AH/AG/DG	86-87	CK1241	Use CK1190	
CK1225	Use CK1248		CK1242	Use CK1217	
CK1226	Use CK1147		CK1243	Use CK1181	
CK1227	Use CK1165		CK1244	Use CK1181	
CK1228 ■=CT009SP	CB-1 (CB 400 F) CB 400 SF (F2N/F2R) (Super Four) (NC31) CB 400 SF (F2V/F3T) Superfour (NC31) CB 400 SF (F3V) Superfour (NC31) CB 400 Four V/V-II/W-II (NC36) CBR 400 RG/RH-YA (NC23) CBR 400 RRJ/RRK (NC23) CBR 500 FH/FJ/FK/FL CBX 550 FC/F2C/FD/F2D CBR 600 FH/FJ/FK/FL	89-90 ■  92-95 ■  96-97 ■ 97 ■ 97-98 ■ 86-87 ■ 92-93 ■ 87-90 ■ 82-85 ■ 87-90 ■	CK1245	Use CK1230	
			CK1246	Use CK1235	
CK1229 ▲=CT014	VFR 750 RJ/RK/RL (RC30) <b>SUZUKI</b> GSXR 750 Y	88-92 ▲  00-03 ▲	CK1247 CKF1247 ▲=CT009  ■=CT006	CR 250 RL/RM/RN/RP/RR/RS/RT/RV /RW/RX/RY/R1/R2/R3/R4/R5/R6/R7 CRF 450 R2/R3/R4/R5/R6/R7/R8 CRF 450 X5/X6/X7/X8/X9 CRF 450 R9/RA (4 spring type clutch) CRF 450 XRLD CR 500 RLRM/RN/RP/RR/RS/RT /RV/RW/RX/RY/R1 <b>KAWASAKI</b> KX 450 F (D6F/D7F/D8F/E9F/EAF/EBF) KLX 450 A8F/A9F/AAF/ABF/ACF KX 450 F (KC 450 FCF/FDF)	90-07 ▲ 02-08 ▲ 05-11 ▲ 09-10 ▲ 13 ▲  90-01 ▲  06-11 ■ 08-12 ■ 12-13 ■
			CK1248 ▲=CT009	CB 1000 FP/FR/FS/FT/FV CBR 1000 FH/FJ/FK/FL/FM/FN/ FP/FR/FS/FT/FV/FW/FX	93-97 ▲ 87-99 ▲
CK1230 ■=CT013SP	NTV 600 J/K/M NTV 650 J/K/L/M/P/S/T/V NT 650 J/K/L (BRO5) NT 650 VW/VX/VY/V1-V5 Deauville XL 650 VY/V1/V2/V3/V4/V5/V6/V7 XRV 650 J/K XL 700 V8/V9/VA Transalp XL 700 VA8/VA9/VAA Transalp NT 700 V6/VA7/V7/V8/VA8/VA/VAA Deauville VT 750 CV/C2V/CW/C2W/CX/C2X /CY/C2Y/C1/C21/C4/C5/C6/C7/C8 VT 750 C2BA/C2BB/C2BC/C2SB Shadow Black Spirit VT 750 CS2A/C2SB Shadow VT 750 DC1/DC2 'Black Widow' VT 750 DC7/DC8 Shadow Spirit VT 750 S (VT 750 SA/SB)	88-91 ■ 93-97 ■ 88-92 ■ 98-05 ■ 00-07 ■ 88-89 ■ 08-11 ■ 08-11 ■  06-13 ■  97-09 ■  10-13 ■ 10-12 ■ 01-03 ■ 07-09 ■ 10-12 ■	CK1249	Use CK1167	
			CK1250 ▲=CT002	VFR 400 R3K/R3L/R3M/R3N (NC30)	89-92 ▲
			CK1251	Use CK1247	
			CK1252 ■=CT012SP	CA 125 S/T CB 125 TDJ CBR 125 R4/R5/RS5/RS6/RW5/RW6 CG 125 M1/1/ES4-8 LS 125 R CBR 150 R TA 200 (TA Shadow) FTR 223 Y/2/A2 (MC34) CRF 230 L CRF 230 M Supermoto SL 230 V/W/X/1 XL 230-2 (NC36)	95-96 ■ 87-89 ■ 04-06 ■ 01-08 ■ 00- ■ 00- ■ 02-05 ■ 00-02 ■ 08-10 ■ 09-10 ■ 97-02 ■ 02 ■

Part No.	Make/Model	Year	Part No.	Make/Model	Year
CK1253 ▲=CT014	<b>HONDA Cont.</b> VFR 800 Fi-Y/Fi-1	00-01 ▲	CK1292 ▲=CT013	<b>HONDA Cont.</b> VT 125 CX/CY/C1/C21/C3/C4/C7/C8 XL 125 V1/V2/V3/V4/V5/V6/V7/V8 /V9/VA	99-08 ▲ 01-11 ▲
CK1254	Use CK1285		CK1293 CKF1293 ▲=CT001	CR 125 RY/R1/R2/R3 CR 125 R4/R5/R6/R7 CRF 250 R4/R5/R6/R7 CRF 250 RA <b>GAS-GAS</b> EC 125 (2T) SM 125 (2T) Supermotard <b>KTM</b> EXC-F 250 EXC-F 250 (4T) Six Days SX-F 250 (4T) XC-F 250 (USD) XC-F 250	00-03 ▲ 04-07 ▲ 04-07 ▲ 10 ▲ 00-08 ▲ 03-06 ▲ 07-13 ▲ 11-12 ▲ 05-12 ▲ 11-12 ▲ 12 ▲
CK1255	Use CK1230		CK1294	Use CK1218	
CK1256	Use CK1206		CK1295 ▲=CT009	XR 650 RY/R1-R7 <b>HONDA-DALL'ARA</b> XR 650 R	00-07 ▲ 04 ▲
CK1257 ▲=CT031 ■=CT009	NR 750 N RVF 750 RR-R/RR-S (RC45) XL 1000 V3/V4/V5/V6 V7/V8/V9 /VA/VB Varadero Non ABS Model XL 1000 VA4/VA5/VA6/VA7/VA8/VA9 /VAA/VAB Varadero - ABS Model CB 1300 F3/F13 CB 1300 5/6/7/8/9 (Superfour) CB 1300 A5/A6/A7/A8/A (Superfour ABS) CB 1300 SA5/SA6/SA7/SA8/SA9/SAA CB 1300 S5/S6/S7/S8/S9	92 94-98 ▲ 03-11 ■ 04-11 ■ 03-04 ■ 05-09 ■ 05-09 ■ 05-11 ■ 05-09 ■	CK1296	USE CK1151	
CK1258	Use CK1206		CK1297 ▲=CT021	ST 1300 A2/A3/A4/A6 Pan European (ABS Model) ST 1300 8/9 Pan European (Non ABS) ST 1300 A8/A9/AA Pan European (ABS Model) GL 1800 A1/A2/A3/A4/A5 Goldwing GL 1800 6/7/8/9/A Goldwing F6B Goldwing	02-07 ▲ 08-09 ▲ 08-13 ▲ 01-05 ▲ 06-13 ▲ 13 ▲
CK1261	Use CK1191		CK1298 ▲=CT021	VTX 1300 S3/S4/S5/S6/S7/S8 VT 1300 CXA Chopper VTX 1300 CXAA VTX 1800 C2/C3/C4/C5/C15/C16/C17	03-08 ▲ 10-1S ▲ 10-11 02-08 ▲
CK1264 ■=CT056SP	ST 1100 AN/AP/AR/AS Pan European (ABS Model) ST 1100 AT/AV/AW/AX/AY/A1/A2 Pan European (ABS Model) ST 1100 L/M/N/P/R/S/T/V/W/X/Y Pan European - Non ABS	92-95 ■ 96-02 ■ 90-02 ■	CK1299 ▲=CT009	CB 1300 FW/FX/FY/F1 (SC40)	98-01 ▲
CK1265 ■=CT009SP	CB 400 SFX/SFY/SF1/SF2/SF3 /SF4/S/S5 Super Four (NC39) CB 750 F2N/F2R/ F2S/F2T/F2W/F2X/F2Y/F21	99-05 ■ 92-02 ■	CK1300 ▲=CT021	VTR 1000 SP2/SP3/SP4/SP5/SP6	02-07 ▲
CK1266	Use CK1190		CK1302 CKF1302 ▲=CT009	TRX 450 R4/R5/R6/ER6/R7/ER7 /R8/ER8/R9/ER9 TRX 700 XX8/XX9/XXB	04-08 ▲ 08-11 ▲
CK1268	Use CK1160		CK1303 ■=CT009SP	CBR 1000 RR4/RR5/RR6/RR7 CB 1000 R9/RA/RB/RC Non ABS Model CB 1000 RA9/RAA/RAB/RAC (ABS Model) CBF 1000 6/7/8/9/A (Non ABS Model) CBF 1000 A6/A7/A8/A9/AA (ABS Model) CBF 1000 S (S7/S8/S9/SA) CBF 1000 T (T7/T8/T9/TA) CBF 1000 FA (FAA/FBB) CBF 1000 FS (FSA) CBF 1000 FT (FTA)	04-07 ■ 09-13 ■ 09-13 ■ 06-11 ■ 06-10 ■ 07-11 ■ 07-12 ■ 10-13 ■ 10-11 ■ 10-11 ■
CK1273	Use CK1181		CK1304 ■=CT012SP	CRF 150 F3/F4/F5 CRF 230 F4/F5/F6/F7/F8/F9	03-05 ■ 04-09 ■
CK1275	Use CK1257		CK1305 CKF1305 ▲=CT001	CRF 250 X4/X5/X6/X7/X8/X9/XB/XC CRF 250 R8-R9 CRF 250 RB/RC/RD CRF 250 XRLD MD 250 H MD 250 S	04-12 ▲ 08-09 ▲ 11-13 ▲ 13 ▲ 08-11 ▲ 08-11 ▲
CK1278	Use CK1206		CK1307	ANF 125 3/5/T5/6/T6/7/A Innova	03-11
CK1284 ▲=CT014	CBR 900 RRT/RRV (918cc)	96-97 ▲	CK1308 ▲=CT009	<b>ELSTARS (Pit bikes)</b> Various models	
CK1285 ▲=CT021	GL 1500 CV/CW/CX/CY/C1/C2 'F6C' GL 1500 SEV/SEW/SEX/SEY GL 1500 J-SES	97-02 ▲ 97-00 ▲ 88-96 ▲			
CK1286 ▲=CT021	CBR 1100 XXV/XXW 'Blackbird'	97-98 ▲			
CK1287	CBR 750 FH/FJ (Superaero)	87-88			
CK1288 Dry Clutch	NSR 250 R2R/R3R/R2T/R3T NSR 250 R6K/R6K-2 NSR 250 R8L-3/R9L/R8N/R8N-3 NSR 250 R9N RGV 250 T (RGVR 250 SP)	94 89 90-92 92 96			
CK1289 ▲=CT002	RVF 400 RR/RR-II/RT/RT-II (NC35) -100/110	94-96 ▲			
CK1290 ▲=CT009	VTR 1000 FV/FW/FX/FY/F1/F2/F3 /F4/F5/F6 'Firestorm' XL 1000 VX/VY/V1/V2 Varadero - Non ABS Model CB 1300 DCV/DCW/DCX/DCY SC38	97-06 ▲ 99-02 ▲ 97-00 ▲			
CK1291 ▲=CT021	CBR 1100 XXX/XXY/XX1/XX2/XX3 /XX4/XX5/XX6 'Blackbird' CB 1100 SFY/SF1 "XII" VTR 1000 SPY/SP1 (SC45)	99-07 ▲ 00-03 ▲ 00-01 ▲			

Part No.	Make/Model	Year	Part No.	Make/Model	Year
CK1312 ▲=CT043SP	<b>HONDA Cont.</b> CBR 1000 RR8/RR9/RA9/RAA/RAB /RRB/RRC/RAC/RRD/RAD Fireblade VFR 1200 FA/FB	08-13 ▲ 10-13 ▲	CK2228	<b>YAMAHA Cont.</b> Use CK2296	
CK1313	CBR 250 RB/RC (Non ABS) CBR 250 RAB/RAC (ABS)	11-13 11-13	CK2229	Use CK2234	
CK1314	CRF 250 LD	13	CK2230 ▲=CT017	XS 1100 /1100 S	78-81 ▲
CK2201	<b>YAMAHA</b> No fitment		CK2231	Use CK2303	
CK2203	Use CK2303		CK2232	No fitment	
CK2204	No fitment		CK2233	No fitment	
CK2205 ▲=CT044	DT 50 M/MX FS1E/FS1DX/FS1/FS1SE RD 50/M/MX TY 50M (2KO)	80-95 ▲ 74-90 ▲ 80-87 ▲ 80 ▲	CK2234 ▲=CT039	YZ 100 E/F/G/H/K IT 125 G/H/J TW 125 (5rs) (5 friction plate type) TY 125 YZ 125 C YZ 125 F/G TY 175 TW 200 (2JL/4CS1/2/3/5) TW 200 E (4CS4/6/5LB1/2) TW 225 E (5VC1/2)	78-83 ▲ 80-82 ▲ 03-04 ▲ 80-82 ▲ 76 ▲ 79-80 ▲ 77-80 ▲ 91-98 ▲ 98-01 ▲ 02-03 ▲
CK2206 ▲=CT044	DT 50 M DT 50 MX Type 5J2/12Y DT 50 LC RD 50 M TY 50/TY 50 M (1F4/1G7) YZ 50 G-K TY 80 RD 80	78-79 ▲ 81-83 ▲ 98 ▲ 78-79 ▲ 77-78 ▲ 80-83 ▲ 77-83 ▲ 82 ▲	CK2235 ▲=CT039	YZ 125 D/E YZ 125 H IT 175 G-J IT 200 L	77-78 ▲ 81 ▲ 80-82 ▲ 84 ▲
CK2207 ▲=CT044	YB 100	78-92 ▲	CK2236 ▲=CT039	DT 100 DT 125/125F/125E/125 MX RD 125 DX RS 125/125 DX DT 175	76-80 ▲ 76-81 ▲ 75-76 ▲ 75-76 ▲ 74-77 ▲
CK2208 ▲=CT039	RS 100 AG 100 E 'Farm Bike' AG 100 J (3HAA)	75-76 ▲ 93 ▲ 82 ▲	CK2237	Use CK2254	
CK2209 ▲=CT039	DT 125 RD 200 DX RS 200	74 ▲ 76-81 ▲ 79-80 ▲	CK2238 ▲=CT044	RZ 50 (5FC1/2) DT 80 LC1 RD 80 LC YZ 80 G DT 80 MX (Type 36N) DT 80 MXS YZ 80 D	02 ▲ 81-84 ▲ 82 ▲ 80 ▲ 83-85 ▲ 84 ▲ 77 ▲
CK2210	No fitment		CK2239	Use CK2279	
CK2211	No fitment		CK2240 ▲=CT008	DT 250 RD 250 A/B RD 250 C/D/E/F RD 250 LC RZ 250 R (1AR/1XG) RZ 250 R (29L) RZ 250 RR (51L) RZ 250 (4L3) TY 250 D/E RD 350 A/B RD 350 LC/YPVS RD 350 N/F/F2/R TT 350 (ITJ) TT 350 A (3GJ) XT 350 YFM 350 FX 'Wolverine' All models DT 400 RD 400 C-F	75-76 ▲ 74-75 ▲ 76-79 ▲ 80-82 ▲ ▲ ▲ ▲ ▲ 77-78 ▲ 74-75 ▲ 80-84 ▲ 85-95 ▲ 85-89 ▲ 90-95 ▲ 85-95 ▲ 95-03 ▲ 75-76 ▲ 76-79 ▲
CK2212	No fitment		CK2241	Use CK2267	
CK2213	Use CK2330		CK2242	XS 650 XS 650 SE	80-81 79-81
CK2214	Use CK2240		CK2243	Use CK2238	
CK2215	Use CK2330		CK2244	YZ 250 G YZ 250 D/E	80 ▲ 77-78 ▲
CK2216	No fitment		CK2245 ▲=CT039	DT 175 MX	78-81 ▲
CK2217	No fitment				
CK2218	No fitment				
CK2219	Use CK2236				
CK2220	Use CK2255				
CK2221	No fitment				
CK2222	Use CK2240				
CK2223	DT 250 MX	77-80			
CK2224	No fitment				
CK2225	Use CK2209				
CK2226 ▲=CT017	XS 650 YZF R1	75-79 98 ▲			
CK2227	Use CK2255				



Part No.	Make/Model	Year	Part No.	Make/Model	Year
CK2246	<b>YAMAHA Cont.</b> Use CK2240		CK2255 ■=CT008SP Contd.	<b>YAMAHA Cont.</b> XJ 650 G/H/J/K 'Maxim' XJ 650 LH 'Midnight' XJ 650 RJ/LK Seca FZX 700 S/SC/T/TC 'Fazer' FZ 750 XJ 750 XJ 750 RF/RJ/RK 'Seca' XTZ 750 TDM 850 XJ 900/900 F XJ 900 S Diversion	80-83 ■
CK2247	Use CK2273				81 ■
CK2248	Use CK2269				82-83 ■
CK2249	No fitment				86-87 ■
CK2250 ▲=CT008	IT 250 G	80 ▲			85-86 ■
	XS 250 SE/C	80-81 ▲			82-83 ■
	YZ 250 F	79 ▲			81-83 ■
	XVS 250 Dragstar	01-03 ▲			89-95 ■
CK2251	No fitment				91-95 ■
CK2252	No fitment				83-92 ■
CK2253	Use CK2254		95-03 ■		
CK2254 CKF2254 ▲=CT044	DT 80 LC2	85-97 ▲	CK2256 ▲=CT039SP	SR 125 SE	81-83 ▲
	YZ 80 E/F	78-79 ▲	SR 125 XT 125 (5EK) (4 friction plates) TW 125	89-03 ▲	
	RS 100/RS 100 'S'	77-78 ▲		99-02 ▲	
	RS 100 (IY8 Europe)	77-78 ▲		82-83 ▲	
	RS 100 (IY8 Europe)	80-82 ▲	CK2257	Use CK2310	
	RS 100 S (IY8 UK)	77-78 ▲	CK2258	Use CK2264	
	RS 100/RS 100 DX	79 ▲	CK2259	Use CK2208	
	RS 100 DX (IY8 Europe)	79 ▲	CK2260	No fitment	
	RS 100 (IY9 UK)	79-81 ▲	CK2261 ▲=CT008	SR 250 (4GR1/2/3/4) (5 plate clutch) SR 250 Classic (2IL) (5 plate clutch) SRX 250	94-96 ▲
	RS 100	80-81 ▲			96-00 ▲
	RT 100 E/F/K	93-03 ▲			▲
	RXS 100	83-97 ▲	CK2262 ▲=CT017	XS 400	82 ▲
	RX 115 (5FS3)	99 ▲	CK2263	No fitment	
	RD 125 DX	78-81 ▲	CK2264	No fitment	
	RS 125	77-81 ▲	CK2265	No fitment	
	TT-R 125 M/LWM/N/LWN/LWP/P		CK2266	Use CK2287	
	/R/LWR/T/ET/LWET/LWT/LV/LEV	00-12 ▲			
	/EV/EW/EX/EY/LWEW/LWX		CK2267 ▲=CT008	SR 250 (3Y8) US Custom (6 plate clutch) SR 250 SE Special (3Y8) (6 plate clutch) XT 250	80-81 ▲
	/LWEX/LEY/LEWY/LWEZ/LWEA		CK2268	Use CK2255	81-83 ▲
	XT 125 R (3D61/3D63)	05-06 ▲			80 ▲
	(5 friction plate clutch)				
	XT 125 R (13D1)	07 ▲			
	(5 friction plate clutch)				
	XT 125 X (3D62/3D64)	05-06 ▲			
	(5 friction plate clutch)				
	XT 125 X (13D2)	07 ▲			
	(5 friction plate clutch)				
XTZ 125 K/K	05-10 ▲				
XYZ 125 (5RM)	03-10 ▲				
YBR 125 E/K ED	00-08 ▲				
CK2255 ■=CT008SP	FZ 400 N (1FK 46X 33M)	85- ■	CK2269	Use CK2306	
	XJR 400	93-99 ■	CK2270	Use CK2230	
	XS 500 B/C/D	78-79 ■	CK2271	Use CK2285	
	FZ 600	87-88 ■	CK2272	Use CK2274	
	FZ6 Fazer	04-07 ■	CK2273 ■=CT008SP	XS 850	80 ■
	FZ6 Naked Version	04-07 ■			
	FZ6 Naked/Non ABS				
	FZ6 Naked/Non ABS	04-07 ■	CK2274 CKF2274 ▲=CT020	WR 250 ZF/ZG/ZH/ZJ/EK YZ 250 E/F/G/H/J/L/M/N/P/R/S /T/V/W/X/Y/Z/A/B (2T) WR 450 FT/FV/FW/FX/FY/FZ/FA /FB/FD (4T) YZ 450 FW/FX/FY/FZ/FA/FB (4T) XV 750 SE XV 750 Virago XV 1000/TR1 BT 1100 P/R/S/T/V "Bulldog" XV 1100 Virago XVS 1100 A Dragstar Classic XVS 1100 Dragstar	94-98 ▲
	2 piston caliper (IB3/IB3D)	04-07 ■			93-12 ▲
	FZ6 S2 ABS (Naked)	07-08 ■			05-13 ▲
	FZ6 Fazer S2 (ABS)	07-08 ■			07-12 ▲
	FZ6-NS Naked/Non ABS				81 ▲
	/2 Piston Caliper (IB35/6)	05-06 ■			92-97 ▲
	FZ6-Fazer (Half Fairing/Non ABS				81-86 ▲
	/2 Piston Caliper) (5VX/5VXL)	04-07 ■			02-06 ▲
	FZ6-Fazer (ABS/Half Fairing				89-00 ▲
	/2 Piston Caliper)	06-07 ■			00-07 ▲
	FZ6 Fazer S2 (ABS/Half Fairing		99-03 ▲		
	/4 Piston Caliper) (5S2)	08 ■			
	FZ6 Fazer S2 (Non ABS/Half				
	Fairing/4 Piston Caliper) (4S81/4S8)	07-09 ■			
	FZ6 S2 (Naked/Non ABS				
	/4 Piston Caliper) (SS51/SSS)	07-09 ■			
	XJ 600	84-92 ■	CK2275	Use CK2279	
	XJ 650	80-84 ■			
	XJ 650 Turbo	82 ■			
	XJ 600 S/N Diversion	92-03 ■			
	YX 600 S/SC/T/TC/UC/U/W/WC/A/AC 'Radian'	86-90 ■			
	YZF R6	99-05 ■			



Part No.	Make/Model	Year	Part No.	Make/Model	Year
CK2276	<b>YAMAHA Cont.</b> YZ 125 J	82	CK2290	<b>YAMAHA Cont.</b> YFM 350 FWT/FWU/FWW/FWA/ FWE Big Bear	86-93 ▲
CK2277	Use CK2278		CKF2290	YFM 350 FWF/FWG/FWH/FWJ	94-97 ▲
CK2278	YZ 125 K-T	83-87 ▲	▲=CT008	YFM 350 ERD/ERE/ERF/ERG	92-95 ▲
CK2279	IT 250 H/J	81-82 ▲		YFM 350 XD/XE/XF/XG/XH/XJ/XK /XL/XM/XN/XP/XR	92-03 ▲
CKF2279	YZ 250 H	81 ▲		YFM 350 S/T/V/R-WV/RW/RX /RY/RZ Raptor	04-10 ▲
▲=CT008	XS 250 C/D/E	78-80 ▲		YFM 350 UH/UJ	96-97 ▲
■=CT008SP	YFZ 350 T/U/W/A/B/D/E/F/G/H/J/ K/L/M/N/P/R/S/T/V	87-06 ▲		DT 400 MX	77-79 ▲
	XS 400	78-79 ▲		YFM 400 FWE/FWF/FWG/FWH /FWJ/FWK/FWL/FWM Kodiak	93-00 ▲
	XS 400 SE	80 ▲		YFM 400 FPR	03 ▲
	YZ 400 D-F	77-79 ▲	CK2291	Use CK2303	
	IT 425 G	80 ▲			
	IT 465 H/J	81-82 ▲	CK2292	WR 125 R	09-13 ■
	YZ 465 G/H	80-81 ▲	▲=CT039	WR 125 X	09-13 ■
	XS 750	77-79 ■	■=CT061	YZF-R 125	08-13 ■
	XS 750 SE	79-80 ■		AG 200 E (3GX6)	93 ▲
CK2280	IT 250 L	84 ▲	CK2293	Use CK2261	
▲=CT060	YZ 250 J-T	82-87 ▲	CK2294	Use CK2240	
	YTZ 250 N/S	85-86 ▲			
	IT 490 L	84 ▲	CK2295	TY 250 S/R	84-92 ▲
	YZ 490 J-U	82-88 ▲	▲=CT060		
	WR 500 ZD	92-93 ▲			
CK2281	DT 125 LC (Type 10V/12W/26G)	82-83	CK2296	SR 400	88 ▲
CK2282	Use CK2299		▲=CT008	SR 500	78-82 ▲
CK2283	DT 125 LC (Type 35A)	85-87 ▲		SR 500 S (3GWS)	98 ▲
▲=CT044	DT 125 (3TT4)	96 ▲		ST 500 (3GW1/3/4/6/7)	96-98 ▲
	RD 125 LC Mk1 - 3	82-87 ▲		TT 500 G/H	80-81 ▲
	RZ 125 (1GV 030101-)	85 ▲		XT 500	77-81 ▲
	RX 135 (13X)	81 ▲		XZ 550	82 ▲
CK2284	Use CK2255		CK2297	SRX 400 (1JL)	▲
CK2285	FJ 1100	84-85 ▲	CKF2297	SRX 400 (3VN1/3VN2/3VN5)	90-96 ▲
▲=CT017	XJR 1200	95-98 ▲	▲=CT008	XT 550	83 ▲
	FJ 1200/1200 A	86-95 ▲		SRX 600	86-87 ▲
	XJR 1300 L 5EA2/5EA3/5EA4	99 ▲		SRX 600 (1JK/3SX)	85-91 ▲
	XJR 1300 M 5EAA/5EAB/5EAC	00 ▲		TT 600 L	84 ▲
	XJR 1300 (5EA1/5EA7)	98-99 ▲		TT 600 N (59X)	
	XJR 1300 (5EA9/5EAG)	00 ▲		Frame # 59X 000101-59X 007852	85-88 ▲
	XJR 1300 N/P (5EAP/5EAR/5EAS /5EAT/5EAW/5EAV/5EAY)	01-02 ▲		TT 600 W (2JT/3SW1)	
	XJR 1300 R/S 5WM1/5WM3 /5WM5/5WM6/5WM7/5WM9	03-04 ▲		Frame # 59X 007853-	
	XJR 1300 T/V/W/X 5WMA/5WMC/5WMD/5WMF	05-12 ▲		TT 600 K	89-92 ▲
	XJR 1300 SP(L) 5EA5/5EA6/5EA8	99 ▲		TT 600 E	93-96 ▲
	XJR 1300 SP (M) 5EAD/5EAE/5EAF	00 ▲		TT 600 R (5CH1)	94-95 ▲
	XJR 1300 SP (N) 5EAL/5EAM/5EAN	01 ▲		TT 600 R (5CH2)	97 ▲
				TT 600 R (5CH3)	98-99 ▲
				TT 600 R (5CH3)	00-02 ▲
				TT 600 RE (5CH5)	04 ▲
				XT 600	84-87 ▲
				XT 600 Z/E/ZE	84-03 ▲
				SZR 660	96-97 ▲
				YFM 660 RN/RP/RR/RS/RT Raptor	01-05 ▲
				XTZ 660 "Tenere"	91-97 ▲
				<b>DERBI</b> Mulhacen 659	06-07 ▲
CK2286	No fitment		CK2298	No fitment	
CK2287	YZ 80 H/J/K/L/N	81-85 ▲	CK2299	XVS 400	96 ▲
▲=CT010	YTM 225 DRN	85 ■	▲=CT020	XV 535/535 S "Virago"	88-03 ▲
■=CT010SP	YFM 200 DKW/DX/DXA	86-90 ■			
	YFM 225 N/S/T/U	85-89 ■			
	YFB 250 D/E/F/G/H/J/K/FWF/FWG/ FWH/FWJ/FWK/FWL/FWM	92-00 ■	CK2300	XVZ 12 TD	85 ▲
	YFM 250 W/A/B	90-92 ■	▲=CT050SP	V-Max All models	91-03 ▲
	YFM 250 XN/XP/XR "Bear Tracker"	99-03 ■		XVZ 13 Royal Star All models	96-01 ▲
	YFM 250 FN	01 ■	CK2301	Use CK2240	
	YFM 250 BT/BV (Bruin)	05-06 ■			
	YFM 250 BW/BX/BY Big Bear	07-10 ■	CK2302	T 50	86
	YFUIWT	89-90 ■			
CK2288	No fitment				
CK2289	Use CK2303				



Part No.	Make/Model	Year	Part No.	Make/Model	Year
CK2347 ▲=CT054SP	<b>YAMAHA Cont.</b> FZS 600 Fazer	98-03 ▲	CK2364 CKF2364 ▲=CT020	<b>YAMAHA Cont.</b> YFZ 450 S/T/V/W/X YFZ 450 RY/RZ (Quad) YFM 700 RV/RW/RX/RZ Raptor YFM 700 RD Raptor FZ8 Naked/Single Headlight/ Non ABS (RN255/39P1) (800cc) FZ8 Naked/Single Headlight/ ABS (RN256/59P1) (800cc) Fazer 8 FZ8-S Top Fairing/Single Headlight/Non ABS (RN251/42P1) (800cc) Fazer 8 FZ8-SA Top Fairing/Twin Headlight/ABS (RN252/1BD1) (800cc)	04-08 ▲ 09-10 ▲ 06-10 ▲ 13 ▲ 11-13 ▲ 11-13 ▲ 11-13 ▲ 11-13 ▲
CK2348 4 plate kit	DT 50 R DT 50 X Supermotard TZR 50 (5WX1) <b>APRILIA</b> AF1 Futura 50 Classic 50 Europa 50 MX 50 Pegaso 50 RS 50 RX 3-5 Marce RX 50 All models Tuono 50	97-08 04-08 04-13 90-92 92-01 90-92 03-05 92-94 93-05 91-94 03-04 03-04	CK2365 ▲=CT044	DT 175 (3TS4)	96 ▲
CK2349 5 plate kit	TZR 50	97-03	CK2366	MT-01 (1670cc) MT-01S (5YUR)	05-10 09
CK2350 ▲=CT017	YZF R1	99-03 ▲	CK2367 ▲=CT017	XV 1900 A	06-12 ▲
CK2351 ▲=CT050SP	XV 1600 A	99-03 ▲	CK2368 ▲=CT020	XT 660 R Model Code 5VK1/3/4/6/8/3S62/3S63 XT 660 X (Model Code - ID21/ID23 /ID24/ID26/3S72/10S1/11B1/10S7) XT 660 R (Model Code 5VKE) XT 660 R (5VKA/5VKC) XT 660 Z MT 03 <b>Aprilia</b> 650 Pegaso Trail	04-07 ▲ 04-13 ▲ 10-13 ▲ 08-09 ▲ 08-13 ▲ 06-12 ▲ 05-06 ▲
CK2352 ▲=CT020	YZ 426 FM WR 450 FS YZ 450 FR/FS/FT/FV YZF-R1	00 ▲ 04 ▲ 03-06 ▲ 09-13 ▲	CK2370 CKF2370 ▲=CT005	Serrow 250 (3C51/52) TT 250 R (4GY1 Japan) TT 250 R (4RR1/2 Japan) TT 250 R (4MR2 UK) TT 250 RL (4PX5) TT 250 R (4GY3/4GY5/4WA1) Raid XG 250 Tricker (5XT1) XT 250 X (5C1) YFM 250 RX/RZ Raptor	06 ▲ 93-94 ▲ 95-97 ▲ 96 ▲ 99 ▲ 94-96 ▲ 04-06 ▲ 06-08 ▲ 08-09 ▲
CK2353 ▲=CT020	YZF R7	99-00 ▲	CK2371 ▲=CT010	FZ 400 (4YR1)	96 ▲
CK2354	TT-R 90 M/N/P/R/ES/S/ET/T/EV/EW T 90 N/D (4NM1-9) Mate T 105/105 E Crypton V 110 ZE/ZK/ZHE/ZHK FIZR/FIZR Sporty T 105 E (5ER1/2) Crypton-R	00-07 00- 96 96 99	CK2378	XP 500 (T-Max Scooter - All models)	01-11
CK2355 CKF2355 ▲=CT005	YZ 250 FN/FP/FR/FT/FV/FW /FX/FY/FZ/FA/FB WR 250 FN/FP/FR/FT/FV/FW /FX/FY/FZ/FA/FB/FD	01-12 ▲ 01-13 ▲	CK2379 ▲=CT017	XVS 950 A Midnight Star	09-13 ▲
CK2356 ▲=CT020	YZ 426 FN/FP WR 426 FN/FP WR 450 FR YZF R1 YZF R1SP FZ1 Naked (2D11) FZ1 Fazer (3C3) Non ABS FZ1 Fazer (Half fairing - ABS - 5D0) FZ1 N/NA Naked (Non ABS/ABS)	01-02 ▲ 01-02 ▲ 03- 04-08 ▲ 06 06-09 ▲ 06-10 ▲ 08-12 ▲ 10-13 ▲	CK2380 ▲=CT017	XV 1700 V-Max (2S3)	09-12 ▲
CK2358 ■=CT008SP	FZS 1000 Fazer	01-05 ■	CK3301	<b>SUZUKI</b> No fitment	
CK2362 ▲=CT017	XTZ 1200 Super Tenere (ABS/UBS Brake System) FJR 1300 A (ABS) (Manual G/Shift) FJR 1300 A (1MC) (ABS/Manual G/Shift) FJR 1300 AS (ABS/Electric Shift) FJR 1300 AS (ABS Electric Shift) FJR 1300 (Non ABS) XVS 1300 A Midnight Star	11-13 ▲ 03-10 ▲ 13 ▲ 06-09 ▲ 13 ▲ 01-04 ▲ 07-13 ▲	CK3302	No fitment	
CK2363 ▲=CT050SP	XV 1700 PCR	03-05 ▲	CK3303 CK3304	No fitment No fitment	
			CK3305	No fitment	
			CK3306 ▲=CT052	B 120 T 125/T 125 -11/R 'Stinger'	69-71 ▲
			CK3307	No fitment	
			CK3308	Use CK3318	
			CK3309	Use CK3319	
			CK3310 ▲=CT038SP	T 20 Super Six	66-68 ▲

Part No.	Make/Model	Year	Part No.	Make/Model	Year
CK3311 ▲=CT051	<b>SUZUKI Contd.</b> AP 50	-78 ▲	CK3319 ▲=CT011 Contd.	<b>SUZUKI Contd.</b> RM 125 G/H TS 125 X (all models) TS 125 RK/RL/RM/RN/RP/RR TS 250 XE/XG/XH/XJ/XK GT 185 (K/L/M/A/B/C/EC) TS 185 K/L/M/B/C/ERN/ERT/ERX DF 200 EV/EW/EY (SH42A) DR 200 G/H/J DR 200 SE Trojan DR 200 SEK1-SEK8 DR 200 SEP/SER/SES/SEV/SEW /SEX/SEY (SH42A) Djebel RV 200 K2/K3 GT 200 EN/EX 'X5' SB 200 N/X SX 200 R/R-Z/RJ/RM GSF 250 N/ZM/P/NP/ZP/N/NR GSX 250 R CH/H (GJ72A) GSXR 250 J (GJ72A) GSXR 250 CK <b>SACHS</b> XTC 125	86-87 ▲ 84-90 ▲ 90-94 ▲ 85-89 ▲ 73-79 ▲ 73-81 ▲ 98-00 86-89 ▲ ▲ 01-08 ▲ ▲ 93-00 ▲ 02-03 ▲ 79-80 ▲ 79-80 ▲ 90-91 ▲ 92-96 ▲ ▲ ▲ ▲ 00-04 ▲
CK3312 ▲=CT051	A 100 L/M/N	74-80 ▲	CK3320	Use CK3324	
CK3313 ▲=CT046	GT 250 K/L T 250 II/R/J T 350 1/2/R/J	73-74 ▲ 70-72 ▲ 69-72 ▲	CK3321 ▲=CT035SP	GT 550 J/K/L/M/A/B	72-77 ▲
CK3314 ▲=CT046	T 500 1/2/3 (18 ears)	68-70 ▲	CK3322	Use CK3343	
CK3315 ▲=CT022	TS 250 K-M/A-C TS 250 ERN/ERT/ERX GT 250 M/A/B/C RL 250 L/M GT 380 K-M/A/B RM 400 C GT 250 X7 EN/ET/EX	73-78 ▲ 79-81 ▲ 75-78 ▲ 74-75 ▲ 73-77 ▲ 78 ▲ 79-81 ▲	CK3323	Use CK3344	
CK3316 ▲=CT022	GT 500 A/B T 500 R/J/K/L/M (12 ears)	76-77 ▲ 71-75 ▲	CK3324 ▲=CT018SP	GT 750 J/K/L/M/A/B GS 750 B/DB/DC/EC/EN	72-77 ▲ 77-79 ▲
CK3317	Use CK3393		CK3325	No fitment	
CK3318 CKF3318 ▲=CT011	RM 80 B/C/N/XT/XX RM 80 XE/XF/HF RM 80 K/L/M/N/P/R/S/T/V/W/X/Y/K1 RM 85 K2/LK2/K3/LK3/K4/LK4 RM 85 K5/K6/K7/K8/K9/L0/L2 (Small 17" Front Wheel) RM 85 LK5/LK6/LK7/LK8/LK9 /LL0/LL2 (Large 21" Front Wheel) TS 100 C TS 100 ERN (Up to E/No 300563) TS 100 ERZ/ERH DF 125 DR 125 SZ/SD/SE/SF/SH/SJ DR-Z 125 K3/K4/K5/K6/K7/K8/K9 DR-Z 125 LK3/LK4/LK5/LK6/LK7 /LK8/LK9 FX 125 GN 125 Z/D/K GN 125 Z/M/R/V/W/X/Y/K1 GN 125 ER/EV/EW/EX/EY/EK1 GN 125 HS GS 125 Z/D/ESZ/ESD/ESF/ESK/ ESM/ESR/ESX GT 125 L/M/A/B/C/EC GZ 125 W/X/Y/K1-K9 RV 125 K2-K9/L0 (Van-Van) TF 125 Farm Bike (All models) TS 125 ERZ TS 125 K/L/M/A/B/C/C2 TS 125 ERN (Up to E/No.-: 302345) TS 125 N (Up to F/No 178871) DR 125 SEX/SEY <b>KAWASAKI</b> KLX 125 A1/A2/A3/A6F KLX 125 L (B1/B2/B3/B6F) <b>SACHS</b> XTC 125 X Road 125	78-81 ▲ 84-85 ▲ 89-01 ▲ 02-04 ▲ 05-12 ▲ 05-13 ▲ 78 ▲ ▲ 79 ▲ 82 ▲ ▲ 82-94 ▲ 03-12 ▲ 03-13 ▲ ▲ 82-90 ▲ 94-01 ▲ 94-01 ▲ 00-11 ▲ ▲ 82-00 ▲ 74-78 ▲ 98-11 ▲ 02-13 ▲ 78-05 ▲ 82 ▲ 73-78 ▲ ▲ 79 ▲ 84 ▲ 99-01 ▲ 03-06 ▲ 03-06 ▲ 00-07 ▲ 06-07 ▲	CK3326 ▲=CT051	TS 100 K/L/M/A/B	73-77 ▲
CK3319 ▲=CT011	GP 100 N/UN GP 100 C/UC RM 100 A RM 100 N/T/X GP 125 C/N RG 125 CG/CH/J Gamma RG 125 UCG/UCH/UJ/UAJ/BUJ Gamma RG 125 FN/FP/FR Gamma RG 125 FUN/FUP/FUR Gamma RG 125 UN Wolf Naked RM 125 N/T	79 ▲ 78 ▲ 76 ▲ 79-81 ▲ 78-79 ▲ 86-90 ▲ 86-90 ▲ 92-94 ▲ 92-94 ▲ 92-94 ▲ 79-80 ▲	CK3327	Use CK3345	
			CK3328 ▲=CT011	ZR 50 SKE/SKH GS 50 K5 (NA41A) GT 50 KB/KEN OR 50 ET RM 50 C/N/T/X/Z TS 50 KN/ERKT/ERKX/ERKZ/ERKD ZR 50 KEN/KEX/SLKX/SKX LT 125 D/E/F/G/H LT 185 E/F	84-87 ▲ 05 ▲ 77-80 ▲ 80 ▲ 78-82 ▲ 79-83 ▲ 79-81 ▲ 84-86 ▲ 84-85 ▲
			CK3329 ▲=CT011	RM 100 B/C RM 125 A/B/C RM 125 X/Z/D RM 125 F PE 175 C/N/T/X/Z TS 200 RK/RL/RM/RN/RP/R GSX 250 ET/EX/EZ GS 250 TT/TX	77-78 ▲ 76-78 ▲ 81-83 ▲ 85 ▲ 78-82 ▲ 89-94 ▲ 80-82 ▲ 80-81 ▲
			CK3330 ▲=CT018	GS 650 GX/GZ 'Katana' GS 650 GTX/GTZ/GTD GS 700 EF/ESF GSX 750 ET/EX/ESD/EFE/ESG/ESE/FFF GSX 750 SE 'Katana' GSX 750 S/SS Katana (GS75X-106815-) GSX 750 S-2/S-2C (GS75X-114747-) Katana GS 850 (all models)	81-82 ▲ 81-83 ▲ 85 ▲ 80-86 ▲ 84 ▲ 84 ▲ 84 ▲ 84 ▲ 79-85 ▲
			CK3331 ▲=CT022	PE 250 T/X/Z RM 250 N/T/X/Z/D/E/F	80-82 ▲ 79-85 ▲

Part No.	Make/Model	Year	Part No.	Make/Model	Year
CK3332 ▲=CT022	<b>SUZUKI Contd.</b> RG 250 WD DR 400 ST/SX GN 400 TT GSX 400 FEX/FZ/FD GSX 400 FW/FWS/FWS-2 PE 400 T/X RM 400 N/T SP 400 T	83 ▲ 80-81 ▲ 80 ▲ 81-83 ▲ 80-81 ▲ 79-80 ▲ 80 ▲	CK3348 ▲=CT047SP ■=CT022	<b>SUZUKI Contd.</b> RM 465 X/Z RM 500 D/E GSF 600 Y/K1/K2/K3/K4 (Naked Bandit) GSF 600 SY/SK1/SK2/SK3/SK4 (Faired Bandit) GSX 600 FJ/FK/FL/FM GSF 650 S/T/V/W/X Naked Bandit GSX 650 ST/SV/SW/SX Faired Bandit GSX R 750 F/G/H	81-82 ■ 83-84 ■ 00-04 ▲ 00-04 ▲ 88-91 ▲ 95-99 95-99 ▲ 85-87 ▲
CK3333 ▲=CT022	RGV 250 M/N/P/R/S GSX 400 ET/EX/EZ GSX 400 TX/LX GS 450 ET/EG/EJ GS 500 EK/EL/EM/EN/EP/ER/ES/ET /EV/EW/EX/EY/K1/K2/K3/K4/FK4 /FK5/K5/FK6/K6/FK7/K7/K8/FK8 <b>APRILIA</b> RS 250	91-95 ▲ 80-82 ▲ 81 ▲ 80-88 ▲ 89-08 ▲ 95-02 ▲	CK3349 ▲=CT011	TS 50 X (all models) RG 50 EW	84-02 ▲ ▲
CK3334 ▲=CT022	RM 250 A-C SP 370 C/N PE 250 B/C/N	76-78 ▲ 78-79 ▲ 77-79 ▲	CK3350	Use CK3315	
CK3335 ▲=CT024	GS 1000 GT/GX GSX 1000 SZ GS 1100 GZ GSX 1100 ET/EX/EZ/SZ GSX 1100 EFE/EFG/ESF VL 1500 W/X/Y/K1/K2/K3 VL 1500 K5/K6/K7/K8 (C 1500 Intruder)	80-81 ▲ 82 ▲ 82 ▲ 80-82 ▲ 84-86 ▲ 98-03 ▲ 05-08 ▲	CK3351 ▲=CT022	RG 250 WE/FG/FH/CH/FCH RGV 250 J RGV 250 K/L TV 250 J/K/AK/L (VJ21A) Wolf	84-88 ▲ 88 ▲ 89-90 ▲ 88-90 ▲
CK3336	Use CK3348		CK3352	Use CK3351	
CK3337 ▲=CT011	TS 100 ERN/ERT/ERX (From F/No300564) DR 125 SMK8/SMK9/SML0 TS 125 ERN (From F/No 302346) TS 125 N (From F/No 178872) TS 125 ERT/ERX GT 125 EN	80-81 ▲ 08-12 ▲ 79 ▲ 84 ▲ 80-81 ▲ 79 ▲	CK3353	Use CK4503	
CK3338 ▲=CT011	GP 125 X/XD	81-84	CK3354	No fitment	
CK3339 ▲=CT011	GP 100 X/UX/D/UD/UL GSXR 250 RK (GJ73A) GSX 250 SSM Katana (GJ76A)	81-92 ▲ ▲ 91 ▲	CK3355	No fitment	
CK3340 ▲=CT011	DS 80 T/X/Z/D/F/G/H/J/K/L/M/N /P/R/S/T/V/W/X/Y JR 80 K1/K2/K3/K4/K5/K6/K7 RM 80 XZ/XD/HD	80-00 ▲ 01-07 ▲ 82-83 ▲	CK3356 ▲=CT011	RM 125 E RM 125 J/K/L/M LT-F 300 FX/FY/FK1 <b>ARCTIC CAT</b> 300 (2 x 4/4 x 4) 300 (4 x 4)	84 ▲ 88-91 ▲ 99-01 ▲ 98-04 ▲ 05 ▲
CK3341	Use CK3340		CK3357 ▲=CT029	GSX 600 FW/FX/FY/FK1/FK2/FK3 /FK4/FK5/FK6 GR 650 D/XD GSF 650 K5/K6 Naked Bandit - Non ABS GSF 650 AK5/AK6 Naked Bandit - ABS GSF 650 SAK5/SAK6 Faired Bandit - ABS GSF 650 SK5/SK6 Faired Bandit - Non ABS GSX 750 FW/W/FX/X/FY/Y/FK1-FK6 GSX 750 W/X/Y/K1	98-06 ▲ 83 ▲ 05-06 ▲ 05-06 ▲ 05-06 ▲ 05-06 ▲ 98-06 ▲ 98-03 ▲
CK3342	Use CK3328		CK3358 ▲=CT029	SW-1 (NJ45A) GN 250 F/J/M/R/T GW 250 L3 Inazuma GZ 250 X/Y/K1-K8 Marauder TU 250 XV/XW TU 250 S/T/XS/XT/X-ST/X-SV/XT-W (NJ47A 100001-115972) Volty TU 250 XTX/X/XTY (NJ47A-115-) Volty TU 250 GY/GBK1 Grass Tracker Big Boy (NJ47A-117/123) VL 250 Y/K1/K5/K6/K7 Intruder	92 ▲ 87-97 ▲ 13 99-08 ▲ 97-00 ▲ 92-97 ▲ 99-00 ▲ 00-01 ▲ 00-01/07 ▲
CK3343 ▲=CT018SP	RL 250 Beamish Model Reed Valve Engine RL 325 Beamish Model Reed Valve Engine GS 400 B/C GS 425 EN	78-82 ▲ 78-82 ▲ 77-78 ▲ 79 ▲	CK3359 ▲=CT047SP ■=CT029SP	GSX 400 FSV/FSK1 (GK7BA) Inazuma ST 400 Tempter V/W/X/Y/K1/K2/K3 DR 500 X/Z/D DR 600 RG/RH/RJ/RK (SN41A) DR 600 SF/SG/SH/SJ/SK (SN41A) LS 650 'Savage' FG/PK/PM/PR/ PS/PT/PV	00 ▲ 97-03 ■ 81-83 ■ 86-89 ■ 85-89 ■ 87-97 ■
CK3344 ▲=CT018SP	GS 550 (all models) GSX 550 (all models)	77-82 ▲ 84-87 ▲	CK3360	Use CK3390	
CK3345 ▲=CT035SP	GS 1000 HC/EC/EN/SN/ET	78-80 ▲	CK3361	Use CK3364	
CK3346 ▲=CT024	GSX 1100 SD/ESD	83 ▲	CK3362	Use CK3364	
CK3347 ▲=CT018	XN 85 D 'Turbo'	83 ▲			







Part No.	Make/Model	Year	Part No.	Make/Model	Year
CK3402 ■=CT029SP	<b>SUZUKI Contd.</b> DR 650 RL/RM (SP41A) DR 650 RSL/RSM (SP42A) DR 650 RUN/RN/RUP/RP (SP44A/B) DR 650 RER/RES (SP45A/B) DR 650 RSEM/RSEN/RSEP (SP45A/B)	90-91 ■ 90-91 ■ 92-93 ■ 94-95 ■ 91-93 ■	CK3433 CKF3433 ▲=CT006 ■=CT009	<b>SUZUKI Contd.</b> CRF 450 RB/RC DR-Z 400 SEY/EY/Y/SK1/EK1/K1 /SK2/EK2/K2/SK3/EK3/K3/SK4 /EK4/K4/SK5/K5/K6/EK6/SK6 /SK7/EK7/K7/SK8/SK9 DR-Z 400 SMK5/6/7/8/9 LT-Z 400 K3/K4 CRF 450 RD (6 spring)	11-12 ▲     00-09 ▲ 05-09 ▲ 03-04 ▲ 13 ■  04-06 ▲
CK3403	No fitment			<b>ARCTIC CAT</b> 400 DVX	
CK3405	Use CK3392			<b>CCM</b> R 35/R 35 S	
CK3406	Use CK3387			CR 40 S Cafe Racer	07 ▲
CK3407	Use CK3333			CR 40 Street	07 ▲
CK3408 ▲=CT036SP	RF 600 RP/RR/RS/RT	93-96 ▲		SR 40 Street Scrambler	07 ▲
CK3409	Use CK3418			404 E/DS/Supermoto	03-04 ▲
CK3410	Use CK3318			<b>KAWASAKI</b> KSF 400 A1/A2 (KFX 400)	03-04 ▲
CK3411	Use CK3399		CK3435 ▲=CT009	KLX 400 R (KLX 400 B1/B2)	03-04 ▲
CK3412	Use CK3402		CK3437 ▲=CT022	TL 1000 SK1/RK1	01-02 ▲
CK3413	Use CK3390		CK3439 ▲=CT009	RMX 250 SN/SR/SS (SJ13A)	95-97 ▲
CK3414	Use CK3386		CK3441	GSX 1400 K2/K3/K4/K5/K6/K7	02-07 ▲
CK3417 ▲=CT014 ■=CT055SP	GSR 750 L1/L2/L3 GSXR 750 T/V/W/X GSXR 750 K4/K5 RF 900 RS/R2S/RT/RV/RW TL 1000 SV/SW GS 1200 SSK1/ZK1 (GV78A) GSF 1200 SAV ABS Bandit GSF 1200 T/V/W/X/Y (Naked bandit) 4 piston caliper GSF 1200 ST/SV/SW/SX/SY (Faired bandit) 4 piston caliper GSX 1200 FSW/FSX Inazuma GSF 1200 K1/K2/K3/K4/K5 (Naked Bandit - 6 piston caliper) GSF 1200 SK1/SK2/SK3/SK4/SK5 (Faired Bandit - 6 piston caliper) GSF 1200 K6/AK6 (Naked Bandit - 4 piston caliper) ABS & Non ABS Version GSF 1200 SK6/SAK6 (Faired Bandit - 4 piston caliper) ABS & Non ABS Version	11-13 ▲ 97-99 ■ 04-05 ▲ 95-98 ▲ 97-98 ▲ 01 ■ 97 ■ 96-00 ■ 96-00 ■ 98-99 ■ 01-05 ■ 01-05 ■ 06 ■ 06 ■	CK3443 ▲=CT021	DL 1000 K2-K9/L0 SV 1000 K3/K4/K5//K6/K7 Naked SV 1000 SK3/SK4/SK5/SK6/SK7 (Faired model) GSX 1300 RK2/RZK3/RK3/RK4 /RK5/K6/K7 GSX 1300 RK8/RK9/RL0/RL1/RL2 Hayabusa GSX 1300 BKK8/BKK9/BKL0 /BKL1 B-King <b>KAWASAKI</b> KLV 1000 (LV 1000 A1H/A2H)	02-10 ▲ 03-08 ▲ 03-07 ▲ 02-07 ▲ 08-12 ▲ 08-12 ▲ 04-05 ▲
CK3418 ■=CT055SP	RF 900 RR GSXR 1100 WP/WR/WS/WT	94 ■ 93-96 ■	CK3445 ▲=CT009	GSX 1400 K1	01 ▲
CK3420	Use CK1177		CK3447 CKF3447 ▲=CT006	LT-Z 400 K5-K9/L0/L1 QuadSport <b>KAWASAKI</b> KSF 400 A3/A6F <b>ARCTIC CAT</b> 400 DVX	05-12 ▲ 05-06 ▲ 04-06 ▲
CK3421	No fitment		CK3448 ▲=CT011	LT-F 250 K4 Ozark LT-Z 250 K4-K9/L0 QuadSport	04 ▲ 05-12 ▲
CK3422	Use CK1206		CK3450 CKF3450 ▲=CT045	RMX 450 ZL0 RM-Z 450 K5/K6/K7/K8/K9/L0/L1/L2/L3 LT-R 450 K6/K7/K8/K9/L0/L1	10-12 ▲ 05-13 ▲ 06-12 ▲
CK3425	Use CK3397		CK3451 ▲=CT015	GSXR 1000 K5/K6/K7/K8	05-08 ▲
CK3426	Use CK3399		CK3452 ▲=CT006	LT-F 500 FK3-FK7 <b>ARCTIC CAT</b> 500 (4 x 4 Manual) 500 (Manual 4 x 4)	03-07 ▲ 03-04 ▲ 05-09 ▲
CK3428 ▲=CT009	TL 1000 RW/RX/RV/SW/SX/SY TL 1000 SX/SY	98-00 ▲ 99-00 ▲	CK3453 ▲=CT016	RM 250 K6/K7/K8/K9 RM 250 XCK8	06-12 ▲ 09 ▲
CK3429	Use CK3377		CK3454 ▲=CT016	RM 250 K3/K4/K5	03-05 ▲
CK3430 ▲=CT021	GSX 1300 RY/RK1 "Hayabusa" GSX 1300 RX	00-01 ▲ 99 ▲	CK3455 ▲=CT015	GSXR 600 K6/K7	06-07 ▲
CK3432 ▲=CT029	VL 125 Y/K1-K7 "Intruder"	00-08 ▲			

Part No.	Make/Model	Year	Part No.	Make/Model	Year
CK3456 ▲=CT015	<b>SUZUKI Contd.</b> GSXR 600 K8/K9/L0/L1/L2/L3 GSXR 750 K6/K7/K8/K9/L0/L1/L2/L3	08-13 ▲ 06-13 ▲	CK4413 ▲=CT019	<b>KAWASAKI Contd.</b> Z 650 B1/B2/B3/D2-D3/F1-F4 Z 650 C1/C2/C3 Custom Z 650 F1/F2/F3/F4 Z 700 A1 'Ltd' ZN 700 A1/A2 'Ltd' ZN 750 N1/N2 'Spectre' Z 750 E1/H1-H2/L1-L4 GT 750 P1-P5 GPZ 750 R1 GPZ 750 A1-A5	77-79 ▲ 77-79 ▲ 80-83 ▲ 84 ▲ 84-85 ▲ 82-83 ▲ 80-84 ▲ 82-90 ▲ 82 ▲ 83-87 ▲
CK3457	M 1800 R (VZR 1800 K6/K7/K8 /K9 Intruder handlebar cowling) M 1800 R2 (VZR 1800 NK8/NK9) Intruder - No handlebar cowling M 1800 RZ (VZR 1800 ZK7/ZK8 /ZL1/ZL2) intruder - With handlebar cowling with central tape strip	06-09 08-09 07-13	CK4414	No fitment	
CK3458	DR-70 K8/K9/L0	08-13	CK4415 ▲=CT004	H2/H2-A Mach IV (750cc)	72-73 ▲
CK3459 ▲=CT021	GSF 1250 K7/K8/K9/OLO (Naked Bandit 4 Piston Caliper) Non ABS GSF 1250 SAK7/SAK8/SAK9/SAZK9 /SALO (Faired bandit - 4 Piston Caliper) ABS Model GSF 1250 AK7/AK8 (Naked bandit - 4 piston caliper) ABS Model GSX 1250 FALO/FAL1/FAL2 GSX 1250 FALOST Sport Touring M 1500 (VZ 1500 K9/L0 - Intruder) VL 1500 L3 (CT 1500 T Intruder)	07-11 ▲ 07-12 ▲ 07-08 ▲ 10-13 ▲ 10-12 ▲ 09-12 ▲ 13 ▲	CK4416	No fitment	
CK3462 ▲=CT009	GSXR 1000 K9/L0/L1/L2/L3/ZL3	09-13 ▲	CK4417	Use CK4421	
CK3463	C 1800 R (VLR 1800 K8/K9/L0/L1) (C 1800 R Intruder) C 1800 RT Touring Intruder VLR 1800 K8RT/K9RT	08-13 08-10	CK4418	No fitment	
CK3465 ▲=CT014	GSXR K1/K2/K3	00-03 ▲	CK4419 ▲=CT006	KX 250 KX 250 A/A3/A4/A5 KEF 300 B1/B2/B3 Lakota Sport KLF 300 A1/A2/B1-B17/C1-C17 <b>ARCTIC CAT</b> 400 (2 x 4/4 x 4)	74 ▲ 75-79 ▲ 01-03 ▲ 87-05 ▲ 00-02 ▲
CK3466 ▲=CT014	GSXR 600 K1/K2/K3/SK3	01-03 ▲	CK4420	Use CK4411	
CK4401	<b>KAWASAKI</b> No fitment		CK4421	Z 400 B1/B2 Z 400 G1 Z 440 A2 LTD Z 440 A2/C1-C2/H1/H2 Z 440 D4-D6 (Ltd)	78-79 79 80-83 82-84
CK4402	No fitment		CK4422	Use CK4446	
CK4403	Use CK4440		CK4423	Use CK4425	
CK4404	No fitment		CK4424 ▲=CT016	Z 400 J1-J3 ZR 400 A1/B1 (Z400 F) ZX 400 C2 (Z400 F11) ZL 400 A 'Eliminator' ZL 400 'B' Eliminator' 400 SE ZL 400 D1/D2 FX 400 R (ZX 400 E1-E3) GPZ 400 R (ZX400 D1/D2/D3/D3A) GPZ 400 R (ZX 400 F1) ZR 400 Zephyr (G2/G3/G3A/G4/G5) ZRX 400 (ZR 400 E1-E7) ZZR 400 (ZX 400 K1/K2/K3) ZZR 400 (ZX 400 N1-N7) EN 450 A1-A5 (Ltd 450) EX 500 A1-A6/D1-D7 (GPZ 500 S) KLE 500 A1-A12 EN 500 A1-A4/B1/B2/C1-C9 ER-5 (ER 500 A1/A2/A3/A4/C1-C5P) GPZ 500 (S) (EX 500 B1-B5) GPZ 500 S (EX 500 E1-E10) KLE 500 B1P/B6F/B7F Z 500 A1-A3/B1-B2 Z 550 C1-C2 (Ltd) GT 550 G1-G9 GPZ 550 D1/H1-H2/A1-A4 ZR 550 A1-A2 (Z550 F) ZR 550 B2/B3/B4/B5/B6 "Zephyr" KL 600 A1 (KLR 600) KLR 600 B1/B2/B4/B6-B9 GPZ 600 R A1-A6 GPX 600 R C1-C3/C6-C7 ZL 600 B1 ZZR 600 D1/D2/D2A/D3 ZZR 600 (ZX 600 E1-E13) ZZR 600 (ZX 600 E6F) ER-6f (EX 650 A6F/A7F/A8F /C9F/CAF/CBF)	80-83 ▲ 83-84 ▲ 85 ▲ 86-87 ▲ 88 ▲ 94-95 ▲ 86-88 ▲ 85-87 ▲ 87 ▲ 97-01 ▲ 94-01 ▲ 90-92 ▲ 93-99 ▲ 86-89 ▲ 87-01 ▲ 91-04 ▲ 90-04 ▲ 97-07 ▲ 88-93 ▲ 94-04 ▲ 05-07 ▲ 79-81 ▲ 80-81 ▲ 83-01 ▲ 81-87 ▲ 83-84 ▲ 91-99 ▲ 84 ▲ 85-94 ▲ 85-89 ▲ 86-96 ▲ 95-97 ▲ 90-92 ▲ 93-05 ▲ 06-07 ▲ 06-10 ▲
CK4405	No fitment				
CK4406	Use CK4425				
CK4407	No fitment				
CK4408	No fitment				
CK4409 ▲=CT019	Z1/Z1A/Z1B Z 900 A4/A5 Z 1000 D1-D3 'ZIR' Z 1000 A1/A2/A3/A4 Z 1000 H1	74-76 ▲ 76-77 ▲ 78-80 ▲ 77-80 ▲ 80 ▲			
CK4410	Use CK4425				
CK4411 ▲=CT058	KE 125 A7-A12 KH 125 A1-A4 KE 175 D1-D5 KT 250 A/A2	80-85 ▲ 77-81 ▲ 79-83 ▲ 75-76 ▲			
CK4412	No fitment				

Part No.	Make/Model	Year	Part No.	Make/Model	Year
CK4424 ▲=CT016 Contd.	<b>KAWASAKI Contd.</b> ER-6f (ABS Model) (EX 650 B6F/B7F/B8F/D9F/DAF) ER-6f (ECF/EDF) (Double pipe type frame/non ABS) ER-6f (FCF/FDF) (Double pipe type frame/with ABS) ER-6n (ER 650 A6F/A7F/A8F/C9F/CAF) ER-6n (ABS) ER 650 B6F/B7F/B8F/D9F ER-6n (ECF/EDF) (Double pipe type frame/non ABS) ER-6n (FCF/FDF) (Double pipe type frame/with ABS) KLE 650 A7F/A8F/A9F/CAF/CBF Versys KLE 650 B7F/B8F/B9F/DAF/DBF Versys ABS 650 (KLE 650 CBF/CCF) Versys (Non ABS) 650 (KLE 650 DCF) Versys (ABS) KLR 650 A1-A3 KL 650 B1/B2/B3 Tengai KLX 650 C1/C2/C3 ZXR 750 H1/H2	06-10 ▲ 12-13 ▲ 12-13 ▲ 06-11 ▲ 06-09 ▲ 12-13 ▲ 12-13 ▲ 07-11 ▲ 07-11 ▲ 12 12 87-89 ▲ 89-92 ▲ 93-97 ▲ 89-90 ▲	CK4435 CKF4435 ▲=CT016	<b>KAWASAKI Contd.</b> KX 250 J1/J2/K1-K4/K5/L1-L4/M1 /M2/R1/R6F/R7F/R8F EJ 650 A1/C3-C7 (W650) KLR 650 C1-C10 KLR 650 (KL 650 E8F/E9F) VN 700 A1 'Vulcan' Z 750 Y1 (Ltd) GPZ 750 R G2/G3 GPZ 900 R A1-A8 ZX-7 RR (ZX 750 N1/N2) GPX 750 F1/F2/F3/F2A VN 750 A2/A3/A4/A5/A10 ZXR 750 J1/J2/L1/L2/L3/P1-P7 ZXR 750 R (ZX 750 K1/K2/M1/M2) Z 750 B1/B2 Z 750 D1 EJ 800 ABF/ACF (W 800/Solid F Disc) EJ 800 (W 800 Cafe style/Cockpit fairing) EJ 800 ACFA (W 800 Special Edition Black Exhaust/Gold Rims EJ 800 ADF (W800) VN 800 A1-A3/B1-B10/B6F/C1/C2/E1-E3 VN 900 AF6 Classic VN 900 BBFA Classic Special Edition VN 900 BCFA Classic Special Edition VN 900 C7F/C8F/C9F/CAF/CBF/CCF Custom (Cast wheel) VN 900 B7F/B8F/B9F/BAF/BBF/BCF Classic (Spoke wheel) ZX-9R (ZX 900 B1-B4) <b>SUZUKI</b> RM 250 T RM 250 V/W/X/Y/K1/K2	92-08 ▲ 99-05 ▲ 95-04 ▲ 08-09 ▲ 85 ▲ 82 ▲ 85-86 ▲ 84-96 ▲ 96-99 ▲ 87-89 ▲ 86-94 ▲ 91-03 ▲ 91-94 ▲ 77-78 ▲ 76 ▲ 11-12 ▲ 11 ▲ 12 ▲ 13 ▲ 95-06 ▲ 06 ▲ 11 ▲ 12 ▲ 07-12 ▲ 07-12 ▲ 94-97 ▲ 96 ▲ 97-02 ▲
CK4425 ▲=CT004	KX 125 K4-K5/L1-L4/M1-M3/M6F/M7F/M8F KX 125 K1/K2/K3 Z 200 A1 (From E/No 005063) Z 200 A2-A6 KL 250 A1-A4/C1/C2 KSF 250 A1-A18 (KXF 250 Mojave) Z 250 C1/C2/G1/G2 KLT 250 C1-C3 HI 500 Mach III HI-A 500 S Mach III HI-B/C 500 Mach III HI-D/E/F 500 KH 500 A8	97-08 ▲ 94-96 ▲ 78 ▲ 79-83 ▲ 78-84 ▲ 87-04 ▲ 80-83 ▲ 83-85 ▲ 69-70 ▲ 71 ▲ 72 ▲ 73-75 ▲ 76 ▲	CK4436 ▲=CT058	KX 125 B1 KDX 175 A1-A3 KH 250 B4-B5	82 ▲ 80-82 ▲ 79-80 ▲
CK4426	Use CK4440		CK4437	Use CK4436	
CK4427	Use CK4440		CK4438 CKF4438	KX 60 A1-A2/B1-B19 KX 65 A1/A2/A3/A4/A5/A6/A6F/A7F /A8F/A9F/AA/ABF/ACF/ADF KX 80 E1/E2 KLX 110 R (KLX 110 A1-A4/A6F /A7F/A8F/A9F/CAF/CBF/CCF/CDF) KH 125 K2-10 KH 125 L1 (KH 125 EX)	83-03 00-13 83-84 02-13 82-98 83
CK4428	Use CK4434		<b>MODENAS</b> Kriss 110/115 <b>SUZUKI</b> Smash 110cc DR-Z 110 K3/K4/K5 RM 60 K3 RM 65 K3/K4/K5	03 03-05 03 03-05	
CK4429	Use CK4435		CK4439 ▲=CT006	KDX 250 B1 KX 250 A6/A7 KLF 400 B1/B3/B3A/B4/B5/B6/B7 KX 420 A1/A2 <b>SUZUKI</b> LT-F 400 K2 Eiger LT-F 400 K3-K7 Eiger 2WD LT-F 400 FK2-FK7 Eiger 4WD LT-F 400 FK8/FK9/FL0/FL1 King Quad 4WD LT-F 500 FW/FX/FY/FK1/FK2 <b>ARCTIC CAT</b> 400 (2 x 4/4 x 4) 400 (2 x 4) 400 (2 x 4/4 x 4) 400 (4 x 4/Manual) Bearcat 454 (4 x 4) Bearcat 454 (2 x 4) 500 (4 x 4)	81 ▲ 80-81 ▲ 93-98 ▲ 80-81 ▲ 02 ▲ 03-07 ▲ 02-07 ▲ 09-12 ▲ 98-02 ▲ 98- ▲ 98 ▲ 03-04 ▲ 05-08 ▲ 96-98 ▲ 97-98 ▲ 98-02 ▲
CK4430	No fitment				
CK4431	Use CK4457				
CK4432	Use CK4436				
CK4433 ▲=CT006	KDX 250 B2/B3 KXT 250 A1 'Tecate' Z 250 A1-A3/B1-B2 ER 250 B1-B3 'Scorpion' GPZ 305 A1/B2-B10 KX 500 A1/A2	82-83 ▲ 84 ▲ 79-81 ▲ 83-88 ▲ 83-96 ▲ 83-84 ▲			
CK4434 ▲=CT016	ZL 900 A1/A2 'Eliminator' GPZ 1000 RX A1-A3 1000 GTR (AG 1000 A1-A18) Z 1000 E1/E2 (ST Shaft) Z 1000 J1/J2/J3 Z 1000 K1/K2 LTD Z 1000 R1/R2 (Eddie Lawson Replica) ZL 1000 A1 GPZ 1100 B1/B2 GPZ 1100 A1-A3 Z 1100 A1-A3 Z 1100 D1/D2 'Spectre' Z 1100 R1 ZR 1100 A1/A2/A3/A4/B1 ZR 1100 B5 (Zephyr 1100 RS) ZX 10 B1/B2/B3 ZRX 1100 (ZX 1100 C1/C2/C3/C4) ZRX 1200 A1/A2/A3/A4/A5/A6F ZRX 1200 B1-B3 <b>APRILIA</b> RST 1000 Futura	85-86 ▲ 86-88 ▲ 89-03 ▲ 79-80 ▲ 81-83 ▲ 81-82 ▲ 82-83 ▲ 87 ▲ 81-82 ▲ 82-85 ▲ 81-83 ▲ 82-83 ▲ 84 ▲ 92-97 ▲ 02 ▲ 88-90 ▲ 97-00 ▲ 01-07 ▲ 01-08 ▲ 01-04			

Part No.	Make/Model	Year	Part No.	Make/Model	Year
CK4440	<b>KAWASAKI Contd.</b> AE 80 A1/B1 AR 80 A1/C1-C8 KSR II (KMX 80 B1/B2) KC 100 C1-C4 KE 100 A8-A10 KE 100 B1-B15 KH 100 A2-A4/G2-G8 KM 100 A4-A6 KH 125 K1	81-83 81-91 90-91 81-83 79-81 82-98 78-87 79-80 82	CK4457 ▲=CT058	<b>KAWASAKI Contd.</b> KX 125 B2/C1 KDX 200 A1-A3 S3/S3A (400cc) S2/S2-A (350cc) KH 400 A3-A5	83-84 ▲ 83-85 ▲ 74-75 ▲ 72-73 ▲ 76-78 ▲
CK4441	Use CK4457		CK4458	Z 1300 A4/A5	82-83
CK4442	AE 50 A1-A2 AR 50 A1/C2-C10 KSR I (KMX 50 B1/B2)	81-84 81-97 90-91	CK4459 ▲=CT006	KX 250 D1/D2 KXT 250 B1/B2 (Tecate - 3 wheel model) KX 500 B1/B2	85-86 ▲ 86-87 ▲ 85-86 ▲
CK4443 ▲=CT019	ZX 750 E1/E2 'Turbo'	84-87 ▲	CK4460	Use CK4419	
CK4444	Use CK4435		CK4461	Use CK4439	
CK4445	Use CK4438		CK4462	No fitment	
CK4446 ▲=CT004	Z 200 A1 (Up to Eng No.005062) KLR 250 D2-D22 ZXR 400 L1-L5/L8/L9 ZXR 400 H1/H2 ZXR 400 R (ZX 400 M1-M4) ZX 400 J1/J2 Xanthus (ZR 400 D1/D3/D4)	77 ▲ 84-05 ▲ 91-03 ▲ 89 ▲ 91-94 ▲ 89-90 ▲ 92-95 ▲	CK4463	KLF 110 B1-B2	87-88
CK4447	Use CK4425		CK4464	Use CK1119	
CK4448	Use CK4459		CK4465 ▲=CT006	KX 250 B1/C1/C2 KXT 250 A2 (Tecate - 3 wheel model)	82-84 ▲ 85 ▲
CK4449	Use CK4433		CK4466	Use CK4459	
CK4450	Use CK4459		CK4467	No fitment	
CK4451	Use CK4434		CK4468	KX 80 E3/G1/G2/J1/J2	85-87
CK4452	Z 1300 A1-A3	79-81	CK4469 ▲=CT042	KX 125 D1/E1/E2 KDX 200 C1/C2/C3 KL 250 H1 KL 250 J1 Stockman KLX 250 D1/D2/F1-F4 KLX 250 G1 KLX 250 J1-J6 D-Tracker KLX 250 H6F/H7F KLX 250 S9F/SAF/SBF/SCF/SDF KLX 300 A2-A10/A6F/A7F <b>SUZUKI</b> 250 S BK2 (LX 250L)	85-87 ▲ 86-88 ▲ 98 ▲ ▲ ▲ 93-97 ▲ 94 ▲ 98-03 ▲ 98-03 ▲ 06-07 ▲ 09-13 ▲ 97-07 ▲ 02 ▲
CK4453 CKF4453 ▲=CT002	KX 80 W1/W2/W3 KX 85 A1-A5/A6F/A7F/A8F/A9F /AAF/ABF/ACF/ADF KX 85 II B1-B5/B6F/B7F/B8F/B9F /BAF/BBF/BCF/BDF KX 100 C1/C2/C3 AR 125 A1A-A7/B1-B8 KMX 125 A1/A2/B1/B2 (From E/No MX 125 AE 000001-013436) <b>SUZUKI</b> RM 100 K3	98-00 ▲ 01-13 ▲ 01-13 ▲ 98-00 ▲ 83-94 ▲ 86-87 ▲ 03 ▲	CK4470	Use CK4475	
CK4454	Use CK4465		CK4471	Use CK4435	
CK4455 ▲=CT032	ZG 1300 A1-A3 VN 1500 B2/C1/C2/D1 VN 1500 C1/C2/D1/D2 VN 1500 E1/E2 'Classic' VN 1500 B2-B6 VN 1500 G1/G2 VN 1500 J1/J2/R1/R2/R3 VN 1500 N1/N2/N3 "Classic Fi" VN 1500 P1/P2 VN 1500 L1/L2/L3/L4 "Nomad Fi" M 1600 (VZ 1600 K4/K5 Intruder) VN 1600 A1/A2/A3/A6F VN 1600 B1 Mean Streak VN 1600 B2H/B6F/B7F (Mean Streak) VN 1600 D1H/D6F Classic Tourer	84-86 ▲ 88-96 ▲ 94-98 ▲ 98-99 ▲ 88-92 ▲ 98-99 ▲ 99-04 ▲ 00-04 ▲ 02-04 ▲ 00-03 ▲ 04-05 ▲ 03-08 ▲ 04 ▲ 05-08 ▲ 05-08 ▲	CK4472	Use CK4435	
CK4456	Use CK4438		CK4473 ▲=CT016	GPX 250 F2 (ZX250 F2/F3/F6/F8/F9) GPX 250 RII (EX 250 G) EL 250 D1-D5 EL 250 B1-B3 'Eliminator' KLE 250 A1/A1A/A2 (Anhelos) GPZ 250 R (EX 250 E) ZZR 250 (EX 250 H1-H13) EL 252 (EL 250 F2/F3/F5/F6)	88-95 ▲ 88 ▲ 90-94 ▲ 87-89 ▲ 86 ▲ 90-03 ▲ 96-03 ▲
			CK4474	Use CK4424	
			CK4475 ▲=CT006	KX 250 E1/F1/G1/H1H2 KXF 250 A1/A2 KDX 250 D1 KX 500 C1/D1/E1-E16	87-91 ▲ 87-88 ▲ 91-93 ▲ 87-04 ▲
			CK4476	Use CK4479	
			CK4477	KX 80 L1 KX 100 N1	88 88
			CK4478	KX 80 L2/L3/R1-R7 KX 100 A1/A2/B1-B7	89-97 89-97
			CK4479	Use CK4482	

Part No.	Make/Model	Year	Part No.	Make/Model	Year
CK4480	<b>KAWASAKI Contd.</b> Use CK4425		CK4508	<b>KAWASAKI Contd.</b> BJ 250 B1-B7A 'Estrella' BJ 250 C1-C7/D1-D7/F1/F2 BJ 250 E1-E4A Estrella-RS Custom ZR 250 A1-A5 ZR 250 B6 (Ballius II) ZXR 250 C1-C5/D1 ZXR 250 (ZX 250 A1/A2) ZXR 250 R (ZX 250 B1/B2) <b>SUZUKI</b> GSX 250 FXK2	92-99 95-03 96-99 91-95 02 91-95 89-90 89-90
CK4481	Use CK1180		CK4509	KDX 250 SR (KDX 250 F1)	91
CK4482	KX 125 F1/G1 KDX 200 E1/E2/E3/E4/E5/E6	88-89 89-94	CK4510 ▲=CT004	ZX9R (ZX 900 C1/C2/E1/E2/F1/F2) KLZ 1000 ACF/ADF Versys Z 1000 (ZR 1000 A1/A2/A3/A6F) Z 1000 (ZR 1000 B7F/B8F) Z 1000 ABS (ZR 1000 C7F/C8F/C9F) Z 1000 SX (ZR 1000 GBF/GCF/GDF) (Non ABS) Z 1000 SX (ZR 1000 HBF/HCF/HDF) (ABS) ZR 1000 DAF/DBF/DCF/DDF ZR 1000 DCFA/DDFB ZX 10R (ZX 1000 C1/C2/D6F/D7F) ZX 10R (ZX 1000 E8F/E9F/FAF) ZX 10R ABS (ZX 1000 KBF/KCF/KDF) ZX 10R (ZX 1000 JBF/JCF/JDF) <b>SUZUKI</b> GSXR 1000 K1/K2/K3/K4	98-04 ▲ 12-13 ▲ 03-06 ▲ 07-08 ▲ 07-09 ▲ 11-13 ▲ 11-13 ▲ 10-13 ▲ 12-13 ▲ 05-07 ▲ 08-10 ▲ 11-13 ▲ 11-13 ▲ 01-04 ▲
CK4483	Use CK4455		CK4511	BN 125 A1-A5/A6F/A7F Eliminator	98-07
CK4484 ▲=CT016	KR1 (250 cc) (KR 250 B2/C2/C3)	89-92 ▲	CK4513 ▲=CT009	ZX12R (ZX 1200 A1)	00 ▲
CK4485	KX 125 H1/H2/J1	90-92	CK4514 CKF4514 ▲=CT003 ■=CT004	<b>SUZUKI</b> RM 125 K2/K3/K4/K5/K6/K7/K8/K9 RM 125 XCK8 RM-Z 250 K4/K5/K6/K7/K8/K9 /L0/L1/L2/L3 <b>KAWASAKI</b> KX 250 F (KX 250 N1/N2/T6F/T7F/T8F) KX 250 W9F/XAFB/YBF/YCF/ZDF ZX-6R (ZX 600 P7F/P8F/R9F/RAF /RBF/RCF/RDF) ZX-6R (ZX 636 C1/C6F) ZX-6R EDF (Non ABS 636cc) ZX-6R FDF (ABS 636cc) ZX-6RR (ZX 600 M1) ZX-6RR (ZX 600 N1/N6F)	02-12 ▲ 09 ▲ 04-13 ■ 04-08 ■ 09-13 ■ 07-13 ■ 05-06 ■ 13 ■ 13 ■ 04 ■ 05-06 ■
CK4486 ▲=CT002	KMX 125 B2-B12 (From E/No MX 125AE 013437) KMX 125 A3/A4/A5 KMX 200 A2/A3 <b>KTM</b> Duke 200	87-03 ▲ 88-89 ▲ 88-92 ▲ 12 ▲	CK4515 ▲=CT009	ZX12R (ZX 1200 A2-A4/B1-B4/B6F)	01-06 ▲
CK4487	Use CK4424		CK4516 ▲=CT032	VN 1700 DAF/DBF/DCF/DDF Classic Tourer ABS VN 1700 B9F/BAF/BBF/BCF/BDF Voyager ABS VN 1700 C9F Classic Tourer VN 1700 FAF/BBF/FCF/FDF Classic ABS VN 1700 E9F Classic VN 1700 KBF/KCF/KDF Voyager Custom VN 2000 A1/A2/A6F VN 2000 H8F/H9F Classic	10-13 ▲ 09-13 ▲ 09 ▲ 10-13 ▲ 09 ▲ 11-13 ▲ 04-07 ▲ 08-09 ▲
CK4488 ▲=CT021	ZZR 1100 C1/C2/C2A/C3/D1-D9 ZX 1100 E1/E2/F1 ZZR 1200 C1H/C2H	90-01 ▲ 95-98 ▲ 02-04 ▲	CK4517 ▲=CT016	KR 250 A1/A2	84-86 ▲
CK4489	KDX 125 A1/A2/B1/B2	90-94	CK4518 ▲=CT021	ZX 1400 A6F/A7F ZZR 1400 ABS (ZX 1400 B6F/B7F D8F/D9F/DAF/DBF/FCF/FDF)	06-07 ▲ 06-13 ▲
CK4490	Use CK4446		CK4519 ▲=CT006	KXF 450 R (KSF 450 B8F/B9F/BAF /BBF/BCS)	07-12 ▲
CK4491	Use CK4485		CK4520 ▲=CT021	GTR 1400 (ZG 1400 A8F/A9F/CAF /CBF/CCF/CDF)	08-13 ▲
CK4492	Use CK4435				
CK4493 ▲=CT019	GT 750 P7/P9 ZR 750 C1/C2/C3/C4/C5/D1 'Zephyr' ZR-7 (ZR 750 F1/F3/F5) ZR-7S (ZR 750 H1/H3)	92-96 ▲ 91-98 ▲ 99-04 ▲ 01-04 ▲			
CK4494	Use CK4435				
CK4495	Use CK4439				
CK4496	Use CK4424				
CK4497	Use CK4434				
CK4498	KX 125 J2	93			
CK4499	Use CK4425				
CK4500	Use CK4435				
CK4501	Use CK4488				
CK4502	Use CK4469				
CK4503 ▲=CT004 ■=CT037SP	ZX-6R F1/F2/F3/G1/G2/J1/J2 ZX6RR (ZX 600 K1) ZX6R (636cc) (ZX636A1P/B1/B2) Z 750 S (ZR 750 K1/K6F) Z 750 J1/J2/J6F Z 750 R (ZR 750 NBF/NCF) Z 750 R ABS (ZR 750 PBF/PCF) ZR 750 L7F/L8F/L9F/LAF ZR 750 M7F/M8F/M9F Z 800 E (Z 800 CDS - Non ABS) Z 800 E (Z 800 DDS - ABS) Z 800 (Z 800 ADS - Non ABS) Z 800 (Z 800 BDS - ABS) <b>SUZUKI</b> RG 400 EWF/EW-2G/EWH Walter Wolf (Type 1&2) RG 500 G/CH	95-01 ▲ 03 ▲ 02-04 ▲ 05-06 ▲ 04-07 ▲ 11-12 ▲ 11-12 ▲ 07-10 ▲ 07-09 ▲ 13 ▲ 13 ▲ 13 ▲ 13 ▲ 85-87 ■ 85-87 ■			
CK4505	KDX 200 H1/H2/H3/H4/H5 KDX 220 R A4-A12/A6F KDX 220 SR	95-99 97-06			



Part No.	Make/Model	Year	Part No.	Make/Model	Year
CK4521 ▲=CT014	<b>KAWASAKI Contd.</b> EX 250 K8F/K9F/KAF/KBF/KCF Ninja 250 R	08-12 ▲	CK5596	<b>KTM</b> 350 MX (2T) 350 Enduro (2T) 500 MX (2T) 500 MX (4T) LC 500 Enduro (2T) 500 Enduro (4T) LC 600 MX (4T) LC 600 Enduro (4T) LC	89 89 89 89 89 89 89 89
CK4522 ▲=CT012SP	KLX 125 CAF/CBF/CCF/CDF KLX 125 DAF/DBF/DCF/DDF D-Tracker <b>KTM</b> Duke 125	10-13 ▲ 10-13 ▲ 11-12 ▲	CK5597 ■=CT009SP	<b>TRIUMPH</b> Bonneville (790cc) Speedmaster 800 (790cc) Bonneville T100	01-05 ■ 03-04 ■ 02-04 ■
CK4523 ▲=CT004	H2-B/H-C Mach IV (750cc)	74-75 ▲	CK5598 ▲=CT034SP	<b>APRILIA</b> AF1 125 Classic 125 MX 125 Pegaso 125 Red Rose 125 RS 125 (2T) RX 125	87-91 ▲ 95-01 ▲ 04-06 ▲ 91-95 ▲ 87-94 ▲ 92-13 ▲ 92-98 ▲
CK4524 ▲=CT009	EX 300 ADF Ninja (Non ABS) EX 300 BDF Ninja (ABS) KAF 400 ABF/ACF/ADF (Mule 610 4x4)	▲ 13 ▲ 11-13	CK5599 ▲=CT009	<b>TRIUMPH</b> Speed Triple (from VIN 141872 to 210444) Speed Triple 1050 Daytona (from VIN 132513) RS Sprint (from VIN 139277) ST Sprint (from VIN 138277) Sprint ST (From VIN 208167) Tiger 1050cc Tiger 1050cc SE	05-08 ▲ 01-06 ▲ 02-04 ▲ 02-04 ▲ 05-09 ▲ 07-12 ▲ 10-12 ▲
CK5588 ▲=CT021	<b>TRIUMPH</b> Adventurer Trophy 3 cyl 900 Trophy 4 cyl 1200 Trident 750/900 Legend TT Thunderbird/Sport Speed Triple Sprint Daytona 900/Cyl Daytona 1200 4 cyl Daytona 750 3 cyl Daytona 1000 4 cyl Tiger Daytona Super 3	96-01 ▲ 92-01 ▲ 92-01 ▲ 92-98 ▲ 98-01 ▲ 95-04 ▲ 94-99 ▲ 94-98 ▲ 93-96 ▲ 93-98 ▲ 92 ▲ 92 ▲ 93-98 ▲ 94-97 ▲	CK5602	<b>KTM</b> 250 EXC-G Racing 250 EXC Racing 400 EXC 400 MXC SX 400 450 EXC Racing 450 EXC-G Racing 450 MXC-G Racing 520 EXC SX 520 525 EXC Racing 525 EXC-G Racing 525 MXC Desert Racing 525 MXC-G Racing 525 SX Racing	04 04 00-01 01 00-01 04 04 04 00-01 00-01 04 04 04 04 04-05
CK5589 ▲=CT009	<b>TRIUMPH</b> T595/955i Daytona T509 'Speed Triple' 885/955cc Sprint ST Upto VIN 139235 Sprint RS Upto VIN 138656 Tiger 955cc	97-00 ▲ 97-01 ▲ 98-01 ▲ 98-01 ▲ 99-06 ▲	CK5604 ▲=CT026	<b>APRILIA</b> RS 50 RX 50 SX 50 <b>DERBI</b> GPR 50 Nude GPR 50 R GPR 50 Racing GPR 50 Replica Senda (Most models) 4 plate clutch	06-11 ▲ 06-10 ▲ 06-10 ▲ 04-05 ▲ 97-00 ▲ 04-05 ▲ 99-05 ▲ 99-05 ▲
CK5594 CKF5594 ▲=CT027 ■=CT057SP	<b>KTM</b> SX 60 SX 65 SX 65	98-00 ▲ 98-08 ▲ 09-13 ■	CK5605	<b>BMW</b> F 650/93/97 (K60/0161/0162) F 650 (E169/0161 Standard) F 650 (E169/0162) (Funduro /High Screen) (19" front wheel) F 650 ST (K60/0163) F 650 ST (E169/0163/168) Strada (18" front wheel/low screen)	93-03 09/93-96 97-00 96-00 97-00
CK5595 CKF5595 ▲=CT007 ■=CT049	<b>KTM</b> 250 EGS 250 EXC (2T) EXC 250 (2T) Six Days 250 MXC SX 250 (2T) XC 250 (USD) XC 250 (2T) 250 SXS Reklus Aftermarket Clutch Kit SX 250/300 (2T) 24T Steel Plate Reklus Aftermarket Clutch Kit EXC 250/300 (2T) 24T Steel Plate EXC 300 (2T) 300 E-GS 300 EXC EXC 300 (2T) Six Days 300 MXC 300 Six Days SX 300 XC 300 (USD) 360 EGS 360 MXC 360 SXC 360 SX 360 Six Days 380 EXC SX 380 RXC-E 400 EXC-E 620	94-99 ▲ 94-12 ▲ 11-12 ▲ 98-99 ▲ 94-12 ▲ 11 ▲ 11-12 ▲ 01-03 ▲ 03-11 ■ 03-11 ■ 00-12 ▲ 94-99 ▲ 94-07 ▲ 11-12 ▲ 94-05 ▲ 96 ▲ 94 ▲ 11-12 ▲ 96-97 ▲ 96-01 ▲ 96-97 ▲ 96-97 ▲ 96 ▲ 98-02 ▲ 98-02 ▲ 95 ▲ 95 ▲			





Part No.	Make/Model	Year	Part No.	Make/Model	Year
CK5636	<b>BMW</b> F 650 CS Scarver (K14/0174/0184 Belt drive/17" cast wheels) F 650 GS (R13/0172/0182) 19" front wheel F 650 GS Dakar (R13/0173/0183) 21" front wheel	00-03 99-03 99-03	CK5651 ▲=CT023	<b>KTM</b> EXC 250 (2T) Six Days SX 250 (2T) Diaphragm Spring SX-F 250 (2T) Coil Spring XC-F 250 (4T) Coil Spring EXC 300 (2T) Diaphragm Spring EXC 300 (2T) Six Days SX-F 350 (USD Forks) EXC-F 350 (USD Forks) EXC-F 350 (Diaphragm Spring) EXC-F 350 Six Days (Diaphragm Spring) XC-F 350 350 Freeride EXC-F 450 (4T) EXC 450 (4T) Six Days EXC 450 (4T) Diaphragm Spring SX-F 450 (4T) Diaphragm Spring EXC 500 (4T) EXC 500 Six Days (4T) (Diaphragm Spring) EXC 500 Six Days (4T)	13 ▲ 13 ▲ 13 ▲ 13 ▲ 13 ▲ 13 ▲ 11-13 ▲ 11 ▲ 12-13 ▲  12 ▲ 12-13 ▲ 12-13 ▲ 12 ▲ 12-13 ▲ 13 ▲ 12-13 ▲ 12 ▲ 12-13 ▲ 13 ▲
CK5638 ▲=CT009	<b>KTM</b> SX-F 450 450 SX (Quad) SX-F 505 505 SX-F (Quad)	07-10 ▲ 09-11 ▲ 07-09 ▲ 09-12 ▲			
CK5639 ▲=CT030	<b>KTM</b> 620 LC4 Super Moto 620 TXC 625 SMC 625 SXC 640 Adventure-R 640 Duke-E 640 Duke II Duke-E 610 Duke II 640 640 LC4 640 LC4 Adventure 640 LC4 Supermoto 640 LC4-E 640 LC4 Six Days 660 LC4 Rallye 660 SM Factory Replica 660 SMC	99 ▲ 98 ▲ 04/06 ▲ 03-04 ▲ 98-02 ▲ 98 ▲ 99-04 ▲ 98 ▲ 99-07 ▲ 99-00 ▲ 03-06 ▲ 03-04 ▲ 00-02 ▲ 99 ▲ 99-00 ▲ 02-03 ▲ 03-04 ▲			
CK5640 ▲=CT041	<b>KTM</b> EXC 530 EXC-R 530	08 ▲ 08 ▲			
CK5641 ▲=CT030	<b>KTM</b> 690 Rally Factory Replica	07-09 ▲			
CK5642	<b>KTM</b> 690 Duke 690 Duke R 690 Enduro 690 R Enduro 690 SMR 690 SM 690 SMC 690 SM-LE (Limited Edition)	08-13 10-11 08-10 09-13 07-11 07-09 08-11 10-11			
CK5643 ▲=CT009	<b>GAS-GAS</b> EC 200/250/300 (2T) EC 450 FSR/FSE (4T) Enduro SM 450 FSR (4T) Supermotard Wild HP 450 Quad EC 515 FSR/FSE (4T) Enduro SM 515 FSR (4T) Supermotard	00-08 ▲ 05-08 ▲ 07-08 ▲ 04-08 ▲ 05-08 ▲ 07-08 ▲			
CK5644 ▲=CT021	<b>KTM</b> RC8 (1190cc) RC8 R (1190cc) Track	08-10 ▲ 10-13 ▲			
CK5648 ▲=CT041	<b>KTM</b> EXC 400 (4T) EXC-R 450 (4T) EXC 450 (4T) EXC 450 (4T) Six Days EXC 530 EXC 530 (4T) Six Days	09-11 08 ▲ 09-11 ▲ 11 09-11 ▲ 11			
			CK6601	<b>BMW</b> R 45 R 45/N R 45 T R 45 T/N R 65 R 65 LS R 65 T R 65 GS R 65 RT R 80 GS R 80 ST R 80 R 80 RT R 80 TIC R 100/7 T R 100 CS R 100 RS R 80 R 80 RT R 80 GS R 80 PD/CH R 80 MYS R 80 R R 80 GS R 100 MYS R 100 R R 100 GS R 100 PD	09/80-85 09/80-85 09/80-85 09/80-85 09/80-85 81-85 80-85 87-92 85-88 80-87 82-84 09/80-84 82-84 09/80-85 09/80-84 80-84 09/80-84 84-95 84-95 87-90 90 94-95 91-94 96 93-96 91-95 86-90 89-90
			CK6602	<b>BMW</b> R 45 R 45 R 45 N R 65	-09/80 78-09/80 -09/80 78-09/80
			CK6603	<b>BMW</b> R 50/5 R 60/5 R 60/6 R 75/5 R 75/6 R 90/6 R 90 S R 60/7 R 60 TIC R 75/7 R 80 R 80 TIC R 100 R 100/7T R 100 RS R 100 RT R 100 S	69-73 69-73 73-76 69-73/80 73-76 73-79 73-76 76-09/80 78-09/80 76-79 77-09/80 78-09/80 76-77 77-09/80 76-09/80 78-09/80 76-80

Part No.	Make/Model	Year	Part No.	Make/Model	Year
CK6604	<b>BMW</b> K 75 K 75/2 K 75 C K 75 RT K 75 S	84-96 84-96 85-88 89-96 85-95			
CK6605	<b>BMW</b> K 100 K 100/2 K 100 LT K 100 RS K 100 RT (Valve models) K1 K 100 RS K 1100 LT K 1100 RS	82-88 87-90 86-91 83-89 83-89 88-93 89-92 89-99 92-96			
CK6680	<b>APRILIA</b> RSV 1000 Mille/R Mille RSV 1000 SP RSV 1000 R Factory RSV 1000 R RSV 1000 R Tuono SL 1000 Falco	00-02 99-00 04-08 04-08 02-06 00-04			
CK6681 ▲=CT041	<b>APRILIA</b> RSV4R RSV4R Factory SBK Racing RSV4 Factory APRC RSV4R APRC	10 ▲ 09-10 ▲ 11-13 ▲ 11-13 ▲			

Part No.	Make/Model	Year	Part No.	Make/Model	Year
DRC001 ■=CT012SP	<b>HONDA</b> CR 80 RF/R2F CR 80 RG/R2G CR 80 RH/RJ/RK/RL/RM/RN/RP/RR/RS /RT/RBT/RV/RBV/RW/RBW/RX/RBX /RY/RBY/R1/RB1/R2/RB2 CR 85 R3/RB3/R4/RB4/R5/RB5 /R6/RB6/R7/RB7	85 ■ 86 ■  87-02 ■  03-07 ■	DRC020 ▲=CT011	<b>SUZUKI</b> RM 80 K/L	89-90 ▲
DRC002 ▲=CT001	<b>HONDA</b> CR 125 RG/RH/RJ/RK/RL/RM/RN/RP /RR/RS/RT/RV/RW/RX	86-99 ▲	DRC021 ▲=CT011	<b>SUZUKI</b> RM 125 G/H	86-87 ▲
DRC003 ▲=CT009	<b>HONDA</b> CR 250 RD/RE/RF/RG/RH/RJ/RK CR 480 RD CR 500 RE/RG/RH/RJ/RK	83-89 ▲ 83 ▲ 84-89 ▲	DRC022 ▲=CT011	<b>SUZUKI</b> RM 125 J/K/L/M	88-91 ▲
DRC004 ■=CT012SP	<b>HONDA</b> TRX 200 D TRX 200 L/M Fourtrax TRX 200 SX TRX 250 EX1/EX2 (Sportrax 250 EX) TRX 250 V/W/X/Y/1/TE2-9/TEA TEB/TEC/TM2-9/TMA/TMB/TMC Recon/ES TRX 250 X9/XA/XB TRX 250 EX1/2/3/4/5/6/7/8	91-97 ■ 90-91 ■ 86-87 ■ 01-02 ■  97-12 ■ 09-11 ■ 01-08 ■	DRC023	<b>SUZUKI</b> LT 250 RH/RJ/RK	87-90
DRC005 ▲=CT013	<b>HONDA</b> TRX 250 RG/RH	86-87 ▲	DRC024 ▲=CT022	<b>SUZUKI</b> RM 250 J/K/L	88-90 ▲
DRC006 ■=CT013SP	<b>HONDA</b> TRX 300 FWJ/K/L/T/V/W/X/Y/J /K/L/T/V/W/X/Y TRX 350 G/H/J/K/L/M/N TRX 400 FWS/T/V/W/X/Y TRX 450 ESW/ESX/ESY/ES1	88-00 ■ 86-93 ■ 95-00 ■ 98-01 ■	DRC025 DRCF025 ▲=CT011	<b>SUZUKI</b> RM 80 M/N/P/R/S/T/V/W/X/Y/K1 RM 85 K2/LK2/K3/LK3/K4/LK4 RM 85 K5/LK5/K6/LK6/K7/LK7 /K8/LK8/K9/LK9/L0/LL0/L2/LL2	91-01 ▲ 02-04 ▲ 05-12 ▲
DRC007	<b>KAWASAKI</b> KX 60 A1/A2/B1-B19 SUZUKI RM 60 K3	83-03  03	DRC026 ▲=CT010	<b>SUZUKI</b> LT 500 RL/RM	90-91 ▲
DRC008	<b>KAWASAKI</b> KX 80 E3/G1/G2/J1/J2	85-87	DRC027	<b>YAMAHA</b> YZ 80 S/T/U/W	86-89
DRC009	<b>KAWASAKI</b> KX 80 L1 KX 100 N1	88 88	DRC028	<b>YAMAHA</b> YZ 125 S/T	86-87
DRC010	<b>KAWASAKI</b> KX 80 L2/L3/R1-R7 KX 100 A1/A2/B1-B7	89-97 89-97	DRC029	<b>YAMAHA</b> YZ 125 U	88
DRC011	<b>KAWASAKI</b> KX 125 D1/E1/E2 KDX 200 C3	85-87 88	DRC030	<b>YAMAHA</b> YZ 125 W/A	89-90
DRC013	<b>KAWASAKI</b> KX 125 F1/G1	88-89	DRC031	<b>YAMAHA</b> YZ 250 U/W/A/B/D	88-92
DRC015	<b>KAWASAKI</b> KX 250 E1/F1/G1	87-89	DRC032 ▲=CT060	<b>YAMAHA</b> YZ 250 N/S (TRI Z) YZ 490 J/K/L/N/S/T/U	85-86 ▲ 82-88 ▲
DRC016	<b>KAWASAKI</b> KX 500 C1/D1 KX 500 E1-E16	87-88 89-04	DRC033 DRCF033 ▲=CT008	<b>YAMAHA</b> YFM 350 FWT/FWU/FWW/FWA /FWE Big Bear YFM 350 XD/XE/XF/XG/XH/XJ/XK /XL/XM/XN/XP/XR/XS YFM 350 ERD/ERE/ERF YFM 350 S/T/V/R-WV/RW /RX/RV/RZ Raptor	86-93 ▲ 92-04 ▲ 92-94 ▲ 04-10 ▲
DRC017	<b>KAWASAKI</b> KX 250 H1	90	DRC035 ▲=CT060	<b>YAMAHA</b> YZ 250 N/S/T	85-87 ▲
DRC019	<b>SUZUKI</b> RM 80 XH/XJ	87-88	DRC036	<b>KAWASAKI</b> KX 125 H1/H2	90-91
			DRC038	<b>KAWASAKI</b> KXT 250 B1/B2 (Tecate - 3 Wheel Model) KX 50 B1/B2	86-87 85-86
			DRC039 ▲=CT011	<b>YAMAHA</b> YZ 125 B/D WR 250 RX/RV (32D1/3) WR 250 XX/XY (Supermoto) (32D2/4)	91-92 ▲ 08-10 ▲ 08-10 ▲
			DRC040 ▲=CT022	<b>SUZUKI</b> RM 250 M	91 ▲

Part No.	Make/Model	Year	Part No.	Make/Model	Year
DRC041 ▲=CT006	<b>KAWASAKI</b> KX 250 H2 KDX 250 D1	91 ▲ 91-93 ▲	DRC056 ▲=CT008	<b>YAMAHA</b> TT 350 A (3GJ) TT 350 (ITJ) XT 350	90-95 ▲ 85-89 ▲ 85-95 ▲
DRC042 DRCF042 ▲=CT010	<b>YAMAHA</b> DT 125 R DT 125 RE DT 125 X TDR 125 (4GW/GX1/2/3/4) TZR 125 R/RR SDR 200 (2TV) WR 200 D/E/F YFS 200 B/F/G/H/J/K/L/M/N /P/R/S/T/V Blaster DT 230 R Lanza (4TP1/2)	88-03 ▲ 04-07 ▲ 05-06 ▲ 93-03 ▲ 93-95 ▲ 87-89 ▲ 92-94 ▲ 91-06 ▲ 97-98 ▲	DRC057 ▲=CT008	<b>YAMAHA</b> TT 600 L TT 600 N (59X) Frame # 59X 000101-59X 007852 TT 600 W (2JT/3SW1) Frame # 59X 007853- TT 600 K TT 600 E TT 600 R (5CH1) TT 600 R (5CH2) TT 600 R (5CH3) TT 600 RE (5CH5) XT 600 XT 600 Z	84 ▲ 85-88 ▲ 89-92 ▲ 93-96 ▲ 94-95 ▲ 97 ▲ 98-99 ▲ 00-02 ▲ 04 ▲ 84-87 ▲ 84-85 ▲
DRC043 DRCF043 ▲=CT008	<b>YAMAHA</b> YFZ 350 T/U/W/A/B/D/E/F/G/H/J/ K/L/M/N/P/R/S/T/V Banshee	87-09 ▲	DRC058 DRCF058 ▲=CT022	<b>SUZUKI</b> DR 350 SL/SM/SN/SP/SER/SES /SET/SEV/SEW/SEX <b>QUADZILLA</b> WK 300	90-99 ▲ 06 ▲
DRC044 DRCF044 ■=CT013SP	<b>HONDA</b> XR 250 RG/RH/RJ/RK/RL/RM/RN /RP/RR/RS TRX 300 EX P/R/S/T/V/W/X/Y/1-8 TRX 300 X9 XR 350 RD/RE	86-95 ■ 93-08 ■ 09 ■ 83-84 ■	DRC059 ■=CT029SP	<b>SUZUKI</b> DR 650 RL/RM (SP41A) DR 650 RSEM/RSEN/RSEP (SP45A/B) DR 650 RSL/RSM (SP42A) DR 650 RUN/RN/RUP/RP (SP44A/B)	90-91 ■ 91-93 ■ 90-91 ■ 92-93 ■
DRC045 DRCF045 ▲=CT002	<b>KAWASAKI</b> KX 80 W1/W2/W3 KX 85 A1-A5/A6F/A7F/A8F/A9F /AAF/ABF/ACF/ADF KX 85 II B1-B5/B6F/B7F/B8F/B9F /BAF/BBF/BCF/BDF KX 100 C1/C2/C3 <b>SUZUKI</b> RM 100 K3	98-00 ▲ 01-13 ▲ 01-13 ▲ 98-00 ▲ 03 ▲	DRC060 ■=CT013SP	<b>HONDA</b> XR 200 R XL 250 RE/RF XLR 250 R Baja (5 Plate) (MD22) XR 250 RE/RF	84-85 ■ 84-85 ■ 84-85 ■ 84-85 ■
DRC046 DRCF046 ▲=CT016	<b>KAWASAKI</b> KX 250 J1/J2/K1-K5/L1-L4 KX 250 M1/M2/R1/R6F/R7F/R8F	92-02 ▲ 03-08 ▲	DRC061	<b>KAWASAKI</b> KDX 200 E1/E2/E3/E4/E5/E6	89-94
DRC048 ▲=CT022	<b>SUZUKI</b> RM 250 N/P	92-93 ▲	DRC062	<b>KAWASAKI</b> KDX 200 H1/H2/H3/H4/H5 KDX 220 R A4-A12/A6F KDX 220 SR	95-99 97-06
DRC049 DRCF049 ■=CT012SP	<b>HONDA</b> CRF 100 F4/F5/F6/R7/F8/F9 XR 100 RP/RR/RS/RT/RV/RW/RX /RY/R1/R2/R3	04-09 ■ 93-03 ■	DRC063	<b>KAWASAKI</b> KLR 250 D2-D22	84-05
DRC051	<b>HONDA</b> AX-1 (NX 250 J/K/R/R3)	89-94	DRC064 ▲=CT016	<b>KAWASAKI</b> KLE 500 A1-A12 KLE 500 B1P/B6F/B7F	91-04 ▲ 05-07 ▲
DRC052	<b>SUZUKI</b> RM 250 H	87	DRC065 ▲=CT016	<b>KAWASAKI</b> KLR 650 A1-A3 KL 650 B1/B2/B3 Tengai KLX 650 C1/C2/C3	87-89 ▲ 89-92 ▲ 93-97 ▲
DRC053 ■=CT013SP	<b>HONDA</b> XL 600 VH/VJ/VK/VM/VN/VP/VR /VT/VV/VW/VX Transalp	87-99 ■	DRC066 ▲=CT010	<b>YAMAHA</b> YZ 80 E/LC/LW/F	93-94 ▲
DRC054 DRCF054 ▲=CT009	<b>HONDA</b> NX 500 J/K/L/M/N/P/R/S/T/V /W/X Dominator XL 600 LMF/RMG/LMH XR 600 RF/RG/RH/RJ/RK/RL/RM /RP/RR/RS/RT/RV/RW/RX/RY FMX 650 5/6 FX 650 X/Y Vigor NX 650 J/K/L/M/N/P/R/S/T/V/W/X SLR 650 V/W XR 650 L	88-99 ▲ 85-87 ▲ 84-00 ▲ 05-08 ▲ 99-03 ▲ 88-02 ▲ 97-98 ▲ 93-12 ▲	DRC067 ▲=CT013	<b>HONDA</b> CR 125 RD/RE	83-84 ▲
DRC055 ▲=CT039	<b>YAMAHA</b> AG 200 E (3G x 6)	93 ▲	DRC068 ▲=CT001	<b>HONDA</b> CR 125 RF	85 ▲
			DRC069	<b>KAWASAKI</b> KX 125 J2	93
			DRC070 DRCF070 ▲=CT005	<b>YAMAHA</b> YZ 125 E/F/G/H/J/K/L/M/N YZ 125 T/V/W/X/Y/Z/A/B/D	93-01 ▲ 05-13 ▲

Part No.	Make/Model	Year	Part No.	Make/Model	Year
DRC071	<b>YAMAHA</b> YZ 250 E/F/G/H/J/L	93-99	DRC089 ▲=CT011	<b>SUZUKI</b> LT-F 250 J/K/L/M/N/P/R/S/T/V/W/Y/K1 LT-F4WDH/J/K/L/M/N/P/R/S/T/V/W LT 250 EFF/EFG LT-F 250 FX/FY/FK1/FK2 LT-F 300 J/K <b>ARCTIC CAT</b> 250 (2 x 4/4 x 4)	89-01 ▲ 87-98 ▲ 85-86 ▲ 99-02 ▲ 88-89 ▲ 01-05 ▲
DRC072 ▲=CT022	<b>SUZUKI</b> RM 250 R/S RMX 250 R/S/T/V/W RMX 250 ST/SV/SW/SX (SJ14A)	94-95 ▲ 94-98 ▲ 96-99 ▲	DRC091 ■=CT012SP	<b>HONDA</b> CTX 200/CTX 200 A Bushlander XR 200 R XR 200 R XR 200 TLR 250 F	04-05 ■ 81-83 ■ 86-02 ■ 80-84 ■ 85- ■
DRC073 ▲=CT004	<b>KAWASAKI</b> KX 125 K4/K5/L1-L4	97-02 ▲	DRC092 ▲=CT009	<b>HONDA</b> XL 600 RD/LD/RE/LE/RF/RG/RH	83-87 ▲
DRC074	<b>KAWASAKI</b> KDX 200 C1/C2	86-87	DRC093 ▲=CT013	<b>HONDA</b> CRM 250 R (RK) MK1 MD24 (100001-1008385) CRM 250 R (RM) MK2 MD24 (1200001-1211634) CRM 250 R (RP/RP-11) MK2/2 /MD24(1300001-) XR 400 RT	89-90 ▲ 91-92 ▲ 93 ▲ 96 ▲
DRC075 ▲=CT009	<b>HONDA</b> CR 250 RL/RM/RN/RP CR 500 RL/RM/RN/RP/RR /RS/RT/RV/RW/RX/R1	90-93 ▲ 90-01 ▲	DRC094 ▲=CT011	<b>SUZUKI</b> DR 200 G/H/J	86-89 ▲
DRC076 ▲=CT003	<b>SUZUKI</b> RM 125 P/R/S/T/V/W	93-96 ▲	DRC095 ▲=CT016	<b>SUZUKI</b> RM 250 V/W/X/Y/K1/K2	97-02 ▲
DRC078 ▲=CT010	<b>YAMAHA</b> YZ 80 G/H/J/K/L/M/N	95-01 ▲	DRC097	<b>YAMAHA</b> YZ 250 M/N	00-01
DRC079 DRCF079 ▲=CT009	<b>HONDA</b> CR 250 RR/RS/RT/RV/RW/RX /RY/R1-R7	94-07 ▲	DRC098 DRCF098	<b>KAWASAKI</b> KX 65 A1/A2/A3/A4/A5/A6/A6F /A7F/A8F/A9F/AAF/ABF/ACF/ADF <b>SUZUKI</b> RM 65 K3/K4/K5	00-13 03-05
DRC080 ▲=CT016	<b>SUZUKI</b> RM 250 T	96 ▲	DRC099 ▲=CT008	<b>YAMAHA</b> YZ 400 FK/FL WR 400 FK/FL/FM/FN	98-99 ▲ 98-01 ▲
DRC081 ▲=CT013	<b>HONDA</b> TRX 250 RJ/RK	88-89 ▲	DRC100 DRCF100 ▲=CT013	<b>HONDA</b> TRX 400 EX/EY/EXX/EXY/EX1-EX8 TRX 400 X9	99-08 ▲ 09 ▲
DRC082 ▲=CT008	<b>YAMAHA</b> YFM 350 FWF/FWG/FWH/FWJ YFM 350 ERG YFM 350 UH/UJ YFM 400 FWE/FWF/FWG/FWH /FWJ/FWK Kodiak YFM 400 FPR/FPS Big Bear	94-97 ▲ 95 ▲ 96-97 ▲ 93-00 ▲ 03-04 ▲	DRC101 DRCF101 ▲=CT001	<b>HONDA</b> CR 125 R4/R5/R6/R7	04-07 ▲
DRC083	<b>KAWASAKI</b> KX 125 J1	92	DRC102 ▲=CT020	<b>YAMAHA</b> YZ 426 FM	00 ▲
DRC084 ■=CT013SP	<b>HONDA</b> XR 250 RT/RV/RW/RX/R1 /R2/R3/R4 <b>HONDA DALL ARA</b> XR 250 R XR 250 RM	96-04 ■ 04 ■ 04 ■	DRC103 ▲=CT011	<b>SUZUKI</b> LT-F 4WD X M/N/P/R/S/T/V/W 300 Quadrunner LT-F 300 FX/FY/FK1 <b>ARCTIC CAT</b> 300 (2 x 4/4 x 4) 300 (4 x 4)	91-98 ▲ 99-01 ▲ 98-04 ▲ 05 ▲
DRC085 ▲=CT005	<b>SUZUKI</b> YZ 125 P/R/S	02-04 ▲			
DRC086	<b>SUZUKI</b> DR 250 SL/SM/SN/SEP/SER /SES (SJ44A)	90-95			
DRC087	<b>SUZUKI</b> DR 650 SET/SEV CCM R30 (644 Suzuki Engine) 644 DS/Supermoto	96-97 02-04 04			
DRC088 DRCF088 ▲=CT008	<b>YAMAHA</b> XT 600 Z XT 600 E/ZE SZR 660 XTZ 660 Tenere YFM 660 RN/RP/RR/RS/RT Raptor	86-90 ▲ 90-03 ▲ 96-97 ▲ 91-97 ▲ 01-05 ▲			



Part No.	Make/Model	Year	Part No.	Make/Model	Year			
DRC104 ■=CT010SP	<b>YAMAHA</b> YTM 225 DRN YFB 250 D/E/F/G/H/J/K/FWF/FWG /FWH/FWJ/FWK/FWL/FWM YFM 250 W/A/B YFM 250 XN/XP/XR/XS Bear Tracker YFM 250 FN YFM 250 BT/BV Bruin YFM 250 BW/BX/BY Big Bear YFU1W/T	85 ■ 92-00 ■ 90-92 ■ 00-04 ■ 01 ■ 05-06 ■ 07-10 ■ 89-90 ■	DRC111 DRCF111 ▲=CT010	<b>YAMAHA</b> YZ 85 P/LWP/R/LWR/S/LWS/T/ LWT/V/LWV/W/LWW/X/LWX/LWY /Y/Z/LWZ/LWA/LWB/LWD	02-13 ▲			
DRC105 DRCF105 ▲=CT006	<b>KAWASAKI</b> KLX 400 R (KLX 400 B1/B2) KSF 400 A1/A2 (KFX 400) <b>SUZUKI</b> DR-Z 400 SY/EY/Y/SK1/EK1/K1 /SK2/EK2/K2/SK3/EK3/K3/SK4 /EK4/K4/EK5/SK5/K6/SK6/EK6 /SK7/EK7/K7/SK8/SK9 DR-Z 400 SMK5/SMK6/SMK7 /SMK8/SMK9 LT-Z 400 K3/K4 <b>ARCTIC CAT</b> 400 DVX <b>CCM</b> R35/R35S 404 E/DS/Supermoto CR 40 S Cafe Racer CR 40 Street	03-04 ▲ 03-04 ▲ 00-09 ▲ 05-09 ▲ 03-04 ▲ 04-06 ▲ 06-07 ▲ 03-04 ▲ 07 ▲ 07 ▲	DRC113 DRCF113	<b>YAMAHA</b> YZ 250 P/R/S/T/V/W/X/Y/Z/A/B (2T)	02-12			
			DRC114 ▲=CT003	<b>SUZUKI</b> RM 125 N	92 ▲			
			DRC115 ▲=CT003	<b>SUZUKI</b> RM 125 X/Y/K1	97-01 ▲			
			DRC116 ▲=CT020	<b>YAMAHA</b> YZ 426 FN/FP	01-02 ▲			
DRC106 ▲=CT013	<b>HONDA</b> XR 400 RV/RW/RX/RY/R1-R5 <b>HONDA DALL ARA</b> XR 400/440 R XR 400/440 SM	97-05 ▲ 04 ▲ 04 ▲	DRC117 250 EXC Racing 250 EXC-G Racing 400 EXC 400 MXC SX 400 450 EXC-G Racing 450 EXC Racing 450 MXC-G Racing 520 EXC SX 520 525 EXC Racing 525 EXC-G Racing 525 MXC Desert Racing 525 MXC-G Racing 525 SX Racing	04 04 00-01 01 00-01 04 04 04 00-01 00-01 04 04 04 04 04 04				
DRC107 DRCF107 ▲=CT027	<b>KTM</b> SX 60 SX 65	98-00 98-08		04 04 00-01 04 04 04 04 04 04 04				
DRC108 DRCF108 ▲=CT007	<b>KTM</b> SX 250 (2T) 250 EGS 250 EXC (2T) EXC 250 (2T) Six Days 250 MXC 250 SXS XC 250 (USD) XC 250 (2T) 300 EGS EXC 300 (2T) 300 EXC EXC 300 (2T) Six Days 300 MXC 300 MXC SX 300 300 Six Days XC 300 (USD) 360 EGS 360 EXC 360 MXC 360 SX 360 Six Days 380 EXC 380 MXC SX 380 RXC-E 400 RXC-E 620	94-12 ▲ 94-99 ▲ 94-12 ▲ 11-12 ▲ 98-99 ▲ 01-03 ▲ 11 ▲ 11-12 ▲ 94-99 ▲ 00-12 ▲ 94-07 ▲ 11-12 ▲ 94-03 ▲ 04-05 ▲ 94 ▲ 96 ▲ 11-12 ▲ 96-97 ▲ 96-97 ▲ 96-97 ▲ 96-97 ▲ 96 ▲ 98-02 ▲ 98-01 ▲ 98-02 ▲ 95 ▲ 95 ▲		DRC119 DRC119 ▲=CT005	<b>YAMAHA</b> WR 250 FN/FP/FR/FS/FT/FV/FW /FX/FY/FZ/FA/FB/FD (4T)	01-13 ▲		
							DRC120	<b>SUZUKI</b> LT-F 400 FK2-FK7 (Eiger 4WD) LT-F 400 FK8/FK9/FL0/FL1 King Quad 4WD LT-F 400 K3-K7 Eiger 2WD <b>ARCTIC CAT</b> 400 (2 x 4/4 x 4) 400 (4 x 4 Manual)
			DRC121 ▲=CT020				<b>YAMAHA</b> YZ 450 FR/FS	03-04 ▲
			DRC122 ▲=CT004				<b>KAWASAKI</b> KX 125 M1/M2/M3/M6F/M7F/M8F	03-08 ▲
			DRC123 DRCF123 ▲=CT004				<b>KAWASAKI</b> KX 250 F (KX 250 N1/N2/T6F/T7F/T8F) KX 250 W9F/XAFB/YBF/YCF/ZDF <b>SUZUKI</b> RM-Z 250 K4/K5/K6	04-08 ▲ 09-13 ▲ 04-06 ▲
			DRC126 ■=CT013SP				<b>HONDA</b> TRX 350 FMY/1-5 FourtraxRancher/4x4	00-05 ■
			DRC127 ■=CT013SP				<b>HONDA</b> TRX 350 TE/FE Fourtrax Rancher ES/ES 4x4 FEY/1-5	00-05 ■
			DRC109 DRCF109 ▲=CT005				<b>YAMAHA</b> YZ 250 FN/FP/FR/FS/FT/FV/FW	01-07 ▲
			DRC110 ▲=CT020				<b>YAMAHA</b> WR 426 FN/FP WR 450 FR	01-02 ▲ 03 ▲

Part No.	Make/Model	Year	Part No.	Make/Model	Year
DRC128 DRCF128 ▲=CT020	<b>YAMAHA</b> YFM 700 RV/RW/RX/R5 Raptor YFM 700 RD Raptor	06-10 13 ▲	DRC155 DRCF155 ▲=CT045	<b>SUZUKI</b> RMX 450 ZL0 RM-Z 450 K5/K6/K7/K8/K9/L0/L1/L2/L3	10-12 ▲ 05-13 ▲
DRC129 DRCF129 ▲=CT001	<b>HONDA</b> CRF 250 R4/R5/R6/R7	04-07 ▲	DRC157	<b>KAWASAKI</b> DISCONTINUED	
DRC130 DRCF130 ▲=CT003	<b>SUZUKI</b> RM 125 K2/K3/K4/K5/K6/K7/K8/K9 RM 125 XCK8	02-12 ▲ 09 ▲	DRC158 DRCF158 ▲=CT006	KX 450 F (D6F/D7F/D8F/E9F/EAF EBF) KLX 450 R (A8F/A9F/AAF/ABF/ACF)	06-11 ▲ 08-12 ▲
DRC131 DRCF131 ▲=CT009	<b>HONDA</b> TRX 450 R4/R5/R6/ER6/R7/ER7 /R8/ER8/R9/ER9	04-09 ▲	DRC159 DRCF159	<b>YAMAHA</b> YFZ 450 S/T/V Quad	04-06
DRC136 ▲=CT002SP	<b>HONDA</b> CRF 230 F4/F5/F6/F7/F8/F9	04-09 ▲	DRC160 ▲=CT016	<b>SUZUKI</b> RM 250 K6/K7/K8/K9 RM 250 XCK8	06-12 ▲ 09 ▲
DRC137 DRCF137 ▲=CT006	<b>KAWASAKI</b> KSF 400 A3/A6F (KFX 400) <b>SUZUKI</b> LT-Z 400 K5/K6/K7/K8/K9 /L0/L1 Quadsport <b>ARCTIC CAT</b> 400 DVX	05-06 ▲ 05-12 ▲ 07-08 ▲	DRC161 ▲=CT016	<b>SUZUKI</b> RM 250 K3/K4/K5	03-05 ▲
DRC139 ▲=CT028	<b>KTM</b> SX 85 (17"/14" wheels) SX 85 (19"/16" wheels)	11-13 ▲ 03-13 ▲	DRC162 ▲=CT020	<b>YAMAHA</b> YZ 450 FT/FV	05-06 ▲
DRC142 ■=CT029SP	<b>SUZUKI</b> DR 650 RER/RES (SP45A/B)	94-95 ■	DRC163 DRCF163 ▲=CT001	<b>KTM</b> SX-F 250 (4T) EXC-F 250 (4T) EXC-F 250 (4T) Six Days XC-F 250 (USD) XC-F 250	05-12 ▲ 06-13 ▲ 11-12 ▲ 11-12 ▲ 12 ▲
DRC144 ▲=CT001	<b>KTM</b> SX 150 XC 150 (USD) 200 EGS 200 EXC 200 MXC SX 200	08-13 ▲ 11-13 ▲ 98-99 ▲ 97-12 ▲ 98-03 ▲ 03/06-07 ▲	DRC164 DRCF164 ▲=CT045	<b>SUZUKI</b> LT-R 450 K6/K7/K8/K9/L0/L1	06-12 ▲
DRC145 ▲=CT001	<b>KTM</b> 125 EGS 125 EXC 125 EXE 125 Supermoto SX 125 SX 125 (2T) 125 SXS	98-99 ▲ 98-05 ▲ 00-01 ▲ 00-01 ▲ 98-07 ▲ 09-13 ▲ 01-02 ▲	DRC165 ▲=CT040SP	<b>CCM</b> 604 Trial/SM/RS/R30 (Rotax Engine)	98-03 ▲
DRC148 DRCF148 ▲=CT009	<b>HONDA</b> CRF 450 R4/R5 CRF 450 X5/X6/X7/X8/X9 CRF 450 XRLD	04-05 ▲ 05-11 ▲ 13 ▲	DRC166 ▲=CT016	<b>KAWASAKI</b> KLR 650 C1-C10 KLR 650 (KL 650 E8F/E9F)	95-04 ▲ 08-09 ▲
DRC154 ▲=CT023	<b>KTM</b> 250 EXC Racing (2T) 400 EXC Racing 400 EXC-G Racing 450 EXC-G Racing 450 EXC Racing 450 MXC-G Racing 450 SMR SX 450 (4T) 525 EXC Racing 525 EXC-G Racing 525 MXC Desert Racing 525 SMR 525 SX Racing	05 ▲ 05 ▲ 05 ▲ 05 ▲ 05 ▲ 05 ▲ 04-05 ▲ 04-05 ▲ 05 ▲ 05 ▲ 05 ▲ 04-05 ▲ 05 ▲ 05 ▲ 05 ▲ 04-05 ▲ 05 ▲	DRC169 ▲=CT030	<b>KTM</b> 350 EXC 350 Super Comp 400 Duke 400 EGS 400 EXC 400 Super Comp 620 Duke 620 EGS 620 EXC 620 Super Comp SX 620	94 ▲ 94-95 ▲ 94-95 ▲ 94 ▲ 94 ▲ 95 ▲ 94 ▲ 94-95 ▲ 94-95 ▲ 94-95 ▲ 94 ▲
			DRC170 ▲=CT030	<b>KTM</b> 380 EGS 400 EGS-E 400 EGS 400 EXC 400 LC-4 400 LC4-E 400 LC4 R 400 400 LSE 400 LS-E 400 Super Comp/EXC 400 RXC-E SXC 400 400 SX-X 400 SX 400 SXC 400 TXC	98-99 ▲ 97 ▲ 96-97 ▲ 96 ▲ 98 ▲ 00-01 ▲ 99 ▲ 97 ▲ 04 ▲ 96-99 ▲ 96-97 ▲ 97 ▲ 98 ▲ 99 ▲ 00 ▲ 98 ▲

Part No.	Make/Model	Year	Part No.	Make/Model	Year
DRC170 ▲=CT030 Contd.	<b>KTM</b> 620 Duke 620 EGS/Adventure 620 EGS-E 620 Enduro Ltd 620 LC-4 620 LSE 620 RXC-E 620 Six Days 620 SC SXC 620 640 LC Rallye Dakar 660 LC4	97 ▲ 96-97 ▲ 97 ▲ 97 ▲ 98 ▲ 97 ▲ 96-97 ▲ 96 ▲ 00-01 ▲ 97 ▲ 97 ▲ 97 ▲	DRC177 ▲=CT015	<b>KTM</b> 690 Duke R 690 SM-LE (Limited Edition) 950 Adventure S 950 Adventure 950 Superenduro R 990 Adventure/S 990 Adventure Dakar Edition (ABS) 990 Adventure R 990 Adventure (ABS Model) 990 Superduke 990 Superduke R 990 Supermoto T (SM-T) 990 Supermoto R (SM-R)	10-11 10-11 03-04 ▲ 06 ▲ 07-08 ▲ 06-08 ▲ 11 ▲ 09-12 ▲ 09-12 ▲ 05-11 ▲ 07-13 ▲ 08-13 ▲ 08-13 ▲
DRC171 ▲=CT023	<b>KTM</b> 250 EXC-G Racing 250 EXC Racing 400 EXC Racing 400 EXC-G Racing 400 EXC 400 EXC-G Racing 400 MXC 400 SX Racing 450 EXC Racing 450 EXC-G Racing 450 EXC 450 MXC-G Racing MXC 450 SMR 450 SX 450 (4T) SX 450 (4T) XC 450 Quad (4T) 520 SX Racing 525 EXC-G Racing 525 EXC 525 MXC Desert Racing MXC 525 525 SX Racing SX 525 XC 525 (Quad) 540 SXS Racing SMR 560	03 ▲ 02-03 ▲ 02 ▲ 02 ▲ 07-09 ▲ 06 ▲ 02 ▲ 02 ▲ 03 ▲ 03 ▲ 06-09 ▲ 03 ▲ 06 ▲ 06-07 ▲ 03 ▲ 06 ▲ 08-09 ▲ 02 ▲ 03 ▲ 03 ▲ 03 ▲ 06 ▲ 03 ▲ 06 ▲ 08-12 ▲ 02 ▲ 06-07 ▲	DRC178	<b>KTM</b> EXC 400 (LC4 Engine) 400 RXC-E SC 400 (LC4 Engine) 620 RXC-E	93-95 95 95 95
			DRC179 ▲=CT009	<b>HONDA</b> XR 650 RY/R1-R7	00-07 ▲
			DRC180 ■=CT002SP	<b>HONDA</b> CRF 150 F3/F4/F5	03-05 ■
			DRC181 ■=CT002SP	<b>HONDA</b> CRF 150 F6/F7	06-07 ■
			DRC182 DRCF182 ▲=CT002	<b>HONDA</b> CRF 150 RB7/R7/RB8/R8/RB9/R9 /RC/RBC/RD/RBD	07-13 ▲
			DRC184 ▲=CT009	<b>KTM</b> SX-F 450 450 SX-F (Quad) SX-F 505 505 SX-F (Quad)	07-10 ▲ 09-11 ▲ 07-09 ▲ 09-12 ▲
DRC172	<b>KTM</b> 450 SMS	04	DRC185 ▲=CT006	<b>KAWASAKI</b> KFX 450 R Quad (KSF 450 B8F/B9F/BAF/BBF/BCS)	08-12 ▲
DRC173	<b>KTM</b> 350 MX (2T) 350 Enduro (2T) 500 MX (2T) 500 Enduro (2T) 500 Enduro (4T) LC 500 MX (4T) LC 600 MX (4T) LC 600 Enduro (4T) LC	89 89 89 89 89 89 89 89	DRC189 DRCF189 ▲=CT004	<b>SUZUKI</b> RM-Z 250 K7/K8/K9	07-09 ▲
DRC174 ▲=CT001	<b>KTM</b> EXC 125 EXC 125 (2T) Six Days SX 125	07-13 ▲ 11-13 ▲ 08 ▲	DRC194 ▲=CT020	<b>YAMAHA</b> WR 450 FT/FV/FW/FX/FY/FZ/FA/FB/FD	05-13 ▲
DRC175 ▲=CT030	<b>KTM</b> 660 LC4 Rallye 660 SM Factory Replica 660 SMC	99-00 ▲ 02-03 ▲ 03-04 ▲	DRC195 DRCF195 ▲=CT020	<b>YAMAHA</b> YZ 450 FW/FX/FY/FZ/FA	07-11 ▲
DRC176 ▲=CT030	<b>KTM</b> 660 Rallye 660 Rallye factory	01-03 ▲ 04 ▲	DRC196 ▲=CT030	<b>KTM</b> 540 SX-C 620 LC4 Competition 620 LC4 Super Moto 620 Super Comp SX 620 620 Supermoto 620 TXC 625 SC 625 SMC 625 SXC 640 Adventure-R 640 Duke-E Duke-E 640 Duke II 640 Duke II 640	98-99 ▲ 99 ▲ 99 ▲ 96-99 ▲ 97-99 ▲ 98 ▲ 98 ▲ 02 ▲ 04/06 ▲ 03-04 ▲ 98-02 ▲ 98 ▲ 98 ▲ 99-02 ▲ 03-07 ▲

Part No.	Make/Model	Year	Part No.	Make/Model	Year
DRC196 ▲=CT030 Contd.	<b>KTM</b> 640 LC4 640 LC4 640 LC4 Six Days 640 LC4-E 640 LC4 Adventure 640 LC4 Supermoto	99 ▲ 99-00 ▲ 99 ▲ 00-02 ▲ 03-06 ▲ 03-04 ▲	DRC218 ▲=CT011	<b>SUZUKI</b> LT 160 EK/EL/EM/EN LT-F 160 L/M/N/P/R/S/T/V/W/X/Y/K1-K3 LT 160 K3/K4 QuadSport LT 230 GEF/GEG LT-F 230 G/H	89-92 ▲ 90-03 ▲ 03-04 ▲ 85-86 ▲ 86-87 ▲
DRC198 ▲=CT041	<b>KTM</b> EXC 530 EXC-R 530	08 ▲ 08 ▲	DRC220 ▲=CT011	<b>SUZUKI</b> LT-F 250 K2 Ozark (Up to F/No JSAAJ51A22100696)	02 ▲
DRC199 ▲=CT030	<b>KTM</b> 690 Rally Factory Replica	07-09 ▲	DRC221 ▲=CT011	<b>SUZUKI</b> LT-F 250 K3 Ozark LT-F 250 K5/K6/K7/K8/K9/L2 Ozark	03 ▲ 05-12 ▲
DRC200 DRCF200 ▲=CT005	<b>YAMAHA</b> YFM 250 RX/RV Raptor	08-09 ▲	DRC222 ▲=CT011	<b>SUZUKI</b> LT-F 250 K4 Ozark LT-Z 250 K4/K5/K6/K7/K8/K9/L0 QuadSport	04 ▲ 04-12 ▲
DRC201 DRCF201	<b>YAMAHA</b> YZF 450 W/X Quad YZF 450 RY/RZ (Quad)	07-08 09-10	DRC223	<b>SUZUKI</b> LT-F 400 K2 (Eiger)	02
DRC205	<b>KTM</b> 690 Enduro 690 Duke 690 R Enduro 690 SMC 690 SMR	08-10 08-13 09-13 08-11 07-11	DRC224	<b>KAWASAKI</b> KLF 220 A1-A15 KLF 250 A1/A2/A3/A6F/A78F/A8F /A9F/AAF/ABF (Bayou 250)	88-02 03-11
DRC206 ▲=CT001	<b>GAS-GAS</b> EC 125 (2T) SM 125 (2T) Supermotard	00-08 ▲ 03-06 ▲	DRC225 ▲=CT004	<b>KAWASAKI</b> KSF 250 A1-A18 (KXF 250 Mojave)	87-04 ▲
DRC207 ▲=CT009	<b>GAS-GAS</b> EC200/250/300 (2T) EC 450 FSR/FSE (4T) Enduro SM 450 FSR (4T) Supermotard Wild HP 450 Quad EC 515 FSR/FSE (4T) Enduro SM 515 FSR (4T) Supermotard	00-08 ▲ 05-08 ▲ 07-08 ▲ 04-08 ▲ 05-08 ▲ 07-08 ▲	DRC226 ▲=CT005	<b>YAMAHA</b> TT 250 RM (4PX6)	00 ▲
DRC208 DRCF208 ▲=CT001	<b>HONDA</b> CRF 250 R8-R9 CRF 250 X4/X5/X6/X7/X8/X9/XB/XC CRF 250 XRLD	08-09 ▲ 04-12 ▲ 13 ▲	DRC227 DRCF227 ▲=CT005	<b>YAMAHA</b> YZ 250 FX/FY/FZ/FB (4T)	08-12 ▲
DRC211 ▲=CT012SP	<b>KAWASAKI</b> KLX 125 CAF/CBF/CCF/CDF KLX 125 DAF/DBF/DCF/DDF (D-Tracker)	10-13 ▲ 10-13 ▲	DRC228 ▲=CT008	<b>YAMAHA</b> YFM 350 FX Wolverine All models	95-04 ▲
DRC212 ▲=CT042	<b>KAWASAKI</b> KLX 250 H6F/H7F KLX 250 S9F/SAF/SBF/SCF/SDF	06-07 ▲ 09-13 ▲	DRC229 ▲=CT039	<b>YAMAHA</b> XT 225 (3RW4) Serrow (1KH 080101-) XT 225 W (4JG1/2/3/4) Serrow XT 225 WE (4JG5/6) Serrow ST 225 (5BT) Bronco	92 ▲ 93-96 ▲ 97-98 ▲ 97 ▲
DRC213 ▲=CT011	<b>SUZUKI</b> LT-F 250 K2 Ozark (From F/No JSAAJ51A22100697-)	02 ▲	DRC230 DRCF230 ▲=CT044	<b>YAMAHA</b> TT-R 125 (All models)	00-13 ▲
DRC214	<b>ARCTIC CAT</b> 400 (2 x 4) 500 (4 x 4)	98 98-02	DRC231 ▲=CT039	<b>YAMAHA</b> TW 200 (2JL/4CS1/2/3/5) TW 200 E (4CS4/6/5LB1/2) TW 225 E (5VC1/2) XT 225 (3RW1/2/4/5) Serrow (1KH-) XT 225 S (3RW3) (1KH- 202101-109000)	91-98 ▲ 98-01 ▲ 02-03 ▲ 89-93 ▲ 92 ▲
DRC215	<b>ARCTIC CAT</b> 400 (2 x 4/4 x 4)	98-02	DRC232 ■=CT010SP	<b>YAMAHA</b> YFM 200 DKW/DX/DXA	86-90 ■
DRC216 ▲=CT006	<b>ARCTIC CAT</b> Bearcat 454 (4 x 4) Bearcat 454 (2 x 4) 500 (4 x 4 Manual) 500 (Manual 4 x 4)	96-98 ▲ 97-98 ▲ 03-04 ▲ 05-09 ▲	DRC233	<b>KAWASAKI</b> KEF 300 B1/B2 Lakota Sport KLF 300 A1/A2/B1-B17/C1-C17	01-02 87-05
DRC217 ▲=CT006	<b>SUZUKI</b> LT-F 500 FW/FX/FY/FK1/FK2	98-02 ▲	DRC236 ■=CT013SP	<b>HONDA</b> TRX 500 FE5/FE6/FE7/FE8/FE9 /FEA Fourtrax Foreman 4WD-ES TRX 500 FE8/FE9 Fourtrax Foreman 4x4 EPS TRX 500 FPE8/FPE9/FPEA Fourtrax Foreman - Power Steering	05-10 ■ 08-09 ■ 08-10 ■

Part No.	Make/Model	Year	Part No.	Make/Model	Year
DRC237 ■=CT013SP	<b>HONDA</b> TRX 500 FM5/FM6/FM7/FM8/FM9 /FMA Fourtrax Foreman 4WD TRX 500 TM5/TM6 Fourtrax Foreman	05-10 ■ 05-06 ■	DRC259 DRCF259 ▲=CT009	<b>HONDA</b> CRF 450 RB/RC	11-12 ▲
DRC238 ■=CT013SP	<b>HONDA</b> TRX 420 FE7/FE8/FE9/FEA/FEB 4WD - Fourtrax ES TRX 420 TE7/TE8/TE9 Fourtrax ES - 2WD	07-11 ■ 07-09 ■	DRC260 ▲=CT023	<b>KTM</b> SX-F 250 (2T) Coil Spring XC-F 250 (4T) Coil Spring SX-F 350 (USD Forks) EXC-F 350 (USD Forks) XC-F 350	13 ▲ 13 ▲ 11-13 ▲ 11 ▲ 12-13 ▲
DRC239 ■=CT013SP	<b>HONDA</b> TRX 420 FM7/FM8/FM9/FMA/FMB 4WD - Fourtrax TRX 420 FPM9/FPMA/FPMB Fourtrax - 4WW - Power Steering TRX 420 TM7/TM8/TM9/TMA/TMB Fourtrax 2WD	07-11 ■ 09-11 ■ 07-11 ■	DRC261 DRCF261 ▲=CT001	<b>HONDA</b> CRF 250 RB/RC/RD	11-13 ▲
DRC240 DRCF240 ▲=CT009	<b>HONDA</b> TRX 700 XX8/XX9/XXB	08-11 ▲	DRC262 DRCF262 ▲=CT001	<b>HONDA</b> CR 125 RY/R1/R2/R3	00-03 ▲
DRC241 DRCF241 ▲=CT057SP	<b>KTM</b> SX 65	09-13 ▲	DRC263 ▲=CT020	<b>YAMAHA</b> WR 450 FS	04 ▲
DRC244 DRC244 ▲=CT009	<b>HONDA</b> CRF 450 R9/RA (4 spring type clutch)	09-10 ▲	DRC264 ▲=CT264	<b>HUSQVARNA</b> CR 125 SMS 125 WR 125 WRE 125	00-11 ▲ 00-11 ▲ 00-11 ▲ 00-11 ▲
DRC247 ▲=CT034SP	<b>APRILIA</b> AF1 125 Classic 125 MX 125 Pegaso 125 Red Rose 125 (Cast Wheel) Red Rose 125 (Spoke Wheel) RS 125 (2T) RX 125 Tuono 125	87-91 ▲ 95-01 ▲ 04-06 ▲ 91-95 ▲ 87 ▲ 88-94 ▲ 92-13 ▲ 92-98 ▲ 03-04 ▲	DRC265 ▲=CT008	<b>YAMAHA</b> YZ 400 FK/FL	98-99 ▲
DRC249 ■=CT012SP	<b>HONDA</b> CRF 230 L CRF 230 M Supermoto	08-10 ■ 09-10 ■	DRC266 ▲=CT013	<b>HONDA</b> XR 400 R5/R6 Motard (NC38E) XR 400 M Supermotard (ND08/NC38E)	05-06 ▲ 06-08 ▲
DRC250 ▲=CT009	<b>MONTESA-HONDA</b> 315R (2T)	97-04 ▲	DRC267 ▲=CT009	XL 1000 VX/VY/V1/V2 Varadero Non ABS Model/10 Plate Kit	99-02 ▲
DRC252 ▲=CT041	<b>KTM</b> EXC 400 (4T) EXC-R 450 (4T) EXC 450 (4T) EXC 450 (4T) Six Days EXC 530 EXC 530 (4T) Six Days	09-11 ▲ 08 ▲ 09-11 ▲ 11 ▲ 09-11 ▲ 11 ▲	DRC268 ▲=CT009	XL 1000 V3/V4/V5/V6/V7/V8/V9/VA/VB Varadero Non ABS Model/8 Plate Kit XL 1000 V6/VA6/VA7/VA8/VA9/VAA/VAB Varadero ABS Model/8 Plate Kit	03-11 ▲ 06-11 ▲
DRC254 DRCF254 ▲=CT045	<b>SUZUKI</b> RM-Z 450 K5/K6/K7	05-07 ▲	DRC269 DRCF269 ▲=CT006	KX 450 F (FCF/FDF)	12-13 ▲
DRC255 DRCF255 ▲=CT004	<b>SUZUKI</b> RM-Z 250 L0/L1/L2/L3	10-13 ▲	DRC270 ▲=CT013SP	TRX 500 FEC TRX 500 FPEC	12 ▲ 12 ▲
DRC256 DRCF256 ▲=CT001	<b>HONDA</b> CRF 250 RA	10 ▲	DRC271 ▲=CT013SP	TRX 500 FMC	12 ▲
			DRC273 ▲=CT023	EXC-F 350 Six Days EXC-F 350 (Diaphragm Spring) 350 Freeride EXC 450 EXC 450 (4T) Six Days EXC 450 Six Days EXC-F 450 (4T) SX-F 450 (4T) Diaphragm Spring EXC 500 EXC 500 Six Days EXC 500 (4T) EXC 500 (4T) Six Days Diaphragm Spring	12 ▲ 12-13 ▲ 12-13 ▲ 12 ▲ 12 ▲ 12 ▲ 12 ▲ 12 ▲ 12 ▲ 12 ▲ 12 ▲ 12 ▲
			DRC274 ▲=CT011	DF 200 EV/EW/EY DR 200 SE Trojan DR 200 SEK1-SEK9 RV 200 K2/K3	97-99 ▲ ▲ 01-09 ▲ 02-03 ▲

Part No.	Make/Model	Year	Part No.	Make/Model	Year
DRC275 ▲=CT023	EXC 250 (2T) Six Days SX 250 (2T) Diaphragm Spring EXC 300 (2T) Diaphragm Spring EXC 300 (2T) Six Days EXC 450 (4T) Diaphragm Spring EXC 450 (4T) Six Days SX-F 450 (4T) Diaphragm Spring EXC 500 Six Days (4T)	13 ▲ 13 ▲ 13 ▲ 13 ▲ 13 ▲ 13 ▲ 13 ▲ 13 ▲			
DRC276 DRCF276 ▲=CT009	CRF 450 RD (6 spring)	13 ▲			
DRC277	CRF 250 LD	13			



Part No.	Make/Model	Year	Part No.	Make/Model	Year
SRC002	<b>HONDA</b> VF 750 FD/FE	83-85	SRC017 ▲=CT036SP	<b>SUZUKI</b> GSX 600 FN/FP/FR/FS/FT/FV GSXR 750 L/M/WN/WP/WR/WS	92-97 ▲ 90-95 ▲
SRC003 ▲=CT014	<b>HONDA</b> VFR 750 FG/FH/FJ/FL/FMFN/FP /FR/FS/FT/FV	86-97 ▲	SRC019 ▲=CT014 ●=CT014SP	<b>HONDA</b> CB 600 Hornet FW/FX/FY/F2-Y/ F1/F21/F2/F22/F3/F4/F5/F6 CBF 600 N4/N5/N6 (Non ABS) CBF 600 NA4/NA5/NA6 (ABS) CBF 600 S4/S5/S6 (Non ABS) CBF 600 SA4/SA5/SA6 (ABS) CBR 600 FM/FN/FP/FR/FS/FT/FV/FW CBR 900 RRY/RR1 (929cc Fireblade) CBR 900 RR2/RR3 (954cc) Fireblade	98-06 ● 04-06 ● 04-06 ● 04-06 ● 04-06 ● 91-98 ● 00-01 ▲ 02-03 ▲
SRC004	<b>HONDA</b> CB 1000 FP/FR/FS/FT/FV CBR 1000 FH/FJ/FK/FL/FM/FN/FP /FR/FS/FT/FV/FW/FX	93-97 87-99	SRC020 ▲=CT016	<b>KAWASAKI</b> ZL 900 A1/A2 Eliminator Z 1000 E1/E2 (ST-Shaft) GPz 1000 RX A1-A3 1000 GTR (ZG 1000 A1-A18) ZX 10 B1/B2/B3 ZL 1000 A1 GPz 1100 A1-A3 Z 1100 R1 Z 1100 A1-A3 Z 1100 D1/D2 Spectre ZR 1100 A1/A2/A3/A4/B1 ZRX 1100 (ZX 1100 C1/C2/C3/C4)	85-86 ▲ 79-80 ▲ 86-88 ▲ 86-03 ▲ 88-90 ▲ 87 ▲ 82-85 ▲ 84 ▲ 81-83 ▲ 82-83 ▲ 92-97 ▲ 97-00 ▲
SRC005 ▲=CT014	<b>HONDA</b> VFR 750 RJ/RK/RL (RC30)	88-92 ▲	SRC021 ▲=CT004	<b>KAWASAKI</b> ZXR 400 (ZX 400 L1-L5/L8/L9)	91-02 ▲
SRC006 ▲=CT010	<b>YAMAHA</b> FZR 400 RR (4DX) FZR 400 Genesis (1WG) FZR 400 (3EN1/3EN2) FZR 400 RR (3TJ)	92 ▲ 86 ▲ 88-89 ▲ ▲	SRC022 ▲=CT016	<b>KAWASAKI</b> ZL 400 A Eliminator ZL 400 B Eliminator 400 SE ZZ-R 600 D1/D2/D2A/D3 ER-6f (EX 650 A6F/A7F/A8F/ CF/CAF/CBF) ER-6f (ABS Model) (EX 650 B6F /B7F/B8F) ER-6f (ECF) (Double pipe type frame/non ABS) ER-6f (FCF) (Double pipe type frame/with ABS) ER-6n (ER 650 A6F/A7F/A8F) ER-6n (ABS) ER 650 B6F/B7F/B8F ER-6n (ECF) (Double pipe type frame/non ABS) ER-6n (FCF) (Double pipe type frame/with ABS) KLE 650 A7F/A8F/A9F/CAF/CBF /CCF/CDF Versys KLE 650 B7F/B8F/B9F/DAF/DBF /DCF/DDF Versys ABS	86-87 ▲ 88 ▲ 90-92 ▲ 06-08 ▲ 06-08 ▲ 12 ▲ 12 ▲ 06-11 ▲ 06-08 ▲ 12 ▲ 12 ▲ 07-13 ▲ 07-13 ▲
SRC007 ▲=CT010	<b>YAMAHA</b> FZR 400 RSP (2TK-EXUP) FZR 400 RRS (3TJ2/6/7) FZR 600	87 ▲ ▲ 89-93 ▲	SRC024 ▲=CT016	<b>KAWASAKI</b> ZXR 750 J1/J2/L1-L3/P1-P7 ZXR 750 R (ZX 750 K1/K2/M1/M2)	91-03 ▲ 91-94 ▲
SRC008 ■=CT008	<b>YAMAHA</b> FZR 750 FZR 1000	87 ■ 87-88 ■	SRC025 ▲=CT021	<b>KAWASAKI</b> ZZ-R 1100 C1/C2/C2A/C3/D1-D9 ZX 1100 E1/E2/F1 ZZR 1200 C1H/C2H	90-01 ▲ 95-98 ▲ 02-04 ▲
SRC009 ■=CT008SP	<b>YAMAHA</b> FZR 750 R OWO1 YZF 750 R/SP TDM 850 TRX 850	89-90 ■ 93-97 ■ 96-98 ■ 96-98 ■	SRC029 ■=CT008SP	<b>YAMAHA</b> FZR 1000 GTS 1000 YZF 1000 Thunder Ace	93-95 ■ 93-96 ■ 96-02 ■
SRC010 ▲=CT055SP	<b>SUZUKI</b> GSX 1100 GM/GN GSXR 1100 K/L/M/N	91-94 ▲ 89-92 ▲	SRC031 ■=CT008SP	<b>YAMAHA</b> FZR 1000	89-92 ■
SRC011 ▲=CT016	<b>KAWASAKI</b> Z 400 J1-J3 ZR 400 A1/B1 (Z 400 F) ZX 400 C2 (Z 400 F 11) EN 450 A1-A5 (Ltd 454) EN 500 A1/A2/A3/A4/B1/B2/C1-C9 ER-5 (ER 500 A1/A2/A3/A4/C1-C5P) EX 500 A1-A6/D1-D7 (GPz 500 S) GPZ 500 (S) (EX 500 B1-B5) GPZ 500 S (EX 500 E1-E10) Z 500 A1-A3/B1/B2 GT 550 G1-G9 GPz 550 D1/H1/H2/A1-A4 ZR 550 A1/A2 (Z 550 F) ZR 550 B2-B6 Zephyr Z 550 C1/C2 (Ltd) KL 600 A1 (KLR 600) KLR 600 B1/B2/B4/B6-B9 GPz 600 R A1-A6 GPX 600 R (C1-C3/C6-C7)	80-83 ▲ 83-84 ▲ 85 ▲ 86-89 ▲ 90-04 ▲ 97-07 ▲ 87-02 ▲ 88-93 ▲ 94-04 ▲ 79-81 ▲ 83-01 ▲ 81-87 ▲ 83-84 ▲ 91-99 ▲ 80-81 ▲ 84 ▲ 85-94 ▲ 85-89 ▲ 88-96 ▲	SRC033 ▲=CT054SP	<b>YAMAHA</b> YZF 600 Thunder Cat	96-03 ▲
SRC013 ▲=CT029	<b>SUZUKI</b> GSX 600 FJ/FK/FL/FM GSXR 750 F/G/H (GR75A)	88-91 ▲ 85-87 ▲			
SRC014 ▲=CT036SP	<b>SUZUKI</b> GSXR 750 J/K	88-89 ▲			
SRC015 ▲=CT048SP	<b>SUZUKI</b> GSX R 1100 G/H/J	86-88 ▲			
SRC016 ▲=CT009SP	<b>HONDA</b> CBR 500 FH/FJ/FK/FL CBR 600 FH/FJ	87-90 ▲ 87-88 ▲			

Part No.	Make/Model	Year	Part No.	Make/Model	Year
SRC034 ▲=CT010	<b>YAMAHA</b> FZR 250 FZR 250 R (3LN1/3/5/6/7) FZX 250 Zeal (3YX1/2/4)	87 ▲ ▲ 91-92 ▲	SRC046 ▲=CT016SP Contd.	<b>KAWASAKI</b> VN 900 BBFA/BCFA/BDFA Classic Special Edition	11-13 ▲
SRC038 ▲=CT004	<b>KAWASAKI</b> ZX-6R F1/F2/F3 ZX-6R (ZX 600 J1/J2) ZX6R (ZX636A1P) 636cc ZX6R (ZX 636 B1/B2) Z 750 (ZR 750 J1/J2/J6F) Z 750 S (ZR 750 K1/K6) Z 750 (ZR 750 L7F/L8F/L9F/LAF/LBF) Z 750 ABS (ZR 750 M7F/M8F/M9F/MAF/MBF) Z 750 R (ZR 750 NBF/NCF) Z 750 R ABS (ZR 750 PBF/PCF)	95-97 ▲ 00-01 ▲ 02 ▲ 03-04 ▲ 04-06 ▲ 05-07 ▲ 07-11 ▲ 07-11 ▲ 11-12 ▲ 11-12 ▲	SRC047 ■=CT012SP	<b>HONDA</b> CB 250 FT/FV/FX/FY/F1 (MC31) Hornet CBR 250 FG/RH/RJ/RK/RK2 (MC14/17/19) CBR 250 RRL/RRN/RRR (MC22/100/105/110) VT 250 CR/CT/CV Magna (MC29) VTZ 250 H/J/K VTR 250 W/Y (MC33)/1-7	96-01 ■  86-89 ■  90-94 ■ 95-97 ■ 86-88 ■ 98-07 ■
SRC039 ▲=CT055SP	<b>SUZUKI</b> RF 900 RR GSXR 1100 WP/WR/WS/WT	94 ▲ 93-96 ▲	SRC048 ▲=CT009SP	<b>HONDA</b> CBX 550 FC/F2C/FD/F2D	82-85 ▲
SRC040 ▲=CT055SP	<b>SUZUKI</b> GSXR 750 T/V/W/X GS 1200 SSK/ZK1 (GV78A) GSF 1200 SAV ABS Bandit GSF 1200 K1/K2/K3/K4/K5 (Naked Bandit - 6 piston caliper) GSF 1200 SK1/SK2/SK3/SK4/SK5 (Faired Bandit) (6 piston caliper) GSF 1200 T/V/W/X/Y (Naked Bandit) 4 piston caliper GSF 1200 ST/SV/SW/SX/SY (Faired Bandit) 4 piston caliper GSX 1200 FSW/FSX Inazuma GSF 1200 K6/AK6 (Naked Bandit) (4 piston caliper) Non & Non ABS GSF 1200 SK6/SAK6 (Faired Bandit) (4 piston caliper) Non & Non ABS Version	96-99 ▲ 01 ▲ 97 ▲  01-05 ▲ 01-05 ▲  96-00 ▲ 96-00 ▲ 98-99 ▲  06 ▲ 06 ▲	SRC049 ■=CT013SP	<b>HONDA</b> CBR 400 RRL/RRN/RRR (NC29)	90-94 ■
SRC041 ▲=CT016	<b>KAWASAKI</b> ZX7 RR (ZX 750 N1/N2) ZX-9R (ZX 900 B1-B4)	96-99 ▲ 94-97 ▲	SRC050	<b>SUZUKI</b> GS 1000 GT/GX GSX 1000 SZ GS 1100 GZ GSX 1100 ET/EX/EZ GSX 1100 SZ GSX 1100 EFE/EFG/ESF	80-81 82 82 80-82 82 84-86
SRC042 ▲=CT009	<b>HONDA</b> CBR 600 FK/FL	89-90 ▲	SRC051 ■=CT008SP	<b>YAMAHA</b> YZF 600 R R6 (8 plate) FZ6 Naked/Non ABS 2 piston caliper (1B3/1B3D) FZ6-NS Naked/Non ABS (2 piston caliper) (1B35/6) FZ6-Fazer (Half Fairing/Non ABS /2 piston caliper) (5VX/5VXL) FZ6-Fazer (ABS/Half Fairing /2 piston caliper) FZ6 Fazer S2 (ABS/Half Fairing /4 piston caliper) FZ6 Fazer S2 (Non ABS/Half Fairing/4 piston caliper) FZ6 S2 (Naked/Non ABS /4 piston caliper) (5S51/5S5) FZX 700 S/SC/T/TC Fazer FZ 750	99-02 ■  04-07 ■  05-06 ■ 04-07 ■  06-07 ■ 08 ■ 07-09 ■ 07-09 ■ 86-87 ■ 85-86 ■
SRC043 ▲=CT016	<b>KAWASAKI</b> ZZR 600 (ZX 600 E1-E13) ZZR 600 (ZX 600 E6F)	93-05 ▲ 06-07 ▲	SRC052	<b>KAWASAKI</b>	
SRC044 ▲=CT016	<b>KAWASAKI</b> ZR 400 Zephyr (G2/G3/G3A/G4/G5) GPX 600 R (C1-C3/C6-C7) ZL 600 B1	97-01 ▲ 88-96 ▲ 95-97 ▲	SRC053	<b>KAWASAKI</b> GPX 750 F1/F2/F2A/F3 Z 750 D1 Z 750 Y1 (Ltd) GPz 900 R A1-A8 GPZ 900 R (ZX 900 A11)	87-89 ▲ 76 ▲ 82 ▲ 84-96 ▲ 98 ▲
SRC045 ▲=CT036SP	<b>SUZUKI</b> RF 600 RP/RR/RS/RT	93-96 ▲	SRC054 ▲=CT016	<b>KAWASAKI</b> Z 1000 R1/R2 (Eddie Lawson Replica) Z 1000 J1/J2/J3 Z 1000 K1/K2 LTD GPZ 1100 B1/B2	82-83 ▲ 81-83 ▲ 81-82 ▲ 81-82 ▲
SRC046 ▲=CT016SP	<b>KAWASAKI</b> W 650 (EJ 650 A1/C3-C7) VN 700 A1 Vulcan VN 750 A2/A3/A4/A5/A10 Z 750 B1/B2 EJ 800 ABF/ACF (W 800/Solid F Disc) EJ 800 (W 800 Cafe style/Cockpit fairing) EJ 800 ACFA (W 800 Special Edition Black Exhaust/Gold Rims EJ 800 ADF (W800) VN 800 A1-A3/B1-B10/B6F VN 800 C1/C2/E1/E2/E3 Drifter GPZ 900 R (ZX 900 A12-15) VN 900 A6F Classic VN 900 C7F/C8F/C9F/CAF/CBF/CCF /CDF Custom (Cast wheel) VN 900 B7F/B8F/B9F/BAF/BBF Classic (Spoke wheel)	99-05 ▲ 85 ▲ 86-94 ▲ 77-78 ▲ 11-12 ▲ 11 ▲ 12 ▲ 13 ▲ 95-06 ▲ 99-04 ▲ 99-02 ▲ 06 ▲ 07-13 ▲ 07-11 ▲	SRC055 ▲=CT014	<b>HONDA</b> CBR 900 RRT/RRV	96-97 ▲
			SRC056	<b>YAMAHA</b> YZF R1 (4XV1/2)	98

Part No.	Make/Model	Year	Part No.	Make/Model	Year
SRC057 ▲=CT014	<b>HONDA</b> CBR 600 FS1/FS2 Sport CBR 600 FB/FC/FAB/FAC CB 900 F2/F3/F4/F5/F6/F7 Hornet CBR 900 RRW/RRX (918cc)	01-02 ▲ 11-13 ▲ 02-07 ▲ 98-99 ▲	SRC075 ▲=CT014	<b>HONDA</b> CB 600 F7/F8/F9/FA/FB/FC Hornet CB 600 FA7/FA8/FA9/FAA /FAB/FAC Hornet CBF 600 N8/N9/NA (Non ABS) CBF 600 NA8/NA9/NAA (ABS) CBF 600 S8/S9 (Non ABS) CBF 600 SA8/SA9/SA (ABS) CBR 600 RR3/RR4/RR5/RR6/RR7 /RR8/RR9/RRR/RRB/RRC/RRD CBR 600 RR/RAD Hannspree CBR 600 RA9/RAA/RAB/RAC (C-ABS)	07-13 ▲ 07-13 ▲ 08-11 ▲ 08-11 ▲ 08-09 ▲ 08-12 ▲ 03-13 ▲ 08 ▲ 09-13 ▲
SRC058 ■=CT055SP	<b>SUZUKI</b> GSXR 600 V/W/X/Y	97-00 ■	SRC076 ▲=CT004	<b>KAWASAKI</b> ZX6RR (ZX 600 K1)	03 ▲
SRC059 ▲=CT004	<b>KAWASAKI</b> ZX9R (ZX 900 C1/C2/E1/E2/F1/F2) Z 1000 (ZR 1000 A1/A2/A3/A6F)	98-04 ▲ 03-06 ▲	SRC077 ▲=CT020	<b>YAMAHA</b> FZ1 (Naked) (1000cc) (2D11) FZ-1 Fazer Non ABS (1000cc) (3C3) FZ-1 Fazer (Half Fairing - ABS - 5D0) FZ1 N/NA Naked (Non ABS/ABS) YZF R1	06-09 06-13 08-13 10-13 ▲ 04-06
SRC060	<b>HONDA</b> VTR 1000 FV/FW/FX/FY/F1-F6 Firestorm	97-06	SRC078 ▲=CT014	<b>SUZUKI</b> GSXR 600 K4/K5	04-05 ▲
SRC061 ■=CT013SP	<b>HONDA</b> NT 400 Bros NC 25 NV 400 C/J/CK (Steed) NV 400 CS/CV Steed NV 400 DCY/DC1/DC2 (NC40) Shadow Slasher	92-93 ■ 95-97 ■ 00-02 ■	SRC079 ▲=CT004	<b>KAWASAKI</b> ZX 10R (ZX 1000 C1/C2/D6F/D7F) ZX10R (ZX 1000 E8F/E9F/FAF/ KBF/KCF/JBF/JCF/KDF/JDF)	04-07 ▲ 08-13 ▲
SRC062 ■=CT013SP	<b>HONDA</b> NTV 650 J/K/L/M/P/S/T/V NT 650 VW/VX/VY/V1-V5 Deauville NT 700 VA6/V6/VA7/V7/V8/VA8 /VA/VAA Deauville	88-97 ■ 98-05 ■ 06-12 ■	SRC080 ■=CT009SP	<b>HONDA</b> CBR 1000 RR4/RR5/RR6/RR7 Fireblade CB 1000 R9/RA/RB/RC Non ABS Model CB 1000 RA9/RAA/RAB/RAC (ABS Model)	04-07 ■ 09-13 ■ 09-13 ■
SRC063 ▲=CT002	<b>HONDA</b> VFR 400 R3K/R3L/R3M/R3N (NC30)	89-92 ▲	SRC081 ▲=CT022 ●=CT033SP	<b>SUZUKI</b> SV 400 N (VK53A) SV 400 SN (VK53A) SV 400 X/Y/K1/K2 SV 400 SX/SY/SK1/SK2 SV 650 A/Y/K1/K2 Naked - Non ABS SV 650 SX/SY/SK1/SK2 Top Fairing Non ABS	98 ● 98 ● 00-02 ● 00-02 ● 99-02 ▲ 99-02 ▲
SRC064 ■=CT013SP	<b>HONDA</b> NT 650 J/K/L (BROS) VT 750 CV/C2V/CW/C2W/CX/C2X /CY/C2Y/C1/C1Y/C4/C5/C6/C7/C8 VT 750 S (VT 750 SA/SB)	88-92 ■ 97-09 ■ 10-12 ■	SRC082 ▲=CT033SP	<b>SUZUKI</b> SV 400 K3/K4/K5 SV 400 SK3/SK4/SK5 DL 650 K4-K6 V-Strom DL 650 AK7/AK8/AK9/AL0 V-Strom ABS DL 650 AL1XP V-Strom Xpedition DL 650 AL2/AL3 V-Strom DL 650 AK9 GT V-Strom Traveller ABS SFV 650 K9/L0/L1 SV 650 K3/K4/K5/K6/K7/K8/K9/L0 Naked - Non ABS SV 650 AK7/AK8/AK9/AL0 Naked - ABS SV 650 SAK7/SAK8/SAK9/SAL0 SV 650 SK3/SK4/SK5/SK6/SK7/SK8 /SK9/SL0 Top Fairing - Non ABS SFV 650 AK9/AL0/AL1/AL3 (ABS)	03-05 ▲ 03-05 ▲ 04-06 ▲ 07-11 ■ 11 ■ 12-13 ■ 09-11 ■ 09-12 ▲ 03-10 ▲ 07-10 ▲ 07-13 ▲ 03-11 ▲ 09-13 ▲
SRC065	<b>YAMAHA</b> YZF R1 (4XV7/8 5JJ1/8 5PW1/7)	99-03	SRC083 ▲=CT004	<b>KAWASAKI</b> ZX6RR (ZX 600 M1)	04 ▲
SRC066 ▲=CT014	<b>HONDA</b> CBR 600 FX/FY/F1/F2/F3/F4/F5/F6	99-06 ▲	SRC084 ▲=CT004	<b>KAWASAKI</b> ZX-6R (ZX 636 C1/C6F) ZX6RR (ZX 600 N1/N6F)	05-06 ▲ 05-06 ▲
SRC067 ▲=CT021	<b>SUZUKI</b> GSX 1300 RX	99 ▲	SRC085 ▲=CT015	<b>SUZUKI</b> GSXR 1000 K5/K6/K7/K8	05-08 ▲
SRC068 ▲=CT019	<b>SUZUKI</b> TL 1000 RW/RX/RV TL 1000 SX/SY	98-00 ▲ 99-00 ▲			
SRC070 ▲=CT056SP	<b>HONDA</b> ST 1100 AN/AP/AR/AS Pan European (ABS Model) ST 1100 AT/AV/AW/AX/AY/A1/A2 Pan European (ABS Model) ST 1100 L/M/N/P/R/S/T/V/W/X/Y Pan European - Non ABS	92-95 ▲ 96-02 ▲ 90-02 ▲			
SRC071 ▲=CT014	<b>SUZUKI</b> GSXR 750 Y/K1	00-01 ▲			
SRC072 ▲=CT008	<b>YAMAHA</b> XT 550 SRX 600 SRX 600 (1JK/3SX)	83 ▲ 86-87 ▲ 85-91 ▲			
SRC074 ■=CT008SP	<b>YAMAHA</b> YZF-R6 (8 plate)	03-05 ■			

Part No.	Make/Model	Year	Part No.	Make/Model	Year
SRC086 ▲=CT015	<b>SUZUKI</b> GSXR 600 K6/K7	06-07 ▲	SRC113 ▲=CT041	RSV4 Factory SBK Racing RSV4 Factory APRC RSV4R RSV4R APRC	09-10 ▲ 11-13 ▲ 10 ▲ 11-13 ▲
SRC087 ■=CT008SP	<b>YAMAHA</b> YZF R6 (9 plate) YZF R6 (13S1) (9 plate)	06-07 ■ 08-12 ■	SRC115 ▲=CT035SP	GS 1000 HC/EC/EN/SN/ET	78-80 ▲
SRC088 ▲=CT015	<b>SUZUKI</b> GSXR 600 K8/K9/L0 GSXR 750 K6/K7/K8/K9/L0	08-10 ▲ 06-10 ▲	SRC117	<b>APRILIA</b> RST 1000 Futura	01-04
SRC089 ▲=CT004	<b>SUZUKI</b> GSXR 1000 K1/K2/K3/K4	01-04 ▲	SRC118 ▲=CT009	EX 300 ADF Ninja (Non ABS) EX 300 BDF Ninja (ABS) KAF 400 ABF/ACF/ADF (Mule 610 4x4)	▲ 13 ▲ 11-13
SRC090	<b>HONDA</b> CRF 50 F4/F5/F6/F7/F8/F9/FA/FB/FC	04-12			
SRC091	<b>ELSTARS (Pit Bikes)</b> Various models (Check parts before fitting)				
SRC093 ▲=CT020	<b>YAMAHA</b> YZF R1SP YZF R1	06 ▲ 07-08 ▲			
SRC094 ▲=CT014	<b>HONDA</b> CBR 900 RRN/RRP/RRR/RRS	92-95 ▲			
SRC095 ▲=CT043SP	<b>HONDA</b> CBR 1000 RR8/RR9/RA9/RRA/RAA /RRB/RAB/RRC/RAC/RRD /RAD Fireblade	08-13 ▲			
SRC096 ▲=CT020	<b>YAMAHA</b> YZF R1	09-13 ▲			
SRC097 ▲=CT009	<b>SUZUKI</b> GSXR 1000 K9/L0/L1/L2	09-12 ▲			
SRC098 ▲=CT021	<b>KTM</b> RC8 (1190cc) RC8 R (1190cc) Track	08-10 ▲ 10-13 ▲			
SRC099	<b>YAMAHA</b> XP 500 (T-Max Scooter - All models)	01-11			
SRC101 ▲=CT004	<b>KAWASAKI</b> ZX6R (ZX 600 P7F/P8F/R9F/RAF /RBF/RCF/RDF) (599cc)	07-13 ▲			
SRC103 ▲=CT009	<b>HONDA</b> VFR 1200 FA/FB	10-12 ▲			
SRC104	NOT USED				
SRC105	USE SRK044				
SRC106	NOT USED				
SRC107	NOT USED				
SRC110 ▲=CT015	GSXR 600 L1/L2/L3 GSXR 750 L1/L2/L3	11-13 ▲ 11-13 ▲			
SRC111 ▲=CT014	GSXR 750 K1/K2/K3	01-03 ▲			
SRC112 ▲=CT014	GSXR 600 K1/K2/K3/ZK3	01-03 ▲			

Part No.	Make/Model	Year	Part No.	Make/Model	Year
SRK002	<b>HONDA</b> VF 750 FD/FE	83-85	SRK019 ●=CT014SP	<b>HONDA</b> CB 600 Hornet FW/FX/FY/F2-Y /F1/F21/F2/F22/F3/F4/F5/F6 CBR 600 FM/FN/FP/FR/FS/FT/FV/FW CBF 600 N4/N5/N6 (Non ABS) CBF 600 NA4/NA5/NA6 (ABS) CBF 600 S4/S5/S6 (Non ABS) CBF 600 SA4/SA5/SA6 (ABS)	98-06 ● 91-98 ● 04-06 ● 04-06 ● 04-06 ● 04-06 ●
SRK003 ▲=CT014	<b>HONDA</b> VFR 750 FG/FH/FJ/FL/FM/FN/FP /FR/FS/FT/FV	86-97 ▲	SRK020 ▲=CT016	<b>KAWASAKI</b> ZL 900 A1/A2 Eliminator Z 1000 E1/E2 (ST-Shaft) GPz 1000 RX A1-A3 1000 GTR (ZG 1000 A1-A18) ZL 1000 A1 GPz 1100 A1-A3 Z 1100 A1-A3 Z 1100 D1/D2 Spectre Z 1100 R1 ZR 1100 A1/A2/A3/A4/B1 ZRX 1100 (ZX 1100 C1/C2/C3/C4)	85-86 ▲ 79-80 ▲ 86-88 ▲ 86-03 ▲ 87 ▲ 82-85 ▲ 81-83 ▲ 82-83 ▲ 84 ▲ 92-97 ▲ 97-00 ▲
SRK004	<b>HONDA</b> CB 1000 FP/FR/FS/FT/FV CBR 1000 FH/FJ/FK/FL/FM/FN/FP /FR/FS/FT/FV/FW/FX	93-97 87-99	SRK021 ▲=CT004	<b>KAWASAKI</b> ZXR 400 (ZX 400 L1-L5/L8/L9)	91-02 ▲
SRK005 ▲=CT014	<b>HONDA</b> VFR 750 RJ/RK/RL (RC30)	88-92 ▲	SRK022 ▲=CT016	<b>KAWASAKI</b> ZL 400 A Eliminator ZL 400 B Eliminator 400 SE ZZ-R 600 D1/D2/D2A/D3	86-87 ▲ 88 ▲ 90-92 ▲
SRK006 ▲=CT010	<b>YAMAHA</b> FZR 400 RR (4DX) FZR 400 Genesis (1WG) FZR 400 (3EN1/3EN2) FZR 400 RR (3TJ)	92 ▲ 86 ▲ 88-89 ▲ ▲	SRK024 ▲=CT016	<b>KAWASAKI</b> ZXR 750 J1/J2/L1-L3/P1-P7 ZXR 750 R (ZX 750 K1/K2/M1/M2)	91-03 ▲ 91-94 ▲
SRK007 ▲=CT010	<b>YAMAHA</b> FZR 400 RSP (2TK-EXUP) FZR 400 RRS (3TJ2/6/7) FZR 600	87 ▲ ▲ 89-93 ▲	SRK025 ▲=CT021	<b>KAWASAKI</b> ZZ-R 1100 C1/C2/C2A/C3/D1-D9 ZX 1100 E1/E2/F1 ZZR 1200 C1H/C2H	90-01 ▲ 95-98 ▲ 02-04 ▲
SRK008 ■=CT008SP	<b>YAMAHA</b> FZR 750 FZR 1000	87 ■ 87-88 ■	SRK029 ■=CT008SP	<b>YAMAHA</b> FZR 1000 GTS 1000 YZF 1000 Thunder Ace	93-95 ■ 93-96 ■ 96-02 ■
SRK009 ■=CT008SP	<b>YAMAHA</b> FZR 750 R OWO1 YZF 750 R/SP TDM 850 TRX 850	89-90 ■ 93-97 ■ 96-98 ■ 96-98 ■	SRK031 ■=CT008SP	<b>YAMAHA</b> FZR 1000	89-92 ■
SRK010 ▲=CT055SP	<b>SUZUKI</b> GSX 1100 GM/GN GSXR 1100 K/L/M/N	91-94 ▲ 89-92 ▲	SRK033 ▲=CT054SP	<b>YAMAHA</b> YZF 600 Thunder Cat	96-03 ▲
SRK011 ▲=CT016	<b>KAWASAKI</b> Z 400 J1-J3 ZR 400 A1/B1 (Z 400 F) ZX 400 C2 (Z 400 F 11) EN 450 A1-A5 (Ltd 454) EN 500 A1/A2/A3/A4/B1/B2/C1-C9 ER-5 (ER 500 A1/A2/A3/A4/C1-C5P) EX 500 A1-A6/D1-D7 (GPz 500 S) GPZ 500 (S) (EX 500 B1-B5) GPZ 500 S (EX 500 E1-E10) Z 500 A1-A3/B1/B2 GT 550 G1-G9 GPz 550 D1/H1/H2/A1-A4 ZR 550 A1/A2 (Z 550 F) Z 550 C1/C2 (Ltd) KL 600 A1 (KLR 600) KLR 600 B1/B2/B4/B6-B9 GPz 600 R A1-A6	80-83 ▲ 83-84 ▲ 85 ▲ 86-89 ▲ 90-04 ▲ 97-07 ▲ 87-02 ▲ 88-93 ▲ 94-04 ▲ 79-81 ▲ 83-01 ▲ 81-87 ▲ 83-84 ▲ 80-81 ▲ 84 ▲ 85-94 ▲ 85-89 ▲	SRK034 ▲=CT010	<b>YAMAHA</b> FZR 250 FZR 250 R (3LN1/3/5/6/7) FZX 250 Zeal (3YX1/2/4)	87 ▲ ▲ 91-92 ▲
SRK013 ▲=CT029	<b>SUZUKI</b> GSX 600 FJ/FK/FL/FM GSXR 750 F/G/H (GR75A)	88-91 ▲ 85-87 ▲	SRK038 ▲=CT004	<b>KAWASAKI</b> ZX-6R (ZX 600 J1/J2) ZX6R (ZX636A1P) 636cc ZX6R (ZX 636 B1/B2) Z 750 (ZR 750 J1/J2/J6F) Z 750 S (ZR 750 K1/K6) Z 750 (ZR 750 L7F/L8F/L9F/LAF/LBF) Z 750 ABS (ZR 750 M7F/M8F/M9F MAF/MBF) Z 750 R (ZR 750 NBF/NCF) Z 750 R ABS (ZR 750 PBF/PCF)	00-01 ▲ 02 ▲ 03-04 ▲ 04-06 ▲ 05-07 ▲ 07-11 ▲ 07-11 ▲ 11-12 ▲ 11-12 ▲
SRK014	<b>SUZUKI</b> GSXR 750 J/K	88-89	SRK039 ▲=CT055SP	<b>SUZUKI</b> RF 900 RR GSXR 1100 WP/WR/WS/WT	94 ▲ 93-96 ▲
SRK015 ▲=CT048SP	<b>SUZUKI</b> GSX R 1100 G/H/J	86-88 ▲			
SRK016 ■=CT009SP	<b>HONDA</b> CBR 500 FH/FJ/FK/FL CBR 600 FH/FJ	87-90 ■ 87-88 ■			
SRK017	<b>SUZUKI</b> GSX 600 FN/FP/FR/FS/FT/FV GSXR 750 L/M/WN	92-97 90-92			



Part No.	Make/Model	Year	Part No.	Make/Model	Year
SRK040 ▲=CT055SP	<b>SUZUKI</b> GSXR 750 T/V/W/X GS 1200 SSK/ZK1 (GV78A) GSF 1200 SAV ABS Bandit GSF 1200 K1/K2/K3/K4/K5 (Naked Bandit - 6 piston caliper) GSF 1200 SK1/SK2/SK3/SK4/SK5 (Faired Bandit) (6 piston caliper) GSF 1200 T/V/W/X/Y (Naked Bandit) 4 piston caliper GSF 1200 ST/SV/SW/SX/SY (Faired Bandit) 4 piston caliper GSX 1200 FSW/FSX Inazuma GSF 1200 K6/AK6 (Naked Bandit) (4 piston caliper) Non & Non ABS Version GSF 1200 SK6/SAK6 (Faired Bandit) (4 piston caliper) Non & Non ABS Version	96-99 ▲ 01 ▲ 97 ▲ 01-05 ▲ 01-05 ▲ 96-00 ▲ 96-00 ▲ 98-99 ▲ 06 ▲ 06 ▲	SRK050	<b>SUZUKI</b> GS 1000 GT/GX GSX 1000 SZ GS 1100 GZ GSX 1100 ET/EX/EZ GSX 1100 SZ GSX 1100 EFE/EFG/ESF	80-81 82 82 80-82 82 84-86
SRK041 ▲=CT016	<b>KAWASAKI</b> ZX7 RR (ZX 750 N1/N2) ZX-9R (ZX 900 B1-B4)	96-99 ▲ 94-97 ▲	SRK051 ■=CT008SP	<b>YAMAHA</b> YZF 600 R R6 (8 plate) FZ6 Naked/Non ABS 2 piston caliper (1B3/1B3D) FZ6-NS Naked/Non ABS (2 piston caliper) (1B35/6) FZ6-Fazer (Half Fairing/Non ABS /2 piston caliper) (5VX/5VXL) FZ6-Fazer (ABS/Half Fairing /2 piston caliper) FZ6 Fazer S2 (ABS/Half Fairing /4 piston caliper) FZ6 Fazer S2 (Non ABS/Half Fairing/4 piston caliper) FZ6 S2 (Naked/Non ABS /4 piston caliper) (5S51/5S5) FZX 700 S/SC/T/TC Fazer FZ 750	99-02 ■ 04-07 ■ 05-06 ■ 04-07 ■ 06-07 ■ 08 ■ 07-09 ■ 07-09 ■ 86-87 ■ 85-86 ■
SRK042 ■=CT009SP	<b>HONDA</b> CBR 600 FK/FL	89-90 ■	SRK052 ▲=CT016	NOT USED IN UK	
SRK043 ▲=CT016	<b>KAWASAKI</b> ZZR 600 (ZX 600 E1-E13) ZZR 600 (ZX 600 E6F)	93-05 ▲ 06-07 ▲	SRK053 ▲=CT016	<b>KAWASAKI</b> VN 700 A1 Vulcan Z 750 Y1 (Ltd) VN 800 C1/C2/E1/E2/E3 Drifter GPz 900 R A1-A8 GPZ 900 R (ZX 900 A11) GPZ 900 R (ZX 900 A12-15)	85 ▲ 82 ▲ 99-04 ▲ 84-96 ▲ 98 ▲ 99-02 ▲
SRK44 ▲=CT016	<b>KAWASAKI</b> ZR 400 Zephyr (G2/G3/G3A/G4/G5) ZL 600 B1 ZR 550 B2-B6 Zephyr GPX 600 R (C1-C3/C6/C7)	97-01 ▲ 95-97 ▲ 91-99 88-96	SRK054 ▲=CT016	<b>KAWASAKI</b> Z 1000 R1/R2 (Eddie Lawson Replica) Z 1000 J1/J2/J3 Z 1000 K1/K2 LTD GPZ 1100 B1/B2	82-83 ▲ 81-83 ▲ 81-82 ▲ 81-82 ▲
SRK045	<b>SUZUKI</b> RF 600 RP/RR/RS/RT	93-96	SRK055 ▲=CT014	<b>HONDA</b> CBR 900 RRT/RRV	96-97 ▲
SRK046 ▲=CT016	<b>KAWASAKI</b> W 650 (EJ 650 A1/C3-C7) GPX 750 F1/F2/F2A/F3 VN 750 A2/A3/A4/A5/A10 Z 750 D1 Z 750 B1/B2 EJ 800 ABF/ACF (W 800/Solid F Disc) EJ 800 (W 800 Cafe style/Cockpit fairing) EJ 800 ACFA (W 800 Special Edition Black Exhaust/Gold Rims EJ 800 ADF (W800) VN 800 A1-A3/B1-B10/B6F VN 900 A6F Classic VN 900 C7F/C8F/C9F/CAF/CBF/CCF /CDF Custom (Cast wheel) VN 900 B7F/B8F/B9F/BAF/BBF /BCF/BDF Classic (Spoke wheel) VN 900 BBFA/BCFA/B DFA Classic Special Edition	99-05 ▲ 87-89 ▲ 86-94 ▲ 76 ▲ 77-78 ▲ 11-12 ▲ 11 ▲ 12 ▲ 13 ▲ 95-06 ▲ 06 ▲ 07-13 ▲ 07-13 ▲ 11-13 ▲	SRK056	<b>YAMAHA</b> YZF R1 (4XV1/2)	98
SRK047 ■=CT012SP	<b>HONDA</b> CB 250 FT/FV/FX/FY/F1 (MC31) Hornet CBR 250 FG/RH/RJ/RK/RK2 (MC14/17/19) CBR 250 RRL/RRN/RRR (MC22 100/105/110) VT 250 CR/CT/CV Magna (MC29) VTZ 250 H/J/K VTR 250 W/Y (MC33)/1-7	96-01 ■ 86-89 ■ 90-94 ■ 95-97 ■ 86-88 ■ 98-07 ■	SRK057 ▲=CT014	<b>HONDA</b> CBR 600 FS1/FS2 Sport CBR 600 FB/FAB/FC/FAC CB 900 F2/F3/F4/F5/F6/F7 Hornet CBR 900 RRW/RRX (918cc)	01-02 ▲ 11-13 ▲ 02-07 ▲ 98-99 ▲
SRK048 ■=CT009SP	<b>HONDA</b> CBX 550 FC/F2C/FD/F2D	82-85 ■	SRK058 ▲=CT014	<b>SUZUKI</b> GSXR 600 X/Y	99-00 ▲
SRK049 ■=CT013SP	<b>HONDA</b> CBR 400 RRL/RRN/RRR (NC29)	90-94 ■	SRK059 ▲=CT004	<b>KAWASAKI</b> ZX9R (ZX 900 C1/C2/E1/E2/F1/F2) Z 1000 (ZR 1000 A1/A2/A3/A6F)	98-04 ▲ 03-06 ▲
			SRK060	<b>HONDA</b> VTR 1000 FV/FW/FX/FY/F1-F6 Firestorm	97-06
			SRK061 ■=CT013SP	<b>HONDA</b> NT 400 Bros NC 25 NV 400 CJ/CK (Steed) NV 400 CS/CV Steed NV 400 DCY/DC1/DC2 (NC40) Shadow Slasher	92-93 ■ 95-97 ■ 00-02 ■



Part No.	Make/Model	Year	Part No.	Make/Model	Year
SRK062 ■=CT013SP	<b>HONDA</b> NTV 650 J/K/L/M/P/S/T/V NT 650 VW/VX/VY/V1-V5 Deauville NT 700 VA6/VA6/VA7/V7/V8 /VA8/VA/VAA Deauville	88-97 ■ 98-05 ■ 06-12 ■	SRK078 ▲=CT014	<b>SUZUKI</b> GSXR 600 K4/K5	04-05 ▲
SRK063 ▲=CT002	<b>HONDA</b> VFR 400 R3K/R3L/R3M/R3N (NC30)	89-92 ▲	SRK079 ▲=CT004	<b>KAWASAKI</b> ZX 10R (ZX 1000 C1/C2)	04-05 ▲
SRK064 ■=CT013SP	<b>HONDA</b> NT 650 J/K/L (BROS) VT 750 CV/C2V/CW/C2W/CX/C2X /CY/C2Y/C1/C1Y/C4/C5/C6/C7/C8 VT 750 S (VT 750 SA/SB)	88-92 ■ 97-09 ■ 10-12 ■	SRK080 ■=CT009SP	<b>HONDA</b> CBR 1000 RR4/RR5/RR6/RR7 Fireblade CB 1000 R9/RA/RB/RC Non ABS Model CB 1000 RA9/RAA/RAB/RAC (ABS Model)	04-07 ■ 09-12 ■ 09-12 ■
SRK065	<b>YAMAHA</b> YZF R1 (4XV7/8 5JJ1/8 5PW1/7)	99-03	SRK081 ▲=CT022 ●=CT033SP	<b>SUZUKI</b> SV 400 N (VK53A) SV 400 SN (VK53A) SV 400 X/Y/K1/K2 SV 400 SX/SY/SK1/SK2 SV 650 A/Y/K1/K2 Naked - Non ABS SV 650 SX/SY/SK1/SK2 Top Fairing Non ABS	98 ● 98 ● 00-02 ● 00-02 ● 99-02 ▲ 99-02 ▲
SRK066 ▲=CT014	<b>HONDA</b> CBR 600 FX/FY/F1/F2/F3/F4/F5/F6	99-06 ▲	SRK082 ▲=CT033SP	<b>SUZUKI</b> SV 400 K3/K4/K5 SV 400 SK3/SK4/SK5 DL 650 K4-K6 V-Strom DL 650 AK7/AK8/AK9/AL0 V-Strom ABS DL 650 AL1XP V-Strom Xpedition DL 650 AL2/AL3 V-Strom DL 650 AK9GT V-Strom Traveller SFV 650 K9/L0/L1 SV 650 K3/K4/K5/K6/K7/K8/K9/L0 Naked - Non ABS SV 650 SK3/SK4/SK5/SK6/SK7/SK8 /SK9/SL0 Top Fairing - Non ABS SV 650 AK7/AK8/AK9/AL0 Naked - ABS SV 650 SAK7/SAK8/SAK9/SAL0 (ABS) SFV 650 AK9/AL0/AL1/AL3 (ABS)	03-05 ▲ 03-05 ▲ 04-06 ▲ 07-11 ▲ 11 ▲ 12-13 ■ 09-11 ▲ 09-12 ▲ 03-10 ▲ 03-13 ▲ 07-10 ▲ 07-12 ▲ 09-13 ▲
SRK067 ▲=CT021	<b>SUZUKI</b> GSX 1300 RX	99 ▲	SRK083 ▲=CT004	<b>KAWASAKI</b> ZX6RR (ZX 600 M1)	04 ▲
SRK068 ▲=CT009	<b>SUZUKI</b> TL 1000 RW/RX/RY TL 1000 SX/SY	98-00 ▲ 99-00 ▲	SRK084 ▲=CT004	<b>KAWASAKI</b> ZX-6R (ZX 636 C1/C6F) ZX-6RR (ZX 600 N1/N6F)	05-06 ▲ 05-06 ▲
SRK070 ▲=CT056SP	<b>HONDA</b> ST 1100 AN/AP/AR/AS Pan European (ABS Model) ST 1100 AT/AV/AW/AX/AY/A1/A2 Pan European (ABS Model) ST 1100 L/M/N/P/R/S/T/V/W/X/Y Pan European - Non ABS	92-95 ▲ 96-02 ▲ 90-02 ▲	SRK085 ▲=CT015	<b>SUZUKI</b> GSXR 1000 K5/K6/K7/K8	05-08 ▲
SRK071 ▲=CT014	<b>SUZUKI</b> GSXR 750 Y/K1	00-01 ▲	SRK086 ▲=CT015	<b>SUZUKI</b> GSXR 600 K6/K7	06-07 ▲
SRK072 ▲=CT008	<b>YAMAHA</b> XT 550 SRX 600 SRX 600 (1JK/3SX)	83 ▲ 86-87 ▲ 85-91 ▲	SRK087 ▲=CT008SP	<b>YAMAHA</b> YZF R6 (9 plate) YZF R6 (13S1) (9 plate)	06-07 ■ 08-12 ■
SRK074 ■=CT008SP	<b>YAMAHA</b> YZF-R6 (8 plate)	03-05 ■	SRK088 ▲=CT015	<b>SUZUKI</b> GSXR 750 K6/K7	06-07 ▲
SRK075 ▲=CT014	<b>HONDA</b> CB 600 F7/F8/F9/FA/FB/FC Hornet CB 600 FA7/FA8/FA9/FAA/FAB /FAC Hornet (ABS) CBF 600 N8/N9/NA (Non ABS) CBF 600 NA8/NA9/NAA (ABS) CBF 600 S8/S9 (Non ABS) CBF 600 SA8/SA9/SAA (ABS) CBR 600 RR3/RR4/RR5/RR6/RR7 /RR8/RR9/RRA/RRB/RRC/RRD CBR 600 RR Hannspeer CBR 600 RA9/RAA/RAB /RAC/RAD (C-ABS) CBR 600 FB/FC	07-13 ▲ 07-13 ▲ 08-11 ▲ 08-11 ▲ 08-09 ▲ 08-12 ▲ 03-13 ▲ 08 ▲ 09-13 ▲ 11-13 ▲	SRK089 ▲=CT004	<b>SUZUKI</b> GSXR 1000 K1/K2/K3/K4	01-04 ▲
SRK076 ▲=CT004	<b>KAWASAKI</b> ZX6RR (ZX 600 K1)	03 ▲	SRK090	<b>HONDA</b> CRF 50 F4/F5/F6/F7/F8/F9/FA/FB/FC	04-12
SRK077 ▲=CT020	<b>YAMAHA</b> FZ1 (Naked) (1000cc) (2D11) FZ-1 Fazer Non ABS (1000cc) (3C3) FZ-1 Fazer (Half Fairing - ABS - 5D0) FZ1 N/NA Naked (Non ABS/ABS) YZF R1	06-09 06-13 08-13 10-13 ▲ 04-06	SRK091	<b>ELSTARS (Pit Bikes)</b> Various models (Check parts before fitting)	

Part No.	Make/Model	Year	Part No.	Make/Model	Year
SRK093 ▲=CT020	<b>YAMAHA</b> YZF R1SP YZF R1	06 ▲ 07-08 ▲	SRK109 ▲=CT015	<b>SUZUKI</b> GSXR 600 K8/K9/L0 GSXR 750 K8/K9/L0	08-10 ▲ 08-10 ▲
SRK094 ▲=CT014	<b>HONDA</b> CBR 900 RRN/RRP/RRR/RRS	92-95 ▲	SRK110 ▲=CT015	GSXR 600 L1/L2/L3 GSXR 750 L1/L2/L3	11-13 ▲ 11-13 ▲
SRK095 ▲=CT043SP	<b>HONDA</b> CBR 1000 RR8/RR9/RA9/RRA/RAA RAB/RRB/RRC/RAC/RRD/RAD Fireblade	08-13 ▲	SRK111 ▲=CT014	GSXR 750 K1/K2/K3	01-03 ▲
SRK096 ▲=CT020	<b>YAMAHA</b> YZF R1	09-13 ▲	SRK112 ▲=CT014	GSXR 600 K1/K2/K3/ZK3	01-03 ▲
SRK097 ▲=CT009	<b>SUZUKI</b> GSXR 1000 K9/L0/L1/L2	09-12 ▲	SRK113	RSV4 Factory SBK Racing RSV4 Factory APRC RSV4R RSV4R APRC	09-10 11-12 10 11-12
SRK098 ▲=CT021	<b>KTM</b> RC8 (1190cc) RC8 R (1190cc) Track	08-10 ▲ 10-13 ▲	SRK115 ▲=CT035SP	GS 1000 HC/EC/EN/SN/ET	78-80 ▲
SRK099	<b>YAMAHA</b> XP 500 (T-Max Scooter - All models)	01-11	SRC117	<b>APRILIA</b> RST 1000 Futura	01-04
SRK100 ▲=CT014	<b>HONDA</b> CBR 900 RRY/RR1 (929cc Fireblade) CBR 900 RR2/RR3 (954cc) Fireblade	00-01 ▲ 02-03 ▲	SRK118 ▲=CT009	EX 300 ADF Ninja (Non ABS) EX 300 BDF Ninja (ABS) KAF 400 ABF/ACF/ADF (Mule 610 4x4)	▲ 13 ▲ 11-13
SRK101 ▲=CT004	<b>KAWASAKI</b> ZX-6R (ZX 600 P7F/P8F/R9F/RAF /RBF/RCF/RDF) (599cc)	07-13 ▲			
SRK102 ▲=CT016	<b>KAWASAKI</b> ER-6f (EX 650 A6F/A7F/A8F) ER-6f (ABS Model) (EX 650 B6F/B7F/B8F) ER-6f (FCF/FDF) (Double pipe type frame/with ABS) ER-6n (ER 650 A6F/A7F/A8F) ER-6n (ABS) ER 650 B6F/B7F/B8F /C9F/CAF/CBF ER-6f (ECF/EDF) (Double pipe type frame/non ABS) ER-6n (ECF/EDF) (Double pipe type frame/non ABS) ER-6n (FCF/FDF) (Double pipe type frame/with ABS) KLE 650 A7F/A8F/A9F/CAF/CBF /CCF/CDF Versys KLE 650 B7F/B8F/B9F/DAF/DBF DCF/DDF Versys ABS	06-08 ▲ 06-08 ▲ 12-13 ▲ 06-08 ▲ 06-08 ▲ 12-13 ▲ 12-13 ▲ 12-13 ▲ 12-13 ▲ 12-13 ▲ 07-13 ▲ 07-13 ▲			
SRK103 ▲=CT009	<b>HONDA</b> VFR 1200 FA/FB	10-12 ▲			
SRK104 ▲=CT036SP	<b>SUZUKI</b> GSXR 750 WP/WR/WS	93-95			
SRK105	USE SRK044				
SRK106 ▲=CT014	<b>SUZUKI</b> GSXR 600 V/W	97-98 ▲			
SRK107 ▲=CT004	<b>KAWASAKI</b> ZX-6RR (ZX 600 N1/N6F)	05-06 ▲			
SRK108 ▲=CT004	<b>KAWASAKI</b> ZX-6R (ZX 600 F1/F2/F3) ZX-6R (ZX 600 G1/G2)	95-97 ▲ 98-99 ▲			

# NOTES

# How To Make Precision Pilot Jets

Everyone knows how sensitive an engine is to pilot jets in the acceleration stages from 1000 to 3500 rpm and getting fuel mixture right in this area is critical. For this reason jets have to be perfectly accurate in their marked size and incremental size steps. EBC Brakes sister company A-BAX Precision Engineering Ltd in the UK has purchased the most accurate machine on the planet for this work shown below. A-BAX Precision Engineering Ltd pilot jets are precise, clearly marked and reliably gauged using pin gauges, accurate to one tenth of a thousandth of an inch, you can rely on their accuracy.

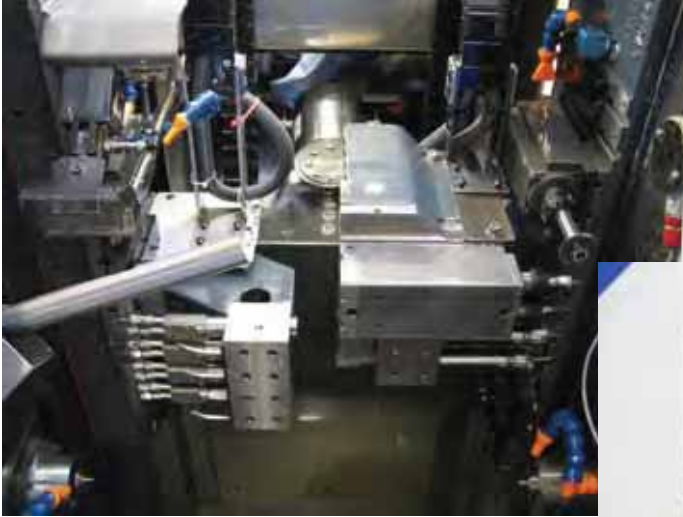

# A-BAX Precision Engineering Ltd Pilot Jets for Mikuni Carbs (Sold in packs of 4)

### Jet Style - VM22/210

8 bleed hole type  
VM18 / VM22 / VM26-34 Flange Type  
VM26-44 Spigot Type  
TM24-38 (No accelerator pump)  
Early TMX/TMX Carb Types

Size	Part #
10	EBC22/210-10
12.5	EBC22/210-12.5
15	EBC22/210-15
17.5	EBC22/210-17.5
20	EBC22/210-20
22.5	EBC22/210-22.5
25	EBC22/210-25
27.5	EBC22/210-27.5
30	EBC22/210-30
32.5	EBC22/210-32.5
35	EBC22/210-35
37.5	EBC22/210-37.5
40	EBC22/210-40
42.5	EBC22/210-42.5
45	EBC22/210-45
47.5	EBC22/210-47.5
50	EBC22/210-50
52.5	EBC22/210-52.5
55	EBC22/210-55
57.5	EBC22/210-57.5
60	EBC22/210-60
65	EBC22/210-65
70	EBC22/210-70
75	EBC22/210-75
80	EBC22/210-80
85	EBC22/210-85
90	EBC22/210-90
95	EBC22/210-95
100	EBC22/210-100
105	EBC22/210-105
110	EBC22/210-110
120	EBC22/210-120
130	EBC22/210-130
140	EBC22/210-140

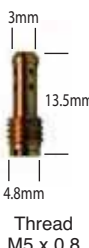

### Jet Style - N224.103

2.5mm bleed end  
Early TMS/TMX  
OEM MX36/38 BSR CV type  
Honda / Kawasaki / Suzuki / Yamaha

Size	Part #
10	EBC224-10
12.5	EBC224-12.5
15	EBC224-15
17.5	EBC224-17.5
20	EBC224-20
22.5	EBC224-22.5
25	EBC224-25
27.5	EBC224-27.5
30	EBC224-30
32.5	EBC224-32.5
35	EBC224-35
37.5	EBC224-37.5
40	EBC224-40
42.5	EBC224-42.5
45	EBC224-45
47.5	EBC224-47.5
50	EBC224-50
52.5	EBC224-52.5
55	EBC224-55
57.5	EBC224-57.5
60	EBC224-60
62.5	EBC224-62.5
65	EBC224-65
67.5	EBC224-67.5
70	EBC224-70



### Jet Style - N151.067

No bleed holes  
Later OEM BS range CV carbs  
Kawasaki / Suzuki / Yamaha

Size	Part #
30	EBC151-30
32.5	EBC151-32.5
35	EBC151-35
37.5	EBC151-37.5
40	EBC151-40
42.5	EBC151-42.5
45	EBC151-45
47.5	EBC151-47.5
50	EBC151-50
52.5	EBC151-52.5
55	EBC151-55
57.5	EBC151-57.5
60	EBC151-60



### Jet Style - VM28/486

2mm bleed hole type  
HS40 / HSR42 / 45 / 48 / RS34-40  
TM33 / 36 / 40 with accelerator pump  
Kawasaki / Suzuki / Yamaha

Size	Part #
10	EBC28/486-10
12.5	EBC28/486-12.5
15	EBC28/486-15
17.5	EBC28/486-17.5
20	EBC28/486-20
22.5	EBC28/486-22.5
25	EBC28/486-25
27.5	EBC28/486-27.5
30	EBC28/486-30
32.5	EBC28/486-32.5
35	EBC28/486-35
37.5	EBC28/486-37.5
40	EBC28/486-40
42.5	EBC28/486-42.5
45	EBC28/486-45
47.5	EBC28/486-47.5
50	EBC28/486-50
52.5	EBC28/486-52.5
55	EBC28/486-55
57.5	EBC28/486-57.5
60	EBC28/486-60
62.5	EBC28/486-62.5
65	EBC28/486-65
67.5	EBC28/486-67.5
70	EBC28/486-70



### Jet Style - BS30/96

6 bleed hole type  
Various OEM BS range CV carbs  
Kawasaki / Suzuki / Yamaha

Size	Part #
30	EBC30/96-30
32.5	EBC30/96-32.5
35	EBC30/96-35
37.5	EBC30/96-37.5
40	EBC30/96-40
42.5	EBC30/96-42.5
45	EBC30/96-45
47.5	EBC30/96-47.5
50	EBC30/96-50
52.5	EBC30/96-52.5
55	EBC30/96-55
57.5	EBC30/96-57.5
60	EBC30/96-60

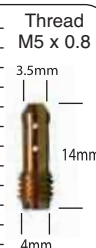

# A-BAX Precision Engineering Ltd Pilot Jets for Keihin Carbs (Sold in packs of 4)

### Jet Style - N424-21

Pilot / Slow Running Jet  
PB16 / 18 / 20  
Yamaha R6 99-07  
Various Kawasaki / Suzuki Quads

Size	Part #
35	EBC424-21-35
38	EBC424-21-38
40	EBC424-21-40
42	EBC424-21-42
45	EBC424-21-45
48	EBC424-21-48
50	EBC424-21-50
52	EBC424-21-52
55	EBC424-21-55
58	EBC424-21-58
60	EBC424-21-60
62	EBC424-21-62
65	EBC424-21-65
68	EBC424-21-68
70	EBC424-21-70
72	EBC424-21-72
75	EBC424-21-75
78	EBC424-21-78
80	EBC424-21-80



### Jet Style - N424-25

Pilot / Slow Running Jet  
FCR 28 / 32 / 33 / 35 / 37 / 39 / 41mm  
Harley D Keihin BH (Non CV Type)  
Various Kawasaki / Yamaha Models with CVK  
/ FCR / BD style carbs

Size	Part #
35	EBC424-25-35
38	EBC424-25-38
40	EBC424-25-40
42	EBC424-25-42
45	EBC424-25-45
48	EBC424-25-48
50	EBC424-25-50
52	EBC424-25-52
55	EBC424-25-55
58	EBC424-25-58
60	EBC424-25-60
62	EBC424-25-62
65	EBC424-25-65





# Dealer Pilot Jet Selection Kits

(Kits include one pilot jet per size)



Kit No.	Carb Model	Jet Style	Qty Jets in Kit	Sizes
KPJK-01	Keihin	424-21	19	35-80
KPJK-02	Keihin	424-25B	13	35-65
MPJK-01	Mikuni	VM22/210	34	10-140
MPJK-02	Mikuni	N224.103	25	10-70
MPJK-03	Mikuni	N151.067	13	30-60
MPJK-04	Mikuni	BS30/96	13	30-60
MPJK-05	Mikuni	28.486	25	10-70

Precision machined in the UK ABAX Dealer selection kits include all the popular sizes for the better selling pilot jets and refills can be purchased from your distributor in packets of four.





# MAIN JETS

## A-BAX Precision Engineering Ltd MAINJETS

Made in the UK, these high precision BRASS carburettor jets are available in dealer selection kits or in top-up packs of 5 jets or 4 jets. All jets are flow calibrated and extremely accurate in terms of fuel flow rate as stamped.

### DEALER SELECTION KITS.

KIT TYPE	PART#	CONTENTS	
Mikuni Slot	SJK 36	4pcs each jet sizes 72.5 thru 160	160 Jets
Mikuni Hex	HJK 36	4pcs each jet sizes 70 thru 120	72 Jets
Keihin Slot	KJK 36	4pcs each jet sizes 70 thru 120	72 Jets
Keihin Hex	CRK 30	2pcs each jet sizes 80 thru 225	60 Jets



NOTE - Jets listed below only sold in packets of 4pcs (5 pcs on Dell Orto)

<p><b>ABAX Slot Jets for Mikuni</b></p>	<p><b>ABAX Hex Jets for Mikuni</b></p>	<p><b>ABAX Slot Jets for Keihin</b></p>	<p><b>ABAX Hex Jets for Keihin</b></p>	<p><b>ABAX Slot Jets for Dell 'Orto</b></p>
<b>(N 100/604) SJ Prefix</b>	<b>(4/042) HJ Prefix</b>	<b>(N102 221) KJ Prefix</b>	<b>(357) CR Prefix</b>	<b>(6413) DO Prefix</b>

SIZES AVAILABLE	SIZES AVAILABLE	SIZES AVAILABLE	SIZES AVAILABLE	SIZES AVAILABLE
SJ72.5	HJ70	HJ400	KJ72.5	CR80
SJ75	HJ80	HJ410	KJ75	CR85
SJ77.5	HJ90	HJ420	KJ77.5	CR90
SJ80	HJ100	HJ430	KJ80	CR95
SJ82.5	HJ105	HJ440	KJ82.5	CR100
SJ85	HJ110	HJ450	KJ85	CR105
SJ87.5	HJ115		KJ87.5	CR110
SJ90	HJ120		KJ90	CR115
SJ92.5	HJ125		KJ92.5	CR120
SJ95	HJ130		KJ95	CR125
SJ97.5	HJ135		KJ97.5	CR130
SJ100	HJ140		KJ100	CR135
SJ102.5	HJ145		KJ102.5	CR140
SJ105	HJ150		KJ105	CR145
SJ107.5	HJ155		KJ107.5	CR150
SJ110	HJ160		KJ110	CR155
SJ112.5	HJ165		KJ112.5	CR160
SJ115	HJ170		KJ115	CR165
SJ117.5	HJ175		KJ117.5	CR170
SJ120	HJ180		KJ120	CR175
SJ122.5	HJ185		KJ122.5	CR180
SJ125	HJ190		KJ125	CR185
SJ127.5	HJ195		KJ127.5	CR190
SJ130	HJ200		KJ130	CR195
SJ132.5	HJ210		KJ132.5	CR200
SJ135	HJ220		KJ135	CR205
SJ137.5	HJ230		KJ137.5	CR210
SJ140	HJ240		KJ140	CR215
SJ142.5	HJ250		KJ142.5	CR220
SJ145	HJ260		KJ145	CR225
SJ147.5	HJ270		KJ147.5	CR230
SJ150	HJ280		KJ150	CR235
SJ152.5	HJ290		KJ152.5	
SJ155	HJ300		KJ160	
SJ157.5	HJ310		KJ170	
SJ160	HJ320		KJ172	
SJ170	HJ330		KJ175	
	HJ340		KJ177	
	HJ350		KJ180	
	HJ360		KJ185	
	HJ370		KJ190	
	HJ380			
	HJ390			

**NOTE:** The names Mikuni & Keihin are for description purposes only. These are NOT original Mikuni or Keihin jets, simply a high quality replacement.

# MAIN JETS



DEALER SELECTION KIT  
PART NO - HDJK-12

A-BAX Precision Engineering Ltd brass main jets for Keihin CVH carburetors, used on most big twins. Sold in packets of 2 pieces and in dealer assortment kits of 12 sizes (2 pieces each size).





**A-BAX Slot Jets**  
for Harley Davidson



**(424-27)**  
**HDJK Prefix**

**SIZES AVAILABLE**

- EBC424-27-165
- EBC424-27-170
- EBC424-27-175
- EBC424-27-180
- EBC424-27-185
- EBC424-27-190
- EBC424-27-195
- EBC424-27-200
- EBC424-27-205

# S&B FILTERS



Made in the USA, S&B Custom Filters are a great choice for all types of carburetor and feature a special man made gauze called "Remay" made by Dupont® which has the benefit of perfectly uniform hole patterns. This enables the S&B filter to catch dust better than an oil soaked filter and to be run DRY. Oiled filters require regular washing and relube which plays havoc with carburetor balance. Available in parallel or cone type design, with high lustre chrome end caps.



## DIMENSION CHART

CONICAL TYPES					PARALLEL TYPES				
FILTER No.	A	B	C	D	FILTER No.	A	B	C	D
RC79	35	63	58	51	RC17	40	89	38	74
RC106	48	76	76	51	RC34	44	114	38	114
RC107	43	76	70	51	RU99	(Special Norton Filter)			
RC120	52.5	89	102	51	<b>OVAL TYPES</b>				
RC125	57	86	95	51	RC059	43	112	70	75
RC135	55	88	104	88	RC069	50	112	70	75
RC234	55	76	70	51	RC84	40	72	51	51
RC311	28	57	57	51	RC098	55	112	70	75
RC312	51	73	63	51					
RC313	43	76	60	51					

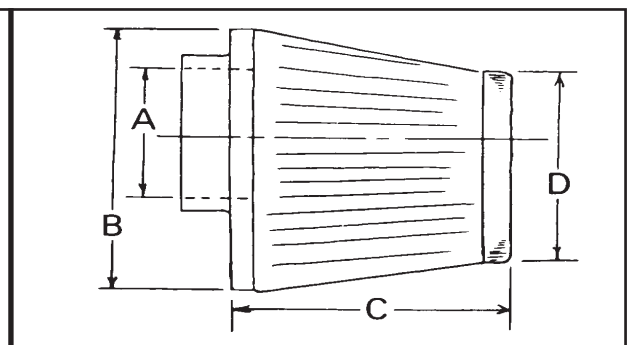
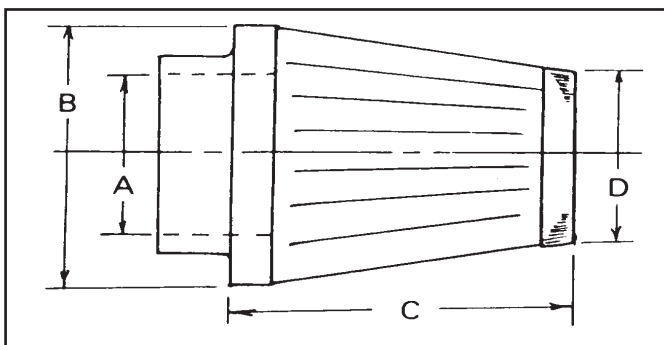

# hy-tech racing reeds

**For STREET Bikes** New CW38 Fibre for higher durability and perfect Reed block seal in high revving 2 stroke motors.

**For DIRT Bikes** New TWO STAGE Action. By using a lighter fibre on the lower reed block position New Hy-Tech "D" suffix. Reed Kits open earlier and give perfect TWO STAGE response without turbulence or early primary stage reed petal fatigue or New Carbon Fibre CF Series. See below.

## CARBON FIBRE REEDS for most Street and Dirt Bike models Prefix **CF** for Carbon Fibre.

### ROAD BIKE REEDS ALSO AVAILABLE IN CARBON FIBRE

CF02, CF11, CF15, CF18, CF81,  
CF118, CF201, CF202, CF210, CF215

DIRT BIKE APPLICATIONS		DIRT BIKE APPLICATIONS		STREET BIKE APPLICATIONS	
<b>CAGIVA</b>		<b>SUZUKI Cont.</b>		<b>KAWASAKI</b>	
WMX 125/250 (1985)	HT09D	RM 125 T/V/W/X/Y/K1-K5	CF93	AE/AR 50	HT05
WMX 500	CF14	RM 250 X-G (81-86)	CF14	AE/AR 80	HT05
<b>HONDA</b>		RM 250 H/J (87-88)	CF06	KMX 125 (All Models)	CF06
CR 80 RG-R2 (86-02)	CF48	RM 250 K/L (89-90)	CF68	KDX 125 A1-A2/B1-B2	CF64
CR 85 R3-R7 (03-07)	CF48	RM 250 M/N	CF83	KR1/KR1-S	HT81
CR 125 (All Models) up to 01	CF18	RM 250 P/R/S	CF65	<b>SUZUKI</b>	
CR 125 R1/R2/R3/R4	CF208	RM 250 T/V/W/X/Y/K1-K5	CF94	TS/ZR 50 (All models)	HT16
CR 250 RC/RD/RE/RF		RMX 250 K/L	HT68D	TS 100/125/185/250	
/RG/RH	HT61D	LT 250 RF/RG/RH	HT38	(C&ER Models)	HT12
CR 250 RJ-RW	CF66	LT 250/500 RJ/RK/RL/RM/RN	HT68D	RG 125 (All Models up to 91)	CF11
CR 250 RX/R1/R2/R3	CF167	RM 465 X/Z	CF57	RG 125 FUN/FUP/UN	CF18
CR 500 RE/RF/RG/RH		RM 500 D/E	CF57	TS 125 X (All Models)	CF11
/RJ/RK	HT17D	<b>YAMAHA</b>		TS 125 RK/RL/RR	CF18
CR 500 RL-R1	CF77	YZ 50 G-K	HT05	GT 250 "X7"	HT216
ATC/TRX 250 (All Models)	CF06	YZ 80 N-S	HT32D	RG 250 (All Models)	CF211
<b>HUSQVARNA</b>		YZ 80 T/U/W/A/B	HT46	RGV 250 L/M/N/P/R	N/A
125 (82-98)	HT33D	YZ 80 E/F/G/H/J/K/L/M/N	CF88	TS 250 XE	HT38
<b>KTM</b>		YZ 85 P/R/S	CF88	TS 250 XG/XH/XJ	HT09D
125 (All Models) (84-96)	CF22	YZ 125 G-T/E (86-87/93)	CF03	<b>YAMAHA</b>	
250 (All Models) (84-96)	CF22	YZ 125 U-D (88-92)	HT67D	DT/RD 50 M	HT105
495/500 (All Models) (82-96)	HT23D	YZ 125 F/G/H/J/K/L/M (94-00)	CF89	DT/RD 50 MX	HT30
<b>KAWASAKI</b>		YZ 125 N/P/R/S/T/V/W/X/Y (01-09)	CF185	RD 80 MX/LC	HT05
KX 60 B1-B19	HT40D	WR 200 89-96	CF04	DT 80 MX (81-)	HT30
KX 65 A1/A2/A3/A4	HT40D	YZ 250 E-J	CF04	DT 80 MX (82-)	HT05
KX 80 G1/G2/J1/J2	HT54D	YZ 250 K	HT31D	RS 100	HT05
KX 80 L1-L3/R1-R7/W1/W3	CF01NC	YZ 250 L-U	HT07D	DT/RXS 100	HT01
KX 85 A1/B1/A2/B2/A3/B3	CF01NC	YZ 250 W-H	CF04	DT 125 MX	HT01
KX 100 A1/A2/B1-B7/C1-C3	CF01NC	YZ 250 J/K/L/M/N/P/R/S/T/V/W/X	CF150	RD 125/200	HT205
KX 125 (All Models) (82-93)	CF64	YZ 465 G/H	CF04	DT 125 LC/LC2	HT02R
KX 125 K1-K3	CF78	YZ 490 J to L	CF04	RD 125 LC MK1-3	HT02R
KX 125 K4-M7F	N/A	YZ 490 N to U	HT07D	DT 125 R	HT15
KDX 200 (All Models)	CF64	IT 125/175/200 "All Models"	CF03	RS 125	HT01
KDX 220 A4-A10	CF64	IT 250 D/E/F	CF03	TZR 125/TDR 125	HT15
KX 250 C2/D1/D2/E1/F1/G1/H1		IT 250 E/F/G/H	CF04	DT 175 MX	HT01
/H2/J1/J2/K1/K2/K3	CF14	TY 80/175	HT05	DT 250/400	CF18
KX 250 K4/K5/L1/L2	CF66	TY 250	HT01	DT 250/400 MX	HT29D
KX 250 L3/L4/M1/M2	CF184	TY 250 S/R	HT29D	RD 250/350/400	
KX 500 A2/B1	HT20D	WR 250 ZB/ZD/ZE/ZF/ZG/ZH/ZJ	CF04	(Air Cooled)	HT201R
KX 500 B2/C1/D1/E1-E15	CF57	<b>STREET BIKE APPLICATIONS</b>		RD 250/350 LC	HT201R
<b>MAICO</b>		<b>HONDA</b>		TDR/TZR 250	HT215
250/490	CF06	MB/MT/MTX 50	HT21	RD 350 YPVS	HT202R
<b>SUZUKI</b>		MBX 50	HT34	<b>CARBON FIBRE REEDS</b>	
RM 80 G/H/J	HT56D	MBX/MTX 80	HT34	Last longer, work better – increase rev range & performance	
RM 80 K/L/M/N/P/R/S/T/V/W/X/Y/K1	CF48	H 100	HT21		
RM 85 K2/K3/K4	CF48	MBX 125	HT36		
RM 125 H/J	CF18	MTX 125/200	HT36		
RM 125 L/M/N/P/R/S	CF78	NS 125 FG/FH/RK/RL	HT210		
		NSR 125 All models	HT118		

# NEW BRAKE CLEANER

## EBC Cleanstuff Brake Cleaner



- Made in the UK
- No CFC Content
- Non Chlorinated
- No Ozone deterioration
- New propellant system guarantees constant spray pressure til full can contents used

Ideal for all degreasing de-oiling tasks, especially cleaning brake disc surfaces before installation. Avoid prolonged contact with caliper seals and rubber caliper parts or brake hoses to avoid damage.

Sold in cases of 12 x 400ml cans.

**BC001 - Per Bottle**  
**BC012 - Case of 12**

# BAFFLE PAC

## BAFFLE-PAC-Silencer Glass. PART NO. BP001

This material is labelled and conforms to BSAU 193T2. BEWARE of distributors selling cheaper roofing felt in its place. Repackable Tailpipes as the name implies require regular cleaning and repacking with BSAU approved "SILENCER GLASS" such as Winning BAFFLE PAC. Failure to maintain tailpipes in such a way will lead to clogging of the silencer wool and raised noise output together with reduced engine performance. Freeman Automotive (nor Dealers) are responsible for noise offences due to lack of maintenance as described above. "Recommended repacking period is every 3000 miles on two-strokes or when bike becomes noisy if sooner".

# EBC<sup>®</sup> BRAKE FLUID



**DOT 4** - A refined specification polyglycol fluid as fitted to most faster street bikes now produced.

**DOT 5** - Silicone fluid as used in Harley Davidson Motorcycles and many special High Performance Brake systems.

**NEW BF307** - Highly refined Dot 4 Brake fluid, ideal for Racing or High performance Road bikes. Can be used in all systems specifying Dot 3 or Dot 4 but **NOT** with (Dot 5) silicone fluids.

**EBC Brake Fluid is available in DOT 4 or DOT 5 (Silicone) Grades or new BF 307 Race Grade.**

### TO ORDER USE THESE NUMBERS

DOT 4 (Six Pack) .....BF 004  
 DOT 5 (Six Pack) (Silicone) .....BF 005  
 BF 307 (Six Pack) .....BF 307

# BRAKE CALIPER LUBE



These sachets of dedicated, high viscosity greases are perfect for all of your customers' brake service needs. Always use sparingly on caliper slider pins and rails, but do NOT get near the pad surface and do NOT use as anti-squeal as it will not help at all. Each sachet contains 5 grammes of grease.

### TO ORDER USE THESE NUMBERS

Ten Sachets.....LUBE010  
 Fifty Sachets .....LUBE050



# GALINDO/BAJA GRIPS



## 4 1/2" GALINDO Superbike Grips

Made in USA with KRATON G material. Without doubt the highest quality grip sold worldwide for street bikes. All below colours at 4.1/2" with separate spacer ring to accommodate 5" throttle units. Complete with heavy plastic bar end plugs & new high visual "Clamshell" packaging.

Colour	Part No.
Black	GX01
Red	GX02
Blue	GX03

## BAJA FOAM GRIPS

BAJA Foam grips made in USA with "reticulated" foam closed cell construction. Sounds fancy but what it means is Baja foam grips do not "sponge" up water as will other cheap open cell foam rubber units. Complete with bar end caps and mounting glue.

Colour	Part No.
Black	BG001
Red	BG002
Blue	BG003

## LEDAR NOZZLES

### LEDAR POWER NOZZLES 2 STROKE DETAILS

- Simply Change standard OE Nozzle for Immediate Power Boost.
- More Power through the range.
- Better Carburation, improved specific fuel consumption.
- Less Unburnt Hydro Carbons means cleaner exhaust & less pollution.

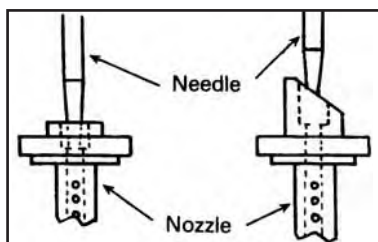

NOZZLE No.	FITMENT
LN43	RD 125 LC Mk 1/Mk 1 2 (Not YPVS), DT 125 MX
LN44	DT 125 LC/RXS 100
LN45	RD 80 LC
LN46	MBX 125/MBX 50
LN59	AR 50/AE 50/AR 80
LN61	AR 125 LC
LN63	RD 125 LC Mk 3 (YPVS)
LN66	GP 100
LN66A	GP 100 Big Bore 125 Conversion
LN67	RG 125
LN68	NS 125 FH/FG/RK

## RACING REEDS

hy-tech racing reeds



**STREET** - CW38 fibre still ideal for smaller high revving two strokes but new for track or road Hy-Tech **CARBON FIBRE** reeds for these designs suffix regular part No with "CF" to order.

**DIRT** - Two stage system with stiffer top reed and standard lower reed gives wider power band + longer reed life on upper reed block position.

**OR** - NEW CF Carbon Fibre series now available.

**Introducing.....**

# EBC Mountain Bike Disc Brake Pads & Disc Kits



**Oversize Disc  
Conversion Kit  
including Bracket  
(MTBD230)**



## Now Available:

- Mechanical Systems
- Closed Systems
- Open Systems
- Hydraulic Systems

## Oversize Brake Disc Kits

EBC offers two upgrade options with these oversize brake disc conversion kits - 160/165mm-180mm (medium power upgrade) and 160/165mm 203mm (mega power upgrade) and the option of full circle profile or new lightweight contoured profile.







These mount on most standard 6 bolt wheel hubs and together with the bracket provided, which again fits most 50mm centre forks, your caliper is relocated outwards giving you a stronger brake and better brake feel. Easy to fit - no other changes are necessary to your caliper, cables, hydraulics or lever. All you need are two allen keys. These are premium quality heat treated stainless steel discs, diamond ground and compatible with every type of mountain bike brake pad. Kits are available to convert standard 160/165mm up to 180mm or 160/165mm to 203mm or 180mm to 203mm.



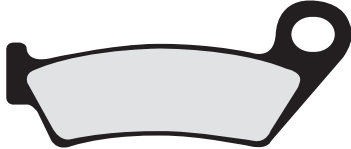
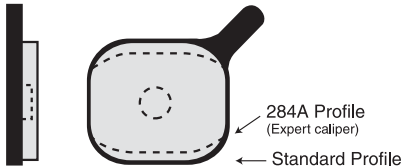
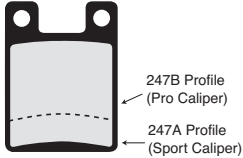
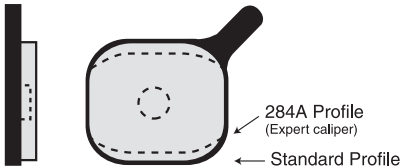
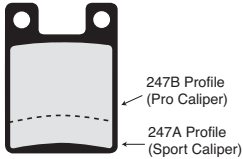

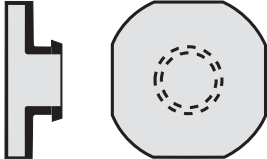
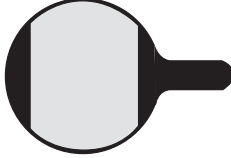
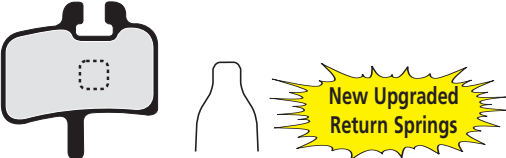
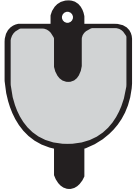

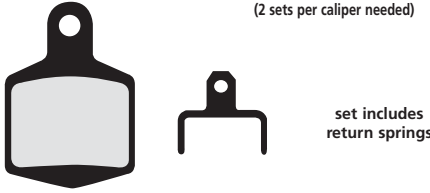

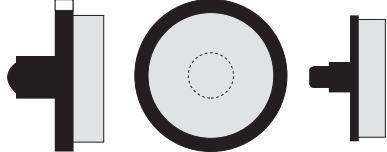

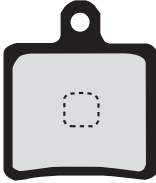
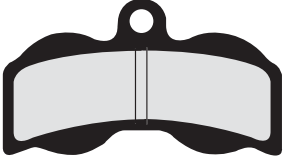

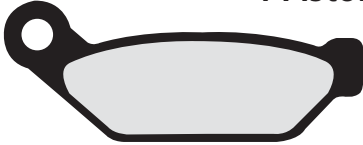
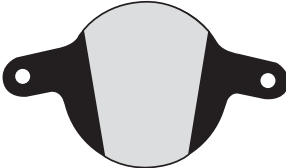
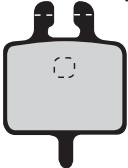
Used and endorsed by  
**Steve Peat of  
Team Orange  
England**  
World  
Champion and  
Multiple Gold  
Medallist

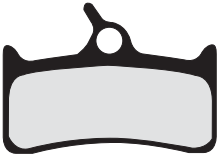

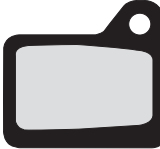
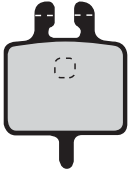
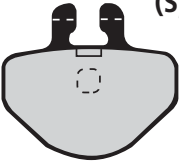

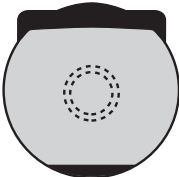
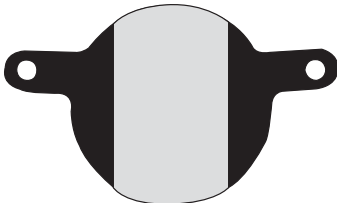



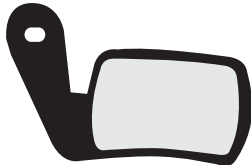
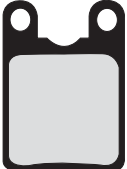
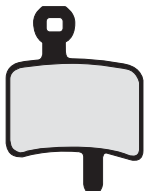
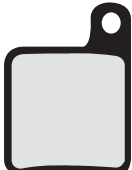
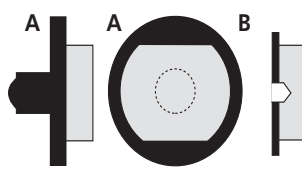
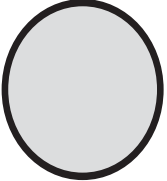
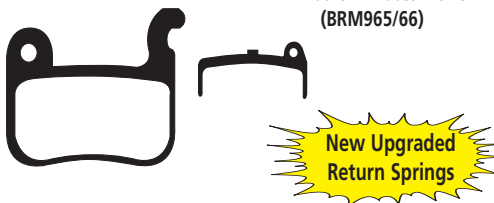
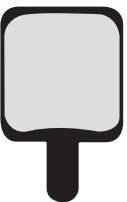
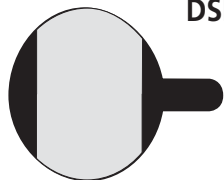
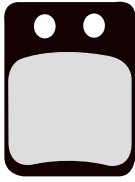
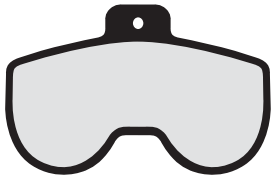
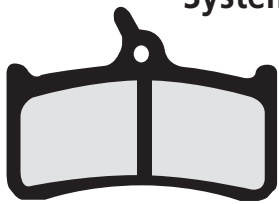
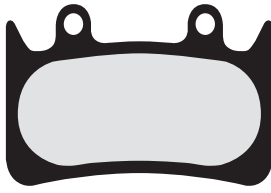

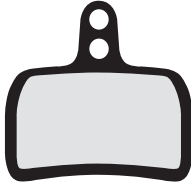
**MOUNTAIN BIKE  
FITMENTS**

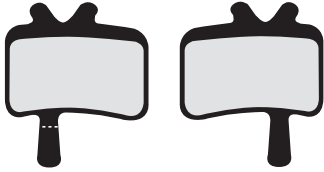



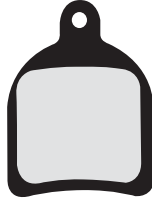

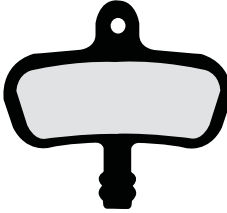
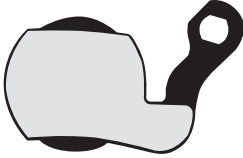
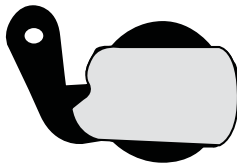
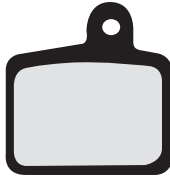



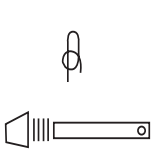

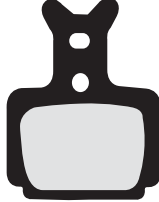
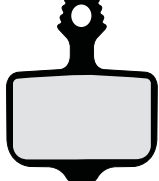
		-	R	HH		-	R	HH		
<b>CFA242</b>	<b>Rock Shox &amp; AMP</b>		✓	✓	✓	<b>CFA284</b>	<b>Coda (Cannondale)</b>		✓	✓
<b>CFA247A</b>	<b>Hope Technology</b>		✓	✓	✓	<b>CFA284A</b>	<b>Coda (Cannondale)</b>		✓	✓
<b>CFA247B</b>	<b>Hope Technology</b>		✓	✓	✓	<b>CFA285</b>	<b>Diatech / Nifon Mechanical</b>		✓	✓
<b>CFA274</b>	<b>Formula Hydraulic</b>		✓	✓		<b>CFA286</b>	<b>Magura 'Louise' &amp; 'Clara' (early) Imperial Mechanical caliper</b>		✓	✓
<b>CFA277</b>	<b>Hayes/Promax/HFX (Mechanical &amp; Hydraulic) Imperial DX04 Hydraulic</b>		✓	✓	✓	<b>CFA288</b>	<b>RST Mechanical</b>		✓	✓
<b>CFA278</b>	<b>Pro Stop</b>		✓	✓		<b>CFA289/4</b>	<b>Hope Tech '4-0' Four Piston Downhill/Grimeca System 11/17 (2 sets per caliper needed)</b>		✓	✓
<b>CFA280</b>	<b>Magura 'Gustaff'</b>		✓	✓	✓	<b>CFA290</b>	<b>Formula MD1 Mechanical Grimeca System 6-9</b>		✓	✓

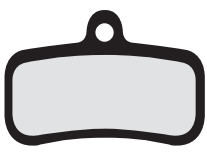
		-	R	HH			-	R	HH
<b>CFA292/A</b>					<b>CFA318</b>	Hope 2 Pot 'Mini' 2001			
	USE CFA394	✓	✓	✓			✓	✓	✓
<b>CFA300</b>	Hope Tech 4 Piston XC-4 Cross Country				<b>CFA325</b>	Formula Hydraulic Fits both 2 piston B4 & 4 Piston 2002 types 4 Racing (4 piston)			
		✓	✓	✓		New Upgraded Return Springs	✓	✓	✓
<b>CFA308</b>	Grimeca Early Hydraulic 4 Piston				<b>CFA326</b>	Magura 'Clara' 2001/2 & 'Louise' 2002/3 & Louise FR			
		✓	✓				✓	✓	✓
<b>CFA309</b>	Grimeca Mechanical (System 1 & 15)				<b>CFA327</b>	Shimano Deore HY Hydraulic 2001 (BRM-525) Nexave C500/600 Tektro Auriga/Aquila			
		✓	✓			set includes return springs	✓	✓	✓
<b>CFA310</b>	Shimano XT/XTR Hydraulic (BR-M755) & Grimeca System 8 (SRAM) 'Cleg Caliper' Hope Mono M4				<b>CFA329</b>	Shimano Deore Mechanical 2001 & 2002 Nexave Hydraulic (BRM-525/555)			
	 set includes return springs	✓	✓	✓		set includes return springs	✓	✓	✓
<b>CFA311</b>	Grimeca Hydraulic (System 7)				<b>CFA330</b>	Promax Tektro Novela/ Gemini			
		✓	✓				✓		✓
<b>CFA316</b>	Diatech Spiral Y2K				<b>CFA331</b>	Magura 'Julie'			
		✓	✓				✓	✓	✓

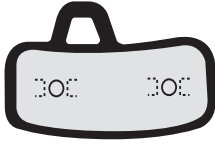
		-	R	HH		-	R	HH			
<b>CFA332</b>	QUAD Taiwan		✓			<b>CFA360</b>	Magura Marta & Marta SL		✓	✓	✓
<b>CFA333</b>	Giant 'MPH' Hydraulic Caliper		✓	✓	✓	<b>CFA364</b>	Diatech Anchor/ Promax DSK901		✓		
<b>CFA338</b>	Giant NTH/MPH3		✓	✓	✓	<b>CFA365</b>	Formula Activa & MD1 2002	 Pad B retained by screw	✓		
<b>CFA339</b>	Voxa MD35		✓	✓	✓	<b>CFA370</b>	Shimano XTR 02/03 Deore XT 04 Saint XT 2004/LX 2005/ Hone (BRM965/66)		✓	✓	✓
<b>CFA340</b>	Eberle EM		✓	✓	✓	<b>CFA378</b>	Promax DSK400 DSK700 DSK810		✓		
<b>CFA341</b>	Suntour DB700		✓		✓	<b>CFA383</b>	Clarke Clim 8		✓		
<b>CFA359</b>	Grimeca System 12		✓	✓	✓	<b>CFA385</b>	Hope 6 Piston Mono 6 Ti		✓	✓	✓

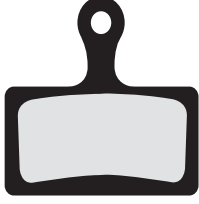
		-	R	HH		-	R	HH
<b>CFA386</b>	Hope Mono Mini NG		New Upgraded Return Springs	✓	✓	✓		
<b>CFA391</b>	SR Mechanical			✓				
<b>CFA392</b>	Joytech Mechanical			✓				
<b>CFA394</b>	BB7, Avid Hydraulic & Avid Juicy 5/7			✓	✓	✓		
<b>CFA402</b>	Formula Oro		New Upgraded Return Springs	✓	✓	✓		
<b>CFA404</b>	Hayes El Camino		 set includes return springs	✓	✓	✓		
<b>CFA421</b>	Hayes MX2 / MX3 / Sole			✓	✓	✓		
<b>CFA422</b>	Hope Trials			✓				
<b>CFA439</b>	Avid BB5			✓	✓	✓		
<b>CFA440</b>	Avid Code 2007		New Upgraded Return Springs	✓	✓	✓		
<b>CFA449</b>	Magura Louise 2008			✓	✓	✓		
<b>CFA451</b>	Magura Marta Marta SL 2006-			✓	✓	✓		
<b>CFA466</b>	Hayes Stroker Ryde			✓	✓	✓		
<b>CFA467</b>	Hayes Stroker Trail		 set includes 2 x clips	✓	✓	✓		

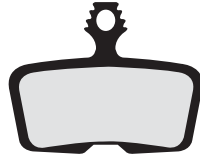
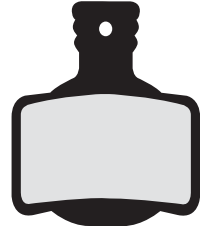
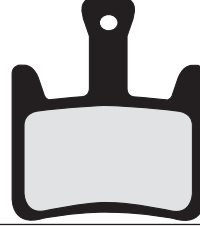
		-	R	HH		-	R	HH
<b>CFA469</b>	Hope Moto V2				✓	✓	✓	
<b>CFA470</b>	Formula The One/Mega				✓	✓	✓	
<b>CFA472</b>	Avid Elixir 08				✓	✓	✓	
<b>CFA487</b>	Hope Tech X2				✓	✓	✓	
<b>CFA493</b>	Shimano Saint 09/Zee				✓	✓	✓	
<b>CFA494</b>	Hayes Stroker Ace				✓	✓	✓	
<b>CFA614</b>	Shimano XTR 2011 (M985)				✓	✓	✓	
<b>CFA615</b>	Tektro 2011				✓	✓		
<b>CFA616</b>	Avid Code 2011-2012				✓	✓	✓	
<b>CFA619</b>	Magura MT Series 2/4/6/8 2012				✓	✓	✓	
<b>CFA620</b>	Hayes Prime Pro & Expert 2012				✓	✓	✓	
<b>Compound Selection Guide</b>								
<b>X-country - No Suffix</b>								
<b>Green</b>		Crosscountry/Trekking grade for general use.						
<b>Downhill - Suffix R</b>								
<b>Red</b>		High friction "Soft" compound for Downhill race use only.						
<b>Wet Riding - Suffix HH</b>								
<b>Gold</b>		High durability sintered metal compound for longer life in arduous conditions such as wet riding or use in mud or sand. NOT to be used for Downhill race use unless system is fitted originally with gold (sintered) brake pads to avoid brake overheating.						





