

ARTESYN LCC1200 SERIES

1200 Watts Conduction Cooling

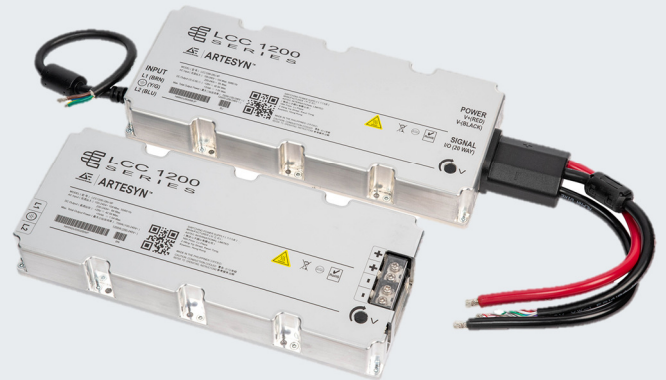

PRODUCT DESCRIPTION

Advanced Energy's Artesyn LCC1200 series of fully enclosed conduction cooled AC-DC power supplies comprises four models, offering main output voltages of 24 V, 28 V, 36 V or 48 V. Each model also provides a 5 V standby output that can supply up to 1.5 A. Rated at 1200 W, these power supplies incorporate a thermal baseplate and are capable of delivering full output power over a wide operating baseplate temperature range of -40 to 85°C. For maximum applications flexibility, the main output is adjustable. The 28 V model, for example, can be adjusted from 24 to 30 V and has a maximum current rating of 42.9 amps.

SPECIAL FEATURES

- Full power up to 85°C baseplate temperature
- Wide operating temperature range (-40°C to 95°C baseplate)
- Adjustable output
- Remote output on/off
- AC_OK, DC_OK signals
- 5 V standby voltage
- Active current share
- Conduction-cooled/fanless
- I²C/PMBus™
- Active power factor correction
- ITE safety
- Optional IP65 variant (-4P suffix)
- Build-in OR-ing FETs for parallel operation

COMPLIANCE

- EMI Class B
- EN 61000 immunity

SAFETY

- UL + CSA IEC 62368-1
- Demko IEC 62368-1
- CB Scheme IEC 60950-1/IEC 62368-1
- CCC
- CE Mark
- UKCA Mark

AT A GLANCE

Total Power

1200 Watts

Input Voltage

90 to 264 Vac

of Outputs

Main and Standby



MODEL NUMBERS

Model	Output Voltage (V)	Adjustment Range (V)	Minimum Load (A)	Maximum Load (A)	Maximum Output Power ¹ (W)	Standby Output	IP Rating
LCC1200-28U-4P	28	24 to 30	0	42.9	1200	5 V @ 1.5 A	IP65
LCC1200-28U-9P	28	24 to 30	0	42.9	1200	5 V @ 1.5 A	IP20
LCC1200-28U-4P24	24	-	0	50.0	1200	5 V @ 1.5 A	IP65
LCC1200-28U-9P24	24	-	0	50.0	1200	5 V @ 1.5 A	IP20
Future Models							
LCC1200-36U-XXXX ²	36	32 to 38	0	33.3	1200	5 V @ 1.5 A	IP20 or IP65
LCC1200-48U-XXXX	48	44 to 54	0	25.0	1200	5 V @ 1.5 A	IP20 or IP65

Note 1 - $V_{IN} < 180\text{Vac}$, $P_O = 700\text{W}$; $V_{IN} \geq 180\text{Vac}$, $P_O = 1200\text{W}$.

Note 2 - Suffix "XXXX" for different enclosure type/IP rating.

ELECTRICAL SPECIFICATIONS

Absolute Maximum Ratings

Stress in excess of those listed in the “Absolute Maximum Ratings” may cause permanent damage to the power supply. These are stress ratings only and functional operation of the unit is not implied at these or any other conditions above those given in the operational sections of this TRN. Exposure to any absolute maximum rated condition for extended periods may adversely affect the power supply’s reliability.

Table 1. Absolute Maximum Ratings						
Parameter	Model	Symbol	Min	Typ	Max	Unit
Input Voltage AC continuous operation	All models	$V_{IN,AC}$	90	-	264	Vac
Maximum Output Power $90Vac \leq V_{IN} < 180Vac$ $180Vac \leq V_{IN} \leq 264Vac$	All models All models	$P_{O,max}$	- -	- -	700 1200	W W
Isolation Voltage (Qualification) Input to output Input to safety ground Outputs to safety ground	All models		- - -	- - -	3000 1500 500	Vac Vac Vdc
Isolation Voltage (Production) ¹ Input to output Input to safety ground Outputs to safety ground	All models		- - -	- - -	2500 2200 500	Vdc Vdc Vdc
Baseplate Operating Temperature ²	All models	$T_{BASEPLATE}$	-40	-	+95	°C
Storage Temperature	All models	T_{STG}	-40	-	+85	°C
Ambient Temperature	All models	T_{AMB}	-40	-	+50	°C
Humidity (non-condensing) Operating Non-operating	All models All models		10 10	- -	95 95	% %
Altitude Operating Non-operating	All models All models		- -	- -	16,402 50,000	feet feet

Note 1 - Duration 2 to 6 Sec, maximum trip current is 10 mA (For AC Hi-Pot). Arc detect is Mid-level.

Note 2 - Refer Figure 13 and Figure 14 on page 24 and page 25 for details.

ELECTRICAL SPECIFICATIONS

Input Specifications

Table 2. Input Specifications							
Parameter	Condition	Symbol	Min	Typ	Max	Unit	
Operating Input Voltage, AC ¹	All	$V_{IN,AC}$	90	115/230	264	Vac	
Operating Input Voltage, DC ²	All	$V_{IN,DC}$	127	-	374	Vdc	
Input AC Frequency	All	$f_{IN,AC}$	47	50/60	63 (440 ³)	Hz	
Startup Surge Current (Inrush) @ 25°C ⁴	$V_{IN,AC} = 264 \text{ Vac}$		-	-	25	A _{PK}	
Input Current ($V_O = \text{On}$, $I_O = I_{O,max}$)	$V_{IN,AC} = 180 \text{ Vac}$ 50/60 Hz	$P_{IN,no-load}$	-	-	8	A	
No Load Input Power ⁵ ($V_O = \text{On}$, $I_O = 0 \text{ A}$, $I_{SB} = 0 \text{ A}$)	$V_{IN,AC} = 180 \text{ Vac}$	$P_{IN,no-load}$	-	-	10	W	
	$V_{IN,AC} = 180 \text{ Vac}$ Inhibit pin = 0 - 0.5 Vdc	$P_{IN,no-load}$	-	-	8	W	
Harmonic Line Currents	All	THD	Per EN 61000-3-2 Class A and Class C ⁶				
Power Factor ⁷ (47 - 63Hz)	$V_{IN,AC} = 180 \text{ Vac}$	PF	-	0.98	0.99		
	$V_{IN,AC} = 230 \text{ Vac}$		-	0.96	0.97		
	$V_{IN,AC} = 264 \text{ Vac}$		-	0.93	0.96		
Power Factor ⁷ (440Hz)	$V_{IN,AC} = 180 \text{ Vac}$	PF	-	0.79	0.88		
	$V_{IN,AC} = 230 \text{ Vac}$		-	0.50	0.69		
	$V_{IN,AC} = 264 \text{ Vac}$		-	0.46	0.63		
Input Fuse	All		-	-	16	A	
Earth Leakage Current	$V_{IN,AC} = 264 \text{ Vac}$ 50/60 Hz		-	-	3500	uA	
PFC Switching Frequency	All	$f_{SW,PFC}$	-	60	-	kHz	
Operating Efficiency	LCC1200-28U-XX ²⁴⁸ LCC1200-28U LCC1200-36U LCC1200-48U	$T_{AMB} = 25^\circ\text{C}$ $I_O = I_{O,max}$ $V_{IN,AC} = 230 \text{ Vac}$	η	-	-	-	%
				-	93.5	-	
				-	-	-	
				-	-	-	

Note 1 - Safety rating: 100 to 240 Vac, PSU can meet functional requirement with 180 to 264 Vac.

Note 2 - No safety approval for DC input.

Note 3 - Safety rating: 50/60Hz.

Note 4 - Cold start, 25°C ambient temperature, excluding X caps.

Note 5 - Standalone operation only, input power is measured using a moving average function on power meter with 16 samples updating every 0.25 Sec, minimum load is 4% of full load current.

Note 6 - Meets Class C at 100% load.

Note 7 - The PSU has an active power factor, the requirements includes harmonics that meet AC Harmonic Current Emissions (IEC 1000-3-2).

Note 8 - Suffix "XX" for different enclosure type/IP rating.

ELECTRICAL SPECIFICATIONS

Output Specifications

Table 3. Output Specifications							
Parameter		Condition	Symbol	Min	Typ	Max	Unit
Factory Set Voltage	LCC1200-28U-XX24	$I_o = 50\%$ rated load	V_o	23.88	24.00	24.12	Vdc
	LCC1200-28U			27.86	28.00	28.14	
	LCC1200-36U			35.82	36.00	36.18	
	LCC1200-48U			47.76	48.00	48.24	
Output Voltage Adjustment Range	LCC1200-28U-XX24	$I_o = 0$ A	V_o	-	24.00	-	Vdc
	LCC1200-28U			24.00	28.00	30.00	
	LCC1200-36U			32.00	36.00	38.00	
	LCC1200-48U			44.00	48.00	54.00	
Output Regulation	LCC1200-28U-XX24	Inclusive of set-point, temperature change, warm-up drift	V_o	23.52	24.00	24.48	Vdc
	LCC1200-28U			27.44	28.00	28.56	
	LCC1200-36U			35.28	36.00	36.72	
	LCC1200-48U			47.04	48.00	48.96	
	All models		V_{SB}	4.75	5.00	5.25	
Output Ripple, pk-pk ¹	LCC1200-28U-XX24	20 MHz bandwidth Measure with a 0.1 μ F ceramic capacitor in parallel with a 10 μ F E-cap ² .	V_o	-	-	240	mV_{PK-PK}
	LCC1200-28U			-	-	280	
	LCC1200-36U			-	-	360	
	LCC1200-48U			-	-	480	
	All models		V_{SB}	-	-	50	
Analog Dimming		By external voltage	-	0	-	10	Vdc
		By external resistance	-	0	-	100	K ohm
Main Output Switching Frequency		All	f_{sw}	-	200	-	kHz
Quantity of Units in Parallel Operation ³		Main Output "ISHARE" connected	-	-	-	3	Units
V_o Load Capacitance		Start up	-	0	-	330	μ F/A
V_o Long Term Stability ⁴		After thermal equilibrium (30 mins, maximum)	$\pm\%V_o$	-	-	2	%

Note 1 - If voltage is adjust above nominal setting, ripple expected is 1% of output voltage. Ripple noise at extreme low temperature (below 0°C) is expected higher until unit gets stabilized due to ESR change of the E-caps. Ripple noise at -20°C ambient is expected to be around +/-10% of output voltage. The main output peak to peak ripple is less than 300 mV at no load condition.

Note 2 - Ripple noise measurement below -20°C ambient is measured together with minimum load capacitance of 1000 μ F with maximum ESR of 14 m ohm.

Note 3 - Power supply designed with output OR'ing built in. ISHARE pin for main output only.

Note 4 - Input voltage for stability over time is 100 Vac and 200 Vac. Maximum change over 24 hours.

ELECTRICAL SPECIFICATIONS

Output Specifications

Table 3. Output Specifications							
Parameter		Condition	Symbol	Min	Typ	Max	Unit
Output Current	LCC1200-28U-XX24	All	I_o	0	-	50	A
	LCC1200-28U			0	-	42.9	A
	LCC1200-36U			0	-	33.3	A
	LCC1200-48U			0	-	25	A
	All models		I_{SB}	0	-	1.5 ¹	A
V_o Dynamic Response ²	Peak Deviation Settling Time	$I_{O,min}$ to 25% $I_{O,max}$ change, $I_{O,min}$ to 50% $I_{O,max}$ change, 50% $I_{O,max}$ to $I_{O,max}$ change, slew rate = 1 A/us, load frequency < 1 kHz	$\pm\%V_o$ T_s	- -	- -	5 500	% mSec

Note 1 - Including parallel/redundant application. Standby output only support droop current share.

Note 2 - Tested with low ESR output capacitors and dynamic limits at 5°C to 85°C and with minimum capacitors of 1000 uF with maximum ESR of 14 m ohm, typically +/-5% of average nominal voltage. If operation conditions is at 0 to -40°C, the power supply will be able to handle dynamic load and regulation limits expected and typically -20%/+5% of average nominal voltage. $I_{O,min}$ is 50 W, tested with minimum output capacitor of 330 uF/A.

ELECTRICAL SPECIFICATIONS

System Timing Specifications

Table 5. Specifications					
Label	Parameter	Min	Typ	Max	Unit
T1	Delay from AC being applied to V_O being within regulation	-	1500	2500	mSec
T2	Delay from AC being applied to G_ACOK_C signal assertion (going Low)	200	450	1000	mSec
T3	V_O rise time, 10% V_O to 95% V_O in regulation	-	-	100	mSec
T4	Delay from V_O within regulation to G_DCOK_C signal assertion (going Low)	-	200	500	mSec
T5	Delay from AC loss to V_O falling out of regulation. V_O at nominal set point.	20	35	-	mSec
T6	Delay from AC loss to G_ACOK_C signal de-assertion (going High)	-	16	19	mSec
T7	Delay from G_DCOK_C signal de-assertion (going High) to V_O dropping to less than the output lower regulation range	1	9	-	mSec
T8	Delay from INH_EN going High to V_O being within regulation	-	112	1500	mSec
T9	Delay from INH_EN assertion (Pulled low) to G_DCOK_C signal going High.	-	3	8	mSec
T10	Delay from AC being applied to V_{SB} output being within regulation.	-	120	1500	mSec
T11	Delay from AC loss to V_{SB} going out of regulation. Last one to turn-off to guarantee other logic & control functionality	30	120	-	mSec

ELECTRICAL SPECIFICATIONS

System Timing Diagram

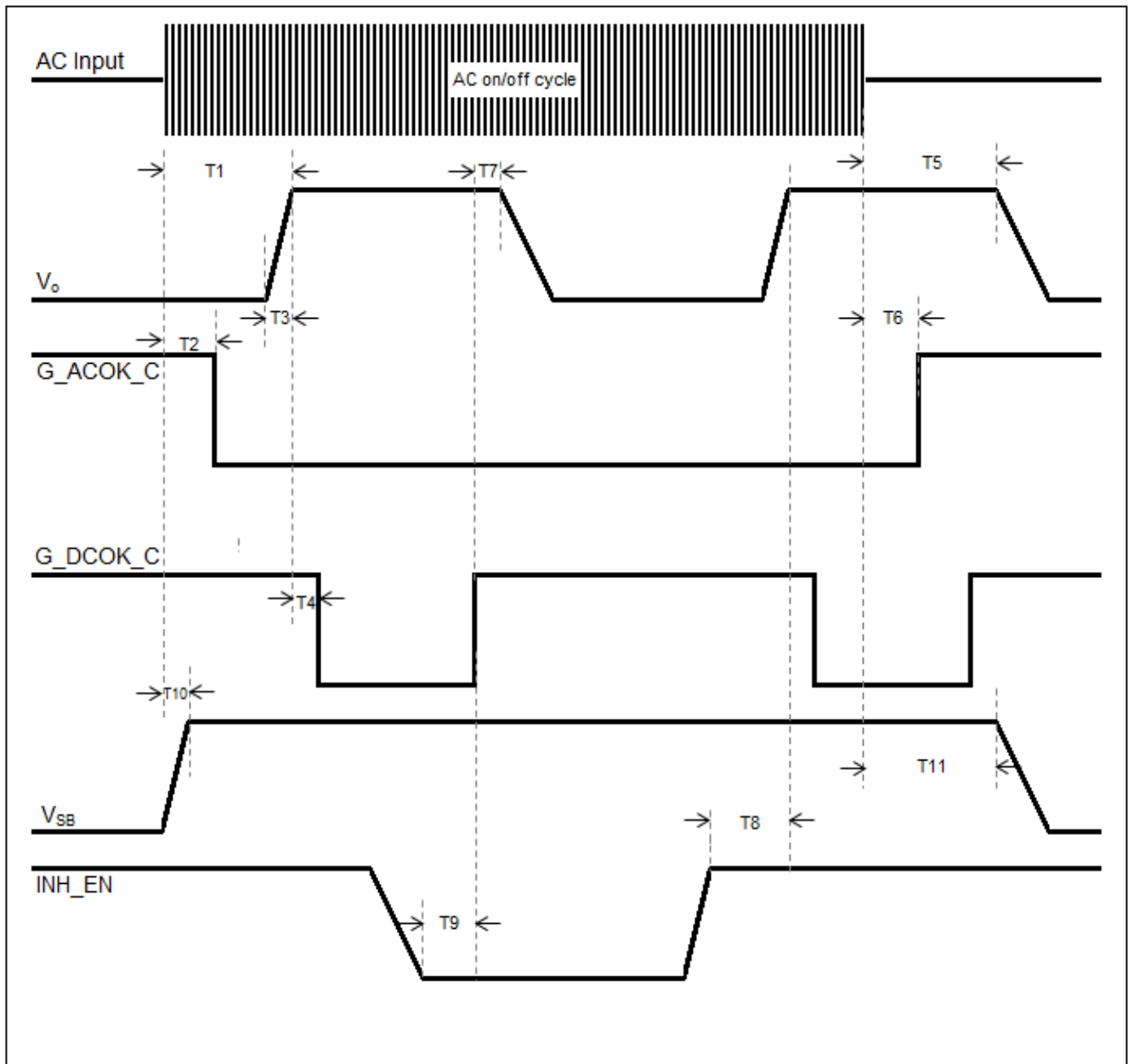

ELECTRICAL SPECIFICATIONS

LCC1200-28U-9P Performance Curves

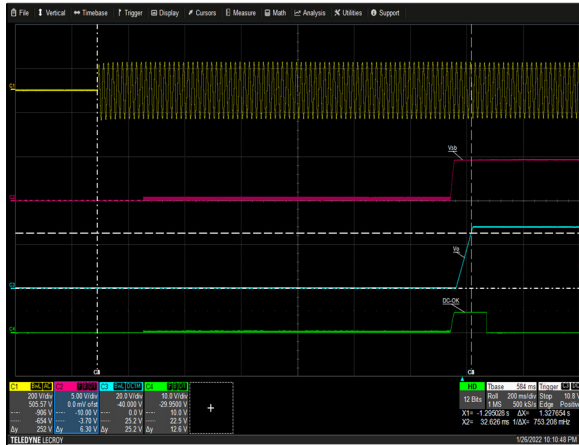

Figure 1: LCC1200-28U-9P Turn-on delay via AC mains
 Vin = 90Vac Load: Io = 25A (28V), I_{SB} = 1.5A (5V)
 Ch 1: AC Mains Ch 2: V_{SB} Ch 3: V₀ CH 4: G_DCOK_C

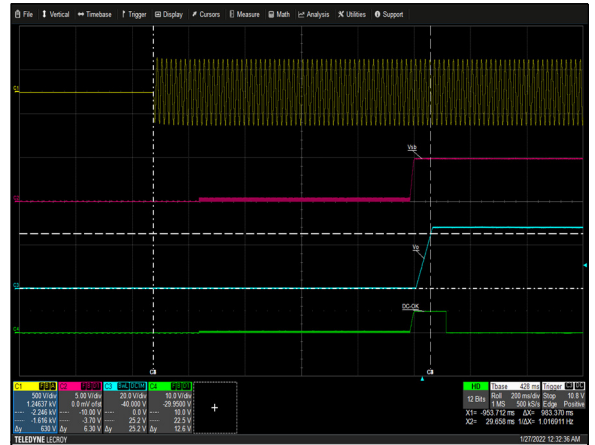

Figure 2: LCC1200-28U-9P Turn-on delay via AC mains
 Vin = 264Vac Load: Io = 42.9A (28V), I_{SB} = 1.5A (5V)
 Ch 1: AC Mains Ch 2: V_{SB} Ch 3: V₀ CH 4: G_DCOK_C

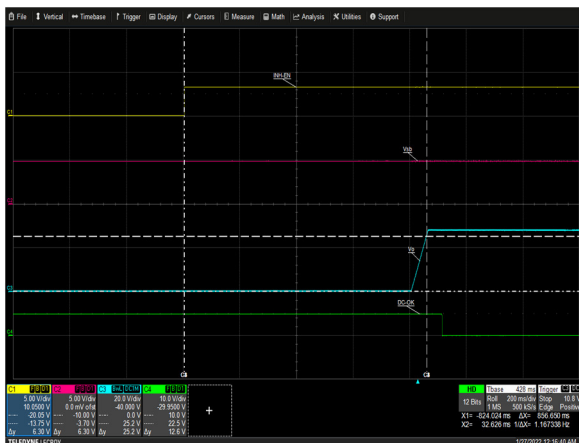

Figure 3: LCC1200-28U-9P Turn-on delay via INH_EN
 Vin = 90Vac Load: Io = 25A (12V), I_{SB} = 1.5A (5V)
 Ch 1: INH_EN Ch 2: V_{SB} Ch 3: V₀ CH 4: G_DCOK_C

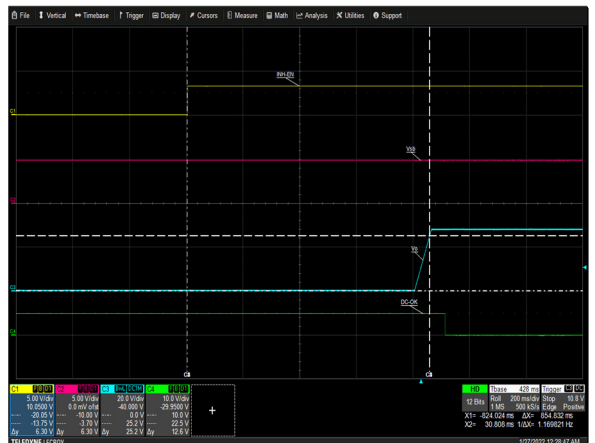

Figure 4: LCC1200-28U-9P Turn-on delay via INH_EN
 Vin = 264Vac Load: Io = 42.9A (12V), I_{SB} = 1.5A (5V)
 Ch 1: INH_EN Ch 2: V_{SB} Ch 3: V₀ CH 4: G_DCOK_C

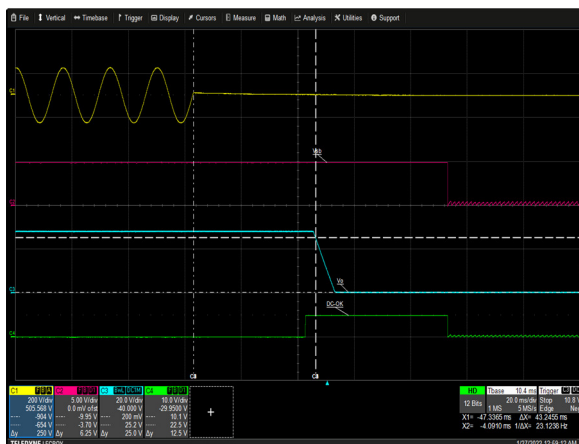

Figure 5: LCC1200-28U-9P Hold-up Time
 Vin = 90Vac Load: Io = 25A (12V), I_{SB} = 1.5A (5V)
 Ch 1: AC Mains Ch 2: V_{SB} Ch 3: V₀ CH 4: G_DCOK_C



Figure 6: LCC1200-28U-9P Hold-up Time
 Vin = 264Vac Load: Io = 42.9A (12V), I_{SB} = 1.5A (5V)
 Ch 1: AC Mains Ch 2: V_{SB} Ch 3: V₀ CH 4: G_DCOK_C

ELECTRICAL SPECIFICATIONS

LCC1200-28U-9P Performance Curves



Figure 7: LCC1200-28U-9P Output Startup Characteristic
 Vin = 264Vac Load: Io = 42.9A (12V), I_{SB} = 1.5A (5V)
 Ch 3: V_O Ch 4: G_DCOK_C

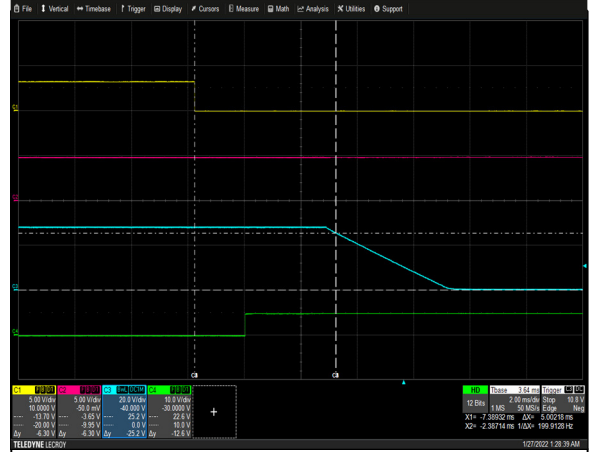

Figure 8: LCC1200-28U-9P Turn Off Characteristic via INH_EN
 Load: Io = 42.9A (12V), I_{SB} = 1.5A (5V)
 Ch 1: INH_EN Ch 2: V_{SB} Ch 3: V_O CH 4: G_DCOK_C

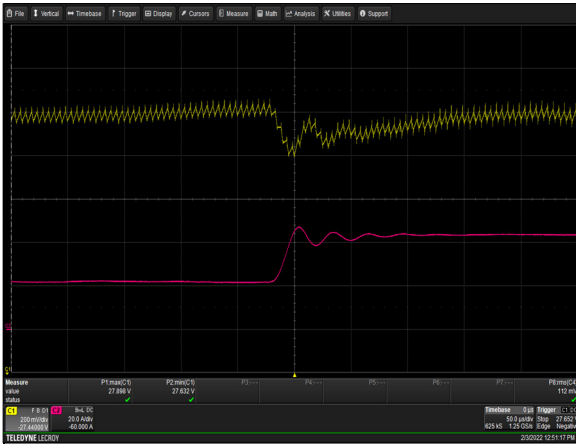

Figure 9: LCC1200-28U-9P Transient Response - Vo Deviation
 50% to 100% load change (1KHz) 1A/uS slew rate Vin = 230Vac
 Ch 1: V_O Ch 2: I_O

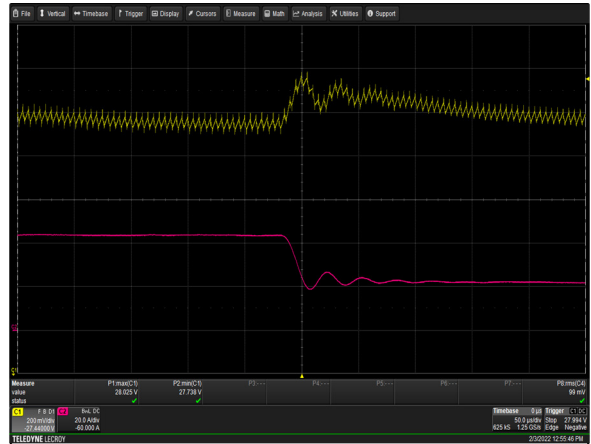

Figure 10: LCC1200-28U-9P Transient Response - Vo Deviation
 100% to 50% load change(1KHz) 1A/uS slew rate Vin = 230Vac
 Ch 1: V_O Ch 2: I_O

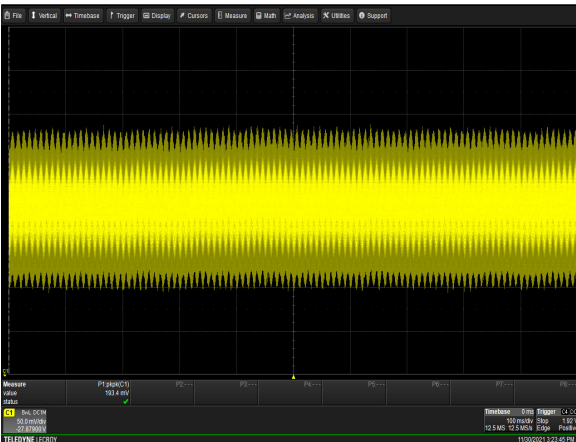

Figure 11: LCC1200-28U-9P Ripple and Noise Measurement
 Vin = 230Vac Load: Io = 42.9A (12V), I_{SB} = 1.5A (5V)
 Ch 1: V_O

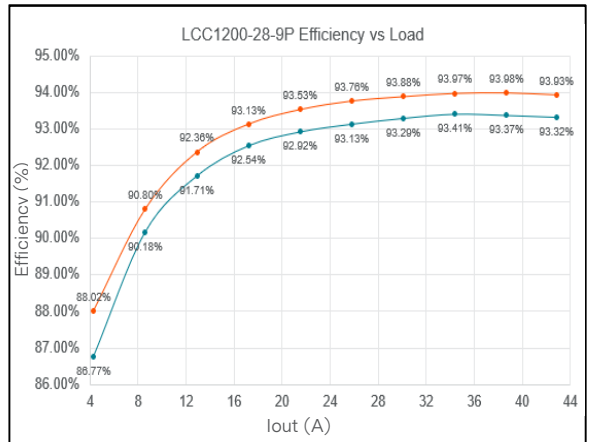
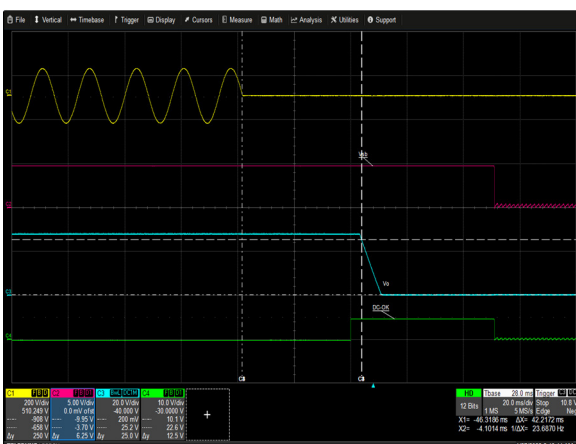
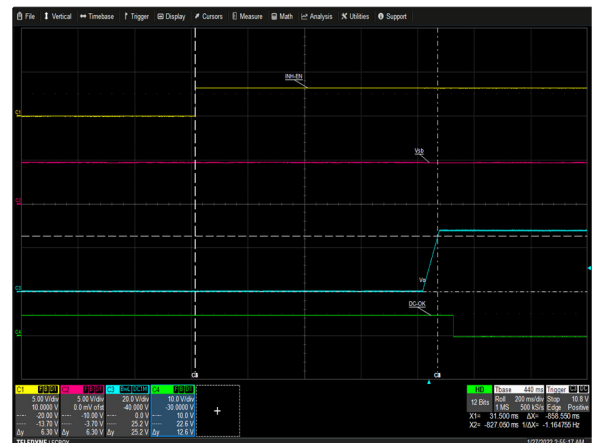
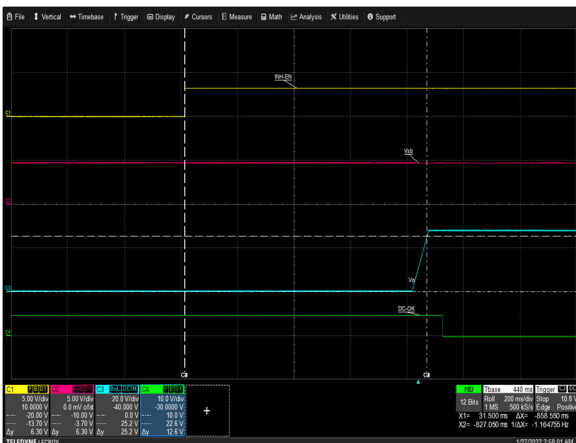
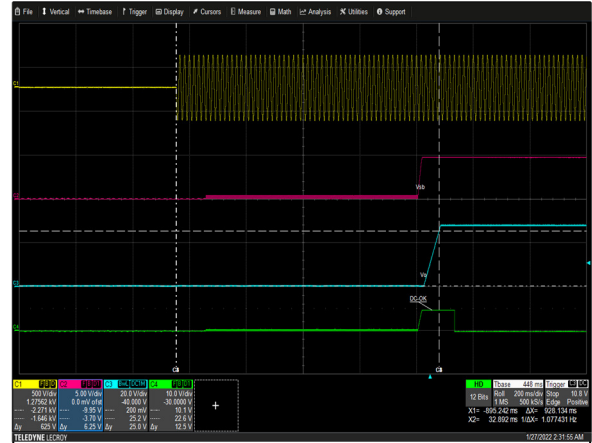
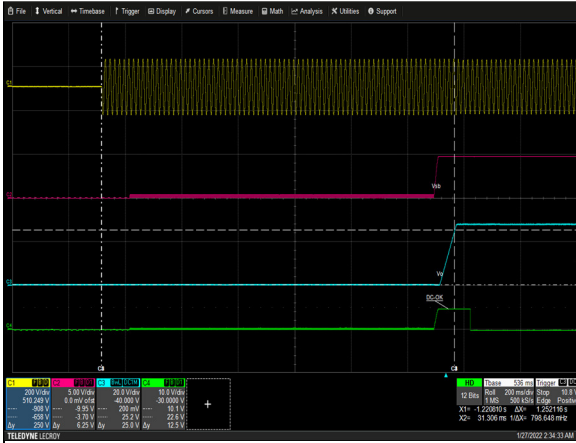

Figure 12: LCC1200-28U-9P Efficiency Curve @ 25°C
 Loading: I_{o,main} = 10% I_{o,max} increment to 1200W@180/230vac

ELECTRICAL SPECIFICATIONS

LCC1200-28U-4P Performance Curves



ELECTRICAL SPECIFICATIONS

LCC1200-28U-4P Performance Curves

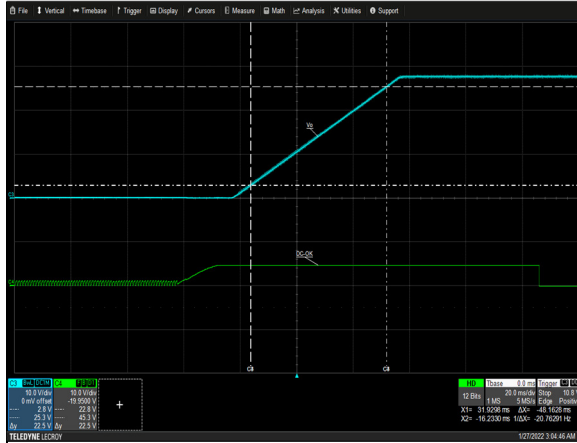

Figure 19: LCC1200-28U-4P Output Startup Characteristic
 Vin = 264Vac Load: Io = 42.9A (12V), I_{SB} = 1.5A (5V)
 Ch 3: V_O Ch 4: G_DCOK_C



Figure 20: LCC1200-28U-4P Turn Off Characteristic via INH_EN
 Load: Io = 42.9A (12V), I_{SB} = 1.5A (5V)
 Ch 1: INH_EN Ch 2: V_{SB} Ch 3: V_O CH 4: G_DCOK_C

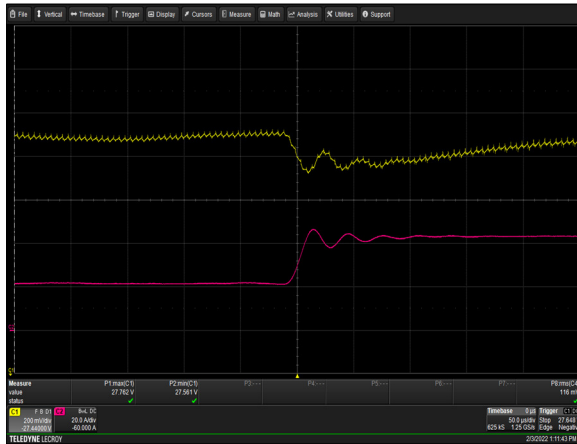

Figure 21: LCC1200-28U-4P Transient Response - Vo Deviation
 50% to 100% load change 1A/uS slew rate Vin = 230Vac
 Ch 1: V_O Ch 2: I_O

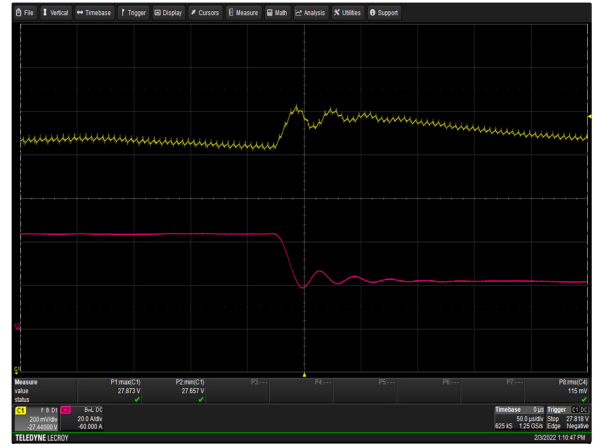

Figure 22: LCC1200-28U-4P Transient Response - Vo Deviation
 100% to 50% load change 1A/uS slew rate Vin = 230Vac
 Ch 1: V_O Ch 2: I_O

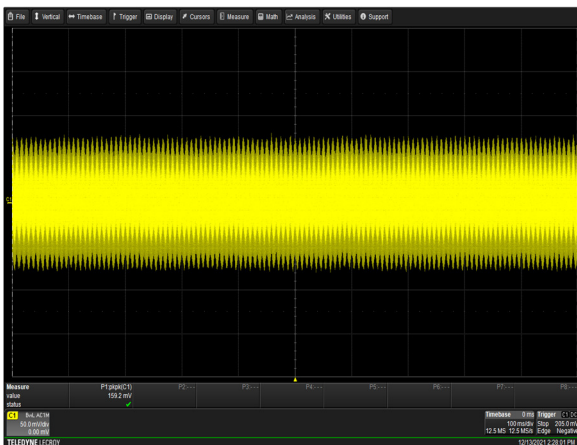

Figure 23: LCC1200-28U-4P Ripple and Noise Measurement
 Vin = 230Vac Load: Io = 42.9A (28V), I_{SB} = 1.5A (5V)
 Ch 1: V_O

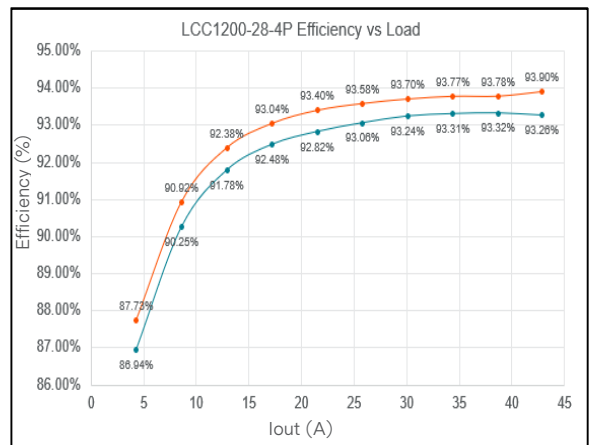

Figure 12: LCC1200-28U-4P Efficiency Curve @ 25°C
 Loading: I_{o,main} = 10% I_{o,max} increment to 1200W@180/230Vac

ELECTRICAL SPECIFICATIONS

Protection Function Specifications

Input Fuse

LCC1200 is equipped with an internal primary fuse of 250 V, 16 A to protect against catastrophic failures.

Over Voltage Protection (OVP)

The main and standby output is over voltage protected. The power supply latches off when output overvoltage is activated and needs an AC line recycled manually to reset the power supply and remove the fault condition.

Parameter	Min	Typ	Max	Unit
V _O Output Overvoltage	105	/	145	% V _O
Standby Voltage Overvoltage	120	/	155	% V _{SB}

Over Current Protection (OCP)

LCC1200 series includes internal current limit circuitry to prevent damage in the event of overload or short circuit. Recovery is automatic when the overload is removed. No damage will result to the supply as the result of either short term or long term overloads of the output at all line and load conditions. In case of continued overload, main output will retry after 20 Sec. Optional digital or analog constant current limit adjustment is available.

Main output OCP response: output will shutdown and auto recover approximately every 2 to 3 Sec within a period 20 Sec. If overload still present after the 20 Sec time frame, main output will latch and needs AC recycle or inhibit toggling or thru PMBus command to turn unit back on.

5 V Standby OCP response: output will shutdown and auto recover approximately every 2 to 3 Sec within a period 20 Sec. If overload still present after the 13 to 21 Sec time frame, 5V standby and main output will latch needs AC recycle.

Parameter	Min	Typ	Max	Unit ¹
V _O Output Overcurrent	105	/	130	% I _{O,rated}
Standby Voltage Overcurrent	105	/	140	% I _{O,rated}

Note 1 - $I_{O,rated} = P_{max}/V_{O,set}$

Short Circuit Protection (SCP)

The LCC1200 series will protect itself when any output is shorted to ground or to any other output. The power supply can withstand a continuous short circuit applied to its main output during start-up or while running with no permanent damage.

Over Temperature Protection (OTP)

The power supply is internally protected against over temperature conditions. The power supply will shut off and auto-recover once the OTP condition is removed.

Baseplate Temperature	Min	Typ	Max	Unit
OTP Level	/	/	95	°C
Hysteresis	5	/	10	°C

MECHANICAL SPECIFICATIONS

Mechanical Outlines (unit:mm)

“-9P” Suffix

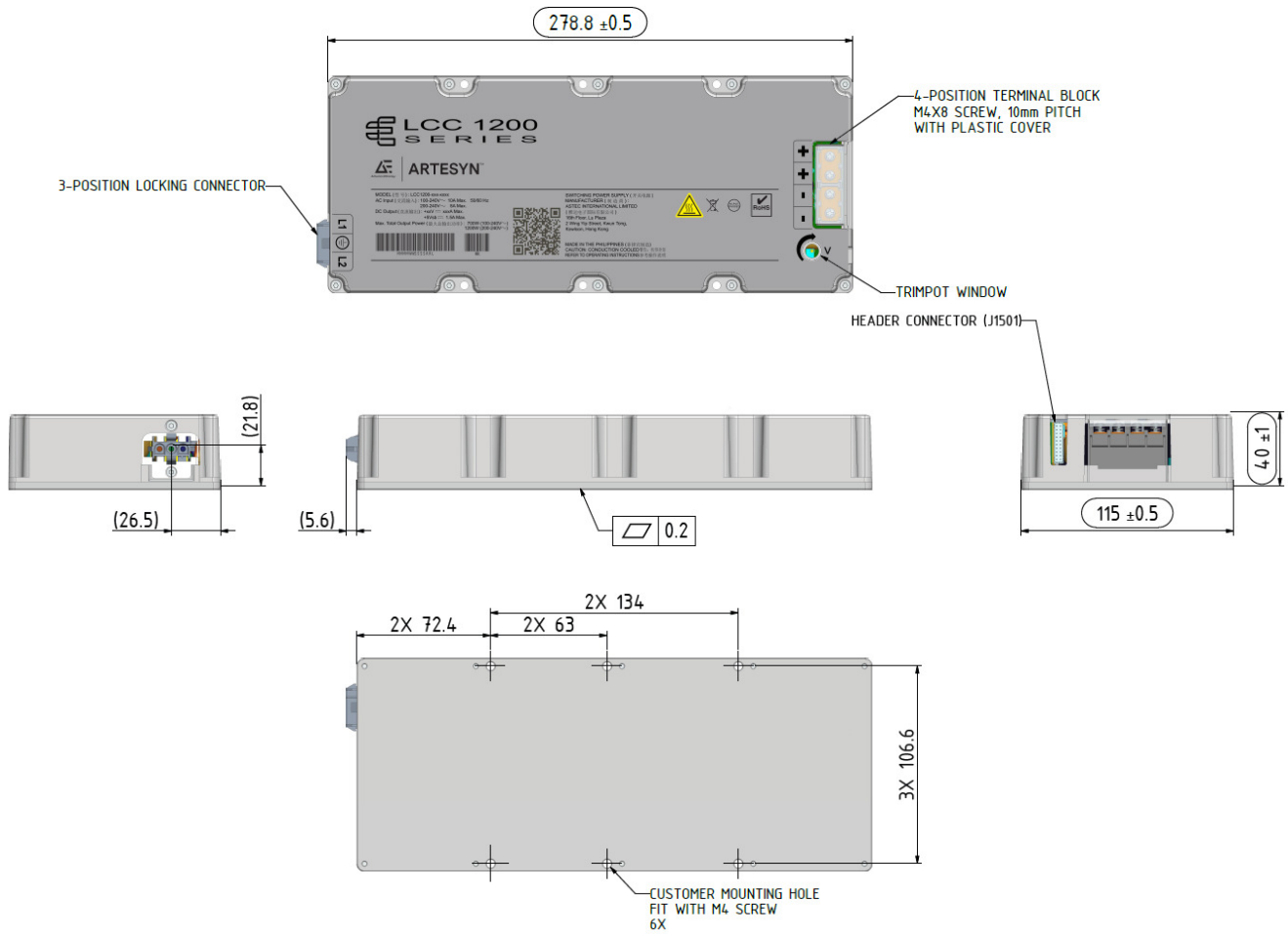

MECHANICAL SPECIFICATIONS

Mechanical Outlines (unit:mm)

“-4P” Suffix

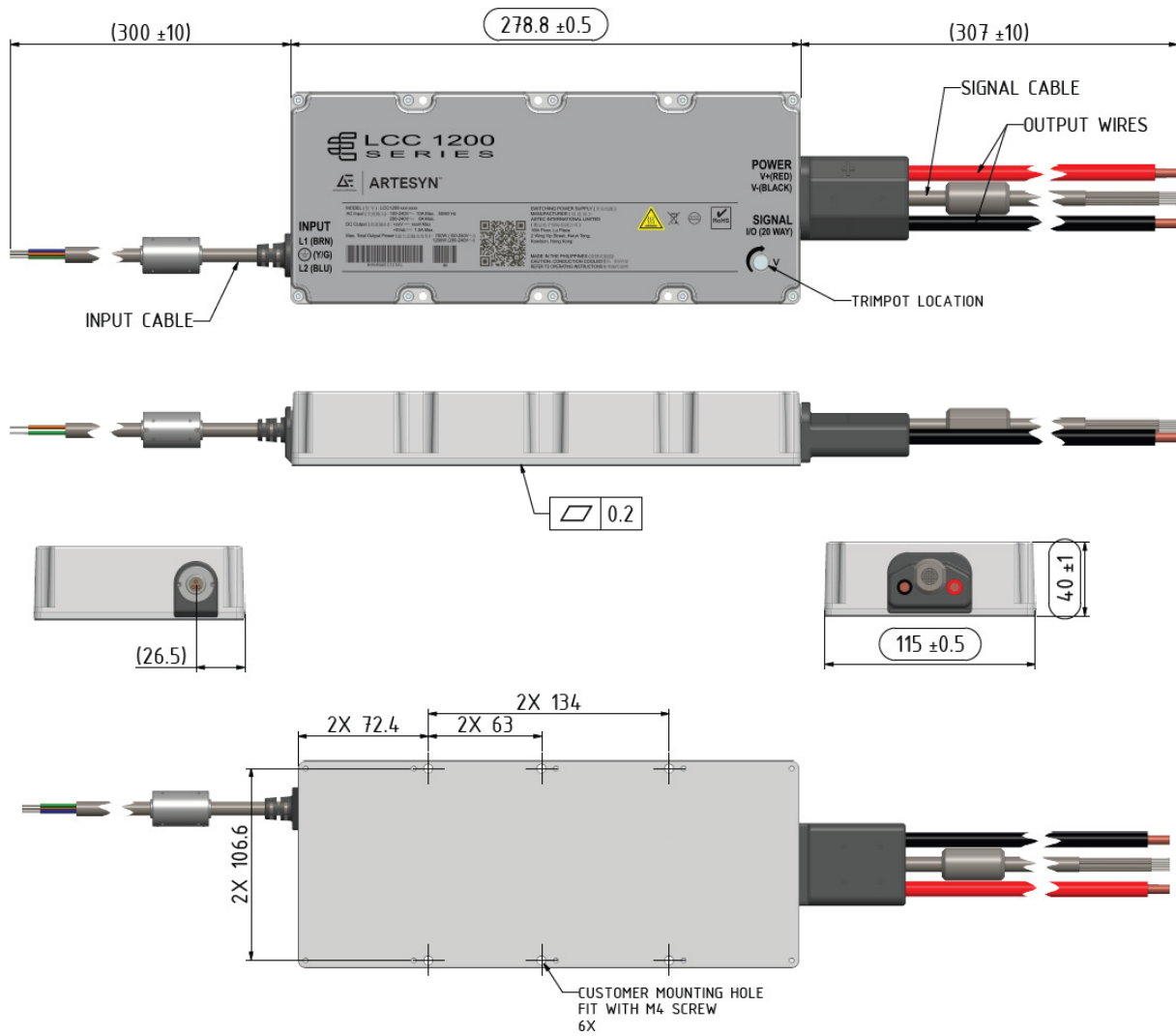

MECHANICAL SPECIFICATIONS

Connector Definitions

AC Input Connector (-9P)

L1 - Line1

L2 - Line2

⊕ - Ground

“-9P”
Input

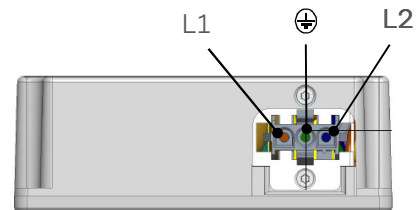

AC Input Connector (-4P)

BRW - Line1

BLU - Line2

Y/G - Ground

“-4P”
Input

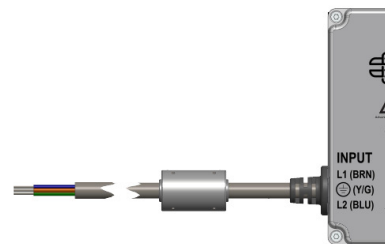

Output Connector (-9P)

“+” - Main Output

“-” - Main Output Return

“-9P”
Output

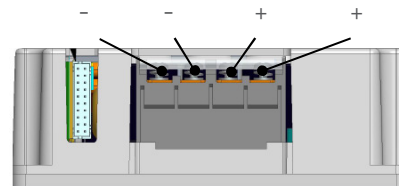

Output Connector (-4P)

RED - Main Output

BLACK - Main Output Return

“-4P”
Output

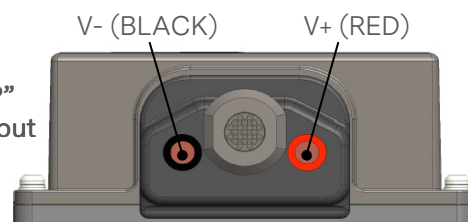

MECHANICAL SPECIFICATIONS

Pin Assignment

Table 6. Output Signal Connector Pin Assignment				
Signals	Description	Amps per Pin	-9P Suffix J1501 Pin Number	-4P Suffix Wire Color
CC_CV_SELECT	Select between CC and CV mode	N/A	1	BLACK
GND	Ground	N/A	2	BROWN
A1	I ² C Bit Address	N/A	3	RED
-VOUT_RS	Remote Sense Return (main O/P)	N/A	4	ORANGE
ISHARE	Load Share Voltage	N/A	5	YELLOW
A0	I ² C Bit Address	N/A	6	GREEN
SDA	Serial Data Signal (I ² C)	N/A	7	BLUE
CC_SET_POINT	Constant Current Level Adjust	N/A	8	VIOLET
SCL	Serial Clock Signal (I ² C)	N/A	9	GRAY
+VOUT_RS	Remote Sense Positive	N/A	10	WHITE
5VSB	5 V Standby (1.5 A maximum)	1.5	11	PINK
5VSB_RET	5 V Standby Return	1.5	12	LIGHT BLUE
5VSB_SENSE	For Factory Use	N/A	13	WHITE/VIOLET
G_DCOK_C	Global DC_OK Collector	N/A	14	WHITE/YELLOW
RESERVE	RESERVE	N/A	15	WHITE/ORANGE
G_DCOK_E	Global DCOK Emitter (GND)	N/A	16	WHITE/BLACK
GND	Return Ground (for the output signal and I ² C communication)	N/A	17	WHITE/RED
G_ACOK_C	Global AC_OK Collector	N/A	18	WHITE/BROWN
INH_EN #	Output Inhibit_Enable Pin (turns output off)	N/A	19	WHITE/GREEN
RESERVE	RESERVE	N/A	20	WHITE/BLUE

-9P Suffix J1501 connector

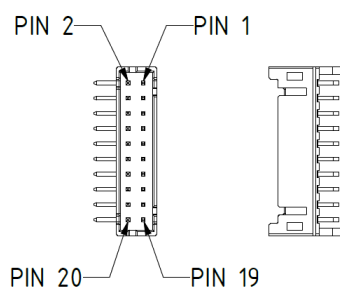

MECHANICAL SPECIFICATIONS

Power/Signal Mating Connectors and Pin Types

“-9P” Suffix (Non IP65 Enclosure)

Reference	On Power Supply	Mating Connector or Equivalent
AC Input Connector	3-Position locking connector Part number: 350767-1 (Housing)/350218-1 or equivalent (Contact Pin) Manufacturer: Tyco	Part number: 350766-1 (Housing)/350536-1 (Contact Terminal) Manufacturer: Tyco
J1501	Part number: CI0120P1HD0-LF Manufacturer: LANDWIN Co., Ltd. Part number: S20B-PHDSS Manufacturer: JST Mfg. Co., Ltd.	Part number: PHDR-20VS (Housing) Manufacturer: JST Mfg. Co., Ltd. Part number: SPHD-001T-P0.5 (Contact Pins) Manufacturer: JST Mfg. Co., Ltd.
Output Power Connector	4-Position Terminal Block (M4x8 screw, 10mm pitch with plastic cover)	Part number: BB-124-08 (19141-0058) or equivalent ring/spade terminal Manufacturer: Molex Co., Ltd. Or equivalent ring/spade terminal.

“-4P” Suffix (IP65 Enclosure)

Reference	On Power Supply	Mating Connector or Equivalent
AC Input	Live = Brown Neutral = Blue Ground = Y/GR	SJTW 18AWGX3C; PVC jacket; 105°C/300 V
DC Output	(36V, 48V future model) +Vout = Red +Vout = Red -Vout = Black -Vout = Black	12AWGX2C; PVC Jacket; 105°C/300 V
	(28V model) +Vout = Red -Vout = Black	6AWG Multi-Strand; PVC Jacket; 105°C/600 V
Control Cable	Table 6. Output Signal Connector Pin Assignment	26AWGX20C+AL; PVC Jacket; 105°C/300 V

MECHANICAL SPECIFICATIONS

Weight

The LCC1200 series weight as below.

For “-9P” suffix, weight is 1.8 kg typical.

For “-4P” suffix, weight is 2.2 kg typical.

ENVIRONMENTAL SPECIFICATIONS

EMC Immunity

The LCC1200 series are designed to meet the following EMC immunity specifications.

Table 7. ENVIRONMENTAL SPECIFICATIONS	
Document	Description
EN 61000-3-2	Harmonics Current – Meets Class A at full load condition – Meets Class C from 100% load to full load
EN 61000-3-3	Voltage Fluctuations and Flicker – Meets the requirements, tested with full load condition
IEC/EN 61000-4-2	Electrostatic Discharge (ESD) – ± 8 KV contact, performance criteria A, at user-accessible points – ± 15 KV air discharge, performance criteria A, at user-accessible points
IEC/EN 61000-4-3	Radio Frequency Electromagnetic Field (RS) – 80 - 1000 MHz, 1000 - 2700 MHz (1kHz sine wave with 80% AM: 10 V/m) – Performance criteria A
IEC/EN 61000-4-4	Fast Transient Common Mode (EFT) – ± 0.5 KV, ± 1.0 KV, ± 2.0 KV for Power Lines and Protective Earth Terminal – Performance criteria A
IEC/EN 61000-4-5	Surge – Criteria A: 2 KV CM; 1 KV DM with 230 Vac input
EN 61000-4-6	Radio Freq Common Mode (CS) – 0.15 – 10 MHz (1 kHz sine wave with 80% AM: 3 V/m) – Performance criteria A
EN 61000-4-8	Power Freq Magnetic Field (PFMF) – Performance criteria A, level 4 for continuous field, 30 A/m
IEC/EN 61000-4-11	Voltage Dips and Interruptions (DIP) – 30% reduction for 500 mS, Criteria B – > 95% reduction for 10 mS, Criteria A – > 95% reduction for 5000 mS, Criteria C – Hold-up time of 20 mS can be met at full load and nominal output voltage
MIL-STD-461G	MIL-STD-461G EMI – For CE101; CE102; CS101; CS114; CS115; CS116 – External EMI filter with P/N ZGLPG-10-02M or ZGLPG-10-02M Type "C" (Zhongguang Hi Tech) required for Mil-STD EMI compliance (28 V, 36 V, 48 V models only)
EN 55032	Conducted Emissions from Power Ports Minimum passing Class B margin is -8.93 dB at 0.40000 MHz
EN 55032	Radiated Emissions up to 1 GHz Minimum passing Class B margin is -6.33 dB at 219.68 MHz

ENVIRONMENTAL SPECIFICATIONS

Safety Certifications

The LCC1200 series are intended for inclusion in other equipment and the installer must ensure that it is in compliance with all the requirements of the end application. This product is only for inclusion by professional installers within other equipment and must not be operated as a standard alone product.

Table 8. Safety Certifications for LCC1200 Series Power Supply System		
Standard	Agency	Description
IEC 62368-1	UL + CSA	US and Canada Requirements
IEC 60950-1/62368-1	Demko + CB	European Requirements
CE Mark		European Requirements
UKCA Mark		UK Requirements
CHINA CCC Approval		China Requirements

ENVIRONMENTAL SPECIFICATIONS

EMI Emissions

The LCC1200 series has been designed to comply with the Class B limits of EMI requirements of EN55035 (FCC Part 15) and CISPR 32 (EN 55032) for emissions and relevant sections of EN 61000 (IEC 61000) for immunity. The unit was tested at 1200 W using resistive load. Conditions is 28V output, 100% Load, 110 Vac input, 60Hz. Recommend to use a snap on ferrite (Wurth Elektronik PN 74271222 or equivalent) on the AC input cable of LCC1200-28U-9P for radiated EMI performance.

Conducted Emissions

The applicable standard for conducted emissions is EN55032 (FCC Part 15). Conducted noise can appear as both differential mode and common mode noise currents. Differential mode noise is measured between the two input lines, with the major components occurring at the supply fundamental switching frequency and its harmonics. Common mode noise, a contributor to both radiated emissions and input conducted emissions, is measured between the input lines and system ground and can be broadband in nature.

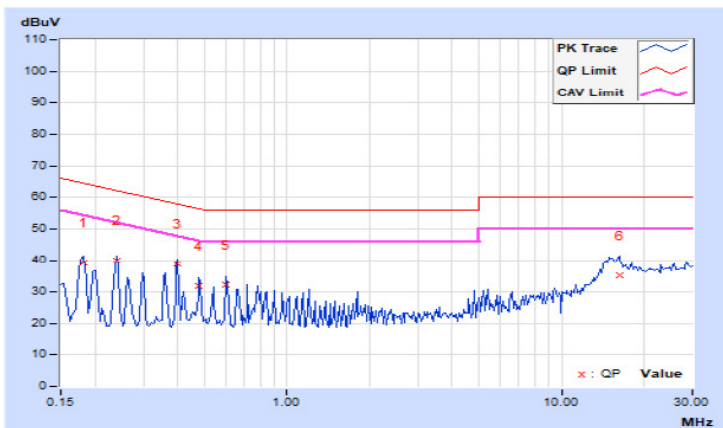

The LCC1200 power supplies have internal EMI filters to ensure the convertor’s conducted EMI levels comply with EN 55032 (FCC Part 15) Class B and EN 55032 (CISPR 22) Class B limits. The EMI measurements are performed with resistive loads at maximum rated loading.

Sample of EN 55032 Conducted EMI Measurement at 110 Vac input

Note: Red Line refers to Artesyn Quasi Peak margin, which is 6 dB below the CISPR international limit. Pink Line refers to the Artesyn Average margin, which is 6 dB below the CISPR international limit.

Parameter	Model	Symbol	Min	Typ	Max	Unit
FCC Part 15, Class B	All	Margin	-	-	6	dB
EN 60601-1-2: 2001	All	Margin	-	-	6	dB
CISPR 32 (EN55032) Class B	All	Margin	-	-	6	dB

ENVIRONMENTAL SPECIFICATIONS

Radiated Emissions

Unlike conducted EMI, radiated EMI performance in a system environment may differ drastically from that in a stand-alone power supply. The shielding effect provided by the system enclosure may bring the EMI level from Class A to Class B. It is thus recommended that radiated EMI be evaluated in a system environment. The applicable standard is EN55032 Class A (FCC Part 15). Testing ac-dc convertors as a stand-alone component to the exact requirements of EN55032 can be difficult, because the standard calls for 1m leads to be attached to the input and outputs and aligned such as to maximize the disturbance. In such a set-up, it is possible to form a perfect dipole antenna that very few ac-dc convertors could pass. However, the standard also states that 'an attempt should be made to maximize the disturbance consistent with the typical application by varying the configuration of the test sample.

ENVIRONMENTAL SPECIFICATIONS

Output Power Derating

The LCC1200 series power supplies can provide high useable power at elevated temperature, full power up to 85°C baseplate temperature, derated from 85°C to 95°C.

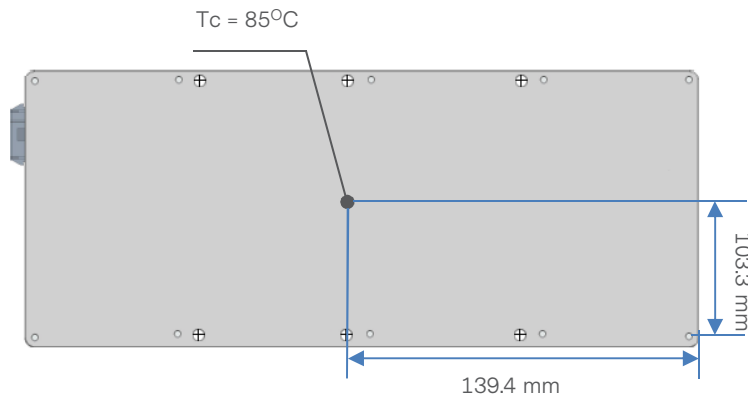

Thermal Derating Curves

LCC1200 series total output power will be derated according to the curves shown below.

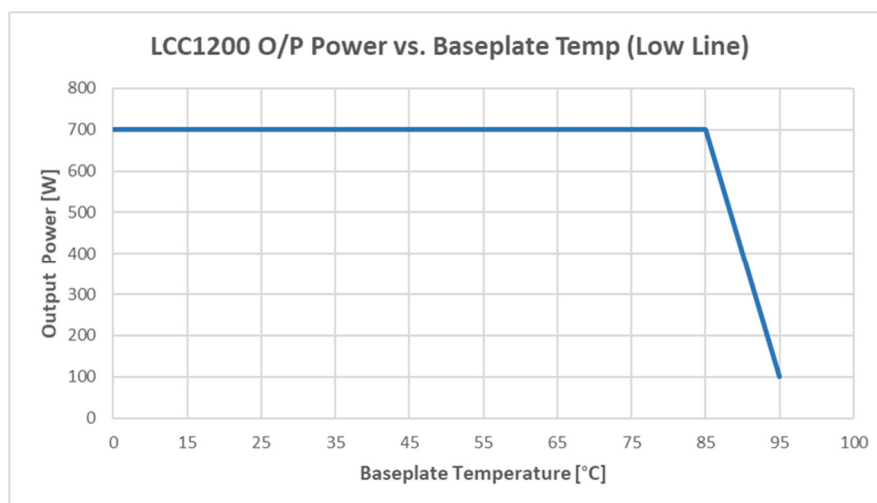

Figure 13. Output Power Vs Baseplate Temperature (low line: 90 Vac to 179 Vac)

ENVIRONMENTAL SPECIFICATIONS

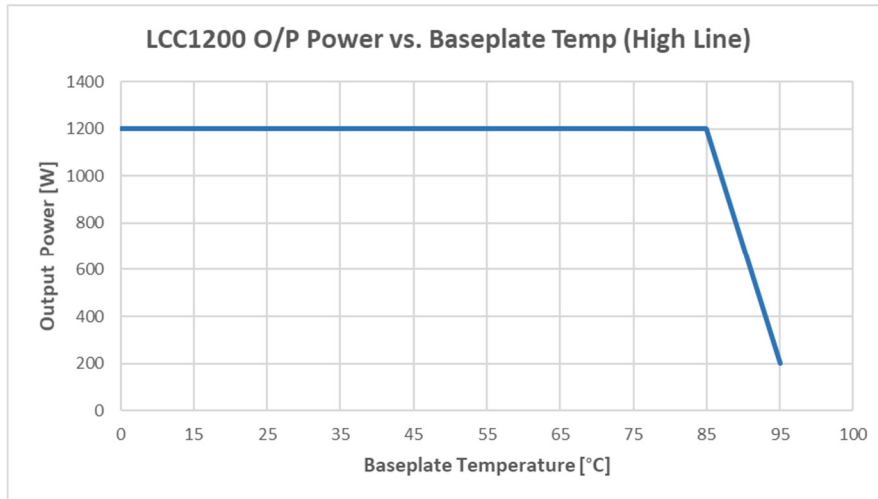

Figure 14. Output Power Vs Baseplate Temperature (High Line: 180 Vac to 264 Vac)

Input Voltage and Output Power Derating

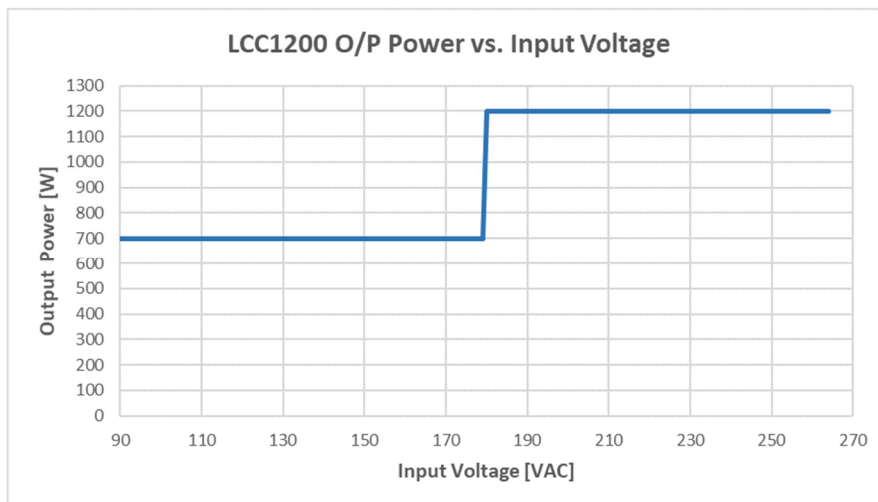

Figure 15. Output Power Vs Input Voltage

ENVIRONMENTAL SPECIFICATIONS

Storage and Shipping Temperature

The LCC1200 series power supplies can be stored or shipped at temperatures between -40°C to $+85^{\circ}\text{C}$ and humidity from 10% to 95% non-condensing.

Altitude

The LCC1200 series will operate within specifications at altitudes up to 16,402 feet above sea level. The power supply will not be damaged when stored at altitudes of up to 50,000 feet above sea level.

Humidity

The LCC1200 series will operate within specifications when subjected to a relative humidity from 10% to 95% non-condensing. The LCC1200 series can be stored in a relative humidity from 10% to 95% non-condensing.

Vibration

The LCC1200 series power supply will pass the following vibration specifications (per MIL-STD-810F 514.5 Cat. 4,10):

Non-operating Random Vibration

Acceleration	1.87	gRMS	
Frequency Range	10 to 500	Hz	
Duration	30	mins	
Direction	Three orthogonal axis		
PSD Profile	Frequency(Hz)	Slope(db/oct)	PSD(g^2/Hz)
	10	-	0.01
	200	-2.66	0.01
	500	-	0.003

Operating Random Vibration

Acceleration	0.15	gRMS	
Frequency Range	5 to 100	Hz	
Duration	30	mins	
Direction	Three orthogonal axis		
PSD Profile	Frequency(Hz)	Slope(db/oct)	PSD(g^2/Hz)
	5	11	0.000025
	10 - 50	-	0.0004
	100	-10	0.000025

ENVIRONMENTAL SPECIFICATIONS

Shock

The LCC1200 series power supply will pass the following shock specifications (per MIL-STD-810F 516.5 Procedure I, VI):

Non-operating Half-Sine Shock

Acceleration	30	G
Duration	11	mSec
Pulse	Half-Sine	
Number of Shock	3 shocks on each of 6 faces	

Operating Half-Sine Shock

Acceleration	4	G
Duration	22	mSec
Pulse	Half-Sine	
Number of Shock	3 shocks on each of 6 faces	

POWER AND CONTROL SIGNAL DESCRIPTIONS

AC Input Connector

This connector supplies the AC Mains to the LCC1200 series power supply.

L1 = Live
G = Ground
L2 = Neutral

Output Connector – Terminal Block

These pins provide the main output for the LCC1200 series. The + Main Output (V_O) and the Main Output Return pins are the positive and negative rails, respectively, of the V_O main output of the LCC1200 series power supply. The Main Output (V_O) is electrically isolated from the power supply chassis.

+Vout – Positive Main Output
+Vout – Positive Main Output
-Vout – Return GND for Main Output
-Vout – Return GND for Main Output

Control Signals – J1501

The LCC1200 series J1501 contains 20 pins control signal header providing analogy control interface, standby power and I²C interface.

PN Number	Maximum Voltage Inject with Respect to GND
Pin 1, 3, 6, 7, 9, 14, 18	5 V
Pin 15, 19, 20	3.3 V
Pin 4, 5, 8, 10	Refer below for details

CC_CV_SELECT – (Pin 1)

Select between CC and CV mode.

CC mode – 0 V (Pull low/Close)

CV mode – 3.3 V (Pull High/Open)

A0, A1 – (Pin 6, Pin3)

Please refer to “COMMUNICATION BUS DESCRIPTIONS” section.

-VOUT_RS, +VOUT_RS – (Pin 4, Pin10)

This remote sense circuit is designed to compensate for a power path drop around the entire loop of 0.5 V. These pins should be connected as close to the loading as possible. Preferred termination of O/P load capacitor. In case if remote send is not required, connect this signal close to power supply mating connector side for proper operation. If left open, the remote sense does not work proper operation and the main output will fail regulation requirements.

Reverse connection protected.

ISHARE – (Pin 5)

The main output have active load sharing feature using single wire loop signal connection. This signal should be tied with same signal of other power supply intended to do current sharing. Short trace length with good ground(return line) shield is recommended for better performance on system back plane. Recommend to use Pin2 of J1501 for ISHARE Return.

POWER AND CONTROL SIGNAL DESCRIPTIONS

SDA, SCL – (Pin 7, Pin9)

Please refer to “COMMUNICATION BUS DESCRIPTIONS” section.

CC_SET_POINT – (Pin 8)

LED dimming input pin for analog voltage (0 to 10 V) or resistance.

The analog DC voltage should be between CC_SET_POINT and 5VSB_RET pin.

The resistor should be between CC_SET_POINT pin and 5VSB pin, dim resistor pulled up to 5VSB or external 5 V supply.

5VSB, 5VSB_RET – (Pin11, Pin12)

The LCC1200 series provides a regulated 5 volt 1.5 amp auxiliary output voltage to power critical circuitry that must remain active regardless of the on/off status of the power supply’s main output. 5VSB does not have active current sharing, only droop sharing. The 5VSB output residual voltage at absolute no load condition is less than 0.7 Vdc.

G_DCOK_C, G_DCOK_E – (Pin14, Pin16)

G_DCOK_C is a power good signal and is pulled LOW by the power supply to indicate the main output is valid. If the output fails, then this output signal will be driven HIGH. This is an open collector/drain output capable of driving the output pin below 0.5 V with load of 10 mA.

This signal should be pulled up to 5VSB using 4.7 K to 10 K ohm resistor on system side with suitable noise filter capacitor.

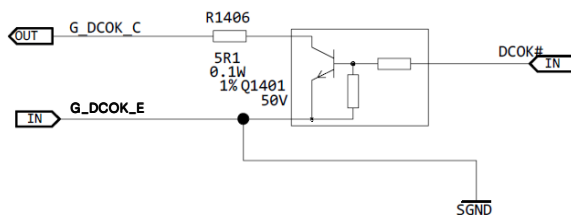

G_ACOK_C – (Pin18)

G_ACOK_C is an open collector signal, active logic LOW level (Isink-10 mA with Vlow-0.5 Vmax) indicates input supply voltage is within allowable limits. It is pulled high (requires external 4.7 K to 10 K ohm pull up to 5VSB) at least 5mS early warning signal is sent before the main DC output loses regulation. Suitable noise filter capacitor (4.7 nF max) is recommended to avoid noise pick-up by system during surge operation.

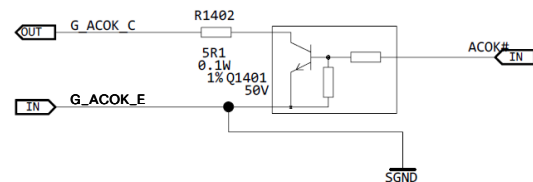

INH_EN # – (Pin19)

This signal is an input pin used to enable or disable the main output. This pin is active high if left open or floating to enable the main output.

Shorting this pin to GND (less than 0.5 V contact closure) will disable the main output.

The 5V standby is not affected by INH_EN pin and continues to run regardless of the pin status.

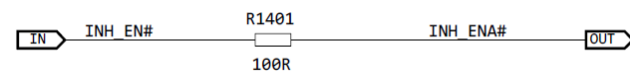

POWER AND CONTROL SIGNAL DESCRIPTIONS

Output Current Adjustability (For CC option)

The unit supports constant current mode of operation with tolerance of +/-10% around a default or programmed current limit. The CC mode supports down to the lowest output voltage trim range.

The PSU operating at 20% or below of the maximum programmed CC limit may have reduced accuracy (tolerance of about +/-30% due to signal-noise ratio limitation on the current sensing circuit).

The output current will be adjustable approximately 0 to 100% relative to the full load current. Full load current is equal $P_{out\ max}/output\ voltage\ setting$, where $P_{out\ max}$ is 1200 W at high line, 700 W at low line.

The output current can be adjusted by the methods of below.

0-10 V dimming

The output current is adjustable approximately 0 to 100% relative to the rated load current.

The adjustment method is via a 2-wire connection.

0-10 V source connected across pin8 and GND of J1501 which sets an output current approximately proportional to the applied voltage.

Voltage	0 V / Shorted	1 V	2 V	3 V	4 V	5 V	6 V	7 V	8 V	9 V	10 V	11-12 V / Open
% Full load current	3% to 5%	10%	20%	30%	40%	50%	60%	70%	80%	90%	100%	100%

Resistance Dimming

The output current is adjustable approximately 0 to 100% relative to the rated current.

The adjustment method is via 2-wire connection.

A resistor connected across SGND and Pin8 of connector J1501 which sets an output current approximately proportional to the applied resistance.

Resistance	0 K ohm / Shorted	10 K ohm	20 K ohm	30 K ohm	40 K ohm	50 K ohm	60 K ohm	70 K ohm	80 K ohm	90 K ohm	100 K ohm	Open
% Full load current	3% to 5%	10%	20%	30%	40%	50%	60%	70%	80%	90%	100%	100%

Digital Dimming

The adjustment method is via PMBus MFR. SPECIFICATION Command thru I²C communication. IOOUT_COMMAND is for setting fix output current. VOUT_COMMAND for setting both maximum output current ($P_{out\ max}/V_{out}$) and output voltage.

Zero value written on PMBus VOUT_COMMAND or IOOUT_COMMAND means analog output voltage trimming or analog output current trimming respectively.

Note:

- CV CC selection can be done thru Pin1 of J1501: Open (CV mode), short to GND (CC mode). Main output must be off or turned OFF for the change to take effect, main output can be turn OFF by either AC OFF or thru inhibit.
- CC mode operation limited for single unit configuration for LED type load.
- Default dimming configuration is analog, through external voltage dimming or resistance dimming.
- LED driver mode/CC mode tested using Electronic Load set on Constant Voltage mode.
- Minimum CV load of 14 V. For CV load of 14 V to 18 V, using digital dimming to adjust current to high load.

POWER AND CONTROL SIGNAL DESCRIPTIONS

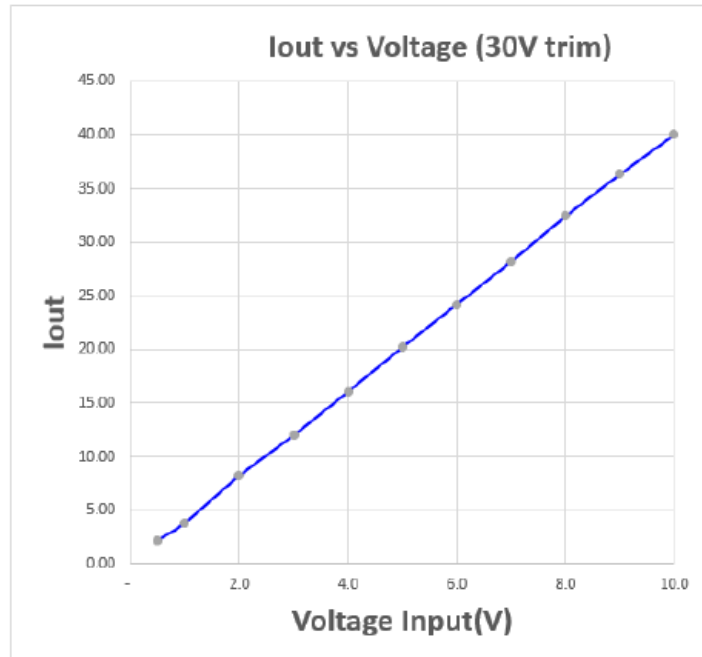

Figure 16. Typical Voltage Dimming using LED load at around 25°C

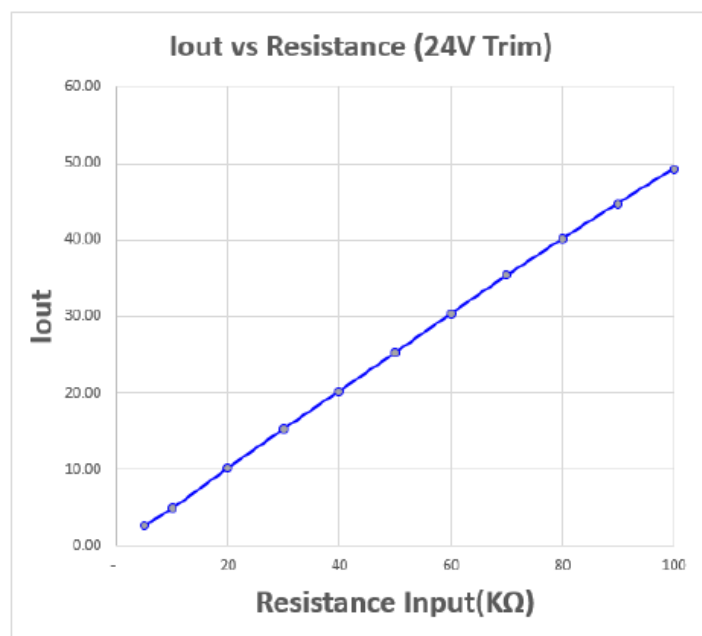

Figure 17: Typical Resistance Dimming using LED load at around 25°C

COMMUNICATION BUS DESCRIPTIONS

I²C Bus Signals

The LCC1200 series contains enhanced monitor and control functions implemented via the I²C bus. The LCC1200 series I²C functionality (PMBus™ and FRU data) can be accessed via the output connector control signals. The communication bus is powered either by the internal 3.3 V supply or from an external power source connected to the Standby Output (ie: accessing an unpowered power supply as long as the Standby Output of another power supply connected in parallel is on).

If units are connected in parallel or in redundant mode, the Standby Outputs must be connected together in the system. Otherwise, the I²C bus will not work properly when a unit is inserted into the system without the AC source connected.

Note - PMBus™ functionality can be accessed only when the PSU is powered-up. Guaranteed communication I²C speed is 10KHz to 100KHz.

SDA, SCL (I²C Data and Clock Signals) - (pin7, pin 9)

These pins used for I²C communication. SCL is an open drain serial bus clock line, it requires an external 2.2 K ohm pull up resistor. SDA is an open drain digital serial data line for I²C devices, it requires an external 2.2 K ohm pull up resistor.

The SDA/SCL should come from 3V3 internal pull-up. If 5 V pull-up will be used, it will need to be level shifted to 3.3 V outside the power supply.

If units are connected in parallel or redundant mode, the standby output must be connected in the system, otherwise, these pins will malfunction when a unit is inserted into the system without the AC source connected.

A0, A1 (I²C Address BIT 0, BIT1 Signals) - (pin6, pin3)

These input pins are the address lines A0, A1 to indicate the slot position the power supply occupies in the power bay and define the power supply addresses for FRU data and PMBus™ data communication. This allows the system to assign different addresses for each power supply. During I²C communication between system and power supplies, the system will be the master and power supplies will be slave. These lines are pulled up to +3.3 V internal supply.

Slave device address is configurable via address pins. Base address is 0xB0.

Below table shows the possible address that can be used via the address pin configuration. Note that the address pins are high state initially.

Address Pins		PMBus Write Address	PMBus Read Address
A1	A0		
1	1	0xB6	0xB7
1	0	0xB4	0xB5
0	1	0xB2	0xB3
0	0	0xB0	0xB1

I²C Bus Communication Interval

The interval between two consecutive I²C communications to the power supply should be at least 15 mSec to ensure proper monitoring functionality.

I²C Bus Signal Integrity

The ripple noise on the I²C bus (SDA, SCL lines) will be less than 450 mV peak-to-peak when measured external 2.2 K ohm pull up.

COMMUNICATION BUS DESCRIPTIONS

I²C Bus Internal Implementation, Pull-ups and Bus Capacitances

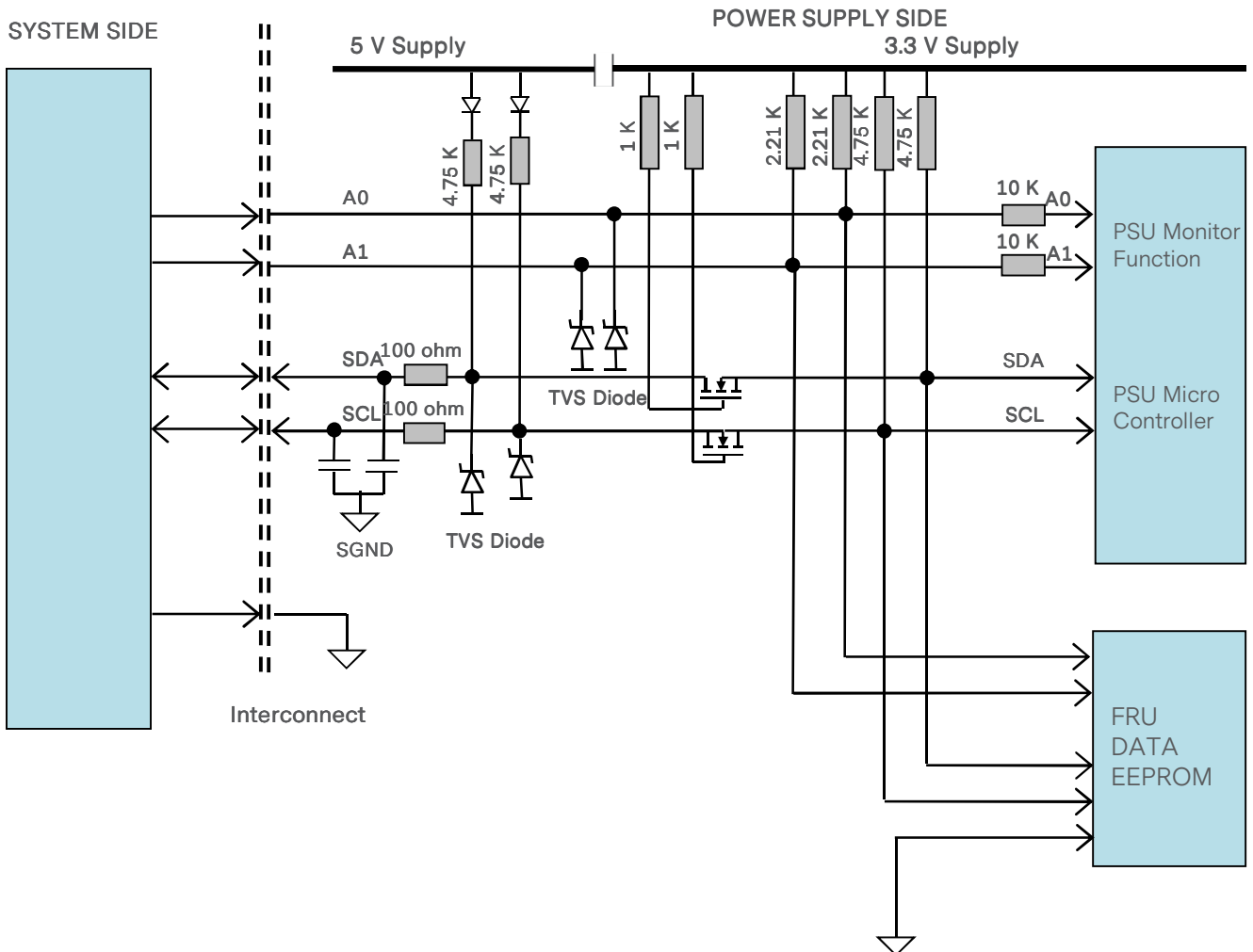

I²C Bus - Recommended External Pull-ups

Electrical and interface specifications of I²C signals (referenced to standby output return pin, unless otherwise indicated):

Parameter	Condition	Symbol	Min	Type	Max	Unit
SDA, SCL Internal Pull-up Resistor	-	R _{int}	-	4.7	-	K ohm
Recommended External Pull-up Resistor	-	R _{ext}	-	-	2.2	K ohm

COMMUNICATION BUS DESCRIPTIONS

Logic Levels

LCC1200 series power supply I²C communication bus will respond to logic levels as per below:

Logic High: 5.1 V nominal (Spec is 2.1 V to 5.5 V)**

Logic Low: 500 mV nominal (Spec is 800 mV max)**

**Note - Artesyn 73-769-001 I²C adapter was used.

Timings

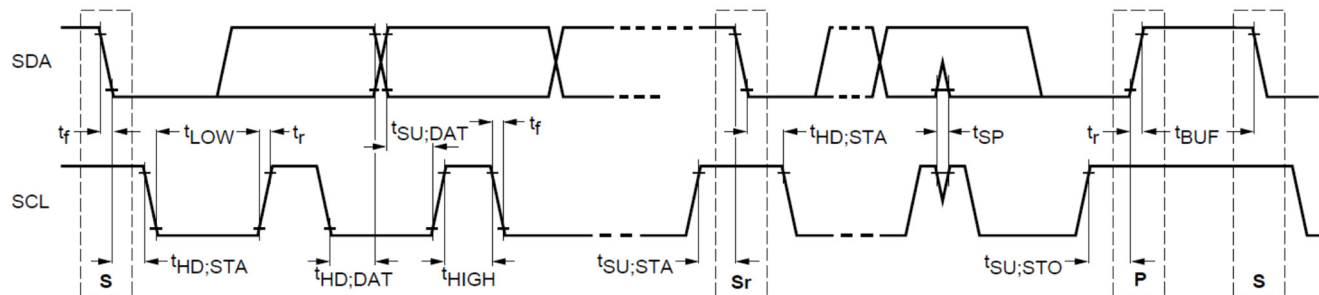

Parameter	Symbol	Standard-Mode Specs		Actual Measured		Unit
		Min	Max			
SCL clock frequency	f_{SCL}	10	100	104.6		KHz
Hold time (repeated) START condition	$t_{HD;STA}$	4.0	-	4.83		uSec
LOW period of SCL clock	t_{LOW}	4.7	-	14.9		uSec
HIGH period of SCL clock	t_{HIGH}	4.0	50	15.24		uSec
Setup time for repeated START condition	$t_{SU;STA}$	4.7	-	5.04		uSec
Data hold time	$t_{HD;DAT}$	300	-	414		uSec
Data setup time	$t_{SU;DAT}$	250	-	454		uSec
Rise time	t_r	-	1000	SCL = 260	SDA = 280	uSec
Fall time	t_f	-	300	SCL = 58	SDA = 67	uSec
Setup time for STOP condition	$t_{SU;STO}$	4.0	-	10.216		uSec
Bus free time between a STOP and START condition	t_{BUF}	4.7	-	9.79***		uSec

***Note: Artesyn 73-769-001 I²C adapter (USB-to-I²C) and Universal PMBus™ GUI software was used.

PMBUS™ SPECIFICATIONS

The LCC1200 series is compliant with the industry standard PMBus™ protocol for monitoring and control of the power supply via the I²C interface port.

LCC1200 Series PMBus™ General Instructions

Equipment Setup

The following is typical I²C communication setup:

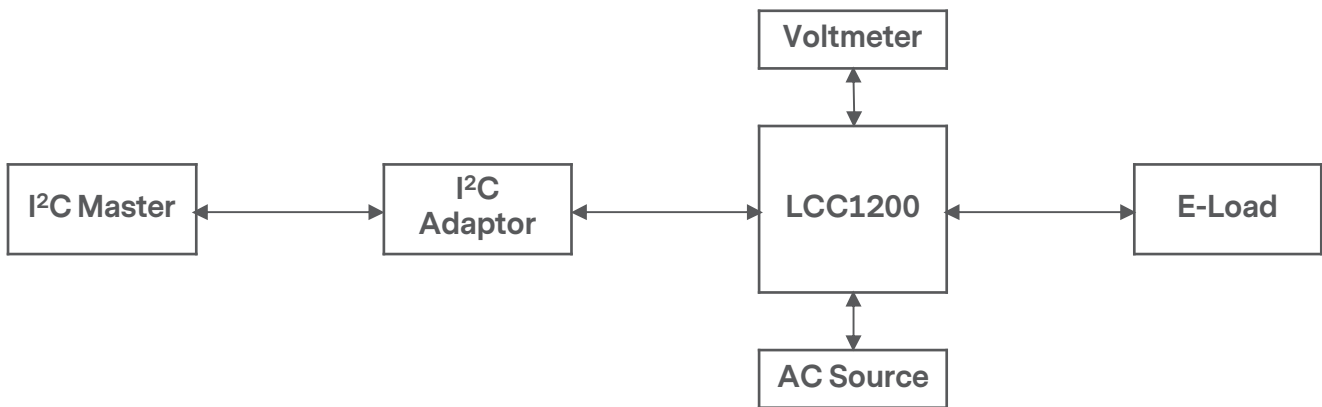

PMBus™ Writing Instructions

When writing to any PMBus™ R/W registers, ALWAYS do the following:

Disable Write Protect (command 10h) by writing any of the following accordingly:

Levels: 80h - Disable write except 0x10h

To save changes on the USER PMBus™ Table:

Use send byte command: 15h STORE_USER_ALL

Wait for 5 Sec, turn-off the PSU, wait for another 5 Sec before turning it on.

PMBUS™ SPECIFICATIONS

PMBus™ Accuracy

Parameter Type	Reporting Function	Command Code	Command Name	Accuracy Range		
				0% to 5% load	5% to 20% load	20% to 100% load
Input	Input Voltage	88h	READ_VIN	No requirement	+/-10%	+/-5%
	Input Current	89h	READ_IIN	No requirement	+/-10% of rated max input current (5% to 35% load)	+/-10% (35% to 100% load)
	Input Power	97h	READ_PIN	No requirement	+/-10% of rated max input power (5% to 35% load)	+/-30% (35% to 100% load)
Output	Output Voltage	8Bh	READ_VOUT	+/-2%		
	Output Current	8Ch	READ_IOUT	+/-10% (+/-1.5 A for < 8% load)		+/-5%
	Output Power	96h	READ_POUT	+/-10%		+/-5%
Thermal	Temperature	8Dh	READ_TEMPERATURE_1	+/-5%°C		
		8Eh	READ_TEMPERATURE_2	+/-5%°C		

PMBUS™ SPECIFICATIONS

The LCC1200 Series Supported PMBus™ Command List:

Command Code	Command Name	Default Value	Access Type	Data Bytes	Data Format	Description
01h	OPERATION	80h	R/W	1	Bitmapped	Used to turn the unit ON/OFF in conjunction with the input CONTROL pin
	b7:6 7 - Unit off 6 - Soft off					00 - Invalid input 01 - PSU off 10 - PSU on(default) 11 - Invalid input
	b5:4 5 - Margin high 4 - Margin low					00 - Invalid input (default)
	b3:2 3 - Margin act on fault 2 - Margin ignore fault					00 - Invalid input (default)
	b1:0 Reserved					00 - Invalid input (default)
02h	ON_OFF_CONFIG ¹	1Eh	R	1	Bitmapped	Configures the combination of CONTROL pin and serial communication commands needed to turn the unit ON/OFF
	b7:5 Reserved	000				Default
	b4 - Control pin and serial communication control	1				1 - Unit powers up as dictated by CONTROL pin and OPERATION command
	b3 - Serial communication control	1				1 - Enables serial communication ON/OFF portion of OPERATION command Requires CONTROL pin to be asserted for the unit to start and energize the output
	b2 - Control pin	1				1 - Unit requires CONTROL pin to be asserted to start the unit
	b1 - Control pin polarity	0				1 - Active low (Pull low to start the unit)
	b0 - Control pin action	0				0 - Use programmed turn ON/OFF delay
03h	CLEAR_FAULTS	N/A	S	0	N/A	
10h	WRITE_PROTECT	80h	R/W	1	Bitmapped	Used to control writing to the PMBus device 80h - Write protection
15h	STORE_USER_ALL	N/A	S	0	N/A	Needs AC recycle to take effect
20h	VOUT_MODE	17h	R	1	Bitmapped	Specifies the mode and parameters of output voltage related data formats
21h	VOUT_COMMAND	0	R/W	2	Linear (VOUT)	LCC1200-28U: 24 - 30 V LCC1200-36U: 30 - 38 V LCC1200-48U: 42 - 54 V If value is set to 0 V, target voltage will be based from trimmer If value is set between minimum and maximum value, target voltage will be based on VOUT command

Note 1 - Control pin is the INH_ENA input to PSU.

PMBUS™ SPECIFICATIONS

The LCC1200 Series Supported PMBus™ Command List:

Command Code	Command Name	Default Value	Access Type	Data Bytes	Data Format	Description
35h	VIN_ON	87 Vac	R	2	Linear	Sets the value of input, in volts, at which the unit should start
36h	VIN_OFF	80 Vac	R	2	Linear	Sets the value of input, in volts, at which the unit should stop power conversion
40h	VOUT_OV_FAULT_LIMIT	-	R	2	Linear (VOUT)	Tracks SET_POINT input and Vout command (125% of the target output voltage) LCC1200-28U Default: 35 V LCC1200-36U Default: 32.5 V LCC1200-48U Default: 60 V
42h	VOUT_OV_WARN_LIMIT	-	R	2	Linear (VOUT)	LCC1200-28U Default: 31 V LCC1200-36U Default: 39.86 V LCC1200-48U Default: 53.14 V
43h	VOUT_UV_WARN_LIMIT	-	R	2	Linear (VOUT)	LCC1200-28U Default: 13.5 V LCC1200-36U Default: 17.36 V LCC1200-48U Default: 40 V
44h	VOUT_UV_FAULT_LIMIT	-	R	2	Linear (VOUT)	LCC1200-28U Default: 8.4 V LCC1200-36U Default: 10.8 V LCC1200-48U Default: 14.4 V
46h	IOUT_OC_FAULT_LIMIT	-	R	2	Linear	Tracks SET_POINT input and VOUT_COMMAND (115% of rated output current) LCC1200-28U Default: 49.23 A (high line), 28.75 A (low line) LCC1200-36U Default: 38.33 A (high line), 22.36 A (low line) LCC1200-48U Default: 28.75 A (high line), 16.77 A (low line)
4Ah	IOUT_OC_WARN_LIMIT	-	R	2	Linear	LCC1200-28U Default: 47.14 A (high line), 27.5 A (low line) LCC1200-36U Default: 36.67 A (high line), 21.39 A (low line) LCC1200-48U Default: 27.5 A (high line), 16.04 A (low line)
4Fh	OT_FAULT_LIMIT	97.5°C	R	2	Linear	
51h	OT_WARN_LIMIT	95°C	R	2	Linear	
58h	VIN_UV_WARN_LIMIT	86 Vac	R	2	Linear	
59h	VIN_UV_FAULT_LIMIT	80 Vac	R	2	Linear	
6Ah	POUT_OP_WARN_LIMIT	1395 W	R	2	Linear	
78h	STATUS_BYTE	00	R	1	Bitmapped	PMBUs status bits that are supported in the different status registers
	b7 - BUSY					Not support
	b6 - OFF					Unit is OFF
	b5 - VOUT_OV_FAULT					Reflect status 7Ah bit 7, auto clear
	b4 - IOUT_OC_FAULT					Reflect status 7Bh bit 7, auto clear
	b3 - VIN_UV_FAULT					Reflect bit 4 of STATUS_INPUT
	b2 - TEMPERATURE					Reflect STATUS_TEMPERATURE
	b1 - CML					
	b0 - NONE OF THE ABOVE					Not support

PMBUS™ SPECIFICATIONS

The LCC1200 Series Supported PMBus™ Command List:

Command Code	Command Name	Default Value	Access Type	Data Bytes	Data Format	Description
79h	STATUS_WORD	0000	R	2	Bitmapped	PMBus status bits that are supported in the different status registers
	b15 - VOUT					An output voltage fault or warning has occurred
	b14 - IOUT/POUT					An output current or power fault or warning has occurred.
	b13 - INPUT					An input voltage, current or power fault or warning as occurred
	b12 - MFR_SPECIFIC					Not support
	b11 - POWER_GOOD#					The POWER_GOOD signal is de-asserted
	b10 - FANS					Not support
	b9 - OTHER					Not support
	b8 - UNKNOWN					Not support
	b7 - BUSY					Not support
	b6 - OFF					Unit is OFF
	b5 - VOUT_OV_FAULT					Reflect status 7Ah bit 7, auto clear
	b4 - IOUT_OC_FAULT					Reflect status 7Bh bit 7, auto clear
	b3 - VIN_UV_FAULT					Reflect bit 4 of STATUS_INPUT
	b2 - TEMPERATURE					Reflect STATUS_TEMPERATURE
	b1 - CML					
b0 - NONE OF THE ABOVE					Not support	
7Ah	STATUS_VOUT	00	R/W	1	Bitmapped	Output voltage related faults
	b7 - VOUT_OV_FAULT					VOUT over-voltage fault
	b6 - VOUT_OV_LV_FAULT					VOUT over-voltage warning, auto clear
	b5 - VOUT_UV_WARNING					VOUT under-voltage warning, auto clear
	b4 - VOUT_UV_FAULT					
	b3 - VOUT_MAX Warning					Not support
	b2 - TON_MAX_FAULT					Default limit 1 Sec
	b1 - TOFF_MAX_WARNING					Not support
	b0 - VOUT Tracking Error					Not support

PMBUS™ SPECIFICATIONS

The LCC1200 Series Supported PMBus™ Command List:

Command Code	Command Name	Default Value	Access Type	Data Bytes	Data Format	Description
7Bh	STATUS_IOUT	00	R/W	1	Bitmapped	Output current related faults
	b7 - IOUT_OC_FAULT					IOUT Over current fault
	b6 - IOUT_OC_LV_FAULT					This bit will assert only at CC mode
	b5 - IOUT_OC_WARNING					This bit will not assert when CC mode is enabled, auto clear when CV mode
	b4 - IOUT_UC_FAULT					Not support
	b3 - Current Share Fault					Not support
	b2 - In Power Limiting Mode					Not support
	b1 - POUT_OP_FAULT					Not support
	b0 - POUT_OP_WARNING					This bit will not assert when CC mode is enable
7Ch	STATUS_INPUT	00	R/W	1	Bitmapped	Input related faults and warnings
	b7 - VIN_OV_FAULT					VIN over voltage fault, auto clear
	b6 - VIN_OV_WARNING					VIN over voltage warning, auto clear
	b5 - VIN_UV_WARNING					VIN under voltage warning, auto clear
	b4 - VIN_UV_FAULT					VIN under voltage fault, auto clear
	b3 - Unit Off For Insufficient Input Voltage					Absence of or no input condition (not UV), auto clear
	b2 - IIN_OC_FAULT					Not support
	b1 - IIN_OC_WARNING					Not support
	b0 - PIN_OP_WARNING					Not support
7Dh	STATUS_TEMPERATURE	00	R/W	1	Bitmapped	Temperature related faults and warnings
	b7 - OT_FAULT					Over temperature fault
	b6 - OT_WARNING					Over temperature warning
	b5 - UT_WARNING					Not support
	b4 - UT_FAULT					Not support
	b3 : 0					Not support
7Eh	STATUS_CML	00	R/W	1	Bitmapped	
	b7 - Invalid or unsupported command received					
	b6 - Invalid or unsupported data received					
	b5 - Packet error check failed					
	b4 - Memory fault detected					
	b3 - Processor fault detected					Not support
	b2 - Reserved					Not support
	b1 - A communication fault other than the ones listed in this table has occurred.					Not support
b0 - Other memory or logic fault has occurred					Not support	

PMBUS™ SPECIFICATIONS

The LCC1200 Series Supported PMBus™ Command List:

Command Code	Command Name	Default Value	Access Type	Data Bytes	Data Format	Description
80h	STATUS_MFR_SPECIFIC	00	R/W	1	Bitmapped	
88h	READ_VIN	Varies	R	2	Linear	
89h	READ_IIN	Varies	R	2	Linear	
8Bh	READ_VOUT	Varies	R	2	Linear (VOUT)	
8Ch	READ_IOUT	Varies	R	2	Linear	
8Dh	READ_TEMPERATURE_1	Varies	R	2	Linear	Read base SEC temperature
8Eh	READ_TEMPERATURE_2	Varies	R	2	Linear	Read base PRI temperature
96h	READ_POUT	Varies	R	2	Linear	
97h	READ_PIN	Varies	R	2	Linear	
98h	PMBUS_REVISION	22	R	1	Linear	
99h	MFR_ID	ARTESYN	BR	Varies	ASCII	
9Ah	MFR_MODEL	-	BR	Varies	ASCII	# of byte is 14 Default value: LCC1200-28U-XXXX LCC1200-36U-XXXX LCC1200-48U-XXXX
9Bh	MFR_REVISION	-	BR	Varies	ASCII	Default: default value can be found on serial number
9Ch	MFR_LOCATION	-	BR	Varies	ASCII	Linked to FRU, default: "Philippines"
9Dh	MFR_DATE	-	BR	Varies	ASCII	Default: "WW" Default value can be found on serial number
9Eh	MFR_SERIAL	-	BR	Varies	ASCII	Default "MMMMWWSSSSRRL"
A0h	MFR_VIN_MIN	90 Vac	R	2	Linear	Minimum input voltage
A1h	MFR_VIN_MAX	264 Vac	R	2	Linear	Maximum input voltage
A2h	MFR_IIN_MAX	8 A	R	2	Linear	
A3h	MFR_PIN_MAX	1320 W	R	2	Linear	
A4h	MFR_VOUT_MIN	-	R	2	Linear	Minimum output voltage LCC1200-28U Default: 24 V LCC1200-36U Default: 32 V LCC1200-48U Default: 44 V
A5h	MFR_VOUT_MAX	-	R	2	Linear	Maximum output voltage LCC1200-28U Default: 30 V LCC1200-36U Default: 38 V LCC1200-48U Default: 54 V
A6h	MFR_IOUT_MAX	-	R	2	Linear	Maximum output current LCC1200-28U Default: 50 A LCC1200-36U Default: 33.3 A LCC1200-48U Default: 25.0 A
A7h	MFR_POUT_MAX	1200 W	R	2	Linear	Maximum output power
A8h	MFR_TAMBIENT_MAX	50°C	R	2	Linear	Maximum operating ambient
A9h	MFR_TAMBIENT_MIN	-40°C	R	2	Linear	Minimum Operating Ambient
AAh	MFR_EFFICIENCY_LL	-	BR	14	Linear	Default: 100, 700, 90, 700, 90, 700, 90
ABh	MFR_EFFICIENCY_HL	-	BR	14	Linear	Default: 230, 1200, 87, 1200, 87, 1200, 87

PMBUS™ SPECIFICATIONS

The LCM1200 Series Supported PMBus™ Command List:

Command Code	Command Name	Default Value	Access Type	Data Bytes	Data Format	Description
D0h	CONFIG_OUTPUT_SIGNAL_POLARITY	0	R/W	2	Bitmapped	
	b15:2 Reserved	00000000000000				
	b1 - DC_OK					0 - DC_OK pin set to active low 1 - DC_OK pin set to active high
	b0 - AC_OK					0 - AC_OK pin set to active low 1 - AC_OK pin set to active high
D1h	IOUT_COMMAND	0	R/W	2	Linear	LCC1200-28U-XXXX: 2 - 50 A LCC1200-36U-XXXX: 1.5 - 37.5 A LCC1200-48U-XXXX: 1 - 28.57 A If value is set to 0 A, target current will be based from trimmer If value is set between minimum and maximum value, target voltage will be based on IOUT Command
E0h	FW_PRI_VERSION	-	BR	8	ASCII	Varies
E1h	FW_SEC_VERSION	-	BR	8	ASCII	Varies
F1h	ISP_UNLOCK_CODE	-	BR/W	4	ASCII	Default: 00h, 00h, 00h, 00h
F2h	ISP_CTRL_CMD	-	W	1	Bitmapped	Command available in ISP mode
F3h	ISP_STATUS_BYTE	-	R	1	Bitmapped	Varies, command available in ISP Mode
F4h	ISP_FLASH_ADDR	-	BR/W	4	Hex	Varies, command available in ISP Mode
F5h	ISP_FLASH_DATA	-	BR/W	4	Hex	Varies, command available in ISP Mode

APPLICATION NOTES

Current Sharing and Parallel Operation

The LCC1200 series main output is equipped with current sharing capability. This allows up to 3 power supplies to be connected in parallel for higher power application. The power supply is designed with output OR'ing FETs/Diodes built in.

Considering the 10% load sharing tolerance. The table below shows the possible maximum power capacity when units are in parallel configuration.

Max load during start-up in parallel operation is limited to 1200 W.

Number of Units in Parallel (N)	Maximum Output power Rated + [(N-1) x 0.8] x Rated, Where: Rated = 1200 W N = Number of PSU in Parallel
Stand-alone	1200 W
2	2160 W
3	3120 W

Typical sharing percentage of 2 PSU in parallel.

Rail Loading (%)	Sharing Percent Error (%)
25%	30%
50%	15%
75%	15%
100%	10%

$$\text{Percent Err} = \text{ABS} (\text{PSU1} - \text{average current}) / (\text{average current})$$

PSU1 - current delivered by PSU1

PSU2 - current delivered by PSU2

Average current = (PSU1+PSU2)/2

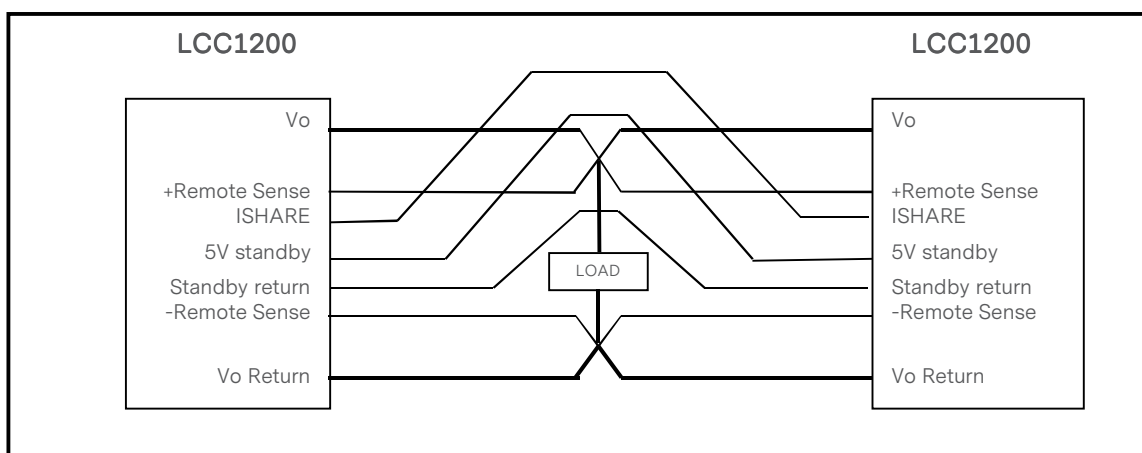

APPLICATION NOTES

Mounting Configurations

Customer can mount the supply in various configurations. Thermals need to be considered in these various mounting and placement.



Vertical Mount
(with either output/input on top or bottom orientation)



Horizontal Mount



Vertical Sideways Mount



Mounted Upside Down

APPLICATION NOTES



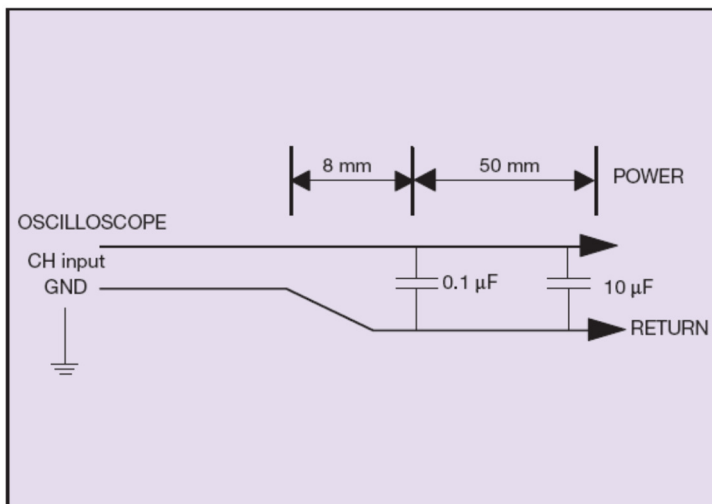

Output Ripple and Noise Measurement

The setup outlined in the diagram below has been used for output voltage ripple and noise measurements on the LCC1200 series when measuring output ripple and noise, a scope jack in parallel with a 0.1 uF ceramic chip capacitor, and a 10 uF tantalum electrolytic capacitor should be used. Oscilloscope should be set to 20 MHz bandwidth for this measurement.

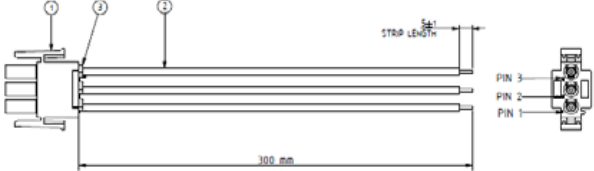

APPLICATION NOTES

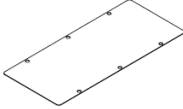
Accessories

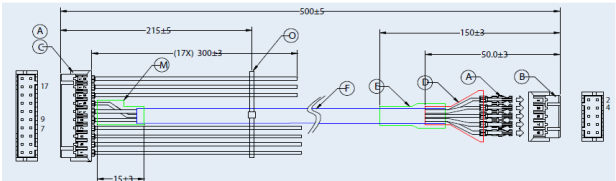
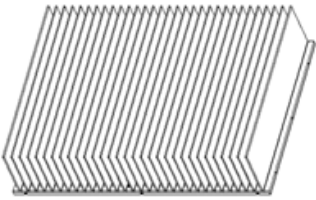
Orderable Part Number	Description	Diagram
70-841-030	For Suffix "-9P" AC Input Mating Connector Cable Assembly (with 0.3 m wire length)	
73-788-001	J1501 (20 Pin Control Signal) Mating Connector with 300mm flying leads (for "-9P" suffix)	
TBD	Pre-Cut thermal insulator (Laird TFLEX HR220FG)	
700-014447-0000	MIL-STD-461F AC input In-line EMI filter (Zhongguang ZGLPG-10-02M)	
73-769-002	USB to I ² C High Speed Adaptor for PMBus Communication	
750-0072130-0000	J1501 (20 Pin) Mating connector with 10 Pin header termination for use with 73-769-002	
TBD	Test Heatsink for unit characterization. Size: 331 x 220 x 69 mm; Aluminum with natural finish; Weight = 1.7 kgs.	

RECORD OF REVISION AND CHANGES

Issue	Date	Description	Originators
1.0	03.02.2022	First Release	K. Ma



For international contact information,
visit advancedenergy.com.

powersales@aei.com (Sales Support)
productsupport.ep@aei.com (Technical Support)
+1 888 412 7832

ABOUT ADVANCED ENERGY

Advanced Energy (AE) has devoted more than three decades to perfecting power for its global customers. AE designs and manufactures highly engineered, precision power conversion, measurement and control solutions for mission-critical applications and processes.

Our products enable customer innovation in complex applications for a wide range of industries including semiconductor equipment, industrial, manufacturing, telecommunications, data center computing, and medical. With deep applications know-how and responsive service and support across the globe, we build collaborative partnerships to meet rapid technological developments, propel growth for our customers, and innovate the future of power.

PRECISION | POWER | PERFORMANCE

Specifications are subject to change without notice. Not responsible for errors or omissions. ©2022 Advanced Energy Industries, Inc. All rights reserved. Advanced Energy®, and AE® are U.S. trademarks of Advanced Energy Industries, Inc.