

Firestone

World's Number 1
Air Spring.



FIRESTONE INDUSTRIAL PRODUCTS COMPANY

2016 Air Spring Replacement Catalog



800.888.0650 • firestoneip.com

The True Value of a Leader: Quality, Reliability & Service

The Firestone brand is internationally known and respected. We are the industry leader with a large base of customers we're proud to call loyalists. So whether you're looking for OEM, aftermarket or industrial application solutions, you can trust Firestone's quality, reliability and unparalleled service. It's value for the long haul.

Quality

Firestone Industrial Products are engineered to meet the strictest local standards, globally. We engineer and manufacture each product to provide years and thousands of miles of trouble-free service. Our extensive product development process has resulted in applying automotive technology to our heavy-duty products. Our innovations span many additional technologies from electronic sensors to higher strength fabrics and compounds—in addition to rigorous testing unmatched by any other manufacturer. It's an obsession with quality you can only expect from a leader.



Reliability

Firestone Industrial Products allow you to buy with confidence. No one has more stringent production and testing standards than we do. In fact, Firestone air springs often outlast other maintenance items on your suspension, such as bushings, shocks, leveling valves or regulators. It's a commitment that we're willing to stand by. Not only do we have an industry-leading warranty, we also have the lowest warranty claim rates in the industry. Now that's reliability you can count on.

Service

Firestone Industrial Products has the global service to match our global production. From our engineers to our customer service line, we pride ourselves on being a true partner, not just a vendor. And with global testing and R&D facilities, we ensure the partnership remains a close one.

As problem solvers, our expertise extends to your business as a whole, not just air spring technology. Our engineering department is your engineering department and if we don't make what you need, we can engineer it. Our customer service line is so dependable and knowledgeable that our competitors often use us to cross reference parts. And no one offers more training to aftermarket staffs than Firestone. Because we strongly believe it takes world-class people to make world-class products.

The information contained in this publication is intended to provide a general guide for the identification and application of these products. The material, herein, was compiled from our close working relationship with the OEM suspension manufacturers and is believed to be reliable and accurate. Firestone, however, makes no warranty, expressed or implied, of this information. Anyone making use of this information does so at his own risk and assumes all liability resulting from such use. It is suggested that competent professional assistance be employed for specific applications.

Table of Contents

Although air springs are produced in single, double and triple convoluted and reversible sleeve styles, only those manufactured by Firestone Industrial Products Company bear the trademark "Airide™."

Airide springs were pioneered and perfected by Firestone, and only Firestone offers a complete line of Airide springs, with replacement springs available for virtually every vehicular air suspension system. Today, Airide springs are used by practically all manufacturers who offer air suspension on their vehicles.

While it may appear simple, an air spring is actually a highly sophisticated and complex product. Even slight changes in design, methods of construction, or materials used can make vast and significant differences in performance.

It makes good sense to specify Airide springs by Firestone. That trade name on an air spring guarantees you the benefit of the very latest technical developments and improvements. It is your assurance of a product not only engineered and perfected to perform, but which also has a long history of superior performance in actual use.



Firestone Airide™ springs.....	1
Components of Airide springs.....	2
Identifying Airide springs.....	3
General Specifications.....	4

I. New Parts	
1T Reversible Sleeve Style Springs	5-6
II. 1T Reversible Sleeve Style Springs	
Reading the Parts Table.....	7-8
Parts Tables.....	9-104
III. Convoluted Style Springs	
Reading the Parts Table.....	106-107
Single Convoluted.....	108-111
Double Convoluted.....	111-133
Triple Convoluted.....	133-143
IV. Sleeve Style Springs	
(Cab, Seat & Miscellaneous Applications)	
Reading the Parts Table.....	144
Components of Sleeve style springs	145
Parts Tables by Logo Color.....	146-165
V. Cross Reference Information	
Sleeve Cross Reference by Manufacturer	166-168
Sleeve by Cap and Piston Drawing No.	169-170
Sleeve by Cap and Piston Component No.	171-172
1T & Convoluted Manufacturer to Firestone No.	173-191
OE Suspension Index.....	192-197
1T & Convoluted Goodyear to Firestone Number	198-207
1T & Convoluted Contitech Assembly to Firestone	208-214
1T & Convoluted Bellows Indexes.....	215-221
1T Piston Indexes.....	222-241
All Parts Assembly Order Number Index.....	242-248
VI. Miscellaneous	
Warranty.....	249-252
Alignment Definitions.....	253

New Parts

1T Style Springs

Convoluted Style Springs

Sleeve Style Springs

Cross Reference

The Components of Airide™ springs

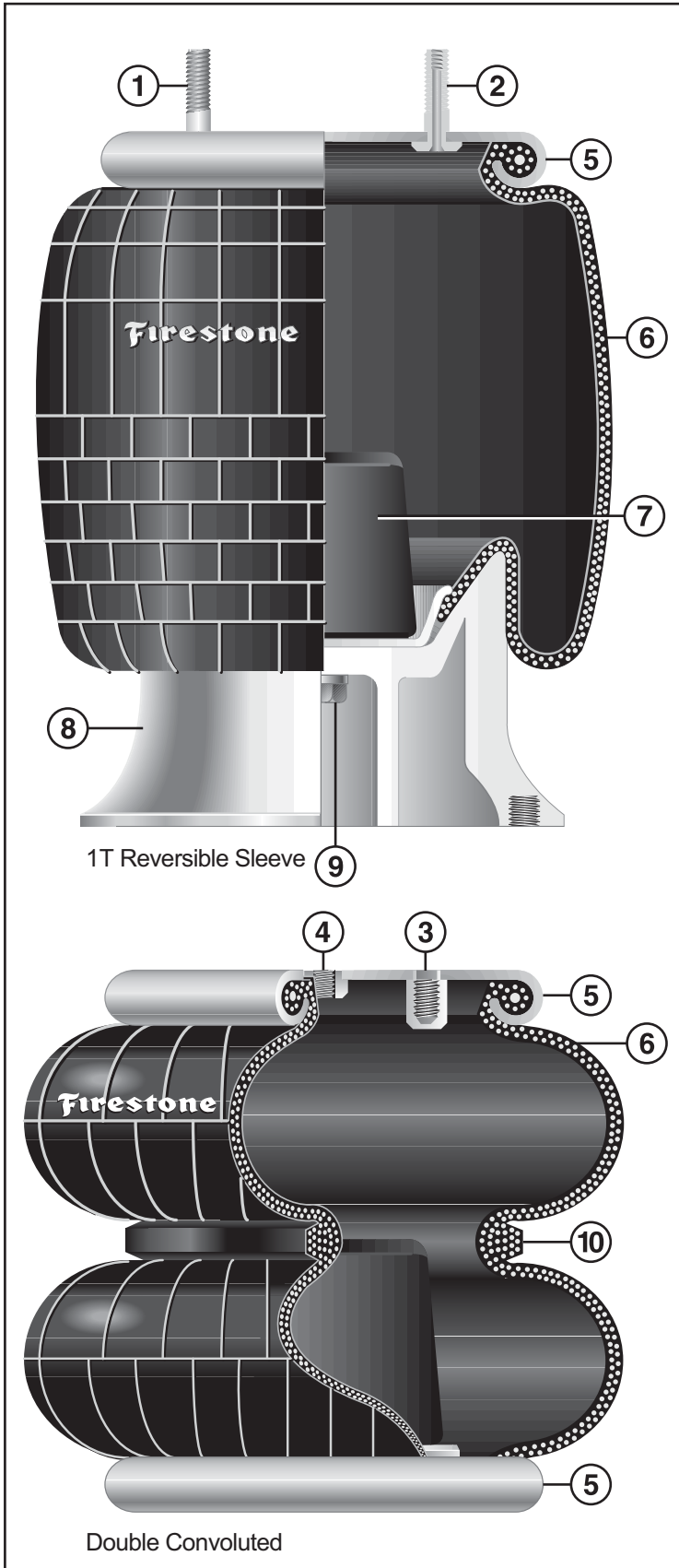

- 1. Stud**
A permanent part of the bead plate assembly used to attach the airspring to the suspension.
- 2. Combo Stud**
Combination mounting stud and air fitting.
- 3. Blind Nut**
A permanent part of the bead plate assembly providing an alternate mounting system to the stud.
- 4. Air Fitting Hole**
A tapped hole usually 1/4" N.P.T. providing air entrance for the part.
- 5. Bead Plate**
Permanently crimped onto the bellows at the factory allowing complete part leak testing prior to shipment.
- 6. Bellows**
The heart of an Airide spring. Includes at least four plies, or layers, of material—an inner layer, two plies of cord-reinforced fabric, and an outer layer.
- 7. Bumper (Optional)**
A solid molded rubber fail-safe device used on many suspension applications. Prevents excessive damage to vehicle and suspension in the case of sudden air pressure loss.
- 8. Piston**
The lower section of the 1T and 1X style of airspring made from aluminum, steel or fiber reinforced plastic. Provides lower mounting arrangement for the airspring in the form of tapped holes or studs.
- 9. Piston Bolt**
Attaches the piston to the bellows assembly. Extended, in some cases, to serve as a means of attaching the spring to the suspension.
- 10. Girdle Hoop**
A ring between the convolutions of the convoluted-type air spring.

Service Assembly

On Firestone Airide springs of the 1T style, the rubber bellows bead plate portion of the spring is a separate hermetically sealed unit, available for replacement use without the piston. Called a "service assembly," it includes a bead plate, bellows, internal bumper (if any), and all attaching hardware.

Identifying Airide™ springs



1. Read AON and bellows number.

The first step to identifying an Airide™ spring for replacement is to read the assembly order number on the label adhered to the bead plate (i.e., W01-358-9082). If the number is illegible, read the bellows number which is normally molded directly underneath the Firestone logo. A style number such as 1T15M-6 or 22 would tell exactly which bellows is needed and one could skip steps 2 and 3.

If the bellows number is illegible, then determine whether it is a convoluted style or a 1T style by comparing it to the pictures in this guide. Proceed to step 2 if 1T style or step 3 if convoluted.

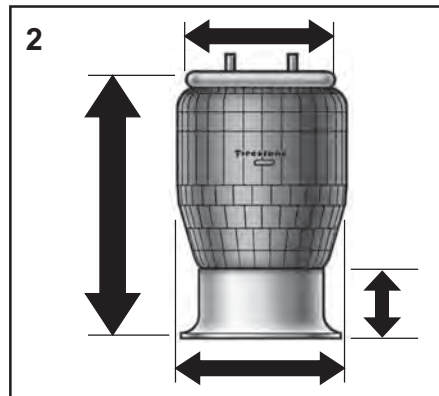

2. 1T Style

Measure the bead plate diameter and molded (**uninflated**) diameter of the rubber bellows and compare this with the 1T styles in the bellows index until a match is found (please note that the molded diameter can grow slightly with years of service). Then measure from the bottom of the piston to the top of the bead plate while the part is **uninflated** and **extended**. Next, find this same or similar measurement in the specific bellows section that was previously determined. When this has been done, skip to step 4. If the piston number is illegible in step 5, measure the piston height and compare it to pictures with the same dimensions.

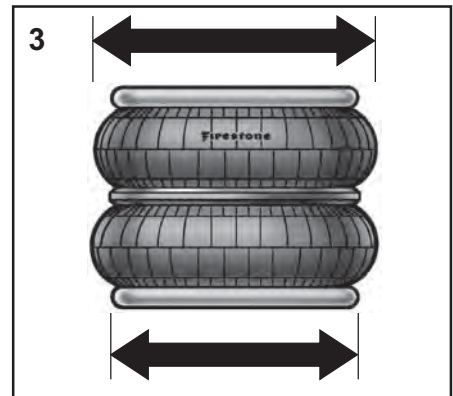

3. Convoluted style

First determine whether it is a single, double, or triple convoluted style by comparing it to the pictures in this guide. Then measure the bead plate diameter and the diameter of the bellows (**uninflated**) across its widest area and compare these dimensions with those given in the bellows index. Once a match has been made, proceed to step 4.

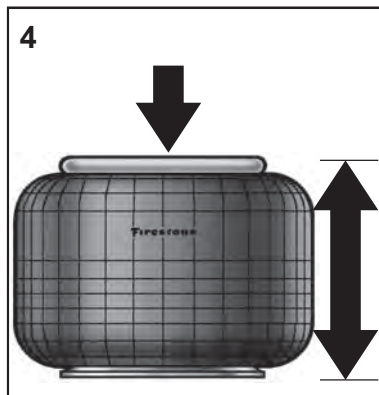

4. Rubber Bumper

Many Airide™ springs include a rubber bumper inside the spring. To determine if one is present, compress the spring to its minimum height and measure from the bottom plate or piston to the top of the bead plate.

Compare this compressed height with the pictures in the appropriate bellows section that was determined in step 2 (1T style) or step 3 (convoluted style). Proceed to step 5 if you have a 1T style spring or step 6 if you have a convoluted spring.

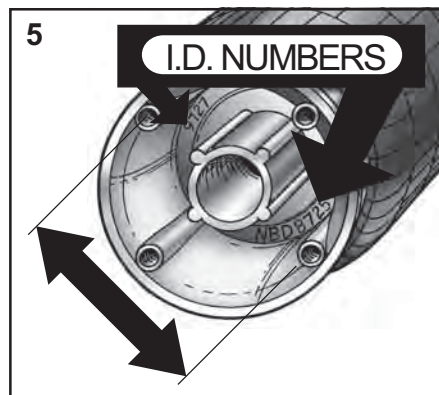

5. 1T style (bead plate and piston)

The same bellows is used with many different combinations of bead plates and pistons, so be sure to check closely. Compare the bead plate and piston with the pictures from the "Cross Section View", "Bead Plate Top View" and "Piston Bottom View" columns from the appropriate bellows section that was previously determined. Also, verify that the alignment (bead plate mounting in reference to piston mounting holes) is correct.

In addition, the piston can be further verified by reading the identification numbers inside the piston and comparing these with those shown in the "Piston Bottom View" or piston index. Once a match has been determined, the corresponding assembly order number (i.e. W01-358-9082) can be used to order the part.

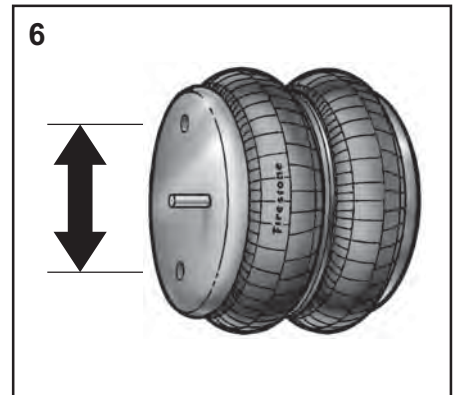

6. Convoluted style (bead plates)

The same bellows is used with many different combinations of bead plates. Compare these bead plates with those diagrammed in this guide under the "Bead Plate Top View" and "Bead Plate Bottom View" columns for the specific style convoluted part that was previously determined and find the unit with the identical hardware, measurements and alignment (top bead plate mounting in reference to lower bead plate mounting). Once a match has been determined, the corresponding assembly order number (e.g., W01-358-7135) can be used to order the part.

General Specifications

Fastener Tightening Specifications

Description	Size	Torque (lb-ft)
· Bead ring nuts on bolts	5/16-24	17-22
· Bead ring bolts and nuts	3/8-24	28-32
· Bolts in blind nuts in bead plates	3/8-16	15-20
· End of adapter studs in blind nut	3/8-16	15-20
· Nut on end of adapter stud	1/2-13	25-30
· Studs on bead plates or blind nuts	1/2-13 or 1/2-20 M12 x 1.75	25-30
· Bolt to attach piston base to lower mounting surface	1/2-13	25-30
· Nut on air entrance stud	3/4-16 M16 x 1.5 M20 x 1.5	40-45
· Nut to an entrance stud	1 5/16-12UNF 1 1/4-12UNF	45-50
· NPT air supply fitting	1/4 & up	17-22
· Nut on end closure lower mounting	3/4-10	45-50

Operational Cautions

Air spring failure can be caused by a variety of situations, including internal or external rubbing, excessive heat and overextension. For further details, refer to Warranty Considerations.

Temperature/Pressure Range

The ambient operating temperature range for standard vehicular air springs may vary. See the website for temperature ranges for individual parts by part number. The maximum pressure is 100 psi.

Bumpers

In general, bumpers are used to support the vehicle weight to prevent damage to the flexible member during times when no air is in the system. They are also used as stops when the axle is raised by a lift unit. In applications that require frequent bumper contact, consult Firestone.

Down and Up Stops

Positive stops in both directions (compression and extension) should always be used with Airide™ springs.

1. In COMPRESSION, the minimum height shown for each air spring is at, or slightly above the PINCH POINT of the bellows. Here is a #22 shown in the collapsed or "pinch point" condition:

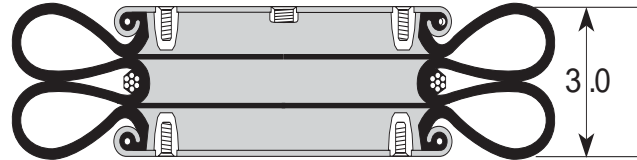

The bellows can be damaged if allowed to constantly bottom out as shown above; therefore, a downstop is required to prevent this. An external downstop can be something as simple as a steel block and should be sized at or slightly greater than the minimum height of the Airide™ spring. In our #22 example, the block would need to be at least 3.0 inches high. If an external downstop cannot be used, many parts are available with internal rubber bumpers.

2. In EXTENSION, an upstop is necessary to prevent the air spring from overextending. The reasons for this are twofold:
 - a) the life of the bellows may be reduced, and
 - b) the crimp may open up, allowing the bellows bead to blow out of the metal end closure. There are many ways to design-in an upstop, including:
 - a. shocks,
 - b. a chain,
 - c. a cable or strap,
 - d. contacting a metal stop, etc.

Contaminates

Shielding should be used to protect the bellows from exposure to hot metal, sand, petroleum base fluids, acids, etc. Please consult Firestone if you wish to know how the bellows will withstand a specific contaminant (For liquids such as acids, it is important to know both concentration and temperature.)

Storage

The best storage environment is a dark, dry area at normal room temperature.

WARNING

DO NOT INFLATE ASSEMBLY WHEN IT IS UNRESTRICTED. ASSEMBLY MUST BE RESTRICTED BY SUSPENSION OR OTHER ADEQUATE STRUCTURE. DO NOT INFLATE BEYOND PRESSURES RECOMMENDED IN DESIGN LITERATURE (CONTACT FIRESTONE FOR INFORMATION). IMPROPER USE OR OVERINFLATION MAY CAUSE ASSEMBLY TO BURST CAUSING PROPERTY DAMAGE OR SEVERE PERSONAL INJURY.

BELLOW NO. ASSEMBLY ORDER NO.	CROSS SECTION VIEW	BEAD PLATE TOP VIEW	PISTON BOTTOM VIEW	ASSEMBLY WEIGHT (lbs.)	REPLACES
1T15M-6 W01-358-1096		3226 LOCATING PIN	9656/NBD-10440 Order No. WC1-358-0652	14.5	
1T15XMR-7 W01-M58-8463 BRACKET 70-3582-6070		2959 LOCATING PIN	4008/FIP-101526 	14.7	Volvo 20733034 Goodyear 1R12-647
1T15XMR-7 W01-M58-8468		2960 LOCATING PIN	4008/FIP-101526 	14.7	Volvo 21132005 Goodyear 1R12-654
1T15XMR-7 W01-M58-9741		2960 LOCATING PIN	4060/FIP-103138 	14.7	Volvo 21627074 Goodyear 1R12-1039
1T17GJ-6 W01-358-8539		3301 LOCATING PIN	9594 / NAD-28384 	30.6	Dana/Spicer SR1VA101-1 SR1VA105

New Parts
1T Style Springs

Hardware Key

- Bolt or Stud 1/2-13
- ⊕ Threaded Hole 3/8-16 Blind Nut on Bead Plates 1/2-13 Pistons
- ⊗ Air Inlet 1/4 N.P.T.
- ▲ No Alignment Specified-Center Stud Mounting is Standard
- ⊗ Combination Stud/Air Inlet Stud Outside Thread is 3/4-16
- ⊗ Studs Inside Thread (Air Inlet) is 1/4 N.P.T. Exceptions Will Be Noted on Part View as ⊗

Firestone

BELLOW NO. ASSEMBLY ORDER NO.	CROSS SECTION VIEW	BEAD PLATE TOP VIEW	PISTON BOTTOM VIEW	ASSEMBLY WEIGHT (lbs.)	REPLACES
1T19LG-8 W01-358-5530		2819 	9766/NAD-28978 	19.13	Neway 90557434
1T19ZK-5.7 W01-358-5523		3196 	9644/NAD-31862 	21.7	Hend. Trailer S-4771 Hend Canada B-12514-013 Tuthill-Reyco 23631-01 WatsonChalin AS-0039 Supersedes 1T19J-6

Hardware Key

- Bolt or Stud 1/2-13
- ⊕ Threaded Hole 3/8-16 Blind Nut on Bead Plates 1/2-13 Pistons
- ⊗ Air Inlet 1/4 N.P.T.
- ▲ No Alignment Specified-Center Stud Mounting is Standard
- ⊗ Combination Stud/Air Inlet Stud Outside Thread is 3/4-16
- ⊗ Studs Inside Thread (Air Inlet) is 1/4 N.P.T. Exceptions Will Be Noted on Part View as ⊗

Reading the parts table for 1T-reversible sleeve style springs

1	2	3	4	5	6
BELLOW # ASSEMBLY ORDER NO.	CROSS SECTION VIEW	BEAD PLATE TOP VIEW	PISTON BOTTOM VIEW	ASSEMBLY WEIGHT	REPLACES
1T15L-4 W01-358-9415 Service Assembly #0701				17.47	Kenworth K-303-5
Hardware Key ● Bolt or Stud 1/2-13 ◐ Threaded Hole 3/8-16 Blind Nut on Bead Plates 1/2-13 Pistons ◑ Air Inlet 1/4 N.P.T. ▲ No Alignment Specified-Center Stud Mounting is Standard. ◑ Combination Stud/Air Inlet Stud Outside Thread is 3/4-16 ◑ Studs Inside Thread (Air Inlet) is 1/4 N.P.T. Exceptions Will Be Noted on Part View as ◑					

1T Style Springs

1. Bellows # and Assembly Order Number (AON)

This number identifies the specific bellows number and the assembly order number for ordering purposes. Complete Order No. for any type of electronic ordering (EDI) is W01-358-9415.

2. Airide Cross Section View

A cross sectional view of the Airide spring showing dimensional information in inches on **uninflated** diameter, maximum height, and collapsed height. A bumper drawing number is also referenced, if applicable (e.g.—3159).

3. Bead Plate—Top View

A top view of the upper bead plate with dimensional information and detail on mounting attachments (see hardware key). An Internal Firestone Reference Number is also shown.

4. Piston—Bottom View

A bottom view of the piston with dimensional information and detail on mounting attachments (see hardware key). The Internal Firestone Reference Number (4 digit) and the piston drawing number are also shown. Both of these numbers are molded in the underside of the piston for identification purposes. If available, a 4 digit order number is shown to order the piston separately (complete number for EDI purposes, WC1-358-0606).

5. Assembly Weight

Gives total weight of the assembly in pounds.

6. Replaces

Vehicle and suspension manufacturers' part numbers for the particular Airide springs.

7. Service Assembly

On Firestone Airide springs of the 1T style, the rubber bellows bead plate portion of the spring is a separate hermetically sealed unit, available for replacement use without the piston. Called a "service assembly," it includes a bead plate, bellows, internal bumper (if any), and all attaching hardware. Please note the service assembly has its own separate ordering number. For example, a W01-358-9082 uses Service Assembly Order Number W01-358-0712.

1T Reversible Sleeve Style



The Firestone 1T or Reversible Sleeve type spring is the most popular style used on suspensions. Most replacement work will probably be with this style.

Identification of the proper replacement assembly requires identifying the bellows type and the bead plate and piston type used, as well as whether the spring includes an internal rubber bumper.

As with other styles, the quickest way to identify the airspring is to read the manufacturer or Firestone order number on the bead plate. If the number is illegible, read the part number molded on the bellows, normally directly under the Firestone name. This will lead you directly to the proper section of the guide, narrowing your choice of assemblies to just a few.

Should the bellows number be unreadable, the type can still be determined by measuring the bead plate diameter and the bellows diameter (**uninflated**) and comparing this with the 1T styles in the bellows index until you find a match. Then measure the extended height as shown and compare this measurement with the maximum height shown in the "Cross Section View" of the parts tables for the general style of bellows (1T14, 1T15, 1T17 etc.) that was previously determined.

To determine whether the spring has an internal bumper, remove the air and compress the spring to its minimum collapsed height. Measure this, as shown, and compare it to the minimum height shown in the parts tables.

Finally, to complete identification of the assembly, carefully compare the bead plate and piston with those listed in the tables until you find a match.

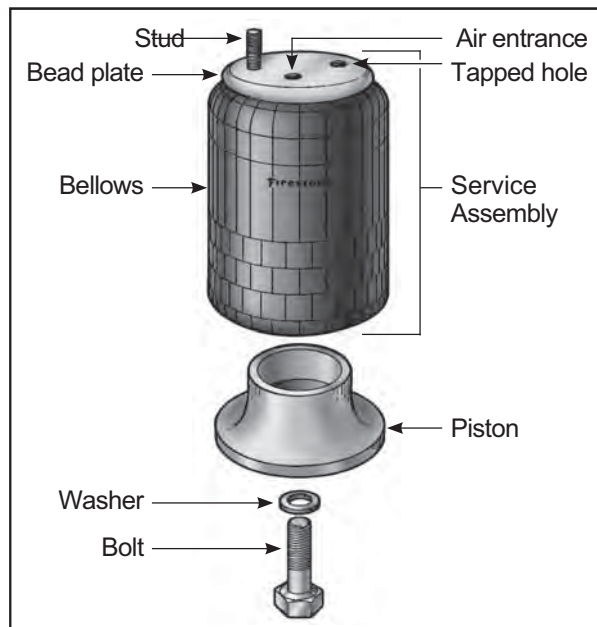

Service Assembly Most 1T style springs are available as either a complete assembly, including the piston, or as a service assembly, which includes the bellows and bead plate only. Before you order a service assembly only, we advise close inspection of the piston to be reused. A slight imperfection or build-up of corrosion or dirt on the piston may cause a new bellows to wear out prematurely.

Special Note Further information on pistons used with 1T style springs can be found in the Piston Index section of this catalog.

In addition to the center attaching hole, most newer pistons have four threaded holes in the outer diameter to make the piston more universal. All of the outer holes may not be used in some cases. Check the drawing for the assembly you are replacing to be sure.

Some pistons are also supplied with threaded studs inserted in the proper mounting holes on the piston. Be certain to check the listings for this feature as well.

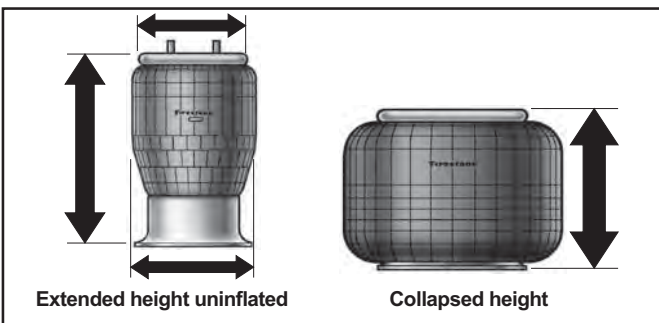

1T - Reversible Sleeve

BELLOW NO. ASSEMBLY ORDER NO.	CROSS SECTION VIEW	BEAD PLATE TOP VIEW	PISTON BOTTOM VIEW	ASSEMBLY WEIGHT (lbs.)	REPLACES
1T14C-1 W01-358-2119		3093 	9491/FIP-100744 Order No. WC1-358-0609	5.9	Granning 5122 Hendrickson Trailer S2394 Rowe Truck ASC1400HL Lift
1T14C-1 W01-358-2120		3148 	9651/NBD-11498 Order No. WC1-358-9095	7.0	Granning 5691 Granning 6104 (no stud) Rowe Truck ASCS2000 Lift Rowe Trailer ASCST2000
1T14C-1 W01-358-2131		3140 	9491/FIP-100744 Order No. WC1-358-0609	5.9	Kelderman
1T14C-1 W01-358-5310		3079 	9708/NBD-8626 Order No. WC1-358-0600	6.4	American Carrier 9003-001 Hendrickson Trailer S8832 Ridewell 1003585310C Circle R
1T14C-1 W01-358-5311		3079 	9708/NBD-8626 Order No. WC1-358-0600	6.7	Ridewell 1003585311C

1T Style Springs

Hardware Key

- Bolt or Stud 1/2-13 ⊕ Threaded Hole 3/8-16 Blind Nut on Bead Plates 1/2-13 Pistons ⊗ Air Inlet 1/4 N.P.T. ▲ No Alignment Specified-Center Stud Mounting is Standard
- ⊗ Combination Stud/Air Inlet Stud Outside Thread is 3/4-16 Studs Inside Thread (Air Inlet) is 1/4 N.P.T. Exceptions Will Be Noted on Part View as ⊗

Firestone

BELLOW NO. ASSEMBLY ORDER NO.	CROSS SECTION VIEW	BEAD PLATE TOP VIEW	PISTON BOTTOM VIEW	ASSEMBLY WEIGHT (lbs.)	REPLACES
1T14C-1 W01-358-5323		3148 	9708/NBD-8626 Order No. WC1-358-0600	6.8	Air Ax (Roelofs) Granning 7504 Ridewell 1003585323C
1T14C-1 W01-358-5328 OBSOLETE REPLACED BY W01-358-5311		3079 	9708/ NBD-8626 ORDER NO. WC1-358-0600	6.9	American Carrier 8003-017
1T14C-1 W01-358-5343		3079 	9651/NBD-11498 Order No. WC1-358-9095	6.5	Iveco 504035755
1T14C-3 W01-358-5405		3079 	9708/NBD-8626 Order No. WC1-358-0600	6.6	Circle R Hendrickson Trailer S9346
1T14C-3 W01-358-5406		3140 	9708/NBD-8626 Order No. WC1-358-0600	6.7	Granning 1971

Hardware Key

- Bolt or Stud 1/2-13 ⊕ Threaded Hole 3/8-16 Blind Nut on Bead Plates 1/2-13 Pistons ⊗ Air Inlet 1/4 N.P.T. ▲ No Alignment Specified-Center Stud Mounting is Standard
- ⊗ Combination Stud/Air Inlet Stud Outside Thread is 3/4-16 Studs Inside Thread (Air Inlet) is 1/4 N.P.T. Exceptions Will Be Noted on Part View as ⊗

1T - Reversible Sleeve

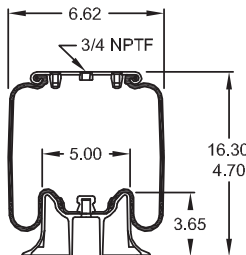
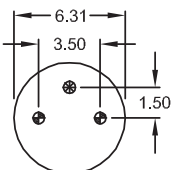
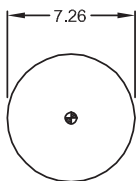
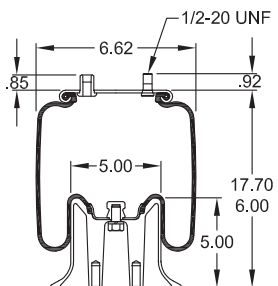
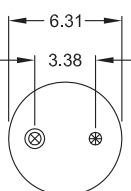
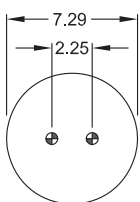
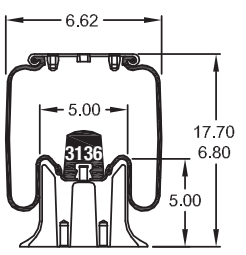
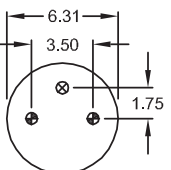
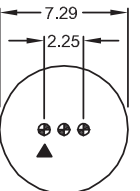
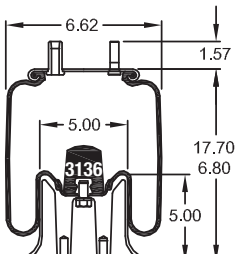
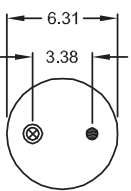
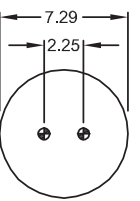
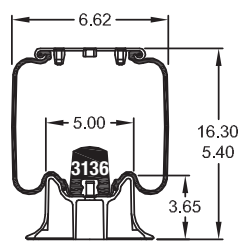
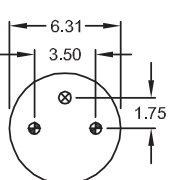
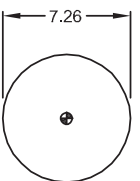
BELLOW NO. ASSEMBLY ORDER NO.	CROSS SECTION VIEW	BEAD PLATE TOP VIEW	PISTON BOTTOM VIEW	ASSEMBLY WEIGHT (lbs.)	REPLACES
1T14C-3 W01-358-5408		3096 	9708/NBD-8626  Order No. WC1-358-0600	6.3	Jet Company
1T14C-3 W01-358-5410		3140 	9778/NAD-18053  Order No. WC1-358-0686	8.0	Granning 2112 Watson & Chain AS-0029 Ridewell 1003585410C
1T14C-3 W01-358-5412		3079 	9778/NAD-18053  Order No. WC1-358-0686	8.2	American Carrier 8003-011 Oshkosh Neway 90057057
1T14C-3 W01-358-5414		3148 	9778/NAD-18053  Order No. WC1-358-0686	8.6	Air AX (Roelofs) Ridewell 1003585414C
1T14C-3 W01-358-5422		3079 	9708/NBD-8626  Order No. WC1-358-0600	6.9	Circle R

1T Style Springs

Hardware Key

- Bolt or Stud 1/2-13 ⊕ Threaded Hole 3/8-16 Blind Nut on Bead Plates 1/2-13 Pistons ⊗ Air Inlet 1/4 N.P.T. ▲ No Alignment Specified-Center Stud Mounting is Standard
- ⊗ Combination Stud/Air Inlet Stud Outside Thread is 3/4-16 Studs Inside Thread (Air Inlet) is 1/4 N.P.T. Exceptions Will Be Noted on Part View as ⊗

Firestone

BELLOW NO. ASSEMBLY ORDER NO.	CROSS SECTION VIEW	BEAD PLATE TOP VIEW	PISTON BOTTOM VIEW	ASSEMBLY WEIGHT (lbs.)	REPLACES
1T14C-3 W01-358-5423		3148 	9651/NBD-11498 Order No. WC1-358-9095	7.2	Granning 5235 Granning 5307 (no stud) Rowe Truck ASC1500/ASC1500/ ASC2000 Lift Rowe Trailer ASCT1500/ ASCST1500/ ASCST2000
1T14C-3 W01-358-5433		3102 	9778/NAD-18053 Order No. WC1-358-0686	8.2	Watson & Chain AS-0069
1T14C-3 W01-358-5434		3148 	9708/NBD-8626 Order No. WC1-358-0600	7.3	Granning 7765
1T14C-3 W01-358-5436		3148 	9708/NBD-8626 Order No. WC1-358-0600	7.4	Granning 7831
1T14C-3 W01-358-9478		3140 	9493/FIP-100743 Order No. WC1-358-0754	6.8	Granning 6250

Hardware Key

- Bolt or Stud 1/2-13
- ⊕ Threaded Hole 3/8-16 Blind Nut on Bead Plates 1/2-13 Pistons
- ⊗ Air Inlet 1/4 N.P.T.
- ▲ No Alignment Specified-Center Stud Mounting is Standard
- ⊗ Combination Stud/Air Inlet Stud Outside Thread is 3/4-16
- ⊗ Studs Inside Thread (Air Inlet) is 1/4 N.P.T. Exceptions Will Be Noted on Part View as ⊗

1T - Reversible Sleeve

BELLOW NO. ASSEMBLY ORDER NO.	CROSS SECTION VIEW	BEAD PLATE TOP VIEW	PISTON BOTTOM VIEW	ASSEMBLY WEIGHT (lbs.)	REPLACES
1T14C-5 W01-358-5335		3140 	9778/NAD-18053 Order No. WC1-358-0686	8.8	General Coach
1T14C-5 W01-358-5336 TANK VALVE WC1-358-0009		3148 	9778/NAD-18053 Order No. WC1-358-0686	8.5	John Deere AH160823
1T14C-5 W01-358-5354		3148 	9651/NBD-11498 Order No. WC1-358-9095	8.5	Rowe Truck
1T14C-5 W01-358-8868		3106 	9651/NBD-11498 Order No. WC1-358-9095	7.1	Hendrickson 57965-2 (reuse old bracket) Supersedes Hendrickson 57839 Hendrickson 57920-2 w/bracket Includes Bracket 57966-2 (left) 57967-2 (right)
1T14C-6 W01-358-5439		3148 	9754/NBD-11689 Order No. WC1-358-1603	10.3	Link 1103-0500 UltraRide

1T Style Springs

Hardware Key

- Bolt or Stud 1/2-13 ⊕ Threaded Hole 3/8-16 Blind Nut on Bead Plates 1/2-13 Pistons ⊗ Air Inlet 1/4 N.P.T. ▲ No Alignment Specified-Center Stud Mounting is Standard
- ⊗ Combination Stud/Air Inlet Stud Outside Thread is 3/4-16 Studs Inside Thread (Air Inlet) is 1/4 N.P.T. Exceptions Will Be Noted on Part View as ⊗





Firestone

BELLOW NO. ASSEMBLY ORDER NO.	CROSS SECTION VIEW	BEAD PLATE TOP VIEW	PISTON BOTTOM VIEW	ASSEMBLY WEIGHT (lbs.)	REPLACES
1T14C-6 W01-358-8875		3096 	9754/NBD-11689 Order No. WC1-358-1603	10.4	
1T14C-6 W01-358-8977		3148 	9754/NBD-11689 Order No. WC1-358-1603	10.4	Granning 5301 General Coach Air Ax (Roelofs)
1T14C-6 W01-358-8979		3148 	9754/NBD-11689 Order No. WC1-358-1603	10.0	Granning 5553
1T14C-7 W01-358-5426		3148 	9778 / NAD-18053 ORDER NO. WC1-358-0686	9.1	Granning 6117
1T14C-7 W01-358-5702		3148 	9754 / NBD-11689 ORDER NO. WC1-358-1603	10.3	Granning 8609

Hardware Key

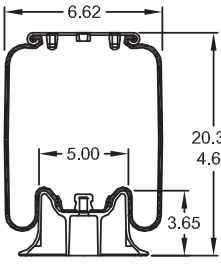
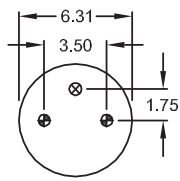
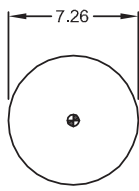
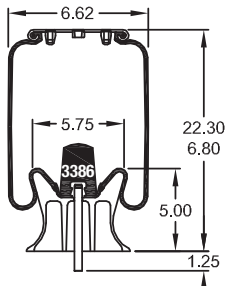
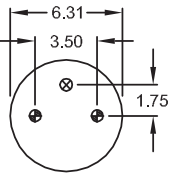
- Bolt or Stud 1/2-13
- ⊕ Threaded Hole 3/8-16 Blind Nut on Bead Plates 1/2-13 Pistons
- ⊗ Air Inlet 1/4 N.P.T.
- ▲ No Alignment Specified-Center Stud Mounting is Standard
- ⊗ Combination Stud/Air Inlet Stud Outside Thread is 3/4-16
- ⊗ Studs Inside Thread (Air Inlet) is 1/4 N.P.T. Exceptions Will Be Noted on Part View as ⊗

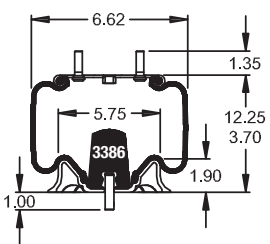
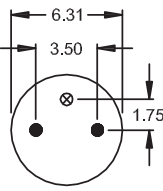
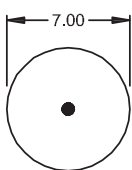
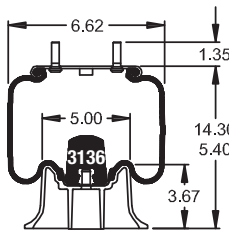
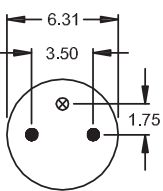
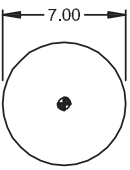
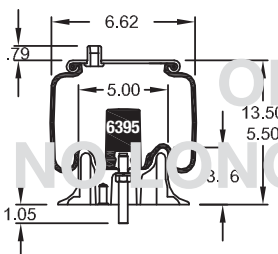
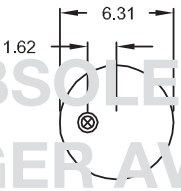
1T - Reversible Sleeve

BELLOW NO. ASSEMBLY ORDER NO.	CROSS SECTION VIEW	BEAD PLATE TOP VIEW	PISTON BOTTOM VIEW	ASSEMBLY WEIGHT (lbs.)	REPLACES
1T14C-7 W01-358-5712		3079 	9708 / NBD-8626 	7.1	Capacity of Texas
			ORDER NO. WC1-358-0600		
1T14C-8 W01-358-5429		3079 	9754/NBD-11689 	10.6	Silent Drive
			ORDER NO. WC1-358-1603		
1T14CB-1 W01-358-5297		3101 	9491/FIP-100744 	5.8	Watson & Chalin AS-0106
			Order No. WC1-358-0609		
1T14CB-1 W01-358-5319		3101 	9493/FIP-100743 	6.1	Monaco Coach 8618
			Order No. WC1-358-0754		
1T14CB-1 W01-358-8872 OBSOLETE			9651/ NBD-11498 	6.6	Hendrickson 64827-2
			ORDER NO. WC1-358-9095		

1T Style Springs

Hardware Key

- Bolt or Stud 1/2-13
- ⊕ Threaded Hole 3/8-16 Blind Nut on Bead Plates 1/2-13 Pistons
- ⊗ Air Inlet 1/4 N.P.T.
- ▲ No Alignment Specified-Center Stud Mounting is Standard
- ⊗ Combination Stud/Air Inlet Stud Outside Thread is 3/4-16
- ⊗ Studs Inside Thread (Air Inlet) is 1/4 N.P.T. Exceptions Will Be Noted on Part View as ⊗

Firestone

BELLOW NO. ASSEMBLY ORDER NO.	CROSS SECTION VIEW	BEAD PLATE TOP VIEW	PISTON BOTTOM VIEW	ASSEMBLY WEIGHT (lbs.)	REPLACES
1T14CB-1 W01-358-8876		3148 	9491/FIP-100744 Order No. WC1-358-0609	5.5	
1T14CB-1 W01-358-8992		3148 	9491/FIP-100744 Order No. WC1-358-0609	5.9	Ridewell 1003588992C
1T14CB-1 W01-358-8997		3148 	9491/FIP-100744 Order No. WC1-358-0609	6.0	Holland (Neway) 90557034 90557029 Watson & Chalin (AS-0026) Ridewell 1003588997C Silent Drive
1T15AA-3 W01-358-9589 OBSOLETE REPLACED BY W01-358-8478		3201 	9757/ NBD-9242 		Peterbilt 03-01686 Peterbilt 03-08424 - replaces W01-358-9146 (1T15S-6)
1T15AA-6 W01-358-8965		3235 	9536/NAD-29594 ORDER NO. WC1-358-0755	15.4	Granning 6057

Hardware Key

- Bolt or Stud 1/2-13 ⊕ Threaded Hole 3/8-16 Blind Nut on Bead Plates 1/2-13 Pistons ⊗ Air Inlet 1/4 N.P.T. ▲ No Alignment Specified-Center Stud Mounting is Standard
- ⊗ Combination Stud/Air Inlet Stud Outside Thread is 3/4-16 Studs Inside Thread (Air Inlet) is 1/4 N.P.T. Exceptions Will Be Noted on Part View as ⊗

1T - Reversible Sleeve

BELLOW NO. ASSEMBLY ORDER NO.	CROSS SECTION VIEW	BEAD PLATE TOP VIEW	PISTON BOTTOM VIEW	ASSEMBLY WEIGHT (lbs.)	REPLACES
1T15CCR-6 W01-358-8184 BRACKET WC1-358-3887				20.3	Neway 90557290 (RL228, KL230) Neway 90557308 (Same except piston Stud length 1.5 W01-358-8182)
1T15L-1.5 W01-358-8886 OBSOLETE				11.5	Dexter Axle 034-279-00
1T15L-1.5 W01-358-9422			 Order No. WC1-358-0646	10.0	Kenworth K303-6 Kenworth K303-14 Kenworth K303-15 (Airglide 100) -older version with no bracket
1T15L-1.5 W01-358-9584 BRACKET WC1-358-3887			 Order No. WC1-358-0647	12.1	Neway 90557250 (replaces W01-675-9613, 90557224-flush fitting)
1T15L-1.5 W01-358-9616 BRACKET WC1-358-3893			 ORDER NO. WC1-358-0646	11.2	Kenworth K-303-16 (Airglide 100)

1T Style Springs

Hardware Key

- Bolt or Stud 1/2-13
- ⊕ Threaded Hole 3/8-16 Blind Nut on Bead Plates 1/2-13 Pistons
- ⊗ Air Inlet 1/4 N.P.T.
- ▲ No Alignment Specified-Center Stud Mounting is Standard
- ⊗ Combination Stud/Air Inlet Stud Outside Thread is 3/4-16
- Studs Inside Thread (Air Inlet) is 1/4 N.P.T. Exceptions Will Be Noted on Part View as ⊗

Firestone

BELLOW NO. ASSEMBLY ORDER NO.	CROSS SECTION VIEW	BEAD PLATE TOP VIEW	PISTON BOTTOM VIEW	ASSEMBLY WEIGHT (lbs.)	REPLACES
1T15L-2 W01-358-8897		3205 	9571/NAD-18130 	11.8	Monaco 1804591
1T15L-2 W01-358-8900		3235 	9654 / NBD-10438 ORDER NO. WC1-358-0663	13.0	Reyco 17361-01
1T15L-2 W01-358-8901		3271 	9549 / NAD-29454 ORDER NO. WC1-358-1616	11.6	Ridewell 1003588901C
1T15L-2 W01-358-9075		3220 	9743/NBD-8183 Order No. WC1-358-0653	14.1	Hutchen H-2007 Holland (Neway) 90557030 Pezzani
1T15L-2 W01-358-9376		3220 	9571/NAD-18130 Order No. WC1-358-0646	11.8	Monaco Coach 8619 Monaco Coach W01-358-8897 with 3/4" NPT

Hardware Key

- Bolt or Stud 1/2-13
- ⊕ Threaded Hole 3/8-16 Blind Nut on Bead Plates 1/2-13 Pistons
- ⊗ Air Inlet 1/4 N.P.T.
- ▲ No Alignment Specified-Center Stud Mounting is Standard
- ⊗ Combination Stud/Air Inlet Stud Outside Thread is 3/4-16
- ⊗ Studs Inside Thread (Air Inlet) is 1/4 N.P.T. Exceptions Will Be Noted on Part View as ⊗

1T - Reversible Sleeve

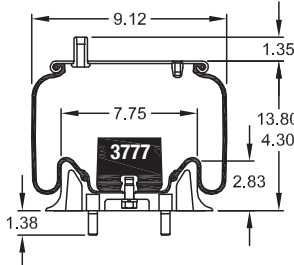
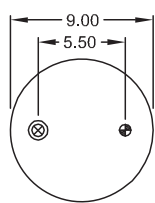
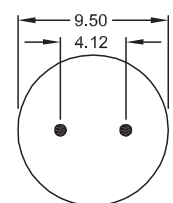
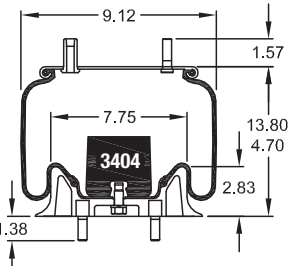
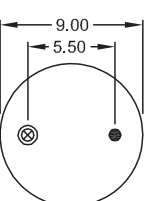
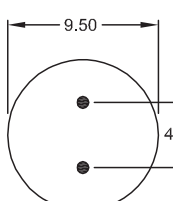
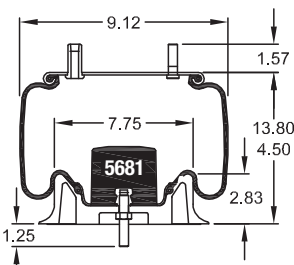
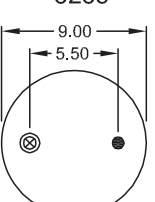
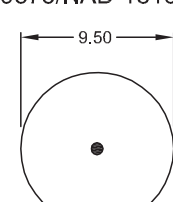
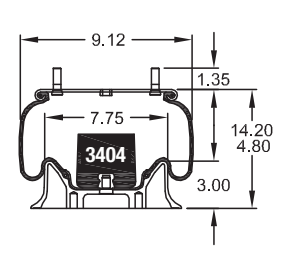
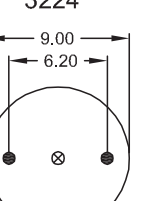
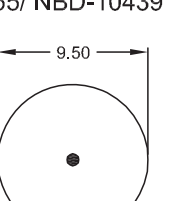
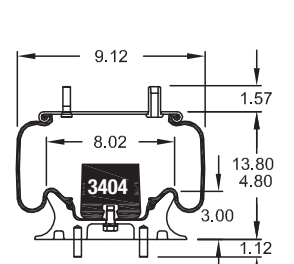
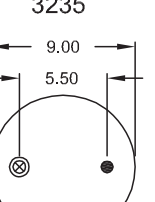
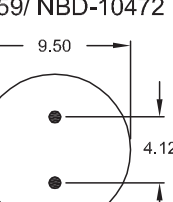
BELLOW NO. ASSEMBLY ORDER NO.	CROSS SECTION VIEW	BEAD PLATE TOP VIEW	PISTON BOTTOM VIEW	ASSEMBLY WEIGHT (lbs.)	REPLACES
1T15L-2 W01-358-9377		3210 	9571/NAD-18130  Order No. WC1-358-0646	11.4	Reyco 21054-01
1T15L-2 W01-358-9378		3235 	9571/NAD-18130  Order No. WC1-358-0646	11.7	Ridewell 1003589378C
1T15L-2 W01-358-9387		3235 	9573/NAD-18162 	10.4	Ridewell 1003589387C
1T15L-2 W01-358-9440		3224 	9655/ NBD-10439  ORDER NO. WC1-358-9454	13.2	Madsen (replaces 9014)
1T15L-2 W01-358-9445		3235 	9659/ NBD-10472  ORDER NO. WC1-358-0683	14.3	Ridewell 1003589445C REPLACEMENT PISTON COMES WITHOUT STUDS

1T Style Springs

Hardware Key

- Bolt or Stud 1/2-13
- ⊕ Threaded Hole 3/8-16 Blind Nut on Bead Plates 1/2-13 Pistons
- ⊗ Air Inlet 1/4 N.P.T.
- ▲ No Alignment Specified-Center Stud Mounting is Standard
- ⊗ Combination Stud/Air Inlet Stud Outside Thread is 3/4-16
- ⊗ Studs Inside Thread (Air Inlet) is 1/4 N.P.T. Exceptions Will Be Noted on Part View as ⊗

Firestone

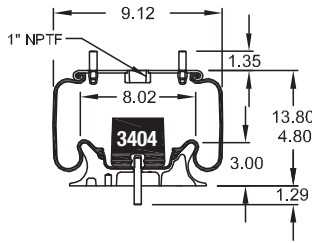
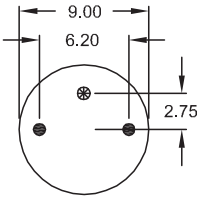
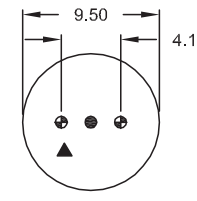
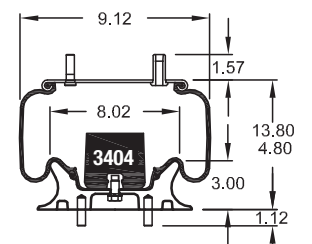
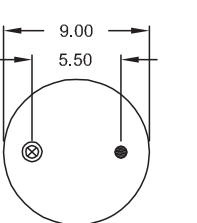
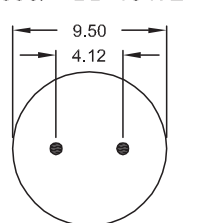
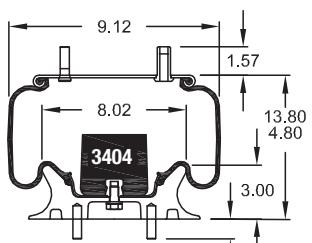
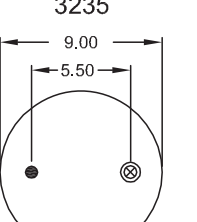
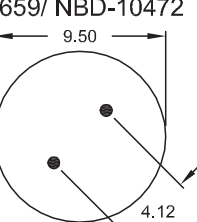
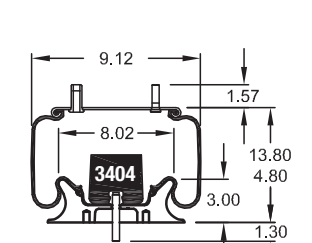
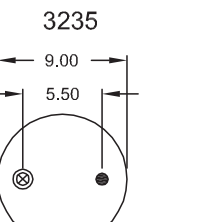
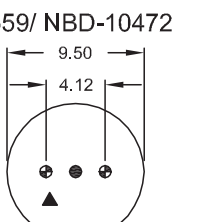
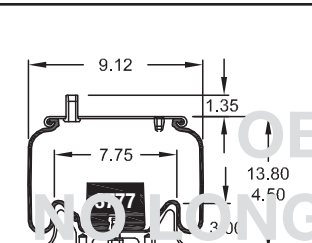
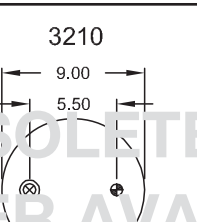
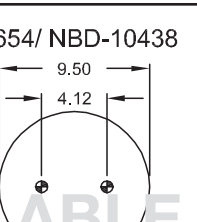
BELLOW NO. ASSEMBLY ORDER NO.	CROSS SECTION VIEW	BEAD PLATE TOP VIEW	PISTON BOTTOM VIEW	ASSEMBLY WEIGHT (lbs.)	REPLACES
1T15L-2 W01-358-9447		3241 	9659/ NBD-10472 	14.1	Ridewell 1003589447C
			ORDER NO. WC1-358-0683		
1T15L-2 W01-358-9448		3235 	9659/ NBD-10472 	14.0	Ridewell 1003589448C Foretravel Inc. REPLACEMENT PISTON COMES WITHOUT STUDS
			ORDER NO. WC1-358-0683		
1T15L-2 W01-358-9457		3235 	9659/ NBD-10472 	14.0	Ridewell 1003589457C REPLACEMENT PISTON COMES WITHOUT STUDS
			ORDER NO. WC1-358-0683		
1T15L-2 W01-358-9459		3235 	9659/ NBD-10472 	14.0	Ridewell 1003589459C ArvinMeritor A-2258-U-1451 RFA23ER-RV
			ORDER NO. WC1-358-0683		
1T15L-2 W01-358-9476 OBSOLETE		3210 	9654/ NBD-10438 	13.0	Reyco 20446-01
			ORDER NO. WC1-358-0663		

Hardware Key

- Bolt or Stud 1/2-13 ⊕ Threaded Hole 3/8-16 Blind Nut on Bead Plates 1/2-13 Pistons ⊗ Air Inlet 1/4 N.P.T. ▲ No Alignment Specified-Center Stud Mounting is Standard
- ⊗ Combination Stud/Air Inlet Stud Outside Thread is 3/4-16 Studs Inside Thread (Air Inlet) is 1/4 N.P.T. Exceptions Will Be Noted on Part View as ⊗

1T - Reversible Sleeve

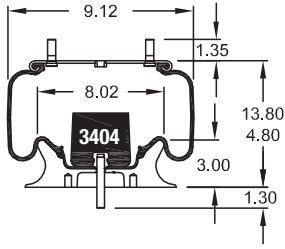
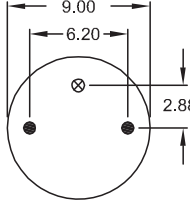
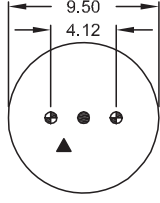
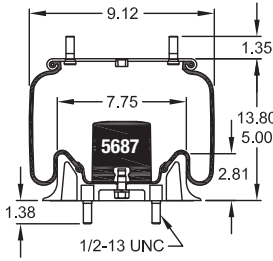
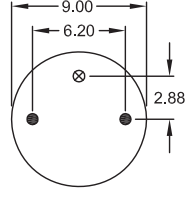
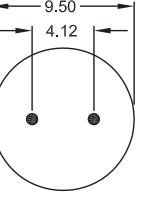
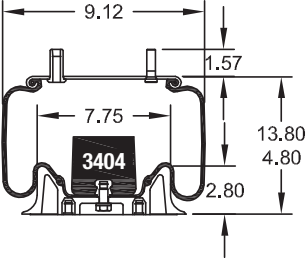
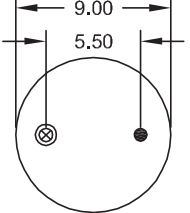
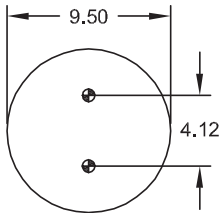
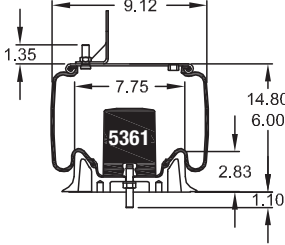
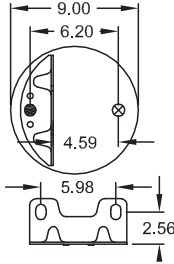
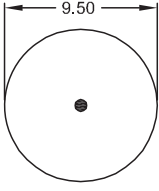
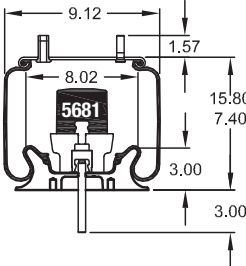
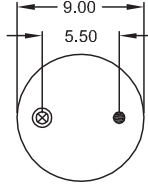
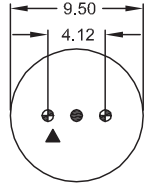
BELLOW NO. ASSEMBLY ORDER NO.	CROSS SECTION VIEW	BEAD PLATE TOP VIEW	PISTON BOTTOM VIEW	ASSEMBLY WEIGHT (lbs.)	REPLACES
1T15L-2 W01-358-9477		3220 	9659/ NBD-10472  ORDER NO. WC1-358-0683	13.7	Ridewell 1003589477C
1T15L-2 W01-358-9551		3220 	9571/NAD-18130  Order No. WC1-358-0646	10.6	Roadmaster
1T15L-2 W01-358-9562		3235 	9572/ NAD-18161 	11.6	Link 1103-0501 Liftable
1T15L-3 W01-358-9284 BRACKET WC1-358-9284		3313 	9573/ NAD-18162  ORDER NO. WC1-358-1634	12.3	Hendrickson 56916 (class 6 Freightliner) -not current production - ref 56917 (W01-358-9335)
1T15L-4 W01-358-8918		3235 	9659/ NBD-10472  ORDER NO. WC1-358-0683	15.4	Granning 7692

1T Style Springs

Hardware Key

- Bolt or Stud 1/2-13
- ⊕ Threaded Hole 3/8-16 Blind Nut on Bead Plates 1/2-13 Pistons
- ⊗ Air Inlet 1/4 N.P.T.
- ▲ No Alignment Specified-Center Stud Mounting is Standard
- ⊗ Combination Stud/Air Inlet Stud Outside Thread is 3/4-16
- ⊗ Studs Inside Thread (Air Inlet) is 1/4 N.P.T. Exceptions Will Be Noted on Part View as ⊗

Firestone

BELLOW NO. ASSEMBLY ORDER NO.	CROSS SECTION VIEW	BEAD PLATE TOP VIEW	PISTON BOTTOM VIEW	ASSEMBLY WEIGHT (lbs.)	REPLACES
1T15L-4 W01-358-8919		3271 	9549/ NAD-29454 	13.0	Ridewell 1003588919C
1T15L-4 W01-358-8922		3235 	9659/ NBD-10472 	13.6	Granning 5492 Granning 5385 (no stud)
1T15L-4 W01-358-8941		3004 	9659/NBD-10472 	13.5	Hendrickson 59031-2
1T15L-4 W01-358-8942 BRACKET WC1-358-3904		3004 	9549/ NAD-29454 	14.4	Hendrickson 58983-2 (Blue Bird)
1T15L-4 W01-358-8951		3235 	9659/ NBD-10472 	12.9	Reyco 19624-01 REPLACEMENT PISTON COMES WITHOUT STUDS

Hardware Key

- Bolt or Stud 1/2-13
- ⊕ Threaded Hole 3/8-16 Blind Nut on Bead Plates 1/2-13 Pistons
- ⊗ Air Inlet 1/4 N.P.T.
- ▲ No Alignment Specified-Center Stud Mounting is Standard
- ⊗ Combination Stud/Air Inlet Stud Outside Thread is 3/4-16
- Studs Inside Thread (Air Inlet) is 1/4 N.P.T. Exceptions Will Be Noted on Part View as ⊗

1T - Reversible Sleeve

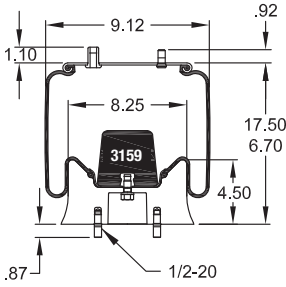
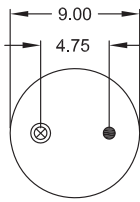
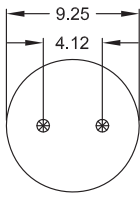
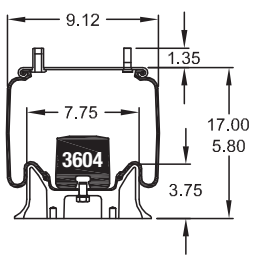
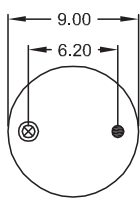
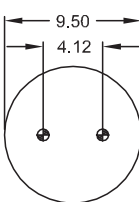
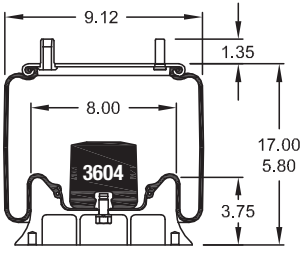
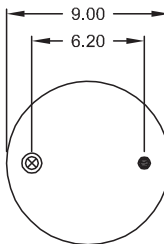
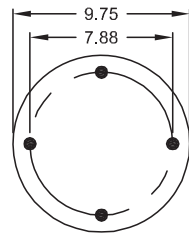
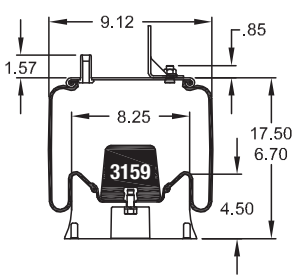
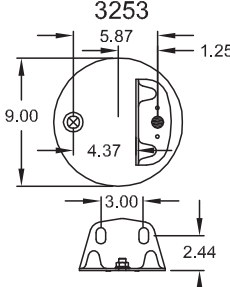
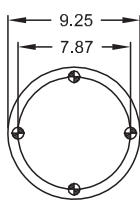
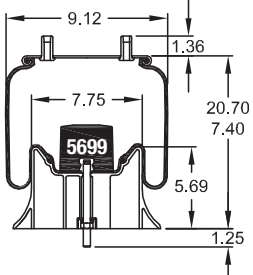
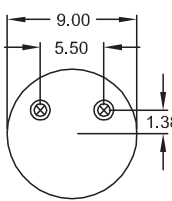
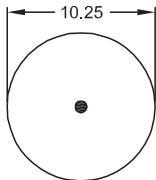
BELLOW NO. ASSEMBLY ORDER NO.	CROSS SECTION VIEW	BEAD PLATE TOP VIEW	PISTON BOTTOM VIEW	ASSEMBLY WEIGHT (lbs.)	REPLACES
1T15L-4 W01-358-9415		3264 	9691/ NBD-14503  ORDER NO. WC1-358-0606	15.7	Kenworth K-303-5 Replacement piston comes without studs
1T15L-4 W01-358-9438		3271 	9743/ NBD-8183  ORDER NO. WC1-358-0653	14.6	Waggoner's Truck
1T15L-4 W01-358-9439		3271 	9656 / NBD-10440  ORDER NO. WC1-358-0652	14.5	Waggoner's Truck Hagie Mfg.
1T15L-4 W01-358-9855		3253 	9691/ NBD-14503 	16.9	Holland 90557354 Replaces 90557284
1T15L-6 W01-358-9626		3306 	9532/ NAD-29827  ORDER NO. WC1-358-1619	13.4	Hendrickson Trailer S23720

1T Style Springs

Hardware Key

- Bolt or Stud 1/2-13
- ⊕ Threaded Hole 3/8-16 Blind Nut on Bead Plates 1/2-13 Pistons
- ⊗ Air Inlet 1/4 N.P.T.
- ▲ No Alignment Specified-Center Stud Mounting is Standard
- ⊗ Combination Stud/Air Inlet Stud Outside Thread is 3/4-16
- Studs Inside Thread (Air Inlet) is 1/4 N.P.T. Exceptions Will Be Noted on Part View as ⊗

Firestone

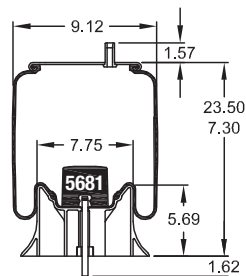
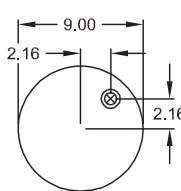
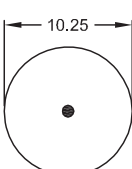
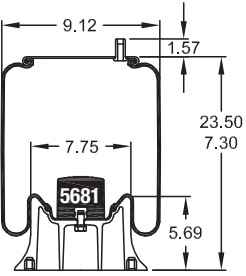
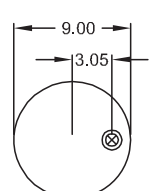
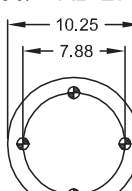
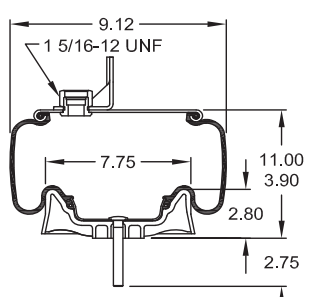
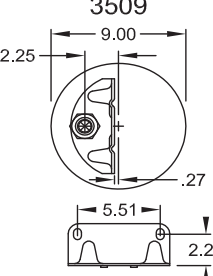
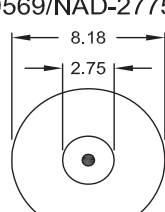
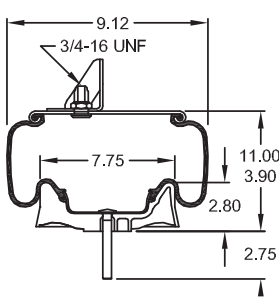
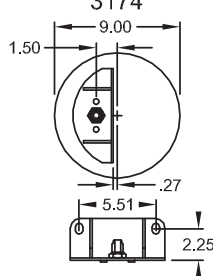
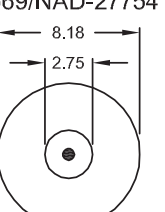
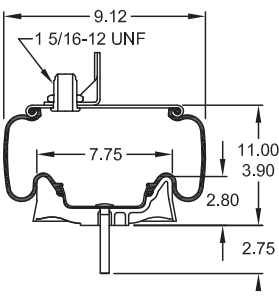
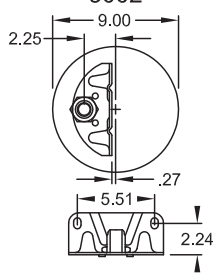
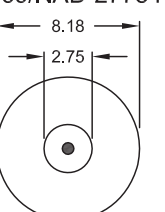
BELLOW NO. ASSEMBLY ORDER NO.	CROSS SECTION VIEW	BEAD PLATE TOP VIEW	PISTON BOTTOM VIEW	ASSEMBLY WEIGHT (lbs.)	REPLACES
1T15L-9 W01-358-9559		3242 	9532/ NAD-29827 	13.7	Reyco 25437-01
1T15L-9 W01-358-9560		3242 	9530/ NAD-27809 	14.1	Reyco 25396-01
1T15LA-(1) 1T15KW-(1) W01-358-9547 BRACKET WC1-358-3883		3509 	9569/NAD-27754  Order No. WC1-358-1629	11.0	Kenworth C81-1004 Airglide 200 5/5/03 or later Airglide 400
1T15LA-(-1) W01-358-9617 BRACKET WC1-358-3892		3174 	9569/NAD-27754  Order No. WC1-358-1629	11.2	Kenworth K-303-18(Airglide 200) - small air fitting - original design (1996 & 1997 prod.) - replaced by K - 303-22(9622)
1T15LA-(1) 1T15KW-(1) W01-358-9622 BRACKET WC1-358-3883		3002 	9569/NAD-27754  Order No. WC1-358-1629	11.0	Kenworth K-303-22 (Airglide 200-1998 to 5/5/03) - (large air fitting with interconnected airsprings)

Hardware Key

- Bolt or Stud 1/2-13 ⊕ Threaded Hole 3/8-16 Blind Nut on Bead Plates 1/2-13 Pistons ⊗ Air Inlet 1/4 N.P.T. ▲ No Alignment Specified-Center Stud Mounting is Standard
- ⊗ Combination Stud/Air Inlet Stud Outside Thread is 3/4-16 Studs Inside Thread (Air Inlet) is 1/4 N.P.T. Exceptions Will Be Noted on Part View as ⊗

1T - Reversible Sleeve

BELLOW NO. ASSEMBLY ORDER NO.	CROSS SECTION VIEW	BEAD PLATE TOP VIEW	PISTON BOTTOM VIEW	ASSEMBLY WEIGHT (lbs.)	REPLACES
1T15LA-0 W01-358-9541 BRACKET WC1-358-3890		3509 	9569/NAD-27754 Order No. WC1-358-1629	11.0	Kenworth C81-1005 Airglide 200 5/5/03 or later Airglide 460 Airglide 690
1T15LA-0 W01-358-9618 BRACKET WC1-358-3892		3174 	9569/NAD-27754 PLASTIC Order No. WC1-358-1629	13.5	Kenworth K-303-19 (Airglide 200) 46,000# - small air fitting - -1996 & 97 prod. - replaced by K-303-25(9625)
1T15LA-0 W01-358-9625 BRACKET WC1-358-3890		3002 	9569/NAD-27754 Order No. WC1-358-1629	13.5	Kenworth K-303-25 (Airglide 200-46,000#, 1998 & later prod.)
1T15LA-0 W01-358-9675 BRACKET WC1-358-3890		3002 	9569/NAD-27754 Order No. WC1-358-1629	11.6	Kenworth K-303-28 Airglide 200 Before 5/5/03
1T15LB-10 W01-358-9621		3306 	9532/ NAD-29827 ORDER NO. WC1-358-1619	14.5	Hendrickson Trailer S23613

1T Style Springs

Hardware Key

- Bolt or Stud 1/2-13
- ⊕ Threaded Hole 3/8-16 Blind Nut on Bead Plates 1/2-13 Pistons
- ⊗ Air Inlet 1/4 N.P.T.
- ▲ No Alignment Specified-Center Stud Mounting is Standard
- ⊗ Combination Stud/Air Inlet Stud Outside Thread is 3/4-16
- ⊗ Studs Inside Thread (Air Inlet) is 1/4 N.P.T. Exceptions Will Be Noted on Part View as ⊗

Firestone

BELLOW NO. ASSEMBLY ORDER NO.	CROSS SECTION VIEW	BEAD PLATE TOP VIEW	PISTON BOTTOM VIEW	ASSEMBLY WEIGHT (lbs.)	REPLACES
1T15LC-2.5 W01-358-9379		3252 	9663/ NBD-12639 	13.6	Navistar (U-Haul) 1660694C-1
1T15LC-2.5 W01-358-9565		3291 	9663/ NBD-12639 	11.8	Navistar 2027912C1 (GY 1R12-324)
1T15LC-2.5 W01-358-9566		3291 	9663/ NBD-12639 	11.8	Navistar 1672401C1 (GY 1R12-204)
1T15LC-4.5 W01-358-9567		3252 	9663/ NBD-12639 	14.1	Navistar 2027913C1 (GY 1R12-325)
1T15LC-4.5 W01-358-9568		3252 	9663/ NBD-12639 	14.5	Navistar 1675495C1 (GY 1R12-205)

Hardware Key

- Bolt or Stud 1/2-13
- ⊕ Threaded Hole 3/8-16 Blind Nut on Bead Plates 1/2-13 Pistons
- ⊗ Air Inlet 1/4 N.P.T.
- ▲ No Alignment Specified-Center Stud Mounting is Standard
- ⊗ Combination Stud/Air Inlet Stud Outside Thread is 3/4-16
- ⊗ Studs Inside Thread (Air Inlet) is 1/4 N.P.T. Exceptions Will Be Noted on Part View as ⊗

1T - Reversible Sleeve

BELLOW NO. ASSEMBLY ORDER NO.	CROSS SECTION VIEW	BEAD PLATE TOP VIEW	PISTON BOTTOM VIEW	ASSEMBLY WEIGHT (lbs.)	REPLACES
1T15LC-12 W01-358-9619		3306 	9540/ NAD-29828 	16.2	Hendrickson Trailer S23614 ORDER NO. WC1-358-0664
1T15LP-1.5 W01-358-8597		3377 	9659 / NBD-10472 	14.6	Hendrickson Truck 65790-2 Order No. WC1-358-0683
1T15LP-2 W01-358-8958		3235 	9656 / NBD-10440 	14.5	Granning 6978 Order No. WC1-358-0652
1T15LP-2 W01-358-8959		3156 	9549/ NAD-29454 	14.6	Reyco 20773-01 ORDER NO. WC1-358-1616
1T15LP-2 W01-358-9554 METRIC		3767 	9569/ NAD-27754 	11.2	Hendrickson 60716-2 Volvo 20462941 ORDER NO. WC1-358-1629

1T Style Springs

Hardware Key

- Bolt or Stud 1/2-13
- ⊕ Threaded Hole 3/8-16 Blind Nut on Bead Plates 1/2-13 Pistons
- ⊗ Air Inlet 1/4 N.P.T.
- ▲ No Alignment Specified-Center Stud Mounting is Standard
- ⊗ Combination Stud/Air Inlet Stud Outside Thread is 3/4-16
- ⊗ Studs Inside Thread (Air Inlet) is 1/4 N.P.T. Exceptions Will Be Noted on Part View as ⊗

Firestone

BELLOW NO. ASSEMBLY ORDER NO.	CROSS SECTION VIEW	BEAD PLATE TOP VIEW	PISTON BOTTOM VIEW	ASSEMBLY WEIGHT (lbs.)	REPLACES
1T15LP-2 W01-358-9681		3190 	9572/ NAD-18161 	9.8	Link 1103-0508
1T15LP-3 W01-358-8478 REPLACES W01-358-9259		3201 	9567 / NAD-35451 		
1T15LP-3 W01-358-9049 (REPLACES 1T15S-6)		3215 	9565/NAD-35451 	13.6	East Mfg. Granning 6252
1T15LP-3 W01-358-9073		3264 	9566/NAD-35451 Order No. N/A	15.9	Circle R Kenworth K-102-A Hendrickson Trailer S-7193 Ridewell 1003589073C
1T15LP-3 W01-358-9285		3271 	9565 / NAD-35451 	11.6	Hendrickson Trailer S-7364 REPLACEMENT PISTON COMES WITHOUT STUDS

Hardware Key

- Bolt or Stud 1/2-13
- ⊕ Threaded Hole 3/8-16 Blind Nut on Bead Plates 1/2-13 Pistons
- ⊗ Air Inlet 1/4 N.P.T.
- ▲ No Alignment Specified-Center Stud Mounting is Standard
- ⊗ Combination Stud/Air Inlet Stud Outside Thread is 3/4-16
- ⊗ Studs Inside Thread (Air Inlet) is 1/4 N.P.T. Exceptions Will Be Noted on Part View as ⊗

1T - Reversible Sleeve

BELLOW NO. ASSEMBLY ORDER NO.	CROSS SECTION VIEW	BEAD PLATE TOP VIEW	PISTON BOTTOM VIEW	ASSEMBLY WEIGHT (lbs.)	REPLACES
1T15AA-3 1T15LP-3 W01-358-9290		3235 	9566/NAD-35451 Order No. WC1-358-1659	14.4	American Carrier 8003-025 (supersedes 9234) Ridewell 1003589290C Peerless
1T15LP-3 W01-358-9553		3249 	9567/NAD-35451 PLASTIC 	14.3	Arvin Meritor A-2258-J-1466 WCC Rear RV
1T15LP-3 W01-358-9587 BRACKET WC1-358-3887		3347 	9567/NAD-35451 	14.7	Holland (Neway) 90557248 (replaces 90557220-1/2"NPT flush) - ref. W01-358-9597
1T15LP-3 W01-358-9592		3190 	9566/NAD-35451 Order No. WC1-358-1659	14.5	General Coach
1T15LP-3 W01-358-9597 BRACKET WC1-358-3887		3253 	9567/NAD-35451 	14.7	Holland (Neway) 90557172 (AD-200) - ref. 90557220 90557248 (1/2"NPT)

1T Style Springs

Hardware Key

- Bolt or Stud 1/2-13 ⊕ Threaded Hole 3/8-16 Blind Nut on Bead Plates 1/2-13 Pistons ⊗ Air Inlet 1/4 N.P.T. ▲ No Alignment Specified-Center Stud Mounting is Standard
- ⊗ Combination Stud/Air Inlet Stud Outside Thread is 3/4-16 Studs Inside Thread (Air Inlet) is 1/4 N.P.T. Exceptions Will Be Noted on Part View as ⊗

Firestone

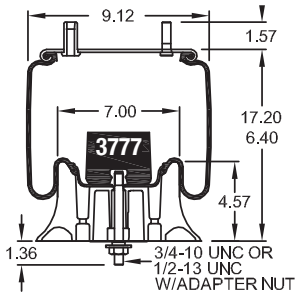
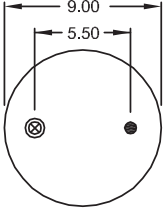
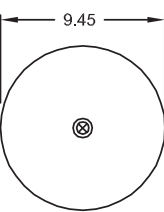
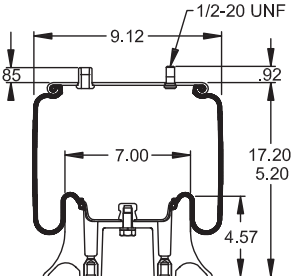
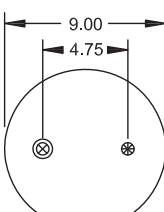
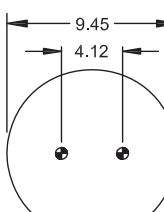
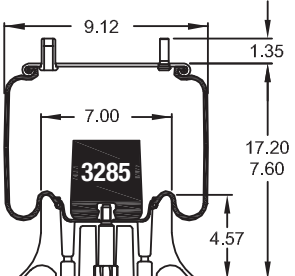
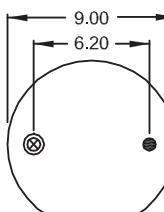
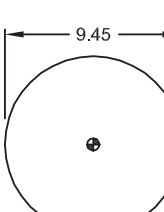
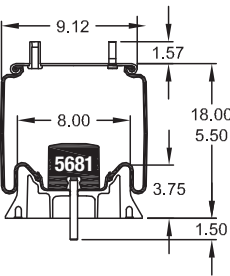
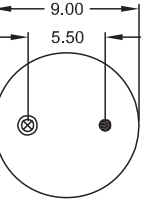
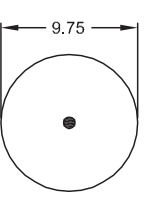
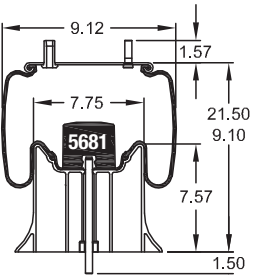
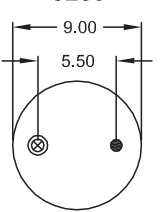
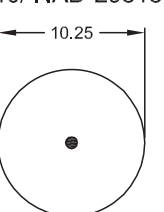
BELLOW NO. ASSEMBLY ORDER NO.	CROSS SECTION VIEW	BEAD PLATE TOP VIEW	PISTON BOTTOM VIEW	ASSEMBLY WEIGHT (lbs.)	REPLACES
1T15LP-3 W01-358-9599		3235 	9567/NAD-35451 	14.0	Holland (Neway) 90557094 (ARD suspensions) - reference 90557128 (bead plate-3215) Holland (Neway) 90557128
(1T15AA-3) 1T15LP-3 W01-358-9652		3190 	9565/NAD-35451 	11.4	Mack 57QL1115 Hendrickson Trailer S14147 Supersedes W01-358-9043 Order No. WC1-358-1658
1T15LP-3 W01-358-9953		3271 	9567/NAD-35451 	17.9	Air AX (Roelofs)
1T15LP-5 W01-358-8949		3235 	9549/ NAD-29454 	12.8	Holland (Neway) 90557150 ORDER NO. WC1-358-1616
1T15LP-5 W01-358-9291		3235 	9540/ NAD-29818 	14.7	Holland (Neway) 90557139 (RL196-17) (RL196A-17) - replaces 90557122 -originally 1T15M-4 bellows ORDER NO. WC1-358-0664

Hardware Key

- Bolt or Stud 1/2-13
- ⊕ Threaded Hole 3/8-16 Blind Nut on Bead Plates 1/2-13 Pistons
- ⊗ Air Inlet 1/4 N.P.T.
- ▲ No Alignment Specified-Center Stud Mounting is Standard
- ⊗ Combination Stud/Air Inlet Stud Outside Thread is 3/4-16
- Studs Inside Thread (Air Inlet) is 1/4 N.P.T. Exceptions Will Be Noted on Part View as ⊗

1T - Reversible Sleeve

BELLOW NO. ASSEMBLY ORDER NO.	CROSS SECTION VIEW	BEAD PLATE TOP VIEW	PISTON BOTTOM VIEW	ASSEMBLY WEIGHT (lbs.)	REPLACES
1T15LP-5 W01-358-9293		3235 	9544/NAD-29826 	13.3	Holland (Neway) 90557120 (RL196-14, RL196A-14)
			Order No. WC1-358-0666		
1T15LP-5 W01-358-9294		3235 	9573/ NAD-18162 	11.4	Holland (Neway) 90557127 (RL-196-12)
			ORDER NO. WC1-358-1634		
1T15LP-5 W01-358-9295		3235 	9532/ NAD-29827 	13.2	Holland (Neway) 90557121 (RL196-15 & 16) (RL196A-15 & 16)
			ORDER NO. WC1-358-1619		
1T15LP-6 W01-358-9015		3242 	9694/ NAD-25396 	17.8	Hendrickson Trailer S20217 (HT-190U) - superseded by W01-358-8944 1T15MLW-7
			ORDER NO. WC1-358-1694		
1T15M-0 W01-358-8961		3003 	9572/ NAD-18161 	10.1	Reyco 23377-01

1T Style Springs

Hardware Key

- Bolt or Stud 1/2-13 ⊕ Threaded Hole 3/8-16 Blind Nut on Bead Plates 1/2-13 Pistons ⊗ Air Inlet 1/4 N.P.T. ▲ No Alignment Specified-Center Stud Mounting is Standard
- ⊗ Combination Stud/Air Inlet Stud Outside Thread is 3/4-16 Studs Inside Thread (Air Inlet) is 1/4 N.P.T. Exceptions Will Be Noted on Part View as ⊗

Firestone

BELLOW NO. ASSEMBLY ORDER NO.	CROSS SECTION VIEW	BEAD PLATE TOP VIEW	PISTON BOTTOM VIEW	ASSEMBLY WEIGHT (lbs.)	REPLACES
1T15M-0 W01-358-8963		3188 	9655/ NBD-10439 ORDER NO. WC1-358-9454	13.2	Ridewell 1003588963C
1T15M-0 W01-358-8964		3210 	9571/ NAD-18130 ORDER NO. WC1-358-0646	11.6	Reyco 21598-01
1T15M-0 W01-358-8971		3271 	9573/ NAD-18162 ORDER NO. WC1-358-1634	10.1	Hendrickson 59484-2 (Blue Bird)
1T15M-0 W01-358-8972		3271 	9573/ NAD-18162 ORDER NO. WC1-358-1634	11.2	Hendrickson 59601-2
1T15M-0 W01-358-8976		3210 	9571/ NAD-18130 ORDER NO. WC1-358-0646	11.1	Reyco 21055-01

Hardware Key

- Bolt or Stud 1/2-13
- ⊕ Threaded Hole 3/8-16 Blind Nut on Bead Plates 1/2-13 Pistons
- ⊗ Air Inlet 1/4 N.P.T.
- ▲ No Alignment Specified-Center Stud Mounting is Standard
- ⊗ Combination Stud/Air Inlet Stud Outside Thread is 3/4-16
- ⊗ Studs Inside Thread (Air Inlet) is 1/4 N.P.T. Exceptions Will Be Noted on Part View as ⊗

1T - Reversible Sleeve

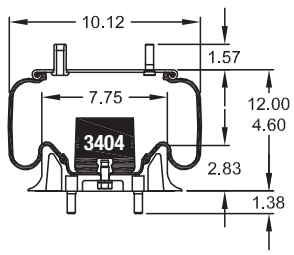
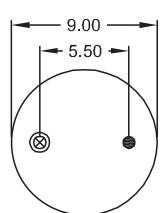
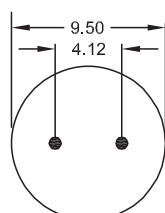
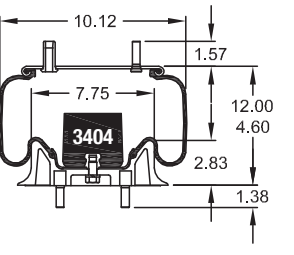
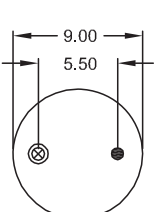
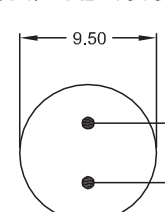
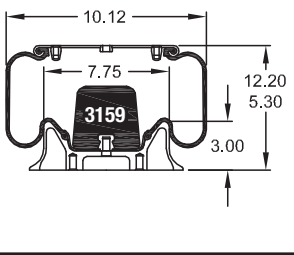
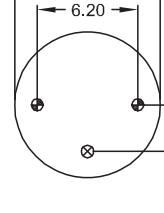
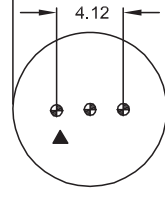
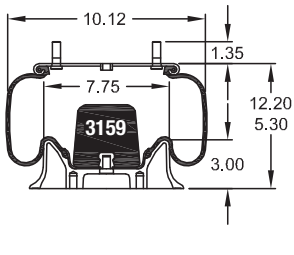
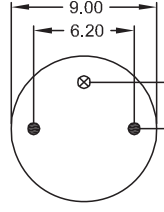
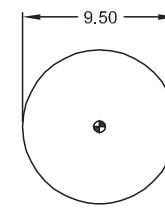
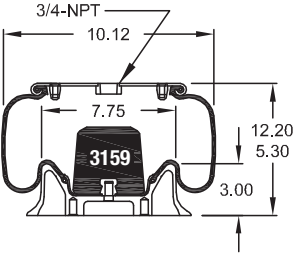
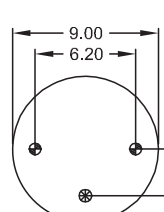
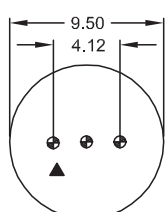
BELLOW NO. ASSEMBLY ORDER NO.	CROSS SECTION VIEW	BEAD PLATE TOP VIEW	PISTON BOTTOM VIEW	ASSEMBLY WEIGHT (lbs.)	REPLACES
1T15M-0 W01-358-8986		3235 	9571/ NAD-18130 	11.5	Ridewell 1003588986C
			ORDER NO. WC1-358-0646		
1T15M-0 W01-358-9029		3235 	9571/ NAD-18130 	11.3	Ridewell 1003589029C
			ORDER NO. WC1-358-0646		
1T15M-0 W01-358-9031		3215 	9654/ NBD-10438 	13.0	Peerless 0550-00051
			ORDER NO. WC1-358-0663		
1T15M-0 W01-358-9033		3220 	9655/ NBD-10439 	13.4	Holland (Neway) 90557012 Mfg.SV.# Holland (Neway) 90044198
			ORDER NO. WC1-358-9454		
1T15M-0 W01-358-9036		3201 	9654/ NBD-10438 	13.4	Willmar
			ORDER NO. WC1-358-0663		

1T Style Springs

Hardware Key

- Bolt or Stud 1/2-13
- ⊕ Threaded Hole 3/8-16 Blind Nut on Bead Plates 1/2-13 Pistons
- ⊗ Air Inlet 1/4 N.P.T.
- ▲ No Alignment Specified-Center Stud Mounting is Standard
- ⊗ Combination Stud/Air Inlet Stud Outside Thread is 3/4-16
- ⊗ Studs Inside Thread (Air Inlet) is 1/4 N.P.T. Exceptions Will Be Noted on Part View as ⊗

Firestone

BELLOW NO. ASSEMBLY ORDER NO.	CROSS SECTION VIEW	BEAD PLATE TOP VIEW	PISTON BOTTOM VIEW	ASSEMBLY WEIGHT (lbs.)	REPLACES
1T15M-0 W01-358-9039 SEVICE ASSEMBLY W01-358-0702		3235 	9655/ NBD-10439 ORDER NO. WC1-358-9454	13.4	Hendrickson Trailer S2064/S11650 Holland (Neway) 90557001 90557023 90557085 Hutchens H-9424-01 R & S Truck & Body 1090218 Ridewell 1013589039C FabTek 101827 Sauer P50-734 Watson & Chalin AS-0012
1T15M-0 W01-358-9077		3255 	9654/ NBD-10438 ORDER NO. WC1-358-0663	13.2	Fruehauf UCB-44531 Fruehauf MFR 022354
1T15M-0 W01-358-9308		3235 	9654/ NBD-10438 ORDER NO. WC1-358-0663	13.0	Reyco 17360-01 Holland (Neway) 90557089 (remove bolt)
1T15M-0 W01-358-9332		3235 	9654/ NBD-10438 ORDER NO. WC1-358-0663	11.3	Reyco 20074-01
1T15M-0 W01-358-9333		3210 	9654/ NBD-10438 ORDER NO. WC1-358-0663	12.8	Reyco 20437-01

Hardware Key

- Bolt or Stud 1/2-13
- ⊕ Threaded Hole 3/8-16 Blind Nut on Bead Plates 1/2-13 Pistons
- ⊗ Air Inlet 1/4 N.P.T.
- ▲ No Alignment Specified-Center Stud Mounting is Standard
- ⊗ Combination Stud/Air Inlet Stud Outside Thread is 3/4-16
- ⊗ Studs Inside Thread (Air Inlet) is 1/4 N.P.T. Exceptions Will Be Noted on Part View as ⊗

1T - Reversible Sleeve

BELLOW NO. ASSEMBLY ORDER NO.	CROSS SECTION VIEW	BEAD PLATE TOP VIEW	PISTON BOTTOM VIEW	ASSEMBLY WEIGHT (lbs.)	REPLACES
1T15M-0 W01-358-9334		3235 	9654/ NBD-10438 	12.9	Ridewell 1003589334C ORDER NO. WC1-358-0663
1T15M-0 W01-358-9505		3246 	9570/ NAD-18162 	10.4	Holland (Neway) 90557312 Freightliner Custom Chassis ORDER NO. WC1-358-0647
1T15M-0.5 W01-358-9307		3235 	9573/NAD-18162 	10.1	Holland (Neway) 90557129 (AR-41, 45 & 45-1) (plastic) ORDER NO. WC1-358-1634
1T15M-1 W01-358-8882		3235 	9569/NAD-27754 	10.9	Holland 90557306 CB-4000 90557363 OBSOLETE REPLACED BY W01-358-9807 SPACER NEEDED
1T15M-2 W01-358-9807		3235 	9489/FIP-101211 	11.0	Spacer Options WC1-358-1690 WC1-358-1691 WC1-358-1692 (see specs for each following) Holland 90557372 50857000 Order No. WC1-358-1660

1T Style Springs

Hardware Key

- Bolt or Stud 1/2-13 ⊕ Threaded Hole 3/8-16 Blind Nut on Bead Plates 1/2-13 Pistons ⊗ Air Inlet 1/4 N.P.T. ▲ No Alignment Specified-Center Stud Mounting is Standard
- ⊗ Combination Stud/Air Inlet Stud Outside Thread is 3/4-16 Studs Inside Thread (Air Inlet) is 1/4 N.P.T. Exceptions Will Be Noted on Part View as ⊗

Firestone

BELLOW NO. ASSEMBLY ORDER NO.	CROSS SECTION VIEW	BEAD PLATE TOP VIEW	PISTON BOTTOM VIEW	ASSEMBLY WEIGHT (lbs.)	REPLACES
WC1-358-1690					Use with Neway CB-4000 W01-358-9807 Ride Height 15.5 & 16 Holland Kit # 48100492
WC1-358-1691					Use with Neway CB-4000 W01-358-9807 Ride Height 16.5 Kit # 48100493
WC1-358-1692					Use with Neway CB-4000 W01-358-9807 Ride Height 17 Holland Kit # 48100494 48100495 18" Ride Height
1T15M-2 W01-358-7667 OBSOLETE REPLACED BY W01-358-8195		3508 	9550/NAD-29456 	12.1	Holland (Neway) 90557256 IFS-114
1T15M-2 W01-358-8197		3226 	9573/ NAD-18162 	10.7	Holland (Neway) 90557230

Hardware Key

- Bolt or Stud 1/2-13
- ⊕ Threaded Hole 3/8-16 Blind Nut on Bead Plates 1/2-13 Pistons
- ⊗ Air Inlet 1/4 N.P.T.
- ▲ No Alignment Specified-Center Stud Mounting is Standard
- ⊗ Combination Stud/Air Inlet Stud Outside Thread is 3/4-16
- Studs Inside Thread (Air Inlet) is 1/4 N.P.T. Exceptions Will Be Noted on Part View as ⊗

1T - Reversible Sleeve

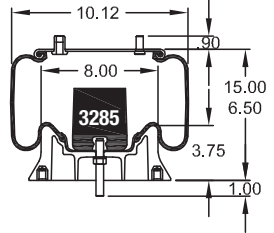
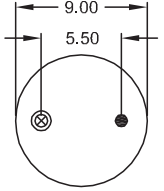
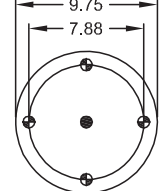
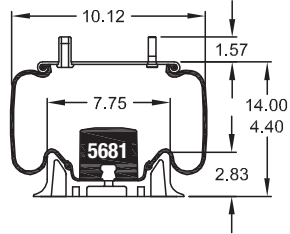
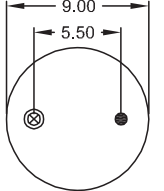
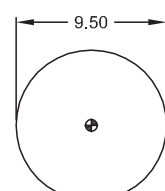
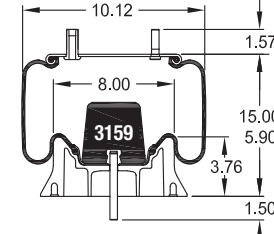
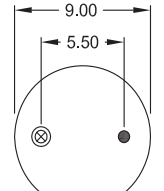
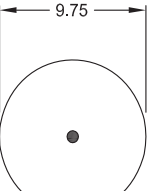
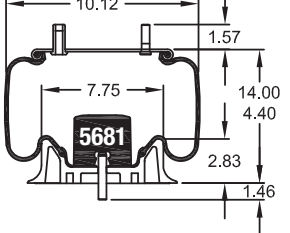
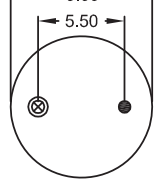
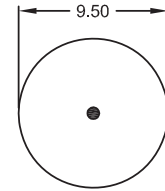
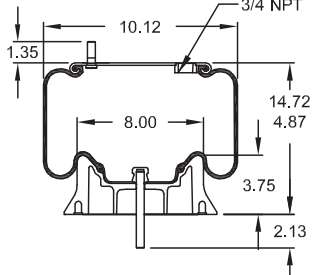
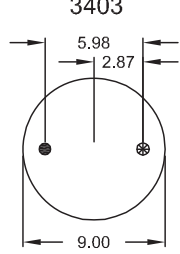
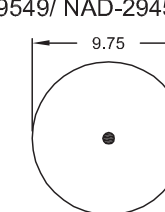
BELLOW NO. ASSEMBLY ORDER NO.	CROSS SECTION VIEW	BEAD PLATE TOP VIEW	PISTON BOTTOM VIEW	ASSEMBLY WEIGHT (lbs.)	REPLACES
1T15M-2 W01-358-8198		3508 	9550/ NAD-29456  ORDER NO. WC1-358-1652	13.3	Holland (Neway) 90557229 (IFS-114) - (center stud used for locating in pre-assembly)
1T15M-2 W01-358-8201		3235 	9573/ NAD-18162  ORDER NO. WC1-358-1634	10.5	Ridewell 1003588201C
1T15M-2 W01-358-8203		3235 	9549/NAD-29454  Order No. WC1-358-1616	13.1	Holland (Neway) 90557210 - (replaces W01-358-8987) Wabash Trailer ArvinMeritor 2258-C-1459
1T15M-2 W01-358-8204		3235 	9573/ NAD-18162  ORDER NO. WC1-358-1634	10.4	Holland (Neway) 90557173 (RL196A-12) Holland (Neway) 90557223 Binkley Newlite (NS 190-16)
1T15M-2 W01-358-8207		3403 	9549/ NAD-29454  ORDER NO. WC1-358-1616	11.4	Freightliner Custom Chassis 16-16019-000

1T Style Springs

Hardware Key

- Bolt or Stud 1/2-13
- ⊕ Threaded Hole 3/8-16 Blind Nut on Bead Plates 1/2-13 Pistons
- ⊗ Air Inlet 1/4 N.P.T.
- ▲ No Alignment Specified-Center Stud Mounting is Standard
- ⊗ Combination Stud/Air Inlet Stud Outside Thread is 3/4-16
- Studs Inside Thread (Air Inlet) is 1/4 N.P.T. Exceptions Will Be Noted on Part View as ⊗

Firestone

BELLOW NO. ASSEMBLY ORDER NO.	CROSS SECTION VIEW	BEAD PLATE TOP VIEW	PISTON BOTTOM VIEW	ASSEMBLY WEIGHT (lbs.)	REPLACES
1T15M-2 W01-M58-8650 OBSOLETE METRIC BRACKET WC1-358-3903		3512 	9573/ NAD-18162 	12.5	Hendrickson 64403-2
1T15M-2 W01-358-8878		3235 	9550/ NAD-29456 	11.9	Arvin Meritor A-2258-A-1483 (WCC Front RV)
1T15M-2 W01-358-8930 SERVICE ASSEMBLY W01-358-0725		3235 	9727/ NBD-8725 	14.3	Ridewell 1003588930C
1T15M-2 W01-358-8931 METRIC		3700 	3822/ NBD-10378 	15.8	John Deere
1T15M-2 W01-358-8932		3003 	9530/ NAD-27809 	12.7	Reyco 22241-01

Hardware Key

- Bolt or Stud 1/2-13
- ⊕ Threaded Hole 3/8-16 Blind Nut on Bead Plates 1/2-13 Pistons
- ⊗ Air Inlet 1/4 N.P.T.
- ▲ No Alignment Specified-Center Stud Mounting is Standard
- ⊗ Combination Stud/Air Inlet Stud Outside Thread is 3/4-16
- ⊗ Studs Inside Thread (Air Inlet) is 1/4 N.P.T. Exceptions Will Be Noted on Part View as ⊗

1T - Reversible Sleeve

BELLOW NO. ASSEMBLY ORDER NO.	CROSS SECTION VIEW	BEAD PLATE TOP VIEW	PISTON BOTTOM VIEW	ASSEMBLY WEIGHT (lbs.)	REPLACES
1T15M-2 W01-358-8934		3242 	9571/ NBD-18130 	10.9	Hendrickson Trailer S20228
1T15M-2 W01-358-8935 OBSOLETE		3003 	9550/ NAD-29456 	12.1	Tuthill Reyco 23027-01
1T15M-2 W01-358-8991		3235 	9528/ NBD-14404 	12.7	Reyco 17414-01
1T15M-2 W01-358-9053		3215 	9656 / NBD-10440 	14.6	EZ Ride 8030192 Ridewell 1003589053C Fruehauf UCE-1304-2
1T15M-2 W01-358-9078		3255 	9742/ NBD-8055 	14.0	Fruehauf UCB-9668-1 Fruehauf MFR-022355

1T Style Springs

Hardware Key

- Bolt or Stud 1/2-13
- ⊕ Threaded Hole 3/8-16 Blind Nut on Bead Plates 1/2-13 Pistons
- ⊗ Air Inlet 1/4 N.P.T.
- ▲ No Alignment Specified-Center Stud Mounting is Standard
- ⊗ Combination Stud/Air Inlet Stud Outside Thread is 3/4-16
- ⊗ Studs Inside Thread (Air Inlet) is 1/4 N.P.T. Exceptions Will Be Noted on Part View as ⊗

Firestone

BELLOW NO. ASSEMBLY ORDER NO.	CROSS SECTION VIEW	BEAD PLATE TOP VIEW	PISTON BOTTOM VIEW	ASSEMBLY WEIGHT (lbs.)	REPLACES
1T15M-2 W01-358-9105 SERVICE ASSEMBLY W01-358-0725		3235 	9550/ NAD-29456 ORDER NO. WC1-358-1652	13.2	Hendrickson Trailer S1245 Granning 5065 Ridewell 1003589105C Watson & Chalin AS-0015
1T15M-2 W01-358-9113		3210 	9656/ NBD-10267 ORDER NO. WC1-358-0652	14.6	Hendrickson
1T15M-2 W01-358-9118		3190 	9656/ NBD-10267 ORDER NO. WC1-358-0652	14.3	Ridewell 1003589118C
1T15M-2 W01-358-9302 SERVICE ASSEMBLY W01-358-0725		3235 	9550/ NAD-29456 ORDER NO. WC1-358-1652	13.2	Hendrickson Can. B-12514-003
1T15M-2 W01-358-9325		3235 	9532/ NAD-29827 ORDER NO. WC1-358-1619	13.6	Holland (Neway) 90557149

Hardware Key

- Bolt or Stud 1/2-13
- ⊕ Threaded Hole 3/8-16 Blind Nut on Bead Plates 1/2-13 Pistons
- ⊗ Air Inlet 1/4 N.P.T.
- ▲ No Alignment Specified-Center Stud Mounting is Standard
- ⊗ Combination Stud/Air Inlet Stud Outside Thread is 3/4-16
- ⊗ Studs Inside Thread (Air Inlet) is 1/4 N.P.T. Exceptions Will Be Noted on Part View as ⊗

1T - Reversible Sleeve

BELLOW NO. ASSEMBLY ORDER NO.	CROSS SECTION VIEW	BEAD PLATE TOP VIEW	PISTON BOTTOM VIEW	ASSEMBLY WEIGHT (lbs.)	REPLACES
1T15M-2 W01-358-9339 BRACKET WC1-358-3903			9573/ NAD-19162 ORDER NO. WC1-358-1634	12.0	Hendrickson 56808-2 (class 6 Ford) Hendrickson 57150 RH Hendrickson 57140 LH - Remove new bracket and reuse old (class 6 & 7 GM)
1T15M-2 W01-358-9365			9544/ NAD-29826 ORDER NO. WC1-358-0666	12.5	Holland (Neway) 9057159
1T15M-2 W01-358-9366			9549/ NAD-29454 ORDER NO. WC1-358-1616	11.8	Holland (Neway) 9057160 Holland (Neway) 9057210 Holland (Neway) 9057225 Watson & Chalin AS-0054 Wabash Holland (Neway) 9057225
1T15M-2 W01-358-9556 OBSOLETE			9550/ NAD-29456 ORDER NO. WC1-358-1652	14.8	Tuthill Granning 703180-01
1T15M-4 W01-358-8802			9549/ NAD-29454 ORDER NO. WC1-358-1616	12.0	Ridewell 1003588802C Holland (Neway) 9057170

1T Style Springs

Hardware Key

- Bolt or Stud 1/2-13
- ⊕ Threaded Hole 3/8-16 Blind Nut on Bead Plates 1/2-13 Pistons
- ⊗ Air Inlet 1/4 N.P.T.
- ▲ No Alignment Specified-Center Stud Mounting is Standard
- ⊗ Combination Stud/Air Inlet Stud Outside Thread is 3/4-16
- ⊗ Studs Inside Thread (Air Inlet) is 1/4 N.P.T. Exceptions Will Be Noted on Part View as ⊗

Firestone

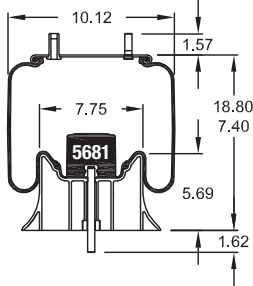
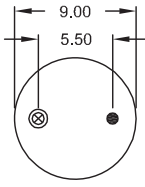
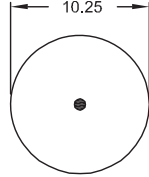
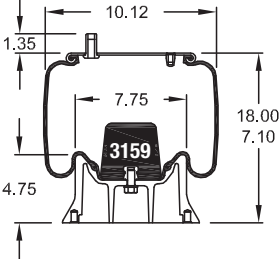
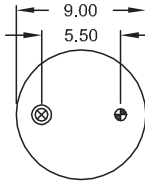
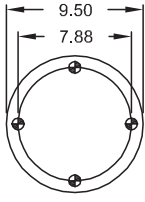
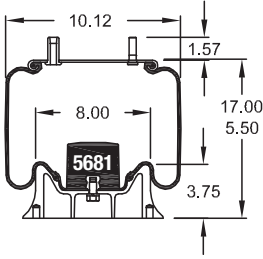
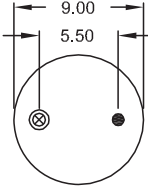
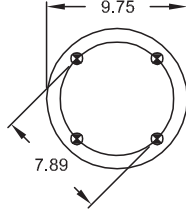
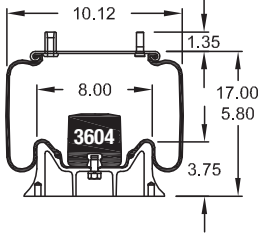
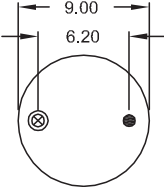
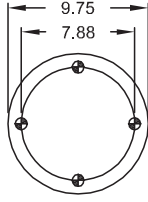
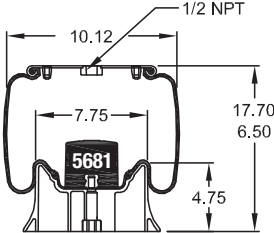
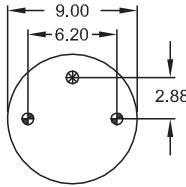
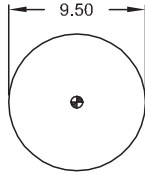
BELLOW NO. ASSEMBLY ORDER NO.	CROSS SECTION VIEW	BEAD PLATE TOP VIEW	PISTON BOTTOM VIEW	ASSEMBLY WEIGHT (lbs.)	REPLACES
1T15M-4 W01-358-8803		3235 	9532/ NAD-29827  ORDER NO. WC1-358-1619	13.1	Ridewell 1003588803C Holland (Neway) 90557194 (Dock-Mate)
1T15M-4 W01-358-8805		3210 	9727/ NBD-8725  ORDER NO. WC1-358-0651	16.2	Ridewell 1003588805C
1T15M-4 W01-358-8806		3235 	9656/ NBD-10267  ORDER NO. WC1-358-0652	14.0	Ridewell 1003588806C
1T15M-4 W01-358-8810		3271 	9656/ NBD-10267  ORDER NO. WC1-358-0652	15.0	Hagie
1T15M-4 W01-358-8813		3202 	9544/ NAD-29826  ORDER NO. WC1-358-0666	12.6	Kenworth C81-1003 Airglide 380 Peterbilt C81-6000 Flex Air

Hardware Key

- Bolt or Stud 1/2-13
- ⊕ Threaded Hole 3/8-16 Blind Nut on Bead Plates 1/2-13 Pistons
- ⊗ Air Inlet 1/4 N.P.T.
- ▲ No Alignment Specified-Center Stud Mounting is Standard
- ⊗ Combination Stud/Air Inlet Stud Outside Thread is 3/4-16
- ⊗ Studs Inside Thread (Air Inlet) is 1/4 N.P.T. Exceptions Will Be Noted on Part View as ⊗

1T - Reversible Sleeve

BELLOW NO. ASSEMBLY ORDER NO.	CROSS SECTION VIEW	BEAD PLATE TOP VIEW	PISTON BOTTOM VIEW	ASSEMBLY WEIGHT (lbs.)	REPLACES
1T15M-4 W01-358-8816 BRACKET WC1-358-3904		3004 	9573/ NAD-18162 	13.1	Hendrickson 60929-2
1T15M-4 W01-358-8817 BRACKET WC1-358-3904		3004 	9573/ NAD-18162 	13.4	Hendrickson 60925-2
1T15M-4 W01-358-9008		3235 	9727/ NBD-8725 	14.1	Ridewell 1003589008C
1T15M-4 W01-358-9010		3235 	9727/ NBD-8725 	16.1	Ridewell 1003589010C (replaces 9064) Reyco 12928-01 Hendrickson Trailer S2827 Hendrickson Trailer S11566 (remove bolt) Watson & Chalin AS-0044
1T15M-4 W01-358-9011		3188 	9727/ NBD-8725 	16.1	Hendrickson Trailer S2307

1T Style Springs

Hardware Key

- Bolt or Stud 1/2-13
- ⊕ Threaded Hole 3/8-16 Blind Nut on Bead Plates 1/2-13 Pistons
- ⊗ Air Inlet 1/4 N.P.T.
- ▲ No Alignment Specified-Center Stud Mounting is Standard
- ⊗ Combination Stud/Air Inlet Stud Outside Thread is 3/4-16
- Studs Inside Thread (Air Inlet) is 1/4 N.P.T. Exceptions Will Be Noted on Part View as ⊗

Firestone

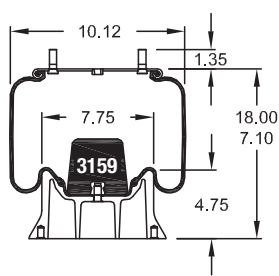
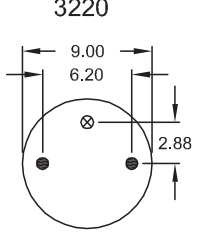
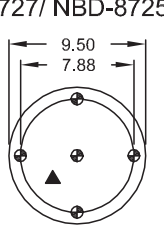
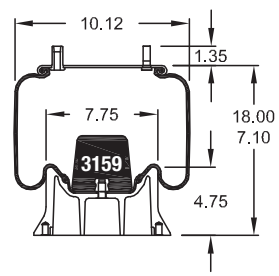
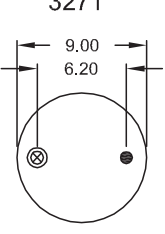
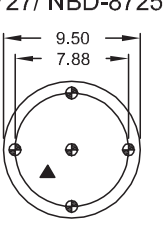
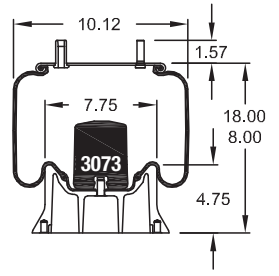
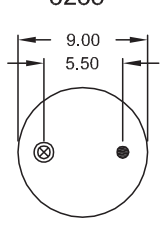
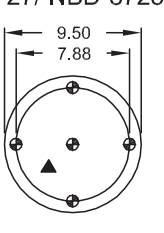
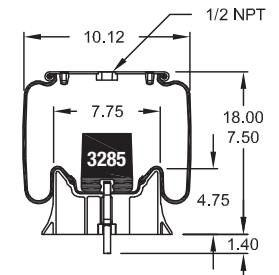
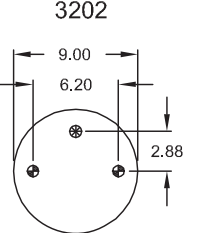
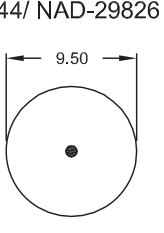
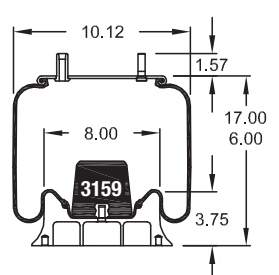
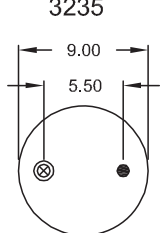
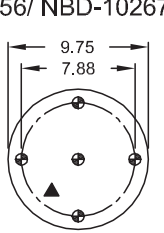
BELLOW NO. ASSEMBLY ORDER NO.	CROSS SECTION VIEW	BEAD PLATE TOP VIEW	PISTON BOTTOM VIEW	ASSEMBLY WEIGHT (lbs.)	REPLACES
1T15M-4 W01-358-9059		3220 	9727/ NBD-8725 	16.3	Hutchens H-1913-1
			ORDER NO. WC1-358-0651		
1T15M-4 W01-358-9063		3271 	9727/ NBD-8725 	16.2	Navistar 359519C-1
			ORDER NO. WC1-358-0651		
1T15M-4 W01-358-9068		3235 	9727/ NBD-8725 	16.6	Navistar
			ORDER NO. WC1-358-0651		
1T15M-4 W01-358-9069		3202 	9544/ NAD-29826 	14.2	Peterbilt 03-02456 Peterbilt 03-04759 Peterbilt 03-01649 Peterbilt 03-06746 Peterbilt 03-07112 Peterbilt 03-02038 (Air-Trac) MFG.SV# Peterbilt 03-10042
			ORDER NO. WC1-358-0666		
1T15M-4 W01-358-9070		3235 	9656/ NBD-10267 	15.2	Holland (Neway) 90557038 Holland (Neway) 90557090 (AR-90-1-12) Silent Drive
			ORDER NO. WC1-358-0652		

Hardware Key

- Bolt or Stud 1/2-13 ⊕ Threaded Hole 3/8-16 Blind Nut on Bead Plates 1/2-13 Pistons ⊗ Air Inlet 1/4 N.P.T. ▲ No Alignment Specified-Center Stud Mounting is Standard
- ⊗ Combination Stud/Air Inlet Stud Outside Thread is 3/4-16 Studs Inside Thread (Air Inlet) is 1/4 N.P.T. Exceptions Will Be Noted on Part View as ⊗

1T - Reversible Sleeve

BELLOW NO. ASSEMBLY ORDER NO.	CROSS SECTION VIEW	BEAD PLATE TOP VIEW	PISTON BOTTOM VIEW	ASSEMBLY WEIGHT (lbs.)	REPLACES
1T15M-4 W01-358-9071		3215 	9727/ NBD-8725 	16.1	Fab Tek (West Unit) 101357 Ridewell 1003589071C Pioneer Trailer
			ORDER NO. WC1-358-0651		
1T15M-4 W01-358-9335 BRACKET WC1-358-3903		3313 	9573/ NBD-18162 	12.3	Hendrickson 56917-1 & 2 (Class 6 & 7 Freightliner) - -ref.56916 (W01-358-9284) -superseded
			ORDER NO. WC1-358-1634		
1T15M-4 W01-358-9336		3235 	9549/ NAD-29454 	13.4	Watson & Chalm AS-0053
			ORDER NO. WC1-358-1616		
1T15M-4 W01-358-9463		3235 	9656/ NBD-10267 	15.2	Holland (Neway) 90557130-RH Holland (Neway) 90557131-LH
			ORDER NO. WC1-358-0652		
1T15M-4 W01-358-9467		3235 	9462/FIP-101776 	18.6	Ridewell 1003589467C

1T Style Springs

Hardware Key

- Bolt or Stud 1/2-13
- ⊕ Threaded Hole 3/8-16 Blind Nut on Bead Plates 1/2-13 Pistons
- ⊗ Air Inlet 1/4 N.P.T.
- ▲ No Alignment Specified-Center Stud Mounting is Standard
- ⊗ Combination Stud/Air Inlet Stud Outside Thread is 3/4-16
- ⊗ Studs Inside Thread (Air Inlet) is 1/4 N.P.T. Exceptions Will Be Noted on Part View as ⊗

Firestone

BELLOW NO. ASSEMBLY ORDER NO.	CROSS SECTION VIEW	BEAD PLATE TOP VIEW	PISTON BOTTOM VIEW	ASSEMBLY WEIGHT (lbs.)	REPLACES
1T15M-4 W01-358-9482 BRACKET WC1-358-3887			9549/ NAD-29454 ORDER NO. WC1-358-1616	15.0	Holland (Neway) 90557161 (AD200-7) (Gillig) - ref. W01-358-9585 (1/ 2"NPT)
1T15M-4 W01-358-9483 OBSOLETE BRACKET WC1-358-3887			9544/ NAD-29826 ORDER NO. WC1-358-0666	15.2	Holland (Neway) 90557166 (AD200-8) (Gillig)
1T15M-4 W01-358-9484			9544/ NAD-29826 ORDER NO. WC1-358-0666	12.9	Holland (Neway) 90557158
1T15M-4 W01-358-9507 BRACKET WC1-358-3887			9727/ NBD-8724 ORDER NO. WC1-358-0651	16.2	Holland (Neway) 90557313
1T15M-4 W01-358-9585 BRACKET WC1-358-3887			9549/ NAD-29454 ORDER NO. WC1-358-1616	15.4	Holland (Neway) 90557247 (replaces 90557219-flush fitting) - ref.W01-358-9482

Hardware Key

- Bolt or Stud 1/2-13
- ⊕ Threaded Hole 3/8-16 Blind Nut on Bead Plates 1/2-13 Pistons
- ⊗ Air Inlet 1/4 N.P.T.
- ▲ No Alignment Specified-Center Stud Mounting is Standard
- ⊗ Combination Stud/Air Inlet Stud Outside Thread is 3/4-16
- Studs Inside Thread (Air Inlet) is 1/4 N.P.T. Exceptions Will Be Noted on Part View as ⊗

1T - Reversible Sleeve

BELLOW NO. ASSEMBLY ORDER NO.	CROSS SECTION VIEW	BEAD PLATE TOP VIEW	PISTON BOTTOM VIEW	ASSEMBLY WEIGHT (lbs.)	REPLACES
1T15M-4 W01-358-9697		3252 	9532/ NAD-29827 	13.3	Holland 90557329
			ORDER NO. WC1-358-1619		
1T15M-4 W01-358-9797		3210 	9656 / NBD-10440 	13.9	Ridewell 1003589797C
			ORDER NO. WC1-358-0652		
1T15M-4 W01-358-9798		3225 	9656/NBD-10440 	15.3	Holland (Neway) 90557105 (GM-U-Haul) Holland (Neway) 90557137 (only 2 studs in piston and 90deg alignment) REPLACEMENT PISTON COMES WITHOUT STUDS
			ORDER NO. WC1-358-0652		
1T15M-4 W01-358-9978		3306 	9484/FIP-101468 	14.1	Hendrickson S-28929
			Order No. WC1-358-1674		
1T15M-6 W01-358-8591		3313 	9538/NAD-27740 	14.9	Volvo 3180673
			Order No. WC1-358-1628		

1T Style Springs

Hardware Key

- Bolt or Stud 1/2-13
- ⊕ Threaded Hole 3/8-16 Blind Nut on Bead Plates 1/2-13 Pistons
- ⊗ Air Inlet 1/4 N.P.T.
- ▲ No Alignment Specified-Center Stud Mounting is Standard
- ⊗ Combination Stud/Air Inlet Stud Outside Thread is 3/4-16
- ⊗ Studs Inside Thread (Air Inlet) is 1/4 N.P.T. Exceptions Will Be Noted on Part View as ⊗

Firestone

BELLOW NO. ASSEMBLY ORDER NO.	CROSS SECTION VIEW	BEAD PLATE TOP VIEW	PISTON BOTTOM VIEW	ASSEMBLY WEIGHT (lbs.)	REPLACES
1T15M-6 W01-358-8824		3242 	9530 NAD-27809 PL Order No. WC1-358-9452 PL	13.9	Tuthill-Reyco 702614-01
1T15M-6 W01-358-8825		3192 	9530/NAD-27809 Order No. WC1-358-9452	13.8	Watson & Chalin AS-0113 Goodyear 1R12-541
1T15M-6 W01-358-8924		3210 	9530 NAD-27809 Order No. WC1-358-9452	14.9	Ridewell 1003588924C
1T15M-6 W01-358-8927		3235 	9544/ NAD-29826 ORDER NO. WC1-358-0666	14.5	Watson & Chalin AS-0062
1T15M-6 W01-358-9004		3235 	9727/ NBD-8725 ORDER NO. WC1-358-0651	15.3	Watson & Chalin AS-0043

Hardware Key

- Bolt or Stud 1/2-13
- ⊕ Threaded Hole 3/8-16 Blind Nut on Bead Plates 1/2-13 Pistons
- ⊗ Air Inlet 1/4 N.P.T.
- ▲ No Alignment Specified-Center Stud Mounting is Standard
- ⊗ Combination Stud/Air Inlet Stud Outside Thread is 3/4-16
- ⊗ Studs Inside Thread (Air Inlet) is 1/4 N.P.T. Exceptions Will Be Noted on Part View as ⊗

1T - Reversible Sleeve

BELLOW NO. ASSEMBLY ORDER NO.	CROSS SECTION VIEW	BEAD PLATE TOP VIEW	PISTON BOTTOM VIEW	ASSEMBLY WEIGHT (lbs.)	REPLACES
1T15M-6 W01-358-9026		3202 	9532/ NAD-29827 	12.7	Peterbilt 03-06213 Peterbilt 03-07111 (Low Air Leaf) ORDER NO. WC1-358-1619
1T15M-6 W01-358-9082 SERVICE ASSEMBLY W01-358-0712		3235 	9530/ NAD-27809 	15.0	Hendrickson Can. S2066, S11651, B-12514-007 Kelderman Hutchens H-9630-01 Kwik Lok/ToDo (Jifflox) CP-5125 Holland (Neway) 90557006, 90557027, 90557033 (special mounting), 90557037, 90557054, 90557075 Reyco 12882-01 R & S Truck & body 1090217 Ridewell 1003589082C Silent Drive Watson & Chain AS-0011
1T15M-6 W01-358-9083 SERVICE ASSEMBLY W01-358-9080		3235 	9530/ NAD-27809 	13.2	Granning 1359 Watson & Chain AS-0028 Ridewell 1003589083C Hendrickson Trailer S1561 ORDER NO. WC1-358-9452
1T15M-6 W01-358-9092		3235 	9530/ NBD-21809 	15.1	Holland (Neway) 90557031 Hendrickson Can. S12353 ORDER NO. WC1-358-9452

1T Style Springs

Hardware Key

- Bolt or Stud 1/2-13
- ⊕ Threaded Hole 3/8-16 Blind Nut on Bead Plates 1/2-13 Pistons
- ⊗ Air Inlet 1/4 N.P.T.
- ▲ No Alignment Specified-Center Stud Mounting is Standard
- ⊗ Combination Stud/Air Inlet Stud Outside Thread is 3/4-16
- Studs Inside Thread (Air Inlet) is 1/4 N.P.T. Exceptions Will Be Noted on Part View as ⊗

Firestone

BELLOW NO. ASSEMBLY ORDER NO.	CROSS SECTION VIEW	BEAD PLATE TOP VIEW	PISTON BOTTOM VIEW	ASSEMBLY WEIGHT (lbs.)	REPLACES
1T15M-6 W01-358-9093 SERVICE ASSEMBLY W01-358-0712		3235 	9553/ NBD-29457 ORDER NO. WC1-358-9453	16.0	Holland (Neway) 90557007 Holland (Neway) 90557032 Holland (Neway) 90557035
1T15M-6 W01-358-9096 SERVICE ASSEMBLY W01-358-0707		3215 	9530/NAD-27809 Order No. WC1-358-9452	14.8	Fruehauf UCE-1304-1
1T15M-6 W01-358-9193		3235 	9530/ NAD-27809 ORDER NO. WC1-358-9452	15.1	Holland (Neway) 90557101 REPLACEMENT PISTON COMES WITHOUT STUDS
1T15M-6 W01-358-9194		3246 	9532/NAD-29827 Order No. WC1-358-1619	13.0	Peterbilt 03-05107
1T15M-6 W01-358-9210 SERVICE ASSEMBLY W01-358-9080		3235 	9951/ NAD-17833 ORDER NO. WC1-358-0697	15.9	Granning 2577

Hardware Key

- Bolt or Stud 1/2-13
- ⊕ Threaded Hole 3/8-16 Blind Nut on Bead Plates 1/2-13 Pistons
- ⊗ Air Inlet 1/4 N.P.T.
- ▲ No Alignment Specified-Center Stud Mounting is Standard
- ⊗ Combination Stud/Air Inlet Stud Outside Thread is 3/4-16
- ⊗ Studs Inside Thread (Air Inlet) is 1/4 N.P.T. Exceptions Will Be Noted on Part View as ⊗

1T - Reversible Sleeve



BELLOW NO. ASSEMBLY ORDER NO.	CROSS SECTION VIEW	BEAD PLATE TOP VIEW	PISTON BOTTOM VIEW	ASSEMBLY WEIGHT (lbs.)	REPLACES
1T15M-6 W01-358-9211 SERVICE ASSEMBLY W01-358-0712		3235 	9951/ NAD-17833 ORDER NO. WC1-358-0697	17.3	Granning 2692
1T15M-6 W01-358-9213 SERVICE ASSEMBLY W01-358-0748		3291 	9560/ NAD-32768 ORDER NO. WC1-358-1620	13.3	Navistar 501559C-1 Navistar 501559C-2 Navistar 1660581C-1
1T15M-6 W01-358-9219		3279 	9560/ NAD-32768 ORDER NO. WC1-358-1620	13.5	Volvo/GM Heavy Duty Truck 35003-3201 Volvo/GM Heavy Duty Truck 35203-3202 Volvo/GM Heavy Duty Truck 35003-3204 Volvo/GM Heavy Duty Truck 35003-3209
1T15M-6 W01-358-9223 (REPLACES 1T15LX8)		3235 	9583/FIP-101543 	20.6	Reyco 12884-01 Reyco 12884-01A (102AR) Hendrickson 48195-2
1T15M-6 W01-358-9227		3188 	9530/ NAD-27809 ORDER NO. WC1-358-9452	15.0	Hendrickson Trailer S2924 Hendrickson 48195-1 (b.plate studs-1.35) (2 studs in piston at 90deg alignment)

1T Style Springs

Hardware Key

- Bolt or Stud 1/2-13
- ⊕ Threaded Hole 3/8-16 Blind Nut on Bead Plates 1/2-13 Pistons
- ⊗ Air Inlet 1/4 N.P.T.
- ▲ No Alignment Specified-Center Stud Mounting is Standard
- ⊗ Combination Stud/Air Inlet Stud Outside Thread is 3/4-16
- ⊗ Studs Inside Thread (Air Inlet) is 1/4 N.P.T. Exceptions Will Be Noted on Part View as ⊗

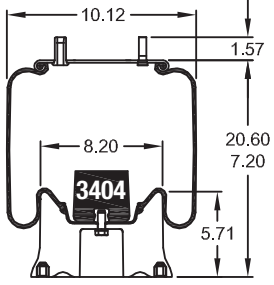
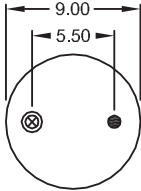
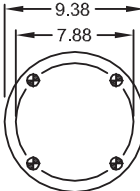
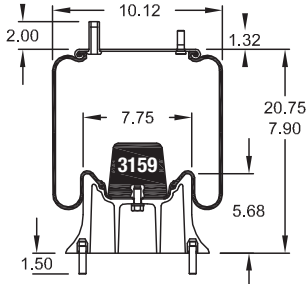
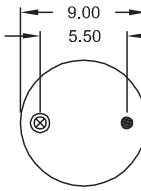
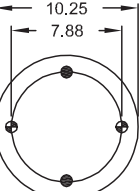
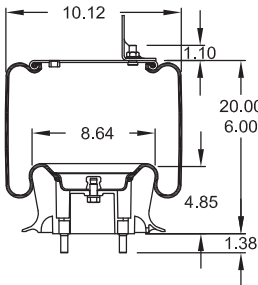
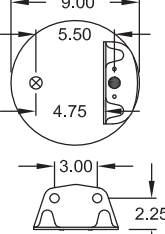
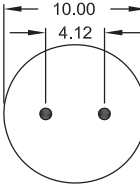
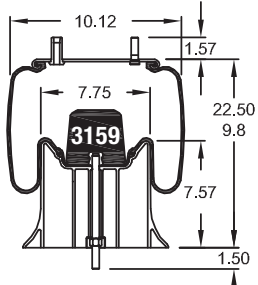
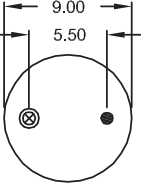
Firestone

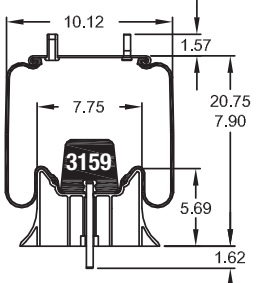
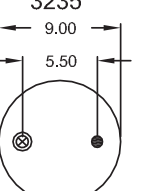
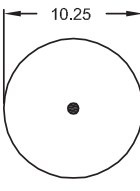
BELLOW NO. ASSEMBLY ORDER NO.	CROSS SECTION VIEW	BEAD PLATE TOP VIEW	PISTON BOTTOM VIEW	ASSEMBLY WEIGHT (lbs.)	REPLACES
1T15M-6 W01-358-9228		3235 	9462/FIP-101776 	18.7	Hendrickson S-3411
1T15M-6 W01-358-9256		3232 	9530/ NAD-27809  ORDER NO. WC1-358-9452	15.4	Hendrickson 49160-0E REPLACEMENT PISTON COMES WITHOUT STUDS
1T15M-6 W01-358-9296 BRACKET WC1-358-3873		3254 	9560/ NAD-32768  ORDER NO. WC1-358-1620	14.4	Volvo/GM 8061151 Volvo/GM 8169868
1T15M-6 W01-358-9304		3235 	9540/ NAD-29828  ORDER NO. WC1-358-0664	16.2	Holland (Neway) 90557124 (AR-90115 & 16) Watson & Chalin AS-0059
1T15M-6 W01-358-9362		3235 	9532/ NAD-29827  ORDER NO. WC1-358-1619	14.9	Watson & Chalin AS-0049 Holland (Neway) 90557113 (AR90-1-14&17) (AR75-6&9)

Hardware Key

- Bolt or Stud 1/2-13
- ⊕ Threaded Hole 3/8-16 Blind Nut on Bead Plates 1/2-13 Pistons
- ⊗ Air Inlet 1/4 N.P.T.
- ▲ No Alignment Specified-Center Stud Mounting is Standard
- ⊗ Combination Stud/Air Inlet Stud Outside Thread is 3/4-16
- Studs Inside Thread (Air Inlet) is 1/4 N.P.T. Exceptions Will Be Noted on Part View as ⊗

1T - Reversible Sleeve

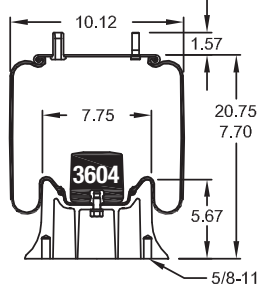
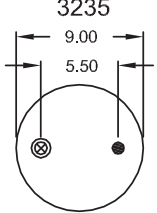
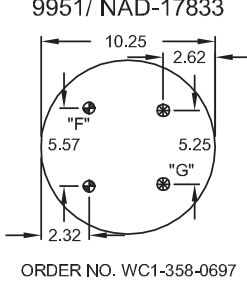
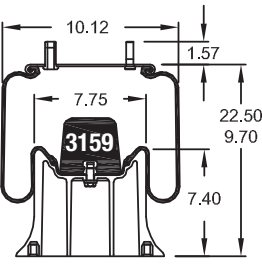
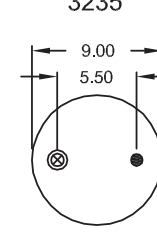
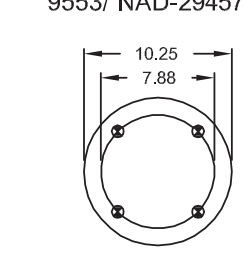
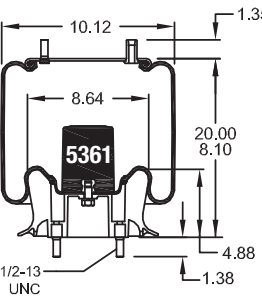
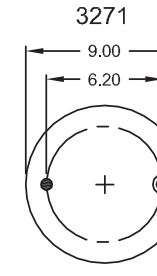
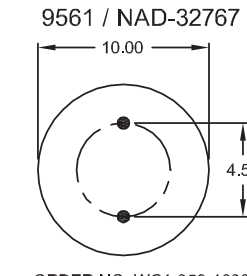
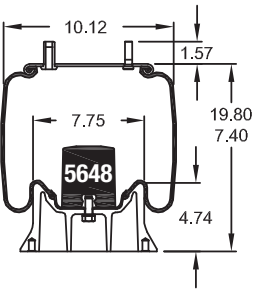
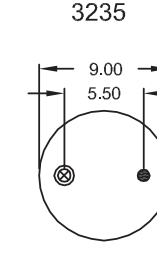
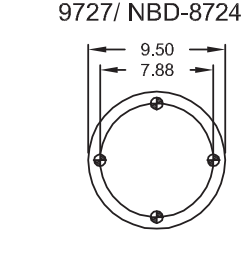
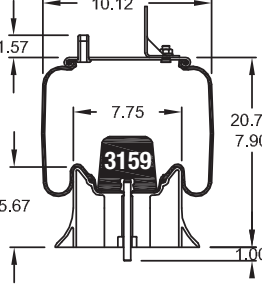
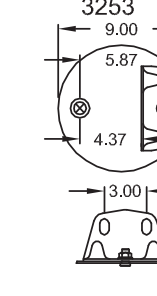
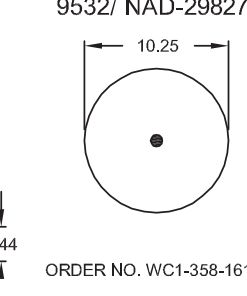
BELLOW NO. ASSEMBLY ORDER NO.	CROSS SECTION VIEW	BEAD PLATE TOP VIEW	PISTON BOTTOM VIEW	ASSEMBLY WEIGHT (lbs.)	REPLACES
1T15M-6 W01-358-9388				17.3	Granning 3750
1T15M-6 W01-358-9392 SERVICE ASSEMBLY W01-358-0712				16.0	Hendrickson Trailer S4773
1T15M-6 W01-358-9466				14.3	Hendrickson 49048 (Ford) Hendrickson 49674-1&2 (Mack) (57QL411M) Hendrickson 49207 (Marmor) HA-360/400/460 [up to 1991]
1T15M-6 W01-358-9474				15.1	Reycos 20966-01 Everly
1T15M-6 W01-358-9496 BRACKET WC1-358-3887				15.9	Holland (Neway) 90557208

1T Style Springs

Hardware Key

- Bolt or Stud 1/2-13
- ⊕ Threaded Hole 3/8-16 Blind Nut on Bead Plates 1/2-13 Pistons
- ⊗ Air Inlet 1/4 N.P.T.
- ▲ No Alignment Specified-Center Stud Mounting is Standard
- ⊗ Combination Stud/Air Inlet Stud Outside Thread is 3/4-16
- ⊗ Studs Inside Thread (Air Inlet) is 1/4 N.P.T. Exceptions Will Be Noted on Part View as ⊗

Firestone

BELLOW NO. ASSEMBLY ORDER NO.	CROSS SECTION VIEW	BEAD PLATE TOP VIEW	PISTON BOTTOM VIEW	ASSEMBLY WEIGHT (lbs.)	REPLACES
1T15M-6 W01-358-9690		3310 	9583/FIP-101543 	22.5	Reyco 24894-02
1T15M-6 W01-358-9944		3235 	9583/FIP-101543 	21.4	Reyco 12884-01B
1T15M-6 W01-358-9966		3310 	9583/FIP-101543 Order No. WC1-358-0660	22.4	Reyco 20124-02 (1/2 NPT) Reyco 20124-01 Reyco 20124-01K (1/4 NPT) - [Use 1/2 to 1/4 NPT adaptor]
1T15M-7.5 W01-358-8888		3235 	9530 / NAD-27809 ORDER NO. WC1-358-9452	14.0	Rowe Truck 0027 ASC2500
1T15M-7.5 W01-358-9342		3235 	9530 / NAD-27809 ORDER NO. WC1-358-9452	13.7	Granning 2727 (supersedes 9298) Chalmers (remove bolt) - Suspension should have axle stops-if not-use W01-358-9245

Hardware Key

- Bolt or Stud 1/2-13 ⊕ Threaded Hole 3/8-16 Blind Nut on Bead Plates 1/2-13 Pistons ⊗ Air Inlet 1/4 N.P.T. ▲ No Alignment Specified-Center Stud Mounting is Standard
- ⊗ Combination Stud/Air Inlet Stud Outside Thread is 3/4-16 Studs Inside Thread (Air Inlet) is 1/4 N.P.T. Exceptions Will Be Noted on Part View as ⊗

1T - Reversible Sleeve

BELLOW NO. ASSEMBLY ORDER NO.	CROSS SECTION VIEW	BEAD PLATE TOP VIEW	PISTON BOTTOM VIEW	ASSEMBLY WEIGHT (lbs.)	REPLACES
1T15M-7.5 W01-358-9902		3249 	9544/NAD-29826 Order No. WC1-358-0666	14.7	Holland (Neway) 90557138
1T15M-7.5 W01-358-9921		3235 	9544 / NAD-29826 ORDER NO. WC1-358-0666	13.7	Holland (Neway) 90557117 (AR92-12& 14), (AR93-14) Watson & Chalin AS-0090 Silent Drive
1T15M-7.5 W01-358-9922		3235 	9540/NAD-29828 Order No. WC1-358-0664	15.0	Holland (Neway) 90557119 (AR92-17) (AR93-17)
1T15M-7.5 W01-358-9923		3235 	9532 / NAD-29827 ORDER NO. WC1-358-1619	13.7	Holland (Neway) 90557118 (AR92& 93-15&16)
1T15M-7.5 W01-358-9935		3226 	9532/NAD-29827 Order No. WC1-358-1619	13.8	Holland (Neway) 90557157 (RL-228-17) Holland (Neway) 90557301

1T Style Springs

Hardware Key

- Bolt or Stud 1/2-13
- ⊕ Threaded Hole 3/8-16 Blind Nut on Bead Plates 1/2-13 Pistons
- ⊗ Air Inlet 1/4 N.P.T.
- ▲ No Alignment Specified-Center Stud Mounting is Standard
- ⊗ Combination Stud/Air Inlet Stud Outside Thread is 3/4-16
- Studs Inside Thread (Air Inlet) is 1/4 N.P.T. Exceptions Will Be Noted on Part View as ⊗

Firestone

BELLOW NO. ASSEMBLY ORDER NO.	CROSS SECTION VIEW	BEAD PLATE TOP VIEW	PISTON BOTTOM VIEW	ASSEMBLY WEIGHT (lbs.)	REPLACES
1T15M-7.5 W01-358-9936		3226 	9544/NAD-29826 Order No. WC1-358-0666	13.9	Holland (Neway) 90557156 (RL-228-14,15,16) Holland (Neway) 90557300
1T15M-7.5 W01-358-9942		3249 	9532/NAD-29827 Order No. WC1-358-1619	14.1	Holland (Neway) 90557142
1T15M-7.5 W01-358-9943		3249 	9540/NAD-29828 Order No. WC1-358-0664	15.2	Holland (Neway) 90557143
1T15M-7.5 W01-358-9947		3254 	9544/NAD-29826 Order No. WC1-358-0666	15.9	Reyco 20142-01 & 01K
1T15M-7.5 W01-358-9948 OBSOLETE		3235 	9696 / NBD-14366 ORDER NO. WC1-358-1636	17.7	Holland (Neway) 90557227 V-Steer 1 (Ride Bag)

Hardware Key

- Bolt or Stud 1/2-13
- ⊕ Threaded Hole 3/8-16 Blind Nut on Bead Plates 1/2-13 Pistons
- ⊗ Air Inlet 1/4 N.P.T.
- ▲ No Alignment Specified-Center Stud Mounting is Standard
- ⊗ Combination Stud/Air Inlet Stud Outside Thread is 3/4-16
- Studs Inside Thread (Air Inlet) is 1/4 N.P.T. Exceptions Will Be Noted on Part View as ⊗

1T - Reversible Sleeve

BELLOW NO. ASSEMBLY ORDER NO.	CROSS SECTION VIEW	BEAD PLATE TOP VIEW	PISTON BOTTOM VIEW	ASSEMBLY WEIGHT (lbs.)	REPLACES
1T15M-7.5 W01-358-9971		3235 	9652/ NBD-10486 ORDER NO. WC1-358-0659	15.5	Holland (Neway) 90557295 (RL230,GRL228)
1T15M-7.5 W01-358-9972		3226 	9532 NAD-29827 Order No. WC1-358-1619	14.0	Holland (Neway) 90557302 RL230
1T15M-7.5 W01-358-9974		3306 	9652 / NBD-10436 ORDER NO. WC1-358-0659	14.3	Holland 90557332
1T15M-8 W01-358-9287 BRACKET WC1-358-3903		3313 	9561 / NAD-32767 Order No. WC1-358-1606	18.5	Hendrickson 50405-1&2 (Ford, W.Star) HA-360/400/ 460 [1991-Up] Hendrickson 50405 (remove intermediate plate and use new production version with bracket)
1T15M-8 W01-358-9297 BRACKET WC1-358-3903		3313 	9538/NAD-27740 Order No. WC1-358-1628	16.5	Hendrickson 50898-1 & 2 (GH & Ford) (class 6, 7 & 8) Hendrickson Truck 64651-2

1T Style Springs

Hardware Key

- Bolt or Stud 1/2-13
- ⊕ Threaded Hole 3/8-16 Blind Nut on Bead Plates 1/2-13 Pistons
- ⊗ Air Inlet 1/4 N.P.T.
- ▲ No Alignment Specified-Center Stud Mounting is Standard
- ⊗ Combination Stud/Air Inlet Stud Outside Thread is 3/4-16
- ⊗ Studs Inside Thread (Air Inlet) is 1/4 N.P.T. Exceptions Will Be Noted on Part View as ⊗

Firestone

BELLOW NO. ASSEMBLY ORDER NO.	CROSS SECTION VIEW	BEAD PLATE TOP VIEW	PISTON BOTTOM VIEW	ASSEMBLY WEIGHT (lbs.)	REPLACES
1T15M-8 W01-358-9371 BRACKET WC1-358-3888			 ORDER NO. WC1-358-1620	18.0	Navistar 1670073C-1 Navistar 1686386C-1
1T15M-8 W01-M58-9372			 Order No. WC1-358-1628	16.7	Hendrickson 58520-2 (Nissan) (replaces 58654-2) Hendrickson Truck 64489-2
1T15M-8 W01-358-9373 BRACKET WC1-358-3903			 Order No. WC1-358-1628	16.1	Hendrickson 57122-2 (Ford, class 8) HAS-360/400/402/460
1T15M-8 W01-358-9375 BRACKET WC1-358-3904			 ORDER NO. WC1-358-1628	16.9	Hendrickson 50899-1 & 2 (Mack-class 8) 57QL414M Mack 3645Q27
1T15M-8 W01-358-9641			 Order No. WC1-358-1628	16.8	Hendrickson 59010-2

Hardware Key

- Bolt or Stud 1/2-13
- ⊕ Threaded Hole 3/8-16 Blind Nut on Bead Plates 1/2-13 Pistons
- ⊗ Air Inlet 1/4 N.P.T.
- ▲ No Alignment Specified-Center Stud Mounting is Standard
- ⊗ Combination Stud/Air Inlet Stud Outside Thread is 3/4-16
- Studs Inside Thread (Air Inlet) is 1/4 N.P.T. Exceptions Will Be Noted on Part View as ⊗

1T - Reversible Sleeve

BELLOW NO. ASSEMBLY ORDER NO.	CROSS SECTION VIEW	BEAD PLATE TOP VIEW	PISTON BOTTOM VIEW	ASSEMBLY WEIGHT (lbs.)	REPLACES
1T15M-8 W01-M58-9642 METRIC			 Order No. WC1-358-1628	14.6	Hendrickson 59055-2 - (HAD 150 & 190) replaces 58817-2 RVI/US
1T15M-8 W01-358-9647 BRACKET WC1-358-3906 REPLACES 1T15MT-8			 Order No. WC1-358-1628	15.9	Hendrickson 58786-2 (MACK 57QL417M) Replaces 1T15MT-8
1T15M-8 W01-358-9649			 ORDER NO. WC1-358-1606	17.2	Holland (Neway) 90557252
1T15M-8 W01-358-9654			 Order No. WC1-358-1628 Order No. WC1-358-3715	15.1	Hendrickson 65032-2 Mack 57QL53M
1T15M-8 W01-M58-9656 METRIC			 ORDER NO. WC1-358-1628	19	Hendrickson Truck 64651-2 Mack 57QL57M

1T Style Springs

Hardware Key

- Bolt or Stud 1/2-13 ⊕ Threaded Hole 3/8-16 Blind Nut on Bead Plates 1/2-13 Pistons ⊗ Air Inlet 1/4 N.P.T. ▲ No Alignment Specified-Center Stud Mounting is Standard
- ⊗ Combination Stud/Air Inlet Stud Outside Thread is 3/4-16 Studs Inside Thread (Air Inlet) is 1/4 N.P.T. Exceptions Will Be Noted on Part View as ⊗



Firestone

BELLOW NO. ASSEMBLY ORDER NO.	CROSS SECTION VIEW	BEAD PLATE TOP VIEW	PISTON BOTTOM VIEW	ASSEMBLY WEIGHT (lbs.)	REPLACES
1T15M-8 W01-358-9663 BRACKET WC1-358-3906		3385 	9538/NAD-27740 	16.2	Hendrickson Truck 60271-2 Mack 57WL57M Order No. WC1-358-1628
1T15M-9 W01-358-0783		3226 	9530/NAD-27809 	16.0	Goodyear 1R12-467 Ridewell 1000001
1T15M-9 W01-358-8842		3313 	9532/ NAD-29827 	15.2	Link 1103-0058 ORDER NO. WC1-358-1619
1T15M-9 W01-358-8852		3302 	9532/NAD-29827 	13.2	Peterbilt 03-07887 (Low Air Leaf) ORDER NO. WC1-358-1619
1T15M-9 W01-358-8855		3242 	9530/ NAD-27809 	14.6	Reyco 23521-01 ORDER NO. WC1-358-9452

Hardware Key

- Bolt or Stud 1/2-13
- ⊕ Threaded Hole 3/8-16 Blind Nut on Bead Plates 1/2-13 Pistons
- ⊗ Air Inlet 1/4 N.P.T.
- ▲ No Alignment Specified-Center Stud Mounting is Standard
- ⊗ Combination Stud/Air Inlet Stud Outside Thread is 3/4-16
- ⊗ Studs Inside Thread (Air Inlet) is 1/4 N.P.T. Exceptions Will Be Noted on Part View as ⊗

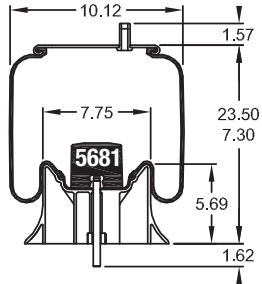
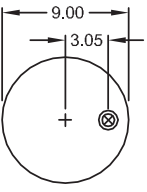
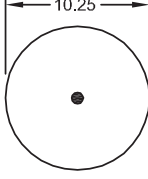
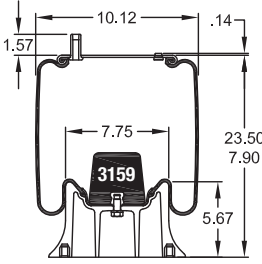
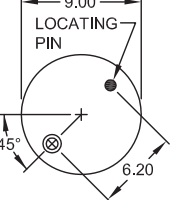
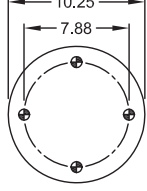
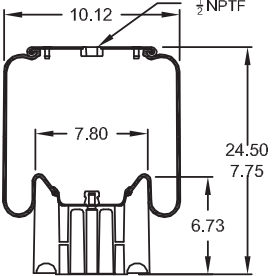
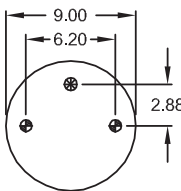
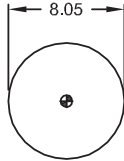
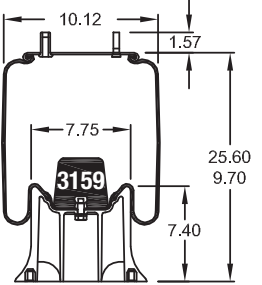
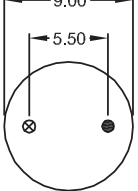
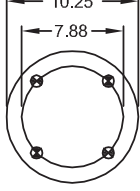
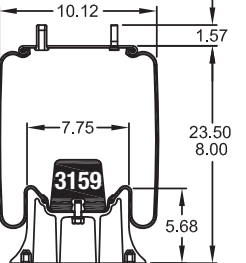
1T - Reversible Sleeve

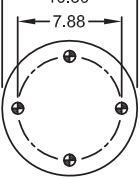
BELLOW NO. ASSEMBLY ORDER NO.	CROSS SECTION VIEW	BEAD PLATE TOP VIEW	PISTON BOTTOM VIEW	ASSEMBLY WEIGHT (lbs.)	REPLACES
1T15M-9 W01-358-8856		3242 	9532/NAD-29827  Order No. WC1-358-1619	14.5	Reyco 23521-02
1T15M-9 W01-358-8861		3192 	9530/NAD-27809  Order No. WC1-358-9452	15.5	Watson & Chalin AS-0061-1 Goodyear 1R12-534
1T15M-9 W01-358-8864		3202 	9531 / NAD-28197  ORDER NO. WC1-358-1626	14.1	Peterbilt 03-08716 (New Low Leaf Supersedes 03-07887 effective 04/04) C811011 Paccar Part
1T15M-9 W01-358-9101 SERVICE ASSEMBLY W01-358-9102		3235 	9553 / NAD-29467  ORDER NO. WC1-358-9453	16.7	Holland (Neway) 90557008 90557009 90557082 Ridewell 1003589101C Reyco 12883-01 Silent Drive Truckstell (Marion Mfg.) 63647 MFG.SV.# Neway 90044201 Watson & Chalin AS-0040
1T15M-9 W01-358-9192 SERVICE ASSEMBLY W01-358-9102		3235 	9530/NAD-27809  Order No. WC1-358-9452	15.9	Hendrickson Trailer S6195 Holland (Neway) 90557086 90557108 (AR-90) Watson & Chalin AS-0038 AS-0046 Rotate Piston 90557135-28LH Rotate Piston 90557136-28RH

1T Style Springs

Hardware Key

- Bolt or Stud 1/2-13
- ⊕ Threaded Hole 3/8-16 Blind Nut on Bead Plates 1/2-13 Pistons
- ⊗ Air Inlet 1/4 N.P.T.
- ▲ No Alignment Specified-Center Stud Mounting is Standard
- ⊗ Combination Stud/Air Inlet Stud Outside Thread is 3/4-16
- Studs Inside Thread (Air Inlet) is 1/4 N.P.T. Exceptions Will Be Noted on Part View as ⊗

Firestone

BELLOW NO. ASSEMBLY ORDER NO.	CROSS SECTION VIEW	BEAD PLATE TOP VIEW	PISTON BOTTOM VIEW	ASSEMBLY WEIGHT (lbs.)	REPLACES
1T15M-9 W01-358-9203		3271 	9530/NAD-27809 Order No. WC1-358-9452	16.0	Hendrickson Trailer S2694
1T15M-9 W01-358-9238		3210 	9553/NAD-29467 Order No. WC1-358-9453	16.4	Hendrickson Trailer S5060
1T15M-9 W01-358-9240		3235 	9553 / NAD-29467 ORDER NO. WC1-358-9453	16.6	Hendrickson Trailer S3842 Hendrickson Can. S10352
1T15M-9 W01-358-9243		3235 	9532 / NAD-29827 ORDER NO. WC1-358-1619	14.4	Holland (Neway) 900557112 (AR90-[All]) (ARU92-9&10) Watson & Chain AS-0061
1T15M-9 W01-358-9245 SERVICE ASSEMBLY W01-358-9102		3490 	9530 / NAD-27809 Order No. WC1-358-9452	15.8	Ridewell 1003589245C

Hardware Key

- Bolt or Stud 1/2-13
- ⊕ Threaded Hole 3/8-16 Blind Nut on Bead Plates 1/2-13 Pistons
- ⊗ Air Inlet 1/4 N.P.T.
- ▲ No Alignment Specified-Center Stud Mounting is Standard
- ⊗ Combination Stud/Air Inlet Stud Outside Thread is 3/4-16
- ⊗ Studs Inside Thread (Air Inlet) is 1/4 N.P.T. Exceptions Will Be Noted on Part View as ⊗

1T - Reversible Sleeve

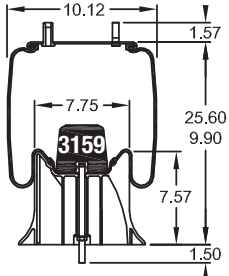
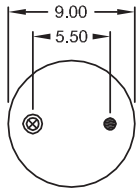
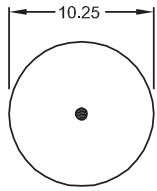
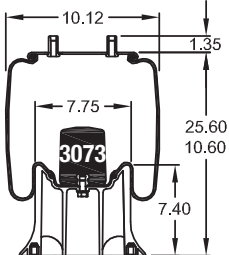
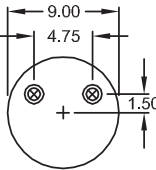
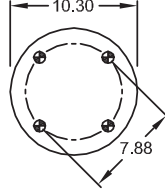
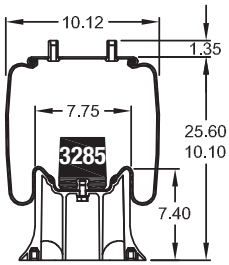
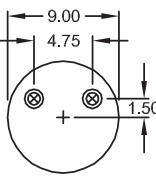
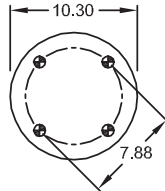
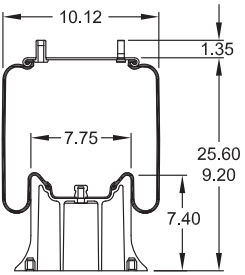
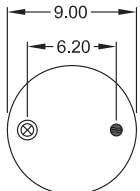
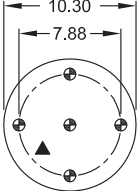
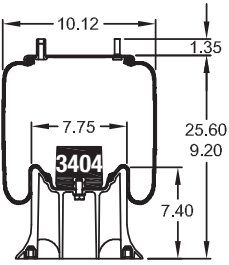
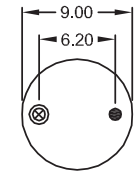
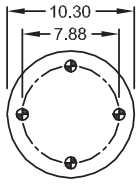
BELLOW NO. ASSEMBLY ORDER NO.	CROSS SECTION VIEW	BEAD PLATE TOP VIEW	PISTON BOTTOM VIEW	ASSEMBLY WEIGHT (lbs.)	REPLACES
1T15M-9 W01-358-9346 SERVICE ASSEMBLY W01-358-9102		3235 	9540/NAD-29828  Order No. WC1-358-0664	16.6	Holland (Neway) 90557126 (AR-75-12) (AR-75-1-12) (ARU92-12) Watson & Chain AS-0056
1T15M-9 W01-358-9348		3173 	9553/NAD-29467  Order No. WC1-358-9453	16.9	CCG McCullough Trailer
1T15M-9 W01-358-9349		3173 	9553/NAD-29467  Order No. WC1-358-9453	19.8	Hendrickson Trailer S8988 Reyco 17636-01
1T15M-9 W01-358-9350		3271 	9553/NAD-29467  Order No. WC1-358-9453	14.6	Watson & Chain
1T15M-9 W01-358-9394		3271 	9553/NAD-29467  Order No. WC1-358-9453	16.5	Fruehauf UCD-9393-2 (-if bolt is removed, this part can replace the UCE-9393-1) Suspensions Inc. 200041 supersedes 9241

1T Style Springs

Hardware Key

- Bolt or Stud 1/2-13
- ⊕ Threaded Hole 3/8-16 Blind Nut on Bead Plates 1/2-13 Pistons
- ⊗ Air Inlet 1/4 N.P.T.
- ▲ No Alignment Specified-Center Stud Mounting is Standard
- ⊗ Combination Stud/Air Inlet Stud Outside Thread is 3/4-16
- ⊗ Studs Inside Thread (Air Inlet) is 1/4 N.P.T. Exceptions Will Be Noted on Part View as ⊗

Firestone

BELLOW NO. ASSEMBLY ORDER NO.	CROSS SECTION VIEW	BEAD PLATE TOP VIEW	PISTON BOTTOM VIEW	ASSEMBLY WEIGHT (lbs.)	REPLACES
1T15M-9 W01-358-9875 OBSOLETE REPLACED BY W01-358-1191		3173 	9538/NAD-27740 	15.2	Bead plate Bracket (Single Hole) 70-3582-6063 NAVISTAR 3541731C1
1T15M-9 W01-358-9876 OBSOLETE REPLACED BY W01-358-1190		2883 	9538/NAD-27740 	15.2	Bead plate Bracket (Double Hole)
1T15M-11 W01-358-9320		3490 	9553/NAD-29467 Order No. WC1-358-9453	17.3	Holland (Neway) 90557099 Silent Drive
1T15M-11 W01-358-9321		3271 	9653/NBD-10437 Order No. WC1-358-0620	19.8	Watson & Chain AS-0036
1T15M-11 W01-358-9338		3490 	9553/NAD-29467 Order No. WC1-358-9453	18.2	Silent Drive

Hardware Key

- Bolt or Stud 1/2-13
- ⊕ Threaded Hole 3/8-16 Blind Nut on Bead Plates 1/2-13 Pistons
- ⊗ Air Inlet 1/4 N.P.T.
- ▲ No Alignment Specified-Center Stud Mounting is Standard
- ⊗ Combination Stud/Air Inlet Stud Outside Thread is 3/4-16
- ⊗ Studs Inside Thread (Air Inlet) is 1/4 N.P.T. Exceptions Will Be Noted on Part View as ⊗

1T - Reversible Sleeve

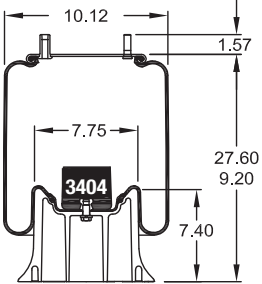
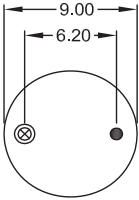
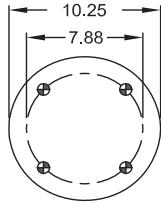
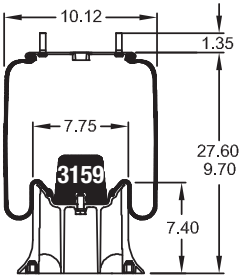
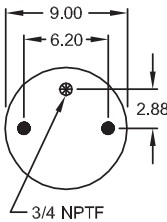
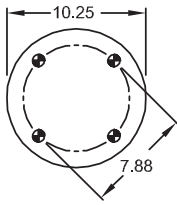
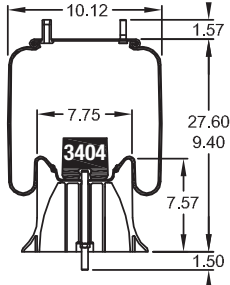
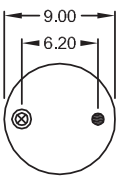
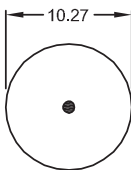
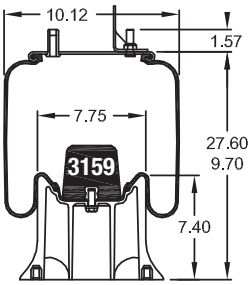
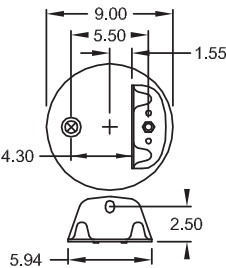
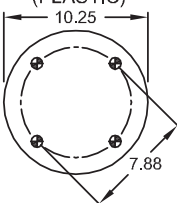
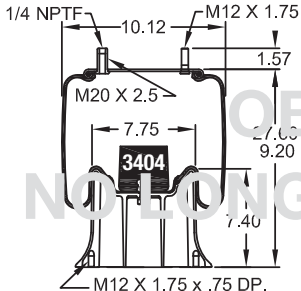
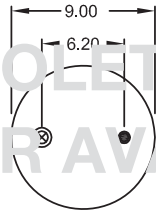
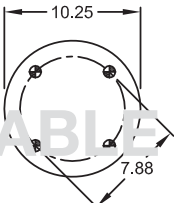
BELLOW NO. ASSEMBLY ORDER NO.	CROSS SECTION VIEW	BEAD PLATE TOP VIEW	PISTON BOTTOM VIEW	ASSEMBLY WEIGHT (lbs.)	REPLACES
1T15M-11 W01-358-9367		3188 	9653/NBD-10437  Order No. WC1-358-0620	20.4	Hendrickson S14249 (W01-455-9321) Hendrickson Aux. 003319 (metric equivalent)
1T15M-11 W01-358-9368		3205 	9553/NAD-29467  Order No. WC1-358-9453	20.7	Ridewell 1003589368C
1T15M-11 W01-358-9370		3188 	9540/NAD-29828  Order No. WC1-358-0664	17.0	Watson & Chalm AS-0057
1T15M-11 W01-358-9538 BRACKET WC1-358-3906		3490 	9553/NAD-29467 (PLASTIC)  Order No. WC1-358-9453	18.2	Ridewell 1003589538C
1T15M-11 W01-M58-9668 OBSOLETE METRIC		3749 	3853/NBD-14153 ALUM. 	19.8	Hendrickson Aux. 003319 (Same as SAE version W01-358-9367)

1T Style Springs

OBSOLETE
NO LONGER AVAILABLE

Hardware Key

- Bolt or Stud 1/2-13
- ⊕ Threaded Hole 3/8-16 Blind Nut on Bead Plates 1/2-13 Pistons
- ⊗ Air Inlet 1/4 N.P.T.
- ▲ No Alignment Specified-Center Stud Mounting is Standard
- ⊗ Combination Stud/Air Inlet Stud Outside Thread is 3/4-16
- ⊗ Studs Inside Thread (Air Inlet) is 1/4 N.P.T. Exceptions Will Be Noted on Part View as ⊗

Firestone

BELLOW NO. ASSEMBLY ORDER NO.	CROSS SECTION VIEW	BEAD PLATE TOP VIEW	PISTON BOTTOM VIEW	ASSEMBLY WEIGHT (lbs.)	REPLACES
1T15MA-4 W01-M58-9851 METRIC (WAS 1T15M-4)		3313 	9573/NAD-18162 Order No. WC1-358-1634	13.0	Hendrickson 65086-2
1T15MJ-6 W01-358-9097 OBSOLETE		3271 	9744/NBD-9673 Order No. N/A		Navistar 426213C-1 Navistar 4545910C-1 Navistar 442307C-91 Navistar 4545889C-1
1T15MJ-6 W01-358-9098 OBSOLETE		3235 	9744 NBD-9673 Order No. N/A		Navistar 350243C-94 Navistar 442305C-91 Navistar 426212C-1 Navistar 442306C-91 Navistar 454590C-1 Navistar 454588C-91
1T15MM-9 W01-358-9265 REPLACES 1T15MW-10		3242 	9694/NAD-25396 Order No. WC1-358-1694	16.7	Hendrickson Trailer S20124 Hendrickson Trailer HT-250T Hendrickson Trailer C20413 (rotate piston to 45deg alignment) Hendrickson Trailer HT-250U (all others) Hendrickson Trailer HT-250U-Y (9Y-001)
1T15MR-2 W01-358-9268 CUSTOMER SUPPLIED PISTON		3253 			Holland (Neway) 90557123 - Service assembly only (no piston) ARD120 & 240-5 (Air Beam) (90054540 w/o bracket)

Hardware Key

- Bolt or Stud 1/2-13
- ⊕ Threaded Hole 3/8-16 Blind Nut on Bead Plates 1/2-13 Pistons
- ⊗ Air Inlet 1/4 N.P.T.
- ▲ No Alignment Specified-Center Stud Mounting is Standard
- ⊗ Combination Stud/Air Inlet Stud Outside Thread is 3/4-16
- ⊗ Studs Inside Thread (Air Inlet) is 1/4 N.P.T. Exceptions Will Be Noted on Part View as ⊗

1T - Reversible Sleeve

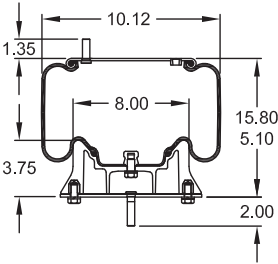
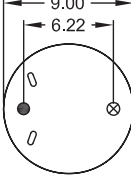
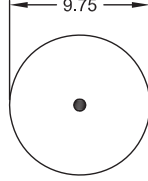
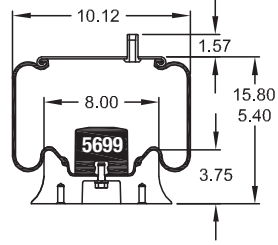
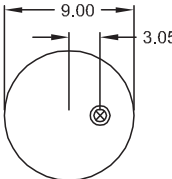
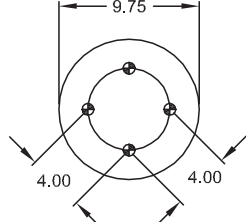
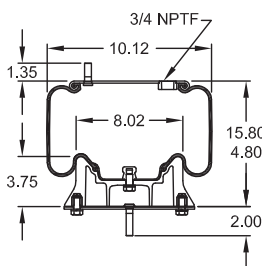
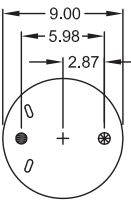
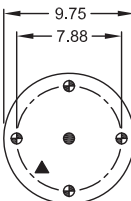
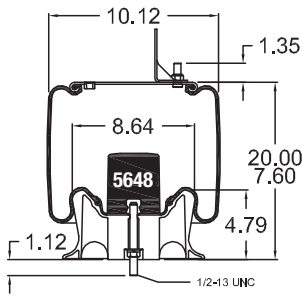
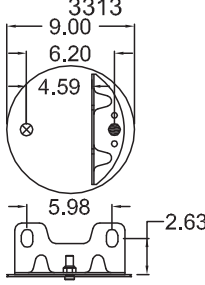
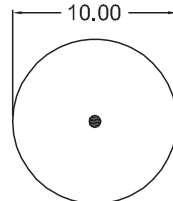
BELLOW NO. ASSEMBLY ORDER NO.	CROSS SECTION VIEW	BEAD PLATE TOP VIEW	PISTON BOTTOM VIEW	ASSEMBLY WEIGHT (lbs.)	REPLACES
1T15MT-3 W01-358-9634 REPLACES 1T15ZR-3		3404 	9550/NAD-29456  Order No. WC1-358-1652	16.2	Freightliner 16-14263-000 Freightliner 16-15443-000 (6033 bracket) Freightliner 16-14263-001 Freightliner 16-15443-001 (6034 bracket) Freightliner 16-15444-000 service (no bracket, no piston) --reuse old bracket or purchase separately (pg.62) replacement Freightliner 16-19470-000 16-18333-000 16-18333-001
1T15MT-3 W01-358-9640		3242 	9702/ NAD-27357  ORDER NO. WC1-358-1608	14.3	Hendrickson Trailer S20223 (HT-190T, HS-190T) - replaces W01-358-9630
1T15MT-3 W01-358-9774 REPLACES 1T15ZR-3		3403 	9550/NAD-29456  Order No. WC1-358-1652	16.0	Freightliner Custom Chassis 16-15762-000 Ambulance Freightliner 16-18334-000 16-19471-000
1T15MT-6 W01-358-9643 BRACKET WC1-358-3903		3313 	9538 / NAD-27740  ORDER NO. WC1-358-1628	16.0	Hendrickson 58995-2 (Freightliner)

1T Style Springs

Hardware Key

- Bolt or Stud 1/2-13
- ⊕ Threaded Hole 3/8-16 Blind Nut on Bead Plates 1/2-13 Pistons
- ⊗ Air Inlet 1/4 N.P.T.
- ▲ No Alignment Specified-Center Stud Mounting is Standard
- ⊗ Combination Stud/Air Inlet Stud Outside Thread is 3/4-16
- Studs Inside Thread (Air Inlet) is 1/4 N.P.T. Exceptions Will Be Noted on Part View as ⊗

Firestone

BELLOW NO. ASSEMBLY ORDER NO.	CROSS SECTION VIEW	BEAD PLATE TOP VIEW	PISTON BOTTOM VIEW	ASSEMBLY WEIGHT (lbs.)	REPLACES
1T15MW-6 W01-358-9299		3242 	9694/NAD-25396 Order No. WC1-358-1694	16.4	Hendrickson Trailer S20716 [HT250U(6.5-002)]
1T15MLW-7 W01-358-8944		3242 	9694/NAD-25396 Order No. WC1-358-1694	16.7	Hendrickson Trailer S20217 (HT-190U) - supersedes W01-358-9015
1T15MPW-7 W01-M58-6260 METRIC		3746 	9538/NAD-27740 PLASTIC Order No. WC1-358-1628	15.4	Hendrickson Truck 59053-2
1T15MPW-7 W01-M58-6317 METRIC		3441 	9544/NAD-29826 M12 x 1.75 Order No. WC1-358-0666	19.5	Holland (Neway) 90557233
1T15MPW-7 W01-358-6231 SUPERSEDES W01-358-6262		3249 	9507/NAD-31763 	14.5	Arvin Meritor 21227742FS FS230

Hardware Key

- Bolt or Stud 1/2-13
- ⊕ Threaded Hole 3/8-16 Blind Nut on Bead Plates 1/2-13 Pistons
- ⊗ Air Inlet 1/4 N.P.T.
- ▲ No Alignment Specified-Center Stud Mounting is Standard
- ⊗ Combination Stud/Air Inlet Stud Outside Thread is 3/4-16
- Studs Inside Thread (Air Inlet) is 1/4 N.P.T. Exceptions Will Be Noted on Part View as ⊗

1T - Reversible Sleeve

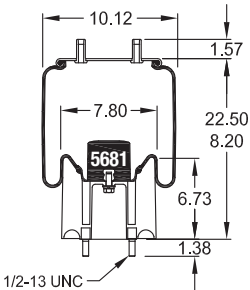
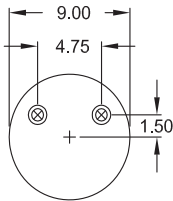
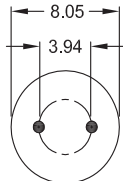
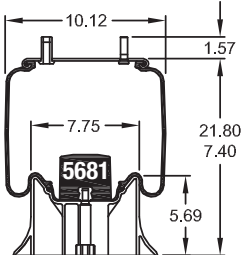
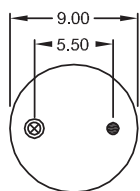
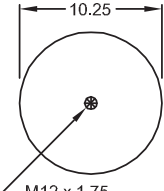
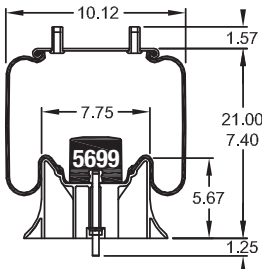
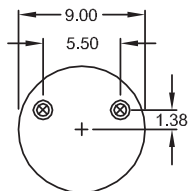
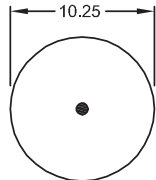
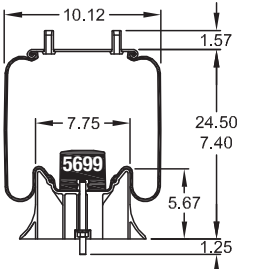
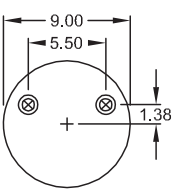
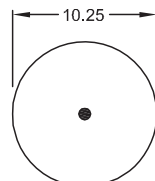
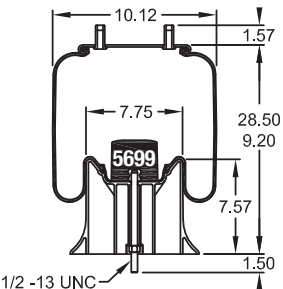
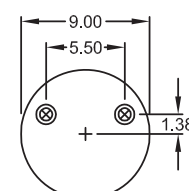
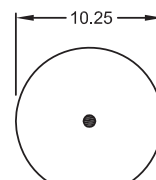
BELLOW NO. ASSEMBLY ORDER NO.	CROSS SECTION VIEW	BEAD PLATE TOP VIEW	PISTON BOTTOM VIEW	ASSEMBLY WEIGHT (lbs.)	REPLACES
1T15MPW-7 W01-358-6262		3249 	9557/NAD-31181  Order No. WC1-358-1654	14.3	
1T15MPW-7 W01-358-8903		3235 	9532/NAD-29827  Order No. WC1-358-1619	13.6	Holland (Neway) 90557169 (Advance Mixer)
1T15MBTW-6 W01-358-9644		3306 	9532/NAD-29827  Order No. WC1-358-1619	13.8	Hendrickson Trailer S23721
1T15MBTW-10 W01-358-9646		3306 	9532/NAD-29827  Order No. WC1-358-1619	14.4	Hendrickson Trailer S23611
1T15MBTW-12 W01-358-9645		3306 	9540/NAD-29828  Order No. WC1-358-0664	16.9	Hendrickson Trailer S23612

1T Style Springs

Hardware Key

- Bolt or Stud 1/2-13
- ⊕ Threaded Hole 3/8-16 Blind Nut on Bead Plates 1/2-13 Pistons
- ⊗ Air Inlet 1/4 N.P.T.
- ▲ No Alignment Specified-Center Stud Mounting is Standard
- ⊗ Combination Stud/Air Inlet Stud Outside Thread is 3/4-16
- ⊗ Studs Inside Thread (Air Inlet) is 1/4 N.P.T. Exceptions Will Be Noted on Part View as ⊗

Firestone

BELLOW NO. ASSEMBLY ORDER NO.	CROSS SECTION VIEW	BEAD PLATE TOP VIEW	PISTON BOTTOM VIEW	ASSEMBLY WEIGHT (lbs.)	REPLACES
1T15S-5 W01-358-9076		3220 	9757/NBD-9242 	13.3	Pezzani
		ORDER NO. N/A			
1T15S-6 W01-358-9043 OBSOLETE REPLACED BY W01-358-9652		3190 	9789 / NBD-8881 		Mack 57QL1115 Hendrickson Trailer S-14147
1T15S-6 W01-358-9259 OBSOLETE REPLACED BY W01-358-8478		3201 	9535 / NAD-29592 	14.3	Jet Co. (replace 9255) (11.0" max. OD) Bolt removed for center mounting
		ORDER NO. N/A			
1T15SN-3 W01-358-8911		3235 	9535/NAD-29592 	12.9	Rockwell
1T15SN-6 W01-358-9260		3201 	9535/NAD-29592 	13.2	Jet Co. (10.3 max. OD) Bolt removed for center mounting
		Order No. N/A			

Hardware Key

- Bolt or Stud 1/2-13 ⊕ Threaded Hole 3/8-16 Blind Nut on Bead Plates 1/2-13 Pistons ⊗ Air Inlet 1/4 N.P.T. ▲ No Alignment Specified-Center Stud Mounting is Standard
- ⊗ Combination Stud/Air Inlet Stud Outside Thread is 3/4-16 Studs Inside Thread (Air Inlet) is 1/4 N.P.T. Exceptions Will Be Noted on Part View as ⊗

1T - Reversible Sleeve

BELLOW NO. ASSEMBLY ORDER NO.	CROSS SECTION VIEW	BEAD PLATE TOP VIEW	PISTON BOTTOM VIEW	ASSEMBLY WEIGHT (lbs.)	REPLACES
1T15SN-6 W01-358-9278		3225 	9535/NAD-29592 	11.4	Caterpillar 102-9283
1T15T-1 W01-358-9402		3215 	9492 / FIP-100742 	10.6	Capacity of Texas Order No. WC1-358-1642
1T15T-1 W01-358-9410		3266 	9492/FIP-100742 	9.8	Columbia Trailer Order No. WC1-358-1642
1T15T-1 W01-358-9650		3235 	9654/NBD-10438 	12.3	Holland (Neway) 90557097 Order No. WC1-358-0663
1T15T-1 W01-358-9651		3220 	9571/NAD-18130 	9.8	Monaco Coach 01806160 Order No. WC1-358-0646

1T Style Springs

Hardware Key

- Bolt or Stud 1/2-13
- ⊕ Threaded Hole 3/8-16 Blind Nut on Bead Plates 1/2-13 Pistons
- ⊗ Air Inlet 1/4 N.P.T.
- ▲ No Alignment Specified-Center Stud Mounting is Standard
- ⊗ Combination Stud/Air Inlet Stud Outside Thread is 3/4-16
- ⊗ Studs Inside Thread (Air Inlet) is 1/4 N.P.T. Exceptions Will Be Noted on Part View as ⊗



Firestone

BELLOW NO. ASSEMBLY ORDER NO.	CROSS SECTION VIEW	BEAD PLATE TOP VIEW	PISTON BOTTOM VIEW	ASSEMBLY WEIGHT (lbs.)	REPLACES
1T15T-2 W01-358-8600		3215 	9492/FIP-100742 	11.5	Capacity of Texas
1T15TM-1 W01-358-5765		3235 	9492/FIP-100742 	11.9	American Carrier 8003-024
1T15TM-1 W01-358-5766		3235 	9492/FIP-100742 	12.1	American Carrier 8003-023 Hutchens 19141-01
1T15TM-1 W01-358-9421		3235 	9492/FIP-100742 	10.1	American Carrier 8003-003
1T15TM-1 W01-358-9423		3235 	9655/NBD-10439 	13.0	Ridewell 1003589423C

Hardware Key

- Bolt or Stud 1/2-13
- ⊕ Threaded Hole 3/8-16 Blind Nut on Bead Plates 1/2-13 Pistons
- ⊗ Air Inlet 1/4 N.P.T.
- ▲ No Alignment Specified-Center Stud Mounting is Standard
- ⊗ Combination Stud/Air Inlet Stud Outside Thread is 3/4-16
- ⊗ Studs Inside Thread (Air Inlet) is 1/4 N.P.T. Exceptions Will Be Noted on Part View as ⊗

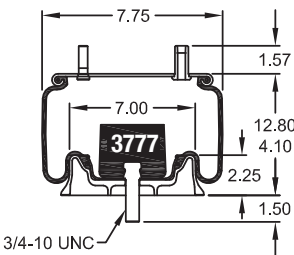
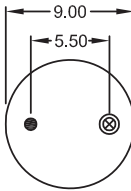
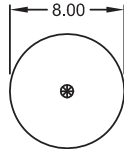
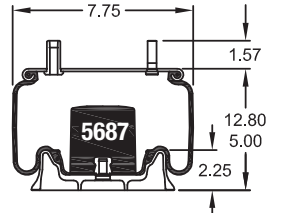
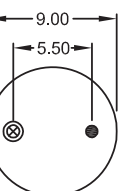
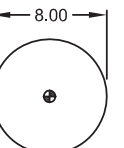
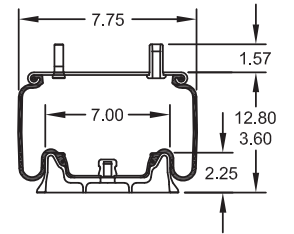
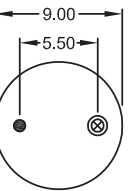
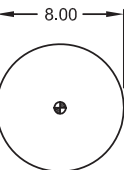
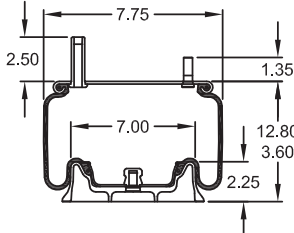
1T - Reversible Sleeve

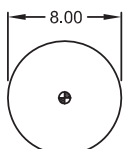
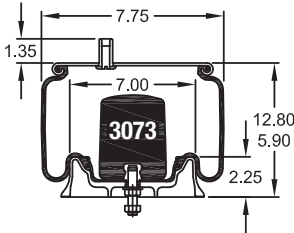
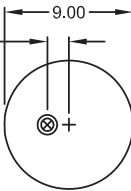
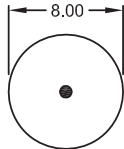
BELLOW NO. ASSEMBLY ORDER NO.	CROSS SECTION VIEW	BEAD PLATE TOP VIEW	PISTON BOTTOM VIEW	ASSEMBLY WEIGHT (lbs.)	REPLACES
1T15TQ-1 W01-358-5770		3235 	9681/NBD-14213  Order No. WC1-358-1612	11.2	Ridewell 1003585770C Watson & Chalin AS-0042
1T15TQ-1 W01-358-5771		3235 	9681/NBD-14213  Order No. WC1-358-1612	10.3	Brock
1T15TQ-1 W01-358-5772		3235 	9681/NBD-14213  Order No. WC1-358-1612	9.4	Brock Link (see 5789)
1T15TQ-1 W01-358-5773		3267 	9681/NBD-14213  Order No. WC1-358-1612	9.8	Kenworth
1T15TQ-1 W01-358-5775		3211 	9681/NBD-14213  Order No. WC1-358-1612	11.9	Reyco 20783-01

1T Style Springs

Hardware Key

- Bolt or Stud 1/2-13 ⊕ Threaded Hole 3/8-16 Blind Nut on Bead Plates 1/2-13 Pistons ⊗ Air Inlet 1/4 N.P.T. ▲ No Alignment Specified-Center Stud Mounting is Standard
- ⊗ Combination Stud/Air Inlet Stud Outside Thread is 3/4-16 Studs Inside Thread (Air Inlet) is 1/4 N.P.T. Exceptions Will Be Noted on Part View as ⊗

Firestone

BELLOW NO. ASSEMBLY ORDER NO.	CROSS SECTION VIEW	BEAD PLATE TOP VIEW	PISTON BOTTOM VIEW	ASSEMBLY WEIGHT (lbs.)	REPLACES
1T15TQ-1 W01-358-5776 BRACKET WC1-358-3887		3253 	9681/NBD-14213 Order No. WC1-358-1612	11.6	Holland (Neway) 90557174 (AS 120) ref. W01-358-9586 (1/2 NPT)
1T15TQ-1 W01-358-5777		3211 	9681/NBD-14213 Order No. WC1-358-1612	11.1	Reyco 22425-01
1T15TQ-1 W01-358-5789		3235 	9681/NBD-14213 Order No. WC1-358-1612	11.2	Link 1103-0503 Ultraride
1T15TQ-1 W01-358-5792		3235 	9492/FIP-100742 Order No. WC1-358-1642	11.6	Ridewell 1003585792C
1T15TQ-1 W01-358-9586 BRACKET WC1-358-3887		3347 	9681/NBD-14213 Order No. WC1-358-1612	11.7	Holland (Neway) 90557249 replaces 90557221 (1/2 NPT-flush) (ref. W01-358-5776)

Hardware Key

- Bolt or Stud 1/2-13
- ⊕ Threaded Hole 3/8-16 Blind Nut on Bead Plates 1/2-13 Pistons
- ⊗ Air Inlet 1/4 N.P.T.
- ▲ No Alignment Specified-Center Stud Mounting is Standard
- ⊗ Combination Stud/Air Inlet Stud Outside Thread is 3/4-16
- ⊗ Studs Inside Thread (Air Inlet) is 1/4 N.P.T. Exceptions Will Be Noted on Part View as ⊗

1T - Reversible Sleeve

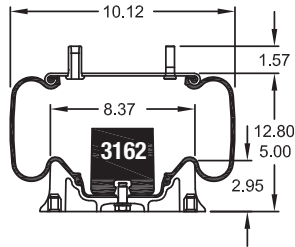
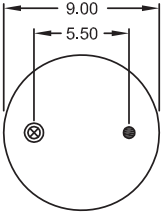
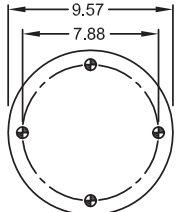
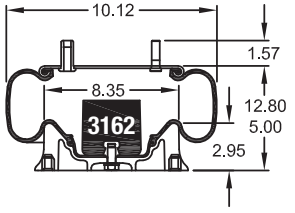
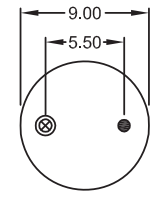
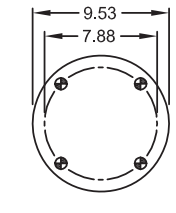
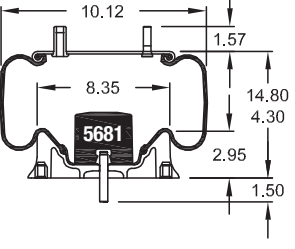
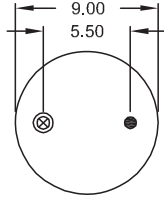
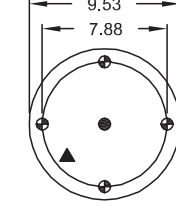
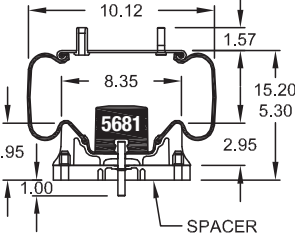
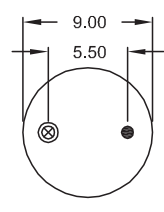
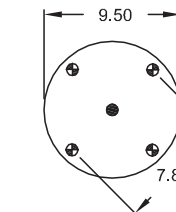
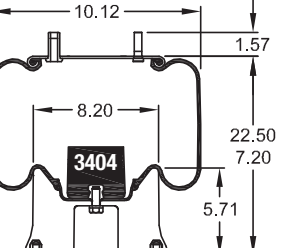
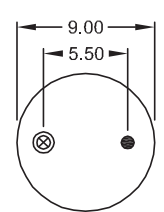
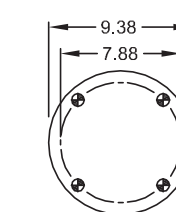
BELLOW NO. ASSEMBLY ORDER NO.	CROSS SECTION VIEW	BEAD PLATE TOP VIEW	PISTON BOTTOM VIEW	ASSEMBLY WEIGHT (lbs.)	REPLACES
1T15V-1 W01-358-9249			 Order No. WC1-358-0667	12.2	Holland (Neway) 90557107 Mercedes Bus Mexico Front
1T15V-1 W01-358-9251			 Order No. WC1-358-0667	12.3	Ridewell 1003589251C Suspensions 200182
1T15V-3 W01-358-9578			 ORDER NO. WC1-358-0667	11.7	Holland (Neway) 90557232
1T15V-3 W01-358-9582 SPACER WC1-358-3701			 ORDER NO. WC1-358-0667	13.0	Holland (Neway) 90557240 REPLACEMENT PISTON DOES NOT INCLUDE SPACER
1T15V-8 W01-358-9274				19.0	Ridewell 1003589274C

1T Style Springs

Hardware Key

- Bolt or Stud 1/2-13
- ⊕ Threaded Hole 3/8-16 Blind Nut on Bead Plates 1/2-13 Pistons
- ⊗ Air Inlet 1/4 N.P.T.
- ▲ No Alignment Specified-Center Stud Mounting is Standard
- ⊗ Combination Stud/Air Inlet Stud Outside Thread is 3/4-16
- ⊗ Studs Inside Thread (Air Inlet) is 1/4 N.P.T. Exceptions Will Be Noted on Part View as ⊗

Firestone

BELLOW NO. ASSEMBLY ORDER NO.	CROSS SECTION VIEW	BEAD PLATE TOP VIEW	PISTON BOTTOM VIEW	ASSEMBLY WEIGHT (lbs.)	REPLACES
1T15V-8 W01-358-9275		3235 	9462/FIP-101776 	19.3	Ridewell 1003589275C
1T15V-8 W01-358-9470 BRACKET WC1-358-3887		3253 	9532/ NAD-29827 	16.2	Holland (Neway) 90557145 (AD-246) Holland (Neway) 90557211 (2 bolt mounting on piston)
1T15V-8 W01-358-9471 BRACKET WC1-358-3887		3253 	9540/ NAD-29828 	17.8	Holland (Neway) (AD-123/246-10) 90557146 90557182 (no bracket) 90557177 (special lower connection) Holland (Neway) 90557212 (146) Holland (Neway) 90557214 (182) (2 bolt mounting on piston)
1T15V-8 W01-358-9472 BRACKET WC1-358-3887		3253 	9544/ NAD-29826 	16.2	Holland (Neway) 90557147 (AD-123/ 246-6.5 & 8.75) 90557213 (147) (2 bolt mounting on piston) 90557178-Ford (special lower connection)
1T15V-8 W01-358-9473 BRACKET WC1-358-3887		3253 	9540/ NAD-29828 	18.0	Holland (Neway) 90557152 90557179 (no bracket) 90557215 (152) 90557216 (179) (2 bolt mounting on piston)

Hardware Key

- Bolt or Stud 1/2-13
- ⊕ Threaded Hole 3/8-16 Blind Nut on Bead Plates 1/2-13 Pistons
- ⊗ Air Inlet 1/4 N.P.T.
- ▲ No Alignment Specified-Center Stud Mounting is Standard
- ⊗ Combination Stud/Air Inlet Stud Outside Thread is 3/4-16
- Studs Inside Thread (Air Inlet) is 1/4 N.P.T. Exceptions Will Be Noted on Part View as ⊗

1T - Reversible Sleeve

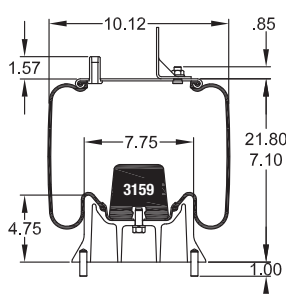
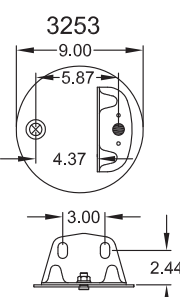
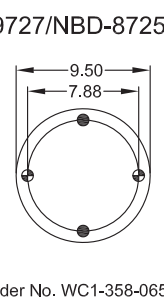
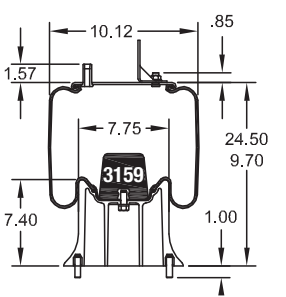
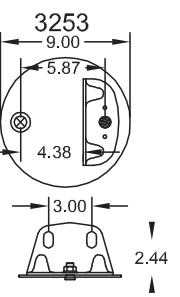
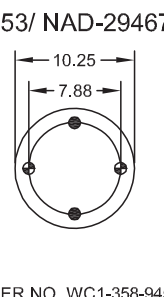
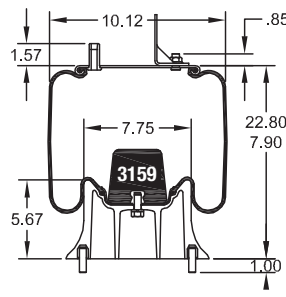
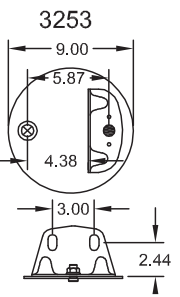
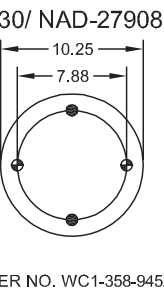
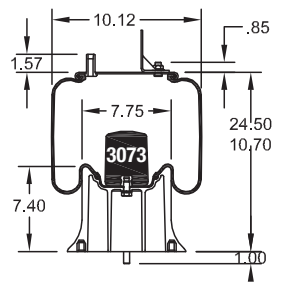
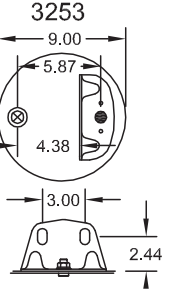
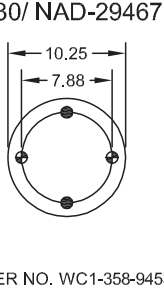
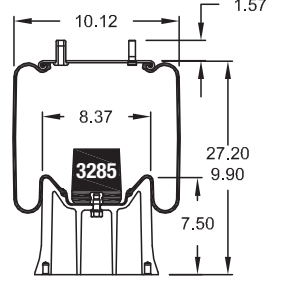
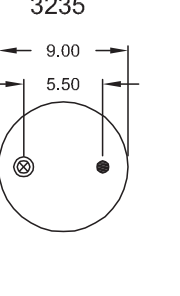
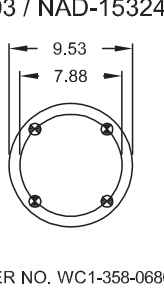
BELLOW NO. ASSEMBLY ORDER NO.	CROSS SECTION VIEW	BEAD PLATE TOP VIEW	PISTON BOTTOM VIEW	ASSEMBLY WEIGHT (lbs.)	REPLACES
1T15V-8 W01-358-9491 BRACKET WC1-358-3887				18.4	Holland (Neway) 90557206 90557213 REPLACEMENT PISTON COMES WITHOUT STUDS
1T15V-8 W01-358-9501				17.6	Holland 90557214 REPLACEMENT PISTON COMES WITHOUT STUDS
1T15V-8 W01-358-9502				16.2	Holland 90557211 REPLACEMENT PISTON COMES WITHOUT STUDS
1T15V-8 W01-358-9504				17.9	Holland 90557216
1T15V-11 W01-358-9250				23.7	Ridewell 1003589250C Silent Drive

1T Style Springs

Hardware Key

- Bolt or Stud 1/2-13
- ⊕ Threaded Hole 3/8-16 Blind Nut on Bead Plates 1/2-13 Pistons
- ⊗ Air Inlet 1/4 N.P.T.
- ▲ No Alignment Specified-Center Stud Mounting is Standard
- ⊗ Combination Stud/Air Inlet Stud Outside Thread is 3/4-16
- ⊗ Studs Inside Thread (Air Inlet) is 1/4 N.P.T. Exceptions Will Be Noted on Part View as ⊗

Firestone

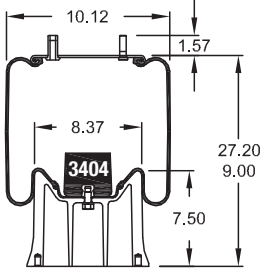
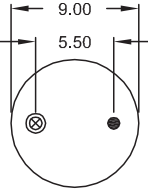
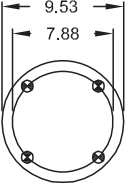
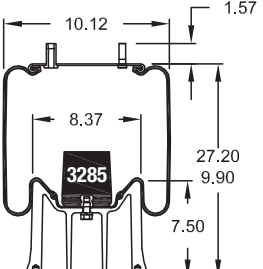
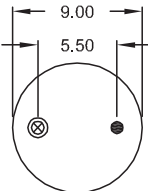
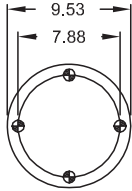
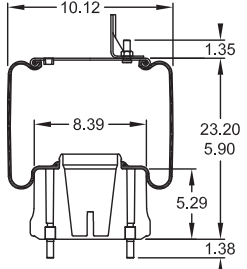
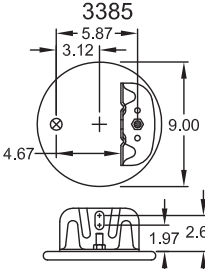
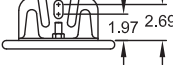
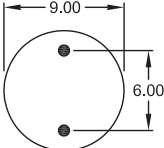
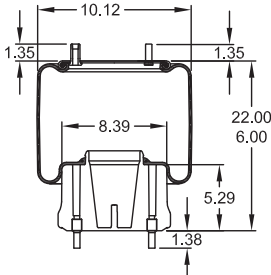
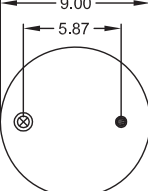
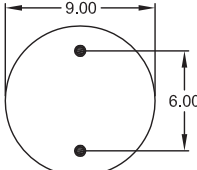
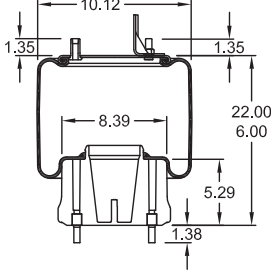
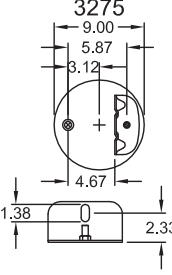
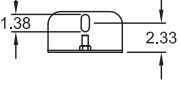
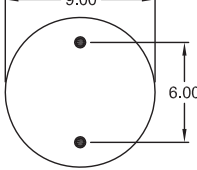
BELLOW NO. ASSEMBLY ORDER NO.	CROSS SECTION VIEW	BEAD PLATE TOP VIEW	PISTON BOTTOM VIEW	ASSEMBLY WEIGHT (lbs.)	REPLACES
1T15V-11 W01-358-9252		3235 	9803 / NAD-15324  ORDER NO. WC1-358-0680	23.3	Ridewell 1003589252C
1T15V-11 W01-358-9269		3235 	9803 / NAD-15324  ORDER NO. WC1-358-0680	23.5	Oshkosh RX-08-03
1T15VMR-8 W01-358-9865		3385  	9485/FIP-101705 		Hendrickson 67043-2
1T15VMR-8 W01-358-9866		3275 	9485/FIP-101705 	14.62	Hendrickson 67391-2
1T15VMR-8 W01-358-9867		3275  	9485 / FIP-101705 	15.54	Hendrickson 67392-2

Hardware Key

- Bolt or Stud 1/2-13
- ⊕ Threaded Hole 3/8-16 Blind Nut on Bead Plates 1/2-13 Pistons
- ⊗ Air Inlet 1/4 N.P.T.
- ▲ No Alignment Specified-Center Stud Mounting is Standard
- ⊗ Combination Stud/Air Inlet Stud Outside Thread is 3/4-16
- Studs Inside Thread (Air Inlet) is 1/4 N.P.T. Exceptions Will Be Noted on Part View as ⊗

1T - Reversible Sleeve

BELLOW NO. ASSEMBLY ORDER NO.	CROSS SECTION VIEW	BEAD PLATE TOP VIEW	PISTON BOTTOM VIEW	ASSEMBLY WEIGHT (lbs.)	REPLACES
1T15VMW-8 W01-358-6258		3249 	9557/ NAD-31181 	14.7	Arvin Meritor 21227892 FS25 ORDER NO. WC1-358-1654
1T15VP-4 W01-358-8800		3312 	9648/NAD-31288 	21.5	Hendrickson Trailer S-25559 Order No. WC1-358-1649
1T15VP-4 W01-358-9270 (REPLACES 1T15VM-4)		3242 	9602/ NAD-28351 	14.3	Hendrickson S-20010 (HT230T) ref.S21208 W01-455-9579 (different bead plate) Also replaces 1T15VM-4 ORDER NO. WC1-358-1613
1T15VP-4 W01-358-9579 OBSOLETE REPLACED BY W01-358-8800		3312 	9602/ NAD-28351 	14.8	Hendrickson Trailer S-21208 ORDER NO. WC1-358-1613
1T15XR-9 W01-358-1190 REPLACES W01-358-9876		2883 	4008/FIP-101526 	12.3	Bead plate Bracket (Double Hole) 70-358-6064 Navistar 3541732C1 Goodyear 1R12-523

1T Style Springs

Hardware Key

- Bolt or Stud 1/2-13
- ⊕ Threaded Hole 3/8-16 Blind Nut on Bead Plates 1/2-13 Pistons
- ⊗ Air Inlet 1/4 N.P.T.
- ▲ No Alignment Specified-Center Stud Mounting is Standard
- ⊗ Combination Stud/Air Inlet Stud Outside Thread is 3/4-16
- ⊗ Studs Inside Thread (Air Inlet) is 1/4 N.P.T. Exceptions Will Be Noted on Part View as ⊗

Firestone

BELLOW NO. ASSEMBLY ORDER NO.	CROSS SECTION VIEW	BEAD PLATE TOP VIEW	PISTON BOTTOM VIEW	ASSEMBLY WEIGHT (lbs.)	REPLACES
1T15XR-9 W01-358-1191 REPLACES W01-358-9875			4008/FIP-101526 	12.2	Bead plate Bracket (Single Hole) 70-358-6063 NAVISTAR 3541731C1 Goodyear 1R12-432
1T15XR-9 W01-358-1192			4008/FIP-101526 		Navistar 3691773C1
1T15XMR-7 BRACKET WC1-358_3873 W01-358-8829 REPLACES 1T15M-6			4008/FIP-101526 	12.2	Volvo 3934699 Volvo 8079902
1T15XNR-5 W01-358-9648 BRACKET 70-3582-6047 REPLACES 1T15M-8			4008/FIP-101526 	12.4	Navistar 2027911C1 & C2
C01-358-0583 1T15 X-SERIES W01-358-9780 REPLACES 1T15ZR-6			9527/NAD-27265 PLASTIC Order No. WC1-358-1627	16.6	Freightliner 16-13810-000 (plastic) Freightliner 681-320-0017 (aluminum) See W01-358-9781 Freightliner Piston 16-1673-000 (steel) See W01-358-9782 A16-18335-000 A16-18335-001

Hardware Key

- Bolt or Stud 1/2-13
- ⊕ Threaded Hole 3/8-16 Blind Nut on Bead Plates 1/2-13 Pistons
- ⊗ Air Inlet 1/4 N.P.T.
- ▲ No Alignment Specified-Center Stud Mounting is Standard
- ⊗ Combination Stud/Air Inlet Stud Outside Thread is 3/4-16
- ⊗ Studs Inside Thread (Air Inlet) is 1/4 N.P.T. Exceptions Will Be Noted on Part View as ⊗

1T - Reversible Sleeve

BELLOW NO. ASSEMBLY ORDER NO.	CROSS SECTION VIEW	BEAD PLATE TOP VIEW	PISTON BOTTOM VIEW	ASSEMBLY WEIGHT (lbs.)	REPLACES
C01-358-0583 1T15 X-SERIES		3191 	9604/NAD-30174 Order No. WC1-358-1624	13.25	Freightliner 681-320-0017, A16-14004-000 (aluminum) A16-17574-001 (w/o bracket) A16-17574-002 (w/o bracket) Freightliner Piston 16-13840-000 (plastic) - see W01-358-9780 Freightliner Piston 16-16773-000 (steel) - see W01-358-9782 A16-17574-001 A16-17574-002
W01-358-9781 REPLACES 1T15ZR-6					
C01-358-0583 1T15 X-SERIES		3191 	9676/ NAD-31612 ORDER NO. N/A	20.7	Freightliner Custom Chassis 16-16773-000 Steel Piston 681-320-0017 Alum. Piston See W01-358-9781 16-13810-000 Plastic Piston See W01-358-9780
W01-358-9782 REPLACES 1T15ZR-6					
BRACKET			6013/NAD-33041 	2.0	Freightliner 16-17010-001 16-15762-000
WC1-358-3874					
BRACKET			6012/NAD-33042 	2.0	Freightliner 16-17010-002
WC1-358-3876					
BRACKET			6033/ NBD-13722 ORDER NO. N/A	1.6	Freightliner A16-14004-000 (aluminum) 9781 Freightliner 16-13810-001 (plastic) 9780 Add bracket to 9780 or 9781
WC1-358-3900					

1T Style Springs

Hardware Key

- Bolt or Stud 1/2-13 ⊕ Threaded Hole 3/8-16 Blind Nut on Bead Plates 1/2-13 Pistons ⊗ Air Inlet 1/4 N.P.T. ▲ No Alignment Specified-Center Stud Mounting is Standard
- ⊗ Combination Stud/Air Inlet Stud Outside Thread is 3/4-16 ⊗ Studs Inside Thread (Air Inlet) is 1/4 N.P.T. Exceptions Will Be Noted on Part View as ⊗



Firestone

BELLOW NO. ASSEMBLY ORDER NO.	CROSS SECTION VIEW	BEAD PLATE TOP VIEW	PISTON BOTTOM VIEW	ASSEMBLY WEIGHT (lbs.)	REPLACES
BRACKET WC1-358-3901			6034/ NBD-13721 ORDER NO. N/A	2.0	Freightliner A16-14004-001 (aluminum) Freightliner 16-13810-002 (plastic) (cabover) Add bracket to 9780 or 9781
1T17AZR-4.5 W01-358-8676 OBSOLETE		3505 	9671/ NAD-32590 		Holland 90557314
1T17AEZR-5 W01-358-8632 OBSOLETE		3497 	9671/ NAD-32590 	24.0	Freightliner Custom Chassis 16-17315-000 ZF-IFS
1T17B-5 W01-358-8631		3305 	9648/NAD-31288 Order No. WC1-358-1649	25.5	Watson & Chalm AS-0098-01F
1T17B-5 W01-358-8723		3301 	9603/ NAD-29630 ORDER NO. WC1-358-1635	15.2	

Hardware Key

- Bolt or Stud 1/2-13
- ⊕ Threaded Hole 3/8-16 Blind Nut on Bead Plates 1/2-13 Pistons
- ⊗ Air Inlet 1/4 N.P.T.
- ▲ No Alignment Specified-Center Stud Mounting is Standard
- ⊗ Combination Stud/Air Inlet Stud Outside Thread is 3/4-16
- ⊗ Studs Inside Thread (Air Inlet) is 1/4 N.P.T. Exceptions Will Be Noted on Part View as ⊗

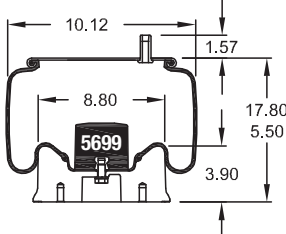
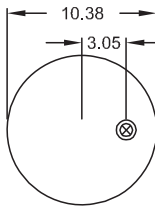
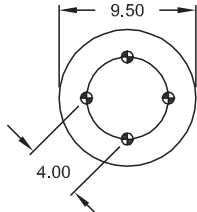
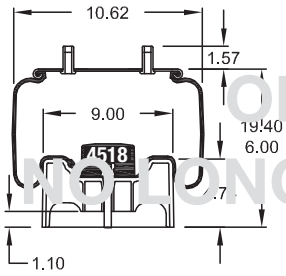
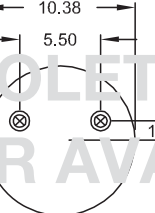
1T - Reversible Sleeve

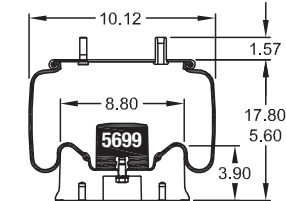
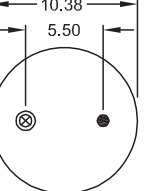
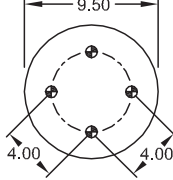
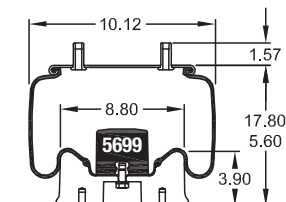
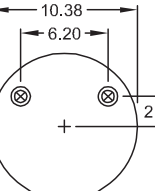
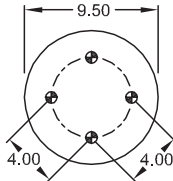
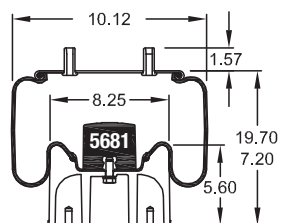
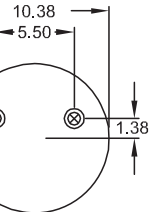
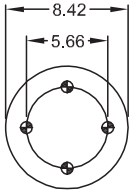
BELLOW NO. ASSEMBLY ORDER NO.	CROSS SECTION VIEW	BEAD PLATE TOP VIEW	PISTON BOTTOM VIEW	ASSEMBLY WEIGHT (lbs.)	REPLACES
1T17B-5 W01-358-8740		3244 	9602/ NAD-28351  ORDER NO. WC1-358-1613	15.2	Reyco 23433-01
1T17B-5 W01-358-8751 OBSOLETE (SEE W01-358-8709)		3300 	9525/ NAD-26906  ORDER NO. WC1-358-1609	15.3	Hendrickson S20900 (Intraax AA230) [Up to 7/97] -replaced by W01-358-8709 (approx. 6/98) 1T17CA-5
1T17B-5 W01-358-8752		3301 	9602/NAD-28351  Order No. WC1-358-1613	15.3	Watson & Chalm AS-0084 Ridewell 1003588752C Suspensions Inc. 201642 [piston mounting may vary with GY bag-7.87 BC]
1T17B-5 W01-358-8753		3305 	9602/NAD-28351  Order No. WC1-358-1613	15.4	Ridewell 1003588753C Watson & Chalm AS-0098
1T17B-5 W01-358-8755		3300 	9734/ NAD-28002  ORDER NO. WC1-358-1610	17.1	Hendrickson Trailer S22045 (HK190T) Hendrickson Trailer Prototype C21623

1T Style Springs

Hardware Key

- Bolt or Stud 1/2-13 ⊕ Threaded Hole 3/8-16 Blind Nut on Bead Plates 1/2-13 Pistons ⊗ Air Inlet 1/4 N.P.T. ▲ No Alignment Specified-Center Stud Mounting is Standard
- ⊗ Combination Stud/Air Inlet Stud Outside Thread is 3/4-16 ⊕ Studs Inside Thread (Air Inlet) is 1/4 N.P.T. Exceptions Will Be Noted on Part View as ⊗

Firestone

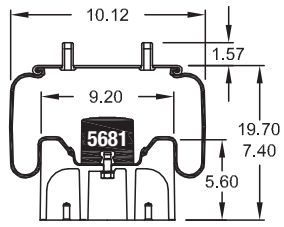
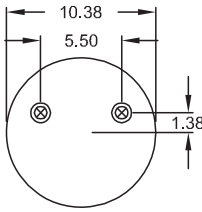
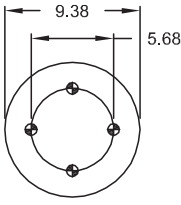
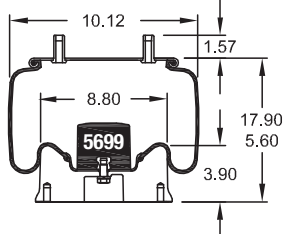
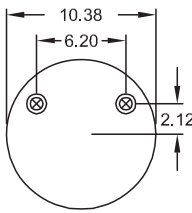
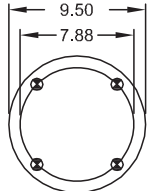
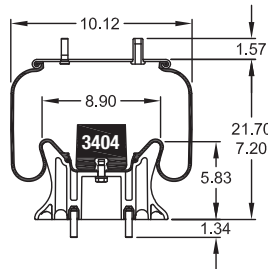
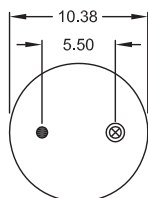
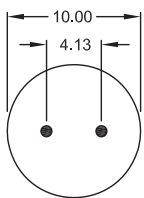
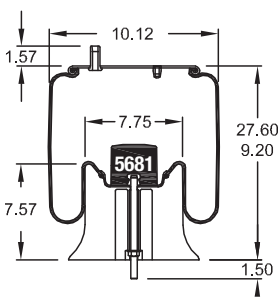
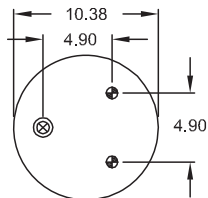
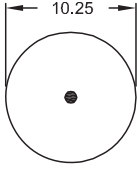
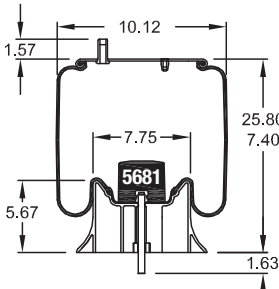
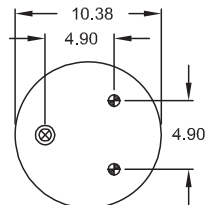
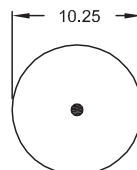
BELLOW NO. ASSEMBLY ORDER NO.	CROSS SECTION VIEW	BEAD PLATE TOP VIEW	PISTON BOTTOM VIEW	ASSEMBLY WEIGHT (lbs.)	REPLACES
1T17B-5 W01-358-8756		3300 	9802/ NAD-27999 	18.9	Hendrickson Trailer S22046 (HK230) -will be replaced by W01-358-8710 1T17CL-5 Hendrickson Trailer Prototype C21624
			ORDER NO. WC1-358-1611		
1T17B-5 W01-358-8782		3305 	9603/ NAD-29630 	15.6	Ridewell 1001R13109G
			ORDER NO. WC1-358-1635		
1T17B-7 W01-358-8720		3301 	9583/FIP-101543 	22.3	Reyco 22747-01
1T17B-11 W01-358-8744		3335 	9540/ NAD-29828 	16.5	Holland (Neway) 90557243
			ORDER NO. WC1-358-0664		
1T17B-11 W01-358-8746		3335 	9532/ NAD-29827 	16.0	Holland (Neway) 90557235
			ORDER NO. WC1-358-1619		

Hardware Key

- Bolt or Stud 1/2-13
- ⊕ Threaded Hole 3/8-16 Blind Nut on Bead Plates 1/2-13 Pistons
- ⊗ Air Inlet 1/4 N.P.T.
- ▲ No Alignment Specified-Center Stud Mounting is Standard
- ⊗ Combination Stud/Air Inlet Stud Outside Thread is 3/4-16
- ⊗ Studs Inside Thread (Air Inlet) is 1/4 N.P.T. Exceptions Will Be Noted on Part View as ⊗

1T - Reversible Sleeve

BELLOW NO. ASSEMBLY ORDER NO.	CROSS SECTION VIEW	BEAD PLATE TOP VIEW	PISTON BOTTOM VIEW	ASSEMBLY WEIGHT (lbs.)	REPLACES
1T17B-11 W01-358-8748		3301 	9532/ NAD-29827 ORDER NO. WC1-358-1619	16.0	Holland (Neway) 90557167 (AR250-14 & 15)
1T17B-11 W01-358-8749		3301 	9540/ NAD-29828 ORDER NO. WC1-358-0664	18.0	Holland (Neway) 90557168 (AR250-12,16,17)
1T17BB-2 W01-358-8729		3301 	9533/ NAD-30515 Order No. WC1-358-1644	13.2	Meritor 202796 (GY 1R13-130)
1T17BM-6 W01-358-8673		3302 	9699/NAD-33165 	20.5	Hendrickson 66643-002
1T17BP-17 W01-358-8724 SERVICE ASSEMBLY 761		3301 	9646/ NAD-31215 	38.9	Hendrickson Trailer S22697

1T Style Springs

Hardware Key

- Bolt or Stud 1/2-13
- ⊕ Threaded Hole 3/8-16 Blind Nut on Bead Plates 1/2-13 Pistons
- ⊗ Air Inlet 1/4 N.P.T.
- ▲ No Alignment Specified-Center Stud Mounting is Standard
- ⊗ Combination Stud/Air Inlet Stud Outside Thread is 3/4-16
- ⊗ Studs Inside Thread (Air Inlet) is 1/4 N.P.T. Exceptions Will Be Noted on Part View as ⊗

Firestone

BELLOW NO. ASSEMBLY ORDER NO.	CROSS SECTION VIEW	BEAD PLATE TOP VIEW	PISTON BOTTOM VIEW	ASSEMBLY WEIGHT (lbs.)	REPLACES
1T17C-3 W01-358-8636		3338 	9603/ NAD-29630 	14.7	Tuthill Granning 705951-01
1T17C-3 W01-358-8733		3338 	9603/NAD-29630 	15.0	Tuthill Granning 700999-01 Order No. WC1-358-1635
1T17C-3 W01-358-8737		3301 	9528/ NBD-14404 	17.0	Holland (Neway) 90557272 (NS225, NSH450, WN225, NSH450)
1T17C-3 W01-358-8738		3301 	9528/ NBD-14404 	12.8	Holland (Neway) 90557271 (NSH225, NSB225, RLU250) ORDER NO. WC1-358-0667
1T17C-6 W01-358-8637		3305 	9602/NAD-28351 	17.5	Watson & Chalin AS-0107 Order No. WC1-358-1613

Hardware Key

- Bolt or Stud 1/2-13
- ⊕ Threaded Hole 3/8-16 Blind Nut on Bead Plates 1/2-13 Pistons
- ⊗ Air Inlet 1/4 N.P.T.
- ▲ No Alignment Specified-Center Stud Mounting is Standard
- ⊗ Combination Stud/Air Inlet Stud Outside Thread is 3/4-16
- ⊗ Studs Inside Thread (Air Inlet) is 1/4 N.P.T. Exceptions Will Be Noted on Part View as ⊗

1T - Reversible Sleeve

BELLOW NO. ASSEMBLY ORDER NO.	CROSS SECTION VIEW	BEAD PLATE TOP VIEW	PISTON BOTTOM VIEW	ASSEMBLY WEIGHT (lbs.)	REPLACES
1T17C-8 W01-358-8109		3302 	9488/FIP-101115 	20.9	Hendrickson 67234-002
1T17C-8 W01-M58-8712 METRIC		3739 	9690/NAD-28840 Order No. N/A	19.68	Hendrickson 59319-2
1T17CA-3 W01-358-8614		3300 	9648/ NAD-31288 ORDER NO. WC1-358-1649	24.0	Hendrickson Trailer S26773 Wilson Trailer
1T17CA-5 W01-358-8709		3300 	9525/ NAD-26906 ORDER NO. WC1-358-1609	14.1	Hendrickson Trailer S21800 (Intraax AA230) [8/97-up] -replaces W01-358-8751 (approx. 6/98)
1T17CA-6 W01-358-8623 OBSOLETE		3375 	3882/ NAD-31635 ORDER NO. N/A	21.8	Hendrickson Trailer S27031

1T Style Springs

Hardware Key

- Bolt or Stud 1/2-13
- ⊕ Threaded Hole 3/8-16 Blind Nut on Bead Plates 1/2-13 Pistons
- ⊗ Air Inlet 1/4 N.P.T.
- ▲ No Alignment Specified-Center Stud Mounting is Standard
- ⊗ Combination Stud/Air Inlet Stud Outside Thread is 3/4-16
- ⊗ Studs Inside Thread (Air Inlet) is 1/4 N.P.T. Exceptions Will Be Noted on Part View as ⊗

Firestone

BELLOW NO. ASSEMBLY ORDER NO.	CROSS SECTION VIEW	BEAD PLATE TOP VIEW	PISTON BOTTOM VIEW	ASSEMBLY WEIGHT (lbs.)	REPLACES
1T17CA-6.5 W01-358-8708		3300 	9537/ NAD-29798 	15.2	Hendrickson Trailer S21966 (HKA200 Special)
			ORDER NO. WC1-358-1637		
1T17CA-6.5 W01-358-8713		3344 	9537/ NAD-29798 	18.0	Hendrickson Trailer S22948 (Van Traax) - Prior to 9/99- used 9525 piston with bumper spacer
			Order No. WC1-358-1637		
1T17CA-6.5 W01-358-8735		3302 	9603/ NAD-29630 	17.0	Granning 7901 (replaced W01-681-8770) [1T19F-7]
			ORDER NO. WC1-358-1635		
1T17CD-3 W01-358-8617		3301 	9533/ NAD-30515 	14.1	Arvin Meritor A2258-E-1461 RHP-55 Arvin Meritor 202796 Ride Sentry
			ORDER NO. WC1-358-1635		
1T17CL-5 W01-358-8710		3300 	9802/ NAD-27999 	17.5	Hendrickson Trailer S22046 (HK230) Approximate availability 1-98 - replaces W01-358-8756
			ORDER NO. WC1-358-1611		

Hardware Key

- Bolt or Stud 1/2-13
- ⊕ Threaded Hole 3/8-16 Blind Nut on Bead Plates 1/2-13 Pistons
- ⊗ Air Inlet 1/4 N.P.T.
- ▲ No Alignment Specified-Center Stud Mounting is Standard
- ⊗ Combination Stud/Air Inlet Stud Outside Thread is 3/4-16
- ⊗ Studs Inside Thread (Air Inlet) is 1/4 N.P.T. Exceptions Will Be Noted on Part View as ⊗

1T - Reversible Sleeve

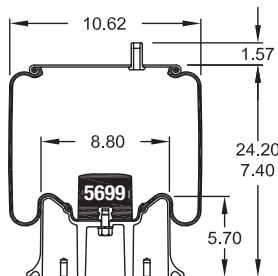
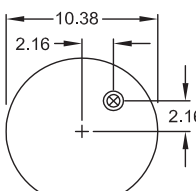
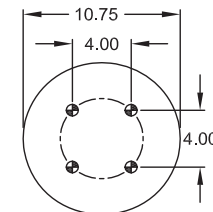
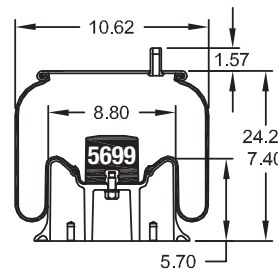
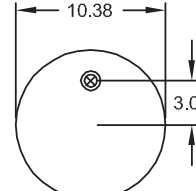
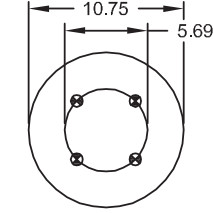
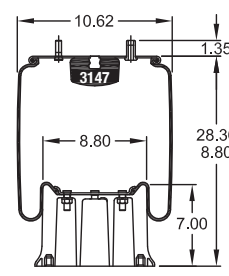
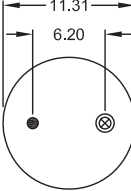
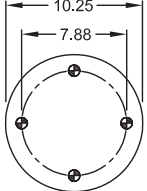
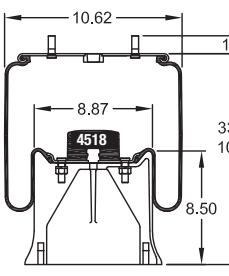
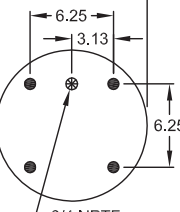
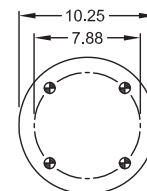
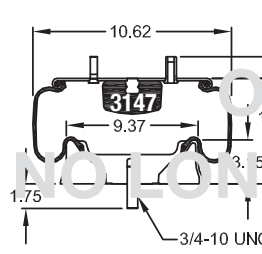
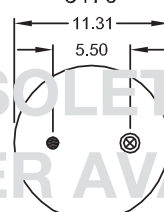
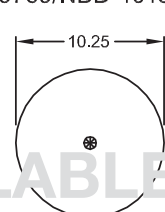
BELLOW NO. ASSEMBLY ORDER NO.	CROSS SECTION VIEW	BEAD PLATE TOP VIEW	PISTON BOTTOM VIEW	ASSEMBLY WEIGHT (lbs.)	REPLACES
1T17CL-9.5 W01-358-9580 REPLACES 1T15VLT-10.5		3244 	9689/NAD-28838  Order No. WC1-358-1607	18.9	Hendrickson Trailer S20127 [HT-250U 9-006] [HT-250UY 9Y-006] replaces 1T15VLT-10.5 1T15V-11 W01-358-9262
1T17CL-9.5 W01-358-9581 REPLACES 1T15VLT-10.5		3244 	9689/ NAD-28838  ORDER NO. WC1-358-1607	19.0	Hendrickson Trailer S20414 [HT-250U (9-006)] [HT-250U-Y (9Y-006)] Replaces 1T15VLT-10.5 1T15V-11
1T19F-12 W01-358-5514		3185 	9580/NAD-27909  Order No. WC1-358-0528	21.9	Watson & Chain AS-0047G Goodyear 1R14-170
1T19F-16 W01-358-9895		3115  3/4 NPTF	9669/NAD-26291  Order No. WC1-358-1602	25.5	Holland 90557241
1T19J-1 W01-358-8055 OBSOLETE	 3/4-10 UNC	3170 	9769/NBD-10180  Order No. WC1-358-0685	17.0	Ridewell 1003588055C

1T Style Springs

Hardware Key

- Bolt or Stud 1/2-13
- ⊕ Threaded Hole 3/8-16 Blind Nut on Bead Plates 1/2-13 Pistons
- ⊗ Air Inlet 1/4 N.P.T.
- ▲ No Alignment Specified-Center Stud Mounting is Standard
- ⊗ Combination Stud/Air Inlet Stud Outside Thread is 3/4-16
- Studs Inside Thread (Air Inlet) is 1/4 N.P.T. Exceptions Will Be Noted on Part View as ⊗

Firestone

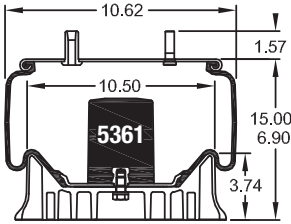
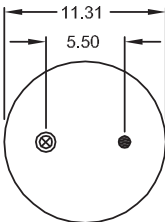
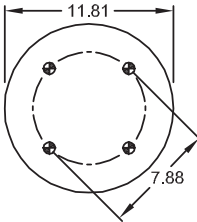
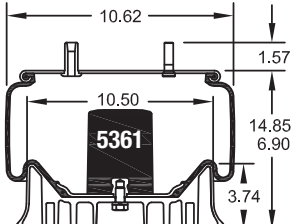
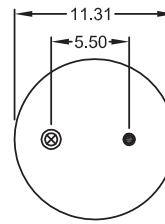
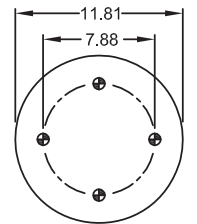
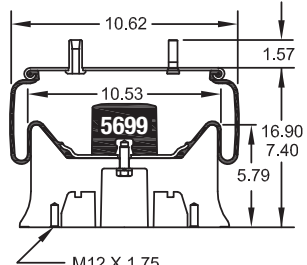
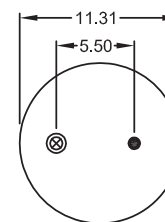
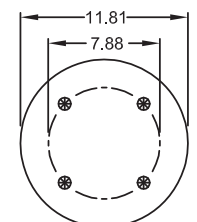
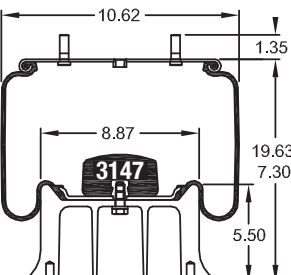
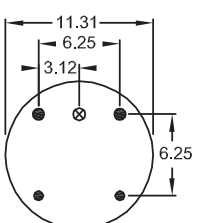
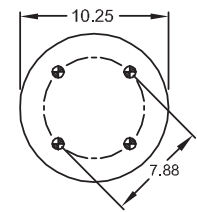
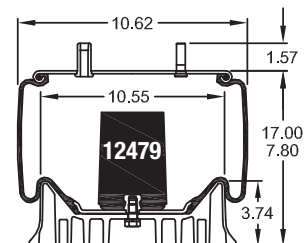
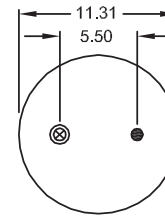
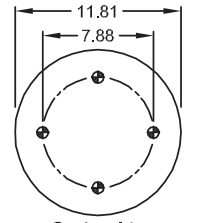
BELLOW NO. ASSEMBLY ORDER NO.	CROSS SECTION VIEW	BEAD PLATE TOP VIEW	PISTON BOTTOM VIEW	ASSEMBLY WEIGHT (lbs.)	REPLACES
1T19L-3 W01-358-8760			 ORDER NO. WC1-358-0631	19.0	Granning 7593
1T19L-3 W01-358-8761			 Order No. WC1-358-0631	18.7	Tuthill Granning 702228-01
1T19L-3 W01-358-8787			 Order No. N/A	20.8	Tuthill Granning 703667-01
1T19L-5 W01-358-8088			 ORDER NO. WC1-358-9450	21.9	Ridewell 1003588088C
1T19L-5 W01-358-8500			 Order No. WC1-358-0631	21.0	Rowe RV ASC1000/ ASC1001ASC1002/ ASC1003 Spartan

Hardware Key

- Bolt or Stud 1/2-13
- ⊕ Threaded Hole 3/8-16 Blind Nut on Bead Plates 1/2-13 Pistons
- ⊗ Air Inlet 1/4 N.P.T.
- ▲ No Alignment Specified-Center Stud Mounting is Standard
- ⊗ Combination Stud/Air Inlet Stud Outside Thread is 3/4-16
- ⊗ Studs Inside Thread (Air Inlet) is 1/4 N.P.T. Exceptions Will Be Noted on Part View as ⊗

1T - Reversible Sleeve

BELLOW NO. ASSEMBLY ORDER NO.	CROSS SECTION VIEW	BEAD PLATE TOP VIEW	PISTON BOTTOM VIEW	ASSEMBLY WEIGHT (lbs.)	REPLACES
1T19L-5 W01-358-9200		3506 	9766/NAD-28978 Order No. WC1-358-0631	21.7	Hendrickson Trailer S3839 Ridewell 1003589200C MEXICAN DE AUTOBUS FRONT-REAR TAG
1T19L-5 W01-358-9204		3131 	9766/NAD-28978 Order No. WC1-358-0631	21.4	Ravens Trailer
1T19L-5 W01-358-9215		3131 	9766 / NAD-28978 Order No. WC1-358-0631	21.7	Hendrickson Trailer S3648
1T19L-5 W01-358-9216		3131 	9657/NAD-18101 Order No. WC1-358-9450	22.5	City Welding
1T19L-5 W01-358-9218		3388 	9766/NAD-28978 Order No. WC1-358-0631	21.4	Ridewell 1003589218C Holland (Neway) 90557209 Suspensions Inc. Watson & Chain AS-0073 Rowe RV ASC1000/ ASC1001/ASC1002/ ASC1003 Spartan

1T Style Springs

Hardware Key

- Bolt or Stud 1/2-13
- ⊕ Threaded Hole 3/8-16 Blind Nut on Bead Plates 1/2-13 Pistons
- ⊗ Air Inlet 1/4 N.P.T.
- ▲ No Alignment Specified-Center Stud Mounting is Standard
- ⊗ Combination Stud/Air Inlet Stud Outside Thread is 3/4-16
- ⊗ Studs Inside Thread (Air Inlet) is 1/4 N.P.T. Exceptions Will Be Noted on Part View as ⊗

Firestone

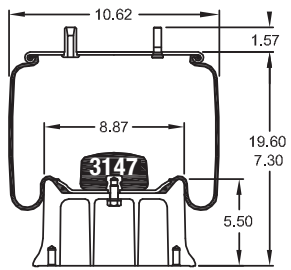
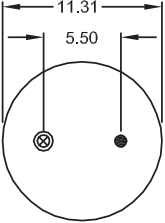
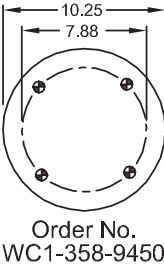
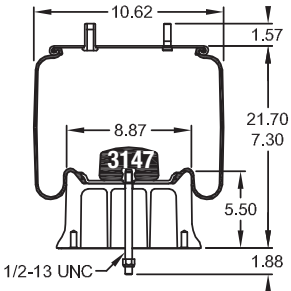
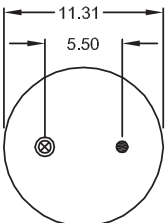
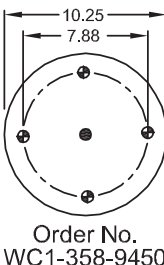
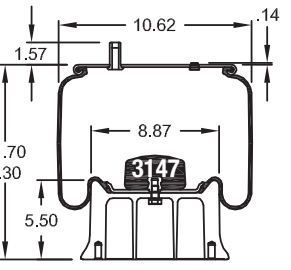
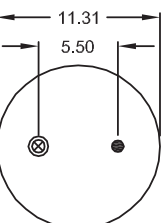
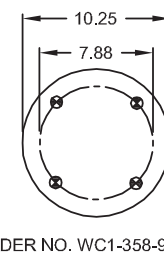
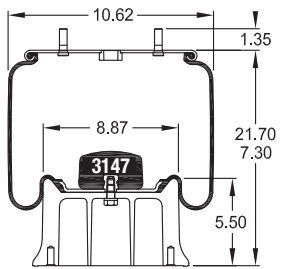
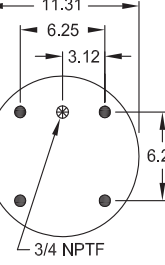
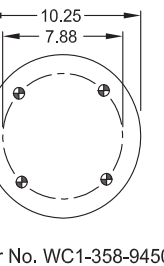
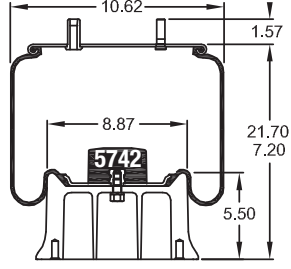
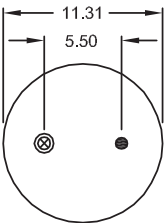
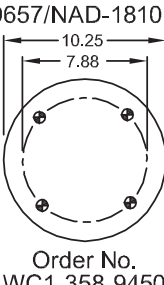
BELLOW NO. ASSEMBLY ORDER NO.	CROSS SECTION VIEW	BEAD PLATE TOP VIEW	PISTON BOTTOM VIEW	ASSEMBLY WEIGHT (lbs.)	REPLACES
1T19L-5 W01-358-9277		3388 	9657/NAD-18101 	21.8	Ridewell 1003589277C Reyco 24556-01
1T19L-7 W01-358-8776		3388 	9657/NAD-18101 	22.8	Reyco 21767-01
1T19L-7 W01-358-8778		3127 	9657/ NAD-18101 	22.7	Holland (Neway) 90557164
1T19F-7 1T19L-7 W01-358-9116		3115 	9657/NAD-18101 	22.7	Pezzani
1T19L-7 W01-358-9121		3388 	9657/NAD-18101 	21.7	Holland (Neway) 90557019 90557052 90557078 90557083 90557110 (parallel alignment) R & S Truck & Body 1090023 Ridewell 1003589121C Sauer P50-733 Reyco 12882-02 Watson & Chalin AS-0013

Hardware Key

- Bolt or Stud 1/2-13 ⊕ Threaded Hole 3/8-16 Blind Nut on Bead Plates 1/2-13 Pistons ⊗ Air Inlet 1/4 N.P.T. ▲ No Alignment Specified-Center Stud Mounting is Standard
- ⊗ Combination Stud/Air Inlet Stud Outside Thread is 3/4-16 Studs Inside Thread (Air Inlet) is 1/4 N.P.T. Exceptions Will Be Noted on Part View as ⊗

1T - Reversible Sleeve

BELLOW NO. ASSEMBLY ORDER NO.	CROSS SECTION VIEW	BEAD PLATE TOP VIEW	PISTON BOTTOM VIEW	ASSEMBLY WEIGHT (lbs.)	REPLACES
1T19L-7 W01-358-9135		3506 	9482 / NAD-36702 	30.6	Dart 21-4048 Unit Rig 1016034
1T19L-7 W01-358-9144		3388 	9657/NAD-18101 Order No. WC1-358-9450	24.2	Holland (Neway) 90557155
1T19L-7 W01-358-9148		3131 	9657/NAD-18101 Order No. WC1-358-9450	20.9	Peerless 0550-00070
1T19L-7 W01-358-9149		3131 	9657/NAD-18101 Order No. WC1-358-9450	21.8	City Welding Peerless 0550-00010
1T19L-7 W01-358-9164		3388 	9657/NAD-18101 Order No. WC1-358-9450	23.2	R & S Truck & Body 1090326

1T Style Springs

Hardware Key

- Bolt or Stud 1/2-13
- ⊕ Threaded Hole 3/8-16 Blind Nut on Bead Plates 1/2-13 Pistons
- ⊗ Air Inlet 1/4 N.P.T.
- ▲ No Alignment Specified-Center Stud Mounting is Standard
- ⊗ Combination Stud/Air Inlet Stud Outside Thread is 3/4-16
- ⊗ Studs Inside Thread (Air Inlet) is 1/4 N.P.T. Exceptions Will Be Noted on Part View as ⊗

Firestone

BELLOW NO. ASSEMBLY ORDER NO.	CROSS SECTION VIEW	BEAD PLATE TOP VIEW	PISTON BOTTOM VIEW	ASSEMBLY WEIGHT (lbs.)	REPLACES
1T19L-7 W01-358-9177		3506 	9657/NAD-18101 Order No. WC1-358-9450	21.8	Hendrickson Trailer S2065 R & S Truck & Body 1090216 Holland (Neway) 90557003 Ridewell 1003589177C Columbia Trailer
1T19L-7 W01-358-9179 OBSOLETE		3123 	9657/NAD-18101 Order No. WC1-358-9450	22.5	Columbia Trailer Obsolete See W01-358-9177
1T19L-7 W01-358-9221		3123 	9657/NAD-18101 Order No. WC1-358-9450	21.4	Load Air P60733
1T19L-7 W01-358-9811		3388 	9766/NAD-28978 Order No. WC1-358-0631	19.6	Rowe Truck ASCC2000 Ride
1T19L-7 W01-358-9961		3123 	9580/NAD-27909 Order No. WC1-358-0528	20.7	Ridewell 1003589961C

Hardware Key

- Bolt or Stud 1/2-13
- ⊕ Threaded Hole 3/8-16 Blind Nut on Bead Plates 1/2-13 Pistons
- ⊗ Air Inlet 1/4 N.P.T.
- ▲ No Alignment Specified-Center Stud Mounting is Standard
- ⊗ Combination Stud/Air Inlet Stud Outside Thread is 3/4-16
- ⊗ Studs Inside Thread (Air Inlet) is 1/4 N.P.T. Exceptions Will Be Noted on Part View as ⊗

1T - Reversible Sleeve

BELLOW NO. ASSEMBLY ORDER NO.	CROSS SECTION VIEW	BEAD PLATE TOP VIEW	PISTON BOTTOM VIEW	ASSEMBLY WEIGHT (lbs.)	REPLACES
1T19L-9 W01-358-8779		3127 	9657/NAD-18101 ORDER NO. WC1-358-9450	20.2	Holland (Neway) 90557163
1T19L-9 W01-358-8780		3127 	9657/NAD-18101 ORDER NO. WC1-358-9450	19.9	Holland (Neway) 90557162
1T19L-9 W01-358-8781		3388 	9580/ NAD-27909 ORDER NO. WC1-358-0528	19.9	Holland (Neway) 90557205
1T19L-9 W01-358-9134		3388 	9657/NAD-18101 Order No. WC1-358-9450	19.9	Holland (Neway) 90557125 (AR-80-9) (AR-80-9WST)
1T19L-9 W01-358-9138		3388 	9657/NAD-18101 Order No. WC1-358-9450	20.0	Holland (Neway) 90557111 (AR-80-9FM)

1T Style Springs

Hardware Key

- Bolt or Stud 1/2-13
- ⊕ Threaded Hole 3/8-16 Blind Nut on Bead Plates 1/2-13 Pistons
- ⊗ Air Inlet 1/4 N.P.T.
- ▲ No Alignment Specified-Center Stud Mounting is Standard
- ⊗ Combination Stud/Air Inlet Stud Outside Thread is 3/4-16
- ⊗ Studs Inside Thread (Air Inlet) is 1/4 N.P.T. Exceptions Will Be Noted on Part View as ⊗

Firestone

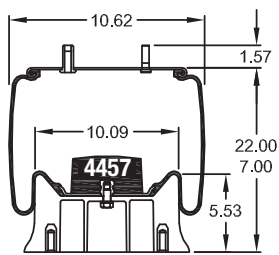
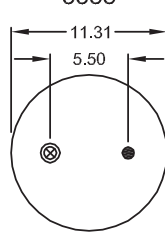
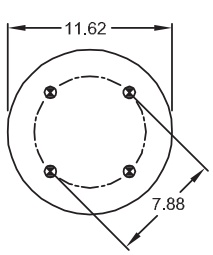
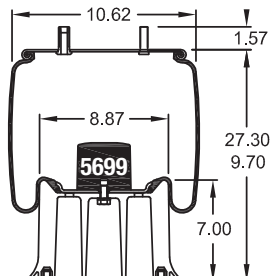
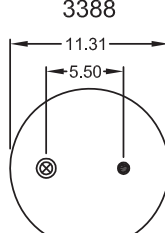
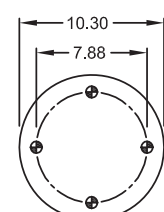
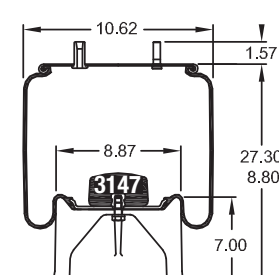
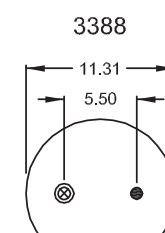
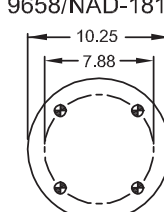
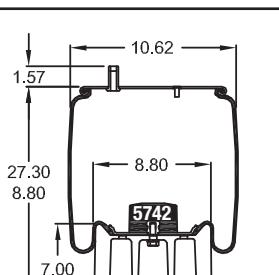
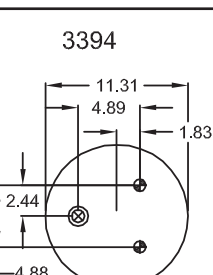
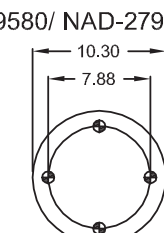
BELLOW NO. ASSEMBLY ORDER NO.	CROSS SECTION VIEW	BEAD PLATE TOP VIEW	PISTON BOTTOM VIEW	ASSEMBLY WEIGHT (lbs.)	REPLACES
1T19L-9 W01-358-9984		3388 	9562 / NAD-33610 	21.0	Watson & Chalin AS-0060
1T19L-11 W01-358-8764		3388 	9580/NAD-27909  Order No. WC1-358-0528	20.1	Holland 90557260
1T19L-11 W01-358-8792		3388 	9658/NAD-18102  Order No. WC1-358-1640	23.9	Aluminum version of W01-358-9122
1T19L-11 W01-358-8796		3394 	9580/ NAD-27909  ORDER NO. WC1-358-0528	19.9	Holland (Neway) 90557283 RL300

Hardware Key

- Bolt or Stud 1/2-13
- ⊕ Threaded Hole 3/8-16 Blind Nut on Bead Plates 1/2-13 Pistons
- ⊗ Air Inlet 1/4 N.P.T.
- ▲ No Alignment Specified-Center Stud Mounting is Standard
- ⊗ Combination Stud/Air Inlet Stud Outside Thread is 3/4-16
- Studs Inside Thread (Air Inlet) is 1/4 N.P.T. Exceptions Will Be Noted on Part View as ⊗

1T - Reversible Sleeve

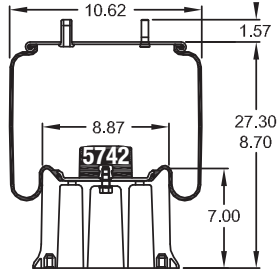
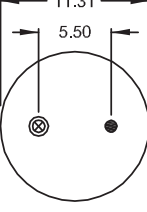
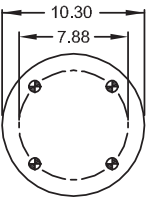
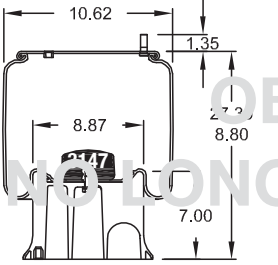
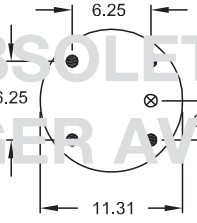
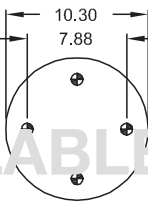
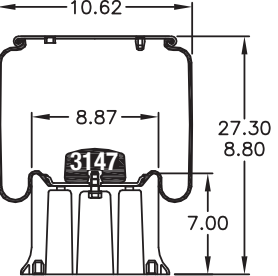
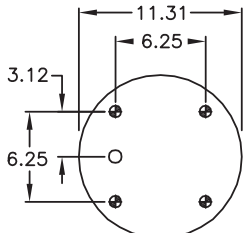
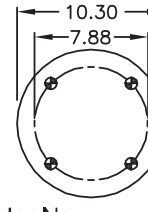
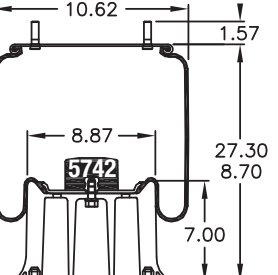
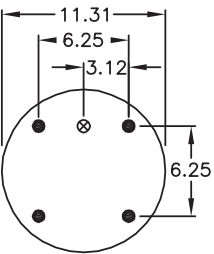
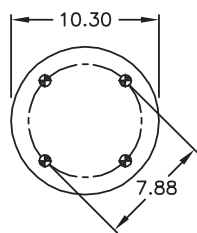
BELLOW NO. ASSEMBLY ORDER NO.	CROSS SECTION VIEW	BEAD PLATE TOP VIEW	PISTON BOTTOM VIEW	ASSEMBLY WEIGHT (lbs.)	REPLACES
1T19L-11 W01-358-9122		3388 	9580/NAD-27909  Order No. WC1-358-0528	23.1	Hendrickson Trailer S3467, S3830 Holland (Neway) 90557020, 90557071, 90557076, 90557077 Hendrickson Can. B-12514-008, B-12514-010 Porcupine Reyco 12883-02 Sauer P50-732 Ridewell 1003589122C Temisko Watson & Chalin AS-0023 Holland (Neway) 90557185 (parallel align.)
1T19L-11 W01-358-9152 OBSOLETE REPLACED BY W01-358-9122		3123 	9580/NAD27909  ORDER NO. WC1-358-0528	21.6	Columbia Trailer Obsolete Use W01-358-9122
1T19L-11 W01-358-9156		3131 	9580 / NAD-27909  Order No. WC1-358-0528	21.3	City Welding Peerless 0550-00080 Hendrickson Trailer S7128
1T19L-11 W01-358-9158		3506 	9580 / NAD-27909  ORDER NO. WC1-358-0528	21.8	Hendrickson Can. B-12514-004, B-12514-011 Holland (Neway) 90557005 Hendrickson Trailer S2063 Holland (Neway) 90557069 Peerless Ridewell 1003589158C Porcupine MFG.SV.# Neway 90044197

1T Style Springs

Hardware Key

- Bolt or Stud 1/2-13
- ⊕ Threaded Hole 3/8-16 Blind Nut on Bead Plates 1/2-13
- ⊗ Pistons 1/4 N.P.T.
- ▲ No Alignment Specified-Center Stud Mounting is Standard
- ⊗ Combination Stud/Air Inlet Stud Outside Thread is 3/4-16
- ⊗ Studs Inside Thread (Air Inlet) is 1/4 N.P.T. Exceptions Will Be Noted on Part View as ⊗

Firestone

BELLOW NO. ASSEMBLY ORDER NO.	CROSS SECTION VIEW	BEAD PLATE TOP VIEW	PISTON BOTTOM VIEW	ASSEMBLY WEIGHT (lbs.)	REPLACES
1T19L-11 W01-358-9199				22.2	Pezzani
1T19L-11 W01-358-9201				28.8	Ridewell 1003589201C
1T19L-11 W01-358-9214				31.4	Granning 2598
1T19L-11 W01-358-9804				23.3	Watson & Chalin AS-0162-1G Ridewell 1000006 Goodyear 1R14-151
1T19L-11 W01-358-9985				22.3	Watson & Chalin AS-0081

Hardware Key

- Bolt or Stud 1/2-13
- ⊕ Threaded Hole 3/8-16 Blind Nut on Bead Plates 1/2-13 Pistons
- ⊗ Air Inlet 1/4 N.P.T.
- ▲ No Alignment Specified-Center Stud Mounting is Standard
- ⊗ Combination Stud/Air Inlet Stud Outside Thread is 3/4-16
- ⊗ Studs Inside Thread (Air Inlet) is 1/4 N.P.T. Exceptions Will Be Noted on Part View as ⊗

1T - Reversible Sleeve

BELLOW NO. ASSEMBLY ORDER NO.	CROSS SECTION VIEW	BEAD PLATE TOP VIEW	PISTON BOTTOM VIEW	ASSEMBLY WEIGHT (lbs.)	REPLACES
1T19L-12 W01-358-5503		3388 	9580/NAD-27909 	21.8	Holland (Neway) 90557200 Watson & Chalin AS-0047
1T19L-12 W01-358-5505		3388 	9669/NAD-26291 	24.0	Holland (Neway) 90557103
1T19L-12 W01-358-5508		3388 	9669 / NAD-26291 	25.2	
1T19L-12 W01-358-5509 OBSOLETE REPLACED BY W01-358-5508		3388 	9669/NAD-26291 	25.3	Suspension Inc.
1T19L-12 W01-358-5511		3388 	9580/NAD-27909 	22.0	Holland (Neway) 90557102 Hendrickson Trailer S22173

1T Style Springs

Hardware Key

- Bolt or Stud 1/2-13 ⊕ Threaded Hole 3/8-16 Blind Nut on Bead Plates 1/2-13 Pistons ⊗ Air Inlet 1/4 N.P.T. ▲ No Alignment Specified-Center Stud Mounting is Standard
- ⊗ Combination Stud/Air Inlet Stud Outside Thread is 3/4-16 Studs Inside Thread (Air Inlet) is 1/4 N.P.T. Exceptions Will Be Noted on Part View as ⊗

Firestone

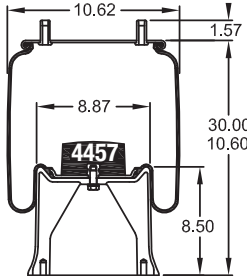
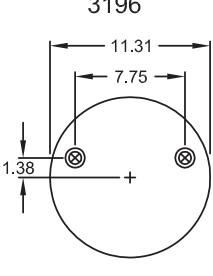
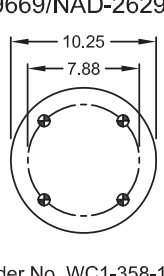
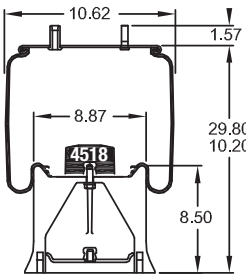
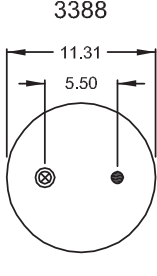
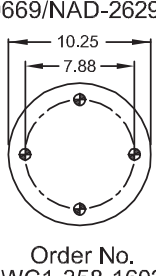
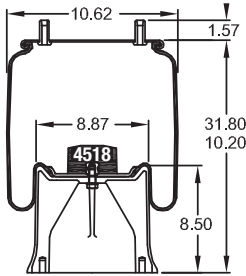
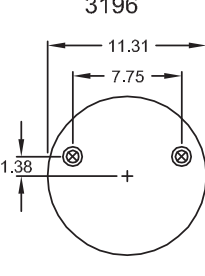
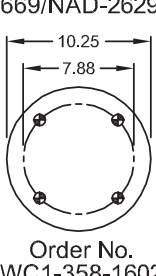
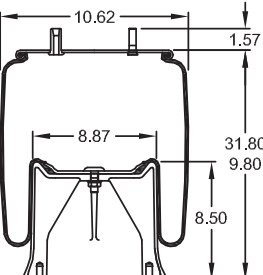
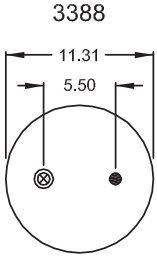
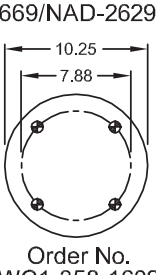
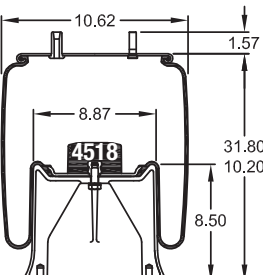
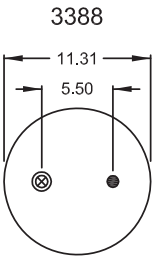
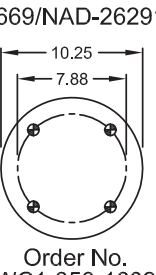
BELLOW NO. ASSEMBLY ORDER NO.	CROSS SECTION VIEW	BEAD PLATE TOP VIEW	PISTON BOTTOM VIEW	ASSEMBLY WEIGHT (lbs.)	REPLACES
1T19L-12 W01-358-5513		3196 	9669/NAD-26291  Order No. WC1-358-1602	23.6	
1T19L-12 W01-358-9891		3388 	9669/NAD-26291  Order No. WC1-358-1602	24.5	Holland (Neway) 90557218
1T19L-14 W01-358-9264		3196 	9669/NAD-26291  Order No. WC1-358-1602	24.9	Hendrickson Trailer S13122 [HT250U(9-020)] Holland (Neway) 90557104 Watson Chalin AS-0063
1T19L-14 W01-358-9915		3388 	9669/NAD-26291  Order No. WC1-358-1602	24.3	Holland (Neway) 90557104 Watson & Chalin AS-0063
1T19L-14 W01-358-9929		3388 	9669/NAD-26291  Order No. WC1-358-1602	25.2	Holland (Neway) 90557106

Hardware Key

- Bolt or Stud 1/2-13
- ⊕ Threaded Hole 3/8-16 Blind Nut on Bead Plates 1/2-13 Pistons
- ⊗ Air Inlet 1/4 N.P.T.
- ▲ No Alignment Specified-Center Stud Mounting is Standard
- ⊗ Combination Stud/Air Inlet Stud Outside Thread is 3/4-16
- ⊗ Studs Inside Thread (Air Inlet) is 1/4 N.P.T. Exceptions Will Be Noted on Part View as ⊗

1T - Reversible Sleeve

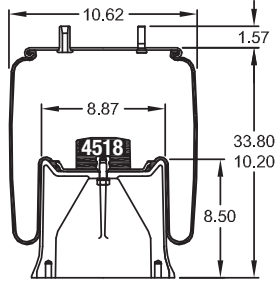
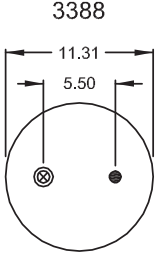
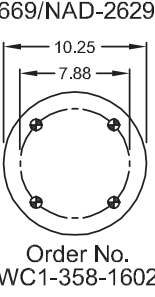
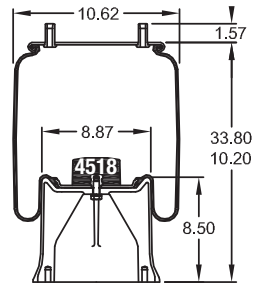
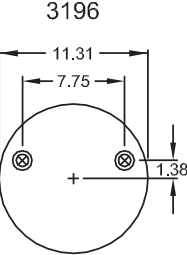
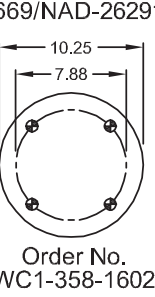
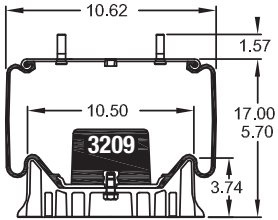
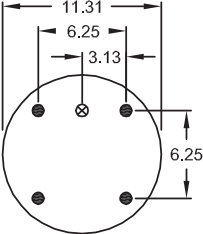
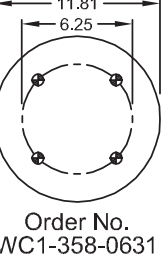
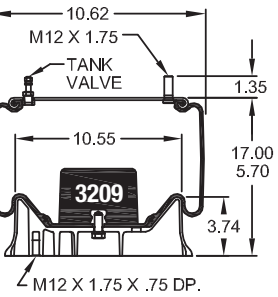
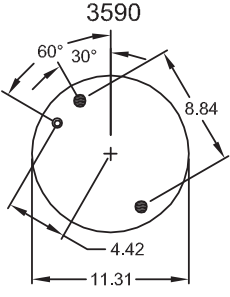
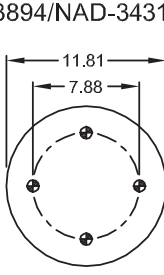
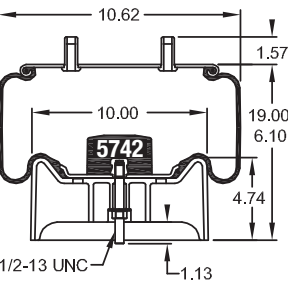
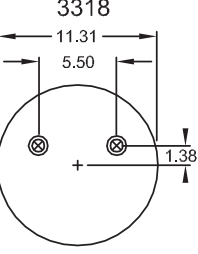
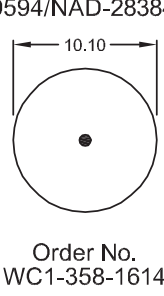
BELLOW NO. ASSEMBLY ORDER NO.	CROSS SECTION VIEW	BEAD PLATE TOP VIEW	PISTON BOTTOM VIEW	ASSEMBLY WEIGHT (lbs.)	REPLACES
1T19L-16 W01-358-9896				25.5	Neway 90557144 Rotate Piston: 90557133-28 Degrees RH 90557134-28 Degrees LH 90557148 Parallel
1T19L-16 W01-358-9928				25.4	Suspensions Inc. (Wabash) Hendrickson Trailer S20157
1T19LC-5 W01-358-8092				21.4	Ag Chem
1T19LC-5 W01-M58-8798				14.4	John Deere AN205761
1T19LC-6 W01-358-8091				17.9	Hendrickson Trailer S20901 (Intraux 250) -reuse metal disk Hendrickson Trailer S21784 w/ metal disk for piston support

1T Style Springs

Hardware Key

- Bolt or Stud 1/2-13
- ⊕ Threaded Hole 3/8-16 Blind Nut on Bead Plates 1/2-13 Pistons
- ⊗ Air Inlet 1/4 N.P.T.
- ▲ No Alignment Specified-Center Stud Mounting is Standard
- ⊗ Combination Stud/Air Inlet Stud Outside Thread is 3/4-16
- ⊗ Studs Inside Thread (Air Inlet) is 1/4 N.P.T. Exceptions Will Be Noted on Part View as ⊗

Firestone

BELLOW NO. ASSEMBLY ORDER NO.	CROSS SECTION VIEW	BEAD PLATE TOP VIEW	PISTON BOTTOM VIEW	ASSEMBLY WEIGHT (lbs.)	REPLACES
1T19LC-8 W01-358-8093		3318 	9594/NAD-28384 	21.2	Hendrickson Trailer S23748 (w/disk S24443)
			ORDER NO. WC1-358-1614		
1T19LE-8 W01-358-9825		3388 	9666/NAD-19631 	22.1	Tuthill Granning 700136-01
			Order No. N/A		
1T19LE-12 W01-358-8793		3388 	9666/NAD-19631 	22.8	Holland (Neway) 90557270 AD-130
1T19LF-7 W01-358-8774		3318 	9594/ NAD-28384 	18.0	Hendrickson Trailer S25873 Replacement piston comes without mounting plate Watson & Chalin AS-0159
			Order No. WC1-358-1614		
1T19ZK-5.7 W01-358-8050 (REPLACES 1T19J-6)		2690 	9640/FIP-101136 	21.7	Hendrickson Trailer S4771 HEND. CANADA B-12514-013 TUTHILL-REYCO 23631-01 Watson & Chalin AS-0039 Supersedes AT19J-6

Hardware Key

- Bolt or Stud 1/2-13
- ⊕ Threaded Hole 3/8-16 Blind Nut on Bead Plates 1/2-13 Pistons
- ⊗ Air Inlet 1/4 N.P.T.
- ▲ No Alignment Specified-Center Stud Mounting is Standard
- ⊗ Combination Stud/Air Inlet Stud Outside Thread is 3/4-16
- ⊗ Studs Inside Thread (Air Inlet) is 1/4 N.P.T. Exceptions Will Be Noted on Part View as ⊗

1T - Reversible Sleeve

BELLOW NO. ASSEMBLY ORDER NO.	CROSS SECTION VIEW	BEAD PLATE TOP VIEW	PISTON BOTTOM VIEW	ASSEMBLY WEIGHT (lbs.)	REPLACES
1T19ZK-5.7 W01-358-8051 (REPLACES 1T19J-6)		3123 	9644/NAD-31862 Order No. WC1-358-9999	21.5	Ridewell 1003588051C Hendrickson Can. B-12514-013 Tuthill-Reyco 23631-01 Watson & Chalin AS-0039 Supersedes 1T19J-6
1T19ZK-5.7 W01-358-8052 (REPLACES 1T19J-6)		3388 	9644/NAD-31862 Order No. WC1-358-9999	21.3	Hendrickson Can. B12514-012 Watson & Chalin AS-0078 Watson & Chalin AS-0039
1T19ZK-5.7 W01-358-8053 (REPLACES 1T19J-6)		3395 	9644/NAD-31862 Order No. WC1-358-9999	20.9	Holland (Neway) 90557098 (ARDTB125-6A&6B)
1T19ZK-5.7 W01-358-8058		3196 	9640/FIP-101136 	25.0	Hendrickson Trailer S-4771 HEND. CANADA B-12514-013 TUTHILL-REYCO 23631-01 Watson & Chalin AS-0039
1T26D-7 W01-358-9310		3452 	9889/NBD-9253 1/2-13 UNC-2B x .87 DP.	5.7	

1T Style Springs

Hardware Key

- Bolt or Stud 1/2-13
- ⊕ Threaded Hole 3/8-16 Blind Nut on Bead Plates 1/2-13 Pistons
- ⊗ Air Inlet 1/4 N.P.T.
- ▲ No Alignment Specified-Center Stud Mounting is Standard
- ⊗ Combination Stud/Air Inlet Stud Outside Thread is 3/4-16
- Studs Inside Thread (Air Inlet) is 1/4 N.P.T. Exceptions Will Be Noted on Part View as ⊗

Firestone

BELLOW NO. ASSEMBLY ORDER NO.	CROSS SECTION VIEW	BEAD PLATE TOP VIEW	PISTON BOTTOM VIEW	ASSEMBLY WEIGHT (lbs.)	REPLACES
1T26D-7 W01-358-9327		3450 	9889/NBD-9253 	5.6	
1T66E-11.8 W01-358-8984 (REPLACES 1T19J-6)		3295 	9461/FIP-101678 	25.2	Wabash (Roadrailer Rowe Truck ASC1400HL Ride

Hardware Key

- Bolt or Stud 1/2-13
- ⊕ Threaded Hole 3/8-16 Blind Nut on Bead Plates 1/2-13 Pistons
- ⊗ Air Inlet 1/4 N.P.T.
- ▲ No Alignment Specified-Center Stud Mounting is Standard
- ⊗ Combination Stud/Air Inlet Stud Outside Thread is 3/4-16
- ⊗ Studs Inside Thread (Air Inlet) is 1/4 N.P.T. Exceptions Will Be Noted on Part View as ⊗

NOTES

Reading the parts table for convoluted style springs

1	2	3	4	5	6
BELLOW NO. ASSEMBLY ORDER NO.	CROSS SECTION VIEW	BEAD PLATE TOP VIEW	PISTON BOTTOM VIEW	ASSEMBLY WEIGHT (lbs.)	REPLACES
25 W01-358-7025				N/A	Western Star (cab spring)

Hardware Key

- Bolt or Stud 1/2-13
- ⊙ Threaded Hole 3/8-16 Blind Nut on Bead Plates 1/2-13 Pistons
- ⊗ Air Inlet 1/4 N.P.T. No Alignment Specified-Center Stud Mounting is Standard
- ⊗ Combination Stud/Air Inlet Stud Outside Thread is 3/4-16
- ⊗ Studs Inside Thread (Air Inlet) is 1/4 N.P.T. Exceptions Will Be Noted on Part View as ⊗

1. Bellow No. and Assembly Order Number (AON)

This number identifies the specific bellows number and the assembly order number for ordering purposes. (i.e. - Complete Order No. for any type of electronic ordering - EDI - is W01-358-7025).

2. Airide Cross Section View

A cross sectional view of the Airide spring showing dimensional information in inches on **uninflated** diameter and minimum height. A bumper drawing is also referenced if applicable.

3. Bead Plate–Top View

A top view of the upper bead plate with dimensional information and detail on mounting attachments (see hardware key). An Internal Firestone reference Number is also shown (i.e.–3030).

4. Bead Plate–Bottom View

A bottom view of the lower bead plate with dimensional information and detail on mounting attachments (see hardware key). An Internal Firestone reference Number is also shown (i.e.–3025).

5. Assembly Weight

Gives total weight of the assembly in pounds.

6. Replaces

Vehicle and suspension manufacturers' part numbers for the particular Airide spring.

Convolved Style

Double Convolved

Triple Convolved

Single Convolved



Firestone convolved Airide springs are available in three styles—single, double, or triple convolved—as shown above.

To identify the exact style and part number to replace your current air spring, you need to identify the type of bellows, bead plates, and attaching hardware used, as well as determining whether the spring has an internal bumper.

First, look for the manufacturer’s part number and Firestone order number stamped in ink on the bead plate. If illegible, read the part number molded on the bellows, normally under the Firestone name. If the number (20, 22, etc.) is present, simply refer to the proper section of this guide.

If for any reason the number is unreadable, you can determine the bellows type with two simple measurements. Remove the air entrance and allow the bellows to assume its normal shape. Then, measure the bead plate diameter

and the outer diameter of the bellows, as shown below. Compare these diameters with those listed in the bellows index for the specific type of convolved (single, double or triple) bellows that you have.

To determine the presence of an internal bumper in the spring, remove the air and collapse the spring to its minimum height. Then, measure this height, as shown below, and compare that measurement with those listed in the proper section of this guide.

Finally, to complete the parts identification, compare the metal bead plates and attaching hardware with the assemblies detailed in that same section of the guide.

For your convenience, typical types of attaching hardware are illustrated below.

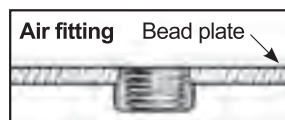
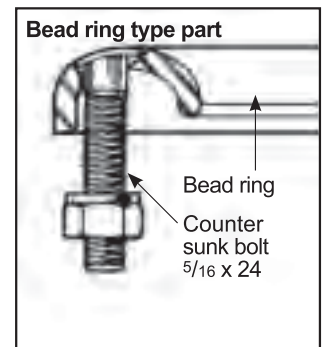
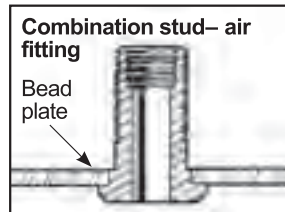
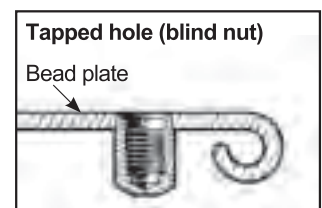
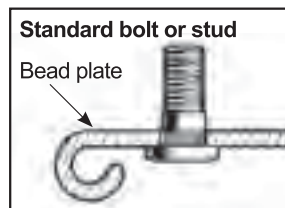
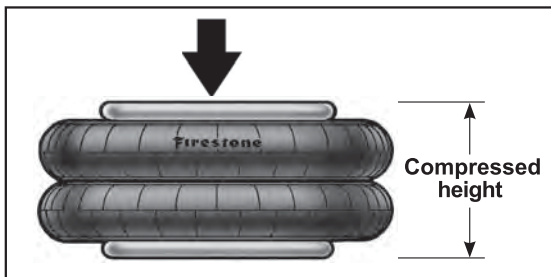
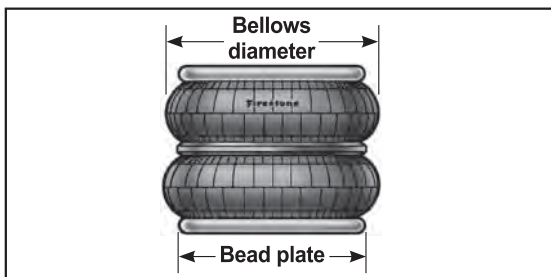

Firestone

BELLOW NO. ASSEMBLY ORDER NO.	CROSS SECTION VIEW	BEAD PLATE TOP VIEW	BEAD PLATE BOTTOM VIEW	ASSEMBLY WEIGHT (lbs.)	REPLACES
19 W01-358-6994		3235 	3183 	11.2	Capacity of Texas
19 W01-358-7008		3215 	3212 OR 3183 	9.6	Holland (Neway) 90557226
19 W01-358-7009		3215 	3183 	11.4	Holland (Neway) 90557002
19-.75 W01-358-7043		3201 	3183 	11.8	Chalmers
113 W01-358-7103		3131 or 3134 	3130 	14.2	Peerless 0550-00015

Hardware Key

- Bolt or Stud 1/2-13
- ⊕ Threaded Hole 3/8-16 Blind Nut on Bead Plates 1/2-13 Pistons
- ⊗ Air Inlet 1/4 N.P.T.
- ▲ No Alignment Specified-Center Stud Mounting is Standard
- ⊗ Combination Stud/Air Inlet Stud Outside Thread is 3/4-16
- Studs Inside Thread (Air Inlet) is 1/4 N.P.T. Exceptions Will Be Noted on Part View as ⊗

Convoluted Style Parts

BELLOW NO. ASSEMBLY ORDER NO.	CROSS SECTION VIEW	BEAD PLATE TOP VIEW	BEAD PLATE BOTTOM VIEW	ASSEMBLY WEIGHT (lbs.)	REPLACES
113 W01-358-7104		3134 	3130 	16.0	Miscellaneous
113-5 W01-358-7093		3170 	3122 	17.1	American Carrier 8003-013
113-5 W01-358-7105		3134 	3130 	16.1	American Carrier 8003-007
113-1 W01-358-7088		3132 	3122 	18.6	Suspensions Inc. 200175
113-1 W01-358-7094		3135 	3130 	16.4	Chalmers

Convoluted Style Parts

Hardware Key

- Bolt or Stud 1/2-13
- ⊕ Threaded Hole 3/8-16 Blind Nut on Bead Plates 1/2-13 Pistons
- ⊗ Air Inlet 1/4 N.P.T.
- ▲ No Alignment Specified-Center Stud Mounting is Standard
- ⊗ Combination Stud/Air Inlet Stud Outside Thread is 3/4-16
- ⊗ Studs Inside Thread (Air Inlet) is 1/4 N.P.T. Exceptions Will Be Noted on Part View as ⊗

Firestone

BELLOW NO. ASSEMBLY ORDER NO.	CROSS SECTION VIEW	BEAD PLATE TOP VIEW	BEAD PLATE BOTTOM VIEW	ASSEMBLY WEIGHT (lbs.)	REPLACES
113-1 W01-358-7096		3134/3132 	3122 	16.6	Suspensions Inc. 200792
113-1 W01-358-7112		3123/3132 	3122 	15.2	Holland (Neway) 90557028 Ridewell 1003587112C
113-1 W01-358-7113 OBSOLETE		3322 	3319 	25.0	Granning 1080
113-1 W01-358-7117		3170 	3122 	17.1	American Carrier
126 W01-358-7726		3473 	3474 	43.6	Air Suspended Fifth Wheel Tartan Transportation (Classic Ride)/Airglide

Hardware Key

- Bolt or Stud 1/2-13 ⊕ Threaded Hole 3/8-16 Blind Nut on Bead Plates 1/2-13 ⊗ Pistons ⊗ Air Inlet 1/4 N.P.T. ▲ No Alignment Specified-Center Stud Mounting is Standard
- ⊗ Combination Stud/Air Inlet Stud Outside Thread is 3/4-16 Studs Inside Thread (Air Inlet) is 1/4 N.P.T. Exceptions Will Be Noted on Part View as ⊗

Convoluted Style Parts

BELLOW NO. ASSEMBLY ORDER NO.	CROSS SECTION VIEW	BEAD PLATE TOP VIEW	BEAD PLATE BOTTOM VIEW	ASSEMBLY WEIGHT (lbs.)	REPLACES
150 W01-358-7462		3079 	3100 	6.3	Load Share
20 W01-358-6890		3101 	3090 	7.3	Holland (Neway) 90557228 V-Steer 1 (Lift Bag)
20 W01-358-6900		3096 	3090 	7.1	Ridewell
20 W01-358-6910		3079 	3090 	7.2	Granning 1371 Hendrickson Trailer S8768 Hendrickson Can. 45843-3 Ridewell 1003586910C Watson & Chalin AS-0001
20 W01-358-6926		3079 	3100 	8.0	Load Share

Convuluted Style Parts

Hardware Key

- Bolt or Stud 1/2-13 ⊕ Threaded Hole 3/8-16 Blind Nut on Bead Plates 1/2-13 Pistons ⊗ Air Inlet 1/4 N.P.T. ▲ No Alignment Specified-Center Stud Mounting is Standard
- ⊗ Combination Stud/Air Inlet Stud Outside Thread is 3/4-16 Studs Inside Thread (Air Inlet) is 1/4 N.P.T. Exceptions Will Be Noted on Part View as ⊗

Firestone

BELLOW NO. ASSEMBLY ORDER NO.	CROSS SECTION VIEW	BEAD PLATE TOP VIEW	BEAD PLATE BOTTOM VIEW	ASSEMBLY WEIGHT (lbs.)	REPLACES
20 W01-358-6856		3079 	3100 	8.1	Tuthill Granning 702932-01
20 W01-358-6884		3148 	3099 	8.3	Link 1103-0019
20 W01-358-6897		3102 	3084 	7.3	Watson & Chalm AS-0058
20 W01-358-6902		3079 	3100 	8.3	Granning 4848 Hendrickson Trailer S2630 R & S Truck & Body 1027505 Ridewell 1003586902C American Carrier Suspensions Inc. 2000-42 Watson & Chalm AS-0002
20 W01-358-6905		3101 	3100 	8.5	Hendrickson Trailer S3518 Hendrickson Trailer S5270 Hendrickson Can. 45843-1 Ridewell 1003586905C Silent Drive EZ Ride 8030120 Monaco Coach Watson & Chalm AS-0020

Hardware Key

- Bolt or Stud 1/2-13
- ⊕ Threaded Hole 3/8-16 Blind Nut on Bead Plates 1/2-13
- ⊗ Air Inlet 1/4 N.P.T.
- ▲ No Alignment Specified-Center Stud Mounting is Standard
- ⊗ Combination Stud/Air Inlet Stud Outside Thread is 3/4-16
- ⊗ Studs Inside Thread (Air Inlet) is 1/4 N.P.T. Exceptions Will Be Noted on Part View as ⊗

Convoluted Style Parts

BELLOW NO. ASSEMBLY ORDER NO.	CROSS SECTION VIEW	BEAD PLATE TOP VIEW	BEAD PLATE BOTTOM VIEW	ASSEMBLY WEIGHT (lbs.)	REPLACES
20 W01-358-6908		3101 	3090 	7.8	Watson & Chain AS-0035
20 W01-358-6932		3148 	3095 	8.3	Ridewell 1003586932C
20 W01-358-6935		3079 	3100 	8.0	Hendrickson Trailer S14318 HLM Lift Bag Hendrickson Aux. 003318 (metric version)
20 W01-358-6940		3102 	3099 	8.6	Histeer 10305
20 W01-358-6941		3140 	3099 	8.4	Histeer 10302

Convoluted Style Parts

Hardware Key

- Bolt or Stud 1/2-13 ⊕ Threaded Hole 3/8-16 Blind Nut on Bead Plates 1/2-13 ⊗ Air Inlet 1/4 N.P.T. ▲ No Alignment Specified-Center Stud Mounting is Standard
- ⊗ Combination Stud/Air Inlet Stud Outside Thread is 3/4-16 ⊗ Studs Inside Thread (Air Inlet) is 1/4 N.P.T. Exceptions Will Be Noted on Part View as ⊗

Firestone

BELLOW NO. ASSEMBLY ORDER NO.	CROSS SECTION VIEW	BEAD PLATE TOP VIEW	BEAD PLATE BOTTOM VIEW	ASSEMBLY WEIGHT (lbs.)	REPLACES
20 W01-358-6949		3148 	3095 		Load Air P-10872-A
20 W01-358-7686		3148 	3095 	8.9	Rowe Truck 0035 ASC2500 ASC1600
20 W01-358-7788		3102 	3095 	8.6	Watson & Chalin AS-0088
20 W01-358-7795 REPLACES 257C		3102 	3090 	7.3	Hendrickson Trailer S14486 (lift bag) Hendrickson Aux. (Paralift, Paralift Ultra) Hendrickson Aux. 003317 (metric version)
20 W01-358-7892		3148 	3100 	8.0	Ridewell 1003587893C

Hardware Key

- Bolt or Stud 1/2-13
- ⊕ Threaded Hole 3/8-16 Blind Nut on Bead Plates 1/2-13 Pistons
- ⊗ Air Inlet 1/4 N.P.T.
- ▲ No Alignment Specified-Center Stud Mounting is Standard
- ⊗ Combination Stud/Air Inlet Stud Outside Thread is 3/4-16
- ⊗ Studs Inside Thread (Air Inlet) is 1/4 N.P.T. Exceptions Will Be Noted on Part View as ⊗

Convoluted Style Parts

BELLOW NO. ASSEMBLY ORDER NO.	CROSS SECTION VIEW	BEAD PLATE TOP VIEW	BEAD PLATE BOTTOM VIEW	ASSEMBLY WEIGHT (lbs.)	REPLACES
20-1 W01-358-6883		3102 	3095 	8.3	Watson & Chalin AS-0092
20-1 W01-358-6886		3102 	3084 	8.1	Watson & Chalin AS-0058-1F Tuthill-Reyco 701784-01
20-1 W01-358-7897		3102 	3090 	7.6	Hendrickson Aux. 002878 (Lift Bag) Hendrickson Aux. (Pararev) Hendrickson Trailer S23114
20-2 W01-358-5900		3048 	3047 	7.7	Link 1103-0059
20-2 W01-358-6392		3349 	3367 	8.3	Arvin Meritor 2258-G-1489

Convoluted Style Parts

Hardware Key

- Bolt or Stud 1/2-13
- ⊕ Threaded Hole 3/8-16 Blind Nut on Bead Plates 1/2-13
- ⊗ Air Inlet 1/4 N.P.T.
- ▲ No Alignment Specified-Center Stud Mounting is Standard
- ⊗ Combination Stud/Air Inlet Stud Outside Thread is 3/4-16
- ⊗ Studs Inside Thread (Air Inlet) is 1/4 N.P.T. Exceptions Will Be Noted on Part View as ⊗

Firestone

BELLOW NO. ASSEMBLY ORDER NO.	CROSS SECTION VIEW	BEAD PLATE TOP VIEW	BEAD PLATE BOTTOM VIEW	ASSEMBLY WEIGHT (lbs.)	REPLACES
20-2 W01-358-6817		3085 	3090 	8.1	Ridewell 1003586817C
20-2 W01-358-6927		3102 	3090 	8.0	Reyco 12906-01
20-2 W01-358-6943		3101 	3090 	8.1	Watson & Chalin AS-0041 Van Raden Holland (Neway) 90557237 V-Steer II (Lift Bag)
20-2 W01-358-6944		3140 	3099 	8.6	Histeer 10307 Suspensions Inc.
20-2 W01-358-6945		3101 	3100 	8.6	Ridewell 1003586945C

Hardware Key

- Bolt or Stud 1/2-13 ⊕ Threaded Hole 3/8-16 Blind Nut on Bead Plates 1/2-13 Pistons ⊗ Air Inlet 1/4 N.P.T. ▲ No Alignment Specified-Center Stud Mounting is Standard
- ⊗ Combination Stud/Air Inlet Stud Outside Thread is 3/4-16 Studs Inside Thread (Air Inlet) is 1/4 N.P.T. Exceptions Will Be Noted on Part View as ⊗

Convoluted Style Parts

BELLOW NO. ASSEMBLY ORDER NO.	CROSS SECTION VIEW	BEAD PLATE TOP VIEW	BEAD PLATE BOTTOM VIEW	ASSEMBLY WEIGHT (lbs.)	REPLACES
20-2 W01-358-6946		3140 	3100 	8.8	Ridewell 1003586946C
20-2 W01-358-6947		3079 	3100 	8.7	Hendrickson Trailer S8701 Ridewell 1003586947C
20-2 W01-358-6948		3101 	3100 	8.6	Ridewell 1003586948C Silent Drive
20-2 W01-358-6960		3101 	3099 		Granning 7025
20-2 W01-358-6962		3148 	3100 	8.4	Hendrickson Trailer S21323

Convoluted Style Parts

Hardware Key

- Bolt or Stud 1/2-13 ⊕ Threaded Hole 3/8-16 Blind Nut on Bead Plates 1/2-13 ⊗ Air Inlet 1/4 N.P.T. ▲ No Alignment Specified-Center Stud Mounting is Standard
- ⊗ Combination Stud/Air Inlet Stud Outside Thread is 3/4-16 Studs Inside Thread (Air Inlet) is 1/4 N.P.T. Exceptions Will Be Noted on Part View as ⊗

Firestone

BELLOW NO. ASSEMBLY ORDER NO.	CROSS SECTION VIEW	BEAD PLATE TOP VIEW	BEAD PLATE BOTTOM VIEW	ASSEMBLY WEIGHT (lbs.)	REPLACES
20CT W01-358-6892		3101 	3095 	9.3	
20F W01-358-7886		3409 	3090 	7.8	Holland 90557360
20F W01-358-7891		3366 	3051 	7.9	Hendrickson 5360
20F-2 W01-358-6393		3101 	3100 	8.7	
21 W01-358-7135		3123 or 3132 	3122 	17.5	Holland (Neway) 90557001 Pezzani AR-21-A Ridewell 1003587135C Silent Drive Truckstell (Marion Mfg.) 63641 Truckstell (Marion Mfg.) 63644 Hendrickson Can. B-12514-014

Hardware Key

- Bolt or Stud 1/2-13
- ⊕ Threaded Hole 3/8-16 Blind Nut on Bead Plates 1/2-13 Pistons
- ⊗ Air Inlet 1/4 N.P.T.
- ▲ No Alignment Specified-Center Stud Mounting is Standard
- ⊗ Combination Stud/Air Inlet Stud Outside Thread is 3/4-16
- Studs Inside Thread (Air Inlet) is 1/4 N.P.T. Exceptions Will Be Noted on Part View as ⊗

Convoluted Style Parts

BELLOW NO. ASSEMBLY ORDER NO.	CROSS SECTION VIEW	BEAD PLATE TOP VIEW	BEAD PLATE BOTTOM VIEW	ASSEMBLY WEIGHT (lbs.)	REPLACES
21 W01-358-7123		3109 	3167 	19.2	Kwik Lok/Todco (Jifflox) 53671 (supersedes 7133)
21 W01-358-7136		3134 	3130 	22.1	Fargo Trailer Granning 1626 Hendrickson Trailer S1080 R & S Truck & Body 1027556 Ridewell 1003587136C Watson & Chalin AS-0004
21 W01-358-7140		3132 	3122 	22.7	Granning 1015 Hendrickson Trailer S3184 Porcupine (replaces 7142) R & S Truck & Body 1090214 Ridewell 1003587140C Temisko Watson & Chalin AS-0008
21 W01-358-7145		3131 	3130 	16.8	Mack 57QL239 Ridewell 1003587145C Volvo/GM-Heavy Duty Truck 35203-0005
21 W01-358-7146		3134 	3130 	20.4	American Carrier 8003-005 EZ Ride Holland (Neway) 90557039 Ridewell 1003587146C Willmar Gallenberg Mod. Flow Equip.

Convuluted Style Parts

Hardware Key

- Bolt or Stud 1/2-13
- ⊕ Threaded Hole 3/8-16 Blind Nut on Bead Plates 1/2-13 Pistons
- ⊗ Air Inlet 1/4 N.P.T.
- ▲ No Alignment Specified-Center Stud Mounting is Standard
- ⊗ Combination Stud/Air Inlet Stud Outside Thread is 3/4-16
- Studs Inside Thread (Air Inlet) is 1/4 N.P.T. Exceptions Will Be Noted on Part View as ⊗

Firestone

BELLOW NO. ASSEMBLY ORDER NO.	CROSS SECTION VIEW	BEAD PLATE TOP VIEW	BEAD PLATE BOTTOM VIEW	ASSEMBLY WEIGHT (lbs.)	REPLACES
21 W01-358-8171		3317 	3398 		Arvin Meritor A-2258-A-1457 RPH-11
21-2 W01-358-6800		3131 or 3134 	3130 	17.6	Watson & Chalin AS-0034 (see W01-358-6808)
21-2 W01-358-6801		3134 	3130 	23.1	EZ Ride 8030160 Hendrickson Trailer S2734 Ridewell 1003586801C Watson & Chalin AS-0021
21-2 W01-358-6803		3193 	3122 	21.3	Hendrickson Trailer S6412
21-2 W01-358-6805		3135 	3130 	20.7	Ridewell 1003586805C

Hardware Key

- Bolt or Stud 1/2-13
- ⊕ Threaded Hole 3/8-16 Blind Nut on Bead Plates 1/2-13 Pistons
- ⊗ Air Inlet 1/4 N.P.T.
- ▲ No Alignment Specified-Center Stud Mounting is Standard
- ⊗ Combination Stud/Air Inlet Stud Outside Thread is 3/4-16
- ⊗ Studs Inside Thread (Air Inlet) is 1/4 N.P.T. Exceptions Will Be Noted on Part View as ⊗

Convoluted Style Parts

BELLOW NO. ASSEMBLY ORDER NO.	CROSS SECTION VIEW	BEAD PLATE TOP VIEW	BEAD PLATE BOTTOM VIEW	ASSEMBLY WEIGHT (lbs.)	REPLACES
21-2 W01-358-6808		3132 	3122 	21.2	Watson & Chain AS-0034 Holland (Neway) (replaced by 6799)
21C W01-358-6777		3111 	3316 	18.8	
22 W01-358-7180		3215 	3212 	12.2	EZ Ride 8030190 Hendrickson Kwiklok/Todco (Jifflox) Peerless 0550-00001 Talbert Ridewell 1003587180C
22 W01-358-7181		3255 	3163 	12.8	Fruehauf UAB-5620 Fruehauf UCC-3054-1
22 W01-358-7183		3255 	3265 	14.5	Fruehauf UCA-0112 Fruehauf UCA-0112-B

Convuluted Style Parts

Hardware Key

- Bolt or Stud 1/2-13 ⊕ Threaded Hole 3/8-16 Blind Nut on Bead Plates 1/2-13 Pistons ⊗ Air Inlet 1/4 N.P.T. ▲ No Alignment Specified-Center Stud Mounting is Standard
- ⊗ Combination Stud/Air Inlet Stud Outside Thread is 3/4-16 Studs Inside Thread (Air Inlet) is 1/4 N.P.T. Exceptions Will Be Noted on Part View as ⊗

Firestone

BELLOW NO. ASSEMBLY ORDER NO.	CROSS SECTION VIEW	BEAD PLATE TOP VIEW	BEAD PLATE BOTTOM VIEW	ASSEMBLY WEIGHT (lbs.)	REPLACES
22 W01-358-7185		3201 	3183 	14.4	Chalmers
22 W01-358-7344		3271 	3163 	12.3	Load Air P10-755C Sauer P10-755C
22 W01-358-7400		3215 	3183 	14.1	Fab Tek 04-0080 Freightliner 16-10769-000 GMC 693230 Granning 2726 Hendrickson Trailer S1013 Holland (Neway) 90557016 R & S Truck & Body 1027519 Ridewell 1003587400C
22 W01-358-7401		3220 	3256 	15.9	GMC 711954 GMC 2076095 Volvo/GM Heavy Duty Truck 2076095 Watson & Chalin AS-0014
22 W01-358-7403		3210 	3183 	14.0	Granning 2725 Hendrickson Trailer S1159 Hendrickson Trailer S2883 Hendrickson Can. B-12514-001 R & S Truck & Body 1040201 Ridewell 1003587403C Watson & Chalin AS-0007

Hardware Key

- Bolt or Stud 1/2-13
- ⊕ Threaded Hole 3/8-16 Blind Nut on Bead Plates 1/2-13 Pistons
- ⊗ Air Inlet 1/4 N.P.T.
- ▲ No Alignment Specified-Center Stud Mounting is Standard
- ⊗ Combination Stud/Air Inlet Stud Outside Thread is 3/4-16
- Studs Inside Thread (Air Inlet) is 1/4 N.P.T. Exceptions Will Be Noted on Part View as ⊗

Convoluted Style Parts

BELLOW NO. ASSEMBLY ORDER NO.	CROSS SECTION VIEW	BEAD PLATE TOP VIEW	BEAD PLATE BOTTOM VIEW	ASSEMBLY WEIGHT (lbs.)	REPLACES
22 W01-358-7404		3210 	3183 	12.2	Hendrickson Trailer S5468 Hendrickson Can. S1345 (replaced by 7472)
22 W01-358-7405		3235 	3256 	14.5	Hutchens H-10384-01 Suspensions Inc.
22 W01-358-7406		3220 	3183 	13.8	Ridewell 1003587406C
22 W01-358-7408		3210 	3183 	13.8	EZ Ride
22 W01-358-7409		3271 	3256 	14.2	Fruehauf

Convoluted Style Parts

Hardware Key
 ● Bolt or Stud 1/2-13 ⊕ Threaded Hole 3/8-16 Blind Nut on Bead Plates 1/2-13 ⊗ Air Inlet 1/4 N.P.T. ▲ No Alignment Specified-Center Stud Mounting is Standard
 ⊗ Combination Stud/Air Inlet Stud Outside Thread is 3/4-16 ⊗ Studs Inside Thread (Air Inlet) is 1/4 N.P.T. Exceptions Will Be Noted on Part View as ⊗

Firestone

BELLOW NO. ASSEMBLY ORDER NO.	CROSS SECTION VIEW	BEAD PLATE TOP VIEW	BEAD PLATE BOTTOM VIEW	ASSEMBLY WEIGHT (lbs.)	REPLACES
22 W01-358-7410		3271 	3183 	14.6	Freightliner 16-11378-000
22 W01-358-7423		3271 	3256 	12.7	Sauer P10-784
22 W01-358-7424		3220 	3256 	12.6	Intergrated Holland (Neway) 90557014 (AL-41 & 45) Porcupine R & S Truck & Body 1090215 Sauer P10-755
22 W01-358-7429		3235 	3212 OR 3183 	12.4	Kwik Lok/Todco (Jifflox) CP-5223 Silent Drive
22 W01-358-7437		3220 	3256 	14.6	Holland (Neway) 90557015 Ridewell 1003587437C

Hardware Key

- Bolt or Stud 1/2-13
- ⊕ Threaded Hole 3/8-16 Blind Nut on Bead Plates 1/2-13 Pistons
- ⊗ Air Inlet 1/4 N.P.T.
- ▲ No Alignment Specified-Center Stud Mounting is Standard
- ⊗ Combination Stud/Air Inlet Stud Outside Thread is 3/4-16
- ⊗ Studs Inside Thread (Air Inlet) is 1/4 N.P.T. Exceptions Will Be Noted on Part View as ⊗

Convoluted Style Parts

BELLOW NO. ASSEMBLY ORDER NO.	CROSS SECTION VIEW	BEAD PLATE TOP VIEW	BEAD PLATE BOTTOM VIEW	ASSEMBLY WEIGHT (lbs.)	REPLACES
22-1.5 W01-358-6789		3271 	3281 	14.6	Hendrickson Aux. 001503
22-1.5 W01-358-7443		3208 	3212 or 3183 	12.7	Granning 1218 (replaces 7416) Watson & Chain AS-0027 (replaces 7416) Ridewell 1003587443C
22-1.5 W01-358-7444		3215 	3212 or 3183 	12.7	Hendrickson Trailer S9830
22-1.5 W01-358-7446		3271 	3183 	14.7	Hendrickson Trailer S3798 R & S Truck & Body 1082914 Watson & Chain AS-0005
22-1.5 W01-358-7447		3210 	3183 	14.3	EZ Ride 8030150 Hendrickson Trailer S6242 Silent Drive

Convuluted Style Parts

Hardware Key

- Bolt or Stud 1/2-13
- ⊕ Threaded Hole 3/8-16 Blind Nut on Bead Plates 1/2-13 Pistons
- ⊗ Air Inlet 1/4 N.P.T.
- ▲ No Alignment Specified-Center Stud Mounting is Standard
- ⊗ Combination Stud/Air Inlet Stud Outside Thread is 3/4-16
- ⊗ Studs Inside Thread (Air Inlet) is 1/4 N.P.T. Exceptions Will Be Noted on Part View as ⊗

Firestone

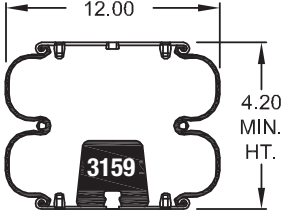
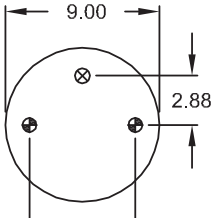
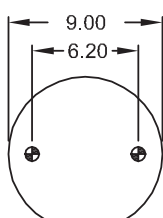
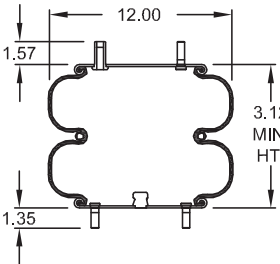
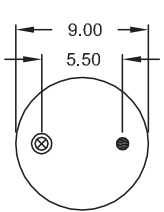
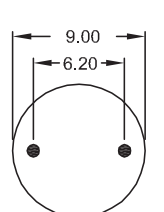
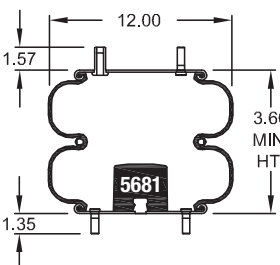
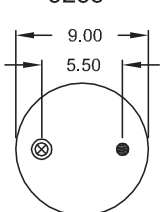
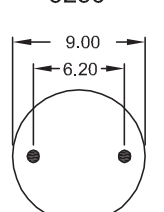
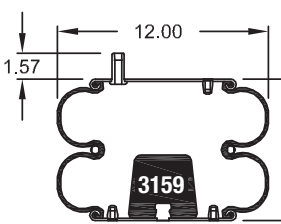
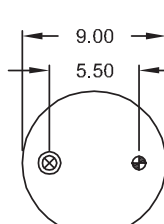
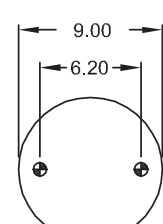
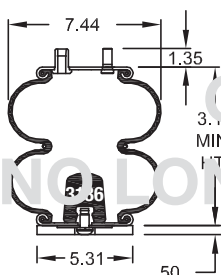
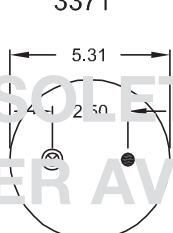
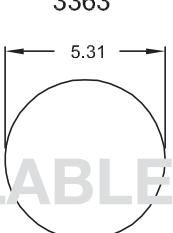
BELLOW NO. ASSEMBLY ORDER NO.	CROSS SECTION VIEW	BEAD PLATE TOP VIEW	BEAD PLATE BOTTOM VIEW	ASSEMBLY WEIGHT (lbs.)	REPLACES
22-1.5 W01-358-7473		3215 	3183 	14.3	Ridewell 1003587473C
22-1.5 W01-358-7483		3235 	3256 	12.9	Ridewell 1003587483C
22-1.5 W01-358-7499		3235 	3256 	13.7	Suspensions Inc.
22-1.5 W01-358-7790		3003 	3183 	14.3	Hendrickson Aux. 001475
26 W01-358-7279 OBSOLETE		3371 	3363 	6.7	Hendrickson 45843-2

Hardware Key

- Bolt or Stud 1/2-13
- ⊕ Threaded Hole 3/8-16 Blind Nut on Bead Plates 1/2-13 Pistons
- ⊗ Air Inlet 1/4 N.P.T.
- ▲ No Alignment Specified-Center Stud Mounting is Standard
- ⊗ Combination Stud/Air Inlet Stud Outside Thread is 3/4-16
- Studs Inside Thread (Air Inlet) is 1/4 N.P.T. Exceptions Will Be Noted on Part View as ⊗

Convoluted Style Parts

BELLOW NO. ASSEMBLY ORDER NO.	CROSS SECTION VIEW	BEAD PLATE TOP VIEW	BEAD PLATE BOTTOM VIEW	ASSEMBLY WEIGHT (lbs.)	REPLACES
26 W01-358-7325		3450 	3436 	5.3	American Carrier 8003-006 Mack 227QS-32 & 57QK1113 Sauer P10-754 Texas Truck Watson & Chalin AS-0030
26 W01-358-7330		3371 	3363 	5.4	Ridewell 1003587330
26 W01-358-7505		3452 	3363 	5.5	Hendrickson 001347
26 W01-358-7705		3371 	3436 	4.9	Watson Chalin AS-006 (Replaces 7503)
26C W01-358-7339		3071 	3363 	4.8	

Convoluted Style Parts

Hardware Key

- Bolt or Stud 1/2-13
- ⊕ Threaded Hole 3/8-16 Blind Nut on Bead Plates 1/2-13 Pistons
- ⊗ Air Inlet 1/4 N.P.T.
- ▲ No Alignment Specified-Center Stud Mounting is Standard
- ⊗ Combination Stud/Air Inlet Stud Outside Thread is 3/4-16
- Studs Inside Thread (Air Inlet) is 1/4 N.P.T. Exceptions Will Be Noted on Part View as ⊗

Firestone

BELLOW NO. ASSEMBLY ORDER NO.	CROSS SECTION VIEW	BEAD PLATE TOP VIEW	BEAD PLATE BOTTOM VIEW	ASSEMBLY WEIGHT (lbs.)	REPLACES
26C W01-358-7659		3071 	3436 	5.0	Hendrickson 005079
28 W01-358-7271		3471 	3472 	31.7	Ridwell 1003587271C
28 W01-358-7512	 3157	3471 	3472 	36.3	Wilmar Gallenberg
29 W01-358-7275		3473 	3474 	53.2	Ridwell 1003587275C
201 W01-358-7244	 (Includes bolts, nuts, & washers)	4299 	4299 	19.9	Ridwell 1003587271C

Hardware Key

- Bolt or Stud 1/2-13
- ⊕ Threaded Hole 3/8-16 Blind Nut on Bead Plates 1/2-13
- ⊗ Pistons
- ⊗ Air Inlet 1/4 N.P.T.
- ▲ No Alignment Specified-Center Stud Mounting is Standard
- ⊗ Combination Stud/Air Inlet Stud Outside Thread is 3/4-16
- Studs Inside Thread (Air Inlet) is 1/4 N.P.T. Exceptions Will Be Noted on Part View as ⊗

Convoluted Style Parts

BELLOW NO. ASSEMBLY ORDER NO.	CROSS SECTION VIEW	BEAD PLATE TOP VIEW	BEAD PLATE BOTTOM VIEW	ASSEMBLY WEIGHT (lbs.)	REPLACES
203 W01-358-7226	<p>(Includes bolts, nuts, & washers)</p>	<p>4302</p>	<p>4302</p>	24.8	Rimpull
203 W01-358-7273		<p>3475</p>	<p>3476</p>	42.6	Ridewell 1003587273C Watson & Chain AS-0045
205 W01-358-7118		<p>3136</p>	<p>3122</p>	25.1	Granning 2279
205 W01-358-7927		<p>3132</p>	<p>3122</p>	22.3	Maurice Welding
215 W01-358-7230 BEAD RING WC1-358-3499	<p>(Includes bolts, nuts, & washers)</p>	<p>4311</p>	<p>4311</p>	42.2	Pollard Holland Hitch 6788

Convuluted Style Parts

Hardware Key

- Bolt or Stud 1/2-13
- ⊕ Threaded Hole 3/8-16 Blind Nut on Bead Plates 1/2-13
- ⊗ Air Inlet 1/4 N.P.T.
- ▲ No Alignment Specified-Center Stud Mounting is Standard
- ⊗ Combination Stud/Air Inlet Stud Outside Thread is 3/4-16
- ⊗ Studs Inside Thread (Air Inlet) is 1/4 N.P.T. Exceptions Will Be Noted on Part View as ⊗

Firestone

BELLOW NO. ASSEMBLY ORDER NO.	CROSS SECTION VIEW	BEAD PLATE TOP VIEW	BEAD PLATE BOTTOM VIEW	ASSEMBLY WEIGHT (lbs.)	REPLACES
218 W01-358-7294 BEAD RING WC1-358-3509	<p>(Includes bolts, nuts, & washers)</p>	4302 	4302 	25.4	Unit Rig 1016031 Dart 21-40061
224 W01-358-3400		3450 	3436 	4.6	American Carrier 8003-009
224 W01-358-3402		3355 	3453 	5.0	American Carrier 8003-026 (supersedes 9455-Bellows 1T47A-1) (replaces W01-358-3401 and W01-358-3405)
224 W01-358-3406		3371 	3436 	5.0	Sauer P20-706
228-1.5 W01-358-7550		3271 	3183 	14.5	Watson & Chalin AS-0087 Histeer 10315

Hardware Key

- Bolt or Stud 1/2-13
- ⊕ Threaded Hole 3/8-16 Blind Nut on Bead Plates 1/2-13
- ⊗ Air Inlet 1/4 N.P.T.
- ▲ No Alignment Specified-Center Stud Mounting is Standard
- ⊗ Combination Stud/Air Inlet Stud Outside Thread is 3/4-16
- ⊗ Studs Inside Thread (Air Inlet) is 1/4 N.P.T. Exceptions Will Be Noted on Part View as ⊗

Convoluted Style Parts

BELLOW NO. ASSEMBLY ORDER NO.	CROSS SECTION VIEW	BEAD PLATE TOP VIEW	BEAD PLATE BOTTOM VIEW	ASSEMBLY WEIGHT (lbs.)	REPLACES
228-1.5 W01-358-7555		3271 	3194 	14.5	Reyco 20018-01 (86AR) Binkley XB-SPN-053-37 (Note: supersedes W01-358-7550)
228-1.5 W01-358-7472		3210 	3212 or 3183 	14.1	Hendrickson Can. B-12514-005
228-1.5 W01-358-7545		3271 	3183 	14.9	Hendrickson Aux. 001796 (Paralift Ultra/ High Lift) -lift bag Watson & Chain AS-0087-1F
233-2 W01-358-6799		3132 	3122 	21.8	Holland (Neway) 90557203
233-2 W01-358-7557		3187 	3108 	20.6	Reyco 19983-01 (21AR, 74AR) Watson & Chain AS-0089 Histeer 10316 (W01-358-6805) (W01-358-7557)

Convuluted Style Parts

Hardware Key

- Bolt or Stud 1/2-13
- ⊕ Threaded Hole 3/8-16 Blind Nut on Bead Plates 1/2-13 Pistons
- ⊗ Air Inlet 1/4 N.P.T.
- ▲ No Alignment Specified-Center Stud Mounting is Standard
- ⊗ Combination Stud/Air Inlet Stud Outside Thread is 3/4-16
- ⊗ Studs Inside Thread (Air Inlet) is 1/4 N.P.T. Exceptions Will Be Noted on Part View as ⊗

Firestone

BELLOW NO. ASSEMBLY ORDER NO.	CROSS SECTION VIEW	BEAD PLATE TOP VIEW	BEAD PLATE BOTTOM VIEW	ASSEMBLY WEIGHT (lbs.)	REPLACES
233-2 W01-358-7781		3134 	3130 	22.7	Ridewell 1003587781C
233-2 W01-358-7782		3132 	3122 	23.3	Porcupine (replaces 7140) Watson & Chalin AS-0032 (replaces 7240)
252 W01-358-8235 TANK VALVE WC1-358-0009		3341 	3342 	14.5	Caterpillar
256-2 W01-358-7792		3132 	3122 		Watson & Chalin AS-0064
256-2 W01-358-7794		3123 	3122 	19.0	Suspensions Inc.

Hardware Key

- Bolt or Stud 1/2-13
- ⊕ Threaded Hole 3/8-16 Blind Nut on Bead Plates 1/2-13 Pistons
- ⊗ Air Inlet 1/4 N.P.T.
- ▲ No Alignment Specified-Center Stud Mounting is Standard
- ⊗ Combination Stud/Air Inlet Stud Outside Thread is 3/4-16
- ⊗ Studs Inside Thread (Air Inlet) is 1/4 N.P.T. Exceptions Will Be Noted on Part View as ⊗

Convoluted Style Parts

BELLOW NO. ASSEMBLY ORDER NO.	CROSS SECTION VIEW	BEAD PLATE TOP VIEW	BEAD PLATE BOTTOM VIEW	ASSEMBLY WEIGHT (lbs.)	REPLACES
264 W01-358-3420		3435 	3356 	5.3	Hendrickson Aux. 004647
267-1.5 W01-358-6831 TANK VALVE WC1-358-0009		3030 	3025 	3.3	John Deere AW30683
268 W01-358-7025		3030 	3025 	3.2	WESTERN STAR (Cab Spring)
268 W01-358-7057		3065 	3025 	3.4	Sauer P10-794
38 W01-358-7990		3351 	3183 	16.0	Watson & Chalin AS-0048

Convoluted Style Parts

Hardware Key

- Bolt or Stud 1/2-13
- ⊕ Threaded Hole 3/8-16 Blind Nut on Bead Plates 1/2-13 Pistons
- ⊗ Air Inlet 1/4 N.P.T.
- ▲ No Alignment Specified-Center Stud Mounting is Standard
- ⊗ Combination Stud/Air Inlet Stud Outside Thread is 3/4-16
- ⊗ Studs Inside Thread (Air Inlet) is 1/4 N.P.T. Exceptions Will Be Noted on Part View as ⊗

Firestone

BELLOW NO. ASSEMBLY ORDER NO.	CROSS SECTION VIEW	BEAD PLATE TOP VIEW	BEAD PLATE BOTTOM VIEW	ASSEMBLY WEIGHT (lbs.)	REPLACES
38 W01-358-7994		3210 	3183 	16.4	Watson & Chalin AS-0019-1F (ref. W01-358-8008)
38 W01-358-7995		3210 	3183 	17.5	Watson & Chalin AS-0048-1F (ref. W01-358-8032)
38 W01-358-7996		3271 	3183 	15.9	Granning 8221
38 W01-358-7998		3173 	3183 	15.9	Hendrickson Aux. 001560
38 W01-358-8006		3208 	3212 or 3183 	14.5	Superior

Hardware Key

- Bolt or Stud 1/2-13
- ⊕ Threaded Hole 3/8-16 Blind Nut on Bead Plates 1/2-13 Pistons
- ⊗ Air Inlet 1/4 N.P.T.
- ▲ No Alignment Specified-Center Stud Mounting is Standard
- ⊗ Combination Stud/Air Inlet Stud Outside Thread is 3/4-16
- Studs Inside Thread (Air Inlet) is 1/4 N.P.T. Exceptions Will Be Noted on Part View as ⊗

Convoluted Style Parts

BELLOW NO. ASSEMBLY ORDER NO.	CROSS SECTION VIEW	BEAD PLATE TOP VIEW	BEAD PLATE BOTTOM VIEW	ASSEMBLY WEIGHT (lbs.)	REPLACES
38 W01-358-8008		3210 	3183 	17.7	EZ Ride Histeer Ridewell 1003588008C Silent Drive Watson & Chalin AS-0019 Hendrickson Trailer S11637
38 W01-358-8010		3215 	3183 	18.0	Ridewell 1003588010C Tafco Oshkosh (ref.8013)
38 W01-358-8014		3241 	3183 	16.6	Ridewell 1003588014C
38 W01-358-8016		3235 	3183 	13.9	Ridewell 1003588016C
38 W01-358-8018		3271 	3183 	17.3	Histeer Reyco 93AR Suspensions Inc. Watson & Chalin

Convoluted Style Parts

Hardware Key

- Bolt or Stud 1/2-13
- Threaded Hole 3/8-16 Blind Nut on Bead Plates 1/2-13
- Pistons
- Air Inlet 1/4 N.P.T.
- No Alignment Specified-Center Stud Mounting is Standard
- Combination Stud/Air Inlet Stud Outside Thread is 3/4-16
- Studs Inside Thread (Air Inlet) is 1/4 N.P.T. Exceptions Will Be Noted on Part View as

Firestone

BELLOW NO. ASSEMBLY ORDER NO.	CROSS SECTION VIEW	BEAD PLATE TOP VIEW	BEAD PLATE BOTTOM VIEW	ASSEMBLY WEIGHT (lbs.)	REPLACES
38 W01-358-8025		3210 	3183 	17.3	Silent Drive (replaces W01-358-8028) Van Raden
38 W01-358-8027		3271 	3183 	16.6	Suspensions Inc. 200117 Histeer (supersedes 8029) Silent Drive
38 W01-358-8030		3215 	3183 	18.3	Ridewell 1003588030C
38 W01-358-8032		3210 	3183 	18.1	Hendrickson Trailer S12405
38 W01-358-8033		3271 	3292 	18.6	Hendrickson Trailer S14487 (Ride Bag) [Paralift Ultra] [Pararev] Hendrickson Aux. 003316 (metric version)

Hardware Key

- Bolt or Stud 1/2-13
- ⊕ Threaded Hole 3/8-16 Blind Nut on Bead Plates 1/2-13 Pistons
- ⊗ Air Inlet 1/4 N.P.T.
- ▲ No Alignment Specified-Center Stud Mounting is Standard
- ⊗ Combination Stud/Air Inlet Stud Outside Thread is 3/4-16
- ⊗ Studs Inside Thread (Air Inlet) is 1/4 N.P.T. Exceptions Will Be Noted on Part View as ⊗

Convolved Style Parts

BELLOW NO. ASSEMBLY ORDER NO.	CROSS SECTION VIEW	BEAD PLATE TOP VIEW	BEAD PLATE BOTTOM VIEW	ASSEMBLY WEIGHT (lbs.)	REPLACES
39 W01-358-7852 (4 PLY)		3132 	3122 		Porcupine Maurice Welding
39 W01-358-7816		3132 	3122 	23.5	Granning 1476 Superior Temisko
312 W01-358-7286		3741 	3472 	38.2	Ridewell 1003587286C Superior
312 W01-358-7761		4299 	4299 	24.6	Superior
312 W01-358-7915					Superior

Convolved Style Parts

Hardware Key

- Bolt or Stud 1/2-13
- ⊕ Threaded Hole 3/8-16 Blind Nut on Bead Plates 1/2-13 Pistons
- ⊗ Air Inlet 1/4 N.P.T.
- ▲ No Alignment Specified-Center Stud Mounting is Standard
- ⊗ Combination Stud/Air Inlet Stud Outside Thread is 3/4-16
- Studs Inside Thread (Air Inlet) is 1/4 N.P.T. Exceptions Will Be Noted on Part View as ⊗

Firestone

BELLOW NO. ASSEMBLY ORDER NO.	CROSS SECTION VIEW	BEAD PLATE TOP VIEW	BEAD PLATE BOTTOM VIEW	ASSEMBLY WEIGHT (lbs.)	REPLACES
313 W01-358-7796		3193 	3122 	25.2	Ridewell 1003587796C
313 W01-358-7797		3187 	3389 	21.0	Hendrickson Aux. 001346
313 W01-358-7798		3134 	3130 	23.3	Allison Granning 1613 R & S Truck & Body Watson & Chain AS-0006
313 W01-358-7800		3123 or 3132 	3122 	23.9	Granning 4514 Holland Hitch 4514 Ridewell 1003587800C Silent Drive
313 W01-358-7808		3131 or 3134 	3130 	20.2	Ridewell 1003587808C Truckstell (Marion Mfg.) 63640 EZ Ride 8030170

Hardware Key

- Bolt or Stud 1/2-13
- ⊕ Threaded Hole 3/8-16 Blind Nut on Bead Plates 1/2-13 Pistons
- ⊗ Air Inlet 1/4 N.P.T.
- ▲ No Alignment Specified-Center Stud Mounting is Standard
- ⊗ Combination Stud/Air Inlet Stud Outside Thread is 3/4-16
- Studs Inside Thread (Air Inlet) is 1/4 N.P.T. Exceptions Will Be Noted on Part View as ⊗

Convolved Style Parts

BELLOW NO. ASSEMBLY ORDER NO.	CROSS SECTION VIEW	BEAD PLATE TOP VIEW	BEAD PLATE BOTTOM VIEW	ASSEMBLY WEIGHT (lbs.)	REPLACES
313 W01-358-7818		3132 	3122 	23.7	EZ Ride 8030180 Granning 1014 Ridewell 1003587818C Superior Watson & Chalin AS-0025
320 W01-358-7276 (4 PLY)		3473 	3474 		Wabash
321 W01-358-7304		4311 	4311 	54.5	Ottawa 53500516 Pollard Holland Hitch 6764 Supersedes 7320
323 W01-358-7274		3475 	3476 	52.5	Ridewell 1003587274C
333 W01-358-7838 REPLACES W01-358-7849		3134 	3130 	28.6	EZ Ride

Convolved Style Parts

Hardware Key

- Bolt or Stud 1/2-13
- ⊕ Threaded Hole 3/8-16 Blind Nut on Bead Plates 1/2-13
- ⊗ Pistons
- ⊗ Air Inlet 1/4 N.P.T.
- ▲ No Alignment Specified-Center Stud Mounting is Standard
- ⊗ Combination Stud/Air Inlet Stud Outside Thread is 3/4-16
- ⊗ Studs Inside Thread (Air Inlet) is 1/4 N.P.T. Exceptions Will Be Noted on Part View as ⊗

Firestone

BELLOW NO. ASSEMBLY ORDER NO.	CROSS SECTION VIEW	BEAD PLATE TOP VIEW	BEAD PLATE BOTTOM VIEW	ASSEMBLY WEIGHT (lbs.)	REPLACES
333 W01-358-7839		3111 	3316 	28.4	Hendrickson Trailer S6861 Histeer 10300 Porcupine (replaces 7818) Ridewell Watson & Chalin AS-0033 Silent Drive Superior
333 W01-358-7843		3193 	3122 	28.3	Hendrickson Trailer S7100
333 W01-358-7844		3109 	3167 	26.6	Ridewell 1003587844C
333 W01-358-7845		3134 	3130 		EZ Ride
333 W01-358-7846		3193 	3122 	28.3	Hendrickson Trailer S7853

Hardware Key

- Bolt or Stud 1/2-13 ⊕ Threaded Hole 3/8-16 Blind Nut on Bead Plates 1/2-13 ⊗ Air Inlet 1/4 N.P.T. ▲ No Alignment Specified-Center Stud Mounting is Standard
- ⊗ Combination Stud/Air Inlet Stud Outside Thread is 3/4-16 Studs Inside Thread (Air Inlet) is 1/4 N.P.T. Exceptions Will Be Noted on Part View as ⊗

Convolved Style Parts

BELLOW NO. ASSEMBLY ORDER NO.	CROSS SECTION VIEW	BEAD PLATE TOP VIEW	BEAD PLATE BOTTOM VIEW	ASSEMBLY WEIGHT (lbs.)	REPLACES
333 W01-358-7847		3193 	3149 	29.7	Hendrickson Trailer S8874
333 W01-358-7848		3123 or 3132 	3122 	24.7	Superior Suspensions Inc.
333 W01-358-7850		3187 	3197 	28.5	Histeer 10301 Suspensions Inc. 200177 Watson & Chalin AS-0086 (Replaces old 7837 supersedes 7851 - adapter plates might be required)
333 W01-358-7853		3136 	3316 	28.3	Chalmers
333 W01-358-7855		3132 	3130 	29.1	Granning 7026

Convolved Style Parts

Hardware Key

- Bolt or Stud 1/2-13
- ⊕ Threaded Hole 3/8-16 Blind Nut on Bead Plates 1/2-13 Pistons
- ⊗ Air Inlet 1/4 N.P.T.
- ▲ No Alignment Specified-Center Stud Mounting is Standard
- ⊗ Combination Stud/Air Inlet Stud Outside Thread is 3/4-16
- ⊗ Studs Inside Thread (Air Inlet) is 1/4 N.P.T. Exceptions Will Be Noted on Part View as ⊗

Firestone

BELLOW NO. ASSEMBLY ORDER NO.	CROSS SECTION VIEW	BEAD PLATE TOP VIEW	BEAD PLATE BOTTOM VIEW	ASSEMBLY WEIGHT (lbs.)	REPLACES
333 W01-358-7859		3187 	3130 		Hendrickson Aux. 001285
333 W01-358-7862		3196 	3130 		Hendrickson Aux. 001795 (Paralift Ultra/ High Lift) -ride bag
333 W01-358-7872		3187 	3384 	25.2	Hendrickson Aux. 004828
352 W01-358-7954		3346 	3303 	20.3	Hendrickson Aux. 002348
352 W01-358-7956		3302 	3303 	19.1	Rowe Truck 0059 ASC 1500

Hardware Key

- Bolt or Stud 1/2-13
- ⊕ Threaded Hole 3/8-16 Blind Nut on Bead Plates 1/2-13
- ⊗ Air Inlet 1/4 N.P.T.
- ▲ No Alignment Specified-Center Stud Mounting is Standard
- ⊗ Combination Stud/Air Inlet Stud Outside Thread is 3/4-16
- Studs Inside Thread (Air Inlet) is 1/4 N.P.T. Exceptions Will Be Noted on Part View as ⊗

Convoluted Style Parts

BELLOW NO. ASSEMBLY ORDER NO.	CROSS SECTION VIEW	BEAD PLATE TOP VIEW	BEAD PLATE BOTTOM VIEW	ASSEMBLY WEIGHT (lbs.)	REPLACES
352 W01-358-8042		3300 	3303 	19.8	Hendrickson Aux. 001015 Holland (Neway) 90557236 V-Steer II (Ride Bag)
352 W01-358-8043		3302 	3303 	20.1	Hendrickson Trailer S14795
354 W01-358-8038		3210 	3183 	18.1	Silent Drive Longer Stroke 8008 Histeer 10313
354 W01-358-8039		3271 	3183 	16.7	Histeer 10303 (Longer Stroke 8018)

Convuluted Style Parts

Hardware Key

- Bolt or Stud 1/2-13
- ⊕ Threaded Hole 3/8-16 Blind Nut on Bead Plates 1/2-13
- ⊗ Pistons
- ⊗ Air Inlet 1/4 N.P.T.
- ▲ No Alignment Specified-Center Stud Mounting is Standard
- ⊗ Combination Stud/Air Inlet Stud Outside Thread is 3/4-16
- ⊗ Studs Inside Thread (Air Inlet) is 1/4 N.P.T. Exceptions Will Be Noted on Part View as ⊗

Reading the parts table for sleeve style springs

1	2	3	4	5	6	7
ASSEMBLY ORDER NO.	CROSS SECTION VIEW	CAP	PISTON	BCR	ASSEMBLY WEIGHT (lbs.)	APPLICATIONS
		DRAWING NUMBER	DRAWING NUMBER	LOGO COLOR		
W02-358-7059		7042	6896	8.25"	N/A	NATIONAL SEATING 324663-01 (W02-N19-7059) 328035-01 (W02-N19-7069) 329666-01 (W02-N19-7084)
		NBD-10409	NBD-12708	Orange		

1. Order Number

This number identifies the specific assembly order number that needs to be used for ordering purposes. It is important that the complete order number is used to avoid any confusion, especially with any type of electronic ordering. The complete order number in the example is W02-358-7017.

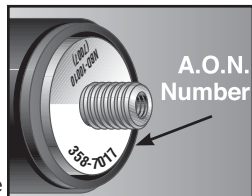

2. Cross Section View

This section is a cross sectional drawing of the Airide™ spring showing dimensional information in inches. The two heights shown to the right of the drawing are for extended and compressed measurements **uninflated**. The part number shown at the left is the last four digits of the A.O.N. (Airide™ Order Number). In the example, W02-358-7017 is abbreviated to "7017". The last 7 digits of the A.O.N. are stamped into the lip of the cap, around the perimeter. The AON number may also be stamped on the crimping.

3. Cap Drawing Number

Shown in this section of the table above is the drawing number molded into the material of most caps, followed by an additional four digit number enclosed in parentheses. The drawing numbers will generally start with the letters NBD. The four digit number is a stores number for this component, not an assembly identification number. In this book you will see another notation following the four digit number. This refers to the material that the cap is made of, specifically aluminum or plastic.

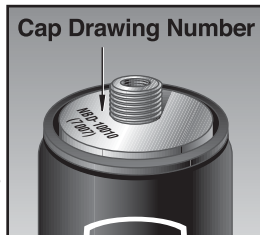

4. Piston Drawing Number

This section refers to the piston end of the sleeve. It is shown in the same way as the cap information.

5. BCR/Logo Color

This dimension is the measurement taken between the two metal rings on each end of the assembly. Note: BCR measurement on a used Airide™ spring will be somewhat shorter than specified in this catalog. The Airide™ spring shield logo color indicates a very specific construction of the bellows.

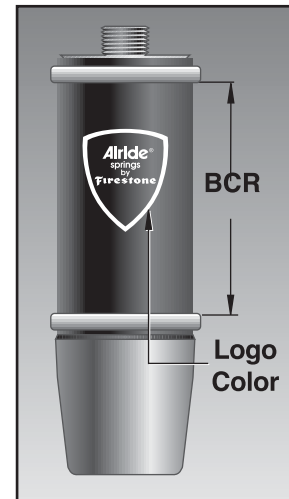

6. Weight

This is the total weight of the Airide™ spring assembly.

7. Applications

In this section, we provide all the information that is known about this specific application (i.e., model number, years of manufacture, part numbers, Firestone reference numbers and competitor numbers if known).

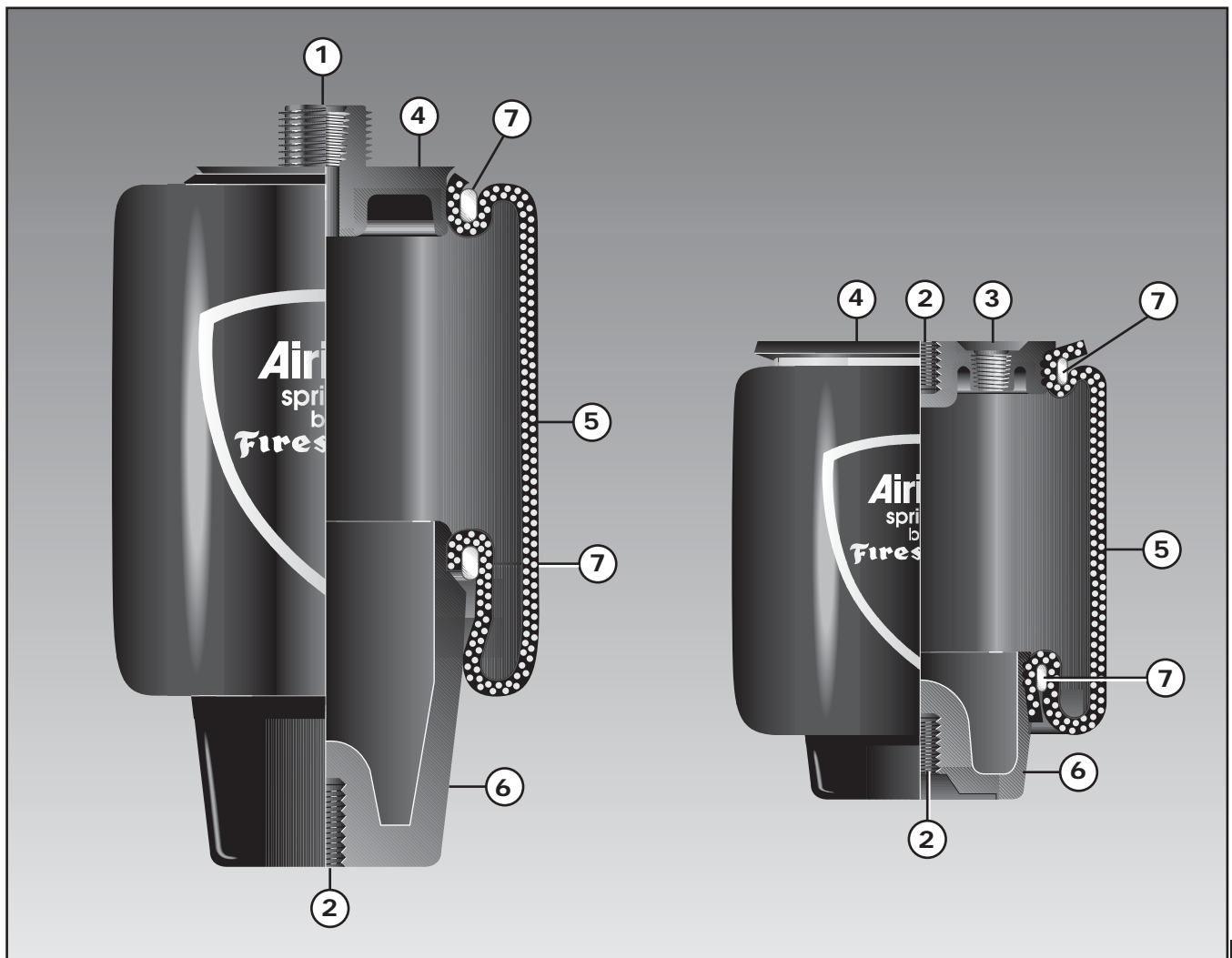

1. Combo Stud

Combination mounting stud and air fitting.

2. Blind Nut

A blind tapped hole in either the piston or cap.

3. Air Fitting Hole

When using a blind nut or stud instead of a combo stud, a separate air fitting is required.

4. Clamp Plate

Also called the "Cap", this is the upper aluminum or plastic end. This provides the mounting hardware, and normally the air fitting.

5. Bellows

The heart of an Airide™ spring is the sleeve, or bellows.

It is made of four layers: an inner liner of rubber, two plies of cord reinforcement, and an outer cover.

6. Piston

The lower end of the assembly that the rubber rolls over is called the "piston". This is also made of either aluminum or plastic. It provides the lower mounting hardware for the assembly.

7. Clamp Ring

These are the metal rings used to permanently attach the bellows to the clamp plate and piston.

Firestone

ASSEMBLY ORDER NO.	CROSS SECTION VIEW	CAP DRAWING NUMBER	PISTON DRAWING NUMBER	BCR LOGO COLOR	ASSEMBLY WEIGHT (lbs.)	APPLICATIONS
W01-358-7025		3030	3025		3.2	FREIGHTLINER / WESTERN STAR (STYLE #25 BELLOWS)
W02-358-7086		7018	6913	5.25"	0.7	LINK MANUFACTURING LTD 1102-0025 (FORD)
		NBD-10218	NBD-16538	ORANGE		
W02-358-7046		7068	6912	6"	0.7	LINK MANUFACTURING LTD 1102-0022 (FORD, FRT. GMC, PETE)
		NBD-10470	NBD-16537	ORANGE		
W02-358-7079		7074	6912	6"	0.7	LINK MANUFACTURING LTD 1102-0026 (NAV.)
		NBD-11636	NBD-16537	ORANGE		

INF. - Inflated (Max.) / UNINF. - Uninflated / (P) - Plastic / (AL) - Aluminum / BCR - Between Clamp Rings / N/A - Not Available

1T - Reversible Sleeve

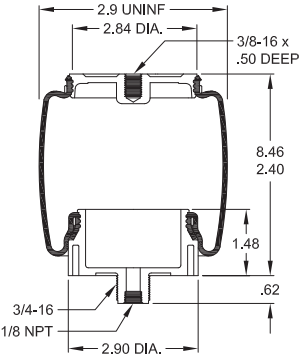
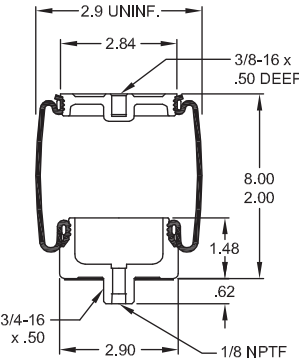
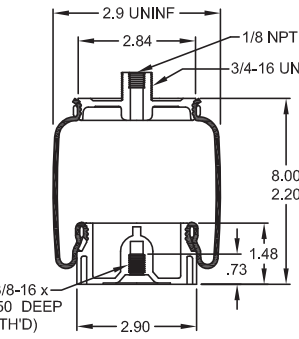
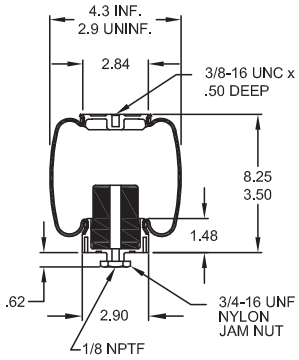
ASSEMBLY ORDER NO.	CROSS SECTION VIEW	CAP DRAWING NUMBER	PISTON DRAWING NUMBER	BCR LOGO COLOR	ASSEMBLY WEIGHT (lbs.)	APPLICATIONS
W02-358-7001		7018	6913	6.25"	0.7	LINK MANUFACTURING LTD 1102-0020 (NAV.) SEE 1102-0023 1102-0023 (FORD, FRT, GMC, KW, NAV., VOLVO) COMFORT RIDE WISE KENWORTH T81-1001
		NBD-10218	NBD-16538	ORANGE		
W02-358-7002		7014	7049	6.75"	1	
		NBD-10082	NBD-10549	ORANGE		
W02-358-7150		7015	6912	7.00"	0.7	SEARS/ DURAFORM S13384 (W02-811-7150)
		NBD-10239	NBD-16537	ORANGE		
W02-358-7201		7018	6913	7.25"	0.9	FREIGHTLINER / STERLING 18-45068-000 STERLING DAY CAB OLD FORD # P/N F6HT5C06CAB HN-80 DAY CAB (1996 & LATER)
		NBD-10218	NBD-16538	ORANGE		

Sleeve Style Springs

Firestone

ASSEMBLY ORDER NO.	CROSS SECTION VIEW	CAP DRAWING NUMBER	PISTON DRAWING NUMBER	BCR LOGO COLOR	ASSEMBLY WEIGHT (lbs.)	APPLICATIONS
W02-358-6754 OBSOLETE REPLACED BY W02-358-7132		7014	6996	7.50"	1	PETERBILT 20-16754 DAY CAB (1994 & LATER) DYNACRAFT D5000-2250
		NBD-10082	NBD-13499	ORANGE		
W02-358-7132		7018	6908	7.50"	0.8	PETERBILT R81-6003
		NBD-10218	NBD-16510	ORANGE		
W02-358-7100		7068	6912	7.50"	0.7	3-TS W02-T03-7100
		NBD-10470	NBD-13727	ORANGE		
W02-358-7155 OBSOLETE		6991	6996	7.50"	1	PETERBILT 20-19036 UNI-BUILT HIGHWAY FRONT SUPPORT SPRING DYNACRAFT D5000-2253
		NBD-14314	NBD-13499	ORANGE		

INF. - Inflated (Max.) / UNINF. - Uninflated / (P) - Plastic / (AL) - Aluminum / BCR - Between Clamp Rings / N/A - Not Available

1T - Reversible Sleeve

ASSEMBLY ORDER NO.	CROSS SECTION VIEW	CAP DRAWING NUMBER	PISTON DRAWING NUMBER	BCR LOGO COLOR	ASSEMBLY WEIGHT (lbs.)	APPLICATIONS
W02-358-7041		7015	7033	8.25"	1.2	SEARS / DURAFORM S8645 (W02-811-7041)
		NBD-10239	NBD-10238	ORANGE		
W02-358-7059		7042	6896	8.25"	1.3	NATIONAL SEATING 324663-01 (W02-N19-7059) 328035-01 (W02-N19-7069) 329666-01 (W02-N19-7084)
		NBD-10409	NBD-12708	ORANGE		
W02-358-7058		7042	6896	9.00"	1.3	NATIONAL SEATING 324662-01 (W02-N19-7058)
		NBD-10409	NBD-12708	ORANGE		
W02-358-7076		7007	7054	9.25"	0.8	RIDE-RITE
		NBD-10010	NBD-10795	ORANGE		

Sleeve Style Springs

Firestone

ASSEMBLY ORDER NO.	CROSS SECTION VIEW	CAP DRAWING NUMBER	PISTON DRAWING NUMBER	BCR LOGO COLOR	ASSEMBLY WEIGHT (lbs.)	APPLICATIONS
W02-358-7054		7018	9638	9.25"	1.2	WISE
		NBD-10218	FIP-102216	ORANGE		
W02-358-7098		6997	9638	9.62"	1.2	LINK MANUFACTURING LTD 1102-0027
		NBD-13262	FIP-102216	ORANGE		
W02-358-7040		7015	9636	10.00"	1.2	KNOEDLER 7010 AL (USE 7040) (W02-K50-7060) SEARS / DURAFORM S5388 SEATS 707338 AIR FLEX
		NBD-10239	FIP-102217	ORANGE		
W02-358-7049		7068	9636	10.00"	1.2	3-TS W02-T03-7049
		NBD-10470	FIP-102217	ORANGE		

INF. - Inflated (Max.) / UNINF. - Uninflated / (P) - Plastic / (AL) - Aluminum / BCR - Between Clamp Rings / N/A - Not Available

1T - Reversible Sleeve

ASSEMBLY ORDER NO.	CROSS SECTION VIEW	CAP DRAWING NUMBER	PISTON DRAWING NUMBER	BCR LOGO COLOR	ASSEMBLY WEIGHT (lbs.)	APPLICATIONS
W02-358-7055		7042	9637	10.00"	1.2	NATIONAL SEATING 2112283 7050 PLASTIC (USE 7055)
		NBD-10409	FIP-102215	ORANGE		
W02-358-7149		7068	6896	10.00"	1.3	3-TS W02-T03-7149
		NBD-10470	NBD-12708	ORANGE		
W02-358-7073		7013	7023	11.00"	1.4	CARE CONCEPT
		NBD-10183	NBD-10071	ORANGE		
W02-358-9901		7066	7059	16.67"	3.2	PETERBILT 02-02031 FRONT AXLE AIR SPRING (PRODUCTION-1989 TO 1992)
		NAD-25400	NBD-11340	ORANGE		

Sleeve Style Springs

Firestone

ASSEMBLY ORDER NO.	CROSS SECTION VIEW	CAP DRAWING NUMBER	PISTON DRAWING NUMBER	BCR LOGO COLOR	ASSEMBLY WEIGHT (lbs.)	APPLICATIONS
W02-358-9904		7066	6980	16.37"	3.9	LINK 1103-0504
		NAD-25400	NBD-15764	ORANGE		
W02-358-7031		7014	7049	7.00"	1.3	MACK 227QS33 GY 1S4-007
		NBD-10082	NBD-10549	GREEN		
W02-358-7209		7042	6979	7.00"	1.3	SEATS 708220 (W02-812-7209)
		NBD-10409	FIP-100105	GREEN		
W02-358-7106		6997	9637	9.87"	1.2	LINK MANUFACTURING LTD 1102-0030 (PETE.)
		NBD-13262	FIP-102215	GREEN		

INF. - Inflated (Max.) / UNINF. - Uninflated / (P) - Plastic / (AL) - Aluminum / BCR - Between Clamp Rings / N/A - Not Available

1T - Reversible Sleeve

ASSEMBLY ORDER NO.	CROSS SECTION VIEW	CAP DRAWING NUMBER	PISTON DRAWING NUMBER	BCR LOGO COLOR	ASSEMBLY WEIGHT (lbs.)	APPLICATIONS
W02-358-7085		7013	7023	11.5"	N/A	AIR FLEX (W02-A05-7085)
		NBD-10183	NBD-10071	GREEN		
W02-358-7007		7005	7049	6.25"	1.3	MACK 227QS34 GY 1S6-067
		NBD-9930	NBD-10549	RED		
W02-358-7204		6990	6913	8.00"	1.2	FREIGHTLINER / STERLING STERLING ACTERA 18-43472-000
		NBD-13706	NBD-16538	RED		
W02-358-7080		7015	7033	10"	0.9	LINK MANUFACTURING LTD 1102-0031 (FRT.)
		NBD-10239	NBD-10238	RED		

Sleeve Style Springs

Firestone

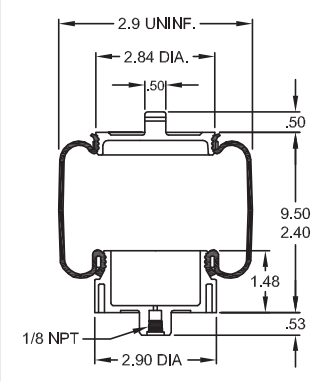
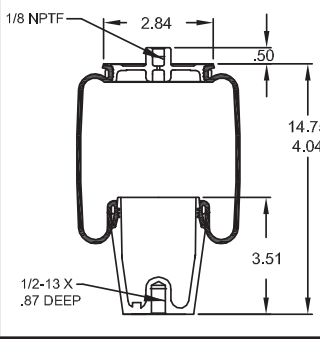
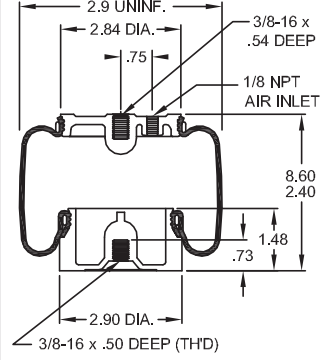
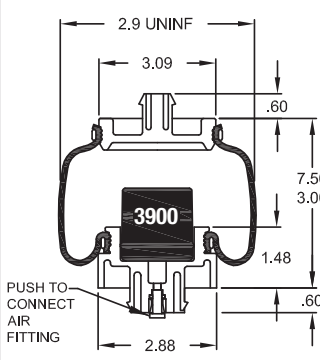
ASSEMBLY ORDER NO.	CROSS SECTION VIEW	CAP DRAWING NUMBER	PISTON DRAWING NUMBER	BCR LOGO COLOR	ASSEMBLY WEIGHT (lbs.)	APPLICATIONS
W02-358-7070		7042	6911	7.5"	0.7	NATIONAL SEATING 2123403 (W02-N19-7070) W02-N19-7160
		NBD-10409	NBD-16536	PINK		
W02-358-7116		7050	7033	11.38"	1	LINK MANUFACTURING 1101-0030
		NBD-10604	NBD-10238	PINK		
W02-358-7035		7068	6912	6.5"	0.7	SEARS / DURAFORM S9383 (W02-811-7035) 7025 AL (USE 7035)
		NBD-10470	NBD-16537	WHITE		
W02-358-7206		6987	6986	6.5"	1.2	FREIGHTLINER 18-29919-000 CENTURY CLASS & ARGOSY COE (W02-377-7202) 2002 AND EARLIER (REPLACES 7202)
		NBD-15430	NBD-15431	WHITE		

INF. - Inflated (Max.) / UNINF. - Uninflated / (P) - Plastic / (AL) - Aluminum / BCR - Between Clamp Rings / N/A - Not Available

1T - Reversible Sleeve

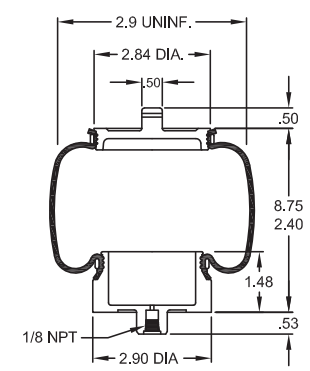
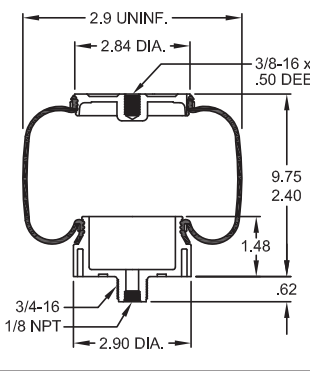
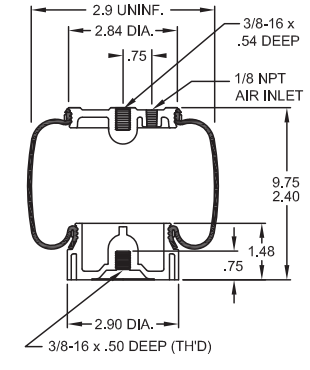
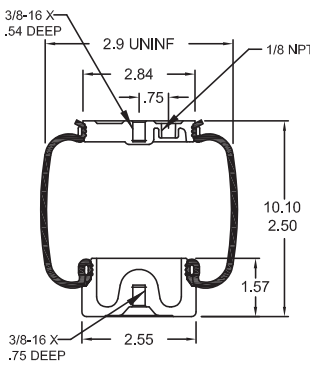
ASSEMBLY ORDER NO.	CROSS SECTION VIEW	CAP DRAWING NUMBER	PISTON DRAWING NUMBER	BCR LOGO COLOR	ASSEMBLY WEIGHT (lbs.)	APPLICATIONS
W02-358-7087		7042	6911	6.75"	0.7	FREIGHTLINER FLD (1988 & LATER) GY 1S5-040
		NBD-10409	NBD-16536	WHITE		
W02-358-7075		7018	6913	7.75"	0.7	LINK MANUFACTURING LTD 1102-0048
		NBD-10218	NBD-16538	WHITE		
W02-358-7103		7068	6912	7.75"	0.7	3-TS W02-T03-7103
		NBD-10470	NBD-16537	WHITE		
W02-358-7037		7013	7054	8.0"	0.7	AIR FLEX (W02-A05-7037)
		NBD-10183	NBD-10795	WHITE		

Sleeve Style Springs

Firestone

ASSEMBLY ORDER NO.	CROSS SECTION VIEW	CAP DRAWING NUMBER	PISTON DRAWING NUMBER	BCR LOGO COLOR	ASSEMBLY WEIGHT (lbs.)	APPLICATIONS
W02-358-7061		7042	6913	8"	0.7	C. E. WHITE
		NBD-10409	NBD-16538	WHITE		
W02-358-7074		6997	9638	10.12"	1.2	FREIGHTLINER LINK (1102-0047) LINK MANUFACTURING LTD 1102-0045 1102-0047 (FRT.)
		NBD-13262	FIP-102216	WHITE		
W02-358-7012		7007	7023	10.87"	1.5	LINK MANUFACTURING LTD 1102-0040 RIDE-RITE VANTAGE WHEEL CHAIR
		NBD10010	NBD-10071	WHITE		
W02-358-7032		7068	9636	10.87"	1.2	CARE CONCEPT 7022 AL (USE 7032) INDEPENDENT MOBILITY 3-TS
		NBD-10470	FIP-102217	WHITE		

INF. - Inflated (Max.) / UNINF. - Uninflated / (P) - Plastic / (AL) - Aluminum / BCR - Between Clamp Rings / N/A - Not Available

1T - Reversible Sleeve

ASSEMBLY ORDER NO.	CROSS SECTION VIEW	CAP DRAWING NUMBER	PISTON DRAWING NUMBER	BCR LOGO COLOR	ASSEMBLY WEIGHT (lbs.)	APPLICATIONS
W02-358-7042		7015	9636	10.87"	1.2	COMFORT RIDE
		NBD-10239	FIP-102217	WHITE		
W02-358-7045		7042	9638	10.87"	1.2	LINK MANUFACTURING LTD 1102-0042 (WESTERN STAR)
		NBD-10409	FIP-102216	WHITE		
W02-358-7056		6997	9637	10.87"	1.2	LINK MANUFACTURING LTD 1102-0043 (FRT. KW, MACK)
		NBD-13262	FIP-102215	WHITE		
W02-358-7151		7068	7033	10.88"	1.4	SEARS/DURAFORM S16894 (W02-811-7151) PISTON ADAPTOR 7802/NBD 14989
		NBD-10470	NBD-10238	WHITE		

Sleeve Style Springs

Firestone

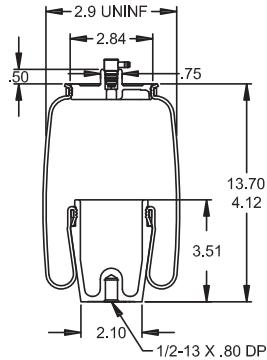
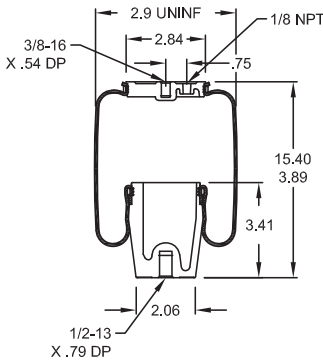
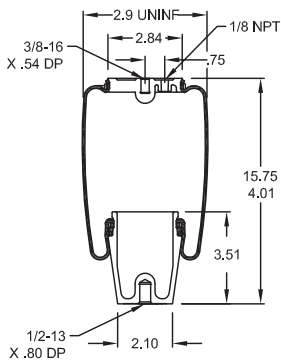
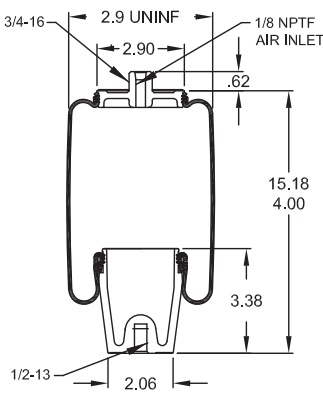
ASSEMBLY ORDER NO.	CROSS SECTION VIEW	CAP DRAWING NUMBER	PISTON DRAWING NUMBER	BCR LOGO COLOR	ASSEMBLY WEIGHT (lbs.)	APPLICATIONS
W02-358-7208		6978	9636	11.12"	1	SEATS 708015 (W02-812-7208)
		FIP-100102	FIP-102217	WHITE		
W02-358-7067		7013	7023	11.5"	1.5	AIR FLEX (W02-A05-7067)
		NBD-10183	NBD-10071	WHITE		
W02-358-7029		7068	9636	11.75"	1.2	CARE CONCEPT INDEPENDENT MOBILITY
		NBD-10470	FIP-102217	WHITE		
W02-358-7017		7007	7023	11.5"	1.5	MACK 227QS38
		NBD-10010	NBD-10071	MAROON		

INF. - Inflated (Max.) / UNINF. - Uninflated / (P) - Plastic / (AL) - Aluminum / BCR - Between Clamp Rings / N/A - Not Available

1T - Reversible Sleeve

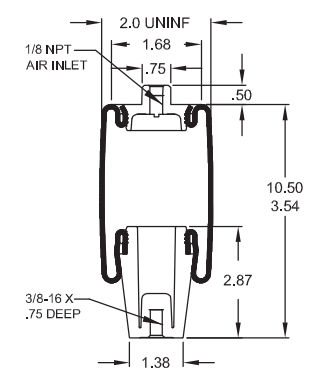
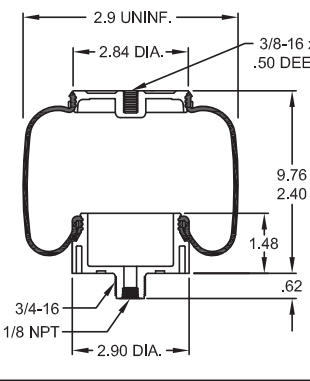
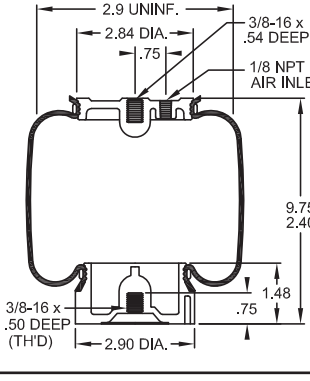
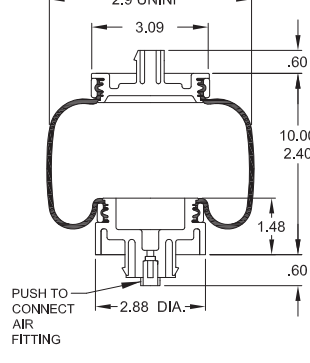
ASSEMBLY ORDER NO.	CROSS SECTION VIEW	CAP DRAWING NUMBER	PISTON DRAWING NUMBER	BCR LOGO COLOR	ASSEMBLY WEIGHT (lbs.)	APPLICATIONS
W02-358-4003		7009	7044	7.25"	1.01	COMFORT RIDE SEARS / DURAFORM S6197 (W02-811-4003)
		NBD-10049	NBD-10514	YELLOW		
W02-358-7064		7018	6913	7.75"	0.7	KENWORTH KW AEROCAB (MID 1999 & EARLIER) LINK (1102-0074) LINK MANUFACTURING LTD 1102-0074 (KW, MARMON)
		NBD-10218	NBD-16538	YELLOW		
W02-358-7108		7068	6912	7.75"	0.7	LINK MANUFACTURING LTD 1102-0075 (NAV.) MILSCO 07067A GY 1S5-057
		NBD-10470	NBD-16537	YELLOW		
W02-358-7109		6990	6894	7.87"	1	KENWORTH KW AEROCAB (MID 1999 & LATER) LINK (1102-0077) LINK MANUFACTURING LTD 1102-0077 (KW) T81-1000 KENWORTH
		NBD-13706	NBD-14218	YELLOW		

Sleeve Style Springs

Firestone

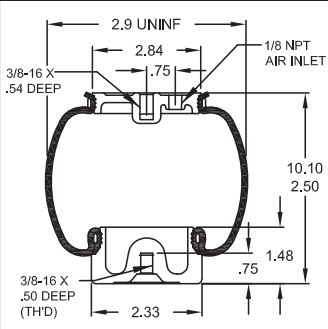
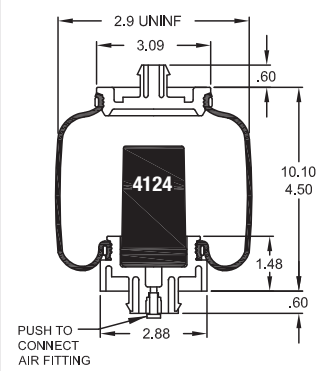
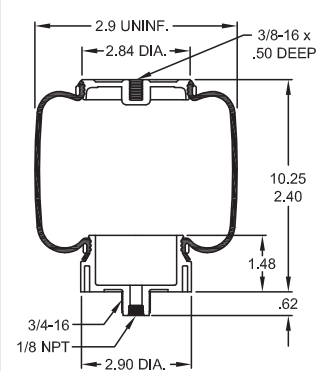
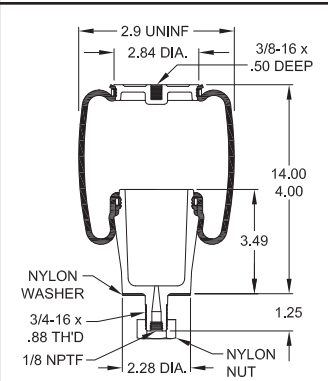
ASSEMBLY ORDER NO.	CROSS SECTION VIEW	CAP DRAWING NUMBER	PISTON DRAWING NUMBER	BCR LOGO COLOR	ASSEMBLY WEIGHT (lbs.)	APPLICATIONS
W02-358-7038		7013	7054	8.0"	1.4	AIR FLEX 7048 AL (USE 7038) DONVEL
		NBD-10183	NBD-10795	YELLOW		
W02-358-7205		6987	6986	8.0"	1.2	FREIGHTLINER / WESTERN STAR CONSTELLATION (SUPERSEDES 7203)
		NBD-15430	NBD-15431	YELLOW		
W02-358-7082		7018	6913	8.25"	0.7	FREIGHTLINER / WESTERN STAR
		NBD-10218	NBD-16538	YELLOW		
W02-358-7036		7014	6906	10"	1.5	PETERBILT 29-03200 UNI-BUILT- HIGHWAY CAB/ SLEEPER 1993 & LATER UNI-BUILT FT SUPPORT SPRING 7155 PETERBILT T81-6000
		NBD-10082	NBD-16484	YELLOW		

INF. - Inflated (Max.) / UNINF. - Uninflated / (P) - Plastic / (AL) - Aluminum / BCR - Between Clamp Rings / N/A - Not Available

1T - Reversible Sleeve

ASSEMBLY ORDER NO.	CROSS SECTION VIEW	CAP DRAWING NUMBER	PISTON DRAWING NUMBER	BCR LOGO COLOR	ASSEMBLY WEIGHT (lbs.)	APPLICATIONS
W02-358-7024		7007	7023	10.0"	1.5	LINK MANUFACTURING LTD 1102-0071
		NBD-10010	NBD-10071	YELLOW		
W02-358-7043		7013	7023	11.5"	1.4	DONVEL
		NBD-10183	NBD-10071	YELLOW		
W02-358-7044		7015	9636	11.5"	1.2	AIR FLEX 7014 AL (USE 7044) LINK MANUFACTURING LTD 1102-0070 7014 AL (USE 7044)
		NBD-10239	FIP-102217	YELLOW		
W02-358-7081		7050	9636	11.5"	0.9	NAVISTAR LINK 1102-0076 LINK 1101-0043 GY 1S5-038 LINK MANUFACTURING LTD 1102-0076 (NAV.) NAVISTAR 2501300C1
		NBD-10604	FIP-102217	YELLOW		

Sleeve Style Springs

Firestone

ASSEMBLY ORDER NO.	CROSS SECTION VIEW	CAP DRAWING NUMBER	PISTON DRAWING NUMBER	BCR LOGO COLOR	ASSEMBLY WEIGHT (lbs.)	APPLICATIONS
W02-358-7152		7068	6912	6.50"	0.7	KNOEDLER 100095-000 (W02-K50-7152)
		NBD-10470	NBD-16537	BLUE		
W02-358-7092		7018	6913	8.75"	0.9	KENWORTH KWCSA (LINK 1102-0083) LINK MANUFACTURING LTD 1102-0083 (KW)
		NBD-10218	NBD-16538	BLUE		
W02-358-7093		6991	6891	10.0"	1.4	PETERBILT 29-06016 MODEL 387 (NEW IN 1999)
		NBD-14314	NBD-14589	BLUE		
W02-358-7200		7018	6913	10.25"	1.2	FREIGHTLINER / STERLING 18-42609-000 STERLING SLEEPER OLD FORD # P/N F6HT5C063BA HN-80 SLEEPER (1996 & LATER)
		NBD-10218	NBD-16538	BLUE		

INF. - Inflated (Max.) / UNINF. - Uninflated / (P) - Plastic / (AL) - Aluminum / BCR - Between Clamp Rings / N/A - Not Available

1T - Reversible Sleeve

ASSEMBLY ORDER NO.	CROSS SECTION VIEW	CAP DRAWING NUMBER	PISTON DRAWING NUMBER	BCR LOGO COLOR	ASSEMBLY WEIGHT (lbs.)	APPLICATIONS
W02-358-7215		6987	6986	10.43"	2	FREIGHTLINER 18-40977-000 CENTURY CLASS ST (SUPERSEDES BY 7111)
		NBD-15430	NBD-15431	BLUE		
W02-358-7083		7015	9636	11.5"	1.2	LINK MANUFACTURING LTD 1102-0081 (FRT.)
		NBD-10239	FIP-102217	BLUE		
W02-358-7110		7018	9637	11.75"	1.2	KENWORTH T2000-1998 & LATER LINK (1102-0082) LINK MANUFACTURING LTD 1102-0082 (KW) 1102-K082 KENWORTH R81-1002
		NBD-10218	FIP-102215	BLUE		
W26-358-9913		6713	6888	12.13"	4.7	HENDRICKSON TRUCK 60750-2 (W26-455-9913) VOLVO / MACK
		NAD-30942	NAD-31336	BLUE		

Sleeve Style Springs

Firestone

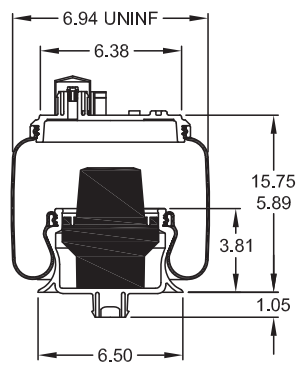
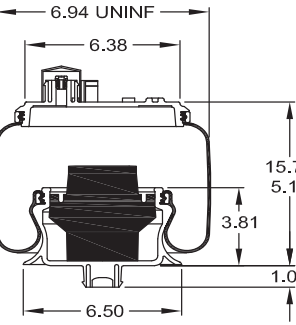
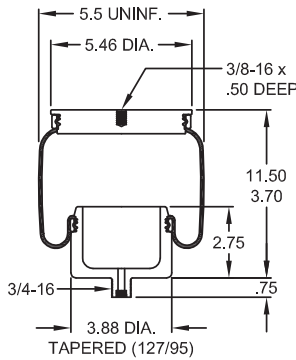
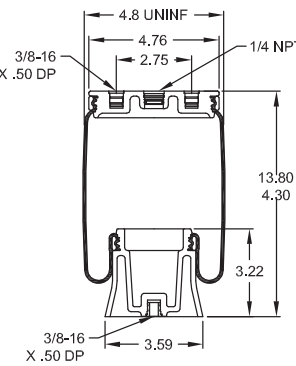
ASSEMBLY ORDER NO.	CROSS SECTION VIEW	CAP DRAWING NUMBER	PISTON DRAWING NUMBER	BCR LOGO COLOR	ASSEMBLY WEIGHT (lbs.)	APPLICATIONS
W26-358-9911		6711	6890	12.13"	4.7	HENDRICKSON TRUCK 59823-2 (W26-455-9911)
		NAD-30942	NAD-30940	BLACK		FREIGHTLINER / WESTERN STAR
W26-358-9912		6714	6888	12.13"	4.7	HENDRICKSON TRUCK 64075-2 (W26-455-9912)
		NAD-30942	NAD-31336	CREAM		BLUE BIRD BUS
W26-358-9902		6700	6897	8"		LINK MANUFACTURING LTD 1102-0080
		NBD-13938	NBD-13939	N/A		
W21-760-9000		6988	7572	9.9"	2.6	RIDE-RITE (LONG PART)
		NBD-15305	NBD-14048			

INF. - Inflated (Max.) / UNINF. - Uninflated / (P) - Plastic / (AL) - Aluminum / BCR - Between Clamp Rings / N/A - Not Available

1T - Reversible Sleeve

ASSEMBLY ORDER NO.	CROSS SECTION VIEW	CAP DRAWING NUMBER	PISTON DRAWING NUMBER	BCR LOGO COLOR	ASSEMBLY WEIGHT (lbs.)	APPLICATIONS
W21-760-9001		6988	7572	7.9"	2.5	RIDE-RITE (SHORT PART)
		NBD-15305	NBD-14048			
W21-760-9002		6988	7572	8.9"		RIDE-RITE (MEDIUM PART)
		NBD-15305	NBD-14048			
W21-760-9011		7526	7571	12.8"		RIDE-RITE W21-760-9010 (USE 9011)
		NBD-14584	NAD-28088	N/A		
W26-358-9933		6975	6885	13.0"	4.4	PACCAR B81-6023
		FIP-100913	FIP-100912	N/A		

Sleeve Style Springs

Firestone

Sleeve Cross Reference by Manufacturer

MANUFACTURER NAME/ PART NUMBER	FIRESTONE AON	PAGE NO.
3-T'S		
W02-T03-7100	W02-358-7100	148
W02-T03-7049	W02-358-7049	150
W02-T03-7149	W02-358-7149	151
7022 AL (use 7032)	W02-358-7032	156
W02-T03-7103	W02-358-7103	155
AIR FLEX		
(W02-A05-7085)	W02-358-7085	153
(W02-A05-7037)	W02-358-7037	155
(W02-A05-7067)	W02-358-7067	158
7048 AL (use 7038)	W02-358-7038	160
7014 AL (use 7044)	W02-358-7044	161
	W02-358-7040	150
C. E. WHITE		
	W02-358-7061	156
CARE CONCEPT		
	W02-358-7073	151
7022 AL (use 7032)	W02-358-7032	156
	W02-358-7029	158
	W02-358-7042	157
	W02-358-4003	159
CENTURY CLASS & ARGOSY COE (W02-377-7202) 2002 AND EARLIER		
	W02-358-7206 (replaces 7202)	154
	W02-358-7215 (Supersedes by 7111)	163
COMFORT RIDE		
	W02-358-7001	147
DAY CAB (1994 & LATER)		
	W02-358-6754	148
DONVEL		
	W02-358-7043	161
	W02-358-7038	160
DYNACRAFT		
D5000-2250	W02-358-6754	148
D5000-2253	W02-358-7155	148

MANUFACTURER NAME/ PART NUMBER	FIRESTONE AON	PAGE NO.
FREIGHTLINER		
18-29919-000	W02-358-7206	154
FLD (1988 & later)	W02-358-7087	155
Link (1102-0047)	W02-358-7074	156
18-40977-000	W02-358-7215	163
FREIGHTLINER / STERLING		
18-45068-000 Sterling Day Cab	W02-358-7201	147
Sterling Actera	W02-358-7204	153
18-42609-000 Sterling Sleeper	W02-358-7200	162
FREIGHTLINER / WESTERN STAR		
(style #25 bellows)	W01-358-7025	133, 146
Constellation	W02-358-7205 (supersedes 7203)	160
	W02-358-7082	160
GOODYEAR		
GY 1S4-007	W02-358-7031	152
GY 1S5-038	W02-358-7081	161
GY 1S5-040	W02-358-7087	155
GY 1S5-057	W02-358-7108	159
GY 1S6-067	W02-358-7007	153
HENDRICKSON TRUCK		
59823-2 (W26-455-9911)	W26-358-9911	164
60750-2 (W26-455-9913)	W26-358-9913	163
64075-2 (W26-455-9912)	W26-358-9912	164
INDEPENDENT MOBILITY		
	W02-358-7032	156
	W02-358-7029	158
KENWORTH		
KW Aerocab (mid 1999 & earlier)	W02-358-7064	159
KW Aerocab (mid 1999 & later)	W02-358-7109	159
KWCSA (Link 1102-0083)	W02-358-7092	162

Cross References

Sleeve Cross Reference by Manufacturer

MANUFACTURER NAME/ PART NUMBER	FIRESTONE AON	PAGE NO.
KENWORTH cont.		
T2000-1998 & later	W02-358-7110	163
KNOEDLER		
7010 AL (use 7040) (W02-K50-7060)	W02-358-7040	150
100095-000 (W02-K50-7152)	W02-358-7152	162
LINK MANUFACTURING		
1101-0030	W02-358-7116	154
1102-0025 (Ford)	W02-358-7086	146
1102-0022 (Ford, Frt. GMC, Pete)	W02-358-7046	146
1102-0023 (Ford, Frt, GMC, KW, Nav., Volvo)	W02-358-7001	147
1102-0026 (Nav.)	W02-358-7079	146
1102-0020 (NAV.) see 1102-0023	W02-358-7001	147
1102-0027	W02-358-7098	150
1102-0030 (Pete.)	W02-358-7106	152
1102-0031 (Frt.)	W02-358-7080	153
1102-0045	W02-358-7074	156
1102-0047 (Frt.)	W02-358-7074	156
1102-0048	W02-358-7075	155
1102-0040	W02-358-7012	156
1102-0042 (Western Star)	W02-358-7045	157
1102-0043 (Frt. KW, Mack)	W02-358-7056	157
1102-0075 (Nav.)	W02-358-7108	159
1102-0070	W02-358-7044 7014 AL (use 7044)	161
1102-0071	W02-358-7024	161
1102-0074 (KW, MARMON)	W02-358-7064	159
1102-0077 (KW)	W02-358-7109	159
1102-0080	W02-358-9902	#N/A
1102-0081 (Frt.)	W02-358-7083	163
1102-0082 (KW)	W02-358-7110	163
1102-0083 (KW)	W02-358-7092	162

MANUFACTURER NAME/ PART NUMBER	FIRESTONE AON	PAGE NO.
MACK		
227QS33	W02-358-7031	152
227QS34	W02-358-7007	153
227QS38	W02-358-7017	158
MILSCO		
07067A	W02-358-7108	159
NATIONAL SEATING		
2112283	W02-358-7055	151
2123403 (W02-N19-7070)	W02-358-7070	154
324663-01 (W02-N19-7059)	W02-358-7059	149
324662-01 (W02-N19-7058)	W02-358-7058	149
328035-01 (W02-N19-7069)	W02-358-7059	149
329666-01 (W02-N19-7084)	W02-358-7059	149
NAVISTAR		
Link 1102-0076	W02-358-7081	161
Link 1101-0043	W02-358-7081	161
PETERBILT		
20-16754	W02-358-6754	148
20-19036	W02-358-7155	148
02-02031	W02-358-9901	151
29-03200	W02-358-7036	160
29-06016	W02-358-7093	162
RIDE-RITE		
	W02-358-7012	156
	W02-358-7076	149
(Long Part)	W21-760-9000	164
(Short Part)	W21-760-9001	165
(Medium Part)	W21-760-9002	165
W21-760-9010 (use 9011)	W21-760-9011	165
SEARS / DURAFORM		
S5388	W02-358-7040	150
S6197 (W02-811-4003)	W02-358-4003	159

Firestone

Sleeve Cross Reference by Manufacturer

MANUFACTURER NAME/ PART NUMBER	FIRESTONE AON	PAGE NO.
SEARS / DURAFORM cont.		
S8645 (W02-811-7041)	W02-358-7041	149
S9383 (W02-811-7035)	W02-358-7035	154
S13384 (W02-811-7150)	W02-358-7150	147
S16894 (W02-811-7151)	W02-358-7151	157
SEATS		
707338	W02-358-7040	150
708220	W02-358-7209	152
708015	W02-358-7208	158

MANUFACTURER NAME/ PART NUMBER	FIRESTONE AON	PAGE NO.
UNI-BUILT HIGHWAY		
	W02-358-7155 Front Support Spring	148
	W02-358-7036 Support Spring 7155	160
VANTAGE WHEEL CHAIR		
	W02-358-7012	156
WISE		
	W02-358-7054	150
	W02-358-7001	147

Cross References

Sleeve Index by Cap Drawing Number

CAP DRAWING NO.	CAP COMP NO.	MATERIAL	AON'S (W02-358-)	PAGE NO.
FIP-100102	6978	Plastic	7208	158
FIP-100913	6975		W26-358-9933	165
NAD-25400	7066	Plastic	9901	151
NAD-30942	6711	Plastic	W26-358-9911	164
NAD-30942	6713	Plastic	W26-358-9913	163
NAD-30942	6714	Plastic	W26-358-9912	164
NBD-10010	7007	Aluminum	7076, 7012, 7017, 7024	149, 156, 158, 161
NBD-10049	7009	Aluminum	4003	159
NBD-10082	7014	Aluminum	6754, 7031, 7036	148, 152, 160
NBD-10183	7013	Aluminum	7073, 7085, 7037, 7067, 7038, 7043	151, 153, 155, 158, 160, 161
NBD-10218	7018	Plastic	7086, 7001, 7201, 7054, 7064, 7082, 7092, 7200, 7110	146, 147, 150, 159, 160, 162, 163
NBD-10239	7015	Plastic	7150, 7041, 7040, 7080, 7042, 7044, 7083,	147, 149, 150, 153, 157, 161, 163
NBD-10409	7042	Plastic	7059, 7058, 7055, 7209, 7070, 7087, 7061, 7045	149, 151, 152, 154, 155, 156, 157
NBD-10470	7068	Plastic	7046, 7100, 7049, 7149, 7035, 7103, 7032, 7151, 7029, 7108, 7152	146, 148, 150, 151, 154, 155, 156, 157, 158, 159, 162
NBD-10604	7050	Plastic	7116	154
NBD-11636	7074	Plastic	7079, 7081	146, 161
NBD-13262	6997	Plastic	7098, 7106, 7074, 7056	150, 152, 156, 157
NBD-13706	6990	Plastic	7204, 7109	153, 159
NBD-13938	6700	Aluminum	9902	#N/A
NBD-14314	6991	Plastic	7155, 7093	148, 162
NBD-14584	7526	Aluminum	W21-760-9011	165
NBD-15305	6988	Aluminum	9000, 9001, 9002	
NBD-15430	6987	Plastic	7206, 7205, 7215	154, 160, 163
NBD-9930	7005	Aluminum	7007	153

Firestone

Sleeve Index by Piston Drawing Number

PISTON DRAWING NO.	PISTON COMP NO.	MATERIAL	AON'S (W02-358-)	PAGE NO.
FIP-100105	6979	Plastic	7209	152
NAD-28088	7571	Plastic	W21-760-9011	165
NAD-30940	6890	Plastic	W26-358-9911	164
NAD-31336	6888	Plastic	W26-358-9913, 9912	
NBD-10071	7023	Aluminum	7012, 7017, 7024, 7073, 7085, 7067, 7043	151, 153, 156, 158, 161
NBD-10215	7041	Plastic	7098, 7074, 7054, 7045	150, 156, 157
NBD-10238	7033	Plastic	7208, 7041, 7040, 7080, 7042, 7044, 7083, 7116, 7049, 7032, 7151, 7029, 7081	149, 150, 153, 154, 156, 157, 158, 161, 163
NBD-10514	7044	Aluminum	4003	159
NBD-10526	7047	Plastic	7106, 7056, 7110, 7055	151, 152, 157, 163
NBD-10549	7049	Aluminum	7007, 7031	152, 153
NBD-10552	7052	Plastic	7204, 7086, 7001, 7201, 7075, 7064, 7082, 7092, 7200, 7061	146, 147, 153, 155, 156, 159, 160, 162
NBD-10795	7054	Aluminum	7076, 7037, 7038	149, 155, 160
NBD-11340	7059	Plastic	9901	151
NBD-12708	6896	Plastic	7059, 7058, 7149	149, 151
NBD-12802	6998	Plastic	7070, 7087	154, 155
NBD-12816	7069	Aluminum	7036	160
NBD-13499	6996	Plastic	7155, 6754	148
NBD-13727	7083	Plastic	7150, 7046, 7100, 7035, 7103, 7108, 7152, 7079	146, 147, 148, 154, 155, 159, 162
NBD-13939	6897	Aluminum	9902	#N/A
NBD-14048	7572	Aluminum	9000, 9001, 9002	
NBD-14218	6894	Plastic	7109	159
NBD-14589	6891	Plastic	7093	162
NBD-15431	6986	Plastic	7206, 7205, 7215	154, 160, 163

Cross References

Sleeve Index by Cap Component Number

CAP COMP NO.	CAP DRAWING NO.	MATERIAL	AON'S (W02-358-)	PAGE NO.
6711	NAD-30942	Plastic	W26-358-9911	164
6713	NAD-30942	Plastic	W26-358-9913	163
6714	NAD-30942	Plastic	W26-358-9912	164
6975	FIP-100913		W26-358-9933	165
6978	FIP-100102	Plastic	7208	158
6987	NBD-15430	Plastic	7206, 7205, 7215	154, 160, 163
6988	NBD-15305	Aluminum	9000, 9001, 9002	
6990	NBD-13706	Plastic	7204, 7109	153, 159
6991	NBD-14314	Plastic	7155, 7093	148, 162
6997	NBD-13262	Plastic	7098, 7106, 7074, 7056	150, 152, 156, 157
7005	NBD-9930	Aluminum	7007	153
7007	NBD-10010	Aluminum	7076, 7012, 7017, 7024	149, 156, 158, 161
7009	NBD-10049	Aluminum	4003	159
7013	NBD-10183	Aluminum	7073, 7085, 7037, 7067, 7038, 7043	151, 153, 155, 158, 160, 161
7014	NBD-10082	Aluminum	6754, 7031, 7036	148, 152, 160
7015	NBD-10239	Plastic	7150, 7041, 7040, 7080, 7042, 7044, 7083,	147, 149, 150, 153, 157, 161, 163
7018	NBD-10218	Plastic	7086, 7001, 7201, 7054, 7064, 7082, 7092, 7200, 7110	146, 147, 150, 159, 160, 162, 163
7042	NBD-10409	Plastic	7059, 7058, 7055, 7209, 7070, 7087, 7061, 7045	149, 151, 152, 154, 155, 156, 157
7050	NBD-10604	Plastic	7116	154
7066	NAD-25400	Plastic	9901	151
7068	NBD-10470	Plastic	7046, 7100, 7049, 7149, 7035, 7103, 7032, 7151, 7029, 7108, 7152	146, 148, 150, 151, 154, 155, 156, 157, 158, 159, 162
7074	NBD-11636	Plastic	7079, 7081	146, 161
7526	NBD-14584	Aluminum	W21-760-9011	165

Firestone

Sleeve Index by Piston Component Number

PISTON COMP NO.	PISTON DRAWING NO.	MATERIAL	AON'S (W02-358-)	PAGE NO.
6888	NAD-31336	Plastic	W26-358-9913, 9912	
6890	NAD-30940	Plastic	W26-358-9911	164
6891	NBD-14589	Plastic	7093	162
6894	NBD-14218	Plastic	7109	159
6896	NBD-12708	Plastic	7059, 7058, 7149	149, 151
6897	NBD-13939	Aluminum	9902	#N/A
6979	FIP-100105	Plastic	7209	152
6986	NBD-15431	Plastic	7206, 7205, 7215	154, 160, 163
6996	NBD-13499	Plastic	7155, 6754	148
6998	NBD-12802	Plastic	7070, 7087	154, 155
7023	NBD-10071	Aluminum	7012, 7017, 7024, 7073, 7085, 7067, 7043	151, 153, 156, 158, 161
7033	NBD-10238	Plastic	7208, 7041, 7040, 7080, 7042, 7044, 7083, 7116, 7049, 7032, 7151, 7029, 7081	149, 150, 153, 154, 156 - 158, 161, 163
7041	NBD-10215	Plastic	7098, 7074, 7054, 7045	150, 156, 157
7044	NBD-10514	Aluminum	4003	159
7047	NBD-10526	Plastic	7106, 7056, 7110, 7055	151, 152, 157, 163
7049	NBD-10549	Aluminum	7007, 7031	152, 153
7052	NBD-10552	Plastic	7204, 7086, 7001, 7201, 7075, 7064, 7082, 7092, 7200, 7061	146, 147, 153, 155, 156, 159, 160, 162
7054	NBD-10795	Aluminum	7076, 7037, 7038	149, 155, 160
7059	NBD-11340	Plastic	9901	151
7069	NBD-12816	Aluminum	7036	160
7083	NBD-13727	Plastic	7150, 7046, 7100, 7035, 7103, 7108, 7152, 7079	146 - 148, 154, 155, 159, 162
7571	NAD-28088	Plastic	W21-760-9011	165
7572	NBD-14048	Aluminum	9000, 9001, 9002	

Cross References

1T & Convoluted Manufacturer to Firestone Number

MANUFACTURER NAME/ PART NUMBER	FIRESTONE AON	PAGE NO.
AG CHEM		
	W01-358-8092	101
	duplicate	#N/A
AIR AX (ROELOFS)		
	W01-358-5323	10
	W01-358-5414	11
	W01-358-9953	30
	W01-358-8977	14
AIR SUSPENDED		
	W01-358-7726	110
AIRGLIDE		
	W01-358-7726	110
200 05/05/03 or later	W01-358-9547	24
200 05/05/03 or later	W01-358-9541	25
200 Before 05/05/03	W01-358-9675	25
380	W01-358-8813	42
400	W01-358-9547	24
460	W01-358-9541	25
690	W01-358-9541	25
ALLISON		
	W01-358-7798	138
	W01-358-8792	96
AMERICAN CARRIER		
	W01-358-7117	110
	W01-358-6902	112
8003-003	W01-358-9421	72
8003-005	W01-358-7146	119
8003-006	W01-358-7325	127
8003-007	W01-358-7105	109
8003-009	W01-358-3400	130
8003-011	W01-358-5412	11
8003-013	W01-358-7093	109
8003-017	W01-358-5328	10
8003-023	W01-358-5766	72
8003-024	W01-358-5765	72
8003-025 (supersedes 9234)	W01-358-9290	29

MANUFACTURER NAME/ PART NUMBER	FIRESTONE AON	PAGE NO.
AMERICAN CARRIER cont.		
8003-026 (supersedes 9455-Bellows 1T47A-1) (replaces W01-358-3401 and W01-358-3405)	W01-358-3402	130
9003-001	W01-358-5310	9
ARVIN MERITOR		
202796 (GY 1R13-130)	W01-358-8729	85
202796	W01-358-8617	88
21227742 FS25	W01-358-6262	69
21227892 FS25	W01-358-6258	79
2258-G-1489	W01-358-6392	115
A-2258-A-1457 RPH-11	W01-358-8171	120
A-2258-A-1483 (WCC Front RV)	W01-358-8878	38
A-2258-C-1459	W01-358-8203	37
A2258-E-1461 RHP-55	W01-358-8617	88
A-2258-J-1466 WCC Rear RV	W01-358-9553	29
A-2258-U-1451 RFA23ER-RV	W01-358-9459	20
BINKLEY		
XB-SPN-053-60	W01-358-8204	37
XB-SPN-053-37 (Note: supersedes W01-358-7550)	W01-358-7555	131
BROCK		
	W01-358-5772	73
	W01-358-5771	73
CAPACITY OF TEXAS		
	W01-358-5712	15
	W01-358-9402	71
	W01-358-8600	72
	W01-358-6994	108
CATERPILLAR		
	W01-358-8235	132

Firestone

1T & Convuluted Manufacturer to Firestone Number

MANUFACTURER NAME/ PART NUMBER	FIRESTONE AON	PAGE NO.
CCG		
	W01-358-9348	63
CHALMERS		
	W01-358-7043	108
	W01-358-7094	109
	W01-358-7185	122
	W01-358-7853	141
(remove bolt) - Suspension should have axle stops-if not-use W01-358-9245	W01-358-9342	54
CIRCLE R		
	W01-358-5310	9
	W01-358-5405	10
	W01-358-9073	28
	W01-358-5422	11
CITY WELDING		
	W01-358-9149	93
	W01-358-9156	97
	W01-358-9216	91
COLUMBIA TRAILER		
	W01-358-9177	94
	W01-358-9179	94
	W01-358-9152	97
	W01-358-9410	71
CUSTOM CHASSIS		
	W01-358-9505	35
16-16019-000	W01-358-8207	37
DART		
21-4048	W01-358-9135	93
21-40057	W01-358-7244	128
21-40061	W01-358-7294	130
DEXTER AXLE		
034-279-00	W01-358-8886	17
EAST MFG.		
	W01-358-9049	28

MANUFACTURER NAME/ PART NUMBER	FIRESTONE AON	PAGE NO.
EVERLY		
	W01-358-9474	53
EZ RIDE		
	W01-358-7146	119
	W01-358-8008	135
	W01-358-7408	123
	W01-358-7838	139
	W01-358-7845	140
8030120	W01-358-6905	112
8030150	W01-358-7447	125
8030160	W01-358-6801	120
8030170	W01-358-7808	138
8030180	W01-358-7818	139
8030190	W01-358-7180	121
8030192	W01-358-9053	39
FAB TEK		
101357	W01-358-9071	45
04-0080	W01-358-7400	122
101827	W01-358-9039	34
FARGO TRAILER		
	W01-358-7136	119
FIFTH WHEEL		
	W01-358-7726	110
FLEX AIR		
	W01-358-8813	42
FORETRAVEL INC.		
	W01-358-9448	20
FREIGHTLINER		
	W01-358-8207	37
16-10769-000	W01-358-7400	122
16-15444-000 service (no bracket, no piston) --reuse old bracket or purchase separately (pg.62)	W01-358-9634	67
16-17010-002A16- 18334-001	WC1-358-3876	81
16-13810-001 (plastic) 9780	WC1-358-3900	81

Cross References

1T & Convoluted Manufacturer to Firestone Number

MANUFACTURER NAME/ PART NUMBER	FIRESTONE AON	PAGE NO.
FREIGHTLINER cont.		
16-13810-002 (plastic) (cabover)	WC1-358-3901	82
16-11378-000	W01-358-7410	124
16-13810-000 (plastic)	W01-358-9780	80
16-14263-000	W01-358-9634	67
16-15443-000 (6033 bracket)	W01-358-9634	67
16-1673-000 (steel) See W01-358-9782	W01-358-9780	80
16-16773-000 (steel) - See W01-358-9782	W01-358-9781	81
681-320-0017 (aluminum) See W01-358-9781	W01-358-9780	80
681-320-0017, A16-14004-000 (aluminum)	W01-358-9781	81
A16-14004-000 (aluminum) 9781	WC1-358-3900	81
A16-14004-001 (aluminum)	WC1-358-3901	82
16-15443-001 (6034 BRACKET)		
FREIGHTLINER CUSTOM CHASSIS		
16-15762-000 Ambulance	W01-358-9774	67
16-16773-000 Steel Piston	W01-358-9782	81
16-17315-000 ZF-IFS	W01-358-8632	82
16-17010-00116- 15762-000	WC1-358-3874	81
FRUEHAUF		
	W01-358-7409	123
MFR-022355	W01-358-9078	39
MFR 022354	W01-358-9077	34
UCA-0112-B	W01-358-7183	121
UCC-3054-1	W01-358-7181	121
UAB-5620	W01-358-7181	121
UCA-0112	W01-358-7183	121
UCB-44531	W01-358-9077	34
UCB-9668-1	W01-358-9078	39

MANUFACTURER NAME/ PART NUMBER	FIRESTONE AON	PAGE NO.
FRUEHAUF cont.		
UCD-9393-2	W01-358-9394	63
UCE-1304-1	W01-358-9096	50
UCE-1304-2	W01-358-9053	39
GALLENBERG		
	W01-358-7146	119
	W01-358-7512	128
GENERAL COACH		
	W01-358-5335	13
	W01-358-8977	14
	W01-358-9592	29
GMC		
693230	W01-358-7400	122
711954	W01-358-7401	122
2076095	W01-358-7401	122
GOODYEAR		
(GY 1R12-204)	W01-358-9566	26
(GY 1R12-205)	W01-358-9568	26
(GY 1R12-324)	W01-358-9565	26
(GY 1R12-325)	W01-358-9567	26
GRANNING		
1014	W01-358-7818	139
1015	W01-358-7140	119
1080	W01-358-7113	110
1218 (replaces 7416)	W01-358-7443	125
1359	W01-358-9083	49
1371	W01-358-6910	111
1476	W01-358-7816	137
1613	W01-358-7798	138
1626	W01-358-7136	119
1971	W01-358-5406	10
2112	W01-358-5410	11
2279	W01-358-7118	129
2577	W01-358-9210	50
2598	W01-358-9214	98
2692	W01-358-9211	51

Firestone

1T & Convuluted Manufacturer to Firestone Number

MANUFACTURER NAME/ PART NUMBER	FIRESTONE AON	PAGE NO.
GRANNING cont.		
2725	W01-358-7403	122
2726	W01-358-7400	122
2727 (supersedes 9298)	W01-358-9342	54
3750	W01-358-9388	53
4514	W01-358-7800	138
4848	W01-358-6902	112
5065	W01-358-9105	40
5122	W01-358-2119	9
5235	W01-358-5423	12
5301	W01-358-8977	14
5307 (no stud)	W01-358-5423	12
5385 (no stud)	W01-358-8922	22
5492	W01-358-8922	22
5553	W01-358-8979	14
5691	W01-358-2120	9
6057	W01-358-8965	16
6104 (no stud)	W01-358-2120	9
6117	W01-358-5426	14
6250	W01-358-9478	12
6252	W01-358-9049	28
6978	W01-358-8958	27
7025	W01-358-6960	117
7026	W01-358-7855	141
7504	W01-358-5323	10
7593	W01-358-8760	90
7692	W01-358-8918	21
7765	W01-358-5434	12
7831	W01-358-5436	12
7901 (replaced W01-681-8770) [1T19F-7]	W01-358-8735	88
8221	W01-358-7996	134
8273	W01-358-9825	102
8609	W01-358-5702	14

MANUFACTURER NAME/ PART NUMBER	FIRESTONE AON	PAGE NO.
HAGIE		
	W01-358-8810	42
	W01-358-9439	23
HENDRICKSON TRUCK		
	W01-358-9113	40
	W01-358-7180	121
1347	W01-358-7505	127
28929	W01-358-8708	88
45843-2	W01-358-7279	126
48195-2	W01-358-9223	51
48195-1 (b.plate studs-1.35") (2 studs in piston at 90 alignment)	W01-358-9227	51
49048 (Ford)	W01-358-9466	53
49160-0"	W01-358-9256	52
49207 (Marmon)	W01-358-9466	53
49674-1&2 (Mack) (57QL411M)	W01-358-9466	53
50405-1&2 (Ford, W.Star) HA-360/400/ 460 [1991-Up]	W01-358-9287	57
50898-1 & 2 (GH & Ford) (class 6, 7 & 8)	W01-358-9297	57
50899-1 & 2 (Mack-class 8) 57QL414M	W01-358-9375	58
56808-2 (class 6 Ford)	W01-358-9339	41
56916 (class 6 Freightliner) -not current production - ref 56917 (W01-358-9335)	W01-358-9284	21
56917-1 & 2 (Class 6 & 7 Freightliner) - -ref.56916 (W01-358-9284) -superseded	W01-358-9335	45
57122-2 (Ford, class 8)	W01-358-9373	58
57140 LH - Remove new bracket and reuse old (class 6 & 7 GM)	W01-358-9339	41

Cross References

1T & Convuluted Manufacturer to Firestone Number

MANUFACTURER NAME/ PART NUMBER	FIRESTONE AON	PAGE NO.
HENDRICKSON TRUCK cont.		
57150 RH	W01-358-9339	41
57920-2 w/bracket	W01-358-8868	13
57965-2 (reuse old bracket)	W01-358-8868	13
58520-2 (Nissan) (replaces 58654-2)	W01-358-9372	#N/A
58786-2	W01-358-9647	59
58983-2 (Blue Bird)	W01-358-8942	22
58995-2 (Freightliner)	W01-358-9643	67
59053-2	W01-M58-6260	68
59055-2 - (HAD 150 & 190) replaces 58817-2 RVI/US	W01-M58-9642	59
59319-2	W01-M58-8712	87
59484-2 (Blue Bird)	W01-358-8971	32
59601-2	W01-358-8972	32
60716-2	W01-358-9554	27
60925-2	W01-358-8817	43
60929-2	W01-358-8816	43
64403-2	W01-M58-8650	38
64827-2	W01-358-8872	15
65032-2	W01-358-9654	59
60271-2	W01-358-9663	60
64489-2	W01-358-9372	#N/A
64651-2	W01-358-9297	57
64651-2	W01-M58-9656	59
65790-2	W01-358-8597	27
HENDRICKSON AUX.		
(Paralift, Paralift Ultra)	W01-358-7795	114
(Pararev)	W01-358-7897	115
1015	W01-358-8042	#N/A
1285	W01-358-7859	142
1346	W01-358-7797	138
1475	W01-358-7790	126
1503	W01-358-6789	125
1560	W01-358-7998	134
2348	W01-358-7954	142

MANUFACTURER NAME/ PART NUMBER	FIRESTONE AON	PAGE NO.
HENDRICKSON AUX. cont.		
4647	W01-358-3420	133
4828	W01-358-7872	142
001795 (Paralift Ultra/ High Lift) -ride bag	W01-358-7862	142
001796 (Paralift Ultra/ High Lift) -lift bag	W01-358-7545	131
002878 (Lift Bag)	W01-358-7897	115
003316 (metric version)	W01-358-8033	136
003316 (metric version)	W01-358-8033	136
003317 (metric version)	W01-358-7795	114
003318 (metric version)	W01-358-6935	113
003319 (metric equivalent)	W01-358-9367	65
003319 (Same as SAE version W01-358-9367)	W01-358-9668	#N/A
003319 (metric equivalent)	W01-358-9367	65
HENDRICKSON CANADA		
B-12514-001	W01-358-7403	122
B-12514-003	W01-358-9302	40
B-12514-013	W01-358-8051	103
B-12514-014	W01-358-7135	118
B-12514-004, B-12514-011	W01-358-9158	97
B-12514-005	W01-358-7472	131
B12514-012	W01-358-8052	103
S10352	W01-358-9240	62
S12353	W01-358-9092	49
S1345 (replaced by 7472)	W01-358-7404	123
S2066, S11651, B-12514-007	W01-358-9082	49
B-3411	W01-358-9228	52
45843-1	W01-358-6905	112
45843-3	W01-358-6910	111

Firestone

1T & Convuluted Manufacturer to Firestone Number

MANUFACTURER NAME/ PART NUMBER	FIRESTONE AON	PAGE NO.
HENDRICKSON CANADA cont.		
B-12514-008, B-12514-010	W01-358-9122	97
HENDRICKSON TRAILER		
Prototype C21623	W01-358-8755	83
Prototype C21624	W01-358-8756	84
C20413 (rotate piston to 45 alignment)	W01-358-9265	66
HT-250T	W01-358-9265	66
HT-250U (all others)	W01-358-9265	66
HT-250U-Y (9Y-001)	W01-358-9265	66
S1013	W01-358-7400	122
S1080	W01-358-7136	119
S1159	W01-358-7403	122
S11566 (remove bolt)	W01-358-9010	43
S11637	W01-358-8008	135
S12405	W01-358-8032	136
S1245	W01-358-9105	40
S13122 [HT250U(9-020)]	W01-358-9264	100
S14147	W01-358-9652	30
S14147	W01-358-9043	70
S14249 (W01-455-9321)	W01-358-9367	65
S14318	W01-358-6935	113
S14486 (lift bag)	W01-358-7795	114
S14487 (Ride Bag) [Paralift Ultra] [Pararev]	W01-358-8033	136
S14795	W01-358-8043	143
S1561	W01-358-9083	49
S20010 (HT230T)	W01-358-9270	79
S20124	W01-358-9265	66
S20127 [HT-250U 9-006] [HT-250UY 9Y-006] replaces 1T15VLT-10.5 1T15V-11 W01-358-9262	W01-358-9580	89
S20157	W01-358-9928	101

MANUFACTURER NAME/ PART NUMBER	FIRESTONE AON	PAGE NO.
HENDRICKSON TRAILER cont.		
S20217 (HT-190U) - superseded by W01-358-8944 1T15MLW-7	W01-358-9015	31
S20217 (HT-190U) - supersedes W01-358-9015	W01-358-8944	68
S20223 (HT-190T, HS-190T) - replaces W01-358-9630	W01-358-9640	67
S20228	W01-358-8934	39
S20414 [HT-250U (9-006)] [HT-250U-Y (9Y-006)] Replaces 1T15VLT-10.5 1T15V-11	W01-358-9581	89
S2063	W01-358-9158	97
S2064/S11650	W01-358-9039	34
S2065	W01-358-9177	94
S20716 [HT250U(6.5-002)]	W01-358-9299	68
S20900 (Intraax AA230) [Up to 7/97] -replaced by W01-358-8709 (approx. 6/98) 1T17CA-5	W01-358-8751	83
S20901 (Intraax 250) -reuse metal disk	W01-358-8091	101
S21208	W01-358-9579	79
S21323	W01-358-6962	117
S21784 w/metal disk for piston support	W01-358-8091	101
S21800 (Intraax AA230) [8/97-up] -replaces W01-358-8751 (approx. 6/98)	W01-358-8709	87
S21966 (HKA200 Special)	W01-358-8708	88
S22045 (HK190T)	W01-358-8755	83
S22046 (HK230) Approximate availability 1-98 -replaces W01-358-8756	W01-358-8710	88

Cross References

1T & Convuluted Manufacturer to Firestone Number

MANUFACTURER NAME/ PART NUMBER	FIRESTONE AON	PAGE NO.
HENDRICKSON TRAILER cont.		
S22046 (HK230) -will be replaced by W01-358-8710 1T17CL-5	W01-358-8756	84
S22173	W01-358-5511	99
S22697	W01-358-8724	85
S22948 (Van Traax) - Prior to 9/99- used 9525 piston w/bumper spacer	W01-358-8713	88
S2307	W01-358-9011	43
S23114	W01-358-7897	115
S23611	W01-358-9646	69
S23612	W01-358-9645	69
S23613	W01-358-9621	25
S23614	W01-358-9619	27
S23720	W01-358-9626	23
S23721	W01-358-9644	69
S23748 (w/disk S24443)	W01-358-8093	102
S2394	W01-358-2119	9
S25873	W01-358-8774	102
S2630	W01-358-6902	112
S26773	W01-358-8614	87
S2694	W01-358-9203	62
S27031	W01-358-8623	87
S2734	W01-358-6801	120
S2827	W01-358-9010	43
S2883	W01-358-7403	122
S2924	W01-358-9227	51
S29892	W01-358-8539	5
S3184	W01-358-7140	119
S3467, S3830	W01-358-9122	97
S3518	W01-358-6905	112
S3648	W01-358-9215	91
S3798	W01-358-7446	125
S3839	W01-358-9200	91
S3842	W01-358-9240	62

MANUFACTURER NAME/ PART NUMBER	FIRESTONE AON	PAGE NO.
HENDRICKSON TRAILER cont.		
S4771	W01-358-8050	102
S4773	W01-358-9392	53
S5060	W01-358-9238	62
S5270	W01-358-6905	112
S5468	W01-358-7404	123
S6195	W01-358-9192	61
S6242	W01-358-7447	125
S6412	W01-358-6803	120
S6861	W01-358-7839	140
S7100	W01-358-7843	140
S7128	W01-358-9156	97
S7193	W01-358-9073	28
S7364	W01-358-9285	28
S7853	W01-358-7846	140
S8701	W01-358-6947	117
S8768	W01-358-6910	111
S8832	W01-358-5310	9
S8874	W01-358-7847	141
S8988	W01-358-9349	63
S9346	W01-358-5405	10
S9830	W01-358-7444	125
HISTEER		
	W01-358-8018	135
	W01-358-8008	135
(supercedes 8029)	W01-358-8027	136
10300	W01-358-7839	140
10301	W01-358-7850	141
10302	W01-358-6941	113
10303	W01-358-8039	143
10305	W01-358-6940	113
10307	W01-358-6944	116
10313	W01-358-8038	143
10315	W01-358-7550	130
10316	W01-358-7557	131

Firestone

1T & Convuluted Manufacturer to Firestone Number

MANUFACTURER NAME/ PART NUMBER	FIRESTONE AON	PAGE NO.
HLM LIFT BAG		
	W01-358-6935	113
HOLLAND (NEWAY)		
(AD-123/246-10) 90557146 90557182 (no bracket) 90557177 (special lower connection)	W01-358-9471	76
(replaced by 6799)	W01-358-6808	121
90044197	W01-358-9158	97
90044201	W01-358-9101	61
900557112 (AR90-[All]) (ARU92-9&10)	W01-358-9243	62
90557001	W01-358-9039	34
90557001	W01-358-7135	118
90557002	W01-358-7009	108
90557003	W01-358-9177	94
90557005	W01-358-9158	97
90557006, 90557027, 90557033 (special mounting), 90557037, 90557054, 90557075	W01-358-9082	49
90557007	W01-358-9093	50
90557008	W01-358-9101	61
90557009	W01-358-9101	61
90557012	W01-358-9033	33
90557014 (AL-41 & 45)	W01-358-7424	124
90557015	W01-358-7437	124
90557016	W01-358-7400	122
90557019	W01-358-9121	92
90557020, 90557071, 90557076, 90557077	W01-358-9122	97
90557023	W01-358-9039	34
90557028	W01-358-7112	110
90557030	W01-358-9075	18
90557031	W01-358-9092	49
90557032	W01-358-9093	50
90557034 90557029	W01-358-8997	16

MANUFACTURER NAME/ PART NUMBER	FIRESTONE AON	PAGE NO.
HOLLAND (NEWAY) cont.		
90557035	W01-358-9093	50
90557038	W01-358-9070	44
90557039	W01-358-7146	119
90557052	W01-358-9121	92
90557057	W01-358-5412	11
90557069	W01-358-9158	97
90557078	W01-358-9121	92
90557082	W01-358-9101	61
90557083	W01-358-9121	92
90557085	W01-358-9039	34
90557086	W01-358-9192	61
90557089 (remove bolt)	W01-358-9308	34
90557090 (AR-90-1-12)	W01-358-9070	44
90557094 (ARD suspensions) - reference 90557128 (bead plate-3215)	W01-358-9599	30
90557097	W01-358-9650	71
90557098 (ARDTB125-6A&6B)	W01-358-8053	103
90557099	W01-358-9320	64
90557101	W01-358-9193	50
90557102	W01-358-5511	99
90557103	W01-358-5505	99
90557104	W01-358-9915	100
90557104	W01-358-9264	100
90557105 (GM-U-Haul)	W01-358-9798	47
90557106	W01-358-9929	100
90557107	W01-358-9249	75
90557108 (AR-90)	W01-358-9192	61
90557110 (parallel alignment)	W01-358-9121	92
90557111 (AR-80-9FM)	W01-358-9138	95

Cross References

1T & Convoluted Manufacturer to Firestone Number

MANUFACTURER NAME/ PART NUMBER	FIRESTONE AON	PAGE NO.
HOLLAND (NEWAY) cont.		
90557113 (AR90-1-14&17) (AR75-6&9)	W01-358-9362	52
90557117 (AR92-12&14), (AR93-14)	W01-358-9921	55
90557118 (AR92&93-15&16)	W01-358-9923	55
90557119 (AR92-17) (AR93-17)	W01-358-9922	55
90557120 (RL196-14, RL196A-14)	W01-358-9293	31
90557121 (RL196-15 & 16) (RL196A-15 & 16)	W01-358-9295	31
90557123 - Service assembly only (no piston)	W01-358-9268	66
90557124 (AR-90115 & 16)	W01-358-9304	52
90557125 (AR-80-9) (AR-80-9WST)	W01-358-9134	95
90557126 (AR-75-12) (AR-75-1-12) (ARU92-12)	W01-358-9346	63
90557127 (RL-196-12)	W01-358-9294	31
90557128	W01-358-9599	30
90557129 (AR-41, 45 & 45-1) (plastic)	W01-358-9307	35
90557130-RH	W01-358-9463	45
90557131-LH	W01-358-9463	45
90557137 (only 2 studs in piston and 90 alignment)	W01-358-9798	47
90557138	W01-358-9902	55
90557139 (RL196-17) (RL196A-17) - replaces 90557122 -originally 1T15M-4 bellows	W01-358-9291	30
90557142	W01-358-9942	56
90557143	W01-358-9943	56
90557145 (AD-246)	W01-358-9470	76

MANUFACTURER NAME/ PART NUMBER	FIRESTONE AON	PAGE NO.
HOLLAND (NEWAY) cont.		
90557147 (AD-123/ 246-6.5 & 8.75)	W01-358-9472	76
90557149	W01-358-9325	40
90557150	W01-358-8949	30
90557152	W01-358-9473	76
90557155	W01-358-9144	93
90557156 (RL-228-14,15,16)	W01-358-9936	56
90557157 (RL-228-17)	W01-358-9935	55
90557158	W01-358-9484	46
90557159	W01-358-9365	41
90557160	W01-358-9366	41
90557161 (AD200-7) (Gillig) - ref. W01-358-9585 (1/ 2"NPT)	W01-358-9482	46
90557162	W01-358-8780	95
90557163	W01-358-8779	95
90557164	W01-358-8778	92
90557166 (AD200-8) (Gillig)	W01-358-9483	46
90557167 (AR250-14 & 15)	W01-358-8748	85
90557168 (AR250-12,16,17)	W01-358-8749	85
90557169 (Advance Mixer)	W01-358-8903	69
90557170	W01-358-8802	41
90557172 (AD-200) - ref. 90557220 90557248 (1/2"NPT)	W01-358-9597	29
90557173 (RL196A-12)	W01-358-8204	37
90557174 (AS 120)	W01-358-5776	74
90557179 (no bracket)	W01-358-9473	76
90557185 (parallel align.)	W01-358-9122	97
90557194 (Dock-Mate)	W01-358-8803	42
90557200	W01-358-9587	29
90557203	W01-358-6799	131

Firestone

1T & Convuluted Manufacturer to Firestone Number

MANUFACTURER NAME/ PART NUMBER	FIRESTONE AON	PAGE NO.
HOLLAND (NEWAY) cont.		
90557205	W01-358-8781	95
90557206	W01-358-9491	77
90557208	W01-358-9496	53
90557209	W01-358-9218	91
90557210 - (replaces W01-358-8987)	W01-358-8203	37
90557210	W01-358-9366	41
90557211 (2 bolt mounting on piston)	W01-358-9470	76
90557212 (146)	W01-358-9471	76
90557214 (182) (2 bolt mounting on piston)	W01-358-9471	76
90557215 (152)	W01-358-9473	76
90557216 (179) (2 bolt mounting on piston)	W01-358-9473	76
90557218	W01-358-9891	100
90557221 (1/2" NPT-flush)	W01-358-9586	74
90557223	W01-358-8204	37
90557225	W01-358-9366	41
90557226	W01-358-7008	108
90557227	W01-358-9948	56
90557228	W01-358-6890	111
90557229 (IFS-114) - (center stud used for locating in pre-assembly)	W01-358-8198	37
90557230	W01-358-8197	36
90557232	W01-358-9578	75
90557233	W01-M58-6317	68
90557235	W01-358-8746	84
90557236	W01-358-8042	#N/A
90557237	W01-358-6943	116
90557240	W01-358-9582	75
90557243	W01-358-8744	84
90557247 (replaces 90557219-flush fitting) - ref.W01-358-9482	W01-358-9585	46

MANUFACTURER NAME/ PART NUMBER	FIRESTONE AON	PAGE NO.
HOLLAND (NEWAY) cont.		
90557248 (replaces 90557220-1/2"NPT flush) - ref. W01-358-9597	W01-358-9587	29
90557249 replaces	W01-358-9586	74
90557252	W01-358-9649	59
90557256 IFS-114	W01-358-7667	36
90557270 AD-130	W01-358-8793	102
90557271 (NSH225, NSB225, RLU250)	W01-358-8738	86
90557272 (NS225,NS450, WN225, NSH450)	W01-358-8737	86
90557283 RL300	W01-358-8796	96
90557295 (RL230,GRL228)	W01-358-9971	57
90557300	W01-358-9936	56
90557301	W01-358-9935	55
90557302 RL230	W01-358-9972	57
90557312	W01-358-9505	35
90557313	W01-358-9507	46
90557211 REPLACEMENT PISTON COMES WITHOUT STUDS	W01-358-9502	77
90557214 REPLACEMENT PISTON COMES WITHOUT STUDS	W01-358-9501	77
90557216	W01-358-9504	77
90557260	W01-358-8764	96
90557306	W01-358-8882	35
90557308 (Same except piston Stud length 1.5 W01-358-8182)	W01-358-8184	17
90557314	W01-358-8676	82
90557329	W01-358-9697	47
90557332	W01-358-9974	57
90557354	W01-358-9855	23
90557144	W01-358-9896	101

Cross References

1T & Convuluted Manufacturer to Firestone Number

MANUFACTURER NAME/ PART NUMBER	FIRESTONE AON	PAGE NO.
HOLLAND (NEWAY) cont.		
90557250 (replaces W01-675-9613, 90557224-flush fitting)	W01-358-9584	17
90557290 (RL228, KL230)	W01-358-8184	17
Use with Neway CB-4000 W01-358-9807	WC1-358-1690	36
Use with Neway CB-4000 W01-358-9807	WC1-358-1691	36
Use with Neway CB-4000 W01-358-9807	WC1-358-1692	36
HOLLAND HITCH		
4514	W01-358-7800	138
6764	W01-358-7304	139
6788	W01-358-7230	129
HUTCHENS		
H-2007	W01-358-9075	18
H-10384-01	W01-358-7405	123
H-1913-1	W01-358-9059	44
H-9424-01	W01-358-9039	34
H-9630-01		
H-19141-01	W01-358-5766	72
INTERGRATED		
	W01-358-7424	124
JET CO.		
(10.3" max.OD) Bolt removed for center mounting	W01-358-9260	70
(replace 9255) (11.0"max.OD) Bolt removed for center mounting	W01-358-9259	70
	W01-358-5408	11
JOHN DEERE		
	W01-358-8931	38
AH160823	W01-358-5336	13
AN205761	W01-M58-8798	101
AW30683	W01-358-6831	133

MANUFACTURER NAME/ PART NUMBER	FIRESTONE AON	PAGE NO.
KELDERMAN		
	W01-358-2131	9
	W01-358-9082	49
KENWORTH		
	W01-358-5773	73
C81-1003	W01-358-8813	42
C81-1004	W01-358-9547	24
C81-1005	W01-358-9541	25
K-102-A	W01-358-9073	28
K303-14	W01-358-9422	17
K303-15 (Airglide 100) -older version with no bracket	W01-358-9422	17
K-303-18(Airglide 200) - small air fitting - original design (1996 & 1997 prod.) - replaced by K - 303-22(9622)	W01-358-9617	24
K-303-19 (Airglide 200) 46,000# - small air fitting - -1996 & 97 prod. - replaced by K-303-25(9625)	W01-358-9618	25
K-303-22 (Airglide 200-1998 to 5-5-03) - (large air fitting with interconnected airsprings)	W01-358-9622	24
K-303-25 (Airglide 200-46,000#,1998 & later prod.)	W01-358-9625	25
K-303-28	W01-358-9675	25
K-303-5	W01-358-9415	23
K303-6	W01-358-9422	17
KWIK LOK/TODCO (JIFFLOX)		
CP-5125	W01-358-9082	49
53671 (supersedes 7133)	W01-358-7123	119
	W01-358-7180	121
CP-5223	W01-358-7429	124
LINK		
1103-0019	W01-358-6884	112

Firestone

1T & Convuluted Manufacturer to Firestone Number

MANUFACTURER NAME/ PART NUMBER	FIRESTONE AON	PAGE NO.
LINK cont.		
(see 5789)	W01-358-5772	73
1103-0058	W01-358-8842	60
1103-0059	W01-358-5900	115
1103-0500	W01-358-5439	13
1103-0501 Lifiable	W01-358-9562	21
1103-0503 Ultraride	W01-358-5789	74
1103-0508	W01-358-9681	28
LOAD AIR P10-755C		
	W01-358-7344	122
P-10872-A	W01-358-6949	114
P60733	W01-358-9221	94
LOAD SHARE		
	W01-358-7462	111
	W01-358-6926	111
LONGER STROKE		
8008	W01-358-8038	143
MCCULLOUGH TRAILER		
	W01-358-9348	63
MACK		
227QS-32 & 57QK1113	W01-358-7325	127
3645Q27 57QL414M	W01-358-9375	58
57QL1115	W01-358-9652	30
57QL1115	W01-358-9043	70
57QL239	W01-358-7145	119
57QL417M)	W01-358-9647	59
MADSEN		
(replaces 9014)	W01-358-9440	19
MAURICE WELDING		
	W01-358-7927	129
MOD. FLOW EQUIP.		
	W01-358-7146	119
	W01-358-7852	137
MONACO COACH		
	W01-358-6905	112

MANUFACTURER NAME/ PART NUMBER	FIRESTONE AON	PAGE NO.
MONACO COACH cont.		
W01-358-8897 with 3/4 NPT	W01-358-9376	18
1806160	W01-358-9651	71
8618	W01-358-5319	15
8619	W01-358-9376	18
NAVISTAR		
	W01-358-9068	44
(U-Haul) 1660694C-1	W01-358-9379	26
1660581C-1	W01-358-9213	51
1670073C-1	W01-358-9371	58
1672401C1	W01-358-9566	26
1675495C1	W01-358-9568	26
1686386C-1	W01-358-9371	58
2027911C-1	W01-358-9371	58
2027911C1 & C2 & C3	W01-358-9648	80
2027912C1	W01-358-9565	26
2027913C1	W01-358-9567	26
350243C-94	W01-358-9098	66
3541731C1	W01-358-1191	80
3541732C1	W01-358-1190	79
359519C-1	W01-358-9063	44
3691773C1	W01-358-1192	80
426212C-1	W01-358-9098	66
426213C-1	W01-358-9097	66
442305C-91	W01-358-9098	66
442306C-91	W01-358-9098	66
442307C-91	W01-358-9097	66
454590C-1	W01-358-9098	66
454588C-91	W01-358-9098	66
4545889C-1	W01-358-9097	66
4545910C-1	W01-358-9097	66
501559C-1	W01-358-9213	51
501559C-2	W01-358-9213	51
NEWLITE (NS 190-16)		
	W01-358-8204	37

Cross References

1T & Convoluted Manufacturer to Firestone Number

MANUFACTURER NAME/ PART NUMBER	FIRESTONE AON	PAGE NO.
OSHKOSH		
RX-08-03	W01-358-9269	78
	W01-358-5412	11
(ref.8013)	W01-358-8010	135
OTTAWA 53500516		
	W01-358-7304	139
PEERLESS		
	W01-358-9158	97
	W01-358-9290	29
0550-00001	W01-358-7180	121
0550-00010	W01-358-9149	93
0550-00015	W01-358-7103	108
0550-00051	W01-358-9031	33
0550-00070	W01-358-9148	93
0550-00080	W01-358-9156	97
PETERBILT		
03-10042	W01-358-9069	44
03-01649	W01-358-9069	44
03-01686	W01-358-9589	16
03-02038 (Air-Trac)	W01-358-9069	44
03-02456	W01-358-9069	44
03-04759	W01-358-9069	44
03-05107	W01-358-9194	50
03-06213	W01-358-9026	49
03-06746		
03-07111 (Low Air Leaf)	W01-358-9026	49
03-07112	W01-358-9069	44
03-08424 - replaces W01-358-9146 (1T15S-6)	W01-358-9589	16
03-07887 (Low Air Leaf)	W01-358-8852	60
03-08716 (New Low Leaf Supersedes 03-07887 effective 04/04)	W01-358-8864	61
C81-6000	W01-358-8813	42

MANUFACTURER NAME/ PART NUMBER	FIRESTONE AON	PAGE NO.
PEZZANI		
	W01-358-9075	18
	W01-358-9076	70
	W01-358-9116	92
	W01-358-9199	98
AR-21-A	W01-358-7135	118
PIONEER TRAILER		
	W01-358-9071	45
POLLARD		
	W01-358-7230	129
	W01-358-7304	139
PORCUPINE		
	W01-358-9158	97
	W01-358-9122	97
	W01-358-7424	124
	W01-358-7852	137
(replaces 7140)	W01-358-7782	132
(replaces 7142)	W01-358-7140	119
(replaces 7818)	W01-358-7839	140
R & S TRUCK & BODY		
	W01-358-7798	138
1027505	W01-358-6902	112
1027519	W01-358-7400	122
1027556	W01-358-7136	119
1040201	W01-358-7403	122
1082914	W01-358-7446	125
1090023	W01-358-9121	92
1090214	W01-358-7140	119
1090215	W01-358-7424	124
1090216	W01-358-9177	94
1090217	W01-358-9082	49
1090218	W01-358-9039	34
1090326	W01-358-9164	93
RAVENS TRAILER		
	W01-358-9204	91

Firestone

1T & Convuluted Manufacturer to Firestone Number

MANUFACTURER NAME/ PART NUMBER	FIRESTONE AON	PAGE NO.
REYCO		
12882-01	W01-358-9082	49
12882-02	W01-358-9121	92
12883-01	W01-358-9101	61
12883-02	W01-358-9122	97
12884-01	W01-358-9223	51
12884-01A (102AR)	W01-358-9223	51
12884-01B	W01-358-9944	54
12906-01	W01-358-6927	116
12928-01	W01-358-9010	43
17360-01	W01-358-9308	34
17361-01	W01-358-8900	18
17414-01	W01-358-8991	39
17636-01	W01-358-9349	63
19624-01	W01-358-8951	22
19983-01 (21AR, 74AR)	W01-358-7557	131
20018-01 (86AR)	W01-358-7555	131
20074-01	W01-358-9332	34
20124-01	W01-358-9966	54
20124-01K (1/4 NPT) - [Use 1/2 to 1/4 NPT adaptor]	W01-358-9966	54
20124-02 (1/2 NPT)	W01-358-9966	54
20142-01 & 01K	W01-358-9947	56
20437-01	W01-358-9333	34
20446-01	W01-358-9476	20
20773-01	W01-358-8959	27
20783-01	W01-358-5775	73
20966-01	W01-358-9474	53
21054-01	W01-358-9377	19
21055-01	W01-358-8976	32
21598-01	W01-358-8964	32
21767-01	W01-358-8776	92
22241-01	W01-358-8932	38
22425-01	W01-358-5777	74
23377-01	W01-358-8961	31

MANUFACTURER NAME/ PART NUMBER	FIRESTONE AON	PAGE NO.
REYCO cont.		
23433-01	W01-358-8740	83
23521-01	W01-358-8855	60
23521-02	W01-358-8856	61
24894-02	W01-358-9690	54
25396-01	W01-358-9560	24
24556-01	W01-358-9277	92
25437-01	W01-358-9559	24
93AR	W01-358-8018	135
RIDE SENTRY		
	W01-358-8617	88
RIDEWELL		
	W01-358-7839	140
	W01-358-6900	111
1000003	W01-358-1096	5
1001R13109G	W01-358-8782	84
1003585310C	W01-358-5310	9
1003585311C	W01-358-5311	9
1003585323C	W01-358-5323	10
1003585410C	W01-358-5410	11
1003585414C	W01-358-5414	11
1003585770C	W01-358-5770	73
1003585792C	W01-358-5792	74
1003586801C	W01-358-6801	120
1003586805C	W01-358-6805	120
1003586817C	W01-358-6817	116
1003586902C	W01-358-6902	112
1003586905C	W01-358-6905	112
1003586910C	W01-358-6910	111
1003586932C	W01-358-6932	113
1003586945C	W01-358-6945	116
1003586946C	W01-358-6946	117
1003586947C	W01-358-6947	117
1003586948C	W01-358-6948	117
1003587112C	W01-358-7112	110
1003587135C	W01-358-7135	118
1003587136C	W01-358-7136	119

Cross References

1T & Convuluted Manufacturer to Firestone Number

MANUFACTURER NAME/ PART NUMBER	FIRESTONE AON	PAGE NO.
RIDEWELL cont.		
1003587140C	W01-358-7140	119
1003587145C	W01-358-7145	119
1003587146C	W01-358-7146	119
1003587180C	W01-358-7180	121
1003587271C	W01-358-7271	128
1003587273C	W01-358-7273	129
1003587274C	W01-358-7274	139
1003587275C	W01-358-7275	128
1003587286C	W01-358-7286	137
1003587330	W01-358-7330	127
1003587400C	W01-358-7400	122
1003587403C	W01-358-7403	122
1003587406C	W01-358-7406	123
1003587437C	W01-358-7437	124
1003587443C	W01-358-7443	125
1003587473C	W01-358-7473	126
1003587483C	W01-358-7483	126
1003587781C	W01-358-7781	132
1003587796C	W01-358-7796	138
1003587800C	W01-358-7800	138
1003587808C	W01-358-7808	138
1003587818C	W01-358-7818	139
1003587844C	W01-358-7844	140
1003587893C	W01-358-7892	114
1003588008C	W01-358-8008	135
1003588010C	W01-358-8010	135
1003588014C	W01-358-8014	135
1003588016C	W01-358-8016	135
1003588030C	W01-358-8030	136
1003588051C	W01-358-8051	103
1003588055C	W01-358-8055	89
1003588088C	W01-358-8088	90
1003588201C	W01-358-8201	37
1003588752C	W01-358-8752	83
1003588753C	W01-358-8753	83

MANUFACTURER NAME/ PART NUMBER	FIRESTONE AON	PAGE NO.
RIDEWELL cont.		
1003589053C	W01-358-9053	39
1003588802C	W01-358-8802	41
1003588803C	W01-358-8803	42
1003588805C	W01-358-8805	42
1003588806C	W01-358-8806	42
1003588919C	W01-358-8919	22
1003588924C	W01-358-8924	48
1003588930C	W01-358-8930	38
1003588963C	W01-358-8963	32
1003588986C	W01-358-8986	33
1003588992C	W01-358-8992	16
1003588997C	W01-358-8997	16
1003589008C	W01-358-9008	43
1003589010C (replaces 9064)	W01-358-9010	43
1003589029C	W01-358-9029	33
1013589039C	W01-358-9039	34
1003589071C	W01-358-9071	45
1003589073C	W01-358-9073	28
1003589082C	W01-358-9082	49
1003589083C	W01-358-9083	49
1003589101C	W01-358-9101	61
1003589105C	W01-358-9105	40
1003589118C	W01-358-9118	40
1003589121C	W01-358-9121	92
1003589122C	W01-358-9122	97
1003589158C	W01-358-9158	97
1003589177C	W01-358-9177	94
1003589200C	W01-358-9200	91
1003589201C	W01-358-9201	98
1003589218C	W01-358-9218	91
1003589245C	W01-358-9245	62
1003589250C	W01-358-9250	77
1003589251C	W01-358-9251	75
1003589252C	W01-358-9252	78
1003589274C	W01-358-9274	75

Firestone

1T & Convuluted Manufacturer to Firestone Number

MANUFACTURER NAME/ PART NUMBER	FIRESTONE AON	PAGE NO.
RIDEWELL cont.		
1003589275C	W01-358-9275	76
1003589277C	W01-358-9277	92
1003589290C	W01-358-9290	29
1003589334C	W01-358-9334	35
1003589368C	W01-358-9368	65
1003589378C	W01-358-9378	19
1003589387C	W01-358-9387	19
1003589423C	W01-358-9423	72
1003589445C	W01-358-9445	19
1003589447C	W01-358-9447	20
1003589448C	W01-358-9448	20
1003589457C	W01-358-9457	20
1003589459C	W01-358-9459	20
1003589467C	W01-358-9467	45
1003589477C	W01-358-9477	21
1003589538C	W01-358-9538	65
1003589797C	W01-358-9797	47
1003589961C	W01-358-9961	94
1003588901C	W01-358-8901	18
RIMPULL		
	W01-358-7226	129
ROCKWELL		
	W01-358-8911	70
ROWE RV		
ASC1000/ ASC1001ASC1002/ ASC1003 Spartan	W01-358-8500	90
ASC1000/ASC1001/ ASC1002/ASC1003 Spartan	W01-358-9218	91
ROWE TRAILER		
ASCT1500/ ASCST1500/ ASCST2000	W01-358-5423	12
ASCST2000	W01-358-2120	9
ASCT2500	W01-358-8888	54

MANUFACTURER NAME/ PART NUMBER	FIRESTONE AON	PAGE NO.
ROWE TRUCK		
0035 ASC2500 ASC1600	W01-358-7686	114
0059 ASC 1500	W01-358-7956	142
ASC1400HL Lift	W01-358-2119	9
ASC1400HL Ride	W01-358-8984	104
ASC1500ASCS1500/ ASCS2000 Lift	W01-358-5423	12
ASC2500/ ASC2500ROS Ride	W01-358-8888	54
ASCC2000 Ride	W01-358-9811	94
ASCS2000 Lift	W01-358-2120	9
SAUER		
P10-733	W01-358-9221	94
P10-754	W01-358-7325	127
P10-755	W01-358-7424	124
P10-755C	W01-358-7344	122
P10-784	W01-358-7423	124
P10-794	W01-358-7057	133
P10-872A	W01-358-6949	114
P20-706	W01-358-3406	130
P50-732	W01-358-9122	97
P50-733	W01-358-9221	94
P50-734	W01-358-9039	34
SILENT DRIVE		
	W01-358-9082	49
	W01-358-9101	61
	W01-358-7839	140
	W01-358-6905	112
	W01-358-8997	16
	W01-358-7135	118
	W01-358-8008	135
	W01-358-7800	138
	W01-358-9070	44
	W01-358-9921	55
	W01-358-7447	125
	W01-358-8027	136

Cross References

1T & Convuluted Manufacturer to Firestone Number

MANUFACTURER NAME/ PART NUMBER	FIRESTONE AON	PAGE NO.
SILENT DRIVE cont.		
	W01-358-8038	143
	W01-358-5429	15
	W01-358-9338	64
	W01-358-7344	122
	W01-358-9320	64
	W01-358-7429	124
	W01-358-6948	117
	W01-358-9250	77
(replaces W01-358-8028)	W01-358-8025	136
SUPERIOR		
	W01-358-7839	140
	W01-358-7818	139
	W01-358-7848	141
	W01-358-8006	134
	W01-358-7761	137
	W01-358-7816	137
	W01-358-7286	137
	W01-358-7915	137
SUSPENSION DYNAMICS		
55015	W01-358-9249	75
SUSPENSION INC.		
	W01-358-9218	91
	W01-358-8018	135
	W01-358-5509	99
	W01-358-7499	126
	W01-358-7794	132
	W01-358-6944	116
	W01-358-7405	123
	W01-358-7848	141
200041	W01-358-9394	63
200042	W01-358-6902	112
200182	W01-358-9251	75
201150	W01-358-9249	75
201642	W01-358-8752	83
200177	W01-358-7850	141

MANUFACTURER NAME/ PART NUMBER	FIRESTONE AON	PAGE NO.
SUSPENSION INC. cont.		
(Wabash)	W01-358-9928	101
200117	W01-358-8027	136
200175	W01-358-7088	109
200792	W01-358-7096	110
TAFCO		
	W01-358-8010	135
TALBERT		
	W01-358-7180	121
TARTAN		
	W01-358-7726	110
TEMISKO		
	W01-358-9122	97
	W01-358-7140	119
	W01-358-7816	137
TEXAS TRUCK		
	W01-358-7325	127
TRANSPORTATION		
	W01-358-7726	110
TRUCKSTELL (MARION MFG.)		
63640	W01-358-7808	138
63641	W01-358-7135	118
63644	W01-358-7135	118
63647	W01-358-9101	61
TUTHILL GRANNING		
700135-01	W01-358-9825	102
700136-01	W01-358-9825	102
700999-01	W01-358-8733	86
702228-01	W01-358-8761	90
702932-01	W01-358-6856	112
703180-01	W01-358-9556	41
703667-01	W01-358-8787	90
705951-01	W01-358-8636	86
TUTHILL REYCO		
23027-01	W01-358-8935	39
23631-01	W01-358-8051	103

Firestone

1T & Convuluted Manufacturer to Firestone Number

MANUFACTURER NAME/ PART NUMBER	FIRESTONE AON	PAGE NO.
TUTHILL REYCO cont.		
701784-01	W01-358-6886	115
702614-01	W01-358-8824	48
ULTRARIDE		
	W01-358-5439	13
UNIT RIG		
1001404	W01-358-7244	128
1016031	W01-358-7294	130
1016034	W01-358-9135	93
V-STEER 1		
(Ride Bag)	W01-358-9948	56
(Lift Bag)	W01-358-6890	111
V-STEER II		
(Lift Bag)	W01-358-6943	116
(Ride Bag)	W01-358-8042	#N/A
VAN RADEN		
	W01-358-8025	136
	W01-358-6943	116
VOLVO		
3934699	W01-358-8829	80
8079902	W01-358-8829	80
8061151	W01-358-9296	52
8169868	W01-358-9296	52
VOLVO/GM HEAVY DUTY TRUCK		
2076095	W01-358-7401	122
35003-3209	W01-358-9219	51
35203-0005	W01-358-7145	119
35003-3201	W01-358-9219	51
35203-3203	W01-358-9219	51
35003-3204	W01-358-9219	51
WABASH		
	W01-358-7276	139
	W01-358-9366	41
WABASH (ROADTRAILER)		
	W01-358-8984	104

MANUFACTURER NAME/ PART NUMBER	FIRESTONE AON	PAGE NO.
WABASH TRAILER		
	W01-358-8203	37
WAGGONER'S TRUCK		
	W01-358-9439	23
	W01-358-9438	23
WATSON & CHALIN		
	W01-358-9350	63
	W01-358-8018	135
AS-0001	W01-358-6910	111
AS-0002	W01-358-6902	112
AS-0004	W01-358-7136	119
AS-0005	W01-358-7446	125
AS-0006	W01-358-7798	138
AS-0007	W01-358-7403	122
AS-0008	W01-358-7140	119
AS-0011	W01-358-9082	49
AS-0012	W01-358-9039	34
AS-0013	W01-358-9121	92
AS-0014	W01-358-7401	122
AS-0015	W01-358-9105	40
AS-0019	W01-358-8008	135
AS-0019-1F (ref. W01-358-8008)	W01-358-7994	134
AS-0020	W01-358-6905	112
AS-0021	W01-358-6801	120
AS-0023	W01-358-9122	97
AS-0025	W01-358-7818	139
AS-0026	W01-358-8997	16
AS-0027 (replaces 7416)	W01-358-7443	125
AS-0028	W01-358-9083	49
AS-0029	W01-358-5410	11
AS-0030	W01-358-7325	127
AS-0032 (replaces 7240)	W01-358-7782	132
AS-0033	W01-358-7839	140
AS-0034	W01-358-6808	121

Cross References

1T & Convuluted Manufacturer to Firestone Number

MANUFACTURER NAME/ PART NUMBER	FIRESTONE AON	PAGE NO.
WATSON & CHALIN cont.		
AS-0034 (see W01-358-6808)	W01-358-6800	120
AS-0035	W01-358-6908	113
AS-0036	W01-358-9321	64
AS-0038 AS-0046	W01-358-9192	61
AS-0039	W01-358-8051	103
AS-0039	W01-358-8053	103
AS-0040	W01-358-9101	61
AS-0041	W01-358-6943	116
AS-0042	W01-358-5770	73
AS-0043	W01-358-9004	48
AS-0044	W01-358-9010	43
AS-0045	W01-358-7273	129
AS-0047	W01-358-5503	99
AS-0048	W01-358-8032	136
AS-0048	W01-358-7990	133
AS-0048-1F (ref. W01-358-8032)	W01-358-7995	134
AS-0049	W01-358-9362	52
AS-0053	W01-358-9336	45
AS-0054	W01-358-9366	41
AS-0056	W01-358-9346	63
AS-0057	W01-358-9370	65
AS-0058	W01-358-6897	112
AS-0058-1F	W01-358-6886	115
AS-0059	W01-358-9304	52
AS-0060	W01-358-9984	96
AS-0061	W01-358-9243	62
AS-0062	W01-358-8927	48
AS-0063	W01-358-9915	100

MANUFACTURER NAME/ PART NUMBER	FIRESTONE AON	PAGE NO.
WATSON & CHALIN cont.		
AS-0063	W01-358-9264	100
AS-0064	W01-358-7792	132
AS-0069	W01-358-5433	12
AS-0073	W01-358-9218	91
AS-0078	W01-358-8053	103
AS-0081	W01-358-9985	98
AS-0084	W01-358-8752	83
AS-0086 (Replaces old 7837 supersedes 7851 - adaper plates might be required)	W01-358-7850	141
AS-0087	W01-358-7550	130
AS-0087-1F	W01-358-7545	131
AS-0088	W01-358-7788	114
AS-0089	W01-358-7557	131
AS-0090	W01-358-9921	55
AS-0092	W01-358-6883	115
AS-0098	W01-358-8753	83
AS-0106	W01-358-5297	15
AS-006 (Replaces 7503)	W01-358-7705	127
WESTERN STAR (CAB SPRING)		
	W01-358-7025	133, 146
WILLMAR		
	W01-358-9036	33
	W01-358-7512	128
	W01-358-7146	119
WILSON TRAILER		
	W01-358-8614	87

OE Suspension Index

MANUFACTURER NAME/ PART NUMBER	FIRESTONE AON	PAGE NO.
HENDRICKSON AUXILLARY HLM Series		
HL-015		
(Ride)	W01-358-8050	102
(Lift)	W01-358-7403	122
HLM-1&2		
(Ride)	W01-358-9367	65
(Lift)	W01-358-6935	113
MTL-45&50		
(Ride)	W01-358-9367	65
(Lift)	W01-358-6902	112
HENDRICKSON AUXILLARY HLN Series		
HLN(Truck)		
(Ride)	W01-358-8033	136
(Lift)	W01-358-7795	114
HLN (Trailer)		
(Ride)	W01-358-8042	143
(Lift)	W01-358-7795	114
HENDRICKSON AUXILLARY HLP Series		
HLP		
(Ride)	W01-358-8033	136
(Lift)	W01-358-7795	114
HLP (Trailer)		
(Ride)	W01-358-8042	143
(Lift)	W01-358-7795	114
HENDRICKSON AUXILLARY HLQ Series		
QS16A-X	W01-358-7403	122
QT20A-X	W01-358-7790	126
QU22C-X&QU22D-X	W01-358-9105	40
QW12A-X	W01-358-7136	119
HENDRICKSON AUXILLARY HLR Series		
ST-004		
(Ride)	W01-358-7843	140
(Lift)	W01-358-6902	112
ST-031		
(Ride)	W01-358-7846	140
(Lift)	W01-358-6902	112

MANUFACTURER NAME/ PART NUMBER	FIRESTONE AON	PAGE NO.
RT14D-X (Truck)		
(Ride)	W01-358-7847	141
(Lift)	W01-358-7403	122
RW14A-X		
(Ride)	W01-358-7843	140
(Lift)	W01-358-6902	112
RW14B-X&14C-X (trailer)		
(Ride)	W01-358-7847	141
(Lift)	W01-358-7403	122
HENDRICKSON AUXILLARY HLU Series		
HLU		
(Ride)	W01-358-8033	136
(Lift)	W01-358-7795	114
HLUS		
(Ride)	W01-358-8033	136
(Lift)	W01-358-7795	114
HLUH (ultra high lift)		
(Ride)	W01-358-7862	142
(Lift)	W01-358-7545	131
HLUR (pararev)		
(Ride)	W01-358-8033	136
(Lift)	W01-358-7897	115
HENDRICKSON TRAILER T-Series		
T-15-140, 150, 172, 244, 376	W01-358-8050	102
T-15-324	W01-358-8050	102
T-17-141, 174, 284	W01-358-8050	102
T-30-US-9,17	W01-358-9122	97
T-4-392	W01-358-9010	43
T-6-062	W01-358-9039	34
T-6-071	W01-358-9105	40
T-6-295	W01-358-9039	34
T-6-370	W01-358-9039	34
T-6-422	W01-358-9039	34
T-9-084	W01-358-9122	97
T-9-106,278,313	W01-358-9082	49
T-9-175	W01-358-9158	97

Cross References

OE Suspension Index

MANUFACTURER NAME/ PART NUMBER	FIRESTONE AON	PAGE NO.
HENDRICKSON TRAILER T-Series cont.		
T-9-325	W01-358-9092	49
T-9-390	W01-358-9092	49
TDC-014	W01-358-9039	34
TMB-14-120	W01-358-9082	49
TMB-17-135	W01-358-9082	49
HENDRICKSON TRAILER HT-SERIES		
HT190T	W01-358-9640	67
HT190U	W01-358-8944	68
HT230T	W01-358-9270	79
HT250T	W01-358-9265	66
HT250U	W01-358-9265	66
HT250U"Y"	W01-358-9265	66
HT-250U	W01-358-9299	68
HT-250U-Y (majority of versions)	W01-358-9265	66
HT-250U-Y	W01-358-9580	89
HT-250U-Y	W01-358-9580	89
HT-250US	W01-358-9580	89
HT-250US	W01-358-9580	89
HT-250US	W01-358-9265	66
HT-250US	W01-358-9265	66
HT-250US	W01-358-9299	68
HT-300T (all)	W01-358-8050	102
HT-300U (all)	W01-358-9122	97
HENDRICKSON TRAILER Intraax Series		
AA230T	W01-358-8709	87
AA250T (reuse metal disk)	W01-358-8091	101
AA230L	W01-358-9626	23
AA230L	W01-358-9621	25
AA230L	W01-358-9619	27
AA250L	W01-358-9644	69
AA250L	W01-358-9646	69
AA250L	W01-358-9645	69
HENDRICKSON TRAILER HT Dolly		
HT Dolly	W01-358-9640	67

MANUFACTURER NAME/ PART NUMBER	FIRESTONE AON	PAGE NO.
HENDRICKSON TRAILER HT Dolly cont.		
HT Dolly	W01-358-9270	79
HENDRICKSON TRAILER Slider Box		
HS-190T	W01-358-9640	67
HS-230	W01-358-9270	79
HK-190T	W01-358-8755	83
HK-230	W01-358-8756	84
HENDRICKSON TRAILER Van Traax		
HKA-180	W01-358-8713	88
HKA-180	W01-358-8709	87
HKA-200	W01-358-8708	88
HKA-250 (reuse metal disk)	W01-358-8091	101
HENDRICKSON TRAILER Lifts		
CL	W01-358-7136	119
CL	W01-358-6801	120
HTCL	W01-358-7447	125
HENDRICKSON TRUCK		
HA360		
(up to 1991)	W01-358-9466	53
(1991 and up)	W01-358-9287	57
HA400		
(up to 1991)	W01-358-9466	53
(1991 and up)	W01-358-9287	57
HA460		
(up to 1991)	W01-358-9466	53
(1991 and up)	W01-358-9287	57
HAS40LH	W01-358-9297	57
HAS360	W01-358-9373	58
HAS400	W01-358-9373	58
HAS402	W01-358-9373	58
HAS460	W01-358-9373	58
HAS210/230/400/460	W01-358-9656	#N/A
AIRTEK 12K/12.6K/14.6K	W01-358-8597	27
PAX460	W01-358-9663	60



OE Suspension Index

MANUFACTURER NAME/ PART NUMBER	FIRESTONE AON	PAGE NO.
HOLLAND LIFT SUSPENSIONS		
AL-40-US (Lift)	W01-358-7424	124
AL-41, AL-41-US (Lift)	W01-358-7424	124
AL-42, AL-42-US (Lift)	W01-358-7424	124
AL-45-9, 12, 14, 17 (Lift)	W01-358-7424	124
AL-50, AL-50US (Lift)	W01-358-7424	124
AL-70, AL-70-US (Lift)	W01-358-7424	124
AL-75-B, AL-76-A, AL-77, AL-78 (Lift)	W01-358-7135	118
ALT-40, ALT-40-L (Lift)	W01-358-7424	124
ALT-40-US, ALT-50-US, ALT-70-US (Lift)	W01-358-7424	124
ALT-500-US, ALT-550-US (Lift)	W01-358-7135	118
HOLLAND TRAILER AIR		
AR-41, AR-45, AR-45-1	W01-358-9039	34
AR-50-US, -F, -F-1,-F-2, AR-51-US	W01-358-9039	34
AR-70-9, AR-70-14	W01-358-9121	92
AR-70A-9, -14	W01-358-9121	92
AR-75-12, 1-12	W01-358-9101	61
AR-75-12, 1-12	W01-358-9346	63
AR-75-6, -9	W01-358-9082	49
AR-80-6.75	W01-358-9121	92
AR-80-9	W01-358-9134	95
AR-80-9FM	W01-358-9138	95
AR-80-9-WST	W01-358-9134	95
AR-85-A	W01-358-9121	92
AR-90-1-12	W01-358-9463	45
AR-90-1-12	W01-358-9463	45
AR-90-1-14, 17	W01-358-9362	52
AR-90-1-15, 16	W01-358-9304	52
AR-90-14,15,16,17	W01-358-9243	62
AR-92-12, 14	W01-358-9921	55
AR-92-15	W01-358-9921	55
AR-92-16	W01-358-9921	55

MANUFACTURER NAME/ PART NUMBER	FIRESTONE AON	PAGE NO.
HOLLAND TRAILER AIR cont.		
AR-92-17	W01-358-9921	55
AR-92-18	W01-358-9921	55
AR-93-14	W01-358-9921	55
AR-93-15	W01-358-9923	55
AR-93-16	W01-358-9923	55
AR-93-17	W01-358-9922	55
AR-120	W01-358-9082	49
AR-120-L	W01-358-9101	61
AR-120-US	W01-358-9082	49
AR-120-US-F	W01-358-9082	49
AR-120-US-L-1,2,3	W01-358-9101	61
AR-125	W01-358-9177	94
AR-125-L	W01-358-9158	97
AR-125-US	W01-358-9177	94
AR-125-US-F	W01-358-9121	92
AR-125-US-L-1,2,3	W01-358-9158	97
AR-165-US	W01-358-9082	49
AR-955-9, 12, 14, 17	W01-358-9122	97
AR-955-9-HD, 12-HD, 14-HD, 17-HD	W01-358-9122	97
AR-955A-9, 12, 14, 17	W01-358-9122	97
AR-955A-9-HD, 12-HD, 14-HD, 17-HD	W01-358-9122	97
AR-95-9,12,14,17	W01-358-9122	97
AR-95-9-HD, 12-HD, 14-HD, 17-HD	W01-358-9122	97
AR-95A-9,-12, -14, -17	W01-358-9122	97
AR-95A-9-HD, 12-HD, 14-HD, 17-HD	W01-358-9122	97
ARDST-246	W01-358-9121	92
ARL-20-D	W01-358-7437	124
ARL-20-D	W01-358-9039	34
ARL-20-D-US	W01-358-7437	124
ARL-20-D-US	W01-358-9039	34
ARU-92-10	W01-358-9243	62
ARU-92-8	W01-358-9921	55

Cross References

OE Suspension Index

MANUFACTURER NAME/ PART NUMBER	FIRESTONE AON	PAGE NO.
HOLLAND TRAILER AIR cont.		
ARU-92-9	W01-358-9243	62
ARU-93-6	W01-358-9921	55
ARU-93-7	W01-358-9921	55
CB-2300	W01-358-9974	57
NS190	W01-358-9366	41
NS190-16	W01-358-8204	37
RL-196-12	W01-358-9294	31
RL-196-14	W01-358-9293	31
RL-196-15	W01-358-9295	31
RL-196-16	W01-358-9295	31
RL-196-17	W01-358-9291	30
RL-196A-14	W01-358-9293	31
RL-196A-15	W01-358-9295	31
RL-196A-16	W01-358-9295	31
RL-300	W01-358-8764	96
RL228-14, 15, 16	W01-358-9936	56
RL228-17	W01-358-8749	85
RL250-12,	W01-358-8749	85
RL250-14,15	W01-358-8748	85
RL250-16, 17	W01-358-8749	85
RLU-228 (12) -4	W01-358-9346	63
RLU-228 (6,7) -3	W01-358-9921	55
RLU-228 (8) -3	W01-358-9923	55
RLU-228 (8) -4	W01-358-9921	55
RLU-228 (9,10) -3	W01-358-9922	55
RLU-228 (9,10) -4	W01-358-9243	62
RLU-250 (12)	W01-358-8744	84
RLU-250 (6.75,9)	W01-358-8746	84
Intermodel	W01-358-9896	101
HOLLAND POWERED TRUCK		
AD-123,246(6.5,8.75)	W01-358-9472	76
AD-123,246(10)	W01-358-9471	76
AD-123,246(FORD)	W01-358-9472	76
AD-123	W01-358-9502	77
AD-123	W01-358-9501	77

MANUFACTURER NAME/ PART NUMBER	FIRESTONE AON	PAGE NO.
HOLLAND POWERED TRUCK cont.		
AD-200(7)	W01-358-9482	46
AD-200(8)	W01-358-9483	46
AD-200(9)	W01-358-9496	53
AD-200(11)	W01-358-9471	76
ADTB	W01-358-9697	47
ARDST-123/244-6	W01-358-9082	49
ARDST-244-6	W01-358-9193	50
ARDST-246-6, ARDSTM/L-246-6	W01-358-9121	92
ARDTB-125-6A	W01-358-8053	103
ARDAB-120-5, 240-5	W01-358-9268	66
ARD-120-6, ARD-238-6	W01-358-9082	49
ARD-125-6, 244-6	W01-358-9093	50
ARD-125-6, 244-6	W01-358-9082	49
ARD-125, -6, 244-6	W01-358-9082	49
ARD-125, -8, 244-8	W01-358-9082	49
ARD-125, -8, 244-8	W01-358-9082	49
ARD-165-A	W01-358-9082	49
ARD-165-B	W01-358-9082	49
ARD-190-B	W01-358-9082	49
ARL-20-D, -US	W01-358-7437	124
ARL-20-D, -US	W01-358-9039	34
HOLLAND NON-POWERED TRUCK		
IFS-114	W01-358-8198	37
ART-500-B, -B1	W01-358-9082	49
ART-550-US	W01-358-9082	49
ART-500-US-A	W01-358-9082	49
ART-505-B, B-1	W01-358-9082	49
ART-500-B, -B1	W01-358-9082	49
ART-505-C, C-1	W01-358-9082	49
ART-505-B, B-1	W01-358-9082	49
ART-541-B	W01-358-9082	49
ART-505-B, B-1	W01-358-9082	49
ART-505-C, C-1	W01-358-9082	49
TC-120-D	W01-358-9082	49

Firestone

OE Suspension Index

MANUFACTURER NAME/ PART NUMBER	FIRESTONE AON	PAGE NO.
HOLLAND NON-POWERED TRUCK cont.		
ART-551-B-1, -2, -3	W01-358-9101	61
ART-551-US-1, -2, -3	W01-358-9101	61
ART-555-B-1, -2, -3	W01-358-9101	61
ART-551-B-1, -2, -3	W01-358-9101	61
ART-555-C-1, -2, -3	W01-358-9101	61
ART-551-B-1, -2, -3	W01-358-9101	61
ART-555-B-1, -2, -3	W01-358-9101	61
ART-551-B-1, -2, -3	W01-358-9101	61
TC-120-D, -44	W01-358-9177	94
WATSON CHALIN STEERING LIFTABLES		
LWSTL-1100		
(Ride)	W01-358-8008	135
(Lift)	W01-358-6897	112
STL-1100 TRU-TRACK		
(Ride)	W01-358-8032	136
(Lift)	W01-358-6897	112
STL-1800		
(Ride)	W01-358-7798	138
(Lift)	W01-358-6897	112
WATSON CHALIN TRAILER		
TA-250-14,15,16,17	W01-358-8753	83
TA-250U-12	W01-358-9243	62
TA-250U-14	W01-358-9243	62
TA-250U-5.5	W01-358-9243	62
TA-250U-7.5	W01-358-9243	62
TA-250U-7.5FS	W01-358-9243	62
TA-250U-9	W01-358-9243	62
TA-251-10	W01-358-9243	62
TA-251-12	W01-358-9243	62
TA-251-6.5FS	W01-358-9243	62
TA-251-7.5	W01-358-9243	62
TA-251-8FS	W01-358-9243	62
TA-251-9.0	W01-358-9243	62
TA-251-9.0 FS	W01-358-9243	62
TA-2590-12,14,15	W01-358-9243	62

MANUFACTURER NAME/ PART NUMBER	FIRESTONE AON	PAGE NO.
WATSON CHALIN TRAILER cont.		
TA-280-7.5	W01-358-9243	62
TA-280-9.0	W01-358-9243	62
TA-280D	W01-358-9039	34
TA-300-15	W01-358-8050	102
TA-300-16/17	W01-358-8050	102
TA-300-17	W01-358-8050	102
TA-300-22	W01-358-8050	102
TA-300-23B	W01-358-8050	102
TA-300-9	W01-358-9121	92
TA-300FM-16B	W01-358-8050	102
TA-300U-12	W01-358-9122	97
TA-300U-14	W01-358-9122	97
TA-300U-17	W01-358-9122	97
TA-300U-9	W01-358-9122	97
TA-3090-14	W01-358-9121	92
TA-3090-17	W01-358-9122	97
TA-3090-19	W01-358-9122	97
TA-5000-DB-24	W01-358-8050	102
TA-5000-DB-30	W01-358-8050	102
TA-5000-F-24	W01-358-8050	102
TA-525DB	W01-358-8050	102
TA-525FS	W01-358-8050	102
TA-791	W01-358-9921	55
TA-791-17-B	W01-358-9243	62
TA-2075 (12)	W01-358-9101	61
TA-2075-9	W01-358-9082	49
WATSON CHALIN LIFTABLES		
TL-1100	W01-358-6897	112
(Lift)		
TL-2200-23 thru 34		
(Ride)	W01-358-9370	65
(Lift)	W01-358-6897	112
TL-2200-9 thru 20		
(Ride)	W01-358-9370	65
(Lift)	W01-358-6897	112

Cross References

OE Suspension Index

MANUFACTURER NAME/ PART NUMBER	FIRESTONE AON	PAGE NO.
TL-2200LP		
(Lift)	W01-358-6897	112
(Ride)	W01-358-9243	62
TL-2200-SSR		
(Ride)	W01-358-9370	65
(Lift)	W01-358-6897	112
TL-2590-12,14,15	W01-358-9243	62
TL-2590-14,17 HD	W01-358-9243	62
TL-2700-HD-14-ES	W01-358-6943	116
TL-800 (Ride)	W01-358-8032	136
TL-8100		
(Ride)	W01-358-8032	136
(Lift)	W01-358-6897	112
TL-9000-16B		
(Ride)	W01-358-8008	135
(Lift)	W01-358-6897	112
TL-9000-17.5/16.5		
(Ride)	W01-358-8008	135
(Lift)	W01-358-6897	112
TL-9000-19		
(Ride)	W01-358-8008	135
(Lift)	W01-358-6897	112
TL-9000-21		
(Ride)	W01-358-8008	135
(Lift)	W01-358-6897	112
TL-9000-24 (Ride)	W01-358-8008	135
TL-9000-30		
(Ride)	W01-358-8008	135

MANUFACTURER NAME/ PART NUMBER	FIRESTONE AON	PAGE NO.
TL-9000-30 cont.		
(Lift)	W01-358-6897	112
TLC-2590-12,14,15	W01-358-9243	62
TRU-TRACK		
(Ride)	W01-358-8008	135
(Lift)	W01-358-6897	112
WB-2500-6	W01-358-9105	40
WB-2500-7.5	W01-358-9082	49
WB-2500-9	W01-358-9082	49
WB-251-7.5	W01-358-9243	62
WB-251-9.0	W01-358-9243	62
WB-280-9.0	W01-358-9243	62
WATSON CHALIN TRUCK		
AL-2200, -LW, -SSR, -RO		
(Lift)	W01-358-9219	51
(Ride)	W01-358-6897	112
SL-2200-13.5, -15		
(Lift)	W01-358-9370	65
(Ride)	W01-358-6897	112
AL-2200-LP		
(Lift)	W01-358-9370	65
(Ride)	W01-358-6897	112
AL-2200 ES		
(Ride)	W01-358-6897	112
AS-0048		
(Ride)	W01-358-7990	133



1T & Convuluted Goodyear Assembly Number to Firestone

GOODYEAR PART NO.	GOODYEAR BELLOW NO.	FIRESTONE AON	PAGE NO.
1B12-300	N/A	W01-358-7008	108
1B12-301	578913301	W01-358-7009	108
1B12-305	578913301	W01-358-7043	108
1B12-313	578913301	W01-358-7008	108
1B12-900	N/A	W01-358-7043	108
1B14-350	578913351	W01-358-7103	108
1B14-351	578913351	W01-358-7105	109
1B14-358	578913352	W01-358-7112	110
1B14-362	N/A	W01-358-7096	110
1R10-013	N/A	W01-358-9238	62
1R10-036	N/A	W01-358-9049	28
1R10-101	566203027	W01-358-5770	73
1R10-120	566203021	W01-358-9293	31
1R10-122	566203021	W01-358-9291	30
1R11-018	566223006	W01-358-9073	28
1R11-018	566223006	W01-358-9415	23
1R11-028	566223021	W01-358-9422	17
1R11-039	566223143	W01-358-9439	23
1R11-051	N/A	W01-358-9073	28
1R11-066	566223021	W01-358-9447	20
1R11-149	566223143	W01-358-8901	18
1R11-150	566223021	W01-358-9448	20
1R11-151	566223021	W01-358-9457	20
1R11-152	566223021	W01-358-9459	20
1R11-159	566223021	W01-358-9387	19
1R11-161	566223057	W01-358-5766	72
1R11-166	566223048	W01-358-9295	31
1R11-166	566223143	W01-358-9295	31
1R11-171	566223057	W01-358-9421	72
1R11-191	566223143	W01-358-8919	22
1R11-200	566223021	W01-358-9376	18
1R11-201	566223021	W01-358-9377	19
1R11-202	566223021	W01-358-9378	19
1R11-203	566223021	W01-358-9387	19
1R11-204	566223021	W01-358-8900	18
1R11-205	566223021	W01-358-9476	20
1R11-219	566223021	W01-358-9617	24

GOODYEAR PART NO.	GOODYEAR BELLOW NO.	FIRESTONE AON	PAGE NO.
1R11-220	566223021	W01-358-9618	25
1R11-221	566223021	W01-358-9622	24
1R11-222	566223021	W01-358-9625	25
1R11-225	566223057	W01-358-9650	71
1R11-242	566223021	W01-358-9616	17
1R11-268	566223021	W01-358-9547	24
1R12-014	566243019	W01-358-9098	66
1R12-047	566243019	W01-358-9098	66
1R12-066	566243038	W01-358-9083	49
1R12-069	566243038	W01-358-9069	44
1R12-090	566243038	W01-358-9213	51
1R12-092	566243038	W01-358-9082	49
1R12-093	566243038	W01-358-9082	49
1R12-095	566243067	W01-358-9039	34
1R12-097	566243067	W01-358-9039	34
1R12-103	566243066	W01-358-9101	61
1R12-113	566243066	W01-358-9101	61
1R12-130	566243038	W01-358-9227	51
1R12-132	566243076	W01-358-9105	40
1R12-132	566243076	W01-358-9113	40
1R12-132	566243076	W01-358-9302	40
1R12-142	566243066	W01-358-9394	63
1R12-143	566243048	W01-358-9392	53
1R12-143	566243038	W01-358-9392	53
1R12-145	566243066	W01-358-9238	62
1R12-155	566243038	W01-358-9096	50
1R12-167	566243066	W01-358-9245	62
1R12-173	566243173	W01-358-9466	53
1R12-178	566243067	W01-358-9379	26
1R12-182	566243038	W01-358-9219	51
1R12-182	566243110	W01-358-9219	51
1R12-185	566243038	W01-358-9192	61
1R12-188	566243038	W01-358-9223	51
1R12-189	566243275	W01-358-9780	80
1R12-195	566243066	W01-358-9349	63
1R12-197	566243180	W01-358-9466	53
1R12-204	566243067	W01-358-9566	26

Cross References

1T & Convuluted Goodyear Assembly Number to Firestone

GOODYEAR PART NO.	GOODYEAR BELLOW NO.	FIRESTONE AON	PAGE NO.
1R12-205	566243076	W01-358-9568	26
1R12-220	566243038	W01-358-9092	49
1R12-256	566243090	W01-358-9367	65
1R12-261	566243066	W01-358-9394	63
1R12-265	566243066	W01-358-9245	62
1R12-275	NA	W01-358-9240	62
1R12-278	566243066	W01-358-9394	63
1R12-279	566243066	W01-358-9394	63
1R12-281	566243066	W01-358-9394	63
1R12-303	566243275	W01-358-9780	80
1R12-309	566243067	W01-358-9053	39
1R12-324	566243067	W01-358-9565	26
1R12-325	566243076	W01-358-9567	26
1R12-335	566243090	W01-358-9321	64
1R12-350	566243061	W01-358-9031	33
1R12-351	566243067	W01-358-9033	33
1R12-352	566243076	W01-358-9010	43
1R12-355	566243076	W01-358-9078	39
1R12-356	566243038	W01-358-9194	50
1R12-357	566243066	W01-358-9348	63
1R12-358	566243038	W01-358-9096	50
1R12-359	566243061	W01-358-9077	34
1R12-363	566243090	W01-358-9320	64
1R12-365	566243038	W01-358-9466	53
1R12-365	566243180	W01-358-9466	53
1R12-365	566243173	W01-358-9466	53
1R12-366	566243038	W01-358-8944	68
1R12-367	566243076	W01-358-9640	67
1R12-370	566243076	W01-358-9070	44
1R12-373	566243080	W01-358-9491	77
1R12-375	566243066	W01-358-9265	66
1R12-395	566243066	W01-358-9203	62
1R12-398	566243038	W01-358-9648	80
1R12-400	566243038	W01-358-9296	52
1R12-401	566243038	W01-358-9371	58
1R12-402	566243097	W01-358-9297	57
1R12-402	566241007	W01-358-9297	57

GOODYEAR PART NO.	GOODYEAR BELLOW NO.	FIRESTONE AON	PAGE NO.
1R12-403	566243097	W01-358-9373	58
1R12-404	566243097	W01-358-9375	58
1R12-405	566243110	W01-358-8829	80
1R12-421	566243076	W01-358-9010	43
1R12-423	566243038	W01-358-8591	47
1R12-424	566243097	W01-358-9287	57
1R12-424	566243225	W01-358-9287	57
1R12-432	566243066	W01-358-1191	80
1R12-434	566243076	W01-358-8802	41
1R12-435	566243067	W01-358-9307	35
1R12-435	566243067	W01-358-9334	35
1R12-436	566243038	W01-358-8924	48
1R12-437	566243076	W01-358-9797	47
1R12-438	566243038	W01-358-8805	42
1R12-439	566243066	W01-358-9346	63
1R12-440	566243090	W01-358-9370	65
1R12-441	566243038	W01-358-9362	52
1R12-445	566243076	W01-358-8806	42
1R12-446	566243097	W01-358-9245	62
1R12-467	566243066	W01-358-0783	60
1R12-480	566243066	W01-358-9243	62
1R12-481	566243097	W01-358-9923	55
1R12-484	566243038	W01-358-9504	77
1R12-485	566243038	W01-358-9501	77
1R12-486	566243038	W01-358-9504	77
1R12-487	566243067	W01-358-9366	41
1R12-498	566243097	W01-358-9922	55
1R12-499	566243038	W01-358-9936	56
1R12-501	N/A	W01-358-9293	31
1R12-502	566243038	W01-358-9921	55
1R12-503	566243090	W01-358-9370	65
1R12-504	566243066	W01-358-9471	76
1R12-505	566243076	W01-358-9325	40
1R12-508	566243067	W01-358-8204	37
1R12-509	566243038	W01-358-9082	49
1R12-522	566243067	W01-358-8204	37
1R12-523	566243066	W01-358-1190	79



1T & Convuluted Goodyear Assembly Number to Firestone

GOODYEAR PART NO.	GOODYEAR BELLOW NO.	FIRESTONE AON	PAGE NO.
1R12-532	566243097	W01-358-9935	55
1R12-533	566243097	W01-358-9923	55
1R12-534	566243116	W01-358-8861	61
1R12-538	566243038	W01-358-9648	80
1R12-541	566243038	W01-358-8825	48
1R12-543	566243076	W01-358-9507	46
1R12-552	566243038	W01-358-9471	76
1R12-553	566243038	W01-358-9472	76
1R12-554	566243038	W01-358-9470	76
1R12-555	566243067	W01-358-8961	31
1R12-556	566243067	W01-358-8964	32
1R12-557	566243067	W01-358-8976	32
1R12-558	566243067	W01-358-8986	33
1R12-559	566243067	W01-358-9029	33
1R12-560	566243067	W01-358-9308	34
1R12-561	566243067	W01-358-9332	34
1R12-562	566243067	W01-358-8197	36
1R12-563	566243067	W01-358-8934	39
1R12-566	566243067	W01-358-8964	32
1R12-567	566243038	W01-358-9026	49
1R12-568	566243066	W01-358-8852	60
1R12-571	566243067	W01-358-9365	41
1R12-580	566243117	W01-358-9370	65
1R12-586	566243038	W01-358-9473	76
1R12-603	566243275	W01-358-9781	81
1R12-603	566243108	W01-358-9781	81
1R12-615	566243097	W01-358-8829	80
1R12-620	566243076	W01-358-9335	45
1R12-621	566243097	W01-358-9093	50
1R12-636	566243076	W01-358-9634	67
1R12-647	N/A	W01-M58-8463	5
1R12-648	566243076	W01-358-9336	45
1R12-654	N/A	W01-M58-8468	5
1R12-663	566243090	W01-358-9320	64
1R12-669	566243038	W01-358-9069	44
1R12-689	566243066	W01-358-1192	80
1R12-901	566243055	W01-358-9053	39

GOODYEAR PART NO.	GOODYEAR BELLOW NO.	FIRESTONE AON	PAGE NO.
1R12-903	566243038	W01-358-9223	51
1R12-907	N/A	W01-358-9026	49
1R12-911	N/A	W01-358-9922	55
1R12-1039	N/A	W01-M58-9741	5
1R12-1047	N/A	W01-358-9807	35
1R12-1048	N/A	W01-358-9974	57
1R13-038	566263072	W01-358-9122	97
1R13-039	566263051	W01-358-9121	92
1R13-043	566263051	W01-358-9121	92
1R13-047	566263051	W01-358-9144	93
1R13-048	566263072	W01-358-9122	97
1R13-049	566263051	W01-358-9121	92
1R13-077	566263036	W01-358-9270	79
1R13-097	566263050	W01-358-8723	82
1R13-097	566263081	W01-358-8723	82
1R13-102	N/A	W01-358-9270	79
1R13-109	566263050	W01-358-8782	84
1R13-109	566263081	W01-358-8782	84
1R13-115	566263044	W01-358-9250	77
1R13-116	566263044	W01-358-9252	78
1R13-117	566263043	W01-358-9275	76
1R13-118	566263034	W01-358-9580	89
1R13-119	566263036	W01-358-9270	79
1R13-119	566263053	W01-358-9270	79
1R13-120	566263054	W01-358-9218	91
1R13-124	566263050	W01-358-8710	88
1R13-124	566263050	W01-358-8755	83
1R13-128	N/A	W01-358-8708	88
1R13-130	566263055	W01-358-8729	85
1R13-138	566263050	W01-358-8752	83
1R13-144	566263144	W01-358-9580	89
1R13-152	566263071	W01-358-8748	85
1R13-153	566263071	W01-358-8749	85
1R13-155	566263051	W01-358-8637	86
1R13-159	566263073	W01-358-8709	87
1R13-176	566263078	W01-358-8713	88
1R13-177	566263080	W01-358-8708	88

Cross References

1T & Convuluted Goodyear Assembly Number to Firestone

GOODYEAR PART NO.	GOODYEAR BELLOW NO.	FIRESTONE AON	PAGE NO.
1R13-207	566263081	W01-358-8753	83
1R13-210	566263081	W01-358-8740	83
1R13-908	N/A	W01-358-9134	95
1R14-018	566283021	W01-358-9149	93
1R14-019	566283020	W01-358-9152	97
1R14-024	566283021	W01-358-9149	93
1R14-025	566283020	W01-358-9152	97
1R14-026	566283021	W01-358-9148	93
1R14-027	566283021	W01-358-9148	93
1R14-028	566283021	W01-358-9177	94
1R14-028	566283021	W01-358-9179	94
1R14-029	566283021	W01-358-9177	94
1R14-030	566283020	W01-358-9158	97
1R14-031	566283020	W01-358-9158	97
1R14-037	566283015	W01-358-9215	91
1R14-038	566283015	W01-358-9200	91
1R14-039	566283015	W01-358-8050	102
1R14-042	566283015	W01-358-8052	103
1R14-045	566283020	W01-358-8792	96
1R14-045	566283020	W01-358-9122	97
1R14-054	N/A	W01-358-9158	97
1R14-055	566283023	W01-358-8050	102
1R14-060	566283020	W01-358-9122	97
1R14-083	566283023	W01-358-8050	102
1R14-113	566283030	W01-358-5505	99
1R14-115	566283021	W01-358-9961	94
1R14-127	566283029	W01-358-9264	100
1R14-130	566283021	W01-358-8778	92
1R14-137	566283021	W01-358-9134	95
1R14-147	566283015	W01-358-8053	103
1R14-151		W01-358-9804	98
1R14-159	566283021	W01-358-9164	93
1R14-160	566283021	W01-358-9144	93
1R14-170	566283020	W01-358-5514	89
1R14-171	566283015	W01-358-8091	101
1R14-172	566283042	W01-358-8774	102
1R14-174	566283020	W01-358-5503	99

GOODYEAR PART NO.	GOODYEAR BELLOW NO.	FIRESTONE AON	PAGE NO.
1R9-038	566183010	W01-358-5406	10
1R9-065	566183003	W01-358-2119	9
1R9-065	566183003	W01-358-8997	16
1R9-070	566183004	W01-358-5410	11
1S12-002	566241008	W01-358-8829	80
1S12-022	566241008	W01-358-9296	52
1S12-027	566241012	W01-358-9287	57
1S12-029	566241012	W01-358-9297	57
1S12-030	566241012	W01-358-9373	58
1S12-030	566241012	W01-358-9375	58
1S12-244	566241000	W01-358-9371	58
2B10-226	578923250	W01-358-7795	114
2B12-300	578923309	W01-358-7424	124
2B12-304	578923309	W01-358-7344	122
2B12-305	578923310	W01-358-7443	125
2B12-307	578923309	W01-358-7403	122
2B12-309	578923309	W01-358-7400	122
2B12-313	578923309	W01-358-7405	123
2B12-317	578923310	W01-358-7499	126
2B12-318	578923309	W01-358-7185	122
2B12-319	578923309	W01-358-7409	123
2B12-320	578923309	W01-358-7401	122
2B12-320	578923309	W01-358-7437	124
2B12-324	578923310	W01-358-7447	125
2B12-324	578923310	W01-358-7790	126
2B12-340	578923309	W01-653-7124	#N/A
2B12-345	578923315	W01-358-7545	131
2B12-346	578923315	W01-358-7550	130
2B12-402	578923310	W01-358-7446	125
2B12-406	578923309	W01-358-7410	124
2B12-410	578923309	W01-358-7404	123
2B12-411	578923309	W01-358-7181	121
2B12-412	578923309	W01-358-7183	121
2B12-416	578923315	W01-358-7444	125
2B12-425	578923309	W01-358-7180	121
2B12-426	578923309	W01-358-7406	123
2B12-427	578923309	W01-358-7429	124



1T & Convuluted Goodyear Assembly Number to Firestone

GOODYEAR PART NO.	GOODYEAR BELLOW NO.	FIRESTONE AON	PAGE NO.
2B12-428	578923310	W01-358-7473	126
2B12-432	578923309	W01-358-7423	124
2B12-434	578923310	W01-358-7472	131
2B12-440	578923315	W01-358-7555	131
2B12-446	578923310	W01-358-7444	125
2B14-354	578923353	W01-358-7145	119
2B14-355	578923353	W01-358-7146	119
2B14-356	578923353	W01-358-7136	119
2B14-359	578923353	W01-358-7140	119
2B14-360	578923353	W01-358-7135	118
2B14-365	578923356	W01-358-6801	120
2B14-366	578923353	W01-358-6803	120
2B14-367	578923353	W01-358-7123	119
2B14-383	578923356	W01-358-7557	131
2B14-462	578923356	W01-358-6805	120
2B14-470	578923356	W01-358-7782	132
2B14-476	578923356	W01-358-6799	131
2B7-540	N/A	W01-358-3400	130
2B8-550	579923530	W01-358-7325	127
2B9-200	578923202	W01-358-6910	111
2B9-201	578923202	W01-358-6935	113
2B9-206	578923202	W01-358-6905	112
2B9-210	578923206	W01-358-6908	113
2B9-218	578923206	W01-358-6927	116
2B9-229	578923202	W01-358-6897	112
2B9-229	556238325	W01-358-6897	112
2B9-230	578923202	W01-358-6940	113
2B9-239	578923211	W01-358-6902	112
2B9-245	578923202	W01-358-7788	114
2B9-246	578923211	W01-358-6932	113
2B9-250	578923206	W01-358-6943	116
2B9-251	578923206	W01-358-6948	117
2B9-252	578923206	W01-358-6944	116
2B9-253	578923206	W01-358-6945	116
2B9-254	578923206	W01-358-6946	117
2B9-255	578923206	W01-358-6947	117
2B9-280	578923211	W01-358-6941	113

GOODYEAR PART NO.	GOODYEAR BELLOW NO.	FIRESTONE AON	PAGE NO.
2B9-288	578923211	W01-358-6926	111
2B9-352	578923208	W01-358-6944	116
3B12-300	578933100	W01-358-8008	135
3B12-301	578933100	W01-358-8010	135
3B12-303	578933100	W01-358-8018	135
3B12-304	578933100	W01-358-8006	134
3B12-310	578933100	W01-358-8027	136
3B12-312	578933100	W01-358-8033	136
3B12-315	578933100	W01-358-8032	136
3B12-319	578933100	W01-358-8032	136
3B12-322	578933103	W01-358-8042	143
3B12-323	578933103	W01-358-8043	143
3B12-328	578933100	W01-358-7994	134
3B12-329	578933100	W01-358-7995	134
3B12-335	578933100	W01-358-7996	134
3B12-415	578933105	W01-358-8038	143
3B12-416	578933105	W01-358-8039	143
3B14-350	578933350	W01-358-7808	138
3B14-354	578933350	W01-358-7808	138
3B14-356	578933350	W01-358-7798	138
3B14-356	578933350	W01-358-7838	139
3B14-359	578933350	W01-358-7818	139
3B14-359	578933350	W01-358-7839	140
3B14-360	578933350	W01-358-7800	138
3B14-360	578933350	W01-358-7848	141
3B14-364	578933350	W01-358-7843	140
3B14-367	578933350	W01-358-7847	141
3B14-451	556338335	W01-358-7846	140
3B14-452	556338335	W01-358-7850	141
3B14-457	556338335	W01-358-7843	140
3B14-459	556338335	W01-358-7847	141
3B14-464	556338335	W01-358-7862	142
1R12-1047	566243142	W01-358-9807	35
1R12-1048	566243097	W01-358-9974	57
1R12-494	566243038	W01-358-1096	5
1R13-188	566263078	W01-358-8539	5

Cross References

1T & Convoluted Goodyear Bellow Number to Firestone

GOODYEAR BELLOW NO.	GOODYEAR PART NO.	FIRESTONE AON	PAGE NO.
556238325	2B9-229	W01-358-6897	112
556338335	3B14-451	W01-358-7846	140
556338335	3B14-452	W01-358-7850	141
566183003	1R9-065	W01-358-2119	9
566183003	1R9-065	W01-358-8997	16
566183004	1R9-070	W01-358-5410	11
566183010	1R9-038	W01-358-5406	10
566203021	1R10-120	W01-358-9293	31
566203021	1R10-122	W01-358-9291	30
566203027	1R10-101	W01-358-5770	73
566203027	1R10-101	W01-358-5770	73
566223006	1R11-018	W01-358-9073	28
566223006	1R11-018	W01-358-9415	23
566223021	1R11-028	W01-358-9422	17
566223021	1R11-066	W01-358-9447	20
566223021	1R11-150	W01-358-9448	20
566223021	1R11-151	W01-358-9457	20
566223021	1R11-152	W01-358-9459	20
566223021	1R11-152	W01-358-9459	20
566223021	1R11-200	W01-358-9376	18
566223021	1R11-201	W01-358-9377	19
566223021	1R11-202	W01-358-9378	19
566223021	1R11-203	W01-358-9387	19
566223021	1R11-204	W01-358-8900	18
566223021	1R11-205	W01-358-9476	20
566223021	1R11-219	W01-358-9617	24
566223021	1R11-220	W01-358-9618	25
566223021	1R11-221	W01-358-9622	24
566223021	1R11-222	W01-358-9625	25
566223048	1R11-166	W01-358-9295	31
566223057	1R11-161	W01-358-5766	72
566223057	1R11-171	W01-358-9421	72
566223057	1R11-225	W01-358-9650	71
566223143	1R11-039	W01-358-9439	23
566223143	1R11-039	W01-358-9439	23
566223143	1R11-191	W01-358-8919	22
566241000	1S12-244	W01-358-9371	58

GOODYEAR BELLOW NO.	GOODYEAR PART NO.	FIRESTONE AON	PAGE NO.
566241007	1R12-402	W01-358-9297	57
566241008	1S12-002	W01-358-8829	80
566241008	1S12-022	W01-358-9296	52
566241012	1S12-027	W01-358-9287	57
566241012	1S12-029	W01-358-9297	57
566241012	1S12-030	W01-358-9373	58
566241012	1S12-030	W01-358-9375	58
566243000	1R12-398	W01-358-9648	80
566243019	1R12-014	W01-358-9098	66
566243019	1R12-047	W01-358-9098	66
566243038	1R12-066	W01-358-9083	49
566243038	1R12-069	W01-358-9069	44
566243038	1R12-090	W01-358-9213	51
566243038	1R12-092	W01-358-9082	49
566243038	1R12-093	W01-358-9082	49
566243038	1R12-130	W01-358-9227	51
566243038	1R12-143	W01-358-9392	53
566243038	1R12-155	W01-358-9096	50
566243038	1R12-182	W01-358-9219	51
566243038	1R12-188	W01-358-9223	51
566243038	1R12-220	W01-358-9092	49
566243038	1R12-356	W01-358-9194	50
566243038	1R12-358	W01-358-9096	50
566243038	1R12-365	W01-358-9466	53
566243038	1R12-366	W01-358-8944	68
566243038	1R12-398	W01-358-9648	80
566243038	1R12-401	W01-358-9371	58
566243038	1R12-436	W01-358-8924	48
566243038	1R12-438	W01-358-8805	42
566243038	1R12-441	W01-358-9362	52
566243038	1R12-499	W01-358-9936	56
566243038	1R12-538	W01-358-9648	80
566243038	1R12-552	W01-358-9471	76
566243038	1R12-553	W01-358-9472	76
566243038	1R12-554	W01-358-9470	76
566243038	1R12-567	W01-358-9026	49
566243038	1R12-586	W01-358-9473	76



1T & Convuluted Goodyear Bellow Number to Firestone

GOODYEAR BELLOW NO.	GOODYEAR PART NO.	FIRESTONE AON	PAGE NO.
566243038	1R12-669	W01-358-9069	44
566243038	1R12-903	W01-358-9223	51
566243048	1R12-143	W01-358-9392	53
566243055	1R12-901	W01-358-9053	39
566243061	1R12-359	W01-358-9077	34
566243066	1R12-103	W01-358-9101	61
566243066	1R12-113	W01-358-9101	61
566243066	1R12-142	W01-358-9394	63
566243066	1R12-145	W01-358-9238	62
566243066	1R12-167	W01-358-9192	61
566243066	1R12-195	W01-358-9349	63
566243066	1R12-261	W01-358-9394	63
566243066	1R12-265	W01-358-9245	62
566243066	1R12-278	W01-358-9394	63
566243066	1R12-279	W01-358-9394	63
566243066	1R12-281	W01-358-9394	63
566243066	1R12-281	W01-358-9394	63
566243066	1R12-357	W01-358-9348	63
566243066	1R12-375	W01-358-9265	66
566243066	1R12-395	W01-358-9203	62
566243066	1R12-439	W01-358-9346	63
566243066	1R12-480	W01-358-9243	62
566243066	1R12-504	W01-358-9471	76
566243066	1R12-568	W01-358-8852	60
566243067	1R12-095	W01-358-9039	34
566243067	1R12-095	W01-358-9307	35
566243067	1R12-097	W01-358-9039	34
566243067	1R12-178	W01-358-9379	26
566243067	1R12-204	W01-358-9566	26
566243067	1R12-309	W01-358-9053	39
566243067	1R12-309	W01-358-9053	39
566243067	1R12-324	W01-358-9565	26
566243067	1R12-324	W01-358-9565	26
566243067	1R12-324	W01-358-9566	26
566243067	1R12-350	W01-358-9031	33
566243067	1R12-351	W01-358-9033	33
566243067	1R12-359	W01-358-9077	34

GOODYEAR BELLOW NO.	GOODYEAR PART NO.	FIRESTONE AON	PAGE NO.
566243067	1R12-435	W01-358-9307	35
566243067	1R12-435	W01-358-9334	35
566243067	1R12-487	W01-358-9366	41
566243067	1R12-522	W01-358-8204	37
566243067	1R12-555	W01-358-8961	31
566243067	1R12-557	W01-358-8976	32
566243067	1R12-558	W01-358-8986	33
566243067	1R12-559	W01-358-9029	33
566243067	1R12-560	W01-358-9308	34
566243067	1R12-561	W01-358-9332	34
566243067	1R12-562	W01-358-8197	36
566243067	1R12-563	W01-358-8934	39
566243067	1R12-566	W01-358-8964	32
566243067	1R12-571	W01-358-9365	41
566243076	1R12-132	W01-358-9105	40
566243076	1R12-132	W01-358-9113	40
566243076	1R12-132	W01-358-9302	40
566243076	1R12-205	W01-358-9568	26
566243076	1R12-325	W01-358-9567	26
566243076	1R12-352	W01-358-9010	43
566243076	1R12-355	W01-358-9078	39
566243076	1R12-367	W01-358-9640	67
566243076	1R12-370	W01-358-9070	44
566243076	1R12-370	W01-358-9336	45
566243076	1R12-370	W01-358-9336	45
566243076	1R12-434	W01-358-8802	41
566243076	1R12-437	W01-358-9797	47
566243076	1R12-445	W01-358-8802	41
566243076	1R12-445	W01-358-8806	42
566243076	1R12-445	W01-358-8806	42
566243076	1R12-505	W01-358-9325	40
566243076	1R12-620	W01-358-9335	45
566243076	1R12-620	W01-358-9335	45
566243080	1R12-373	W01-358-9491	77
566243090	1R12-256	W01-358-9321	64
566243090	1R12-256	W01-358-9367	65
566243090	1R12-256	W01-358-9367	65

Cross References

1T & Convuluted Goodyear Bellow Number to Firestone

GOODYEAR BELLOW NO.	GOODYEAR PART NO.	FIRESTONE AON	PAGE NO.
566243090	1R12-335	W01-358-9321	64
566243090	1R12-363	W01-358-9320	64
566243090	1R12-440	W01-358-9370	65
566243090	1R12-503	W01-358-9370	65
566243090	1R12-663	W01-358-9320	64
566243097	1R12-402	W01-358-9297	57
566243097	1R12-403	W01-358-9373	58
566243097	1R12-404	W01-358-9375	58
566243097	1R12-405	W01-358-8829	80
566243097	1R12-424	W01-358-9287	57
566243097	1R12-446	W01-358-9245	62
566243097	1R12-481	W01-358-9923	55
566243097	1R12-498	W01-358-9922	55
566243097	1R12-502	W01-358-9921	55
566243097	1R12-532	W01-358-9935	55
566243097	1R12-533	W01-358-9923	55
566243097	1R12-615	W01-358-8829	80
566243110	1R12-182	W01-358-9219	51
566243110	1R12-405	W01-358-8829	80
566243173	1R12-173	W01-358-9466	53
566243173	1R12-197	W01-358-9466	53
566243173	1R12-365	W01-358-9466	53
566243180	1R12-365	W01-358-9466	53
566243225	1R12-424	W01-358-9287	57
566243275	1R12-186	W01-358-9780	80
566243275	1R12-189	W01-358-9780	80
566243275	1R12-303	W01-358-9780	80
566243275	1R12-603	W01-358-9780	80
566263015	1R13-038	W01-358-9122	97
566263034	1R13-118	W01-358-9580	89
566263036	1R13-077	W01-358-9270	79
566263036	1R13-119	W01-358-9270	79
566263043	1R13-117	W01-358-9275	76
566263044	1R13-115	W01-358-9250	77
566263044	1R13-116	W01-358-9252	78
566263050	1R13-097	W01-358-8723	82
566263050	1R13-109	W01-358-8782	84

GOODYEAR BELLOW NO.	GOODYEAR PART NO.	FIRESTONE AON	PAGE NO.
566263050	1R13-124	W01-358-8710	88
566263050	1R13-124	W01-358-8755	83
566263051	1R13-039	W01-358-9121	92
566263051	1R13-043	W01-358-9121	92
566263051	1R13-047	W01-358-9144	93
566263051	1R13-049	W01-358-9121	92
566263053	1R13-119	W01-358-9270	79
566263054	1R13-120	W01-358-9218	91
566263055	1R13-130	W01-358-8729	85
566263071	1R13-152	W01-358-8748	85
566263071	1R13-153	W01-358-8749	85
566263072	1R13-048	W01-358-9122	97
566263073	1R13-159	W01-358-8709	87
566263078	1R13-176	W01-358-8713	88
566263080	1R13-177	W01-358-8708	88
566263144	1R13-144	W01-358-9580	89
566283015	1R14-037	W01-358-9215	91
566283015	1R14-038	W01-358-9200	91
566283015	1R14-039	W01-358-8050	102
566283015	1R14-042	W01-358-8052	103
566283015	1R14-147	W01-358-8053	103
566283015	1R14-171	W01-358-8091	101
566283020	1R14-019	W01-358-9152	97
566283020	1R14-019	W01-358-9152	97
566283020	1R14-019	W01-358-9156	97
566283020	1R14-025	W01-358-9156	97
566283020	1R14-030	W01-358-9158	97
566283020	1R14-031	W01-358-9158	97
566283020	1R14-045	W01-358-8792	96
566283020	1R14-045	W01-358-9122	97
566283020	1R14-174	W01-358-5503	99
566283021	1R14-018	W01-358-9149	93
566283021	1R14-024	W01-358-9149	93
566283021	1R14-026	W01-358-9148	93
566283021	1R14-027	W01-358-9148	93
566283021	1R14-028	W01-358-9177	94
566283021	1R14-028	W01-358-9179	94

Firestone

1T & Convuluted Goodyear Bellow Number to Firestone

GOODYEAR BELLOW NO.	GOODYEAR PART NO.	FIRESTONE AON	PAGE NO.
566283021	1R14-029	W01-358-9177	94
566283021	1R14-115	W01-358-9961	94
566283021	1R14-137	W01-358-9134	95
566283021	1R14-159	W01-358-9164	93
566283021	1R14-160	W01-358-9144	93
566283023	1R14-055	W01-358-8050	102
566283023	1R14-083	W01-358-8050	102
566283029	1R14-127	W01-358-9264	100
566283030	1R14-113	W01-358-5505	99
566283015	1R14-170	W01-358-5514	89
566283042	1R14-172	W01-358-8774	102
578913301	1B12-301	W01-358-7009	108
578913301	1B12-305	W01-358-7043	108
578913351	1B14-350	W01-358-7103	108
578913351	1B14-351	W01-358-7104	109
578913352	1B14-358	W01-358-7112	110
578923202	2B9-200	W01-358-6910	111
578923202	2B9-201	W01-358-6902	112
578923202	2B9-201	W01-358-6935	113
578923202	2B9-201	W01-358-6935	113
578923202	2B9-206	W01-358-6905	112
578923202	2B9-229	W01-358-6897	112
578923202	2B9-230	W01-358-6940	113
578923202	2B9-245	W01-358-7788	114
578923202	2B9-265	W01-358-6941	113
578923206	2B9-210	W01-358-6908	113
578923206	2B9-218	W01-358-6927	116
578923206	2B9-246	W01-358-6944	116
578923206	2B9-250	W01-358-6943	116
578923206	2B9-251	W01-358-6948	117
578923206	2B9-252	W01-358-6944	116
578923206	2B9-253	W01-358-6945	116
578923206	2B9-254	W01-358-6946	117
578923206	2B9-255	W01-358-6947	117
578923208	2B9-352	W01-358-6944	116
578923211	2B9-246	W01-358-6932	113
578923250	2B10-226	W01-358-7795	114

GOODYEAR BELLOW NO.	GOODYEAR PART NO.	FIRESTONE AON	PAGE NO.
578923309	2B12-300	W01-358-7424	124
578923309	2B12-307	W01-358-7403	122
578923309	2B12-309	W01-358-7400	122
578923309	2B12-313	W01-358-7405	123
578923309	2B12-318	W01-358-7185	122
578923309	2B12-319	W01-358-7409	123
578923309	2B12-320	W01-358-7401	122
578923309	2B12-320	W01-358-7437	124
578923309	2B12-406	W01-358-7410	124
578923309	2B12-410	W01-358-7404	123
578923309	2B12-411	W01-358-7181	121
578923309	2B12-412	W01-358-7183	121
578923309	2B12-425	W01-358-7180	121
578923309	2B12-426	W01-358-7406	123
578923309	2B12-427	W01-358-7429	124
578923309	2B12-432	W01-358-7423	124
578923310	2B12-305	W01-358-7443	125
578923310	2B12-317	W01-358-7499	126
578923310	2B12-324	W01-358-7447	125
578923310	2B12-402	W01-358-7446	125
578923310	2B12-428	W01-358-7473	126
578923310	2B12-434	W01-358-7472	131
578923310	2B12-446	W01-358-7444	125
578923315	2B12-345	W01-358-7545	131
578923315	2B12-346	W01-358-7550	130
578923315	2B12-416	W01-358-7444	125
578923315	2B12-440	W01-358-7550	130
578923315	2B12-440	W01-358-7555	131
578923353	2B14-354	W01-358-7145	119
578923353	2B14-355	W01-358-7146	119
578923353	2B14-356	W01-358-7136	119
578923353	2B14-359	W01-358-7140	119
578923353	2B14-359	W01-358-7782	132
578923353	2B14-360	W01-358-7135	118
578923353	2B14-366	W01-358-6803	120
578923353	2B14-367	W01-358-7123	119
578923356	2B14-365	W01-358-6801	120

Cross References

1T & Convuluted Goodyear Bellow Number to Firestone

GOODYEAR BELLOW NO.	GOODYEAR PART NO.	FIRESTONE AON	PAGE NO.
578923356	2B14-383	W01-358-7557	131
578923356	2B14-462	W01-358-6805	120
578923356	2B14-470	W01-358-7782	132
578923356	2B14-476	W01-358-6799	131
578933100	3B12-300	W01-358-8008	135
578933100	3B12-301	W01-358-8010	135
578933100	3B12-303	W01-358-8018	135
578933100	3B12-304	W01-358-8006	134
578933100	3B12-310	W01-358-8027	136
578933100	3B12-312	W01-358-8033	136
578933100	3B12-315	W01-358-8032	136
578933100	3B12-319	W01-358-8032	136
578933100	3B12-328	W01-358-7994	134
578933100	3B12-329	W01-358-7995	134
578933100	3B12-335	W01-358-7996	134
578933103	3B12-322	W01-358-8042	143
578933103	3B12-323	W01-358-8043	143

GOODYEAR BELLOW NO.	GOODYEAR PART NO.	FIRESTONE AON	PAGE NO.
578933350	3B14-350	W01-358-7808	138
578933350	3B14-354	W01-358-7808	138
578933350	3B14-356	W01-358-7798	138
578933350	3B14-356	W01-358-7838	139
578933350	3B14-359	W01-358-7818	139
578933350	3B14-359	W01-358-7839	140
578933350	3B14-360	W01-358-7800	138
578933350	3B14-360	W01-358-7848	141
578933350	3B14-364	W01-358-7843	140
578933350	3B14-367	W01-358-7796	138
578933350	3B14-367	W01-358-7796	138
578933350	3B14-367	W01-358-7847	141
579923530	2B8-550	W01-358-7325	127
566243142	1R12-1047	W01-358-9807	35
566243097	1R12-1048	W01-358-9974	57
566243038	1R12-494	W01-358-1096	5
566263078	1R13-188	W01-358-8539	5

Firestone

1T & Convuluted Contitech Assembly Number to Firestone

CONTI PART NO.	FIRESTONE PART NO.	PAGE NO.
6 6.5-11 S 027	W01-358-2119	9
6 6.5-11 S 028	W01-358-2120	9
6 6.5-11 S 029	W01-358-2131	9
6 6.5-11 S 030	W01-358-5310	9
6 6.5-11 S 031	W01-358-5311	9
6 6.5-11 S 032	W01-358-5323	10
6 6.5-11 S 033	W01-358-5328	10
6 6.5-11 S 048	W01-358-5300	#N/A
6 6.5-11 S 051	W01-358-5315	#N/A
6 6.5-11 S 052	W01-358-5316	#N/A
6 6.5B-11 S 034	W01-358-5297	15
6 6.5B-11 S 035	W01-358-5319	15
6 6.5B-11 S 036	W01-358-8872	15
6 6.5B-11 S 037	W01-358-8992	16
6 6.5B-11 S 054	W01-358-5298	#N/A
6 6.5B-11 S 525	W01-358-8997	16
6 6.5-13 S 038	W01-358-5405	10
6 6.5-13 S 039	W01-358-5406	10
6 6.5-13 S 040	W01-358-5408	11
6 6.5-13 S 041	W01-358-5412	11
6 6.5-13 S 042	W01-358-5414	11
6 6.5-13 S 043	W01-358-5422	11
6 6.5-13 S 044	W01-358-5433	12
6 6.5-13 S 045	W01-358-5434	12
6 6.5-13 S 046	W01-358-5436	12
6 6.5-13 S 047	W01-358-9478	12
6 6.5-13 S 056	W01-358-5409	#N/A
6 6.5-13 S 446	W01-358-5410	11
6 6.5-13 S 559	W01-358-5423	12
8 10-10 P 481	W01-358-9333	34
9 10-10 P 311	W01-358-9039	34
9 10-10 P 328	W01-358-9033	33
9 10-10 P 331	W01-358-9077	34
9 10-10 P 338	W01-358-9030	#N/A
9 10-10 P 339	W01-358-9031	33
9 10-10 P 397	W01-358-9332	34

CONTI PART NO.	FIRESTONE PART NO.	PAGE NO.
9 10-10 P 398	W01-358-9308	34
9 10-10 P 399	W01-358-9029	33
9 10-10 P 400	W01-358-8986	33
9 10-10 P 471	W01-358-9307	35
9 10-10 P 473	W01-358-8963	32
9 10-10 P 480	W01-358-8964	32
9 10-10 P 481	W01-358-9333	34
9 10-10 P 482	W01-358-9334	35
9 10-10 P 503	W01-358-8976	32
9 10-10 P 542	W01-358-8961	31
9 10-10.5 P 883	W01-358-9307	35
9 10-12 A 327	W01-358-9053	39
9 10-12 A 341	W01-358-9113	40
9 10-12 A 342	W01-358-9118	40
9 10-12 A 427	W01-358-9640	67
9 10-12 P 024	W01-358-8197	36
9 10-12 P 319	W01-358-9105	40
9 10-12 P 329	W01-358-9078	39
9 10-12 P 343	W01-358-9302	40
9 10-12 P 395	W01-358-9325	40
9 10-12 P 396	W01-358-8930	38
9 10-12 P 483	W01-358-8201	37
9 10-12 P 484	W01-358-8204	37
9 10-12 P 485	W01-358-8932	38
9 10-12 P 485	W01-358-8932	38
9 10-12 P 487	W01-358-9339	41
9 10-12 P 488	W01-358-9366	41
9 10-12 P 495	W01-358-9365	41
9 10-12 P 543	W01-358-8203	37
9 10-12 P 544	W01-358-8934	39
9 10-12 P 720	W01-358-7667	36
9 10-12 P 839	W01-358-8882	35
9 10-13.5 P 874	W01-358-9807	35
9 10-13.5 S 433	W01-358-9270	79
9 10-13.5 S 881	W01-358-8800	79
9 10-14 A 330	W01-358-9070	44

Cross References

1T & Convuluted Contitech Assembly Number to Firestone

CONTI PART NO.	FIRESTONE PART NO.	PAGE NO.
9 10-14 A 490	W01-358-9336	45
9 10-14 A 491	W01-358-9467	45
9 10-14 A 496	W01-358-9797	47
9 10-14 A 545	W01-358-8806	42
9 10-14 A 546	W01-358-8810	42
9 10-14 A 707	W01-358-9127	#N/A
9 10-14 P 312	W01-358-9069	44
9 10-14 P 335	W01-358-9059	44
9 10-14 P 344	W01-358-9008	43
9 10-14 P 345	W01-358-9010	43
9 10-14 P 346	W01-358-9011	43
9 10-14 P 347	W01-358-9063	44
9 10-14 P 348	W01-358-9068	44
9 10-14 P 349	W01-358-9071	45
9 10-14 P 381	W01-358-9798	47
9 10-14 P 437	W01-358-9463	45
9 10-14 P 450	W01-358-9568	26
9 10-14 P 461	W01-358-9567	26
9 10-14 P 462	W01-358-8805	42
9 10-14 P 465	W01-358-9335	45
9 10-14 P 469	W01-358-8802	41
9 10-14 P 489	W01-358-8803	42
9 10-14 P 490	W01-358-9336	45
9 10-14 P 492	W01-358-9482	46
9 10-14 P 493	W01-358-9483	46
9 10-14 P 494	W01-358-9484	46
9 10-14 P 534	W01-358-9492	#N/A
9 10-14 P 575	W01-358-9634	67
9 10-14 P 577	W01-358-8813	42
9 10-14 P 709	W01-358-9060	#N/A
9 10-14 P 718	W01-358-9507	46
9 10-14 P 882	W01-358-9697	47
9 10-14 P 905	W01-358-8816	43
9 10-14 P 906	W01-358-8817	43
9 10-16 A 354	W01-358-9228	52
9 10-16 P 310	W01-358-9082	49

CONTI PART NO.	FIRESTONE PART NO.	PAGE NO.
9 10-16 P 325	W01-358-9096	50
9 10-16 P 332	W01-358-9093	50
9 10-16 P 333	W01-358-9083	49
9 10-16 P 351	W01-358-9193	50
9 10-16 P 352	W01-358-9194	50
9 10-16 P 353	W01-358-9227	51
9 10-16 P 371	W01-358-9256	52
9 10-16 P 372	W01-358-9092	49
9 10-16 P 376	W01-358-9392	53
9 10-16 P 391	W01-358-9362	52
9 10-16 P 392	W01-358-9304	52
9 10-16 P 393	W01-358-9026	49
9 10-16 P 394	W01-358-9004	48
9 10-16 P 408	W01-358-9219	51
9 10-16 P 409	W01-358-9223	51
9 10-16 P 410	W01-358-9466	53
9 10-16 P 416	W01-358-9296	52
9 10-16 P 441	W01-358-9213	51
9 10-16 P 449	W01-358-8829	80
9 10-16 P 497	W01-358-8924	48
9 10-16 P 498	W01-358-8927	48
9 10-16 P 500	W01-358-9474	53
9 10-16 P 510	W01-358-9944	54
9 10-16 P 547	W01-358-9496	53
9 10-16 P 549	W01-358-9643	67
9 10-16 P 710	W01-358-9299	68
9 10-17.5 A 535	W01-358-9948	56
9 10-17.5 P 023	W01-358-9972	57
9 10-17.5 P 418	W01-358-9342	54
9 10-17.5 P 426	W01-358-9902	55
9 10-17.5 P 428	W01-358-9922	55
9 10-17.5 P 429	W01-358-9923	55
9 10-17.5 P 430	W01-358-9942	56
9 10-17.5 P 436	W01-358-8944	68
9 10-17.5 P 436	W01-358-9015	31
9 10-17.5 P 440	W01-358-9375	58



1T & Convuluted Contitech Assembly Number to Firestone

CONTI PART NO.	FIRESTONE PART NO.	PAGE NO.
9 10-17.5 P 443	W01-358-9921	55
9 10-17.5 P 445	W01-358-9473	76
9 10-17.5 P 452	W01-358-9947	56
9 10-17.5 P 454	W01-358-9936	56
9 10-17.5 P 467	W01-358-9472	76
9 10-17.5 P 475	W01-358-9943	56
9 10-17.5 P 501	W01-358-9470	76
9 10-17.5 P 502	W01-358-9471	76
9 10-17.5 P 536	W01-358-8903	69
9 10-17.5 P 548	W01-358-9935	55
9 10-17.5 P 550	W01-358-9647	59
9 10-17.5 P 551	W01-358-9649	59
9 10-17.5 P 571	W01-358-9502	77
9 10-17.5 P 574	W01-358-9504	77
9 10-17.5 P 731	W01-358-9966	54
9 10-17.5 P 732	W01-358-9947	56
9 10-17.5 P 733	W01-358-9223	51
9 10-17.5 P 779	W01-358-6258	79
9 10-17.5 P 831	W01-358-6262	69
9 10-17.5 P 904	W01-358-8888	54
9 10-17.5 P 930	W01-358-9974	57
9 10-18.5 P 406	W01-358-9287	57
9 10-18.5 P 440	W01-358-9373	58
9 10-18.5 P 451	W01-358-9375	58
9 10-18.5 P 456	W01-358-9648	80
9 10-18.5 P 519	W01-358-9373	58
9 10-18.5 P 520	W01-358-9297	57
9 10-18.5 P 521	W01-358-9371	58
9 10-18.5 P 550	W01-358-9647	59
9 10-18.5 P 551	W01-358-9649	59
9 10-18.5 P 935	W01-358-9297	57
9 10-18.5 P 939	W01-358-9663	60
9 10-19 A 358	W01-358-9394	63
9 10-19 A 830	W01-358-0783	60
9 10-19 P 315	W01-358-9101	61
9 10-19 P 321	W01-358-9130	#N/A

CONTI PART NO.	FIRESTONE PART NO.	PAGE NO.
9 10-19 P 326	W01-358-9192	61
9 10-19 P 355	W01-358-9203	62
9 10-19 P 356	W01-358-9238	62
9 10-19 P 357	W01-358-9240	62
9 10-19 P 358	W01-358-9394	63
9 10-19 P 359	W01-358-9350	63
9 10-19 P 383	W01-358-9394	63
9 10-19 P 384	W01-358-9243	62
9 10-19 P 390	W01-358-9245	62
9 10-19 P 391	W01-358-9362	52
9 10-19 P 435	W01-358-9265	66
9 10-19 P 438	W01-358-9349	63
9 10-19 P 439	W01-358-9348	63
9 10-19 P 470	W01-358-9346	63
9 10-19 P 472	W01-358-8852	60
9 10-19 P 552	W01-358-8855	60
9 10-19 P 553	W01-358-8856	61
9 10-19 P 762	W01-358-8861	61
9 10-19 P 765	W01-358-8842	60
9 10-19 P 801	W01-358-0783	60
9 10-19 P 898	W01-358-8864	61
9 10-19 P 946	W01-358-9241	#N/A
9 10-21 A 361	W01-358-9321	64
9 10-21 A 505	W01-358-9367	65
9 10-21 P 360	W01-358-9320	64
9 10-21 P 361	W01-358-9321	64
9 10-21 P 448	W01-358-9370	65
9 10-21 P 505	W01-358-9367	65
9 10-21 P 511	W01-358-9338	64
9 10B-17.5 A 323	W01-358-9275	76
9 10B-17.5 A 362	W01-358-9274	75
9 10B-17.5 P 554	W01-358-9491	77
9 10B-19.5 P 889	W01-358-1191	80
9 10BP-16 P 569	W01-358-9644	69
9 10BP-20 P 738	W01-358-9646	69
9 10BP-22 P 739	W01-358-9645	69

Cross References

1T & Convuluted Contitech Assembly Number to Firestone

CONTI PART NO.	FIRESTONE PART NO.	PAGE NO.
9 10D-21 A 324	W01-358-9250	77
9 10D-21 A 363	W01-358-9252	78
9 10D-21 A 555	W01-358-9269	78
9 10S-16 A 382	W01-358-9781	81
9 10S-16 P 382	W01-358-9780	80
9 9-10 P 538	W01-358-9625	25
9 9-10 P 576	W01-358-9675	25
9 9-10 P 861	W01-358-9541	25
9 9-10 P 862	W01-358-9618	25
9 9-12 A 334	W01-358-9075	18
9 9-12 A 464	W01-358-8900	18
9 9-12 P 314	W01-358-9422	17
9 9-12 P 379	W01-358-9379	26
9 9-12 P 401	W01-358-8900	18
9 9-12 P 447	W01-358-9378	19
9 9-12 P 464	W01-358-8901	18
9 9-12 P 477	W01-358-9376	18
9 9-12 P 478	W01-358-9377	19
9 9-12 P 479	W01-358-9387	19
9 9-12 P 515	W01-358-9616	17
9 9-12 P 516	W01-358-9476	20
9 9-12 P 563	W01-358-9448	20
9 9-12 P 705	W01-358-9421	72
9 9-14 A 337	W01-358-9439	23
9 9-14 A 517	W01-358-8903	69
9 9-14 P 517	W01-358-8919	22
9 9-14 P 895	W01-358-9385	#N/A
9 9-14 P 933	W01-358-9465	#N/A
9 9-16 P 568	W01-358-9626	23
9 95-15 A 455	W01-358-8949	30
9 9-9 P 537	W01-358-9622	24
9 9-9 P 756	W01-358-9651	71
9 9-9 P 767	W01-358-5789	74
9 9-9 P 859	W01-358-9547	24
9 9-9 P 860	W01-358-9617	24
9 9-9 S 537	W01-358-9622	24

CONTI PART NO.	FIRESTONE PART NO.	PAGE NO.
9 9-9 S 860	W01-358-9617	24
9 9B-20 P 740	W01-358-9621	25
9 9B-22 P 741	W01-358-9619	27
9 9K-12 P 780	W01-358-9681	28
9 9K-15 P 417	W01-358-9295	31
9 9K-15 P 423	W01-358-9294	31
9 9K-15 P 424	W01-358-9293	31
9 9K-15 P 425	W01-358-9291	30
9 9K-15 P 455	W01-358-8949	30
9 9K-15 P423	W01-358-9294	31
9 9K-15 P425	W01-358-9291	30
10 10-15 P 453	W01-358-8751	83
10 10-15 S 518	W01-358-8752	83
10 10-15 S 522	W01-358-8755	83
10 10-15 S 711	W01-358-8710	88
10 10-15 S 711	W01-358-8756	84
10 10-15 S 713	W01-358-8753	83
10 10.5-15 P 480	W01-358-8709	87
10 10-15 S 773	W01-358-8740	83
10 10-15 S 871	W01-358-8782	84
10 10-15 S 962	W01-358-8723	82
10 10-16 S 526	W01-358-8708	88
10 10-16 S 533	W01-358-8713	88
10 10-21 P015	W01-358-9581	89
10 10-21 P 434	W01-358-9580	89
10 10-21 P 486	W01-358-8749	85
10 10-21 P 570	W01-358-8748	85
10 10-21 P 774	W01-358-8746	84
10 10-21 P 964	W01-358-8744	84
10 10AV-13 P 513	W01-358-8729	85
11 10.5-15 A 414	W01-358-9215	91
11 10.5-15 A 415	W01-358-9200	91
11 10.5-15 A 419	W01-358-8088	90
11 10.5-15 A 420	W01-358-9277	92
11 10.5-15 A 421	W01-358-9216	91
11 10.5-15 A 422	W01-358-9218	91



1T & Convuluted Contitech Assembly Number to Firestone

CONTI PART NO.	FIRESTONE PART NO.	PAGE NO.
11 10.5-15 A 506	W01-358-9204	91
11 10.5A-16 P 523	W01-358-8091	101
11 10.5C-16 A 320	W01-358-8050	102
11 10.5C-16 A 378	W01-358-8052	103
11 10.5C-16 A 380	W01-358-8053	103
11 10.5C-16 A 385	W01-358-8051	103
11 10.5-17 A 316	W01-358-9177	94
11 10.5-17 A 316	W01-358-9179	94
11 10.5-17 A 317	W01-358-9121	92
11 10.5-17 A 364	W01-358-9148	93
11 10.5-17 A 365	W01-358-9149	93
11 10.5-17 A 366	W01-358-9179	94
11 10.5-17 A 367	W01-358-9961	94
11 10.5-17 A 368	W01-358-9135	93
11 10.5-17 A 377	W01-358-9144	93
11 10.5-17 A 388	W01-358-9221	94
11 10.5-17 A 405	W01-358-9164	93
11 10.5-17 A 507	W01-358-8778	92
11 10.5-17 A 556	W01-358-9116	92
11 10.5F-17 P 745	W01-358-8774	102
11 10.5B-18 P 743	W01-358-8093	102
11 10.5-19 A 431	W01-358-9134	95
11 10.5-19 A 432	W01-358-9138	95
11 10.5-19 A 508	W01-358-8779	95
11 10.5-19 A 509	W01-358-8780	95
11 10.5-19 A 557	W01-358-8781	95
11 10.5-21 A 025	W01-358-8764	96
11 10.5-21 A 313	W01-358-8792	96
11 10.5-21 A 313	W01-358-9122	97
11 10.5-21 A 318	W01-358-9152	97
11 10.5-21 A 318	W01-358-9158	97
11 10.5-21 A 370	W01-358-9156	97
11 10.5-21 A 558	W01-358-9199	98
11 10.5-22 A 530	W01-358-5503	99
11 10.5-22 A 931	W01-358-5511	99
11 10.5-22 S 712	W01-358-9264	100

CONTI PART NO.	FIRESTONE PART NO.	PAGE NO.
11 10.5-22 S 750	W01-358-5505	99
FD 120-17A 789	W01-358-7505	127
FD 120-20 509	W01-358-7325	127
FD 120-20 715	W01-358-7705	127
FD 120-20 767	W01-358-7689	#N/A
FD 200-19 310	W01-358-6902	112
FD 200-19 315	W01-358-6905	112
FD 200-19 319	W01-358-6900	111
FD 200-19 320	W01-358-6910	111
FD 200-19 362	W01-358-6908	113
FD 200-19 448	W01-358-6941	113
FD 200-19 450	W01-358-6940	113
FD 200-19 452	W01-358-6932	113
FD 200-19 452	W01-358-7686	114
FD 200-19 499	W01-358-6856	112
FD 200-19 499	W01-358-6935	113
FD 200-19 504	W01-358-6926	111
FD 200-19 505	W01-358-6897	112
FD 200-19 506	W01-358-6949	114
FD 200-19 510	W01-358-7788	114
FD 200-19 539	W01-358-6890	111
FD 200-19 713	W01-358-7795	114
FD 200-19 724	W01-358-6884	112
FD 200-22 524	W01-358-7897	115
FD 200-22 529	W01-358-6883	115
FD 200-22 706	W01-358-6886	115
FD 200-22 765	W01-358-6703	#N/A
FD 200-23A 709	W01-358-7897	115
FD 200-25 426	W01-358-6943	116
FD 200-25 427	W01-358-6945	116
FD 200-25 428	W01-358-6947	117
FD 200-25 429	W01-358-6948	117
FD 200-25 453	W01-358-6927	116
FD 200-25 454	W01-358-6944	116
FD 200-25 463	W01-358-6946	117
FD 200-25 507	W01-358-6960	117

Cross References

1T & Convoluted Contitech Assembly Number to Firestone

CONTI PART NO.	FIRESTONE PART NO.	PAGE NO.
FD 200-25 511	W01-358-6962	117
FD 330-22 313	W01-358-7400	122
FD 330-22 318	W01-358-7403	122
FD 330-22 327	W01-358-7424	124
FD 330-22 331	W01-358-7410	124
FD 330-22 334	W01-358-7437	124
FD 330-22 337	W01-358-7401	122
FD 330-22 343	W01-358-7429	124
FD 330-22 346	W01-358-7404	123
FD 330-22 363	W01-358-7180	121
FD 330-22 364	W01-358-7405	123
FD 330-22 365	W01-358-7406	123
FD 330-22 366	W01-358-7408	123
FD 330-22 367	W01-358-7409	123
FD 330-22 368	W01-358-7423	124
FD 330-22 471	W01-358-7183	121
FD 330-22 472	W01-358-7181	121
FD 330-22 500	W01-358-7344	122
FD 330-22 540	W01-358-6850	#N/A
FD 330-22 780	W01-358-7184	#N/A
FD 330-30 323	W01-358-7443	125
FD 330-30 340	W01-358-7447	125
FD 330-30 369	W01-358-7444	125
FD 330-30 370	W01-358-7446	125
FD 330-30 371	W01-358-7472	131
FD 330-30 372	W01-358-7473	126
FD 330-30 373	W01-358-7483	126
FD 330-30 502	W01-358-7499	126
FD 330-30 512	W01-358-6789	125
FD 330-30-513	W01-358-7790	126
FD 331-26 480	W01-358-7555	131
FD 331-26 514	W01-358-7545	131
FD 331-26 541	W01-358-7550	130
FD 530-22 311	W01-358-7135	118
FD 530-22 316	W01-358-7140	119
FD 530-22 321	W01-358-7136	119

CONTI PART NO.	FIRESTONE PART NO.	PAGE NO.
FD 530-22 342	W01-358-7146	119
FD 530-22 345	W01-358-7123	119
FD 530-22 374	W01-358-7145	119
FD 530-30 449	W01-358-6803	120
FD 530-30 451	W01-358-6801	120
FD 530-30 518	W01-358-6800	120
FD 530-30 519	W01-358-6808	121
FD 530-30 532	W01-358-6805	120
FD 530-35 530	W01-358-7557	131
FD 530-35 543	W01-358-6799	131
FD 530-35 544	W01-358-7782	132
FD 530-35 545	W01-358-7781	132
FS 330-11 467	W01-358-6994	108
FS 330-11 468	W01-358-7009	108
FS 330-11 474	W01-358-7008	108
FS 530-14 339	W01-358-7112	110
FS 530-14 361	W01-358-7117	110
FS 530-14 442	W01-358-7103	108
FS 530-14 446	W01-358-7104	109
FS 530-14 447	W01-358-7105	109
FS 530-14 515	W01-358-7093	109
FS 530-14 516	W01-358-7096	110
FS 530-14 517	W01-358-7088	109
FS 530-14 538	W01-358-7094	109
FT 330-29 413	W01-358-8032	136
FT 330-29 430	W01-358-8006	134
FT 330-29 431	W01-358-8008	135
FT 330-29 432	W01-358-8010	135
FT 330-29 433	W01-358-8016	135
FT 330-29 434	W01-358-8018	135
FT 330-29 466	W01-358-8027	136
FT 330-29 469	W01-358-8025	136
FT 330-29 494	W01-358-8018	135
FT 330-29 498	W01-358-8030	136
FT 330-29 520	W01-358-7996	134
FT 330-29 525	W01-358-8033	136

Firestone

1T & Convuluted Contitech Assembly Number to Firestone

CONTI PART NO.	FIRESTONE PART NO.	PAGE NO.
FT 330-29 546	W01-358-7994	134
FT 330-29 547	W01-358-7995	134
FT 330-29 548	W01-358-7998	134
FT 330-29 554	W01-358-8038	143
FT 330-29 703	W01-358-7990	133
FT 530-32 325	W01-358-7818	139
FT 530-32 329	W01-358-7798	138
FT 530-32 333	W01-358-7800	138
FT 530-32 336	W01-358-7808	138
FT 530-32 535	W01-358-7797	138
FT 530-32 536	W01-358-7796	138
FT 530-32-333	W01-358-7800	138
FT 530-35 436	W01-358-7838	139
FT 530-35 437	W01-358-7839	140
FT 530-35 438	W01-358-7844	140
FT 530-35 439	W01-358-7848	141
FT 530-35 441	W01-358-7850	141
FT 530-35 455	W01-358-7843	140
FT 530-35 456	W01-358-7846	140
FT 530-35 457	W01-358-7847	141
FT 530-35 521	W01-358-7845	140
FT 530-35 522	W01-358-7855	141
FT 530-35 523	W01-358-7859	142
FT 530-35 534	W01-358-7862	142
FT 530-35 537	W01-358-7853	141

CONTI PART NO.	FIRESTONE PART NO.	PAGE NO.
FT 530-35 726	W01-358-7872	142
SK 68-10 P01	W21-760-9001	165
SK 68-15 P01	W21-760-9000	164
SC29-B092	W02-358-7092	162
SC29-B152	W02-358-7152	162
SC29-B200	W02-358-7200	162
SC29-O001	W02-358-7001	147
SC29-O046	W02-358-7046	146
SC29-O086	W02-358-7086	146
SC29-O100	W02-358-7100	148
SC29-O201	W02-358-7201	147
SC29-W035	W02-358-7035	154
SC29-W035	W02-358-7061	156
SC29-W075	W02-358-7075	155
SC29-W085	W02-358-7085	153
SC29-W103	W02-358-7103	155
SC29-Y036	W02-358-7036	160
SC29-Y064	W02-358-7064	159
SC29-Y082	W02-358-7082	160
SC29-Y108	W02-358-7108	159
SC31-B207	W02-358-7215	163
SC31-W206	W02-358-7206	154
SC31-Y205	W02-358-7205	160
SC31-Y215	W02-358-7215	163

Cross References

1T & Convoluted Bellows Index by Bellows Number

BELLOW NO.	PAGE NO.
1T-REVERSIBLE SLEEVE	
1T14C-1	9, 10
1T14C-3	10 - 12
1T14C-5	13
1T14C-6	13, 14
1T14C-7	14, 15
1T14C-8	15
1T14CB-1	15, 16
1T14CP-3	#N/A
1T14F-2 (Replaced by 1T14C-1)	#N/A
1T14F-4 (Replaced by 1T14C-3)	#N/A
1T14F-8 (Replaced by 1T14C-7)	#N/A
1T15A (Replaced by 1T15M-0)	#N/A
1T15A-3 (Replaced by 1T15M-2)	#N/A
1T15AA-3 (Replaced by 1T15LP-3)	#N/A
1T15AA-6 (Replaced by 1T15LP-6)	#N/A
1T15AB-7 (Replaced by 1T15MPW-7)	#N/A
1T15AE-5 (Replaced by 1T15LP-5)	#N/A
1T15AF-6 (Replaced by 1T15SN-6)	#N/A
1T15AG-9 (Replaced by 1T15MM-9)	#N/A
1T15B (Replaced by 1T15L-2)	#N/A
1T15B-2 (Replaced by 1T15L-2 or 1T15S-5)	#N/A
1T15B-3 (Replaced by 1T15S-6)	#N/A
1T15CCR-6	17
1T15DR-5.5	#N/A
1T15K-0 (Replaced by 1T15M-0)	#N/A
1T15K-1 (Replaced by 1T15M-6)	#N/A
1T15K-2 (Replaced by 1T15M-9)	#N/A
1T15K-4 (Replaced by 1T15M-4)	#N/A
1T15KW-(-1) (Replaced by 1T15LA-(-1))	#N/A
1T15KW-0 (Replaced by 1T15LA-0)	#N/A
1T15KW-1.5 (Replaced by 1T15L-1.5)	#N/A
1T15L-0.5	#N/A
1T15L-1.5	17

BELLOW NO.	PAGE NO.
1T-REVERSIBLE SLEEVE cont.	
1T15L-2	18 - 21
1T15L-2.5X (Replaced by 1T15LC-2.5)	#N/A
1T15L-3	21
1T15L-4	21 - 23
1T15L-6	23
1T15L-8X (Replaced by 1T15M-6)	#N/A
1T15L-9	24
1T15LA-(-1)	24
1T15LA-0	25
1T15LB-10	25
1T15LC-12	27
1T15LC-2.5	26
1T15LC-4.5	26
1T15LP-2	27, 28
1T15LP-3	28, 30
1T15LP-5	30, 31
1T15LP-6	31
1T15M-0	31 - 35
1T15M-0.5	35
1T15M-11	64, 65
1T15M-2	35 - 41
1T15M-3 (Replaced by 1T15MT-3)	#N/A
1T15M-4	41 - 47
1T15M-6	5, 47 - 54
1T15M-7 (Replaced by 1T15M-7.5)	#N/A
1T15M-7.5	54 - 57
1T15M-8	57-60
1T15M-9	60 - 64
1T15MBTW-10	69
1T15MBTW-12	69
1T15MBTW-6	69
1T15MJ-6	66
1T15MLW-7	68
1T15MM-5 (Replaced by 1T15MW-6)	#N/A

1T & Convoluted Bellows Index by Bellows Number

BELLOW NO.	PAGE NO.
1T-REVERSIBLE SLEEVE cont.	
1T15MM-9	66
1T15MN-7 (Replaced by 1T15M-7.5)	#N/A
1T15MP-7	#N/A
1T15MPW-6	#N/A
1T15MPW-7	68, 69
1T15MR-2	66
1T15MT-3	67
1T15MT-6	67
1T15MT-8	#N/A
1T15MT-9	#N/A
1T15MW-10 (Replaced by 1T15MM-9)	#N/A
1T15MW-6	68
1T15S-5	70
1T15S-6 (Replaced by 1T15LP-3)	#N/A
1T15SN-3	70
1T15SN-6	70, 71
1T15T-1	71
1T15T-2	72
1T15TM-1	72
1T15TQ-1	73, 74
1T15TQ-5	#N/A
1T15V-1	75
1T15V-11	77, 78
1T15V-3	75
1T15V-8	75 - 77
1T15VL-9 (Replaced by 1T15M-2)	#N/A
1T15VLT-10.5 (Replaced by 1T17CL-9.5)	#N/A
1T15VM-3.5 (Replaced by 1T15VP-4)	#N/A
1T15VM-4 (Replaced by 1T15VP-4)	#N/A
1T15VM-8	#N/A
1T15VMR-8	78
1T15VMW-8	79
1T15VP-4	79

BELLOW NO.	PAGE NO.
1T-REVERSIBLE SLEEVE cont.	
1T15X-1 (Replaced by 1T15M-7.5)	#N/A
1T15XBZR-7.5	#N/A
1T15XMR-7	80
1T15XNR-5	80
1T15XR-9	79, 80
1T15Y-1 (Replaced by 1T15TQ-1)	#N/A
1T15Y-5 (Replaced by 1T15TQ-5)	#N/A
1T15ZR-3 (use 1T15MT-3)	#N/A
1T15ZR-6 (Replaced by C01-358-0583)	#N/A
1T17AZR-4.5	82
1T15AEZR-5	#N/A
1T17B-11	84, 85
1T17B-5	82 - 84
1T17BB-2	85
1T17BP-4	#N/A
1T17BP-17	85
1T17C-3	86
1T17C-6	86
1T17C-6.5	#N/A
1T17C-8	87
1T17CA-3	87
1T17CA-5	87
1T17CA-6	87
1T17CA-6.5	88
1T17CD-3	88
1T17CL-5	88
1T17CL-9.5	89
1T19E-1 (Replaced by 1T19F-7)	#N/A
1T19E-2 (Replaced by 1T19F-11)	#N/A
1T19F-11	#N/A
1T19F-12	89
1T19F-14	#N/A
1T19F-16	89

Cross References

1T & Convoluted Bellows Index by Bellows Number

BELLOW NO.	PAGE NO.
1T-REVERSIBLE SLEEVE cont.	
1T19F-3	#N/A
1T19F-5	#N/A
1T19F-7	92
1T19F-9	#N/A
1T19FC-5	#N/A
1T19FC-6	#N/A
1T19FC-8	#N/A
1T19L-11	96 - 98
1T19L-12	99, 100
1T19L-14	100
1T19L-16	101
1T19L-3	90
1T19L-5	90 - 92
1T19L-7	92 - 94
1T19L-9	95, 96
1T19LC-5	101
1T19LC-6	101
1T19LC-8	102
1T19G-8	#N/A
1T19J-1	89
1T19J-6 (can be 1T19ZK-5.7)	#N/A
1T19LC-11	#N/A
1T19LE-8	102
1T19LE-12	102
1T19LF-7	102
1T19N-9	#N/A
1T19ZK-5.7	102, 103
1T19ZK-6.7	#N/A
1T26D-7	103, 104
1T30E-1 (Replaced by 1T19F-7)	#N/A
1T60BA-326	#N/A
1T66E-11.8 (Replaced by 1T66G-11.8)	#N/A
1T66G-11.8	#N/A
1T66G-19.8	#N/A

BELLOW NO.	PAGE NO.
1T-REVERSIBLE SLEEVE cont.	
C01-358-0583	80, 81
CONVOLUTED STYLE BELLOWS	#N/A
SINGLE CONVOLUTED	
113-1x88-1 (Obsolete No replacement)	#N/A
19	108
19-.75	108
113	108, 109
113-.5	109
113-1	109, 110
126	110
150	111
DOUBLE CONVOLUTED	
20	111 - 114
20-1	115
20-2	115 - 117
21	118 - 120
21-2	120, 121
22	121 - 124
22-1.5	125, 126
25 (Replaced by 268C)	#N/A
26	126, 127
28	128
29	128
201	128
203	129
205	129
215	129
218	130
224	130
228-1.5	130, 131
233-2	131, 132
252	132
255-1.5 (Replaced by 267-1.5)	#N/A

Firestone

1T & Convoluted Bellows Index by Bellows Number

BELLOW NO.	PAGE NO.
DOUBLE CONVOLUTED cont.	
256-2	132
257 (Replaced by 20)	#N/A
257-1 (Replaced by 20-1)	#N/A
264	133
267-1.5	133
TRIPLE CONVOLUTED	
38	133 - 136
39	137

BELLOW NO.	PAGE NO.
TRIPLE CONVOLUTED cont.	
312	137
313	138, 139
320	139
321	139
323	139
333	139 - 142
352	142, 143
354	143

Cross References

1T & Convoluted Bellows Index by Size

BELLOW NO.	PAGE NO.
1T-REVERSIBLE SLEEVE	
6.31" DIA. BEAD PLATE, 6.62" MOLDED DIA.	
1T14C-1	9, 10
1T14C-3	10 - 12
1T14C-5	13
1T14C-6	13, 14
1T14C-7	14, 15
1T14C-8	15
9.00" DIA. BEAD PLATE, 7.75" MOLDED DIA.	
1T15S-5 or 1T15AA-3	16, 29, 70
1T15S-6 or 1T15AA-3	16, 29, 70
1T15SN-3	70
1T15SN-6	70, 71
1T15T-1	71
1T15TM-1	72
1T15TQ-1	73, 74
1T15T-2	72
9.00" DIA. BEAD PLATE, 9.12" MOLDED DIA.	
1T15AA-3	16, 29
1T15AA-6	16
1T15LA-(-1) 1T15KW- (-1)	24
1T15LA-0 1T15KW-0	25
1T15-L-1.5	#N/A
1T15L-1.5	17
1T15LP-1.5	27
1T15L-2	18 - 21
1T15LP-2	27, 28
1T15LC-2.5	26
1T15L-3	21
1T15L-4	21 - 23
1T15LC-4.5	26
1T15LP-5	30, 31
1T15L-6	23
1T15LP-6	31
1T15L-9	24

BELLOW NO.	PAGE NO.
9.00" DIA. BEAD PLATE, 9.12" MOLDED DIA.	
1T15LB-10	25
1T15LC-12	27
9.00" DIA. BEAD PLATE, 10.12" MOLDED DIA.	
1T15M-0	31 - 35
1T15M-2	35 - 41
1T15MR-2	66
1T15MT-3	67
1T15M-4	41 - 47
1T15M-6	5, 47 - 54
1T15MBTW-6	69
1T15MJ-6	66
1T15MT-6	67
1T15MW-6	68
1T15MLW-7	68
1T15M-7.5	54 - 57
1T15M-8	57 - 60
1T15M-9	60 - 64
1T15MM-9	66
1T15MBTW-10	69
1T15M-11	64, 65
1T15MBTW-12	69
1T15V-1	75
1T15V-3	75
1T15VP-4	79
1T15V-8	75 - 77
1T15VMW-8	79
1T15V-11	77, 78
9.00" DIA. BEAD PLATE, 10.62" MOLDED DIA.	
1T15ZR-6	#N/A
10.38" DIA. BEAD PLATE, 10.12" MOLDED DIA.	
1T17AZR-4.5	82
1T17AEZR-5	82
1T17BB-2	85
1T17B-5	82 - 84

Firestone

1T & Convoluted Bellows Index by Size

BELLOW NO.	PAGE NO.
10.38" DIA. BEAD PLATE, 10.12" MOLDED DIA.	
1T17B-11	84, 85
1T17BP-17	85
1T17C-3	86
1T17CA-3	87
1T17CD-3	88
1T17CA-5	87
1T17CL-5	88
1T17CA-6	87
1T17CA-6.5	88
1T17C-8	87
1T17CL-9.5	89
11.31" DIA. BEAD PLATE, 10.62" MOLDED DIA.	
1T19F-3 or 1T19L-3	90
1T19F-5 or 1T19L-5	90 - 92
1T19L-5	90 - 92
1T19LC-5	101
1T19FC-6 or 1T19LC-6	101
1T19LF-7	102
1T19F-7 or 1T19L-7	92 - 94
1T19FC-8 or 1T19LC-8	102
1T19LE-8	102
1T19F-9 or 1T19L-9	95, 96
1T19F-11 or 1T19L-11	96 - 98
1T19F-12 or 1T19L-12	89, 99, 100
1T19F-14 or 1T19L-14	100
1T19F-16 or 1T19L-16	89, 101
1T19LE-8	102
1T19J-1	89
1T19N-9 or 1T19L-9	95, 96
1T19ZK-5.7	102, 103
12.21" DIA. BEAD PLATE, 12.62" MOLDED DIA.	
1T66E-11.8	104

BELLOW NO.	PAGE NO.
SINGLE CONVOLUTED	
11.31" DIA. BEAD PLATE, 14.12" MOLDED DIA.	
113-1X88-1	#N/A
9.00" DIA. BEAD PLATE, 12.00" MOLDED DIA.	
19	#N/A
19-.75	#N/A
11.31" DIA. BEAD PLATE, 14.12" MOLDED DIA.	
113	#N/A
113-.5	#N/A
113-1	#N/A
19.00" DIA. BEAD PLATE, 21.50" MOLDED DIA.	
126	#N/A
6.31" DIA. BEAD PLATE, 8.88" MOLDED DIA.	
150	#N/A
DOUBLE CONVOLUTED	
4.5" DIA. BEAD PLATE, 5.75" MOLDED DIA.	
25 (Replaced by 268C)	#N/A
255-1.5 (Replaced by 267-1.5)	#N/A
5.31" DIA. BEAD PLATE, 7.25" MOLDED DIA.	
224	130
264	133
5.31" DIA. BEAD PLATE, 7.44" MOLDED DIA.	
26	127, 128
6.31" DIA. BEAD PLATE, 8.88" MOLDED DIA.	
20	111-114
201	128
20-2	115-117
9.00" DIA. BEAD PLATE, 12.00" MOLDED DIA.	
22	121-124
22-1.5	125-126
228-1.5	130-131
10.38" DIA. BEAD PLATE, 12.00" MOLDED DIA.	
252	132
11.31" DIA. BEAD PLATE, 14.5" MOLDED DIA.	
21	118-120

Cross References

1T & Convoluted Bellows Index by Size

BELLOW NO.	PAGE NO.
11.31" DIA. BEAD PLATE, 14.5" MOLDED DIA.	
205	129
21-2	120-121
233-2	131-132
256-2	132
13.79" DIA. BEAD PLATE, 16.00" MOLDED DIA.	
28	128
15.13" DIA. BEAD PLATE, 16.00" MOLDED DIA.	
201	128
17.75" DIA. BEAD PLATE, 19.5" MOLDED DIA.	
203	129
16.5" DIA. BEAD PLATE, 19.5" MOLDED DIA.	
203	129
17.75" DIA. BEAD PLATE, 19.5" MOLDED DIA.	
218	130
19.00" DIA. BEAD PLATE, 21.5" MOLDED DIA.	
29	128
25.13" DIA. BEAD PLATE, 26.3" MOLDED DIA.	
215	129

BELLOW NO.	PAGE NO.
TRIPLE CONVOLUTED	
9.00" DIA. BEAD PLATE, 11.7" MOLDED DIA.	
38	133
354	143
10.38" DIA. BEAD PLATE, 11.7" MOLDED DIA.	
352	142-143
11.31" DIA. BEAD PLATE, 14.5" MOLDED DIA.	
313	138-139
39	137
333	139-142
13.79" DIA. BEAD PLATE, 16.00" MOLDED DIA.	
312	137
15.13" DIA. BEAD PLATE, 16.00" MOLDED DIA.	
312	137
16.5" DIA. BEAD PLATE, 19.5" MOLDED DIA.	
323	139
19.00" DIA. BEAD PLATE, 21.5" MOLDED DIA.	
320	139
25.13" DIA. BEAD PLATE, 26.3" MOLDED DIA.	
321	139

Firestone

1T Piston Index by Piston Component Number

PISTON COMPONENT NO.	PISTON TYPE	MATERIAL	PISTON AON	PISTON DRAWING NO.	BELLOWS	PAGE NO.
3819	1T19G-9	Aluminum	N/A	NAD-19654	1T19F-3 or 1T19L-3,	#N/A
3819	1T19G-9	Aluminum	N/A	NAD-19654	1T19LC-8 or 1T19 LE-8	102
3819	1T19G-9	Aluminum	N/A	NAD-19654	1T19LE-12 or 1T19G-12	102
3822	1T15M-2	Aluminum	N/A	NBD-10378	1T15M-2	35 - 41
3822	1T15M-2	Aluminum	N/A	NBD-10378	1T17B-5	82 - 84
3822	1T15M-2	Aluminum	N/A	NBD-10378	1T15L-4	21 - 23
3822	1T15M-2	Aluminum	N/A	NBD-10378	1T15MP-4.5	#N/A
3822	1T15M-2	Aluminum	N/A	NBD-10378	1T15MT-3	67
3853	1T15M-9	Aluminum	N/A	NBD-14153	1T15M-11	64, 65
3853	1T15M-9	Aluminum	N/A	NBD-14153	1T15M-9	60 - 64
3882	1T17CA-5	Steel	N/A	NAD-31635	1T17CA-6	87
3882	1T17CA-5	Steel	N/A	NAD-31635	1T17B-7	84
3894	1T19G-5	Aluminum	N/A	NAD-34318	1T19LC-5	101
3894	1T19G-5	Aluminum	N/A	NAD-34318	1T19L-5 or 1T19F-5	90 - 92
6885	N/A	Plastic	N/A	FIP-100912		165
6913	N/A	Plastic	N/A	NBD-16538		147
9461	1T66	Steel	WC1-358-9999	FIP-101678	1T66E-11.8	104
9462	1T15V-7	Plastic	WC1-358-0669	FIP-101776	1T15M-6	5, 47 - 54
9462	1T15V-7	Plastic	WC1-358-0669	FIP-101776	1T15V-8	75 - 77
9462	1T15V-7	Plastic	WC1-358-0669	FIP-101776	1T15M-4	41 - 47
9482	1T19E-1	Steel	N/A	NAD-36702	1T19L-7	92 - 94
9492	1T15T-0	Plastic	WC1-358-1642	FIP-100742	1T15TM-1	72
9492	1T15T-0	Plastic	WC1-358-1642	FIP-100742	1T15TQ-1	73, 74
9492	1T15T-0	Plastic	WC1-358-1642	FIP-100742	1T15T-2	72
9492	1T15T-0	Plastic	WC1-358-1642	FIP-100742	1T15T-1	71
9492	1T15T-0	Plastic	WC1-358-1642	FIP-100742	1T15TM-1	72
9493	1T14C-1	Plastic	WC1-358-0754	FIP-100743	1T14CB-1	15, 16
9494	1T14C-1	Plastic	WC1-358-0754	FIP-100743	1T14C-3	10 - 12
9494	1T14C-1	Plastic	WC1-358-0754	FIP-100743	1T14C-6	13, 14
9500	replaced by 9503			NAD-17855		#N/A
9503	replaced by 9544			NAD-29826		#N/A

Cross References

1T Piston Index by Piston Component Number

PISTON COMPONENT NO.	PISTON TYPE	MATERIAL	PISTON AON	PISTON DRAWING NO.	BELLOWS	PAGE NO.
9505	replaced by 9492			NBD-14537		#N/A
9508	replaced by 9493			NBD-10441		#N/A
9513	replaced by 9536			NBD-17736		#N/A
9514	replaced by 9596			NAD-19027		#N/A
9515	replaced by 9535			NAD-19027		#N/A
9516	replaced by 9530			NAD-19477		#N/A
9519	replaced by 9532			NAD-19774		#N/A
9522	replaced by 9560			NAD-25610		#N/A
9523	replaced by 9561			NAD-25614		#N/A
9525	1T17B-6	Plastic	WC1-358-1609	NAD-26906	1T17CA-5	87
9525	1T17B-6	Plastic	WC1-358-1609	NAD-26906	1T17B-5	82 - 84
9525	1T17B-6	Plastic	WC1-358-1609	NAD-26906	1T17BM-6	85
9527	1T15ZR-6	Plastic	WC1-358-1627	NAD-27265	C01-358-0583	80
9528	1T15V-1	Plastic	WC1-358-0667	NBD-14404	1T17C-3	86
9528	1T15V-1	Plastic	WC1-358-0667	NBD-14404	1T15M-2	35 - 41
9528	1T15V-1	Plastic	WC1-358-0667	NBD-14404	1T15V-1	75
9528	1T15V-1	Plastic	WC1-358-0667	NBD-14404	1T15V-3	75
9528	1T15V-1	Plastic	WC1-358-0667	NBD-14404	1T17B-3	#N/A
9530	1T15M-6	Plastic	WC1-358-9452	NAD-27809	1T15M-6	5, 47 - 54
9530	1T15M-6	Plastic	WC1-358-9452	NAD-27809	1T15M-9	60 - 64
9530	1T15M-6	Plastic	WC1-358-9452	NAD-27809	1T15M-7.5	54 - 57
9530	1T15M-6	Plastic	WC1-358-9452	NAD-27809	1T15M-2	35 - 41
9530	1T15M-6	Plastic	WC1-358-9452	NAD-27809	1T15V-8	75 - 77
9530	1T15M-6	Plastic	WC1-358-9452	NAD-27809	1T15L-9	24
9530	1T15M-6	Plastic	WC1-358-9452	NAD-27809	1T15M-11	64, 65
9530	1T15M-6	Plastic	WC1-358-9452	NAD-27809	1T15VM-8	#N/A
9531	1T15MP-6	Plastic	WC1-358-1626	NAD-28197	1T15M-9	60 - 64
9531	1T15MP-6	Plastic	WC1-358-1626	NAD-28197	1T15MA-9	#N/A
9531	1T15MP-6	Plastic	WC1-358-1626	NAD-28197	1T15MPW-7	68, 69
9531	1T15MP-6	Plastic	WC1-358-1626	NAD-28197	1T15MMW-8.5	#N/A

Firestone

1T Piston Index by Piston Component Number

PISTON COMPONENT NO.	PISTON TYPE	MATERIAL	PISTON AON	PISTON DRAWING NO.	BELLOWS	PAGE NO.
9531	1T15MP-6	Plastic	WC1-358-1626	NAD-28197	1T15MMW-10.5	#N/A
9532	1T15M-6	Plastic	WC1-358-1619	NAD-29827	1T17B-11	84, 85
9532	1T15M-6	Plastic	WC1-358-1619	NAD-29827	1T15M-4	41 - 47
9532	1T15M-6	Plastic	WC1-358-1619	NAD-29827	1T15M-9	60 - 64
9532	1T15M-6	Plastic	WC1-358-1619	NAD-29827	1T15MPW-7	68, 69
9532	1T15M-6	Plastic	WC1-358-1619	NAD-29827	1T15M-6	5, 47 - 54
9532	1T15M-6	Plastic	WC1-358-1619	NAD-29827	1T15LP-5	30, 31
9532	1T15M-6	Plastic	WC1-358-1619	NAD-29827	1T15M-2	35 - 41
9532	1T15M-6	Plastic	WC1-358-1619	NAD-29827	1T15M-6	5, 47 - 54
9532	1T15M-6	Plastic	WC1-358-1619	NAD-29827	1T15V-8	75 - 77
9532	1T15M-6	Plastic	WC1-358-1619	NAD-29827	1T15L-9	24
9532	1T15M-6	Plastic	WC1-358-1619	NAD-29827	1T15LB-10	25
9532	1T15M-6	Plastic	WC1-358-1619	NAD-29827	1T15L-6	23
9532	1T15M-6	Plastic	WC1-358-1619	NAD-29827	1T15MBTW-6	69
9532	1T15M-6	Plastic	WC1-358-1619	NAD-29827	1T15MBTW-10	69
9532	1T15M-6	Plastic	WC1-358-1619	NAD-29827	1T15M-7.5	54 - 57
9532	1T15M-6	Plastic	WC1-358-1619	NAD-29827	1T17B-5	82 - 84
9532	1T15M-6	Plastic	WC1-358-1619	NAD-29827	1T15MPW-6	#N/A
9532	1T15M-6	Plastic	WC1-358-1619	NAD-29827	1T15L-4	21 - 23
9532	1T15M-6	Plastic	WC1-358-1619	NAD-29827	1T15MT-9	#N/A
9533	1T17BB-2	Plastic	WC1-358-1644	NAD-30515	1T17CD-3	88
9533	1T17BB-2	Plastic	WC1-358-1644	NAD-30515	1T17BB-2	85
9533	1T17BB-2	Plastic	WC1-358-1644	NAD-30515	1T17C-3	86
9534	1T15S-6	Plastic	N/A	NAD-29634	1T15S-6 or 1T15AA-3	16, 29, 70
9534	1T15S-6	Plastic	N/A	NAD-29634	1T15S-5 or 1T15AA-3	16, 29, 70
9534	1T15S-6	Plastic	N/A	NAD-29634	1T15AA-3	16, 29
9534	1T15S-6	Plastic	N/A	NAD-29634	1T15LP-3	28, 30
9534	1T15S-6	Plastic	N/A	NAD-29634	1T15SN-6	70, 71
9535	1T15S-6	Aluminum	N/A	NAD-29592	1T15SN-3	70
9535	1T15S-6	Plastic	N/A	NAD-29592	1T15S-6 or 1T15AA-3	16, 29, 70
9535	1T15S-6	Plastic	N/A	NAD-29592	1T15SN-6	70, 71
9535	1T15S-6	Plastic	N/A	NAD-29592	1T15AA-3	16, 29
9535	1T15S-6	Plastic	N/A	NAD-29592	1T15S-6 or 1T15AA-3	16, 29, 70

Cross References

1T Piston Index by Piston Component Number

PISTON COMPONENT NO.	PISTON TYPE	MATERIAL	PISTON AON	PISTON DRAWING NO.	BELLOWS	PAGE NO.
9535	1T15S-6	Plastic	N/A	NAD-29592	1T15AA-6	16
9535	1T15S-6	Plastic	N/A	NAD-29592	1T15LP-3	28, 30
9536	1T15S-6	Plastic	WC1-358-0755	NAD-29594	1T15AA-6	16
9536	1T15S-6	Plastic	WC1-358-0755	NAD-29594	1T15S-6 or 1T15AA-3	16, 29, 70
9536	1T15S-6	Plastic	WC1-358-0755	NAD-29594	1T15S-6 or 1T15AA-3	16, 29, 70
9536	1T15S-6	Plastic	WC1-358-0755	NAD-29594	1T15AA-3	16, 29
9536	1T15S-6	Plastic	WC1-358-0755	NAD-29594	1T15LP-3	28, 30
9537	1T17B-7	Plastic	WC1-358-1637	NAD-29798	1T17CA-6.5	88
9538	1T15M-6	Plastic	WC1-358-1628	NAD-27740	1T15M-6	5, 47 - 54
9538	1T15M-6	Plastic	WC1-358-1628	NAD-27740	1T15M-8	57 - 60
9538	1T15M-6	Plastic	WC1-358-1628	NAD-27740	1T15MT-6	67
9538	1T15M-6	Plastic	WC1-358-1628	NAD-27740	1T15M-8	57 - 60
9538	1T15M-6	Plastic	WC1-358-1628	NAD-27740	1T15MPW-7	68, 69
9538	1T15M-6	Plastic	WC1-358-1628	NAD-27740	1T15XMR-7	80
9538	1T15M-6	Plastic	WC1-358-1628	NAD-27740	1T15MT-8	#N/A
9538	1T15M-6	Plastic	WC1-358-1628	NAD-27740	1T15XNR-5	80
9538	1T15M-6	Plastic	WC1-358-1628	NAD-27740	1T17C-6	86
9538	1T15M-6	Plastic	WC1-358-1628	NAD-27740	1T17CB-6.5	#N/A
9540	1T15M-9	Plastic	WC1-358-0664	NAD-29828	1T15LC-12	27
9540	1T15M-9	Plastic	WC1-358-0664	NAD-29825	1T15LP-5	30, 31
9540	1T15M-9	Plastic	WC1-358-0664	NAD-29848	1T15M-11	64, 65
9540	1T15M-9	Plastic	WC1-358-0664	NAD-29828	1T15M-6	5, 47 - 54
9540	1T15M-9	Plastic	WC1-358-0664	NAD-29828	1T15M-7.5	54 - 57
9540	1T15M-9	Plastic	WC1-358-0664	NAD-29828	1T15M-9	60 - 64
9540	1T15M-9	Plastic	WC1-358-0664	NAD-29828	1T15MBTW-12	69
9540	1T15M-9	Plastic	WC1-358-0664	NAD-29828	1T15V-8	75 - 77
9540	1T15M-9	Plastic	WC1-358-0664	NAD-29828	1T17B-11	84, 85
9541	replaced by 9540			NAD-25608		#N/A
9544	1T15M-4	Plastic	WC1-358-0666	NAD-29826	1T15LP-5	30, 31
9544	1T15M-4	Plastic	WC1-358-0666	NAD-29826	1T15M-2	35 - 41
9544	1T15M-4	Plastic	WC1-358-0666	NAD-29826	1T15M-4	41 - 47
9544	1T15M-4	Plastic	WC1-358-0666	NAD-29826	1T15M-6	5, 47 - 54
9544	1T15M-4	Plastic	WC1-358-0666	NAD-29826	1T15M-7.5	54 - 57

Firestone

1T Piston Index by Piston Component Number

PISTON COMPONENT NO.	PISTON TYPE	MATERIAL	PISTON AON	PISTON DRAWING NO.	BELLOWS	PAGE NO.
9544	1T15M-4	Plastic	WC1-358-0666	NAD-29826	1T15MPW-7	68, 69
9544	1T15M-4	Plastic	WC1-358-0666	NAD-29826	1T15V-8	75 - 77
9545	replaced by 9549			NAD-26205		#N/A
9546	replaced by 9550			NAD-26204		#N/A
9549	1T15M-2	Plastic	WC1-358-1616	NAD-29454	1T15L-2	18 - 21
9549	1T15M-2	Plastic	WC1-358-1616	NAD-29454	1T15L-4	21 - 23
9549	1T15M-2	Plastic	WC1-358-1616	NAD-29454	1T15LP-2	27, 28
9549	1T15M-2	Plastic	WC1-358-1616	NAD-29454	1T15LP-5	30, 31
9549	1T15M-2	Plastic	WC1-358-1616	NAD-29454	1T15M-2	35 - 41
9549	1T15M-2	Plastic	WC1-358-1616	NAD-29454	1T15M-4	41 - 47
9550	1T15M-2	Plastic	WC1-358-1652	NAD-29456	1T15M-2	35 - 41
9550	1T15M-2	Plastic	WC1-358-1652	NAD-29456	1T15MT-3	67
9550	1T15M-2	Plastic	WC1-358-1652	NAD-29456	1T17BV-3	#N/A
9550	1T15M-2	Plastic	WC1-358-1652	NAD-29456	1T15L-4	21 - 23
9553	1T15M-9	Plastic	WC1-358-9453	NAD-29467	1T15M-11	64, 65
9553	1T15M-9	Plastic	WC1-358-9453	NAD-29467	1T15M-6	5, 47 - 54
9553	1T15M-9	Plastic	WC1-358-9453	NAD-29467	1T15M-9	60 - 64
9553	1T15M-9	Plastic	WC1-358-9453	NAD-29467	1T15V-8	75 - 77
9555	1T14C-1	Plastic	WC1-358-0609	NBD-10500	1T14C-1	9, 10
9555	1T14C-1	Plastic	WC1-358-0609	NBD-10500	1T14CB-1	15, 16
9557	1T15MP-6	Plastic	WC1-358-1654	NAD-31181	1T15VMW-8	79
9557	1T15MP-6	Plastic	WC1-358-1654	NAD-31181	1T15MPW-7	68, 69
9560	1T15M-6	Plastic	WC1-358-1620	NAD-32768	1T15M-6	5, 47 - 54
9560	1T15M-6	Plastic	WC1-358-1620	NAD-32768	1T15M-8	57 - 60
9561	1T15M-6	Plastic	WC1-358-1606	NAD-32767	1T15MT-6	67
9561	1T15M-6	Plastic	WC1-358-1606	NAD-32767	1T15M-8	57 - 60
9562	1T19L-9	Plastic	WC1-358-1651	NAD-33610	1T19L-11	96 - 98
9562	1T19L-9	Plastic	WC1-358-1651	NAD-33610	1T19L-9	95, 96
9562	1T19L-9	Plastic	WC1-358-1651	NAD-33610	1T19L-7	92 - 94
9563	1T15M-6	Plastic	N/A	NAD-34178	1T15M-7.5	54 - 57
9565	1T15M-7	Plastic	WC1-358-9652	NAD-35451	1T15LP-3	28, 30
9567	1T15B-2	Aluminum	N/A	NAD-35451	1T15LP-3 or 1T15AA-3	16, 28 - 30
9567	1T15B-2	Aluminum	N/A	NAD-35451	1T15AA-3	16, 29

Cross References

1T Piston Index by Piston Component Number

PISTON COMPONENT NO.	PISTON TYPE	MATERIAL	PISTON AON	PISTON DRAWING NO.	BELLOWS	PAGE NO.
9569	1T15KW-0	Plastic	WC1-358-1629	NAD-27754	1T15M-0.5	35
9569	1T15KW-0	Plastic	WC1-358-1629	NAD-27754	1T15LA-0	25
9569	1T15KW-0	Plastic	WC1-358-1629	NAD-27754	1T15LA-(-1)	24
9569	1T15KW-0	Plastic	WC1-358-1629	NAD-27754	1T15KW- (-1)	#N/A
9569	1T15KW-0	Plastic	WC1-358-1629	NAD-27754	1T15LP-2	27, 28
9569	1T15KW-0	Plastic	WC1-358-1629	NAD-27754	1T15KW-0	#N/A
9570	1T15KW-1.5	Plastic	WC1-358-0647	NAD-18162	1T15M-0	31 - 35
9570	1T15KW-1.5	Plastic	WC1-358-0647	NAD-18162	1T15L-1.5	17
9571	1T15KW-1.5	Plastic	WC1-358-0646	NAD-18130	1T15M-2	35 - 41
9571	1T15KW-1.5	Plastic	WC1-358-0646	NAD-18130	1T15M-0	31 - 35
9571	1T15KW-1.5	Plastic	WC1-358-0646	NAD-18130	1T15L-2	18 - 21
9571	1T15KW-1.5	Plastic	WC1-358-0646	NAD-18130	1T15L-1.5 1T15KW-1.5	#N/A
9571	1T15KW-1.5	Plastic	WC1-358-0646	NAD-18130	1T15T-1	71
9572	1T15KW-1.5	Plastic	N/A	NAD-18161	1T15-L-1.5	#N/A
9572	1T15KW-1.5	Plastic	N/A	NAD-18161	1T15-L-0.5	#N/A
9572	1T15KW-1.5	Plastic	N/A	NAD-18161	1T15M-0	31 - 35
9572	1T15KW-1.5	Plastic	N/A	NAD-18161	1T15L-2	18 - 21
9572	1T15KW-1.5	Plastic	N/A	NAD-18161	1T15LP-2	27, 28
9573	1T15KW-1.5	Plastic	WC1-358-1634	NAD-18162	1T15L-2	18 - 21
9573	1T15KW-1.5	Plastic	WC1-358-1634	NAD-18162	1T15L-3	21
9573	1T15KW-1.5	Plastic	WC1-358-1634	NAD-18162	1T15LP-5	30, 31
9573	1T15KW-1.5	Plastic	WC1-358-1634	NAD-18162	1T15M-0	31 - 35
9573	1T15KW-1.5	Plastic	WC1-358-1634	NAD-18162	1T15M-0.5	35
9573	1T15KW-1.5	Plastic	WC1-358-1634	NAD-18162	1T15M-2	35 - 41
9573	1T15KW-1.5	Plastic	WC1-358-1634	NAD-18162	1T15M-4	41 - 47
9575	1T66E-11	Plastic	N/A	NAD-26944	1T66E-11.8	104
9579	1T19F-9	Plastic	WC1-358-1679	NAD-19969	1T19N-9 or 1T19L-9	95, 96
9580	1T19F-11	Plastic	WC1-358-0528	NAD-27909	1T19F-12 or 1T19L-12	89, 99, 100
9580	1T19F-11	Plastic	WC1-358-0528	NAD-27909	1T19LC-11	#N/A
9580	1T19F-11	Plastic	WC1-358-0528	NAD-27909	1T19F-9 or 1T19L-9	95, 96
9580	1T19F-11	Plastic	WC1-358-0528	NAD-27909	1T19F-11 or 1T19L-11	96 - 98
9580	1T19F-11	Plastic	WC1-358-0528	NAD-27909	1T19F-7 or 1T19L-7	92

Firestone

1T Piston Index by Piston Component Number

PISTON COMPONENT NO.	PISTON TYPE	MATERIAL	PISTON AON	PISTON DRAWING NO.	BELLOWS	PAGE NO.
9594	1T19LC-5	Plastic	WC1-358-1614	NAD-28384	1T19FC-6 or 1T19LC-6	101
9594	1T19LC-5	Plastic	WC1-358-1614	NAD-28384	1T19FC-8 or 1T19LC-8	102
9594	1T19LC-5	Plastic	WC1-358-1614	NAD-28384	1T19LF-7	102
9596	1T15S-6	Plastic	N/A	NAD-31791	1T15AA-3	16, 29
9601	replaced by 9527					#N/A
9602	1T15V-5	Aluminum	WC1-358-1613	NAD-28351	1T17B-5	82 - 84
9602	1T15V-5	Aluminum	WC1-358-1613	NAD-28351	1T15VP-4	79
9602	1T15V-5	Aluminum	WC1-358-1613	NAD-28351	1T17CC7	#N/A
9602	1T15V-5	Aluminum	WC1-358-1613	NAD-28351	1T17C6	#N/A
9603	1T15V-5	Aluminum	WC1-358-1635	NAD-29630	1T17C-3	86
9603	1T15V-5	Aluminum	WC1-358-1635	NAD-29630	1T17B-5	82 - 84
9603	1T15V-5	Aluminum	WC1-358-1635	NAD-29630	1T17C-3	86
9603	1T15V-5	Aluminum	WC1-358-1635	NAD-29630	1T17C-6.5	#N/A
9603	1T15V-5	Aluminum	WC1-358-1635	NAD-29630	1T17B-5	82 - 84
9604	1T15ZR-6	Aluminum	WC1-358-1624	NAD-30174	C01-358-0583	81
9637	N/A	Plastic	N/A	FIP-102215		163
9640	1T19ZK5.7	Aluminum	N/A	FIP-101136	1T19ZK-5.7	102
9642	1T19F-9	Aluminum	N/A	NAD-33001	1T19F-11 or 1T19L-11	96 - 98
9644	1T19ZR-6.2	Steel	WC1-358-9999	NAD-31862	1T19ZK-5.7	102, 103
9645	1T15CCR-6	Steel	N/A	NAD-31622	1T15CCR6	#N/A
9646	1T17B17	Steel	N/A	NAD-31215	1T17BP-17	85
9648	1T17B-4	Steel	WC1-358-1649	NAD-31288	1T17CA-3	87
9648	1T17B-4	Steel	WC1-358-1649	NAD-31288	1T17B-5	82 - 84
9648	1T17B-4	Steel	WC1-358-1649	NAD-31288	1T15VP-4	79
9651	1T14C-3	Aluminum	WC1-358-9095	NBD-11498	1T14C-1	9, 10
9651	1T14C-3	Aluminum	WC1-358-9095	NBD-11498	1T14C-3	10 - 12
9651	1T14C-3	Aluminum	WC1-358-9095	NBD-11498	1T14C-5	13
9651	1T14C-3	Aluminum	WC1-358-9095	NBD-11498	1T14CB-1	15, 16
9652	1T15M6	Aluminum	WC1-358-0659	NBD-10436	1T15M-7.5	57
9652	replaced by 9530			NBD-10436		#N/A
9653	1T15M-9	Aluminum	WC1-358-0620	NBD-10437	1T15M-11	64, 65
9653	1T15M-9	Aluminum	WC1-358-0620	NBD-10437	1T15M-9	60 - 64

Cross References

1T Piston Index by Piston Component Number

PISTON COMPONENT NO.	PISTON TYPE	MATERIAL	PISTON AON	PISTON DRAWING NO.	BELLOWS	PAGE NO.
9653	replaced by 9553			NBD-12639		#N/A
9654	1T15M-0	Aluminum	WC1-358-0663	NBD-10438	1T15L-2	18 - 21
9654	1T15M-0	Aluminum	WC1-358-0663	NBD-10438	1T15M-0	31 - 35
9654	1T15M-0	Aluminum	WC1-358-0663	NBD-10438	1T15L-2	18 - 21
9654	1T15M-0	Aluminum	WC1-358-0663	NBD-10438	1T15T-1	71
9655	1T15M-0	Aluminum	WC1-358-9454	NBD-10439	1T15M-0	31 - 35
9655	1T15M-0	Aluminum	WC1-358-9454	NBD-10439	1T15M-0	31 - 35
9655	1T15M-0	Aluminum	WC1-358-9454	NBD-10439	1T15M-0	31 - 35
9655	1T15M-0	Aluminum	WC1-358-9454	NBD-10439	1T15TM-1	72
9655	1T15M-0	Aluminum	WC1-358-9454	NBD-10439	1T15L-2	18 - 21
9656	1T15M-2	Aluminum	WC1-358-0652	NBD-10267	1T15M-4	41 - 47
9656	1T15M-2	Aluminum	WC1-358-0652	NBD-10267	1T15LP-2	27, 28
9656	1T15M-2	Aluminum	WC1-358-0652	NBD-10267	1T15M-2	35 - 41
9656	1T15M-2	Aluminum	WC1-358-0652	NBD-10267	1T15M-4	41 - 47
9656	1T15M-2	Aluminum	WC1-358-0652	NBD-10267	1T15L-4	21 - 23
9656	1T15M-2	Aluminum	WC1-358-0652	NBD-10267	1T15M-4	41 - 47
9657	1T19E-1	Aluminum	WC1-358-9450	NAD-18101	1T19F-5 or 1T19L-5	90 - 92
9657	1T19E-1	Aluminum	WC1-358-9450	NAD-18101	1T19F-7 or 1T19L-7	92 - 94
9657	1T19E-1	Aluminum	WC1-358-9450	NAD-18101	1T19F-9 or 1T19L-9	95, 96
9657	1T19E-1	Aluminum	WC1-358-9450	NAD-18101	1T19F-7	92
9657	1T19E-1	Aluminum	WC1-358-9450	NAD-18101	1T19F-5 or 1T19L-5	90 - 92
9657	1T19E-1	Aluminum	WC1-358-9450	NAD-18101	1T19F-7 or 1T19L-7	92 - 94
9657	1T19E-1	Aluminum	WC1-358-9450	NAD-18101	1T19L-11	96 - 98
9658	1T19E-2	Aluminum	WC1-358-1640	NAD-18102	1T19F-11 or 1T19L-11	96 - 98
9658	replaced by 9580			NAD-18102		#N/A
9659	1T15T-3	Aluminum	WC1-358-0683	NBD-10472	1T15LP-1.5	27
9659	1T15T-3	Aluminum	WC1-358-0683	NBD-10472	1T15L-4	21 - 23
9659	1T15T-3	Aluminum	WC1-358-0683	NBD-10472	1T15L-2	18 - 21
9659	1T15T-3	Aluminum	WC1-358-0683	NBD-10472	1T15L-2	18 - 21
9663	1T15L-2	Aluminum	N/A	NBD-12639	1T15LC-2.5	26

Firestone

1T Piston Index by Piston Component Number

PISTON COMPONENT NO.	PISTON TYPE	MATERIAL	PISTON AON	PISTON DRAWING NO.	BELLOWS	PAGE NO.
9663	1T15L-2	Aluminum	N/A	NBD-12639	1T15LC-4.5	26
9666	1T19G-9	Aluminum	N/A	NAD-19631	1T19LE-12	102
9666	1T19G-9	Aluminum	N/A	NAD-19631	1T19LE-8	102
9668	replaced by 9669			NAD-18727		#N/A
9669	1T19F-12	Aluminum	WC1-358-1602	NAD-26291	1T19F-12 or 1T19L-12	89, 99, 100
9669	1T19F-12	Aluminum	WC1-358-1602	NAD-26291	1T19F-14 or 1T19L-14	100
9669	1T19F-12	Aluminum	WC1-358-1602	NAD-26291	1T19F-16 or 1T19L-16	89, 101
9671	1T17AZF	Steel	N/A	NAD-32590	1T17AEZR-5	82
9671	1T17AZF	Steel	N/A	NAD-32590	1T17AZR-4.5	82
9676	1T15ZR-6	Steel	N/A	NAD-31612	C01-358-0583	81
9677	1T19E-2	Steel	N/A	NAD-32770	1T19F-11 or 1T19L-11	96 - 98
9680	replaced by 9681			NBD-10444		#N/A
9681	1T15Y-1	Aluminum	WC1-358-1612	NBD-14213	1T15TQ-1	73, 74
9686	replaced by 9646			NAD-28449		#N/A
9689	1T15V-11	Aluminum	WC1-358-1607	NAD-28838	1T17CL-9.5	89
9690	1T15V-11	Aluminum	N/A	NAD-28840	1T17C-8	87
9691	1T15L-4	Aluminum	WC1-358-0606	NBD-14503	1T15L-4	21 - 23
9694	1T15MM-9	Aluminum	WC1-358-1694	NAD-25396	1T15MLW-7	68
9694	1T15MM-9	Aluminum	WC1-358-1694	NAD-25396	1T15LP-6	31
9694	1T15MM-9	Aluminum	WC1-358-1694	NAD-25396	1T15MM-9	66
9694	1T15MM-9	Aluminum	WC1-358-1694	NAD-25396	1T15MW-6	68
9696	1T15M-7.5	Aluminum	WC1-358-1636	NBD-14366	1T15M-7.5	54 - 57
9702	1T15M-2	Aluminum	WC1-358-1608	NAD-27357	1T15MT-3	67
9708	1T14C-1	Aluminum	WC1-358-0600	NBD-8626	1T14C-1	9, 10
9708	1T14C-1	Aluminum	WC1-358-0600	NBD-8626	1T14C-1 or 1T14F-2	9, 10
9708	1T14C-1	Aluminum	WC1-358-0600	NBD-8626	1T14C-3 or 1T14F-4	10 - 12
9708	1T14C-1	Aluminum	WC1-358-0600	NBD-8626	1T14C-3	10 - 12
9708	1T14C-1	Aluminum	WC1-358-0600	NBD-8626	1T14C-7 or 1T14F-8	14, 15
9727	1T15M-4	Aluminum	WC1-358-0651	NBD-8724	1T15M-4	41 - 47

Cross References

1T Piston Index by Piston Component Number

PISTON COMPONENT NO.	PISTON TYPE	MATERIAL	PISTON AON	PISTON DRAWING NO.	BELLOWS	PAGE NO.
9727	1T15M-4	Aluminum	WC1-358-0651	NBD-8724	1T15M-2	35 - 41
9727	1T15M-4	Aluminum	WC1-358-0651	NBD-8724	1T15M-6	5, 47 - 54
9727	1T15M-4	Aluminum	WC1-358-0651	NBD-8724	1T15V-8	75 - 77
9727	1T15M-4	Aluminum	WC1-358-0651	NBD-8724	1T15M-4	41 - 47
9728	replaced by 9642			NBD-8987		#N/A
9734	1T15M-6	Aluminum	WC1-358-1610	NAD-28002	1T17B-5	82 - 84
9742	1T15M-2	Aluminum	WC1-358-0658	NBD-8055	1T15M-2	35 - 41
9743	1T15M-2	Aluminum	WC1-358-0653	NBD-8183	1T15L-2	18 - 21
9743	1T15M-2	Aluminum	WC1-358-0653	NBD-8183	1T15L-4	21 - 23
9744	1T15MJ-6	Aluminum	N/A	NBD-9673	1T15MJ-6	66
9745	1T15T-0	Aluminum	WC1-358-0682	NBD-8312	1T15T-1	71
9745	replaced by 9505			NBD-14537		#N/A
9754	1T14C-7	Aluminum	WC1-358-1603	NBD-11689	1T14C-8	15
9754	1T14C-7	Aluminum	WC1-358-1603	NBD-11689	1T14C-6	13, 14
9754	1T14C-7	Aluminum	WC1-358-1603	NBD-11689	1T14C-7	14, 15
9754	1T14C-7	Aluminum	WC1-358-1603	NBD-11689	1T14C-6	13, 14
9757	replaced by 9567			NBD-9242		#N/A
9760	replaced by 9482	Steel		NAD-11668		#N/A
9765	1T19J-6	Aluminum	WC1-358-0684	NAD-29060	1T19J-6	#N/A
9766	1T19G-5	Aluminum	WC1-358-0631	NAD-28978	1T19FC-5 or 1T19LC-5	101
9766	1T19G-5	Aluminum	WC1-358-0631	NAD-28978	1T19L-5	90 - 92
9766	1T19G-5	Aluminum	WC1-358-0631	NAD-28978	1T19F-3 or 1T19L-3	90
9766	1T19G-5	Aluminum	WC1-358-0631	NAD-28978	1T19F-5 or 1T19L-5	90 - 92
9766	1T19G-5	Aluminum	WC1-358-0631	NAD-28978	1T19F-7 or 1T19L-7	92 - 94
9767	replaced by 9766			NAD-15321		#N/A
9769	1T19J-2	Aluminum	WC1-358-0685	NBD-10180	1T19J-1	89
9778	1T14F-4	Aluminum	WC1-358-0686	NAD-18053	1T14C-5	13
9778	1T14F-4	Aluminum	WC1-358-0686	NAD-18053	1T14C-3 or 1T14F-4	10 - 12
9778	1T14F-4	Aluminum	WC1-358-0686	NAD-18053	1T14C-7	14, 15

Firestone

1T Piston Index by Piston Component Number

PISTON COMPONENT NO.	PISTON TYPE	MATERIAL	PISTON AON	PISTON DRAWING NO.	BELLOWS	PAGE NO.
9778	1T14F-4	Aluminum	WC1-358-0686	NAD-18053	1T14C-3	10 - 12
9786	replaced by 9691			NBD-8514		#N/A
9796	replaced by 9666			NAD-17742		#N/A
9801	replaced by 9765			NAD-17936		#N/A
9802	1T17B-7	Aluminum	WC1-358-1611	NAD-27999	1T17CL-5	88
9802	1T17B-7	Aluminum	WC1-358-1611	NAD-27999	1T17B-5	82 - 84
9803	1T15V-11	Aluminum	WC1-358-0680	NAD-15324	1T15V-11	77, 78
9804	replaced by 9528			NBD-9171		#N/A
9809	replaced by 9583			NBD-9611		#N/A
9951	1T15M-6	Aluminum	WC1-358-0697	NAD-17833	1T15M-6	5, 47 - 54

Cross References

1T Piston Index by Piston Drawing Number

PISTON DRAWING NO.	PISTON COMPONENT NO.	PISTON TYPE	MATERIAL	PISTON AON	BELLOWS	PAGE NO.
NAD-11668	9760	1T19F-11	Steel	WC1-358-0675	1T19F-7 or 1T30E-1	92
NAD-15324	9803	1T15V-11	Aluminum	WC1-358-0680	1T15V-11	77, 78
NAD-17833	9951	1T15M-6	Aluminum	WC1-358-0697	1T15M-6	5, 47 - 54
NAD-18053	9778	1T14F-4	Aluminum	WC1-358-0686	1T14C-5	13
NAD-18053	9778	1T14F-4	Aluminum	WC1-358-0686	1T14C-3 or 1T14F-4	10 - 12
NAD-18053	9778	1T14F-4	Aluminum	WC1-358-0686	1T14C-7	14, 15
NAD-18053	9778	1T14F-4	Aluminum	WC1-358-0686	1T14C-3	10 - 12
NAD-18101	9657	1T19E-1	Aluminum	WC1-358-9450	1T19F-5 or 1T19L-5	90 - 92
NAD-18101	9657	1T19E-1	Aluminum	WC1-358-9450	1T19F-7 or 1T19L-7	92 - 94
NAD-18101	9657	1T19E-1	Aluminum	WC1-358-9450	1T19F-9 or 1T19L-9	95, 96
NAD-18101	9657	1T19E-1	Aluminum	WC1-358-9450	1T19F-7	92
NAD-18101	9657	1T19E-1	Aluminum	WC1-358-9450	1T19F-5 or 1T19L-5	90 - 92
NAD-18101	9657	1T19E-1	Aluminum	WC1-358-9450	1T19F-7 or 1T19L-7	92 - 94
NAD-18102	9658	1T19E-2	Aluminum	WC1-358-1640	1T19F-11 or 1T19L-11	96 - 98
NAD-18130	9571	1T15KW-1.5	Plastic	WC1-358-0646	1T15M-2	35 - 41
NAD-18130	9571	1T15KW-1.5	Plastic	WC1-358-0646	1T15M-0	31 - 35
NAD-18130	9571	1T15KW-1.5	Plastic	WC1-358-0646	1T15L-2	18 - 21
NAD-18130	9571	1T15KW-1.5	Plastic	WC1-358-0646	1T15L-1.5 1T15KW-1.5	#N/A
NAD-18130	9571	1T15KW-1.5	Plastic	WC1-358-0646	1T15T-1	71
NAD-18161	9572	1T15KW-1.5	Plastic	N/A	1T15-L-1.5	#N/A
NAD-18161	9572	1T15KW-1.5	Plastic	N/A	1T15M-0	31 - 35
NAD-18161	9572	1T15KW-1.5	Plastic	N/A	1T15L-2	18 - 21
NAD-18161	9572	1T15KW-1.5	Plastic	N/A	1T15LP-2	27, 28
NAD-18162	9570	1T15KW-1.5	Plastic	WC1-358-0647	1T15M-0	31 - 35
NAD-18162	9570	1T15KW-1.5	Plastic	WC1-358-0647	1T15L-1.5	17
NAD-18162	9573	1T15KW-1.5	Plastic	WC1-358-1634	1T15M-2	35 - 41
NAD-18162	9573	1T15KW-1.5	Plastic	WC1-358-1634	1T15M-4	41 - 47
NAD-18162	9573	1T15KW-1.5	Plastic	WC1-358-1634	1T15M-4	41 - 47
NAD-18162	9573	1T15KW-1.5	Plastic	WC1-358-1634	1T15M-0	31 - 35
NAD-18162	9573	1T15KW-1.5	Plastic	WC1-358-1634	1T15L-3	21

1T Piston Index by Piston Drawing Number

PISTON DRAWING NO.	PISTON COMPONENT NO.	PISTON TYPE	MATERIAL	PISTON AON	BELLOWS	PAGE NO.
NAD-18162	9573	1T15KW-1.5	Plastic	WC1-358-1634	1T15LP-5	30, 31
NAD-18162	9573	1T15KW-1.5	Plastic	WC1-358-1634	1T15M-0.5	35
NAD-18162	9573	1T15KW-1.5	Plastic	WC1-358-1634	1T15M-4	41 - 47
NAD-18162	9573	1T15KW-1.5	Plastic	WC1-358-1634	1T15M-2	35 - 41
NAD-18162	9573	1T15KW-1.5	Plastic	WC1-358-1634	1T15L-2	18 - 21
NAD-18162	9573	1T15KW-1.5	Plastic	WC1-358-1634	1T15M-2	35 - 41
NAD-19631	9666	1T19G-9	Aluminum	N/A	1T19LE-12	102
NAD-19631	9666	1T19G-9	Aluminum	N/A	1T19LE-8	102
NAD-19654	3819	1T19G-9	Aluminum		1T19F-3 or 1T19L-3	90
NAD-19969	9579	1T19F-9	Plastic	WC1-358-1679	1T19N-9 or 1T19L-9	95, 96
NAD-25396	9694	1T15MM-9	Aluminum	WC1-358-1694	1T15MLW-7	68
NAD-25396	9694	1T15MM-9	Aluminum	WC1-358-1694	1T15LP-6	31
NAD-25396	9694	1T15MM-9	Aluminum	WC1-358-1694	1T15MM-9	66
NAD-25396	9694	1T15MM-9	Aluminum	WC1-358-1694	1T15MW-6	68
NAD-26291	9669	1T19F-12	Aluminum	WC1-358-1602	1T19F-12 or 1T19L-12	89, 99, 100
NAD-26291	9669	1T19F-12	Aluminum	WC1-358-1602	1T19F-14 or 1T19L-14	100
NAD-26291	9669	1T19F-12	Aluminum	WC1-358-1602	1T19F-16 or 1T19L-16	89, 101
NAD-26906	9525	1T17B-6	Plastic	WC1-358-1609	1T17CA-5	87
NAD-26906	9525	1T17B-6	Plastic	WC1-358-1609	1T17B-5	82 - 84
NAD-26944	9575	1T66E-11	Plastic	N/A	1T66E-11.8	104
NAD-27265	9527	1T15ZR-6	Plastic	WC1-358-1627	C01-358-0583	80
NAD-27357	9702	1T15M-2	Aluminum	WC1-358-1608	1T15MT-3	67
NAD-27740	9538	1T15M-6	Plastic	WC1-358-1628	1T15M-6	5, 47 - 54
NAD-27740	9538	1T15M-6	Plastic	WC1-358-1628	1T15M-8	57 - 60
NAD-27740	9538	1T15M-6	Plastic	WC1-358-1628	1T15MT-6	67
NAD-27740	9538	1T15M-6	Plastic	WC1-358-1628	1T15M-8	57 - 60
NAD-27740	9538	1T15M-6	Plastic	WC1-358-1628	1T15MPW-7	68, 69
NAD-27754	9569	1T15KW-0	Plastic	WC1-358-1629	1T15M-0.5	35
NAD-27754	9569	1T15KW-0	Plastic	WC1-358-1629	1T15LA-0 1T15KW-0	25
NAD-27754	9569	1T15KW-0	Plastic	WC1-358-1629	1T15LA-(-1) 1T15KW-(-1)	24
NAD-27754	9569	1T15KW-0	Plastic	WC1-358-1629	1T15LP-2	27, 28

Cross References

1T Piston Index by Piston Drawing Number

PISTON DRAWING NO.	PISTON COMPONENT NO.	PISTON TYPE	MATERIAL	PISTON AON	BELLOWS	PAGE NO.
NAD-27754	9569	1T15KW-0	Plastic	WC1-358-1629	1T15LA-0 1T15KW-0	25
NAD-27809	9530	1T15M-6	Plastic	WC1-358-9452	1T15M-6	5, 47 - 54
NAD-27809	9530	1T15M-6	Plastic	WC1-358-9452	1T15M-9	60 - 64
NAD-27809	9530	1T15M-6	Plastic	WC1-358-9452	1T15M-7.5	54 - 57
NAD-27809	9530	1T15M-6	Plastic	WC1-358-9452	1T15M-2	35 - 41
NAD-27809	9530	1T15M-6	Plastic	WC1-358-9452	1T15M-6	5, 47 - 54
NAD-27809	9530	1T15M-6	Plastic	WC1-358-9452	1T15M-6	5, 47 - 54
NAD-27809	9530	1T15M-6	Plastic	WC1-358-9452	1T15M-7.5	54 - 57
NAD-27809	9530	1T15M-6	Plastic	WC1-358-9452	1T15V-8	75 - 77
NAD-27809	9530	1T15M-6	Plastic	WC1-358-9452	1T15L-9	24
NAD-27909	9580	1T19F-11	Plastic	WC1-358-0528	1T19F-12 or 1T19L-12	89, 99, 100
NAD-27909	9580	1T19F-11	Plastic	WC1-358-0528	1T19LC-11	#N/A
NAD-27909	9580	1T19F-11	Plastic	WC1-358-0528	1T19F-9 or 1T19L-9	95, 96
NAD-27909	9580	1T19F-11	Plastic	WC1-358-0528	1T19F-11 or 1T19L-11	96 - 98
NAD-27909	9580	1T19F-11	Plastic	WC1-358-0528	1T19F-7 or 1T19L-7	92
NAD-27999	9802	1T17B-7	Aluminum	WC1-358-1611	1T17CL-5	88
NAD-27999	9802	1T17B-7	Aluminum	WC1-358-1611	1T17B-5	82 - 84
NAD-28002	9734	1T15M-6	Aluminum	WC1-358-1610	1T17B-5	82 - 84
NAD-28197	9531	1T15MP-6	Plastic	WC1-358-1626	1T15M-9	60 - 64
NAD-28351	9602	1T15V-5	Aluminum	WC1-358-1613	1T17B-5	82 - 84
NAD-28351	9602	1T15V-5	Aluminum	WC1-358-1613	1T15VP-4	79
NAD-28384	9594	1T19LC-5	Plastic	WC1-358-1614	1T19FC-6 or 1T19LC-6	101
NAD-28384	9594	1T19LC-5	Plastic	WC1-358-1614	1T19FC-8 or 1T19LC-8	102
NAD-28384	9594	1T19LC-5	Plastic	WC1-358-1614	1T19LF-7	102
NAD-28838	9689	1T15V-11	Aluminum	WC1-358-1607	1T17CL-9.5	89
NAD-28840	9690	1T15V-11	Aluminum	N/A	1T17C-8	87
NAD-28978	9766	1T19G-5	Aluminum	WC1-358-0631	1T19FC-5 or 1T19LC-5	101
NAD-28978	9766	1T19G-5	Aluminum	WC1-358-0631	1T19L-5	90 - 92
NAD-28978	9766	1T19G-5	Aluminum	WC1-358-0631	1T19F-3 or 1T19L-3	90

Firestone

1T Piston Index by Piston Drawing Number

PISTON DRAWING NO.	PISTON COMPONENT NO.	PISTON TYPE	MATERIAL	PISTON AON	BELLOWS	PAGE NO.
NAD-28978	9766	1T19G-5	Aluminum	WC1-358-0631	1T19F-5 or 1T19L-5	90 - 92
NAD-28978	9766	1T19G-5	Aluminum	WC1-358-0631	1T19F-7 or 1T19L-7	92 - 94
NAD-29060	9765	1T19J-6	Aluminum	WC1-358-0684	1T19J-6	#N/A
NAD-29454	9549	1T15M-2	Plastic	WC1-358-1616	1T15M-2	35 - 41
NAD-29454	9549	1T15M-2	Plastic	WC1-358-1616	1T15M-4	41 - 47
NAD-29454	9549	1T15M-2	Plastic	WC1-358-1616	1T15L-2	18 - 21
NAD-29454	9549	1T15M-2	Plastic	WC1-358-1616	1T15L-4	21 - 23
NAD-29454	9549	1T15M-2	Plastic	WC1-358-1616	1T15LP-5	30, 31
NAD-29454	9549	1T15M-2	Plastic	WC1-358-1616	1T15LP-2	27, 28
NAD-29454	9549	1T15M-2	Plastic	WC1-358-1616	1T15M-4	41 - 47
NAD-29454	9549	1T15M-2	Plastic	WC1-358-1616	1T15M-2	35 - 41
NAD-29456	9550	1T15M-2	Plastic	WC1-358-1652	1T15MT-3	67
NAD-29456	9550	1T15M-2	Plastic	WC1-358-1652	1T15MT-3	67
NAD-29467	9553	1T15M-9	Plastic	WC1-358-9453	1T15M-6	5, 47 - 54
NAD-29467	9553	1T15M-9	Plastic	WC1-358-9453	1T15M-9	60 - 64
NAD-29467	9553	1T15M-9	Plastic	WC1-358-9453	1T15M-11	64, 65
NAD-29467	9553	1T15M-9	Plastic	WC1-358-9453	1T15M-9	60 - 64
NAD-29467	9553	1T15M-9	Plastic	WC1-358-9453	1T15M-11	64, 65
NAD-29467	9553	1T15M-9	Plastic	WC1-358-9453	1T15M-6	5, 47 - 54
NAD-29467	9553	1T15M-9	Plastic	WC1-358-9453	1T15M-9	60 - 64
NAD-29467	9553	1T15M-9	Plastic	WC1-358-9453	1T15V-8	75 - 77
NAD-29467	9553	1T15M-9	Plastic	WC1-358-9453	1T15M-11	64, 65
NAD-29592	9535	1T15S-6	Plastic	N/A	1T15SN-3	70
NAD-29592	9535	1T15S-6	Plastic	N/A	1T15S-6 or 1T15AA-3	16, 29, 70
NAD-29592	9535	1T15S-6	Plastic	N/A	1T15SN-6	70, 71
NAD-29592	9535	1T15S-6	Plastic	N/A	1T15AA-3	16, 29
NAD-29592	9535	1T15S-6	Plastic	N/A	1T15S-6 or 1T15AA-3	16, 29, 70
NAD-29594	9536	1T15S-6	Plastic	WC1-358-0755	1T15AA-6	16
NAD-29594	9536	1T15S-6	Plastic	WC1-358-0755	1T15S-6 or 1T15AA-3	16, 29, 70
NAD-29594	9536	1T15S-6	Plastic	WC1-358-0755	1T15S-6 or 1T15AA-3	16, 29, 70
NAD-29594	9536	1T15S-6	Plastic	WC1-358-0755	1T15AA-3	16, 29
NAD-29630	9603	1T15V-5	Aluminum	WC1-358-1635	1T17C-3	86

Cross References

1T Piston Index by Piston Drawing Number

PISTON DRAWING NO.	PISTON COMPONENT NO.	PISTON TYPE	MATERIAL	PISTON AON	BELLOWS	PAGE NO.
NAD-29630	9603	1T15V-5	Aluminum	WC1-358-1635	1T17B-5	82 - 84
NAD-29630	9603	1T15V-5	Aluminum	WC1-358-1635	1T17C-3	86
NAD-29630	9603	1T15V-5	Aluminum	WC1-358-1635	1T17C-6.5	#N/A
NAD-29630	9603	1T15V-5	Aluminum	WC1-358-1635	1T17B-5	82 - 84
NAD-29634	9534	1T15S-6	Plastic	N/A	1T15S-6 or 1T15AA-3	16, 29, 70
NAD-29634	9534	1T15S-6	Plastic	N/A	1T15S-5 or 1T15AA-3	16, 29, 70
NAD-29634	9534	1T15S-6	Plastic	N/A	1T15AA-3	16, 29
NAD-29798	9537	1T17B-7	Plastic	WC1-358-1637	1T17CA-6.5	88
NAD-29825	9540	1T15M-9	Plastic	WC1-358-0664	1T15LP-5	30, 31
NAD-29826	9544	1T15M-4	Plastic	WC1-358-0666	1T15M-4	41 - 47
NAD-29826	9544	1T15M-4	Plastic	WC1-358-0666	1T15M-6	5, 47 - 54
NAD-29826	9544	1T15M-4	Plastic	WC1-358-0666	1T15LP-5	30, 31
NAD-29826	9544	1T15M-4	Plastic	WC1-358-0666	1T15M-2	35 - 41
NAD-29826	9544	1T15M-4	Plastic	WC1-358-0666	1T15V-8	75 - 77
NAD-29826	9544	1T15M-4	Plastic	WC1-358-0666	1T15M-4	41 - 47
NAD-29826	9544	1T15M-4	Plastic	WC1-358-0666	1T15M-7.5	54 - 57
NAD-29826	9544	1T15M-4	Plastic	WC1-358-0666	1T15M-7.5	54 - 57
NAD-29826	9544	1T15M-4	Plastic	WC1-358-0666	1T15MPW-7	68, 69
NAD-29827	9532	1T15M-6	Plastic	WC1-358-1619	1T17B-11	84, 85
NAD-29827	9532	1T15M-6	Plastic	WC1-358-1619	1T15M-4	41 - 47
NAD-29827	9532	1T15M-6	Plastic	WC1-358-1619	1T15M-9	60 - 64
NAD-29827	9532	1T15M-6	Plastic	WC1-358-1619	1T15MPW-7	68, 69
NAD-29827	9532	1T15M-6	Plastic	WC1-358-1619	1T15M-6	5, 47 - 54
NAD-29827	9532	1T15M-6	Plastic	WC1-358-1619	1T15M-9	60 - 64
NAD-29827	9532	1T15M-6	Plastic	WC1-358-1619	1T15LP-5	30, 31
NAD-29827	9532	1T15M-6	Plastic	WC1-358-1619	1T15M-2	35 - 41
NAD-29827	9532	1T15M-6	Plastic	WC1-358-1619	1T15M-6	5, 47 - 54
NAD-29827	9532	1T15M-6	Plastic	WC1-358-1619	1T15V-8	75 - 77
NAD-29827	9532	1T15M-6	Plastic	WC1-358-1619	1T15M-6	5, 47 - 54
NAD-29827	9532	1T15M-6	Plastic	WC1-358-1619	1T15L-9	24
NAD-29827	9532	1T15M-6	Plastic	WC1-358-1619	1T15LB-10	25
NAD-29827	9532	1T15M-6	Plastic	WC1-358-1619	1T15L-6	23
NAD-29827	9532	1T15M-6	Plastic	WC1-358-1619	1T15MBTW-6	69
NAD-29827	9532	1T15M-6	Plastic	WC1-358-1619	1T15MBTW-10	69

Firestone

1T Piston Index by Piston Drawing Number

PISTON DRAWING NO.	PISTON COMPONENT NO.	PISTON TYPE	MATERIAL	PISTON AON	BELLOWS	PAGE NO.
NAD-29827	9532	1T15M-6	Plastic	WC1-358-1619	1T15M-4	41 - 47
NAD-29827	9532	1T15M-6	Plastic	WC1-358-1619	1T15M-7.5	54 - 57
NAD-29828	9540	1T15M-9	Plastic	WC1-358-0664	1T17B-11	84, 85
NAD-29828	9540	1T15M-9	Plastic	WC1-358-0664	1T15M-6	5, 47 - 54
NAD-29828	9540	1T15M-9	Plastic	WC1-358-0664	1T15M-9	60 - 64
NAD-29828	9540	1T15M-9	Plastic	WC1-358-0664	1T15V-8	75 - 77
NAD-29828	9540	1T15M-9	Plastic	WC1-358-0664	1T15LC-12	27
NAD-29828	9540	1T15M-9	Plastic	WC1-358-0664	1T15MBTW-12	69
NAD-29828	9540	1T15M-9	Plastic	WC1-358-0664	1T15M-7.5	54 - 57
NAD-29848	9540	1T15M-9	Plastic	WC1-358-0664	1T15M-11	64, 65
NAD-30174	9604	1T15ZR-6	Aluminum	WC1-358-1624	C01-358-0583	81
NAD-30515	9533	1T17BB-2	Plastic	WC1-358-1644	1T17CD-3	88
NAD-30515	9533	1T17BB-2	Plastic	WC1-358-1644	1T17BB-2	85
NAD-31181	9557	1T15MP-6	Plastic	WC1-358-1654	1T15VMW-8	79
NAD-31181	9557	1T15MP-6	Plastic	WC1-358-6262	1T15MPW-7	68, 69
NAD-31215	9646	1T17B17	Steel	N/A	1T17BP-17	85
NAD-31288	9648	1T17B-4	Steel	WC1-358-1649	1T17CA-3	87
NAD-31612	9676	1T15ZR-6	Steel	N/A	C01-358-0583	81
NAD-31622	9645	1T15CCR-6	Steel	N/A	1T15AA-6	16
NAD-31635	3882	1T17CA-5	Steel		1T17CA-6	87
NAD-31791	9596	1T15S-6	Plastic	N/A	1T15AA-3	16, 29
NAD-31862	9644	1T19ZR-6.2	Steel	WC1-358-9999	1T19ZK-5.7	102, 103
NAD-32590	9671	1T17AZF	Steel	N/A	1T17AEZR-5	82
NAD-32590	9671	1T17AZF	Steel	N/A	1T17AZR-4.5	82
NAD-32767	9561	1T15M-6	Plastic	WC1-358-1606	1T15MT-6	67
NAD-32767	9561	1T15M-6	Plastic	WC1-358-1606	1T15M-8	57 - 60
NAD-32768	9560	1T15M-6	Plastic	WC1-358-1620	1T15M-6	5, 47 - 54
NAD-32768	9560	1T15M-6	Plastic	WC1-358-1620	1T15M-6	5, 47 - 54
NAD-32768	9560	1T15M-6	Plastic	WC1-358-1620	1T15M-8	57 - 60
NAD-32770	9677	1T19E-2	Steel	N/A	1T19F-11 or 1T19L-11	96 - 98
NAD-33001	9642	1T19F-9	Aluminum	N/A	1T19F-11 or 1T19L-11	96 - 98
NAD-33610	9562	1T19L-9	Plastic	WC1-358-1651	1T19L-11	96 - 98
NAD-34178	9563	1T15M-6	Plastic	N/A	1T15M-7.5	54 - 57
NAD-34318	3894	1T19G-5	Aluminum	WC1-M58-1653	1T19LC-5	101

Cross References

1T Piston Index by Piston Drawing Number

PISTON DRAWING NO.	PISTON COMPONENT NO.	PISTON TYPE	MATERIAL	PISTON AON	BELLOWS	PAGE NO.
NAD-35451	9565	1T15M-7	Plastic	WC1-358-9652	1T15LP-3	28, 30
NBD-10180	9769	1T19J-2	Aluminum	WC1-358-0685	1T19J-1	89
NBD-10267	9656	1T15M-2	Aluminum	WC1-358-0652	1T15M-4	41 - 47
NBD-10267	9656	1T15M-2	Aluminum	WC1-358-0652	1T15LP-2	27, 28
NBD-10267	9656	1T15M-2	Aluminum	WC1-358-0652	1T15M-2	35 - 41
NBD-10267	9656	1T15M-2	Aluminum	WC1-358-0652	1T15M-4	41 - 47
NBD-10267	9656	1T15M-2	Aluminum	WC1-358-0652	1T15L-4	21 - 23
NBD-10267	9656	1T15M-2	Aluminum	WC1-358-0652	1T15M-4	41 - 47
NBD-10378	3822	1T15M-2	Aluminum		1T15M-2	35 - 41
NBD-10436	9652	1T15M-6	Aluminum	WC1-358-0659	1T15M-7.5	54 - 57
NBD-10437	9653	1T15M-9	Aluminum	WC1-358-9453	1T15M-11	64, 65
NBD-10438	9654	1T15M-0	Aluminum	WC1-358-0663	1T15L-2	18 - 21
NBD-10438	9654	1T15M-0	Aluminum	WC1-358-0663	1T15M-0	31 - 35
NBD-10438	9654	1T15M-0	Aluminum	WC1-358-0663	1T15L-2	18 - 21
NBD-10438	9654	1T15M-0	Aluminum	WC1-358-0663	1T15T-1	71
NBD-10439	9655	1T15M-0	Aluminum	WC1-358-9454	1T15M-0	31 - 35
NBD-10439	9655	1T15M-0	Aluminum	WC1-358-9454	1T15M-0	31 - 35
NBD-10439	9655	1T15M-0	Aluminum	WC1-358-9454	1T15M-0	31 - 35
NBD-10439	9655	1T15M-0	Aluminum	WC1-358-9454	1T15TM-1	72
NBD-10439	9655	1T15M-0	Aluminum	WC1-358-9454	1T15L-2	18 - 21
NBD-10441	9508	1T14C-1	Plastic	WC1-358-0754	1T14CB-1	15, 16
NBD-10441	9508	1T14C-1	Plastic	WC1-358-0754	1T14C-3	10 - 12
NBD-10472	9659	1T15T-3	Aluminum	WC1-358-0683	1T15LP-1.5	27
NBD-10472	9659	1T15T-3	Aluminum	WC1-358-0683	1T15L-4	21 - 23
NBD-10472	9659	1T15T-3	Aluminum	WC1-358-0683	1T15L-2	18 - 21
NBD-10472	9659	1T15T-3	Aluminum	WC1-358-0683	1T15L-2	18 - 21
NBD-10500	9555	1T14C-1	Plastic	WC1-358-0609	1T14C-1	9, 10
NBD-10500	9555	1T14C-1	Plastic	WC1-358-0609	1T14CB-1	15, 16
NBD-11498	9651	1T14C-3	Aluminum	WC1-358-9095	1T14C-1	9, 10
NBD-11498	9651	1T14C-3	Aluminum	WC1-358-9095	1T14C-3	10 - 12
NBD-11498	9651	1T14C-3	Aluminum	WC1-358-9095	1T14C-5	13
NBD-11498	9651	1T14C-3	Aluminum	WC1-358-9095	1T14CB-1	15, 16
NBD-11689	9754	1T14C-7	Aluminum	WC1-358-1603	1T14C-8	15
NBD-11689	9754	1T14C-7	Aluminum	WC1-358-1603	1T14C-6	13, 14
NBD-11689	9754	1T14C-7	Aluminum	WC1-358-1603	1T14C-7	14, 15

1T Piston Index by Piston Drawing Number

PISTON DRAWING NO.	PISTON COMPONENT NO.	PISTON TYPE	MATERIAL	PISTON AON	BELLOWS	PAGE NO.
NBD-11689	9754	1T14C-7	Aluminum	WC1-358-1603	1T14C-6	13, 14
NBD-12639	9663	1T15L-2	Aluminum	N/A	1T15LC-2.5	26
NBD-12639	9663	1T15L-2	Aluminum	N/A	1T15LC-4.5	26
NBD-14153	3853	1T15M-9	Aluminum		1T15M-11	64, 65
NBD-14213	9681	1T15Y-1	Aluminum	WC1-358-1612	1T15TQ-1	73, 74
NBD-14366	9696	1T15M-7.5	Aluminum	WC1-358-1636	1T15M-7.5	54 - 57
NBD-14404	9528	1T15V-1	Plastic	WC1-358-0667	1T17C-3	86
NBD-14404	9528	1T15V-1	Plastic	WC1-358-0667	1T15M-2	35 - 41
NBD-14404	9528	1T15V-1	Plastic	WC1-358-0667	1T15V-1	75
NBD-14404	9528	1T15V-1	Plastic	WC1-358-0667	1T15V-3	75
NBD-14503	9691	1T15L-4	Aluminum	WC1-358-0606	1T15L-4	21 - 23
NBD-14537	9505	1T15T-0	Plastic	WC1-358-1642	1T15TM-1	72
NBD-14537	9505	1T15T-0	Plastic	WC1-358-1642	1T15TQ-1	73, 74
NBD-14537	9505	1T15T-0	Plastic	WC1-358-1642	1T15T-2	72
NBD-14537	9505	1T15T-0	Plastic	WC1-358-1642	1T15T-1	71
NBD-14537	9505	1T15T-0	Plastic	WC1-358-1642	1T15TM-1	72
NBD-16538	6913	N/A	Plastic	N/A		147
NBD-8055	9742	1T15M-2	Aluminum	WC1-358-0658	1T15M-2	35 - 41
NBD-8183	9743	1T15M-2	Aluminum	WC1-358-0653	1T15L-2	18 - 21
NBD-8183	9743	1T15M-2	Aluminum	WC1-358-0653	1T15L-4	21 - 23
NBD-8312	9745	1T15T-0	Aluminum	WC1-358-0682	1T15T-1	71
NBD-8626	9708	1T14C-1	Aluminum	WC1-358-0600	1T14C-1	9, 10
NBD-8626	9708	1T14C-1	Aluminum	WC1-358-0600	1T14C-1 or 1T14F-2	9, 10
NBD-8626	9708	1T14C-1	Aluminum	WC1-358-0600	1T14C-3 or 1T14F-4	10 - 12
NBD-8626	9708	1T14C-1	Aluminum	WC1-358-0600	1T14C-3	10 - 12
NBD-8626	9708	1T14C-1	Aluminum	WC1-358-0600	1T14C-7 or 1T14F-8	14, 15
NBD-8724	9727	1T15M-4	Aluminum	WC1-358-0651	1T15M-4	41 - 47
NBD-8725	9727	1T15M-4	Aluminum	WC1-358-0651	1T15M-4	41 - 47
NBD-8725	9727	1T15M-4	Aluminum	WC1-358-0651	1T15M-2	35 - 41
NBD-8725	9727	1T15M-4	Aluminum	WC1-358-0651	1T15M-6	5, 47 - 54
NBD-8725	9727	1T15M-4	Aluminum	WC1-358-0651	1T15V-8	75 - 77
NBD-8881	8789	1T15S-6	Plastic	N/A	1T15S-6 or 1T15AA-3	16, 29, 70
NBD-8987	9728	1T15V-7	Aluminum	WC1-358-0669	1T15M-6	5, 47 - 54

Cross References

1T Piston Index by Piston Drawing Number

PISTON DRAWING NO.	PISTON COMPONENT NO.	PISTON TYPE	MATERIAL	PISTON AON	BELLOWS	PAGE NO.
NBD-8987	9728	1T15V-7	Aluminum	WC1-358-0669	1T15V-8	75 - 77
NBD-8987	9728	1T15V-7	Aluminum	WC1-358-0669	1T15M-4	41 - 47
NBD-9242	9757	1T15B-2	Aluminum	N/A	1T15S-6 or 1T15AA-3	16, 29, 70
NBD-9242	9757	1T15B-2	Aluminum	N/A	1T15AA-3	16, 29
NBD-9611	9806	1T15L-6HG	Aluminum	WC1-358-0660	1T15M-6	5, 47 - 54
NBD-9611	9809	1T15L-6HG	Aluminum	WC1-358-0660	1T15M-6	5, 47 - 54
NBD-9673	9744	1T15MJ-6	Aluminum	N/A	1T15MJ-6	66
FIP-102215	9637	N/A	Plastic	N/A	N/A	163
FIP-101136	9640	1T19ZK5.7	Aluminum	N/A	1T19ZK-5.7	102
FIP-101678	9461	1T66	Steel	WC1-358-9999	1T66E-11.8	104
FIP-101776	9462	1T15V-7	Plastic	WC1-358-0669	1T15M-6	5, 47 - 54
FIP-101776	9462	1T15V-7	Plastic	WC1-358-0669	1T15V-8	75 - 77
FIP-101776	9462	1T15V-7	Plastic	WC1-358-0669	1T15M-4	41 - 47
FIP-100742	9492	1T15T-0	Plastic	WC1-358-1642	1T15TM-1	72
FIP-100742	9492	1T15T-0	Plastic	WC1-358-1642	1T15TQ-1	73, 74
FIP-100742	9492	1T15T-0	Plastic	WC1-358-1642	1T15T-2	72
FIP-100742	9492	1T15T-0	Plastic	WC1-358-1642	1T15T-1	71
FIP-100742	9492	1T15T-0	Plastic	WC1-358-1642	1T15TM-1	72
FIP-100743	9493	1T14C-1	Plastic	WC1-358-0754	1T14CB-1	15, 16
FIP-100743	9494	1T14C-1	Plastic	WC1-358-0754	1T14C-3	10 - 12
FIP-100743	9494	1T14C-1	Plastic	WC1-358-0754	1T14C-6	13, 14
FIP-100912	6885	N/A	Plastic	N/A	15	163

Firestone

All Parts Assembly Order Number Index

AON'S	PAGE NO.
W01-358-0783	60
W01-358-1096	5
W01-358-1190	79
W01-358-1191	80
W01-358-1192	80
W01-358-2119	9
W01-358-2120	9
W01-358-2131	9
W01-358-3020	#N/A
W01-358-3400	130
W01-358-3402	130
W01-358-3406	130
W01-358-3420	133
W01-358-5297	15
W01-358-5310	9
W01-358-5311	9
W01-358-5319	15
W01-358-5323	10
W01-358-5328	10
W01-358-5335	13
W01-358-5336	13
W01-358-5343	10
W01-358-5354	13
W01-358-5405	10
W01-358-5406	10
W01-358-5408	11
W01-358-5410	11
W01-358-5412	11
W01-358-5414	11
W01-358-5422	11
W01-358-5423	12
W01-358-5426	14
W01-358-5429	15
W01-358-5433	12
W01-358-5434	12

AON'S	PAGE NO.
W01-358-5436	12
W01-358-5439	13
W01-358-5503	99
W01-358-5505	99
W01-358-5509	99
W01-358-5511	99
W01-358-5514	89
W01-358-5523	6
W01-358-5530	6
W01-358-5702	14
W01-358-5712	15
W01-358-5765	72
W01-358-5766	72
W01-358-5770	73
W01-358-5771	73
W01-358-5772	73
W01-358-5773	73
W01-358-5775	73
W01-358-5776	74
W01-358-5777	74
W01-358-5789	74
W01-358-5792	74
W01-358-5900	115
W01-358-6258	79
W01-358-6262	69
W01-358-6392	115
W01-358-6393	118
W01-358-6777	121
W01-358-6789	125
W01-358-6799	131
W01-358-6800	120
W01-358-6801	120
W01-358-6803	120
W01-358-6805	120
W01-358-6808	121

AON'S	PAGE NO.
W01-358-6817	116
W01-358-6831	133
W01-358-6856	112
W01-358-6883	115
W01-358-6884	112
W01-358-6886	115
W01-358-6890	111
W01-358-6892	118
W01-358-6897	112
W01-358-6900	111
W01-358-6902	112
W01-358-6905	112
W01-358-6908	113
W01-358-6910	111
W01-358-6926	111
W01-358-6927	116
W01-358-6932	113
W01-358-6935	113
W01-358-6940	113
W01-358-6941	113
W01-358-6943	116
W01-358-6944	116
W01-358-6945	116
W01-358-6946	117
W01-358-6947	117
W01-358-6948	117
W01-358-6949	114
W01-358-6960	117
W01-358-6962	117
W01-358-6994	108
W01-358-7008	108
W01-358-7009	108
W01-358-7025	133, 146
W01-358-7043	108
W01-358-7057	133

Cross References

All Parts Assembly Order Number Index

AON'S	PAGE NO.
W01-358-7088	109
W01-358-7093	109
W01-358-7094	109
W01-358-7096	110
W01-358-7103	108
W01-358-7104	109
W01-358-7105	109
W01-358-7112	110
W01-358-7113	110
W01-358-7117	110
W01-358-7118	129
W01-358-7123	119
W01-358-7135	118
W01-358-7136	119
W01-358-7140	119
W01-358-7145	119
W01-358-7146	119
W01-358-7180	121
W01-358-7181	121
W01-358-7183	121
W01-358-7185	122
W01-358-7226	129
W01-358-7230	129
W01-358-7244	128
W01-358-7271	128
W01-358-7273	129
W01-358-7274	139
W01-358-7275	128
W01-358-7276	139
W01-358-7279	126
W01-358-7286	137
W01-358-7294	130
W01-358-7304	139
W01-358-7325	127
W01-358-7330	127

AON'S	PAGE NO.
W01-358-7339	127
W01-358-7344	122
W01-358-7400	122
W01-358-7401	122
W01-358-7403	122
W01-358-7404	123
W01-358-7405	123
W01-358-7406	123
W01-358-7408	123
W01-358-7409	123
W01-358-7410	124
W01-358-7423	124
W01-358-7424	124
W01-358-7429	124
W01-358-7437	124
W01-358-7443	125
W01-358-7444	125
W01-358-7446	125
W01-358-7447	125
W01-358-7462	111
W01-358-7472	131
W01-358-7473	126
W01-358-7483	126
W01-358-7499	126
W01-358-7505	127
W01-358-7512	128
W01-358-7545	131
W01-358-7550	130
W01-358-7555	131
W01-358-7557	131
W01-358-7659	128
W01-358-7667	36
W01-358-7686	114
W01-358-7705	127
W01-358-7726	110

AON'S	PAGE NO.
W01-358-7761	137
W01-358-7781	132
W01-358-7782	132
W01-358-7788	114
W01-358-7790	126
W01-358-7792	132
W01-358-7794	132
W01-358-7795	114
W01-358-7796	138
W01-358-7797	138
W01-358-7798	138
W01-358-7800	138
W01-358-7808	138
W01-358-7816	137
W01-358-7818	139
W01-358-7838	139
W01-358-7839	140
W01-358-7843	140
W01-358-7844	140
W01-358-7845	140
W01-358-7846	140
W01-358-7847	141
W01-358-7848	141
W01-358-7850	141
W01-358-7852	137
W01-358-7853	141
W01-358-7855	141
W01-358-7859	142
W01-358-7862	142
W01-358-7872	142
W01-358-7886	118
W01-358-7891	118
W01-358-7892	114
W01-358-7897	115
W01-358-7915	137

Firestone

All Parts Assembly Order Number Index

AON'S	PAGE NO.
W01-358-7927	129
W01-358-7954	142
W01-358-7956	142
W01-358-7990	133
W01-358-7994	134
W01-358-7995	134
W01-358-7996	134
W01-358-7998	134
W01-358-8006	134
W01-358-8008	135
W01-358-8010	135
W01-358-8014	135
W01-358-8016	135
W01-358-8018	135
W01-358-8025	136
W01-358-8027	136
W01-358-8030	136
W01-358-8032	136
W01-358-8033	136
W01-358-8038	143
W01-358-8039	143
W01-358-8043	143
W01-358-8050	102
W01-358-8051	103
W01-358-8052	103
W01-358-8053	103
W01-358-8055	89
W01-358-8088	90
W01-358-8091	101
W01-358-8092	101
W01-358-8093	102
W01-358-8109	87
W01-358-8171	120
W01-358-8180	#N/A
W01-358-8184	17

AON'S	PAGE NO.
W01-358-8197	36
W01-358-8198	37
W01-358-8201	37
W01-358-8203	37
W01-358-8204	37
W01-358-8207	37
W01-358-8235	132
W01-358-8478	28
W01-358-8500	90
W01-358-8539	5
W01-358-8591	47
W01-358-8597	27
W01-358-8600	72
W01-358-8614	87
W01-358-8617	88
W01-358-8623	87
W01-358-8631	82
W01-358-8632	82
W01-358-8636	86
W01-358-8637	86
W01-358-8673	85
W01-358-8676	82
W01-358-8708	88
W01-358-8709	87
W01-358-8710	88
W01-358-8713	88
W01-358-8720	84
W01-358-8723	82
W01-358-8724	85
W01-358-8729	85
W01-358-8733	86
W01-358-8735	88
W01-358-8737	86
W01-358-8738	86
W01-358-8740	83

AON'S	PAGE NO.
W01-358-8744	84
W01-358-8746	84
W01-358-8748	85
W01-358-8749	85
W01-358-8751	83
W01-358-8752	83
W01-358-8753	83
W01-358-8755	83
W01-358-8756	84
W01-358-8760	90
W01-358-8761	90
W01-358-8764	96
W01-358-8774	102
W01-358-8776	92
W01-358-8778	92
W01-358-8779	95
W01-358-8780	95
W01-358-8781	95
W01-358-8782	84
W01-358-8787	90
W01-358-8792	96
W01-358-8793	102
W01-358-8796	96
W01-358-8802	41
W01-358-8803	42
W01-358-8805	42
W01-358-8806	42
W01-358-8810	42
W01-358-8813	42
W01-358-8816	43
W01-358-8817	43
W01-358-8824	48
W01-358-8825	48
W01-358-8829	80
W01-358-8842	60

Cross References

All Parts Assembly Order Number Index

AON'S	PAGE NO.
W01-358-8852	60
W01-358-8855	60
W01-358-8856	61
W01-358-8861	61
W01-358-8864	61
W01-358-8868	13
W01-358-8872	15
W01-358-8875	14
W01-358-8876	16
W01-358-8878	38
W01-358-8882	35
W01-358-8886	17
W01-358-8888	54
W01-358-8897	18
W01-358-8900	18
W01-358-8901	18
W01-358-8903	69
W01-358-8911	70
W01-358-8918	21
W01-358-8919	22
W01-358-8922	22
W01-358-8924	48
W01-358-8927	48
W01-358-8930	38
W01-358-8931	38
W01-358-8932	38
W01-358-8934	39
W01-358-8935	39
W01-358-8941	22
W01-358-8942	22
W01-358-8944	68
W01-358-8949	30
W01-358-8951	22
W01-358-8958	27
W01-358-8959	27

AON'S	PAGE NO.
W01-358-8961	31
W01-358-8963	32
W01-358-8964	32
W01-358-8965	16
W01-358-8971	32
W01-358-8972	32
W01-358-8976	32
W01-358-8977	14
W01-358-8979	14
W01-358-8984	104
W01-358-8986	33
W01-358-8991	39
W01-358-8992	16
W01-358-8997	16
W01-358-9004	48
W01-358-9008	43
W01-358-9010	43
W01-358-9011	43
W01-358-9015	31
W01-358-9026	49
W01-358-9029	33
W01-358-9031	33
W01-358-9033	33
W01-358-9036	33
W01-358-9039	34
W01-358-9043	70
W01-358-9049	28
W01-358-9053	39
W01-358-9059	44
W01-358-9063	44
W01-358-9068	44
W01-358-9069	44
W01-358-9070	44
W01-358-9071	45
W01-358-9073	28

AON'S	PAGE NO.
W01-358-9075	18
W01-358-9076	70
W01-358-9077	34
W01-358-9078	39
W01-358-9082	49
W01-358-9083	49
W01-358-9092	49
W01-358-9093	50
W01-358-9096	50
W01-358-9097	66
W01-358-9098	66
W01-358-9101	61
W01-358-9105	40
W01-358-9113	40
W01-358-9116	92
W01-358-9118	40
W01-358-9121	92
W01-358-9122	97
W01-358-9134	95
W01-358-9135	93
W01-358-9138	95
W01-358-9144	93
W01-358-9148	93
W01-358-9149	93
W01-358-9152	97
W01-358-9156	97
W01-358-9158	97
W01-358-9164	93
W01-358-9177	94
W01-358-9179	94
W01-358-9192	61
W01-358-9193	50
W01-358-9194	50
W01-358-9199	98
W01-358-9200	91

Firestone

All Parts Assembly Order Number Index

AON'S	PAGE NO.
W01-358-9201	98
W01-358-9203	62
W01-358-9204	91
W01-358-9210	50
W01-358-9211	51
W01-358-9213	51
W01-358-9214	98
W01-358-9215	91
W01-358-9216	91
W01-358-9218	91
W01-358-9219	51
W01-358-9221	94
W01-358-9223	51
W01-358-9227	51
W01-358-9228	52
W01-358-9238	62
W01-358-9240	62
W01-358-9243	62
W01-358-9245	62
W01-358-9249	75
W01-358-9250	77
W01-358-9251	75
W01-358-9252	78
W01-358-9256	52
W01-358-9259	70
W01-358-9260	70
W01-358-9264	100
W01-358-9265	66
W01-358-9268	66
W01-358-9269	78
W01-358-9270	79
W01-358-9274	75
W01-358-9275	76
W01-358-9277	92
W01-358-9278	71

AON'S	PAGE NO.
W01-358-9284	21
W01-358-9285	28
W01-358-9287	57
W01-358-9290	29
W01-358-9291	30
W01-358-9293	31
W01-358-9294	31
W01-358-9295	31
W01-358-9296	52
W01-358-9297	57
W01-358-9299	68
W01-358-9302	40
W01-358-9304	52
W01-358-9307	35
W01-358-9308	34
W01-358-9310	103
W01-358-9320	64
W01-358-9321	64
W01-358-9325	40
W01-358-9327	104
W01-358-9332	34
W01-358-9333	34
W01-358-9334	35
W01-358-9335	45
W01-358-9336	45
W01-358-9338	64
W01-358-9339	41
W01-358-9342	54
W01-358-9346	63
W01-358-9348	63
W01-358-9349	63
W01-358-9350	63
W01-358-9362	52
W01-358-9365	41
W01-358-9366	41

AON'S	PAGE NO.
W01-358-9367	65
W01-358-9368	65
W01-358-9370	65
W01-358-9371	58
W01-358-9373	58
W01-358-9375	58
W01-358-9376	18
W01-358-9377	19
W01-358-9378	19
W01-358-9379	26
W01-358-9387	19
W01-358-9388	53
W01-358-9392	53
W01-358-9394	63
W01-358-9402	71
W01-358-9410	71
W01-358-9415	23
W01-358-9421	72
W01-358-9422	17
W01-358-9423	72
W01-358-9438	23
W01-358-9439	23
W01-358-9440	19
W01-358-9445	19
W01-358-9447	20
W01-358-9448	20
W01-358-9457	20
W01-358-9459	20
W01-358-9463	45
W01-358-9466	53
W01-358-9467	45
W01-358-9470	76
W01-358-9471	76
W01-358-9472	76
W01-358-9473	76

Cross References

All Parts Assembly Order Number Index

AON'S	PAGE NO.
W01-358-9474	53
W01-358-9476	20
W01-358-9477	21
W01-358-9478	12
W01-358-9482	46
W01-358-9483	46
W01-358-9484	46
W01-358-9491	77
W01-358-9496	53
W01-358-9501	77
W01-358-9502	77
W01-358-9504	77
W01-358-9505	35
W01-358-9507	46
W01-358-9538	65
W01-358-9541	25
W01-358-9547	24
W01-358-9551	21
W01-358-9553	29
W01-358-9554	27
W01-358-9556	41
W01-358-9559	24
W01-358-9560	24
W01-358-9562	21
W01-358-9565	26
W01-358-9566	26
W01-358-9567	26
W01-358-9568	26
W01-358-9578	75
W01-358-9579	79
W01-358-9580	89
W01-358-9581	89
W01-358-9582	75
W01-358-9584	17
W01-358-9585	46

AON'S	PAGE NO.
W01-358-9586	74
W01-358-9587	29
W01-358-9589	16
W01-358-9592	29
W01-358-9597	29
W01-358-9599	30
W01-358-9616	17
W01-358-9617	24
W01-358-9618	25
W01-358-9619	27
W01-358-9621	25
W01-358-9622	24
W01-358-9625	25
W01-358-9626	23
W01-358-9634	67
W01-358-9640	67
W01-358-9641	58
W01-358-9643	67
W01-358-9644	69
W01-358-9645	69
W01-358-9646	69
W01-358-9647	59
W01-358-9648	80
W01-358-9649	59
W01-358-9650	71
W01-358-9651	71
W01-358-9652	30
W01-358-9654	59
W01-358-9663	60
W01-358-9675	25
W01-358-9681	28
W01-358-9690	54
W01-358-9697	47
W01-358-9774	67
W01-358-9780	80

AON'S	PAGE NO.
W01-358-9781	81
W01-358-9782	81
W01-358-9797	47
W01-358-9798	47
W01-358-9804	98
W01-358-9807	35
W01-358-9811	94
W01-358-9825	102
W01-358-9855	23
W01-358-9865	78
W01-358-9866	78
W01-358-9867	78
W01-358-9891	100
W01-358-9895	89
W01-358-9896	101
W01-358-9902	55
W01-358-9915	100
W01-358-9921	55
W01-358-9922	55
W01-358-9923	55
W01-358-9928	101
W01-358-9929	100
W01-358-9935	55
W01-358-9936	56
W01-358-9942	56
W01-358-9943	56
W01-358-9944	54
W01-358-9947	56
W01-358-9948	56
W01-358-9953	30
W01-358-9961	94
W01-358-9966	54
W01-358-9971	57
W01-358-9972	57
W01-358-9974	57

Firestone

All Parts Assembly Order Number Index

AON'S	PAGE NO.
W01-358-9978	47
W01-358-9984	96
W01-358-9985	98
W01-M58-6260	68
W01-M58-6317	68
W01-M58-8463	5
W01-M58-8468	5
W01-M58-8650	38
W01-M58-8712	87
W01-M58-8798	101
W01-M58-9372	58
W01-M58-9642	59
W01-M58-9656	59
W01-M58-9741	5
W01-M58-9851	66
W02-358-4003	159
W02-358-6754	148
W02-358-7001	147
W02-358-7002	147
W02-358-7007	153
W02-358-7012	156
W02-358-7017	158
W02-358-7024	161
W02-358-7029	158
W02-358-7031	152
W02-358-7032	156
W02-358-7035	154
W02-358-7036	160
W02-358-7037	155
W02-358-7038	160
W02-358-7040	150
W02-358-7041	149
W02-358-7042	157

AON'S	PAGE NO.
W02-358-7043	161
W02-358-7044	161
W02-358-7045	157
W02-358-7046	146
W02-358-7049	150
W02-358-7054	150
W02-358-7055	151
W02-358-7056	157
W02-358-7058	149
W02-358-7059	149
W02-358-7061	156
W02-358-7064	159
W02-358-7067	158
W02-358-7070	154
W02-358-7073	151
W02-358-7074	156
W02-358-7075	155
W02-358-7076	149
W02-358-7079	146
W02-358-7080	153
W02-358-7081	161
W02-358-7082	160
W02-358-7083	163
W02-358-7085	153
W02-358-7086	146
W02-358-7087	155
W02-358-7092	162
W02-358-7093	162
W02-358-7098	150
W02-358-7100	148
W02-358-7103	155
W02-358-7106	152
W02-358-7108	159

AON'S	PAGE NO.
W02-358-7109	159
W02-358-7110	163
W02-358-7115	#N/A
W02-358-7116	154
W02-358-7132	148
W02-358-7149	151
W02-358-7150	147
W02-358-7151	157
W02-358-7152	162
W02-358-7155	148
W02-358-7200	162
W02-358-7201	147
W02-358-7204	153
W02-358-7205	160
W02-358-7206	154
W02-358-7208	158
W02-358-7209	152
W02-358-7215	163
W02-358-9901	151
W02-358-9904	152
W21-760-9000	164
W21-760-9001	165
W21-760-9002	165
W21-760-9011	165
W26-358-9902	164
W26-358-9911	164
W26-358-9912	164
W26-358-9913	163
W26-358-9933	165
WC1-358-3874	81
WC1-358-3876	81
WC1-358-3900	81
WC1-358-3901	82

Firestone

World's Number 1
Air Spring.



FIRESTONE INDUSTRIAL PRODUCTS COMPANY

Air Spring Warranty Evaluation Criteria



Firestone air springs are designed to provide years and thousands of miles of trouble free service. The durability of Firestone air springs is such that they will often outlast other maintenance items on your suspension, such as bushings, shocks, leveling valves or regulators. Airide springs by Firestone are warranted to be free of material defects and/or workmanship for various periods of time, depending upon the application.

Firestone Industrial Products Company offers a complete line of Airide springs, with replacement springs available for virtually every vehicular air suspension system.

Since each individual air spring is closely examined and pressure tested at the factory, the vast majority of premature failures and consequent warranty returns are found not to be defective, but fail because of abuse caused by other problems associated with the suspension.

Before you install a new air spring, you should carefully examine the old one to determine what caused it to fail. If it was due to a defect in the suspension system, then the new air spring may also fail unless you correct the problem.

The information on the next two pages was developed to illustrate the types of failures that may occur, and to assist you in determining the cause and corrective action required.

AIRIDE[™]

SPRINGS

AIRIDE[™]

SPRINGS

When applied and maintained properly, Airide® springs can provide thousands of miles of trouble-free service. Most failures are caused by a lack of suspension maintenance or improper application. This is a guide to common air spring failures that are *not* covered by warranty.

MISALIGNMENT

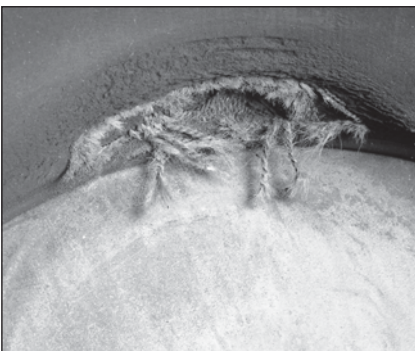

Appearance or Condition

- Off-center bumper contact
- Same as abrasion or bottoming out

Possible Causes

- Worn bushing
- Improper suspension installation

LOOSE GIRDLE HOOP

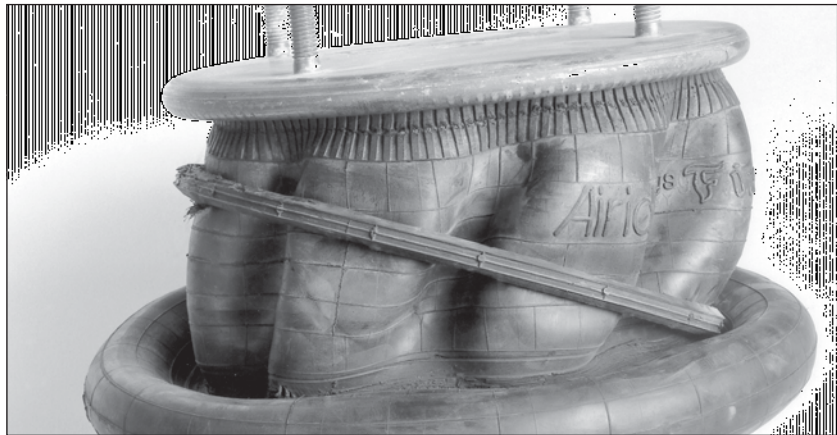

Appearance or Condition

- Rubber bellows distorted and girdle hoop torn loose

Possible Causes

- Running at extended positions with low air pressure

BOTTOMING OUT

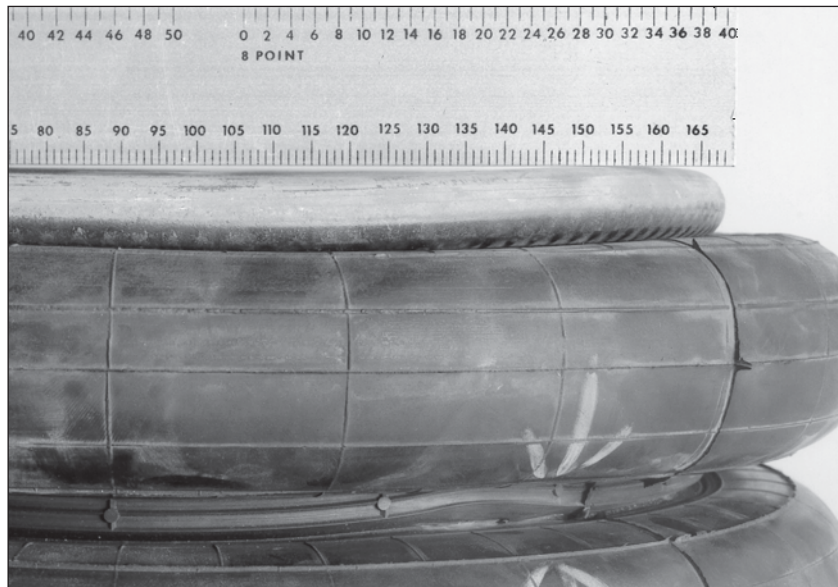

Appearance or Condition

- Bead plate concave
- Internal bumper loose
- Hole in girdle hoop area (convoluted)
- Hole in bead plate junction area
- Leaking around blind nuts

Possible Causes

- Broken or defective shock absorber
- Defective leveling valve
- Overloaded vehicle
- Pressure regulator set too low
- Wrong air spring (too tall)

Warranty Evaluation Criteria

ABRASION



Appearance or Condition

- Hole rubbed into side of bellows
- Hole in bellows area that rolls over piston (reversible sleeve style)

Possible Causes

- Structural interference, such as:
 - broken shock
 - loose air line
 - misalignment
 - worn bushings
- No air pressure (reversible sleeve style)
- Foreign material (sand, rocks, etc.)
- Wrong air spring

CIRCUMFERENTIAL CUTS

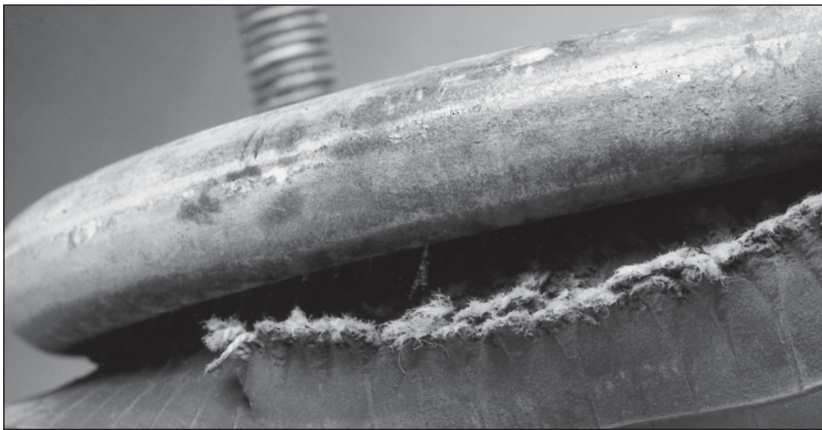

Appearance or Condition

- Bellows cut in circle at bead plate junction
- Bellows cut in circle at piston junction (reversible sleeve style)

Possible Causes

- High pressure, fully extended for long periods of time
- Impact in compressed position

OVER EXTENSION

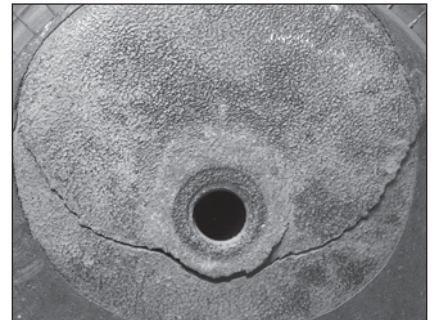
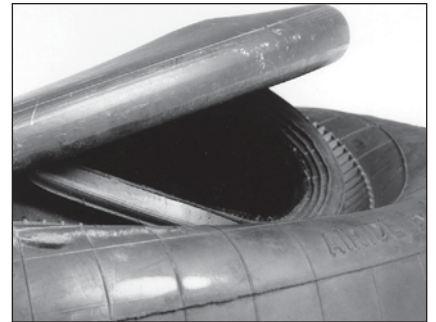
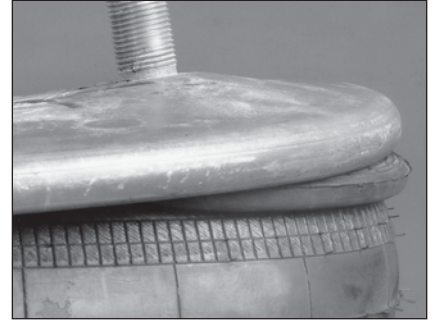

Appearance or Condition

- Bead plate convex, especially around blind nuts or studs
- Rubber bellows separated from bead plate
- Leaking at blind nuts or studs
- Leaking at end closure (reversible sleeve)
- Loose girdle hoop on convoluted style

Possible Causes

- Broken or wrong shock absorber
- Defective leveling valve
- Ride position too high
- Defective upper stop (lift)
- Wrong air spring (too short)

PREVENTIVE MAINTENANCE CHECKLIST

Listed below are items that can be checked when the vehicle is in for periodic maintenance.

Never attempt to service the air suspension on a truck or trailer with the air springs inflated.

1 Inspect the O.D. of the airspring. Check for signs of irregular wear or heat cracking.

2 Inspect air lines to make sure contact doesn't exist between the air line and the O.D. of the air spring. Air lines can rub a hole in an air spring very quickly.

3 Check to see that there is sufficient clearance around the complete circumference of the air spring while at its maximum diameter.

4 Inspect the O.D. of the piston for buildup of foreign materials. (On a reversible sleeve style air spring, the piston is the bottom component of the air spring).

5 Correct ride height should be maintained. All vehicles with air springs have a specified ride height established by the O.E.M. manufacturer. This height, which is found in your service manual, should be maintained within 1/4". This dimension can be checked with the vehicle loaded or empty.

6 Leveling valves (or height control valves) play a large part in ensuring that the total air spring system works as required. Clean, inspect and replace, if necessary.

7 Make sure you have the proper shock absorbers and check for leaking hydraulic oil and worn or broken end connectors. If a broken shock is found, replace it immediately. The shock absorber will normally limit the rebound of an air spring and keep it from overextending.

8 Check the tightness of all mounting hardware (nuts and bolts). If loose, re-torque to the manufacturer's specifications. Do not over-tighten.

CLEANING

9 APPROVED Approved cleaning media are soap and water, methyl alcohol, ethyl alcohol and isopropyl alcohol.

NON-APPROVED

Non-approved cleaning media include all organic solvents, open flames, abrasives and direct pressurized steam cleaning.

The total inspection process described on this page can be done in just a matter of minutes. If you find one of the above conditions exists, please take corrective action to ensure that it is fixed properly. It will save you both time and money.

Firestone

World's Number 1
Air Spring.



FIRESTONE INDUSTRIAL PRODUCTS COMPANY

1-800-888-0650

www.firestoneip.com

Alignment Definitions

Alignment is based on the orientation of the lower bead plate or piston compared to the upper bead plate. Alignments other than those shown are noted in the bottom view.

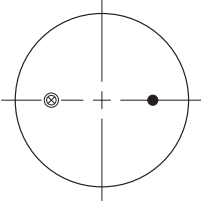
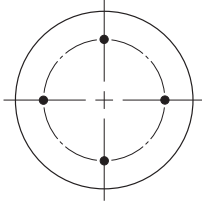
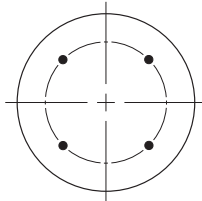
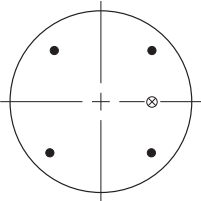
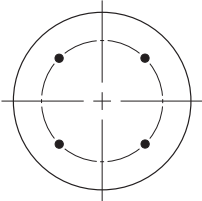
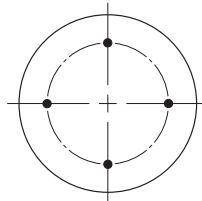
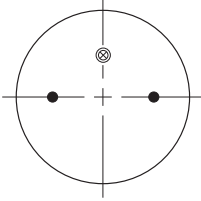
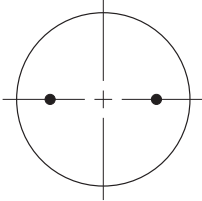
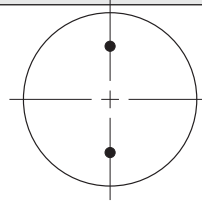
BEAD PLATE TOP VIEW	BEAD PLATE OR PISTON BOTTOM VIEW	
	PARALLEL ALIGNMENT	45 DEGREE ALIGNMENT
I. 		
II. 		
III. 		90° ALIGN. 

Firestone

NOTES



+

KEEP THE ROAD FROM FEELING LIKE THE OFF-ROAD.

Firestone Ride-Rite Air Springs give you the added support your suspension needs for hauling.

+ MORE LEVEL LOADS

PROTECT & STABILIZE LOADS

+ LESS BOTTOMING OUT



Firestone

Learn About A Cleaner/Greener Alternative To Hydraulic Applications:

ACTUATION

ISOLATION

PICK & PLACE



EXPERIENCE IS EVERYTHING.

Firestone
World's Number 1 Air Spring.
FIRESTONE INDUSTRIAL PRODUCTS COMPANY

www.firestoneip.com/actuators-isolators

1.800.888.0650

Cab • Seat • Heavy Duty Suspension

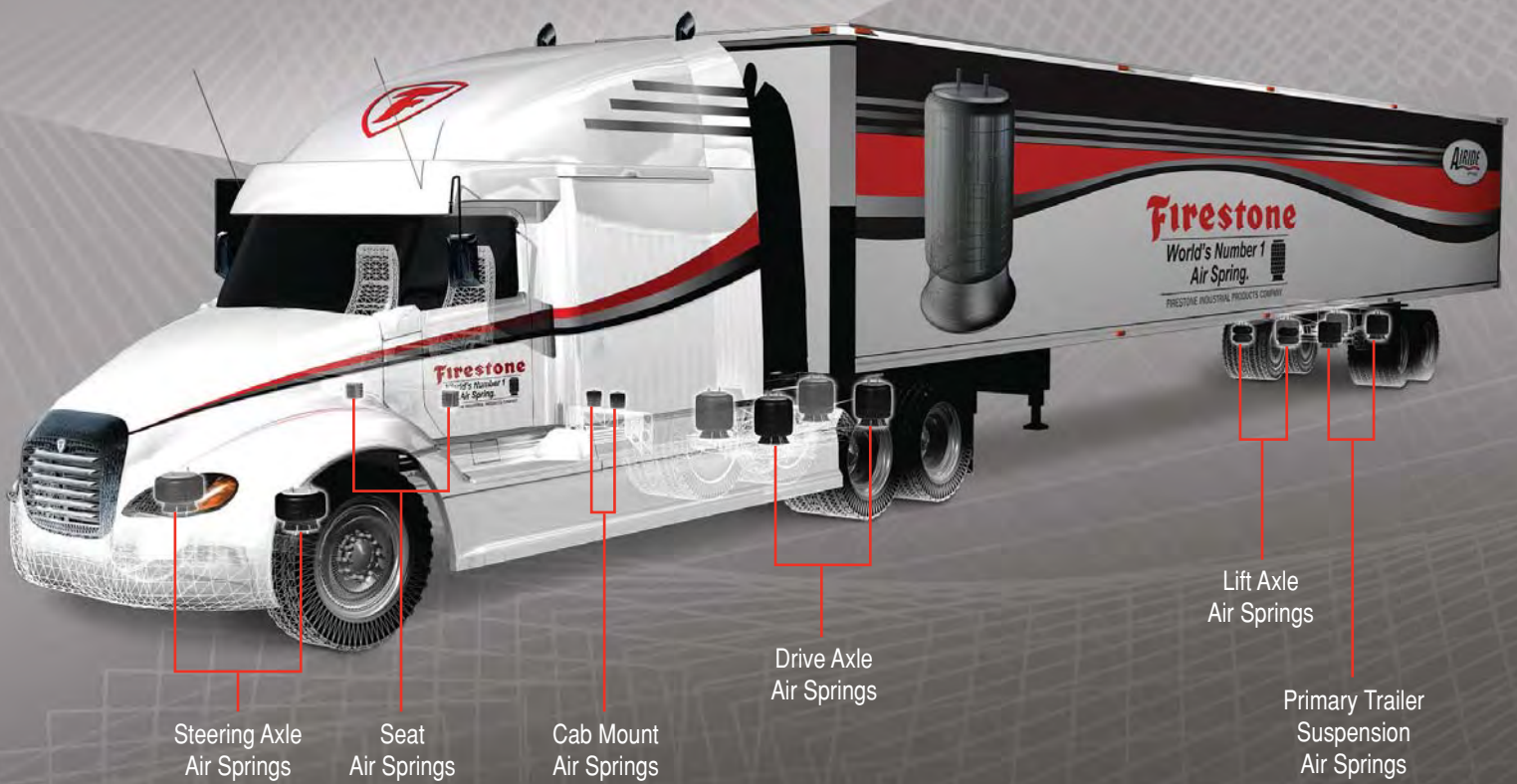

firestoneip.com • 800.888.0650