

FURUNO

OPERATOR'S MANUAL

ALARM UNIT

MODEL **IC-350**

IMPORTANT NOTICES

- No part of this manual may be copied or reproduced without written permission.
- If this manual is lost or worn, contact your dealer about replacement.
- The contents of this manual and equipment specifications are subject to change without notice.
- Store this manual in a convenient place for future reference.
- FURUNO will assume no responsibility for the damage caused by improper use or modification of the equipment (including software) by an unauthorized agent or a third party.
- When it is time to discard this product it must be done according to local regulations for disposal of industrial waste. For disposal in the USA, refer to the Electronics Industries Alliance (<http://www.eiae.org/>).



SAFETY INSTRUCTIONS

The installer and operator of this equipment must read these safety instructions before attempting to install or operate the equipment.



WARNING

Indicates a potentially hazardous situation which, if not avoided, could result in death or serious injury.



CAUTION

Indicates a potentially hazardous situation which, if not avoided, may result in minor or moderate injury.



Warning, Caution



Prohibitive Action



Mandatory Action



WARNING



If something is dropped into the equipment or water leaks into the equipment, turn off the power at the switchboard immediately.

Continued use of the equipment can cause fire or electrical shock.



If the equipment is emitting smoke or fire, shut off the power at the switchboard immediately.

Continued use of the equipment can cause fire or electrical shock. Consult a FURUNO agent or dealer for advice.



If the equipment is acting abnormally, shut off the power at the switchboard immediately.

Continued use of the equipment can cause fire or electrical shock. Consult a FURUNO agent or dealer for advice.



WARNING



Do not operate a DISTRESS button unless YOUR vessel is in distress.

The distress signal is sent when a DISTRESS button is operated. If the distress signal is accidentally sent, contact a coast station immediately to report accidental distress transmission.



Do not place liquid-filled containers on the top of the equipment.

Fire or electrical shock can result.



Do not operate the equipment with wet hands.

Electrical shock can result.



Do not disassemble or modify the equipment.

Electrical shock, fire or bodily injury can result.









CAUTION

If distress is accidentally sent, immediately contact a coast station and provide the following information:

- Ship's name
- Ship's call sign and DSC number
- Position at time of distress transmission
- Time of distress transmission

Precautions for the installer

 WARNING	
	<p>Shut off the power at the switchboard before beginning the installation.</p> <p>Fire or electrical shock can result if the equipment is powered while it is being installed.</p>
	<p>Use only the specified power cable.</p> <p>Fire or electrical shock can result if a different cable is used.</p>
	<p>Do not install the equipment where it can get wet from rain or water splash.</p> <p>Fire or electrical shock can result if water gets inside the equipment.</p>

 CAUTION	
	<p>Be sure the voltage at the ship's switchboard is compatible with the voltage rating of this equipment.</p> <p>The rated voltage of this equipment is 24 VDC. Damage to the equipment can result if the equipment is connected to an incompatible power supply.</p>
	<p>Observe the compass safe distances shown below to prevent interference to a magnetic compass.</p> <p>Standard compass: 1.20 m Steering compass: 0.75 m</p>





Warning Labels

Warning labels are attached to the equipment. Do not remove any label.

If a label is missing or damaged, contact a FURUNO agent or dealer about replacement.

 WARNING 
<p>To avoid electrical shock, do not remove cover. No user-serviceable parts inside.</p>
 警告 
<p>感電の恐れあり。 サービスマン以外の方はカバーを開けないで下さい。内部には高電圧部分が数多くあり、万一さわると危険です。</p>

Name: Warning label (1)
Type: 86-003-1011
Code No.: 100-236-233-10

 WARNING 	 警告 
<p>To avoid electrical shock, do not remove cover. No user-serviceable parts inside.</p>	<p>感電の恐れあり。 サービスマン以外の方はカバーを開けないで下さい。内部には高電圧部分が数多くあり、万一さわると危険です。</p>

Name: Warning label (2)
Type: 03-129-1001
Code No.: 100-236-743-10

TABLE OF CONTENTS

FOREWORD	v
SYSTEM CONFIGURATION	vi
1. HOW TO INSTALL THE ALARM UNIT	1
1.1 Equipment Lists.....	1
1.2 How to Install the Alarm Unit.....	1
1.3 Connections	2
1.3.1 Where to connect the cables	2
1.3.2 How to prepare the cables.....	3
2. OPERATION	7
2.1 Controls and Lamps	7
2.2 Preparations.....	7
2.3 When You Receive a Distress Signal	8
2.4 How to Send a Distress Signal.....	8
3. MAINTENANCE	9
3.1 Maintenance.....	9
3.2 How to Clean the Equipment	9
3.3 Internal Breaker.....	10
3.4 Troubleshooting	10
3.5 Equipment Test.....	10
SPECIFICATIONS	SP-1
OUTLINE DRAWING	D-1
INTERCONNECTION DIAGRAM	S-1

FOREWORD

Congratulations on your choice of the FURUNO IC-350 Alarm Unit. We are confident you will see why the FURUNO name has become synonymous with quality and reliability.

For 60 years FURUNO Electric Company has enjoyed an enviable reputation for quality marine electronics equipment. This dedication to excellence is furthered by our extensive global network of agents and dealers.

This equipment is designed and constructed to meet the rigorous demands of the marine environment. However, no machine can perform its intended function unless installed, operated and maintained properly. Please carefully read and follow the recommended procedures for installation, operation and maintenance.

Features

The IC-350 globally controls the distress functions of all GMDSS equipment connected to it. The main features are

- Connects to six GMDSS units: one SSB radiotelephone, two VHF radiotelephones, two Inmarsat-C mobile earth stations (MES), and one NAVTEX receiver.
- Dedicated DISTRESS buttons for sending a distress alert.
- MUTE ALARM button stops audio alarm.

SYSTEM CONFIGURATION

Standard configuration shown with solid lines.

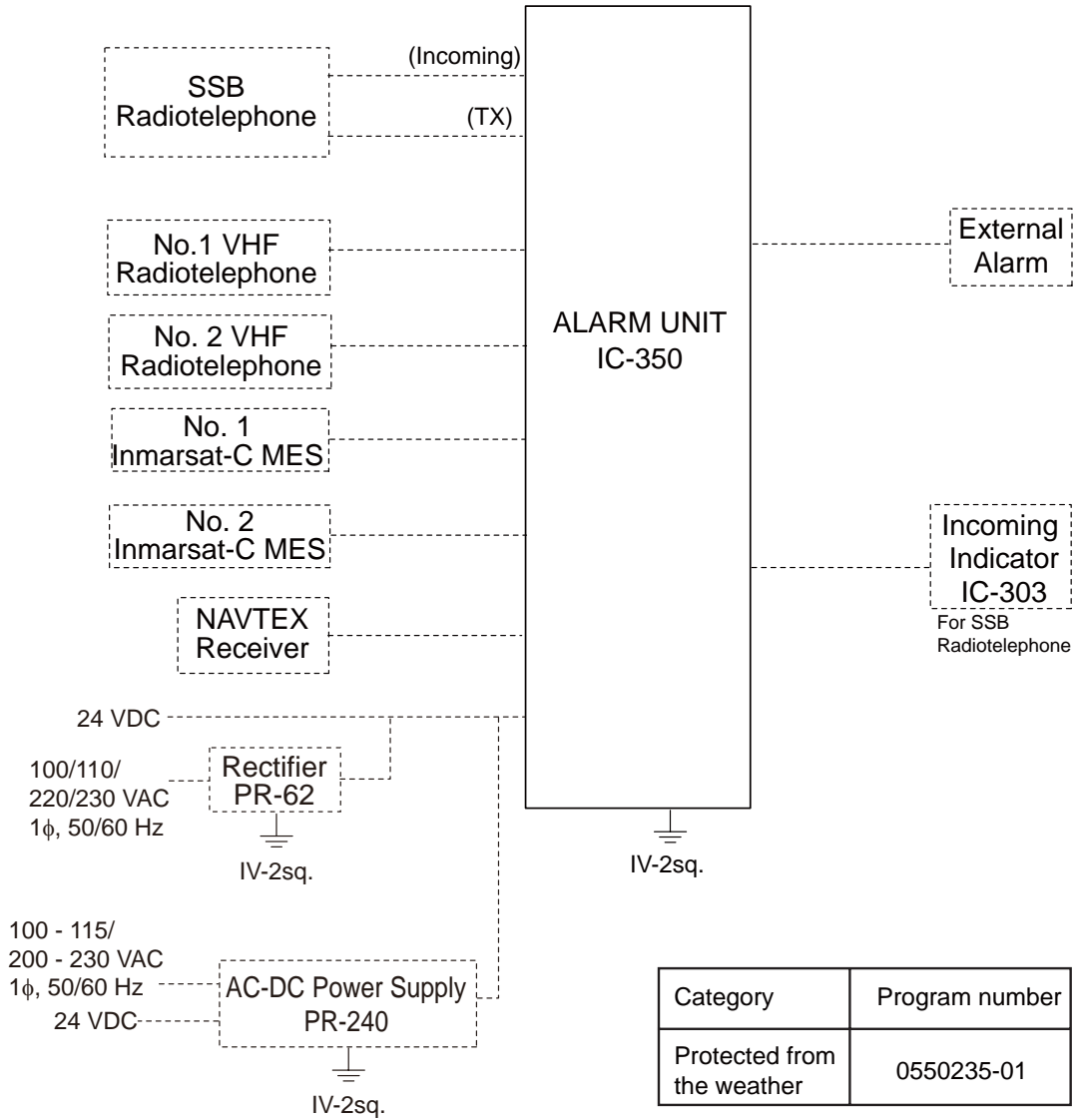

Category	Program number
Protected from the weather	0550235-01

1. HOW TO INSTALL THE ALARM UNIT

1.1 Equipment Lists

Standard supply

Name	Type	Code No.	Qty	Comment
Alarm Unit	IC-350	—	1	
Installation Materials	CP05-11701	000-041-190	1 set	Self-tapping screws (4×20) (code no. 000-158-850-10, 4 pieces)

Optional supply

Name	Type	Qty	Comment
Rectifier	PR-62	1	AC input, 24 VDC output
AC-DC Power Supply	PR-240	1	AC, DC input, 24 VDC output

1.2 How to Install the Alarm Unit

See the outline drawing at the back of this manual for dimensions. Install the alarm unit in a console. Make a cutout in the location for the unit, the dimensions of which are 277(W)×287(H). Set the unit to the cutout. Fasten the unit with four self-tapping screws (supplied).

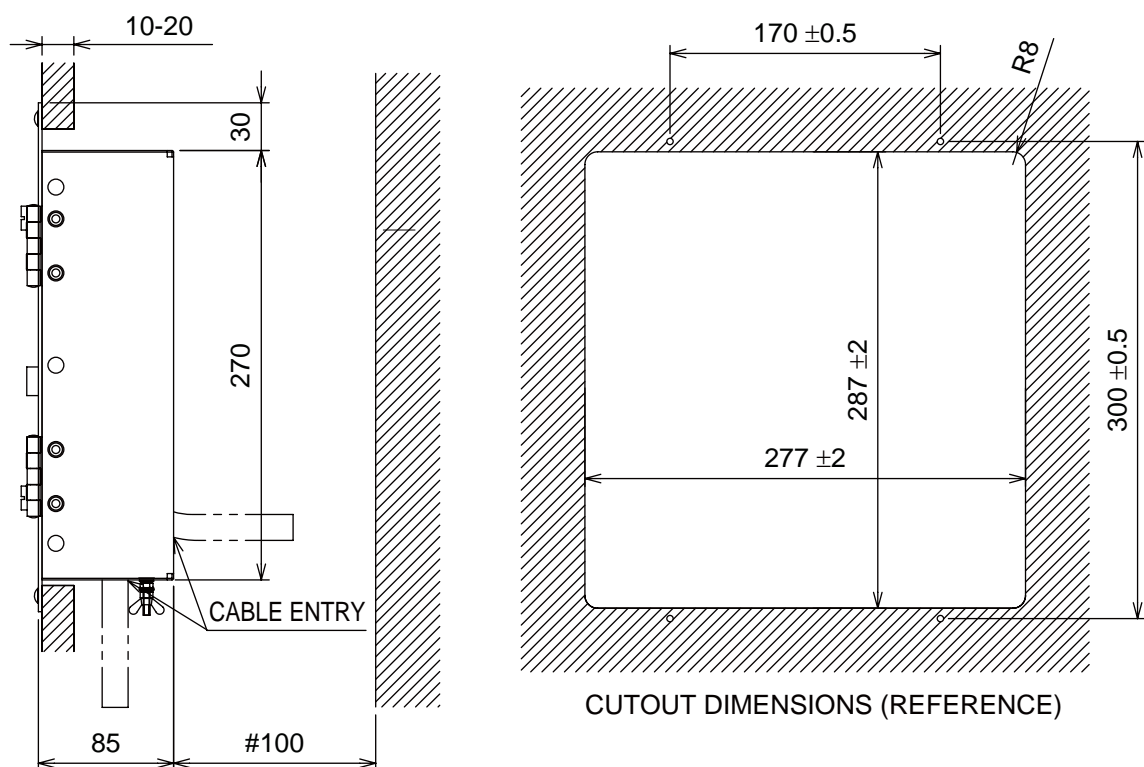

1. HOW TO INSTALL THE ALARM UNIT

1.3 Connections

1.3.1 Where to connect the cables

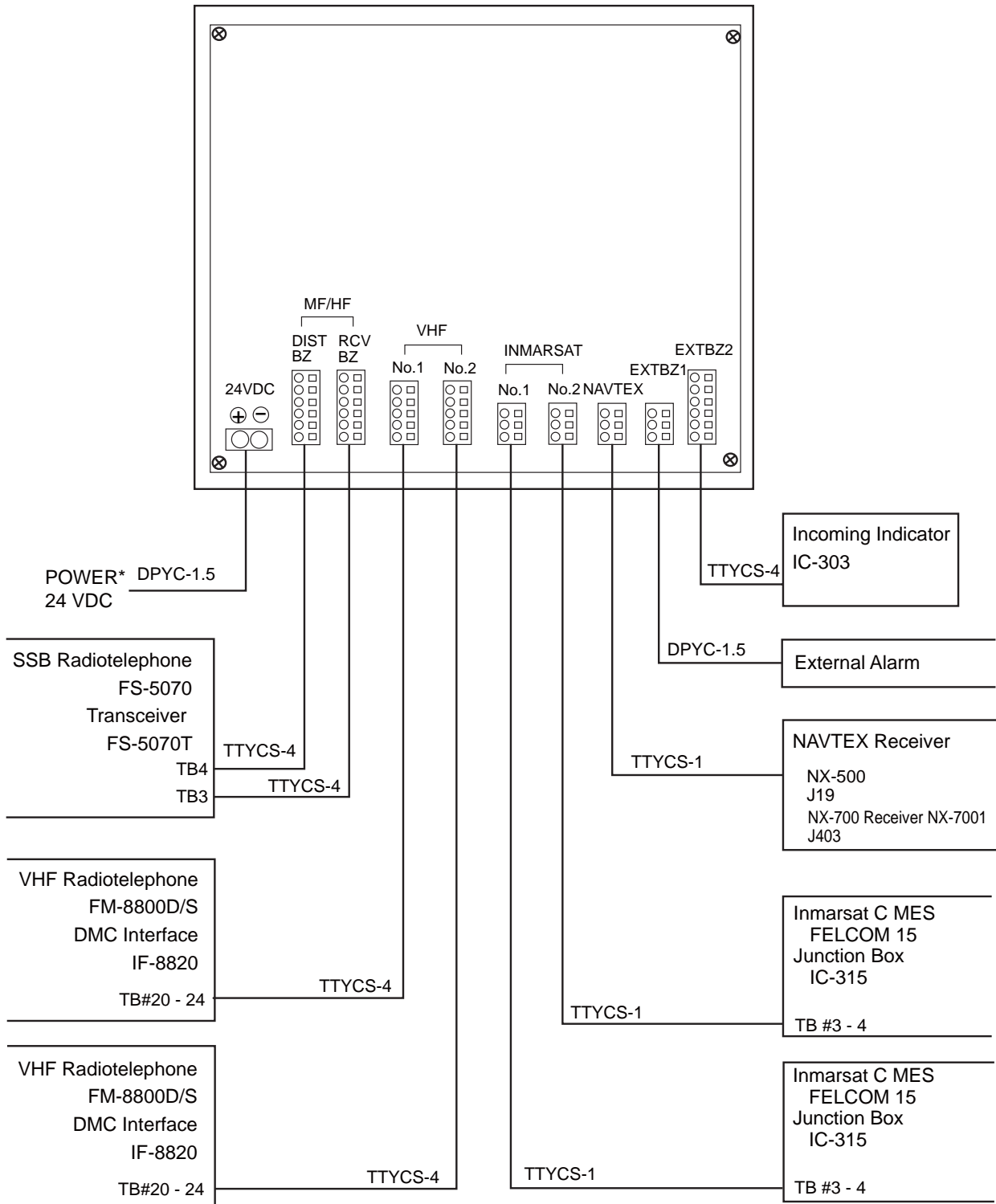

* Power must be supplied from a breaker on the ship's switchboard.

1.3.2 How to prepare the cables

This section shows you how to prepare the cables. The text between parentheses in the section titles are the names of Japan Industry Standard (JIS) cables. Use those cables or their equivalents.

Power cable (DPYC-1.5)

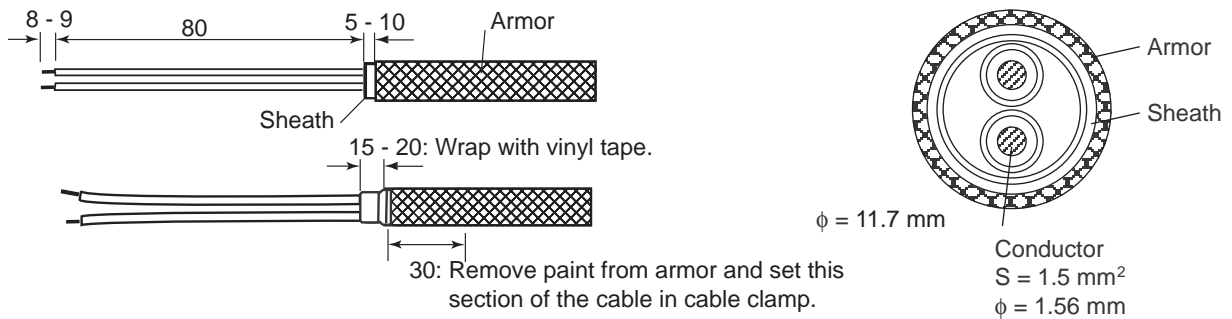

Signal cable (TTYCS-1, TTYCS-4)

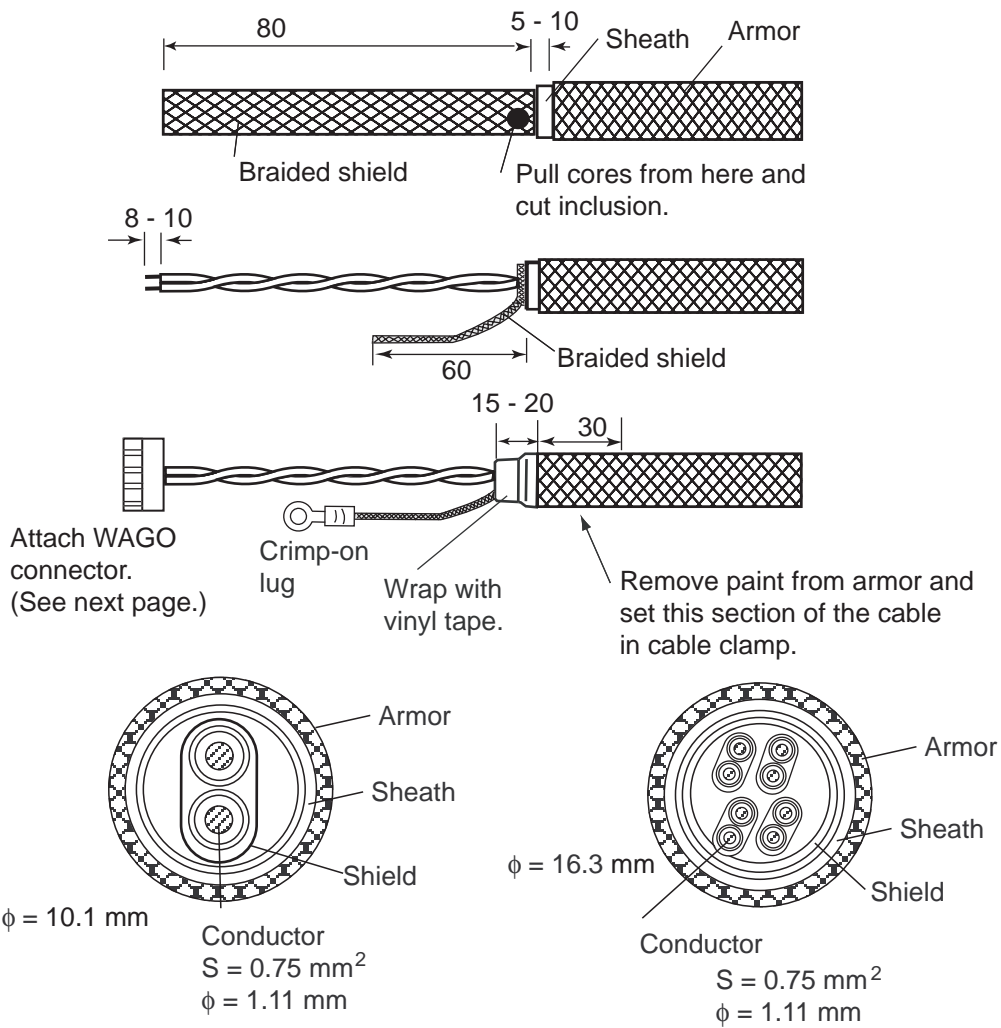

1. HOW TO INSTALL THE ALARM UNIT

Cable for external alarm (DPYC-1.5)

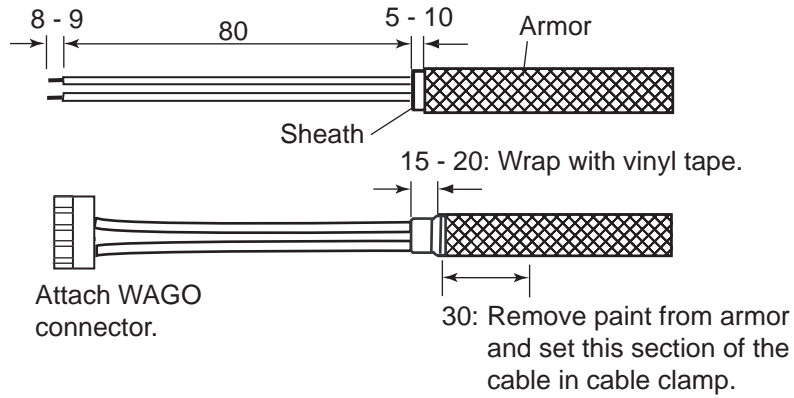

How to fasten a WAGO connector

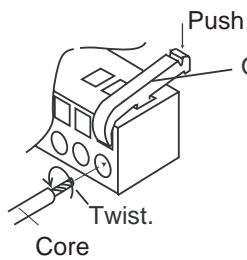

1. Twist conductors.
2. Set opener as shown and push down.
3. Set core to hole.
4. Release opener.
5. Pull the core to check if it is inserted correctly.

How to connect the cables

The lid at the bottom of the chassis seals the bottom cable entrance. To lead in cables through the bottom of the chassis (rather than the rear) unfasten two screws to remove the lid and use the lid to cover the rear panel cable entrance.

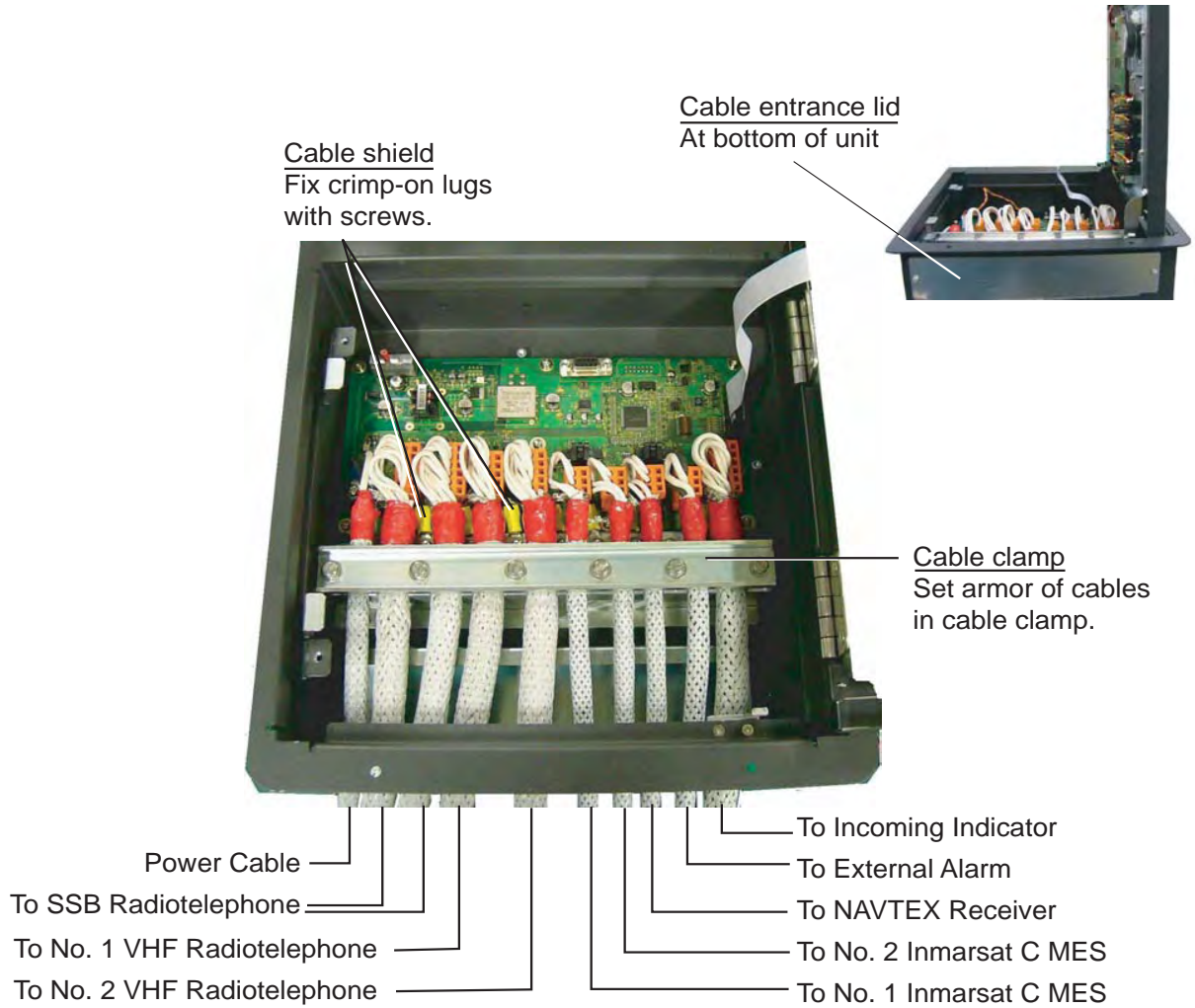

1. HOW TO INSTALL THE ALARM UNIT

DIP switch settings

Set the DIP switch S101 on the PANEL Board (05P0820) according to equipment connected. All switches are in the OFF position in the factory setting. Set a switch in the ON position if the related equipment is not connected.

		OFF	ON
1	No.1 VHF	ENABLE	DISABLE
2	No.2 VHF	ENABLE	DISABLE
3	MF/HF	ENABLE	DISABLE
4	No.1 INMARSAT	ENABLE	DISABLE
5	No.2 INMARSAT	ENABLE	DISABLE
6	NAVTEX	ENABLE	DISABLE
7	NAVTEX SEL	NC	NO
8			

#1-#6
ON: Equipment not connected.
OFF: Equipment connected.

← #7
NX-700: OFF
NX-500: ON

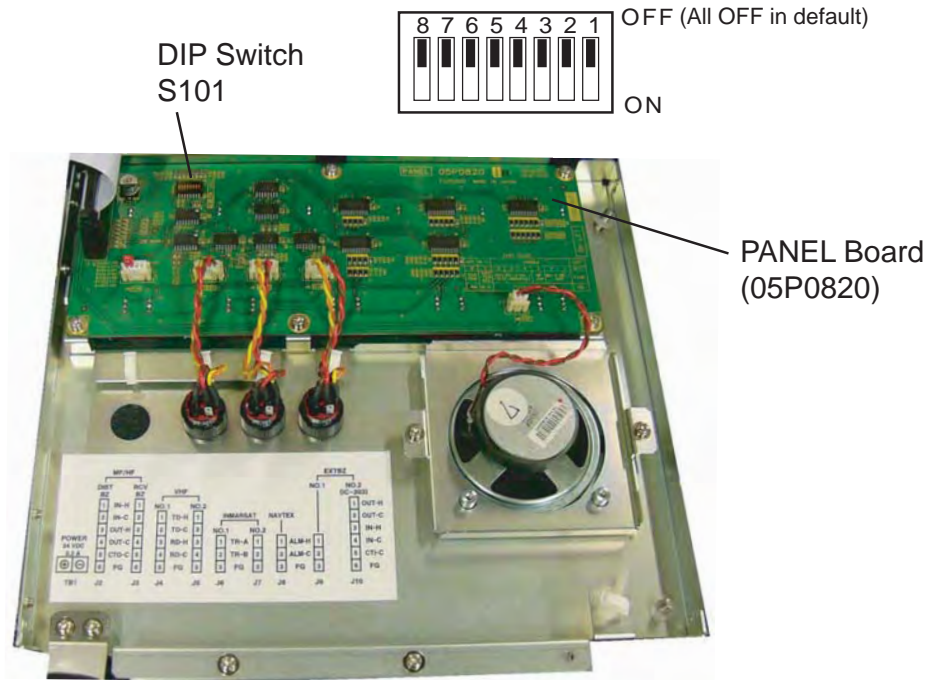

“SPARE” sticker

If you connect one Inmarsat C only, put the “SPARE” stickers on No.2 INMARSAT indications for LED lamp and DISTRESS button. The “SPARE” stickers are attached on the reverse side of the operation panel.

2. OPERATION

2.1 Controls and Indicators

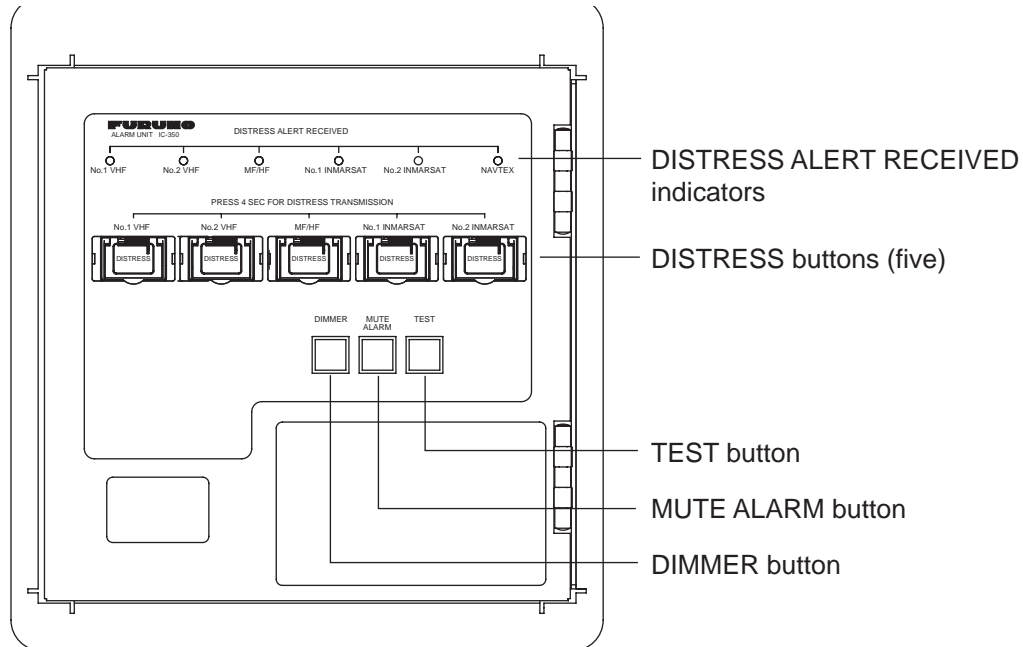

VHF: VHF radiotelephone
MF/HF: SSB radiotelephone
INMARSAT: Inmarsat-C Mobile Earth Station
NAVTEX: Navtex Receiver

2.2 How to Set the Unit to Stand-by

- 1) Activate the breaker for the IC-350 at the ship's switchboard to turn on the IC-350. All buttons in the IC-350 illuminate. Run the IC-350 while underway. A DISTRESS button does not illuminate if the equipment name shown above the button is not connected. If a DISTRESS button does not illuminate if the equipment is connected, check the DIP switch setting. See page 6.
- 2) Push the DIMMER button to adjust the illumination for all the buttons. The equipment starts with the previous illumination setting.

2. OPERATION

2.3 When You Receive a Distress Signal

When you receive a distress signal, the related DISTRESS lamp flashes and the two-tone alarm sounds. The volume of the alarm gets louder after five seconds.

To stop the audio alarm, push the MUTE ALARM button. The related DISTRESS indicator then illuminates. The indicator turns off when the distress signal is stopped.

2.4 How to Send a Distress Signal

If **YOUR ship is in distress**, send a distress signal and do distress communications with a coast station by radiocommunications. The IC-350 has five distress buttons. Use the No.1 VHF button (leftmost DISTRESS button) to send a distress signal in normal use.

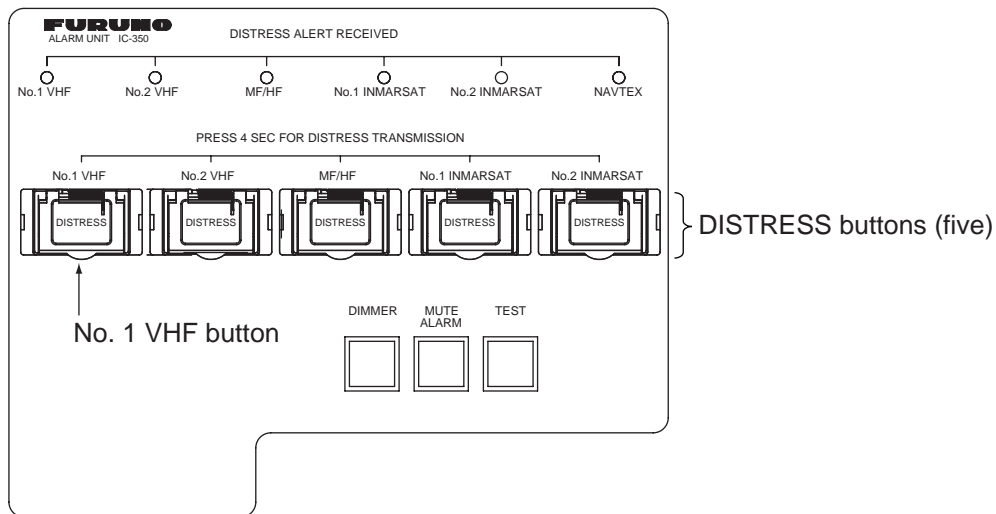

To send a distress signal, open the cover of the correct DISTRESS button and push the button more than four seconds. In the first three seconds, the button flashes and the speaker releases three beeps. The button then illuminates and the distress signal is sent. Do distress communications with a coast station by the same equipment used to send the distress signal.

If you release a DISTRESS button within three seconds after you pressed the button, the distress signal is not sent. If you accidentally sent a distress signal (DISTRESS button pressed more than three seconds), contact a coast station to report accidental distress transmission. Contact the coast station by the same communications equipment used to send the distress signal.

If a DISTRESS button does not flash when the button is pushed more than four seconds, the related communications equipment is turned off. If a DISTRESS button does not illuminate, related communications equipment is not connected, and the distress signal is not sent.

If you accidentally sent the distress signal with the MF/HF DISTRESS button and powered off the SSB radiotelephone after realizing the mis-transmission, the lamp in the DISTRESS button continues to illuminate. If this happens, long-push the MUTE ALARM button to restore normal operation.

Note: If you accidentally sent the distress signal, refer to the operator's manual of the radiocommunications equipment for the procedure to cancel the distress signal.

3. MAINTENANCE

NOTICE

Do not apply paint, anti-corrosive sealant or contact spray to coating or plastic parts of the equipment.

Those items contain organic solvents that can damage coating and plastic parts, especially plastic connectors.

3.1 Maintenance

Check the points shown below once a month to help keep the equipment in good condition.

Item	Check point
Cables	Check cables for damage.
Screws on chassis	Check that screws are correctly fastened.
Ground	Check for corrosion.
Voltage	Check that the voltage is within the rating of the equipment. (The voltage at the power terminal is 20.4 - 31.6 VDC)

3.2 How to Clean the Equipment

Remove dust from the equipment with a soft and dry cloth. To remove dirt, use a moist cloth. Do not use chemical cleaners as those types of cleaners can remove paint and markings.

3.3 Circuit Breaker

The circuit breaker inside the IC-350 activates for equipment problems or high voltage. The button on the breaker comes out when the breaker activates. Push the button to reset the breaker. If you cannot turn ON the power (from the ship's switchboard), contact a FURUNO agent or dealer for instruction.

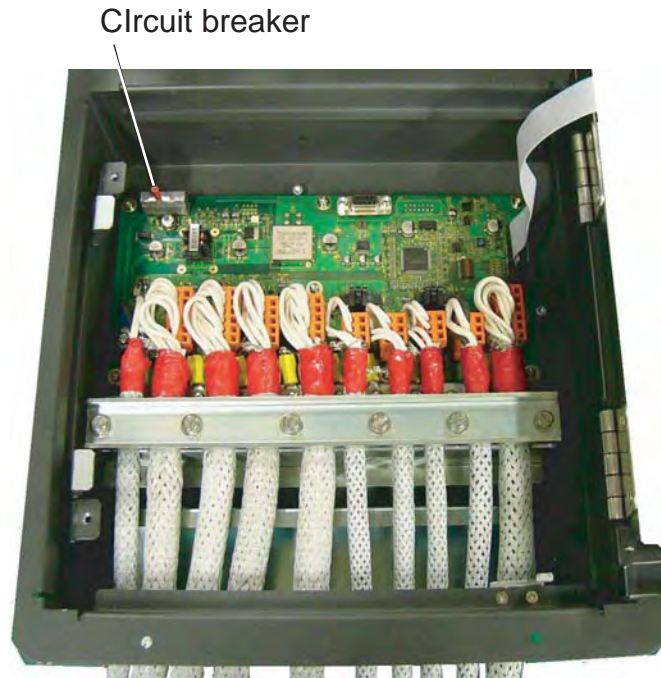

3.4 Troubleshooting

Problem	Possible cause	Remedy
You cannot turn ON the unit	<ul style="list-style-type: none"> The power switch at the ship's switchboard is OFF. The circuit breaker inside the unit has activated. The input voltage is not within the voltage rating. 	<ul style="list-style-type: none"> Turn ON the power at the ship's switchboard. Press the button on the breaker to restore normal operation. Check the input voltage. <p>If you cannot turn ON the equipment, contact a FURUNO agent or dealer for instruction.</p>

3.5 Equipment Test

Push the TEST button to test the two-tone signal and the illumination for the buttons. The test completes in approximately three seconds. All the buttons illuminate and the two-tone signal sounds.

CAUTION
You cannot send or receive a distress signal during the test.

SPECIFICATIONS OF ALARM UNIT IC-350

IC-350 is a GMDSS Distress Alarm Panel that is normally installed at conning position. Pressing the button on the panel transmits the distress alert. When the incoming distress or urgency call is received, the panel generates audible and visible alarms. The buttons on panel are clearly and visibly identified.

1 GENERAL

- | | | |
|-----|-----------------------|--|
| 1.1 | Indication of receive | LED illumination and audible alarm generated when distress callings are received (SAR message for Navtex receiver) |
| 1.2 | Nature of distress | |
| | Distress button | LED illumination independently for each equipments |
| | Audible alarm | Synchronized with LED behavior (continuous/ intermittent/ halt) |
| 1.3 | External alarm | |
| | Alarm 1 | Distress alert indication, Photo-MOS relay contact, normal close
Max. 80 mA, 50 V |
| | Alarm 2 | Incoming indicator (IC-303-DSC) for SSB radiotelephone |

2 INTERFACE

- | | | |
|-----|---------------------------|---|
| 2.1 | I/O port | |
| | SSB radiotelephone | FS-5070/2570/1570 |
| | Marine VHF radiotelephone | FM-8800D/S (2 sets) |
| | Inmarsat-C MES | FELCOM 15 |
| | Navtex receiver | NX-500/700 |
| | External alarm | General: 1 port, IC-303-DSC: 1 port (for FS-5070/2570/1570) |
| 2.2 | Control panel | TEST/ MUTE ALARM/ DIMMER/ DISTRESS |
| 2.3 | LED indication | DISTRESS call, 6 sets |
| 2.4 | Speaker | Receiving alarm/ Audible alarm |

3 POWER SUPPLY

- | | | |
|-----|--|---------------------------------------|
| 3.1 | Alarm unit | 24 VDC: 0.15A |
| 3.2 | AC/DC power supply unit (PR-240, option) | 100-115/200-230VAC, 1 phase, 50/60Hz |
| 3.3 | Rectifier (PR-62, option) | 100/110/220/230 VAC, 1 phase, 50/60Hz |

4 ENVIRONMENTAL CONDITION

- | | | |
|-----|----------------------|-------------------|
| 4.1 | Ambient temperature | -15°C to +55°C |
| 4.2 | Relative humidity | 95% at 40°C |
| 4.3 | Degree of protection | Front panel: IP22 |
| 4.4 | Bearing vibration | IEC 60945 |

5 COATING COLOR

N2.5

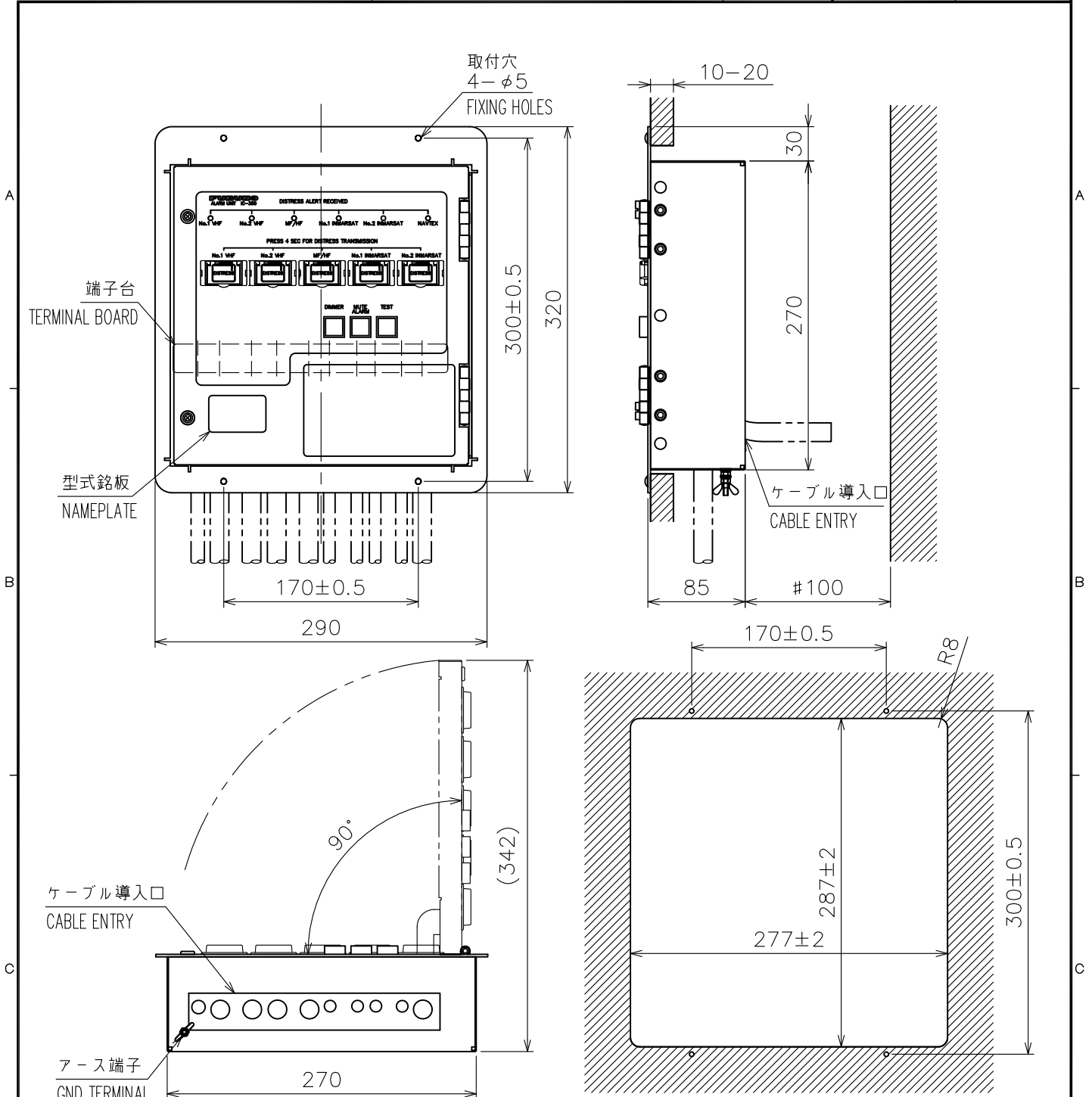

取付穴寸法図 (参考図)

CUTOUT DIMENSIONS (REFERENCE)

注 記

- 1) 指定外の寸法公差は表 1 による。
- 2) # 印寸法は最小サービス空間を示す。
- 3) 取付用ネジはトラスタップンネジ呼び径 4×20 を使用のこと。

NOTE

1. TABLE 1 INDICATES TOLERANCE OF DIMENSIONS WHICH IS NOT SPECIFIED.
2. #: MINIMUM SERVICE CLEARANCE.
3. USE TAPPING SCREWS $\phi 4 \times 20$ FOR FIXING THE UNIT.

表1 TABLE 1

寸法区分 (mm) DIMENSION	公差 (mm) TOLERANCE
$L \leq 50$	± 1.5
$50 < L \leq 100$	± 2.5
$100 < L \leq 500$	± 3

DRAWN	20/May/08 T.YAMASAKI	TITLE	IC-350
CHECKED	20/May/08 T.TAKENO	名称	アラームユニット (埋込装備)
APPROVED	27/May/08 R.Esumi		外寸図
SCALE	1/5 MASS 4.7 ±10% kg	NAME	ALARM UNIT (FLUSH MOUNT)
DWG.No.	C5665-G01-B	REF.No.	05-099-250G-1
		OUTLINE DRAWING	

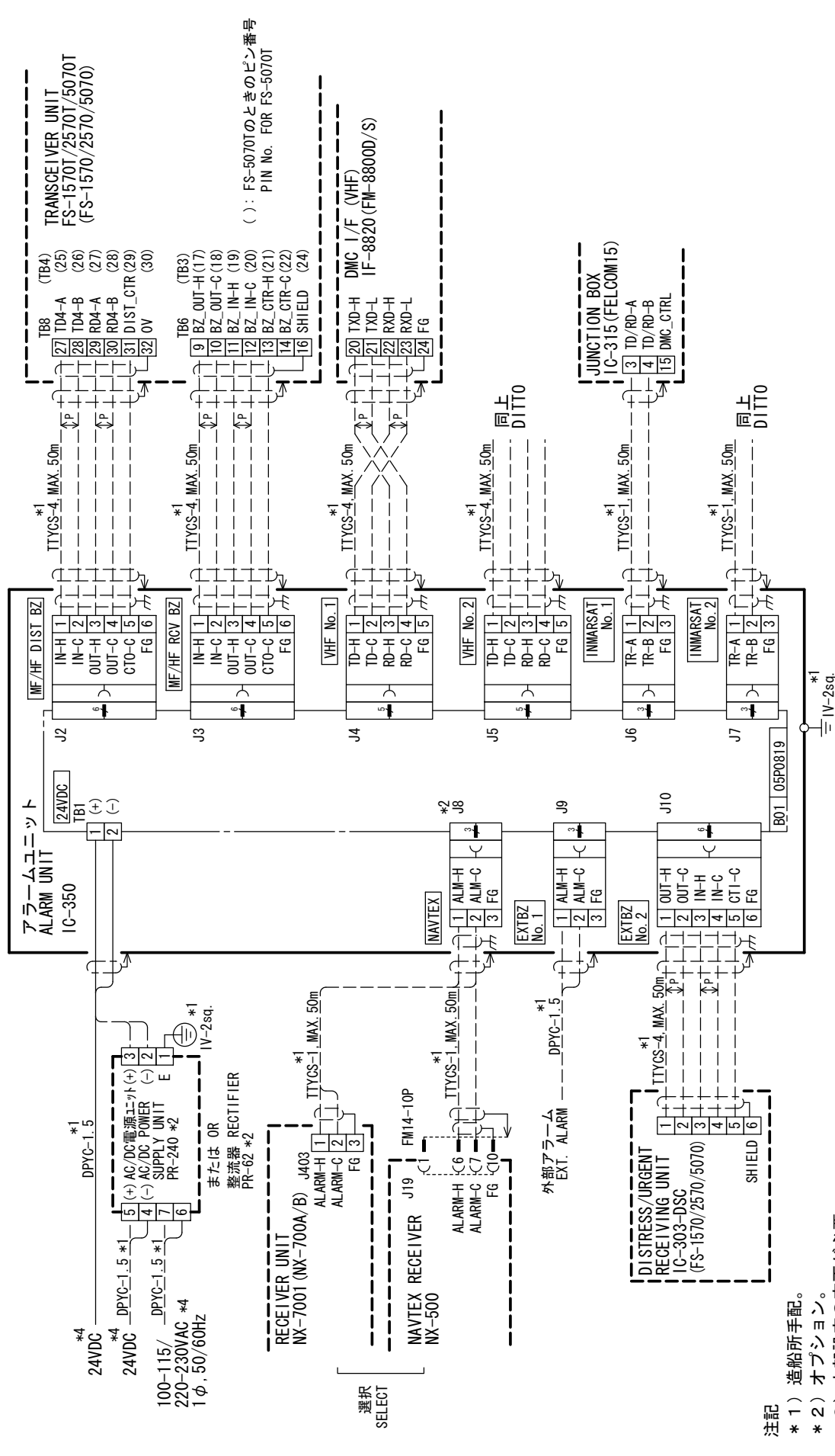

DRAWN	18/Jun/08	T. YAMASAKI	TITLE	IC-350
CHECKED	18/Jun/08	T. TAKENO	名称	アラームユニット
APPROVED	27/Jun/08	R. Esumi	相互結線図	
SCALE	1/25	kg	NAME	ALARM UNIT
DWG No.	C5665-001-C	REF No.	05-099-2002-1	INTERCONNECTION DIAGRAM

ECF

(Elemental Chlorine Free)

The paper used in this manual
is elemental chlorine free.

FURUNO ELECTRIC CO., LTD.

9-52 Ashihara-cho,
Nishinomiya, 662-8580, JAPAN

Telephone : +81-(0)798-65-2111

Fax : +81-(0)798-65-4200

• FURUNO Authorized Distributor/Dealer

All rights reserved. Printed in Japan

Pub. No. OME-56650-B

(TATA) IC-350

A : JUN . 2008

B : SEP . 30, 2008



* 0 0 0 1 6 9 2 0 4 1 1 *