

Specialty Heated and  
Water Systems Components  
Catalog



**Collins Aerospace**

# System Components



# Table of Contents

Category	Page(s)
Water Storage Tanks	4-6
28 VDC Motorized Valves	8-12
Manual Valves	14-15
Control Cables and Gearboxes	16-17
Miscellaneous Valves	18-19
Freeze Protection Heaters	20-21
Heated Hoses	22-23
Service Panels	24-25
Fill Caps and Adapters	26-27
Pneumatic Components	28-29
Water Pumps and Air Compressor	30-31
Lavatory / Galley Water Heaters / Water System / Shower Heaters	32-34
Heated Drain Masts	36-38
Electronic Controllers	40-41
Air Heaters	42-43
Heated Floor Panels	44



# Water Storage Tanks

Collins Aerospace offers cylindrical or conformed titanium and stainless steel water tanks that have been sized for various flight requirements. Structural analysis and full qualification testing have been performed on each water tank design. Water tanks include ports for vent and relief valves. Numerous tanks include level sensing and optional heating.





## Water Storage Tanks

Part Number	Description	Usable Water Capacity in Gallons	Max Operating Pressure	Envelope	Weight	Qual Level	Material	Fitting Type	Manual Fill Port	Special Features
5E2655-1	Cylindrical water tank	9.9	50 psig	27.0"x12.0" dia.	12.5 lbs	DO-160C	300 series stainless steel	Drain & Overboard: AS33514G8, Air line: AS33514G6	N	Ports included: 5 water level sensors, drain, overboard line, and air line
5E2657-1	Cylindrical water tank	11.7	50 psig	36.0"x11.0" dia.	12.7 lbs	DO-160C	300 series stainless steel	Fill/Drain & Overboard: AS33514G8, Pneu Port: AS33514G6	N	Ports included: 5 water level sensors, fill/drain, overboard line, and pneumatic
4E4357-2	Conformal water tank	24.7	55 psig	25.4"x10.2"x37.6"	63.7 lbs	DO-160D	300 series stainless steel	Drain & Overboard: AS33514-08, Fill: AS33514-10, Drip Tray Drain: MS33660-6	Y	Ports included: fill, overboard, drain, and sight tube
4E4604-1	Cylindrical water tank	28.6	55 psig	12.7"x19.3"x51.2"	44 lbs	DO-160D	Titanium	Overboard: AS33514-08, Drain: AS33514-12, Return: AS1656-1-08, Drip Fitting: AS5131B06	Y	Ports included: return line, overflow, auxiliary tank, and drain
4E4605-1	Cylindrical water tank	10.0	55 psig	32.3"x12.0" dia.	12.5 lbs	DO-160D	Titanium	Fill: AS33514G8, Drain: AS33514G12, Drip Fitting: AS5131B6	N	Ports included: drain tee
4E4605-2	Cylindrical water tank	17.5	55 psig	52.8"x12.0" dia.	20 lbs	DO-160D	Titanium	Fill: AS33514G8, Drain: AS33514G12, Drip Fitting: AS5131B6	Y	Ports included: drain tee
4E4307-2	Conformal water tank	7.0	30 psig	18.2"x16.7"x9.0"	26.2 lbs	DO-160C	300 series stainless steel	Fill, Drain & Overflow: AS1656-1-08	Y	Ports included: fill, overflow, deployable water tank fill arm

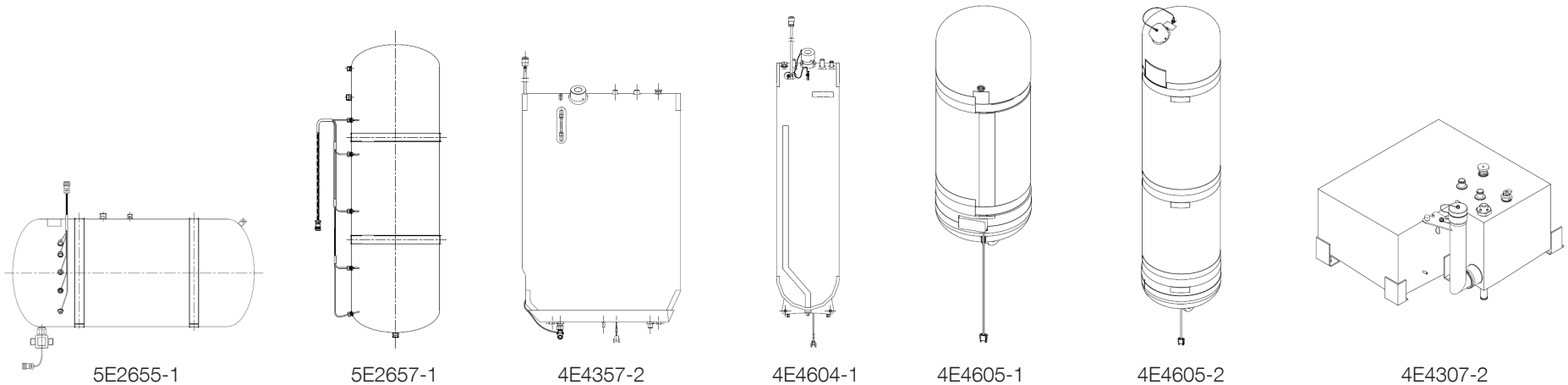

## Water Storage Tanks

Part Number	Description	Usable Water Capacity in Gallons	Max Operating Pressure	Envelope	Weight	Qual Level	Material	Fitting Type	Manual Fill Port	Special Features
4E4293-3	Conformal water tank	30.0	50 psig	20.3"x12.5"x35.1"	64.7 lbs	DO-160D	300 series stainless steel	Air conn: AS1656-3-06, Drain & Fill: AS1656-1-08, Overflow: AS1656-3-08	Y	Ports included: air connection, fill, drain, overflow, four way valve
4E4979-1	Conformal water tank	20.0	58 psig	22.1"x12.2"x28.3"	33 lbs	DO-160E	Titanium	Fill & Drain: AS1656-1-08, Overflow: AS1656-3-08, Air conn: AS4375E6 (on check valves)	Y	Ports included: fill, overflow, pressure transducer
4E4979-2	Conformal water tank	20.0	58 psig	22.1"x12.2"x28.3"	33 lbs	DO-160E	Titanium	Fill & Drain: AS1656-1-08, Overflow: AS1656-3-08, Air conn: AS4375E6 (on check valves)	Y	Ports included: fill, overflow, pressure transducer
4E5418-1	Conformal water tank	15.0	58 psig	14.8"x15.5"x30.3"	28.8 lbs	DO-160G	Titanium	Fill & Drain: AS1656-1-08, Overflow: AS1656-1-08, Air conn: AS4375E6 (on check valves)	Y	Ports included: fill, overflow, pressure transducer
4E5418-2	Conformal water tank	15.0	58 psig	14.1"x16.5"x30.9"	28.5 lbs	DO-160G	Titanium	Fill & Drain: AS1656-1-08, Overflow: AS1656-1-08, Air conn: AS4375E6 (on check valves)	Y	Ports included: fill, overflow, pressure transducer

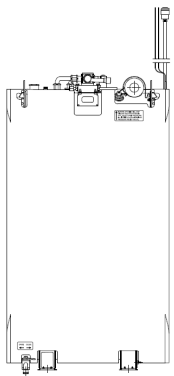

4E4293-3

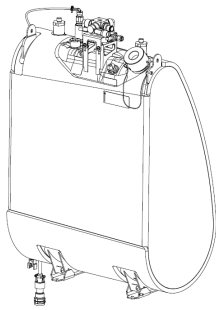

4E4979-1

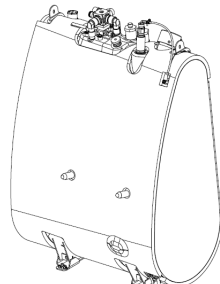

4E4979-2



4E5418-1

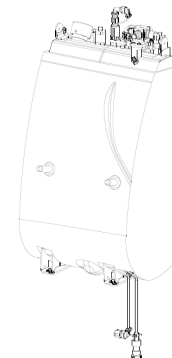

4E5418-2



# 28 VDC Motorized Valves

Collins Aerospace offers 28 VDC motorized stainless steel ball valves with low pressure drop levels. Pulse width modulation is available on selected models only. Full qualification testing has been performed on each motorized valve design. Position switches are used for fault detection and optional valve heaters are available on select models.





## 28 VDC Motorized Valves

Note: All are 300 series stainless steel, 11 watts, and include mounting brackets.

Part Number	Number of Positions	Number of Ports	Envelope	Weight	Qual Level	Fitting Type	Electrical Connector	Silicon Heater Option	Special Features
4E4348-1	3	4	6.2"x4.7"x3.3"	2.5 lbs	DO-160D	4x end fitting AS33514E8 (MS33514E8)	MIL-C-38999 (D38999/20MB35P) Mates with D38999/26MB35S or equiv.	Y - PN 4E4372	Electrical position indication
4E4348-2	3	3	5.0"x4.7"x3.1"	2.1 lbs	DO-160D	2X End Fitting AS1656-1-08, center fitting AS33514E8 (MS33514E8)	MIL-C-38999 (D38999/20MB35P) Mates with D38999/26MB35S or equiv.	N	Electrical position indication
4E4348-4	2	2	5.0"x4.7"x2.6"	2 lbs	DO-160D	2X End Fitting AS33514E8 (MS33514E8)	MIL-C-38999 (D38999/20MB35P) Mates with D38999/26MB35S or equiv.	Y - PN 4E4372-8	Electrical position indication
4E4348-5	2	4	5.3"x4.7"x2.6"	2.5 lbs	DO-160D	4X End Fitting AS33514E8 (MS33514E8)	MIL-C-38999 (D38999/20MB35P) Mates with D38999/26MB35S or equiv.	Y - PN 4E4372-6	Electrical position indication
4E4348-6	2	2	5.3"x4.7"x2.6"	2.3 lbs	DO-160D	2X End Fitting AS33514E12 (MS33514E12)	MIL-C-38999 (D38999/20MB35P) Mates with D38999/26MB35S or equiv.	N	Electrical position indication
4E4348-7	2	2	5.3"x4.7"x2.6"	2.5 lbs	DO-160D	2X End Fitting AS33514E8 (MS33514E8)	MIL-C-38999 (D38999/20MB35P) Mates with D38999/26MB35S or equiv.	N	Manual override, electrical position indication
4E4348-12	2	2	5.3"x4.7"x3.3"	2.3 lbs	DO-160D	3X End Fitting AS33514E8 (MS33514E8)	MIL-C-38999 (D38999/20MB35P) Mates with D38999/26MB35S or equiv.	Y - PN 4E4372-9	Electrical position indication

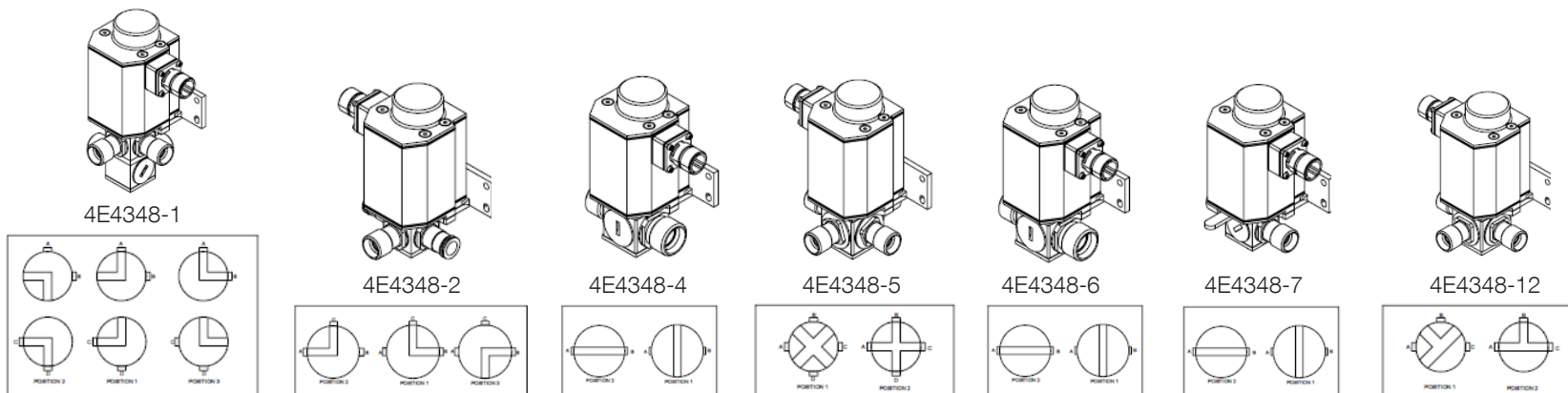

## 28 VDC Motorized Valves

Note: All are 300 series stainless steel, 11 watts, and include mounting brackets.

Part Number	Number of Positions	Number of Ports	Envelope	Weight	Qual Level	Fitting Type	Electrical Connector	Silicon Heater Option	Special Features
4E4348-13	2	2	5.3"x4.7"x2.6"	2.1 lbs	DO-160D	2X End Fitting AS33514E12 (MS33514E12)	MIL-C-38999 (D38999/20MB35P) Mates with D38999/26MB35S or equiv.	N	Manual override, electrical position indication
4E4348-14	2	2	5.1"x4.7"x2.6"	2.5 lbs	DO-160D	2X End Fitting AS1656-1-08	MIL-C-38999 (D38999/20MB35PN) Mates with D38999/26MB35SN or equiv.	N	Electrical position indication
4E4482-1	2	2	5.1"x3.7"x2.6"	2 lbs	DO-160D	2X End Fitting AS33514E6	MS24266R14B15PN Mates with MS24264R14B15SN or equiv.	N	Manual override, stall protection, electrical position indication
4E4483-1	2	3	5.1"x3.7"x3.3"	2.5 lbs	DO-160D	3X End Fitting AS1656-1-08	MS24266R14B15PN Mates with MS24264R14B15SN or equiv.	N	Manual override, stall protection, electrical position indication
4E4484-1	2	4	6.3"x4.7"x2.6"	2.5 lbs	DO-160D	4X End Fitting AS1656-1-08	MS24266R14B15PN Mates with MS24264R14B15SN or equiv.	N	Manual override, stall protection, electrical position indication
4E4485-1	2	2	5.1"x3.9"x2.6"	2 lbs	DO-160D	2X End Fitting AS1656-1-08	MS24266R14B15PN Mates with MS24264R14B15SN or equiv.	N	Manual override, stall protection, electrical position indication
4E4491-1	2	3	6.3"x3.7"x2.8"	2 lbs	DO-160D	2X End Fitting AS33514E8, center ell fitting AS1656-2-08	MS24266R14B15PN Mates with MS24264R14B15SN or equiv.	N	Visual position indicator, stall protection, electrical position indication
4E4492-1	3	3	5.1"x4.5"x3.5"	2.1 lbs	DO-160D	3X End Fitting AS33514E8	MS24266R14B15PN Mates with MS24264R14B15SN or equiv.	N	Manual override, stall protection, electrical position indication

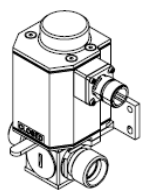

4E4348-13

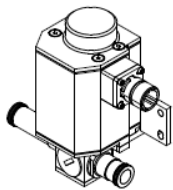

4E4348-14

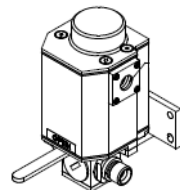

4E4482-1

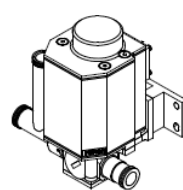

4E4483-1

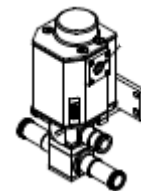

4E4484-1

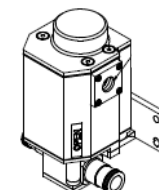

4E4485-1

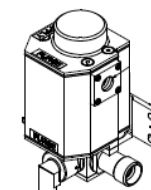

4E4491-1

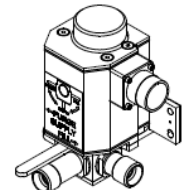

4E4492-1

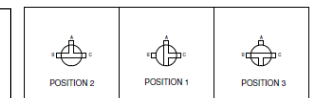
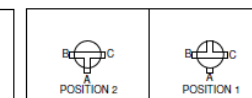
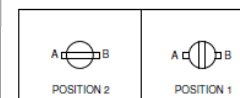
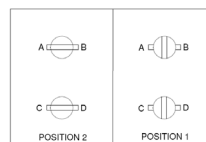
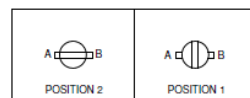
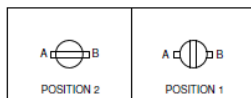
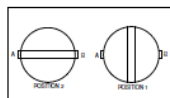
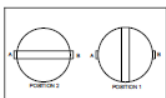

## 28 VDC Motorized Valves

Note: All are 300 series stainless steel, 11 watts, and include mounting brackets.

Part Number	Number of Positions	Number of Ports	Envelope	Weight	Qual Level	Fitting Type	Electrical Connector	Silicon Heater Option	Special Features
4E4493-1	2	3	6.3"x4.0"x2.9"	2.25 lbs	DO-160D	2X End Fitting AS33514E10, center ell fitting AS1656-2-10	MS24266R14B15PN Mates with MS24264R14B15SN or equiv.	N	Visual position indicator, stall protection, electrical position indication
4E4872-1	2	2	5.1"x5.4"x3.0"	1.8 lbs	DO-160E	2X End Fitting AS1656-1-08	MIL-C-38999 (D38999/20MB35PA) Mates with D38999/26MB35SA or equiv.	N	Manual override, stall protection, electrical position indication
4E4872-2	2	2	5.1"x5.4"x3.0"	1.8 lbs	DO-160E	2X End Fitting AS1656-1-08	MIL-C-38999 (D38999/20MB35PB) Mates with D38999/26MB35SB or equiv.	N	Manual override, stall protection, electrical position indication
4E4872-3	2	2	5.1"x4.7"x2.7"	1.8 lbs	DO-160E	2X End Fitting AS1656-1-08	MIL-C-38999 (D38999/20MB35PA) Mates with D38999/26MB35SA or equiv.	N	Manual override, stall protection, electrical position indication
4E4872-4	2	2	5.1"x4.7"x3.0"	1.8 lbs	DO-160E	2X End Fitting AS1656-1-08	MIL-C-38999 (D38999/20MB35PB) Mates with D38999/26MB35SB or equiv.	N	Manual override, stall protection, electrical position indication
4E4873-11	2	3	6.3"x4.2"x2.6"	2 lbs	DO-160E	3X End Fitting AS1656-1-08	MIL-C-38999 (D38999/20MB35PA) Mates with D38999/26MB35SA or equiv.	N	Manual override, stall protection, electrical position indication
4E4873-22	2	3	6.3"x4.2"x2.6"	2 lbs	DO-160E	3X End Fitting AS1656-1-08	MIL-C-38999 (D38999/20MB35PB) Mates with D38999/26MB35SB or equiv.	N	Manual override, stall protection, electrical position indication

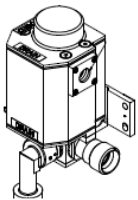

4E4493-1

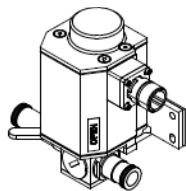

4E4872 Series

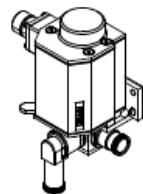

4E4873 Series

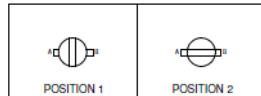
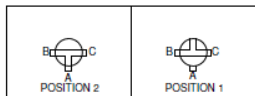

## 28 VDC Motorized Valves

Note: All are 300 series stainless steel, 11 watts, and include mounting brackets.

Part Number	Number of Positions	Number of Ports	Envelope	Weight	Qual Level	Fitting Type	Electrical Connector	Silicon Heater Option	Special Features
4E4874-11	2	3	5.1"x4.1"x5.1"	2.2 lbs	DO-160E	2X End Fitting AS33514E8, center ell fitting AS1656-1-08	MIL-C-38999 (D38999/20MB35PA) Mates with D38999/26MB35SA or equiv.	N	Manual override, stall protection, electrical position indication
4E4874-22	2	3	5.1"x4.1"x5.1"	2.2 lbs	DO-160E	2X End Fitting AS33514E8, center ell fitting AS1656-1-08	MIL-C-38999 (D38999/20MB35PB) Mates with D38999/26MB35SB or equiv.	N	Manual override, stall protection, electrical position indication
4E4875-3	2	3	5.3"x4.1"x5.1"	2.5 lbs	DO-160E	2X End Fitting AS33514E10, center ell fitting AS1656-1-10	MIL-C-38999 (D38999/26MB35PN) Mates with D38999/20MB35SN or equiv.	N	Manual override, stall protection, electrical position indication
4E4876-1	2	2	5.1"x4.2"x3.0"	1.8 lbs	DO-160E	2X End Fitting AS33514E6	MIL-C-38999 (D38999/20MB35PN) Mates with D38999/26MB35SN or equiv.	N	Manual override, stall protection, electrical position indication
4E4916-11	3	3	5.1"x4.1"x2.8"	2.2 lbs	DO-160E	3X End Fitting AS1656-1-08	MIL-C-38999 (D38999/26MB35PN) Mates with D38999/20MB35SN or equiv.	N	Manual override, stall protection, electrical position indication
4E4916-33	2	3	5.1"x4.1"x2.8"	2.2 lbs	DO-160E	3X End Fitting AS1656-1-08	MIL-C-38999 (D38999/26MB35PN) Mates with D38999/20MB35SN or equiv.	N	Manual override, stall protection, electrical position indication
4E4916-5	2	2	5.1"x4.1"x3.0"	2.2 lbs	DO-160E	2X End Fitting AS1656-1-08	MIL-C-38999 (D38999/26MB35PA) Mates with D38999/20MB35SA or equiv.	N	Manual override, stall protection, electrical position indication

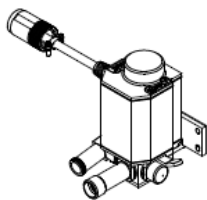

4E4874 Series

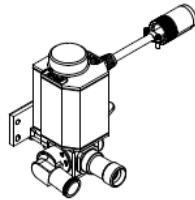
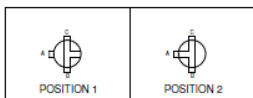

4E4875-3

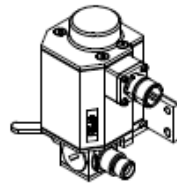

4E4876-1

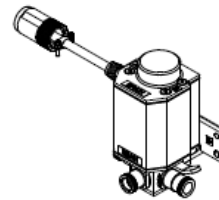

4E4916-11

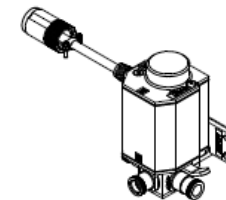
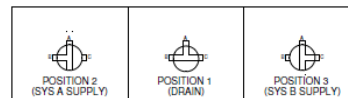

4E4916-33

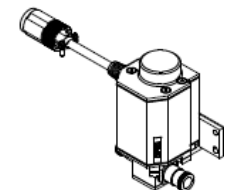
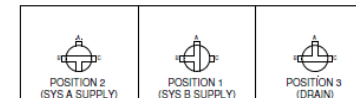

4E4916-5

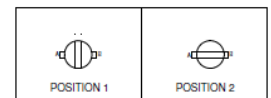





# Manual Valves

Collins Aerospace also offers manual or cable actuated valves for fill, drain and shut-off.



## Manual Valves

Note: All are 300 series stainless steel and include mounting brackets.

Part Number	Number of Ports	Number of Positions	Envelope	Weight	Qual Level	Fitting Type	Special Features
3E3209-1	5	3	2.8"x3.8"x6.0"	2.5 lbs	MIL-STD-810E/DO-160C	4X End Fitting AS33514E8 (MS33514E8)	Fill/Drain/Flight positions, 50 psig
4E4277-2	4	2	4.0"x2.5"x4.6"	1 lb	DO-160D	2X End Fitting AS1656-1-08, center fitting AS33514E8 (MS33514E8)	Fill/Flight positions, 55 psig
4E4278-1	4	2	3.0"x3.6"x3.6"	1.8 lbs	DO-160D	2X End Fitting AS33514E8 (MS33514E8)	Fill/Flight positions, 55 psig
4E4474-1	2	2	2.6"x2.0"x2.1"	0.5 lbs	DO-160D	4X End Fitting AS33514E8 (MS33514E8)	Open/Close positions, 50 psig

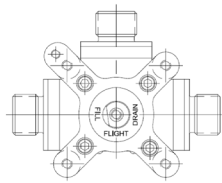

3E3209-1

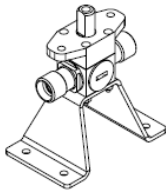

4E4277-2

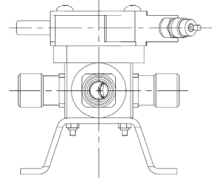

4E4278-1

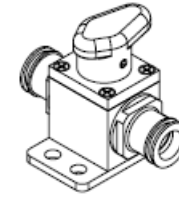

4E4474-1-1



**FILL MODE**  
PORTS A AND B = OPEN  
PORTS D AND E = OPEN  
PORT C = CLOSED



**FLIGHT MODE**  
PORTS A AND C = OPEN  
PORTS B, D AND E = CLOSED



**DRAIN MODE**  
PORTS B AND C = OPEN  
PORTS D AND E = OPEN  
PORT A = CLOSED

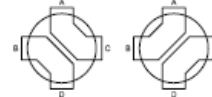
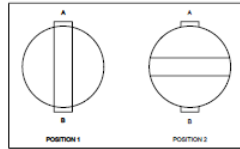

**POSITION 1**  
FLIGHT (CLOSED)

**POSITION 2**  
FILL (OPEN)

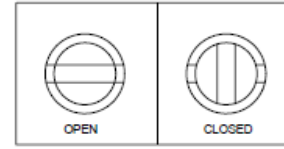

**OPEN**

**CLOSED**

# Control Cables and Gear Boxes

The Control Cable, Handle Assembly and Gearbox Assembly provide the mechanical means for opening the Potable Water System (PWS) tank fill valves. These components are typically accessed from the aircraft's external service panel.

To operate, the control cable handle is rotated 90° counterclockwise from its detented closed position, and the handle is then pulled, opening the fill/overflow valve. After the PWS is filled, the handle is pushed in to the closed position and turned 90° clockwise to lock in place.





## Control Cables and Gearboxes

Part Number	Length	Weight	Qual Level	Special Features
4E3384-1	134.7"	2.9 lbs	DO-160C	Input & output gearboxes included. Input handle is 3E3204-1
4E4181-3	138.0"	2.0 lbs	DO-160D	Input Handle and cable only (no gearbox). Output gearbox is 4E4181-2
4E4181-5	146.8"	2.1 lbs	DO-160D	Input Handle and cable only (no gearbox). Output gearbox is 4E4181-2
4E4877-1	172.6"	2.3 lbs	DO-160E	Input handle and cable only (no gearbox) Output gearbox is 4E4877-3
4E4877-2	163.1"	2.2 lbs	DO-160E	Input handle and cable only (no gearbox) Output gearbox is 4E4877-4

# Miscellaneous Valves

## Vent Valves, Drain Check Valves, Float Check Valves

Vent and check valves are available to allow proper system drainage, isolation and prevent a backflow condition.



## Miscellaneous Valves

Part Number	Description	Envelope	Weight	Qual Level	Material	Operating Pressure	Fittings	Special Features
2E1922-2	Check valve	1.4"x0.9" dia.	N/A	N/A	316 series stainless steel	140 psig cracking	0.25" NPT (male)	
4E3262-1	Check valve	2.6"x1.3"x1.3"	0.6 lbs	MIL-STD-810E/ DO-160C	300 series stainless steel	50 psig	AS33514E6 inlet fitting, AS4995E6 outlet fitting	
4E3261-4	Vent valve	1.2"x1.1"x1.1"	0.1 lbs	DO-160D	300 series stainless steel	55 psig	AS33514E6 fitting	
4E3261-5	Vent valve	1.4"x1.1"x1.1"	0.1 lbs	DO-160D	300 series stainless steel	55 psig	AS5201C04 fitting	
4E4350-1	Float check valve	2.6"x1.4"x1.4"	0.3 lbs	DO-160E	Ultem 1000	80 psig proof	AS1656-3-8 inlet fitting, AS1656-1-8 outlet fitting	Prevents drained water from backing up into drain tray.
4E4350-2	Float check valve	2.6"x1.4"x1.4"	0.3 lbs	DO-160D	Ultem 1000	80 psig proof	AS5131-08 fitting	Prevents drained water from backing up into drain tray.

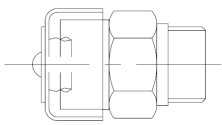

2E1922-2

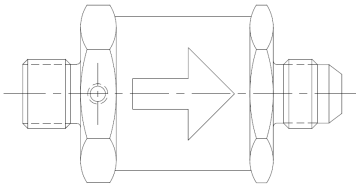

4E3262-1

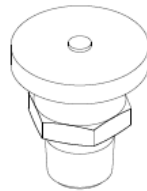

4E3261-4

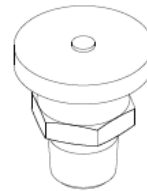

4E3261-5

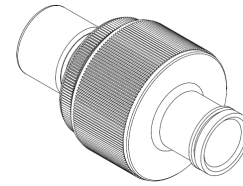

4E4350 Series

# Freeze Protection Heaters

## Silicone, Kapton and Innerline

Collins Aerospace heaters offer freeze protection for the water system throughout the aircraft. Several heaters offer integrated electronic thermostats with fault sensing (ESTAT™ Controller).





## Freeze Protection Heaters

Part Number	Description	Envelope	Weight	Heater Fits Part Number	Qual Level	Material	Power Consumption	Supply Voltage	Temp Control	Special Features
4E3268-2	Water tank heater	37.5"x10.9"x0.3"	0.7 lbs	5E2655-2	DO-160C	Polyimide film	181.2W	115 VAC	External Temp Control	Integral temp sensor
3E3295-1	Check valve heater	1.0"x1.8"x1.8"	0.1 lbs	3E3262-1	DO-160C	Silicone	10.6W	115 VAC	External Temp Control	
3E3299-2	Fill/drain valve heater	3.3"x3.4"x2.7"	0.3 lbs	3E3209-1	DO-160C	Silicone	21.9W	115 VAC	External Temp Control	
3E3303-1	Pressure relief valve heater	0.7"x1.8"x1.8"	0.1 lbs	4E3263-1	DO-160C	Silicone	6.0W	115 VAC	External Temp Control	
4E4385-1	Flow restrictor heater	1.6"x1.8"x2.4"	0.4 lbs	3E2650-2	DO-160D	Silicone	19.0W	115 VAC	Electronic Thermostat	Fault monitoring
4E4372-2	Valve heater	3.9"x3.9"x3.5"	0.5 lbs	4E4384-1	DO-160D	Silicone	20.0W	115 VAC	Electronic Thermostat	Fault monitoring
4E4372-6	Valve heater	4.3"x4.3"x2.5"	0.4 lbs	4E4348-5	DO-160D	Silicone	16.0W	115 VAC	Electronic Thermostat	Fault monitoring
4E4372-8	Valve heater	4.0"x2.0"x2.5"	0.4 lbs	4E4348-4	DO-160D	Silicone	11.0W	115 VAC	Electronic Thermostat	Fault monitoring
4E4377-2	Heated valve manifold	7.2"x2.0"x5.0"	0.9 lbs	N/A	DO-160D	Glass fiber cloth reinforced	11.0W	115 VAC	Electronic Thermostat	Fault monitoring
4E3389-19	Heated wye fitting	6.0"x1.0"x3.0"	0.9 lbs	N/A	DO-160D	Glass fiber cloth reinforced	16.1W	115 VAC	Electronic Thermostat	Fault monitoring
4E3389-20	Heated wye fitting	3.7"x1.1"x2.8"	0.4 lbs	N/A	DO-160D	Silicone	11.5W	115 VAC	External Temp Control	
4E4308-2	Tube heater	2.9"x1.5"x1.5"	0.2 lbs	4E3264-3 drain mast	DO-160D	Silicone	12.1W	115 VAC	External Temp Control	
4E4282-1	Drain port heater	9.3"x4.3"x0.8"	0.5 lbs	N/A	DO-160D	Silicone	63.9W	115 VAC	Electronic Thermostat	
4E4460 series	Drain port heaters	4.3"x3.3"x2.2"	0.5 lbs	N/A	DO-160D	Silicone	35.0W	115 VAC	Electronic Thermostat	
4E4879-101	Drain port heater	4.4"x4.5"x3.3"	0.9 lbs	N/A	DO-160E	300 series stainless steel	75.0W	115 VAC	Electronic Thermostat	Fault monitoring
4E4880 series	Innerline heaters	90.5-178.6"x0.8"x0.8"	0.6-0.8 lbs	N/A	DO-160E	300 series stainless steel	38.8 - 97.6W	115 VAC	Electronic Thermostat	Fault monitoring
4E4888-3	Fill port heater	3.3"x2.7"x0.8"	0.2 lbs	3E3203-3	DO-160E	Polyimide film	26.5W	28 VDC	External Temp Control	TD5A sensor
4E4887-104	Fitting heater	5.4"x2.2"x2.5"	0.4 lbs	N/A	DO-160E	Silicone	14.9W	115 VAC	Electronic Thermostat	Fault monitoring
4E4887-105	Fitting heater	4.9"x7.8"x3.1"	0.8 lbs	N/A	DO-160E	Silicone	35.0W	115 VAC	Electronic Thermostat	Fault monitoring

# Heated Hoses

Collins Aerospace heated hoses offer freeze protection for potable water systems. The heaters are controlled by an electronic thermostat (ESTAT™ Controller) with fault sensing which reduces size and weight while offering effective temperature control.



## Heated Hoses

Part-number series denotes multiple part numbers on the same drawing

Part Number	Hose Length	Hose Sizes	Weight	Qual Level	Power Range	Supply Voltage	Temp Control Method	Special Features
4E3265 series	10.1-183"	0.5"	0.4-2.6 lbs	DO-160D	15.2-197.4W	115 VAC	External temp control	Various end fittings, available w/integral temp sensor
4E4135 series	12.8-12.9"	0.5"	0.4-0.4 lbs	DO-160C	11.6W	115 VAC	External temp control	Available with/without integral temp sensor
4E4365 series	7.4-172.9"	0.5"	0.5-2.5 lbs	DO-160D	12-157W	115 VAC	Electronic thermostat	Various end fittings, fault monitoring
4E4376 series	10.8-150.9"	0.75"	0.6-3.7 lbs	DO-160D	12-165W	115 VAC	Electronic thermostat	Various end fittings, fault monitoring
4E4422 series	6.4-77.8"	0.5"	0.4-1.4 lbs	DO-160D	11-44W	115 VAC	Electronic thermostat	Various end fittings, fault monitoring
4E4425 series	10.0-151.3"	0.75"	0.8-3.5 lbs	DO-160D	14-113W	115 VAC	Electronic thermostat	Various end fittings, fault monitoring
4E4864 series	23.4-221.3"	0.5"	0.6-3.0 lbs	DO-160E	27-200W	115 VAC	Electronic thermostat	Various end fittings, fault monitoring
4E4866 series	40.3-108.6"	0.625"	1.3-2.5 lbs	DO-160E	54-144W	115 VAC	Electronic thermostat	Various end fittings, fault monitoring
4E5412 series	79.5-213.3"	0.5"	1.6-3.3 lbs	DO-160G	81-193W	115 VAC	Electronic thermostat	Various end fittings, fault monitoring
4E5414 series	73.9-105.5"	0.625"	1.9-2.3 lbs	DO-160G	86-109W	115 VAC	Electronic thermostat	Various end fittings, fault monitoring
4E5439 series	45.9-91.8"	0.5"	1.3-2.0 lbs	DO-160G	51-101W	115 VAC	Electronic thermostat	Various end fittings, fault monitoring
4E5441 series	76.9-87.8"	0.625"	1.9-2.4 lbs	DO-160G	94-104W	115 VAC	Electronic thermostat	Various end fittings, fault monitoring

# Service Panels

External or Internal Service Panels have capabilities for pressurized fill, mode selection, backup control, internal and external level indication.

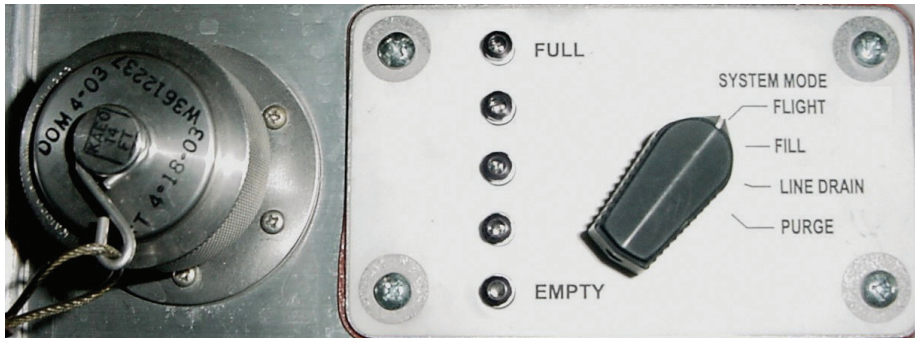

## Service Panels

Part-number series denotes multiple part numbers on the same drawing

Part Number	Description	Envelope	Weight	Qual Level	Material	Special Features
4E3600-1	External service panel	4.8"x0.1"x2.8"	0.9 lbs	DO-160D	300 series stainless steel	4 position switch, 5 discrete levels
4E4381-1	Backup control panel	4.0"x2.6"x2.8"	0.5 lbs	DO-160D	Aluminum	3 push button w/integral LED indicators
4E4980-1	Shower indicator panel	3.9"x3.0"x2.5"	0.4 lbs	DO-160E	Aluminum	Lighted push button, 7 level indicators
4E4884 series	Indicator panel	3.3"x1.1"x3.3"	0.8 lbs	DO-160E	Aluminum/300 series stainless steel	2 tanks, 5 gal. interval, 20 gal max.

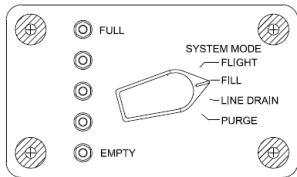

4E3600-1

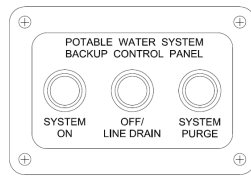

4E4381-1

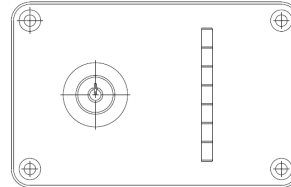

4E4980-1

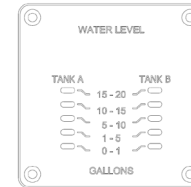

4E4884 Series

# Fill Caps and Adaptors

The Fill Adapter and Cap Assemblies are installed on the aircraft's external service panel and provide a means for attaching the potable water service truck to the aircraft's potable water storage tank. The Fill Adapter is designed to mate with standard aircraft potable water service vehicles and is configured with an attached Cap Assembly that isolates the potable water system from outside contamination.





## Fill Caps and Adaptors

Part Number	Description	Envelope	Weight	Qual Level	Material	Fitting Size
3E3203-1	Fill cap & adaptor	2.8"x2.4"x4.0"	0.7 lbs	MIL-STD-810E	300 series stainless steel	AS33514E8, Roylyn 3/4" nipple
3E3203-3	Fill cap & adaptor	2.8"x2.4"x4.0"	0.7 lbs	DO-160E	300 series stainless steel	AS33514E8, Roylyn 3/4" nipple
3E3590-1	Fill adaptor	2.2"x2.3"x2.3"	0.3 lbs	Customer Spec	300 series stainless steel	AS33514E8, Roylyn 3/4" nipple
3E3542-1	Fill cap	1.4"x2.3"x1.8"	0.5 lbs	Customer Spec	300 series stainless steel	

# Pneumatic Components

## Flow Restrictor, Air Filter, Check Valves, Pressure Regulator and Pressure Relief Valves

The pneumatic components are normally used with air pressurized potable water systems. Systems use pressure from bleed air (minimal air flow) with an air compressor assist. Check valves provide bleed line backflow protection and the regulators maintain air pressure for constant water flow rates. Pressure transducers provide system pressure indication.

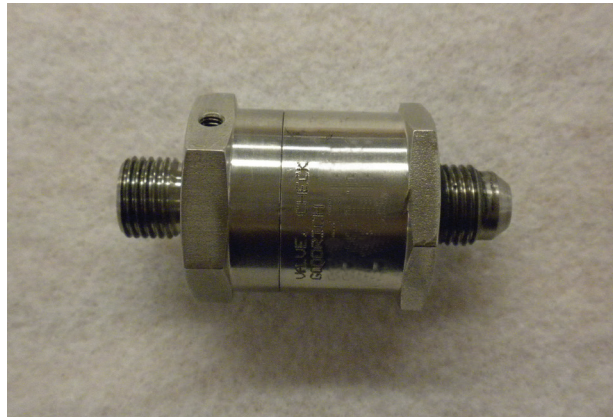

## Pneumatic Components

Part Number	Description	Envelope	Weight	Qual Level	Material	Operating Pressure	Electrical Interface	Special Features
3E3296-1	Flow limiter	1.2"x0.8"x0.8"	1.1 lbs	DO-160C/MIL-STD-810E	300 series stainless steel	120 psig	N/A	0.062" orifice
3E3291-1	Air filter	5.1"x1.9"x1.9"	0.4 lbs	DO-160C/MIL-STD-810E	Aluminum	50 psig	N/A	Replaceable filter, 10 micron
3E3292-1	Pressure regulator	3.3"x2.6"x3.4"	0.6 lbs	DO-160C/MIL-STD-810E	Aluminum	30 psig	N/A	120 psig max inlet
4E3261-1	Vent valve	1.2"x1.1"x1.1"	0.04 lbs	DO-160C/MIL-STD-810E	Aluminum/300 series stainless steel	50 psig	N/A	0.34 scfm air flow rate
4E3262-2	Check valve	2.6"x1.3"x1.3"	0.2 lbs	DO-160C/MIL-STD-810E	Aluminum	120 psig	N/A	Proof 180 psig/ burst 360
4E3263-1	Pressure relief valve	1.4"x1.1"x1.1"	0.2 lbs	DO-160C/MIL-STD-810E	300 series stainless steel	50 psig	N/A	20 scfm @ 90 psig
2E1976-1	Pressure transducer	3.0"x1.0"x1.0"	0.2 lbs	DO-160C/MIL-STD-810E	Stainless steel	50 psig (range)	10V in, 105mV out (max.)	
2E1976-2	Pressure transducer	3.0"x1.0"x1.0"	0.3 lbs	DO-160D	Stainless steel	51 psig (range)	10V in, 105mV out (max.)	

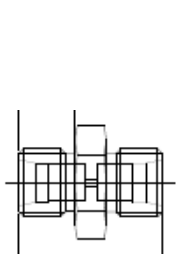

3E3296-1

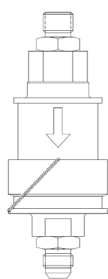

3E3291-1

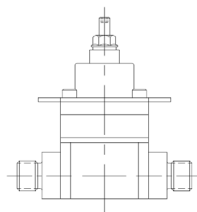

3E3292-1

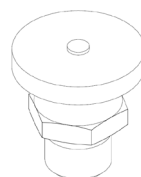

4E3261-1

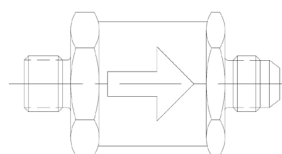

4E3262-2

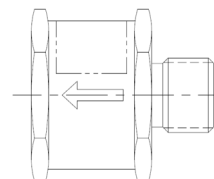

4E3263-1

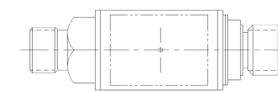

2E1976-1/2

# Water Pump and Air Compressor

The water pump housing is 300 series stainless steel with magnetic coupling, 28 VDC brushless motor and thermal protection.

The air compressor has an aluminium housing and runs on 115 VAC, 3 phase.



Water Pump



Air Compressor

## Water Pump and Air Compressor

Part Number	Description	Envelope	Weight	Qual Level	Material	Performance	Supply Voltage	Special Features
4E3271-1	Air compressor	8.2"x5.3"x6.5"	6.5 lbs	DO-160C/MIL-STD-810E	Aluminum	1 scfm @ 30 psig	115 VAC, 3 phase, 400 Hz, 2 Amp	
4E4360-1	Water pump	8.5"x3.0"x5.1"	6 lbs	DO-160D	Stainless steel	2.5 gpm @ 38.5 psig	28 VDC, 7 A	3 selectable speeds
4E4177-1	Water pump	5.7"x2.3" dia.	2.5 lbs	N/A	300 series stainless steel	27 gal./hour with open flow	115 VAC, 3 phase, 400 Hz, 114 W nominal	Adjustable pressure; use this pump with tanks 4E4176-1 and 4E4176-2

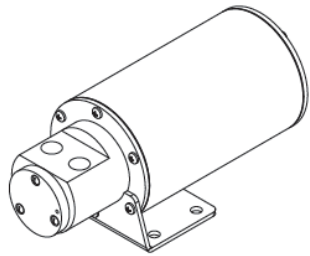

4E4177-1

# Lavatory / Galley Water Heaters / Water System / Shower Heaters

Collins Aerospace lavatory water heaters provide numerous options. Nominally 2-3 pints with 115 VAC and 28 VDC models available. Many lavatory water heaters have electronic temperature selection that can be controlled by various methods.





**Lavatory / Galley Water Heaters / Water System / Shower Heaters**

Note: All are 300 series stainless steel; the 4E4986-1 shower heater also has aluminum housing.

Part Number	Description	Envelope	Weight	Qual Level	Fitting Type	Power Consumption	Supply Voltage	Water Temp Setpoint	Capacity	Special Features
4E4132-1	Tank, unheated	Cylindrical, 27" long, 12" dia.	18.5 lbs	DO-160D	Inlet & outlet: AS1656-1-12	N/A	N/A	N/A	10 gal.	
4E4132-2	Tank, heated	Cylindrical, 27" long, 12" dia.	28.5 lbs	DO-160D	Inlet & outlet: AS1656-1-12	15 kW	115 VAC, 3 phase, 400 Hz	125°F	10 gal.	Overheating protection includes three step controller and sensor, ultrasonic and float water level sensors, 3 immersion heaters with thermal cutoffs and manual reset thermostat
4E4176-1	Tank, heated	Cylindrical, 27" long, 12" dia.	28.5 lbs	DO-160D	Inlet & outlet: AS1656-1-12	15 kW	115 VAC, 3 phase, 400 Hz	125°F	10 gal.	Overheating protection includes three step controller and sensor, ultrasonic and float water level sensors, 3 immersion heaters with thermal cutoffs and manual reset thermostat
4E4176-2	Tank, heated	Cylindrical, 27" long, 12" dia.	27.6 lbs	DO-160D	Inlet & outlet: AS1656-1-12	7.5 kW	115 VAC, 3 phase, 400 Hz	125°F	10 gal.	Overheating protection includes, three step controller and sensor, ultrasonic and float water level sensors, 3 immersion heaters with thermal cutoffs and manual reset thermostat
4E3168-2	Tank, heated with controller	4" dia. x 6.25" vessel only	3.5 lbs	DO-160C/MIL-STD-810E	Inlet & outlet: MS33514G6	140 W	115 VAC, 400 Hz	85°F, 95°F or 107°F	1 quart	Two components, heated tank and controller; overheating protection includes controller, manual resettable thermostat, pressure switch and thermal cutoff
24E507040G06	Lavatory water heater	4" dia. x 13"	4 lbs	DO-160C	Inlet & outlet: MS33514G6	420 W	115 VAC, 400 Hz	105°F, 115°F or 125°F	1.9 quarts	Overheating protection includes controller and manual reset thermostat
24E507040G05	Lavatory water heater	4" dia. x 13"	4 lbs	DO-160C	Inlet & outlet: MS33514G6	420 W	115 VAC, 400 Hz	105°F, 115°F or 125°F	1.9 quarts	Overheating protection includes controller, pressure switch and manual reset thermostat
8921460G5	Lavatory water heater	4" dia. x 11.5"	4 lbs	DO-160C	Inlet & outlet: MS33514G6	420 W	115 VAC, 400 Hz	105°F, 115°F or 125°F	1.5 quarts	Overheating protection includes controller and manual reset thermostat
8921460G6	Lavatory water heater	4" dia. x 11.5"	3.7 lbs	DO-160C	Inlet & outlet: MS33514G6	420 W	115 VAC, 400 Hz	105°F, 115°F or 125°F	1.5 quarts	Overheating protection includes controller, pressure switch and manual reset thermostat

## Lavatory / Galley Water Heaters / Water System / Shower Heaters

Note: All are 300 series stainless steel; the 4E4986-1 shower heater also has aluminum housing.

Part Number	Description	Envelope	Weight	Qual Level	Fitting Type	Power Consumption	Supply Voltage	Water Temp Setpoint	Capacity	Special Features
8921460G7	Lavatory water heater	4" dia. x 11.5"	3.7 lbs	DO-160C	Inlet & outlet: MS33514G6	420 W	115 VAC, 400 Hz	105°F, 115°F or 125°F	1.5 quarts	Overheating protection includes controller and manual reset thermostat
24E507009G03	Lavatory water heater	4" dia. x 12"	3.8 lbs	DO-160C	Custom	420 W	115 VAC, 400 Hz	125°F	1.6 quarts	Overheating protection includes water level sensing, controller and manual reset thermostat
4E3176-1	Lavatory water heater	4" dia. x 12"	3.7 lbs	DO-160C	Inlet & outlet: MS33514G6	450 W	28 VDC	100°F, 115°F or 130°F	1.6 quarts	Overheating protection includes controller and manual reset thermostat
4E3176-2	Lavatory water heater	4" dia. x 12"	3.7 lbs	DO-160C	Inlet & outlet: MS33514G6	300 W	28 VDC	100°F, 115°F or 130°F	1.6 quarts	Overheating protection includes controller and manual reset thermostat
4E4099-2	Lavatory water heater	4" dia. x 9.5"	3.8 lbs	DO-160D	Inlet & outlet: AS33514G6	420 W	115 VAC 250-800 Hz	115°F, 135°F or 155°F	1.2 quarts	Overheating protection includes water level sensing, controller and thermal cutoff
4E4099-3	Lavatory water heater	4" dia. x 13"	4.2 lbs	DO-160D	Inlet & outlet: AS33514G6	420 W	115 VAC 250-800 Hz	115°F, 135°F or 155°F	1.9 quarts	Overheating protection includes water level sensing, controller and thermal cutoff
4E4986-1	Shower heater	16.5"x15.5"x 5.0"	24 lbs	N/A	N/A	10 kW	115 VAC	120°F max.	No tank	Internal temp control, water detection, fault monitoring, adjustable temperature, overheat protection



# Heated Drain Masts

Collins Aerospace drain masts are aluminum or composite fairings with corrosion resistant, long-life stainless steel or copper drain tube(s). A coaxial tube heater prevents ice formation and assures continuous drain flow. Numerous drain masts offer dual-mode operation: full power in flight and low power on ground. The over temperature thermostat/sensors allow for ice-free operation and prevent overheating.

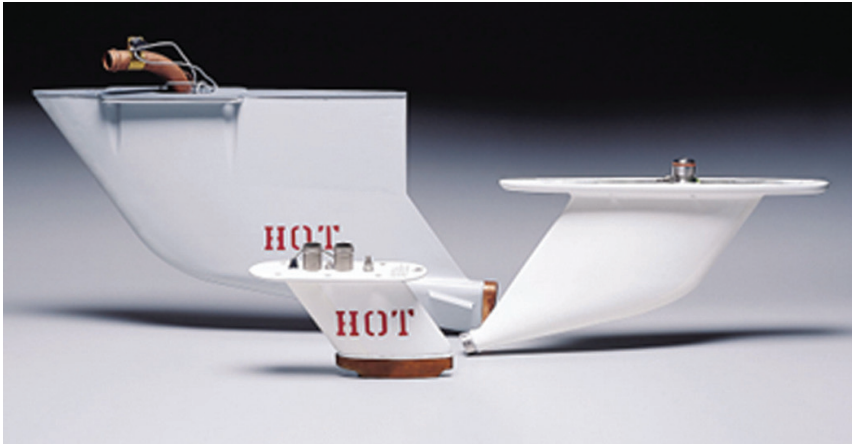

## Heated Drain Masts

Part Number	Envelope	Weight	Qual Level	Material	Inlet Port	Power	Supply Voltage	Temp Control	Special Features
4E3160-1	8.1"x2.8"x6.5"	1.7 lbs	DO-160C	Composite fairing	Double 3/4" tubes, 1.25" length	220W	115 VAC	Thermostat	
4E3169-1	8.1"x2.8"x8.5"	1.9 lbs	N/A	Composite fairing	Double 1/2" tubes, 3.25" length	220W	115 VAC	Thermostat	
4E3169-2	8.1"x2.8"x7.2"	1.9 lbs	N/A	Composite fairing	Double 1/2" tubes, 1.37", 2" length	220W	115 VAC	Thermostat	
4E3169-3	8.1"x2.8"x7.4"	1.9 lbs	N/A	Composite fairing	Double 1/2" tubes, AS1656-1-10 (1.29" length), AS1656-1-08 (2.17" length)	220W	115 VAC	Thermostat	
4E3169-4	8.1"x2.8"x7.7"	1.9 lbs	N/A	Composite fairing	Double 1/2" tubes, AS1656-1-08 (1.5" length), AS1656-1-10 (2.45" length)	220W	115 VAC	Thermostat	
4E4150-2	8.1"x2.8"x6.5"	2 lbs	DO-160D	Composite fairing	Double 3/4" tubes, 1.25" length	220W	115 VAC	Overtemperature thermostat, safety thermostat and TCO; requires external control based on sensor value	
8921270G2	16.4"x2.7"x6.4"	2.4 lbs	N/A	Aluminum fairing	Single 1" tube, 2.5" length angled	285W Flight	115 VAC Flight, 28 V Ground	Weight on wheels control	
5E2675-1	18.6"x3.3"x10.2"	2.8 lbs	DO-160C	Composite fairing	Single 1" tube, 2.3" length 55.3 angle	259-311W Flight	115 VAC Flight, 28 V Ground	Weight on wheels control	
5E2675-2	18.6"x3.3"x10.3"	2.8 lbs	DO-160C	Composite fairing	Single 1" tube, 2.3" length 55.3 angle	259-311W Flight	115 VAC Flight, 28 V Ground	Weight on wheels control	
5E2675-3	18.4"x2.8"x10.2"	2.6 lbs	DO-160C	Composite fairing	Single 1" tube, 2.55" length 55.3 angle	259-311W Flight	115 VAC Flight, 28 V Ground	Weight on wheels control	
5E2675-4	18.6"x3.3"x10.2"	2.8 lbs	DO-160C	Composite fairing	Single 1" tube, 2.3" length 55.3 angle	259-311W Flight	115 VAC Flight, 28 V Ground	Weight on wheels control	
5E2675-5	20"x2.8"x17.1"	3.6 lbs	DO-160C	Composite fairing	Single 1" tube, 4.19" length	286.6-336W Flight	115 VAC Flight, 28 V Ground	Weight on wheels control	
5E2675-6	20.2"x2.8"x15.6"	3.8 lbs	DO-160C	Composite fairing	Single 1" tube, 2.3" length curved	286.6-336W Flight	115 VAC Flight, 28 V Ground	Weight on wheels control	
5E2675-7	20.2"x2.7"x17.1"	3.6 lbs	DO-160C	Composite fairing	Single 1" tube, 4.19" length	286.6-336W Flight	115 VAC Flight, 28 V Ground	Weight on wheels control	
5E2675-8	18.4"x2.8"x10.2"	2.3 lbs	DO-160C	Composite fairing	Single 1" tube, 2.55" length 55.3 angle	259-311W Flight	115 VAC Flight, 28 V Ground	Weight on wheels control	

## Heated Drain Masts

Part Number	Envelope	Weight	Qual Level	Material	Inlet Port	Power Consumption	Supply Voltage	Temp Control	Special Features
5E2675-9	18.4"x2.8"x10.2"	2.3 lbs	DO-160C	Composite fairing	Single 1" tube, 2.55" length 55.3 angle	259-311W Flight	115 VAC Flight, 28 V Ground	Weight on wheels control	
5E2675-10	20.3"x2.8"x17.1"	3.3 lbs	DO-160C	Composite fairing	Single 1" tube, 4.19" length	286.6-336W Flight	115 VAC Flight, 28 V Ground	Weight on wheels control	
5E2675-11	20.3"x2.7"x17.1"	3.3 lbs	DO-160C	Composite fairing	Single 1" tube, 4.19" length	286.6-336W Flight	115 VAC Flight, 28 V Ground	Weight on wheels control	
5E2675-12	20.2"x2.8"x15.6"	3.4 lbs	DO-160C	Composite fairing	Single 1" tube, 2.3" length curved	286.6-336W Flight	115 VAC Flight, 28 V Ground	Weight on wheels control	
5E2675-13	18.6"x3.3"x10.2"	2.8 lbs	DO-160C	Composite fairing	Single 1" tube, 2.3" length 55.3 angle	259-311W Flight	115 VAC Flight, 28 V Ground	Weight on wheels control	
5E2675-14	18.6"x3.3"x10.2"	2.8 lbs	DO-160C	Composite fairing	Single 1" tube, 2.3" length 55.3 angle	286.6-336W Flight	115 VAC Flight, 28 V Ground	Weight on wheels control	
5E2675-15	18.4"x2.8"x10.2"	2.3 lbs	DO-160C	Composite fairing	Single 1" tube, 2.55" length 55.3 angle	259-311W Flight	115 VAC Flight, 28 V Ground	Weight on wheels control	
4E4878-5	7.0"x2.5"x5.5"	1.6 lbs	DO-160E	Composite fairing	Double 1/2" and 5/8" tubes with AS33514-08 and AS33514-10 fittings, 2.19", 2.24" length	2 Circuits @ 220W	115 VAC, 250- 800 Hz	2 TCOs	Redundant heating elements and control circuitry, thermal cutoff for each as over temperature control; fault reporting; requires controller 4E4951-121
4E3264-3	8.1"x2.8"x7.6"	2 lbs	DO-160D	Composite fairing	Double 1/2" tubes with AS33514-08 fittings, 2.36" length	220W	115 VAC, 250- 800 Hz	Integral electronic temp control	
4E3264-4	8.1"x2.8"x6.3"	1.8 lbs	DO-160C	Composite fairing	Double 1/2" tubes with AS33514-08 fittings, 1.13" length	220W	115 VAC	External temp control	Integral temp sensor
24E506700G1	16.4"x2.7"x6.4"	2.5 lbs	N/A	Aluminum fairing	Double 1" tubes, 2.57" angled, 2.94" length	350W	115 VAC Flight, 28 V Ground	Weight on wheels control	





# Electronic Controllers

Collins Aerospace offers a centralized controller that provides zone control of heated lines, tanks and valves along with control of water heaters, drain masts, level sensing and indication and all power switching integral to the potable water system. The controller has an integrated display panel, integrated CB's, fuses, control switches with fault sensing and annunciation. The controller uses ARINC 429 bus communication.



## Electronic Controllers

Part Number	Description	Input Power	I/O	Qual Level	Operation
4E4186-1	Level sensors controller	28 VDC	5 filtered + 5 unfiltered open/grounded outputs, max. current sinking 20mA each	DO-160D	Monitors conductive point level sensors and provides both filtered and instantaneous open/grounded outputs to drive LEDs on internal/external indicator panels or interfacing with cabin management systems
4E4265-1	Power switching controller	28 VDC	1 4PDT outputs, 5 3PDT outputs, 2 SPST output; open/ground activation	DO-160D	Receives open/grounded inputs which control power; power switches to switch power to loads
5E2621 series	Control unit/panel, PWS	28 VDC, 115 VAC 400 Hz, 3 phase	Integrated front panel control switches and water level indicators. Temperature control of up to 56 PWS heaters based on readings from up to 13 sensors, temperature control of 2 drain masts and one air compressor. Monitoring of up to 10 level sensors and one pressure transducer. Bidirectional ARINC 429 digital databus.	DO-160C	Full PWS controller with integral water level/control display interface. Provides level sensing on water tanks and control of PWS water heaters, drain masts and various other PWS heaters. Controls air compress to pressurize PWS. Fault monitoring/reporting capability through ARINC 429 databus. Automatic aircraft configuration detection.
5E2651 series	PWS controller	28 VDC, 115 VAC 400 Hz	Power control of 36 28 VDC outputs for pumps, valves, etc. Temperature control of 2 115 VAC drain masts. Monitoring of up to two pressure transducers, 48 open/ground inputs, 10 level sensors and 58 ESTAT heater inputs. Bidirectional ARINC 429 digital databus for cabin management control and fault/status reporting.	DO-160D	PWS controller that interfaces with cabin management system through bi-directional ARINC 429 databus for full system control and fault/status reporting. Interfaces with discrete control panels for alternate control and status indication. Provides level sensing on water tanks, control of motorized valves, drain masts and water pumps. Monitors various other PWS heaters with integrated electronic thermostats.

# Air Heaters

Supplemental Air Heaters warm cabin air in “cold spots” in and around exit doors, galleys, lower lobe crew rest areas and cargo holds. Air heaters are controlled via internal thermostats, electronic solid state control or can be provided with sensors for customer designed controls. Additionally, a closed loop heating system for compartments is available. This consists of a self-regulating, microprocessor based controller and air temperature sensor used with standard supplemental air heaters.



## Air Temperature Sensors

Part Number	Description	Envelope	Weight	Qual Level	Material	Resistance	Features
24B508385P1	Probe assembly	1/8" NPT, 3.5" long	0.05 lbs	DO-160C	300 series stainless steel	30 Kohm NTC	Two lead wires
3E2593-1	Sensor	0.750-16 UNJF-3A, 5.3" long	0.17 lbs	Boeing PN S210W110-2022	300 series stainless steel	30 Kohm NTC	Connector mates with BACC63BP

## Air Heaters — Closed Loop Kits

Part Number	Description	Envelope	Weight	Qual Level	Material	Power and Voltage	Features
4E3441-1	Kit, Air heating with CLTC	N/A	4 lbs	N/A	N/A	28 VDC/3 phase 115 VAC, 1.5 kW	Contains: 1x CLTC 4E3437-2, 2x temp probe 3E2593-1, 1x air heater 24E508322G02
4E3441-3	Kit, Air heating with CLTC	N/A	4 lbs	N/A	N/A	28 VDC/3 phase 115 VAC, 1.5 kW	Contains: 1x CLTC 4E3437-7, 2x temp probe 24B508385P1, 1x air heater 24E508322G02
4E3441-4	Kit, Air heating with CLTC	N/A	3.6 lbs	N/A	N/A	28 VDC/3 phase 115 VAC, 750 W	Contains: 1x CLTC 4E3437-7, 2x temp probe 24B508385P1, 1x air heater 24E508321G02
4E3441-5	Kit, Air heating with CLTC	N/A	6.1 lbs	N/A	N/A	28 VDC/3 phase 115 VAC, 1.5 kW	Contains: 1x CLTC 4E3437-7, 2x temp probe 24B508385P1, 1x air heater 24E508321G02
4E3441-6	Kit, Air heating with CLTC	N/A	7.3 lbs	N/A	N/A	28 VDC/3 phase 115 VAC, 5.5 kW	Contains: 1x CLTC 4E3437-7, 2x temp probe 24B508385P1, 2x air heater 4E3239-1
4E3441-7	Kit, Air heating with CLTC	N/A	3.6 lbs	N/A	N/A	28 VDC/3 phase 115 VAC, 750 W	Contains: 1x CLTC 4E3437-6, 2x temp probe 24B508385P1, 1x air heater 24E508321G02

## Air Heaters — Closed Loop Controllers

Part Number	Description	Envelope	Weight	Qual Level	Material	Power and Voltage	Features
4E3437-6	Closed loop temperature controller with 15 second backlight	2.7"x4"x4"	1 lb	DO-160D/MIL-STD 810E	Aluminum	28 VDC, 4W	Unit selection, fault reporting, backlit display
4E3437-7	Closed loop temperature controller	2.7"x4"x4"	1 lb	DO-160D/MIL-STD 810E	Aluminum	28 VDC, 4W	Unit selection, fault reporting, backlit display

## Air Heaters

Part Number	Description	Envelope	Weight	Qual Level	Material	Power and Voltage	Features
24E508321G02	Air heater	10.1"x3"x4.5" (tube shape, controller affixed)	2.5 lbs	DO-160C	Aluminum	750 W, 3 phase 115/200 VAC 400 Hz	Thermal fuse, overheating protection, controllable by potentiometer or UTC controller
24E508322G02	Air heater	12.4"x3"x4.5" (tube shape, controller affixed)	2.9 lbs	DO-160C	Aluminum	1500 W, 3 phase 115/200 VAC 400 Hz	Thermal fuse, overheating protection, controllable by potentiometer or UTC controller
4E3239-1	Air heater	14.9"x3"x4.5" (tube shape, controller affixed)	3.1 lbs	DO-160C	Aluminum	2250 W, 3 phase 115/200 VAC 400 Hz	Thermal fuse, overheating protection, controllable by potentiometer or UTC controller
8921560G1	Air heater	24"x4"x3.5" (tube)	4 lbs	DO-160C	Aluminum	2300 W, 150/200 VAC 400 Hz	Automatic overheating protection
8921560G2	Air heater	24"x4"x3.5" (tube)	4 lbs	DO-160C	Aluminum	1150/2300 W, 115/200 VAC 400 Hz	Automatic overheating protection, dual power selection
8921560G3	Air heater	24"x4"x3.5" (tube)	4 lbs	DO-160C	Aluminum	1500/3000 W, 115/200 VAC 400 Hz	Automatic overheating protection, dual power selection
8921560G4	Air heater	24"x4"x3.5" (tube)	4.5 lbs	DO-160C	Aluminum	1500/3000 W, 115/200 VAC 400 Hz	Automatic overheating protection, dual power selection
8921560G5	Air heater	24"x4"x3.5" (tube)	4.5 lbs	DO-160C	Aluminum	1500/3000 W, 115/200 VAC 400 Hz	Manual overtemperature reset, dual power selection

# Heated Floor Panels

Collins Aerospace heated floor panels are installed on a variety of aircraft from jumbo to business jets. Heated floor panels consist of a titanium or composite skin and provide heat in areas of an aircraft susceptible to cold to assure passenger and crew comfort. The heated floor panels feature low profile with hermetic sealing to prevent moisture ingression, redundant over-temperature protection, tailored power density and rapid heat transfer.

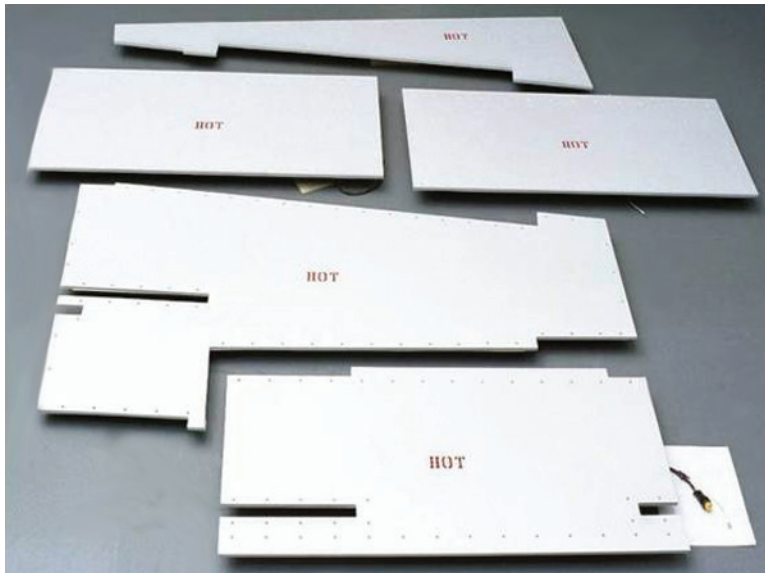





This document does not contain any export controlled technical data.

**For additional information:**

Collins Aerospace  
Ice Protection & Water Solutions  
1555 Corporate Woods Parkway  
Uniontown, OH 44685  
U.S.A.  
Tel: 800 DEICERS (800-334-2377)  
deicers@collins.com

[goodrichdeicing.com](http://goodrichdeicing.com)

Rev. J 6/2019

© Goodrich Corporation, a Collins Aerospace company, acting by and through its De-icing Specialty Systems business unit, 2019



**Collins Aerospace**