

HYPEX electronics
YOUR OEM AUDIO
INDUSTRY PARTNER

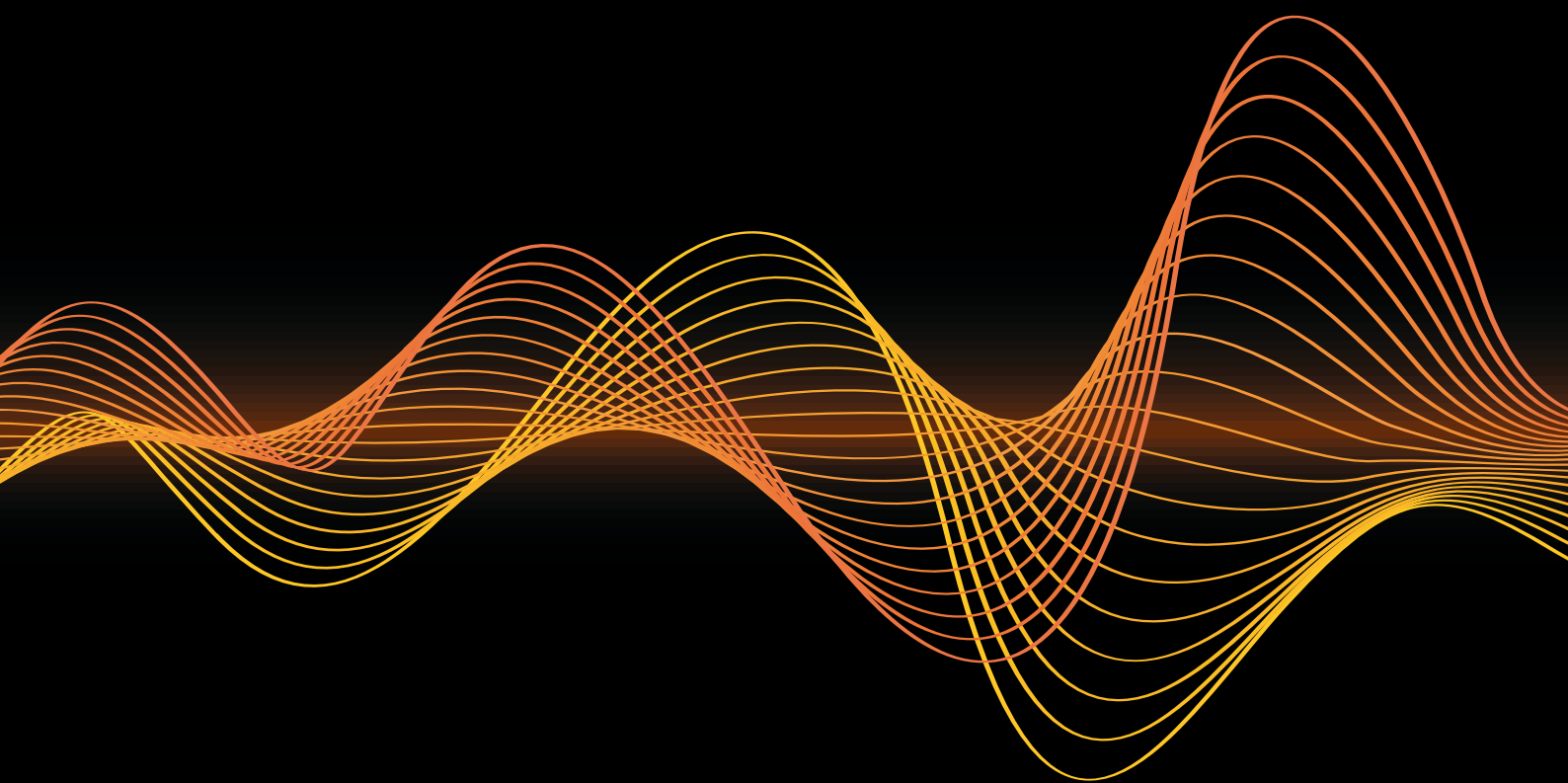

OEM PRODUCT GUIDE

INTRODUCTION

Founded in 1996, Hypex Electronics is a leading specialist supplier, designer and manufacturer of Class-D power amplifiers, power supplies, DSP solutions and plate amplifiers in the HiFi, high-end and Pro Audio industries.

Hypex Electronics works closely with its customers to find the ultimate solution for their applications, from initial idea to final product.

The company designs and manufactures very high-performance Class-D amplifiers based on the world-renowned Nilsai® NCOREx®, NCORE® and UcD™ technologies.

In this brochure we explain our technologies and show you our OEM product range starting from Amplifier modules, Switch Mode Power Supplies and Mains powered amplifier modules all the way to DSP solutions and complete plate amplifiers.

Hypex Electronics - when sound quality matters.

INTRODUCTION

Introduction	3	Technology	10
About us	6	Certification	13
Our story	7	Integration	13
Production	8		

UcD™ Family	15	UcD180 OEM	24
UcD102 OEM	16	UcD400 OEM	26
UcD180LP OEM	18	UcD700LZ OEM	28
UcD250LP OEM	20	UcD2k OEM	30
UcD400LP OEM	22		

NCORE® Family	33	NC1200 OEM	36
NC500 OEM	34	NC2k OEM	38

NCOREx® Family	41	NCx1000 OEM	44
NCx500 OEM	42		

DSA Family	47	DSA254	48
------------	----	--------	----

Switch Mode Power Supply Family	50	SMPS1200	54
SMPS400	52	SMPS3k	56

Mains Powered NCORE® Family	61	NC252MP	68
NC52MP	62	NC500MP	70
NC122MP	64	NC502MP	72
NC250MP	66	NC100HF	74

NCORE® Active Speaker Family	77	NCAS500MP	80
NCAS250MP	78	NCAS1000MP	82

DSP Family	84	DSP3-213	94
Hypex Filter Design	86	DSP3-224	96
DSP2-114	88	SUBin3-110	98
ANAIN2-111	90	DIGin3-322	100
DIGin2-221	92		

Fusion Amplifier Family	104	FA502	110
FA251	106	FA123	111
FA501	107	FA253	112
FA122	108	FA503	113
FA252	109		

UcD™

NCORE®

NCOREx®

DSA

SMPS

NCxxxMP

NCAS

DSP

Fusion Amp



ABOUT US

Hypex Electronics B.V. is a specialist supplier, designer and manufacturer of Class-D power amplifiers, power supplies, DSP solutions and plate amplifiers for the HiFi, high-end and Pro Audio Industry. The company manufactures extremely high-performance and high-quality Class-D amplifiers, based on world leading Nilai®, NCORe®, NCORe® and the worldwide well-renowned UcD™ technologies.

Our goal is to provide everyone with the best possible audio experience. That's why our products are used in some of the most high-end audio applications found in every market segment today. Hypex products are manufactured in our own factory in Malaysia, where we can strictly control the production environment. To ensure fast delivery of the products, we keep stock in a Hong Kong-based warehouse and at our headquarters in The Netherlands. Controlling the entire production process enables us to deliver customized services and support to our customers.

We have a simple philosophy: *we want our customers to implement the best possible Class-D amplifier technology in the most user-friendly way.*

We are always looking for the best performance, combined with the best and most cost-effective solutions, short lines of communication and fast delivery.

Our commitment goes beyond just OEM solutions. We also offer the DIY community our DIY-friendly products through www.diyclassd.com.

WHAT WE DO

- Class-D amplifier design and manufacturing
- SMPS (Switch Mode Power Supply) design and manufacturing
- DSP (digital signal processor) solution design and manufacturing
- Analog and digital circuit design and manufacturing
- Software & firmware, including network audio
- DANTE/AES70 solutions
- Extensive R&D, with regard to various high-end audio, SMPS and DSP designs
- In-house engineering and other support for all customers (OEM and DIY)
- Custom projects

Hypex Electronics works closely with its customers to find the ultimate solution for their applications, from initial idea to final product. Product development is divided between general power amplifier and power modules and custom projects for selected customers.

Areas where we can provide additional value to customers include production design, AD/DA conversion, active speaker design, and DSP solutions for speaker and system control.

APPLICATIONS WE SUPPORT

- Active loudspeakers
- Home theatre
- Amplifiers for the audiophile market
- Live sound purposes
- Musical instrument amplification
- Studio based solutions

OUR STORY

Hypex was founded in 1996 by Jan-Peter van Amerongen (1964 - 2021). The company started as a supplier of plate amplifiers for live sound loudspeakers. The products attracted the attention of HiFi loudspeaker manufacturers, resulting first in a range of active subwoofer amplifiers, followed shortly afterwards by multi-channel units with active crossover filters for the studio market.

In 2003, a full migration to Class-D was started. The newly invented 'Universal Class-D' technology was selected for this, later followed by the leading NCORe® technology. The decision was made not only to use UcD™ and NCORe® in end-user products, but also to market these as general amplifier modules. The quality of the UcD™ and NCORe® modules quickly became recognized as the new industry standard in both measured and subjective performance.

In 2005, Hypex decided to become a technology resource instead of a technology user. Hypex now serves many major audiophiles, HiFi and Pro Audio brands, incorporating the world-class NCORe® technology into their final products.



In 2013 Hypex built its own production facility in Malaysia, named Seetek EMS SDN BHD. This factory only manufactures Hypex products. One of Hypex's core values is to deliver high-quality products at all times. That is why Hypex requires strict control during the production, assembly, and quality assurance process. With Seetek we can maintain our core values.

Same support, different name: In 2016, in line with its strategy to manufacture amplifiers for both the OEM and DIY markets, Hypex assessed its business model to distinguish between these markets. Hypex Electronics continues to produce OEM Class-D modules. To serve the DIY community we set up a new department, named DIYclassD.com. This department takes care of the DIY market and provides comprehensive customer support and a direct and personal approach to the DIY audio market. The company in the background that makes everything possible is Hypex Electronics, but all sales and support is facilitated through DIYclassD.com.

Hypex Electronics kicked off the year 2021 by celebrating its 25th anniversary. In the second half of the year, however, founder Jan-Peter van Amerongen lost an unwinnable battle and passed away in November. We will remember Jan-Peter as an enthusiastic and kind entrepreneur and we will miss him in our personal lives and within our company. Jan-Peter appointed the former R&D Manager Jan-Willem Winters as CEO of Hypex Electronics B.V.



PRODUCTION

Seetek EMS SDN BHD is Hypex Electronics's own Malaysian-based manufacturing affiliate. It is with great pride that we would like to present to you the benefits of this partnership and tell you a bit more about our working methods and how that relates to you as our customer.

In 2013 Hypex Electronics started manufacturing its audio products on a large scale at Seetek EMS SDN BHD. Malaysia is the perfect location for an internationally focused production facility because of its strategic location, sufficient and highly skilled labour force, high-quality production standards, and low production costs. Malaysia is also not affected by import and export limitations as the result of the nation's stability and flexibility in business and investment policies.

Today, almost a decade later, a team of 80 highly skilled on-site engineers, craftsmen, and production staff members are all contributing to the success of Seetek. Their expertise and dedication combined with the latest technology and state-of-the-art machinery is the perfect match between evolution and intelligence resulting in the production of our high-quality products. Annually Seetek is responsible for the production of hundreds of thousands of products from our Hypex catalog.

CONTROL

Communication between our two companies has always been open and clear and we work together efficiently. One of the primary advantages of backward vertical integration is control. Since we keep all processing 'in house', Hypex and Seetek staff have complete control over the entire production process ranging from product supplies to assembly and testing. This way IP protection is completely guaranteed. Hypex has developed an on-site test system 'HTS' (Hypex Test System) which allows us to log every single step of the testing procedure. Our modules will have completed 100% functional tests with a burn-in process at the end of the line by the time they leave our production facility. Hypex staff regularly visit Seetek for system updates or system expansions. These physical meetings and one-on-one communication with the on-site staff benefit the working relationship between the two companies resulting in agility and the ability to quickly respond to changes in the market. It also guarantees cost-efficient production, easy customization and rapid testing of new iterations of prototypes.

In 2020 we were faced with a sudden change in the components market due to Covid-19 and the effects it had on the worldwide production and distribution of electronic components. All of a sudden easy access to regular electronic components was no longer a given. Our dedicated and professional Seetek purchasing team are able to source the components for the necessary products on a daily basis and thus minimize lead times for production.

At both Hypex and Seetek we value and appreciate our workers and we believe that the well-being of our employees is crucial to achieving a healthy and high-performing work culture. Seetek makes it a priority to guarantee their staff a working environment that has the same high-quality of our products. We believe that happy employees show increased productivity, improved confidence, and take greater responsibility, resulting in a shared commitment to deliver world-class products.

TRUSTED PARTNERSHIP

The combination of Dutch design and Malaysian manufacturing has proven to be a great match for Hypex and is greatly appreciated by our customers. Business has grown rapidly and is only expected to increase over the next decade. Over the last few years, Seetek has needed to relocate to larger locations several times in order to meet current and future customer demands. Our current factory is our third location in Malaysia. Hypex Electronics is proud and grateful to have Seetek as its trusted partner. Together with our Dutch and Hong Kong warehouses we look to the future with confidence and enthusiasm and we look forward to continuing to sell our Dutch-designed and Malaysian-produced products all over the world.

Seetek complies with the highest quality assurance and environmental protection standards ISO 9001:2015 and ISO 27001:2015.

TECHNOLOGY

NILAI®

The word Nilai® is Malay and means value. We couldn't have chosen a more appropriate name for this brand-new technology. With Nilai®, we've taken our existing control-loop topology to a whole new level, resulting in an immense performance upgrade compared to NCORE®. The overall performance has increased again by a factor of ten!

PERFORMANCE BOOST

This huge performance boost results in distortion rates that are ten times lower, a power supply noise reduction that is ten times higher, and a reduced output impedance that has dropped ten times. These numbers sound good, but wait until you let Nilai® prove its true worth when you hear these numbers come to life through your speakers!

DIY COMMUNITY

After twenty years of making amplifier history, we are very aware of the fact that we owe much of our success to our incredibly loyal DIY community. Not only have they always supported and encouraged us, they have also challenged us to excel, which has resulted in the development of Nilai®. We couldn't have done it without their support. As a token of our appreciation and to show them that we don't take their loyalty for granted, we've decided to let them be the first to exclusively try out our brand-new Nilai®.

NCOREx®

Evolution in audio excellence takes a leap forward with NCOREx®, where the added "x" signifies exceptional performance. While working on our brand-new Nilai® technology, it became apparent that it would be relatively simple to improve the existing NCORE®-technology by a factor of two, and that's precisely what we've accomplished.

NCOREx® is not a complete departure from, but a deliberate evolution of the trusted NCORE® technology. It emerged seamlessly from the groundwork laid by NCORE®, building upon its strengths and enhancing them twofold. This evolutionary step ensures that NCOREx® is a worthy and future-proof successor, promising an audio experience that surpasses expectations.

In line with the modular approach established by our UcD™ and NCORE® amplifier modules, NCOREx® necessitates the use of a separate Switch Mode Power Supply (SMPS). This design philosophy not only ensures familiarity but also guarantees an exceptional and scalable system that aligns with diverse audio applications. The modular structure facilitates adaptability and future expansions.

Nilai

ncorex
exceptional audio power conversion

TECHNOLOGY

NCORE®

In the realm of audio power, NCORE® is as a revolutionary technology, marking a significant milestone in performance enhancement since its debut in 2011. Born from the distinguished legacy of UcD™, NCORE® not only inherits but elevates those strengths to an unprecedented level, surpassing them by a factor of ten. This groundbreaking technology, unveiled by Hypex after nearly two years of meticulous development, has set a new standard in the audio industry.

NCORE® represents a quantum leap in power amplifier technology. It builds upon the foundation of UcD™, pushing boundaries and redefining what is possible in audio performance. The result is a technology that doesn't just enhance; it transforms, offering a level of excellence previously unimaginable.

Our design philosophy is modular, introducing separate amplifier modules with half-bridge and full-bridge configurations, complemented by independent Switch Mode Power Supplies (SMPS). This modular setup isn't just about increasing flexibility; it's about creating an exceptional, top-of-the-line system that integrates seamlessly into a diverse array of applications. With NCORE®, the possibilities are not just expanded – they are virtually unlimited.

UCD™

Over the past two decades UcD™ (Universal Class-D) has played a significant role in Class-D amplifier technology. What started at the time as a modest amplifier for the DIY market soon became a worldwide success.

2003 saw the start of a migration of all Hypex products to Class-D. For this, a license deal was closed with Philips for the 'Universal Class-D' circuit. Realizing the market potential of the circuit, Hypex decided not only to use the technology in completed subassemblies, but also to sell amplifier modules to the DIY market. The UcD180 and UcD400 modules have quickly established themselves as the new standard, both in terms of measured and subjective performance.

The astonishing simplicity combined with a powerful performance guaranteed that UcD™ successfully found its way into numerous homes, churches, cinemas, recording studios and even stadiums. UcD™ is used in HiFi, high-end and Pro audio applications and has become a highly appreciated and true universal amplifier technique.

But progress comes with change. To stay ahead of the competition and meet current and future consumer demands, our Research & Development team never sits still. They are constantly working on new techniques and innovations. After 20 years of loyal service and after having sold well over 1,000,000 amplifiers it was time for UcD™ to take a step back and make room for a brand-new technology called NCORE®.

To this date UcD™ is still manufactured and sold by Hypex.

ncore
audio power conversion

UCD

TECHNOLOGY

SWITCH MODE POWER SUPPLIES (SMPS)

SMPS is a high-efficiency, switch mode power supply specifically designed to be used in combination with our modules. Key features include high efficiency over the entire load range, extremely small form factor, Light weight and very low radiated and conducted EMI.

The SMPS also features an upgraded over current protection which in case of temporary overload simply reduces the output voltage, only when the overload condition remains for a longer time the supply will enter hiccup mode until the overload condition disappears. This feature combined with large electrolytic buffer capacitors results in the ability to deliver high dynamic headroom power to the connected amplifier.

A new feature in our new power supplies is the automatic input voltage selector which accommodates quasi universal mains capabilities. An auxiliary isolated supply to power possible user applications is also included.

The supply is triggered for normal operation or latched off in case of a critical fault via built-in actuators. The SMPS is optimized from the first phase of design to final implementation to achieve the low EMI signature required of the most demanding audio applications.

HIGHLIGHTS

- High efficiency
- Extremely small form factor required
- Low EMI

APPLICATIONS

- Supply for single or multiple Hypex Electronics UcD™, NCORE® and NCOREx® amplifiers
- High-end audio amplification

HYPEX DSP SOLUTIONS

Meet our dynamic family of DSP solutions, each crafted to elevate your audio experience. The DSP2-114, part of our Series 2, is a mono DSP solution tailored for synergy with our NCORE® Active Speaker Family of amplifier bricks. Boasting an ADAU1450 base, it features one input and four outputs, setting a new standard for supporting professional active speakers up to 4-way configurations. With a XLR/Jack combination as the standard input and SigmaStudio graphical software, programming and tuning your system is a breeze.

Step into high-grade audio with the DSP3-213, our Series 3, mono DSP solution. Built on the ADAU1452, it's optimized for use with mains-powered NCORE® Family amplifier power bricks. Expand its capabilities with optional boards for digital inputs or subwoofers, and customize behavior with HFD supporting IIR and FIR filter options. Configure multiple DSP3-213 boards for a premium stereo or 2.1 system, with features like Auto-signal-detect ensuring a seamless audio experience.

For stereo applications or crafting a high-grade 4-way active loudspeaker, the DSP3-224, our Series 3 stereo/4-way DSP solution, is engineered for excellence. With ADAU1452 at its core, optimized for Mains Powered NCORE® Family power amplifier bricks, the DSP3-224 allows you to customize behavior with HFD and expand capabilities with optional DIGin3-322 digital input board. Its features like Auto-signal-detect and adjustable standby settings empower you to create the perfect active speaker system.

CERTIFICATION

YOUR SOUND, YOUR SUCCESS, OUR EXPERTISE

At Hypex Electronics, we understand that safety certification is vital for your product's success. Our innovative audio solutions and comprehensive testing procedures guarantee compliance with industry regulations and guidelines. From electrical safety to electromagnetic compatibility, we cover it all, leaving no room for compromise.

Our team of highly skilled engineers and technicians has extensive experience in audio product safety certification. With their deep understanding of the latest standards and meticulous attention to detail, they work tirelessly to identify potential risks and offer effective solutions to mitigate them. We are committed to safeguarding your brand reputation and protecting your customers.

Partnering with Hypex Electronics means having a dedicated compliance team throughout the certification process. We offer personalized consultations, tailored to your specific needs, to ensure a seamless experience. Our customer-centric approach and timely responses make us the trusted choice for numerous successful audio product manufacturers.

INTEGRATION

An active audio system thrives on the right electronics. A proper integration of these electronics often holds the key to extracting the maximum potential from your audio product, and it indeed distinguishes a good audio system from a flawless one.

TRUSTED SINCE 1996

Since 1996, Hypex Electronics has been a trusted OEM audio industry partner. We specialize in providing, designing, and manufacturing Class-D amplifiers, power supplies, DSP solutions, and plate amplifiers for the HiFi, High-End, and Pro-Audio industries.

Leveraging our extensive experience and broad knowledge in the audio field, we are the go-to partner for integration advice. From design to the final product, we work closely with our clients, to ensure they get precisely what they want.

UcD™ Family

Discover the epitome of Class-D amplification with our meticulously engineered UcD™ amplifier modules. Crafted to exceed expectations, these amplifiers redefine performance standards across a broad spectrum of audio applications – from dynamic Public Address systems to the refined realms of high-fidelity studio and home replay systems.

Versatility is our hallmark. The UcD™ amplifier modules shine in every scenario, delivering a sonic experience that captivates. Whether in large-scale public spaces or intimate home environments, these amplifiers consistently excel.

FLAT FREQUENCY RESPONSE

A standout feature lies in their ability to maintain a flat frequency response, irrespective of load impedance. This, coupled with virtually frequency-independent distortion behavior and minimal electromagnetic interference (EMI), ensures a pristine audio output that stands unrivaled in quality.

The heart of these modules lies in a sophisticated design, featuring a phase-shift-controlled self-oscillating loop with feedback exclusively derived from the speaker output. This ensures not only optimal performance but also unwavering stability, even in demanding audio environments.

Embrace a new era of flexibility with our modular approach. The UcD™ Family introduces separate half-bridge and full-bridge amplifier modules, complemented by dedicated Switch Mode Power Supplies (SMPS). This modular design not only offers unparalleled flexibility but also delivers cost-effectiveness, providing our customers with endless integration possibilities that align with their unique requirements.

Tailored for the intricate needs of professionals in the audio industry, our UcD™ amplifier modules are specifically designed for multichannel amplifiers, line arrays, and other audio applications that demand a substantial number of amplifier channels. Step into the future of audio amplification, where precision meets innovation, where performance knows no bounds, and flexibility becomes the cornerstone of your sound design.

AVAILABLE MODULES

Module name	Channels	Bridgable?	Power 4Ω	Power 8Ω
UcD102 OEM	2	Yes	2 × 100W	2 × 60W
UcD180LP OEM	1	Yes	180W	120W
UcD250LP OEM	1	Yes	250W	180W
UcD400LP OEM	1	Yes	400W	250W
UcD180 OEM	1	Yes	180W	120W
UcD400 OEM	1	Yes	400W	250W
UcD700LZ OEM	1	Yes	700W	440W
UcD2k OEM	1	No	2500W	1600W

UcD102 OEM - Amplifier module



The UcD102 OEM, the singular dual-channel UcD™ amplifier module, is meticulously designed to deliver an impressive 100W@40hm per channel. This module not only sets a standard in audio amplification but also seamlessly integrates into a diverse array of applications, ranging from the precision demands of studio monitor loudspeakers to the immersive landscapes of advanced audio systems.

At the heart of its distinction lies the dual-channel brilliance of two equal Class-D amplifiers on one board, elevating your audio experience with a robust 100W per channel. This carefully calibrated configuration achieves a harmonious balance across a wide spectrum of applications, ensuring unparalleled clarity, accuracy, and reliability in every subtle nuance of sound.

Recognized globally for its exceptional adaptability, this amplifier module has become the preferred choice for manufacturers worldwide. Its reputation stems from its ability to cater to a wide spectrum of audio applications, making it a staple in the arsenals of audio professionals across various industries.

The UcD102 OEM stands out with innovative design features, setting itself apart from competitors and making it an excellent option not only for stereo amplifiers but also for complex multichannel configurations, supporting up to 16 channels.

Beyond its versatility, the UcD102 OEM boasts exceptional performance and remarkable features, making it the quintessential choice for discerning audio professionals. Whether deployed in pro-audio setups demanding precision and power, integrated seamlessly into home applications for an immersive audio experience, or enhancing the sonic landscape of professional studios, this amplifier module promises an unparalleled audio journey.

HIGHLIGHTS

- Flat, fully load-independent frequency response
- Low output impedance
- Very low, frequency-independent THD
- Very low noise
- Fully passive loop control

FEATURES

- Unbuffered input
- Runs on unregulated +/- rails
- Pop-free start and stop control
- Differential audio input

UcD102 OEM - Data

Item	Min	Typ	Max	BTL	Unit	Notes
Output Power 2Ω		2 × 60			W	
Output Power 4Ω		2 × 100		100	W	
Output Power 8Ω		2 × 60		200	W	
Distortion			0.03		%	20Hz < f < 20kHz. Pout = 1W
Output Noise		17	25		μV	
Power Bandwidth		20-35k			Hz	
Frequency Response	DC		48		kHz	+0/-3dB. All loads
Power Supply Voltage	20	36	42		HV+/-	
Idle Power		4	4.5		W	With external VDR
Idle Power		6			W	With internal VDR
Output Impedance			22		mΩ	f < 1kHz
Output Impedance			90		mΩ	f < 20kHz

COMPATIBLE SMPS

SMPS400A100 / SMPS1200A100

COMPATIBLE MODULES

UcD102 Evaluation board

SIZE AND WEIGHT

70 × 70 × 24 mm (LxWxH), 55 g

MEASUREMENTS

THD+N vs. power @ 1kHz into 2Ω, 4Ω and 8Ω

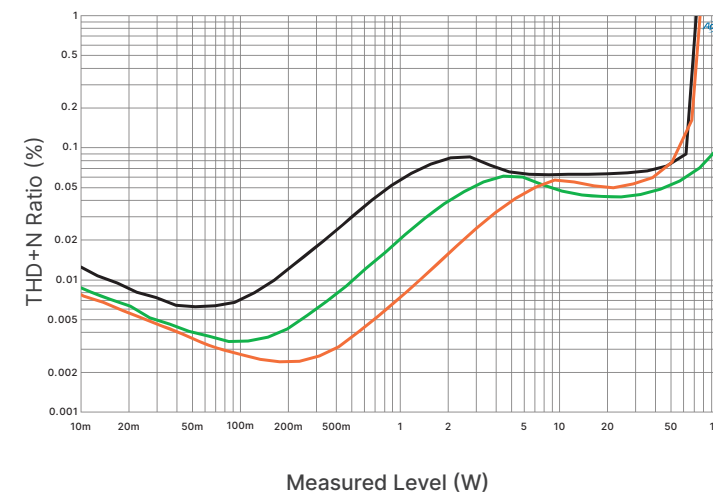

APPLICATION EXAMPLE

16 channel amplifier

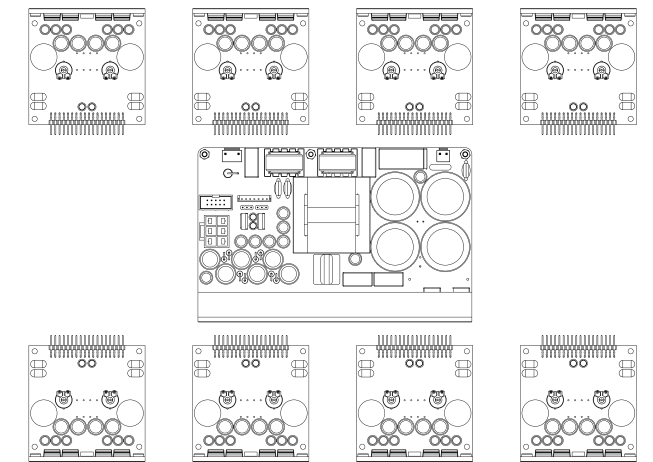

8 x UcD102 OEM + 1 x SMPS1200A100

PROTECTIONS

- Overcurrent protection
- Overvoltage protection
- DC-fault detection
- Short circuit protection

POSSIBLE APPLICATIONS

- Active Loudspeakers, for home and professional use
- Power Amplifiers, for home and professional use
- Line Array and Immersive Systems
- Home Theatre Systems
- Multichannel Power Amplifiers

UcD180LP OEM - Amplifier module



The UcD180LP OEM amplifier module emerges as a paragon of high-performance Class-D amplification, meticulously engineered for versatility across an expansive array of audio applications. Tailored to excel in environments ranging from Active Studio Monitors to sophisticated Public Address systems, Line Arrays, and Immersive Audio setups, this amplifier module is a testament to innovation, reliability, and great audio quality.

With an unwavering commitment to versatility, the UcD180LP OEM amplifier module effortlessly caters to the diverse needs of professionals. From the intricate demands of Public Address systems to the discerning requirements of studio and home playback scenarios, this amplifier module is poised to deliver exemplary performance with finesse.

The Low Profile OEM design extends the boundaries of performance with its thoughtfully crafted compact design. This attribute is not merely an aesthetic consideration; it serves a practical purpose by addressing the constraints of space-limited applications. The amalgamation of its low-profile design and great audio capabilities positions the UcD180LP OEM as the epitome of sophistication in amplifier technology.

HIGHLIGHTS

- Flat, fully load-independent frequency response
- Low output impedance
- Very low, frequency-independent THD
- Very low noise
- Fully passive loop control

Recognizing the growing demand for audio solutions that seamlessly integrate into space-limited environments, the UcD180LP OEM shines as an ideal choice. Its low-profile design not only meets the spatial constraints of modern setups but also renders it perfect for multichannel applications, where a compact footprint and uncompromised audio quality are paramount.

The UcD180LP OEM amplifier module is not just a technical marvel; it has earned its place as a preferred choice through rigorous testing and trials. Professionals across the world who demand a compact design with great performance and proven reliability have chosen the UcD180LP OEM for many years as their go-to solution.

FEATURES

- Unbuffered input
- Runs on unregulated +/- rails
- Pop-free start and stop control
- Differential audio input

UcD180LP OEM - Data

Item	Min	Typ	Max	BTL	Unit	Notes
Output Power 2Ω					W	Not supported
Output Power 4Ω		180			W	
Output Power 8Ω		120			W	
Distortion			0.02		%	20Hz < f < 20kHz, Pout = 1W
Output Noise		17	25		μV	
Power Bandwidth		20-35k			Hz	
Frequency Response	DC		48		kHz	+0/-3dB. All loads
Power Supply Voltage	20	45	50		HV+/-	
Idle Power		2.8	3.1		W	With external VDR
Idle Power		3.6	4		W	With internal VDR
Output Impedance			22		mΩ	f < 1kHz
Output Impedance			90		mΩ	f < 20kHz

COMPATIBLE SMPS

SMPS400A180 / SMPS1200A180

COMPATIBLE MODULES

UcDxxxLP OEM Evaluation Board

SIZE AND WEIGHT

55 × 38 × 26 mm (LxWxH), 55 g

MEASUREMENTS

THD+N vs. power @ 1kHz into 4Ω and 8Ω

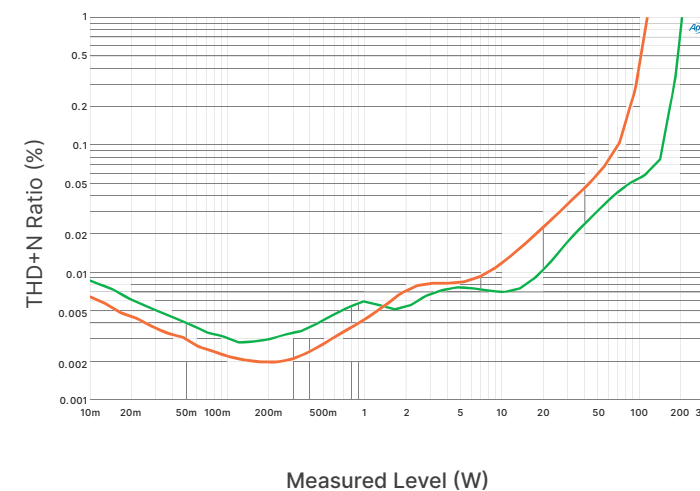

APPLICATION EXAMPLE

8 channel amplifier

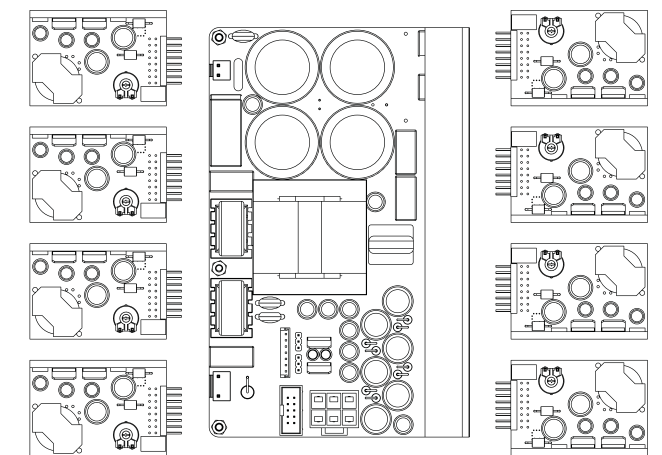

8 x UcD180LP OEM + 1 x SMPS1200A180

PROTECTIONS

- Overcurrent protection
- Overvoltage protection
- DC-fault detection
- Short circuit protection

POSSIBLE APPLICATIONS

- Active Loudspeakers, for home and professional use
- Power Amplifiers, for home and professional use
- Line Array and Immersive Systems
- Home Theatre Systems
- Multichannel Power Amplifiers

UcD250LP OEM - Amplifier module



The UcD250LP OEM amplifier module emerges as a paragon of high-performance Class-D amplification, meticulously engineered for versatility across an expansive array of audio applications. Tailored to excel in environments ranging from Active Studio Monitors to sophisticated Public Address systems, Line Arrays, and Immersive Audio setups, this amplifier module is a testament to innovation, reliability, and great audio quality.

With an unwavering commitment to versatility, the UcD250LP OEM amplifier module effortlessly caters to the diverse needs of professionals. From the intricate demands of Public Address systems to the discerning requirements of studio and home playback scenarios, this amplifier module is poised to deliver exemplary performance with finesse.

The Low Profile OEM design extends the boundaries of performance with its thoughtfully crafted compact design. This attribute is not merely an aesthetic consideration; it serves a practical purpose by addressing the constraints of space-limited applications. The amalgamation of its low-profile design and great audio capabilities positions the UcD250LP OEM as the epitome of sophistication in amplifier technology.

HIGHLIGHTS

- Flat, fully load-independent frequency response
- Low output impedance
- Very low, frequency-independent THD
- Very low noise
- Fully passive loop control

Recognizing the growing demand for audio solutions that seamlessly integrate into space-limited environments, the UcD250LP OEM shines as an ideal choice. Its low-profile design not only meets the spatial constraints of modern setups but also renders it perfect for multichannel applications, where a compact footprint and uncompromised audio quality are paramount.

The UcD250LP OEM amplifier module is not just a technical marvel; it has earned its place as a preferred choice through rigorous testing and trials. Professionals across the world who demand a compact design with great performance and proven reliability have chosen the UcD250LP OEM for many years as their go-to solution.

FEATURES

- Unbuffered input
- Runs on unregulated +/- rails
- Pop-free start and stop control
- Differential audio input

UcD250LP OEM - Data

Item	Min	Typ	Max	BTL	Unit	Notes
Output Power 2Ω					W	Not supported
Output Power 4Ω		250			W	
Output Power 8Ω		180			W	
Distortion			0.02		%	20Hz < f < 20kHz, Pout = 1W
Output Noise		20	25		μV	
Power Bandwidth		20-35k			Hz	
Frequency Response	DC		56		kHz	+0/-3dB. All loads
Power Supply Voltage	25	60	68		HV+/-	
Idle Power		4.6	5.2		W	With external VDR
Idle Power		6.6	7.4		W	With internal VDR
Output Impedance		15	22		mΩ	f < 1kHz
Output Impedance		60	90		mΩ	f < 20kHz

COMPATIBLE SMPS

SMPS400A400 / SMPS1200A400 / SMPS3kA400

COMPATIBLE MODULES

UcDxxxLP OEM Evaluation Board

SIZE AND WEIGHT

55 × 38 × 26 mm (LxWxH), 55 g

MEASUREMENTS

THD+N vs. power @ 1kHz into 4Ω and 8Ω

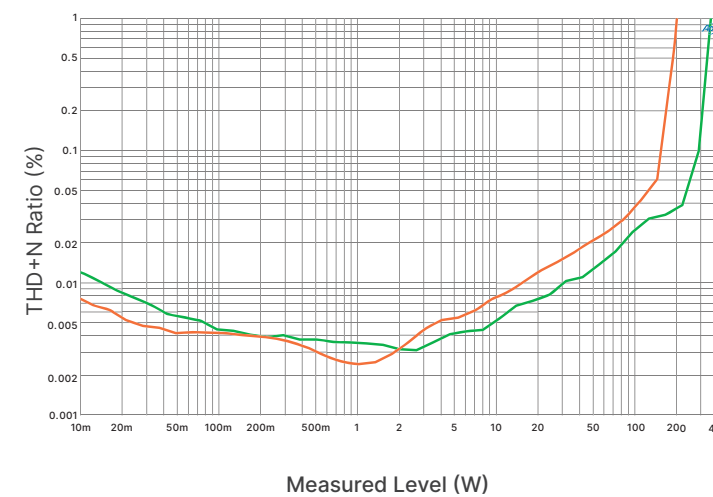

APPLICATION EXAMPLE

8 channel amplifier

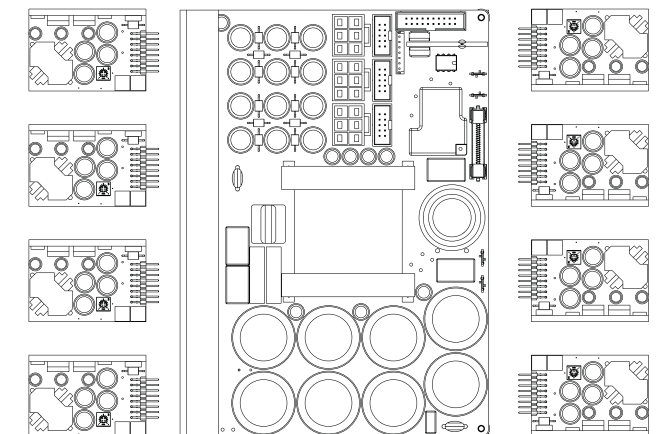

8 x UcD250LP OEM + 1 x SMPS3kA400

PROTECTIONS

- Overcurrent protection
- Overvoltage protection
- DC-fault detection
- Short circuit protection

POSSIBLE APPLICATIONS

- Active Loudspeakers, for home and professional use
- Power Amplifiers, for home and professional use
- Line Array and Immersive Systems
- Home Theatre Systems
- Multichannel Power Amplifiers

UcD400LP OEM - Amplifier module



The UcD400LP OEM amplifier module emerges as a paragon of high-performance Class-D amplification, meticulously engineered for versatility across an expansive array of audio applications. Tailored to excel in environments ranging from Active Studio Monitors to sophisticated Public Address systems, Line Arrays, and Immersive Audio setups, this amplifier module is a testament to innovation, reliability, and great audio quality.

With an unwavering commitment to versatility, the UcD400LP OEM amplifier module effortlessly caters to the diverse needs of professionals. From the intricate demands of Public Address systems to the discerning requirements of studio and home playback scenarios, this amplifier module is poised to deliver exemplary performance with finesse.

The Low Profile OEM design extends the boundaries of performance with its thoughtfully crafted compact design. This attribute is not merely an aesthetic consideration; it serves a practical purpose by addressing the constraints of space-limited applications. The amalgamation of its low-profile design and great audio capabilities positions the UcD400LP OEM as the epitome of sophistication in amplifier technology.

HIGHLIGHTS

- Flat, fully load-independent frequency response
- Low output impedance
- Very low, frequency-independent THD
- Very low noise
- Fully passive loop control

Recognizing the growing demand for audio solutions that seamlessly integrate into space-limited environments, the UcD400LP OEM shines as an ideal choice. Its low-profile design not only meets the spatial constraints of modern setups but also renders it perfect for multichannel applications, where a compact footprint and uncompromised audio quality are paramount.

The UcD400LP OEM amplifier module is not just a technical marvel; it has earned its place as a preferred choice through rigorous testing and trials. Professionals across the world who demand a compact design with great performance and proven reliability have chosen the UcD400LP OEM for many years as their go-to solution.

FEATURES

- Unbuffered input
- Runs on unregulated +/- rails
- Pop-free start and stop control
- Differential audio input

UcD400LP OEM - Data

Item	Min	Typ	Max	BTL	Unit	Notes
Output Power 2Ω					W	Not supported
Output Power 4Ω		400			W	
Output Power 8Ω		250			W	
Distortion			0.02		%	20Hz < f < 20kHz, Pout = 1W
Output Noise		20	25		μV	
Power Bandwidth		20-35k			Hz	
Frequency Response	10		50k		Hz	+0/-3dB. All loads
Power Supply Voltage	45	64	73		HV+/-	
Idle Power		4.3	4.6		W	With external VDR
Idle Power		6.6	7.4		W	With internal VDR
Output Impedance			18		mΩ	f < 1kHz
Output Impedance			40		mΩ	f < 20 kHz

COMPATIBLE SMPS

SMPS400A400 / SMPS1200A400 / SMPS3kA400

COMPATIBLE MODULES

UcDxxxLP OEM Evaluation Board

SIZE AND WEIGHT

55 × 38 × 26 mm (LxWxH), 55 g

MEASUREMENTS

THD+N vs. power @ 1kHz into 4Ω and 8Ω

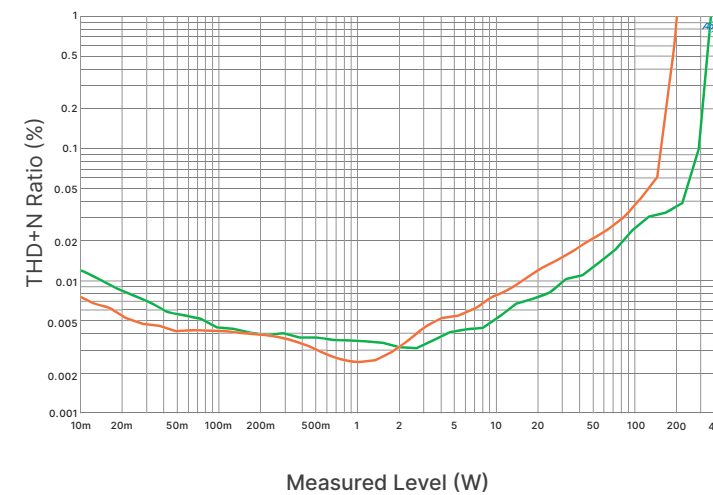

APPLICATION EXAMPLE

8 channel amplifier

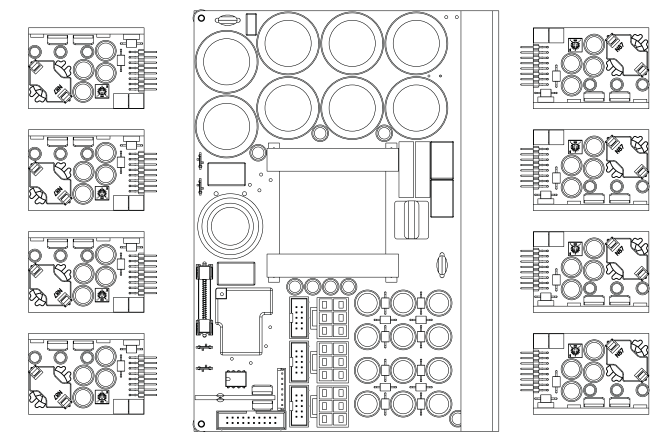

8 x UcD400LP OEM + 1 x SMPS3kA400

PROTECTIONS

- Overcurrent protection
- Overvoltage protection
- DC-fault detection
- Short circuit protection

POSSIBLE APPLICATIONS

- Active Loudspeakers, for home and professional use
- Power Amplifiers, for home and professional use
- Line Array and Immersive Systems
- Home Theatre Systems
- Multichannel Power Amplifiers

UcD180 OEM - Amplifier module



The UcD180 OEM amplifier module is the extended version of the Low-profile UcD amplifier module, a Class-D amplifier module meticulously crafted for a multitude of applications. This versatile module seamlessly integrates cutting-edge technology with a more complete set of detection and protection features, making it an ideal choice for applications ranging from studio setups to high-fidelity home audio systems.

The module is engineered to deliver great audio performance across diverse applications, setting a high standard for clarity, fidelity, and versatility. With a Class-D architecture at its core, it ensures efficiency without compromising on sonic excellence, making it a reliable choice for professionals.

This OEM module goes beyond amplification by incorporating advanced detection and protection features compared with the Low-profile version. The safeguards included, such as clipping detection and DC-fault protection guarantee the longevity of your investment, ensuring a robust and reliable performance even in challenging conditions.

The UcD180 OEM amplifier module features a built-in buffer stage, contributing to enhanced signal integrity and stability. This additional stage ensures that your audio signal remains pure and unaltered, resulting in a faithful reproduction of your music or sound.

Whether you're setting up a professional recording studio, crafting a high-performance home audio system, or integrating audio amplification into other applications, the UcD180 OEM amplifier module offers unparalleled versatility. Its adaptability and broad range of applications make it an invaluable component for professionals.

HIGHLIGHTS

- Flat, fully load-independent frequency response
- Low output impedance
- Very low, frequency-independent THD
- Very low noise
- Fully passive loop control

FEATURES

- Buffered input
- Runs on unregulated +/- rails
- Pop-free start and stop control
- Differential audio input

UcD180 OEM - Data

Item	Min	Typ	Max	BTL	Unit	Notes
Output Power 2Ω					W	Not supported
Output Power 4Ω		180			W	
Output Power 8Ω		120			W	
Distortion			0.05		%	20Hz < f < 20kHz. Pout = 1W
Output Noise			80		μV	With or without input buffer
Power Bandwidth		20-35k			Hz	
Frequency Response	10		50		kHz	+0/-3dB. All loads
Power Supply Voltage	25	45	50		HV+/-	
Idle Power		4			W	With external VDR
Idle Power		7			W	With internal VDR
Output Impedance			20		mΩ	f < 1kHz
Output Impedance			150		mΩ	f < 20kHz

COMPATIBLE SMPS

SMPS400A180 / SMPS1200A180

COMPATIBLE MODULES

UcD180/400 Evaluation Board

SIZE AND WEIGHT

73 × 67 × 33 mm (LxWxH), 100 g

MEASUREMENTS

THD+N vs. power @ 1kHz into 4Ω and 8Ω

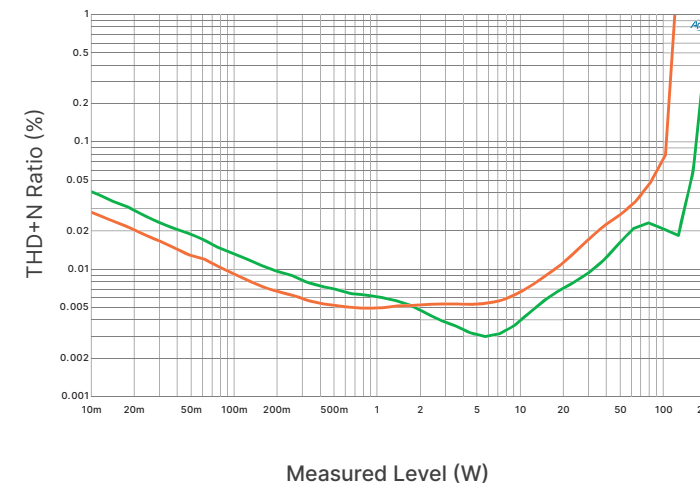

APPLICATION EXAMPLE

stereo amplifier

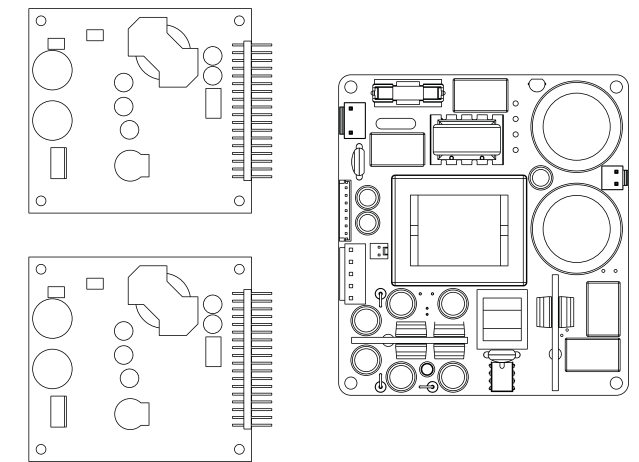

2 x UcD180 OEM + 1 x SMPS400A180

PROTECTIONS

- Overcurrent protection
- Overvoltage protection
- DC-fault detection
- Short circuit protection

POSSIBLE APPLICATIONS

- Active Loudspeakers, for home and professional use
- Power Amplifiers, for home and professional use
- Line Array and Immersive Systems
- Home Theatre Systems
- Multichannel Power Amplifiers

UcD400 OEM - Amplifier module



The UcD400 OEM amplifier module is the extended version of the Low-profile UcD amplifier module, a Class-D amplifier module meticulously crafted for a multitude of applications. This versatile module seamlessly integrates cutting-edge technology with a more complete set of detection and protection features, making it an ideal choice for applications ranging from studio setups to high-fidelity home audio systems.

The module is engineered to deliver great audio performance across diverse applications, setting a high standard for clarity, fidelity, and versatility. With a Class-D architecture at its core, it ensures efficiency without compromising on sonic excellence, making it a reliable choice for professionals.

This OEM module goes beyond amplification by incorporating advanced detection and protection features compared with the Low-profile version. The safeguards included, such as clipping detection and DC-fault protection guarantee the longevity of your investment, ensuring a robust and reliable performance even in challenging conditions.

The UcD400 OEM amplifier module features a built-in buffer stage, contributing to enhanced signal integrity and stability. This additional stage ensures that your audio signal remains pure and unaltered, resulting in a faithful reproduction of your music or sound.

Whether you're setting up a professional recording studio, crafting a high-performance home audio system, or integrating audio amplification into other applications, the UcD400 OEM amplifier module offers unparalleled versatility. Its adaptability and broad range of applications make it an invaluable component for professionals.

HIGHLIGHTS

- Flat, fully load-independent frequency response
- Low output impedance
- Very low, frequency-independent THD
- Very low noise
- Fully passive loop control

FEATURES

- Buffered input
- Runs on unregulated +/- rails
- Pop-free start and stop control
- Differential audio input

UcD400 OEM - Data

Item	Min	Typ	Max	BTL	Unit	Notes
Output Power 2Ω					W	Not supported
Output Power 4Ω		400			W	
Output Power 8Ω		250			W	
Distortion			0.005		%	20Hz < f < 20kHz, Pout = 1W
Output Noise			80		μV	
Power Bandwidth		20-35k			Hz	
Frequency Response	10		50k		Hz	+0/-3dB. All loads
Power Supply Voltage	45	64	73		HV+/-	
Idle Power		4			W	With external VDR
Idle Power		7			W	With internal VDR
Output Impedance			11		mΩ	f < 1kHz
Output Impedance			35		mΩ	f < 20kHz

COMPATIBLE SMPS

SMPS400A400 / SMPS1200A400 / SMPS3kA400

COMPATIBLE MODULES

UcD180/400 Evaluation Board

SIZE AND WEIGHT

82 × 75 × 38 mm (LxWxH), 145 g

MEASUREMENTS

THD+N vs. power @ 1kHz into 4Ω and 8Ω

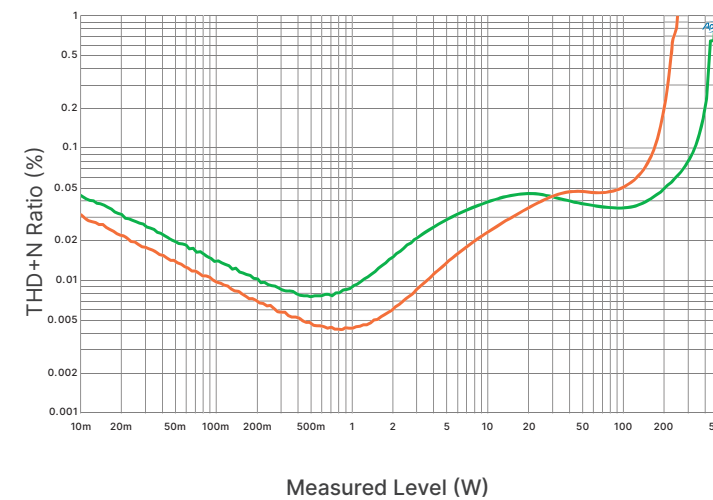

APPLICATION EXAMPLE

stereo amplifier

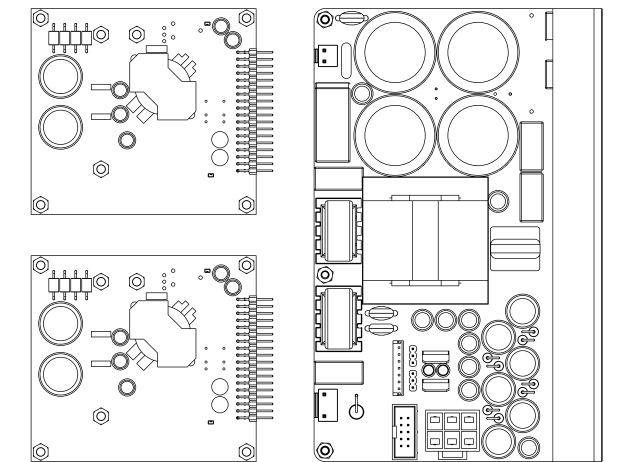

2 x UcD400 OEM + 1 x SMPS1200A400

PROTECTIONS

- Overcurrent protection
- Overvoltage protection
- DC-fault detection
- Short circuit protection

POSSIBLE APPLICATIONS

- Active Loudspeakers, for home and professional use
- Power Amplifiers, for home and professional use
- Line Array and Immersive Systems
- Home Theatre Systems
- Multichannel Power Amplifiers

UcD700LZ OEM - Amplifier module



The UcD700LZ OEM amplifier module is a technological marvel designed to redefine the boundaries of power and versatility. The “LZ” insignia, denoting “Low Impedance capability”, propels this amplifier into a league of its own, delivering an astonishing 1200W into 2 Ohms. This powerhouse seamlessly combines raw power with precision engineering.

While every Hypex amplifier maintains stability down to 2 Ohms, the UcD700LZ OEM surpasses expectations by providing the extra current needed for applications with low impedance and demanding requirements. At the heart of the UcD700LZ OEM lies an outstanding power capacity, resulting in an impressive output into 2 Ohms. This amplifier is intricately designed to meet the demands of high-performance audio setups, delivering a dynamic range and impact that will enchant both audiophiles and professionals.

The “LZ” designation specifically highlights the UcD700LZ OEM's remarkable proficiency in handling low impedance loads. This technological breakthrough ensures optimal performance, establishing it as the perfect choice for scenarios where compatibility with low impedance is paramount. Unleash the full potential of your speakers with a module that seamlessly adapts to even the most demanding loads.

Beyond its raw power, the UcD700LZ OEM comes equipped with advanced detection and protection features. Over temperature, overcurrent and overvoltage protection mechanisms ensure the longevity of the amplifier, providing peace of mind even in the most challenging audio environments.

Crafted with versatility in mind, the UcD700LZ OEM is a powerhouse that effortlessly adapts to a multitude of applications. Whether you're designing a high-end home audio system, a professional studio setup, or pushing the limits of audio innovation, this amplifier module is ready to meet your expectations.

The UcD700LZ OEM amplifier module is a tour de force, combining dominating power with low impedance capability to create a versatile and reliable audio solution.

HIGHLIGHTS

- Flat, fully load-independent frequency response
- Low output impedance
- Very low, frequency-independent THD
- Very low noise
- Fully passive loop control

FEATURES

- Pop-free start and stop control
- Differential audio input
- Short term 1200W in 2Ω

UcD700LZ OEM - Data

Item	Min	Typ	Max	BTL	Unit	Notes
Output Power 2Ω		1200			W	
Output Power 4Ω		700		2400	W	
Output Power 8Ω		440		1400	W	
Distortion			0.005		%	20Hz < f < 20kHz, Pout = 1W
Output Noise		30	35		μV	
Power Bandwidth		20-35k			Hz	
Frequency Response	10		50k		Hz	+0/-3dB. All loads
Power Supply Voltage	75	90	95		HV+/-	
Idle Power		15			W	
Output Impedance			20		mΩ	f < 1kHz
Output Impedance			150		mΩ	f < 20kHz

COMPATIBLE SMPS

SMPS1200A700 / SMPS3kA700

SIZE AND WEIGHT

130 × 79 × 36 mm (LxWxH), 250 g

MEASUREMENTS

THD+N vs. power @ 1kHz into 2Ω, 4Ω and 8Ω

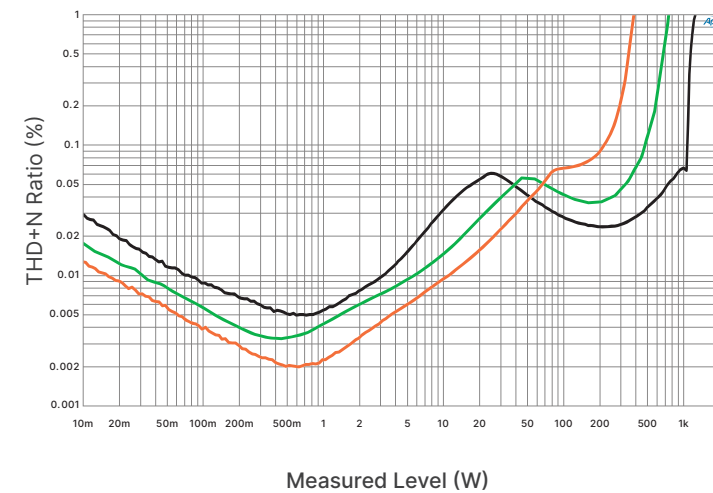

APPLICATION EXAMPLE

4 channel touring amplifier

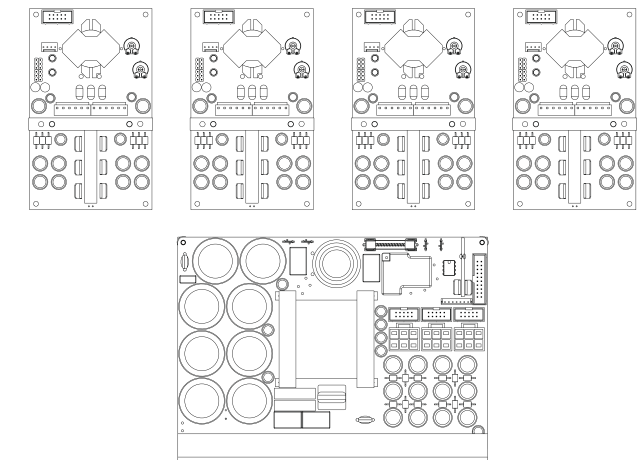

4 x UcD700LZ OEM + 1 x SMPS3kA700

PROTECTIONS

- Overcurrent protection
- Overvoltage protection
- DC-fault detection
- Over temperature protection
- Short circuit protection

POSSIBLE APPLICATIONS

- Active Loudspeakers, for home and professional use
- Power Amplifiers, for home and professional use
- Line Array and Immersive Systems
- Home Theatre Systems
- Multichannel Power Amplifiers

UcD2k OEM - Amplifier module



The UcD2k OEM amplifier module is a full-bridge Class-D marvel designed to be the unchallenged powerhouse for massive subwoofers and touring amplifiers. With an astounding 2500W capacity, this amplifier module sets a new standard for raw power, precision engineering, and adaptability.

The UcD2k OEM takes the concept of powerful amplification to a new level, delivering a staggering 2500W of real power. Whether you're crafting a formidable professional subwoofer or creating a touring amplifier system, this module is ready to propel your audio experience into realms of deep bass and unparalleled impact.

At the core of the UcD2k OEM you will find a full-bridge Class-D amplifier, a testament to our commitment to pushing the boundaries of amplifier design. This architecture ensures optimal efficiency, low heat generation, and uncompromised audio quality, making it an ideal choice for applications where power and precision are paramount.

Designed with the demands of touring amplifiers in mind, the UcD2k OEM is a robust and reliable solution for audio professionals on the move. Its formidable power output, coupled with a durable design, positions it as the go-to choice for touring setups where reliability and performance are non-negotiable.

Built to withstand the rigors of demanding applications, the UcD2k OEM is equipped with advanced detection and protection features. Overcurrent and overvoltage safeguards ensure uninterrupted performance, even in the most challenging and dynamic audio environments.

From stadium-sized subwoofers to touring setups that demand the utmost in reliability, the UcD2k OEM excels in diverse configurations. Its adaptability makes it the amplifier of choice for those seeking a singular solution that can meet the demands of different audio applications with ease.

The UcD2k OEM amplifier module is a sonic juggernaut, with an extraordinary and true 2500W power output. Whether you're unleashing colossal subwoofer bass or taking your touring amplifiers to new heights, the UcD2k OEM is your gateway to a realm of unparalleled audio power and precision.

HIGHLIGHTS

- Flat, fully load-independent frequency response
- Low output impedance
- Very low, frequency-independent THD
- Very low noise
- Fully passive loop control

FEATURES

- Runs on unregulated +/- rails
- Pop-free start and stop control
- Differential audio input

UcD2k OEM - Data

Item	Min	Typ	Max	BTL	Unit	Notes
Output Power 2Ω		2000			W	
Output Power 4Ω		2500			W	
Output Power 8Ω		1600			W	
Distortion			0.03		%	20Hz < f < 20kHz. Pout = 1W
Output Noise			35		μV	
Power Bandwidth		20-35k			Hz	
Frequency Response	10		50k		Hz	+0/-3dB. All loads
Power Supply Voltage	50	90	98		HV+/-	
Idle Power		35			W	
Output Impedance			10		mΩ	f < 1kHz
Output Impedance			50		mΩ	f < 20kHz

COMPATIBLE SMPS

SMPS1200A400 / SMPS1200A700 /
SMPS3kA400 / SMPS3kA700

SIZE AND WEIGHT

141 × 108 × 38 mm (LxWxH), 550 g

MEASUREMENTS

THD+N vs. power @ 1kHz into 2Ω, 4Ω and 8Ω

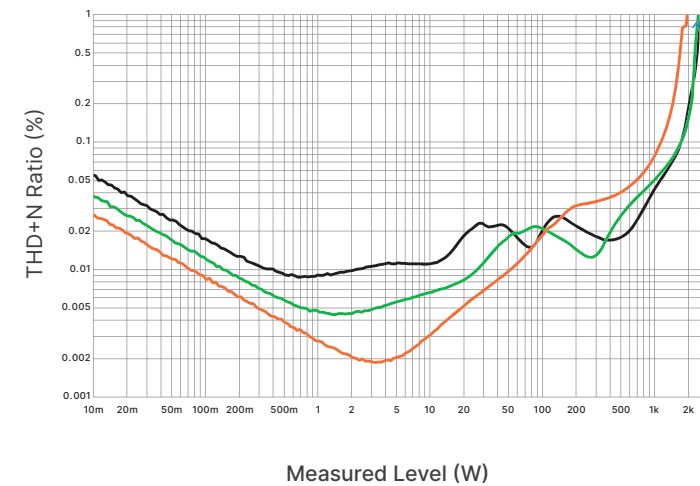

APPLICATION EXAMPLE

4 channel touring amplifier

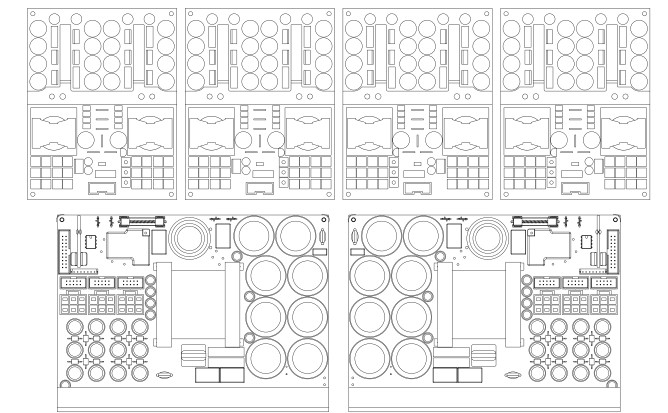

4 x UcD2k OEM + 2 x SMPS3kA700

PROTECTIONS

- Overcurrent protection
- Overvoltage protection
- DC-fault detection
- Over temperature protection
- Short circuit protection

POSSIBLE APPLICATIONS

- Active Loudspeakers, for home and professional use
- Power Amplifiers, for home and professional use
- Line Array and Immersive Systems
- Home Theatre Systems
- Multichannel Power Amplifiers

NCORE® Family

In the realm of audio power, NCORE® is a revolutionary technology, marking a significant milestone in performance enhancement since its debut in 2011. Born from the distinguished legacy of UcD™, NCORE® not only inherits but elevates those strengths to an unprecedented level, surpassing them by a factor of ten. This groundbreaking technology, unveiled by Hypex after nearly two years of meticulous development, has set a new standard in the audio industry.

NCORE® represents a quantum leap in power amplifier technology. It builds upon the foundation of UcD™, pushing boundaries and redefining what is possible in audio performance. The result is a technology that doesn't just enhance; it transforms, offering a level of excellence previously unimaginable.

CREATE EXCEPTIONAL SYSTEMS

Our design philosophy is modular, introducing separate amplifier modules with half-bridge and full-bridge configurations, complemented by independent Switch Mode Power Supplies (SMPS). This modular setup isn't just about increasing flexibility; it's about creating an exceptional, top-of-the-line system that integrates seamlessly into a diverse array of applications. With NCORE®, the possibilities are not just expanded – they are virtually unlimited.

The NCORE® amplifier modules are purposefully designed with high-end and HiFi applications in mind. Tailored to cater to the discerning audiophile, these modules represent a commitment to delivering nothing less than excellence. Every component, every detail is meticulously crafted to meet the highest standards of audio performance.

With NCORE®, your audio experience transcends the ordinary. It's not just about amplification; it's about redefining what's possible. Whether you are designing a high-end audio setup or pursuing the ultimate HiFi experience, NCORE® opens the door to a world of limitless possibilities. Step into the future of audio power with NCORE®, where innovation meets perfection, and your audio journey reaches new heights.

AVAILABLE MODULES

Module name	Channels	Bridgable?	Power 2Ω	Power 4Ω	Power 8Ω
NC500 OEM	1	Yes	550W	700W	400W
NC1200 OEM	1	Yes	1200W	700W	400W
NC2k OEM OEM	1	no	2000W	2500W	1600W



NC500 OEM - Amplifier module



NCORE®

The NC500 OEM, an NCORE® amplifier module, the supreme successor to our UcD™ Family modules, delivers unparalleled performance in a Class-D design. As we navigate a world increasingly conscious of energy consumption, the NC500 OEM not only supports audiophile music reproduction but sets a new standard for excellence in audio amplification after many years.

At the heart of its operation is a non-hysteresis 5th order self-oscillating control loop, uniquely taking feedback solely at the speaker output. This innovative approach contributes to both measured and sonic performance, elevating the NC500 OEM above traditional audio amplifiers.

Notably, the NC500 OEM is designed as an unbuffered amplifier, providing manufacturers the flexibility to implement their preferred input buffer. This feature, combined with the amplifier's minimal sonic signature, allows for a tailored tuning of a distinct "house sound."

Applications of the NC500 OEM span a wide range, from high-end stereo and multichannel amplifiers to the creation of high-fidelity

active loudspeakers for recording and mastering studios, as well as the heart of premium home theatre systems.

Deep within the amplifier's architecture lies a commitment to endurance. Meticulously crafted with a conservative rating, the NC500 OEM is a testament to reliability. Each component is a thread in the fabric of longevity, ensuring years of unwavering performance.

As the story unfolds, the NC500 OEM introduces a unique chapter dedicated to signal integrity. A differential audio input, like a skilled narrator, enhances the clarity of the audio tale. It meticulously preserves the nuances of every note, presenting an unblemished narrative from input to output.

HIGHLIGHTS

- Extremely low distortion across the frequency and power range
- Exceptionally low output impedance for precise speaker control
- Minimal noise for a pure audio experience
- Remarkably neutral and transparent sound reproduction

FEATURES

- Differential audio input for enhanced signal integrity
- 2-ohm capability for versatility in speaker configurations
- Microprocessor-controlled error protection for peace of mind

NC500 OEM - Data

Item	Min	Typ	Max	BTL	Unit	Notes
Output Power 2Ω		550			W	
Output Power 4Ω		700		1100	W	
Output Power 8Ω		400		1400	W	
Distortion			0.01		%	20Hz < f < 20kHz. Pout = 1W
Output Noise		9	10		μV	
Power Bandwidth		20-35k			Hz	
Frequency Response	DC		50		kHz	+0/-3dB. All loads
Power Supply Voltage	35	84	98		HV+/-	
Idle Power		6.3	7		W	
Output Impedance		1.5	2		mΩ	f < 16kHz
Output Impedance			5		mΩ	f < 20kHz

COMPATIBLE SMPS

SMPS1200A400 / SMPS1200A700 /
SMPS3kA400 / SMPS3kA700

COMPATIBLE MODULES

NC500 Evaluation board

SIZE AND WEIGHT

82 × 63 × 32 mm (LxWxH), 135 g

MEASUREMENTS

THD+N vs. power @ 1kHz into 2Ω, 4Ω and 8Ω

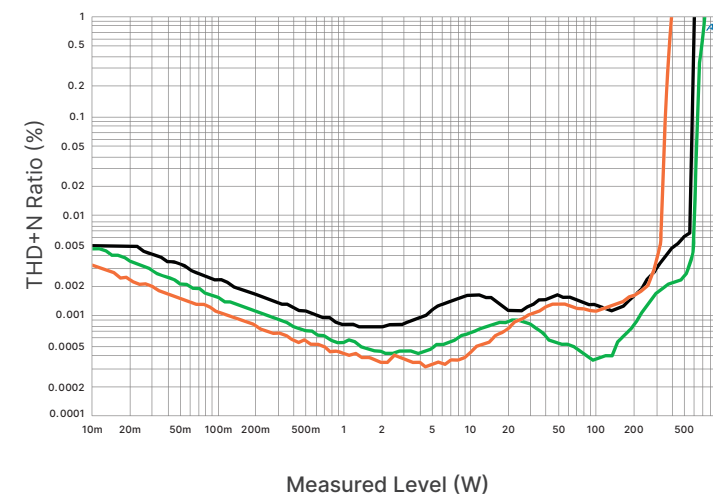

APPLICATION EXAMPLE

8 channel amplifier

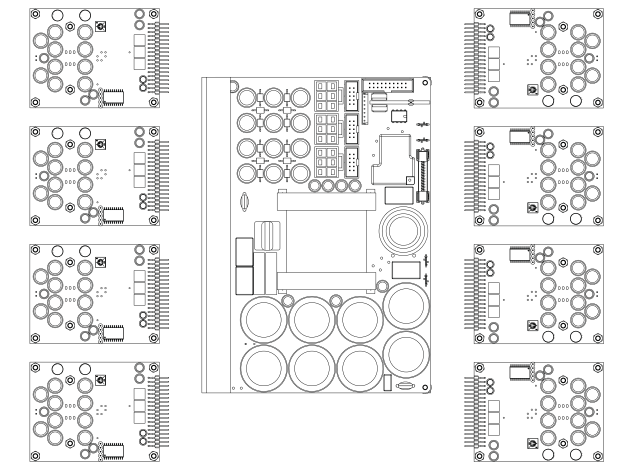

8 x NC500 OEM + 1 x SMPS3kA700

PROTECTIONS

- Two-stage overcurrent protection
- Under- and overvoltage protection
- Clip indicator
- DC error protection

POSSIBLE APPLICATIONS

- Audiophile Home Theatre systems
- Audiophile Power Amplifiers; for home and professional use
- Audiophile Immersive Audio systems
- Audiophile Multichannel Power Amplifiers

NCORE®

NC1200 OEM - Amplifier module



NCORE®

NCORE®

Unveil the epitome of audio engineering with the NC1200 amplifier module, a masterpiece designed for the avid audiophile used to power-hungry high-end loudspeakers. In an era where energy consciousness meets the pursuit of sonic excellence, the NC1200 not only champions the cause of audiophile music reproduction but provides excellent performance for current needed applications.

At the heart of the NC1200 OEM lies an outstanding power capacity, resulting in an impressive output into 2 Ohms. This amplifier is intricately designed to meet the demands of high-performance audio setups, delivering a dynamic range and impact that will for sure enchant both audiophiles and professionals.

Operating seamlessly in Class-D, the NC1200 is more than a device; it's a symphony of efficiency and uncompromised sonic performance. This amplifier module is a testament to precision engineering, where every detail is meticulously crafted to redefine and elevate your audio experience.

HIGHLIGHTS

- Extremely low distortion across the frequency and power range
- Exceptionally low output impedance for precise speaker control
- Minimal noise for a pure audio experience
- Remarkably neutral and transparent sound reproduction

Setting a new benchmark, the NC1200 boasts measured and sonic performance that transcends conventional standards. Its operation is orchestrated by a non-hysteresis 5th order self-oscillating control loop, an innovation that captures feedback exclusively at the speaker output, ensuring unparalleled clarity and precision in audio reproduction.

Crafted with versatility in mind, the NC1200 OEM is a powerhouse that effortlessly adapts to a multitude of applications. Whether you are designing a high-end home audio system, a professional studio setup, or pushing the limits of audio innovation, this amplifier module is ready to meet your expectations.

FEATURES

- Differential audio input for enhanced signal integrity
- 2-ohm powerhouse for current hungry applications
- Extensive, Microprocessor-controlled error protection

NC1200 OEM - Data

Item	Min	Typ	Max	BTL	Unit	Notes
Output Power 2Ω		1200			W	
Output Power 4Ω		700		2400	W	
Output Power 8Ω		400		1400	W	
Distortion			0.001		%	20Hz < f < 20kHz. Pout = 1W
Output Noise		20	28		μV	Including input buffer
Power Bandwidth		20-35k			Hz	
Frequency Response	DC		50		kHz	+0/-3dB. All loads
Power Supply Voltage	35	84	98		HV+/-	
Idle Power		15	17		W	
Output Impedance			2		mΩ	f < 1kHz
Output Impedance			3		mΩ	f < 20kHz

COMPATIBLE SMPS

SPMS1200A400 / SMPS1200A700 / SMPS3kA400 / SMPS3kA700

SIZE AND WEIGHT

130 × 79 × 42,8 mm (LxWxH), 135 g

MEASUREMENTS

THD+N vs. power @ 1kHz into 2Ω, 4Ω and 8Ω

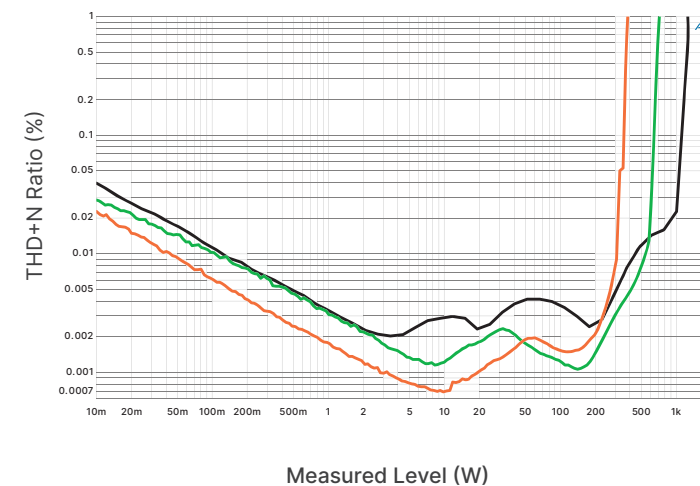

APPLICATION EXAMPLE

High-end mono block

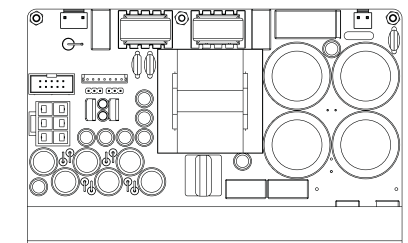
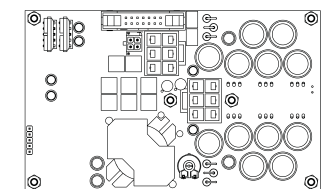

1 x NC1200 OEM + 1 x SMPS1200A700

PROTECTIONS

- Two-stage overcurrent protection
- Under- and overvoltage protection
- Clip indicator
- DC error protection

POSSIBLE APPLICATIONS

- Audiophile Home Theatre systems
- Audiophile Power Amplifiers; for home and professional use
- Audiophile Immersive Audio systems
- Audiophile Multichannel Power Amplifiers

NC2k OEM - Amplifier module



Step into a realm of extraordinary audio power and precision with the NC2k OEM OEM amplifier module, a groundbreaking addition to our NCORE® amplifier lineup. As a high-quality audio power amplifier operating in Class-D, the NC2k OEM OEM not only ensures the continuation of audiophile music reproduction in an energy-conscious world but also sets a new benchmark for touring amplifiers and stadium size subwoofers with extreme power and deep bass reproduction.

At its core, the NC2k OEM OEM inherits the legacy of its predecessors in the NCORE® Family, and expands upon it with a class-leading 2500W true power output. This module is not merely an amplifier; it's a testament to our commitment to pushing the boundaries of amplifier design to deliver raw power, precision engineering, and adaptability. Operating on a non-hysteresis 5th order self-oscillating control loop, the NC2k OEM OEM takes feedback exclusively at the speaker output. This innovative approach ensures measured and sonic performance that raises the bar for audio amplifiers. Immerse yourself in a sonic experience where every note is reproduced with extreme precision.

The NC2k OEM amplifier, distinguished by its impressive 160V voltage peak, is a testament to our technology in the realm of professional audio. This substantial voltage peak is paramount for the optimal performance of professional loudspeakers paired with the NC2k OEM amplifier. In the dynamic world of pro audio, where clarity and power are non-negotiable, the 160V voltage peak ensures that the amplifier can deliver robust and undistorted signals to the connected loudspeakers. Such a high voltage peak equips the NC2k OEM to handle demanding transients, sudden peaks in audio signals, and challenging dynamic ranges commonly encountered in live performances or large-scale sound reinforcement setups.

Designed for a multitude of applications, the NC2k OEM OEM excels as a stand-alone power amplifier for both professional and consumer use, active loudspeakers in recording and mastering studios, and as the cornerstone of very high-end home theatre systems all the way to professional PA systems, touring amplifiers and stadium size subwoofers. Its adaptability makes it a singular solution that effortlessly meets the demands of power-hungry audio applications.

Built with touring amplifiers in mind, the NC2k OEM OEM is a robust and reliable companion for audio professionals on the move. Its formidable power output and durable design make it the go-to choice for touring setups where reliability and performance are non-negotiable. Equipped with advanced detection and protection features, the NC2k OEM OEM ensures uninterrupted performance in the face of challenging and dynamic audio environments. Overcurrent and overvoltage safeguards guarantee the longevity of the module, providing peace of mind to audio professionals in the field.

With extremely low distortion across the frequency and power range, extremely low output impedance, extremely low noise, and an extremely neutral and transparent sound, the NC2k OEM is a sonic juggernaut, redefining what is possible in high-quality Class-D amplification.

HIGHLIGHTS

- Extremely low distortion across the frequency and power range
- Exceptionally low output impedance for precise speaker control
- Minimal noise for a pure audio experience
- Remarkably neutral and transparent sound reproduction

FEATURES

- Differential audio input for enhanced signal integrity
- 48A current capability
- 2-ohm powerhouse for current hungry applications
- Extensive, Microprocessor-controlled error protection

NC2k OEM - Data

Item	Min	Typ	Max	BTL	Unit	Notes
Output Power 2Ω		2000			W	
Output Power 4Ω		2500			W	
Output Power 8Ω		1600			W	
Distortion		0.0006			%	20Hz < f < 20kHz. Pout = 1W
Output Noise		7			μV	
Power Bandwidth		20-35k			Hz	
Frequency Response	DC		50		kHz	+0/-3dB. All loads
Power Supply Voltage	35	84	98		HV+/-	
Idle Power		34			W	
Output Impedance			3		mΩ	f < 1kHz
Output Impedance			2		mΩ	f < 20kHz

COMPATIBLE SMPS

SMPS3kA400 / SMPS3kA700

SIZE AND WEIGHT

133 × 107 × 49 mm (LxWxH), 547 g

MEASUREMENTS

THD+N vs. power @ 1kHz into 2Ω, 4Ω and 8Ω

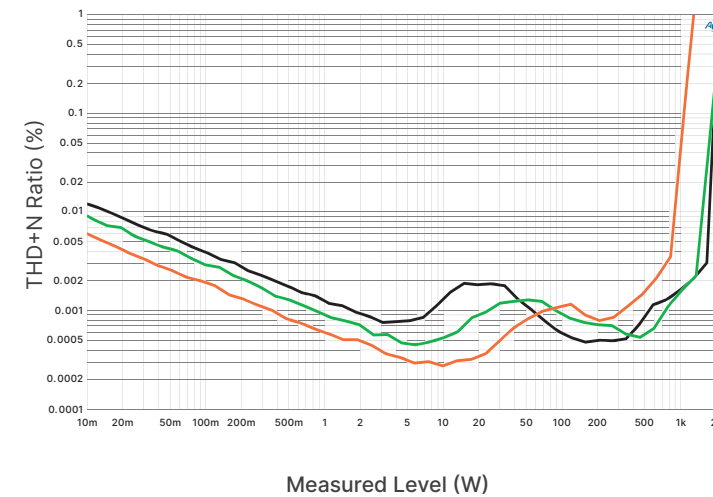

APPLICATION EXAMPLE

4 channel touring amplifier

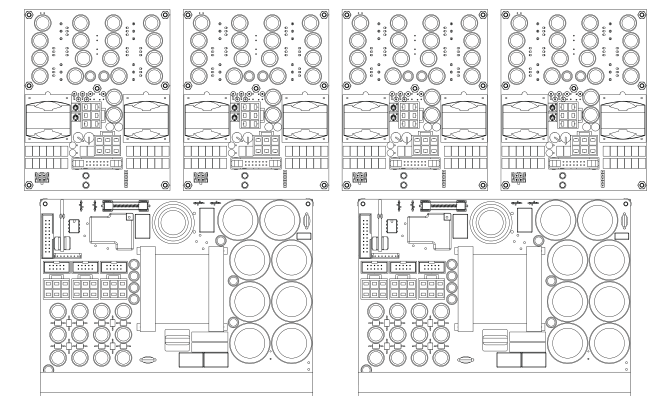

4 x NC2k OEM + 2 x SMPS3kA700

PROTECTIONS

- Two-stage overcurrent protection
- Under- and overvoltage protection
- Clip indicator
- DC error protection

POSSIBLE APPLICATIONS

- Audiophile Home Theatre systems
- Audiophile Power Amplifiers; for home and professional use
- Pro Audio Touring Amplifiers
- Pro Audio Subwoofers

NCOREx[®] Family

Evolution in audio excellence takes a leap forward with NCOREx[®], where the added “x” signifies exceptional performance. While working on our brand-new Nilai[®] technology, it became apparent that it would be relatively simple to improve the existing NCORE[®] technology by a factor of two, and that’s precisely what we’ve accomplished.

NCOREx[®] is not a complete departure but a deliberate evolution of the trusted NCORE[®] technology. It emerged seamlessly from the groundwork laid by NCORE[®], building upon its strengths and enhancing them twofold. This evolutionary step ensures that NCOREx[®] is a worthy and future-proof successor, promising an audio experience that surpasses expectations.

EXCEPTIONAL SCALABILITY

Following the modular approach established by our UcD™ and NCORE[®] amplifier modules, NCOREx[®] necessitates the use of a separate Switch Mode Power Supply (SMPS). This design philosophy not only ensures familiarity but also guarantees an exceptional and scalable system that aligns with diverse audio applications. The modular structure facilitates adaptability and future expansions.

In a bold move, we introduced the NCx500 OEM in 2022. This is just the beginning; the NCOREx[®] family is set to expand with new additions in the coming years. Stay tuned for more cutting-edge solutions designed to redefine the benchmarks of audio quality.

NCOREx[®] isn’t just an evolution for us; it’s an invitation to all manufacturers who aspire to push the boundaries of quality in their audio products. Whether you’re crafting professional-grade studio equipment or elevating the audio experience for the home, NCOREx[®] is your gateway to unparalleled performance.

Embrace evolution with NCOREx[®], where performance meets evolution, and the future of audio excellence is redefined.

AVAILABLE MODULES

Module name	Channels	Power 2Ω	Power 4Ω	Power 4Ω BTL	Power 8Ω	Power 8Ω BTL
NCx500 OEM	1	700W	700W	1000W	380W	1400W
NCx1000 OEM	1	1000W ¹	1400W ¹	-	1400W ¹	-

¹ preliminary data

NCOREx[®]

NCx500 OEM - Amplifier module



NCOREx®

The NCx500 OEM is a superior amplifier module designed to revolutionize your audio experience. With our groundbreaking exceptional NCOREx® technology, this product offers an astounding 2x better noise reduction and THD compared to its predecessor, the NC500 OEM.

Prepare to be immersed in unparalleled audio performance as the NCx500 OEM takes high-end audio products to new heights. Whether you require a mono, stereo, multichannel, or active speaker application, this amplifier module is the ultimate solution.

Not only does the NCx500 OEM deliver exceptional sound quality, but it also offers added functionality that sets it apart from its competitors. Our engineers have gone above and beyond to ensure that this product exceeds your expectations.

One of the most remarkable qualities of the NCx500 OEM is its versatility. It can seamlessly replace the NC500 OEM without any hassle, making it a convenient drop-in replacement.

Invest in the future of audio technology with the NCx500 OEM. It is meticulously crafted to meet the demands of discerning audiophiles who seek nothing but the best. Immerse yourself in crystal-clear sound, with every nuance and detail captured flawlessly.

Order the NCx500 OEM today and experience audio like never before. Enjoy the perfect blend of cutting-edge technology, exceptional performance, and new features. Elevate your audio experience and let the NCx500 OEM redefine your understanding of audio excellence.

HIGHLIGHTS

- On-board high-end buffer stage
- Incorporating our highly acclaimed HxR discrete regulators
- Built with thoughtfully chosen, superior-quality components
- Reduced idle losses

FEATURES

- Ultra Low Distortion
- Very Low Idle Power
- Very Low Noise
- Extremely Low Output Impedance
- Buffered / Unbuffered Input Selectable

NCx500 OEM - Data

Item	Min	Typ	Max	BTL	Unit	Notes
Output Power 2Ω		700			W	
Output Power 4Ω		700		1000	W	
Output Power 8Ω		380		1400	W	
Distortion		0.0006			%	20Hz < f < 20kHz, Pout = 1W
Output Noise		20			μV	Buffered
Power Bandwidth		20-35k			Hz	
Frequency Response	DC		70		kHz	+0/-3dB. All loads
Power Supply Voltage	55		95		HV+/-	
Idle Power		5.3	5.8		W	
Output Impedance		250			μΩ	

COMPATIBLE SMPS

SMPS1200A400 / SMPS1200A700 / SMPS3kA400 / SMPS3kA700

COMPATIBLE MODULES

NCx Evaluation board

SIZE AND WEIGHT

82 × 63 × 38 mm (LxWxH), 116 g

NCOREx®

MEASUREMENTS

THD+N vs. power @ 1kHz into 2Ω, 4Ω and 8Ω

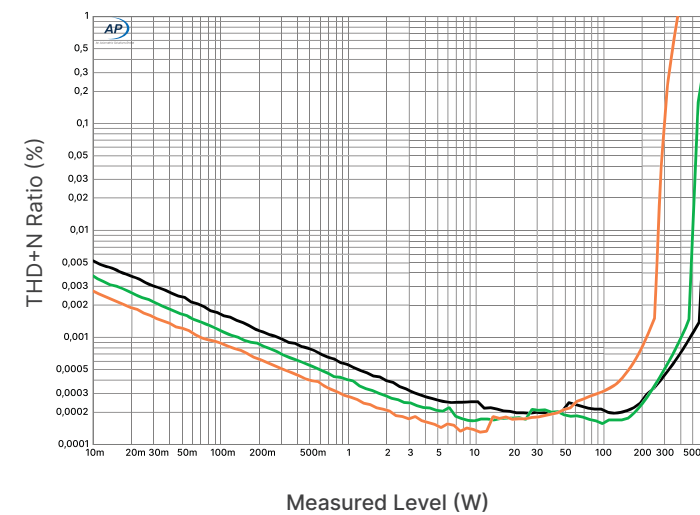

APPLICATION EXAMPLE

700 Watt 8 channel amplifier

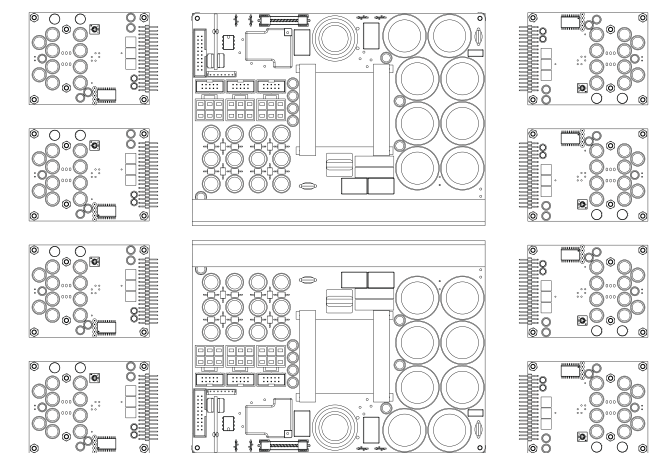

8 x NCx500 OEM + 2 x SMPS3kA700

PROTECTIONS

- Two-stage overcurrent protection
- DC error detection
- Over- and undervoltage protection
- Over temperature protection
- Short circuit protection

POSSIBLE APPLICATIONS

- Home Theatre systems
- Power Amplifiers; for home and professional use
- Immersive Audio systems
- Multichannel Power Amplifiers

NCx1000 OEM - Amplifier module



Prepare to elevate your audio experience to unprecedented levels with the NCx1000 OEM, the full-bridge enhanced high-performance variant to the groundbreaking NCx500 OEM. Building upon the success of its predecessor, the NCx1000 OEM is designed to deliver at least twice the power output at 40hm, setting a new standard for audio power and performance in the NCOREx Family.

Powered by our revolutionary exceptional NCOREx® technology, the NCx1000 OEM takes noise reduction and Total Harmonic Distortion (THD) to a whole new dimension, providing an unmatched improvement. Immerse yourself in audio purity as every note and nuance is reproduced with unparalleled clarity and precision.

Versatility is at the core of our design philosophy. The NCx1000 OEM seamlessly extends the family of amplifiers from the NCOREx® Family, ensuring an effortless upgrade with compatible pin-outs shared two-thirds of the way. Enhance your audio system effortlessly, immersing yourself in a new era of power and fidelity in this Family without sacrificing convenience.

The NCx1000 OEM goes beyond exceptional excellence power; it's a symphony of innovation and functionality. Our team of dedicated engineers has pushed the limits to ensure this amplifier module not only meets but exceeds your expectations. This is not just an amplifier; it's our statement of audio prowess.

Join the future of audio technology with the NCx1000 OEM. Meticulously crafted for discerning audiophiles and professionals who demand nothing but the best, this amplifier module invites you to rediscover your favorite music with unprecedented clarity and detail.

HIGHLIGHTS

- On-board high-end buffer stage
- Incorporating our highly acclaimed HxR discrete regulators
- Built with thoughtfully chosen, superior-quality components
- Reduced idle losses

FEATURES

- Ultra Low Distortion
- Very Low Idle Power
- Very Low Noise
- Very Low Output Impedance
- Buffered / Unbuffered Input Selectable
- SMPS dependent High-current/High-Voltage mode

NCx1000 OEM - Preliminary data

Item	Min	Typ	Max	BTL	Unit	Notes
Output Power 2Ω			1000		W	With 1200A400
Output Power 4Ω			1400		W	With 3kA700 (3kA400 possible 1600+)
Output Power 8Ω			1400		W	With 3kA700
Distortion		0.0005			%	20Hz < f < 20kHz. Pout = 1W
Output Noise		7			μV	
Power Bandwidth		20-35k			Hz	
Frequency Response	DC		70		kHz	+0/-3dB. All loads
Power Supply Voltage			90		HV+/-	
Idle Power			<10		W	
Output Impedance		250			μΩ	

COMPATIBLE SMPS

SMPS1200A400 / SMPS1200A700 / SMPS3kA400 / SMPS3kA700

COMPATIBLE MODULES

NCx Evaluation board

SIZE AND WEIGHT

To be announced

MEASUREMENTS

THD+N vs. power @ 1kHz into 2Ω, 4Ω and 8Ω

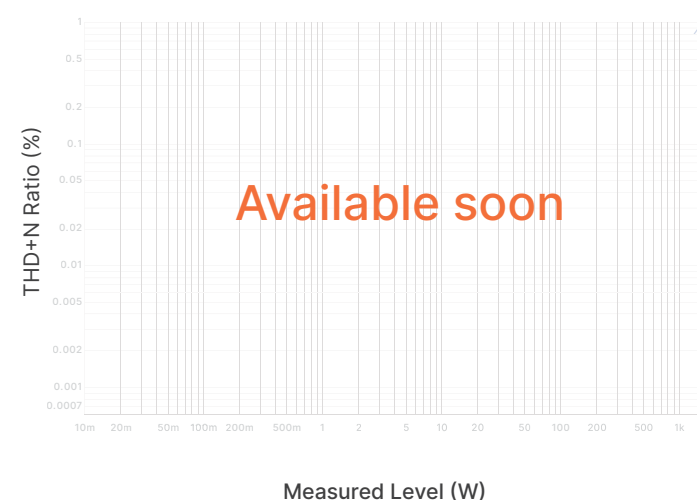

APPLICATION EXAMPLE

Exceptional high-end touring amplifier

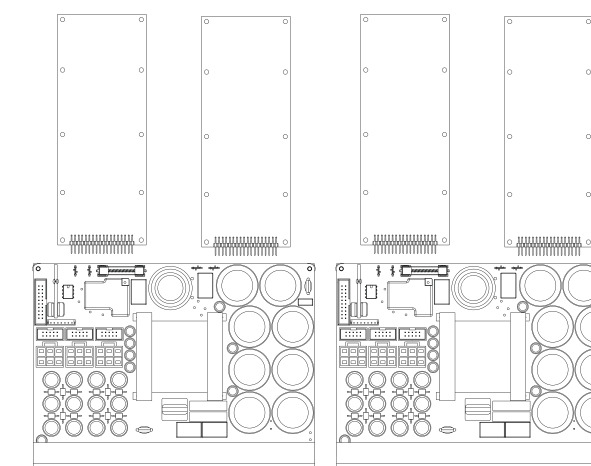

4 x NCx1000 OEM + 2 x SMPS3kA700

PROTECTIONS

- Two-stage overcurrent protection
- DC error detection
- Over- and undervoltage protection
- Over temperature protection
- Short circuit protection

POSSIBLE APPLICATIONS

- Home Theatre systems
- Power Amplifiers; for home and professional use
- Immersive Audio systems
- Multichannel Power Amplifiers

DSA Family

The Distribution Amplifier (DSA) Family stands out not only for its exceptional audio quality but also for its adaptability to various audio setups. Whether you're in the realm of traditional low-impedance loudspeaker configurations, navigating the intricacies of multichannel systems, or working with dynamic 70/100V distribution systems, the DSA Family effortlessly tailors its performance to meet your specific needs. This adaptability ensures that audio professionals have a singular solution that caters to a wide spectrum of applications.

At the heart of the DSA Family lies the revolutionary NCOREx® technology. This groundbreaking innovation not only allows for near-load-impedance independent amplifier design but also paves the way for a seamless system that can effortlessly drive both low and high impedance loudspeakers. This ensures a consistent and high-quality audio experience across a variety of speaker configurations, making the DSA Family a versatile powerhouse in audio amplification.

Gone are the days of cumbersome designs and bulky transformers. The DSA Family leverages high voltage semiconductors to directly drive a 70/100V audio distribution system. This not only reduces the overall weight of the amplifier but also enhances the volume of your audio, delivering an unparalleled audio experience that defies expectations. The streamlined design not only contributes to portability but also underscores the commitment to innovation in audio engineering.

In a rapidly evolving audio landscape, the DSA Family ensures future-proof integration. Its forward-thinking design and adaptability make it a reliable choice for audio professionals who want a solution that can seamlessly integrate with emerging technologies and evolving industry standards. This future-proofing aspect enhances the longevity of the DSA Family, making it a wise investment for those looking to stay ahead in the audio amplification game.

The ability to navigate both traditional and high-voltage audio landscapes positions it as an indispensable tool for those who demand the utmost in audio quality and flexibility. The DSA Family is not just a product; it's a testament to the commitment to advancing the art and science of audio amplification.

The DSA Family goes beyond being a product; it's a comprehensive solution that combines innovation, adaptability, and professional endorsement, setting a new standard in the world of audio amplification.

AVAILABLE MODULES

Module name	Channels	Bridgable?	Power 4Ω	Power 8Ω
DSA254 OEM	4	Yes	4 × 250W ¹	4 × 250W ¹

¹ preliminary data



DSA

DSA254 OEM - 4-Channel Amplifier module

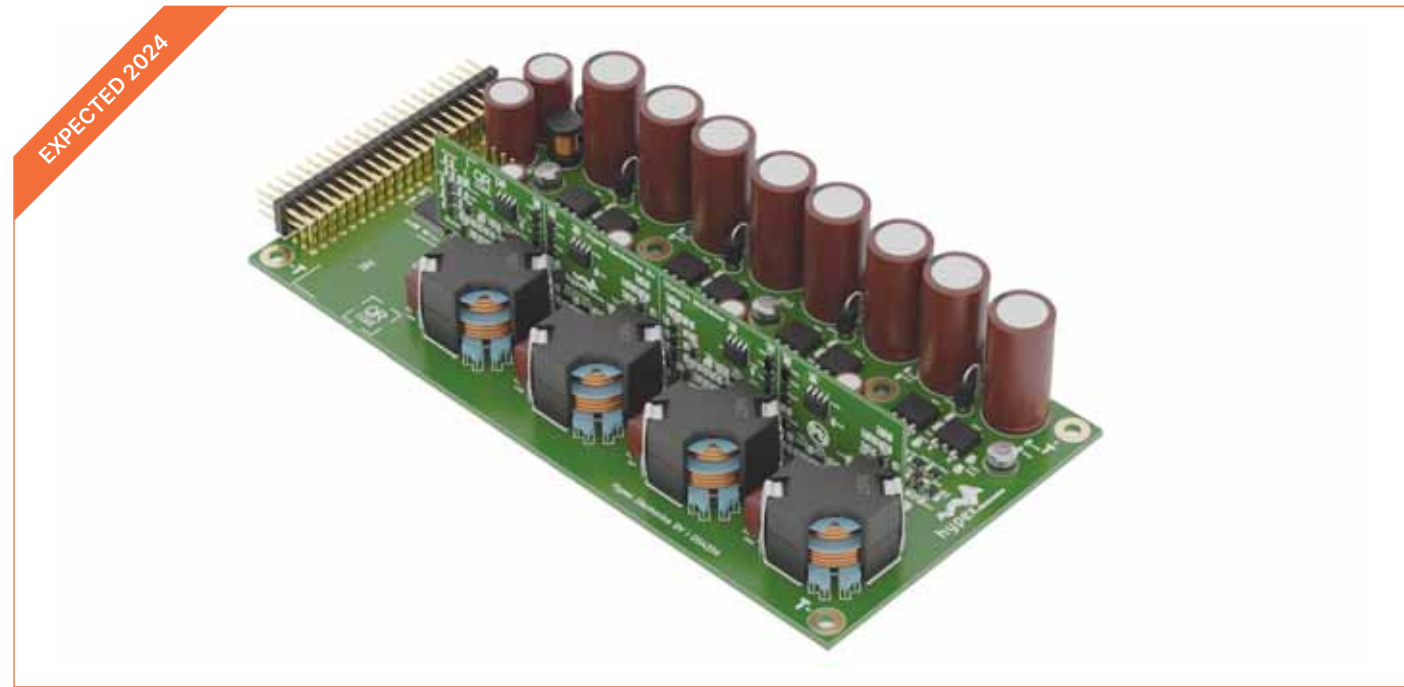

In a world where sound quality meets unparalleled flexibility, we proudly present the brand-new DSA254 OEM, a cutting-edge audio amplifier that transcends the boundaries of traditional loudspeaker systems. Tailored for both the regular loudspeaker market and dynamic 70Vrms (US) and 100Vrms (EU) distribution systems, the DSA254 OEM redefines what's possible in the world of audio amplification.

Whether you're aiming for a classic single-ended setup, the power-packed performance of a bridge-tied-load arrangement, or the enhanced capability of a parallel-bridge-tied-load configuration, the DSA254 effortlessly caters to your unique audio preferences.

Unlike its competitive counterparts, the DSA254 OEM is not confined to a single purpose. It's not just an amplifier; it's a sonic chameleon. Designed to seamlessly integrate into traditional low-impedance loudspeaker setups and 70/100V distribution systems, this amplifier offers unparalleled versatility. Say goodbye to the limitations of dedicated designs; the DSA254 OEM effortlessly adapts to your diverse audio needs.

At the heart of the DSA254 OEM lies the revolutionary Hypex NCOREx® technology. This groundbreaking innovation allows for a near-load-impedance independent amplifier design, paving the way for a singular system that effortlessly drives both low and high

impedance loudspeakers. The challenges posed by long cables in a 70/100V distribution system become mere nuances as the DSA254 OEM conquers them with ease.

Gone are the days of bulky transformers and cumbersome designs. The DSA254 OEM leverages high voltage semiconductors to directly drive a 70/100V audio distribution system, eliminating the need for a step-up transformer. This not only reduces weight but also amplifies the volume of your audio, giving you an unparalleled audio experience that defies expectations.

In a market with purpose-built solutions, the Hypex DSA254 OEM stands out as a beacon of innovation. Its ability to effortlessly navigate both traditional and high-voltage audio landscapes makes it a game-changer for audio professionals. It's not just a product; it's a statement, a statement that says your audio deserves the best, and the best just got better and easier with the DSA254 OEM.

HIGHLIGHTS

- Thoughtfully chosen, superior-quality components
- Reduced idle losses

FEATURES

- Very Low Distortion
- Extremely Low Idle Power
- Very Low Noise
- Very Low Output Impedance

DSA254 OEM - Preliminary data

Item	Min	Typ	Max	BTL	PBTL	Unit	Notes
Output Power 2Ω			125	125	250	W	
Output Power 4Ω			250	250	1000	W	All 4 channels
Output Power 8Ω			500	500	1000	W	
Distortion			0.05			%	20Hz < f < 20kHz, Pout = 1W
Output Noise			10			μV	
Power Bandwidth		20-35k				Hz	
Frequency Response	DC		50			kHz	+0/-3dB. All loads
Idle Power All Channels Total			12			W	
Output Impedance			10			μΩ	
Power Supply Voltage		35		98		V	
70V and 100V capable							

COMPATIBLE SMPS

SMPS1200A400 / SMPS1200A700 / SMPS3kA400 / SMPS3kA700

SIZE AND WEIGHT

150 × 75 × 34 mm (LxWxH), 150 g

MEASUREMENTS

THD+N vs. power @ 1kHz into 2Ω, 4Ω and 8Ω

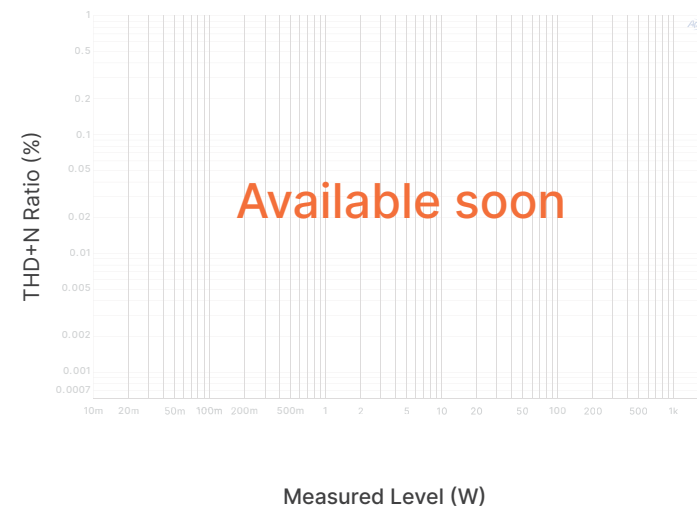

APPLICATION EXAMPLE

250W 70V/100V 16 channel amplifier

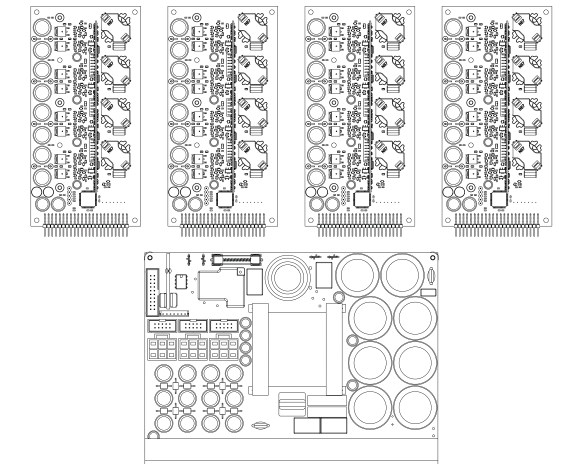

4 x DSA254 OEM + 1 x SMPS3kA700

PROTECTIONS

- Two-stage overcurrent protection
- DC error detection
- Over- and undervoltage protection
- Over temperature protection
- Short circuit protection

POSSIBLE APPLICATIONS

- 70V/100V Distribution Systems
- Multichannel Amplifier Systems
- Line Array and Immersive Systems
- Active Loudspeakers; for home and professional use
- Power Amplifiers; for home and professional use

Switch Mode Power Supply Family

Introducing our family of Switch Mode Power Supplies (SMPS), meticulously crafted to redefine the audio landscape while embodying our adaptable audio design philosophy. These power supplies are designed as highly efficient Safety Class 1 or 2 devices, dedicated to seamlessly integrate with our UcD™, N CORE®, and N COREx® amplifier modules.

We believe in providing audio solutions that cater to diverse needs and environments. Our products are designed to seamlessly integrate into various setups, whether it's a recording studio, a home entertainment system, or a professional audio system. The versatility inherent in our design philosophy ensures that our audio solutions can effortlessly adapt to different scenarios.

The SMPS family stands out for its remarkable efficiency, ensuring optimal energy utilization and uncompromised audio performance regardless of the load. Prioritizing space efficiency and portability, featuring a compact form factor and minimal weight, offering versatility for diverse audio applications.

PRISTINE AUDIO QUALITY

Immerse yourself in pristine audio quality - the SMPS units deliver remarkably low levels of both radiated and conducted electromagnetic interference (EMI), prioritizing signal integrity. From the initial design phase to the final implementation, each SMPS undergoes meticulous optimization to achieve a low EMI signature, meeting the stringent requirements of the most demanding audio applications.

The SMPS distinguishes itself by incorporating advanced protection mechanisms. Coupled with large electrolytic buffer capacitors, these features empower the supply to deliver substantial dynamic headroom power to your connected amplifier.

Switch Mode Power Supply Family

A GLOBAL APPROACH

Designed with adaptability in mind, our SMPS units offer a selectable input voltage range, accommodating various power input specifications. This flexibility enhances adaptability for different regions and power grid configurations, making them a versatile choice for international applications.

Standardized to comply with relevant industry standards and certifications, the SMPS family upholds the highest benchmarks for quality, safety, and performance. This commitment to standards reinforces their reliability in professional audio applications.

Experience the power and precision of our SMPS family – a harmonious blend of innovation, efficiency, and uncompromising quality, delivering an audio experience beyond expectation.

AVAILABLE MODULES

Module name	Version	Output Power	Output Voltage
SMPS400	A100	400W	2 × 37V
	A180	400W	2 × 46V
	A400	400W	2 × 62V
SMPS1200	A100	1200W	2 × 40V
	A180	1200W	2 × 46V
	A400	1200W	2 × 63V
	A700	1200W	2 × 85V
SMPS3k	A400	3000W	2 × 63V
	A700	3000W	2 × 85V

SMPS400 - 400W Switch Mode Power Supply



SMPS400 - Data

Item	Min	Typ	Max	Unit	Notes
Output Power		400		W	20Hz into amplifier load
Output Voltage Main A100	2 × 29	2 × 37	2 × 43	Vdc	Proportional to AC Mains
Output Voltage Main A180	2 × 35	2 × 46	2 × 43	Vdc	Proportional to AC Mains
Output Voltage main A400	2 × 48	2 × 62	2 × 72	Vdc	Proportional to AC Mains
Output Voltage Vaux A100, A180	2 × 16	2 × 21	2 × 24	Vdc	
Output Voltage Vaux A400	2 × 15	2 × 20	2 × 23	Vdc	
Output Current Vaux			500	mA	

COMPATIBLE MODULES

- SMPS400A100: UcD102 OEM
- SMPS400A180: UcD180LP OEM, UcD180 OEM
- SMPS400A400: UcD250LP OEM, UcD400LP OEM, UcD400 OEM

SIZE AND WEIGHT

105 × 95 × 40 mm (LxWxH), 300 g

SMPS

The SMPS400 stands out as a highly efficient Safety Class 2 switch mode power supply explicitly crafted for seamless integration with our UcD™ amplifier modules. Noteworthy attributes include exceptional efficiency across the entire load spectrum, an exceptionally compact form factor, minimal weight, and remarkably low levels of both radiated and conducted electromagnetic interference (EMI).

Distinguishing itself further, the SMPS400 incorporates advanced overcurrent protection mechanisms. In the event of a temporary overload, it intelligently diminishes the output voltage. Only when the overload persists for an extended duration does the supply transition into hiccup mode, maintaining this state until the overload resolves. This unique feature, coupled with large electrolytic buffer capacitors, empowers the supply to deliver substantial dynamic headroom power to the connected amplifier.

Moreover, the SMPS400 encompasses an auxiliary isolated supply and a control circuit seamlessly interfacing with our UcD™ amplifier modules. Activation for routine operation or disconnection during a critical fault is executed through built-in actuators, providing a reliable safeguard. From the initial design phase to the final implementation, the SMPS400 undergoes optimization to achieve the low EMI signature essential for the most demanding audio applications.

The SMPS400 is designed with a selectable input voltage range, allowing it to accommodate various power input specifications. This flexibility enhances its adaptability to different regions and power grid configurations, making it a versatile choice for international applications.

The SMPS400 complies with relevant industry standards and certifications, ensuring that it meets the highest benchmarks for quality, safety, and performance. This commitment to standards reinforces its reliability in professional audio applications. Relevant standards: The SMPS400A100, SMPS400A180 and SMPS400A400 revision 1500 and higher fulfil the requirements of: IEC60065:2014 + A11:2017, IEC62368-1:2014 + A11:2017, UL62368-1:2014 Ed.2 and CSA C22.2#62368-1:2014 Ed.2. The SMPS400 is an ETL listed component for the USA (UL62368-1:2014 Ed. 2) and Canada (CSA C22.2#62368-1:2014 Ed.2).

HIGHLIGHTS

- High efficiency
- Small form factor
- Low EMI
- Can be fitted in 1HE

FEATURES

- Selectable input voltage range
- Remote controlled operation
- 3 variants available: A100 / A180 / A400

MEASUREMENTS

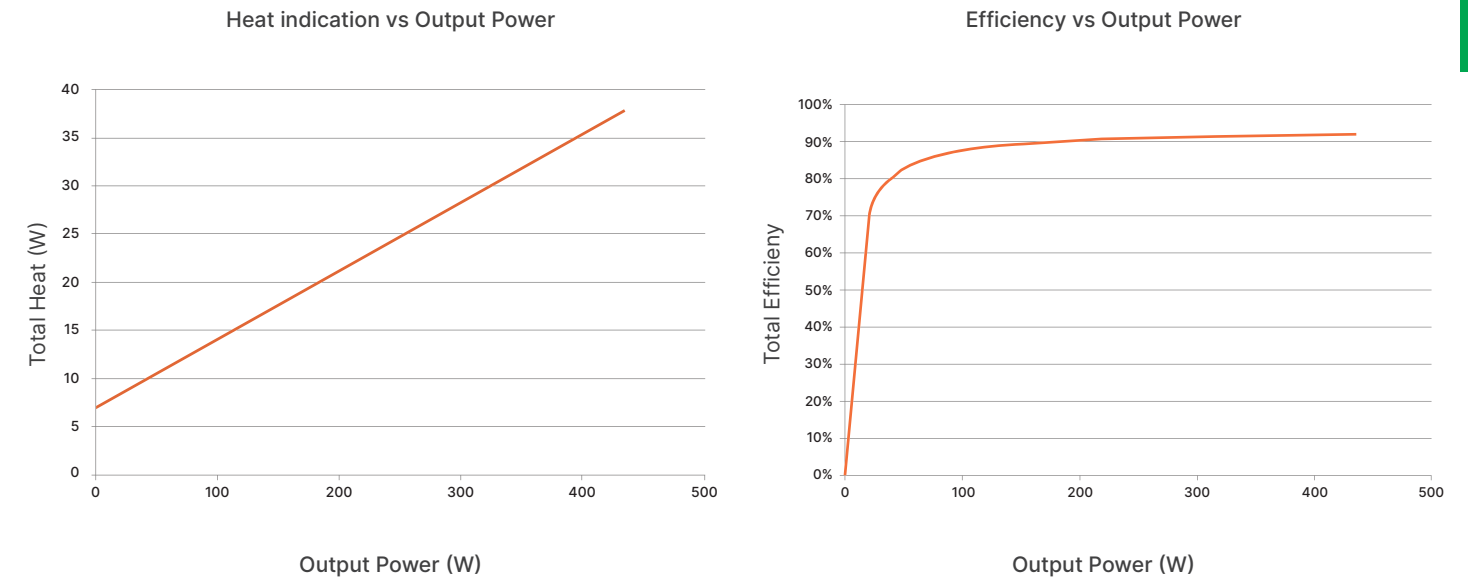

PROTECTIONS

- Advanced Overcurrent protection
- Over temperature protection
- DC detection input

POSSIBLE APPLICATIONS

- Active Loudspeakers, for home and professional use
- Power Amplifiers, for home and professional use
- Line Array and Immersive Systems
- Home Theatre Systems
- Multichannel Power Amplifiers

SMPS

SMPS1200 - 1200W Switch Mode Power Supply



The SMPS1200 represents a high-efficiency Safety Class 2 switch mode power supply meticulously engineered for compatibility with our UcD™, NCORE® and NCOREx® amplifier modules. Highlighted features encompass superior efficiency across the entire load spectrum, an exceptionally compact form factor, light-weight construction, and minimal radiated and conducted electromagnetic interference (EMI).

Additionally, the SMPS1200 boasts an advanced overcurrent protection mechanism that, during a temporary overload, restricts the output current. Only when the overload persists for an extended duration does the supply transition into hiccup mode, maintaining this state until the overload condition resolves. This attribute, in conjunction with substantial primary electrolytic buffer capacitors, enables the supply to deliver robust dynamic headroom power to the connected amplifier.

Furthermore, the SMPS1200 includes a symmetrical auxiliary output and a control circuit seamlessly interfacing with our UcD™, NCORE® and NCOREx® amplifier modules. Activation for routine operation or deactivation during a critical fault is managed through built-in actuators, ensuring a reliable safeguard. From the initial design phase to the final implementation, the SMPS1200 is optimized to achieve the lowest possible EMI signature, meeting the stringent demands of the most sophisticated audio applications.

The SMPS1200 is designed with a selectable input voltage range, allowing it to accommodate various power input specifications. This flexibility enhances its adaptability to different regions and power grid configurations, making it a versatile choice for international applications.

The SMPS1200 complies with relevant industry standards and certifications, ensuring that it meets the highest benchmarks for quality, safety, and performance. This commitment to standards reinforces its reliability in professional audio applications. Relevant standards: The SMPS1200A100, SMPS1200A180, SMPS1200A400 and SMPS1200A700 revision 1001 and higher fulfil the requirements of: IEC60065:2014 + A11:2017, IEC62368-1:2014 + A11:2017, UL62368-1:2014 Ed.2 and CSA C22.2#62368-1:2014 Ed.2. The SMPS1200 is an ETL listed component for the USA (UL62368-1:2014 Ed. 2) and Canada (CSA C22.2#62368-1:2014 Ed.2).

HIGHLIGHTS

- High efficiency
- Small form factor
- Low EMI

FEATURES

- Selectable input voltage range
- Remote controlled operation
- 4 variants available: A100 / A180 / A400 / A700

SMPS1200 - Data

Item	Min	Typ	Max	Unit	Notes
Output Power		1200		W	20Hz into amplifier load
Output Voltage Main A100	2 × 31	2 × 40	2 × 46	Vdc	Proportional to AC Mains
Output Voltage Main A180	2 × 36	2 × 46	2 × 53	Vdc	Proportional to AC Mains
Output Voltage main A400	2 × 49	2 × 63	2 × 72	Vdc	Proportional to AC Mains
Output Voltage main A700	2 × 66	2 × 85	2 × 98	Vdc	Proportional to AC Mains
Output Voltage Vaux A100	2 × 15	2 × 20	2 × 22	Vdc	Proportional to AC Mains
Output Voltage Vaux A180, A400	2 × 17	2 × 22	2 × 25	Vdc	Proportional to AC Mains
Output Voltage Vaux A700	2 × 16	2 × 21	2 × 24	Vdc	Proportional to AC Mains
Output Current Vaux			500	mA	

COMPATIBLE MODULES

- SMPS1200A100: UcD102 OEM
- SMPS1200A180: UcD180LP OEM, UcD180 OEM
- SMPS1200A400: UcD250LP OEM, UcD400LP OEM, UcD400 OEM, NC500 OEM, NCx500 OEM, NCx1000 OEM, DSA254 OEM
- SMPS1200A700: UcD700LZ OEM, NC500 OEM, NC1200 OEM, NCx500 OEM, NCx1000 OEM, DSA254 OEM

SIZE AND WEIGHT

165 × 105 × 52 mm (LxWxH), 850 g

MEASUREMENTS

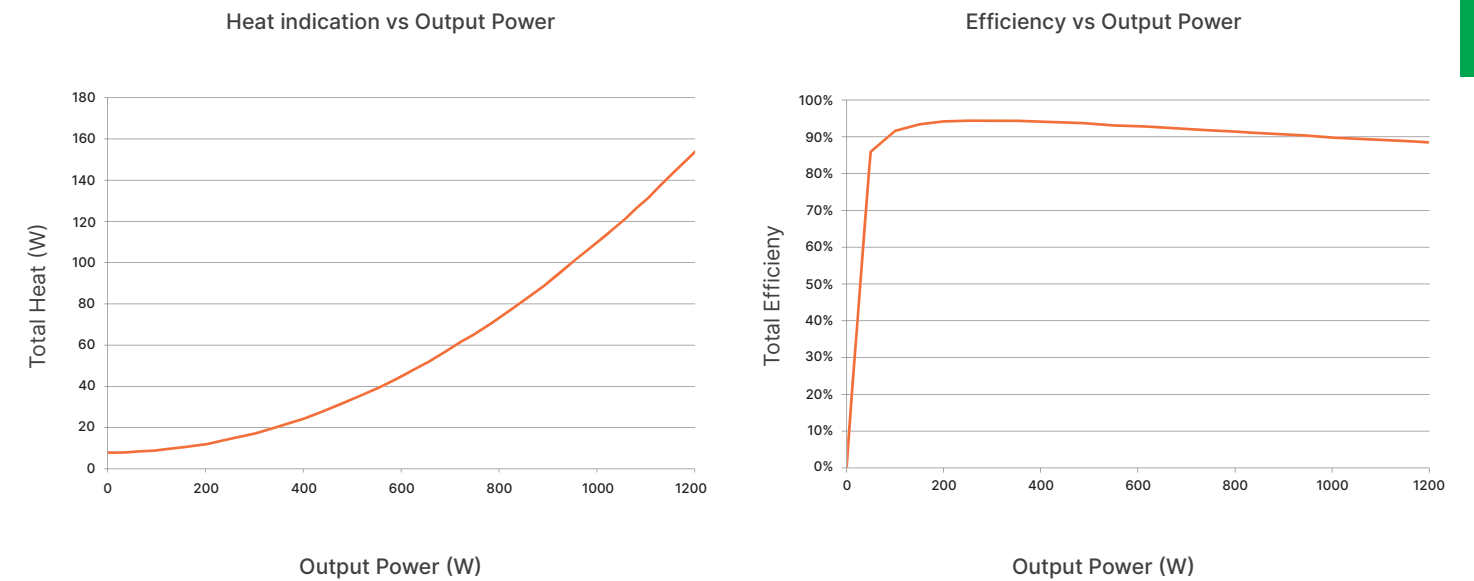

PROTECTIONS

- Advanced Overcurrent protection
- Over temperature protection
- DC detection input

POSSIBLE APPLICATIONS

- Active Loudspeakers, for home and professional use
- Power Amplifiers, for home and professional use
- Line Array and Immersive Systems
- Home Theatre Systems
- Multichannel Power Amplifiers

SMPS3k - 3000W Switch Mode Power Supply



The SMPS3K stands out as a high power, high-efficiency Safety Class 1 switch mode power supply meticulously crafted for seamless integration with our UcD™, NCORE® and NCOREx® amplifier modules. Its key attributes include superior efficiency across the entire load spectrum, an exceptionally compact form factor, lightweight design, and minimal radiated and conducted electromagnetic interference (EMI).

Adding to its capabilities, the SMPS3K incorporates advanced overcurrent protection. In the event of a temporary overload, it restricts the output current. Only if the overload condition persists for an extended period does the supply transition into hiccup mode, maintaining this state until the overload condition dissipates. This feature, coupled with large primary electrolytic buffer capacitors, enables the supply to deliver high dynamic headroom power to the connected amplifier.

Moreover, the SMPS3K includes a symmetrical auxiliary output and a control circuit seamlessly interfacing with our UcD™, NCORE® and NCOREx® amplifier modules. Activation for routine operation or deactivation during a critical fault is managed through built-in actuators, providing a reliable safeguard. From the initial design phase to the final implementation, the SMPS3K undergoes optimization to achieve the lowest possible EMI signature, meeting the stringent requirements of the most demanding audio applications.

The SMPS3K is designed with a selectable input voltage range, allowing it to accommodate various power input specifications. This flexibility enhances its adaptability to different regions and power grid configurations, making it a versatile choice for international applications.

The SMPS3K complies with relevant industry standards and certifications, ensuring that it meets the highest benchmarks for quality, safety, and performance. This commitment to standards reinforces its reliability in professional audio applications. Relevant standards: The SMPS3A400 and SMPS3KA700 revision 1000 and higher fulfil the requirements of: IEC60065:2014 + A11:2017, IEC62368-1:2014 + A11:2017, UL62368-1:2014 Ed.2 and CSA C22.2#62368-1:2014 Ed.2. The SMPS3KA400 and SMPS3KA700 are ETL listed components for the USA (UL62368-1:2014 Ed. 2) and Canada (CSA C22.2#62368-1:2014 Ed.2).

HIGHLIGHTS

- High efficiency
- Small form factor
- Low EMI

FEATURES

- Selectable input voltage range
- Remote controlled operation
- 2 variants available: A400 / A700

SMPS3k - Data

Item	Min	Typ	Max	Unit	Notes
Output Power		3000		W	20Hz into amplifier load
Output Voltage Main A400	2 × 49	2 × 63	2 × 72	Vdc	Proportional to AC Mains
Output Voltage Main A700	2 × 66	2 × 85	2 × 97	Vdc	Proportional to AC Mains
Output Voltage Vaux A400	2 × 15	2 × 20	2 × 23	Vdc	Proportional to AC Mains
Output Voltage Vaux A700	2 × 18	2 × 23	2 × 26	Vdc	Proportional to AC Mains
Output Current Vaux			500	mA	

COMPATIBLE MODULES

SMPS3kA400: UcD250LP OEM, UcD400LP OEM, UcD400 OEM, NC500 OEM, NCx500 OEM¹, NCx1000 OEM, DSA254 OEM
 SMPS3kA700: UcD700LZ OEM, UcD2k OEM, NC500 OEM, NC1200 OEM, NC2k, NCx500 OEM¹, NCx1000 OEM, DSA254 OEM

¹: For half-bridge amplifier modules please beware of power supply pumping phenomenon. This can happen with high power, low frequencies. Contact support@hypex.nl for these applications

SIZE AND WEIGHT

200 × 145 × 55 mm (LxWxH), 1475 g

MEASUREMENTS

Heat indication vs Output Power

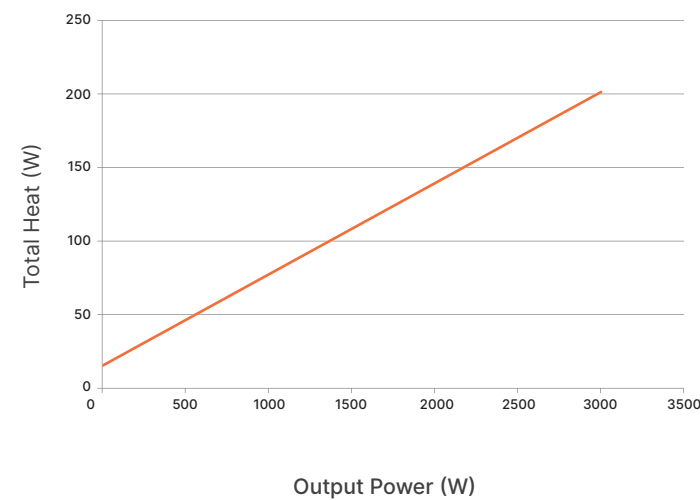

Efficiency vs Output Power

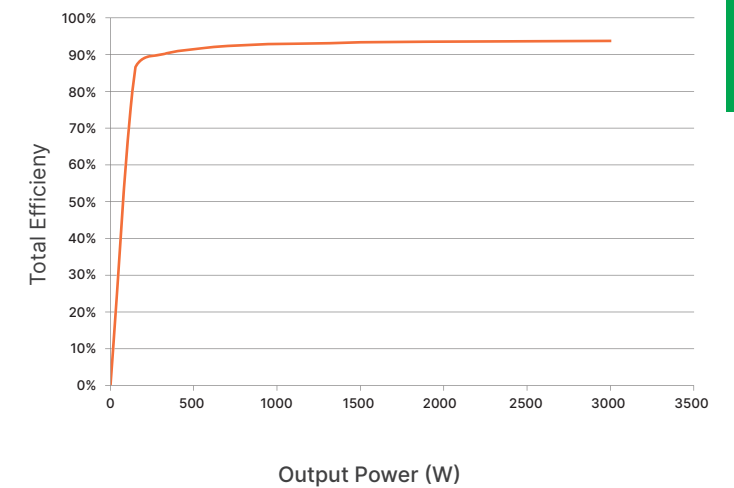

PROTECTIONS

- Advanced Overcurrent protection
- Over temperature protection
- DC detection input

POSSIBLE APPLICATIONS

- Active Loudspeakers, for home and professional use
- Power Amplifiers, for home and professional use
- Line Array and Immersive Systems
- Home Theatre Systems
- Multichannel Power Amplifiers

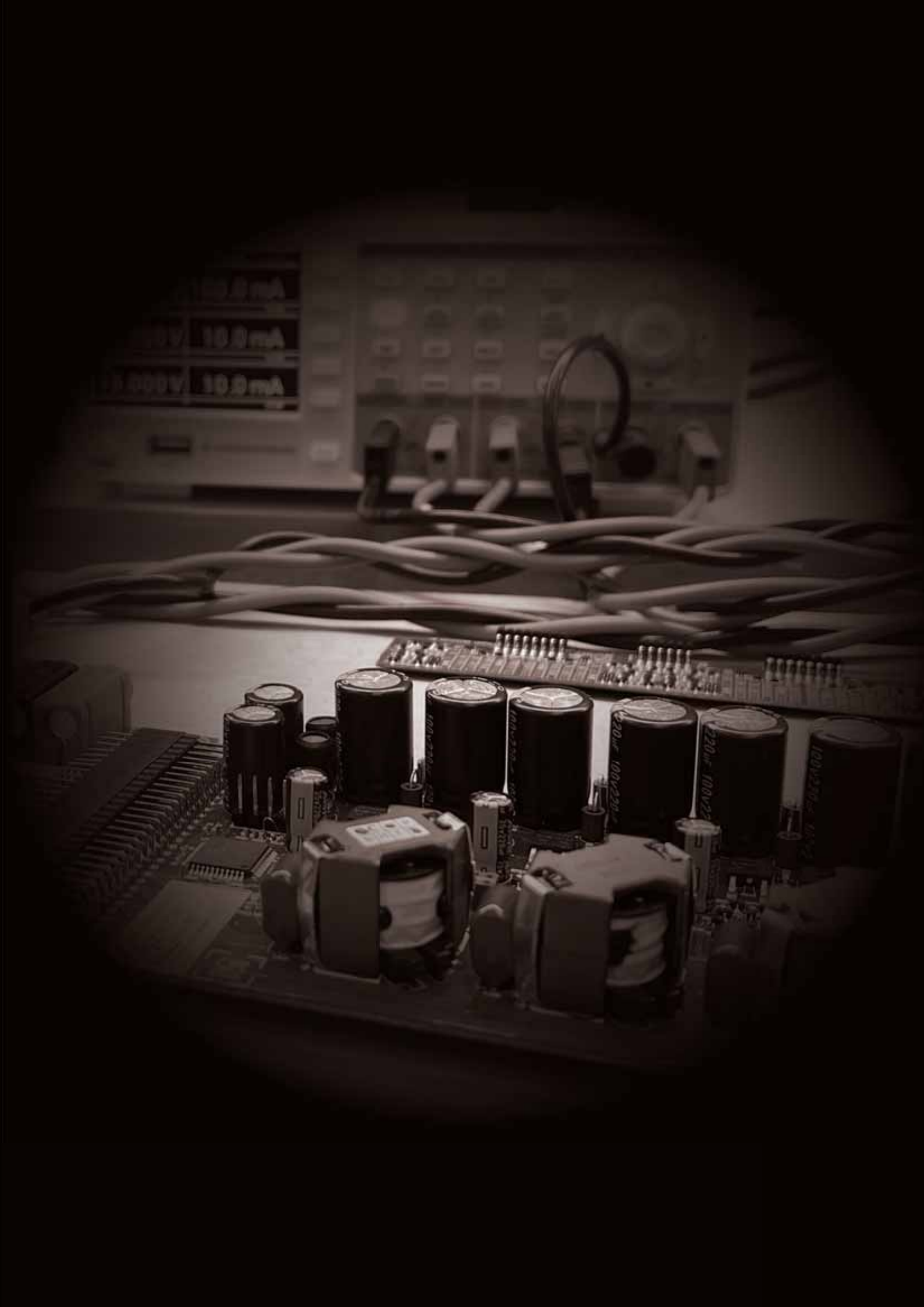
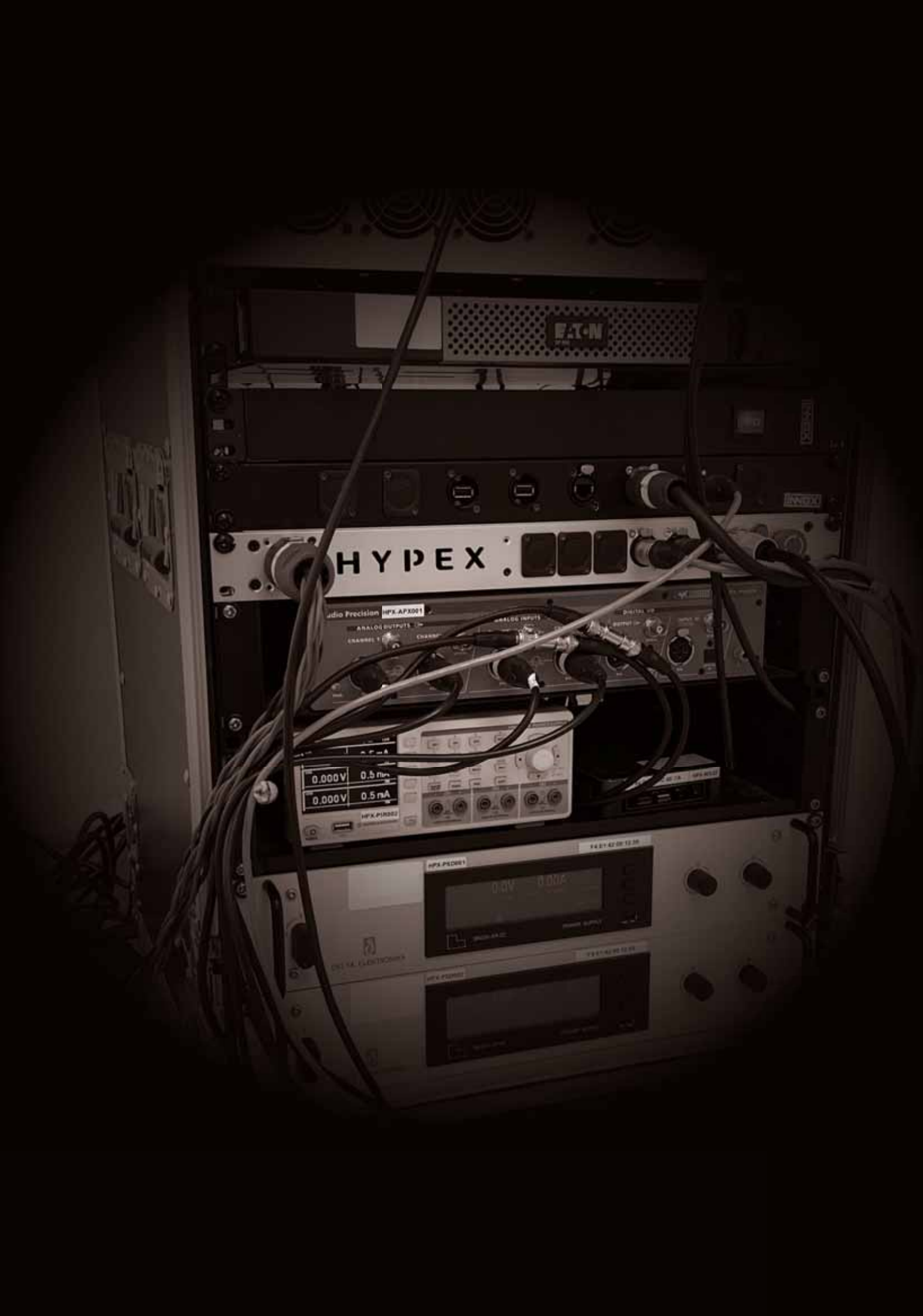

Mains Powered NCORE® Family

Meticulously engineered, the Mains Powered NCORE® modules seamlessly integrate a low-power standby supply, a highly efficient switch mode power supply (SMPS), and a high-performance Class-D amplifier into a singular, compact power brick, setting high standards in audio amplification and integration.

At the heart of the Mains Powered NCORE® Family power bricks is a self-contained, high-performance Class-D amplifier, purpose-built for a diverse spectrum of audio applications. From public address systems to ultrahigh-fidelity studio and home replay systems, these amplifiers deliver outstanding results. Notable features include a flat frequency response regardless of load impedance, nearly frequency-independent distortion behavior, and exceptionally low radiated and conducted electromagnetic interference (EMI). Control is achieved through a phase shift-controlled self-oscillating loop, taking feedback exclusively at the speaker output.

The core power source for the Mains Powered NCORE® Family power bricks is a compact, high-power, and highly efficient Switch Mode Power Supply. This technology was specifically chosen for its ability to seamlessly power Class-D audio amplifiers. The result is an amplifier that not only meets but exceeds the demands of modern audio systems, providing unparalleled efficiency and reliability.

In response to the evolving needs of audio applications, the Mains Powered NCORE® Family power bricks include a low-power standby SMPS for applications requiring standby mode functionality. Designed for universal mains input compatibility, this standby SMPS ensures energy efficiency without compromising on performance.

From the smallest component to the overall design, the Mains Powered NCORE® Family power bricks exemplify quality and precision. Compliant with 2013 ERP Lot 6 0.5W requirements, these amplifier power bricks are not only a technological marvel but also environmentally conscious.

Whether configuring a professional studio or enhancing your home audio setup, the Mains Powered NCORE® amplifier power bricks offer a versatile solution. Their adaptability, coupled with exceptional performance characteristics, makes them the amplifiers of choice for those who demand the best in audio reproduction and are seeking an easy-to-integrate solution.

AVAILABLE MODULES

Module name	Channels	Bridgable?	Power 4Ω	Power 4Ω BTL	Power 8Ω	Power 8Ω BTL
NC52MP	2	Yes	2 × 50W	1 × 125W	2 × 25W	1 × 100W
NC122MP	2	Yes	2 × 125W	1 × 200W	2 × 75W	1 × 250W
NC250MP	1	No	1 × 250W		1 × 130W	
NC252MP	2	Yes	2 × 250W	1 × 400W	2 × 150W	1 × 500W
NC500MP	1	No	1 × 500W		1 × 270W	
NC502MP	2	Yes	2 × 500W	1 × 1000W	2 × 350W	1 × 1200W
NC100HF	1	No	1 × 100W		1 × 100W	



NC52MP - Amplifier module & power supply



The NC52MP is an extremely compact power dual-amplifier brick. A cutting-edge, easy to integrate, amplifier solution that seamlessly combines advanced technology with an integration-friendly design. This versatile module is equipped with a host of features to elevate your implementation experience, making it an ideal choice for a wide range of audio applications, from high-quality power amplifiers to high-quality active loudspeakers.

The NC52MP stands out with its innovative power supply architecture. Incorporating a low-power standby supply that complies with 2013 ERP Lot 6 0.5W requirements, a highly efficient switch mode power supply (SMPS), and dual high-performance 50W NCORE® Class-D amplifiers, this module redefines compact power delivery. The result is a compact yet powerful brick that is highly compatible with various audio applications.

The Class-D amplifier employed in the NC52MP is a self-contained marvel, crafted for versatility in audio applications ranging from public address systems to ultra high-fidelity replay systems for both studio and home use. Key features that set it apart include a flat frequency response across load impedances, nearly frequency-independent distortion behavior, and minimal radiated and conducted electromagnetic interference (EMI). The control mechanism is based on a phase shift-controlled self-oscillating loop, with feedback sourced exclusively from the speaker output.

Driving the amplifiers is a main SMPS, a compact, high-power, highly efficient, regulated flyback. These exceptional properties make it the perfect technology to power this Class-D audio power amplifier brick, ensuring optimal performance and reliability. This SMPS is designed for universal mains input compatibility, offering flexibility and efficiency in various applications. For situations requiring a standby mode, the NC52MP incorporates a low-power standby SMPS.

Now, redefine your expectations with the NC52MP's remarkably low heat dissipation. This module has been engineered to deliver superior performance while efficiently managing heat generation, enhancing both longevity and reliability.

HIGHLIGHTS

- High efficiency & Universal mains operation
- Flat, fully load-independent frequency response
- Low output impedance
- Very low, frequency independent THD
- Very low noise

FEATURES

- Two-channel amplifier
- 5W standby SMPS
- Advanced protections
- Universal mains (100/240Vac)
- Light weight and compact size

NC52MP - Data

Item	Min	Typ	Max	BTL	Unit	Notes
Output Power 2Ω			2 × 40		W	
Output Power 4Ω			2 × 50	125	W	
Output Power 8Ω			2 × 25	100	W	
Distortion		0.002	0.004		%	20Hz < f < 20kHz, Pout = 1W
Output Noise			35		μV	
Power Bandwidth		20-35k			Hz	
Frequency Response	10		50k		Hz	+0/-3dB. All loads
Idle Power		4			W	
Output Impedance			2		mΩ	f < 1kHz
Output Impedance			4		mΩ	f < 20 kHz
Standby Output Voltage	4.9	5	5.1		Vdc	
Standby Output Current			1		A	
Output Voltage Vaux	2 × 17	2 × 18	2 × 19		Vdc	
Output Current Vaux			0.1		A	

COMPATIBLE MODULES

NCxxxMP Evaluation board / DSP3-213 / DSP3-224 / DSP 2-114

SIZE AND WEIGHT

125 × 80 × 38 mm (LxWxH), 176 g

MEASUREMENTS

THD+N vs. power @ 1kHz into 2Ω, 4Ω and 8Ω

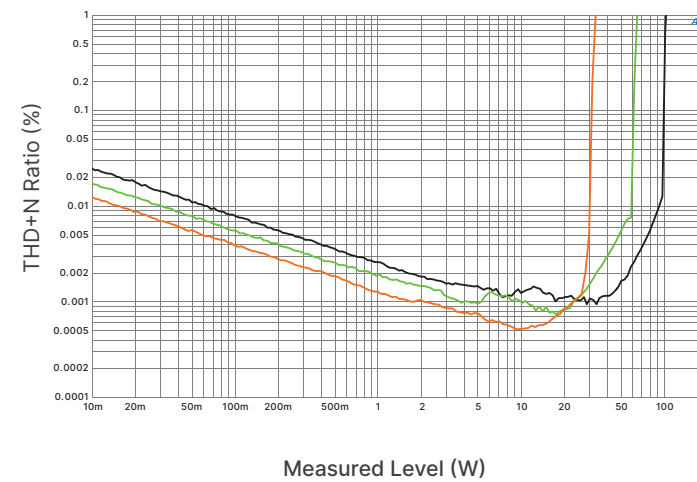

APPLICATION EXAMPLE

2 × 50W active loudspeaker

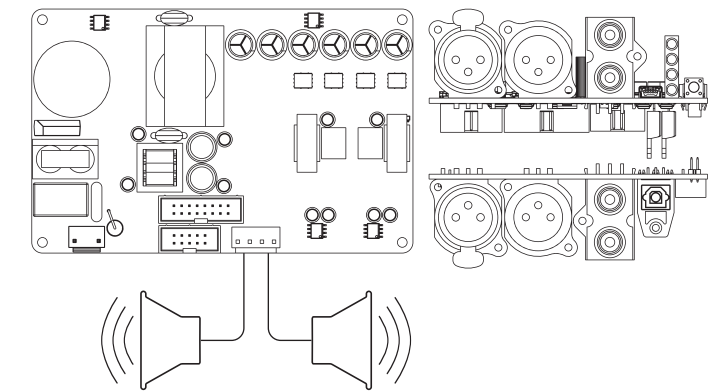

1 x NC52MP + 1 x DSP3-213 + 1x DIGin3-322

PROTECTIONS

- Overcurrent protection
- Clip indicator
- DC error protection
- Over temperature protection
- Short circuit protection

POSSIBLE APPLICATIONS

- Monitor loudspeakers for studios
- Active loudspeakers
- Public Address systems
- Home Theatre systems
- Power Amplifiers; for home and professional use

NC122MP - Amplifier module & power supply



The NC122MP, a compact power dual-amplifier brick, is a cutting-edge, easy to integrate, amplifier that seamlessly combines advanced technology with an integration-friendly design. This versatile module is equipped with a host of features to elevate your implementation experience, making it an ideal choice for a wide range of audio applications, from high-quality power amplifiers to high-quality active loudspeakers.

The NC122MP stands out with its innovative power supply architecture. Incorporating a low-power standby supply that complies with 2013 ERP Lot 6 0.5W requirements, a highly efficient switch mode power supply (SMPS), and dual high-performance 125W NCORE® Class-D amplifiers, this module redefines compact power delivery. The result is a compact yet powerful brick that is highly compatible with various audio applications.

At the heart of the NC122MP you'll find a dual self-contained high-performance NCORE® Class-D amplifier. Boasting a flat frequency response regardless of load impedance, nearly frequency-independent distortion behavior, and minimal radiated and conducted electromagnetic interference (EMI), this amplifier ensures a superior audio experience. The control mechanism, based on a phase shift-controlled self-oscillating loop with feedback only at the speaker output, enhances precision and clarity in audio reproduction.

HIGHLIGHTS

- High efficiency & Universal mains operation
- Flat, fully load-independent frequency response
- Low output impedance
- Very low, frequency independent THD
- Very low noise

The main SMPS that powers the amplifier is a compact, high-power, highly efficient, regulated half-bridge converter with synchronous rectification on the main output rails. This advanced technology is specifically tailored for Class-D audio amplifiers, delivering unparalleled performance and efficiency. The automatic input voltage doubler enhances universal mains input compatibility, making it convenient for use in various environments. For applications requiring standby mode, the NC122MP integrates a low-power standby SMPS. Designed with energy efficiency in mind, this feature ensures minimal power consumption during periods of inactivity.

Taking versatility to the next level, the NC122MP features the Hypex Extension connector. This innovative addition allows for an extra low-power tweeter amplifier channel, expanding your audio setup possibilities and making it suitable for building three-way loudspeakers.

FEATURES

- Two-channel amplifier
- 5W standby SMPS
- Advanced protections
- Auto-switching (115/230V)
- Light weight and compact size

NC122MP - Data

Item	Min	Typ	Max	BTL	Unit	Notes
Output Power 2Ω			2 × 115		W	
Output Power 4Ω			2 × 125	230	W	
Output Power 8Ω			2 × 75	250	W	
Distortion			0.0014		%	20Hz < f < 20kHz. Pout = 1W
Output Noise			40		μV	
Power Bandwidth		20-35k			Hz	
Frequency Response	10		48k		Hz	+0/-3dB. All loads
Idle Power		7.5			W	
Output Impedance			2		mΩ	f < 1kHz
Output Impedance			3.5		mΩ	f < 20 kHz
Standby Output Voltage	4.9	5	5.1		Vdc	
Standby Output Current			1		A	
Output Voltage Vaux	2 × 19	2 × 20	2 × 21		Vdc	
Output Current Vaux			1		A	

COMPATIBLE MODULES

NCxxxMP Evaluation board / NC100HF / DSP3-213 / DSP3-224 / DSP 2-114

SIZE AND WEIGHT

170 × 85 × 40 mm (LxWxH), 415 g

MEASUREMENTS

THD+N vs. power @ 1kHz into 2Ω, 4Ω and 8Ω

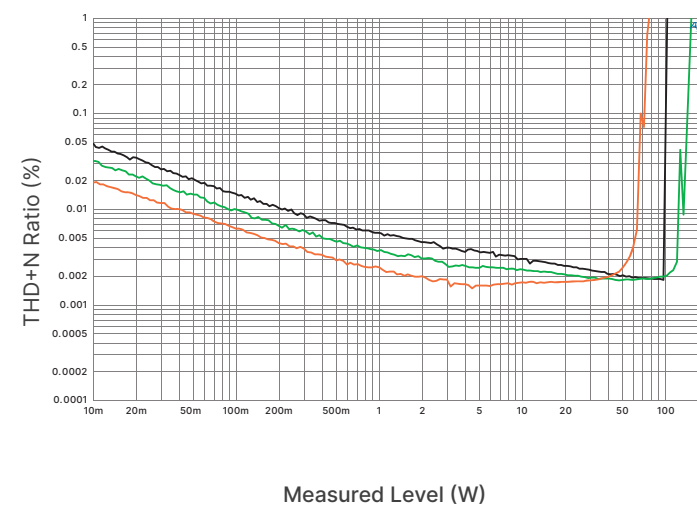

APPLICATION EXAMPLE

Integrated dual channel amplifier

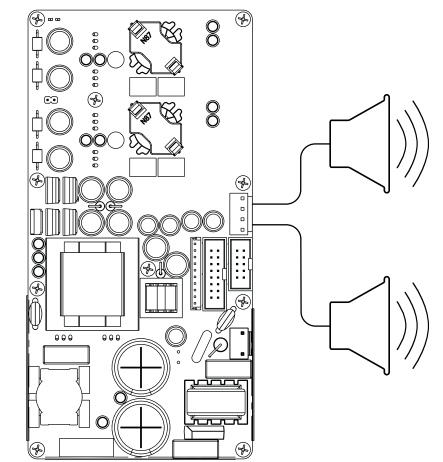

1 x NC122MP

PROTECTIONS

- Overcurrent protection
- Clip indicator
- DC error protection
- Over temperature protection
- Short circuit protection

POSSIBLE APPLICATIONS

- Monitor loudspeakers for studios
- Active loudspeakers and subwoofers
- Public Address systems
- Home Theatre systems
- Power Amplifiers; for home and professional use

NC250MP - Amplifier module & power supply



The NC250MP compact power single amplifier brick is a cutting-edge, easy to integrate, amplifier that seamlessly combines advanced technology with an integration-friendly design. This versatile module is equipped with a host of features to elevate your implementation experience, making it an ideal choice for a wide range of audio applications, from musical instrument amplifiers, high-quality power amplifiers to high-quality active loudspeakers and subwoofers.

The NC250MP stands out with its innovative power supply architecture. Incorporating a low-power standby supply that complies with 2013 ERP Lot 6 0.5W requirements, a highly efficient switch mode power supply (SMPS), and a single high-performance 250W NCORE® Class-D amplifier, this module redefines compact power delivery. The result is a compact yet powerful brick that is easily applicable in various audio applications.

At the heart of the NC250MP is a self-contained high-performance NCORE® Class-D amplifier. Boasting a flat frequency response regardless of load impedance, nearly frequency-independent distortion behavior, and minimal radiated and conducted electro-magnetic interference (EMI), this amplifier ensures a superior audio experience. The control mechanism, based on a phase shift-controlled self-oscillating loop with feedback only at the speaker output, enhances precision and clarity in audio reproduction.

The main SMPS that powers the amplifier is a compact, high-power, highly efficient, regulated half-bridge converter with synchronous rectification on the main output rails. This advanced technology is specifically tailored for Class-D audio amplifiers, delivering unparalleled performance and efficiency. The automatic input voltage doubler enhances universal mains input compatibility, making it convenient for use in various environments. For applications requiring standby mode, the NC250MP integrates a low-power standby SMPS. Designed with energy efficiency in mind, this feature ensures minimal power consumption during periods of inactivity.

Taking versatility to the next level, the NC250MP features the Hypex Extension connector. This innovative addition allows for an extra low-power tweeter amplifier channel, expanding your audio setup possibilities and making it suitable for two-way loudspeakers.

HIGHLIGHTS

- High efficiency & Universal mains operation
- Flat fully load-independent frequency response
- Low output impedance
- Very low, frequency independent THD
- Very low noise

FEATURES

- Single-channel amplifier
- 5W standby SMPS
- Advanced protections
- Auto-switching (115/230V)
- Light weight and compact size

NC250MP - Data

Item	Min	Typ	Max	BTL	Unit	Notes
Output Power 2Ω			180		W	
Output Power 4Ω			250		W	
Output Power 8Ω			130		W	
Distortion			0.003		%	20Hz < f < 20kHz, Pout = 1W
Output Noise			40		μV	
Power Bandwidth		20-35k			Hz	
Frequency Response	0		50k		Hz	+0/-3dB. All loads
Idle Power		7.5			W	
Output Impedance			2		mΩ	f < 1kHz
Output Impedance			3.5		mΩ	f < 20 kHz
Standby Output Voltage	4.9	5	5.1		Vdc	
Standby Output Current			1		A	
Output Voltage Vaux	2 × 19	2 × 20	2 × 21		Vdc	
Output Current Vaux			1		A	

COMPATIBLE MODULES

NCxxxMP Evaluation board / NC100HF / DSP3-213 / DSP3-224 / DSP2-114

SIZE AND WEIGHT

140 × 85 × 40 mm (LxWxH), 360 g

MEASUREMENTS

THD+N vs. power @ 1kHz into 2Ω, 4Ω and 8Ω

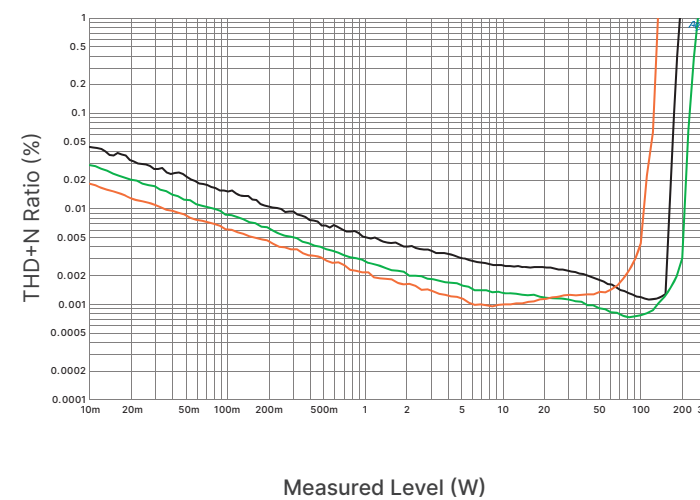

APPLICATION EXAMPLE

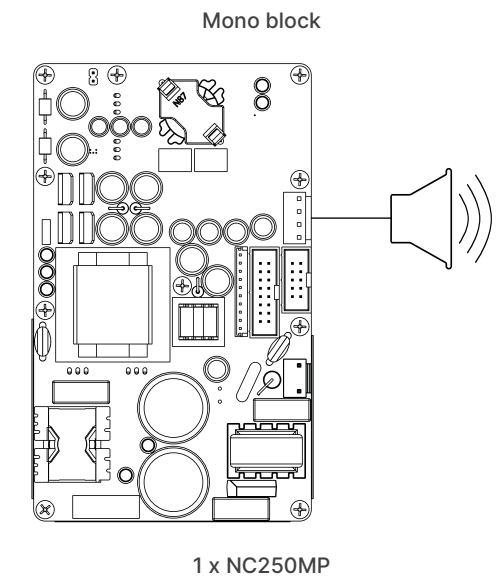

PROTECTIONS

- Overcurrent protection
- Clip indicator
- DC error protection
- Over temperature protection
- Short circuit protection

POSSIBLE APPLICATIONS

- Monitor loudspeakers for studios
- Active loudspeakers and subwoofers
- Public Address systems
- Home Theatre systems
- Power Amplifiers; for home and professional use

NC252MP - Amplifier module & power supply



The NC252MP compact power dual-amplifier brick is a cutting-edge, easy to integrate, amplifier that seamlessly combines advanced technology with an integration-friendly design. This versatile module is equipped with a host of features to elevate your implementation experience, making it an ideal choice for a wide range of audio applications, from high-quality power amplifiers to high-quality active loudspeakers.

The NC252MP stands out with its innovative power supply architecture. Incorporating a low-power standby supply that complies with 2013 ERP Lot 6 0.5W requirements, a highly efficient switch mode power supply (SMPS), and dual high-performance 250W NCORE® Class-D amplifiers, this module redefines compact power delivery. The result is a compact yet powerful brick that is highly compatible with various audio applications.

At the heart of the NC252MP you'll find a dual self-contained high-performance NCORE® Class-D amplifier. Boasting a flat frequency response regardless of load impedance, nearly frequency-independent distortion behavior, and minimal radiated and conducted electromagnetic interference (EMI), this amplifier ensures a superior audio experience. The control mechanism, based on a phase shift-controlled self-oscillating loop with feedback only at the speaker output, enhances precision and clarity in audio reproduction.

HIGHLIGHTS

- High efficiency & Universal mains operation
- Flat, fully load-independent frequency response
- Low output impedance
- Very low, frequency independent THD
- Very low noise

The main SMPS that powers the amplifier is a compact, high-power, highly efficient, regulated half-bridge converter with synchronous rectification on the main output rails. This advanced technology is specifically tailored for Class-D audio amplifiers, delivering unparalleled performance and efficiency. The automatic input voltage doubler enhances universal mains input compatibility, making it convenient for use in various environments. For applications requiring standby mode, the NC252MP integrates a low-power standby SMPS. Designed with energy efficiency in mind, this feature ensures minimal power consumption during periods of inactivity.

Taking versatility to the next level, the NC252MP features the Hypex Extension connector. This innovative addition allows for an extra low-power tweeter amplifier channel, expanding your audio setup possibilities and making it suitable for three-way loudspeakers.

FEATURES

- Two-channel amplifier
- 5W standby SMPS
- Advanced protections
- Auto-switching (115/230V)
- Light weight and compact size

NC252MP - Data

Item	Min	Typ	Max	BTL	Unit	Notes
Output Power 2Ω			2 × 180		W	
Output Power 4Ω			2 × 250	400	W	
Output Power 8Ω			2 × 150	500	W	
Distortion			0.003		%	20Hz < f < 20kHz. Pout = 1W
Output Noise			40		μV	
Power Bandwidth		20-35k			Hz	
Frequency Response	10		50k		Hz	+0/-3dB. All loads
Idle Power		8.5			W	
Output Impedance			2.5		mΩ	f < 1kHz
Output Impedance			5		mΩ	f < 20 kHz
Standby Output Voltage	4.9	5	5.1		Vdc	
Standby Output Current			1		A	
Output Voltage Vaux	2 × 19	2 × 20	2 × 21		Vdc	
Output Current Vaux			1		A	

COMPATIBLE MODULES

NCxxxMP Evaluation board / NC100HF / DSP3-213 / DSP3-224 / DSP2-114

SIZE AND WEIGHT

170 × 105 × 42 mm (LxWxH), 575 g

MEASUREMENTS

THD+N vs. power @ 1kHz into 2Ω, 4Ω and 8Ω

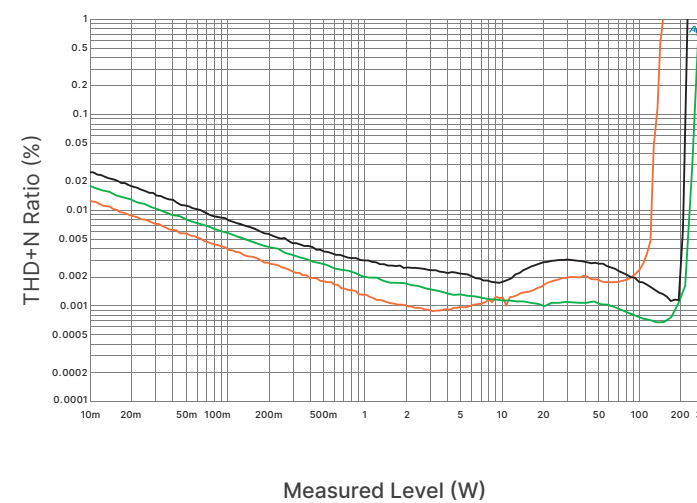

APPLICATION EXAMPLE

3-way active loudspeaker

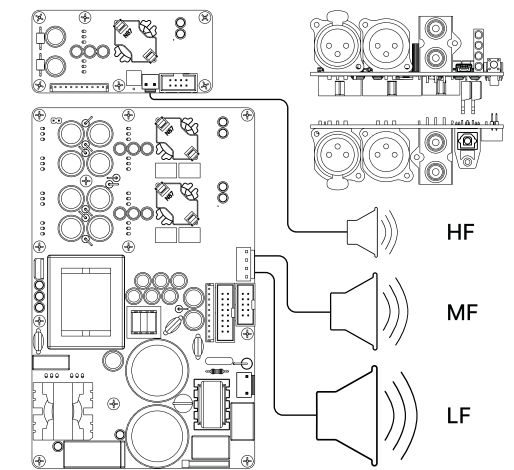

1 x NC252MP + 1 x NC100HF + 1 x DSP3-213 + 1 x DIGin3-322

PROTECTIONS

- Overcurrent protection
- Clip indicator
- DC error protection
- Over temperature protection
- Short circuit protection

POSSIBLE APPLICATIONS

- Monitor loudspeakers for studios
- Active loudspeakers and subwoofers
- Public Address systems
- Home Theatre systems
- Power Amplifiers; for home and professional use

NC500MP - Amplifier module & power supply



The NC500MP compact power single amplifier brick is a cutting-edge, easy to integrate, amplifier that seamlessly combines advanced technology with an integration-friendly design. This versatile module is equipped with a host of features to elevate your implementation experience, making it an ideal choice for a wide range of audio applications, from musical instrument amplifiers, high-quality power amplifiers to high-quality active loudspeakers and subwoofers.

The NC500MP stands out with its innovative power supply architecture. Incorporating a low-power standby supply that complies with 2013 ERP Lot 6 0.5W requirements, a highly efficient switch mode power supply (SMPS), and a single high-performance NCORE® Class-D amplifier, this module redefines compact power delivery. The result is a compact yet powerful brick that is highly compatible with various audio applications.

At the heart of the NC500MP is a self-contained high-performance 500W NCORE® Class-D amplifier. Boasting a flat frequency response regardless of load impedance, nearly frequency-independent distortion behavior, and minimal radiated and conducted electromagnetic interference (EMI), this amplifier ensures a superior audio experience. The control mechanism, based on a phase shift-controlled self-oscillating loop with feedback only at the speaker output, enhances precision and clarity in audio reproduction.

HIGHLIGHTS

- High efficiency & Universal mains operation
- Flat, fully load-independent frequency response
- Low output impedance
- Very low, frequency independent THD
- Very low noise

The main SMPS that powers the amplifier is a compact, high-power, highly efficient, regulated half-bridge converter with synchronous rectification on the main output rails. This advanced technology is specifically tailored for Class-D audio amplifiers, delivering unparalleled performance and efficiency. The automatic input voltage doubler enhances universal mains input compatibility, making it convenient for use in various environments. For applications requiring standby mode, the NC500MP integrates a low-power standby SMPS. Designed with energy efficiency in mind, this feature ensures minimal power consumption during periods of inactivity.

Taking versatility to the next level, the NC500MP features the Hypex Extension connector. This innovative addition allows for an extra low-power tweeter amplifier channel, expanding your audio setup possibilities and making it suitable for two-way loudspeakers.

FEATURES

- Single-channel amplifier
- 5W standby SMPS
- Advanced protections
- Auto-switching (115/230V)
- Light weight and compact size

NC500MP - Data

Item	Min	Typ	Max	BTL	Unit	Notes
Output Power 2Ω			400		W	
Output Power 4Ω			500		W	
Output Power 8Ω			270		W	
Distortion			0.003		%	20Hz < f < 20kHz, Pout = 1W
Output Noise			40		μV	
Power Bandwidth		20-35k			Hz	
Frequency Response	10		50k		Hz	+0/-3dB. All loads
Idle Power		7.5			W	
Output Impedance			2		mΩ	f < 1kHz
Output Impedance			3.5		mΩ	f < 20 kHz
Standby Output Voltage	4.9	5	5.1		Vdc	
Standby Output Current			1		A	
Output Voltage Vaux	2 × 19	2 × 20	2 × 21		Vdc	
Output Current Vaux			1		A	

COMPATIBLE MODULES

NCxxxMP Evaluation board / NC100HF / DSP3-213 / DSP3-224 / DSP2-114

SIZE AND WEIGHT

146 × 105 × 42 mm (LxWxH), 500 g

MEASUREMENTS

THD+N vs. power @ 1kHz into 2Ω, 4Ω and 8Ω

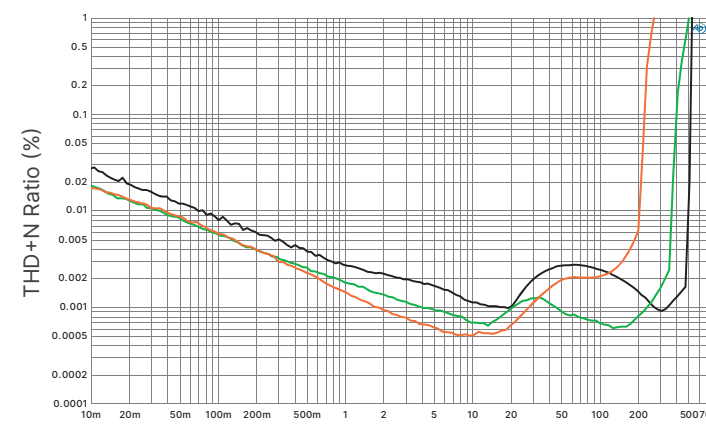

Measured Level (W)

APPLICATION EXAMPLE

500 Watt subwoofer

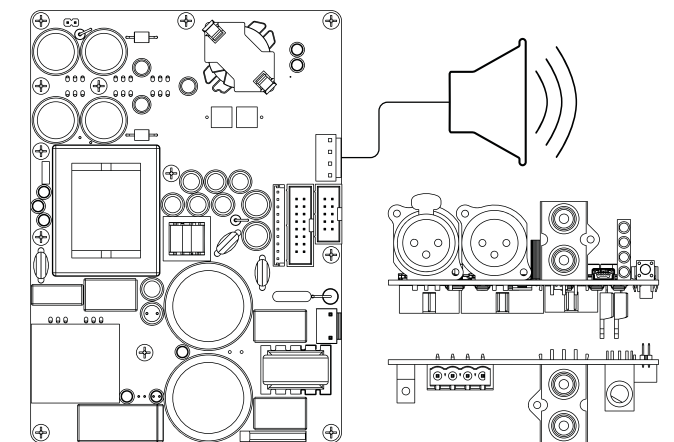

1 x NC500MP + 1 x DSP3-213 + 1 x SUBIn3-110

PROTECTIONS

- Overcurrent protection
- Clip indicator
- DC error protection
- Over temperature protection
- Short circuit protection

POSSIBLE APPLICATIONS

- Monitor loudspeakers for studios
- Active loudspeakers and subwoofers
- Public Address systems
- Home Theatre systems
- Power Amplifiers; for home and professional use

NC502MP - Amplifier module & power supply



The NC502MP compact power dual-amplifier brick is a cutting-edge, easy to integrate, amplifier that seamlessly combines advanced technology with an integration-friendly design. This versatile module is equipped with a host of features to elevate your implementation experience, making it an ideal choice for a wide range of audio applications, from high-quality power amplifiers to high-quality active loudspeakers.

The NC502MP stands out with its innovative power supply architecture. Incorporating a low-power standby supply that complies with 2013 ERP Lot 6 0.5W requirements, a highly efficient switch mode power supply (SMPS), and dual high-performance 500W NCORE® Class-D amplifiers, this module redefines compact power delivery. The result is a compact yet powerful brick that is easy to use in various audio applications.

At the heart of the NC502MP you'll find a dual self-contained high-performance NCORE® Class-D amplifier. Boasting a flat frequency response regardless of load impedance, nearly frequency-independent distortion behavior, and minimal radiated and conducted electromagnetic interference (EMI), this amplifier ensures a superior audio experience. The control mechanism, based on a phase shift-controlled self-oscillating loop with feedback only at the speaker output, enhances precision and clarity in audio reproduction.

The main SMPS that powers the amplifier is a compact, high-power, highly efficient, regulated half-bridge converter with synchronous rectification on the main output rails. This advanced technology is specifically tailored for Class-D audio amplifiers, delivering unparalleled performance and efficiency. The automatic input voltage doubler enhances universal mains input compatibility, making it convenient for use in various environments. For applications requiring standby mode, the NC502MP integrates a low-power standby SMPS. Designed with energy efficiency in mind, this feature ensures minimal power consumption during periods of inactivity.

Taking versatility to the next level, the NC502MP features the Hypex Extension connector. This innovative addition allows for an extra low-power tweeter amplifier channel, expanding your audio setup possibilities and making it suitable for three-way loudspeakers.

HIGHLIGHTS

- High efficiency & Universal mains operation
- Flat, fully load-independent frequency response
- Low output impedance
- Very low, frequency independent THD
- Very low noise

FEATURES

- Two-channel amplifier
- 5W standby SMPS
- Advanced protections
- Auto-switching (115/230V)
- External controlled operation

NC502MP - Data

Item	Min	Typ	Max	BTL	Unit	Notes
Output Power 2Ω			2 × 450		W	
Output Power 4Ω			2 × 500	1000	W	
Output Power 8Ω			2 × 350	1200	W	
Distortion			0.0024		%	20Hz < f < 20kHz, Pout = 1W
Output Noise			47		μV	
Power Bandwidth		20-35k			Hz	
Frequency Response	10		48k		Hz	+0/-3dB, All loads
Idle Power		17			W	
Output Impedance			1.5		mΩ	f < 1kHz
Output Impedance			3		mΩ	f < 20 kHz
Standby Output Voltage	4.9	5	5.1		Vdc	

COMPATIBLE MODULES

NCxxxMP Evaluation board / NC100HF / DSP3-213 / DSP3-224 / DSP2-114

SIZE AND WEIGHT

230 × 115 × 47 mm (LxWxH), 1055 g

MEASUREMENTS

THD+N vs. power @ 1kHz into 2Ω, 4Ω and 8Ω

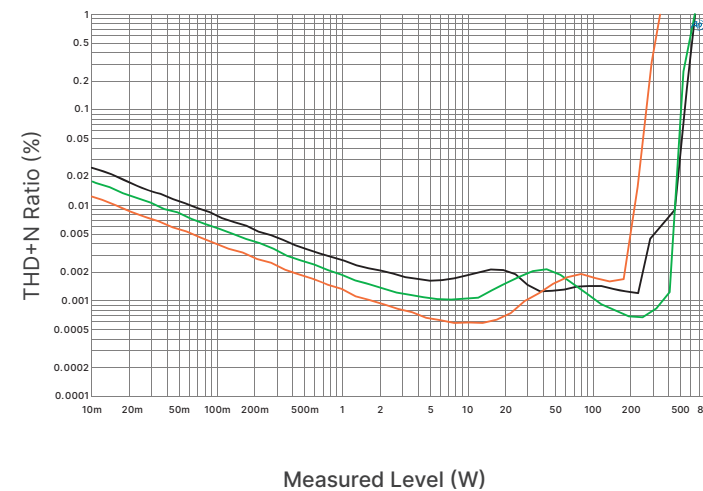

APPLICATION EXAMPLE

1000 Watt active subwoofer

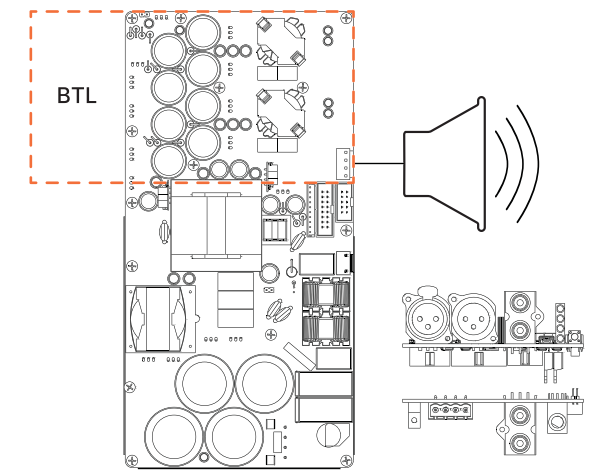

1 x NC502MP + 1 x DSP3-213 + 1 x SUBin3-110

PROTECTIONS

- Overcurrent protection
- Clip indicator
- DC error protection
- Over temperature protection
- Short circuit protection

POSSIBLE APPLICATIONS

- Monitor loudspeakers for studios
- Active loudspeakers and subwoofers
- Public Address systems
- Home Theatre systems
- Power Amplifiers; for home and professional use

NC100HF - Amplifier hanger module



Unleash precision in high-frequency amplification and elevate your audio experience with the NC100HF, a dedicated tweeter-amplifier meticulously crafted to seamlessly integrate with the Mains Powered NCORE® family modules. As an added benefit, NC100HF also seamlessly integrates with the NCAS1000MP module.

As a vital component of the revolutionary Mains Powered NCORE® amplifier family, the NC100HF extends your system's capabilities, creating an additional channel that caters specifically to the nuances of high and mid-frequency ranges.

Tailored for high- and mid-frequencies and designed with a singular focus on high- and mid-frequency reproduction, the NC100HF takes your audio to new heights, starting at approximately 500Hz. Immerse yourself in the crispness and detail that these frequencies demand.

The NC100HF effortlessly interfaces with the on-board Switched Mode Power Supply (SMPS) of the Mains Powered NCORE® amplifier family modules. This synergy ensures a harmonious collaboration, enabling you to expand your NCORE® based system effortlessly.

Active speaker amplification: unlock the full potential for a complete NCORE® based system in an instant. The NC100HF empowers you to build a sophisticated audio setup with ease, whether you're creating a two-, three- or four-way active speaker configuration.

HIGHLIGHTS

- High efficiency
- Flat, fully load-independent frequency response
- Low output impedance
- Very low, frequency independent THD
- Very low noise

FEATURES

- Single-channel amplifier
- Advanced over current protection
- External controlled operation
- Light weight and compact size

NC100HF - Data

Item	Min	Typ	Max	BTL	Unit	Notes
Output Power 2Ω					W	
Output Power 4Ω			100		W	
Output Power 8Ω			100		W	
Distortion			0.0018		%	20Hz < f < 20kHz, Pout = 1W
Output Noise			40		μV	
Power Bandwidth		500-35k			Hz	
Frequency Response	10		50k		Hz	+0/-3dB. All loads
Idle Power		3.5			W	
Output Impedance			2		mΩ	f < 1kHz
Output Impedance			10		mΩ	f < 20 kHz

COMPATIBLE MODULES

Mains Powered NCORE® amplifier family / NCAS1000MP / DSP3-213 / DSP3-224 / DSP2-114

SIZE AND WEIGHT

85 × 39 × 27 mm (LxWxH), 75 g

MEASUREMENTS

THD+N vs. power @ 1kHz into 4Ω and 8Ω

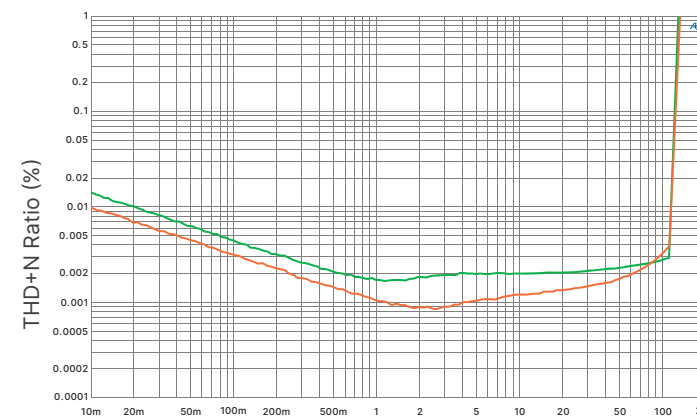

Measured Level (W)

APPLICATION EXAMPLE

3-way active speaker

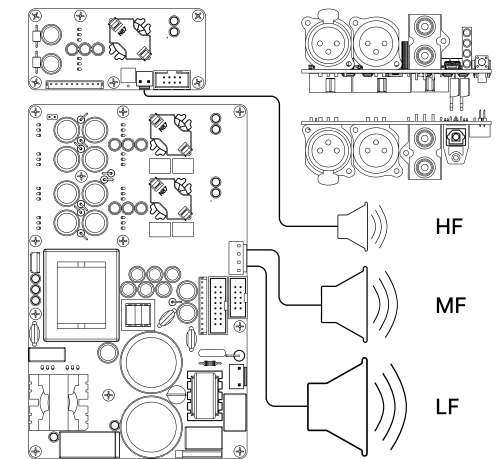

1 x NC100HF + 1 x NC252MP + 1 x DSP3-213 + 1 x DIGin3-322

PROTECTIONS

- Overcurrent protection
- DC error protection
- Short circuit protection

POSSIBLE APPLICATIONS

- Monitor loudspeakers for studios
- Active loudspeakers
- Public Address systems
- Home Theatre systems
- Power Amplifiers; for home and professional use

NCORE® Active Speaker Family

Crafted for excellence in active speaker design, the NCORE® Active Speaker (NCAS) power bricks stand at the forefront of audio innovation. Purposefully engineered, these modules boast two onboard NCORE® amplifiers - a full-bridge high-power channel and a half-bridge medium-power channel.

The series seamlessly integrates a low-power standby power supply (compliant with 2013 ERP Lot 6 0.5W requirements), a highly efficient switch mode power supply, and a high-performance Class-D amplifier within a singular, compact power brick.

FLAT FREQUENCY RESPONSE

Chief among the distinguishing features of the family are its flat frequency response, irrespective of load impedance, nearly frequency-independent distortion behavior, and exceptionally low radiated and conducted electromagnetic interference (EMI). Control is achieved through a phase-shift-controlled self-oscillating loop, with feedback exclusively taken at the speaker output.

For applications necessitating a standby mode, the family integrates a low-power standby SMPS. Noteworthy in its design, the core SMPS incorporates an automatic input voltage doubler to ensure universal mains input compatibility.

From its compact form to its advanced circuitry, the family exemplifies precision and quality. Committed to energy efficiency, these amplifier power bricks are designed not only to meet but exceed the stringent 2013 ERP Lot 6 0.5W requirements, demonstrating our dedication to both technological advancement and environmental consciousness.

Whether you're engineering professional studio-grade systems or refining a home audio setup, the NCORE® Active Speaker power bricks offer a tailored solution. Their adaptability, coupled with exceptional performance characteristics, positions them as the amplifiers of choice for those who demand the utmost in audio reproduction and seek seamless integration, a testament to precision, innovation, and a commitment to redefining the standards of active speaker design.

AVAILABLE MODULES

Module name	Channels	Bridgable?	Power 4Ω	Power 8Ω
NCAS250MP	2	No	1 × 200W + 1 × 50W ¹	1 × 200W + 1 × 50W ¹
NCAS500MP	2	No	1 × 440W + 1 × 120W	1 × 400W + 1 × 100W
NCAS1000MP	2	No	1 × 800W + 1 × 200W ¹	1 × 800W + 1 × 200W ¹

¹ preliminary data

NCAS250MP - Amplifier module & power supply

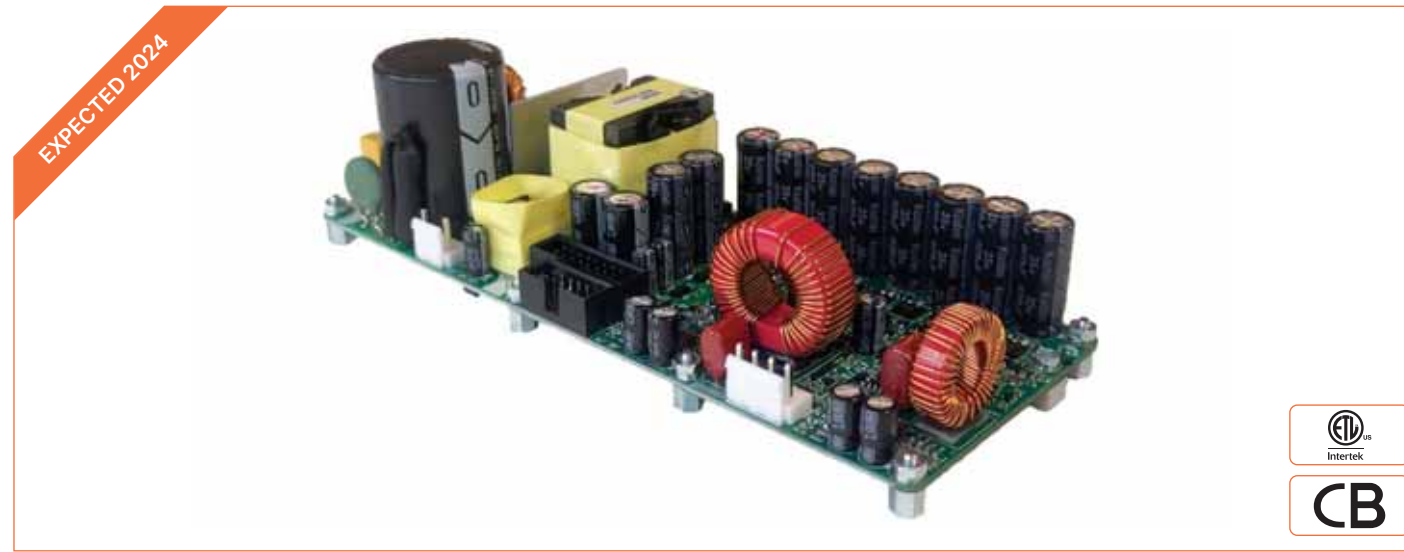

The NCAS250MP amplifier power brick boasts a groundbreaking design featuring two distinct amplification channels, a full-bridge high-power channel and a half-bridge medium-power channel. This dual-channel architecture is tailored to cater to different audio requirements, providing a comprehensive solution for active loudspeaker designs.

The full-bridge 200W high-power channel is engineered for robust performance, delivering an impressive power output suitable for driving the low-frequency drivers with high efficiency. This channel excels in handling demanding audio signals, ensuring clarity and precision in reproducing the full spectrum of sound. It is the powerhouse of the module, where high output and dynamic range are paramount.

Complementing the high-power channel, the half-bridge 50W medium-power channel is designed for versatility. It offers a balanced mix of power and efficiency, making it well-suited for driving secondary drivers, such as tweeters or full-range drivers. This channel is optimized to handle mid-level power requirements, providing a nuanced and controlled audio response for a well-balanced sound profile.

Together, these dual channels create a synergy that elevates the overall audio performance of the NCAS250MP. The full-bridge high-power channel tackles the heavy lifting, while the half-bridge medium-power channel handles the subtleties, resulting in a harmonious blend of power and precision. This dynamic amplifica-

tion duo ensures that the NCAS250MP is a versatile solution for a wide range of active speaker applications, from studio monitors to high-quality PA loudspeakers.

Driving the amplifiers is a main SMPS, a compact, high-power, highly efficient, regulated flyback. These exceptional properties make it the perfect technology to power this Class-D audio power amplifier brick, ensuring optimal performance and reliability. This SMPS is designed for universal mains input compatibility, offering flexibility and efficiency in various applications. For added versatility, the NCAS250MP is equipped with a low-power standby SMPS, meeting the 2013 ERP Lot 6 0.5W requirements. This feature ensures energy efficiency during idle periods, aligning with modern eco-conscious standards without compromising on performance.

The NCAS250MP compact power brick form factor makes it easily applicable in a range of active speaker designs. Whether you're building a compact studio monitor or powerful PA loudspeaker, the NCAS250MP adapts effortlessly to your design needs, providing a seamless integration of power and precision in one innovative module.

HIGHLIGHTS

- High efficiency
- Universal mains operation
- Flat, fully load independent frequency response
- Low output impedance
- Very low, frequency independent THD
- Very low noise

FEATURES

- Two-channel amplifier
- 5W standby SMPS
- Advanced protections
- External controlled operation

NCAS250MP - Preliminary data

Item	Min	Typ	Max	Unit	Notes
Output Power 2Ω				W	Not supported
Output Power 4Ω			200 + 50	W	
Output Power 8Ω			200 + 50	W	
Distortion			TBD	%	20Hz < f < 20kHz, Pout = 1W
Output Noise LF			40	μV	
Output Noise HF			20	μV	
Power Bandwidth		TBD		Hz	
Frequency Response	10		50k	Hz	+1/-3dB. All loads
Idle Power		3.8		W	
Output Impedance		TBD		mΩ	
Standby Output Voltage	4.9	5	5.1	Vdc	
Standby Output Current			1	A	
Output Voltage Vaux	2 × 14	2 × 15	2 × 16	Vdc	
Output Current Vaux			0.2	A	

COMPATIBLE MODULES

NCxxxMP Evaluation board / DSP2-114 / DSP3-213 / DSP3-224

SIZE AND WEIGHT

To be announced

MEASUREMENTS

THD+N vs. power @ 1kHz into 2Ω, 4Ω and 8Ω

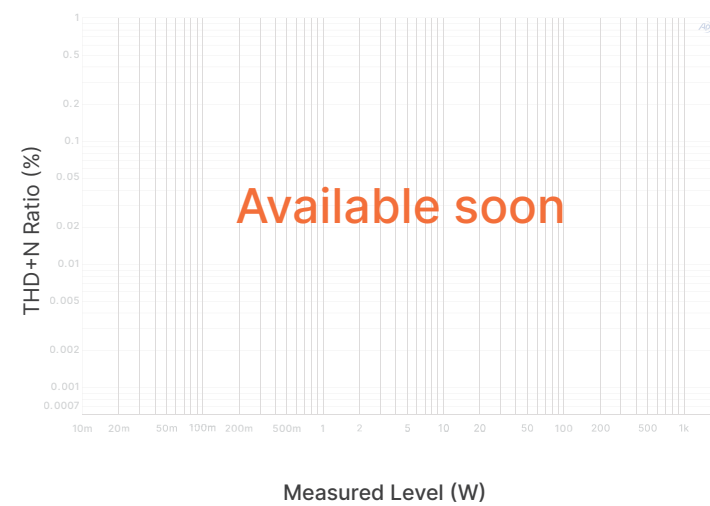

APPLICATION EXAMPLE

200 Watt + 50 Watt active loudspeaker

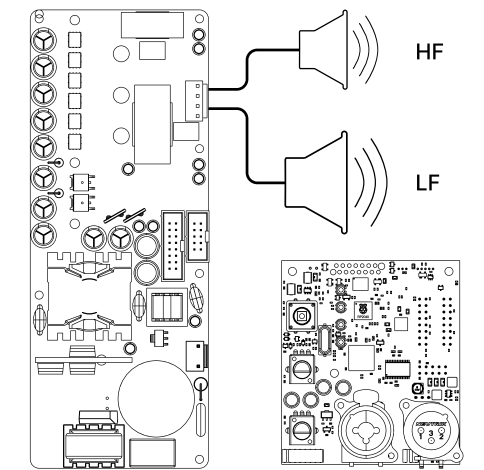

1 x NCAS250MP + DSP2-114

PROTECTIONS

- Advanced overcurrent protection
- DC error protection
- Over temperature protection
- Short circuit protection

POSSIBLE APPLICATIONS

- Monitor loudspeakers for studios
- Active PA loudspeakers
- Active HiFi loudspeakers

NCAS500MP - Amplifier module & power supply



The NCAS500MP amplifier power brick boasts a groundbreaking design featuring two distinct amplification channels, a full-bridge high-power channel and a half-bridge medium-power channel. This dual-channel architecture is tailored to cater to different audio requirements, providing a comprehensive solution for active loudspeaker designs.

The full-bridge 400W high-power channel is engineered for robust performance, delivering an impressive power output suitable for driving the low-frequency drivers with high efficiency. This channel excels in handling demanding audio signals, ensuring clarity and precision in reproducing the full spectrum of sound. It is the powerhouse of the module, where high output and dynamic range are paramount.

Complementing the high-power channel, the half-bridge 100W medium-power channel is designed for versatility. It offers a balanced mix of power and efficiency, making it well-suited for driving secondary drivers, such as tweeters or full-range drivers. This channel is optimized to handle mid-level power requirements, providing a nuanced and controlled audio response for a well-balanced sound profile.

Together, these dual channels create a synergy that elevates the overall audio performance of the NCAS500MP. The full-bridge high-power channel tackles the heavy lifting, while the half-bridge medium-power channel handles the subtleties, resulting in a harmonious blend of power and precision. This dynamic amplification duo ensures that the NCAS500MP is a versatile solution for a

wide range of active speaker applications, from studio monitors to high-quality PA loudspeakers.

The main SMPS that powers the amplifier is a compact, high-power, highly efficient, regulated half-bridge converter with synchronous rectification on the main output rails. This advanced technology is specifically tailored for Class-D audio amplifiers, delivering unparalleled performance and efficiency. The automatic input voltage doubler enhances universal mains input compatibility, making it convenient for use in various environments. For added versatility, the NCAS500MP is equipped with a low-power standby SMPS, meeting the 2013 ERP Lot 6 0.5W requirements. This feature ensures energy efficiency during idle periods, aligning with modern eco-conscious standards without compromising on performance.

The NCAS500MP compact power brick form factor makes it easily applicable in a range of active speaker designs. Whether you're building a compact studio monitor or powerful PA loudspeaker, the NCAS500MP adapts effortlessly to your design needs, providing a seamless integration of power and precision in one innovative module.

HIGHLIGHTS

- High efficiency
- Universal mains operation
- Flat, fully load independent frequency response
- Low output impedance
- Very low, frequency independent THD
- Very low noise

FEATURES

- Two-channel amplifier
- 5W standby SMPS
- Advanced protections
- External controlled operation

NCAS500MP - Data

Item	Min	Typ	Max	Unit	Notes
Output Power 2Ω				W	Not supported
Output Power 4Ω			440 + 120	W	
Output Power 8Ω			400 + 100	W	
Distortion			0.005	%	20Hz < f < 20kHz, Pout = 1W
Output Noise LF			60	μV	
Output Noise HF			60	μV	
Power Bandwidth		20-35k		Hz	
Frequency Response	10		50k	Hz	+0/-3dB. All loads
Idle Power		7.5		W	
Output Impedance			2	mΩ	f < 1kHz
Output Impedance			10	mΩ	f < 20kHz
Standby Output Voltage	4.9	5	5.1	Vdc	
Standby Output Current			1	A	
Output Voltage Vaux	2 × 19	2 × 20	2 × 21	Vdc	
Output Current Vaux			0.5	A	

COMPATIBLE MODULES

NCxxxMP Evaluation board / DSP2-114 / DSP3-213 / DSP3-224

SIZE AND WEIGHT

195 × 85 × 40 mm (LxWxH), 415 g

MEASUREMENTS

THD+N vs. power @ 1kHz into 4Ω (LF), 4Ω (HF), 8Ω (LF) and 8Ω (HF)

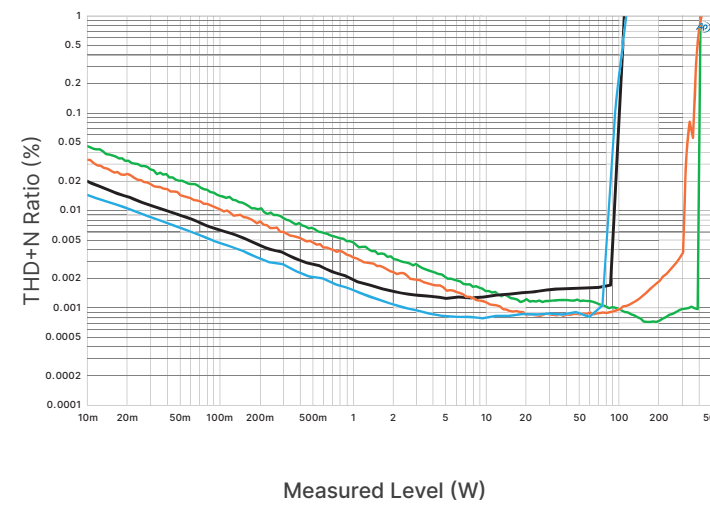

APPLICATION EXAMPLE

400 Watt + 100 Watt active loudspeaker

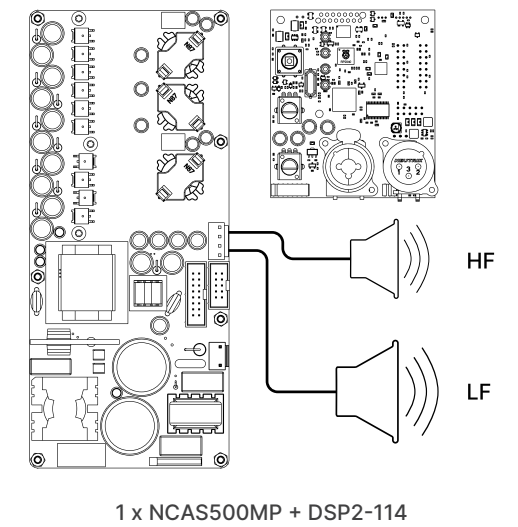

PROTECTIONS

- Advanced overcurrent protection
- DC error protection
- Over temperature protection
- Short circuit protection

POSSIBLE APPLICATIONS

- Monitor loudspeakers for studios
- Active PA loudspeakers
- Active HiFi loudspeakers

NCAS1000MP - Amplifier module & power supply



The NCAS1000MP amplifier power brick boasts a groundbreaking design featuring two distinct amplification channels, a full-bridge high-power channel and a half-bridge medium-power channel. This dual-channel architecture is tailored to cater to different audio requirements, providing a comprehensive solution for active loudspeaker designs.

The full-bridge 800W high-power channel is engineered for robust performance, delivering an impressive power output suitable for driving the low-frequency drivers with high efficiency. This channel excels in handling demanding audio signals, ensuring clarity and precision in reproducing the full spectrum of sound. It is the powerhouse of the module, where high output and dynamic range are paramount.

Complementing the high-power channel, the half-bridge 200W medium-power channel is designed for versatility. It offers a balanced mix of power and efficiency, making it well-suited for driving secondary drivers, such as tweeters or full-range drivers. This channel is optimized to handle mid-level power requirements, providing a nuanced and controlled audio response for a well-balanced sound profile.

Taking versatility to the next level, the NCAS1000MP features the Hypex Extension connector. This innovative addition allows for an extra, low-power 100W tweeter amplifier channel, expanding your audio setup possibilities and making it suitable for three-way loudspeakers.

HIGHLIGHTS

- High efficiency
- Universal mains operation
- Flat, fully load-independent frequency response
- Low output impedance
- Very low, frequency-independent THD
- Very low noise

Together, all channels create a synergy that elevates the overall audio performance of the NCAS1000MP. The full-bridge high-power channel tackles the heavy lifting, while the half-bridge medium-power channel handles the subtleties, and the optional NC100HF for tweeters, resulting in a harmonious blend of power and precision. This dynamic amplification duo or trio ensures that the NCAS1000MP is a versatile solution for a wide range of active speaker applications, from studio monitors to high-quality PA loudspeakers.

The NCAS1000 main SMPS consists of an active power factor corrected universal mains power supply with regulated output, delivering consistent power to the amplifiers in all operating conditions. Auxiliary power is available for external hardware e.g. DSP input cards. For added versatility, the NCAS1000MP is equipped with a low-power standby SMPS, meeting the 2013 ERP Lot 6 0.5W requirements. This feature ensures energy efficiency during idle periods, aligning with modern eco-conscious standards without compromising on performance.

FEATURES

- Two-channel amplifier
- 5W standby SMPS
- Advanced protections
- External controlled operation
- Option to add NC100HF

NCAS1000MP - Preliminary data

Item	Min	Typ	Max	Unit	Notes
Output Power 2Ω				W	Not supported
Output Power 4Ω			800 + 200	W	
Output Power 8Ω			800 + 200	W	
Distortion			TBD	%	20Hz < f < 20kHz, Pout = 1W
Output Noise LF			TBD	μV	
Output Noise HF			TBD	μV	
Power Bandwidth		20-35k		Hz	
Frequency Response	10		50k	Hz	+0/-3dB. All loads
Idle Power		TBD		W	
Output Impedance			TBD	mΩ	
Standby Output Voltage	4.9	5	5.1	Vdc	
Standby Output Current			1	A	
Output Voltage Vaux	2 x 14	2 x 15	2 x 16	Vdc	
Output Current Vaux			0.5	A	

COMPATIBLE MODULES

NCxxxMP Evaluation board / DSP2-114 / DSP3-213 / DSP3-224 / NC100HF

SIZE AND WEIGHT

To be announced

MEASUREMENTS

THD+N vs. power @ 1kHz into 2Ω, 4Ω and 8Ω



APPLICATION EXAMPLE

800 Watt + 200 Watt +100 Watt active loudspeaker

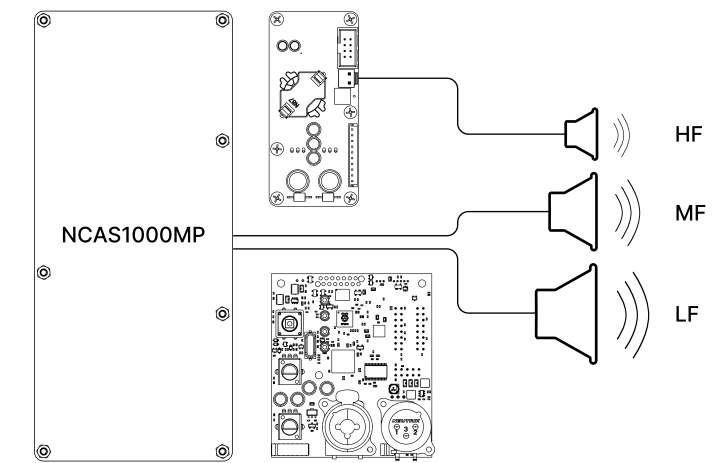

PROTECTIONS

- Advanced overcurrent protection
- DC error protection
- Over temperature protection
- Short circuit protection

POSSIBLE APPLICATIONS

- Monitor loudspeakers for studios
- Active PA loudspeakers
- Active HiFi loudspeakers

DSP Family

At Hypex Electronics, we pride ourselves on years of expertise in developing cutting-edge DSP solutions. Our commitment to DSP innovation extends beyond hardware, with the creation of our proprietary filter design software, Hypex Filter Design (HFD). This software serves as a versatile tool for configuring our Series 3 DSP modules and Fusion Amp plate amplifiers, providing a seamless integration of technology and creativity.

DSP2-114: ELEVATING ACTIVE PRO AUDIO LOUDSPEAKERS

Meet the DSP2-114, our Series 2, mono DSP solution meticulously designed for synergy with our NCORE® Active Speaker Family of amplifier bricks. The perfect combination for Professional Active Loudspeakers. This DSP, based on the ADAU1450, boasts one input and four outputs, setting a new standard for supporting active speakers up to 4-way configurations. The standard input on the DSP2-114 is a XLR/Jack combination. With SigmaStudio graphical software, you have the freedom to program, develop, and tune your system with many filtering options. The DSP2-114 can be expanded with an optional extra analog or digital input board, offering additional flexibility for your specific needs.

DSP3-213: VERSATILE MONO/3-WAY DSP SOLUTION

Step into the realm of high-grade audio with our Series 3, mono DSP solution, the DSP3-213. Built on the Analog Devices ADAU1452, this board is optimized for use with the mains-powered NCORE® Family of amplifier power bricks. Expand its capabilities with optional boards like the DIGin3-322 for digital inputs or the SUBin3-110 for subwoofers. Customize the DSP behavior and filtering with HFD, supporting IIR and FIR filter options. Configure multiple DSP3-213 boards in a master-slave setup for a premium stereo or 2.1 system. Store different presets for varied filter settings, inputs, and volume offsets, while features like Auto-signal-detect and adjustable standby settings ensure a seamless audio experience. The Fusion Amplifier Family encapsulates the same powerful DSP3-213 platform.

DSP3-224: STEREO/4-WAY AUDIO EXCELLENCE

Introducing the DSP3-224, our Series 3, stereo/4-way DSP solution, engineered for excellence with the ADAU1452 and optimized for the Mains Powered NCORE® Family of amplifier power bricks. Ideal for stereo applications with DSP functionalities or crafting a high-quality 4-way active loudspeaker, the DSP3-224 delivers pristine audio. Customize the DSP behavior and filtering with HFD, supporting IIR and FIR filter options. Expand its capabilities with the optional DIGin3-322 digital input board. Configure outputs for BTL operation when connected to a 2-channel amplifier with ease. With Auto-signal-detect, adjustable standby settings, and EQ features, the DSP3-224 empowers you to create the perfect active speaker system.

Hypex Electronics brings you a comprehensive DSP product family, combining hardware prowess with intuitive software solutions. Whether you're a seasoned audio professional or an enthusiast, our DSP lineup provides the tools you need to elevate your audio experience to unprecedented heights.

DSP Family

DSP COMPATIBILITY

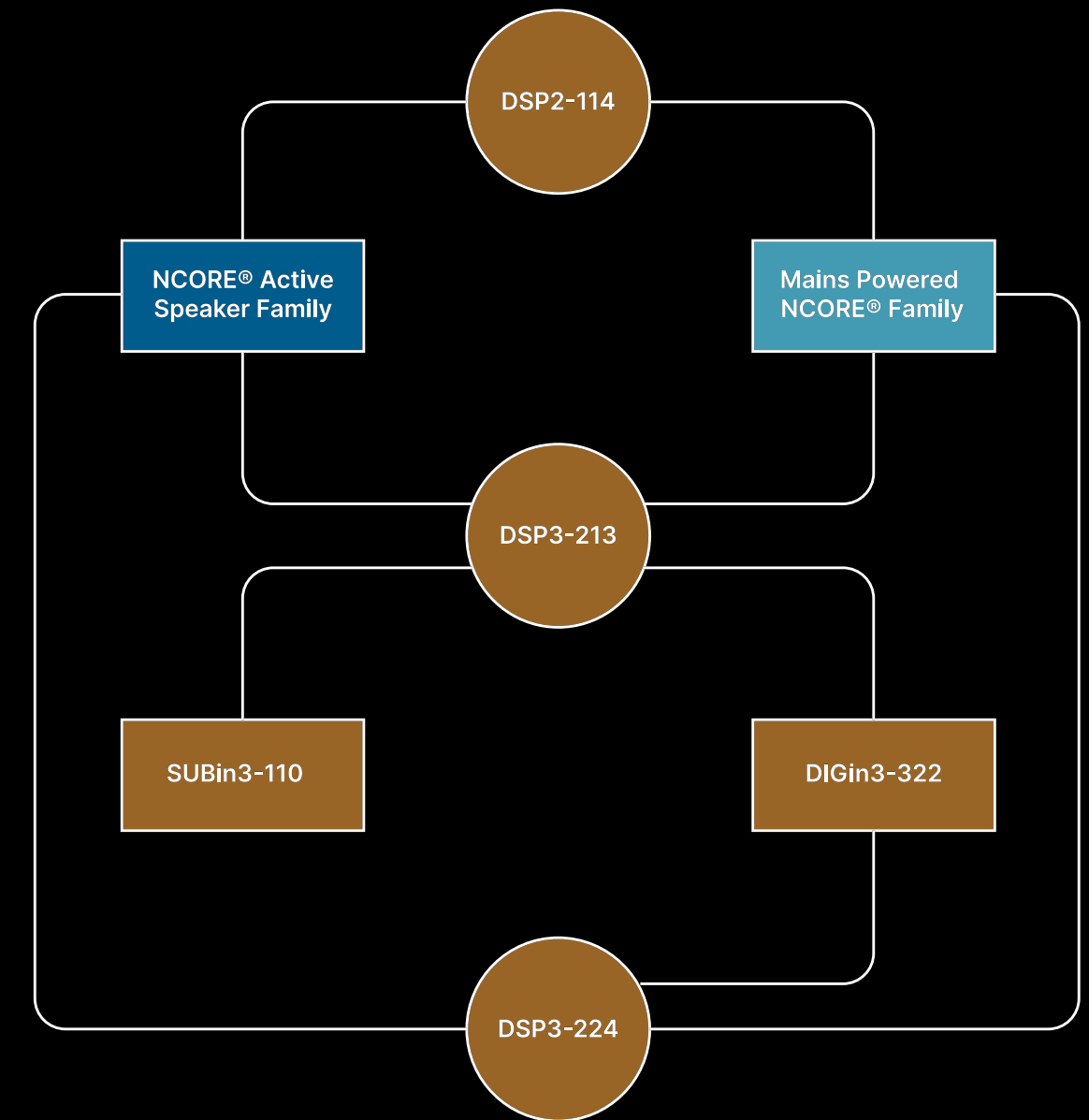

Hypex Filter Design

Elevate your audio customization experience with the Hypex Filter Design (HFD) Software, a powerful Windows program designed to seamlessly manage Hypex DSP products. Tailored for compatibility with renowned offerings such as our Fusion Amp Family and the DSP3-213 and DSP3-224 DSP modules, HFD empowers you to take full command of your audio system as never before.

With HFD, you have the ability to configure all essential filters and exercise complete control over the available options. This software is your gateway to a world of audio customization, allowing you to fine-tune your system according to your preferences.

While HFD offers advanced functionalities, its user-friendly interface ensures that setting up filters and managing options is intuitive. Unlock the full potential of your DSP-powered products with ease.

ESSENTIAL FUNCTIONS

Volume Control: Adjust volume levels with precision.

Channel Assignment: Customize channel configurations effortlessly.

Speaker Measurements: Load and take measurements for speakers, including impulse response.

Microphone Correction: Apply correction data for accurate sound reproduction.

Filter Sum View: Visualize the combined effect of applied filters.

Filter Inversion: Invert filter functions for creative control.

Delay Control: Fine-tune audio synchronization with delay options.

Graph Smoothing: Enhance visual representation with smoothing capabilities.

Biquad Filter Setups: Explore a wide range of filter setups for diverse audio scenarios.

Input Gain Adaptation: Easily adapt input gain to match your requirements.

Phase Response Viewer: Gain insights into phase response for meticulous system tuning.

Compatibility: HFD is designed to seamlessly integrate with DSP3-213 and DSP3-224, ensuring a broad spectrum of compatibility with Hypex DSP products.

While HFD provides advanced functionalities, a basic understanding of creating and designing active speakers with digital filters is recommended. This ensures that users with varied levels of expertise can unlock the full potential of their audio systems.

Step into a new era of audio customization with the Hypex Filter Designer Software. Elevate your audio experience, from adjusting volume levels to fine-tuning intricate filter settings. Unleash the power of precision control with HFD and redefine your sonic journey.

Hypex Filter Design

STARTUP SCREEN



DEVICE SETTINGS SCREEN

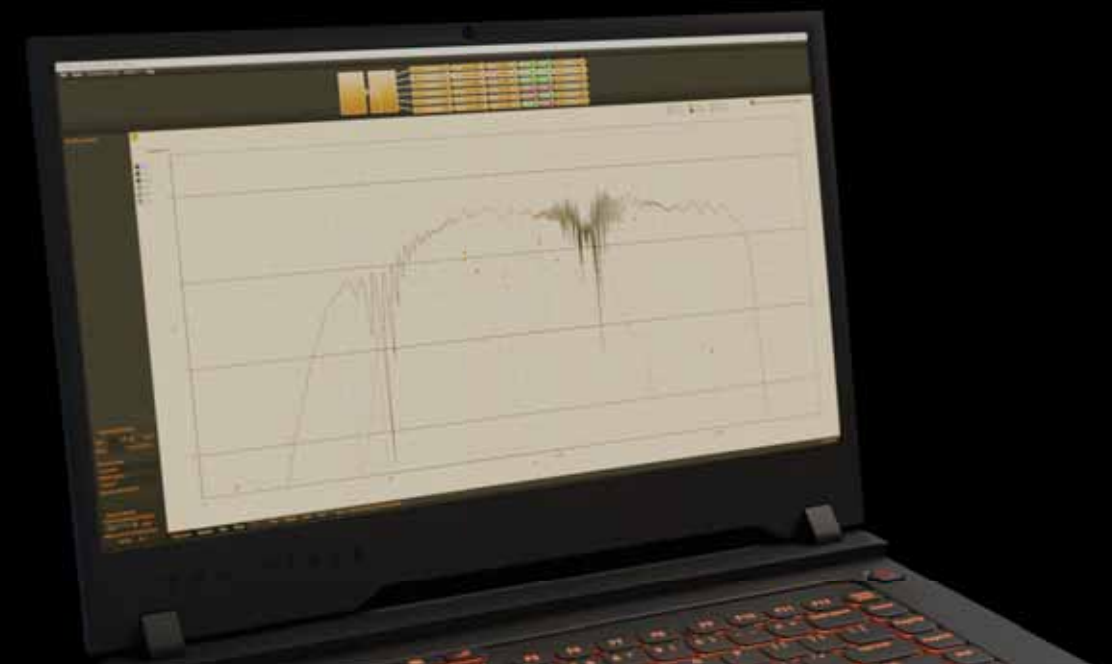

DSP2-114 - Elevating Active Pro Audio Speakers



Elevate your professional audio experience with the DSP2-114, a new addition of our DSP Family, Series 2. Meticulously crafted to seamlessly integrate with our NCORE® Active Speaker Family of amplifier bricks, the DSP2-114 is the epitome of synergy for Professional Active Loudspeakers.

The DSP2-114, based on the ADAU1450, is a testament to precision engineering. With one input and four outputs, it establishes a new benchmark in supporting active speakers with configurations of up to 4 ways. This level of customization ensures that the DSP2-114 adapts effortlessly to the unique demands of your audio setup.

Equipped with a standard XLR/Jack combination input, the DSP2-114 ensures compatibility with various audio sources. This versatility makes it an ideal choice for professionals seeking seamless integration into their audio setups. Whether you're connecting instruments, mixers, or other audio devices, the DSP2-114 provides a universal interface for a hassle-free audio experience.

Experience unparalleled control over your audio system with the SigmaStudio graphical software. Program, develop, and fine-tune your setup effortlessly, thanks to a myriad of filtering options. SigmaStudio empowers you to customize your audio environment with precision and ease. From shaping the frequency response

to optimizing signal paths, SigmaStudio puts the power of audio control in your hands.

Adapt the DSP2-114 to your unique loudspeaker design with ease. The optional extra analog ANAin2-111 or digital DIGin2-221 input board expands the capabilities of the DSP, providing added flexibility for a tailored audio solution. Whether you need more input options for complex setups or desire enhanced connectivity, the DSP2-114 ensures that your evolving audio needs are met.

Crafted with meticulous attention to detail, the DSP2-114 embodies the perfect balance of form and function. Its sleek and durable design not only enhances the visual appeal of your setup but also ensures long-lasting performance in demanding professional environments. The robust construction of the DSP2-114 is a testament to our commitment to delivering audio solutions that withstand the rigors of professional use.

HIGHLIGHTS

- Microphone and line-level capable analog input
- Analog input gain control
- Digital master volume control
- Programmable DSP application with SigmaStudio
- Compatible with NCMP & NCAS families

FEATURES

- IIR & FIR capable
- Three programmable presets
- Four channel active filtering

DSP2-114 - Preliminary data

Item	Min	Typ	Max	Unit	Notes
Input Level XLR			TBD	dBu (Vrms)	Default gain setting
Output Level XLR			TBD	dBu (Vrms)	Default gain setting
Signal / Noise Ratio			TBD	dBu	Analog in
Distortion			TBD	dBu	Analog in
Analog Latency			TBD	µs	
Digital Latency			TBD	ms	
DSP & ADC Sampling Rate			TBD	kHz	
Delay Per Channel					Customer defined
Input Channels		1			
Output Channels		4			
DSP		ADAU1450			
ADC		AK4621EF			CODEC
ADC Bit Depth		24			
DAC CH1/2		AK4621EF			CODEC
DAC CH3/4		AK4452VN			
Filter Options					Customer defined

COMPATIBLE MODULES

NCORE® Active Speaker Family / Mains Powered NCORE® Family

SIZE AND WEIGHT

70 × 80 × 47 mm (LxWxH), 60 g

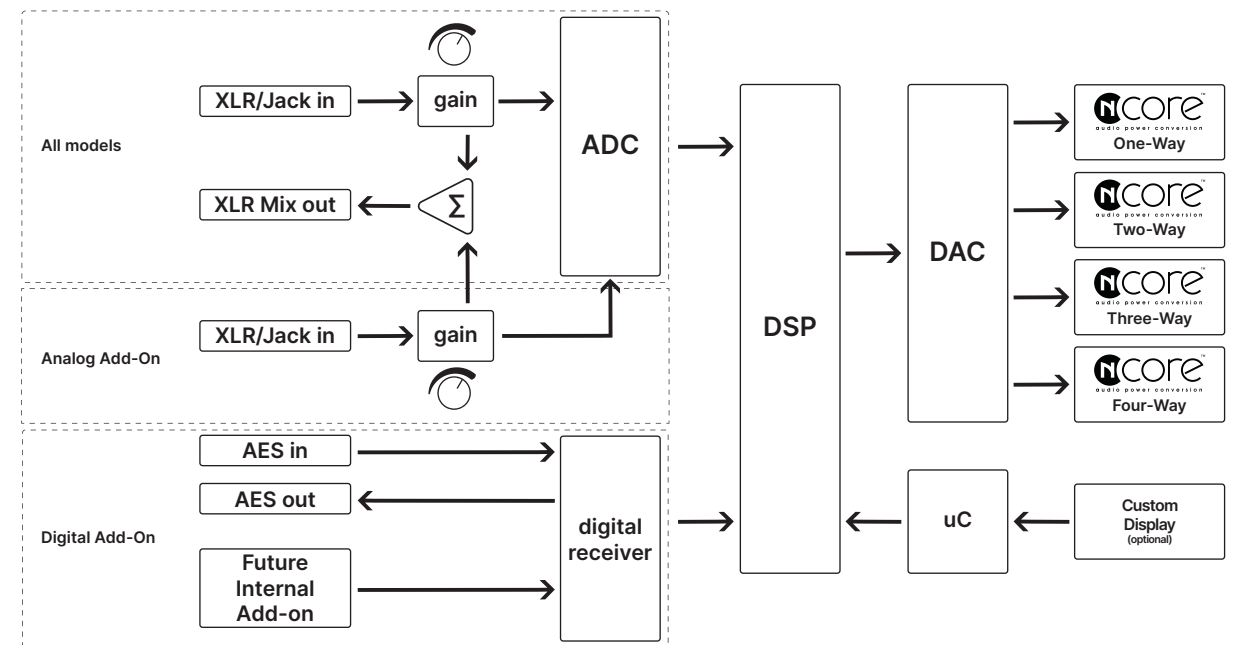

POSSIBLE APPLICATIONS

- Active loudspeakers
- Subwoofers
- PA systems
- Studio monitors

ANAIN2-111 - Analog add-on for DSP2-114



Introducing a new innovation, the ANAIN2-111, an add-on analog input board meticulously crafted for seamless integration with the DSP2-114. Engineered with precision and versatility in mind, the ANAIN2-111 comes equipped with a sophisticated XLR/Jack combination input, providing a universal interface for a diverse range of audio sources. The addition of a dedicated user-friendly volume control knob further enhances the ease of use, allowing users to finely tune their audio setups with precision and efficiency.

Designed to meet the demands of professionals, the ANAIN2-111 opens up a world of possibilities for audio connectivity. Its compatibility with various audio sources ensures a smooth and hassle-free integration into your existing setup.

Whether you're configuring a professional speaker system for a dynamic event or live performance, the combination of the DSP2-114 and the ANAIN2-111 emerges as the prime selection. This remarkable analog input board seamlessly caters to both music or

instrument and microphone inputs simultaneously together with the DSP2-114, presenting an optimal choice for those seeking unparalleled functionality and convenience in the realm of live sound applications.

Experience a new level of control and flexibility with the ANAIN2-111, an analog input board that not only meets but exceeds the expectations of audio professionals in the event and live music industry, seeking top-notch performance and seamless integration.

HIGHLIGHTS

TBD

FEATURES

TBD

ANAIN2-111 - Preliminary data

Item	Min	Typ	Max	Unit	Notes
Input Level XLR		TBD		dBu (Vrms)	Default gain setting
Output Level XLR		TBD		dBu (Vrms)	Default gain setting
Signal / Noise Ratio		TBD		dB	Analog in
Distortion		TBD		dB	Analog in

COMPATIBLE MODULES

DSP2-114

SIZE AND WEIGHT

To be announced

APPLICATION EXAMPLE

200 Watt + 50 Watt active loudspeaker

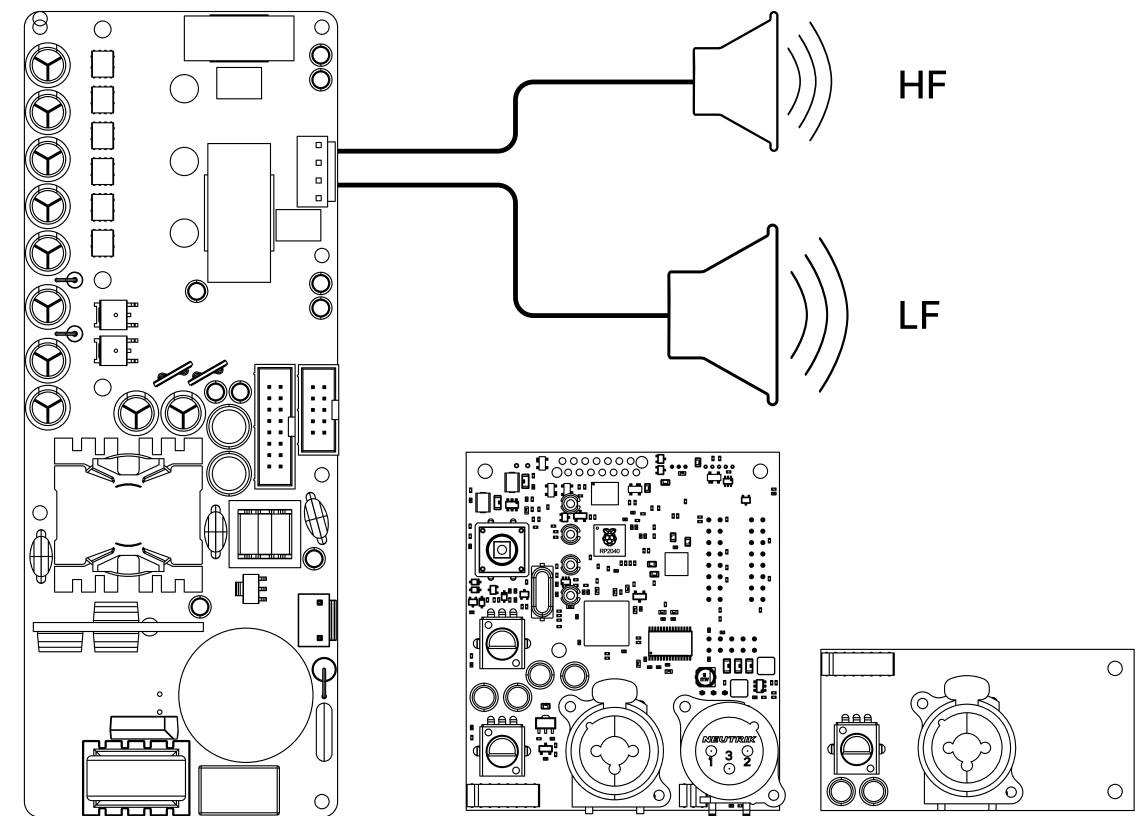

1 x NCAS250MP + DSP2-114 + ANAIN2-111

POSSIBLE APPLICATIONS

- Active loudspeakers
- Subwoofers
- PA systems
- Studio monitors

DIGin2-221 - Digital input board for DSP2-series



Unlock a new dimension of professional digital audio possibilities with the DIGin2-221, an innovative digital input board meticulously crafted to complement and extend the capabilities of the DSP2 -114 DSP solution. Engineered with precision to seamlessly integrate into your audio system, the DIGin2-221 empowers you to take your professional audio experience to new digital heights.

Elevate the potential of the DSP2-114 DSP solution with the DIGin2-221. This digital input board seamlessly integrates into your audio system, adding a digital powerhouse to your professional audio setup. Its advanced digital input capabilities ensure that every digital signal is handled with utmost precision, delivering an uncompromised audio quality that matches the overall performance of the DSP2-114.

Adaptability lies at the core of the DIGin2-221. Offering support for a variety of digital sources, this board serves as the perfect link between your digital devices and the DSP2-114 DSP solution. Connect your digital source via AES, but taking adaptability to the

next level, the DIGin2-221 offers an internal I2S input for a wireless connection like Bluetooth or a WISA implementation. This opens up a realm of wireless possibilities, allowing you to tailor your audio setup to your preferences and stay ahead in the ever-evolving landscape of audio technology.

Seamless integration is paramount, and the DIGin2-221 is designed for simplicity without compromising sophistication. Experience hassle-free installation combined with your DSP2-series DSP solutions. Plug in, power up your system, and let the DIGin2-221 seamlessly transform your audio world.

HIGHLIGHTS

TBD

FEATURES

TBD

DIGin2-221 - Data

Item	Min	Typ	Max	Unit	Notes
Signal / Noise Ratio		TBD		dB	
Distortion		TBD		dB	
Signal / Noise Ratio		TBD		kHz	
Digital Latency		TBD		ms	
SRC		TBD			

COMPATIBLE MODULES

DSP2 series

SIZE AND WEIGHT

To be announced

APPLICATION EXAMPLE

200 Watt + 50 Watt active loudspeaker

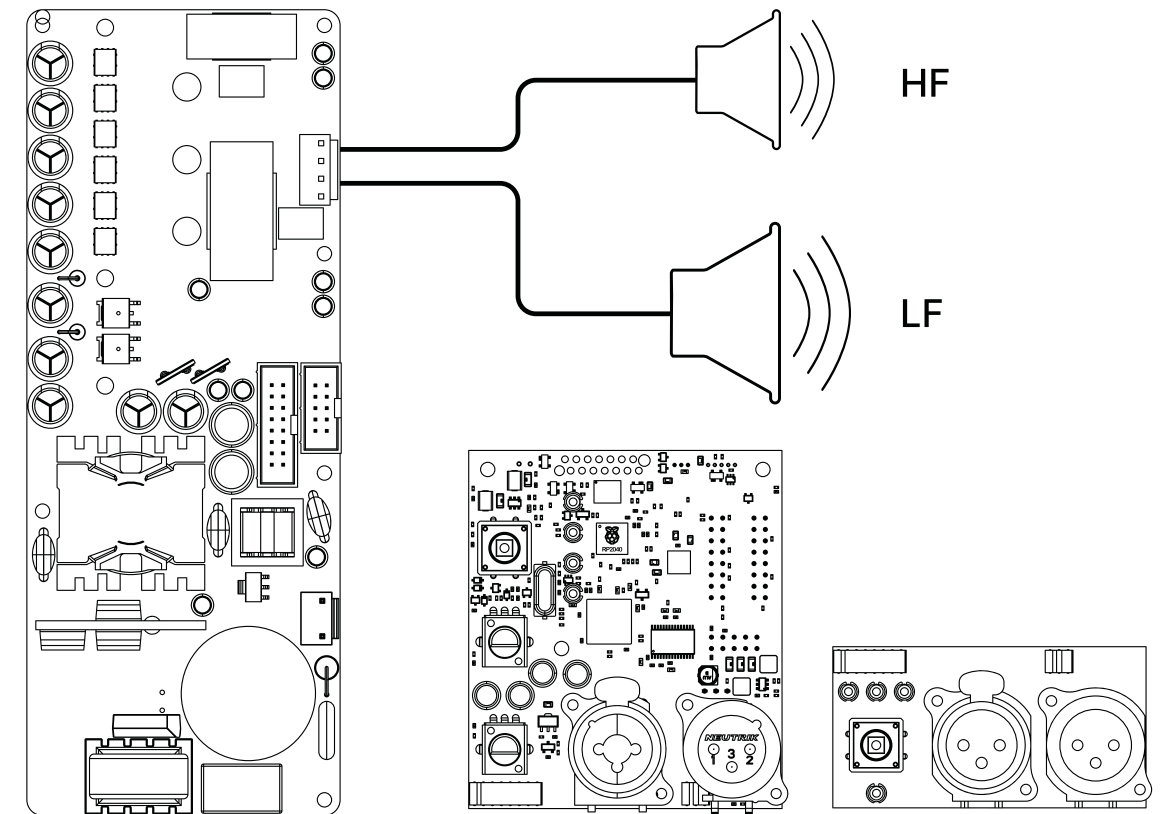

1 x NCAS250MP + DSP2-114 + DIGin2-221

POSSIBLE APPLICATIONS

- Active loudspeakers
- Subwoofers
- PA systems
- Studio monitors

DSP3-213 - Versatile mono/3-way DSP solution



Step into the realm of high-grade audio with our series 3, mono/3-way DSP solution, a gateway to a high-grade audio experience like never before. Engineered with precision and passion, this board, built on the Analog Devices ADAU1452, beckons audiophiles to enter the world of high-grade audio perfection.

Crafted to perfection, the DSP3-213 is optimized for use with our mains-powered N CORE® Family of amplifier power bricks. The marriage of cutting-edge technology and meticulous design ensures unparalleled audio quality, setting new standards in the pursuit of sonic excellence.

Elevate your audio journey by expanding the DSP3-213's capabilities with optional boards such as the DIGin3-322 for digital inputs or the SUBin3-110 tailor-made for subwoofers. This modular design ensures adaptability to your evolving audio needs, allowing you to create a personalized audio system. Whether you're aiming for a full-scale home theater experience or a refined stereo setup, the DSP3-213 adapts to your aspirations.

Immerse yourself in the power of customizations with the HFD (Hypex Filter Design) software. The DSP3-213 supports a wide array of IIR and FIR filter options, enabling you to fine-tune the DSP behavior and filtering to meet the unique demands of your audio environment. From crystal-clear highs to powerful lows, every nuance of your audio is sculpted to perfection.

Envision a premium stereo or 2.1 system by configuring multiple DSP3-213 boards in a master-slave setup. This innovative configuration unlocks the full potential of your audio setup, delivering an immersive and captivating auditory experience that transcends

traditional boundaries. Whether you're a discerning audiophile or a professional sound engineer, the DSP3-213's versatility elevates your audio ambitions.

Store and recall different presets effortlessly. The DSP3-213 allows you to save varied filter settings, inputs, and volume offsets, ensuring seamless transitions between different audio environments. This flexibility caters to the diverse preferences of audiophiles, putting the power of audio personalization in your hands. Effortlessly switch between movie nights and music sessions with presets that enhance every experience.

Experience intelligence in audio with features like Auto-signal-detect and adjustable standby settings. These intuitive functionalities ensure that your audio system seamlessly adapts to your needs, providing an uninterrupted and enjoyable listening experience. The DSP3-213 isn't just a device; it's a partner in your quest for audio perfection, intelligently adapting to your preferences.

The same powerful DSP3-213 platform is the heartbeat of our Fusion Amplifier Family. Immerse yourself in a world where innovation meets performance, and redefine your audio expectations with the Fusion Amplifier Family. Each Fusion amplifier embodies the same commitment to excellence, ensuring that your audio experience remains consistently exceptional.

HIGHLIGHTS

- Three channel active filtering
- One FIR (4500 taps) or three (1500 taps per channel) per preset
- Compatible with NCMP and NCAS series
- Three programmable presets

FEATURES

- Configurable Soft clip limiter
- IIR & FIR capable
- Programmable with Hypex Filter Design (HFD)
- Automatic source selection
- Automatic signal detection
- Optional IR remote control

DSP3-213 - Data

Item	Min	Typ	Max	Unit	Notes
Input Level XLR		18 (6,15)		dBu (Vrms)	Default gain setting
Output Level XLR		9 (2,18)		dBu (Vrms)	Default gain setting
Signal / Noise Ratio		-109		dB	Analog in
Distortion		-100		dB	Analog in
Analog Latency		350		µs	
Digital Latency		1.8		ms	96kHz input sample rate
DSP & ADC Sampling Rate		93.75		kHz	
Delay Per Channel	0		32	ms	
Input Channels		1			
Output Channels		3			
DSP		ADAU1452			
ADC		AK5554			
ADC Bit Depth		24			
DAC		AK4454			
Filter Options		IIR / FIR		HFD	

COMPATIBLE MODULES

NCORE® Active Speaker Family / Mains Powered N CORE® Family

SIZE AND WEIGHT

91.3 × 47 × 32.7 mm (LxWxH), 55 g

BLOCK DIAGRAM

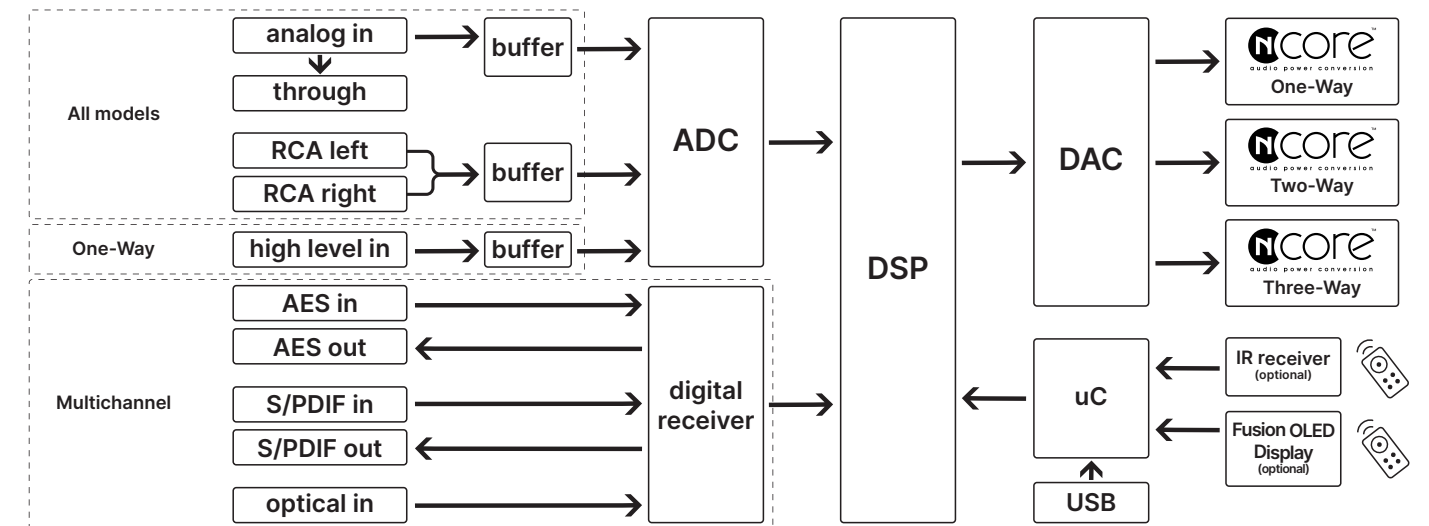

POSSIBLE APPLICATIONS

- High-end consumer audio
- Active loudspeakers
- Subwoofers
- PA systems
- Studio monitors

DSP3-224 - Stereo/4-way Audio Excellence

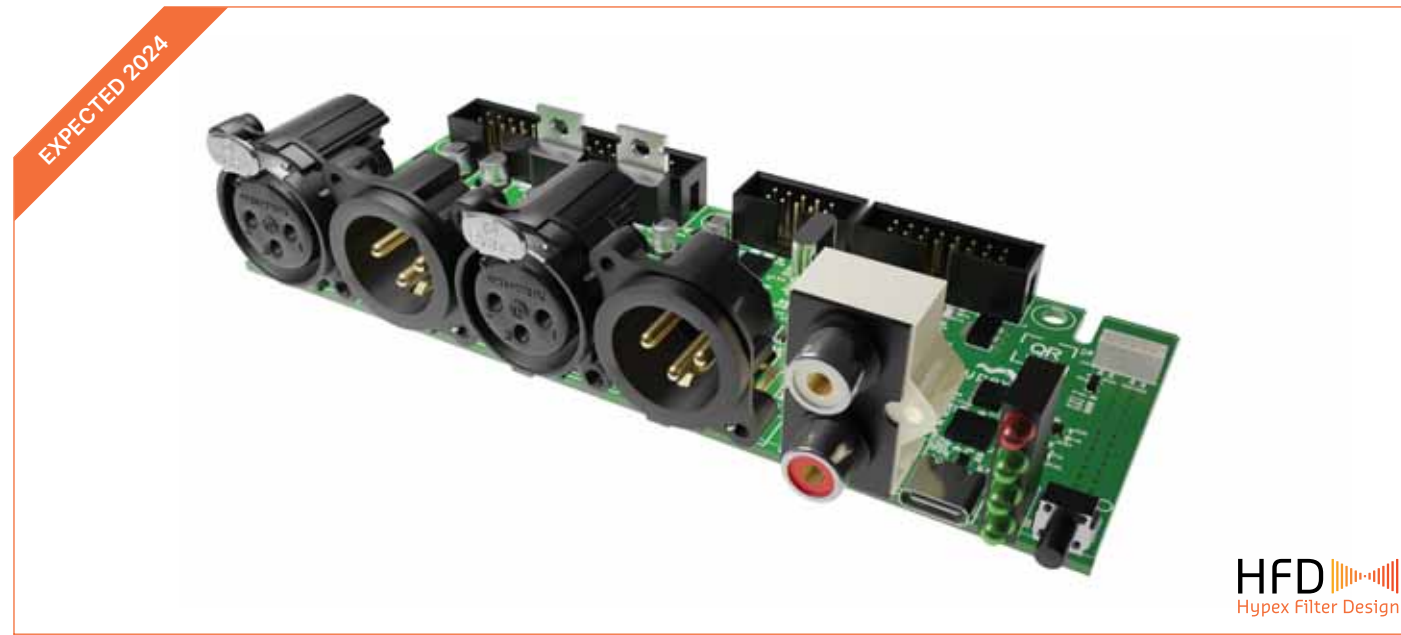

We are thrilled to introduce the DSP3-224, a new creation in our Series 3 lineup that redefines the standards of audio excellence. Engineered with precision and ingenuity, this stereo/4-way DSP solution is a beacon of innovation, poised to elevate your audio experience. With the advanced ADAU1452 and optimization for seamless integration with the Mains Powered N CORE® Family of power amplifier bricks, the DSP3-224 is not just a product; it's an auditory masterpiece.

Tailored for versatile applications, the DSP3-224 boasts robust DSP functionalities, making it an exceptional choice for crafting high-quality audio applications. Whether you are immersing yourself in the nuances of a stereo setup, pushing the boundaries of a 4-way speaker system, or exploring the possibilities of a 2.1 loudspeaker configuration, the DSP3-224 consistently delivers an unparalleled level of pristine audio that transcends expectations.

Immerse yourself in the power of customizations with the HFD (Hypex Filter Design) software. The DSP3-224 supports a wide array of IIR and FIR filter options, enabling you to fine-tune the DSP behavior and filtering to meet the unique demands of your audio environment. From crystal-clear highs to powerful lows, every nuance of your audio is sculpted to perfection.

Future-proof your audio system with the DSP3-224 by enhancing its capabilities with the optional DIGin3-322 digital input board.

This modular approach allows you to adapt and grow your audio setup as your needs evolve, ensuring a flexible and scalable solution for even the most discerning audiophiles.

Configure outputs effortlessly for Bridge-Tied Load (BTL) operation when connected to a 2-channel amplifier. The DSP3-224's intuitive design ensures a seamless and straightforward integration process, providing you with the flexibility to optimize your audio setup for maximum performance.

The DSP3-224 empowers you with a suite of intelligent features, including Auto-signal-detect, adjustable standby settings, and EQ functionalities. Experience a level of control that puts you in the driver's seat, allowing you to create the perfect active speaker system tailored to your unique preferences. Effortlessly adapt to different audio environments with a system that responds intelligently to your needs.

- Configurable Soft clip limiter
- IIR & FIR capable
- Programmable with Hypex Filter Design (HFD)
- Automatic source selection
- Automatic signal detection
- Optional IR remote control

HIGHLIGHTS

- Four channel active filtering
- Stereo input XLR & RCA
- Stereo input FIR (2048 taps) or four mono output FIR (1024 taps per channel)
- Compatible with NCMP and NCAS series
- Three programmable presets

FEATURES

DSP3-224 - Preliminary data

Item	Min	Typ	Max	Unit	Notes
Input Level XLR		18 (6,15)		dBu (Vrms)	Default gain setting
Output Level XLR		9 (2,18)		dBu (Vrms)	Default gain setting
Signal / Noise Ratio		-109		dB	Analog in
Distortion		-100		dB	Analog in
Analog Latency		350		µs	
Digital Latency		1.8		ms	96kHz input sample rate
DSP & ADC Sampling Rate		93.75		kHz	
Delay Per Channel	0		10	ms	75ms for all channels
Input Channels		2			
Output Channels		4			
DSP		ADAU1452			
ADC		AK5554			
ADC Bit Depth		24bit			
DAC		AK4454			
SRC		SRC4382			
Filter Options		IIR / FIR		HFD	

COMPATIBLE MODULES

NCORE® Active Speaker Family / Mains Powered N CORE® Family

SIZE AND WEIGHT

138 × 53 × 32.7 mm (LxWxH), 80 g

BLOCK DIAGRAM

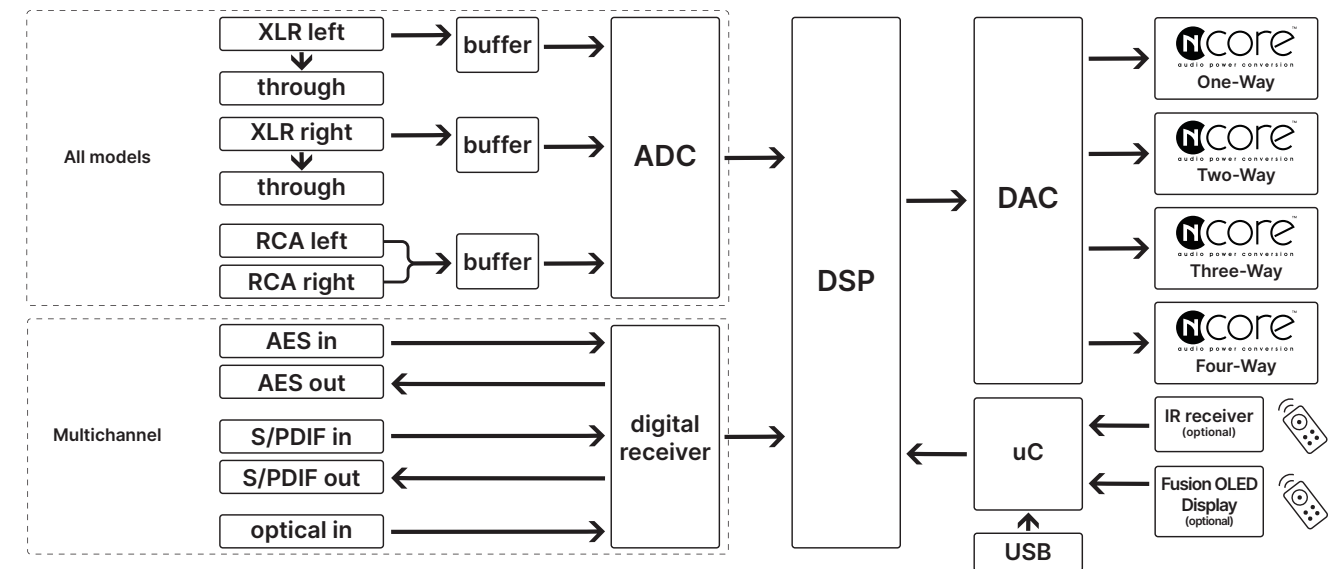

POSSIBLE APPLICATIONS

- High-end consumer audio
- Stereo power and integrated amplifiers
- Active loudspeakers
- PA systems
- Studio monitors

SUBin3-110 - High-level input for DSP3-213

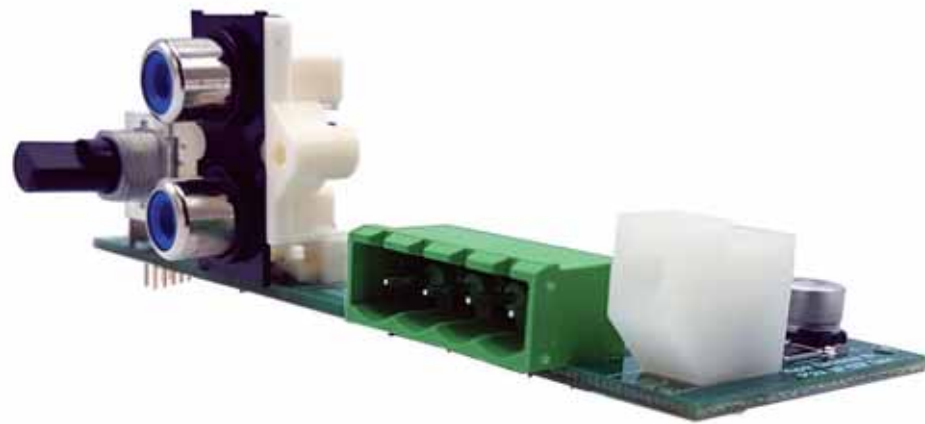

The SUBin3-110 stands out as an innovative addition to your audio setup, specifically engineered for use with subwoofers! This sophisticated device serves as an add-on, specially designed to incorporate a high-level input and a user-friendly volume control knob seamlessly into the DSP3-213 DSP-solution.

With the SUBin3-110, you can elevate your audio experience by gaining more control over your subwoofer. The high-level input ensures versatile connectivity, allowing you to integrate this add-on effortlessly into your existing audio application. This feature is designed to enhance compatibility and convenience.

The inclusion of a dedicated volume control knob literally puts the power of precision in your hands. Adjust the audio output according to your preferences, fine-tuning it to perfection. This intuitive control enhances your ability to tailor the sound to suit different

occasions, making your audio setup more versatile than ever. If desired, the package of a DSP3-213 and SUBin3-110 also works with the Fusion Remote Control or Fusion OLED Display for remote adjustments.

Upgrade your DSP3-213 with the SUBin3-110, and enjoy the benefits of expanded connectivity and refined control. Unleash the full potential of your subwoofer with this seamless integration, offering both functionality and ease of use.

HIGHLIGHTS

High-level inputs

FEATURES

Volume control

SUBin3-110 - Data

Item	Min	Typ	Max	Unit	Notes
Input Level High Level		52.5		dB	Default gain setting
Knob Gain Adjust	- 12		+ 12	dB	Relative to master volume

COMPATIBLE MODULES

DSP3-213

SIZE AND WEIGHT

91.3 × 35 × 29.6 mm (LxWxH), 27 g

APPLICATION EXAMPLE

1000 Watt active subwoofer

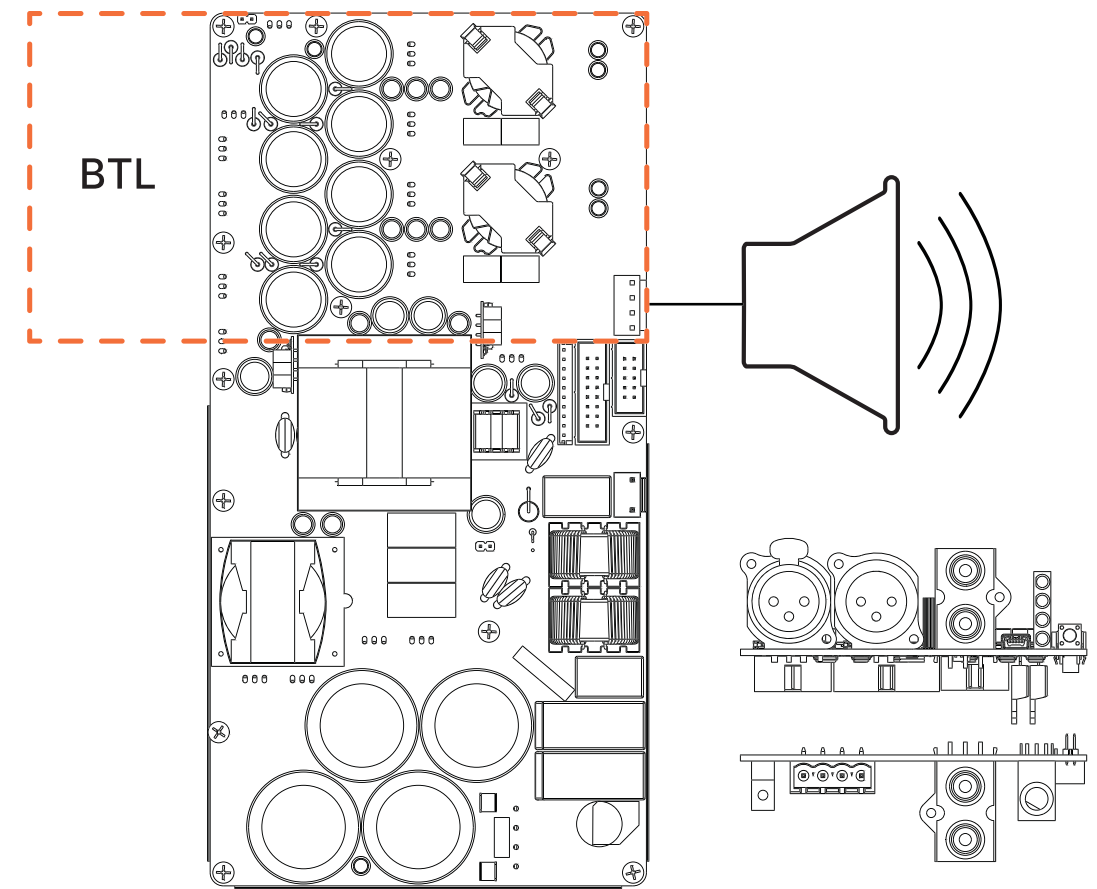

1 x NC502MP + 1 x DSP3-213 + 1 x SUBin3-110

POSSIBLE APPLICATIONS

- High-end consumer audio
- Active loudspeakers
- Subwoofers
- PA systems
- Studio monitors

DIGin3-322 - Digital input board for DSP3-series



Unleash the full potential of the DSP3-series DSP solutions with the DIGin3-322, a digital input board designed to extend the DSP3-series input capability. Engineered to match the DSP3-series DSP solutions and will increase the usability of the DSP.

The DIGin3-322 transforms the DSP3-series solutions by adding a digital powerhouse. With its advanced digital input capabilities, this board ensures that every digital signal is handled with precision, delivering uncompromised audio quality to your system.

Adaptability is at the heart of the DIGin3-322. Designed to seamlessly integrate with a variety of audio sources, it serves as the perfect link between your digital devices and the immersive world of high-fidelity sound. Digital sources can be connected via the AES, SPDIF, or Optical inputs, providing a wide range of digital input options. Taking adaptability to the next level, the DIGin3-322 offers an internal digital input for a wireless connection like Bluetooth or a WISA implementation. This opens up a realm of wireless possibilities, allowing you to tailor your audio setup to your preferences and stay ahead in the ever-evolving landscape of audio technology.

If desired, the package of a DSP3-213 and DIGin3-322 also works in cooperation with the Fusion Remote Control or Fusion OLED Display for remote adjustments.

Experience hassle-free integration combined with the DSP3-series DSP solutions. Designed for simplicity without sacrificing sophistication, this digital input board ensures an effortless installation process. Plug in, power the system up, and let the DIGin3-322 transform your audio world.

Elevate your listening experience with the support for high-resolution audio formats. The DIGin3-322 preserves the intricacies of your music, ensuring that every note and detail is faithfully reproduced, providing a listening experience that captivates and immerses.

HIGHLIGHTS

- AES input and output
- SPDIF input and output
- Optical input
- Low jitter

FEATURES

- Maximum optical sample rate: 96kHz
- Maximum SPDIF & AES sample rate: 192kHz

DIGin3-322 - Data

Item	Typ	Unit	Notes
Signal/Noise ratio	-111	dB	Digital in
Distortion	-100	dB	Digital in
Supported sample rates	32 / 44.1 / 48 / 88.2 / 96 / 192	kHz	
Digital latency	1.8	ms	96kHz
SRC	SRC4382		

COMPATIBLE MODULES

DSP3-213 / DSP3-224

SIZE AND WEIGHT

91.3 × 35 × 29.6 mm (LxWxH), 37 g

APPLICATION EXAMPLE

3-way active speaker

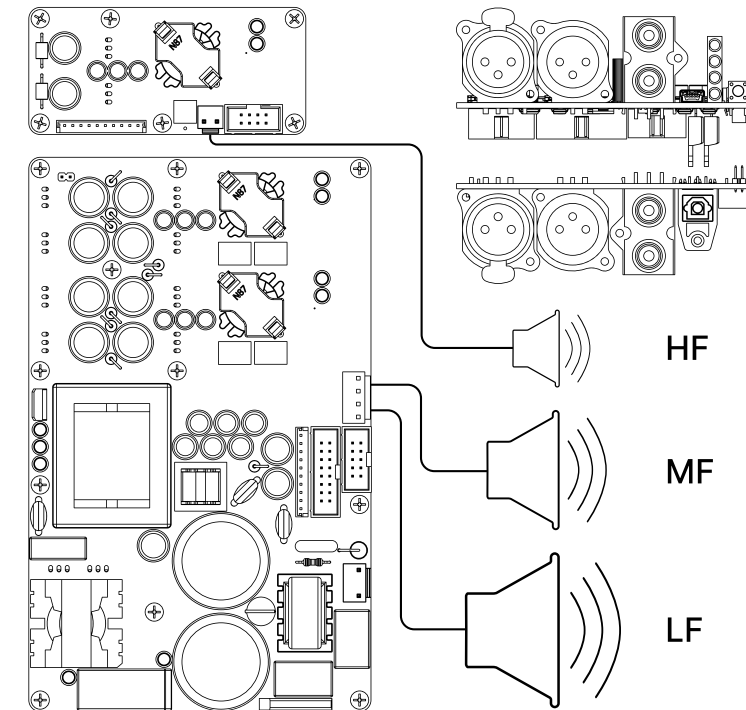

1 x NC100HF + 1 x NC252MP + 1 x DSP3-213 + 1 x DIGin3-322

POSSIBLE APPLICATIONS

- High-end consumer audio
- Active loudspeakers
- Subwoofers
- PA systems
- Studio monitors



*"It's not just about amplification;
it's about amplifying your brand."*

The ultimate turnkey integration

Looking to reduce your time to market and elevate your audio experience to the next level? Look no further! Hypex Fusion amplifiers are here to revolutionize your audio setup with their unmatched performance, versatility, and seamless integration capabilities.

Simplify Your Integration: Gone are the days of complicated wiring and endless configurations. Hypex Fusion amplifiers offer a turnkey solution that integrates seamlessly with your existing loudspeakers. With their intuitive design and straightforward installation process, you can say goodbye to the headache of complex setups and go to market in no time.

Energy-Efficient Innovation: Hypex Fusion amplifiers not only excel in performance but also prioritize energy efficiency. With their state-of-the-art Class-D amplification technology and smart DSP energy options, these amplifiers consume minimal power while delivering maximum output, resulting in a greener and more sustainable audio solution. Feel good about enjoying good quality audio while minimizing your environmental footprint.

Fusion Amplifier Family

Discover the epitome of amplifier excellence with the Fusion Amplifier Family - a turnkey solution that seamlessly integrates SMPS, DSP, and the power of NCORE®-based amplification. Tailored for active speaker designs, the Fusion Amp Family stands out as one of the finest amplifier solutions available.

At the heart of the Fusion Amplifier lies an exceptional fusion of a Switch Mode Power Supply (SMPS), Digital Signal Processing (DSP), and NCORE®-based amplification. This synergy creates a powerhouse of audio engineering, setting a new standard for active speaker designs. The integrated DSP delivers remarkable audio processing capabilities, while the NCORE® technology ensures negligible distortion across the entire audio and power spectrum.

Gone are the days of complicated wiring and endless configurations. The Hypex Fusion Amplifier Family offers a turnkey solution that integrates seamlessly with your existing loudspeakers. With their intuitive design and straightforward installation process, you can say goodbye to the headache of complex setups and go to market in no time.

BUILDING POWERHOUSES

All equal dual-channel Fusion Amplifiers (2ch and 3ch versions) can be used in Bridged-Tied Load (BTL), transforming them into robust powerhouses so that they become a force to be reckoned with. Distortion, whether in Total Harmonic Distortion (THD) or Intermodulation Distortion (IMD), is virtually nonexistent. Even at low listening levels (1W), distortion is immeasurable.

HYPEX FILTER DESIGN

The Fusion Amplifier Family offers a range of input options for compatibility with various source equipment. Hypex provides the HFD software (Hypex Filter Design) for designing and configuring filters for the Fusion Amplifiers. Enhance the capabilities of the Fusion Amplifiers with the Fusion Remote Kit or Fusion OLED Display for convenient remote control. The thermal regulation ensures optimal performance without compromising on ventilation.

Download the HFD software from www.hypex.nl for a seamless configuration process.

CONFIGURATION OPTIONS

Multiple Fusion Amplifiers can be used in master-slave configuration to create a stereo or a 2.1 system. Three presets are available to store different filter settings, inputs and volume offsets. In each preset either one 4500 tap FIR filter right after the input, or three 1500 tap FIR filters on the output (one for each channel) can be implemented.

KEY FEATURES

- 15 biquads per output channel
- Three selectable presets for filters
- Source selection
- Signal detection
- Automatic shutdown
- Bridge-Tied Load (BTL) capable
- Clip protection
- Thermal protection
- IIR and FIR filter options

OEM OPTIONS AVAILABLE:

Custom Faceplate Color:

Tailor the faceplate color to align with your brand or aesthetic preferences.

Custom Logo:

Personalize your product with your logo, reinforcing brand identity and recognition.

Contact us for additional customization options.

AVAILABLE MODULES

Module name	Configuration	Power 4Ω	Power 8Ω	Inputs
FA251	1 channel / 1-way	1 × 250W	1 × 130W	XLR, RCA, High level
FA501	1 channel / 1-way	1 × 500W	1 × 270W	XLR, RCA, High level
FA122	1 channel / 2-way	2 × 125W	2 × 75W	XLR, RCA, AES/EBU, SPDIF, Optical
FA252	1 channel / 2-way	2 × 250W	2 × 150W	XLR, RCA, AES/EBU, SPDIF, Optical
FA502	1 channel / 2-way	2 × 500W	2 × 350W	XLR, RCA, AES/EBU, SPDIF, Optical
FA123	1 channel / 3-way	2 × 125W + 1 × 100W	3 × 75W	XLR, RCA, AES/EBU, SPDIF, Optical
FA253	1 channel / 3-way	2 × 250W + 1 × 100W	2 × 150W + 1 × 100W	XLR, RCA, AES/EBU, SPDIF, Optical
FA503	1 channel / 3-way	2 × 500W + 1 × 100W	2 × 350W + 1 × 100W	XLR, RCA, AES/EBU, SPDIF, Optical

FA251 - 1 Channel / 1-way plate amplifier

The Fusion Amp FA251 – a revolutionary mono, one-way, audio powerhouse designed to be the backbone of your premium active sound system. With the capability to serve as the core for a robust 250W active subwoofer or a sophisticated one-way active 250W monitor, the FA251 is a versatile solution for audio professionals.



The FA251 is driven by a formidable 250W NCORE® amplifier, ensuring a powerful and nuanced audio performance. Experience the richness of deep bass and the clarity of highs with uncompromising power. Unlock the full potential of your audio setup with the on-board DSP. Configure and fine-tune your sound using the HFD software, allowing for precise adjustments tailored to your preferences.

The FA251 offers a range of input options, including Analog balanced XLR in and through, Analog unbalanced RCA input, and a High-level input. This flexibility ensures compatibility with various audio sources and setups.

The front faceplate features a convenient gain knob, providing easy and quick adjustments to match your audio requirements. Fine-tune the volume effortlessly for an optimized listening experience. Elevate your user experience by combining the FA251 with the Fusion Remote kit or Fusion OLED Display for remote-controlled options. Enjoy the convenience of managing your audio setup from a distance.

Take your audio setup to the next level by incorporating multiple Fusion Amps in a Master and Slave configuration. Create a seamless, complete active audio system for an immersive and synchronized listening experience.

Craft your audio oasis with the Fusion Amp FA251 – where power, precision, and versatility converge. Unleash the potential of your sound system and elevate your auditory experience to new heights with this exceptional fusion of technology and performance.

COMPATIBLE MODULES

- Fusion remote kit + Hypex remote
- Fusion OLED display + Hypex remote

SIZE AND WEIGHT

280 × 120 × 55 mm (LxWxH), 725 g

FEATURES

- IIR and FIR filter options
- 15 biquads per amplifier
- Three selectable presets for filters
- Source selection
- Signal detect
- Auto shutdown

PROTECTIONS

- Clip protection
- Thermal protection

POSSIBLE APPLICATIONS

- Active Subwoofers
- Active Guitar Cabinets
- Active Monitor Loudspeakers
- Active 1-way Loudspeakers

FA501 - 1 Channel / 1-way plate amplifier

The Fusion Amp FA501 – a revolutionary mono, one-way, audio powerhouse designed to be the backbone of your premium active sound system. With the capability to serve as the core for a robust 500W active subwoofer or a sophisticated one-way active 500W monitor, the FA501 is a versatile solution for audio professionals.



The FA501 is driven by a formidable 500W NCORE® amplifier, ensuring a powerful and nuanced audio performance. Experience the richness of deep bass and the clarity of highs with uncompromising power. Unlock the full potential of your audio setup with the on-board DSP. Configure and fine-tune your sound using the HFD software, allowing for precise adjustments tailored to your preferences.

The FA501 offers a range of input options, including Analog balanced XLR in and through, Analog unbalanced RCA input, and a High-level input. This flexibility ensures compatibility with various audio sources and setups.

The front faceplate features a convenient gain knob, providing easy and quick adjustments to match your audio requirements. Fine-tune the volume effortlessly for an optimized listening experience. Elevate your user experience by combining the FA501 with the Fusion Remote kit or Fusion OLED Display for remote-controlled options. Enjoy the convenience of managing your audio setup from a distance.

Take your audio setup to the next level by incorporating multiple Fusion Amps in a Master and Slave configuration. Create a seamless, complete active audio system for an immersive and synchronized listening experience.

Craft your audio oasis with the Fusion Amp FA501 – where power, precision, and versatility converge. Unleash the potential of your sound system and elevate your auditory experience to new heights with this exceptional fusion of technology and performance.

COMPATIBLE MODULES

- Fusion remote kit + Hypex remote
- Fusion OLED display + Hypex remote

SIZE AND WEIGHT

280 × 135 × 55 mm (LxWxH), 925 g

FEATURES

- IIR and FIR filter options
- 15 biquads per amplifier
- Three selectable presets for filters
- Source selection
- Signal detect
- Auto shutdown

PROTECTIONS

- Clip protection
- Thermal protection

POSSIBLE APPLICATIONS

- Active Subwoofers
- Active Guitar Cabinets
- Active Monitor Loudspeakers
- Active 1-way Loudspeakers

FA122 - 2 Channel / 2-way plate amplifier

The Fusion Amp FA122 – a revolutionary mono, two-way, audio powerhouse designed to be the backbone of your premium active sound system. With the capability to serve as the core for a quality active loudspeaker, the FA122 is a quality solution for audio professionals.



The FA122 is driven by a formidable dual 125W N CORE® amplifier, ensuring a powerful and nuanced audio performance. Experience the richness of deep bass and the clarity of highs with uncompromising power. Unlock the full potential of your audio setup with the on-board DSP. Configure and fine-tune your sound using the HFD software, allowing for precise adjustments tailored to your preferences.

The FA122 offers a range of input options, including Analog balanced XLR in and through, Analog unbalanced RCA input, Digital AES in and through, Digital S/PDIF in and through and a Digital Optical Toslink input. This flexibility ensures compatibility with various analog and digital audio sources and setups.

Elevate your user experience by combining the FA122 with the Fusion Remote kit or Fusion OLED Display for remote-controlled options. Enjoy the convenience of managing your audio setup from a distance.

Take your audio setup to the next level by incorporating multiple Fusion Amps in a Master and Slave configuration. Create a seamless, complete active audio system for an immersive and synchronized listening experience.

Craft your audio oasis with the Fusion Amp FA122 – where power, precision, and versatility converge. Unleash the potential of your sound system and elevate your auditory experience to new heights with this exceptional fusion of technology and performance.

SIZE AND WEIGHT

315 × 120 × 55 mm (LxWxH), 815 g

COMPATIBLE MODULES

- Fusion remote kit + Hypex remote
- Fusion OLED display + Hypex remote

FEATURES

- IIR and FIR filter options
- 15 biquads per amplifier
- Three selectable presets for filters
- Source selection
- Signal detect
- Auto shutdown

PROTECTIONS

- Clip protection
- Thermal protection

POSSIBLE APPLICATIONS

- Active 2-way Monitor Loudspeakers
- Active 2-way Loudspeakers; for home and professional use
- Active 250W Subwoofer with digital inputs

FA252 - 2 Channel / 2-way plate amplifier

The Fusion Amp FA252 – a revolutionary mono, two-way, audio powerhouse designed to be the backbone of your premium active sound system. With the capability to serve as the core for a quality active loudspeaker, the FA252 is a quality solution for audio professionals.



The FA252 is driven by a formidable dual 250W N CORE® amplifier, ensuring a powerful and nuanced audio performance. Experience the richness of deep bass and the clarity of highs with uncompromising power. Unlock the full potential of your audio setup with the on-board DSP. Configure and fine-tune your sound using the HFD software, allowing for precise adjustments tailored to your preferences.

The FA252 offers a range of input options, including Analog balanced XLR in and through, Analog unbalanced RCA input, Digital AES in and through, Digital S/PDIF in and through and a Digital Optical Toslink input. This flexibility ensures compatibility with various analog and digital audio sources and setups.

Elevate your user experience by combining the FA252 with the Fusion Remote kit or Fusion OLED Display for remote-controlled options. Enjoy the convenience of managing your audio setup from a distance.

Take your audio setup to the next level by incorporating multiple Fusion Amps in a Master and Slave configuration. Create a seamless, complete active audio system for an immersive and synchronized listening experience.

Craft your audio oasis with the Fusion Amp FA252 – where power, precision, and versatility converge. Unleash the potential of your sound system and elevate your auditory experience to new heights with this exceptional fusion of technology and performance.

COMPATIBLE MODULES

- Fusion remote kit + Hypex remote
- Fusion OLED display + Hypex remote

FEATURES

- IIR and FIR filter options
- 15 biquads per amplifier
- Three selectable presets for filters
- Source selection
- Signal detect
- Auto shutdown

PROTECTIONS

- Clip protection
- Thermal protection

POSSIBLE APPLICATIONS

- Active 2-way Monitor Loudspeakers
- Active 2-way Loudspeakers; for home and professional use
- Active 500W Subwoofer with digital inputs

SIZE AND WEIGHT

315 × 135 × 55 mm (LxWxH), 1000 g

FA502 - 2 Channel / 2-way plate amplifier

The Fusion Amp FA502 – a revolutionary mono, two-way, audio powerhouse designed to be the backbone of your premium active sound system. With the capability to serve as the core for a quality active loudspeaker, the FA502 is a quality solution for audio professionals.



The FA502 is driven by a formidable dual 500W NCORE® amplifier, ensuring a powerful and nuanced audio performance. Experience the richness of deep bass and the clarity of highs with uncompromising power. Unlock the full potential of your audio setup with the on-board DSP. Configure and fine-tune your sound using the HFD software, allowing for precise adjustments tailored to your preferences.

The FA502 offers a range of input options, including Analog balanced XLR in and through, Analog unbalanced RCA input, Digital AES in and through, Digital S/PDIF in and through and a Digital Optical Toslink input. This flexibility ensures compatibility with various analog and digital audio sources and setups. Elevate your user experience by combining the FA502 with the Fusion Remote kit or Fusion OLED Display for remote-controlled options. Enjoy the convenience of managing your audio setup from a distance.

Take your audio setup to the next level by incorporating multiple Fusion Amps in a Master and Slave configuration. Create a seamless, complete active audio system for an immersive and synchronized listening experience.

Craft your audio oasis with the Fusion Amp FA502 – where power, precision, and versatility converge. Unleash the potential of your sound system and elevate your auditory experience to new heights with this exceptional fusion of technology and performance.

COMPATIBLE MODULES

- Fusion remote kit + Hypex remote
- Fusion OLED display + Hypex remote

SIZE AND WEIGHT

380 × 150 × 90 mm (LxWxH), 2105 g

FEATURES

- IIR and FIR filter options
- 15 biquads per amplifier
- Three selectable presets for filters
- Source selection
- Signal detect
- Auto shutdown

PROTECTIONS

- Clip protection
- Thermal protection

POSSIBLE APPLICATIONS

- Active 2-way Monitor Loudspeakers
- Active 2-way Loudspeakers; for home and professional use
- Active 1000W Subwoofer with digital inputs

FA123 - 3 Channel / 3-way plate amplifier

The Fusion Amp FA123 – a revolutionary mono, three-way, audio powerhouse designed to be the backbone of your premium active sound system. With the capability to serve as the core for a quality active loudspeaker, the FA123 is a quality solution for audio professionals.



The FA123 is driven by a formidable dual 125W + one 100W NCORE® amplifier, ensuring a powerful and nuanced audio performance. Experience the richness of deep bass and the clarity of highs with uncompromising power. Unlock the full potential of your audio setup with the on-board DSP. Configure and fine-tune your sound using the HFD software, allowing for precise adjustments tailored to your preferences.

The FA123 offers a range of input options, including Analog balanced XLR in and through, Analog unbalanced RCA input, Digital AES in and through, Digital S/PDIF in and through and a Digital Optical Toslink input. This flexibility ensures compatibility with various analog and digital audio sources and setups. Elevate your user experience by combining the FA123 with the Fusion Remote kit or Fusion OLED Display for remote-controlled options. Enjoy the convenience of managing your audio setup from a distance.

Take your audio setup to the next level by incorporating multiple Fusion Amps in a Master and Slave configuration. Create a seamless, complete active audio system for an immersive and synchronized listening experience.

Craft your audio oasis with the Fusion Amp FA123 - where power, precision, and versatility converge. Unleash the potential of your sound system and elevate your auditory experience to new heights with this exceptional fusion of technology and performance.

COMPATIBLE MODULES

- Fusion remote kit + Hypex remote
- Fusion OLED display + Hypex remote

SIZE AND WEIGHT

360 × 120 × 55 mm (LxWxH), 955 g

FEATURES

- IIR and FIR filter options
- 15 biquads per amplifier
- Three selectable presets for filters
- Source selection
- Signal detect
- Auto shutdown

PROTECTIONS

- Clip protection
- Thermal protection

POSSIBLE APPLICATIONS

- Active 3-way Monitor Loudspeakers
- Active 3-way Loudspeakers; for home and professional use

FA253 - 3 Channel / 3-way plate amplifier

The Fusion Amp FA253 – a revolutionary mono, three-way, audio powerhouse designed to be the backbone of your premium active sound system. With the capability to serve as the core for a quality active loudspeaker, the FA253 is a quality solution for audio professionals.



The FA253 is driven by a formidable dual 250W + one 100W NCORE® amplifier, ensuring a powerful and nuanced audio performance. Experience the richness of deep bass and the clarity of highs with uncompromising power. Unlock the full potential of your audio setup with the on-board DSP. Configure and fine-tune your sound using the HFD software, allowing for precise adjustments tailored to your preferences.

The FA253 offers a range of input options, including Analog balanced XLR in and through, Analog unbalanced RCA input, Digital AES in and through, Digital S/PDIF in and through and a Digital Optical Toslink input. This flexibility ensures compatibility with various analog and digital audio sources and setups. Elevate your user experience by combining the FA253 with the Fusion Remote kit or Fusion OLED Display for remote-controlled options. Enjoy the convenience of managing your audio setup from a distance.

Take your audio setup to the next level by incorporating multiple Fusion Amps in a Master and Slave configuration. Create a seamless, complete active audio system for an immersive and synchronized listening experience.

Craft your audio oasis with the Fusion Amp FA253 – where power, precision, and versatility converge. Unleash the potential of your sound system and elevate your auditory experience to new heights with this exceptional fusion of technology and performance.

COMPATIBLE MODULES

- Fusion remote kit + Hypex remote
- Fusion OLED display + Hypex remote

SIZE AND WEIGHT

360 × 135 × 55 mm (LxWxH), 1145 g

FEATURES

- IIR and FIR filter options
- 15 biquads per amplifier
- Three selectable presets for filters
- Source selection
- Signal detect
- Auto shutdown

PROTECTIONS

- Clip protection
- Thermal protection

POSSIBLE APPLICATIONS

- Active three-3 Monitor Loudspeakers
- Active three-3 Loudspeakers; for home and professional use

FA503 - 3 Channel / 3-way plate amplifier

The Fusion Amp FA503 – a revolutionary mono, three-way, audio powerhouse designed to be the backbone of your premium active sound system. With the capability to serve as the core for a quality active loudspeaker, the FA503 is a quality solution for audio professionals.



The FA503 is driven by a formidable dual 500W + one 100W NCORE® amplifier, ensuring a powerful and nuanced audio performance. Experience the richness of deep bass and the clarity of highs with uncompromising power. Unlock the full potential of your audio setup with the on-board DSP. Configure and fine-tune your sound using the HFD software, allowing for precise adjustments tailored to your preferences.

The FA503 offers a range of input options, including Analog balanced XLR in and through, Analog unbalanced RCA input, Digital AES in and through, Digital S/PDIF in and through and a Digital Optical Toslink input. This flexibility ensures compatibility with various analog and digital audio sources and setups. Elevate your user experience by combining the FA503 with the Fusion Remote kit or Fusion OLED Display for remote-controlled options. Enjoy the convenience of managing your audio setup from a distance.

Take your audio setup to the next level by incorporating multiple Fusion Amps in a Master and Slave configuration. Create a seamless, complete active audio system for an immersive and synchronized listening experience.

Craft your audio oasis with the Fusion Amp FA503 – where power, precision, and versatility converge. Unleash the potential of your sound system and elevate your auditory experience to new heights with this exceptional fusion of technology and performance.

COMPATIBLE MODULES

- Fusion remote kit + Hypex remote
- Fusion OLED display + Hypex remote

SIZE AND WEIGHT

420 × 150 × 90 mm (LxWxH), 2275 g

FEATURES

- IIR and FIR filter options
- 15 biquads per amplifier
- Three selectable presets for filters
- Source selection
- Signal detect
- Auto shutdown

PROTECTIONS

- Clip protection
- Thermal protection

POSSIBLE APPLICATIONS

- Active 3-way Monitor Loudspeakers
- Active 3-way Loudspeakers; for home and professional use

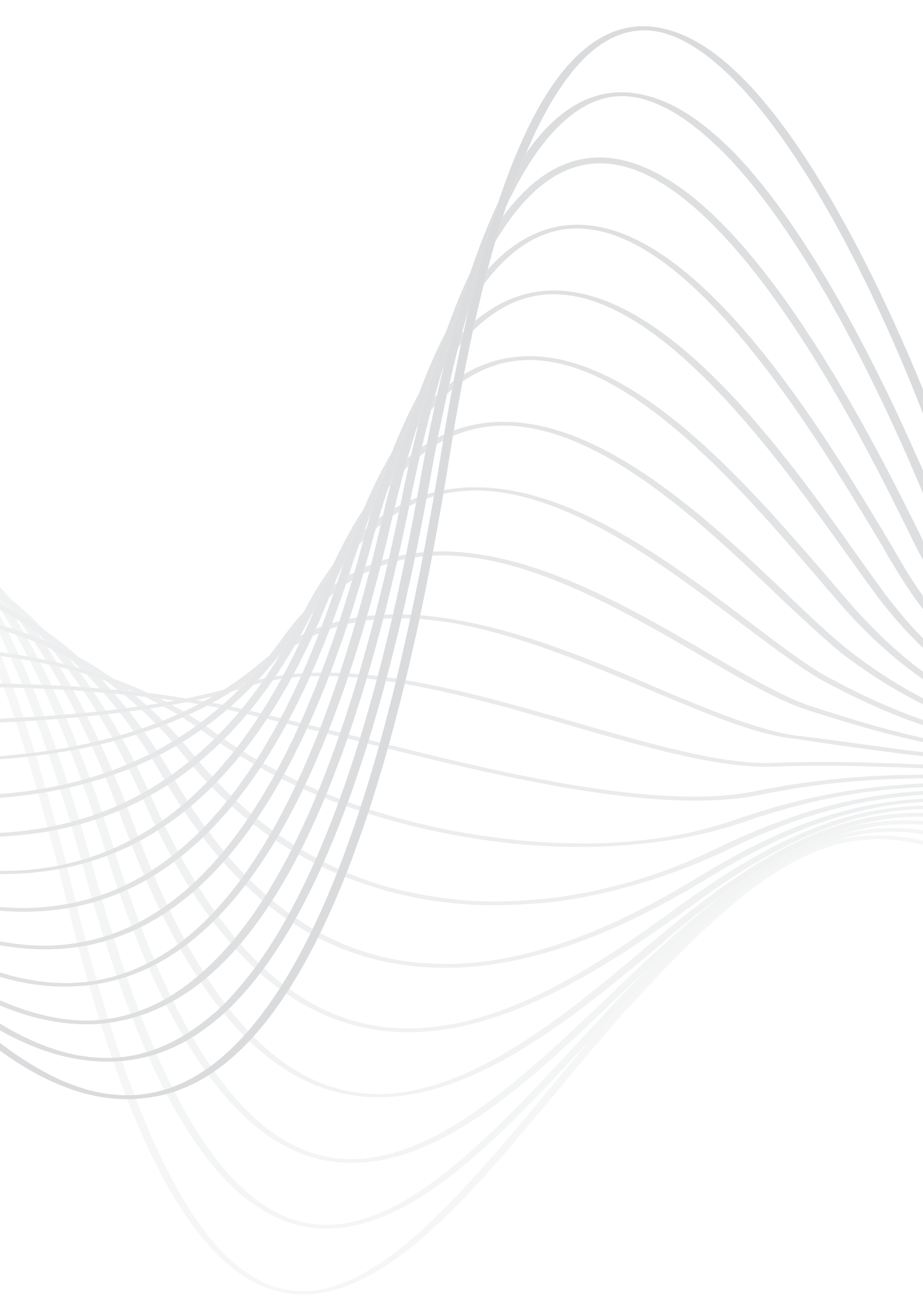

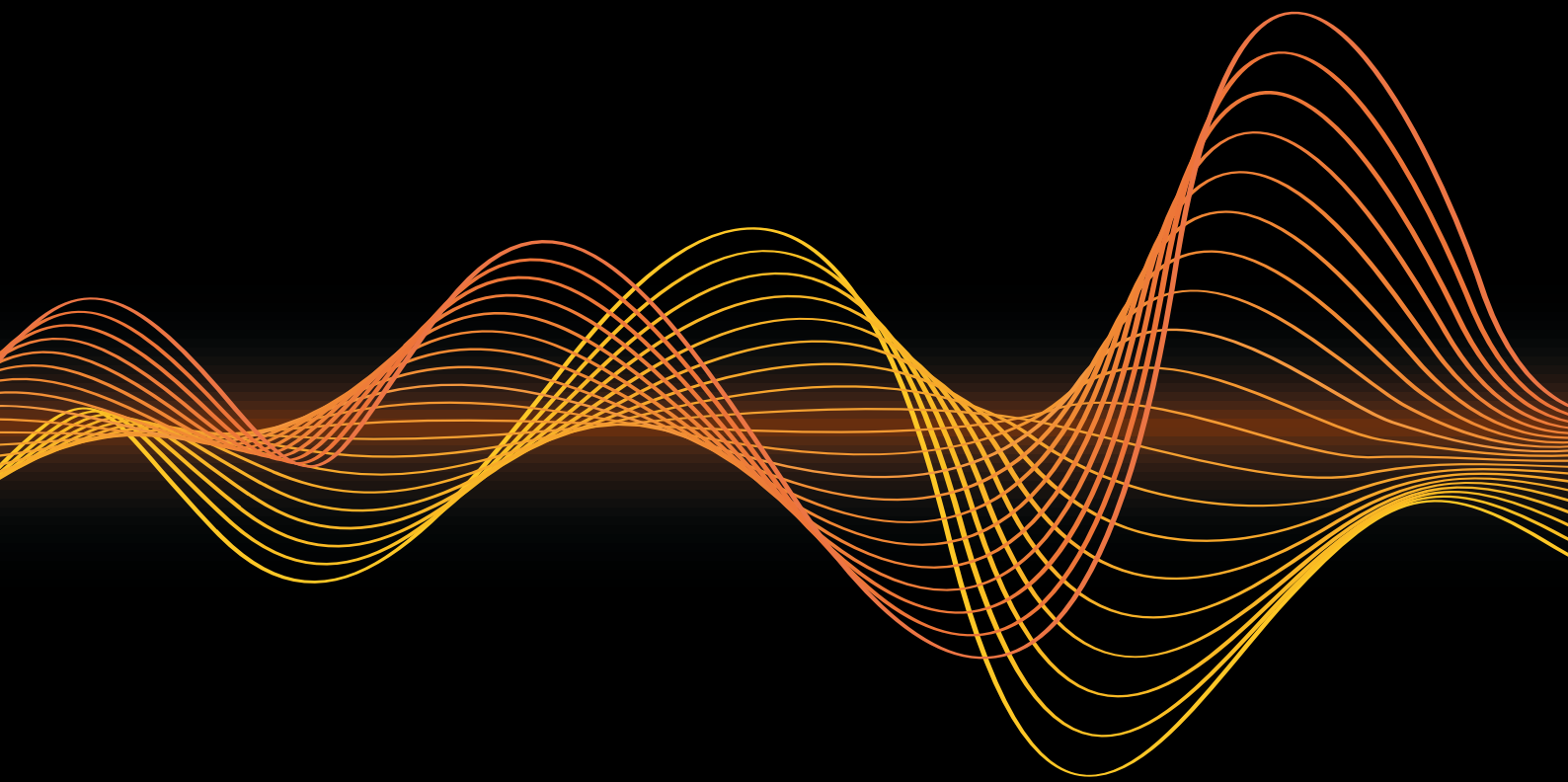

Hypex Electronics BV

Kattegat 8

9723JP Groningen

The Netherlands

Tel: +31 50 526 4993

Email: sales@hypex.nl

Web: www.hypex.nl

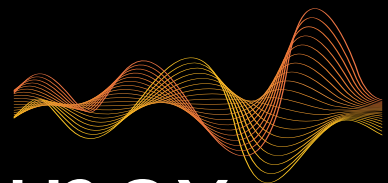

hypex electronics