

Intel® Server Board S2600CP2

Intel® Server Board S2600CP4

Intel® Server System P4000CP4 Family

Spares/Accessories List and Configuration Guide

A reference guide to assist customers in ordering the necessary components to configure the Intel® Server Board S2600CP2, Intel® Server Board S2600CP4, and the Intel® Server System P4000CP4 family.



Revision 1.7

May 2014

Intel® Server Boards and Systems

Revision History

Jan '12	Rev 1.0	Initial Release.
Feb '12	Rev 1.1	Updated software product codes in sections 2.5 and 2.6.
May '12	Rev 1.2	Updated description details.
July '12	Rev 1.3	Added Intel® Server Continuity Suite SKUs
Dec '12	Rev 1.4	Removed VMware, Symantec, Intel® Server Continuity Suite, and Intel® Onsite Repair for Servers SKUs
July'13	Rev 1.5	Updated MM# s.
Aug'13	Rev 1.6	Added E5-2600 v2 processor support
May'14	Rev 1.7	Modified typos

INFORMATION IN THIS DOCUMENT IS PROVIDED IN CONNECTION WITH INTEL PRODUCTS. NO LICENSE, EXPRESS OR IMPLIED, BY ESTOPPEL OR OTHERWISE, TO ANY INTELLECTUAL PROPERTY RIGHTS IS GRANTED BY THIS DOCUMENT. EXCEPT AS PROVIDED IN INTEL'S TERMS AND CONDITIONS OF SALE FOR SUCH PRODUCTS, INTEL ASSUMES NO LIABILITY WHATSOEVER, AND INTEL DISCLAIMS ANY EXPRESS OR IMPLIED WARRANTY, RELATING TO SALE AND/OR USE OF INTEL PRODUCTS INCLUDING LIABILITY OR WARRANTIES RELATING TO FITNESS FOR A PARTICULAR PURPOSE, MERCHANTABILITY, OR INFRINGEMENT OF ANY PATENT, COPYRIGHT OR OTHER INTELLECTUAL PROPERTY RIGHT.

Intel products are not intended for use in medical, life saving, life sustaining applications. Intel may make changes to specifications and product descriptions at any time, without notice.

Intel server boards, server chassis, and processors may contain design defects or errors known as errata, which may cause the product to deviate from published specifications. Current characterized errata are available on request.

Intel, Intel Xeon, Pentium, and the Intel logo are trademarks or registered trademarks of Intel Corporation or its subsidiaries in the United States and other countries.

*Other names and brands may be claimed as the property of others.

Copyright © 2014, Intel Corporation

Table of Contents:

- 1. SYSTEM PRODUCT ORDER CODES 4**
 - 1.1 PRODUCT DESCRIPTIONS – OVERVIEW 4
 - 1.2 SUMMARY TABLE 4
 - 1.3 AVAILABLE PRODUCTION BOARD ORDER CODE FOR S2600CP 4
 - 1.4 AVAILABLE PRODUCTION SYSTEM ORDER CODES FOR P4000CP4 FAMILY 7
- 2. SPARES AND ACCESSORIES ORDER CODES 9**
 - 2.1 GENERAL SPARES AND ACCESSORIES 9
 - 2.2 DRIVE/STORAGE SUBSYSTEM SPARES AND ACCESSORIES 12
 - 2.3 EXPANSION MODULES: SAS MODULE, RMM4, TPM 15

1. System Product Order Codes

1.1 Product Descriptions – Overview

The Intel® Server Boards S2600CP2 and S2600CP4 are mainstream server boards supporting up to two Intel® Xeon® E5-2600 and E5-2600 v2 processors. These boards are standard SSI EEB (12"x13") designed for the small/medium business and embedded markets. These will be offered as board-only as well as a fully integrated system in a 4U pedestal chassis. For more details, please review the tables in the subsequent sections.

The Intel® Server Chassis P4000M family is also sold separately in various configurations. For more information, please refer to the **Intel® Server Chassis P4000M Family Configuration Guide and Spares/Accessories List**.





1.2 Summary Table





For a quick overview, all configuration options described in this document are summarized in the table below. For more details such as MM numbers and product order codes, please refer to the other sections in this document.

Product Code	FF	HDD	# of HDD	Power supply	Rails	RAID	Storage Activation	Expander
P4308CP4MHEN	4U	3.5" HS	8	1x550W Fixed	None	1,0,10+	RKSATA8	No
P4308CP4MHGC	4U	3.5" HS	8	2x750W CRPS	None	1,0,10+	RKSATA8	No
P4208CP4MHGC	4U	2.5" HS	8	2x750W CRPS	None	1,0,10+	RKSAS8	No

1.3 Available Production Board Order Code for S2600CP

Image For illustration only, not to scale.	Product Code MM UPC EAN MOQ	Description
	<p>BBS2600CP2 916039 735858238816 5032037033596 10</p>	<p>Intel® Server Board S2600CP2 OEM 10-pack with Dual NIC</p> <ul style="list-style-type: none"> • Supports Dual Intel® Xeon® E5-2600 and E5-2600 v2 processors with max TDP 135W. • Intel® C600 Series Chipset • 16 DDR3/DDR3L DIMM slots • 6 PCIe slots • 8 SCU SATA/SAS ports <ul style="list-style-type: none"> ○ 4 ports functional with no storage keys and 4 ports require storage keys. • 2 SATA 6Gbps AHCI ports and 4 SATA 3Gbps AHCI ports • Intel® Dual Gigabit Ethernet with Intel® Virtualization Technology • Integrated Baseboard Management Controller with IPMI 2.0 • Option for advanced management functions with KVM (AXXRMM4LITE) and dedicated NIC for remote management (AXXRMM4) • Support for Intel® SAS and RAID modules in PCIe form factor. Modules sold separately. <p>*Does not include IO shield. IO shield (AXX2IOS) sold separately.</p>

	<p>BBS2600CP2J 921042 735858244800 5032037039376 10</p>	<p>Intel® Server Board S2600CP2 OEM 10-pack with Dual NIC</p> <ul style="list-style-type: none"> • Supports Dual Intel® Xeon® E5-2600 and E5-2600 v2 processors with max TDP 135W. • Intel® C602J Chipset • 16 DDR3/DDR3L DIMM slots • 6 PCIe slots • 2 SATA 6Gbps AHCI ports and 4 SATA 3Gbps AHCI ports (No SCU SATA/SAS ports are supported in this SKU) • Intel® Dual Gigabit Ethernet with Intel® Virtualization Technology • Integrated Baseboard Management Controller with IPMI 2.0 • Option for advanced management functions with KVM (AXXRMM4LITE) and dedicated NIC for remote management (AXXRMM4) • Support for Intel® SAS and RAID modules in PCIe form factor. Modules sold separately. <p>*Does not include IO shield. IO shield (AXX2IOS) sold separately. Note: Only available in a 10-pack and only available upon request, build to order.</p>
	<p>DBS2600CP2 916040 735858238823 5032037033602 5</p>	<p>Intel® Server Board S2600CP2 Retail Single pack with Dual NIC</p> <ul style="list-style-type: none"> • Supports Dual Intel® Xeon® E5-2600 and E5-2600 v2 processors with max TDP 135W. • Intel® C600 Series Chipset • 16 DDR3/DDR3L DIMM slots • 6 PCIe slots • 8 SCU SATA/SAS ports <ul style="list-style-type: none"> ◦ 4 ports functional with no storage keys and 4 ports require storage keys. • 2 SATA 6Gbps AHCI ports and 4 SATA 3Gbps AHCI ports • Intel® Dual Gigabit Ethernet with Intel® Virtualization Technology • Integrated Baseboard Management Controller with IPMI 2.0 • Option for advanced management functions with KVM (AXXRMM4LITE) and dedicated NIC for remote management (AXXRMM4) • Support for Intel® SAS and RAID modules in PCIe form factor. Modules sold separately. • IO shield included.
 <p>and</p>  <p>RMS25KB080</p>	<p>DBS2600CP2IOC 920971 735858244817 5032037039383 5</p>	<p>Intel® Server Board S2600CP2 Retail Single pack with Dual NIC and 6 Gbps SAS</p> <ul style="list-style-type: none"> • Supports Dual Intel® Xeon® E5-2600 and E5-2600 v2 processors with max TDP 135W. • Intel® C600 Series Chipset • 16 DDR3/DDR3L DIMM slots • 6 PCIe slots • 8 SCU SATA/SAS ports <ul style="list-style-type: none"> ◦ 4 ports functional with no storage keys and 4 ports require storage keys. • 2 SATA 6Gbps AHCI ports and 4 SATA 3Gbps AHCI ports • Intel® Dual Gigabit Ethernet with Intel® Virtualization Technology • Integrated Baseboard Management Controller with IPMI 2.0 • Option for advanced management functions with KVM (AXXRMM4LITE) and dedicated NIC for remote management (AXXRMM4) • Intel® 6Gbps 8-port SAS module, PCIe form factor included (RMS25KB080). • Includes IO shield <p>Cables for SAS module sold separately:</p> <ul style="list-style-type: none"> • If using hot-swap disk drives, 2 mini-SAS to mini-SAS cables are required. See product code AXXCBL650MSMS. • If using fixed disk drives, 2 SAS cables are required. See product code AXXCBL850MS7R.



	<p>BBS2600CP4 916042 735858238830 5032037033619 10</p>	<p>Intel® Server Board S2600CP4 OEM 10-pack with Quad NIC</p> <ul style="list-style-type: none"> • Supports Dual Intel® Xeon® E5-2600 and E5-2600 v2 processors with max TDP 135W. • Intel® C600 Series Chipset • 16 DDR3/DDR3L DIMM slots • 6 PCIe slots • 8 SCU SATA/SAS ports <ul style="list-style-type: none"> ○ 4 ports functional with no storage keys and 4 ports require storage keys. • 2 SATA 6Gbps AHCI ports and 4 SATA 3Gbps AHCI ports • Intel® Quad Gigabit Ethernet with Intel® Virtualization Technology • Integrated Baseboard Management Controller with IPMI 2.0 • Option for advanced management functions with KVM (AXXRMM4LITE) and dedicated NIC for remote management (AXXRMM4) • Support for Intel® SAS and RAID modules in PCIe form factor. <p>*Does not include IO shield. IO shield (AXX4IOS) sold separately.</p>
	<p>DBS2600CP4 916041 735858238847 5032037033626 5</p>	<p>Intel® Server Board S2600CP4 Retail Single pack with Quad NIC</p> <ul style="list-style-type: none"> • Supports Dual Intel® Xeon® E5-2600 and E5-2600 v2 processors with max TDP 135W. • Intel® C600 series chipset • 16 DDR3/DDR3L DIMM slots • 6 PCIe slots • 8 SCU SATA/SAS ports <ul style="list-style-type: none"> ○ 4 ports functional with no storage keys and 4 ports require storage keys. • 2 SATA 6Gbps AHCI ports and 4 SATA 3Gbps AHCI ports • Intel® Quad Gigabit Ethernet with Intel® Virtualization Technology • Integrated Baseboard Management Controller with IPMI 2.0 • Option for advanced management functions with KVM (AXXRMM4LITE) and dedicated NIC for remote management (AXXRMM4) • Support for Intel® SAS and RAID modules in PCIe form factor. • IO shield is included.
 <p>And</p>  <p>RMS25KB080</p>	<p>DBS2600CP4IOC 920972 735858244824 5032037039390 5</p>	<p>Intel® Server Board S2600CP4 Retail Single pack with Quad NIC and 6Gbps SAS</p> <ul style="list-style-type: none"> • Supports Dual Intel® Xeon® E5-2600 and E5-2600 v2 processors with max TDP 135W. • Intel® C600 series chipset • 16 DDR3/DDR3L DIMM slots • 6 PCIe slots • 8 SCU SATA/SAS ports <ul style="list-style-type: none"> ○ 4 ports functional with no storage keys and 4 ports require storage keys. • 2 SATA 6Gbps AHCI ports and 4 SATA 3Gbps AHCI ports • Intel® Quad Gigabit Ethernet with Intel® Virtualization Technology • 2 SATA 6G AHCI ports and 4 SATA 3G AHCI ports • Intel® Quad Gigabit Ethernet with Intel® Virtualization Technology • Integrated Baseboard Management Controller with IPMI 2.0 • Intel® 6Gbps 8-port SAS module, PCIe form factor included (RMS25KB080) • Includes IO shield <p>Cables for SAS module sold separately</p> <ul style="list-style-type: none"> • If using <u>hot-swap</u> disk drives, 2 mini-SAS to mini-SAS cables are required. See product code AXXCBL650SMS.

- If using fixed disk drives, 2 SAS cables are required. See Product code AXXCBL850MS7R.

1.4 Available Production System Order Codes for P4000CP Family

The systems described in this section are integrated at the factory. To purchase a chassis separately, please see the Intel® Server Chassis P4000 Family Configuration Guide and Spares/Accessories List document.

Intel Chassis and Systems shipped to the US & Canada will contain North American power cords. North American customers no longer need to order SKU's ending in "NA" to receive power cords on Intel products.

Image For illustration only, not to scale.	Product Code MM UPC EAN MOQ	Description
 <p>Demonstration only. See description for configuration details.</p>	P4308CP4MHEN 916067 735858238809 5032037033589 1	Integrated Intel® Server System P4308CP4MHEN S2600CP4 board in an Intel P4000 pedestal chassis, rackable* <ul style="list-style-type: none"> • Standard control panel (FXXFPANEL) • 8x3.5" Hot-swap backplane • 8x3.5" HDD carriers • Two CPU heat sinks (AUPSRCBTP) • Non-Redundant system fans • Single 550W PSU, Silver level efficiency (FUP550SNRPS) • Intel® RAID C600 Upgrade Key (RKSATA8) • Processor/Memory air-duct (FCPUPMAD) • No Power Distribution Board needed. • Bezel supporting Hot Swap drives (FUPBEZELHSD) • IO shield (AXX4IOS) • 480mm 7-pin SATA (board) to Mini-SAS (backplane) cable • 630mm 24-pin power extension cable • Quick User Guide *Rails are not included
 <p>Demonstration only. See description for configuration details.</p>	P4308CP4MHGC 918994 735858238755 5032037033534 1	Integrated Intel® Server System P4308CP4MHGC S2600CP4 board in an Intel P4000 pedestal chassis, rackable* <ul style="list-style-type: none"> • Standard control panel (FXXFPANEL) • 8x3.5" Hot-swap backplane • 8x3.5" HDD carriers • Two CPU heat sinks (AUPSRCBTP) • Redundant system fans • Two 750W CRPS PSU, Platinum level efficiency (FXX750PCRPS) • Intel® RAID C600 Upgrade Key (RKSATA8) • Processor/Memory airduct (FCPUPMAD) • Power Distribution Board (High Current) • Bezel supporting Hot Swap drives • IO shield (AXX4IOS) • 480mm 7-pin SATA (board) to Mini-SAS (backplane) cable • 630mm 24-pin power extension cable • Quick User Guide *Rails are not included



Demonstration only.
See description for
configuration details.

P4208CP4MHGC
918995
735858238779
5032037033558
1

Integrated Intel® Server System P4208CP4MHGC







S2600CP4 board in Intel P4000 pedestal chassis, rackable*

- Standard control panel (FXXFPANEL)
- 8x2.5" Hot-swap backplane
- 8x2.5" HDD carriers
- Two CPU heat sinks (AUPSRCBTP)
- Redundant system fans
- Two 750W CRPS PSU, Platinum level efficiency (FXX750PCRPS)
- Intel® RAID C600 Upgrade Key (RKSAS8)
- Processor/Memory airduct (FCPUPMAD)
- Power Distribution Board (High Current)
- Bezel supporting Hot Swap drives
- IO shield (AXX4IOS)
- 480mm 7-pin SATA (board) to Mini-SAS (backplane) cable
- 630mm 24-pin power extension cable
- 100mm 1x4 to 2x2 power adapter cable
- Quick User Guide

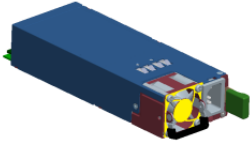
*Rails are not included



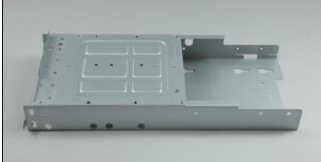

2. Spares and Accessories Order Codes

2.1 General Spares and Accessories

Image (For illustration only, not to scale.)	Product Code MM UPC EAN MOQ	Description
	FXX460GCRPS 915603 735858235846 5032037030595 1	460W Common Redundant Power Supply (CRPS) 80Plus Gold efficiency power supply accessory.
	FUP550SNRPS 915602 735858235839 5032037030588 1	550W Fixed 80Plus Silver efficiency power supply spare.
	FXX750PCRPS 915604 00735858234979 5032037030601 1	750W Common Redundant Power Supply (CRPS) spare 80Plus Platinum efficiency.
	FXX1200PCRPS 915605 735858225137 5032037035071 1	1200W Common Redundant Power Supply spare 80Plus Platinum efficiency.
Image not yet available	FUPNRPSADP 912769 735858219471 5032037016278 1	P4000 Non-Redundant Power Supply adaptor kit Includes; bracket, screws, locker
	FUPCRPSCAGE 915607 00735858235891 5032037030656 1	Common Pedestal CRPS PSU cage assembly (cage, adaptor bracket, screws, supporting bulkhead, 1x blank filler)
	FUPPDBLC 916812 735858238731 5032037033510 1	Power Distribution Board Spare (Low Current) for P4000 server chassis. Recommend to use with FXX460GCRPS or FXX750PCRPS power supplies.
	FUPPDBHC 916813 735858238748 5032037033527 1	Power Distribution Board Spare (High Current) for P4000 server chassis. Recommend to use with FXX750PCRPS, FXX1200PCRPS, or FXX1600PCRPS power supplies.

	<p>AUPSRCBTP 915293 735858238724 5032037033497 2</p>	<p>Spare/Accessory SRC-B tower passive heat sinks, 98mmx100mm. 2 are required with Intel® Server Board S2600CP in P4000 chassis if two processors are installed.</p>
	<p>BXSTS200P 915972</p>	<p>Intel Boxed Thermal Solutions, passive 25.5mm heat sink supports E5-2600 processors. For use with non-Intel chassis.</p>
	<p>BXSTS200C 915970</p>	<p>Intel Boxed Thermal Solutions, heat sink combo with removable fan supports E5-2600 processors. For use with non-Intel chassis.</p>
	<p>FUPMLHSFAN 915620 00735858235969 5032037030724 1</p>	<p>80mm system fan kit for P4000M/P4000L server chassis includes fan, fan holder, for use in redundant cooling configuration</p>
	<p>FUPNHFANCPU 919572 00735858236034 5032037030793 1</p>	<p>Fixed Fan Spare Kit for P4000M (24") for CPU area fan. Includes: (1) 120mm fixed fan</p>
	<p>FUPMNHFANPCI 919575 735858236041 5032037030809 1</p>	<p>Fixed Fan spare kit for P4000M (24") for PCI area fan. Includes: (1) 120mm fixed fan</p>
 <p>AND</p> 	<p>FCPUPMAD 915623 00735858225267 5032037030823 1</p>	<p>Air duct and unique cable kit for Intel® Server Board S2600CP to be used Intel® Server Chassis P4000M</p> <p>Includes: SATA Cable Mini-SAS to SATA Cable SGPIO Cable 24pin Power Extend Cable</p> <p>Note: Common cables are remained in P4000M chassis package</p>

	<p>AXXELVRAIL 920970 00735858244367 5032037038980 1</p>	<p>Value Rail Kit, half extension, extended inner slide member</p> <p>Works for 438mm wide Intel 2U/4U Rack Chassis and System families (H2000, R2000LH/R2000LT Swan Peak 2U, P4000M/P4000L/P4000L-WS)</p>
	<p>AXX3U5UPRAIL 915634 00735858236119 5032037030892 1</p>	<p>Advanced rail kit for P4000 Server Chassis used when converting Pedestal chassis to 4U rack chassis, and full extension rails are needed.</p> <p>Includes: (2) rails</p>
	<p>AXX3U5UCMA 915635 00735858236126 5032037030908 1</p>	<p>Rack Cable Management for use with Advanced Rail Kit AXX3U5UPRAIL for Intel® Server Chassis P4000 Family.</p>
	<p>FUPBEZELFIX 911886 00735858219457 5032037016254 1</p>	<p>Bezel spare for P4000 server chassis with fixed drives (no door)</p>
	<p>FUPBEZELHSD 911896 00735858219464 5032037016261 1</p>	<p>Bezel spare for P4000 server chassis with Hot Swap HDDs (w/door for HS bays) Fits P4304, P4308, P4208, and P4216 with HS drive bays installed.</p>
	<p>AUPBEZEL4UF 915636 00735858235976 5032037030731 1</p>	<p>Rack bezel kit for converting P4000 pedestal server chassis to rack chassis</p> <p>Includes: (1) bezel frame; (2) rack handles</p>
	<p>AUPBEZEL4UD 915637 00735858235983 5032037030748 1</p>	<p>Rack bezel accessory for P4000 chassis in rack configuration - security door only</p>
	<p>FXXFPANEL 915982 00735858222419 5032037018968 1</p>	<p>Front Panel board spare for P4000 server chassis</p>

	A4ULCP 921029 00735858244695 5032037039260 1	LCP Module (local control panel) Enables system to display critical errors from SEL for instant diagnostic. Also allows custom message for branding.
Image not yet available	AXX2IOS 919757 735858239264 5032037034036 50	I/O Shield spare/accessory for Intel® Server Board S2600CP2
	AXX4IOS 919758 735858238939 5032037033718 50	I/O Shield spare/accessory for Intel® Server Board S2600CP4
	AUPMGPUBR 920613 00735858244428 5032037039048 1	Bracket for securing full length GPU cards to fan bulkhead, for use in P4000M, includes 1 bracket, 2 GPGPU power cables, and 5 screws for GPGPU fixture.
Image not yet available	FUPMMSK 915638 735858235990 5032037030755 1	Chassis Maintenance kit for UPM – (Mechanical Spares Kit) Including EMI cover, ODD rail, PCI card retainer {4x 3.5" EMI cover, 8x 3.5" EMI cover, ODD rail x4, #6-32 screw x20, M3x12 USB cable screw x2, M2x10 Intrusion cable
	FUPMESK 915653 735858236003 5032037030762 1	Chassis Maintenance kit for UPM – (Electric Spares Kit) Including power cable extension, 1x4 -> 2x2 power adaptor cable accessory (for 2.5" HDD connector)
	FPWRCABLENA 879287 00735858181129 1	North American Power Cord Spare

2.2 Drive/storage subsystem spares and accessories

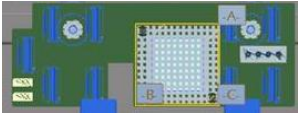
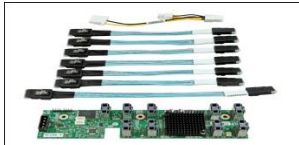



Image For illustration only, not to scale.	Product Code MM UPC EAN MOQ	Description
	FUP8X35HSBP 916353 735858222792 5032037033480 1	Spare 8x3.5" Hot Swap Backplane for use with P4000 server chassis Includes: (1) 8x3.5" backplane board

	<p>FXX8X25HSBP 917973 735858240987 5032037035736 1</p>	<p>8x2.5" hot swap HSBP spare (for R2200, and P4200 Chassis families)</p>
	<p>FXX8X25DPBP 917974 735858240994 5032037035743 1</p>	<p>Spare 8x2.5" Dual Port Hot Swap Backplane for use with P4200 chassis.</p>
	<p>FUP4X35HSDK 911885 00735858219440 5032037016230 1</p>	<p>3.5" Hot Swap Drive Kit for P4000 server chassis Includes: Drive Cage, Hot Swap Back Plane, 4 Hot Swap Drive carriers, data cables, I²C cable, and ID filler</p>
	<p>FUP8X35HSDK 915608 00735858235907 5032037030663 1</p>	<p>8x3.5" Hot Swap Drive Cage Kit for P4000 server chassis Includes: Drive Cage, Hot Swap Back Plane, 8 Hot Swap Drive Carriers, data cables, I²C cable, and ID filler panel</p>
	<p>FUP8X25HSDKS 915819 00735858235914 5032037030670 1</p>	<p>8x2.5 Hot Swap Drive Cage Kit for P4000 server chassis Includes: Drive cage, Hot Swap Back Plane, 8 Hot Swap Drive carriers, data cables, I²C cable, ID filler panels, and power adaptor cable accessory</p>
	<p>FXX35HSADPB 912771 00735858219495 5032037016391 8</p>	<p>3.5" HDD Hot Swap Drive Carrier spares for P4300 chassis families</p>
	<p>FXX25HSCAR 918807 00735858241182 5032037035910 1</p>	<p>2.5" HDD Hot Swap Drive Carrier spares for P4200 chassis families</p>
	<p>FUP4X35NHDK 912770 00735858219488 5032037016247 4</p>	<p>Fixed Drive Carrier spare for P4300 server chassis (compatible with 2.5" HDDs/SSDs)</p>



	RKSATA4R5 916346 735858238861 5032037033640 5	4port SATA SW LSI RAID 5 Key, Black
	RKSATA8 916347 735858238878 5032037033657 5	8port SATA Key, Blue
	RKSATA8R5 916348 735858238885 5032037033664 5	8port SATA with LSI SW RAID 5 Key, White
	RKSAS4 916349 735858238892 5032037033671 5	4port SAS Key, Green
	RKSAS4R5 916350 735858238908 5032037033688 5	4port SAS with LSI SW RAID 5 Key, Yellow
	RKSAS8 916351 735858238922 5032037033701 5	8port SAS Key, Orange
	RKSAS8R5 916352 735858238915 5032037033695 5	8port SAS with LSI SW RAID 5 Key, Purple

2.3 Expansion modules: SAS Module, RMM4, TPM

Image For illustration only, not to scale.	Product Code MM UPC EAN MOQ	Description
	RES2CV240 918934 735858241175 5032037035903 1	Integrated 24-port 6Gbps SAS expander, compatible with R2200 family and P4000M/P4000L of chassis (only supported in 2.5" drive 2U or 4U chassis) Includes 3 screws and bumpers, 4 cables and power cable.
	RES2CV360 918935 735858241168 5032037035897 1	Integrated 36-port 6Gbps SAS expander, compatible with R2200 family and P4000M/P4000L family of chassis (only supported in 2.5" drive 2U or 4U chassis) Includes 3 screws and bumpers, 6 Mini-SAS cables and power cable.
	AXXRMM4LITE 911660 00735858219297 5032037014946 1	Intel® Remote Management Module RMM4LITE - Activation key for advanced management features including remote KVM.
	AXXRMM4 911670 00735858219303 5032037014922 1	Intel® Remote Management Module RMM4 – Activation key for advanced management features including remote KVM <u>plus</u> Dedicated NIC Module.
	AXXTPE5 919737 735858240352 5032037035088 1	Trusted Platform Module for server systems
	RMS25KB080 924454 735858239028 5032037033800 5	Intel® Integrated RAID Module RMS25KB080, PCIe Slot, LSI2308 I/O Controller, 8P Internal SAS, LSI IR-based RAID 0,1,1E Requires PCIe x8 slot If using hot-swap disk drives, 2 mini-SAS to mini-SAS cables are required. See product code AXXCBL650MSMS. If using fixed disk drives, 2 SAS cables are required. See Product code AXXCBL850MS7R.







	<p>RMS25KB040 924455 735858239035 5032037033817 5</p>	<p>Intel® Integrated RAID Module RMS25KB040, PCIe Slot, LSI2308 I/O Controller, 4P SAS, LSI IR-based RAID 0,1,1E</p> <p>Requires PCIe8 slot</p> <p>If using hot-swap disk drives, 2 mini-SAS to mini-SAS cables are required. See product code AXXCBL650MSMS.</p> <p>If using fixed disk drives, 2 SAS cables are required. See Product code AXXCBL850MS7R.</p>
	<p>RMS25PB080 924868 735858238946 5032037033725 5</p>	<p>Intel® Integrated RAID Module RMS25PB080, PCIe Slot, LSI2208 ROC, 8P Internal SAS/SATA, LSI MegaRAID-based Firmware, 1GB DDR3, RAID 0,1,10,5,50,6,60</p> <p>Requires PCIe8 slot</p> <p>If using hot-swap disk drives, 2 mini-SAS to mini-SAS cables are required. See product code AXXCBL650MSMS.</p> <p>If using fixed disk drives, 2 SAS cables are required. See Product code AXXCBL850MS7R.</p>
	<p>RMS25PB040 924869 735858238953 5032037033732 5</p>	<p>Intel® Integrated RAID Module RMS25PB040, PCIe Slot, LSI2208 ROC, 4P Internal SAS/SATA, LSI MegaRAID-based Firmware, 1GB DDR3, RAID 0,1,10,5,50,6,60</p> <p>Requires PCIe8 slot</p> <p>If using hot-swap disk drives, 2 mini-SAS to mini-SAS cables are required. See product code AXXCBL650MSMS.</p> <p>If using fixed disk drives, 2 SAS cables are required. See Product code AXXCBL850MS7R.</p>
	<p>RMT3PB080 924870 735858238960 5032037033749 5</p>	<p>Intel® Integrated RAID Module RMT3PB080, PCIe Slot, LSI2208 ROC, 8P Internal SATA (only), LSI MegaRAID-based Firmware, 512MB DDR3, Restricted to use only SATA drives, R0,1,10,5,50,6,60</p> <p>Requires PCIe8 slot</p> <p>If using hot-swap disk drives, 2 mini-SAS to mini-SAS cables are required. See product code AXXCBL650MSMS.</p> <p>If using fixed disk drives, 2 SAS cables are required. See Product code AXXCBL850MS7R.</p>

Image not yet available	<p>AXXRMFBU2 919876 735858244541 5032037039116 5</p>	Intel® RAID Maintenance Free Backup Unit
	<p>AXXRSBBU9 914238 735858220286 5032037039567 5</p>	Intel® RAID Smart Battery AXXRSBBU9 provides optional battery backup for mainstream RS25, RMS25, RT3 and RMT3 family RAID products.
Image not yet available	<p>AXXCBL650MSMS 918376 735858224444 5032037019910</p>	Mini-SAS to Mini-SAS cable (650MM) Kit of 2 cables, 650mm length, straight SFF-8087 to SFF-8087 connectors. Cable to be ordered for use with the S2600CP board, the P4000M chassis, <u>hot-swap</u> disk drives, and any of the Intel® Integrated RAID Modules listed above. 2 cables required.
Image not yet available	<p>AXXCBL850MS7R 921114 735858245371 5032037039895</p>	Mini-SAS to 7-Pin cable (850MM) Kit of 2 cables, 850mm length, straight SFF-8087 to right angle 7-pin SATA connectors. Cable to be ordered for use with the S2600CP board, the P4000M chassis, <u>fixed</u> disk drives, and any of the Intel® Integrated RAID Modules listed above. 2 cables required.
	<p>SVCEWDPSY 911295 1</p>	Two year extended warranty for Intel® Server Systems or Intel® Server Knock Down Kits + Intel® Server Boards that support two processors. Intel® RAID controller extended warranty is purchased separately.
	<p>SVCEWDPBD 911294 1</p>	Two year extended warranty for Intel® Server Boards that support two processors.