

Options for ABB drives, converters and inverters

User's manual

FENA-01/11/21 Ethernet adapter module

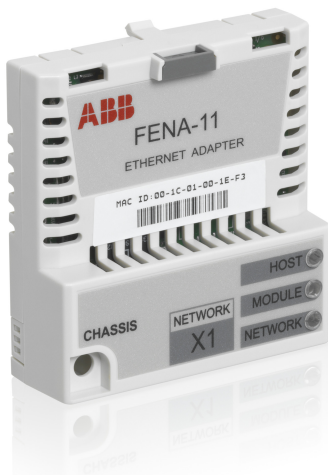

Power and productivity
for a better world™



List of related manuals

Drive manuals and guides

Code (EN/Multilingual)

<i>ACS355 drives (0.37...22 kW, 0.5...30 hp) user's manual</i>	3AUA0000066143
<i>ACS580-01 manuals</i>	9AKK105713A8085
<i>ACSM1 manuals</i>	00578051
<i>ACS850-04 manuals</i>	00592009
<i>ACQ810 manuals</i>	00598718
<i>ACS880-01 manuals</i>	9AKK105408A7004
<i>ACS880-04 manuals</i>	9AKK105713A4819
<i>ACS880-07 manuals</i>	9AKK105408A8149

Option manuals and guides

<i>FENA-01/-11/-21 Ethernet adapter module user's manual</i>	3AUA0000093568
--	--------------------------------

You can find manuals and other product documents in PDF format on the Internet. See section [Document library on the Internet](#) on the inside of the back cover. For manuals not available in the Document library, contact your local ABB representative.

User's manual

FENA-01/-11/-21 Ethernet adapter module

Table of contents



1. Safety instructions



4. Mechanical installation



5. Electrical installation



Modbus/TCP protocol

M

EtherNet/IP protocol

E

PROFINET IO protocol

P

Table of contents

List of related manuals	2
-----------------------------------	---

1. Safety instructions

Contents of this chapter	17
Use of warnings	18
Safety in installation	19

2. Introduction to the manual

Contents of this chapter	21
Applicability	21
Compatibility	21
Drives	21
Protocols	22
Tools	23
Cyber Security Disclaimer	23
Target audience	23
Purpose of the manual	24
Contents	24
Terms and abbreviations	26
General terms and abbreviations	26
Modbus/TCP terms and abbreviations	27
EtherNet/IP terms and abbreviations	27
PROFINET IO terms and abbreviations	28

3. Overview of the Ethernet network and the FENA-01/-11/-21 module

Contents of this chapter	33
Ethernet network	33
Example topology of the Ethernet link	34
FENA-01/-11/-21 Ethernet adapter module	35
Layout of the adapter module	36



4. Mechanical installation

Contents of this chapter	39
Necessary tools and instructions	39
Unpacking and examining the delivery	39
Installing the adapter module	40

5. Electrical installation

Contents of this chapter	43
Warnings	43
Necessary tools and instructions	43
General cabling instructions	44
Connecting the adapter module to the Ethernet network	44
Connection procedure	45

Modbus/TCP protocol

6. Modbus/TCP – Start-up

Contents of this chapter	49
Warnings	49
Drive configuration	50
Modbus/TCP connection configuration	50
FENA-01/-11/-21 configuration parameters – group A (group 1)	51
FENA-01/-11/-21 configuration parameters – group B (group 2)	62
FENA-01/-11/-21 configuration parameters – group C (group 3)	63
Control locations	64
Starting up fieldbus communication for ACS355 drives	65
Parameter setting examples – ACS355	66
Speed and torque control using the ABB Drives – Enhanced communication profile	66
Starting up fieldbus communication for ACSM1 drives	69
Parameter setting examples – ACSM1	70
Speed and torque control using the ABB Drives – Enhanced communication profile	70

Starting up fieldbus communication for ACS850 and ACQ810 drives	74
Parameter setting examples – ACS850 and ACQ810	75
Speed control using the ABB Drives – Enhanced communication profile	75
Starting up fieldbus communication for ACS880 and ACS580 drives	78
Parameter setting examples – ACS880	80
Speed control using the ABB Drives – Enhanced communication profile	80
Parameter setting examples – ACS580	83
Frequency control using the ABB Drives – Enhanced communication profile	83
Client configuration	86
Modbus register maps	86



7. Modbus/TCP – Communication profiles

Contents of this chapter	87
Communication profiles	87
ABB Drives communication profile	89
Control word and Status word	89
Control word contents	89
Status word contents	91
State machine	93
References	94
Scaling	94
Actual values	95
Scaling	95

8. Modbus/TCP – Communication protocol

Contents of this chapter	97
Modbus/TCP	97
Register addressing	98
Function codes	98
Encapsulated Interface Transport / Read Device Identification ..	99
Exception codes	100

Communication profiles	100
ABB Drives profile - Classic	101
ABB Drives profile - Enhanced	102
Transparent 16-bit	104
Transparent 32-bit	106

9. Modbus/TCP – Diagnostics

Contents of this chapter	109
Fault and warning messages	109
LEDs	110
Internal error code registers	112

EtherNet/IP protocol

10. EtherNet/IP – Start-up

 Contents of this chapter	117
Warnings	117
Drive configuration	118
EtherNet/IP connection configuration	118
FENA-01/-11/-21 configuration parameters – group A (group 1)	119
FENA-01/-11/-21 configuration parameters – group B (group 2)	132
FENA-01/-11/-21 configuration parameters – group C (group 3)	133
Control locations	134
Starting up fieldbus communication for ACS355 drives	135
Parameter setting examples – ACS355	136
Speed control using the ODVA AC/DC drive profile, Extended speed control assembly	136
Starting up fieldbus communication for ACSM1 drives	139
Parameter setting examples – ACSM1	140
Speed control using the ODVA AC/DC drive profile, Extended speed control assembly	140
Starting up fieldbus communication for ACS850 and ACQ810 drives	143
Parameter setting examples – ACS850 and ACQ810	144

Speed control using the ODVA AC/DC drive profile, Extended speed control assembly	144
Starting up fieldbus communication for ACS880 and ACS580 drives	147
Parameter setting examples – ACS880 and ACS580	148
Speed control using the ODVA AC/DC drive profile, Extended speed control assembly	148
Configuring the client	151
Before you start	151
Select protocol/profile.	151
Select output and input assembly instances	151
Select connection method	153
EDS files	154
Configuring an Allen-Bradley® PLC	155
Example 1: RSLogix 5000	155
Example 2: Studio 5000	161
Configuring DLR topology for FENA-21	168
Setup using Logix Designer	168
Setup using RSLinx® Classic	170

11. EtherNet/IP – Communication profiles

Contents of this chapter	173
Communication profiles	173
ODVA AC/DC drive profile	175
ODVA output attributes	176
Run Forward & Run Reverse (Control supervisor object) . 176	
Fault Reset (Control supervisor object)	176
Net Ctrl (Control supervisor object)	176
Net Ref (AC/DC drive object)	176
Speed Reference (AC/DC drive object)	177
Torque Reference (AC/DC drive object)	179
ODVA input attributes	180
Faulted (Control supervisor object)	180
Warning (Control supervisor object)	180
Running Forward (Control supervisor object)	180



Running Reverse (Control supervisor object)	180
Ready (Control supervisor object)	180
Ctrl From Net (Control supervisor object)	180
Ref From Net (AC/DC drive object)	180
At Reference (AC/DC drive object)	181
State (Control supervisor object)	181
Speed Actual (AC/DC drive object)	183
Torque Actual (AC/DC drive object)	185
ABB Drives communication profile	186
Control word and Status word	186
Control word contents	186
Status word contents	189
State machine	191
References	192
Scaling	192
Actual values	193
Scaling	193

12. EtherNet/IP – Communication protocol

Contents of this chapter	195
EtherNet/IP	195
Object modeling and functional profiles	196
Assembly objects	196
Basic speed control assembly	196
Basic speed control plus drive parameters assembly	197
Extended speed control assembly	199
Extended speed control plus drive parameters assembly	200
Basic speed and torque control assembly	203
Basic speed and torque control plus drive parameters assembly	204
Extended speed and torque control assembly	206
Extended speed and torque control plus drive parameters assembly	207
ABB Drives profile with set speed assembly	210
ABB Drives profile with set speed plus drive parameters assembly	211

ABB Drives profile with set speed and set torque assembly	213
ABB Drives profile with set speed and set torque plus drive parameters assembly	214
Transparent 16 with one assembly	217
Transparent 16 with one assembly plus drive parameters	218
Transparent 16 with two assembly	220
Transparent 16 with two assembly plus drive parameters	221
Transparent 32 with one assembly	223
Transparent 32 with one assembly plus drive parameters	224
Transparent 32 with two assembly	227
Transparent 32 with two assembly plus drive parameters	228
Class objects	231
Identity object, class 01h	232
Class attributes (Instance #0)	232
Instance attributes (Instance #1)	232
Reset service (Service code 05h)	233
Attribute explanations.	233
Motor data object, class 28h	236
Class attributes (Instance #0)	236
Instance attributes (Instance #1)	236
Control supervisor object, class 29h	237
Class attributes (Instance #0)	237
Instance attributes (Instance #1)	238
AC/DC-drive object, class 2Ah	239
Class attributes (Instance #0)	239
Instance attributes (Instance #1)	240
Drive parameter object, class 90h	241
Fieldbus configuration object, class 91h	242
Class attributes	242
Instance #1: FENA-01/-11/-21 configuration parameters group A (group 1)	242
Instance #2: FENA-01/-11/-21 configuration parameters group B (group 2)	246
Instance #3: FENA-01/-11/-21 configuration parameters group C (group 3)	248



TCP/IP interface object, class F5h	250
Class attributes (Instance #0)	250
Attribute explanations	252
Ethernet link object, class F6h	254
Class attributes (Instance #0)	254
Instance attributes (Instance #1)	254
Connection object, class 05h	254
Class attributes	255
Instance attributes	255
Acknowledge handler object, class 2Bh	258
Class attributes (Instance #0)	258
Instance attributes (Instance #1)	258

13. EtherNet/IP – Diagnostics

 Contents of this chapter	259
Fault and warning messages	259
LEDs	260

PROFINET IO protocol

14. PROFINET IO – Start-up

Contents of this chapter	265
Warnings	265
Drive configuration	266
PROFINET IO connection configuration	266
FENA-01/-11/-21 configuration parameters – group A (group 1)	267
FENA-01/-11/-21 configuration parameters – group B (group 2)	278
FENA-01/-11/-21 configuration parameters – group C (group 3)	280
Virtual address area allocation with ACSM1	281
Control locations	282
Starting up fieldbus communication for ACS355 drives	283
Parameter setting examples – ACS355	284
Speed control using the PROFIdrive communication profile with PPO Type 4	284

Speed and torque control using the ABB Drives communication profile with PPO Type 4	286
Starting up fieldbus communication for ACSM1 drives	289
Parameter setting examples – ACSM1	290
Speed control using the PROFIdrive communication profile with PPO Type 4	290
Position control using the PROFIdrive communication profile with PPO Type 4	292
Speed and torque control using the ABB Drives communication profile with PPO Type 4	296
Starting up fieldbus communication for ACS850 and ACQ810 drives	299
Parameter setting examples – ACS850 and ACQ810	300
Speed control using the PROFIdrive communication profile with PPO Type 4	300
Starting up fieldbus communication for ACS880 and ACS580 drives	303
Parameter setting examples – ACS880	304
Speed control using PROFIdrive communication profile with PPO Type 4	304
Parameter setting examples – ACS580	306
Frequency control using PROFIdrive communication profile with PPO Type 4	306
Configuring the master station	309
Downloading the GSD file	309
Configuring an ABB AC500 PLC	309
Configuring a Siemens SIMATIC S7 PLC	315
Resetting PROFINET IO device to factory default via S7 .	324

15. PROFINET IO – Communication profiles

Contents of this chapter	327
Communication profiles	327
PROFIdrive communication profile	329
Control word and Status word	329
Control word contents	329
Status word contents	332

State machine for all operating modes	335
State machine for the positioning mode	336
References	337
References in speed control mode	337
References in positioning mode (ACSM1 only)	337
Actual values	338
Actual values in speed control mode	338
Actual values in positioning mode (ACSM1 only).	338
ABB Drives communication profile	339
Control word and Status word	339
Control word contents.	339
Status word contents	341
State machine.	343
References	344
Scaling	344
Actual values	345
Scaling	345

16. PROFINET IO – Communication protocol

Contents of this chapter	347
PROFINET IO	347
PROFINET network settings	349
PROFINET IO in FENA	350
Cyclic message types	352
PPO types	352
Standard telegram (ST) types (DP-V1)	353
Parameter handling using acyclic parameter access mechanism (DP-V1)	353
Header and frame structures	354
ErrorCode1.	355
DP-V1 read/write request sequence	356
Read and write blocks	357
Data block.	358
Function blocks for sending DP-V1 messages (Siemens S7)	364
Parameter data transfer examples	365

Example 1a: Reading a drive parameter (array element)	365
Example 1b: Reading 3 drive parameters (multi-parameter)	367
Example 2a: Writing a drive parameter (one array element)	369
Example 2b: Writing 2 drive parameters (multi-parameter)	371
Example 3: Reading a PROFIdrive parameter.	373
Example 4: Configuring the process data written to the drive	374
Example 5: Determining the source of the process data read from the drive	376
Diagnostic and alarm mechanism	377
Alarm mechanism	378
Fault code mapping	378
Fault buffer mechanism	380



17. PROFINET IO – Diagnostics

Contents of this chapter	383
Fault and warning messages	383
LEDs	384

18. Technical data

Contents of this chapter	387
FENA-01/-11/-21	387
Ethernet link	388

19. Appendix A – PROFIdrive parameters and I&M records of PROFINET IO

Contents of this chapter	389
PROFIdrive parameters	390
I&M records	397
Call-REQ-PDU telegram for read/write access to I&M records	397
Response structure for I&M0 (Read-only)	398

Response structure for I&M1 (Read/Write)	398
Response structure for I&M2 (Read/Write)	399
Response structure for I&M3 (Read/Write)	399
Response structure for I&M4 (Read/Write)	399

20. Appendix B – ABB IP configuration tool for FENA

Contents of this chapter	401
Installation	401
Finding adapter modules in the network	402
Rewriting the IP configuration of adapter modules	403

21. Appendix C – FENA configuration web pages

Contents of this chapter	405
Browser requirements	405
Compatibility	405
Logging in	406
Menu overview	408
Status page	409
Configuration page	410
Changing the PROFINET IO station name via web page	412
Service configuration page	414
Support page	416
Password page	417
Reset FENA web page password to default	418
Enable web page access after it was disabled	419

Further information

Product and service inquiries	421
Product training	421
Providing feedback on ABB Drives manuals	421
Document library on the Internet	421



1

Safety instructions

Contents of this chapter

The chapter contains the warning symbols used in this manual and the safety instructions which you must obey when you install or connect an optional module to a drive, converter or inverter. If you ignore the safety instructions, injury, death or damage can occur. Read this chapter before you start the installation.



Use of warnings

Warnings tell you about conditions which can cause injury or death, or damage to the equipment. They also tell you how to prevent the danger. The manual uses these warning symbols:



Electricity warning tells you about hazards from electricity which can cause injury or death, or damage to the equipment.



General warning tells you about conditions, other than those caused by electricity, which can cause injury or death, or damage to the equipment.



Safety in installation

These instructions are for all who install or connect an optional module to a drive, converter or inverter and need to open its front cover or door to do the work.



WARNING! Obey these instructions. If you ignore them, injury or death, or damage to the equipment can occur.

- If you are not a qualified electrician, do not do installation or maintenance work.
- Disconnect the drive, converter or inverter from all possible power sources. After you have disconnected the drive, converter or inverter, always wait for 5 minutes to let the intermediate circuit capacitors discharge before you continue.
- Disconnect all dangerous voltages connected to other control signal connectors in reach. For example, it is possible that 230 V AC is connected from outside to a relay output of the drive, converter or inverter.
- Always use a multimeter to make sure that there are no parts under voltage in reach. The impedance of the multimeter must be at least 1 Mohm.





2

Introduction to the manual

Contents of this chapter

This chapter introduces this manual.

Applicability

This manual applies to the FENA-01/-11/-21 Ethernet adapter module, software version 3.10 and later.

Compatibility

The FENA-01/-11/-21 Ethernet adapter module is compatible with different ABB drives and solar inverters.

Note: Later in this manual, the term drive is used to refer converters and inverters as well.

■ Drives

This table shows the compatibility of the FENA adapter module with the different ABB drives.

	ACS355	ACSM1	ACS850	ACQ810	ACS880	ACS580
FENA-01	x					
FENA-11	x	x	x	x	x	x
FENA-21	x	x	x	x	x	x

■ Protocols

The FENA adapter module is compatible with Ethernet standards IEEE 802.3 and IEEE 802.3u.

This table shows the protocols supported by the FENA adapter module from SW version 0.290 onwards.

	Modbus/TCP¹⁾	EtherNet/IP™	PROFINET IO
FENA-01	x	x	x
FENA-11	x	x	x
FENA-21	x	x	x

¹⁾ In addition to Modbus/TCP, FENA-01/-11/-21 supports Modbus over UDP.

This table specifies the clients/masters that are compatible with the supported protocols.

Protocol	Compatible client/master
Modbus/TCP ¹⁾	All Modbus/TCP clients that support: <ul style="list-style-type: none"> • Modbus Application Protocol Specification v1.1b • Modbus Messaging on TCP/IP Implementation Guide v1.0b
EtherNet/IP	All EtherNet/IP clients that support: <ul style="list-style-type: none"> • The CIP Networks Library, Volume 1, Common Industrial Protocol (CIP), Edition 3.0 May, 2006 • The CIP Networks Library, Volume 2, EtherNet/IP Adaptation of CIP, Edition 1.2 May, 2006 • Recommended Functionality for EtherNet/IP Devices Version 1.2, Feb., 2006
PROFINET IO	All PROFINET IO masters that support: <ul style="list-style-type: none"> • GSDML file version 2.31 • PROFINET IO protocol according IEC standards 61158 and 61784 • PROFINET-IO conformance class B

■ Tools

The FENA-11/-21 adapter module can be used in the Ethernet tool network for ACS880. The Ethernet tool network enables commissioning and monitoring several single drives, or inverter and supply units of a multidrive from a single location by using the Drive composer pro PC tool.

Note: When the FENA-11/-21 adapter module is used only in the Ethernet tool network, the recommended setting for parameters 50.21 FBA A timelevel sel and 50.51 FBA B timelevel sel is *Slow or Monitoring*.

For more information on the Ethernet tool network, see:

- *Ethernet tool network for ACS880 drives application guide* (3AUA0000125635) [English]
- *Drive composer user's manual* (3AUA0000094606 [English]).

■ Cyber Security Disclaimer

This product is designed to be connected to and to communicate information and data via a network interface. It is Customer's sole responsibility to provide and continuously ensure a secure connection between the product and Customer network or any other network (as the case may be). Customer shall establish and maintain any appropriate measures (such as but not limited to the installation of firewalls, application of authentication measures, encryption of data, installation of anti-virus programs, etc.) to protect the product, the network, its system and the interface against any kind of security breaches, unauthorized access, interference, intrusion, leakage and/or theft of data or information. ABB and its affiliates are not liable for damages and/or losses related to such security breaches, any unauthorized access, interference, intrusion, leakage and/or theft of data or information.

Target audience

This manual is intended for people who plan the installation, install, start up, use and service the adapter module. Before you do work on the module, read this manual and the applicable drive manual that contains the hardware and safety instructions for the product in question.

You are expected to know the fundamentals of electricity, wiring, electrical components and electrical schematic symbols.

The manual is written for readers worldwide. Both SI and imperial units are shown.

Purpose of the manual

The manual provides information on installing, commissioning and using the FENA-01/-11/-21 Ethernet adapter module.

Contents

The manual consists of the following chapters:

- [*Safety instructions*](#) gives the safety instructions which you must obey when you install a fieldbus adapter module.
 - [*Overview of the Ethernet network and the FENA-01/-11/-21 module*](#) contains a short description of the Ethernet network and the adapter module.
 - [*Mechanical installation*](#) contains a delivery checklist and instructions on installing the adapter module.
 - [*Electrical installation*](#) contains instructions on cabling and connecting the adapter module to the Ethernet network.
 - [*Technical data*](#) contains the technical data of the adapter module and the Ethernet link.
 - [*Appendix A – PROFIdrive parameters and I&M records of PROFINET IO*](#) contains the PROFIdrive profile parameters and telegram and response structures for the I&M records of the PROFINET IO protocol.
 - [*Appendix B – ABB IP configuration tool for FENA*](#) shows how to use the APP IP configuration tool for FENA.
 - [*Appendix C – FENA configuration web pages*](#) presents the FENA configuration web pages.
-

Modbus/TCP protocol

- [Modbus/TCP – Start-up](#) presents the steps to take during the start-up of the drive with the adapter module and gives information on configuring the Modbus/TCP client.
- [Modbus/TCP – Communication profiles](#) describes the communication profiles used in the communication between the client, the adapter module and the drive.
- [Modbus/TCP – Communication protocol](#) describes the Modbus/TCP communication protocol for the adapter module.
- [Modbus/TCP – Diagnostics](#) explains how to trace faults with the status LEDs on the adapter module.

EtherNet/IP protocol

- [EtherNet/IP – Start-up](#) presents the steps to take during the start-up of the drive with the adapter module and gives examples of configuring the EtherNet/IP client.
- [EtherNet/IP – Communication profiles](#) describes the communication profiles used in the communication between the client, the adapter module and the drive.
- [EtherNet/IP – Communication protocol](#) describes the EtherNet/IP communication protocol for the adapter module.
- [EtherNet/IP – Diagnostics](#) explains how to trace faults with the status LEDs on the adapter module.

PROFINET IO protocol

- [PROFINET IO – Start-up](#) presents the steps to take during the start-up of the drive with the adapter module and gives examples of configuring the PROFINET master.
 - [PROFINET IO – Communication profiles](#) describes the communication profiles used in the communication between the master, the adapter module and the drive.
 - [PROFINET IO – Communication protocol](#) describes the PROFINET IO communication protocol for the adapter module.
 - [PROFINET IO – Diagnostics](#) explains how to trace faults with the status LEDs on the adapter module.
-

Terms and abbreviations

■ General terms and abbreviations

Term	Definition
Command word	See Control word.
Control word	16-bit or 32-bit word from master to slave with bit-coded control signals (sometimes called the Command word).
Drive	Frequency converter for controlling AC motors. The drive consists of a rectifier and an inverter connected together by the DC link. In drives up to approximately 500 kW, these are integrated into a single module (drive module). Larger drives typically consist of separate supply and inverter units. This manual uses the term drive to refer converters and inverter as well.
FENA-01/-11/-21 Ethernet adapter module	One of the optional fieldbus adapter modules available for ABB drives. FENA-01/-11/-21 is a device through which an ABB drive is connected to an Ethernet network.
Fieldbus adapter module	Device through which the drive is connected to an external communication network, that is, a fieldbus. The communication with the module is activated with a drive parameter.
MAC address	Media Access Control address. A unique factory-programmed identifier used to address a node in an Ethernet network.
Profile	Adaptation of the protocol for certain application field, for example, drives. In this manual, drive-internal profiles (eg, DCU or FBA) are called native profiles.
Status word	16-bit or 32-bit word from slave to master with bit-coded status messages.

Abbreviation	Explanation
DHCP	Dynamic Host Control Protocol. A protocol for automating the configuration of IP devices. DHCP can be used to automatically assign IP addresses and related network information.
EMC	Electromagnetic compatibility
FBA	Fieldbus adapter
LSB	Least significant bit
MSB	Most significant bit
PLC	Programmable logic controller

■ Modbus/TCP terms and abbreviations

Term	Explanation
Exception code	If an error related to the requested Modbus function occurs, the data field contains an exception code that the server application can use to determine the next action to be taken.
Function code	The second byte sent by the client. The function tells the server what kind of action to perform.
Holding register	Holds data that will be later executed by an application program.

■ EtherNet/IP terms and abbreviations

Term	Explanation
DLR	Device Level Ring. DLR network is a single-fault tolerant ring network topology intended for interconnection of automation devices. FENA-21 supports DLR.
EDS file	The Electronic Data Sheet (EDS) file identifies the properties of the device to the EtherNet/IP client. Each type of drive and application program requires its own EDS file.

Term	Explanation
Input	In the ODVA EtherNet/IP specification the word 'input' is used to describe data flow from a device (such as the adapter module) to the network.
I/O Assembly selection	Smart networked devices (like FENA) can produce and/or consume more than one I/O value. Typically, they will produce and/or consume one or more I/O value, as well as status and diagnostic information. Each piece of data communicated by a device is represented by an attribute of one of the device's internal objects. Communicating multiple pieces of data (attributes) across a single I/O connection requires that the attributes be grouped or assembled together into a single block.
ODVA™	ODVA stands for Open DeviceNet Vendor Association. ODVA is an independent organization that promotes interoperativity between different manufacturers' EtherNet/IP products. ABB is an Associate Member at ODVA.
Output	In the ODVA EtherNet/IP specification the word 'output' is used to describe data flow from the network into a device (such as the adapter module).

■ PROFINET IO terms and abbreviations

Term	Explanation
Acyclic communication	Communication in which messages are sent only once on request
Array	Parameter consisting of data fields of equal data type
Cyclic communication	Communication in which parameter/process data objects are sent cyclically at pre-defined intervals

Term	Explanation
DCP	Discovery Control Protocol. A protocol that allows the master controller to find every PROFINET IO device on a subnet.
Fault	Event that leads to tripping of the device
GSD file	ASCII-format device description file in a specified form. Each different slave type on the PROFINET IO network needs to have its own GSD file. GSD files in PROFINET IO are written in GSDML.
Index	Access reference for objects in PROFINET IO
I/O controller	Control system with bus initiative. In PROFINET IO terminology, I/O controllers are also called master stations.
Master	Control system with bus initiative. In PROFINET IO terminology, master stations are also called active stations.
Name	Symbolic name of a parameter
Parameter	Value that can be accessed as an object, eg, variable, constant, signal
Parameter number	Parameter address
Parameter/Process	Special object that contains parameter and process
Data object	Special object that contains parameter and process data
Process data	Data that contains Control word and reference value or Status word and actual value. May also contain other (user-definable) control information.
Slave	Passive bus participant. In PROFINET IO terminology, slave stations (or slaves) are also called passive stations. Also referred to as node.
Warning	Signal caused by an existing alarm which does not lead to tripping of the device

The text in *italics* is the original German term.

Abbreviation	Explanation
ACT	Actual value <i>Istwert</i>
DAP	Device access point
DP	Decentralised Periphery <i>Dezentrale Peripherie</i>
DP-V0	PROFINET IO extension to the EN 50170 standard, providing the basic functionality of DP, including cyclic data exchange
DP-V1	PROFINET IO extension to the EN 50170 standard, including, eg, acyclic data exchange
GSDML	General Station Description Markup Language
ISW	See ACT.
MAP	Module access point
PAP	Parameter access point
PD	Process data <i>Prozessdaten</i>
PKE	Parameter identification <i>Parameter-Kennung</i>
PKW	Parameter identification value <i>Parameter-Kennung-Wert</i>
PNU	Parameter number <i>Parameternummer</i>
PPO	Parameter/Process data object <i>Parameter-/Prozessdaten-Objekt</i>
PWE	Parameter value <i>Parameter-Wert</i>
PZD	See PD.
PZDO	Process data object <i>Prozessdatenobjekt</i>
SAP	Service access point

Abbreviation	Explanation
SOW	Reference <i>Sollwert</i>
STW	Control word <i>Steuerwort</i>
ZSW	Status word <i>Zustandswort</i>

3

Overview of the Ethernet network and the FENA-01/-11/-21 module

Contents of this chapter

This chapter contains a short description of the Ethernet network and the FENA adapter module.

Ethernet network

Ethernet standards support a variety of physical media (coaxial cable, twisted pair, fiber optics) and topologies (bus and star). The FENA-01/-11/-21 adapter module supports twisted pair as the physical media in a star topology. In addition, FENA-21 supports a daisy chain topology with all protocols and DLR with EtherNet/IP protocol.

The maximum length for an Ethernet segment on twisted pair media is 100 meters. All twisted pair media between the Ethernet node and the switch or router must be shorter than 100 meters, including media within patch panels. For more information, see chapter [Technical data](#).

■ Example topology of the Ethernet link

This figure shows an example of an allowable topology for an Ethernet network with FENA-01/-11.

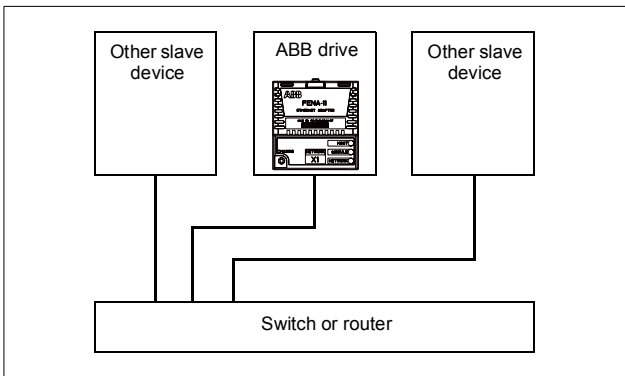

This figure shows an example of an allowable topology for an Ethernet network with FENA-21.

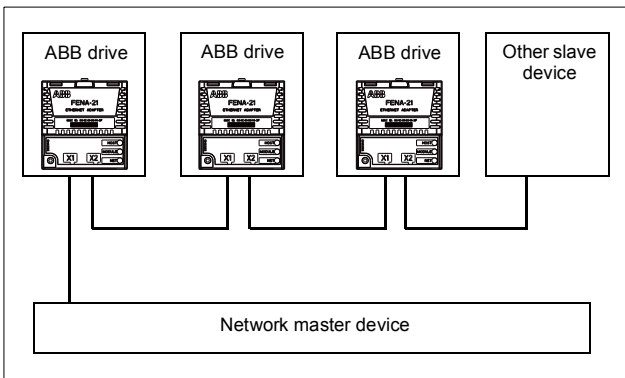

FENA-01/-11/-21 Ethernet adapter module

The FENA-01/-11/-21 Ethernet adapter module is an optional device for ABB drives which enables the connection of the drive to an Ethernet network.

Through the adapter module you can:

- give control commands to the drive (for example, Start, Stop, Run enable)
- feed a motor speed or torque reference to the drive
- give a process actual value or a process reference to the PID controller of the drive
- read status information and actual values from the drive
- reset a drive fault.

The protocols used to access these functionalities over Ethernet are described in chapters:

- [*Modbus/TCP – Communication protocol*](#)
- [*EtherNet/IP – Communication protocol*](#)
- [*PROFINET IO – Communication protocol*](#).

The adapter module supports 10 Mbit/s and 100 Mbit/s data transfer rates and automatically detects the data transfer rate used in the network.

Note: PROFINET IO uses only 100 Mbit/s in the Full duplex mode.

The adapter module is installed into an option slot on the drive control unit. See the drive manuals for module placement options.

Layout of the adapter module

This figure shows the layout of FENA-01/-11.

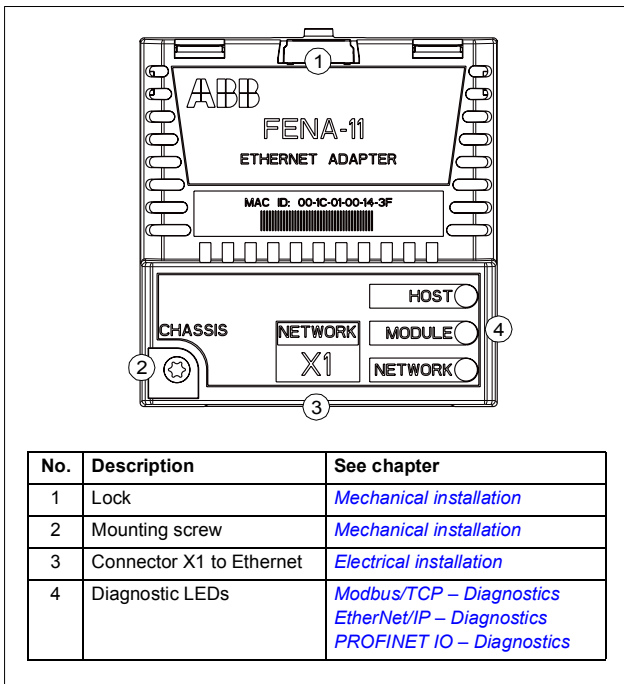

No.	Description	See chapter
1	Lock	Mechanical installation
2	Mounting screw	Mechanical installation
3	Connector X1 to Ethernet	Electrical installation
4	Dagnostic LEDs	Modbus/TCP – Diagnostics EtherNet/IP – Diagnostics PROFINET IO – Diagnostics

This figure shows the layout of FENA-21.

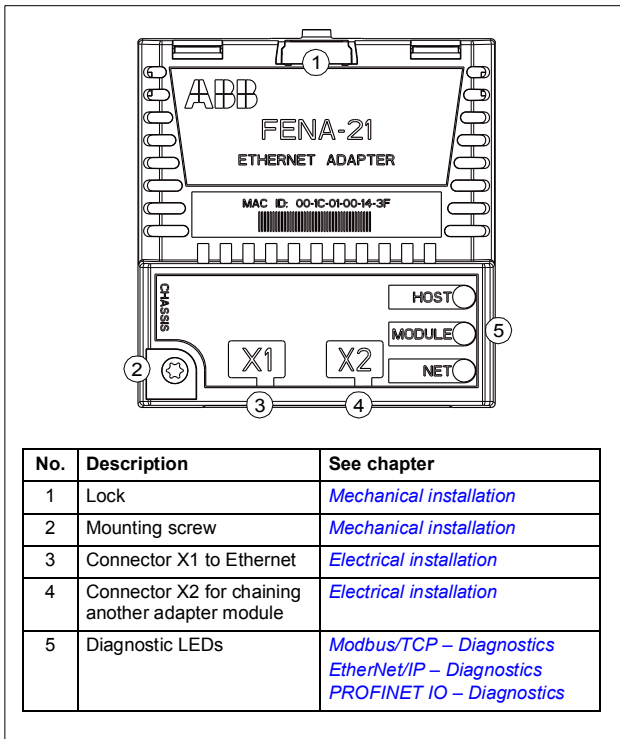

4

Mechanical installation

Contents of this chapter

This chapter contains a delivery checklist and instructions to install the adapter module.

Necessary tools and instructions

You will need a Torx TX10 screwdriver to secure the FENA adapter module to the drive. See also, the applicable drive hardware manual.



Unpacking and examining the delivery

1. Open the option package.
 2. Make sure that the package contains:
 - Ethernet adapter module, type FENA-01/-11/-21
 - this manual.
 3. Make sure that there are no signs of damage.
-

Installing the adapter module



WARNING! Obey the safety instructions. See chapter [Safety instructions](#) on page 17. If you ignore the safety instructions, injury or death can occur.

The adapter module has a specific position in the drive. Plastic pins, a lock and one screw hold the adapter module in place. The screw also makes an electrical connection between the module and drive frame for cable shield termination.

When the adapter module is installed, it makes the signal and power connection to the drive through a 20-pin connector.

When you install or remove the adapter module from the control unit:

1. Pull out the lock.

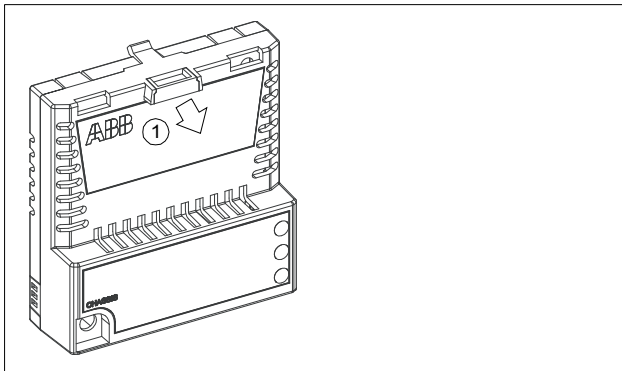

- Put the adapter module carefully into its position on the drive.
- Push in the lock.

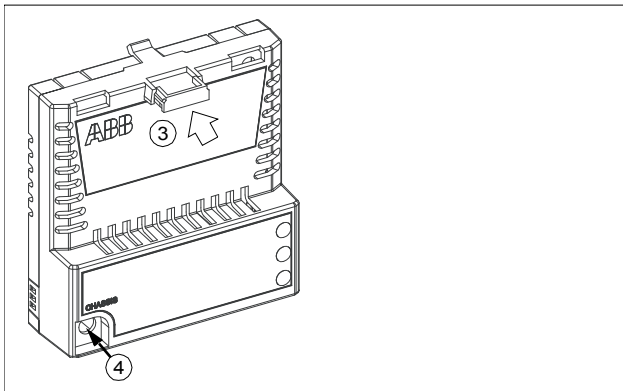

- Tighten the screw to torque 0.8 N·m using a Torx TX10 screwdriver.

Note: A too high torque may break the screws. It is necessary to tighten the screw properly to fulfill the EMC requirements and to ensure the proper operation of the module.

See the applicable drive manual for further instructions on how to install the adapter module to the drive.



5

Electrical installation

Contents of this chapter

This chapter contains:

- general cabling instructions
- instructions on connecting the adapter module to the Ethernet network.

Warnings



WARNING! Obey the safety instructions. See chapter [Safety instructions](#) on page 17. If you ignore the safety instructions, injury or death can occur. If you are not a qualified electrician, do not do electrical work.

Necessary tools and instructions

See the applicable drive hardware manual.



General cabling instructions

- Arrange the bus cables as far away from the motor cables as possible.
- Avoid parallel runs.
- Use bushings at cable entries.

Connecting the adapter module to the Ethernet network

The network cable can be CAT5 or higher, and type UTP, FTP or STP.

When CAT5 FTP or STP is used, the cable shield is connected to the drive frame through an RC network. In FENA-01, it is possible to change this connection by using jumper J1 located next to the X1 connector.

- Position 1-2 connects the cable shield directly to the drive frame.
- Position 2-3 connects the cable shield to the drive frame through an RC network. This is the default setting of the jumper.

The figure below shows the location of jumper pin 1 on the FENA-01 adapter module.

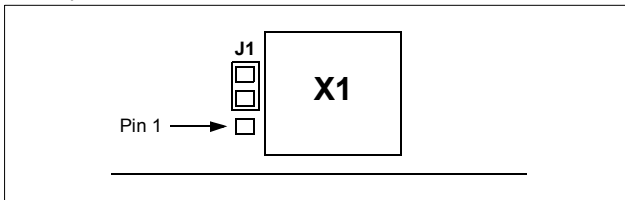

■ Connection procedure

1. Connect the network cable to the RJ-45 connector (X1) on the adapter module.
2. If you want to create a daisy chain with FENA-21 adapter modules, connect the X2 connector of the first adapter module to X1 on the next adapter module, and so on.

Note: If a device in the daisy chain is powered off or fails, the rest of the chain is disconnected from the network. In applications where this is not acceptable, consider using the ring topology instead. The ring topology is supported with Ethernet/IP protocol using DLR.





Modbus/TCP protocol

<i>Modbus/TCP – Start-up</i>	49
<i>Modbus/TCP – Communication profiles</i>	87
<i>Modbus/TCP – Communication protocol</i>	97
<i>Modbus/TCP – Diagnostics</i>	109

M

6

Modbus/TCP – Start-up

Contents of this chapter

This chapter contains:

- information on configuring the drive for operation with the adapter module
- drive-specific instructions on starting up the drive with the adapter module
- information on configuring the client for communication with the adapter module.

Warnings



WARNING! Obey the safety instructions given in this manual and the drive documentation.



Drive configuration

The information in this section applies to all drive types compatible with the adapter module, unless otherwise stated.

■ Modbus/TCP connection configuration

After the adapter module has been mechanically and electrically installed according to the instructions in chapters [Mechanical installation](#) and [Electrical installation](#), you must prepare the drive for communication with the module.

The detailed procedure of activating the module for Modbus/TCP communication with the drive depends on the drive type. Normally, you must adjust a parameter to activate the communication. See the drive-specific start-up sections starting on page [65](#).

Once communication between the drive and the adapter module has been established, several configuration parameters are copied to the drive. These parameters are shown in the tables below and must be checked first and adjusted where necessary. You can adjust the parameters via a drive control panel, a PC tool or a web user interface. For more information on the web user interface, see [Appendix C – FENA configuration web pages](#).

Note:

- Not all drives display descriptive names for the configuration parameters. To help you identify the parameters in different drives, the names displayed by each drive are given in gray boxes in the tables.
- The new parameter settings take effect only when you power up the module the next time or when you activate the fieldbus adapter refresh parameter.



FENA-01/-11/-21 configuration parameters – group A (group 1)

Note: The actual parameter group number depends on the drive type. Group A (group 1) corresponds to:

- parameter group 51 in ACS355, ACSM1, ACS580, ACS850 and ACQ810
- parameter group is typically 51/54 (group 151/154 in some variants) in ACS880 if the adapter is installed as fieldbus adapter A/B.

No.	Name/Value	Description	Default
01	FBA TYPE	Read-only. Shows the fieldbus adapter type as detected by the drive. The value cannot be adjusted by the user. If the value is 0 = None, the communication between the drive and the module has not been established.	128 = ETHER- NET
02	PROTOCOL/ PROFILE ACS355: FBA PAR 2 ACSM1: FBA PAR2 ACS850/ACQ810: FBA par2 ACS880/ACS580: Protocol/Profile	Selects the application protocol and communication profile for the network connection. The selections available for Modbus communication are listed below.	0 = MB/TCP ABB C
	0 = MB/TCP ABB C	Modbus/TCP: ABB Drives profile - Classic	
	1 = MB/TCP ABB E	Modbus/TCP: ABB Drives profile - Enhanced	
	2 = MB/TCP T16	Modbus/TCP: Transparent 16-bit profile	
	3 = MB/TCP T32	Modbus/TCP: Transparent 32-bit profile	
	4 = MB/UDP ABB C	Modbus over UDP: ABB Drives profile - Classic	
	5 = MB/UDP ABB E	Modbus over UDP: ABB Drives profile - Enhanced	
	6 = MB/UDP T16	Modbus over UDP: Transparent 16-bit profile	
	7 = MB/UDP T32	Modbus over UDP: Transparent 32-bit profile	



No.	Name/Value	Description	Default
03	COMM RATE ACS355: FB PAR 3 ACSM1: FBA PAR3 ACS850/ACQ810: FBA par3 ACS880/ACS580: Commrate	Sets the bit rate for the Ethernet interface.	0 = Auto
	0 = Auto	Autonegotiate	
	1 = 100 Mbps FD	100 Mbps, full duplex	
	2 = 100 Mbps HD	100 Mbps, half duplex	
	3 = 10 Mbps FD	10 Mbps, full duplex	
	4 = 10 Mbps HD	10 Mbps, half duplex	
04	IP CONFIGURATION ACS355: FB PAR 4 ACSM1: FBA PAR4 ACS850/ACQ810: FBA par4 ACS880/ACS580: IP configuration	Sets the method for configuring the IP address, subnet mask and gateway address for the module.	1 = Dyn IP DHCP
	0 = Static IP	Configuration will be obtained from parameters 05...13 .	
	1 = Dyn IP DHCP	Configuration will be obtained via DHCP.	
05	IP ADDRESS 1 ACS355: FB PAR 5 ACSM1: FBA PAR5 ACS850/ACQ810: FBA par5 ACS880/ACS580: IP address 1	An IP address is assigned to each IP node on a network. An IP address is a 32-bit number that is typically represented in "dotted decimal" notation consisting of four decimal integers, on the range 0...255, separated by periods. Each integer represents the value of one octet (8-bits) in the IP address. Parameters 05...08 define the four octets of the IP address.	0
	0...255	IP address	
...



No.	Name/Value	Description	Default																																																																				
08	IP ADDRESS 4 ACS355: FB PAR 8 ACSM1: FBA PAR8 ACS850/ACQ810: FBA par8 ACS880/ACS580: IP address 4	See parameter <i>05 IP ADDRESS 1</i> .	0																																																																				
	0...255	IP address																																																																					
09	SUBNET CIDR ACS355: FB PAR 9 ACSM1: FBA PAR9 ACS850/ACQ810: FBA par9 ACS880/ACS580: Subnet CIDR	<p>Subnet masks are used for splitting networks into smaller networks called subnets. A subnet mask is a 32-bit binary number that splits the IP address into a network address and host address.</p> <p>Subnet masks are typically represented in either dotted decimal notation or the more compact CIDR notation, as shown in the table below.</p>	0																																																																				
		<table border="1"> <thead> <tr> <th>Dotted decimal</th> <th>CIDR</th> <th>Dotted decimal</th> <th>CIDR</th> </tr> </thead> <tbody> <tr><td>255.255.255.254</td><td>31</td><td>255.254.0.0</td><td>15</td></tr> <tr><td>255.255.255.252</td><td>30</td><td>255.252.0.0</td><td>14</td></tr> <tr><td>255.255.255.248</td><td>29</td><td>255.248.0.0</td><td>13</td></tr> <tr><td>255.255.255.240</td><td>28</td><td>255.240.0.0</td><td>12</td></tr> <tr><td>255.255.255.224</td><td>27</td><td>255.224.0.0</td><td>11</td></tr> <tr><td>255.255.255.192</td><td>26</td><td>255.224.0.0</td><td>10</td></tr> <tr><td>255.255.255.128</td><td>25</td><td>255.128.0.0</td><td>9</td></tr> <tr><td>255.255.255.0</td><td>24</td><td>255.0.0.0</td><td>8</td></tr> <tr><td>255.255.254.0</td><td>23</td><td>254.0.0.0</td><td>7</td></tr> <tr><td>255.255.252.0</td><td>22</td><td>252.0.0.0</td><td>6</td></tr> <tr><td>255.255.248.0</td><td>21</td><td>248.0.0.0</td><td>5</td></tr> <tr><td>255.255.240.0</td><td>20</td><td>240.0.0.0</td><td>4</td></tr> <tr><td>255.255.224.0</td><td>19</td><td>224.0.0.0</td><td>3</td></tr> <tr><td>255.255.192.0</td><td>18</td><td>192.0.0.0</td><td>2</td></tr> <tr><td>255.255.128.0</td><td>17</td><td>128.0.0.0</td><td>1</td></tr> <tr><td>255.255.0.0</td><td>16</td><td></td><td></td></tr> </tbody> </table>	Dotted decimal	CIDR	Dotted decimal	CIDR	255.255.255.254	31	255.254.0.0	15	255.255.255.252	30	255.252.0.0	14	255.255.255.248	29	255.248.0.0	13	255.255.255.240	28	255.240.0.0	12	255.255.255.224	27	255.224.0.0	11	255.255.255.192	26	255.224.0.0	10	255.255.255.128	25	255.128.0.0	9	255.255.255.0	24	255.0.0.0	8	255.255.254.0	23	254.0.0.0	7	255.255.252.0	22	252.0.0.0	6	255.255.248.0	21	248.0.0.0	5	255.255.240.0	20	240.0.0.0	4	255.255.224.0	19	224.0.0.0	3	255.255.192.0	18	192.0.0.0	2	255.255.128.0	17	128.0.0.0	1	255.255.0.0	16			
Dotted decimal	CIDR	Dotted decimal	CIDR																																																																				
255.255.255.254	31	255.254.0.0	15																																																																				
255.255.255.252	30	255.252.0.0	14																																																																				
255.255.255.248	29	255.248.0.0	13																																																																				
255.255.255.240	28	255.240.0.0	12																																																																				
255.255.255.224	27	255.224.0.0	11																																																																				
255.255.255.192	26	255.224.0.0	10																																																																				
255.255.255.128	25	255.128.0.0	9																																																																				
255.255.255.0	24	255.0.0.0	8																																																																				
255.255.254.0	23	254.0.0.0	7																																																																				
255.255.252.0	22	252.0.0.0	6																																																																				
255.255.248.0	21	248.0.0.0	5																																																																				
255.255.240.0	20	240.0.0.0	4																																																																				
255.255.224.0	19	224.0.0.0	3																																																																				
255.255.192.0	18	192.0.0.0	2																																																																				
255.255.128.0	17	128.0.0.0	1																																																																				
255.255.0.0	16																																																																						
	1...31	Subnet mask in CIDR notation																																																																					



No.	Name/Value	Description	Default
10	GW ADDRESS 1 ACS355: FB PAR 10 ACSM1: FBA PAR10 ACS850/ACQ810: FBA par10 ACS880/ACS580: GW address 1	IP gateways connect individual physical IP subnets into a unified IP network. When an IP node needs to communicate with an IP node on another subnet, the IP node sends the data to the IP gateway for forwarding. Parameters 10...13 define the four octets of the gateway address.	0
	0...255	GW address	
...
13	GW ADDRESS 4 ACS355: FB PAR 13 ACSM1: FBA PAR13 ACS850/ACQ810: FBA par13 ACS880/ACS580: GW address 4	See parameter 10 GW ADDRESS 1 .	0
	0...255	GW address	
14	COMM RATE PORT2 ACS355: FB PAR 14 ACSM1: FBA PAR14 ACS850/ACQ810: FBA par14 ACS880/ACS580: Commrate port 2	Sets the bit rate for the Ethernet port 2. This parameter is used only with FENA-21.	0 = Auto
	0 = Auto	Autonegotiate	
	1 = 100 Mbps FD	100 Mbps, full duplex	
	2 = 100 Mbps HD	100 Mbps, half duplex	
	3 = 10 Mbps FD	10 Mbps, full duplex	
	4 = 10 Mbps HD	10 Mbps, half duplex	
15	Reserved	These parameters are not used by the adapter module when the module is configured for Modbus/TCP.	N/A
...			
18			



No.	Name/Value	Description	Default
19	T16 SCALE ACS355: FB PAR 19 ACSM1: FBA PAR19 ACS850/ACQ810: FBA par19 ACS880/ACS580: T16 scale	<p>Defines the reference multiplier/actual value divisor for the adapter module. The parameter is effective only when the Transparent 16 profile is selected AND the drive is using the native communication profile (eg, DCU or FBA) and a 16-bit transparent Reference 1/Actual value 1.</p> <p>Reference 1 is multiplied by the value of this plus one and the actual value 1 is divided by the value of this plus one. With value 0, the reference 1/actual value 1 scale in the adapter module is $1 = 1$.</p> <p>With an ACS355 drive: For example, if the parameter has a value 99 and the reference of 1000 is given by the master, the reference is multiplied by 100 (i.e. $99 + 1$) and forwarded to the drive as 100000.</p> <p>According to the DCU profile, speed scale is $1000 = 1$ rpm. This value is interpreted as a reference of 100 rpm in the drive.</p> <p>With ACSM1, ACS850 and ACQ810, the DCU profile speed scale is approximately $65535 = 1$ rpm.</p> <p>With ACS880 and ACS580 reference 1/actual value 1 base scale in transparent mode is $100 = 1$, but using this reference value depends on the application of drive.</p>	99
	0...65535	Reference multiplier/actual value divisor	



No.	Name/Value	Description	Default
20	MODBUS/TCP TIMEOUT ACS355: FB PAR 20 ACSM1: FBA PAR20 ACS850/ACQ810: FBA par20 ACS880/ACS580: Timeout time	Defines the Modbus/TCP timeout value. The Modbus protocol does not specify a timeout mechanism for the application layer. A timeout mechanism may be desired when controlling a drive, so the adapter module provides a method for this purpose. <ul style="list-style-type: none"> • If the parameter value is zero, this feature is disabled. • If the parameter value is non-zero, the timeout is: (Modbus/TCP timeout value) * 100 milliseconds For example, a value of 22 results in a timeout of: $22 * 100 \text{ milliseconds} = 2.2 \text{ seconds}$ If a timeout occurs, the adapter module signals the drive that communication with the client has been lost. The drive configuration then determines how to respond. Example: If the Modbus/TCP timeout is 250 ms and the drive is configured to fault on a communication failure with a delay of 500 ms, the drive will fault 750 ms after communications is lost.	20
	0...65535	Modbus/TCP timeout value	
21	TIMEOUT MODE ACS355: FB PAR 21 ACSM1: FBA PAR21 ACS850/ACQ810: FBA par21 ACS880/ACS580: Timeout mode	Selects which Modbus/TCP register accesses reset the timeout counter.	2 = Control RW
	0 = None	The Modbus/TCP timeout feature is disabled.	
	1 = Any message	The timeout counter is reset when any Modbus register of the drive is accessed.	
	2 = Control RW	The timeout counter is reset when the drive receives either a new Control word or new reference value (REF1 or REF2) from the Modbus/TCP client.	

No.	Name/Value	Description	Default
22	WORD ORDER ACS355: FB PAR 22 ACSM1: FBA PAR22 ACS850/ACQ810: FBA par22 ACS880/ACS580: Word order	Selects in which order the 16-bit registers of 32-bit parameters are transferred. For each register (16-bit), the first byte contains the high order byte and the second byte contains the low order byte.	1 = HILO
	0 = LoHi	The first register contains the low order word and the second register contains the high order word.	
	1 = HiLo	The first register contains the high order word and the second register contains the low order word.	
23	ADDRESS MODE ACS355: FB PAR 23 ACSM1: FBA PAR23 ACS850/ACQ810: FBA par23 ACS880/ACS580: Address mode	Defines the mapping between parameters and holding registers in the 0...65535 Modbus register range.	0 = Mode 0
	0 = Mode 0	Used when access to parameter indexes greater than 99 is not needed. Allows 5-digit addressing ¹⁾ used by legacy Modbus masters. Mode is backward compatibility with old firmware versions of FENA-xx and with, for example, ACx550. 16-bit access: ¹⁾ Register address ²⁾ = 100 * parameter group + parameter index (16-bit values, groups 1...199, indexes 1...99) 32-bit access: Register address = 20000 + 200 * parameter group + 2 * parameter index (32-bit values, groups 1...199, indexes 1...99)	



No.	Name/Value	Description	Default
	1 = Mode 1	16-bit access: Register address = 256 * parameter group + parameter index (16-bit values, groups 1...255, indexes 1...255) Example: 13057 (0x3301) is group 51 index 1 No access to 32-bit parameter values.	
	2 = Mode 2	32-bit access: Register address = 512 * parameter group + 2 * parameter index (32-bit values, groups 1...127, indexes 1...255). Example: 26114 (0x6602) is group 51 index 1 Used when 32-bit parameter values are needed and there is no need to access groups 128 or higher.	
	3 = Mode 3	32-bit access: Register address = 256 * parameter group + 2 * parameter index (32-bit values, groups 1...255, indexes 1...127). Example: 13058 (0x3302) is group 51 index 1 Used when 32-bit parameter values are needed and there is no need to access parameter index 128 or higher.	
24 ... 26	Reserved for web page functionality. For more information, see Appendix C – FENA configuration web pages .	These parameters are not used by the adapter module when the module is configured for Modbus/TCP.	N/A
27	FBA PAR REFRESH ACS355/ACSM1: FBA PAR REFRESH ACS850/ACQ810: FBA par refresh ACS880/ACS580: FBA A/B par refresh	Validates any changed adapter module configuration parameter settings. After refreshing, the value reverts automatically to 0 = Done. Note: This parameter cannot be changed while the drive is running.	0 = Done
	0 = Done	Refreshing done	
	1 = Refresh	Refreshing	

No.	Name/Value	Description	Default
28	PAR TABLE VER ACS355: FILE CPI FW REV ACSM1: PAR TABLE VER ACS850/ACQ810: Par table ver ACS880/ACS580: FBA A/B par table ver	Read-only. Displays the parameter table revision of the fieldbus adapter module mapping file stored in the memory of the drive. In format xyz , where x = major revision number y = minor revision number z = correction number OR in format axyz , where a = major revision number xy = minor revision numbers z = correction number or letter.	N/A
		Parameter table revision	
29	DRIVE TYPE CODE ACS355: FILE CONFIG ID ACSM1: DRIVE TYPE CODE ACS850/ACQ810: Drive type code ACS880/ACS580: FBA A/B drive type code	Read-only. Displays the drive type code of the fieldbus adapter module mapping file stored in the memory of the drive.	N/A
		Drive type code of the fieldbus adapter module mapping file	
30	MAPPING FILE VER ACS355: FILE CONFIG REV ACSM1: MAPPING FILE VER ACS850/ACQ810: Mapping file ver ACS880/ACS580: FBA A/B mapping file ver	Read-only. Displays the fieldbus adapter module mapping file revision stored in the memory of the drive in decimal format.	N/A
		Mapping file revision	



No.	Name/Value	Description	Default
31	D2FBA COMM STA ACS355: FBA STATUS ACSM1: D2FBA COMM STA ACS850/ACQ810: D2FBA comm sta ACS880/ACS580: D2FBA A/B comm status	Read-only. Displays the status of the fieldbus adapter module communication. Note: The value names may vary by drive.	0 = Idle OR 4 = Off-line OR 2 = Time out
	0 = Idle	Adapter is not configured.	
	1 = Exec.init	Adapter is initializing.	
	2 = Time out	A timeout has occurred in the communication between the adapter and the drive.	
	3 = Conf.err	Adapter configuration error: The major or minor revision code of the common program revision in the fieldbus adapter module is not the revision required by the module or mapping file upload has failed more than three times.	
	4 = Off-line	Adapter is off-line.	
	5 = On-line	Adapter is on-line.	
	6 = Reset	Adapter is performing a hardware reset.	
32	FBA COMM SW VER ACS355: FBA CPI FW REV ACSM1: FBA COMM SW VER ACS850/ACQ810: FBA comm sw ver ACS880/ACS580: FBA A/B comm SW ver	Read-only. Displays firmware patch and build number of the adapter module in the xyyy format, where: xx = patch number yy = build number Example: C80D ≥ 200.13 or 0 ≥ 0.0	N/A
		Common program version of the adapter module	

No.	Name/Value	Description	Default
33	FBA APPL SW VER ACS355: FBA APPL FW REV ACSM1: FBA APPL SW VER ACS850/ACQ810: FBA appl sw ver ACS880/ACS580: FBA A/B appl SW ver	Read-only. Displays firmware version of the adapter module in xxyy format, where: xx = major revision number yy = minor revision number Example: 310 = 3.10 Version number is the form: <major>.<minor>.<patch>.<build> Example: 3.10.200.13 or 3.10.0.0	N/A
		Application program revision of the adapter module	

¹⁾ 6-digit register addressing (400001) is used instead of 5-digit register addressing (40001) to describe register map.

²⁾ Register address = Register address + 40000 (0) if holding register area indication should be used.

For more information, see [Register addressing](#) on page 98.



FENA-01/-11/-21 configuration parameters – group B (group 2)

Note: The actual parameter group number depends on the drive type. Group B (group 2) corresponds to:

- parameter group 55 in ACS355
- parameter group 53 in ACSM1, ACS580, ACS850 and ACQ810
- parameter group is typically 53/56 (group 153/156 in some variants) in ACS880 if the adapter is installed as fieldbus adapter A/B.

No. ¹⁾	Name/Value	Description	Default						
01	DATA OUT 1 (client to drive) ACS355: FBA DATA OUT 1 ACSM1: FBA DATA OUT 1 ACS850/ACQ810: FBA data out1 ACS880/ACS580: FBA A/B data out1	<p>Selects the drive parameter address into which the value of the DATA OUT 1 register is written (from the client to the server). The Modbus register address maps are explained in chapter Modbus/TCP – Communication protocol.</p> <p>The content is defined by a decimal number in the range of 0 to 9999 as follows:</p> <table border="1"> <tr> <td>0</td> <td>Not used</td> </tr> <tr> <td>1...99</td> <td>Virtual address area of drive control. Not used when the Modbus/TCP protocol is used.</td> </tr> <tr> <td>101...9999</td> <td>Parameter area of the drive</td> </tr> </table>	0	Not used	1...99	Virtual address area of drive control. Not used when the Modbus/TCP protocol is used.	101...9999	Parameter area of the drive	0 = None
0	Not used								
1...99	Virtual address area of drive control. Not used when the Modbus/TCP protocol is used.								
101...9999	Parameter area of the drive								
	0 = None	Not used							
	101...9999	<p>Parameter index with format xyyy, where</p> <ul style="list-style-type: none"> • xx is the parameter group number (1...99) • yy is the parameter number index within that group (01...99). <p>Note: In ACS880 and ACS580, choose Other to display a list of mappable drive parameters.</p>							
02... 12	DATA OUT 2 ... DATA OUT 12	See parameter 01 DATA OUT 1 .	0 = None						

¹⁾ The number of parameters in this group may vary by drive type and drive firmware.

FENA-01/-11/-21 configuration parameters – group C (group 3)

Note: The actual parameter group number depends on the drive type. Group C (group 3) corresponds to:

- parameter group 54 in ACS355
- parameter group 52 in ACSM1, ACS580, ACS850 and ACQ810
- parameter group is typically 52/55 (group 152/155 in some variants) in ACS880 if the adapter is installed as fieldbus adapter A/B.

No. ¹⁾	Name/Value	Description	Default						
01	DATA IN 1 (drive to client) ACS355: FBA DATA IN 1 ACSM1: FBA DATA IN1 ACS850/ACQ810: FBA data in1 ACS880/ACS580: FBA A/B data in1	Selects the drive parameter address from which the data is read to the DATA IN 1 register (from the server to the client). The Modbus register address maps are explained in chapter Modbus/TCP – Communication protocol . The content is defined by a decimal number in the range of 0 to 9999 as follows: <table border="1" data-bbox="422 681 857 870"> <tr> <td>0</td> <td>Not used</td> </tr> <tr> <td>1...99</td> <td>Virtual address area of drive control. Not used when the Modbus/TCP protocol is used.</td> </tr> <tr> <td>101...9999</td> <td>Parameter area of the drive</td> </tr> </table>	0	Not used	1...99	Virtual address area of drive control. Not used when the Modbus/TCP protocol is used.	101...9999	Parameter area of the drive	0 = None
0	Not used								
1...99	Virtual address area of drive control. Not used when the Modbus/TCP protocol is used.								
101...9999	Parameter area of the drive								
	0 = None	Not used							
	101...9999	Parameter index with format xyyy , where <ul style="list-style-type: none"> xx is the parameter group number (1...99) yy is the parameter number index within that group (01...99). Note: In ACS880 and ACS580, choose Other to display a list of mappable drive parameters.							
02... 12	DATA IN 2 ... DATA IN 12	See parameter 01 DATA IN 1 .	0 = None						

¹⁾ The number of parameters in this group may vary by drive type and drive firmware.

■ Control locations

ABB drives can receive control information from multiple sources including digital inputs, analog inputs, the drive control panel and a fieldbus adapter module. ABB drives allow the user to separately determine the source for each type of control information (Start, Stop, Direction, Reference, Fault reset, etc.).

To give the fieldbus client the most complete control over the drive, you must select the adapter module as the source of this information. The drive-specific parameter setting examples below contain the drive control parameters relevant in the examples. For a complete parameter list, see the drive documentation.



Starting up fieldbus communication for ACS355 drives

1. Power up the drive.
2. Enable the communication between the adapter module and the drive with parameter 9802 COMM PROT SEL.
3. Set the module configuration parameters in group 51.
 - Select the communication protocol and profile with parameter 5102 and configure the network settings with parameters 5103...5113.
 - With parameters 5120 and 5121, select how the adapter module detects fieldbus communication breaks.
4. With parameter 3018 COMM FAULT FUNC, select how the drive reacts to a fieldbus communication break.
5. With parameter 3019 COMM FAULT TIME, define the time between communication break detection and the selected action.
6. Define the process data transferred to and from the drive in parameter groups 54 and 55.

Note: The adapter module assigns the Control word, Status word, references 1...2 and actual values 1...2 automatically to Modbus registers. Process data groups are not available for the ABB Drives - Classic communication profile.

7. Validate the settings made in parameter groups 51, 54 and 55 with parameter 5127 FBA PAR REFRESH.
8. Set the relevant drive control parameters to control the drive according to the application.

Examples of appropriate values are shown in the tables below.



Parameter setting examples – ACS355

Speed and torque control using the ABB Drives – Enhanced communication profile

This example shows how to configure a speed and torque control application that uses the ABB Drives - Enhanced profile. In addition, some application-specific data is added to the communication.

The start/stop commands and reference are according to the ABB Drives profile. For more information, see section [ABB Drives communication profile](#) on page 89.

When Reference 1 (REF1) is used, a reference value of ± 20000 (decimal) corresponds to the reference set with parameter 1105 REF1 MAX in the forward and reverse directions.

When Reference 2 (REF2) is used, a reference value of ± 10000 (decimal) corresponds to the reference set with parameter 1108 REF2 MAX in the forward and reverse directions.

The minimum and maximum 16-bit integer values that can be given through the fieldbus are -32768 and 32767 respectively.

Output data	Modbus register	Input data	Modbus register
Control word	(4)00001	Status word	(4)00051
Speed reference	(4)00002	Speed actual value	(4)00052
Torque reference	(4)00003	Torque actual value	(4)00053
Constant speed 1 ¹⁾	(4)00004	Power ¹⁾	(4)00054
Constant speed 2 ¹⁾	(4)00005	DC bus voltage ¹⁾	(4)00055

¹⁾ Example

The table below gives the recommended drive parameter settings.

Drive parameter	Setting for ACS355 drives	Description
9802 COMM PROT SEL	4 = EXT FBA	Enables communication between the drive and the fieldbus adapter module.
5101 FBA TYPE	ETHERNET ¹⁾	Displays the type of the fieldbus adapter module.

Drive parameter	Setting for ACS355 drives	Description
5102 FB PAR 2 (PROTOCOL/PROFILE)	1 (= MB/TCP ABB E)	Selects the Modbus/TCP protocol and the ABB Drives - Enhanced profile.
5103 FB PAR 3 (COMMRATE)	0 (= Auto) ²⁾	Ethernet communication rate is negotiated automatically by the device.
5104 FB PAR 4 (IP CONFIGURATION)	0 (= Static IP)	Configuration will be obtained from parameters 05...13.
5105 FB PAR 5 (IP ADDRESS 1)	192 ²⁾	First part of the IP address
5106 FB PAR 6 (IP ADDRESS 2)	168 ²⁾	Second part of the IP address
5107 FB PAR 7 (IP ADDRESS 3)	0 ²⁾	Third part of the IP address
5108 FB PAR 8 (IP ADDRESS 4)	16 ²⁾	Last part of the IP address
5109 FBA PAR 9 (SUBNET CIDR)	24 ²⁾	Sets the network mask as 255.255.255.0, allowing access only to the last subnet.
5120 FB PAR 20 (MODBUS/TCP TIMEOUT)	10 ²⁾	Sets the communication timeout as 1 second.
5121 FB PAR 21 (TIMEOUT MODE)	2 (= Control RW) ²⁾	The timeout feature monitors the updating of the Control word and Reference 1.
3018 COMM FAULT FUNC	1 = FAULT ²⁾	Enables fieldbus communication fault monitoring.
3019 COMM FAULT TIME	3.0 s ²⁾	Defines the fieldbus communication break supervision time.
5401 FBA DATA IN 1	106 ²⁾	Power
5402 FBA DATA IN 2	107 ²⁾	DC bus voltage
5501 FBA DATA OUT 1	1202 ²⁾	Constant speed 1
5502 FBA DATA OUT 2	1203 ²⁾	Constant speed 2
5127 FBA PAR REFRESH	1 = REFRESH	Validates the FENA-01/-11/-21 configuration parameter settings.



Drive parameter	Setting for ACS355 drives	Description
9904 MOTOR CTRL MODE	2 = VECTOR: TORQ	Selects the vector control mode as the motor control mode.
1001 EXT1 COMMANDS	10 = COMM	Selects the fieldbus interface as the source of the start and stop commands for external control location 1.
1002 EXT2 COMMANDS	10 = COMM	Selects the fieldbus interface as the source of the start and stop commands for external control location 2.
1102 EXT1/EXT2 SEL	8 = COMM	Enables external control location 1/2 selection through the fieldbus.
1103 REF1 SELECT	8 = COMM	Selects the fieldbus reference 1 as the source for speed reference 1.
1106 REF2 SELECT	8 = COMM	Selects the fieldbus reference 2 as the source for speed reference 1.
1601 RUN ENABLE	7 = COMM	Selects the fieldbus interface as the source for the inverted Run enable signal (Run disable).
1604 FAULT RESET SEL	8 = COMM	Selects the fieldbus interface as the source for the fault reset signal.

¹⁾ Read-only or automatically detected/set

²⁾ Example



The start sequence for the parameter example above is given below.

Control word:

- Reset the fieldbus communication fault (if active).
- Enter 47Eh (1150 decimal) → READY TO SWITCH ON.
- Enter 47Fh (1151 decimal) → OPERATING (Speed mode)
or
C7Fh (3199 decimal) → OPERATING (Torque mode).

Starting up fieldbus communication for ACSM1 drives

1. Power up the drive.
2. Enable the communication between the adapter module and the drive with parameter 50.01 FBA ENABLE.
3. With parameter 50.02 COMM LOSS FUNC, select how the drive reacts to a fieldbus communication break.

Note that this function monitors both communication between the fieldbus master and the adapter module and communication between the adapter module and the drive.

4. With parameter 50.03 COMM LOSS T OUT, define the time between communication break detection and the selected action.
5. Select application-specific values for parameters 50.04...50.11.

Examples of appropriate values are shown in the tables below.

6. Set the module configuration parameters in group 51.
 - Select the communication protocol and profile with parameter 51.02 and configure the network settings with parameters 51.03...51.13.
 - With parameters 51.20 and 51.21, select how the adapter module detects fieldbus communication breaks.



7. Define the process data transferred to and from the drive in parameter groups 52 and 53.

Note: The adapter module assigns the Control word, Status word, references 1...2 and actual values 1...2 automatically to Modbus registers. Process data groups are not available in the ABB Drives - Classic communication profile.

8. Validate the settings made in parameter groups 51, 52 and 53 with parameter 51.27 FBA PAR REFRESH.
9. Set the relevant drive control parameters to control the drive according to the application.

Examples of appropriate values are shown in the tables below.

■ Parameter setting examples – ACSM1

Speed and torque control using the ABB Drives – Enhanced communication profile

This example shows how to configure a speed and torque control application that uses the ABB Drives - Enhanced profile. In addition, some application-specific data is added to the communication.

The start/stop commands and reference are according to the ABB Drives profile. For more information, see section [ABB Drives communication profile](#) on page 89.



When Reference 1 (REF1) is used, a reference value of ± 20000 (4E20h) corresponds to the reference set with parameter 25.02 SPEED SCALING in the forward and reverse directions.

When Reference 2 (REF2) is used, a reference value of ± 10000 (2710h) corresponds to the reference set with parameter 32.04 TORQUE REF 1 MAX in the forward and reverse directions.

The minimum and maximum 16-bit integer values that can be given through the fieldbus are -32768 and 32767 respectively.

Output data	Modbus register	Input data	Modbus register
Control word	(4)00001	Status word	(4)00051
Speed reference	(4)00002	Speed actual value	(4)00052
Torque reference	(4)00003	Torque actual value	(4)00053
Constant speed ¹⁾	(4)00004 (4)00005	Power ¹⁾	(4)00054 (4)00055
Speed reference for jogging function 1 ¹⁾	(4)00006 (4)00007	DC bus voltage ¹⁾	(4)00056 (4)00057

¹⁾ Example

The table below gives the recommended drive parameter settings.

Drive parameter	Setting for ACSM1 drives	Description
50.01 FBA ENABLE	Enable	Enables communication between the drive and the fieldbus adapter module.
50.02 COMM LOSS FUNC	Fault ²⁾	Enables fieldbus communication fault monitoring.
50.03 COMM LOSS T OUT	3.0 s ²⁾	Defines the fieldbus communication break supervision time.
50.04 FBA REF1 MODESEL	Speed	Selects the fieldbus reference 1 scaling.
50.05 FBA REF2 MODESEL	Torque	Selects the fieldbus reference 2 scaling.
51.01 FBA TYPE	ETHERNET ¹⁾	Displays the type of the fieldbus adapter module.
51.02 FBA PAR2 (PROTOCOL/PROFILE)	1 (= MB/TCP ABB E)	Selects the Modbus/TCP protocol and the ABB Drives - Enhanced profile.
51.03 FBA PAR3 (COMM RATE)	0 (= Auto) ²⁾	Ethernet communication rate is negotiated automatically by the device.
51.04 FBA PAR4 (IP CONFIGURATION)	0 (= Static IP) ²⁾	Configuration will be obtained from parameters 05...13 .



Drive parameter	Setting for ACSM1 drives	Description
51.05 FBA PAR5 (IP ADDRESS 1)	192 ²⁾	First part of the IP address
51.06 FBA PAR6 (IP ADDRESS 2)	168 ²⁾	Second part of the IP address
51.07 FBA PAR7 (IP ADDRESS 3)	0 ²⁾	Third part of the IP address
51.08 FBA PAR8 (IP ADDRESS 4)	16 ²⁾	Last part of the IP address
51.09 FBA PAR9 (SUBNET CIDR)	24 ²⁾	Sets the network mask as 255.255.255.0, allowing access only to the last subnet.
51.20 FBA PAR20 (MODBUS/TCP TIMEOUT)	10 ²⁾	Sets the communication timeout as 1 second.
51.21 FBA PAR21 (TIMEOUT MODE)	2 (= Control RW) ²⁾	The timeout feature monitors the updating of the Control word and Reference 1.

52.01 FBA DATA IN1	122 ²⁾	Power
52.03 FBA DATA IN3	107 ²⁾	DC bus voltage
53.01 FBA DATA OUT1	2408 ²⁾	Constant speed
53.03 FBA DATA OUT3	2410 ²⁾	Speed reference for jogging function 1

51.27 FBA PAR REFRESH	REFRESH	Validates the FENA-11/-21 configuration parameter settings.
-----------------------	---------	---

10.01 EXT1 START FUNC	FBA	Selects the fieldbus interface as the source of the start and stop commands for external control location 1.
10.04 EXT2 START FUNC	FBA	Selects the fieldbus interface as the source of the start and stop commands for external control location 2.
10.08 FAULT RESET SEL	P.FBA MAIN CW.8	Selects the fieldbus interface as the source for the fault reset signal.
24.01 SPEED REF1 SEL	FBA REF1	Selects the fieldbus reference 1 as the source for speed reference 1.

Drive parameter	Setting for ACSM1 drives	Description
32.02 TORQ REF ADD SEL	FBA REF2	Selects the fieldbus reference 2 as the source for torque reference 1.
34.01 EXT1/EXT2 SEL	P.FBA MAIN CW.15	Enables external control location 1/2 selection through the fieldbus only (bit 15 in the fieldbus Control word).
34.03 EXT1 CTRL MODE1	Speed	Selects speed control as the control mode 1 for external control location 1.
34.05 EXT2 CTRL MODE1	Torque	Selects torque control as the control mode 1 for external control location 2.

¹⁾ Read-only or automatically detected/set

²⁾ Example

The start sequence for the parameter example above is given below.

Control word:

- Reset the fieldbus communication fault (if active).
- Enter 47Eh (1150 decimal) → READY TO SWITCH ON.
- Enter 47Fh (1151 decimal) → OPERATING (Speed mode)
or
C7Fh (3199 decimal) → OPERATING (Torque mode).



Starting up fieldbus communication for ACS850 and ACQ810 drives

1. Power up the drive.
2. Enable the communication between the adapter module and the drive with parameter 50.01 FBA enable.
3. With parameter 50.02 Comm loss func, select how the drive reacts to a fieldbus communication break.

Notes:

- This function monitors both communication between the fieldbus master and the adapter module and communication between the adapter module and the drive.
 - In ACQ810, you can select the control locations to be monitored with parameter 50.21 Comm loss enable. By default, the monitoring is enabled in both control locations (EXT1 and EXT2).
4. With parameter 50.03 Comm loss t out, define the time between communication break detection and the selected action.
 5. Select application-specific values for parameters 50.04...50.11.

Examples of appropriate values are shown in the tables below.

- 
6. Set the module configuration parameters in group 51.
 - Select the communication protocol and profile with parameter 51.02 and configure the network settings with parameters 51.03...51.13.
 - With parameters 51.20 and 51.21, select how the adapter module detects fieldbus communication breaks.
-

7. Define the process data transferred to and from the drive in parameter groups 52 and 53.
Note: The adapter module assigns the Control word, Status word, references 1...2 and actual values 1...2 automatically to Modbus registers. Process data groups are not available in the ABB Drives - Classic communication profile.
8. Validate the settings made in parameter groups 51, 52 and 53 with parameter 51.27 FBA par refresh.
9. Set the relevant drive control parameters to control the drive according to the application.
Examples of appropriate values are shown in the tables below.

■ Parameter setting examples – ACS850 and ACQ810

Speed control using the ABB Drives – Enhanced communication profile

This example shows how to configure a speed control application that uses the ABB Drives - Enhanced profile. In addition, some application-specific data is added to the communication.

The start/stop commands and reference are according to the ABB Drives profile. For more information, see section [ABB Drives communication profile](#) on page 89.

When Reference 1 (REF1) is used, a reference value of ± 20000 (4E20h) corresponds to the reference set with parameter 19.01 Speed scaling in the forward and reverse directions.



The minimum and maximum 16-bit integer values that can be given through the fieldbus are -32768 and 32767 respectively.

Output data	Modbus register	Input data	Modbus register
Control word	(4)00001	Status word	(4)00051
Speed reference	(4)00002	Speed actual value	(4)00052
Reference 2 (Not used)	(4)00003	Actual value 2 (Not used)	(4)00053
Constant speed 1 ¹⁾	(4)00004 (4)00005	Power ¹⁾	(4)00054 (4)00055
Constant speed 2 ¹⁾	(4)00006 (4)00007	DC bus voltage ¹⁾	(4)00056 (4)00057

¹⁾ Example

The table below gives the recommended drive parameter settings.

Drive parameter	Setting for ACS850/ACQ810 drives	Description
50.01 Fba enable	Enable	Enables communication between the drive and the fieldbus adapter module.
50.02 Comm loss func	Fault ²⁾	Enables fieldbus communication fault monitoring.
50.03 Comm loss t out	3.0 s ²⁾	Defines the fieldbus communication break supervision time.
50.04 Fb ref1 modesel	Speed	Selects the fieldbus reference 1 scaling.

51.01 FBA type	Ethernet ¹⁾	Displays the type of the fieldbus adapter module.
51.02 FBA par2 (PROTOCOL/PROFILE)	1 (= MB/TCP ABB E)	Selects the Modbus/TCP protocol and the ABB Drives - Enhanced profile.
51.03 FBA par3 (COMMRATE)	0 (= Auto) ²⁾	Ethernet communication rate is negotiated automatically by the device.
51.04 FBA par4 (IP CONFIGURATION)	0 (= Static IP) ²⁾	Configuration will be obtained from parameters 05...13.

Drive parameter	Setting for ACS850/ACQ810 drives	Description
51.05 FBA par5 (IP ADDRESS 1)	192 ²⁾	First part of the IP address
51.06 FBA par6 (IP ADDRESS 2)	168 ²⁾	Second part of the IP address
51.07 FBA par7 (IP ADDRESS 3)	0 ²⁾	Third part of the IP address
51.08 FBA par8 (IP ADDRESS 4)	16 ²⁾	Last part of the IP address
51.09 FBA par9 (SUBNET CIDR)	24 ²⁾	Sets the network mask as 255.255.255.0, allowing access only to the last subnet.
51.20 FBA par20 (MODBUS/TCP TIMEOUT)	10 ²⁾	Sets the communication timeout as 1 second.
51.21 FBA par21 (TIMEOUT MODE)	2 (= Control RW) ²⁾	The timeout feature monitors the updating of the Control word and Reference 1.
52.01 FBA data in1	122 ²⁾	Power
52.03 FBA data in3	107 ²⁾	DC bus voltage
53.01 FBA data out1	2606 ²⁾	Constant speed 1
53.03 FBA data out3	2607 ²⁾	Constant speed 2
51.27 FBA par refresh	Refresh	Validates the FENA-11/-21 configuration parameter settings.
10.01 Ext1 start func	FB	Selects the fieldbus interface as the source of the start and stop commands for external control location 1.
10.10 Fault reset sel	P.FBA main cw.8	Selects the fieldbus interface as the source for the fault reset signal.
21.01 Speed ref1 sel (ACS850)	FBA ref1	Selects the fieldbus reference 1 as the source for speed reference 1.
21.01 Speed ref sel (ACQ810)	FBA ref1	

1) Read-only or automatically detected/set

2) Example



The start sequence for the parameter example above is given below.

Control word:

- Reset the fieldbus communication fault (if active).
- Enter 47Eh (1150 decimal) → READY TO SWITCH ON.
- Enter 47Fh (1151 decimal) → OPERATING (Speed mode).

Starting up fieldbus communication for ACS880 and ACS580 drives

1. Power up the drive.
2. Enable the communication between the adapter module and the drive by selecting the correct slot number in parameter 50.01 FBA A enable.

The selection must correspond to the slot where the adapter module is installed. For example, if the adapter module is installed in slot 1, you must select slot 1.

3. With parameter 50.02 FBA A comm loss func, select how the drive reacts to a fieldbus communication break.

Note that this function monitors both communication between the fieldbus master and the adapter module and communication between the adapter module and the drive.

4. With parameter 50.03 FBA A comm loss t out, define the time between communication break detection and the selected action.



5. Select application-specific values for the rest of the parameters in group 50, starting from 50.04.

Examples of appropriate values are shown in the tables below.

6. Set the module configuration parameters in group 51.
 - Select the communication protocol and profile with parameter 51.02 and configure the network settings with parameters 51.03...51.13.
 - With parameters 51.20 and 51.21, select how the adapter module detects fieldbus communication breaks.
7. Define the process data transferred to and from the drive in parameter groups 52 and 53.

Note: The adapter module assigns the Control word, Status word, references 1...2 and actual values 1...2 automatically to Modbus registers. Process data groups are not available in the ABB Drives - Classic communication profile.

8. Save the valid parameter values to permanent memory with parameter 96.07 Parameter save manually.
9. Validate the settings made in parameter groups 51, 52 and 53 with parameter 51.27 FBA A par refresh.
10. Set the relevant drive control parameters to control the drive according to the application.

Examples of appropriate values are shown in the tables below.



Parameter setting examples – ACS880

Speed control using the ABB Drives – Enhanced communication profile

This example shows how to configure a speed control application that uses the ABB Drives - Enhanced profile. In addition, some application-specific data is added to the communication.

The start/stop commands and reference are according to the ABB Drives profile. For more information, see section [ABB Drives communication profile](#) on page 89.

When Reference 1 (REF1) is used, a reference value of ± 20000 (4E20h) corresponds to the reference set with parameter 46.01 Speed scaling in the forward and reverse directions.

The minimum and maximum 16-bit integer values that can be given through the fieldbus are -32768 and 32767 respectively.

Output data	Modbus register	Input data	Modbus register
Control word	(4)00001	Status word	(4)00051
Speed reference	(4)00002	Speed actual value	(4)00052
Reference 2 (Not used)	(4)00003	Actual value 2 (Not used)	(4)00053
Constant speed 1 [32] ¹⁾	(4)00004 (4)00005	Output power [32] ¹⁾	(4)00054 (4)00055
Constant speed 2 [32] ¹⁾	(4)00006 (4)00007	DC voltage [32] ¹⁾	(4)00056 (4)00057

¹⁾ Example

The table below gives the recommended drive parameter settings.

Drive parameter	Setting for ACS880 drives	Description
50.01 FBA A enable	1 = Option slot 1 ²⁾	Enables communication between the drive and the fieldbus adapter module.
50.02 FBA A comm loss func	1 = Fault ²⁾	Enables fieldbus A communication fault monitoring.

Drive parameter	Setting for ACS880 drives	Description
50.03 FBA A comm loss t out	3.0 s ²⁾	Defines the fieldbus A communication break supervision time.
50.04 FBA A ref1 type	4 = Speed	Selects the fieldbus A reference 1 type and scaling.
51.01 FBA A type	128 = ETHERNET ¹⁾	Displays the type of the fieldbus adapter module.
51.02 Protocol/Profile	1 = MB/TCP ABB E	Selects the Modbus/TCP protocol and the ABB Drives - Enhanced profile.
51.03 Commrate	0 = Auto ²⁾	Ethernet communication rate is negotiated automatically by the device.
51.04 IP configuration	0 = Static IP ²⁾	Configuration will be obtained from parameters 05...13.
51.05 IP address 1	192 ²⁾	First part of the IP address
51.06 IP address 2	168 ²⁾	Second part of the IP address
51.07 IP address 3	0 ²⁾	Third part of the IP address
51.08 IP address 4	16 ²⁾	Last part of the IP address
51.09 Subnet CIDR	24 ²⁾	Sets the network mask as 255.255.255.0, allowing access only to the last subnet.
51.20 Timeout time	10 ²⁾	Sets the communication timeout as 1 second.
51.21 Timeout mode	2 = Control RW ²⁾	The timeout feature monitors the updating of the Control word and Reference 1.
52.01 FBA A data in1	01.14 ²⁾	Output power
52.03 FBA a data in3	01.11 ²⁾	DC voltage
53.01 FBA A data out1	22.26 ²⁾	Constant speed 1
53.03 FBA A data out3	22.27 ²⁾	Constant speed 2
51.27 FBA A par refresh	1 = Refresh	Validates the FENA-11/-21 configuration parameter settings.



Drive parameter	Setting for ACS880 drives	Description
20.01 Ext1 commands	12 = Fieldbus A	Selects the fieldbus A interface as the source of the start and stop commands for external control location 1.
22.11 Speed ref1 source	4 = FB A ref1	Selects the fieldbus A reference 1 as the source for speed reference 1.
31.11 Fault reset selection	30 = FBA A MCW bit 7	Selects the fieldbus interface as the source for the fault reset signal.

¹⁾ Read-only or automatically detected/set

²⁾ Example

The start sequence for the parameter example above is given below.

Control word:

- Reset the fieldbus communication fault (if active).
- Enter 47Eh (1150 decimal) → READY TO SWITCH ON.
- Enter 47Fh (1151 decimal) → OPERATING (Speed mode).



■ Parameter setting examples – ACS580

Frequency control using the ABB Drives – Enhanced communication profile

This example shows how to configure a frequency control application that uses the ABB Drives - Enhanced profile. In addition, some application-specific data is added to the communication.

The start/stop commands and reference are according to the ABB Drives profile. For more information, see section [ABB Drives communication profile](#) on page 89.

In the frequency control mode, when Reference 1 (REF1) is used, a reference value of ± 20000 (4E20h) corresponds to the reference set with parameter 46.02 Frequency scaling in the forward and reverse directions.

The minimum and maximum 16-bit integer values that can be given through the fieldbus are -32768 and 32767 respectively.

Output data	Modbus register	Input data	Modbus register
Control word	(4)00001	Status word	(4)00051
Frequency reference	(4)00002	Frequency actual value	(4)00052
Reference 2 (Not used)	(4)00003	Actual value 2 (Not used)	(4)00053
Constant frequency 1 ¹⁾	(4)00004 (4)00005	Power ¹⁾	(4)00054 (4)00055
Constant frequency 2 ¹⁾	(4)00006 (4)00007	DC bus voltage ¹⁾	(4)00056 (4)00057

¹⁾ Example

The table below gives the recommended drive parameter settings.

Drive parameter	Setting for ACS580 drives	Description
50.01 FBA A enable	1 = Option slot 1 ²⁾	Enables communication between the drive and the fieldbus adapter module.
50.02 FBA A comm loss func	1 = Fault ²⁾	Enables fieldbus A communication fault monitoring.

Drive parameter	Setting for ACS580 drives	Description
50.03 FBA A comm loss t out	3.0 s ²⁾	Defines the fieldbus A communication break supervision time.
50.04 FBA A ref1 type	0 = Speed or frequency	Selects the fieldbus A reference 1 type and scaling.
51.01 FBA A type	128 = ETHERNET ¹⁾	Displays the type of the fieldbus adapter module.
51.02 Protocol/Profile	1 = MB/TCP ABB E	Selects the Modbus/TCP protocol and the ABB Drives - Enhanced profile.
51.03 Commrate	0 = Auto ²⁾	Ethernet communication rate is negotiated automatically by the device.
51.04 IP configuration	0 = Static IP ²⁾	Configuration will be obtained from parameters 05...13.
51.05 IP address 1	192 ²⁾	First part of the IP address
51.06 IP address 2	168 ²⁾	Second part of the IP address
51.07 IP address 3	0 ²⁾	Third part of the IP address
51.08 IP address 4	16 ²⁾	Last part of the IP address
51.09 Subnet CIDR	24 ²⁾	Sets the network mask as 255.255.255.0, allowing access only to the last subnet.
51.20 Timeout time	10 ²⁾	Sets the communication timeout as 1 second.
51.21 Timeout mode	2 = Control RW ²⁾	The timeout feature monitors the updating of the Control word and Reference 1.
52.01 FBA A data in1	01.14 ²⁾	Output power
52.03 FBA a data in3	01.11 ²⁾	DC voltage
53.01 FBA A data out1	28.26 ²⁾	Constant frequency 1
53.03 FBA A data out3	28.27 ²⁾	Constant frequency 2
51.27 FBA A par refresh	1 = Refresh	Validates the FENA-11/-21 configuration parameter settings.



Drive parameter	Setting for ACS580 drives	Description
20.01 Ext1 commands	12 = Fieldbus A	Selects the fieldbus A interface as the source of the start and stop commands for external control location 1.
22.11 Speed ref1 source	4 = FB A ref1	Selects the fieldbus A reference 1 as the source for speed reference 1.
31.11 Fault reset selection	06.1.7	Selects the fieldbus interface as the source for the fault reset signal.

¹⁾ Read-only or automatically detected/set

²⁾ Example

The start sequence for the parameter example above is given below.

Control word:

- Reset the fieldbus communication fault (if active).
- Enter 47Eh (1150 decimal) → READY TO SWITCH ON.
- Enter 47Fh (1151 decimal) → OPERATING (Scalar motor control mode).



Client configuration

After the adapter module has been initialized by the drive, you must prepare the client for communication with the module. Due to the large number of different Modbus clients, specific instructions cannot be provided here. Refer to the documentation of your client for more information.

■ Modbus register maps

The Modbus register map which the adapter module presents to the Modbus client is selected with parameter *02 PROTOCOL PROFILE* (see page 51).

For Modbus register map definitions, see chapter *Modbus/TCP – Communication protocol*.

For definitions of the Control word, Status word, references and actual values for a given communication profile, see chapter *Modbus/TCP – Communication profiles*.



6

Modbus/TCP – Communication profiles

Contents of this chapter

This chapter describes the communication profiles used in the communication between the Modbus/TCP client, the adapter module and the drive.

Communication profiles

Communication profiles are ways of conveying control commands (Control word, Status word, references and actual values) between the Modbus client and the drive.

With the FENA adapter module, the Modbus/TCP network may employ either the ABB Drives profile or one of two Transparent modes for 16-bit and 32-bit words respectively. For the ABB Drives profile, data is converted by the adapter module into the native profile (eg, DCU or FBA). For the Transparent modes, no data conversion takes place.

The figure below illustrates the profile selection:

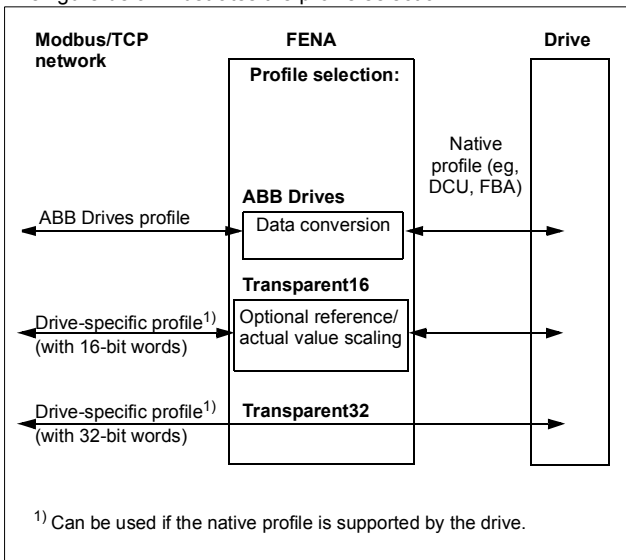

The following sections describe the Control word, the Status word, references and actual values for the ABB Drives communication profile. Refer to the drive manuals for details on the native profiles.

ABB Drives communication profile

■ Control word and Status word

The Control word is the principal means for controlling the drive from a fieldbus system. It is sent by the fieldbus client station to the drive through the adapter module. The drive switches between its states according to the bit-coded instructions in the Control word and returns status information to the client in the Status word.

The contents of the Control word and the Status word are detailed below. The drive states are presented on page 93.

Control word contents

The table below shows the contents of the Control word for the ABB Drives communication profile. The upper case boldface text refers to the states shown in the state machine on page 93.

Bit	Name	Value	STATE/Description
0	OFF1_ CONTROL	1	Proceed to READY TO OPERATE .
		0	Stop along currently active deceleration ramp. Proceed to OFF1 ACTIVE ; proceed to READY TO SWITCH ON unless other interlocks (OFF2, OFF3) are active.
1	OFF2_ CONTROL	1	Continue operation (OFF2 inactive).
		0	Emergency OFF, coast to stop. Proceed to OFF2 ACTIVE , proceed to SWITCH-ON INHIBITED .
2	OFF3_ CONTROL	1	Continue operation (OFF3 inactive).
		0	Emergency stop, stop within time defined by drive parameter. Proceed to OFF3 ACTIVE ; proceed to SWITCH-ON INHIBITED . Warning: Ensure that motor and driven machine can be stopped using this stop mode.

Bit	Name	Value	STATE/Description
3	INHIBIT_OPERATION	1	Proceed to OPERATION ENABLED . Note: Run enable signal must be active; see drive documentation. If the drive is set to receive the Run enable signal from the fieldbus, this bit activates the signal.
		0	Inhibit operation. Proceed to OPERATION INHIBITED .
4	RAMP_OUT_ZERO	1	Normal operation. Proceed to RAMP FUNCTION GENERATOR: OUTPUT ENABLED .
		0	Force Ramp Function Generator output to zero. Drive ramps to stop (current and DC voltage limits in force).
5	RAMP_HOLD	1	Enable ramp function. Proceed to RAMP FUNCTION GENERATOR: ACCELERATOR ENABLED .
		0	Halt ramping (Ramp Function Generator output held).
6	RAMP_IN_ZERO	1	Normal operation. Proceed to OPERATION . Note: This bit is effective only if the fieldbus interface is set as the source for this signal by drive parameters.
		0	Force Ramp Function Generator input to zero.
7	RESET	0 → 1	Fault reset if an active fault exists. Proceed to SWITCH-ON INHIBITED . Note: This bit is effective only if the fieldbus interface is set as the source for this signal by drive parameters.
		0	Continue normal operation.
8...9	Reserved.		

Bit	Name	Value	STATE/Description
10	REMOTE_CMD	1	Fieldbus control enabled.
		0	Control word and reference not getting through to the drive, except for CW bits OFF1, OFF2 and OFF3.
11	EXT_CTRL_LOC	1	Select External Control Location EXT2. Effective if control location parameterized to be selected from fieldbus.
		0	Select External Control Location EXT1. Effective if control location parameterized to be selected from fieldbus.
12... 15	Reserved or freely programmable control bits (Not supported with ACS355)		

Status word contents

The table below shows the contents of the Status word for the ABB Drives communication profile. The upper case boldface text refers to the states shown in the state machine on page 93.

Bit	Name	Value	STATE/Description
0	RDY_ON	1	READY TO SWITCH ON
		0	NOT READY TO SWITCH ON
1	RDY_RUN	1	READY TO OPERATE
		0	OFF1 ACTIVE
2	RDY_REF	1	OPERATION ENABLED
		0	OPERATION INHIBITED
3	TRIPPED	1	FAULT
		0	No fault
4	OFF_2_STA	1	OFF2 inactive
		0	OFF2 ACTIVE
5	OFF_3_STA	1	OFF3 inactive
		0	OFF3 ACTIVE
6	SWC_ON_INHIB	1	SWITCH-ON INHIBITED
		0	–

Bit	Name	Value	STATE/Description
7	ALARM	1	Warning/Alarm
		0	No warning/alarm
8	AT_ SETPOINT	1	OPERATION. Actual value equals reference (= is within tolerance limits, ie, in speed control, speed error is 10% max. of nominal motor speed).
		0	Actual value differs from reference (= is outside tolerance limits.)
9	REMOTE	1	Drive control location: REMOTE (EXT1 or EXT2)
		0	Drive control location: LOCAL
10	ABOVE_ LIMIT	1	Actual frequency or speed equals or exceeds supervision limit (set by drive parameter). Valid in both directions of rotation.
		0	Actual frequency or speed within supervision limit
11	EXT_CTRL_ LOC	1	External Control Location EXT2 selected. Note concerning ACS880: This bit is effective only if the fieldbus interface is set as the target for this signal by drive parameters. User bit 0 selection (06.33)
		0	External Control Location EXT1 selected
12	EXT_RUN_ ENABLE	1	External Run Enable signal received. Note concerning ACS880: This bit is effective only if the fieldbus interface is set as the target for this signal by drive parameters. User bit 1 selection (06.34)
		0	No External Run Enable signal received
13... 14	Reserved or freely programmable status bits (Not supported with ACS355)		
15	FBA_ERROR	1	Communication error detected by fieldbus adapter module
		0	Fieldbus adapter communication OK

State machine

The state machine for the ABB Drives communication profile is shown below.

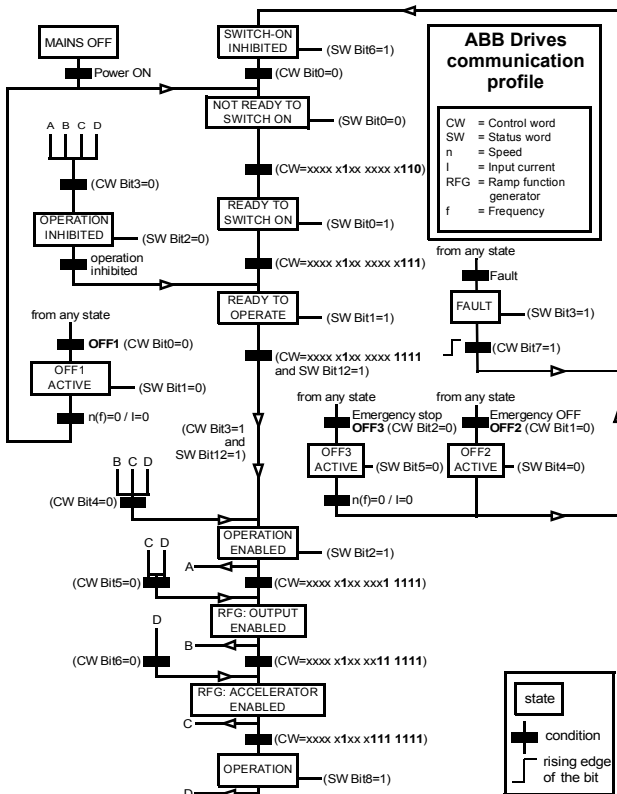

References

References are 16-bit words containing a sign bit and a 15-bit integer. A negative reference (indicating reversed direction of rotation) is formed by calculating the two's complement from the corresponding positive reference.

ABB drives can receive control information from multiple sources including analog and digital inputs, the drive control panel and a fieldbus adapter module (for example, FENA). To have the drive controlled through the fieldbus, you must select the module as the source for control information, for example, reference.

Scaling

References are scaled as shown below.

Note: The values of REF1 MAX and REF2 MAX are set with drive parameters. See the drive manuals for further information.

In ACSM1, ACS850, ACQ810, ACS880 and ACS580, the speed reference (REFx) in decimal (0...20000) corresponds to 0...100% of the speed scaling value (as defined with a drive parameter).

In ACS355, drive parameter REFx MIN may limit the actual minimum reference.

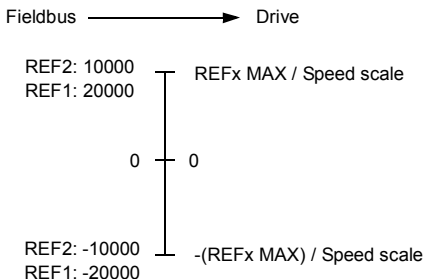

Actual values

Actual values are 16-bit words containing information on the operation of the drive. The functions to be monitored are selected with a drive parameter.

Scaling

Actual values are scaled as shown below.

Note: The values of REF1 MAX and REF2 MAX are set with drive parameters. See the drive manuals for further information.

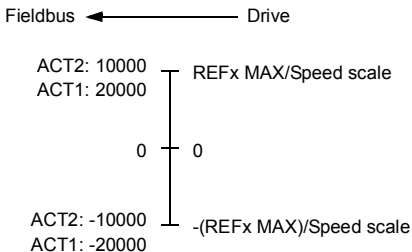

6

Modbus/TCP – Communication protocol

Contents of this chapter

This chapter describes the Modbus/TCP communication protocol for the adapter module.

Modbus/TCP

Modbus/TCP is a variant of the Modbus family of simple, vendor neutral communication protocols intended for supervision and control of automation equipment. Specifically, it covers the use of Modbus messaging over TCP connection on an IP network.

The FENA adapter module acts as a Modbus/TCP server with support for the ABB Drives and Transparent profiles. The adapter module also supports Modbus over UDP. The only difference between Modbus/TCP and Modbus/UDP is that in Modbus/UDP the transport layer protocol is UDP instead of TCP.

The supported Modbus commands are listed in section [Function codes](#) on page 98. Two simultaneous Modbus/TCP connections are supported, that is, two clients can be connected to the adapter module at a time.

Further information on the Modbus/TCP protocol is available at www.modbus.org.

Register addressing

The address field of Modbus Requests for accessing Holding registers is 16 bits. This allows the Modbus protocol to support addressing of 65536 Holding registers.

Historically, Modbus client devices used 5-digit decimal addresses from 40001 to 49999 to represent Holding register addresses. 5-digit decimal addressing limited to 9999 the number of holding registers that could be addressed.

Modern Modbus client devices typically provide a means to access the full range of 65536 Modbus Holding registers. One of these methods is to use 6-digit decimal addresses from 400001 to 465536. This manual uses 6-digit decimal addressing to represent Modbus Holding register addresses.

Modbus client devices that are limited to 5-digit decimal addressing may still access registers 400001 to 409999 by using 5-digit decimal addresses 40001 to 49999. Registers 410000-465536 are inaccessible to these clients.

Function codes

The adapter module supports the Modbus function codes shown below.

Function code	Name	Description
03h	Read Holding Registers	Reads the contents of a contiguous block of holding registers in a server device.
06h	Write Single Register	Writes a single holding register in a server device.
10h	Write Multiple Registers	Writes the contents of a contiguous block of holding registers in a server device.
17h	Read/Write Multiple Registers	Writes the contents of a contiguous block of holding registers in a server device, then reads the contents of a contiguous block of holding registers (same or different than those written) in a server device.

Function code	Name	Description
2Bh/0Eh	Encapsulated Interface Transport / Read Device Identification	<p>Allows reading identification and other information of the server.</p> <p>Parameter "Read Device ID code" allows one to define three access types:</p> <ul style="list-style-type: none"> • 01: Request to get the basic device identification (stream access) • 02: Request to get the regular device identification (stream access) • 04: Request to get one specific identification object (individual access).

Encapsulated Interface Transport / Read Device Identification

The adapter module supports the Modbus EIT/RDI objects shown below.

Object ID	Name
00h	Vendor Name
01h	Product Code
02h	Major/Minor Revision
03h	Vendor URL
04h	Product Name

Exception codes

The adapter module supports the Modbus exception codes shown below.

Exception Code	Name	Description
01h	ILLEGAL FUNCTION	The function code received in the query is not an allowable action for the server.
02h	ILLEGAL DATA ADDRESS	The data address received in the query is to an allowable address for the server.
03h	ILLEGAL DATA VALUE	A value contained in the query data field is not an allowable value for the server.
04h	SLAVE DEVICE FAILURE	An unrecoverable error occurred while the server was attempting to perform the requested action.
06h	SLAVE DEVICE BUSY	The server is engaged in processing a long-duration command. The client should retransmit the message later when the server is free.

Communication profiles

Modbus is an application layer messaging protocol. It describes how data is transferred between the client and a server, but not the meaning of that data. Communication profiles are used to define the meaning of the data.

■ ABB Drives profile - Classic

The ABB Drives profile - Classic communication profile provides register mapped access to the control, status, reference and actual values of the ABB Drives profile in the classic format for backward compatibility.

Register Address ¹⁾	Register Data (16-bit)
(4)00001	ABB Drives Profile Control
(4)00002	ABB Drives Profile Reference 1
(4)00003	ABB Drives Profile Reference 2
(4)00004	ABB Drives Profile Status
(4)00005	ABB Drive Profile Actual 1
(4)00006	ABB Drive Profile Actual 2
(4)00101...(4)09999	<p>Drive Parameter Access (16-bit) Register Address = (4)00000 + 100 × Group + Index Example for Drive Parameter 3.18: (4)00000 + 100 × 3 + 18 = 400318 Note: Addressing depends on the address mode selected with parameter group 23 in group A (51/151, 54/154).</p>
(4)20000...(4)29999	<p>Drive Parameter Access (32-bit) (not supported with ACS355): Register Address = (4)20000 + 200 × Group + 2 × Index Example for Drive Parameter 1.27: (4)20000 + 200 × 1 + 2 × 27 = 420254 Note: Addressing depends on the address mode selected with parameter group 23 in group A (51/151, 54/154).</p>

¹⁾ 6-digit register addressing ([4]00001) is used instead of 5-digit register addressing ([4]0001) to describe the register map. See section [Register addressing](#) on page 98 for additional information.

■ ABB Drives profile - Enhanced

The ABB Drives profile - Enhanced communication profile provides register mapped access to the control, status, reference and actual values of the ABB Drives profile. The mapping of the registers has been enhanced to allow writing of control and reading of status in a single Read/Write Multiple Register request.

Register Address ^{1), 2)}	Register Data (16-bit)
(4)00001	ABB Drives Profile Control
(4)00002	ABB Drives Profile Reference 1
(4)00003	ABB Drives Profile Reference 2
(4)00004	DATA OUT 1
(4)00005	DATA OUT 2
(4)00006	DATA OUT 3
(4)00007	DATA OUT 4
(4)00008	DATA OUT 5
(4)00009	DATA OUT 6
(4)00010	DATA OUT 7
(4)00011	DATA OUT 8
(4)00012	DATA OUT 9
(4)00013	DATA OUT 10
(4)00014	DATA OUT 11
(4)00015	DATA OUT 12
(4)00051	ABB Drives Profile Status
(4)00052	ABB Drive Profile Actual 1
(4)00053	ABB Drive Profile Actual 2
(4)00054	DATA IN 1
(4)00055	DATA IN 2
(4)00056	DATA IN 3
(4)00057	DATA IN 4
(4)00058	DATA IN 5
(4)00059	DATA IN 6

Register Address ^{1), 2)}	Register Data (16-bit)
(4)00060	DATA IN 7
(4)00061	DATA IN 8
(4)00062	DATA IN 9
(4)00063	DATA IN 10
(4)00064	DATA IN 11
(4)00065	DATA IN 12
(4)00101...(4)09999	<p>Drive Parameter Access (16-bit) Register Address = (4)00000 + 100 × Group + Index Example for Drive Parameter 3.18: (4)00000 + 100 × 3 + 18 = 400318 Note: Addressing depends on the address mode selected with parameter group 23 in group A (51/151, 54/154).</p>
(4)20000...(4)29999	<p>Drive Parameter Access (32-bit) (not supported with ACS355): Register Address = (4)20000 + 200 × Group + 2 × Index Example for Drive Parameter 1.27: (4)20000 + 200 × 1 + 2 × 27 = 420254 Note: Addressing depends on the address mode selected with parameter group 23 in group A (51/151, 54/154).</p>

- ¹⁾ 6-digit register addressing ([4]00001) is used instead of 5-digit register addressing ([4]0001) to describe register map. See section [Register addressing](#) on page 98 for additional information.
- ²⁾ Register addresses of the 32-bit parameters cannot be accessed by using 5-digit register numbers.

■ Transparent 16-bit

The Transparent 16-bit communication profile provides unaltered 16-bit access to the configured drive profile.

Register Address ^{1), 2)}	Register Data (16-bit)
(4)00001	Native Drive Profile Control
(4)00002	Native Drive Profile Reference 1
(4)00003	Native Drive Profile Reference 2
(4)00004	DATA OUT 1
(4)00005	DATA OUT 2
(4)00006	DATA OUT 3
(4)00007	DATA OUT 4
(4)00008	DATA OUT 5
(4)00009	DATA OUT 6
(4)00010	DATA OUT 7
(4)00011	DATA OUT 8
(4)00012	DATA OUT 9
(4)00013	DATA OUT 10
(4)00014	DATA OUT 11
(4)00015	DATA OUT 12
(4)00051	Native Drive Profile Status
(4)00052	Native Drive Profile Actual 1
(4)00053	Native Drive Profile Actual 2
(4)00054	DATA IN 1
(4)00055	DATA IN 2
(4)00056	DATA IN 3
(4)00057	DATA IN 4
(4)00058	DATA IN 5
(4)00059	DATA IN 6
(4)00060	DATA IN 7
(4)00061	DATA IN 8

Register Address ^{1), 2)}	Register Data (16-bit)
(4)00062	DATA IN 9
(4)00063	DATA IN 10
(4)00064	DATA IN 11
(4)00065	DATA IN 12
(4)00101... (4)19999	Drive Parameter Access (16-bit) Register Address = $400000 + 100 \times \text{Group} + \text{Index}$ Example for Drive Parameter 3.18: $(4)00000 + 100 \times 3 + 18 = 400318$ Note: Addressing depends on the address mode selected with parameter group 23 in group A (51/151, 54/154).
(4)20000... (4)29999	Drive Parameter Access (32-bit) (not supported with ACS355): Register Address = $(4)20000 + 200 \times \text{Group} + 2 \times \text{Index}$ Example for Drive Parameter 1.27: $(4)20000 + 200 \times 1 + 2 \times 27 = 420254$ Note: Addressing depends on the address mode selected with parameter group 23 in group A (51/151, 54/154).

- ¹⁾ 6-digit register addressing ([4]00001) is used instead of 5-digit register addressing ([4]0001) to describe register map. See section [Register addressing](#) on page 98 for additional information.
- ²⁾ Register addresses of the 32-bit parameters cannot be accessed by using 5-digit register numbers.

■ Transparent 32-bit

The Transparent 32-bit communication profile provides unaltered 32-bit access to the configured drive profile.

Register Address ^{1), 2)}	Register Data (16-bit)
(4)00001	Native Drive Profile Control - Least Significant 16-bits
(4)00002	Native Drive Profile Control - Most Significant 16-bits
(4)00003	Native Drive Profile Reference 1 - Least Significant 16-bits
(4)00004	Native Drive Profile Reference 1 - Most Significant 16-bits
(4)00005	Native Drive Profile Reference 2 - Least Significant 16-bits
(4)00006	Native Drive Profile Reference 2 - Most Significant 16-bits
(4)00007	DATA OUT 1
(4)00008	DATA OUT 2
(4)00009	DATA OUT 3
(4)00010	DATA OUT 4
(4)00011	DATA OUT 5
(4)00012	DATA OUT 6
(4)00013	DATA OUT 7
(4)00014	DATA OUT 8
(4)00015	DATA OUT 9
(4)00016	DATA OUT 10
(4)00017	DATA OUT 11
(4)00018	DATA OUT 12
(4)00051	Native Drive Profile Status - Least Significant 16-bits
(4)00052	Native Drive Profile Status - Most Significant 16-bits
(4)00053	Native Drive Profile Actual 1 - Least Significant 16-bits

Register Address ^{1), 2)}	Register Data (16-bit)
(4)00054	Native Drive Profile Actual 1 - Most Significant 16-bits
(4)00055	Native Drive Profile Actual 2 - Least Significant 16-bits
(4)00056	Native Drive Profile Actual 2 - Most Significant 16-bits
(4)00057	DATA IN 1
(4)00058	DATA IN 2
(4)00059	DATA IN 3
(4)00060	DATA IN 4
(4)00061	DATA IN 5
(4)00062	DATA IN 6
(4)00063	DATA IN 7
(4)00064	DATA IN 8
(4)00065	DATA IN 9
(4)00066	DATA IN 10
(4)00067	DATA IN 11
(4)00068	DATA IN 12

Register Address ^{1), 2)}	Register Data (16-bit)
(4)00101...(4)09999	Drive Parameter Access (16-bit) Register Address = (4)00000 + 100 × Group + Index Example for Drive Parameter 3.18: (4)00000 + 100 × 3 + 18 = 400318 Note: Addressing depends on the address mode selected with parameter group 23 in group A (51/151, 54/154).
(4)20000...(4)29999	Drive Parameter Access (32-bit) (not supported with ACS355): in group A (51/151, 54/154) Register Address = (4)20000 + 200 × Group + 2 × Index Example for Drive Parameter 1.27: (4)20000 + 200 × 1 + 2 × 27 = 420254 Note: Addressing depends on the address mode selected with parameter group 23 in group A (51/151, 54/154).

¹⁾ 6-digit register addressing ([4]00001) is used instead of 5-digit register addressing ([4]0001) to describe register map. See section [Register addressing](#) on page 98 for additional information.

²⁾ Register addresses of the 32-bit parameters cannot be accessed by using 5-digit register numbers.

9

Modbus/TCP – Diagnostics

Contents of this chapter

This chapter explains how to trace faults with the status LEDs on the adapter module when the module is used for Modbus/TCP communication.

Fault and warning messages

For the fault and warning messages concerning the adapter module, see the drive firmware manual.

LEDs

The adapter module is equipped with three bicolor diagnostic LEDs. The LEDs are described below.

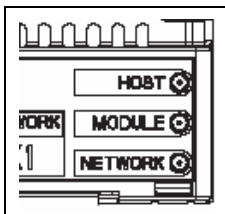

Name	Color	Function
HOST	Blinking green	Establishing communication to host
	Green	Connection to host OK
	Blinking red	Communication to host lost temporarily
	Flashing orange, alternating with the MODULE flashing orange	Internal file system error. The error may be cleared by cycling drive power. If the error persists, contact your local ABB representative.

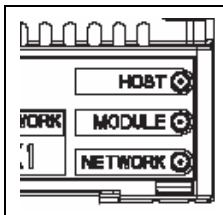

Name	Color	Function
MODULE	Off	There is no power applied to the device.
	Flashing orange	Device is attempting to obtain IP configuration from the DHCP server.
	Orange	Device is executing Duplicate Address Detection.
	Flashing green	Device is waiting for a Modbus request.
	Green	Device has received a Modbus request within the Modbus/TCP Timeout period.
	Flashing red	Ethernet link is down.
	Red	Ethernet interface is disabled. Duplicate Address Detection may have detected a duplicate address. Check the IP configuration and either initiate a Fieldbus Adapter parameter refresh or cycle power to the drive.
	Flashing orange, alternating with the HOST flashing orange	Internal file system error. The error may be cleared by cycling drive power. If the error persists, contact your local ABB representative.
NETWORK /NET	Off	Ethernet link is down.
	Flashing green	Ethernet link is up at 100 Mbps. Flashing indicates activity on interface.
	Flashing orange	Ethernet link is up at 10 Mbps. Flashing indicates activity on interface.

Internal error code registers

A Modbus query can fail in many ways in the drive. The Modbus standard does not specify detailed error descriptions. In addition to the standard error codes, the FENA adapter module provides an internal error register area for more detailed diagnostics.

The internal error register area is used if Modbus error code 0x04 occurs. The registers contain information about the last query. You can figure out the reason of the failure by reading the registers. The internal error register is cleared when a query has finished successfully.

Address	Registers (16-bit word)
(4)00090	Reset internal error registers (0 = Do nothing, 1 = Reset)
(4)00091	Function code of the failed query
(4)00092	Internal error code; see the error number.
(4)00093	Failed register
(4)00094	Last register that was written successfully
(4)00095	Last register that was read successfully

Error code	Description	Situation
0x00	No error	Used when a Modbus query was successful
0x02	Low or high limit exceeded	Change access with a value outside the value limits
0x03	Faulty subindex	Access to an unavailable subindex of an array parameter
0x05	Incorrect data type	Change access with a value that does not match the data type of the parameter
0x65	General error in drive communication	Undefined error when handling a Modbus query
0x66	Timeout	Timeout in drive communication when handling a Modbus query
0x70	Read-only	An attempt to write a non-zero value to a read-only drive parameter

Error code	Description	Situation
0x71	Parameter group ended	An attempt to write to multiple parameter groups
0x72	MSB is not zero	An attempt to write a 16-bit parameter with a 32-register address and the MSB bytes are not zero
0x73	LSB query start	An attempt to access only the LSB register of the 32-bit parameter
0x74	MSB query end	An attempt to access only the MSB register of the 32-bit parameter

EtherNet/IP protocol

<i>EtherNet/IP – Start-up</i>	117
<i>EtherNet/IP – Communication profiles</i>	173
<i>EtherNet/IP – Communication protocol</i>	195
<i>EtherNet/IP – Diagnostics</i>	259



6

EtherNet/IP – Start-up

Contents of this chapter

This chapter contains:

- information on configuring the drive for operation with the adapter module
- drive-specific instructions on starting up the drive with the adapter module
- examples of configuring the client for communication with the adapter module.

Warnings



WARNING! Obey the safety instructions given in this manual and the drive documentation.



Drive configuration

The information in this section applies to all drive types compatible with the adapter module, unless otherwise stated.

■ EtherNet/IP connection configuration

After the adapter module has been mechanically and electrically installed according to the instructions in chapters [Mechanical installation](#) and [Electrical installation](#), you must prepare the drive for communication with the module.

The detailed procedure of activating the module for EtherNet/IP communication with the drive depends on the drive type. Normally, you must adjust a parameter to activate the communication. See the drive-specific start-up sections starting on page [135](#).

Once communication between the drive and the adapter module has been established, several configuration parameters are copied to the drive. These parameters are shown in the tables below and must be checked first and adjusted where necessary. You can adjust the parameters via a drive control panel, a PC tool or a web user interface. For more information on the web user interface, see [Appendix C – FENA configuration web pages](#).

Note:

- Not all drives display descriptive names for the configuration parameters. To help you identify the parameters in different drives, the names displayed by each drive are given in gray boxes in the tables.
- The new parameter settings take effect only when you power up the module the next time or when you activate the fieldbus adapter refresh parameter.



FENA-01/-11/-21 configuration parameters – group A (group 1)

Note: The actual parameter group number depends on the drive type. Group A (group 1) corresponds to:

- parameter group 51 in ACS355, ACSM1, ACS580, ACS850 and ACQ810
- parameter group is typically 51/54 (group 151/154 in some variants) in ACS880 if the adapter is installed as fieldbus adapter A/B.

No.	Name/Value	Description	Default
01	FBA TYPE	Read-only. Shows the fieldbus adapter type as detected by the drive. The value cannot be adjusted by the user. If the value is 0 = None, the communication between the drive and the module has not been established.	128 = ETHER-NET
02	PROTOCOL/ PROFILE ACS355: FB PAR 2 ACSM1: FBA PAR2 ACS850/ACQ810: FBA par2 ACS880/ACS580: Protocol/Profile	Selects the application protocol and communication profile for the network connection. The selections available for EtherNet/IP communication are listed below. 1) 0 = Modbus/TCP: ABB Drives profile - Classic	0 ¹⁾
	100 = EIP AC/DC	EtherNet/IP protocol: ODVA AC/DC drive profile	
	101 = EIP ABB Pro	EtherNet/IP protocol: ABB Drives profile	
	102 = EIP T16	EtherNet/IP protocol: Transparent 16-bit profile	
	103 = EIP T32	EtherNet/IP protocol: Transparent 32-bit profile	



No.	Name/Value	Description	Default
03	COMM RATE ACS355: FB PAR 3 ACSM1: FBA PAR3 ACS850/ACQ810: FBA par3 ACS880/ACS580: Commrate	Sets the bit rate for the Ethernet interface. In FENA-21 this parameter is used for configuring port 1. For configuring port 2, see parameter 14.	0 = Auto
	0 = Auto	Auto negotiate	
	1 = 100 Mbps FD	100 Mbps, full duplex	
	2 = 100 Mbps HD	100 Mbps, half duplex	
	3 = 10 Mbps FD	10 Mbps, full duplex	
	4 = 10 Mbps HD	10 Mbps, half duplex	
04	IP CONFIGURATION ACS355: FB PAR 4 ACSM1: FBA PAR4 ACS850/ACQ810: FBA par4 ACS880/ACS580: IP configuration	Sets the method for configuring the IP address, subnet mask and gateway address for the adapter module.	1 = Dyn IP DHCP
	0 = Static IP	Configuration will be obtained from parameters <i>05...13</i> .	
	1 = Dyn IP DHCP	Configuration will be obtained via DHCP.	
05	IP ADDRESS 1 ACS355: FB PAR 5 ACSM1: FBA PAR5 ACS850/ACQ810: FBA par5 ACS880/ACS580: IP address 1	An IP address is assigned to each IP node on a network. An IP address is a 32-bit number that is typically represented in "dotted decimal" notation consisting of four decimal integers, on the range 0...255, separated by periods. Each integer represents the value of one octet (8- bits) in the IP address. Parameters <i>05...08</i> define the four octets of the IP address.	0
	0...255	IP address	
...



No.	Name/Value	Description	Default																																																																				
08	IP ADDRESS 4 ACS355: FB PAR 8 ACSM1: FBA PAR8 ACS850/ACQ810: FBA par8 ACS880/ACS580: IP address 4	See parameter <i>05 IP ADDRESS 1</i> .	0																																																																				
	0...255	IP address																																																																					
09	SUBNET CIDR ACS355: FB PAR 9 ACSM1: FBA PAR9 ACS850/ACQ810: FBA par9 ACS880/ACS580: Subnet CIDR	<p>Subnet masks are used for splitting networks into smaller networks called subnets. A subnet mask is a 32-bit binary number that splits the IP address into a network address and host address.</p> <p>Subnet masks are typically represented in either dotted decimal notation or the more compact CIDR notation, as shown in the table below.</p>	0																																																																				
		<table border="1"> <thead> <tr> <th>Dotted decimal</th> <th>CIDR</th> <th>Dotted decimal</th> <th>CIDR</th> </tr> </thead> <tbody> <tr><td>255.255.255.254</td><td>31</td><td>255.254.0.0</td><td>15</td></tr> <tr><td>255.255.255.252</td><td>30</td><td>255.252.0.0</td><td>14</td></tr> <tr><td>255.255.255.248</td><td>29</td><td>255.248.0.0</td><td>13</td></tr> <tr><td>255.255.255.240</td><td>28</td><td>255.240.0.0</td><td>12</td></tr> <tr><td>255.255.255.224</td><td>27</td><td>255.224.0.0</td><td>11</td></tr> <tr><td>255.255.255.192</td><td>26</td><td>255.224.0.0</td><td>10</td></tr> <tr><td>255.255.255.128</td><td>25</td><td>255.128.0.0</td><td>9</td></tr> <tr><td>255.255.255.0</td><td>24</td><td>255.0.0.0</td><td>8</td></tr> <tr><td>255.255.254.0</td><td>23</td><td>254.0.0.0</td><td>7</td></tr> <tr><td>255.255.252.0</td><td>22</td><td>252.0.0.0</td><td>6</td></tr> <tr><td>255.255.248.0</td><td>21</td><td>248.0.0.0</td><td>5</td></tr> <tr><td>255.255.240.0</td><td>20</td><td>240.0.0.0</td><td>4</td></tr> <tr><td>255.255.224.0</td><td>19</td><td>224.0.0.0</td><td>3</td></tr> <tr><td>255.255.192.0</td><td>18</td><td>192.0.0.0</td><td>2</td></tr> <tr><td>255.255.128.0</td><td>17</td><td>128.0.0.0</td><td>1</td></tr> <tr><td>255.255.0.0</td><td>16</td><td></td><td></td></tr> </tbody> </table>	Dotted decimal	CIDR	Dotted decimal	CIDR	255.255.255.254	31	255.254.0.0	15	255.255.255.252	30	255.252.0.0	14	255.255.255.248	29	255.248.0.0	13	255.255.255.240	28	255.240.0.0	12	255.255.255.224	27	255.224.0.0	11	255.255.255.192	26	255.224.0.0	10	255.255.255.128	25	255.128.0.0	9	255.255.255.0	24	255.0.0.0	8	255.255.254.0	23	254.0.0.0	7	255.255.252.0	22	252.0.0.0	6	255.255.248.0	21	248.0.0.0	5	255.255.240.0	20	240.0.0.0	4	255.255.224.0	19	224.0.0.0	3	255.255.192.0	18	192.0.0.0	2	255.255.128.0	17	128.0.0.0	1	255.255.0.0	16			
Dotted decimal	CIDR	Dotted decimal	CIDR																																																																				
255.255.255.254	31	255.254.0.0	15																																																																				
255.255.255.252	30	255.252.0.0	14																																																																				
255.255.255.248	29	255.248.0.0	13																																																																				
255.255.255.240	28	255.240.0.0	12																																																																				
255.255.255.224	27	255.224.0.0	11																																																																				
255.255.255.192	26	255.224.0.0	10																																																																				
255.255.255.128	25	255.128.0.0	9																																																																				
255.255.255.0	24	255.0.0.0	8																																																																				
255.255.254.0	23	254.0.0.0	7																																																																				
255.255.252.0	22	252.0.0.0	6																																																																				
255.255.248.0	21	248.0.0.0	5																																																																				
255.255.240.0	20	240.0.0.0	4																																																																				
255.255.224.0	19	224.0.0.0	3																																																																				
255.255.192.0	18	192.0.0.0	2																																																																				
255.255.128.0	17	128.0.0.0	1																																																																				
255.255.0.0	16																																																																						
	1...31	Subnet mask in CIDR notation																																																																					

No.	Name/Value	Description	Default
10	GW ADDRESS 1 ACS355: FB PAR 10 ACSM1: FBA PAR10 ACS850/ACQ810: FBA par10 ACS880/ACS580: GW address 1	IP gateways connect individual physical IP subnets into a unified IP network. When an IP node needs to communicate with an IP node on another subnet, the IP node sends the data to the IP gateway for forwarding. Parameters 10...13 define the four octets of the gateway address.	0
	0...255	GW address	
...
13	GW ADDRESS 4 ACS355: FB PAR 13 ACSM1: FBA PAR13 ACS850/ACQ810: FBA par13 ACS880/ACS580: GW address 4	See parameter 10 GW ADDRESS 1 .	0
	0...255	GW address	
14	COMM RATE PORT 2 ACS355: FB PAR 3 ACSM1: FBA PAR3 ACS850/ACQ810: FBA par3 ACS880/ACS580: Commrate Port 2	Sets the bit rate for the Ethernet port 2. This parameter is used only with FENA-21.	0 = Auto
	0 = Auto	Auto negotiate	
	1 = 100 Mbps FD	100 Mbps, full duplex	
	2 = 100 Mbps HD	100 Mbps, half duplex	
	3 = 10 Mbps FD	10 Mbps, full duplex	
	4 = 10 Mbps HD	10 Mbps, half duplex	
15	Reserved	These parameters are not used by the adapter module when the module is configured for EtherNet/IP.	N/A
...			
18			



No.	Name/Value	Description	Default
19	T16 SCALE ACS355: FB PAR 19 ACSM1: FBA PAR19 ACS850/ACQ810: FBA par19 ACS880/ACS580: T16 scale	<p>Defines the reference multiplier/actual value divisor for the adapter module. The parameter is effective only when the Transparent 16 profile is selected AND the drive is using the native communication profile (eg, DCU or FBA) and a 16-bit transparent Reference 1/Actual value 1.</p> <p>Reference 1 is multiplied by the value of this plus one and the actual value 1 is divided by the value of this plus one. With value 0, the reference 1/actual value 1 scale in the adapter module is $1 = 1$.</p> <p>With an ACS355 drive: For example, if the parameter has a value 99 and the reference of 1000 is given by the master, the reference is multiplied by 100 (i.e. $99 + 1$) and forwarded to the drive as 100000.</p> <p>According to the DCU profile, speed scale is $1000 = 1$ rpm. This value is interpreted as a reference of 100 rpm in the drive.</p> <p>With ACSM1, ACS850 and ACQ810, the DCU profile speed scale is approximately $65535 = 1$ rpm.</p> <p>With ACS880 and ACS580 reference 1/actual value 1 base scale in transparent mode is $100 = 1$, but using this reference value depends on the application of drive.</p>	99
	0...65535	Reference multiplier/actual value divisor	



No.	Name/Value	Description	Default
20	CONTROL TIMEOUT ACS355: FB PAR 20 ACSM1: FBA PAR20 ACS850/ACQ810: FBA par20 ACS880/ACS580: Control timeout	Defines the control timeout value. The EtherNet/IP protocol specifies connection timeout for I/O messaging (Class 1) and Connected explicit messaging (Class 3), but not Unconnected explicit messaging. This parameter provides a timeout for Unconnected explicit messaging and for instances of Connected explicit messaging (Class 3), where the client breaks the connection in between requests.	0

Connection type	Control timeout	Timeout source
I/O messaging (Class 1)	0...65535	(Requested Packet Interval) X (Connection Timeout Multiplier) Note: Timeout behavior may be modified by Watchdog Timeout Action attribute of Connection object.
Connected explicit messaging (Class 3)	0	(Requested Packet Interval) X (Connection Timeout Multiplier) Note: Timeout behavior may be modified by Watchdog Timeout Action attribute of Connection object.
	1...65534	100ms X (Control Timeout Value) since last Control Event
	65535	Never Timeout
Unconnected explicit messaging	0	Always Timeout Note: Control Timeout must be greater than zero to control drive with Unconnected Explicit Messaging.
	1...65534	100ms X (Control Timeout Value) since last Control Event
	65535	Never Timeout



No.	Name/Value	Description	Default
		<p>Control timeout events:</p> <ul style="list-style-type: none"> • Write of an output assembly object instance • Write of control bits (Run1, Run2, NetCtrl, NetRef and FaultReset) • Write Speed Reference • Write Torque Reference • Reset Control Supervisor object • Write Force Fault via Control Supervisor object <p>If a timeout occurs, the adapter module signals the drive that communication with the client has been lost. The drive configuration then determines how to respond.</p> <p>Example: If the timeout is 250 ms and the drive is configured to fault on a communication failure with a delay of 500 ms, then the drive will fault 750 ms after communications is lost.</p>	
	0...65535	Control timeout value	
21	<p>IDLE ACTION</p> <p>ACS355: FB PAR 21</p> <p>ACSM1: FBA PAR21</p> <p>ACS850/ACQ810: FBA par21</p> <p>ACS880/ACS580: Idle action</p>	<p>I/O connections may include a Run/Idle notification. This parameter determines the action the drive takes in response to an Idle notification.</p>	0 = Off-line
	0 = Off-line	<p>In the event of an Idle notification, the adapter module signals the drive that communication with the client has been lost. The drive configuration then determines how to respond.</p> <p>Example: If the timeout is 250 ms and the drive is configured to fault on a communication failure with a delay of 500 ms, then the drive will fault 750 ms after communications is lost.</p>	
	1 = On-line	<p>In the event of an Idle notification, the drive will continue to operate using the last command and references received.</p>	



No.	Name/Value	Description	Default
22	ODVA STOP FUNCTION ACS355: FB PAR 22 ACSM1: FBA PAR22 ACS850/ACQ810: FBA par22 ACS880/ACS580: Stop function	Determines how the motor is to be stopped when a stop command is received via EtherNet/IP. This parameter only applies to the ODVA AC/DC drive profile.	0 = Ramp
	0 = Ramp	The motor decelerates along the active deceleration ramp.	
	1 = Coast	The motor comes to a stop by coasting.	



No.	Name/Value	Description	Default																																				
23	ODVA SPEED SCALE ACS355: FB PAR 23 ACSM1: FBA PAR23 ACS850/ACQ810: FBA par23 ACS880/ACS580: Speed scale	<p>This parameter only applies to the ODVA AC/DC drive profile. The units of reference and actual speeds for the ODVA AC/DC drive profile are given by the formula below.</p> <p>Speed unit = $\text{RPM} \times 2^{(-1 \times \text{ODVA speed scale value})}$</p> <p>Note: While a wide range of resolutions may be configured, the actual performance is limited to the performance capabilities of the drive.</p> <p>The table below shows the how the drive ODVA speed scale parameter values correspond to the ODVA speed scale units.</p>	128																																				
<table border="1"> <thead> <tr> <th data-bbox="228 486 495 505">ODVA speed scale value¹⁾</th> <th data-bbox="505 486 736 529">Speed scale value of drive parameter²⁾</th> <th data-bbox="746 486 788 505">Unit</th> </tr> </thead> <tbody> <tr><td>-5</td><td>123</td><td>32 RPM</td></tr> <tr><td>-4</td><td>124</td><td>16 RPM</td></tr> <tr><td>-3</td><td>125</td><td>8 RPM</td></tr> <tr><td>-2</td><td>126</td><td>4 RPM</td></tr> <tr><td>-1</td><td>127</td><td>2 RPM</td></tr> <tr><td>0 (default)</td><td>128</td><td>1 RPM</td></tr> <tr><td>1</td><td>129</td><td>0.5 RPM</td></tr> <tr><td>2</td><td>130</td><td>0.25 RPM</td></tr> <tr><td>3</td><td>131</td><td>0.125 RPM</td></tr> <tr><td>4</td><td>132</td><td>0.0625 RPM</td></tr> <tr><td>5</td><td>133</td><td>0.03125 RPM</td></tr> </tbody> </table>				ODVA speed scale value ¹⁾	Speed scale value of drive parameter ²⁾	Unit	-5	123	32 RPM	-4	124	16 RPM	-3	125	8 RPM	-2	126	4 RPM	-1	127	2 RPM	0 (default)	128	1 RPM	1	129	0.5 RPM	2	130	0.25 RPM	3	131	0.125 RPM	4	132	0.0625 RPM	5	133	0.03125 RPM
ODVA speed scale value ¹⁾	Speed scale value of drive parameter ²⁾	Unit																																					
-5	123	32 RPM																																					
-4	124	16 RPM																																					
-3	125	8 RPM																																					
-2	126	4 RPM																																					
-1	127	2 RPM																																					
0 (default)	128	1 RPM																																					
1	129	0.5 RPM																																					
2	130	0.25 RPM																																					
3	131	0.125 RPM																																					
4	132	0.0625 RPM																																					
5	133	0.03125 RPM																																					
<p>¹⁾ Use the ODVA speed scale value when reading/writing parameter <i>ODVA SPEED SCALE</i> via <i>AC/DC-drive object, class 2Ah</i>. When written via the AC/DC drive object, the new value takes effect immediately.</p> <p>²⁾ Use the speed scale value of the drive parameter when reading/writing parameter <i>ODVA SPEED SCALE</i> via the drive control panel, <i>Drive parameter object, class 90h</i> and <i>Fieldbus configuration object, class 91h</i>. When written via these methods, the new value takes effect after the drive is repowered or a "Fieldbus Adapter Parameter refresh" is given.</p>																																							
0...255	Speed scale value of drive parameter																																						



No.	Name/Value	Description	Default
24	ODVA TORQUE SCALE ACS355: FB PAR 24 ACSM1: FBA PAR4 ACS850/ACQ810: FBA par24 ACS880/ACS580: Torque scale	<p>This parameter only applies to the ODVA AC/DC drive profile. The units of reference and actual torques for the ODVA AC/DC drive profile are given by the formula below.</p> <p>Torque unit = $N \cdot m \times 2^{(-1 \times \text{ODVA torque scale})}$</p> <p>where: (N·m = Newton × Meter)</p> <p>Note: While a wide range of resolutions may be configured, the actual performance is limited to the performance capabilities of the drive. The table below shows the how the drive ODVA torque scale parameter values correspond to the ODVA torque scale units.</p>	128

ODVA torque scale value ¹⁾	Torque scale value of drive parameter ²⁾	Unit
-5	123	32 N·m
-4	124	16 N·m
-3	125	8 N·m
-2	126	4 N·m
-1	127	2 N·m
0 (default)	128	1 N·m
1	129	0.5 N·m
2	130	0.25 N·m
3	131	0.125 N·m
4	132	0.0625 N·m
5	133	0.03125 N·m

¹⁾ Use the ODVA torque scale value when reading/writing parameter **ODVA TORQUE SCALE** via **AC/DC-drive object, class 2Ah**. When written via the AC/DC drive object, the new value takes effect immediately.

²⁾ Use the torque scale value of the drive parameter when reading/writing parameter **ODVA TORQUE SCALE** via the drive control panel, **Drive parameter object, class 90h** and **Fieldbus configuration object, class 91h**. When written via these methods, the new value takes effect after the drive is repowered or a "Fieldbus Adapter Parameter refresh" is given.

0...255

Torque scale value of drive parameter

No.	Name/Value	Description	Default
25 ... 26	Reserved for web page functionality. For more information, see Appendix C – FENA configuration web pages .	These parameters are not used by the adapter module when the module is configured for EtherNet/IP.	N/A
27	FBA PAR REFRESH ACS355/ACSM1: FBA PAR REFRESH ACS850/ACQ810: FBA par refresh ACS880/ACS580: FBA A/B par refresh	Validates any changed adapter module configuration parameter settings. After refreshing, the value reverts automatically to 0 = Done . Note: This parameter cannot be changed while the drive is running.	0 = Done
	0 = Done	Refreshing done	
	1 = Refresh	Refreshing	
28	PAR TABLE VER ACS355: FILE CPI FW REV ACSM1: PAR TABLE VER ACS850/ACQ810: Par table ver ACS880/ACS580: FBA A/B par table ver	Read-only. Displays the parameter table revision of the fieldbus adapter module mapping file stored in the memory of the drive. In format xyz , where x = major revision number y = minor revision number z = correction number OR in format axyz , where a = major revision number xy = minor revision numbers z = correction number or letter.	N/A
		Parameter table revision	



No.	Name/Value	Description	Default
29	DRIVE TYPE CODE ACS355: FILE CONFIG ID ACSM1: DRIVE TYPE CODE ACS850/ACQ810: Drive type code ACS880/ACS580: FBA A/B drive type code	Read-only. Displays the drive type code of the fieldbus adapter module mapping file stored in the memory of the drive.	N/A
		Drive type code of the fieldbus adapter module mapping file	
30	MAPPING FILE VER ACS355: FILE CONFIG REV ACSM1: MAPPING FILE VER ACS850/ACQ810: Mapping file ver ACS880/ACS580: FBA A/B mapping file ver	Read-only. Displays the fieldbus adapter module mapping file revision stored in the memory of the drive in decimal format.	N/A
		Mapping file revision	
31	D2FBA COMM STA ACS355: FBA STATUS ACSM1: D2FBA COMM STA ACS850/ACQ810: D2FBA comm sta ACS880/ACS580: D2FBA A/B comm status	Read-only. Displays the status of the fieldbus adapter module communication. Note: The value names may vary by drive.	0 = Idle OR 4 = Off-line
	0 = Idle	Adapter is not configured.	
	1 = Exec.init	Adapter is initializing.	



No.	Name/Value	Description	Default
	2 = Time out	A timeout has occurred in the communication between the adapter and the drive.	
	3 = Conf.err	Adapter configuration error: The major or minor revision code of the common program revision in the fieldbus adapter module is not the revision required by the module or mapping file upload has failed more than three times.	
	4 = Off-line	Adapter is off-line.	
	5 = On-line	Adapter is on-line.	
	6 = Reset	Adapter is performing a hardware reset.	
32	FBA COMM SW VER ACS355: FBA CPI FW REV ACSM1: FBA COMM SW VER ACS850/ACQ810: FBA comm sw ver ACS880/ACS580: FBA A/B comm SW ver	Read-only. Displays firmware patch and build number of the adapter module in the xyyy format, where: xx = patch number yy = build number Example: C80D ≥ 200.13 or 0 ≥ 0.0	N/A
		Common program version of the adapter module	
33	FBA APPL SW VER ACS355: FBA APPL FW REV ACSM1: FBA APPL SW VER ACS850/ACQ810: FBA appl sw ver ACS880/ACS580: FBA A/B appl SW ver	Read-only. Displays firmware version of the adapter module in xxyy format, where: xx = major revision number yy = minor revision number Example: 310 = 3.10 Version number is the form: <major>.<minor>.<patch>.<build> Example: 3.10.200.13 or 3.10.0.0	N/A
		Application program revision of the adapter module	



FENA-01/-11/-21 configuration parameters – group B (group 2)

Note: The actual parameter group number depends on the drive type. Group B (group 2) corresponds to:

- parameter group 55 in ACS355
- parameter group 53 in ACSM1, ACS580, ACS850 and ACQ810
- parameter group is typically 53/56 (group 153/156 in some variants) in ACS880 if the adapter is installed as fieldbus adapter A/B.

No. ¹⁾	Name/Value	Description	Default						
01	DATA OUT 1 (client to drive) ACS355: FBA DATA OUT 1 ACSM1: FBA DATA OUT 1 ACS850/ACQ810: FBA data out1 ACS880/ACS580: FBA A/B data out1	In output assembly instances that include drive parameters, this parameter specifies which parameter's value will be placed in location DATA OUT 1 value received by the drive from the EtherNet/IP client. The content is defined by a decimal number in the range of 0 to 9999 as follows: <table border="1" data-bbox="339 659 778 848"> <tr> <td>0</td> <td>Not used</td> </tr> <tr> <td>1...99</td> <td>Virtual address area of drive control. Not used when the EtherNet/IP protocol is used.</td> </tr> <tr> <td>101...9999</td> <td>Parameter area of the drive</td> </tr> </table>	0	Not used	1...99	Virtual address area of drive control. Not used when the EtherNet/IP protocol is used.	101...9999	Parameter area of the drive	0 = None
0	Not used								
1...99	Virtual address area of drive control. Not used when the EtherNet/IP protocol is used.								
101...9999	Parameter area of the drive								
	0 = None	Not used							
	101...9999	Parameter index with format xyy , where <ul style="list-style-type: none"> • xx is the parameter group number (1...99) • yy is the parameter number index within that group (01...99). Note: In ACS880 and ACS580, choose Other to display a list of mappable drive parameters.							
02... 10	DATA OUT 2 ... DATA OUT 10	See parameter 01 DATA OUT 1 .	0 = None						

¹⁾ The number of parameters in this group may vary by drive type and drive firmware.

FENA-01/-11/-21 configuration parameters – group C (group 3)

Note: The actual parameter group number depends on the drive type. Group C (group 3) corresponds to:

- parameter group 54 in ACS355
- parameter group 52 in ACSM1, ACS580, ACS850 and ACQ810
- parameter group is typically 52/55 (group 152/155 in some variants) in ACS880 if the adapter is installed as fieldbus adapter A/B.

No. ¹⁾	Name/Value	Description	Default						
01	DATA IN 1 (drive to client) ACS355: FBA DATA IN 1 ACSM1: FBA DATA IN1 ACS850/ACQ810: FBA data in1 ACS880/ACS580: FBA A/B data in1	In input assembly instances that include drive parameters, this parameter specifies which parameter's value will be placed in location DATA IN 1 value sent by the drive to the EtherNet/IP client. The content is defined by a decimal number in the range of 0 to 9999 as follows: <table border="1" data-bbox="422 659 857 848"> <tr> <td>0</td> <td>Not used</td> </tr> <tr> <td>1...99</td> <td>Virtual address area of drive control. Not used when the EtherNet/IP protocol is used.</td> </tr> <tr> <td>101...9999</td> <td>Parameter area of the drive</td> </tr> </table>	0	Not used	1...99	Virtual address area of drive control. Not used when the EtherNet/IP protocol is used.	101...9999	Parameter area of the drive	0 = None
0	Not used								
1...99	Virtual address area of drive control. Not used when the EtherNet/IP protocol is used.								
101...9999	Parameter area of the drive								
	0 = None	Not used							
	101...9999	Parameter index with format xxyy , where <ul style="list-style-type: none"> • xx is the parameter group number (1...99) • yy is the parameter number index within that group (01...99). Note: In ACS880 and ACS580, choose Other to display a list of mappable drive parameters.							
02... 10	DATA IN 2 ... DATA IN 10	See parameter 01 DATA IN 1 .	0 = None						

¹⁾ The number of parameters in this group may vary by drive type and drive firmware.

■ Control locations

ABB drives can receive control information from multiple sources including digital inputs, analog inputs, the drive control panel and a fieldbus adapter module. ABB drives allow the user to separately determine the source for each type of control information (Start, Stop, Direction, Reference, Fault reset, etc.).

To give the fieldbus client the most complete control over the drive, you must select the adapter module as the source of this information. The drive-specific parameter setting examples below contain the drive control parameters relevant in the examples. For a complete parameter list, see the drive documentation.



Starting up fieldbus communication for ACS355 drives

1. Power up the drive.
2. Enable the communication between the adapter module and the drive with parameter 9802 COMM PROT SEL.
3. Set the module configuration parameters in group 51.
At the minimum, select the communication protocol and profile with parameter 5102 and configure the network settings with parameters 5103...5113.
4. With parameter 3018 COMM FAULT FUNC, select how the drive reacts to a fieldbus communication break.
5. With parameter 3019 COMM FAULT TIME, define the time between communication break detection and the selected action.
6. Define the process data transferred to and from the drive in parameter groups 54 and 55.
Note: The adapter module assigns the Control word, Status word, references 1...2 and actual values 1...2 automatically to cyclical communication according to the selected assembly instances.
7. Validate the settings made in parameter groups 51, 54 and 55 with parameter 5127 FBA PAR REFRESH.
8. Set the relevant drive control parameters to control the drive according to the application.
Examples of appropriate values are shown in the tables below.



Parameter setting examples – ACS355

Speed control using the ODVA AC/DC drive profile, Extended speed control assembly

This example shows how to configure a speed control application that uses the ODVA AC/DC drive profile, Extended speed control assembly. In addition, some application-specific data is added to the communication.

The start/stop commands and reference scaling are according to the ODVA AC/DC drive profile. For more information, see section [ODVA AC/DC drive profile](#) on page 175.

When Reference 1 (REF1) is used for speed control and the parameter 5123 value is 128, an ODVA speed reference value of ± 30000 (decimal) corresponds to an equal amount of rpm in the drive. The reference value sent from the PLC is limited by parameter 1105 REF1 MAX in the forward and reverse directions.

The minimum and maximum 16-bit integer values that can be given through the fieldbus are -32768 and 32767 respectively.

Bytes	Instance 121	Instance 171
0...1	Control word	Status word
2...3	Speed reference	Speed actual value
4...5	Constant speed 1 ¹⁾	Power ¹⁾
6...7	Constat speed 2 ¹⁾	DC bus voltage ¹⁾

¹⁾ Example



The table below gives the recommended drive parameter settings.

Drive parameter	Setting for ACS355 drives	Description
9802 COMM PROT SEL	4 = EXT FBA	Enables communication between the drive and the fieldbus adapter module.
5101 FBA TYPE	ETHERNET ¹⁾	Displays the type of the fieldbus adapter module.
5102 FB PAR 2 (PROTOCOL/PROFILE)	100 (= EIP AC/DC)	Selects the EtherNet/IP protocol and the ODVA AC/DC drive profile.

Drive parameter	Setting for ACS355 drives	Description
5103 FB PAR 3 (COMMRATE)	0 (= Auto) ²⁾	Ethernet communication rate is negotiated automatically by the device.
5104 FB PAR 4 (IP CONFIGURATION)	0 (= Static IP) ²⁾	Configuration will be obtained from parameters 05...13.
5105 FB PAR 5 (IP ADDRESS 1)	192 ²⁾	First part of the IP address
5106 FB PAR 6 (IP ADDRESS 2)	168 ²⁾	Second part of the IP address
5107 FB PAR 7 (IP ADDRESS 3)	0 ²⁾	Third part of the IP address
5108 FB PAR 8 (IP ADDRESS 4)	16 ²⁾	Last part of the IP address
5123 FB PAR 23 (ODVA SPEED SCALE)	128 ²⁾	Sets the scaling for the ODVA speed reference.
3018 COMM FAULT FUNC	1 = FAULT ²⁾	Enables fieldbus communication fault monitoring.
3019 COMM FAULT TIME	3.0 s ²⁾	Defines the fieldbus communication break supervision time.
5401 FBA DATA IN 1	106 ²⁾	Power
5402 FBA DATA IN 2	107 ²⁾	DC bus voltage
5501 FBA DATA OUT 1	1202 ²⁾	Constant speed 1
5502 FBA DATA OUT 2	1203 ²⁾	Constant speed 2
5127 FBA PAR REFRESH	1 = REFRESH	Validates the FENA-01/-11/-21 configuration parameter settings.
9904 MOTOR CTRL MODE	1 = VECTOR: SPEED	Selects the speed control mode as the motor control mode.
1001 EXT1 COMMANDS	10 = COMM	Selects the fieldbus interface as the source of the start and stop commands for external control location 1.
1103 REF1 SELECT	8 = COMM	Selects the fieldbus reference 1 as the source for speed reference 1.



Drive parameter	Setting for ACS355 drives	Description
1601 RUN ENABLE	7 = COMM	Selects the fieldbus interface as the source for the inverted Run enable signal (Run disable).
1604 FAULT RESET SEL	8 = COMM	Selects the fieldbus interface as the source for the fault reset signal.

¹⁾ Read-only or automatically detected/set

²⁾ Example

The start sequence for the parameter example above is given below.

Control word:

- Reset the fieldbus communication fault (if active).
 - Enter 0h (0 decimal) → READY.
 - Enter 1h (1 decimal) → ENABLED (Running forward)
- OR
- Enter 2h (2 decimal) → ENABLED (Running reverse).



Starting up fieldbus communication for ACSM1 drives

1. Power up the drive.
2. Enable the communication between the adapter module and the drive with parameter 50.01 FBA ENABLE.
3. With parameter 50.02 COMM LOSS FUNC, select how the drive reacts to a fieldbus communication break.

Note that this function monitors both communication between the fieldbus master and the adapter module and communication between the adapter module and the drive.

4. With parameter 50.03 COMM LOSS T OUT, define the time between communication break detection and the selected action.
5. Select application-specific values for parameters 50.04...50.11.

Examples of appropriate values are shown in the tables below.

6. Set the module configuration parameters in group 51.

At the minimum, select the communication protocol and profile with parameter 51.02 and configure the network settings with parameters 51.03...51.13.

7. Define the process data transferred to and from the drive in parameter groups 52 and 53.

Note: The adapter module assigns the Control word, Status word, references 1...2 and actual values 1...2 automatically to cyclical communication according to the selected assembly instances.

8. Validate the settings made in parameter groups 51, 52 and 53 with parameter 51.27 FBA PAR REFRESH.



9. Set the relevant drive control parameters to control the drive according to the application.

Examples of appropriate values are shown in the tables below.

■ Parameter setting examples – ACSM1

Speed control using the ODVA AC/DC drive profile, Extended speed control assembly

This example shows how to configure a speed control application that uses the ODVA AC/DC drive profile, Extended speed control assembly. In addition, some application-specific data is added to the communication.

The start/stop commands and reference scaling are according to the ODVA AC/DC drive profile. For more information, see section [ODVA AC/DC drive profile](#) on page 175.

When Reference 1 (REF1) is used for speed control and the value of parameter 51.23 is 128, an ODVA speed reference value of ± 30000 (decimal) corresponds to an equal amount of rpm in the drive. The speed reference value sent by the PLC is limited by parameter 20.01 MAXIMUM SPEED in the forward direction and 20.02 MINIMUM SPEED in the reverse direction.

The minimum and maximum 16-bit integer values that can be given through the fieldbus are -32768 and 32767 respectively.

Bytes	Instance 121	Instance 171
0...1	Control word	Status word
2...3	Speed reference	Speed actual value
4...7	Constant speed ¹⁾	Power ¹⁾
8...11	Speed reference for jogging function ¹⁾	DC bus voltage ¹⁾

¹⁾ Example



The table below gives the recommended drive parameter settings.

Drive parameter	Setting for ACSM1 drives	Description
50.01 FBA ENABLE	Enable	Enables communication between the drive and the fieldbus adapter module.
50.02 COMM LOSS FUNC	Fault ²⁾	Enables fieldbus communication fault monitoring.
50.03 COMM LOSS T OUT	3.0 s ²⁾	Defines the fieldbus communication break supervision time.
50.04 FBA REF1 MODESEL	Speed	Selects the fieldbus reference 1 scaling.
51.01 FBA TYPE	ETHERNET ¹⁾	Displays the type of the fieldbus adapter module.
51.02 FBA PAR2 (PROTOCOL/PROFILE)	100 (= EIP AC/DC)	Selects the EtherNet/IP protocol and the ODVA AC/DC drive profile.
51.03 FBA PAR3 (COMMRATE)	0 (= Auto ²⁾)	Ethernet communication rate is negotiated automatically by the device.
51.04 FBA PAR4 (IP CONFIGURATION)	0 (= Static IP) ²⁾	Configuration will be obtained from parameters 05...13.
51.05 FBA PAR5 (IP ADDRESS 1)	192 ²⁾	First part of the IP address
51.06 FBA PAR6 (IP ADDRESS 2)	168 ²⁾	Second part of the IP address
51.07 FBA PAR7 (IP ADDRESS 3)	0 ²⁾	Third part of the IP address
51.08 FBA PAR8 (IP ADDRESS 4)	16 ²⁾	Last part of the IP address
51.09 FBA PAR9 (SUBNET CIDR)	24 ²⁾	Sets the network mask as 255.255.255.0, allowing access only to the last subnet.
51.23 FBA PAR23 (ODVA SPEED SCALE)	128 ²⁾	Sets the scaling for the ODVA speed reference.
52.01 FBA DATA IN1	122 ²⁾	Power
52.03 FBA DATA IN3	107 ²⁾	DC bus voltage
53.01 FBA DATA OUT1	2408 ²⁾	Constant speed



Drive parameter	Setting for ACSM1 drives	Description
53.03 FBA DATA OUT3	2410 ²⁾	Speed reference for jogging function 1
51.27 FBA PAR REFRESH	REFRESH	Validates the FENA-11/-21 configuration parameter settings.
10.01 EXT1 START FUNC	FBA	Selects the fieldbus interface as the source of the start and stop commands for external control location 1.
24.01 SPEED REF1 SEL	FBA REF1	Selects the fieldbus reference 1 as the source for speed reference 1.
34.01 EXT1/EXT2 SEL	C.FALSE	Selects that the external control location is always EXT1.
34.03 EXT1 CTRL MODE1	Speed	Selects speed control as the control mode 1 for external control location 1.

¹⁾ Read-only or automatically detected/set

²⁾ Example

The start sequence for the parameter example above is given below.

Control word:

- Reset the fieldbus communication fault (if active).
- Enter 0h (0 decimal) → READY.
- Enter 1h (1 decimal) → ENABLED (Running forward).
- Enter 2h (2 decimal) → ENABLED (Running reverse).



Starting up fieldbus communication for ACS850 and ACQ810 drives

1. Power up the drive.
2. Enable the communication between the adapter module and the drive with parameter 50.01 FBA enable.
3. With parameter 50.02 Comm loss func, select how the drive reacts to a fieldbus communication break.

Notes:

- This function monitors both communication between the fieldbus master and the adapter module and communication between the adapter module and the drive.
 - In ACQ810, you can select the control locations to be monitored with parameter 50.21 Comm loss enable. By default, the monitoring is enabled in both control locations (EXT1 and EXT2).
4. With parameter 50.03 Comm loss t out, define the time between communication break detection and the selected action.
 5. Select application-specific values for parameters 50.04...50.11.
Examples of appropriate values are shown in the tables below.
 6. Set the module configuration parameters in group 51.
At the minimum, select the communication protocol and profile with parameter 51.02 and configure the network settings with parameters 51.03...51.13.



7. Define the process data transferred to and from the drive in parameter groups 52 and 53.

Note: The adapter module assigns the Control word, Status word, references 1...2 and actual values 1...2 automatically to cyclical communication according to the selected assembly instances.

8. Validate the settings made in parameter groups 51, 52 and 53 with parameter 51.27 FBA par refresh.
9. Set the relevant drive control parameters to control the drive according to the application.

Examples of appropriate values are shown in the tables below.

■ Parameter setting examples – ACS850 and ACQ810

Speed control using the ODVA AC/DC drive profile, Extended speed control assembly

This example shows how to configure a speed control application that uses the ODVA AC/DC drive profile, Extended speed control assembly. In addition, some application-specific data is added to the communication.

The start/stop commands and reference scaling are according to the ODVA AC/DC drive profile. For more information, see section [ODVA AC/DC drive profile](#) on page 175.



When Reference 1 (REF1) is used for speed control and the value of parameter 51.23 is 128, an ODVA speed reference value of ± 30000 (decimal) corresponds to an equal amount of rpm in the drive. The speed reference value sent from the PLC is limited by parameter 20.01 Maximum speed in the forward direction and 20.02 Minimum speed in the reverse direction.

The minimum and maximum 16-bit integer values that can be given through the fieldbus are -32768 and 32767 respectively.

Bytes	Instance 121	Instance 171
0...1	Control word	Status word
2...3	Speed reference	Speed actual value
4...7	Constant speed 1 ¹⁾	Power ¹⁾
8...11	Constant speed 2 ¹⁾	DC bus voltage ¹⁾

¹⁾ Example

The table below gives the recommended drive parameter settings.

Drive parameter	Setting for ACS850/ACQ810 drives	Description
50.01 Fba enable	Enable	Enables communication between the drive and the fieldbus adapter module.
50.02 Comm loss func	Fault ²⁾	Enables fieldbus communication fault monitoring.
50.03 Comm loss t out	3.0 s ²⁾	Defines the fieldbus communication break supervision time.
50.04 Fb ref1 modesel	Speed	Selects the fieldbus reference 1 scaling.
51.01 FBA type	Ethernet ¹⁾	Displays the type of the fieldbus adapter module.
51.02 FBA par2 (PROTOCOL/PROFILE)	100 (= EIP AC/DC)	Selects the EtherNet/IP protocol and the ODVA AC/DC drive profile.
51.03 FBA par3 (COMMRATE)	0 (= Auto) ²⁾	Ethernet communication rate is negotiated automatically by the device.
51.04 FBA par4 (IP CONFIGURATION)	0 (= Static IP) ²⁾	Configuration will be obtained from parameters 05...13 .
51.05 FBA par5 (IP ADDRESS 1)	192 ²⁾	First part of the IP address
51.06 FBA par6 (IP ADDRESS 2)	168 ²⁾	Second part of the IP address



Drive parameter	Setting for ACS850/ACQ810 drives	Description
51.07 FBA par7 (IP ADDRESS 3)	0 ²⁾	Third part of the IP address
51.08 FBA par8 (IP ADDRESS 4)	16 ²⁾	Last part of the IP address
51.09 FBA par9 (SUBNET CIDR)	24 ²⁾	Sets the network mask as 255.255.255.0, allowing access only to the last subnet.
51.23 FBA par23 (ODVA SPEED SCALE)	128 ²⁾	Sets the scaling for the ODVA speed reference.
52.01 FBA data in1	122 ²⁾	Power
52.03 FBA data in3	107 ²⁾	DC bus voltage
53.01 FBA data out1	2606 ²⁾	Constant speed 1
53.03 FBA data out3	2607 ²⁾	Constant speed 2
51.27 FBA par refresh	Refresh	Validates the FENA-11/-21 configuration parameter settings.
10.01 Ext1 start func	FB	Selects the fieldbus interface as the source of the start and stop commands for external control location 1.
21.01 Speed ref1 sel (ACS850) 21.01 Speed ref sel (ACQ810)	FBA ref1 FBA ref1	Selects the fieldbus reference 1 as the source for speed reference 1.

 1) Read-only or automatically detected/set

2) Example

The start sequence for the parameter example above is given below.

Control word:

- Reset the fieldbus communication fault (if active).
- Enter 0h (0 decimal) → READY.
- Enter 1h (1 decimal) → ENABLED (Running forward).
- Enter 2h (2 decimal) → ENABLED (Running reverse).

Starting up fieldbus communication for ACS880 and ACS580 drives

1. Power up the drive.
2. Enable the communication between the adapter module and the drive by selecting the correct slot number in parameter 50.01 FBA A enable.
The selection must correspond to the slot where the adapter module is installed. For example, if the adapter module is installed in slot 1, you must select slot 1.
3. With parameter 50.02 FBA A comm loss func, select how the drive reacts to a fieldbus communication break.
Note that this function monitors both communication between the fieldbus master and the adapter module and communication between the adapter module and the drive.
4. With parameter 50.03 FBA A comm loss t out, define the time between communication break detection and the selected action.
5. Select application-specific values for the rest of the parameters in group 50, starting from 50.04.
Examples of appropriate values are shown in the tables below.
6. Set the module configuration parameters in group 51.
At the minimum, select the communication protocol and profile with parameter 51.02 and configure the network settings with parameters 51.03...51.13.
7. Define the process data transferred to and from the drive in parameter groups 52 and 53.
Note: The adapter module assigns the Control word, Status word, references 1...2 and actual values 1...2 automatically to cyclical communication according to the selected assembly instances.



8. Save the valid parameter values to permanent memory with parameter 96.07 Parameter save manually.
9. Validate the settings made in parameter groups 51, 52 and 53 with parameter 51.27 FBA A par refresh.
10. Set the relevant drive control parameters to control the drive according to the application.

Examples of appropriate values are shown in the tables below.

■ Parameter setting examples – ACS880 and ACS580

Speed control using the ODVA AC/DC drive profile, Extended speed control assembly

This example shows how to configure a speed control application that uses the ODVA AC/DC drive profile, Extended speed control assembly. In addition, some application-specific data is added to the communication.

The start/stop commands and reference scaling are according to the ODVA AC/DC drive profile. For more information, see section [ODVA AC/DC drive profile](#) on page 175.

When Reference 1 (REF1) is used for speed control and the value of parameter 51.23 is 128, an ODVA speed reference value of ± 30000 (decimal) corresponds to an equal amount of rpm in the drive. The speed reference value sent from the PLC is limited by parameter 30.12 Maximum speed in the forward direction and 30.11 Minimum speed in the reverse direction.

The minimum and maximum 16-bit integer values that can be given through the fieldbus are -32768 and 32767 respectively.

Bytes	Instance 121	Instance 171
0...1	Control word	Status word
2...3	Speed reference	Speed actual value
4...7	Constant speed 1 [32] ¹⁾	Output power [32] ¹⁾
8...11	Constant speed 2 [32] ¹⁾	DC voltage [32] ¹⁾

¹⁾ Example

The table below gives the recommended drive parameter settings.

Drive parameter	Setting for ACS880 /ACS580 drives	Description
50.01 FBA A enable	1 = Option slot 1 ²⁾	Enables communication between the drive and the fieldbus adapter module.
50.02 FBA A comm loss func	1 = Fault ²⁾	Enables fieldbus A communication fault monitoring.
50.03 FBA A comm loss t out	3.0 s ²⁾	Defines the fieldbus A communication break supervision time.
50.04 FBA A ref1 type	4 = Speed	Selects the fieldbus A reference 1 type and scaling.
51.01 FBA A type	128 = ETHERNET ¹⁾	Displays the type of the fieldbus adapter module.
51.02 Protocol/Profile	100 = EIP AC/DC	Selects the EtherNet/IP protocol and the ODVA AC/DC drive profile.
51.03 Commrate	0 = Auto ²⁾	Ethernet communication rate is negotiated automatically by the device.
51.04 IP configuration	0 = Static IP ²⁾	Configuration will be obtained from configuration parameters 05...13 .
51.05 IP address 1	192 ²⁾	First part of the IP address
51.06 IP address 2	168 ²⁾	Second part of the IP address
51.07 IP address 3	0 ²⁾	Third part of the IP address
51.08 IP address 4	16 ²⁾	Last part of the IP address
51.09 Subnet CIDR	24 ²⁾	Sets the network mask as 255.255.255.0, allowing access only to the last subnet.
51.23 ODVA speed scale	128 ²⁾	Sets the scaling for the ODVA speed reference.
52.01 FBA data in1	01.14 ²⁾	Output power
52.03 FBA data in3	01.11 ²⁾	DC voltage
53.01 FBA data out1	22.26 ²⁾	Constant speed 1
53.03 FBA data out3	22.27 ²⁾	Constant speed 2



Drive parameter	Setting for ACS880 /ACS580 drives	Description
51.27 FBA A par refresh	1 = Refresh	Validates the FENA-11/-21 configuration parameter settings.
20.01 Ext1 commands	12 = Fieldbus A	Selects the fieldbus A interface as the source of the start and stop commands for external control location 1.
22.11 Speed ref1 source	4 = FB A ref1	Selects the fieldbus A reference 1 as the source for speed reference 1.

¹⁾ Read-only or automatically detected/set

²⁾ Example

The start sequence for the parameter example above is given below.

Control word:

- Reset the fieldbus communication fault (if active).
- Enter 0h (0 decimal) → READY.
- Enter 1h (1 decimal) → ENABLED (Running forward).
- Enter 2h (2 decimal) → ENABLED (Running reverse).



Configuring the client

After the adapter module has been initialized by the drive, you must prepare the client for communication with the module. An example of an Allen-Bradley® PLC is given below. If you are using another client system, refer to its documentation for more information.

The example applies to all drive types compatible with the module.

■ Before you start

Decide on these points before you start the client configuration.

Select protocol/profile

During the configuration of the drive and the client, it is necessary to select a communication protocol, in this case EtherNet/IP, and a communication profile. The communication profile determines which I/O assemblies and objects are available. See chapter [EtherNet/IP – Communication profiles](#) for more information.

Select output and input assembly instances

EtherNet/IP devices implement multiple objects each with many attributes. While it is possible to write or read each attribute separately to control the drive, this is inefficient. Assembly object instances provide a means to group writes or reads of attributes. The selection of assembly objects is limited by the choice of the communication profile. This table gives a listing of the output and input assemblies.

Name	Output instance	Input instance	Size (bytes)	Profile
Basic Speed Control	20	70	4	ODVA AC/DC drive
Enhanced Speed Control	21	71	4	ODVA AC/DC drive
Basic Speed and Torque Control	22	72	6	ODVA AC/DC drive
Enhanced Speed and Torque Control	23	73	6	ODVA AC/DC drive
Basic Speed Control plus Drive Parameters	120	170	24	ODVA AC/DC drive

Name	Output instance	Input instance	Size (bytes)	Profile
Enhanced Speed Control plus Drive Parameters	121	171	24	ODVA AC/DC drive
Basic Speed and Torque Control plus Drive Parameters	122	172	26	ODVA AC/DC drive
Enhanced Speed and Torque Control plus Drive Parameters	123	173	26	ODVA AC/DC drive
ABB Drives Profile w/ Set Speed	1	51	4	ABB Drives profile
ABB Drives Profile w/ Set Speed and Set Torque	2	52	6	ABB Drives profile
ABB Drives Profile w/ Set Speed plus Drive Parameters	101	151	24	ABB Drives profile
ABB Drives Profile w/ Set Speed and Set Torque plus Drive Parameters	102	152	26	ABB Drives profile
Transparent16 w/One	11	61	4	Transparent16 profile
Transparent16 w/Two	12	62	6	Transparent16 profile
Transparent16 w/One plus Drive Parameters	111	161	24	Transparent16 profile
Transparent16 w/Two plus Drive Parameters	112	162	26	Transparent16 profile
Transparent32 w/One	21	71	8	Transparent32 profile
Transparent32 w/Two	22	72	12	Transparent32 profile
Transparent32 w/One plus Drive Parameters	121	171	28	Transparent32 profile
Transparent32 w/Two plus Drive Parameters	122	172	32	Transparent32 profile



Select connection method

EtherNet/IP provides a variety of connection methods to communicate between devices. Not all methods are supported by all devices. Refer to the client documentation to determine which method(s) are supported by the client.

Note: The choice of the connection method has a significant impact on the timeout behavior. Refer to configuration parameters [20 CONTROL TIMEOUT](#) and [21 IDLE ACTION](#) for more information.

The FENA adapter module supports the following connection methods:

I/O connections

The adapter module supports Class 1 I/O connections. I/O connections are often also referred to as “Implicit Messaging”. I/O connections are typically established by configuring an I/O scanner to write and read assembly object instances.

Connected explicit messaging

The adapter module supports Class 3 connected explicit messaging. Class 3 connected explicit messages are typically established by using a “message instruction” to write or read an attribute.

Note: When using Class 3 explicit messaging, some EtherNet/IP clients may close the connection after the MSG instruction is done. This will cause the module to behave as if it were controlled via unconnected explicit messaging.

Unconnected explicit messaging

The adapter module supports unconnected explicit messaging. Unconnected explicit messages are typically established by using a “message instruction” to write or read an attribute.

Note: EtherNet/IP does not provide a timeout means for unconnected explicit messaging. To use unconnected explicit messaging for control, refer to configuration parameter [20 CONTROL TIMEOUT](#).



■ EDS files

Electronic Data Sheet (EDS) files specify the properties of the device for the EtherNet/IP client. The client identifies the device by means of the product code, device type and major revision attributes.

To enable the use of different ABB drive types on the same EtherNet/IP network, a unique product code has been given to each drive type and application combination.

EDS files are available from the Document library (<http://new.abb.com/drives/ethernet-ip>).

Note: Only one EDS file with the same EtherNet/IP product code can be installed in the PLC at a time.



■ Configuring an Allen-Bradley® PLC

Example 1: RSLogix 5000

This example shows how to prepare an Allen-Bradley® Control-Logix5555™ PLC for communication with the adapter module by using the RSLogix 5000® software as the configuration tool.

1. Start the RSLogix software and open/create an RSLogix project.

Note: It is assumed that the PLC configuration has already been established in the RSLogix project.

2. In the RSLogix I/O, right-click the EtherNet/IP communication module and select **New Module**.

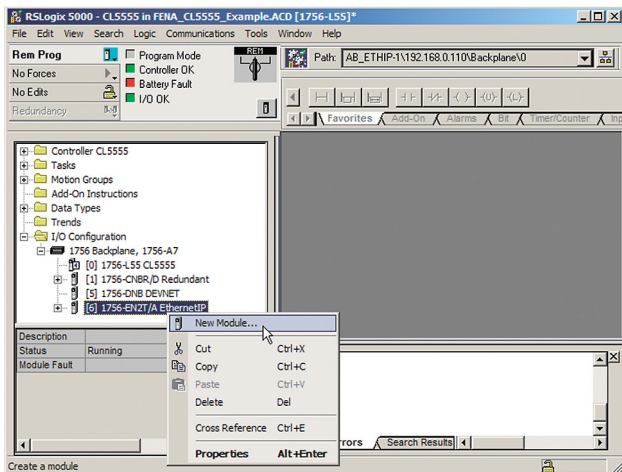

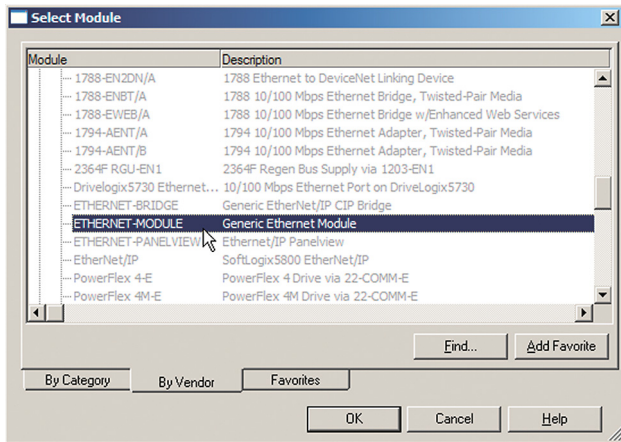
3. In the **Select Module** window, select ETHERNET-MODULE.

4. Select the input and output assembly instances and the PLC I/O memory size to be used.

The table below shows the available combinations. The example below uses the ODVA AC/DC assembly instances 121 and 171.

Input assembly instances	Output assembly instances	PLC word settings
70	20	2
71	21	2
72	22	3
73	23	3
170	120	12
171	121	12
172	122	13
173	123	13
51	1	2
52	2	3
151	101	12
152	102	13
61	11	2
62	12	3
161	111	12
162	112	13

For more information on the input/output assembly instances, see chapter [Select output and input assembly instances](#) on page 151.



5. Enter the following information.

The example below uses ODVA AC/DC assembly instances 121 and 171. The PLC will transmit and receive 12 words.

Type a name for the adapter module.

Type the Input and Output Assembly Instance numbers.

Select the sizes of the Input and Output words for the adapter module.

FENA uses 16-bit words. Change **Comm Format** to **Data - INT** (16 bits).

Type the IP address of the adapter module.

Set **Configuration** as 1 and **Size** as 0.

6. Click **OK**.

The adapter module is now added to the PLC I/O.

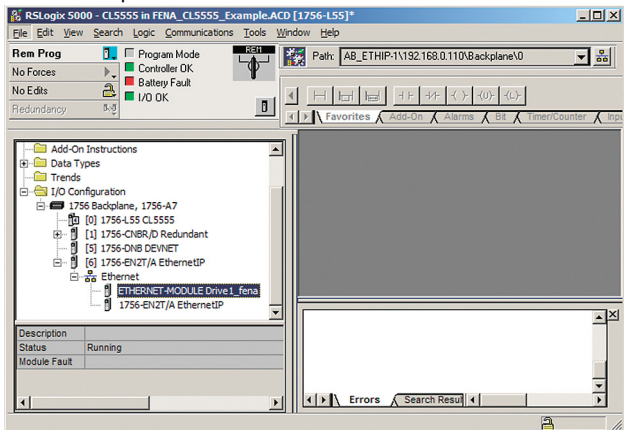
7. Click the FENA module to open the **Module Properties** window.

- On the **Connection** tab, select the Requested Packet Interval (RPI) for the adapter module I/O communication.

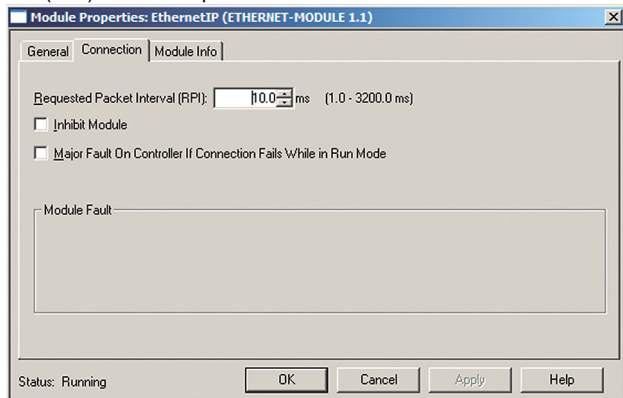

- Download the new configuration to the PLC.
The PLC is now ready for communication with the adapter module.



Example 2: Studio 5000

This example shows how to prepare an Allen-Bradley® CompactLogix™ PLC for communication with the adapter module using the Studio 5000® software as the configuration tool.

1. Start the RSLogix software and open/create an RSLogix project.

Note: It is assumed that the PLC configuration was already established in the Studio 5000® project.

2. If EDS file for the correct device is not installed, use the EDS hardware installation tool. To register a new EDS file:

- Select **Tools** → **EDS Hardware Installation Tool**.

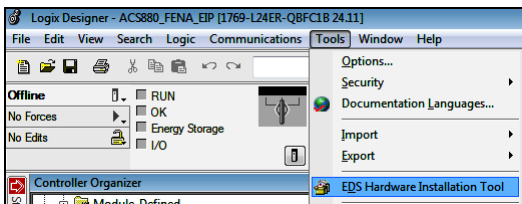

- Select the option Register an EDS file(s). Click **Next**.

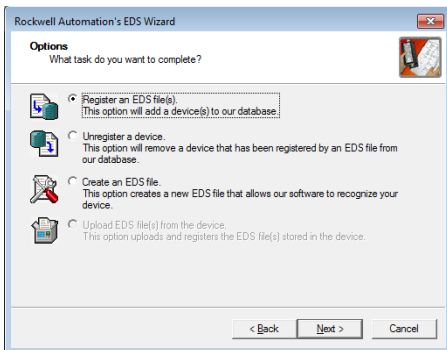

- Browse to FENA EDS file and select the file. Click **Next** to register the EDS file.

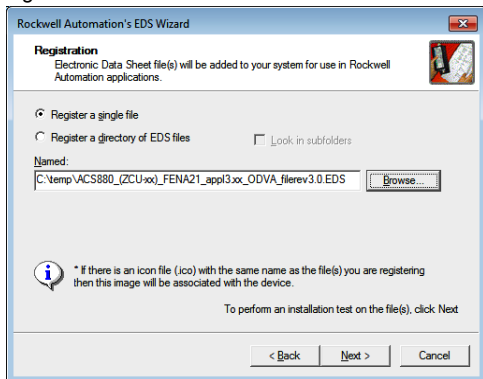

- Click **Next** and **Finish** to finalize registration. After the EDS file is successfully registered the device can be used in the PLC project.

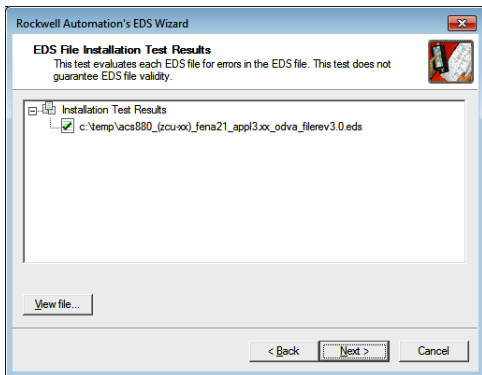

3. Add new devices to EtherNet/IP bus by right-clicking **Ethernet** under I/O Configuration and selecting **New Module**.

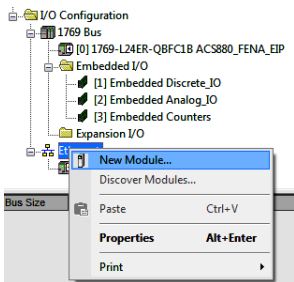

4. In the Select Module Type window, select ACS880 module (AC Drive Device). You can easily find the ABB devices using filters. Click **Create** to add a new module.

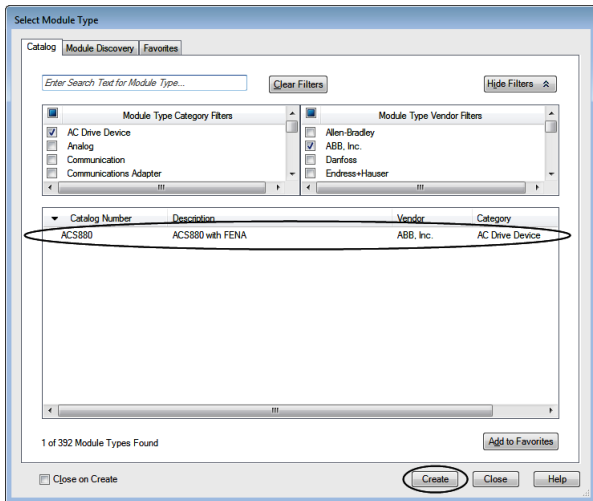

5. Enter the following information to configure the IP address and module name.

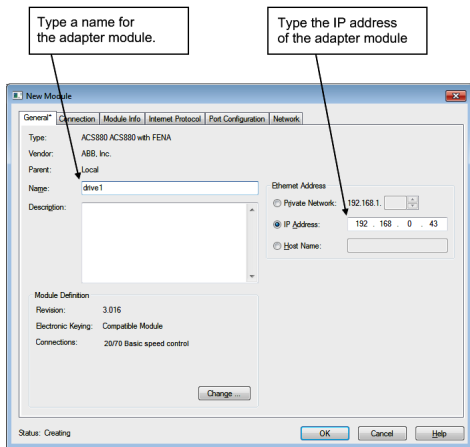

6. Click **Change**, to select the input and output assembly instances and the PLC I/O memory size to be used. The table below shows the available combinations.

Input assembly instances	Output assembly instances	PLC word settings
70	20	2
71	21	2
72	22	3
73	23	3
170	120	12
171	121	12
172	122	13
173	123	13
51	1	2
52	2	3

Input assembly instances	Output assembly instances	PLC word settings
151	101	12
152	102	13
61	11	2
62	12	3
161	111	12
162	112	13

For more information on the input/output assembly instances, see [Select output and input assembly instances](#) on page 151. FENA uses 16-bit words. Change the size to INT (16 bits). The example below uses ODVA AC/DC assembly instances 121 and 171. The PLC transmits and receives 12 words.

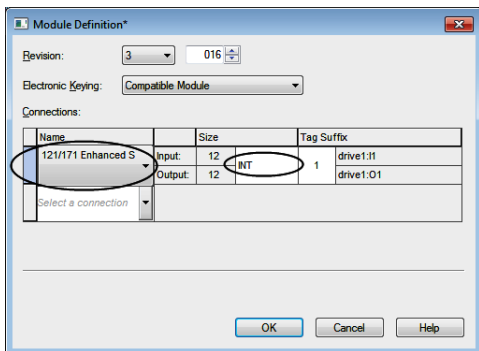

7. Click **OK** and confirm selection to change the module data types.

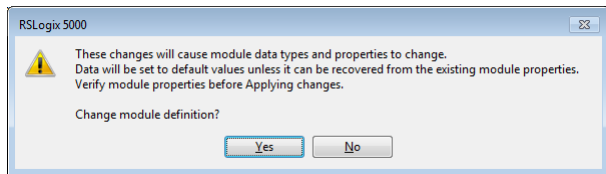

8. On the Connection tab, select the Requested Packet Interval (RPI) for the adapter module I/O communication.

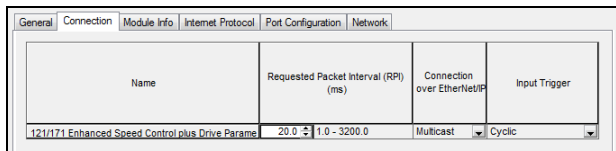

9. Click **OK**. The adapter module is now added to the PLC I/O. You can add more modules by choosing **Create** or exit the window by choosing **Close**.



- Download the new configuration to the PLC. The PLC is now ready for communication with the adapter module.

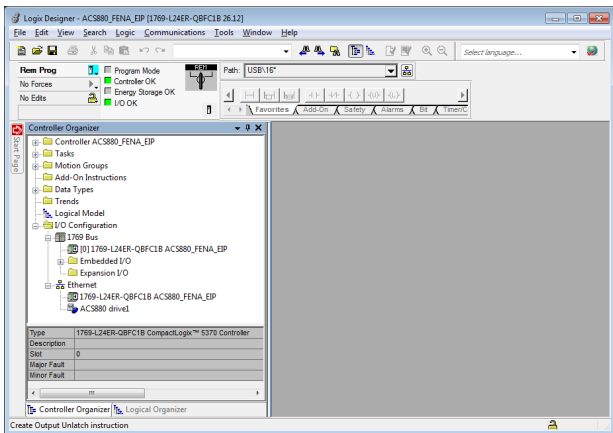

■ Configuring DLR topology for FENA-21

This example shows how to prepare an Allen-Bradley® CompactLogix™ PLC for DLR topology with FENA-21 adapter modules. After installing the devices on the DLR network, at least one supervisor node must be configured. Configuration can be done by using the Studio 5000® Logix Designer or RSLinx® Classic Lite software.

Setup using Logix Designer

1. Open the Studio 5000® software. Test setup uses an Allen Bradley PLC connected in a ring topology with two FENA-21 fieldbus Ethernet modules. The topology used in the example is shown below. More devices can be added, but the recommended maximum number of nodes on a single DLR network is 50.

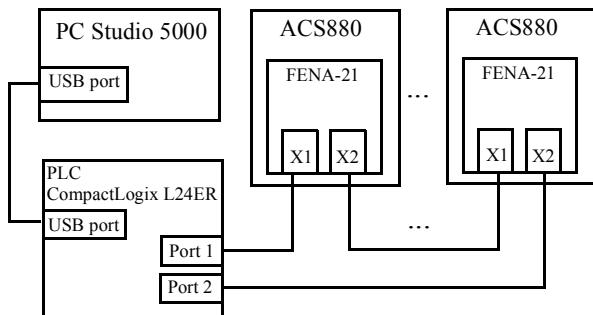

Note: It is assumed that the PLC configuration was already established in the Studio 5000® project and the EDS file(s) are installed and at least two FENA-21 modules are added to the project.

For more information on adding modules to a project and installing EDS files, see chapter *Configuring an Allen-Bradley® PLC*.

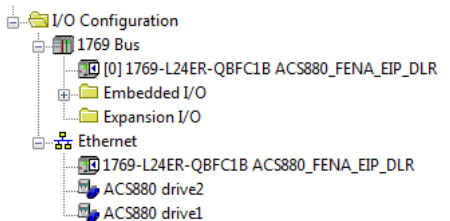

2. Download the project to the PLC.
3. Go online with the PLC and leave it in Program mode.
4. Double-click the module in the **I/O Configuration**. In the Controller Properties window, open Network tab and select **Enable Supervisor Mode**. Click **OK**.

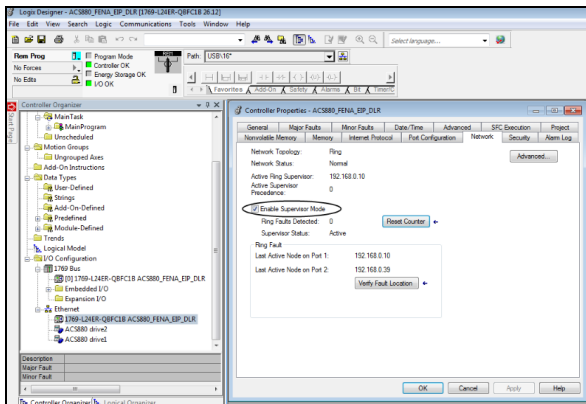

Setup using RSLinx[®] Classic

You can configure and enable DLR supervisor via RSLinx[®] Classic.

1. Open the RSLinx[®] Classic software.
2. Browse to the DLR network.

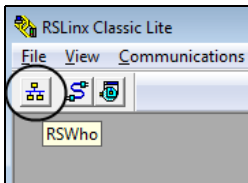

3. Open the **Module Configuration** by right-clicking on the ring supervisor in the list.

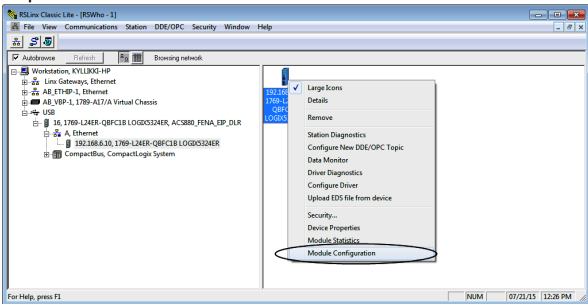

- On the Network tab, select **Enable Ring Supervisor**, to enable DLR messages in the ring.

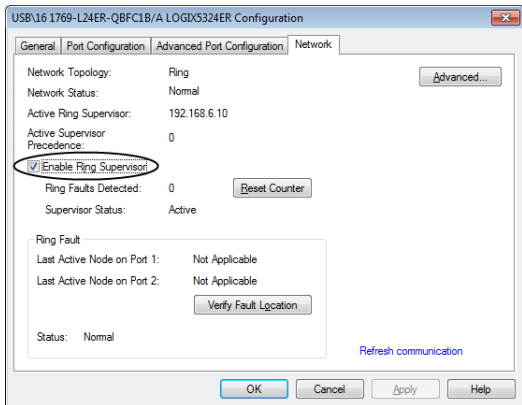

- Click **Advanced..** to configure DLR parameters, such as Beacon Interval and Beacon Timeout.
Note: It is recommended to use the default values.
- Go back to Logix Designer and make sure that none of the FENA-21 modules are faulted, that is no warning symbols are displayed.

ACS880 drive1





11

EtherNet/IP – Communication profiles

Contents of this chapter

This chapter describes the communication profiles used in the communication between the EtherNet/IP client, the adapter module and the drive.

Communication profiles

Communication profiles are ways of conveying control commands (Control word, Status word, references and actual values) between the master station and the drive.

With the FENA adapter module, the EtherNet/IP network may employ either the ODVA AC/DC drive profile or the ABB Drives profile. Both are converted to the native profile (eg, DCU or FBA) by the adapter module. In addition, two Transparent modes – for 16-bit and 32-bit words respectively – are available. With the Transparent modes, no data conversion takes place.

The figure below illustrates the profile selection:

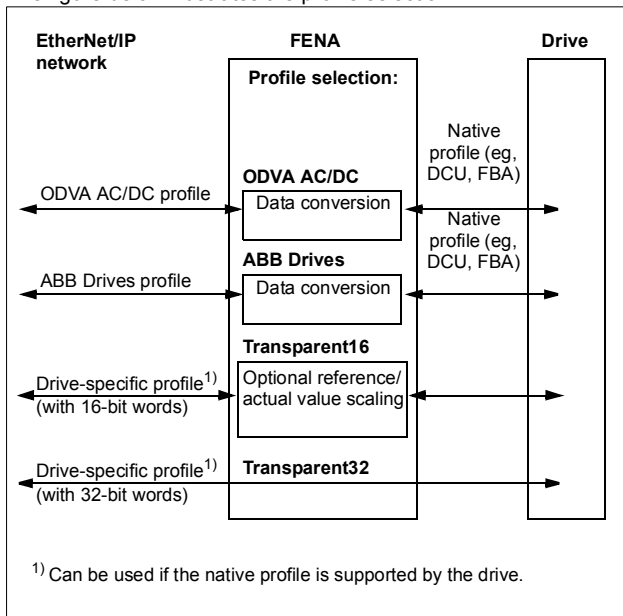

The following sections describe the Control word, the Status word, references and actual values for the ODVA AC/DC drive and ABB Drives communication profiles. Refer to the drive manuals for details on the native profiles.

ODVA AC/DC drive profile

This section briefly describes the ODVA AC/DC drive profile. Additional information is available at www.odva.org.

An EtherNet/IP node is modeled as a collection of abstract objects. Each object represents the interface to and behavior of a component within the product. The ODVA AC/DC drive profile defines a collection of objects suitable for the control of AC and DC drives. The objects supported by the adapter module are listed in section *Class objects* on page 231.

Objects are defined by:

- Service
- Class
- Instance
- Attribute
- Behavior.

For example, to set the drive speed reference, the `Set_Attribute_Single` service can be requested for the `SpeedRef` attribute of the AC/DC drive object class. The resulting behavior is that the reference speed of the drive is set to the requested value.

This is an example of explicit messaging, where each attribute of a class is set individually. While this is allowed, it is inefficient. Instead, implicit messaging using input and output assembly instances is recommended. Implicit messaging allows the EtherNet/IP client to set or get predefined groups of attributes in a single message exchange. The assembly instances supported by the adapter module are listed and defined in section *Assembly objects* on page 196.

■ ODVA output attributes

This section briefly describes the instances found in the output assemblies of the ODVA AC/DC drive profile. Note that all output assembly instances do not support all attributes listed here.

Run Forward & Run Reverse (Control supervisor object)

These attributes are used to assert run and stop commands to the Control supervisor object state machine according to the following Run/Stop event matrix. See [State \(Control supervisor object\)](#) on page 181.

RunFwd (Run1)	RunRev (Run2)	Trigger event	Run type
0	0	Stop	N/A
0 → 1	0	Run	RunFwd
0	0 → 1	Run	RunRev
0 → 1	0 → 1	No Action	N/A
1	1	No Action	N/A
0 → 1	1	Run	RunRev
1	1 → 0	Run	RunFwd

Fault Reset (Control supervisor object)

This attribute resets a drive fault on a transition from zero to one if the condition that caused the fault has been cleared.

Net Ctrl (Control supervisor object)

- E** This attribute requests that the drive Run/Stop command be supplied locally (Net Ctrl = 0) or by the network (Net Ctrl = 1).

Net Ref (AC/DC drive object)

This attribute requests that the drive speed and torque references be supplied locally (Net Ref = 0) or by the network (Net Ref = 1).

Speed Reference (AC/DC drive object)

This attribute is the speed reference for the drive. The units are scaled by the Speed Scale attribute of the AC/DC drive object. See parameter [23 ODVA SPEED SCALE](#) for details.

Scalar mode

When the drive is operating in the scalar mode, the adapter module provides the drive with a frequency reference. The ODVA AC/DC drive profile uses rpm units for the speed reference. The drive frequency reference is calculated as follows:

$$Dfr = \frac{Osr \times Us \times Mf}{Mss}$$

where

Dfr = Drive Frequency Reference in Hz

Osr = ODVA Speed Reference

Us = ODVA Speed Unit (see [23 ODVA SPEED SCALE](#) on page 127)

Mf = Motor Nominal Frequency in Hz

Mss = Motor Synchronous Speed in rpm (not Motor Nominal Speed).

For example, for a 4-pole 60 Hz motor (Mss = 1800 rpm) with a unit of 1 rpm and an ODVA Speed Reference of 900, the drive frequency reference is:

$$Dfr = \frac{Osr \times Us \times Mf}{Mss} = \frac{900 \times 1 \text{ rpm} \times 60 \text{ Hz}}{1800 \text{ rpm}} = 30 \text{ Hz}$$

Vector mode

When the drive is operating in the vector mode, the adapter module provides the drive with a speed reference. The ODVA AC/DC drive profile uses rpm units for the speed reference. The drive speed reference is calculated as follows:

$$Dsr = Osr \times Us$$

where

Dsr = Drive Speed Reference in rpm

Osr = ODVA Speed Reference

Us = ODVA Speed Unit (see [23 ODVA SPEED SCALE](#) on page 127).

For example, for an ODVA Speed Reference of 900 rpm with a unit of 0.5 rpm, the drive speed reference is:

$$Dsr = Osr \times Us = 900 \times 0.5 \text{rpm} = 450 \text{rpm}$$

Torque Reference (AC/DC drive object)

This attribute is the torque reference for the drive. The units are scaled by the Torque Scale attribute of the AC/DC drive object. See parameter [24 ODVA TORQUE SCALE](#) for details.

The adapter module provides the drive with a torque reference in percent of the motor nominal torque. The ODVA AC/DC drive profile uses Newton-meter (N·m) units for the torque reference. The drive torque reference is calculated as follows:

$$D_{tr} = \frac{100 \times O_{tr} \times U_t}{M_t}$$

where

D_{tr} = Drive Torque Reference in Percent of Motor Nominal Torque

O_{tr} = ODVA Torque Reference

U_t = ODVA Torque Unit (see [24 ODVA TORQUE SCALE](#) on page 128)

M_t = Motor Nominal Torque in N·m.

For example, for a 1000 N·m Motor Nominal Torque with a unit of 1 N·m and an ODVA Torque Reference of 500, the drive torque reference is:

$$D_{tr} = \frac{100 \times O_{tr} \times U_t}{M_t} = \frac{100 \times 500 \times 1 \text{ Nm}}{1000 \text{ Nm}} = 50$$

■ ODVA input attributes

This section briefly describes the instances found in the ODVA AC/DC drive profile's input assemblies. Note that all input assembly instances do not support all attributes listed here.

Faulted (Control supervisor object)

This attribute indicates that the drive has experienced a fault. The fault code may be read from the FaultCode attribute of the Control supervisor object.

Warning (Control supervisor object)

This attribute indicates that the drive is experiencing a warning condition. The warning code may be read from the WarnCode attribute of the Control supervisor object.

Running Forward (Control supervisor object)

This attribute indicates that the drive is running in the forward direction.

Running Reverse (Control supervisor object)

This attribute indicates that the drive is running in the reverse direction.

Ready (Control supervisor object)

This attribute indicates that the Control supervisor object state machine is in the Ready, Running or Stopping state. See [State \(Control supervisor object\)](#) on page 181.

E Ctrl From Net (Control supervisor object)

This attribute indicates if the Run/Stop command is being supplied locally (Ctrl From Net = 0) or by the network (Ctrl From Net = 1).

Ref From Net (AC/DC drive object)

This attribute indicates if the speed and torque references are being supplied locally (Ref From Net = 0) or by the network (Ref From Net = 1).

At Reference (AC/DC drive object)

This attribute indicates that the drive is operating at the specified speed or torque reference.

State (Control supervisor object)

This attribute indicates the current state of the Control supervisor object.

State	Description	State	Description
0	Vendor Specific	4	Enabled
1	Startup	5	Stopping
2	Not Ready	6	Fault Stop
3	Ready	7	Faulted

The ODVA state transition diagram is shown below:

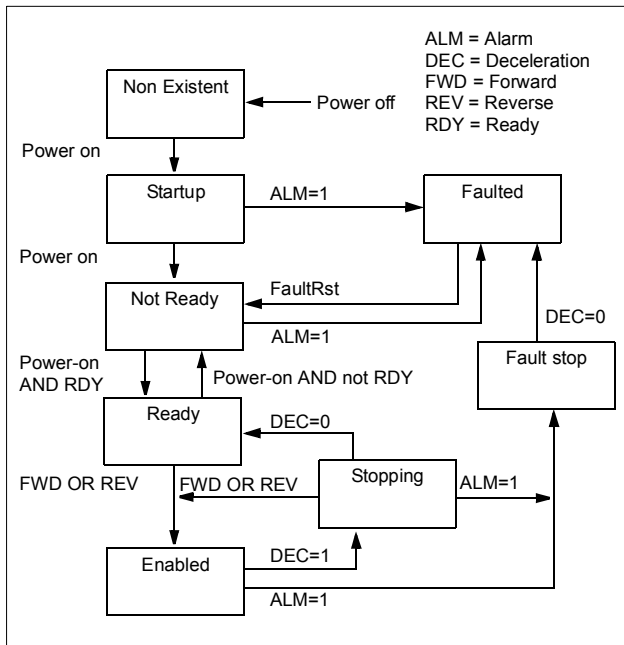

Speed Actual (AC/DC drive object)

This attribute indicates the actual speed at which the drive is operating. The units are scaled by the SpeedScale attribute of the AC/DC drive object. See parameter [23 ODVA SPEED SCALE](#) for details.

Scalar mode

When the drive is operating in the scalar mode, the drive provides the adapter module with a frequency actual. The ODVA AC/DC drive profile uses rpm units for the speed actual. The ODVA Speed Actual is calculated as follows:

$$O_{sa} = \frac{D_{fa} \times M_{ss}}{M_f \times U_s}$$

where

O_{sa} = ODVA Speed Actual

D_{fa} = Drive Frequency Actual in Hz

U_s = ODVA Speed Unit (see [23 ODVA SPEED SCALE](#) on page 127)

M_f = Motor Nominal Frequency in Hz

M_{ss} = Motor Synchronous Speed in rpm (not Motor Nominal Speed).

For example, for a 4-pole 60 Hz motor ($M_{ss} = 1800$ rpm) with a unit of 1 rpm and a Drive Frequency Actual of 30 Hz, the ODVA Speed Actual is:

$$O_{sa} = \frac{D_{fa} \times M_{ss}}{M_f \times U_s} = \frac{30\text{Hz} \times 1800\text{rpm}}{60\text{Hz} \times 1\text{rpm}} = 900$$

Vector mode

When the drive is operating in the vector mode, the drive provides the adapter module with a speed actual. The ODVA AC/DC drive profile uses rpm units for the speed actual. The ODVA Speed Actual is calculated as follows:

$$Osa = \frac{Dsa}{Us}$$

where

Dsa = Drive Speed Actual in rpm

Osa = ODVA Speed Actual

Us = ODVA Speed Unit (see [23 ODVA SPEED SCALE](#) on page 127).

For example, for a Drive Speed Actual of 900 rpm with a unit of 0.5 rpm, the ODVA Speed Actual is:

$$Osa = \frac{Dsa}{Us} = \frac{450 \text{ rpm}}{0.5 \text{ rpm}} = 900$$

Torque Actual (AC/DC drive object)

This attribute indicates the actual torque at which the drive is operating. The units are scaled by the Torque Scale attribute of the AC/DC drive object. See parameter [24 ODVA TORQUE SCALE](#) for details.

The drive provides the adapter module with a torque actual in percent of the Motor Nominal Torque. The ODVA AC/DC drive profile uses Newton-meter (N·m) units for the torque actual. The ODVA Torque Actual is calculated as follows:

$$Ota = \frac{Dta \times Mt}{100 \times Ut}$$

where

Dta = Drive Torque Actual in Percent of Motor Nominal Torque

Ota = ODVA Torque Actual

Ut = ODVA Torque Unit (see [24 ODVA TORQUE SCALE](#) on page 128)

Mt = Motor Nominal Torque in N·m.

For example, for a 1000 N·m Motor Nominal Torque with a unit of 1 N·m and a drive torque actual of 50%, the ODVA Torque Actual is:

$$Ota = \frac{Dta \times Mt}{100 \times Ut} = \frac{50 \times 1000 \text{ Nm}}{100 \times 1 \text{ Nm}} = 500$$

ABB Drives communication profile

Control word and Status word

The Control word is the principal means for controlling the drive from a fieldbus system. It is sent by the fieldbus client station to the drive through the adapter module. The drive switches between its states according to the bit-coded instructions in the Control word and returns status information to the client in the Status word.

The contents of the Control word and the Status word are detailed below. The drive states are presented on page [191](#).

Control word contents

The table below shows the contents of the Control word for the ABB Drives communication profile. The upper case boldface text refers to the states shown in the state machine on page [191](#).

Bit	Name	Value	STATE/Description
0	OFF1_ CONTROL	1	Proceed to READY TO OPERATE .
		0	Stop along currently active deceleration ramp. Proceed to OFF1 ACTIVE ; proceed to READY TO SWITCH ON unless other interlocks (OFF2, OFF3) are active.
1	OFF2_ CONTROL	1	Continue operation (OFF2 inactive).
		0	Emergency OFF, coast to stop. Proceed to OFF2 ACTIVE , proceed to SWITCH-ON INHIBITED .
2	OFF3_ CONTROL	1	Continue operation (OFF3 inactive).
		0	Emergency stop, stop within time defined by drive parameter. Proceed to OFF3 ACTIVE ; proceed to SWITCH-ON INHIBITED . Warning: Ensure that motor and driven machine can be stopped using this stop mode.

Bit	Name	Value	STATE/Description
3	INHIBIT_OPERATION	1	Proceed to OPERATION ENABLED . Note: Run enable signal must be active; see drive documentation. If the drive is set to receive the Run enable signal from the fieldbus, this bit activates the signal.
		0	Inhibit operation. Proceed to OPERATION INHIBITED .
4	RAMP_OUT_ZERO	1	Normal operation. Proceed to RAMP FUNCTION GENERATOR: OUTPUT ENABLED .
		0	Force Ramp Function Generator output to zero. Drive ramps to stop (current and DC voltage limits in force).
5	RAMP_HOLD	1	Enable ramp function. Proceed to RAMP FUNCTION GENERATOR: ACCELERATOR ENABLED .
		0	Halt ramping (Ramp Function Generator output held).
6	RAMP_IN_ZERO	1	Normal operation. Proceed to OPERATION . Note: This bit is effective only if the fieldbus interface is set as the source for this signal by drive parameters.
		0	Force Ramp Function Generator input to zero.
7	RESET	0 → 1	Fault reset if an active fault exists. Proceed to SWITCH-ON INHIBITED . Note: This bit is effective only if the fieldbus interface is set as the source for this signal by drive parameters.
		0	Continue normal operation.
8...9	Drive-specific (For information, see the drive documentation.)		

Bit	Name	Value	STATE/Description
10	REMOTE_ CMD	1	Fieldbus control enabled.
		0	Control word and reference not getting through to the drive, except for CW bits OFF1, OFF2 and OFF3.
11	EXT_CTRL_ LOC	1	Select External Control Location EXT2. Effective if control location parameterized to be selected from fieldbus.
		0	Select External Control Location EXT1. Effective if control location parameterized to be selected from fieldbus.
12... 15	Reserved		

Status word contents

The table below shows the contents of the Status word for the ABB Drives communication profile. The upper case boldface text refers to the states shown in the state machine on page 191.

Bit	Name	Value	STATE/Description
0	RDY_ON	1	READY TO SWITCH ON
		0	NOT READY TO SWITCH ON
1	RDY_RUN	1	READY TO OPERATE
		0	OFF1 ACTIVE
2	RDY_REF	1	OPERATION ENABLED
		0	OPERATION INHIBITED
3	TRIPPED	1	FAULT
		0	No fault
4	OFF_2_STA	1	OFF2 inactive
		0	OFF2 ACTIVE
5	OFF_3_STA	1	OFF3 inactive
		0	OFF3 ACTIVE
6	SWC_ON_INHIB	1	SWITCH-ON INHIBITED
		0	–
7	ALARM	1	Warning/Alarm
		0	No warning/alarm
8	AT_SETPOINT	1	OPERATION. Actual value equals reference (= is within tolerance limits, ie, in speed control, speed error is 10% max. of nominal motor speed).
		0	Actual value differs from reference (= is outside tolerance limits).
9	REMOTE	1	Drive control location: REMOTE (EXT1 or EXT2)
		0	Drive control location: LOCAL

Bit	Name	Value	STATE/Description
10	ABOVE_ LIMIT	1	Actual frequency or speed equals or exceeds supervision limit (set by drive parameter). Valid in both directions of rotation.
		0	Actual frequency or speed within supervision limit
11	EXT_CTRL_ LOC	1	External Control Location EXT2 selected. Note concerning ACS880: This bit is effective only if the fieldbus interface is set as the target for this signal by drive parameters. User bit 0 selection (06.33)
		0	External Control Location EXT1 selected
12	EXT_RUN_ ENABLE	1	External Run Enable signal received. Note concerning ACS880: This bit is effective only if the fieldbus interface is set as the target for this signal by drive parameters. User bit 1 selection (06.34)
		0	No External Run Enable signal received
13... 14	Reserved		
15	FBA_ ERROR	1	Communication error detected by fieldbus adapter module
		0	Fieldbus adapter communication OK

State machine

The state machine for the ABB Drives communication profile is shown below.

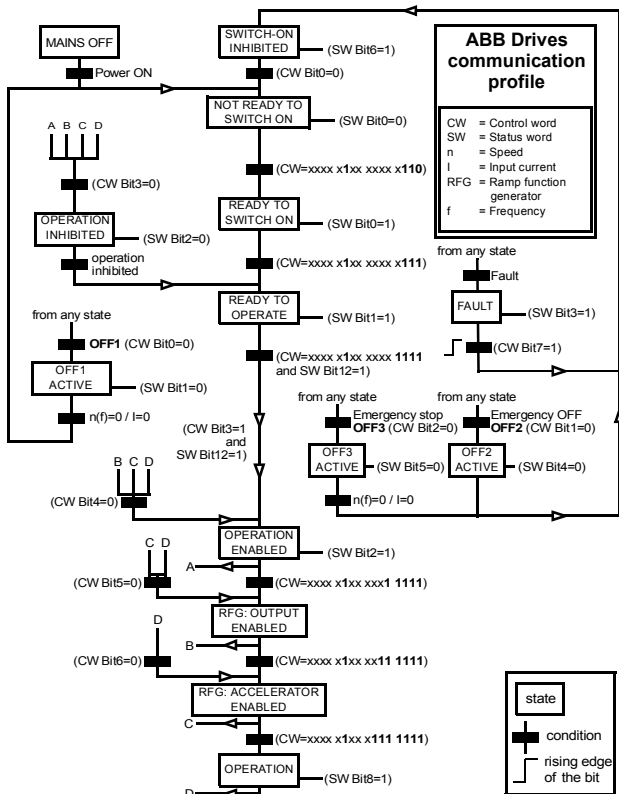

References

References are 16-bit words containing a sign bit and a 15-bit integer. A negative reference (indicating reversed direction of rotation) is formed by calculating the two's complement from the corresponding positive reference.

ABB drives can receive control information from multiple sources including analog and digital inputs, the drive control panel and a fieldbus adapter module (for example, FENA). To have the drive controlled through the fieldbus, you must select the module as the source for control information, for example, reference.

Scaling

References are scaled as shown below.

Note: The values of REF1 MAX and REF2 MAX are set with drive parameters. See the drive manuals for further information.

In ACSM1, ACS850, ACQ810, ACS880 and ACS580, the speed reference (REFx) in decimal (0...20000) corresponds to 0...100% of the speed scaling value (as defined with a drive parameter).

In ACS355, drive parameter REFx MIN may limit the actual minimum reference.

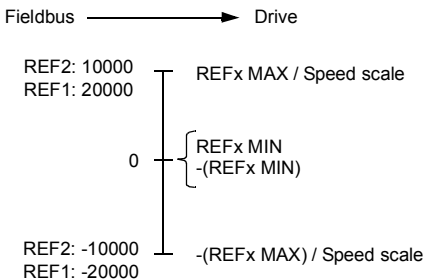

Actual values

Actual values are 16-bit words containing information on the operation of the drive. The functions to be monitored are selected with a drive parameter.

Scaling

Actual values are scaled as shown below.

Note: The values of REF1 MAX and REF2 MAX are set with drive parameters. See the drive manuals for further information.

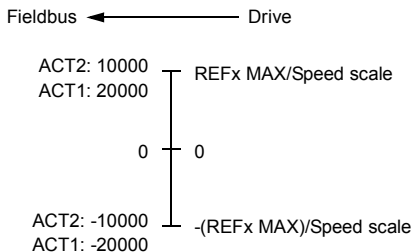

12

EtherNet/IP – Communication protocol

Contents of this chapter

This chapter describes the EtherNet/IP communication protocol for the adapter module.

EtherNet/IP

EtherNet/IP is a variant of the Common Industrial Protocol (CIP) family of communication protocols intended for supervision and control of automation equipment. Specifically, it covers the use of CIP messaging over an IP network, typically using Ethernet as the media.

The FENA adapter module acts as a server on an EtherNet/IP network with support for the ODVA AC/DC drive, ABB Drives and Transparent profiles.

Two simultaneous EtherNet/IP connections are supported, that is, two clients can be connected to the adapter module at a time.

Further information on the EtherNet/IP protocol is available at www.odva.org.

Object modeling and functional profiles

One of the main features of EtherNet/IP is object modeling. A group of objects can be described with a Functional Profile. The FENA adapter module realizes the ODVA AC/DC drive Functional Profile with additional features.

Assembly objects

I/O assembly instances may also be referred to as Block Transfer of data. Intelligent devices realizing a Functional Profile, such as FENA, have several objects. Since it is not possible to transmit more than one object data through a single connection, it is practical and more efficient to group attributes from different objects into a single I/O connection using the assembly object. The assembly object acts as a tool for grouping these attributes.

The assembly selections described above are, in fact, instances of the assembly object class. The adapter module uses static assemblies (in other words, fixed groupings of different object data only). The following tables describe the assembly instances supported by the adapter module.

■ Basic speed control assembly

The Basic speed control assembly is defined by the ODVA AC/DC drive profile. The format of the output assembly is:

Instance 20 (ODVA AC/DC profile)								
Byte	Bit 7	Bit 6	Bit 5	Bit 4	Bit 3	Bit 2	Bit 1	Bit 0
0						Fault Reset		Run Fwd
1								
2	Speed Reference (Low Byte)							
3	Speed Reference (High Byte)							

The format of the input assembly is:

Instance 70 (ODVA AC/DC profile)								
Byte	Bit 7	Bit 6	Bit 5	Bit 4	Bit 3	Bit 2	Bit 1	Bit 0
0						Running1 (Fwd)		Faulted
1								
2	Speed Actual (Low Byte)							
3	Speed Actual (High Byte)							

■ Basic speed control plus drive parameters assembly

The Basic speed control plus drive parameters assembly, defined by ABB, adds configurable drive parameters to the Basic speed control assembly of the ODVA AC/DC drive profile.

The format of the output assembly is:

Instance 120 (ODVA AC/DC profile)								
Byte	Bit 7	Bit 6	Bit 5	Bit 4	Bit 3	Bit 2	Bit 1	Bit 0
0						Fault Reset		Run Fwd
1								
2	Speed Reference (Low Byte)							
3	Speed Reference (High Byte)							
4	DATA OUT 1 Value (Low Byte)							
5	DATA OUT 1 Value (High Byte)							
6	DATA OUT 2 Value (Low Byte)							
7	DATA OUT 2 Value (High Byte)							
8	DATA OUT 3 Value (Low Byte)							
9	DATA OUT 3 Value (High Byte)							
10	DATA OUT 4 Value (Low Byte)							
11	DATA OUT 4 Value (High Byte)							
12	DATA OUT 5 Value (Low Byte)							

Instance 120 (ODVA AC/DC profile)								
Byte	Bit 7	Bit 6	Bit 5	Bit 4	Bit 3	Bit 2	Bit 1	Bit 0
13	DATA OUT 5 Value (High Byte)							
14	DATA OUT 6 Value (Low Byte)							
15	DATA OUT 6 Value (High Byte)							
16	DATA OUT 7 Value (Low Byte)							
17	DATA OUT 7 Value (High Byte)							
18	DATA OUT 8 Value (Low Byte)							
19	DATA OUT 8 Value (High Byte)							
20	DATA OUT 9 Value (Low Byte)							
21	DATA OUT 9 Value (High Byte)							
22	DATA OUT 10 Value (Low Byte)							
23	DATA OUT 10 Value (High Byte)							

The format of the input assembly is:

Instance 170 (ODVA AC/DC profile)								
Byte	Bit 7	Bit 6	Bit 5	Bit 4	Bit 3	Bit 2	Bit 1	Bit 0
0						Running1 (Fwd)		Faulted
1								
2	Speed Actual (Low Byte)							
3	Speed Actual (High Byte)							
4	DATA IN 1 Value (Low Byte)							
5	DATA IN 1 Value (High Byte)							
6	DATA IN 2 Value (Low Byte)							
7	DATA IN 2 Value (High Byte)							
8	DATA IN 3 Value (Low Byte)							
9	DATA IN 3 Value (High Byte)							
10	DATA IN 4 Value (Low Byte)							
11	DATA IN 4 Value (High Byte)							

Instance 170 (ODVA AC/DC profile)								
Byte	Bit 7	Bit 6	Bit 5	Bit 4	Bit 3	Bit 2	Bit 1	Bit 0
12	DATA IN 5 Value (Low Byte)							
13	DATA IN 5 Value (High Byte)							
14	DATA IN 6 Value (Low Byte)							
15	DATA IN 6 Value (High Byte)							
16	DATA IN 7 Value (Low Byte)							
17	DATA IN 7 Value (High Byte)							
18	DATA IN 8 Value (Low Byte)							
19	DATA IN 8 Value (High Byte)							
20	DATA IN 9 Value (Low Byte)							
21	DATA IN 9 Value (High Byte)							
22	DATA IN 10 Value (Low Byte)							
23	DATA IN 10 Value (High Byte)							

■ Extended speed control assembly

The Extended speed control assembly is defined by the ODVA AC/DC drive profile. The format of the output assembly is:

Instance 21 (ODVA AC/DC profile)								
Byte	Bit 7	Bit 6	Bit 5	Bit 4	Bit 3	Bit 2	Bit 1	Bit 0
0		NetRef	NetCtrl			Fault Reset	Run Rev	Run Fwd
1								
2	Speed Reference (Low Byte)							
3	Speed Reference (High Byte)							

The format of the input assembly is:

Instance 71 (ODVA AC/DC profile)								
Byte	Bit 7	Bit 6	Bit 5	Bit 4	Bit 3	Bit 2	Bit 1	Bit 0
0	At Reference	Ref From Net	Ctrl From Net	Ready	Running2 (Rev)	Running1 (Fwd)	Warning	Faulted
1	Drive State. See section State (Control supervisor object) on page 181.							
2	Speed Actual (Low Byte)							
3	Speed Actual (High Byte)							

Extended speed control plus drive parameters assembly

The Extended speed control plus drive parameters assembly, defined by ABB, adds configurable drive parameters to the Extended speed control assembly of the ODVA AC/DC drive profile.

The format of the output assembly is:

Instance 121 (ODVA AC/DC profile)								
Byte	Bit 7	Bit 6	Bit 5	Bit 4	Bit 3	Bit 2	Bit 1	Bit 0
0		Net Ref	Net Ctrl			Fault Reset	Run Rev	Run Fwd
1								
2	Speed Reference (Low Byte)							
3	Speed Reference (High Byte)							
4	DATA OUT 1 Value (Low Byte)							
5	DATA OUT 1 Value (High Byte)							
6	DATA OUT 2 Value (Low Byte)							
7	DATA OUT 2 Value (High Byte)							
8	DATA OUT 3 Value (Low Byte)							
9	DATA OUT 3 Value (High Byte)							
10	DATA OUT 4 Value (Low Byte)							

Instance 121 (ODVA AC/DC profile)								
Byte	Bit 7	Bit 6	Bit 5	Bit 4	Bit 3	Bit 2	Bit 1	Bit 0
11	DATA OUT 4 Value (High Byte)							
12	DATA OUT 5 Value (Low Byte)							
13	DATA OUT 5 Value (High Byte)							
14	DATA OUT 6 Value (Low Byte)							
15	DATA OUT 6 Value (High Byte)							
16	DATA OUT 7 Value (Low Byte)							
17	DATA OUT 7 Value (High Byte)							
18	DATA OUT 8 Value (Low Byte)							
19	DATA OUT 8 Value (High Byte)							
20	DATA OUT 9 Value (Low Byte)							
21	DATA OUT 9 Value (High Byte)							
22	DATA OUT 10 Value (Low Byte)							
23	DATA OUT 10 Value (High Byte)							

The format of the input assembly is:

Instance 171 (ODVA AC/DC profile)								
Byte	Bit 7	Bit 6	Bit 5	Bit 4	Bit 3	Bit 2	Bit 1	Bit 0
0	At Reference	Ref From Net	Ctrl From Net	Ready	Running2 (Rev)	Running1 (Fwd)	Warning	Faulted
1	Drive State See section State (Control supervisor object) on page 181.							
2	Speed Actual (Low Byte)							
3	Speed Actual (High Byte)							
4	DATA IN 1 Value (Low Byte)							
5	DATA IN 1 Value (High Byte)							
6	DATA IN 2 Value (Low Byte)							
7	DATA IN 2 Value (High Byte)							
8	DATA IN 3 Value (Low Byte)							

Instance 171 (ODVA AC/DC profile)								
Byte	Bit 7	Bit 6	Bit 5	Bit 4	Bit 3	Bit 2	Bit 1	Bit 0
9	DATA IN 3 Value (High Byte)							
10	DATA IN 4 Value (Low Byte)							
11	DATA IN 4 Value (High Byte)							
12	DATA IN 5 Value (Low Byte)							
13	DATA IN 5 Value (High Byte)							
14	DATA IN 6 Value (Low Byte)							
15	DATA IN 6 Value (High Byte)							
16	DATA IN 7 Value (Low Byte)							
17	DATA IN 7 Value (High Byte)							
18	DATA IN 8 Value (Low Byte)							
19	DATA IN 8 Value (High Byte)							
20	DATA IN 9 Value (Low Byte)							
21	DATA IN 9 Value (High Byte)							
22	DATA IN 10 Value (Low Byte)							
23	DATA IN 10 Value (High Byte)							

Basic speed and torque control assembly

The Basic speed and torque control assembly is defined by the ODVA AC/DC drive profile. The format of the output assembly is:

Instance 22 (ODVA AC/DC profile)								
Byte	Bit 7	Bit 6	Bit 5	Bit 4	Bit 3	Bit 2	Bit 1	Bit 0
0						Fault Reset		Run Fwd
1								
2	Speed Reference (Low Byte)							
3	Speed Reference (High Byte)							
4	Torque Reference (Low Byte)							
5	Torque Reference (High Byte)							

The format of the input assembly is:

Instance 72 (ODVA AC/DC profile)								
Byte	Bit 7	Bit 6	Bit 5	Bit 4	Bit 3	Bit 2	Bit 1	Bit 0
0						Running1 (Fwd)		Faulted
1								
2	Speed Actual (Low Byte)							
3	Speed Actual (High Byte)							
4	Torque Actual (Low Byte)							
5	Torque Actual (High Byte)							

Basic speed and torque control plus drive parameters assembly

The Basic speed and torque control plus drive parameters assembly, defined by ABB, adds configurable drive parameters to the Basic speed and torque control assembly of the ODVA AC/DC drive profile.

The format of the output assembly is:

Instance 122 (ODVA AC/DC profile)								
Byte	Bit 7	Bit 6	Bit 5	Bit 4	Bit 3	Bit 2	Bit 1	Bit 0
0						Fault Reset		Run Fwd
1								
2	Speed Reference (Low Byte)							
3	Speed Reference (High Byte)							
4	Torque Reference (Low Byte)							
5	Torque Reference (High Byte)							
6	DATA OUT 1 Value (Low Byte)							
7	DATA OUT 1 Value (High Byte)							
8	DATA OUT 2 Value (Low Byte)							
9	DATA OUT 2 Value (High Byte)							
10	DATA OUT 3 Value (Low Byte)							
11	DATA OUT 3 Value (High Byte)							
12	DATA OUT 4 Value (Low Byte)							
13	DATA OUT 4 Value (High Byte)							
14	DATA OUT 5 Value (Low Byte)							
15	DATA OUT 5 Value (High Byte)							
16	DATA OUT 6 Value (Low Byte)							
17	DATA OUT 6 Value (High Byte)							
18	DATA OUT 7 Value (Low Byte)							
19	DATA OUT 7 Value (High Byte)							
20	DATA OUT 8 Value (Low Byte)							

Instance 122 (ODVA AC/DC profile)								
Byte	Bit 7	Bit 6	Bit 5	Bit 4	Bit 3	Bit 2	Bit 1	Bit 0
21	DATA OUT 8 Value (High Byte)							
22	DATA OUT 9 Value (Low Byte)							
23	DATA OUT 9 Value (High Byte)							
24	DATA OUT 10 Value (Low Byte)							
25	DATA OUT 10 Value (High Byte)							

The format of the input assembly is:

Instance 172 (ODVA AC/DC profile)								
Byte	Bit 7	Bit 6	Bit 5	Bit 4	Bit 3	Bit 2	Bit 1	Bit 0
0						Running1 (Fwd)		Faulted
1								
2	Speed Actual (Low Byte)							
3	Speed Actual (High Byte)							
4	Torque Actual (Low Byte)							
5	Torque Actual (High Byte)							
6	DATA IN 1 Value (Low Byte)							
7	DATA IN 1 Value (High Byte)							
8	DATA IN 2 Value (Low Byte)							
9	DATA IN 2 Value (High Byte)							
10	DATA IN 3 Value (Low Byte)							
11	DATA IN 3 Value (High Byte)							
12	DATA IN 4 Value (Low Byte)							
13	DATA IN 4 Value (High Byte)							
14	DATA IN 5 Value (Low Byte)							
15	DATA IN 5 Value (High Byte)							
16	DATA IN 6 Value (Low Byte)							
17	DATA IN 6 Value (High Byte)							

Instance 172 (ODVA AC/DC profile)								
Byte	Bit 7	Bit 6	Bit 5	Bit 4	Bit 3	Bit 2	Bit 1	Bit 0
18	DATA IN 7 Value (Low Byte)							
19	DATA IN 7 Value (High Byte)							
20	DATA IN 8 Value (Low Byte)							
21	DATA IN 8 Value (High Byte)							
22	DATA IN 9 Value (Low Byte)							
23	DATA IN 9 Value (High Byte)							
24	DATA IN 10 Value (Low Byte)							
25	DATA IN 10 Value (High Byte)							

■ Extended speed and torque control assembly

The Extended speed and torque control assembly is defined by the ODVA AC/DC drive profile. The format of the output assembly is:

Instance 23 (ODVA AC/DC profile)								
Byte	Bit 7	Bit 6	Bit 5	Bit 4	Bit 3	Bit 2	Bit 1	Bit 0
0		Net Ref	Net Ctrl			Fault Reset	Run Rev	Run Fwd
1								
2	Speed Reference (Low Byte)							
3	Speed Reference (High Byte)							
4	Torque Reference (Low Byte)							
5	Torque Reference (High Byte)							

The format of the input assembly is:

Instance 73 (ODVA AC/DC profile)								
Byte	Bit 7	Bit 6	Bit 5	Bit 4	Bit 3	Bit 2	Bit 1	Bit 0
0	At Reference	Ref From Net	Ctrl From Net	Ready	Run-ning2 (Rev)	Run-ning1 (Fwd)	Warn-ing	Faulted
1	Drive State See section State (Control supervisor object) on page 181.							
2	Speed Actual (Low Byte)							
3	Speed Actual (High Byte)							
4	Torque Actual (Low Byte)							
5	Torque Actual (High Byte)							

Extended speed and torque control plus drive parameters assembly

The Extended speed and torque control plus drive parameters assembly, defined by ABB, adds configurable drive parameters to the Extended speed and torque control assembly of the ODVA AC/DC drive profile.

The format of the output assembly is:

Instance 123 (ODVA AC/DC profile)								
Byte	Bit 7	Bit 6	Bit 5	Bit 4	Bit 3	Bit 2	Bit 1	Bit 0
0		NetRef	NetCtl			Fault Reset	Run Rev	Run Fwd
1								
2	Speed Reference (Low Byte)							
3	Speed Reference (High Byte)							
4	Torque Reference (Low Byte)							
5	Torque Reference (High Byte)							
6	DATA OUT 1 Value (Low Byte)							
7	DATA OUT 1 Value (High Byte)							
8	DATA OUT 2 Value (Low Byte)							

Instance 123 (ODVA AC/DC profile)								
Byte	Bit 7	Bit 6	Bit 5	Bit 4	Bit 3	Bit 2	Bit 1	Bit 0
9	DATA OUT 2 Value (High Byte)							
10	DATA OUT 3 Value (Low Byte)							
11	DATA OUT 3 Value (High Byte)							
12	DATA OUT 4 Value (Low Byte)							
13	DATA OUT 4 Value (High Byte)							
14	DATA OUT 5 Value (Low Byte)							
15	DATA OUT 5 Value (High Byte)							
16	DATA OUT 6 Value (Low Byte)							
17	DATA OUT 6 Value (High Byte)							
18	DATA OUT 7 Value (Low Byte)							
19	DATA OUT 7 Value (High Byte)							
20	DATA OUT 8 Value (Low Byte)							
21	DATA OUT 8 Value (High Byte)							
22	DATA OUT 9 Value (Low Byte)							
23	DATA OUT 9 Value (High Byte)							
24	DATA OUT 10 Value (Low Byte)							
25	DATA OUT 10 Value (High Byte)							

The format of the input assembly is:

Instance 173 (ODVA AC/DC profile)								
Byte	Bit 7	Bit 6	Bit 5	Bit 4	Bit 3	Bit 2	Bit 1	Bit 0
0	At Reference	Ref From Net	Ctrl From Net	Ready	Running2 (Rev)	Running1 (Fwd)	Warning	Faulted
1	Drive State See section State (Control supervisor object) on page 181.							
2	Speed Actual (Low Byte)							
3	Speed Actual (High Byte)							
4	Torque Actual (Low Byte)							

Instance 173 (ODVA AC/DC profile)								
Byte	Bit 7	Bit 6	Bit 5	Bit 4	Bit 3	Bit 2	Bit 1	Bit 0
5	Torque Actual (High Byte)							
6	DATA IN 1 Value (Low Byte)							
7	DATA IN 1 Value (High Byte)							
8	DATA IN 2 Value (Low Byte)							
9	DATA IN 2 Value (High Byte)							
10	DATA IN 3 Value (Low Byte)							
11	DATA IN 3 Value (High Byte)							
12	DATA IN 4 Value (Low Byte)							
13	DATA IN 4 Value (High Byte)							
14	DATA IN 5 Value (Low Byte)							
15	DATA IN 5 Value (High Byte)							
16	DATA IN 6 Value (Low Byte)							
17	DATA IN 6 Value (High Byte)							
18	DATA IN 7 Value (Low Byte)							
19	DATA IN 7 Value (High Byte)							
20	DATA IN 8 Value (Low Byte)							
21	DATA IN 8 Value (High Byte)							
22	DATA IN 9 Value (Low Byte)							
23	DATA IN 9 Value (High Byte)							
24	DATA IN 10 Value (Low Byte)							
25	DATA IN 10 Value (High Byte)							

■ ABB Drives profile with set speed assembly

The ABB Drives profile with set speed assembly is defined by ABB. The format of the output assembly is:

Instance 1 (ABB Drives profile)								
Byte	Bit 7	Bit 6	Bit 5	Bit 4	Bit 3	Bit 2	Bit 1	Bit 0
0	Reset	Ramp in Zero	Ramp Hold	Ramp Out Zero	Inhibit Operation	Off 3 Control	Off 2 Control	Off 1 Control
1					Ext Ctrl Loc	Remote Cmd		
2	Set Speed (Low Byte)							
3	Set Speed (High Byte)							

The format of the input assembly is:

Instance 51 (ABB Drives profile)								
Byte	Bit 7	Bit 6	Bit 5	Bit 4	Bit 3	Bit 2	Bit 1	Bit 0
0	Alarm	Swc On Inhib	Off 3 Sta	Off 2 Sta	Tripped	Rdy Ref	Rdy Run	Rdy On
1	Field-bus Error			Ext Run Enable	Ext Ctrl Loc	Above Limit	Re- mote	At Set- point
2	Actual Speed (Low Byte)							
3	Actual Speed (High Byte)							

■ ABB Drives profile with set speed plus drive parameters assembly

The ABB Drives profile with set speed plus drive parameters assembly, defined by ABB, adds configurable drive parameters to the ABB Drives profile with set speed of the ABB Drives profile.

The format of the output assembly is:

Instance 101 (ABB Drives profile)								
Byte	Bit 7	Bit 6	Bit 5	Bit 4	Bit 3	Bit 2	Bit 1	Bit 0
0	Reset	Ramp in Zero	Ramp Hold	Ramp Out Zero	Inhibit Operation	Off 3 Control	Off 2 Control	Off 1 Control
1					Ext Ctrl Loc	Remote Cmd		
2	Set Speed (Low Byte)							
3	Set Speed (High Byte)							
4	DATA OUT 1 Value (Low Byte)							
5	DATA OUT 1 Value (High Byte)							
6	DATA OUT 2 Value (Low Byte)							
7	DATA OUT 2 Value (High Byte)							
8	DATA OUT 3 Value (Low Byte)							
9	DATA OUT 3 Value (High Byte)							
10	DATA OUT 4 Value (Low Byte)							
11	DATA OUT 4 Value (High Byte)							
12	DATA OUT 5 Value (Low Byte)							
13	DATA OUT 5 Value (High Byte)							
14	DATA OUT 6 Value (Low Byte)							
15	DATA OUT 6 Value (High Byte)							
16	DATA OUT 7 Value (Low Byte)							
17	DATA OUT 7 Value (High Byte)							
18	DATA OUT 8 Value (Low Byte)							

Instance 101 (ABB Drives profile)								
Byte	Bit 7	Bit 6	Bit 5	Bit 4	Bit 3	Bit 2	Bit 1	Bit 0
19	DATA OUT 8 Value (High Byte)							
20	DATA OUT 9 Value (Low Byte)							
21	DATA OUT 9 Value (High Byte)							
22	DATA OUT 10 Value (Low Byte)							
23	DATA OUT 10 Value (High Byte)							

The format of the input assembly is:

Instance 151 (ABB Drives profile)								
Byte	Bit 7	Bit 6	Bit 5	Bit 4	Bit 3	Bit 2	Bit 1	Bit 0
0	Alarm	Swc On Inhib	Off 3 Sta	Off 2 Sta	Tripped	Rdy Ref	Rdy Run	Rdy On
1	Field-bus Error			Ext Run Enable	Ext Ctrl Loc	Above Limit	Remote	At Set-point
2	Actual Speed (Low Byte)							
3	Actual Speed (High Byte)							
4	DATA IN 1 Value (Low Byte)							
5	DATA IN 1 Value (High Byte)							
6	DATA IN 2 Value (Low Byte)							
7	DATA IN 2 Value (High Byte)							
8	DATA IN 3 Value (Low Byte)							
9	DATA IN 3 Value (High Byte)							
10	DATA IN 4 Value (Low Byte)							
11	DATA IN 4 Value (High Byte)							
12	DATA IN 5 Value (Low Byte)							
13	DATA IN 5 Value (High Byte)							
14	DATA IN 6 Value (Low Byte)							
15	DATA IN 6 Value (High Byte)							

Instance 151 (ABB Drives profile)								
Byte	Bit 7	Bit 6	Bit 5	Bit 4	Bit 3	Bit 2	Bit 1	Bit 0
16	DATA IN 7 Value (Low Byte)							
17	DATA IN 7 Value (High Byte)							
18	DATA IN 8 Value (Low Byte)							
19	DATA IN 8 Value (High Byte)							
20	DATA IN 9 Value (Low Byte)							
21	DATA IN 9 Value (High Byte)							
22	DATA IN 10 Value (Low Byte)							
23	DATA IN 10 Value (High Byte)							

■ ABB Drives profile with set speed and set torque assembly

The ABB Drives profile with set speed and set torque assembly is defined by ABB. The format of the output assembly is:

Instance 2 (ABB Drives profile)								
Byte	Bit 7	Bit 6	Bit 5	Bit 4	Bit 3	Bit 2	Bit 1	Bit 0
0	Reset	Ramp in Zero	Ramp Hold	Ramp Out Zero	Inhibit Operation	Off 3 Control	Off 2 Control	Off 1 Control
1					Ext Ctrl Loc	Remote Cmd		
2	Set Speed (Low Byte)							
3	Set Speed (High Byte)							
4	Set Torque (Low Byte)							
5	Set Torque (High Byte)							

The format of the input assembly is:

Instance 52 (ABB Drives profile)								
Byte	Bit 7	Bit 6	Bit 5	Bit 4	Bit 3	Bit 2	Bit 1	Bit 0
0	Alarm	Swc On Inhib	Off 3 Sta	Off 2 Sta	Tripped	Rdy Ref	Rdy Run	Rdy On
1	Field- bus Error			Ext Run Enable	Ext Ctrl Loc	Above Limit	Remote	At Set- point
2	Actual Speed (Low Byte)							
3	Actual Speed (High Byte)							
4	Actual Torque (Low Byte)							
5	Actual Torque (High Byte)							

■ ABB Drives profile with set speed and set torque plus drive parameters assembly

The ABB Drives profile with set speed and set torque plus drive parameters assembly, defined by ABB, adds configurable drive parameters to the ABB Drives profile with set speed and set torque of the ABB Drives profile.

The format of the output assembly is:

Instance 102 (ABB Drives profile)								
Byte	Bit 7	Bit 6	Bit 5	Bit 4	Bit 3	Bit 2	Bit 1	Bit 0
0	Reset	Ramp in Zero	Ramp Hold	Ramp Out Zero	Inhibit Oper- ation	Off 3 Con- trol	Off 2 Con- trol	Off 1 Con- trol
1					Ext Ctrl Loc	Re- mote Cmd		
2	Set Speed (Low Byte)							
3	Set Speed (High Byte)							
4	Set Torque (Low Byte)							
5	Set Torque (High Byte)							

Instance 102 (ABB Drives profile)								
Byte	Bit 7	Bit 6	Bit 5	Bit 4	Bit 3	Bit 2	Bit 1	Bit 0
6	DATA OUT 1 Value (Low Byte)							
7	DATA OUT 1 Value (High Byte)							
8	DATA OUT 2 Value (Low Byte)							
9	DATA OUT 2 Value (High Byte)							
10	DATA OUT 3 Value (Low Byte)							
11	DATA OUT 3 Value (High Byte)							
12	DATA OUT 4 Value (Low Byte)							
13	DATA OUT 4 Value (High Byte)							
14	DATA OUT 5 Value (Low Byte)							
15	DATA OUT 5 Value (High Byte)							
16	DATA OUT 6 Value (Low Byte)							
17	DATA OUT 6 Value (High Byte)							
18	DATA OUT 7 Value (Low Byte)							
19	DATA OUT 7 Value (High Byte)							
20	DATA OUT 8 Value (Low Byte)							
21	DATA OUT 8 Value (High Byte)							
22	DATA OUT 9 Value (Low Byte)							
23	DATA OUT 9 Value (High Byte)							
24	DATA OUT 10 Value (Low Byte)							
25	DATA OUT 10 Value (High Byte)							

The format of the input assembly is:

Instance 152 (ABB Drives profile)								
Byte	Bit 7	Bit 6	Bit 5	Bit 4	Bit 3	Bit 2	Bit 1	Bit 0
0	Alarm	Swc On Inhib	Off 3 Sta	Off 2 Sta	Tripped	Rdy Ref	Rdy Run	Rdy On
1	Field-bus Error			Ext Run Enable	Ext Ctrl Loc	Above Limit	Remote	At Set- point
2	Actual Speed (Low Byte)							
3	Actual Speed (High Byte)							
4	Actual Torque (Low Byte)							
5	Actual Torque (High Byte)							
6	DATA IN 1 Value (Low Byte)							
7	DATA IN 1 Value (High Byte)							
8	DATA IN 2 Value (Low Byte)							
9	DATA IN 2 Value (High Byte)							
10	DATA IN 3 Value (Low Byte)							
11	DATA IN 3 Value (High Byte)							
12	DATA IN 4 Value (Low Byte)							
13	DATA IN 4 Value (High Byte)							
14	DATA IN 5 Value (Low Byte)							
15	DATA IN 5 Value (High Byte)							
16	DATA IN 6 Value (Low Byte)							
17	DATA IN 6 Value (High Byte)							
18	DATA IN 7 Value (Low Byte)							
19	DATA IN 7 Value (High Byte)							
20	DATA IN 8 Value (Low Byte)							
21	DATA IN 8 Value (High Byte)							
22	DATA IN 9 Value (Low Byte)							
23	DATA IN 9 Value (High Byte)							

Instance 152 (ABB Drives profile)								
Byte	Bit 7	Bit 6	Bit 5	Bit 4	Bit 3	Bit 2	Bit 1	Bit 0
24	DATA IN 10 Value (Low Byte)							
25	DATA IN 10 Value (High Byte)							

■ Transparent 16 with one assembly

The Transparent 16 with one assembly, defined by ABB, provides unaltered 16-bit access to the configured drive profile.

The format of the output assembly is:

Instance 11 (Transparent 16 profile)								
Byte	Bit 7	Bit 6	Bit 5	Bit 4	Bit 3	Bit 2	Bit 1	Bit 0
0	Drive Profile 16-bit Control Word (Low Byte)							
1	Drive Profile 16-bit Control Word (High Byte)							
2	Drive Profile 16-bit Reference 1 Word (Low Byte)							
3	Drive Profile 16-bit Reference 1 Word (High Byte)							

The format of the input assembly is:

Instance 61 (Transparent 16 profile)								
Byte	Bit 7	Bit 6	Bit 5	Bit 4	Bit 3	Bit 2	Bit 1	Bit 0
0	Drive Profile 16-bit Status Word (Low Byte)							
1	Drive Profile 16-bit Status Word (High Byte)							
2	Drive Profile 16-bit Actual 1 Word (Low Byte)							
3	Drive Profile 16-bit Actual 1 Word (High Byte)							

■ Transparent 16 with one assembly plus drive parameters

The Transparent 16 with one assembly plus drive parameters, defined by ABB, adds configurable drive parameters to the Transparent 16 with one assembly.

The format of the output assembly is:

Instance 111 (Transparent 16 profile)								
Byte	Bit 7	Bit 6	Bit 5	Bit 4	Bit 3	Bit 2	Bit 1	Bit 0
0	Drive Profile 16-bit Control Word (Low Byte)							
1	Drive Profile 16-bit Control Word (High Byte)							
2	Drive Profile 16-bit Reference 1 Word (Low Byte)							
3	Drive Profile 16-bit Reference 1 Word (High Byte)							
4	DATA OUT 1 Value (Low Byte)							
5	DATA OUT 1 Value (High Byte)							
6	DATA OUT 2 Value (Low Byte)							
7	DATA OUT 2 Value (High Byte)							
8	DATA OUT 3 Value (Low Byte)							
9	DATA OUT 3 Value (High Byte)							
10	DATA OUT 4 Value (Low Byte)							
11	DATA OUT 4 Value (High Byte)							
12	DATA OUT 5 Value (Low Byte)							
13	DATA OUT 5 Value (High Byte)							
14	DATA OUT 6 Value (Low Byte)							
15	DATA OUT 6 Value (High Byte)							
16	DATA OUT 7 Value (Low Byte)							
17	DATA OUT 7 Value (High Byte)							
18	DATA OUT 8 Value (Low Byte)							
19	DATA OUT 8 Value (High Byte)							
20	DATA OUT 9 Value (Low Byte)							
21	DATA OUT 9 Value (High Byte)							

Instance 111 (Transparent 16 profile)								
Byte	Bit 7	Bit 6	Bit 5	Bit 4	Bit 3	Bit 2	Bit 1	Bit 0
22	DATA OUT 10 Value (Low Byte)							
23	DATA OUT 10 Value (High Byte)							

The format of the input assembly is:

Instance 161 (Transparent 16 profile)								
Byte	Bit 7	Bit 6	Bit 5	Bit 4	Bit 3	Bit 2	Bit 1	Bit 0
0	Drive Profile 16-bit Status Word (Low Byte)							
1	Drive Profile 16-bit Status Word (High Byte)							
2	Drive Profile 16-bit Actual 1 Word (Low Byte)							
3	Drive Profile 16-bit Actual 1 Word (High Byte)							
4	DATA IN 1 Value (Low Byte)							
5	DATA IN 1 Value (High Byte)							
6	DATA IN 2 Value (Low Byte)							
7	DATA IN 2 Value (High Byte)							
8	DATA IN 3 Value (Low Byte)							
9	DATA IN 3 Value (High Byte)							
10	DATA IN 4 Value (Low Byte)							
11	DATA IN 4 Value (High Byte)							
12	DATA IN 5 Value (Low Byte)							
13	DATA IN 5 Value (High Byte)							
14	DATA IN 6 Value (Low Byte)							
15	DATA IN 6 Value (High Byte)							
16	DATA IN 7 Value (Low Byte)							
17	DATA IN 7 Value (High Byte)							
18	DATA IN 8 Value (Low Byte)							
19	DATA IN 8 Value (High Byte)							
20	DATA IN 9 Value (Low Byte)							
21	DATA IN 9 Value (High Byte)							

Instance 161 (Transparent 16 profile)								
Byte	Bit 7	Bit 6	Bit 5	Bit 4	Bit 3	Bit 2	Bit 1	Bit 0
22	DATA IN 10 Value (Low Byte)							
23	DATA IN 10 Value (High Byte)							

■ Transparent 16 with two assembly

The Transparent 16 with two assembly, defined by ABB, provides unaltered 16-bit access to the configured drive profile.

The format of the output assembly is:

Instance 12 (Transparent 16 profile)								
Byte	Bit 7	Bit 6	Bit 5	Bit 4	Bit 3	Bit 2	Bit 1	Bit 0
0	Drive Profile 16-bit Control Word (Low Byte)							
1	Drive Profile 16-bit Control Word (High Byte)							
2	Drive Profile 16-bit Reference 1 Word (Low Byte)							
3	Drive Profile 16-bit Reference 1 Word (High Byte)							
4	Drive Profile 16-bit Reference 2 Word (Low Byte)							
5	Drive Profile 16-bit Reference 2 Word (High Byte)							

The format of the input assembly is:

Instance 62 (Transparent 16 profile)								
Byte	Bit 7	Bit 6	Bit 5	Bit 4	Bit 3	Bit 2	Bit 1	Bit 0
0	Drive Profile 16-bit Status Word (Low Byte)							
1	Drive Profile 16-bit Status Word (High Byte)							
2	Drive Profile 16-bit Actual 1 Word (Low Byte)							
3	Drive Profile 16-bit Actual 1 Word (High Byte)							
4	Drive Profile 16-bit Actual 2 Word (Low Byte)							
5	Drive Profile 16-bit Actual 2 Word (High Byte)							

■ Transparent 16 with two assembly plus drive parameters

The Transparent 16 with two assembly plus drive parameters, defined by ABB, adds configurable drive parameters to the Transparent 16 with two assembly.

The format of the output assembly is:

Instance 112 (Transparent 16 profile)								
Byte	Bit 7	Bit 6	Bit 5	Bit 4	Bit 3	Bit 2	Bit 1	Bit 0
0	Drive Profile 16-bit Control Word (Low Byte)							
1	Drive Profile 16-bit Control Word (High Byte)							
2	Drive Profile 16-bit Reference 1 Word (Low Byte)							
3	Drive Profile 16-bit Reference 1 Word (High Byte)							
4	Drive Profile 16-bit Reference 2 Word (Low Byte)							
5	Drive Profile 16-bit Reference 2 Word (High Byte)							
6	DATA OUT 1 Value (Low Byte)							
7	DATA OUT 1 Value (High Byte)							
8	DATA OUT 2 Value (Low Byte)							
9	DATA OUT 2 Value (High Byte)							
10	DATA OUT 3 Value (Low Byte)							
11	DATA OUT 3 Value (High Byte)							
12	DATA OUT 4 Value (Low Byte)							
13	DATA OUT 4 Value (High Byte)							
14	DATA OUT 5 Value (Low Byte)							
15	DATA OUT 5 Value (High Byte)							
16	DATA OUT 6 Value (Low Byte)							
17	DATA OUT 6 Value (High Byte)							
18	DATA OUT 7 Value (Low Byte)							
19	DATA OUT 7 Value (High Byte)							
20	DATA OUT 8 Value (Low Byte)							
21	DATA OUT 8 Value (High Byte)							

Instance 112 (Transparent 16 profile)								
Byte	Bit 7	Bit 6	Bit 5	Bit 4	Bit 3	Bit 2	Bit 1	Bit 0
22	DATA OUT 9 Value (Low Byte)							
23	DATA OUT 9 Value (High Byte)							
24	DATA OUT 10 Value (Low Byte)							
25	DATA OUT 10 Value (High Byte)							

The format of the input assembly is:

Instance 162 (Transparent 16 profile)								
Byte	Bit 7	Bit 6	Bit 5	Bit 4	Bit 3	Bit 2	Bit 1	Bit 0
0	Drive Profile 16-bit Status Word (Low Byte)							
1	Drive Profile 16-bit Status Word (High Byte)							
2	Drive Profile 16-bit Actual 1 Word (Low Byte)							
3	Drive Profile 16-bit Actual 1 Word (High Byte)							
4	Drive Profile 16-bit Actual 2 Word (Low Byte)							
5	Drive Profile 16-bit Actual 2 Word (High Byte)							
6	DATA IN 1 Value (Low Byte)							
7	DATA IN 1 Value (High Byte)							
8	DATA IN 2 Value (Low Byte)							
9	DATA IN 2 Value (High Byte)							
10	DATA IN 3 Value (Low Byte)							
11	DATA IN 3 Value (High Byte)							
12	DATA IN 4 Value (Low Byte)							
13	DATA IN 4 Value (High Byte)							
14	DATA IN 5 Value (Low Byte)							
15	DATA IN 5 Value (High Byte)							
16	DATA IN 6 Value (Low Byte)							
17	DATA IN 6 Value (High Byte)							
18	DATA IN 7 Value (Low Byte)							
19	DATA IN 7 Value (High Byte)							

Instance 162 (Transparent 16 profile)								
Byte	Bit 7	Bit 6	Bit 5	Bit 4	Bit 3	Bit 2	Bit 1	Bit 0
20	DATA IN 8 Value (Low Byte)							
21	DATA IN 8 Value (High Byte)							
22	DATA IN 9 Value (Low Byte)							
23	DATA IN 9 Value (High Byte)							
24	DATA IN 10 Value (Low Byte)							
25	DATA IN 10 Value (High Byte)							

■ Transparent 32 with one assembly

The Transparent 32 with one assembly, defined by ABB, provides unaltered 32-bit access to the configured drive profile.

The format of the output assembly is:

Instance 21 (Transparent 32 profile)								
Byte	Bit 7	Bit 6	Bit 5	Bit 4	Bit 3	Bit 2	Bit 1	Bit 0
0	Drive Profile 32-bit Control Word (Low Byte)							
1	Drive Profile 32-bit Control Word							
2	Drive Profile 32-bit Control Word							
3	Drive Profile 32-bit Control Word (High Byte)							
4	Drive Profile 32-bit Reference 1 Word (Low Byte)							
5	Drive Profile 32-bit Reference 1 Word							
6	Drive Profile 32-bit Reference 1 Word							
7	Drive Profile 32-bit Reference 1 Word (High Byte)							

The format of the input assembly is:

Instance 71 (Transparent 32 profile)								
Byte	Bit 7	Bit 6	Bit 5	Bit 4	Bit 3	Bit 2	Bit 1	Bit 0
0	Drive Profile 32-bit Status Word (Low Byte)							
1	Drive Profile 32-bit Status Word							
2	Drive Profile 32-bit Status Word							
3	Drive Profile 32-bit Status Word (High Byte)							
4	Drive Profile 32-bit Actual 1 Word (Low Byte)							
5	Drive Profile 32-bit Actual 1 Word							
6	Drive Profile 32-bit Actual 1 Word							
7	Drive Profile 32-bit Actual 1 Word (High Byte)							

■ Transparent 32 with one assembly plus drive parameters

The Transparent 32 with one assembly plus drive parameters, defined by ABB, adds configurable drive parameters to the Transparent 32 with one assembly.

The format of the output assembly is:

Instance 121 (Transparent 32 profile)								
Byte	Bit 7	Bit 6	Bit 5	Bit 4	Bit 3	Bit 2	Bit 1	Bit 0
0	Drive Profile 32-bit Control Word (Low Byte)							
1	Drive Profile 32-bit Control Word							
2	Drive Profile 32-bit Control Word							
3	Drive Profile 32-bit Control Word (High Byte)							
4	Drive Profile 32-bit Reference 1 Word (Low Byte)							
5	Drive Profile 32-bit Reference 1 Word							
6	Drive Profile 32-bit Reference 1 Word							
7	Drive Profile 32-bit Reference 1 Word (High Byte)							
8	DATA OUT 1 Value (Low Byte)							
9	DATA OUT 1 Value (High Byte)							

Instance 121 (Transparent 32 profile)								
Byte	Bit 7	Bit 6	Bit 5	Bit 4	Bit 3	Bit 2	Bit 1	Bit 0
10	DATA OUT 2 Value (Low Byte)							
11	DATA OUT 2 Value (High Byte)							
12	DATA OUT 3 Value (Low Byte)							
13	DATA OUT 3 Value (High Byte)							
14	DATA OUT 4 Value (Low Byte)							
15	DATA OUT 4 Value (High Byte)							
16	DATA OUT 5 Value (Low Byte)							
17	DATA OUT 5 Value (High Byte)							
18	DATA OUT 6 Value (Low Byte)							
19	DATA OUT 6 Value (High Byte)							
20	DATA OUT 7 Value (Low Byte)							
21	DATA OUT 7 Value (High Byte)							
22	DATA OUT 8 Value (Low Byte)							
23	DATA OUT 8 Value (High Byte)							
24	DATA OUT 9 Value (Low Byte)							
25	DATA OUT 9 Value (High Byte)							
26	DATA OUT 10 Value (Low Byte)							
27	DATA OUT 10 Value (High Byte)							

The format of the input assembly is:

Instance 171 (Transparent 32 profile)								
Byte	Bit 7	Bit 6	Bit 5	Bit 4	Bit 3	Bit 2	Bit 1	Bit 0
0	Drive Profile 32-bit Status Word (Low Byte)							
1	Drive Profile 32-bit Status Word							
2	Drive Profile 32-bit Status Word							
3	Drive Profile 32-bit Status Word (High Byte)							
4	Drive Profile 32-bit Actual 1 Word (Low Byte)							
5	Drive Profile 32-bit Actual 1 Word (High Byte)							

Instance 171 (Transparent 32 profile)								
Byte	Bit 7	Bit 6	Bit 5	Bit 4	Bit 3	Bit 2	Bit 1	Bit 0
6	Drive Profile 32-bit Actual 1 Word							
7	Drive Profile 32-bit Actual 1 Word (High Byte)							
8	DATA IN 1 Value (Low Byte)							
9	DATA IN 1 Value (High Byte)							
10	DATA IN 2 Value (Low Byte)							
11	DATA IN 2 Value (High Byte)							
12	DATA IN 3 Value (Low Byte)							
13	DATA IN 3 Value (High Byte)							
14	DATA IN 4 Value (Low Byte)							
15	DATA IN 4 Value (High Byte)							
16	DATA IN 5 Value (Low Byte)							
17	DATA IN 5 Value (High Byte)							
18	DATA IN 6 Value (Low Byte)							
19	DATA IN 6 Value (High Byte)							
20	DATA IN 7 Value (Low Byte)							
21	DATA IN 7 Value (High Byte)							
22	DATA IN 8 Value (Low Byte)							
23	DATA IN 8 Value (High Byte)							
24	DATA IN 9 Value (Low Byte)							
25	DATA IN 9 Value (High Byte)							
26	DATA IN 10 Value (Low Byte)							
27	DATA IN 10 Value (High Byte)							

■ Transparent 32 with two assembly

The Transparent 32 with two assembly, defined by ABB, provides unaltered 32-bit access to the configured drive profile.

The format of the output assembly is:

Instance 22 (Transparent 32 profile)								
Byte	Bit 7	Bit 6	Bit 5	Bit 4	Bit 3	Bit 2	Bit 1	Bit 0
0	Drive Profile 32-bit Control Word (Low Byte)							
1	Drive Profile 32-bit Control Word							
2	Drive Profile 32-bit Control Word							
3	Drive Profile 32-bit Control Word (High Byte)							
4	Drive Profile 32-bit Reference 1 Word (Low Byte)							
5	Drive Profile 32-bit Reference 1 Word							
6	Drive Profile 32-bit Reference 1 Word							
7	Drive Profile 32-bit Reference 1 Word (High Byte)							
8	Drive Profile 32-bit Reference 2 Word (Low Byte)							
9	Drive Profile 32-bit Reference 2 Word							
10	Drive Profile 32-bit Reference 2 Word							
11	Drive Profile 32-bit Reference 2 Word (High Byte)							

The format of the input assembly is:

Instance 72 (Transparent 32 profile)								
Byte	Bit 7	Bit 6	Bit 5	Bit 4	Bit 3	Bit 2	Bit 1	Bit 0
0	Drive Profile 32-bit Status Word (Low Byte)							
1	Drive Profile 32-bit Status Word							
2	Drive Profile 32-bit Status Word							
3	Drive Profile 32-bit Status Word (High Byte)							
4	Drive Profile 32-bit Actual 1 Word (Low Byte)							
5	Drive Profile 32-bit Actual 1 Word							
6	Drive Profile 32-bit Actual 1 Word							
7	Drive Profile 32-bit Actual 1 Word (High Byte)							

Instance 72 (Transparent 32 profile)	
8	Drive Profile 32-bit Actual 2 Word (Low Byte)
9	Drive Profile 32-bit Actual 2 Word
10	Drive Profile 32-bit Actual 2 Word
11	Drive Profile 32-bit Actual 2 Word (High Byte)

■ Transparent 32 with two assembly plus drive parameters

The Transparent 32 with two assembly plus drive parameters, defined by ABB, adds configurable drive parameters to the Transparent 32 with two assembly.

The format of the output assembly is:

Instance 122 (Transparent 32 profile)								
Byte	Bit 7	Bit 6	Bit 5	Bit 4	Bit 3	Bit 2	Bit 1	Bit 0
0	Drive Profile 32-bit Control Word (Low Byte)							
1	Drive Profile 32-bit Control Word							
2	Drive Profile 32-bit Control Word							
3	Drive Profile 32-bit Control Word (High Byte)							
4	Drive Profile 32-bit Reference 1 Word (Low Byte)							
5	Drive Profile 32-bit Reference 1 Word							
6	Drive Profile 32-bit Reference 1 Word							
7	Drive Profile 32-bit Reference 1 Word (High Byte)							
8	Drive Profile 32-bit Reference 2 Word (Low Byte)							
9	Drive Profile 32-bit Reference 2 Word							
10	Drive Profile 32-bit Reference 2 Word							
11	Drive Profile 32-bit Reference 2 Word (High Byte)							
12	DATA OUT 1 Value (Low Byte)							
13	DATA OUT 1 Value (High Byte)							
14	DATA OUT 2 Value (Low Byte)							
15	DATA OUT 2 Value (High Byte)							

Instance 122 (Transparent 32 profile)								
Byte	Bit 7	Bit 6	Bit 5	Bit 4	Bit 3	Bit 2	Bit 1	Bit 0
16	DATA OUT 3 Value (Low Byte)							
17	DATA OUT 3 Value (High Byte)							
18	DATA OUT 4 Value (Low Byte)							
19	DATA OUT 4 Value (High Byte)							
20	DATA OUT 5 Value (Low Byte)							
21	DATA OUT 5 Value (High Byte)							
22	DATA OUT 6 Value (Low Byte)							
23	DATA OUT 6 Value (High Byte)							
24	DATA OUT 7 Value (Low Byte)							
25	DATA OUT 7 Value (High Byte)							
26	DATA OUT 8 Value (Low Byte)							
27	DATA OUT 8 Value (High Byte)							
28	DATA OUT 9 Value (Low Byte)							
29	DATA OUT 9 Value (High Byte)							
30	DATA OUT 10 Value (Low Byte)							
31	DATA OUT 10 Value (High Byte)							

The format of the input assembly is:

Instance 172 (Transparent 32 profile)								
Byte	Bit 7	Bit 6	Bit 5	Bit 4	Bit 3	Bit 2	Bit 1	Bit 0
0	Drive Profile 32-bit Status Word (Low Byte)							
1	Drive Profile 32-bit Status Word							
2	Drive Profile 32-bit Status Word							
3	Drive Profile 32-bit Status Word (High Byte)							
4	Drive Profile 32-bit Actual 1 Word (Low Byte)							
5	Drive Profile 32-bit Actual 1 Word							
6	Drive Profile 32-bit Actual 1 Word							
7	Drive Profile 32-bit Actual 1 Word (High Byte)							

Instance 172 (Transparent 32 profile)								
Byte	Bit 7	Bit 6	Bit 5	Bit 4	Bit 3	Bit 2	Bit 1	Bit 0
8	Drive Profile 32-bit Actual 2 Word (Low Byte)							
9	Drive Profile 32-bit Actual 2 Word							
10	Drive Profile 32-bit Actual 2 Word							
11	Drive Profile 32-bit Actual 2 Word (High Byte)							
12	DATA IN 1 Value (Low Byte)							
13	DATA IN 1 Value (High Byte)							
14	DATA IN 2 Value (Low Byte)							
15	DATA IN 2 Value (High Byte)							
16	DATA IN 3 Value (Low Byte)							
17	DATA IN 3 Value (High Byte)							
18	DATA IN 4 Value (Low Byte)							
19	DATA IN 4 Value (High Byte)							
20	DATA IN 5 Value (Low Byte)							
21	DATA IN 5 Value (High Byte)							
22	DATA IN 6 Value (Low Byte)							
23	DATA IN 6 Value (High Byte)							
24	DATA IN 7 Value (Low Byte)							
25	DATA IN 7 Value (High Byte)							
26	DATA IN 8 Value (Low Byte)							
27	DATA IN 8 Value (High Byte)							
28	DATA IN 9 Value (Low Byte)							
29	DATA IN 9 Value (High Byte)							
30	DATA IN 10 Value (Low Byte)							
31	DATA IN 10 Value (High Byte)							

Class objects

The following table lists the data types used in the class object descriptions of this manual.

Legend	Data type
UINT8	Unsigned Integer 8 bit
UINT16	Unsigned Integer 16 bit
SINT16	Signed Integer 16 bit
UINT32	Unsigned Integer 32 bit
BOOL	Boolean value

Note: The adapter module is designed to provide EtherNet/IP communications for a variety of drives with different capabilities. Default, minimum and maximum values for attributes necessarily vary based upon the capabilities of the drive to which the module is attached and are not documented herein. Default, minimum and maximum values for attributes may be found in the:

- drive manuals
- Electronic Data Sheet Files (EDS) for the drive.

Note that the units of the attributes may differ from those of the parameters documented elsewhere, and those differences must be considered when interfacing to the drive via the module.

The table below shows the service names of the class objects.

Service	Name
GET	0x0E Get_Attribute_Single
SET	0x10 Set_Attribute_Single
SET ALL	0x02 Set_Attribute_All
GET ALL	0x01 Get_Attribute_All

■ Identity object, class 01h

This object provides identification of and general information about the device.

Class attributes (Instance #0)

#	Attribute name	Services	Description	Data type
1	Revision	Get	Revision of the identity object	Array of UINT8

Instance attributes (Instance #1)

#	Attribute name	Services	Description	Data type
1	Vendor ID	Get	Identification of the device vendor	UINT16
2	Device Type	Get	Identification of the general product type	UINT16
3	Product Code	Get	Assigned vendor code to describe the device	UINT16
4	Revision	Get	Revision of the item the identity object represents	Array[UINT8 UINT8]
5	Status	Get	Summary status of the device	UINT16
6	ODVA Serial Number	Get	Serial number of the EtherNet/IP module	UINT32
7	Product Name	Get	Product identification. Max 32 characters.	Short String

Reset service (Service code 05h)

Value (reset type)	Type of reset
0	Reset the adapter
1	Reset the adapter (* and factory default configuration)
2	Reset the adapter (* and set the out-of-box configuration with the exception of communication link parameters)

* not implemented

Attribute explanations*Vendor ID*

Vendor IDs are managed by the Open DeviceNet Vendor Association, Inc. (ODVA). The ABB Vendor ID is 46.

Device Type

The list of device types is managed by ODVA. It is used to identify the device profile that a particular product is using.

Drive Type	Profile	Device Type	Value
AC	ODVA AC/DC Drive	ODVA AC Drive	02h
	ABB Drives Profile	ABB AC Drive	64h
	Transparent 16	ABB AC Drive	64h
	Transparent 32	ABB AC Drive	64h
DC	ODVA AC/DC Drive	ODVA DC Drive	13h
	ABB Drives Profile	ABB DC Drive	65h
	Transparent 16	ABB DC Drive	65h
	Transparent 32	ABB DC Drive	65h

Product Code

Every ABB drive type or application of the drive has a dedicated product code. The product code is 100 + the value of parameter [29 DRIVE TYPE CODE](#).

Revision

Revision attribute, which consists of Major and Minor Revisions, identifies the revision of the item the identity object represents.

Status

This attribute represents the current status of the entire device. Its value changes as the state of the device changes. The Status attribute is a WORD, with the following bit definitions:

Bit(s)	Type/Name	Definition
0	Owned	TRUE indicates the device (or an object within the device) has an owner. Within the Master/Slave paradigm the setting of this bit means that the Predefined Master/Slave Connection Set has been allocated to a master. Outside the Master/Slave paradigm the meaning of this bit is to be defined.
1		Reserved, set to 0
2	Configured	TRUE indicates that the application of the device has been configured to do something that differs from the “out-of-box” default. This does not include configuration of the communications.
3		Reserved, set to 0
4, 5, 6, 7		Vendor-specific
8	Minor Recoverable Fault	TRUE indicates the device detected a recoverable problem. The problem does not cause the device fault state.
9	Minor Unrecoverable Fault	TRUE indicates the device detected a unrecoverable problem. The problem does not cause the device fault state.
10	Major Recoverable Fault	TRUE indicates the device detected a problem which caused the device to transfer into the “Major Recoverable Fault” state.
11	Major Unrecoverable Fault	TRUE indicates the device detected a problem which caused the device to transfer into the “Major Unrecoverable Fault” state.
12, 13, 14, 15		Reserved, set to 0

ODVA Serial Number

This attribute is a number used in conjunction with the Vendor ID to form a unique identifier for each device on EtherNet/IP. The value of this attribute is 02000000h plus the SERNO value from the device label.

Product Name

This text string should represent a short description of the product/product family represented by the product code in attribute 3.

Motor data object, class 28h

The Motor data object can only be used if the ODVA AC/DC drive profile is in use.

The object serves as a database for motor parameters. Different motor types require different data to describe the motor. For example, AC induction motors do not need field current data like a DC motor to describe the motor.

Motor class	Motor types in class
AC motors	3 - PM synchronous 6 - Wound rotor induction 7 - Squirrel cage induction motor
DC motors	1 - PM DC motor 2 - FC DC motor

Class attributes (Instance #0)

#	Attribute name	Services	Description	Data type
1	Revision	Get	Revision of the CIP Object Class Definition upon which the implementation is based	Array of UINT8

Instance attributes (Instance #1)

#	Attribute name	Services	Description	Motor type	Data type
3	Motor Type	Get	See the table above.	AC	UINT8
6	Rated Current	Get, Set	Rated Stator Current from motor name plate Units: [100mA]	AC/DC	UINT16
7	Rated Voltage	Get, Set	Rated Base Voltage from motor name plate Units: [V]	AC/DC	UINT16
8	Rated Power	Get, Set	Rated Power at Rated Frequency Units: [W]	AC/DC	UINT32

#	Attribute name	Services	Description	Motor type	Data type
9	Rated Frequency	Get, Set	Rated Electrical Frequency Units: [Hz]	AC	UINT16
12	Pole Count	Get	Number of poles in the motor	AC	UINT16
15	Base Speed	Get, Set	Nominal speed at rated frequency from nameplate Units [RPM]	AC/DC	UINT16

■ Control supervisor object, class 29h

The Control supervisor object can only be used if the ODVA AC/DC drive profile is in use.

The object models all the management functions for devices within the 'Hierarchy of Motor Control Devices'. The behavior of motor control devices is described by:

- [AC/DC-drive object, class 2Ah](#) (page 239) and
- Run/Stop event matrix under [Run Forward & Run Reverse \(Control supervisor object\)](#) (page 176).

See also section [State \(Control supervisor object\)](#) on page 181.

Note: If assembly instances are used, they override this object, for example, upon drive power-up.

Class attributes (Instance #0)

#	Attribute name	Services	Description	Data type
1	Revision	Get	Revision of the CIP Object Class Definition upon which the implementation is based	Array of UINT8

Instance attributes (Instance #1)

#	Attribute name	Services	Description	Data type
3	Run 1 (RunFwd)	Get, Set	0 = Stop, 1 = Run. See the Run/Stop event matrix on page 176.	BOOL
4	Run 2 (RunRev)	Get, Set	0 = Stop, 1 = Run. See the Run/Stop event matrix on page 176.	BOOL
5	Net Control	Get, Set	0 = Local Control, 1 = Network Control	BOOL
6	State	Get	State of Object. See section <i>State (Control supervisor object)</i> on page 181.	UINT8
7	Running 1 (Fwd)	Get	0 = Stopped, 1 = Running	BOOL
8	Running 2 (Rev)	Get	0 = Stopped, 1 = Running	BOOL
9	Ready	Get	1 = Ready, Enabled or Stopping; 0 = Other state	BOOL
10	Faulted	Get	0 = Not faulted, 1 = Fault occurred	BOOL
11	Warning	Get	0 = No Warnings present, 1 = Warning	BOOL
12	FaultRst	Get, Set	0 → 1 Fault Reset	BOOL
13	Fault Code	Get	The fault that caused the last transition to the Faulted state. DRIVECOMM codes are reported. See the drive manual for further information on DRIVECOMM codes.	UINT16

#	Attribute name	Services	Description	Data type
14	Warning Code	Get	Code word indicating the warning present. If multiple warnings are present, the lowest code value is displayed. DRIVECOMM codes are reported. See the drive manual for further information on DRIVECOMM codes.	UINT16
15	CtlFromNet	Get	0 = NetControl disabled 1 = NetControl enabled	BOOL
16	DNFaultMode	Get, Set	2 = Vendor specified	UINT8
17	ForceFault	Get, Set	0 → 1 forces the drive to fault	BOOL

■ AC/DC-drive object, class 2Ah

The AC/DC-drive object can only be used if the ODVA AC/DC drive profile is in use.

The object models the functions specific to an AC or DC Drive.

Class attributes (Instance #0)

#	Attribute name	Services	Description	Data type
1	Revision	Get	Revision of the CIP Object Class Definition upon which the implementation is based	Array of UINT8

Instance attributes (Instance #1)

#	Attribute name	Services	Description	Data type
3	At Reference	Get	Frequency arrival	BOOL
4	NetRef	Get, Set	Requests torque or speed reference to be local or from the network. 0 = Set Reference not DN Control 1 = Set Reference at DN Control Note that the actual status of torque or speed reference is reflected in attribute 29, RefFromNet.	BOOL
6	Drive mode	Get, Set	0 = Vendor specific	UINT8
7	Speed Actual	Get	Units = See parameter 23 ODVA SPEED SCALE .	SINT16
8	SpeedRef	Get, Set	Units = See parameter 23 ODVA SPEED SCALE .	SINT16
11	Torque Actual	Get	Units = See parameter 24 ODVA TORQUE SCALE .	SINT16
12	TorqueRef	Get, Set	Units = See parameter 24 ODVA TORQUE SCALE .	SINT16
18	AccelTime	Get, Set	Units = milliseconds	UINT16
19	DecelTime	Get, Set	Units = milliseconds	UINT16
22	Speed Scale	Get, Set	Speed scaling factor. See parameter 23 ODVA SPEED SCALE .	UINT8
24	Torque Scale	Get, Set	Torque scaling factor. See parameter 24 ODVA TORQUE SCALE .	UINT8
29	Ref From Net	Get	Reflecting attribute 4	BOOL

■ Drive parameter object, class 90h

With the FENA adapter module, drive parameters can also be accessed via Explicit Messaging. Explicit Messaging makes use of objects consisting of three parts: *class*, *instance* and *attribute*.

Note: When you use the drive parameter object to update the fieldbus configuration groups, changes to the fieldbus configuration will only take effect when the module is powered up the next time or when a 'Fieldbus Adapter parameter refresh' is given.

Class is always 144 (90h). *Instance* and *attribute* correspond to the drive parameter group and index in the following way:

- *Instance* = Parameter group (0...99) (ACx880/580: 0...255)
- *Attribute* = Parameter index (01...99) (ACx880/580: 0...255)

For example, Parameter 99.01 is accessed as follows:

- *Class* = 144 = 90h
- *Instance* = 99 = 63h
- *Attribute* = 1 = 01h

Fieldbus configuration object, class 91h

The fieldbus configuration object allows you to configure the fieldbus configuration groups without the need to know the drive-specific groups associated with the configuration groups.

Note: When you use the fieldbus configuration object to update the fieldbus configuration groups, changes to the fieldbus configuration will only take effect when a reset service is requested of the Identity Object, the module is powered up the next time or when a 'Fieldbus Adapter parameter refresh' is given.

Class attributes

#	Attribute name	Services	Description	Data type
1	Revision	Get	Revision of the Configuration Object	Array of UINT8

Instance #1: FENA-01/-11/-21 configuration parameters group A (group 1)

The actual parameter group number depends on the drive type. Group A (group 1) corresponds to:

- parameter group 51 in ACS355, ACSM1, ACS580, ACS850 and ACQ810
- parameter group is typically 51/54 (group 151/154 in some variants) in ACS880 if the adapter is installed as fieldbus adapter A/B.

#	Attribute name	Services	Description	Data type
1	Configuration Group A (Group 1) - Parameter 1	Get, Set	See 01 FBA TYPE on page 119 .	UINT16
2	Configuration Group A (Group 1) - Parameter 2	Get, Set	See 02 PROTOCOL/PROFILE on page 119 .	UINT16
3	Configuration Group A (Group 1) - Parameter 3	Get, Set	See 03 COMM RATE on page 120 .	UINT16

#	Attribute name	Services	Description	Data type
4	Configuration Group A (Group 1) - Parameter 4	Get, Set	See <i>04 IP CONFIGURATION</i> on page 120.	UINT16
5	Configuration Group A (Group 1) - Parameter 5	Get, Set	See <i>05 IP ADDRESS 1 ... 08 IP ADDRESS 4.</i>	UINT16
6	Configuration Group A (Group 1) - Parameter 6	Get, Set	See <i>05 IP ADDRESS 1 ... 08 IP ADDRESS 4.</i>	UINT16
7	Configuration Group A (Group 1) - Parameter 7	Get, Set	See <i>05 IP ADDRESS 1 ... 08 IP ADDRESS 4.</i>	UINT16
8	Configuration Group A (Group 1) - Parameter 8	Get, Set	See <i>05 IP ADDRESS 1 ... 08 IP ADDRESS 4.</i>	UINT16
9	Configuration Group A (Group 1) - Parameter 9	Get, Set	See <i>09 SUBNET CIDR</i> on page 121.	UINT16
10	Configuration Group A (Group 1) - Parameter 10	Get, Set	See <i>10 GW ADDRESS 1 ... 13 GW ADDRESS 4.</i>	UINT16
11	Configuration Group A (Group 1) - Parameter 11	Get, Set	See <i>10 GW ADDRESS 1 ... 13 GW ADDRESS 4.</i>	UINT16
12	Configuration Group A (Group 1) - Parameter 12	Get, Set	See <i>10 GW ADDRESS 1 ... 13 GW ADDRESS 4.</i>	UINT16
13	Configuration Group A (Group 1) - Parameter 13	Get, Set	See <i>10 GW ADDRESS 1 ... 13 GW ADDRESS 4.</i>	UINT16
14	Configuration Group A (Group 1) - Parameter 14	Get, Set	See <i>15... 18 Reserved</i> on page 122.	UINT16
15	Configuration Group A (Group 1) - Parameter 15	Get, Set	See <i>15... 18 Reserved</i> on page 122.	UINT16

#	Attribute name	Services	Description	Data type
16	Configuration Group A (Group 1) - Parameter 16	Get, Set	See 15... 18 Reserved on page 122 .	UINT16
17	Configuration Group A (Group 1) - Parameter 17	Get, Set	See 15... 18 Reserved on page 122 .	UINT16
18	Configuration Group A (Group 1) - Parameter 18	Get, Set	See 15... 18 Reserved on page 122 .	UINT16
19	Configuration Group A (Group 1) - Parameter 19	Get, Set	See 19 T16 SCALE on page 123 .	UINT16
20	Configuration Group A (Group 1) - Parameter 20	Get, Set	See 20 CONTROL TIMEOUT on page 124 .	UINT16
21	Configuration Group A (Group 1) - Parameter 21	Get, Set	See 21 IDLE ACTION on page 125 .	UINT16
22	Configuration Group A (Group 1) - Parameter 22	Get, Set	See 22 ODVA STOP FUNCTION on page 126 .	UINT16
23	Configuration Group A (Group 1) - Parameter 23	Get, Set	See 23 ODVA SPEED SCALE on page 127 .	UINT16
24	Configuration Group A (Group 1) - Parameter 24	Get, Set	See 24 ODVA TORQUE SCALE on page 128 .	UINT16
25	Configuration Group A (Group 1) - Parameter 25	Get, Set	See 25 ... 26 Reserved for web page functionality on page 129 .	UINT16
26	Configuration Group A (Group 1) - Parameter 26	Get, Set	See 25 ... 26 Reserved for web page functionality on page 129 .	UINT16

#	Attribute name	Services	Description	Data type
27	Configuration Group A (Group 1) - Parameter 27	Get, Set	See 27 FBA PAR REFRESH on page 129 .	UINT16
28	Configuration Group A (Group 1) - Parameter 28	Get	See 28 PAR TABLE VER on page 129 .	UINT16
29	Configuration Group A (Group 1) - Parameter 29	Get	See 29 DRIVE TYPE CODE on page 130 .	UINT16
30	Configuration Group A (Group 1) - Parameter 30	Get	See 30 MAPPING FILE VER on page 130 .	UINT16
31	Configuration Group A (Group 1) - Parameter 31	Get	See 31 D2FBA COMM STA on page 130 .	UINT16
32	Configuration Group A (Group 1) - Parameter 32	Get	See 32 FBA COMM SW VER on page 131 .	UINT16
33	Configuration Group A (Group 1) - Parameter 33	Get	See 33 FBA APPL SW VER on page 131 .	UINT16

Instance #2: FENA-01/-11/-21 configuration parameters group B (group 2)

The actual parameter group number depends on the drive type. Group B (group 2) corresponds to:

- parameter group 55 in ACS355
- parameter group 53 in ACSM1, ACS580, ACS850 and ACQ810
- parameter group is typically 53/56 (group 153/156 in some variants) in ACS880 if the adapter is installed as fieldbus adapter A/B.

#	Attribute name	Services	Description	Data type
1	Configuration Group B (Group 2) - Parameter 1	Get, Set	See 01 DATA OUT 1 on page 132 .	UINT16/ UNIT32 ACx880 /580
2	Configuration Group B (Group 2) - Parameter 2	Get, Set	See 01 DATA OUT 1 on page 132 .	UINT16/ UNIT32 ACx880 /580
3	Configuration Group B (Group 2) - Parameter 3	Get, Set	See 01 DATA OUT 1 on page 132 .	UINT16/ UNIT32 ACx880 /580
4	Configuration Group B (Group 2) - Parameter 4	Get, Set	See 01 DATA OUT 1 on page 132 .	UINT16/ UNIT32 ACx880 /580
5	Configuration Group B (Group 2) - Parameter 5	Get, Set	See 01 DATA OUT 1 on page 132 .	UINT16/ UNIT32 ACx880 /580
6	Configuration Group B (Group 2) - Parameter 6	Get, Set	See 01 DATA OUT 1 on page 132 .	UINT16/ UNIT32 ACx880 /580

#	Attribute name	Services	Description	Data type
7	Configuration Group B (Group 2) - Parameter 7	Get, Set	See 01 DATA OUT 1 on page 132 .	UINT16/ UNIT32 ACx880 /580
8	Configuration Group B (Group 2) - Parameter 8	Get, Set	See 01 DATA OUT 1 on page 132 .	UINT16/ UNIT32 ACx880 /580
9	Configuration Group B (Group 2) - Parameter 9	Get, Set	See 01 DATA OUT 1 on page 132 .	UINT16/ UNIT32 ACx880 /580
10	Configuration Group B (Group 2) - Parameter 10	Get, Set	See 01 DATA OUT 1 on page 132 .	UINT16/ UNIT32 ACx880 /580

Instance #3: FENA-01/-11/-21 configuration parameters group C (group 3)

The actual parameter group number depends on the drive type. Group C (group 3) corresponds to:

- parameter group 54 in ACS355
- parameter group 52 in ACSM1, ACS580, ACS850 and ACQ810
- parameter group is typically 52/55 (group 152/155 in some variants) in ACS880 if the adapter is installed as fieldbus adapter A/B.

#	Attribute name	Services	Description	Data type
1	Configuration Group C (Group 3) - Parameter 1	Get, Set	See 01 DATA IN 1 on page 133 .	UINT16/ UNIT32 ACx880/ 580
2	Configuration Group C (Group 3) - Parameter 2	Get, Set	See 01 DATA IN 1 on page 133 .	UINT16/ UNIT32 ACx880/ 580
3	Configuration Group C (Group 3) - Parameter 3	Get, Set	See 01 DATA IN 1 on page 133 .	UINT16/ UNIT32 ACx880/ 580
4	Configuration Group C (Group 3) - Parameter 4	Get, Set	See 01 DATA IN 1 on page 133 .	UINT16/ UNIT32 ACx880/ 580
5	Configuration Group C (Group 3) - Parameter 5	Get, Set	See 01 DATA IN 1 on page 133 .	UINT16/ UNIT32 ACx880/ 580
6	Configuration Group C (Group 3) - Parameter 6	Get, Set	See 01 DATA IN 1 on page 133 .	UINT16/ UNIT32 ACx880/ 580

#	Attribute name	Services	Description	Data type
7	Configuration Group C (Group 3) - Parameter 7	Get, Set	See 01 DATA IN 1 on page 133 .	UINT16/ UNIT32 ACx880/ 580
8	Configuration Group C (Group 3) - Parameter 8	Get, Set	See 01 DATA IN 1 on page 133 .	UINT16/ UNIT32 ACx880/ 580
9	Configuration Group C (Group 3) - Parameter 9	Get, Set	See 01 DATA IN 1 on page 133 .	UINT16/ UNIT32 ACx880/ 580
10	Configuration Group C (Group 3) - Parameter 10	Get, Set	See 01 DATA IN 1 on page 133 .	UINT16/ UNIT32 ACx880/ 580

TCP/IP interface object, class F5h

This object provides the mechanism to configure the TCP/IP network interface of the device.

Class attributes (Instance #0)

#	Attribute name	Services	Description	Data type
1	Revision	Get	Revision of the TCP/IP Interface Object Class Definition upon which the implementation is based	Array of UINT8

Instance attributes (Instance #1)

#	Attribute name	Services	Description	Data type
1	Interface Status	Get	See Interface Status attribute (#1) bits on page 252.	DWORD
2	Configuration Capability	Get	See Configuration Capability attribute (#2) bits on page 252.	DWORD
3	Configuration Control	Get	See Configuration Control attribute (#3) bits on page 253.	DWORD
4	Physical Link Object	Get	Path to physical link object	STRUCT of:
	Path Size		Path size	UINT
	Path		Logical segments identifying the physical link object	Padded EPATH

#	Attribute name	Services	Description	Data type
5	Interface Configuration	Get		STRUCT of:
	IP Address		IP Address	UDINT
	Network Mask		Network Mask	UDINT
	Gateway Address		Gateway Address	UDINT
	Unused			UDINT
	Unused			UDINT
	Default Domain Name		Default Domain Name for unqualified host names.	STRING
6	Host Name	Get/Set	Host name	STRING
8	TTL Value	Get/Set	TTL value for EtherNet/IP multicast packets	USINT 1...255
13	NV Encapsulation Inactivity	Get/Set	Encapsulation inactivity timeout	UINT 0 = disabled 1...3600 timeout in seconds

Attribute explanations*Interface Status attribute (#1) bits*

Bit	Name	Description
0...3	Interface configuration status	<p>Indicates the status of the Interface Configuration attribute.</p> <p>Value Description</p> <p>0 The Interface Configuration attribute has not been configured.</p> <p>1 The Interface Configuration attribute contains valid configuration obtained from BOOTP, DHCP or non-volatile storage.</p> <p>2 The IP address member of the Interface Configuration attribute contains valid configuration obtained from hardware settings (eg, pushwheel, thumbwheel).</p> <p>3...15 Reserved</p>
4	Mcast pending	<p>Indicates a pending configuration change in the TTL Value and/or Mcast Config attributes. This bit is set when either the TTL Value or Mcast Config attribute is set, and cleared the next time the device starts.</p>
5...31		Reserved, set to 0

Configuration Capability attribute (#2) bits

Bit	Name	Description
0	BOOTP client	1 (True) = The device is capable of obtaining its network configuration via BOOTP.
1	DNS client	1 (True) = The device is capable of resolving host names by querying a DNS server.
2	DHCP client	1 (True) = The device is capable of obtaining its network configuration via DHCP.
3	DCHP-DNS update	1 (True) = The device is capable of sending its host name in the DHCP request as documented in Internet draft <draft-ietf-dhc-dhcp-dnc-12.txt>

Bit	Name	Description
4	Configuration settable	1 (True) = The Interface Configuration attribute is settable. Some devices, eg, a PC or workstation, may not allow interface configuration to be set via the TCP/IP interface object.
5	Hardware configurable	1 (True) = The IP address member of the Interface Configuration attribute can be obtained from hardware settings (eg, pushwheel, thumbwheel).
		0 (False) = The Status instance attribute (1) Interface configuration status field value shall never be 2. (The Interface configuration attribute contains valid configuration obtained from hardware settings.)
6...31		Reserved, set to 0

Configuration Control attribute (#3) bits

Bit	Name	Description
0...3	Start-up configuration	Determines how the device obtains its initial configuration and start-up.
		<p>Value Description</p> <p>0 The device uses the interface configuration values previously stored (eg, in non-volatile memory or via hardware switches).</p> <p>1 The device obtains its interface configuration values via BOOTP.</p> <p>2 The device obtains its interface configuration values via DHCP upon start-up.</p> <p>3...15 Reserved</p>
4	DNS enable	1 (True) = The device resolves host names by querying a DNS server.
5...31		Reserved, set to 0.

■ Ethernet link object, class F6h

This object maintains link-specific counters and status information for the Ethernet communication interface.

Class attributes (Instance #0)

#	Attribute name	Services	Description	Data type
1	Revision	Get	Revision of the Ethernet Link Object Class Definition upon which the implementation is based	Array of UINT8

Instance attributes (Instance #1)

#	Attribute name	Services	Description	Data type														
1	Interface Speed	Get, Set	10 or 100 Mbps	UDINT														
2	Interface Flags	Get, Set	Interface status flags: <table border="0"> <thead> <tr> <th>Bit</th> <th>Description</th> </tr> </thead> <tbody> <tr> <td>0</td> <td>Link status</td> </tr> <tr> <td>1</td> <td>Half/Full duplex</td> </tr> <tr> <td>2...4</td> <td>Negotiation status</td> </tr> <tr> <td>5</td> <td>Manual setting requires reset</td> </tr> <tr> <td>6</td> <td>Local hardware fault</td> </tr> <tr> <td>7...31</td> <td>Reserved</td> </tr> </tbody> </table>	Bit	Description	0	Link status	1	Half/Full duplex	2...4	Negotiation status	5	Manual setting requires reset	6	Local hardware fault	7...31	Reserved	DWORD
Bit	Description																	
0	Link status																	
1	Half/Full duplex																	
2...4	Negotiation status																	
5	Manual setting requires reset																	
6	Local hardware fault																	
7...31	Reserved																	
3	Physical Address	Get	Ethernet MAC address of the module	ARRAY 6XUSINT														

■ Connection object, class 05h

Do not modify this object. This object is only used while establishing the connection between the adapter module and the PLC.

The connection class allocates and manages the internal resources associated with both I/O and explicit messaging connections. The specific instance generated by the connection class is referred to as connection instance or connection object. The table below shows the connection object states.

State	Description	State	Description
00	Non-Existent	03	Established
01	Configuring	04	Timed Out
02	Waiting for Connection ID	05	Deferred Delete

Class attributes

#	Attribute name	Services	Description	Data type
1	Revision	Get	Revision of the connection object	Array of UINT8

Instance attributes

Instance number	Description
1	Explicit messaging connection
2	Polled I/O connection
4	Change-of-State/Cyclic I/O connection

#	Attribute name	Services	Description	Data type
1	State	Get	State of the object. See the state table on page 254 .	UINT8
2	Instance Type	Get	Indicates either I/O (1) or messaging connection (0).	UINT8
3	Transport Class Trigger	Get	Defines the behavior of the connection.	UINT8

#	Attribute name	Services	Description	Data type
4	Produced Cnxn Id	Get	Placed in CAN Identifier Field when the connection transmits.	UINT16
5	Consumed Cnxn Id	Get	CAN Identifier Field value that denotes the message to be received	UINT16
6	Comm Characteristics	Get	Defines the Message Group(s) across which productions and consumptions are associated in this connection.	UINT8
7	Produced Connection Size	Get	Maximum number of bytes transmitted across this connection	UINT16
8	Consumed Connection size	Get	Maximum number of bytes received across this connection	UINT16
9	Expected Packet Rate	Get, Set	Defines the timing associated with this connection in milliseconds. A value of 0 deactivates the associated timers.	UINT16
12	Watchdog Timeout Action	Get, Set	Defines how to handle Inactivity/Watchdog timeouts.	UINT8
13	Produced Connection Path Length	Get	Number of bytes in the produced_connection_path length attribute	UINT16
14	Produced Connection Path	Get	Application object producing data on this connection	Array of UINT8
15	Consumed Connection Path Length	Get	Number of bytes in the consumed_connection_path length attribute	UINT16

#	Attribute name	Services	Description	Data type
16	Consumed Connection Path	Get	Specifies the application object(s) that are to receive the data consumed by this connection object.	Array of UINT8
17	Production Inhibit Time	Get	Defines the minimum time between new data production in milliseconds.	UINT16

■ Acknowledge handler object, class 2Bh

The acknowledge handler object is used to manage the reception of message acknowledgements. This object communicates with a message producing application object within the device. The acknowledge handler object notifies the producing application of acknowledge reception, acknowledge timeouts and production retry limit.

Class attributes (Instance #0)

#	Attribute name	Services	Description	Data type
1	Revision	Get	Revision of the CIP Object Class Definition upon which the implementation is based	Array of UINT8

Instance attributes (Instance #1)

#	Attribute name	Services	Description	Data type
1	Acknowledge Timer	Get, Set	Time in milliseconds to wait for acknowledge before resending	UINT16
2	Retry Limit	Get, Set	Number of Acknowledge Timeouts to wait before informing the producing application of a Retry-Limit_Reached event	UINT8
3	COS Producing Connection Instance	Get	Connection Instance Id which contains the path of the producing I/O application object which will be notified of Acknowledge Handler events	UINT16

13

EtherNet/IP – Diagnostics

Contents of this chapter

This chapter explains how to trace faults with the status LEDs on the adapter module when the module is used for EtherNet/IP communication.

Fault and warning messages

For the fault and warning messages concerning the adapter module, see the drive firmware manual.

LEDs

The adapter module is equipped with three bicolor diagnostic LEDs. The LEDs are described below.

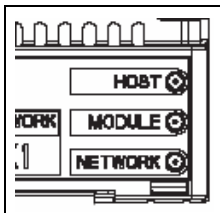

Name	Color	Function
HOST	Blinking green	Establishing communication to host
	Green	Connection to host OK
	Blinking red	Communication to host lost temporarily
	Flashing orange, alternating with the MODULE Flashing orange	Internal file system error. The error may be cleared by cycling drive power. If the error persists, contact your local ABB representative.

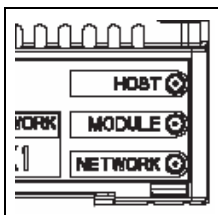

Name	Color	Function
MODULE	Off	There is no power applied to the device.
	Green	Device is operating in a normal condition.
	Flashing green	Device needs commissioning due to configuration missing, incomplete or incorrect. The device may be in the Standby state. This may be caused by the adapter waiting for a response from a DHCP server or Duplicate Address Detection to complete.
	Flashing red	Ethernet interface is disabled. Duplicate Address Detection may have detected a duplicate address. Check the IP configuration and either initiate a Fieldbus Adapter parameter refresh or cycle power to the drive.
	Flashing red-green	Device is in Self Test.
	Flashing orange, alternating with the HOST Flashing orange	Internal file system error. The error may be cleared by cycling drive power. If the error persists, contact your local ABB representative.

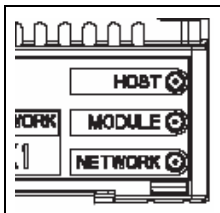

Name	Color	Function
NETWORK /NET	Off	Device is not on-line. <ul style="list-style-type: none"> • The device has not completed the Duplicate Address Detection yet. • The device may not be powered; look at the MODULE status LED.
	Flashing green	Device is on-line but has no connections in the established state. <ul style="list-style-type: none"> • The device has passed Duplicate Address Detection, is on-line, but has no established connections to other nodes.
	Green	Device is on-line and has connections in the established state.
	Flashing red	One or more I/O connections are in the Timed-out state.
	Red	Failed communication device. The device has detected an error that has rendered it incapable of communicating on the network (Duplicate MAC ID or IP address detected).

PROFINET IO protocol

<i>PROFINET IO – Start-up</i>	265
<i>PROFINET IO – Communication profiles</i>	327
<i>PROFINET IO – Communication protocol</i>	347
<i>PROFINET IO – Diagnostics</i>	383

14

PROFINET IO – Start-up

Contents of this chapter

This chapter contains:

- information on configuring the drive for operation with the adapter module
- drive-specific instructions on starting up the drive with the adapter module
- examples of configuring the master station for communication with the adapter module.

Warnings



WARNING! Obey the safety instructions given in this manual and the drive documentation.



Drive configuration

The information in this section applies to all drive types compatible with the adapter module, unless otherwise stated.

■ PROFINET IO connection configuration

After the adapter module has been mechanically and electrically installed according to the instructions in chapters [Mechanical installation](#) and [Electrical installation](#), you must prepare the drive for communication with the module.

The detailed procedure of activating the module for PROFINET IO communication with the drive depends on the drive type. Normally, you must activate a parameter to activate the communication. See the drive-specific start-up instructions starting on page [283](#).

Once communication between the drive and the adapter module has been established, several configuration parameters are copied to the drive. These parameters are shown in the tables below and must be checked first and adjusted where necessary. You can adjust the parameters via a drive control panel, a PC tool or a web user interface. For more information on the web user interface, see [Appendix C – FENA configuration web pages](#).

Note:

- Not all drives display descriptive names for the configuration parameters. To help you identify the parameters in different drives, the names displayed by each drive are given in gray boxes in the tables below.
- The new parameter settings take effect only when you power up the module the next time or when you activate the fieldbus adapter refresh parameter.



FENA-01/-11/-21 configuration parameters – group A (group 1)

Note: The actual parameter group number depends on the drive type. Group A (group 1) corresponds to:

- parameter group 51 in ACS355, ACSM1, ACS580, ACS850 and ACQ810
- parameter group is typically 51/54 (group 151/154 in some variants) in ACS880 if the adapter is installed as fieldbus adapter A/B.

No.	Name/Value	Description	Default
01	FBA TYPE	Read-only. Shows the fieldbus adapter type as detected by the drive. The value cannot be adjusted by the user. If the value is 0 = None, the communication between the drive and the module has not been established.	128 = ETHER-NET
02	PROTOCOL/ PROFILE ACS355: FB PAR 2 ACSM1: FBA PAR2 ACS850/ACQ810: FBA par2 ACS880/ACS580: Protocol/Profile	Selects the application protocol and communication profile for the network connection. The selections available for PROFINET IO communication are listed below. 1) 0 = Modbus/TCP: ABB Drives profile - Classic	0 ¹⁾
	10 = PNIO Pdrive	PROFINET IO protocol: PROFIdrive profile	
	11 = PNIO ABB Pro	PROFINET IO protocol: ABB Drives profile	
	12 = PNIO T16	PROFINET IO protocol: Transparent 16-bit profile	
	13 = PNIO T32	PROFINET IO protocol: Transparent 32-bit profile	
	14 = PNIO PdriveM	PROFINET IO protocol: PROFIdrive positioning mode	



No.	Name/Value	Description	Default
03	COMM RATE ACS355: FB PAR 3 ACSM1: FBA PAR3 ACS850/ACQ810: FBA par3 ACS880/ACS580: Commrate	Sets the bit rate for the Ethernet interface. In case of FENA-21 this parameter is used for configuring port 1.	0 = Auto
	0 = Auto	Autonegotiate	
	1 = 100 Mbps FD	100 Mbps, full duplex	
	2 = 100 Mbps HD	100 Mbps, half duplex	
	3 = 10 Mbps FD	10 Mbps, full duplex	
	4 = 10 Mbps HD	10 Mbps, half duplex	
04	IP CONFIGURATION ACS355: FB PAR 4 ACSM1: FBA PAR4 ACS850/ACQ810: FBA par4 ACS880/ACS580: IP configuration	Sets the method for configuring the IP address, subnet mask and gateway address for the module. In a PROFINET IO network, the master controller has a Duplicate Address Detection mechanism. Note: It is recommended to use IP setting for PROFINET as Static IP and address 0.0.0.0. Use PLC hardware configuration to set the IP address for each device in the network.	1 = Dyn IP DHCP
	0 = Static IP	Configuration will be obtained from parameters 05...13 or from the PLC via DCP. The DCP protocol allows the master controller to find every PROFINET IO device on a subnet. When the adapter module is configured for the PROFINET IO protocol, the IP address is transferred to the PROFINET IO communication stack. If there is a need to change the IP address configured via DCP, it should be done with a DCP tool, such as Siemens Step7. If some of the other methods are used to change the IP address, the module must be restarted to enable any changes.	
	1 = Dyn IP DHCP	Configuration will be obtained via DHCP.	



No.	Name/Value	Description	Default
	2 = Temp IP	IP address is set as Temporary through DCP by the controller. Parameters 05...13 shows the set IP. After reboot this setting goes back to static IP and address 0.0.0.0 is taken to use. This setting is not allowed to be set by the user.	
05	IP ADDRESS 1 ACS355: FB PAR 5 ACSM1: FBA PAR5 ACS850/ACQ810: FBA par5 ACS880/ACS580: IP address 1	An IP address is assigned to each IP node on a network. An IP address is a 32-bit number that is typically represented in "dotted decimal" notation consisting of four decimal integers, on the range 0...255, separated by periods. Each integer represents the value of one octet (8-bits) in the IP address. Parameters 05...08 define the four octets of the IP address.	0
	0...255	IP address	
...
08	IP ADDRESS 4 ACS355: FB PAR 8 ACSM1: FBA PAR8 ACS850/ACQ810: FBA par8 ACS880/ACS580: IP address 4	See parameter 05 IP ADDRESS 1 .	0
	0...255	IP address	



No.	Name/Value	Description	Default																																																																				
09	SUBNET CIDR ACS355: FB PAR 9 ACSM1: FBA PAR9 ACS850/ACQ810: FBA par9 ACS880/ACS580: Subnet CIDR	Subnet masks are used for splitting networks into smaller networks called subnets. A subnet mask is a 32-bit binary number that splits the IP address into a network address and host address. Subnet masks are typically represented in either dotted decimal notation or the more compact CIDR notation, as shown in the table below.	0																																																																				
<table border="1"> <thead> <tr> <th>Dotted decimal</th> <th>CIDR</th> <th>Dotted decimal</th> <th>CIDR</th> </tr> </thead> <tbody> <tr><td>255.255.255.254</td><td>31</td><td>255.254.0.0</td><td>15</td></tr> <tr><td>255.255.255.252</td><td>30</td><td>255.252.0.0</td><td>14</td></tr> <tr><td>255.255.255.248</td><td>29</td><td>255.248.0.0</td><td>13</td></tr> <tr><td>255.255.255.240</td><td>28</td><td>255.240.0.0</td><td>12</td></tr> <tr><td>255.255.255.224</td><td>27</td><td>255.224.0.0</td><td>11</td></tr> <tr><td>255.255.255.192</td><td>26</td><td>255.224.0.0</td><td>10</td></tr> <tr><td>255.255.255.128</td><td>25</td><td>255.128.0.0</td><td>9</td></tr> <tr><td>255.255.255.0</td><td>24</td><td>255.0.0.0</td><td>8</td></tr> <tr><td>255.255.254.0</td><td>23</td><td>254.0.0.0</td><td>7</td></tr> <tr><td>255.255.252.0</td><td>22</td><td>252.0.0.0</td><td>6</td></tr> <tr><td>255.255.248.0</td><td>21</td><td>248.0.0.0</td><td>5</td></tr> <tr><td>255.255.240.0</td><td>20</td><td>240.0.0.0</td><td>4</td></tr> <tr><td>255.255.224.0</td><td>19</td><td>224.0.0.0</td><td>3</td></tr> <tr><td>255.255.192.0</td><td>18</td><td>192.0.0.0</td><td>2</td></tr> <tr><td>255.255.128.0</td><td>17</td><td>128.0.0.0</td><td>1</td></tr> <tr><td>255.255.0.0</td><td>16</td><td></td><td></td></tr> </tbody> </table>				Dotted decimal	CIDR	Dotted decimal	CIDR	255.255.255.254	31	255.254.0.0	15	255.255.255.252	30	255.252.0.0	14	255.255.255.248	29	255.248.0.0	13	255.255.255.240	28	255.240.0.0	12	255.255.255.224	27	255.224.0.0	11	255.255.255.192	26	255.224.0.0	10	255.255.255.128	25	255.128.0.0	9	255.255.255.0	24	255.0.0.0	8	255.255.254.0	23	254.0.0.0	7	255.255.252.0	22	252.0.0.0	6	255.255.248.0	21	248.0.0.0	5	255.255.240.0	20	240.0.0.0	4	255.255.224.0	19	224.0.0.0	3	255.255.192.0	18	192.0.0.0	2	255.255.128.0	17	128.0.0.0	1	255.255.0.0	16		
Dotted decimal	CIDR	Dotted decimal	CIDR																																																																				
255.255.255.254	31	255.254.0.0	15																																																																				
255.255.255.252	30	255.252.0.0	14																																																																				
255.255.255.248	29	255.248.0.0	13																																																																				
255.255.255.240	28	255.240.0.0	12																																																																				
255.255.255.224	27	255.224.0.0	11																																																																				
255.255.255.192	26	255.224.0.0	10																																																																				
255.255.255.128	25	255.128.0.0	9																																																																				
255.255.255.0	24	255.0.0.0	8																																																																				
255.255.254.0	23	254.0.0.0	7																																																																				
255.255.252.0	22	252.0.0.0	6																																																																				
255.255.248.0	21	248.0.0.0	5																																																																				
255.255.240.0	20	240.0.0.0	4																																																																				
255.255.224.0	19	224.0.0.0	3																																																																				
255.255.192.0	18	192.0.0.0	2																																																																				
255.255.128.0	17	128.0.0.0	1																																																																				
255.255.0.0	16																																																																						
	1...31	Subnet mask in CIDR notation																																																																					
10	GW ADDRESS 1 ACS355: FB PAR 10 ACSM1: FBA PAR10 ACS850/ACQ810: FBA par10 ACS880/ACS580: GW address 1	IP gateways connect individual physical IP subnets into a unified IP network. When an IP node needs to communicate with an IP node on another subnet, the IP node sends the data to the IP gateway for forwarding. Parameters 10...13 define the four octets of the gateway address.	0																																																																				
	0...255	GW address																																																																					



No.	Name/Value	Description	Default
...
13	GW ADDRESS 4 ACS355: FB PAR 13 ACSM1: FBA PAR13 ACS850/ACQ810: FBA par13 ACS880/ACS580: GW address 4	See parameter 10 GW ADDRESS 1 .	0
	0...255	GW address	
14	COMM RATE PORT 2 ACS355: FB PAR 14 ACSM1: FBA PAR14 ACS850/ACQ810: FBA par14 ACS880/ACS580: Commrate port 2	Sets the bit rate for the Ethernet port 2. This parameter is used only with FENA-21.	0 = Auto
	0 = Auto	Autonegotiate	
	1 = 100 Mbps FD	100 Mbps, full duplex	
	2 = 100 Mbps HD	100 Mbps, half duplex	
	3 = 10 Mbps FD	10 Mbps, full duplex	
	4 = 10 Mbps HD	10 Mbps, half duplex	
14 ... 18	Reserved	These parameters are not used by the adapter module when the module is configured for PROFINET IO.	N/A



No.	Name/Value	Description	Default
19	T16 SCALE ACS355: FB PAR 19 ACSM1: FBA PAR19 ACS850/ACQ810: FBA par19 ACS880/ACS580: T16 scale	<p>Defines the reference multiplier/actual value divisor for the adapter module. The parameter is effective only when the Transparent 16 profile is selected AND the drive is using the native communication profile (eg, DCU or FBA) and a 16-bit transparent Reference 1/Actual value 1.</p> <p>Reference 1 is multiplied by the value of this plus one and the actual value 1 is divided by the value of this plus one. With value 0, the reference 1/actual value 1 scale in the adapter module is 1 = 1.</p> <p>With an ACS355 drive: For example, if the parameter has a value 99 and the reference of 1000 is given by the master, the reference is multiplied by 100 (i.e. 99 + 1) and forwarded to the drive as 100000.</p> <p>According to the DCU profile, speed scale is 1000 = 1 rpm. This value is interpreted as a reference of 100 rpm in the drive.</p> <p>With ACSM1, ACS850 and ACQ810, speed scale is approximately 65535 = 1 rpm.</p> <p>With ACS880 and ACS580 reference 1/actual value 1 base scale in transparent mode is 100 = 1, but using this reference value depends on the application of drive.</p>	99
	0...65535	Reference multiplier/actual value divisor	
20	TELEGRAM TYPE ACS355: FB PAR 20 ACSM1: FBA PAR20 ACS850/ACQ810: FBA par20 ACS880/ACS580: Telegram type	<p>Read-only. Indicates the telegram type selected for PROFINET IO communication. The adapter module automatically detects the telegram type defined in the PLC.</p> <p>For more information on the supported PPO message types, see section PPO types on page 352.</p>	0 = Unknown
	0 = Unknown	Cyclical communication between the master and the module has not been established yet.	
	1 = PPO1	Not supported	
	2 = PPO2	Not supported	
	3 = PPO3	PPO3 selected	
	4 = PPO4	PPO4 selected	



No.	Name/Value	Description	Default
	5 = PPO5	Not supported	
	6 = PPO6	PPO6 selected	
	7 = PPO7	PPO7 selected. Not supported with ACS355.	
	8 = ST1	ST1 selected	
	9 = ST2	ST2 selected. Not supported with ACS355.	
21	ALARM DISABLE ACS355: FB PAR 21 ACSM1: FBA PAR21 ACS850/ACQ810: FBA par21 ACS880/ACS580: Alarm disable	Disables PROFINET IO alarms. For more information on the diagnostics and alarm mechanism for PROFINET IO, see section Diagnostic and alarm mechanism on page 377.	0 = Enabled
	0 = Enabled	PROFINET IO alarms are enabled.	
	1 = Disabled	PROFINET IO alarms are disabled.	
22	MAP SELECTION ACS355: FB PAR 22 ACSM1: FBA PAR22 ACS850/ACQ810: FBA par22 ACS880/ACS580: Map selection	Defines the preferred data type of mapped parameters when mapping is done through PROFIdrive parameters. Supported with ACS880 and ACS580 drives.	1 = 16bit
	0 = 32bit	32 bits	
	1 = 16bit	16 bits	
23 ... 24	Reserved	These parameters are not used by the adapter module when the module is configured for PROFINET IO.	N/A



No.	Name/Value	Description	Default
25	PN NAME INDEX ACS355: FB PAR 25 ACSM1: FBA PAR25 ACS850/ACQ810: FBA par25 ACS880/ACS580: PN Name Index	Allows defining the Profinet station name in the format: "abbdrive-xx", where xx is the value of parameter 24. Example: A value 12 results in the name "abbdrive-12" Value 0 means rotary switch is disabled, other values mean rotary switch is active. Note: During every boot FENA checks the value of PN Name Index, <ul style="list-style-type: none"> • If the value is not Zero then the active PN Name Index overrides the Profinet station name. • If the new name is set by DCP Set command as permanent, the new name is used and stored to flash. The PN Name Index parameter value is not changed, so after next boot, the name is taken according to the PN Name Index. • If the new name is set by DCP Set command as temporary, the new name is used and the empty name is stored to flash. The PN Name Index parameter value is not changed, so after next boot name is taken according to the PN Name Index. • The Profinet DCP factory reset also resets the PN Name Index value to default (0). 	0
	0...65535		
26	Reserved	This parameter is not used by the adapter module when the module is configured for PROFINET IO.	N/A
27	FBA PAR REFRESH ACS355/ACSM1: FBA PAR REFRESH ACS850/ACQ810: FBA par refresh ACS880/ACS580: FBA A/B par refresh	Validates any changed adapter module configuration parameter settings. After refreshing, the value reverts automatically to 0 = Done. Note: This parameter cannot be changed while the drive is running.	0 = Done
	0 = Done	Refreshing done	
	1 = Refresh	Refreshing	



No.	Name/Value	Description	Default
28	PAR TABLE VER ACS355: FILE CPI FW REV ACSM1: PAR TABLE VER ACS850/ACQ810: Par table ver ACS880/ACS580: FBA A/B par table ver	Read-only. Displays the parameter table revision of the fieldbus adapter module mapping file stored in the memory of the drive. In format xyz , where x = major revision number y = minor revision number z = correction number OR in format axyz , where a = major revision number xy = minor revision numbers z = correction number or letter.	N/A
		Parameter table revision	
29	DRIVE TYPE CODE ACS355: FILE CONFIG ID ACSM1: DRIVE TYPE CODE ACS850/ACQ810: Drive type code ACS880/ACS580: FBA A/B drive type code	Read-only. Displays the drive type code of the fieldbus adapter module mapping file stored in the memory of the drive.	N/A
		Drive type code of the fieldbus adapter module mapping file	
30	MAPPING FILE VER ACS355: FILE CONFIG REV ACSM1: MAPPING FILE VER ACS850/ACQ810: Mapping file ver ACS880/ACS580: FBA A/B mapping file ver	Read-only. Displays the fieldbus adapter module mapping file revision stored in the memory of the drive in decimal format.	N/A
		Mapping file revision	



No.	Name/Value	Description	Default
31	D2FBA COMM STA ACS355: FBA STATUS ACSM1: D2FBA COMM STA ACS850/ACQ810: D2FBA comm sta ACS880/ACS580: D2FBA A/B comm status	Read-only. Displays the status of the fieldbus adapter module communication. Note: The value names may vary by drive.	0 = Idle OR 4 = Off-line
	0 = Idle	Adapter is not configured.	
	1 = Exec.init	Adapter is initializing.	
	2 = Time out	A timeout has occurred in the communication between the adapter and the drive.	
	3 = Conf.err	Adapter configuration error: The major or minor revision code of the common program revision in the fieldbus adapter module is not the revision required by the module or mapping file upload has failed more than three times.	
	4 = Off-line	Adapter is off-line.	
	5 = On-line	Adapter is on-line.	
	6 = Reset	Adapter is performing a hardware reset.	
32	FBA COMM SW VER ACS355: FBA CPI FW REV ACSM1: FBA COMM SW VER ACS850/ACQ810: FBA comm sw ver ACS880/ACS580: FBA A/B comm SW ver	Read-only. Displays the common program revision of the adapter module in format axyz , where: a = major revision number xy = minor revision numbers z = correction number or letter.	N/A
		Common program version of the adapter module	



No.	Name/Value	Description	Default
33	FBA APPL SW VER ACS355: FBA APPL FW REV ACSM1: FBA APPL SW VER ACS850/ACQ810: FBA appl sw ver ACS880/ACS580: FBA A/B appl SW ver	Read-only. Displays the application program revision of the adapter module in format axyz , where: a = major revision number xy = minor revision numbers z = correction number or letter.	N/A
		Application program revision of the adapter module	



FENA-01/-11/-21 configuration parameters – group B (group 2)

Note: The actual parameter group number depends on the drive type. Group B (group 2) corresponds to:

- parameter group 55 in ACS355
- parameter group 53 in ACSM1, ACS580, ACS850 and ACQ810
- parameter group is typically 53/56 (group 153/156 in some variants) in ACS880 if the adapter is installed as fieldbus adapter A/B.

No. ¹⁾	Name/Value	Description	Default						
01	DATA OUT 1 (master to drive) ACS355: FBA DATA OUT 1 ACSM1: FBA DATA OUT 1 ACS850/ACQ810: FBA data out1 ACS880/ACS580: FBA A/B data out1	Selects data word 1 received by the drive over the PROFINET network. The content is defined by a decimal number in the range of 0 to 9999 as follows: <table border="1" data-bbox="339 594 783 733"> <tr> <td>0</td> <td>Not used</td> </tr> <tr> <td>1...99</td> <td>Virtual address area of drive control</td> </tr> <tr> <td>101...9999</td> <td>Parameter area of the drive</td> </tr> </table> See also <i>Virtual address area allocation with ACSM1</i> on page 281.	0	Not used	1...99	Virtual address area of drive control	101...9999	Parameter area of the drive	1 or 11 ²⁾
0	Not used								
1...99	Virtual address area of drive control								
101...9999	Parameter area of the drive								
	0 = None	Not used							
	1 = CW 16bit	Control word (16 bits) ³⁾							
	2 = Ref1 16bit	Reference REF1 (16 bits) ³⁾							
	3 = Ref2 16bit	Reference REF2 (16 bits) ³⁾							
	11 = CW 32bit	Control word (32 bits)							
	12 = Ref1 32bit	Reference REF1(32 bits)							
	13 = Ref2 32bit	Reference REF2 (32 bits)							
	21 = CW2 16bit	Control word 2 (16 bits)							
	101...9999	Parameter index with format xyyy , where <ul style="list-style-type: none"> xx is the parameter group number (1...99) yyy is the parameter number index within that group (01...99). Note: In ACS880 and ACS580, choose Other to display a list of mappable drive parameters.							



No. ¹⁾	Name/Value	Description	Default
02	DATA OUT 2	See parameter <i>01 DATA OUT 1</i> .	0 or 2 ⁴⁾
03... 10	DATA OUT 3... DATA OUT 10	See parameter <i>01 DATA OUT 1</i> .	0

1) The number of parameters in this group may vary by drive type and drive firmware.

2) 11 (CW 32bit) is the default setting if the Transparent 32 profile is used.

3) With an ACS355 drive, Control word and REF1 are always fixed to virtual addresses 1 and 2 respectively. If REF2 is used, its virtual address is always 3.

4) 2 (Ref1 16bit) is a fixed setting with an ACS355 drive.



FENA-01/-11/-21 configuration parameters – group C (group 3)

Note: The actual parameter group number depends on the drive type. Group C (group 3) corresponds to:

- parameter group 54 in ACS355
- parameter group 52 in ACSM1, ACS580, ACS850 and ACQ810
- parameter group is typically 52/55 (group 152/155 in some variants) in ACS880 if the adapter is installed as fieldbus adapter A/B.

No. ¹⁾	Name/Value	Description	Default						
01	DATA IN 1 (drive to master) ACS355: FBA DATA IN 1 ACSM1: FBA DATA IN1 ACS850/ACQ810: FBA data in1 ACS880/ACS580: FBA A/B data in1	Selects data word 1 sent by the drive over the PROFINET network. The content is defined by a decimal number in the range of 0 to 9999 as follows: <table border="1" data-bbox="339 594 782 735"> <tr> <td>0</td> <td>Not used</td> </tr> <tr> <td>1...99</td> <td>Virtual address area of drive control</td> </tr> <tr> <td>101...9999</td> <td>Parameter area of the drive</td> </tr> </table> See also Virtual address area allocation with ACSM1 on page 281.	0	Not used	1...99	Virtual address area of drive control	101...9999	Parameter area of the drive	4 or 14 ²⁾
0	Not used								
1...99	Virtual address area of drive control								
101...9999	Parameter area of the drive								
	0 = None	Not used							
	4 = SW 16bit	Status word (16 bits)							
	5 = Act1 16bit	Actual value ACT1 (16 bits)							
	6 = Act2 16bit	Actual value ACT2 (16 bits)							
	14 = SW 32bit	Status word (32 bits)							
	15 = Act1 32bit	Actual value ACT1 (32 bits)							
	16 = Act2 32bit	Actual value ACT2 (32 bits)							
	24 = SW2 16bit	Status word 2 (16 bits)							
	101...9999	Parameter index with format xyyy , where <ul style="list-style-type: none"> xx is the parameter group number (1...99) yy is the parameter number index within that group (01...99). Note: In ACS880 and ACS580, choose Other to display a list of mappable drive parameters.							



No. ¹⁾	Name/Value	Description	Default
02	DATA IN 2	See parameter <i>01 DATA IN 1</i> .	0 or 5 ³⁾
03... 10	DATA IN 3... DATA IN 10	See parameter <i>01 DATA IN 1</i> .	0

1) The number of parameters in this group may vary by drive type and drive firmware.

2) 14 (SW 32bit) is the default setting if the Transparent 32 profile is used.

3) 5 (Act1 16bit) is a fixed setting with an ACS355 drive.

Virtual address area allocation with ACSM1

When the PROFIdrive profile or PROFIdrive positioning mode is used with an ACSM1 drive, the virtual addresses shown below are recommended. (FBA REFx mode is selected with drive parameter 50.04/50.05.)

The information in the table is applicable only if PPO messaging is used (see parameter *20 TELEGRAM TYPE*). If standard telegrams (STx) are used, virtual addresses for standard telegrams (ST1 and ST2) are updated automatically.

Abbreviation	Description	Data length	Recommended virtual address with ACSM1 FBA REFx modes	
			Speed mode	Position mode
STW1	Control word 1	16-bit	1	1
NSOLL_A	Speed set point A	16-bit	2 or 3	
NSOLL_B	Speed set point B	32-bit	12 or 13	
STW2	Control word 2	16-bit	21	21
XSOLL_A	Position set point A	32-bit		12 or 13
VELOCITY_A	Velocity	32-bit		13
ZSW2	Status word 2	16-bit	24	24
NIST_A	Speed actual value A	16-bit	5 or 6	
NIST_B	Speed actual value B	32-bit	15 or 16	
ZSW1	Status word 1	16-bit	4	4
XIST_A	Position actual value A	32-bit		15 or 16



■ Control locations

ABB drives can receive control information from multiple sources including digital inputs, analog inputs, the drive control panel and a fieldbus adapter module. ABB drives allow the user to separately determine the source for each type of control information (Start, Stop, Direction, Reference, Fault reset, etc.).

To give the fieldbus master the most complete control over the drive, you must select the adapter module as the source of this information. The drive-specific parameter setting examples below contain the drive control parameters relevant in the examples. For a complete parameter list, see the drive documentation.



Starting up fieldbus communication for ACS355 drives

1. Power up the drive.
2. Enable the communication between the adapter module and the drive with parameter 9802 COMM PROT SEL.
3. Set the module configuration parameters in group 51.
At the minimum, select the communication protocol and profile with parameter 5102 and configure the network settings with parameters 5103...5113. See also [PROFINET network settings](#) on page 349.
4. With parameter 3018 COMM FAULT FUNC, select how the drive reacts to a fieldbus communication break.
5. With parameter 3019 COMM FAULT TIME, define the time between communication break detection and the selected action.
6. Define the process data transferred to and from the drive in parameter groups 54 and 55.
Note: The adapter module sets the Status word and actual value automatically in parameters 5401 and 5402, and Control word and reference in parameters 5501 and 5502.
7. Validate the settings made in parameter groups 51, 54 and 55 with parameter 5127 FBA PAR REFRESH.
8. Set the relevant drive control parameters to control the drive according to the application.

Examples of appropriate values are shown in the tables below.



Parameter setting examples – ACS355

Speed control using the PROFIdrive communication profile with PPO Type 4

This example shows how to configure a basic speed control application that uses the PROFIdrive profile. In addition, some application-specific data is added to the communication.

The start/stop commands and reference are according to the PROFIdrive profile. For more information, see the PROFIdrive state machine on page 335.

The reference value ± 16384 (4000h) corresponds to parameter 1105 REF1 MAX in the forward and reverse directions.

Direction	PZD1	PZD2	PZD3	PZD4	PZD5	PZD6
Out	Control word	Speed reference	Constant speed 1 ¹⁾	Constant speed 2	N/A	N/A
In	Status word	Speed actual value	Power ¹⁾	DC bus voltage	N/A	N/A

¹⁾ Example

The table below gives the recommended drive parameter settings.

Drive parameter	Setting for ACS355 drives	Description
9802 COMM PROT SEL	4 = EXT FBA	Enables communication between the drive and the fieldbus adapter module.
5101 FBA TYPE	ETHERNET ¹⁾	Displays the type of the fieldbus adapter module.
5102 FB PAR 2 (PROTOCOL/PROFILE)	10 (= PNIO Pdrive)	Selects the PROFINET IO protocol and PROFIdrive profile.
5210 FB PAR 3 (COMMRATE)	0 (= Auto) ²⁾	Ethernet communication rate is negotiated automatically by the device.
5104 FB PAR 4 (IP CONFIGURATION)	0 (= Static IP) ²⁾	Configuration will be obtained from parameters 05...13 or from the PLC via the DCP protocol.
5105 FB PAR 5 (IP ADDRESS 1)	0 ²⁾	First part of the IP address



Drive parameter	Setting for ACS355 drives	Description
5106 FB PAR 6 (IP ADDRESS 2)	0 ²⁾	Second part of the IP address
5107 FB PAR 7 (IP ADDRESS 3)	0 ²⁾	Third part of the IP address
5108 FB PAR 8 (IP ADDRESS 4)	0 ²⁾	Last part of the IP address
5109 FB PAR 9 (SUBNET CIDR)	24 ²⁾	Sets the network mask as 255.255.255.0, allowing access only to the last subnet.
3018 COMM FAULT FUNC	3 = LAST SPEED ²⁾	Enables fieldbus communication fault monitoring.
3019 COMM FAULT TIME	3.0 s ²⁾	Defines the fieldbus communication break supervision time.
5401 FBA DATA IN 1	4 (= SW 16bit) ¹⁾	Status word
5402 FBA DATA IN 2	5 (= Act1 16bit) ¹⁾	Actual value 1 (speed)
5403 FBA DATA IN 3	106 ²⁾	Power
5404 FBA DATA IN 4	107 ²⁾	DC bus voltage
5501 FBA DATA OUT 1	1 (= CW 16bit) ¹⁾	Control word
5502 FBA DATA OUT 2	2 (= Ref1 16bit) ¹⁾	Reference 1 (speed)
5503 FBA DATA OUT 3	1202 ²⁾	Constant speed 1
5504 FBA DATA OUT 4	1203 ²⁾	Constant speed 2
5127 FBA PAR REFRESH	1 = REFRESH	Validates the FENA-01/-11/-21 configuration parameter settings.
1001 EXT1 COMMANDS	10 = COMM	Selects the fieldbus interface as the source of the start and stop commands for external control location 1.
1103 REF1 SELECT	8 = COMM	Selects the fieldbus reference 1 as the source for speed reference 1.
1601 RUN ENABLE	7 = COMM	Selects the fieldbus interface as the source for the inverted Run enable signal (Run disable).



Drive parameter	Setting for ACS355 drives	Description
1604 FAULT RESET SEL	8 = COMM	Selects the fieldbus interface as the source for the fault reset signal.

¹⁾ Read-only or automatically detected/set

²⁾ Example

The start sequence for the parameter example above is given below.

Control word:

- Reset the fieldbus communication fault (if active).
- Enter 47Eh (1150 decimal) → READY TO SWITCH ON.
- Enter 47Fh (1151 decimal) → OPERATING (Speed mode).

Speed and torque control using the ABB Drives communication profile with PPO Type 4

This example shows how to configure a speed and torque control application that uses the ABB Drives profile. From the PLC programming point, the ABB Drives profile is similar to the PROFIdrive profile shown in the first example.

The start/stop commands and reference are according to the ABB Drives profile. For more information, see section [ABB Drives communication profile](#) on page 339.

When Reference 1 (REF1) is used, a reference value of ± 20000 (decimal) corresponds to the reference set by parameter 1105 REF1 MAX in the forward and reverse directions.

When Reference 2 (REF2) is used, a reference value of ± 10000 (decimal) corresponds to the reference set by parameter 1108 REF2 MAX in the forward and reverse directions.

The minimum and maximum 16-bit integer values that can be given through the fieldbus are -32768 and 32767 respectively.

Direction	PZD1	PZD2	PZD3	PZD4	PZD5	PZD6
Out	Control word	Speed reference	Torque reference	N/A	N/A	N/A
In	Status word	Speed actual value	Torque actual	N/A	N/A	N/A

The table below gives the recommended drive parameter settings.

Drive parameter	Setting for ACS355 drives	Description
9802 COMM PROT SEL	4 = EXT FBA	Enables communication between the drive and the fieldbus adapter module.
5101 FBA TYPE	ETHERNET ¹⁾	Displays the type of the fieldbus adapter module.
5102 FBAPAR 2 (PROTOCOL/PROFILE)	11 (= PNIO ABB Pro)	Selects the PROFINET IO protocol and ABB Drives profile.
5103 FB PAR 3 (COMMRATE)	0 (= Auto) ²⁾	Ethernet communication rate is negotiated automatically by the device.
5104 FB PAR 4 (IP CONFIGURATION)	0 (= Static IP)	Configuration will be obtained from parameters 05...13 or from the PLC via the DCP protocol.
3018 COMM FAULT FUNC	3 = LAST SPEED ²⁾	Enables fieldbus communication fault monitoring.
3019 COMM FAULT TIME	3.0 s ²⁾	Defines the fieldbus communication break supervision time.
5401 FBA DATA IN 1	4 (= SW 16bit) ¹⁾	Status word
5402 FBA DATA IN 2	5 (= Act1 16bit) ¹⁾	Actual value 1 (speed)
5403 FBA DATA IN 3	6 (= Act2 16bit) ²⁾	Actual value 2 (torque)
5501 FBA DATA OUT 1	1 (= CW 16bit) ¹⁾	Control word
5502 FBA DATA OUT 2	2 (= Ref1 16bit) ¹⁾	Reference 1 (speed)
5503 FBA DATA OUT 3	2 (= Ref2 16bit) ²⁾	Reference 2 (torque)
5127 FBA PAR REFRESH	1 = REFRESH	Validates the FENA-01/-11 configuration parameter settings.
9904 MOTOR CTRL MODE	2 = VECTOR: TORQ	Selects the vector control mode as the motor control mode.
1001 EXT1 COMMANDS	10 = COMM	Selects the fieldbus interface as the source of the start and stop commands for external control location 1.



Drive parameter	Setting for ACS355 drives	Description
1002 EXT2 COMMANDS	10 = COMM	Selects the fieldbus interface as the source of the start and stop commands for external control location 2.
1102 EXT1/EXT2 SEL	8 = COMM	Enables external control location 1/2 selection through the fieldbus.
1103 REF1 SELECT	8 = COMM	Selects the fieldbus reference 1 as the source for speed reference 1.
1106 REF2 SELECT	8 = COMM	Selects the fieldbus reference 2 as the source for speed reference 1.
1601 RUN ENABLE	7 = COMM	Selects the fieldbus interface as the source for the inverted Run enable signal (Run disable).
1604 FAULT RESET SEL	8 = COMM	Selects the fieldbus interface as the source for the fault reset signal.

¹⁾ Read-only or automatically detected/set

²⁾ Example

The start sequence for the parameter example above is given below.

Control word:

- Reset the fieldbus communication fault (if active).
 - Enter 47Eh (1150 decimal) → READY TO SWITCH ON.
 - Enter 47Fh (1151 decimal) → OPERATING (Speed mode)
- or
- C7Fh (3199 decimal) → OPERATING (Torque mode).



Starting up fieldbus communication for ACSM1 drives

1. Power up the drive.
2. Enable the communication between the adapter module and the drive with parameter 50.01 FBA ENABLE.
3. With parameter 50.02 COMM LOSS FUNC, select how the drive reacts to a fieldbus communication break.

Note that this function monitors both communication between the fieldbus master and the adapter module and communication between the adapter module and the drive.

4. With parameter 50.03 COMM LOSS T OUT, define the time between communication break detection and the selected action.
5. Select application-specific values for parameters 50.04...50.11.

Examples of appropriate values are shown in the tables below.

6. Set the module configuration parameters in group 51.

At the minimum, select the communication protocol and profile with parameter 51.02 and configure the network settings with parameters 51.03...51.13. See also [PROFINET network settings](#) on page 349.

7. Define the process data transferred to and from the drive in parameter groups 52 and 53.

Note: The adapter module automatically sets the communication profile-specific virtual address for the Status word in parameter 52.01 and for the Control word in parameter 53.01.

8. Validate the settings made in parameter groups 51, 52 and 53 with parameter 51.27 FBA PAR REFRESH.



9. Set the relevant drive control parameters to control the drive according to the application.

Examples of appropriate values are shown in the tables below.

■ Parameter setting examples – ACSM1

Speed control using the PROFIdrive communication profile with PPO Type 4

This example shows how to configure a basic speed control application that uses the PROFIdrive profile. In addition, some application-specific data is added to the communication.

The start/stop commands and reference are according to the PROFIdrive profile, speed control mode. For more information, see the PROFIdrive state machine on page [335](#).

The reference value ± 16384 (4000h) corresponds to parameter 25.02 SPEED SCALING in the forward and reverse directions.

Direction	PZD1	PZD2	PZD3	PZD4	PZD5	PZD6
Out	Control word	Speed reference	Constant speed ¹⁾		Speed reference for jogging function ¹⁾	
In	Status word	Speed actual value	Power ¹⁾		DC bus voltage ¹⁾	

¹⁾ Example

The table below gives the recommended drive parameter settings.

Drive parameter	Setting for ACSM1 drives	Description
50.01 FBA ENABLE	Enable	Enables communication between the drive and the fieldbus adapter module.
50.02 COMM LOSS FUNC	Last speed	Enables fieldbus communication fault monitoring.
50.03 COMM LOSS T OUT	3.0 s	Defines the fieldbus communication break supervision time.
50.04 FBA REF1 MODESEL	Speed	Selects the fieldbus reference 1 scaling.



Drive parameter	Setting for ACSM1 drives	Description
51.01 FBA TYPE	ETHERNET ¹⁾	Displays the type of the fieldbus adapter module.
51.02 FBA PAR2 (PROTOCOL/PROFILE)	10 (= PNIO Pdrive)	Selects the PROFINET IO protocol and PROFIdrive profile.
51.03 FBA PAR3 (COMMRATE)	0 (= Auto) ²⁾	Ethernet communication rate is negotiated automatically by the device.
51.04 FBA PAR4 (IP CONFIGURATION)	0 (= Static IP)	Configuration will be obtained from parameters 05...13 or from the PLC via the DCP protocol.
52.01 FBA DATA IN1	4 (= SW 16bit) ¹⁾	Status word
52.02 FBA DATA IN2	5 (= Act1 16bit)	Actual value 1 (speed)
52.03 FBA DATA IN3	122 ²⁾	Power
52.05 FBA DATA IN5	107 ²⁾	DC bus voltage
53.01 FBA DATA OUT1	1 (= CW 16bit) ¹⁾	Control word
53.02 FBA DATA OUT2	2 (= Ref1 16bit)	Reference 1 (speed)
53.03 FBA DATA OUT3	2408 ²⁾	Constant speed
53.05 FBA DATA OUT5	2410 ²⁾	Speed reference for jogging function 1
51.27 FBA PAR REFRESH	REFRESH	Validates the FENA-11/-21 configuration parameter settings.
10.01 EXT1 START FUNC	FBA	Selects the fieldbus interface as the source of the start and stop commands for external control location 1.
24.01 SPEED REF1 SEL	FBA REF1	Selects the fieldbus reference 1 as the source for speed reference 1.
34.03 EXT1 CTRL MODE1	Speed	Selects speed control as the control mode 1 for external control location 1.

¹⁾ Read-only or automatically detected/set

²⁾ Example



The start sequence for the parameter example above is given below.

Control word:

- Reset the fieldbus communication fault (if active).
- Enter 47Eh (1150 decimal) → READY TO SWITCH ON.
- Enter 47Fh (1151 decimal) → OPERATING (Speed mode).

Position control using the PROFIdrive communication profile with PPO Type 4

This example shows how to configure a basic positioning application. The start/stop commands and reference are according to the PROFIdrive profile, positioning mode. For more information, see the PROFIdrive state machine on page 336.

Note: By default, fieldbus is not the only control source. See actual signal 02.12 FBA MAIN CW in *ACSM1 Motion Control Program Firmware Manual* for details.

The position set point and velocity reference are defined as 32-bit integer values; both are scaled as defined in the drive parameter settings.

Direction	PZD1	PZD2	PZD3	PZD4	PZD5	PZD6
Out	Control word (STW1)	Position set point		Velocity reference		N/A
In	Status word (ZSW1)	Position actual value		Velocity actual value		N/A

The table below gives the recommended drive parameter settings.

Drive parameter	Setting for ACSM1 drives	Description
50.01 FBA ENABLE	Enable	Enables communication between the drive and the fieldbus adapter module.
50.02 COMM LOSS FUNC	Fault	Enables fieldbus communication fault monitoring.
50.03 COMM LOSS T OUT	3.0 s	Defines the fieldbus communication break supervision time.
50.04 FBA REF1 MODESEL	Position	Selects the fieldbus reference 1 scaling.



Drive parameter	Setting for ACSM1 drives	Description
50.05 FBA REF2 MODESEL	Velocity	Selects the fieldbus reference 2 scaling.
51.01 FBA TYPE	ETHERNET ¹⁾	Displays the type of the fieldbus adapter module.
51.02 FBA PAR2 (PROTOCOL/PROFILE)	14 (= PNIO PdriveM)	Selects the PROFINET IO protocol and PROFIdrive positioning mode.
51.03 FBA PAR3 (COMMRATE)	0 (= Auto ²⁾)	Ethernet communication rate is negotiated automatically by the device.
51.04 FBA PAR4 (IP CONFIGURATION)	0 (= Static IP)	Configuration will be obtained from parameters 05...13 or from the PLC via the DCP protocol.
52.01 FBA DATA IN1	4 (= SW 16bit) ¹⁾	Status word
52.02 FBA DATA IN2	15 (= Act1 32bit)	Actual value 1
52.04 FBA DATA IN4	16 (= Act2 32bit)	Actual value 2
53.01 FBA DATA OUT1	1 (= CW 16bit) ¹⁾	Control word
53.02 FBA DATA OUT2	12 (= Ref1 32bit)	Reference 1
53.04 FBA DATA OUT4	13 (= Ref2 32bit)	Reference 2
51.27 FBA PAR REFRESH	REFRESH	Validates the FENA-11/-21 configuration parameter settings.
10.01 EXT1 START FUNC	FBA	Selects the fieldbus interface as the source of the start and stop commands for external control location 1.
10.05 JOG ENABLE	C.FALSE	Disables the jogging functions.
22.01 SPEED FB SEL	Enc1 speed ²⁾	Selects the actual speed measured by encoder 1 as the speed feedback.
34.02 EXT1 MODE 1/2SEL	P.FBA MAIN CW.26	Selects the source for external 1 control mode 1/2 selection. Selection is done by START_HOMING bit (bit 26 in the fieldbus Control word). Mode 1: Position, Mode 2: Homing
34.03 EXT1 CTRL MODE1	Position	Selects position control as the control mode 1 for external control location 1.



Drive parameter	Setting for ACSM1 drives	Description
34.04 EXT1 CTRL MODE2	Homing	Selects homing control as the control mode 2 for external control location 1.
62.01 HOMING METHOD	CAN Methodxx	Selects the homing mode. Select the appropriate CAN Method.
62.03 HOMING START	C.False	Selects the fieldbus as the homing start source.
65.01 POS REFSOURCE	Fieldbus	Position reference and speed are read from the fieldbus.
65.03 POS START 1	C.False	Selects the fieldbus as the position start1source.
65.04 POS REF 1 SEL	FBA REF 1	Selects the FBA reference 1 as the position reference source.
65.11 POS START 2	C.False	Selects the fieldbus as the position start2 source.
65.22 PROF VEL REF SEL	FBA REF2	Selects the FBA reference 2 as the velocity reference source.
66.05 POS ENABLE	C.False	Selects the fieldbus as the source for enabling the position reference generator.
70.03 POS REF ENA	C.False	Selects the fieldbus as the source for the position reference enable command.

¹⁾ Read only or automatically detected/set

²⁾ Example

The position set point is scaled as follows:

Drive parameter	Setting
60.05 POS UNIT (Position unit)	m ¹⁾
60.08 POS2INT SCALE	100 ¹⁾

¹⁾ Example



The position set point and actual values are scaled with the above example values as follows:

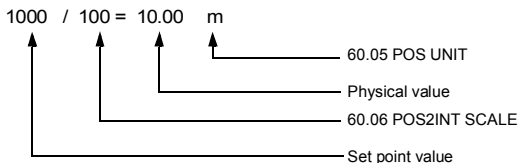

Example for velocity set point scale:

Drive parameter	Name	Value	Description
60.10	POS SPEED UNIT	u/s ¹⁾	Unit/s (in this case m/s)
60.11	POS SPEED2INT	100 ¹⁾	Scales position speed values to integer values. Selections: 1/10/100/1000/10000/100000

¹⁾ Example

The velocity set point and actual values are scaled with the above example values as follows:

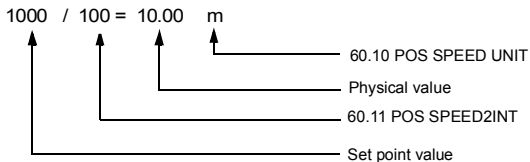

Pay attention to the following parameters:

Group	Description
90	Encoder selection
91/92/93	Settings of the encoder



The start sequence for the above parameter example is given below:

Control word:

- Reset the fieldbus communication fault (if active).
- Enter 406h (1030 decimal) → READY TO SWITCH ON.
- Enter 40Fh (1039 decimal) → OPERATING.
- Enter 43Fh (1087 decimal) → OPERATING (Do reject traversing task with no intermediate stop).
- Enter 47Fh (1151 decimal) → OPERATING (Activate traversing task).
- Enter C0Fh (3087 decimal) → OPERATING (Start Homing procedure).

Speed and torque control using the ABB Drives communication profile with PPO Type 4

This example shows how to configure a speed and torque control application that uses the ABB Drives profile. From the PLC programming point, the ABB Drives profile is similar to the PROFIdrive profile shown in the first example.

The start/stop commands and reference are according to the ABB Drives profile. For more information, see section [ABB Drives communication profile](#) on page 339.

When Reference 1 (REF1) is used, a reference value of ± 20000 (4E20h) corresponds to the reference set by parameter 25.02 SPEED SCALING in the forward and reverse directions.

When Reference 2 (REF2) is used, a reference value of ± 10000 (2710h) corresponds to the reference set by parameter 32.04 TORQUE REF 1 MAX in the forward and reverse directions.

Direction	PZD1	PZD2	PZD3	PZD4	PZD5	PZD6
Out	Control word	Speed reference	Torque reference	N/A	N/A	N/A
In	Status word	Speed actual value	Torque actual	N/A	N/A	N/A



The table below gives the recommended drive parameter settings.

Drive parameter	Setting for ACSM1 drives	Description
50.01 FBA ENABLE	Enable	Enables communication between the drive and the fieldbus adapter module.
50.02 COMM LOSS FUNC	Fault	Enables fieldbus communication fault monitoring.
50.03 COMM LOSS T OUT	3.0 s	Defines the fieldbus communication break supervision time.
50.04 FBA REF1 MODESEL	Speed	Selects the fieldbus reference 1 scaling.
50.05 FBA REF2 MODESEL	Torque	Selects the fieldbus reference 2 scaling.
51.01 FBA TYPE	ETHERNET ¹⁾	Displays the type of the fieldbus adapter module.
51.02 FBA PAR2 (PROTOCOL/PROFILE)	11 (= PNIO ABB Pro)	Selects the PROFINET IO protocol and the ABB Drives profile.
51.03 FBA PAR3 (COMMRATE)	0 (= Auto) ²⁾	Ethernet communication rate is negotiated automatically by the device.
51.04 FBA PAR4 (IP CONFIGURATION)	0 (= Static IP)	Configuration will be obtained from parameters 05...13 or from the PLC via the DCP protocol.
52.01 FBA DATA IN1	4 (= SW 16bit) ¹⁾	Status word (PZD 1)
52.02 FBA DATA IN2	5 (= Act1 16bit)	Actual value 1
52.03 FBA DATA IN3	6 (= Act2 16bit)	Actual value 2
53.01 FBA DATA OUT1	1 (= CW 16bit) ¹⁾	Control word
53.02 FBA DATA OUT2	2 (= Ref1 16bit)	Reference 1
53.03 FBA DATA OUT3	3 (= Ref2 16bit)	Reference 2
51.27 FBA PAR REFRESH	REFRESH	Validates the FENA-11/-21 configuration parameter settings.



Drive parameter	Setting for ACSM1 drives	Description
10.01 EXT1 START FUNC	FBA	Selects the fieldbus interface as the source of the start and stop commands for external control location 1.
10.04 EXT2 START FUNC	FBA	Selects the fieldbus interface as the source of the start and stop commands for external control location 2.
24.01 SPEED REF1 SEL	FBA REF 1	Selects the fieldbus reference 1 as the source for speed reference 1.
32.02 TORQ REF ADD SEL	FBA REF 2	Selects the fieldbus reference 2 as the source for torque reference 1.
34.01 EXT1/EXT2 SEL	P.FBA MAIN CW.15	Enables external control location 1/2 selection through the fieldbus only (bit 15 in the fieldbus Control word).
34.03 EXT1 CTRL MODE1	Speed	Selects speed control as the control mode 1 for external control location 1.
34.05 EXT2 CTRL MODE1	Torque	Selects torque control as the control mode 1 for external control location 2.

¹⁾ Read-only or automatically detected/set

²⁾ Example

The start sequence for the parameter example above is given below.

Control word:

- Reset the fieldbus communication fault (if active).
 - Enter 47Eh (1150 decimal) → READY TO SWITCH ON.
 - Enter 47Fh (1151 decimal) → OPERATING (Speed mode)
- or
- C7Fh (3199 decimal) → OPERATING (Torque mode).



Starting up fieldbus communication for ACS850 and ACQ810 drives

1. Power up the drive.
2. Enable the communication between the adapter module and the drive with parameter 50.01 FBA enable.
3. With parameter 50.02 Comm loss func, select how the drive reacts to a fieldbus communication break.

Notes:

- This function monitors both communication between the fieldbus master and the adapter module and communication between the adapter module and the drive.
 - In ACQ810, you can select the control locations to be monitored with parameter 50.21 Comm loss enable. By default, the monitoring is enabled in both control locations (EXT1 and EXT2).
4. With parameter 50.03 Comm loss t out, define the time between communication break detection and the selected action.
 5. Select application-specific values for parameters 50.04...50.11.
Examples of appropriate values are shown in the tables below.
 6. Set the module configuration parameters in group 51.
At the minimum, select the communication protocol and profile with parameter 51.02 and configure the network settings with parameters 51.03...51.13.



- Define the process data transferred to and from the drive in parameter groups 52 and 53.

Note: The adapter module automatically sets the communication profile-specific virtual address for the Status word in parameter 52.01 and for the Control word in parameter 53.01.

- Validate the settings made in parameter groups 51, 52 and 53 with parameter 51.27 FBA par refresh.
- Set the relevant drive control parameters to control the drive according to the application.

Examples of appropriate values are shown in the tables below.

■ Parameter setting examples – ACS850 and ACQ810

Speed control using the PROFIdrive communication profile with PPO Type 4

This example shows how to configure a basic speed control application that uses the PROFIdrive profile. In addition, some application-specific data is added to the communication.

The start/stop commands and reference are according to the PROFIdrive profile, speed control mode. For more information, see the PROFIdrive state machine on page [335](#).

The reference value ± 16384 (4000h) corresponds to parameter 19.01 Speed scaling in the forward and reverse directions.

Direction	PZD1	PZD2	PZD3	PZD4	PZD5	PZD6
Out	Control word	Speed reference	Constant speed 1 ¹⁾		Constant speed 2 ¹⁾	
In	Status word	Speed Actual value	Power ¹⁾		DC bus voltage ¹⁾	

 1) Example

The table below gives the recommended drive parameter settings.

Drive parameter	Setting for ACS850/ACQ810 drives	Description
50.01 Fba enable	Enable	Enables communication between the drive and the fieldbus adapter module.
50.02 Comm loss func	Fault ²⁾	Enables fieldbus communication fault monitoring.
50.03 Comm loss t out	3.0 s ²⁾	Defines the fieldbus communication break supervision time.
50.04 Fb ref1 modesel	Speed	Selects the fieldbus reference 1 scaling.
51.01 FBA type	Ethernet ¹⁾	Displays the type of the fieldbus adapter module.
51.02 FBA par2 (PROTOCOL/PROFILE)	10 (= PNIO Pdrive)	Selects the PROFINET IO protocol and the PROFIdrive profile.
51.03 FBA par3 (COMMRATE)	0 (= Auto ²⁾)	Ethernet communication rate is negotiated automatically by the device.
51.04 FBA par4 (IP CONFIGURATION)	0 (= Static IP)	Configuration will be obtained from parameters 05...13 or from the PLC via the DCP protocol.
52.01 FBA data in1	4 (= SW 16bit) ¹⁾	Status word
52.02 FBA data in2	5 (= Act1 16bit)	Actual value 1 (speed)
52.03 FBA data in3	122 ²⁾	Power
52.05 FBA data in5	107 ²⁾	DC bus voltage
53.01 FBA data out1	1 (= CW 16bit) ¹⁾	Control word
53.02 FBA data out2	2 (= Ref1 16bit)	Reference 1 (speed)
53.03 FBA data out3	2606 ²⁾	Constant speed 1
53.05 FBA data out5	2607 ²⁾	Constant speed 2
51.27 FBA par refresh	Refresh	Validates the FENA-11/-21 configuration parameter settings.
10.01 Ext1 start func	FB	Selects the fieldbus interface as the source of the start and stop commands for external control location 1.



Drive parameter	Setting for ACS850/ACQ810 drives	Description
21.01 Speed ref1 sel (ACS850)	FBA ref1	Selects the fieldbus reference 1 as the source for speed reference 1.
21.01 Speed ref sel (ACQ810)	FBA ref1	

¹⁾ Read-only or automatically detected/set

²⁾ Example

The start sequence for the parameter example above is given below.

Control word:

- Reset the fieldbus communication fault (if active).
- Enter 47Eh (1150 decimal) → READY TO SWITCH ON.
- Enter 47Fh (1151 decimal) → OPERATING (Speed mode).



Starting up fieldbus communication for ACS880 and ACS580 drives

1. Power up the drive.
2. Enable the communication between the adapter module and the drive by selecting the correct slot number in parameter 50.01 FBA A enable.

The selection must correspond to the slot where the adapter module is installed. For example, if the adapter module is installed in slot 1, you must select slot 1.

3. With parameter 50.02 FBA A comm loss func, select how the drive reacts to a fieldbus communication break.

Note that this function monitors both communication between the fieldbus master and the adapter module and communication between the adapter module and the drive.

4. With parameter 50.03 FBA A comm loss t out, define the time between communication break detection and the selected action.

5. Select application-specific values for the rest of the parameters in group 50, starting from 50.04.

Examples of appropriate values are shown in the tables below.

6. Set the module configuration parameters in group 51.

At the minimum, select the communication protocol and profile with parameter 51.02 Protocol/Profile and configure the network settings with parameters 51.03...51.13.



7. Define the process data transferred to and from the drive in parameter groups 52 and 53.
Note: The adapter module automatically sets the communication profile-specific virtual address for the Status word in parameter 52.01 and for the Control word in parameter 53.01.
8. Save the valid parameter values to permanent memory with parameter 96.07 Parameter save manually.
9. Validate the settings made in parameter groups 51, 52 and 53 with parameter 51.27 FBA A par refresh.
10. Set the relevant drive control parameters to control the drive according to the application.
 Examples of appropriate values are shown in the tables below.

■ Parameter setting examples – ACS880

Speed control using PROFIdrive communication profile with PPO Type 4

This example shows how to configure a basic speed control application that uses the PROFIdrive profile. In addition, some application-specific data is added to the communication.

The start/stop commands and reference are according to the PROFIdrive profile, speed control mode. For more information, see the PROFIdrive state machine on page [335](#).

The reference value ± 16384 (4000h) corresponds to parameter 46.01 Speed scaling in the forward and reverse directions.

Direction	PZD1	PZD2	PZD3	PZD4	PZD5	PZD6
Out	Control word	Speed reference	Constant speed ¹⁾		Constant speed ²⁾	
In	Status word	Speed actual value	Power ¹⁾		DC bus voltage ¹⁾	

¹⁾ Example

The table below gives the recommended drive parameter settings.

Drive parameter	Setting for ACS880 drives	Description
50.01 FBA A enable	1 = Option slot 1 ²⁾	Enables communication between the drive and the fieldbus adapter module.
50.04 FBA A ref1 type	4 = Speed	Selects the fieldbus A reference 1 type and scaling.
50.07 FBA A act1 type	0 = Auto	Selects the actual value type and scaling according to the currently active Ref1 mode defined in parameter 50.04.
51.01 FBA A type	128 = ETHERNET ¹⁾	Displays the type of the fieldbus adapter module.
51.02 Protocol/Profile	10 = PNIO Pdrive	Selects the PROFINET IO protocol and the PROFIdrive profile.
51.03 Commrate	0 = Auto ²⁾	Ethernet communication rate is negotiated automatically by the device.
51.04 IP configuration	0 = Static IP	Configuration will be obtained from parameters 05...13 or from the PLC via the DCP protocol.
52.01 FBA data in1	4 = SW 16bit ¹⁾	Status word
52.02 FBA data in2	5 = Act1 16bit	Actual value 1
52.03 FBA data in3	01.14	Output power
52.05 FBA data in5	01.11	DC voltage
53.01 FBA data out1	1 = CW 16bit ¹⁾	Control word
53.02 FBA data out2	2 = Ref1 16bit	Reference 1 (speed)
53.03 FBA data out3	22.26	Constant speed 1
53.05 FBA data out5	22.27	Constant speed 2
51.27 FBA A par refresh	1 = Refresh	Validates the FENA-11/-21 configuration parameter settings.
19.12 Ext1 control mode	2 = Speed	Selects speed control as the control mode 1 for external control location 1.



Drive parameter	Setting for ACS880 drives	Description
20.01 Ext1 commands	12 = Fieldbus A	Selects the fieldbus A interface as the source of the start and stop commands for external control location 1.
22.11 Speed ref1 source	4 = FB A ref1	Selects the fieldbus A reference 1 as the source for speed reference 1.

¹⁾ Read-only or automatically detected/set

²⁾ Example

The start sequence for the parameter example above is given below.

Control word:

- Reset the fieldbus communication fault (if active).
- Enter 47Eh (1150 decimal) → READY TO SWITCH ON.
- Enter 47Fh (1151 decimal) → OPERATING (Speed mode).

■ Parameter setting examples – ACS580

Frequency control using PROFIdrive communication profile with PPO Type 4

This example shows how to configure a basic frequency control application that uses the PROFIdrive profile. In addition, some application-specific data is added to the communication.

The start/stop commands and reference are according to the PROFIdrive profile, speed control mode. For more information, see the PROFIdrive state machine on page [335](#).

The reference value ± 16384 (4000h) corresponds to parameter 46.02 Frequency scaling in the forward and reverse directions.

Direction	PZD1	PZD2	PZD3	PZD4	PZD5	PZD6
Out	Control word	Frequency reference	Constant frequency ¹⁾		Constant frequency ²⁾	
In	Status word	Frequency actual value	Power ¹⁾		DC bus voltage ¹⁾	

¹⁾ Example

The table below gives the recommended drive parameter settings.

Drive parameter	Setting for ACS580 drives	Description
50.01 FBA A enable	1 = Option slot 1 ²⁾	Enables communication between the drive and the fieldbus adapter module.
50.04 FBA A ref1 type	0 = Speed or frequency	Selects the fieldbus A reference 1 type and scaling.
50.07 FBA A act1 type	0 = Auto	Selects the actual value type and scaling according to the currently active Ref1 mode defined in parameter 50.04.
51.01 FBA A type	128 = ETHERNET ¹⁾	Displays the type of the fieldbus adapter module.
51.02 Protocol/Profile	10 = PNIO Pdrive	Selects the PROFINET IO protocol and the PROFIdrive profile.
51.03 Commrate	0 = Auto ²⁾	Ethernet communication rate is negotiated automatically by the device.
51.04 IP configuration	0 = Static IP	Configuration will be obtained from parameters 05...13 or from the PLC via the DCP protocol.
52.01 FBA data in1	4 = SW 16bit ¹⁾	Status word
52.02 FBA data in2	5 = Act1 16bit	Actual value 1
52.03 FBA data in3	01.14	Output power
52.05 FBA data in5	01.11	DC voltage
53.01 FBA data out1	1 = CW 16bit ¹⁾	Control word
53.02 FBA data out2	2 = Ref1 16bit	Reference 1 (frequency)
53.03 FBA data out3	28.26	Constant frequency 1
53.05 FBA data out5	28.27	Constant frequency 2
51.27 FBA A par refresh	1 = Refresh	Validates the FENA-11/-21 configuration parameter settings.
19.12 Ext1 control mode	2 = Speed	Selects speed control as the control mode 1 for external control location 1.



Drive parameter	Setting for ACS580 drives	Description
20.01 Ext1 commands	12 = Fieldbus A	Selects the fieldbus A interface as the source of the start and stop commands for external control location 1.
22.11 Speed ref1 source	4 = FB A ref1	Selects the fieldbus A reference 1 as the source for speed reference 1.

¹⁾ Read-only or automatically detected/set

²⁾ Example

The start sequence for the parameter example above is given below.

Control word:

- Reset the fieldbus communication fault (if active).
- Enter 47Eh (1150 decimal) → READY TO SWITCH ON.
- Enter 47Fh (1151 decimal) → OPERATING (Scalar motor control mode).



Configuring the master station

After the adapter module has been initialized by the drive, you must prepare the master station for communication with the module. Examples of an ABB AC500 PLC and Siemens SIMATIC S7 PLC are given below. If you are using another master system, refer to its documentation for more information.

The examples apply to all drive types compatible with the module.

■ Downloading the GSD file

Configuration of the master station requires a type definition (GSD) file. In PROFINET IO, the GSD file is written in XML-based language called GSDML.

Download the FENA GSD file from the Document library (<http://new.abb.com/drives/profitnet>). The file name format is **GSDML-Vx.x-ABB-FENA-yyyymmdd.xml**.

The GSD file describes the vendor-specific and PROFIdrive-specific features of the adapter module. Vendor-specific features can be used, for example, in the ABB Drives communication profile. The PROFIdrive profile supports a set of services described in the PROFIdrive specification.

■ Configuring an ABB AC500 PLC

This example shows how to configure communication between an ABB AC500 PLC and the adapter module using Control Builder Plus PS501, software version 2.1.0 and later.

Before you start, make sure that you have downloaded the FENA GSD file from the Document library.

1. Start the ABB Control Builder software.
2. On the **Tools** menu, select **Device Repository**.



3. In the window that opens, click **Install...** and browse for the GSD file.

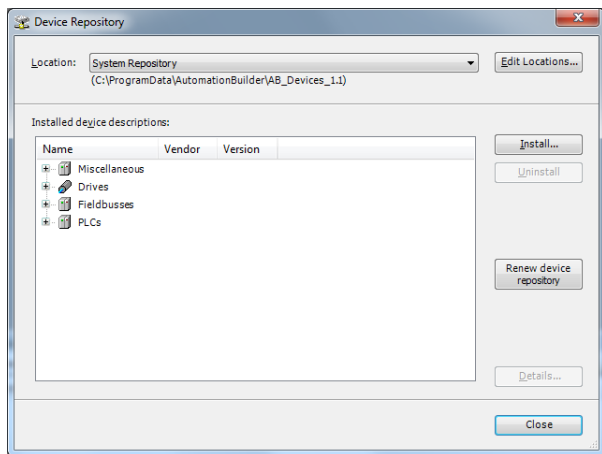

4. Open or create the PLC project that is used to control the drive.
5. Add the CM579-PNIO PROFINET master device to the PLC project, if necessary.
6. Add the adapter module to the PROFINET IO network.
7. Add the I/O module, for example, PPO Type 4 to the adapter module to define cyclical communication between the module and the PLC.



8. Define the CM579-PNIO master properties, such as the IP address and address settings for slaves.

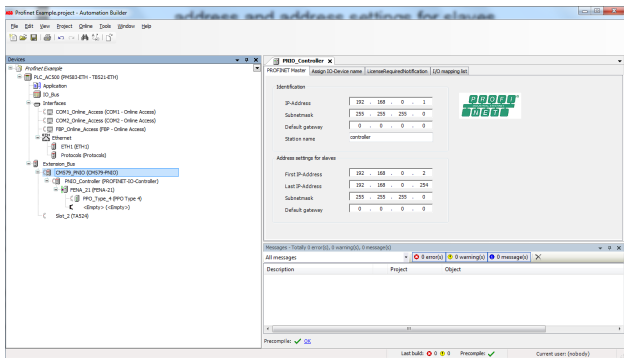

9. Define the adapter module properties:

On the **PNIO identification** tab, select the IP address and Subnet mask, and type the Station name. **Note:** Use only small letters for the Station name.

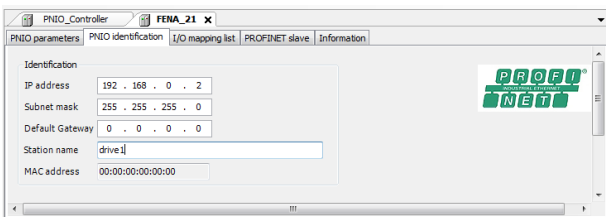

10. Open the PLC program.

11. Compile the project and download it to the PLC.

This is necessary for you to be able to configure the CM579-PNIO master device and allow it to scan the network.

12. Return to the CM579-PNIO master properties. On the **Assign station name** tab, do the following tasks:

- Click **Connect to PLC (Login)** and select the communication link used between Control Builder and the PLC. Then, click **Scan slaves** to find all PROFINET slaves connected to the network.

PNIO_Controller x FENA_21

Diagnostics for ProFINET | PROFINET Master | Assign IO-Device name | LicenseRequiredNotification | I/O mapping list

Connect to PLC (Login) Scan

Disconnect from PLC

Device name	Device type	IP address	MAC address	Vendor Id	Device Id	Device role	Network mask	Gateway address
FENA-11		0.0.0.0	00-1C-01-00-37-B2	26	3	1	0.0.0.0	0.0.0.0

Configure IO-Device name :

Selected IO-Device type :

MAC address of selected IO-Device :

IP address :

Network mask :

Gateway address :

Parameter flag :

Assign IO-Device name Start LED signal

Assign IP configuration Factory reset

- In the **Configure station name** box, select the station name defined for the module in step 9, and then click **Assign station name**.
- In the **IP address** and **Network mask** boxes, select/type the IP address and subnet mask defined in step 9, and then click **Assign IP configuration**.



13. Define the I/O module properties:

- On the **PNIO parameters** tab, configure the Stop mode and Control-zero mode functionalities, and define fail safe values for the PLC output process data (PZDs).

PNIO parameters I/O mapping list PNIO Module I/O Mapping Information

Module Information:

Ident number

Slot number

User Parameters:

Parameters	Value	Allowed values
General parameters		
Stop Mode Action selection	Freeze data	0..2
Control-zero modeselection	Use data	0..1
Fail safe Control Word	0	0..65535
Fail safe Reference	0	0..65535
Fail safe value of Ref PZD3	0	0..65535
Fail safe value of Ref PZD4	0	0..65535
Fail safe value of Ref PZD5	0	0..65535
Fail safe value of Ref PZD6	0	0..65535



- On the **PNIO Module I/O Mapping** tab, type names for the variables that refer to the drive's signals in the PLC program.

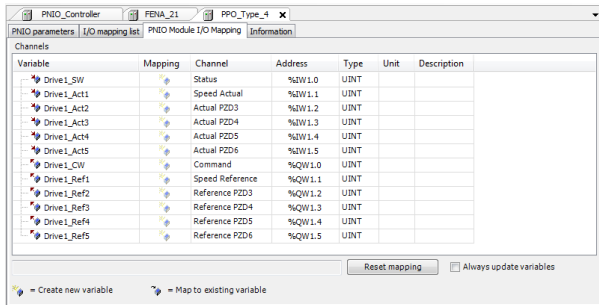

14. Open the PLC program and create a program that controls the drive.

15. Compile the project and download it to the PLC.

Note: Make sure that the variable names defined for the drive's signals are used in the PLC program. Otherwise the communication will not work.

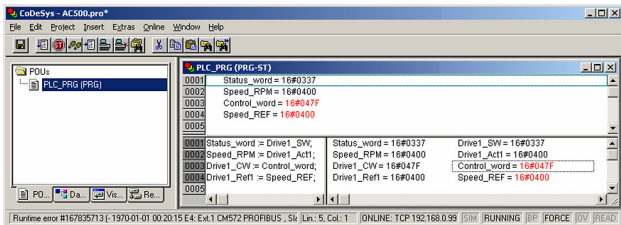

■ Configuring a Siemens SIMATIC S7 PLC

This example shows how to configure communication between a Siemens SIMATIC S7 PLC and the adapter module using SIMATIC Manager Step 7.

Before you start, make sure that you have downloaded the FENA GSD file from the Document library.

1. Start the SIMATIC manager and open/create a SIMATIC program.
2. Open the hardware configuration of the project.

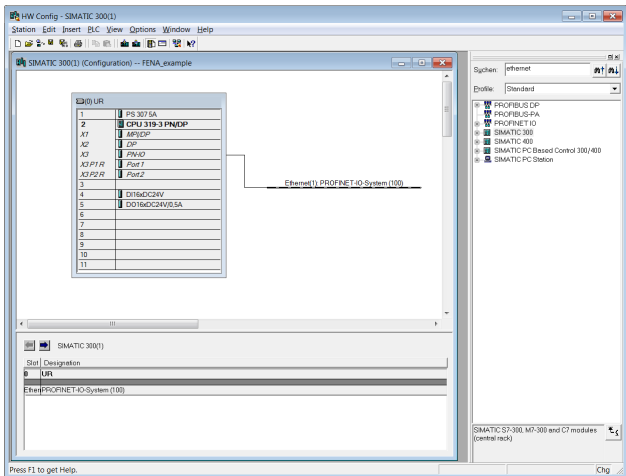

3. Install the FENA GSD file:

- On the **Options** menu, select **Install GSD Files**.
- Browse for the GSD file downloaded from the Document library and click **Install**.

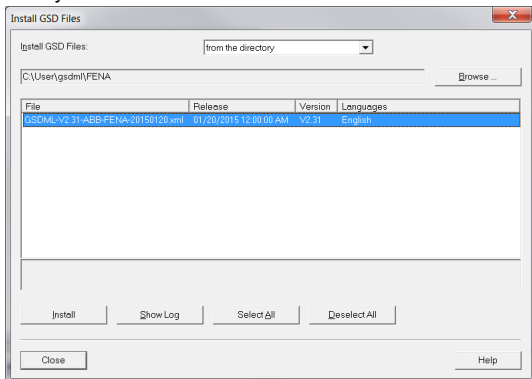

4. Click and drag the FENA object from the device catalog to the Ethernet (1): PROFINET-IO-System.

HW Config - SIMATIC 300(1)

Station Edit Insert PLC View Options Window Help

SIMATIC 300(1) (Configuration) -- FENA_example

System: Standard

Drinks: Standard

PROFINET IO

Additional Field Devices

ABB FENA

FENA-11

FENA-21

PPO Types

PPO Type 3

PPO Type 4

PPO Type 6

PPO Type 7

Standard Telegrams

Gateway

HMI

I/O

Network Components

Sensors

Switching devices

SIMATIC 300

SIMATIC 400

SIMATIC PC Based Control 300/400

SIMATIC PC Station

ABB
PPO Type 7
GSDML-V2.31-ABB-FENA-20150120.xml

Slot	Module	Order number	I address	Q address	Diagnostic address	Comment
0	FENA	6-ES117701452			81B5**	
X7	Interface				81B6**	
X7 A	Port 1				81B7**	
X7 A	Port 2				81B8**	
1	PPO Type 7		286-279	286-279		
2						

Insertion possible

Chg



- Click and drag the PPO Type 7 object to Slot 1.
Then, double-click FENA to open the **Properties** window.

HW Config - SIMATIC 300(1)

Station Edit Insert PLC View Options Window Help

SIMATIC 300(1) (Configuration) -- FENA_example

System: Standard

System Tree:

- PROFIBUS DP
- PROFIBUS-PA
- PROFINET IO
 - Additional Field Devices
 - Drives
 - ABB FENA
 - FENA-01
 - FENA-11
 - FENA-21
 - PPO Types
 - PPO Type 3
 - PPO Type 4
 - PPO Type 6
 - PPO Type 7**
 - PROFISafe telegrams
 - Standard Telegrams
 - Gateway
 - HMI
 - I/O
 - Network Components
 - Sensors
 - Switching devices
 - SIMATIC 300
 - SIMATIC 300
 - SIMATIC PC Based Control 300/400
 - SIMATIC PC Station

Module List (UR):

1	PS 307 5A
2	CPU 319-3 PN/DP
X1	MP/DP
X2	DP
X3	PN/IO
X3 P1 R	Port 1
X3 P2 R	Port 2
3	
4	DI16/DO24V
5	DO16/DO24V/0.5A
6	
7	
8	
9	
10	
11	

Network Diagram: Ethernet1: PROFINET-IO-System (100)

Module Configuration Table:

Slot	Module	Order number	I address	Q address	Diagnostic address	Comment
0	FENA	643817287452			075*	
X1	Interface				076*	
X1 A	Port 1				070*	
X1 A	Port 2				078*	
1	PPO Type 7		56..278	56..278		
2						

ABB
PPO Type 7
GSDML-V2.31-ABB-FENA-20150120.xml

Insertion possible



6. On the **General** tab, type a name for the adapter module in the **Device name** box.

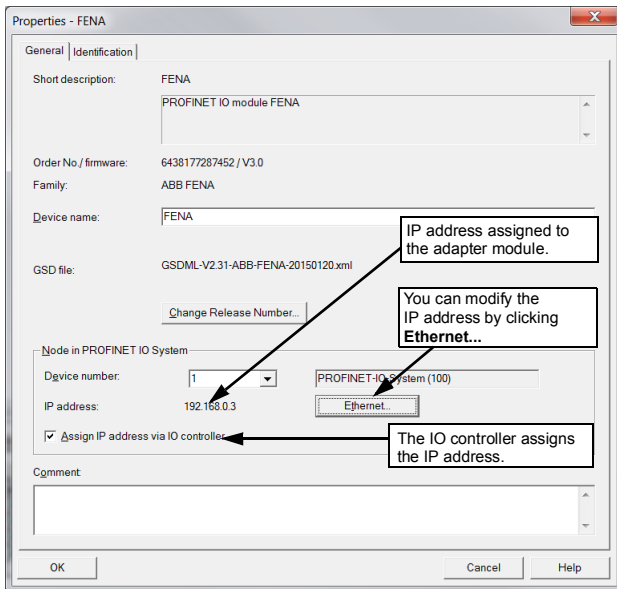

- In the hardware configuration, double-click PPO Type 7 in Slot 1 to open the **Properties** window.
- On the **Parameters** tab, configure the stop mode and control-zero mode functionality, and define fail safe values for the PLC output process data (PZDs).

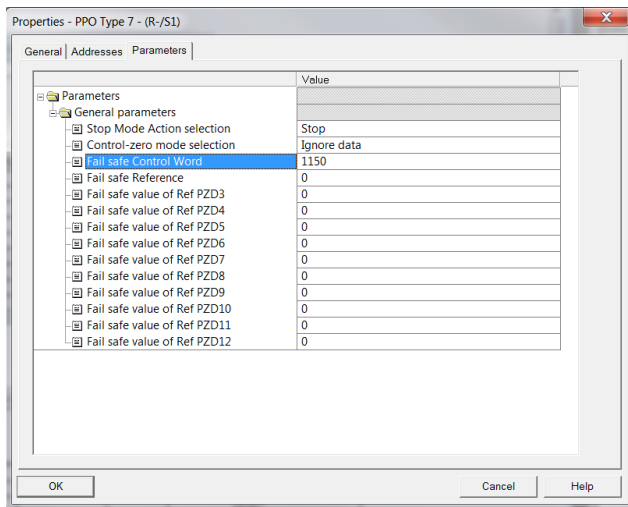

9. Assign the device name (defined in step 6) to the adapter module:

- In the hardware configuration, click FENA.
- On the **PLC** menu, select **Ethernet**, and then select **Assign Device Name**.

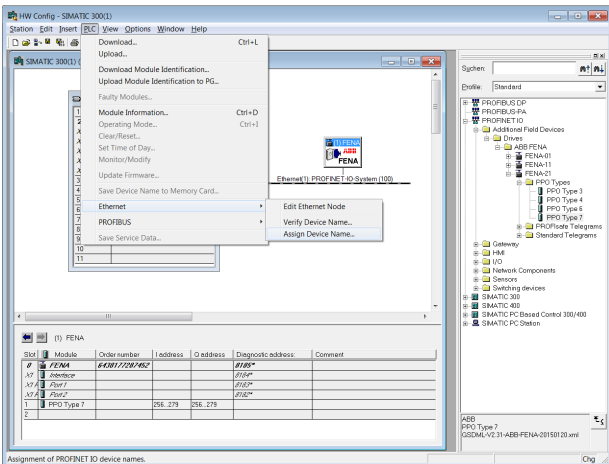

- Click the available device with the correct MAC address to which the device name is to be assigned. This will assign the name to the FENA adapter module. Then click **Assign name**.

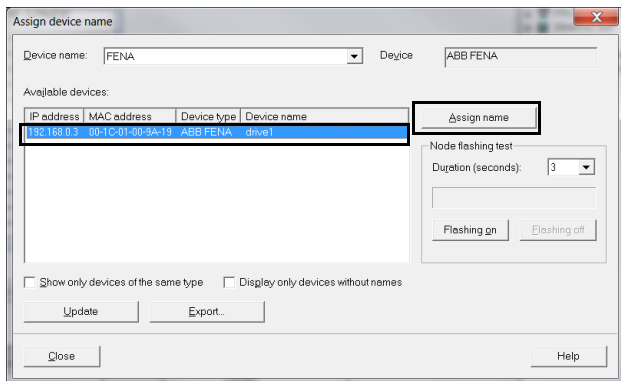

10. Download the hardware configuration to the PLC.

The PLC is now ready for communication with the adapter module.

The screenshot shows the HW Config window for a SIMATIC 300 rack. The rack configuration is as follows:

Slot	Module
1	PS 307 5A
2	CPU 319-3 PN/DP
X1	MP1/DP
X2	DP
X3	PM40
X1 P1 R	Port 1
X1 P2 R	Port 2
3	
4	DI16xDC24V
5	DO16xDC24V/0.5A
6	
7	
8	
9	
10	
11	

The PROFNET IO adapter module is connected to the Ethernet network (Ethernet1: PROFNET-IO-System (100)).

The hardware catalog on the right shows the following configuration:

- PROFIBUS DP
 - PROFIBUS-PA
 - PROFINET IO
 - Additional Field Devices
 - ABB FENA
 - FENA-01
 - FENA-11
 - FENA-21
 - FPO Types
 - PROFsafe Telegrams
 - Standard Telegrams
 - Gateway
 - HMI
 - I/O
 - Network Components
 - Sensors
 - Switching devices
 - SIMATIC 300
 - SIMATIC 400
 - SIMATIC PC Based Control 300/400
 - SIMATIC PC Station

The hardware table at the bottom shows the following configuration:

Slot	M.	Order number	I address	Q address	Diagnostic address	Comment
1	FENA	643817287452			0182*	
X1	MP1/DP				0182*	
X1 A	Port 1				0182*	
X1 A	Port 2				0182*	
1						
2						

The status bar at the bottom indicates "Insertion possible" and "Chg".



■ Resetting PROFINET IO device to factory default via S7

You can reset the PROFINET IO device to factory default.

1. In HW configuration go to **PLC** → **Ethernet** → **Edit Ethernet Node**.

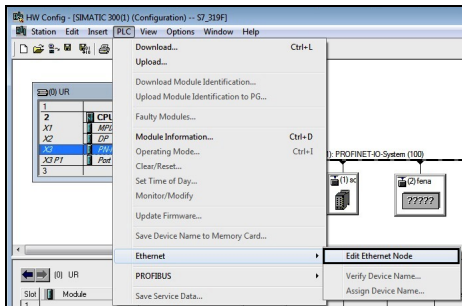

2. In the Edit Ethernet Node window, click **Browse...**

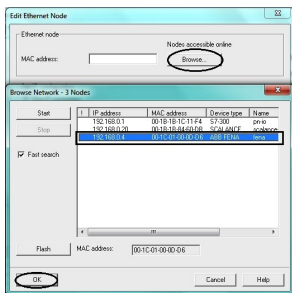

The list of available devices appear.

3. Select the device that needs to be reset to default. Click **OK**.

4. Click **Reset** to clear configuration.

The screenshot shows the 'Edit Ethernet Node' window with the following configuration details:

- Ethernet node:** MAC address: 00-1C-01-00-0D-D6. Nodes accessible online: Browse...
- Set IP configuration:**
 - Use IP parameters:
 - IP address: 192.168.0.4
 - Subnet mask: 255.255.255.0
 - Gateway:
 - Do not use router
 - Use router (Address: 192.168.0.4)
 - Obtain IP address from a DHCP server:
 - Identified by:
 - Client ID
 - MAC address
 - Device name
 - Client ID: [Empty text box]
- Assign device name:** Device name: Iena. Assign Name
- Reset to factory settings:** Reset (circled in black)

5. A pop-up window appears when reset started. Click **OK**.

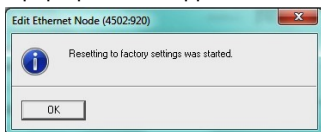

The configuration is now reset to default (Profinet IO station name, Ethernet services configuration).





15

PROFINET IO – Communication profiles

Contents of this chapter

This chapter describes the communication profiles used in the communication between the PROFINET IO master, the adapter module and the drive.

Communication profiles

Communication profiles are ways of conveying control commands (Control word, Status word, references and actual values) between the master station and the drive.

With the FENA adapter module, the PROFINET network may employ either the PROFIdrive profile or the ABB Drives profile. Both are converted to the native profile (eg, DCU or FBA) by the adapter module. In addition, two Transparent modes – for 16-bit and 32-bit words respectively – are available. With the Transparent modes, no data conversion takes place.

The figure below illustrates the profile selection:

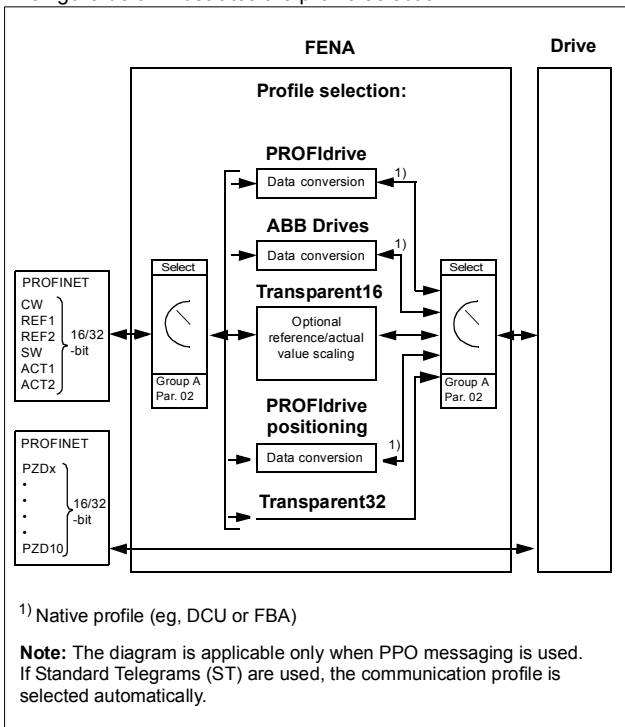

P

The following sections describe the Control word, the Status word, references and actual values for the PROFIdrive and ABB Drives communication profiles. Refer to the drive manuals for details on the native profiles.

PROFIdrive communication profile

Control word and Status word

The Control word (PROFIdrive parameter 967) is the principal means for controlling the drive from a fieldbus system. It is sent by the fieldbus master station to the drive through the adapter module. The drive switches between its states according to the bit-coded instructions in the Control word and returns status information to the master in the Status word (PROFIdrive parameter 968).

The contents of the Control word and the Status word are detailed below. See the drive documentation for information on the drive-specific bits. The drive states are presented on page 335. The drive states for the positioning mode are presented on page 336.

Control word contents

The table below shows the contents of the Control word for the PROFIdrive communication profile (PROFIdrive parameter 967). The upper case boldface text refers to the states shown in the state machine on page 335.

Bit	Name	Value	STATE/Description	
			Speed control mode	Positioning mode
0	ON	1	Proceed to READY TO OPERATE .	
	OFF1	0	Emergency OFF, stop by the selected deceleration ramp. Proceed to OFF1 ACTIVE ; proceed further to READY TO SWITCH ON unless other interlocks (OFF2, OFF3) are active.	
1	OFF2	1	Continue operation (OFF2 inactive).	
		0	Emergency OFF, coast to stop. Proceed to OFF2 ACTIVE ; proceed further to SWITCH-ON INHIBIT .	

Bit	Name	Value	STATE/Description	
			Speed control mode	Positioning mode
2	OFF3	1	Continue operation (OFF3 inactive).	
		0	Emergency stop, stop according to fastest possible deceleration mode. Proceed to OFF3 ACTIVE ; proceed further to SWITCH-ON INHIBIT . Warning: Ensure motor and driven machine can be stopped using this stop mode.	
3	OPERATION_ENABLE	1	Proceed to ENABLE OPERATION .	
		0	Inhibit operation. Proceed to OPERATION INHIBIT .	
4	ENABLE_RAMP_GENERATOR or TRAVERSING_TASK	1	Normal operation. Proceed to RAMP FUNCTION GENERATOR: ENABLE OUTPUT .	Normal operation. Do not reject traversing task.
		0	Stop according to selected stop type.	Reject traversing task.
5		1	Normal operation. Proceed to RAMP FUNCTION GENERATOR: ENABLE ACCELERATION .	Normal operation. No intermediate stop.
		0	Halt ramping (Ramp Function Generator output held).	Intermediate stop

Bit	Name	Value	STATE/Description	
			Speed control mode	Positioning mode
6		1	Normal operation. Proceed to OPERATING . Note: This bit is effective only if the fieldbus interface is set as the source for this signal by drive parameters.	Activate traversing task (0 → 1). This is a toggle bit; each rising edge of signal enables a traversing task or a new set point.
		0	Force Ramp Function Generator input to zero.	
7	RESET	0 → 1	Fault reset if an active fault exists. Proceed to SWITCH-ON INHIBIT . Note: This bit is effective only if the fieldbus interface is set as the source for this signal by drive parameters.	
		0	(Continue normal operation)	
8	JOGGING_1		Jogging 1 (Not supported by all drive types)	
9	JOGGING_2		Jogging 2 (Not supported by all drive types)	
10	REMOTE_CMD	1	Fieldbus control enabled	
		0	Control word <> 0 or reference <> 0: Retain last Control word and reference. Control word = 0 and reference = 0: Fieldbus control enabled.	
11		1	Vendor-specific bit as defined by PROFIdrive parameter 933	Start homing procedure.
		0		Stop homing procedure.
12			Vendor-specific bit as defined by PROFIdrive parameter 934. As default mapped to Drive Main CW bit 12.	
13			Vendor-specific bit as defined by PROFIdrive parameter 935. As default mapped to Drive Main CW bit 13.	

Bit	Name	Value	STATE/Description	
			Speed control mode	Positioning mode
14			Vendor-specific bit as defined by PROFIdrive parameter 936. As default mapped to Drive Main CW bit 14.	
15			Vendor-specific bit as defined by PROFIdrive parameter 937. As default mapped to Drive Main CW bit 15.	

Status word contents

The table below shows the contents of the Status word for the PROFIdrive communication profile (PROFIdrive parameter 968). The upper case boldface text refers to the states shown in the state machine on page [335](#).

Bit	Name	Value	STATE/Description	
			Speed control mode	Positioning mode
0	RDY_ON	1	READY TO SWITCH ON	
		0	NOT READY TO SWITCH ON	
1	RDY_RUN	1	READY TO OPERATE	
		0	OFF1 ACTIVE	
2	RDY_REF	1	ENABLE OPERATION	
		0	OPERATION INHIBIT	
3	TRIPPED	1	FAULT	
		0	No fault	
4	OFF_2_STA	1	OFF2 inactive	
		0	OFF2 ACTIVE	
5	OFF_3_STA	1	OFF3 inactive	
		0	OFF3 ACTIVE	
6	SWC_ON_INHIB	1	SWITCH-ON INHIBIT ACTIVE	
		0	SWITCH-ON INHIBIT NOT ACTIVE	
7	ALARM	1	Warning/Alarm	
		0	No Warning/Alarm	

Bit	Name	Value	STATE/Description	
			Speed control mode	Positioning mode
8	AT_SETPOINT	1	OPERATING. Actual value equals reference value (= is within tolerance limits).	
		0	Actual value differs from reference value (= is outside tolerance limits).	
9	REMOTE	1	Automation system is requested to assume control.	
		0	Control by automation system is not possible. Control is possible only at the device or by another interface.	
10		1	Actual frequency or speed value equals or is greater than supervision limit.	Target position reached.
		0	Actual frequency or speed value is within supervision limit.	Not at target position
11		1	Mapped to PROFIdrive SW bit 11.	Homing procedure was executed and is valid.
		0	Vendor-specific bit as defined by PROFIdrive parameter 939. As default mapped to PROFIdrive SW bit 11.	No valid home position available.

Bit	Name	Value	STATE/Description	
			Speed control mode	Positioning mode
12		1	Mapped to PROFIdrive SW bit 11. Vendor-specific bit as defined by PROFIdrive parameter 940. As default mapped to PROFIdrive SW bit 12.	Traversing task acknowledgement (0 → 1)
		0		
13		1	Mapped to PROFIdrive SW bit 11. Vendor-specific bit as defined by PROFIdrive parameter 941. As default mapped to PROFIdrive SW bit 13.	Drive stopped.
		0		Drive moving. Traversing task is executed (n <> 0).
14			Vendor-specific bit as defined by PROFIdrive parameter 942. As default mapped to PROFIdrive SW bit 14.	
15			Vendor-specific bit as defined by PROFIdrive parameter 943	

State machine for all operating modes

The general PROFdrive state machine for all operating modes is shown below.

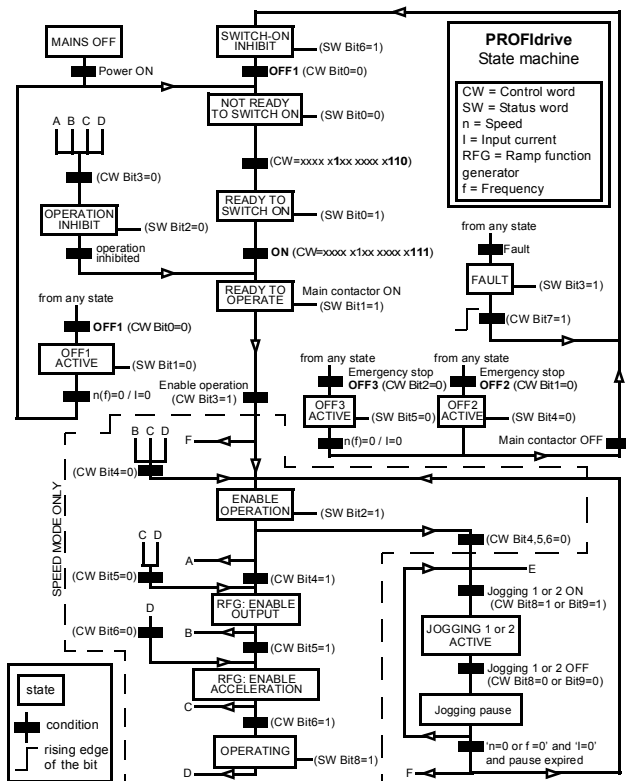

State machine for the positioning mode

The PROFdrive state machine for the positioning mode is shown below.

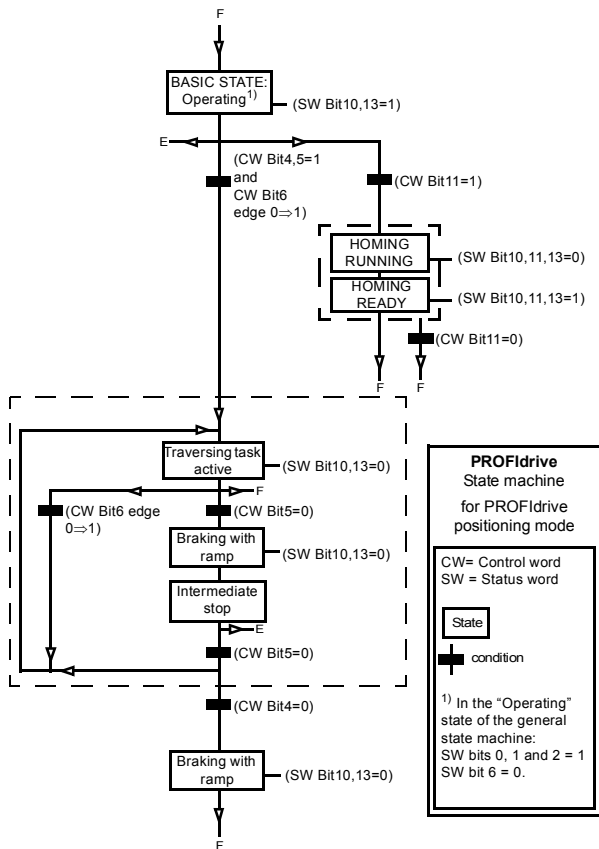

■ References

ABB drives can receive control information from multiple sources including analog and digital inputs, the drive control panel and a fieldbus adapter module (for example, FENA). To have the drive controlled through PROFINET, you must select the module as the source for control information, for example, reference.

References in speed control mode

In the speed control mode, references are 16-bit or 32-bit words containing a sign bit and a 15-bit or 31-bit integer. A negative reference (indicating reversed direction of rotation) is formed by calculating the two's complement from the corresponding positive reference.

A 16-bit speed reference (REF or NSOLL_A) in hexadecimal (0...4000h) corresponds to 0...100% of Maximum Reference (as defined with a drive parameter).

A 32-bit speed reference (NSOLL_B) in hexadecimal (0...4000 0000h) corresponds to 0...100% of Maximum Reference (as defined with a drive parameter).

References in positioning mode (ACSM1 only)

In the positioning mode, references are 16-bit or 32-bit words. A 32-bit reference contains a sign bit and a 31-bit integer. A negative reference (indicating reversed direction of rotation) is formed by calculating the two's complement from the corresponding positive reference.

For a 32-bit position reference (XSOLL_A), the unit and scaling are defined with drive parameters (for example, POS UNIT, POS2INT SCALE and FEED CONST).

For a 32-bit velocity reference (VELOCITY_A), the unit and scaling are defined with drive parameters (for example, POS SPEED UNIT and POS SPEED2INT).

■ Actual values

Actual values are 16-bit or 32-bit words containing information on the operation of the drive. The functions to be monitored are selected with a drive parameter.

Actual values in speed control mode

The scaling of 16-bit actual speed values (ACT or NIST_A) in hexadecimal (0...4000h) corresponds to 0...100% of the maximum reference (as defined with a drive parameter, for example, speed scaling in ACSM1, ACS850, ACQ810, ACS880 and ACS580, and external reference in ACS355).

The scaling of 32-bit actual speed values (NIST_B) in hexadecimal (0...4000 0000h) corresponds to 0...100% of the maximum reference (as defined with a drive parameter, for example, speed scaling in ACSM1, ACS850, ACQ810, ACS880 and ACS580, and external reference in ACS355).

Actual values in positioning mode (ACSM1 only)

For a 32-bit actual position value (XIST_A), the unit and scaling are defined with drive parameters (for example, POS UNIT, POS2INT SCALE and FEED CONST).

ABB Drives communication profile

■ Control word and Status word

The Control word is the principal means for controlling the drive from a fieldbus system. It is sent by the fieldbus master station to the drive through the adapter module. The drive switches between its states according to the bit-coded instructions in the Control word and returns status information to the master in the Status word.

The contents of the Control word and the Status word are detailed below. The drive states are presented on page 343.

Control word contents

The table below shows the contents of the Control word for the ABB Drives communication profile. The upper case boldface text refers to the states shown on page 343.

Bit	Name	Value	STATE/Description
0	OFF1_ CONTROL	1	Proceed to READY TO OPERATE .
		0	Stop along currently active deceleration ramp. Proceed to OFF1 ACTIVE ; proceed to READY TO SWITCH ON unless other interlocks (OFF2, OFF3) are active.
1	OFF2_ CONTROL	1	Continue operation (OFF2 inactive).
		0	Emergency OFF, coast to stop. Proceed to OFF2 ACTIVE , proceed to SWITCH-ON INHIBITED .
2	OFF3_ CONTROL	1	Continue operation (OFF3 inactive).
		0	Emergency stop, stop within time defined by drive parameter. Proceed to OFF3 ACTIVE ; proceed to SWITCH-ON INHIBITED . Warning: Ensure that motor and driven machine can be stopped using this stop mode.

Bit	Name	Value	STATE/Description
3	INHIBIT_OPERATION	1	Proceed to OPERATION ENABLED . Note: Run enable signal must be active; see drive documentation. If the drive is set to receive the Run enable signal from the fieldbus, this bit activates the signal.
		0	Inhibit operation. Proceed to OPERATION INHIBITED .
4	RAMP_OUT_ZERO	1	Normal operation. Proceed to RAMP FUNCTION GENERATOR: OUTPUT ENABLED .
		0	Force Ramp Function Generator output to zero. Drive ramps to stop (current and DC voltage limits in force).
5	RAMP_HOLD	1	Enable ramp function. Proceed to RAMP FUNCTION GENERATOR: ACCELERATOR ENABLED .
		0	Halt ramping (Ramp Function Generator output held).
6	RAMP_IN_ZERO	1	Normal operation. Proceed to OPERATION . Note: This bit is effective only if the fieldbus interface is set as the source for this signal by drive parameters.
		0	Force Ramp Function Generator input to zero.
7	RESET	0 → 1	Fault reset if an active fault exists. Proceed to SWITCH-ON INHIBITED . Note: This bit is effective only if the fieldbus interface is set as the source for this signal by drive parameters.
		0	Continue normal operation.
8...9	Reserved		

Bit	Name	Value	STATE/Description
10	REMOTE_CMD	1	Fieldbus control enabled
		0	Control word and reference not getting through to the drive, except for CW bits OFF1, OFF2 and OFF3.
11	EXT_CTRL_LOC	1	Select External Control Location EXT2. Effective if control location parameterized to be selected from fieldbus.
		0	Select External Control Location EXT1. Effective if control location parameterized to be selected from fieldbus.
12... 15	Drive-specific (For information, see the drive documentation.)		

Status word contents

The table below shows the contents of the Status word for the ABB Drives communication profile. The upper case boldface text refers to the states shown on page [343](#).

Bit	Name	Value	STATE/Description
0	RDY_ON	1	READY TO SWITCH ON
		0	NOT READY TO SWITCH ON
1	RDY_RUN	1	READY TO OPERATE
		0	OFF1 ACTIVE
2	RDY_REF	1	OPERATION ENABLED
		0	OPERATION INHIBITED
3	TRIPPED	1	FAULT
		0	No fault
4	OFF_2_STA	1	OFF2 inactive
		0	OFF2 ACTIVE
5	OFF_3_STA	1	OFF3 inactive
		0	OFF3 ACTIVE
6	SWC_ON_INHIB	1	SWITCH-ON INHIBITED
		0	–

Bit	Name	Value	STATE/Description
7	ALARM	1	Warning/Alarm
		0	No warning/alarm
8	AT_SETPOINT	1	OPERATION. Actual value equals reference (= is within tolerance limits, ie, in speed control, speed error is 10% max. of nominal motor speed).
		0	Actual value differs from reference (= is outside tolerance limits).
9	REMOTE	1	Drive control location: REMOTE (EXT1 or EXT2)
		0	Drive control location: LOCAL
10	ABOVE_LIMIT	1	Actual frequency or speed equals or exceeds supervision limit (set by drive parameter). Valid in both directions of rotation.
		0	Actual frequency or speed within supervision limit
11	EXT_CTRL_LOC	1	External Control Location EXT2 selected. Note concerning ACS880: This bit is effective only if the fieldbus interface is set as the target for this signal by drive parameters. User bit 0 selection (06.33)
		0	External Control Location EXT1 selected
12	EXT_RUN_ENABLE	1	External Run Enable signal received. Note concerning ACS880: This bit is effective only if the fieldbus interface is set as the target for this signal by drive parameters. User bit 1 selection (06.34)
		0	No External Run Enable signal received
13... 14	Drive-specific (For information, see the drive documentation.)		
15	FBA_ERROR	1	Communication error detected by fieldbus adapter module
		0	Fieldbus adapter communication OK

State machine

The state machine for the ABB Drives communication profile is shown below.

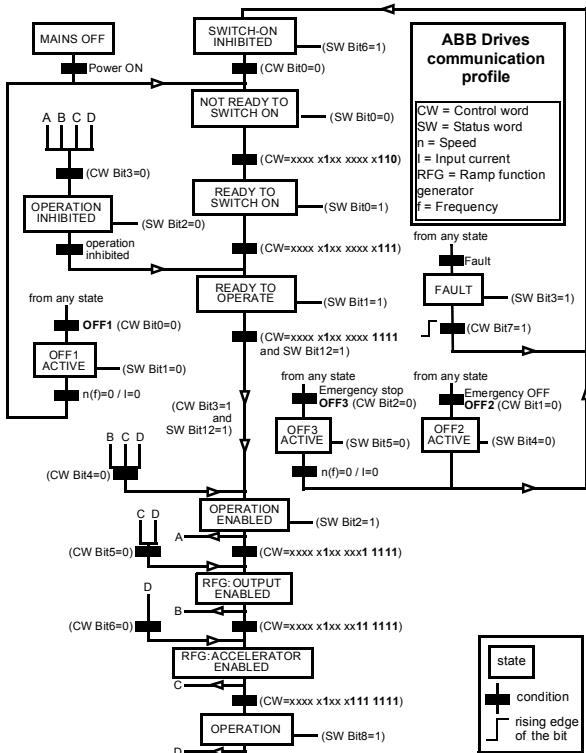

References

References are 16-bit words containing a sign bit and a 15-bit integer. A negative reference (indicating reversed direction of rotation) is formed by calculating the two's complement from the corresponding positive reference.

ABB drives can receive control information from multiple sources including analog and digital inputs, the drive control panel and a fieldbus adapter module (for example, FENA). To have the drive controlled through the fieldbus, you must select the module as the source for control information, for example, reference.

Scaling

References are scaled as shown below.

Note: The values of REF1 MAX and REF2 MAX are set with drive parameters. See the drive manuals for further information.

In ACSM1, ACS850, ACQ810, ACS880 and ACS580, the speed reference (REFx) in decimal (0...20000) corresponds to 0...100% of the speed scaling value (as defined with a drive parameter).

In ACS355, drive parameter REFx MIN may limit the actual minimum reference.

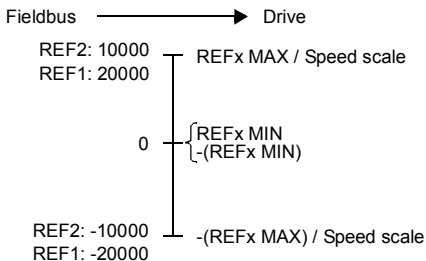

Actual values

Actual values are 16-bit words containing information on the operation of the drive. The functions to be monitored are selected with a drive parameter.

Scaling

Actual values are scaled as shown below.

Note: The values of REF1 MAX and REF2 MAX are set with drive parameters. See the drive manuals for further information.

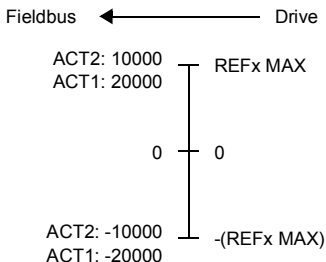

16

PROFINET IO – Communication protocol

Contents of this chapter

This chapter describes the PROFINET IO communication protocol for the adapter module. For detailed information on PROFINET IO communication, refer to *PROFINET specification Application Layer protocol for decentralized periphery and distributed automation v2.0*.

PROFINET IO

PROFINET IO is a fieldbus protocol that enables communication between programmable controllers and distributed field devices in an Ethernet network. The protocol classifies devices into I/O controllers, I/O supervisors and I/O devices, which have a specific collection of services.

PROFINET IO uses three different communication channels to exchange data:

- The standard UDP/IP and TCP/IP channel is used for parameterization and configuration of devices and for acyclic operations.
- The real time (RT) channel is used for cyclic data transfer and alarms.
- The isochronous real time (IRT) channel is used, for example, in motion control applications (not implemented in FENA).

PROFINET IO devices are structured in slots and sub-slots, which can contain modules and sub-modules correspondingly. A device can have almost any number of slots and sub-slots, and they can be virtual or real. Device-specific data is represented in slot 0; module-specific and sub-module-specific data in subsequent slots and sub-slots.

One of the benefits of PROFINET IO is the diagnostics and alarm mechanism. Every module and sub-module provide alarm data to the I/O controller using the cyclic channel. Diagnostic data can be read non-cyclically from the device by using record data.

The properties and services of a PROFINET IO device are described in a GSD file written in GSDML (General Station Description Markup Language). The GSD file describes the device-specific modules and the method of assigning modules and sub-modules to predefined slots and sub-slots. For more information, see section [Downloading the GSD file](#) on page 309.

PROFINET network settings

In PROFINET, network devices are identified with station names. The controller uses DCP (Discovery and Configuration protocol) to find devices with configured names from the network. Device with the given name responds with an Identity response which also contains the current IP address of the device.

If the current IP address differs from the address in the hardware configuration of the controller, the controller sets the device with a new IP address according to the configuration. This IP is set as temporary, which means that after reboot of the device, the IP address will be 0.0.0.0 as specified in the PROFINET standard.

The recommended IP setting for PROFINET is Static IP and address is 0.0.0.0. With this setting, there is need to configure the IP in only one place (hardware configuration) and this avoids any IP conflicts among the devices.

PROFINET IO in FENA

When PROFINET IO is selected as the communication protocol, the FENA adapter module can employ the ABB Drives, Transparent 16 and Transparent 32 communication profiles or the PROFIdrive profile. You can select the profile with a GSD file in a PROFINET IO hardware configuration tool. You can select the appropriate device access point (DAP) and functional module with the tool as well.

The adapter module uses slots 0, 1 and 2.

- Slot 0 does not have any sub-slots, and the DAP module attached to it represents the device itself.
- Slot 1 and its sub-slots support other functional modules and sub-modules described in the GSD file.
- Slot 2 is supported with FENA-11 and FENA-21

In the ABB Drives and Transparent profiles:

- Slot 0 = Device access point (DAP)
- Slot 1, sub-slot 1 = Vendor object (PPO types)
- Slot 1, sub-slot 1 = Acyclic parameter access (MAP/PAP)
- Slot 2, sub-slot 1 = PROFIsafe telegram

In the PROFIdrive profile:

- Slot 0 = Device access point
- Slot 1 = Drive object
- Slot 1, sub-slot 1 = Acyclic parameter access (MAP/PAP)
- Slot 1, sub-slot 2 = Standard telegram
- Slot 2, sub-slot 1 = PROFIsafe telegram

The adapter module provides the following services:

- Cyclic messaging
- Acyclic parameter access mechanism
- Identification & Maintenance functions (I&M)
- PROFIdrive parameters (limited in the ABB Drives and Transparent profiles)
- Diagnostic and alarm mechanism (only with the PROFIdrive profile)
- Fault buffer mechanism (limited in the ABB Drives and Transparent profiles).

Cyclic message types

PPO types

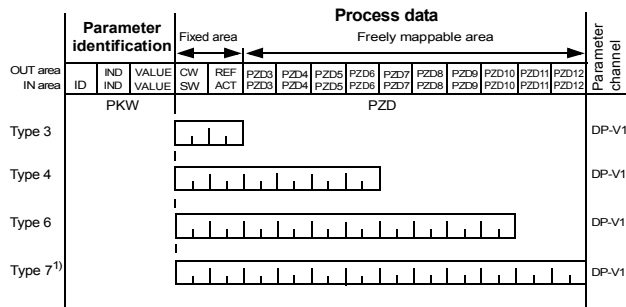

OUT area – Data sent from master to slave (control data)

IN area – Data sent from slave to master (actual data)

Parameter identification:

ID – Parameter identification

IND – Index for arrays

VALUE – Parameter value (Max. 4 bytes)

PKW – Parameter ID/value

Process data:

CW – Control word

SW – Status word

REF – Reference

ACT – Actual value

PZD – Process data (application-specific)

DW – Data word

¹⁾ Not supported by ACS355 drives

Standard telegram (ST) types (DP-V1)

ST1	PZD1	PZD2
OUT area	STW1 Control word 1	NSOLL_A Speed set point A
IN area	ZSW1 Status word 1	NIST_A Speed actual value A

ST2	PZD1	PZD2...3	PZD4
OUT area	STW1 Control word 1	NSOLL_B Speed set point B	STW2 Control word 2
IN area	ZSW1 Status word 1	NIST_B Speed actual value B	ZSW2 Status word 2

Note: For the contents of the Control word, the Status word, references and actual values, see chapter [PROFINET IO – Communication profiles](#).

Parameter handling using acyclic parameter access mechanism (DP-V1)

PROFINET IO offers record read and write services for the acyclic parameter access mechanism. When the drive parameters or FENA parameters are accessed, the corresponding slot, sub-slot and index are set, and a PROFIdrive DP-V1 message is placed on the data block of the record read or write frame.

■ Header and frame structures

PROFINET IO uses the DCE RPC (Distributed Computing Environment Remote Procedure Call) protocol for acyclic read and write services. I/O controllers and supervisors take care of formulating most of the request frames. However, it is possible that handling the PROFIdrive request and response headers must be performed in the application logic. The acyclic frame structure, headers and error codes are described further below.

Frames	Dest addr.	Src addr.	Ether type	IP UDP	RPC	NDR	Read or Write	Data
Bytes	6	6	2	28	80	20	64	...

Dest addr. and **Src addr.** are the destination and the source of the communication relationship. The addresses are in hexadecimal format, for example, 00-30-11-02-57-AD.

Ether type is 0x800 for non-real-time communication.

IP and **UDP** fields contain the IP address of the source and the destination as well as the communication ports and length of the message.

RPC contains, for example, the read or write service ID, interface description and selected objects.

NDR request block describes the length of the following data block. The response block also contains bytes **ErrorCode**, **ErrorDecode**, **ErrorCode1** and **ErrorCode2** for presenting the status of the request. The response error codes are listed in the table below.

Byte	Value and meaning
P ErrorCode	0xDF (Error Write)
	0xDE (Error Read)
ErrorDecode	0x80 (PNIORW) ErrorCode1 decoded as shown in section Error Code 1 on page 355. ErrorCode2 is 0.
	0x81 (PNIO) ErrorCode1 and ErrorCode2 decoded as shown in section Error Code 1 on page 355.
ErrorCode1	Error class and error code. See section Error Code 1 on page 355.
ErrorCode2	Not described here

ErrorCode1

The table below lists the ErrorCode1 with PNIOBW decoding.

Error class	Meaning	Error code
0...9	(Reserved)	
10 (0x0A)	Application	0 = Read error 1 = Write error 2 = Module failure 3...7 = Reserved 8 = Version conflict 9 = Feature not supported 10...15 = User-specific
11 (0x0B)	Access	0 = Invalid index 1 = Write length error 2 = Invalid slot 3 = Type conflict 4 = Invalid area 5 = State conflict 6 = Access denied 7 = Invalid range 8 = Invalid parameter 9 = Invalid type 10...15 = User-specific
12 (0x0C)	Resource	0 = Read constraint conflict 1 = Write constraint conflict 2 = Resource busy 3 = Resource unavailable 4...7 = Reserved 8...15 = User-specific
13...15	User-specific	

■ DP-V1 read/write request sequence

A read/write service on a drive parameter is illustrated below.

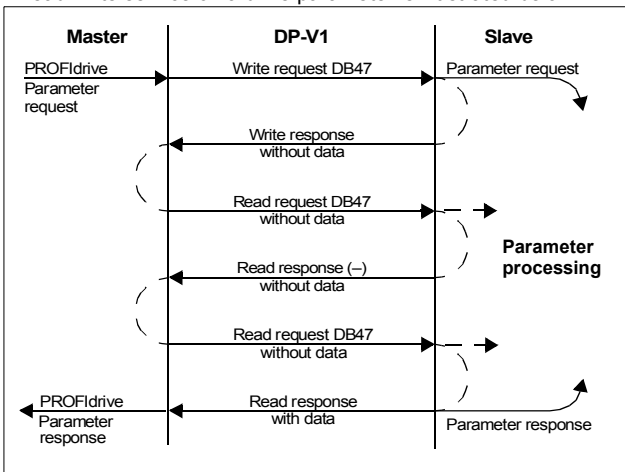

The messaging employs DP-V1 data units. The PROFdrive parameter request is included within the DP-V1 request as data. Likewise, the DP-V1 response contains the PROFdrive parameter response as data.

A write request is first sent containing the parameter request. If the write request is valid, the adapter module acknowledges it with a DP-V1 write response with no data. The master will then send a read request. If the adapter module is still busy performing the internal parameter request, it will return a negative response with the DP-V1 error code B5h (State conflict). In this case, the master will repeat the read request until the adapter module has the PROFdrive response data ready.

P

If the write request is invalid, a negative response is returned with a DP-V1 error code (see section [ErrorCode1](#) on page 355).

Read and write blocks

A read block is used in read requests and responses, while a write block is used in write requests and responses. A request consists of unique identifiers for the connection, addressing information and the length of the record data. A response also contains two additional fields for transferring information.

The table below shows the structure of the read and write blocks in detail.

Field(s)	Description	Range	Type
Service	Request or Response service	Request (0x00) Response (0x80)	UI8
Operation	Read or Write operation	Write (0x08) Read (0x09)	UI8
Block length	Length of the block	0...0xFFFF	UI16
ARJUID	Identifier <ul style="list-style-type: none"> • time low • time mid • time high and version • clock • node 		UI32 UI16 UI16 Octet[2] Octet[6]
API	Application process identifier	Device access point (0x0000) PROFIdrive (0x3A00)	UI32
Slot	Slot of the module access point (MAP/PAP)	0x01	UI16
Subslot	Subslot of the module access point (MAP/PAP)	0x01	UI16
Padding	2 bytes		
Index	Index of the record data object	0x2F 0xB02E 0xB02F	UI16
Data length	Length of the data block	0...0xFFFFFFFF	UI32

Field(s)	Description	Range	Type
Additional value 1 (response only)	Field for transferring additional data		UI16
Additional value 2 (response only)	Field for transferring additional data		UI16
Padding	24 bytes for request, 20 bytes for response.		
Data block	Used only with write request and read response.		

Data block

The data block contains a PROFIdrive-specific request or response header.

The table below shows the contents of the PROFIdrive request.

Field(s)	Description	Range	Byte/ Word
Request Reference	Unique identification set by the master. Changed for each new request.	1...255	Byte
Request ID	Request type for the issued block	Request Parameter (01h) Change Parameter (02h)	Byte
Drive Object ID	To be set to 0 or 1.	0...255	Byte
No. of Parameters	Number of the parameters that are present in the request	1...37	Byte
Attribute	Type of the object being accessed. Note: "Description" and "Text" are not supported.	Value (10h) Description (20h) Text (30h)	Byte
No. of Elements	Number of the array elements accessed or length of the string accessed. Set to 0 if non-array parameters are used.	0, 1...234	Byte

Field(s)	Description	Range	Byte/ Word
Parameter Index	Address of the parameter that is being accessed. "0" is allowed by FENA.	1...65535	Word
Subindex	Addresses <ul style="list-style-type: none"> • the first array element of the parameter or • the beginning of a string access or • the text array or • the description element that is being accessed 	0...65535	Word
Format ¹⁾	See the table on page 361.	See the table on page 361.	Byte
Number of Values ¹⁾	Number of the values following	0...234	Byte
Values ¹⁾	The values of the request. In case of an odd number of bytes, a zero byte is appended to ensure the word structure of the telegram.	–	See the <i>Format</i> field.

¹⁾ Only if Request ID is 02h (Change Parameter). The Format, Number of Values and Values fields are repeated for other parameters.

The table below shows the contents of the PROFIdrive response.

Field(s)	Description	Range
Request Reference (mirrored)	Mirrored from the request.	1...255
Response ID	Response from the slave. In case any requested services fail, a “not acknowledged” (NAK) response will be indicated.	Request Param OK (01h) Request Param NAK (81h) Change Param OK (02h) Change Param NAK (82h)
Drive Object ID	To be set to 1.	0...255
No. of Parameters	Number of the parameters that are present in the response	1...37
Format ¹⁾	See the table on page 361.	See the table on page 361.
Number of Values ¹⁾	Number of the values following	0...234
Values ¹⁾	The values of the request. In case of an odd number of bytes, a zero byte is appended to ensure the word structure of the telegram.	–

¹⁾ Only if Response ID is 01h (Request Parameter OK). The Format, Number of Values and Values fields are repeated for other parameters.

The table below shows the data types for the *Format* field in the PROFIdrive response.

Code	Type
0x00	(Reserved)
0x01...0x36	Standard data types 1 Boolean (not supported) 2 Integer8 (not supported) 3 Integer16 4 Integer32 5 Unsigned8 (not supported) 6 Unsigned16 7 Unsigned32 8 Floating point (not supported) 9 Visible string (not supported) ...
0x37...0x3F	(Reserved)
0x40	Zero
0x41	Byte
0x42	Word
0x43	Double word
0x44	Error
0x45...0xFF	(Reserved)

The table below shows the PROFIdrive parameter request error codes.

Error #	Meaning	Used at
00h	Impermissible parameter number	Access to an unavailable parameter
01h	Parameter value cannot be changed	Change access to a parameter value that cannot be changed
02h	Low or high limit exceeded	Change access with a value outside the limits
03h	Invalid subindex	Access to an unavailable subindex
04h	No array	Access with a subindex to a non-indexed parameter
05h	Incorrect data type	Change access with a value that does not match the data type of the parameter
06h	Setting not permitted (can only be reset)	Change access with a value unequal to 0 when this is not permitted
07h	Description element cannot be changed	Change access to a description element that cannot be changed
09h	No description data available	Access to an unavailable description (parameter value is available)
0Bh	No operation priority	Change access rights without rights to change parameters
0Fh	No text array available	Access to a text array that is not available (Parameter value is available.)
11h	Request cannot be executed because of operating mode	Access is temporarily not possible for reasons that are not specified in detail.
14h	Value impermissible	Change access with a value that is within limits but is not permissible for other long-term reasons (parameter with defined single values)
15h	Response too long	The length of the current response exceeds the maximum transmittable length.

Error #	Meaning	Used at
16h	Parameter address impermissible	Illegal value or value that is not supported for the attribute, number of elements, parameter number or sub-index, or a combination
17h	Illegal format	Write request: Illegal format or format of parameter data that is not supported
18h	Number of values inconsistent	Write request: Number of values of the parameter data does not match the number of elements at the parameter address.
65h...FF	Manufacturer-specific error area	–
65h	Vendor-specific error	Vendor-specific error
66h	Request not supported	Request not supported
67h	Communication error	Request cannot be completed because of a communication error.
6Eh	Non-volatile error	Failure during write to non-volatile memory
6Fh	Time-out error	Request aborted because of a timeout.
78h	PZD map failure	Parameter cannot be mapped to PZD (size mismatch or non-existent).
79h	PZD memory failure	Parameter cannot be mapped to PZD (out of memory).
7Ah	Multiple PZD map	Parameter cannot be mapped to PZD (multiple PZD write).
82h	Control word bit map	Cannot map Control word bit (parameter 933...937, eg, double mapping of bits).
8Ch	Set torque mode error	Cannot change mode to TORQUE (frequency is used).
90h	Illegal Request ID	The request ID of the response is illegal.

Error #	Meaning	Used at
96h	Internal buffer	Buffer overflow
A0h	Internal communication	Communication error between the module and the drive

■ Function blocks for sending DP-V1 messages (Siemens S7)

In IEC 61131-3 compatible systems, function blocks are available for accessing data non-cyclically. In Siemens S7, SFB 52 "RDREC" can be used for reading and SFB53 "WRREC" for writing data records as follows:

- On INDEX: Connect the value 0xB02F, 0xB02E or 0x2F.
- On Write record: Set the length of the DP-V1 write request to MLEN.
- On Read record: Set the maximum length of the DP-V1 read response.
- Connect the DP-V1 message to RECORD.

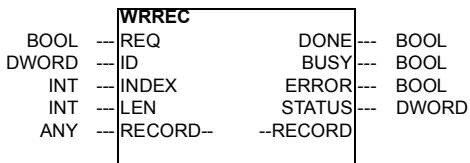
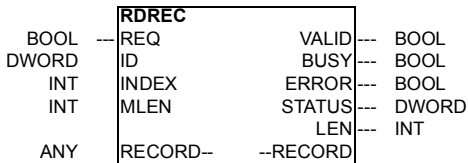

For more information on the above function blocks, see document *Communication Function Blocks for PROFIBUS DP and PROFINET IO v2.0* available at www.profibus.com.

Parameter data transfer examples

The following examples show how parameter data is transferred using the DP-V1 mechanisms READ and WRITE.

Note: Only the data block part of the request is presented in the examples. See section [Read and write blocks](#) on page 357.

Example 1a: Reading a drive parameter (array element)

Drive parameters are addressed so that the drive parameter group corresponds to the *Parameter index* (PNU), and the drive parameter number within the group corresponds to the *Subindex* (IND). In the following example, a value is read from drive parameter 12.04 (0C.04h).

- DP-V1 Write request (Read parameter value):

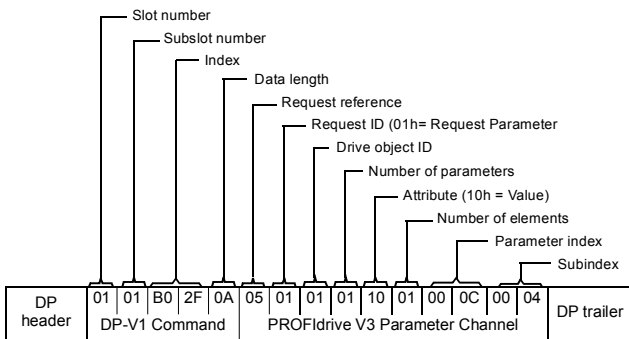

- Positive Read response to DP-V1 Read request:

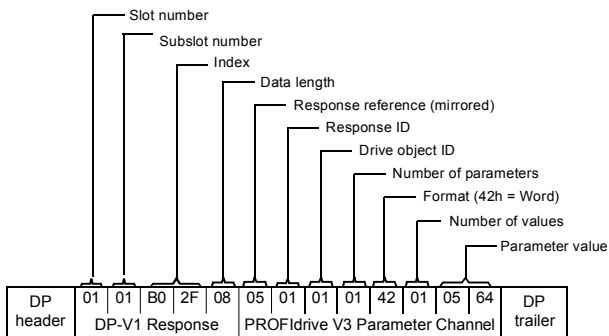

- Negative response to PROFdrive Read request:

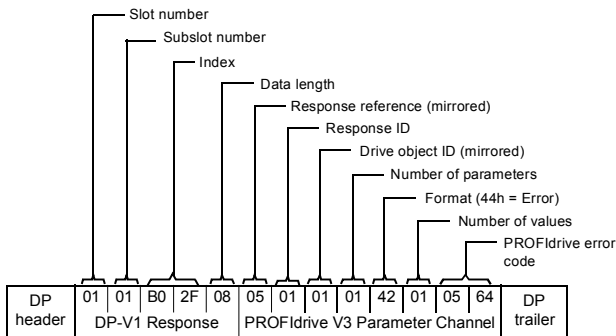

Example 1b: Reading 3 drive parameters (multi-parameter)

In this example, three parameters (12.04, 20.08 and 30.19) are read using one telegram.

- DP-V1 Write request (Read parameter value):

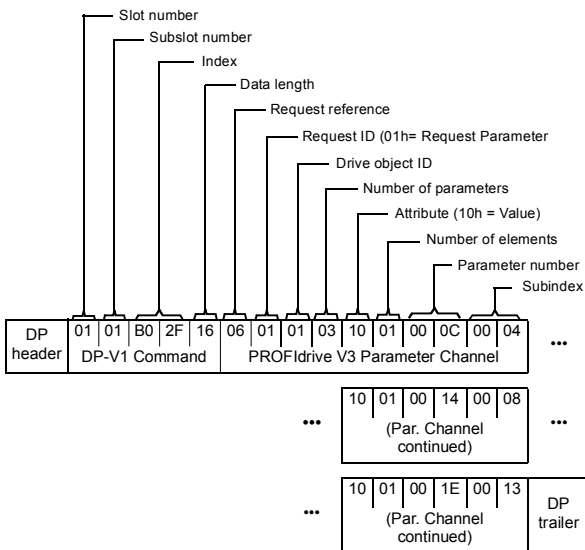

- Positive Read response to DP-V1 Read request:

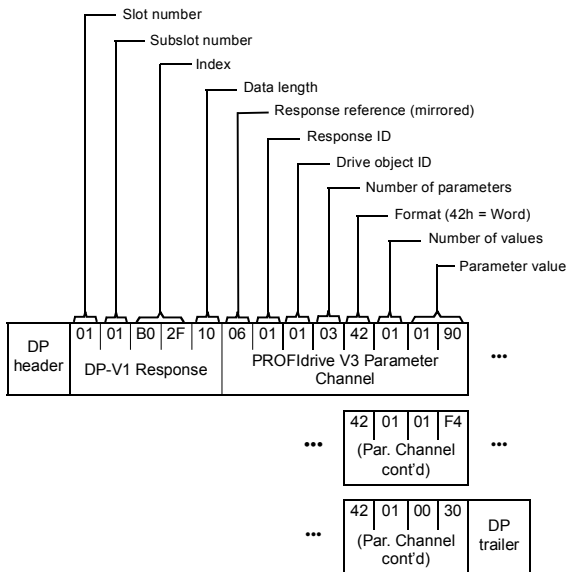

The values 190h (400), 1F4h (500) and 1Eh (30) are returned.

Example 2a: Writing a drive parameter (one array element)

Drive parameters are addressed so that the drive parameter group corresponds to the *Parameter index* (PNU), and the drive parameter number within that group corresponds to the *Subindex* (IND). In the following example, a value is written to drive parameter 12.02 (0C.02h).

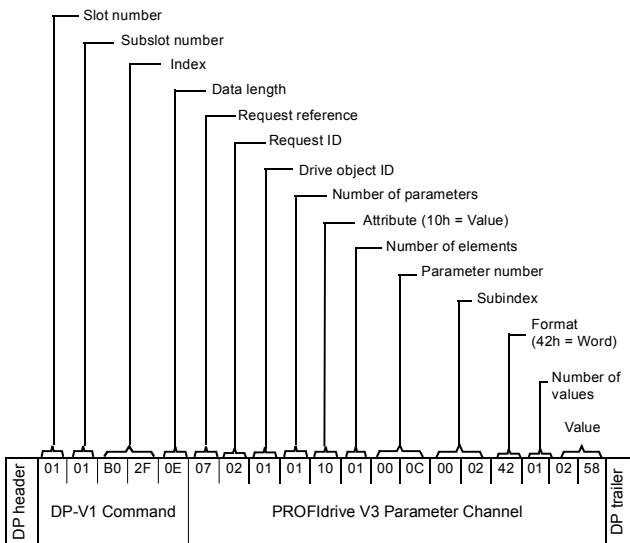

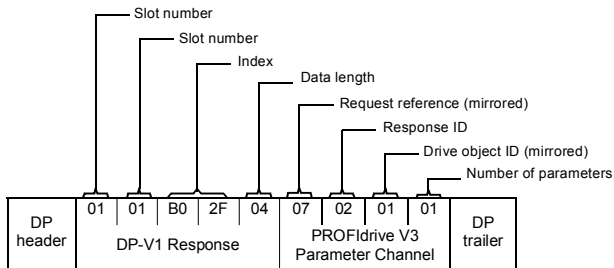

Example 2b: Writing 2 drive parameters (multi-parameter)

In this example, the values 300 (12Ch) and 500 (1F4h) are written to drive parameters 12.02 (0C.02h) and 20.08 (14.08h) respectively using one telegram.

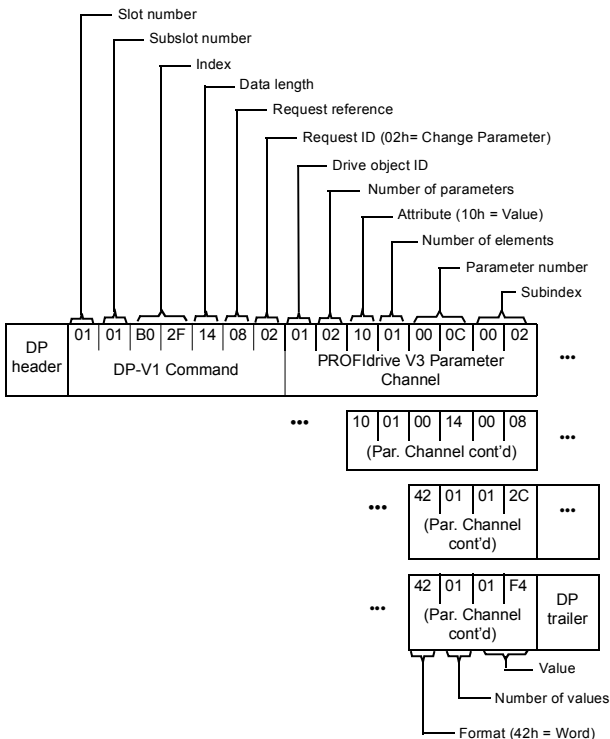

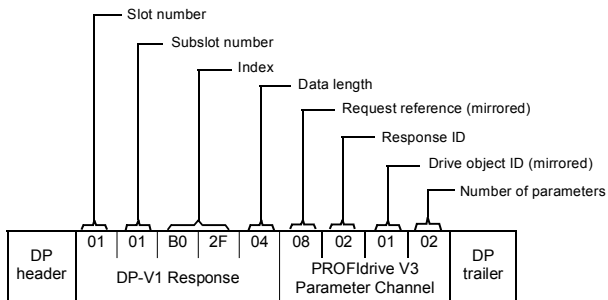

Example 3: Reading a PROFDrive parameter

In this example, PROFDrive parameter 919 (397h) is used to read the device system number of the slave, which is the product code of the drive.

- DP-V1 Write request (Reading a PROFDrive parameter):

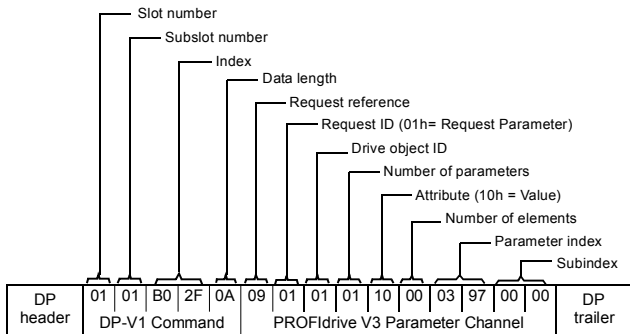

- DP-V1 Read response:

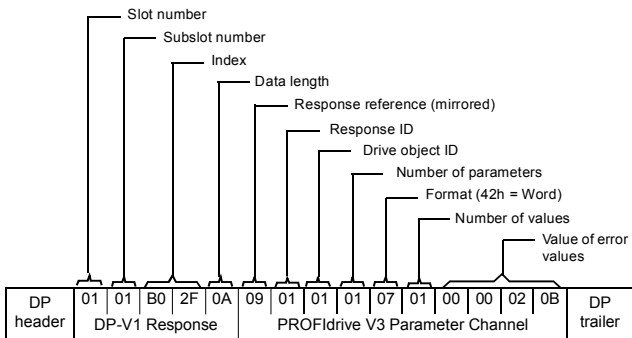

The slave returns the product code of the drive (20Bh in this example).

Example 4: Configuring the process data written to the drive

PROFIdrive parameter 915 (393h) can be used to define which data is written cyclically to a drive parameter as application-specific process data.

In the example below, the value of drive parameter 12.06 (0C.06h) is selected to be taken from PZD3. The parameter will continue to be updated with the contents of PZD3 in each Request frame until a different selection is made.

Subindex (IND) defines which process data word the required data is taken from. *Value* selects the drive parameter to which that word is mapped.

- DP-V1 Write request:

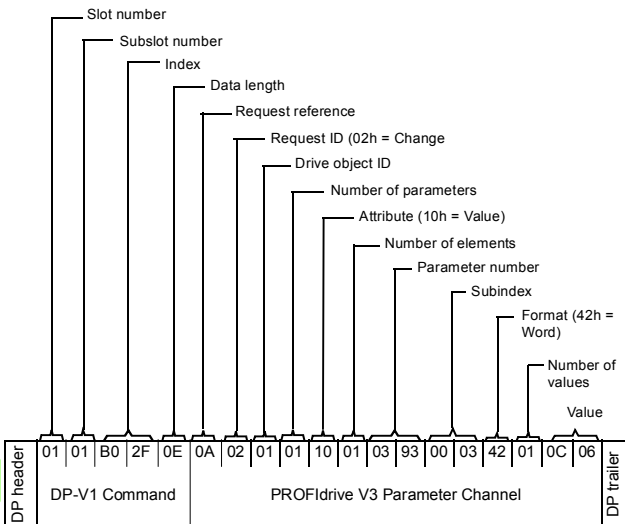

- DP-V1 Read response:

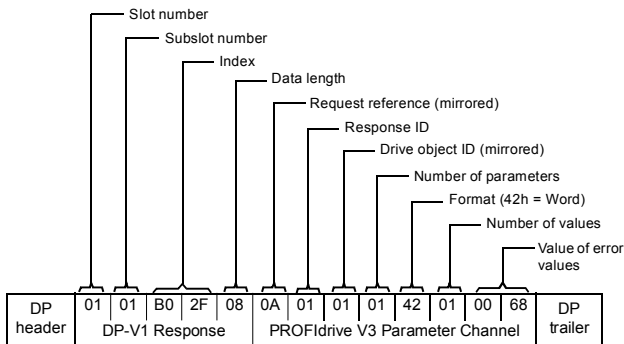

Subsequently, the contents of PZD3 in each Request frame are written to drive parameter 12.06 until a different selection is made.

Example 5: Determining the source of the process data read from the drive

PROFIdrive parameter 916 (394h) can be used to define which data is read cyclically from the drive as application-specific process data. In the example below, the parameter is used to determine which drive parameter the contents of PZD3 are taken from. *Subindex* (IND) defines which process data word the required data is transmitted in.

- DP-V1 Write request:

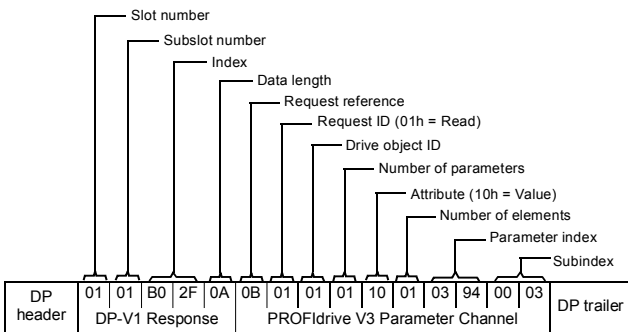

- DP-V1 Read response:

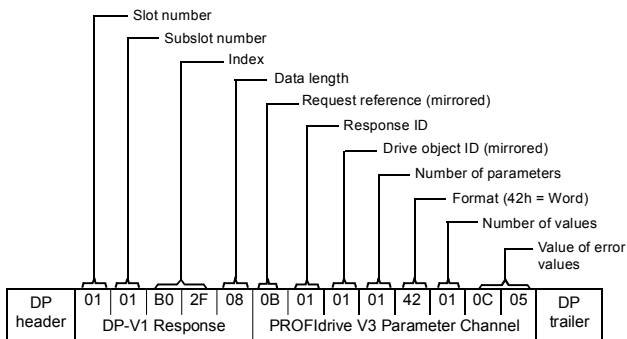

Value indicates the source of PZD3 as drive parameter 12.05 (0C.05h).

Diagnostic and alarm mechanism

The FENA adapter module has mechanisms for sending alarms and saving diagnostics data to a fault buffer. An alarm is triggered if the host or drive has faults in communication or operation. The alarm and fault buffer mechanisms are enabled by default and can be disabled with a configuration parameter ([21 ALARM DISABLE](#) on page [273](#)).

Alarm mechanism

When a fault situation occurs, the adapter module sends an alarm notification, which the master station has to acknowledge. Alarm notifications can be acknowledged, viewed and handled, for example, with Siemens S7 blocks OB82, OB83, OB86 and OB122.

- Block OB82 is used to make sure that the drive does not go to the stop mode during a diagnostic alarm.
- Block OB83 is called if a module is inserted or removed from the system or if the module is modified.
- Block OB86 indicates if there is a failure or event in the distributed periphery.
- Block OB122 is called if the CPU calls a device that is not accessible.

Fault code mapping

An alarm notification contains a fault code, which is called ChannelErrorType. For PROFIdrive API, the drive internal DRIVECOM fault numbers are mapped to PROFIdrive ChannelErrorTypes according to the table below. The fault numbers that are not listed are mapped to ChannelErrorType *Other*.

ChannelErrorType	Description	DRIVECOM fault numbers
0x9000	Microcontroller hardware or software	4211, 5000, 5401, 5402, 5403, 5484, 5691, 5693, 6100, 6180, 6300, 6306, 6306, 6320, 6481, 6487, 630D, 630F, 64A1, 64A2, 64A3, 64E1, 6581, 65A1, 6682, 6683, 6684, 6881, FF55
0x9001	Mains supply	3291
0x9002	Low voltage supply	3130, 3220
0x9003	DC link overvoltage	3210

ChannelErrorType	Description	DRIVECOM fault numbers
0x9004	Power electronics	2211, 2281, 2310, 2312, 2340, 2381, 3180, 3181, 3182, 3183, 3184, 3185, 3186, 3187, 3381, 3385, 5400, 5482, 5682, 5692, FF56
0x9005	Overtemperature electronic device	4110, 4210, 4212, 4290, 4310, 4313, 4981, 7182, 42F1, 4380
0x9006	Earth/ground fault	2330
0x9007	Motor overload	7121
0x9008	Fieldbus system	
0x9009	Safety channel	8182, 8183, 5090, 5091, FA81, FA82, FF7A, FFA0, FFA1, FFA2
0x900A	Feedback	7301, 7310, 7380, 7381, 7389, 7391, 8480, 8584, 738A, 738B, 738C, 73A0, 73A1
0x900B	Internal communication	5480, 5681, 5690, 7000, 7080, 7081, 7510, 7520, 7540, 7584
0x900C	Infeed	
0x900D	Brake resistor	7111, 7112, 7113, 7181, 7183, 7184, 7185, 7186, 7187, 7191, 71A2, 71A3, 71A5
0x900E	Line filter	

ChannelErrorType	Description	DRIVECOM fault numbers
0x900F	External	9000, 9001, 9081, FF81, FF82, FF8E, FF90
0x9010	Technology	6382
0x9011	Engineering	
0x9012	Other	5080, 5093, 5210, 5300, 6200, 7583, 8110, 8500, 8582, 8583, FF61, FF69, FF6A, FF83, FF84, FF95

■ Fault buffer mechanism

The PROFIdrive profile has a mechanism that can store eight fault situations to PROFIdrive parameters. Fault and diagnostic data, like fault number and fault code, can be accessed simultaneously with only one subindex. The mechanism consists of four PROFIdrive parameters:

- PNU944: Fault message counter.
 - Incremented each time the fault buffer changes.
- PNU945: PROFIdrive fault codes presented in section *Fault code mapping* on page 378.
- PNU946: Fault code list that converts fault numbers to fault codes.
 - Read using the fault number as a subindex to get the corresponding fault code.
- PNU947: Fault numbers according to the DRIVECOM profile.

The table below illustrates the structure of a fault buffer. The fault buffer consists of two parameters: fault number (PNU 947) and fault code (PNU 945). The rows of the fault buffer are represented by the parameter subindices. Fault messages are entered into the buffer in the sequence they are detected. Each line in the fault buffer represents a fault message, which is a part of a fault situation. A fault situation lasts from a detection of a fault to its acknowledgement.

	PNU947	PNU945	
	Fault number	Fault code	Subindex
Actual fault situation n	0x4210	0x9005	0
	0	0	1
	0	0	2
	0	0	3
	0	0	4
	0	0	5
	0	0	6
	0	0	7
Fault situation n-1	0x7510	0x900B	8
	0	0	9
	0	0	10
	0	0	11
	0	0	12
	0	0	13
	0	0	14
	0	0	15
...

	PNU947	PNU945	
	Fault number	Fault code	Subindex
Fault situation n-7	0	0	56
	0	0	57
	0	0	58
	0	0	59
	0	0	60
	0	0	61
	0	0	62
	0	0	63

17

PROFINET IO – Diagnostics

Contents of this chapter

This chapter explains how to trace faults with the status LEDs on the adapter module when the module is used for PROFINET IO communication.

Fault and warning messages

For the fault and warning messages concerning the adapter module, see the drive firmware manual.

LEDs

The adapter module is equipped with three bicolor diagnostic LEDs. The LEDs are described below.

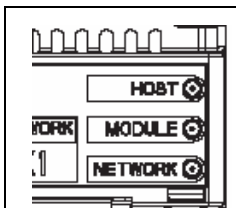

Name	Color	Function
HOST	Blinking green	Establishing communication to host
	Green	Connection to host OK
	Blinking red	Communication to host lost temporarily
	Flashing orange, alternating with the MODULE flashing orange	Internal file system error. The error may be cleared by cycling drive power. If the error persists, contact your local ABB representative.
MODULE	Off	There is no power applied to the device.
	Flashing orange	<p>Device is attempting to obtain IP configuration from DHCP server if network LED is off (FENA-11/ -21).</p> <p>Device is blinking. Used for identification. The blinking is started by the PROFINET master and also the network LED is flashing green.</p>

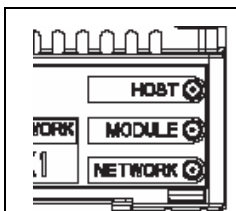

Name	Color	Function
MODULE	Flashing green	<p>Device needs commissioning due to configuration missing, incomplete or incorrect. The device may be in the Standby state.</p> <p>This may also be caused by the adapter waiting for Duplicate Address Detection to complete. If Duplicate Address Detection has detected an IP conflict, the IP is configured to 0.0.0.0 and can be reconfigured by PLC.</p>
	Green	Device is operating in a normal condition.
	Flashing red	Recoverable fault
	Red	<p>Ethernet interface is disabled. Duplicate Address Detection may have detected a duplicate address. Check the IP configuration and either initiate a Fieldbus Adapter parameter refresh or cycle power to the drive.</p>
	Flashing red-green	Device is in Self Test.
	Flashing orange, alternating with the HOST flashing orange	<p>Internal file system error. The error may be cleared by cycling drive power. If the error persists, contact your local ABB representative.</p>

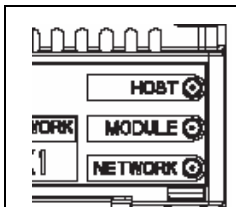

Name	Color	Function
NETWORK /NET	Off	Device is not on-line. <ul style="list-style-type: none"> • The device has not completed the Duplicate Address Detection yet. • The device may not be powered; look at the MODULE status LED.
	Flashing green	Device is receiving/transmitting on the Ethernet.

18

Technical data

Contents of this chapter

This chapter contains the technical specifications of the adapter module and the Ethernet link.

FENA-01/-11/-21

The figure below shows the enclosure of the adapter module from the front and side.

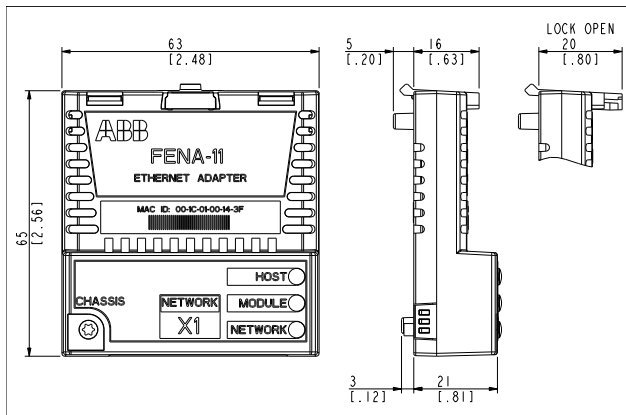

Installation	Into an option slot on the drive control unit
Degree of protection	IP20
Ambient conditions	The applicable ambient conditions specified for the drive in its manuals are in effect.
Package	Cardboard. Plastic wrapping: Antistatic air bubble sheet (PE).
Indicators	Three bicolor LEDs (HOST, MODULE, NETWORK/NET)
Connectors	A 20-pin connector to the drive RJ-45 connector to Ethernet (X1) <u>FENA-21 only</u> : RJ-45 connector for chaining another adapter module (X2)
Power supply	+3.3 V \pm 5% max. 400 mA (supplied by the drive)
General	Complies with EMC standard EN 61800-3:2004 Printed circuit board conformal coated

Ethernet link

Compatible devices	Ethernet Standard IEEE 802.3 and IEEE 802.3u devices
Medium	10BASE-TX or 100Base-TX with Auto-negotiation and Auto-MDIX (Auto-crossover) <ul style="list-style-type: none"> • Wiring: CAT5/6 UTP, CAT5/6 FTP, CAT5/6 STP • Connector: RJ-45 • Termination: Internal • Maximum segment length: 100 m / 328 ft
Topology	Bus or star. Max. 50 nodes allowed for FENA-21 in a daisy chain topology.
Transfer rate	10 Mbps or 100 Mbps
Serial communication type	Half or full duplex
Protocol	Modbus/TCP, EtherNet/IP, PROFINET IO

19

Appendix A – PROFIdrive parameters and I&M records of PROFINET IO

Contents of this chapter

This chapter contains:

- PROFIdrive parameters of the PROFINET IO communication protocol
 - telegram and response structures for the I&M (Identification & Maintenance) records of the PROFINET IO communication protocol.
-

PROFIdrive parameters

Par. no.	R/W ¹⁾	Data type	Description																						
915	R/W	Array [12] Unsigned16	Assignment PZD1 to PZD12 in PPO-write																						
916	R/W	Array [12] Unsigned16	Assignment PZD1 to PZD12 in PPO-read																						
919	R	Octet String4	Device system number																						
922	R	Unsigned16	Telegram selection																						
923	R	Array [n] Unsigned16	<p>List of all parameters for signals. Mandatory if process data normalization is used and/or parameters 915 and 916 are implemented.</p> <table border="1"> <thead> <tr> <th>Signal no. and name</th> <th>Type</th> </tr> </thead> <tbody> <tr> <td>1 – Control word 1 (STW1)</td> <td>Unsigned16</td> </tr> <tr> <td>2 – Status word 1 (ZSW1)</td> <td>Unsigned16</td> </tr> <tr> <td>3 – Control word 2 (STW2)</td> <td>Unsigned16</td> </tr> <tr> <td>4 – Status word 2 (ZSW2)</td> <td>Unsigned16</td> </tr> <tr> <td>5 – Speed set point A (NSOLL_A)</td> <td>Signed16</td> </tr> <tr> <td>6 – Speed actual value A (NIST_A)</td> <td>Signed16</td> </tr> <tr> <td>7 – Speed set point B (NSOLL_B)</td> <td>Signed32</td> </tr> <tr> <td>8 – Speed actual value B (NIST_B)</td> <td>Signed32</td> </tr> <tr> <td>27 – Position set point A (XSOLL_A)</td> <td>Signed32</td> </tr> <tr> <td>28 – Position actual value A (XIST_A)</td> <td>Signed32</td> </tr> </tbody> </table>	Signal no. and name	Type	1 – Control word 1 (STW1)	Unsigned16	2 – Status word 1 (ZSW1)	Unsigned16	3 – Control word 2 (STW2)	Unsigned16	4 – Status word 2 (ZSW2)	Unsigned16	5 – Speed set point A (NSOLL_A)	Signed16	6 – Speed actual value A (NIST_A)	Signed16	7 – Speed set point B (NSOLL_B)	Signed32	8 – Speed actual value B (NIST_B)	Signed32	27 – Position set point A (XSOLL_A)	Signed32	28 – Position actual value A (XIST_A)	Signed32
Signal no. and name	Type																								
1 – Control word 1 (STW1)	Unsigned16																								
2 – Status word 1 (ZSW1)	Unsigned16																								
3 – Control word 2 (STW2)	Unsigned16																								
4 – Status word 2 (ZSW2)	Unsigned16																								
5 – Speed set point A (NSOLL_A)	Signed16																								
6 – Speed actual value A (NIST_A)	Signed16																								
7 – Speed set point B (NSOLL_B)	Signed32																								
8 – Speed actual value B (NIST_B)	Signed32																								
27 – Position set point A (XSOLL_A)	Signed32																								
28 – Position actual value A (XIST_A)	Signed32																								

Par. no.	R/W ¹⁾	Data type	Description
			32 – Traversing block selection (SATZANW) (not supported) Unsigned16 33 – Actual traversing block (AKTSATZ) (not supported) Unsigned16 34 – Target position (TARPOS_A) (not supported) Signed32 35 – Velocity (VELOCITY_A) Unsigned32 101...9999 – Drive-specific –
927	R/W	Unsigned16	Operator control rights (parameter identification, PKW) Value Mode 0 Parameters cannot be written, only read (927 can be written). 1 Parameters can be written and read (default).
928	R/W	Unsigned16	Control rights (process data, PZD). Value Mode 0 PZD part is disabled, ie, Receipt of new PZD data is ignored. 1 PZD part is enabled (default).

Par. no.	R/W ¹⁾	Data type	Description																
929	R	Unsigned16	<p>Selected PPO type</p> <table> <thead> <tr> <th>Value</th> <th>PPO type</th> </tr> </thead> <tbody> <tr> <td>1</td> <td>PPO1</td> </tr> <tr> <td>2</td> <td>PPO2</td> </tr> <tr> <td>3</td> <td>PPO3</td> </tr> <tr> <td>4</td> <td>PPO4</td> </tr> <tr> <td>5</td> <td>PPO5</td> </tr> <tr> <td>6</td> <td>PPO6</td> </tr> <tr> <td>7</td> <td>PPO7</td> </tr> </tbody> </table> <p>Note: This parameter is not available if Standard telegram ST1 or ST2 is selected.</p>	Value	PPO type	1	PPO1	2	PPO2	3	PPO3	4	PPO4	5	PPO5	6	PPO6	7	PPO7
Value	PPO type																		
1	PPO1																		
2	PPO2																		
3	PPO3																		
4	PPO4																		
5	PPO5																		
6	PPO6																		
7	PPO7																		
930	R/W	Unsigned16	<p>Selection switch for communication profile.</p> <table> <thead> <tr> <th>Value</th> <th>Mode</th> </tr> </thead> <tbody> <tr> <td>1</td> <td>PROFIdrive</td> </tr> <tr> <td>8001h</td> <td>ABB Drives</td> </tr> <tr> <td>8002h</td> <td>Transparent 16</td> </tr> <tr> <td>8003h</td> <td>Transparent 32</td> </tr> <tr> <td>8004h</td> <td>PROFIdrive positioning mode</td> </tr> </tbody> </table>	Value	Mode	1	PROFIdrive	8001h	ABB Drives	8002h	Transparent 16	8003h	Transparent 32	8004h	PROFIdrive positioning mode				
Value	Mode																		
1	PROFIdrive																		
8001h	ABB Drives																		
8002h	Transparent 16																		
8003h	Transparent 32																		
8004h	PROFIdrive positioning mode																		
933	R/W	Unsigned16	<p>Selection switch for Control word, bit 11.</p> <table> <thead> <tr> <th>Value</th> <th>Module Control word bit</th> </tr> </thead> <tbody> <tr> <td>0</td> <td>None</td> </tr> <tr> <td>1 to 5</td> <td>Vendor specific 1 to 5²⁾</td> </tr> </tbody> </table>	Value	Module Control word bit	0	None	1 to 5	Vendor specific 1 to 5 ²⁾										
Value	Module Control word bit																		
0	None																		
1 to 5	Vendor specific 1 to 5 ²⁾																		
934	R/W	Unsigned16	Selection switch for Control word, bit 12. (See parameter 933 for coding.)																
935	R/W	Unsigned16	Selection switch for Control word, bit 13. (See parameter 933 for coding.)																

Par. no.	R/W ¹⁾	Data type	Description
936	R/W	Unsigned16	Selection switch for Control word, bit 14. (See parameter 933 for coding.)
937	R/W	Unsigned16	Selection switch for Control word, bit 15. (See parameter 933 for coding.)
939	R/W	Unsigned16	Selection switch for Status word, bit 11. Value Module Status word bit 0 None 1 to 4 Vendor specific 1 to 4 ²⁾
940	R/W	Unsigned16	Selection switch for Status word, bit 12. (See parameter 939 for coding.)
941	R/W	Unsigned16	Selection switch for Status word, bit 13. (See parameter 939 for coding.)
942	R/W	Unsigned16	Selection switch for Status word, bit 14. (See parameter 939 for coding.)
943	R/W	Unsigned16	Selection switch for Status word, bit 15. (See parameter 939 for coding.)
944	R	Unsigned16	Fault message counter
945	R	Array[64] Unsigned16	Fault code (Channel Error Type) Subindex Contents 0 Last fault 8 Second last ackn. fault 16 Third last ackn. fault 24 Fourth last ackn. fault 32 Fifth last ackn. fault 40 Sixth last ackn. fault 48 Seventh last ackn. fault 56 Eighth last ackn. fault

Par. no.	R/W ¹⁾	Data type	Description
946	R	Array [n] Unsigned16	Fault code list. Contains the mapping between DRIVECOM fault codes and Channel Error Types. If you use a DRIVECOM fault code as an index when reading PNU946, the corresponding Channel Error Type is returned.
947	R	Array [64] Unsigned16	Fault number (coded according to the DRIVECOM profile). Subindex Contents See parameter 945 .
953	R	Unsigned16	Last alarm ³⁾
954	R	Unsigned16	Second last alarm ³⁾
955	R	Unsigned16	Third last alarm ³⁾
956	R	Unsigned16	Fourth last alarm ³⁾
957	R	Unsigned16	Fifth last alarm ³⁾
964	R	Array [7] Unsigned16	Subindex Contents 0 Manufacturer 1 Device type 2 Version 3 Firmware date (year) 4 Firmware date (day/month) 5 Number of Axes
965	R	Octet String2	Profile number of this device. Eg: 0302h = Profile 3, Version 2
967	R	Unsigned16	Control word (CW)
968	R	Unsigned16	Status word (SW)

Par. no.	R/W ¹⁾	Data type	Description						
970	R/W	Unsigned16	<p>Load parameter record</p> <table border="1"> <thead> <tr> <th>Value</th> <th>Description</th> </tr> </thead> <tbody> <tr> <td>0</td> <td>No action</td> </tr> <tr> <td>1</td> <td>Restore factory settings</td> </tr> </tbody> </table> <p>The parameter must do a zero-to-one transition and the motor must be stopped.</p>	Value	Description	0	No action	1	Restore factory settings
Value	Description								
0	No action								
1	Restore factory settings								
971	R/W	Unsigned16	<p>Save parameter record</p> <table border="1"> <thead> <tr> <th>Value</th> <th>Description</th> </tr> </thead> <tbody> <tr> <td>0</td> <td>No action</td> </tr> <tr> <td>1</td> <td>Save the drive parameters to non-volatile memory</td> </tr> </tbody> </table> <p>The parameter must do a zero-to-one transition and the motor must be stopped.</p>	Value	Description	0	No action	1	Save the drive parameters to non-volatile memory
Value	Description								
0	No action								
1	Save the drive parameters to non-volatile memory								
972	R/W	Unsigned16	<p>Software reset</p> <table border="1"> <thead> <tr> <th>Value</th> <th>Description</th> </tr> </thead> <tbody> <tr> <td>0</td> <td>No action</td> </tr> <tr> <td>1</td> <td>Re-boot PROFIBUS module</td> </tr> </tbody> </table> <p>The parameter must do a zero-to-one transition and the motor must be stopped.</p>	Value	Description	0	No action	1	Re-boot PROFIBUS module
Value	Description								
0	No action								
1	Re-boot PROFIBUS module								
975	R	Array[n] Unsigned16	<p>DO identification. For subindexes 0...4, see parameter 964.</p> <table border="1"> <thead> <tr> <th>Subindex</th> <th>Meaning</th> </tr> </thead> <tbody> <tr> <td>5</td> <td>Value 2 = Axis</td> </tr> </tbody> </table>	Subindex	Meaning	5	Value 2 = Axis		
Subindex	Meaning								
5	Value 2 = Axis								
980 981	R	Array[n] Unsigned16	<p>Number list of defined parameters. If the subindex is 0, the end of the list has been reached. If the subindex is the number of the next list parameter, the list is continued there.</p>						

Par. no.	R/W ¹⁾	Data type	Description						
1000	R/W	Unsigned16	Map 16-bit selection ³⁾ . Used to request the data type for mapped parameters if mapping is done with parameter 915 or 916. <table border="1"> <thead> <tr> <th>Value</th> <th>Description</th> </tr> </thead> <tbody> <tr> <td>1</td> <td>Use 16-bit mapping, if available.</td> </tr> </tbody> </table>	Value	Description	1	Use 16-bit mapping, if available.		
Value	Description								
1	Use 16-bit mapping, if available.								
50000	R/W	Unsigned16	Disable alarms. <table border="1"> <thead> <tr> <th>Value</th> <th>Description</th> </tr> </thead> <tbody> <tr> <td>0</td> <td>PNIO alarms enabled.</td> </tr> <tr> <td>1</td> <td>PNIO alarms disabled.</td> </tr> </tbody> </table>	Value	Description	0	PNIO alarms enabled.	1	PNIO alarms disabled.
Value	Description								
0	PNIO alarms enabled.								
1	PNIO alarms disabled.								
61000	R	VisibleString24	Name of station						
61001	R	Unsigned32	IP of station						
61002	R	OctetString[6]	MAC address of station						
61003	R	Unsigned32	Default gateway of station						
61004	R	Unsigned32	Subnet mask of station						

¹⁾ Read and/or Write

²⁾ The meaning of vendor-specific bits is defined by the drive control program.

³⁾ Support depends on the drive type.

I&M records

I&M (Identification & Maintenance) records can be read, for example, with the DTM tool. The FENA adapter module supports the mandatory I&M0 record as well as the optional I&M1, I&M2, I&M3 and I&M4 records.

■ Call-REQ-PDU telegram for read/write access to I&M records

Function	Record Data Index
I&M0	0xAFF0
I&M1	0xAFF1
I&M2	0xAFF2
I&M3	0xAFF3
I&M4	0xAFF4

■ Response structure for I&M0 (Read-only)

	Contents	Size	Coding
Header		10 Octets	–
I&M block	MANUFACTURER_ID	2 Octets	0x1A = ABB Automation
	ORDER_ID	20 Octets	For instance, “68469422” for FENA-01 kit)
	SERIAL_NUMBER	16 Octets	Serial number of FENA module
	HARDWARE_REVISION	2 Octets	Hardware version of FENA module
	SOFTWARE_REVISION	4 Octets	Format: V255.255.255 Eg, V1.0.0 = software version 100
	REVISION_COUNTER	2 Octets	(Marks a change of hardware or its parameters)
	PROFILE_ID	2 Octets	3A00 (...3AFF) PROFIdrive
	PROFILE_SPECIFIC_TYPE	2 Octets	0 = no specific type
	IM_VERSION	2 Octets	0x0101 = version 1.1
IM_SUPPORTED	2 Octets	30 = I&M0, I&M1, I&M2, I&M3 and I&M4 supported	

■ Response structure for I&M1 (Read/Write)

	Contents	Size	Coding
Header		10 Octets	–
I&M block	TAG_FUNCTION	32 Octets	Device function or task
	TAG_LOCATION	22 Octets	Device location

■ Response structure for I&M2 (Read/Write)

	Contents	Size	Coding
Header		10 Octets	–
I&M block	INSTALLATION_DATE	16 Octets	Installation date. Eg, 2011-01-01 16:23
	RESERVED	38 Octets	Reserved

Note: I&M1, I&M2 and I&M3 are blank (0x20) by default.

■ Response structure for I&M3 (Read/Write)

	Contents	Size	Coding
Header		10 Octets	–
I&M block	DESCRIPTOR	54 Octets	Description of the device set by the user

■ Response structure for I&M4 (Read/Write)

I&M4 is read/write only in FENA-01. In FENA-11 and FENA-21, it is read-only and shows the FSO configuration CRC.

	Contents	Size	Coding
Header		10 Octets	–
I&M block	SIGNATURE	54 Octets	Security code for identifying sessions and changes

Note: I&M4 is filled with zeros (0x0) by default.

20

Appendix B – ABB IP configuration tool for FENA

Contents of this chapter

This chapter shows how to use the ABB IP configuration tool to:

- find configured and unconfigured FENA adapter modules in the network
- rewrite the IP configuration of the adapter modules.

Installation

The ABB IP configuration tool is part of the Control Builder Plus software. No separate installation is needed.

Finding adapter modules in the network

1. Open the ABB IP configuration tool.

2. Click the **Scan** button.

The FENA adapter modules present in the network appear on the results list.

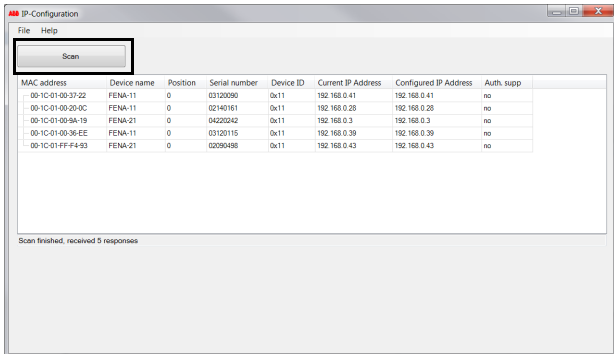

Rewriting the IP configuration of adapter modules

- Scan the network for adapter modules.
For instructions, see section [Finding adapter modules in the network](#) on page 402.
- On the results list, click to select the adapter module whose IP configuration you want to modify.

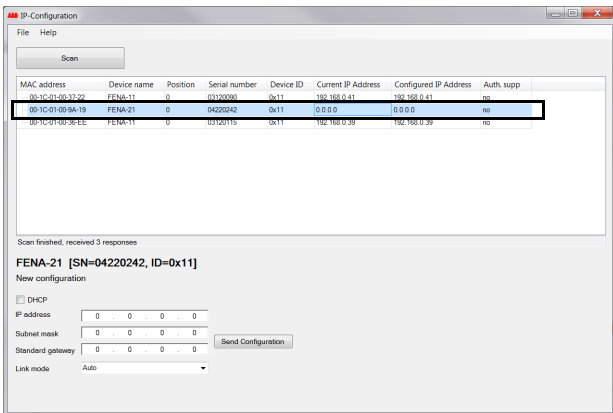

- Below **New configuration**, define the IP configuration settings according to your network configuration.
- If you want the adapter module to use a static IP address instead of DHCP, clear the **DHCP** check box.

- To apply the new settings, click the **Send Configuration** button.

The new current IP address and configured IP address appear on the results list.

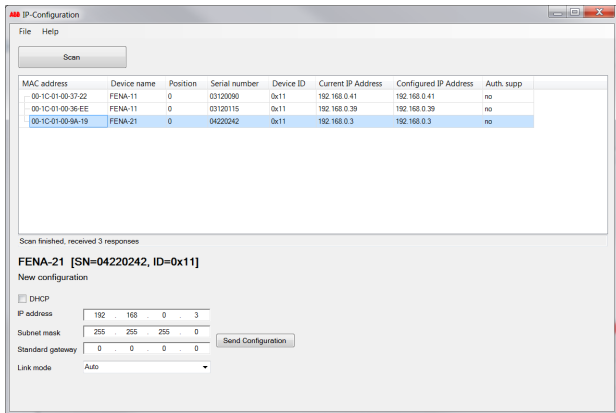

21

Appendix C – FENA configuration web pages

Contents of this chapter

This chapter presents the FENA configuration web pages.

Browser requirements

Any web browser can be used.

Compatibility

The web pages work with all drives compatible with the FENA adapter module. For a compatibility table, see section [Drives](#) on page [21](#).

Logging in

1. Open a web browser and type the IP address of the adapter module in the address field. The IP address is visible in group A, parameter 5...8.

Example: <http://192.168.0.24/>

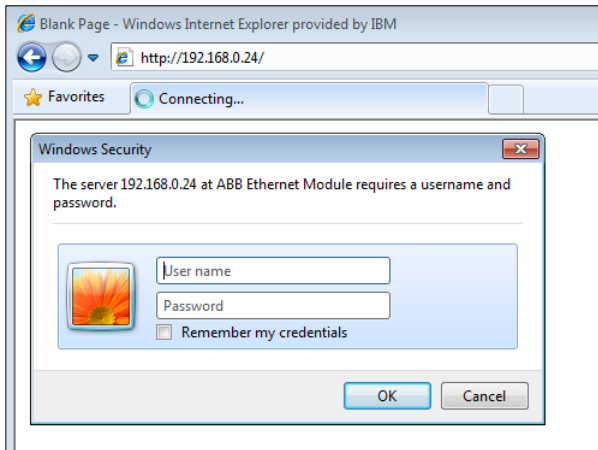

2. Log in with a user name and a password.

Default user name: admin

Password: The last six digits of the MAC address of the adapter module, in upper case, without hyphens.

The MAC ID is visible on the cover of the adapter module and in the ABB IP configuration tool (see [Appendix B – ABB IP configuration tool for FENA](#)).

- **Example:** If the MAC address of the adapter module is 00-1C-01-00-2F-73, the password is 002F73.

The user interface is loaded.

- After successful login, you will be prompted to change the password for security reasons.

It is recommended to change the default password.

 Power and productivity
for a better world™

FENA-21 ETHERNET ADAPTER

[Status](#) [Configuration](#) [Service configuration](#) [Support](#) [Password](#) [Logout](#)

Please change your password!

Your password is still the default administrative password. It is recommended to change the password.

Change password	
Username	<input type="text"/>
New password	<input type="text"/>
Confirm new password	<input type="text"/>

Menu overview

To navigate on the web pages, use the menu items available:

- **Status**
- **Configuration**
- **Service configuration**
- **Support**
- **Password**

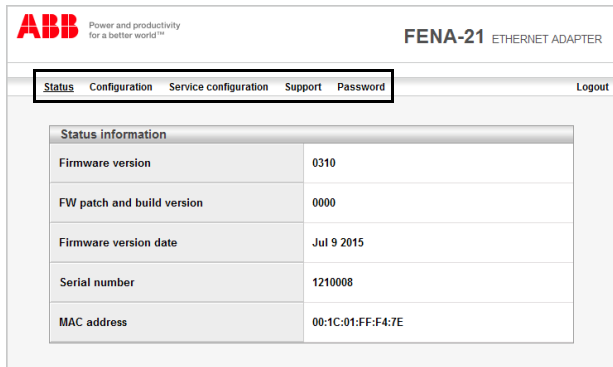

The screenshot displays the web interface for the FENA-21 Ethernet Adapter. At the top left is the ABB logo with the tagline "Power and productivity for a better world™". At the top right, the device is identified as "FENA-21 ETHERNET ADAPTER". A navigation menu is located below the header, with "Status", "Configuration", "Service configuration", "Support", and "Password" listed. The "Status" menu item is highlighted with a black border. To the right of the menu is a "Logout" link. Below the menu is a "Status information" section containing a table with the following data:

Status information	
Firmware version	0310
FW patch and build version	0000
Firmware version date	Jul 9 2015
Serial number	1210008
MAC address	00:1C:01:FF:F4:7E

Status page

The Status page shows various version information, as well as the serial number and MAC address (MAC ID) of the adapter module.

 Power and productivity
for a better world™**FENA-21** ETHERNET ADAPTER

[Status](#)[Configuration](#)[Service configuration](#)[Support](#)[Password](#)[Logout](#)

Status information	
Firmware version	0310
FW patch and build version	0000
Firmware version date	Jul 9 2015
Serial number	1210008
MAC address	00:1C:01:FF:F4:7E

Configuration page

On the Configuration page, you can modify parameter settings in the configuration parameter groups A (1), B (2) and C (3).

 Power and productivity for a better world™	
Status Configuration Service configuration Support Password	
Configuration parameters - Group A	
Module information	
54.01 Fieldbus adapter type	ETHERNET
Ethernet configuration	
54.02 Protocol/Profile	PROFINET IO, PROFIdrive (10) ▼
54.03 Communication rate	Auto-negotiate (0) ▼
54.04 IP configuration	Static IP (0) ▼
54.05-08 IP address	192.168.0.112
54.09 Subnet mask	255.255.255.0 (24) ▼
54.10-13 Gateway address	0.0.0.0
54.14 Communication rate for Port 2	Auto-negotiate (0) ▼
54.19 Transparent16 scale	99

After you have changed any setting in any of the groups, you must click **Save and reboot** at the bottom of Group A to validate the settings.

Modbus/TCP/UDP configuration	
54.20 Modbus/TCP/UDP Timeout (x 100 ms)	<input type="text" value="20"/>
54.21 Modbus/TCP/UDP Timeout mode	<input type="text" value="None (0)"/>
54.22 Modbus/TCP/UDP Word order	<input type="text" value="HiLo [High Low] (1)"/>
54.23 Modbus/TCP/UDP Address mode	<input type="text" value="Mode 0 (0)"/>

PROFINET IO configuration	
54.20 PROFINET IO Telegram type	<input type="text" value="20"/>
54.21 PROFINET IO Alarm sending	<input type="text" value="Enabled (0)"/>
54.22 PROFINET IO Map selection	<input type="text" value="16bit (1)"/>
54.25 PROFINET IO Name Index	<input type="text" value="0"/>
54.PROFINET IO Station Name	<input type="text"/>

EtherNet/IP configuration	
54.20 Control timeout	<input type="text" value="20"/>
54.21 Idle action	<input type="text" value="Off-line (0)"/>
54.22 ODVA Stop function	<input type="text" value="Coast (1)"/>
54.23 ODVA Speed scale	<input type="text" value="0"/>
54.24 ODVA Torque scale	<input type="text" value="128"/>

■ Changing the PROFINET IO station name via web page

The PROFINET IO configuration web page is shown below with default values. The **PROFINET IO Station Name** field is blank by default.

PROFINET IO configuration	
54.20 PROFINET IO Telegram type	<input type="text" value="7"/>
54.21 PROFINET IO Alarm sending	<input type="text" value="Enabled (0)"/>
54.22 PROFINET IO Map selection	<input type="text" value="16bit (1)"/>
54.25 PROFINET IO Name Index	<input type="text" value="0"/>
54.PROFINET IO Station Name	<input type="text" value=""/>

To set a new name, type the name in the **PROFINET IO Station Name** field. Click **Save without rebooting**, and then click **Save and reboot** to reboot FENA. See screen in [Configuration page](#).

The new name is effective only after FENA reboot.

Note: The value in **PROFINET IO Name Index** field must be 0 to use the set station name. Otherwise the name generated by the PROFINET IO Name index overrides it.

For example, if **PROFINET IO Station Name** is set as *fena-21*. After you click **Save without rebooting**, and then click **Save and reboot**, the refreshed web page is as shown below.

PROFINET IO configuration	
54.20 PROFINET IO Telegram type	<input type="text" value="7"/>
54.21 PROFINET IO Alarm sending	<input type="text" value="Enabled (0)"/>
54.22 PROFINET IO Map selection	<input type="text" value="16bit (1)"/>
54.25 PROFINET IO Name Index	<input type="text" value="0"/>
54.PROFINET IO Station Name	<input type="text" value="fena-21"/>

The web page validates the Station name format and displays any correction to the new name, as shown in this example screen.

PROFINET IO configuration	
54.20 PROFINET IO Telegram type	<input type="text" value="7"/>
54.21 PROFINET IO Alarm sending	<input type="text" value="Enabled (0)"/>
54.22 PROFINET IO Map selection	<input type="text" value="16bit (1)"/>
54.25 PROFINET IO Name Index	<input type="text" value="0"/>
54.PROFINET IO Station Name	<input type="text" value="192.168.0.5"/> <i>Profinet name can't be in same format as an IP address.</i>

If **PROFINET IO Name Index** was set from web page or from parameters, the **PROFINET IO Station Name** field shows its generated name after reboot, as shown in this example screen.

PROFINET IO configuration	
54.20 PROFINET IO Telegram type	<input type="text" value="7"/>
54.21 PROFINET IO Alarm sending	<input type="text" value="Enabled (0)"/>
54.22 PROFINET IO Map selection	<input type="text" value="16bit (1)"/>
54.25 PROFINET IO Name Index	<input type="text" value="123"/>
54.PROFINET IO Station Name	<input type="text" value="abdrive-123"/>

Service configuration page

On the Service configuration page, you can enable or disable certain Ethernet services. All services are enabled by default. You can disable the following services on this page:

- access to FENA configuration web page
- allow to change IP settings remotely via ABB IP configuration tool
- remote access drive with Drive composer tool via Ethernet tool network
- Ping response.

The new settings take effect after reboot of the module. You can click **Save and reboot**, to validate the new settings immediately or click the **Save without rebooting** if you want to do other settings also and then reboot.

ABB Power and productivity for a better world™ FENA-21 ETHERNET ADAPTER

Status Configuration **Service configuration** Support Password Logout

Ethernet service configuration (saved settings will be in use after reboot)

FENA configuration web pages	Enabled
ABB IP Configuration tool	Enabled
ABB Drive composer tool	Enabled
Ping response	Enabled

save and reboot save without rebooting

Note:

- These settings are available only through web pages. When you select to disable the web page, a warning appears to confirm before you can save the selection.
- If you want to access the disabled web page again,
 - the web page can be accessed only by PROFINET reset to factory settings command. See [Resetting PROFINET IO device to factory default via S7](#) on page 324.

Or

- You can use the web page password. See [Enable web page access after it was disabled](#) on page 419.
 - It is recommended to disable all services that are not used after commissioning.
-

Support page

On the Support page, you can access documentation related to the adapter module, and the EDS and GSDML files. The latest files corresponding to the drive firmware are available through the hyperlinks given below **WWW documentation and downloads**.

You can read more information about each parameter using the **Click here for more information about fieldbus parameters**.

ABB Power and productivity for a better world™

FENA-21 ETHERNET ADAPTER

Status Configuration Service configuration **Support** Password Logout

[Click here for more information about fieldbus parameters.](#)

EDS files

Local EtherNet/IP EDS files	EDS Files
-----------------------------	---------------------------

GSDML file

Local PROFINET GSDML file	GSDML File
---------------------------	----------------------------

WWW documentation and downloads

Fieldbus connectivity web page:	Fieldbus communications
FENA-21 web page:	FENA-21 Ethernet adapter module

Password page

On the Password page, you can change password.

FENA supports only one user access level.

ABB Power and productivity for a better world™		FENA-21 ETHERNET ADAPTER	
Status		Configuration	Service configuration
Support		Password	Logout
Change password			
Username	<input type="text"/>		
New password	<input type="text"/>		
Confirm new password	<input type="text"/>		
			<input type="button" value="change"/>

Reset FENA web page password to default

You can reset the FENA web page password to factory default.

Note: The password can be reset only with local access to the drive.

1. Disconnect all cable connections to FENA-01/-11/-21.
The NET led should switch off.
 2. Write 0 (zero) to the parameter 26 under Group A (e.g. 51.26).
 3. Refresh the settings by selecting **Refresh** in parameter 27 (e.g. 51.27).
 4. Write **17989** to parameter 26 under Group A.
 5. Refresh the settings by selecting **Refresh** in parameter 27.
 6. Write **20033** to parameter 26 under Group A.
 7. Refresh the settings by selecting **Refresh** in parameter 27.
 8. Write **0** to parameter 26 under Group A.
FENA password is now reset to the default password. For information of default password, see section [Logging in](#) on page [406](#).
-

Enable web page access after it was disabled

You can enable the access to web page with drive parameters.

1. Disconnect all cable connections to FENA-01/-11/-21.
The NET led should switch off.
 2. Write 0 (zero) to the parameter 26 under Group A (e.g. 51.26).
 3. Refresh the settings by selecting **Refresh** in parameter 27 (e.g. 51.27).
 4. Write **87** to parameter 26 under Group A.
 5. Refresh the settings by selecting **Refresh** in parameter 27.
 6. Write **17730** to parameter 26 under Group A.
 7. Refresh the settings by selecting **Refresh** in parameter 27.
 8. Write **0** to parameter 26 under Group A.
Access to web pages is now enabled.
-

Further information

Product and service inquiries

Address any inquiries about the product to your local ABB representative, quoting the type designation and serial number of the unit in question. A listing of ABB sales, support and service contacts can be found by navigating to www.abb.com/searchchannels.

Product training

For information on ABB product training, navigate to new.abb.com/service/training.

Providing feedback on ABB Drives manuals

Your comments on our manuals are welcome. Navigate to new.abb.com/drives/manuals-feedback-form.

Document library on the Internet

You can find manuals and other product documents in PDF format on the Internet at www.abb.com/drives/documents.

Contact us

www.abb.com/drives

www.abb.com/solar

www.abb.com/windpower

www.abb.com/drivespartners

3AUA0000093568 Rev C (EN) 2015-08-26



Power and productivity
for a better world™

