

PPL SUSQUEHANNA, LLC
JOB PERFORMANCE MEASURE

APPROVAL AND ADMINISTRATIVE DATA SHEET

Task Title Implement Reactor Coolant System Temperature Monitoring, HUR Exceeded

<u>S/RO</u>	<u>00.SO.1178.152</u>	<u>0</u>	<u>01/26/2014</u>	<u>Classroom</u>
Applicability	JPM Number	Revision	Date	Setting
<u>Generic</u>	<u>2.1.23</u>	<u>4.3 / 4.4</u>	<u>Y</u>	<u>N</u>
NUREG-1123 E/APE / Sys	K/A Number	K/A Importance	Alternate Path	Time Critical

Prepared	Validated
<u>Robert A. Thompson</u>	<u>Robert A. Thompson</u>
Author	Instructor
<u>02/12/2014</u>	<u>02/20/2014</u>
Date	Date

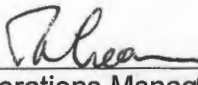
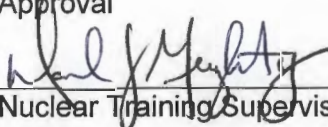
Review	Approval
	
Operations Management	Nuclear Training Supervisor
<u>6-29-14</u>	<u>6/30/14</u>
Date	Date

45
Validation Time (min)

Examinee Name: _____
Last, First MI
Employee Number

Exam Date: _____ Exam Duration (Min) _____

Evaluation Result: Satisfactory Unsatisfactory

Evaluator _____
Name
Signature

Comments



JPM REVISION SUMMARY

Revision	Description/Purpose of Revision
0	New JPM

REQUIRED TASK INFORMATION

1. SAFETY CONSIDERATIONS

- A. All Operations personnel are responsible for maintaining their radiation exposure As Low As Reasonably Achievable in accordance with OP-AD-002, Standards for Shift Operations.
- B. All applicable safety precautions shall be taken in accordance with established PPL safety policies and the Safety Rule Book, for example:
 - 1. Whenever any electrical panel is opened for inspection during JPM performance.
 - 2. Whenever entering any plant area where specific safety equipment such as hearing or eye protection, safety shoes, hardhats, etc., is required and/or posted as being necessary.
- C. If, in the judgment of the Evaluator any safety issue occurs during the performance of a JPM, the JPM will be terminated until the issue is resolved.
- D. Peer checking is the expectation for all evolutions; however, since a JPM is an individual effort, no peer check will be provided and Self Checking is required.

2. REFERENCES

- A. SO-100-011, Reactor Vessel Temperature And Pressure Recording (Revision 23)
- B. TS 3.4.7, RCS PRESSURE AND TEMPERATURE (P/T) LIMITS

3. TASK CONDITIONS

A reactor startup is in progress on Unit 1.

SO-100-011 is in progress for monitoring reactor coolant system and reactor pressure vessel heatup.

Another operator is completing Table 1 of SO-100-011 to monitor RPV heatup for compliance with TS 3.4.10 RPV metal temperature versus pressure (P/T) limits.

4. INITIATING CUE

Perform SO-100-011 Table 2 to monitor RCS heatup rate using the provided data.

For SRO examinees who identified a TS heatup rate violation: Identify any applicable TS LCOs not met and the associated Conditions, the Required Action(s) to be performed and the date and time the Required Action(s) must be completed. Document your findings on your SRO cue sheet.

5. TASK STANDARD

Records RCS and reactor pressure vessel temperatures per SO-100-011. Determines RCS heatup rate is violated.

SRO, identifies entry into TS LCO 3.4.10 Condition A, Required Actions A.1 and A.2. Identifies time when heatup rate restored for compliance with Required Action A.1. Identifies time that Required Action A.2 must be completed.

PERFORMANCE CHECKLIST

Examinee _____

Step	Action	Standard	Eval	Comments
<p><u>EVALUATOR INSTRUCTIONS</u></p> <ul style="list-style-type: none"> • Marking a step as UNSAT requires written comments on respective step. • Critical steps are marked with a *. If elements of the Standard are non-critical, the critical elements of the Standard are marked with a *. • The time clock starts when the candidate acknowledges the Initiating Cue. • This JPM may be performed in the classroom or simulator. Ensure a controlled copy of Unit 1 Technical Specifications and Bases is available. • Mark-up a copy of SO-100-011 per the attached EXAMINEE INITIAL DATA. 				
<p><u>EVALUATOR CUE</u> Record JPM start time: _____</p>				
1	<p>Identifies governing procedure and obtain controlled copy.</p>	<p>Obtains controlled copy of SO-100-011, selects Section 5.1.</p>		
2	<p>Records data source used to obtain temperature data.</p>	<p>Observes on Reactor Coolant System Temperature and Pressure Log (Attachment D, Table 2), the following data sources have been circled:</p> <ul style="list-style-type: none"> • Recirc loop A temperature: NRT01 • Recirc loop B temperature: NRT02 • Reactor vessel bottom head drain temperature: NLT01 • Reactor pressure: NFP02 • Reactor steam dome temperature: NFA05 		

PERFORMANCE CHECKLIST

Examinee _____

Step	Action	Standard	Eval	Comments
*3	<p>Records reactor coolant temperature data.</p>	<p>On Reactor Coolant System Temperature and Pressure Log (Attachment D, Table 2), record following information every 15 minutes from R*Time printouts :</p> <ul style="list-style-type: none"> • Recirc loop A temperature • Recirc loop B temperature • Reactor vessel bottom head drain temperature • Reactor vessel pressure • Reactor steam dome temperature (when reactor coolant temperature > 212 °F) 		
<p><u>EVALUATOR NOTE</u> Calculated temperature change is change in temperature that occurred in previous 15 minutes. The 60 minute ΔT is calculated by adding the last four 15 minute ΔT readings.</p>				
*4	<p>Calculates 15-minute temperature changes for the following:</p> <ul style="list-style-type: none"> • Recirc loop A • Recirc loop B • Reactor vessel bottom head drain • Reactor dome temperature (only when reactor coolant temperature > 212 °F) 	<p>For each of the following parameters, subtracts temperature recorded 15 minutes ago from the current temperature and records the difference on Reactor Coolant System Temperature and Pressure Log (Attachment D, Table 2):</p> <ul style="list-style-type: none"> • Recirc loop A • Recirc loop B • Reactor vessel bottom head drain • Reactor dome temperature (only when reactor coolant temperature > 212 °F) 		

PERFORMANCE CHECKLIST

Examinee _____

Step	Action	Standard	Eval	Comments
*5	<p>Calculates 60-minute temperature changes for the following:</p> <ul style="list-style-type: none"> • Recirc loop A • Recirc loop B • Reactor vessel bottom head drain • Reactor dome temperature (only when reactor coolant temperature > 212 °F) 	<p>For each of the following parameters, sums the last four recorded 15-minute temperature changes and records the difference on Reactor Coolant System Temperature and Pressure Log (Attachment D, Table 2):</p> <ul style="list-style-type: none"> • Recirc loop A • Recirc loop B • Reactor vessel bottom head drain • Reactor dome temperature (only when reactor coolant temperature > 212 °F) 		
<p><u>FAULT STATEMENT</u> THE DATA AT TIME 2230 WILL INDICATE A HEATUP RATE > 100 °F/HR ON RECIRC LOOP A AND B AND BOTTOM HEAD DRAIN TEMPERATURES. THE DATA AT TIME 2245 WILL INDICATE A HEATUP RATE > 100 °F/HR ON STEAM DOME TEMPERATURE. THE DATA AT TIME 2300 WILL LINDICATE HEATUP RATE FOR ALL PARAMETERS ≤ 100 °F/HR.</p>				
6	<p>Confirms compliance with reactor coolant system heatup rate ≤ 100 °F/hr.</p>	<p>For each 15-minute reading of the following parameters, verifies that the 60-minute temperature change is ≤ 100 °F/hr:</p> <ul style="list-style-type: none"> • Recirc loop A • Recirc loop B • Reactor vessel bottom head drain • Reactor dome temperature (only when reactor coolant temperature > 212 °F) 		

PERFORMANCE CHECKLIST

Examinee _____

Step	Action	Standard	Eval	Comments
*7	Identifies reactor coolant system heatup rate exceeded at time 2230.	Performs the following: <ul style="list-style-type: none"> • Reviews 60-minute temperature changes and observes the values for the following parameters are > 100 °F/hr: <ul style="list-style-type: none"> ○ Recirc loop A ○ Recirc loop B ○ Reactor vessel bottom head drain • Indicates UNSAT results in Confirm Compliance column on Reactor Coolant System Temperature and Pressure Log (Attachment D, Table 2) 		
*8	Identifies reactor coolant system heatup rate exceeded at time 2245.	Performs the following: <ul style="list-style-type: none"> • Reviews 60-minute temperature changes and observes the values for the following parameters are > 100 °F/hr: <ul style="list-style-type: none"> ○ Reactor dome temperature • Indicates UNSAT results in Confirm Compliance column on Reactor Coolant System Temperature and Pressure Log (Attachment D, Table 2) 		
9	Informs Unit Supervisor.	Notifies Unit Supervisor TS heatup rate exceeded at time 2230 and 2245, and restored at 2300.		
<u>EVALUATOR CUE</u> This completes the JPM for the RO examinees. For SRO examinees who identified a TS heatup rate violation, provide the SRO cue.				
*10	Identifies TS LCO 3.4.10 is not met and that Condition A applies.	Reviews TS and identifies the following: <ul style="list-style-type: none"> • TS LCO 3.4.10 is not met • Condition A applies 		

PERFORMANCE CHECKLIST

Examinee _____

Step	Action	Standard	Eval	Comments
*11	Identifies TS 3.4.10 Required Actions A.1 and A.2 must be performed.	Reviews TS 3.4.10 and identifies the following: <ul style="list-style-type: none"> • Required Actions A.1 and A.2 must be completed • Required Action A.2 must be completed once the LCO is entered 		
*12	Identifies heatup rate must be lowered ≤ 100 °F/hr by 2300.	Review TS 3.4.10 Required Action A.1 Completion Time and calculates heatup rate must be ≤ 100 °F/hr by 2300.		
*13	Identifies a determination if the RCS is acceptable for continued operation must be completed by 05/31/14 at 2130.	Review TS 3.4.10 Required Action A.2 Completion Time (and Condition A Note) and calculates a determination if the RCS is acceptable for continued operation must be completed by 05/31/14 at 2130.		

EVALUATOR CUE
Record JPM stop time: _____

EVALUATOR NOTE
That completes the JPM.

EVALUATOR:
Do you have ALL your JPM exam materials? Task Cue Sheets? Procedures?

EXAMINEE INITIAL DATA

SO-100-011

TABLE 2

REACTOR COOLANT SYSTEM TEMPERATURE AND PRESSURE LOG

DATA SOURCE	NFP02 NFP03	NRT01 NRT51 NRT52	NA	N/A	NRT02 NRT53 NRT54	NA	NA	NLT01	NA	NA	NFA05	NA	NA	NA	NA
TIME/DATE AS NECESSARY	REACTOR PRESSURE PSIG	RECIRC LOOP A TEMP °F	RECIRC LOOP A DELTA TEMP °F	RECIRC LOOP A DELTA TEMP 60 Minute ΔT	RECIRC LOOP B TEMP °F	RECIRC LOOP B DELTA TEMP °F	RECIRC LOOP B DELTA TEMP 60 Minute ΔT	BOTTOM HEAD DRAIN TEMP °F	BTM HD DRAIN DELTA TEMP °F	BTM HD DRAIN DELTA TEMP 60 Minute ΔT	RX STM DOME TEMP °F Enter NA when Stm Dome Temp <212°F *	RX STM DOME DELTA TEMP °F *	RX STM DOME DELTA TEMP 60 Minute ΔT *	CONFIRM COMPLIANCE W/SR 3.4.10.1	Shift Supervision review
2100 05/28/14	0	126.7	1.1	2.8	127.0	1.1	2.7	127	1	3.0	N/A	N/A	N/A	RO	SRO
2115 05/28/14	0	128.3	1.6	3.8	128.3	1.3	3.5	128	1	3	N/A	N/A	N/A	RO	SRO
2130 05/28/14	0	133.8	5.5	8.9	136.8	8.5	11.6	137	9	12	N/A	N/A	N/A	RO	SRO
2145 05/28/14	0	163.8	30.0	38.2	165.7	28.9	39.8	166	29	40	N/A	N/A	N/A	RO	SRO
2200 05/28/14	0	185.7	21.9	59.0	187.7	22.0	60.7	187	21	60	N/A	N/A	N/A	RO	SRO

KEY

SO-100-011

TABLE 2

REACTOR COOLANT SYSTEM TEMPERATURE AND PRESSURE LOG

DATA SOURCE	NFP02 NFP03	NRT01 NRT51 NRT52	NA	NA	NRT02 NRT53 NRT54	NA	NA	NLT01	NA	NA	NFA05	NA	NA	NA	NA
TIME/DATE AS NECESSARY	REACTOR PRESSURE PSIG	RECIRC LOOP A TEMP °F	RECIRC LOOP A DELTA TEMP °F	RECIRC LOOP A DELTA TEMP 60 Minute ΔT	RECIRC LOOP B TEMP °F	RECIRC LOOP B DELTA TEMP °F	RECIRC LOOP B DELTA TEMP 60 Minute ΔT	BOTTOM HEAD DRAIN TEMP °F	BTM HD DRAIN DELTA TEMP °F	BTM HD DRAIN DELTA TEMP 60 Minute ΔT	RX STM DOME TEMP °F Enter NA when Stm Dome Temp <212°F *	RX STM DOME DELTA TEMP °F *	RX STM DOME DELTA TEMP 60 Minute ΔT *	CONFIRM COMPLIANCE W/SR 3.4.10.1	Shift Supervision review
2100 05/28/14	0	126.7	1.1	2.8	127.0	1.1	2.7	127	1	3.0	N/A	N/A	N/A	RO	SRO
2115 05/28/14	0	128.3	1.6	3.8	128.3	1.3	3.5	128	1	3	N/A	N/A	N/A	RO	SRO
2130 05/28/14	0	133.8	5.5	8.9	136.8	8.5	11.6	137	9	12	N/A	N/A	N/A	RO	SRO
2145 05/28/14	0	163.8	30.0	38.2	165.7	28.9	39.8	166	29	40	N/A	N/A	N/A	RO	SRO
2200 05/28/14	0	185.7	21.9	59.0	187.7	22.0	60.7	187	21	60	N/A	N/A	N/A	RO	SRO
2215 05/28/14	0	211.5	25.8	83.2	213.5	25.8	85.2	213	26	85	222	24	87	RO	SRO
2230 05/28/14	10.0	243.8	32.3	110.0	245.6	32.1	108.8	245	32	108	248	26	100	RO	SRO
2245 05/28/14	22.0	260.7	16.9	96.9	263.7	18.1	98.0	262	17	96	276	28	102	RO	SRO
2300 05/28/14	34.0	285.5	24.8	99.8	287.6	23.9	99.9	286	24	99	295	19	97	RO	SRO

RO EXAMINEE

TASK CONDITIONS

A reactor startup is in progress on Unit 1.

SO-100-011 is in progress for monitoring reactor coolant system and reactor pressure vessel heatup.

Another operator is completing Table 1 of SO-100-011 to monitor RPV heatup for compliance with TS 3.4.10 RPV metal temperature versus pressure (P/T) limits.

INITIATING CUE

Perform SO-100-011 Table 2 to monitor RCS heatup rate using the provided data.

RO EXAMINEE

SIM A: A: ACT B:		POWER LEVEL PRESS	Tabular Display		SPDS	ALARM	05/28/14 22:15:00
		CONTN RAD MODE: 1					
POINT NAME	DESCRIPTION	VALUE	UNITS	QUALITY			
NFP02	WIDE RANGE REACTOR PRESS	0	PSIG	LRL			
NBL01	RX LVL SHTDWN RANGE	11	INCHES	GOOD			
NJF01	JET PP TOTAL CORE FLOW	41.25	MLBS/H	GOOD			
NRT01	RECIRC PP A SUCT TEMP - VALUE	211.5	DEGF	GOOD			
NRT02	RECIRC PP B SUCT TEMP - VALUE	213.5	DEGF	GOOD			
NHT01	RHR INLET TEMP TO HX A	76.9	DEGF	GOOD			
NHT02	RHR INLET TEMP TO HX B	77.0	DEGF	GOOD			
NLT01	RX BOTTOM HEAD DRN TEMP	213	DEGF	GOOD			
NFA05	RX STEAM DOME TEMP	222	DEG F	GOOD			
MAT37	SUP POOL D1 BULK TEMP	78.8	DEG F	GOOD			
MAT38	SUP POOL D2 BULK TEMP	78.8	DEG F	GOOD			
MAL03	SUPPRESSION POOL LEVEL A	22.9	FEET	GOOD			
CSL01	COND STORAGE TANK 1 LVL	87.1	%	HALM			
CSL02	COND STORAGE TANK 2 LVL	74.4	%	GOOD			
MRL01	REFUEL WATER STORAGE LVL	51.3	%	GOOD			
WDL01	DEMIN WTR STOR TANK LVL	85	%	GOOD			
TNL01	CONDENSER HOTWELL LEVEL	4.50	FEET	GOOD			
WRP01	MAKEUP WATER SUPPLY PRESS	154	PSIG	GOOD			
ATT01	TBCCW HEADER TEMP	95	DEGF	GOOD			
WCL01	COOLING TOWER LEVEL	6.83	FEET	GOOD			
VMT08	AMBIENT TEMP-10M	69.03	DEGF	GOOD			
MVI01	RB CHIL MTR 1A CURRENT	59	AMPS	GOOD			
MVI02	RB CHIL MTR 1B CURRENT	0	AMPS	GOOD			
SPA015	DRYWELL TEMPERATURE	130.6	DEG F	GOOD			
MVI03	TB CHIL MTR 1A CURRENT	34	AMPS	GOOD			

Display Program Field.

USER: RE \$SERVER: S5E51 | NUM: |

RO EXAMINEE

SIM A ACT		POWER	LEVEL	PRESS	Tabular Display		SPDS	ALARM	05/28/14 22:30:00
A: B:		CONTN	RAD	MODE: 1					
POINT NAME	DESCRIPTION	VALUE	UNITS	QUALITY					
NFP02	WIDE RANGE REACTOR PRESS	10.0	PSIG	LRL					
NBL01	RX LVL SHUTDOWN RANGE	11	INCHES	GOOD					
NJF01	JET PP TOTAL CORE FLOW	41.25	MLBS/H	GOOD					
NRT01	RECIRC PP A SUCT TEMP - VALUE	243.8	DEGF	GOOD					
NRT02	RECIRC PP B SUCT TEMP - VALUE	245.6	DEGF	GOOD					
NHT01	RHR INLET TEMP TO HX A	76.9	DEGF	GOOD					
NHT02	RHR INLET TEMP TO HX B	77.0	DEGF	GOOD					
NLT01	RX BOTTOM HEAD DRN TEMP	245	DEGF	GOOD					
NFA05	RX STEAM DOME TEMP	248	DEG F	GOOD					
MAT37	SUP POOL D1 BULK TEMP	78.8	DEG F	GOOD					
MAT38	SUP POOL D2 BULK TEMP	78.8	DEG F	GOOD					
MAL03	SUPPRESSION POOL LEVEL A	22.9	FEET	GOOD					
CSL01	COND STORAGE TANK 1 LVL	87.1	%	HALM					
CSL02	COND STORAGE TANK 2 LVL	74.4	%	GOOD					
MRL01	REFUEL WATER STORAGE LVL	51.3	%	GOOD					
WDL01	DEMIN WTR STOR TANK LVL	85	%	GOOD					
TNL01	CONDENSER HOTWELL LEVEL	4.50	FEET	GOOD					
WRP01	MAKEUP WATER SUPPLY PRESS	154	PSIG	GOOD					
ATT01	TBCCW HEADER TEMP	95	DEGF	GOOD					
WCL01	COOLING TOWER LEVEL	6.83	FEET	GOOD					
VMT08	AMBIENT TEMP-10M	69.03	DEGF	GOOD					
MVI01	RB CHIL MTR 1A CURRENT	59	AMPS	GOOD					
MVI02	RB CHIL MTR 1B CURRENT	0	AMPS	GOOD					
SPA015	DRYWELL TEMPERATURE	130.6	DEG F	GOOD					
MVI03	TB CHIL MTR 1A CURRENT	34	AMPS	GOOD					

RO EXAMINEE

#1248 Data Viewer - [Tabgrp1x.d3s]
File Edit View Display Viewers Security Window Help

Tabgrp1x
Tabgrp1x

SIM A	ACT B:	<input type="checkbox"/> POWER	<input type="checkbox"/> LEVEL	<input type="checkbox"/> PRESS	Tabular Display	SPDS	ALARM	05/28/14 22:45:00
A:	B:	<input type="checkbox"/> CONTN	<input type="checkbox"/> RAD	MODE: 1				

POINT NAME	DESCRIPTION	VALUE	UNITS	QUALITY
NFP02	WIDE RANGE REACTOR PRESS	22.0	PSIG	LRL
NBL01	RX LVL SHTDWN RANGE	11	INCHES	GOOD
NJF01	JET PP TOTAL CORE FLOW	41.25	MLBS/H	GOOD
NRT01	RECIRC PP A SUCT TEMP - VALUE	260.7	DEGF	GOOD
NRT02	RECIRC PP B SUCT TEMP - VALUE	263.7	DEGF	GOOD
NHT01	RHR INLET TEMP TO HX A	76.9	DEGF	GOOD
NHT02	RHR INLET TEMP TO HX B	77.0	DEGF	GOOD
NLT01	RX BOTTOM HEAD DRN TEMP	262	DEGF	GOOD
NFA05	RX STEAM DOME TEMP	276	DEG F	GOOD
MAT37	SUP POOL D1 BULK TEMP	78.8	DEG F	GOOD
MAT38	SUP POOL D2 BULK TEMP	78.8	DEG F	GOOD
MAL03	SUPPRESSION POOL LEVEL A	22.9	FEET	GOOD
CSL01	COND STORAGE TANK 1 LVL	87.1	%	HALM
CSL02	COND STORAGE TANK 2 LVL	74.4	%	GOOD
MRL01	REFUEL WATER STORAGE LVL	51.3	%	GOOD
WDL01	DEMIN WTR STOR TANK LVL	85	%	GOOD
TNL01	CONDENSER HOTWELL LEVEL	4.50	FEET	GOOD
WRP01	MAKEUP WATER SUPPLY PRESS	154	PSIG	GOOD
ATT01	TBCCW HEADER TEMP	95	DEGF	GOOD
WCL01	COOLING TOWER LEVEL	6.83	FEET	GOOD
VMT08	AMBIENT TEMP-10M	69.03	DEGF	GOOD
MVI01	RB CHIL MTR 1A CURRENT	59	AMPS	GOOD
MVI02	RB CHIL MTR 1B CURRENT	0	AMPS	GOOD
SPA015	DRYWELL TEMPERATURE	130.6	DEG F	GOOD
MVI03	TB CHIL MTR 1A CURRENT	34	AMPS	GOOD

View PDF	View Excel	Export	Excel Data	Fixed Trends Menu	Custom Trends Menu	Bar Group Display	Load Group	Previous	PAGE
									1 2 3 4 5

Display Program Field.
USER: RE SSERVER: 55853 NUM:

RO EXAMINEE

SIM A: ACT A: <input type="checkbox"/> POWER <input type="checkbox"/> LEVEL <input type="checkbox"/> PRESS <input type="checkbox"/> CONTN <input type="checkbox"/> RAD MODE: 1		Tabular Display		SPDS	ALARM	05/28/14 23:00:00
POINT NAME	DESCRIPTION	VALUE	UNITS	QUALITY		
NFP02	WIDE RANGE REACTOR PRESS	34.0	PSIG	LRL		
NBL01	RX LVL SHUTDOWN RANGE	11	INCHES	GOOD		
NJF01	JET PP TOTAL CORE FLOW	41.25	MLBS/H	GOOD		
NRT01	RECIRC PP A SUCT TEMP - VALUE	285.5	DEGF	GOOD		
NRT02	RECIRC PP B SUCT TEMP - VALUE	287.6	DEGF	GOOD		
NHT01	RHR INLET TEMP TO HX A	76.9	DEGF	GOOD		
NHT02	RHR INLET TEMP TO HX B	77.0	DEGF	GOOD		
NLT01	RX BOTTOM HEAD DRN TEMP	286	DEGF	GOOD		
NFA05	RX STEAM DOME TEMP	295	DEG F	GOOD		
MAT37	SUP POOL D1 BULK TEMP	78.8	DEG F	GOOD		
MAT38	SUP POOL D2 BULK TEMP	78.8	DEG F	GOOD		
MAL03	SUPPRESSION POOL LEVEL A	22.9	FEET	GOOD		
CSL01	COND STORAGE TANK 1 LVL	87.1	%	HALM		
CSL02	COND STORAGE TANK 2 LVL	74.4	%	GOOD		
MRL01	REFUEL WATER STORAGE LVL	51.3	%	GOOD		
WDL01	DEMIN WTR STOR TANK LVL	85	%	GOOD		
TNL01	CONDENSER HOTWELL LEVEL	4.50	FEET	GOOD		
WRP01	MAKEUP WATER SUPPLY PRESS	154	PSIG	GOOD		
ATT01	TBCCW HEADER TEMP	95	DEGF	GOOD		
WCL01	COOLING TOWER LEVEL	6.83	FEET	GOOD		
VMT08	AMBIENT TEMP-10M	69.03	DEGF	GOOD		
MVI01	RB CHIL MTR 1A CURRENT	59	AMPS	GOOD		
MVI02	RB CHIL MTR 1B CURRENT	0	AMPS	GOOD		
SPA015	DRYWELL TEMPERATURE	130.6	DEG F	GOOD		
MVI03	TB CHIL MTR 1A CURRENT	34	AMPS	GOOD		

PAGE 1 2 3 4 5

RO EVALUATOR

TASK CONDITIONS

A reactor startup is in progress on Unit 1.

SO-100-011 is in progress for monitoring reactor coolant system and reactor pressure vessel heatup.

Another operator is completing Table 1 of SO-100-011 to monitor RPV heatup for compliance with TS 3.4.10 RPV metal temperature versus pressure (P/T) limits.

INITIATING CUE

Perform SO-100-011 Table 2 to monitor RCS heatup rate using the provided data.

SRO EXAMINEE

INITIATING CUE

Identify any applicable TS LCOs not met and the associated Conditions, the Required Action(s) to be performed and the date and time the Required Action(s) must be completed.

Document your findings on your SRO cue sheet.

SRO EVALUATOR

INITIATING CUE

Identify any applicable TS LCOs not met and the associated Conditions, the Required Action(s) to be performed and the date and time the Required Action(s) must be completed.

Document your findings on your SRO cue sheet.

JPM ASSEMBLY INSTRUCTIONS

Seq	Item	Copier Program	Binding
1.	Examinee cue sheet	cue	loose
2.	Examinee Rtime prints	exam	staple
3.	SO-100-011 (markup)	exam	staple
4.	Evaluator cue sheet	cue	loose
5.	SRO Examinee cue sheet	cue	loose
6.	SRO Evaluator cue sheet	cue	loose
7.	JPM	jpm	loose
8.	Procedure (replacement)	sim	PC

PPL SUSQUEHANNA, LLC
 JOB PERFORMANCE MEASURE

APPROVAL AND ADMINISTRATIVE DATA SHEET

Task Title Implement On-Site Class 1E Operability Test for Inoperable Diesel Generator

S/RO	24.SO.1475.002	2	02/13/2014	Simulator
Applicability	JPM Number	Revision	Date	Setting
262001 NUREG-1123 E/APE / Sys	G2.2.40 K/A Number	3.4 / 4.7 K/A Importance	N Alternate Path	N Time Critical

Prepared

Validated

Robert A. Thompson

02/13/2014

Robert A. Thompson

02/20/2014

Author

Date

Instructor

Date

Review

Approval

[Signature]
Operations Management

6-29-14
Date

[Signature]
Nuclear Training Supervisor

6/30/14
Date

25

Validation Time (min)

Examinee Name:

_____ Last, First MI

_____ Employee Number

Exam Date: _____

Exam Duration (Min) _____

Evaluation Result: Satisfactory

Unsatisfactory

Evaluator

_____ Name

_____ Signature

Comments



JPM REVISION SUMMARY

Revision	Description/Purpose of Revision
0	New JPM
1	Revised for current revision of procedure. Revalidation not required, no changes to critical steps/sequence and no change of procedure direction/intent.
2	Revise for TQ procedures, minor editorial corrections. Renumbered from 24.AD.1475.001.

REQUIRED TASK INFORMATION

1. SAFETY CONSIDERATIONS

- A. All Operations personnel are responsible for maintaining their radiation exposure As Low As Reasonably Achievable in accordance with OP-AD-002, Standards for Shift Operations.
- B. All applicable safety precautions shall be taken in accordance with established PPL safety policies and the Safety Rule Book, for example:
 1. Whenever any electrical panel is opened for inspection during JPM performance.
 2. Whenever entering any plant area where specific safety equipment such as hearing or eye protection, safety shoes, hardhats, etc., is required and/or posted as being necessary.
- C. If, in the judgment of the Evaluator any safety issue occurs during the performance of a JPM, the JPM will be terminated until the issue is resolved.
- D. Peer checking is the expectation for all evolutions; however, since a JPM is an individual effort, no peer check will be provided and Self Checking is required.

2. REFERENCES

- A. SO-024-013, Offsite Power Source And Onsite Class 1E Operability Test (Reversion)
- B. TS 3.8.1, AC SOURCES - OPERATING
- C. TS 3.1.7, STANDBY LIQUID CONTROL SYSTEM

3. TASK CONDITIONS

Units 1 and 2 are operating at rated power in the normal electrical lineup.

All equipment is operable except as noted:

- Unit 1 CRD Pump 1B is out service for routine maintenance for a gear box oil change.
- Unit 2 SLC Pump 2A is inoperable. It failed to develop the required discharge pressure during performance of SO-253-003. Unit 2 has entered TS 3.1.7 Condition B for the inoperable SLC pump.
- I&C is performing SI-145-201, Quarterly Functional Test Of Feedwater System Main Turbine Trip System Reactor Vessel Water Level Channels PDT-C32-1N004A(B)(C). Channel A is currently in trip as part of the surveillance.
- Diesel Generator E is unavailable due to a scheduled overhaul in progress.

Diesel Generator A has just experienced a malfunction. A fitting on the fuel oil system failed, resulting in a fuel oil leak. The leak has been isolated. Diesel Generator A is being maintained in LOCAL until the fuel oil leak can be cleaned up.

4. INITIATING CUE

RO Examinee

Perform SO-024-013, Offsite Power Source And Onsite Class 1E Operability Test, for an inoperable Diesel Generator A.

SRO Examinee

Identify and perform, or specify the method of performing, any applicable Technical Specification Required Actions.

5. TASK STANDARD

Performs SO-024-013 and determines that Unit 2 must enter TS 3.1.7 Condition C after 4 hours for 2 SLC subsystems inoperable. Determines that within 24 hours either a common cause failure determination is required to be complete, or Diesel Generators B, C and D must be tested in accordance with SO-024-001.

PERFORMANCE CHECKLIST

Examinee _____

Step	Action	Standard	Eval	Comments
<p><u>EVALUATOR INSTRUCTIONS</u></p> <ul style="list-style-type: none"> Marking a step as UNSAT requires written comments on respective step. Critical steps are marked with a *. If elements of the Standard are non-critical, the critical elements of the Standard are marked with a *. The time clock starts when the candidate acknowledges the Initiating Cue. This JPM must be performed in the simulator. Reset to any IC with the normal electrical distribution lineup. The simulator may be left in FREEZE for performance of this JPM. Ensure Unit 1 and 2 Technical Specifications are available. Ensure a copy of SO-024-013 is available to provide to the examinee when requested. 				
<p><u>EVALUATOR CUE</u> Record JPM start time: _____</p>				
1	Identifies governing procedure and obtain controlled copy.	Obtains controlled copy of SO-024-013.		
2	Verifies prerequisites are satisfied.	Performs the following from review of the Task Conditions: <ul style="list-style-type: none"> Observes Units 1 and 2 in Mode 1 Observes no maintenance or testing is in progress that would conflict with performance of SO-024-013 Observes only 1 DG is inoperable, no reportability is required 		
3	Records operational conditions of both units.	On Attachment A, PROCEDURE DATA RECORD, item 5.1, records Mode 1 as AS-FOUND Unit 1 and Unit 2 Operational Condition and initials.		
4	Records Plant Condition(s) which requires performance of this surveillance.	On Attachment A, PROCEDURE DATA RECORD, item 5.2, performs the following and initials each: <ul style="list-style-type: none"> Records YES for 5.2.a Loss of D/G A Records NO for all others 		

PERFORMANCE CHECKLIST

Examinee _____

Step	Action	Standard	Eval	Comments
5	Records operable Diesel Generators aligned for standby automatic operation.	On Step 5.4.1 of SO-024-013, circles Diesel Generators B, C and D.		
6	Confirms breaker alignment for inoperable Diesel Generator.	Observes the following breakers are CLOSED at 0C653; and initials, signs and records date and time on Checksheet #2 of Attachment C: <ul style="list-style-type: none"> • SU XFMR 10 TO BUS 10 BKR 0A10301 • SU XFMR 20 TO BUS 20 BKR 0A10401 • SU BUS 10 TO XFMR 101 BKR 0A10306 • SU BUS 10 TO XFMR 111 BKR 0A10312 • SU BUS 20 TO XFMR 201 BKR 0A10406 • SU BUS 20 TO XFMR 211 BKR 0A10412 • XFMR 101 TO BUS 1A BKR 1A20101 • XFMR 111 TO BUS 1C BKR 1A20301 • XFMR 211 TO BUS 1B BKR 1A20209 • XFMR 201 TO BUS 1D BKR 1A20409 • XFMR 101 TO BUS 2A BKR 2A20101 • XFMR 111 TO BUS 2C BKR 2A20301 • XFMR 211 TO BUS 2B BKR 2A20209 • XFMR 201 TO BUS 2D BKR 2A20408 		
7	Observes all ESS buses are energized.	At 0C653 observes WHITE power available lights are ON for all Unit 1 and Unit 2 ESS Buses.		
*8	Confirms systems and equipment redundant to systems and equipment supported by Diesel Generator A are operable.	Performs the following on Attachment D of SO-024-013: <ul style="list-style-type: none"> • Records NO for Unit 2 SLC Pump 2A OPERABLE • Records YES for all other systems and equipment OPERABLE for Units 1 and 2 		

PERFORMANCE CHECKLIST

Examinee _____

Step	Action	Standard	Eval	Comments
9	Evaluates common cause failure.	Informs Unit Supervisor to determine how to comply with Step 5.4.2c (common-mode failure determination).		
<u>EVALUATOR CUE</u> (For the R/O examinee) The SRO will determine how to perform Step 5.4.2c. Continue with the SO. The SRO will record whether Acceptance Criteria 2 of Attachment A is met.				
10	Notifies Unit 1 and 2 Unit Supervisors and USW of inoperable Diesel Generator	Notifies Unit 1 and 2 Unit Supervisors and USW of the following: <ul style="list-style-type: none"> • Equipment on Attachment D of SO-024-013 should not be impaired without meeting the requirements of TS 3.8.1 Required Action B.2 • Maintain this requirement on their turnover sheet until Diesel Generator A is operable 		
*11	Records on-site Class 1E distribution system breaker alignment and power availability is acceptable.	On Attachment A of SO-024-013, records YES for Acceptance Criteria 1 and initials.		
*12	Records systems/equipment are not operable as required for Diesel Generator A inoperable.	On Attachment A of SO-024-013, records NO for Acceptance Criteria 3 and initials.		
13	Notifies Shift Supervision of Acceptance Criteria not met.	Notifies Unit 1 and 2 Unit Supervisors that SO-024-013 Acceptance Criteria are not met.		
<u>EVALUATOR CUE</u> (For the R/O examinee) That completes the JPM.				

PERFORMANCE CHECKLIST

Examinee _____

Step	Action	Standard	Eval	Comments
*14	Evaluates common cause failure.	Determines that within 24 hours EITHER of the following actions must be performed: <ul style="list-style-type: none"> • Determe cause of diesel generator inoperability and ensuring it does not represent a common mode/generic failure mechanism for remaining diesel generators • Test Diesel Generators B, C and D in accordance with SO-024-001 		
*15	Identifies applicable REQUIRED ACTIONS are in effect	On Attachment A of SO-024-013, REQUIRED ACTIONS, performs the following and initials each: <ul style="list-style-type: none"> • Marks NO for TS 3.8.1 Condition A actions APPLICABLE for Units 1 and 2 • Marks NO for TS 3.8.1 Condition B actions APPLICABLE for Unit 1 • Marks YES for TS 3.8.1 Condition B actions APPLICABLE for Unit 2 • Marks NO for TS 3.8.1 Condition C actions APPLICABLE for Units 1 and 2 • Marks NO for TS 3.8.1 Condition D actions APPLICABLE for Units 1 and 2 • Marks NO for TS 3.8.1 Condition E actions APPLICABLE for Units 1 and 2 		

PERFORMANCE CHECKLIST

Examinee _____

Step	Action	Standard	Eval	Comments
*16	Identifies applicable TS Required Actions and Completion Times for inoperable Unit 2 SLC Pump 2A.	Performs the following: <ul style="list-style-type: none"> • Identifies Unit 2 SLC Pump 2B must be declared inoperable within 4 hours per TS 3.8.1 Required Action B.2 • Determines that within 8 hours of declaring Unit 2 SLC Pump 2B inoperable, either SLC Pump 2A must be restored OPERABLE, or Diesel Generator A must be restored OPERABLE 		
<u>EVALUATOR CUE</u> Record JPM stop time: _____				
<u>EVALUATOR NOTE</u> That completes the JPM.				
<u>EVALUATOR:</u> Do you have ALL your JPM exam materials? Task Cue Sheets? Procedures?				

RO EXAMINEE

TASK CONDITIONS

Units 1 and 2 are operating at rated power in the normal electrical lineup.

All equipment is operable except as noted:

- Unit 1 CRD Pump 1B is out service for routine maintenance for a gear box oil change.
- Unit 2 SLC Pump 2A is inoperable. It failed to develop the required discharge pressure during performance of SO-253-003. Unit 2 has entered TS 3.1.7 Condition B for the inoperable SLC pump.
- I&C is performing SI-145-201, Quarterly Functional Test Of Feedwater System Main Turbine Trip System Reactor Vessel Water Level Channels PDT-C32-1N004A(B)(C). Channel A is currently in trip as part of the surveillance.
- Diesel Generator E is unavailable due to a scheduled overhaul in progress.

Diesel Generator A has just experienced a malfunction. A fitting on the fuel oil system failed, resulting in a fuel oil leak. The leak has been isolated. Diesel Generator A is being maintained in LOCAL until the fuel oil leak can be cleaned up.

INITIATING CUE

Perform SO-024-013, Offsite Power Source And Onsite Class 1E Operability Test, for an inoperable Diesel Generator A.

RO EVALUATOR

TASK CONDITIONS

Units 1 and 2 are operating at rated power in the normal electrical lineup.

All equipment is operable except as noted:

- Unit 1 CRD Pump 1B is out service for routine maintenance for a gear box oil change.
- Unit 2 SLC Pump 2A is inoperable. It failed to develop the required discharge pressure during performance of SO-253-003. Unit 2 has entered TS 3.1.7 Condition B for the inoperable SLC pump.
- I&C is performing SI-145-201, Quarterly Functional Test Of Feedwater System Main Turbine Trip System Reactor Vessel Water Level Channels PDT-C32-1N004A(B)(C). Channel A is currently in trip as part of the surveillance.
- Diesel Generator E is unavailable due to a scheduled overhaul in progress.

Diesel Generator A has just experienced a malfunction. A fitting on the fuel oil system failed, resulting in a fuel oil leak. The leak has been isolated. Diesel Generator A is being maintained in LOCAL until the fuel oil leak can be cleaned up.

INITIATING CUE

Perform SO-024-013, Offsite Power Source And Onsite Class 1E Operability Test, for an inoperable Diesel Generator A.

SRO EXAMINEE

TASK CONDITIONS

Units 1 and 2 are operating at rated power in the normal electrical lineup.

All equipment is operable except as noted:

- Unit 1 CRD Pump 1B is out service for routine maintenance for a gear box oil change.
- Unit 2 SLC Pump 2A is inoperable. It failed to develop the required discharge pressure during performance of SO-253-003. Unit 2 has entered TS 3.1.7 Condition B for the inoperable SLC pump.
- I&C is performing SI-145-201, Quarterly Functional Test Of Feedwater System Main Turbine Trip System Reactor Vessel Water Level Channels PDT-C32-1N004A(B)(C). Channel A is currently in trip as part of the surveillance.
- Diesel Generator E is unavailable due to a scheduled overhaul in progress.

Diesel Generator A has just experienced a malfunction. A fitting on the fuel oil system failed, resulting in a fuel oil leak. The leak has been isolated. Diesel Generator A is being maintained in LOCAL until the fuel oil leak can be cleaned up.

INITIATING CUE

Identify and perform, or specify the method of performing, any applicable Technical Specification Required Actions.

SRO EVALUATOR

TASK CONDITIONS

Units 1 and 2 are operating at rated power in the normal electrical lineup.

All equipment is operable except as noted:

- Unit 1 CRD Pump 1B is out service for routine maintenance for a gear box oil change.
- Unit 2 SLC Pump 2A is inoperable. It failed to develop the required discharge pressure during performance of SO-253-003. Unit 2 has entered TS 3.1.7 Condition B for the inoperable SLC pump.
- I&C is performing SI-145-201, Quarterly Functional Test Of Feedwater System Main Turbine Trip System Reactor Vessel Water Level Channels PDT-C32-1N004A(B)(C). Channel A is currently in trip as part of the surveillance.
- Diesel Generator E is unavailable due to a scheduled overhaul in progress.

Diesel Generator A has just experienced a malfunction. A fitting on the fuel oil system failed, resulting in a fuel oil leak. The leak has been isolated. Diesel Generator A is being maintained in LOCAL until the fuel oil leak can be cleaned up.

INITIATING CUE

Identify and perform, or specify the method of performing, any applicable Technical Specification Required Actions.

JPM ASSEMBLY INSTRUCTIONS

Seq	Item	Copier Program	Binding
1.	RO Examinee cue sheet	cue	loose
2.	RO Evaluator cue sheet	cue	loose
3.	SRO Examinee cue sheet	cue	loose
4.	SRO Evaluator cue sheet	cue	loose
5.	JPM	jpm	loose
6.	SO-024-013	exam	staple

PPL SUSQUEHANNA, LLC
JOB PERFORMANCE MEASURE

APPROVAL AND ADMINISTRATIVE DATA SHEET

Task Title Review and Verify Blocking Required per NDAP-QA-0322

<u>S/RO</u>	<u>00.AD.3274.103</u>	<u>1</u>	<u>06/29/2014</u>	<u>Classroom</u>
Applicability	JPM Number	Revision	Date	Setting
<u>Generic</u>	<u>2.2.41</u>	<u>3.5 / 3.9</u>	<u>N</u>	<u>N</u>
NUREG-1123 E/APE / Sys	K/A Number	K/A Importance	Alternate Path	Time Critical

Prepared	Validated
<u>Robert A. Thompson</u>	<u>Robert A. Thompson</u>
Author	Instructor
<u>06/29/2014</u>	<u>08/03/2012</u>
Date	Date
Review	Approval
<u><i>Thompson</i></u>	<u><i>Robert A. Thompson</i></u>
Operations Management	Nuclear Training Supervisor
<u>6-29-14</u>	<u>6/30/14</u>
Date	Date

25
Validation Time (min)

Examinee Name: _____
Last, First MI
Employee Number

Exam Date: _____ Exam Duration (Min) _____

Evaluation Result: Satisfactory Unsatisfactory

Evaluator _____
Name
Signature

Comments _____



JPM REVISION SUMMARY

Revision	Description/Purpose of Revision
0	New JPM
1	Revise for new TQ procedures

REQUIRED TASK INFORMATION

1. SAFETY CONSIDERATIONS

- A. All Operations personnel are responsible for maintaining their radiation exposure As Low As Reasonably Achievable in accordance with OP-AD-002, Standards for Shift Operations.
- B. All applicable safety precautions shall be taken in accordance with established PPL safety policies and the Safety Rule Book, for example:
 - 1. Whenever any electrical panel is opened for inspection during JPM performance.
 - 2. Whenever entering any plant area where specific safety equipment such as hearing or eye protection, safety shoes, hardhats, etc., is required and/or posted as being necessary.
- C. If, in the judgment of the Evaluator any safety issue occurs during the performance of a JPM, the JPM will be terminated until the issue is resolved.
- D. Peer checking is the expectation for all evolutions; however, since a JPM is an individual effort, no peer check will be provided and Self Checking is required.

2. REFERENCES

- A. M-115 Sheet 1 (Revision 53)
- B. E-137 Sheet 1 (Revision 14)
- C. E-138 Sheet 1 (Revision 13), Sheet 19 (Revision 6)
- F. NDAP-QA-0322, Energy Control Process (Revision 49)

3. TASK CONDITIONS

Unit 1 is at 100% power.

Circulating Water Pump 1A has been scheduled for routine pump and motor PMs, but due to an oversight, no clearance package was developed

Database problems within eSoms have prevented development of a clearance order by electronic means

4. INITIATING CUE

Using the appropriate drawings referenced on the proposed clearance, review the requested blocking to ensure it meets the requirements of NDAP-QA-0322 for accuracy and adequacy.

5. TASK STANDARD

Review the list of proposed blocking for Circulating Water Pump 1A; discrepancies identified and noted in accordance with JPM.

PERFORMANCE CHECKLIST

Examinee _____

Step	Action	Standard	Eval	Comments
<p><u>EVALUATOR INSTRUCTIONS</u></p> <ul style="list-style-type: none"> • Marking a step as UNSAT requires written comments on respective step. • Critical steps are marked with a *. If elements of the Standard are non-critical, the critical elements of the Standard are marked with a *. • The time clock starts when the candidate acknowledges the Initiating Cue. • This JPM may be performed in the simulator or classroom. • If performed in the classroom, ensure copies of the following documents are available: <ul style="list-style-type: none"> ○ NDAP-QA-0322 ○ M-115 Sheet 1 ○ E-137 Sheet 1 ○ E-138 Sheet 1, 19 				
<p><u>EVALUATOR CUE</u> Record JPM start time: _____</p>				
<p><u>EVALUATOR NOTE</u></p> <ul style="list-style-type: none"> • NDAP-QA-0322 is an information use only procedure. Candidate should reference clearance standards (6.1) and attachments N & O for general equipment blocking rules for verifying correct blocking. • Candidate may at any time reference NDAP-QA-0322 to ensure compliance and follow appropriate check sheets. 				
1	Reviews the scope of work planned for Circulating Water Pump 1A.	Determines that motor needs blocked and should isolate all pump flowpaths to allow for work on pump.		
*2	Recognizes requested breaker 1B511-011 for HV-11511A, Circ Water Pump A Discharge Vlv, is incorrect.	Identifies 1B511-034 as the correct breaker for HV-11511A, Circ Water Pump A Discharge Vlv.		
*3	Recognizes requested 115185, CW Pump A Suction Corrosion Sample Iso Vlv, is not required to be blocked, but 115186, CW Pump A Discharge Corrosion Sample Iso Vlv, is required to be blocked to isolate flowpath back to pump.	Identifies 115186, CW PUMP A DISCHARGE CORROSION SAMPLE ISO VLV, is required to be red tagged closed.		
*4	Recognizes requested 115153 is the CW Pump B IB Bearing Seal Water Supply Iso Vlv and should not be blocked.	Identifies 115153 as CW PUMP B IB BEARING SEAL WATER SUPPLY ISO VLV and deletes from clearance.		

PERFORMANCE CHECKLIST

Examinee _____

Step	Action	Standard	Eval	Comments
*5	Identifies requested 115151, CW Pump A IB Bearing Seal Water Supply Iso Vlv is required to be blocked to isolate seal water to the pump.	Adds 115151, CW PUMP A IB BEARING SEAL WATER SUPPLY ISO VLV, to the clearance.		
6	Provides corrected blocking sheet to Unit Supervisor to be forwarded to WCC.	Unit Supervisor is given the corrected blocking sheet.		
<u>EVALUATOR CUE</u> Acknowledge the receipt of the corrected blocking and inform examinee that it will be forwarded to the WCC.				
<u>EVALUATOR NOTE</u> Due to the nature of this JPM other blocking points may be acceptable. Consult with additional SMEs as necessary to determine acceptability of alternate blocking points.				
<u>EVALUATOR CUE</u> Record JPM stop time: _____				
<u>EVALUATOR CUE</u> That completes the JPM.				
<u>EVALUATOR:</u> Do you have ALL your JPM exam materials? Task Cue Sheets? Procedures?				

EXAMINEE

TASK CONDITIONS

Unit 1 is at 100% power.

Circulating Water Pump 1A has been scheduled for routine pump and motor PMs, but due to an oversight, no clearance package was developed

Database problems within eSoms have prevented development of a clearance order by electronic means

INITIATING CUE

Using the appropriate drawings referenced on the proposed clearance, review the requested blocking to ensure it meets the requirements of NDAP-QA-0322 for accuracy and adequacy.

EVALUATOR

TASK CONDITIONS

Unit 1 is at 100% power.

Circulating Water Pump 1A has been scheduled for routine pump and motor PMs, but due to an oversight, no clearance package was developed

Database problems within eSoms have prevented development of a clearance order by electronic means

INITIATING CUE

Using the appropriate drawings referenced on the proposed clearance, review the requested blocking to ensure it meets the requirements of NDAP-QA-0322 for accuracy and adequacy.

JPM ASSEMBLY INSTRUCTIONS

Seq	Item	Copier Program	Binding
1.	Examinee cue sheet	cue	loose
2.	Clearance order handout	exam	staple
3.	Prints (total of 4)	exam	staple
4.	NDAP-QA-0322	exam	staple
5.	Evaluator cue sheet	cue	loose
6.	JPM	jpm	loose

Library Clearance Order
Susquehanna
0 -UNIT 1 & COMMON SYS

42-001-1P501A CIRC WTR PUMP & MOTOR

1P501A

CIRCULATING WATER PUMP A (PP MOTOR MR N NOUN LOC TEXT:
 RM: CW-003 A:50 E:661 R670' COL:14 S 21.2

Clearance Order Description:

CIRCULATING WATER PUMP 1P501A OOS FOR PUMP & MOTOR PMs STANDARD CLEARANCE ORDER

Notes:

- 1) WORK GROUP VENT AND DRAIN (Wst Pregen form)
- 2) Clearance order effectiveness determined by NVC, Live-Dead-Live checks and ability to drain within blocking.
- 3) Motor heater may be energized.

Impacts / Effects:

1 REMOVE 1P501A FROM SERVICE IAW OP-142-001 BEFORE HANGING BLOCKING

EFFECTS: LOSS OF CONTROL, POWER & INDICATION @ 1C668 & 1C511
 FOR 1P501A, HV11511A, & HV11513A
 ENERGIZE MOTOR SPACE HEATER 1P501A
 COMPUTER POINT WCZ01 PUMP RUNNING CHANGES STATE

ALARMS: CIRC.WTR PP. 'A' SEAL WATER LOW PRESSURE AT 1C511
 CIRC. WATER PUMP 'A' TRIP AT 1C668 FOR 1P501A

NOTE: MECH. MAINT. WILL DRAIN PUMP PER WASTE PREGEN FORM

REFERENCES: E-137 SH 1 E-138 SH 1, 19 M-115 SH 1

Post Maintenance Testing Req.:

PSP-29; PLACE SW PUMP 2P502A I/S IAW OP-211-001

Level	Verified By	Verification Date/Time	Verification Description	Status
1	Cochran, Herman	3/24/2014 14:57:01	Prepared	
2	Killingsworth, David	3/24/2014 14:59:55	Reviewed	

Attribute Description	Attribute Value
NVC Required	Yes
Sequential Blocking Required	No
Atypical Clearance	No
Draining Complete	MAINT TO DRAIN-ACCEPTED AS IS
Depressurized	MAINT TO ASSIST DEPRESS - ACCEPT AS IS
Continuously Vented	N/A
Purge Complete	N/A

Tagged Component	Description	Location	Tag Type	Pl. Seq.	Place Verif	Rest. Seq.	Rest Verif	Tagged Position	Restoration Position	Tag Placement Notes	Tag Removal Notes
NOTE 1	SEE BLOCKING COMMENTS FOR DETAILS NOUN LOC TEXT:	A:0 E:0	Info	1	NV	6	NV	SEE TAG PLACEMENT NOTES	SEE TAG REMOVAL NOTES	ENSURE 1P501A CIRCULATING WATER PUMP A SHUTDOWN IAW OP-142-001 SECT 2.2 PRIOR TO HANGING TAGS	
1A10103 (RM)	CIRC WATER PUMP A 1P501A BKR 13.8 KV BKR NOUN LOC TEXT:	RM:I-220 A:4 E:699 R699' COL:3 N 27.5	Pink Tag	2	SC	5	CV	OPEN, RACKED OUT, REMOVED	RACKED IN		
1A10103 GROUND & TEST DEVICE	CIRC WATER PUMP A 1P401A BKR 13.8 KV BKR	RM:I-220 A:4 E:699'	Red Tag	3	CV	4	CV	RACKED IN	RACK OUT REMOVE		
1B511013	CIRC WATER PUMP A SUCTION VLV HV-11513A BKR NOUN LOC TEXT:	RM: CW-020 A:51 E:676 R676' COL:12 N 30.4	Red Tag	4	CV	3	CV	OPEN	CLOSE		
1B511011	CIRC WATER PUMP A DISCHARGE VLV HV-11511A BKR NOUN LOC TEXT:	RM: CW-020 A:51 E:676 R676' COL:12 N 30.4	Red Tag	4	CV	3	CV	OPEN	CLOSE		

HV11513A	CIRC WATER PUMP A SUCTION VLV NOUN LOC TEXT: CAUTION: DURING MANUAL OPERATION, DO NOT POSITION PAST SCRIBE MARKS	RM:CW-003 A:50 E:661 R665' COL:14 S 21.2	Red Tag	5	CV	2	CV	CLOSED	CLOSED		
HV11511A	CIRC WATER PUMP A DISCHARGE VLV NOUN LOC TEXT: CAUTION: DURING MANUAL OPERATION, DO NOT POSITION PAST SCRIBE MARKS	RM:CS-003 A:50 E:661 R667' COL:6 S 21.2	Red Tag	5	CV	2	CV	CLOSED	CLOSED		
115185	CW PUMP A SUCTION CORROSION SAMPLE ISO VLV NOUN LOC TEXT:	RM:? A:50 E:661	Red Tag	5	CV	2	CV	CLOSED	OPEN		
115152	CWP A OB BEARING SEAL WATER SUPPLY ISO VLV NOUN LOC TEXT:	RM:CW-003 A:50 E:676 R671' COL:12 S 21.2	Red Tag	5	CV	2	CV	CLOSED	OPEN		
115153	CWP A IB BEARING SEAL WATER SUPPLY ISO VLV NOUN LOC TEXT:	RM:CW-003 A:50 E:676 R671' COL:18 S 21.2	Red Tag	5	CV	2	CV	CLOSED	OPEN		
115139A	CW PUMP A SUCTION VENT VLV NOUN LOC TEXT:	RM:? A:50 E:661 R661'	No Tag	6	SC	1	CV	CLOSED	CLOSED PLUGGED		
115137A	CW PUMP A DISCHARGE VENT VLV NOUN LOC TEXT:	RM:? A:50 E:661 R661'	No Tag	6	SC	1	CV	CLOSED	CLOSED PLUGGED		
1A	CW PUMP A SUCTION VENT VLV NOUN LOC TEXT:	RM:? A:50 E:661 R661'	No Tag	6	SC	1	CV	CLOSED	CLOSED PLUGGED		
115142A	CIRC WATER PUMP A DISCHARGE DRAIN VLV NOUN LOC TEXT:	RM:? A:50 E:661 R661'	No Tag	6	SC	1	CV	CLOSED	CLOSED		
115143A	CIRC WATER PUMP A SUCTION DRAIN VLV NOUN LOC TEXT:	RM:? A:50 E:661 R661'	No Tag	6	SC	1	CV	CLOSED	CLOSED		

PPL SUSQUEHANNA, LLC

JOB PERFORMANCE MEASURE

APPROVAL AND ADMINISTRATIVE DATA SHEET

Task Title Perform Control Room Actions in Response to Fuel Handling Accident

<u>RO</u> Applicability	<u>81.ON.2356.001</u> JPM Number	<u>0</u> Revision	<u>02/18/2014</u> Date	<u>Simulator</u> Setting
<u>Generic</u> NUREG-1123 E/APE / Sys	<u>2.3.13</u> K/A Number	<u>3.4 / 3.8</u> K/A Importance	<u>N</u> Alternate Path	<u>N</u> Time Critical

Prepared

Validated

Robert A. Thompson

02/18/2014

Robert A. Thompson

02/20/2014

Author

Date

Instructor

Date

Review

Approval

[Signature]
Operations Management

6-29-14
Date

[Signature]
Nuclear Training Supervisor

6/30/14
Date

15

Validation Time (min)

Examinee Name:

Last, First MI

Employee Number

Exam Date: _____

Exam Duration (Min) _____

Evaluation Result:

Satisfactory

Unsatisfactory

Evaluator

Name

Signature

Comments



JPM REVISION SUMMARY

Revision	Description/Purpose of Revision
0	New JPM
1	Revise for TQ procedures, minor editorial corrections

REQUIRED TASK INFORMATION

1. SAFETY CONSIDERATIONS

- A. All Operations personnel are responsible for maintaining their radiation exposure As Low As Reasonably Achievable in accordance with OP-AD-002, Standards for Shift Operations.
- B. All applicable safety precautions shall be taken in accordance with established PPL safety policies and the Safety Rule Book, for example:
 - 1. Whenever any electrical panel is opened for inspection during JPM performance.
 - 2. Whenever entering any plant area where specific safety equipment such as hearing or eye protection, safety shoes, hardhats, etc., is required and/or posted as being necessary.
- C. If, in the judgment of the Evaluator any safety issue occurs during the performance of a JPM, the JPM will be terminated until the issue is resolved.
- D. Peer checking is the expectation for all evolutions; however, since a JPM is an individual effort, no peer check will be provided and Self Checking is required.

2. REFERENCES

- A. ON-081-001, Fuel Handling Accident (Revision 13)

3. TASK CONDITIONS

Unit 1 is in a refueling outage, core shuffle in progress, when a fuel bundle falls from the Refueling Platform main grapple onto the Unit 1 Spent Fuel Pool rack. The fuel bundle is heavily damaged.

The Refueling SRO and HP coordinated an evacuation of all personnel off of the Refuel Floor.

Both divisions of SGTS initiated successfully due to Zone III isolation on high Refuel Floor radiation.

The Unit 1 Unit Supervisor has entered ON-081-001.

Cavity and Fuel Pool levels are unchanged and stable.

The Shift Manager is reviewing the Emergency Plan.

4. INITIATING CUE

Perform the Control Room actions of ON-081-001.

5. TASK STANDARD

Performs a local zone evacuation of both Unit 1 and Unit 2 Reactor Buildings per OP-099-004, directs Security to preclude access to the Unit 1 and Unit 2 Reactor Buildings, and directs HP to evaluate onsite and offsite radiological conditions (including projected offsite dose).

PERFORMANCE CHECKLIST

Examinee _____

Step	Action	Standard	Eval	Comments
<p><u>EVALUATOR INSTRUCTIONS</u></p> <ul style="list-style-type: none"> • Marking a step as UNSAT requires written comments on respective step. • Critical steps are marked with a *. If elements of the Standard are non-critical, the critical elements of the Standard are marked with a *. • The time clock starts when the candidate acknowledges the Initiating Cue. • This JPM must be performed in the simulator. Access to the plant evacuation siren controls is required. • Provide a copy of ON-081-001 for the examinee. 				
<p><u>EVALUATOR CUE</u> Record JPM start time: _____</p>				
1	<p>Identifies governing procedure and obtain controlled copy.</p>	<p>Obtains controlled copy of ON-081-001.</p>		
2	<p>Determines Operation Actions for fuel bundle placement, Refuel Floor evacuation, and Shift Supervision notification are complete.</p>	<p>From Task Conditions identifies the following:</p> <ul style="list-style-type: none"> • ON entry was due to fuel bundle drop, bundle placement is not applicable • The Refuel Floor has been evacuated • Cavity and Fuel Pool levels are normal 		
3	<p>Determines Emergency Plan is being implemented.</p>	<p>Observes per Task Conditions Shift Manager is reviewing Emergency Plan.</p>		
4	<p>Secures RCS draining activities.</p>	<p>Determines no RCS draining activities in progress with fuel movement authorized per Task Conditions.</p>		
*5	<p>Directs HP to determine onsite radiological conditions and offsite release with dose projections.</p>	<p>Contacts HP and directs the following:</p> <ul style="list-style-type: none"> • Determine onsite radiological conditions (e.g., survey) • Determine extent of offsite radiological releases and dose projections (i.e. offsite dose calculations) 		

PERFORMANCE CHECKLIST

Examinee _____

Step	Action	Standard	Eval	Comments
6	Determines Zone 1 and 2 Reactor Building HVAC not required to be in operation due to SGTS initiation on high radiation on the Refuel Floor.	Determines Zone 1 and 2 RB HVAC isolated with both divisions of SGTS initiated successfully due to high Refuel Floor radiation, per Task Conditions.		
7	Determines evacuation of Unit 1 and 2 Reactor Buildings is required.	Observes Zone III isolation occurred per Task Conditions and evacuation of Unit 1 and 2 Reactor Buildings is required.		
<u>EVALUATOR CUE</u>				
When the examinee identifies OP-099-004 is needed, provide the examinee a copy of the procedure.				
8	Identifies governing procedure and obtain controlled copy.	Obtains controlled copy of OP-099-004, selects Section 3.2.		
<u>EVALUATOR NOTE</u>				
The Pistol Grip EVACUATION ALARM switch is NOT pushed in at this time, as the correct tone is not selected.				
*9	Selects Plant Alarm function.	Performs the following at 0C695: <ul style="list-style-type: none"> • Pulls out the Pistol Grip EVACUATION ALARM switch • Turns the Pistol Grip EVACUATION ALARM switch to the PLANT ALARM position 		
*10	Selects Local Zone Evacuation.	Places the SIREN TONE GENERATOR switch in the LOCAL ZONE EVAC (WARBLE) position.		
*11	Sounds the Local Zone Evacuation alarm.	Performs the following: <ul style="list-style-type: none"> • Pushes in the Pistol Grip EVACUATION ALARM switch to initiate the alarm • After 5-10 seconds, pulls out the Pistol Grip EVACUATION ALARM switch to stop the alarm 		

PERFORMANCE CHECKLIST

Examinee _____

Step	Action	Standard	Eval	Comments
<p><u>EVALUATOR NOTE</u></p>				
<p>The exact wording of the announcement is not critical, but the announcement must include these elements:</p>				
<ul style="list-style-type: none"> • Evacuation is due to high radiation • Both Unit 1 and Unit 2 Reactor Buildings are to be evacuated 				
*12	<p>Makes announcement to evacuate Unit 1 and 2 Reactor Buildings due to high radiation.</p>	<p>Makes announcement over the Plant PA as follows: "There is high radiation in the Unit 1 and 2 Reactor Buildings. All personnel stay clear of the Unit 1 and 2 Reactor Buildings."</p>		
13	<p>Places station alarm panel in standby condition.</p>	<p>Performs the following:</p> <ul style="list-style-type: none"> • Turns the Pistol Grip EVACUATION ALARM switch to the OFF position • Pushes in the Pistol Grip EVACUATION ALARM switch 		
*14	<p>Directs Security to restrict access to Unit 1 and 2 Reactor Buildings.</p>	<p>Contacts CAS and directs Security to inactivate Reactor Building ingress readers for both Reactor Buildings using the Susquehanna Security Computer System.</p>		
15	<p>Directs HP to establish radiological controls for onsite areas and personnel.</p>	<p>Contacts HP and directs HP staff to establish radiological controls for onsite areas and personnel.</p>		
16	<p>Verifies normal ventilation isolated and SGTS in operation.</p>	<p>Performs ON-159-002 and ON-259-002 for containment isolation.</p>		
<p><u>EVALUATOR CUE</u></p>				
<p>Another operator will complete that task.</p>				
<p><u>EVALUATOR CUE</u></p>				
<p>Record JPM stop time: _____</p>				

PERFORMANCE CHECKLIST

81.ON.2356.001 Rev 0
02/18/2014
Page 4 of 4

Examinee _____

Step	Action	Standard	Eval	Comments
<u>EVALUATOR CUE</u> That completes the JPM.				
EVALUATOR: Do you have ALL your JPM exam materials? Task Cue Sheets? Procedures?				

EXAMINEE

TASK CONDITIONS

Unit 1 is in a refueling outage, core shuffle in progress, when a fuel bundle falls from the Refueling Platform main grapple onto the Unit 1 Spent Fuel Pool rack. The fuel bundle is heavily damaged.

The Refueling SRO and HP coordinated an evacuation of all personnel off of the Refuel Floor.

Both divisions of SGTS initiated successfully due to Zone III isolation on high Refuel Floor radiation.

The Unit 1 Unit Supervisor has entered ON-081-001.

Cavity and Fuel Pool levels are unchanged and stable.

The Shift Manager is reviewing the Emergency Plan.

INITIATING CUE

Perform the Control Room actions of ON-081-001.

EVALUATOR

TASK CONDITIONS

Unit 1 is in a refueling outage, core shuffle in progress, when a fuel bundle falls from the Refueling Platform main grapple onto the Unit 1 Spent Fuel Pool rack. The fuel bundle is heavily damaged.

The Refueling SRO and HP coordinated an evacuation of all personnel off of the Refuel Floor.

Both divisions of SGTS initiated successfully due to Zone III isolation on high Refuel Floor radiation.

The Unit 1 Unit Supervisor has entered ON-081-001.

Cavity and Fuel Pool levels are unchanged and stable.

The Shift Manager is reviewing the Emergency Plan.

INITIATING CUE

Perform the Control Room actions of ON-081-001.

JPM ASSEMBLY INSTRUCTIONS

Seq	Item	Copier Program	Binding
1.	Examinee cue sheet	cue	loose
2.	ON-081-001	exam	staple
3.	Evaluator cue sheet	cue	loose
4.	JPM	jpm	loose
5.	OP-099-004	exam	loose

PPL SUSQUEHANNA, LLC

JOB PERFORMANCE MEASURE

APPROVAL AND ADMINISTRATIVE DATA SHEET

Task Title Respond to SGTS Exhaust High Radiation While Purging Primary Containment

<u>SRO</u> Applicability	<u>00.AD.1018.101</u> JPM Number	<u>2</u> Revision	<u>02/18/2014</u> Date	<u>Plant</u> Setting
<u>Generic</u> NUREG-1123 E/APE / Sys	<u>2.3.11</u> K/A Number	<u>3.8 / 4.3</u> K/A Importance	<u>N</u> Alternate Path	<u>N</u> Time Critical

Prepared

Validated

Robert A. Thompson

02/18/2014

Robert A. Thompson

02/20/2014

Author

Date

Instructor

Date

Review

Approval

[Signature]
Operations Management

6-29-14
Date

[Signature]
Nuclear Training Supervisor

6/30/14
Date

20

Validation Time (min)

Examinee Name: _____

Last, First MI

Employee Number

Exam Date: _____

Exam Duration (Min) _____

Evaluation Result:

Satisfactory

Unsatisfactory

Evaluator

Name

Signature

Comments



JPM REVISION SUMMARY

Revision	Description/Purpose of Revision
2	Revise for TQ procedures, minor editorial corrections

REQUIRED TASK INFORMATION**1. SAFETY CONSIDERATIONS**

- A. All Operations personnel are responsible for maintaining their radiation exposure As Low As Reasonably Achievable in accordance with OP-AD-002, Standards for Shift Operations.
- B. All applicable safety precautions shall be taken in accordance with established PPL safety policies and the Safety Rule Book, for example:
1. Whenever any electrical panel is opened for inspection during JPM performance.
 2. Whenever entering any plant area where specific safety equipment such as hearing or eye protection, safety shoes, hardhats, etc., is required and/or posted as being necessary.
- C. If, in the judgment of the Evaluator any safety issue occurs during the performance of a JPM, the JPM will be terminated until the issue is resolved.
- D. Peer checking is the expectation for all evolutions; however, since a JPM is an individual effort, no peer check will be provided and Self Checking is required.

2. REFERENCES

- A. ON-070-001, Abnormal Gaseous Radiation Release/CAM Alarms (Revision 18)
- B. NDAP-QA-0309, Primary Containment Access and Control (Revision 30)
- C. TS 3.3.6.1, PRIMARY CONTAINMENT ISOLATION INSTRUMENTATION

3. TASK CONDITIONS

Unit 1 is in Mode 3.

Suppression Chamber purge is being conducted in preparation for containment entry, using SGTS Train B.

Annunciator AR-016-C13, CONTROL STRUCTURE PANEL 1C605 HI RADIATION has alarmed.

The Standby Gas Treatment Room Area Radiation Monitor indicates 15 mR/hr, up slow.

Radiation Recorder RR-D12-0R609, SGTS Exhaust Rad Monitors indicates the following

- Channel A 35 mR/hr, up slow
- Channel B 34 mR/hr, up slow

Suppression Chamber purge is still in service with SGTS B flow steady at 10,100 scfm.

4. INITIATING CUE

Determine what actions are required, if any, in response to the Task Conditions.

Document any actions required on the answer sheet provided.

5. TASK STANDARD

Determine that BOTH SGTS Exhaust Rad Monitors have exceeded their Hi-Hi radiation setpoints and failed to initiate the required Containment Atmosphere Control system isolation; AND that CAC should be isolated and SGTS secured.

Determine that the SGTS Train B room should be evacuated due to high radiation in the area.

Evaluate TS 3.3.6.1, and determine that BOTH SGTS Exhaust Radiation Monitors are required to be operable while purging containment in Mode 3, and:

- BOTH channels are INOPERABLE and must be placed in TRIP per TS LCO 3.3.6.1 Required Action A.1 within 24 hours
- Function 2.e automatic isolation capability is NOT maintained and the isolation capability must be restored per TS LCO 3.3.6.1 Required Action B.1 within 1 hour

Evaluate TRM 3.6.1, and determine that Primary Containment Purge must be suspended IMMEDIATELY per Required Action A.1, and NDAP-QA-0309

PERFORMANCE CHECKLIST

Examinee _____

Step	Action	Standard	Eval	Comments
<p><u>EVALUATOR INSTRUCTIONS</u></p> <ul style="list-style-type: none"> • Marking a step as UNSAT requires written comments on respective step. • Critical steps are marked with a *. If elements of the Standard are non-critical, the critical elements of the Standard are marked with a *. • The time clock starts when the candidate acknowledges the Initiating Cue. • This JPM may be performed in the classroom. Ensure copies of the following are available: <ul style="list-style-type: none"> ○ Unit 1 TS and TRM ○ NDAP-QA-0309 ○ ON-070-001 ○ AR-015-H01 ○ AR-016-C13 				
<p><u>EVALUATOR CUE</u> Record JPM start time: _____</p>				
<p><u>EVALUATOR CUE</u> Cue</p>				
<p><u>EVALUATOR NOTE</u> The steps of this JPM may be performed in any order.</p>				
*1	<p>Determines SBTG B room should be evacuated per AR-016-C13.</p>	<p>Identifies a local zone evacuation of the SBTG B room is required to be performed per OP-099-004 due to high radiation conditions in the area.</p>		
*2	<p>Determines SBTG failed to automatically isolate on a valid Hi-Hi exhaust radiation signal.</p>	<p>Performs the following:</p> <ul style="list-style-type: none"> • Identifies current SGTS exhaust radiation levels exceed the isolation setpoint of 23 mR/hr • Determines SGTS and CAC are still in service as indicated by SBTG B system flow 10,100 scfm • Determines that Containment Atmosphere Control should be manually isolated. 		

PERFORMANCE CHECKLIST

Examinee _____

Step	Action	Standard	Eval	Comments
<p><u>EVALUATOR NOTE</u></p>				
<p>Swapping operating SGTS train with standby train will have very limited effect on Noble Gas Channel levels.</p>				
3	<p>Swaps operating SBGT trains due to high exhaust radiation levels per ON-070-001.</p>	<p>Identifies the following:</p> <ul style="list-style-type: none"> • SBGT Train A should be started • SBGT Train B should be secured 		
*4	<p>Complies with TS 3.3.6.1.</p>	<p>Evaluates TS 3.3.6.1, and determines the following:</p> <ul style="list-style-type: none"> • BOTH SGTS Exhaust Radiation Monitors are required to be operable • BOTH channels are INOPERABLE and must be placed in TRIP per TS LCO 3.3.6.1 Required Action A.1 within 24 hours • Function 2.e automatic isolation capability is NOT maintained and the isolation capability must be restored per TS LCO 3.3.6.1 Required Action B.1 within 1 hour 		
5	<p>Determines requirements for containment purge in NDAP-QA-0309 are not met.</p>	<p>Identifies that BOTH SGTS Exhaust Radiation High trips are required to be operable for containment purge in Mode 3.</p>		
*6	<p>Complies with TRM 3.6.1.</p>	<p>Evaluates TRM 3.6.1, and determines the following:</p> <ul style="list-style-type: none"> • BOTH SGTS Exhaust Radiation Monitors are required to be operable • Primary containment purging must be immediately suspended per TRM 3.6.1 Required Action A.1 		
<p><u>EVALUATOR CUE</u></p>				
<p>Record JPM stop time: _____</p>				

PERFORMANCE CHECKLIST

00.AD.1018.101 Rev 2
02/18/2014
Page 3 of 3

Examinee _____

Step	Action	Standard	Eval	Comments
<u>EVALUATOR NOTE</u> That completes the JPM.				
<u>EVALUATOR:</u> Do you have ALL your JPM exam materials? Task Cue Sheets? Procedures?				

EXAMINEE

TASK CONDITIONS

Unit 1 is in Mode 3.

Suppression Chamber purge is being conducted in preparation for containment entry, using SGTS Train B.

Annunciator AR-016-C13, CONTROL STRUCTURE PANEL 1C605 HI RADIATION has alarmed.

The Standby Gas Treatment Room Area Radiation Monitor indicates 15 mR/hr, up slow.

Radiation Recorder RR-D12-0R609, SGTS Exhaust Rad Monitors indicates the following

- Channel A 35 mR/hr, up slow
- Channel B 34 mR/hr, up slow

Suppression Chamber purge is still in service with SGTS B flow steady at 10,100 scfm.

INITIATING CUE

Determine what actions are required, if any, in response to the Task Conditions. Document any actions required on the answer sheet provided.

EXAMINEE
ANSWER SHEET

EVALUATOR

TASK CONDITIONS

Unit 1 is in Mode 3.

Suppression Chamber purge is being conducted in preparation for containment entry, using SGTS Train B.

Annunciator AR-016-C13, CONTROL STRUCTURE PANEL 1C605 HI RADIATION has alarmed.

The Standby Gas Treatment Room Area Radiation Monitor indicates 15 mR/hr, up slow.

Radiation Recorder RR-D12-0R609, SGTS Exhaust Rad Monitors indicates the following

- Channel A 35 mR/hr, up slow
- Channel B 34 mR/hr, up slow

Suppression Chamber purge is still in service with SGTS B flow steady at 10,100 scfm.

INITIATING CUE

Determine what actions are required, if any, in response to the Task Conditions. Document any actions required on the answer sheet provided.

JPM ASSEMBLY INSTRUCTIONS

Seq	Item	Copier Program	Binding
1.	Examinee cue sheet	cue	loose
2.	Examinee answer sheet (mail-merged)	Mail-merged	loose
3.	Evaluator cue sheet	cue	loose
4.	JPM	jpm	loose
5.	Procedure (NDAP-QA-0309)	exam	staple
6.	Procedure (ON-070-001)	exam	staple

PPL SUSQUEHANNA, LLC

JOB PERFORMANCE MEASURE

APPROVAL AND ADMINISTRATIVE DATA SHEET

Task Title Classify an Emergency Condition and Complete Emergency Notification Report

<u>SRO</u> Applicability	<u>00.EP.1132.180</u> JPM Number	<u>0</u> Revision	<u>06/24/2014</u> Date	<u>Classroom</u> Setting
<u>Generic</u> NUREG-1123 E/APE / Sys	<u>2.4.41</u> K/A Number	<u>4.6</u> K/A Importance	<u>N</u> Alternate Path	<u>Y</u> Time Critical

Prepared Robert A. Thompson Date 06/24/2014 Validated [Signature] Date 6/27/14
Author
Review [Signature] Date 6-29-14 Approval [Signature] Date 6/30/14
Operations Management Date Nuclear Training Supervisor Date

15
Validation Time (min)

Examinee Name: «LastName», «FirstName» («Docket_ ») «Employee»
Last, First MI Employee Number

Exam Date: _____ Exam Duration (Min) _____

Evaluation Result: Satisfactory Unsatisfactory

Evaluator _____
Name Signature

Comments

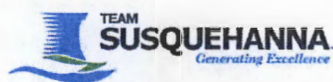

JPM REVISION SUMMARY

Revision	Description/Purpose of Revision
0	New JPM

REQUIRED TASK INFORMATION

1. SAFETY CONSIDERATIONS

- A. All Operations personnel are responsible for maintaining their radiation exposure As Low As Reasonably Achievable in accordance with OP-AD-002, Standards for Shift Operations.
- B. All applicable safety precautions shall be taken in accordance with established PPL safety policies and the Safety Rule Book, for example:
 - 1. Whenever any electrical panel is opened for inspection during JPM performance.
 - 2. Whenever entering any plant area where specific safety equipment such as hearing or eye protection, safety shoes, hardhats, etc., is required and/or posted as being necessary.
- C. If, in the judgment of the Evaluator any safety issue occurs during the performance of a JPM, the JPM will be terminated until the issue is resolved.
- D. Peer checking is the expectation for all evolutions; however, since a JPM is an individual effort, no peer check will be provided and Self Checking is required.

2. REFERENCES

- A. EP-PS-100, Emergency Director, Control Room
- B. EP-RM-004, EAL CLASSIFICATION BASES (Revision 1)

3. TASK CONDITIONS

Each examinee evaluated in the SRO position for a scenario will be required to classify the event once the scenario concludes. Task Conditions for each scenario are provided.

4. INITIATING CUE

Make the initial emergency classification and as Emergency Director complete any associated notification form(s) in accordance with the applicable procedures for activation of the Emergency Plan.

5. TASK STANDARD

Classify the event at the appropriate level on the correct EAL and complete the Emergency Notification Report.

PERFORMANCE CHECKLIST

Examinee «LastName», «FirstName» _____

Step	Action	Standard	Eval	Comments
<u>EVALUATOR INSTRUCTIONS</u>				
<ul style="list-style-type: none"> Marking a step as UNSAT requires written comments on respective step. Critical steps are marked with a *. If elements of the Standard are non-critical, the critical elements of the Standard are marked with a *. The time clock starts when the candidate acknowledges the Initiating Cue. Ensure that a copy of EP-RM-004, EP-PS-100 and blank ENR and PAR forms are available. 				
<u>EVALUATOR NOTE</u>				
This is a TIME CRITICAL JPM.				
<u>EVALUATOR CUE</u>				
Record JPM start time: _____				
<u>EVALUATOR NOTE</u>				
Note				
<u>EVALUATOR CUE</u>				
Cue				
1	Obtains copy of EP-PS-100, Emergency Director, Control Room and EP-RM-004, EAL Classification Bases.	Obtains copy of EP-PS-100, Emergency Director, Control Room and EP-RM-004, EAL Classification Bases.		
2	Refers to classification matrix.	Selects the correct Table.		
*3	Chooses appropriate emergency action level.	Declares an event on an EAL within 15 minutes of start time.		
4	Determines appropriate procedure section.	Identifies the appropriate procedure TAB for the event classification of EP-PS-100.		
5	Documents and communicates the Emergency Classification.	Announces the following: <ul style="list-style-type: none"> I am assuming duties of the Emergency Director [Event] declared based on [EAL summary] Time and Date of Classification 		

PERFORMANCE CHECKLIST

Examinee «LastName», «FirstName»

Step	Action	Standard	Eval	Comments
6	If not performed earlier appoints an Emergency Plan Communicator.	Appoints an Emergency Plan Communicator and instructs communicator to immediately perform EP-PS-126, E-Plan Communicator.		
7	If not performed earlier, appoints an NRC communicator.	Appoints an NRC Communicator and instructs communicator to perform EP-PS-135, NRC Communicator.		
8	Initiates an ENR form.	Performs the following: <ul style="list-style-type: none"> • Refers to ENR Form under Tab 9 and IF necessary EP-TP-003 for instructions on filling out the form • Records CR-1 as the control # • Line 1, places checkmark in THIS IS A DRILL box 		
<u>EVALUATOR NOTE</u>				
The time recorded on Line 3 of the ENR form is compared to the start time recorded at the beginning of the JPM to determine if the examinee is successful in meeting the 15 minute event declaration requirement of the JPM.				
9	Completes Line 3 of the ENR	Performs the following: <ul style="list-style-type: none"> • Places checkmark in the correct event box • Places checkmark in the correct unit box • Records declaration time and date • Places checkmark in INITIAL DECLARATION box 		
10	Completes Line 4 of the ENR	Performs the following: <ul style="list-style-type: none"> • Places checkmark in EMERGENCY EVENT box • Records a brief non-technical description of EAL 		

PERFORMANCE CHECKLIST

Examinee «LastName», «FirstName»

Step	Action	Standard	Eval	Comments
11	Completes Line 5 of the ENR	Performs the following: <ul style="list-style-type: none"> • Refers to Tab H for guidance in determining if there is a radiological release in progress due to the event • Places checkmark in release box as appropriate 		
12	Completes Lines 6 and 7 of the ENR	Performs the following: <ul style="list-style-type: none"> • Records wind direction, wind speed. • Places checkmark in THIS IS A DRILL box 		
*13	Approves the ENR.	Signs the ENR and records the current date and time.		
14	Provides the ENR to the Emergency Plan Communicator.	Performs the following: <ul style="list-style-type: none"> • Provides the approved ENR to the Emergency Plan Communicator. • Reviews the ENR with the Communicator • Directs the Communicator to complete the notification within 15 minutes of the event declaration time 		

EVALUATOR CUE

That completes the JPM.

EVALUATOR:

Do you have ALL your JF'M exam materials? Task Cue Sheets? Procedures?

JPM KEY

Scenario	Classification	EAL	Release
1	Site Area Emergency	MS3	No
2	Site Area Emergency	FS1	No
3	Site Area Emergency	FS1	Yes
4	Alert	FA1	No
5*	Alert	FA1	No

*A SAE on FS1 may be declared with a discretionary
Loss/Potential Loss of Primary Containment

EXAMINEE – SCENARIO 1

TASK CONDITIONS

Unit 1 was operating at 95 percent power.

All RBCCW cooling is lost. Both Recirc Pumps are tripped.

The reactor is plotted in Region 1 of the power/flow map.

The reactor scrams on an OPRM trip.

A hydraulic-block ATWS occurs. Initial ATWS power is 15 percent.

INITIATING CUE

Make the initial emergency classification and as Emergency Director complete any associated notification form(s) in accordance with the applicable procedures for activation of the Emergency Plan.

EVALUATOR – SCENARIO 1

TASK CONDITIONS

Unit 1 was operating at 95 percent power.

All RBCCW cooling is lost. Both Recirc Pumps are tripped.

The reactor is plotted in Region 1 of the power/flow map.

The reactor scrams on an OPRM trip.

A hydraulic-block ATWS occurs. Initial ATWS power is 15 percent.

INITIATING CUE

Make the initial emergency classification and as Emergency Director complete any associated notification form(s) in accordance with the applicable procedures for activation of the Emergency Plan.

EXAMINEE – SCENARIO 2

TASK CONDITIONS

Unit 1 was operating at 80 percent power.

1B227 feeder breaker trips due to an faulted load on the MCC. There was no visible damage to the MCC.

All Feedwater is subsequently lost and the reactor scrams.

The scram results in a grid disturbance and a loss of offsite power. TCC reports offsite power is expected to be restored within 4 hours.

After the scram a small RCS leak in the Drywell occurs.

ADS fails to automatically initiate in response to a valid signal, but is manually initiated.

Low-pressure ECCS fails to respond automatically, but is started to manually restore level above TAF after the blowdown is complete.

INITIATING CUE

Make the initial emergency classification and as Emergency Director complete any associated notification form(s) in accordance with the applicable procedures for activation of the Emergency Plan.

EVALUATOR – SCENARIO 2

TASK CONDITIONS

Unit 1 was operating at 80 percent power.

1B227 feeder breaker trips due to an faulted load on the MCC. There was no visible damage to the MCC.

All Feedwater is subsequently lost and the reactor scrams.

The scram results in a grid disturbance and a loss of offsite power. TCC reports offsite power is expected to be restored within 4 hours.

After the scram a small RCS leak in the Drywell occurs.

ADS fails to automatically initiate in response to a valid signal, but is manually initiated.

Low-pressure ECCS fails to respond automatically, but is started to manually restore level above TAF after the blowdown is complete.

INITIATING CUE

Make the initial emergency classification and as Emergency Director complete any associated notification form(s) in accordance with the applicable procedures for activation of the Emergency Plan.

EXAMINEE – SCENARIO 3

TASK CONDITIONS

Unit 1 is shutting down for an unplanned maintenance outage.

Unidentified Drywell leakage is steady at 0.5 gpm.

ESS Bus 1C experiences a lockout due to a faulted ESW Pump C motor.

Drywell temperature and leakage rises. Drywell pressure exceeds the reactor scram setpoint, but RPS fails to function.

ARI initiates and results in all control rods inserting full-in, but significant fuel failure occurs.

A Rapid Depressurization is performed as required by EO-100-104 on high radiation levels in two areas and an unisolable RCS leak outside primary containment.

INITIATING CUE

Make the initial emergency classification and as Emergency Director complete any associated notification form(s) in accordance with the applicable procedures for activation of the Emergency Plan.

EVALUATOR – SCENARIO 3

TASK CONDITIONS

Unit 1 is shutting down for an unplanned maintenance outage.

Unidentified Drywell leakage is steady at 0.5 gpm.

ESS Bus 1C experiences a lockout due to a faulted ESW Pump C motor.

Drywell temperature and leakage rises. Drywell pressure exceeds the reactor scram setpoint, but RPS fails to function.

ARI initiates and results in all control rods inserting full-in, but significant fuel failure occurs.

A Rapid Depressurization is performed as required by EO-100-104 on high radiation levels in two areas and an unisolable RCS leak outside primary containment.

INITIATING CUE

Make the initial emergency classification and as Emergency Director complete any associated notification form(s) in accordance with the applicable procedures for activation of the Emergency Plan.

EXAMINEE – SCENARIO 4

TASK CONDITIONS

Unit 1 is operating at 80 percent power.

A spurious Main Turbine trip occurs. Bypass valves fail to operate.

A number of control rods fail to insert on the automatic scram due to fuel channel distortion. Initial ATWS power is < 5 percent.

One SRV experiences a tailpipe rupture in the Suppression Chamber and fails to reseal properly.

Suppression Chamber pressure exceeds the Pressure Suppression Limit and Rapid Depressurization is performed.

INITIATING CUE

Make the initial emergency classification and as Emergency Director complete any associated notification form(s) in accordance with the applicable procedures for activation of the Emergency Plan.

EVALUATOR – SCENARIO 4

TASK CONDITIONS

Unit 1 is operating at 80 percent power.

A spurious Main Turbine trip occurs. Bypass valves fail to operate.

A number of control rods fail to insert on the automatic scram due to fuel channel distortion. Initial ATWS power is < 5 percent.

One SRV experiences a tailpipe rupture in the Suppression Chamber and fails to reseal properly.

Suppression Chamber pressure exceeds the Pressure Suppression Limit and Rapid Depressurization is performed.

INITIATING CUE

Make the initial emergency classification and as Emergency Director complete any associated notification form(s) in accordance with the applicable procedures for activation of the Emergency Plan.

EXAMINEE – SCENARIO 5

TASK CONDITIONS

Unit 1 is starting up, in Mode 2 at 500 psig.

MSIVs spuriously close. The reactor is manually scrammed.

Drywell pressure rises and exceeds 1.72 psig.

An unisolable leak from the Suppression Pool into the Reactor Building occurs.

Suppression Pool level lowers below 12 feet. A Rapid Depressurization is performed.

INITIATING CUE

Make the initial emergency classification and as Emergency Director complete any associated notification form(s) in accordance with the applicable procedures for activation of the Emergency Plan.

EVALUATOR – SCENARIO 5

TASK CONDITIONS

Unit 1 is starting up, in Mode 2 at 500 psig.

MSIVs spuriously close. The reactor is manually scrammed.

Drywell pressure rises and exceeds 1.72 psig.

An unisolable leak from the Suppression Pool into the Reactor Building occurs.

Suppression Pool level lowers below 12 feet. A Rapid Depressurization is performed.

INITIATING CUE

Make the initial emergency classification and as Emergency Director complete any associated notification form(s) in accordance with the applicable procedures for activation of the Emergency Plan.

VALIDATION CHECKLIST

NOTE: All steps of this checklist should be performed upon initial validation. Prior to JPM usage, revalidate JPM using steps 10-13 below.

Instructor

Initials

- _____ 1. Task description and number, JPM description and number are identified.
- _____ 2. Knowledge and Abilities (K/A) references are included.
- _____ 3. Performance location specified. (in-plant, control room, or simulator)
- _____ 4. Initial setup conditions are identified.
- _____ 5. Initiating and terminating cues are properly identified.
- _____ 6. Task standards identified and verified by SME review.
- _____ 7. Critical steps meet the criteria for critical steps and are identified with an asterisk (*).
- _____ 8. Verify cues both verbal and visual are free of conflict.
- _____ 9. Ensure performance time is accurate.
- _____ 10. Verify the JPM reflects the most current revision of the procedure.

Procedure _____	Rev _____
Procedure _____	Rev _____
Procedure _____	Rev _____

- _____ 11. Pilot the JPM.
 For Sim JPMs, ensure simulator response is unchanged. Run concurrent JPMs simultaneously to ensure proper simulator response and there is no interaction between JPMs.
 For plant JPMs, ensure the JPM is consistent with conditions in the plant (labeling, radiological, etc.).
- _____ 12. If the JPM cannot be performed as written, then revise as necessary and revalidate.
- _____ 13. When JPM is validated, sign and date JPM cover page.

JPM ASSEMBLY INSTRUCTIONS

Seq	Item	Copier Program	Binding
1.	Examinee cue sheet	cue	loose
2.	Evaluator cue sheet	cue	loose
3.	JPM	jpm	loose

PPL SUSQUEHANNA, LLC
JOB PERFORMANCE MEASURE

APPROVAL AND ADMINISTRATIVE DATA SHEET

Task Title Respond to Control Rod Drift In During Performance of Rod Exercise Test

<u>S/RO</u>	<u>55.ON.1998.151</u>	<u>1</u>	<u>02/18/2014</u>	<u>Simulator</u>
Applicability	JPM Number	Revision	Date	Setting
<u>201003</u>	<u>A2.03</u>	<u>3.4 / 3.7</u>	<u>Y</u>	<u>N</u>
NUREG-1123 E/APE / Sys	K/A Number	K/A Importance	Alternate Path	Time Critical

Prepared

Validated

Robert A. Thompson

02/18/2014

Robert A. Thompson

02/20/2014

Author

Date

Instructor

Date

Review

Approval

[Signature]
Operations Management

6-29-14
Date

[Signature]
Nuclear Training Supervisor

6/30/14
Date

25

Validation Time (min)

Examinee Name: _____

Last, First MI

Employee Number

Exam Date: _____

Exam Duration (Min) _____

Evaluation Result:

Satisfactory

Unsatisfactory

Evaluator

Name

Signature

Comments



JPM REVISION SUMMARY

Revision	Description/Purpose of Revision
0	New JPM
1	Revise for TQ procedures, minor editorial corrections

REQUIRED TASK INFORMATION**1. SAFETY CONSIDERATIONS**

- A. All Operations personnel are responsible for maintaining their radiation exposure As Low As Reasonably Achievable in accordance with OP-AD-002, Standards for Shift Operations.
- B. All applicable safety precautions shall be taken in accordance with established PPL safety policies and the Safety Rule Book, for example:
 - 1. Whenever any electrical panel is opened for inspection during JPM performance.
 - 2. Whenever entering any plant area where specific safety equipment such as hearing or eye protection, safety shoes, hardhats, etc., is required and/or posted as being necessary.
- C. If, in the judgment of the Evaluator any safety issue occurs during the performance of a JPM, the JPM will be terminated until the issue is resolved.
- D. Peer checking is the expectation for all evolutions; however, since a JPM is an individual effort, no peer check will be provided and Self Checking is required.

2. REFERENCES

- A. SO-156-010, Monthly Control Rod Exercising (Revision 5)
- B. ON-155-001, Control Rod Problems (Revision 37)

3. TASK CONDITIONS

Unit 1 is at 100% power.

All systems are in service in accordance with their respective OP.

All control rods are operable and have normal withdraw speeds.

SO-156-010 has been completed through Step 5.4.

4. INITIATING CUE

Perform Monthly Control Rod exercising for all withdrawn control rods, per SO-156-010.

5. TASK STANDARD

Performs Monthly Control Rod exercising for control rods 02-19 and 02-23 per SO-156-010. Inserts control rod 02-27 to position 00 when control rod drifts in per ON-155-007.

SIMULATOR SETUP INSTRUCTIONS

1. **Reset** the simulator to any rated-power IC.
2. **Run** scenario file EVAL55ON1998151.SCN

```
aet ETEVAL55ON1998151  
aet ETEVAL55ON1998151A  
scn exam\EVAL55ON1998151-MP
```

EVAL55ON1998151-MP.SCN

```
insmp lssblpos(71)  
changemp lssblpos(71) ,,,CONTROL ROD 02-27 POS  
insmp diHSC12S3.CurrValue  
changemp diHSC12S3.CurrValue ,,bool,SWITCH:DISPLAY RODS DRIFTING  
insmp diHSC121S08.CurrValue  
changemp diHSC121S08.CurrValue ,,bool,SWITCH:ROD DRIFT RESET
```

ETEVAL55ON1998151.et/scn

```
lssblpos(71) <= 46  
IMF mFRD1550040227 f:3
```

ETEVAL55ON1998151A.et/scn

```
;delete drift  
lssblpos(71) <= 10  
DMF mFRD1550040227
```

PERFORMANCE CHECKLIST

Examinee _____

Step	Action	Standard	Eval	Comments
<p><u>EVALUATOR INSTRUCTIONS</u></p> <ul style="list-style-type: none"> • Marking a step as UNSAT requires written comments on respective step. • Critical steps are marked with a *. If elements of the Standard are non-critical, the critical elements of the Standard are marked with a *. • The time clock starts when the candidate acknowledges the Initiating Cue. • This JPM must be performed in the simulator. Reset to exam-specific IC-____, or configure the simulator per the Simulator Setup Instructions. • Mark-up a copy of SO-156-010 complete through Step 5.4. 				
<p><u>EVALUATOR NOTE</u> The FAULTED step in this JPM is preceded by a fault statement in BOLD TYPE WITH ALL CAPITAL LETTERS.</p>				
<p><u>EVALUATOR CUE</u> Record JPM start time: _____</p>				
<p><u>BOOTH OPERATOR CUE</u> When the evaluator indicates the examinee is ready to begin the JPM, place the simulator in RUN.</p>				
1	Identifies governing procedure and obtain controlled copy.	Obtains controlled copy of SO-156-010.		
*2	Selects control rod 02-19.	Performs the following: <ul style="list-style-type: none"> • *Depresses the 02 and 19 CONTROL ROD SELECTION PBs • Observes 02 and 19 CONTROL ROD SELECTION PBs backlit WHITE • Observes FULL CORE DISPLAY for control rod 02-19 illuminated GREEN • Observes 02-19 indicates selected on PICSY RWM and/or OD7 displays • Observes PICSY and SIP 1C652 FOUR ROD DISPLAY indicate control rod 02-19 position 48 		

PERFORMANCE CHECKLIST

Examinee _____

Step	Action	Standard	Eval	Comments
*3	Inserts control rod 02-19 to position 46.	Performs the following: <ul style="list-style-type: none"> • *Momentarily depresses INSERT ROD PB • Observes ROD INSERT and ROD SETLG lights lit in series • Observes PICSY and SIP 1C652 FOUR ROD DISPLAY indicate control rod 02-19 position 46 		
*4	Withdraws control rod 02-19 to position 48.	Performs the following: <ul style="list-style-type: none"> • *Momentarily depresses W/DRAW ROD PB until the ROD INSERT light illuminates • Observes ROD INSERT, ROD W/DRAWG and ROD SETLG lights lit in series • Observes PICSY and SIP 1C652 FOUR ROD DISPLAY indicate control rod 02-19 position 48 		

PERFORMANCE CHECKLIST

Examinee _____

Step	Action	Standard	Eval	Comments
*5	Obtains control rod 02–19 withdraw stall flow and verifies control rod coupled.	Performs the following: <ul style="list-style-type: none"> • *Depresses and hold the W/DRAW ROD and CONT W/DRAW ROD PBs • Observes ROD INSERT light lit then extinguished, ROD W/DRAWG remains lit • Observes PICSY and SIP 1C652 FOUR ROD DISPLAY indicate control rod 02-19 position 48 • Notes CRD drive water flow • Observes absence of ROD OVERTRAVEL alarm • *Releases W/DRAW ROD and CONT W/DRAW ROD PBs • Observes ROD SETLG light lit, then extinguished • Records withdraw stall flow for control rod 02–19 on Attachment A • *Circles Rod Coupling Check SAT for control rod 02–19 on Attachment A 		
6	Verifies control rod 02–19 at position 48.	Performs the following: <ul style="list-style-type: none"> • Depresses DISPLAY RODS FULL–IN FULL–OUT PB • Observes FULL CORE DISPLAY for control rod 02–19 illuminated RED • Releases DISPLAY RODS FULL–IN FULL–OUT PB • Observes PICSY and SIP 1C652 FOUR ROD DISPLAY indicate control rod 02-19 position 48 		

PERFORMANCE CHECKLIST

Examinee _____

Step	Action	Standard	Eval	Comments
7	Documents completion of test for control rod 02-19.	Performs the following: <ul style="list-style-type: none"> • Circles Operability Check SAT for control rod 02-19 on Attachment A • Initials Confirm for control rod 02-19 on Attachment A 		
EVALUATOR CUE Initial Verify for control rod 02-19 on Attachment A.				
*8	Selects control rod 02-23.	Performs the following: <ul style="list-style-type: none"> • *Depresses the 02 and 23 CONTROL ROD SELECTION PBs • Observes 02 and 23 CONTROL ROD SELECTION PBs backlit WHITE • Observes FULL CORE DISPLAY for control rod 02-23 illuminated GREEN • Observes 02-23 indicates selected on PICSY RWM and/or OD7 displays • Observes PICSY and SIP 1C652 FOUR ROD DISPLAY indicate control rod 02-23 position 48 		
*9	Inserts control rod 02-23 to position 46.	Performs the following: <ul style="list-style-type: none"> • *Momentarily depresses INSERT ROD PB • Observes ROD INSERT and ROD SETLG lights lit in series • Observes PICSY and SIP 1C652 FOUR ROD DISPLAY indicate control rod 02-23 position 46 		

PERFORMANCE CHECKLIST

Examinee _____

Step	Action	Standard	Eval	Comments
*10	Withdraws control rod 02–23 to position 48.	Performs the following: <ul style="list-style-type: none"> • *Momentarily depresses W/DRAW ROD PB until the ROD INSERT light illuminates • Observes ROD INSERT, ROD W/DRAWG and ROD SETLG lights lit in series • Observes PICSY and SIP 1C652 FOUR ROD DISPLAY indicate control rod 02-23 position 48 		
*11	Obtains control rod 02–23 withdraw stall flow and verifies control rod coupled.	Performs the following: <ul style="list-style-type: none"> • *Depresses and hold the W/DRAW ROD and CONT W/DRAW ROD PBs • Observes ROD INSERT light lit then extinguished, ROD W/DRAWG remains lit • Observes PICSY and SIP 1C652 FOUR ROD DISPLAY indicate control rod 02-23 position 48 • Notes CRD drive water flow • Observes absence of ROD OVERTRAVEL alarm • *Releases W/DRAW ROD and CONT W/DRAW ROD PBs • Observes ROD SETLG light lit, then extinguished • Records withdraw stall flow for control rod 02–23 on Attachment A • *Circles Rod Coupling Check for control rod 02–23 SAT on Attachment A 		

PERFORMANCE CHECKLIST

Examinee _____

Step	Action	Standard	Eval	Comments
12	Verifies control rod 02–23 at position 48.	Performs the following: <ul style="list-style-type: none"> • Depresses DISPLAY RODS FULL–IN FULL–OUT PB • Observes FULL CORE DISPLAY for control rod 02–23 illuminated RED • Releases DISPLAY RODS FULL–IN FULL–OUT PB • Observes PICSY and SIP 1C652 FOUR ROD DISPLAY indicate control rod 02-23 position 48 		
13	Documents completion of test for control rod 02-23.	Performs the following: <ul style="list-style-type: none"> • Circles Operability Check SAT for control rod 02–23 on Attachment A • Initials Confirm for control rod 02–23 on Attachment A 		
EVALUATOR CUE Initial Verify for control rod 02-23 on Attachment A.				
*14	Selects control rod 02–27.	Performs the following: <ul style="list-style-type: none"> • *Depresses the 02 and 27 CONTROL ROD SELECTION PBs • Observes 02 and 27 CONTROL ROD SELECTION PBs backlit WHITE • Observes FULL CORE DISPLAY for control rod 02–27 illuminated GREEN • Observes 02–27 indicates selected on PICSY RWM and/or OD7 displays • Observes PICSY and SIP 1C652 FOUR ROD DISPLAY indicate control rod 02-27 position 48 		

PERFORMANCE CHECKLIST

Examinee _____

Step	Action	Standard	Eval	Comments
<p><u>FAULT STATEMENT</u> CONTROL ROD 02-27 WILL DRIFT TO POSITION 10 DURING PERFORMANCE OF THE FOLLOWING STEP</p>				
<p><u>BOOTH OPERATOR CUE</u></p> <ul style="list-style-type: none"> • Ensure Event Trigger ET55ON1998151 fires when control rod 02-27 is at position 46 to drift the control rod in. • Ensure Event Trigger ET55ON1998151A fires when control rod 02-27 is at position 10 to delete the drift malfunction. 				
*15	<p>Inserts control rod 02-27.</p>	<p>Performs the following:</p> <ul style="list-style-type: none"> • *Momentarily depresses INSERT ROD PB • Observes ROD INSERT and ROD SETLG lights lit in series • Observes PICSY and SIP 1C652 FOUR ROD DISPLAY indicate control rod 02-27 position 46 • Observes AR-104-H05 in alarm • Notifies Unit Supervisor control rod 02-27 is drifting in • Observes control rod 02-27 stop at position 10 		
<p><u>EVALUATOR CUE</u> Respond per procedure.</p>				

PERFORMANCE CHECKLIST

Examinee _____

Step	Action	Standard	Eval	Comments
16	Identifies ON-155-001 Section 4.4 is governing procedure and obtains controlled copy.	Controlled copy of ON-155-001 obtained, selects Section 4.4 to perform.		
EVALUATOR CUE				
Unit Supervisor concurs with entry into ON-155-001.				
17	Checks for control rod drifts.	Performs the following: <ul style="list-style-type: none"> Depresses the DISPLAY RODS DFTING PB Observes FULL CORE DISPLAY for control rod 02-27 illuminated RED Releases DISPLAY RODS DFTING PB 		
18	Checks for scram valves open.	Performs the following: <ul style="list-style-type: none"> Depresses the DISPLAY SCRAM VALVES OPEN PB Observes FULL CORE DISPLAY for all control rods extinguished Releases DISPLAY SCRAM VALVES OPEN PB 		
19	Observes control rod 02-27 position.	Observes PICSY and SIP 1C652 FOUR ROD DISPLAY indicate control rod 02-27 position 10.		
20	Resets control rod drift alarm.	Performs the following: <ul style="list-style-type: none"> Depresses the ROD DRIFT RESET PB Observes AR-104-H05 clears 		
21	Ensures cooling water ΔP and flow normal.	Performs the following: <ul style="list-style-type: none"> Observes PDI-C12-1R603, RPV - CRD COOLING WATER DIFF PRESSURE, indicate less than 20 psig Observes FI-C12-1R605, COOLING WATER FLOW, indicate approximately 60 gpm 		

PERFORMANCE CHECKLIST

Examinee _____

Step	Action	Standard	Eval	Comments
*22	Inserts control rod to position 00.	Performs the following: <ul style="list-style-type: none"> • *Depresses INSERT ROD PB and maintains depressed • Observes ROD INSERT light lit • Observes PICSY and SIP 1C652 FOUR ROD DISPLAY indicate control rod 02-27 position 00 • Releases INSERT ROD PB • Observes ROD SETLG light lit, then extinguished • Observes PICSY and SIP 1C652 FOUR ROD DISPLAY continue to indicate control rod 02-27 position 00 		
23	Hydraulically disarms 02-27 HCU.	Directs NPO to hydraulically disarm control rod HCU 02-27 per OP-155-001.		
<u>EVALUATOR CUE</u> Record JPM stop time: _____				
<u>EVALUATOR CUE</u> That completes the JPM.				
<u>EVALUATOR:</u> Do you have ALL your JPM exam materials? Task Cue Sheets? Procedures?				

EXAMINEE

TASK CONDITIONS

Unit 1 is at 100% power.

All systems are in service in accordance with their respective OP.

All control rods are operable and have normal withdraw speeds.

SO-156-010 has been completed through Step 5.4.

INITIATING CUE

Perform Monthly Control Rod exercising for all withdrawn control rods, per SO-156-010.

EVALUATOR

TASK CONDITIONS

Unit 1 is at 100% power.

All systems are in service in accordance with their respective OP.

All control rods are operable and have normal withdraw speeds.

SO-156-010 has been completed through Step 5.4.

INITIATING CUE

Perform Monthly Control Rod exercising for all withdrawn control rods, per SO-156-010.

JPM ASSEMBLY INSTRUCTIONS

Seq	Item	Copier Program	Binding
1.	Examinee cue sheet	cue	loose
2.	SO-156-010 (marked-up)	exam	staple
3.	Evaluator cue sheet	cue	loose
4.	JPM	jpm	loose
5.	ON-155-001	sim	PC

PPL SUSQUEHANNA, LLC

JOB PERFORMANCE MEASURE

APPROVAL AND ADMINISTRATIVE DATA SHEET

Task Title Shutdown RFP Primary Woodward Governor, RFP Speed Oscillates

<u>S/RO</u> Applicability	<u>45.OP.1671.151</u> JPM Number	<u>0</u> Revision	<u>02/20/2014</u> Date	<u>Simulator</u> Setting
<u>259001</u> NUREG-1123 E/APE / Sys	<u>A1.05</u> K/A Number	<u>2.8 / 2.7</u> K/A Importance	<u>Y</u> Alternate Path	<u>N</u> Time Critical

Prepared

Validated

Robert A. Thompson

02/20/2014

Robert A. Thompson

02/20/2014

Author

Date

Instructor

Date

Review

Approval

[Signature]
Operations Management

6-29-14
Date

[Signature]
Nuclear Training Supervisor

6/30/14
Date

15

Validation Time (min)

Examinee Name: _____

Last, First MI

Employee Number

Exam Date: _____

Exam Duration (Min) _____

Evaluation Result:

Satisfactory

Unsatisfactory

Evaluator

Name

Signature

Comments



JPM REVISION SUMMARY

Revision	Description/Purpose of Revision
0	New JPM

REQUIRED TASK INFORMATION

1. SAFETY CONSIDERATIONS

- A. All Operations personnel are responsible for maintaining their radiation exposure As Low As Reasonably Achievable in accordance with OP-AD-002, Standards for Shift Operations.
- B. All applicable safety precautions shall be taken in accordance with established PPL safety policies and the Safety Rule Book, for example:
 - 1. Whenever any electrical panel is opened for inspection during JPM performance.
 - 2. Whenever entering any plant area where specific safety equipment such as hearing or eye protection, safety shoes, hardhats, etc., is required and/or posted as being necessary.
- C. If, in the judgment of the Evaluator any safety issue occurs during the performance of a JPM, the JPM will be terminated until the issue is resolved.
- D. Peer checking is the expectation for all evolutions; however, since a JPM is an individual effort, no peer check will be provided and Self Checking is required.

2. REFERENCES

- A. OP-145-007, RFPT Woodward Governor Operations (Revision 0)

3. TASK CONDITIONS

A reactor startup is in progress.

RFPT B has just been placed in-service as the second RFP in Flow Control Mode.

An intermittent fault in the control valve position feedback circuitry to the RFPT B Control Valve Primary Woodward Governor is suspected.

Additional troubleshooting on the Control Valve Primary Woodward Governor is to be performed once it is shutdown.

4. INITIATING CUE

Transfer RFPT B speed control to the Control Valve Backup Woodward Governor and shutdown the Control Valve Primary Woodward Governor per OP-145-007.

5. TASK STANDARD

RFPT B Control Valve Backup Woodward Governor selected for control. RFPT B speed oscillations noted and RFPT B Control Valve Backup Woodward Governor shutdown.

SIMULATOR SETUP INSTRUCTIONS

1. **Reset** the simulator to IC-16.
2. **Place** RFP B in FCM and allow RFP flows to equalize.
3. **Run** scenario file EVAL45OP1671151.SCN

```
aet ETEVAL450P1671151
EVAL45OP1671151A.SCN
IMF mffw145014B f:50 r:11
+10 DMF mffw145014B
+15 IMF mffw145014B f:100 r:6
+5 DMF mffw145014B
+15 IMF mffw145014B f:100 r:6
+5 DMF mffw145014B
+15 IMF mffw145014B f:100 r:6
+5 DMF mffw145014B
+15 IMF mffw145014B f:100 r:6
+5 DMF mffw145014B
+15 IMF mffw145014B f:100 r:6
+5 DMF mffw145014B
+15 IMF mffw145014B f:100 r:6
+5 DMF mffw145014B
+15 IMF mffw145014B f:100 r:6
+5 DMF mffw145014B
scn exam\EVAL450P1671151B
EVAL45OP1671151B.SCN
+15 scn exam\EVAL450P1671151A
EVAL45OP1671151.ET/SCN
fx1BB_SPC_05.COUT = 1
+10 scn exam\EVAL450P1671151A
aet ETEVAL450P1671151A
EVAL45OP1671151A.ET/SCN
fx1BB_SPC_05.COUT = 0
abort exam\EVAL450P1671151A
abort exam\EVAL450P1671151B
```

PERFORMANCE CHECKLIST

Examinee _____

Step	Action	Standard	Eval	Comments
<p><u>EVALUATOR INSTRUCTIONS</u></p> <ul style="list-style-type: none"> Marking a step as UNSAT requires written comments on respective step. Critical steps are marked with a *. If elements of the Standard are non-critical, the critical elements of the Standard are marked with a *. The time clock starts when the candidate acknowledges the Initiating Cue. This JPM must be performed in the simulator. Reset to exam-specific IC-377, or configure the simulator per the Simulator Setup Instructions. 				
<p><u>EVALUATOR NOTE</u> The FAULTED step in this JPM is preceded by a fault statement in BOLD TYPE WITH ALL CAPITAL LETTERS.</p>				
<p><u>EVALUATOR CUE</u> Record JPM start time: _____</p>				
<p><u>BOOTH OPERATOR CUE</u> When the evaluator indicates the examinee is ready to begin the JPM, place the simulator in RUN.</p>				
1	<p>Identifies governing procedure and obtains controlled copy for transfer to Backup Control Valve Woodward Governor.</p>	<p>Obtains controlled copy of OP-145-007, selects Section 5.2.</p>		
2	<p>Ensures Primary Control Valve Woodward Governor in-service.</p>	<p>Performs the following on any ICS HMI:</p> <ul style="list-style-type: none"> Selects the RFP_B screen Selects the B RFP WG SPC Observes PRIMARY CHANNEL SELECTED light is lit GREEN 		
3	<p>Ensures Backup Control Valve Feedback Position indication is valid for current plant conditions.</p>	<p>On B RFP WG SPC screen, observes BACKUPCTL VLV FEEDBACK POSITION indication agrees with PRI CTL VLV FEEDBACK POSITION.</p>		

PERFORMANCE CHECKLIST

Examinee _____

Step	Action	Standard	Eval	Comments
*4	Selects Backup Control Valve Woodward Governor.	Performs the following on the B RFP WG SPC screen: <ul style="list-style-type: none"> • *Touches the RFPT B WOODWARD GOVERNOR SPC SELECTION PB • *Touches the SELECT BACKUP WG SPC AND CV POSN FEEDBACK PB on the confirmation overlay • Observes BACKUP CHANNEL SELECTED light lit GREEN • Observes RFPT B speed remains stable 		
<u>FAULT STATEMENT</u> RFPT B CONTROL VALVE OSCILLATIONS BEGIN 10 SECONDS AFTER BACKUP WG GOVERNOR SELECTED				
<u>BOOTH OPERATOR CUE</u> Ensure Event Trigger ETEVAL45OP1671151 initiates when the Backup CV Woodward Governor is selected to cause RFPT B control valve oscillations.				
5	Observes RFPT B speed oscillations.	Observes the following: <ul style="list-style-type: none"> • NR level oscillations on 1C652 indications, ICS FW HMI and/or R*Time • Observes RFPT B control valve feedback position spiking with lowering RFPT B control valve position demand 		
6	Determines RFPT B Speed Control is erratic.	Informs Unit Supervisor of RFPT B control valve oscillation, intention to shutdown RFPT B Control Valve Backup Woodward Governor.		
7	Identifies governing procedure and obtains controlled copy for shutdown of Backup Control Valve Woodward Governor.	Obtains controlled copy of OP-145-007, selects Section 5.4.		
8	Ensures Primary Control Valve Woodward Governor is not shutdown.	On B RFP WG SPC screen observes PRIMARY WG STATUS SHUTDOWN light is extinguished.		

PERFORMANCE CHECKLIST

Examinee _____

Step	Action	Standard	Eval	Comments
9	Ensures Primary Control Valve Woodward Governor is in-service with stable operation.	Observes Backup Control Valve Woodward Governor is in-service with erratic operation, determines control must be transferred to Primary.		
10	Identifies governing procedure and obtains controlled copy for transfer to Primary Control Valve Woodward Governor.	Obtains controlled copy of OP-145-007, selects Section 5.1.		
11	Ensures Backup Control Valve Woodward Governor in-service.	Performs the following on any ICS HMI: <ul style="list-style-type: none"> • Selects the RFP_B screen • Selects the B RFP WG SPC • Observes BACKUP CHANNEL SELECTED light is lit GREEN 		
12	Ensures Primary Control Valve Feedback Position indication is valid for current plant conditions.	On B RFP WG SPC screen, observes PRI CTL VLV FEEDBACK POSITION indication agrees with BACKUP CTL VLV FEEDBACK POSITION.		
<p><u>BOOTH OPERATOR CUE</u> Ensure Event Trigger ETEVAL45OP1671151A initiates when the Primary CV Woodward Governor is selected to terminate scenarios exam\EVAL45OP1671151A and exam\EVAL45OP1671151B to stop the RFPT B control valve oscillations.</p>				
*13	Selects Primary Control Valve Woodward Governor.	Performs the following on the B RFP WG SPC screen: <ul style="list-style-type: none"> • *Touches the RFPT B WOODWARD GOVERNOR SPC SELECTION PB • *Touches the SELECT PRIMARY WG SPC AND CV POSN FEEDBACK PB on the confirmation overlay • Observes PRIMARY CHANNEL SELECTED light lit GREEN • Observes RFPT B speed stabilizes 		

PERFORMANCE CHECKLIST

Examinee _____

Step	Action	Standard	Eval	Comments
14	Ensures Primary Control Valve Woodward Governor is in-service with stable operation.	Observes PRIMARY CHANNEL SELECTED light lit GREEN and RFPT B speed and control valve positions are stable.		

EVALUATOR NOTE

The following step is performed as part of the Backup Governor shutdown procedure of Section 5.4.

*15	Shuts down Backup Control Valve Woodward Governor.	Performs the following on the B RFP WG SPC screen: <ul style="list-style-type: none"> • *#Touches RFPT B CV BACKUP WOODWARD GOVERNOR SHUTDOWN PB • *#Touches ENABLE RFPT "B" CV SHUTDOWN PB on the confirmation overlay • *#Touches the ENABLE B RFPT CV B/U WG S/D PB on the confirmation overlay and observes it backlit YELLOW • *#Touches INITIATE B RFPT CV SHUTDOWN within 15 seconds • Observes BACKUP CTL VLV WG STATUS SHUTDOWN light lit RED 		
-----	---	---	--	--

EVALUATOR CUE

Record JPM stop time: _____

EVALUATOR CUE

That completes the JPM.

EVALUATOR:

Do you have ALL your JPM exam materials? Task Cue Sheets? Procedures?

EXAMINEE

TASK CONDITIONS

A reactor startup is in progress.

RFPT B has just been placed in-service as the second RFP in Flow Control Mode.

An intermittent fault in the control valve position feedback circuitry to the RFPT B Control Valve Primary Woodward Governor is suspected.

Additional troubleshooting on the Control Valve Primary Woodward Governor is to be performed once it is shutdown.

INITIATING CUE

Transfer RFPT B speed control to the Control Valve Backup Woodward Governor and shutdown the Control Valve Primary Woodward Governor per OP-145-007.

EVALUATOR

TASK CONDITIONS

A reactor startup is in progress.

RFPT B has just been placed in-service as the second RFP in Flow Control Mode.

An intermittent fault in the control valve position feedback circuitry to the RFPT B Control Valve Primary Woodward Governor is suspected.

Additional troubleshooting on the Control Valve Primary Woodward Governor is to be performed once it is shutdown.

INITIATING CUE

Transfer RFPT B speed control to the Control Valve Backup Woodward Governor and shutdown the Control Valve Primary Woodward Governor per OP-145-007.

JPM ASSEMBLY INSTRUCTIONS

Seq	Item	Copier Program	Binding
1.	Examinee cue sheet	cue	loose
2.	Evaluator cue sheet	cue	loose
3.	JPM	jpm	loose
4.	OP-145-007	sim	PC

JPM REVISION SUMMARY

Revision	Description/Purpose of Revision
0	New JPM

REQUIRED TASK INFORMATION

1. SAFETY CONSIDERATIONS

- A. All Operations personnel are responsible for maintaining their radiation exposure As Low As Reasonably Achievable in accordance with OP-AD-002, Standards for Shift Operations.
- B. All applicable safety precautions shall be taken in accordance with established PPL safety policies and the Safety Rule Book, for example:
 - 1. Whenever any electrical panel is opened for inspection during JPM performance.
 - 2. Whenever entering any plant area where specific safety equipment such as hearing or eye protection, safety shoes, hardhats, etc., is required and/or posted as being necessary.
- C. If, in the judgment of the Evaluator any safety issue occurs during the performance of a JPM, the JPM will be terminated until the issue is resolved.
- D. Peer checking is the expectation for all evolutions; however, since a JPM is an individual effort, no peer check will be provided and Self Checking is required.

2. REFERENCES

- A. OP-152-001, HPCI System (Revision 52)

3. TASK CONDITIONS

Unit 1 scrammed due to a MSIV isolation.

Reactor water level and pressure are currently being controlled with RCIC and SRVs.

ESW, Suppression Pool Cooling, and Standby Gas Treatment have been placed in service in preparation for starting HPCI.

Another operator is performing SO-159-010 and maintaining Suppression Pool level per OP-159-001.

4. INITIATING CUE

Place HPCI in pressure control mode per OP-152-001 and maximize pressure reduction with HPCI.

5. TASK STANDARD

HPCI is started in pressure control mode at 2500-5200 gpm flowrate and discharge pressure > 1000 psig, with reactor cooldown in progress at less than 100 °F/hr.

SIMULATOR SETUP INSTRUCTIONS

1. **Reset** the simulator to any at-power IC.
2. **Run** scenario file EVAL52OP1950101.SCN
scn exam\EVAL52OP1950101-MP
IMF mfHP152002
{Key[1]} IMF mfRP158005
{Key[1]} IMF mfRR164022A d:5 c:10 f:60
{Key[1]} IMF mfRR164022B d:5 c:10 f:60
{Key[1]} IMF mfRR164022C d:5 c:10 f:60
{Key[1]} IOR diHS07555B c:1 f:OPEN
{Key[1]} IOR diHS07551B f:STR
{Key[1]} IOR diHS01102A c:1 f:RUN
{Key[1]} IOR diHS01102B c:1 f:RUN
3. **Depress** KEY 1 to scram the reactor and trip RFPs. Alternatively, it is allowable to perform this JPM with the reactor at power with MSIV indication overridden.
4. **Close** the MSIVs.
5. **Stabilize** RPV level with RCIC.
6. **Allow** pressure to cycle on SRVs (alternatively, may be acceptable to override lights to indicate MSIVs open, while allowing Main Turbine Bypass valves to control reactor pressure).
7. **Place** Suppression Pool cooling in-service op OP-149-004.
8. **Ensure** SBGT and ESW in-service.

PERFORMANCE CHECKLIST

Examinee _____

Step	Action	Standard	Eval	Comments
<u>EVALUATOR INSTRUCTIONS</u>				
<ul style="list-style-type: none"> Marking a step as UNSAT requires written comments on respective step. Critical steps are marked with a *. If elements of the Standard are non-critical, the critical elements of the Standard are marked with a *. The time clock starts when the candidate acknowledges the Initiating Cue. This JPM must be performed in the simulator. Reset to exam-specific IC-____, or configure the simulator per the Simulator Setup Instructions. 				
<u>EVALUATOR CUE</u>				
Record JPM start time: _____				
<u>BOOTH OPERATOR CUE</u>				
When the evaluator indicates the examinee is ready to begin the JPM, place the simulator in RUN.				
1	Identifies governing procedure and obtain controlled copy.	Obtains controlled copy of OP-152-001, selects Section 2.6.		
<u>BOOTH OPERATOR CUE</u>				
2	Verifies prerequisites are satisfied.	Performs the following: <ul style="list-style-type: none"> Observes HPCI in normal standby alignment per OP-152-001 Section 2.1 Observes HS-E41-1S17, HPCI INIT SIG RESET GREEN light EXTINGUISHED 		
3	Places Standby Gas Treatment, ESW and Suppression Pool Cooling in service.	Observes SBGT, ESW and Suppression Pool Cooling in service per Task Conditions.		
4	Performs SO-159-010, Suppression Chamber Average Water Temperature Verification.	Observes that another operator performing SO-159-010 per Task Conditions.		
5	Maintains Suppression Pool level < 23' 9" per OP-159-001.	Observes that another operator maintaining Suppression Pool level per Task Conditions.		
6	Evacuates HPCI Pump Room and HPCI Pipe Area 670' Reactor Building.	Makes plant announcement: <ul style="list-style-type: none"> Unit 1 is starting HPCI, evacuate HPCI Pump Room and HPCI Pipe Area 670' Reactor Building until further notice 		

PERFORMANCE CHECKLIST

Examinee _____

Step	Action	Standard	Eval	Comments
7	Ensures HPCI TEST LINE TO CST ISO HV-155-F008 CLOSED.	Observes HPCI TEST LINE TO CST ISO HV-155-F008 indicates FULL CLOSED.		
8	Ensures HPCI PUMP DSCH HV-155-F007 OPEN	Observes HPCI PUMP DSCH HV-155-F007 indicates FULL CLOSED.		
EVALUATOR NOTE HPCI PUMP SUCT FROM CST HV-155-F004 will automatically CLOSE and will not OPEN if HPCI PUMP SUCT FROM SUPP POOL HV-155-F042 FULL OPEN.				
9	Ensures HPCI PUMP SUCT FROM SUPP POOL HV-155-F042 CLOSED.	Observes HPCI PUMP SUCT FROM SUPP POOL HV-155-F042 indicates FULL CLOSED.		
10	Ensures HPCI PUMP SUCT FROM CST HV-155-F004 OPEN.	Observes HPCI PUMP SUCT FROM CST HV-155-F004 indicates FULL OPEN.		
EVALUATOR NOTE HPCI TEST LINE TO CST HV-155-F011 will not OPEN if HPCI system initiation signal present or HPCI PUMP SUCT FROM SUPP POOL HV-155-F042 FULL OPEN				
*11	Opens HPCI TEST LINE TO CST HV-155-F011.	Places HPCI TEST LINE TO CST HV-155-F011 HS to OPEN and observe valve strokes FULL OPEN.		
*12	Places HPCI TURBINE FLOW CONTROL FC-E41-1R600 in MANUAL set at minimum	Performs the following on HPCI TURBINE FLOW CONTROL FC-E41-1R600 controller: <ul style="list-style-type: none"> • Places selector switch to MANUAL • Depresses CLOSE PB until controller output indicates 0 percent 		
*13	Opens HPCI L-O CLG WTR HV-156-F059.	Places HPCI L-O CLG WTR HV-156-F059 HS to OPEN and observes valve strokes FULL OPEN.		

PERFORMANCE CHECKLIST

Examinee _____

Step	Action	Standard	Eval	Comments
14	Starts HPCI BARO CDSR VACUUM PP 1P216	Places HPCI BARO CDSR VACUUM PP 1P216 to START and observes pump indicates running.		
15	Initiates TRA.	Directs STA to initiate TRA.		
EVALUATOR CUE TRA has been initiated				
*16	Starts HPCI.	Simultaneously performs the following: <ul style="list-style-type: none"> Places HPCI AUXILIARY OIL PUMP 1P213 HS to START Places HPCI TURBINE STEAM SUPPLY HV-155-F001 HS to OPEN 		
EVALUATOR NOTE RPV pressure reduction may not be achievable immediately, depending upon plant conditions (i.e., simulator runtime). Action to raise HPCI flow and pressure as specified in the standard meets the intent of the critical step.				
*17	Establishes HPCI flow rate 2500-5000 gpm at sufficient HPCI discharge pressure to maintain or lower reactor pressure.	Perform the following simultaneously: <ul style="list-style-type: none"> *On FC-E41-1R600, HPCI TURBINE FLOW CONTROL, depress the OPEN and CLOSE PB as necessary to raise HPCI speed to obtain 2500-5000 gpm indicated on FI-E41-1R600-1, HPCI FLOW *Throttle HV-155-F008, HPCI TEST LINE TO CST ISO, closed as necessary to obtain >1000 psig indicated on PI-E41-1R601, HPCI PP DSCH PRESS Observe reactor pressure as indicated on UR-14201B, RPV PARAMETERS PAM RECORDER, lowering 		

PERFORMANCE CHECKLIST

Examinee _____

Step	Action	Standard	Eval	Comments
18	Ensures HPCI system response.	Observe the following: <ul style="list-style-type: none"> • HV-155-F028, HPCI STM LINE DRN TO CDSR IB ISO, indicates FULL CLOSED • HV-155-F029, HPCI STM LINE DRN TO CDSR OB ISO, indicates FULL CLOSED • HV-156-F025, HPCI BARO CDSR COND PP DSCH DRN, indicates FULL CLOSED • HV-156-F026, HPCI BARO CDSR COND PP DSCH DRN, indicates FULL CLOSED • 1V209A(B), HPCI PUMP ROOM UNIT COOLER, indicates RUNNING • HV-155-F012, HPCI MIN FLOW TO SUPP POOL, indicates FULL CLOSED 		
19	Places HPCI flow control in AUTO.	Performs the following on FC-E41-1R600, HPCI TURBINE FLOW CONTROL: <ul style="list-style-type: none"> • Adjusts the setpoint up and down as necessary until the flow indicator is within the GREEN band • Places the Auto/Manual toggle switch to AUTO 		
20	Observes HPCI barometric condenser pump automatically cycle on vacuum tank level.	Observes HPCI BARO CDSR COND PP 1P215 automatically starts to control vacuum tank level		
21	Notifies STA to plot TRA data.	Notifies STA to plot TRA STDP63 at a resolution of 1 second/inch and forward TRA plot to HPCI System Engineer		

EVALUATOR CUE

Record JPM stop time: _____

PERFORMANCE CHECKLIST

52.OP.1950.101 Rev 0
02/18/2014
Page 5 of 5

Examinee _____

Step	Action	Standard	Eval	Comments
<u>EVALUATOR NOTE</u> That completes the JPM.				
<u>EVALUATOR:</u> Do you have ALL your JPM exam materials? Task Cue Sheets? Procedures?				

EXAMINEE

TASK CONDITIONS

Unit 1 scrammed due to a MSIV isolation.

Reactor water level and pressure are currently being controlled with RCIC and SRVs.

ESW, Suppression Pool Cooling, and Standby Gas Treatment have been placed in service in preparation for starting HPCI.

Another operator is performing SO-159-010 and maintaining Suppression Pool level per OP-159-001.

INITIATING CUE

Place HPCI in pressure control mode per OP-152-001 and maximize pressure reduction with HPCI.

EVALUATOR

TASK CONDITIONS

Unit 1 scrammed due to a MSIV isolation.

Reactor water level and pressure are currently being controlled with RCIC and SRVs.

ESW, Suppression Pool Cooling, and Standby Gas Treatment have been placed in service in preparation for starting HPCI.

Another operator is performing SO-159-010 and maintaining Suppression Pool level per OP-159-001.

INITIATING CUE

Place HPCI in pressure control mode per OP-152-001 and maximize pressure reduction with HPCI.

JPM ASSEMBLY INSTRUCTIONS

Seq	Item	Copier Program	Binding
1.	Examinee cue sheet	cue	loose
2.	Evaluator cue sheet	cue	loose
3.	JPM	jpm	loose
4.	OP-152-001 Sect 2.6 (replacement)	sim	PC
5.	AR-114-E02	sim	loose

PPL SUSQUEHANNA, LLC

JOB PERFORMANCE MEASURE

APPROVAL AND ADMINISTRATIVE DATA SHEET

Task Title Place Shell Warming in Service, Warming Demand Fails High

<u>S/RO</u> Applicability	<u>93.OP.2440.151</u> JPM Number	<u>0</u> Revision	<u>02/20/2014</u> Date	<u>Simulator</u> Setting
<u>241000</u> NUREG-1123 E/APE / Sys	<u>A4.18</u> K/A Number	<u>2.9 / 2.8</u> K/A Importance	<u>Y</u> Alternate Path	<u>N</u> Time Critical

Prepared	Validated		
<u>Robert A. Thompson</u> Author	<u>02/20/2014</u> Date	<u>Robert A. Thompson</u> Instructor	<u>02/20/2014</u> Date

Review	Approval		
<u>[Signature]</u> Operations Management	<u>6-29-14</u> Date	<u>[Signature]</u> Nuclear Training Supervisor	<u>6/30/14</u> Date

35
Validation Time (min)

Examinee Name: _____
Last, First MI _____ Employee Number _____

Exam Date: _____ Exam Duration (Min) _____

Evaluation Result: Satisfactory Unsatisfactory

Evaluator _____
Name _____ Signature _____

Comments



JPM REVISION SUMMARY

Revision	Description/Purpose of Revision
0	New JPM

REQUIRED TASK INFORMATION

1. SAFETY CONSIDERATIONS

- A. All Operations personnel are responsible for maintaining their radiation exposure As Low As Reasonably Achievable in accordance with OP-AD-002, Standards for Shift Operations.
- B. All applicable safety precautions shall be taken in accordance with established PPL safety policies and the Safety Rule Book, for example:
 - 1. Whenever any electrical panel is opened for inspection during JPM performance.
 - 2. Whenever entering any plant area where specific safety equipment such as hearing or eye protection, safety shoes, hardhats, etc., is required and/or posted as being necessary.
- C. If, in the judgment of the Evaluator any safety issue occurs during the performance of a JPM, the JPM will be terminated until the issue is resolved.
- D. Peer checking is the expectation for all evolutions; however, since a JPM is an individual effort, no peer check will be provided and Self Checking is required.

2. REFERENCES

- A. OP-193-001, Main Turbine Operation (Revision 52)

3. TASK CONDITIONS

Unit 1 is in Mode 2 with a startup is in progress. Reactor pressure is being held at approximately 155 psig.

The Main Turbine was tripped for a special test.

The Main Turbine had been in shell warming prior to the test. Main Turbine shell warming was secured per OP-193-001 prior to tripping the turbine for the test.

The test is complete and the Main Turbine trip has been reset.

All prerequisites for placing Main Turbine shell warming in service are met.

Electrical Maintenance has installed jumpers for shell warming by completing Part A of OP-193-001-5 (Attachment E of OP-193-001).

The breakers for the RFPT low-pressure steam admission valves HV-12709A(B)(C) are open (1B142062(1B152044)(1B112082)).

The Main Turbine remained on the turning gear for the duration of the test with Bearing Lift Pumps G,E,C shut down. Turning gear amps have been stable with the current lift pump configuration.

4. INITIATING CUE

Continue placing Main Turbine shell warming in service per OP-193-001 Section 2.5, beginning at Step 2.5.4.

5. TASK STANDARD

Establishes Main Turbine shell warming in service per OP-193-001. Secures Main Turbine shell warming on failure of the shell warming demand signal high prior to automatic reactor scram.

SIMULATOR SETUP INSTRUCTIONS

1. **Reset** the simulator to IC-8.
2. **Trend** points TEP02 and TEP03 on the 1C651DR*Time display.
3. **Trip** the Main Turbine
4. **Open** drain valves HV-10151 (MS lead drn byps), HV-10153 (stm lead drn) and HV-10151A,B (turb xarnd drn) until turbine 1st stage pressure is < 0 psig
5. **Reset** the Main Turbine
6. **Set** TURB SHELL MTL TEMP fast time to 100 on SFC and run the simulator until turbine first stage inner metal temperature is < 250 °F, then return fast time to 1.
7. **Run** scenario file EVAL93OP2440151.SCN

```
IRF rfDB106166 f:OPEN  
IRF rfDB106197 f:OPEN  
IRF rfDB106129 f:OPEN  
aet ETEVAL93OP2440151
```

```
EVAL93OP2440151A.SCN  
aet ETEVAL93OP2440151A  
IOR diM2J115S517 f:OFF  
IOR diM2J115S516 f:OFF  
set tcfwarm=0.70
```

ETEVAL93OP2440151

```
doM2J115S516.CurrValue = #OR.doM2J115S516.ON & tcfwarm > 0.42  
scn exam\EVAL93OP2440151A
```

ETEVAL93OP2440151A

```
aoM2J115M11.CurrValue<0.01  
abort exam\EVAL93OP2440151A
```

PERFORMANCE CHECKLIST

Examinee _____

Step	Action	Standard	Eval	Comments
<p><u>EVALUATOR INSTRUCTIONS</u></p> <ul style="list-style-type: none"> • Marking a step as UNSAT requires written comments on respective step. • Critical steps are marked with a *. If elements of the Standard are non-critical, the critical elements of the Standard are marked with a *. • The time clock starts when the candidate acknowledges the Initiating Cue. • This JPM must be performed in the simulator. Reset to exam-specific IC-378, or configure the simulator per the Simulator Setup Instructions. • Prepare a copy of OP-193-001 Section 2.5, completed up to Step 2.5.4. 				
<p><u>EVALUATOR NOTE</u> The FAULTED step in this JPM is preceded by a fault statement in BOLD TYPE WITH ALL CAPITAL LETTERS.</p>				
<p><u>EVALUATOR CUE</u> Record JPM start time: _____</p>				
<p><u>BOOTH OPERATOR CUE</u> When the evaluator indicates the examinee is ready to begin the JPM, place the simulator in RUN.</p>				
1	<p>Identifies governing procedure and obtain controlled copy.</p>	<p>Obtains controlled copy of OP-193-001, Section 2.5.</p>		
2	<p>Checks drip leg and TSV/TCV below-seat drain valves open.</p>	<p>At 1C668, observes the following valves indicate FULL OPEN:</p> <ul style="list-style-type: none"> • HV-10112A1, DRIP LEG DRN • HV-10112B1, DRIP LEG DRN • HV-10112C1, DRIP LEG DRN • HV-10112D1, DRIP LEG DRN • HV-10101A,B,C,D, MSV BST DRN • HV-10102, CV 1,2,3,4 BST DRN 		
*3	<p>Closes main steam lead and bypass drain valves.</p>	<p>Performs the following:</p> <ul style="list-style-type: none"> • Depresses the CLOSE PB for HV-10153, MAIN STEAM LEAD DRAIN VALVE • Depresses the CLOSE PB for HV-10152, MAIN STEAM LEAD DRAIN BYPASS VALVE 		

PERFORMANCE CHECKLIST

Examinee _____

Step	Action	Standard	Eval	Comments
4	Checks MSL drip leg drain valves open.	Directs NPO to verify following valves indicate FULL OPEN at 1C110: <ul style="list-style-type: none"> • HV-10112A2, MN STM LINE A DRIP LEG DRN VLV • HV-10112B2, MN STM LINE B DRIP LEG DRN VLV • HV-10112C2, MN STM LINE C DRIP LEG DRN VLV • HV-10112D2, MN STM LINE D DRIP LEG DRN VLV 		
<u>EVALUATOR CUE</u> Valves indicate full open				
5	Checks RFP A, B, C HP steam low-point drain valves open.	Directs NPO to verify following valves indicate FULL OPEN: <ul style="list-style-type: none"> • At 1C116, HV-12707A, HP STEAM LOW POINT DRAIN • At 1C117, HV-12707B, HP STEAM LOW POINT DRAIN • At 1C118, HV-12707C, HP STEAM LOW POINT DRAIN 		
<u>EVALUATOR CUE</u> Valves indicate full open				
6	Verifies all RFPs out of service.	Observes annunciators AR-101-A10, A12, A14, RFPT A(B)(C) TRIP, in alarm.		
7	Verifies RFPT A, B, C LP steam admission valve breakers open.	At 1C668, observes RFPT A(B)(C) LP ISO HV-12709A,B,C have no indication.		

PERFORMANCE CHECKLIST

Examinee _____

Step	Action	Standard	Eval	Comments
8	Verifies FW heater extraction steam isolation valves closed.	Observes following valves indicate FULL CLOSED: <ul style="list-style-type: none"> • HV-10242A, HTR 5A HP EXTR ISO • HV-10242B, HTR 5B HP EXTR ISO • HV-10242C, HTR 5C HP EXTR ISO • HV-10241A, HTR 4A LP EXTR ISO • HV-10241B, HTR 4B LP EXTR ISO • HV-10241C, HTR 4C LP EXTR ISO • HV-10240A, HTR 3A LP EXTR ISO • HV-10240B, HTR 3B LP EXTR ISO • HV-10240C, HTR 3C LP EXTR ISO 		
*9	Closes Main Turbine cross-around drain.	Depresses HV-10151A,B TURB XARND DRN CLOSE PB.		
10	Checks RFP A, B, C LP steam low-point drain valves open.	Directs NPO to verify following valves indicate FULL CLOSED: <ul style="list-style-type: none"> • At 1C116, HV-12708A, LP STEAM LOW POINT DRAIN • At 1C117, HV-12708B, LP STEAM LOW POINT DRAIN • At 1C118, HV-12708C, LP STEAM LOW POINT DRAIN 		
EVALUATOR CUE The valves are closed.				

PERFORMANCE CHECKLIST

Examinee _____

Step	Action	Standard	Eval	Comments
11	Verifies Moisture Separator drains closed.	Observes following valves indicate FULL CLOSED: • HV-10213A, MSEP A DRN TO HTR 4A • HV-10213B, MSEP A DRN TO HTR 4B • HV-10213C, MSEP A DRN TO HTR 4C • HV-10216A, MSEP B DRN TO HTR 4A • HV-10216B, MSEP B DRN TO HTR 4B • HV-10216C, MSEP B DRN TO HTR 4C • HV-10231A, MSEP A DRN TO CDSR • HV-10231B, MSEP B DRN TO CDSR		
12	Confirms HP Turbine shell warming jumpers installed.	Observes jumpers installed per Task Conditions.		
13	Verifies Bearing Lift Pumps G, E, C shut down.	At 1C651, observes LIFT PUMP IP-109G, E, C indicate not running.		
14	Checks Main Turbine still on turning gear.	Observes TURNING GEAR HS-10168 SLOW and ENG lights lit RED.		
*15	Selects Shell warming mode.	Depresses CHEST / SHELL WARMING SHELL PB.		

PERFORMANCE CHECKLIST

Examinee _____

Step	Action	Standard	Eval	Comments
<p><u>EVALUATOR NOTE</u> WHEN SHELL selected, warming rate meter and MSV-2 servo current will peg downscale while speed signal integrates. After about 2 minutes, Control Valves OPEN and MSV-2 servo current returns to ZERO. The simulator models this 2 minute delay as 5 minutes.</p>				
<p><u>EVALUATOR CUE</u> Control valve opening may be delayed 5 minutes or more in the simulator.</p>				
16	<p>Observes shell warming initiated.</p>	<p>Observes the following:</p> <ul style="list-style-type: none"> • SHELL Warming light lit RED • ISV 1(2)(3)(4)(5)(6) POSITION ZI-10160A2(B2)(C2)(D2)(E2)(F2) indicates 0 percent • IV 1(2)(3)(4)(5)(6) POSITION ZI-10160A1(B1)(C1)(D1)(E1)(F1) indicates 0 percent • CONTROL VLV-1(2)(3)(4) POSITION indicates 100 percent • MSV-2 indicates 0 milliamps 		

PERFORMANCE CHECKLIST

Examinee _____

Step	Action	Standard	Eval	Comments
<p><u>EVALUATOR NOTE</u></p> <ul style="list-style-type: none"> • WHEN HP Turbine pressure reaches about 30 PSI, INTERCEPT VLV FAST CLOSING alarm will annunciate. • Warming demand meter represents a position demand signal to MSV-2. First 35-40% is valve over travel. Steam admission occurs in 40-100% region. • First Stage Shell lower inner surface shall be limited to less than 150 °F/HR temperature change. • Do <u>not</u> allow HP Turbine pressure to rise to 130.1 PSIG on TEP02 or TEP03 <u>OR</u> Control and Stop Valve Closure Scram Bypass is removed <u>AND</u> a Reactor Scram will occur. 				
<p><u>FAULT STATEMENT</u> WHEN WARMING DEMAND EXCEEDS 42 PERCENT AND WITH NO INCREASE IN DEMAND, THE WARMING DEMAND WILL FAIL HIGH</p>				
<p><u>BOOTH OPERATOR CUE</u> Ensure Event Trigger ETEVAL93OP2440151 initiates when warming demand > 42 percent and the INCREASE PB is released to momentarily pulse the warming demand pot to 70 percent.</p>				
*17	Initiates steam admission to HP turbine shell.	Depresses CHEST/SHELL WARMING INCREASE and DECREASE PBs as necessary until CHEST/SHELL WARMING DEMAND indicates 42-50 percent.		

PERFORMANCE CHECKLIST

Examinee _____

Step	Action	Standard	Eval	Comments
<p><u>BOOTH OPERATOR CUE</u></p>				
<p>If HP Turbine pressure stabilizes at < 130 psig, with examiner concurrence adjust the warming demand signal in 1 percent increments until pressure begins rising.</p>				
18	<p>Observes warming demand malfunction.</p>	<p>Observes the following:</p> <ul style="list-style-type: none"> • WARMING DEMAND rising above 50 percent • MSV-2 POSITION ZI-10141B rising • HP turbine pressure on R*Time points TEP02, TEP03 rising 		
19	<p>Lowers warming demand.</p>	<p>Performs the following:</p> <ul style="list-style-type: none"> • Depresses CHEST/SHELL WARMING DECREASE PB to attempt to lower CHEST/SHELL WARMING DEMAND to 42-50 percent • Informs Unit Supervisor 		
<p><u>BOOTH OPERATOR CUE</u></p>				
<p>Ensure Event Trigger ETEVAL93OP2440151A initiates when action is taken to terminate shell warming to remove the warming demand malfunction.</p>				
*20	<p>Terminates shell warming.</p>	<p>Before the reactor automatically scrams on TSV/TCV closure, performs any of the following:</p> <ul style="list-style-type: none"> • *Depresses CHEST / SHELL WARMING OFF PB • *Depresses ALL VALVES CLOSED PB • *Depresses Main Turbine TRIP PB • Observes WARMING DEMAND lower to 0 percent • MSV-2 POSITION ZI-10141B lower to 0 percent • Observes HP turbine pressure lower 		

PERFORMANCE CHECKLIST

Examinee _____

Step	Action	Standard	Eval	Comments
<u>EVALUATOR: CUE</u> Record JPM stop time: _____				
<u>EVALUATOR: CUE</u> That completes the JPM.				
<u>EVALUATOR:</u> Do you have ALL your JPM exam materials? Task Cue Sheets? Procedures?				

EXAMINEE

TASK CONDITIONS

Unit 1 is in Mode 2 with a startup in progress. Reactor pressure is being held at approximately 155 psig.

The Main Turbine was tripped for a special test.

The Main Turbine had been in shell warming prior to the test. Main Turbine shell warming was secured per OP-193-001 prior to tripping the turbine for the test.

The test is complete and the Main Turbine trip has been reset.

All prerequisites for placing Main Turbine shell warming in service are met.

Electrical Maintenance has installed jumpers for shell warming by completing Part A of OP-193-001-5 (Attachment E of OP-193-001).

The breakers for the RFPT low-pressure steam admission valves HV-12709A(B)(C) are open (1B142062(1B152044)(1B112082)).

The Main Turbine remained on the turning gear for the duration of the test with Bearing Lift Pumps G,E,C shut down. Turning gear amps have been stable with the current lift pump configuration.

INITIATING CUE

Continue placing Main Turbine shell warming in service per OP-193-001 Section 2.5, beginning at Step 2.5.4.

EVALUATOR

TASK CONDITIONS

Unit 1 is in Mode 2 with a startup is in progress. Reactor pressure is being held at approximately 155 psig.

The Main Turbine was tripped for a special test.

The Main Turbine had been in shell warming prior to the test. Main Turbine shell warming was secured per OP-193-001 prior to tripping the turbine for the test.

The test is complete and the Main Turbine trip has been reset.

All prerequisites for placing Main Turbine shell warming in service are met.

Electrical Maintenance has installed jumpers for shell warming by completing Part A of OP-193-001-5 (Attachment E of OP-193-001).

The breakers for the RFPT low-pressure steam admission valves HV-12709A(B)(C) are open (1B142062(1B152044)(1B112082)).

The Main Turbine remained on the turning gear for the duration of the test with Bearing Lift Pumps G,E,C shut down. Turning gear amps have been stable with the current lift pump configuration.

INITIATING CUE

Continue placing Main Turbine shell warming in service per OP-193-001 Section 2.5, beginning at Step 2.5.4.

JPM ASSEMBLY INSTRUCTIONS

Seq	Item	Copier Program	Binding
1.	Examinee cue sheet	cue	loose
2.	OP-193-001 Section 2.5 (marked-up) with Att A and B	exam	staple
3.	Evaluator cue sheet	cue	loose
4.	JPM	jpm	loose

PCL XL error

Warning: IllegalMediaSource

JPM REVISION SUMMARY

Revision	Description/Purpose of Revision
4	Revise for TQ procedures, minor editorial corrections. Revised from 73.OP.001.001 Rev 3.

REQUIRED TASK INFORMATION

1. SAFETY CONSIDERATIONS

- A. All Operations personnel are responsible for maintaining their radiation exposure As Low As Reasonably Achievable in accordance with OP-AD-002, Standards for Shift Operations.
- B. All applicable safety precautions shall be taken in accordance with established PPL safety policies and the Safety Rule Book, for example:
 - 1. Whenever any electrical panel is opened for inspection during JPM performance.
 - 2. Whenever entering any plant area where specific safety equipment such as hearing or eye protection, safety shoes, hardhats, etc., is required and/or posted as being necessary.
- C. If, in the judgment of the Evaluator any safety issue occurs during the performance of a JPM, the JPM will be terminated until the issue is resolved.
- D. Peer checking is the expectation for all evolutions; however, since a JPM is an individual effort, no peer check will be provided and Self Checking is required.

2. REFERENCES

- A. OP-173-003, Primary Containment Nitrogen Makeup And Venting (Revision 13)
- B. OP-070-001, Standby Gas Treatment System (Revision 26)

3. TASK CONDITIONS

Unit 1 is in Mode 1.

Drywell pressure is 0.4 psig up slow.

Standby Gas Treatment System is available per OP-070-001.

No containment inerting/de-inerting activities are in progress on Unit 2.

Nitrogen makeup to Unit 1 Drywell is secured.

All TR/TS requirements are met for venting the Drywell.

4. INITIATING CUE

Reduce Drywell pressure to 0.2 psig per OP-173-003, Primary Containment Nitrogen Makeup and Venting, Section 2.3. Utilize SGTS Train A.

5. TASK STANDARD

SGTS in operation, Drywell vent initiated with Drywell pressure lowering, then Drywell vent secured.

SIMULATOR SETUP INSTRUCTIONS

1. **Reset** the simulator to any rated-power IC.
2. **Open** N2 makeup valves SV-15767 and SV-15789 (sim PID PC5) until DW pressure reaches 0.4 psig, then **close** the valves.

PERFORMANCE CHECKLIST

Examinee _____

Step	Action	Standard	Eval	Comments
<u>EVALUATOR INSTRUCTIONS</u>				
<ul style="list-style-type: none"> Marking a step as UNSAT requires written comments on respective step. Critical steps are marked with a *. If elements of the Standard are non-critical, the critical elements of the Standard are marked with a *. The time clock starts when the candidate acknowledges the Initiating Cue. This JPM must be performed in the simulator. Reset to exam-specific IC-____, or configure the simulator per the Simulator Setup Instructions. 				
<u>EVALUATOR CUE</u>				
Record JPM start time: _____				
<u>BOOTH OPERATOR CUE</u>				
When the evaluator indicates the examinee is ready to begin the JPM, place the simulator in RUN.				
1	Identifies governing procedure and obtain controlled copy.	Obtains controlled copy of OP-173-003, selects Section 2.3.		
2	Complies with TR/TS requirements for venting the Drywell.	Observes all TR/TS requirements for venting the Drywell met from Task Conditions.		
<u>EVALUATOR CUE</u>				
As Unit Supervisor, direct the examinee to place SGTS A in-service to support Drywell venting.				
3	Identifies governing procedure and obtain controlled copy.	Obtains controlled copy of OP-070-001, selects Section 2.2.		
4	Evaluates entry into TS 3.6.4.3 for SGBT.	Notes all TS/TRM requirements for venting Drywell met per Task Conditions.		
<u>EVALUATOR NOTE</u>				
HD07555A remains open for approximately 120 seconds after its respective pushbutton is released. The next two steps must be performed expeditiously to establish a flow path and allow SGTS to start.				
*5	Opens SGTS Cooling Outside Air Damper HD07555A.	Perform the following: <ul style="list-style-type: none"> *Depress SGTS Clg 0A Dmp HD07555A OPEN pushbutton Observe SGTS Clg 0A Dmp HD07555A indicate FULL OPEN 		

PERFORMANCE CHECKLIST

Examinee _____

Step	Action	Standard	Eval	Comments
*6	Starts SGTS Fan A.	Perform the following: <ul style="list-style-type: none"> • *Place selector switch for SGTS Fan 0V109A(B) to START • Observe flow increases >3000 cfm on SGTS Air Flow FR07553A 		
7	Checks SGTS A alignment.	Observes the following: <ul style="list-style-type: none"> • SGTS Makeup 0A Dmp FD07551A2 MODULATED/OPEN approximately 120 seconds after SGTS Fan 0V109A started • SGTS Fan Inlet Dmp HD07552A FULL OPEN • SGTS A Inlet Dmp HD07553A FULL OPEN 		
<p><u>EVALUATOR NOTE</u> Examinee should indicate where to observe Drywell to Suppression Chamber differential pressure and note current value.</p>				
<p><u>EVALUATOR CUE</u> Another operator will update the log.</p>				
8	Updates the Unit 1 Log.	Notify other operator to log start time of Drywell vent in Unit 1 log.		
*9	Vents the Drywell to SGTS A.	Open the following dampers: <ul style="list-style-type: none"> • HD17508A DRWL/WETWELL BURP DMP • HD17508B DRWL/WETWELL BURP DMP • HV-15713 DRWL VENT IB ISO • HV-15711 DRWL VENT BYPS OB ISO 		

PERFORMANCE CHECKLIST

Examinee _____

Step	Action	Standard	Eval	Comments
10	Monitors Drywell pressure.	Observe Drywell pressure lowering on any of the following: <ul style="list-style-type: none"> • Computer point MAP01 or MAP001Z • PPC screen CONTN • PI-15702 CONTN OR SUPP CHMBR PRESS with selector switch HSS-15702 selected to CONTN 		
<p><u>EVALUATOR NOTE</u> The JPMI may be stopped as soon as the examinee notes a lowering trend in Drywell pressure.</p>				
<p><u>EVALUATOR CUE</u> Drywell pressure is acceptable, secure venting.</p>				
*11	Secures Drywell vent.	When Drywell pressure is approximately 0.2 psig, close the following dampers: <ul style="list-style-type: none"> • HV-15713 DRWL VENT IB ISO • HV-15711 DRWL VENT BYPS OB ISO • HD17508A DRWL/WETWELL BURP DMP • HD17508B DRWL/WETWELL BURP DMP 		
<p><u>EVALUATOR CUE</u> Record JPM stop time: _____</p>				
<p><u>EVALUATOR CUE</u> That completes the JPM.</p>				
<p><u>EVALUATOR:</u> Do you have ALL your JPM exam materials? Task Cue Sheets? Procedures?</p>				

EXAMINEE

TASK CONDITIONS

Unit 1 is in Mode 1.

Drywell pressure is 0.4 psig up slow.

Standby Gas Treatment System is available per OP-070-001.

No containment inerting/de-inerting activities are in progress on Unit 2.

Nitrogen makeup to Unit 1 Drywell is secured.

All TR/TS requirements are met for venting the Drywell.

INITIATING CUE

Reduce Drywell pressure to 0.2 psig per OP-173-003, Primary Containment Nitrogen Makeup and Venting, Section 2.3. Utilize SGTS Train A.

EVALUATOR

TASK CONDITIONS

Unit 1 is in Mode 1.

Drywell pressure is 0.4 psig up slow.

Standby Gas Treatment System is available per OP-070-001.

No containment inerting/de-inerting activities are in progress on Unit 2.

Nitrogen makeup to Unit 1 Drywell is secured.

All TR/TS requirements are met for venting the Drywell.

INITIATING CUE

Reduce Drywell pressure to 0.2 psig per OP-173-003, Primary Containment Nitrogen Makeup and Venting, Section 2.3. Utilize SGTS Train A.

JPM ASSEMBLY INSTRUCTIONS

Seq	Item	Copier Program	Binding
1.	Examinee cue sheet	cue	loose
2.	Evaluator cue sheet	cue	loose
3.	JPM	jpm	loose
4.	OP-173-003 partial	sim	PC
5.	OP-070-001 partial	sim	PC

PPL SUSQUEHANNA, LLC
JOB PERFORMANCE MEASURE

APPROVAL AND ADMINISTRATIVE DATA SHEET

Task Title Energize ESS Transformer 211, Re-Energize ESS Bus 2D after Transformer Lockout

<u>S/RO</u>	<u>04.OP.2529.151</u>	<u>1</u>	<u>06/29/2014</u>	<u>Simulator</u>
Applicability	JPM Number	Revision	Date	Setting
<u>262001</u>	<u>A2.07</u>	<u>3.0 / 3.2</u>	<u>Y</u>	<u>N</u>
NUREG-1123 E/APE / Sys	K/A Number	K/A Importance	Alternate Path	Time Critical

Prepared	Validated
<u>Robert A. Thompson</u>	<u>Robert A. Thompson</u>
Author	Instructor
<u>06/29/2014</u>	<u>02/20/2014</u>
Date	Date

Review	Approval
<u>Operations Management</u>	<u>[Signature]</u>
Date	Nuclear Training Supervisor
<u>25</u>	<u>6/30/14</u>
Validation Time (min)	Date

Examinee Name: _____
Last, First MI
Employee Number

Exam Date: _____ Exam Duration (Min) _____

Evaluation Result: Satisfactory Unsatisfactory

Evaluator _____
Name
Signature

Comments



JPM REVISION SUMMARY

Revision	Description/Purpose of Revision
0	New JPM
1	Revise for bus lockout

REQUIRED TASK INFORMATION**1. SAFETY CONSIDERATIONS**

- A. All Operations personnel are responsible for maintaining their radiation exposure As Low As Reasonably Achievable in accordance with OP-AD-002, Standards for Shift Operations.
- B. All applicable safety precautions shall be taken in accordance with established PPL safety policies and the Safety Rule Book, for example:
 - 1. Whenever any electrical panel is opened for inspection during JPM performance.
 - 2. Whenever entering any plant area where specific safety equipment such as hearing or eye protection, safety shoes, hardhats, etc., is required and/or posted as being necessary.
- C. If, in the judgment of the Evaluator any safety issue occurs during the performance of a JPM, the JPM will be terminated until the issue is resolved.
- D. Peer checking is the expectation for all evolutions; however, since a JPM is an individual effort, no peer check will be provided and Self Checking is required.

2. REFERENCES

- A. OP-004-001, 4KV Common System (Revision 15)
- B. OP-204-001, 4KV Electrical System (Revision 11)
- C. ON-004-002, Energizing Dead 4KV ESS Bus (Revision 25)

3. TASK CONDITIONS

ESS Transformer 201 was de-energized for planned maintenance.

Maintenance is complete and the transformer is ready to be returned to service.

The 13.8 KV and 125V DC power systems are in-service per their respective OPs.

All CLs required to be re-performed due to the scope of maintenance activities are complete.

The system status file has been reviewed.

Unit 2 is ready to return ESS Bus 2D to the normal source.

Unit 1 ESS Bus 1D will be returned to the normal source at a later time.

4. INITIATING CUE

Re-energize ESS Transformer 201 per OP-004-001 and return ESS Bus 2D to the normal source per OP-204-001.

5. TASK STANDARD

Re-energizes ESS Transformer 201 per OP-004-001 and transfers ESS Bus 2B to the normal source per OP-204-001. Re-energizes ESS Bus 2D after transformer lockout per ON-004-002.

SIMULATOR SETUP INSTRUCTIONS

1. **Reset** the simulator to any rated-power IC.
2. **Transfer** ESS Buses 1D and 2D to the alternate source.
3. **De-energize** ESS Transformer 201 by opening its breaker.
4. **Run** scenario file EVAL04OP2529151.SCN

```
IMF cmfBR04_2A20404  
aet ETEVAL04OP2529151  
{Key[1]} IMF cmfBR01_2A20404  
{Key[2]} DMF cmfEB01_2A204  
{Key[2]} IRF crfRL04_86A12A204 d:1 f:RESET  
{Key[3]} IRF crfRL04_86A2A204 f:RESET  
{Key[4]} IRF crfRL04_86A22A204 f:RESET  
{Key[5]} DMF cmfBR01_2A20404  
{Key[6]} IRF rfdS204012 f:CLOSE
```

```
ETEVAL04OP2529151.ET/SCN  
diHS00050B.CurrValue = #OR.diHS00050B.ON  
aet ETEVAL04OP2529151A  
ETEVAL04OP2529151A.ET/SCN  
diHS00050B.CurrValue = #OR.diHS00050B.OFF  
IMF cmfEB01_2A204 d:5  
IMF mfdS004004C d:6
```

PERFORMANCE CHECKLIST

Examinee _____

Step	Action	Standard	Eval	Comments
<p><u>EVALUATOR INSTRUCTIONS</u></p> <ul style="list-style-type: none"> Marking a step as UNSAT requires written comments on respective step. Critical steps are marked with a *. If elements of the Standard are non-critical, the critical elements of the Standard are marked with a *. The time clock starts when the candidate acknowledges the Initiating Cue. This JPM must be performed in the simulator. Reset to exam-specific IC-____, or configure the simulator per the Simulator Setup Instructions. 				
<p><u>EVALUATOR NOTE</u> The FAULTED step in this JPM is preceded by a fault statement in BOLD TYPE WITH ALL CAPITAL LETTERS.</p>				
<p><u>EVALUATOR CUE</u> Record JPM start time: _____</p>				
<p><u>BOOTH OPERATOR CUE</u> When the evaluator indicates the examinee is ready to begin the JPM, place the simulator in RUN.</p>				
1	<p>Identifies governing procedure for re-energizing ESS Transformer 201 and obtains controlled copy.</p>	<p>Obtains controlled copy of OP-004-001 and selects Section 2.1.</p>		
2	<p>Verifies prerequisites are met.</p>	<p>Observes the following per the Task Conditions:</p> <ul style="list-style-type: none"> DC power available CLs are complete 13.8 KV electrical system is energized 		
3	<p>Selects procedure section to re-energize ESS Transformer 201.</p>	<p>Selects Section 2.1.5.</p>		
4	<p>Checks Startup Bus 20 energized.</p>	<p>Observes either of the following at OC653A:</p> <ul style="list-style-type: none"> STARTUP BUS 20 status light illuminated WHITE XI-00002, SU BUS 20 VOLTS, indicates nominal 14 KV 		

PERFORMANCE CHECKLIST

Examinee _____

Step	Action	Standard	Eval	Comments
5	Checks Startup Bus 20 lockout relays reset.	Directs NPO to report status of following lockout relays as 0A104: <ul style="list-style-type: none"> • 86A1-10406 • 86A1-104A • 86A1-104B • 86A1-10401A • 86A1-10401B • 86A1-10401C 		
EVALUATOR CUE Lockouts are reset.				
*6	Re-energizes ESS Transformer 201.	Places SU BUS 20 XFMR 201 BKR (0A104-06) HS to CLOSE.		
7	Verifies ESS Transformer 201 energized.	Observes the following: <ul style="list-style-type: none"> • SU BUS 20 XFMR 201 BKR (0A104-06) indicates CLOSED • XI-00031, VOLTS, indicates nominal 4200 V 		
8	Places ESS Transformer 201 cooling systems in service.	Directs NPO to perform OP-004-001 Section 2.3 for ESS Transformer 201.		
EVALUATOR CUE Transformer cooling is in-service.				
9	Identifies governing procedure for transferring ESS Bus 2D to normal supply and obtains controlled copy.	Obtains controlled copy of OP-204-001 and selects Section 2.2.		
10	Selects procedure section to transfer ESS Bus 2D to the normal source.	Selects Section 2.2.6.		
11	Ensures ESS Transformer 201 energized.	Observes SU BUS 20 XFMR 201 BKR (0A104-06) indicates CLOSED.		

PERFORMANCE CHECKLIST

Examinee _____

Step	Action	Standard	Eval	Comments
12	Ensures ESS Transformer 201 load will not exceed 1500 A.	Observes XI-00025B, CURRENT (ESS Bus 2D alternate feeder current, indicates less than 100 A.		
<u>BOOTH OPERATOR CUE</u> Ensure Event Trigger ETEVAL04OP2529151 initiates when the sync switch is turned on to activate Event Trigger ETEVAL04OP2529151.				
*13	Turns on ESS Bus 2D normal feeder synchroscope.	Inserts key and places XFMR 201-BUS 2D SYNC SEL HS to ON.		
14	Checks ESS Bus 2D normal and alternate source voltages matched.	Observes XI-00036, DIFF AC VOLTS, indicates < 297 V on RED scale.		
15	Checks ESS Bus 2D normal and alternate sources are in-phase.	Observes XI-00037, SYNCHROSCOPE, is at 12-o'clock position.		
<u>EVALUATOR NOTE</u> Annunciator AR-016-D03 is an expected alarm for performance of this step.				
*16	Closes ESS Bus 2D normal source feeder breaker 2A204-08.	Places XFMR 201 TO BUS 2D BKR 2A20408 HS to CLOSE.		
17	Verifies ESS Bus 2D transferred to normal source.	Observes the following: <ul style="list-style-type: none"> • XFMR 201 TO BUS 2D BKR 2A20408 indicates CLOSED • XFMR 101 TO BUS 2D BKR 2A20401 indicates OPEN • R*Time voltage indication for ESS Bus 2D (display 4KV) 		
18	Checks ESS Bus 2D voltage on all three phases	Directs NPO to check voltage on all three phases of ESS Bus 2D, using VOLTAGE PHASE SLECT HS at 200204-04.		
<u>EVALUATOR CUE</u> All three phases indicate 4 KV.				

PERFORMANCE CHECKLIST

Examinee _____

Step	Action	Standard	Eval	Comments
19	Ensures ESS Transformer 201 load does not exceed 1500 A.	Observes XI-00017, CURRENT (ESS Transformer 201 feeder current, indicates less than full scale.		
FAULT STATEMENT				
ESS TRANSFORMER 201 LOCOUT OCCURS WHEN THE SYNC SWITCH IS TURNED OFF				
BOOTH OPERATOR CUE				
Ensure Event Trigger ETEVAL04OP2529151A initiates when the sync switch is turned off.				
*20	Turns off ESS Bus 2D normal feeder synchroscope.	Places XFMR 201-BUS 2D SYNC SEL HS to OFF and removes key.		
21	Observes ESS Transformer 201 lockout with spurious ESS Bus 2D lockout.	Observes the following and informs the Unit Supervisor: <ul style="list-style-type: none"> • AR-015-E07, 13.8KV FDR BUS 20 TO ESS XFMR 201 TRIP • SU BUS 20 XFMR 201 BKR (0A104-06) indicates OPEN • XFMR 201 TO BUS 2D BKR 2A20408 indicates OPEN • 4KV BUS 2D BUS LOCKOUT RELAY TRIP 		
EVALUATOR CUE				
[once ESS Bus 2D lockout reported] Maintenance has determined ESS Bus 2D lockouts may be reset and the bus re-energized.				
EVALUATOR CUE				
Re-energize ESS Bus 2D from offsite power per ON-004-002.				
22	Identifies governing procedure for re-energizing ESS Bus 2D and obtains controlled copy.	Obtains controlled copy of ON-004-002.		
23	Aligns ESS Bus 2D normal and alternate feeders to prevent auto-closure.	Places the following HS to CLOSE: <ul style="list-style-type: none"> • XFMR 101 TO BUS 2D BKR 2A20401 • XFMR 201 TO BUS 2D BKR 2A20408 		

PERFORMANCE CHECKLIST

Examinee _____

Step	Action	Standard	Eval	Comments
24	Selects procedure section to re-energize ESS Bus 2D from the DG.	Selects Attachment B, Section 8.2.		
25	Ensures all synchroscope switches OFF.	Observe all keylock synch switches are in the OFF position at 0C653.		
<u>EVALUATOR NOTE</u> Resetting lockout relays with DG running will automatically close DG breaker. Resetting lockout relays with control switches for normal and alternate ESS bus supply breakers in trip position will cause normal and alternate ESS bus supply breakers to automatically close, resulting in JPM failure.				
<u>EVALUATOR NOTE</u> Examinee may elect to place HS for 2A204-01 and 2A204-08 in CLOSE momentarily to verify semaphores mis-matched.				
26	Ensures offsite feeder breakers to ESS Bus 2D semaphores in NORMAL AFTER CLOSED.	Observe the following: <ul style="list-style-type: none"> • Observe RED target on XFMR 201 TO BUS 2D BKR 2A20408 HS • Observe RED target on XFMR 101 TO BUS 2D BKR 2A20401 HS 		
*27	Prevents automatic closure of DG D output breaker to ESS Bus 2D.	Directs NPO to open DG D main breaker 2A204-04 DC control and trip power knife switch.		
<u>BOOTH OPERATOR CUE</u> When requested, depress KEY 1 to open DC knife for DG D output breaker.				
<u>EVALUATOR CUE</u> DC knife is open.				
*28	Resets ESS Bus 2D lockouts.	Direct NPO at ESS Bus 2D Cubicle 2A20401 to reset following lockout relays in order specified: <ul style="list-style-type: none"> • 86A1-204 • 86A-204 • 86A2-204 		

PERFORMANCE CHECKLIST

Examinee _____

Step	Action	Standard	Eval	Comments
<u>BOOTH OPERATOR CUE</u>				
<ul style="list-style-type: none"> When requested, depress KEY 2 to reset 86A1-204, KEY 3 to reset 86A-204, KEY 4 to reset 86A2-204. 				
<u>EVALUATOR CUE</u> Lockouts are reset.				
29	Ensures all ESS Bus 2D breakers are open.	Direct NPO to confirm all ESS Bus 2D 4KV breakers are OPEN.		
<u>EVALUATOR CUE</u> Breakers are open.				
30	Evacuates personnel from Switchgear Room.	Direct NPO to verify Switchgear Room is evacuated.		
<u>EVALUATOR CUE</u> Switchgear room is clear.				
31	Confirms ESS Transformer 101 voltage > 4.01 KV.	R*Time voltage indication for ESS Transformer 101 (display 4KV) > 4.01 KV.		
*#32	Turns on ESS Transformer 101 to ESS Bus 2D synchroscope.	Place XFMR 101-BUS 2D SYNC SEL switch to ON.		
*#33	Closes ESS Transformer 101 output breaker to ESS Bus 2D.	Place breaker XFMR 101 TO BUS 2D BKR 2A20401 HS to CLOSE.		
*34	Turns off ESS Transformer 101 to ESS Bus 2D synchroscope.	Place XFMR 101-BUS 2D SYNC SEL switch to OFF.		
35	Enables automatic closure of DG D output breaker to ESS Bus 2D.	Directs NPO to close DG D main breaker 2A204-04 DC control and trip power knife switch.		
<u>BOOTH OPERATOR CUE</u> When requested, depress KEY 5 to close DC knife for DG D output breaker.				
<u>EVALUATOR CUE</u> DC knife is closed.				

PERFORMANCE CHECKLIST

Examinee _____

Step	Action	Standard	Eval	Comments
36	Verifies ESS Bus 2D re-energized.	Observes the following: <ul style="list-style-type: none"> • R*Time voltage indication for ESS Bus 2D (display 4KV) > 4 KV • ESS BUS 2D 2A204 status light ILLUMINATED • Directs NPO to check all 3 phases of ESS Bus 2D voltage using VOLTAGE PHASE SELECT at 2A2040-04 		
<u>EVALUATOR CUE</u> ESS Bus 2D voltage nominal 4KV.				
37	Ensure Engineered Safeguard System Load Center Trans 2X240 2A20406 CLOSED.	Directs NPO to close breaker 2A204-06.		
<u>BOOTH OPERATOR CUE</u> When requested, depress KEY 6 to close 2A204-06.				
<u>EVALUATOR CUE</u> Breaker is closed.				
<u>EVALUATOR CUE</u> Record JPM stop time: _____				
<u>EVALUATOR CUE</u> That completes the JPM.				
<u>EVALUATOR:</u> Do you have ALL your JPM exam materials? Task Cue Sheets? Procedures?				

EXAMINEE

TASK CONDITIONS

ESS Transformer 201 was de-energized for planned maintenance.

Maintenance is complete and the transformer is ready to be returned to service.

The 13.8 KV and 125V DC power systems are in-service per their respective OPs.

All CLs required to be re-performed due to the scope of maintenance activities are complete.

The system status file has been reviewed.

Unit 2 is ready to return ESS Bus 2D to the normal source.

Unit 1 ESS Bus 1D will be returned to the normal source at a later time.

INITIATING CUE

Re-energize ESS Transformer 201 per OP-004-001 and return ESS Bus 2D to the normal source per OP-204-001.

EVALUATOR

TASK CONDITIONS

ESS Transformer 201 was de-energized for planned maintenance.

Maintenance is complete and the transformer is ready to be returned to service.

The 13.8 KV and 125V DC power systems are in-service per their respective OPs.

All CLs required to be re-performed due to the scope of maintenance activities are complete.

The system status file has been reviewed.

Unit 2 is ready to return ESS Bus 2D to the normal source.

Unit 1 ESS Bus 1D will be returned to the normal source at a later time.

INITIATING CUE

Re-energize ESS Transformer 201 per OP-004-001 and return ESS Bus 2D to the normal source per OP-204-001.

JPM ASSEMBLY INSTRUCTIONS

Seq	Item	Copier Program	Binding
1.	Examinee cue sheet	cue	loose
2.	Evaluator cue sheet	cue	loose
3.	JPM	jpm	loose
4.	OP-004-001 Section 2.1	sim	PC
5.	OP-204-001 Section 2.2	sim	PC
6.	ON-004-002 Section Attachment B	sim	PC
7.	AR-015-D07 AR-015-E07	sim	PC
8.	AR-016-A02 AR-016-C03 AR-016-D02 AR-016-D03 AR-016-D05	sim	PC

PPL SUSQUEHANNA, LLC

JOB PERFORMANCE MEASURE

APPROVAL AND ADMINISTRATIVE DATA SHEET

Task Title Restore Bypassed Control Rod Position in RWM

<u>S/RO</u> Applicability	<u>31.OP.1552.101</u> JPM Number	<u>0</u> Revision	<u>01/17/2014</u> Date	<u>Simulator</u> Setting
<u>201006</u> NUREG-1123 E/APE / Sys	<u>A4.06</u> K/A Number	<u>3.2 / 3.2</u> K/A Importance	<u>N</u> Alternate Path	<u>N</u> Time Critical

Prepared

Validated

Robert A. Thompson

01/17/2014

Robert A. Thompson

02/20/2014

Author

Date

Instructor

Date

Review

Approval

Thompson
Operations Management

6-29-14
Date

Robert A. Thompson
Nuclear Training Supervisor

6/30/14
Date

10

Validation Time (min)

Examinee Name: _____

Last, First MI

Employee Number

Exam Date: _____

Exam Duration (Min) _____

Evaluation Result: Satisfactory

Unsatisfactory

Evaluator

Name

Signature

Comments



JPM REVISION SUMMARY

Revision	Description/Purpose of Revision
0	New JPM

REQUIRED TASK INFORMATION

1. SAFETY CONSIDERATIONS

- A. All Operations personnel are responsible for maintaining their radiation exposure As Low As Reasonably Achievable in accordance with OP-AD-002, Standards for Shift Operations.
- B. All applicable safety precautions shall be taken in accordance with established PPL safety policies and the Safety Rule Book, for example:
 - 1. Whenever any electrical panel is opened for inspection during JPM performance.
 - 2. Whenever entering any plant area where specific safety equipment such as hearing or eye protection, safety shoes, hardhats, etc., is required and/or posted as being necessary.
- C. If, in the judgment of the Evaluator any safety issue occurs during the performance of a JPM, the JPM will be terminated until the issue is resolved.
- D. Peer checking is the expectation for all evolutions; however, since a JPM is an individual effort, no peer check will be provided and Self Checking is required.

2. REFERENCES

- A. OP-131-001, Rod Worth Minimizer (RWM) (Revision 15)

3. TASK CONDITIONS

Unit 1 startup is in progress at approximately 3 percent power.

Control rod position indication for control rod 46-19 at position 10 is bad.

Control rod position for control rod 46-19 was substituted in the RWM at position 10.

The control rod has now been withdrawn to the target position of 12, which has good rod position indication.

4. INITIATING CUE

Delete the substituted control rod position for control rod 46-19 in the RWM per OP-131-001 Section 2.6.

5. TASK STANDARD

Control rod position substituted in RWM for control rod 46-19 is deleted.

SIMULATOR SETUP INSTRUCTIONS

1. **Reset** the simulator to IC-11.
2. **Run** scenario file EVAL31OP1552101.SCN
IMF mfLS1550094619A f:10
3. **Select** control rod 46-19.

NOTE: The following steps will have to be performed each time the sim is reset to perform this JPM

4. **Enter** a substitute position for control rod 46-19 of 10 in the RWM per OP-131-001 Sect. 2.6 (RWM Menu, Subst. Control Rod)
5. **Acknowledge** all RWM alarms.
6. **Request** OD7 new scans as necessary to clear the RWM message area.

PERFORMANCE CHECKLIST

Examinee _____

Step	Action	Standard	Eval	Comments
<u>EVALUATOR INSTRUCTIONS</u>				
<ul style="list-style-type: none"> Marking a step as UNSAT requires written comments on respective step. Critical steps are marked with a *. If elements of the Standard are non-critical, the critical elements of the Standard are marked with a *. The time clock starts when the candidate acknowledges the Initiating Cue. This JPM must be performed in the simulator. Reset to exam-specific IC-379, or configure the simulator per the Simulator Setup Instructions. 				
<u>EVALUATOR CUE</u>				
Record JPM start time: _____				
<u>BOOTH OPERATOR CUE</u>				
Before bringing the examinee into the simulator, re-perform the Simulator Setup Instructions to configure the RWM as required for the JPM.				
<u>BOOTH OPERATOR CUE</u>				
When the evaluator indicates the examinee is ready to begin the JPM, place the simulator in RUN.				
<u>EVALUATOR NOTE</u>				
A control rod withdrawal block alarm may be received on RWM re-initialization activities.				
1	Identifies governing procedure and obtain controlled copy.	Obtains controlled copy of OP-131-001, selects Section 2.6.		
2	Verifies prerequisites satisfied.	Observes position indication for control rod 46-19 is operable at current position per Task Conditions.		
*3	Initiates RWM Substitute Control Rod function.	On the 1C651 RWM terminal, performs either of the following: <ul style="list-style-type: none"> From any RTime screen, depresses the RWM display PB and then depresses the SUBSTITUTE CONTROL ROD PB From the RWM Main Display, depresses the SUB CR button 		
*4	Selects the desired quadrant.	On the RWM SUB Control Rod Level 1 screen, touches the lower-right quadrant.		

PERFORMANCE CHECKLIST

Examinee _____

Step	Action	Standard	Eval	Comments
*5	Selects control rod 46-19.	Performs the following on the RWM SUB Control Rod Quadrant 4 screen: <ul style="list-style-type: none"> • Observes control rod 46-19 highlighted YELLOW • *Touches control rod 46-19 • Observes control rod 46-19 box outlined RED 		
*6	Deletes control rod 46-19 position substitution.	Performs the following: <ul style="list-style-type: none"> • *Depresses the DELETE PB • *On the confirmation screen, depresses DELETE • Acknowledges message • Observes control rod 46-19 indicate selected at position 12 		
7	Opens the RWM Main Display.	Performs the following: <ul style="list-style-type: none"> • Depresses the RWM MENU PB • Depresses the RWM MAIN DISPLAY PB 		
<p><u>EVALUATOR NOTE</u> RTime automatically generates a new OD7 scan request on any change to control rod substituted positions.</p>				
8	Demands a OD-7 new scan.	Performs the following: <ul style="list-style-type: none"> • Depresses the OD7 NEW SCAN PB • Observes FCRS Running displayed above the OD7 NEW SCAN PB • Observes Full Core Scan has completed message • Observes Available displayed above the OD7 NEW SCAN PB 		

PERFORMANCE CHECKLIST

Examinee _____

Step	Action	Standard	Eval	Comments
9	Verifies control rod 46-19 position displayed on RWM is correct.	Performs the following: <ul style="list-style-type: none">Depresses the FULL CORE DISPLAY PBObserves control rod 46-19 indicates selected, at position 12		

EVALUATOR CUE

Record JPM stop time: _____

EVALUATOR NOTE

That completes the JPM.

EVALUATOR:

Do you have ALL your JPM exam materials? Task Cue Sheets? Procedures?

EXAMINEE

TASK CONDITIONS

Unit 1 startup is in progress at approximately 3 percent power.

Control rod position indication for control rod 46-19 at position 10 is bad.

Control rod position for control rod 46-19 was substituted in the RWM at position 10.

The control rod has now been withdrawn to the target position of 12, which has good rod position indication.

INITIATING CUE

Delete the substituted control rod position for control rod 46-19 in the RWM per OP-131-001 Section 2.6.

EVALUATOR

TASK CONDITIONS

Unit 1 startup is in progress at approximately 3 percent power.

Control rod position indication for control rod 46-19 at position 10 is bad.

Control rod position for control rod 46-19 was substituted in the RWM at position 10.

The control rod has now been withdrawn to the target position of 12, which has good rod position indication.

INITIATING CUE

Delete the substituted control rod position for control rod 46-19 in the RWM per OP-131-001 Section 2.6.

JPM ASSEMBLY INSTRUCTIONS

Seq	Item	Copier Program	Binding
1.	Examinee cue sheet	cue	loose
2.	Evaluator cue sheet	cue	loose
3.	JPM	jpm	loose
4.	OP-131-003 (partial)	sim	PC

PPL SUSQUEHANNA, LLC
JOB PERFORMANCE MEASURE

APPROVAL AND ADMINISTRATIVE DATA SHEET

Task Title Perform RBCCW System Flush, RBCCW Pump Trips

<u>S/RO</u> Applicability	<u>14.ON.1335.151</u> JPM Number	<u>1</u> Revision	<u>02/20/2014</u> Date	<u>Simulator</u> Setting
<u>400000</u> NUREG-1123 E/APE / Sys	<u>A2.01</u> K/A Number	<u>3.3 / 3.4</u> K/A Importance	<u>Y</u> Alternate Path	<u>N</u> Time Critical

Prepared

Validated

<u>Robert A. Thompson</u> Author	<u>02/20/2014</u> Date	<u>Robert A. Thompson</u> Instructor	<u>02/20/2014</u> Date
-------------------------------------	---------------------------	---	---------------------------

Review

Approval

<u>[Signature]</u> Operations Management	<u>6-29-14</u> Date	<u>[Signature]</u> Nuclear Training Supervisor	<u>6/30/14</u> Date
---	------------------------	---	------------------------

15

Validation Time (min)

Examinee Name: _____
Last, First MI Employee Number

Exam Date: _____ Exam Duration (Min) _____

Evaluation Result: Satisfactory Unsatisfactory

Evaluator _____
Name Signature

Comments



JPM REVISION SUMMARY

Revision	Description/Purpose of Revision
0	New JPM

REQUIRED TASK INFORMATION

1. SAFETY CONSIDERATIONS

- A. All Operations personnel are responsible for maintaining their radiation exposure As Low As Reasonably Achievable in accordance with OP-AD-002, Standards for Shift Operations.
- B. All applicable safety precautions shall be taken in accordance with established PPL safety policies and the Safety Rule Book, for example:
 - 1. Whenever any electrical panel is opened for inspection during JPM performance.
 - 2. Whenever entering any plant area where specific safety equipment such as hearing or eye protection, safety shoes, hardhats, etc., is required and/or posted as being necessary.
- C. If, in the judgment of the Evaluator any safety issue occurs during the performance of a JPM, the JPM will be terminated until the issue is resolved.
- D. Peer checking is the expectation for all evolutions; however, since a JPM is an individual effort, no peer check will be provided and Self Checking is required.

2. REFERENCES

- A. GO-100-014, Unit 1 Hot Weather Operation (Revision 7)
- B. ON-114-001, Loss of RBCCW (Revision 25)
- C. OP-114-001, Reactor Building Closed Cooling Water System (Revision 21)
- D. OP-AD-001, Operations Standards for System and Equipment Operation (Revision 55)

3. TASK CONDITIONS

Systems cooled by Unit 1 RBCCW are experiencing degraded performance due to hot weather operation.

Engineering has recommended a flush of the in-service RBCCW Heat Exchanger A to see if performance improves.

The RBCCW TCV bypass valve is unavailable to be operated.

No throttled isolation valves are to be operated during the flush.

4. INITIATING CUE

Perform a flush of RBCCW HX A per GO-100-014 Section 5.3.

5. TASK STANDARD

RBCCW system flush initiated per GO-100-014. RBCCW Pump 1B started when RBCCW Pump 1A trips. RBCCW Pump 1B directed to be vented when RBCCW Pump 1B fails to deliver flow.

SIMULATOR SETUP INSTRUCTIONS

1. **Reset** the simulator to any IC with RBCCW in operation.
2. **Run** scenario file EVAL14ON1335151.SCN

```
aet ETEVAL14ON1335151
IMF cmfPM04_1P210B
IRF rfrW114002 f:20
{Key[1]} IRF rfrW114002 f:100 r:10
ETEVAL14ON1335161.ET/SCN
;METER:RBCCW HX TEMP CONTROL (HORZ METER)
aoTIC11028B.CurrValue > 90
IMF cmfPM03_1P210A d:30
```

PERFORMANCE CHECKLIST

Examinee _____

Step	Action	Standard	Eval	Comments
<u>EVALUATOR INSTRUCTIONS</u>				
<ul style="list-style-type: none"> • Marking a step as UNSAT requires written comments on respective step. • Critical steps are marked with a *. If elements of the Standard are non-critical, the critical elements of the Standard are marked with a *. • The time clock starts when the candidate acknowledges the Initiating Cue. • This JPM must be performed in the simulator. Reset to exam-specific IC-____, or configure the simulator per the Simulator Setup Instructions. • Mark-up a copy of GO-100-014 complete up to initiating flush of RBCCW with TCV. N/A steps associated with the TCV bypass and throttled isolation valves. 				
<u>EVALUATOR NOTE</u>				
The FAULTED step in this JPM is preceded by a fault statement in BOLD TYPE WITH ALL CAPITAL LETTERS .				
<u>EVALUATOR CUE</u>				
Record JPM start time: _____				
<u>BOOTH OPERATOR CUE</u>				
When the evaluator indicates the examinee is ready to begin the JPM, place the simulator in RUN.				
1	Identifies governing procedure and obtain controlled copy.	Obtains controlled copy of GO-100-014.		
<u>FAULT STATEMENT</u>				
RBCCW PUMP 1A TRIPS 30 SECONDS AFTER CONTROLLER OUTPUT EXCEEDS 90 PERCENT				
*2	Initiates flush of system heat exchangers cooled by RBCCW.	Performs the following on controller TIC-11028, RBCCW COOLER TEMP:		
<ul style="list-style-type: none"> • Places M/A toggle switch to M • Depresses OPEN PB until controller output indicates 100 percent 				

PERFORMANCE CHECKLIST

Examinee _____

Step	Action	Standard	Eval	Comments
3	Observes RBCCW Pump 1A tripped.	Performs the following: <ul style="list-style-type: none"> • Observes RBCCW Pump 1A indication lost • Observes RBCCW system pressure low on PI-11308, RBCCW HX DSCH PRESS • Observes AR-123-E03, RBCCW PUMPS DISCHARGE HEADER LO PRESS, and AR-123-E04, RBCCW HEAT EXCHANGER HEADER LO PRESS, in alarm • Observes RBCCW Pump 1B fails to automatically start • Informs Unit Supervisor 		
<u>EVALUATOR CUE</u> (As Unit Supervisor) Respond in accordance with plant procedures.				
*4	Starts RBCCW Pump 1B.	Depresses RBCCW PUMP 1P210B START PB.		
<u>EVALUATOR NOTE</u> Norma RBCCW system pressure on PI-11308 is approximately 75 psig.				

PERFORMANCE CHECKLIST

Examinee _____

Step	Action	Standard	Eval	Comments
5	Observes RBCCW Pump 1B fails to develop flow.	Performs the following: <ul style="list-style-type: none"> • Observes RBCCW Pump 1B indicates running • Observes RBCCW system pressure low on PI-11308, RBCCW HX DSCH PRESS • Observes AR-123-E03, RBCCW PUMPS DISCHARGE HEADER LO PRESS, and AR-123-E04, RBCCW HEAT EXCHANGER HEADER LO PRESS, in alarm • Informs Unit Supervisor 		
<u>EVALUATOR CUE</u> (As Unit Supervisor) Perform ON-114-001.				
6	Records Recirc Pump bearing and seal cavity temperatures.	Recirc Pumps A&B Motor Temperature TRSH B31 1R601 Panel 1C614, records Reactor Recirc Pump A(B) Motor Bearing and Seal Cavity temperatures.		
<u>EVALUATOR CUE</u> (When first set of data collected) Another operator will monitor Recirc Pump temperatures. I will determine when action is required before the temperature limits. Continue in ON-114-001 at Step 3.4.				
7	Determines loss of flow has occurred.	Selects Section 3.6 to perform.		
8	Ensures RBCCW Pump 1B running.	Observes RBCCW Pump 1B indicates running, but pump discharge header pressure low annunciator remains in alarm.		
9	Checks RBCCW Pump breakers.	Directs NPO to check the following breakers: <ul style="list-style-type: none"> • RBCCW Pump 1A: 1B216-103 • RBCCW Pump 1B: 1B237-093 		

PERFORMANCE CHECKLIST

Examinee _____

Step	Action	Standard	Eval	Comments
<u>EVALUATOR CUE</u> 1B216-103 is tripped. 1B237-093 is closed.				
10	Identifies performance of ON-125-001 for loss of CIG compressors is required.	Informs Unit Supervisor to enter ON-125-001.		
<u>EVALUATOR CUE</u> Another operator will perform ON-125-001.				
11	Determines if RBCCW Pump 1B is developing flow.	Directs the NPO to report the status of RBCCW Pump 1B.		
<u>EVALUATOR CUE</u> (As NPO) RBCCW Pump 1B is running, but sounds air-bound.				
*12	Vents RBCCW Pump 1B.	Directs NPO to vent RBCCW Pump 1B.		
<u>BOOTH OPERATOR CUE</u> When directed to vent RBCCW Pump 1B, depress KEY 1 to simulate venting the pump.				
<u>EVALUATOR CUE</u> I got a lot of air when I initially opened the pump casing vents, then a solid stream of water. RBCCW Pump 1B sounds to be running normally now.				
13	Verifies RBCCW flow is restored.	Observes the following: <ul style="list-style-type: none"> • Observes RBCCW system pressure approximately 75 psig on PI-11308, RBCCW HX DSCH PRESS • Observes AR-123-E03, RBCCW PUMPS DISCHARGE HEADER LO PRESS, and AR-123-E04, RBCCW HEAT EXCHANGER HEADER LO PRESS, clear 		
14	Ensures RBCCW Head Tank filled.	Observes annunciator AR-132-E06, RBCCW HEAD TANK HI LO LEVEL, is clear.		

PERFORMANCE CHECKLIST

14.ON.1335.151 Rev 1
02/20/2014
Page 5 of 5

Examinee _____

Step	Action	Standard	Eval	Comments
<u>EVALUATOR CUE</u> Record JPM stop time: _____				
<u>EVALUATOR CUE</u> That completes the JPM.				
<u>EVALUATOR:</u> Do you have ALL your JPM exam materials? Task Cue Sheets? Procedures?				

EXAMINEE

TASK CONDITIONS

Systems cooled by Unit 1 RBCCW are experiencing degraded performance due to hot weather operation.

Engineering has recommended a flush of the in-service RBCCW Heat Exchanger A to see if performance improves.

The RBCCW TCV bypass valve is unavailable to be operated.

No throttled isolation valves are to be operated during the flush.

INITIATING CUE

Perform a flush of RBCCW HX A per GO-100-014 Section 5.3.

EVALUATOR

TASK CONDITIONS

Systems cooled by Unit 1 RBCCW are experiencing degraded performance due to hot weather operation.

Engineering has recommended a flush of the in-service RBCCW Heat Exchanger A to see if performance improves.

The RBCCW TCV bypass valve is unavailable to be operated.

No throttled isolation valves are to be operated during the flush.

INITIATING CUE

Perform a flush of RBCCW HX A per GO-100-014 Section 5.3.

JPM ASSEMBLY INSTRUCTIONS

Seq	Item	Copier Program	Binding
1.	Examinee cue sheet	cue	loose
2.	GO-100-014 (marked-up)	exam	staple
3.	Evaluator cue sheet	cue	loose
4.	JPM	jpm	loose
5.	AR-123-E02,E03,E04	sim	PC
6.	ON-114-001	sim	PC

PPL SUSQUEHANNA, LLC

JOB PERFORMANCE MEASURE

APPROVAL AND ADMINISTRATIVE DATA SHEET

Task Title Manual Emergency Shutdown of Diesel Generator from Panel 0C521A(B)

<u>S/RO</u> Applicability	<u>24.OP.1443.051</u> JPM Number	<u>1</u> Revision	<u>02/18/2014</u> Date	<u>Plant</u> Setting
<u>264000</u> NUREG-1123 E/APE / Sys	<u>A4.04</u> K/A Number	<u>3.7 / 3.7</u> K/A Importance	<u>Y</u> Alternate Path	<u>N</u> Time Critical

Prepared _____ Validated _____
Robert A. Thompson 02/18/2014 Robert A. Thompson 02/20/2014
Author Date Instructor Date

Review _____ Approval _____
[Signature] 6-29-14 [Signature] 6/30/14
Operations Management Date Nuclear Training Supervisor Date

15
Validation Time (min)

Examinee Name: _____
Last, First MI Employee Number

Exam Date: _____ Exam Duration (Min) _____

Evaluation Result: Satisfactory Unsatisfactory

Evaluator _____
Name Signature

Comments

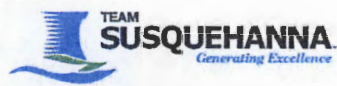

JPM REVISION SUMMARY

Revision	Description/Purpose of Revision
0	New JPM
1	Revise for TQ procedures, minor editorial corrections

REQUIRED TASK INFORMATION

1. SAFETY CONSIDERATIONS

- A. All Operations personnel are responsible for maintaining their radiation exposure As Low As Reasonably Achievable in accordance with OP-AD-002, Standards for Shift Operations.
- B. All applicable safety precautions shall be taken in accordance with established PPL safety policies and the Safety Rule Book, for example:
 - 1. Whenever any electrical panel is opened for inspection during JPM performance.
 - 2. Whenever entering any plant area where specific safety equipment such as hearing or eye protection, safety shoes, hardhats, etc., is required and/or posted as being necessary.
- C. If, in the judgment of the Evaluator any safety issue occurs during the performance of a JPM, the JPM will be terminated until the issue is resolved.
- D. Peer checking is the expectation for all evolutions; however, since a JPM is an individual effort, no peer check will be provided and Self Checking is required.

2. REFERENCES

- A. OP-024-001, Diesel Generators (Revision 70)

3. TASK CONDITIONS

Unit 2 has experienced a reactor coolant leak in the Drywell.

Unit 2 Drywell pressure is 2.1 psig, up slow.

All Emergency Diesel Generators have started in Emergency Mode.

DG A(B) output breaker failed to close and cannot be closed manually.

There is no Emergency Service Water cooling being supplied to DG A(B).

4. INITIATING CUE

Perform a manual emergency shutdown of Diesel Generator A(B) per OP-024-001 Section 2.7.

5. TASK STANDARD

DG A(B) given an Emergency Stop signal from OC521A(B). DG A(B) stopped using the Overspeed Fuel Shutdown Valve and Fuel Quadrant Lever.

PERFORMANCE CHECKLIST

Examinee _____

Step	Action	Standard	Eval	Comments
<p><u>EVALUATOR INSTRUCTIONS</u></p> <ul style="list-style-type: none"> Marking a step as UNSAT requires written comments on respective step. Critical steps are marked with a *. If elements of the Standard are non-critical, the critical elements of the Standard are marked with a *. The time clock starts when the candidate acknowledges the Initiating Cue. This JPM must be performed in the plant. Obtain Shift Manager authorization to proceed. This JPM requires access to Diesel Generator A or B. This JPM is written to be performed on either DG A or DG B. Select the appropriate cue sheet for the DG to be used to perform the JPM. The JPM refers to DG A components, with DG B components identified in (). 				
<p><u>EVALUATOR NOTE</u> The FAULTED step in this JPM is preceded by a fault statement in BOLD TYPE WITH ALL CAPITAL LETTERS.</p>				
<p><u>EVALUATOR CUE</u> Record JPM start time: _____</p>				
1	Identifies governing procedure and obtain controlled copy.	Obtains controlled copy of OP-024-001, selects Section 2.7		
<p><u>EVALUATOR NOTE</u> LOCA auto start signal is bypassed in local mode.</p>				
2	Determines if DG A(B) running in Emergency Mode.	Observes the following: <ul style="list-style-type: none"> DG A(B) IN EMERGENCY MODE light illuminated DG A(B) MASTER TRIP CIRCUIT RESET light illuminated, TRIPPED light extinguished DG A(B) SEQUENCE INDICATION RUNNING IDLE light illuminated SI-03497/1A(B) DG A(B) ENGINE SPEED indicates 600 rpm 		
*#3	Places DG A(B) in local mode.	At OC521A(B), places 43CM DG A(B) CONTROL MODE SELECT SWITCH to LOCAL.		

PERFORMANCE CHECKLIST

Examinee _____

Step	Action	Standard	Eval	Comments
<u>EVALUATOR CUE</u> <ul style="list-style-type: none"> Switch is in position indicated LOCAL light is illuminated REMOTE light is extinguished Annunciator E08, CONTROL SWITCHES NOT PROPER FOR REMOTE AUTO OPER, is in alarm 				
<u>FAULT STATEMENT</u> DG A(B) WILL FAIL TO STOP WHEN THE EMERGENCY STOP PB IS DEPRESSED				
*#4	Emergency Stops DG A(B).	Depresses 5ES EMERGENCY STOP PB.		
<u>EVALUATOR CUE</u> PB depressed.				
5	Observes DG A(B) fails to stop.	Observes the following: <ul style="list-style-type: none"> Master Trip Circuit Tripped Green light Running Idle light Pre-lube pump 0P532A(B) start at 280 rpm 		
<u>EVALUATOR CUE</u> <ul style="list-style-type: none"> DG A(B) MASTER TRIP CIRCUIT RESET light illuminated, TRIPPED light extinguished DG A(B) SEQUENCE INDICATION RUNNING IDLE light illuminated SI-03497/1A(B) DG A(B) ENGINE SPEED indicates 600 rpm 				
6	Considers personnel safety.	Communicate procedure warning to supervision (US/FUS).		
<u>EVALUATOR CUE</u> (As Unit Supervisor/FUS) Proceed with emergency shutdown of DG A(B).				
7	Obtains maintenance assistance.	Contacts FUS for maintenance assistance.		
<u>EVALUATOR CUE</u> Maintenance personnel are ready to assist.				

PERFORMANCE CHECKLIST

Examinee _____

Step	Action	Standard	Eval	Comments
<u>EVALUATOR NOTE</u>				
This knob is located on top of engine on the right side by the overspeed governor.				
*8	Actuates the Overspeed Fuel Shutdown Vlv Reset valve.	Pulls the black knob labeled SX-03483A(B), OVERSPEED FUEL SHUTDOWN VLV RESET.		
<u>EVALUATOR CUE</u>				
Black knob is pulled.				
*9	Isolates fuel oil to DG A(B).	On the FUEL CONTROL QUADRANT LEVER, depresses the release PB in the end of the lever and then pull the lever down until the engine comes to a complete stop.		
<u>EVALUATOR CUE</u>				
<ul style="list-style-type: none"> • (If release PB not depressed) Lever did not move • (If release PB depressed) Lever pulled down fully • (After short pause with lever held down) DG A(B) is stopped 				
10	Resets Overspeed Fuel Shutdown Vlv Reset.	Pushes in the black knob labeled SX-03483A(B), OVERSPEED FUEL SHUTDOWN VLV RESET.		
<u>EVALUATOR CUE</u>				
Black knob is depressed.				
<u>EVALUATOR CUE</u>				
Record JPM stop time: _____				
<u>EVALUATOR CUE</u>				
That completes the JPM.				
<u>EVALUATOR:</u>				
Do you have ALL your JPM exam materials? Task Cue Sheets? Procedures?				

EXAMINEE

TASK CONDITIONS

Unit 2 has experienced a reactor coolant leak in the Drywell.

Unit 2 Drywell pressure is 2.1 psig, up slow.

All Emergency Diesel Generators have started in Emergency Mode.

DG A output breaker failed to close and cannot be closed manually.

There is no Emergency Service Water cooling being supplied to DG A.

INITIATING CUE

Perform a manual emergency shutdown of Diesel Generator A per OP-024-001 Section 2.7.

EVALUATOR

TASK CONDITIONS

Unit 2 has experienced a reactor coolant leak in the Drywell.

Unit 2 Drywell pressure is 2.1 psig, up slow.

All Emergency Diesel Generators have started in Emergency Mode.

DG A output breaker failed to close and cannot be closed manually.

There is no Emergency Service Water cooling being supplied to DG A.

INITIATING CUE

Perform a manual emergency shutdown of Diesel Generator A per OP-024-001 Section 2.7.

EXAMINEE

TASK CONDITIONS

Unit 2 has experienced a reactor coolant leak in the Drywell.

Unit 2 Drywell pressure is 2.1 psig, up slow.

All Emergency Diesel Generators have started in Emergency Mode.

DG B output breaker failed to close and cannot be closed manually.

There is no Emergency Service Water cooling being supplied to DG B.

INITIATING CUE

Perform a manual emergency shutdown of Diesel Generator B per OP-024-001 Section 2.7.

EVALUATOR

TASK CONDITIONS

Unit 2 has experienced a reactor coolant leak in the Drywell.

Unit 2 Drywell pressure is 2.1 psig, up slow.

All Emergency Diesel Generators have started in Emergency Mode.

DG B output breaker failed to close and cannot be closed manually.

There is no Emergency Service Water cooling being supplied to DG B.

INITIATING CUE

Perform a manual emergency shutdown of Diesel Generator B per OP-024-001 Section 2.7.

JPM ASSEMBLY INSTRUCTIONS

Seq	Item	Copier Program	Binding
1.	Examinee cue sheet	cue	loose
2.	OP-024-001 Section 2.7	exam	staple
3.	Evaluator cue sheet	cue	loose
4.	JPM	jpm	loose

PPL SUSQUEHANNA, LLC
JOB PERFORMANCE MEASURE

APPROVAL AND ADMINISTRATIVE DATA SHEET

Task Title Venting Suppression Chamber without Radiological Release Limitations

<u>S/RO</u> Applicability	<u>73.EO.2282.101</u> JPM Number	<u>2</u> Revision	<u>02/18/2014</u> Date	<u>Plant - RCA</u> Setting
<u>223001</u> NUREG-1123 E/APE / Sys	<u>A2.07</u> K/A Number	<u>4.2 / 4.3</u> K/A Importance	<u>N</u> Alternate Path	<u>N</u> Time Critical

Prepared	Validated		
<u>Robert A. Thompson</u> Author	<u>02/18/2014</u> Date	<u>Robert A. Thompson</u> Instructor	<u>02/20/2014</u> Date
Review	Approval		
<u>[Signature]</u> Operations Management	<u>6-29-14</u> Date	<u>[Signature]</u> Nuclear Training Supervisor	<u>6/30/14</u> Date

20
Validation Time (min)

Examinee Name: _____
Last, First MI
Employee Number

Exam Date: _____ Exam Duration (Min) _____

Evaluation Result: Satisfactory Unsatisfactory

Evaluator _____
Name
Signature

Comments



JPM REVISION SUMMARY

Revision	Description/Purpose of Revision
0	New JPM
1	Updated format. Update to the current revision of the reference procedures. Reduced the scope of the task to just that needed to align the flowpath and initiate the Suppression Chamber pressure reduction.
2	Revise for TQ procedures, minor editorial corrections

REQUIRED TASK INFORMATION**1. SAFETY CONSIDERATIONS**

- A. All Operations personnel are responsible for maintaining their radiation exposure As Low As Reasonably Achievable in accordance with OP-AD-002, Standards for Shift Operations.
- B. All applicable safety precautions shall be taken in accordance with established PPL safety policies and the Safety Rule Book, for example:
 - 1. Whenever any electrical panel is opened for inspection during JPM performance.
 - 2. Whenever entering any plant area where specific safety equipment such as hearing or eye protection, safety shoes, hardhats, etc., is required and/or posted as being necessary.
- C. If, in the judgment of the Evaluator any safety issue occurs during the performance of a JPM, the JPM will be terminated until the issue is resolved.
- D. Peer checking is the expectation for all evolutions; however, since a JPM is an individual effort, no peer check will be provided and Self Checking is required.

2. REFERENCES

- A. ES-173-003, Venting Suppression Chamber Without Radiological Release Limitation (Revision 19)

3. TASK CONDITIONS

A LOCA and Station Blackout have occurred.

Drywell pressure is approaching 60 psig.

Zones 1 and 3 are isolated.

The Unit 1 and 2 Reactor Buildings have been evacuated.

The TSC has directed venting the Suppression Chamber per EP-DS-004, Primary Containment and RPV Venting.

ES-173-003, Venting Suppression Chamber without Radiological Release Limitation, has been authorized. Appropriate steps of Section 4.2 are complete.

4. INITIATING CUE

Vent the Suppression Chamber in accordance with ES-173-003 Section 4.6.

5. TASK STANDARD

Suppression Chamber vent path established with Suppression Chamber pressure lowering.

PERFORMANCE CHECKLIST

Examinee _____

Step	Action	Standard	Eval	Comments
<u>EVALUATOR INSTRUCTIONS</u>				
<ul style="list-style-type: none"> Marking a step as UNSAT requires written comments on respective step. Critical steps are marked with a *. If elements of the Standard are non-critical, the critical elements of the Standard are marked with a *. The time clock starts when the candidate acknowledges the Initiating Cue. This JPM must be performed in the plant. Obtain Shift Manager authorization to proceed. This JPM requires access to Unit 1 683' and 779' Reactor Building. Mark-up a copy of ES-173-003 authorizing performance of Section 4.6 and indicating completion of the appropriate steps of Section 4.2. 				
<u>EVALUATOR CUE</u>				
Record JPM start time: _____				
1	Identifies governing procedure and obtain controlled copy.	Obtains controlled copy of ES-173-003, selects Section 4.6.		
2	Ensures appropriate steps of Section 4.2 have been performed.	Observes appropriate steps of Section 4.2 have been performed per Task Conditions.		
3	Obtains required tools and equipment.	From either the Shift Manager or OSC ES Toolboxes, obtains the following tools: <ul style="list-style-type: none"> Groove pliers (also located in B.5.b storage area in the 0P911 Garage) Pliers (also located in B.5.b storage area in the 0P911 Garage) Grease gun (also located in B.5.b storage area in the 0P911 Garage) 13/16" wrench (also located in B.5.b storage area in the 0P911 Garage) Fire Protection turnout gear (from Fire Brigade Shed) 11/16" deep-well socket and ratchet 		
<u>EVALUATOR CUE</u>				
You have the tools.				

PERFORMANCE CHECKLIST

Examinee _____

Step	Action	Standard	Eval	Comments
4	Evacuates Unit 1 and 2 Reactor Buildings.	Observes from Task Conditions that Unit 1 and 2 Reactor Buildings have been evacuated.		
5	Notifies Health Physics to commence continuous background radiation monitoring in areas where personnel are stationed.	Contacts HP and directs commencement of continuous background radiation monitoring in the Control Room, TSC and any other personnel staging areas.		
<u>EVALUATOR CUE</u> Health Physics has been notified to commence continuous background radiation monitoring in the Control Room, TSC and other personnel staging areas.				
<u>EVALUATOR NOTE</u> Access panel is located at 27-779', approximately 24" above floor level just under damper HD-17508A.				
*6	Removes access panel from the upstream side of HD-17508A, SGTS UNIT 1 CONTN BURP & PURGE ISO DMP	Performs the following at access panel upstream of HD-17508A, SGTS UNIT 1 CONTN BURP & PURGE ISO DMP: <ul style="list-style-type: none"> • Using pliers, removes all thumbscrews from panel • Removes panel from duct work 		
<u>EVALUATOR CUE</u> <ul style="list-style-type: none"> • Screws removed • Panel removed 				
7	Determines if Maintenance personnel are available.	Contacts the US/FUS/OSC and requests Maintenance personnel assistance with opening vent dampers.		
<u>EVALUATOR CUE</u> Maintenance personnel are not available.				

PERFORMANCE CHECKLIST

73.EO.2282.101 Rev 2
02/18/2014
Page 3 of 5

Examinee _____

Step	Action	Standard	Eval	Comments
<u>EVALUATOR NOTE</u>				
HV-15704 is located at 27-683', directly across from 1B262, approximately 13' in the overhead. Have the examinee identify the damper to be operated and use Figure 1 to describe how the damper jackscrew arrangement is manipulated in the following steps.				
*8	Rotates the HV-15704, SUPP CHMBR VENT TO SGTS OB ISO VLV, jam nut counter clockwise the full length of the jackscrew threads	Using the 13/16" wrench, at HV-15704, SUPP CHMBR VENT TO SGTS OB ISO VLV, rotates the jam nut counter-clockwise until it contacts the welded nut at the end of the jackscrew.		
<u>EVALUATOR CUE</u> The jam nut has been rotated.				
<u>EVALUATOR NOTE</u>				
HV-15703 is located at 27-683', directly across from 1B262, approximately 13' in the overhead. Have the examinee identify the damper to be operated and use Figure 1 to describe how the damper jackscrew arrangement is manipulated in the following steps.				
*9	Rotates the HV-15703, SUPP CHMBR VENT TO SGTS IB ISO VLV, jam nut counter-clockwise the full length of the jackscrew threads.	Using the 13/16" wrench, at HV-15703, SUPP CHMBR VENT TO SGTS IB ISO VLV, rotates the jam nut counter-clockwise until it contacts the welded nut at the end of the jackscrew.		
<u>EVALUATOR CUE</u> The jam nut has been rotated.				
10	Applies grease to the jackscrews of the following two valves: <ul style="list-style-type: none"> • HV-15704, SUPP CHMBR VENT TO SGTS OB ISO VLV • HV-15703, SUPP CHMBR VENT TO SGTS IB ISO VLV 	Greases the full length of the jackscrews of the following two valves: <ul style="list-style-type: none"> • HV-15704, SUPP CHMBR VENT TO SGTS OB ISO VLV • HV-15703, SUPP CHMBR VENT TO SGTS IB ISO VLV 		
<u>EVALUATOR CUE</u> Grease applied.				

PERFORMANCE CHECKLIST

Examinee _____

Step	Action	Standard	Eval	Comments
*11	Opens HV-15704, SUPP CHMBR VENT TO SGTS OB ISO VLV.	At HV-15704, SUPP CHMBR VENT TO SGTS OB ISO VLV, fully strokes the actuator by placing the 11/16" wrench on the welded nut and rotating the wrench clockwise.		
<u>EVALUATOR CUE</u> You feel resistance in the clockwise direction.				
<u>EVALUATOR NOTE</u> Protective clothing is due to possible failure of the duct work, resulting in discharge of steam/high energy gasses into the area. If this condition is observed individuals will immediately exit the area.				
<u>EVALUATOR CUE</u> Location of turnout gear not required for the following step. Have the examinee identify storage location of turnout gear				
<ul style="list-style-type: none"> • Fire Truck house • Unit 2 Turbine 676' elevation, near the Tool Room • Unit 1 Turbine 729' elevation 				
12	Don's fire protection turnout gear.	Simulates donning turnout gear.		
<u>EVALUATOR NOTE</u>				
<ul style="list-style-type: none"> • The next steps will turn the jack screw until flow through the ductwork is heard. Additional turns are performed incrementally to avoid failure of the ductwork. If required, individuals should move to a lower dose and noise area while Control Room/TSC is monitoring for a decreasing pressure. • Valve will need to be opened approximately 7% to pass sufficient flow to depressurize containment. 				
*13	Opens HV-15703, SUPP CHMBR VENT TO SGTS IB ISO VLV, until flow noise is heard.	At HV-15703, SUPP CHMBR VENT TO SGTS IB ISO VLV, strokes the actuator by placing the 13/16" wrench on the welded nut and rotating the wrench clockwise until flow noise is heard in ductwork.		
<u>EVALUATOR CUE</u> You feel resistance in the clockwise direction.				

PERFORMANCE CHECKLIST

Examinee _____

Step	Action	Standard	Eval	Comments
*14	Determines if Suppression Chamber pressure is lowering.	Contacts the Control Room/TSC and requests status of Suppression Chamber pressure.		
<u>EVALUATOR CUE</u> Suppression Chamber pressure is steady.				
*15	Opens HV-15703, SUPP CHMBR VENT TO SGTS IB ISO VLV, an additional two full turns.	At HV-15703, SUPP CHMBR VENT TO SGTS IB ISO VLV, strokes the actuator by placing the 13/16" wrench on the welded nut and rotating the wrench clockwise two full turns.		
16	Determines if Suppression Chamber pressure is lowering.	Contacts the Control Room/TSC and requests status of Suppression Chamber pressure.		
<u>EVALUATOR CUE</u> Suppression Chamber pressure is lowering.				
17	Exits the Unit 1 Reactor Building.	Proceeds to the Unit 1 Turbine Building through the nearest airlock.		
<u>EVALUATOR CUE</u> Record JPM stop time: _____				
<u>EVALUATOR CUE</u> That completes the JPM.				
<u>EVALUATOR:</u> Do you have ALL your JPM exam materials? Task Cue Sheets? Procedures?				

Figure 1

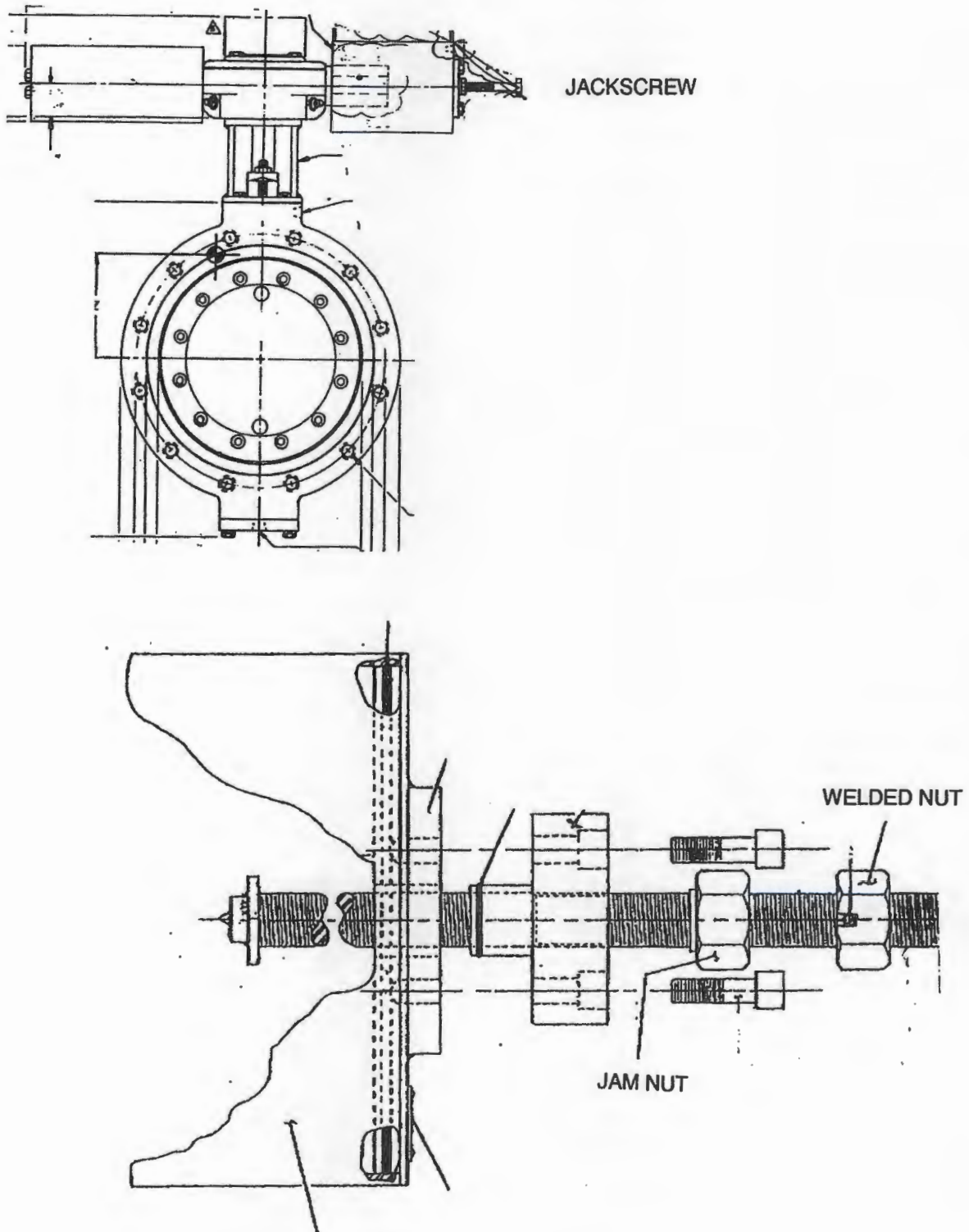

EXAMINEE

TASK CONDITIONS

A LOCA and Station Blackout have occurred.

Drywell pressure is approaching 60 psig.

Zones 1 and 3 are isolated.

The Unit 1 and 2 Reactor Buildings have been evacuated.

The TSC has directed venting the Suppression Chamber per EP-DS-004, Primary Containment and RPV Venting.

ES-173-003, Venting Suppression Chamber without Radiological Release Limitation, has been authorized. Appropriate steps of Section 4.2 are complete.

INITIATING CUE

Vent the Suppression Chamber in accordance with ES-173-003 Section 4.6.

EVALUATOR

TASK CONDITIONS

A LOCA and Station Blackout have occurred.

Drywell pressure is approaching 60 psig.

Zones 1 and 3 are isolated.

The Unit 1 and 2 Reactor Buildings have been evacuated.

The TSC has directed venting the Suppression Chamber per EP-DS-004, Primary Containment and RPV Venting.

ES-173-003, Venting Suppression Chamber without Radiological Release Limitation, has been authorized. Appropriate steps of Section 4.2 are complete.

INITIATING CUE

Vent the Suppression Chamber in accordance with ES-173-003 Section 4.6.

JPM ASSEMBLY INSTRUCTIONS

Seq	Item	Copier Program	Binding
1.	Examinee cue sheet	cue	loose
2.	ES-173-001 (marked-up)	exam	staple
3.	Evaluator cue sheet	cue	loose
4.	JPM	jpm	loose

PPL SUSQUEHANNA, LLC
JOB PERFORMANCE MEASURE

APPROVAL AND ADMINISTRATIVE DATA SHEET

Task Title Perform Operator Actions Outside the Control Room in Accordance With ON-100-009

<u>S/RO</u> Applicability	<u>00.ON.1153.102</u> JPM Number	<u>2</u> Revision	<u>01/26/2014</u> Date	<u>Plant</u> Setting
<u>295016</u> NUREG-1123 E/APE / Sys	<u>AA1.07</u> K/A Number	<u>4.2 / 4.3</u> K/A Importance	<u>N</u> Alternate Path	<u>N</u> Time Critical

Prepared	Validated		
<u>Robert A. Thompson</u> Author	<u>01/26/2014</u> Date	<u>Robert A. Thompson</u> Instructor	<u>02/20/2014</u> Date
Review	Approval		
<u>[Signature]</u> Operations Management	<u>6-29-14</u> Date	<u>[Signature]</u> Nuclear Training Supervisor	<u>6/30/14</u> Date

10
Validation Time (min)

Examinee Name: _____
Last, First MI
Employee Number

Exam Date: _____ Exam Duration (Min) _____

Evaluation Result: Satisfactory Unsatisfactory

Evaluator _____
Name
Signature

Comments



JPM REVISION SUMMARY

Revision	Description/Purpose of Revision
0	New JPM
1	Revise to incorporate MSIV logic HS MSO modification, limited task to scram and MSIV closure
2	Revise for TQ procedures, minor editorial corrections

REQUIRED TASK INFORMATION

1. SAFETY CONSIDERATIONS

- A. All Operations personnel are responsible for maintaining their radiation exposure As Low As Reasonably Achievable in accordance with OP-AD-002, Standards for Shift Operations.
- B. All applicable safety precautions shall be taken in accordance with established PPL safety policies and the Safety Rule Book, for example:
 - 1. Whenever any electrical panel is opened for inspection during JPM performance.
 - 2. Whenever entering any plant area where specific safety equipment such as hearing or eye protection, safety shoes, hardhats, etc., is required and/or posted as being necessary.
- C. If, in the judgment of the Evaluator any safety issue occurs during the performance of a JPM, the JPM will be terminated until the issue is resolved.
- D. Peer checking is the expectation for all evolutions; however, since a JPM is an individual effort, no peer check will be provided and Self Checking is required.

2. REFERENCES

- A. ON-100-009, Control Room Evacuation (Revision 29)

3. TASK CONDITIONS

A fire has occurred in the Control Room.

The Control Room has been evacuated due to the fire.

All immediate operator actions for Control Room evacuation could not be completed.

A reactor scram was not inserted and MSIVs were not closed prior to Control Room evacuation.

4. INITIATING CUE

Perform Steps 4.3.4a and 4.3.4b of ON-100-109 to ensure reactor scram and MSIV closure.

5. TASK STANDARD

Opens RPS bus output breakers to de-energize RPS and MSIV logics to ensure reactor scram and MSIV closure, and transfers both MSIV logic power supply HS to EMERGENCY to prevent spurious MSIV and MSL drain opening due to fire-induced circuit faults.

PERFORMANCE CHECKLIST

Examinee _____

Step	Action	Standard	Eval	Comments
<p><u>EVALUATOR INSTRUCTIONS</u></p> <ul style="list-style-type: none"> Marking a step as UNSAT requires written comments on respective step. Critical steps are marked with a *. If elements of the Standard are non-critical, the critical elements of the Standard are marked with a *. The time clock starts when the candidate acknowledges the Initiating Cue. This JPM must be performed in the plant. Obtain Shift Manager authorization to proceed. This JPM requires access to Unit 1 RPS A and B panels 1Y201A,B and 1C609,611. Panel doors at 1Y201A(B) will <u>NOT</u> be opened. Mark-up a copy of ON-100-009 complete up to Step 4.3.4. 				
<p><u>EVALUATOR CUE</u> Record JPM start time: _____</p>				
1	Identifies governing procedure and obtain controlled copy.	Obtains controlled copy of ON-100-109, selects Step 4.3.4 to perform.		
<p><u>EVALUATOR NOTE</u> A screwdriver has been stored in Sound Powered Phone Headset Storage Box JP1203 (by A RPS Panel) if needed to open RPS panels.</p>				
<p><u>EVALUATOR CUE</u> If examinee proceeds to vent scram air header, question why RPS de-energization is not preferred, and then direct them to de-energize RPS.</p>				
<p><u>EVALUATOR NOTE</u> 1Y201 panels will not be opened for performance of the JPM. Once the examinee has identified 1Y201A, provide the examinee Figure 1.</p>				
*2	Opens Div 1 RPS breaker CB2A.	At panel 1Y201A (27/749'), places breaker CB2A control paddle to the OFF position.		
<p><u>EVALUATOR CUE</u> Breaker is as described.</p>				
<p><u>EVALUATOR NOTE</u> 1Y201 panels will not be opened for performance of the JPM. Once the examinee has identified 1Y201B, provide the examinee Figure 2.</p>				
*3	Opens Div 2 RPS breaker CB8B.	At panel 1Y201B (27/749'), places breaker CB8B control paddle to the OFF position.		

PERFORMANCE CHECKLIST

Examinee _____

Step	Action	Standard	Eval	Comments
<u>EVALUATOR CUE</u> Breaker is as described.				
<u>EVALUATOR NOTE</u> HS-54101A and HS-54101B Switches have three positions, NORM/unlabeled/EMERGENCY. Switch must be taken all the way to EMERGENCY position to perform the intended function. Normal position is the key removed in the locked left (NORM) position.				
4	Obtains two #235 keys.	Contacts Unit Supervisor/FUS to obtain two #235 keys.		
<u>EVALUATOR CUE</u> You have two #235 keys.				
*5	Places MSIV LOGIC A POWER SUPPLY to EMERGENCY.	At panel 1C609 (Upper Relay Room), performs the following <ul style="list-style-type: none"> • Inserts #235 key in HS-54101A, MSIV LOGIC A POWER SUPPLY. • Rotates key inserted in HS-54101A to the EMERGENCY position. 		
<u>EVALUATOR CUE</u> Switch is repositioned.				
*6	Places MSIV LOGIC B POWER SUPPLY to EMERGENCY.	At panel 1C611 (Lower Relay Room), performs the following <ul style="list-style-type: none"> • Inserts #235 key in HS-54101B, MSIV LOGIC B POWER SUPPLY. • Rotates key inserted in HS-54101B to the EMERGENCY position. 		
<u>EVALUATOR CUE</u> Switch is repositioned.				
<u>EVALUATOR CUE</u> Record JPM stop time: _____				
<u>EVALUATOR CUE</u> That completes the JPM.				

PERFORMANCE CHECKLIST

00.ON.1153.102 Rev 2
01/26/2014
Page 3 of 3

Examinee _____

Step	Action	Standard	Eval	Comments
EVALUATOR: Do you have ALL your JPM exam materials? Task Cue Sheets? Procedures?				

FIGURE 1
1Y201A PANEL INTERNALS

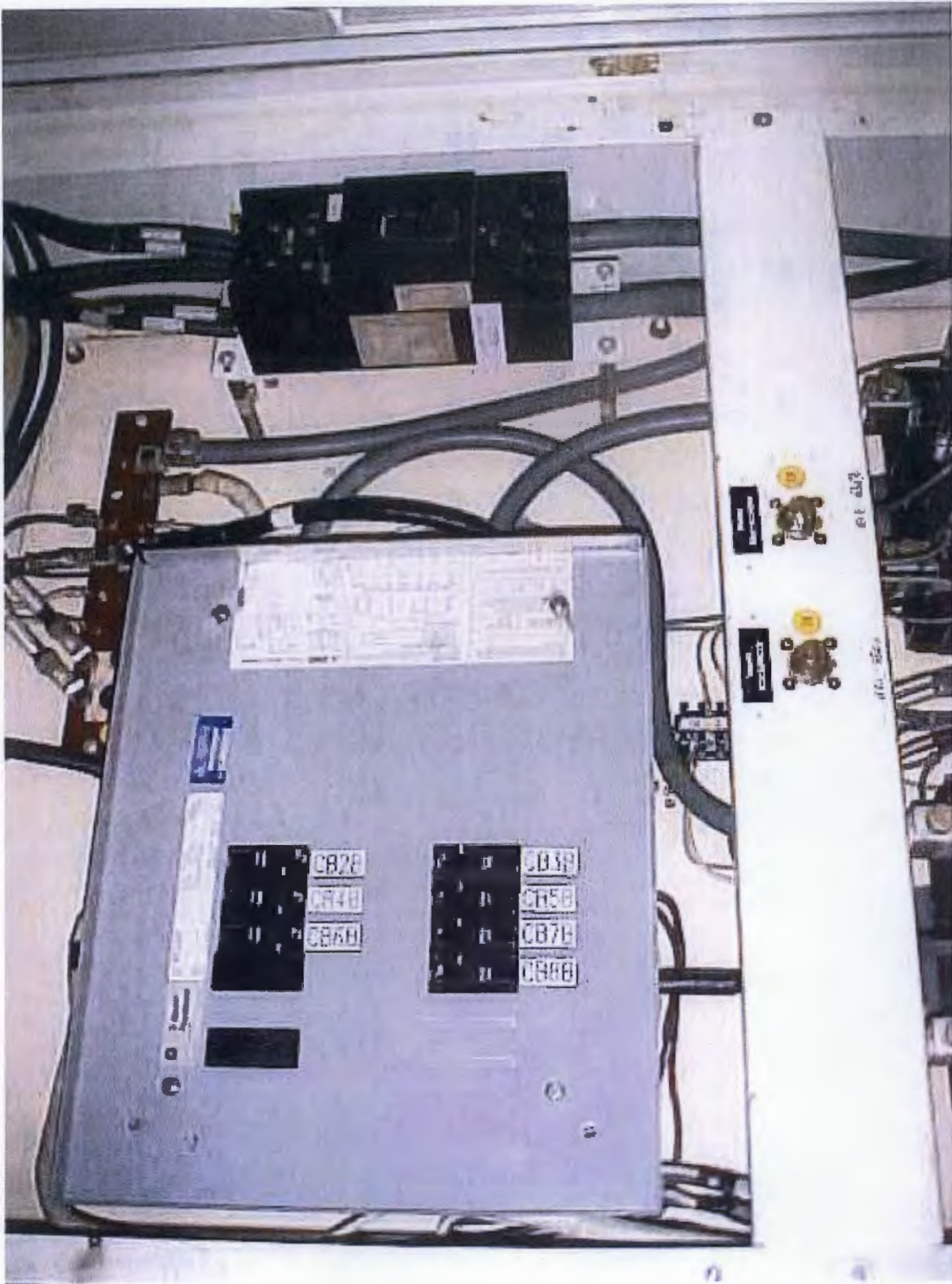
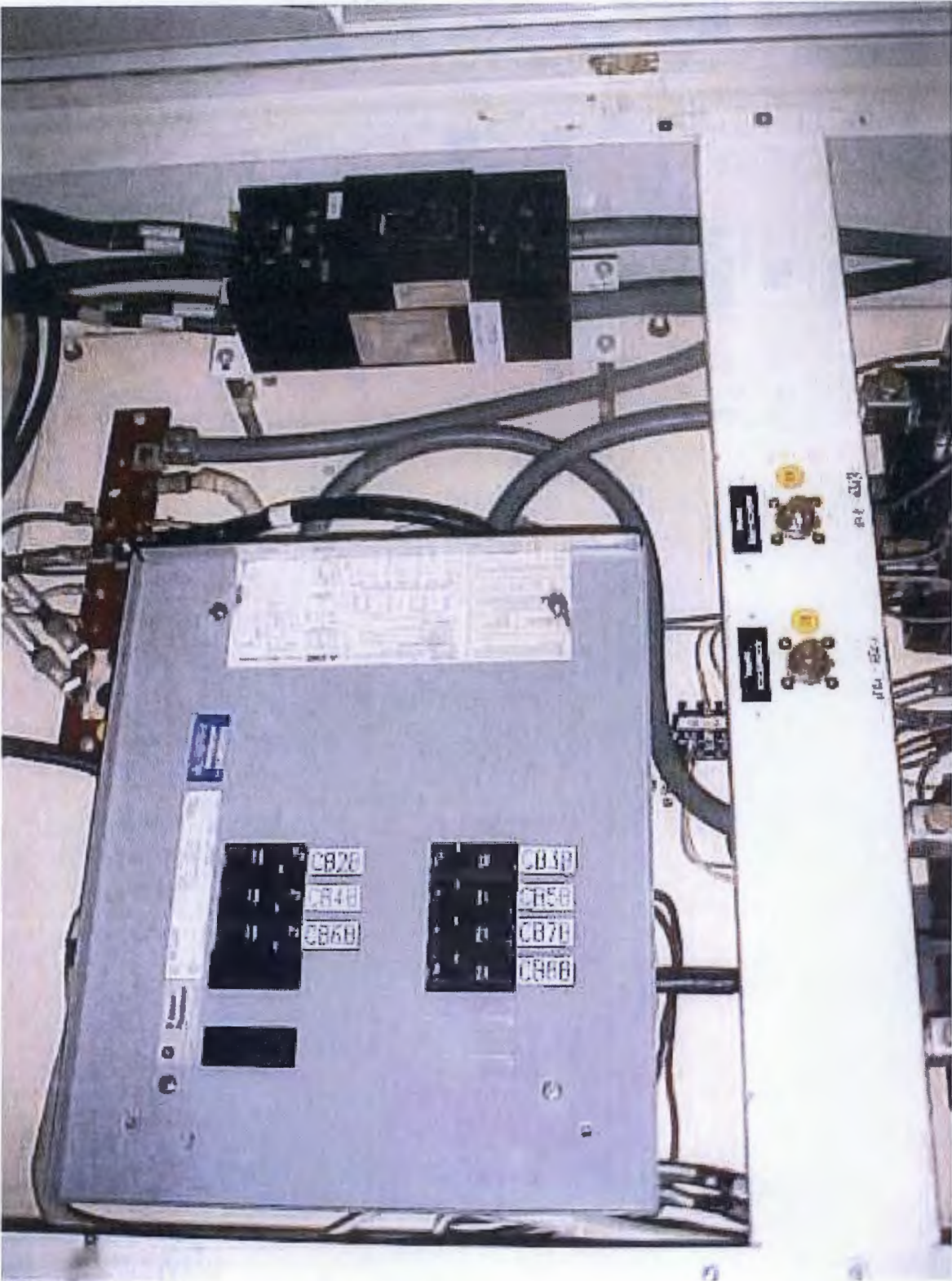

FIGURE 2
1Y201B PANEL INTERNALS



EXAMINEE

TASK CONDITIONS

A fire has occurred in the Control Room.

The Control Room has been evacuated due to the fire.

All immediate operator actions for Control Room evacuation could not be completed.

A reactor scram was not inserted and MSIVs were not closed prior to Control Room evacuation.

INITIATING CUE

Perform Steps 4.3.4a and 4.3.4b of ON-100-109 to ensure reactor scram and MSIV closure.

EVALUATOR

TASK CONDITIONS

A fire has occurred in the Control Room.

The Control Room has been evacuated due to the fire.

All immediate operator actions for Control Room evacuation could not be completed.

A reactor scram was not inserted and MSIVs were not closed prior to Control Room evacuation.

INITIATING CUE

Perform Steps 4.3.4a and 4.3.4b of ON-100-109 to ensure reactor scram and MSIV closure.

JPM ASSEMBLY INSTRUCTIONS

Seq	Item	Copier Program	Binding
1.	Examinee cue sheet	cue	loose
2.	ON-100-009 (marked-up)	exam	staple
3.	Evaluator cue sheet	cue	loose
4.	JPM	jpm	loose

Facility:	SSES Units 1 and 2	Scenario No.:	1	Op-Test No.:	LOC26
Examiners:	_____	Operators:	_____	_____	_____
Initial Conditions	Unit 1 95 percent power for control rod pattern adjustment, EOL HPCI OOSVC, DG E substituted for DG A (IC-380)				
Turnover	RFP lube oil conditioner swapped from A to B last shift Control rods 42-15 and 46-19 declared slow last scram time test Severe thunderstorm watch in effect				

Event No.	Malf. No.	Event Type*	Event Description
1	N/A	R SRO,ATC	Withdraw control rods to raise reactor power 3 percent (OP-AD-338, GO-100-012)
2	N/A	N SRO,BOP	Place CRD Pump B in-service, secure CRD Pump A (OP-155-001)
3	mfFW145 007B	C SRO,ATC	RFPT B vibration rises, reduce RFPT speed to lower vibration (AR-101-A16)
4	mfFW145 007B	C All	RFPT B trips on high vibration, Recirc LIM2 runback (ON-164-002)
5	cmfTR03_ FTB31 1N014C	I SRO,ATC	APRM 2 and 3 Recirc Loop A drive flows fail high during Recirc LIM2 runback (TS 3.3.1.1)
6	cmfAV04_ TV11028	C SRO,BOP	RBCCW TCV fails, ESW placed in-service to restore RBCCW cooling (ON-114-001), ESW loop declared inoperable when aligned to RBCCW (TS 3.7.2)
7	rFCU161001 rFCU161009 cmfMV06_ HV144F004	I SRO,ATC	RWCU fails to automatically isolate on high temperature, manual isolation successful (AR-101-A01)
8	mfRD155 017	M ALL	Hydraulic-block ATWS (EO-100-113, OP-145-005, ES-158-002)
9	cmfPM03_ 1P208A cmfPM03_ 1P208B	C SRO,BOP	SLC pump trips after start, standby SLC pump successfully injects boron (OP-153-001)
10	cmfTR01_ LT14201A	I SRO,ATC	Wide Range level instrument fails, RFP flow must be raised to maintain reactor level in ATWS band
11	mfFW148 002	C ALL	In-service RFPT trips after first scram, RCIC restored to maintain RPV level while standby RFPT placed in-service

*(N)ormal, (R)eactivity, (I)nstrument, (C)omponent, (M)ajor

Target Quantitative Attributes (Per Scenario; See Section D.5.d)	Scenario Events	Actual Attributes
1. Total malfunctions (5-8)	3,6,7,9,10,11	6
2. Malfunctions after EOP entry (1-2)	9,10,11	3
3. Abnormal events (2-4)	4,6	2
4. Major transients (1-2)	8	1
5. EOPs entered/requiring substantive actions (1-2)	EO-100-102	1
6. EOP contingencies requiring substantive actions (0-2)	EO-100-113	1
7. Critical tasks (2-3)		3
CT-1 Inject SLC		
CT-2 Lowers RPV level to < -60" but > -161"		
CT-3 Inserts control rods IAW EO-100-113 Sht. 2		



PPL-SUSQUEHANNA, LLC LEARNING CENTER

SIMULATOR SCENARIO

Scenario Title:

Control Rod Pattern Adjustment / CRD Pump Rotation / RFP
Vibration / Loss of RBCCW / Hydraulic-Block ATWS

Scenario Duration:

1 hour 15 minutes

Scenario Number:

LOC26-NRC-1

Revision / Date:

0 / March 17, 2014

Course:

PC017 SRO License
PC018 RO License

Prepared By:

Robert A. Thompson
Instructor

03/17/2014
Date

Reviewed By:

Neil J. Muffly
Operations Training Management

6/30/14
Date

Approved By:

T. Alcorn
Operations Line Management

6-30-14
Date

THIS PAGE IS INTENTIONALLY LEFT BLANK

SCENARIO SUMMARY

The scenario begins with Unit 1 at 95 percent power, 500 days into the operating cycle. Preparations are set for performing a control rod pattern adjustment. HPCI is in day 2 of a planned 4-day system outage window. Diesel Generator E is substituted for DG A for a system outage window. The RFP lube oil conditioner was swapped from the RFP A reservoir to the B reservoir last shift. Control rods 42-15 and 46-19 were declared slow during the last scram time test. A severe thunderstorm watch is in effect for northeast Pennsylvania for the next 12 hours.

The first task for the crew is to withdraw control rods in accordance with the Reactivity Maneuver Request provided by Reactor Engineering. The pattern adjustment will raise reactor power approximately 3 percent. When the pattern adjustment is complete, the crew will commence rotating CRD Pumps per OP-155-001 in support of scheduled maintenance on the next shift. WCC personnel will hang a clearance on CRD Pump 1A when it has been removed from service.

When the reactivity maneuver has been completed and CRD pump rotation is complete, RFP B will experience a rising vibration trend. Vibration will quickly rise to the alarm setpoint, then continue to rise at a slower rate toward the RFP trip setpoint. The crew should initiate action to first reduce the speed of the RFP per the associated alarm response procedure, then remove the pump from service. The vibration will rise to the trip setpoint when the crew takes manual control of RFP B speed or adjusts the speed bias. The crew will respond per off-normal procedures to the RFP trip and recirc LIM2 runback. Control rod insertion may be performed due to margin to the MELLA rod-line, but is not required. The Recirc loop A drive flow inputs to APRM flow channels C and D (APRMs 2 and 3) will drift high during the runback, resulting in a RBM flow compare control rod withdrawal block. The inoperable flow-biased scram and rod-block functions of the two APRMs will require entry into TS 3.3.1.1 and TRO 3.1.3.

When the crew has lowered power below the MELLA rod-line, the RBCCW TCV will malfunction resulting in a loss of cooling to RBCCW. RBCCW temperature will quickly rise. RWCU will fail to trip on high motor temperature or isolate on high F/D inlet temperature and must be manually tripped and isolated (F004). The RBCCW TCV bypass valve will be stuck closed. The crew will be required to place RBCCW on ESW which bypasses the RBCCW TCVs and will restore cooling to RBCCW loads. Entry into TS 3.7.2 will be required for the loop of ESW made inoperable when aligned to the RBCCW HX.

Once the crew has placed ESW in-service to RBCCW the supply valve HV11024A1 will fail closed after approximately 5 minutes, due to its solenoid failing, resulting in a total loss of RBCCW cooling. Recirc Pump A lower motor bearing temperature will rise rapidly on the second loss of cooling, requiring a reactor scram and tripping of the Recirc Pump. If the reactor is not scrammed before the recirc pump is tripped, Region 1 of the power-flow map will be entered and the reactor will automatically scram on OPRMs.

The reactor scram will result in a hydraulic-block ATWS. The crew will trip both Recirc Pumps and reduce level to the ATWS band to lower power. The crew will perform the ES to bypass RPS trips, allowing the scram to be reset to drain the SDV and scram again. The crew will be able to insert control rods using RMCS. The first SLC pump started will trip shortly after starting, requiring the second pump to be started. As reactor level is lowered one channel of Wide Range reactor level will fail, requiring the crew to diagnose the failure and raise FW flow to maintain reactor level within the ATWS band.

The first attempt at draining the SDV and re-inserting a scram will result in limited control rod motion. The crew should reset the scram and allow the SDV to drain again while continuing control rod insertion. The in-service RFP will trip after the scram is reset. RCIC can be used to maintain reactor level as the standby RFP is placed in service. The scenario may be terminated when level is stable in the ATWS band and the standby RFP has been placed in service.

SCENARIO REFERENCES

1. OP-AD-001	Operations Standards For System And Equipment Operation
2. OP-AD-002	Standards For Shift Operations
3. OP-AD-004	Operations Standards For Error And Event Prevention
4. OP-AD-055	Operations Procedure Program
5. OP-AD-338	Reactivity Manipulations Standards and Communication Requirements
6. OP-111-001	Service Water System
7. OP-145-001	RFP and RFP Lube Oil System
8. OP-145-005	Infrequent Manual RFP System Operations
9. OP-145-006	Feedwater HMI Operations
10. OP-153-001	Standby Liquid Control System
11. OP-155-001	Control Rod Drive Hydraulic System
12. OP-156-001	Reactor Manual Control System RMCS
13. OP-183-001	Automatic Depressurization System and Safety Relief Valves
14. OP-184-001	Main Steam System
15. G0-100-012	Power Maneuvers
16. ON-100-101	Scram, Scram Imminent
17. ON-114-001	Loss of RBCCW
18. ON-156-001	Unanticipated Reactivity Change
19. ON-164-002	Loss of Reactor Recirculation Flow
20. ON-178-002	Core Flux Oscillations
21. EO-100-102	RPV Control
22. EO-100-103	Primary Containment Control
23. EO-100-104	Secondary Containment Control
24. EO-100-112	Rapid Depressurization
25. EO-100-113	Power/Level Control
26. AR-101-A01	RWCU FILTER INLET HI TEMP ISO
27. AR-101-A10	RFPT A TRIP
28. AR-101-A12	RFPT B TRIP
29. AR-101-A16	RFPT RFP A,B,C HI VIBRATION
30. AR-102-F03	RECIRC PUMP A SEAL CLG WATER LO FLOW
31. AR-103-E06	APRM FLOW REFERENCE OFF NORMAL
32. AR-104-H03	ROD OUT BLOCK
33. AR-106-C09	GEN VOLT REG AOTO TO MAN SET POINT UNBALANCED
34. AR-110-A01	ADS LOGIC A TIMER INITIATED
35. AR-110-A02	ADS LOGIC B TIMER INITIATED
36. AR-110-A03	ADS LOGIC C TIMER INITIATED
37. AR-110-A04	ADS LOGIC D TIMER INITIATED
38. AR-123-E05	RBCCW HEADER HI TEMP
39. LA-1295-001	RWCU SYSTEM PANEL 1C295
40. EP-RM-004	EAL Classification Bases
41. EP-PS-100	Emergency Director Position-Specific (ED)
42. ES-158-002	RPS and ARI Trip Bypass
43. TS 3.3.1.1	Instrumentation Reactor Protection System (RPS)
44. TS 3.7.2	Plant Systems Emergency Service Water System
45. TRM 3.1.3	Reactivity Control Systems Control Rod Block Instrumentation

THIS PAGE IS INTENTIONALLY LEFT BLANK

SCENARIO TASKS

Crew Position	Task	Description
PCO	2034	Implement Withdraw Control Rod One Notch
PCO	2008	Shifting Control Rod Drive Pumps
PCO	4793	Implement RFP A(B)(C) Speed Control Operations
PCO	4717	Implement Speed Adjustment of Reactor Recirc Pump During Normal Operation (ICS)
PCO	1270	Implement RBCCW Heat Exchanger Manual Transfer Of Service Water And Emergency Service Water
PCO	2386	Inhibit ADS
PCO	2393	Implement Bypassing MSIV And CIG Interlocks
PCO	1967	Implement Initiation Of Standby Liquid Control System
PCO	2005	Implement Maximizing CRD Flow
PCO	4710	Implement Manual RFP Post Scram Recovery (ICS)
PCO	1926	Implement Manual Startup Using Turbine Trip And Throttling Valve
PCO	1915	Implement Overriding Injection (RCIC)
PCO	1954	Implement Overriding Injection (HPCI)
US	1185	Apply Technical Specification (TS) And Technical Requirements Manual (TRM) Requirements
ALL	2131	Implement Loss Of Reactor Recirculation Flow
ALL	2030	Implement Unanticipated Reactivity Change
ALL	2336	Implement Core Flux Oscillations
ALL	1335	Implement Loss Of RBCCW
ALL	1130	Implement Level/Power Control
ALL	2072	Implement RPS And ARI Trip Bypass
ALL	2784	Implement Reactivity Manipulations Standards and Communication Requirements
ALL	1081	Implement Appropriate Portions Of Operations Standards For System and Equipment Operation
ALL	1091	Implement Operations Standards For Error And Event Prevention

THIS PAGE IS INTENTIONALLY LEFT BLANK

CRITICAL TASKS

Inject SLC	
Safety Significance	<p>Early boron injection has the following benefits:</p> <ul style="list-style-type: none"> • Stop or prevent large magnitude Limit Cycle Oscillations which can lead to core damage. • Limit fuel damage from uneven flux patterns that could result from partial rod inserts.
Consequences for Failure To Perform Task	<p>Failure to inject Boron can result in</p> <ul style="list-style-type: none"> • Cycle Oscillations which can lead to core damage. • Fuel damage from uneven flux patterns that could result from partial rod inserts.
Indications/Cues for Event Requiring Critical Task	ATWS with initial reactor power level greater than 5% APRM power.
Performance Criteria	Inject SLC by inserting key into keylock switch and turning to start selected SLC pump, fire the Squib valves and close the Reactor Water Cleanup isolation valve.
Performance Feedback	Successful SLC injection would be indicated by a lowering SLC tank level and a corresponding power level decrease.
Lowers RPV level to < -60" but > -161"	
Safety Significance	Core damage due to unstable operation can be prevented or at least mitigated by promptly reducing Feedwater flow so that level is lowered below the Feedwater spargers.
Consequences for Failure To Perform Task	A General Electric Company study (NEDO-32047) indicates that the major threat to fuel integrity from ATWS is caused by large-amplitude power/flow instabilities. The power oscillations can become large enough to cause melting of fuel in high-power bundles.
Indications/Cues for Event Requiring Critical Task	ATWS with initial reactor power level greater than 5% APRM power.
Performance Criteria	Lower reactor water level by manually controlling injection rate from Feedwater, HPCI and/or RCIC.
Performance Feedback	Reducing vessel injection will result in Wide Range level indications lowering to -60 to -110 inches and will result in power level lowering as indicated on the Average Power Range Monitors.

Inserts control rods IAW EO-100-113 Sht. 2	
Safety Significance	Control rod insertion initiates power reduction immediately.
Consequences for Failure To Perform Task	Failure to insert control rods allows power to remain elevated with resultant power oscillations and potential core damage.
Indications/Cues for Event Requiring Critical Task	Exceeding a RPS scram setting with NO reactor scram signal, or RPS/ARI fail to fully insert all control rods.
Performance Criteria	Insert Control Rods by one or more of the following methods: <ul style="list-style-type: none"> • Drive control rods after bypassing RWM • Reset and Scram again by performing ES-158-002 Bypass RPS logic trips
Performance Feedback	Successful insertion of control rods will be indicated by: <ul style="list-style-type: none"> • Rod position full in indication for manual insertion of control rods • Rod position showing control rod insertion after resetting scram, draining scram discharge volume and re-scram • Power level lowering as indicated on the Average Power Range Monitors

POTENTIAL EMERGENT CRITICAL TASKS

Inhibits ADS (if RPV level lowers below -129" and conditions for ADS initiation are met)	
Performance Criteria	Inhibit ADS by placing 1C601 keylock switches to INHIBIT, resetting both divisions of ADS logic.
Performance Feedback	Successful ADS inhibiting is indicated by Green Indicating Light at switch illuminating.

SCENARIO MALFUNCTIONS

Event	Description	Crew Response
1	RFPT B vibration rises	Reduce RFPT B speed to attempt to lower vibration (AR-101-A16)
2	RBCCW TCV fails	ESW placed in-service to restore RBCCW cooling (ON-114-001)
3	RWCU fails to automatically isolate on high temperature	Manually isolate RWCU (AR-101-A01)
4	SLC pump trips after start	Start standby SLC pump to successfully inject boron (OP-153-001)
5	Wide Range level instrument fails	RFP flow must be raised to maintain reactor level in ATWS band (ON-145-005)
6	In-service RFPT trips after first scram	RCIC restored to maintain RPV level while standby RFPT placed in-service

ABNORMAL EVENTS / MAJOR TRANSIENTS / TECH SPEC

Malfunction	Description
R	Withdraw control rods to raise reactor power 3 percent (OP-AD-338, GO-100-012)
N	Place CRD Pump B in-service, secure CRD Pump A (OP 155-001)
AE1	RFP B trip, Recirc LIM2 runback (ON-164-002)
AE2	Loss of RBCCW (ON-114-001)
MT1	Hydraulic-block ATWS (EO-100-113)
TS1	APRM 2 and 3 Recirc Loop A drive flows fail high during Recirc LIM2 runback (TS 3.3.1.1)
TS2	ESW loop declared inoperable when aligned to RBCCW (TS 3.7.2)

THIS PAGE IS INTENTIONALLY LEFT BLANK

SCENARIO SPECIAL INSTRUCTIONS

1. Simulator setup
 - a. **Initialize** to an exam-specific IC (IC-380). If an exam-specific IC is not available, then setup the IC as follows:
 - i) **Initialize** to IC-20.
 - ii) **Place** the simulator in RUN.
 - iii) **Reduce** core power to 95 percent using recirc flow, matching loop flows.
 - iv) **Isolate** the HPCI steam supply by closing the F002 and F003 isolation valves.
 - v) **Depressurize** the HPCI steam supply line once the F002 and F003 are full closed by opening the F054 valve. Close the F054 once the steam line is depressurized.
 - vi) **Run** SCN file **batch\HPB_HPCIOOS** to tagout HPCI steam-side.
 - vii) **Place** the simulator in FREEZE
 - b. **Run** SCN file **exam\LOC26-N01.scn**
 - c. **Open** TREND files **rat.tnd, LOC26-N01-1.tnd, LOC26-N01-2.tnd**

2. **Place** the simulator in RUN
3. **Verify** the following malfunctions/overrides, event triggers and key assignments:

MF	RF	OR	SCN	ET	COND
8:8	6:6	0:0	0:0	8:0	17

4. **Prepare** the simulator for evaluation
 - a. **Complete** a simulator exam checklist, TQ-106-0315
 - b. **Reset** ODAs and all Overhead, PICSY, HMI and RWM alarms
 - c. **Ensure** FWLC is selected to LEFM
 - d. **Place** DG E labels on the DG/ESW A controls and indications
 - e. **Ensure** correct CRC book is staged and marked-up for current plant conditions
 - f. **Stage** Reactivity Package cover sheet and RMR#2 for control rod withdrawal
5. **Prepare** a Turnover Sheet including the following:
 - a. Unit 1
 - i) 95 percent power for control rod pattern adjustment, 500 days on-line
 - ii) HPCI in day 2 of 4-day system outage window for steam-side maintenance
 - iii) Diesel Generator E substituted for Diesel Generator A for a system outage window
 - iv) RFP lube oil conditioner was swapped from RFP A reservoir to B reservoir last shift
 - v) Control rods 42-15, 46-19 were declared slow during last scram time test
 - vi) Perform control rod pattern adjustment per RMR
 - vii) Rotate CRD Pumps, place CRD Pump 1B in-service, secure CRD Pump 1A for SOW
 - b. Common
 - i) Unit 2 at rated power
 - ii) Severe thunderstorm watch is in effect for NE Penn for the next 12 hours
6. **Document** training participation and feedback
 - a. **Ensure** all present have signed Security Agreements per NUREG-1021
 - b. **Show** the crew that the Evaluators and Booth Operators are qualified
 - c. **Complete** an Operator Fundamental Score Card

SCENARIO FILES

LOC26-N01.scn

```

; Monitored Parameters
SCN rat_mp
SCN exam\LOC26-N01-MP
; 0-G alarms suppressed SDR #
IMF annAR106F15 f:ALARM_OFF
IMF annAR131A04 f:ALARM_OFF
; E DG subst for A
IRF rfdG024001 f:A
; Recirc loop A xmitter offset
initialization
IMF cmfTR03_FTB311N014C f:0
IMF cmfTR03_FTB311N014D f:0
; RWCU high-temp trip/isol fails
IRF rfcU161001 f:JUMPER
IRF rfcU161009 f:BYPASS
IMF cmfMV06_HV144F004
; Hyd-block ATWS
IMF mfrD155017
; CRD PCV binding
IMF cmfMV07_PV146F003 f:AsIs
; Stops rise in FWP A vibes if they reach
4.5 mils
aet LOC26-N01-1
; Recirc loop A channel D flow xmitter
malfunctions
aet LOC26-N01-1A
; align ESW to RBCCW HX
aet LOC26-N01-2
; activate NRHX iso alarm on high temp
aet LOC26-N01-2A
; RFP trip on 1st rescrum
aet LOC26-N01-3
; 1st SLC pump trips
aet LOC26-N01-4A
aet LOC26-N01-4B
; CRD PCV fails on rx scram
aet LOC26-N01-5
; WR level A fails as-is
aet LOC26-N01-6
; Close CRD pump B discharge 146F014B
{Key[1]} IRF rfrD155014 f:0
; Slowly re-open F014B
{Key[2]} IRF rfrD155014 r:60 f:100
; RFP B vibration
{Key[3]} SCN exam\LOC26-N01-A
; RFP B trips on high vibration
{Key[4]} abort exam\LOC26-N01-A
{Key[4]} cet LOC26-N01-1
{Key[4]} MMF mfw145007B r:60 f:10
; RBCCW HX TCV fails
{Key[5]} IMF cmfAV04_TV11028 r:10 f:0
; Adjust RBCCW cooling
{Key[6]} IMF cmfAV04_TV11028 d:15 r:30 f:5
; ESW to RBCCW fails, RRP A bearing degrades
{Key[7]} IMF cmfAV01_HV11024A1
{Key[7]} IMF cmfTH02_TE14357A1A2 r:300 f:250
; Byp CRD pump suct filter
{Key[8]} IRF rfrD155028 d:120 f:100
; Close CRD chrg wtr isol F034
{Key[9]} IRF rfrD155017 d:120 f:0

```

```

; ES-158-002 - ARI (2-min TD)
{Key[10]} SCN exam\RPB_DISABLARI
; ES-158-002 - Div 1 RPS
{Key[11]} IRF rfrP158039 f:BYPASS d:120
{Key[11]} IRF rfrP158040 f:BYPASS d:120
; ES-158-002 - Div 2 RPS
{Key[12]} IRF rfrP158041 f:BYPASS d:120
{Key[12]} IRF rfrP158042 f:BYPASS d:120
; Re-open CRD chrg wtr isol F034
{Key[13]} IRF rfrD155017 d:120 f:100
; HPCI OOSVC - isolate and depress steam-
side first
{Key[40]} SCN exam\HPB_HPCI00S

```

LOC26-N01-A.scn

```

IMF cmfTH02_TE11969B r:1800 f:206
IMF mfw145007B r:120 f:3.4
+135 MMF mfw145007B r:30 f:3.6
+30 MMF mfw145007B r:180 f:3.7
+180 MMF mfw145007B r:90 f:4.0
+180 MMF mfw145007B r:900 f:4.7

```

LOC26-N01-MP.scn

```

insmp ycpxftv03
changemp ycpxftv03 0,10,mils,RFP B VIBR
insmp fx10FWCTRL_B21.OUT
changemp fx10FWCTRL_B21.OUT ,%,FW MASTER
LVL CTRL OUTPUT
insmp fx1BRFP_B115.OUT
changemp fx1BRFP_B115.OUT ,%,RFP B DEMAND
insmp fx1BB_SM_B1.OUT
changemp fx1BB_SM_B1.OUT ,RPM,RFPT B SPEED
insmp fx1BRFP_B115.MA
changemp fx1BRFP_B115.MA ,,bool,RFPT B
AUTO/MAN
insmp rwtt11305
changemp rwtt11305 ,,,RBCCW HX OUTLET TEMP
insmp swvsptv11028
changemp swvsptv11028 ,,,RBCCW HX TCV POS
insmp aoTRSHB311R601D.CurrValue
changemp aoTRSHB311R601D.CurrValue 0,300,DEG
F,RRP A LO GUIDE BRG TEMP(PT4)
insmp aoTRSHB311R601I.CurrValue
changemp aoTRSHB311R601I.CurrValue 0,300,DEG
F,RRPA #1 SEAL CAV TEMP
insmp cuteg331n019
changemp cuteg331n019 ,,DEG F,RWCU NRHX
INLET

```

LOC26-N01-1.et/scn

```

;adjust rfpt a vibra on hi vib
ycpxftv03 > 4.5
MMF mfw145007B r:0 f:AsIs

```

LOC26-N01-1A.et/scn

```

fx1B_LIMITERS_5432.B001 = 1
MMF cmfTR03_FTB311N014C r:30 i:0 f:21789
MMF cmfTR03_FTB311N014D r:30 i:0 f:19876

```

LOC26-N01-2.et/scn

```
;SWITCH:RBCCW HX A SW-ESW CHANGEOVER  
diHS11024A.CurrValue = #OR.diHS11024A.EMERG  
IMF cmfAV04_HV11024A1 f:0  
IMF cmfAV04_HV11024A2 f:0  
IRF rfsW111032 f:0  
IMF cmfCV02_110050  
+5 DMF cmfAV04_HV11024A1  
DMF cmfAV04_HV11024A2
```

LOC26-N01-2A.et/scn

```
cuteg331n019 > 145  
IMF annAR101A01 f:ALARM_ON
```

LOC26-N01-3.et/scn

```
;SWITCH:MODE SWITCH  
diHSC72A1S01.CurrValue !=  
#OR.diHSC72A1S01.RUN & ( rp_c721k14a = 1 |  
rp_c721k14b = 1 ) & rp_c721k1a = 0  
aet LOC26-N01-3A
```

LOC26-N01-3A.et/scn

```
; SDV drain  
rp_c721k1a = 1 | rp_c721k1b = 1  
aet LOC26-N01-3B
```

LOC26-N01-3B.et/scn

```
;SWITCH:MODE SWITCH  
diHSC72A1S01.CurrValue !=  
#OR.diHSC72A1S01.RUN & ( rp_c721k14a = 1 |  
rp_c721k14b = 1 ) & rp_c721k1a = 0  
IMF mfFW148002
```

LOC26-N01-4A.et/scn

```
;SWITCH:SBLC MANUAL INITIATION  
diHSS14804.CurrValue =  
#OR.diHSS14804.START_A  
IMF cmfPM03_1P208A d:45  
cet LOC26-N01-4B
```

LOC26-N01-4B.et/scn

```
;SWITCH:SBLC MANUAL INITIATION  
diHSS14804.CurrValue =  
#OR.diHSS14804.START_B  
IMF cmfPM03_1P208B d:45  
cet LOC26-N01-4A
```

LOC26-N01-5.et/scn

```
;SWITCH:MODE SWITCH  
diHSC72A1S01.CurrValue !=  
#OR.diHSC72A1S01.RUN  
aet LOC26-N01-5A
```

LOC26-N01-5A.et/scn

```
;SWITCH:DRIVE WTR PRESS THTLG  
diHS14603.CurrValue = #OR.diHS14603.OPEN  
IMF cmfMV01_PV146F003
```

LOC26-N01-6.et/scn

```
rllwr < -50  
IMF cmfTR01_LT14201A
```

SCENARIO EVENT DESCRIPTION FORM

Initial Conditions: Ensure shift positions are assigned, have the Crew conduct the turnover and perform a panel walk down before the start of the scenario.

EVENT	TIME	DESCRIPTION
N/A	0	Crew assumes shift
A	0	Control rod pattern adjustment
B	15	CRD pump rotation
C	20	RFP B vibration / RFP B trip
D	30	RBCCW TCV failure
E	45	Complete loss of RBCCW / Recirc Pump A bearing failure / scram
F	50	Hydraulic-block ATWS
G	65	Control rod insertion
H	70	RFP trip
N/A	75	Termination

INSTRUCTOR ACTIVITIES / ROLE PLAY / NOTES
--

EVENT	A
BRIEF DESCRIPTION	Control rod pattern adjustment

SIMULATOR ACTIVITY

1. When control rod withdrawal is complete, **perform** Role Play 3.

ROLE PLAY

1. As **RxEng** contacted for assistance, **report**

Core thermal limits are within our predictions. You may proceed with the pattern adjustment.

2. As **Shift Manager** contacted for approval to commence the reactivity manipulation, **report**

The reactivity manipulation may proceed per the RMR.

3. As **RxEng**, contact the Control Room and **report**

Thermal limits are sat per step #3 of the reactivity maneuvering plan, we will bring the RMR for returning to rated power with recirc flow momentarily.

4. **Role play** any other directed actions as required.

EVALUATOR NOTES

1. The pattern adjustment should be completed to ensure rod-line is raised high enough to challenge the MELLA boundary during the runback for the RFP trip in Event 3.

SCENARIO EVENT FORM

EVENT	A
BRIEF DESCRIPTION	Control rod pattern adjustment

POSITION	TIME	STUDENT ACTIVITIES
PCOM		<p>Withdraws control rods 22-23, 38-39, 38-23, and 22-39 from position 00 to position 04 per OP-156-001 and OP-AD-338</p> <ul style="list-style-type: none"> • Select control rod to be withdrawn one notch by depressing corresponding CONTROL ROD SELECTION pushbuttons • Observe <ul style="list-style-type: none"> ○ CONTROL ROD SELECTION pushbuttons ILLUMINATED. ○ FULL CORE DISPLAY ILLUMINATED Green at selected location. ○ Present position of selected rod INDICATED on FOUR ROD DISPLAY on CRT and Standby Information Panel 1C652. • Momentarily depress W/DRAW ROD pushbutton until the rod insert light illuminates • During withdraw cycle, Observe following occur in sequence within ~ 10 seconds <ul style="list-style-type: none"> ○ ROD INSERT light MOMENTARILY ILLUMINATED. ○ ROD W/DRAWG light ILLUMINATED THEN EXTINGUISHED. ○ Withdrawal drive flow of approx. 2 3 gpm during control rod withdrawal on CRT FOUR ROD DISPLAY. ○ ROD SETLG light ILLUMINATED THEN EXTINGUISHED at end of cycle. • Observe at FOUR ROD DISPLAY control rod withdraws one notch from previous position AND position indicated is an even number • When all 4 steps are complete, reselects and confirms previous moves per the control rod movement sheet by performing the following for each control rod moved: <ul style="list-style-type: none"> ○ Selects each control rod by depressing corresponding CONTROL ROD SELECTION pushbuttons ○ Observe <ul style="list-style-type: none"> ▪ CONTROL ROD SELECTION pushbuttons ILLUMINATED. ▪ FULL CORE DISPLAY ILLUMINATED Green at selected location. ▪ Present position of selected rod INDICATED on FOUR ROD DISPLAY on CRT and Standby Information Panel 1C652 matches control rod movement sheet as-left position
		Depress ROD SELCT CLEAR pushbutton
		Per GO-100-012, plots power change on power/flow map

SCENARIO EVENT FORM

EVENT	A
BRIEF DESCRIPTION	Control rod pattern adjustment

POSITION	TIME	STUDENT ACTIVITIES
PCOM (cont'd)		Monitor diverse indications of reactor power (APRMs, heat balance, Main Generator output) per OP-AD-001 Attachment G
PCOP		Verifies control rods to be withdrawn as directed by RMR per OP-AD-338
		Per OP-AD-002 Section 7.11 (or AR-106-C09) null Manual and Automatic regulators using MAN VOLT REG ADJUST HC-10002 potentiometer
		Maintains Load Set approximately 100 MWe above actual generator load per GO-100-012 by depressing LOAD SELECTOR DECREASE and INCREASE PBs as necessary
US		Obtains permission from the Shift Manager prior to commencing reactivity manipulations
		Informs GCC of load change on Unit 1
		Conducts a Crew Update prior to commencing rod withdrawal
		Directs control rod withdrawal per OP-156-001, RMR and GO-100-012
		Monitors control rod movement with independent copy of RMR
		Conducts a Crew Update after control rod withdrawal complete

★ Denotes Critical Task

NOTES	
--------------	--

SCENARIO EVENT DESCRIPTION FORM

EVENT	TIME	DESCRIPTION
N/A	0	Crew assumes shift
A	0	Control rod pattern adjustment
B	15	CRD pump rotation
C	20	RFP B vibration / RFP B trip
D	30	RBCCW TCV failure
E	45	Complete loss of RBCCW / Recirc Pump A bearing failure / scram
F	50	Hydraulic-block ATWS
G	65	Control rod insertion
H	70	RFP trip
N/A	75	Termination

INSTRUCTOR ACTIVITIES / ROLE PLAY / NOTES
--

EVENT	B
BRIEF DESCRIPTION	CRD pump rotation

SIMULATOR ACTIVITY

1. When requested, **depress KEY 1** to close CRD Pump B discharge valve 146F014B. **Monitor** remote function value on sim RF display and **report** when full closed.

{Key[1]} IRF r:RD155014 f:0

Close CRD pump B discharge 146F014B

2. When requested, **depress KEY 2** to slowly re-open 146F014B. **Monitor** remote function value on sim PID RD1 and **report** when full open.

{Key[2]} IRF r:RD155014 r:60 f:100

Slowly re-open F014B

ROLE PLAY

1. If necessary to prompt continuation of the scenario, **contact** the Control Room as **WWM** and **report**

What is the status of CRD Pump swap on Unit 1? Personnel are standing by to begin the SOW.

2. As **NPO** dispatched to CRD Pump B, **report**

Pre-start checks for CRD Pump B are sat. The area is clear and ready for pump start.

3. **Role play** any other directed actions as required.

EVALUATOR NOTES

1. This activity is not required to advance in the scenario.
2. Initiate Event C as soon as CRD Pump 1A is secured.

SCENARIO EVENT FORM

EVENT	B
BRIEF DESCRIPTION	CRD pump rotation

POSITION	TASK	STUDENT ACTIVITIES
PCOP		Direct NPO at CRD Pump B to perform pre-start checks
		Announces CRD Pump B start over PA per OP-AD-001 Step 8.1.4
		Places CRD Pump B in-service and secures CRD Pump A per OP-155-001 Section 2.10 as follows: <ul style="list-style-type: none"> • Directs NPO at CRD Pump B to perform the following: <ul style="list-style-type: none"> ○ Check 1P132B, Ctl Rod Drive Water Pump B, motor bearing oil reservoir level. ○ Check 1P132B, Ctl Rod Drive Water Pump B, speed increaser reservoir level. ○ Check 1P132B, Ctl Rod Drive Water Pump B, bearing oil reservoir level. ○ Close 146F014B, CRD Pump B Discharge. • Start 1P132B, Ctl Rod Drive Water Pump B, by Placing control switch CRD Pump 1P132B to RUN • Directs NPO at CRD Pump B to perform the following <ul style="list-style-type: none"> ○ SLOWLY Open 146F014B, CRD Pump B Discharge, to FULL OPEN position ○ Check 1P132B, Ctl Rod Drive Water Pump B, Gear Box oil temperature ~ 100°F, indicated locally • Stop previous running 1P132A, Ctl Rod Drive Water Pump A, by Placing control switch CRD Pump 1P132A to STOP • On PI-C12-1R601, Panel 1C601, Check 1P132B, Ctl Rod Drive Water Pump B, discharge pressure ~ 1450 psig • Ensure PDI-C12-1R602, Drive Water Diff Pressure, ~ 250 psid
US		Directs rotating CRD Pumps (B in, A out) per OP-155-001 Section 2.10

★ Denotes Critical Task

NOTES	
--------------	--

THIS PAGE IS INTENTIONALLY LEFT BLANK

SCENARIO EVENT DESCRIPTION FORM

EVENT	TIME	DESCRIPTION
N/A	0	Crew assumes shift
A	0	Control rod pattern adjustment
B	15	CRD pump rotation
C	20	RFP B vibration / RFP B trip
D	30	RBCCW TCV failure
E	45	Complete loss of RBCCW / Recirc Pump A bearing failure / scram
F	50	Hydraulic-block ATWS
G	65	Control rod insertion
H	70	RFP trip
N/A	75	Termination

INSTRUCTOR ACTIVITIES / ROLE PLAY / NOTES

EVENT	C
BRIEF DESCRIPTION	RFP B vibration / RFP B trip

SIMULATOR ACTIVITY

1. As soon as CRD Pump A is secured, or on lead examiner direction, **depress KEY 3** to initiate high vibration on RFP B.

{Key[3]} SCN exam\LOC26-N01-A RFP B vibration

2. **Monitor** RFP B vibration on trend LOC26-N01-1. **Ensure** Event Trigger LOC26-N01-1 initiates if RFP B vibration reaches 4.5 mils to terminate the ramp on the vibration malfunction severity.
3. Approximately 2 minutes after RFP B speed is reduced, or on lead examiner direction, **depress KEY 4** to trip RFP B on high vibration.

{Key[4]} abort exam\LOC26-N01-A RFP B trips on high vibration
 {Key[4]} cet LOC26-N01-1
 {Key[4]} MMF mfFW145007B r:60 f:10

4. **Ensure** Event Trigger LOC26-N01-1A initiates when a Recirc LIM2 is actuated by the RFP B trip, to fail the APRM 2 drive flow input from Recirc Loop A.

ROLE PLAY

1. As NPO/FUS dispatched to RFP B, **wait 2 minutes and report**

There is a noticeable thrum sound from RFP B and it feels like there is a higher vibration level in the area around the pump.

If asked about recommendations for continued operation, **report**

I do not have any concerns about remaining in the area.

2. As NPO/FUS contacted for RFP B status post-trip, **report**

RFP B is coasting down (on the turning gear), I don't see anything abnormal.

3. As NPO dispatched to the Lower Relay Room to report the status of APRMs, **wait 2 minutes and report**

No APRMs indicate any alarms.

(continued on next page)

INSTRUCTOR ACTIVITIES / ROLE PLAY / NOTES

EVENT	C
BRIEF DESCRIPTION	RFP B vibration / RFP B trip

4. As **WWM** contacted for assistance with RFP B vibration, **wait 5 minutes and report**

Predictive Maintenance is enroute to take vibration measurements at the pump. Engineering is looking at the vibration data, but doesn't have a specific recommendation at this time.

5. As **WWM** contacted for assistance with APRM flow reference abnormal alarm, **wait 5 minutes and report**

I&C reports they have found that Recirc Loop A recirc flow transmitters B31-1N014C and -1N014D are indicating approximately 20,000 gpm higher than the other two Recirc Loop A drive flow transmitters.

6. **Role play** any other directed actions as required.

EVALUATOR NOTES

1. None

SCENARIO EVENT FORM

EVENT	C
BRIEF DESCRIPTION	RFP B vibration / RFP B trip

POSITION	TIME	STUDENT ACTIVITIES
PCOM		Performs AR-101-A16 for RFP B
		Reports power/pressure/level steady and in-band
		If directed, reduces RFP B speed per OP-145-006 Section 2.3 as follows: <ul style="list-style-type: none"> • Touch RFP B Symbol to open RFP B SPD CTL/DEMAND SIGNAL SIC-C32-1R601B controller • Touch MAN button on RFP B SPD CTL/DEMAND SIGNAL controller SIC-C32-1R601B overlay • Touch DEC buttons on RFP B SPD CTL/DEMAND controller SIC-C32-1R601B as necessary required to lower RFPT speed
		If directed, reduces core power per OP-164-002 Section 2.1 by Slowly Adjusting REACTOR RECIRC PUMP A(B) SPEED SY-B31-1R621A(B) Controller Demand with the applicable INC/DEC pushbuttons as required
		Observes AR-101-A12, reports RFP B trip
		Plots position on power/flow map, reports reactor power above MELLA rod-line
		Performs ON-178-002 as follows: <ul style="list-style-type: none"> • Ensure non peripheral rod selected to monitor LPRM's for oscillations by depressing corresponding CONTROL ROD SELECTION pushbuttons for a non-peripheral control rod • Monitor OPRM PPC Screen • Monitor OPRM's, APRM's and LPRM's (OD8 PPC screen or ODAs) for instability

SCENARIO EVENT FORM

EVENT	C
BRIEF DESCRIPTION	RFP B vibration / RFP B trip

POSITION	TIME	STUDENT ACTIVITIES
PCOM (cont'd)		If directed, inserts control rods 30-15, 30-47, 46-31, 14-31 from position 48 to position 00 per OP-156-001 and OP-AD-338 <ul style="list-style-type: none"> • Select control rod to be inserted one notch by depressing corresponding CONTROL ROD SELECTION pushbuttons • Observe <ul style="list-style-type: none"> ○ CONTROL ROD SELECTION pushbuttons ILLUMINATED. ○ FULL CORE DISPLAY ILLUMINATED Green at selected location. ○ Present position of selected rod INDICATED on FOUR ROD DISPLAY on CRT and Standby Information Panel 1C652. • Momentarily depress INSERT ROD pushbutton until the rod insert light illuminates • During insert cycle, Observe following occur in sequence within ~ 10 seconds <ul style="list-style-type: none"> ○ ROD INSERT light ILLUMINATES THEN EXTINGUISHES. ○ Insert drive flow of approx. 4-5 gpm during control rod insertion on CRT FOUR ROD DISPLAY. ○ Withdrawal drive flow of approx. 2 3 gpm during control rod withdrawal on CRT FOUR ROD DISPLAY. ○ ROD SETLG light ILLUMINATED THEN EXTINGUISHED at end of cycle. • Observe at FOUR ROD DISPLAY control rod inserts one notch from previous position AND position indicated is an even number
		Performs AR-104-H03 and AR-103-E06 as follows: <ul style="list-style-type: none"> • Observes RBM A and B indicate flow compare alarm • Observes APRM 2 recirc flow indicates high • Informs US to comply with TS
		Directs NPO to investigate APRMs in Lower Relay Room
PCOP		Per AR-101-A16, Checks alarm condition and trend on RFPT VIBRATION XRSH-12728 and observes rise in RFP B vibration; informs US
		Directs NPO to report conditions locally at RFP B
		Reports no reduction in RFP B vibration at XRSH-12728 after RFP B speed reduction

SCENARIO EVENT FORM

EVENT	C
BRIEF DESCRIPTION	RFP B vibration / RFP B trip

POSITION	TIME	STUDENT ACTIVITIES
PCOP (cont'd)		<p>Performs ON-164-002 Section 4.4 as follows:</p> <ul style="list-style-type: none"> • Determine LIM2 initiated runback by observing Speed Limiter #2 (48%) Initiated status block blinks red on any Rx Recirc HMI screen • Observes the following <ul style="list-style-type: none"> ○ Rx Recirc Pumps A and B run back to 48 percent speed ○ SY-B31-1R621A and B controller(s) have transferred to Manual • Monitors Main Steam Line Radiation Monitor, RR-D12-1R603, Offgas Pretreatment Log Radiation Monitor, RR-D12-1R601 • Determine signal that initiated runback as follows: <ul style="list-style-type: none"> ○ Touches LIM 2 STATUS button on bottom of screen. ○ Observes B Feedwater flow lowers to ≤16.4% (~ 0.9Mlbm/hr) with a red background
US		<p>Directs either of the following to reduce RFP B speed to determine if vibration condition is load related per AR-101-A16:</p> <ul style="list-style-type: none"> • Reduce RFP B speed by operating RFP B speed control in manual per OP-145-006 • Reduce core power per GO-100-012
		Contacts WWM for Maintenance and Engineering investigation of RFP B vibration
		Reviews GO-100-012 to identify prerequisite unit conditions for removing RFP B from service
		Directs Transient Actions in effect per OP-AD-004 Section 12 when RFP B trips
		Performs crew update and directs entry into ON-164-002, ON-156-001 due to Recirc LIM2 runback on RFP B trip
		May direct control rod insertion to raise margin to the MELLA rod-line per the Shutdown Control Rod Sequence package and ON-178-002 Section 3.5
		Notifies Chemistry and HP of > 15 percent core power change in 1 hour per GO-100-012
		Notifies Reactor Engineering per ON-156-001
		Contacts WWM for Maintenance investigation of APRM flow compare alarm

SCENARIO EVENT FORM

EVENT	C
BRIEF DESCRIPTION	RFP B vibration / RFP B trip

POSITION	TIME	STUDENT ACTIVITIES
US (cont'd)		Enters Tech Specs as follows for B31N014C and B31N014D recirc flow transmitter inoperable <ul style="list-style-type: none"> • TS 3.3.1.1 Condition A for 2 inoperable channels in Functions 2.b and 2.f (place channel in trip within 12 hours) • Tracking LCO for TRM 3.1.3 Conditions A, B for Function 1.b

★ Denotes Critical Task

NOTES	
--------------	--

THIS PAGE IS INTENTIONALLY LEFT BLANK

SCENARIO EVENT DESCRIPTION FORM

EVENT	TIME	DESCRIPTION
N/A	0	Crew assumes shift
A	0	Control rod pattern adjustment
B	15	CRD pump rotation
C	20	RFP B vibration / RFP B trip
D	30	RBCCW TCV failure
E	45	Complete loss of RBCCW / Recirc Pump A bearing failure / scram
F	50	Hydraulic-block ATWS
G	65	Control rod insertion
H	70	RFP trip
N/A	75	Termination

INSTRUCTOR ACTIVITIES / ROLE PLAY / NOTES

EVENT	D
BRIEF DESCRIPTION	RBCCW TCV failure

SIMULATOR ACTIVITY

1. After the crew has completed activities associated with the trip of RFP B, **depress KEY 5** to initiate a failure of the RBCCW HX TCV.

{Key[5]} IMF cmfAV04_TV11028 r:10 f:0 **RBCCW HX TCV fails**

2. **Ensure** Event Trigger LOC26-N01-2A initiates when RWCU NRHX inlet temperature reaches 145 °F to activate RWCU F/D inlet high temperature isolation alarm.
3. **Monitor** Recirc Pump bearing temperature on Monitored Parameters. If required to prevent Recirc Pump bearing temperatures exceeding 195 °F, **depress KEY 6. Adjust** the severity of malfunction **cmfAV04_TV11028** in 1 percent increments as necessary to slowly raise bearing temperatures toward the 195 °F limit without going over.

{Key[6]} IMF cmfAV04_TV11028 d:15 r:30 f:5 **Adjust RBCCW cooling**

4. **Ensure** Event Trigger LOC26-N01-2 initiates when ESW is aligned to the RBCCW HX to complete the in-field valve alignments.

ROLE PLAY

1. As **NPO** dispatched to RBCCW, **wait 2 minutes and report**

The in-service RBCCW pump is operating normally. The RBCCW HX TCV is full closed.

2. As **NPO** directed to open the RBCCW HX TCV bypass, 110062, **wait 1 minute and then report**

The bypass valve wouldn't come off the seat. I don't hear any flow noise

3. As **NPO** directed to support aligning ESW A to RBCCW HX A, when asked to report local valve positions per OP-114-001 Step 5.13.9b, **report**

HV-11024A1 and HV-11024A2 are open, HV-11024A3 is closed.

When directed to close 110046 per Step 5.13.9c, **wait 1 minute then report** the valve is closed.

4. As **WWM** contacted for assistance with RBCCW HX TCV, **wait 5 minutes and report**

I&C believes the positioner is getting a close signal from the controller. Additional investigation is required. A troubleshooting plan is being developed.

(continued on next page)

SCENARIO EVENT FORM

EVENT	D
BRIEF DESCRIPTION	RBCCW TCV failure

5. As **WWM** contacted for assistance with RBCCW HX TCV bypass valve, **acknowledge** the request and take no further action.
6. **Role play** any other directed actions as required.

EVALUATOR NOTES

1. A total loss of RBCCW occurs in the next event.

SCENARIO EVENT FORM

EVENT	D
BRIEF DESCRIPTION	RBCCW TCV failure

POSITION	TASK	STUDENT ACTIVITIES
PCOM		Reports power/pressure/level steady and in-band
		Identifies RWCU fails to trip/isolate on high temperature, manually trips RWCU pump and closes HV-144F004
		Dispatches NPO to RWCU Pump Control Panel 1C295
PCOP		<p>Performs AR-123-E05</p> <ul style="list-style-type: none"> • Checks alarm condition on RBCCW HX DSCH TEMP TI-11305 • Observes rise in header temp
		Dispatches NPO to RBCCW pump/heat exchanger area
		<p>Performs ON-114-001 as follows:</p> <ul style="list-style-type: none"> • At Recirc Pumps A&B Motor Temperature TRSH-B31-1R601 Panel 1C614, Monitor Reactor Recirc Pump A(B) Motor Bearing and Seal Cavity temperatures • Ensure at least one Service Water Pump 1P502A <u>OR</u> B <u>OR</u> C in operation • Check operation of Temperature Control Valve TCV-11028 <ul style="list-style-type: none"> ○ Directs NPO to report conditions locally at RBCCW ○ <u>IF</u> Temperature Control Valve TCV-11028 has failed, directs NPO to Throttle Open RBCCW HX SW Dsch Temp CV BPV 110062 to maintain RBCCW Heat Exchanger outlet temperature 95 to 105°F • When determined that TCV-11028 <u>AND</u> Bypass Valve 110062 cannot be opened, Transfers in-service RBCCW Heat Exchanger to ESW supply in accordance with OP-111-001, Service Water system
		<p>Aligns ESW to RBCCW HX A as follows per OP-111-001:</p> <ul style="list-style-type: none"> • Informs US to comply with TS 3.7.2 and TR 3.7.1 • Starts ESW Loop A per OP-054-001 as follows: <ul style="list-style-type: none"> ○ Place ESW Loop A in service by depressing ESW Pump 0P504A RUN pushbutton ○ Ensures OPEN HV-01222A ESW Pond Spr Bpv A ○ On Panel 0C681, Ensure ESW Pp Supply Fan 0V521A STARTS ○ Directs NPO to ensure ventilation damper alignment in accordance with OP-128-001 • SUPPLY A RBCCW Heat Exchanger with ESW by pressing RBCCW HX A SW/ESW SUP HS 11024A EMERG pushbutton <ul style="list-style-type: none"> ○ Directs NPO to ensure RBCCW HX valves reposition, close 110046

SCENARIO EVENT FORM

EVENT	D
BRIEF DESCRIPTION	RBCCW TCV failure

POSITION	TASK	STUDENT ACTIVITIES
US		Performs crew update and directs entry into ON-114-001 due to loss of RBCCW cooling
		Contacts WWM for Maintenance and I&C investigation of RBCCW TCV
		Directs transient actions in effect per OP-AD-004 section 12
		Directs aligning ESW to the RBCCW HX in accordance with OP-111-001, Service Water System
		Declares ESW loop to be aligned inoperable per OP-111-001 section 5.13.6.c <ul style="list-style-type: none"> • Enters TS LCO .3.7.2 Condition C for one ESW subsystem inoperable for reasons other than Condition B (7 day completion time) • Determines TR 3.7.1 does not apply in Mode 1

★ Denotes Critical Task

NOTES	
--------------	--

THIS PAGE IS INTENTIONALLY LEFT BLANK

SCENARIO EVENT DESCRIPTION FORM

EVENT	TIME	DESCRIPTION
N/A	0	Crew assumes shift
A	0	Control rod pattern adjustment
B	15	CRD pump rotation
C	20	RFP B vibration / RFP B trip
D	30	RBCCW TCV failure
E	45	Complete loss of RBCCW / Recirc Pump A bearing failure / scram
F	50	Hydraulic-block ATWS
G	65	Control rod insertion
H	70	RFP trip
N/A	75	Termination

INSTRUCTOR ACTIVITIES / ROLE PLAY / NOTES

EVENT	E
BRIEF DESCRIPTION	Complete loss of RBCCW / Recirc Pump A bearing failure / scram

SIMULATOR ACTIVITY

1. Once ESW has been aligned to RBCCW HX A, **depress KEY 7** to isolate ESW to RBCCW HX A and initiate degradation of Recirc Pump A bearing.

**{Key[7]} IMF cmfAV01_HV11024A1 ESW to RBCCW fails, RRP A bearing degrades
 {Key[7]} IMF cmfTH02_TE14357A1A2 r:300 f:250**

2. **Perform** Role Play 1.
3. **Ensure** Event Trigger LOC26-N01-5 initiates when the mode switch is placed in SHUTDOWN to fail the CRD PCV as-is and activate Event Trigger LOC26-N01-5A.

ROLE PLAY

1. As **NPO** at RBCCW HX, when Simulator Activity 1 has been completed **contact** the Control Room and **report**

ESW flow to the A RBCCW heat exchange just stopped. The supply valve, HV-11024A1, is now closed.
2. As **WWM** contacted for assistance with HV-11024A1, **acknowledge** the request and take no further action.
3. **Role play** any other directed actions as required.

EVALUATOR NOTES

1. If the reactor is not scrammed before the recirc pump is tripped, Region 1 of the power-flow map will be entered and the reactor will automatically scram on OPRMs.

SCENARIO EVENT FORM

EVENT	E
BRIEF DESCRIPTION	Complete loss of RBCCW / Recirc Pump A bearing failure / scram

POSITION	TASK	STUDENT ACTIVITIES
PCOM		If directed, trips Reactor Recirc Pump A by depressing MG SET A DRV MTR BKR HS-14001A STOP PB
		Inserts a manual scram by placing the Mode Switch to Shutdown
		Identifies more than 1 control rod is greater than position 00
		Reports ATWS
		At 1C651, ARM AND DEPRESS Manual Scram Pushbuttons; <ul style="list-style-type: none"> • RPS MAN SCRAM CHAN A1 HS-C72A-1S03A • RPS MAN SCRAM CHAN B1 HS-C72A-1S03B • RPS MAN SCRAM CHAN A2 HS-C72A-1S03C • RPS MAN SCRAM CHAN B2 HS-C72A-1S03D
	Performs scram report	
PCOP		Performs AR-102-F03 for RRP A as follows: <ul style="list-style-type: none"> • Monitor Recirc Pump A motor bearing and seal cavity Temperatures • If Recirc pump A Seal Cavity temperature exceeds 195F on Recirc Pps A&B Motor Temperature TRSH-B31-1R601 Panel 1C614; <ul style="list-style-type: none"> ○ Trip Reactor Recirc Pump A ○ Perform ON-164-002, Loss of Reactor Recirc Flow
		<ul style="list-style-type: none"> • At 1C601, INITIATE ARI by arming and depressing: <ul style="list-style-type: none"> ○ ARI DIV 1 MAN TRIP HS-147103A1 TRIP ○ ARI DIV 2 MAN TRIP HS-147103B1 TRIP • Reports failure of ARI
US		Performs either of the following on Reactor Recirc Pump A temperature exceeding 195 °F: <ul style="list-style-type: none"> • Directs PCOM to trip Reactor Recirc Pump A <ul style="list-style-type: none"> ○ Directs PCOM to insert a manual scram on observing elevated OPRM count rates • Directs PCOM to insert a manual scram by placing the Mode Switch to Shutdown, then directs PCOM to trip the A Reactor Recirc Pump
		Enters EO-100-102 for ATWS and exits to EO-100-113

★ Denotes Critical Task

NOTES	
--------------	--

THIS PAGE IS INTENTIONALLY LEFT BLANK

SCENARIO EVENT DESCRIPTION FORM

EVENT	TIME	DESCRIPTION
N/A	0	Crew assumes shift
A	0	Control rod pattern adjustment
B	15	CRD pump rotation
C	20	RFP B vibration / RFP B trip
D	30	RBCCW TCV failure
E	45	Complete loss of RBCCW / Recirc Pump A bearing failure / scram
F	50	Hydraulic-block ATWS
G	65	Control rod insertion
H	70	RFP trip
N/A	75	Termination

INSTRUCTOR ACTIVITIES / ROLE PLAY / NOTES
--

EVENT	F
BRIEF DESCRIPTION	Hydraulic-block ATWS

SIMULATOR ACTIVITY

1. **Ensure** Event Trigger LOC26-N01-4A(B) initiates when the first SLC pump is started, to trip the running pump due to a motor fault after a time delay.
2. **Ensure** Event Trigger LOC26-N01-5A initiates when the CRD PCV, PV-146-F003 is opened to trip the breaker.
3. When directed, **depress KEY 8** to bypass CRD pump suction filter. **Monitor** sim RF count and **report** when complete.

{Key[8]} IRF rRD155028 d:120 f:100

Byp CRD pump suct filter

4. When directed, **depress KEY 9** to close CRD charging water isolation valve 146-F034. **Monitor** sim RF count and **report** when complete.

{Key[9]} IRF rRD155017 d:120 f:0

Close CRD chrg wtr isol F034

5. **Ensure** Event Trigger LOC26-N01-6 initiates when RPV level falls below -50 inches to fail Wide Range RPV level transmitter 14201A.

ROLE PLAY

1. As **NPO** dispatched to CRD PCV breaker 1B227-024, **wait 2 minutes and report**

The breaker is tripped on magnetics.

If directed to open CRD PCV bypass valve 146-F004, **wait 2 minutes and report**

The valve is stuck closed.

2. As **WWM** contacted for assistance, **acknowledge** the request and take no further action.
3. **Role play** any other directed actions as required.

EVALUATOR NOTES

1. Actions for ES-158-002 are found in Event G.

SCENARIO EVENT FORM

EVENT	F
BRIEF DESCRIPTION	Hydraulic-block ATWS

POSITION	TASK	STUDENT ACTIVITIES
★TEAM		Inject SLC
★TEAM		Lowers RPV level to < -60" but > -161"
PCOM		Reports initial ATWS power > 5 percent
		Performs actions following Scram per ON-100-101 Att. A (HC) <ul style="list-style-type: none"> • Inserts IRMs and SRMs • Verify Scram Discharge Volume Vent and Drain valves CLOSED
		Performs ATWS power/level reduction strategy (OP-145-005 Att B) as follows: <ul style="list-style-type: none"> • Lower Rx Recirc Pump Speeds to <u>Minimum</u> by performing the following: <ul style="list-style-type: none"> ○ Depress the MANUAL FLOW REDUCTION INITIATION PB ○ Depress the RRP SPEED TO MINIMUM PB ○ Depress the INITIATE RRP FLOW REDUCTION PB • Ensure Rx Recirc Pump Speeds are approximately 20%. • WHEN directed by Shift Supervision, Trips B Rx Recirc Pump by depressing MG SET B DRV MTR BKR HS-14001B STOP PB
		IF RFP A(C) is in DPM OR transfer to DPM is in progress: <ul style="list-style-type: none"> • Control level in MANUAL via LV-10641 FW LO LOAD VALVE controller LIC-C32-1R602. • NOTE: RFP A(C) SPD CTL/DEMAND SIGNAL controller SIC-C32-1R601 will transfer to AUTO when transfer to DPM is completed • As required, adjust feeding RFP A(C) SPD CTL/DEMAND SIGNAL controller SIC-C32-1R601A(C) in MANUAL to establish and maintain assigned level band.

SCENARIO EVENT FORM

EVENT	F
BRIEF DESCRIPTION	Hydraulic-block ATWS

POSITION	TASK	STUDENT ACTIVITIES
PCOM (cont'd)		IF RFP A(C) is operating in Flow Control Mode: <ul style="list-style-type: none"> • Place LV-10641 FW LO LOAD VALVE controller LIC-C32-1R602 in MANUAL. • Perform following for RFP A(C) which will continue feeding: <ul style="list-style-type: none"> ○ Touch A(C) RFPT MAN VLV CTL button. ○ Place feeding RFP A(C) SPD CTL/DEMAND SIGNAL controller SIC C32 1R601A(C) in MANUAL. • IF FW LEVEL CTL/DEMAND SIGNAL controller LIC-C32-1R600 Tracking light not lit, Place controller in MANUAL and Lower controller output to 0%. • Ensure remaining non feeding RFP C(A) operating in IDLE MODE. • Adjust feeding RFP A(C) SPD CTL/DEMAND SIGNAL controller SIC-C32-1R601A(C) in MANUAL to establish and maintain assigned level band. • Ensure FW LO LOAD VALVE controller LIC-C32-1R602 output is 0%.
		Stop Condensate Pumps 1P102A(B)(C)(D) as necessary to leave 2 pumps in operation
		Identifies Wide Range Level A instrument channel failure, maintains RPV level -60" to -110" as indicated by Wide Range channel B
		Uses FW flow to maintain RPV level within ATWS level band
PCOP		Injects SBLC per OP-153-001 as follows: <ul style="list-style-type: none"> • Place HS-14804 SBLC Manual Initiation keylock control switch to A(B) START • Observe SBLC Pumps 1P208A(B) STARTS • Once initiated, Observe the following: <ul style="list-style-type: none"> ○ HV-144-F004 RWCU INLET OB ISO CLOSES ○ SBLC SQUIB READY A-B white indicating lights EXTINGUISHED ○ SBLC SQUIB VALVES LOSS OF CKT CONTINUITY annunciator ALARMS ○ Pump 1P208A(B) Red indicating light ILLUMINATED ○ SBLC PUMP discharge header pressure ~ 200 psig greater than reactor pressure ○ SBLC FLOW Indicates ~ ≥ 40 GPM ○ SBLC Storage Tank level decreasing ○ Reactor power level decreasing

SCENARIO EVENT FORM

EVENT	F
BRIEF DESCRIPTION	Hydraulic-block ATWS

POSITION	TASK	STUDENT ACTIVITIES
PCOP (cont'd)		<p>Inhibits ADS per OP-183-001 as follows:</p> <ul style="list-style-type: none"> • Depress the following timers for another 102 seconds: <ul style="list-style-type: none"> ○ ADS Logic A Timer Reset HS-B21-1S13A ○ ADS Logic B Timer Reset HS-B21-1S13B • Place the following keylock switches to INHIBIT: <ul style="list-style-type: none"> ○ ADS A Logic Control ○ ADS B Logic Control • Observe the following annunciators EXTINGUISH: <ul style="list-style-type: none"> ○ ADS Logic A Timer Initiated (AR-110-A01) ○ ADS Logic B Timer Initiated (AR-110-A03) • Depress following to reset remaining annunciators: <ul style="list-style-type: none"> ○ ADS Logic A Timer Reset HS-B21-1S13A ○ ADS Logic B Timer Reset HS-B21-1S13B • Observe the following annunciators extinguish: <ul style="list-style-type: none"> ○ ADS Logic C Timer Initiated (AR-110-A02) ○ ADS Logic D Timer Initiated (AR-110-A04)
		<p>Overrides RCIC as follows per OP-150-001:</p> <ul style="list-style-type: none"> • Prevents Auto Injection if RCIC NOT initiated by closing RCIC TURBINE TRIP AND THROTTLING HV 15012 • To stop injection if RCIC auto-initiated, Place RCIC pump on minimum flow as follows: <ul style="list-style-type: none"> ○ Place RCIC TURBINE FLOW CONTROL FC-E51-1R600 in MANUAL. ○ Adjust RCIC TURBINE FLOW CONTROL FC-E51-1R600 to reduce RCIC discharge pressure less than reactor pressure while maintaining turbine above 2200 RPM. ○ WHEN RCIC pump discharge pressure > 190 psig with flow < 75 gpm, Ensure RCIC MIN FLOW TO SUPP POOL FV 149-F019 OPENS. ○ IF above steps do not stop RCIC injection, Close RCIC TURBINE TRIP AND THROTTLING HV-15012.

SCENARIO EVENT FORM

EVENT	F
BRIEF DESCRIPTION	Hydraulic-block ATWS

POSITION	TASK	STUDENT ACTIVITIES
PCOP (cont'd)		<p>Bypasses MSIV and CIG Interlocks per OP-184-001:</p> <ul style="list-style-type: none"> • Bypass MSIV Low Water Level 1 Isolation at 1C645 by Placing the following to BYPASS <ul style="list-style-type: none"> ○ HS-B21-S38A Rx Wtr Lvl 1 MSIV Bypass Logic A ○ HS-B21-S38C Rx Wtr Lvl 1 MSIV Bypass Logic C • Bypass CIG Low Water Level 1 and High Drywell Pressure Isolation by Placing the following to BYPASS <ul style="list-style-type: none"> ○ At 1C645, HS-12694 Low Lvl 1/Hi Drywell Press CIG Bypass (HV-12603) ○ At 1C645, HS 12695 Low Lvl 1/Hi Drywell Press CIG Bypass (SV 12651) ○ At 1C644, HS 12696 Low Lvl 1/Hi Drywell Press CIG Bypass (SV 12605)
		<p>Maximizes CRD:</p> <ul style="list-style-type: none"> • Start standby CRD pump as follows: <ul style="list-style-type: none"> ○ Place control switch CRD Pump 1P132B(A) to RUN, to start 1P132B(A), Ctl Rod Drive Water Pump B(A). • Using FC-C12-1R600, CRD Flow Controller, in MANUAL, Fully Open FV146F002A(B), CRD Flow Control Vlv. • Fully Open THTLG PV-146-F003, DRIVE WTR PRESS THTLG valve, observes valve fails to reposition to raise cooling water ΔP <ul style="list-style-type: none"> ○ Directs NPO to open bypass valve F004 • <u>IF</u> CRD pump suction filter Hi differential pressure alarm received, <u>THEN</u> Perform the following to prevent pump trips. (HC) <ul style="list-style-type: none"> ○ Reduce CRD flow to clear the Hi differential pressure alarm. (HC) ○ Open 146F116, CRD Pump Suction Filter Bypass. (HC) ○ Re-Establish Maximum Flow in accordance with Steps 2 and 3 of this Hardcard, <u>OR</u> 2.14.4 and 2.14.5 of the procedure.
		<p>Identifies A(B) SBLC pump has tripped and starts B(A) SBLC pump by placing HS-14804 SBLC Manual Initiation keylock control switch to B(A) START and observing SBLC Pumps 1P208B(A) STARTS</p>

SCENARIO EVENT FORM

EVENT	F
BRIEF DESCRIPTION	Hydraulic-block ATWS

POSITION	TASK	STUDENT ACTIVITIES
US		Enters EO-100-113, Level Power Control at step LQ-1
		Records initial ATWS power > 5 percent
		Directs PCOP to inject SBLC and Inhibit ADS
		Directs PCOM to reduce Recirc Pump speed to minimum, then trip Recirc Pumps sequentially
		Directs PCOP to override HPCI and RCIC
		Directs PCOM to throttle and prevent injection from Feedwater to maintain reactor level -60" to -110"
		Directs PCOP to bypass MSIV and CIG interlocks
		Directs PCOP to maximize CRD
		Directs PCOM to maintain reactor pressure 800-1050 psig using Main Turbine EHC
		Contacts WWM for Maintenance investigation of SLC pump trip

★ Denotes Critical Task

NOTES	
--------------	--

THIS PAGE IS INTENTIONALLY LEFT BLANK

SCENARIO EVENT DESCRIPTION FORM

EVENT	TIME	DESCRIPTION
N/A	0	Crew assumes shift
A	0	Control rod pattern adjustment
B	15	CRD pump rotation .
C	20	RFP B vibration / RFP B trip
D	30	RBCCW TCV failure
E	45	Complete loss of RBCCW / Recirc Pump A bearing failure / scram
F	50	Hydraulic-block ATWS
G	65	Control rod insertion
H	70	RFP trip
N/A	75	Termination

INSTRUCTOR ACTIVITIES / ROLE PLAY / NOTES

EVENT	G
BRIEF DESCRIPTION	Control rod insertion

SIMULATOR ACTIVITY

1. When ES-158-002 is requested, **depress KEY 10. Monitor** sim SCN count, and when complete **perform** Role Play 1 and then **perform** Simulator Activity 2.

{Key[10]} SCN exam\RPB_DISABLARI
ES-158-002 - ARI (2-min TD)

2. When directed by SIMULATOR ACTIVITY 1, **depress KEY 11. Monitor** sim RF count, and when complete **perform** Role Play for RPS Div 1 and **perform** Simulator Activity 3.

{Key[11]} IRF rRP158039 f:BYPASS d:120
{Key[11]} IRF rRP158040 f:BYPASS d:120
ES-158-002 - Div 1 RPS

3. When directed by SIMULATOR ACTIVITY 2, **depress KEY 12. Monitor** sim RF count, and when complete **perform** the Role Play for RPS Div 2.

{Key[12]} IRF rRP158041 f:BYPASS d:120
{Key[12]} IRF rRP158042 f:BYPASS d:120
ES-158-002 - Div 2 RPS

4. When requested, **depress KEY 13** to reopen CRD charging water isolation valve 146-F034. **Monitor** sim RF count and **report** when complete.

{Key[13]} IRF rRD155017 d:120 f:100
Re-open CRD chrg wtr isol F034

ROLE PLAY

1. As NPO/FUS dispatched to perform ES-158-002, **contact** the Control Room and **report**
ARI has been disabled. Proceeding to RPS Division 1.
2. As NPO/FUS dispatched to perform ES-158-002, **contact** the Control Room and **report**
RPS Division 1 has been bypassed, the scram can be reset. Proceeding to Division 2.
3. As NPO/FUS dispatched to perform ES-158-002, **contact** the Control Room and **report**
RPS Division 2 has been bypassed, ES-158-002 is complete.
4. As **WWM** contacted for assistance, **acknowledge** the request and take no further action.
5. **Role play** any other directed actions as required.

(continued on next page)

INSTRUCTOR ACTIVITIES / ROLE PLAY / NOTES

EVENT	H
BRIEF DESCRIPTION	Control rod insertion

EVALUATOR NOTES

1. None

SCENARIO EVENT FORM

EVENT	H
BRIEF DESCRIPTION	Control rod insertion

POSITION	TASK	STUDENT ACTIVITIES
★TEAM		Inserts control rods IAW EO-100-113 Sht. 2
PCOM		<p>Performs hard card for driving control rods</p> <ul style="list-style-type: none"> • Bypasses RWM • Establish approximately: <ul style="list-style-type: none"> ○ 63 gpm cooling water flow ○ 350 psid drive water pressure • Dispatches NPO to close charging water isolation valve 146F034 • Selects rods in rotating quadrants AND • Depress continuous insert for each of following until full-in or rod will not move: <ul style="list-style-type: none"> ○ Intermediate position rods ○ Full-out rods • When rods will not insert ensures charging water isolation valve 146F034 is open
		Resets the scram when directed by ES-158-002 by momentarily positioning REACTOR SCRAM RESET HS-C72A-1S05 to GROUP 1/4 position AND THEN to GROUP 2/3 position
		Resets control rod drift alarm AR-104-H05 by depressing ROD DRIFT RESET PB
		<p>When SDV hi-hi level alarm AR-103(4)-F02 clears, inserts manual scram by performing the following per OP-158-001:</p> <ul style="list-style-type: none"> • Arm and depress RPS MAN SCRAM CHAN A1(A2) HS-C72A-1S03A(C) control switch • Arm and depress RPS MAN SCRAM CHAN B1(B2) HS-C72A-1S03B(D) control switch
		Observes control rod motion indicated by receipt of AR-104-H05, OD7 and 4-rod display
		Resets the scram when directed by ES-158-002 by momentarily positioning REACTOR SCRAM RESET HS-C72A-1S05 to GROUP 1/4 position AND THEN to GROUP 2/3 position
PCOP		Directs NPO to re-open charging water isolation valve 146F034 when scram is reset

SCENARIO EVENT FORM

EVENT	H
BRIEF DESCRIPTION	Control rod insertion

POSITION	TASK	STUDENT ACTIVITIES
US		Goes to Control Rod Insertion, EO-100-113 sheet 2 for Hydraulic ATWS.
		Directs FUS to perform ES-158-002 to defeat ARI and bypass RPS trips
		Directs PCOM to drive Control Rods in accordance with hard card
		Directs PCOP to ensure charging water isolation valve 146F034 is open
		Directs PCOM to insert manual scram when SDV partially drains
		Following first scram attempt, directs PCOM to reset scram and insert another scram when SDV partially drains

★ Denotes Critical Task

NOTES	
--------------	--

THIS PAGE IS INTENTIONALLY LEFT BLANK

SCENARIO EVENT DESCRIPTION FORM

EVENT	TIME	DESCRIPTION
N/A	0	Crew assumes shift
A	0	Control rod pattern adjustment
B	15	CRD pump rotation
C	20	RFP B vibration / RFP B trip
D	30	RBCCW TCV failure
E	45	Complete loss of RBCCW / Recirc Pump A bearing failure / scram
F	50	Hydraulic-block ATWS
G	65	Control rod insertion
H	70	RFP trip
N/A	75	Termination

INSTRUCTOR ACTIVITIES / ROLE PLAY / NOTES

EVENT	I
BRIEF DESCRIPTION	RFP trip

SIMULATOR ACTIVITY

1. **Ensure** Event Trigger LOC26-N01-3 initiates when the scram is reset, to activate Event Trigger LOC26-N01-3A.
2. **Ensure** Event Trigger LOC26-N01-3A initiates when the SDV drains below the scram setpoint, to activate LOC26-N01-3B.
3. **Ensure** Event Trigger LOC26-N01-3B initiates when the reactor is scrammed to trip RFP A after a time delay.

ROLE PLAY

1. As **NPO** dispatched to RFP A, **wait 2 minutes and report**
RFP A is coasting down normally. I don't see any indication of why it tripped.
2. As **WWM** contacted for assistance, **acknowledge** the request and take no further action.
3. **Role play** any other directed actions as required.

EVALUATOR NOTES

1. The scenario may be terminated when level is stable in the ATWS band and the standby RFP has been placed in service.

SCENARIO EVENT FORM

EVENT	I
BRIEF DESCRIPTION	RFP trip

POSITION	TASK	STUDENT ACTIVITIES
PCOM		Observes AR-101-A10, reports RFP A trip
		Perform the following to place a standby RFP in service per OP-145-005 Att B: <ul style="list-style-type: none"> • Open RFP C DISCHARGE ISO VLV HV-10603C. • WHEN HV-10603 indicates dual, Place RFP C SPD CTL/DEMAND SIGNAL controller SIC-C32-1R601C in MANUAL. • Adjust RFP C SPD CTL/DEMAND SIGNAL controller SIC-C32-1R601C to establish and maintain assigned level band
PCOP		If directed, restores injection from RCIC as follows per OP-150-001 Att C: <ul style="list-style-type: none"> • Throttle Open TURBINE TRIP AND THROTTLING HV-15012 until turbine speed > 2200 rpm • WHEN RCIC Pump discharge pressure > 190 psig with flow < 75 gpm, Ensure RCIC MIN FLOW TO SUPP POOL FV-149-F019 OPENS. • Using TURBINE TRIP AND THROTTLING HV-15012, establish desired flow • Ensure MIN FLOW TO SUPP POOL FV-149-F019 CLOSES.
US		Directs PCOM to place standby RFP in-service in accordance with OP-145-005 Att B
		Directs PCOP to maintain reactor level -60" to -110" using RCIC per OP-150-001 until Feedwater is restored

★ Denotes Critical Task

NOTES	
--------------	--

UNIT SUPERVISOR TURNOVER SHEET

UNIT 1 to/dd/yy
Date

SHIFT 1900 to 0700
Start End

SHIFT 0700 to 1900
Start End

MODE 1
POWER LEVEL 95 %
GENERATOR OUTPUT 1270 MWe
CASK STORAGE GATE INSTALLED: YES/NO

MODE _____
POWER LEVEL _____ %
GENERATOR OUTPUT _____ MWe
CASK STORAGE GATE INSTALLED: YES/NO

REMARKS:

- 1) 95 percent power for control rod pattern adjustment, 500 days on-line
- 2) HPCI in day 2 of 4-day system outage window for steam-side maintenance
- 3) Diesel Generator E substituted for Diesel Generator A for a SOW
- 4) RFP lube oil conditioner was swapped from RFP A reservoir to B reservoir last shift
- 5) Control rods 42-15, 46-19 were declared slow during last scram time test
- 6) Perform control rod pattern adjustment per Reactivity Manipulation Package. Contact RxEng when complete for evaluation.
- 7) Rotate CRD Pumps, place CRD Pump 1B in-service, secure CRD Pump 1A for SOW. NPO and FUS briefed and standing by.
- 8) _____
- 9) _____
- 10) _____
- 11) _____
- 12) _____
- 13) _____
- 14) _____
- 15) _____

COMMON:

- 1) Unit 2 at rated power
- 2) Severe thunderstorm watch is in effect for NE Penn for the next 12 hours
- 3) _____
- 4) _____
- 5) _____
- 6) _____
- 7) _____
- 8) _____
- 9) _____

OFFGOING UNIT SUPERVISOR CHECKLIST:

NRC CODE PRIOR TO 0800 FOXTROT DELTA HOTEL OSCAR

NRC CODE AFTER 0800 FOXTROT UNIFORM BRAVO ROMEO

1900-0700	0700-1900

1. Evolutions in progress and items to be completed during next shift, as noted in remarks, have been discussed with oncoming Unit Supervisor (including special evolutions, i.e. SICT/E, OPDRVs, etc.).
2. Problems encountered during past shift and abnormal plant conditions, as noted in remarks, have been discussed with oncoming Unit Supervisor.
3. Information in SOMS Log is complete and discussed with oncoming Unit Supervisor.
4. As applicable, turnover plastic Security Badge cover and CRS Monitor function to oncoming Unit Supervisor.

1900 - 0700 _____

0700 - 1900 _____

Offgoing Unit Supervisor

ONCOMING UNIT SUPERVISOR CHECKLIST:

0700	1900
-	-

1. LCO/TRO Log reviewed.
2. SOMS Log reviewed for entries made in past 24 hours.
3. Report any changes to license or medical status PER NDAP-QA-0723.

0700 - 1900 _____

1900 - 0700 _____

Oncoming Qualified
Unit Supervisor

POST RELIEF

0700	1900
-	-

1. Walk down Control Room panels with Unit Responsible PCO.
2. CRC Book reviewed and Reactivity Brief performed with PCO.
3. Completed System Status Operable audit for open PMT this shift.
4. From the OPS Web page, Review OPS Aggregate Index for Challenges, Work Arouds, and Deficiencies Reports for impact on scheduled work activities and compensatory actions. ⁽²⁰⁾

0700 - 1900 _____

1900 - 0700 _____

Oncoming Unit Supervisor

2.10 SHIFTING CONTROL ROD DRIVE PUMPS

2.10.1 Prerequisites

- Control Rod Hydraulic System operation in accordance with "Startup Of Control Rod Drive Hydraulic System" section of this procedure.

2.10.2 Precautions

None

2.10.3 **IF** 1P132B(A), Ctl Rod Drive Water Pump B(A), being placed in service for first time following pump maintenance, **THEN Perform** following to vent pump casing:

- a. **Ensure** 146F013B(A), CRD Pump B(A) Suction Iso, **OPEN**.
- b. **Open** 146F109B1(A1), CRD Pump B(A) Casing Vent.
- c. **WHEN** solid stream of water discharges, **THEN Close** 146F109B1(A1), CRD Pump B(A) Casing Vent.
- d. **Open** 146F109B2(A2), CRD Pump B(A) Casing Vent.
- e. **WHEN** solid stream of water discharges, **THEN Close** 146F109B2(A2), CRD Pump B(A) Casing Vent.

- 2.10.4 **Check** 1P132B(A), Ctl Rod Drive Water Pump B(A), motor bearing oil reservoir level.

- 2.10.5 **Check** 1P132B(A), Ctl Rod Drive Water Pump B(A), speed increaser reservoir level.

- 2.10.6 **Check** 1P132B(A), Ctl Rod Drive Water Pump B(A), bearing oil reservoir level.

- 2.10.7 **Close** 146F014B(A), CRD Pump B(A) Discharge.

- 2.10.8 **Start** 1P132B(A), Ctl Rod Drive Water Pump B(A), by **Placing** control switch CRD Pump 1P132B(A) to **RUN**.

- 2.10.9 **SLOWLY Open** 146F014B(A), CRD Pump B(A) Discharge, to **FULL OPEN** position.

- 2.10.10 On local PI-14606B(A), **Check** 1P132B(A), Ctl Rod Drive Water Pump B(A), Gear Box oil pressure ~ **20 psig**.
- 2.10.11 **Check** 1P132B(A), Ctl Rod Drive Water Pump B(A), Gear Box oil temperature ~ **100°F**, indicated locally.
- 2.10.12 **Stop** previous running 1P132A(B), Ctl Rod Drive Water Pump A(B), by **Placing** control switch CRD Pump 1P132A(B) to **STOP**.
- 2.10.13 On PI-C12-1R601, Panel 1C601, **Check** 1P132B(A), Ctl Rod Drive Water Pump B(A), discharge pressure ~ **1425 psig**.
- 2.10.14 **Ensure** PDI-C12-1R602, Drive Water Diff Pressure, ~ **250 psid**.

REACTIVITY MANIPULATION PACKAGE COVERSHEET

*PAGE 1 of 1

Unit #: 1

Cycle #: 18

***Title / Purpose of the Evolution:**

Control rod pattern adjustment. Withdraw 4 deep controls rods to raise load-line due to EOC core reactivity lowering.

***Manipulation Steps:**

1) Lower core power to 95 percent using recirc flow

2) Withdraw control rods per included control rod movement instructions

3) Verify thermal limit margins

4) Raise core power to rated using recirc flow as allowed by preconditioning ramp rate monitor

***General Issues:**

None

* Use multiple pages as necessary.

Prepared By / Date: <i>Paul M. Different</i> <i>to/dd/yy</i>	Qualified Reactor Engineer Review / Date <i>Robert B. Martin</i> <i>to/dd/yy</i>
	Senior Reactor Operator Review / Date: <i>Robert A. Thompson</i> <i>to/dd/yy</i>

Reactor Engineering Approval:

Robert A. Thompson / *to/dd/yy* / *n:ow*

Reactor Engineer Supervisor, Designee, or Shift Manager

Date

Time

REACTIVITY MANIPULATION REQUEST ⁽⁵⁾

Unit #: 1

Cycle #: 18

STEP # 2 of 4

(*PAGE 1 of 1)

Initial Conditions Confirmed By:

APPROVAL to Start:

Qualified Reactor Engineer / Date / Time

Reactivity Manager (SRO) / Date / Time

Michelle Bedard to/dd/vv

Robert A. Thompson to/dd/vv

***Description of Manipulation:**

Withdraw control rods per included control rod movement instructions

*** Precautions and Limitations:**

None

***Critical Parameters to be Observed During the Manipulation**

Critical Parameter	As applicable, describe method of monitoring, frequency, and contingency actions	High	Low

* Use multiple pages as necessary.

Reactivity Manipulation Completed:

POST Manipulation Conditions Confirmed:

Reactivity Manager (SRO) / Date / Time

Qualified Reactor Engineer / Date

CONTROL ROD MOVEMENT SHEET

If applicable, then identify the corresponding RMR Step # 2

<u>STEP</u>	<u>ROD ID</u>	<u>FROM</u>	<u>TO</u>	<u>MANIPULATOR INITIALS</u>	<u>VERIFIER INITIALS</u>
<u>001</u>	<u>22-23</u>	<u>00</u>	<u>04</u>	_____	_____
<u>002</u>	<u>38-39</u>			_____	_____
<u>003</u>	<u>38-23</u>			_____	_____
<u>004</u>	<u>22-39</u>			_____	_____
Reselect and confirm previous moves:				_____	_____
_____	_____	_____	_____	_____	_____
_____	_____	_____	_____	_____	_____
_____	_____	_____	_____	_____	_____
_____	_____	_____	_____	_____	_____
Reselect and confirm previous moves:				_____	_____
_____	_____	_____	_____	_____	_____
_____	_____	_____	_____	_____	_____
_____	_____	_____	_____	_____	_____
_____	_____	_____	_____	_____	_____
Reselect and confirm previous moves:				_____	_____
_____	_____	_____	_____	_____	_____
_____	_____	_____	_____	_____	_____
_____	_____	_____	_____	_____	_____
_____	_____	_____	_____	_____	_____
Reselect and confirm previous moves:				_____	_____
_____	_____	_____	_____	_____	_____
_____	_____	_____	_____	_____	_____
_____	_____	_____	_____	_____	_____
_____	_____	_____	_____	_____	_____
Reselect and confirm previous moves:				_____	_____
_____	_____	_____	_____	_____	_____
_____	_____	_____	_____	_____	_____
_____	_____	_____	_____	_____	_____
_____	_____	_____	_____	_____	_____
Reselect and confirm previous moves:				_____	_____

CONTROL ROD MOVEMENT SHEET

If applicable, then identify the corresponding RMR Step # 2

<u>STEP</u>	<u>ROD ID</u>	<u>FROM</u>	<u>TO</u>	<u>MANIPULATOR INITIALS</u>	<u>VERIFIER INITIALS</u>
<u>001</u>	<u>22-23</u>	<u>00</u>	<u>04</u>	_____	_____
<u>002</u>	<u>38-39</u>	_____	_____	_____	_____
<u>003</u>	<u>38-23</u>	_____	_____	_____	_____
<u>004</u>	<u>22-39</u>	_____	_____	_____	_____
Reselect and confirm previous moves:				_____	_____
_____	_____	_____	_____	_____	_____
_____	_____	_____	_____	_____	_____
_____	_____	_____	_____	_____	_____
Reselect and confirm previous moves:				_____	_____
_____	_____	_____	_____	_____	_____
_____	_____	_____	_____	_____	_____
_____	_____	_____	_____	_____	_____
Reselect and confirm previous moves:				_____	_____
_____	_____	_____	_____	_____	_____
_____	_____	_____	_____	_____	_____
_____	_____	_____	_____	_____	_____
Reselect and confirm previous moves:				_____	_____
_____	_____	_____	_____	_____	_____
_____	_____	_____	_____	_____	_____
_____	_____	_____	_____	_____	_____
Reselect and confirm previous moves:				_____	_____

UNIT 1 SEQUENCE A2 REQUIRED STARTING PATTERN FOR S/D 15200 MWD/T 06-17-12
 CYCLE 18 *** NOTE *** : CRAM ARRAY RODS MAY BE AT POSITION 00 IF USED
 BEFORE STARTING THIS PROCEDURE

	2	6	10	14	18	22	26	30	34	38	42	46	50	54	58
59															
55															
51															
47															
43															
39						04				04					
35															
31								00							
27															
23						04				04					
19															
15															
11															
7															
3															

RODS AT POSITION 48 ARE SHOWN AS BLANKS

REACTIVITY MANIPULATION REQUEST ⁽⁵⁾

Unit #: 1

Cycle #: 18

STEP # 4 of 4

(*PAGE 1 of 1)

Initial Conditions Confirmed By:

APPROVAL to Start:

Qualified Reactor Engineer / Date / Time

Reactivity Manager (SRO) / Date / Time

***Description of Manipulation:**

Raise core power to rated using recirc flow within fuel preconditioning ramp limitations

*** Precautions and Limitations:**

None

*Critical Parameters to be Observed During the Manipulation

Critical Parameter	As applicable, describe method of monitoring, frequency, and contingency actions	High	Low

* Use multiple pages as necessary.

Reactivity Manipulation Completed:

POST Manipulation Conditions Confirmed:

Reactivity Manager (SRO) / Date / Time

Qualified Reactor Engineer / Date

Facility:	SSES Units 1 and 2	Scenario No.:	2	Op-Test No.:	LOC26
Examiners:	_____	Operators:	_____	_____	_____
Initial Conditions	Unit 1 80 percent power starting up from forced outage, BOL HPCI OOSVC				
Turnover	Swap RFP A main lube oil pumps RFP lube oil conditioner being swapped from A to B Control rods 42-15 and 46-19 declared slow last scram time test Severe thunderstorm watch in effect				
Event No.	Malf. No.	Event Type*	Event Description		
1	N/A	N SRO,BOP	Swap RFP A main lube oil pumps (OP-145-003)		
2	rDB105106	C ALL	1B227 feeder trips (AR-016-B04) and is inoperable (TS 3.8.7), re-energize RPS B from alternate (ON-158-001)		
3	cmfPM02_1P124A(B)	C SRO,ATC	RFP A main lube oil pump trips due to FME (AR-120-A03), RFP A manually secured (OP-145-001)		
4	N/A	R SRO,ATC	Reduce power to < 65 percent using recirc flow and control rods to secure RFP A (OP-AD-338)		
5	cmfRL01_B211K3B	I SRO	MSL flow transmitter fails high causing MSIV half-isolation (TS 3.6.1.3)		
6	cmfRL02_C721K6A-D cmfPM02_1P124C-D	I SRO,ATC	Insert manual scram on loss of Feedwater (only 1 RFP in-service), RPS low-level auto-scram is failed (OP-AD-004)		
7	rDS0010xx crfAB03_xx	M ALL	Loss of offsite power on reactor scram (ON-104-001)		
8	mfDG024_001B	I SRO,BOP	Diesel Generator B fails to automatically start, manual start from Control Room successful (ON-104-001)		
9	mfRR164_010 mfRR164_011A	M ALL	Drywell LOCA (EO-102, EO-103)		
10	cmfRV02_PSV141 F13G-N	I ALL	ADS auto-initiation fails, perform Rapid Depressurization (EO-112)		
*(N)ormal, (R)eactivity, (I)nstrument, (C)omponent, (M)ajor					

Event No.	Malf. No.	Event Type*	Event Description
11	cmfMV06_ HV152 F005A	I ALL	Division 1 Core Spray injection valve fails to automatically open, can be manually opened from Control Room
12	cmfRL01_ E111Kxxx cmfMV06_ HV151 F015B	I ALL	Division 2 RHR LPCI initiation logic fails to initiate, manual alignment to LPCI required
*(N)ormal, (R)eactivity, (I)nstrument, (C)omponent, (M)ajor			
Target Quantitative Attributes (Per Scenario; See Section D.5.d)			Scenario Events
1. Total malfunctions (5-8)			2,3,6,8,10,11,12
2. Malfunctions after EOP entry (1-2)			8,10,11,12
3. Abnormal events (2-4)			2,6
4. Major transients (1-2)			7,9
5. EOPs entered/requiring substantive actions (1-2)			EO-100-102 EO-100-103
6. EOP contingencies requiring substantive actions (0-2)			EO-100-102 (ALC) EO-100-112
7. Critical tasks (2-3)			
CT-1	Rapid Depressurization at TAF		
CT-2	Manually align Division 1 Core Spray and Division 2 RHR for reactor vessel injection		
			Actual Attributes
			7
			4
			2
			2
			2
			2
			2

SCENARIO SUMMARY

The scenario begins with Unit 1 at 80 percent power starting up from a forced outage, 50 days into the operating cycle. HPCI is inoperable with the steam supply isolated to repair a small steam leak in the steam supply piping in the HPCI room. The RFP lube oil conditioner is being placed on the RFP B reservoir after being removed from the RFP A reservoir last shift in preparation for a RFP A main lube oil pump test. Control rods 42-15 and 46-19 were declared slow during the last scram time test. A severe thunderstorm watch is in effect for northeast Pennsylvania for the next 12 hours.

The first task for the crew is to test the RFP A main lube oil pumps, and perform a pump swap in the process, per OP-145-003. NPOs will report the RFP lube oil conditioner is in-service on the RFP B reservoir once the lube oil pump swap is complete.

When the RFP lube oil pump swap is complete, the 1B227 feeder breaker 1B220-013 will trip, de-energizing the MCC and RPS B. The MCC will not be recovered during the scenario. The crew will respond per ON-158-001 to re-energize RPS B and reset the half-scram, reset NSSSS logic, and restore cooling to the Recirc Pumps. The crew should reference ON 104-202 to identify other significant loads affected by the loss of the MCC, which include Division 2 Core Spray and Division 2 RHR Drywell spray. TS 3.8.7 should be entered for the inoperable ESS MCC.

Once activities associated with recovery from the loss of 1B227 are complete, RFP A main lube oil pump B (1P124B) will trip. Investigation will show significant quantities of foreign material in the reservoir with failure of the remaining RFP A main lube oil pump (1P124A) expected. The crew should reduce power per GO 100-012 and remove RFP A from service per OP-145-001. During the power reduction a MSL B flow transmitter will fail high, resulting in a MSIV half-isolation signal. The inoperable transmitter will require entry into TS 3.3.6.1.

Once RFP A has been secured and the MSL flow transmitter failure evaluated, the RFP B in-service main lube oil pump (1P124C) will trip. The standby pump (1P124D) will automatically start, but trip almost immediately, resulting in a trip of RFP B. With only 1 RFP in-service reactor level will fall rapidly. The scram on low RPV level will fail, requiring a manual scram.

The Unit 1 reactor scram will initiate a grid disturbance which will result in a total loss of offsite power. Diesel Generator B will fail to start, but can be automatically started from the Control Room to re-energize ESS Buses 1B and 2B. The crew will respond to the Scram and LOOP per EO-102 and ON-104-001. RPV level and pressure control will be with RCIC and SRVs.

Once RPV level and pressure are stabilized after the LOOP, a small RCS leak will develop in the Drywell. The leak will be within the capability of RCIC and CRD to maintain RPV level above TAF. The crew response to the LOCA will be to align RHR for containment cooling. Once RHR is aligned for containment cooling, the leak will degrade resulting in level slowly falling below TAF. ADS will fail to initiate. Rapid Depressurization will be performed per EO-112 once level falls below TAF.

Low-pressure ECCS systems will fail to respond automatically to the LPCI initiation signal, requiring operator action to initiate ECCS flow to recover RPV level above TAF. The Division 1 Core Spray (HV 152-F005A) and RHR (HV-151-F015A) injection valves will fail to automatically open when the low RPV pressure permissive is reached. Operator action to manually open the Division 1 Core Spray valve will be successful. The Division 1 RHR LPCI valve will trip its breaker when it is manually opened. The Division 2 RHR LPCI initiation logic will fail, requiring

manual isolation of any in service containment cooling flow paths, the second RHR pump to be manually started, and the LPCI injection valves to be manually opened. The scenario may be terminated when level has been restored to the normal band by low-pressure ECCS and RHR is being aligned to containment cooling.



PPL-SUSQUEHANNA, LLC LEARNING CENTER

SIMULATOR SCENARIO

Scenario Title:	RFP Main Lube Oil Pump Test / 1B227 Trip / RFP A Shutdown Lube Oil FME / MSL Flow Transmitter Fails / Loss of FW / LOOP / LOCA
Scenario Duration:	1 hour 15 minutes
Scenario Number:	LOC26-NRC-2
Revision / Date:	0 / June 20, 2014
Course:	PC017 SRO License PC018 RO License

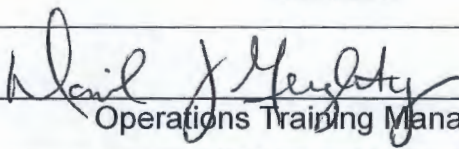
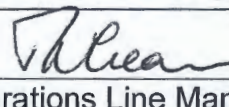
Prepared By:	Robert A. Thompson	06/20/2014
	Instructor	Date
Reviewed By:		6/30/14
	Operations Training Management	Date
Approved By:		6-30-14
	Operations Line Management	Date

THIS PAGE IS INTENTIONALLY LEFT BLANK

SCENARIO SUMMARY

The scenario begins with Unit 1 at 80 percent power starting up from a forced outage, 50 days into the operating cycle. HPCI is inoperable with the steam supply isolated to repair a small steam leak in the steam supply piping in the HPCI room. The RFP lube oil conditioner is being placed on the RFP B reservoir after being removed from the RFP A reservoir last shift in preparation for a RFP A main lube oil pump test. Control rods 42-15 and 46-19 were declared slow during the last scram time test. A severe thunderstorm watch is in effect for northeast Pennsylvania for the next 12 hours.

The first task for the crew is to test the RFP A main lube oil pumps, and perform a pump swap in the process, per OP-145-003. NPOs will report the RFP lube oil conditioner is in-service on the RFP B reservoir once the lube oil pump swap is complete.

When the RFP lube oil pump swap is complete, the 1B227 feeder breaker 1B220-013 will trip, de-energizing the MCC and RPS B. The MCC will not be recovered during the scenario. The crew will respond per ON-158-001 to re-energize RPS B and reset the half-scram, reset NSSSS logic, and restore cooling to the Recirc Pumps. The crew should reference ON-104-202 to identify other significant loads affected by the loss of the MCC, which include Division 2 Core Spray and Division 2 RHR Drywell spray. TS 3.8.7 should be entered for the inoperable ESS MCC.

Once activities associated with recovery from the loss of 1B227 are complete, RFP A main lube oil pump B (1P124B) will trip. Investigation will show significant quantities of foreign material in the reservoir with failure of the remaining RFP A main lube oil pump (1P124A) expected. The crew should reduce power per GO-100-012 and remove RFP A from service per OP-145-001. During the power reduction a MSL B flow transmitter will fail high, resulting in a MSIV high-isolation signal. The inoperable transmitter will require entry into TS 3.3.6.1.

Once RFP A has been secured and the MSL flow transmitter failure evaluated, the RFP B in-service main lube oil pump (1P124C) will trip. The standby pump (1P124D) will automatically start, but trip almost immediately, resulting in a trip of RFP B. With only 1 RFP in-service reactor level will fall rapidly. The scram on low RPV level will fail, requiring a manual scram.

The Unit 1 reactor scram will initiate a grid disturbance which will result in a total loss of offsite power. Diesel Generator B will fail to start, but can be automatically started from the Control Room to re-energize ESS Buses 1B and 2B. The crew will respond to the LOOP per EO-102 and ON-104-001. RPV level and pressure control will be with RCIC and SRVs.

Once RPV level and pressure are stabilized after the LOOP, a small RCS leak will develop in the Drywell. The leak will be within the capability of RCIC and CRD to maintain RPV level above TAF. The crew response to the LOCA will be to align RHR for containment cooling. Once RHR is aligned for containment cooling, the leak will degrade resulting in level slowly falling below TAF. ADS will fail to initiate. Rapid Depressurization will be performed per EO-112 once level falls below TAF.

Low-pressure ECCS systems will fail to respond automatically to the LPCI initiation signal, requiring operator action to initiate ECCS flow to recover RPV level above TAF. The Division 1 Core Spray (HV-152-F005A) and RHR (HV-151-F015A) injection valves will fail to automatically open when the low RPV pressure permissive is reached. Operator action to manually open the Division 1 Core Spray valve will be successful. The Division 1 RHR LPCI valve will trip its breaker when it is manually opened. The Division 2 RHR LPCI initiation logic will fail, requiring isolation of any containment cooling flow paths, the second RHR pump to be manually started, and the LPCI injection valves to be manually opened. The scenario may be terminated when level has been restored to the normal band by low-pressure ECCS and RHR is being aligned to containment cooling.

SCENARIO REFERENCES

- | | | |
|-----|------------|--|
| 1. | OP-AD-001 | Operations Standards For System And Equipment Operation |
| 2. | OP-AD-002 | Standards For Shift Operations |
| 3. | OP-AD-004 | Operations Standards For Error And Event Prevention |
| 4. | OP-AD-055 | Operations Procedure Program |
| 5. | OP-111-001 | Service Water System |
| 6. | OP-145-001 | RFP and RFP Lube Oil System |
| 7. | OP-145-003 | RFP and RFP lube Oil System Testing |
| 8. | OP-149-004 | RHR Containment Cooling |
| 9. | OP-054-001 | Emergency Service Water System |
| 10. | OP-155-001 | Control Rod Drive Hydraulic System |
| 11. | GO-100-012 | Power Maneuvers |
| 12. | SO-100-006 | MSL Channel Checks |
| 13. | ON-100-101 | Scram, Scram Imminent |
| 14. | ON-104-001 | Unit 1 Response to Loss of Offsite Power |
| 15. | ON-104-202 | Loss of 4KV ESS Bus 1A202 |
| 16. | ON-158-001 | Loss of RPS |
| 17. | EO-100-102 | RPV Control |
| 18. | EO-100-103 | Primary Containment Control |
| 19. | EO-000-112 | Rapid Depressurization |
| 20. | ES-134-001 | Restoring Drywell Cooling with a LOCA Signal Present |
| 21. | EP-RM-004 | EAL Classification Levels |
| 22. | AR-016-B04 | ESS 480V LC 1B220 Trouble |
| 23. | AR-120-A03 | RFPT A Mn LO PP A or B Trip |
| 24. | AR-120-A06 | RFPT A Mn LO PP C or D Trip |
| 25. | AR-120-B03 | RFPT A MN LO Alternate PP Auto Start |
| 26. | AR-120-B06 | RFPT B MN LO Alternate PP Auto Start |
| 27. | AR-120-B09 | RFPT C MN LO Alternate PP Auto Start |
| 28. | AR-101-H10 | RFPT A Emerg Oil Pump Running |
| 29. | AR-101-H12 | RFPT B Emerg Oil Pump Running |
| 30. | AR-101-H14 | RFPT C Emerg Oil Pump Running |
| 31. | TS 3.3.1.1 | RPS Instrumentation |
| 32. | TS 3.3.6.1 | Primary Containment Instrument Isolation |
| 33. | TS 3.6.1.3 | Primary Containment Isolation Valves |
| 34. | TS 3.8.7 | Distribution Systems Operating |
| 35. | TR 3.1.3 | Reactivity Control Systems Control Rod Block Instrumentation |

THIS PAGE IS INTENTIONALLY LEFT BLANK

SCENARIO TASKS

Crew Position	Task	Description
PCO	1839	Implement Test Of Standby Main And Emergency Oil Pumps
	4717	Implement Speed Adjustment of Reactor Recirc Pump During Normal Operation
	4668	Implement Shutdown of Reactor Feed Pump and Turbine (ICS)
	2005	Implement Maximizing CRD Flow
	1270	Implement RBCCW Heat Exchanger Manual Transfer Of Service Water And Emergency Service Water
	1271	Implement TBCCW Heat Exchanger Manual Transfer Of Service Water And Emergency Service Water
	1967	Implement Initiation Of Standby Liquid Control System
	1874	Implement RHR Operation In Containment Cooling Mode
	1938	Implement Core Spray Response During Automatic Initiation
	1878	Implement RHR Response During Automatic Initiation Of LPCI Mode Of Operation
US	1185	Apply Technical Specification (TS) And Technical Requirements Manual (TRM) Requirements
ALL	2073	Implement Loss Of RPS
	1833	Implement Loss of Reactor Heat Balance Calculation
	1138	Implement Appropriate Portions Of Plant Shutdown To Minimum Power
	1125	Implement RPV Control
	1202	Implement Loss Of All Off-site Power
	1126	Implement Primary Containment Control
	1129	Implement Rapid Depressurization
	2784	Implement Reactivity Manipulations Standards and Communication Requirements
	1081	Implement Appropriate Portions Of Operations Standards For System and Equipment Operation
	1091	Implement Operations Standards For Error And Event Prevention

THIS PAGE IS INTENTIONALLY LEFT BLANK

CRITICAL TASKS

Rapid Depressurization at TAF	
Safety Significance	RPV leakage impacts the ability to provide continued adequate core cooling through core submergence based on inventory loss.
Consequences for Failure to Perform Task	Failure to take the EOP actions will result in uncovering the core and breach of the fuel clad due to overheating.
Indications/Cues for Event Requiring Critical Task	Reactor water level trending downward, eventually indicating less than the top of active fuel height on the Compensated Fuel Zone Level Indicator.
Performance Criteria	Perform a Rapid Depressurization by manually opening all 6 ADS/SRVs per EO-100-112 when water level reaches the TAF -161" as read on the Compensated Fuel Zone Instrument.
Performance Feedback	Verify ADS valves are open using light red light indication, acoustic monitoring and lowering Reactor pressure
Manually align Division 1 Core Spray and Division 2 RHR for reactor vessel injection	
Safety Significance	Loss of injection systems impacts the ability to restore adequate core cooling through core submergence based on inventory loss after Rapid Depressurization is complete.
Consequences for Failure to Perform Task	Failure to take the EOP actions will result in uncovering the core and breach of the fuel clad due to overheating.
Indications/Cues for Event Requiring Critical Task	Alarms indicating reactor pressure below the ECCS injection valve auto-permissive pressure and injection valve indication shows the valve remains full closed.
Performance Criteria	When reactor pressure falls below the ECCS injection valve automatic open permissive, manually opens the HV-149-F005A and HV-151-F015B valves.
Performance Feedback	ECCS injection valves indicate full open and system flow indications rise as injection flowpath is established and reactor pressure falls below pump shutoff head.

THIS PAGE IS INTENTIONALLY LEFT BLANK

SCENARIO MALFUNCTIONS

Event	Description	Crew Response
1	1B227 de-energized	Transfer RPS to alternate power supply, reset half-scam and half-isolations, re-establish Recirc Pump cooling
2	RFP A main lube oil pump trips due to foreign material intrusion	Lower reactor power and secure RFP A
3	Loss of Feedwater with RPS automatic scram on low reactor level failed	Insert a manual reactor scram
4	Diesel Generator B fails to automatically start	Manually start Diesel Generator B from the Control Room
5	ADS automatic initiation fails	Perform Rapid Depressurization by manually opening 6 ADS/SRVs
6	Division 1 Core Spray injection valve fails to automatically open	Manually open the valve from the Control Room
7	Div 2 RHR LPCI initiation logic fails to initiate	Manually secure the containment cooling lineup, start the second RHR Pump, and open the LPCI inboard and outboard injection valves

ABNORMAL EVENTS / MAJOR TRANSIENTS / TECH SPEC

Malfunction	Description
N	Swap RFP A main lube oil pumps (OP-145-003)
AE1	1B227 feeder trips (ON-158-001)
AE2	Loss of feedwater due to lube oil foreign material intrusion (ON-100-101)
MT1	Loss of offsite power on reactor scram (ON-104-001)
MT2	Drywell LOCA (EO-102, EO-103)
TS1	1B227 feeder trips and is inoperable (TS 3.8.7)
TS2	MSL Flow Transmitter fails high causing MSIV half-isolations (TS 3.6.1.3)

THIS PAGE IS INTENTIONALLY LEFT BLANK

SCENARIO SPECIAL INSTRUCTIONS

1. Simulator setup
 - a. **Initialize** to an exam-specific IC (IC-381). If an exam-specific IC is not available, then setup the IC as follows:
 - i) **Initialize** to IC-17.
 - ii) **Place** RFP C in-service in FCM and enable the LSP feature and the low-flow LIM2 runback
 - iii) **Raise** reactor power to 80 percent with recirc flow
 - iv) **Isolate** the HPCI steam supply and **depressurize** the steam line with the LV-155-F054
 - v) **Run** SCN file exam\HPB_HPCIOOS
 - b. **Run** SCN file exam\LOC26-N02.scn
 - c. **Open** TREND files rat.tnd
2. **Place** the simulator in RUN
3. **Verify** the following malfunctions/overrides, event triggers and key assignments:

MF	RF	OR	SCN	ET	COND
25:25	3:3	0:0	0:0	7:0	17

4. **Prepare** the simulator for evaluation
 - a. **Complete** a simulator exam checklist, TQ-106-0315
 - b. **Reset** ODAs and all Overhead, PICSY, HMI and RWM alarms
 - c. **Ensure** FWLC is selected to LEFM
 - d. **Ensure** correct CRC book is staged and marked-up for current plant conditions
5. **Prepare** a Turnover Sheet including the following:
 - a. Unit 1
 - i) Startup from forced outage in progress. Reactor power 80 percent.
 - ii) 50 days into the cycle
 - iii) HPCI inoperable, steam supply isolated and de-pressurized to repair small steam leak in the HPCI pump room
 - iv) Control rods 42-15 and 46-19 were declared slow during the last scram time test
 - v) RFP lube oil conditioner being aligned to RFP B after removed from RFP A last shift
 - vi) Test RFP A main lube oil pump B and swap to main lube oil pump B
 - b. Common
 - i) Unit 2 is at rated power
 - ii) Severe thunderstorm watch is in effect for northeast Pennsylvania for the next 12 hours
6. **Document** training participation and feedback
 - a. **Ensure** all present have signed Security Agreements per NUREG-1021 and TQ-104-0306
 - b. **Show** the crew that the Evaluators and Booth Operators are qualified
 - c. **Complete** an Operator Fundamental Score Card

SCENARIO FILES

LOC26-N02.scn

```

; Monitored Parameters
SCN rat_mp
SCN exam\LOC26-N02-MP
; 0-G alarms suppressed SDR #
IMF annAR106F15 f:ALARM_OFF
IMF annAR131A04 f:ALARM_OFF
; B RFP DC lube oil pump fails
IMF cmfPM05_1P125B
; RPS Level 3 trips defeated
IMF cmfRL02_C721K6A
IMF cmfRL02_C721K6B
IMF cmfRL02_C721K6C
IMF cmfRL02_C721K6D
; DG B auto-start fails
IMF mfdG024001B
; ADS solenoids fail to open SRVs
IMF cmfRV02_PSV141F13G
IMF cmfRV02_PSV141F13J
IMF cmfRV02_PSV141F13K
IMF cmfRV02_PSV141F13L
IMF cmfRV02_PSV141F13M
IMF cmfRV02_PSV141F13N
; CS F005A auto-open fails
IMF cmfMV06_HV152F005A
; RHR F015A fails
IMF cmfMV06_HV151F015A
IMF cmfMV07_HV151F015A f:0
; Div 2 RHR LPCI fails
IMF cmfRL01_E111K20B
IMF cmfRL01_E111K11A
IMF cmfRL01_E111K201A
IMF cmfRL01_E111K12B
IMF cmfRL01_E111K77A
IMF cmfRL01_E111K200A
IMF cmfMV06_HV151F015B
; MSL B flow xmitter fail
aet LOC26-N02-1
; Level 3 alarm
aet LOC26-N02-2
; LOOP on mode sw to S/D
aet LOC26-N02-3
; DG A start
aet LOC26-N02-4
; LOCA degrades on ctmt clg
aet LOC26-N02-5
; RHR A DW spray OB F016A breaker trips on
stroke
aet LOC26-N02-5A
; RHR F015A trips on open
aet LOC26-N02-6
; 1B227 feeder trip
{Key[1]} IRF rfdB105106 f:OPEN
; Reset Div 2 rad monitors
{Key[11]} SCN exam\RMA_DIV2RST
; RFP A mn lube oil pump trips
{Key[2]} IMF cmfPM02_1P124A
{Key[22]} IMF cmfPM02_1P124B
; isol HWC to RFP A
{Key[32]} IRF rfdW145030 d:60 f:CLOSE
; RFP B mn and standby lube oil pumps trip

```

```

{Key[3]} IMF cmfPM02_1P124C
{Key[3]} IMF cmfPM02_1P124D d:60
{Key[3]} IOR diHS11913B f:TEST_1 c:1
; RFP A lube oil lost
{Key[23]} IMF cmfPM02_1P124A
{Key[23]} IMF cmfPM02_1P124B
; RFP B standby lube oil pump immediate trip
{Key[4]} IMF cmfPM02_1P124D d:0
; Close CRD chrg wtr isol F034
{Key[5]} IRF rfdR155017 d:120 f:0
; Small DW LOCA
{Key[6]} IMF mfdR164010 f:5
{Key[6]} IMF mfdR164011A f:0.25 d:120
; Byp CRD pump suct filter
{Key[7]} IRF rfdR155028 d:120 f:100
; Re-open CRD chrg wtr isol F034
{Key[13]} IRF rfdR155017 d:120 f:100
; HPCI 00SVC - isolate and depress steam-
side first
{Key[40]} SCN exam\HPB_HPCI00S

```

LOC26-N02-A.scn

```

; 230 KV yard
IRF rfdS001003 f:OPEN
IRF rfdS001004 f:OPEN
IRF rfdS001006 f:OPEN
IRF rfdS001002 f:OPEN
; other 230 kv yard
IRF rfdS001010 f:OPEN
IRF rfdS001011 f:OPEN
; 500 KV yard
IRF crfAB03_2T f:TRIP
IRF crfAB03_2S f:TRIP
IRF crfAB03_3N f:TRIP
IRF crfAB03_3T f:TRIP
IRF crfAB03_4T f:TRIP
IRF crfAB03_4S f:TRIP

```

LOC26-N02-MP.scn

```

insmp aoTRSHB311R601D.CurrValue
changemp aoTRSHB311R601D.CurrValue 0,300,DEG
F,RRP A LO BRG TEMP
insmp aoTRSHB311R601I.CurrValue
changemp aoTRSHB311R601I.CurrValue 0,300,DEG
F,RRP A SEAL CAV #1 TEMP
insmp aoFI15120AB.CurrValue
changemp aoFI15120AB.CurrValue 0,750,GPM,RHR
A SC SPRAY FL
insmp aoFI15120AA.CurrValue
changemp aoFI15120AA.CurrValue
0,12000,GPM,RHR A DW SPRAY FL
insmp aoFI15120BB.CurrValue
changemp aoFI15120BB.CurrValue 0,750,GPM,RHR
B SC SPRAL FL

```

RMA_DIV2RST.scn

```
+1 IRF rFRM179088 f:RESET
+2 IRF rFRM179089 f:RESET
+2 IRF rFRM179090 f:RESET
+2 IRF rFRM179091 f:RESET
+2 IRF rFRM179092 f:RESET
```

HPB_HPCIOOS.scn

```
;;# HV-F002 BRKR OPEN (IB)
IRF rfDB106236 f:OPEN
;;# HV-F003 BRKR OPEN (OB)
IRF rfDC188113 f:OPEN
;;# HPCI AOP BRK OPEN
IRF rfDC188128 f:OPEN
;;# LOSS OF PWR TO HV-F100 SOLENOID
IMF cmfAV01_HV155F100
```

LOC26-N02-1.et/scn

```
thwflow(8) < 80
IMF cmfRL01_B211K3B d:120
```

LOC26-N02-2.et/scn

```
rrlnr < 13
IMF annAR103C01 f:ALARM_ON
IMF annAR104C01 f:ALARM_ON
aet LOC26-N02-2A
```

LOC26-N02-2A.et/scn

```
rrlnr > 14
DMF annAR103C01 f:ALARM_ON
DMF annAR104C01 f:ALARM_ON
aet LOC26-N02-2
```

LOC26-N02-3.et/scn

```
;;SWITCH:MODE SWITCH
diHSC72A1501.CurrValue !=
#OR.diHSC72A1501.RUN
+5 SCN exam\LOC26-N02-A
```

LOC26-N02-4.et/scn

```
;;SWITCH:DG B START BLACK PB
diHS00051B.CurrValue !=
#OR.diHS00051B.NORMAL
DMF mfdG024001B
```

LOC26-N02-5.et/scn

```
rhfsupplsprhdr > 400
MMF mfRR164011A f:2 r:600
```

LOC26-N02-5A.et/scn

```
diHS15116A.CurrValue != #OR.diHS15116A.CLOSE
IMF cmfMV01_HV151F016A
```

LOC26-N02-6.et/scn

```
;;SWITCH:RHR INJ OB ISO HV-1F015A (E11A-S8A)
diHS15115A.CurrValue = #OR.diHS15115A.OPEN
IMF cmfMV01_HV151F015A
```

SCENARIO EVENT DESCRIPTION FORM

Initial Conditions: Ensure shift positions are assigned, have the Crew conduct the turnover and perform a panel walk down before the start of the scenario.

EVENT	TIME	DESCRIPTION
N/A	0	Crew assumes shift
A	0	RFP A main lube oil pump swap
B	10	1B227 feeder trip
C	25	RFP A main lube oil pump B trip, RFP A shutdown
D	45	RFP B lube oil pumps trip / scram
E	50	Loss of offsite power
F	55	Drywell LOCA
G	70	Rapid Depressurization
N/A	75	Termination

INSTRUCTOR ACTIVITIES / ROLE PLAY / NOTES

EVENT	A
BRIEF DESCRIPTION	RFP A main lube oil pump swap

OPERATOR ACTIVITY

1. None

ROLE PLAY

1. As **NPO** dispatched to RFP A main lube oil pumps for pre-start checks, **report Standing by for test and swap of RFP A main lube oil pumps.**
2. **Role play** any other directed actions as required.

EVALUATOR NOTES

1. Completion of this activity is **NOT** required to advance the scenario.

SCENARIO EVENT FORM

EVENT	A
BRIEF DESCRIPTION	RFP A main lube oil pump swap

POSITION	TIME	STUDENT ACTIVITIES
PCOP		Identifies the following as expected alarms for the evolution per OP-AD-004 section 11.2.1; <ul style="list-style-type: none"> • AR-120 windows B03, B06 and B09 • AR-101 windows H10, H12 and H14
		Dispatches NPO to perform pre-start checks of RFPT A main lube oil pump
		Swap RFPT A main lube oil pump as follows: <ul style="list-style-type: none"> • Depress <u>AND</u> Hold TEST pushbutton for RFPT A ALT MN L-O PPS HS-11912A • Observe standby lube oil pump starts by appropriate Red light ILLUMINATED at RFPT A ALT MN L-O PPS HS-11912A switch • Release TEST pushbutton for RFPT A ALT MN L-O PPS HS-11912A • Depress RUN pushbutton for RFPT A MN L-O PP 1P124B • Perform following for RFPT A MN L-O PP 1P124A to place in Standby: <ul style="list-style-type: none"> ○ Depress AUTO pushbutton ○ Depress STOP pushbutton ○ Depress AUTO pushbutton
US		Performs a crew brief on testing and swapping the RFPT A main lube oil pump in accordance with OP-145-003
		Directs PCOP to test the RFP A main lube oil pumps, and perform a pump swap in the process, per OP-145-003
		Conducts a crew update after RFPT A main lube oil pump swap is complete

★ Denotes Critical Task

NOTES	
--------------	--

THIS PAGE IS INTENTIONALLY LEFT BLANK

SCENARIO EVENT DESCRIPTION FORM

EVENT	TIME	DESCRIPTION
N/A	0	Crew assumes shift
A	0	RFP A main lube oil pump swap
B	10	1B227 feeder trip
C	25	RFP A main lube oil pump B trip, RFP A shutdown
D	45	RFP B lube oil pumps trip / scram
E	50	Loss of offsite power
F	55	Drywell LOCA
G	70	Rapid Depressurization
N/A	75	Termination

INSTRUCTOR ACTIVITIES / ROLE PLAY / NOTES

EVENT	B
BRIEF DESCRIPTION	1B227 feeder trip

OPERATOR ACTIVITY

1. When the RFP A main lube oil pumps have been swapped, **depress KEY 1** to initiate a fault on 1B227 with trip of the feeder breaker 1B220-013.

{Key[1]} IRF rFDB105106 f:OPEN
1B227 feeder trip

2. When requested, **depress KEY 11** to reset rad monitors powered from RPS B.

{Key[11]} SCN exam\RMA_DIV2RST
Reset Div 2 rad monitors

ROLE PLAY

1. As **NPO** dispatched to 1B220, **wait 2 minutes and report**

The only problem at 1B220 is that breaker 13, which says it is the feeder to 1B227, is tripped, with a bell device trip.

When dispatched to 1B227, **wait 1 minute and report**

Everything at 1B227 appears normal, there are no breakers tripped. There is a slight burnt electrical smell, no smoke or fire though.

2. As **NPO** dispatched to investigate 1L660 alarm, **wait 2 minutes and report**

1D662 is on the battery, bus voltage is 240 VDC. Charger 1D663 has no power.

3. As **WWM** contacted for assistance with 1B227, **wait 5 minutes and report**

Electrical Maintenance suspects that one of the loads on 1B227 faulted but its breaker did not trip. They are still evaluating the condition of the MCC.

4. **Role play** any other directed actions as required.

EVALUATOR NOTES

1. **CIG compressors are not affected by the loss of power; reopening isolation valves is required.**

SCENARIO EVENT FORM

EVENT	B
BRIEF DESCRIPTION	1B227 feeder trip

POSITION	TIME	STUDENT ACTIVITIES
PCOM		Identifies a half scram from the loss of RPS B
		Reports power/pressure/level steady and in-band
		Reset B RPS half scram by momentarily positioning REACTOR SCRAM RESET HS-C72A-1S05 to GROUP 1/4 position <u>AND THEN</u> to GROUP 2/3 position
PCOP		Performs AR-016-B04 for ESS 480v LC 1B220 trouble
		Dispatches NPO to investigate LC 1B220 trouble
		Performs ON-158-001 Attachment B for a loss of RPS B
		Energize B RPS bus as follows by transferring B RPS to alternate power supply: <ul style="list-style-type: none"> • Ensure ALTERNATE B FEED White indicating light ILLUMINATED • Ensure RPS M-G SET TRANSFER SWITCH HS-C72B-S1 in NORM position. • Place RPS M-G SET TRANSFER SWITCH HS-C72B-S1 in ALT B position
		Direct NPO to reset the Main Steam Line Rad Monitors at Panel 1C633 <ul style="list-style-type: none"> • Rad Monitor RIS-D12-1K603B • Rad Monitor RIS-D12-1K603D
		Reset NSSSS isolation logic as follows: <ul style="list-style-type: none"> • Depress MN STM LINE DIV 1 ISO RESET HS-B21-1S32 • Depress MN STM LINE DIV 2 ISO RESET HS-B21-1S33

★ Denotes Critical Task

SCENARIO EVENT FORM

EVENT	B
BRIEF DESCRIPTION	1B227 feeder trip

POSITION	TIME	STUDENT ACTIVITIES
PCOP (cont.)		Recover from RBCW isolation as follows: <ul style="list-style-type: none"> • Ensure RRP A CLG WTR OB ISO VALVES HV-18791A1&A2 CLOSED • Ensure RRP B CLG WTR IB ISO VALVES HV-18792A1&A2 CLOSED • Ensure RRP B CLG WTR OB ISO VALVES HV-18791B1&B2 CLOSED • Ensure RRP A CLG WTR IB ISO VALVES HV-18792B1&B2 CLOSED • Depress HV-18791A1&A2 ISOLATION RESET • Depress HV-18792A1&A2 ISOLATION RESET • Depress HV-18791B1&B2 ISOLATION RESET • Depress HV-18792B1&B2 ISOLATION RESET • Ensure RRP A CLG WTR OB ISO VALVES HV-18791A1&A2 OPEN • Ensure RRP B CLG WTR IB ISO VALVES HV-18792A1&A2 OPEN • Ensure RRP B CLG WTR OB ISO VALVES HV-18791B1&B2 OPEN • Ensure RRP A CLG WTR IB ISO VALVES HV-18792B1&B2 OPEN
		Directs NPO to reset Division 2 exhaust isolation rad monitors at 1C633.
		Recover from CIG isolation as follows: <ul style="list-style-type: none"> • Direct NPO to ensure CIG compressors operational per OP-125-001 • Open INSTR GAS TIP INDEX ISO SV-12661 • Open INSTR GAS MN STM RV OB ISO SV-12644 • Ensure INSTR GAS STOR 1T212 ISO SV-12643 CLOSES when INSTR GAS MN STM RV OB ISO SV-12644 OPENS • Open INSTR GAS MN STM RV OB ISO SV 12649 • Ensure INSTR GAS STOR 1T213 ISO SV-12648 CLOSES WHEN INSTR GAS MN STM RV OB ISO SV-12649 OPENS.
US		Directs PCOP to perform ON-158-001, Loss of RPS Att B to reset the half scram
		Enters ON-100-006 for loss of heat balance due to RWCU isolation
		Directs PCOP to energize RPS B

★ Denotes Critical Task

SCENARIO EVENT FORM

EVENT	B
BRIEF DESCRIPTION	1B227 feeder trip

POSITION	TIME	STUDENT ACTIVITIES
US (cont'd)		Contacts WWM for Electrical Maintenance to investigate 480v ESS LC 1B220 trouble
		References ON-104-202 Att E to identify significant loads affected by the loss of 1B227
		Enters Tech Specs as follows for inoperable 480V LC 1B220 <ul style="list-style-type: none"> • TS 3.8.7 Condition A

★ Denotes Critical Task

NOTES	
--------------	--

THIS PAGE IS INTENTIONALLY LEFT BLANK

SCENARIO EVENT DESCRIPTION FORM

EVENT	TIME	DESCRIPTION
N/A	0	Crew assumes shift
A	0	RFP A main lube oil pump swap
B	10	1B227 feeder trip
C	25	RFP A main lube oil pump B trip, RFP A shutdown
D	45	RFP B lube oil pumps trip / scram
E	50	Loss of offsite power
F	55	Drywell LOCA
G	70	Rapid Depressurization
N/A	75	Termination

INSTRUCTOR ACTIVITIES / ROLE PLAY / NOTES

EVENT	C
BRIEF DESCRIPTION	RFP A main lube oil pump B trip, RFP A shutdown

OPERATOR ACTIVITY

1. When crew activities are complete for the loss of 1B227, **depress KEY 2(22)** to initiate a trip of the in-service RFP A main lube oil pump A(B).

{Key[2]} IMF cmfPM02_1P124A **RFP A mn lube oil pump A(B) trips**
{Key[22]} IMF cmfPM02_1P124B

2. **Ensure** Event Trigger LOC26-N02-1 initiates when core flow is reduced below 80 Mlbm/hr to initiate an upscale failure of MSL B steam flow transmitter FIS-B21-1N007B (simulated by failure of NSSSS relay B21-1K3B).

3. When directed, **depress KEY 32** to secure HWC injection to RFP A.

{Key[32]} IRF rFW145030 d:60 f:CLOSE **isol HWC to RFP A**

ROLE PLAY

1. As **NPO** dispatched to RFP A lube oil reservoir, **wait 2 minutes and report**

The A(B) main lube oil pump is tripped. The standby pump is running, but sounds abnormal. I looked inside the reservoir, and it looks like there is some kind of foreign material in the lube oil.

If directed to report pump discharge or lube oil filter inlet/outlet pressures or filter ΔP, **wait 1 minute and report requested values as follows:**

Pump discharge	240 psig
Filter inlet	70 psig
Filter outlet	55 psig
Filter ΔP	15 psig

2. As **WWM** contacted for assistance with RFP A main lube oil pump trip, **wait 5 minutes and report**

Maintenance reports that a significant amount of foreign material has entered the RFP A lube oil reservoir. It appears to be some kind of fibrous or resin-like material. They have no estimate of how long the standby pump will continue to run.

If questioned about the RFP lube oil conditioner being the source of the foreign material, **report**

Maintenance confirms the debris in the reservoir is consistent with the filter media used in the lube oil conditioner.

(continued on next page)

INSTRUCTOR ACTIVITIES / ROLE PLAY / NOTES

EVENT	C
BRIEF DESCRIPTION	RFP A main lube oil pump B trip, RFP A shutdown

3. As **NPO** dispatched to perform channel check of the MSL steam flow transmitters, **wait 2 minutes and report**

Channel check was sat for all MSL flow transmitters, except FIS-B21-1N007B. It is indicating upscale.

4. As **NPO** dispatched to check MSL isolation logic in Lower Relay Room, **wait 2 minutes and report**

I found the K3B and K13B relays tripped on the 1C611 panel, all other relays are reset.

5. As **WWM** contacted for assistance with MSIV isolation logic B high-flow trip, **wait 5 minutes and report**

I&C reports that the B MSL flow transmitter to the B MSIV logic is failed upscale. There is no estimate on when a new transmitter can be installed.

6. **Role play** any other directed actions as required.

EVALUATOR NOTES

1. If the crew does not proceed directly to securing RFP A, contact the Control Room as Operations Management and recommend an immediate controlled shutdown of RFP A.

SCENARIO EVENT FORM

EVENT	C
BRIEF DESCRIPTION	RFP A main lube oil pump B trip, RFP A shutdown

POSITION	TIME	STUDENT ACTIVITIES
PCOM		Reports power/pressure/level steady and in-band
		Commences lowering power in accordance with RE instructions in the CRC book
		Plots position on power/flow map
		Places RFP A in IDLE MODE at 1,000 rpm as follows on RFP A HMI screen <ul style="list-style-type: none"> • Touch A(B)(C) RFPT <u>IDLE MODE</u> button • Touch <u>IDLE MODE</u> button, THEN • Touch <u>1,000 RPM</u> button
		IF RFP A was previously operating in Flow Control Mode, Observe the following: <ul style="list-style-type: none"> • Monitor RPV Vessel level closely and ensure level Maintained with in service pump(s). • SIC-C32-1R601A RFP/T A speed controller RFP A SPD CTL/DEMAND SIGNAL lowers admission as necessary to obtain RFPT A speed of 1,000 rpm, AND • FV-10604A(B)(C) RX FEED PUMP A(B)(C) RECIRC FLOW throttles open to establish required Recirc Flow • HV-10603A(B)(C) RFP A(B)(C) DISCH ISO VLV Closes after a 180 second time delay.
		Trips RFP A as follows: <ul style="list-style-type: none"> • Depress HS-12745A(B)(C) RFP TURBINE A(B)(C) TRIP pushbutton • At 1C668, Observe following: <ul style="list-style-type: none"> ○ HV 12709A(B)(C) RFPT A(B)(C) LP ISO CLOSES ○ HV 12710A(B)(C) RFPT A(B)(C) HP ISO CLOSES ○ HV 12717A(B)(C) RFPT A(B)(C) FIRST STAGE DRN OPENS ○ HV-10606A(B)(C) RFP A(B)(C) DSCH CKV CLOSES • Ensure SIC-C32-1R601A(B)(C) RFP A(B)(C) SPD CTL/DEMAND SIGNAL controller in MANUAL with controller output signal (horizontal meter) set at 0 • Ensure FIC 10604A(B)(C) RX FEED PUMP A(B)(C) RECIRC FLOW controller in AUTO with a controller output of 0%
		Dispatch NPO to perform local actions at RFP A

★ Denotes Critical Task

SCENARIO EVENT FORM

EVENT	C
BRIEF DESCRIPTION	RFP A main lube oil pump B trip, RFP A shutdown

POSITION	TIME	STUDENT ACTIVITIES
PCOP		Performs AR-120-A03, for trip of RFP A Main LO pump
		Dispatches NPO to RFP A lube oil reservoir to investigate lube oil pump trip and perform running checks on alternate lube oil pump
		Dispatched NPO to perform Main Steam Line flow instrument channel checks
US		Contacts WWM for Maintenance investigation of the RFP Main LO pump trip.
		Performs crew brief to reduce power in accordance with GO-100-012 in preparation for removing the RFP A from service per OP-145-001 (based on information from Maintenance)
		Directs PCOM to lower reactor power in accordance with RE instructions in the CRC book.
		Contacts Chemistry and HP for thermal power change greater than 15% Rated Thermal Power in one hour.
		Directs PCOP to perform SO-100-006, Shift Surveillance Operating Log for Main Steam Line Channel Instrumentation Checks
		At approximately 65% power, Directs PCOM to remove RFP A from service in accordance with OP-145-001
		Contacts WWM for I&C investigation of the B MSIV logic failed upscale
		Enters Tech Specs as follows for Main Steam Line Flow Transmitter failure <ul style="list-style-type: none"> • TS 3.3.6.1 Conditions A and D

★ Denotes Critical Task

NOTES	
--------------	--

THIS PAGE IS INTENTIONALL LEFT BLANK

SCENARIO EVENT DESCRIPTION FORM

EVENT	TIME	DESCRIPTION
N/A	0	Crew assumes shift
A	0	RFP A main lube oil pump swap
B	10	1B227 feeder trip
C	25	RFP A main lube oil pump B trip, RFP A shutdown
D	45	RFP B lube oil pumps trip / scram
E	50	Loss of offsite power
F	55	Drywell LOCA
G	70	Rapid Depressurization
N/A	75	Termination

INSTRUCTOR ACTIVITIES / ROLE PLAY / NOTES

EVENT	D
BRIEF DESCRIPTION	RFP B lube oil pumps trip / scram

OPERATOR ACTIVITY

- Once the crew has complete the activities associated with securing RFP A, **depress KEY 3** to initiate a loss of RFP B lube oil. The main lube oil pumps will trip, and the emergency lube oil pump will fail to develop discharge pressure.

 {Key[3]} IMF cmfPM02_1P124C **RFP B mn and standby lube oil pumps trip**
 {Key[3]} IMF cmfPM02_1P124D d:60
- If desired to immediately trip RFP B due to a loss of lube oil, **depress KEY 4** to delete the time-delay on the D lube oil pump.

 {Key[4]} IMF cmfPM02_1P124D d:0 **RFP B standby lube oil pump immediate trip**
- If the crew initiates effort to return RFP A to service, **depress KEY 23** to trip the in-service RFP A main lube oil pump.

 {Key[23]} IMF cmfPM02_1P124A **Force loss of FW if necessary**
 {Key[23]} IMF cmfPM02_1P124B
- Ensure** Event Trigger LOC26-N02-2 initiates when reactor level falls below +13 inches to activate the RPS low-level scram alarms and activate LOC26-N02-2A.
- Ensure** Event Trigger LOC26-N02-2 initiates when reactor level falls rises above +14 inches to clear the RPS low-level scram alarms and activate LOC26-N02-2
- Ensure** Event Trigger LOC26-N02-3 initiates when the mode switch is placed in shutdown to cause a loss of offsite power.

ROLE PLAY

- As **NPO** dispatched to RFP B lube oil reservoir, **wait** 1 minute and **report**

The standby main lube oil pump at RFP B lube oil reservoir is running, but it doesn't sound normal.
- As **WWM** contacted for assistance with RFP lube oil issues, **acknowledge** the request and take no further action.
- Role play** any other directed actions as required.

(continued on the next page)

INSTRUCTOR ACTIVITIES / ROLE PLAY / NOTES

EVENT	D
BRIEF DESCRIPTION	RFP B lube oil pumps trip / scram

EVALUATOR NOTES

1. None

SCENARIO EVENT FORM

EVENT	D
BRIEF DESCRIPTION	RFP B lube oil pumps trip / scram

POSITION	TIME	STUDENT ACTIVITIES
PCOM		PLACE Mode Switch to SHUTDOWN
		Performs Scram report in accordance with OP-AD-004 section 12.2.4 <ul style="list-style-type: none"> • States Mode switch in SHUTDOWN, all control rods inserted • Reports reactor pressure and MSIVs open, reactor level and FW available
		Completes PCO Actions Following a Scram as follows: <ul style="list-style-type: none"> • INSERT IRMs and SRMs • VERIFY Scram Discharge Volume Vent and Drain valves CLOSED
PCOP		Performs AR-120-A06, for trip of RFP B Main LO pump
		Dispatches NPO to RFP B lube oil reservoir to investigate lube oil pump trip and perform running checks on alternate lube oil pump
US		Contacts WWM for Maintenance investigation of the RFP lube oil issues
		Performs crew update and directs entry into ON-100-101 Scram, Scram imminent.
		Directs PCOM to place the Mode Switch to Shutdown on RFP B trip
		Enters EO-100-102, RPV Control at RC-1 for low reactor level

★ Denotes Critical Task

NOTES	
--------------	--

SCENARIO EVENT DESCRIPTION FORM

EVENT	TIME	DESCRIPTION
N/A	0	Crew assumes shift
A	0	RFP A main lube oil pump swap
B	10	1B227 feeder trip
C	25	RFP A main lube oil pump B trip, RFP A shutdown
D	45	RFP B lube oil pumps trip / scram
E	50	Loss of offsite power
F	55	Drywell LOCA
G	70	Rapid Depressurization
N/A	75	Termination

INSTRUCTOR ACTIVITIES / ROLE PLAY / NOTES

EVENT	E
BRIEF DESCRIPTION	Loss of offsite power

OPERATOR ACTIVITY

1. **Ensure** Event Trigger LOC26-N02-4 initiates when the DG B start PB is depressed to allow the DG to start.
2. When directed, **depress KEY 5** to close CRD charging water isolation valve 146-F034.

{Key[5]} IRF rfRD155017 d:120 f:0

Close CRD chrg wtr isol F034

ROLE PLAY

1. As **NPO** dispatched to DG B, **wait 2 minutes and report**
DG B is running normally, I don't see any reason for the failure to auto-start.
2. As **NPO** directed to align RBCCW(TBCCW) to ESW, **wait 2 minutes and report** (no simulator action is required for closing 110046(109086)).

The ESW supply and isolation valves to RBCCW(TBCCW) are open, the Service Water emergency isolation valve is closed, and I have closed 110046(109086).

3. As **TCC/GCC** contacted for the status of offsite power, **report**

When Susquehanna Unit 1 tripped offline, it resulted in a grid disturbance that has caused a wide-spread blackout through the NE Pennsylvania area. Restoration will take a couple of hours.

4. **Role play** any other directed actions as required.

EVALUATOR NOTES

1. None

SCENARIO EVENT FORM

EVENT	E
BRIEF DESCRIPTION	Loss of offsite power

POSITION	TIME	STUDENT ACTIVITIES
PCOM		Maximizes CRD in accordance with OP-155-001 Att K <ul style="list-style-type: none"> • Start standby CRD pump by placing control switch CRD Pump 1P132B(A) to RUN, to start 1P132B(A), Ctl Rod Drive Water Pump B(A) • Using FC-C12-1R600, CRD Flow Controller, in MANUAL, Fully Open FV146F002A(B), CRD Flow Control Vlv • Fully Open THTLG PV-146-F003, DRIVE WTR PRESS THTLG valve • IF CRD pump suction filter Hi differential pressure alarm received, THEN Perform the following to prevent pump trips <ul style="list-style-type: none"> ○ Reduce CRD flow to clear the Hi differential pressure alarm using the FCV ○ Dispatches NPO to Open 146F116, CRD Pump Suction Filter Bypass ○ Maximize flow by fully opening the FCV when 146F116 is reported open
PCOP		Performs ON-100-101 Att B to ensure isolations, initiations and DG's start. Reports to US that DG B failed to start.
		Dispatches NPO to investigate DG B failure to start
		Manually starts DG B from Control Room by <ul style="list-style-type: none"> • Place DG B Engine Governor Mode Select switch to ISOCHRONOUS • Start diesel by Depressing DG B Engine Control Start pushbutton • Observe DG B STARTS AND DG B to Bus 1B Bkr 1A20204AUTOMATICALLY CLOSES • Observe white ESS Bus available light ILLUMINATED on mimic bus
		Ensures ESW pumps operating in accordance with OP-054-001

★ Denotes Critical Task

SCENARIO EVENT FORM

EVENT	E
BRIEF DESCRIPTION	Loss of offsite power

POSITION	TIME	STUDENT ACTIVITIES
PCOP (cont'd)		Transfers RBCCW HX to ESW per OP-111-001 as follows: <ul style="list-style-type: none"> • PRESS RBCCW HX A SW/ESW SUP HS-11024A EMERG pushbutton. • Directs NPO to ENSURE the following occurs at RBCCW/TBCCW HX A Control Box 1CB216A: <ul style="list-style-type: none"> ○ HV-11024A1 RBCCW HX A ESW Sup Iso OPENS. ○ HV-11024A2 RBCCW HX A ESW Dsch Iso OPENS. ○ HV-11024A3 RBCCW HX A SW Dsch Emerg Iso CLOSES. • Directs NPO to CLOSE 110046 RBCCW HX A SW Sup Iso
		Transfers TBCCW HX to ESW per OP-111-001 as follows: <ul style="list-style-type: none"> • PRESS TBCCW HX A SW/ESW SUP HS-10943A EMERG pushbutton. • Directs NPO to ENSURE the following occurs at RBCCW/TBCCW HX A Control Box 1CB216A: <ul style="list-style-type: none"> ○ HV-10943A2 TBCCW HX A ESW Dsch Iso OPENS ○ HV-11143A ESW Loop A Sup to TBCCW HX 1A OPENS ○ HV-10943A3 TBCCW HX A SW Out Iso CLOSES • Directs NPO to CLOSE 109086 TBCCW HX A SW Sup Iso
US		Directs PCOP to attempt to start DG B from the control room to reenergize ESS buses 1B and 2B.
		Performs a crew update for entering ON-104-001 for LOOP
		Directs PCOP to perform ON-104-001 for LOOP-U1 Response
		Contacts TCC/GCC for status of offsite power
		Conducts crew update that restoration of offsite power will take a couple of hours
		Directs PCOM to restore and maintain RPV level between +20" to +45" using CRD and RCIC
		Directs PCOM to maintain RPV pressure 800 psig to 1050 psig using SRVs.
		Directs PCOM to maximize CRD

★ Denotes Critical Task

NOTES	
--------------	--

SCENARIO EVENT DESCRIPTION FORM

EVENT	TIME	DESCRIPTION
N/A	0	Crew assumes shift
A	0	RFP A main lube oil pump swap
B	10	1B227 feeder trip
C	25	RFP A main lube oil pump B trip, RFP A shutdown
D	45	RFP B lube oil pumps trip / scram
E	50	Loss of offsite power
F	55	Drywell LOCA
G	70	Rapid Depressurization
N/A	75	Termination

INSTRUCTOR ACTIVITIES / ROLE PLAY / NOTES

EVENT	F
BRIEF DESCRIPTION	Drywell LOCA

OPERATOR ACTIVITY

- Once the crew has stabilized reactor level with RCIC and SRVs, **depress KEY 6** to initiate a small Drywell LOCA.

{Key[6]} IMF mfRR164010 f:5 **Small DW LOCA**
{Key[6]} IMF mfRR164011A f:0.25 d:120
- When directed, **depress KEY 7** to bypass the CRD pump suction filter by opening 146F116.

{Key[7]} IRF rRD155028 d:120 f:100 **Byb CRD pump suct filter**
- When directed, **depress KEY 8** to reopen CRD charging water isolation valve F034.

{Key[8]} IRF rRD155017 d:120 f:100 **Re-open CRD chrg wtr isol F034**
- Ensure** Event Trigger LOC26-N02-5 imitates when Suppression Chamber flow exceeds 400 gpm to raise the LOCA severity.
- Ensure** Event Trigger LOC26-N02-5A initiates when Div 1 RHR DW spray outboard valve HV-151-F016A is stroked open to trip its breaker.

ROLE PLAY

- As **NPO** dispatched to 1B217-032, HV-151-F016A breaker, **report**

The breaker is in the tripped-free condition.

If directed to manually operate the valve, **acknowledge** the request and take no further action.
- As **WWM** contacted for the status of 1B227, **report**

Maintenance has discovered some damage to the bus work around 1B227-042, the feeder breaker to 250V DC charger 1D663. They have no estimate when 1B227 may be returned to service.
- As **WWM** contacted to expedite HPCI return to service, **report**

Maintenance is expediting activities to recover HPCI, however a second pass on the welding is required. HPCI may be available in about 6 hours.
- Role play** any other directed actions as required.

(continued on next page)

INSTRUCTOR ACTIVITIES / ROLE PLAY / NOTES

EVENT	F
BRIEF DESCRIPTION	Drywell LOCA

EVALUATOR NOTES

1. None

SCENARIO EVENT FORM

EVENT	F
BRIEF DESCRIPTION	Drywell LOCA

POSITION	TIME	STUDENT ACTIVITIES
PCOM		<p>Injects SBLC per OP-153-001 as follows:</p> <ul style="list-style-type: none"> • Place HS-14804 SBLC Manual Initiation keylock control switch to A(B) START • Observe SBLC Pumps 1P208A(B) STARTS • Once initiated, Observe the following: <ul style="list-style-type: none"> ○ HV-144-F004 RWCU INLET OB ISO CLOSES ○ SBLC SQUIB READY A-B white indicating lights EXTINGUISHED ○ SBLC SQUIB VALVES LOSS OF CKT CONTINUITY annunciator ALARMS ○ Pump 1P208A(B) Red indicating light ILLUMINATED ○ SBLC PUMP discharge header pressure ~ 200 psig greater than reactor pressure ○ SBLC FLOW Indicates ~ ≥ 40 GPM ○ SBLC Storage Tank level decreasing ○ Reactor power level decreasing
PCOP		<p>Places RHR B in Suppression Chamber spray per OP-149-004 as follows:</p> <ul style="list-style-type: none"> • Place HS E11 1S17B LOCA ISOLATION MANUAL OVERRIDE Switch to OVERRIDE and observe the following: <ul style="list-style-type: none"> ○ White Indicating Light ILLUMINATED above HS-E11-1S17B LOCA ISOLATION MANUAL OVERRIDE ○ LOCA ISO SWITCH LOOP (A)B MANUAL OVERRIDE (AR-113-C5) Annunciator alarms • Open HV-151-F028B SUPP CHMBR SPR TEST SHUTOFF • Close HV-151-F017B RHR INJ FLOW CTL • Start 1P202B(D)RHR PUMP • Throttle Open HV-151-F027B SUPP POOL SPRAY CTL, as necessary, to maintain ≤ 500 GPM as indicated on FI-15120B CONTN SPRAY DIV 2 <u>AND</u> maintain total loop flowrate ≤ 10,000 gpm • <u>IF</u> Suppression Chamber pressure drops to 0 psig, <u>THEN</u> Stop Suppression Chamber Sprays

★ Denotes Critical Task

SCENARIO EVENT FORM

EVENT	F
BRIEF DESCRIPTION	Drywell LOCA

POSITION	TIME	STUDENT ACTIVITIES
PCOP (cont'd)		Aligns RHR SW cooling to RHR B HX per OP-149-004 as follows: <ul style="list-style-type: none"> • Open HV-11210B Unit 1 RHR SW Hx B INLET to 10% Open • OPEN HV-11215B Unit 1 RHR SW Hx B OUTLET • Place HS-11202B3 RHR SW PUMP B LOCA-TRIP switch to RESET • Start 1P506B RHR SW Pump B • Throttle HV-11210B Unit 1 RHR SW Hx B INLET to establish 8000 to 9000 gpm on FI-E11-1R602B RHR SW HX B INLET FLOW • Place HV-151-F048B HX B SHELL SIDE BYPS Control Switch to OFF/LOCA RESET position and observe White Indicating Light ILLUMINATED above HV-151-F048B Control Switch • Close HV-151-F048B HX B SHELL SIDE BYPS
		Places RHR B in Suppression Pool cooling per OP-149-004 as follows: <ul style="list-style-type: none"> • Throttle Open HV-151-F024B TEST LINE CTL to establish a total loop flowrate 9,500 to 10,000 gpm as indicated on FI-E11-1R603B RHR B/D Flow
		Places RHR A in Drywell spray per OP-149-004 as follows: <ul style="list-style-type: none"> • Open HV-151-F021A DRYWELL SPRAY IB ISO • Ensure both RX Recirc Pumps, all DW Coolers and Fans are Shutdown • Throttle open HV-151-F016A DRYWELL SPRAY OB ISO, observes breaker trips
US		Directs PCOP to initiate Suppression Chamber spray with RHR B per OP-149-004
		Directs PCOP to initiate Suppression Pool cooling with RHR B per OP-149-004
		Directs PCOP to initiate Drywell spray with RHR A per OP-149-004
		Contacts WWM for Maintenance to expedite return of HPCI
		Contacts WWM for the status of 1B227

★ Denotes Critical Task

NOTES	
--------------	--

THIS PAGE IS INTENTIONALLY LEFT BLANK

SCENARIO EVENT DESCRIPTION FORM

EVENT	TIME	DESCRIPTION
N/A	0	Crew assumes shift
A	0	RFP A main lube oil pump swap
B	10	1B227 feeder trip
C	25	RFP A main lube oil pump B trip, RFP A shutdown
D	45	RFP B lube oil pumps trip / scram
E	50	Loss of offsite power
F	55	Drywell LOCA
G	70	Rapid Depressurization
N/A	75	Termination

INSTRUCTOR ACTIVITIES / ROLE PLAY / NOTES

EVENT	G
BRIEF DESCRIPTION	Rapid Depressurization

OPERATOR ACTIVITY

1. **Ensure** Event Trigger LOC26-N02-6 initiates when the Division 1 RHR F015A is stroked open from the Control Room to trip its breaker.

ROLE PLAY

1. As **NPO** dispatched to breaker 1B219-011 for RHR HV-151-F015A, **wait 2 minutes and report**

The breaker is tripped on magnetics.

2. As **NPO** dispatched to manually operate ECCS valves, **acknowledge** the request and take no further action. If contacted for status, **report**

I just got to the valve and was about to report. The valve will not come off of its closed seat with the manual operator.

3. As **WWM** contacted for assistance with ECCS injection valves, **acknowledge** the request and take no further action.
4. **Role play** any other directed actions as required.

EVALUATOR NOTES

1. The scenario may be terminated when reactor level is re-established stable in the normal band with ECCS flow throttled, and efforts to return RHR to containment cooling are initiated.

SCENARIO EVENT FORM

EVENT	G
BRIEF DESCRIPTION	Rapid Depressurization

POSITION	TIME	STUDENT ACTIVITIES
PCOM		Observes reactor level lowering, informs US
		When reactor level reaches -129", observes the following: <ul style="list-style-type: none"> • AR-110-A1(A2)(A3)(A4) in alarm, ADS timers initiated • All RHR and Core Spray pumps start
		Reports Wide Range reactor level < -145", Compensated Fuel Zone indicates level < TAF
		Observes HV-151-F015A breaker trip on valve stroke
		Manually opens CORE SPRAY LOOP A IB INJ SHUTOFF HV-152-F005A with reactor pressure < 435 psig
		Manually opens RHR INJ FLOW CTL HV-151-F015B with reactor pressure < 435 psig
		Observes Compensated Fuel Zone indicates level < TAF, throttles ECCS flow to restore and maintain reactor level +20" to +45" using <ul style="list-style-type: none"> • CORE SPRAY LOOP A IB INJ SHUTOFF HV-152-F005A • RHR INJ FLOW CTL HV-151-F017B
PCOP		Observes ADS A(B) solenoids indicate energized at 1C601, observes SRV OPEN PSV-141-F013 VI-14181A(B) indicates all SRVs closed by acoustic monitor
		Open 6 ADS/SRVs by placing SAFETY RELIEF VALVE G(J)(K)(L)(M)(N) PSV-141-F013G(J)(K)(L)(M)(N) to OPEN
		Observes SRV OPEN PSV-141-F013 VI-14181A(B) indicates all ADS SRVs open by acoustic monitor
		Realigns RHR A(B) for LPCI by performing the following per OP-149-004: <ul style="list-style-type: none"> • Close HV-151-F024A(B) TEST LINE CTL holding control switch to CLOSE for 10 seconds AFTER closed indication OBSERVED • Place HS-E11-1S17A(B) LOCA ISOLATION MANUAL OVERRIDE switch to RESET • Ensure RHR containment cooling valves close: <ul style="list-style-type: none"> ○ HV-151-F027A(B) SUPP POOL SPRAY CTL ○ HV-151-F028A(B) SUPP CHMBR SPR TEST SHUTOFF ○ HV-151-F016A(B) DRYWELL SPRAY OB ISO ○ HV-151-F021A(B) DRYWELL SPRAY IB ISO • Ensure Open HV-151-F048A(B) HX A(B) SHELLSIDE BYPS • Open HV-151-F017A(B) RHR INS FLOW CTL

★ Denotes Critical Task

SCENARIO EVENT FORM

EVENT	G
BRIEF DESCRIPTION	Rapid Depressurization

POSITION	TIME	STUDENT ACTIVITIES
US		Determines reactor level cannot be maintained above -129"
		Performs crew update and enters EO-100-112 for Rapid Depressurization for ADS automatic initiation and reactor level < TAF
		Ensures Suppression Pool level > 5' and orders 6 ADS/SRVs open
		Directs all ECCS systems lined up for vessel injection
		Directs PCOM to manually align low pressure ECCS to recover reactor level above TAF
		With reactor level above TAF, directs PCOM to throttle ECCS flow as necessary to restore and maintain reactor level +20" to +45"
		Directs RHR returned to containment cooling

★ Denotes Critical Task

NOTES	
--------------	--

THIS PAGE IS INTENTIONALLY LEFT BLANK

UNIT SUPERVISOR TURNOVER SHEET

UNIT 1 to/dd/yy
Date

SHIFT 1900 to 0700
Start End

SHIFT 0700 to 1900
Start End

MODE 1
POWER LEVEL 79 %
GENERATOR OUTPUT 1044 MWe
CASK STORAGE GATE INSTALLED: YES/NO

MODE _____
POWER LEVEL _____ %
GENERATOR OUTPUT _____ MWe
CASK STORAGE GATE INSTALLED: YES/NO

REMARKS:

- 1) Startup from forced outage in progress, 50 days since the refueling outage
- 2) Reactor power 80 percent
- 3) HPCI inoperable, steam supply isolated and de-pressurized to repair small steam leak in the HPCI pump room
- 4) Control rods 42-15 and 46-19 were declared slow during the last scram time test
- 5) RFP lube oil conditioner being aligned to RFP B after removed from RFP A last shift
- 6) Test RFP A main lube oil pump B and swap to B main lube oil pump. NPO and FUS briefed and standing by to support.
- 7) _____
- 8) _____
- 9) _____
- 10) _____
- 11) _____
- 12) _____
- 13) _____
- 14) _____
- 15) _____

COMMON:

- 1) Unit 2 at rated power
- 2) Severe thunderstorm watch is in effect for NE Penn for the next 12 hours
- 3) _____
- 4) _____
- 5) _____
- 6) _____
- 7) _____
- 8) _____
- 9) _____

OFFGOING UNIT SUPERVISOR CHECKLIST:

NRC CODE PRIOR TO 0800 FOXTROT DELTA HOTEL OSCAR
 NRC CODE AFTER 0800 FOXTROT UNIFORM BRAVO ROMEO

1900-0700	0700-1900

1. Evolutions in progress and items to be completed during next shift, as noted in remarks, have been discussed with oncoming Unit Supervisor (including special evolutions, i.e. SICT/E, OPDRVs, etc.).
2. Problems encountered during past shift and abnormal plant conditions, as noted in remarks, have been discussed with oncoming Unit Supervisor.
3. Information in SOMS Log is complete and discussed with oncoming Unit Supervisor.
4. As applicable, turnover plastic Security Badge cover and CRS Monitor function to oncoming Unit Supervisor.

1900 - 0700 _____
 0700 - 1900 _____
 Offgoing Unit Supervisor

ONCOMING UNIT SUPERVISOR CHECKLIST:

0700	1900
-	-

1. LCO/TRO Log reviewed.
2. SOMS Log reviewed for entries made in past 24 hours.
3. Report any changes to license or medical status PER NDAP-QA-0723.

0700 - 1900 _____
 1900 - 0700 _____
 Oncoming Qualified Unit Supervisor

POST RELIEF

0700	1900
-	-

1. Walk down Control Room panels with Unit Responsible PCO.
2. CRC Book reviewed and Reactivity Brief performed with PCO.
3. Completed System Status Operable audit for open PMT this shift.
4. From the OPS Web page, Review OPS Aggregate Index for Challenges, Work Arounds, and Deficiencies Reports for impact on scheduled work activities and compensatory actions. ⁽²⁰⁾

0700 - 1900 _____
 1900 - 0700 _____
 Oncoming Unit Supervisor

1. PURPOSE

To provide instructions for performing periodic testing of the Reactor Feed Pumps and the Reactor Feed Pump support systems.

2. PROCEDURE

2.1 TEST OF STANDBY MAIN AND EMERGENCY OIL PUMPS

2.1.1 Prerequisites

- a. Lube oil systems in operation in accordance with OP-145-001.
- b. To test RFPT A(B)(C) EMERG L-O PP 1P125A(B)(C), Battery 1D650 and 1D660 equalize charge not in progress.

2.1.2 Precautions

None

NOTE (1): RFPT A(B)(C) main lube oil pumps are swapped quarterly. Pump 1P124A(C)(E) should be in service First and Third Quarters. Pump 1P124B(D)(F) should be in service Second and Fourth Quarters.

NOTE (2): The following alarms will be generated during this test:

AR-120 windows B03, B06 and B09
AR-101 windows H10, H12 and H14

2.1.3 **Determine** if pump swap will be performed.

- a. **IF** pump swap to be performed, **Continue** with Step 2.1.4.
- b. **IF not**, **Proceed** to Step 2.1.5.

2.1.4 **Swap** RFPT A(B)(C) main lube oil pumps as follows:

- a. **Depress AND Hold TEST** pushbutton for RFPT A(B)(C) ALT MN L-O PPS HS-11912A(B)(C).
- b. **Observe** standby lube oil pump starts by appropriate Red light **ILLUMINATED** at RFPT A(B)(C) ALT MN L-O PPS HS-11912A(B)(C) switch.

- c. **Release TEST** pushbutton for RFPT A(B)(C) ALT MN L-O PPS HS-11912A(B)(C).
- d. For Pump started in Step b., **Depress RUN** pushbutton for RFPT A(B)(C) MN L-O PP 1P124B(A) (1P124D(C)) (1P124F(E)).
- e. For pump previously in service, **Perform** following for RFPT A(B)(C) MN L-O PP 1P124A(B) (1P124C(D)) (1P124E(F)) to place in Standby:
 - (1) **Depress AUTO** pushbutton.
 - (2) **Depress STOP** pushbutton.
 - (3) **Depress AUTO** pushbutton.

2.1.5

Test RFPT A(B)(C) standby main lube oil pump auto-start as follows:

- a. **Depress AND Hold TEST** pushbutton for RFPT A(B)(C) ALT MIN L-O PPS HS-11912A(B)(C).
- b. **Observe** standby pump starts by appropriate red light **ILLUMINATED** at RFPT A(B)(C) ALT MN L-O PPS HS-11912A(B)(C) switch.
- c. **Release TEST** pushbutton for RFPT A(B)(C) ALT MN L-O PPS HS-11912A(B)(C).
- d. For pump started in Step b, **Perform** following for RFPT A(B)(C) MN L-O PP 1P124B(A) (1P124D(C)) (1P124F(E)) to return to Standby:
 - (1) **Depress AUTO** pushbutton.
 - (2) **Depress STOP** pushbutton.
 - (3) **Depress AUTO** pushbutton.

2.1.6 **Test RFPT A(B)(C) emergency oil pump auto-start as follows:**

- a. **Depress AND Hold TEST 1** pushbutton for RFPT A(B)(C) EMERG L-O PUMP TEST HS-11913A(B)(C) switch.
- b. **Observe Red light ILLUMINATES** at RFPT A(B)(C) EMERG L-O PP 1P125A(B)(C) switch.
- c. **Release TEST 1** pushbutton for RFPT A(B)(C) EMERG L-O PUMP TEST HS-11913A(B)(C).
- d. **Depress STOP** pushbutton at RFPT A(B)(C) EMERG L-O PP 1P125A(B)(C) switch.
- e. **Depress AUTO** pushbutton at RFPT A(B)(C) EMERG L-O PP 1P125A(B)(C) switch.
- f. **Depress AND Hold TEST 2** pushbutton for RFPT A(B)(C) EMERG L-O PUMP TEST HS-11913A(B)(C) switch.
- g. **Observe Red light ILLUMINATES** at RFPT A(B)(C) EMERG L-O PP 1P125A(B)(C) switch.
- h. **Release TEST 2** pushbutton for RFPT A(B)(C) EMERG L-O PUMP TEST HS-11913A(B)(C).
- i. **Depress STOP** pushbutton at RFPT A(B)(C) EMERG L-O PP 1P125A(B)(C) switch.
- j. **Depress AUTO** pushbutton at RFPT A(B)(C) EMERG L-O PP 1P125A(B)(C) switch.

Facility:	SSSES Units 1 and 2	Scenario No.:	3	Op-Test No.:	LOC26
Examiners:	_____	Operators:	_____	_____	_____
Initial Conditions	Unit 1 33 percent power shutting down for DW RCS leak, MOL HPCI OOSVC				
Turnover	Insert control rods, then test Turbine Bypass valve #3 RFP lube oil conditioner being swapped from A to B Control rods 42-15 and 46-19 declared slow last scram time test				

Event No.	Malf. No.	Event Type*	Event Description
1	N/A	R SRO,ATC	Insert control rods (OP-156-001, OP-AD-338)
2	N/A	N SRO,BOP	Test turbine bypass valve #3 (SO-182-001)
3	cmfHX02_1E102C	C SRO,BOP	FW heater 2C tube leak (AR-120-C10,D10), isolate FW heater extraction steam (ON-147-002), TS MCPR limits not applicable (TS 3.2.2)
4	cmfPM04_0P504C	I SRO,BOP	Diesel Generator C spurious start without cooling, manual ESW initiation required
5	cmfEB01_1A203 mfRR164 010	I SRO, ATC	ESS Bus 1C lockout, DW leak severity rises, reactor scram required (ON-104-203, TS 3.8.7)
6	mfRP158 003	M ALL	Electrical ATWS (EO-100-113), ARI inserts control rods
7	mfRR179 003	C ALL	Fuel failure with high MSL radiation, MSIV isolation required (AR-103-D01, AR-104-D01)
8	cmfMV06_HV149F013	I SRO,ATC	RCIC injection valve fails to open on initiation (OP-150-001)
9	mfRC150 004	M ALL	Unisolable RCS leak into Secondary Containment, 2 areas above Max Safe radiation (EO-100-104)
10	cmfMV01_HV149F007 cmfMV09_HV149F008	I SRO,BOP	RCIC steam isolation valves fail to automatically close (AR-108-F04,F05), manual isolation successful after reactor pressure reduced

*(N)ormal, (R)eactivity, (I)nstrument, (C)omponent, (M)ajor

Target Quantitative Attributes (Per Scenario; See Section D.5.d)	Scenario Events	Actual Attributes
1. Total malfunctions (5–8)	3,4,5,7,8,10	6
2. Malfunctions after EOP entry (1–2)	7,8,10	3
3. Abnormal events (2–4)	3,5	2
4. Major transients (1–2)	6,9	2
5. EOPs entered/requiring substantive actions (1–2)	EO-100-102 EO-100-104	3
6. EOP contingencies requiring substantive actions (0–2)	EO-100-113 EO-100-112	2
7. Critical tasks (2–3) CT-1 Manually initiate ARI. CT-2 Rapidly depressurize the reactor when two Secondary Containment Areas exceed Max Safe Rad levels.		2



PPL-SUSQUEHANNA, LLC LEARNING CENTER

SIMULATOR SCENARIO

Scenario Title: Reactor Shutdown / FW Heater Tube Leak / ESS Bus Lockout / ATWS / Fuel Failure / RCIC Steam Leak / Rapid Depressurization

Scenario Duration: 1 hour 15 minutes

Scenario Number: LOC26-NRC-3

Revision / Date: 0 / June 23, 2014

Course: PC017 SRO License
PC018 RO License

Prepared By:	Robert A. Thompson	06/23/2014
	Instructor	Date

Reviewed By:	<i>Neil J. Meylitz</i>	6/30/14
	Operations Training Management	Date

Approved By:	<i>T. Cleary</i>	6-30-14
	Operations Line Management	Date

THIS PAGE IS INTENTIONALLY LEFT BLANK

SCENARIO SUMMARY

The scenario begins with Unit 1 shutting down for an unplanned maintenance outage to identify and repair a small RCS leak in the Drywell, 300 days into the operating cycle. Unidentified DW leakage is steady at approximately 0.5 gpm. Reactor power is 33 percent with RFP A in-service in Flow Control Mode. HPCI is in day 2 of a 4-day unplanned maintenance window. The RFP lube oil conditioner is being placed on the RFP B reservoir after being removed from the RFP A reservoir last shift in preparation for a RFP A main lube oil pump test. Control rods 42-15 and 46-19 were declared slow during the last scram time test.

The first task for the crew is to insert control rods to lower power to approximately 30 percent. The crew will then cycle Main Turbine Bypass valve #3 per SO-182-001 to demonstrate functionality of the valve prior to scram.

When the reactivity maneuver has been completed, a tube leak will develop on the 2C feedwater heater. The leak will initially be within the capability of the dump valve, but will continue to degrade until a heater isolation on high-high level occurs. The crew will respond to the isolation by isolating the extraction steam supplies to the 3C, 4C and 5C heaters and other inputs in accordance with off-normal procedures, and verify the high FW heater levels clear within 15 minutes or trip the main turbine.

Once the crew has completed off-normal procedures for the feedwater heater isolation, Diesel Generator C will spuriously start. ESW Pump C will fail to automatically start and must be manually started to provide cooling to the DG. When the breaker for ESW Pump C closes, a fault in the breaker will result in an ESS Bus 1C lockout. The crew will align Instrument Air to Containment Instrument Gas to maintain AOVs in the Drywell functional. The leak in the Drywell will degrade coincident with the bus lockout, resulting in a more rapid rise in Drywell temperature and pressure. The crew should complete activities associated with the loss of ESS Bus 1C and insert a manual scram before an automatic scram on high Drywell pressure is received.

When the reactor is scrammed RPS will fail to de-energize, resulting in an electrical ATWS. When ARI is initiated, control rods will slowly drift in when ARI is initiated, resulting in significant fuel cladding failure. The Scram Discharge Volume drains will be failed open, allowing the spread of highly radioactive coolant into the CRD HCU area. This will result in radiation levels rapidly exceeding the EO-104 maximum safe values. The magnitude of the fuel failure will also result in MSL high radiation signals that will require the MSIVs to be closed.

RPV level and pressure control will be with RCIC and SRVs. The RCIC injection valve will fail to automatically open and must be manually opened. Reactor pressure may be lowered to 500-600 psig to allow Condensate to be used for reactor level control.

Once RCIC has been initiated and the CRD HCU area radiation levels have exceeded the max safe value a steam leak will develop in the RCIC room. The isolation logic will fail and both isolation valves will fail to close automatically or manually. RCIC room radiation levels will quickly rise to maximum safe levels. With radiation levels in two areas above max safe, and an unisolable primary system leak outside the primary containment, EO-104 requires Rapid Depressurization. As reactor pressure lowers, the RCIC outboard isolation valve will stroke fully closed. The scenario may be terminated when reactor level has been stabilized in the normal band with Condensate and actions to place RHR in Suppression Pool cooling have been initiated.

THIS PAGE IS INTENTIONALLY LEFT BLANK

SCENARIO REFERENCES

1. OP-AD-001 Operations Standards For System And Equipment Operation
2. OP-AD-002 Standards For Shift Operations
3. OP-AD-004 Operations Standards For Error And Event Prevention
4. OP-AD-055 Operations Procedure Program
5. OP-AD-338 Reactivity Manipulation Standards and Communication Requirements
6. OP-054-001 Emergency Service Water
7. OP-156-001 Reactor Manual Control System
8. SO-182-001 Monthly Turbine Bypass Valve Testing
9. ON-100-101 Scram, Scram Imminent
10. ON-004-002 Energizing Dead 4KV ESS Bus
11. ON-104-203 Loss of 4KV ESS Bus(1A203)
12. On-125-001 Loos of Containment Instrument Gas
13. ON-147-002 Anticipated Loss of FW HTR String
14. ON-179-001 Increasing Offgas MSL Rad Levels
15. EO-000-102 RPV Control
16. EO-000-103 Primary Containment Control
17. EO-000-104 Secondary Containment Control
18. EO-000-105 Radioactivity Release Control
19. EO-000-112 Rapid Depressurization
20. EO-100-113 Power/Level Control
21. EO-100-114 RPV Flooding
22. ES-2158-001 De-energizing Scram Pilot Solenoids
23. EP-RM-004 EAL Classification Levels
24. AR-015-C16 DG Panel 0C521C LO Priority Trouble
25. AR-106-F03 Offgas Hi Hi Radiation
26. AR-108-E05 RCIC Leak Detection Hi Temp/Hi Diff Temp
27. AR-110-A01 ADS Logic A Timer Initiated
28. AR-110-A02 ADS Logic C Timer Initiated
29. AR-110-A03 ADS Logic B Timer Initiated
30. AR-110-A04 ADS Logic D Timer Initiated
31. AR-120-D10 FW HTR C Dump Vlv Open
32. TS 3.8.1 AC Sources Operating
33. TS 3.7.6 Plant Systems Main Turbine Bypass System
34. TR 3.2.1 Core Operating Limits Report (COLR)

THIS PAGE IS INTENTIONALLY LEFT BLANK

SCENARIO TASKS

Crew Position	Task	Description
PCO	2032	Implement Insert Control Rod One Notch
	3519	Implement Monthly Turbine Bypass Valve Cycling
	4670	Implement Placing Feedwater In Startup Level Control Following Reactor Scram
	1923	Implement Automatic Initiation (RCIC)
	1296	Implement Appropriate Portions Of Fire Alarm Response
	2387	Implement Manual Operation Of Safety/Relief Valves
	1874	Implement RHR Operation In Containment Cooling Mode
US	1185	Apply Technical Specification (TS) And Technical Requirements Manual (TRM) Requirements
TEAM	1138	Implement Appropriate Portions Of Plant Shutdown To Minimum Power
	1861	Implement Loss Of Feedwater Heater String
	1977	Implement Loss Of Emergency Service Water (ESW)
	1204	Implement Loss Of 4 KV ESS Bus 1C
	1484	Implement Loss Of Containment Instrument Gas
	1151	Implement Excess Drywell Leakage
	1147	Implement Scram, Scram Imminent
	1125	Implement RPV Control
	2565	Implement Increasing Offgas / MSL Rad Levels
	1127	Implement Secondary Containment Control
	2084	Implement Containment Isolation
	1129	Implement Rapid Depressurization
	2784	Implement Reactivity Manipulations Standards and Communication Requirements
	1081	Implement Appropriate Portions Of Operations Standards For System and Equipment Operation
1091	Implement Operations Standards For Error And Event Prevention	

THIS PAGE IS INTENTIONALLY LEFT BLANK

CRITICAL TASKS

Manually initiate ARI	
Safety Significance	Control rod insertion initiates power reduction immediately.
Consequences for Failure to Perform the Task	Failure to insert control rods allows power to remain elevated with resultant power oscillations and potential core damage.
Indications/Cues for Event Requiring Critical Task	Exceeding a RPS scram setting with NO reactor scram signal, or RPS/ARI fail to fully insert all control rods.
Performance Criteria	Insert Control Rods by one or more of the following methods: arm and depress Division 1 and 2 ARI initiation pushbuttons.
Performance Feedback	ARI Division 1 and 2 vent valves open, block valves close. Rod position full-in indication when control rod insertion complete.
Rapidly depressurize the reactor when two Secondary Containment Areas exceed Max Safe Rad levels	
Safety Significance	High energy leak in the Secondary Containment Area impacts the integrity of Secondary Containment. Failure of the Secondary Containment directly relates to the 10CFR50.67 design criteria of dose to the General Public.
Consequences for Failure to Perform the Task	Failure to take actions to mitigate the energy released to the secondary containment directly affects the radiation dose to the General Public.
Indications/Cues for Event Requiring Critical Task	Increasing area radiation and alarms for RB Areas indicating levels at Max Safe values, PICSY formats indicating radiation values greater than Max Safe values.
Performance Criteria	Perform a Rapid Depressurization per EO 100 112 when two or more RB areas exceed max safe radiation per EO 100 104 Table 9 (10 R/hr for all areas)
Performance Feedback	Initiating a rapid depressurization causes Reactor pressure to lower which lowers the driving force of any primary system breach. Verify ADS valves are open using light red light indication, acoustic monitoring and lowering Reactor pressure and rising reactor water level.

THIS PAGE IS INTENTIONALLY LEFT BLANK

SCENARIO MALFUNCTIONS

Event	Description	Crew Response
1	FW Heater 2C tube leak	Isolate FW Heater extraction steam (ON-147-002)
2	Diesel Generator C spurious start without cooling	Manual ESW initiation required (OP-054-001)
3	ESS Bus 1C lockout, Drywell leak severity rises	Manually scrams the reactor (ON-104-203)
4	Fuel failure with high MSL radiation	Manual isolation of MSIVs required
5	RCIC injection valve fails to automatically open on initiation	Manually opens RCIC injection valve (OP-150-001)
6	RCIC steam isolation valves fail to automatically close	Dispatches NPO to close locally

ABNORMAL EVENTS / MAJOR TRANSIENTS / TECH SPEC

Malfunction	Description
AE1	FW Heater 2C tube leak (ON-147-002)
AE2	ESS Bus 1C lockout, Drywell leak severity rises (ON-104-203)
MT1	Electrical ATWS, ARI inserts rods (EO-100-113)
MT2	Unisolable RCIC leak into secondary containment, 2 areas above max safe radiation (EO-100-104)
TS1	FW Heater 2C tube leak (TS 3.2.2)
TS2	ESS Bus 1C lockout, Drywell leak severity rises (TS 3.8.7)

THIS PAGE IS INTENTIONALLY LEFT BLANK

SCENARIO SPECIAL INSTRUCTIONS

1. Simulator setup
 - a. **Initialize** to an exam-specific IC (IC-382). If an exam-specific IC is not available, then setup the IC as follows:
 - i) **Initialize** to IC-20
 - ii) **Insert** a recirc LIM2 runback
 - iii) **Disable** the IND RFP FLOW < 16.4% LIM2 runback and **select** FW flow to VENTURI
 - iv) **Insert** remote function rFW145032 to CLOSE
 - v) **Place** RFP C in STANDBY, **secure** Condensate Pump D
 - vi) **Remove** 2 condensate demins from service and shutdown HWC
 - vii) **Insert** control rods to < 60 percent rod-line and lower power to 37-38 percent using recirc
 - viii) **Place** RFP B in STANDBY and trip RFP C
 - ix) **Reduce** Recirc Pump speeds to < 30 percent
 - x) **Isolate** HPCI, **depressurize** the steam line with the LV-155-F054, and **run** SCN file exam\HPB_HPCIOOS.scn.
 - b. **Run** SCN file exam\LOC26-N03.scn
 - c. **Open** TREND files rat.tnd, LOC26-N03-1.tnd, LOC26-N03-2.tnd, LOC26-N03-3.tnd

2. **Place** the simulator in RUN
3. **Verify** the following malfunctions/overrides, event triggers and key assignments:

MF	RF	OR	SCN	ET	COND
17:17	4:4	1:1	0:0	8:0	7

4. **Prepare** the simulator for evaluation
 - a. **Complete** a simulator exam checklist, TQ-106-0315
 - b. **Reset** ODAs and all Overhead, PICSY, HMI and RWM alarms
 - c. **Ensure** FWLC is selected to VENTURI
 - d. **Ensure** correct CRC book is staged and marked-up for current plant conditions
5. **Prepare** a Turnover Sheet including the following:
 - a. Unit 1
 - i) 300 days on-line
 - ii) Shutdown in progress to identify and repair small RCS leak in Drywell. Unidentified leak rate 0.5 gpm steady for 36 hours. ON-100-005 actions are complete. 12-hour leakrate calculations are being performed.
 - iii) Reactor power approximately 33 percent, 1 RFP in FCM.
 - iv) Next activity is to perform test of Bypass Valve #3 per SO-182-001 for valve functional test.
 - v) Insert next step of control rods once Bypass Valve test complete.
 - vi) HPCI in day 2 of a 4-day system outage window.
 - vii) RFP lube oil conditioner being placed on RFP B reservoir. Removed from RFP A for upcoming main lube oil pump test.
 - viii) Control rods 42-15 and 46-19 were declared slow during the last scram time test.
 - b. Common
 - i) Unit 2 at rated power.
6. **Document** training participation and feedback
 - a. **Ensure** all present have signed Security Agreements per NUREG-1021 and TQ-104-0306
 - b. **Show** the crew that the Evaluators and Booth Operators are qualified
 - c. **Complete** an Operator Fundamental Score Card

THIS PAGE IS INTENTIONALLY LEFT BLANK

SCENARIO FILES

LOC26-N03.scn

```

; Monitored Parameters
SCN rat_mp
SCN exam\LOC26-N03-MP
; 0-G alarms suppressed SDR #
IMF annAR106F15 f:ALARM_OFF
IMF annAR131A04 f:ALARM_OFF
; small dw leak
IMF mFRR164010 f:.1
IMF cmfTR01_LT16102A
IMF cmfTR01_LT16102B
; ESW Pump C fail to auto-start
IMF cmfPM04_0P504C
; FWH trouble alarms defeated
IMF annAR120H10 f:ALARM_ON
IMF annAR120H07 f:ALARM_ON
IMF annAR120H04 f:ALARM_ON
; Electrical ATWS
IMF mFRP158003
; ARI outlets partially blocked
IRF rFRD155030 f:1
; SLC HS fails
IOR diHSS14804 f:STOP
; SDV drains failed open, vents delayed
closure
IMF mFRD155018
IMF cmfAV09_XV147F010 f:300
IMF cmfAV09_XV147F180 f:300
; RCIC F013 valve auto-open failure
IMF cmfMV06_HV149F013
; RCIC isol valve auto logic fail
IMF cmfMV06_HV149F007
IMF cmfMV06_HV149F008
; ESS Bus 1C lockout on ESW C start
aet LOC26-N03-1
; terminate LOCA severity on scram
aet LOC26-N03-1A
; Fuel failure and spurious RCIC init on
rod drift
aet LOC26-N03-2
; Delete MSIV rad malfunction on MSIV
closure
aet LOC26-N03-3
; RCIC room steam leak
aet LOC26-N03-4
; RCIC I/B F007 breaker trip on close
aet LOC26-N03-5
; RCIC O/B F008 breaker stuck on close
aet LOC26-N03-6
; RCIC O/B F008 valve closes on blowdown
aet LOC26-N03-7
; FWH 2C tube leak
{Key[1]} IMF cmfHX02_1E102C r:300 i:5 f:15
; FWH 2C tube leak degrades
{Key[2]} IMF cmfHX02_1E102C r:60 f:20
; FWH 2C dump/drain 3C drain
{Key[3]} SCN exam\LOC26-N03-A
; RFP seal water iso
{Key[4]} IMF cmfAV01_HV10244B
; Spurious DG C start
{Key[5]} IOR diHS00051C c:1 f:RESET

```

```

{Key[5]} IMF annLA521CD06 c:10 f:ALARM_ON
; Xtie I/A to CIG
{Key[6]} IRF rFPC125001 f:OPEN

```

LOC26-N03-A.scn

```

IOR diLIC10306CD_Q f:MANUAL
IOR diLIC10306CB_Q f:OPEN
IOR diLIC10302CD_Q f:MANUAL
IOR diLIC10302CA_Q f:OPEN
IOR diLIC10407CD_Q f:MANUAL
IOR diLIC10407CB_Q f:CLOSE

```

LOC26-N03-B.scn

```

IMF mFRR179003 i:2 f:5 r:600
IMF cmfTR02_RIT13705 r:68 f:1000
IMF cmfTR02_RIT13706 r:59 f:1000
IMF cmfTR02_RIT13750 d:45 r:30:00 f:65
IMF cmfTR02_RIT13751 d:40 r:30:00 f:66
IMF mFRM179004A r:300 f:50000
IMF mFRM179004B r:300 f:50000
IMF mFRM179004C r:300 f:50000
IMF mFRM179004D r:300 f:50000

```

LOC26-N03-MP.scn

```

insmp tcvpbv3
changemp tcvpbv3 ,,BYPASS VALVE POSITION 3
insmp fwlt10303c1
changemp fwlt10303c1 ,,FWH 2C LEVEL
insmp ycpxnbt01
changemp ycpxnbt01 ,,DEG F,TFW A
insmp rdpic121r013
changemp rdpic121r013 ,,psig,SCRAM AIR HDR
PRESS
insmp ycpxpar05
changemp ycpxpar05 ,,MR/HR,CRD N ARM LO-RNG
insmp ycpxpar06
changemp ycpxpar06 ,,MR/HR,CRD S ARM LO-RNG
insmp ycpxpar50
changemp ycpxpar50 ,,MR/HR,CRD N ARM HI-RNG
insmp ycpxpar51
changemp ycpxpar51 ,,MR/HR,CRD S ARM HI-RNG
insmp ycpxpar02
changemp ycpxpar02 ,,MR/HR,RCIC RM ARM LO-
RNG
insmp ycpxpar57
changemp ycpxpar57 ,,MR/HR,RCIC RM ARM HI-
RNG
insmp ycpxmar01
changemp ycpxmar01 ,,R/HR,CTMT HI-RANGE ARM
insmp aoURSG331N605A.CurrValue
changemp aoURSG331N605A.CurrValue 0,350,DEG
F,RCIC RM TEMP

```

HPB_HPCIOOS.scn

```

IRF rFDB106236 f:OPEN
IRF rFDC188113 f:OPEN
IRF rFDC188128 f:OPEN
IMF cmfAV01_HV155F100

```

LOC26-N03-1.et/scn

doHS01102C_2.CurrValue =
#OR.doHS01102C_2.ON
IMF cmfEB01_1A203 d:1
MMF mfRR164010 f:.2

LOC26-N03-1A.et/scn

pcpdwg > 1.8 | diHSC72A1501.CurrValue !=
#OR.diHSC72A1501.RUN
MMF mfRR164010 f:0.0

LOC26-N03-2.et/scn

rdpic121r013 < 42
SCN exam\LOC26-N03-B
IMF mfRC150006

LOC26-N03-3.et/scn

msvsphv141f022a < .1 & msvsphv141f022b < .1
& msvsphv141f022c < .1 & msvsphv141f022d < .1
.1
MMF mFRM179004A r:300 f:50 c:300
MMF mFRM179004B r:300 f:50 c:300
MMF mFRM179004C r:300 f:50 c:300
MMF mFRM179004D r:300 f:50 c:300

LOC26-N03-4.et/scn

rcvsphv150f045 > 0.1 & ycpxpar50 > 10
IMF mfRC150004 f:20
IMF cmfTR03_RIT13702 i:0 f:1000 r:120
IMF cmfTR02_RIT13757 d:30 r:900 f:16

LOC26-N03-5.et/scn

diHS14907A.CurrValue = #OR.diHS14907A.CLOSE
IMF cmfMV01_HV149F007 d:1

LOC26-N03-6.et/scn

diHS14908A.CurrValue = #OR.diHS14908A.CLOSE
IMF cmfMV09_HV149F008 f:90 d:2
IMF cmfMV07_HV149F008 f:90 d:10

LOC26-N03-7.et/scn

rrpdome < 100
MMF cmfMV09_HV149F008 f:0 r:10

LOC26-N03-8A.et/scn

asdf diHS15128A.CurrValue =
#OR.diHS15128A.OPEN
cet LOC26-N03-8B
IMF cmfMV07_HV151F028A f:0
IOR doHS15128A_2 d:1 f:ON
IOR doHS15128A_1 d:56 f:OFF

LOC26-N03-8B.et/scn

diHS15128B1.CurrValue =
#OR.diHS15128B1.OPEN
cet LOC26-N03-8A
IMF cmfMV07_HV151F028B f:0
IOR doHS15128B1_2 d:1 f:ON
IOR doHS15128B1_1 d:56 f:OFF

THIS PAGE IS INTENTIONALLY LEFT BLANK

SCENARIO EVENT DESCRIPTION FORM

Initial Conditions: Ensure shift positions are assigned, have the Crew conduct the turnover and perform a panel walk down before the start of the scenario.

EVENT	TIME	DESCRIPTION
N/A	0	Crew assumes shift
A	0	Control rod insertion to lower power
B	10	Turbine bypass valve #3 test
C	20	FW Heater 2C tube leak
D	35	ESS Bus 1C lockout / reactor scram
E	45	Electrical ATWS
F	50	Fuel failure / MSIV closure
G	60	RCIC unisolable steam leak
H	70	Rapid Depressurization
N/A	75	Termination

INSTRUCTOR ACTIVITIES / ROLE PLAY / NOTES

EVENT	A
BRIEF DESCRIPTION	Control rod insertion to lower power

OPERATOR ACTIVITY

1. None

ROLE PLAY

1. As **RxEng** contacted for assistance, **report**
Core thermal limits are within our predictions. You may proceed with the pattern adjustment.
2. As **Shift Manager** contacted for approval to commence the reactivity manipulation, **report**
The reactivity manipulation may proceed per the RMR.
3. **Role play** any other directed actions as required.

EVALUATOR NOTES

1. None

SCENARIO EVENT FORM

EVENT	A
BRIEF DESCRIPTION	Control rod insertion to lower power

POSITION	TIME	STUDENT ACTIVITIES
PCOM		<p>Inserts control rods 30-23, 30-39, 38-31 and 22-31 from position 48 to position 00 per OP-156-001 and OP-AD-338 to lower power to approximately 30 percent</p> <ul style="list-style-type: none"> • Select control rod to be inserted one notch by Depressing corresponding CONTROL ROD SELECTION pushbuttons • Observe: <ul style="list-style-type: none"> ○ CONTROL ROD SELECTION pushbuttons ILLUMINATED ○ FULL CORE DISPLAY ILLUMINATED GREEN at selected location ○ Present position of selected rod INDICATED on FOUR ROD DISPLAY on CRT and Standby Information Panel 1C652 • Momentarily Depress INSERT ROD pushbutton until the rod insert light illuminates • During insert cycle, Observe following occur in sequence within ~ 10 seconds <ul style="list-style-type: none"> ○ ROD INSERT light ILLUMINATES <u>THEN</u> EXTINGUISHES ○ Insert drive flow of approx. 4-5 gpm during control rod insertion on CRT FOUR ROD DISPLAY ○ ROD SETLG light ILLUMINATED <u>THEN</u> EXTINGUISHES at end of cycle • Observe at FOUR ROD DISPLAY control rod inserts one notch from previous position <u>AND</u> position indicated is an even number • When all 4 steps are complete, reselects and confirms previous moves per the control rod movement sheet by performing the following for each control rod moved: <ul style="list-style-type: none"> ○ Select control rod to be withdrawn one notch by depressing corresponding CONTROL ROD SELECTION pushbuttons ○ Observe <ul style="list-style-type: none"> ▪ CONTROL ROD SELECTION pushbuttons ILLUMINATED. ▪ FULL CORE DISPLAY ILLUMINATED Green at selected location. • Present position of selected rod INDICATED on FOUR ROD DISPLAY on CRT and Standby Information Panel 1C652 matches control rod movement sheet as-left position
		Depress ROD SELCT CLEAR pushbutton
		Per GO-100-012, plots power change on power/flow map

★ Denotes Critical Task

SCENARIO EVENT FORM

EVENT	A
BRIEF DESCRIPTION	Control rod insertion to lower power

POSITION	TIME	STUDENT ACTIVITIES
PCOM (cont'd)		Monitors diverse indications of reactor power (APRMs, heat balance, Main Generator output) per OP-AD-001 Att G
PCOP		Verifies control rods to be inserted as directed by RMR per OP-AD-338
		Per OP-AD-002 Section 7.11 (or AR-106-C09) null Manual and Automatic regulators using MAN VOLT REG ADJUST HC-10002 potentiometer
		Maintains Load Set approximately 100 MWe above actual generator load per GO-100-004 by depressing LOAD SELECTOR DECREASE and INCREASE PBs as necessary
US		Obtains permission from the Shift Manager prior to commencing reactivity manipulations
		Informs GCC/TCC of load change on Unit 1
		Conducts a Crew Update prior to commencing rod insertion
		Directs control rod insertion per OP-156-001, RMR and GO-100-012
		Monitors control rod movement with independent copy of RMR
		Conducts a Crew Update after control rod insertion is complete

★ Denotes Critical Task

NOTES	
--------------	--

SCENARIO EVENT DESCRIPTION FORM

EVENT	TIME	DESCRIPTION
N/A	0	Crew assumes shift
A	0	Control rod insertion to lower power
B	10	Turbine bypass valve #3 test
C	20	FW Heater 2C tube leak
D	35	ESS Bus 1C lockout / reactor scram
E	45	Electrical ATWS
F	50	Fuel failure / MSIV closure
G	60	RCIC unisolable steam leak
H	70	Rapid Depressurization
N/A	75	Termination

INSTRUCTOR ACTIVITIES / ROLE PLAY / NOTES

EVENT	B
BRIEF DESCRIPTION	Turbine bypass valve #3 test

OPERATOR ACTIVITY

1. None

ROLE PLAY

1. As **GCC/TCC** informed of turbine bypass test, **report**

Grid conditions are stable thank you for the notification. Inform us when testing is completed.

2. **Role play** any other directed actions as required.

EVALUATOR NOTES

1. None

SCENARIO EVENT FORM

EVENT	B
BRIEF DESCRIPTION	Turbine bypass valve #3 test

POSITION	TIME	STUDENT ACTIVITIES
PCOM		Monitors diverse indications of reactor power (APRMs, heat balance, Main Generator output) per OP-AD-001 Att G
PCOP		<p>Performs Testing of Bypass Valve #3 as follows:</p> <ul style="list-style-type: none"> • SELECT position 3 on BPV TEST SELECT switch AND • Verify the following BYPASS VALVE TEST status lights: <ul style="list-style-type: none"> ○ Green READY light ILLUMINATED ○ Amber TESTING light ILLUMINATED • DEPRESS <u>AND</u> HOLD TEST BYPASS VALVE pushbutton • VERIFY the following BYPASS VALVE TEST status light indications: <ul style="list-style-type: none"> ○ Green READY light EXTINGUISHED ○ Amber TESTING light ILLUMINATED ○ Amber DO NOT SELECT light ILLUMINATED • OBSERVE MAIN STEAM BYPASS VALVE 3 (BPV 3) normal AND fast acting devices are operational as follows: <ul style="list-style-type: none"> ○ BPV 3 slowly opens for first approximately 90 percent of stroke ○ BPV 3 fast opens for last approximately 10 percent of stroke • VERIFY MAIN TURBINE BYPASS VALVES OPEN, annunciator AR105-I06 ILLUMINATES • <u>WHEN</u> BPV 3 indicates FULL OPEN • <u>THEN</u> RELEASE TEST BYPASS VALVE pushbutton • VERIFY the following: <ul style="list-style-type: none"> ○ BPV 3 indicates FULL CLOSED ○ Amber DO NOT SELECT status light <u>NOT</u> ILLUMINATED ○ Green READY status light ILLUMINATED ○ MAIN TURBINE BYPASS VALVES OPEN, annunciator AR105-I06 <u>NOT</u> ILLUMINATED ○ Amber TESTING light ILLUMINATED

★ Denotes Critical Task

SCENARIO EVENT FORM

EVENT	B
BRIEF DESCRIPTION	Turbine bypass valve #3 test

POSITION	TIME	STUDENT ACTIVITIES
US		Conducts Crew Update for performing SO-182-001, Monthly Turbine Bypass Valve Cycling to demonstrate functionality of Main Turbine Bypass Valve #3
		Directs PCOP to perform SO-182-001 to demonstrate functionality of the Main Turbine Bypass Valve #3
		Evaluates Tech Spec 3.7.6 Condition A. Determines four bypass valves are required, only 3 are operable
		Reviews TR 3.2.1 (COLR) section 5.0 for MCPR and determines bypass valves are inoperable. Contacts RE to determine current MCPR value

★ Denotes Critical Task

NOTES	
--------------	--

SCENARIO EVENT DESCRIPTION FORM

EVENT	TIME	DESCRIPTION
N/A	0	Crew assumes shift
A	0	Control rod insertion to lower power
B	10	Turbine bypass valve #3 test
C	20	FW Heater 2C tube leak
D	35	ESS Bus 1C lockout / reactor scram
E	45	Electrical ATWS
F	50	Fuel failure / MSIV closure
G	60	RCIC unisolable steam leak
H	70	Rapid Depressurization
N/A	75	Termination

INSTRUCTOR ACTIVITIES / ROLE PLAY / NOTES

EVENT	C
BRIEF DESCRIPTION	FW Heater 2C tube leak

OPERATOR ACTIVITY

1. When the bypass valve test circuit has been turned off, **depress KEY 1** to initiate a tube leak in FW heater 2C. The tube leak will take 2-3 minutes to result in a noticeable rise in FW heater level.

{Key[1]} IMF cmfHX02_1E102C r:300 i:5 f:15 **FWH 2C tube leak**

2. Once the crew has diagnosed the tube leak and initiated actions to isolate FW heater 2C, if desired **depress KEY 2** to raise the severity of the leak.

{Key[2]} IMF cmfHX02_1E102C r:60 f:20 **FWH 2C tube leak degrades**

3. When directed, **depress KEY 3** to configure FW heater 2C and 3C drains and dumps per ON-147-002 Step 3.7.

{Key[3]} SCN exam\LOC26-N03-A **FWH 2C dump/drain 3C drain**

4. When directed, **depress KEY 4** to close RFP C seal water bleed-off valve HV-10244C per Step 3.8 of ON-147-002.

{Key[4]} IMF cmfAV01_HV10244B **RFP seal water iso**

ROLE PLAY

1. As **NPO** dispatched to FW heater C panel 1C103, **wait 2 minutes and report**

The 2C FW heater level control and emergency dump valves are responding. Heater level is continuing to rise.

2. As **WWM** contacted for assistance with FW heater C, **wait 5 minutes and report**

Engineering recommends removing the 2C FW heater from service and isolating it.

3. **Role play** any other directed actions as required.

EVALUATOR NOTES

1. None

SCENARIO EVENT FORM

EVENT	C
BRIEF DESCRIPTION	FW Heater 2C tube leak

POSITION	TIME	STUDENT ACTIVITIES
PCOM		Monitors neutron instrumentation for indication of core instability
PCOP		Performs AR-120-D10,FW HTR STRING C DUMP VLV FULL OPEN
		Dispatches NPO to 1C103 to ensure FW Htr 3C to 2C Iso Vlv 100% OPEN and Identify Feedwater Heater level control valve 100% open alarm
		Performs ON-147-002 to isolate extraction steam supplies to the 3C, 4C and 5C heaters as follows: <ul style="list-style-type: none"> • Close/Ensure Closed the affected Feedwater Heater String's Extraction Steam Isolation Valves: <ul style="list-style-type: none"> ○ HTR 5C HP EXTR ISO HV-10242C ○ HTR 4C LP EXTR ISO HV-10241C ○ HTR 3 LP EXTR ISO HV-10240C • Close/Ensure Closed the following inputs to the affected Feedwater Heater: <ul style="list-style-type: none"> ○ SSE DRN TO HTR 2C HV-10270C ○ MSEP A DRN TO HTR 4C HV-10213C ○ MSEP B DRN TO HTR 4C HV-10216C • Close/Ensure Closed the Feedwater Heater String Isolation valves: <ul style="list-style-type: none"> ○ HTR STRING C DSCH ISO HV-10620C ○ HTR STRING C INLET HV-10639C ○ HTR STRING C INLET BYPS HV-10659C • Check other feedwater heater instrumentation for high level
		Dispatches NPO to perform ON-147-002, step 3.7 at panel 1C103 to configure FW heater vent and drain valves
		Directs NPO to perform ON-147-002, step 3.8 to Close the RFP Seal Water Bleed Off HV-10244C at 1C153B-C instrument rack (699').
US		Performs Crew Update for entering ON-147-002 for Anticipated Loss/Loss of Feedwater Heater String.
		Directs PCOP to perform ON-147-002 to isolate FW Heater String C

★ Denotes Critical Task

NOTES

THIS PAGE IS INTENTIONALLY LEFT BLANK

SCENARIO EVENT DESCRIPTION FORM

EVENT	TIME	DESCRIPTION
N/A	0	Crew assumes shift
A	0	Control rod insertion to lower power
B	10	Turbine bypass valve #3 test
C	20	FW Heater 2C tube leak
D	35	ESS Bus 1C lockout / reactor scram
E	45	Electrical ATWS
F	50	Fuel failure / MSIV closure
G	60	RCIC unisolable steam leak
H	70	Rapid Depressurization
N/A	75	Termination

INSTRUCTOR ACTIVITIES / ROLE PLAY / NOTES

EVENT	D
BRIEF DESCRIPTION	ESS Bus 1C lockout / reactor scram

OPERATOR ACTIVITY

- When the crew has completed isolation of FW heater 2C, **depress KEY 5** to initiate a spurious start of Diesel Generator C.

{Key[5]} IOR diHS00051C c:1 f:RESET **Spurious DG C start**
{Key[5]} IMF annLA521CD06 c:10 f:ALARM_ON
- Ensure** Event Trigger LOC26-N03-1 initiates when ESW Pump C is started to cause a lockout of ESS Bus 1C.
- When directed, **depress KEY 6** to cross-tie Instrument Air to CIG.

{Key[6]} IRF rPC125001 f:OPEN **Xtie I/A to CIG**
- Ensure** Event Trigger LOC26-N03-1A initiates when the mode switch is placed to SHUTDOWN or DW pressure reaches 1.72 psig to terminate the rise in DW leak severity.

ROLE PLAY

- As **NPO** dispatched to DG C, **wait 2 minutes and report**

The diesel is running normally. The only alarm was low starting air pressure, but both compressors are running and it is clear now.
- As **WWM** contacted for assistance with DG C spurious start, **acknowledge** the request and take no further action.
- As **NPO** dispatched to ESS Bus 1C, **wait 2 minutes and report**

There is a lockout tripped, it looks like a bus differential.
- As **WWM** contacted for assistance with ESS Bus 1C lockout, **wait 5 minutes and report**

Electrical Maintenance found that a fault of the ESS Pump C breaker was the cause of the bus lockout. Repairs to the ESS bus will be required before it can be re-energized.
- Role play** any other directed actions as required.

EVALUATOR NOTES

- None

SCENARIO EVENT FORM

EVENT	D
BRIEF DESCRIPTION	ESS Bus 1C lockout / reactor scram

POSITION	TIME	STUDENT ACTIVITIES
PCOM		Inserts a manual scram by placing the Mode Switch to Shutdown. Identifies more than 1 control rod is greater than position 00. Informs US of ATWS.
PCOP		Performs AR-015-C16 for DG C PANEL 0C521C LO PRIORITY TROUBLE, DG C spurious start
		Dispatches NPO to DG C.
		Informs US that C ESW pump did not automatically start with the spurious start of DG C.
		Places ESW in service in accordance with OP-054-001 as follows: <ul style="list-style-type: none"> • Depresses ESW Pump 0P504C RUN pushbutton • Depresses ESW Pump 0P504B(D) RUN pushbutton
		Per ON-104-203 Att C directs NPO to crosstie Instrument Air to CIG 90# header in accordance with ON-125-001, Loss of CIG
		Performs ON-104-203 Att D by confirming the following auto starts and transfers as follows: <ul style="list-style-type: none"> • RBCCW pump 1P210A STARTS • TB Chiller 1K102B STARTS • TB Chiller 2K102B STARTS • RB Chiller 1K206B STARTS • RB Chiller 2K206B STARTS • Train B Fans START • CS Chiller 0K112B STARTS • D/G MCC 0B536 TRANSFERS to Unit 2 source • Instrument Bus 1Y218/1Y219 TRANSFERS to alternate source 1B216

SCENARIO EVENT FORM

EVENT	D
BRIEF DESCRIPTION	ESS Bus 1C lockout / reactor scram

US		Contacts WWM for Maintenance investigation of spurious start of DG C
		Directs PCOP to manually initiate cooling to the DG C
		Enters following LCOs <ul style="list-style-type: none"> • For DG C spurious initiation, TS 3.8.1 Condition B for 1 required DG inoperable • For ESS Bus 1C lockout TS 3.8.7 Condition A for a required AC distribution system inoperable
		Conducts a Crew Update for entering ON-104-203 for a loss of 4kV bus 1C, On-004-002, Energizing a Dead 4kV ESS Bus, ON-125-001 for a Loss of CIG.
		Directs PCOP to perform ON-104-203 for loss of 4kV Bus 1C
		Contacts WWM for Electrical Maintenance for investigation of ESS Bus 1C lockout
		Per ON-104-203, PRIOR to reaching 1.72 psig in Primary Containment, directs reactor scram per ON-100-101.

★ Denotes Critical Task

NOTES	
--------------	--

SCENARIO EVENT DESCRIPTION FORM

EVENT	TIME	DESCRIPTION
N/A	0	Crew assumes shift
A	0	Control rod insertion to lower power
B	10	Turbine bypass valve #3 test
C	20	FW Heater 2C tube leak
D	35	ESS Bus 1C lockout / reactor scram
E	45	Electrical ATWS
F	50	Fuel failure / MSIV closure
G	60	RCIC unisolable steam leak
H	70	Rapid Depressurization
N/A	75	Termination

INSTRUCTOR ACTIVITIES / ROLE PLAY / NOTES
--

EVENT	E
BRIEF DESCRIPTION	Electrical ATWS

OPERATOR ACTIVITY

1. **Ensure** Event Trigger LOC26-N03-2 initiates when scram air header pressure falls below 42 psig (at which time control rods should begin to drift in) to initiate a spurious RCIC initiation, fuel failure and radioactivity release in the CRD HCU area.

ROLE PLAY

1. As **NPO** dispatched to vent the scram air header, **acknowledge** the request and take no further action.
2. As **FUS** contacted to implement ES-158-001, **acknowledge** the request and take no further action. **Acknowledge** a request to stop ES-158-001 by replying that the briefing for the ES was just completed, no action has been taken yet.

Role play any other directed actions as required.

EVALUATOR NOTES

1. Actions for the fuel failure and MSIV high radiation levels are in Event F.
2. Actions performed per EO-100-113 will depend on when ARI is initiated and all control rods inserted is recognized.

SCENARIO EVENT FORM

EVENT	E
BRIEF DESCRIPTION	Electrical ATWS

POSITION	TIME	STUDENT ACTIVITIES
★TEAM		Initiate ARI
PCOM		Performs Scram report in accordance with OP-AD-004 section 12.2.4 <ul style="list-style-type: none"> • Reports reactor pressure and MSIVs open, reactor level and FW available
		Completes PCO Actions Following a Scram as follows: <ul style="list-style-type: none"> • INSERT IRMs and SRMs • VERIFY Scram Discharge Volume Vent and Drain valves CLOSED
		<ul style="list-style-type: none"> • At 1C651, ARM AND DEPRESS Manual Scram Pushbuttons; <ul style="list-style-type: none"> ○ RPS MAN SCRAM CHAN A1 HS-C72A-1S03A ○ RPS MAN SCRAM CHAN B1 HS-C72A-1S03B ○ RPS MAN SCRAM CHAN A2 HS-C72A-1S03C ○ RPS MAN SCRAM CHAN B2 HS-C72A-1S03D • Inserts IRMs and SRMs • Verify Scram Discharge Volume Vent and Drain valves CLOSED, reports vent valves indicate OPEN • Ensure RPV pressure less than 1087 psig, with a target band of 800 to 1050 psig
		If directed, performs ATWS power/level reduction strategy (OP-145-005 Att B) as follows: <ul style="list-style-type: none"> • Lower Rx Recirc Pump Speeds to <u>Minimum</u> by performing the following: <ul style="list-style-type: none"> ○ Depress the MANUAL FLOW REDUCTION INITIATION PB ○ Depress the RRP SPEED TO MINIMUM PB ○ Depress the INITIATE RRP FLOW REDUCTION PB • Ensure Rx Recirc Pump Speeds are approximately 20%. • WHEN directed by Shift Supervision, Trip 'A' and 'B' Rx Recirc Pumps one at a time by depressing MG SET A(B) DRV MTR BKR HS-14001A(B) STOP PB

★ Denotes Critical Task

NOTES	
--------------	--

SCENARIO EVENT FORM

EVENT	E
BRIEF DESCRIPTION	Electrical ATWS

POSITION	TIME	STUDENT ACTIVITIES
PCOM (cont'd)		If directed, IF RFP A(B)(C) is in DPM OR transfer to DPM is in progress: <ul style="list-style-type: none"> • Control level in MANUAL via LV-10641 FW LO LOAD VALVE controller LIC-C32-1R602. • NOTE: RFP A(B)(C) SPD CTL/DEMAND SIGNAL controller SIC-C32-1R601 will transfer to AUTO when transfer to DPM is completed • As required, Adjust feeding RFP A(B)(C) SPD CTL/DEMAND SIGNAL controller SIC-C32-1R601A(B)(C) in MANUAL to establish and maintain assigned level band.
		If directed, IF RFP A(B)(C) is operating in Flow Control Mode: <ul style="list-style-type: none"> • Place LV-10641 FW LO LOAD VALVE controller LIC-C32-1R602 in MANUAL. • Perform following for RFP A(B)(C) which will continue feeding: <ul style="list-style-type: none"> ○ Touch A(B)(C) RFPT MAN VLV CTL button. ○ Place feeding RFP A(B)(C) SPD CTL/DEMAND SIGNAL controller SIC C32 1R601A(B)(C) in MANUAL. • IF FW LEVEL CTL/DEMAND SIGNAL controller LIC-C32-1R600 Tracking light not lit, Place controller in MANUAL and Lower controller output to 0%. • Ensure remaining non feeding RFP B(C)(A) operating in IDLE MODE. • Adjust feeding RFP A(B)(C) SPD CTL/DEMAND SIGNAL controller SIC-C32-1R601A(B)(C) in MANUAL to establish and maintain assigned level band. • Ensure FW LO LOAD VALVE controller LIC-C32-1R602 output is 0%.
		Stop Condensate Pumps 1P102A(B)(C)(D) as necessary to leave 2 pumps in operation
		Uses FW flow to maintain RPV level within ATWS level band
PCOP		<ul style="list-style-type: none"> • At 1C601, INITIATE ARI by arming and depressing: <ul style="list-style-type: none"> ○ ARI DIV 1 MAN TRIP HS-147103A1 TRIP ○ ARI DIV 2 MAN TRIP HS-147103B1 TRIP

★ Denotes Critical Task

SCENARIO EVENT FORM

EVENT	E
BRIEF DESCRIPTION	Electrical ATWS

POSITION	TIME	STUDENT ACTIVITIES
PCOP (cont'd)		If directed, Injects SBLC: <ul style="list-style-type: none"> • Place HS-14804 SBLC Manual Initiation keylock control switch to A(B) START • Observe SBLC Pumps 1P208A(B) does not start • Place HS-14804 SBLC Manual Initiation keylock control switch to B(A) START <ul style="list-style-type: none"> ○ Observe SBLC Pumps 1P208B(A) does not start
		If directed, Inhibits ADS: <ul style="list-style-type: none"> • Depress the following timers for another 102 seconds: <ul style="list-style-type: none"> ○ ADS Logic A Timer Reset HS-B21-1S13A ○ ADS Logic B Timer Reset HS-B21-1S13B • Place the following keylock switches to INHIBIT: <ul style="list-style-type: none"> ○ ADS A Logic Control ○ ADS B Logic Control • Observe the following annunciators EXTINGUISH: <ul style="list-style-type: none"> ○ ADS Logic A Timer Initiated (AR-110-A01) ○ ADS Logic B Timer Initiated (AR-110-A03) • Depress following to reset remaining annunciators: <ul style="list-style-type: none"> ○ ADS Logic A Timer Reset HS-B21-1S13A ○ ADS Logic B Timer Reset HS-B21-1S13B • Observe the following annunciators extinguish: <ul style="list-style-type: none"> ○ ADS Logic C Timer Initiated (AR-110-A02) ○ ADS Logic D Timer Initiated (AR-110-A04)
		If directed, Maximizes CRD: <ul style="list-style-type: none"> • Start standby CRD pump by placing control switch CRD Pump 1P132B(A) to RUN, to start 1P132B(A), Ctl Rod Drive Water Pump B(A). • Using FC-C12-1R600, CRD Flow Controller, in MANUAL, Fully Open FV146F002A(B), CRD Flow Control Vlv. • Fully Open THTLG PV-146-F003, DRIVE WTR PRESS THTLG valve. • IF CRD pump suction filter Hi differential pressure alarm received, THEN Perform the following to prevent pump trips <ul style="list-style-type: none"> ○ Reduce CRD flow to clear the Hi differential pressure alarm. ○ Open 146F116, CRD Pump Suction Filter Bypass. (HC) ○ Re-Establish Maximum Flow

★ Denotes Critical Task

SCENARIO EVENT FORM

EVENT	E
BRIEF DESCRIPTION	Electrical ATWS

POSITION	TIME	STUDENT ACTIVITIES
PCOP (cont'd)		If directed, Bypasses MSIV and CIG Interlocks (5 keys required) <ul style="list-style-type: none"> • Bypass MSIV Low Water Level 1 Isolation at 1C645 by Placing the following to BYPASS <ul style="list-style-type: none"> ○ HS-B21-S38A Rx Wtr Lvl 1 MSIV Bypass Logic A ○ HS-B21-S38C Rx Wtr Lvl 1 MSIV Bypass Logic C • Bypass CIG Low Water Level 1 and High Drywell Pressure Isolation by Placing the following to BYPASS <ul style="list-style-type: none"> ○ At 1C645, HS-12694 Low Lvl 1/Hi Drywell Press CIG Bypass (HV-12603) ○ At 1C645, HS-12695 Low Lvl 1/Hi Drywell Press CIG Bypass (SV-12651) ○ At 1C644, HS-12696 Low Lvl 1/Hi Drywell Press CIG Bypass (SV-12605)
US		Enters EO-100-102, RPV Control at RC-1 for Existing Scram Conditions and Power >5% or cannot be determined
		Enters EO-100-113, Level Power Control at step LQ-1
		Records initial ATWS power
		Directs PCOP to inject SBLC and Inhibit ADS
		Directs PCOM to reduce Recirc Pump speed to minimum, then trip Recirc Pumps sequentially
		Directs PCOP to override HPCI and RCIC
		Directs PCOM to throttle and prevent injection from Feedwater to maintain reactor level -60" to -110"
		Directs PCOP to maintain reactor pressure 800-1050 psig using Main Turbine EHC
		Directs PCOP to bypass MSIV and CIG interlocks
		Directs PCOP to maximize CRD

★ Denotes Critical Task

NOTES	
--------------	--

SCENARIO EVENT DESCRIPTION FORM

EVENT	TIME	DESCRIPTION
N/A	0	Crew assumes shift
A	0	Control rod insertion to lower power
B	10	Turbine bypass valve #3 test
C	20	FW Heater 2C tube leak
D	35	ESS Bus 1C lockout / reactor scram
E	45	Electrical ATWS
F	50	Fuel failure / MSIV closure
G	60	RCIC unisolable steam leak
H	70	Rapid Depressurization
N/A	75	Termination

INSTRUCTOR ACTIVITIES / ROLE PLAY / NOTES

EVENT	F
BRIEF DESCRIPTION	Fuel failure / MSIV closure

OPERATOR ACTIVITY

1. **Ensure** Event Trigger LOC26-N03-3 initiates when all inboard MSIVs are closed to terminate the elevated MSL radiation readings.

ROLE PLAY

1. As **WWM/Reactor Engineering** contacted for assistance with the fuel failure, **wait** 5 minutes and **report**

Engineering saw that the scram air header was very slow to vent, as if the vent ports were blocked or otherwise restricted. Control rods drifted in very slowly, apparently causing a number of fuel rods to fail.

2. As **NPO** dispatched to investigate a fire alarm in the Reactor Building sump room area, **wait** 2 minutes and **report**

There was steam coming from the Reactor Building sumps. I had to leave immediately due to area dose rates.

3. As **Chemistry** contacted for sampling due to the fuel failure, **wait** 5 minutes and **report**

Dose rates in the area of the sample stations are preventing us from collecting samples. We are working with HP to gain access.

Role play any other directed actions as required.

EVALUATOR NOTES

1. None

SCENARIO EVENT FORM

EVENT	F
BRIEF DESCRIPTION	Fuel failure / MSIV closure

POSITION	TIME	STUDENT ACTIVITIES
PCOM		Performs AR-106-F03, Offgas Hi Hi Radiation Alarm
		Performs AR-103(104)-D01, MN STM LINE HI HI RADIATION
PCOP		Performs ON-179-001, Increasing Offgas/MSL Rad Levels
		Performs AR-SP-002 for X108_Z1 alarm, observes Fire Pumps start.
		Dispatches NPO to investigate RB 645' sump area and Div 1 Core Spray room
		Closes the following valves at 1C601 <ul style="list-style-type: none"> • MN STM LINE A IB ISO HV-141-F022A • MN STM LINE B IB ISO HV-141-F022B • MN STM LINE C IB ISO HV-141-F022C • MN STM LINE D IB ISO HV-141-F022D • MN STM LINE A OB ISO HV-141-F028A • MN STM LINE B OB ISO HV-141-F028B • MN STM LINE C OB ISO HV-141-F028C • MN STM LINE D OB ISO HV-141-F028D • MN STM LINE IB DRAIN HV-141-F016 • MN STM LINE OB DRAIN HV-141-F019
US		Enters ON-179-001 for MSL/Offgas hi rad conditions
		Directs Unit 2 to perform evacuation of Unit 1 and Unit 2 Turbine Building
		Contacts WWM to support investigation of elevated dose rates
		Contacts Chemistry to collect samples due to the fuel failure
		Contacts HP to support Chemistry in sample collection
		Directs MSIVs and MSL drains closed when MSL hi-hi radiation alarms received

★ Denotes Critical Task

NOTES	
--------------	--

THIS PAGE IS INTENTIONALLY LEFT BLANK

SCENARIO EVENT DESCRIPTION FORM

EVENT	TIME	DESCRIPTION
N/A	0	Crew assumes shift
A	0	Control rod insertion to lower power
B	10	Turbine bypass valve #3 test
C	20	FW Heater 2C tube leak
D	35	ESS Bus 1C lockout / reactor scram
E	45	Electrical ATWS
F	50	Fuel failure / MSIV closure
G	60	RCIC unisolable steam leak
H	70	Rapid Depressurization
N/A	75	Termination

INSTRUCTOR ACTIVITIES / ROLE PLAY / NOTES
--

EVENT	G
BRIEF DESCRIPTION	RCIC unisolable steam leak

OPERATOR ACTIVITY

1. **Ensure** Event Trigger LOC26-N03-4 initiates when the RCIC steam supply valve HV-150-F045 opens with CRD area rad levels above Max Safe to cause an unisolable steam line break in the RCIC room.
2. **Ensure** Event Trigger LOC26-N03-5 initiates when the RCIC inboard isolation valve HV-149-F007 is stroked closed to trip its breaker, 1B246-022.
3. **Ensure** Event Trigger LOC26-N03-6 initiates when the RCIC outboard HV-149-F008 isolation valve is stroked closed to stick the valve to simulate pressure binding.

ROLE PLAY

1. As **NPO** dispatched to the RCIC room, **wait 2 minutes and report**

I can hear an active steam leak in the RCIC room.

2. As **NPO** dispatched to 1B246-022, the breaker for the RCIC inboard isolation F007 valve, **wait 2 minutes and report**

The breaker is tripped on magnetics.

3. As **NPO** dispatched to the RCIC outboard isolation valve F008, **wait 2 minutes and report**

The valve appears to be approximately 90 percent closed.

If directed to attempt to manually close the valve, **wait** one moment then **report** that the manual handwheel will not engage.

4. As **WWM** contacted for assistance with RCIC F007 valve and breaker 1B246-022, **wait 5 minutes and report**

Electrical maintenance believes there is a fault of the F007 actuator motor. A Drywell entry will be required to close the valve.

5. As **WWM** contacted for assistance with RCIC F008 valve, **acknowledge** the request and take no further action.
6. **Role play** any other directed actions as required.

EVALUATOR NOTES

1. None

SCENARIO EVENT FORM

EVENT	G
BRIEF DESCRIPTION	RCIC unisolable steam leak

POSITION	TIME	STUDENT ACTIVITIES
PCOM		Performs AR-108-E05, RCIC Leak Detection Hi Temp/Hi Diff Temp
		Dispatches NPO to 1B246-022, breaker for the RCIC inboard isolation HV-147-F007 valve
		Dispatches NPO to the RCIC outboard isolation HV-147-F008 valve to manually close the valve
		Informs US that RCIC cannot be isolated
PCOP		Performs AR-SP-002 for X108_Z3 alarm
		Dispatches NPO to RCIC room to investigate Leak Detection alarm
US		Performs Crew Update for re-entry into EO-100-104 Secondary Containment Control for high RCIC room temperature.
		Directs PCOM to isolate RCIC
		Contacts WWM for Maintenance support with isolating RCIC F007 valve
		Contacts WWM for Maintenance support with isolating RCIC F008 valve

★ Denotes Critical Task

NOTES	
--------------	--

THIS PAGE IS INTENTIONALLY LEFT BLANK

SCENARIO EVENT DESCRIPTION FORM

EVENT	TIME	DESCRIPTION
N/A	0	Crew assumes shift
A	0	Control rod insertion to lower power
B	10	Turbine bypass valve #3 test
C	20	FW Heater 2C tube leak
D	35	ESS Bus 1C lockout / reactor scram
E	45	Electrical ATWS
F	50	Fuel failure / MSIV closure
G	60	RCIC unisolable steam leak
H	70	Rapid Depressurization
N/A	75	Termination

INSTRUCTOR ACTIVITIES / ROLE PLAY / NOTES

EVENT	H
BRIEF DESCRIPTION	Rapid Depressurization

OPERATOR ACTIVITY

1. **Ensure** Event Trigger LOC26-N03-7 initiates when reactor pressure falls below 100 psig to allow the RCIC inboard isolation F008 valve to stroke closed.

ROLE PLAY

1. **Role play** any other directed actions as required.

EVALUATOR NOTES

1. The scenario may be terminated when reactor level has been stabilized in the normal band with Condensate and actions to place RHR in Suppression Pool cooling have been initiated.

SCENARIO EVENT FORM

EVENT	H
BRIEF DESCRIPTION	Rapid Depressurization

POSITION	TIME	STUDENT ACTIVITIES
★TEAM		Rapidly depressurize the reactor when two Secondary Containment Areas exceed Max Safe Rad levels
PCOM		Prevents injection of RHR pumps not required for adequate core cooling <ul style="list-style-type: none"> • Close RHR INJ FLOW CTL HV 151 F017A(B)
		Prevents injection of Core Spray pumps not required for adequate core cooling <ul style="list-style-type: none"> • Close CORE SPRAY LOOP A(B) INJ SHUTOFF HV 152F005A(B) OR <ul style="list-style-type: none"> • Shutdown pumps by placing pump control switches to STOP
		Restores and maintains RPV level using condensate as reactor pressure lowers
PCOP		Opens all ADS valves by placing hand switches for the ADS SRVs to open
		Places RHR in Suppression Pool Cooling in accordance with OP-149-004 Att A as follows: <ul style="list-style-type: none"> • IF available, Place Emergency Service Water System in operation supplying RHR Room Cooler and RHR Pump to be placed in service. • IF LOCA signal present, Place HS-E11-1S17A(B) LOCA ISOLATION MANUAL OVERRIDE Switch to OVERRIDE <ul style="list-style-type: none"> ○ Observe White Indicating Light ILLUMINATED above HS-E11-1S17A(B) LOCA ISOLATION MANUAL OVERRIDE ○ Observe LOCA ISO SWITCH LOOP (A)B MANUAL OVERRIDE (AR 109(113) C5) Annunciator alarms • Open HV-151-F028A(B) SUPP CHMBR SPR TEST SHUTOFF • Close HV-151-F017A(B)RHR INJ FLOW CTL • IF a RHR Pump not in service, Perform EITHER a OR b: <ul style="list-style-type: none"> ○ IF RHR loop pressure \geq 50 PSIG, OR determined to be filled, Start 1P202A(B)(C)(D)RHR PUMP • Throttle Open HV-151-F024A(B) TEST LINE CTL to establish a total loop flowrate 9,500 to 10,000 gpm as indicated on FI-E11-1R603A(B) RHR A/C (B/D) Flow

SCENARIO EVENT FORM

EVENT	H
BRIEF DESCRIPTION	Rapid Depressurization

POSITION	TIME	STUDENT ACTIVITIES
PCOP (cont'd)		<ul style="list-style-type: none"> • Place RHRSW in service to RHR Hx as follows: <ul style="list-style-type: none"> ○ Ensure Closed Unit 2 HV-21210A(B) RHRSW Hx A(B) INLET ○ Open HV-11210A(B) Unit 1 RHRSW Hx A(B) INLET to 10% Open ○ OPEN HV-11215A(B) Unit 1 RHRSW Hx A(B) OUTLET ○ IF required, Place HS-11202A3(B3) RHRSW PUMP A(B) LOCA-TRIP switch to RESET ○ Start 1P506A(B) RHRSW Pump A(B) ○ Throttle HV-11210A(B) Unit 1 RHRSW Hx A(B) INLET to establish 8000 to 9000 gpm on FI-E11-1R602A(B) RHRSW HX A(B) INLET FLOW ○ Place HV-151-F048A(B) HX A(B) SHELL SIDE BYPS Control Switch to OFF/LOCA RESET position ○ Observe White Indicating Light ILLUMINATED above HV-151-F048A(B) Control Switch ○ Close HV-151-F048A(B) HX A(B) SHELL SIDE BYPS • AFTER RHRSW placed in service, Monitor Suppression Pool temperature
US		Performs Crew Update for entry into EO-100-112 Rapid Depressurization when RB area rad exceeds Max Safe in 2 or more areas; Scram Discharge Volume and RCIC PP Turb Room
		Directs PCOM to prevent injection from LPCI and Core Spray pumps not required to assure adequate core cooling
		Directs PCOP to open all ADS valves
		Directs PCOM to restore and maintain RPV level using Condensate
		Directs PCOP to place Suppression Pool Cooling in service.

★ Denotes Critical Task

NOTES	
--------------	--

THIS PAGE IS INTENTIONALLY LEFT BLANK

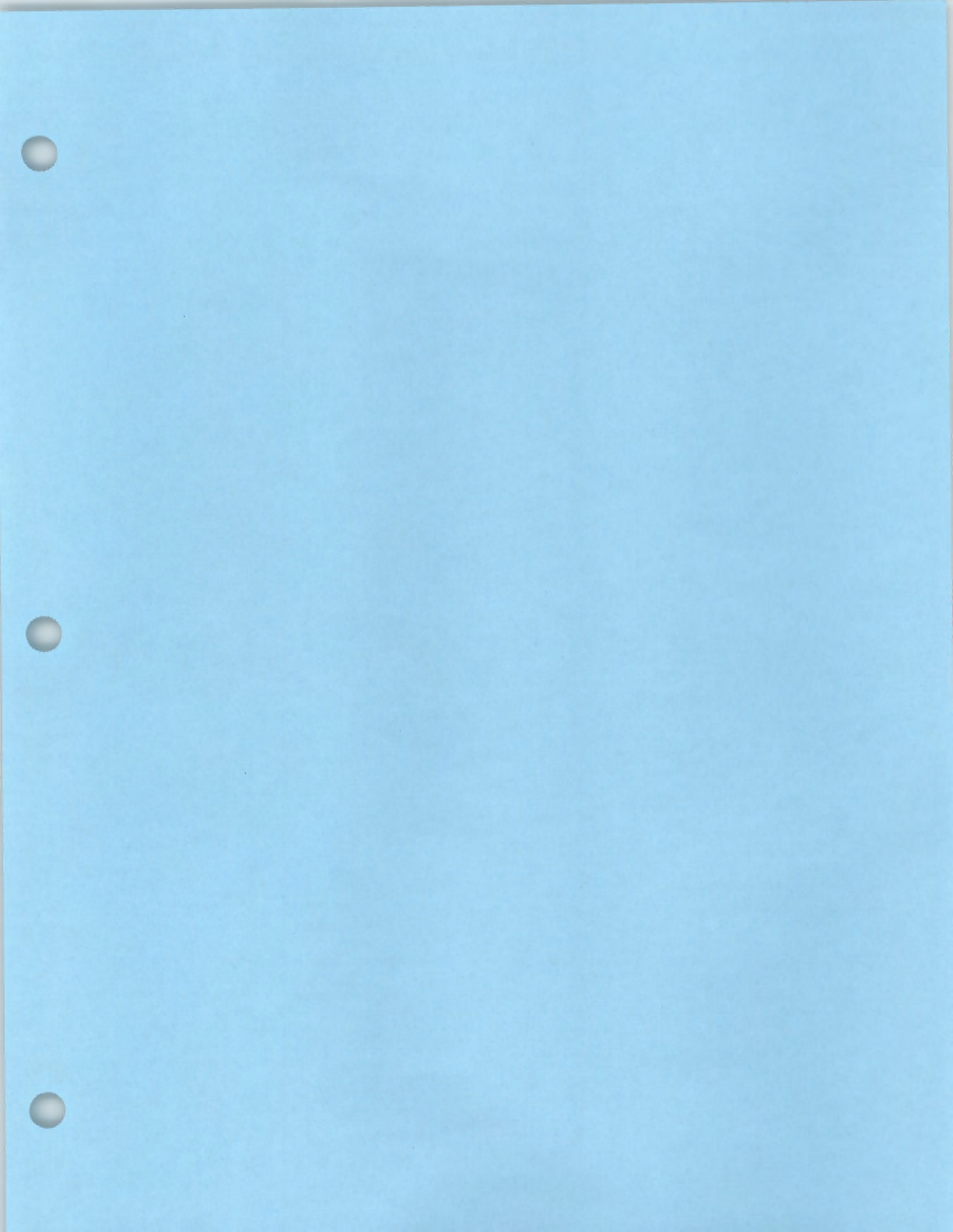

UNIT SUPERVISOR TURNOVER SHEET

UNIT 1 to/dd/yy
Date

SHIFT 1900 to 0700
Start End

SHIFT 0700 to 1900
Start End

MODE 1
POWER LEVEL 33 %
GENERATOR OUTPUT 351 MWe
CASK STORAGE GATE INSTALLED: YES/NO

MODE _____
POWER LEVEL _____ %
GENERATOR OUTPUT _____ MWe
CASK STORAGE GATE INSTALLED: YES/NO

REMARKS:

- 1) 300 days on-line
- 2) Shutdown in progress to identify and repair small RCS leak in Drywell. Unidentified leak rate 0.5 gpm. ON-100-005 actions are complete. Leak rate is stable and 12-hour calculations are being performed.
- 3) Reactor power approximately 33 percent, 1 RFP in FCM.
- 4) Perform test of Bypass Valve #3 per SO-182-001 for valve functional test
- 5) Insert next step of control rods once Bypass Valve test complete
- 6) HPCI in day 2 of a 4-day system outage window
- 7) RFP lube oil conditioner being placed on RFP B reservoir. Removed from RFP A for upcoming main lube oil pump test.
- 8) Control rods 42-15 and 46-19 were declared slow during the last scram time test.
- 9) _____
- 10) _____
- 11) _____
- 12) _____
- 13) _____
- 14) _____
- 15) _____

COMMON:

- 1) Unit 2 at rated power
- 2) _____
- 3) _____
- 4) _____
- 5) _____
- 6) _____
- 7) _____
- 8) _____
- 9) _____

OFFGOING UNIT SUPERVISOR CHECKLIST:

NRC CODE PRIOR TO 0800 FOXTROT DELTA HOTEL OSCAR

NRC CODE AFTER 0800 FOXTROT UNIFORM BRAVO ROMEO

1900-0700	0700-1900

1. Evolutions in progress and items to be completed during next shift, as noted in remarks, have been discussed with oncoming Unit Supervisor (including special evolutions, i.e. SICT/E, OPDRVs, etc.).
2. Problems encountered during past shift and abnormal plant conditions, as noted in remarks, have been discussed with oncoming Unit Supervisor.
3. Information in SOMS Log is complete and discussed with oncoming Unit Supervisor.
4. As applicable, turnover plastic Security Badge cover and CRS Monitor function to oncoming Unit Supervisor.

1900 - 0700 _____

0700 - 1900 _____

Offgoing Unit Supervisor

ONCOMING UNIT SUPERVISOR CHECKLIST:

0700	1900
-	-

1. LCO/TRO Log reviewed.
2. SOMS Log reviewed for entries made in past 24 hours.
3. Report any changes to license or medical status PER NDAP-QA-0723.

0700 - 1900 _____

1900 - 0700 _____

Oncoming Qualified
Unit Supervisor

POST RELIEF

0700	1900
-	-

1. Walk down Control Room panels with Unit Responsible PCO.
2. CRC Book reviewed and Reactivity Brief performed with PCO.
3. Completed System Status Operable audit for open PMT this shift.
4. From the OPS Web page, Review OPS Aggregate Index for Challenges, Work Arounds, and Deficiencies Reports for impact on scheduled work activities and compensatory actions. ⁽²⁰⁾

0700 - 1900 _____

1900 - 0700 _____

Oncoming Unit Supervisor

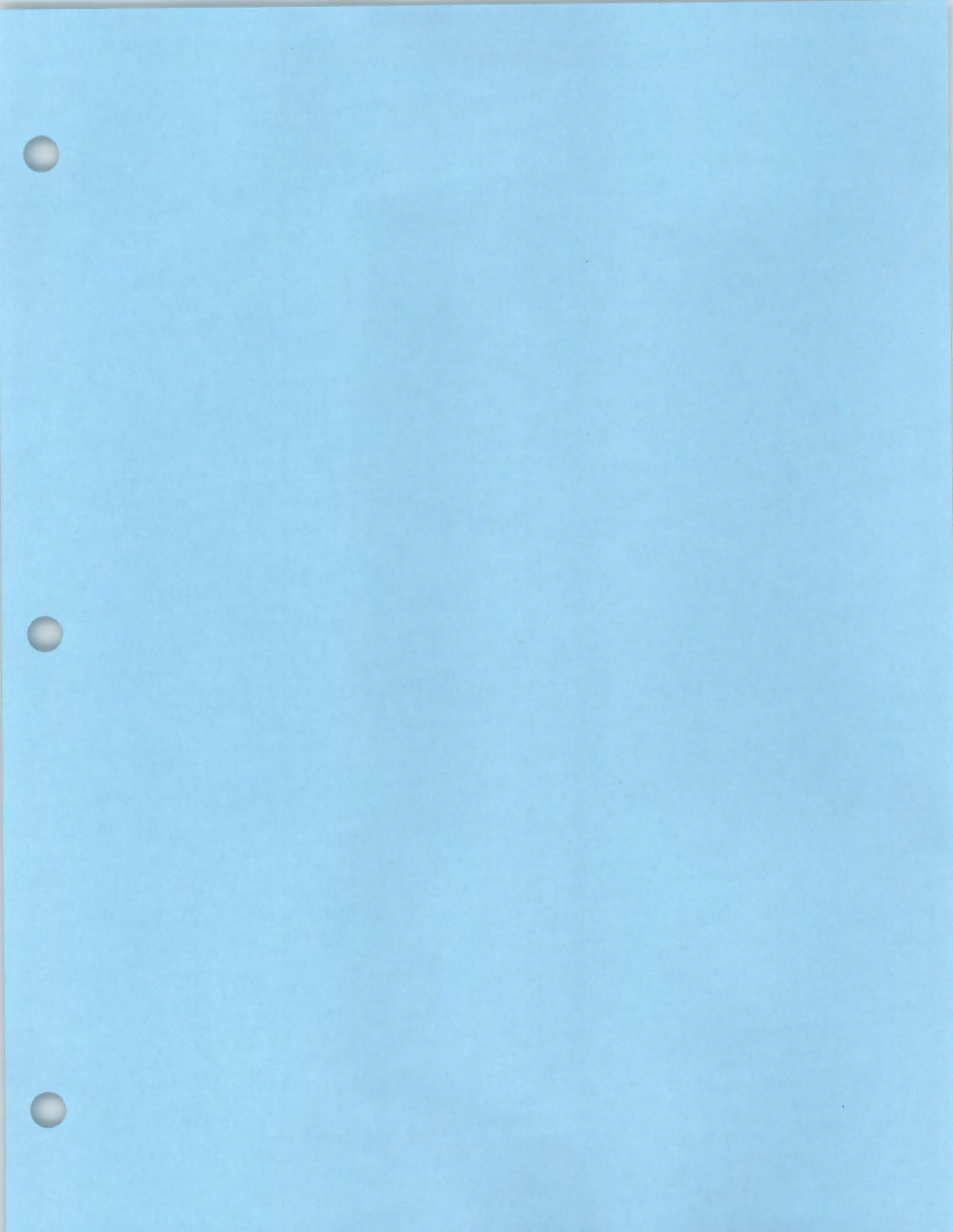

PROCEDURE COVER SHEET

PPL SUSQUEHANNA, LLC PROCEDURE		
MONTHLY TURBINE BYPASS VALVE CYCLING		SO-182-001 Revision 29 Page 1 of 16 Unit 1
ADHERENCE LEVEL: CONTINUOUS USE		
<u>QUALITY CLASSIFICATION:</u> <input checked="" type="checkbox"/> QA Program <input type="checkbox"/> Non-QA Program		<u>APPROVAL CLASSIFICATION:</u> <input checked="" type="checkbox"/> Plant <input type="checkbox"/> Non-Plant <input type="checkbox"/> Instruction
EFFECTIVE DATE: <u>6-17-14</u>		
PERIODIC REVIEW FREQUENCY: <u>N/A</u>		
PERIODIC REVIEW DUE DATE: <u>N/A</u>		
<u>RECOMMENDED REVIEWS:</u>		
Procedure Owner: <u>C Shift</u>		
Responsible Supervisor: <u>Shift Manager-C Shift</u>		
Responsible FUM: <u>Manager-Nuclear Operations</u>		
Responsible Approver: <u>Manager-Nuclear Operations</u>		

PROCEDURE REVISION SUMMARY

- 1) Removed Step 4.8 due to deletion of Attachment B.

TABLE OF CONTENTS

<u>SECTION</u>	<u>PAGE</u>
1. PURPOSE AND SCOPE	4
2. REFERENCES AND COMMITMENTS	4
3. PRECAUTIONS AND LIMITATIONS	5
4. PREREQUISITES	5
5. INSTRUCTIONS	7
5.1 Test Bypass Valve 1 (BPV 1)	7
5.2 Test Bypass Valve 2 (BPV 2)	8
5.3 Test Bypass Valve 3 (BPV 3)	10
5.4 Test Bypass Valve 4 (BPV 4)	11
5.5 Test Bypass Valve 5 (BPV 5)	13
5.6 Bypass Valve Test Restoration	14
5.7 Test Completion	14
6. ACCEPTANCE CRITERIA	15
7. RECORDS	15

ATTACHMENTS

<u>ATTACHMENT</u>	<u>PAGE</u>
A Data Form	16

1. PURPOSE AND SCOPE**1.1 Purpose**

1.1.1 Perform monthly Turbine Bypass Valve Cycling test to satisfy Surveillance Requirement (SR) 3.7.6.1. This surveillance satisfies completion of one cycle of each required main turbine bypass valve every 31 days.

1.2 Scope

1.2.1 This surveillance will test all five bypass valves. However, the current cycle specific safety analysis will determine the actual number of Main Turbine Bypass Valves required.

1.2.2 This procedure may be performed by individual sections as determined by Shift Supervision. Sections not performed need not be marked NA.

2. REFERENCES AND COMMITMENTS**2.1 Performance References**

2.1.1 ON-172-002, Hi Hi Hydrogen Concentration in Unit 1 Off Gas Recombiner Discharge

2.1.2 TRO 3.7.5.2

(1) 2.1.3 EWR 2014-01231

2.2 Developmental References

2.2.1 FSAR Section 10.4.4

2.2.2 LCO 3.7.6

2.2.3 NDAP-QA-0722, Surveillance Test Program

2.2.4 Electrical Schematic E-120

2.2.5 P&ID-M-101, Unit 1 Main Steam (Sh. 1-3)

2.2.6 OP-102-001, 125V DC System

2.2.7 OP-117-001, 120V Instrument AC Distribution System

2.2.8 OP-193-001, Main Turbine Operation

2.3 Commitments

2.3.1 [C-1] CR 1341965 Initial operability determination did not include evaluation of all potentially affected functions (TS 3.3.1.1 and TS 3.3.4.1).

3. PRECAUTIONS AND LIMITATIONS

3.1 Precautions

- 3.1.1 To prevent flashing of Moisture Separators 1A and 1B, Cross-Around Steam Piping Drain Valves HV-10151A1, A2, A3 or HV-10151B1, B2, B3 are to remain closed during test.
- 3.1.2 Minimizing length of time the TEST pushbutton is depressed will decrease the time the fast acting solenoid is open draining the EHC fluid, thereby reducing the perturbations on the EHC System.
- 3.1.3 Plant must be allowed to stabilize between each Bypass Valve test.
- 3.1.4 ON-172-002, (ON-072-002 if Unit 1 on Common Recombiner) HI-HI Hydrogen Concentration in Unit 1 Offgas Recombiner Discharge need not be entered for short term alarm receipt caused solely by performance of this surveillance as long as Offgas hydrogen remains below 4-percent or if H₂ concentrations exceed 4-percent but immediately begin to return to Normal after the Bypass Valve is closed.
- 3.1.5 If H₂ concentrations exceed 4-percent at any time during operation of the main condenser air ejector and offgas treatment system, compliance with TRO 3.7.5.2 is required.
- 3.1.6 If operating within 5 MWe to the Generator Capability Curve then ICS recirculation controls should be placed in Manual Mode of Operation.

3.2 Limitations

- 3.2.1 None

4. PREREQUISITES

- 4.1 IF in Mode 1,

THEN PERFORM the following:

- 4.1.1 **VERIFY** Main Turbine Generator at a minimum of 10 percent load.
- 4.1.2 **CONTACT** GCC due to fluctuations in MWe.

4.2 **IF** in Mode 4 **OR** 5,

THEN PERFORM the following:

- **ENSURE** either Inboard or Outboard MSIV in each Main Steam Line CLOSED.
- **WALKDOWN** Bypass Valve area to ensure plant personnel are made aware of impending valve operation.
- **ENSURE** MN STM LINE DRAIN TO CDSR, HV-141-F021 CLOSED.

4.3 **IF** Main Condenser Vacuum **NOT** established,

- THEN ENSURE** I&C has BYPASSED Low Condenser Vacuum trip of Bypass Valves.

4.4 **REVIEW** of the following should be performed due to frequency of HWC and Off Gas HI HI Hydrogen alarms:

4.4.1 ON-172-002, Hi Hi Hydrogen Concentration in Unit 1 Off Gas Recombiner Discharge

- 4.4.2 TRO 3.7.5.2

4.5 **REVIEW** the following Control Room alarms that will annunciate during this test:

- AR105-I06, MAIN TURBINE BYPASS VALVES OPEN
- AR105-J06, STM BYPASS & PRESS REG AID DISPLAYED

4.6 **REVIEW** of the following Control Room alarms that may annunciate during this test should be performed:

- AR105-E04, MOIST SEPARATOR DRN TANK A LO LEVEL
- AR105-F04, MOIST SEPARATOR DRN TANK B LO LEVEL
- AR121-C02, HWC PANEL 1C198 TROUBLE
- AR131-D05, UNIT 1 RECOMB DISCHARGE H2 CONC HI HI
- AR106-F15, OFFGAS RECOMBINER PANEL 0C673 SYSTEM TROUBLE
- AR106-G15, TRA SETINEL TRIP/OUT OF SCAN
- AR120-H04, FW LOOP A PANEL 1C101 TROUBLE
- AR120-H07, FW LOOP B PANEL 1C102 TROUBLE
- AR120-H10, FW LOOP C PANEL 1C103 TROUBLE
- AR101-C05, TURB BLDG AREA PANEL 1C605 HI RADIATION

- 4.7 **ENSURE** an NPO is available for any local panel alarms.

5. INSTRUCTIONS

- NOTE**

All operations are performed at Unit Operating Benchboard 1C651 unless otherwise specified.

5.1 Test Bypass Valve 1 (BPV 1)

- 5.1.1 **SELECT** position 1 on BPV TEST SELECT switch

AND

VERIFY the following BYPASS VALVE TEST status lights:

- a. Green READY light ILLUMINATED
- b. Amber TESTING light ILLUMINATED

- NOTE**

The transition from slow to fast opening of the Bypass Valve will occur at the nominal 90% open position dependent on the actual setting of the test limit switch. If fast opening is not clearly discernable by observation of the position indication meter, then high speed computer data can be used to confirm fast opening. The transition from slow to fast open will be evident from an abrupt upward change in slope of the Total Bypass Valve Position curve (**Computer point TRA203**) coincident with a drop in EHC supply header pressure. Acceptance criteria is satisfied by confirming the fast opening function occurs and is not dependent on the exact valve position when it occurs. ⁽¹⁾

- 5.1.2 **DEPRESS AND HOLD TEST BYPASS VALVE** pushbutton.

- a. **VERIFY** the following BYPASS VALVE TEST status light indications:

- (1) Green READY light EXTINGUISHED
- (2) Amber TESTING light ILLUMINATED
- (3) Amber DO NOT SELECT light ILLUMINATED

5.1.2 (continued)

- b. **OBSERVE MAIN STEAM BYPASS VALVE 1 (BPV 1) normal AND fast acting devices are operational as follows:**
- (1) BPV 1 slowly opens for first approximately 90 percent of stroke.
- (2) BPV 1 fast opens for last approximately 10 percent of stroke.
- c. **VERIFY MAIN TURBINE BYPASS VALVES OPEN, annunciator AR105-I06 ILLUMINATES.**

5.1.3 **WHEN BPV 1 indicates FULL OPEN,**

- THEN RELEASE TEST BYPASS VALVE pushbutton.**

5.1.4 **VERIFY the following:**

- a. BPV 1 indicates FULL CLOSED [C-1]
- b. Amber DO NOT SELECT status light **NOT** ILLUMINATED
- c. Green READY status light ILLUMINATED
- d. MAIN TURBINE BYPASS VALVES OPEN, annunciator AR105-I06 **NOT** ILLUMINATED
- e. Amber TESTING light ILLUMINATED

- 5.1.5 **RECORD** BPV 1 completed one full cycle of travel in Attachment A, Data Form.

5.2 **Test Bypass Valve 2 (BPV 2)**

- 5.2.1 **SELECT** position 2 on BPV TEST SELECT switch
- AND**
- VERIFY** the following BYPASS VALVE TEST status lights:
- a. Green READY light ILLUMINATED
- b. Amber TESTING light ILLUMINATED

NOTE

The transition from slow to fast opening of the Bypass Valve will occur at the nominal 90% open position dependent on the actual setting of the test limit switch. If fast opening is not clearly discernable by observation of the position indication meter, then high speed computer data can be used to confirm fast opening. The transition from slow to fast open will be evident from an abrupt upward change in slope of the *Total Bypass Valve Position* curve (**Computer point TRA203**) coincident with a drop in EHC supply header pressure. Acceptance criteria is satisfied by confirming the fast opening function occurs and is not dependent on the exact valve position when it occurs. ⁽¹⁾

5.2.2 **DEPRESS AND HOLD TEST BYPASS VALVE** pushbutton.a. **VERIFY** the following BYPASS VALVE TEST status light indications:

(1) Green READY light EXTINGUISHED

(2) Amber TESTING light ILLUMINATED

(3) Amber DO NOT SELECT light ILLUMINATED

b. **OBSERVE MAIN STEAM BYPASS VALVE 2 (BPV 2) normal AND fast acting devices** are operational as follows:

(1) BPV 2 slowly opens for first approximately 90 percent of stroke.

(2) BPV 2 fast opens for last approximately 10 percent of stroke.

c. **VERIFY MAIN TURBINE BYPASS VALVES OPEN**, annunciator AR105-106 ILLUMINATES.5.2.3 **WHEN** BPV 2 indicates FULL OPEN,**THEN RELEASE** TEST BYPASS VALVE pushbutton.

5.2.4 **VERIFY** the following:

- a. BPV 2 indicates FULL CLOSED [C-1]
- b. Amber DO NOT SELECT status light **NOT** ILLUMINATED
- c. Green READY status light ILLUMINATED
- d. MAIN TURBINE BYPASS VALVES OPEN, annunciator AR105-I06 **NOT** ILLUMINATED
- e. Amber TESTING light ILLUMINATED

5.2.5 **RECORD** BPV 2 completed one full cycle of travel in Attachment A, Data Form.5.3 **Test Bypass Valve 3 (BPV 3)**

- 5.3.1 **SELECT** position 3 on BPV TEST SELECT switch

AND**VERIFY** the following BYPASS VALVE TEST status lights:

- a. Green READY light ILLUMINATED
- b. Amber TESTING light ILLUMINATED

NOTE

The transition from slow to fast opening of the Bypass Valve will occur at the nominal 90% open position dependent on the actual setting of the test limit switch. If fast opening is not clearly discernable by observation of the position indication meter, then high speed computer data can be used to confirm fast opening. The transition from slow to fast open will be evident from an abrupt upward change in slope of the *Total Bypass Valve Position* curve (**Computer point TRA203**) coincident with a drop in EHC supply header pressure. Acceptance criteria is satisfied by confirming the fast opening function occurs and is not dependent on the exact valve position when it occurs.⁽¹⁾

- 5.3.2 **DEPRESS AND HOLD** TEST BYPASS VALVE pushbutton.
 - a. **VERIFY** the following BYPASS VALVE TEST status light indications:
 - (1) Green READY light EXTINGUISHED
 - (2) Amber TESTING light ILLUMINATED
 - (3) Amber DO NOT SELECT light ILLUMINATED

5.3.2 (continued)

b. **OBSERVE MAIN STEAM BYPASS VALVE 3 (BPV 3) normal AND fast acting devices are operational as follows:**

- (1) BPV 3 slowly opens for first approximately 90 percent of stroke.
- (2) BPV 3 fast opens for last approximately 10 percent of stroke.

c. **VERIFY MAIN TURBINE BYPASS VALVES OPEN, annunciator AR105-I06 ILLUMINATES.**

5.3.3 **WHEN BPV 3 indicates FULL OPEN,**

THEN RELEASE TEST BYPASS VALVE pushbutton.

5.3.4 **VERIFY the following:**

- a. BPV 3 indicates FULL CLOSED [C 1]
- b. Amber DO NOT SELECT status light **NOT ILLUMINATED**
- c. Green READY status light ILLUMINATED
- d. MAIN TURBINE BYPASS VALVES OPEN, annunciator AR105-I06 **NOT ILLUMINATED**
- e. Amber TESTING light ILLUMINATED

5.3.5 **RECORD BPV 3 completed one full cycle of travel in Attachment A, Data Form.**

5.4 **Test Bypass Valve 4 (BPV 4)**

5.4.1 **SELECT position 4 on BPV TEST SELECT switch**

AND

VERIFY the following BYPASS VALVE TEST status lights:

- a. Green READY light ILLUMINATED
- b. Amber TESTING light ILLUMINATED

NOTE

The transition from slow to fast opening of the Bypass Valve will occur at the nominal 90% open position dependent on the actual setting of the test limit switch. If fast opening is not clearly discernable by observation of the position indication meter, then high speed computer data can be used to confirm fast opening. The transition from slow to fast open will be evident from an abrupt upward change in slope of the *Total Bypass Valve Position* curve (**Computer point TRA203**) coincident with a drop in EHC supply header pressure. Acceptance criteria is satisfied by confirming the fast opening function occurs and is not dependent on the exact valve position when it occurs.⁽¹⁾

 5.4.2 **DEPRESS AND HOLD TEST BYPASS VALVE** pushbutton. a. **VERIFY** the following BYPASS VALVE TEST status light indications: (1) Green READY light EXTINGUISHED (2) Amber TESTING light ILLUMINATED (3) Amber DO NOT SELECT light ILLUMINATED b. **OBSERVE MAIN STEAM BYPASS VALVE 4 (BPV 4) normal AND fast acting devices** are operational as follows: (1) BPV 4 slowly opens for first approximately 90 percent of stroke. (2) BPV 4 fast opens for last approximately 10 percent of stroke. c. **VERIFY MAIN TURBINE BYPASS VALVES OPEN**, annunciator AR105-I06 ILLUMINATES. 5.4.3 **WHEN BPV 4 indicates FULL OPEN**, **THEN RELEASE TEST BYPASS VALVE** pushbutton. 5.4.4 **VERIFY** the following: a. BPV 4 indicates FULL CLOSED [C-1] b. Amber DO NOT SELECT status light **NOT** ILLUMINATED c. Green READY status light ILLUMINATED d. MAIN TURBINE BYPASS VALVES OPEN, annunciator AR105-I06 **NOT** ILLUMINATED e. Amber TESTING light ILLUMINATED

- 5.4.5 **RECORD** BPV 4 completed one full cycle of travel in Attachment A, Data Form.

5.5 **Test Bypass Valve 5 (BPV 5)**

- 5.5.1 **SELECT** position 5 on BPV TEST SELECT switch

AND

VERIFY the following BYPASS VALVE TEST status lights:

- a. Green READY light ILLUMINATED
- b. Amber TESTING light ILLUMINATED

NOTE

The transition from slow to fast opening of the Bypass Valve will occur at the nominal 90% open position dependent on the actual setting of the test limit switch. If fast opening is not clearly discernable by observation of the position indication meter, then high speed computer data can be used to confirm fast opening. The transition from slow to fast open will be evident from an abrupt upward change in slope of the *Total Bypass Valve Position* curve (**Computer point TRA203**) coincident with a drop in EHC supply header pressure. Acceptance criteria is satisfied by confirming the fast opening function occurs and is not dependent on the exact valve position when it occurs.⁽¹⁾

- 5.5.2 **DEPRESS AND HOLD TEST BYPASS VALVE** pushbutton.
- a. **VERIFY** the following BYPASS VALVE TEST status light indications:
- (1) Green READY light EXTINGUISHED
- (2) Amber TESTING light ILLUMINATED
- (3) Amber DO NOT SELECT light ILLUMINATED
- b. **OBSERVE MAIN STEAM BYPASS VALVE 5 (BPV 5) normal AND fast acting devices** are operational as follows:
- (1) BPV 5 slowly opens for first approximately 90 percent of stroke.
- (2) BPV 5 fast opens for last approximately 10 percent of stroke.
- c. **VERIFY MAIN TURBINE BYPASS VALVES OPEN**, annunciator AR105 I06 ILLUMINATES.

5.5.3 **WHEN** BPV 5 indicates FULL OPEN,

THEN RELEASE TEST BYPASS VALVE pushbutton.

5.5.4 **VERIFY** the following:

- a. BPV 5 indicates FULL CLOSED [C-1]
- b. Amber DO NOT SELECT status light **NOT** ILLUMINATED
- c. Green READY status light ILLUMINATED
- d. MAIN TURBINE BYPASS VALVES OPEN, annunciator AR105-I06 **NOT** ILLUMINATED
- e. Amber TESTING light ILLUMINATED

5.5.5 **RECORD** BPV 5 completed one full cycle of travel in Attachment A, Data Form.

5.6 Bypass Valve Test Restoration

5.6.1 **PLACE** BPV TEST SELECT switch to OFF.

5.6.2 **VERIFY** the following:

- a. Amber TESTING light EXTINGUISHED
- b. Green READY status light ILLUMINATED

5.6.3 **IF** Low Condenser Vacuum trip of Bypass Valves has been BYPASSED,

THEN NOTIFY I&C that trip can be restored.

5.6.4 **IF** ON-172-002 **OR** ON-072-002, HI-HI Hydrogen Concentration in Unit 1 Offgas Recombiner Discharge

OR TRO 3.7.5.2 ENTERED,

THEN EXIT when H₂ concentrations return to pre-test values.

5.7 Test Completion

5.7.1 **COMPLETE** the following Sections of Attachment A, Data Form:

- a. Acceptance Criteria
- b. Independent Verification

5.7.2 **IF** Acceptance Criteria **NOT** met,

THEN NOTIFY Shift Supervision.

5.7.3 NOTIFY Shift Supervision test is complete.

5.7.4 **FORWARD** surveillance to Shift Supervision for review.

6. ACCEPTANCE CRITERIA

6.1 **REVIEW** of Acceptance Criteria in Attachment A, Data Form is performed by Shift Supervision.

6.1.1 **IF** Acceptance Criteria **NOT** met,

THEN COMPLETE Attachment A, Required Actions Section.

7. RECORDS

7.1 Attachment A, Data Form

DATA FORM

MONTHLY TURBINE BYPASS VALVE CYCLING TEST

<u>ACCEPTANCE CRITERIA</u>	<u>ACCEPTABLE</u>	<u>INITIALS</u>
1. <u>Unit 1 SR 3.7.6.1</u> BPV 1 cycled through one complete cycle of full travel (Steps 5.1.2 b and 5.1.4 a)	YES/NO	_____
2. <u>Unit 1 SR 3.7.6.1</u> BPV 2 cycled through one complete cycle of full travel (Steps 5.2.2 b and 5.2.4 a)	YES/NO	_____
3. <u>Unit 1 SR 3.7.6.1</u> BPV 3 cycled through one complete cycle of full travel (Steps 5.3.2 b and 5.3.4 a)	YES/NO	_____
4. <u>Unit 1 SR 3.7.6.1</u> BPV 4 cycled through one complete cycle of full travel (Steps 5.4.2 b and 5.4.4 a)	YES/NO	_____
5. <u>Unit 1 SR 3.7.6.1</u> BPV 5 cycled through one complete cycle of full travel (Steps 5.5.2 b and 5.5.4 a)	YES/NO	_____

INDEPENDENT VERIFICATION

1. BPV TEST SELECT switch is verified in the OFF position. (Step 5.7.1 b)		_____
		IND VERIFY

REQUIRED ACTIONS

	<u>APPLICABLE</u>	<u>INITIALS</u>
1. VERIFY the required number of bypass valves per the current cycle specific analysis are operable.	YES/NO	_____
2. ENSURE the following are in effect as applicable:		
• LCO 3.7.6	YES/NO	_____

Shift Supervision: _____
Print
Signature
Date

Facility:	SSES Units 1 and 2	Scenario No.:	5	Op-Test No.:	LOC26
Examiners:	_____	Operators:	_____	_____	_____
Initial Conditions	Unit 1 Mode 2, 3 percent power, 500 psig				
Turnover	Place RFP in-service in DPM in AUTO per OP-145-001				
	Control rods 42-15 and 46-19 declared slow last scram time test				
	Severe thunderstorm watch in effect				

Event No.	Malf. No.	Event Type*	Event Description
1	N/A	N SRO,BOP	Place RFP in-service in Discharge Pressure Mode (OP-145-001)
2	N/A	R SRO,ATC	Withdraw control rods to raise reactor power (OP-AD-338, GO-100-002)
3	mfLS155 0145435	I SRO,ATC	Inoperable control rod position indication (TS 3.1.3)
4	set fx10 SULC_B9. OUT=100	I SRO,ATC	Startup level control bypass valve HV-10640 controller fails to maximum demand, take manual control (ON-145-001)
5	IMF cmfRL02_ 86A1102	C SRO,BOP	Aux Bus 11B lockout, Start Condensate Pump C to maintain 2-pump Condensate alignment with RFP in-service (ON-103-003. OP 144-001)
6	cmfFU01_ 1C618FU21	I SRO	RCIC Division 2 initiation logic power loss (TS 3.3.5.1)
7	cmfRL01_ B211K7x	C ALL	Spurious MSIV closure, insert a manual scram due to loss of the normal heat sink (ON-100-101)
8	mfMS183 007	C ALL	Drywell LOCA, place Suppression Chamber spray in-service to cool Primary Containment (OP-149-004)
9	cmfMV01_ HV151 F028x	C SRO,BOP	RHR Suppression Chamber cooling isolation valve breaker trips, place other division of RHR in Suppression Chamber spray (OP-149-004)
10	mfRH149 004x	M ALL	Unisolable Suppression Pool leak (EO-100-103, 112)

*(N)ormal, (R)eactivity, (I)nstrument, (C)omponent, (M)ajor

Target Quantitative Attributes (Per Scenario; See Section D.5.d)	Scenario Events	Actual Attributes
1. Total malfunctions (5-8)	4,5,7,8,9	5
2. Malfunctions after EOP entry (1-2)	8,9	2
3. Abnormal events (2-4)	4,5	2
4. Major transients (1-2)	10	1
5. EOPs entered/requiring substantive actions (1-2)	EO-100-102 EO-100-103	2
6. EOP contingencies requiring substantive actions (0-2)	EO-100-112	1
7. Critical tasks (2-3) CT-1 Isolate HPCI when Suppression Pool level cannot be maintained above 17 feet. CT-2 Rapidly Depressurize the reactor when Suppression Pool level cannot be maintained above 12 feet.		2



PPL-SUSQUEHANNA, LLC LEARNING CENTER

SIMULATOR SCENARIO

Scenario Title:	Plant Startup / Place RFP In-Service / Startup Level Controller Failure / Aux Bus 11B Lockout / Spurious MSIV Isolation / DW Leak / Suppression Pool Leak / Rapid Depressurization
Scenario Duration:	1 hour 15 minutes
Scenario Number:	LOC26-NRC-05
Revision / Date:	0 / June 24, 2014
Course:	PC017 SRO License PC018 RO License

Prepared By:	Robert A. Thompson	06/24/2014
	Instructor	Date
Reviewed By:	<i>Paul J. Meylitz</i>	6/30/14
	Operations Training Management	Date
Approved By:	<i>J. Kearney</i>	6-30-14
	Operations Line Management	Date

THIS PAGE IS INTENTIONALLY LEFT BLANK

SCENARIO SUMMARY

The scenario begins with Unit 1 starting up from a refueling outage in Mode 2 at 500 psig, approximately 3 percent power. Control rods 42-15 and 46-19 were declared slow during the last scram time test. A severe thunderstorm watch is in effect for northeast Pennsylvania for the next 12 hours.

RFP A is in standby with RFP B in Idle. The first task for the crew is to place RFP A in-service in Discharge Pressure Mode per OP-145-001. Once the RFP is in DPM the crew will pull the next step of control rods to raise power slightly. As the crew withdraws the third control rod the PIP probe will fail, causing a loss of indication for the control rod, requiring the crew to declare it inoperable and entering TS 3.1.3.

When activities associated with TS for the inoperable PIP probe are complete, the controller for the HV-10640 will be set to 100 percent demand. The crew will respond by manually closing the HV-10640 with the controller.

Once reactor level has been stabilized, the power to Division 2 of the RCIC initiation logic will be lost. The crew will enter TS 3.3.5.2 for RCIC instrumentation inoperable.

After TS are addressed Aux Bus 11B will experience a lockout. The crew will enter ON-103-003 for loss of the Aux Bus and ensure the unit remains stable. The crew will place Condensate Pump C in service per OP-144-001 to maintain a two Condensate Pumps in-service with a RFP in-service.

Once the crew has placed a second Condensate Pump in-service, a spurious Group 1 MSIV and MSL drain isolation will occur. Reactor pressure will slowly begin to rise, with pressure soon exceeding the shutoff head of the Condensate Pumps. All automatic scrams are disabled. The crew should elect to conservatively insert a manual scram due to the main steam isolation. When the MSIVs stroke closed a small steam leak will develop on one of the inboard MSIVs, resulting in Drywell pressure quickly rising to the scram setpoint.

The crew will enter EO-100-102 and -103 on high Drywell pressure. For Primary Containment control the crew will first place Suppression Chamber spray in service. The first SC spray valve to be operated will fail to open and trip its breaker. The crew must shift to the other division of RHR to place in SC spray. When the 2nd RHR pump is placed in SC spray, the RHR pump motor will experience a catastrophic fault, The pump breaker will fail to open, however, resulting in a lockout of the associated ESS bus. The motor fault will result in major Suppression Pool leakage from the pump, which will be unisolable.

The Suppression Pool leakage will result in re-entry into EO-103. SP level will slowly fall until HPCI is required to be isolated. Once HPCI is isolated, the severity of the leak will rise due to flooding spreading into an adjacent compartment. Once the second room flooded alarm is in the crew should recognize that SP level cannot be maintained above 12 feet and perform a Rapid Depressurization. Low-pressure ECCS will have to be overridden when Rapid Depressurization is initiated due to the LOCA signal and the availability of Condensate to maintain reactor water level.

The scenario may be terminated when Rapid Depressurization is complete and reactor level is stable in the normal band.

THIS PAGE IS INTENTIONALLY LEFT BLANK

SCENARIO REFERENCES

1. OP-AD-001 Operations Standards For System And Equipment Operation
2. OP-AD-002 Standards For Shift Operations
3. OP-AD-004 Operations Standards For Error And Event Prevention
4. OP-AD-055 Operations Procedure Program
5. OP-AD-338 Reactivity Manipulation Standards and Communication Requirements
6. OP-144-001 Condensate and Feedwater System
7. OP-145-006 Feedwater System HMI Operations
8. OP-149-004 RHR Containment Cooling
9. OP-152-002 HPCI System
10. OP-156-001 Reactor Manual Control System
11. OP-164-001 Reactor Recirculation System
12. OP-183-001 ADS and SRVs
13. ON-037-001 Loss of Condensate Transfer System
14. ON-100-101 Scram, Scram Imminent
15. ON-103-003 13.8 KV BUS 11A AND 11B LOSS OF BUS LOAD SHEDDING ON BUS UNDERVOLTAGE
16. ON-184-001 Main Steam Line Isolation and Quick Recovery
17. EO-000-102 RPV Control
18. EO-000-103 Primary Containment Control
19. EO-000-104 Secondary Containment Control
20. EO-000-112 Rapid Depressurization
21. SO-100-011 Reactor Vessel Temperature and Pressure Recording
22. EP-RM-004 EAL Classification Levels

THIS PAGE IS INTENTIONALLY LEFT BLANK

SCENARIO TASKS

Crew Position	Task	Description
PCO	4611	Implement Automatic Transfer of the First RFP from Standby Mode to Discharge Pressure Mode (ICS)
	2034	Implement Withdraw Control Rod One Notch
	2032	Implement Insert Control Rod One Notch
	4793	Implement RFP A(B)(C) Spd Control Operations
	4791	Implement Rx Feed Pump Valve Control Manipulations
	4655	Implement Place Additional Condensate Pumps in Service (ICS)
	1980	Implement ESW System Manual Startup
	1874	Implement RHR Operation In Containment Cooling Mode
	2383	Implement Manual Operation of Automatic Depressurization System
	1880	Implement Overriding RHR Injection
	1936	Implement Overriding Core Spray Injection
US	1183	Ensure Plant Operates In Accordance With The Operating License, Technical Specifications (TS), and Technical Requirements Manual (TRM)
ALL	1145	Implement Appropriate portions of Plant Startup, Heatup, and Power Operation
	1196	Implement 13.8KV Bus 11A And 11B Load Shedding On Bus UnderVoltage
	1125	Implement RPV Control
	1126	Implement Primary Containment Control
	1204	Implement Loss Of 4 KV ESS Bus
	1129	Implement Rapid Depressurization
	1081	Implement Appropriate Portions Of Operations Standards For System and Equipment Operation
	1091	Implement Operations Standards For Error And Event Prevention
2784	Implement Reactivity Manipulations Standards and Communication Requirements	

THIS PAGE IS INTENTIONALLY LEFT BLANK

CRITICAL TASKS

Isolate HPCI when Suppression Pool level cannot be maintained above 17 feet.	
Safety Significance	Maintain integrity of Primary Containment by preventing direct release of HPCI exhaust steam to the Suppression Chamber air space, bypassing the pressure suppression capability of the Suppression Pool.
Consequences for Failure To Perform Task	Potential failure of primary containment.
Indications/Cues for Event Requiring Critical Task	Multiple Control Room and PICSY indications of Suppression Pool water level. Determination by Unit Supervisor that attempts to maintain pool level will not be successful maintaining level above 17 feet.
Performance Criteria	Regardless of HPCI use for adequate core cooling, close steam isolation valves before Suppression Pool level drops below 17 feet.
Performance Feedback	Full closed indication of HPCI steam isolation valves; HPCI trip.
Rapidly Depressurize the reactor when Suppression Pool level cannot be maintained above 12 feet.	
Safety Significance	Maintenance of primary containment by ensuring RPV depressurization is accomplished prior to additional Suppression Pool inventory loss.
Consequences for Failure To Perform Task	Potential failure of primary containment.
Indications/Cues for Event Requiring Critical Task	Multiple Control Room and PICSY indications of Suppression Pool water level. Determination by Unit Supervisor that attempts to maintain pool level will not be successful maintaining level above 12 feet.
Performance Criteria	Recognize that efforts to maintain Suppression Pool level above 12' are unsuccessful perform rapid depressurization per EO 112. Initiate ADS and/or manually open all 6 ADS/SRVs.
Performance Feedback	Verify ADS valves are open using light red light indication, acoustic monitoring and lowering reactor pressure and rising reactor level.

THIS PAGE IS INTENTIONALLY LEFT BLANK

SCENARIO MALFUNCTIONS

Event	Description	Crew Response
1	Startup level control bypass valve HV-10640 controller fails to maximum demand	Lower output of controller to closed HV-10640 or reduce speed of in-service RFP to maintain reactor water level (ON-145-001)
2	Aux Bus 11B lockout	Start Condensate Pump C to maintain 2-pump Condensate alignment with RFP in-service (OP-144-001)
3	Spurious MSIV closure	Insert a manual scram due to loss of the normal heat sink (ON-100-101)
4	Small RCS leak in the Drywell	Place Suppression Chamber spray in-service to cool Primary Containment (OP-149-004)
5	RHR Suppression Chamber cooling isolation valve breaker trips	Place other division of RHR in Suppression Chamber spray (OP-149-004)

ABNORMAL EVENTS / MAJOR TRANSIENTS / TECH SPEC

Malfunction	Description
N	Place RFP in-service in Discharge Pressure Mode (OP-145-001)
R	Withdraw control rods to raise reactor power (OP-AD-338, GO-100-002)
AE1	HV-10640 controller fails to maximum demand (ON-145-001)
AE2	Aux Bus 11B lockout (ON-103-003)
MT1	Unisolable Suppression Pool leak (EO-100-103, 112)
TS1	Inoperable control rod position indication (TS 3.1.3)
TS2	RCIC Division 2 initiation logic power supply loss (TS 3.3.5.1)

THIS PAGE IS INTENTIONALLY LEFT BLANK

SCENARIO SPECIAL INSTRUCTIONS

1. Simulator setup
 - a. **Initialize** to an exam-specific IC (IC-385). If an exam-specific IC is not available, then setup the simulator as follows:
 - i) **Initialize** to IC-17.
 - ii) **Place** the simulator in RUN.
 - iii) **Place** RFP A in STANDBY per OP-145-001.
 - b. **Run** SCN file **exam\LOC26-N05.scn**
 - c. **Open** TREND files **rat.tnd, LOC26-N05-1.tnd**

2. **Verify** the following malfunctions/overrides, event triggers and key assignments:

MF	RF	OR	SCN	ET	COND
7:7	0:0	0:0	0:0	4:0	10

3. **Prepare** the simulator for evaluation
 - a. **Complete** a simulator exam checklist, TQ-106-0315
 - b. **Reset** ODAs and all Overhead, PICSY, HMI and RWM alarms
 - c. **Ensure** FWLC is selected to VENTURI
 - d. **Ensure** correct CRC book is staged and marked-up for current plant conditions
4. **Prepare** a Turnover Sheet including the following:
 - a. Unit 1
 - i) Startup from refueling outage in progress. Mode 2, 3 percent power, reactor pressure 500 psig.
 - ii) Control rods 42-15, 46-19 were declared slow during last scram time test
 - iii) Place RFP A in-service in Discharge Pressure Mode in AUTO per OP-145-001.
 - iv) Another operator is dedicated to performing SO-100-011 heat-up rate tracking
 - b. Common
 - i) Unit 2 at rated power
 - ii) Severe thunderstorm watch is in effect for NE Penn for the next 12 hours
5. **Document** training participation and feedback
 - a. **Ensure** all present have signed Security Agreements per NUREG-1021 and TQ-104-0306
 - b. **Show** the crew that the Evaluators and Booth Operators are qualified
 - c. **Complete** an Operator Fundamental Score Card

THIS PAGE IS INTENTIONALLY LEFT BLANK

SCENARIO FILES

LOC26-N05.SCN

```
; Monitored Parameters
SCN rat_mp
SCN exam\LOC26-N05-MP
; Auto-scrams defeated
IMF mFRP158003
; Wetwell clg valves failed
IMF cmfMV07_HV151F028A f:0
IMF cmfMV07_HV151F028B f:0
; RHR SP suction valves fail open
IMF cmfMV07_HV151F004A f:100
IMF cmfMV07_HV151F004B f:100
IMF cmfMV07_HV151F004C f:100
IMF cmfMV07_HV151F004D f:100
; fail rod position 54-35
aet LOC26-N05-1
; Allow manual scram
aet LOC26-N05-3
; RHR wetwell clg valves fail
aet LOC26-N05-4A
aet LOC26-N05-4B
; Hydraulically disarm HCU 54-35
{Key[1]} IRF rFRD1550075435 f:DISARM
; Fail F040 open
{Key[2]} set fx10SULC_B9.OUT=100
; RCIC initiation logic power loss
{Key[3]} IMF cmfFU01_1C618FU21
; Aux Bus 11B lock-out
{Key[4]} IMF cmfRL02_86A1102
{Key[4]} MMF cmfPM06_1P102A f:30 r:60
; Spurious Group 1 isolation
{Key[5]} IMF cmfRL01_B211K7A c:1
{Key[5]} IMF cmfRL01_B211K7B c:1
{Key[5]} IMF cmfRL01_B211K7C c:1
{Key[5]} IMF cmfRL01_B211K7D c:1
{Key[5]} IMF mfMS183007 r:180 f:0.5
```

LOC26-N05-MP.SCN

```
insmp lssblpos(114)
changemp lssblpos(114) ...,CR 54-35 NOTCH
POS
insmp aoFI15120AB.CurrValue
changemp aoFI15120AB.CurrValue
0,750,norm,RHR A WW SPR FL
insmp aoFI15120BB.CurrValue
changemp aoFI15120BB.CurrValue
0,750,norm,RHR B WW SPR FL
```

LOC26-N05-1.ET/SCN

```
lssblpos(114) > 12
IMF mfLS1550145435
```

LOC26-N05-3.ET/SCN

```
diHSC72A1S01.CurrValue !=
#OR.diHSC72A1S01.STARTUP
DMF mFRP158003
```

LOC26-N05-4A.ET/SCN

```
diHS15128A.CurrValue = #OR.diHS15128A.OPEN
IMF cmfMV01_HV151F028A
DMF cmfMV07_HV151F028B
cet LOC26-N05-4B
aet LOC26-N05-4BB
aet LOC26-N05-4BD
```

LOC26-N05-4AA.ET/SCN

```
aoFI15120AB.CurrValue > 400 &
doHS15102A_3.CurrValue =
#OR.doHS15102A_3.ON
cet LOC26-N05-4AC
IRF crfPM11_1P202A f:CLS
IMF annAR109A07 f:ALARM_ON d:10
IRF rfYCF13085 d:15 f:ALARM
IMF cmfPM03_1P202A d:20
IMF cmfEB01_1A201 d:30
IMF mFRH149004A d:45 f:100
aet LOC26-N05-5A
```

LOC26-N05-4AC.ET/SCN

```
aoFI15120AB.CurrValue > 400 &
doHS15102C_3.CurrValue =
#OR.doHS15102C_3.ON
cet LOC26-N05-4AA
IRF crfPM11_1P202C f:CLS
IMF annAR109A08 f:ALARM_ON d:10
IRF rfYCF13085 d:15 f:ALARM
IMF cmfPM03_1P202C d:20
IMF cmfEB01_1A203 d:30
IMF mFRH149004A d:45 f:100
aet LOC26-N05-5A
```

LOC26-N05-4B.ET/SCN

```
diHS15128B1.CurrValue =
#OR.diHS15128B1.OPEN
IMF cmfMV01_HV151F028B
DMF cmfMV07_HV151F028A
cet LOC26-N05-4A
aet LOC26-N05-4AA
aet LOC26-N05-4AC
```

LOC26-N05-4BB.ET/SCN

```
aoFI15120BB.CurrValue > 400 &
doHS15102B1_3.CurrValue =
#OR.doHS15102B1_3.ON
cet LOC26-N05-4BD
IRF crfPM11_1P202B f:CLS
IMF annAR113A07 f:ALARM_ON d:10
IRF rfYCF13108 d:15 f:ALARM
IMF cmfPM03_1P202B d:20
IMF cmfEB01_1A202 d:30
IMF mFRH149004B d:45 f:100
aet LOC26-N05-5B
```

LOC26-N05-4BD.ET/SCN

doFI15120BB.CurrValue > 400 &
doHS15102D1_3.CurrValue =
#OR.doHS15102D1_3.ON
cet LOC26-N05-4BB
IRF crfPM11_1P202D f:CLS
IMF annAR113A08 f:ALARM_ON d:10
IRF rfyCF13108 d:15 f:ALARM
IMF cmfPM03_1P202D d:20
IMF cmfEB01_1A204 d:30
IMF mfrRH149004B d:45 f:100
aet LOC26-N05-5B

LOC26-N05-5A.ET/SCN

diHS15502.CurrValue != #OR.diHS15502.OPEN |
diHS15503.CurrValue != #OR.diHS15503.OPEN
IMF cmfTR02_LT15776A r:480 f:10.3
IMF cmfTR02_LT15776B r:480 f:10.1
IMF annAR113H08 d:60 f:ALARM_ON

LOC26-N05-5B.ET/SCN

diHS15502.CurrValue != #OR.diHS15502.OPEN |
diHS15503.CurrValue != #OR.diHS15503.OPEN
IMF cmfTR02_LT15776A r:480 f:10.3
IMF cmfTR02_LT15776B r:480 f:10.1
IMF annAR108H03 d:60 f:ALARM_ON

THIS PAGE IS INTENTIONALLY LEFT BLANK

SCENARIO EVENT DESCRIPTION FORM

Initial Conditions: Ensure shift positions are assigned, have the Crew conduct the turnover and perform a panel walk down before the start of the scenario.

EVENT	TIME	DESCRIPTION
N/A	0	Crew assumes shift
A	0	Place RFP A in DPM
B	10	Control rod withdrawal / PIP probe failure
C	25	HV-10640 controller fails to maximum demand
D	30	RCIC logic power failure / Aux Bus 11B lockout
E	40	MSIV spurious isolation / RCS leak in Drywell / Reactor scram
F	50	Containment cooling
G	60	Suppression Pool leak / Rapid Depressurization
N/A	75	Termination

INSTRUCTOR ACTIVITIES / ROLE PLAY / NOTES

EVENT	A
BRIEF DESCRIPTION	Place RFP A in DPM

OPERATOR ACTIVITY

1. None

ROLE PLAY

1. As **NPO** dispatched to monitor RFP operations, **acknowledge** the request and provide **report** RFP operation is nominal.
2. **Role play** any other directed actions as required.

EVALUATOR NOTES

1. None

SCENARIO EVENT FORM

EVENT	A
BRIEF DESCRIPTION	Place RFP A in DPM

POSITION	TIME	STUDENT ACTIVITIES
PCOP		<p>Performs OP-145-001, section 2.8 as follows:</p> <ul style="list-style-type: none"> • Ensure Level Setpoint on the LV-10641 FW Lo Load Valve controller LIC-C32-1R602 is 35" as follows: <ul style="list-style-type: none"> ○ Place LV-10641 FW LO LOAD Valve controller LIC-C32-1R602 to MANUAL ○ Adjust Level Setpoint on LIC C32 1R602 controller to 35" ○ Place LV-10641 FW LO LOAD VALVE controller LIC-C32-1R602 to AUTO • Ensure RFP A is operating in Standby Mode • Ensure A(B)(C) RFP VLV CONTROL is selected to AUTO, by observing A(B)(C) RFPT AUTO VLV CTL button is backlit yellow and Auto text appears next to 603A(B)(C) and 651A(B)(C) valve icons • Ensure at least 120 seconds has elapsed since Auto Valve Control was selected
		<p>Transfer RFP A to DPM as follows:</p> <ul style="list-style-type: none"> • Ensure FIC-10604A RX FEED PUMP A RECIRC FLOW controller in AUTO • Touch A RFPT DSCH PRESS MODE button • Touch INITIATE DSCH PRSS MODE button
		<p>Observe the following:</p> <ul style="list-style-type: none"> • SIC-C32-1R601A RFP A SPD CTL/DEMAND SIGNAL controller raises steam admission as necessary to obtain a variable RFP A discharge pressure of 120 - 400 psig Above reactor pressure • FV-10604A RX FEED PUMP A RECIRC FLOW throttles open to establish required Recirc Flow • AFTER a 30 second time delay, HV-10651A RFP A Startup Iso Vlv automatically OPENS • FV-10604A RX FEED PUMP A RECIRC FLOW throttles open to establish required Recirc Flow
US		Performs a critical brief for placing RFP A in DPM
		Directs PCOP to place RFP A in DPM in accordance with OP-145-001, RFP and RFP Lube Oil System.

★ Denotes Critical Task

NOTES	
--------------	--

THIS PAGE IS INTENTIONALLY LEFT BLANK

SCENARIO EVENT DESCRIPTION FORM

EVENT	TIME	DESCRIPTION
N/A	0	Crew assumes shift
A	0	Place RFP A in DPM
B	10	Control rod withdrawal / PIP probe failure
C	25	HV-10640 controller fails to maximum demand
D	30	RCIC logic power failure / Aux Bus 11B lockout
E	40	MSIV spurious isolation / RCS leak in Drywell / Reactor scram
F	50	Containment cooling
G	60	Suppression Pool leak / Rapid Depressurization
N/A	75	Termination

INSTRUCTOR ACTIVITIES / ROLE PLAY / NOTES

EVENT	B
BRIEF DESCRIPTION	Control rod withdrawal / PIP probe failure

OPERATOR ACTIVITY

1. Ensure Event Trigger LOC26-N05-1 initiates when control rod 54-35 withdraws past position 12 to cause a failure of all position indication for the control rod.
2. When directed, **depress KEY 1** to hydraulically disarm control rod 54-35.

{Key[1]} IRF rfRD1550075435 f:DISARM

Hydraulically disarm HCU 54-35

ROLE PLAY

1. As **Reactor Engineering** contacted for instructions for inserting control rod 54-35, **report**

The control rod may be inserted full-in to comply with Tech Specs.

2. As **WWM** contacted for assistance with failed indication for control rod 54-35, **wait 5 minutes and report**

I&C reports that additional troubleshooting will be required to determine if the failure is the PIP probe or a card in RPIS.

3. **Role play** any other directed actions as required.

EVALUATOR NOTES

1. None

SCENARIO EVENT FORM

EVENT	B
BRIEF DESCRIPTION	Control rod withdrawal / PIP probe failure

POSITION	TIME	STUDENT ACTIVITIES
PCOM		<p>Withdraws control rods in accordance with RMR per OP-156-001 and OP-AD-338</p> <ul style="list-style-type: none"> • Select control rod to be withdrawn one notch by depressing corresponding CONTROL ROD SELECTION pushbuttons • Observe <ul style="list-style-type: none"> ○ CONTROL ROD SELECTION pushbuttons ILLUMINATED. ○ FULL CORE DISPLAY ILLUMINATED Green at selected location. ○ Present position of selected rod INDICATED on FOUR ROD DISPLAY on CRT and Standby Information Panel 1C652. • Momentarily depress W/DRAW ROD pushbutton until the rod insert light illuminates • During withdraw cycle, Observe following occur in sequence within ~ 10 seconds <ul style="list-style-type: none"> ○ ROD INSERT light MOMENTARILY ILLUMINATED. ○ ROD W/DRAWG light ILLUMINATED THEN EXTINGUISHED. ○ Withdrawal drive flow of approx. 2 3 gpm during control rod withdrawal on CRT FOUR ROD DISPLAY. ○ ROD SETLG light ILLUMINATED THEN EXTINGUISHED at end of cycle. • Observe at FOUR ROD DISPLAY control rod withdraws one notch from previous position AND position indicated is an even number • When all 4 steps are complete, reselects and confirms previous moves per the control rod movement sheet
		Depress ROD SELCT CLEAR pushbutton
		Per GO-100-012, plots power change on power/flow map
		Monitor diverse indications of reactor power (APRMs, heat balance, Main Generator output) per OP-AD-001 Attachment G
		Identifies that rod position indication is lost and notifies US

SCENARIO EVENT FORM

EVENT	B
BRIEF DESCRIPTION	Control rod withdrawal / PIP probe failure

POSITION	TIME	STUDENT ACTIVITIES
PCOM (cont'd)		Inserts control rod 54-35 to position 00 per OP-156-001 and OP-AD-338 as follows: <ul style="list-style-type: none"> • Select control rod to be inserted one notch by Depressing corresponding CONTROL ROD SELECTION pushbuttons • Observe: <ul style="list-style-type: none"> ○ CONTROL ROD SELECTION pushbuttons ILLUMINATED ○ FULL CORE DISPLAY ILLUMINATED GREEN at selected location ○ Present position of selected rod INDICATED on FOUR ROD DISPLAY on CRT and Standby Information Panel 1C652 • Momentarily Depress INSERT ROD pushbutton until the rod insert light illuminates • During insert cycle, Observe following occur in sequence within ~ 10 seconds <ul style="list-style-type: none"> ○ ROD INSERT light ILLUMINATES <u>THEN</u> EXTINGUISHES ○ Insert drive flow of approx. 4-5 gpm during control rod insertion on CRT FOUR ROD DISPLAY ○ ROD SETLG light ILLUMINATED <u>THEN</u> EXTINGUISHES at end of cycle • Observe at FOUR ROD DISPLAY control rod inserts one notch from previous position <u>AND</u> position indicated is an even number • When all 4 steps are complete, reselects and confirms previous moves per the control rod movement sheet
		Depress ROD SELCT CLEAR pushbutton
		Per GO-100-012, plots power change on power/flow map
PCOP		Verifies control rods to be withdrawn as directed by RMR per OP-AD-338
		Dispatches NPO to Hydraulically disarm HCU 54-35
US		Obtains permission from the Shift Manager prior to commencing reactivity manipulations
		Conducts a Crew Update prior to commencing rod withdrawal
		Directs control rod withdrawal per OP-156-001, RMR and GO-100-012
		Monitors control rod movement with independent copy of RMR

SCENARIO EVENT FORM

EVENT	B
BRIEF DESCRIPTION	Control rod withdrawal / PIP probe failure

POSITION	TIME	STUDENT ACTIVITIES
		Declares Control Rod 54-35 inoperable and enters Tech Spec 3.1.3, Condition C.
		Directs PCOM to drive control rod 54-35 full in to comply with Tech Specs
		Directs PCOP to dispatch NPO to hydraulically disarm HCU 54-35

★ Denotes Critical Task

NOTES	
--------------	--

THIS PAGE IS INTENTIONALLY LEFT BLANK

SCENARIO EVENT DESCRIPTION FORM

EVENT	TIME	DESCRIPTION
N/A	0	Crew assumes shift
A	0	Place RFP A in DPM
B	10	Control rod withdrawal / PIP probe failure
C	25	HV-10640 controller fails to maximum demand
D	30	RCIC logic power failure / Aux Bus 11B lockout
E	40	MSIV spurious isolation / RCS leak in Drywell / Reactor scram
F	50	Containment cooling
G	60	Suppression Pool leak / Rapid Depressurization
N/A	75	Termination

INSTRUCTOR ACTIVITIES / ROLE PLAY / NOTES

EVENT	C
BRIEF DESCRIPTION	HV-10640 controller fails to maximum demand

OPERATOR ACTIVITY

1. Once crew activities with the inoperable position indication for control rod 54-35 are complete, **depress KEY 2** to fail open the FW startup level control bypass valve HV-10640.

{Key[2]} set fx10SULC_B9.OUT=100

Fail F040 open

ROLE PLAY

1. As **NPO** dispatched to HV-10640, **wait 2 minutes and report**

I don't see anything abnormal with the valve operator locally.

2. As **WWM** contacted for assistance with HV-10640, **wait 5 minutes and report**

I&C and Engineering have not determined why the position demand for the HV-10640 went to 100 percent.

If the valve has not yet been closed, **add**

A walk down of the valve did not reveal any problems; Engineering believes it should be safe to reclose the valve.

3. **Role play** any other directed actions as required.

EVALUATOR NOTES

1. The crew may initiate an investigation into tampering due to the behavior of the HV-10640 valve. The scenario should be advanced to the next event as soon as action is initiated to take control of reactor level.

SCENARIO EVENT FORM

EVENT	C
BRIEF DESCRIPTION	HV-10640 controller fails to maximum demand

POSITION	TIME	STUDENT ACTIVITIES
PCOM		Responds to AR-101-A17, RX WATER HI LEVEL
		Closes the FW STARTUP BYPASS VALVE HV-10640 using the DEC button
US		Refers to ON-145-001, RPV Level System Malfunction
		Contacts WWM to investigate spurious opening of HV-10640

★ Denotes Critical Task

NOTES	
--------------	--

THIS PAGE IS INTENTIONALLY LEFT BLANK

SCENARIO EVENT DESCRIPTION FORM

EVENT	TIME	DESCRIPTION
N/A	0	Crew assumes shift
A	0	Place RFP A in DPM
B	10	Control rod withdrawal / PIP probe failure
C	25	HV-10640 controller fails to maximum demand
D	30	RCIC logic power failure / Aux Bus 11B lockout
E	40	MSIV spurious isolation / RCS leak in Drywell / Reactor scram
F	50	Containment cooling
G	60	Suppression Pool leak / Rapid Depressurization
N/A	75	Termination

INSTRUCTOR ACTIVITIES / ROLE PLAY / NOTES
--

EVENT	D
BRIEF DESCRIPTION	RCIC logic power failure / Aux Bus 11B lockout

OPERATOR ACTIVITY

1. After the crew has stabilized reactor level, **depress KEY 3** to initiate a loss of the RCIC initiation logic power supply due to a blown fuse.

{Key[3]} IMF cmfFU01_1C618FU21

RCIC initiation logic power loss

2. Once TS have been addressed, **depress KEY 4** to initiate a lockout of Auxiliary Bus 11B

{Key[4]} IMF cmfRL02_86A1102

Aux Bus 11B lock-out

{Key[4]} MMF cmfPM06_1P102A f:30 r:60

ROLE PLAY

1. As **NPO** dispatched to walk down RCIC initiation logic, **wait 2 minutes and report**

I don't see anything abnormal with the RCIC initiation logic.

2. As **WWM** contacted for assistance with RCIC initiation logic, **wait 5 minutes and report**

Maintenance is developing a troubleshooting plan. There is nothing to add at this time.

3. As **NPO** dispatched to Aux Bus 11B, **wait 2 minutes and report**

The bus lockout 86 devices are tripped.

4. As **WWM** contacted for assistance with Aux Bus 11B, **wait 5 minutes and report**

Electrical reports damage to Aux Bus 11B. Repairs are going to take some time.

5. **Role play** any other directed actions as required.

EVALUATOR NOTES

1. If the crew performs a manual scram proceed to Event E.

SCENARIO EVENT FORM

EVENT	D
BRIEF DESCRIPTION	RCIC logic power failure / Aux Bus 11B lockout

POSITION	TIME	STUDENT ACTIVITIES
PCOM		Reports power/pressure/level to US
PCOP		Responds to AR-108-B05, RCIC OUT OF SERVICE, informs US to comply with TS 3.5.3
		Identifies lockout of Aux Buss 11B
		Performs ON-103-003
		Restores Condensate Pumps 1P102B(D) in accordance with OP-144-001, Condensate and Feedwater System as follows: <ul style="list-style-type: none"> o Check Open COND PP B(D) SUCT HV-10501B(D) o Depress CONDENSATE PUMP 1P120B(D) START pushbutton o Observe COND PP B(D) DSCH HV -10502B(D) STARTS OPENING within five (5) seconds after Condensate Pump 1P102B(D) starts
US		Refers to TS 3.5.3 and TS 3.3.5.2
		Declares RCIC inoperable per TS 3.5.3
		Directs PCOP to perform ON-103-001
		Directs PCOP to place a 2 nd Condensate pump in-service in accordance with OP-144-001

★ Denotes Critical Task

NOTES	
--------------	--

THIS PAGE IS INTENTIONALLY LEFT BLANK

SCENARIO EVENT DESCRIPTION FORM

EVENT	TIME	DESCRIPTION
N/A	0	Crew assumes shift
A	0	Place RFP A in DPM
B	10	Control rod withdrawal / PIP probe failure
C	25	HV-10640 controller fails to maximum demand
D	30	RCIC logic power failure / Aux Bus 11B lockout
E	40	MSIV spurious isolation / RCS leak in Drywell / Reactor scram
F	50	Containment cooling
G	60	Suppression Pool leak / Rapid Depressurization
N/A	75	Termination

INSTRUCTOR ACTIVITIES / ROLE PLAY / NOTES

EVENT	E
BRIEF DESCRIPTION	MSIV spurious isolation / RCS leak in Drywell / Reactor scram

OPERATOR ACTIVITY

1. When the second Condensate Pump has been placed in-service, **depress KEY 5** to initiate a spurious Group 1 isolation with closure of the MSIVs and MSL drains, with a steam leak in the Drywell.

{Key[5]} IMF cmfRL01_B211K7A c:1
 {Key[5]} IMF cmfRL01_B211K7B c:1
 {Key[5]} IMF cmfRL01_B211K7C c:1
 {Key[5]} IMF cmfRL01_B211K7D c:1
 {Key[5]} IMF mfMS183007 r:180 f:0.5

Spurious Group 1 isolation

2. Ensure Event Trigger LOC26-N05-3 initiates when the Mode switch is taken out of STARTUP to defeat the RPS failure-to-scram malfunction.

ROLE PLAY

1. As **WWM** contacted for assistance with MSIV spurious isolation, **wait 5 minutes and report**
Maintenance cannot determine why the MSIVs isolation logic actuated. It appears to have been a spurious isolation.
2. **Role play** any other directed actions as required.

EVALUATOR NOTES

1. None

SCENARIO EVENT FORM

EVENT	E
BRIEF DESCRIPTION	MSIV spurious isolation / RCS leak in Drywell / Reactor scram

POSITION	TIME	STUDENT ACTIVITIES
PCOM		Reports power/pressure/level to US, pressure is up slow.
		Inserts a manual scram as follows: <ul style="list-style-type: none"> • PLACE Mode Switch HS-C72A-1S01 to SHUTDOWN • VERIFY all Control Rods indicate fully inserted.
		Performs actions following scram per ON-100-101 Att. A <ul style="list-style-type: none"> • Inserts IRMs and SRMs • Verify scram discharge volume vent and drain valves closed • ENSURE RPV Level 13" to 54", with target band of 20" to 45" • REPORT anything abnormal to Unit Supervisor
PCOP		Responds to AR-111-D01, MSIV LOGIC A/C ISO INITIATED
		Responds to AR-104-B03, PRIMARY CONTAINMENT HI LO PRESS, notifies US
US		Refers to ON-184-001, Main Steam Line Isolation and Quick Recovery
		Directs PCOM to insert a manual scram
		Contacts WWM for assistance with MSIV spurious isolation
		Enters EO-100-102, RPV Control on DW Pressure >1.72 psig
		Directs PCOP to ensure all: <ul style="list-style-type: none"> • Isolations • ECCS Initiations • DG Starts
		Directs PCOM to restore and maintain RPV level +20" to +54"
		Directs PCOM to maintain pressure using SRVs
		Directs PCOM to reset Generator Lockouts

★ Denotes Critical Task

NOTES	
--------------	--

THIS PAGE IS INTENTIONALLY LEFT BLANK

SCENARIO EVENT DESCRIPTION FORM

EVENT	TIME	DESCRIPTION
N/A	0	Crew assumes shift
A	0	Place RFP A in DPM
B	10	Control rod withdrawal / PIP probe failure
C	25	HV-10640 controller fails to maximum demand
D	30	RCIC logic power failure / Aux Bus 11B lockout
E	40	MSIV spurious isolation / RCS leak in Drywell / Reactor scram
F	50	Containment cooling
G	60	Suppression Pool leak / Rapid Depressurization
N/A	75	Termination

INSTRUCTOR ACTIVITIES / ROLE PLAY / NOTES

EVENT	F
BRIEF DESCRIPTION	Containment cooling

OPERATOR ACTIVITY

1. **Ensure** Event Trigger LOC26-N05-4A(B) initiates when the first RHR containment cooling isolation valve F028A(B) is opened to trip the valve breaker and allow the other division of RHR wetwell spray to function and activate Event Trigger LOC26-N05-4BB/BD(AA/AC).
2. **Ensure** Event Trigger LOC26-N05-4BB/BD(AA/AC) initiates when the second division of RHR wetwell spray is placed in-service at > 400 gpm to trip the in-service RHR pump with a lockout of the associated ESS Bus and major Suppression Pool leak from the pump.

ROLE PLAY

1. As **NPO** dispatched to RHR containment cooling isolation valve HV-1HV-151-F028A(B), **wait 2 minutes and report**

The F028 valve appears to be full closed. I don't hear any flow noise.
2. As **NPO** dispatched to RHR containment cooling isolation valve HV-1HV-151-F028A(B) breaker, 1B216-044(1B226-032), **wait 2 minutes and report**

The breaker is in the tripped-free condition.
3. As **NPO** dispatched to RHR Pump breaker, 1A20x-02, **wait 2 minutes and report**

The breaker is closed although a number of flags are showing. The ESS Bus 1x is locked-out on overcurrent.
4. As **WWM** contacted for assistance with RHR F028 valve, **acknowledge** the request and take no further action.
5. As **WWM** contacted for assistance with RHR Pump breaker or ESS Bus, **wait 5 minutes and report**

Electrical Maintenance reports the RHR Pump experienced a fault condition, but the breaker failed to trip open, propagating the fault onto the bus. It will take some time to remove the RHR pump breaker and evaluate the condition of the bus.
6. **Role play** any other directed actions as required.

EVALUATOR NOTES

1. Activates associated with the Suppression Pool leak are in Event G.

SCENARIO EVENT FORM

EVENT	F
BRIEF DESCRIPTION	Containment cooling

POSITION	TIME	STUDENT ACTIVITIES
PCOP		Places Suppression Chamber Sprays in service as follows: <ul style="list-style-type: none"> • Start ESW PUMP 0P504A(C) and 0P504B(D) by Depressing RUN pushbutton. • IF a LOCA initiation signal is present, THEN OVERRIDE LOCA Isolation as follows: <ul style="list-style-type: none"> ○ PLACE LOCA ISOLATION MANUAL OVERRIDE HS-E11-1S17A keyswitch to OVRD position ○ VERIFY white indicating light above LOCA ISOLATION MANUAL OVERRIDE HS-E11-1S17A keyswitch is ILLUMINATED ○ VERIFY annunciator AR109-C5, LOCA ISO SWITCH LOOP A MANUAL OVERRIDE is ILLUMINATED • OPEN SUPP CHMBR SPR TEST SHUTOFF HV-151-F028A(B)
		Reports failure of the F028A valve opening to the US
		Dispatches NPO to investigate the F028 valve
		Dispatches NPO to investigate F028 breaker 1B216-044(1B226-032)
		Places Suppression Chamber Sprays in service using the other division of RHR as follows: <ul style="list-style-type: none"> • PLACE ESW System in operation PER OP-054-001, Emergency Service Water System. • IF a LOCA initiation signal is present, THEN OVERRIDE LOCA Isolation as follows: <ul style="list-style-type: none"> ○ PLACE LOCA ISOLATION MANUAL OVERRIDE HS-E11-1S17B(A) keyswitch to OVRD position ○ VERIFY white indicating light above LOCA ISOLATION MANUAL OVERRIDE HS-E11-1S17B(A) keyswitch is ILLUMINATED ○ VERIFY annunciator AR-113(109)-C05, LOCA ISO SWITCH LOOP B(A) MANUAL OVERRIDE is ILLUMINATED • OPEN SUPP CHMBR SPR TEST SHUTOFF HV-151-F028B(A) • CLOSE RHR INJ FLOW CTL HV-151-F017B(A) • START RHR pump 1P202B(D)/A(C)
		Reports failure of 1P202AB(D)/A(C) to the US
		Dispatches NPO to investigate trip of 1P202B(D)/A(C)
		Dispatches NPO to investigate breaker for 1P202B(D)/A(C)

SCENARIO EVENT FORM

EVENT	F
BRIEF DESCRIPTION	Containment cooling

POSITION	TIME	STUDENT ACTIVITIES
US		Enters EO-100-103, PC Control on DW Pressure >1.72 psig
		Directs PCOP to initiate suppression chamber sprays
		Contacts WWM to assist with the RHR F028 valve
		Directs PCOP to initiate suppression chamber sprays using the other division of RHR
		Contacts WWM to assist with the RHR pump breaker and ESS Bus

★ Denotes Critical Task

NOTES	
--------------	--

SCENARIO EVENT DESCRIPTION FORM

EVENT	TIME	DESCRIPTION
N/A	0	Crew assumes shift
A	0	Place RFP A in DPM
B	10	Control rod withdrawal / PIP probe failure
C	25	HV-10640 controller fails to maximum demand
D	30	RCIC logic power failure / Aux Bus 11B lockout
E	40	MSIV spurious isolation / RCS leak in Drywell / Reactor scram
F	50	Containment cooling
G	60	Suppression Pool leak / Rapid Depressurization
N/A	75	Termination

INSTRUCTOR ACTIVITIES / ROLE PLAY / NOTES

EVENT	G
BRIEF DESCRIPTION	Suppression Pool leak / Rapid Depressurization

OPERATOR ACTIVITY

1. **Ensure** Event Trigger LOC26-N05-5A(B) initiates when HPCI is isolated to raise the severity of the Suppression Pool leak and initiate flooding into the adjacent RHR B (RCIC) room.

ROLE PLAY

1. As **NPO** dispatched to investigate RHR A(B) room , **wait** 2 minutes and **report**

It looked like a large leak coming from the RHR pump itself. The motor looked like it had tilted. I closed the door because the water was starting to pour out over the threshold.

2. As **NPO** dispatched to investigate RHR B room flooding, **wait** 1 minute and **report**

The watertight door between the RHR A and B rooms failed open. The RHR B room was filling rapidly.

3. As **NPO** dispatched to investigate RCIC room flooding, **wait** 1 minute and **report**

As I came down the northeast stairway, there was water at the bottom of the stairwell. The RCIC room door had failed open. I couldn't tell where the water was coming from.

4. **Role play** any other directed actions as required.

5. As **WWM** contacted for assistance with RHR Suppression Pool suction valves, **acknowledge** the request and take no further action.

6. As **WWM** contacted for assistance with room flooding, **wait** 5 minutes and **report**

Mechanical Maintenance is trying to determine how to enter the room without spreading the flooding to other areas.

EVALUATOR NOTES

1. The scenario may be terminated when Rapid Depressurization is complete and reactor level is being restored to the normal band.

SCENARIO EVENT FORM

EVENT	G
BRIEF DESCRIPTION	Suppression Pool leak / Rapid Depressurization

POSITION	TIME	STUDENT ACTIVITIES
PCOM		Reports Suppression Pool Low level to US
		Reports room flooded alarms to US
		Verifies uncontrolled condensate injection prevented
		<p>Opens 6 ADS SRVs by placing 1C601 HSs to OPEN and the performs the following:</p> <ul style="list-style-type: none"> • Dispatch NPO and FUS to Auto Depressurization Panel 1C628 (1C631), URR, and Place the following switches to OPEN: <ul style="list-style-type: none"> ○ PSV-141-F013G Mn Stm Line A ADS ○ PSV-141-F013J Mn Stm Line B ADS ○ PSV-141-F013K Mn Stm Line D ADS ○ PSV-141-F013L Mn Stm Line C ADS ○ PSV-141-F013M Mn Stm Line B ADS ○ PSV-141-F013N Mn Stm Line D ADS • Ensure ADS/Safety Relief Valves OPEN by Observing: <ul style="list-style-type: none"> ○ RISE in ADS/Safety Relief Valve outlet temperature on SRV/ADS Temp Recorder TRS-B21-1R614 on Panel 1C614 ○ LOWERING in reactor vessel pressure
PCOP		Isolates HPCI by placing HV-155-F002 and HV-155-F003 keylock switches to CLOSE.
		<p>Prevents injection of CS pumps not required for adequate core cooling per OP-151-001 as follows:</p> <ul style="list-style-type: none"> • Arm AND Depress initiation button HS-E211S16A(B) • Shutdown pumps <ul style="list-style-type: none"> ○ Place pump control switches to STOP and Release ○ Observe white pump over ride lights ILLUMINATED
		<p>Prevents injection from RHR per OP-149-001</p> <ul style="list-style-type: none"> • Waits for 45 seconds after less than 420 psig • Close RHR INJ FLOW CTL HV 151 F017A(B)
US		Re-enters EO-100-103, PC Control on Suppression Pool Water Level <22'
		Directs PCOP to isolate HPCI when suppression pool level reaches 17'

SCENARIO EVENT FORM

EVENT	G
BRIEF DESCRIPTION	Suppression Pool leak / Rapid Depressurization

POSITION	TIME	STUDENT ACTIVITIES
US (cont'd)		Enters EO-100-112 at RD-1, Rapid Depressurization when it is determined suppression pool level cannot be maintained above 12'
		Directs PCOM to prevent uncontrolled condensate injection
		Directs PCOP to prevent injection from LPCI and Core Spray pumps not required to assure adequate core cooling
		Directs PCOM to open all ADS valves

★ Denotes Critical Task

NOTES	
--------------	--

THIS PAGE IS INTENTIONALLY LEFT BLANK

UNIT SUPERVISOR TURNOVER SHEET

UNIT 1 to/dd/yy
Date

SHIFT 1900 to 0700
Start End

SHIFT 0700 to 1900
Start End

MODE 2
POWER LEVEL 3 %
GENERATOR OUTPUT 0 MWe
CASK STORAGE GATE INSTALLED: YES/NO

MODE _____
POWER LEVEL _____ %
GENERATOR OUTPUT _____ MWe
CASK STORAGE GATE INSTALLED: YES/NO

REMARKS:

- 1) Startup from refueling outage in progress. Mode 2, 3 percent power, reactor pressure 500 psig.
- 2) Control rods 42-15, 46-19 were declared slow during last scram time test
- 3) Place RFP A in-service in Discharge Pressure Mode in AUTO per OP-145-001. It is already in STANDBY.
- 4) Another operator is dedicated to performing SO-100-011 heat-up rate tracking for the startup.
- 5) _____
- 6) _____
- 7) _____
- 8) _____
- 9) _____
- 10) _____
- 11) _____
- 12) _____
- 13) _____
- 14) _____
- 15) _____

COMMON:

- 1) Unit 2 at rated power.
- 2) A severe thunderstorm watch is in effect for northeast Pennsylvania for the next 12 hours.
- 3) _____
- 4) _____
- 5) _____
- 6) _____
- 7) _____
- 8) _____
- 9) _____

OFFGOING UNIT SUPERVISOR CHECKLIST:

NRC CODE PRIOR TO 0800

FOXTROT

DELTA

HOTEL

OSCAR

NRC CODE AFTER 0800

FOXTROT

UNIFORM

BRAVO

ROMEO

1900-0700	0700-1900

1. Evolutions in progress and items to be completed during next shift, as noted in remarks, have been discussed with oncoming Unit Supervisor (including special evolutions, i.e. SICT/E, OPDRVs, etc.).
2. Problems encountered during past shift and abnormal plant conditions, as noted in remarks, have been discussed with oncoming Unit Supervisor.
3. Information in SOMS Log is complete and discussed with oncoming Unit Supervisor.
4. As applicable, turnover plastic Security Badge cover and CRS Monitor function to oncoming Unit Supervisor.

1900 - 0700 _____

0700 - 1900 _____

Offgoing Unit Supervisor

ONCOMING UNIT SUPERVISOR CHECKLIST:

0700	1900
-	-

1. LCO/TRO Log reviewed.
2. SOMS Log reviewed for entries made in past 24 hours.
3. Report any changes to license or medical status PER NDAP-QA-0723.

0700 - 1900 _____

1900 - 0700 _____

Oncoming Qualified Unit Supervisor

POST RELIEF

0700	1900
-	-

1. Walk down Control Room panels with Unit Responsible PCO.
2. CRC Book reviewed and Reactivity Brief performed with PCO.
3. Completed System Status Operable audit for open PMT this shift.
4. From the OPS Web page, Review OPS Aggregate Index for Challenges, Work Arouns, and Deficiencies Reports for impact on scheduled work activities and compensatory actions. ⁽²⁰⁾

0700 - 1900 _____

1900 - 0700 _____

Oncoming Unit Supervisor

2.8 AUTO TRANSFER OF FIRST RFP FROM STANDBY MODE TO DPM

2.8.1 Prerequisites

- a. No other Reactor Feed Pump/Turbine A(B)(C) is feeding the vessel in either Discharge Pressure Mode or Flow Control Mode.
 - b. **IF** maintenance activities performed that may have introduced foreign material into the Feedwater system, **Ensure** RFP A(B)(C) in standby on min flow per "Startup of Reactor Feed Pump" section for at least 30 minutes. ⁽⁶⁾
- OR
- c. **Ensure** RFP A(B)(C) in Standby on Min Flow per "Startup of Reactor Feed Pump" section.
 - d. **Perform** a Critical Brief.
 - (1) Brief to discuss the following:
 - (a) How changing one RFP should/will affect the other RFP, critical parameters, and assignment of roles and responsibilities for critical parameters.
 - (b) Establishing margins to ensure safe operation with pre-established criteria for actions to taken.
 - (c) All pertinent precautions and contingency actions.
 - (d) The need for adequate supervisory oversight throughout the evolution to maintain the big picture and ensure proper actions are being taken.
 - (e) The flow path of communications of key information and critical parameters to supervision as anomalies are encountered.

2.8.2 Precautions

- a. Reference Attachment C for a listing of the associated RFP/RFPT trip inputs.
- b. Reference Attachment D for a listing of the Standard RFP/RFPT Precautions.

2.8.3 **IF** RFP A(B)(C) IND RFP FLOW < 16.4% input to Rx Recirc Limiter #2 is Enabled, then **Disable** applicable input in accordance with OP-164-001.

2.8.4 **IF** RFP Suction Pressure Feature is Enabled; then **Disable** RFP Suction Pressure Feature in accordance with OP-145-006.

2.8.5 **Ensure** Level Setpoint on the LV-10641 FW Lo Load Valve controller LIC-C32-1R602 is 35" as follows:

- a. **Place** LV-10641 FW LO LOAD Valve controller LIC-C32-1R602 to **MANUAL**.
- b. **Adjust** Level Setpoint on LIC-C32-1R602 controller to 35".
- c. **Place** LV-10641 FW LO LOAD VALVE controller LIC-C32-1R602 to **AUTO**.

2.8.6 **Ensure** RFP A(B)(C) is operating in Standby Mode.

2.8.7 **Ensure** A(B)(C) RFP VLV CONTROL is selected to **AUTO**, by observing A(B)(C) RFPT AUTO VLV CTL button is backlit yellow and Auto text appears next to 603A(B)(C) and 651A(B)(C) valve icons.

CS 2.8.8 **Ensure** at least 120 seconds has elapsed since Auto Valve Control was selected.

NOTE: Discharge Pressure confirmation overlay will automatically disappear, when 'Initiate Dsch Prss Mode' command has been accepted. There will be a 30 second TD following initiation request for DPM and equipment response.

2.8.9 **Transfer first RFP_A(B)(C) to DPM, as follows on RFP_A(B)(C) HMI screen:**

a. **Ensure** FIC-10604A(B)(C) RX FEED PUMP A(B)(C) RECIRC FLOW controller in **AUTO**.

b. **Touch** A(B)(C) RFPT DSCH PRESS MODE button.

CS

c. **Touch** INITIATE DSCH PRSS MODE button.

2.8.10 On a normal transfer, **Observe** following:

a. SIC-C32-1R601A(B)(C) RFP A(B)(C) SPD CTL/DEMAND SIGNAL controller raises steam admission as necessary to obtain a variable RFP A(B)(C) discharge pressure of 120 - 400 psig **Above** reactor pressure, **AND**

b. FV-10604A(B)(C) RX FEED PUMP A(B)(C) RECIRC FLOW throttles open to establish required Recirc Flow.

c. **AFTER** a 30 second time delay, HV-10651A(B)(C) RFP A(B)(C) Startup Iso Vlv automatically **OPENS**.

d. As reactor pressure raises during startup, RFP A(B)(C) speed will rise to maintain required RFP discharge pressure of 120-400 psig **Above** reactor pressure, **AND**

e. FV-10604A(B)(C) RX FEED PUMP A(B)(C) RECIRC FLOW throttles open to establish required Recirc Flow.

2.8.11 **IF** HV-10651A(B)(C) HMI valve symbols turns gray at any time during transfer to DPM or fails to operate, **Perform** following: ⁽¹¹⁾

a. **Ensure** A(B)(C) RFP Valve Control in **MANUAL**.

b. **Ensure** affected SIC-C32-1R601A(B)(C) RFP A(B)(C) SPD CTL/DEMAND SIGNAL controller remains in AUTO (DPM).

- c. **Ensure** FWLC system continues to maintain RPV Water Level at 35".
- d. **Consult** with System Engineering to determine appropriate course of action needed to be taken to restore the System to a normal alignment.
- e. **IF** desired, **Perform** Attachment G, Manual Completion of RFP A(B)(C) Transfer to DPM to OPEN HV-10651 and align RFP in a DPM alignment.

OR

- f. **IF** desired, **Place** an alternate RFP in DPM as follows:
 - (1) **Place** failed RFP A(B)(C) in Standby Mode in accordance with OP-145-001 or OP-145-005.
 - (2) **Place** an alternate RFP B(C)(A) in DPM in accordance with OP-145-001 or OP-145-005.
 - (3) **IF** HMI control becomes available:
 - (a) **IF** previously open/throttle open, allow failed RFP A(B)(C) HV-10651 to stroke OPEN.
 - (b) **THEN Close** HV-10651A(B)(C) for failed RFP A(B)(C) Startup Iso Vlv.
 - (4) **IF** HMI control **not** available, **Manually Close** HV-10651A(B)(C) for failed RFP A(B)(C) in accordance with Manual RFP A(B)(C) Valve Operations section of OP-145-005.
 - (5) **Ensure** third RFP C(B)(A) is Warmed and placed in Idle Mode in accordance with OP-145-001 or OP-145-005.
 - (6) **Place** Failed RFP A(B)(C) Valve Control in AUTO.
- 2.8.12 **IF** required, **Stop** 1S106A(B)(C) RFPT A(B)(C) TURNGR MOTOR when RFPT speed is > 100 rpm.
- 2.8.13 **IF** required, **Place** 1S106A(B)(C) RFPT A(B)(C) TURNGR in automatic by depressing **AUTO** pushbutton.

- | |
|---|
| NOTE: Maintaining RFP Discharge Pressure in accordance with Attachment E will optimize response of LV-10641 FW Startup Low Load Valve. |
|---|

- 2.8.14 **Periodically Monitor** RFP and RFPT A(B)(C) vibrations when operating within Critical Speed range of 3,400 to 3,600 rpm.

- 2.8.15 **AFTER** (A)(B)(C) RFP discharge flow > 2.0 Mlbm/hr, **Ensure** FIC-10604A(B)(C) RX FEED PUMP A(B)(C) RECIRC FLOW controller in **AUTO**.

- 2.8.16 **IF** no longer needed for drain tank level control, **Ensure** 106249 (106252) (106255) RFP A(B)(C) OB Seal Drain Leg Level Ctl Vlv Bypass Vlv is **CLOSED**.