

2024 PRODUCT CATALOG





CORPORATE HEADQUARTERS

1555 Apex Rd.
Sarasota, FL 34240
Phone: 941.378.5774
Toll Free: 1.800.424.9549
Fax: 941.379.9015

WEST COAST DISTRIBUTION

1531 Edgar Place
Sarasota, FL 34240

ON-LINE

www.PacerGroup.net
Shopping & Account Management

EAST COAST DISTRIBUTION

3633 SW 30th Ave.
Fort Lauderdale, FL 33312
Phone: 954.767.0477
Toll Free: 1.800.634.5031
Fax: 954.767.0775

Hours: Monday - Friday
7:30am - 4:30pm

Pacer offers an unparalleled inventory of marine wire, cable & electrical products.

ORDERING: Pacer's friendly sales staff are experienced and qualified to answer any questions regarding our products. Orders can be placed online, in store, or by contacting one of our experts. Prices do not include freight or any local, state, or federal taxes, and are subject to change without notice. Commercial accounts may apply for terms.



At Pacer we're not about the transaction - we're about the relationship.

SHIPPING: Orders placed after 12pm EST are not guaranteed to ship the same day. All material is shipped F.O.B. from our fulfillment center. Use Pacer routing for best way shipping or specify your own preferred carrier.



At Pacer we're able to keep minimums low & our prices competitive across all our product lines.

RETURNS: Pacer strives to serve our customers to the best of our ability. Most products can be returned for a full refund within 15 days of receipt. Contact customer service to obtain an approved RMA (Return Material Authorization). Product returned without an RMA will not be accepted. After 15 days, a 20% restocking fee will apply. Sales of non-standard products (cut-to-length, striped, cable assemblies, etc.) or after 90 days are non-returnable, non-refundable. Please inspect all items received for transport damage as freight claims are against the carrier.

Price gets us in the door, commitment to quality keeps us there, and day to day service builds long term relationships.

WARRANTY & DISCLAIMER: All statements, technical information, and recommendations related to the Sellers (Pacer) product line are based upon information believed to be true and correct. The accuracy and completeness thereof are not guaranteed. Before using a product, User should determine the suitability of the product for its intended use. User assumes all risks and liability whatsoever in connection with such use. Where Seller is acting as a distributor of products manufactured by other companies, Seller expressly limits its liabilities to any guarantees Seller will pass through to the customer. No warranty will apply if its products are in any way altered or modified after delivery by Seller. Pacer reserves the right to substitute a specified product listed in this catalog with an equivalent product if the listed manufacturer's product is not available at the time of the order.

MEMBERS



PRODUCTS DESIGNED WITH THE MARINE PROFESSIONAL IN MIND

Pacer is an independent, privately owned family business specializing in wire and cable manufacturing in the United States. Initially, ensuring that Pacer products meet and exceed the governing requirements for the industry was paramount. Shortly after, Pacer worked with its suppliers to formulate flexible compounds that will continue to meet and exceed the stringent requirements of UL, CSA, and SAE.

The result of this work is a proprietary compound that is extremely flexible yet maintains resistance requirements to voltage, abrasion, acid, alkali, flame, gasoline, oil, and moisture. The compound is extremely beneficial as it eases and speeds installation.

- **1979** Pacer began operations in Fort Lauderdale, Florida as Pacer Electronics.
- **1990** Pacer introduced its first marine catalog of wire, wire management products, connectors, and electrical parts.
- **1993** Pacer began manufacturing wire & cable in Sarasota, Florida.
- **1994** Pacer gained UL (Underwriters Laboratory) approval and began producing both UL & SAE wire.
- **1997** Pacer begins engineering panels and wiring harnesses.
- **2000** Pacer is selected as vendor of choice for various marine conglomerates.
- **2013** Pacer is the recipient of the "Grow Florida 50 Companies to Watch Award".
- **2020** Pacer's Corporate HQ expands into a second location.
- **2022** Pacer divests Pacer Marine Engineering.
- **2024** Pacer remains unsurpassed in demand by marine professionals from independent marine companies to large conglomerates and consortiums. Pacer wire products are installed in tens of thousands of pleasure boats in service today.

MANUFACTURING

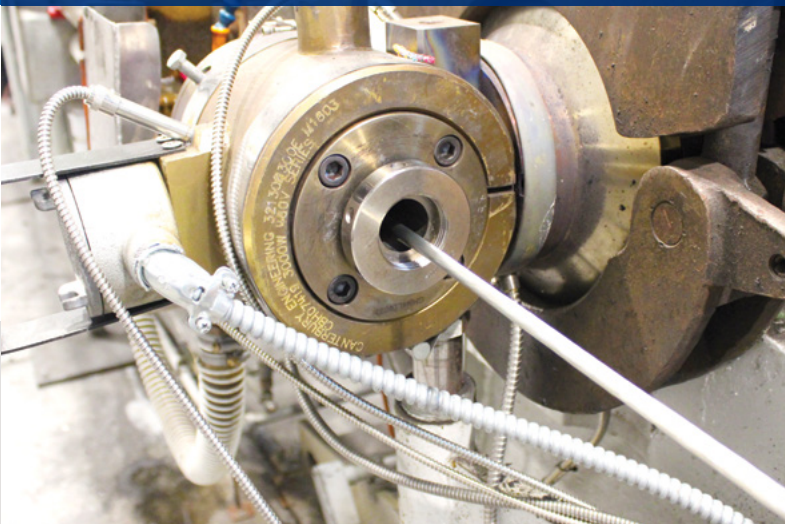

DISTRIBUTION



WIRE & CABLE



BOAT CABLE
Page 6 - 8



UL PRIMARY WIRE
Page 9



BATTERY CABLE
Page 10 - 11



ZIP CORD
Page 15

UL Boat Cable.....	6-8
UL Tinned Primary Wire.....	9
UL Tinned Battery Cable.....	10
Marine SAE SGT Battery Cable.....	11
Battery Cables Assemblies.....	12 & 13
SAE Tinned Wire.....	14
Zip Cord.....	15
Speaker Wire.....	15

MULTI CONDUCTOR CABLE

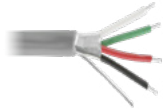

MULTI-CONDUCTOR
SHIELDED
Page 16

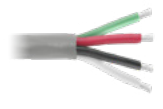

MULTI-CONDUCTOR
UN-SHIELDED
Page 17



MULTI-PAIR
SHIELDED
Page 18



FLAT
BRAIDED
Page 18

Multi-Conductor Shielded Cables.....	16
Multi-Conductor UnShielded Cables.....	17
Multi-Paired Shielded Cables.....	18
Flat Braided Cable.....	18

COAXIAL CABLE



COAXIAL
CABLES
Page 19



LMR
CABLES
Page 19



COAXIAL
CONNECTORS
Page 20



COMPRESSION
SEAL CONNECTORS
Page 21

Coaxial 50 Ohm & 75 Ohm Cables.....	19
LMR (Land Mobile Radio) Cables.....	19
Coaxial Connectors.....	20
Compression Seal Connectors.....	21

NETWORK CABLE



ETHERNET CABLES
Page 22



CAT6 MODULAR PLUGS
Page 22



DEVICENET CABLES
Page 23



DEVICENET
Page 23

Ethernet Cable.....	22
CAT6 Modular Plugs.....	22
DeviceNet™ Cables & Connectors.....	23

HEAT SHRINK



3-TO-1 ADHESIVE LINED
Page 24



PRE-CUT TUBING
Page 24



HEAVY WALL
Page 24



2-TO-1
Page 25

3-TO-1 Adhesive Lined Tubing.....	24
Heavy Wall Tubing.....	24
2-TO-1 Tubing.....	25

ROUTING & BUNDLING MATERIALS



SLIT CONDUIT
Page 26



EXPANDABLE SLEEVING
Page 27



WIRING DUCT
Page 28



CUSHION CLAMPS
Page 29

Slit Conduit.....	26
Spiral Wrap.....	26
Expandable Sleeving.....	27
Wrappable Split Braided Tube.....	27
Wiring Duct.....	28
Stainless Steel Cushion Clamps.....	29
Nylon Clamps.....	29

WIRE MANAGEMENT



CABLE TIES
Page 30



CABLE TIE MOUNTS
Page 31



CABLE GLANDS
Page 33



ELECTRICAL TAPES
Page 34

Cable Ties.....	30
Dome Top® Barb Ty.....	30
Cable Tie Mounts.....	31
Stainless Steel Cable Ties.....	32
Snap Bushings.....	32
Cable Glands & Clams.....	33
Electrical Tapes.....	34

TERMINALS



TERMINAL KITS
Page 35



BUTT SPLICES
Page 36, 38, 48



RING/FORK TERMINALS
Page 37-39



DISCONNECTS
Page 36, 40

Sealants & Coatings.....	35
Terminal Kits.....	35
Heat Shrink Terminals.....	36-37
Butt Splices.....	36,38,48
Ring Terminals & Fork Terminals.....	37-39
Bullet Connectors.....	36,40
Disconnects.....	36,40
Pin Terminals.....	41
Wire Joints.....	41
Wire Ferrules.....	41

Deutsch DT,DTM,DTP Repair packs...42-43
 Deutsch DT,DTM,DTP Series Kits. 44
 Deutsch Machined Contacts. 44-45
 Deutsch Cavity Plugs. 44
 Deutsch Boots. 44
 Deutsch DTHD Series. 45
 Deutsch Contact Removal Tools. 45
 Aptiv (Delphi) Weather Pack kits. 46
 Aptiv (Delphi) Weather Pack terminals. 46
 Aptiv (Delphi) Cavity Plugs & Seals. 46

Pgs 42 - 46

SEALED CONNECTORS



REPAIR PACKS
Page 42 - 43



CONNECTOR BOOTS
Page 44



REMOVAL TOOLS
Page 45



APTIV (DELPHI) PACKS
Page 46

Pgs 42 - 46

Closed End Lugs. 47
 Butt Splices. 36,38,48
 Brazed Seam Lugs. 49
 Battery Post Terminals. 50
 Battery Terminal Insulator Boots. 51

Pgs 47 - 51

LUGS & BOOTS



CLOSED END LUGS
Page 47



BRAZED SEAM LUGS
Page 49



BATTERY POSTS
Page 50



BATTERY BOOTS
Page 51

Pgs 47 - 51

Storage Solutions. 52
 Marker Kits. 53
 Marker Books & Cards. 53

Pgs 52 - 53

I.D. PRODUCTS & LABELERS



STORAGE BOXES
Page 52



MARKER KITS
Page 53



MARKER BOOKS
Page 53



MARKER CARDS
Page 53

Pgs 52 - 53

Multi-Purpose Tools & Crimp Tools. 55
 Cable Cutters & Wire Strippers. 56
 Large Gauge Crimping Tools. 57
 Deutsch & Aptiv Crimping Tools. 57
 Ferrule Crimping Tools. 58
 IDEAL® RJ45 Crimp Tool & Kit. 58
 Coax Cable Compression Tools. 58
 Cable Tie Tools. 58
 Voltage Testers & Multimeters. 59
 Clampmeters. 59
 MASTER® Heat Tools. 60-61

Pgs 55 - 61

TOOLS



CRIMP TOOLS
Page 55, 57, & 58



FERRULE CRIMPERS
Page 58



CLAMP METERS
Page 59



HEAT TOOLS
Page 60 - 61

Pgs 55 - 61

Breakers, Magnetic "A & C" Frame. 62-63
 Thermal Breakers. 64
 Breaker Boots & Covers. 65
 Bussmann MRCB Breakers. 65-66
 Push-to-Reset Breakers. 66
 AGC Fuses, Holders and Blocks. 67
 ATO/ATC Fuses, Holders and Blocks. 68
 Maxi Fuse. 69
 Marine Rated Battery Fuses & Blocks. 69
 ANL Fuses & Blocks. 70
 Class T Fuses & Blocks. 71

Pgs 62 - 71

BREAKERS & FUSES



MAGNETIC BREAKERS
Page 62 - 63



KLIXON BREAKERS
Page 66



FUSES
Page 67 - 71



FUSE BLOCKS
Page 67 - 71

Pgs 62 - 71

Terminal Blocks & Jumpers. 72
 European Terminal Blocks. 72
 Power Posts. 73-74
 Feed Through Connectors. 73
 Bus Bars. 74-76

Pgs 72 - 76

TERMINAL BLOCKS & BUS BARS



TERMINAL BLOCKS
Page 72



TERMINAL JUMPERS
Page 72



POWER POSTS
Page 73 - 74



BUS BARS
Page 74 - 76

Pgs 72 - 76

Contura® Switches. 77
 Actuators. 78-81
 Jumpers. 81
 Panels Blanks. 82
 Metal Bat Toggle Switches & Boots. 83
 Battery Switches. 84-86
 Solenoids/ACR's. 86-87
 Power Transfer Switches. 87
 Battery Chargers. 88

Pgs 77 - 88

SWITCHES & ACTUATORS



ROCKER SWITCHES
Page 77



SWITCH COVERS
Page 78 - 81

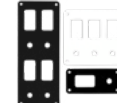

PANEL BLANKS
Page 82



BATTERY SWITCHES
Page 84 - 86

Pgs 77 - 88

Meters. 89-90
 Junction Boxes & Enclosures. 91

Pgs 89 - 91

METERS & BOXES



METERS Page 89-90



COILS Page 90



ENCLOSURES Page 91

Pgs 89 - 94

Wire & Cable

UL 2-CONDUCTOR BOAT CABLE 600V 105°C

- WIRE & CABLE
- MULTI-CONDUCTOR
- COAX CABLES
- NETWORK CABLES
- HEAT SHRINK
- ROUTING & BUNDLING MATERIALS
- WIRE MANAGEMENT
- TERMINALS
- DEUTSCH & APTIV (DELPHI)
- LUGS & BOOTS
- ID PRODUCTS & LABELERS
- TOOLS
- BREAKERS & FUSES
- TERMINAL BLOCKS & BUS BARS
- SWITCHES & ACTUATORS
- METERS & BOXES



PART NUMBER	AWG NO.	NO. OF COND.	CONDUCTOR STRANDING	NOM. INSULATION THICKNESS (IN)	NOM. CABLE O.D. (IN)	STANDARD PUT-UPS	APPRX LB/M
"DC" Red + Black Conductors, White Jacket							
W18/2DC	18	2	16/0.0100	0.035	0.185 x 0.300	C, TL, D, M	40
W16/2DC	16	2	26/0.0100	0.035	0.200 x 0.330	C, TL, D, M	51
W14/2DC	14	2	41/0.0100	0.035	0.225 x 0.370	C, TL, D, M	65
W12/2DC	12	2	65/0.0100	0.035	0.245 x 0.410	C, TL, D, M	82
W10/2DC	10	2	105/0.0100	0.035	0.265 x 0.455	C, TL, D, M	128
W8/2DC	8	2	7x24/0.0100	0.040	0.350 x 0.630	L, C, TL, D	230
W6/2DC	6	2	7x38/0.0100	0.045	0.450 x 0.800	L, C, TL, D*	364
"Safety Wire" Red + Yellow Conductors, White Jacket							
W18/2RYW	18	2	16/0.0100	0.035	0.190 X 0.300	C, TL, D, M	40
W16/2RYW	16	2	26/0.0100	0.035	0.200 x 0.330	C, TL, D, M	51
W14/2RYW	14	2	41/0.0100	0.035	0.225 x 0.370	C, TL, D, M	65
W12/2RYW	12	2	65/0.0100	0.035	0.245 x 0.410	C, TL, D, M	82
W10/2RYW	10	2	105/0.0100	0.035	0.265 x 0.455	C, TL, D, M	128
W8/2RYW	8	2	7x24/0.0100	0.040	0.350 x 0.630	C, TL, D	230
W6/2RYW	6	2	7x38/0.0100	0.045	0.450 x 0.800	C, TL, D	364
White + Black Conductors, White Jacket							
W16/2	16	2	26/0.0100	0.035	0.200 x 0.330	C, TL, D, M	51
W14/2	14	2	41/0.0100	0.035	0.225 x 0.370	C, TL, D, M	65
W12/2	12	2	65/0.0100	0.035	0.245 x 0.410	C, TL, D, M	82
W10/2	10	2	105/0.0100	0.035	0.265 x 0.455	C, TL, D	128

Standard Put-Ups: L=50 ft, C=100 ft, TL=250 ft, D= 500 ft, M=1000 ft

*W6/2DC-D may require a lead time.

Ordering Information: Combine part number with put-up designation. **Example:** 16 AWG, 2 Conductor, 100 feet = W16/2DC-C

WEB ENHANCED - Reel Measurements: Available at PacerGroup.net/reel-measurement-table/



Pacer's manufacturing process extrudes a flexible yet tough PVC jacket. The extrusion process fills the voids between the conductors leaving no airspace for condensation to accumulate. The inner wires are talcum powder coated allowing for the easy removal of the jacket. The finished product is flexible, durable and easy to install.

APPLICATIONS: Two conductor boat cable is a durable product for use in DC circuits as well as low voltage AC applications.

CHARACTERISTICS: Conductor: Annealed Fine Stranded Tinned Copper ASTM B172 Class K **Insulation:** -20° to 105°C Flexible, Color Coded PVC

Voltage Rating: 600V **Temperature Rating:** 105°C Dry, 75°C Wet, 60°C Oil **Resistant to:** Acid, Alkali, Abrasion, Flame, Gasoline, Oil and Moisture

COMPLIANCES: *UL standard 1426 *ABYC: E-11.15 *Coast Guard: 33 CFR part 183 *RoHS compliant *UL compliant

FEATURES: *Stranded, tinned copper *Color coded conductors *Tough PVC jacket *Highly flexible *Easy to strip & route

PRINT: PACER MARINE E157097 (UL) BOAT CABLE _AWG/_COND 600V 105°C DRY, 75°C WET BC-5W2 OIL RESISTANT 1

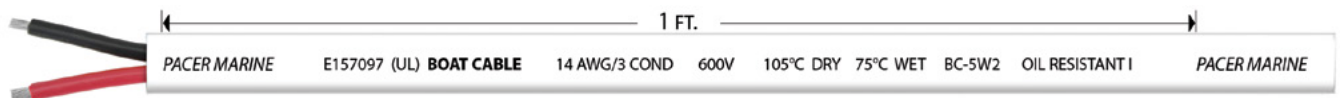

PACER... to PACER equals 1 ft. on all boat and battery cables.

Wire & Cable

UL 3-CONDUCTOR BOAT CABLE 600V 105°C

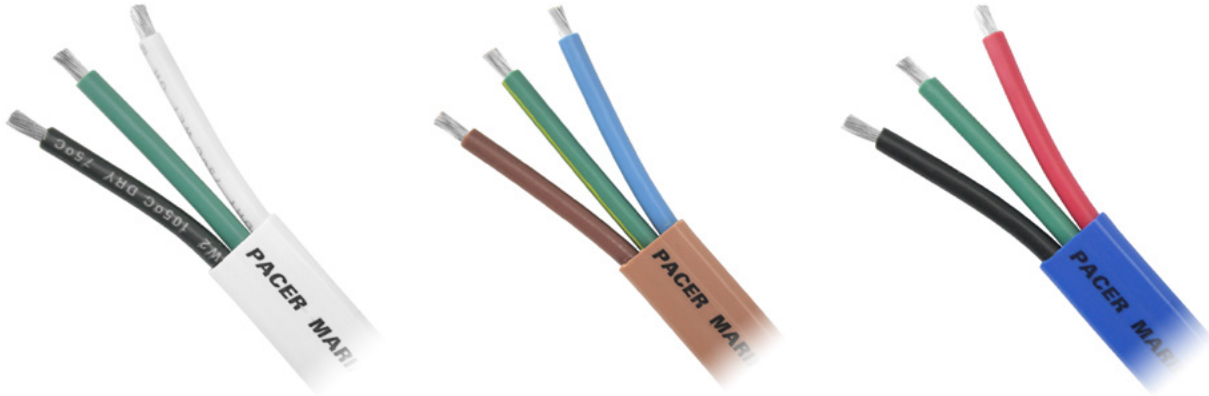

- WIRE & CABLE
- MULTI-CONDUCTOR
- COAX CABLES
- NETWORK CABLES
- HEAT SHRINK
- ROUTING & BUNDLING MATERIALS
- WIRE MANAGEMENT
- TERMINALS
- DEUTSCH & APTIV (DELPHI)
- LUGS & BOOTS
- ID PRODUCTS & LABELERS
- TOOLS
- BREAKERS & FUSES
- TERMINAL BLOCKS & BUS BARS
- SWITCHES & ACTUATORS
- METERS & BOXES

PART NUMBER	AWG NO.	NO. OF COND.	CONDUCTOR STRANDING	NOM. INSULATION THICKNESS (IN)	NOM. CABLE O.D. (IN)	STANDARD PUT-UPS	APPRX LB/M
UL TRIPLEX CABLE - Black, Green, White Conductors, White Jacket							
W16/3	16	3	26/0.0100	0.030	0.200 x 0.465	C, TL, D, M	93
W14/3	14	3	41/0.0100	0.030	0.210 x 0.505	C, TL, D, M	99
W12/3	12	3	65/0.0100	0.030	0.230 x 0.560	C, TL, D, M	128
W10/3	10	3	105/0.0100	0.030	0.265 x 0.645	C, TL, D	180
W8/3	8	3	7x24/0.0100	0.045	0.375 x 0.930	L, C, TL, D	340
W6/3	6	3	7x38/0.0100	0.045	0.450 x 1.140	L, C, TL, D*	523
UL TRIPLEX "EURO" CABLE - Brown, Green/Yellow, Lt. Blue, Tan Jacket							
W14/3EURO	14	3	41/0.0100	0.030	0.210 x 0.505	C, TL, D, M	99
W12/3EURO	12	3	65/0.0100	0.030	0.230 x 0.560	C, TL, D, M	128
W10/3EURO	10	3	105/0.0100	0.030	0.265 x 0.645	C, TL, D	180
W8/3EURO	8	3	7x24/0.0100	0.045	0.375 x 0.930	C, TL, D	340
W6/3EURO	6	3	7x38/0.0100	0.045	0.450 x 1.140	C, TL	523
UL TRIPLEX "240-V" CABLE - Black, Green, Red Conductors, Blue Jacket							
W14/3B	14	3	41/0.0100	0.030	0.210 x 0.505	C, TL, D, M	99
W12/3B	12	3	65/0.0100	0.030	0.230 x 0.560	C, TL, D, M	128
W10/3B	10	3	105/0.0100	0.030	0.265 x 0.645	C, TL, D	180

Standard Put-Ups: L=50 ft, C=100 ft, TL=250 ft, D=500 ft, M=1000 ft *W6/3-D may require a lead time.

Ordering Information: Combine part number with put-up designation. **Example:** 14 AWG, 3 Conductor White Jacket, 500 ft = W14/3-D



WEB ENHANCED - Reel Measurements: Available at PacerGroup.net/reel-measurement-table/

Pacer Boat Cable is designed for maximum durability and easy installation. Type 3 Class K tinned copper wire and PVC jackets provide maximum protection from moisture and fatigue due to vibration and flexing. White jacketing is typical of 120V AC US wiring, tan jacket is typical for 230V AC European wiring, and blue jacket is typical of 240V AC US wiring.

APPLICATIONS: Pacer's UL triplex cable is perfect for AC circuits in boats and recreational vehicles.

CHARACTERISTICS: **Conductor:** Annealed Fine Stranded Tinned Copper ASTM B172 Class K **Insulation:** -20°C to 105°C Flexible,

Voltage Rating: 600V Color Coded PVC **Temp. Rating:** 105°C Dry, 75°C Wet, 60°C Oil

Resistant to: Acid, Alkali, Abrasion, Flame, Gasoline, Oil & Moisture

COMPLIANCES: *UL standard 1426 *ABYC: E-11.15 *Coast Guard: 33 CFR part 183 *RoHS compliant *UL compliant

FEATURES: *Stranded, tinned copper *Color coded conductors *Tough PVC jacket *Highly flexible *Easy to strip & route

PRINT: PACER MARINE E157097 (UL) BOAT CABLE _AWG/_COND 600V 105°C DRY, 75°C WET BC-5W2 OIL RESISTANT 1

Wire & Cable

UL ROUND BOAT CABLE

- WIRE & CABLE
- MULTI-CONDUCTOR
- COAX CABLES
- NETWORK CABLES
- HEAT SHRINK
- ROUTING & BUNDLING MATERIALS
- WIRE MANAGEMENT
- TERMINALS
- DEUTSCH & APTIV (DELPHI)
- LUGS & BOOTS
- ID PRODUCTS & LABELERS
- TOOLS
- BREAKERS & FUSES
- TERMINAL BLOCKS & BUS BARS
- SWITCHES & ACTUATORS
- METERS & BOXES



PART NUMBER	AWG NO.	NO. OF COND.	CONDUCTOR STRANDING	NOM. INSULATION THICKNESS (IN)	NOM. CABLE O.D. (IN)	STANDARD PUT-UPS	CONDUCTOR COLORS	APPRX LB/M
2 CONDUCTOR, WHITE JACKET								
WR16/2DC	16	2	26/0.0100	0.030	0.350	C, TL, D, M	BK, RD	50
WR14/2DC	14	2	41/0.0100	0.030	0.390	C, TL, D, M	BK, RD	67
WR12/2DC	12	2	65/0.0100	0.030	0.410	C, TL, D, M	BK, RD	85
WR10/2DC	10	2	105/0.0100	0.030	0.475	C, TL, D, M	BK, RD	130
3 CONDUCTOR, WHITE JACKET								
WR16/3	16	3	26/0.0100	0.045	0.395	C, TL, D, M	BK, GN, WH	73
WR14/3	14	3	41/0.0100	0.045	0.410	C, TL, D, M	BK, GN, WH	96
WR12/3	12	3	65/0.0100	0.045	0.470	C, TL, D, M	BK, GN, WH	131
WR10/3	10	3	105/0.0100	0.045	0.545	C, TL, D	BK, GN, WH	178
3 CONDUCTOR, GREY JACKET								
WR6/3-8/1	6	4	6 AWG @ 7x38/0.0100 8 AWG @ 7x24/0.0100	0.080	0.985	L, C, TL, D	6 AWG @ BK, RD, WH (8 AWG @ GN)	650
4 CONDUCTOR, WHITE JACKET								
WR16/4	16	4	26/0.0100	0.045	0.420	L, C, TL, D, M	BK, GN, RD, WH	108
WR14/4	14	4	41/0.0100	0.045	0.465	L, C, TL, D, M	BK, GN, RD, WH	136
WR12/4	12	4	65/0.0100	0.045	0.560	L, C, TL, D, M	BK, GN, RD, WH	185
WR10/4	10	4	105/0.0100	0.045	0.600	L, C, TL, D	BK, GN, RD, WH	253
WR8/4	8	4	7x24/0.0100	0.080	0.830	L, C, TL, D	BK, GN, RD, WH	475
6 CONDUCTOR, WHITE JACKET								
WR16/6	16	6	26/0.0100	0.450	0.455	L, C, TL, D	BK, BR, RD, GN, BL, WH	130
WR14/6	14	6	41/0.0100	0.450	0.530	L, C, TL, D	BK, BR, RD, GN, BL, WH	200

Standard Put-Ups: L=50 FT, C=100 ft, TL=250 ft, D=500 ft, M=1000 ft

Ordering Information: Combine part number and put-up designation. **Example:** 10/4 Round, 100 ft = WR10/4-C

Pacer's round boat cable is manufactured in 2, 3, 4, or 6 conductors. The round shape is easy to fit through tight spaces, and is flexible in all bending directions. This style of cable is excellent for running through sailing spars, t-tops and poling platforms. Round boat cable is easily sealed when running through bulkheads or enclosures by using liquid tight cable gland connectors (page 33).

APPLICATIONS: Pacer's round boat cable is excellent for AC and DC internal wiring of boats and recreational vehicles.

CHARACTERISTICS: **Conductor:** Annealed Fine Stranded Tinned Copper ASTM B172 Class K

Insulation: -20°C to 105°C Flexible, Color Coded PVC **Voltage Rating:** 600V **Temperature Rating:** 105°C Dry, 75°C Wet, 60°C Oil

Resistant to: Acid, Alkali, Abrasion, Flame, Gasoline, Oil and Moisture

COMPLIANCES: *UL standard 1426 BC-5W2 *ABYC: E-11.15 *Coast Guard: 33 CFR part 183 *RoHS compliant

FEATURES: *Easy installation *Easy to organize *Easily sealed through bulkheads

PRINT: PACER MARINE E157097 (UL) BOAT CABLE _AWG/_COND 600V 105°C DRY, 75°C WET BC-5W2 OIL RESISTANT 1

Wire & Cable

UL TINNED COPPER PRIMARY WIRE



- WIRE & CABLE
- MULTI-CONDUCTOR
- COAX CABLES
- NETWORK CABLES
- HEAT SHRINK
- ROUTING & BUNDLING MATERIALS
- WIRE MANAGEMENT
- TERMINALS
- DEUTSCH & APTIV (DELPHI)
- LUGS & BOOTS
- ID PRODUCTS & LABELERS
- TOOLS
- BREAKERS & FUSES
- TERMINAL BLOCKS & BUS BARS
- SWITCHES & ACTUATORS
- METERS & BOXES

PART NUMBER	AWG NO.	CONDUCTOR STRANDING	NOM. INSULATION THICKNESS (IN)	NOM. CABLE O.D. (IN)	NOM. CIRCULAR MILS	STANDARD PUT-UPS	APPRX LB/M
18 AWG UL1015/1230 CSA TEW 600V 105°C Dry, 60°C Wet							
WUL18	18	16/0.0100	0.030	0.114	1600	C, TL, D, M	10.3
16 AWG - 8 AWG UL Standard 1426 BC-5W2 600V 105°C Dry, 75°C Wet							
WUL16	16	26/0.0100	0.032	0.125	2600	C, TL, D, M	14.8
WUL14	14	41/0.0100	0.032	0.145	4100	C, TL, D, M	22.0
WUL12	12	65/0.0100	0.032	0.160	6500	C, TL, D, M	32.0
WUL10	10	105/0.0100	0.032	0.185	10500	C, TL, D, M	49.0
WUL8	8	168/0.0100	0.045	0.265	16800	C, TL, D, M	80.0

UL Tinned Copper Primary Wire Ordering Information:
Build the part number. Select (A) Wire Gauge, (B) Jacket Color, (C) Wire Stripe Color, (D) Spool Size

(A) Select Wire Gauge

18	16	14	12	10	8
(WUL18)	(WUL16)	(WUL14)	(WUL12)	(WUL10)	(WUL8)

(B) Select Jacket Color

	Black	Brown	Red	Orange	Yellow	Green	Lt Green	Blue	Lt Blue	Violet	Grey	White	Tan	Pink
WUL18														
WUL16														
WUL14														
WUL12														
WUL10														
WUL8														
	(BK)	(BR)	(RD)	(OR)	(YL)	(GN)	(LG)	(BL)	(LB)	(VI)	(GY)	(WH)	(TN)	(PK)

(C) Select Stripe Color: Optional*

	Black	Brown	Red	Orange	Yellow	Green	Lt Green	Blue	Lt Blue	Violet	Grey	White	Tan	Pink
	(-0)	(-1)	(-2)	(-3)	(-4)	(-5)	(-15)	(-6)	(-16)	(-7)	(-8)	(-9)	(-11)	(-12)

*Striped wire is non-returnable, non-refundable, requires a minimum order of 500 feet.

(D) Select Spool Size

Cut to Order	100 FT.	250 FT.	500 FT.	1000 FT.
(-B)	(-C)	(-TL)	(-D)	(-M)

Example: UL 8 AWG, Red, 250 ft = WUL8RD-TL Longer lengths available. Please call or email a Pacer expert.

Our wire is constructed from Type 3 Class K tinned copper conductor and is insulated with flexible PVC. Pacer's UL wire has been the choice of hundreds of boat builders for over 30 years.

APPLICATIONS: Commonly used for point-to-point wiring and internal wiring of panels and motors.

CHARACTERISTICS: **Conductor:** Type III Annealed Finely Stranded Tinned Copper ASTM B172 Class K **Voltage Rating:** 600V

Insulation: -20°C to 105°C Flexible, Color Coded PVC **Resistant to:** Acid, Alkali, Abrasion, Flame, Gasoline, Oil and Moisture

COMPLIANCES: 18 AWG *UL1015/1230 *CSA: TEW *Temperature Rating: 105°C Dry, 60°C Wet

16 AWG - 8 AWG *UL standard 1426 BC-5W2 *UL: AWM 1015/1230, 1028.1231 (8 AWG) *ABYC: E-11.15 *UL: MTW

*Coast Guard: 33 CFR 183.401 Subpart 1-Electrical Systems *Temperature Rating: 105°C Dry, 75°C Wet

FEATURES: *Stranded, tinned copper conductors *Highly flexible color coded insulation

PRINT: (For 16-10 AWG) PACER E157097 (UL)_AWG 600V BC-5W2 105°C DRY, 75° WET OR MTW OR AWM 1015/1230 (1028/1231 -8AWG ONLY)

VW-1 OIL RESISTANT I

Wire & Cable

UL TINNED COPPER BATTERY CABLE

- WIRE & CABLE
- MULTI-CONDUCTOR
- COAX CABLES
- NETWORK CABLES
- HEAT SHRINK
- ROUTING & BUNDLING MATERIALS
- WIRE MANAGEMENT
- TERMINALS
- DEUTSCH & APTIV (DELPHI)
- LUGS & BOOTS
- ID PRODUCTS & LABELERS
- TOOLS
- BREAKERS & FUSES
- TERMINAL BLOCKS & BUS BARS
- SWITCHES & ACTUATORS
- METERS & BOXES



PART NUMBER	AWG NO.	CONDUCTOR STRANDING	NOM. INSULATION THICKNESS (IN)	NOM. CABLE O.D. (IN)	NOM. CIRCULAR MILS	NOM. MM ²	STANDARD PUT-UPS	APPRX LB/M
WUL6	6	7x38/0.0100	0.060	0.350	26600	13.5	L, C, TL, D	136
WUL4	4	7x60/0.0100	0.060	0.400	42000	21.3	L, C, TL, D	189
WUL2	2	7x95/0.0100	0.060	0.465	66500	33.7	L, C, TL, D	292
WUL1	1	19x44/0.0100	0.080	0.550	83600	42.4	L, C, TL, D	360
WUL1/0	1/0	19x56/0.0100	0.080	0.600	106400	53.9	L, C, TL	450
WUL2/0	2/0	19x70/0.0100	0.080	0.650	133000	67.4	L, C, TL	551
WUL3/0	3/0	19x88/0.0100	0.080	0.705	167200	84.7	L, C, TL	670
WUL4/0	4/0	19X111/0.0100	0.080	0.780	210900	106.9	L, C, TL	820

UL Tinned Copper Battery Cable Ordering Information:
Build the part number. Select (A) Wire Gauge, (B) Jacket Color, (C) Spool Size

(A) Select Wire Gauge

6	4	2	1	1/0	2/0	3/0	4/0
(WUL6)	(WUL4)	(WUL2)	(WUL1)	(WUL1/0)	(WUL2/0)	(WUL3/0)	(WUL4/0)

(B) Select Jacket Color

	Black	Red	Orange	Yellow	Green	White
WUL6						
WUL4						
WUL2						
WUL1						
WUL1/0						
WUL2/0						
WUL3/0						
WUL4/0						
	(BK)	(RD)	(OR)	(YL)	(GN)	(WH)

(C) Select Spool Size

Cut to Order	50 FT.	100 FT.	250 FT.	500 FT.
(-B)	(-L)	(-C)	(-TL)	(-D)

Example: UL 1/0 AWG, Red, 250 ft = WUL1/0RD-TL Longer lengths available. Please call or email a Pacer expert.

Pacer uses finely stranded tinned copper conductors for superior corrosion protection in conjunction with highly flexible PVC compound. Pacer Battery Cables offer easy workability when installing in tight spaces such as boats, cars, industrial equipment and power generators.

APPLICATIONS: Connecting a battery or generator to a switch, starter or ground, windlass, inverter or in any high amperage equipment.
CHARACTERISTICS: **Conductor:** Annealed Fine Stranded Tinned Copper ASTM B172 Class K **Temperature Rating:** 105°C Dry, 75°C Wet 60°C Oil
Insulation: -20°C to 105°C Flexible, Color Coded PVC **Voltage Rating:** 600V **Resistant to:** Acid, Alkali, Abrasion, Flame, Gasoline, Oil and Moisture
COMPLIANCES: *UL standard 1426 BC-5W2 *AWM 1232/1283 (6-2 AWG) *AWM 1232/1284 (1-4/0 AWG) *MTW *CSA: TEW
 *ABYC: E-11.15 *Coast Guard: 33 CFR part 183 Subpart 1
FEATURES: Easy to strip, bend and route. Excellent flexibility with the durable properties of PVC.
PRINT: PACER E157097 (UL) _AWG 600V BC-5W2 105°C DRY, 75°C WET OR MTW OR AWM 1232/1283 (1284 1-4/0)
 VW-1 OIL RESISTANT 1 LL102583 CSA TEW 105°C FT1

Wire & Cable

MARINE SAE SGT FLEXIBLE BATTERY CABLE



PART NUMBER	AWG NO.	CONDUCTOR STRANDING	NOM. INSULATION THICKNESS (IN)	NOM. CABLE O.D. (IN)	NOM. CIRCULAR MILS	NOM. MM ²	STANDARD PUT-UPS	APPRX LB/M
WSA4	4	7x55/0.0100	0.065	0.400	38500	19.5	L, C, TL, D	175
WSA2	2	7x91/0.0100	0.065	0.465	63700	32.3	L, C, TL, D	285
WSA1/0	1/0	19x53/0.0100	0.065	0.560	100700	52.0	L, C, TL	422

Marine SAE SGT Flexible Battery Cable Ordering Information:
Build the part number. Select (A) Wire Gauge, (B) Jacket Color, (C) Spool Size

(A) Select Wire Gauge

4	2	1/0
(WSA4)	(WSA2)	(WSA1/0)

(B) Select Jacket Color

	Black	Red	Green
WSA4			
WSA2			
WSA1/0			
	(BK)	(RD)	(GN)

(C) Select Spool Size

Cut to Order	50 FT.	100 FT.	250 FT.	500 FT.	1000 FT.
(-B)	(-L)	(-C)	(-TL)	(-D)	(-M)

Longer lengths available. Please call or email a Pacer expert.

Example: 2 gauge, Red, 50 ft = WSA2RD-L



WEB ENHANCED - Reel Measurements: Available at PacerGroup.net/reel-measurement-table/



Pacer's flexible SGT battery cable offers dramatic ease of installation and usability. All battery cables are insulated with Pacer's high flex PVC compound. By replacing traditional coarse copper stranding with flexible fine stranded rope constructed conductors of equivalent circular mil area our SGT cable is economical and efficient to install. Intended for applications operating at potentials of 60V DC or less.

APPLICATIONS: Automotive battery cable, connecting a battery or generator to a switch, windless starter or ground, operating at potentials less than 60V.

CHARACTERISTICS: **Conductor:** Soft Annealed Stranded Bare Copper **Insulation:** Flexible PVC, 105°C

Temperature/Voltage Rating: 105°C Dry / 60V DC **Resistant to:** Acid, Alkali, Abrasion, Flame, Gasoline, Oil and Moisture

COMPLIANCES: *SGT J1127 & J378 *ABYC: E-11.15 *Coast Guard: 33 CFR part 183.430

FEATURES: *Finely stranded rope conductors combined with a highly flexible PVC jacket redefines traditional SGT cable while remaining economical.

*Flexible SGT offers speed and easy installation.

PRINT: PACER No. _TYPE SGT 105°C 60V J1127 AND J378

WIRE & CABLE

MULTI-CONDUCTOR

COAX CABLES

NETWORK CABLES

HEAT SHRINK

ROUTING & BUNDLING MATERIALS

WIRE MANAGEMENT

TERMINALS

DEUTSCH & APTIV (DELPHI)

LUGS & BOOTS

ID PRODUCTS & LABELERS

TOOLS

BREAKERS & FUSES

TERMINAL BLOCKS & BUS BARS

SWITCHES & ACTUATORS

METERS & BOXES

Wire & Cable

BATTERY CABLE ASSEMBLIES

- WIRE & CABLE
- MULTI-CONDUCTOR
- COAX CABLES
- NETWORK CABLES
- HEAT SHRINK
- ROUTING & BUNDLING MATERIALS
- WIRE MANAGEMENT
- TERMINALS
- DEUTSCH & APTIV (DELPHI)
- LUGS & BOOTS
- ID PRODUCTS & LABELERS
- TOOLS
- BREAKERS & FUSES
- TERMINAL BLOCKS & BUS BARS
- SWITCHES & ACTUATORS
- METERS & BOXES



B40Y-12-P-12



B2B-38-A38-15



B4R-N-P-18

Battery Cable Assembly Ordering Information:
 Build the part numbers. Select (A) Cable Style, (B) Gauge Size, (C) Cable Color, (D) Boot Type, (E) Lug Type, (F) Length.
 All battery cable assemblies are made to order and are not refundable.

(A) Cable Style



SAE
(A)



UL
(B)

(B) Gauge Size

6 AWG	4 AWG	2 AWG	1 AWG	1/0	2/0	3/0	4/0
(6)	(4)	(2)	(1)	(10)	(20)	(30)	(40)

(C) Cable Color

Red	Black	Yellow
(R)	(B)	(Y)

(D) Boot Type



Alternator
(A)



Marine
(M)



Straight
(S)

(E) Lug Type



#10
(10)



1/4"
(14)



5/16"
(56)



3/8"
(38)



1/2"
(12)



Positive
(P)



Negative
(N)

(F) Length

(Length in Inches)

Additional configurations available. Call customer service for additional options.

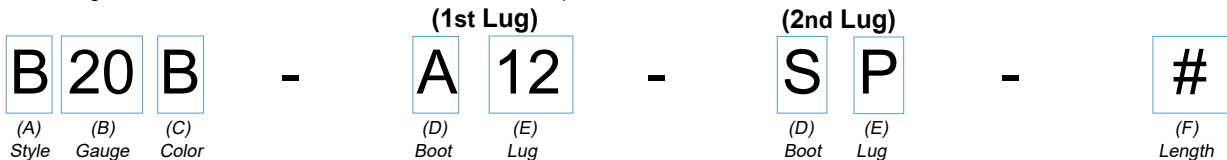

WIRE & CABLE

MULTI-CONDUCTOR

COAX CABLES

NETWORK CABLES

HEAT SHRINK

ROUTING & BUNDLING MATERIALS

WIRE MANAGEMENT

TERMINALS

DEUTSCH & APTIV (DELPHI)

LUGS & BOOTS

ID PRODUCTS & LABELERS

TOOLS

BREAKERS & FUSES

TERMINAL BLOCKS & BUS BARS

SWITCHES & ACTUATORS

METERS & BOXES

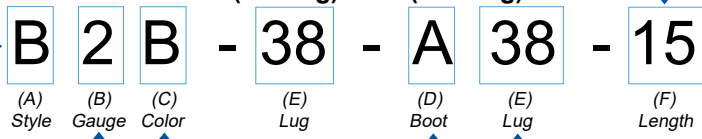

Pacer manufactures all its battery cable assemblies in-house in the USA to ensure the highest level of quality.

We start by using our flexible and durable marine cable that has been designed to handle the toughest marine conditions.

Next, we use a precision cut and strip machine for repeatable and accurate cuts.

Once we have our cable ready, we use a state-of-the-art hydraulic-pneumatic crimper in order to create a superior gas-tight crimp. We use the highest quality types of crimp connectors to get superior connections.

At the last step, we add epoxy-lined heat shrink for an extra level of protection. The heat shrink seals out any moisture and helps to prevent corrosion from forming on your assemblies. This process gives you a moisture and airtight connection built for longevity. Our assemblies can last for decades. In the end, you'll be replacing your battery before you replace our cables.



CHARACTERISTICS (SAE): Conductor: Soft Annealed Stranded Bare Copper Insulation: -20°C to 105°C Flexible, PVC
 Temperature Rating: 105°C Dry Voltage Rating: 60V DC Resistant to: Acid, Alkali, Abrasion, Flame, Gasoline, Oil and Moisture

COMPLIANCES (SAE): *SGT J1127 & J378 *ABYC: E-11.15 *Coast Guard: 33 CFR part 183.430

CHARACTERISTICS (UL): Conductor: Annealed Fine Stranded Tinned Copper ASTM B172 Class K Temperature Rating: 105°C Dry, 75°C Wet 60°C Oil
 Insulation: -20°C to 105°C Flexible, Color Coded PVC Voltage Rating: 600V Resistant to: Acid, Alkali, Abrasion, Flame, Gasoline, Oil and Moisture

COMPLIANCES (UL): *UL Standard 1426 BC-5W2 *AWM 1232/1283 (6-2 AWG) *AWM 1232/1284 (1-4/0 AWG) *MTW *CSA: TEW

*ABYC: E-11.15 *Coast Guard: 33 CFR part 183 Subpart 1

FEATURES: *Easy to bend and route. *Excellent flexibility with the durable properties of PVC.

Wire & Cable

MARINE SAE TINNED COPPER WIRE



- WIRE & CABLE
- MULTI-CONDUCTOR
- COAX CABLES
- NETWORK CABLES
- HEAT SHRINK
- ROUTING & BUNDLING MATERIALS
- WIRE MANAGEMENT
- TERMINALS
- DEUTSCH & APTIV (DELPHI)
- LUGS & BOOTS
- ID PRODUCTS & LABELERS
- TOOLS
- BREAKERS & FUSES
- TERMINAL BLOCKS & BUS BARS
- SWITCHES & ACTUATORS
- METERS & BOXES

PART NUMBER	AWG NO.	CONDUCTOR STRANDING	NOM. INSULATION THICKNESS (IN)	NOM. CABLE O.D. (IN)	NOM. CIRCULAR MILS	NOM. MM ²	STANDARD PUT-UPS	APPRX LB/M
WST16	16	24/0.0100	0.023	0.105	2400	1.22	C, TL, D, M	13
WST14	14	38/0.0100	0.023	0.120	3800	1.93	C, TL, D, M	18
WST12	12	60/0.0100	0.026	0.145	6000	3.04	C, TL, D, M	28
WST10	10	96/0.0100	0.031	0.173	9600	4.86	C, TL, D, M	43
WST8	8	96/0.0126	0.037	0.225	15240	7.72	C, TL, D, M	70
WST6	6	7x36/0.0100	0.060	0.335	25200	12.77	C, TL, D	107

Marine SAE Tinned Copper Wire Ordering Information:
Build the part number. Select (A) Wire Gauge, (B) Jacket Color, (C) Wire Stripe Color, (D) Spool Size

(A) Select Wire Size

16	14	12	10	8	6
(WST16)	(WST14)	(WST12)	(WST10)	(WST8)	(WST6)

(B) Select Jacket Color

	Black	Brown	Red	Orange	Yellow	Green	Lt. Green	Blue	Lt. Blue	Violet	Grey	White	Tan	Pink
WST16														
WST14														
WST12														
WST10														
WST8														
WST6														
	(BK)	(BR)	(RD)	(OR)	(YL)	(GN)	(LG)	(BL)	(LB)	(VI)	(GY)	(WH)	(TN)	(PK)

(C) Select Stripe Color: Optional*

	Black	Brown	Red	Orange	Yellow	Green	Lt Green	Blue	Lt Blue	Violet	Grey	White	Tan	Pink
	(-0)	(-1)	(-2)	(-3)	(-4)	(-5)	(-15)	(-6)	(-16)	(-7)	(-8)	(-9)	(-11)	(-12)

*Striped wire is non-returnable, non-refundable, requires a minimum order of 500 feet.

(D) Select Spool Size

Cut to Order	100 FT.	250 FT.	500 FT.	1000 FT.
(-B)	(-C)	(-TL)	(-D)	(-M)

Example: SAE No. 14, Violet, 250 ft = WST14VI-TL Longer lengths available. Please call or email a Pacer expert.

SAE flexible tinned copper wire provides an excellent cost effective alternative to bare copper automotive wire. Its tinned copper, highly flexible stranding and premium insulation offer superior corrosion resistance. This highly flexible wire made to SAE specifications, fits all major connector systems, and is intended for use at potentials under 60V DC.

CHARACTERISTICS: Conductor: No. 16 to No. 6 Soft Annealed Stranded Tinned Copper Insulation: -20°C to 105°C Flexible, PVC
Temperature/Voltage Rating: 105°C Dry / 60V DC Resistant to: Acid, Alkali, Abrasion, Flame, Gasoline, Oil and Moisture

COMPLIANCES: *GPT J1128 & J378 (No. 16-8) *SGT J1127 & J378 (No. 6) *ABYC: E-11.15 *Coast Guard: 33 CFR part 183.430

PRINT: PACER MARINE TINNED COPPER MARINE SAE No. _TYPE GPT 105°C 60V J1128 AND J378

Wire & Cable

ZIP CORD & SPEAKER WIRE

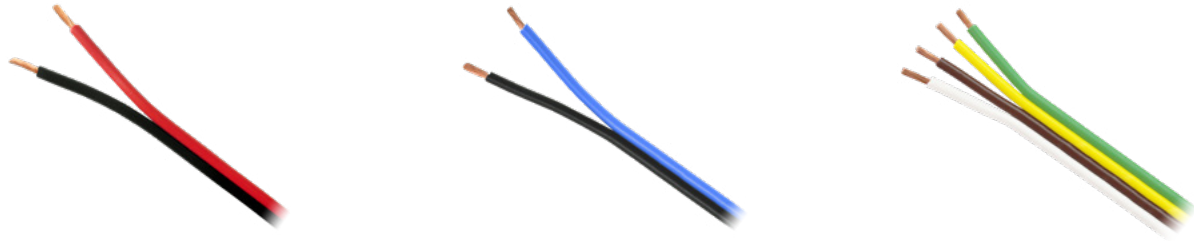

PART NUMBER	AWG NO.	NO. OF COND.	CONDUCTOR STRANDING	CONDUCTOR COLORS	APPRX LB/M
WB16BK-RD	16	2	19/0.0117	Black, Red	25
WB16BK-DKBL	16	2	19/0.0117	Black, Dark Blue	25
WB16BK-GY	16	2	19/0.0117	Black, Grey	25
WB16BK-PK	16	2	19/0.0117	Black, Pink	25
WB14BK-RD	14	2	19/0.0147	Black, Red	35
WB14BK-BL	14	2	19/0.0147	Black, Blue	35
WB14BK-GY	14	2	19/0.0147	Black, Grey	35
WB16-3	16	3	19/29	Brown, Yellow, Green	38
WB16-4	16	4	19/29	Brown, Yellow, Green, White	50

Ordering Information: Sold by the foot. Minimum 25 ft.

An economical alternative to jacketed cable, low voltage lights trailer lights and DC circuits where multiple conductors need to be routed quickly and easily. Constructed from 105°C bare copper primary wire.

APPLICATIONS: Low voltage lights, Trailer lights, DC circuits

CHARACTERISTICS: **Temperature Rating:** -20°C to 105°C **Voltage Rating:** 60V DC

FEATURES: *Annealed stranded bare copper (Type II) *Color coded parallel bonded conductors



PART NUMBER	AWG NO.	CONDUCTOR STRANDING	NOM. WIRE O.D. (IN)	APPRX LB/M
SPEAKER WIRE				
W18-2ACLR	18	16/0.0100	0.100 X 0.187	17
W16-2ACLR	16	26/0.0100	0.112 X 0.210	25
W14-2ACLR	14	41/0.0100	0.120 X 0.230	35

Ordering Information: Sold by the foot. Minimum 25 ft.

Built with two tinned Class K copper conductors, each co-extruded with clear PVC compound. Pacer's speaker cable is printed on one conductor to indicate polarity. The wire can be used in everything from digital audio, stereo speakers, jukeboxes, home theaters, and more. Constructed from finely stranded tinned copper wire conductors. Tinned plating serves to help resist corrosion delaying signal degradation in harsh or humid environments. Splitting, stripping, and polarity identification are easily accomplished for fast installation.

CHARACTERISTICS: **Conductor:** Fully annealed tinned plated copper

Insulation: Clear PVC **Temp. Range:** -20°C to 105°C **Voltage Rating:** 90V

COMPLIANCES: *RoHS *REACH

WIRE & CABLE

MULTI-CONDUCTOR

COAX CABLES

NETWORK CABLES

HEAT SHRINK

ROUTING & BUNDLING MATERIALS

WIRE MANAGEMENT

TERMINALS

DEUTSCH & APTIV (DELPHI)

LUGS & BOOTS

ID PRODUCTS & LABELERS

TOOLS

BREAKERS & FUSES

TERMINAL BLOCKS & BUS BARS

SWITCHES & ACTUATORS

METERS & BOXES

Multi-Conductor Cable

SHIELDED MULTI-CONDUCTOR



- WIRE & CABLE
- MULTI-CONDUCTOR**
- COAX CABLES
- NETWORK CABLES
- HEAT SHRINK
- ROUTING & BUNDLING MATERIALS
- WIRE MANAGEMENT
- TERMINALS
- DEUTSCH & APTIV (DELPHI)
- LUGS & BOOTS
- ID PRODUCTS & LABELERS
- TOOLS
- BREAKERS & FUSES
- TERMINAL BLOCKS & BUS BARS
- SWITCHES & ACTUATORS
- METERS & BOXES



	PART NUMBER	NO. OF COND.	COND. STRAND	NOM. CAP pF/ft**		NOM. INSULATION THICKNESS (IN)	NOM. JACKET THICKNESS (IN)	NOM. CABLE O.D. (IN)
				A	B			
NETWORK CABLES	M22/2F	2	7/30	36.0	65.0	0.010	0.032	0.169
	M22/3F	3	7/30	36.0	65.0	0.010	0.032	0.177
	M22/4F	4	7/30	36.0	65.0	0.010	0.032	0.190
HEAT SHRINK	M22/6F	6	7/30	34.0	61.0	0.010	0.032	0.219
	M22/8F	8	7/30	34.0	61.0	0.010	0.032	0.235
	M22/10F	10	7/30	34.0	61.0	0.010	0.032	0.269
ROUTING & BUNDLING MATERIALS	M20/2F	2	7/28	39.0	70.0	0.016	0.032	0.207
	M20/3F	3	7/28	39.0	70.0	0.016	0.032	0.217
	M20/4F	4	7/28	39.0	70.0	0.016	0.032	0.236
WIRE MANAGEMENT	M20/6F	6	7/28	37.0	66.0	0.016	0.032	0.276
	M20/8F	8	7/28	37.0	66.0	0.016	0.032	0.297
	M20/10F	10	7/28	37.0	66.0	0.016	0.032	0.345
TERMINALS	M20/15F	15	7/28	37.0	66.0	0.016	0.032	0.393
	M18/2F*	2	16/30	54.5	98.0	0.013	0.037	0.221
	M18/3F*	3	16/30	49.0	88.0	0.013	0.037	0.232
DEUTSCH & APTIV (DELPHI)	M18/4F	4	19/30	47.0	84.5	0.010	0.032	0.238
	M18/6F	6	16/30	N/A	N/A	0.016	0.032	0.310
	M18/8F	8	16/30	N/A	N/A	0.016	0.032	0.330
LUGS & BOOTS	M18/10F	10	16/30	N/A	N/A	0.016	0.032	0.390
	M18/15F	15	16/30	N/A	N/A	0.016	0.032	0.450
	M16/2F*	2	19/0.0117	64.0	115.5	0.013	0.037	0.243
ID PRODUCTS & LABELERS	M16/3F*	3	19/0.0117	56.5	102.0	0.013	0.037	0.255
	M16/4F	4	19/0.0117	N/A	N/A	0.016	0.032	0.290
	M16/6F	6	19/0.0117	N/A	N/A	0.016	0.032	0.350
TOOLS	M16/8F	8	19/0.0117	N/A	N/A	0.016	0.032	0.380
	M14/2F*	2	19/0.0147	72.5	131.0	0.013	0.042	0.288
BREAKERS & FUSES	M14/3F*	3	19/0.0147	63.0	113.5	0.013	0.042	0.298

*Compliances: NEC Art. 725 Power-Limited Tray Cable (UL: 105°C 300V) Passes UL 70,000 BTU Vertical Tray Flame Test, Sunlight resistant.

Nom. Capacitance: **A-Between Conductors **B**-Between Conductor and Shield

Ordering Information: Sold by the foot. Minimum 25 ft.

APPLICATIONS: *Public address systems *Intercoms & Internal Telephones *Suitable for EIA RS-232 applications *Remote control circuits

COMPLIANCES:   *NEC Article 800 Type CMR (UL:75°C) (22 AWG) *UL Style 2464 (UL:80°C, 300V, VW-1) *CSA CMG (CSA: 60°C) *CE: Low Voltage Directive (LVD 2006/95/EC) *RoHS compliant directive 2011/65/EU *Vertical tray cable flame test (70,000 BTU)

FEATURES: *100% Flexfoil™ aluminum/polyester foil facing out *Stranded tinned copper drain wire *Grey PVC jacket

*Fully annealed stranded tinned copper per ASTM B-33 *Premium grade color coded PVC insulation

Multi-Conductor Cable

UNSHIELDED MULTI-CONDUCTOR



WIRE
& CABLE

MULTI-
CONDUCTOR

COAX
CABLES

NETWORK
CABLES

HEAT
SHRINK

ROUTING &
BUNDLING
MATERIALS

CABLE
TIES

TERMINALS

DEUTSCH &
APTIV (DELPHI)

LUGS
& BOOTS

ID PRODUCTS
& LABELERS

TOOLS

BREAKERS
& FUSES

TERMINAL
BLOCKS &
BUS BARS

SWITCHES &
ACTUATORS



METERS &
BOXES

PART NUMBER	NO. OF COND	COND. STRAND	NOM. CAP. pF/ft**	NOM. INSULATION THICKNESS (IN)	NOM. JACKET THICKNESS (IN)	NOM. CABLE O.D. (IN)
M22/2	2	7/30	24.5	0.010	0.015	0.130
M22/3	3	7/30	24.5	0.010	0.032	0.176
M22/4	4	7/30	24.5	0.010	0.032	0.182
M22/5	5	7/30	24.5	0.010	0.032	0.203
M22/6	6	7/30	24.5	0.010	0.032	0.218
M22/7	7	7/30	24.5	0.010	0.032	0.205
M22/8	8	7/30	24.5	0.010	0.032	0.230
M22/10	10	7/30	24.5	0.010	0.032	0.268
M22/12	12	7/30	24.5	0.010	0.032	0.276
M22/15	15	7/30	24.5	0.010	0.032	0.303
M22/25	25	7/30	20.0	0.010	0.032	0.354
M20/2	2	7/28	28.0	0.016	0.025	0.192
M20/3	3	7/28	28.0	0.016	0.032	0.216
M20/4	4	7/28	28.0	0.016	0.032	0.235
M20/5	5	7/28	28.0	0.016	0.032	0.254
M20/7	7	7/28	28.0	0.016	0.032	0.275
M20/9	9	7/28	28.0	0.016	0.032	0.317
M20/15	15	7/28	28.0	0.016	0.032	0.392
M18/2*	2	16/30	32.5	0.013	0.037	0.216
M18/3*	3	16/30	32.5	0.013	0.037	0.227
M18/4*	4	16/30	30.5	0.016	0.032	0.258
M18/5	5	16/30	25.0	0.016	0.032	0.272
M18/6	6	16/30	N/A	0.016	0.032	0.290
M18/7	7	16/30	30.5	0.016	0.032	0.309
M18/8	8	16/30	N/A	0.016	0.032	0.306
M18/9	9	16/30	30.5	0.016	0.032	0.358
M18/12	12	16/30	30.5	0.016	0.032	0.401
M16/2*	2	19/0.0117	37.0	0.013	0.037	0.238
M16/3*	3	19/0.0117	37.0	0.013	0.037	0.255
M16/4	4	19/0.0117	30.5	0.021	0.032	0.306
M16/5	5	19/0.0117	N/A	0.021	0.032	0.334
M16/7	7	19/0.0117	30.5	0.021	0.032	0.363
M16/8	8	19/0.0117	N/A	0.021	0.032	0.393
M16/12	12	19/0.0117	30.5	0.021	0.032	0.476
M14/2*	2	19/0.0117	40.5	0.013	0.042	0.278

*Power Limited Tray Cable, NEC Type PLTC, 105°C, Sunlight resistant. **Capacitance between conductors

Ordering Information: Sold by the foot. Minimum 25 ft.

APPLICATIONS: *Public address systems *Intercoms & Internal Telephones *Suitable for EIA RS-232 applications *Remote control circuits

COMPLIANCES:    *NEC Article 800 Type CM (UL:75°C) *UL Style 2464 (UL:80°C, 300V, VW-1)

*CSA CMG (CSA: 60°C) (Except for M18/5) *CE: Low Voltage Directive (LVD 2006/95/EC) *RoHS compliant directive 2011/65/EU

*Vertical tray flame test (70,000 BTU)

FEATURES: *Finely stranded tinned copper conductors *Color coded PVC *Grey PVC jacket

Multi-Conductor Cable

MULTI & INDIVIDUALLY FOILED / FLAT BRAID

WIRE & CABLE

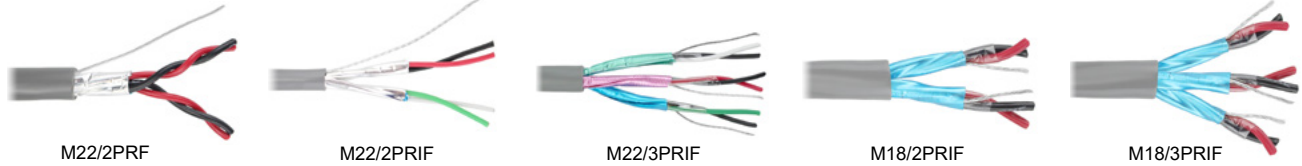

MULTI-CONDUCTOR

PART NUMBER	NO. OF PAIRS	COND. STRAND	NOM. CAP pF/ft*		NOM. INSULATION THICKNESS (IN)	NOM. JACKET THICKNESS (IN)	NOM. O.D. (IN)
			A	B			

MULTI-PAIR, OVERALL SHIELD

M22/2PRF	2	7/.0096	32.0	57.0	0.015	0.042	0.294
----------	---	---------	------	------	-------	-------	-------

Applications: Computers, Industrial Equipment, Data Transmission, Control Circuits. Provides flexibility and superior shielding where noise rejection is critical.
 Compliances: NEC Art. 800 Type CM (UL 105°C, 300V), NEC Art. 725 PLTC, UL Style 2464, CSA CMG

MULTI-PAIR, INDIVIDUALLY SHIELDED

M22/2PRIF	2	7/30	30.0	45.0	0.007	0.020	0.160
-----------	---	------	------	------	-------	-------	-------

Applications: Computers, Industrial Equipment, Control Circuits where total isolation of signal is required.
 Provides excellent high frequency properties and mechanical durability.
 Compliances: NEC Art. 800 Type CM (UL 75°C, 300V), CSA CMH

MULTI-PAIR, INDIVIDUALLY SHIELDED

M22/3PRIF	3	7/30	24.4	43.9	0.011	0.032	0.292
-----------	---	------	------	------	-------	-------	-------

Applications: Computers, Industrial Equipment, Control Circuits where total isolation of signal is required.
 Provides excellent high frequency properties and mechanical durability.
 Compliances: NEC Art. 800 Type CM (UL 75°C, 300V), UL Style 2919, CSA CMH

POWER-LIMITED TRAY CABLE, INDIVIDUALLY SHIELDED PAIRS

M18/2PRIF	2	16/30	50.5	91.0	0.016	0.042	0.380
M18/3PRIF	3	16/30	50.5	91.0	0.016	0.053	0.437

Applications: Burglar Alarms, Power Limited Circuits, Intercom Systems, Computer Interconnects
 Provides superior temperature characteristics, shielded with a robust, highly durable, and sunlight resistant jacket.
 Compliances: NEC Art. 725 (UL 105°C, 300V) UL Style 2464, CSA CMG

Ordering Information: Sold by the foot, minimum 25 ft. *Nom. Capacitance: **A**-Between Conductors **B**-Between Conductor and Shield

CHARACTERISTICS: *Voltage rating: 300V *Temp rating: -20°C to 105°C

COMPLIANCES: *RoHS compliant directive 2011/65/EU

FEATURES: *Finely stranded tinned copper conductors *100% aluminum polyester foil with a stranded tinned copper drain wire with cables that have individually shielded pairs *Color coded PVC insulation *Grey PVC jacket



PART NUMBER	STRAND AWG	CONSTRUCTION	NOM. CIRCULAR MILS	APPROXIMATE AWG EQUIV.	*APPROXIMATE CURRENT CAPACITY (AMPS)
-------------	------------	--------------	--------------------	------------------------	--------------------------------------

FLAT BRAID CABLE (TINNED COPPER BRAID)

M.125FB	36	24x3x36	1800	18	16
M.25FB	36	24x7x36	4200	14	32
M.375FB	36	48x6x36	7200	12	46
M.5FB	36	48x8x36	9600	10	53
M.75FB	36	48x11x36	13200	9	62

Ordering Information: Sold by the foot, minimum 5 ft. *Values based on copper in free air at 65°F and intended as a guide only.

Flat braided cable is a tight weave of soft drawn tinned copper wire. Excellent for use in shielding wire bundle short runs and is easily terminated. It is ideal for use as a low impedance ground path. The flexibility gained from the woven construction and the tinned copper conductors gives this material superb durability against harsh marine conditions.

APPLICATIONS: Useful as battery grounding bonding strap for aircraft, vehicles, marine equipment. Eliminates ignition interference.

FEATURES: *Soft annealed tinned copper braid, tightly woven *Low resistance way to create a point-to-point ground strap

Coaxial Cables

COAX & LMR CABLES



PART NUMBER	COND. AWG	INSULATION MATERIAL	SHIELD COVERAGE	JKT. MAT/ NOM. O.D. (IN)	NOM. CAP		VELOCITY OF PROP. %	NOMINAL IMPEDANCE
					pF/ft	pF/m		

50 OHM COAXIAL CABLES

MRG8U1154	13 (7x21) Bare Copper	Solid Polyethylene	95% Bare Copper Braid 1.2Ω/M	BK PVC 0.405	29.5	96.76	66	52
MRG8U1180	9 1/2 Bare Copper	Semi-solid Polyethylene	100% Bonded Foil +88% Tinned Copper Braid 1.8Ω/M	BK PVC 0.405	24.6	80.71	84	50
MRG8XW	16 (19x.0117) Tinned Copper	Foam Polyethylene	95% Tinned Copper Braid	WH PVC 0.242	27.0	-	80	50
MRG58AU	20 (19x.0071) Tinned Copper	Solid Polyethylene	95% Tinned Copper Braid 4.3Ω/M	BK PVC 0.195	31.8	104.34	66	50
MRG213U	13 (7x21) Bare Copper	Solid Polyethylene	95% Bare Copper Braid 1.2Ω/M	BK PVC 0.405	30.8	101.05	66	50
MRG214U*	12.7 (7x.030) Silver Coated Copper	Solid Polyethylene	98% 2 Silver Coated Copper Braid .70Ω/M	BK PVC 0.425	30.8	101.05	66	50

75 OHM COAXIAL CABLES

MRG6UW	18 Solid Copper Clad Steel	Cellular Polyethylene	100% Flexfoil +95% Tinned Copper Braid 6.5Ω/M	WH PVC 0.275	16.2	53.15	78	75
MRG11U	14 Solid Bare Copper	Foam Polyethylene	95% Bare Copper Braid 1.24Ω/M	BK PVC 0.405	17.3	56.75	78	75
MRG59UW	22 Solid Copper Clad Steel	Solid Polyethylene	95% Tinned Copper Braid 2.6Ω/M	WH PVC 2.6Ω/M	20.5	N/A	66	73

Ordering Information: Sold by the foot. Minimum 25 ft. *MRG214U carries a minimum of 1000 feet.

Pacer stocks a wide variety of coaxial cables, including most standard configurations as well as specialized constructions for marine environments. Pacer stocks a range of 50 and 75 ohm cables to handle most applications.

APPLICATIONS: 50 OHM CABLES *Two-way communications *CB radio *WLAN *Broadcast *RG58 used for interconnecting electronic equipment *RG8X used for VHF<50ft *RG8U used for VHF>50ft *RF connections

FEATURES: 50 OHM CABLES - Used for two-way communications, RF and microwave transmission and instrument control.

APPLICATIONS: 75 OHM CABLES *RF connections *Two-way communications *CB radio *WLAN *Broadcast

FEATURES: 75 OHM CABLES - The broadcast use of coaxial cables is for video distribution. Broadcast CATV (or MATV) signals use RG-59 or RG-6 series. They are designed for use above 50MHz with high strengths, low weight and low cost being the primary factors.



PART NUMBER	CONDUCTOR TYPE	INSULATION MATERIAL	SHIELD TYPE	NOM. O.D. (IN)	NOM. CAP		VELOCITY OF PROP. %	NOMINAL IMPEDANCE
					Pf/ft	% pF/m		

LMR (LAND MOBILE RADIO) CABLES

MLMR240	SOLID BARE COPPER	FOAM PE	TINNED COPPER	0.240	24.2	84%	50
MLMR400	SOLID BCCAL	FOAM PE	TINNED COPPER	0.405	23.9	85%	50
MLMR400-75	SOLID BARE COPPER	FOAM PE	TINNED COPPER	0.405	15.9	85%	75

Ordering Information: Order in multiples of 100 ft.

LMR (Land Mobile Radio) Cables have RF (Radio Frequency) performance comparable to traditional corrugated copper cables, but unlike corrugated cables, they are highly flexible and non-kinking. Compared to RG type braided cables, LMR Cables offer a far lower loss and better RF shielding. The polyethylene jacket, closed cell foam poly dielectric and bonded tape conductor contribute to the superior weather resistance of LMR cables.

APPLICATIONS: *2 way land mobile *Cellular *Wireless local loop *Broadband wireless *Telemetry

FEATURES: LMR has a UV resistant polyethylene jacketed cable designed for 20 years of service for outdoor use.

- WIRE & CABLE
- MULTI-CONDUCTOR
- COAX CABLES
- NETWORK CABLES
- HEAT SHRINK
- ROUTING & BUNDLING MATERIALS
- WIRE MANAGEMENT
- TERMINALS
- DEUTSCH & APTIV (DELPHI)
- LUGS & BOOTS
- ID PRODUCTS & LABELERS
- TOOLS
- BREAKERS & FUSES
- TERMINAL BLOCKS & BUS BARS
- SWITCHES & ACTUATORS
- METERS & BOXES

Coaxial Cables

COAX CONNECTORS

- WIRE & CABLE
- MULTI-CONDUCTOR
- COAX CABLES**
- NETWORK CABLES
- HEAT SHRINK
- ROUTING & BUNDLING MATERIALS
- WIRE MANAGEMENT
- TERMINALS
- DEUTSCH & APTIV (DELPHI)
- LUGS & BOOTS
- ID PRODUCTS & LABELERS
- TOOLS
- BREAKERS & FUSES
- TERMINAL BLOCKS & BUS BARS
- SWITCHES & ACTUATORS
- METERS & BOXES



EF59 & EF6



EF59TW & EF6TW



EF81



EPL258

PART NUMBER	CONNECTOR	FOR CABLE TYPE	PLATING TYPE
EF59	F-Connector Plug	RG 59	Nickel
EF6	F-Connector Plug	RG 6	Nickel
EF59TW	F-Connector Twist On	RG 59	Nickel
EF6TW	F-Connector Twist On	RG 6	Nickel
EF81	F-to-F Connector Coupler	-	Nickel
EPL258	Jack to Jack Coupler	-	Nickel

Ordering Information: Order by the piece.



EBNC-58 & EBNC-59



EPL259S



EUG175 & EUG176S

PART NUMBER	CONNECTOR	FOR CABLE TYPE	PLATING TYPE
EBNC-58	BNC Series 3 Pc	RG 58	Nickel
EBNC-59	BNC Series 3 Pc	RG 59, 62	Nickel
EPL259S	UHF Series Plug	RG8, 11, 213, 214, LMR-400	Silver
EUG175S	PL259S Reducer	RG 58	Silver
EUG176S	PL259S Reducer	RG 59, 62, 8X, LMR-240	Silver

Ordering Information: Order by the piece.

Coaxial Cables

COMPRESSION SEAL CONNECTORS



ECF-6 & ECF-59



ECBNC-59 & ECBNC-6

PART NUMBER	CONN. TYPE	CABLE DIAMETER (IN)	CABLE TYPES	COMPRESSION TOOL
ECF-59	F	0.240	RG-59, LMR-240	VTCL-4040;4080
ECF-6	F	0.270	RG-6	VTCL-4040;4080
ECBNC-59	BNC	0.240	RG-59, LMR-240	VTCL-4080
ECBNC-6	BNC	0.270	RG-6	VTCL-4080

Ordering Information: Each connector can be ordered individually.

These single-piece connectors make installation of RG6, RG6-Quad and RG59 cables go quickly and smoothly and create a high quality, permanent 360° connector-to-cable seal. The connectors are made of machined annealed brass with anti-corrosion nickel plated finish for maximum conductivity and reliability.



INDUSTRY TIP: Properly using Coaxial compression seal connectors:



Step 1: Make sure that all coaxial cables are properly stripped to the correct length. For coaxial stripping tool, please refer to page 56.

Step 2: Using the release screw and adjusting screw on the side of the tool, set the tool to the proper setting based on the connector you intend to use.

Step 3: Insert the properly stripped coaxial cable into the connector making sure the center conductor is the correct length.

Step 4: Line up the center conductor of the coaxial cable into the alignment hole on the crimper. Slide the cable into the tool opening making sure it is parallel to the crimp head.

Step 5: Squeeze both handles engaging the ratcheting action and complete a full cycle.

PART NUMBER: VTCL-4080



For more information on this tool please refer to **page 58**.

Making sure that you have the proper crimping or compression tool is essential to achieving a high-quality, proper connection. If a connector on your cable has not been properly crimped or connected, the quality of the connection is reduced. This has the potential to compromise an entire electrical system. Using the proper tool guarantees the correct crimp each and every time. Regardless of the type of connector you are working with, Pacer has the tool you need. Every tool we offer has undergone a battery of tests to make sure it is the highest quality possible. To see Pacer's selection of tools, refer to **pages 55 - 61**.

LOOKING FOR A DIFFERENT CONNECTOR?

Compression seal connectors may not be what you're looking for. Pacer carries a wide range of terminals and connectors to handle any job. For a full list of options, please refer to **pages 35 - 51**.

WIRE & CABLE

MULTI-CONDUCTOR

COAX CABLES

NETWORK CABLES

HEAT SHRINK

ROUTING & BUNDLING MATERIALS

WIRE MANAGEMENT

TERMINALS

DEUTSCH & APTIV (DELPHI)

LUGS & BOOTS

ID PRODUCTS & LABELERS

TOOLS

BREAKERS & FUSES

TERMINAL BLOCKS & BUS BARS

SWITCHES & ACTUATORS

METERS & BOXES

Network Cables

ETHERNET CABLES



M26/4PRFS-CAT6

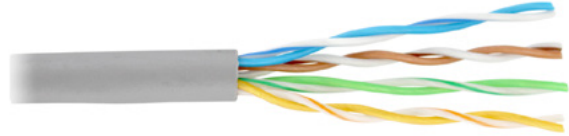

M24/4PRS-CAT5E

PART NUMBER	TYPE	PAIRS	AWG NO.	JACKET COLOR	NEC	SIZE	WEIGHT LB/M
M24/4PR-CAT5E	UNSHIELDED	4	24 (SOLID BARE)	GREY	CM	1000 FT	26
M24/4PRS-CAT5E*	UNSHIELDED	4	24 (7/32 TINNED)	GREY	CMR/CMG	1000 FT	26
M26/4PRFS-CAT5E*	O/ALL SHIELD	4	26 (7/32 TINNED)	BEIGE	CMR	1000 FT	26
M26/4PRFS-CAT6	O/ALL SHIELD	4	26 (SOLID BARE)	GREY	CM	1000 FT	26

Ordering Information: Sold by the foot, minimum of 1000 ft. *ETL verified Category 5E

Category 5 enhanced is a twisted pair cable used for carrying signals used on computer networks such as Ethernet. It is also commonly used to carry telephony and video signals. Cable standard provides performance up to 100 MHz.



PART NUMBER	DESCRIPTION	PACKAGING
CAT 6 RJ-45 MODULAR PLUGS		
ERJ-25	6P6C (Six Position / Six Contact)	25 PER PACK
ERJ-45	8P8C (Eight Position / Eight Contact)	25 PER PACK

Ordering Information: Order by the pack.

RJ45 modular plugs support CAT 6 installations, meeting the TIA/EIA-568-B.2 requirements for NEXT (Near End Cross Talk) and Return Loss. Unique 3-piece design includes a conductor liner, allowing conductors to be ordered and held in position for insertion into the plug body. Plugs are crimped using standard RJ45 crimp nests, allowing existing installation tools to be used.

INDUSTRY TIP: Wiring a 10BaseT / 100BaseT connector with Category cable using USOC Wiring Standards

568A and 568B are the most widely used standard for ethernet cables. If you wire both ends of your cable using 568B, you'll have a straight-through cable usable for most ethernet applications.

Wiring a cable with 568A on one end and 568B on the other will result in a Cross-Over cable for connecting two hubs, or two computers together.

EIA/TIA 568A Wiring Standard

PIN	Wire Color
1	White w/ Green Stripe
2	Green w/ White Stripe
3	White w/ Orange Stripe
4	Blue w/ White Stripe
5	White w/ Blue Stripe
6	Orange w/ White Stripe
7	White w/ Brown Stripe
8	Brown w/ White Stripe

For Cross over Cable Wiring Wire ONE end using 568B and one end as 568A (swap Orange and Green Pairs)

EIA/TIA 568B Wiring Standard

PIN	Wire Color
1	White w/ Orange Stripe
2	Orange w/ White Stripe
3	White w/ Green Stripe
4	Blue w/ White Stripe
5	White w/ Blue Stripe
6	Green w/ White Stripe
7	White w/ Brown Stripe
8	Brown w/ White Stripe

For Cross Over Cable Wiring Wire ONE end using 568B and one end as 568A (swap Orange and Green pairs)

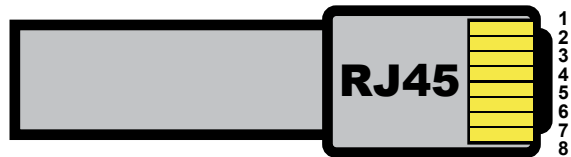

STEP 1:

Cut the outer jacket of the wire about 1.5" to 2" from the end which gives you room to work with the wire pairs.

Separate the pairs and align them in the order shown above.

Begin flattening the wires into a "ribbon" so that it will easily slip into the connector and into the individual channelled areas.

STEP 2:

Once you have all the wires aligned and ready to insert, you must trim them to approximately 1/2" in order to have as little "untwisted" wire in the connection as possible.

Category Cable specifications require a certain number of twists per inch and even the connector counts!

STEP 3:

Insert the wires into the body of the connector making sure that each wire goes into the correct "channel" and extends all the way to the end of the connector underneath the gold connectors.

If the wires do not extend to the end of the connector, the crimp may not make contact.

STEP 4:

Press the cable and the jacket into the connector firmly so that the jacket will be crimped by the plastic wedge near the rear of the connector, insert it into your crimping tool and crimp the cable.

RE-CRIMP the cable to make sure all connections are made.

STEP 5:

Repeat steps 1 thru 4 for the other end of the cable for a standard ethernet cable.

Network Cables

DEVICENET MICRO-C



PART NUMBER: MDN-MICRO						
AWG (Stranding) MAX DCR	NOM. MATERIAL (Color Code)	NOM. O.D. (IN)	NOM. IMPEDANCE (Ohms)	NOM. VEL OR PROP.	CAPACITANCE	APPROVALS
DEVICENET™ MICRO/EURO CABLE (MEETS AND EXCEEDS NMEA 2000 SPECIFICATIONS)						
1 pr - #22 TC Stranded	Power Pair PVC (black/red)	0.280	120.0	Data Pair 75%	12.0 pF/ft	CL2 75°C NMEA 2000®
1 pr - #22 TC Stranded	Data Pair Foam PE (blue/white)	-	-	Data Pair 75%	-	CL2 75°C NMEA 2000®

Ordering Information: Sold per roll, total footage of 328 feet.

MALE/FEMALE EXTENSION PART NUMBER	FEMALE EXTENSION PIGTAIL PART NUMBER	MALE EXTENSION PIGTAILPART NUMBER	LENGTH OF DROP CABLE M (Feet)
MICRO CHANGE CORDSET			
N84854-6034	N84854-7021	N84854-8021	0.5 (1.64)
N84854-6035	N84854-7022	N84854-8022	1.0 (3.28)
N84854-6036	N84854-7023	N84854-8023	2.0 (6.56)
N84854-6037	N84854-7024	N84854-8024	3.0 (9.84)
N84854-6038	N84854-7025	N84854-8025	4.0 (13.12)
N84854-6039	N84854-7026	N84854-8026	5.0 (16.40)
N84854-6055	N84854-7027	N84854-8027	6.0 (19.69)

Ordering Information: Sold per cordset.

PART NUMBER	LENGTH OF DROP CABLE - M (Feet)
MICRO-CHANGE POWER TAP, FEMALE LEFT TO FEMALE RIGHT TEE WITH PIGTAIL DROP	
N84863-9001	1 (3.28)
N84863-9002	5 (16.40)
N84863-9003	10 (32.81)

Ordering Information: Sold by the piece.



N84586-0017



N84586-0019 & N84586-0018



N84584-9317 & N84854-9318

PART NUMBER	DESCRIPTION
ADAPTORS, CONNECTORS, RESISTORS, AND RECEPTACLES	
N84586-0017	T-ADAPTOR, FEMALE, FEMALE (DROP), MALE
N84587-0005	MICRO CHANGE, 6 PORT
N84586-0018	MALE TERMINATION RESISTOR
N84586-0019	FEMALE TERMINATION RESISTOR
N84854-9300	MICRO-C BULKHEAD FEED THROUGH RECEPTACLE
N84854-9317	MICRO-C FEMALE TRUNK FIELD ATTACHABLE CONNECTOR
N84854-9318	MICRO-C MALE TRUNK FIELD ATTACHABLE CONNECTOR
N84854-9319	MICRO C INLINE TERMINATOR

Ordering Information: Sold by the piece.

NMEA 2000 DeviceNet Cables and Connectors are a CAN (Controller Area Network) protocol used to create a network of electronic devices. NMEA 2000 was developed primarily for use with electronic components used in marine applications.

APPLICATIONS: NMEA 2000 is a low-cost data network operating at 250 Kbps and utilizing the Controller Area Network (CAN) Integrated Circuit (IC). It allows multiple electronic devices to be connected together on a common channel for the purpose of easily sharing information.

CHARACTERISTICS: *Molded Connector: PVC Coupling Ring: Brass, Nickel *Contacts: Brass Alloy, Gold Plated *Cable: PVC Grey Jacket

FEATURES: *Share data between NMEA 2000 devices *Up to 4 AMPS *Vibration resistance *Ground circuit mates before other contacts

*Superior strain relief *Compliant with IEC IP67 Standard

WIRE
& CABLE

MULTI-
CONDUCTOR

COAX
CABLES

NETWORK
CABLES

HEAT
SHRINK

ROUTING &
BUNDLING
MATERIALS

WIRE
MANAGEMENT

TERMINALS

DEUTSCH &
APTIV (DELPHI)

LUGS
& BOOTS

ID PRODUCTS
& LABELERS

TOOLS

BREAKERS
& FUSES

TERMINAL
BLOCKS &
BUS BARS

SWITCHES &
ACTUATORS

METERS &
BOXES

Heat Shrink

3-TO-1 & HEAVY WALL HEAT SHRINK



- WIRE & CABLE
- MULTI-CONDUCTOR
- COAX CABLES
- NETWORK CABLES
- HEAT SHRINK
- ROUTING & BUNDLING MATERIALS
- WIRE MANAGEMENT
- TERMINALS
- DEUTSCH & APTIV (DELPHI)
- LUGS & BOOTS
- ID PRODUCTS & LABELERS
- TOOLS
- BREAKERS & FUSES
- TERMINAL BLOCKS & BUS BARS
- SWITCHES & ACTUATORS
- METERS & BOXES

PART NUMBER	EXPANDED I.D. (IN)	RECOVERED I.D. (IN)	APPLICATION RANGE AWG*	RECOVERED WALL THICKNESS (IN)	AVAILABLE COLORS
3-TO-1 EPOXY LINED HEAT SHRINK					
BEHS-1/8	0.125	0.0400	20, 18	0.040	BK, CL, RD
BEHS-3/16	0.188	0.0600	16, 14	0.040	BK, CL, RD, YL
BEHS-1/4	0.250	0.0800	12, 10	0.040	BK, CL, GN, WH, RD, YL
BEHS-3/8	0.375	0.1250	8, 6	0.060	BK, CL, GN, WH, RD, YL
BEHS-1/2	0.500	0.1600	4, 2	0.070	BK, CL, GN, WH, RD, YL
BEHS-3/4	0.750	0.2500	1, 1/0, 2/0	0.070	BK, CL, GN, WH, RD, YL
BEHS-1	1.000	0.3200	3/0, 4/0	0.100	BK, CL, GN, WH, RD, YL
BEHS-1.5	1.500	0.5100	N/A	0.100	BK, RD
BEHS-2.05	2.050	0.8000	N/A	0.100	BK

Ordering Information: BK = Black, RD = Red, GN = Green, CL = Clear, YL = Yellow, WH = White
 Combine part number, length & color for the 12 inch stick. **Example:** 3/4" diameter, 12" length, black = BEHS-3/4-12BK
 Combine part number & color for the 48 inch stick. **Example:** 3/4" diameter, black = BEHS-3/4BK

* Insulation varies with different types of wires; different diameter of tubing may actually be required. When choosing a size, consider any components or connectors that may need to be covered.

PART NUMBER	LENGTH (IN)	AVAILABLE COLORS	PACKAGE SIZE
PRE-CUT EPOXY LINED HEAT SHRINK TUBING FOR BATTERY CABLE ASSEMBLIES			
BEHS-1/2-1.5-10	1.500	BK, RD, YL	10 PCS
BEHS-3/4-1.5-10	1.500	BK, RD, YL	10 PCS
BEHS-1-1.5-10	1.500	BK, RD, YL	10 PCS

APPLICATIONS: *Environment/moisture protection *Sealing electrical connections *Encapsulate splices *Sealing cable ends *Strain relief
 *Rugged abrasion/vibration protection *Clear heat shrink is ideal for labeling

CHARACTERISTICS: Operating Temperature: -55°C to 110°C

FEATURES: *Shrink ratio 3:1 *Semi-flexible *Moisture sealing *Flame retardant (except clear)



PART NUMBER	EXPANDED I.D. (IN)	RECOVERED I.D. (IN)	APPLICATION RANGE AWG*	RECOVERED WALL THICKNESS (IN)
3-TO-1 HEAVY WALL TUBING				
BHW3/4BK	0.750	0.220	6 - 2	0.09
BHW3/4RD	0.750	0.220	6 - 2	0.09
BHW1.1BK	1.100	0.350	1 - 3/0	0.12
BHW1.1RD	1.100	0.350	1 - 3/0	0.12

* Insulation varies with different types of wires; different diameter of tubing may actually be required. When choosing a size, consider any components or connectors that may need to be covered.

Ordering Information: All sizes sold in 12" lengths. BK = Black RD = Red

3:1 BHW is coated internally with a dual purpose thermoplastic liner, which flows and encapsulates when heated. When cooled, the tubing offers the mechanical strength of a superior adhesive and the corrosion protection of a high quality mastic. When choosing a size, consider any components or connectors that may need to be covered.

APPLICATIONS: *Splice sealing *Primary insulation *Cable/jacket repair *Direct burial/submersible *Strain relief

COMPLIANCES: MIL-I-23053/15 Class 1

FEATURES: *Highly abrasion and impact resistant *Easy installation, shrinks when heated over 120°C *Thermoplastic liner will adhere to PVC, neoprene and polyolefin, EPR, steel and aluminum

Heat Shrink

2-TO-1 HEAT SHRINK



PART NUMBER	EXPANDED I.D. (IN)	RECOVERED I.D. (IN)	APPLICATION RANGEAWG*	RECOVERED WALL THICKNESS (IN)	AVAILABLE COLORS
2-TO-1 HEAT SHRINK					
BHS-1/16	0.063	0.031	24, 22, 20	0.014	BK, BL, CL, GN, RD, WH, YL
BHS-1/8	0.125	0.062	20, 18	0.017	BK, BL, CL, GN, RD, WH, YL
BHS-3/16	0.187	0.093	16, 14	0.017	BK, BL, CL, GN, RD, WH, YL
BHS-1/4	0.250	0.125	12, 10	0.022	BK, BL, CL, GN, RD, WH, YL
BHS-3/8	0.375	0.187	8, 6	0.022	BK, BL, CL, GN, GN/YL**, RD, WH, YL
BHS-1/2	0.500	0.250	4, 2	0.022	BK, BL, CL, GN, RD, WH, YL
BHS-3/4	0.750	0.375	1, 1/0, 2/0	0.027	BK, BL, CL, GN, RD, WH, YL
BHS-1	1.000	0.500	3/0, 4/0	0.030	BK, BR, CL, GY, RD
BHS-1.5	1.500	0.750	N/A	0.034	BK, CL, RD, WH, YL
BHS-2	2.000	1.000	N/A	0.038	BK
BHS-3	3.000	1.500	N/A	0.042	BK
BHS-4	4.000	2.000	N/A	0.046	BK

Ordering Information: BK = Black, BL = Blue, BR = Brown, CL = Clear, GY = Grey, GN = Green, RD = Red, WH = White, YL = Yellow

Combine part number with color **Example:** 1/2" black = BHS-1/2BK All sizes sold in 48" lengths. Spools available upon special request.

* Insulation varies with different types of wires; different diameter of tubing may actually be required. When choosing a size, consider any components or connectors that may need to be covered. ** GN/YL is a green tube with yellow tracer. To order, use part number BHS-3/8GN/YL.

Two to one heat shrink tubing slides easily over small inline splices and connectors, and shrinks down to 50% of its original diameter to fit snugly over any wire, hose, or cable. Also, it is the ideal way to terminate the ends of your braided sleeving and to create a tight professional finish.

APPLICATIONS: *Insulation *Wire identification *Wire bundling *Mechanical protection *Physical/electrical protection of components

CHARACTERISTICS: *Oper. Temp.: -55°C to 135°C *Min. Shrink Temp.: 100°C *Dielectric Strength: 500V/mil

COMPLIANCES: *UL 224: VW-1,600V, 125°C (Except Clear) *RoHS & REACH Compliant *SAE AS23053/5 Class 1 & 3, Class 2 is Clear.

FEATURES: *2:1 shrink ratio *Flexible *High tensile strength *Flame retardant (except clear)

HEAT SHRINK SIZE SELECTOR GUIDE FOR 2-TO-1 or 3-TO-1 TUBING			
WIRE AWG	RECOMMENDED TUBING SIZE	WIRE AWG	RECOMMENDED TUBING SIZE
24	1/16"	12	3/16"
22	1/16"	10	1/4"
20	3/32"	8	1/4" or 3/8"
18	1/8"	6	3/8" or 1/2"
16	3/16"	4	1/2" or 3/4"
14	3/16"	2	3/4" or 1"

Note: The chart presented here is a general recommendation. Insulation varies with different types of wires, different diameter or tubing may be required.

- WIRE & CABLE
- MULTI-CONDUCTOR
- COAX CABLES
- NETWORK CABLES
- HEAT SHRINK
- ROUTING & BUNDLING MATERIALS
- WIRE MANAGEMENT
- TERMINALS
- DEUTSCH & APTIV (DELPHI)
- LUGS & BOOTS
- ID PRODUCTS & LABELERS
- TOOLS
- BREAKERS & FUSES
- TERMINAL BLOCKS & BUS BARS
- SWITCHES & ACTUATORS
- METERS & BOXES

Routing & Bundling Materials

SLIT CONDUIT & SPIRAL WRAP



- WIRE & CABLE
- MULTI-CONDUCTOR
- COAX CABLES
- NETWORK CABLES
- HEAT SHRINK
- ROUTING & BUNDLING MATERIALS**
- WIRE MANAGEMENT
- TERMINALS
- DEUTSCH & APTIV (DELPHI)
- LUGS & BOOTS
- ID PRODUCTS & LABELERS
- TOOLS
- BREAKERS & FUSES
- TERMINAL BLOCKS & BUS BARS
- SWITCHES & ACTUATORS
- METERS & BOXES

PART NUMBER	SIZE (IN)	INSIDE DIMENSION RANGE (IN)	OUTSIDE DIMENSION RANGE (IN)	STANDARD LENGTHS	
				Box	Bulk
SLIT CONDUIT					
BSC1/4	1/4	0.236 - 0.264	0.376 - 0.400	100	3200
BSC3/8	3/8	0.337 - 0.362	0.491 - 0.516	100	1800
BSC1/2	1/2	0.484 - 0.509	0.670 - 0.695	100	1100
BSC5/8	5/8	0.605 - 0.630	0.790 - 0.836	100	750
BSC3/4	3/4	0.730 - 0.755	0.960 - 0.985	100	500
BSC1	1	1.000 - 1.039	1.278 - 1.306	25, 50, 100	300
BSC1.25	1.25	1.250 - 1.276	1.437 - 1.484	25, 50	200
BSC1.5	1.5	1.500 - 1.528	1.858 - 1.925	25, 50	100
BSC2	2	1.980 - 2.035	2.343 - 2.409	25, 50	100

Ordering Information: Order by part number listed for black conduit. White conduit is available for special order, please contact a Pacer expert. Combine part numbers with standard length size. **Example:** 1/2" Black slit conduit 100 feet = BSC1/2-100

Corrugated, slit polyethylene conduit is an excellent general purpose cable and harness protector. Efficient to install and economical, convoluted slit tubing provides an ideal method for binding wire harness assemblies, providing abrasion and impact protection, while reducing wire insulation damage. Creates quality appearance in wiring systems. Ideal product for hose abrasion protection.

APPLICATIONS: For protecting wires and harnesses from heat, sunlight, salt, and friction. Can be installed on in-service wires.

CHARACTERISTICS: *Operating Temp: -40°F to 200°F

COMPLIANCES: *UL 94, UL flammability standard V-2 *Meets ABYC standards

FEATURES: *Lightweight & economical *UV resistant *Easy to install *Provides impact and abrasion protection



PART NUMBER	NATURAL	BLACK	OUTSIDE DIAMETER (IN)	BUNDLE DIAMETER (IN)	PACKAGE Roll	WEIGHT LB/Roll
BSW1/8C		BSW1/8B	0.125	1/16 to 1/2	100	0.61
BSW1/4C		BSW1/4B	0.250	3/16 to 2	100	1.93
BSW3/8C		BSW3/8B	0.350	5/16 to 3	100	4.29
BSW1/2C		BSW1/2B	0.500	3/8 to 4	100	5.45
BSW3/4C		BSW3/4B	0.750	5/8 to 5	100	10.01
BSW1C		BSW1B	1.000	7/8 to 6	100	12.80

Ordering Information: Quantity of 1 = 100 ft roll.

Spiral wrap provides abrasion protection for wire and cable insulation as well as hydraulic and pneumatic tubing. Spiral wrap is also handy for kink-proofing all types of tubing. The spiral cut allows for expandability, easy wire breakouts at any point and excellent flexibility. For maximum abrasion resistance, butt the edges together while installing; for flexibility leave a gap between the edges.

APPLICATIONS: Spiral wrap offers abrasion protection for wire, cables, hoses and tubing.

CHARACTERISTICS: *Operating Temp: -40°F to 122°F (-40°C to 50°C) *Material: Polyethylene

FEATURES: *Flexible, neat and fast *Easy wire breakouts *Tool supplied with each package

Routing & Bundling Materials

EXPANDABLE SLEEVING & BRAIDED TUBE



PART NUMBER	NOM. INSIDE DIMENSION (IN)	EXPANSION RANGE		STANDARD LENGTHS		
		Minimum (IN)	Maximum (IN)	Shop	Bulk	
EXPANDABLE SLEEVING						
B1/8FLEX	1/8	3/32	1/4	225	1000	
B1/4FLEX	1/4	1/8	7/16	200	1000	
B3/8FLEX	3/8	3/16	1/2	125	500	
B1/2FLEX	1/2	1/4	3/4	100	500	
B3/4FLEX	3/4	1/2	1 1/4	75	250	
B1.25FLEX	1 1/4	3/4	1 3/4	50	250	
B1.50FLEX	1 1/2	1	2 1/2	40	200	
B1.75FLEX	1 3/4	1 1/4	2 3/4	30	200	

Ordering Information: Order by part number listed for Bulk Standard Length.

Combine part number with quantity for "Shop" Standard Length. **Example:** 1/2" Black Expandable Sleeving, 100 feet = B1/2FLEX-100

Flexo PET Flame Retardant (FR) sleeving is the perfect choice for electronic and high tech applications where flame retardant and durability are primary concerns. Ease of installation makes Flexo FR an efficient choice for long runs of wire or cable. It is ideal for a limitless number of electronic, automotive and industrial wire management and bundling applications wherever flame spread is a primary safety consideration.

APPLICATIONS: *Engine compartment dress-up *Home theater wire management *Computer case wiring *Office wire management
*Automotive harnesses

CHARACTERISTICS: **Operating Temperature:** *(Min Continuous) -94°F / -70°C *(Max Continuous) 257°F / 125°C *(Melt) 482°F / 250°C
*Flammability Rating: UL-94

COMPLIANCES: *UL *CSA *RoHS *VW-1 *ABYC

FEATURES: *Economical and easy to install *Cut and abrasion resistant *Expands up to 150% *Resists gasoline and engine chemicals



PART NUMBER	NOM. SIZE (IN)	EXPANSION RANGE		STANDARD LENGTH		AVAILABLE COLORS	WEIGHT LB/BULK
		Minimum (IN)	Maximum (IN)	Shop	Bulk		
WRAPPABLE BRAIDED TUBE							
BF6-1/4	1/4	1/8	7/16	20	100	BK, CW	1.60
BF6-3/8	3/8	3/16	1/2	12	75	BK, CW	1.75
BF6-1/2	1/2	1/4	3/4	10	75	BK, CW	2.00
BF6-3/4	3/4	1/2	1 1/4	8	50	BK, CW	2.00
BF6-1	1	5/8	1 5/8	8	50	BK, CW	3.00
BF6-1.5	1.5	1	2 1/8	-	25	BK, CW	2.00

Ordering Information: Colors: BK = Black CW = Clear

Combine part numbers with color abbreviation and standard length. **Example:** 3/4" Clear Wrappable Braided Tube, 50 feet = BF6-3/4CW-50

F6's unique split, semi-rigid braided construction makes it the ideal solution for situations where ease of installation is of primary importance. The lateral split allows the tube to open up to accommodate a wide variety of bundling requirements, and the semi-rigid braid configuration simply closes around the entire installation without the need for any additional fasteners. F6 is more flexible than slit conduit or spiral wrap.

APPLICATIONS: *Engine compartment dress-up *Home theater wire management *Customizing computer case wiring *Office wire management
*Automotive harnesses

FEATURES: *F6 is specifically designed to protect previously installed wires and hose *Cut & abrasion resistant *Easily cut with hot knife

WIRE & CABLE

MULTI-CONDUCTOR

COAX CABLES

NETWORK CABLES

HEAT SHRINK

ROUTING & BUNDLING MATERIALS

WIRE MANAGEMENT

TERMINALS

DEUTSCH & APTIV (DELPHI)

LUGS & BOOTS

ID PRODUCTS & LABELERS

TOOLS

BREAKERS & FUSES

TERMINAL BLOCKS & BUS BARS

SWITCHES & ACTUATORS

METERS & BOXES

Routing & Bundling Materials

WIRING DUCT

- WIRE & CABLE
- MULTI-CONDUCTOR
- COAX CABLES
- NETWORK CABLES
- HEAT SHRINK
- ROUTING & BUNDLING MATERIALS**
- WIRE MANAGEMENT
- TERMINALS
- DEUTSCH & APTIV (DELPHI)
- LUGS & BOOTS
- ID PRODUCTS & LABELERS
- TOOLS
- BREAKERS & FUSES
- TERMINAL BLOCKS & BUS BARS
- SWITCHES & ACTUATORS
- METERS & BOXES

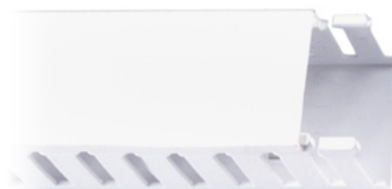

PART NUMBER	WIDTH (IN)	HEIGHT (IN)	SLOT WIDTH (IN)	MAX NUMBER OF 14 AWG WIRES	*COVER PART NUMBER
WHITE DUCT					
BG1X1WH6	1.00	1.00	0.31	26	BDC1WH
BG1X2WH6	1.00	2.00	0.31	52	BDC1WH
BG1X3WH6	1.00	3.00	0.31	52	BDC1WH
BG2X2WH6	2.00	2.00	0.31	104	BDC2WH
BG3X3WH6	3.00	3.00	0.31	233	BDC3WH
BG4X3WH6	4.00	3.00	0.31	310	BDC4WH
BG4X4WH6	4.00	4.00	0.31	414	BDC4WH
LIGHT GREY DUCT					
BG1X1LG6	1.00	1.00	0.31	26	BDC1LG
BG1X2LG6	1.00	2.00	0.31	52	BDC1LG
BG2X2LG6	2.00	2.00	0.31	104	BDC2LG
BG3X2LG6	3.00	2.00	0.31	147	BDC3LG
BG3X3LG6	3.00	3.00	0.31	233	BDC3LG
BG4X4LG6	4.00	4.00	0.31	414	BDC4LG

Ordering Information: Order in multiples of 6 ft. *Duct and Cover are sold separately. Due to the 6 ft. length, additional shipping charges may apply. Other sizes are available, please contact a Pacer Customer Service Expert for pricing.

Duct Example: 2" by 2" white duct, 6 ft. = BG2X2WH6 **Cover Example:** 2" white cover, 6ft. = BDC2WH

Wiring Duct is unique in that wires can easily be added and removed at any time. The cover is flush with the base for mounting in tight areas. Our wide finger, slotted wiring duct is made from lead-free PVC. Bases and covers are sold separately. Cutting wiring duct is easily achieved by using a fine tooth hand saw for small quantities. For large quantities use a fine tooth band-saw or circular saw.

APPLICATIONS: The preferred product for organizing large numbers of wires. Ideal for frequent breakouts or individual wire removal.

CHARACTERISTICS: *Resistant to Acids, Alkali, Fuels and Oils *Lead-free PVC

COMPLIANCES: *UL Recognized continuous use temperature: 122°F (50°C) *UL94 Flammability Rating of V-0 *Conforms with NFPA 79-2007 section 13.3.1 requirement for flame retardant material *UL, CSA, RoHS compliant

FEATURES: *Rigid, non-flammable lead-free PVC *Available in white or light grey *Cover mounts flush to sides *Slotted for easy wire breakouts *Non-slip cover design *Provided with mounting holes *Rounded edges to protect from abrasion



INDUSTRY TIP:

Determining the proper amount of wires for use with wiring duct

Follow the formula here to determine the maximum number of wires used in various sizes of wiring duct. Formula based upon a 50% fill capacity.

$$\text{Number of wires} = \frac{\text{Duct Width} \times \text{Height}}{2 \times (\text{Wire O.D.})^2}$$

Routing & Bundling Materials

STAINLESS STEEL CLAMPS & NYLON CLAMPS

PART NUMBER	SIZE (IN)	A (IN)	B (IN)	C (IN)	D (IN)	E (IN)	WIDTH (IN)	PACKAGE SIZE
STAINLESS STEEL CUSHION CLAMPS								
BSSC04	1/4	0.250	0.529	0.032	0.062	0.062	0.500	10, 25, 100, 2500
BSSC06	3/8	0.375	0.592	0.032	0.062	0.062	0.500	10, 25, 100, 1700
BSSC08	1/2	0.500	0.654	0.032	0.062	0.062	0.500	10, 25, 100, 1200
BSSC10	5/8	0.625	0.780	0.032	0.062	0.109	0.500	10, 25, 100, 1000
BSSC12	3/4	0.750	0.842	0.032	0.062	0.109	0.500	10, 25, 100, 1500
BSSC14	7/8	0.875	0.889	0.032	0.062	0.109	0.500	10, 25, 100, 1200
BSSC16	1	1.000	0.951	0.032	0.062	0.109	0.500	10, 25, 100, 1000
BSSC18	1 1/8	1.125	1.062	0.032	0.062	0.125	0.500	10, 25, 100, 500
BSSC20	1 1/4	1.250	1.093	0.032	0.094	0.125	0.500	10, 25, 100, 700
BSSC22	1 3/8	1.375	1.187	0.032	0.094	0.125	0.500	10, 25, 100, 600
BSSC24	1 1/2	1.500	1.217	0.032	0.094	0.125	0.500	10, 25, 100, 500
BSSC28	1 3/4	1.750	1.342	0.032	0.094	0.125	0.500	10, 25, 100, 450
BSSC32	2	2.000	1.475	0.040	0.125	0.125	0.500	10, 25, 100, 350
BSSC36	2 1/4	2.250	1.598	0.040	0.125	0.125	0.500	5, 10, 25, 300
BSSC40	2 1/2	2.500	1.728	0.040	0.125	0.125	0.500	5, 10, 250
BSSC44	2 3/4	2.750	1.851	0.040	0.125	0.125	0.500	5, 10, 200
BSSC48	3	3.000	1.976	0.040	0.125	0.125	0.500	5, 10, 175
BSSC56	3 1/2	3.500	2.226	0.040	0.125	0.125	0.500	5, 10, 300
BSSC64	4	4.000	2.476	0.040	0.125	0.125	0.500	5, 10, 250

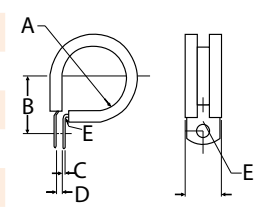

Ordering Information: Combine part number and package size. **Example:** 1/4" diameter, 100 pieces = BSSC04-100.

BSSC are composed of 321 stainless steel with black EPDM cushions for protection of wire & hoses. The EPDM cushions serve to dampen vibrations. The strength and corrosion resistance of stainless steel combined with the protection of EPDM provide a long term, reliable mounting solution.

APPLICATIONS: Stainless steel clamps are used for mounting wire, cable, or hoses where weight and vibration are a factor.

COMPLIANCES: *304/321 Stainless steel meets MIL-S-5059 AMS5510 *General purpose EPDM per SAE J200BC715

FEATURES: *1/4" mounting hole *1/2" width for strength *Sizes from 1/4" to 4"

PART NUMBER	SIZE (IN)	A (IN)	B (IN)	C (IN)	D (IN)	E (IN)	PACKAGE SIZE
NYLON CLAMPS							
BCCH02	1/8	0.120	0.500	0.360	0.203	0.100	100 1000
BCCH03	3/16	0.190	0.500	0.420	0.203	0.100	100 1000
BCCH04	1/4	0.250	0.500	0.460	0.203	0.100	100 1000
BCCH05	5/16	0.310	0.500	0.500	0.203	0.100	100 1000
BCCH06	3/8	0.380	0.500	0.530	0.203	0.100	100 1000
BCCH07	7/16	0.440	0.500	0.560	0.203	0.100	100 1000
BCCH08	1/2	0.500	0.500	0.590	0.203	0.100	100 1000
BCCH09	9/16	0.560	0.500	0.610	0.203	0.100	100 1000
BCCH10	5/8	0.620	0.500	0.650	0.203	0.100	100 1000
BCCH11	11/16	0.690	0.500	0.750	0.203	0.100	100 -
BCCH12	3/4	0.750	0.500	0.780	0.203	0.100	100 500
BCCH13	13/16	0.810	0.500	0.810	0.203	0.100	100 -
BCCH14	7/8	0.870	0.500	0.840	0.203	0.100	100 -
BCCH16	1	1.000	0.500	0.910	0.203	0.100	100 500
BCCH20	1 1/4	1.250	0.500	1.060	0.203	0.100	100 -
BCCH24	1 1/2	1.500	0.500	1.190	0.203	0.100	100 -

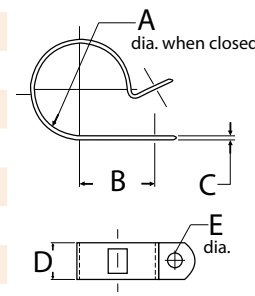

Ordering Information: Order by package size. For Black nylon clamps, add BK to the end of the part number.

APPLICATIONS: BCCH (Battery Cable Clamp Hulls) are an economical, fast and efficient mounting system for a wide variety of materials including cables, hoses, and harnesses.

FEATURES: *Stocked in natural and black heat/UV stabilized 6/6 nylon *1/2" width for strength *Sizes from 1/8" to 1 1/2"

*Mounts with a #10 screw

- WIRE & CABLE
- MULTI-CONDUCTOR
- COAX CABLES
- NETWORK CABLES
- HEAT SHRINK
- ROUTING & BUNDLING MATERIALS
- WIRE MANAGEMENT
- TERMINALS
- DEUTSCH & APTIV (DELPHI)
- LUGS & BOOTS
- ID PRODUCTS & LABELERS
- TOOLS
- BREAKERS & FUSES
- TERMINAL BLOCKS & BUS BARS
- SWITCHES & ACTUATORS
- METERS & BOXES

Wire Management

CABLE TIES & DOME TOP TIES

WIRES & CABLES
MULTI-CONDUCTOR
COAX CABLES
NETWORK CABLES
HEAT SHRINK
ROUTING & BUNDLING MATERIALS
WIRES MANAGEMENT
TERMINALS
DEUTSCH & APTIV (DELPHI)
LUGS & BOOTS
ID PRODUCTS & LABELERS
TOOLS
BREAKERS & FUSES
TERMINAL BLOCKS & BUS BARS
SWITCHES & ACTUATORS
METERS & BOXES



STANDARD PART NUMBER	PKG SIZE	BULK PART NUMBER	PKG SIZE	LENGTH (IN)	BUNDLE DIA (IN)	TENSILE STR. LB
NATURAL	BLACK	NATURAL	BLACK			

STANDARD CABLE TIES

CT1M-C	CT1M-C0	100	CT1M-M	CT1M-M0	1000	3.9	0.87	18 (M)
-	CT1.5I-C0	100	CT1.5I-M	CT1.5I-M0	1000	5.6	1.38	40 (I)
CT2S-C	CT2S-C0	100	CT2S-M	CT2S-M0	1000	7.4	1.88	50 (S)
CT3S-C	CT3S-C0	100	CT3S-M	CT3S-M0	1000	11.5	3.00	50 (S)
CT3H-L	CT3H-L0	50	CT3H-TL	CT3H-TL0	250	11.4	3.00	120 (LH)
CT4S-C	CT4S-C0	100	CT4S-M	CT4S-M0	1000	14.5	4.00	50 (S)
CT4H-L	CT4H-L0	50	CT4H-TL	CT4H-TL0	250	14.5	4.00	120 (LH)
CT7LH-L	CT7LH-L0	50	-	-	-	24.7	7.00	120 (LH)
CT9LH-L	CT9LH-L0	50	-	-	-	30.5	9.00	120 (LH)

CABLE TIES WITH MOUNTING RING

CTMR1M-C	CTMR1M-C0	100	CTMR1M-M	CTMR1M-M0	1000	4.3	0.75	18 (M)
CTMR1.5I-C	CTMR1.5I-C0	100	CTMR1.5I-M	CTMR1.5I-M0	1000	6.1	1.25	40 (I)
CTMR2S-C	CTMR2S-C0	100	-	CTMR2S-M0	1000	7.9	1.84	50 (S)
CTMR4S-C	CTMR4S-C0	100	CTMR4S-M	CTMR4S-M0	1000	15.0	4.00	50 (S)
CTMR4H-L	CTMR4H-L0	50	CTMR4H-TL	CTMR4H-TL0	250	15.1	4.00	120 (LH)

Ordering Information: Order by standard or bulk packages.

APPLICATIONS: Cable ties are the most widely used and versatile bundling and harnessing material available.

Used to secure a cable bundle to another surface such as a control panel, communication rack, wall or ceiling

CHARACTERISTICS: *6/6 Nylon (Nat. & UV res. Blk) *Max. Cont. Temp. 185°F (85°C) *Min. Cont. Temp. -20°F (85°C)

COMPLIANCES: *UL Compliant *Flammability UL 94V-2 *RoHS & CE compliant

FEATURES: *For indoor use *Curved tip is easy to pick up off flat surfaces & allows faster initial threading to speed installation.

STANDARD PART NUMBER	PKG SIZE	BULK PART NUMBER	PKG SIZE	LENGTH (IN)	BUNDLE DIA (IN)	MAX TENSILE STR. LB
NATURAL	BLACK	NATURAL	BLACK			

DOME TOP CABLE TIES

CTB1M-C	CTB1M-C0	100	CTB1M-M	CTB1M-M0	1000	4.0	0.90	18 (M)
CTB1.5I-C	CTB1.5I-C0	100	CTB1.5I-M	CTB1.5I-M0	1000	6.1	1.50	40 (I)
CTB2S-C	CTB2S-C0	100	CTB2S-M	CTB2S-M0	1000	8.0	2.00	50 (S)
CTB3S-C	CTB3S-C0	100	CTB3S-M	CTB3S-M0	1000	12.0	3.00	50 (S)
CTB4S-C	CTB4S-C0	100	CTB4S-M	CTB4S-M0	1000	15.1	4.00	50 (S)
CTB4LH-L	CTB4LH-L0	50	CTB4LH-TL	CTB4LH-TL0	250	14.9	4.00	120 (LH)
CTB7LH-L	CTB7LH-L0	50	-	-	-	24.4	7.00	120 (LH)
CTB9LH-L	CTB9LH-L0	50	-	-	-	30.7	9.00	120 (LH)

DOME TOP CABLE TIES WITH MOUNTING RING

-	-	-	-	CTBMR1M-M0	1000	4.5	0.90	18 (M)
-	-	-	-	CTBMR1.5I-M0	1000	6.5	1.50	40 (I)
-	CTBMR2S-C0	100	CTBMR2S-D	-	500	8.5	2.00	50 (S)
-	CTBMR4S-C0	100	CTBMR4S-D	-	500	15.5	4.00	50 (S)
-	CTBMR4LH-L0	50	-	CTBMR4LH-TL0	250	15.5	4.00	120 (LH)

Ordering Information: Order by standard or bulk packages.

FEATURES: *Stainless steel locking barb provides consistent performance, reliability, and infinite adjustability through the entire bundle. *High strength low tread force *Dome-top head features unique patented design with round smooth edges.

PART NUMBER SYSTEM

CTMR	2	S	-	C	0
CABLE TIE TYPE CT=Standard CTB=Barb Ty CTMR=Mounting Ring CMLT=Stainless Steel	APPROX. BUNDLE DIA. 1 = 1" 1.5 = 1.5" 2 = 2"	LOOP TENSILE STR. M = Mini (18 Lbs.) I = Intermediate (40 Lbs.) S = Standard (50 Lbs.) LH = Heavy Duty (120 Lbs.)		PACKAGE SIZE L = 50 C = 100 TL = 250 D = 500 M = 1000	Designates Black UV Resistant Cable Ties

PROPER TOOLS:
Cable Tie Cutting Tools can be found on page 58.

Wire Management

CABLE TIE MOUNTS

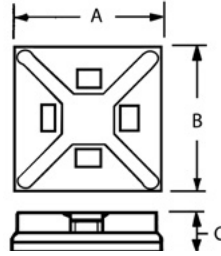

PART NUMBER NATURAL	PART NUMBER BLACK	A (IN)	B (IN)	C (IN)	USE WITH CABLE TIE TYPE	MAX STATIC LOAD LB	PACKAGE SIZE
ADHESIVE BACKED MOUNTS							
CABM.5	-	0.50	0.50	0.16	M	0.13	100
CABM.75	CABM.75BK	0.75	0.75	0.18	M, I	0.30	100
CABM1	CABM1BK	1.00	1.00	0.16	M, I, S	0.50	100

Ordering Information: Order by package.

FEATURES: *Superior adhesive for long term reliability *4-way cable tie entry *Available in multiple sizes to match application load
 *Fast and easy to use. Applies to any clean, dry, smooth, grease-free surface *Available in white or UV resistant black

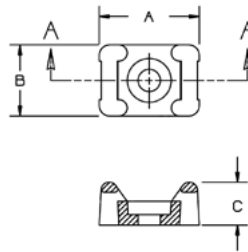

PART NUMBER NATURAL	PART NUMBER BLACK	A (IN)	B (IN)	C (IN)	USE WITH CABLE TIE TYPE	MOUNT METHOD	PACKAGE SIZE
SCREW DOWN MOUNTS							
CTM1S6	CTM1S6BK	0.51	0.32	0.23	M	#6 Screw	100, 1000
CTM2S8	CTM2S8BK	0.63	0.43	0.28	M, I, S	#8 Screw	100, 1000
CTM3S10	CTM3S10BK-100	0.86	0.61	0.37	M, I, S, LH	#10 Screw	100, 1000
-	CTMEH25BK	1.62	0.72	0.61	I, S, LH	1/4" Screw	25

Ordering Information: Order by package.

FEATURES: *Screw fastened nylon cradles *Low profile *Excellent stability and rigidity *Available in natural or UV resistant black

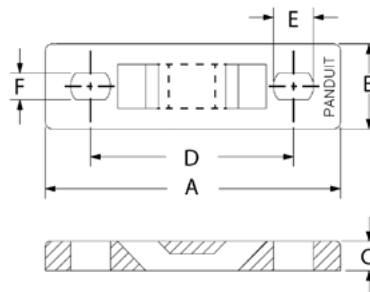

PART NUMBER	A (IN)	B (IN)	C (IN)	D (IN)	E (IN)	F (IN)	USE WITH CABLE TIE TYPE	MOUNT METHOD	PACKAGE SIZE
MULTIPLE TIE MOUNTS									
CTMTP3-10	4.25	0.50	0.13	3.75	0.31	0.21	M, I, S	#10 Screw	PC
CTMTP6-10	9.59	0.63	0.20	9.00	0.22	0.15	M, I, S, LH	#10 Screw	PC

Ordering Information: Order by the piece. CTMTP3-10 holds 3 cable ties. CTMTP6-10 holds 6 cable ties.

FEATURES: *Uniformly anchors parallel wire bundles, cables and tubing *Reduces the number of fasteners

- WIRE & CABLE
- MULTI-CONDUCTOR
- COAX CABLES
- NETWORK CABLES
- HEAT SHRINK
- ROUTING & BUNDLING MATERIALS
- WIRE MANAGEMENT
- TERMINALS
- DEUTSCH & APTIV (DELPHI)
- LUGS & BOOTS
- ID PRODUCTS & LABELERS
- TOOLS
- BREAKERS & FUSES
- TERMINAL BLOCKS & BUS BARS
- SWITCHES & ACTUATORS
- METERS & BOXES

Wire Management

STAINLESS STEEL TIES & BUSHINGS

WIRE & CABLE
MULTI-CONDUCTOR
COAX CABLES
NETWORK CABLES
HEAT SHRINK
ROUTING & BUNDLING MATERIALS
WIRE MANAGEMENT
TERMINALS
DEUTSCH & APTIV (DELPHI)
LUGS & BOOTS
ID PRODUCTS & LABELERS
TOOLS
BREAKERS & FUSES
TERMINAL BLOCKS & BUS BARS
SWITCHES & ACTUATORS
METERS & BOXES

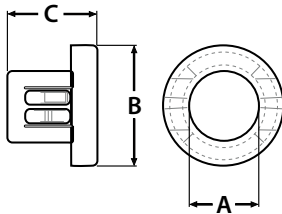
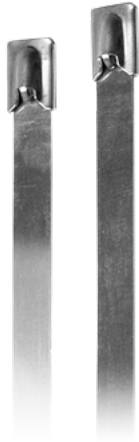

PART NUMBER	LENGTH (IN)	WIDTH (IN)	MAX BUNDLE	MIN. LOOP TENSILE STRENGTH	PACKAGE SIZE
STAINLESS STEEL CABLE TIES					
CMLT2S-CP316	7.90	0.18	2.00	200	100
CMLT4S-CP316	14.3	0.18	4.00	200	100
CMLT4H-LP316	14.3	0.25	4.00	250	50
CMLT6S-CP316	20.5	0.18	6.00	200	100

Ordering Information: Order by standard package.

FEATURES: *Self-locking head makes installation quick & easy *Provides a strong and durable method of cable bundling *Smooth surface and rounded edges ensures cable protection and worker safety

COMPLIANCES: *AISI 316 Stainless steel

PART NUMBER	FOR USE WITH TIE WIDTH (IN)	SLEEVE WIDTH (IN)	PART NUMBER
STAINLESS STEEL CABLE TIE SLEEVES			
CM-PCSS	0.18	0.33	100 FT REEL
CM-PCSH	0.31	0.47	100 FT REEL

Ordering Information: Order by standard package.

High quality, black cushion sleeve series is used with stainless steel cable ties. It is used in applications requiring improved grip, separation of dissimilar metals, and added bundle protection. It additionally has excellent ultraviolet resistance.

COMPLIANCES: *AISI 316 Stainless steel

PART NUMBER	MOUNTING HOLE DIA. (IN)	(A) INSIDE DIAMETER (IN)	(B) HEAD DIAMETER (IN)	(C) TOTAL HEIGHT (IN)	MAX. PANEL THICKNESS (IN)	PACKAGE SIZE
SNAP BUSHINGS						
BSB-1/4	1/4	0.125	0.312	0.312	0.062	10, 25, 100
BSB-3/8	3/8	0.250	0.468	0.406	0.125	10, 25, 100
BSB-1/2	1/2	0.391	0.570	0.406	0.125	10, 25, 100
BSB-5/8	5/8	0.500	0.718	0.406	0.125	10, 25, 100
BSB-3/4	3/4	0.609	0.850	0.406	0.125	10, 25, 100
BSB-7/8	7/8	0.687	0.953	0.453	0.125	10, 25, 100
BSB-1	1	0.766	1.125	0.453	0.125	10, 25, 100
BSB-1.125	1 1/8	0.875	1.218	0.453	0.125	10, 25, 100
BSB-1.25	1 1/4	0.937	1.359	0.453	0.125	10, 25, 100
BSB-1.375	1 3/8	1.000	1.490	0.453	0.125	10, 25, 100
BSB-1.5	1 1/2	1.125	1.609	0.453	0.125	10, 25, 100
BSB-1.75	1 3/4	1.375	1.875	0.453	0.125	10, 25, 100
BSB-2	2	1.640	2.125	0.453	0.125	10, 25, 100
BSB-2.5	2 1/2	1.970	2.660	0.720	0.250	10, 25, 100

Ordering Information: Combine part number and package size.

Example: 3/8" diameter, 25 pieces = BSB-3/8-25.

Snap bushings are used to eliminate sharp edges and to protect wires when passing through holes. Designed to accommodate a variety of panel or box thickness, snap bushings will easily snap into place and resist up to 35 pounds of pull.

Wire Management

CABLE GLANDS - LIQUID TIGHT CONNECTORS



PART NUMBER	DIAMETER RANGE (IN)	MOUNTING HOLE (IN)	MAX LENGTH (IN)	THREAD LENGTH (IN)	*NPT LOCKING NUTS	
					PART NUMBER	THREAD SIZE (IN)
NPT THREAD (*LOCKING NUTS SOLD SEPARATELY)						
BSLC-3/8	0.157 - 0.313	0.657	1.692	0.563	BSLN-3/8	3/8"
BSLC-1/2	0.236 - 0.476	0.825	1.734	0.465	BSLN-1/2	1/2"
BSLC-3/4	0.545 - 0.709	1.050	1.969	0.563	BSLN-3/4	3/4"
BSLC-1	0.708 - 0.984	1.303	2.283	0.563	BSLN-1	1"

Ordering Information: Order by the package. 5, 10 or 25 pieces.



PART NUMBER	DIAMETER RANGE (IN)	MOUNTING HOLE (IN)	MAX LENGTH (N)	THREAD LENGTH (IN)	*NPT LOCKING NUTS	
					PART NUMBER	THREAD SIZE (mm)
PG THREAD (*LOCKING NUTS SOLD SEPARATELY)						
BSLC-36	0.866 - 1.259	1.850	2.519	0.512	BSLN-36	36
BSLC-42	1.259 - 1.496	2.126	2.638	0.512	BSLN-42	42
BSLC-48	1.456 - 1.172	2.335	2.717	0.512	BSLN-48	48

Ordering Information: Order by the individual PG body or locking nut.

CHARACTERISTICS: *Material: Polyamide - flame retardant and self-extinguishing nylon with neoprene bushing *Operating Temperature: -20°C to 80°C *Max. Temp Rating: 125°C *Resistant to common fluids and solvents

COMPLIANCES: *International Approvals: UL, CSA, VDE, SEV *Seal IP 68 *UL Flammability 94 V-2

FEATURES: *For use in areas where cables and wires need to be safely inserted into housings through bulkheads. *Protection up to 70 PSI

*Seal: IP 68 (International protection highest rating, comparable to NEMA 6)

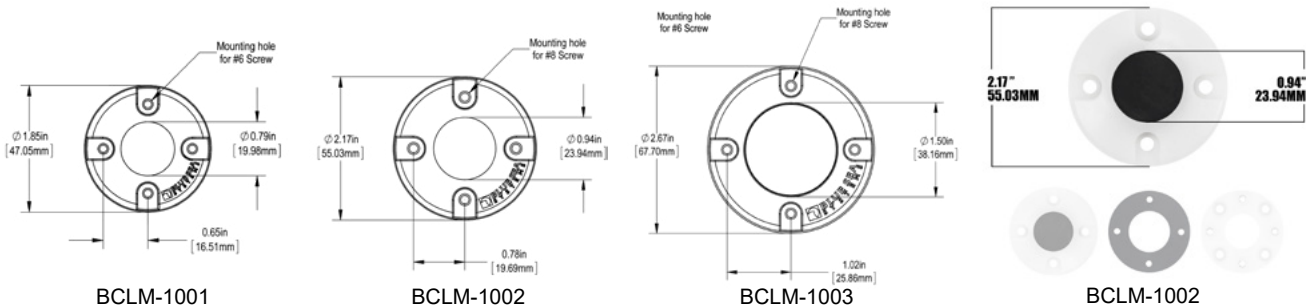

PART NUMBER	DESCRIPTION
CABLE CLAMS	
BCLM-1001	Cable Clam 0.68" Connector Opening
BCLM-1002	Cable Clam 0.83" Connector Opening
BCLM-1003	Cable Clam 1.40" Connector Opening

Ordering Information: Order by the individual clam.

CHARACTERISTICS: *Body Material: Acetate *Seal Material: UV Stabilized Buna-N rubber *Screws: Stainless steel

FEATURES: *Waterproof co-axial installation without removing connectors *Save the expense of removing and replacing

*Avoid poor connections from removing factory connectors



- WIRE & CABLE
- MULTI-CONDUCTOR
- COAX CABLES
- NETWORK CABLES
- HEAT SHRINK
- ROUTING & BUNDLING MATERIALS
- WIRE MANAGEMENT
- TERMINALS
- DEUTSCH & APTIV (DELPHI)
- LUGS & BOOTS
- ID PRODUCTS & LABELERS
- TOOLS
- BREAKERS & FUSES
- TERMINAL BLOCKS & BUS BARS
- SWITCHES & ACTUATORS
- METERS & BOXES

- WIRE & CABLE
- MULTI-CONDUCTOR
- COAX CABLES
- NETWORK CABLES
- HEAT SHRINK
- ROUTING & BUNDLING MATERIALS
- WIRE MANAGEMENT
- TERMINALS
- DEUTSCH & APTIV (DELPHI)
- LUGS & BOOTS
- ID PRODUCTS & LABELERS
- TOOLS
- BREAKERS & FUSES
- TERMINAL BLOCKS & BUS BARS
- SWITCHES & ACTUATORS
- METERS & BOXES



3M Dual Lock

This product is a 1" wide, self-adhering, reclosable fastening system. 3M Stem Type 400/170 locking system is five times stronger than conventional hook and loop fasteners. The adhesive backing will adhere instantly to many surfaces. Resistance of 120°F / 49°C.

Part Number: BDLOCK-BK

2 - 1" wide rolls, 1 @ 170 stems, 1 @ 400 stems. 4.9 yards each

Ordering Information: Order in mini packs of 4.9 yards.



Super 33+

Scotch Brand Super 33+ is a premium grade, 7-mil tape that applies well at temperatures as low as -18°C/0°F and has an operating temperature range up to 105°C/221°F. Use Super 33+ as a primary insulation for wire and cable splices up to 600V and for fixture and wire splices up to 1kV.

Part Number: ETBLK105

Ordering Information: Order by the roll.



Scotch 35

3M Scotch 35 are color coded, American made electrical tapes that are general purpose insulating tapes. They are economical and durable with excellent resistance to a wide range of contaminants and weather conditions.

PART NUMBER	COLOR	PART NUMBER	COLOR	PART NUMBER	COLOR
ETBRN80	BROWN	ETYEL80	YELLOW	ETVIO80	VIOLET
ETWHT80	WHITE	ETGRN80	GREEN	ETGRY80	GREY
ETORG80	ORANGE	ETBLU80	BLUE	ETRED80	RED

Ordering Information: Order by the roll.

FEATURES: *UL Listed 80°C 600V, CSA Certified 105°C *3/4" x 66 feet

*Resists: abrasion, UV rays (white only), moisture, alkalis and solvents



Scotch 35

3M Temflex is an economical, general purpose tape for indoor or outdoor use. 3/4" x 60'.

Ordering Information: Order by the roll.

Part Number: ETBLK80



130C Linerless Rubber Splicing Tape

3M 130C is a highly conformable linerless rubber (EPR), high-voltage insulating tape formulated to provide excellent thermal dissipation of splice heat. It is designed for use in splicing and terminating wires and cables, moisture sealing electrical connections, bus bar insulating and end-sealing cables.

PART NUMBER	DESCRIPTION (DIMENSIONS)
ET130C-1	1.0" X 30'
ET130C-1.5	1.5" X 30'

Ordering Information: Order by the roll.

FEATURES: *Indoor/Outdoor Use *Flame Retardant *Rated for use up to 90°C continuous, short term overload service to 130°C

Terminals

SEALANTS, COATINGS & KITS

PART NUMBER	DESCRIPTION	SIZE
-------------	-------------	------

SEALANTS & COATINGS

ESCOTCHKOTE	3M™ SCOTCHKOTE 3M Scotchkote™ electrical fast dry coating provides a tough, oil-resistant outer seal on electrical insulation subjected to abnormal weathering, oil or moisture conditions. The brush applied coating provides additional oil and moisture protection when used over an application of Scotch™ Vinyl electrical tapes. Tack free time at 72°F / 22°C is approximately 12 minues. Adheres to wood, vinyl, plastic, and metal.	15 fl oz. (443 ml)
	3M™ INSULATING SEALERS 3M™ 1601 and 1602 Sealers insulate, refinish and protect. They are used to overcoat outdoor electrical splices and cases to impede the effects of weather, moisture, acids, alkalis and oils.	15.13 fl oz. (447 ml)
E1601CLR (Clear)		
E1602RD (Red)		



Ordering Information: Order by the piece.

PART NUMBER	DESCRIPTION	CASE SIZE
-------------	-------------	-----------

TERMINAL KITS

TE-KIT	HEAT SHRINK TERMINAL KIT A durable, portable plastic case filled with 180 heat shrink terminals. Each compartment contains 10 butt splices or ring terminals. Ring terminals come with stud sizes: #8, #10, 1/4", 5/16" and 3/8". Kit Contains: (60) Red terminals for 22-18 AWG wire (10) butt splices and (50) rings (60) Blue terminals for 16-14 AWG wire (10) butt splices and (50) rings (60) Yellow terminals for 12-10 AWG wire (10) butt splices and (50) rings	Outside: L=10 7/8" W=6 3/4" H=1 3/4" Compartments: L=1 11/16" W=2" H=1 1/2"
	NYLON TERMINAL KIT A durable, portable plastic case filled with 450 nylon insulated terminals. Each compartment contains 25 butt splices or ring terminals. Ring terminals come with stud sizes: #8, #10, 1/4", 5/16" and 3/8". Kit Contains: (150) Red terminals for 22-18 AWG wire (25) butt splices and (125) rings (150) Blue terminals for 16-14 AWG wire (25) butt splices and (125) rings (150) Yellow terminals for 12-10 AWG wire (25) butt splices and (125) rings	Outside: L=10 7/8" W=6 3/4" H=1 3/4" Compartments: L=1 11/16" W=2" H=1 1/2"
TNF-KIT		



For terminal details and compliances see pages 36-38.

Ordering Information: Order by the kit. For empty cases see page 52.

WIRE & CABLE

MULTI-CONDUCTOR

COAX CABLES

NETWORK CABLES

HEAT SHRINK

ROUTING & BUNDLING MATERIALS

WIRE MANAGEMENT

TERMINALS

DEUTSCH & APTIV (DELPHI)

LUGS & BOOTS

ID PRODUCTS & LABELERS

TOOLS

BREAKERS & FUSES

TERMINAL BLOCKS & BUS BARS

SWITCHES & ACTUATORS

METERS & BOXES

Terminals

HEAT SHRINK SPLICES & DISCONNECTS

WIRE & CABLE
MULTI-CONDUCTOR
COAX CABLES
NETWORK CABLES
HEAT SHRINK
ROUTING & BUNDLING MATERIALS
WIRE MANAGEMENT
TERMINALS
DEUTSCH & APTIV (DELPHI)
LUGS & BOOTS
ID PRODUCTS & LABELERS
TOOLS
BREAKERS & FUSES
TERMINAL BLOCKS & BUS BARS
SWITCHES & ACTUATORS
METERS & BOXES



Heat Shrink Butt Splices



Step Down Butt Splices



Step Down Butt Splices



Fully Insulated (Female)



Partially Insulated (Male)



Bullet Terminals (Recp.)



Closed-End Connectors

Heat shrink terminals and splices provide a rugged, environmentally sealed connection for wire sizes 22-8 AWG. They insulate, seal and protect joints from physical abuse and abrasion, water, salt and other corrosive compounds.

PART NUMBER	WIRE RANGE	INSULATION COLOR	MAX WIRE O.D. (IN)	TERMINAL LENGTH	PACKAGE SIZE
-------------	------------	------------------	--------------------	-----------------	--------------

BUTT SPLICES

TBSE18	22-18 AWG	RED	0.19	1.25	10, 25, 100, 500
TBSE14	16-14 AWG	BLUE	0.21	1.25	10, 25, 100, 500
TBSE10	12-10 AWG	YELLOW	0.28	1.50	10, 25, 100, 500
TBSE8	8 AWG	PINK	0.35	-	4, 10, 50, 500

STEP DOWN BUTT SPLICES - COLORED HEAT SHRINK

TBSDE14-18	22-18 to 16-14	BLUE	0.21	-	10, 25, 100, 500
TBSDE10-14	16-14 to 12-10	YELLOW	0.28	-	10, 25, 100, 250

PART NUMBER	SIDE ONE COLOR STRIPE / WIRE (AWG)	SIDE TWO COLOR STRIPE / WIRE (AWG)	INSULATION COLOR	PACKAGE SIZE
-------------	------------------------------------	------------------------------------	------------------	--------------

STEP DOWN BUTT SPLICES - CLEAR HEAT SHRINK

TSDE118-218	RED/1@22-18	BLUE/2@22-18	CLEAR/RED DASHES	5
TSDE114-214	BLUE/1@16-14	YELLOW/2@16-14	CLEAR/BLUE DASHES	5
TSDE110-210	YELLOW/1@12-10	RED/2@12-10	CLEAR/YELLOW DASHES	5

Step down butt connectors join two wires to one. Color dash on the tubing indicates the wire AWG for the connector. Color strips on the terminal indicate which crimp die to use.

PART NUMBER FEMALE	PART NUMBER MALE	WIRE RANGE	INSULATION COLOR	DISCONNECT / BULLET SIZE (IN)	PACKAGE SIZE
--------------------	------------------	------------	------------------	-------------------------------	--------------

FULLY INSULATED DISCONNECT TERMINALS

TDE18-250FI	TDE18-250FIM	22-18 AWG	RED	0.250	10, 25, 100, 500
TDE14-250FI	TDE14-250FIM	16-14 AWG	BLUE	0.250	10, 25, 100, 500
TDE10-250FI	TDE10-250FIM	12-10 AWG	YELLOW	0.250	10, 25, 100, 500

PARTIALLY INSULATED DISCONNECT TERMINALS

TDE18-250	TDE18-250M	22-18 AWG	RED	0.250	10, 25, 100, 500
TDE14-250	TDE14-250M	16-14 AWG	BLUE	0.250	10, 25, 100, 500
TDE10-250	TDE10-250M	12-10 AWG	YELLOW	0.250	10, 25, 100, 500

BULLET TERMINALS

TBRE18-156	TBPE18-156	22-18 AWG	RED	0.157	10, 25, 100, 500
TBRE14-156	TBPE14-156	16-14 AWG	BLUE	0.157	10, 25, 100, 500

PART NUMBER	WIRE RANGE (MIN/MAX)	INSULATION COLOR	PACKAGE SIZE
-------------	----------------------	------------------	--------------

CLOSED-END CONNECTORS (WIRE JOINTS) WITH HEAT SHRINK

TJE422-216	4@22 AWG / 2@16 AWG	CLEAR/BLUE DASH	5
TJE418-212	4@18 AWG / 2@12 AWG	CLEAR/YELLOW DASH	5

Closed-end connectors (wire-joints), join two to four wires. In an environment where corrosion and/or vibration are a problem. Closed-end connectors can be used to replace wire nuts.

Ordering Information: Combine part number and package size.

Example: Step down butt splices , 10 AWG to 14 AWG, 25 pieces = TBSDE10-14-25.

Terminals

HEAT SHRINK RINGS & FORKS

PART NUMBER	STUD SIZE	TERMINAL PAD WIDTH (IN)	PACKAGE SIZE
-------------	-----------	-------------------------	--------------

22 AWG - 18 AWG HEAT SHRINK RING TERMINALS - RED

TE18-6R	#6	0.29	10, 25, 100, 500
TE18-8R	#8	0.32	10, 25, 100, 500
TE18-10R	#10	0.32	10, 25, 100, 500
TE18-14R	1/4"	0.47	10, 25, 100, 500
TE18-56R	5/16"	0.47	10, 25, 100, 500
TE18-38R	3/8"	0.53	10, 25, 100, 500

16 AWG - 14 AWG HEAT SHRINK RING TERMINALS - BLUE

TE14-6R	#6	0.29	10, 25, 100, 500
TE14-8R	#8	0.32	10, 25, 100, 500
TE14-10R	#10	0.32	10, 25, 100, 500
TE14-14R	1/4"	0.47	10, 25, 100, 500
TE14-56R	5/16"	0.47	10, 25, 100, 500
TE14-38R	3/8"	0.53	10, 25, 100, 500
TE14-12R	1/2"	0.71	10, 25, 100, 500

12 AWG - 10 AWG HEAT SHRINK RING TERMINALS - YELLOW

TE10-6R	#6	0.35	10, 25, 100, 500
TE10-8R	#8	0.34	10, 25, 100, 500
TE10-10R	#10	0.34	10, 25, 100, 500
TE10-14R	1/4"	0.55	10, 25, 100, 500
TE10-56R	5/16"	0.55	10, 25, 100, 500
TE10-38R	3/8"	0.69	10, 25, 100, 500
TE10-12R	1/2"	0.69	10, 25, 100, 500

8 AWG HEAT SHRINK RING TERMINALS - PINK

TE8-10R	#10	0.47	4, 10, 50, 250
TE8-14R	1/4"	0.47	4, 10, 50, 100
TE8-56R	5/16"	0.59	4, 10, 50, 250
TE8-38R	3/8"	0.59	4, 10, 50, 250
TE8-12R	1/2"	0.71	4, 10, 50, 250

PART NUMBER	STUD SIZE	TERMINAL PAD WIDTH (IN)	PACKAGE SIZE
-------------	-----------	-------------------------	--------------

22 AWG - 18 AWG LOCKING FORK TERMINALS - RED

TE18-6SLF	#6	0.32	10, 25, 100, 500
TE18-8SLF	#8	0.32	10, 25, 100, 500
TE18-10SLF	#10	0.32	10, 25, 100, 500

16 AWG - 14 AWG LOCKING FORK TERMINALS - BLUE

TE14-6SLF	#6	0.32	10, 25, 100, 500
TE14-8SLF	#8	0.32	10, 25, 100, 500
TE14-10SLF	#10	0.32	10, 25, 100, 500
TE14-14SLF	1/4"	0.48	10, 25, 100, 500

12 AWG - 10 AWG LOCKING FORK TERMINALS - YELLOW

TE10-6SLF	#6	0.39	10, 25, 100, 500
TE10-8SLF	#8	0.39	10, 25, 100, 500
TE10-10SLF	#10	0.39	10, 25, 100, 500



Heat Shrink Ring Terminals
22 AWG - 18 AWG



Heat Shrink Ring Terminals
16 AWG - 14 AWG



Heat Shrink Ring Terminals
12 AWG - 10 AWG



Heat Shrink Ring Terminals
8 AWG



Heat Shrink Fork Terminals
22 AWG - 18 AWG



Heat Shrink Fork Terminals
16 AWG - 14 AWG



Heat Shrink Fork Terminals
12 AWG - 10 AWG

WIRE & CABLE

MULTI-CONDUCTOR

COAX CABLES

NETWORK CABLES

HEAT SHRINK

ROUTING & BUNDLING MATERIALS

WIRE MANAGEMENT

TERMINALS

DEUTSCH & APTIV (DELPHI)

LUGS & BOOTS

ID PRODUCTS & LABELERS

TOOLS

BREAKERS & FUSES

TERMINAL BLOCKS & BUS BARS

SWITCHES & ACTUATORS

METERS & BOXES

Ordering Information: Combine part number and package size. **Example:** Rings, 8 AWG, 1/4" size, 50 pieces = TE8-14R-50.

CHARACTERISTICS: *Shrink Ratio: Approx. 3:1 at 135°C *Operating Temp.: -55°C/110°C

*Vol. Resistivity: 10¹⁵ Ohm-cm *Dielectric Strength: 900V/mil *Voltage Rating: 600V

COMPLIANCES: *UL *CSA *RoHS

FEATURES: *Protects terminations from water, condensation, salt spray and corrosion

*Vibration protection in rugged environments *Provides strain relief

Terminals

BUTT SPLICES & RING TERMINALS

WIRE & CABLE
MULTI-CONDUCTOR
COAX CABLES
NETWORK CABLES
HEAT SHRINK
ROUTING & BUNDLING MATERIALS
WIRE MANAGEMENT
TERMINALS
DEUTSCH & APTIV (DELPHI)
LUGS & BOOTS
ID PRODUCTS & LABELERS
TOOLS
BREAKERS & FUSES
TERMINAL BLOCKS & BUS BARS
SWITCHES & ACTUATORS
METERS & BOXES



Nylon Butt Splice



Non-Insulated Butt Splice

WIRE RANGE	NYLON INSULATION PART NUMBER	NON INSULATED PART NUMBER	INSULATION COLOR	PACKAGE SIZE
SEAMLESS BARREL BUTT SPLICES				
22 - 18 AWG	TBSN18	TBS18	RED	25, 100, 1000
16 - 14 AWG	TBSN14	TBS14	BLUE	25, 100, 1000
12 - 10 AWG	TBSN10	TBS10	YELLOW	25, 100, 500

Ordering Information: Combine part number and package size. **Example:** 16 AWG, nylon insulated, 100 pieces = TBSN16-100

CHARACTERISTICS: *Base Material: C11000 electrolytic tough pitch (ETP) copper *Plating: Electrodeposited tin

COMPLIANCES: *UL *CSA *ELV *RoHS compliant

FEATURES: *Available in nylon insulated or non-insulated *Tin plated ETP copper for corrosion resistance



Nylon Ring Terminal



Non-Insulated Ring Terminal

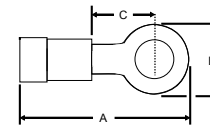

Ring Terminals

STUD SIZE	NYLON INSUL. P/N	NON INSUL. P/N	A* (IN)	B (IN)	C (IN)	PACKAGE SIZE
22 AWG - 18 AWG RING TERMINALS - RED						
#6	TNF18-6R	T18-6R	0.87	0.29	0.26	25, 100, 1000
#8	TNF18-8R	T18-8R	0.88	0.32	0.25	25, 100, 1000
#10	TNF18-10R	T18-10R	0.88	0.32	0.25	25, 100, 1000
1/4"	TNF18-14R	T18-14R	1.11	0.47	0.41	25, 100, 1000
5/16"	TNF18-56R	T18-56R	1.10	0.47	0.41	25, 100, 1000
3/8"	TNF18-38R	T18-38R	1.20	0.56	0.47	25, 100, 1000
16 AWG - 14 AWG RING TERMINALS - BLUE						
#6	TNF14-6R	T14-6R	0.86	0.30	0.26	25, 100, 1000
#8	TNF14-8R	T14-8R	0.91	0.32	0.29	25, 100, 1000
#10	TNF14-10R	T14-10R	0.91	0.32	0.29	25, 100, 1000
1/4"	TNF14-14R	T14-14R	1.10	0.47	0.41	25, 100, 1000
5/16"	TNF14-56R	T14-56R	1.11	0.47	0.41	25, 100, 1000
3/8"	TNF14-38R	T14-38R	1.20	0.56	0.57	25, 100, 1000
1/2"	TNF14-12R**	T14-12R	1.42	0.43	0.62	25, 100, 1000
12 AWG - 10 AWG RING TERMINALS - YELLOW						
#6	TNF10-6R	T10-6R	1.03	0.34	0.30	25, 100, 500
#8	TNF10-8R	T10-8R	1.03	0.34	0.30	25, 100, 500
#10	TNF10-10R	T10-10R	1.03	0.34	0.30	25, 100, 500
1/4"	TNF10-14R	T10-14R	1.30	0.56	0.47	25, 100, 500
5/16"	TNF10-56R	T10-56R	1.30	0.56	0.47	25, 100, 500
3/8"	TNF10-38R	T10-38R	1.30	0.56	0.47	25, 100, 500
1/2"	TNF10-12R	T10-12R	1.51	0.69	0.62	25, 100, 500

*A dimension apply to insulated terminals only and does not apply to non-insulated terminals. **In some instances this terminal insulation may be yellow

Ordering Information: Combine part number and package size. **Example:** 22 AWG, #8 stud size, nylon insulated, 1000 pieces = TNF18-8R-1000.

Terminals

FORK TERMINALS



Nylon Locking Fork



Non-Insulated Locking Fork

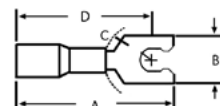

Locking Forks

STUD SIZE	NYLON INSUL. P/N	NON INSUL. P/N	A* (IN)	B (IN)	C (IN)	D* (IN)	PACKAGE SIZE
22 AWG - 18 AWG LOCKING FORK TERMINALS - RED							
#6	TNF18-6SLF	T18-6SLF	0.93	0.25	0.23	0.64	25, 100, 1000
#8	TNF18-8SLF	T18-8SLF	0.93	0.31	0.26	0.67	25, 100, 1000
#10	TNF18-10SLF	T18-10SLF	0.93	0.31	0.26	0.67	25, 100, 1000
16 AWG - 14 AWG LOCKING FORK TERMINALS - BLUE							
#6	TNF14-6SLF	T14-6SLF	0.91	0.25	0.23	1.32	25, 100, 1000
#8	TNF14-8SLF	T14-8SLF	0.97	0.34	0.26	0.68	25, 100, 1000
#10	TNF14-10SLF	T14-10SLF	0.94	0.34	0.26	1.35	25, 100, 1000
1/4"	TNF14-14SLF	-	1.19	0.47	0.35	0.80	25
12 AWG - 10 AWG LOCKING FORK TERMINALS - YELLOW							
#6	TNF10-6SLF	T10-6SLF	1.02	0.35	0.23	0.79	25, 100, 500
#8	TNF10-8SLF	T10-8SLF	1.02	0.35	0.27	0.83	25, 100, 500
#10	TNF10-10SLF	-	1.02	0.37	0.27	0.83	25, 100, 500

*A and D dimensions apply to insulated terminals only

Ordering Information: Combine part number and package size. **Example:** 12 AWG, #10 stud size, non insulated, 500 pieces = T10-10SLF-500

CHARACTERISTICS: *Base Material: C11000 electrolytic-tough pitch (ETP) copper *Plating: Electrodeposited tin

COMPLIANCES: *UL *CSA *ELV *RoHS Compliant

FEATURES: *Available in nylon insulated or non-insulated *Tin plated ETP copper for corrosion resistance



Nylon Flanged Fork

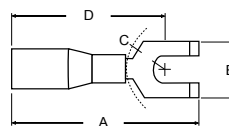

Flanged Forks

STUD SIZE	NYLON INSUL. P/N	A (IN)	B (IN)	C (IN)	D (IN)	PACKAGE SIZE
22 AWG - 18 AWG FLANGED FORK TERMINALS - RED						
#6	TN18-6FF	0.93	0.31	0.21	0.75	25, 100, 1000
#8	TN18-8FF	0.93	0.31	0.21	0.75	25, 100, 1000
#10	TN18-10FF	0.93	0.31	0.21	0.75	25, 100, 1000
16 AWG - 14 AWG FLANGED FORK TERMINALS - BLUE						
#6	TN14-6FF	0.81	0.31	0.21	0.61	25, 100, 1000
#8	TN14-8FF	0.81	0.31	0.21	0.61	25, 100, 1000
#10	TN14-10FF	0.81	0.31	0.21	0.61	25, 100, 1000
12 AWG - 10 AWG FLANGED FORK TERMINALS - YELLOW						
#8	TN10-8FF	1.03	0.39	0.27	0.83	25, 100, 500
#10	TN10-10FF	1.03	0.39	0.27	0.83	25, 100, 500

Ordering Information: Combine part number and package size.

Example: 14 AWG, #8 stud size, nylon insulated, 500 pieces = TN14-8FF-500

COMPLIANCES: *UL *CSA *ELV *RoHS compliant

FEATURES: *Nylon insulated

WIRE & CABLE

MULTI-CONDUCTOR

COAX CABLES

NETWORK CABLES

HEAT SHRINK

ROUTING & BUNDLING MATERIALS

WIRE MANAGEMENT

TERMINALS

DEUTSCH & APTIV (DELPHI)

LUGS & BOOTS

ID PRODUCTS & LABELERS

TOOLS

BREAKERS & FUSES

TERMINAL BLOCKS & BUS BARS

SWITCHES & ACTUATORS

METERS & BOXES

Terminals

DISCONNECTS

WIRE & CABLE
MULTI-CONDUCTOR
COAX CABLES
NETWORK CABLES
HEAT SHRINK
ROUTING & BUNDLING MATERIALS
WIRE MANAGEMENT
TERMINALS
DEUTSCH & APTIV (DELPHI)
LUGS & BOOTS
ID PRODUCTS & LABELERS
TOOLS
BREAKERS & FUSES
TERMINAL BLOCKS & BUS BARS
SWITCHES & ACTUATORS
METERS & BOXES



Non-Insulated Disconnect

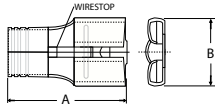

Non-Insulated Disconnect



Nylon Partially Insulated Disconnect

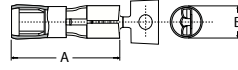

Nylon Partially Insulated Disconnect



Nylon Fully-Insulated Disconnect

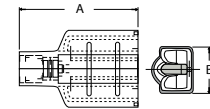

Nylon Fully-Insulated Disconnect

WIRE RANGE	TAB SIZE (IN)	FEMALE P/N	MALE P/N	INSUL. COLOR	A* (IN)	B* (IN)	PACKAGE SIZE
NON-INSULATED FEMALE/MALE DISCONNECTS							
22 - 18 AWG	0.250 X 0.032	TD18-250	TD18-250M	N/A	0.66	0.30	25, 100, 1000
16 - 14 AWG	0.187 X 0.032	TD14-187	-	N/A	0.59	0.23	25, 100, 1000
16 - 14 AWG	0.250 X 0.032	TD14-250	TD14-250M	N/A	0.64	0.30	25, 100, 1000
12 - 10 AWG	0.250 X 0.032	TD10-250	TD10-250M	N/A	0.72	0.30	25, 100, 500
NYLON PARTIALLY INSULATED DISCONNECTS							
22 - 18 AWG	0.250 X 0.032	TDNF18-250	TDNF18-250M	RED	0.87	0.30	25, 100, 1000
16 - 14 AWG	0.250 X 0.032	TDNF14-250	TDNF14-250M	BLUE	0.87	0.30	25, 100, 1000
12 - 10 AWG	0.250 X 0.032	TDNF10-250	TDNF10-250M	YELLOW	1.01	0.30	25, 100, 1000
NYLON FULLY INSULATED DISCONNECTS							
22 - 18 AWG	0.250 X 0.032	TDNF18-250FI	TDNF18-250FIM	RED	0.89	0.38	25, 100, 1000
16 - 14 AWG	0.250 X 0.032	TDNF14-250FI	TDNF14-250FIM	BLUE	0.89	0.38	25, 100, 1000
12 - 10 AWG	0.250 X 0.032	TDNF10-250FI	TDNF10-250FIM	YELLOW	1.04	0.38	25, 100, 500

*Dimensions A and B apply to female disconnect terminals only and does not apply to male disconnect terminals.

Ordering Information: Combine part number & package size. **Example:** Nylon fully insulated disconnect, 14 AWG, female, 100 pieces = TDNF14-250FI-100

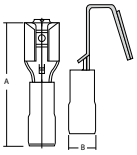

Vinyl Insulated Piggyback Disconnect



Nylon Insulated Piggyback Disconnect



Adaptor TD250A

WIRE RANGE	TAB SIZE (IN)	VINYL INSUL P/N	NYLON INSUL P/N	NON INSUL P/N	INSULATION COLOR	A (IN)	B (IN)	PACKAGE SIZE
PIGGYBACK DISCONNECTS AND DISCONNECT ADAPTORS								
22 - 18 AWG	0.250 X 0.032	TDV18-250PB	-	-	RED	0.87	0.30	25, 100, 1000
16 - 14 AWG	0.250 X 0.032	-	TDNF14-250PB	-	BLUE	0.87	0.30	25, 100, 1000
12 - 10 AWG	0.250 X 0.032	-	TDNF10-250PB	-	YELLOW	0.30	0.25	25, 100, 500
N/A	0.250 X 0.032	-	-	TD250A	N/A	N/A	N/A	25, 100, 500

Ordering Information: Combine part number and package size. **Example:** Vinyl piggyback disconnect, 12 AWG, 500 pieces = TDV10-250PB-500



Bullet - Plug
TBPV18-156



Bullet - Receptacle
TBRV18-180



Bullet - Plug
TBPV14-180



Bullet - Receptacle
TBRV14-180

WIRE RANGE	BULLET SIZE (IN)	PLUG PART NUMBER	RECEPTACLE PART NUMBER	INSULATION COLOR	PACKAGE SIZE
BULLET CONNECTORS					
22 - 18 AWG	0.156	TBPV18-156	TBRV18-156	RED	25, 100, 1000
	0.180	TBPV18-180	TBRV18-180	RED	25, 100, 1000
16 - 14 AWG	0.156	TBPV14-156	TBRV14-156	BLUE	25, 100, 1000
	0.180	TBPV14-180	TBRV14-180	BLUE	25, 100, 1000

Ordering Information: Combine part number and package size. **Example:** 0.156 bullet connector, 16 AWG, receptacle, 100 pieces = TBRV14-156-100

Terminals

SPECIALTY TERMINALS

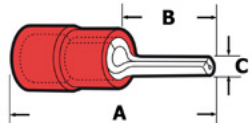

WIRE RANGE	PART NUMBER	INSULATION COLOR	A (IN)	B (IN)	C (IN)	PACKAGE SIZE
PIN TERMINALS						
22 - 18 AWG	TV18-47P	RED	0.93	0.52	0.08	25, 100, 1000
16 - 14 AWG	TV14-47P	BLUE	0.93	0.52	0.08	25, 100, 1000
12 - 10 AWG	TV10-55P	YELLOW	1.12	0.56	0.11	25, 100, 500

Pin terminals are primarily designed for compression type terminal blocks and are available in vinyl insulation only.

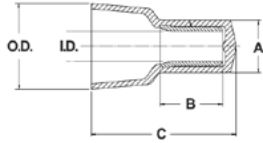

MIN/MAX WIRE RANGE	PART NUMBER	O.D. (IN)	I.D. (IN)	A (IN)	B (IN)	C (IN)	PACKAGE SIZE
CRIMPABLE CLOSED END CONNECTORS (WIRE JOINTS)							
2@24 - 3@18 AWG	TJN224-318	0.32	0.09	0.19	0.30	0.62	25, 100, 1000
2@18 - 2@16 AWG	TJN218-216	0.36	0.10	0.23	0.30	0.76	25, 100, 1000
4@18 - 2@12 AWG	TJN418-212	0.45	0.15	0.28	0.28	0.90	25, 100, 500
3@14 - 4@12 AWG	TJN314-412	0.57	0.21	0.36	0.42	1.10	25, 100, 500

Closed end connectors can be used as a splice, wire butt, parallel or dead-end cap. Each size has a minimum and maximum range of wires it will accept. These are available in clear nylon insulation only.



TFRL24-6MM



TFRL16-8MM

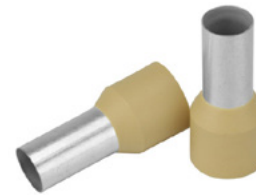

TFRL2-16MM

PART NUMBER	WIRE AWG (mm ²)	FERRULE LENGTH mm (IN)	STRIPPING LENGTH mm (IN)	INSULATION COLOR	PACKAGE SIZE
WIRE FERRULES					
TFRL24-6MM	24-22 (0.34)	6 (0.24)	8 (0.31)	TURQUOISE	25, 100, 500
TFRL22-6MM	22-20 (0.50)	6 (0.24)	8 (0.31)	ORANGE	25, 100, 500
TFRL20-6MM	20-18 (0.75)	6 (0.24)	8 (0.31)	WHITE	25, 100, 500
TFRL18-6MM	18 (1.0)	6 (0.24)	8 (0.31)	YELLOW	25, 100, 500
TFRL16-8MM	16 (1.5)	8 (0.31)	10 (0.39)	RED	25, 100, 500
TFRL14-8MM	14 (2.5)	8 (0.31)	10 (0.39)	BLUE	25, 100, 500
TFRL12-10MM	12 (4.0)	10 (0.39)	12 (0.47)	GREY	25, 100, 500
TFRL10-12MM	10 (6.0)	12 (0.47)	14 (0.55)	BLACK	25, 50, 100
TFRL8-12MM	8 (10.0)	12 (0.47)	14 (0.55)	IVORY	10, 25, 100
TFRL6-12MM	6 (16.0)	12 (0.47)	14 (0.55)	GREEN	10, 25, 100
TFRL4-16MM	4 (25.0)	16 (0.63)	18 (0.70)	BROWN	4, 10, 50
TFRL2-16MM	2 (35.0)	16 (0.63)	19 (0.74)	BEIGE	4, 10, 50

WIRE FERRULES KITS	
TFRL-CC1	(50) 20 AWG WHITE, (100) 18 AWG GREY, (100) 18 AWG RED, (100) 16 AWG BLACK, (50) 14 AWG BLUE
TFRL-CC2	(50) 12 AWG GREY, (20) 10 AWG BLACK, (20) 8 AWG IVORY, (10) 6 AWG GREEN

Wire ferrules are typically used on wires being inserted into IEC (European) style terminal blocks. They prevent fraying when compressed. Ferrules add additional electrical insulation.

Ordering Information: Combine part number and package size. **Example:** 3-way connectors, 18 AWG, 10 pieces = TV18-3W-10

FEATURES: *Prevent strand separation while minimizing strand breakage *Insulated ferrules provide additional electrical insulation

*Increases connection reliability when terminating stranded wire in terminal blocks

- WIRE & CABLE
- MULTI-CONDUCTOR
- COAX CABLES
- NETWORK CABLES
- HEAT SHRINK
- ROUTING & BUNDLING MATERIALS
- WIRE MANAGEMENT
- TERMINALS**
- DEUTSCH & APTIV (DELPHI)
- LUGS & BOOTS
- ID PRODUCTS & LABELERS
- TOOLS
- BREAKERS & FUSES
- TERMINAL BLOCKS & BUS BARS
- SWITCHES & ACTUATORS
- METERS & BOXES

Sealed Connectors

DEUTSCH REPAIR PACKS

DTM, DT and DTP Series of environmentally-sealed connectors are built for cable to cable applications where signal-level circuits must withstand tough environmental conditions. All three series of Deutsch sealed connectors will provide reliability and performance at low cost.



Pacer assembled repair packs have all the parts you require to fix a connection to an existing device. You can also combine a receptacle and plug to create an environmentally sealed point of disconnect. Packs contain a housing, secondary wedge lock, contacts with one or two extra contacts and a few cavity plugs.



Repair Packs Contain:

- * A Housing
- * A Wedgelock
- * Contacts
- * Cavity Plugs

DTM Series connectors are designed for smaller wire gauge applications. The DTM series offers electrical designers the ability to use multiple size 20 contacts (22-14 AWG), each with 7.5 amp continuous capacity, within a single shell. Pacer's DTM repair kits use the larger size 20 contacts (Deutsch Pin P/N 0460-202-20141, Socket P/N 0462-201-20141) for applications using 20 AWG wire.



NO. OF CAVITIES	PART NUMBER RECEPTACLES	CONTENTS
DTM RECEPTACLE REPAIR PACKS (22-14 AWG APPLICATIONS)		
2	TDTM04-2RP	(1) 2 POS. RECEPTACLE, (1) 2 POS. WEDGE LOCK, (3) PINS
3	TDTM04-3RP	(1) 3 POS. RECEPTACLE, (1) 3 POS. WEDGE LOCK, (4) PINS, (1) RED CAVITY PLUG
4	TDTM04-4RP	(1) 4 POS. RECEPTACLE, (1) 4 POS. WEDGE LOCK, (5) PINS, (2) RED CAVITY PLUGS
6	TDTM04-6RP	(1) 6 POS. RECEPTACLE, (1) 6 POS. WEDGE LOCK, (8) PINS, (3) RED CAVITY PLUGS
8	TDTM04-8RP	(1) 8 POS. RECEPTACLE, (1) 8 POS. WEDGE LOCK, (10) PINS, (4) RED CAVITY PLUGS
12	TDTM04-12RP	(1) 12 POS. RECEPTACLE, (1) 12 POS. WEDGE LOCK, (14) PINS, (6) RED CAVITY PLUGS



NO. OF CAVITIES	PART NUMBER PLUGS	CONTENTS
DTM PLUG REPAIR PACKS (22-14 AWG APPLICATIONS)		
2	TDTM06-2RS	(1) 2 POS. PLUG, (1) 2 POS. WEDGE LOCK, (3) SOCKETS
3	TDTM06-3RS	(1) 3 POS. PLUG, (1) 3 POS. WEDGE LOCK, (4) SOCKETS, (1) RED CAVITY PLUG
4	TDTM06-4RS	(1) 4 POS. PLUG, (1) 4 POS. WEDGE LOCK, (5) SOCKETS, (2) RED CAVITY PLUGS
6	TDTM06-6RS	(1) 6 POS. PLUG, (1) 6 POS. WEDGE LOCK, (8) SOCKETS, (3) RED CAVITY PLUGS
8	TDTM06-8RS	(1) 8 POS. PLUG, (1) 8 POS. WEDGE LOCK, (10) SOCKETS, (4) RED CAVITY PLUGS
12	TDTM06-12RS	(1) 12 POS. PLUG, (1) 12 POS. WEDGE LOCK, (14) SOCKETS, (6) RED CAVITY PLUGS

Ordering Information: Order by the pack. For individual item details, See page 44.

APPLICATIONS: Environmentally sealed connectors are designed for cable to cable applications, where signal-level or power circuits must withstand harsh conditions.

FEATURES: *Packs include all parts needed to assemble a connector *One to two extra terminals
*Cavity plugs to seal open circuits

Pacer INDUSTRY TIP: Employing the proper tools for the job:

Deutsch pins and sockets require specific tools in order to get the correct crimp
Deutsch Contact Crimp Tool part numbers are listed on **pg. 42** in the Machined Contact chart.
These, and other Deutsch tools can also be found on **pg. 55**.

Sealed Connectors

DEUTSCH REPAIR PACKS

DT Series connectors are designed for 20-14 wire gauge applications. The DT series offers electrical designers the ability to use multiple size 16 contacts (20-14 AWG), each with 13 amp continuous capacity, within a single shell. Pacer's DT repair kits use the larger size 16 contacts (Deutsch Pin P/N 0460-215-16141, Socket P/N 0462-209-16141) for applications using 14 AWG wire.

NO. OF CAVITIES	PART NUMBER RECEPTACLES	CONTENTS
DT RECEPTACLE REPAIR PACKS (20-14 AWG APPLICATIONS)		
2	TDT04-2RP	(1) 2 POS. RECEPTACLE, (1) 2 POS. WEDGE LOCK, (3) PINS
3	TDT04-3RP	(1) 3 POS. RECEPTACLE, (1) 3 POS. WEDGE LOCK, (4) PINS, (1) CAVITY PLUG
4	TDT04-4RP	(1) 4 POS. RECEPTACLE, (1) 4 POS. WEDGE LOCK, (5) PINS, (2) CAVITY PLUGS
6	TDT04-6RP	(1) 6 POS. RECEPTACLE, (1) 6 POS. WEDGE LOCK, (8) PINS, (3) CAVITY PLUGS
8	TDT04-8RP	(1) 8 POS. RECEPTACLE, (1) 8 POS. WEDGE LOCK, (10) PINS, (4) CAVITY PLUGS
12	TDT04-12RP	(1) 12 POS. RECEPTACLE, (1) 12 POS. WEDGE LOCK, (14) PINS, (6) CAVITY PLUGS



TDT04-4RP

NO. OF CAVITIES	PART NUMBER PLUGS	CONTENTS
DT PLUG REPAIR PACKS (20-14 AWG APPLICATIONS)		
2	TDT06-2RS	(1) 2 POS. PLUG, (1) 2 POS. WEDGE LOCK, (3) SOCKETS
3	TDT06-3RS	(1) 3 POS. PLUG, (1) 3 POS. WEDGE LOCK, (4) SOCKETS, (1) CAVITY PLUG
4	TDT06-4RS	(1) 4 POS. PLUG, (1) 4 POS. WEDGE LOCK, (5) SOCKETS, (2) CAVITY PLUGS
6	TDT06-6RS	(1) 6 POS. PLUG, (1) 6 POS. WEDGE LOCK, (8) SOCKETS, (3) CAVITY PLUGS
8	TDT06-8RS	(1) 8 POS. PLUG, (1) 8 POS. WEDGE LOCK, (10) SOCKETS, (4) CAVITY PLUGS
12	TDT06-12RS	(1) 12 POS. PLUG, (1) 12 POS. WEDGE LOCK, (14) SOCKETS, (6) CAVITY PLUGS



TDT06-2RS

Ordering Information: Order by the pack. For individual item details, See page 44.

FEATURES: *All parts needed to assemble a connector *One to two extra terminals *Cavity plugs seal off open circuits

CHARACTERISTICS: *See page 44 for complete performance characteristics

DTP Series connectors are the solution for power application requirements. The DTP line was developed to fill the need for higher amperage, multi-pin economical connectors. Each circuit, capable of continuous 25 amp service. Both Deutsch solid contacts (14-12 AWG) and Deutsch stamp and formed contacts (12-10 AWG) are included in the packs.

NO. OF CAVITIES	PART NUMBER RECEPTACLES	CONTENTS
DTP RECEPTACLE REPAIR PACKS (14-10* AWG APPLICATIONS)		
2	TDTP04-2RP	(1) 2 POS. RECEPTACLE, (1) 2 POS. WEDGE LOCK, (3) SOLID CONTACT PINS, (3) STAMPED AND FORMED PINS*
4	TDTP04-4RP	(1) 4 POS. RECEPTACLE, (1) 4 POS. WEDGE LOCK, (5) SOLID CONTACT PINS, (5) STAMPED AND FORMED PINS*, (2) CAVITY PLUGS



TDTP04-2RP

NO. OF CAVITIES	PART NUMBER PLUGS	CONTENTS
DTP PLUG REPAIR PACKS (14-10* AWG APPLICATIONS)		
2	TDTP06-2RS	(1) 2 POS. PLUG, (1) 2 POS. WEDGE LOCK, (3) SOLID CONTACT SOCKETS, (3) STAMPED AND FORMED CONTACTS*
4	TDTP06-4RS	(1) 4 POS. PLUG, (1) 4 POS. WEDGE LOCK, (5) SOLID CONTACT SOCKETS, (5) STAMPED AND FORMED CONTACTS*, (2) CAVITY PLUGS



TDTP06-4RS

Ordering Information: Order by the pack. For individual item details, See page 44.

*Deutsch #12 solid contact supports 14-12 AWG (Deutsch Pin P/N 0460-204-12141, Socket P/N 0462-203-12141), 10 AWG can only be used with Deutsch stamped and formed contacts (Deutsch Pin P/N 1060-12-0222, Socket P/N 1062-12-0222). Both solid contacts and stamped and formed contacts have been provided in the pack. Stamped and formed contacts require a crimping tool that supports open barrel terminals.

WIRE & CABLE
MULTI-CONDUCTOR
COAX CABLES
NETWORK CABLES
HEAT SHRINK
ROUTING & BUNDLING MATERIALS
WIRE MANAGEMENT
TERMINALS
DEUTSCH & APTIV (DELPHI)
LUGS & BOOTS
ID PRODUCTS & LABELERS
TOOLS
BREAKERS & FUSES
TERMINAL BLOCKS & BUS BARS
SWITCHES & ACTUATORS
METERS & BOXES

Sealed Connectors

DEUTSCH KITS & PARTS

WIRE & CABLE
MULTI-CONDUCTOR
COAX CABLES
NETWORK CABLES
HEAT SHRINK
ROUTING & BUNDLING MATERIALS
WIRE MANAGEMENT
TERMINALS
DEUTSCH & APTIV (DELPHI)
LUGS & BOOTS
ID PRODUCTS & LABELERS
TOOLS
BREAKERS & FUSES
TERMINAL BLOCKS & BUS BARS
SWITCHES & ACTUATORS
METERS & BOXES



TDTM06-12S-10



TDT06-3S-10



Machined Contact
T14DT-S



Cavity Plugs



Boots
TDT12P-BT

NO. OF CAVITIES	RECEPTACLE (PIN)	PLUG (SOCKET)	RECEPTACLE (PIN)	PLUG (SOCKET)	PKG	RECEPTACLE (PIN)	PLUG (SOCKET)	PKG
DTM KIT (22-16AWG)			DT KIT (20-14AWG)			DTP KIT (14-10AWG)		
2	TDTM04-2P-10	TDTM06-2S-10	TDT04-2P-10	TDT06-2S-10	10	TDTP04-2P-5	TDTP06-2S-5	5
3	TDTM04-3P-10	TDTM06-3S-10	TDT04-3P-10	TDT06-3S-10	10	-	-	-
4	TDTM04-4P-10	TDTM06-4S-10	TDT04-4P-10	TDT06-4S-10	10	TDTP04-4P-5	TDTP06-4S-5	5
6	TDTM04-6P-5	TDTM06-6S-5	TDT04-6P-5	TDT06-6S-5	5	-	-	-
8	TDTM04-8P-5	TDTM06-8S-5	TDT04-8P-5	TDT06-8S-5	5	-	-	-
12	TDTM04-12P-5	TDTM06-12S-5	TDT04-12P-5	TDT06-12S-5	5	-	-	-

Kits contain housing and wedgelock only. Pins and sockets sold separately. See table below.

Ordering Information: Order by standard package.

CHARACTERISTICS: *Oper. Temp.: -55°C to 125°C *Durability: No defects after 100 cycles of engagement/disengagement

COMPLIANCES: *UL recognized *RoHS *IP 6K9K (DT, DTM) *J1939/11, J1939/13 and J1939/15

FEATURES: *Economical harsh environment protection *Protects against corrosion and lengthens the serviceable life of wire

*Common contact system *Increased socket-terminal performance *Hand insertable/removable contacts

*Redundant silicone seals *High-performance molded shells

WIRE AWG	CONNECTOR TYPE	PINS	SOCKETS	CURRENT RATING	PKG	PRODUCTION TOOL p.55	FIELD SERVICE TOOL p.55
MACHINED CONTACTS - PINS & SOCKETS							
20	DTM	T20DTM-P	T20DTM-S	7.5	25, 100	VT-HDT-48	VT-HDT-1561
20 - 16	DT	T16DT-P	T16DT-S	7.5	25, 100	VT-HDT-48	VT-HDT-1561
14	DT	T14DT-P	T14DT-S	13	25, 100	VT-HDT-48	VT-HDT-1561
14 - 12	DTP	T12DTP-P	T12DTP-S	25	10, 25	VT-HDT-48	VT-HDT-1561
10	DTP	T10DTP-P*	T10DTP-S*	25	10, 25	-	-

* T10DTP-S and T10DTP-P are open barrel, stamped and formed terminals. Crimp Tools for this contact are readily available.

Ordering Information: Combine part number and package size. **Example:** 20 AWG, DTM, pins, 100 pieces = T20DTM-P-100

PROPERLY MATING PAIRS: Receptacles require pins. Plugs require sockets.

CONTACT SIZE	PART NUMBER	CONNECTOR SERIES	PKG SIZE
CAVITY PLUGS			
20	T041320	DTM	25, 100
16 & 12	T114017	DT, DTP	25, 100

Ordering Information: Combine part number and package size. **Example:** Contact size 16, 25 pieces = T114017-25

PART NUMBER	DESCRIPTION	COLOR
DEUTSCH BOOTS - DT SERIES		
TDT2P-BT	2 WAY RECEPTACLE	GREY
TDT2S-BT	2 WAY PLUG	GREY
TDT3P-BT	3 WAY RECEPTACLE	GREY
TDT3S-BT	3 WAY PLUG	GREY
TDT4P-BT	4 WAY RECEPTACLE	GREY
TDT4S-BT	4 WAY PLUG	GREY
TDT6P-BT	6 WAY RECEPTACLE	GREY
TDT6S-BT	6 WAY PLUG	GREY
TDT8P-BT	8 WAY RECEPTACLE	GREY
TDT8S-BT	8 WAY PLUG	GREY
TDT12P-BT	12 WAY RECEPTACLE	GREY
TDT12S-BT	12 WAY PLUG	GREY

Ordering Information: Order by the piece.

Sealed Connectors

DEUTSCH DTHD POWER PLUGS

DTHD connectors are single terminal connectors for heavy duty applications. Easy to install, environmentally sealed and compact in size they are a simple, field serviceable alternative to a splice. Pacer assembled power connector kits contain a plug & socket with a receptacle & pin to create a sealed disconnectable power connection for wire gauges 10-6 AWG.

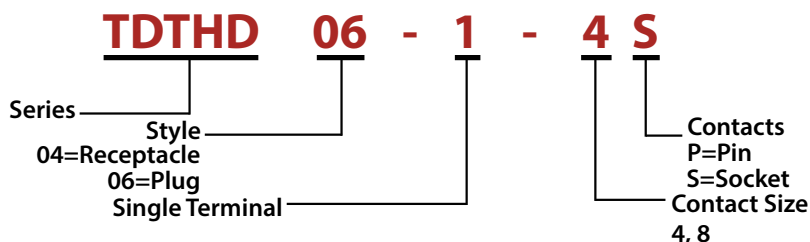

WIRE AWG	KIT PART NUMBER	CONTENTS
DEUTSCH POWER PLUG CONNECTION KITS (RECP., PLUG & CONTACTS INCL.)		
10 - 8	TDTHD-1-8KT	(1) DTHD PLUG, (1) SIZE 8 SOCKET, (1) DTHD RECEPTACLE, (1) SIZE 8 PIN
6	TDTHD-1-4KT	(1) DTHD PLUG, (1) SIZE 4 SOCKET, (1) DTHD RECEPTACLE, (1) SIZE 4 PIN, (2) REDUCER CRIMP SLEEVES FOR 10 OR 8 AWG

Ordering Information: Order by the kit.

FEATURES: *Environmentally sealed disconnectable power wire splicing *10-6 AWG wires *60-100 Amps at 125 °C
*Easy to install *Field serviceable

WIRE AWG	PLUG PART NUMBER	RECEPTACLE PART NUMBER	MAX RATED AMPS @ 125 °C	PKG SIZE
DEUTSCH POWER PLUGS & RECEPTACLES				
10 - 8	TDTHD06-1-8S	TDTHD04-1-8P	60	1
6	TDTHD06-1-4S	TDTHD04-1-4P	100	1

Ordering Information: Order by the piece.

FEATURES: *Environmentally sealed disconnectable power wire splicing *10-6 AWG wires *60-100 Amps at 125 °C
*Easy to install *Field serviceable

WIRE AWG	CONNECTOR TYPE	SOCKETS	PINS	CURRENT RATING	PKG SIZE	PRODUCTION TOOL pg. 57
DEUTSCH DTHD MACHINED CONTACTS						
10 - 8	DTHD	T8DTHD-S	T8DTHD-P	60	1, 5	VT-HDT-04-08
6	DTHD	T6DTHD-S	T6DTHD-P	100	1, 5	VT-HDT-04-08

Ordering Information: Combine part number and package size. **Example:** Wire 6 AWG, pins, 5 pieces = T6DTHD-P-5

PART NUMBER	CONTACT SIZE	WIRE AWG RANGE	COLOR
DEUTSCH INDUSTRIAL CONTACT REMOVAL TOOLS			
VT20-24RT	20	22 - 16	RED
VT16-18RT	16	18 - 16	LIGHT BLUE
VT14-16RT	16	16 - 14	GREEN
VT12RT	12	12	YELLOW
VT8-10RT	8	10 - 8	DARK GREEN
VT6RT	4	6	WHITE
VT4RT	4	4	BLACK

Ordering Information: Order by the piece.

Deutsch industrial removal tools are designed to simplify contact removal and field service repair for the DTM, DT, DTP, and DTHD series. They can also be used for HD10, HDP20, HD30, and DRC series.

CONTACT REMOVAL TOOLS: Contact removal tools are optional for DTM, DT or DTP connector series. Additional contact and wedgelock removal tools can be found on [page 57](#).



TDTHD-1-4KT



TDTHD04-1-8P



TDTHD06-1-8S



T6DTHD-S T6DTHD-P



VT20-24RT



VT8-10RT

- WIRE & CABLE
- MULTI-CONDUCTOR
- COAX CABLES
- NETWORK CABLES
- HEAT SHRINK
- ROUTING & BUNDLING MATERIALS
- WIRE MANAGEMENT
- TERMINALS
- DEUTSCH & APTIV (DELPHI)**
- LUGS & BOOTS
- ID PRODUCTS & LABELERS
- TOOLS
- BREAKERS & FUSES
- TERMINAL BLOCKS & BUS BARS
- SWITCHES & ACTUATORS
- METERS & BOXES

Sealed Connectors

APTIV PRODUCTS (FORMERLY DELPHI)

WIRE & CABLE
MULTI-CONDUCTOR
COAX CABLES
NETWORK CABLES
HEAT SHRINK
ROUTING & BUNDLING MATERIALS
WIRE MANAGEMENT
TERMINALS
DEUTSCH & APTIV (DELPHI)
LUGS & BOOTS
ID PRODUCTS & LABELERS
TOOLS
BREAKERS & FUSES
TERMINAL BLOCKS & BUS BARS
SWITCHES & ACTUATORS
METERS & BOXES



TOWER ASSEMBLY



SHROUD ASSEMBLY



T12015791



T1201996



MALE TERMINAL



FEMALE TERMINAL



CABLE SEALS



CAVITY PLUG

CAVITIES	PART NUMBER	CONTENTS
----------	-------------	----------

WEATHER PACK CONNECTION KITS (16-14 AWG APPLICATIONS)

2	TWP-2POS	(1) 2 POS. TOWER, (1) 2 POS. SHROUD, (3) MALE TERMINALS, (3) FEMALE TERMINALS, (6) LT. GREY 16-14 SEALS
3	TWP-3POS	(1) 3 POS. TOWER, (1) 3 POS. SHROUD, (4) MALE TERMINALS, (4) FEMALE TERMINALS, (8) LT. GREY 16-14 SEALS
4	TWP-4POS	(1) 4 POS. TOWER, (1) 4 POS. SHROUD, (5) MALE TERMINALS, (5) FEMALE TERMINALS, (10) LT. GREY 16-14 SEALS
6	TWP-6POS	(1) 6 POS. TOWER, (1) 6 POS. SHROUD, (8) MALE TERMINALS, (8) FEMALE TERMINALS, (14) LT. GREY 16-14 SEALS, (2) LT. GREEN CAVITY PLUGS

Ordering Information: Order by the kit.

Pacer's assembled weather pack connection kits have all the parts required to create an environmentally sealed, disconnectable, in-line connection. Kits contain a Tower and Shroud housing, male terminals and female terminals with one or two extras and wire seals for 16-14 AWG wire (Light Grey).

FEATURES: *Sealed system specifically designed to withstand exposure to extreme temperatures, chemicals and fluid
 *Pin and sleeve configuration to alleviate stress relaxation *Secondary lock and Connector Position Assurance (CPA) for improved system design
 *Dual-locking tangs on terminals help prevent backing out *Terminal plugging requires no orientation
 *Positive locking indexing prevents mismatching of connectors *Low energy, low voltage capability for vehicle electronics

NO. OF CAVITIES	SHROUD HOUSING CONNECTOR	TOWER HOUSING CONNECTOR	COLOR	PACKAGE SIZE
-----------------	--------------------------	-------------------------	-------	--------------

WEATHER PACK HOUSING

1	T12010996	T12015791	BLACK	5
2	T12010973	T12015792	BLACK	5
3	T12010717	T12015793	BLACK	5
4	T12020830	T12020832	BLACK	5
6	T12010975	T12015799	BLACK	5

Ordering Information: Order by the package.

MALE TERMINALS (Shroud Housing)	FEMALE TERMINALS (Tower Housing)	WIRE AWG	PACKAGE SIZE	FIELD SERVICE CRIMP TOOL
---------------------------------	----------------------------------	----------	--------------	--------------------------

WEATHER PACK TERMINALS

T12089040	-	20 - 18	25	VT12014254
T12124582	T12124580	17 - 14	25	VT12155975
-	T12124581	13 - 12	25	VT12155975

Ordering Information: Order by the package.

SEAL PART NUMBER	WIRE RANGE	WIRE O.D. RANGE mm (IN)	COLOR	PACKAGE SIZE
------------------	------------	-------------------------	-------	--------------

WEATHER PACK CABLE SEALS & CAVITY PLUG

T15324980	19 - 14	3.49-2.81 (.137-.111)	LT. GREY	25
T15324981	14 - 12	4.30-3.45 (.169-.136)	BLUE	25

CAVITY PLUG PART NUMBER

T12010300	LT. GREEN	25
-----------	-----------	----

Ordering Information: Order by package.

Weather pack crimp tools and terminal removal tools can be found on page 57.

Lugs & Boots

TINNED CLOSED END LUGS



WIRE AWG	STUD SIZE	PART NUMBER	LENGTH (IN)	WIDTH (IN)	CLEARANCE (IN)	PACKAGE SIZE
8 AWG	#10	TAE8-10R	1.187	0.438	0.376	4, 25, 100, 250
	1/4"	TAE8-14R	1.187	0.438	0.376	4, 25, 100, 250
	5/16"	TAE8-56R	1.187	0.438	0.376	4, 25, 100, 250
	3/8"	TAE8-38R	1.313	0.594	0.422	4, 25, 100, 250
	1/2"	TAE8-12R	1.469	0.766	0.394	4, 25, 100, 200
6 AWG	#10	TAE6-10R	1.281	0.438	0.381	4, 25, 100, 250
	1/4"	TAE6-14R	1.281	0.438	0.381	4, 25, 100, 250
	5/16"	TAE6-56R	1.281	0.438	0.381	4, 25, 100, 250
	3/8"	TAE6-38R	1.406	0.594	0.427	4, 25, 100, 250
	1/2"	TAE6-12R	1.563	0.766	0.427	4, 25, 100, 200
4 AWG	#10	TAE4-10R	1.500	0.531	0.429	4, 10, 50, 200
	1/4"	TAE4-14R	1.500	0.531	0.429	4, 10, 50, 200
	5/16"	TAE4-56R	1.500	0.531	0.429	4, 10, 50, 200
	3/8"	TAE4-38R	1.500	0.531	0.429	4, 10, 50, 200
	1/2"	TAE4-12R	1.688	0.766	0.444	4, 10, 25, 100
2 AWG	1/4"	TAE2-14R	1.625	0.625	0.437	4, 10, 25, 100
	5/16"	TAE2-56R	1.625	0.625	0.437	4, 10, 25, 100
	3/8"	TAE2-38R	1.625	0.625	0.437	4, 10, 25, 100
	1/2"	TAE2-12R	1.750	0.750	0.474	4, 10, 25, 100
1 AWG	1/4"	TAE1-14R	1.718	0.656	0.446	4, 10, 25, 100
	5/16"	TAE1-56R	1.718	0.656	0.446	4, 10, 25, 100
	3/8"	TAE1-38R	1.718	0.656	0.446	4, 10, 25, 100
	1/2"	TAE1-12R	1.844	0.750	0.474	4, 10, 25, 100
1/0 AWG	1/4"	TAE1/0-14R	1.844	0.728	0.460	4, 10, 25, 100
	5/16"	TAE1/0-56R	1.844	0.728	0.460	4, 10, 25, 100
	3/8"	TAE1/0-38R	1.844	0.728	0.460	4, 10, 25, 100
2/0 AWG	1/2"	TAE1/0-12R	1.844	0.728	0.460	4, 10, 25, 100
	1/4"	TAE2/0-14R	2.000	0.824	0.522	4, 10, 25, 50
	5/16"	TAE2/0-56R	2.000	0.824	0.522	4, 10, 25, 50
3/0 AWG	3/8"	TAE2/0-38R	2.000	0.824	0.522	4, 10, 25, 50
	1/2"	TAE2/0-12R	2.000	0.824	0.522	4, 10, 25, 50
	1/4"	TAE3/0-14R	2.156	0.916	0.501	4, 10, 25
4/0 AWG	5/16"	TAE3/0-56R	2.156	0.916	0.501	4, 10, 25, 50
	3/8"	TAE3/0-38R	2.156	0.916	0.501	4, 10, 25, 50
	1/2"	TAE3/0-12R	2.156	0.916	0.501	4, 10, 50
	1/4"	TAE4/0-14R	2.344	0.984	0.550	4, 10, 25
4/0 AWG	5/16"	TAE4/0-56R	2.344	0.999	0.550	4, 10, 25
	3/8"	TAE4/0-38R	2.344	0.999	0.550	4, 10, 25
	1/2"	TAE4/0-12R	2.344	0.999	0.550	4, 10, 25

- WIRE & CABLE
- MULTI-CONDUCTOR
- COAX CABLES
- NETWORK CABLES
- HEAT SHRINK
- ROUTING & BUNDLING MATERIALS
- WIRE MANAGEMENT
- TERMINALS
- DEUTSCH & APTIV (DELPHI)
- LUGS & BOOTS**
- ID PRODUCTS & LABELERS
- TOOLS
- BREAKERS & FUSES
- TERMINAL BLOCKS & BUS BARS
- SWITCHES & ACTUATORS
- METERS & BOXES

Ordering Information: Combine part number and package size. **Example:** 6 AWG, 1/2" stud, 4 pieces = TAE6-12R-4

FEATURES: *Tin plated *No exposed seams

Lugs & Boots

SEAMLESS, STEP DOWN & NYLON BUTT SPLICES

WIRE & CABLE
MULTI-CONDUCTOR
COAX CABLES
NETWORK CABLES
HEAT SHRINK
ROUTING & BUNDLING MATERIALS
WIRE MANAGEMENT
TERMINALS
DEUTSCH & APTIV (DELPHI)
LUGS & BOOTS
ID PRODUCTS & LABELERS
TOOLS
BREAKERS & FUSES
TERMINAL BLOCKS & BUS BARS
SWITCHES & ACTUATORS
METERS & BOXES



TBS4



TBS6



TBS8

WIRE AWG	PART NUMBER	I.D. MAX (IN)	O.D. MAX (IN)	LENGTH (IN)	PACKAGE SIZE
SEAMLESS BARREL BUTT SPLICES					
8	TBS8	0.165	0.295	0.864	4, 25, 250
6	TBS6	0.230	0.374	1.045	4, 25, 250
4	TBS4	0.277	0.457	1.155	4, 10, 100
2	TBS2	0.357	0.538	1.280	100
1/0	TBS1/0	0.439	0.620	1.440	50
2/0	TBS2/0	0.496	0.697	1.440	50
4/0	TBS4/0	0.621	0.860	1.540	50

Ordering Information: Combine part number and package size. **Example:** 4/0 AWG splices, 50 pieces = TBS4/0-50

FEATURES: *Tin plated *Seamless



TBSD6-8



TBSD10-14

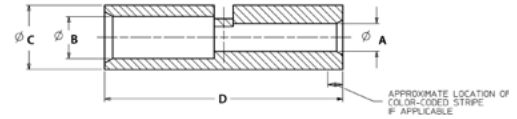

WIRE AWG	PART NUMBER	(A) SM I.D. MAX (IN)	(B) LG I.D. MAX (IN)	(C) O.D. MAX (IN)	(D) LENGTH (IN)	PACKAGE SIZE
STEP DOWN TINNED BUTT SPLICES						
22-18 to 16-14	TBSD14-18	0.071	0.088	0.160	0.675	10, 25, 100, 1000
16-14 to 12-10	TBSD10-14	0.097	0.137	0.223	0.827	10, 25, 100, 500
12-10 to 8	TBSD8-10	0.139	0.172	0.291	0.854	1, 250
8-6	TBSD6-8	0.182	0.237	0.375	1.045	1, 250

Ordering Information: Combine part number and package size.

Example: 10 AWG to 14 AWG wire splice, 25 pieces = TBSD10-14-25

FEATURES: *Tin plated *Barrel Type: Closed



TBSN4



TBSN6



TBSN8

WIRE AWG	PART NUMBER	COLOR	MAX WIRE INSUL. DIA. (IN)	O.D. MAX (IN)	LENGTH (IN)	PACKAGE SIZE
NYLON BUTT SPLICES						
8	TBSN8	RED	0.265	0.395	1.473	4, 25, 250
6	TBSN6	BLUE	0.342	0.480	1.785	4, 25, 100
4	TBSN4	YELLOW	0.429	0.579	2.035	4, 10, 25, 100

Ordering Information: Combine part number and package size. **Example:** 4 AWG splice, 25 pieces = TBSN4-25

FEATURES: *Tin plated *Insulation: Nylon *Barrel Type: Closed - Brazed *Seamless

Lugs & Boots

BRAZED SEAM TINNED LUGS



WIRE AWG	STUD SIZE	NON-INSUL. P/N	NYLON INSUL. P/N	COLOR	LENGTH* (IN)	PAD WIDTH (IN)	PACKAGE SIZE
8 AWG	#10	TL8-10R	TLNF8-10R	RED	0.930	0.379	4, 25, 100, 250
	1/4"	TL8-14R	TLNF8-14R	RED	0.930	0.379	4, 25, 100, 250
	5/16"	TL8-56R	TLNF8-56R	RED	0.984	0.485	4, 25, 100, 250
	3/8"	TL8-38R	TLNF8-38R	RED	1.102	0.598	4, 25, 100, 250
6 AWG	1/2"	TL8-12R	TLNF8-12R	RED	1.394	0.819	4, 25, 100, 250
	#10	TL6-10R	TLNF6-10R	BLUE	1.188	0.485	4, 25, 100, 250
	1/4"	TL6-14R	TLNF6-14R	BLUE	1.188	0.485	4, 25, 100, 250
	5/16"	TL6-56R	TLNF6-56R	BLUE	1.268	0.645	4, 25, 100, 250
4 AWG	3/8"	TL6-38R	TLNF6-38R	BLUE	1.268	0.645	4, 25, 100, 250
	1/2"	TL6-12R	TLNF6-12R	BLUE	1.456	0.837	4, 25, 100, 250
	#10	TL4-10R	TLNF4-10R	YELLOW	1.288	0.475	4, 10, 50, 100
	1/4"	TL4-14R	TLNF4-14R	YELLOW	1.288	0.475	4, 10, 50, 100
2 AWG	5/16"	TL4-56R	TLNF4-56R	YELLOW	1.288	0.475	4, 10, 50, 100
	3/8"	TL4-38R	TLNF4-38R	YELLOW	1.385	0.665	4, 10, 50, 100
	1/2"	TL4-12R	TLNF4-12R	YELLOW	1.385	0.665	4, 10, 50, 100
	1/4"	TL2-14R	-	-	1.583	0.645	4, 10, 25, 100
1/0 AWG	5/16"	TL2-56R	-	-	1.583	0.645	4, 10, 25, 100
	3/8"	TL2-38R	-	-	1.583	0.645	4, 10, 25, 100
	1/2"	TL2-12R	-	-	2.019	0.948	4, 10, 25, 100
	1/4"	TL1/0-14R	-	-	1.920	0.840	4, 10, 25, 50
2/0 AWG	5/16"	TL1/0-56R	-	-	1.920	0.840	4, 10, 25, 50
	3/8"	TL1/0-38R	-	-	1.920	0.840	4, 10, 25, 50
	1/2"	TL1/0-12R	-	-	1.951	0.902	4, 10, 50
	1/4"	TL2/0-14R	-	-	2.190	0.948	4, 10, 50
3/0 AWG	5/16"	TL2/0-56R	-	-	2.190	0.948	4, 10, 25, 50
	3/8"	TL2/0-38R	-	-	2.190	0.948	4, 10, 25, 50
	1/2"	TL2/0-12R	-	-	2.180	0.948	4, 10, 50
	5/16"	TL3/0-56R	-	-	2.154	1.067	4, 10, 25
4/0 AWG	3/8"	TL3/0-38R	-	-	2.154	1.067	4, 10, 25
	1/2"	TL3/0-12R	-	-	2.154	1.067	4, 10, 25
	1/4"	TL4/0-14R	-	-	2.242	1.102	4, 10, 25
	5/16"	TL4/0-56R	-	-	2.242	1.102	4, 10, 25
	3/8"	TL4/0-38R	-	-	2.242	1.102	4, 10, 25
	1/2"	TL4/0-12R	-	-	2.242	1.102	4, 10, 25

- WIRE & CABLE
- MULTI-CONDUCTOR
- COAX CABLES
- NETWORK CABLES
- HEAT SHRINK
- ROUTING & BUNDLING MATERIALS
- WIRE MANAGEMENT
- TERMINALS
- DEUTSCH & APTIV (DELPHI)
- LUGS & BOOTS**
- ID PRODUCTS & LABELERS
- TOOLS
- BREAKERS & FUSES
- TERMINAL BLOCKS & BUS BARS
- SWITCHES & ACTUATORS
- METERS & BOXES

*Length refers to Non-Insulated lugs only.
Ordering Information: Combine part number and package size. **Example:** Nylon insulated lug, 8 AWG, 1/4" stud, 25 pieces = TLNF8-14R-25
FEATURES: *Tin plated *Silver alloy brazed seams

Lugs & Boots

BATTERY POST TERMINALS

- WIRE & CABLE
- MULTI-CONDUCTOR
- COAX CABLES
- NETWORK CABLES
- HEAT SHRINK
- ROUTING & BUNDLING MATERIALS
- WIRE MANAGEMENT
- TERMINALS
- DEUTSCH & APTIV (DELPHI)
- LUGS & BOOTS
- ID PRODUCTS & LABELERS
- TOOLS
- BREAKERS & FUSES
- TERMINAL BLOCKS & BUS BARS
- SWITCHES & ACTUATORS
- METERS & BOXES

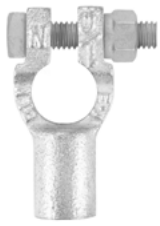

STRAIGHT POST TERMINAL



LEFT POST TERMINAL



RIGHT POST TERMINAL



FLAG POST TERMINAL

WIRE AWG	PART NUMBER STRAIGHT	PART NUMBER LEFT ELBOW	PART NUMBER RIGHT ELBOW	PART NUMBER FLAG	DESCRIPTION
BATTERY POST TERMINALS					
6	TC-6-U	-	-	-	UNIVERSAL
4	TC-4-P	-	-	-	POSITIVE
	TC-4-N	-	-	-	NEGATIVE
1-2	-	TL-2-U	TR-2-U	-	UNIVERSAL
	TC-1-P	-	-	TF-2-P	POSITIVE
	TC-1-N	-	-	TF-2-N	NEGATIVE
1/0	TC-10-P	TL-10-P	TR-10-P	TF-10-P	POSITIVE
	TC-10-N	TL-10-N	TR-10-N	TF-10-N	NEGATIVE
2/0	TC-20-P	TL-20-P	TR-20-P	TF-20-P	POSITIVE
	TC-20-N	TL-20-N	TR-20-N	TF-20-N	NEGATIVE
4/0	TC-40-P	TL-40-P	TR-40-P	TF-40-P	POSITIVE
	TC-40-N	TL-40-N	TR-40-N	TF-40-N	NEGATIVE

Ordering Information: Order by the piece.

All battery terminals are cast with 131 contact copper which is 93% to 95% copper. They are electro-plated with a bright tin finish. Each terminal has raised letters indicating wire size and post type. A deep chamber entry promotes ease of cable installation. For corrosion protection, a thin layer of epoxy is applied to the surface of the nuts and bolts. This thin layer does not affect the ease of assembly and will maintain consistent torque and galvanic protection.

COMPLIANCES: *RoHS Compliant

FEATURES: *Tin plated, 131 contact copper *3.6 times more conductive than lead lugs *High corrosion resistant ultra plating *Chamfered entry *Anti-corrosion applied on all nuts and bolts



PART NUMBER	DESCRIPTION	STUD SIZE (IN)
MARINE TYPE TOP POST TERMINALS		
TC-200-P	POSITIVE	3/8
TC-200-N	NEGATIVE	5/16
TC-210-U	UNIVERSAL	-

Ordering Information: Order by the piece.

COMPLIANCES: *RoHS compliant

FEATURES: *Tin plated *Converts top terminal battery post to accept ring lugs.

Lugs & Boots

INSULATOR BOOTS

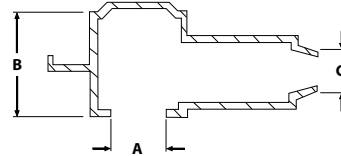

WIRE RANGE	PART NUMBER	(A) TERMINAL O.D. (IN)	(B) POST HEIGHT (IN)	(C) CABLE ENTRY MIN/MAX (IN)	COLOR
ALTERNATOR TYPE					
10-6 AWG	TBCA6-R	0.44	0.79	0.30/0.50	RED
	TBCA6-B	0.44	0.79	0.30/0.50	BLACK
6-2 AWG	TBCA2-R	0.81	1.05	0.30/0.50	RED
	TBCA2-B	0.81	1.05	0.30/0.50	BLACK
1-2/0 AWG	TBCA20-R	0.81	1.05	0.50/0.70	RED
	TBCA20-B	0.81	1.05	0.50/0.70	BLACK
3/0-4/0 AWG	TBCA40-R	1.31	1.60	0.70/0.90	RED
	TBCA40-B	1.31	1.60	0.70/0.90	BLACK

Ordering Information: Order by the piece.

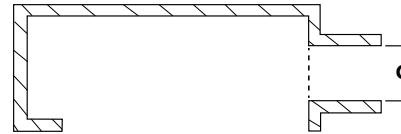

WIRE RANGE	PART NUMBER	(C) CABLE ENTRY (IN)	COLOR
STRAIGHT TYPE			
6-4 AWG	TBCS2-R	0.500	RED
	TBCS2-B	0.500	BLACK
1-2/0 AWG	TBCS20-R	0.630	RED
	TBCS20-B	0.630	BLACK
3/0-4/0 AWG	TBCS40-R	0.680	RED
	TBCS40-B	0.680	BLACK

Ordering Information: Order by the piece.

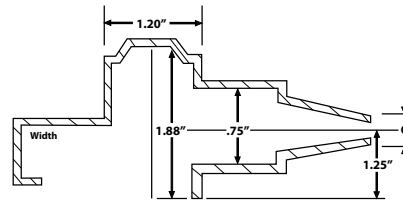

WIRE RANGE	PART NUMBER	(C) CABLE ENTRY MIN/MAX (IN)	COLOR
MARINE TYPE			
6-2 AWG	TBCM2-R	0.32/0.53	RED
	TBCM2-B	0.32/0.50	BLACK
1-2/0 AWG	TBCM20-R	0.55/0.75	RED
	TBCM20-B	0.55/0.75	BLACK

Ordering Information: Order by the piece.

APPLICATIONS: Used for the protection of continuously energized parts, such as positive battery terminals and both ends of wires connected to continuously energized sources. **ALTERNATOR TYPE:** Can be used to cover a power or ground on an alternator or starter.

STRAIGHT TYPE: Commonly used to connect to a post on a battery. **MARINE TYPE:** Can be used with secondary power or ground.

COMPLIANCES: *Meets Coast Guard 33 CFR Part 183 Subpart 1 *Meets S.A.E. J378 and J1128 (low voltage caps) *Meets UL 94 V2 Rated 105°C

FEATURES: *Helps prevent electrical shorts and shock *Recommended per ABYC E-10.6(1) *PVC 105°C

- WIRE & CABLE
- MULTI-CONDUCTOR
- COAX CABLES
- NETWORK CABLES
- HEAT SHRINK
- ROUTING & BUNDLING MATERIALS
- WIRE MANAGEMENT
- TERMINALS
- DEUTSCH & APTIV (DELPHI)
- LUGS & BOOTS**
- ID PRODUCTS & LABELERS
- TOOLS
- BREAKERS & FUSES
- TERMINAL BLOCKS & BUS BARS
- SWITCHES & ACTUATORS
- METERS & BOXES

WIRE & CABLE
MULTI-CONDUCTOR
COAX CABLES
NETWORK CABLES
HEAT SHRINK
ROUTING & BUNDLING MATERIALS
WIRE MANAGEMENT
TERMINALS
DEUTSCH & APTIV (DELPHI)
LUGS & BOOTS
ID PRODUCTS & LABELERS
TOOLS
BREAKERS & FUSES
TERMINAL BLOCKS & BUS BARS
SWITCHES & ACTUATORS
METERS & BOXES



VBOX-MS



VBOX-PL

PART NUMBER	DESCRIPTION
-------------	-------------

STORAGE BOXES

VBOX-MS	Small metal box. Ideal for holding small pieces such as terminals. Box outside dimensions: Height=2 1/8", Width=13 9/16", Depth=9 7/8" Number of compartments=21, Overall Weight=4 lbs.
---------	---

VBOX-ML	Large metal box. Efficient storage and organization for a variety of parts and components. Box outside dimensions: Height=3 1/16", Width=18 5/16", Depth=12 7/16" Number of compartments=21, Overall Weight=8 lbs.
---------	--

VBOX-PL	Small plastic box. Ideal for holding small pieces such as terminals. Lightweight and easy to use. Box outside dimensions: Height=1 3/4", Width=11", Depth=6 3/4" Number of compartments=18, Overall Weight=0.7 lbs.
---------	---

Ordering Information: Order by the piece. Terminals and/or wire NOT included.



VBOXRK-L



VWIRE-RK4

PART NUMBER	DESCRIPTION
-------------	-------------

RACKS & CABINETS

VBOXRK-SM	This cabinet is designed for use with VBOX-MS (see above). Rugged steel, all-welded cabinets are reinforced for rigidity. Easy glide slide racks hold up to 40 lbs. per cradle. Dimensions: Height=11 5/16", Width=15 9/16", Depth=11 7/8", Overall Weight=22 lbs.
-----------	---

VBOXRK-L	This larger cabinet is designed specifically for use with VBOX-ML (see above). Use on the workbench, counter, or the job site with convenient access to storage boxes. Dimensions: Height=14 7/8", Width=20 5/16", Depth=12 5/8", Overall Weight=33 lbs.
----------	---

VWIRE-RK4	Simplify wire access by utilizing four separate rods to hold spools. This wire rack can support multiple spools per rod. Durable, yet small enough for transport, this wire rack is ideal for workshops or job sites. Dimensions: Height=36 1/2", Width=26 1/8", Depth=5 7/8", Overall Weight=17 lbs.
-----------	--

Ordering Information: Order by the piece. Terminals and/or wire NOT included.

I.D. Products & Labelers

MARKER BOOKS & KITS



PART NUMBER	LEGEND		NO. OF LEGENDS		
	ALPHA	NUMERIC			
MARKER BOOKS					
VPCMB-1		0 - 9	45 each		
VPCMB-2	A - Z	0 - 15	+ - /	10 each	
VPCMB-5	A - C			150 each	
VPCMB-8	A - Z	1 - 15, 16 - 90	+ - /	2, 6, 4	
VPCMB-11		1 - 30		15 each	
VPCMB-12	A - Z		+ -	Blanks	15, 8, 7, 21
VPCMB-13			+ -	AC, DC, POS, NEG, GND, NEUT, SPARE	45, 27, 21



Ordering Information: Order by the book.

COMPLIANCES: *RoHS compliant

FEATURES: *Convenient, pocket-sized books *Pre-printed black on white vinyl-cloth, adhesive back markers

*Temp. Range -50° to 170°F *Indoor/Outdoor rated *Durable, temperature resistant and stable for rough surfaces

*Resists oil and abrasion

PART NUMBER	DESCRIPTION	MARKERS PER ROLL	WRITE-ON AREA (IN)	TOTAL AREA (IN)	PACKAGE SIZE
DISPENSER KITS & WRITE ON MARKERS					
VPLD-1	Kit (Disp, Tape, Pen)	200	0.38 X 1	1.25 X 1	1
VPLD-2	Kit (Disp, Tape, Pen)	100	0.75 X 1	3.00 X 1	1
VPX-0	Black Broad Tip Pen	-	-	-	1



Ordering Information: Order by standard package.

FEATURES: *Quick drying & non-smearing *Great for nylon & other glossy surfaces

PART NUMBER	DESCRIPTION	LEGEND OR COLOR	PACKAGE SIZE
MARKER CARDS			
VPCM- 'enter #' Choose between 0 - 9	Cloth	Choose: 0,1,2,3,4 5,6,7,8,9	5, 25 Cards
VPCM-1-9	Markers	1 - 9	5, 25 Cards
VPMD	Empty Dispenser		1
VPMD-0-9	Filled Dispenser	0 - 9	1 with 10 Rolls
VPMDR-'enter #' Choose between 0-9	Flexible Polyester	Choose: 0,1,2,3,4 5,6,7,8,9	1

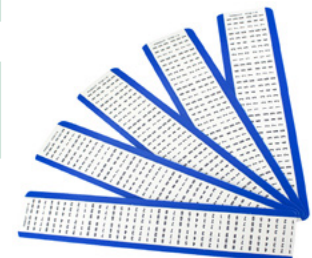

Ordering Information: Order by standard package.

COMPLIANCES: *RoHS compliant

FEATURES: *Vinyl cloth *White background, black legend *Temp. Range -50°F to 170°F

WIRE & CABLE

MULTI-CONDUCTOR

COAX CABLES

NETWORK CABLES

HEAT SHRINK

ROUTING & BUNDLING MATERIALS

WIRE MANAGEMENT

TERMINALS

DEUTSCH & APTIV (DELPHI)

LUGS & BOOTS

ID PRODUCTS & LABELERS

TOOLS

BREAKERS & FUSES

TERMINAL BLOCKS & BUS BARS

SWITCHES & ACTUATORS

METERS & BOXES



Pacer

Wire & Cable Manufacturer

Three generations of wire and cable manufacturing has led Pacer to become a trusted partner to some of the world's largest boat builders.

As boaters ourselves, we understand that the marine environment is unforgiving. That's why we set out to manufacture wire and cable for durability, flexibility, and longevity in the toughest marine environments.



Durability



Flexibility



Longevity

All Pacer manufactured wire and cable products carry a built in measuring system right on the jacket.

The **Pacer** name is positioned one foot apart meaning that measuring the footage is as simple as counting the number of times the word **Pacer** appears on a wire or cable.

PACER MARINE

E157097 (UL) BOAT CABLE

14 AWG/3 COND 600V

105°C DRY 75°C WET

BC-5W2 OIL RESISTANT I

PACER MARINE

Pacer to Pacer = One Foot

Tools

MULTI-PURPOSE & CRIMP TOOLS

PART NUMBER	DESCRIPTION
-------------	-------------

MULTI-PURPOSE TOOLS

VT1000 SOUTHWIRE® 6-IN-1 MULTI-PURPOSE TOOL. Stainless steel construction is durable and rust-proof. Strips and cuts 22-8 AWG solid and 24-10 AWG stranded wire. Crimps insulated and non-insulated terminals and connectors. Shears and rethreads 10-24, 8-32, 6-32, and 4-40 screws. Cuts bolts, strips 22-8 AWG solid and 24-10 AWG stranded wire. Weight: 0.43 lbs.



VT1000

VT1010 SOUTHWIRE® 8' LONG NOSE MULTI-PURPOSE TOOL. Stainless steel construction is durable and rust-proof. Strips and cuts 20-10 AWG solid and 22-12 AWG stranded wire. Crimps insulated and non-insulated terminals and connectors. Long nose design is for forming and looping wire and handling small parts. Shears 10-24, 8-32, 6-32, and 4-40 screws. Weight: 0.36 lbs.



VT1010

CRIMP TOOLS

VT1007 SOUTHWIRE® 9" CRIMPING/CUTTING PLIERS. 22-10 AWG solderless terminals and connectors. Crimps insulated and non-insulated terminals and connectors. Specially hardened wire cutter in nose. Tapered nose for working in confined spaces. Weight: 0.86 lbs.



VT1007

VT3120CT SARGENT CONTROLLED CYCLE CRIMP TOOL. Simple, trouble-free cycle mechanism assures consistent terminations. All cavities are fully machined in high carbon steel then heat treated. This tool crimps the conductor portion of insulated terminals, crimp cavities are color coded: Red 22-18 AWG, Blue 16-14 AWG, Yellow 12-10 AWG. Excellent for use with crimping heat shrink terminals. Weight: 0.94 lbs.



VT3120CT

VTR-490 3M RATCHET CRIMP TOOL. Ruggedly built, this tool crimps the barrel and the insulation grip independently for 22-10 AWG insulated and non-insulated terminals and connectors. Weight: 0.80 lbs.



VTR-490

VTTR50 RATCHET CRIMP TOOL. Ensures uniform crimp termination. Release switch if terminal or wire is inserted improperly. High quality, economical tool. Alignment guide dies won't slip during crimping. Four (4) crimp nests - 22-18, 16-14, 12-10, & 8 AWG.



VTTR50

VT30-500 IDEAL® CRIMPMASTER CRIMP TOOL. High quality ratchet-type crimp tool for electricians, contractors and installers. The ratcheted crimp action provides repeatability and reliability. Interchangeable dies provide versatility. Cushioned comfort grip handles. Crimps 22-10 AWG (.324 mm² - 5.261 mm²) insulated ring tongue terminals and splices.



VT30-500

VT30-506 IDEAL® CRIMPMASTER CRIMP TOOL - FRAME ONLY. Frame is constructed from high grade, stamp-hardened steel and put together with steel pins that will not stretch with use. The tool is full cycle, compound leverage, and triple ratcheted to give exact precision to every crimp.



VT30-506

VT30-577 IDEAL® CRIMPMASTER DIE SET ONLY for RG-8/11, RG-213, RG-216 Ethernet thick-wire, N-series plugs and jacks as well as RG8-11 Connectors.

VT30-579 IDEAL® CRIMPMASTER DIE SET ONLY. For 22-10 AWG insulated ring & fork terminals and splices. Offers colors coded crimp nests.

VT30-580 IDEAL® CRIMPMASTER DIE SET ONLY. For 22-8 AWG non-insulated terminals and connectors.

VT30-581 IDEAL® CRIMPMASTER DIE SET ONLY. For RG-58, RG-59/62, BNC/TNC coax connectors.

VT30-582 IDEAL® CRIMPMASTER DIE SET ONLY. For F-type CATV connectors.

VT30-586 IDEAL® CRIMPMASTER DIE SET ONLY. For 22-12 AWG Non-insulated open barrel connectors.

VT30-594 IDEAL® CRIMPMASTER DIE SET ONLY. For 22-10 AWG fully insulated quick disconnect terminals with thinner wire barrel.



VT30-580

Ordering Information: Order by the tool.

WIRE & CABLE

MULTI-CONDUCTOR

COAX CABLES

NETWORK CABLES

HEAT SHRINK

ROUTING & BUNDLING MATERIALS

WIRE MANAGEMENT

TERMINALS

DEUTSCH & APTIV (DELPHI)

LUGS & BOOTS

ID PRODUCTS & LABELERS

TOOLS

BREAKERS & FUSES











TERMINAL BLOCKS & BUS BARS

SWITCHES & ACTUATORS

METERS & BOXES

Tools

CABLE CUTTERS & WIRE STRIPPERS

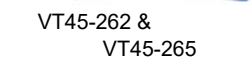
	PART NUMBER	DESCRIPTION
WIRE & CABLE	CABLE CUTTERS	
		VT63055 SOUTHWIRE® COMPACT CABLE CUTTER. The hook jaws grab and hold cable while the shear cutting action allows for clean cuts. Heat treated, precision ground blades ensure clean cuts. Comfortable cushion grips reduce hand fatigue. Weight: 0.94 lbs.
MULTI-CONDUCTOR		VT63050 SOUTHWIRE® HIGH-LEVERAGE CABLE CUTTER. Quality design for exceptional cutting capability. Hardened for longer-lasting cutting surfaces. Maximum cable cutting capacity: 4/0 aluminum, 100-pair 24 AWG cable, 2/0 soft copper. This item is not designed for cutting steel or ACSR. Weight: 1.00 lb.
COAX CABLES	RATCHET CABLE CUTTERS	
NETWORK CABLES		VT63060 SOUTHWIRE® RATCHETING CABLE CUTTER. Patented two-step ratchet mechanism requires fewer strokes per cut. Quick release lever opens blades easily in every cutting position (allows removal of the cable before completion of the cut.) Maximum cable cutting capacity: 750 MCM copper and aluminum (Max. jaw opening 1 1/8"). This item is not designed for cutting steel or ACSR. Weight: 0.51 lbs.
HEAT SHRINK		VT35-053 IDEAL® RATCHETING CABLE CUTTER. Designed to cut 750 KCMIL (MCM) and smaller hard-drawn copper and aluminum cables. Hardened steel blades ensure long term durability. Quick release mechanism simplifies blade back-out. Max. jaw opening 2". Not designed for cutting steel or ACSR.
ROUTING & BUNDLING MATERIALS	CABLE SWIVEL/SPLIT BLADE STRIPPERS	
WIRE MANAGEMENT		VT45-128 IDEAL® SWIVEL BLADE STRIPPER. For 1/4" to 3/4" outside diameter cables. Single or Multi-Conductor Cables up to 1.50" O.D. The blade adjusts for jacket thicknesses up to 1/8 inch. Replacement Blades: VTL-7486
TERMINALS		VT45-605 IDEAL® Multi-Strip Coax/UTP Cable Stripper. Strips UTP, RG-59 and RG-6 coax cable. Provides a 1/4 in (minimum) x 1/4 in. strip on coax. Spare cartridge compartment provided. Push-on ring for easy connector termination. Features a primary and secondary strip cartridge.
DEUTSCH & APTIV (DELPHI)		VT45-144 IDEAL® SWIVEL BLADE/ROUND CABLE SLITTING TOOL Single or Multi-Conductor Cables up to 1.75" O.D. Blade adjusts for jacket thickness up to 1/8". Spare blade in handle base. Replacement Blades: VTLB-1748
LUGS & BOOTS	WIRE & CABLE STRIPPERS & CUTTERS	
		VT45-121 SOUTHWIRE® COMPACT STRANDED WIRE STRIPPER. Specially designed stainless steel cutting blades provide fast and easy wire stripping. Strips, cuts, and loops 26-16 AWG stranded wire and 24-14 AWG solid wire. Spring loaded for self-opening action. Not intended for cutting bolts or steel cable. Wire range: Stranded 26-16 AWG/Solid 24-14 AWG.
ID PRODUCTS & LABELERS		VT45-124 SOUTHWIRE® 6" COMPACT WIRE STRIPPER. Specially designed stainless steel cutting blades provide fast and easy wire stripping. Serrated nose holds cable for easy twisting and pulling. Spring loaded for self-opening action. Not intended for cutting bolts or steel cable. Wire range: Stranded 16-8 AWG, Solid 14-6 AWG.
TOOLS	WIRE STRIPPERS	
BREAKERS & FUSES		VT45-292 IDEAL® STRIPMASTER. Wire stripper for 22-10 AWG stranded wire. Cleanly strips wire up to 7/8" removal of insulation. Eliminates nicking, cutting and fraying of commercial wire. Wire gripper will hold wire centered in stripping hole. Replacement Blades: VTL-4421
TERMINAL BLOCKS & BUS BARS		VT45-671 IDEAL® STRIPMASTER LITE. Wire stripper for 22-16 AWG stranded wire. Cleanly strips wire up to 7/8" removal of insulation. Eliminates nicking, cutting and fraying of commercial wire. Wire gripper will hold wire centered in stripping hole. Replacement Blades: VTLB-1001
SWITCHES & ACTUATORS		VT45-265 IDEAL® COAX STRIPMASTER. Stripper for RG-59. Provides variable stripping lengths. Knife-type blades feature multiple hole diameters. Sized for 2-step removal of outer jacket insulation and center conductor. Replacement Blades: VTLB-743
METERS & BOXES	VT45-262 & VT45-265	VT45-262 IDEAL® COAX STRIPMASTER. Stripper for RG-6. Provides variable stripping lengths. Knife-type blades feature multiple hole diameters. Sized for 2-step removal of outer jacket insulation and center conductor. Replacement Blades: VTLB-740

Ordering Information: Order by the tool.

PART NUMBER	DESCRIPTION
-------------	-------------

LARGE GAUGE CRIMPING TOOLS

VT0280C	CRIMP-MASTER COMPACT BATTERY LUG CRIMPER. Universal, adjustable tool 8 - 1/0 AWG. Characteristics: High-Leverage Handles, Compound-Action Mechanism, Adjustment Screw Allows User To Control Crimp Depth, Application For Crimping Lugs and Terminals, Function Crimps 8 - 1/0 AWG Battery Lugs And Terminals. Length: 16".
---------	---



VT0280	CRIMP-MASTER BATTERY LUG CRIMPER. Universal, adjustable crimping tool 4/0 - 6 AWG. Characteristics: High-Leverage Handles, Compound-Action Mechanism, Adjustment Screw Allows User To Control Crimp Depth, Application For Crimping Lugs and Terminals, Function Crimps 4/0 - 6 AWG Battery Lugs And Terminals. Length: 25".
--------	--



VTK05-SYNCRO	GREENLEE® ROTATING DIE CABLE CRIMPER. 8 - 1/0 AWG crimps smaller copper connectors. New design eliminates crimping errors from mismatched dies. It's laser cut dies are more dimensionally accurate than stamped dies. 50% reduced set up time when changing dies. Allows for rotating dies with one hand. Length: 15.75". Weight: 2.75 lbs.
--------------	--



VTK092SPGL	GREENLEE® ROTATING DIE CABLE CRIMPER. Long length results in low handle efforts. For 1 - 4/0 AWG cable. Color-coded, hexagonal rotating dies, the full cycle mechanism releases only after full crimp cycle is completed. Length: 26.5". Weight: 2.60 lbs.
------------	--



DEUTSCH TOOLS	<i>Additional Deutsch Removal Tools on page 45.</i>
----------------------	---

VT-HDT-48	DEUTSCH PRODUCTION CRIMP TOOL. Crimps solid style pins and sockets only. Provides eight-indent, mil-spec type crimp. For use with 22-12 AWG wire, size 20-12 solid pins and sockets in DT, DTM, DTP and size 12 DTHD series connectors.
-----------	---



VT-HDT-1561	DEUTSCH FIELD SERVICE CRIMP TOOL. Crimps solid style pins and sockets. Two-indent crimp. For use with 24-12 AWG wire, size 20-12 Solid Pins and Sockets in DT, DTM, DTP and size 12 DTHD Series connectors.
-------------	---



VT-DT/RT	DEUTSCH CONTACT/WEDGELOCK REMOVAL TOOL. A multi-use tool with a small hook on one end to remove the wedgelock, and a small screwdriver on the other end to push back the locking fingers and release the contact. The VT-DT/RT is a helpful tool for the DT, DTM, and DTP series connectors.
----------	--



APTIV WEATHER PACK TOOLS (FORMERLY DELPHI)

VT12014254	APTIV WEATHER PACK CRIMPING TOOL (FORMERLY DELPHI) Crimp terminals and seals in a single motion with this ratchet crimper. Works with: Weather-Pack Series terminals , 20-14 gauge. Metri-Pack 280 Series, sealed, 20-14 gauge (must remove terminal locator). Length: 11.5" Weight: 2 lbs. Made in the USA.
------------	--



VT12155975	Designed to crimp the core and insulation wings in a separate motion. 22-14 AWG for metri-pack 150 & 280 series terminals. Length: 9". Made in the USA.
------------	---



VT12014012	APTIV WEATHER PACK TERMINAL REMOVAL TOOL (FORMERLY DELPHI) This tool depresses the terminal retention barbs so the terminals can be removed from the housing connector. Works with all three sizes of Weather Pack Terminals 22-18, 16-14 & 12-10 AWG.
------------	--



Ordering Information: Order by the tool.

WIRE & CABLE

MULTI-CONDUCTOR

COAX CABLES

NETWORK CABLES

HEAT SHRINK

ROUTING & BUNDLING MATERIALS

WIRE MANAGEMENT

TERMINALS

DEUTSCH & APTIV (DELPHI)

LUGS & BOOTS

ID PRODUCTS & LABELERS

TOOLS

BREAKERS & FUSES

TERMINAL BLOCKS & BUS BARS

SWITCHES & ACTUATORS

METERS & BOXES

Tools

SPECIALTY TOOLS CONT.

	PART NUMBER	DESCRIPTION
WIRE & CABLE	FERRULE CRIMPING TOOLS	
MULTI-CONDUCTOR	VT-PZU16R	CRIMP TOOL, FERRULE 28 - 5 AWG SIDE WIRE ENTRY TRAPEZOIDAL CRIMP. For 28 - 5 AWG wire. The cross section range measures: 0.08-16mm ² (AWG 28-5). This tool is easy to use, and offers a forced lock for correct, complete crimping. The conductor entry can be rotated in 45° steps. Weight: 1 lb.
COAX CABLES	VT-PZU35	CONTA-CLIP SIDE WIRE ENTRY FERRULE CRIMPING TOOL. For 3 - 2 AWG wire. The ratcheted controlled crimp action provides repeatability and reliability. Multiple cavity die crimps wires 3 - 2 AWG (mm ² ferrule size 25 & 35). Weight: 1.5 lbs.
NETWORK CABLES	TELEPHONE/DATA CABLE CRIMPERS	
HEAT SHRINK	VT30-496	IDEAL® TELEMASTER CRIMP TOOL. For RJ-11/12 (6 position-1,2,3 pair 6P6C/6P4C) and RJ-45 (8 position-4 pair 8P8C) modular plugs. Multi-function tool for round voice/data cables. Cuts, strips and crimps for easy on-the-job, one-tool application. Round cable stripping for CAT5E/6 cables. Length: 13"
ROUTING & BUNDLING MATERIALS	VT33-750	IDEAL® ECONOMY 10BASE-T TELEMASTER KIT. Basic termination kit for 10Base-T. Kit includes, UTP/Coax Stripper Telemaster RJ-11/RJ-45 Tool, 50 8-Position RJ-45 modular Plugs. Durable hard case.
WIRE MANAGEMENT	COAX CABLE COMPRESSION CRIMP TOOL	
TERMINALS	VTCL-4080	PROFESSIONAL COMPRESSION TOOL. Works with standard BNC, F, & RCA compression connectors. Crimps standard and right angle connectors. Designed with a release dial.
DEUTSCH & APTIV (DELPHI)	CABLE TIE TOOLS	
LUGS & BOOTS	VTGTS	PANDUIT CABLE TIE INSTALLATION TOOL. Body Width Range 0.070 to 0.225 inch, Tool Code E, For 18 to 50 lb tensile strength cable ties, impact resistant resin housing, narrow nose and cushion handle, installs cable ties To correct tension and trims tails flush, tension locking mechanism, easy tension knob adjustment wheel. Use with subminiature, miniature, intermediate, and standard ties (SM, M, I, S). Weight: 0.65 lbs.
ID PRODUCTS & LABELERS	VT-HTMT	PANDUIT STAINLESS STEEL TENSIONING AND COILING TOOL. Installation tool for use with stainless steel cable ties. Coil tie end remaining after tensioning for safe end. Installs parallel to the bundle. Use with MLT, S/LH/H, MLTC/MLTFC S/LH/H, MLTDH, S, LH, H cable ties.
TOOLS	VT-ST2MT	PANDUIT STAINLESS STEEL INSTALLATION TOOL. Cable tie side entry for immediate positioning of tie, one hand operation, lightweight, easy removal of excess tie, tool tension is controlled by installer, twist action cut-off, rugged, lightweight, easy-to-operate pliers-type tool that provides mechanical advantage over standard installation tools. Use with MLT, S/LH/H/EH, MLTC/H, MLTFC S/H, MLTDH, EH cable ties.
BREAKERS & FUSES	Ordering Information: Order by the tool.	
TERMINAL BLOCKS & BUS BARS		
SWITCHES & ACTUATORS		
METERS & BOXES		

PART NUMBER	LENGTH (FT)	HEIGHT X WIDTH (IN)	DIAMETER (IN)	WEIGHT	REPL. TAPE
-------------	-------------	---------------------	---------------	--------	------------

STAINLESS STEEL FISH TAPES & LUBRICANT

VT31-066	125	16 x 12	0.177"	2.50 LBS	VT31-073
VT31-067	240	24 x 24	0.118"	4.30 LBS	VT31-074

VT31-388	IDEAL CLEAR GUIDE™. Wire Pulling Lubricant. Clear and colorless for quick and easy clean up. Exceptional lubricity for super-fast pulls. Polymer based formula perfect for all electrical and data-com applications. Safe to use with all cable types. 1 Qt. Squeeze bottle. 32°F to 180°F (0°C to 82°C).				
----------	---	--	--	--	--

PART NUMBER	DESCRIPTION
-------------	-------------

CIRCUIT AND VOLTAGE TESTERS

VT61-051	GFCI RECEPTACLE CIRCUIT TESTER. No-slip ergonomic design maximizes comfort and premium neon lamps prevents false readings. Constructed with a tough, impact-resistant case. This tool tests GFCI receptacles for proper operation, correct wiring, open ground, open neutral, open hot, reverse hot/ground and reverse hot/neutral in 3-wire 125 VAC circuits.
----------	--

VT61-063	VOLT SENSOR POCKET TESTER. Checks non-contact voltage from 50 - 600 VAC, CAT IV - 600V, audible and visual indication, tests for energized circuits, over-molded rubber cushion grip, compact rugged housing and covered by a manufacturer 1-year warranty. 32°F to 104°F (0°C to 40°C).
----------	--

MULTIMETERS

VT61-484	AUTO-RANGING MULTIMETER. True RMS, auto AC/DC voltage. Has the ability to detect with low impedance and offers 10 functions. Efficient for capacitance, frequency, with an analog bar graph, smart data hold, min/max. IP67, dustproof and waterproof for demanding applications. Easy to read backlit 4,000-count display with bargraph. Low battery indication, auto power off. INCLUDES: Test Leads and Carrying Case.	Case included
----------	---	---------------

CLAMP METERS

VT61-775	MaintenancePRO™ Smart 1000A CLAMP METER. Utilize Bluetooth® connectivity with this rugged high end clamp meter. Used with the MApp™ mobile app, the VT61-775 lets electricians safely get the measurements they need even in hostile environments. INCLUDES: Test leads, Type K temperature probe with banana plug adapter, Magnetic hanging strip, Carrying case & 9-volt battery.	Case included
----------	---	---------------

VT-8110	Mini Clamp Multimeter - AC/DC. Clamp allows measurement of AC and DC current in wires without disturbing the circuits or contacting live terminals. Auto range simplifies operation: 0.01-400A, 0.01-600V. True RMS - required for accurate measurement of inverter output. Test leads included with meter. 32°F to 122°F (0°C to 50°C).	Case included
---------	--	---------------

MICRO TORCH

VMT-4F	This small, lightweight, self igniting micro torch heat tool is perfect for heat shrink terminals, tubing and soldering. Up to 2370°F / 1300°C. Offers 30 minutes of continuous use. This product requires butane to operate. (Not included) Outer body measurement: 71mm (H) x 20mm (W) x 35mm (L)
--------	--

Ordering Information: Order by the tool.



WIRE & CABLE

MULTI-CONDUCTOR

COAX CABLES

NETWORK CABLES

HEAT SHRINK

ROUTING & BUNDLING MATERIALS

WIRE MANAGEMENT

TERMINALS

DEUTSCH & APTIV (DELPHI)

LUGS & BOOTS

ID PRODUCTS & LABELERS

TOOLS

BREAKERS & FUSES

TERMINAL BLOCKS & BUS BARS

SWITCHES & ACTUATORS

METERS & BOXES

Tools

MASTER® ULTRATORCH

WIRE & CABLE
MULTI-CONDUCTOR
COAX CABLES
NETWORK CABLES
HEAT SHRINK
ROUTING & BUNDLING MATERIALS
WIRE MANAGEMENT
TERMINALS
DEUTSCH & APTIV (DELPHI)
LUGS & BOOTS
ID PRODUCTS & LABELERS
TOOLS
BREAKERS & FUSES
TERMINAL BLOCKS & BUS BARS
SWITCHES & ACTUATORS
METERS & BOXES



VUT100SI



VUT100SIK (KIT)

SELF-IGNITING, BUTANE-POWERED SOLDERING IRON AND HEAT TOOL



















- Light weight for easy handling & extended use
- Built-in fuel filter for consistent fuel ignition
- Adjustable temperature up to 1202 °F
- Built-in window indicates fuel level
- UL & GS/TUV Listed for user safety
- Use to pinpoint heat, remove surface mount components, repair vinyl, shrink heat shrink tubing, solder and repair solders and spot dry.
- Kit contains unit, solder tip, heat tip, shrink attachment, spanner and open end wrench, sponge and stand packed in a metal storage/carrying case

SPECIFICATIONS:

- Dimensions: 10.3" L (260 mm)
- Equivalent to Electric Iron: 20 to 80 Watt
- Recommended Fuel: Master Ultratane® Butane
- Gas Tank Capacity: 1 fl. oz. (28 cc)
- Approx. Operating Time: 2hr.
- Net Weight: 5.5 oz. (100 g)
- Approx. Heat Tip Temp.: 1202°F (650°C)
- Approx. Solder Tip Temp.: 482°F to 932°F (250°C to 500°C)
- Shipping Weight: 1 lb.
- Shipped empty

PART NUMBER	DESCRIPTION
-------------	-------------

ULTRATORCH ACCESSORIES

	V70-01-01	1 mm Tapered Needle Soldering Tip
	V70-01-02	3.3 mm Chisel Soldering Tip (Standard)
	V70-01-03	2 mm Spade Soldering Tip
	V70-01-04	3 mm Spade Soldering Tip
	V70-01-05	0.5 mm Tapered Needle Soldering Tip
	V70-01-06	2 mm Micro Spade Soldering Tip
	V70-01-08	2 mm Spade Soldering Tip 35 degree
	V70-01-10	Offset tapered needle, 1 mm diameter
	V70-01-11	8 mm High Powered Chisel Soldering Tip
	V70-01-12	Round head, High Powered 3 mm diameter
	V70-01-14	Adaptor, 8.4 (4mm diameter x 0.7 mm pitch)
	V70-01-16	5.7 O.D. Hot Knife Tip
	V70-01-52	Heat Tip
	V70-01-55	Heat Shrink Attachment
	V70-40U	Metal Storage Box
	V90-02	Protective Cap for VUT-100SI
	V80-04U*	Replacement Burner
	VBUTANE	Butane 145 gm Canister

* For use with VUT100SI with serial number 2491709 and lower. Serial number located on unit housing.

Ordering Information: Order by the piece.

Tools

MASTER® ELECTRIC HEAT TOOLS



PART NUMBER	DESCRIPTION
-------------	-------------

ELECTRIC HEAT TOOLS	
VPH-1100A	<p>MASTER® PROHEAT® QUICK TOUCH HEAT GUN WITH MOMENTARY CONTACT SWITCH 1200°F /648°C, 120V, 50/60 Hz, 13 AMP, and 1560 WATTS</p> <ul style="list-style-type: none"> • Three heat levels; Ambient, 600°F/315°C, 1200°F/648°C • 9 & 18 CFM air flows • Compact, lightweight, easy-to-use • Use to activate adhesives, bend plastics, shrink tubing, dry filler material, stretch vinyl, strip paint, and more
V35216	PROHEAT® BENCH STAND
V35017	PROHEAT® ATTACHMENT 1-3/8" Shrink Tubing
VHG-301A	<p>MASTER® PROFESSIONAL QUALITY, HEAVY-DUTY INDUSTRIAL, MULTIPLE USE HEAT GUN 300 - 500°F, 150 - 260°C, 120-V 60 Hz, 12 AMPS, 1440 WATTS, 23 CFM</p> <ul style="list-style-type: none"> • Powerful high speed universal motor • Sturdy die cast housing • Adjustable non-slip stand • Use to bend plastics, cure adhesives, dry parts, heat parts, shrink tubing and packaging, strip paint, defrost frozen pipes, and more

Ordering Information: Order by the piece.

PART NUMBER	DESCRIPTION
-------------	-------------

MASTER® BUTANE HEAT TOOLS	
VMICROTORCH	<p>MASTER® MICROTORCH® MT-51</p> <ul style="list-style-type: none"> • Wind resistant flame resists moisture & is perfect for outdoor use, such as camping and biking • Quick starting self-igniting piezo electric ignition eliminates the need for lighters and matches • Adjustable flame height allows for low and high temperatures up to 2500°F/1300°C blue flame • Built-in refillable tank allows for repeatability. • VMICROTORCH Meets Consumer Products Safety Commission (CPSC) requirements
VMT-76	<p>MASTER® TRIGGER® MT-76</p> <ul style="list-style-type: none"> • MT-76 includes soldering iron and heat tip for soldering up to 752°F/400°C and heating up to 932°F/500°C • Kit includes triggertorch, solder tip and hot air tip • Gas adjustment wheel provides adjustable long blue torch flame with temperatures up to 2,500°F/1300°C • Incorporates trigger switch with pulldown lock to meet Consumer Products Safety Commission (CPSC) requirements • Incorporates a hands free slide lock for continuous use and instant off operation

Ordering Information: Order by the piece.

Common applications for MASTER® versatile heat tools include activating adhesives, bending & forming plastics, defrosting, drying, curing, heating, shrinking packaging & tubing, soldering, gluing, softening tile, stripping paint and welding plastics.



WIRE & CABLE
MULTI-CONDUCTOR
COAX CABLES
NETWORK CABLES
HEAT SHRINK
ROUTING & BUNDLING MATERIALS
WIRE MANAGEMENT
TERMINALS
DEUTSCH & APTIV (DELPHI)
LUGS & BOOTS
ID PRODUCTS & LABELERS
TOOLS
BREAKERS & FUSES
TERMINAL BLOCKS & BUS BARS
SWITCHES & ACTUATORS
METERS & BOXES

Breakers & Fuses

MAGNETIC CIRCUIT BREAKERS "A" SERIES

WIRE & CABLE
MULTI-CONDUCTOR
COAX CABLES
NETWORK CABLES
HEAT SHRINK
ROUTING & BUNDLING MATERIALS
WIRE MANAGEMENT
TERMINALS
DEUTSCH & APTIV (DELPHI)
LUGS & BOOTS
ID PRODUCTS & LABELERS
TOOLS
BREAKERS & FUSES
TERMINAL BLOCKS & BUS BARS
SWITCHES & ACTUATORS
METERS & BOXES

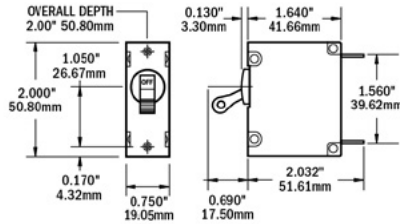

EAA1-20WH

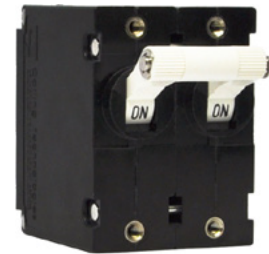

EAB2-20WH

FEATURES:

- *Series = trip
- *"Trip Free"
- *Magnetic operation, operates as a function of current only
- *Panel mounted
- *Power switching round cutout has a diameter of 0.63"

TECHNICAL INFORMATION

- **Series Trip:** Long delay
- **Inrush Pulse Tolerance:** 10 times rated current
- **Oper. Temp:** -40°C to 85°C
- **Shock:** Withstands 100 g or more without tripping, while carrying full rated current per Method 213 test condition "1". Tested @ 90% of rating curve.
- **Vibration:** Withstands 10 g without tripping, while carrying full rated current per Mil-Std-202, Method 204, cond. A
- **Endurance:** 10,000 operations (on-off) at 6 per minute with rated voltage and current or withstands 50 operations at 600% AC or 1000% DC at rated voltage and current, in accordance with UL 1077
- **Moisture Resistance:** Meets requirements of Mil-C-55629, tested in accordance with Mil-Std-202, Method 106
- **Salt Spray:** Meets requirements of Mil-C-55629, tested in accordance with Mil-Std-202, Method 101
- **Trip Free:** Trips on overload, cannot be forcibly held on

PERCENTAGE OVERLOAD VS. TRIP TIME IN SECONDS AT +25C (VERTICAL MOUNT)

DELAY	100%	135%	150%	200%	400%	600%	800%	1000%
DC 50/60-Hz MEDIUM	NO TRIP	7-130	3-60	1.3-20	.085-3	.02-2	.015-.8	.01-.26

MAX RATING	VOLTAGE FREQUENCY	PHASE	CURRENT RATING FULL LOAD AMPS	INTERRUPTING CAPACITY UL/CSA WITHOUT BACKUP FUSE
------------	-------------------	-------	-------------------------------	--

"A" SERIES INTERRUPTING CAPACITY (AMPS)

80	DC	-	0.02 - 30	3000
65	DC	-	31 - 50	3000
125/250	50/60 Hz	1Ø	0.02 - 30	3000
125/250	50/60 Hz	1Ø	31 - 50	2000
RATED AMPS	SINGLE POLE P/N	DOUBLE POLE SINGLE THROW P/N	DOUBLE POLE DOUBLE THROW P/N	**TOGGLE COLOR ABBREVIATION

"A" SERIES HYDRAULIC/MAGNETIC CIRCUIT BREAKERS

5	EAA1-5	-	-	BK, WH
10	EAA1-10	EAB2-10	EAA2-10	BK, WH
15	EAA1-15	EAB2-15	EAA2-15	BK, WH
20	EAA1-20	EAB2-20	EAA2-20	BK, WH
25	EAA1-25	EAB2-25	EAA2-25	BK, WH
30	EAA1-30	EAB2-30	EAA2-30	BK, WH
40	EAA1-40	-	-	BK, WH
50	EAA1-50	EAB2-50	EAA2-50	BK, WH

*Red (RD) Available upon request.

Ordering Information: Combine the part number and the color abbreviation.

Example: Single Pole, 30 AMP, White toggle = EAA1-30WH. All breakers are available by the piece.

Magnetic circuit breakers offer a low cost answer to power switching and reliable circuit protection. Temperature will not affect the operation of magnetic circuit breakers, as is the case with fuses or thermal breakers. The opening of the circuit is accomplished by the amount of current passing through an electromagnetic coil. As the current exceeds the amount specified by the breaker, the circuit will open (See chart "Percentage overload vs. trip time"). "A" series breakers are designed to have long trip delays to avoid nuisance tripping.

PART NUMBER	DESCRIPTION
-------------	-------------

SERIES "A" BREAKER ACCESSORIES

EG6-GUARD	Fits all "A" Frame Breakers. Mounts on the surface of the panel with two (2) 6-32 x 3/8" screws, which are included. Protects critical circuits from being accidentally switched on or off at the breaker.	
EG-SLIDE	Fits all Double Pole "A" Frame circuit breakers. AC Lockout slides allow only one breaker to be activated at a time. EG-SLIDE uses circuit breaker mounting screw holes, no special modifications required.	

Ordering Information: Order by the piece.

Breakers & Fuses

MAGNETIC CIRCUIT BREAKERS "C" SERIES



ECA2-80BK



ECA1-50BK

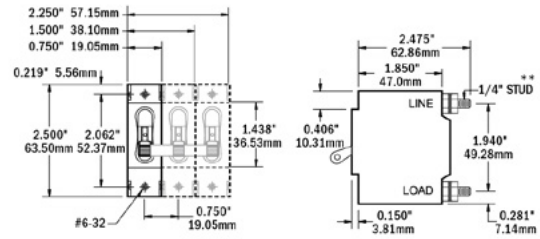

Series C Dimensions

PERCENTAGE OVERLOAD VS. TRIP TIME IN SECONDS AT +25C (VERTICAL MOUNT)

DELAY	100%	135%	150%	200%	400%	600%	800%	1000%
DC 50/60-Hz MEDIUM	NO TRIP	6.5-115	3-65	1.2-20	.08-3	.018-2.5	.015-.8	.009-.25

MAX RATING	VOLTAGE FREQUENCY	PHASE	CURRENT RATING FULL LOAD AMPS	INTERRUPTING CAPACITY UL/CSA WITHOUT BACKUP FUSE
------------	-------------------	-------	-------------------------------	--

"C" SERIES INTERRUPTING CAPACITY (AMPS)

80	DC	-	0.02 - 70	7500
65	DC	-	71 - 100	5000
125/250	50/60 Hz	1Ø	0.02 - 50	3000
125/250	50/60 Hz	1Ø	31 - 50	2000

RATED AMPS	SINGLE POLE P/N	DOUBLE POLE DOUBLE THROW P/N	TRIPLE POLE TRIPLE THROW P/N
------------	-----------------	------------------------------	------------------------------

"C" SERIES HYDRAULIC/MAGNETIC CIRCUIT BREAKERS

15	ECA1-15BK	-	-
20	ECA1-20BK	-	-
25	ECA1-25BK	-	-
30	ECA1-30BK	ECA2-30BK	-
40	ECA1-40BK	-	-
50	ECA1-50BK	ECA2-50BK	ECA3-50BK
60	ECA1-60BK	ECA2-60BK	-
70	ECA1-70BK	-	-
80	ECA1-80BK	ECA2-80BK	-
90	ECA1-90BK	-	-
100	ECA1-100BK	ECA2-100BK	-

Ordering Information: Order by the piece.

Designed for use in industrial, military and marine applications, "C" series breakers are suitable for use in any situation where precision operation is required. Magnetic circuit breakers are a low cost answer to power switching and reliable circuit protection.

Temperature will not affect the operation of magnetic circuit breakers, as it does with thermal breakers or fuses. Boots are available on page 65.

PART NUMBER	DESCRIPTION
-------------	-------------

BREAKER ACCESSORIES

EL-SLIDE	Fits all Double Pole "C" Frame circuit breakers. AC Lockout slides allow only one breaker to be activated at a time. EL-SLIDE uses circuit breaker mounting screw holes, no special modifications are required. Screws are included.	
----------	--	--

Ordering Information: Order by the piece.

Boots are available for circuit breakers on page 65.

FEATURES:

- *Series trip
- *"Trip Free"
- *Magnetic operation, operates as a function of current only
- *Panel mounted
- *Power switching
- *Rectangular panel cutout

TECHNICAL INFORMATION

- **Series Trip:** Long delay
- **Inrush Pulse Tolerance:** 12 times rated current
- **Oper. Temp:** -40°C to 85°C
- **Shock:** Withstands 100 g or more without tripping, while carrying full rated current per Mil-Std-202, method 213
- **Vibration:** Withstands 10 g without tripping, while carrying full rated current per Mil-Std-202, method 204
- **Endurance:** Per UL 1077 (6000 operations at rated load plus 4000 operations with no load) Tested at maximum rate of 6 times per minute
- **Moisture Resistance:** Designed to meet requirements of Mil-C-55629, when tested in accordance with Mil-Std-202, method 106
- **Salt Spray:** Designed to meet requirements of Mil-C-55629, when tested in accordance with Mil-Std-202, method 101
- **Trip Free:** Trips on overload, cannot be forcibly held on or restrained

WIRE & CABLE
MULTI-CONDUCTOR
COAX CABLES
NETWORK CABLES
HEAT SHRINK
ROUTING & BUNDLING MATERIALS
WIRE MANAGEMENT
TERMINALS
DEUTSCH & APTIV (DELPHI)
LUGS & BOOTS
ID PRODUCTS & LABELERS
TOOLS
BREAKERS & FUSES
TERMINAL BLOCKS & BUS BARS
SWITCHES & ACTUATORS
METERS & BOXES

Breakers & Fuses

PANEL MOUNT THERMAL BREAKERS



ETS658



ETS45



ETS41

FEATURES:

TYPE: 1658

- *Very cost effective design to meet international requirements
- *No potential current carrying exposed metal parts, except for terminals.
- *Manual reset
- *Cycling trip free mechanism
- *Extremely small and lightweight
- *UL, CSA, VDE and EN 60934 (IEC 60934) approved

TYPE: 2-5700 (Series 45)

- *Single pole thermal circuit breaker with press-to-reset, tease-free, trip-free, snap action mechanism
- *Push-push switch/circuit breaker
- *Threadneck panel mounting
- *Approved to CBE standard EN 60934 (IEC 60934)

TYPE: 412 & 413

- *Single pole high performance thermal circuit breaker with tease-free, trip-free, snap action mechanism and push/pull on/off manual actuation.
- *An indicator band on the push button clearly shows the tripped/off position.
- *Threadneck panel mounted

SERIES	658	45	41	41
TYPE	1658	2-5700	(<30 AMPS)	(30 AMPS - 70 AMPS)
DESCRIPTION	Series Trip	Series Trip, Push-ON, push OFF switching, B&W reset button for trip indication	Series Trip, Push-pull ON-OFF switching	Series Trip, Push-pull, ON-OFF switching
CURRENT RATINGS	5 - 30 AMPS	5 - 30 AMPS	6 - 25 AMPS	30 - 90 AMPS
MAXIMUM VOLTAGE RATINGS	AC 240V or DC 28V	AC 250V or DC 28V	AC 115V or DC 28V	AC 115V or DC 28V
INTERRUPTING CAPACITY	2000 AMPS @ 120V AC, 2500 AMPS @ 32V DC, 2000 AMPS @ 28V DC	2000 AMPS @ 250 VAC, 2500 AMPS @ 50 VDC	6000 AMPS	6000 AMPS
LIFE	1000 Operations	5000 Operations	4000 cycles at 200% rated current	2000 cycles at rated current
TERMINALS	.250 quick connect	Screw Terminals	Screw Terminals	Screw Terminals
APPROVALS	UL 1077 CSA VDE	UL 1077 CSA VDE	MIL-E-5272C UL 1077 CSA C22.2 No. 235 TL 5925-001	MIL-E-5272C UL 1077 CSA C22.2 No. 235 TL 5925-001
DESIGN NOTES	N/A	N/A	Melamine housing, corrosion, humidity and fungus resistant	Melamine housing, corrosion, humidity and fungus resistant

TRIPPING TIMES IN SECONDS AT 70 °F (21 °C)

	658	45	41	41
100%	No Trip	No Trip	No Trip	No Trip
200%	1.5 - 8.0	10 - 40	10 - 65	12 - 80
300%	1.0 - 5.0	3.0 - 8.0	3.0 - 20	3.0 - 25
400%	-	2.0 - 9.0	1.5 - 12	1.2 - 12
500%	-	1.0 - 6.0	1.0 - 8.0	1.0 - 7.0
600%	-	0.6 - 5.0	0.6 - 6.0	0.5 - 5.0
1000%	-	0.2 - 2.5	0.2 - 3.5	0.1 - 0.2

RATED AMPS	PART NUMBER	PART NUMBER	PART NUMBER	PART NUMBER
5	ETS658-5	ETS45-5	-	-
10	ETS658-10	ETS45-10	-	-
15	ETS658-15	ETS45-15	ETS41-15	-
20	ETS658-20	ETS45-20	ETS41-20	-
25	ETS658-25*	ETS45-25	ETS41-25	-
30	ETS658-30*	ETS45-30	-	ETS41-30
40	-	-	-	ETS41-40
50	-	-	-	ETS41-50
60	-	-	-	ETS41-60
70	-	-	-	ETS41-70

CAP PART NUMBER

ES-PBCAP ES-PBCVR or ES-PBCVR-BK	ES-PBLCAP	ES-PB41CAP
--	-----------	------------

Ordering Information: Order by the piece. For Series 1658 Breakers add WH= WHITE or BK=BLACK to the end of the part number. *Not available in black. **Example:** ETS658-10WH = Series #1685 with white actuator.

Breakers & Fuses

BREAKERS ACCESSORIES & COMPONENTS



ES-PBCAP



ES-PBLCAP



ES-PB41CAP



ES-PBCVR



ES-PBCVR-BK



EG-SGLBOOT

PART NUMBER	DESCRIPTION	FOR USE WITH
-------------	-------------	--------------

BREAKER BOOTS AND COVERS

ES-PBCAP	Clear, 9/16" high, 3/8" thread	ETS658 Series
ES-PBLCAP	Clear, 15/16" high, 3/8" thread	ETS45 Series
ES-PB41CAP	Clear, Variable height, 15/32" thread	EST41 Series
ES-PBCVR	Clear, 9/16" high, 3/8" thread	ETS658 Series
ES-PBCVR-BK	Black, 9/16" high, 3/8" thread	ETS658 Series

BOOTS FOR MAGNETIC CIRCUIT BREAKERS

EG-SGLBOOT	Clear, Mounts Behind Panel, "ON"	"A" Series Sgl. Pole
EG-DBLBOOT	Clear, Mounts Behind Panel, "ON"	"A" Series Dbl. Pole
EL-DBLBOOT	Clear, Mounts Front Panel, "ON/OFF"	"C" Series Dbl. Pole

Ordering Information: Order by the piece.



EG-DBLBOOT

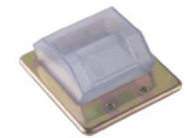

EL-DBLBOOT

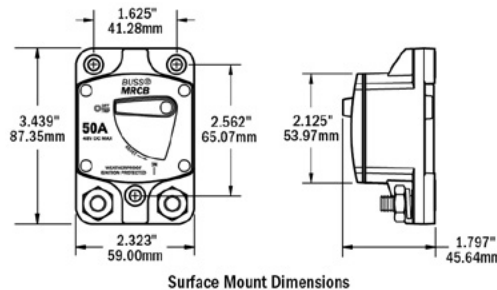

RATED AMPS	PART NUMBER	STUD SIZE
BUSSMANN SERIES 187 MANUAL RESET CIRCUIT BREAKERS WITH SWITCH FUNCTION		
25	EMRCB-25	5/16" - 18
30	EMRCB-30	5/16" - 18
50	EMRCB-50	5/16" - 18
60	EMRCB-60	5/16" - 18
80	EMRCB-80	5/16" - 18
100	EMRCB-100	5/16" - 18
120	EMRCB-120	5/16" - 18
150	EMRCB-150	5/16" - 18
200	EMRCB-200	5/16" - 18

Rating: 25-200 AMPS, 48V DC
Interrupt Rating: Main Breaker Protection Interrupt Rating (5,000 AMPS @ 14V DC, 3,000 AMPS @ 28V DC and 1,500 AMPS @ 48V DC)
Operating Temp. Rating: -40°F (-40°C) to 185°F (85°C)
Storage Temperature Rating: -40°F (-40°C) to 260°F (125°C)
Materials: Black UL-rated 94V-0 thermo-set plastic body. Cover and lever are UL-rated 94V-0 thermoplastic
Marking: Standard marking includes amp/volt ratings
Terminal Stud Size: 5/16" - 18
Ingress Protection Rating: IP66

Ordering Information: Order by the piece.

APPLICATIONS: These breakers are typically used in DC power systems in marine applications.

COMPLIANCES: *ABYC E-11; CE; SAE J1171 (ignition protected)

FEATURES: *A manual reset circuit breaker with On-Off switch capability *"Trip-Free" design cannot be held on during fault current conditions *Ignition protected, all components meet SAE 1171 external circuit protection requirements

*Large clearance around terminals accepts heavy gauge wire lugs

WIRE & CABLE
MULTI-CONDUCTOR
COAX CABLES
NETWORK CABLES
HEAT SHRINK
ROUTING & BUNDLING MATERIALS
WIRE MANAGEMENT
TERMINALS
DEUTSCH & APTIV (DELPHI)
LUGS & BOOTS
ID PRODUCTS & LABELERS
TOOLS
BREAKERS & FUSES
TERMINAL BLOCKS & BUS BARS
SWITCHES & ACTUATORS
METERS & BOXES

Breakers & Fuses

MARINE RATED CIRCUIT BREAKERS

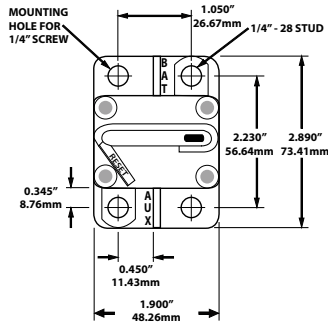

RATED AMPS	PART NUMBER	RATED AMPS	PART NUMBER
BUSSMANN SERIES 185 MANUAL & SWITCHABLE RESET CIRCUIT BREAKERS			
30	ESM-30	70	ESM-70
40	ESM-40	80	ESM-80
50	ESM-50	100	ESM-100
60	ESM-60	150	ESM-150

Ordering Information: Order by the piece.

Rating: 25-150 AMPS, 48V DC **Interrupt Rating:** 3000 AMPS **Operating Temperature Rating:** -25°F (-32°C) to 180°F (82°C)

Termination: 1/4-28 threaded studs **Ingress Protection Rating:** IP67

APPLICATIONS: These breakers are typically used in auxiliary and accessory circuits in truck, bus, RV and marine systems.

Other uses include battery chargers and DC audio systems. Series 185 are sealed for engine compartment and bilge area applications.

COMPLIANCES: *SAE J1171 (ignition protected) *SAE J1625 *ABYC E-11 *CE

FEATURES: *Single pole thermal surface mount breaker *Manual & switchable reset circuit breakers *Series 185 has a unique reset mechanism which provides visual indication of tripped condition. *Series 185 features a push-to-trip option *Ignition protection per SAE J1171



Style 1



Style 2



Style 3

RATED AMPS	PART NUMBER Style 1	PART NUMBER Style 2	PART NUMBER Style 3
KLIXON® THERMAL CIRCUIT PROTECTORS			
5	EPTR-5	-	-
10	EPTR-10	-	-
15	EPTR-15	-	-
20	EPTR-20	-	-
25	EPTR-25	-	-
30	EPTR-30	-	-
40	EPTR-40	-	-
50	-	EPTR-50	-
60	-	-	EPTR-60
70	-	-	EPTR-70
80	-	-	EPTR-80
90	-	-	EPTR-90

Ordering Information: Order by the piece.

APPLICATIONS: *Wire harness protection for heavy trucks, buses, construction equipment, off-road vehicles and RVs.

*Marine applications requiring ignition protected devices *Battery protection in electric vehicles

FEATURES: *Ignition Protected per SAE J1171 *Current: AC/DC

Interrupt Capacity: *Style 1: Per SAE J553 & UL Recognized *Style 2: Per SAE J553 & UL Recognized *Style 3: Per SAE J1625 & UL Recognized

TERMINALS: *Style 1: #8-32x1/4" Screw Terminals *Style 2: #10-32x5/8" Threaded Posts *Style 3: 1/4-28x9/16" Threaded Posts

MOUNTING METHOD: Panel with eyelet #10 screw

SHOCK RESISTANCE: In excess of 10 g

Breakers & Fuses

AGC FUSES, FUSE BLOCKS & HOLDERS

PART NUMBER	VOLTAGE RATING AC	AMPERAGE RATING	PART NUMBER	VOLTAGE RATING AC	AMPERAGE RATING
AGC GLASS FUSES					
EAGC.5	250	.5	EAGC7.5	250	7.5
EAGC1	250	1	EAGC10	250	10
EAGC1.5	250	1.5	EAGC15	32	15
EAGC2.5	250	2.5	EAGC20	32	20
EAGC3	250	3	EAGC25	32	25
EAGC5	250	5	EAGC30	32	30



Ordering Information: Order by the package (5 pieces).

AGC stood for "all glass." The automotive industry uses the "AG" prefix (AGC, AGW) for most glass fuses.

COMPLIANCES: *UL listed and recognized *CSA certified *CE *RoHS compliant

FEATURES: *1/4" Dia. x 1 1/4" Long *Glass tube with Nickel plated brass end caps *Fast-acting for maximum protection *Wide amp/volt ratings allow versatility of protecting electronic circuits

PART NUMBER	NO. OF CIRCUITS	MAX VOLTAGE	MAX AMPS PER CIRCUIT
BLUE SEA ST GLASS 6 CIRCUIT FUSE BLOCK WITH NEGATIVE BUS AND COVER			
EFB30-6IBC	6	32V DC	30 AMPS (100 AMP Per Block)

Ordering Information: Order by the piece.

FEATURES: *Clear insulating cover with label recesses to accept Large Format Labels

* Cover insulates all conductive parts, satisfying ABYC/USCG requirements & provides spare fuse storage

* Tin-plated copper buses and Phosphor Bronze fuse clips give 30 Ampere rating per circuit

* Accepts AGC (Fast Acting), MDL (Time-Delay) and all other 3AG Glass Fuses



PART NUMBER	NO. OF CIRCUITS	MAX VOLTAGE	MAX AMPS PER CIRCUIT
BRASS FUSE BLOCKS WITH INDEPENDENT BUS			
EFB20-4IB	4	32V DC	20 AMPS (80 AMP Per Block)
EFB20-6IB	6	32V DC	20 AMPS (120 AMP Per Block)
EFB20-8IB	8	32V DC	20 AMPS (160 AMP Per Block)

Ordering Information: Order by the piece.

FEATURES: *Made with brass clips and screws with a common bus bar connected to the fuse clips

*Additional independent buses integral to the fuse block *8-32 Screw terminals



EFB20-6IB

AGC FUSE HOLDERS

Ordering Information: Order by the piece.



P/N: EFH-WP
Splash-proof, accepts 18 through 12 AWG, 30 AMP maximum, 250 VAC, 32 VDC. One piece construction. Dimensions: 1/4"x1 1/4"



P/N: EFH-MWP30
10 AWG wire, 30 AMP fuse
P/N EFH-MWP15
14 AWG wire, 15 AMP fuse molded, water-resistant, inline, fuse holder with 8" 14 or 10 AWG wire loop molded into the assembly. AGC fuse included.



P/N: EFH-PMKT
Panel mount "knob-type". Recommended panel cutout 0.505 diameter, terminals 0.250 quick connects.



P/N: EFH-KT
In-line, spring loaded, "knob-type" with wire included. 20A 32V. Operating Temp: -40°F - 257°F -40°C - 1250°C

WIRE & CABLE

MULTI-CONDUCTOR

COAX CABLES

NETWORK CABLES

HEAT SHRINK

ROUTING & BUNDLING MATERIALS

WIRE MANAGEMENT

TERMINALS

DEUTSCH & APTIV (DELPHI)

LUGS & BOOTS

ID PRODUCTS & LABELERS

TOOLS

BREAKERS & FUSES

TERMINAL BLOCKS & BUS BARS

SWITCHES & ACTUATORS

METERS & BOXES

Breakers & Fuses

ATO/ATC FUSES, BLOCKS & HOLDERS

- WIRE & CABLE
- MULTI-CONDUCTOR
- COAX CABLES
- NETWORK CABLES
- HEAT SHRINK
- ROUTING & BUNDLING MATERIALS
- WIRE MANAGEMENT
- TERMINALS
- DEUTSCH & APTIV (DELPHI)
- LUGS & BOOTS
- ID PRODUCTS & LABELERS
- TOOLS
- BREAKERS & FUSES**
- TERMINAL BLOCKS & BUS BARS
- SWITCHES & ACTUATORS
- METERS & BOXES



ATO/ATC TYPE FUSES



EFB30-5025 (left)
EFB30-5026 (right)



EFB30-6ATC



PART NUMBER	RATED AMPS	COLOR	PART NUMBER	RATED AMPS	COLOR
-------------	------------	-------	-------------	------------	-------

ATO/ATC TYPE FUSES

EATC1	1	BLACK	EATC10	10	RED
EATC2	2	GREY	EATC15	15	BLUE
EATC3	3	VIOLET	EATC20	20	YELLOW
EATC4	4	PINK	EATC25	25	NATURAL
EATC5	5	TAN	EATC30	30	GREEN
EATC7.5	7.5	BROWN	EATC40	40	ORANGE

Ordering Information: Order in multiples of 5.

COMPLIANCES: *Meets or exceeds OEM and SAE standards

FEATURES: *Delivers fast-acting protection for electronics and other small loads *Standard 1/4" blade-type automotive fuses *Tin-plated copper-alloy connector blades for corrosion resistance *Voltage rating: 80 VDC *Current rating: 500mA - 40A *Interrupt capacity: 1000A DC

Introduced in the late 1970s, ATC blade fuses are widely used by automotive manufacturers. Clear, easy to read amp legend and color coding make for easy identification.

PART NUMBER	CIRCUITS	SPARE STORAGE	MAX VOLTS	MAX AMPS PER CIRCUIT
-------------	----------	---------------	-----------	----------------------

BLUE SEA ST BLADE FUSE BLOCK - 6 or 12 CIRCUITS WITH NEGATIVE BUS AND COVER

EFB30-5025	6	2	32V DC	30AMPS (100 AMP Max per Block)
EFB30-5026	12	2	32V DC	30AMPS (100 AMP Max per Block)

Ordering Information: Order by the piece.

FEATURES: *Positive distribution bus with #10-32 stud *Cover satisfies ABYC/USCG requirements for insulation *Cover incorporates an easy to open push button latch for easy access to fuses, storage for two spare fuses, and label recesses *Fuse blocks with covers include 20 write-on circuit labels *Tin-plated copper buses and fuse clips *Accepts ATO® and ATC® fast acting blade fuses

PART NUMBER	CIRCUITS	MAX VOLTS	MAX AMPS PER CIRCUIT
-------------	----------	-----------	----------------------

ATO/ATC FUSE BLOCK WITH COMMON HOT FEED AND INDEPENDENT NEGATIVE BUS

EFB30-4ATC	4	24V	30 AMPS (160 AMP Max)
EFB30-6ATC	6	24V	30 AMPS (160 AMP Max)
EFB30-10ATC	10	24V	30 AMPS (160 AMP Max)
EFB30-14ATC	14	24V	30 AMPS (160 AMP Max)

Ordering Information: Order by the piece.

FEATURES: *For ATC, ATO fuses and circuit breakers, various sizes will snap together. *Fuse/breaker contacts are tin plated & recessed for safety. Recessed area in the center accepts a label. *Electrical ratings: 30 AMPS maximum per circuit at 12V to 24V DC 160 AMPS maximum total for the block at 12V DC. * Black thermoplastic block. Blade terminals are .25" wide (6.4 mm). Stud terminal is 10-32.

ATO/ATC FUSE HOLDERS

Ordering Information: Order by the piece.

P/N: EFH-ATC-PKRD

Made from durable, glass reinforced, impact modified plastic, 6" of 10 AWG red wire, holds up to a 40 AMP ATC/ATO fuse, mounting tab integrated to cover. Fuse not included.

P/N: EFH-ATC-WP

Molded, side mount ATC/ATO fuse holder. Made with black high-temp thermoplastic construction, 12 AWG leads. Rated at 30 AMPS. Fuse not included.

Breakers & Fuses

MAXI FUSES & MARINE RATED BATTERY FUSES

PART NUMBER	RATED AMPS	COLOR	PART NUMBER	RATED AMPS	COLOR
MAXI BLADE-TYPE FUSES					
EMF30	30	GREEN	EMF60	60	BLUE
EMF40	40	ORANGE	EMF70	70	TAN
EMF50	50	RED	EMF80	80	CLEAR

Ordering Information: Order by the piece.

FEATURES: *Interrupting Ratings: 1000 AMPS @ 32V DC *Operating Temperature: 40°F to 257°F (40°C to 125°C) *Specifications: SAE 2576, ISO 8820-3:2002(E), UL94 Flammability rating V2

Maxi blade fuses are used when a high amperage circuit is required from 30-80 AMPS. All blade fuses are color-coded to indicate their amps.

PART NUMBER	CIRCUITS	MAX VOLTS	MAX AMPS
BLUE SEA MAXI FUSE HOLDER			
EFH-5006100	1	32V DC	80 AMPS

Ordering Information: Order by the piece.

FEATURES: *Snap-on terminal cover insulates all conductive parts, satisfying ABYC/USCG requirements *Ring terminal screws compress fuse blades within blocks for extremely low resistance connections *Accepts wire sizes 18-4 AWG from sides or bottom

PART NUMBER	CIRCUITS	MAX VOLTS	MAX AMPS
MAXI FUSE HOLDER			
EFH-MFH	1	32V	60 AMPS
EFH-5068	1	32V	48 AMPS

Ordering Information: Order by the piece.

FEATURES: *Maxi fuse holder & cover provides an efficient installation method for MAXI fuses.

PART NUMBER	RATED AMPS	PART NUMBER	RATED AMPS	PART NUMBER	RATED AMPS
MARINE RATED BATTERY FUSES					
EMRBF30	30	EMRBF80	80	EMRBF175	175
EMRBF40	40	EMRBF90	90	EMRBF200	200
EMRBF50	50	EMRBF100	100	EMRBF225	225
EMRBF60	60	EMRBF125	125	EMRBF250	250
EMRBF75	75	EMRBF150	150	EMRBF300	300

Ordering Information: Order by the piece.

FEATURES: *Maximum Amperage: 300 AMPS *Maximum Voltage: 58V DC *Terminal Stud: M8 (5/16")

*Recommended Torque: 75 in-lb (8.47 N·m) *Weight: 0.06 lb (0.03 kg)

*Space-saving ignition protected fuse for 30 to 300 AMP loads. Must use with Terminal Fuse Block. *High Interrupt Rating 10000 AMPS @ 14V DC, 5000 AMPS @ 32V DC, 2000 AMPS @ 58V DC satisfies ABYC requirements for DC main circuit protection on large battery banks *Clear window—visual indication of blown condition, use for main or auxiliary circuits.

MRBF TERMINAL FUSE BLOCK

FEATURES: *New isolated stud design uses standard M8 (5/16") hardware and permits stacking of terminals. *Insulating cap prevents accidental shorts. *Compact, high-amp fuse provides high current protection in tight space constraints. *Appropriate for DC Main, inverter, windlass, and bow thruster circuit protection.

Ordering Information: Order by the piece.

Note: Fuses are NOT included when purchasing the MRFB Terminal Fuse Block.



Maxi Blade-Type Fuses



EFH-5006100



EFH-MFH

EFH-5068



EMRBF40



EMRBF150



EFB-MRBF1



EFB-MRBF2

WIRE & CABLE

MULTI-CONDUCTOR

COAX CABLES

NETWORK CABLES

HEAT SHRINK

ROUTING & BUNDLING MATERIALS

WIRE MANAGEMENT

TERMINALS

DEUTSCH & APTIV (DELPHI)

LUGS & BOOTS

ID PRODUCTS & LABELERS

TOOLS

BREAKERS & FUSES

TERMINAL BLOCKS & BUS BARS

SWITCHES & ACTUATORS

METERS & BOXES

Breakers & Fuses

ANL FUSES & HOLDERS

- WIRE & CABLE
- MULTI-CONDUCTOR
- COAX CABLES
- NETWORK CABLES
- HEAT SHRINK
- ROUTING & BUNDLING MATERIALS
- WIRE MANAGEMENT
- TERMINALS
- DEUTSCH & APTIV (DELPHI)
- LUGS & BOOTS
- ID PRODUCTS & LABELERS
- TOOLS
- BREAKERS & FUSES**
- TERMINAL BLOCKS & BUS BARS
- SWITCHES & ACTUATORS
- METERS & BOXES

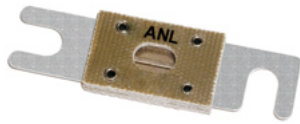

PART NUMBER	RATED AMPS	PART NUMBER	RATED AMPS	PART NUMBER	RATED AMPS
-------------	------------	-------------	------------	-------------	------------

LIMITER ANL LOW VOLTAGE, NON-TIME-DELAY FUSE

EANL35	35	EANL130	130	EANL300	300
EANL40	40	EANL150	150	EANL350	350
EANL50	50	EANL175	175	EANL400	400
EANL60	60	EANL200	200	EANL500	500
EANL80	80	EANL225	225	EANL600	600
EANL100	100	EANL250	250		

Ordering Information: Order by the piece.

COMPLIANCES: *SAE J1171 (35-500 AMPS): Ignition Protected *RoHS Compliant *UL Recognized

FEATURES: *Use with ANL fuse blocks for many applications with 35-600 AMP loads
 *Interrupting Rating: 2,700 AMP DC, 6,000 AMP AC *Voltage: 80V DC (or less), 32V AC
 *Silver-plated connector blades for corrosion resistance *Visible indication of blown fuse condition
 *Isolates faults in equipment systems such as lift trucks and other battery operated system

PART NUMBER	DESCRIPTION
-------------	-------------

ANL FUSE BLOCKS



- ANN & ANL fuse block with lock nuts
- High-strength thermoplastic base
- Two countersunk mounting holes on 1" centers for #10 flat head screws
- 400 AMP max, 80 volts DC, 125 volts AC
- Bolt down fuses are vibration resistant and ideal for heavy equipment application



- Cover included
- Accepts 5/16" (M8) ring terminals
- Rated 35 - 300 AMPS, for use on systems up to 32 Volts DC
- Swing out design allows replacement of the fuse without removing fasteners
- Stainless steel studs provide resistance to corrosion and high torquing for excellent electrical contact
- UL 94-V0 base resists high heat
- Insert molded studs ensure secure fuse mounting
- Insulating cover satisfies ABYC/USCG requirements
- Cover breakouts allow wire access in any direction
- Fuse not included



- Cover included
- Accepts 5/16" (M8) ring terminals
- Rated 35 - 750 AMPS, for use on systems up to 32 Volts DC
- Swing out design allows replacement of the fuse without removing fasteners
- Stainless steel studs provide resistance to corrosion and high torquing for excellent electrical contact
- UL 94-V0 base resists high heat
- Insert molded studs ensure secure fuse mounting
- Insulating cover satisfies ABYC/USCG requirements
- Cover breakouts allow wire access in any direction
- Fuse not included

Ordering Information: Order by the piece.

Breakers & Fuses

CLASS T FUSES & HOLDERS

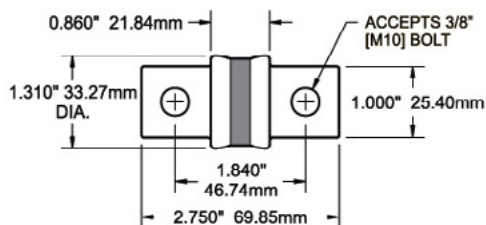

225–400 Amperes

PART NUMBER	STUD SIZE	RATED AMPS	WEIGHT
CLASS T FUSES			
ETF-225	190 3/8"	225	0.30 lb. (0.14 kg.)
ETF-250	190 3/8"	250	0.30 lb. (0.14 kg.)
ETF-300	190 3/8"	300	0.30 lb. (0.14 kg.)
ETF-350	190 3/8"	350	0.30 lb. (0.14 kg.)
ETF-400	190 3/8"	400	0.30 lb. (0.14 kg.)

Ordering Information: Order by the piece.

COMPLIANCES: *UL 248-15

FEATURES: *Extremely fast short-circuit response *20,000 AMP interrupt capacity (AIC)

Class T fuse blocks provide circuit protection for devices, including inverters. High interrupt capacity for large battery banks including Lithium-ion and TPPL batteries. Class T fuse blocks have a small foot print, providing substantial space savings in equipment.

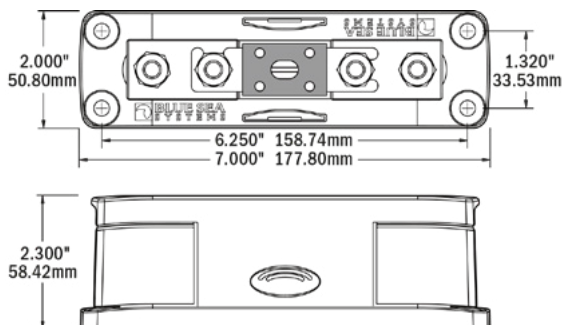

PART NUMBER	DESCRIPTION	MAX AMPS
CLASS T FUSE BLOCK WITH INSULATING COVER		
EFB-T	<ul style="list-style-type: none"> The fuse system recommended by inverter manufacturers for high speed response to short circuits Clear insulating cover, satisfies ABYC/USCG requirements For use on systems up to 160 Volts DC 3/8"-16 stud terminals accept ring terminals for wire up to 4/0 AWG Large heat dissipating tin-plated copper mounting blocks Two # 8 accessory terminals located on each end Fuse not included 	400 AMPS

Ordering Information: Order by the piece.

- WIRE & CABLE
- MULTI-CONDUCTOR
- COAX CABLES
- NETWORK CABLES
- HEAT SHRINK
- ROUTING & BUNDLING MATERIALS
- WIRE MANAGEMENT
- TERMINALS
- DEUTSCH & APTIV (DELPHI)
- LUGS & BOOTS
- ID PRODUCTS & LABELERS
- TOOLS
- BREAKERS & FUSES
- TERMINAL BLOCKS & BUS BARS
- SWITCHES & ACTUATORS
- METERS & BOXES

Terminal Blocks & Bus Bars

TERMINAL BLOCKS

WIRE & CABLE
MULTI-CONDUCTOR
COAX CABLES
NETWORK CABLES
HEAT SHRINK
ROUTING & BUNDLING MATERIALS
WIRE MANAGEMENT
TERMINALS
DEUTSCH & APTIV (DELPHI)
LUGS & BOOTS
ID PRODUCTS & LABELERS
TOOLS
BREAKERS & FUSES
TERMINAL BLOCKS & BUS BARS
SWITCHES & ACTUATORS
METERS & BOXES

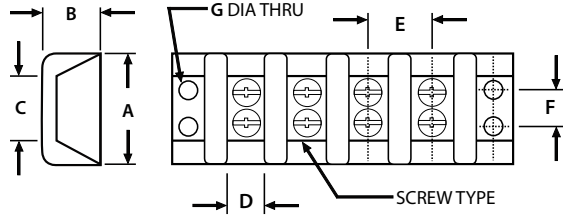

E30TB8



E20TB2



E30TB2



E50TB2



E20TBJ-S



SERIES (AMP)	RATED VOLTS	WIRE RANGE	SCREW TYPE	DIMENSIONS (IN)						
				(A)	(B)	(C)	(D)	(E)	(F)	(G)
20	300V	16-14 AWG	6-32 x 1/4"	1.12	0.53	0.75	0.34	0.44	0.42	0.175
30	600V	14-10 AWG	8-32 x 5/16"	1.31	0.71	0.94	0.42	0.56	0.50	0.203
50	600V	10-8 AWG	10-32 x 3/8"	1.81	0.75	1.06	0.47	0.69	0.62	0.275

NO. OF POSITIONS	20 AMP PART NUMBER	30 AMP PART NUMBER	50 AMP* PART NUMBER
------------------	--------------------	--------------------	---------------------

TERMINAL BLOCKS			
2	E20TB2	E30TB2	E50TB2
3	E20TB3	E30TB3	E50TB3
4	E20TB4	E30TB4	E50TB4
5	E20TB5	E30TB5	-
6	E20TB6	E30TB6	E50TB6
7	E20TB7	E30TB7	-
8	E20TB8	E30TB8	E50TB8
10	E20TB10	E30TB10	E50TB10
12	E20TB12	E30TB12	-
15	E20TB15	E30TB15	-
18	E20TB18	-	-
20	E20TB20	E30TB20	-

Ordering Information: Order by the piece. *Open back design

CHARACTERISTICS: *Insulator base temperature rating: -40°C to 125°C

COMPLIANCES: *UL recognized, CSA Certified

FEATURES: *Nickel plated brass hardware *20 & 30 Amp - thermoplastic base *50 Amp - phenolic base

*Closed back *Eliminates splicing & simplifies wiring

JUMPER STYLE	20 AMP JUMPER	30 AMP JUMPER	50 AMP JUMPER	PACKAGE SIZE
--------------	---------------	---------------	---------------	--------------

TERMINAL BLOCK JUMPERS - Used to combine circuits on a terminal block

ENCLOSED	E20TBJ	E30TBJ	E50TBJ	25, 100, 1000
SLOTTED	E20TBJ-S	E30TBJ-S	N/A	25, 100, 1000

Ordering Information: Combine part number and package size. **Example:** 100 enclosed 20 Amp jumpers = E20TBJ-100

FEATURES: *Terminal block jumpers are constructed of nickel plated brass *Available in enclosed & slotted styles

NO. OF POSITIONS	PART NUMBER	PART NUMBER	PART NUMBER	PART NUMBER
15 AMP		20 AMP	40 AMP	63 AMP
300V		300V	300V	600V
14 AWG MAX		12 AWG MAX	10 AWG MAX	8 AWG MAX

EUROPEAN TERMINAL BLOCKS

12	E150-12	E200-12	E400-12	E650-12
----	---------	---------	---------	---------

Ordering Information: Order by the piece.

COMPLIANCES: *UL recognized, CSA Certified

FEATURES: *Constructed from polyamide 6.6 *Nickel-plated copper alloy *Easily cut

*Recessed screws and terminals to avoid shock hazard *Closed back design

European terminal blocks are constructed from polyamide 6.6 and incorporate nickel-plated copper alloy inserts for corrosion resistance and wire protectors to prevent stranded wire damage during installation.

Terminal Blocks & Bus Bars

POWER POSTS & FEED THROUGH CONNECTORS

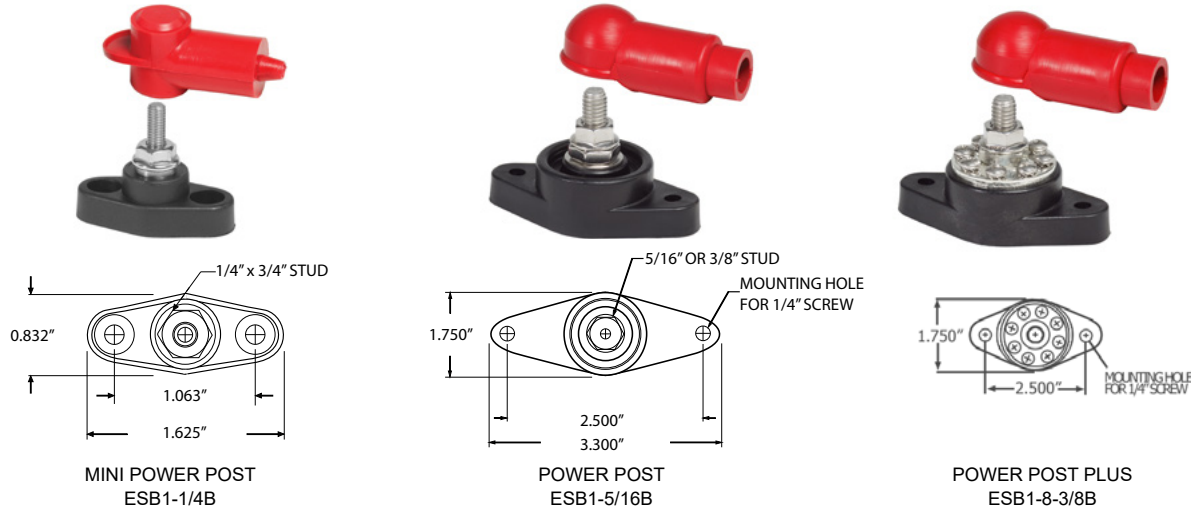

PART NUMBER	CURRENT RATING	STUD TYPE	CONFIGURATION
SINGLE POWER POST			
ESB1-1/4B	NR*	1/4"	Mini Power Post
ESB1-5/16B	NR*	5/16"	Power Post
ESB1-3/8B	NR*	3/8"	Power Post
ESB1-8-5/16B	150	5/16"	Power Post Plus w/ 8 (#8) Screws
ESB1-8-3/8B	150	3/8"	Power Post Plus w/ 8 (#8) Screws

*Not Rated - Amperage flow is between terminals stacked on the post and is dependent on the wire and terminals used.

Ordering Information: Order by the piece.

CHARACTERISTICS: *Base Material: Reinforced thermoplastic *Max. Voltage: 48V DC

FEATURES:

POWER POSTS *Connects high amperage cables securely

POWER POST PLUS *150 Amp bus allows small wire connections at high amperage cable connections *Connects high amperage cables securely

Pacer stocks a large variety of power post solutions. Improper or corroded buses can rob precious voltage from a circuit. In starter and anchor windlass circuits where hundreds of amps flow, this could mean a significant difference in cranking/lifting capability. **Connect all high amperage cables securely.**



PART NUMBER WITHOUT BOOT	COLOR	CURRENT RATING	STUD TYPE
TERMINAL FEED THROUGH CONNECTOR POSTS			
EFC1-5/16B	BLACK	250	5/16"
EFC1-5/16R	RED	250	5/16"
EFC1-3/8B	BLACK	250	3/8"
EFC1-3/8R	RED	250	3/8"

Ordering Information: Order by the piece.

CHARACTERISTICS: *Base Material: Reinforced thermoplastic *Stud Material: Tin-plated copper alloy *Max Voltage: 48V DC

*Amperage: 250 AMPS *Recommended Torque: 100 in-lb (11.3 N-m)

FEATURES: *Available in red or black for both 5/16" and 3/8" stud sizes *Perfect for passing high current cables through hulls, decks and bulkheads

*Large terminals have a mounting face that can be gasketed or bedded to provide a water tight installation *Rated IP66 - protected against powerful water jets

Large cables passed through holes are subject to chafing even when protective grommeting is used. Terminal feed through connectors eliminate chafing and provide excellent strain relief for the cable. **Connect all high amperage cables securely.**

- WIRE & CABLE
- MULTI-CONDUCTOR
- COAX CABLES
- NETWORK CABLES
- HEAT SHRINK
- ROUTING & BUNDLING MATERIALS
- WIRE MANAGEMENT
- TERMINALS
- DEUTSCH & APTIV (DELPHI)
- LUGS & BOOTS
- ID PRODUCTS & LABELERS
- TOOLS
- BREAKERS & FUSES
- TERMINAL BLOCKS & BUS BARS
- SWITCHES & ACTUATORS
- METERS & BOXES

Terminal Blocks & Bus Bars

POWER POSTS & MINI BUS BARS

WIRE & CABLE
MULTI-CONDUCTOR
COAX CABLES
NETWORK CABLES
HEAT SHRINK
ROUTING & BUNDLING MATERIALS
WIRE MANAGEMENT
TERMINALS
DEUTSCH & APTIV (DELPHI)
LUGS & BOOTS
ID PRODUCTS & LABELERS
TOOLS
BREAKERS & FUSES
TERMINAL BLOCKS & BUS BARS
SWITCHES & ACTUATORS
METERS & BOXES

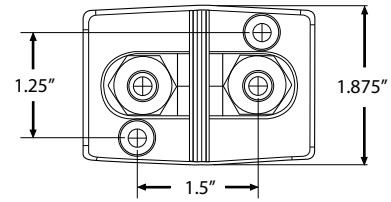

PART NUMBER	BOOTS INCLUDED	CURRENT RATING	STUD TYPE	CONFIGURATION
DUAL POWER POST				
EDB2-5/16	(1) BLACK, (1) RED	N/A*	5/16"	Dual Power Post
EDB2-3/8	(1) BLACK, (1) RED	N/A*	3/8"	Dual Power Post

*Not Rated - Amperage flow is between terminals stacked on the post and is dependent on the wire and terminals used.

Ordering Information: Order by the piece.

FEATURES: *Designed for connecting high amp conductors *Includes one black and one red insulator *Tin plated brass bus *48V DC

Provides a termination point for extending the length of outboard harnesses or other conductors.

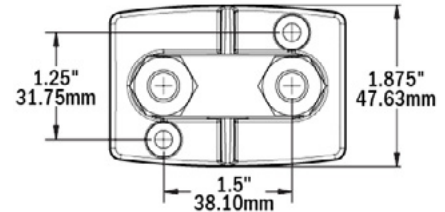

PART NUMBER	BOOTS INCLUDED	CURRENT RATING	STUD TYPE	CONFIGURATION
DUAL POWER BUS BAR				
EPB2	(2) RED	200 Amp	3/8" - 16	Dual Stud Bus Bar

Ordering Information: Order by the piece.

FEATURES: *Provides compact high-ampere busing with 3/8-16 terminal studs *Designed for connecting high amp conductors

*Includes two red insulators *48V DC Max



EMBO-6



EMB2-5



EMB4



EMBC

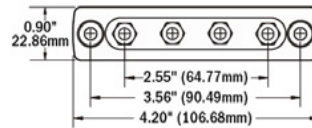
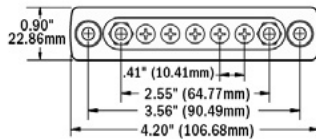
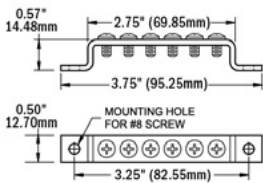

MINI BUS BAR COVER
(for EMB2-5 & EMB4)
Sold Separately

PART NUMBER	AMPS	CONFIGURATION	COVER PART NUMBER
100 AMP MINI BUS BARS			
EMBO-6	100	Non-Insulated Grounding Bar with (6) #8-32 Screws	N/A
EMB2-5	100	Common Bus Bar with (2) #10-32 Studs & (5) #8-32 Screws	EMBC
EMB4	100	Common Bus Bar with (4) #10-32 Studs	EMBC

Ordering Information: Order by the piece.

FEATURES: *Great for limited space applications *100 AMP continuous rating *48V DC Max *300V AC Max (EMB2-5 & EMB4 only)

*Bus Material: Tin-plated copper CDA 110/UNS11000

Terminal Blocks & Bus Bars

DUAL ROW BUS BARS & COMMON BUS BARS



EDB10



EDB20

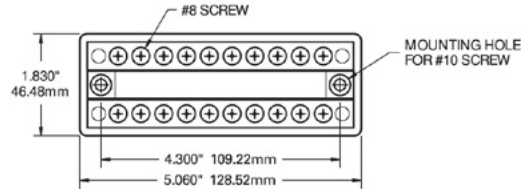
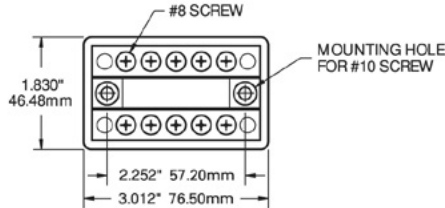

PART NUMBER	AMPS	CONFIGURATION	COVER PART NUMBER
100 AMP DUAL BUS BARS			
EDB10	100	Dual bus bar - 5 circuit has (5) #8-32 screws on each side	EDB10C
EDB20	100	Dual bus bar - 10 circuit has (10) #8-32 screws on each side	EDB20C

Ordering Information: Order by the piece. Bus bars and covers are sold separately.

FEATURES: *100 AMP continuous rating *48V DC Max *300V AC Max *Bus Material: Tin-plated copper CDA 110/UNS11000
 *Base Material: Glass reinforced thermoplastics *Pacer's dual row bus bars combine negative and positive buses on one block.



EDB20C
100 AMP DUAL BUS BAR COVER
Sold Separately



EBB2-20C
150 AMP COMMON BUS BAR COVER
Sold Separately



EBB2-10



EBB2-20



EBB4

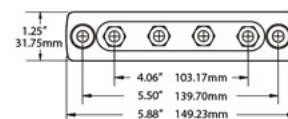
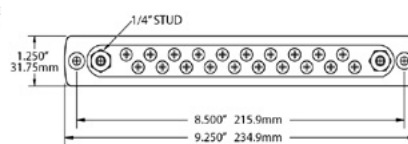
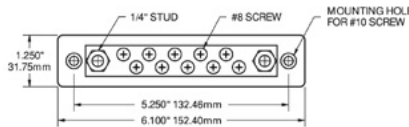

PART NUMBER	AMPS	CONFIGURATION	COVER PART NUMBER
150 AMP COMMON BUS BARS			
EBB2-10	150	Common bus bar with (10) #8-32 screws, (2) 1/4" studs	EBB2-10C
EBB2-20	150	Common bus bar with (20) #8-32 screws, (2) 1/4" studs	EBB2-20C
EBB4	150	Common bus bar with (4) 1/4" studs	EBB2-10C

Ordering Information: Order by the piece. Bus bars and covers are sold separately.

FEATURES: *Industry standard *Continuous rating: 130AAC, 150A DC *48V DC Max *300V AC Max *Bus Material: Tin-plated copper CDA 110/UNS11000 *Base Material: Glass reinforced thermoplastics *Nuts included on studs

- WIRE & CABLE
- MULTI-CONDUCTOR
- COAX CABLES
- NETWORK CABLES
- HEAT SHRINK
- ROUTING & BUNDLING MATERIALS
- WIRE MANAGEMENT
- TERMINALS
- DEUTSCH & APTIV (DELPHI)
- LUGS & BOOTS
- ID PRODUCTS & LABELERS
- TOOLS
- BREAKERS & FUSES
- TERMINAL BLOCKS & BUS BARS
- SWITCHES & ACTUATORS
- METERS & BOXES

Terminal Blocks & Bus Bars

MAXI BUS BARS & POWER BUS BARS

WIRE & CABLE
MULTI-CONDUCTOR
COAX CABLES
NETWORK CABLES
HEAT SHRINK
ROUTING & BUNDLING MATERIALS
WIRE MANAGEMENT
TERMINALS
DEUTSCH & APTIV (DELPHI)
LUGS & BOOTS
ID PRODUCTS & LABELERS
TOOLS
BREAKERS & FUSES
TERMINAL BLOCKS & BUS BARS
SWITCHES & ACTUATORS
METERS & BOXES

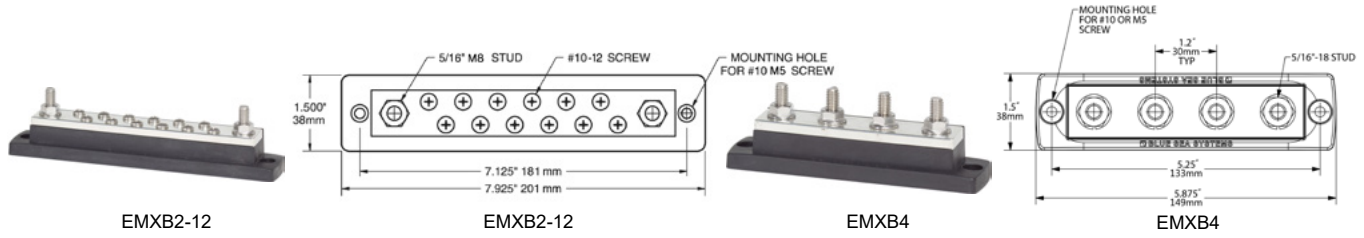

PART NUMBER	AMPS	DESCRIPTION	COVER PART NUMBER
250 AMPS MAXI BUS BARS			
EMXB2-12	250	(2) 5/16" - 18 Studs & (12) #10-24 Screws	EMXBC6
EMXB4	250	(4) 5/16" - 18 Studs	EMXBC4

Ordering Information: Order by the piece.

FEATURES: *250A continuous rating *48V DC Max *300V AC Max *Bus Material: Tin-plated copper CDA 110/UNS11000
 *UL 94-V0 rated base material *Raised bus provides easy access to multiple wires on a single screw or stud

Insert molded stainless steel studs to eliminate the need for securing nuts and allow high torquing for excellent electrical contact. The recessed mounting holes eliminate shorts to metal mounting surfaces.

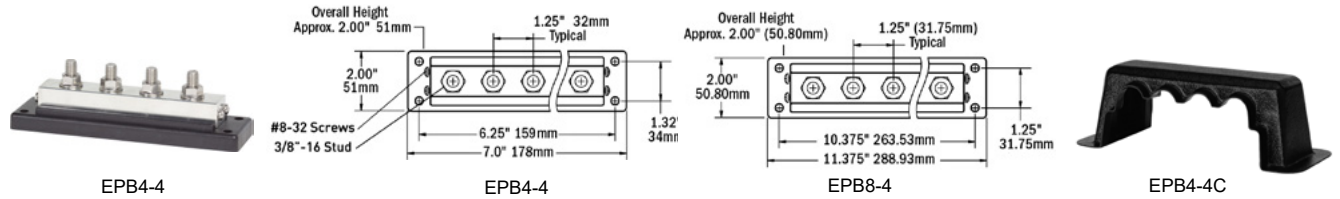

PART NUMBER	AMPS	DESCRIPTION	COVER PART NUMBER
600 AMPS POWER BUS BARS			
EPB8-4	600	(8) 3/8" - 16 Studs	EPB8-4C
EPB4-4	600	(4) 3/8" - 16 Studs	EPB4-4C

Ordering Information: Order by the piece.

FEATURES: *600A DC - 545A AC continuous rating *48V DC Max *300V AC Max *Bus Material: Tin-plated copper CDA 110/UNS11000.
 *UL 94-V0 rated base material *Raised bus provides easy access to multiple wires on a single screw or stud.
 *Four #8-32 screws located at the end of the bus allows for easy small gauge wire connections.

High amperage bus bars are constructed from tinned plate CDA110 copper with a glass reinforced thermoplastic base. Lugs can be stacked and (4) #8-32 screws allow for easy connection of smaller conductors.

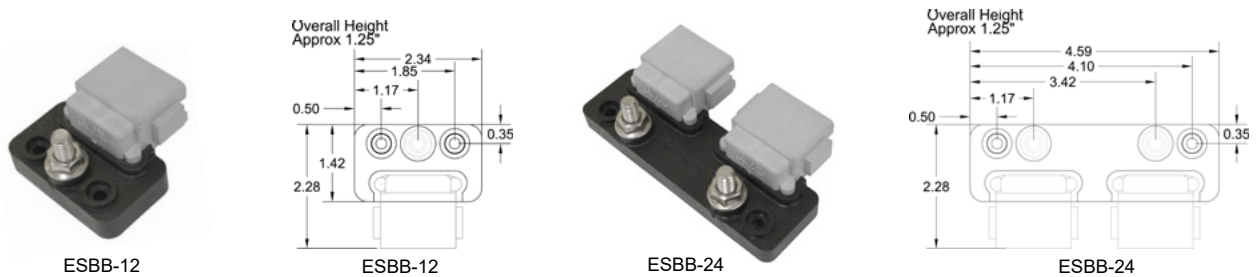

PART NUMBER	AMPS	DESCRIPTION
SEALED BUS BARS		
ESBB-12	150	(1) 5/16" - 18 Stud/(1) 12 pos. Deutsch
ESBB-24	300	(2) 5/16" - 18 Studs/(2) 12 pos. Deutsch

Ordering Information: Order by the piece.

FEATURES: *Ignition protected SAE J1171 *48V DC Max *Bus Material: Encapsulated copper *RETPU thermoplastic base
 *IP67 sealed connector for quick installation (less than 10% of the time of a traditional bus bar.)

Switches & Actuators

CONTURA SWITCHES

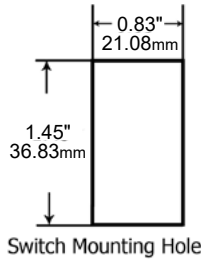

Panel Thickness Range:

Gaskets	Acceptable Panel Thickness
0	0.030 to 0.250 (0.76 to 6.35mm)
1	0.030 to 0.109 & 0.147 to 0.157 (0.76 to 2.77mm & 3.73 to 3.98mm)

Recommended: No gasket with panel thickness of 0.032, 0.062, 0.093, 0.125, 0.187, 0.250

PART NUMBER	SWITCH FUNCTION	MOMENTARY	LAMPS / VOLTS	DESCRIPTION
SINGLE POLE SWITCHES				
ES-V1DA	ON - OFF	No	1 DEP. / 12-V	Single pole, Single throw
ES-V4DA	ON - ON	No	2 DEP. / 12-V	Single pole, Double throw
ES-V6DA	ON - OFF - ON	No	2 DEP. / 12-V	Single pole, Double throw, Center Off
ES-V2DA	(ON) - OFF	Yes (ON)	1 DEP. / 12-V	Single pole, Single throw
ES-V3DA	ON - (OFF)	Yes (OFF)	1 DEP. / 12-V	Single pole, Single throw
ES-V5DA	ON - (ON)	Yes (ON)	2 DEP. / 12-V	Single pole, Double throw
ES-V7DA	ON - OFF - (ON)	Yes (ON)	2 DEP. / 12-V	Single pole, Double throw, Center Off
ES-V8DA	(ON) - OFF - (ON)	Yes (ON)	2 DEP. / 12-V	Single pole, Double throw, Center Off

PART NUMBER	SWITCH FUNCTION*	MOMENTARY	LAMPS / VOLTS	DESCRIPTION
DOUBLE POLE SWITCHES				
ES-VADA	ON - OFF	No	1 DEP. / 12-V	Double pole, Single throw
ES-VDDA	ON - ON	No	2 DEP. / 12-V	Double pole, Double throw
ES-VJDA	ON - OFF - ON	No	2 DEP. / 12-V	Double pole, Double throw, Center Off
ES-VBDA	(ON) - OFF	Yes (ON)	1 DEP. / 12-V	Double pole, Single throw
ES-VFDA	ON - (ON)	Yes (ON)	2 DEP. / 12-V	Double pole, Double throw
ES-VKDA	ON - OFF - (ON)	Yes (ON)	2 DEP. / 12-V	Double pole, Double throw, Center Off
ES-VLDA	(ON) - OFF - (ON)	Yes (ON)	2 DEP. / 12-V	Double pole, Double throw, Center Off

Ordering Information: Order by the piece. *For more available options, contact a Pacer expert today. Actuators sold separately.

CHARACTERISTICS: *Base Material: Polyester blend, rated UL 94 V-0 125°C *Dielectric Strength: 1500V RMS *Insulation Resistance: 50 MegOhms
*Rating: 20 AMPS 12V *Terminal: 0.250 QC Tabs *Mounting Method: Snap-in *Mounting Hole Dimensions: 0.83" x 1.45" (21.08 mm x 36.83 mm)

COMPLIANCES: *Passed a range of environmental, corrosion, temperature, vibration, shock and sealing tests including MIL Std 202F, MIL Std 810C, UL 1500, ISO 8846, and more *UL CSA

FEATURES: *Snap-in mounting *Multi-step mounting wings provide a secure fit for panel thicknesses of 0.030" thru 0.250" in a Contura series 0.830" x 1.450" mounting hole *Silver plated butt contact mechanism provides 50 to 100 thousand electrical cycles and a variety of different electrical ratings
*Single or double pole *Removable actuators *Maximum sealing protection with dual seals around lamps and rocker stem certified to IP66 & IP68.
*Optional panel seals for additional protection *Multiple illumination options

The V-Series CONTURA with sealed front panel components are certified to IP66 and IP68, signifying complete protection against dust, prolonged spray and submersion under pressure. Contura switches are recognized at UL1500 - Ignition Protection for Marine Products.



Single



End



Middle



Panel Seals



Actuator Removal Tool

PART NUMBER	DESCRIPTION	PART NUMBER	DESCRIPTION
MOUNTING PANELS		CONTURA SWITCH ACCESSORIES	
ES-CVMS	Single Mounting Panel	ES-VPS	Panel Seals
ES-CVMM	Middle Panel	ES-CVRT	Actuator Removal Tool
ES-CVME	End Panel		
ES-CVHP	Hole Plug		

Ordering Information: Order by the piece.

- WIRE & CABLE
- MULTI-CONDUCTOR
- COAX CABLES
- NETWORK CABLES
- HEAT SHRINK
- ROUTING & BUNDLING MATERIALS
- WIRE MANAGEMENT
- TERMINALS
- DEUTSCH & APTIV (DELPHI)
- LUGS & BOOTS
- ID PRODUCTS & LABELERS
- TOOLS
- BREAKERS & FUSES
- TERMINAL BLOCKS & BUS BARS
- SWITCHES & ACTUATORS
- METERS & BOXES

Switches & Actuators

CONTURA ACTUATORS

- WIRE & CABLE
- MULTI-CONDUCTOR
- COAX CABLES
- NETWORK CABLES
- HEAT SHRINK
- ROUTING & BUNDLING MATERIALS
- WIRE MANAGEMENT
- TERMINALS
- DEUTSCH & APTIV (DELPHI)
- LUGS & BOOTS
- ID PRODUCTS & LABELERS
- TOOLS
- BREAKERS & FUSES
- TERMINAL BLOCKS & BUS BARS
- SWITCHES & ACTUATORS**
- METERS & BOXES



Actual size

Laser-etched switch covers are the highest quality covers available. With laser precision, our switch covers offer a flawless finish you simply cannot match with other methods. The etched switch covers we offer are available in either single or dual-light formats, giving you the freedom to choose the one that suits your application best. We currently offer a wide selection of etched switch covers, with hundreds of options available to choose from.



A Permanent Marking Solution



Fits Series "V" Contura Switches



Resistant to UV Exposure



Easy to Install



Low Light Visibility

Actuator Ordering Information: Build the part numbers following the steps below. Select (A) the Number of Bulbs followed by (B) the symbol and text to be etched into the switch cover.

EV

Body Style

1

of Bulbs
(A)

LE

Laser Etched

-

ACC

Symbol and text Extension
(B)

(A) Body Style

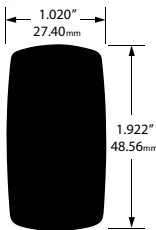

(1) - One Bulb



(2) - Two Bulbs

(B) Symbol and Text (see pages 79 - 81 for more options)



Bilge 1
(BLG1)



Port Vent
(PVNT)



Port Bow Down/Up
(PTRM)



Fresh Water
(FRSH)



Nav/Anc Lights
(NAVANC)



Accessory
(ACC)

Examples of Common Actuators:



EV2LE-BLG1



EV1LE-PVNT



EV2LE-PTRM



EV1LE-FRSH



EV2LE-NAVANC



EV2LE-ACC



INDUSTRY TIP:
Determining the distance between Switches

When determining the proper distance between rocker switches, you can either measure from the center of the cutout to the center of the next cutout or you can measure from inside edge of cutout to inside edge of cutout.

Center to center = 1.030" (26.16mm)
Edge to edge = 0.200" (5.08mm)

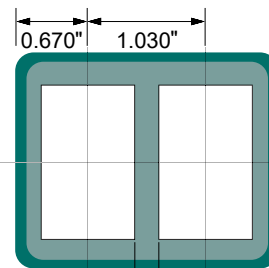

























































1.030" = 26.16mm
0.670" = 17.01mm
0.200" = 5.08mm

0.20" Minimum allowable distance

Switches & Actuators

























































ACTUATOR SYMBOLS

PART NUMBER EXTENSION	ABLG	ACC	ACC1	ACC2	ACCLT	ANC	ARCH	ARTR
ISO PRINT	 AFT BILGE	 ACCY	 ACCY 1	 ACCY 2	 ACC LIGHTS	 ANCHOR	 ARCH	 AERATOR
PART NUMBER EXTENSION	ASPRD	ATPLT	BATT	BDOC	BDLT	BLG	BLG1	BLG2
ISO PRINT	 AFT SPREADER LIGHTS	 AUTOPILOT	 BATTERY PARALLEL	 BRIDGEDECK OPEN/CLOSE	 BRIDGEDECK LIGHTS	 BILGE	 BILGE 1	 BILGE 2
PART NUMBER EXTENSION	BLG3	BLST	BLWR	BTWL	BTWL1	BTWL2	CBN	CHRT
ISO PRINT	 BILGE 3	 FILL BALLAST DRAIN	 BLOWER	 BAITWELL	 BAITWELL 1	 BAITWELL 2	 CABIN	 CHART PLOTTER
PART NUMBER EXTENSION	CKPT	CNSL	CTSY	CWPR	DECK	DMLT	DMMR	DOCK
ISO PRINT	 COCKPIT	 CONSOLE	 COURTESY	 CENTER WIPER	 DECK LIGHTS	 DOME LIGHTS	 DIMMER	 DOCKING LIGHTS
PART NUMBER EXTENSION	DPTH	EHD	ENG	ENGRM	ESTP	ETRM	EXHST	FAN
ISO PRINT	 DEPTH FINDER	 ELECTRIC HEAD	 ENGINE	 ENGINE ROOM	 ENGINE STOP	 ENGINE TRIM	 EXHAUST SYSTEM	 FAN
PART NUMBER EXTENSION	FBLG	FBX	FFBX	FLIR	FRSH	FSPDR	FUEL	FUELG
ISO PRINT	 FWD BILGE	 FISHBOX	 FWD FISHBOX	 FLIR NIGHT CAMERA	 FRESH WATER	 FWD SPREADER LIGHTS	 FUEL	 FUEL GAUGE
PART NUMBER EXTENSION	GLLY	HRN	HTC	HTP	INT	JPT	LT	LVWL
ISO PRINT	 GALLEY	 HORN	 HATCH	 HARDTOP	 INTERIOR	 JACK PLATE	 LIGHT	 LIVWELL

Ordering Information: Order by the piece. See Page 78 for details.

Switches & Actuators

ACTUATOR SYMBOLS

PART NUMBER EXTENSION	LWLLT	LWRC	LZTT	MAC	MAP	MBLG	MCHNRY	MFUELA
ISO PRINT	 LIVWELL LIGHT	 LIVWELL RECIRC	 LAZARETTE	 MACERATOR	 MAP	 MID BILGE	 MACHINERY SPACE	 MAIN FUEL AUX
PART NUMBER EXTENSION	NAV	NAVANC	OC	OH	PBLG	PENG	PFBX	PFBXS
ISO PRINT	 NAVIGATION	 NAV/ANC	 OPEN CLOSE	 OVER HEAD LIGHTS	 PORT BILGE	 PORT ENGINE	 PORT FISHBOX	 PORT FISHBOX STBD
PART NUMBER EXTENSION	PFUELS	PMAC	PNL	PPWR	PSTP	PTRM	PVNT	PWPR
ISO PRINT	 PORT FUEL STBD	 PORT MACERATOR	 PANEL	 PORT ENG POWER	 PORT STOP	 BOW DOWN PORT BOW UP	 PORT VENT	 PORT WIPER
PART NUMBER EXTENSION	PWRSTR	RAW	RCP	RDR	SALT	SBLG	SENG	SFBX
ISO PRINT	 POWER STEERING	 RAW WATER	 RECIRC	 RADAR	 SALT WATER	 STBD BILGE	 STBD ENGINE	 STBD FISHBOX
PART NUMBER EXTENSION	SLN	SMAC	SPDR	SPT	SPWR	SSTP	STR	STRM
ISO PRINT	 SALON LIGHTS	 STBD MACERATOR	 SPREADER LIGHTS	 SPOT	 STBD ENG POWER	 STBD STOP	 STEREO	 BOW DOWN STBD BOW UP
PART NUMBER EXTENSION	STRT	SVNT	SWM	SWPR	TRM	TRNSM	TWR	UFUELL
ISO PRINT	 PARALLEL START	 STBD VENT	 SWIM PLATFORM	 STBD WIPER	 TRIM TABS	 TRANSOM LIGHT	 TOWER	 UPPER FUEL GAUGE LOWER
PART NUMBER EXTENSION	UW	VNT	VHF	WND	WNDPWR	WPR	WSHR	WSHDWN
ISO PRINT	 UNDER WATER LIGHTS	 VENT	 VHF	 DEPLOY WINDLASS RETRIEVE	 WINDLASS POWER	 WIPER	 WINDSHIELD WASHER	 WASHDOWN

Ordering Information: Order by the piece. See Page 78 for details.

Switches & Actuators

BLANK ACTUATORS & WIRE JUMPERS



EC-BLANK



EC1-BLANK



EC2-BLANK

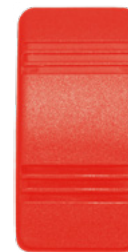

ECRA-BLANK

PART NUMBER	CONTURA SERIES SWITCH COVER	BODY COLOR	NUMBER OF LENSES
EC-BLANK	Series III	Black	0
EC1-BLANK	Series III	Black	1
EC2-BLANK	Series III	Black	2
ECRA-BLANK	Series III	Red	0

Ordering Information: Order by the piece.



EJ-DIODE-PB-PB



EJ10RD4-250-250



EJ14BK6-250-PB

PART NUMBER	AWG NO.	COLOR	LENGTH (IN)	TERMINAL #1	TERMINAL #2
PANEL WIRE JUMPERS					
EJ-DIODE-PB-PB*	N/A	N/A	4	0.250 DISC. w/ MALE TAB	0.250 DISC. w/ MALE TAB
EJ10RD4-10-10-E	10	RED	4	#10 RING TERMINAL	#10 RING TERMINAL
EJ10RD4-250-250	10	RED	4	0.250 FEMALE DISCONNECT	0.250 FEMALE DISCONNECT
EJ10RD4-250-PB	10	RED	4	0.250 FEMALE DISCONNECT	0.250 DISC. w/ MALE TAB
EJ10RD4-8-8-E	10	RED	4	#8 RING TERMINAL	#8 RING TERMINAL
EJ10RD6-250-PB	10	RED	6	0.250 FEMALE DISCONNECT	0.250 DISC. w/ MALE TAB
EJ14BK4-250-PB	14	BLACK	4	0.250 FEMALE DISCONNECT	0.250 DISC. w/ MALE TAB
EJ14BK6-250-PB	14	BLACK	6	0.250 FEMALE DISCONNECT	0.250 DISC. w/ MALE TAB
EJ14BL4-250-PB	14	BLUE	4	0.250 FEMALE DISCONNECT	0.250 DISC. w/ MALE TAB
EJ14BL6-250-PB	14	BLUE	6	0.250 FEMALE DISCONNECT	0.250 DISC. w/ MALE TAB
EJ14OR4-250-PB	14	ORANGE	4	0.250 FEMALE DISCONNECT	0.250 DISC. w/ MALE TAB
EJ14RD4-250-250	14	RED	4	0.250 FEMALE DISCONNECT	0.250 FEMALE DISCONNECT
EJ14RD4-250-8-E	14	RED	4	0.250 FEMALE DISCONNECT	#8 RING TERMINAL
EJ14RD4-250-PB	14	RED	4	0.250 FEMALE DISCONNECT	0.250 DISC. w/ MALE TAB
EJ14YL4-250-PB	14	YELLOW	4	0.250 FEMALE DISCONNECT	0.250 DISC. w/ MALE TAB
EJ14YL6-250-PB	14	YELLOW	6	0.250 FEMALE DISCONNECT	0.250 DISC. w/ MALE TAB

Ordering Information: Order by multiples of 10. *EJ-DIODE-PB-PB, order by the piece.

CHARACTERISTICS:

Conductor: Annealed Finely Stranded Tinned Copper ASTM B172 Class K

Insulation: -20°C to 105°C Flexible, Color Coded PVC

Temperature Rating: 105°C Dry, 75°C Wet 60°C Oil

Voltage Rating: 600V

Resistant to: Acid, Alkali, Abrasion, Flame, Gasoline, Oil and Moisture

COMPLIANCES: *UL stranded 1426 BC-5W2 (16-8 AWG) *AWM 1015/1230 (22-10 AWG) *MTW *CSA: TEW *ABYC: E-11.15 (16-8 AWG)

*Coast Guard: 33 CFR 183.401 Subpart 1-Electrical Systems

FEATURES: *Stranded, tinned copper conductors *Highly flexible color coded insulation

Pre-made wire jumpers save time and money. Pacer wire jumpers are the most common configurations to bus breakers, jumper from breaker to switch or receptacle, connect lights from switch to switch and easily connect switch light grounds.

Switches & Actuators

PANEL BLANKS

WIRE & CABLE
MULTI-CONDUCTOR
COAX CABLES
NETWORK CABLES
HEAT SHRINK
ROUTING & BUNDLING MATERIALS
WIRE MANAGEMENT
TERMINALS
DEUTSCH & APTIV (DELPHI)
LUGS & BOOTS
ID PRODUCTS & LABELERS
TOOLS
BREAKERS & FUSES
TERMINAL BLOCKS & BUS BARS
SWITCHES & ACTUATORS
METERS & BOXES



PSC-31WH

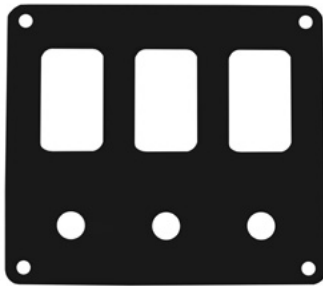

PSBC-31BK

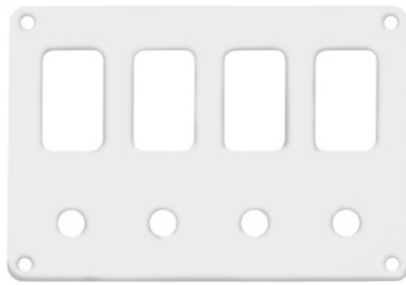

PSBC-41WH

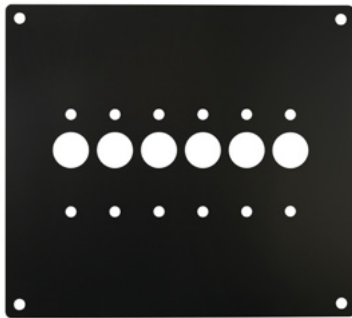

EP-BRK-6

PART NUMBER	POSITIONS	ROWS	WIDTH (IN)	HEIGHT (IN)	AVAILABLE COLORS
-------------	-----------	------	------------	-------------	------------------

CONTURA SWITCH PANEL BLANKS

PSC-11	1	1	1.750	2.750	BK, WH
PSC-21	2	1	3.000	2.750	BK, WH
PSC-22	4	2	3.000	4.750	BK, WH
PSC-31	3	1	4.250	2.750	BK, WH
PSC-41	4	1	5.500	2.750	BK, WH
PSC-61	6	1	8.000	2.750	BK, WH
PSC-81	8	1	10.500	2.750	BK, WH

Ordering Information: Combine part numbers with color.

Example: PSC-11 in Black=PSC-11-BK. Order by the piece.

FEATURES: *Cut from .090 thick 5052 H32 marine grade aluminum alloy *Powder coated on all sides for maximum durability *Powder coat colors are textured black or smooth gloss white

PART NUMBER	POSITIONS	ROWS	WIDTH (IN)	HEIGHT (IN)	AVAILABLE COLORS
-------------	-----------	------	------------	-------------	------------------

CONTURA SWITCH AND BREAKER PANEL BLANKS

PSBC-11	1	1	1.750	4.250	BK, WH
PSBC-21	2	1	3.000	4.250	BK, WH
PSBC-31	3	1	4.250	4.250	BK, WH
PSBC-41	4	1	5.500	4.250	BK, WH
PSBC-61	6	1	8.000	4.250	BK, WH
PSBC-81	8	1	10.500	4.250	BK, WH
PSBC-22	4	2	3.000	7.826	BK, WH
PSBC-32	6	2	4.250	7.826	BK, WH
PSBC-42	8	2	5.500	7.826	BK, WH
PSBC-62	12	2	8.000	7.826	BK, WH
PSBC-82	16	2	10.500	7.826	BK, WH

Ordering Information: Order by the piece.

FEATURES: *Cutouts fit standard Contura switches *See page 77 for selection of switches

*Cutouts for standard 3/8 push to reset breakers. See page 64 for selection of breakers

*Choose from 658 on 45 series *Choose black or clear boots. See page 83.

PART NUMBER	A-FRAME POSITIONS	WIDTH (IN)	HEIGHT (IN)
-------------	-------------------	------------	-------------

A-FRAME BREAKER PANEL BLANKS

EP-BRK-1	1	3.500	3.500
EP-BRK-2	2	3.500	3.500
EP-BRK-3	3	5.375	6.000
EP-BRK-4	4	5.375	6.000
EP-BRK-6	6	5.375	6.000

Ordering Information: Order by the piece.

FEATURES: *Made from durable 3/16 black Lexan *Breaker openings spaced for Breakers Bus Bars

*Cutouts fit standard A-frame breakers. See page 62.

PANEL ACCESSORIES	PAGE #	PANEL ACCESSORIES	PAGE #
Actuators	78 - 81	Busbars	74 - 76
Breakers	62 - 66	Panel Jumpers	81
Breaker Boots	65 & 83	Switches	77, 83-87

Switches & Actuators

METAL BAT TOGGLE SWITCHES



DESCRIPTION KEY	TERMINAL POSITIONS
S.P.S.T. = Single pole, single throw	
S.P.D.T. = Single pole, double throw	
S.P.T.T. = Single pole, triple throw	
D.P.S.T. = Double pole, single throw	
D.P.D.T. = Double pole, double throw	

PART NUMBER	SWITCH FUNCTION	MOMENTARY	DESCRIPTION
-------------	-----------------	-----------	-------------

SINGLE POLE SWITCHES			
ES-B2FA54	ON-OFF	No	S.P.S.T.
ES-B2FB54	ON-ON	No	S.P.D.T.
ES-B2FC54	ON-OFF-ON	No	S.P.D.T. (Center Off)
ES-B2GE54	ON-ON-ON	No	S.P.T.T.
ES-B6FA54	(ON)-OFF	Yes (ON)	S.P.S.T.
ES-B6FA58	ON-(OFF)	Yes (OFF)	S.P.S.T.
ES-B6FB54	ON-(ON)	Yes (ON)	S.P.D.T.
ES-B6FC54	(ON)-OFF-(ON)	Yes (ON)	S.P.D.T. (Center Off)
ES-B6FC58	ON-OFF-(ON)	Yes (ON)	S.P.D.T. (Center Off)

PART NUMBER	SWITCH FUNCTION	MOMENTARY	DESCRIPTION
-------------	-----------------	-----------	-------------

DOUBLE POLE SWITCHES			
ES-B2GK54	ON-OFF	No	D.P.S.T.
ES-B2GL54	ON-ON	No	D.P.D.T.
ES-B2GM54	ON-OFF-ON	No	D.P.D.T. (Center Off)
ES-B6GK5E	(ON)-OFF	Yes (ON)	D.P.S.T.
ES-B6GK5S	ON-(OFF)	Yes (OFF)	D.P.S.T.
ES-B6GL5E	ON-(ON)	Yes (ON)	D.P.D.T.
ES-B6GM5S	(ON)-OFF-(ON)	Yes (ON)	D.P.D.T. (Center Off)
ES-B6GM5E	ON-OFF-(ON)	Yes (ON)	D.P.D.T. (Center Off)
ES-B6GG54	(ON)-ON-OFF	Yes (ON)	PROGRESSIVE

Ordering Information: Order by the piece.

CHARACTERISTICS: *Base Material: Phenolic *Actuator (Bat): Brass/Nickel Plated *Bushing: Brass/Nickel Plated *Screw Terminal: #6-32NC2

*Dielectric Strength: 1000V RMS (Min.) *Insulation Resistance: 100 Megohm *Bushing Length: 0.465" *Panel Mounting Hole: 1/2" diameter

*Rating: 15 AMPS 125V AC / 10 AMPS 250V AC / 3/4" HP 125-250V AC

COMPLIANCES: *UL *CSA

FEATURES: *Durable brass/nickel plated metal bat toggle switch *Nickel plated hardware *Screw Terminal connection

*Single and double pole *Mounting Hole .50"

PART NUMBER	HEIGHT (IN)	THREAD (IN)	COLOR
-------------	-------------	-------------	-------

SILICONE RUBBER BOOTS			
ES-BOOT	15/16	15/32 - 32 UNS-2B	Black
ES-BOOT-W	15/16	15/32 - 32 UNS-2B	White

Ordering Information: Order by the piece.

See page 91 for typical uses of switches on boats.

These one piece bonded silicone rubber boots are resistant to salt, water, acids, weather, dust, sunlight and ozone. They are designed for use on metal bat toggle switches.



WIRE & CABLE

MULTI-CONDUCTOR

COAX CABLES

NETWORK CABLES

HEAT SHRINK

ROUTING & BUNDLING MATERIALS

WIRE MANAGEMENT

TERMINALS

DEUTSCH & APTIV (DELPHI)

LUGS & BOOTS

ID PRODUCTS & LABELERS

TOOLS

BREAKERS & FUSES

TERMINAL BLOCKS & BUS BARS

SWITCHES & ACTUATORS

METERS & BOXES

M-SERIES & E-SERIES BATTERY SWITCHES

300 AMPS continuous, 500 AMPS (5 min.) intermittent rating, Crank rating (30 sec.) 900 AMPS.

EBS-6005

EBS-6006

EBS-6007

M-SERIES MINI BATTERY SWITCHES



Single Circuit ON-OFF

Switches a single battery to a single load group (48V DC Max). Comes with removable key.



Single Circuit ON-OFF

Switches a single battery to a single load group (48V DC Max).



Selector 4-Position

Switches isolated battery banks to all loads or combines battery banks to all loads (36V DC Max).

300 AMPS per circuit continuous, 450 AMPS per circuit (5 min.) intermittent rating, Crank rating (30 sec.) 675 AMPS per circuit

EBS-6010

EBS-6011

M-SERIES MINI DUAL CIRCUIT BATTERY SWITCHES



Dual Circuit ON-OFF

Simultaneously switches two isolated battery banks (32V DC Max).



Dual Circuit Plus ON-OFF

Simultaneously switches two isolated battery banks or combines battery banks to all loads (32V DC Max).

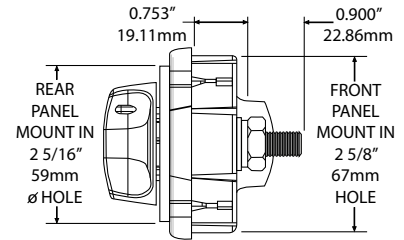

M-SERIES COMPLIANCES: *UL 1500 *CE *IP 66 *ISO 8846 *SAE J1171 *ABYC E-11

M-SERIES FEATURES: *300 Amps continuous rating for outboards and small gasoline or diesel engines *Ignition protected *Tin-plated copper studs for maximum conductivity and corrosion resistance *Studs accept 3/8" (M10) ring terminals *7/8" (22 mm) stud length accepts multiple cable terminals *Mounting Holes: #10 screw *Blue Sea Systems one-piece terminal stud design never loosens over time *Case design allows surface, rear, or front panel mounting options *Selector type battery switches with "make before break" contact design allow switching between battery banks without power interruption

350 AMPS continuous, 600 AMPS (5 min.) intermittent rating, Crank rating (30 sec.) 1200 AMPS

EBS-9001E

EBS-9002E

EBS-9003E

E-SERIES BATTERY SWITCHES



Selector 4-Position

Switches isolated battery banks to all loads or combines battery banks to all loads (32V DC Max).



Selector 4-Position with AFD

Switches isolated battery banks to all loads or combines battery banks to all loads (32V DC Max). Includes Alternator Field Disconnect.



Single Circuit ON-OFF

Switches a single battery to a single load group (48V DC Max).

E-SERIES FEATURES: *350 Amps continuous rating for outboards, small gasoline or diesel engines *Studs accepts 3/8" (M10) ring terminals *Ignition protected *Tin-plated copper studs for maximum conductivity & corrosion resistance *7/8" (22 mm) stud length accepts multiple cable terminals *Blue Sea Systems one-piece terminal stud design never loosens over time *Fits most Perko and Guest low amperage battery switch hole patterns *Case design allows surface, rear, or front panel mounting options *Tactile indicator conveys knob position by feel *Selector type battery switches with a "make before break" contact design allows switching between battery banks without power interruption

Switches & Actuators

E-SERIES & HD-SERIES BATTERY SWITCHES

350 AMPs continuous, 525 AMPs (5 min.) intermittent rating, Crank rating (30 sec.) 700 AMPs per circuit.
EBS-5511E

E-SERIES DUAL CIRCUIT PLUS BATTERY SWITCH

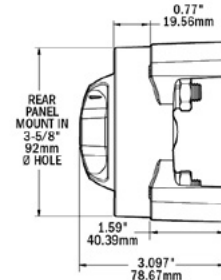
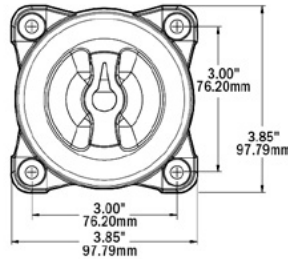

Dual Circuit Plus ON-OFF

Simultaneously switches two isolated battery banks or combines battery banks to all loads (32V DC Max).

E-SERIES COMPLIANCES: *UL 1500, UL 1107 *CE *IP 66 *ISO 8846 Marine *SAE J1171 Marine

EBS-3000

EBS-3002

HD-SERIES BATTERY SWITCHES

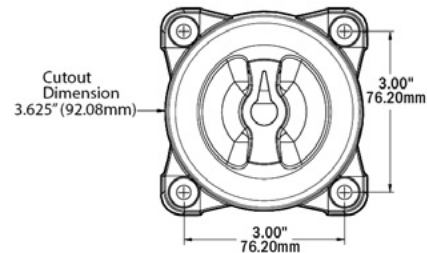

Single Circuit - ON-OFF

Selector 4 Position

Switches a single battery to a single load group (32V DC Max).

Switches isolated battery banks to all loads or combines battery banks to all loads (32V Max).

600 AMPs continuous rating
 900 Amps (5 min) intermittent rating
 Crank rating (30 sec.) 1750 AMPs

500 AMPs continuous rating
 700 Amps (5 min) intermittent rating
 Crank rating (30 sec.) 1600 AMPs

Ordering Information: Order by the piece.

HD-SERIES COMPLIANCES: *UL 1107, UL 1500 *CE *IP 66 *ISO 8846 Marine *SAE J1171 Marine *ABYC E-11

HD-SERIES FEATURES: *Up to 600 Amps continuous rating for large diesel engines. *Accepts up to 4/0 AWG battery cables

*Tin-plated copper studs for maximum conductivity and corrosion resistance *Studs accepts 1/2" (M12) ring terminals

*7/8" (22 mm) stud length accepts multiple cable terminals *Blue Sea Systems one-piece terminal stud design never loosens over time

*Fits most Perko and Guest low amperage battery switch hole patterns *Case design allows surface, rear, or front panel mounting options

WIRE & CABLE

MULTI-CONDUCTOR

COAX CABLES

NETWORK CABLES

HEAT SHRINK

ROUTING & BUNDLING MATERIALS

WIRE MANAGEMENT

TERMINALS

DEUTSCH & APTIV (DELPHI)

LUGS & BOOTS

ID PRODUCTS & LABELERS

TOOLS

BREAKERS & FUSES

TERMINAL BLOCKS & BUS BARS

SWITCHES & ACTUATORS

METERS & BOXES

Switches & Actuators

GUEST BATTERY SWITCHES & CHARGING RELAY

EBS-2111 EBS-2112 EBS-2300A EBS-2303A / EBS-2304A
GUEST UNIVERSAL MOUNT BATTERY SWITCHES



Universal Selector	Universal ON-OFF	Heavy-Duty Selector	Heavy-Duty On-Off with AFD (Alternator Field Disconnect)
Switches battery bank 1 or bank 2 or BOTH to a single load using one switch (32V Max)	Switches a single battery to a single load group (32V Max)	Switches battery bank 1 or bank 2 or BOTH to a single load using one switch (36V Max)	Switches a single battery to a single load group (32V Max)
Continuous AMPS: 230 Momentary AMPS: 345 Cable Lug Size: 3/8" Dimensions: 5.0" x 2.75"	Continuous AMPS: 230 Momentary AMPS: 345 Cable Lug Size: 3/8" Dimensions: 5.0" x 2.75"	Continuous AMPS: 360 Momentary AMPS: 600 Cable Lug Size: 5/8" Dimensions: 5.5" x 3.5"	EBS-2303A Heavy -Duty On/Off Switch Continuous AMPS: 450 Momentary AMPS: 800 EBS-2304A Extra-Duty On/Off Switch Continuous AMPS: 600 Momentary AMPS: 1000 (5 M)

Ordering Information: Order by the piece.

FEATURES: *New ergonomically styled turn knob provides easy On/Off switching *Longer stud lengths for improved assembly and easier cable routing
 *Positive click-stop on all positions *Built with heavy-duty copper sweep contacts to ensure positive circuit control **"Make before break" contacts allow selection of all positions except "Off" while engine is running. *Conforms to USCG safety standard 183.410 for ignition protection.

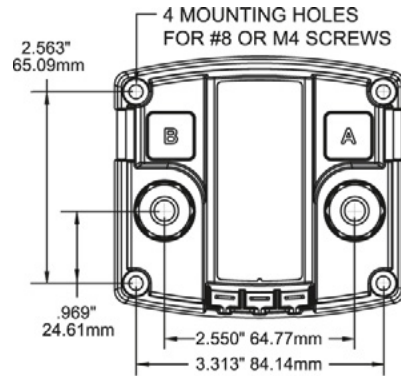

PART NUMBER: EACR-7610

SPECIFICATIONS	12 VOLTS DC		24 VOLTS DC		RELAY CONTACT POSITION	12V DC	24V DC
	12 VOLTS DC	24 VOLTS DC	12V DC	24V DC	12V DC	24V DC	
SI ACR AUTO CHARGING RELAY 12/24V DC 120A							
Intermittent Rating	210 Amps (5 Min.)	210 Amps (5 Min.)	Combine (30 Sec)	13.6V DC	13.6V DC	27.2V DC	
Continuous Rating	120 Amps DC	120 Amps DC	Combine (90 Sec)	13.6V DC	13.6V DC	26.0V DC	
(Combine) Amperage Oper. Current	175 mA	115 mA	Open (10 Sec)	12.35V DC	12.35V DC	24.7V DC	
(Open) Amperage Oper. Current	15 mA	15 mA	Open (30 sec)	12.75V DC	12.75V DC	25.5V DC	
Maximum Cable Size	1/0 AWG	1/0 AWG	Open High 16.0 Volt	16.0V DC	16.0V DC	30.0V DC	
Terminal Stud Size	3/8" - 16 (M10)	3/8" - 16 (M10)	Open Voltage Lockout	16.0V DC	16.0V DC	32.0V DC	
Maximum Torque	140 in-lb	140 in-lb	Under Voltage Lockout	9.5V DC	9.5V DC	19.0V DC	

Ordering Information: Order by the piece.

FEATURES: *Protects sensitive electronics by temporary isolation of house loads from engine circuit during engine cranking *Dual sensing
 *Designed for 12 or 24 volt systems *12/24 volt auto ranging voltage input *Hermetically sealed contacts/vapor-proof *IP67 — protected against immersion up to 1 meter (3.28ft) for 30 minutes *Ignition protected—safe for installation aboard gasoline powered boats
 *Remote LED output indicates relay state away from ACR *Supports high-output alternators up to 120 Amperes *Meets: UL 1500, CE, IP67, ISO 8846, SAE

Automatically handles the charging of two battery banks & isolates batteries during starting to protect sensitive electronics.

Switches & Actuators

SOLENOID & POWER TRANSFER SWITCHES

PART NUMBER: ESOL-9012

L-SERIES SOLENOID SWITCH with COIL ECONOMIZER 12/24V DC 250 AMPS

COIL CIRCUIT

Input Voltage	9 - 36V DC Maximum
Power Consumption	12 - 24V / 3.60A
- inrush max, 130ms	12V / 0.13A
- holding	24V / 0.07A

MAIN POWER CONTACTS

Inrush Rating: 0.25 sec (10 repeats)*	2,000A
Contact Voltage	800V DC
Stud Terminal Size	5/16" (m8)

*Blue Sea Systems Engine Starting Standard

Ordering Information: Order by the piece.

FEATURES: *Hermetically sealed contacts / vapor-proof *Ignition protected - safe for installation aboard gasoline powered boats *Coil control circuit minimizes heating & amperage draw *450 Amp Class *Activated by a low amperage ON-OFF switch mounted anywhere *Designed for 12 or 24 volt systems

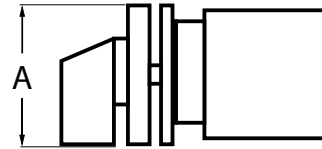

Power Transfer switch

PART NUMBER	# OF POLES	GEN. PURPOSE (UL) RATED AMPS	THERMAL CURRENT AMPS	(A) DIMENSIONS (In ²)
-------------	------------	------------------------------	----------------------	-----------------------------------

“SHIP SHORE” POWER TRANSFER SWITCHES

EPTS-2P-20A-S0	2	20	20	1.89
EPTS-2P-25A-S0	2	25	25	1.89
EPTS-3P-15A-S0	3	15	20	1.89
EPTS-3P-25A-S0	3	25	25	1.89
EPTS-2P-35A-S1	2	35	32	2.52
EPTS-3P-35A-S1	3	35	32	2.52
EPTS-4P-35A-S1	4	35	32	2.52
EPTS-2P-50A-S1	2	50	50	2.52
EPTS-3P-50A-S1	3	50	50	2.52
EPTS-4P-50A-S1	4	50	50	2.52
EPTS-2P-65A-S1	2	65	63	2.52
EPTS-3P-65A-S1	3	65	63	2.52
EPTS-3P-100A-S2	3	100	115	3.46
EPTS-3P-150A-S2	3	150	150	3.46

MULTI-STEP “SHORE 1, SHORE 1 & 2, GEN”

EPTS-MS-65A		65	63	2.52
-------------	--	----	----	------

Alternative escutcheon plates available upon request.

COVER PLATE FOR MULTI-STEP

EPTS-F262	Shore 1, Shore 1 & 2, Gen
-----------	---------------------------

Ordering Information: Order by the piece.

COMPLIANCES: *CSA *CUL *CULUS *GOST *UL

“Ship Shore” Power transfer switches are double throw, multiple pole, and have “SHORE-OFF-GEN” 60° switching.

WIRE & CABLE

MULTI-CONDUCTOR

COAX CABLES

NETWORK CABLES

HEAT SHRINK

ROUTING & BUNDLING MATERIALS

WIRE MANAGEMENT

TERMINALS

DEUTSCH & APTIV (DELPHI)

LUGS & BOOTS

ID PRODUCTS & LABELERS

TOOLS

BREAKERS & FUSES

TERMINAL BLOCKS & BUS BARS

SWITCHES & ACTUATORS

METERS & BOXES

Switches & Actuators

BATTERY CHARGERS

- WIRE & CABLE
- MULTI-CONDUCTOR
- COAX CABLES
- NETWORK CABLES
- HEAT SHRINK
- ROUTING & BUNDLING MATERIALS
- WIRE MANAGEMENT
- TERMINALS
- DEUTSCH & APTIV (DELPHI)
- LUGS & BOOTS
- ID PRODUCTS & LABELERS
- TOOLS
- BREAKERS & FUSES
- TERMINAL BLOCKS & BUS BARS
- SWITCHES & ACTUATORS
- METERS & BOXES



EBC-2713A	EBC-2720A
<ul style="list-style-type: none"> Total Amps: 15 AMPS 12V 15 amp 3 bank on-board battery charger Over-current and over-voltage protection Over-temperature and ignition protection In-line fuses for maximum DC wire protection 100% Waterproof (IP67) Shock resistant for all fresh and saltwater applications Dedicated battery charging, sensing and control per bank For all 12 volt flooded and AGM lead acid batteries Short Circuit Protected Reverse Polarity Protected Dimensions: 7.5" x 2.4" x 12.9" 	<ul style="list-style-type: none"> Total Amps: 20 Number of Outputs: 2 Amps per output: 10/10 Battery System: 2-12V or 1-24V Output Voltage: 12V DC per output Input Voltage: 90-135V AC 50/60Hz Dimensions: 12.9" x 7.5" x 2.4"

Ordering Information: Order by the piece.

FEATURES: *Designed for harsh marine and industrial environments - moisture, salt, and vibration tested *Thermal protection *LED status indicator
 *Reverse polarity protected *Ignition Protection



EBC-7531
<ul style="list-style-type: none"> Maximum Output Current: 25 AMPS Maximum Output Voltage: 16V DC Nominal Voltage: 12V DC Number of Outputs: 1 Negative / 3 Positive Minimum Input Voltage: 115V AC Maximum Input Voltage: 230V AC Minimum Operating Temperature: -20°C Maximum Operating Temperature: 70°C Dimensions: 11.18" H x 7.80" W x 4.30" D

Ordering Information: Order by the piece.

COMPLIANCES: *UL 1236 *CSA *CE *SAE J1171

FEATURES: *Reliability *Electrical Performance *Advanced Multi Stage Charging *Built In Safety Features *Durable Aluminum Case

Rugged, finned aluminum case, universal A/C input voltage 115-230V, 45/65 Hz. PreFloat stage prevents over charging. The three outputs provide charging for up to three battery banks. User selectable charge profiles for lead acid, gel, AGM or new TPPL (Thin Plate Pure Lead), supports Lithium and other battery types with user adjustable charge profiles. ACR Charge Coordination controls ACR state ensuring proper float stage for each battery. Ignition protected, over and under temperature protection for batteries, overheating protection, DC over voltage protection, DC reverse polarity protection, surge and short circuit protection.

Meters & Boxes

DC ANALOG AMPMETERS & VOLTMETERS



**MICRO AMMETER
(SHUNT INCL.)**



DC SHUNTS

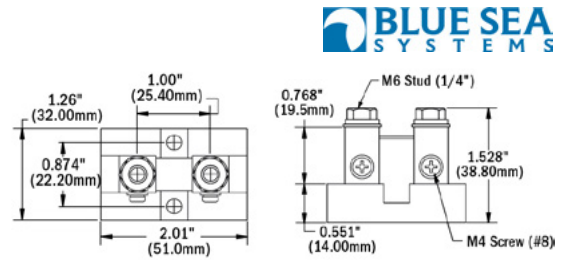

DC Resistive Shunts

PART NUMBER	AMPS	DESCRIPTION
DC ANALOG AMPMETERS		
EMM-DCA-50BS	0 to 50 AMPS	Simple 2-wire connection from shunt (Included). Meter senses and powers from shunt connection. Face dimension: 2"
EM-DCA-50BS	0 to 50 AMPS	Simple 4-wire connection from shunt (Included). Meter senses and powers from shunt connection. Face dimension: 2.75"
EM-DCA-100BS	0 to 100 AMPS	Simple 4-wire connection from shunt (Included). Meter senses and powers from shunt connection. Face dimension: 2.75"
EM-DCA-150BS	0 to 150 AMPS	Simple 4-wire connection from shunt (Included). Meter senses and powers from shunt connection. Face dimension: 2.75"
EM-9228	50 AMPS/50 MV	For continuous operation, it is recommended that shunts not be run at more than two-thirds (66%) the rated current under normal conditions.
EM-9230	100 AMPS/50 MV	For continuous operation, it is recommended that shunts not be run at more than two-thirds (66%) the rated current under normal conditions.

Ordering Information: Order by the meter.

FEATURES: *Micro and standard size meters with back lighting for low light conditions *Meters include shunts

*Surface or Panel mounted *Easy to read characters

Blue Seas analog amp or volt meters can be panel or surface mounted. They feature a simple wire connection and sense power from the same connection.



DC MICRO VOLTMETER



DC ANALOG VOLTMETER



AC VOLTMETER

PART NUMBER	VOLTS	DESCRIPTION
ANALOG DC & AC VOLT METERS		
EMM-DCV-8-16BS	8 to 16V	Meter Current: 1 mA at full scale. Face dimension: 2"
EM-DCV-8-16BS	8 to 16V	Meter Current: 1 mA at full scale. Face dimension: 2.75"
EM-ACV-150BS	0 to 150V	Dial marked in 5 volt increments. 2-wire connections to AC hot and neutral. Meter senses and powers from same connection. Face dimension: 2.75"

Ordering Information: Order by the meter.

- WIRE & CABLE
- MULTI-CONDUCTOR
- COAX CABLES
- NETWORK CABLES
- HEAT SHRINK
- ROUTING & BUNDLING MATERIALS
- WIRE MANAGEMENT
- TERMINALS
- DEUTSCH & APTIV (DELPHI)
- LUGS & BOOTS
- ID PRODUCTS & LABELERS
- TOOLS
- BREAKERS & FUSES
- TERMINAL BLOCKS & BUS BARS
- SWITCHES & ACTUATORS

- WIRE & CABLE
- MULTI-CONDUCTOR
- COAX CABLES
- NETWORK CABLES
- HEAT SHRINK
- ROUTING & BUNDLING MATERIALS
- WIRE MANAGEMENT
- TERMINALS
- DEUTSCH & APTIV (DELPHI)
- LUGS & BOOTS
- ID PRODUCTS & LABELERS
- TOOLS
- BREAKERS & FUSES
- TERMINAL BLOCKS & BUS BARS
- SWITCHES & ACTUATORS
- METERS & BOXES**



AC MICRO AMMETER



AC AMMETER

PART NUMBER	DESCRIPTION
-------------	-------------

ANALOG AC AMP METERS & TRANSFORMER COILS	
EMM-ACA-50BS	0 to 50 AMPS. Face dimension: 2"
EM-ACA-50BS	0 to 50 AMPS. Simple 4-wire connection. Face dimension: 2.75"
EM-ACA-100BS	0 to 100 AMPS. Simple 4-wire connection. Face dimension: 2.75"

Ordering Information: Order by the meter.



TRANSFORMER COIL

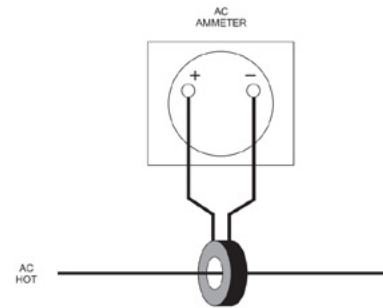

PART NUMBER	DESCRIPTION
-------------	-------------

TRANSFORMER COILS	
EM-8073	Ratio: 50 AC/50 mA AC. For use with AC Ammeters
EM-8257	Ratio: 100 AC/50 mA AC. For use with AC Ammeters
EM-8256	Ratio: 150 AC/50 mA AC. For use with AC Ammeters

Ordering Information: Order by the meter.



DC DIGITAL METERS



AC DIGITAL METERS

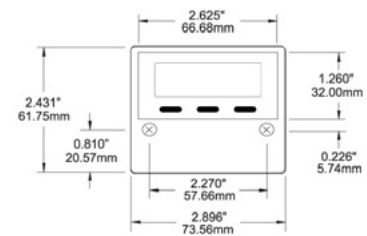

PART NUMBER	DESCRIPTION
-------------	-------------

DIGITAL DC & AC METERS	
EMD-DCMM	Multi-Function Meter with Alarm. Displays amperage from -500 to +500 Amps. Displays voltage from 0 to 60 Volts in 0.01 Volt increments. Includes 500 Amp shunt
EMD-DCV-0-60BS	DC Digital Voltmeter. Displays voltage from 0 to 60 Volts
EMD-ACMM	Multi-Function Meter with Alarm. Displays amperage from 0 to 150. Displays voltage from 80 to 270. Displays power from 0 to 35 Kilowatts. Displays freq. from 40 to 90 Hertz.
EMD-ACV-80-249BS	AC Digital Voltmeter. Displays voltage from 80 to 270

Ordering Information: Order by the meter.

FEATURES: *Micro and standard size meters with backlighting for low light conditions *Meters include shunts *Surface or panel mounted
 *Easy to read characters *They feature a simple wire connection *Sense power from the same connection

Meters & Boxes

JUNCTION BOXES & ENCLOSURES



ENCL606W



ENCL1008HWPL1



ENCL1210W

BOX PART NUMBER	OUTSIDE DIMENSION (IN)			INSIDE DIMENSION (IN)			COVER STYLE	MOUNTING PLATE PART NUMBER (IN)
	HEIGHT	WIDTH	DEPTH	HEIGHT	WIDTH	DEPTH		
JUNCTION BOXES with KNOCKOUTS								
ENCL533	5.03	3.06	3.02	4.69	2.72	2.72	SOLID	EMP533
ENCL533C	5.03	3.06	3.02	4.69	2.72	2.72	CLEAR	4.21 X 2.25
ENCL553	5.03	5.03	3.02	4.69	4.69	2.72	SOLID	EMP553
ENCL553C	5.03	5.03	3.02	4.69	4.69	2.72	CLEAR	4.21 X 4.21
ENCL753	7.00	5.03	2.97	6.65	4.69	2.72	SOLID	EMP753 6.18 x 4.22

Ordering Information: Order by the piece.

BOX PART NUMBER	OUTSIDE DIMENSION (IN)			INSIDE DIMENSION (IN)			COVER STYLE	MOUNTING PLATE PART NUMBER (IN)
	HEIGHT	WIDTH	DEPTH	HEIGHT	WIDTH	DEPTH		
ENCLOSURES								
ENCL606W	7.31	7.31	4.92	6.00	6.00	4.64	SCREW	EMP606A
ENCL606HW	7.31	7.31	4.92	6.00	6.00	4.64	HINGE & SCREW	4.88 x 4.88
ENCL606HWPL1	7.31	7.31	4.92	6.00	6.00	4.64	HINGE & LATCH	
ENCL806W	9.31	7.31	4.92	8.00	6.00	4.64	SCREW	EMP806A
ENCL806HW	9.31	7.31	4.92	8.00	6.00	4.64	HINGE & SCREW	6.75 x 4.88
ENCL806HWPL1	9.31	7.31	4.92	8.00	6.00	4.64	HINGE & LATCH	
ENCL1008W	11.31	9.31	5.43	10.00	8.00	5.15	SCREW	EMP1008A
ENCL1008HW	11.31	9.31	5.43	10.00	8.00	5.15	HINGE & SCREW	8.75 x 6.88
ENCL1008HWPL1	11.31	9.31	5.43	10.00	8.00	5.15	HINGE & LATCH	
ENCL1210W	13.31	11.31	5.50	12.00	10.00	5.27	SCREW	EMP1210A
ENCL1210HW	13.31	11.31	5.50	12.00	10.00	5.27	HINGE & SCREW	10.75 x 8.88
ENCL1210HWPL2	13.31	11.31	5.50	12.00	10.00	5.27	HINGE & LATCH	
ENCL1412W	15.31	13.31	6.60	14.00	12.00	6.27	SCREW	EMP1412A
ENCL1412HW	15.31	13.31	6.60	14.00	12.00	6.27	HINGE & SCREW	12.75 x 10.88
ENCL1412HWPL2	15.31	13.31	6.60	14.00	12.00	6.27	HINGE & LATCH	
ENCL1614W	17.31	15.31	6.67	16.00	14.00	6.41	SCREW	EMP1614A
ENCL1614HW	17.31	15.31	6.67	16.00	14.00	6.41	HINGE & SCREW	14.75 x 12.88
ENCL1614HWPL2	17.31	15.31	6.67	16.00	14.00	6.41	HINGE & LATCH	
ENCL1816W	19.31	17.31	9.58	18.00	16.00	9.33	SCREW	EMP1816A
ENCL1816HW	19.31	17.31	9.58	18.00	16.00	9.33	HINGE & SCREW	16.75 x 14.88
ENCL1816HWPL2	19.31	17.31	9.58	18.00	16.00	9.33	HINGE & LATCH	

Ordering Information: Order by the piece.

- FEATURES:** *Designed in accordance with the Joint Industrial Council (JIC)-USA *All mounting hardware for enclosures are stainless steel
- *Continuous gaskets made of polyurethane foam guarantee optimal integrity *Cover screw holes in corners are outside of gasket area
 - *The enclosure can be readily worked with conventional tools *Junction boxes are sold with solid or clear covers
 - *Withstands continuous temperatures up to 150°C *Enclosures have three configurations: Screw fastened, Hinged & screw fastened Hinged & padlock latch
 - *Aluminum mounting plates sold separately *Junction boxes are made from a polyester, polycarbonate blend and have captive, non-metallic corner screws
 - *All mounting plates are made of aluminium.

- WIRE & CABLE
- MULTI-CONDUCTOR
- COAX CABLES
- NETWORK CABLES
- HEAT SHRINK
- ROUTING & BUNDLING MATERIALS
- WIRE MANAGEMENT
- TERMINALS
- DEUTSCH & APTIV (DELPHI)
- LUGS & BOOTS
- ID PRODUCTS & LABELERS
- TOOLS
- BREAKERS & FUSES
- TERMINAL BLOCKS & BUS BARS
- SWITCHES & ACTUATORS

METERS & BOXES

A			
Actuators.....	78-81	Connectors, RJ45.....	22
Adhesive, Cable Tie Mounts.....	31	Contura, Actuators.....	78-81
Adhesive, Tape.....	34	Contura Switches.....	77
Adhesive, Terminals.....	36-37	Covers, Breaker.....	65
Adhesive, Tubing.....	24-25	Crimp Tools.....	55, 57, 55
AGC Fuse Blocks.....	67	Coils, Current.....	87
AGC Fuse Holders.....	67	Cutters, Wire & Cable.....	56
AGC Fuses.....	67		
ANL Fuses & Blocks.....	70	D	
ATC Fuse Blocks.....	68	Delphi (Aptiv) Connectors.....	46
ATC Fuse Holders.....	68	Deutsch Connectors.....	42-45
Automatic Charge Relay (ACR).....	86	DeviceNet™ Cables.....	23
Automotive Battery Cable.....	11	Disconnect Terminals.....	36,40
		Dual Lock (3M).....	34
		Duct, Wiring.....	28
B			
Battery Terminal, Boots.....	51		
Battery Cable Assemblies.....	12-13	E	
Battery Cable (SAE).....	11	Electrical Tape.....	34
BatteryCable(UL).....	10	Enclosures.....	91
Battery Chargers.....	88	Ethernet Connectors (RJ45).....	22
Battery Post Terminals.....	50	European Terminal Blocks.....	72
Battery Switches.....	84-86	Expandable Sleeving.....	27
Blocks, European.....	72		
Blocks, Fuse AGC.....	67	F	
Blocks, Fuse ANL.....	70	Ferrules, Wire.....	41
Blocks, Fuse ATC.....	68	Fiberglass Enclosures.....	91
Blocks, Terminal.....	72	Flat Braid Cable.....	18
Boat Cable, Flat.....	6-7	Flexible Sleeving.....	27
Boat Cable, Round.....	7	Fork Terminals.....	37,39
Books, Marker.....	53	Fuses, AGC.....	67
Boots, Battery.....	51	Fuses, ANL.....	70
Boots, Breaker.....	65	Fuses, ATO/ATC.....	68
Boots, Thermal Breaker.....	65	Fuses, Class "T".....	71
Boots, Switch.....	65	Fuses, Maxi.....	69
Boxes, Junction.....	91		
Breaker Adapter Plates.....	62	H	
Breaker Covers.....	65	Heat Shrink Terminals.....	36-37
Breaker "Lock-Out" Slides.....	63	Heat Shrink Tubing.....	24-25
Breaker Toggle Guard.....	62	Heat Tools, Butane.....	60-61
Breakers, Magnetic.....	62-63	Heat Tools, Electric.....	61
Breakers, Marine Rated Circuit.....	65-66		
Breakers, Push-to-Reset.....	66	I	
Breakers, Surface Mount.....	66	Identification Products.....	53
Breakers, Thermal.....	64	In-Line Fuse Holders, AGC.....	67
Bullet Connectors.....	36,40	In-Line Fuse Holders, ATO/ATC.....	68
Bus Bars.....	74-76	Insulation Spray.....	35
Bushings, Snap.....	32		
Butt Splices.....	48	J	
Butt Splices, Heat Shrink.....	36	Joints, Wire.....	41
Butt Splices, Terminals.....	38	Jumpers, Terminal Block.....	72
		Jumpers, Panel Switch Wire.....	81
		Junction Boxes.....	91
C			
Cushion Clamps, Stainless Steel.....	29		
Cable Clams.....	33	L	
Cable Tie Mounts.....	31	Lighted Switches.....	77
Cable Tie Tools.....	58	Liquid Tight Connectors.....	33
Cable Ties.....	30,32	LMR Cables.....	19
Cable Ties, Stainless Steel.....	32	Locking Nuts.....	33
Cable, Battery (SAE).....	11	Lugs, Battery.....	47,49
Cable, Battery (UL).....	10	Lugs, Brazed Seam.....	49
Cable, Multi-conductor.....	16-17	Lugs, Closed End.....	47
Cards, Marker.....	53		
CAT5E, Cable.....	22	M	
Clamps, Nylon.....	29	Marine Rated Circuit Breakers.....	65-66
Coaxial Cable.....	19	Markers, Wire.....	53
Compression Seal Connectors.....	21	Marking Pens.....	53
Conduit, Slit.....	26	Maxi Fuses.....	69
Connectors, Coaxial.....	20	Meters.....	59,89-90
Connectors, Liquid Tight.....	33	Mounts, Cable Tie.....	31
Connectors, Feed Through.....	73	Multi-conductor, Pairs.....	18
Connectors, Pin.....	41	Multi-conductor, Shielded.....	16
		Multi-conductor, Unshielded.....	17
		N	
		Network Cables.....	23
		NMEA 2000®.....	23
		P	
		Paired Cables.....	18
		Pens, Marking.....	53
		Pin Terminals.....	41
		Power Posts.....	73-74
		Power Transfer Switches.....	87
		Primary Wire.....	9
		R	
		Ratchet Crimpers.....	55
		Ratchet Cutters.....	56
		Relay, Automatic Charge.....	86
		Ring Terminals.....	37-38
		RJ45 Connectors.....	22
		Rocker Switches.....	77
		Rolls, Marker.....	53
		S	
		SAE Cable.....	11
		SAE Wire.....	13
		Screened Actuators.....	78-81
		Selector Switches, Battery.....	84-86
		Ship-to-Shore Switches.....	87
		Shunts, DC.....	89
		Slit Conduit.....	26
		Solenoid Switches.....	87
		Speaker Wire.....	15
		Spiral Wrap.....	26
		Storage Solutions.....	52
		Switches.....	77,83-87
		Swivel-Blade Stripper.....	56
		T	
		Tape, Electrical.....	34
		Terminal Kits.....	35
		Terminals.....	36-41
		Terminals, Battery.....	47,49-50
		Terminals, Heat Shrink.....	36-37
		Terminal Blocks.....	72
		Toggle Guard, Breaker.....	62,63,65
		Toggle Switches.....	83
		Tools.....	55-61
		Tools, Stripper.....	55-56
		Torches.....	60-61
		Tubing, Adhesive.....	24-25
		Tubing, Heavy Wall.....	24
		U	
		Ultratorch, Master.....	60,61
		Unshielded Cables.....	17
		W	
		Wire, Multiconductor.....	16-17
		Wire, Primary (SAE).....	14
		Wire, Primary (UL).....	9
		Wire, Zip Cord.....	15
		Wiring Duct.....	28
		Wrappable Tube.....	27
		Write-On Markers.....	53

AMERICAN BOAT and YACHT COUNCIL STANDARDS

COLOR	PACER COLOR CODE	PACER STRIPE CODE	ITEM	USE
Black	BK	0	Ground	Negative / Neutral Main Return
Brown	BR	-1	Alternator Charge Light, Generator Armature, Pumps	Generator Terminal, Alternator Auxilliary Terminal to Regulator, Generator Armature to Regulator, Circuit Breaker or Switch to Pumps
Red	RD	-2	Instrument Feed, Power Feeds	Distribution Panel to Electrical Instruments Positive Main Power (particulary un-fused)
Orange	OR	-3	Accessory Feed, Common Feed	Ammeter to Alternator or Generator, Distribution Panel to Accessory Switch, Accessory Circuit Breakers or Switches
Yellow	YL	-4	Generator Field, Ground	Generator to Regulator Field Terminal, Negative / Neutral Main Return
Green	GN	-5	Bonding System	Grounding Wires (if insulated)
Lt. Green	LG	-15		
Blue	BL	-6	Cabin & Instrument Lights	Fuse or Switch to Lights
Lt. Blue	LB	-16	Oil Pressure	Oil Pressure to Sender to Gauge
Violet	VI	-7	Ignition, Instrument Feed	Ignition Switch to Coil & Electrical Instrument Distribution Panel Electrical Instruments
Grey	GY	-8	Navigation Lights, Tachometer	Circuit Breaker or Switch to Lights, Tachometer, Sender to Gauge
White	WH	-9		
Tan	TN	-11	Water Temperature	Water Temperature, Sender to Gauge
Pink	PK	-12	Fuel Gauge	Fuel Gauge, Sender to Gauge

CONDUCTOR CIRCULAR MIL (CM) AREA BY WIRE GAUGE

AWG	Square mm	ISO MH ^c	ABYC UL CM Area E-11.15 Tbl XII	SAE Wire CM Area J1127, J1128
18	0.8	0.75	1,620	1,537
16	1.0	1.50	2,583	2,336
14	2.0	2.50	4,110	3,702
12	3.0	4.00	6,530	5,833
10	5.0	6.00	10,380	9,343
8	8.0	10.0	16,510	14,810
6	13.0	16.0	26,240	24,538
4	19.0	-	41,740	37,360
2	32.0	35.0	66,360	62,450
1	40.0	-	83,690	77,790
1/0	50.0	50.0	105,600	98,980
2/0	62.0	70.0	133,100	125,100
3/0	81.0	95.0	167,800	158,100
4/0	103.0	-	211,600	205,500

TYPICAL USES FOR SWITCHES ON BOATS

ON-OFF	Accessories, Auto-Pilot, Bilge Pumps, Pre-Heat, Converter, Deck Wash Pump, Depth Finder, Loran, Radios, Recorder, Stereo, Water Pressure
(ON)-OFF	Horn, Head Flush, Macerator, Alarm Silence
ON-ON	Meter Read, Battery 1, Battery 2, Bilge Pumps, Auto Man, Fuel Tank, Gauge Select, Port/Starboard
ON-OFF-ON	Bilge Pump, Auto/Off/Man, Aerator, Timed/Off/Man, Spotlight, Spot/Off/Flood, Navigation Lights, Run/Off/Anchor, Motor Control, Fwd/Off/Rev
(ON)-OFF-(ON)	Meter Read, Port/Off/Stbd, Trim Tabs, Forward/Reverse, Windlass, Raise/Off/Lower, Hatch, Open/Off/Close, Motor Reverse
ON-OFF-(ON)	Bilge Pump, Auto/Off/Man, Wiper Washer, Lights

*The parenthesis mean that the action is momentary.

REEL MEASUREMENT TABLE

REEL	FLANGE	HUB	TRAVERSE	ARBOR	MATERIAL
	F (IN)	H (IN)	T (IN)	A (IN)	
#2W	6.50	1.88	2.00	0.75	Plastic
#3	6.50	1.88	3.00	0.75	Plastic
#4	6.50	1.88	4.00	0.75	Plastic
#5	6.50	1.88	5.00	0.75	Plastic
#6	6.50	1.88	6.00	0.75	Plastic
#7	6.50	1.88	7.00	0.75	Plastic
#10	10.50	3.50	5.00	0.75	Plastic
#12	12.00	3.25	6.00	0.75	Plastic
#14	13.50	6.00	11.00	1.25	Wood
#16	15.50	6.00	11.00	1.25	Wood
#18	17.50	6.00	11.00	1.25	Wood
#24	23.50	6.00	11.00	1.25	Wood
#35	34.75	14.50	16.00	3.00	Wood

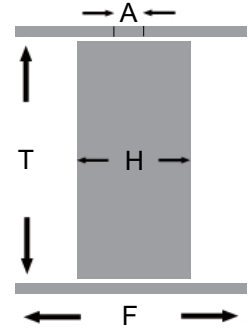

CIRCUIT BREAKERS INTERRUPTING CAPACITY (AMPS) ABYC TABLE V.B E-11.15

SHORE POWER	AMPS	MAIN BREAKER SHORE POWER DISCONNECT BREAKER	BRANCH BREAKER
120V 30 AMPS	30 AMPS	3,000	3,000
120V 50 AMPS	50 AMPS	3,000	3,000

NOTE 1: The main circuit breaker is considered to be the first circuit breaker connected to a source of AC power. All subsequent breakers, including sub-main breakers, connected in series with a main circuit breaker shall be considered to be branch circuit breakers.

NOTE 2: A fuse in series with and ahead of, a circuit breaker may be required by the circuit breaker manufacturer to achieve the interrupting capacity in the above table.

CIRCUIT BREAKER INTERRUPTING CAPACITY (AMPS) ABYC TABLE V.A E-11.15

	TOTAL CONNECTED BATTERY COLD CRANKING AMPS	MAIN BREAKER (AMPERES)	BRANCH BREAKER (AMPERES)
12V to 24V	650 or LESS	1500	750
12V to 24V	651 - 1100	3000	1500
12V to 24V	OVER 1100	5000	2500

NOTE: The main circuit breaker(s) is considered to be the first breaker(s) in a circuit connected in series with the battery. All subsequent breakers, including sub-main breakers, connected in series with a main circuit breaker shall be considered to be branch circuit breakers.

CALCULATING VOLTAGE DROP

All wire has a finite resistance to current flow. This resistance causes voltage to develop across the length of a current carrying conductor. The result is that the intended load is robbed of the full potential of its source battery. The included tables below are calculated for the two allowable voltage drops specified by ABYC (cf. E-11.15). Conductors shall be sized for a voltage drop not to exceed:

3%: For conductors feeding panelboard to switchboards, bilge blowers, navigation lights, electronic equipment and any other circuit where voltage drop must be kept to a minimum.

10%: For conductors used for general lighting (other than navigational lights) and other non-critical circuits.

To calculate the size of the wire required for a given voltage drop the following formula is used:

$$CM = \frac{K \times I \times L}{E}$$

CM = The required circular mil area of the wire. (See Table 1)

K = Equals 10.75 (represents the mil-foot resistance of copper)

I = The load current in amperes. (Note: for maximum current carrying capabilities of a conductor refer to Table 2)

L = The round trip length of the wire measured in feet from the positive terminal of the source, to the load, and back to the negative terminal source.

E = The voltage drop on the conductor in volts. For example: a 3% drop from a 12 volt source results in: E = (12 x 0.03) = 0.36

TABLE 2:
(A) ALLOWABLE AMPERAGE OF CURRENT CARRYING CONDUCTORS UNDER 50 VOLTS FOR 105°C CABLES - ABYC E-11.15

CONDUCTOR SIZE	A SINGLE CONDUCTOR		B 2 BUNDLED CONDUCTORS		B 3 BUNDLED CONDUCTORS		B 4-6 BUNDLED CONDUCTORS		B 7-24 BUNDLED CONDUCTORS		
	ENGLISH (METRIC)	Outside Engine Spaces	Inside Engine Spaces	Outside Engine Spaces	Inside Engine Spaces	Outside Engine Spaces	Inside Engine Spaces	Outside Engine Spaces	Inside Engine Spaces	Outside Engine Spaces	Inside Engine Spaces
18 (0.8)	20	17.0	20	17.0	14.0	11.9	12.0	10.2	10.0	8.5	
16 (1.0)	25	21.3	25	21.3	17.5	14.9	15.0	12.8	12.5	10.6	
14 (2.0)	35	29.8	35	29.8	24.5	20.8	21.0	17.9	17.5	14.9	
12 (3.0)	45	38.8	45	38.3	31.5	26.8	27.0	23.0	22.5	19.1	
10 (5.0)	60	51	60	51.0	42.0	35.7	36.0	30.6	30.0	25.5	
8 (8.0)	80	68	80	68.0	56.0	47.6	48.0	40.8	40.0	34.0	
6 (13)	120	102	120	102	84.0	71.4	72.0	61.2	60.0	51.0	
4 (19)	160	136	160	136	112.0	95.2	96.0	81.6	80.0	68.0	
2 (32)	210	178	210	178	147.0	125.0	126.0	107.1	105.0	89.3	
1 (40)	245	208	245	208	171.5	145.8	147.0	125.0	122.5	104.1	
0 (50)	285	242	285	242	199.5	169.6	171.0	145.4	142.5	121.1	
00 (62)	330	280	330	280	231.0	196.4	198.0	168.3	165.0	140.3	
000 (81)	385	327	385	327	269.5	229.1	231.0	196.4	192.5	163.6	
0000 (103)	445	378	445	378	311.5	264.8	267.0	227.0	222.5	189.1	

(B) ALLOWABLE AMPERAGE OF CONDUCTORS WHEN MULTIPLE CONDUCTORS ARE BUNDLED TOGETHER FOR 105°C CABLES - ABYC E-11.15

WIRE GAUGE & VOLTAGE DROP TABLES

WIRE GAUGE BASED ON MIN CIRCULAR MIL (CM) AREA, 12 VOLT, 3% DROP

LENGTH*	TOTAL CURRENT ON CIRCUIT IN AMPS												
	5	10	15	20	25	30	40	50	60	70	80	90	100
10	18	14	12	10	10	10	8	6	6	6	6	4	4
15	16	12	10	10	8	8	6	6	4	4	4	2	2
20	14	10	10	8	6	6	6	4	4	2	2	2	2
25	12	10	8	6	6	6	4	4	2	2	2	1	1
30	12	10	8	6	6	4	4	2	2	1	1	1/0	1/0
40	10	8	6	6	4	4	2	2	1	1/0	1/0	2/0	2/0
50	10	6	6	4	4	2	2	1	1/0	2/0	3/0	3/0	3/0
60	10	6	6	4	2	2	1	1/0	2/0	3/0	3/0	4/0	4/0
70	8	6	4	2	2	1	1/0	2/0	3/0	3/0	4/0	4/0	-
80	8	6	4	2	2	1	1/0	2/0	3/0	4/0	4/0	-	-
90	8	4	2	2	1	1/0	2/0	3/0	4/0	4/0	-	-	-
100	6	4	2	2	1	1/0	2/0	3/0	4/0	-	-	-	-
110	6	4	2	1	1/0	1/0	2/0	3/0	4/0	-	-	-	-
120	6	4	2	1	1/0	2/0	3/0	4/0	-	-	-	-	-
130	6	2	2	1	1/0	2/0	3/0	4/0	-	-	-	-	-
140	6	2	1	1/0	2/0	3/0	4/0	-	-	-	-	-	-
150	6	2	1	1/0	2/0	3/0	4/0	-	-	-	-	-	-
160	6	2	1	1/0	2/0	3/0	4/0	-	-	-	-	-	-
170	6	2	1	2/0	3/0	3/0	4/0	-	-	-	-	-	-

WIRE GAUGE BASED ON MIN CIRCULAR MIL (CM) AREA, 24 VOLT, 3% DROP

LENGTH*	TOTAL CURRENT ON CIRCUIT IN AMPS												
	5	10	15	20	25	30	40	50	60	70	80	90	100
10	18	18	16	14	12	12	10	10	10	8	8	8	6
15	18	16	14	12	12	10	10	8	8	6	6	6	6
20	18	14	12	10	10	10	8	6	6	6	6	4	4
25	16	12	12	10	10	8	6	6	6	4	4	4	4
30	16	12	10	10	8	8	6	6	4	4	4	2	2
40	14	10	10	8	6	6	6	4	4	2	2	2	2
50	12	10	8	6	6	6	4	4	2	2	2	1	1
60	12	10	8	6	6	4	4	2	2	1	1	1/0	1/0
70	12	8	6	6	4	4	2	2	1	1	1/0	1/0	2/0
80	10	8	6	6	4	4	2	2	1	1/0	1/0	2/0	2/0
90	10	8	6	4	4	4	2	1	1/0	1/0	2/0	2/0	3/0
100	10	6	6	4	4	2	2	1	1/0	1/0	2/0	3/0	3/0
110	10	6	6	4	2	2	1	1/0	1/0	2/0	3/0	3/0	4/0
120	10	6	4	4	2	2	1	1/0	2/0	3/0	3/0	4/0	4/0
130	8	6	4	2	2	2	1	1/0	2/0	3/0	3/0	4/0	4/0
140	8	6	4	2	2	1	1/0	2/0	3/0	3/0	4/0	4/0	-
150	8	6	4	2	2	1	1/0	2/0	3/0	3/0	4/0	4/0	-
160	8	6	4	2	2	1	1/0	2/0	3/0	4/0	4/0	4/0	-
170	8	6	2	2	1	1	2/0	3/0	3/0	4/0	4/0	4/0	-

WIRE GAUGE BASED ON MIN CIRCULAR MIL (CM) AREA, 12 VOLT, 10% DROP

LENGTH*	TOTAL CURRENT ON CIRCUIT IN AMPS												
	5	10	15	20	25	30	40	50	60	70	80	90	100
10	18	18	18	16	16	14	14	12	12	10	10	10	10
15	18	18	16	14	14	12	12	10	10	8	8	8	8
20	18	16	14	14	12	12	10	10	8	8	8	6	6
25	18	16	14	12	12	10	10	8	8	6	6	6	6
30	18	14	12	12	10	10	8	8	6	6	6	6	4
40	16	14	12	10	10	8	8	6	6	6	4	4	4
50	16	12	10	10	8	8	6	6	4	4	4	2	2
60	14	12	10	8	8	6	6	4	4	2	2	2	2
70	14	10	8	8	6	6	6	4	2	2	2	2	1
80	14	10	8	8	6	6	4	4	2	2	2	1	1
90	12	10	8	6	6	6	4	2	2	2	1	1	1/0
100	12	10	8	6	6	4	4	2	2	1	1	1/0	1/0
110	12	8	6	6	4	4	2	2	1	1	1/0	1/0	1/0
120	12	8	6	6	4	4	2	2	1	1	1/0	1/0	2/0
130	12	8	6	6	4	4	2	2	1	1/0	1/0	2/0	2/0
140	10	8	6	6	4	2	2	1	1	1/0	2/0	2/0	2/0
150	10	8	6	4	4	2	2	1	1/0	1/0	2/0	2/0	3/0
160	10	8	6	4	4	2	2	1	1/0	2/0	2/0	3/0	3/0
170	10	6	6	4	2	2	2	1	1/0	2/0	2/0	3/0	3/0

WIRE GAUGE BASED ON MIN CIRCULAR MIL (CM) AREA, 24 VOLT, 10% DROP

LENGTH*	TOTAL CURRENT ON CIRCUIT IN AMPS												
	5	10	15	20	25	30	40	50	60	70	80	90	100
10	18	18	18	18	18	18	16	16	14	14	14	12	12
15	18	18	18	18	16	16	14	14	12	12	12	10	10
20	18	18	18	16	16	16	14	14	12	12	10	10	10
25	18	18	16	16	14	14	12	12	10	10	10	8	8
30	18	18	16	14	14	12	12	10	10	8	8	8	8
40	18	16	14	14	12	12	10	10	8	8	8	6	6
50	18	16	14	12	12	10	10	8	8	6	6	6	6
60	18	14	12	12	10	10	8	8	6	6	6	6	4
70	16	14	12	10	10	8	8	6	6	6	6	4	4
80	16	14	12	10	10	8	8	6	6	6	4	4	4
90	16	12	10	10	8	8	6	6	6	4	4	4	2
100	16	12	10	10	8	8	6	6	4	4	4	2	2
110	14	12	10	8	8	8	6	6	4	4	2	2	2
120	14	12	10	8	8	6	6	6	4	4	2	2	2
130	14	12	10	8	8	6	6	6	4	4	2	2	2
140	14	10	8	8	6	6	6	4	2	2	2	2	1
150	14	10	8	8	6	6	4	4	2	2	2	2	1
160	14	10	8	8	6	6	4	4	2	2	2	1	1
170	12	10	8	6	6	6	4	2	2	2	2	1	1

*Round trip length in feet.



CORPORATE HEADQUARTERS

1555 Apex Rd. Sarasota, FL 34240

Phone: 941.378.5774

WEST COAST DISTRIBUTION

1531 Edgar Place

Sarasota, FL 34240

EAST COAST DISTRIBUTION

3633 SW 30th Ave. Hollywood, FL 33312

Phone: 954.767.0477

Partner to the Marine Industry for Over 45 Years

Pacer is a top US wire and cable manufacturer. Our wire and cable products range from 18 AWG wire to 4/0 battery cable. Additionally, we stock and sell over 9,000 electrical components, supplies, and tools in our storefront and fulfillment center in Fort Lauderdale, Florida. Everything from Heat Shrink and Deutsch connectors, to Multi-Conductor cable and Switches in one great place. We even offer electrical connectors, crimp connectors, and wire connectors. Pacer only sells products known for their quality and performance. That's why we supply OEM's and consortiums around the world with wire, cable, and electrical components.

