

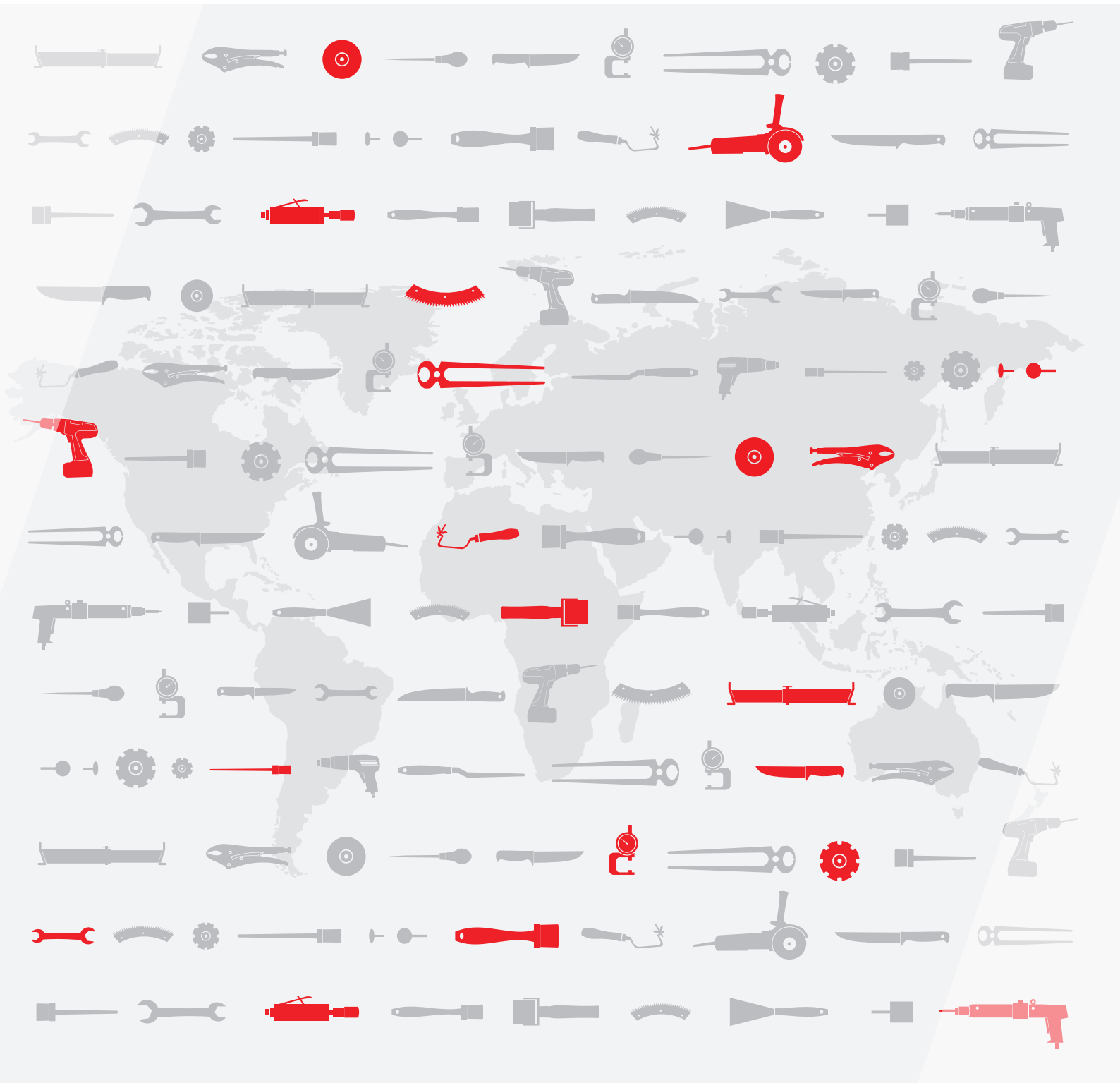

// ONE BRAND // ONE SOURCE // ONE SYSTEM



// SERVICE // MATERIAL PROCESSING // SURFACE PROTECTION // AUTOMOTIVE

REMA TIP TOP
Tool Catalogue 2016/2017





// ONE BRAND // ONE SOURCE // ONE SYSTEM

Editor

REMA TIP TOP AG

Gruber Strasse 65 · 85586 Poing / Germany

Phone: +49 8121 707-0

Fax: +49 8121 707-10 222

info@tiptop.de

www.rema-tiptop.com

Legal Notice

Copyright © 2016 REMA TIP TOP AG

All information is given to the best of our knowledge. All specifications are to be considered non-binding information. Any claim for damages of any kind is excluded. We reserve the right to change technical specifications without prior notice, provided that they ensure product improvement. The information presented is based on technical experience but does not guarantee a product's suitability for specific applications, and does not relieve the users of the responsibility to undertake their own testing, including where any third-party trademark rights are concerned. Pictures in the catalogue may contain optional accessories which are not included in the standard shipment, and need to be ordered additionally.

All relevant product information can be found in the respective documents, including operating instructions, technical datasheets as well as conditions for storage and application. The specified qualities of our products are based on information from the accompanying inspections for approval. They represent statistical product data and are not to be considered as guaranteed properties of an individual product.

In order to preserve product properties, the storage conditions indicated in DIN 7716 should be followed (including storing the product in the original package and in an area that is dry, cool and dark).





Tool sets	13-16
Protective clothing and safety equipment	17-28
Tools and accessories	29-170
Storage and workshop equipment	171-176
Vulcanizing machines	177-198
Index	199-203





REMA TIP TOP means quality, service and innovative solutions in all sectors of business:

ONE BRAND – ONE SOURCE – ONE SYSTEM

// AUTOMOTIVE

As the worldwide market leader in the tyre repair sector, we offer specialist operators everything they require for tyres and wheels, while our cooperation with famous tyre manufacturers and suppliers of retreads always ensures innovative high-quality solutions.



// MATERIAL PROCESSING

REMA TIP TOP has specialized in the consistent optimization of production plant operational readiness.

In over 50 years of research and development work, we continuously improve production and application possibilities in cooperation with our customers.





// SURFACE PROTECTION

In the industrial world, corrosion causes millions of dollars of damage every year. REMA TIP TOP corrosion protection systems prevent such damage and maintain the value of your plant while contributing to environmental protection.

Wherever chemicals and abrasive materials cause damage to containers, pipes, valves etc., we offer “one-stop shopping” corrosion and wear protection solution.





A black and white photograph of an industrial facility. In the foreground, two workers wearing hard hats and high-visibility vests are standing and talking. One worker is pointing towards the facility. The background shows a complex of industrial structures, including a large conveyor belt system supported by metal trusses, a tall vertical structure on the left, and a large cylindrical tank on the right. The sky is clear and bright.

// SERVICE

Our customers have for decades relied on individual all-in care and support by our highly-qualified specialists. As the leading supplier in the areas of material processing, surface protection and automotive, we have the necessary expert knowledge.

Outstanding quality that conforms to the highest safety requirements, materials specifically selected for a long lifetime that we manufacture ourselves, and installed with the greatest care and craftsman-like precision – we can quickly and flexibly offers solutions for any market requirement.

INTRODUCTION

TOOLS AND MORE

REMA TIP TOP is a specialist for innovative products and customized solutions. Not only are technical expertise and the selection of the right materials for our global service partners (in the Automotive, Material Processing, Surface Protection und Service market segments) critical for the success of your project, but also the choice of the correct tool and equipment for each application.

In this new REMA TIP TOP tool catalogue you will find, for the first time, a wide range of standard and special tools from all categories. These innovative and proven products from our company, and from well-known suppliers, are used in all areas in which we are active – no matter if it is wear-protection, equipment lining or tyre repair. Furthermore, you will also find here, as a Service-Partner of REMA TIP TOP, accessories, tool sets and machines for vulcanization and conveyor belt work. The range is complemented by industrial safety material, workshop equipment and storage options for your tools.

TOOL SETS



Conveyor Belt Repair Kit	14
Inspection Tool Kit	15
Vulcanization Tool Kit	16

TOOL SETS

Conveyor Belt Repair Kit

Conveyor Belt Repair Kit

For quickly repairing minor damage to conveyor belts.

This repair kit was compiled in order to easily and effectively fix small to medium damage to conveyor belts. It contains all the materials and tools needed for the repair of breakdowns and longitudinal cracks, as well as cover plate damage of conveyor belts.



Ref. No.	Designation
594 2510	Conveyor Belt Repair Kit

Scope of delivery:

Ref. No.	Designation	Content
594 2130	Tool box, hinged, 5-piece	1
594 0571	Tool rolls bag	1
595 0990	Ball tube marker, white, 6 mm	1
595 0179	Rubber marking pen, white	1
594 0430	Pincers, 250 mm	1
595 1044	Stitcher, with ball bearing, 4 mm	1
595 1123	Stitcher, with ball bearing, 12 mm	1
595 2115	Ply knife, non-adjustable	1
595 2074	Rubber cutting knife, 5", 125 mm blade length	1
595 2177	Don Carlos knife, completely adjustable	1
595 2940	Ply lifter	1
594 0000	Brush, with coconut fibres	1
595 8315	Brush, with short fibre bristles, Ø40 mm	2
594 0370	Rotary wire brush, 18 mm, Ø50 mm	1
595 2690	Angled scissors	1
595 2153	Wetstone, with wooden handle, 200 mm	1
595 8597	Measuring cup, plastic, 180 ml	2

Ref. No.	Designation	Content
525 3105	REMA G00 cartridge, incl. 3 mixing nozzles	1
525 3121	REMA G00 manual cartridge gun	1
525 3112	REMA G00 mixing nozzle, green	1
531 7712	Repair strip, 1.7 x 50 x 10 000 mm	1
531 5738	Repair strip EP 160, fabric reinforced, 3.6 x 100 x 10 000 mm	1
530 5528	Rhomboid Patch EP 160, Size 2, 3.8 x 200 x 260 mm	5
530 5535	Rhomboid Patch EP 160, Size 3, 3.8 x 270 x 360 mm	5
595 9125	SOLVENT CF-R4, CHC-free, 800 ml	1
525 2602	CEMENT SC 4000, black, 780 ml	2
525 1067	HARDENER E-40, 30 g	2
594 0711	Safety goggle XC	1

TOOL SETS

Inspection Tool Kit

Inspection Tool Kit

For on-site inspection.

Customer-oriented solutions to individual problems are the features which distinguish the REMA TIP TOP Service. This Inspection kit for sales representatives includes all of the tools and measuring devices needed to quickly and professionally assess any kind of damage to the equipment or conveyor belts.



Ref. No.	Designation
594 2520	Inspection Tool Kit

Scope of delivery:

Ref. No.	Designation	Content
594 0570	Tool bag	1
594 0450	Engineer's hammer, 0.5 kg	1
594 0240	Glass fibre measuring tape, 25 m	1
594 0230	Roll tape measure, 2 m	1
584 3060	Folding rule, plastic, 2 m	1
594 2010	BOSCH Laser range finder GLM 30 professional	1
595 8528	Shore meter Shore A	1
594 2180	Pocket caliper, 150 mm	1

Ref. No.	Designation	Content
595 8511	Hygrometer	1
571 9070	Infrared radiation thermometer MT6	1
594 0711	Safety goggle XC	1
594 2190	Spirit level, light metal, 600 mm	1
595 8535	Thickness gauge	1
594 2150	Adjustable wrench, chromed, 10"	1

TOOL SETS

Vulcanization Tool Kit

Vulcanization Tool Kit

For conveyor belt splicing.

Decades of experience in conveyor technology is reflected in this tool kit, which consists of extensive basic equipment and specialized tools for professional splicing.

Ref. No.	Designation
594 2500	Vulcanization Tool Kit



Scope of delivery:

Ref. No.	Designation	Content
594 2130	Tool box, hinged, 5-piece	1
594 0571	Tool rolls bag	1
595 1154	Needle stitcher, 46 mm	1
595 2139	Angled knife	1
595 2304	Scissors, 10" (250 mm)	1
595 2153	Wetstone, with wooden handle, 200 mm	1
595 0179	Rubber marking pen, white	1
595 0193	Refill, for rubber marking pen	1
595 8449	Wax marking chalk, white	1
594 0580	Pincers, with lever nose	1
595 1130	Stitcher, with ball bearing, 45 mm	1
595 1044	Stitcher, with ball bearing, 4 mm	1
595 2184	Rubber knife, 10"	1
595 0564	Rotary steel wire brush, Ø100 mm	1
595 0571	Rotary steel wire brush, Ø80 mm	1
595 8803	Grooved wire brush, 100 mm	1
595 4182	Rotary wire brush, cylindrical	1
594 2020	METABO Angle grinder WEV 10-125 Quick	1
595 8205	Tool arbor, for angle grinder	1
594 1070	METABO face disc, Ø125 mm, M 14	1
594 0670	METABO face nut, M 14	1
594 0240	Glass fibre measuring tape, 25 m	1
594 0230	Roll tape measure, 2 m	1
584 3060	Folding rule, plastic, 2 m	1

Ref. No.	Designation	Content
594 0490	Universal knife, 150 mm, retractable blade	1
594 0500	"Trapez" spare blade	10
594 0000	Brush, with coconut fibres	1
595 0310	Chalk line, incl. chalk dust container	1
595 0300	Chalk dust refill	1
594 2140	BOSCH Hot air blower GHG 660 LCD	1
571 8100	Combination spanner set, 12-piece, 10 - 30 mm	1
594 0411	Screwdriver, 14 x 250 mm	1
571 8014	Water pump pliers	1
571 8016	Side-cutting pliers	1
594 0460	Engineer's hammer, 1 kg	1
594 0450	Engineer's hammer, 0.5 kg	1
594 0470	Rubber mallet	1
595 0069	Rotary steel wire brush, adjustable	1
595 8315	Brush, with short fibre bristles, Ø40 mm	2
594 0711	Safety goggle XC	1

● PROTECTIVE CLOTHING AND
SAFETY EQUIPMENT



Personal protective equipment	18-21
Protective clothing	22-26
UV and weather protection	27

Head protection

Safety helmet

- ABS shell provides excellent scratch resistance and dimensional stability also in a warm environment
- Increased lateral stability
- Ideal form for hearing & face protection adaptation
- Rain gutter for outdoor use
- Antistatic: certification ATEX Zone 1, 2
- Effective ventilation system due to a high position holes

Approvals:

- Approvals USA:
SEI - HDMSA36_LT (vented);
SEI - HD37_V12_LT (non-vented)
- Canada Approvals:
CSEI - HD1MSA75_LT
- CE marking according to EN 397



Ref. No.	Designation
594 2200	Safety helmet
594 2205	Chinstrap

Face protector SUPERVIZOR SB 600

Head strap with forehead protection made of polycarbonate without metal parts. Excellent comfort due to adjustable straps and ratchet headgear. Shockproof. Replaceable shield of transparent acetate. Protects against aggressive chemicals and solvents.



Ref. No.	Designation
594 0740	Head strap, without face shield
594 0750	Face shield

PROTECTIVE CLOTHING AND SAFETY EQUIPMENT

Personal protective equipment

Eye protection

Safety goggles

Ref. No.	Designation	Content
594 0711	Safety goggle XC	
594 0715	Hang cord for safety goggle XC	12
594 0712	Eyeshield AX 1H	
594 0716	Pre-moistend lens cleaning towelettes	100



594 0711

Case for safety goggles

Quick-tip opening for fast removal of the safety goggles.
Simple fastener, plastic model, international symbol for "wear safety goggles".

Ref. No.	Designation
594 0720	Case for safety goggles



594 0720

Respirator

Fine dust filter mask 3M

For short-term grinding work. Filter class P1 (EN 149:2001).

Filter class P1: For solid particles of inert materials in accordance with the TLV (threshold limit value) list (for quartz-containing particulate matter only when safely below TLV), with a maximum pollutant concentration of 5 times the TLV.

Ref. No.	Designation
594 0350	Fine dust filter mask 3M



594 0350

PROTECTIVE CLOTHING AND SAFETY EQUIPMENT

Personal protective equipment

Half-mask 244

Half-mask complete with filters and exhalation valve.
Gas filter unit A 90/24. Filter class A1.

Filter class A1: For organic solvents, suitable for all REMA TIP TOP industrial adhesives, primers, cleaning fluids, etc., with a maximum pollutant concentration of 1000 ml/m³ (ppm).



594 0100

Ref. No.	Designation
594 0100	Half-mask 244
594 0110	Gas filter unit A 90/24, Filter class A1



594 0110

Ear protection

Capsule ear protection

- Headband made of stainless spring steel
- Sleek profile and low weight
- Soft, fluid-filled sealing rings for more comfort
- No heat build-up and perspiration among the capsules
- Sealing bags and inserts can individually replaceable
- Can be easily combined with other safety equipment
- Application area: all noisy areas, especially high tones, high volume
- Norm: EN 352-1

Ref. No.	Designation
594 2100	Capsule ear protection



Earplugs

Earplugs, preformed, tapered, made of soft, hypoallergenic foam, box with 200 pairs.

- Application area: all the noisy areas
- Norm: EN 352-2

Ref. No.	Designation	Content
594 2160	3M earplugs 1100	200 pairs



PROTECTIVE CLOTHING AND SAFETY EQUIPMENT

Personal protective equipment



594 0010



519 7200



595 2775,
595 2580



594 0020



595 1453

Gloves

Working gloves

Ref. No.	Designation	Content
594 0010	Working gloves, split leather	1 pair
594 0020	Working gloves, all-leather Fabric back and gauntlet with elastic band. Leather palms, fingertips and knuckle guard.	1 pair
519 7200	Working gloves vulcanizer, 3 fingers, total length 350 mm Special heat- and steam-resistant leather, lined, long gauntlet and pulse guard.	1 pair
595 1453	Cutting protection glove, suitable for right or left hand	1 piece
595 2775	Protective gloves Profi Classic, Size 9 NBR-coated cotton gloves. Extremely durable, highly flexible, allow good touch sensitivity and are highly resistant to abrasion. Feature good resistance to oil, grease and fuel.	1 pair
595 2580	Protective gloves Profi Classic, Size 10 NBR-coated cotton gloves. Extremely durable, highly flexible, allow good touch sensitivity and are highly resistant to abrasion. Feature good resistance to oil, grease and fuel.	1 pair

PROTECTIVE CLOTHING AND SAFETY EQUIPMENT
Personal protective equipment / Protective clothing



574 2872



584 2130

Knee protection

Knee guard

Ref. No.	Designation	Content
574 2872	Knee guard	1 pair

Vest

Safety vest

Ref. No.	Designation	Content
584 2130	Safety vest, one size	

PROTECTIVE CLOTHING AND SAFETY EQUIPMENT

Protective clothing



REMA TIP TOP Safety shoe



595 2850

Safety shoes

REMA TIP TOP Safety shoe

- EN ISO 20345 S1 with steel toe cap
- Extremely breathable softshell fabric
- Comfortable, lightweight, breathable
- Upper material made of windproof and water repellent softshell with TPU punching
- Soft and breathable soft mesh inner lining
- Replaceable insoles
- The anti-slip sole is anti-static, fuel resistant and heat resistant up to approx. 130 °C
- Weight: approx. 590 g (in size 42)
- Colour: black/grey/red

Ref. No.	Designation	Size
595 6180	Safety shoe TRIPOLI	40
595 6181	Safety shoe TRIPOLI	41
595 6182	Safety shoe TRIPOLI	42
595 6183	Safety shoe TRIPOLI	43
595 6184	Safety shoe TRIPOLI	44
595 6185	Safety shoe TRIPOLI	45
595 6186	Safety shoe TRIPOLI	46
595 6187	Safety shoe TRIPOLI	47

Shoe covers

Ref. No.	Designation	Content
595 2850	Shoe covers STANDARD	1 pair

Jackets

REMA TIP TOP Softshell jacket

- Hard-wearing, weatherproof material
- Windproof and breathable
- Warm quilted lining with thermal reflector zone in the back
- Removable hood with double width adjustment and fleece interior
- Fleece inside collar
- Pushbutton pocket, 3 length pockets and pen holders
- Material: 100% polyester
- Washable at 30 °C / 86 °F
- Colour: red/black



REMA TIP TOP Softshell jacket

Ref. No.	Designation	Size
595 6740	Softshell jacket	M
595 6741	Softshell jacket	L
595 6742	Softshell jacket	XL
595 6750	Softshell jacket	XXL

REMA TIP TOP Pilot jacket

- Hard-wearing, weatherproof material
- Shoulder and arm areas equipped with CORDURA®*
- Warming fleece lining and lots of pockets
- 2 breast pockets, 2 deep side pockets, inside pockets, napoleon pocket and mobile phone pocket
- Fleece collar and detachable hood
- Material: 100% polyamide with polyurethane coating
- Lining: 100% polyester
- Washable at 30 °C / 86 °F
- Colour: red/black



REMA TIP TOP Pilot jacket

Caution: Not suitable when working with open flames.

Ref. No.	Designation	Size
595 6770	Pilot jacket	M
595 6771	Pilot jacket	L
595 6772	Pilot jacket	XL
595 6760	Pilot jacket	XXL
595 6761	Pilot jacket	XXXL

PROTECTIVE CLOTHING AND SAFETY EQUIPMENT

Protective clothing

REMA TIP TOP Waist jacket

Ref. No.	Designation	Size
595 6200	TIP TOP Waist Jacket	44
595 6210	TIP TOP Waist Jacket	46
595 6220	TIP TOP Waist Jacket	48
595 6230	TIP TOP Waist Jacket	50
595 6240	TIP TOP Waist Jacket	52
595 6250	TIP TOP Waist Jacket	54
595 6260	TIP TOP Waist Jacket	56
595 6270	TIP TOP Waist Jacket	58
595 6280	TIP TOP Waist Jacket	60
595 6290	TIP TOP Waist Jacket	62
595 6300	TIP TOP Waist Jacket	64
595 6310	TIP TOP Waist Jacket	66
595 6320	TIP TOP Waist Jacket	94
595 6330	TIP TOP Waist Jacket	98
595 6340	TIP TOP Waist Jacket	102
595 6350	TIP TOP Waist Jacket	106
595 6360	TIP TOP Waist Jacket	110
595 6370	TIP TOP Waist Jacket	114

REMA TIP TOP Waist Trousers

Ref. No.	Designation	Size
595 6600	TIP TOP Waist Trousers	46
595 6610	TIP TOP Waist Trousers	48
595 6620	TIP TOP Waist Trousers	50
595 6630	TIP TOP Waist Trousers	52
595 6640	TIP TOP Waist Trousers	54
595 6650	TIP TOP Waist Trousers	56
595 6660	TIP TOP Waist Trousers	58
595 6670	TIP TOP Waist Trousers	60
595 6680	TIP TOP Waist Trousers	64
595 6690	TIP TOP Waist Trousers	66
595 6700	TIP TOP Waist Trousers	94
595 6710	TIP TOP Waist Trousers	98
595 6720	TIP TOP Waist Trousers	106
595 6730	TIP TOP Waist Trousers	110

PROTECTIVE CLOTHING AND SAFETY EQUIPMENT

Protective clothing

Sweatshirt

REMA TIP TOP ZIP sweatshirt

- High ZIP collar and fleecy inside
- Very sturdy zip
- Long-lasting colour brilliance
- Material: 80% cotton, 20% polyester (approx. 300 g/m²)
- Washable at 60 °C / 140 °F
- Colour: black



REMA TIP TOP ZIP sweatshirt

Ref. No.	Designation	Size
595 6790	ZIP sweatshirt	M
595 6791	ZIP sweatshirt	L
595 6792	ZIP sweatshirt	XL
595 6780	ZIP sweatshirt	XXL
595 6781	ZIP sweatshirt	XXXL

REMA TIP TOP Polo Shirt

Black

Ref. No.	Designation	Size
584 3234	Poloshirt, black	S
584 3230	Poloshirt, black	M
584 3231	Poloshirt, black	L
584 3232	Poloshirt, black	XL
584 3233	Poloshirt, black	XXL

White

Ref. No.	Designation	Size
584 3251	Poloshirt, white	S
584 3252	Poloshirt, white	M
584 3253	Poloshirt, white	L
584 3254	Poloshirt, white	XL
584 3255	Poloshirt, white	XXL

Red

Ref. No.	Designation	Size
584 3244	Poloshirt, red	S
584 3240	Poloshirt, red	M
584 3241	Poloshirt, red	L
584 3242	Poloshirt, red	XL
584 3243	Poloshirt, red	XXL



REMA TIP TOP Poloshirt

Mounting tents

Mounting tent BZ 24 and BZ 45

Robust multifunctional tent for many different applications. Anodized aluminium construction, quality tarpaulin and die-casting connections guarantee easy handling and long life. The mounting tent can be build up in almost any location within a very short time. Several tents with the same span can be combined to obtain a larger covered area.

Scope of delivery

- Tent poles made of anodized aluminum 40x1.5 mm
- Tarpaulin, 420 g/m², in accordance with EN 15619
- 2 windows
- PVC anti-putrefaction stripes all around
- Ground anchor
- Storage bags for tent poles, tarpaulin and small parts

Optional accessories on request:

- Floor
- Partitions interior
- Storm bracing
- Side entrance



2

Specifications*	BZ 24	BZ 45
Size	4.75x5.0x2.5 / 1.7 m	8.0x5.65x2.7 / 1.9 m
Floor space	24 m ²	45 m ²
Weight	total: 62 kg	total: 107 kg

Ref. No.	Designation
594 2230	Mounting tent BZ 24
594 2240	Mounting tent BZ 45

TOOLS AND ACCESSORIES

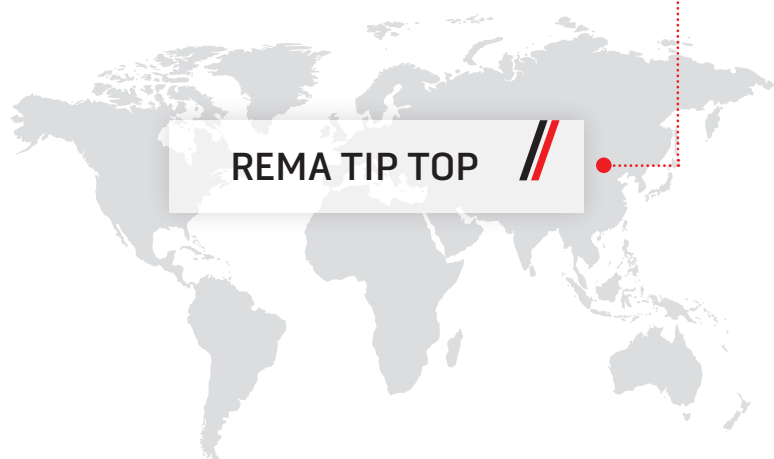

REMA TIP TOP



3

Pneumatic tools and accessories	30-41
Electric tools	42-62
Extruders	63-64
Conveying belt handling	65-71
Cable and chain winches	72-73
Tyre handling	74-85
Valve tools	86-89
Tyre mounting	90-97
Compressed air technique	98-105
Marking and labeling	106-108
Measuring and testing	109-114
Working tools	115-137
Cutting and buffing tools	138-166
Retreading machines	167-170

TOOLS AND ACCESSORIES

Pneumatic tools and accessories



595 2270



518 4251

Rubber cutting machine

Rubber cutting machine Model 32

For cutting rubber, conveyor belts with fabric inserts and Polyurethane.

- The cutting machine is designed to provide forward feed through the rotary movement of the cutting knife
- Overload-proof pneumatic motor
- Straight, right-angled, exact cut
- Cutting capacity (in rubber): up to 50 mm
- Rubber hardness: 40 - 90 Shore A
- Rubber thickness: max. 50 mm
- Air pressure: max. 6.3 bar / 210 psi
- Air volume requirement: 15.5 ltr/sec.
- Air hose connector: 1/4"
- Air hose inner Ø: min. 8 mm
- Weight: 8 kg
- Speed: 60 rpm

Ref. No.	Designation
595 2270	Rubber cutting machine type 32 includes 1x spiral supply hose 5 m

Accessories - Rubber cutting machines type 21/32

Ref. No.	Designation
595 2249	Spare circular blade type 32, Ø 200 mm
595 2706	Adapter for blade
595 2720	Plastic roll, Ø 24 mm
595 2744	Brass roll (blade guide)
595 2751	Spare lamella for compressed-air motor
518 4251	Maintenance set includes 1x air nipple, 1x coupling, 1x wall bracket
595 2713	Spiral supply hose, 5 m, inner diameter 8.0 mm includes nipple and quick coupling
595 2768	Cutting guide SL-32 Roller set with cutting guide (with swivel arm bracket). To be mounted on rubber cutting machine type 32. Used as a cutting guide for cutting REMAGRIP 70/CN-SL strip lagging to size.
595 2232	Spare circular blade type 21, Ø 143 mm

TOOLS AND ACCESSORIES

Pneumatic tools and accessories



517 2847

3

Fret saw, pneumatic

Fret saw, pneumatic

For removal of steel plies embedded within the rubber.

Ref. No.	Designation	Rotating speed	Operating pressure	Weight	Content
517 2847	Fret saw, pneumatic For the preparation of sidewall damages to truck tyres	9500 rpm	6.3 bar / 210 psi	650 g	
517 2854	Special saw blades, 85 mm, for steel/rubber			4.5 g	10

TOOLS AND ACCESSORIES

Pneumatic tools and accessories



595 0234



518 4206



595 5583



519 6775



517 3097

Air buffers

Air buffers (low-speed)

- For operations of rubber
- Rear exhaust system with air inlet/outlet
- Safety lock throttle prevents accidental start-up
- Some units with cold-insulation cover or plastic insulation

	5950234	5184206	5955583
Electric power/connection	1/4"	1/4"	1/4"
Rotating speed	0 - 4000 rpm	0 - 3800 rpm	0 - 3400 rpm
Operating pressure	6.3 bar / 210 psi	6.3 bar / 210 psi	6.3 bar / 210 psi
Length	190 mm	200 mm	200 mm
Weight	1.0 kg	0.72 kg	0.90

Ref. No.	Designation
595 0234	Air buffer AIR SUPER (type PN) UT 8742 HMA, quick release (QR) chuck
518 4206	Air buffer SP 1523 KLSR, with drill chuck
595 5583	Air buffer AIR SUPER RC7078RED, with quick release (QR) chuck
519 6775	Collet chuck reducer, 6 mm to 3 mm Collet chuck adapter, for tools with 3 mm shaft from 6 mm to 3 mm Suitable for: Air buffer UT 8721, high speed; all chucks (6 mm)
517 2861	Exhaust hose PN, 3 m Suitable for: Air buffer AIR SUPER (type PN) UT 8742 HMA; Air buffer GP-0560SW; Air buffer ST-3TB; models up until 2005
595 5590	Exhaust hose RC Suitable for: Air buffer AIR SUPER RC
517 2870	Exhaust hose PN, 3 m Suitable for: Air buffer AIR SUPER (type PN) UT 8742 HMA; Corrugated, 2006 and later models
518 4213	Exhaust hose Suitable for: Air buffer SP 1523 KLSR
517 3097	UNIVERSAL Quick-Twist clamping chuck, with 3/8" thread For changing tools quickly and easily

TOOLS AND ACCESSORIES
Pneumatic tools and accessories



517 2933



595 0258



519 6775



517 2940

Air buffers (high-speed)

- For operations of the steel cord
- Rear exhaust system with air inlet/outlet
- Safety lock throttle prevents accidental start-up
- Some units with cold-insulation cover or plastic insulation

	5172933	5950258	5172940
Rotating speed	0 - 22 000 rpm	0 - 22 000 rpm	
Operating pressure	6.2 bar / 200 psi	6.2 bar / 200 psi	6.2 bar / 200 psi
Power	0.3 kW	0.4 kW	
Length	210 mm	175 mm	3 mm
Weight	0.85 kg	0.6 kg	0.46 kg

Ref. No.	Designation
517 2933	Air buffer CP 871, with drill chuck
595 0258	Air buffer UT 8721, with 6 mm collet chuck
517 2940	Exhaust hose CP Suitable for: Air buffer CP 871
519 6775	Collet chuck reducer, 6 mm to 3 mm Collet chuck adapter, for tools with 3 mm shaft from 6 mm to 3 mm Suitable for: Air buffer UT 8721

TOOLS AND ACCESSORIES
Pneumatic tools and accessories



595 0790



595 0760

Air buffers for retreading work (low-speed)

- These air buffers were specifically designed for tough continuous duty
- Due to their long shape they allow two-handed use, which reduces fatigue
- Low weight
- Plastic machine insulation
- Rear air exhaust

Ref. No.	Designation	Rotating speed	Operating pressure	Size	Weight
595 0790	Air buffer GP-0560SW, with hex quick-change chuck	0 - 3200 rpm	6.3 bar / 210 psi	345 x 48 L x W mm	1.33 kg

Air buffers for retreading work (high-speed)

- These air buffers were specifically designed for tough continuous duty
- Due to their long shape they allow two-handed use, which reduces fatigue
- Low weight
- Plastic machine insulation
- Rear air exhaust

Ref. No.	Designation	Rotating speed	Operating pressure	Power	Weight
595 0760	Air buffer ST3TB	0 - 22000 rpm	6.2 bar / 200 psi	0.4 kW	1.18 kg

TOOLS AND ACCESSORIES
Pneumatic tools and accessories



517 4450



517 3602



538 1009

Patch hammer, vacuum cleaner for dust/water, stapler

Patch hammer

Facilitates the application of large, multi-ply repair patches to car, truck and EM tyres.

	5174450	5173602	5173619	5173626	5381009
Electric power/connection	1/4"	1/4"			
Operating pressure	6 - 8 bar	6 - 8 bar			
Width					1250 mm
Weight	1.0 kg	1.9 kg	55 g	262 g	

Ref. No.	Designation
517 4450	Patch hammer, compact, with plastic ram
517 3602	Patch hammer, large, with metal ram
517 3619	Replacement spring Suitable for: Patch hammer, large
517 3626	Replacement ram Suitable for: Patch hammer, large
538 1009	Pressure equalizing cloth, sold by metres
557 2832	Hammer head, plastic Suitable for: Patch hammer, small

TOOLS AND ACCESSORIES
Pneumatic tools and accessories



519 7028



519 7180



518 4310

Vacuum cleaner for dust/water

For removal of dust and water from the tyre.

Ref. No.	Designation	Intake volume	Length
519 7028	Vacuum cleaner for dust/water		
519 7180	Vacuum cleaner for dust/water EM/OTR	5.0 l/min. with 4 bar / 88 psi	340 mm
519 7080	Spare vacuum bag		
519 7097	Spare hose		
519 7630	Activator		

Stapler

For the joining of tread splices when a tyre is retreaded.

Ref. No.	Designation	Operating pressure	Staple width	Width
518 4310	Tacker GT-8016X for staples of 12 mm width	5- 6 bar / 115 - 185 psi		
519 7170	Staple remover			
518 4316	Staples, refill		10 mm	12 mm
518 4323	Staples, refill		16 mm	12 mm

TOOLS AND ACCESSORIES
Pneumatic tools and accessories



589 0180



518 4102



518 4104



589 5314



518 4106



518 4107

Impact wrenches, pneumatic

Impact wrenches, pneumatic

	5890180	5184102	5184104	5895314	5184106	5184107
Air inlet	R 1/4"	1/4"	1/4"	R 1/2"	R 1/2"	1/2"
Drive	1/2"²	1/2"	3/4"	1 (square) Inch	1 (square) Inch	1"
Torque	max. 576 Nm	813 Nm	1626 Nm	max. 1650 Nm	max. 2200 Nm	2033 Nm
Speed	8400 rpm	8000 rpm	6500 rpm	5000 rpm	6800 rpm	4000 rpm
Air consumption	426 l/min	138 l/min	190 l/min	1404 l/min	335 l/min	255 l/min
Weight	2.33 kg	2.06 kg	3.89 kg	7.7 kg	7 kg	11.3 kg

Ref. No.	Designation
589 0180	DL impact wrench CP 7620, 1/2"
518 4102	Composite impact wrench KI-1450, 1/2"
518 4104	Composite impact wrench KI-1636, 3/4"
589 5314	DL impact wrench CP 7780-6, 1", with 6" extension
518 4106	Impact wrench IR 2190 Ti-6, 1", 6" extended anvil
518 4107	DL impact wrench KI-36-6, 1", with long anvil

Impact sockets and accessories

Impact sockets 1/2"

- Suitable for use with impact wrench
- Hexagon
- Chrome-molybdenum steel
- Surface burnished



Ref. No.	Designation	Drive	Length	Size
571 8071	Impact socket	1/2"	38 mm	16
571 8070	Impact socket	1/2"	38 mm	17
571 8072	Impact socket	1/2"	38 mm	18
571 8073	Impact socket	1/2"	38 mm	19
571 8074	Impact socket	1/2"	38 mm	22
571 8075	Impact socket	1/2"	38 mm	24
571 8076	Impact socket	1/2"	38 mm	27

Impact sockets 1/2", long form

- Suitable for use with impact wrench
- Hexagon
- Chrome-molybdenum steel
- Surface burnished



Ref. No.	Designation	Drive	Length	Size
571 8064	Impact socket, long	1/2"	78 mm	15
571 8065	Impact socket, long	1/2"	78 mm	16
571 8066	Impact socket, long	1/2"	78 mm	17
571 8067	Impact socket, long	1/2"	78 mm	18
571 8068	Impact socket, long	1/2"	78 mm	19
570 9720	Impact socket, long	1/2"	78 mm	21
570 9730	Impact socket, long	1/2"	78 mm	22
571 8069	Impact socket, long	1/2"	78 mm	24

TOOLS AND ACCESSORIES

Pneumatic tools and accessories

Wheel nut impact sockets 1/2", plastic-covered

- Suitable for use with impact wrench
- Completely encapsulated in plastic
- Extra thin walls
- Optimum force transmission
- Rims and bolts no longer become scratched



571 8077



571 8078

Ref. No.	Designation	Drive	Length
571 8077	Wheel nut sockets Three-piece	1/2"	85 mm
571 8078	Wheel nut sockets, extra long Special length especially suitable for drop centre rims - Any falsification of torque caused by putting extensions together is avoided - Three-piece	1/2"	195 mm

Impact sockets 3/4"

- Suitable for use with impact wrench
- Hexagon
- Chrome-molybdenum steel
- Surface burnished



Ref. No.	Designation	Drive	Length	Size
571 8047	Impact socket	3/4"	50 mm	17
571 8048	Impact socket	3/4"	50 mm	18
571 8049	Impact socket	3/4"	50 mm	19
571 8050	Impact socket	3/4"	50 mm	22
571 8051	Impact socket	3/4"	50 mm	24
571 8052	Impact socket	3/4"	55 mm	27
571 8054	Impact socket	3/4"	55 mm	30
571 8055	Impact socket	3/4"	55 mm	32

TOOLS AND ACCESSORIES
Pneumatic tools and accessories

Impact sockets 3/4", long form

- Suitable for use with impact wrench
- Hexagon
- Chrome-molybdenum steel
- Surface burnished



Ref. No.	Designation	Drive	Length	Size
571 8056	Impact socket, long	3/4"	95 mm	19
571 8057	Impact socket, long	3/4"	95 mm	22
571 8058	Impact socket, long	3/4"	90 mm	24
571 8059	Impact socket, long	3/4"	90 mm	27
571 8061	Impact socket, long	3/4"	90 mm	30
571 8062	Impact socket, long	3/4"	90 mm	32
571 8063	Impact socket, long	3/4"	90 mm	36

Impact sockets 1"

- Suitable for use with impact wrench
- Hexagon
- Chrome-molybdenum steel



Ref. No.	Designation	Drive	Length	Size
571 8030	Impact socket	1"	60 mm	24
571 8031	Impact socket	1"	60 mm	27
571 8032	Impact socket	1"	63 mm	30
571 8033	Impact socket	1"	61 mm	32
571 8034	Impact socket	1"	63 mm	33
571 8035	Impact socket	1"	65 mm	36
571 8036	Impact socket	1"	70 mm	41
571 8037	Impact socket	1"	76 mm	46
571 8038	Impact socket	1"	68 mm	50
571 8039	Impact socket	1"	75 mm	55
571 8040	Impact socket	1"	87 mm	60

TOOLS AND ACCESSORIES

Pneumatic tools and accessories

Impact sockets 1", long form

- Suitable for use with impact wrench
- Hexagon
- Chrome-molybdenum steel



Ref. No.	Designation	Drive	Length	Size
571 8041	Impact socket, long	1"	90 mm	24
571 8042	Impact socket, long	1"	90 mm	27
571 8043	Impact socket, long	1"	90 mm	30
571 8044	Impact socket, long	1"	90 mm	32
571 8045	Impact socket, long	1"	90 mm	36
571 8046	Impact socket, long	1"	90 mm	41

Torque limiting sockets

Ref. No.	Designation	Drive	Length	Working range
571 8080	Torque limiting sockets 1/2" Suitable for use with impact wrench - Automatic torque restriction to 80 Nm - Overwinding of wheel bolts and nuts is now practically impossible - No time- consuming setting work required at the torque wrench since it can be actuated with full tightening torque - as during loosening - Three-piece	1/2"	150 mm	80 Nm



571 8080

Force adapter

Ref. No.	Designation
571 9420	Adapter 3/4" concave - 1" full



TOOLS AND ACCESSORIES

Electric tools

Angle grinder and accessories

Angle grinder FLEX LK 602 VR

For use with face disc. Continuously adjustable rpm. Smooth starting.
Only for use with fibre discs (face disc and face nut required).
Not suitable for hard metal buffing discs.

Specifications

Face disc Ø	max. 220	mm
Speed	0 - 2400	rpm
Power consumption	1 500	Watts
Voltage	230	V
Spindle	M 14	
Weight	3.5	kg



594 0610

Ref. No.	Designation
594 0610	Angle grinder FLEX LK 602 VR

Angle grinder FLEX LK 604

With lateral handle and wrench. Only for use with fibre discs.
Not suitable for hard metal buffing discs.

Specifications

Face disc Ø	175	mm
Speed	4 000	rpm
Power consumption	1 200	Watts
Voltage	230	V
Spindle	M 14	
Weight	3.0	kg



594 0630

Ref. No.	Designation
594 0630	Angle grinder FLEX LK 604 includes face wheel and face nut

TOOLS AND ACCESSORIES

Electric tools

Angle grinder FLEX L 1202

For heavy-duty rubber buffing. Metal-plastic housing. High torque. Fibre discs require face disc and face nut; clamping flange and clamping nut are necessary for use of the cutting discs, grinding discs and tungsten carbide buffing disc. The wire brush (595 0564) and tress-shaped brush (595 0090) may be used with the tool arbor (595 8205) for angle grinder.



594 0620

Specifications

Face disc Ø	max. 250	mm
Speed	1 750	rpm
Power consumption	1 600	Watts
Voltage	230	V
Spindle	M 14	
Weight	4.8	kg

Ref. No.	Designation
594 0620	Angle grinder FLEX L 1202

Angle grinder FLEX L 2106 VC

Rigid metal motor housing. Electrical surge protection. Primarily for cutting with 230 mm Ø disc.

Scope of delivery

- Protective cap
- Mounting flange
- Mounting nut
- Lateral handle
- Wheel stopping key
- Single end spanner



594 0600

Specifications

Face disc Ø	230	mm
Speed	6 500	rpm
Power consumption	2 000	Watts
Voltage	230	V
Spindle	M 14	
Weight	5.5	kg

Ref. No.	Designation
594 0600	Angle grinder FLEX L 2106 VC

TOOLS AND ACCESSORIES

Electric tools

Angle grinder FLEX 3403 VRG

Hand-held angle grinder for buffing rubber. Use of the fibre discs requires face disc (594 1070) and face nut (594 0670). Mounting flange (594 0640) and mounting nut (594 0650) are necessary for use of cutting discs, grinding discs and tungsten carbide buffing discs.



Specifications

Face disc Ø	125	mm
Speed	1100 - 3700	rpm
Power consumption	1 400	Watts
Voltage	230	V
Spindle	M 14	
Weight	2.2	kg

Ref. No.	Designation
594 1080	Angle grinder FLEX 3403 VRG

Angle grinder WEV 10-125 Quick

- Compact angle grinder
- Vario-Constamatic for working with customised speed
- New powerful engine
- Full wave electronics with thumbwheel
- Tool-free adjustable guard
- Safety clutch
- Electronic overload protection
- Electronic soft start for smooth startup

Scope of delivery

- Guard
- Inner support flange
- Quick flange nut
- Side handle

NEW

594 2020



3

Specifications

Face disc Ø	125	mm
Speed	Idle: 2800 - 10 500	rpm
Speed at nominal load	8 800	rpm
Power consumption	1 000	Watts
Power output	590	Watts
Torque	2.7	Nm
Spindle	M 14	
Weight	without power cable: 2.1	kg

Ref. No.	Designation
594 2020	METABO Angle grinder WEV 10-125 Quick

TOOLS AND ACCESSORIES

Electric tools



Flexible face disc

Ref. No.	Designation
594 0680	METABO face disc, Ø175 mm, M 14
594 1070	METABO face disc, Ø125 mm, M 14
594 0670	METABO face nut, M 14

Accessories - Angle grinder

Ref. No.	Designation
594 0660	Face key, for face nut (594 0670)
594 0640	Mounting flange, SW 14
594 0650	Mounting nut, M 14

Tool arbor for angle grinder

Suitable for mounting wire brushes on slim angle grinders. Requires: Wire brush (min. Ø100 mm, borehole Ø16 mm), angle grinder spindle (M14). Recommended products from our industrial line: Wire brush (595 0564) and tress-shaped brush (595 0090).

Ref. No.	Designation
595 8205	Tool arbor for angle grinder



Straight grinder 3000 R

Straight grinder

Straight grinder 3000 R

Suitable for buffing rubber also when splicing steel cord conveyer belts. Speed can be controlled in six steps from 1400 min⁻¹ to 3000 min⁻¹. Includes face disc, socket wrench, arbor, tension screw and distance disc.

Specifications

Face disc Ø	max. 150	mm
Speed	1400 - 3000	rpm
Power consumption	1 530	Watts
Voltage	120/230	V
Weight	2.9	kg

Ref. No.	Designation
595 0282	Straight grinder 3000 R 230 V
595 0281	Straight grinder 3000 R 120 V

TOOLS AND ACCESSORIES

Electric tools



595 1265; 595 1272; 595 1289



595 1356

Buffing motors

Special buffing motors

- High-quality motors for driving shafts
- Modern, user-oriented motor technology for long life and improved safety
- High torque
- Motor brake prevents after-running of the tool - providing improved safety at work
- With suspension which can be integrated into existing carrying/rail systems
- Retrofittable safety switch on the hand shaft Piece

Ref. No.	Designation	Electric power/connection	Speed	Shaft
595 1265	Buffing motor, low	220/240 V	1400 rpm	W 15
595 1272	Buffing motor, high	220/240 V	2800 rpm	W 15
595 1289	Buffing motor, two-speed	380/400 V	1400/2800 rpm	W 15
595 1356	Buffing motor VARIO POWER 3000	220/240 V	0 - 3100 rpm	W 15

TOOLS AND ACCESSORIES

Electric tools



Accessories - Special buffing motors

Ref. No.	Designation
595 1295	Adapter Flexible shaft W 12 to shaft connection W 15 (motor)
595 1381	Mobile stand universal, for buffing motors
595 1305	Safety switch, for shaft hand piece (suitable for all buffing motors other than VARIO POWER 300)
595 1340	Safety switch, for shaft hand piece (suitable for VARIO POWER 300)
595 1312	Support

Flexible shafts

Flexible shaft W 10, rubber covering

Ref. No.	Designation
595 0382	Flexible shaft W 10 - G

Flexible shaft W 12, rubber covering

HD design. For 0.6 kW 0.85 kW motors.
Length 2 m, inner shaft \varnothing 12 mm.
Exchangeable handpiece.

Ref. No.	Designation
595 0485	Flexible shaft W 12 - G

TOOLS AND ACCESSORIES

Electric tools



595 0409



595 0492



595 0416

Flexible shaft W 12, metal covering

Solid design.
For 0.6 kW 0.85 kW motors.

Length 2 m, inner shaft \varnothing 12 mm.
Exchangeable handpiece.

Ref. No.	Designation
595 0409	Flexible shaft W 12 - M

Flexible shaft W 15, rubber covering

HD design.
For 0.85 kW - 1.8 kW motors.

Length 2 m, inner shaft \varnothing 15 mm.
Exchangeable handpiece.

Ref. No.	Designation
595 0492	Flexible shaft W 15 - G

Flexible shaft W 15, metal covering

Solid design.
For 0.85 kW - 1.8 kW motors.

Length 2 m, inner shaft \varnothing 15 mm.
Exchangeable handpiece.

Ref. No.	Designation
595 0416	Flexible shaft W 15 - M

TOOLS AND ACCESSORIES

Electric tools



595 0423



595 0911



595 0928



595 0430



595 0447



595 0454



595 0461

Spare parts - Flexible shaft

Ref. No.	Designation
595 0399	Spare inner shaft W 10, for 595 0382
595 0423	Spare inner shaft W 12, for 595 0485, 595 0409
595 0430	Spare inner shaft W 15, for 595 0492, 595 0416
595 0911	Spare covering - rubber, for 595 0485
595 0928	Spare covering - rubber, for 595 0492
595 0447	Spare covering – metal, for 595 0409
595 0454	Spare covering - metal, for 595 0416
595 0461	Spare handpiece for 595 0485, 595 0409, 595 0492, 595 0416

Hand drills

Drill B13/2 RLE

- Clockwise/anticlockwise rotation
- High torque (45 Nm in first gear)
- Rugged magnesium die-cast gear housing
- Robust, generously sized spindle bearing
- Triple reduction 2-speed gear unit

Scope of delivery

- Quick-action keyless chuck
- Side handle
- Drilling depth guide



571 9110

Specifications

Electric power/connection	220 V / 650 W
Speed	0 - 450 / 0 - 1550 rpm
Weight	1.9 kg

Ref. No.

Designation

571 9110

DUSS Drill B13/2 RLE

Impact drill SBE 1010 Plus CODE

- Fast switch-over from drilling to impact mode
- Fast speed in second gear
- Electronic speed control with full-wave electronics
- Thumbwheel for preselection of speed; Forward/reverse change-over switch in ergonomic arrangement with shift lock

- Rugged magnesium die-cast gear housing
- Robust, generously sized spindle bearing

Scope of delivery

- Quick-action keyless chuck
- Rubber-coated handle
- Drilling depth guide



594 0880

Specifications

Electric power/connection	220 - 240 V / 1010 W
Speed	0 - 950 / 0 - 2400 rpm
Impact rate	50000 rpm
Weight	2.4 kg

Ref. No.

Designation

594 0880

METABO impact drill SBE 1010 Plus CODE

Impact drill PSB 550 RE

- Clockwise/anticlockwise rotation
- Integrated switch for continuous operation
- Switch for screwing, drilling and Impact drilling

Scope of delivery

- Additional handle



594 0590

Specifications

Electric power/connection	230 V / 500 W
Speed	50 - 300 rpm
Impact rate	33 000 rpm
Weight	1.6 kg

Ref. No.	Designation
594 0590	BOSCH impact drill PSB 550 RE

Flexible shaft for electric drill

For tools with a maximum diameter of 75 mm.



517 3286

Ref. No.	Designation	Length	Core diameter
517 3286	Flexible shaft, incl. quick coupling	1500 mm	8 mm
517 3293	Holding device, for all common electric drills	1500 mm	8 mm
517 3303	Holder shaft, for mobile stand universal		



517 3293

TOOLS AND ACCESSORIES

Electric tools

Cordless screwdrivers

Cordless percussion drill SB 18 LT Compact

- Strong 4-pole Motor
- Powerful percussion mechanism
- Spindle with hexagonal recess for screwdriver bits
- Integrated working light
- With handy belt hook and bit holder
- Battery packs with capacity display

Scope of delivery

- Quick-action keyless chuck
- Belt hook with bit case
- 2 Li-Power battery packs (18 V/2.0 Ah)
- "AIR COOLED" Charger ASC 30 - 36 V
- Plastic carry case

NEW



594 2060

Specifications

Type of battery pack	Li-Ion
Voltage	Battery pack: 18 V
Capacity	Battery pack: 2.0 Ah
Torque, soft/hard	max. 34/60 Nm
Torque, adjustable	0.7 - 8 Nm
Drill Ø	Concrete/Steel/Wood: 13/13/38 mm
Speed	Idle: 0 - 450 / 0 - 1600 rpm
Impact rate	max. 27 200 rpm
Drill spindle thread	1/2" - 20 UNF
Chuck capacity	1/16" - 1/2"
Weight	1.7 kg

Ref. No.	Designation
594 2060	METABO Cordless percussion drill SB 18 LT Compact

Cordless screwdriver BS 18 Quick

- Light compact drill/screwdriver in compact design
- Quick change of tool holder
- Spindle with hexagonal recess for screwdriver bits
- Integrated working light
- With handy belt hook

Scope of delivery

- Quick-action keyless chuck
- Belt hook
- 2 Li-Power battery packs (18 V/2.0 Ah)
- Charger SC 60 plus
- Plastic carry case

Specifications

Type of battery pack	Li-Ion
Voltage	Battery pack: 18 V
Capacity	Battery pack: 2.0 Ah
Torque, soft/hard	max. 24/48 Nm
Torque, adjustable	0.5 - 4.5 Nm
Drill Ø	Steel/Wood: 10/20 mm
Speed	Idle: 0 - 450 / 0 - 1600 rpm
Chuck capacity	1 - 10 mm
Weight	1.3 kg

Ref. No.	Designation
594 2050	METABO Cordless screwdriver BS 18 Quick



594 2050

Quick-change angle adapter

- For drilling and fastening in hard to reach places
- Magnetic bit holder with 1/4" (6.35 mm) hexagonal shank
- Gear made of special steel
- Suitable for right/left handed rotation up to max. 28 Nm
- Especially for drillers BS 18 Quick



594 2210

Ref. No.	Designation
594 2210	Quick-change angle adapter

TOOLS AND ACCESSORIES

Electric tools

Bit box "SP" 32-piece

- Bits made of chrome-vanadium steel (S2-quality)
- Bits with color coding for quick and easy retrieval
- Magnetic quick-change adapter
- With adapter for sockets
- High-quality, robust box



594 2220

Ref. No.	Designation
594 2220	Bit Box "SP" 32-piece Content 30x Bits (L=25 mm), 1x Adapter 1x Magnetic bit holder (25 mm)

Impact wrenches, electric

Impact wrenches, electric

- Powerful assistants for the commercial vehicle workshop
- Strong and sturdy motor with high durability
- Easy one-man operation
- Long wearing, forged motor shaft
- Optimum weight compensation by integrated tension spring
- Pneumatic tyres
- Right- and left-hand rotation
- New contactless control, no wear
- Mobile lifting carriage running on 4 ball-bearing rollers
- Practical storage compartment for small parts
- Front rollers prevent tilting of the impact wrench

Scope of delivery

- Cable, 15 m



519 1718

Specifications

Electric power/connection	400V
Drive	3/4"
Adjustment step size	230 - 870 mm
Power	1.1 kW
Dimensions	1200 x 620 x 1180 mm
Cable	15 m
Weight	77 kg

Ref. No.	Designation
519 1701	Impact wrench POWER 5000
519 1718	Impact wrench POWER 5000 PLUS

TOOLS AND ACCESSORIES

Electric tools

Fret saw, electric

Fret saw, electric

- For removing damaged material when skiving out injuries on EM tyres; continuously adjustable speed; extra blade motion can be selected to facilitate work
- Highly efficient and resilient motor for more power output
- Electronic control with constant stroke control, soft start with continuous speed control trigger, overload protection and speed selector wheel
- Orbital stroke selective
- Acceleration trigger for sensitive sawing at the first cut
- With adjustable saw stop



595 4852

3

Ref. No.	Designation	Electric power/ connection	Lifting speed	Weight	Content
595 4852	Fret saw, electric	230 V / 1300 W	0 - 2400 rpm	3.9 kg	
595 4876	Saw blades, 150 mm, for steel/rubber				5
595 4883	Saw blades, 200 mm, for steel/rubber				5

TOOLS AND ACCESSORIES

Electric tools



595 0904



Junio Stripper 3



595 3540



595 3520



595 3530

Stripper devices

Stripper device Junio Stripper 3

- For removing old rubber lagging/lining from smooth metal surfaces (e.g. pulley lagging)
- Scope of delivery: Hand stripper Junio3 (230/115 V), blade 120 mm, flat wrench SW10, transport container, ear protection and operating instructions

Ref. No.	Designation	Power	Voltage	Weight
595 0960	Junio Stripper 3 - 230 V, blade width 120 mm	800 W	230 V	3.6 kg
595 0970	Junio Stripper 3 - 115 V, blade width 120 mm	800 W	110 V	3.6 kg
595 0904	Spare blade, 120 mm For Junio Stripper 3 (595 0960, 595 0970) and prior model, Junio Stripper HS 800 (595 0887).			
595 1202	Spare blade, 135 mm For prior model, "Combi-Stripper" (595 1185).			

Supercut FSC 2.0

The Supercut FSC 2.0 with its oscillating blade is suitable for removing small parts of rubber lining especially where space and access is limited.

Top covers of steel cord conveyor belts are safe and easy to remove with the included blade and scraper.

- Wattage/Power: 400 W
- Oscillations: 11 000 - 18 000 rpm
- Weight: 1.5 kg

Ref. No.	Designation	Content
595 3540	Supercut FSC 2.0 - 230 V	
595 3520	Blade for Supercut FSC 2.0	5
595 3530	Scraper for Supercut FSC 2.0	2

TOOLS AND ACCESSORIES

Electric tools



595 1192



RUBBER CUT 314



RUBBER CUT 414

3

Pulling clamp

For holding and pulling rubber with the Junio Stripper.

Ref. No.	Designation
595 1192	Pulling clamp

Regroovers

RUBBER CUT 314

- For regrooving all tread patterns on commercial vehicle tyres
- 4-step temperature switch on main transformer for different cutting speeds
- Handle with separate transformer enables fatigue-free handling
- Flexible connection cable for optimum movability of the handle
- Most advanced safety technology with all approval seals
- Cutting width with FIX regrooving blades 3-28 mm
- Length: 2000 mm connection
- Temperatur range: 4 heat settings
- Weight: 3.8 kg

Ref. No.	Designation	Electric power/connection
564 1200	RUBBER CUT 314 / 230 V	230 V / 300 W
564 1210	RUBBER CUT 314 / 115 V	115 V / 300 W

TOOLS AND ACCESSORIES

Electric tools

RUBBER CUT 414

- Ergonomic design for fatigue- proof regrooving
- 4-step temperature switch on main transformer with MIN/MAX-selector allows 8 heating levels for different cutting speeds
- Automatic overheating cutout according to DIN 30600
- Insulated cutting head
- Greater freedom of movement and easy guiding due to separation of handle and transformer
- Cutting width with FIX regrooving blades 3- 28 mm
- Prepared for wall mounting
- GS-tested, meets recognized safety Standards
- Length: 2000/2500 mm connection
- Temperatur range: 8 heat settings
- Weight: 3.8 kg

Ref. No.	Designation	Electric power/connection
564 1220	RUBBER CUT 414 230 V	230 V / 300 W
564 1230	RUBBER CUT 414 115 V	115 V / 300 W

RUBBER CUT STATION ECO

- Tool stand and gauge for easy regrooving of truck tyres 17.5" - 24.5"
- Tyres can be regrooved on or off their rims
- Efficient working and loading/unloading of the tyres
- Low space requirement, secure holding of tyres
- Integrated setting gauge
- One roller is equipped with a brake preventing accidental tyre rotation
- Equipped with two castors for moving around workshop
- Rubber Cut tool not included in standard shipment

Ref. No.	Designation	Dimensions	Weight
518 3719	RUBBER CUT STATION ECO, for wheel width max. 500 mm	1150 x 1100 x 1100 mm	approx. 40 kg



518 3719

Cutting knives for regroovers

Round blades

Ref. No.	Designation	Groove width	Groove depth	Qty
564 2803	Round blades R Fix 1	3-4 mm	max. 7 mm	20
564 2810	Round blades R Fix 2	5-6 mm	max. 8 mm	20
564 2827	Round blades R Fix 3	6-8 mm	max. 10 mm	20
564 2834	Round blades R Fix 4	9-10 mm	max. 14 mm	20
564 2841	Round blades R Fix 5	10-14 mm	max. 16 mm	20



564 2841

Angular blades

Ref. No.	Designation	Groove width	Groove depth	Qty
564 2858	Angular blades W Fix 1	3-4 mm	max. 7 mm	20
564 2865	Angular blades W Fix 2	5-6 mm	max. 8 mm	20
564 2872	Angular blades W Fix 3	6-8 mm	max. 10 mm	20
564 2889	Angular blades W Fix 4	9-10 mm	max. 14 mm	20
564 2896	Angular blades W Fix 5	10-14 mm	max. 16 mm	20
564 2906	Angular blades W Fix 6	17-20 mm	max. 16 mm	10



564 2906

Hot knife cutting device

This special tool was developed for working with uncured rubber sheets. The heating system makes rubber application much faster than with standard knives, eliminating the need to cut rubber sheets to size on the cutting table.

The hot iron reduces the effort involved in applying the lining material. Use of the appropriate temperature settings ensures continuous operation.

The 42 V operation allows use in closed containers.

Ref. No.	Designation
595 9350	CHEMOCUT - Hot knife cutting device
595 9370	CHEMOCUT - Hollow blade 21 mm
595 9360	CHEMOCUT - Hollow blade 25 mm
595 9390	CHEMOCUT - Pointed blade
595 9380	CHEMOCUT - Straight blade
595 9340	CHEMOCUT - 42 V transformer
595 9400	CHEMOCUT - Hot iron



TOOLS AND ACCESSORIES
Electric tools

NEW



594 2140



594 0760



594 0780



594 0770

Hot air blower

Hot air blower GHG 660 LCD

- Cold level
- Coarse particle filter
- Saves 4 programs for temperature and air supply
- LCD display
- With dust filter (detachable for easy cleaning)

Scope of delivery

- Reducing sleeve
- Glass protective sleeve
- Area nozzle

Specifications

Rated power	2300 W
Temperature range	50 - 660 °C / 122 - 1220 °F
Air volume	500 ltr/min
Weight	1.0 kg

Ref. No.	Designation
594 2140	BOSCH air blower GHG 660 LCD Professional

Hot air blower Jumbotherm K 25.30

With continuously variable temperature control and monitoring against overheating.

Specifications

Rated power	3000 W
Temperature range	max. 600 °C / 1112 °F
Air volume	550 ltr/min
Weight	approx. 2.2 kg

Ref. No.	Designation
594 0760	Jumbotherm K 25.30, 230 V
594 0780	Wide-spray nozzle, 75 x 4 mm
594 0770	Heating element, 3000 W

TOOLS AND ACCESSORIES

Extruders

REMA TIP TOP extruders

- For quick filling when repairing or retreading light truck, truck, agricultural and EM tyres
- Can be used for cushion gum and tread stock qualities
- Please observe the information on the average rubber throughput (in kilogrammes per hour)

Extruder NORMAL

- For quick filling of damages at all types of tyres
- Usable for all ropes of raw-rubber with 8 mm of Diameter
- Rubber throughput: 18 kg/h
- Operating pressure: 5 - 8 bar / 115 - 265 psi
- Weight: 5 kg
- Temperature range: up to 120 °C / 248 °F



517 7505

Ref. No.	Designation	Electric power/ connection
517 7505	REMA TIP TOP extruder NORMAL, pneumatic	230 V / 550 W
517 7490	REMA TIP TOP extruder NORMAL, pneumatic	115 V / 550 W

Extruder GIANT

Temperature range: up to 120 °C / 248 °F



517 7512

Ref. No.	Designation	Electric power/ connection	Rubber throughput	Weight
517 7512	REMA TIP TOP extruder GIANT Operating pressure: 5 - 8 bar / 115 - 265 psi	230 V / 750 W	28 kg/h	6 kg
517 7529	REMA TIP TOP extruder GIANT, electric Particularly suitable for filling skives on EM tyres - High throughput allows quick filling of the skive	230 V / 1600 W	40 kg/h	13 kg



517 7529

TOOLS AND ACCESSORIES

Extruders

Extruder NAILHOLE

- Rubber throughput: 6 kg/h
- Operating pressure: 5 - 8 bar / 115 - 265 psi
- Temperature range: up to 120 °C / 248 °F



517 7608

Ref. No.	Designation	Electric power/ connection
517 7608	REMA TIP TOP extruder NAILHOLE, pneumatic	230 V / 400 W
517 7615	REMA TIP TOP extruder NAILHOLE, pneumatic	115 V / 400 W

Extruder COMPOUND MASTER

- The effective hand extruder for easy processing of unvulcanized T2 COMPOUND in workshops or on site
- Sturdy A.C. drive unit
- Shoulder strap included
- Self-cooling aluminium housing for extruder worm
- Safe material supply due to large feeding hopper
- Homogeneous mixture ensured by integrated mixing chamber
- Quickly exchangeable jet moulding nozzle
- Rubber throughput: 24 kg/h
- Weight: 8.5 kg



517 5160, 517 5150

Ref. No.	Designation	Electric power/ connection
517 5150	REMA TIP TOP extruder COMPOUND MASTER	230 V / 1600 W
517 5160	REMA TIP TOP extruder COMPOUND MASTER	115 V / 1600 W
517 3592	Nozzle adapter set, for COMPOUND MASTER	

STZ Extruder

- Extruder gun for the rational filling of gaps between steel cables with STZ intermediate rubber
- Engine speed of 250 rpm for the optimum viscosity and the uniform flowing of the rubber
- Lightweight, robust design "Made in Germany"
- Handle mountable on both sides for left and right-handed
- New filler neck for safe handling
- Rubber throughput: 28 kg/h
- Weight: 5.6 kg



517 5174, 517 5175

Ref. No.	Designation	Power
517 5174	STZ Extruder	230 V/1300 W
517 5175	STZ Extruder	110 V/1300 W
517 5176	Bow handle (additional accessoire)	

REMASTRIP

REMASTRIP - Cable stripping system

For stripping steel cables when preparing belt splices. The cutting device is designed for cable pitches of 10 - 25 mm and for diameters of 4.9 to 11.3 mm.

Scope of delivery

- 595 1549 5 Blades, top, for cable Ø 7.2 mm
- 595 1642 5 Blades, bottom, for cable Ø 7.2 mm
- 595 1587 5 Blades, top, for cable Ø 9.7 mm
- 595 1680 5 Blades, bottom, for cable Ø 9.7 mm
- 595 1721 1 Blade holder No. 1, top, for max. 8.9 mm cable Ø
- 595 1745 1 Blade holder No. 1, bottom, for max. 8.9 mm cable Ø
- 595 1738 1 Blade holder No. 2, top, for 9.0 mm cable Ø and above
- 595 1752 1 Blade holder No. 2, bottom, for 9.0 mm cable Ø and above
- 595 1769 1 Pressure roller No. 1, top, for max. 8.9 mm cable Ø
- 595 1941 1 Pressure roller No. 2, top, for 9.0 mm cable Ø and above
- 595 1879 2 Setting gauges (for rough adjustment of cutting unit)

Additional articles for ST 10000 belts:

- 595 1753 1 Blade holder No. 3, top
- 595 1754 1 Blade holder No. 3, bottom
- 595 1942 1 Pressure roller No. 3, top



3

Ref. No.	Designation
595 1968	REMASTRIP cutting device, left side version
595 1969	REMASTRIP cutting device, right side version

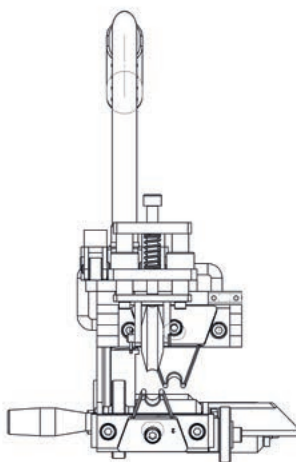

595 1968

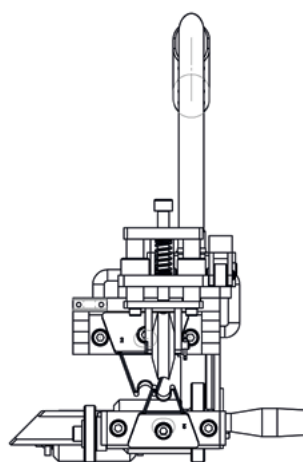

595 1969

TOOLS AND ACCESSORIES

Conveying belt handling

REMASTRIP - Pulling unit

- Opening of the cable sheaves protection on the other side so that the pulley unit can be used as left and right version
- U-profile below the sheave for a safe cable guide
- Securing of the protection against unauthorized removal

Caution: Pulling unit may only be used for pulling in a horizontal direction. The lifting of loads is prohibited!



Specifications	595 1911	595 1913
Voltage	3 PH - 220 V	380 - 500 V
Rated current	5.6 / 9.8 A	5.5 A
Engine power	0.6 / 2.4 kW	0.22 / 2.2 kW
Torque on the gear	625 / 615 Nm	560 Nm / max. 820 Nm
Output speed on the gear	9.2 / 37 r/min	3.8 - 38 r/min continuous setting
Cable length	7 m	7 m
Control voltage on control panel	220 V	24 V
Total weight	approx.: 80 kg	approx.: 83 kg
Protective voltage on control panel		•
Engine with holding brake		•

Ref. No.	Designation
595 1911	Pulling unit, 220 V
595 1913	Pulling unit, 380 - 500 V Protective voltage on control panel - engine with holding brake (no rotating back against the operating direction when cable is under tension)
595 1927	Slide unit, 3 m, for belt widths up to 2200 mm
595 1934	Slide unit, 4 m, for belt widths from 2200 mm

TOOLS AND ACCESSORIES

Conveying belt handling

REMASTRIP - Blades

Ref. No.	Designation	For cable Ø	Qty
595 1524	Blades, top	3.9 mm	50
595 1627	Blades, bottom	3.9 mm	50
595 1525	Blades, top	4.9 mm	50
595 1628	Blades, bottom	4.9 mm	50
595 1532	Blades, top	5.6 mm	50
595 1635	Blades, bottom	5.6 mm	50
595 1604	Blades, top	6.2 mm	50
595 1707	Blades, bottom	6.2 mm	50
595 1549	Blades, top	7.2 mm	50
595 1642	Blades, bottom	7.2 mm	50
595 2335	Blades, top	7.5 mm	50
595 2342	Blades, bottom	7.5 mm	50
595 1556	Blades, top	8.1 mm	50
595 1659	Blades, bottom	8.1 mm	50
595 1563	Blades, top	8.6 mm	50
595 1666	Blades, bottom	8.6 mm	50
595 1570	Blades, top	8.9 mm	50
595 1673	Blades, bottom	8.9 mm	50
595 1587	Blades, top	9.7 mm	50
595 1680	Blades, bottom	9.7 mm	50
595 2359	Blades, top	10.6 mm	50
595 2366	Blades, bottom	10.6 mm	50
595 1594	Blades, top	11.3 mm	50
595 1697	Blades, bottom	11.3 mm	50
595 1611	Blades, top	12.0 mm	50
595 1714	Blades, bottom	12.0 mm	50
595 2311	Blades, top	12.5 / 13.2 mm	50
595 2328	Blades, bottom	12.5 / 13.2 mm	50
595 2312	Blades, top	16.0 mm	50
595 2329	Blades, bottom	16.0 mm	50

Rope winch

Electrical rope winch 990 kg RPE

- Internally brake motor for compact dimensions
- Euro voltage 230/400 V, 3-phase, 50 Hz
- Protection IP 54
- Slip clutch adjustable from 1000 kg
- Very smooth running through helical gears
- Gear used in all mounting positions
- Spring pressure disc brake: integrated in the motor holds the load even during power failures

Cable not included!

Optional on request:

- Drum version with larger cable capacity
- Grooved for improved cable management
- Divider with 2nd cable outlet for simultaneous work with 2 cables
- Traversing operation
- Gear switch for limiting the rope distance in both directions
- Pendant control including control switch with emergency stop control and 2 m control line
- Contactor control with 42 V control voltage
- Slack rope switch
- Frequency converter for stepless speed control
- Operating voltage 230 V, 1 phase, 50 Hz

NEW



594 2080

Specifications

Pulling force	990 daN
Lifting speed	6.0 m/min.
Rope Ø	8 mm
Engine power	1.10 kW
ED at 120 c/h	40%
effective rope length 1./2./3. layer	10.2 / 23.0 / 37.4 m
Weight	76.0 kg (without rope)

Ref. No.	Designation
594 2080	Electrical rope winch, 990 kg, RPE 9-6
594 2250	Wire cable, Ø8 mm, 990-1000 daN

Fabric belt cutting device

Fabric belt cutting device

Precise cutting of EP conveyor belts at right angles. Belt width of up to 1400 mm.

Ref. No.	Designation
595 2500	Fabric belt cutting device
595 2517	Spare cutting blade



595 2500

Conveying belt tension devices

Conveyor belt tensioning device

Ref. No.	Designation
595 8614	Tensioning clamp, size 1, belt width up to 650 mm Set includes: - 2x 595 8621 belt clamps, size 1 - 1x 595 8638 ring spanner 27/30 - 2x 595 8700 conveyor belt tensioners, 3 kN - 2x 595 8724 chains, 13 mm Ø, 5 m long
595 8676	Tensioning clamp, size 2, belt width 650 - 1000 mm Set includes: - 2x 595 8683 belt clamps, size 2 - 1x 595 8638 ring spanner 27/30 - 2x 595 8700 conveyor belt tensioners, 3 kN - 2x 595 8724 chains, 13 mm Ø, 5 m long
595 8731	Tensioning clamp, size 3, belt width 800 - 1200 mm Set includes: - 2x 595 8748 belt clamps, size 3 - 1x 595 8638 ring spanner 27/30 - 2x 595 8700 conveyor belt tensioners, 3 kN - 2x 595 8724 chains, 13 mm Ø, 5 m long



595 8614,
595 8676,
595 8731

TOOLS AND ACCESSORIES

Conveying belt handling

Aluminium belt clamp bar

- Belt clamp bars made of heat-treated extruded aluminium
- All parts resist corrosion and can be use in wet and corrosive environments
- Clamping scissors slide easily into place against both belt edges for easy adjustability
- Load capacity of up to three tons (2.7 metric tons), when used with two 1-12-ton chain come-along
- Ideal for rubber covered and PVC heavy-duty belting from 7/32" (6 mm) to 1" (25 mm)
- Set include 4 clamping bars, 4 clamps and carrying bag (chain hoists and accessories not included!)
- Aluminium alloy type: 6061, 1.00% magnesium, titanium 0%



Additional belt width available on request!

Ref. No.	Designation	Belt width	Weight
594 2030	Aluminium belt clamp bar	up to 900 mm (36")	39.5 kg (87 lbs)
594 2070	Aluminium belt clamp bar	up to 1200 mm (47")	44.5 kg (98 lbs)

TOOLS AND ACCESSORIES

Conveying belt handling

Vice grip, belt tensioner, PSC cutter

Vice grip

Ref. No.	Designation	Tensile load
595 1329	Vice grip Size 2	max. 8 kN
595 1336	Vice grip Size 3, HD model	max. 30 kN



595 1329

TT Belt tensioners

Mechanical clamping device (eccentric clamp) for securing conveyor belts.
Set includes: 1 pair, with hoisting cables

Ref. No.	Designation	Ø	Weight	Content
530 0695	TT Belt tensioners for belt width 650 mm	70 mm	18/18 kg	1 pair
530 0705	TT Belt tensioners for belt width 800 mm	70 mm	20/20 kg	1 pair
530 0712	TT Belt tensioners for belt width 1000 mm	70 mm	24/24 kg	1 pair
530 0729	TT Belt tensioners for belt width 1200 mm	105 mm	55/55 kg	1 pair
530 0736	TT Belt tensioners for belt width 1400 mm	105 mm	60/60 kg	1 pair
530 0743	TT Belt tensioners for belt width 1600 mm	105 mm	65/65 kg	1 pair
530 0750	TT Belt tensioners for belt width 1800 mm	105 mm	70/70 kg	1 pair
530 0781	TT Belt tensioners for belt width 2000 mm	105 mm	75/75 kg	1 pair
530 0798	TT Belt tensioners for belt width 2200 mm	105 mm	82/82 kg	1 pair
530 0808	TT Belt tensioners for belt width 2400 mm	105 mm	88/88 kg	1 pair
530 0891	TT Belt tensioners for belt width 2600 mm	105 mm	94/94 kg	1 pair



TT belt tensioners

PSC cutter

Cutting capacity: DIN belts up to ST3150, max. belt thickness 28 mm.

Ref. No.	Designation
595 2380	PSC cutter
595 0810	Spare blade for PSC cutter



595 2380

TOOLS AND ACCESSORIES

Cable and chain winches

Cable winches

For lifting, pulling and tensioning in any position and direction, without shock and with absolute precision. With tip and hook on hand reel.



594 0050,
594 0060,
594 0070

Cable winches TU 8/TU 16

Ref. No.	Designation	Length	Rope-Ø	Tensile load
594 0050	Cable winch TU 8	20 m	8 mm	0.8 t
594 0060	Cable winch TU 16	20 m	11.5 mm	1.6 t
594 0070	Cable winch TU 16	20 m	16 mm	3.2 t

Chain winches

Chain winch RU 1.5 t and RU 3.0 t

All purpose device UNOplus, round steel chain. Use: lifting, pulling, lashing of loads.

- Compact and robust steel construction
- Lifting hook forged from non-aging, high tensile steel
- Opening in the case of overloading without breaking
- Galvanized, high strength chain corresponds to valid national and international standards
- Robust bottom block: with encapsulated bolts
- Corrosion-protected load pressure brake and asbestos-free friction discs
- Easy handling due to low weight
- Robust design of the chain
- Smoothly chain operation to quickly attach the load
- Chain guiding integrated in the case, flawless flow of the chain over the load chain wheel
- Minimum effort by optimal gear ratio
- Ergonomic handle with rubber coating
- Hand wheel made of impact-resistant ABS plastic



594 0030, 594 0040

Additional lifting power available on request.

Specifications	594 0030	594 0040
Load capacity	750 - 6000 kg	750 - 6000 kg
Tensile load	1500 kg	3000 kg
Number of power drive	1	1
Lifting height	1.5 m	1.5 m
Dimensions of chain	8 x 24-T(8) mm	10 x 30-T(8) mm
Lifting force at nominal load	35 daN	40 daN
Weight at normal lift	12.5 kg	21.5 kg

Ref. No.	Designation
594 0030	Chain winch RU 1.5 t, with round-link chain
594 0040	Chain winch RU 3.0 t, with round-link chain

TOOLS AND ACCESSORIES

Tyre handling

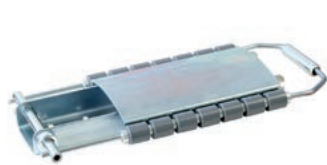

517 8092



595 2988



595 2971



519 8780



519 9222

Tyre spreaders

Tyre spreaders

- Tyre spreaders for preparing the inspection and repair of truck and car tyres
- High stability and strength
- Easy operation
- Wide spreading range
- Suitable for very stiff beads

	5198780	5199222	5176984	5199200	5199181	5176991	5199239
Spreading range	50 - 600 mm	100 - 530 mm	100 - 350 mm	100 - 975 mm	200 - 1150 mm	230 - 360 mm	340 - 550 mm
Operating pressure			6 - 8 bar / 185 - 265 psi		500 bar		
Size	770 x 200 x 90 L x W x H mm	937 x 466 x 120 L x W x H mm					
Tyre size				20 - 57"	20 - 57"		
Weight	4.4 kg	9.0 kg	approx. 4.4 kg	28 kg	42 kg	1.2 kg	6 kg

Ref. No.	Designation						
517 8092	Fire hose tensioner Holds the hose and provides a smooth base for vulcanizing of high-pressure hoses						
595 2988	Tyre/tube tensioner Can fix tubes, car and motorcycle tyres - Can be mounted on work bench		•	•			
595 2971	Car tyre spreader For easy spreading of tyre beads (two required)		•	•			
519 8780	Truck tyre spreader, with clamping mechanism			•	•		
519 9222	EM tyre spreader, with clamping mechanism					•	•

TOOLS AND ACCESSORIES

Tyre handling



517 6984









519 9181



517 6991



519 9239

Ref. No.	Designation						
517 6984	Truck tyre spreader, pneumatic			■	■		
519 9181	EM bead spreader, hydraulic Hydraulic bead spreader for EM tyres with stiff beads - Pump not included in standard shipment Suitable for: Hand/foot pump hydraulic; Foot pump pneumatic-hydraulic						■
517 6991	Spreader bars, truck For securing spreaded tyre beads			■			
519 9239	EM Spreader bars For securing spreaded tyre beads						■

TOOLS AND ACCESSORIES

Tyre handling

REP BOY tyre spreader

- Tyre spreader for preparing the inspection and repair of car and motorcycle tyres
- The tyre can be inspected and prepared inside and outside
- The tyre can be turned and inclined into the perfect working position (patented mechanism)
- Comfortable working height
- Integrated tray for tools and materials
- Halogen lamp and base plate not included but separately available

Ref. No.	Designation	Weight		
517 0777	REP BOY tyre spreader, mechanical	26 kg	•	•
517 0784	Base plate for REP BOY tyre spreader	14 kg		
517 4522	Halogen lamp, magnetic			



REP BOY tyre spreader
(tyre, lamp and base plate not included)

REPMAT tyre spreader

- Tyre spreader for preparing the inspection and repair of car and truck tyres
- Compact, light weight construction
- Operating pressure controlled by hand lever
- The tyre is rolled into position up a detachable ladder
- Comfortable working height

Specifications	5183506
Operating pressure	10 bar / 295 psi
Size	800 x 500 W x H mm
Overall height	700 mm
Working height	510 mm
Weight	45 kg



REPMAT (tyre not included)

Ref. No.	Designation		
518 3506	REPMAT tyre spreader, pneumatic	•	•

TOOLS AND ACCESSORIES

Tyre handling



Tyre lift spreader RHS 300

570 1500

570 1510

570 1650

570 1530

Tyre lift spreader RHS 300



- For preparing the inspection and repair of agricultural, truck, EM and industrial tyres
- For tyres with a max. of 1700 mm outer diameter up to 300 kg at 10 bar / 145 psi operating pressure
- Unique table tilt range of 0 to 40 degrees (fixation on the floor is required)

- Shoulder and sidewall repairs can be carried out ergonomically
- Low roll-on height of 280 mm
- Optimised lifting height up to 880 mm
- Clearly arranged controls

Optional accessories:

- Tool tray
- Slide provides protection of lifting carriage
- Servicing unit
- Multi-socket power strip
- Mounting kit for servicing unit

Specifications	5199210	5199167
Tyre size	up to 520/60 R38	
Lifting height	880 mm	
Size	1380x800x1520 H x W x L mm	
Weight	235 kg	3.9 kg

Ref. No.	Designation			
519 9210	Tyre lift spreader RHS 300	•	•	•
519 9167	Set of EM extensions Suitable for: Tyre lift spreader RHS 300; Tyres up to 23.5R25		•	
570 1500	Tool tray			
570 1510	Slide			
570 1650	Servicing unit up to 16 bar / 465 psi, consisting of compressed air filter/oiler assembly			
570 1530	Multi-socket power strip, 4 outlet			
570 1660	Mounting kit for servicing unit			

TOOLS AND ACCESSORIES

Tyre handling



519 1582



519 1567



519 1598

Bead breakers and pumps

EM mounting set

- Suitable for demounting and mounting EM tyres, also on the vehicle
- The mounting set is used to press off the rings of multi-piece rims
- The mounting set can also be used in case of inflation problems
- The flange ring is then pressed against the sealing ring/tyre bead until the tyre is sufficiently pressurized

Scope of delivery

- 2 Threaded spindles with claw 440 mm
- 2 Threaded spindles with bracket 400 mm
- 2 Tyre levers, different length
- 1 Wrench

Ref. No.	Designation	Size	Bead Breaking force	Weight	
519 1582	EM mounting set, 25" - 38" Base frame in wooden box, without the pump	1200 x 500 x 220 L x W x H mm			•
519 1550	Extension set, 39" - 51", for EM mounting set Includes 1x extension frame, 1x extension spindle, 1x nut M 24, 1x nut M 12, 1x bolt M 12				•
519 1567	Bead breaking cylinder, with adjusting cylinder for inside breaking		500 bar	8 kg	•

EM bead breaker STANDARD

- The EM bead breaker is suitable for EM tyres on 5-piece rims
- Not damaging to the beads
- As a rule, the tyres are demounted on-vehicle
- Pump not included in standard shipment

Ref. No.	Designation	Bead Breaking force	Weight	Tyre size	
519 1598	EM bead breaker STANDARD for hand/-foot pump hydraulic, foot pump air-hydraulic	500 bar	15 kg	23 - 49"	•

TOOLS AND ACCESSORIES

Tyre handling

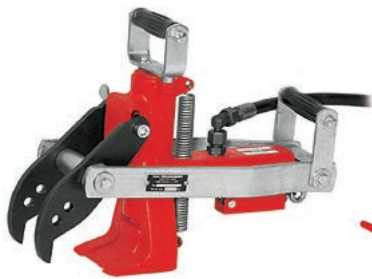

519 1574



519 1731



558 2660



558 2620





558 2630,
558 2640



558 2650

Bead breaker

Hydraulic claw breaker for breaking the beads on mounted or demounted wheels.

Ref. No.	Designation	Bead Breaking force	Weight			
519 1574	Bead breaker AS For combi-ring rims and 4-piece flat base rims of truck wheels, AS-, grader- and EM-tyres on 3-piece semi drop centre rims with locking ring and 1-piece drop centre rims for forklifts and Unimog. Pump not included.	500 bar	22 kg	•	•	
519 1731	OTR EM bead breaker type 3 light For 3-piece OTR-/EM-wheels without groove in bead area. High breaking force and reliable techniques. Pump not included.	700 bar	18 kg			•
558 2620	Bead breaking jaw type 3, up to 25" Suitable for: OTR EM bead breaker type 3					•
558 2630	Bead breaking jaw, standard Suitable for: OTR EM bead breaker type 3					•
558 2640	Bead breaking jaw short, up to 2" Suitable for: OTR EM bead breaker type 3					•
558 2660	Bead breaking jaw long, up to 3"					•
558 2650	Spare support legs Suitable for: OTR EM bead breaker type 3					•

TOOLS AND ACCESSORIES

Tyre handling



519 9088



595 0698



519 9057



518 4550



519 3350

Bead breakers

Ref. No.	Designation	Weight	Breaking force
519 9088	<p>TYRE FOX Mobile, manual bead breaker - Completely mechanical operation, no electricity or air supply required - Can be used for extremely wide wheels with hump or double hump</p> <p>Suitable for: ATVs and off-road vehicles with wheels from 12" to 20"</p>		
595 0698	Bead knocker		
519 9057	Bead breaker FAGUS		
518 4550	<p>Bead breaker BEAD CHEATA Portable bead breaker, simple action can be operated by hand or air impact wrench</p>	4 kg	10 t
519 3350	<p>Bead breaker KOMPAKT PLUS Strong and sturdy hydraulic bead breaker for truck tyres, operated by hand lever - Enables the replacement of defective valve pressure sensors if a suitable tyre changer is not on hand</p> <p>Suitable for: Truck hump rims</p>		

TOOLS AND ACCESSORIES

Tyre handling



EM bead breaker GIGANT I

- The EM bead breaker is suitable for EM tyres on 5-piece rims
- Not damaging to the beads
- As a rule, the tyres are demounted on-vehicle
- Pump not included in standard shipment



Scope of delivery

- 5589234 1 Adjustable counter-support
- 5586440 1 Counter support 49"
- 5586749 1 Puller hook size 2
- 5589227 1 Puller hook size 19
- 1 Insert segment, height 20, 30, 40, 50 mm

Ref. No.	Designation	Bead Breaking force	Weight	Tyre size	
519 1725	EM bead breaker GIGANT I	700 bar	30 kg	23 - 49"	•

Pumps

Hydraulic pumps for bead breakers.

Ref. No.	Designation	Bead Breaking force		
519 1512	Hand/foot pump, hydraulic Suitable for: Wheel/tyre remover	500 bar	•	•
519 1513	Hand/foot pump, hydraulic Suitable for: OTR EM bead breaker type 3	700 bar		•
519 1529	Foot pump, pneumatic-hydraulic Suitable for: Wheel/tyre remover	500 bar	•	•
519 1520	Foot pump, pneumatic-hydraulic Pneumatic assistance speeds up pumping - Foot switch with 2 positions (pump/release) - Electric power/connection: 1/4" - Size: 172x112x295.5 mm - Weight: 5.3 kg Suitable for: OTR EM bead breaker type 3	700 bar		•
519 1691	Foot pump, pneumatic-hydraulic For bead breakers with large oil volume such as the "GIGANT" series Suitable for: EM bead breaker GIGANT I; EM bead breaker GIGANT II	700 bar		•

TOOLS AND ACCESSORIES

Tyre handling

EM bead breaker GIGANT II

- The EM bead breaker is suitable for EM tyres on 5-piece rims
- Not damaging to the beads
- As a rule, the tyres are demounted on-vehicle
- Dual drawing hook mechanism for use on a balancer/suspension device
- Pump not included in standard shipment

Scope of delivery

- 5586457 1 Counter-support 51"
- 1 Adjustable counter-support
- 1 Insert segment, height 17, 25, 40 mm



519 1677

Ref. No.	Designation	Bead Breaking force	Weight	Tyre size	
519 1677	EM bead breaker GIGANT II	700 bar	70 kg	51- 57"	•
519 1684	Carriage, for EM bead breaker GIGANT II				•
558 6464	Counter-support 57", for EM bead breaker GIGANT II				•

TOOLS AND ACCESSORIES

Tyre handling



Bead breakers from AME International

- Well-reputed among industry professionals for excellent quality
- Powerful bead breakers backed by proven technology
- Safe handling of all units

	5200080	5200110	5200100	5200220	5200240	5200250	5200170	5200180	5200190
Electric power/ connection	700 bar	700 bar	700 bar	700 bar					
Breaking force					10 t	10 t	10 t	10 t	10 t
Lifting height						200 mm	121 mm	248 mm	90 mm
Height							54 mm	156 mm	
Weight	17 kg	14.5 kg	23.5 kg	23.5 kg	14 kg	13 kg			4.5 kg

Ref. No.	Designation	
520 0080	Combi bead breaker, modified for 3-piece OTR/EM wheels to 25"	•
520 0110	OTR bead breaker for 5-piece wheels from 25" to 51"	•
520 0100	OTR bead breaker GIANT 2000 for 5-piece wheels from 39" to 63"	•
520 0220	OTR bead breaker for 5-piece wheels without bead loosening pockets	•
520 0240	OTR bead breaker Diamondback 40% lighter compared to steel-breakers. For all types of OTR wheels and dimensions.	•
520 0250	OTR bead breaking cylinder STINGER Lightweight machine for 3-piece wheels	•
520 0230	OTR bead breaker GIANT 3000 for wheels from 57" to 63"	•
520 0170	Bead breaking cylinder, type 1	•
520 0180	Bead breaking cylinder, type 2	•
520 0190	Aluminium hydraulic ram kit	•
520 0270	Aluminium upgrade kit	•

TOOLS AND ACCESSORIES

Tyre handling



520 0010



520 0020



520 0030



520 0060



520 0070

Pumps from AME International

- Powerful, easy to use EM/OTR pumps
- Universal connection means that only one pump is required for all Units
- Suitable for all AME bead breakers, bead breaking cylinders and lifting jacks

Ref. No.	Designation	Operating pressure	Size	Weight	
520 0010	Hand pump An alternative to the pneumatic-hydraulic foot pump - Designed for field use with no air supply	700 bar	520 mm	5.7 kg	•
520 0020	Foot pump Turbo II motor permits fast operation - Foot switch with two positions (pump/release)	700 bar		7.3 kg	•
520 0030	Foot pump, air-hydraulic	700 bar		11.4 kg	•

Lifting jacks from AME International

- The lifting jacks are manufactured from aluminium and are particularly lightweight
- Base plate ensures stability during use, also on sandy ground
- Shut-off valve allows the pump to be removed after actuation of the ram

	5200060	5200070
Electric power/connection	700 bar	700 bar
Lifting capacity	100 t	55 t
Lifting height	450 mm	450 mm
Cylinder movement	300 mm	310 mm
Weight	24 kg	13.2 kg

Ref. No.	Designation	
520 0060	EM/OTR lifting jack	•
520 0070	EM/OTR lifting jack	•

TOOLS AND ACCESSORIES

Tyre handling

Transport trolleys and tyre working tables



Tyre transport

- For easy lifting and unloading whole stacks of tyres/wheels
- The pick-up fork which opens and grabs the tyre avoids damaging the rim or bead
- The adapter console is located by the pick-up fork and thus adjusted properly
- Wheels not included



518 2875

518 3582

Ref. No.	Designation	Size	Weight	Stack width		
518 2875	Tyre CADDY Tyres not included	850x600x1530 L x W x H mm	17 kg	1500 mm	•	
518 3582	BIG CADDY, with pneumatic tyres (3.00-4) The BIG CADDY is a further development of the Tyre CADDY - The force is transferred from the foot pedal jack with gear mechanism to the tyre pick-up - Safe movement is ensured by the support roller - Also suitable for light truck tyres up to 17.5" - Sturdy design	730x750x1630 L x W x H mm	45 kg	1600 mm	•	•

REMA TIP TOP workplace PROFI

- The ideal workbench for the tyre specialist, which makes it easy to keep things tidy
- Saves wasting time searching for tools
- Includes illumination, zinc-plated work surface, 4 shelves and 2 multiple tool holders, multiple socket with on/off switch



517 4508

Truck tyre working table

- Provides the optimum working conditions for professional truck tyre repair
- For ergonomic positioning of tyres up to 24"
- Table can be tilted and swivelled

Ref. No.	Designation	
517 1051	Truck tyre working table	•



517 1051

TOOLS AND ACCESSORIES

Valve tools



Valve tools and accessories

Valve core screwdriver

Ref. No.	Designation	Content
562 8102	Valve core screwdriver standard, VG5 Plastic grip, nickel-plated metal parts	10
562 8092	Valve core screwdriver standard/EM, VG5/VG8 Plastic grip, nickel-plated metal parts	10
562 3956	Valve core screwdriver RDKS	1
562 8160	Valve core screwdriver "Floc" Tool for inserting and removing caps and cores	1
562 8119	Valve core screwdriver standard/EM, VG5/VG8 Plastic grip, burnished metal parts, with sockets for valve cores/caps	1

Valve core screwdriver "LOCK TOOL"

- The valve core is held by a spring clip when fitting or unscrewing

Ref. No.	Designation	Content
562 8360	LOCK TOOL Standard, VG5	50
562 8377	LOCK TOOL flexible, VG5	50
562 8391	LOCK TOOL MOTO, VG5	50
562 8384	LOCK TOOL EM, VG8	50

TOOLS AND ACCESSORIES

Valve tools



TPMS tools

Ref. No.	Designation	Torque	Length	Content
562 8420	Valve core screwdriver VALVE PROOF, red plastic handle Suitable for: Snap-In valves	0.25 Nm	120 mm	1
562 8430	Valve core screwdriver VALVE PROOF, black plastic handle Suitable for: Metal/aluminium valves	0.45 Nm	120 mm	1
562 3485	Torx T10 torque screwdriver Suitable for: Schrader RTPMS Snap-In sensors	1.4 Nm		1
562 3990	Grommet removal tool, red Suitable for: Rubber grommets of TPMS valves			10

Valve mounting tools

Ref. No.	Designation	Content
562 8353	Valve mounting tool	10
562 8410	Valve mounting tool MOTO Mounting tool for motorcycles - A free-wheel at the threaded part allows easy removal after inserting the valve without interference by spokes or brake disc	10
562 8140	Valve mounting tool	10
562 8308	Valve mounting tool	10
562 8230	Valve mounting tool	1
562 8339	Valve mounting tool R	1
562 8250	Valve mounting tool QUICK Fast and easy mounting of Snap-in valves with valve cap attached	1
562 8150	Valve insertion tool	1

TOOLS AND ACCESSORIES

Valve tools



562 8016



562 8023



562 8030



562 8061



562 8315



562 8212

Valve repair tool

For the repair of damaged valve threads.

Ref. No.	Designation	Content			
562 8016	Valve repair tool, 3-piece Core removal tool - External thread VG8 - Internal thread VG5	10	•	•	
562 8023	Valve repair tool, 4-piece Standard valve core mounting/removal tool - External thread VG8/VG12 - Internal thread VG5	10	•	•	•
562 8030	Valve repair tool, 4-piece Core removal tool - External thread VG8/VG12 - Internal thread VG5 I	10	•	•	•
562 8061	Valve repair tool, 4-piece EM valve core mounting/removal tool - External thread VG12 - Internal thread VG5/VG8	10	•	•	•

Valve fishing tool

Designed to assist valve hole location when fitting tubes.

Ref. No.	Designation	Content
562 8315	Valve fishing tool	10

Valve holder

Facilitates cutting of thread stub of broken tube valves with rubber base.

Ref. No.	Designation	Content
562 8212	Valve holder, with cutting gauge	10

TOOLS AND ACCESSORIES

Valve tools

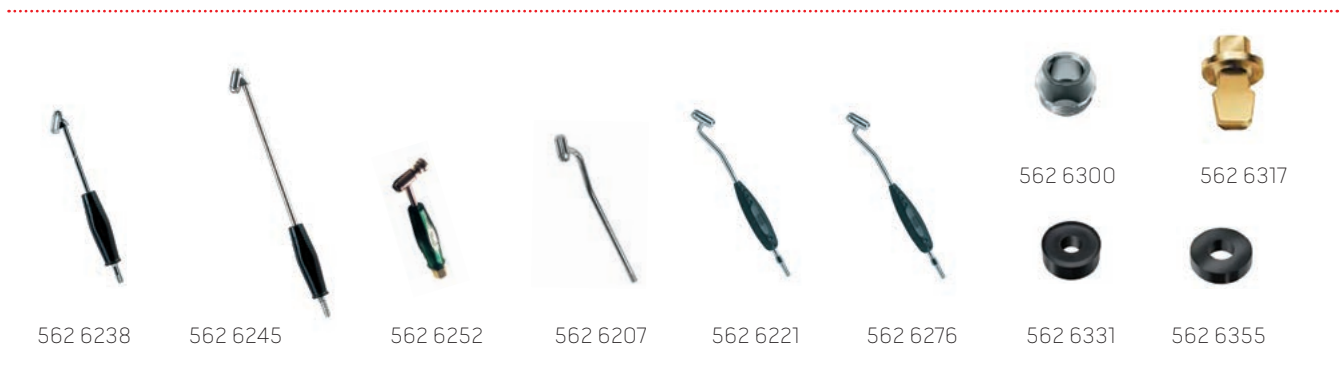

3

Tyre inflating connectors and accessories

Tyre inflating connectors, open end

Ref. No.	Designation
562 6238	Tyre inflating connector
562 6245	Tyre inflating connector

Tyre inflating connectors, closed end

For quick coupling to snap-on connectors.

Ref. No.	Designation	Length
562 6252	Tyre inflating connector	
562 6207	Tyre inflating connector, without handle	200 mm
562 6221	Tyre inflating connector, with handle	270 mm
562 6276	Tyre inflating connector, with handle	320 mm

Accessories - Tyre inflating connectors

Ref. No.	Designation	Content
562 6300	Chuck nut	20
562 6317	Deflator pin	20
562 6331	Rubber washer	20
562 6355	Rubber washer	20

TOOLS AND ACCESSORIES

Tyre mounting

Demounting aid

Wheel trim remover

For demounting plastic wheel trims without damage.

Ref. No.	Designation
519 5040	Wheel trim remover



519 5040

Rim straightening lever

For repairing deformations on the rim flange.

Ref. No.	Designation
519 5099	Rim straightening lever Suitable for: Steel rims



519 5099

Wheel remover, mechanical

- Economic, compact and easy-to-use alternative to the common hydraulic wheel/tyre removers
- Due to its low weight, it is especially suitable for the mobile tyre service
- No pump is required
- Set in between the tyre/rim and the vehicle body the wheel is loosened by turning the hexagon head of the threaded rod with a fork wrench

Ref. No.	Designation
519 1505	Wheel remover, mechanical



519 1505

TOOLS AND ACCESSORIES

Tyre mounting

Wheel/tyre remover

- Used for loosening frozen wheels from the vehicle
- Integrated bead breaking shovel for tubeless 14/80 R 20 tyres on combi-ring rims
- Chassis adjustable in height, four castors
- Operation with hydraulic pumps 5191512 or 5191529
- Pump not included with the tool



519 1536

5191536	
Height	max. 420 mm
Breaking force	8 t
Weight	40 kg
Length	1125 mm



519 1543

Ref. No.	Designation
519 1536	Wheel/tyre remover Suitable for: Twin axles and pilote tyres, also on jumbo axles
519 1543	Chassis for wheel/tyre remover For retrofitting older wheel/tyre removers for Jumbo axles

Mounting aid

Wheel mounters for cars, trucks

The REMA TIP TOP wheel mounters enable easy and precise mounting of heaviest wheels on the vehicle with a minimum of effort.



519 1490

Ref. No.	Designation
519 1490	Wheel mounter for cars, adjustable in width Suitable for: All common sizes from car to SUV wheels
519 1610	Wheel mounter for trucks Suitable for: 17.5" - 24.5" and winter tyres; X-One wheel size 495/45 R 22.5"



519 1610

TOOLS AND ACCESSORIES

Tyre mounting



518 0341



571 9140



571 9160

Mounting lever for alloy rims

Ref. No.	Designation	Length
518 0341	Special tyre lever	500 mm
519 8041	Plastic protection, for special tyre lever	
519 8089	Mounting lever, with plastic protection	

Wheel hub grinder

Wheel hub grinder type 1

Scope of delivery

- 1 Holder with grinding disc
- 2 Spare grinding discs

Ref. No.	Designation	Dia.
571 9140	Wheel hub grinder type 1	160 mm
571 9150	Spare grinding discs type 1 (3 pcs.)	160 mm

Wheel hub grinder type 2

Scope of delivery

- 2 Holders with grinding disc
- 5 Spare grinding discs, small
- 5 Spare grinding discs, large

Ref. No.	Designation
571 9160	Wheel hub grinder type 2, for studs

TOOLS AND ACCESSORIES

Tyre mounting

Wheel hub grinder type 3

Scope of delivery

- 1 Holder with grinding disc
- 2 Spare grinding discs



571 9170

Ref. No.	Designation	Dia.
571 9170	Wheel hub grinder type 3	200 mm
571 9180	Spare grinding discs type 3	200 mm

Centering rings and centering aid

Centering rings for trucks



519 5783

Ref. No.	Designation	Thickness
519 6562	Centering ring, M 20	6 mm
519 6579	Centering ring, M 22	6 mm

Centering sleeves for trucks

Fits on wheel stud M 22.

Ref. No.	Designation	Thickness
519 5783	Centering sleeve Suitable for: Single wheel configuration	9 mm
519 5790	Centering sleeve Suitable for: Twin wheel configuration	20 mm

TOOLS AND ACCESSORIES

Tyre mounting

Wheel mounting tool set for cars

- Set of three centering bolts
- Covers all common vehicle types
- Facilitates mounting, especially of heavy wheels
- A centering bolt is screwed by hand into a bolt hole and the wheel simply pushed on the centering bolt
- Rotation of the brake disc/drum on the wheel hub is thus prevented
- After the bolts have been started the mounting tool is removed

Ref. No.	Designation	Content
519 5820	Wheel mounting tool set for cars Suitable for: Centering bolt thread M 12x1.25; Centering bolt thread M 12x1.5; Centering bolt thread M 14x1.5	3



519 5820

Wheel mounting tool sets for trucks

- For centered commercial vehicle wheels
- 1/2" actuation
- Protects wheel bolt threads and bolt holes against damage
- Locks the brake disk/drum

Ref. No.	Designation	Thread	Bolt hole	Content
519 5862	Centering bolt	18 x 1.5 m	21 mm	3
519 5855	Centering bolt	18 x 1.5 m	24 mm	3
519 5831	Centering bolt	20 x 1.5 m	23 mm	3
519 5879	Centering bolt	20 x 1.5 m	26 mm	3
519 5848	Centering bolt	22 x 1.5 m	26 mm	3
519 5886	Centering bolt Suitable for: Scania and VOLVO (steel rims)	7/8" - 11G	26 mm	3
519 5893	Centering bolt Suitable for: Scania and VOLVO (alloy rims)	7/8" - 11G	30.5 mm	3



TOOLS AND ACCESSORIES

Tyre mounting



519 7035



519 6926



Type 1



Type 3



Type 4

Ari Zentri, truck

- For centered commercial vehicle wheels
- Protects wheel bolts, threads and bolt holes against damage

Ref. No.	Designation	Content
519 7035	Ari Zentri 22.5", with impact weight	3

Mounting lever

Mounting lever for rim locking ring

Ref. No.	Designation
519 6926	Rim locking ring lever, 450 mm

Tyre and mounting levers HAZET

Type 1:

- Double-T profile for high stability
- Chrome-vanadium
- Surface chrome-plated
- For passenger cars and vans
- Ref. No. 571 9600 for motorcycles

Type 3:

- Especially for tubeless tyres
- Chrome-vanadium
- Heavy-duty version

Type 4:

- For example, for commercial vehicles, agricultural and construction machinery
- Chrome-vanadium
- Heavy-duty version

Ref. No.	Designation
571 9600	Tyre and mounting lever type 1, 199 mm
571 9610	Tyre and mounting lever type 1, 303 mm
570 9410	Tyre and mounting lever type 1, 500 mm
570 9400	Tyre and mounting lever type 1, 598 mm
571 9460	Tyre and mounting lever type 3, 600 mm
570 9350	Tyre and mounting lever type 4, 456 mm

TOOLS AND ACCESSORIES

Tyre mounting



519 9071



519 6964



519 6971



570 0200

Tyre levers GEDORE

- Forged from solid stock
- GEDORE vanadium steel 31CrV3
- For passenger cars and vans

Ref. No.	Designation
570 9290	Tyre lever, 200 mm
570 9300	Tyre lever, 305 mm
570 9310	Tyre lever, 400 mm
570 9320	Tyre lever, 500 mm
570 9330	Tyre lever, 610 mm
570 9340	Tyre lever, 610 mm, offset pattern

Tyre levers, wide base, super single rims

Ref. No.	Designation	Length
519 9071	L tyre lever	940 mm
519 6964	M tyre lever	940 mm
519 6971	R tyre lever	970 mm
570 0200	Special tyre lever for trucks	

TOOLS AND ACCESSORIES

Tyre mounting



Michelin type tyre levers

Ref. No.	Designation	Length
519 9002	Tyre lever MOTO Suitable for: Motorcycle wheels	380 mm
519 6892	Tyre lever FUSIL Suitable for: Car wheels	380 mm
519 6957	Tyre lever FIACRE Suitable for: Tube and tubeless truck tyres	450 mm
519 6995	Tyre lever FIFRE Suitable for: Tube and tubeless truck tyres	415 mm
519 9019	Tyre lever HALTE Suitable for: Tubeless truck tyres	800 mm
519 9026	Tyre lever FORCE Suitable for: Tubeless tractor and truck tyres	750 mm
519 9033	Tyre lever FACE Suitable for: Tubeless tractor and truck tyres	530 mm
519 9040	Tyre lever HYDE Suitable for: Low-profile tyres (double X)	990 mm
519 6933	Tyre lever SAYAM Suitable for: EM locking ring	950 mm

Crowbar

- With lace and straight cutting edge
- Forged steel

Ref. No.	Designation	Size
594 2040	Crowbar	Ø 30 x 1 250 mm

Digital tyre inflator

Programmable digital tyre inflator PCI 1000

- Fastest tyre inflator in the market
- 2 years guarantee
- PTB approved
- 4 individually adjustable programmes
- On-screen assisted calibration
- Can be updated via USB
- Free choice of indication kPa/psi/bar



Ref. No.	Designation	Electric power/ connection	Operating pressure
518 4760	Digital tyre inflator PCI 1000 Suitable for: All tyre inflator cages	230/50/1 V/Hz/Ph	12 bar / 350 psi
518 9917	Emergency emptying system		

Digital tyre inflator PROFIAIR

- Designed to meet the demands of tyre fitting shops or service stations
- Multi-functional button for special features
(OPS bead seating mode, nitrogen purge function)
- PTB approved



Ref. No.	Designation	Electric power/ Connection	Accuracy	Temperature range	Inflation pressure
519 1630	PROFIAIR digital tyre inflator, calibrated version	max. 16 bar / 460 psi	± 0.5%	-20 to +70 °C / -4 to 158 °F	max. 10 bar / 295 psi
519 1631	PROFIAIR digital tyre inflator, uncalibrated version				

TOOLS AND ACCESSORIES

Compressed air technique



519 1940



519 1907, 519
9356, 519 9260



519 1930

Tyre inflators

DIGIAIR Hand-held tyre inflation gauges

- Progressive, light design, not susceptible to shocks
- Ceramic sensor
- Clear, precise reading
- Accurate control of inflation
- Battery control light, battery life about 950 hours
- PTB approved

	5191940	5191941
Weight	350 g	350 g
Length, inflation hose	1.8 m	1.8 m
Measuring range	0 - 12 bar / 0 - 350 psi	0 - 12 bar / 0 - 350 psi
Voltage	3 V	3 V
Temperature range	-20 to +60 °C / -4 to 140 °F	-20 to +60 °C / -4 to 140 °F

Ref. No.	Designation
519 1940	DIGIAIR Hand-held tyre inflation gauge digital, calibrated version
519 1941	DIGIAIR Hand-held tyre inflation gauge digital, uncalibrated version

EURODAINU Hand-held tyre inflator gauges

- Pre-calibrated version • CEE: Approved models according to European Directive 86/217/CEE

Ref. No.	Designation	Measuring range	Length, inflation hose	
519 1907	EURODAINU Hand-held tyre inflator gauge, CEE	0 - 11 bar / 0 - 310 psi	3.0 m	
519 9356	EURODAINU Hand-held tyre inflator gauge, CEE	0 - 11 bar / 0 - 310 psi	1.5 m	
519 9260	EURODAINU Hand-held tyre inflator gauge Dual calibration	0 - 11 bar / 0 - 310 psi	1.5 m	
519 1930	EURODAINU Hand-held tyre inflator gauge, CEE EM Suitable for: Large bore valves	0 - 12 bar / 0 - 350 psi	1.5 m	•

TOOLS AND ACCESSORIES
Compressed air technique



519 9370



519 9363



571 9000, 570 9540



571 9010



571 9020

DAINU/EURODAIMO Hand-held tyre inflator gauges

Ref. No.	Designation	Measuring range	Length, inflation hose
519 9370	DAINU Hand-held tyre inflator gauge Dual calibration	1-6 bar / 10-170 psi	1.5 m
519 9363	EURODAIMO 1975 Dual calibration	1-4 bar / 10-85 psi	1.5 m

EUROAIR Hand-held tyre inflator gauges, calibrated

Ref. No.	Designation	Measuring range
571 9000	EUROAIR Hand-held tyre inflator gauge, with clip-on connector	0-4 bar / 0-88 psi
570 9540	EUROAIR Hand-held tyre inflator gauge, with clip-on and twin hold-on connector	0-10 bar / 0-295 psi
571 9010	EUROAIR Hand-held tyre inflator gauge, with twin hold-on connector	0-10 bar / 0-295 psi
570 9550	EUROAIR Hand-held tyre inflator gauge, with quick connector	0-10 bar / 0-295 psi

Accessories - EUROAIR Hand-held tyre inflator gauges

Ref. No.	Designation	Length	Dia.	Measuring range
571 9020	Hose, with clip-on connector	500 mm		
570 9570	Pressure gauge		80 mm	0-10 bar / 0-295 psi

TOOLS AND ACCESSORIES





Compressed air technique



Bicycle tyre inflators

Ref. No.	Designation
508 8617	Universal bicycle tyre inflator gauge
508 8640	Pressure gauge Suitable for: Universal bicycle tyre inflator gauge
508 8601	Bicycle tyre inflator gauge
508 8632	Pressure gauge Suitable for: Bicycle tyre inflator gauge
562 5459	Sealing membrane Suitable for: Connector
562 5105	Clip-on connector

Tyre pressure gauges

Ref. No.	Designation	Measuring range				
519 9340	Tyre pressure gauge, digital High quality - Ergonomic handling - Convenient illumination, pocket lamp function - Precise, calibrated digital indication (bar, psi, kPa)	0 - 5 bar / 0 - 145 psi				
570 9060	Tyre pressure gauge RM/4 S-6 Slapping connector - Dual calibration Suitable for: Standard valves; Spoked wheels; Checking of motorcycle fork pressure and hard to reach valves	0 - 2 bar / 0 - 57 psi	•	•		
571 9490	Tyre pressure gauge RM/10-6 Direct connector - Dual calibration Suitable for: Standard valves	0 - 5 bar / 0 - 145 psi		•	•	•
571 9480	Tyre pressure gauge RM/10 S-6 Slapping connector Suitable for: Standard valves	0 - 5 bar / 0 - 145 psi		•	•	•

Special TPMS tools

Premium TPMS tool kit

Complete set of tools for professional TPMS Service.

- High-quality TPMS tool case
- Contains the most frequently used TPMS tools
- When mounting and servicing sensor installations always observe the torque specifications and instructions of the manufacturers!



562 3997

Scope of delivery

- 1 1/4" torque key 2 - 10 Nm
- 1 Torque screwdriver 1.4 Nm with 4 mm hexagon drive, incl. blade
- 1 Valve insertion tool 0.25 Nm
- 1 Valve insertion tool 0.45 Nm
- 1 Hex head nut, extra deep, SW 11
- 1 Hex head nut, extra deep, SW 12
- 1 Pin punch 2 mm
- 1 Torx T10 screwdriver bit
- 1 Torx T15 screwdriver bit
- 1 Torx T20 screwdriver bit
- 1 Torx bit T10
- 1 Torx bit T15
- 1 Torx bit T20
- 1 Grommet removal tool

Ref. No.	Designation	Torque	Weight	Drive	Content
562 3997	Premium TPMS tool kit	1.4 & 2 - 10 Nm	1.3 kg	1/4"	1 kit

sens.it - Special TPMS tool kit

Kit of special tools for installation of sens.it sensors.

This TPMS tool kit was designed especially for mounting tyre pressure sensors on valves and rims. The torque screwdriver is preset to the values recommended by the ETRTO to ensure that the components are tightened with the right tightening torque and that the sensors are properly fitted.

Benefits:

- Simple and correct mounting of sensor and valve on the rim
- Prevents loss of air through damaged grommets in the case of clamp-in valves
- One-man operation - optimised installation with no wasted time
- High-quality calibrated torque screwdriver preset to 3.3 Nm (measurement accuracy +/- 6%)
- Rapid bit changing through the use of sophisticated technology
- In handy tool pouch



562 3944

Scope of delivery

- 1 Calibrated torque screwdriver, 3.3 Nm
- 1 1/4" adapter
- 1 Torx bit T15
- 1 Torx bit T20
- 1 Hex head nut, extra deep, SW 12
- 1 Valve holder

Ref. No.	Designation	Torque	Weight	Drive	Content
562 3944	sens.it - Special TPMS tool kit	3.3 Nm	0.4 kg	1/4 (6.3 mm) Inch	1 kit

TOOLS AND ACCESSORIES

Compressed air technique

TPMS universal tool kit

High-quality TPMS tool kit. When mounting and servicing sensor installations always observe the torque specifications and instructions of the manufacturer.

Scope of delivery

- 1 1/4" torque screwdriver with pistol grip, adjustable from 4.0 - 8.8 Nm (in 0.25 Nm increments)
- 1 Valve holder
- 1 Hex head nut, extra deep, SW 11
- 1 Hex head nut, extra deep, SW 12
- 1 Torx bit T20
- 1 1/4" adapter 25 mm



562 3995

Ref. No.	Designation	Content
562 3995	TPMS universal tool kit	1 case

TPMS basic tool kit

Low-cost TPMS tool kit. When mounting and servicing sensor installations always observe the torque specifications and instructions of the manufacturers.

Scope of delivery

- 1 1/4" torque screwdriver 1 - 5 Nm
- 1 Hex head nut, extra deep, SW 11
- 1 Hex head nut, extra deep, SW 12
- 1 Torx T20 screwdriver bit



589 3959

Ref. No.	Designation	Torque	Weight	Drive	Content
589 3959	TPMS basic tool kit Low-cost version	1-5 Nm	0.27 kg	1/4"	1 kit

Pump rings for cars, trucks

Pump rings for cars

Ref. No.	Designation	Size
519 3699	Pump ring	10"
519 3709	Pump ring	12"
519 3716	Pump ring	13"
519 3802	Special pump ring	13"
519 3723	Pump ring	14"
519 3730	Pump ring	15"
519 3819	Pump ring	15"/130 mm
519 3747	Pump ring	16"/100 mm
519 3888	Pump ring	18"
519 3834	Pump ring	20"



Pump rings for trucks

Ref. No.	Designation	Size
519 3864	Pump ring	16 - 16.5"/130 mm
519 3754	Pump ring	17 - 17.5"/130 mm
519 3826	Pump ring	18"/130 mm
519 3761	Pump ring	19 - 19.5"
519 3833	Pump ring	20"
519 3778	Pump ring	22.5"
519 3840	Pump ring	24"
519 3785	Pump ring	24.5"



Inflation rings

Inflation ring AIRSYSTEM JA 1000

With electronic operation.

Ref. No.	Designation
518 4718	AIRSYSTEM JA 1000 Suitable for: Wheel diameters 12" - 17"



Tyre fillers

AIR BOY CAR

Ref. No.	Designation	Tank capacity
519 3912	AIR BOY CAR Stationary or mobile use - Can be used from above or below - Filling device provided with safety valve and shutoff valve - Contact-free application possible - Independent of rim size	20 l
519 3929	Support, mobile Allows easy movement in the shop	



AIR BOY CAR, with trolley

AIR BOY TRUCK

Ref. No.	Designation	Tank capacity
519 3905	AIR BOY TRUCK, standard The air blast is controlled manually by means of a ball valve	20 l
519 3637	AIR BOY TRUCK, PLUS Tyres can be seated fast and easily on the bead seat in both horizontal and vertical position - The controlled cycle ensures safe initiation of the air blast	20 l
519 3644	Trolley For easy movement to any location in the workshop	



AIR BOY AS, for agricultural tyres

Ref. No.	Designation	Tank capacity
519 3895	AIR BOY for agricultural tyres Same functionality as AIR BOY TRUCK, but with 2" valve	45 l



519 3905

TOOLS AND ACCESSORIES

Marking and labeling



Marking and accessories

Marking with pen

For labelling rubber items or marking fields of repair patches.

Ref. No.	Designation	Colour	Content
595 0052	Patch marking pen, 0.6 mm F	blue	10
595 0045	Marking pen	silver	1
595 0179	Rubber marking pen	white	5
595 0193	Refill, for rubber marking pen	white	12
595 0990	Ball tube marker	white	10

Marking with chalk

For marking on tyre rubber - clearly visible.

Ref. No.	Designation	Colour	Dia.	Content
595 0131	Lithografic marking chalk SISA	white	17 mm	12
595 0203	Lithografic marking chalk SISA	yellow	17 mm	12
595 8401	REMA TIP TOP tyre marker	rubber white	13 mm	12
595 8418	REMA TIP TOP tyre marker	yellow	13 mm	12
595 8449	Wax marking chalk	white	10 mm	20
595 8432	Wax marking chalk	yellow	10 mm	20
595 8460	Carmel special chalk can also be used for marking on wet rubber	white	17.5 mm	12
595 8456	Chalk holder for Wax marking chalk Ø10 mm			1
595 8425	REMA TIP TOP metal holder for REMA TIP TOP tyre marker Ø13 mm			1
595 0227	Chalk holder SISA for Lithografic marking chalk SISA Ø17 mm			1

TOOLS AND ACCESSORIES
Marking and labeling

Chalk line

Ref. No.	Designation
595 0310	Chalk line, incl. chalk dust container
595 0300	Chalk dust refill



Tyre marking, electric

For branding of tyres. Special characters such as &, % etc. available upon request.



Ref. No.	Designation	Electric power/ connection	Size	Type size
519 0977	Branding iron, 1 line	230 V / 300 W	70 x 35 L x W mm	12 mm
519 0978	Branding iron G 175 The electric branding iron includes a high- performance cartridge which is suitable for permanent operation - The temperature on the heating plate is approx. 550 °C to 600 °C (1022 °F to 1112 °F) and ensures efficient branding - The tool accommodates max. 6 letters (12 mm standard size)	230 V / 315 W	75 x 30 L x W mm	12 mm

TOOLS AND ACCESSORIES
Marking and labeling

Accessories - Tyre marking

Ref. No.	Designation	Content
519 0984	Complete set (letters A - Z)	26
519 0991	Complete set (numbers 0 - 9)	10
558 7195	Letter A	1
558 7205	Letter B	1
558 7212	Letter C	1
558 7229	Letter D	1
558 7236	Letter E	1
558 7243	Letter F	1
558 7250	Letter G	1
558 7267	Letter H	1
558 7274	Letter I	1
558 7281	Letter J	1
558 7298	Letter K	1
558 7315	Letter L	1
558 7322	Letter M	1
558 7339	Letter N	1
558 7346	Letter O	1
558 7353	Letter P	1
558 7360	Letter Q	1
558 7377	Letter R	1
558 7384	Letter S	1
558 7391	Letter T	1
558 7401	Letter U	1
558 7418	Letter V	1
558 7425	Letter W	1
558 7432	Letter X	1
558 7449	Letter Y	1
558 7456	Letter Z	1
558 7463	Number 1	1
558 7470	Number 2	1
558 7487	Number 3	1
558 7494	Number 4	1



519 0991

Letters and numbers (for tyre marking)

Ref. No.	Designation	Content
558 7504	Number 5	1
558 7511	Number 6	1
558 7528	Number 7	1
558 7535	Number 8	1
558 7542	Number 9	1
558 7559	Number 0	1
558 7170	Special character (+)	1
558 7160	Special character (-)	1

Length measuring tools

Caliper

- Pocket Caliper with depth gauge and instantaneous adjustment
- Accuracy according to DIN 862
- Stainless steel
- For 4-fold measurements (inside, outside, depth and step measurements)
- Backside with screw table
- Delivered: in leatherette case
- Measuring range: 150 mm
- Jaw length: 40 mm
- Vernier below: 1/20 (0.05) mm
- Vernier above: 1/128 inch



594 2180

Ref. No.	Designation
594 2180	Pocket caliper, 150 mm

Laser range finder GLM 30

- Laser measure functions include area, distance, length, volume, continuous measurement, addition and subtraction
- Measurement automatically adjusts closer to or farther from target with $\pm 1/16$ in. accuracy
- Backlight for increased visibility in low-light conditions
- Pocket size for easy access anywhere
- Laser diode / Laser class: 635 nm < 1 mW/2
- Scale: 0.15 - 30 m
- Precision: ± 2 mm
- Protection class: IP 54
- Rated power: 2x1.5 V (AAA)
- Maximum operating time: 5000 measurements
- Weight: 0.1 kg

NEW



594 2010

Ref. No.	Designation
594 2010	BOSCH Laser range finder GLM 30 professional

TOOLS AND ACCESSORIES
Measuring and testing

Steel tape measure

Ref. No.	Designation	Measuring range
595 4467	Steel tape measure	0 - 300 mm
571 9080	Steel tape measure, flexible	0 - 150 mm



595 4467

Roll tape measure

Ref. No.	Designation
594 0230	Roll tape measure, 2 m
594 0240	Glass fibre measuring tape, 25 m



594 0230



594 0240

Folding rule

Polyamide with stamped measuring scale, detail level III, 10 elements.

Ref. No.	Designation	Content
584 3060	Folding rule plastic, 2 m	10



584 3060

Metal square

Ref. No.	Designation
594 0210	Metal square, 500 mm



594 0210

Ruler

Ref. No.	Designation
594 0220	Metal workshop ruler, 1 m



594 0220

Thickness measuring equipment

Thickness gauge

Measurement range 0 - 30 mm.

Ref. No.	Designation
595 8535	Thickness gauge



595 8535

Wet-film thickness gauge

The various measuring teeth are ideal for measuring wet film thicknesses quickly and easily.

Ref. No.	Designation
595 2960	Wet film thickness gauge



595 2960

Microtester

The handy Microtester makes it easy to measure the thickness of rubber linings in all positions. This automatic measuring device accurately indicates the thickness of the lining through trailing pointers. Thus, measuring errors are avoided. This device is optimally suited to metallic surfaces, due to its magnetic working process.

Ref. No.	Designation
595 2870	Microtester (0.5 - 5 mm)
595 2880	Microtester (2.5 - 10 mm)



595 2870; 595 2880

Measuring equipment

Shore meters

Ref. No.	Designation
595 8528	Shore meter Shore A
595 8542	Shore meter Shore D



595 8528

TOOLS AND ACCESSORIES

Measuring and testing

Ex Meter II

To measure and monitor the TLV when working, for example, with products containing solvents. If a hazard of exposure to explosive atmospheres exists, the device emits a warning signal.

Ref. No.	Designation
595 2910	Ex Meter II



595 2910

Hygrometer

Measures relative air humidity.

Ref. No.	Designation
595 8511	Hygrometer



595 8511

Hydromette UNI 1

To determine ambient temperature, surface temperature and air humidity. These values are necessary to determine the dew point. To determine ambient temperature, surface temperature and air humidity. These values are necessary to determine the dew point.

Ref. No.	Designation
595 1408	Hydromette UNI 1 Includes temperature sensor (OT 100).



595 1408

TOOLS AND ACCESSORIES

Measuring and testing

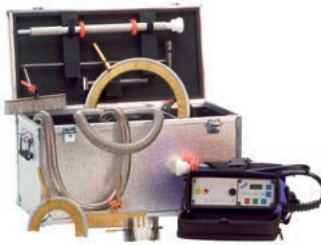

595 1397



595 1415



595 2680



595 2860

3

Electrical insulation tester

Electrical device for detection of perforations in corrosion-protection linings made of special rubber.

Ref. No.	Designation
595 1397	ELMED-Isotest Inspect 35 includes 1x testing device, 1x bag with holding strap, 1x accumulator, 1x charger 230 V/50 Hz, 1x earth cable (10 m) with connector plug and clamping tongs, 1x aluminium transport case, 1x factory and calibration certificate
595 1430	Brazen flat brush, length 300 mm
595 1415	Insulation tester UNION includes 1x testing device with charging unit, 1x aluminium case, 1x earth cable (10 m), 1x flat brush (300 mm)
595 2680	Wegener testing gun The Wegener testing gun provides the only option to spark-test fully rubber-lined components, as it does not require any earth connection. Includes 1x testing device, 1x flat brush, 1x testing broom

Surface Comparator

For testing surface structure following grit- or sand-blasting (4 roughness grades).

Ref. No.	Designation
595 2860	Surface Comparator

Tread depth gauge

Ref. No.	Designation	Measuring range
519 1653	Tread depth gauge car, brass	0 - 30 mm
519 1660	Tread depth gauge OTR/EM	0 - 150 mm

TOOLS AND ACCESSORIES

Measuring and testing

Measuring cup

For dosing adhesives, heating solutions, hardeners, etc.

Ref. No.	Designation
595 8597	Measuring cup, 180 ml, plastic



595 8597

Thermometer

- For measuring operating and process temperatures on objects such as steam lines, heating equipment, vulcanizing machines, motors, etc.
- The temperatures on or in the material to be vulcanized can be measured with the appropriate measuring equipment and sensors
- Regularly monitoring temperatures can help to avoid malfunctions or costs arising from the ensuing damage

Ref. No.	Designation	Temperature range
571 9070	Infrared radiation thermometer MT6	-18 to +275 °C / -0.4 to +527 °F
517 8504	Pen piercing thermometer	0 to +200 °C / -0 to +392 °F
517 8511	Digital thermometer	-200 to +1370 °C / -328 to +2498 °F
517 8528	Thermocouple wire, flexible, with connector	
517 8535	Thermocouple sensitive pin, with connector	
517 8550	PEN universal sensor K, NiCrNi	-200 to +1100 °C / -328 to +2012 °F
517 8560	PEN extension cable	



571 9070



517 8504



517 8511

Spirit level

- With angle-measuring device and strong adhesive magnets
- Two spirit level for normal measurements, a rotating level for an angle measuring device
- Angle scale: 90° - 0° - 90° and tilt 0 - 50%

Ref. No.	Designation
594 2190	Spirit level, light metal, 600 mm



594 2190

TOOLS AND ACCESSORIES

Working tools



510 2202



510 2226



510 1818







510 2415

Inserting tools



Accessories - SEALASTIC and SUPER SEALASTIC

For precise injury preparation.

	5102202	5102219	5102226	5102233
Length		approx. 72 mm	approx. 96 mm	approx. 230 mm

Ref. No.	Designation					
510 2202	Inserting tool, with folding handle Suitable for: RAS, SRAS, SEALASTIC	•	•			
510 2219	Inserting tool for car tyres, with plastic handle		•			
510 2226	Inserting tool for truck tyres, with plastic handle			•		
510 2233	Inserting tool EM, with plastic handle				•	•

Accessories - SEALFIX

Ref. No.	Designation			
510 1818	Inserting tool			
510 1825	Spare needle			
510 2381	Inserting tool car, 4"	•		
510 2398	Inserting tool truck, 6"		•	
510 2408	Inserting tool OTR/EM, 8"			•
510 2415	Tool kit, metal includes 1x Inserting tool, 1x Rasp, 1x Allan key	•		

TOOLS AND ACCESSORIES

Working tools



595 1013



596 1027



595 1123



595 1020



595 1044



595 1160



595 1180

Stichers

Stichers

For smooth application of repair patches or rubber.

Ref. No.	Designation	Size
595 1013	Stitcher, corrugated	Ø 13 mm, width 1.5 mm
595 1020	Stitcher, corrugated	Ø 25 mm, width 2 mm
595 1051	Stitcher, corrugated	Ø 45 mm
596 1027	Stitcher standard, corrugated	Ø 35 mm, width 4 mm
595 1044	Stitcher, with ball bearing, corrugated	Ø 35 mm, width 4 mm
595 1160	Stitcher, with ball bearing, corrugated	Ø 40 mm, width 46 mm
595 1180	Stitcher, with ball bearing, corrugated	Ø 40 mm, width 76 mm
595 1123	Stitcher, with ball bearing, plain surface	Ø 35 mm, width 12 mm
595 1130	Stitcher, with ball bearing, plain surface	Ø 45 mm

Accessories - RAS and SRAS

Ref. No.	Designation			
510 1540	Hand ratchet			
510 2240	Hand rasp Ø 6 mm			

TOOLS AND ACCESSORIES

Working tools



595 1130



595 2790



595 2800



595 2810



595 2820



595 2830



595 2840



595 1147



595 1154



595 1950

Ref. No.	Designation	Size
595 2790	Stitcher, corrugated	31 mm
595 2800	Neckstitcher	4 mm
595 2810	Stitcher, plain surface	34 mm
595 2820	Stitcher, opanol	6 mm
595 2830	Stitcher, pea	2 mm
595 2840	Stitcher, scaled	12 mm

Needle stitchers

For perforating cushion gum.

Ref. No.	Designation	Size	Width	Content
595 1147	Needle stitcher	Ø 50 mm	27 mm	1
595 1154	Needle stitcher	Ø 50 mm	46 mm	1
595 1950	Needle stitcher	Ø 52 mm	76 mm	1
595 0849	Spare needles, chromium	1.5x12 mm		3000

TOOLS AND ACCESSORIES

Working tools

Double-acting rollers

REMAPRESS MDR

Manual Driven Roller (MDR) for the application on fabric conveyor belt splicing.

- Reduced effort due to easy-running needle bearings
- Defined contact pressure over a torque wrench
- Optimized role design
- All components resistant to corrosion due to red and black coating



REMAPRESS MDR

Ref. No.	Designation	Belt Width	Weight
595 1218	Roller Size 1	up to BW 800 mm	3.6 kg
595 1225	Roller Size 2	up to BW 1200 mm	7.5 kg
595 1232	Roller Size 3	up to BW 1600 mm	10 kg
595 1256	Roller Size 4	up to BW 2000 mm	12.5 kg

Retrofit kit

With the retrofit kit all older mechanical double acting rollers can be upgraded with little effort with smooth-running needle bearings.



Retrofit kit

Ref. No.	Designation
595 1210	Retrofit kit

REMAPRESS EDR

The world's first Electric Driven Roller (EDR) for the application on fabric conveyor belt splicing developed and designed by REMA TIP TOP.

- Constant contact pressure over the entire bonding surface and belt width
- Equilibrium speed in forward and reverse motion leads to a homogeneous liability at each point of the splicing
- Defined contact pressure with a torque wrench
- Profiled drive wheel to avoid slip
- Electric power/connection 24 V dc
- Torque 10 Nm
- Voltage 230 V, 60 Hz / 110 V, 50 Hz



REMAPRESS EDR

Ref. No.	Designation	Belt Width	Weight
595 1220	Roller Size 1	up to BW 1200 mm	19.4 kg
595 1230	Roller Size 2	up to BW 1600 mm	20.8 kg
595 1250	Roller Size 3	up to BW 2000 mm	22.1 kg

TOOLS AND ACCESSORIES

Working tools



595 1178



595 4515



595 8126

Tyre scrapers

For the thorough cleaning of damaged surfaces, and tyre liners in conjunction with LIQUID BUFFER.

Ref. No.	Designation
595 1178	Tyre scraper For flat and curved surfaces
595 4515	Tyre scraper PROFI Especially suitable for profiled inner liners

KST scraper

For even pressing of uncured rubber sheets.

Ref. No.	Designation
595 1422	KST scraper

Spatula

Ref. No.	Designation
595 8126	Spatula, 60 mm, with wooden handle
595 8390	Flat scraper, 150 mm, with wooden handle

TOOLS AND ACCESSORIES

Working tools



Knives and cutting tools

Rubber knives

- Chromium-plated blade
- Black, knobbed handle with ergonomic grip

Ref. No.	Designation	Length
595 2074	Rubber knife	5" / 125 mm
595 2067	Rubber knife	6" / 145 mm
595 2050	Rubber knife	8" / 200 mm
595 2184	Rubber knife	10" / 250 mm
595 2191	Rubber knife	12" / 310 mm

Knives

Ref. No.	Designation
595 2012	Knife "Don Carlos", adjustable
595 2029	Spare blade, for 595 2012
595 2115	Ply knife, nonadjustable
595 2373	Ply knife "TOP"
595 2081	Push knife "Quarter moon"
595 2098	Push knife "Flat moon"
594 0490	Universal knife, 150 mm, retractable blade, incl. 5 blades in handle
594 0480	Cutting knife, 135 mm, incl. 5 blades in handle
594 0500	"Trapeze" spare blade, for 594 0490, 594 0480 (10 pieces)
594 0510	"Hook" spare blade, for 594 0490, 594 0480 (10 pieces)
594 0530	All-metal universal knife
594 0520	Spare blade, for 5940530 (10 pieces)

TOOLS AND ACCESSORIES

Working tools

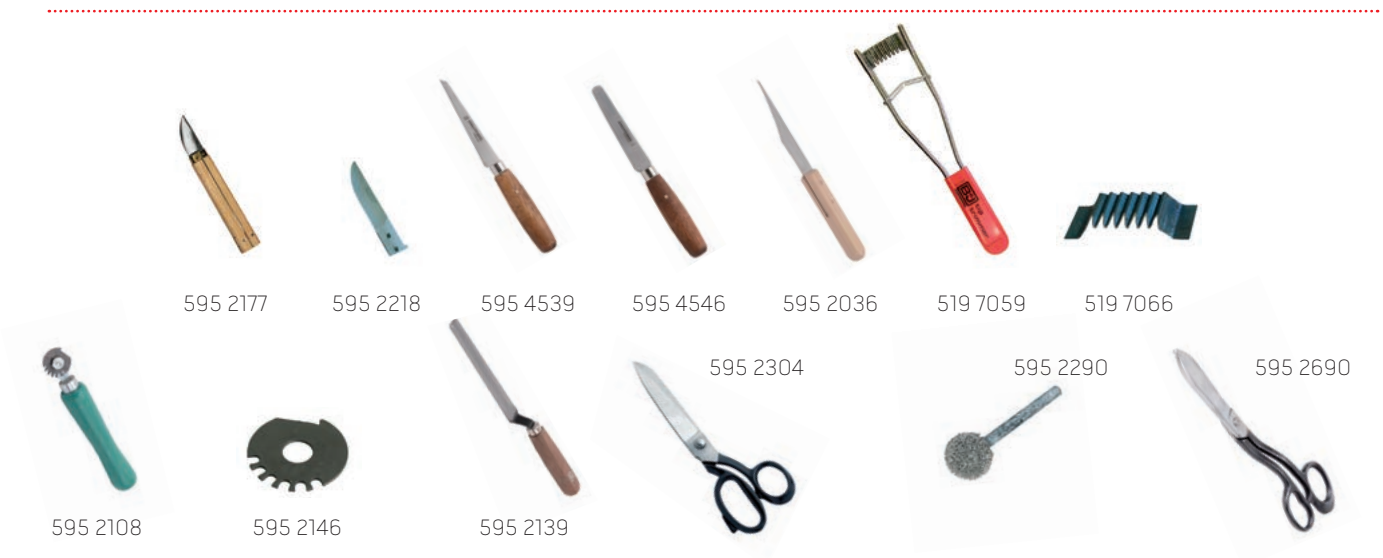

Cutting tools

For the preparation of damages on tyres of every type.

Ref. No.	Designation	Length	Width
595 2177	Don Carlos knife, 8", with retractable blade	210 mm	
595 2218	Spare blade Suitable for: Cutter 8"		
595 4539	Knife, 4", strait	100 mm	
595 4546	Knife, 4", flat	100 mm	
595 2036	Rubber knife	130 mm	
519 7059	Overflow cutter, large		50 mm
519 7066	Spare blade Suitable for: Overflow cutter, large		50 mm
595 2108	Scratch knife, adjustable		
595 2146	Spare blade Suitable for: Scoring knife adjustable		
595 2139	Offset flexible knife		
519 7120	DOT/serial numbers knife handle, with one blade Special knife for removal of original DOT/serial numbers		
519 7130	Blade set (12 pcs.) Suitable for: DOT serial numbers knife handle		
595 2287	Scissors, 8"	200 mm	
595 2304	Scissors, 10"	250 mm	
595 2290	Scissors with ergonomic soft handle made of ABS plastic Blades made of stainless steel. HRC 50-54. For right or left handers.	250 mm	
595 2690	Angled scissors		

TOOLS AND ACCESSORIES

Working tools



Pliers and clamps

Pincers and pliers

- For the easy removal of foreign objects from tyres
- For heaviest duty
- Specially favoured by craftsmen due to precision workmanship
- Extreme wear resistance and good balance

Ref. No.	Designation	Length	Weight
595 0801	Side cutter for steel cord Toggle joint reduces expenditure of force by 40%	160 mm	180 g
594 0580	Pincers, with lever nose Cutting edge hardness approx. 55 HRC - Polished head, black atramentised handles - Special tool steel, oil hardened and tempered	300 mm	774 g
594 0420	Pincers	210 mm	405 g
594 0430	Pincers	250 mm	425 g
595 6160	Universal pliers, insulated For seating Minicombi stems in the tyre	160 mm	178 g
571 9100	Universal pliers, insulated For seating Minicombi stems in the tyre	200 mm	230 g
571 9090	Universal pliers JC 8210-200 For seating Minicombi stems in the tyre	200 mm	376 g

TOOLS AND ACCESSORIES

Working tools



571 8015



571 8016



571 8018



571 8017



571 8014



594 0400

3

Pliers for auto service

Ref. No.	Designation	Length
571 8015	Locking pliers Forged jaws - With wire cutter - Adjustable	250 mm
571 8016	Side-cutting pliers Heavy-duty insulated handles	180 mm
571 8018	Universal pliers Heavy-duty insulated handles - Burner hole	180 mm
571 8017	Telephone pliers Heavy-duty insulated handles - Straight head version	200 mm
571 8014	Water pump pliers Chrome-vanadium - Insulated handles	240 mm

Grip tongs

Ref. No.	Designation
594 0440	Grip tongs

Side nippers

For piano wire. DIN 5238. Type A. Grade H. Chrome vanadium, polished chrome plating.

Ref. No.	Designation
594 0400	Side nippers, up to 2 mm

TOOLS AND ACCESSORIES

Working tools



595 0863



518 7801



570 9530



565 4470



565 4468

Steel cable cutter C 112

Easy cutting of all types of steel cables (up to $\varnothing 12.7$ mm) when splicing steel cord conveyer belts.

Ref. No.	Designation
595 0863	TT Steel cable cutter C 112
595 0890	Spare blade, movable
595 0891	spare blade, fix

Balance weight pliers

- For mounting, removing and relocating balance weights on the rim
- For expanding and compressing of clips

Ref. No.	Designation
518 7801	Balance weight pliers, black handle coat
570 9530	Balance weight pliers, standard

Adhesive balance weight removers

Ref. No.	Designation
565 4470	Adhesive balance weight pliers For easy removal of adhesive weights without damage to the rim
565 4468	Adhesive balance weight remover High-quality, durable plastic

TOOLS AND ACCESSORIES

Working tools

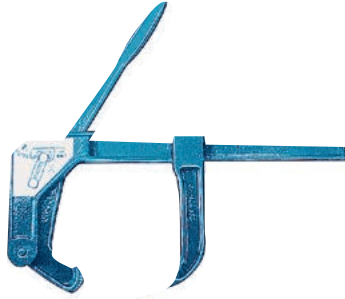

565 4451



518 7818



594 0540

Bead compression tools

Ref. No.	Designation	Operating pressure	Opening width	Weight
565 4451	Bead compression tool 336/1 Manual bead compression tool for fitting/removal of balance weights with separate clip without damage to rim and tyre		335 mm	
518 7818	Bead compression tool CLAMP MASTER Pneumatic bead compression tool for fitting/removal of balance weights with separate clip without damage to rim and tyre - Adjustable height stopper - Suspension strap for use with ceiling balancer	8 - 10 bar / 116 - 145 psi	310 mm	5 kg

Moment clamps

Ref. No.	Designation
594 0540	Moment clamp, 160/80
594 0550	Moment clamp, 250/120
594 0560	Moment clamp, 500/120

TOOLS AND ACCESSORIES

Working tools



595 2153



595 2225



519 6225



595 2940

Working tools and accessories

Wetstones

For sharpening of knife blades.

Ref. No.	Designation	Length	Size
595 2153	Wetstone, with wooden handle	200 mm	
595 2225	Wetstone	230 mm	
595 2160	Steel sharpener 8", with plastic handle	230 mm	
519 6225	Wetstone (block)		150 x 50 x 25 L x W x H mm

Ply lifter

For preparing fabric conveyor belt splices.

Ref. No.	Designation
595 2940	Ply lifter

TOOLS AND ACCESSORIES

Working tools



570 9270



570 9280



570 8400



Pin punches

Tyre probes

- For verifying damages, course of injuries and removing small foreign objects from the tread
- For checking the skive

Ref. No.	Designation	Length
570 9270	Tyre probe, with wooden handle	140 mm
570 9280	Tyre probe, with plastic handle	140 mm
570 8400	Hooked awl	140 mm

Pin punches

- With impact-reducing "PRAXAGRIP-INSULATION"
- High wear resistance
- Tempered punch heads
- Chrome-vanadium

Ref. No.	Designation	Weight	Length	Ø
571 8005	Pin punches	52 g	147 mm	3 mm
571 8006	Pin punches	96 g	192 mm	4 mm
571 8007	Pin punches	136 g	200 mm	5 mm
571 8008	Pin punches	144 g	207 mm	6 mm
571 8009	Pin punches	160 g	210 mm	8 mm
571 8010	Pin punches	242 g	230 mm	10 mm
571 8011	Pin punches	384 g	277 mm	12 mm
571 8012	Pin punches	504 g	290 mm	14 mm
571 8013	Pin punches	586 g	313 mm	16 mm

TOOLS AND ACCESSORIES

Working tools



Hammers

Ref. No.	Designation	Weight	Length of handle
571 8000	Locksmith's hammer Forged steel head - Fibreglass handle - Absolutely "wobble-free" attachment - Handle area with rubber insulation	500 g	340 mm
594 0460	Locksmith's hammer	1000 g	
571 8001	Locksmith's hammer Double-cambered wooden handle - Cast ring wedge	2000 g	400 mm
571 8002	Sledge hammer Forged steel head - Wooden handle	3000 g	600 mm
571 8003	Sledge hammer Forged steel head - Wooden handle	5000 g	700 mm
571 8004	Sledge hammer Forged steel head - Wooden handle	8000 g	900 mm
594 0470	Rubber mallet		

Screwdriver

Ref. No.	Designation
571 8022	Screwdriver set, 12-piece Chrome-vanadium - Through blades - Hexagon drive to increase torque - Ergonomic soft handle
594 0411	Screwdriver, 14x250 mm, wooden handle with leather cap

TOOLS AND ACCESSORIES

Working tools



594 2170



571 8101



571 8100



571 8102



594 2150

Allen wrench

- Chrome-vanadium steel
- Based on ISO 2936 L (DIN 911 L)
- Nickel
- Delivered in plastic holder
- Includes 1.5; 2; 2.5; 3; 4; 5; 6; 8; 10 mm

Ref. No.	Designation
594 2170	Hexagon allen wrench set with ballpoint, long, 9-piece

Open-ended/ring/jaw spanner sets

Ref. No.	Designation
571 8100	Combination spanner set, 12-piece Chrome-vanadium - Matt chrome-plated - Polished heads, 15° cropped - Manufactured according to DIN 3113
571 8101	Double open-ended spanner set, 8-piece Chrome-vanadium - Chrome-plated - Polished heads
571 8102	Double-ring spanner set, 8-piece Chrome-vanadium - Matt chrome-plated - Manufactured according to DIN 837 - Double cropped

Adjustable wrench

- Chrome-vanadium steel
- DIN 3117 A
- Measuring scale in mm
- Matt chrome
- Non-slip and non-glare surface
- Size: 10 inch
- Length: 257 mm
- Spanner opening: 31 mm

Ref. No.	Designation
594 2150	Adjustable wrench, 10"

TOOLS AND ACCESSORIES

Working tools



589 8998



589 8999



571 8020



571 8021



571 8019

Torque wrenches

	5898998	5898999	5719900	5719910
Accuracy	3%	3%	3%	4%
Weight	1.25 kg	1.25 kg	1.5 kg	4.5 kg
Length	530 mm	530 mm	600 mm	1220 mm
Working range	40 - 220 Nm	60 - 330 Nm	60 - 400 Nm	200 - 1000 Nm
Drive	1/2"	1/2"	1/2"	1"

Ref. No.	Designation	Accuracy	Weight	Length	Working range	Drive
589 8998	Torque wrench, 1/2" Does not have to be reset after use	3%	1.25 kg	530 mm	40 - 220 Nm	1/2"
589 8999	Torque wrench, 1/2" Does not have to be reset after use	3%	1.25 kg	530 mm	60 - 330 Nm	1/2"
571 9900	Torque wrench K-TW-4400, 1/2"	3%	1.5 kg	600 mm	60 - 400 Nm	1/2"
571 9910	Torque wrench K-TW-8100, 1"	4%	4.5 kg	1220 mm	200 - 1000 Nm	1"

Ratchet wrenches

Ref. No.	Designation	Drive	Length
571 8020	Reversible ratchet 1/4" Fine toothed, with 72 teeth - With locking device - Chrome-vanadium	1/4"	145 mm
571 8021	Reversible ratchet 3/8" With locking device - Chrome-vanadium - Rubber handle	3/8"	215 mm
571 8019	Reversible ratchet 1/2" Fine toothed, with 72 teeth - With locking device - Chrome-vanadium	1/2"	267 mm

TOOLS AND ACCESSORIES

Working tools



519 5185, 519 5192



571 8103



571 8104

Wheel nut remover, power wrench

Ref. No.	Designation	Weight	Dia.	Structural height	Torque
519 5185	Power wrench XVR 25	6.5 kg	80 mm	310 mm	2300 Nm
519 5192	Power wrench XVR 35	5.5 kg	81 mm	285 mm	3600 Nm

Spider wrenches

Ref. No.	Designation	Drive	Length	Size
571 8103	Spider wrench for cars - with reinforced central plate 17x19x22x1/2" square	1/2"	355 x 358 mm	17x19x21 mm
571 8104	Spider wrench for trucks - with reinforced central plate 24x27x32x3/4" square	3/4"	700 x 700 mm	24x27x32 mm
571 9440	Spider wrench 705N 17x19x13/16" x 21			

TOOLS AND ACCESSORIES

Working tools



595 0186

595 4649

595 8308

595 8315

595 8339

595 9307

595 8322

595 8353

Brushes for solutions

The thickness of the brush and the hardness of the bristles have a determining influence on the quality and economy of the coat of cement in the skive, on the inner liner and on the patch.

Ref. No.	Designation	Dia.	Length	Width	Content
595 0186	Brush, with natural fibre Suitable for: All cements	35 mm	30 mm		
595 4649	Brush cover, with brush				
595 8308	Special brush, with short fibre bristles Suitable for: SPECIAL CEMENT BL, SOLUTION HR etc.	25 mm	39 mm		
595 8315	Special brush, with short fibre bristles Suitable for: SPECIAL CEMENT BL, SOLUTION HR etc.	40 mm	40 mm		
595 8339	Special brush, with long fibre bristles	60 mm			
595 9307	Special brush, specially short bristles Suitable for: SPECIAL CEMENT BLX and paste	20 mm			
595 8322	Flat brush, with short bristles Suitable for: INNERLINER SEALER		25 mm	25 mm	
595 8353	Brush, with screw top Brush, with screw cover Suitable for: 175 g and 225 g tins				10

TOOLS AND ACCESSORIES

Working tools



595 8360



593 0584



593 0618



593 1978

3

Mounting paste brushes

- The flat brush is especially suitable for mounting low-profile tyres
- Brushes with round head are excellent for application of mounting cream

Ref. No.	Designation	Dia.	Length of handle	Width	Content
595 8360	Flat brush car		200 mm	50 mm	1
593 0584	Special brush car	30 mm	300 mm		1
593 0618	Special brush truck, short	50 mm	300 mm		1
593 1978	Special brush truck, long	50 mm	400 mm		1
593 1954	Brush head, round	30 mm			10
593 1961	Brush head, round	50 mm			1

TOOLS AND ACCESSORIES

Working tools



595 4508



595 4820



595 8346



595 8353



595 8370

Tins with brushes

Storage brushes and detergents.

Ref. No.	Designation	Dia.	Content
595 4508	Aluminium can, with brush cover Note: Not to be used with fluids containing trichloroethylene		1
595 4820	Zinc tin, with brush cover		1
595 8298	Brush cleaning tin UNIVERSAL, with brush		1
595 8346	Tin cover, with brush adapter Suitable for: Zinc tin	50 mm	1
595 8353	Brush, with screw top Brush, with screw cover Suitable for: 175 g and 225 g tins		10
595 8370	Plastic cover, with brush adapter Suitable for: RCF Innerliner Sealer; Bead Sealer	60 mm	1

TOOLS AND ACCESSORIES

Working tools



595 4553



571 9060



595 8380



595 8937



595 8944



595 0038



594 0000



595 0069



595 0021

Cleaning brushes

- For cleaning of buffed surfaces
- Removal of buffing dust in conjunction with a vacuum cleaner

Ref. No.	Designation
595 4553	Brass-bristled brush For gentle cleaning of the buffed area
594 0000	Brush, with coconut fibres Removes loose buffing dust
571 9060	Handbrush, with horsehair bristles Removes loose buffing dust
595 0069	Steel-bristled brush, adjustable Hardness of bristles selectable
595 8380	RCF Rotary brush

Rasp

For cleaning and preparing injuries when sealing with SEALASTIC or SUPER SEALASTIC sealing units.

Ref. No.	Designation	Dia.	Length
595 8937	Rasp	4.5 mm	85 mm
595 8944	Rasp	6.5 mm	195 mm

Hand rasp

For manual buffing of rubber surfaces.

Ref. No.	Designation
595 0021	Hand rasp
595 0038	Spare rasp blade

TOOLS AND ACCESSORIES

Working tools



594 2130



594 0570



594 0571

Tool box

- With riveted joints
- Large fully pulled out drawers
- High level of stability
- Double-seamed edges
- Lockable with padlock
- Red powder coated
- Made of galvanized sheet steel
- W x D x H: 540 x 210 x 200 mm

Ref. No.	Designation
594 2130	Tool box, hinged, 5-piece

Tool bag

Real leather, black grained. Bag body reinforced with aluminium corners, stoppers, full-format front pocket, ring tabs, tool holders on front and back walls up to Ø 16/26 mm.
Tool bag without contents.

Ref. No.	Designation	Colour
594 0570	Tool bag, inner dimensions 430 x 190 x 250 mm	black
594 0571	Tool roll, 540 x 320 mm	black

TOOLS AND ACCESSORIES

Working tools



593 0120



593 0137



593 0145



570 9440

Spray bottles

For even distribution of liquids on surfaces.

Ref. No.	Designation	Content
593 0120	Spray bottle For applying liquid bead lubricant for industrial tyres etc. - Not suitable for solvents	500 ml
593 0137	Spray bottle Not suitable for solvents	1000 ml
593 0145	Spray bottle for compressed air, max. 6.2 bar Suitable for solvents - With nipple for compressed air supply - Can be used like a spray can	650 ml
570 9440	Pump spray bottle	1000 ml
593 0300	Set of spray nozzles includes 4x spray heads, 1x spray tube (for 593 0144)	4

Adhesive tape

Ref. No.	Designation
595 0290	TT Adhesive tape, white, with REMA TIP TOP label

TOOLS AND ACCESSORIES



Cutting and buffing tools



Tyre repair tools

Compass saw for steel cord tyres

For cylindrical removal of damaged material from tyres.

Ref. No.	Designation	Speed	Dia.	Arbour for hand drill		
511 1705	Compass saw	max. 2000 rpm	22 mm	511 1736	•	•
511 1712	Compass saw	max. 2000 rpm	32 mm	511 1743	•	•
511 1729	Compass saw	max. 2000 rpm	41 mm	511 1743	•	•
511 1736	Arbour hexagon, for compass saw	max. 2000 rpm	22 mm			
511 1743	Arbour hexagon, for compass saw	max. 2000 rpm	32/41 mm			

Buffing rasps

- These buffings rasps are very efficient for removing large volumes of rubber
- Preparation of the skive when repairing OTR tyres can be drastically reduced

	5196139	5196146	5196249	5196256
Bore Ø	1/2"	1/2"	1/2"	1/2"
Speed	max. 4500 rpm	max. 4500 rpm	max. 4500 rpm	max. 4500 rpm
Dia.	45 mm		76 mm	
Arbour for hand drill	519 6270		519 6270	
Arbour for quick release chuck	519 6641		519 6641	
Arbour MK 1 for flexible shaft	519 6263		519 6263	

Ref. No.	Designation	Content		
519 6139	Buffing rasp R 5	5	•	•
519 6146	Spacer R 5	6		
519 6249	Buffing rasp R 6	6	•	•
519 6256	Spacer R 6	7		

TOOLS AND ACCESSORIES
Cutting and buffing tools



3

Rotary gouges

- Rotary gouge for the removal of loose rubber
- Clean elimination of cut rubber facilitated by integrated internal thread
- Heat-resistant steel provides long service life
- All rotary gouges can be easily re-sharpened
- For precise sharpening of rotary gouges the special sharpening fixture is recommended

	5954328	5954326	5954292
Thread	3/8"	3/8"	3/8"
Speed	max. 4500 rpm	max. 4500 rpm	max. 4500 rpm
Dia.	approx. 19 mm	30 mm	50 mm
Arbour for hand drill	595 4034	595 4034	595 4034
Arbour for quick release chuck	519 6610	519 6610	519 6610
Arbour MK 1 for flexible shaft			595 4027

Ref. No.	Designation	Content				
595 4328	Rotary gouge, Micro	4	•			
595 4326	Rotary gouge, mini	3		•	•	•
595 4292	Rotary gouge, maxi	1		•	•	•
595 4481	Sharpening fixture	1				
595 4498	Replacement stones	2				

TOOLS AND ACCESSORIES

Cutting and buffing tools



Carbide cutter

- For precise injury preparation on radial and cross-ply tyres
- Special profile adapted to steel cord preparation allows professional grinding out of the injury
- Long service life
- All HM cutters are packed individually in a robust plastic box

	5955019	5954962	5954948	5955002	5955060	5955040	5954900	5954924	5954931	5954955
Speed	max. 2500 rpm	max. 2500 rpm	max. 2500 rpm	max. 2500 rpm	max. 2500 rpm	max. 2500 rpm	max. 25000 rpm	max. 25000 rpm	max. 25000 rpm	max. 25000 rpm
Dia.	4.5 mm	6 mm	8 mm	9.5 mm	10 mm	12 mm	3 mm	6 mm	6 mm	20 mm
Blade length	30 mm	50 mm	50 mm	60 mm	60 mm	60 mm	25 mm	25 mm	25 mm	
Length	90 mm	90 mm	100 mm	250 mm	110 mm	110 mm	50 mm	65 mm	65 mm	
Arbour for hand drill	fixed shaft 6 mm	fixed shaft 6 mm	fixed shaft 8 mm	fixed shaft 10 mm	fixed shaft 10 mm	fixed shaft 10 mm	fixed shaft 3 mm	fixed shaft 6 mm	fixed shaft 6 mm	fixed shaft 6 mm
Arbour for quick release chuck	519 6672	519 6672	519 6689	519 6593	519 6593	519 6593	519 6782	519 6672	519 6672	519 6672
Arbour MK 1 for flexible shaft	595 0519	595 0519	595 4278	595 4027 with 519 6593	595 4027 with 519 6593	595 4027 with 519 6596	595 4027 with 519 6782	595 0519	595 0519	595 0519

Ref. No.	Designation						
595 5019	HM mill cutter, pointed	•	•	•	•		
595 4962	HM mill cutter, pointed	•	•	•	•	•	•
595 4948	HM mill cutter, pointed	•	•			•	•
595 5002	HM mill cutter, pointed (extra long) Suitable for: EM SEALASTIC preparation of injuries using a hand drill					•	
595 5060	HM mill cutter, pointed	•	•			•	•
595 5040	HM mill cutter, pointed	•	•			•	•
595 4900	HM router/burr, pointed	•		•			
595 4924	HM router/burr, pointed	•				•	
595 4931	HM router/burr, blunt headed	•				•	
595 4955	HM Ballshaped burr	•				•	

TOOLS AND ACCESSORIES
Cutting and buffing tools



3

HSS mill cutters

- For cylindrical enlargement and cleaning of smaller tread-area punctures
- HSS mill cutters have to be replaced after max. 25 repairs because of wear

	5954917	5111767	5111781	5111798
Speed	max. 2500 rpm	max. 2500 rpm	max. 2500 rpm	max. 2500 rpm
Dia.	3 mm	4.5 mm	6 mm	8 mm
Length	60 mm	110 mm	110 mm	110 mm
Arbour for hand drill	fixed shaft 3 mm	fixed shaft 4.5 mm	fixed shaft 6 mm	fixed shaft 8 mm
Arbour for quick release chuck	519 6782		519 6672	519 6689
Arbour MK 1 for flexible shaft	595 4027 with 519 6782		595 4027 with 519 6672	519 6689 with 595 4027

Ref. No.	Designation
595 4917	HSS mill cutter
511 1767	HSS mill cutter
511 1781	HSS mill cutter
511 1798	HSS mill cutter

TOOLS AND ACCESSORIES

Cutting and buffing tools



595 0746



595 8872



595 0739



595 8982

Chip cones, classic class

- The copper coloured carbide buffing tools have a very long lifespan
- Their quality in measurement and roundness without vibration is outstanding and unique
- Optimised removal of rubber
- For buffing rubber on stitch damages and narrow spots

	5950746	5958872	5950739	5958982
Thread	3/8"	3/8"	3/8"	3/8"
Speed	max. 4500 rpm	max. 4500 rpm	max. 4500 rpm	max. 4500 rpm
Dia.	20 mm	25 mm	25 mm	25 mm
Length	38 mm	50 mm	102 mm	102 mm
Arbour for hand drill	595 4034	595 4034	595 4034	595 4034
Arbour for quick release chuck	519 6610	519 6610	519 6610	519 6610
Arbour MK 1 for flexible shaft	595 4027	595 4027	595 4027	595 4027

Ref. No.	Designation			
595 0746	Chip cone K 18, rounded	•	•	
595 8872	Chip cone K 18, pointed	•		•
595 0739	Chip cone K 18, pointed	•	•	
595 8982	Chip cone K 36, pointed	•	•	

TOOLS AND ACCESSORIES

Cutting and buffing tools



Pencil buffers, classic class

- The copper coloured carbide buffing tools have a very long lifespan
- Their quality in measurement and roundness without vibration is outstanding and unique
- Optimised removal of rubber
- For buffing of rubber in nailhole type injuries

	5955057	5958913	5958906	5958896	5950753	5958968	5958951
Speed	max. 4500 rpm	max. 4500 rpm	max. 4500 rpm	max. 4500 rpm	max. 4500 rpm	max. 4500 rpm	max. 4500 rpm
Dia.	4 - 6 mm	4 - 8 mm	5 - 8 mm	5 - 8 mm	6 mm	8 mm	8 mm
Length	65 mm	102 mm	105 mm	105 mm	65 mm	170 mm	170 mm
Arbour for hand drill	fixed shaft 6 mm	fixed shaft 6 mm	fixed shaft 6 mm	fixed shaft 6 mm	fixed shaft 6 mm	fixed shaft 8 mm	fixed shaft 8 mm
Arbour for quick release chuck	519 6672	519 6672	519 6672	519 6672	519 6672	519 6689	519 6689
Arbour MK 1 for flexible shaft	595 0519	595 0519	595 0519	595 0519	595 0519	595 4278	595 4278

Ref. No.	Designation			
595 5057	Pencil buffer K 36	•	•	
595 8913	Pencil buffer K 46	•	•	
595 8906	Pencil buffer K 18	•	•	
595 8896	Pencil buffer K 36	•	•	
595 0753	Pencil buffer K 18	•	•	
595 8968	Pencil buffer K 18			•
595 8951	Pencil buffer K 36			•

TOOLS AND ACCESSORIES

Cutting and buffing tools



595 8762



595 8755



595 8786



595 8793



595 8810



595 8858



595 8779

Buffing wheels, classic class

- The copper coloured carbide buffing tools have a very long lifespan
- Their quality in measurement and roundness without vibration is outstanding and unique
- Optimised number and placement of cooling holes and slots
- Optimised and efficient removal of rubber

	5958755	5958786	5958793	5958779	5958762	5958810	5958858
Thread	3/8"	3/8"	3/8"	3/8"	3/8"	3/8"	3/8"
Speed	max. 4500 rpm	max. 4500 rpm	max. 4500 rpm	max. 4500 rpm	max. 4500 rpm	max. 4500 rpm	max. 4500 rpm
Dia.	50 mm	50 mm	50 mm	50 mm	50 mm	50 mm	50 mm
Width	3 mm	3 mm	3 mm	3 mm	5 mm	5 mm	10 mm
Arbour for hand drill	595 4034	fixed shaft 6 mm	595 4034	fixed shaft 6 mm	595 4034	595 4034	595 4034
Arbour for quick release chuck	519 6610	519 6672	519 6610	519 6672	519 6610	519 6610	519 6610
Arbour MK 1 for flexible shaft	595 4027		595 4027		595 4027	595 4027	595 4027

Ref. No.	Designation			
595 8755	Buffing wheel K 16	•	•	
595 8786	Buffing wheel K 18	•	•	
595 8793	Buffing wheel K 18	•	•	•
595 8779	Buffing wheel K 36	•	•	
595 8762	Buffing wheel K 14	•	•	•
595 8810	Buffing wheel K 18	•	•	•
595 8858	Buffing wheel K 18	•	•	•

TOOLS AND ACCESSORIES
Cutting and buffing tools



595 6070



595 4388



595 4395



595 8834



595 8827



595 8841

	5954388	5956070	5954395	5958834	5958827	5958841
Thread	3/8"	3/8"	3/8"		3/8"	
Speed	max. 4500 rpm	max. 4500 rpm	max. 4500 rpm	max. 4500 rpm	max. 4500 rpm	max. 4500 rpm
Dia.	50 mm	50 mm	50 mm	76 mm	50 mm	102 mm
Bore Ø				14 mm		14 mm
Width	13 mm	13 mm	13 mm	16 mm	19 mm	19 mm
Arbour for hand drill	595 4034	595 4034	595 4034	595 4261	595 4034	595 4261
Arbour for quick release chuck	519 6610	519 6610	519 6610	519 6634	519 6610	519 6634
Arbour MK 1 for flexible shaft	595 4027	595 4027	595 4027	595 4285	595 4027	595 4285

Ref. No.	Designation			
595 4388	Buffing wheel K 18	•	•	
595 6070	Buffing wheel K 18	•	•	
595 4395	Buffing wheel K 36	•	•	
595 8834	Buffing wheel K 18	•	•	
595 8827	Buffing wheel K 18	•	•	
595 8841	Buffing wheel K 18	•	•	

TOOLS AND ACCESSORIES

Cutting and buffing tools



595 8920

Ball rasp, classic class

- The copper coloured carbide buffing tools have a very long lifespan
- Their quality and measurement as well as roundness without vibration is outstanding and unique
- Optimised and efficient removal of rubber

5958920

Speed	max. 4500 rpm
Dia.	20 mm
Arbour for hand drill	fixed shaft 6 mm
Arbour for quick release chuck	519 6672
Arbour MK 1 for flexible shaft	595 0519

Ref. No.	Designation	
595 8920	Ball rasp K 18	• •

TOOLS AND ACCESSORIES

Cutting and buffing tools



Domed contour rasps, classic class

- The copper coloured carbide buffing tools have a very long lifespan
- Their quality and measurement as well as roundness without vibration is outstanding and unique
- Optimised number and placement of cooling holes and slots
- Optimised and efficient removal of rubber
- For buffing on inner liner, or for finish buffing of the skive filling

	5959000	5958865	5958975	5954216	5954319	5958999	5954223	5954209	5954247	5954230
Thread	3/8"	3/8"	3/8"							
Speed	max. 4500 rpm	max. 4500 rpm	max. 4500 rpm	max. 4500 rpm	max. 4500 rpm	max. 4500 rpm	max. 4500 rpm	max. 4500 rpm	max. 4500 rpm	max. 4500 rpm
Dia.	30 mm	50 mm	50 mm	65 mm	65 mm	76 mm	76 mm	76 mm	102 mm	102 mm
Bore Ø				10 mm	3/8"	16 mm	14 mm	14 mm	14 mm	14 mm
Arbour for hand drill	595 4034	595 4034	595 4034	595 4034	595 4034	595 4261	595 4261	595 4261	595 4261	595 4261
Arbour for quick release chuck	519 6610	519 6610	519 6610	519 6627	519 6627	519 6634	519 6634	519 6634	519 6634	519 6634
Arbour MK 1 for flexible shaft	595 4027	595 4027	595 4027	595 4027	595 4027	595 4285	595 4285	595 4285	595 4285	595 4285

Ref. No.	Designation						
595 9000	Dome rasp K 36	•	•				
595 8865	Dome rasp K 18			•	•	•	
595 8975	Dome rasp K 36					•	•
595 4216	Dome rasp K 36	•	•				
595 4319	Dome rasp K 46	•	•				
595 8999	Dome rasp K 14			•	•		
595 4223	Dome rasp K 18				•	•	
595 4209	Dome rasp K 36					•	•
595 4247	Dome rasp K 18				•	•	
595 4230	Dome rasp K 36					•	•

TOOLS AND ACCESSORIES

Cutting and buffing tools



595 4716



595 4715



595 4717



595 4371

Mini buffing tools, silver class

Buffing tool for fine detail work.

	5954715	5954716	5954717
Speed	max. 4500 rpm	max. 4500 rpm	max. 4500 rpm
Dia.	10 mm	6 mm	15 mm
Length		15 mm	
Arbour for hand drill	fixed shaft 3 mm	fixed shaft 3 mm	fixed shaft 3 mm
Arbour for quick release chuck	519 6782	519 6782	519 6782

Ref. No.	Designation		
595 4715	Mini ball rasp K 46	•	•
595 4716	Mini cone rasp K 46	•	•
595 4717	Mini chip rasp K 46	•	•

Ball rasp, silver class

For finishing work on rubber surfaces.

	5954371
Speed	max. 4500 rpm
Dia.	19 mm
Arbour for hand drill	fixed shaft 1/4"
Arbour for quick release chuck	519 6672
Arbour MK 1 for flexible shaft	595 0519

Ref. No.	Designation		
595 4371	Ball rasp K 36	•	•

TOOLS AND ACCESSORIES

Cutting and buffing tools



595 4735



595 4687



595 4632





595 4656

3

Domed buffing rasps, silver class

- The outstanding quality of the Silver Class range makes these tools unique
- Particularly suitable for sensitive buffings of the inside/innerliner of tyres
- For finishing work on rubber surfaces

	5954735	5954687	5954632	5954656
Speed	max. 4500 rpm	max. 4500 rpm	max. 4500 rpm	max. 4500 rpm
Dia.	32 mm	32 mm	44 mm	76 mm
Bore Ø	3/8"	3/8"	3/8"	14 mm
Length	18 mm	18 mm	19 mm	
Arbour for hand drill	595 4034	595 4034	595 4034	595 4261 with PU insert 595 0533
Arbour for quick release chuck	519 6610	519 6610	519 6610	519 6634 with PU insert 519 6665
Arbour MK 1 for flexible shaft	595 4027	595 4027	595 4027	595 4285 not possible with PU insert

Ref. No.	Designation			
595 4735	Dome rasp K 60	•	•	
595 4687	Dome rasp K 36	•	•	
595 4632	Dome rasp K 36	•	•	
595 4656	Dome rasp K 36	•		•

TOOLS AND ACCESSORIES

Cutting and buffing tools



595 4704



595 4740



595 4330

Chip cone rasp, silver class

	5954704	5954740
Speed	max. 4500 rpm	max. 4500 rpm
Dia.	11 - 22 mm	6 mm
Length	50 mm	75 mm
Arbour for hand drill	595 4034	fixed shaft 6 mm
Arbour for quick release chuck	519 6610	519 6672
Arbour MK 1 for flexible shaft	595 4027	

Ref. No.	Designation			
595 4704	Chip rasp K 18, blunt headed	•	•	
595 4740	Pencil buffer K 36, pointed			•

Domed contour rasps, gold class

- Outstandingly long lifespan
- Efficient removal of rubber due to unique cooling technology

	5954330
Thread	
Speed	max. 4500 rpm
Dia.	76 mm
Bore Ø	14 mm
Arbour for hand drill	595 4261
Arbour for quick release chuck	519 6634
Arbour MK 1 for flexible shaft	595 4285

Ref. No.	Designation		
595 4330	Dome rasp K 36, Patriot	•	•

TOOLS AND ACCESSORIES

Cutting and buffing tools



595 6056



595 6087



595 6111



595 6001



595 6018



595 6049

Domed contour rasps, REMA TIP TOP class

- Economy series for buffing of rubber surfaces
- Carbide buffing tool

	5956056	5956087	5956111
Thread	3/8"		
Speed	max. 4500 rpm	max. 4500 rpm	max. 4500 rpm
Dia.	50 mm	76 mm	102 mm
Bore Ø		14 mm	14 mm
Arbour for hand drill	595 4034	595 4261	595 4261
Arbour for quick release chuck	519 6610	519 6634	519 6634
Arbour MK 1 for flexible shaft	595 4027	595 4285	595 4285

Ref. No.	Designation			
595 6056	Dome rasp K 16	•	•	•
595 6087	Dome rasp K 16		•	•
595 6111	Dome rasp K 16		•	•

Buffing wheels, REMA TIP TOP class

- Economy series for buffing of rubber surfaces
- Carbide buffing tool

	5956001	5956018	5956049
Thread	3/8"	3/8"	3/8"
Speed	max. 4500 rpm	max. 4500 rpm	max. 4500 rpm
Dia.	50 mm	50 mm	50 mm
Height	3 mm	5 mm	10 mm
Arbour for hand drill	595 4034	595 4034	595 4034
Arbour for quick release chuck	519 6610	519 6610	519 6610
Arbour MK 1 for flexible shaft	595 4027	595 4027	595 4027

Ref. No.	Designation			
595 6001	Buffing wheels K 16	•	•	•
595 6018	Buffing wheels K 16	•	•	•
595 6049	Buffing wheels K 16	•	•	•

TOOLS AND ACCESSORIES

Cutting and buffing tools

Buffing kit, REMA TIP TOP

- The convenient box contains eight essential special tools
- All tools are clearly arranged and embedded in foam plastic retainers to avoid damage to the buffing tools
- Flexible use for repair work
- Careful storage of the tools
- All buffing tools can be ordered separately
- Space saving and clear arrangement



595 4750

Scope of delivery

- | | | | |
|-----------|---------------------------------|-----------|--------------------------------|
| • 5958975 | 1 Dome contour rasp K 36, 50 mm | • 5954412 | 1 Cutting disc, pointed, 32 mm |
| • 5958810 | 1 Chip rasp K 18, 50 mm | • 5950650 | 1 Cutting disc, pointed, 40 mm |
| • 5955057 | 1 Pencil buffer K 36, 4-6 mm | • 5959000 | 1 Contour wheel K 36, 30 mm |
| • 5196610 | 1 Adapter NV 11, 3/8" | • 5954319 | 1 Dome rasp K 46 |

Ref. No.	Designation	Content
595 4750	Buffing kit BASIC	8

Rotary plastic brush

- The rotary brush with plastic (SiC) bristles is designed for repairs of Yokohama car and truck tyres which are fitted with a new type of "AIRTEX TM" innerliner
- The brush allows gentle removal of the "AIRTEX TM" innerliner



595 0730

5950730

Speed	max. 3000 rpm
Dia.	50 mm
Width	18 mm
Arbour for hand drill	fixed shaft 6 mm
Arbour for quick release chuck	519 6672
Arbour MK 1 for flexible shaft	595 0519

Ref. No.	Designation		
595 0730	Rotary plastic brush SiC	•	•

TOOLS AND ACCESSORIES

Cutting and buffing tools



595 4175



595 4168

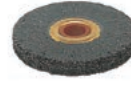

595 4522



595 4560



595 0722



595 0076



595 0571

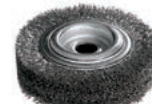

595 0564

Rotary wire brushes

- The rotary wire brushes are made with crimped wires in different qualities
- They are ideal for use in power drills, air buffers and flexible shafts
- For the careful treatment of rubberized steel cord to achieve an optimal buffing texture
- The rotary brushes with brush body encapsulated in a synthetic compound guarantee a long service life

	5954175	5954168	5954522	5954182	5950722	5950076	5950571	5950564	5954560
Speed	max. 2800 rpm	max. 2800 rpm	max. 2800 rpm	max. 2800 rpm	max. 2800 rpm	max. 2800 rpm	max. 2800 rpm	max. 2800 rpm	max. 2800 rpm
Dia.	76 mm	76 mm	50 mm	76 mm	55 mm	60 mm	80 mm	100 mm	8 mm
Bore Ø	14 mm	14 mm	3/8"	14 mm			16 mm	16 mm	
Width	20 mm	8 mm	7 mm	20 mm	8 mm	20 mm	25 mm	25 mm	25 mm
Arbour for hand drill	595 0533	595 0533	595 4034	595 0533	fixed shaft 6 mm	fixed shaft 6 mm	595 0540	595 0540	fixed shaft 6 mm
Arbour for quick release chuck	519 6665	519 6634	519 6627	519 6634	519 6672	519 6672	519 6689	519 6689	519 6672
Arbour MK 1 for flexible shaft	595 4285	595 4285		595 4285			595 0502	595 0502	

Ref. No.	Designation							
595 4175	Rotary brush, contour embedded in plastic	•	•					
595 4168	Rotary brush, cylindrical, plastic embedded			•	•			
595 4522	Rotary brush, cylindrical, plastic embedded			•				•
595 4182	Rotary brush, cylindrical, plastic embedded			•	•			
595 0722	Rotary brush, cylindrical, brass-coated steel wire		•	•	•	•	•	•
595 0076	Rotary brush, steel wire		•	•	•	•	•	•
595 0571	Rotary brush, cylindrical		•	•				
595 0564	Rotary brush, cylindrical		•	•				
595 4560	Spiral/pencil brush For the repair of very small injuries						•	•

TOOLS AND ACCESSORIES

Cutting and buffing tools



595 0090



594 0360



595 8803

Rotary wire brushes, rigid shaft

For buffing, cleaning and derusting. Corrugated special wire (0.3 mm thick).

Ref. No.	Designation	Size
594 0360	Rotary wire brush	Ø 40 x 12 mm
594 0370	Rotary wire brush	Ø 50 x 18 mm
594 0380	Rotary wire brush	Ø 60 x 18 mm

Tress-shaped wire brush

For buffing rubber-coated steel cables when splicing steel cord conveyor belts.
Borehole Ø 16 mm to mount with arbor MK I.

Ref. No.	Designation	Dia.	Bore Ø
595 0090	Tress-shaped wire brush Z 2102, 24 mm	100 mm	16 mm

Grooved wire brush

For buffing rubber-coated steel cables during preparation of belt splices.

Ref. No.	Designation	Dia.	Bore Ø
595 8803	Grooved wire brush, 34 mm	100 mm	13.2 mm
595 8802	Grooved wire brush, 40 mm	100 mm	13.3 mm

TOOLS AND ACCESSORIES
Cutting and buffing tools



595 4041



595 4110

Buffing brushes

For buffing the side wall of tyres before retreading.

Ref. No.	Designation	Dia.	Inside dia.	Width	
595 4041	Buffing brush BANDAG, corrugated	200 mm	100 mm	40 mm	•
595 4150	Buffing brush TRM EAGLE, corrugated	230 mm	100 mm	60 mm	•
595 4199	Buffing brush MATTEUZZI	230 mm	100 mm	40 mm	•
595 4110	Buffing brush MATTEUZZI RAS90	160 mm	76 mm	38 mm	•
519 6809	Buffing brush R8167/0.15D, corrugated, canted contour	160 mm	76 mm	60 mm	•
519 6816	Buffing brush R8167/0.27D, corrugated, canted contour	160 mm	76 mm	60 mm	•
595 4060	Buffing brush COLLMANN 0142	180 mm	100 mm	40 mm	•
595 4120	Buffing brush EAGLE 4200	150 mm	40 mm	80 mm	•
595 4140	Buffing brush	230 mm	60 mm	100 mm	•

TOOLS AND ACCESSORIES

Cutting and buffing tools



595 0643



595 7945



595 7938



595 7622



595 7639





595 7646

Buffing and grinding wheels

- Used for buffing excess rubber and joints
- When ordering, specify bore, diameter and keyway size precisely

	5950643	5957945	5957938	5957866	5196414	5957608	5957610	5957615	5957622	5957639	5957646
Dia.	100 mm	102 mm	76 mm	50 mm	130 mm	200 mm	235 mm	150 mm	150 mm	152 mm	180 mm
Bore Ø	14 mm	14 mm	14 mm	14 mm							
Width	38 mm	38 mm	25 mm	25 mm	30 mm	38 mm	38 mm	38 mm	25 mm	34 mm	34 mm
Arbour for hand drill			595 4261	595 4261							
Arbour for quick release chuck	519 6634	519 6634	519 6634	519 6634							
Arbour MK 1 for flexible shaft	595 4285	595 4285									

Ref. No.	Designation			
595 0643	Buffing wheel, coarse	•	•	
595 7945	Buffing wheel K 46	•		•
595 7938	Buffing wheel K 60	•	•	
595 7866	Buffing wheel K 18, Patriot	•	•	
519 6414	DWM buffing wheel K 18, curved contour Suitable for: Buffing machines, e.g. Marangoni Bunny II; Classic Class version	•	•	
595 7608	Buffing wheel K 18, canted contour Suitable for: Buffing machines e.g. BANDAG	•		
595 7610	Buffing wheel K 18, canted contour Suitable for: Buffing machines e.g. BANDAG	•		
595 7615	Buffing wheel K 18, canted contour Suitable for: Buffing machines e.g. RM 56, BANDAG	•		
595 7622	Buffing wheel K 18, canted contour Suitable for: Buffing machines e.g. RM 56	•		
595 7639	Buffing wheel K 18, curved contour Suitable for: Buffing machines e.g. Collmann ZRM 66, RM 56	•	•	
595 7646	Buffing wheel K 18, curved contour Suitable for: Buffing machines e.g. Collmann ZRM 66/86/90	•	•	

TOOLS AND ACCESSORIES

Cutting and buffing tools



595 0784



595 0117



595 0588



595 0595

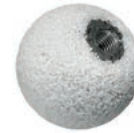

595 0605



595 0083

Hard metal buffing wheel, copper-carbide

Especially for buffing soft rubber at high speeds (3800 - 4500 rpm).
Ensures rough surfaces at low speeds and little heating of surfaces.

Ref. No.	Designation	Dia.	Bore Ø	Grit
595 0784	Hard metal buffing wheel K 18	102 mm	14 mm	18

Limestones

- The "limestones" are designed for buffing rubber surfaces
- The special hollow-sphere corundum surface gives a fine, permanent razor-sharp cutting edge for gentle removal of material
- These tools are therefore particularly suitable for soft rubber grades

	5950117	5950588	5950595	5950605	5950083
Speed	max. 4500 rpm	max. 4500 rpm	max. 4500 rpm	max. 4500 rpm	max. 4500 rpm
Dia.	60 mm	90 mm	90 mm	60 mm	38 mm
Bore Ø		16 mm	16 mm		
Width	15 mm	30 mm	30 mm		
Arbour for hand drill	595 0100	595 0540	595 0540	595 0557	fixed shaft 6 mm
Arbour for quick release chuck	595 0100 + 519 6672	595 0540 + 519 6689	595 0540 + 595 6689	595 0557 + 519 6689	519 6672
Arbour MK 1 for flexible shaft		595 0540 + 595 0502	595 0540 + 595 0502	595 0557 + 595 0526	

Ref. No.	Designation						
595 0117	Limestone, cylindrical	•	•				
595 0588	Limestone, cylindrical	•		•			
595 0595	Limestone, rounded			•	•		
595 0605	Limestone, spherical, M12			•	•		
595 0083	Limestone, spherical, with shaft			•			•

TOOLS AND ACCESSORIES

Cutting and buffing tools



595 4406



595 0650



595 0629



595 4405



595 4810



595 0667



595 0636

Buffing pin

Ref. No.	Designation
595 4406	Buffing pin SP 20326 AR, for use with drill chuck

Grinding tools

Grinding tools for steel cord preparation

- For grinding and removal of damaged steel cord on tyres
- The grinding tools are manufactured from a special ceramic bond and white corundum
- Sharp-edged white corundum gives high removal rates on steel cord

	5950650	5950629	5954405	5954810	5950667	5950636	5954780	5954797	5954412	5950681
Speed	max. 25000 rpm	max. 25000 rpm	max. 25000 rpm	max. 25000 rpm	max. 9000 rpm	max. 9000 rpm	max. 25000 rpm	max. 25000 rpm	max. 25000 rpm	max. 25000 rpm
Dia.	40 mm	20 mm	8 mm	14 mm	76 mm	100 mm	25 mm	50 mm	32 mm	20 mm
Bore Ø					16 mm	16 mm				
Length		65 mm	25 mm	45 mm						
Width	10 mm				7 mm	10 mm	6 mm	10 mm	6 mm	
Arbour for hand drill	fixed shaft 6 mm	fixed shaft 6 mm	fixed shaft 6 mm	fixed shaft 6 mm	595 0674	595 0674	fixed shaft 6 mm	fixed shaft 6 mm	fixed shaft 6 mm	fixed shaft 6 mm
Arbour for quick release chuck	519 6672	519 6672	519 6672	519 6672	595 0674 + 519 6689	595 0674 + 519 6689	519 6672	519 6672	519 6672	519 6672
Arbour MK 1 for flexible shaft					595 0674 + 595 4278	595 0674 + 595 4278				

Ref. No.	Designation					
595 0650	Round mushroom stone, pointed	•	•	•	•	•
595 0629	Cone stone	•				
595 4405	Pencil stone	•				
595 4810	Pointed cone stone	•	•	•	•	•
595 0667	Grinding disc, cylindrical	•				

TOOLS AND ACCESSORIES

Cutting and buffing tools



Ref. No.	Designation					
595 0636	Grinding disc, cylindrical	•				
595 4780	Cutting disc, blunt	•		•	•	•
595 4797	Cutting disc	•			•	
595 4412	Round mushroom stone, pointed	•		•		•
595 0681	Ball stone, spherical	•		•	•	•

Finish buffer ES

- The ES buffing bands can be mounted or removed by turning them slightly to the right
- Buffing bands are easier and quicker to replace
- They are ideal for finish buffing when the skive filling has cooled down

	5955507	5955521	5955514	5955552	5955576	5955569
Speed	max. 2800 rpm	max. 2800 rpm	max. 2800 rpm	max. 2800 rpm	max. 2800 rpm	max. 2800 rpm
Dia.	45 mm	45 mm	45 mm	75 mm	75 mm	75 mm
Height	30 mm	30 mm	30 mm	30 mm	30 mm	30 mm
Arbour for hand drill	fixed shaft 6 mm			fixed shaft 8 mm		
Arbour for quick release chuck	519 6672			519 6689		

Ref. No.	Designation					
595 5507	ES 45 finish buffer kit K 60	•	•			
595 5521	Spare buffing band K 40 Suitable for: ES 45 buffing tool	•	•			
595 5514	Spare buffing band K 60 Suitable for: ES 75 buffing tool	•		•		
595 5552	ES 75 finish buffer kit K 60	•			•	
595 5576	Spare buffing band K 40 Suitable for: ES 75 buffing tool	•				•
595 5569	Spare buffing band K 60 Suitable for: ES 75 buffing tool	•				•

TOOLS AND ACCESSORIES

Cutting and buffing tools



Finish buffer FS

- To finish buff the skive filling on tyres or rubber chains
- The fine grit gives an excellent smooth surface

	5955530
Speed	max. 4500 rpm
Dia.	40 mm
Width	20 mm
Arbour for hand drill	fixed shaft 6 mm
Arbour for quick release chuck	519 6672

Ref. No.	Designation		
595 5530	Finish buffer FS K 60	•	•

Grinding discs

Buffing discs for angle grinders

- For the preparation of large rubber surfaces on the outside of a tyre
- Speed: max. 4500 rpm

Ref. No.	Designation	Dia.	Bore Ø	Grit
595 2531	Buffing disc K 18	125 mm	22 mm	18
595 2548	Buffing disc K 23	125 mm	22 mm	23
595 2555	Buffing disc K 18	175 mm	22 mm	18
595 2562	Buffing disc K 23	175 mm	22 mm	23

TOOLS AND ACCESSORIES

Cutting and buffing tools



Vulkan fibre disc VSM



594 2120



594 2110

Vulkan fibre disc VSM

With cross slots for use in angle grinders with flexible face disc.

Ref. No.	Designation	Dia.	Bore Ø	Grit
594 1090	Fibre disc 125/K 16	180 mm	22	16
594 1060	Fibre disc 125/K 24	180 mm	22	24
594 0290	Fibre disc 180/K 16	180 mm	22	16
594 0300	Fibre disc 180/K 24	180 mm	22	24
594 0310	Fibre disc 180/K 30	180 mm	22	30
594 0320	Fibre disc 180/K 40	180 mm	22	40
594 0340	Fibre disc 180/K 60	180 mm	22	60
594 0330	Fibre disc 180/K 80	180 mm	22	80

Fibre disc

- Corundum
- Vulcanized fiber backing material
- With inner hole and cross slot
- For deburring, smoothing and cleaning of welds

Ref. No.	Designation	Dia.	Bore Ø	Grit
594 2120	Fibre disc K 24, corundum (25 pcs.)	125 mm	22 mm	24
594 2110	Fibre disc K 60, corundum (25 pcs.)	125 mm	22 mm	60

TOOLS AND ACCESSORIES

Cutting and buffing tools



594 0270



594 0280



594 0260

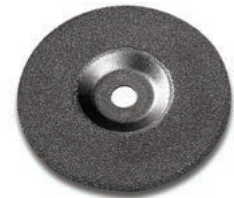

519 6885

Grinding disc

For working steel, steel casting, steel alloys and welding seams.

Ref. No.	Designation	Size
594 0270	Grinding disc	Ø 178 x 8 mm
594 0280	Grinding disc	Ø 230 x 6 mm

Cutting disc

Ref. No.	Designation	Size
594 0260	Cutting disc	Ø 230 x 2 mm
595 3200	Diamond cutting disc	Ø 180 x 2.5 mm

Tungsten carbide buffing disc Silver Class

Longer service life and faster buffing compared with copper-carbide discs.
Recommended for angle grinder L 1202. Risk of damage to bearing when used with less powerful angle grinders.

Ref. No.	Designation	Dia.	Grit
519 6885	Tungsten carbide buffing disc silver class	175 mm	16

TOOLS AND ACCESSORIES

Cutting and buffing tools



Circular cutters



539 4405

Drilling tools

Circular cutters

Grind circular cutters with Allen key adapter for mounting drill chuck.
Recommended speed: max. 1500 rpm

Ref. No.	Designation
511 1413	Circular cutter, 5 mm
511 1420	Circular cutter, 7 mm
511 1437	Circular cutter, 9 mm
511 1444	Circular cutter, 11 mm
511 1451	Circular cutter, 16 mm
511 1468	Circular cutter, 20 mm
511 1475	Circular cutter, 25 mm

HDL drill

- For additional boreholes in rubber such as HDL plates or REMASTEEL
- Shaft for drill chuck (rigid shaft \varnothing 10 mm)

Ref. No.	Designation
539 4405	HDL drill, 50 mm

TOOLS AND ACCESSORIES

Cutting and buffing tools



595 0100



595 3932



595 4034



595 4302



595 0533



595 0540



595 0557



595 4261



519 6270



595 0674

Clamping tools

Jacob chuck type arbours

For secure mounting of buffing tools on driving machine.

Ref. No.	Designation	Shaft dia.	Thread
595 0100	Arbour Suitable for: Limestone, cylindrical	6 mm	M6
595 3932	Arbour Suitable for: Buffing tools with 3/8" thread	6 mm	3/8"
595 4034	Arbour Suitable for: Buffing tools with 3/8" thread	8 mm	3/8"
595 4302	Arbour Suitable for: Buffing tools with 3/8" thread	8 mm	3/8"
595 0533	Arbour Suitable for: Buffing tools with M14 bore; Dome rasp with POLYPLUG 76 mm	8 mm	M14
595 0540	Arbour Suitable for: Buffing tools with M14 bore; Rotary wire brush; Limestone	8 mm	M14
595 0557	Arbour Suitable for: Buffing tools with M12 bore	8 mm	M12
595 4261	Arbour Suitable for: Buffing tools with M14 bore	8 mm	M14
519 6270	Arbour Suitable for: Buffing rasps R5 / R6	8 mm	
595 0674	Arbour Suitable for: Cylindric grinding discs	8 mm	M10

TOOLS AND ACCESSORIES

Cutting and buffing tools



519 6603



519 6782



519 6672



519 6689



519 6593



519 6610



519 6627



519 6634



519 6641



519 6665

Arbours - adapters for quick release chuck type

For the secure fastening of buffing tools in the quick coupling.

Ref. No.	Designation	Thread
519 6603	Quick release action chuck QC Suitable for: Arbour NV 11	3/8"
519 6782	Arbour NV 11 Suitable for: Buffing tools with 3 mm shaft	
519 6672	Arbour NV 11 Suitable for: Buffing tools with 6 mm shaft	
519 6689	Arbour NV 11 Suitable for: Buffing tools with 8 mm shaft	
519 6593	Arbour NV 11 Suitable for: Buffing tools with 10 mm shaft	
519 6610	Arbour NV 11 3/8", 12 mm thread length Suitable for: Buffing tools with 3/8" thread	3/8" x 12 mm
519 6627	Arbour NV 11 3/8", 21 mm thread length Suitable for: Buffing tools with 3/8" thread	3/8" x 21 mm
519 6634	Arbour NV 11 M14, 11 mm thread length Suitable for: Contour discs and buffing wheels with Ø76 mm + Ø102 mm	M14x11 mm
519 6641	Arbour NV 11 Suitable for: Buffing rasp R5 / R6	
519 6665	Arbour NV 11 M14, 18 mm thread length Suitable for: Wire brush; Buffing wheel with PU insert	M14x18 mm

TOOLS AND ACCESSORIES

Cutting and buffing tools



Flex drive arbours MK 1

For secure mounting of buffing tools to flexible shafts.

Ref. No.	Designation	Thread
595 0519	Arbour MK 1 collet chuck type Suitable for: All tools with 6 mm shaft	
595 4278	Arbour MK 1 collet chuck type Suitable for: All tools with 8 mm shaft	
595 4027	Arbour MK 1 Suitable for: Buffing tools with 3/8" thread, 3/8" bore	3/8"
595 0526	Arbour MK 1 Suitable for: Buffing tools with M12 thread	M12
595 0502	Arbour MK 1 Suitable for: Rotary wire brush; Limestone; Tools with 16 mm attachment	M10
595 4285	Arbour MK 1 Suitable for: Buffing tools with 14 mm bore	M14
519 6263	Arbour MK 1 Suitable for: Buffing rasps R5 / R6; Tools with 16 mm attachment	
595 4010	Arbour MK 1 Suitable for: Quick coupling	3/8"

Cutting tools

Pre-cure tread cutters

The two cutters separate the tread and at the same time roughen the cut edges.

Ref. No.	Designation	Thickness	Dia.	Inside dia.
595 0360	Cutter 180	3 mm	180 mm	32.0 mm
595 0361	Cutter 152	3 mm	152 mm	50.8 mm

TOOLS AND ACCESSORIES

Retreading machines

Buffing rasps types and diameter without blade

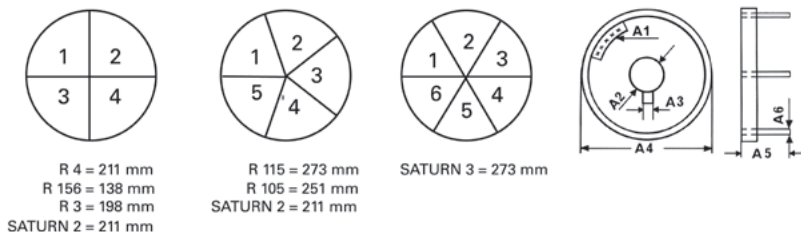

Buffing rasps versions

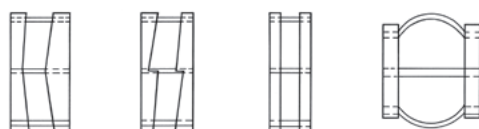

Buffing rasps

Buffing rasps for all common retreading machines are available from stock.

For special orders please specify the details according to items 1 - 8:

1. Type of buffing rasps: e.g. R4-NS, to measure as A 1
2. Bore \emptyset : to measure as A 2
3. Keyway size and number: width to measure as A 3
4. Rasp \emptyset without rocket refills: to measure as A 4
5. Length of pin: length of pin to measure as A 5, dia. as A 6
6. Number, type and size of spacers: to measure as A 7
7. Type and number of refill: e.g. APOLLO II U
8. Buffing machine: e.g. RM 56 N



Buffing rasps R115

Ref. No.	Designation	For bolt hole \emptyset	Content	Qty
519 6067	SPECIAL JET R115-16, teeth alternately offset in two directions	8 mm	25	50
519 6074	SUPER COOL R115-20, teeth alternately offset in two directions	8 mm	25	50
519 6201	SPECIAL JET R115-25, teeth alternately offset in two directions	8 mm	25	50
519 6050	SUPER COOL R115-25, teeth alternately offset in two directions	8 mm	25	50
519 6300	Switch Blade R115-25 SB, for R115-25	8 mm	25	50
519 6840	REMA TIP TOP 115, for R115	8 mm	25	50



519 7341

More sizes and versions on request.

TOOLS AND ACCESSORIES
Retreading machines

Buffing rasps R4

Ref. No.	Designation	For bolt hole Ø	Content	Qty
519 7396	SUPER COOL R4-20, teeth alternately offset in two directions	6 mm	28	50
519 7327	SPECIAL JET R4-20, teeth alternately offset in two directions	6 mm	28	50
519 6012	SPECIAL JET R4-25, teeth alternately offset in two directions	6 mm	28	50
519 6043	SUPER COOL R4-25, teeth alternately offset in two directions	6 mm	28	50
519 7224	GEMINI II R4, alternative for APOLLO II U	6 mm	28	50
519 6870	REMA TIP TOP IV, for R4 buffing rasp	6 mm	28	50



519 7396

Buffing rasps S115/III

Ref. No.	Designation	For bolt hole Ø	Content	Qty
519 7152	SPECIAL JET S115-25			
519 6328	APOLLO III, for SATURN buffing rasp	8 mm	30	50
519 7231	GEMINI III, alternative for SATURN	8 mm	30	50
519 6860	REMA TIP TOP III, for SATURN buffing rasp	8 mm	30	50



519 6328

Buffing rasps II

Ref. No.	Designation	For bolt hole Ø	Content	Qty
519 6311	APOLLO II, for SATURN buffing rasp	8 mm	28	50
519 6483	APOLLO II U R4, for R4 buffing rasp only	6 mm	28	50
519 6850	REMA TIP TOP II, for SATURN buffing rasp	8 mm	28	50



519 6483

More sizes and versions on request.

TOOLS AND ACCESSORIES

Retreading machines

Detreader blades

Detreader blades for buffing machines

Buffing rasp types:

- CONVEX buffing rasps (curved pins) are available e.g. for Collmann RM 75, RM 80, RM 83, Matteuzzi RAS 80/90 and Marangoni buffing machines
- CONVEX are available in R4-AP, R115 REG and SATURN III-AP

Ref. No.	Designation	For bolt hole Ø	Content
519 7451	Detreader blades APOLLO II	8 mm	4
519 7444	Detreader blades R4 - 16	6 mm	4
519 7468	Detreader blades APOLLO III	8 mm	6

Aluminium spacers

Aluminium spacers

Ref. No.	Designation	Thickness	Size
519 7100	Spacer R-115	4.76 mm	3/16"
519 7000	Spacer R-115	6.10 mm	1/4"
519 7010	Spacer R-115	9.53 mm	3/8"
519 6580	Spacer R-4	6.10 mm	1/4"
519 6710	Spacer R-4	9.53 mm	3/8"
519 7190	Spacer R-156	4.76 mm	3/16"
519 7110	Spacer R-156	6.10 mm	1/4"
519 7140	Spacer R-156	9.53 mm	3/8"
519 7490	Spacer SATURN II	4.76 mm	3/16"
519 7410	Spacer SATURN II	6.10 mm	1/4"
519 7420	Spacer SATURN II	9.53 mm	3/8"
519 6400	Spacer SATURN III	4.76 mm	3/16"
519 7600	Spacer SATURN III	6.10 mm	1/4"
519 7610	Spacer SATURN III	9.53 mm	3/8"



More sizes and versions on request.

TOOLS AND ACCESSORIES

Retreading machines

Aluminium spacers, air-cooled

Heavy-duty (HD) spacers:

- HD spacers are available for buffing rasps of type AP, REG and NS in the following widths: 1/4" (6.10 mm), 3/8" (9.53 mm) and 3/16" (4.76 mm)
- For special orders please specify the details according to items 1 - 8

1. Type of buffing rasps: e.g. R4-NS, to measure as A 1
2. Bore Ø: to measure as A 2
3. Keyway size and number: width to measure as A 3
4. Rasp Ø without rocket refills: to measure as A 4
5. Length of pin: length of pin to measure as A 5, dia. as A 6
6. Number, type and size of spacers: to measure as A 7
7. Type and number of refill: e.g. APOLLO II U
8. Buffing machine: e.g. RM 56 N

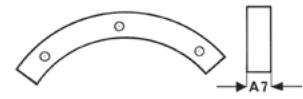

Heavy-duty (HD)

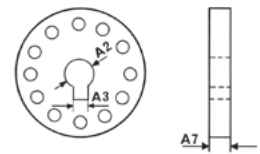

519 6177

Ref. No.	Designation	Thickness	Size
519 6160	Spacer R-115	6.10 mm	1/4"
519 6153	Spacer R-115	9.53 mm	3/8"
519 6184	Spacer R-4	6.10 mm	1/4"
519 6177	Spacer R-4	9.53 mm	3/8"
519 6397	Spacer SATURN II	4.76 mm	3/16"
519 6476	Spacer SATURN II	6.10 mm	1/4"
519 6490	Spacer SATURN II	9.53 mm	3/8"
519 6342	Spacer SATURN III	6.10 mm	1/4"
519 6359	Spacer SATURN III	9.53 mm	3/8"

More sizes and versions on request.

● STORAGE AND WORKSHOP EQUIPMENT

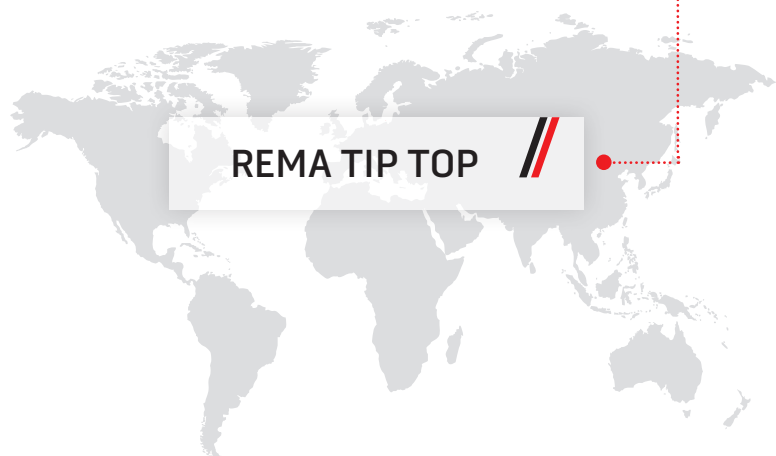

REMA TIP TOP



Storage

172

Workshop equipment

173-175

STORAGE AND WORKSHOP EQUIPMENT

Storage

Storage

REMA TIP TOP workplace PROFI

- The ideal workbench for the tyre specialist, which makes it easy to keep things tidy
- Saves wasting time searching for tools
- Includes illumination, zinc-plated work surface, 4 shelves and 2 multiple tool holders, multiple socket with on/off switch



517 4508

Ref. No.	Designation	Size
517 4508	PROFI workplace	1500 x 750 x 2200 W x D x H mm

Cabinet for repair patches and materials

- For storing patches, tools etc.
- Ideally complements the PROFI workplace
- Local legislation and regulations for the storage of flammable liquids must be observed



517 4546

Ref. No.	Designation	Size
517 4546	Cabinet for repair patches and materials, lockable	950 x 400 x 1800 W x D x H mm

Truck tyre working table

- Provides the optimum working conditions for professional truck tyre repair
- For ergonomic positioning of tyres up to 24"
- Table can be tilted and swivelled



517 1051

Ref. No.	Designation	
517 1051	Truck tyre working table	

STORAGE AND WORKSHOP EQUIPMENT

Workshop equipment







Illumination

Lamps

Ref. No.	Designation
594 0180	Hand lamp, 12 V / 8 W
594 0170	Hand lamp, with 2 fluorescent lamps, 230 V / 8 W
594 0190	Spare fluorescent lamp, 230 V / 8 W
594 0160	Magnetic lamp holder

Mobile working light

The right light for every Job.

Ref. No.	Designation	Electric power/connection				
595 3028	Tyre inspection lamp, without holder Suitable for: Tyre widths from 5.5 to 18"	220 V / 8 W	•	•	•	
595 3011	Holder for Tyre inspection lamp Suitable for: Tyre inspection lamp (595 3028)		•	•	•	
517 4522	Halogen lamp, magnetic	220+12 V / 20 W	•	•	•	
571 9520	Working light OPUS I, without holder	220 V / 11 W	•	•	•	•
594 0910	Flexarm 500 mm magnetic clamp Suitable for: Working light OPUS I (571 9520)					

STORAGE AND WORKSHOP EQUIPMENT

Workshop equipment



571 9740



571 9750

Working light Light-Master

- This series was designed especially for professional use in demanding workshop environments
- The Light-Master is brilliant for providing lighting to tractor/OTR tyres when carrying out repairs
- Safe and simple handling
- Very low heat dissipation
- Low energy consumption
- Quickly replaceable branded fluorescent tube
- Tough rubber-tyred castors ensure good motion of the stand
- Telescopic rail provides wide action radius
- Horizontal multiple locking capability for individual adjustments
- Stable stand due to cast-iron base of approx. 30 kg
- Practical use: two additional sockets for connection of further electrical devices
- Flexible connection cable, oil and petrol resistant
- Lights approved according to EN 60598-2-8 and EN 55015, and EN 60598-2-1

Ref. No.	Designation	Electric power/connection
571 9740	Light-Master 2, with base and telescopic rail	220 V / 2 x 24 W
571 9750	Light-Master 2, with additional socket, without base	220 V / 2 x 24 W

STORAGE AND WORKSHOP EQUIPMENT

Workshop equipment



Working light NOVA



595 2260



594 2090



594 0200

Working light NOVA

- New and strong 30 W COB work light designed with state-of-art LED technology for the professional user
- The new COB LEDs provide a unique, powerful and absolutely uniform illumination, which makes this an ideal working light for use in tyre repair
- Sturdy body made of aluminium, in slim and elegant design
- The lamp is very solid and shockproof
- Cable: 5 m (3x1.5 mm)
- Protection class IP 67 allows the use under open sky

Ref. No.	Designation	Electric power/connection	Power
595 2260	Work light NOVA	220 V / 30 W	2400 Lumen LED

Accessories - Illumination

Ref. No.	Designation
594 0200	Cable drum, 50 m With thermal protection and oil resistant rubber cable. Four power outlets for 230 V with Schuko plug.
594 2090	Cable drum, 25 m Plastic, IP 44, cable quality neoprene. Note: equivalent BGI608.
570 1530	Multi-socket power strip, 4 outlet

VULCANIZING MACHINES



REMA TIP TOP



1-step repair systems

178-181

2-step repair systems

182-194

Presses

195-198

VULCANIZING MACHINES

1-step repair systems

VULCSTAR

VULCSTAR 900-S

- Can be used for 1-step repairs from SUV to agricultural tyres
- Repairs of any tread pattern or tyre profiles, all positions
- For patch sizes up to RAD 188 in a one-step process
- Little rework required for the repair of tread lugs
- The use of pressure granules allows the machine to be adapted to suit every tyre contour and makes finishing work easy
- Pneumatic vibrator for compacting the granules
- No tyre deformation during the curing process

Operating voltage (V):

- Heating element for pressure granules: 2.2 kW/230 V
- Inner heating mat*: max. 0.4 kW/230 V

Operating temperature:

- Heating element for granules: 190 °C +/- 10 °C
- Inner heating mat*: 130 °C +/- 10 °C

Scope of delivery

- | | | | |
|-----------|------------------------------------|---------------|---|
| • 5853049 | 1 Control unit and granule heating | • 5853136 | 1 Pressure plate AS2 (390x450x2 mm) |
| • 5853460 | 1 Spindle adapter set | • 5853111 | 1 Counter-pressure plate GD1 (380x80 mm) |
| • 5853470 | 1 Adapter | • 5853128 | 1 Counter-pressure plate GD2 (250x130 mm) |
| • 5176939 | 1 AIR POWER BAG IV (470 x 300 mm) | • 5857825 | 1 Tubular socket wrench |
| • 5176757 | 1 AIR POWER BAG VI (400x470 mm) | • 5853550 | 4 Bucket for granules (22 litres) |
| • 5853063 | 1 Pressure block L2 (270x250 mm) | • 5853032 | 1 Palette for pressure granules (14x 25 kg) |
| • 5853070 | 1 Pressure block L3 (320x270 mm) | • 5853540 | 1 Shovel for granules (3000 ccm) |
| • 5853094 | 1 Pressure block S2 (250x200 mm) | • 5853166 | 1 Spatula for pressure granules |
| • 5853104 | 1 Pressure block S3 (360x310 mm) | • 5400052 | 4 Rubber pads (100x100 mm) |
| • 5853095 | 1 Pressure block AS2 | • Rubber mats | |
| • 5853135 | 1 Pressure plate AS1 (460x350 mm) | | |



585 3003

Ref. No.	Designation	Voltage	Size	
585 3003	VULCSTAR 900-S for wide agricultural tyres up to 570 mm (sidewall), up to 850 mm (tread) and super-single truck tyres	230 V	1600 x 1200 x 1100 W x D x H mm	 

Operating pressure (bar):

- AIR POWER BAG II* + IV: 3.0 bar / 43 psi
- AIR POWER BAG VI: 2.5 bar / 36 psi

* Optional accessories are available on request!

VULCANIZING MACHINES

1-step repair systems

VULCSTAR Rubber track repair kit

- VULCSTAR Extension kit, specifically developed for the repair of rubber tracks
- Cut injuries as well as lug tear-outs can be repaired with this kit

Scope of delivery

- 5853510 1 Electronic control box for heating plate
- 5853460 1 Spindle unit comprising plug-in adapter housing and pressure spindle
- 5853470 1 Adapter
- 5853500 1 Pressure plate (500x450x34 mm)
- 5853480 1 Equalizing pad (500x450x25 mm)
- 5853520 1 Silicone heater on stainless steel plate, 230 V
- 5853490 1 Pressure plate (550x450x2 mm)
- 5813670 1 Instruction manual



585 2990

Ref. No.	Designation
585 2990	Rubber track repair kit

VULCSTAR SPEED Inner heating

- Suitable for all tyre repairs with VULCSTAR 700-S and VULCSTAR 900-S
- Easy to use
- Reduces curing time by 50 %
- Curing time is controlled from VULCSTAR control box
- Low-voltage system (42 V)
- Temperature of heating mats set to 160 °C / 320 °F
- Inner heating mat size I up to RAD 145 TL/RAD 539 TL in a one-step process
- Inner heating mat size III up to RAD 186 TL in a one-step process

Scope of delivery



- 5853620 1 Control unit 230 V (200x300x155 mm)
- Control unit 230 V (200x300x155 mm)
- 5853630 1 Suspension with cotter lock
- 5853017 1 Inner heating mat size I (approx. 200x380x5 mm)
- 5853024 1 Inner heating mat size III (approx. 310x475x5 mm)
- 5811170 1 Manual
- 1 Connection cable



VULCSTAR SPEED Inner heating



Inner heating mat size I/size III

Ref. No.	Designation	Size			
585 3530	VULCSTAR SPEED Inner heating Electric power/connection to control box via 6-pole threaded coupling connector, metal	200 x 160 x 300 L x W x H mm	•	•	•

VULCANIZING MACHINES

1-step repair systems



Accessories for VULCSTAR 900-S



Accessories for VULCSTAR 700-S



517 6757

Accessories - VULCSTAR

Ref. No.	Designation	Size
517 6946	AIR POWER BAG II	320x300 L x W mm
517 6939	AIR POWER BAG IV	470x300 L x W mm
517 6757	AIR POWER BAG VI	470x400 L x W mm
585 3018	Inner heating mat size II, 230 V / 40 W	380x200 L x W mm
585 3025	Inner heating mat size IV, 230 V / 70 W	475x310 L x W mm
585 3104	Pressure block S3	360x310 L x W mm
585 3135	Pressure block AS1	430x350 L x W mm
585 1807	Wrench, pneumatic	
585 3159	Tyre support, medium	
585 3142	Pressure clamp	
585 3166	Spatula for granules	

VULCANIZING MACHINES

1-step repair systems



517 5080



517 5090



517 5100



517 4290

Latex and bead vulcanizing gripper

Latex

- Vulcanizing machines for 1-step repair of EM/OTR tyres
- The repair patch and the filling of the puncture channel are vulcanized at the same time
- Particularly suited for large-scale repairs
- No deformation of the tyre due to exterior metal mold
- Stationary installed machines for tyres from 17.5 R 25 to 58/80 R 63

Ref. No.	Designation	Electric power/ connection	Curing temperature
517 5080	Latex 50 OTR tyres from 17.5 R 25 to 45/65 R 45 and agricultural tyres up to 1050/50 R 32. Instruments are analogical/digital.	230/380 V	150 °C/302 °F
517 5090	Latex 14-24 OTR tyres from 13.00 R 24 to 45/65 R 45 and agricultural tyres up to 1050/50 R 32. All data is available on a touch screen. Monitor in 4 languages.	230/380 V	150 °C/302 °F
517 5100	Latex 25-63 OTR tyres from 20.5 R 25 to 58/80 R 63. All data is available on a touch screen. Monitor in 8 languages. With hydraulic system.	380 V	150 °C/302 °F

Bead vulcanizing gripper BVS

- For rubber repairs at truck-tire-beads (19.5 to 24")
- Space-saving construction finds a place in every workshop
- Fixed temperatur, stiff segments with good distribution of the heat
- Nearly no buffing work necessary at the repaired area
- BVS = bead vulcanizing system

Ref. No.	Designation	Electric power/connection	Operating pressure	Curing temperature 
517 4290	Bead vulcanizing gripper BVS	230 V	mechanic	approx. 145 °C/293 °F

VULCANIZING MACHINES

2-step repair systems

517 7000



517 8130







Thermopress machines

Thermopress DUPLEX

- For the economic repair from car tyres to agri tyres
- Most minor injuries in radial and crossply tyres can be repaired in a short time
- Repairs small rubber injuries and tears in the fabric fast and professional
- Vulcanizing temperature of approx. 160 °C / 320 °F

Scope of delivery

- 5173570 2 Heating plates
- 5177048 1 Timer unit 0 - 120 min
- 5171295 1 U-clamp
- U-clamp
- 5172438 1 Pressure equalizing pad 180x130 mm
- 5811990 1 User's manual

Ref. No.	Designation	Electric power/connection	   
517 7000	Thermopress DUPLEX	230 V / 600 W	• • • •
517 7017	Thermopress DUPLEX	120 V / 600 W	• • • •

Pressure hose vulcanizer

- Specifically designed for repairing flexible pressure hoses with inner rubber lining and polyester fabric jacket
- Easy to handle
- For application of the pressure hose patches contained in the repair kit
- Compact and robust square frame
- Large-surface, rectangular counter-pressure plate for perfect support of the pressure hose

Scope of delivery

- 5177062 1 Heating plate 230 V/270 W
- 5177048 1 Timer 0 - 120 min
- 5178126 1 Pressure equalizing plate
- 5172294 1 Base plate
- 5811580 1 Instruction manual |

Ref. No.	Designation
517 8130	Thermopress Tube-P
517 8126	Pressure equalizing plate, bottom

VULCANIZING MACHINES

2-step repair systems



517 1525



517 3531



517 4150





Thermopress TP II

- For economic repairs of all type of tyres
- Most minor injuries in radial and cross-ply tyres can be repaired in a short time
- Vulcanizing temperature of approx. 160 °C / 320 °F

Scope of delivery

- 5173570 2 Heating plates
- 5171295 1 U-clamp
- 5173248 1 Extension for heating plate
- 5171941 1 Set of pressure equalizing pads

- 5177172 1 Rubber cover for car tyres
- 5177165 1 Rubber cover for truck tyres
- 5177158 1 Heating plate cover, truck, top
- 5172294 1 Base plate
- 5811560 1 User's manual |

Ref. No.	Designation	Electric power/ connection	Operating pressure	    
517 1525	Thermopress II ECONOMY	230 V / 540 W		• • • • •
517 3531	Thermopress II PNEUMATIC	230 V / 600 W	6 - 10 bar / 87 - 145 psi	• • • • •
517 1532	Thermopress II ECONOMY	120 V / 540 W		• • • • •

Digital extension - Thermopress

- For individual temperature control of the heating plates
- Especially suitable for cosmetic repairs in tyre production and retreading

- Optional for all Thermopress II machines
- Illuminated 1/0 mains switch
- Separate fuse for each heating plate/heating circuit

- Temperature controller with digital display from 0 to 200 °C (32 to 392 °F)
- Mounting clamp (on back of housing)

Ref. No.	Designation	Electric power/connection	   
517 4150	Digital control TP II Suitable for: Thermopress II PNEUMATIC; Thermopress II ECONOMY	230 V / 600 W	• • • • •
517 4030	Heating plate digital		• • • • •

VULCANIZING MACHINES

2-step repair systems



517 3891



517 1130



517 1123







Support stand TP II SHUTTLE
(Scope of delivery without tyre)



Support stand - Thermopress

- Easier use of the Thermopress machines
- Support stands can be floor-mounted
- Ergonomic working height

Ref. No.	Designation					
517 3884	Table support clamp Suitable for: Thermopress DUPLEX					
517 3891	Support stand Suitable for: Thermopress DUPLEX	•	•			
517 1130	Support stand, floor-mounted Support stand for easier working on the tread area of car, van and truck tyres. Includes shelves for storage of small items. Suitable for: Thermopress II PNEUMATIC; Thermopress II ECONOMY; Thermopress Tube-P	•	•	•		
517 1123	Support stand, 6 - 8 bar / 87 - 116 psi Allows easy lifting and lowering of the machine and tyre with a pneumatic system. Two rollers at the base allow tyres to be easily turned into the repair position. Suitable for: Thermopress II PNEUMATIC; Thermopress II ECONOMY	•	•	•		
517 4900	Support stand Thermopress II SHUTTLE Mobile support for all Thermopress II ECONOMY and PNEUMATIC vulcanizing machines. Makes it easy to clamp light truck, truck, agricultural and EM tyres for tread, shoulder or sidewall repairs. Vertically adjustable. Can be swivelled. Four castors (two with integrated stop). Spacious tool tray. Retaining straps 2 and 3 are included. Suitable for: Thermopress II PNEUMATIC; Thermopress II ECONOMY	•	•	•	•	•

VULCANIZING MACHINES

2-step repair systems



517 7701
(Scope of delivery
without tyre)

Thermopress EM

Thermopress EM I

Hot vulcanizing machine for repairing tread, shoulder or sidewall injuries of radial, cross-ply OTR/EM tyres, with the use of REMA TIP TOP repair patches.

- Sturdy construction provides easy maintenance and a long service life
 - Adaptation to every repair position by a built-in tilting and swivelling mechanism
 - Electronic temperature controller with display is integrated
 - Upper parts of frame zinc-plated
 - Electronic temperature control with digital temperature display for each heating plate
 - Electronic curing time control, from 0 to 99 hours
 - Pneumatic pressure system, max. pressing power approx. 3 tons at 8 bar / 115 psi
- Scope of delivery**
- 5176001 1 Mobile undercarriage
 - 5176025 1 Energy block/control unit
 - 1 Complete frame
 - 2 Pressure plates
 - 1 Thermopress EM heating plate No. 1
 - 1 Thermopress EM heating plate No. 2
 - 1 Set of different slip-on contour segments
 - 1 User's manual
 - EM-, truck tyre adapters are not included in delivery |

Voltage	230 V
Operating pressure	4 - 8 bar / 58 - 116 psi
Curing temperature	approx. 175 °C / 347 °F
Size	2550 x 2110 x 1170/1370 L x W x H mm
Weight	270 kg

Ref. No.	Designation	
517 7701	Thermopress EM I, pneumatic for EM tyres up to size 33.25-35	

VULCANIZING MACHINES

2-step repair systems

517 5002
(Scope of delivery without tyre)



517 5727

Thermopress EM II

Hot vulcanizing machine for repairing tread, shoulder or sidewall injuries of radial, cross-ply OTR/EM tyres, with the use of REMA TIP TOP repair patches.

- Universal frame adjustment, suitable for the repair of radial and cross-ply tyres up to size 30.00 - 51 in the basic version
- Electronic temperature controller with digital display of actual and desired temperature
- Upper parts of frame zinc-plated
- Electronic temperature control with digital temperature display for each heating plate
- Electronic curing time control, from 0 to 99 hours

Scope of delivery

- 5176025 1 Mobile undercarriage
- 5176032 1 Energy block/control unit
- 1 Complete undercarriage
- 3 Pressure plates
- 1 Thermopress EM heating plate No. 2
- 1 Thermopress EM heating plate No. 3
- 1 Set of different slip-on contour segments
- 1 User's manual

5175002

Voltage	230 V
Operating pressure	max. 160 bar / 2320 psi
Curing temperature	approx. 175 °C / 347 °F
Size	2600 x 2500 x 1770 L x W x H mm
Weight	459 kg

Ref. No.	Designation
517 5002	Thermopress EM II, electro-hydraulic
517 5727	Thermopress EM accessory GIGANT, for EM tyres up to 40.00 - 57" includes 1x Frame slip-on adapter, 1x Retaining bolt dia = 20 mm, 1x Retaining tube 50 x 280 mm, 1x Heating plate support short 80 x 435 mm, 1x Heating plate support medium 80 x 645 mm, 1x Heating plate support long 80 x 1005 mm Suitable for: Thermopress EM II
517 5253	Extension cable 2.5 m Suitable for: Thermopress EM II

VULCANIZING MACHINES

2-step repair systems



517 7804
(Scope of delivery
without tyre)

5

Thermopress EM III

Hot vulcanizing machine for repairing tread, shoulder or sidewall injuries of radial, cross-ply OTR/EM tyres, with the use of REMA TIP TOP repair patches.

- For the repair of large EM tyres from 30.00 - 51 to 67.5/60 - 51 and 54.00 using REMA TIP TOP OTR/EM repair patches
 - Mobile construction with universal tilt-and-swivel frame
 - Digital instrumentation and electronic control ensure the right pressure, temperature and cure time
 - Can also be connected to 230 V
 - Upper parts of frame zinc-plated
 - Electronic temperature control with digital temperature display for each heating plate
- Scope of delivery**
- 5176032 1 Mobile undercarriage
 - 5176252 1 Energy block/control unit
 - 1 Complete frame
 - 2 Pressure plates
 - 1 Thermopress EM heating plate No. 3
 - 1 Thermopress EM heating plate No. 4
 - 1 Set of different slip-on contour segments
 - 1 User's manual
 - Electronic curing time control, from 0 to 99 hours
 - Hydraulic pressure system with resetting device

Voltage	380 V (230 V)
Operating pressure	max. 160 bar / 2320 psi
Curing temperature	approx. 175 °C / 347 °F
Size	3300 x 3300 x 2900 L x W x H mm
Weight	1300 kg

Ref. No.	Designation	
517 7804	Thermopress EM III, electrohydraulic	

VULCANIZING MACHINES

2-step repair systems

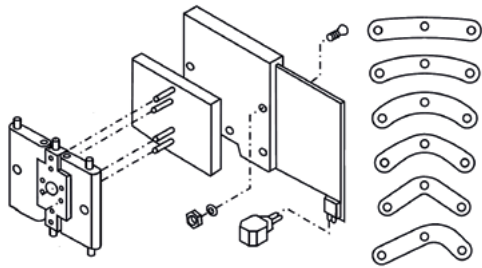

517 6001

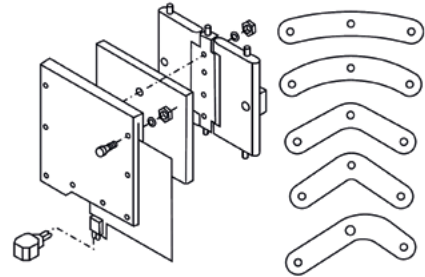

517 6025

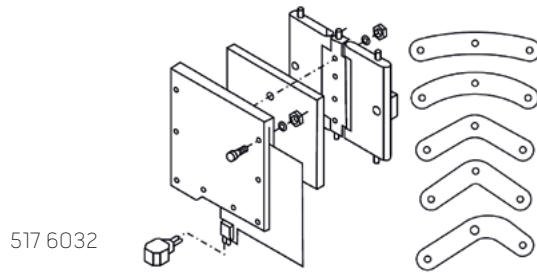

517 6032



517 6040

Thermopress EM heating plate

Complete with heating mat and heating pocket.

Ref. No.	Designation	Size			
517 6001	Thermopress EM heating plate No. 1 Suitable for: Thermopress EM-I; Thermopress EM-II	approx. 230 x 230 mm	•	•	•
517 6025	Thermopress EM heating plate No. 2 Suitable for: Thermopress EM-I; Thermopress EM-II	approx. 330 x 330 mm	•	•	•
517 6032	Thermopress EM heating plate No. 3 Suitable for: Thermopress EM-II; Thermopress EM-III	approx. 430 x 430 mm		•	
517 6252	Thermopress EM heating plate No. 4 Suitable for: Thermopress EM-II; Thermopress EM-III	approx. 530 x 530 mm		•	
517 6040	Thermopress EM heating plate No. 5 Suitable for: Thermopress EM III	approx. 750 x 550 mm		•	



VULCANIZING MACHINES

2-step repair systems



Thermopress addition, accessories and spare parts

Pressure equalizing pads - Thermopress

Ref. No.	Designation	Size			
517 1941	Set of pressure equalizing pads includes 1x Pressure equalizing pads car, 1x Pressure equalizing pads truck, 2x Alloy-heatingmat 210x140 mm		•	•	•
517 3853	Pressure equalizing pad car, size 0	110x110 L x W mm			•
517 2438	Pressure equalizing pad car, small	180x130 L x W mm			•
517 1989	Pressure equalizing pad truck, large	210x150 L x W mm		•	
517 1965	Pressure equalizing pad tractor, long	260x100 L x W mm	•		

Contour pads - Thermopress

Ref. No.	Designation	Size		
517 0715	TP contour pad S2, red, for sidewall	240x200x50 L x W x H mm		•
517 0722	TP contour pad K3, red, for tread	approx. 160x130x50 L x W x H mm	•	•
517 0739	TP contour pad S4, red, for sidewall	approx. 180x160x35 L x W x H mm	•	•
517 0636	TP contour pad K1, red, for tread	approx. 200x170x50 L x W x H mm		•

VULCANIZING MACHINES

2-step repair systems

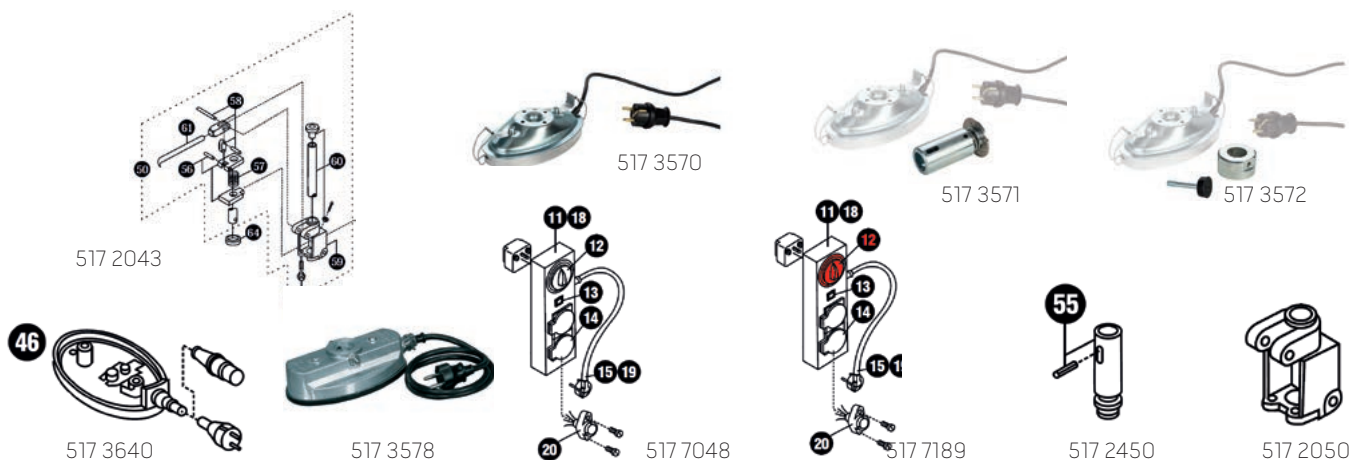

Accessories / spare parts - Thermopress

Ref. No.	Designation					
517 3570	Update Set heating elements Thermopress, 160 °C/320 °F, 230 V Suitable for: Thermopress PNEUMATIC; Thermopress ECONOMY; Thermopress DUPLEX; Thermopress XL
517 3571	Spring switch set for re-equip at 160 °C/320 °F required					
517 3572	Connection adapter for re-equip at 160 °C/320 °F required					
557 2076	Spare heating plate JUNIOR, 230 V / 350 W			.	.	.
517 7062	Spare heating plate DUPLEX, 230 V / 300 W
517 3640	Spare heating plate Thermopress, without aluminium casing, 230 V / 270 W Suitable for: Thermopress PNEUMATIC; Thermopress II ECONOMY
517 3578	Spare heating plate Thermopress, with aluminium casing, 230 V / 270 W Suitable for: Thermopress PNEUMATIC; Thermopress II ECONOMY
517 7048	Thermopress timer unit, 230 V					
517 7189	Timer kit Suitable for: Thermopress PNEUMATIC; Thermopress II ECONOMY					
517 2043	Clamping mechanism, complete Suitable for: Thermopress II ECONOMY					
517 2450	Spring assembly set Suitable for: Thermopress II ECONOMY					
517 2590	Pressure spring set Suitable for: Thermopress II ECONOMY					
517 2460	Clamping mechanism set Suitable for: Thermopress II ECONOMY					
517 2670	Hinge link set Suitable for: Thermopress II ECONOMY					
517 2410	Screws set Suitable for: Thermopress PNEUMATIC; Thermopress II ECONOMY					
517 2225	Extension, long			.		

VULCANIZING MACHINES

2-step repair systems



Ref. No.	Designation					
517 2232	Extension, long					
517 3248	Extension, short Suitable for: Heating plate, lower part					
517 1161	Valve pressure plate Suitable for: Hot vulcanization of valves with rubber base; Thermopress JUNIOR; Thermopress PNEUMATIC; Thermopress ECONOMY					
517 0454	Valve pressure plate, without rubber cover					
517 1264	Rubber cover, for valve pressure plate					
517 1958	Aluminium heating plate, L x W = 210 x 140 mm Suitable for: Thermopress PNEUMATIC; Thermopress II ECONOMY					
517 7172	Rubber cover Suitable for: Thermopress II ECONOMY lower heating plate; Thermopress II ECONOMY lower heating plate					
517 7165	Rubber cover Suitable for: Thermopress PNEUMATIC; Thermopress II ECONOMY					
517 3035	Thermopress balancer Makes work easy and effective - The carrying force can be set from 22 to 32 kg by a worm gear - Safety regulations for suspended loads must be observed					
517 3042	Suspension device Thermopress					
517 3255	Rubber pre-heating plate Even thicker rubber sheets can be easily applied, if pre-heated - Set to 80 °C / 176 °F Suitable for: Thermopress MTR RUBBER					

VULCANIZING MACHINES

2-step repair systems



517 3327



517 3334



517 4003



517 3365



517 3310



517 3963

Aluminium heating plate profile shapes - Thermopress

- For further use of the Thermopress vulcanizing machines
- For faster repairing and for the repairs which are not covered by the standard equipment
- The heat is distributed evenly due to the high thermal conductivity of aluminium

Ref. No.	Designation	Size				
517 3327	Sidewall pressure plate B3 Suitable for: Sidewall repairs trucks, 80-series	130 x 208 L x W mm	•			
517 3334	Sidewall pressure plate B4 Suitable for: Low-section tyres and sidewall repairs	approx. 100 x 160 L x W mm		•		
517 4003	Sidewall pressure plate 275/70 R 22.5 Suitable for: Sidewall repairs trucks, 70-series	210 x 115 L x W mm	•			
517 3365	Tread pressure plate Suitable for: Tread (inside)	200 x 130 L x W mm	•		•	•
517 3310	Aluminium heating plate profile shape, flat Suitable for: Tread (outside)	225 x 150 L x W mm			•	•
517 3963	Aluminium heating plate profile shape, contour Suitable for: Truck tyre tread (outside) and shoulder	230 x 150 L x W mm	•			

VULCANIZING MACHINES

2-step repair systems



517 3970



517 3987



517 7158



517 3451







517 3461



517 3452



517 3462

Ref. No.	Designation	Size				
517 3970	Aluminium contour segment Suitable for: Aluminium heating plate profile shape; tyre tread (outside) and truck tyre shoulder	230x150 L x W mm	•			
517 3987	Aluminium heating plate cover Suitable for: Truck tyre shoulder	210x140 L x W mm	•			
517 7158	Heating plate attachment, top		•			
517 3451	Pressure plate D inside Suitable for: Truck tyre shoulder inside	195x103x35 L x W x H mm	•			
517 3461	Pressure plate E outside Suitable for: Truck tyre shoulder outside	180x120x39 L x W x H mm	•			
517 3452	Pressure plate G inside Suitable for: Truck tyre shoulder inside	195x103x38 L x W x H mm	•			
517 3462	Pressure plate H outside Suitable for: Truck tyre shoulder outside	180x120x35 L x W x H mm	•			

VULCANIZING MACHINES

2-step repair systems



517 3554



517 4254



517 7811
(Scope of delivery without tyre)

Equipment for working places

EM repair stand

For easy handling of EM tyres during the repair process. Speeds up the positioning of the tyre in the EM machine and improves safety at work. For easy handling of EM tyres during the repair process. Speeds up the positioning of the tyre in the EM machine and improves safety at work.

	5173554	5174254	5177811
Electric power/ connection		230/50 V/Hz	380/50 V/Hz
Loading capacity	600 kg	1000 kg	4000 kg
Size	1155 x 1280 x 2000 L x W x H mm	1150 x 1280 x 2200 L x W x H mm	2000 x 2000 x 2600 W x D x H mm
Weight	213 kg	250 kg	1200 kg
Tyre size	max. 29.5 R 29"	max. 29.5 R 29"	max. 33.25 R 35 - 48/95 R 57"

Ref. No.	Designation	
517 3554	EM repair stand, with hoisting winch (manual) Total access to the tyre - Working height of the tyre is adjusted by specially geared hand crank - The roller bars allow easy rotation to the desired position and eliminate the risk of damage to the bead area - Castors enable convenient movement Suitable for: Thermopress EM I; Thermopress EM II	
517 4254	EM repair stand, with hoisting winch (electric) Provides total access to the tyre - Working height of the tyre is adjusted by specially geared hand crank - Electric operation by means of a hand-held controller - The rollers on which the tyre rests allow easy rotation to the desired position and eliminate the risk of damage to the bead area - Castors enable convenient movement Suitable for: Thermopress EM I; Thermopress EM II	
517 7811	EM repair stand, electrically operated Designed for the handling of large tyres - The tyre is lifted by a powerful hydraulic system - The rollers on which the tyre is positioned are driven electrically - Configuration for tyres also for 63" available on request Suitable for: Thermopress EM III	

VULCANIZING MACHINES

Presses

Presses

REMAPRESS IVE

New vulcanizing presses "REMAPRESS IVE" with pressure bags, heating plates and silicone heating mats developed and marketed by REMA TIP TOP impress with highest quality features, application oriented design and certification by German TÜV. They are universally appropriate for all fabric or steel cord conveyor belts.

- REMA TIP TOP pressure bag with aramid inlays certified by German TÜV
- Heating plate connection protection class IP 64 certified by German TÜV
- Evenly heat distribution through various heat zones at the edge and in the middle
- Pressure system up to 70 N / cm² with compressed air pressure and up to 140 N / cm² with water pressure
- 20% less liquid requirement, therefore faster build-up of pressure
- Lightweight, high-strength crossbeams made of aluminium with 20% less deflection
- Despite being made of high-strength steel, the tension bolts weigh 2 kg less apiece than conventional steel tension bolts

REMAPRESS IVE FLUID

For pressures up to 140 N/cm² (200 Psi)

Ref. No.	Designation	Belt Width	Splicing Length
595 9480	REMAPRESS IVE FLUID 800-600 16.7	800 mm	600 mm
595 9640	REMAPRESS IVE FLUID 800-800 16.7	800 mm	800 mm
595 9650	REMAPRESS IVE FLUID 1000-800 16.7	1000 mm	800 mm
595 9670	REMAPRESS IVE FLUID 1200-800 16.7	1200 mm	800 mm
595 9700	REMAPRESS IVE FLUID 1600-800 16.7	1600 mm	800 mm
595 9660	REMAPRESS IVE FLUID 1000-1000 16.7	1000 mm	1000 mm
595 9680	REMAPRESS IVE FLUID 1200-1000 16.7	1200 mm	1000 mm
595 9690	REMAPRESS IVE FLUID 1400-1000 16.7	1400 mm	1000 mm

Other dimensions available on request.



VULCANIZING MACHINES

Presses

REMAPRESS IVE AIR

For pressures up to 70 N/cm² (100 Psi)

Ref. No.	Designation	Belt Width	Splicing Length
595 9460	REMAPRESS IVE AIR 650-600 16.7	650 mm	600 mm
595 9470	REMAPRESS IVE AIR 800-600 16.7	800 mm	600 mm
595 9490	REMAPRESS IVE AIR 1000-600 16.7	1000 mm	600 mm
595 9540	REMAPRESS IVE AIR 800-800 16.7	800 mm	800 mm
595 9580	REMAPRESS IVE AIR 1200-600 16.7	1200 mm	600 mm
595 9560	REMAPRESS IVE AIR 1000-800 16.7	1000 mm	800 mm
595 9590	REMAPRESS IVE AIR 1200-800 16.7	1200 mm	800 mm
595 9610	REMAPRESS IVE AIR 1400-800 16.7	1400 mm	800 mm
595 9550	REMAPRESS IVE AIR 800-1000 16.7	800 mm	1000 mm
595 9570	REMAPRESS IVE AIR 1000-1000 16.7	1000 mm	1000 mm
595 9600	REMAPRESS IVE AIR 1200-1000 16.7	1200 mm	1000 mm
595 9620	REMAPRESS IVE AIR 1400-1000 16.7	1400 mm	1000 mm
595 9630	REMAPRESS IVE AIR 1600-1000 16.7	1600 mm	1000 mm



Other dimensions available on request.

Electronic control cabinet

- Design of required control cabinet depends on number of heating plates
- Exact temperature measurement inside of heating plates via double PT 100 electronics sensor with digital display of set point temperature and real value temperature
- Quick programming of electronic temperature controllers
- In case of electronic control failure switch to manual operation mode
- Digital automatic timer
- Monitoring of differences between the single heating circuits +/- 2.5 K
- Optical signal shows end of vulcanizing time
- Protection class IP 44



Technical modification reserved

VULCANIZING MACHINES

Presses

Electronic control cabinet with data recording

- Exact temperature measurement inside of heating plates via double PT 100, display on touch panel
- Enclosed software for the composition of a vulcanization protocol as a PDF document
- In case of electronic control failure switch to manual operation mode
- Monitoring of differences between the single heating circuits +/- 2.5 K
- USB interface for data transfer
- Optical signal shows end of vulcanizing time
- Optionally equipped with WLAN module for real-time display on MS Windows notebook or tablet
- Illuminated control panel
- Protection class IP 44
- Menu navigation (DE/EN/ES/FR)



Technical modification reserved

REMAPRESS PBP - Tension unit

REMAPRESS PBP (Pneumatic Belt Press) is the first tension unit in the world especially designed for use in the cold bonding of fabric-ply belts (from a strength class of EP 1000/5 upwards or a covering ratio from 10:4 on).

- For fabric-ply belts up to 2200 mm width
- Extremely robust pressure cushion
- Includes mobile compressor
- Operating voltage 220 Volt



5

Ref. No.	Designation	For belt width
595 3310	REMAPRESS PBP	1400 mm
595 3320	REMAPRESS PBP	1800 mm
595 3330	REMAPRESS PBP	2200 mm

WK vulcanizing press

For safe and cost-efficient splicing of fabric-reinforced conveyor belts of low or medium strength class up to EP 1250/5 (multiple vulcanizing cycles).

Ref. No.	Designation	For belt width
595 3138	WK vulcanizing press 800, 230 V, with pressure compensation pad	up to 800 mm
595 3145	WK vulcanizing press 1200, 230 V, with pressure compensation pad	up to 1200 mm
595 3152	Pressure compensation pad 800	
595 3169	Pressure compensation pad 1200	
595 3183	Torque wrench	
527 0550	Silicone paper, 25 m roll	



595 3138



595 3183

VULCANIZING MACHINES

Presses

REMAPRESS CRO

The REMAPRESS CRO system is the ideal solution for safe and cost-efficient splicing of fabric-reinforced conveyor belts of low or medium strength class up to EP 1250/5 (according to DIN 22102) (multiple vulcanizing cycles).

- Easy installation and removal
- Short heating time due to excellent insulation
- Optional water cooling system for even shorter cooling
- Electronic temperature control
- Silicone heating elements
- Pressure bag with aramide reinforcement, 7 bar / 102 psi
- Welded aluminum frame construction
- Voltage: 400 V
- Adjustable temperature range: 100 - 175 °C / 212 - 347 °F
- Specific surface pressure: 70 N/cm²

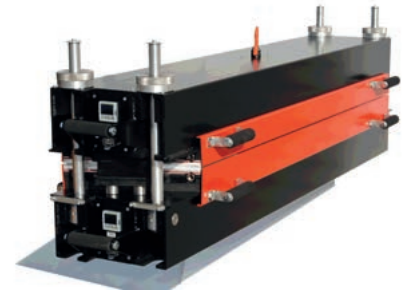

Ref. No.	Designation	For belt width	Weight
595 5140	REMAPRESS CRO 65-350	650 mm	89 kg
595 5150	REMAPRESS CRO 65-540	650 mm	108 kg
595 5160	REMAPRESS CRO 80-350	800 mm	103 kg
595 5170	REMAPRESS CRO 80-540	800 mm	133 kg
595 5180	REMAPRESS CRO 100-350	1000 mm	140 kg
595 5190	REMAPRESS CRO 100-540	1000 mm	174 kg
595 5200	REMAPRESS CRO 120-350	1200 mm	180 kg
595 5210	REMAPRESS CRO 120-540	1200 mm	200 kg
595 5130	Water cooling equipment, for REMAPRESS CRO includes barrel with cover 120 l, submersible pump, cooling water feeding and return hoses, 2-way distributor		
595 5110	Mobile compressor, for REMAPRESS CRO Motor: 1.5 kW / 230 V / 50 Hz - Volume of pressure vessel: 10 l - max. pressure: 10 bar - suction volume: 250 l/min.		

INDEX

A

Accessories - Angle grinder	46
Accessories - EUROAIR Hand-held tyre inflator gauges	100
Accessories - Illumination	175
Accessories - RAS and SRAS	116
Accessories - Rubber cutting machines type 21/32	30
Accessories - SEALASTIC and SUPER SEALASTIC	115
Accessories - SEALFIX	115
Accessories / spare parts - Thermopress	190
Accessories - Special buffing motors	49
Accessories - Tyre inflating connectors	89
Accessories - Tyre marking	108
Accessories - VULCSTAR	180
Adhesive balance weight removers	124
Adhesive tape	137
Adjustable wrench	129
AIR BOY AS, for agricultural tyres	105
AIR BOY CAR	105
AIR BOY TRUCK	105
Air buffers for retreading work (high-speed)	34
Air buffers for retreading work (low-speed)	34
Air buffers (high-speed)	33
Air buffers (low-speed)	32
Allen wrench	129
Aluminium belt clamp bar	70
Aluminium heating plate profile shapes - Thermopress	192
Aluminium spacers	169
Aluminium spacers, air-cooled	170
Angle grinder FLEX 3403 VRG	44
Angle grinder FLEX L 1202	43
Angle grinder FLEX L 2106 VC	43
Angle grinder FLEX LK 602 VR	42
Angle grinder FLEX LK 604	42
Angle grinder WEV 10-125 Quick	45
Angular blades	61

Arbours - adapters for quick release chuck type	165
Ari Zentri, truck	95

B

Balance weight pliers	124
Ball rasp, classic class	146
Ball rasp, silver class	148
Bead breaker	79
Bead breakers	80
Bead breakers from AME International	83
Bead compression tools	125
Bead vulcanizing gripper BVS	181
Bicycle tyre inflators	101
Bit box "SP" 32-piece	56
Brushes for solutions	132
Buffing and grinding wheels	156
Buffing brushes	155
Buffing discs for angle grinders	160
Buffing kit, REMA TIP TOP	152
Buffing pin	158
Buffing rasps	138
Buffing rasps II	168
Buffing rasps R4	168
Buffing rasps R115	167
Buffing rasps S115/III	168
Buffing wheels, classic class	144
Buffing wheels, REMA TIP TOP class	151

C

Cabinet for repair patches and materials	172
Cable winches TU 8/TU 16	72
Capsule ear protection	20
Carbide cutter	140
Case for safety goggles	19
Centering rings for trucks	93

INDEX

Centering sleeves for trucks	93	EM bead breaker STANDARD	78
Chalk line	107	EM mounting set	78
Chip cone rasp, silver class	150	EM repair stand	194
Chip cones, classic class	142	EUROAIR Hand-held tyre inflator gauges, calibrated	100
Circular cutters	163	EURODAINU Hand-held tyre inflator gauges	99
Cleaning brushes	135	Extruder COMPOUND MASTER	64
Compass saw for steel cord tyres	138	Extruder GIANT	63
Contour pads - Thermopress	189	Extruder NAILHOLE	64
Conveyor Belt Repair Kit	14	Extruder NORMAL	63
Conveyor belt tensioning device	69		
Cordless percussion drill SB 18 LT Compact	54	F	
Cordless screwdriver BS 18 Quick	55	Fabric belt cutting device	69
Crowbar	97	Face protector SUPERVIZOR SB 600	18
Cutting disc	162	Fibre disc	161
Cutting tools	121	Fine dust filter mask 3M	19
		Finish buffer ES	159
D		Finish buffer FS	160
DAINU/EURODAIMO Hand-held tyre inflator gauges	100	Fixpaste REMA GOO	65
Detreader blades for buffing machines	169	Flex drive arbours MK 1	166
DIGIAIR Hand-held tyre inflation gauges	99	Flexible face disc	46
Digital extension - Thermopress	183	Flexible shaft for electric drill	53
Digital tyre inflator PROFIAIR	98	Flexible shaft W 10, rubber covering	49
Domed buffing rasps, silver class	149	Flexible shaft W 12, metal covering	50
Domed contour rasps, classic class	147	Flexible shaft W 12, rubber covering	49
Domed contour rasps, gold class	150	Flexible shaft W 15, metal covering	50
Domed contour rasps, REMA TIP TOP class	151	Flexible shaft W 15, rubber covering	50
Drill B13/2 RLE	52	Force adapter	41
		Fret saw, electric	57
E		Fret saw, pneumatic	31
Earplugs	20		
Electrical rope winch 990 kg RPE	68	G	
Electronic control cabinet	196	Grinding disc	162
Electronic control cabinet with data recording	197	Grinding tools for steel cord preparation	158
EM bead breaker GIGANT I	81	Grip tongs	123
EM bead breaker GIGANT II	82	Grooved wire brush	154

INDEX

H

Half-mask 244	20
Hammers	128
Hand rasp	135
Hard metal buffing wheel, copper-carbide	157
HDL drill	163
Hot air blower GHG 660 LCD	62
Hot knife cutting device	61
HSS mill cutters	141

I

Impact drill PSB 550 RE	53
Impact drill SBE 1010 Plus CODE	52
Impact sockets 1"	40
Impact sockets 1/2"	38
Impact sockets 1/2", long form	38
Impact sockets 1", long form	41
Impact sockets 3/4"	39
Impact sockets 3/4", long form	40
Impact wrenches, electric	56
Impact wrenches, pneumatic	37
Inflation ring AIRSYSTEM JA 1000	104
Inspection Tool Kit	15

J

Jacob chuck type arbours	164
--------------------------	------------

K

Knee guard	22
Knives	120
KST scraper	119

L

Lamps	173
Latex	181

Lifting jacks from AME International	84
Limestones	157

M

Marking with chalk	106
Marking with pen	106
Measuring cup	114
Michelin type tyre levers	97
Mini buffing tools, silver class	148
Mobile working light	173
Moment clamps	125
Mounting lever for alloy rims	92
Mounting lever for rim locking ring	95
Mounting paste brushes	133
Mounting tent BZ 24 and BZ 45	27

N

Needle stitchers	117
------------------	------------

O

Open-ended/ring/jaw spanner sets	129
----------------------------------	------------

P

Patch hammer	35
Pencil buffers, classic class	143
Pincers and pliers	122
Pin punches	127
Pliers for auto service	123
Ply lifter	126
Pre-cure tread cutters	166
Premium TPMS tool kit	102
Pressure equalizing pads - Thermopress	189
Pressure hose vulcanizer	182
Programmable digital tyre inflator PCI 1000	98
PSC cutter	71

INDEX

Pulling clamp	59	Rotary gouges	139
Pump rings for cars	103	Rotary plastic brush	152
Pump rings for trucks	104	Rotary wire brushes	153
Pumps	81	Rotary wire brushes, rigid shaft	154
Pumps from AME International	84	Round blades	61
		RUBBER CUT 314	59
		RUBBER CUT 414	60
		RUBBER CUT STATION ECO	60
		Rubber cutting machine Model 32	30
		Rubber knives	120
Q		S	
Quick-change angle adapter	55	Safety goggles	19
		Safety helmet	18
		Safety vest	22
R		Screwdriver	128
Rasp	135	sens.it - Special TPMS tool kit	102
Ratchet wrenches	130	Shoe covers	23
REMAPRESS CRO	198	Side nippers	123
REMAPRESS EDR	118	Spare parts - Flexible shaft	51
REMAPRESS IVE	195	Spatula	119
REMAPRESS IVE AIR	196	Special buffing motors	48
REMAPRESS IVE FLUID	195	Spider wrenches	131
REMAPRESS - MDR	118	Spirit level	114
REMAPRESS PBP - Tension unit	197	Spray bottles	137
REMASTRIP - Blades	67	Stapler	36
REMASTRIP - Cable stripping system	65	Steel cable cutter C 112	124
REMASTRIP - Pulling unit	66	Stitchers	116
REMA TIP TOP Pilot jacket	24	Straight grinder 3000 R	47
REMA TIP TOP Polo Shirt	26	Stripper device Junio Stripper 3	58
REMA TIP TOP Safety shoe	23	STZ Extruder	64
REMA TIP TOP Softshell jacket	24	Supercut FSC 2.0	58
REMA TIP TOP Waist jacket	25	Support stand - Thermopress	184
REMA TIP TOP Waist Trousers	25		
REMA TIP TOP workplace PROF1	85		
REMA TIP TOP workplace PROF1	172		
REMA TIP TOP ZIP sweatshirt	26		
REP BOY tyre spreader	76		
REPMAT tyre spreader	76		
Retrofit kit	118		
Rim straightening lever	90		

INDEX

T

Thermometer	114
Thermopress DUPLEX	182
Thermopress EM heating plate	188
Thermopress EM I	185
Thermopress EM II	186
Thermopress EM III	187
Thermopress TP II	183
Tins with brushes	134
Tool arbor for angle grinder	46
Tool bag	136
Tool box	136
Torque limiting sockets	41
Torque wrenches	130
TPMS basic tool kit	103
TPMS tools	87
TPMS universal tool kit	103
Tress-shaped wire brush	154
Truck tyre working table	85
Truck tyre working table	172
TT Belt tensioners	71
Tungsten carbide buffing disc Silver Class	162
Tyre and mounting levers HAZET	95
Tyre inflating connectors, closed end	89
Tyre inflating connectors, open end	89
Tyre levers GEDORE	96
Tyre levers, wide base, super single rims	96
Tyre lift spreader RHS 300	77
Tyre marking, electric	107
Tyre pressure gauges	101
Tyre probes	127
Tyre scrapers	119
Tyre spreaders	74
Tyre transport	85

V

Vacuum cleaner for dust/water	36
Valve core screwdriver	86
Valve core screwdriver "LOCK TOOL"	86
Valve fishing tool	88
Valve holder	88
Valve mounting tools	87
Valve repair tool	88
Vice grip	71
Vulcanization Tool Kit	16
VULCSTAR 900-S	178
VULCSTAR Rubber track repair kit	179
VULCSTAR SPEED Inner heating	179
Vulkan fibre disc VSM	161

W

Wetstones	126
Wheel hub grinder type 1	92
Wheel hub grinder type 2	92
Wheel hub grinder type 3	93
Wheel mounters for cars, trucks	91
Wheel mounting tool set for cars	94
Wheel mounting tool sets for trucks	94
Wheel nut impact sockets 1/2", plastic-covered	39
Wheel nut remover, power wrench	131
Wheel remover, mechanical	90
Wheel trim remover	90
Wheel/tyre remover	91
WK vulcanizing press	197
Working gloves	21
Working light Light-Master	174
Working light NOVA	175



Your local contact



// ONE BRAND // ONE SOURCE // ONE SYSTEM

- // SERVICE
- // MATERIAL PROCESSING
- // SURFACE PROTECTION
- // AUTOMOTIVE

REMA TIP TOP AG
Gruber Strasse 65 · 85586 Poing / Germany
Phone: +49 8121 707-0
Fax: +49 8121 707-10 222 info@tiptop.de
www.rema-tiptop.com



582 1721 - III.16 Printed in Germany

