



SAMSON
PROFESSIONAL WEIGHT ROOM SOLUTIONS



Official Weightroom
Equipment Provider of the NAIA

CONTACT US

WWW.SAMSONEQUIPMENT.COM

1-800-4-SAMSON

Physical Address:

258 N Armory Rd

Las Cruces, NM 88007

Mailing Address:

P.O Box 353

Fairacres, NM 88033



<https://www.facebook.com/SamsonEquipment/>



https://www.instagram.com/samson_eq/



https://twitter.com/SAMSON_EQ



<https://www.youtube.com/user/samsonequipment>



<https://www.linkedin.com/company/samson-equipment-inc/>



CONTENTS

NAIA PARTNERSHIP	4
SAMSON STANDARD	6
PROCESS	8
CUSTOM SOLUTIONS	26
CUSTOM BRANDING	27
FLOORING	30
FLEX-RACK	34
POWDER COAT & UPHOLSTRY COLORS	40
PRODUCTS	44
TACTICAL	62
FACILITIES	64
SPECS AND WARRANTY	120

SAMSON
COMMENTS

NAIA PARTNERSHIP

QUESTIONS FOR YOUR CONSIDERATION:

Samson Equipment is committed to assisting the NAIA with its member institutions in outfitting first-class weight room facilities. We will share expertise and provide consultation in the planning process, procurement process, and be a valuable partner wherever needed. Our goal is to establish and build long-term relationships with NAIA member institutions and be a trusted resource for any matter regarding weight room facilities.

THE PARTNER:

Based in Las Cruces, New Mexico, Samson Equipment has been a direct manufacturer of high-quality strength equipment since 1976. As our industry has quickly expanded and grown, we have maintained a high level of customer satisfaction, and continue to produce our equipment with only the best materials available. We are passionate about Strength and Conditioning and helping elevate our profession.

WHAT IS PROFESSIONAL WEIGHT ROOM SOLUTIONS MEAN FOR YOU?

Based in Las Cruces, New Mexico, Samson Equipment has been a direct manufacturer of high-quality strength equipment since 1976. As our industry has quickly expanded and grown, we have maintained a high level of customer satisfaction, and continue to produce our equipment with only the best materials available. We are passionate about Strength and Conditioning and helping elevate our profession.

DO I NEED TO PURCHASE A COMPLETE WEIGHT ROOM TO WORK WITH SAMSON?

No, we can assist you with all your needs regarding the weight room big or small.

Who do I need to contact?

Contact our Sales Director, Scott Schroeder or our USA Sales Specialist, Troy Jorgensen.

Scott Schroeder

800-472-6766 ext 202

scott@samsonequipment.com

Troy Jorgensen

800-472-6766 ext 207

troy@samsonequipment.com

NATIONAL ASSOCIATION OF
INTERCOLLEGIATE ATHLETICS





SAMSON STANDARD

For over 40 years we have been providing Professional Weight Room Solutions for our partners. Built for coaches by coaches, our background and company history serves as a relatable foundation to build a life long relationship from. Our qualified team possesses the manufacturing and industry knowledge that separates us from the pack. We remain true to our origins by maintaining manufacturing expertise, delivering high levels of customer satisfaction and possessing reputable industry excellence. Regardless of your project our team, product, and service will prove to be a seamless and successful experience for you.

OUR SALES TEAM

Your needs are important to us! Our mission is to provide Professional Weight Room Solutions to all of our clients. We understand that you have a common need for high quality strength equipment however, total solutions vary tremendously depending on your project. From schools, the United States Armed Forces, professional athletic teams, to elite home gyms, our Samson Equipment team is here to make this process simple for you. By trusting our experts you will save yourself time and a headache.



BRIAN SCHROEDER
DIRECTOR OF OPERATIONS
GSA SALES DIRECTOR
1-800-472-6766 EXT 203
BRIAN@SAMSONEQUIPMENT.COM



SCOTT SCHROEDER
DIRECTOR OF SALES
1-800-472-6766
EXT 202
SCOTT@SAMSONEQUIPMENT.COM



TROY JORGENSEN, MSCC
SALES SPECIALIST - USA
1-800-472-6766
EXT 207
TROY@SAMSONEQUIPMENT.COM

PROCESS

The responsibility of a weight room project can be a real headache while having to coach or be an administrator. We feel you! Put your trust in the hands of experts with over 40 years of experience. We will ease your mind and educate you along the process. As your professional guide, our team members will confidently lead you through your journey.

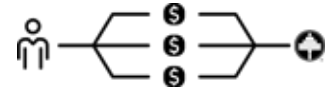

1 MEANS OF PURCHASE

We offer various methods to procure your equipment.

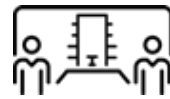

3 PROGRAMMING

The samson difference involves working with professional guides who understand program design, room layouts and flow of your room.

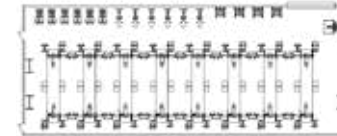

5 2D LAYOUTS

During this step we will design out the best arrangement for your space until you find a layout that is tailored to you.



7 MANUFACTURING

Your planning turns into a project, and our team of professional fabricators go to work for you!



2 BUDGET

It's important to know your budget. We have many options of flooring and equipment selection to achieve your goals. Don't settle for less than what you deserve.



4 EQUIPMENT SELECTION

Selecting the best equipment to satisfy your needs, wants and budget. Your guide will begin to present you with options and recommendations for your project.

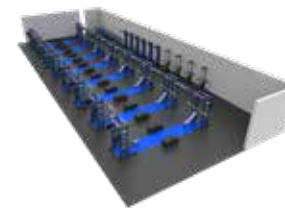

6 3D LAYOUTS

After getting approval of your 2D layout, we begin to design your 3D renders so you can get an accurate picture of what your room will look like installed.



8 DELIVERY/INSTALLATION

We will determine the best shipping methods and install options for your new facility.

MEANS OF PURCHASE

We understand that our customers share a need for having various means of procurement for their equipment. We offer these various methods in order to provide a high level of customer service and a first class experience.

OMNIA[®]
P A R T N E R S

stripe



affirm



BUDGET

This step of the process is vital to your success. An understanding of needs and wants within your scope of budget is key for us to provide you Professional Weight Room Solutions. Our Sales Team can assist you in prioritizing your needs based on the available funding for your project.

QUESTIONS FOR YOUR CONSIDERATION:

- Scope of Project: Will this be done all at once or will this be in phases?
- Stage of Project: Are you in planning for a room or in the procurement process?
- Available Funds: Do you have a budget in place for the project?
- Fundraising: Will there be any fundraising involved in this project?



PROGRAMMING

During initial conversations you will sit down with our Sales Team and talk about your strength and conditioning programming within your organization and how your facility will be utilized to its full capacity.

QUESTIONS FOR YOUR CONSIDERATION:

- What is your room size and limitations?
- How many athletes will be using the room at a time?
- What types of modalities are you implementing?
- How does a typical session flow through your weight room?
- What will make coaching more efficient for you?



EQUIPMENT SELECTION

After a conversation and evaluation of your programming our Sales Team will discuss equipment options that maximize your facility space and your programming philosophy.

QUESTIONS FOR YOUR CONSIDERATION:

- What are non-negotiable pieces of equipment?
- Are there any custom pieces necessary to equip you with the tools you need?
- What are your current pain points. Things you want to do but just cannot get done?

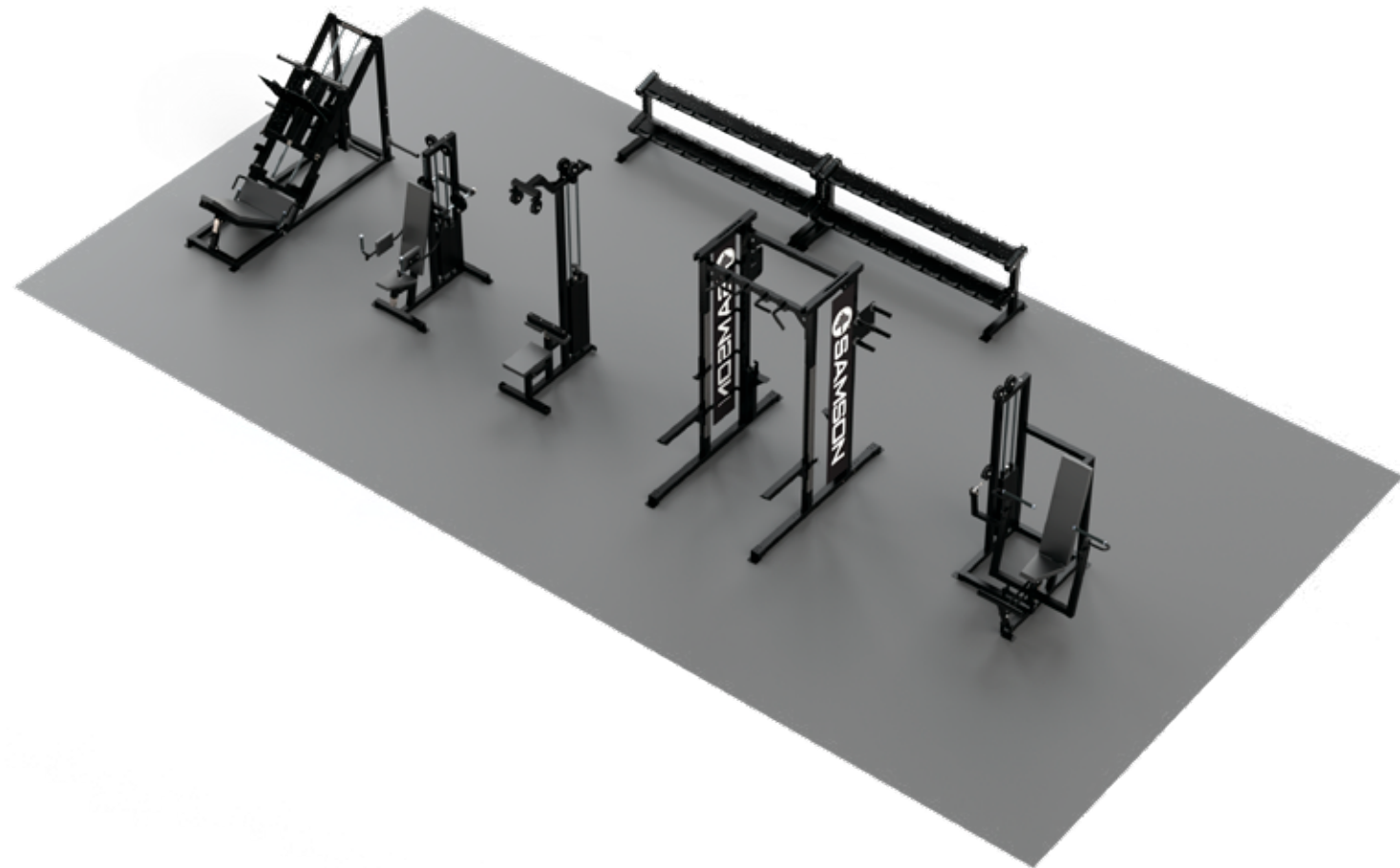

2D LAYOUT

Once our Sales Team knows what equipment we will need to fit in your room we will begin designing your room with 2D layouts to begin painting the picture of how equipment will safely fit in your room.

****ROOM SAFETY IS EXTREMELY IMPORTANT AND WE WILL NEVER FIT MORE THAN WHAT IS SAFE IN A ROOM****

This step is where you will understand if your wants and needs align with your budget.

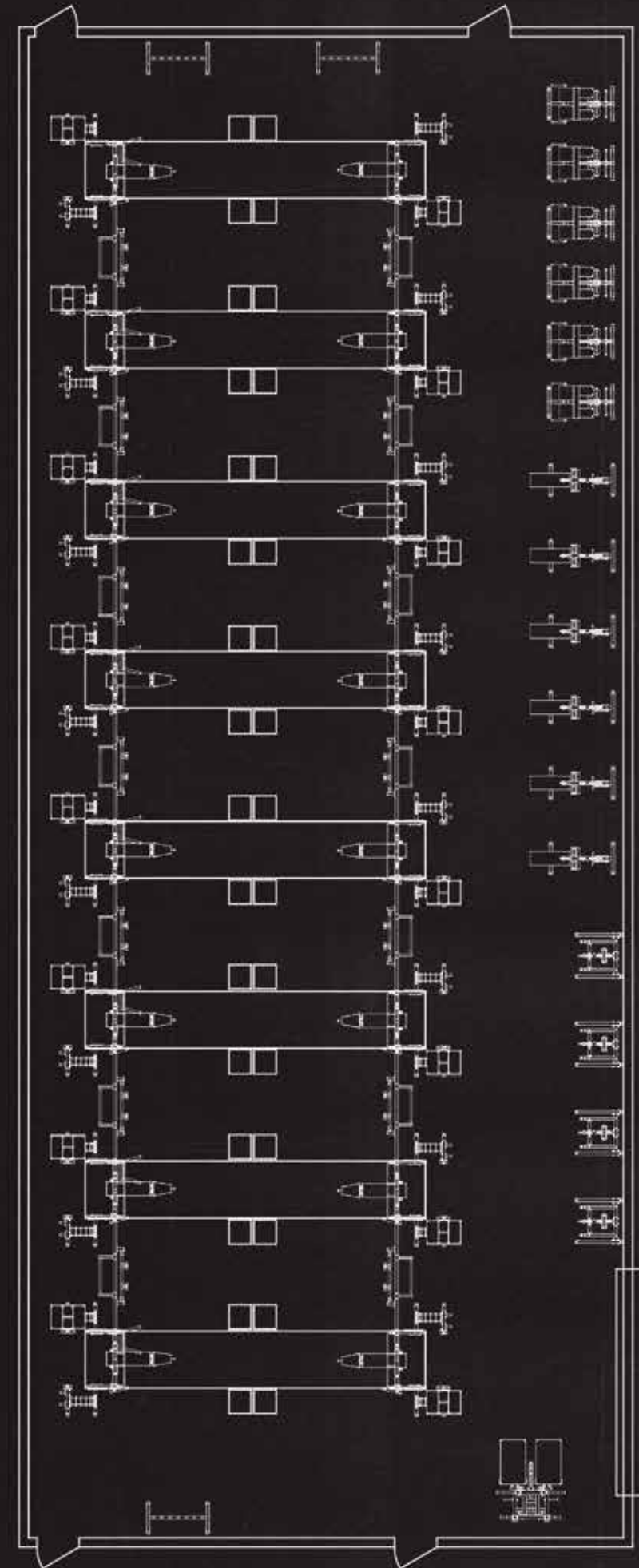

3D LAYOUT

After getting approval of your 2D layout, we begin to design your 3D renders so you can get an accurate picture of what your room will look like installed.

At this stage you will receive lifelike 3D Renderings to bring your room to life to assist you in the decision making process.

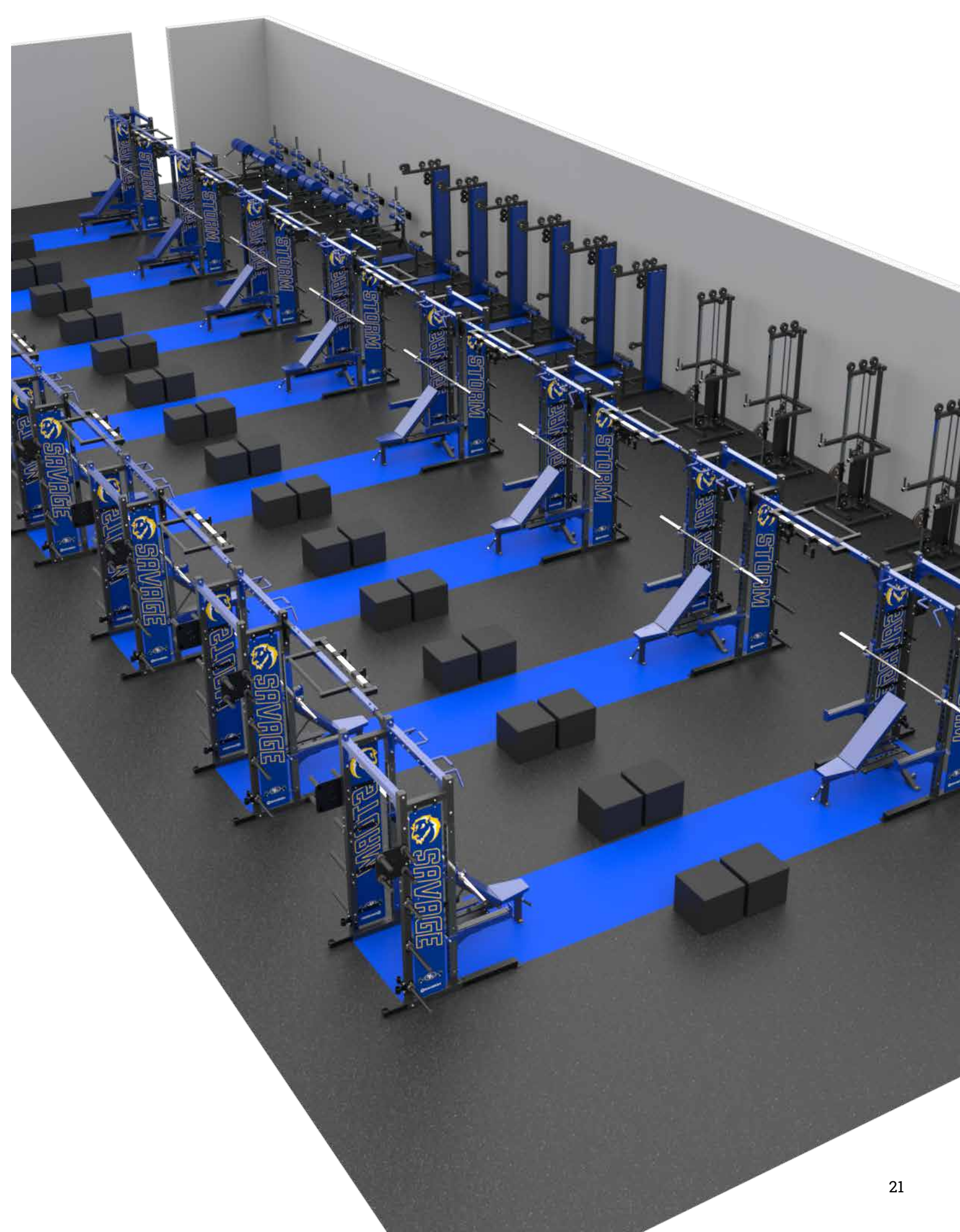
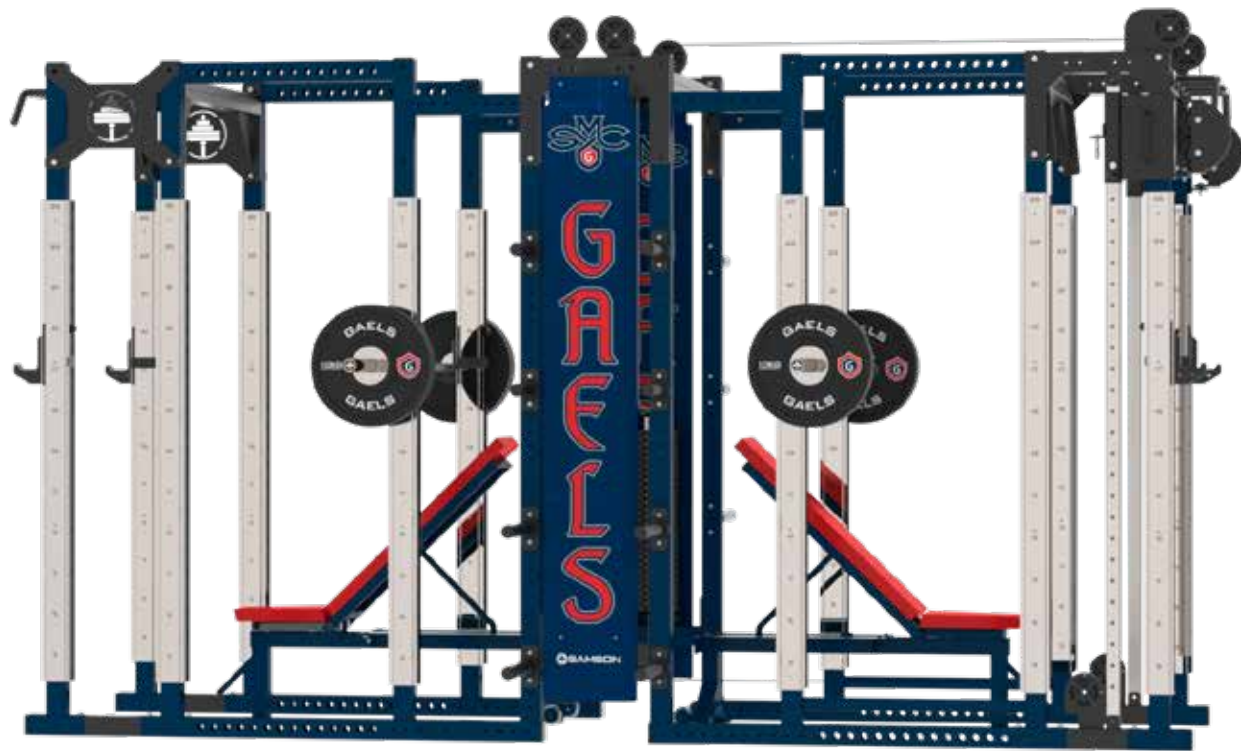

MANUFACTURING

We are a build to order facility on our strength equipment and do not stock inventory which makes each and every job unique as it passes through our manufacturing process. When you place your order, your job goes into our queue and waits in line for its turn on a table of our professional fabricators.

LEAD TIME NOTES:

-Our lead times vary depending on workload and can range from 6 weeks up to 8 weeks and subject to change which means you will need to plan ahead for this.

-Third party procured items vary upon availability of the desired partner company.

-Our custom ordered bumper plates, dumbbells, and barbells are not manufactured in house, which increases lead time.



HEAVY DUTY STEEL

Our Samson Standard Stamp of Durability, a 3/16" (.188) gauge thick steel wall across all our equipment.



POWDER COAT FINISH

Gives your project a final touch of longevity and personalization.



SEALED BALL BEARINGS

Used to go the extra mile to ensure an extended lifetime on your moveable pieces.



HEAVY DUTY STAINLESS STEEL

Added for aesthetic and function these stainless steel pieces are nearly indestructible when used correctly in your room.



CASE HARDENED STEEL

Reinforced steel rods for durability of load bearing guides.



DELIVERY/INSTALLATION

As your job approaches completion in our facility our team will work diligently to align a safe delivery and speedy installation of your project. Depending on the Scope of the project and budget we offer multiple Installation Services.

-DOCK TO DOCK:

We ship from our dock to your dock with no installation.

-SUPERVISED INSTALLATION:

We ship your order along with 1 Samson Team Member to assist you with the installation. It is your responsibility to find help to assist in your installation.

-FULL INSTALLATION:

We ship your order and arrange all necessary help to ensure a timely and successful installation. You are only responsible for giving access to your room where our team will be installing.

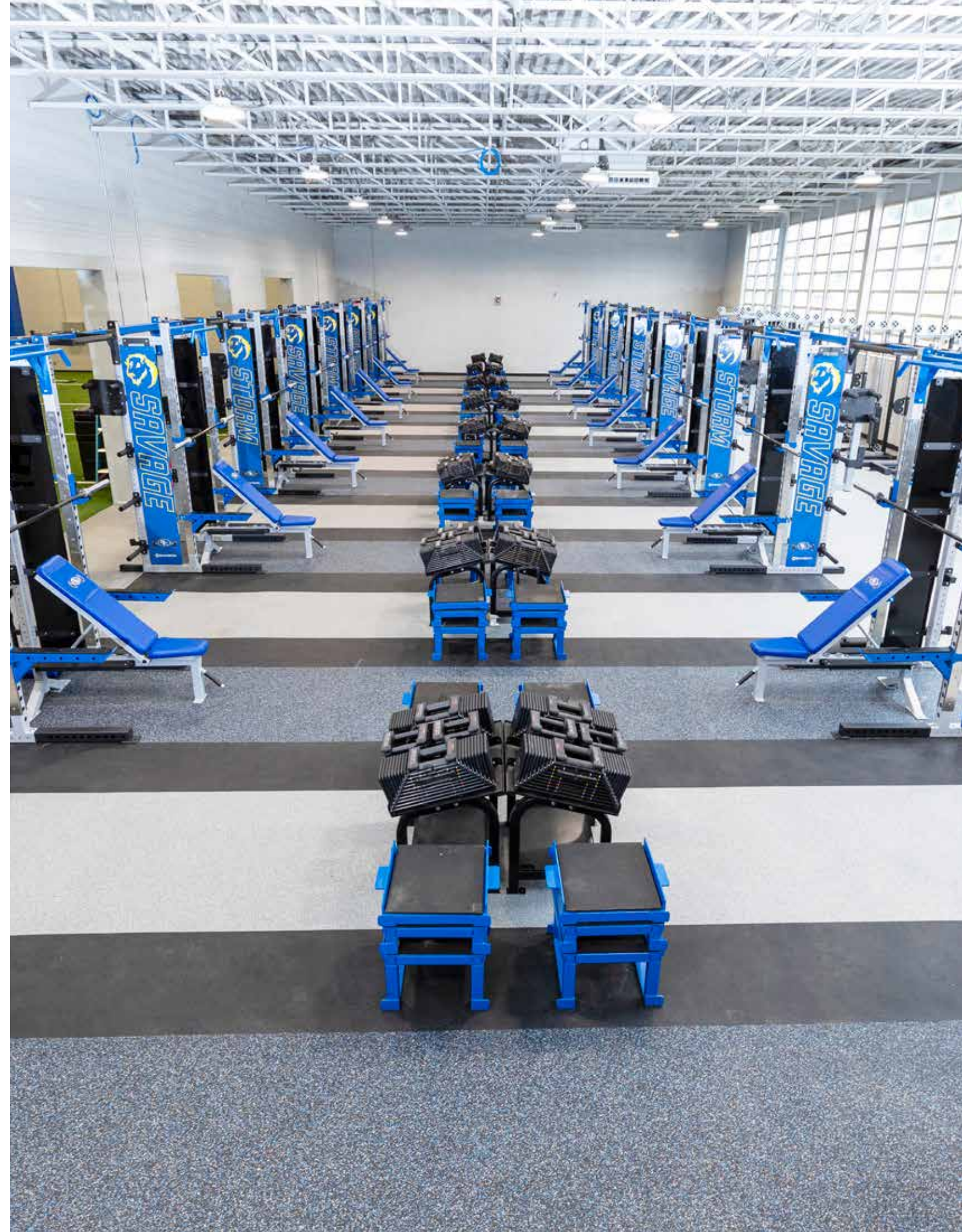

CUSTOM SOLUTIONS

Defined as a unique solution built to your specific needs. Examples include modified racks, special storage, one of a kind strength training equipment.



CUSTOM BRANDING

Defined as colors, logos, and graphics specific to your affiliation. Examples include powder coat color, upholstery color, branded graphic shields, branded bumper plates and dumbbells.



CUSTOM BRANDING



FLOORING

Professional Weight Room Solutions encompasses everything from your floor to your equipment. Your flooring is the foundation of a great and functional room. Utilize our expertise to assist you in making great decisions as you invest in your floor. Our experts will evaluate, educate, and endorse the best flooring solution based on your personal project.

-EVALUATE: We take a look at your current flooring situation, your budget, and your needs.

-EDUCATE: We provide honest feedback and options for you to choose from.

-ENDORSE: We recommend flooring solutions and assist in getting your flooring installed prior to our delivery.



ULTIMATE^{RB}
A CARLISLE COMPANY

ecore[™]

REGUPOL

FLEX SERIES



FLEX SERIES

FLEX-RACK

Our new Patent Pending FLEX-RACK™ Series allows for freedom and flexibility when designing your room. This Rack Series was developed with long term goals and limited budgets in mind.

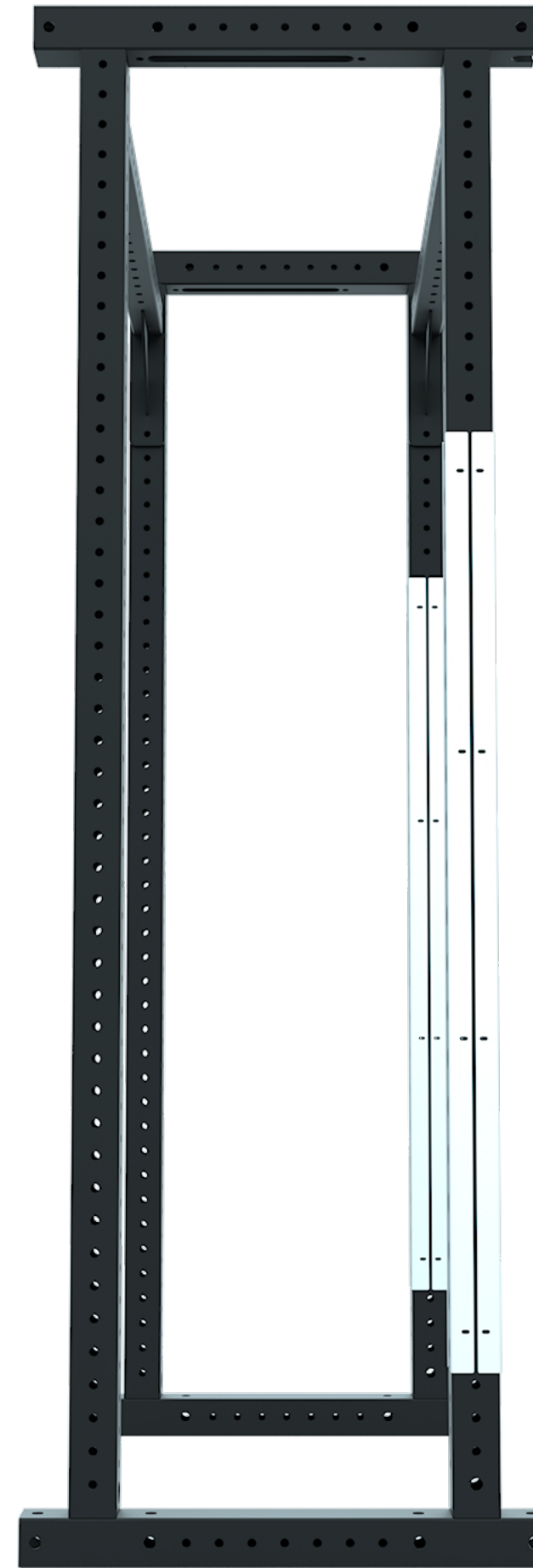

BASE FRAME

With a foundation frame for all our rack designs, you are able to FLEX your rack design into any one of our FLEX models. This gives you maximum possibilities in room planning for many years to come.

Steel Size 3"x3" 7 gauge .188
Depth - 32.5 in
Width - 50 in
Height - 99 in
Mass - 357 lbs

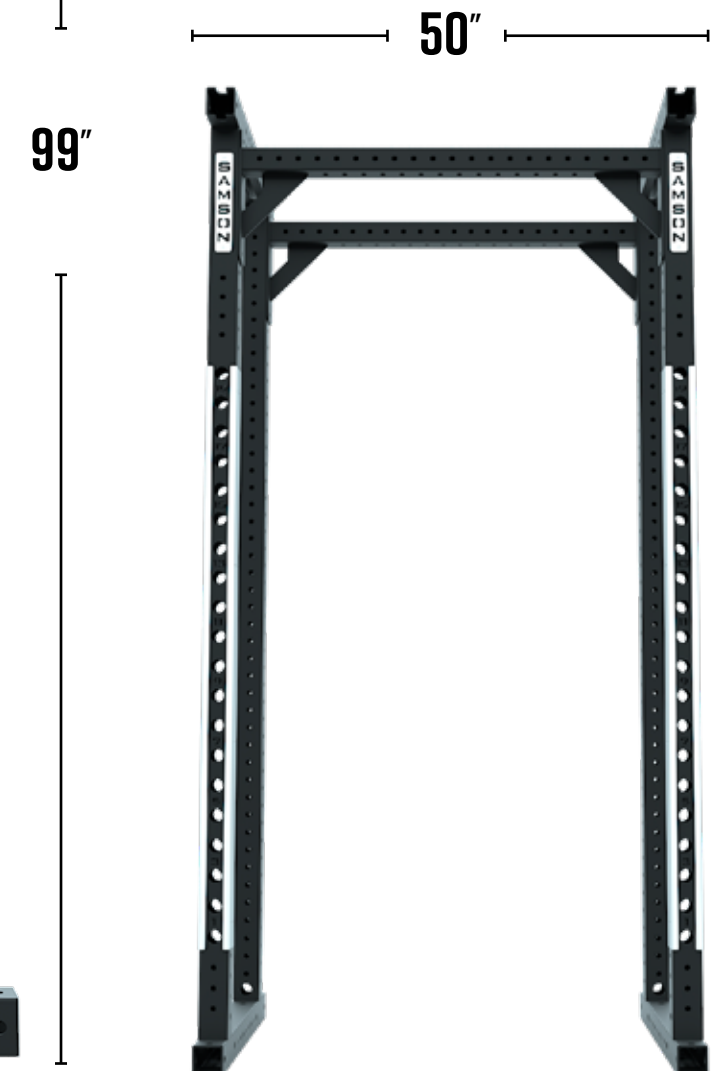

HALF-RACK

Steel Size 3"x3" 7 gauge .188
Depth: 78 in
Width: 50 in
Height: 99 in
Mass: 640 lbs



Rack comes with Stainless Steel Upright Shields, Standard Samson Chin Up Handles, Plate Storage, Safeties, and J-Cups.

****Graphic Shields Sold Separately****

POWER-RACK

Steel Size 3"x3" 7 gauge .188
Depth: 67.5 in
Width: 83 in
Height: 99 in
Mass: 692 lbs



Rack comes with Stainless Steel Upright Shields, Standard Samson Chin Up Handles, Plate Storage, Safeties, and J-Cups.

****Graphic Shields Sold Separately****

DOUBLE-RACK

Steel Size 3"x3" 7 gauge .188
Depth: 113 in
Width: 83 in
Height: 99 in
Mass: 831 lbs



Rack comes with Stainless Steel Upright Shields, Standard Samson Chin Up Handles, Plate Storage, Safeties, and J-Cups.

****Graphic Shields Sold Separately****



FUNCTIONAL TRAINING RACK

Steel Size 3"x3" 7 gauge .188
Depth: 78 in
Width: 83 in
Height: 105 in
Mass: 1302 lbs



Rack comes with Stainless Steel Upright Shields, Standard Samson Chin Up Handles, Plate Storage, Safeties, and J-Cups.

****Graphic Shields Sold Separately****

FUNCTIONAL TRAINING RACK REAR

Steel Size 3"x3" 7 gauge .188
Depth: 78 in
Width: 83 in
Height: 105 in
Mass: 1302 lbs



Rack comes with Stainless Steel Upright Shields, Standard Samson Chin Up Handles, Plate Storage, Safeties, and J-Cups.

****Graphic Shields Sold Separately****

FUNCTIONAL TRAINING RACK-COMBO

Steel Size 3"x3" 7 gauge .188
Depth: 99.5 in
Width: 83 in
Height: 105 in
Mass: 1450 lbs



Hi-Low Cable Columns off of left post. Lat-Row Machine off of the right post.

Rack comes with Stainless Steel Upright Shields, Standard Samson Chin Up Handles, Plate Storage, Safeties, and J-Cups.

****Graphic Shields Sold Separately****



J-Cup designed with 1/2" thick UHMW (ultra high molecular weight polyethylene) plastic and seamless roll pin joints to protect your barbells from damage.



Utility Safety Catch design made to incorporate later attachment additions. 1/2" thick UHMW (ultra high molecular weight polyethylene) top protects your barbells from damage.

POWDER COAT COLORS:

These are standard powder coat options that do not increase your price. All Powder Coat comes with a River Texture. **More colors available for an added cost, ask your Sales Specialist for more information.**



Color Disclaimer: The colors you see above vary across printing and powdercoating and may not accurately portray the correct tint or shade.

UPHOLSTERY COLORS:

Your upholstery adds a true finishing touch to your project, choose from our wide variety of 40oz Texhyde Premier Vinyl colors at no additional cost!



Color Disclaimer: The colors you see above vary across printing and powdercoating and may not accurately portray the correct tint or shade.

UPHOLSTERY COLORS:

					
T08 Sand	T43 Bisque	T07 Camel	T34 Beige	T108 ISO Brown	T130 Pottery
					
T63 Teal	T36 Aqua	T45 Copenhagen	T75 Emerald	T190 Dragonfly	M39 Gingersnap
					
T17 Wine	T170 Copper	T65 Black Cherry	T58 Plum	T48 Jade	T87 Pastel Green
					
T82 Mint	T83 Mist Green	T74 Dusty Jade	T59 Pumpkin	T21 Burnt Orange	T102 Burnt Sienna
					
T109 Luggage Tan	M94 Toast	T54 Platinum	T79 Medium Grey	T103 Dark Chocolate	T150 Shadow Grey
					
T01 Black	T160 Tigermoth	T100 Moss	T140 Sage	T104 Fern	T106 Green Apple
					
T62 Steel Grey	T110 Nickel	T77 Light Grey	T61 Soft Gray	T10 White	T48 Silver
					
T76 Grape					

Color Disclaimer: The colors you see above vary across printing and powdercoating and may not accurately portray the correct tint or shade.

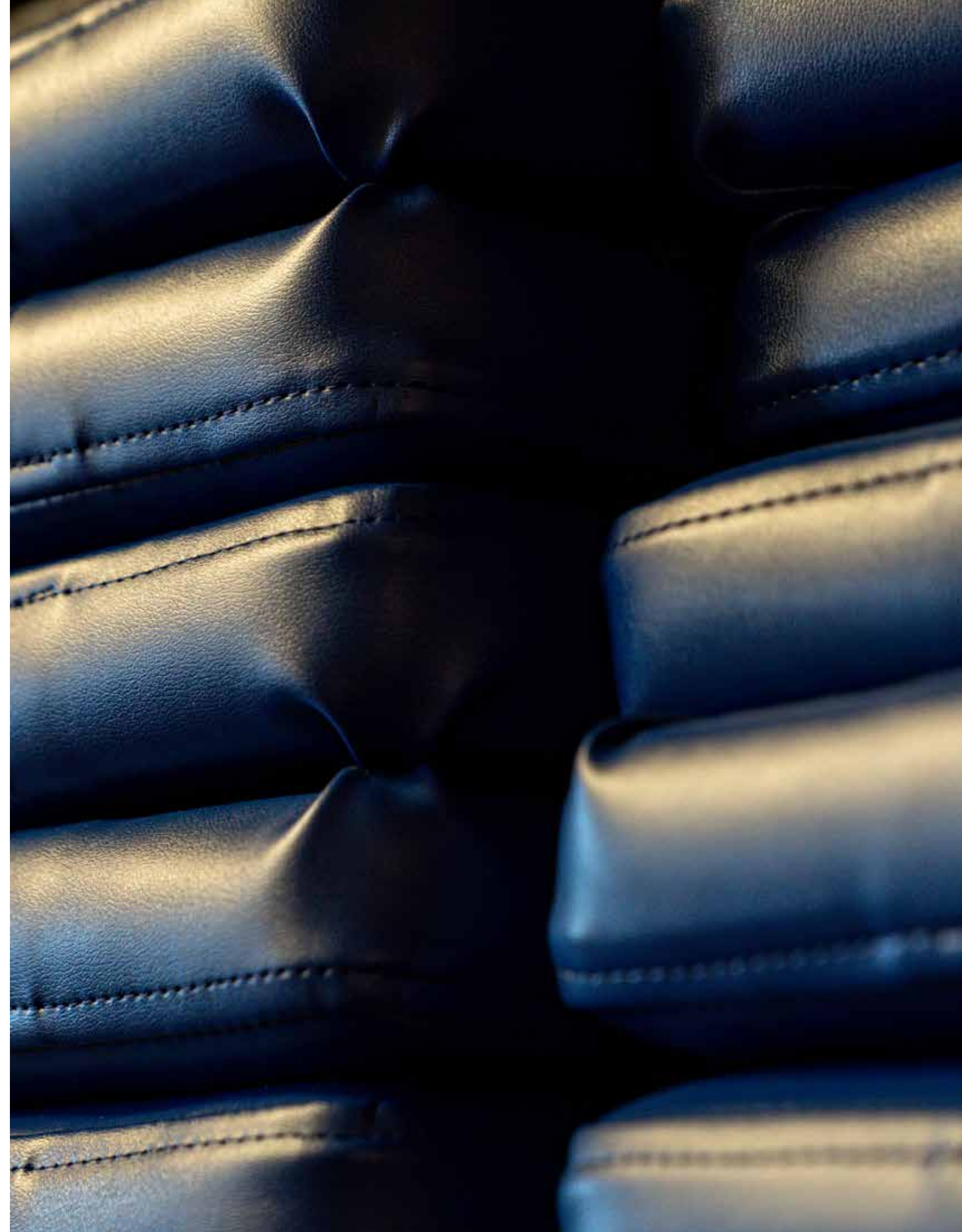

PRODUCTS



PRODUCTS

SAMSON COMBO BENCH

A standard all around bench to fit your needs. This bench goes from flat to 90 degrees. Our Samson Standard .188 Gauge Steel on all your tubing applies to our benches as well. Available for upgrade and add ons.

Depth: 58.25 in
Width: 28.25 in
Height: 19.5 in
Mass: 144 lbs



SAMSON COMBO BENCH WITH VERTICAL STORAGE

A standard all around bench to fit your needs. This bench goes from flat to 90 degrees. Spotter Plates with Anti-Skid Powder Coat allow for spotters to be in great positions for overhead lifts. A Vertical Storage Bracket stores your bench with the smallest footprint. Our Samson Standard .188 Gauge Steel on all your tubing applies to our benches as well.

Depth: 58.25 in
Width: 28.25 in
Height: 19.5 in
Mass: 160 lbs



SAMSON FLAT BENCH

A flat bench pad with wheels. Our Samson Standard .188 Gauge Steel on all your tubing applies to our benches as well.



Depth: 57.5 in
Width: 28.25 in
Height: 19.5 in
Mass: 135 lbs

SAMSON COMBO DECLINE BENCH

The decline bench adds variety to your upper body bench pressing. Our Samson Standard .188 Gauge Steel on all your tubing applies to our benches as well.



Depth: 63.5 in
Width: 28.25 in
Height: 26 in
Mass: 165 lbs

SAMSON STANDARD UPHOLSTERY



Heavy Duty
40oz Texhyde Vinyl

1/2" Scrim Foam
for Extra Padding

Super Dense
1" Closed Cell
Neoprene Padding

Double Stitched Seams
on all Upholstery

High Quality Masonite

3/4" Durable Plywood

SAMSON BARBELLS

Our barbells are manufactured with extreme care and diligence to provide you with great lifting experience. We provide a variety of barbells to choose from.

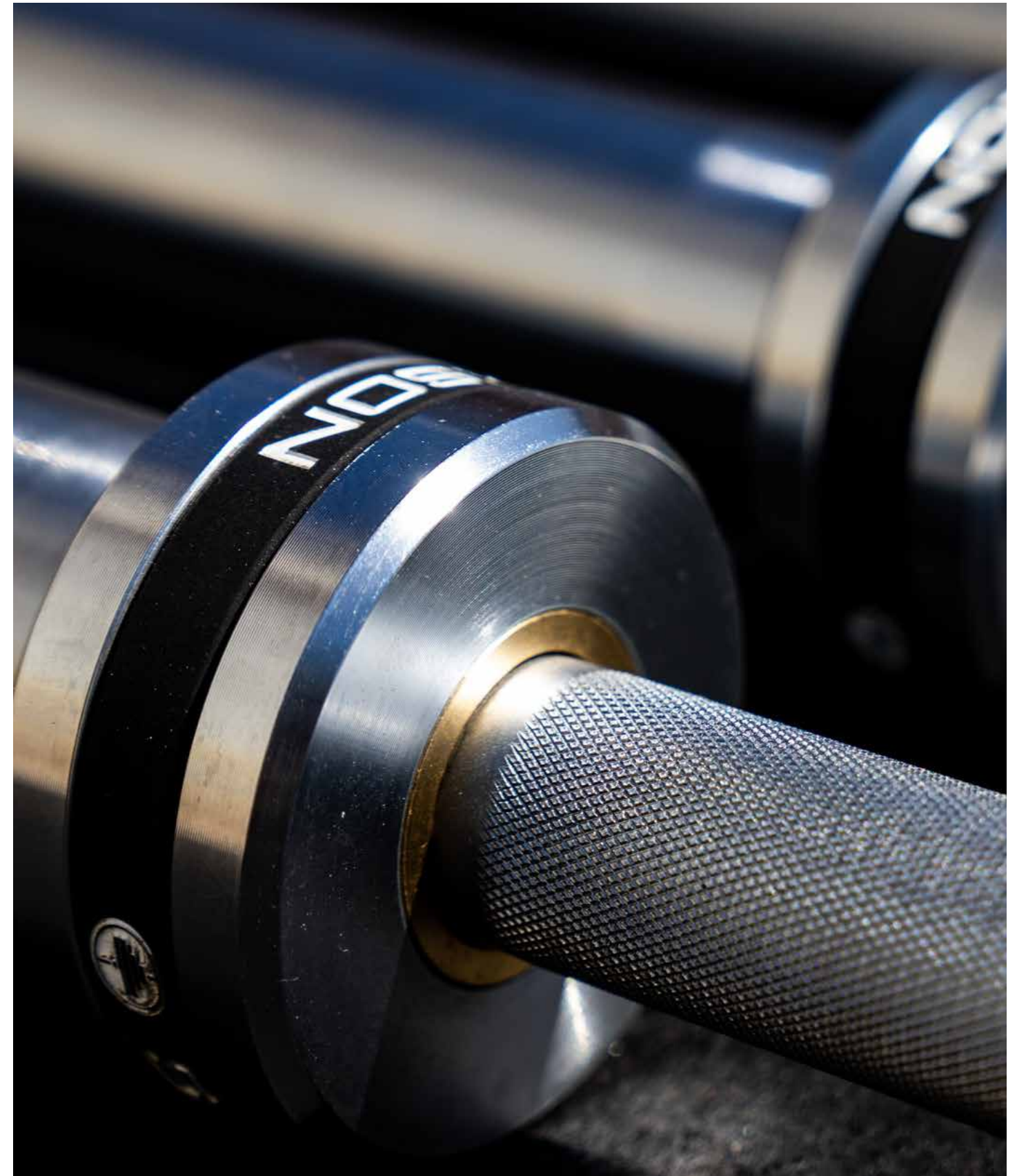

See our website www.samsonequipment.com for more information and barbell selections.

SAMSON PLATES & DUMBBELLS

URETHANE

Our Competition Bumper plate line for elite level training environments.

Available for Custom Branding

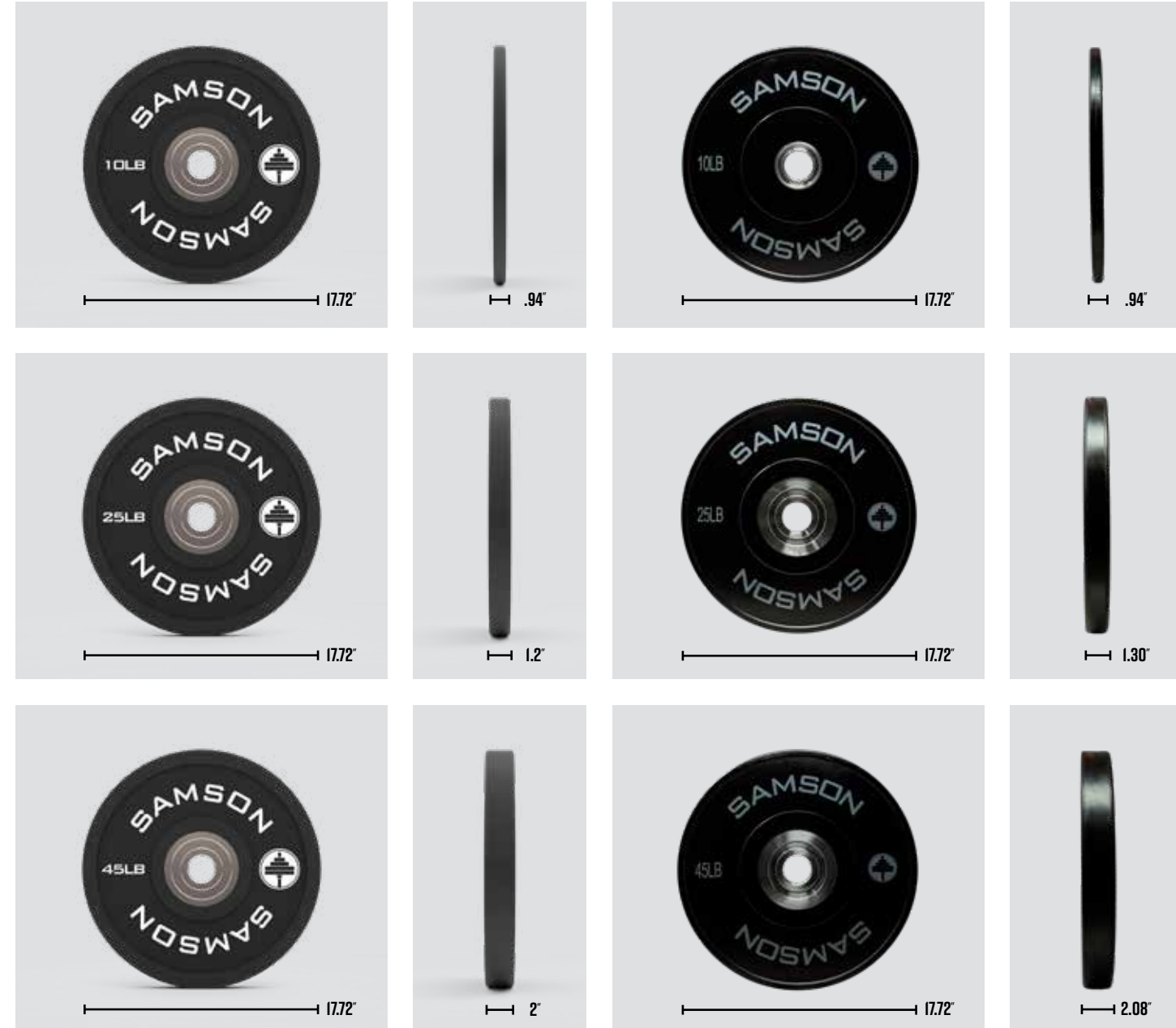

RUBBER

Our Rubber Bumper Plates provide a great solution for high use training environments.

ECONOMY

Our Economy Bumper Plate line are a great solution for anybody.

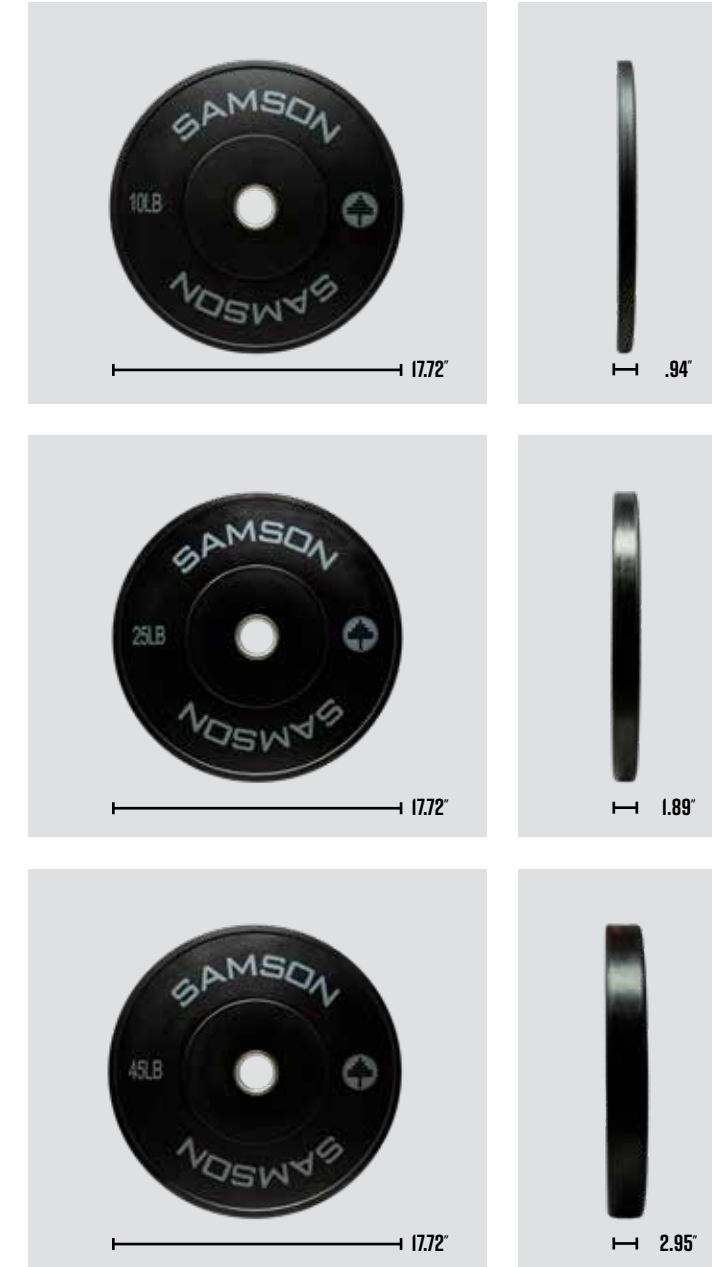

CHANGE PLATES

Our Urethane and Rubber Change Plates solutions help fill weight gaps and create training loads you need.

URETHANE



2.5LB

WIDTH - 22.5MM
DIAMETER - 171MM

RUBBER



2.5LB

WIDTH - 26MM
DIAMETER - 159MM



5LB

WIDTH - 25MM
DIAMETER - 200MM



5LB

WIDTH - 28MM
DIAMETER - 184MM



10LB

WIDTH - 36MM
DIAMETER - 227MM



10LB

WIDTH - 41MM
DIAMETER - 244MM

SAMSON DUMBBELLS

Our dumbbells are made with a polyurethane head and a zinc plated knurled handle. ****Available for Custom Branding****

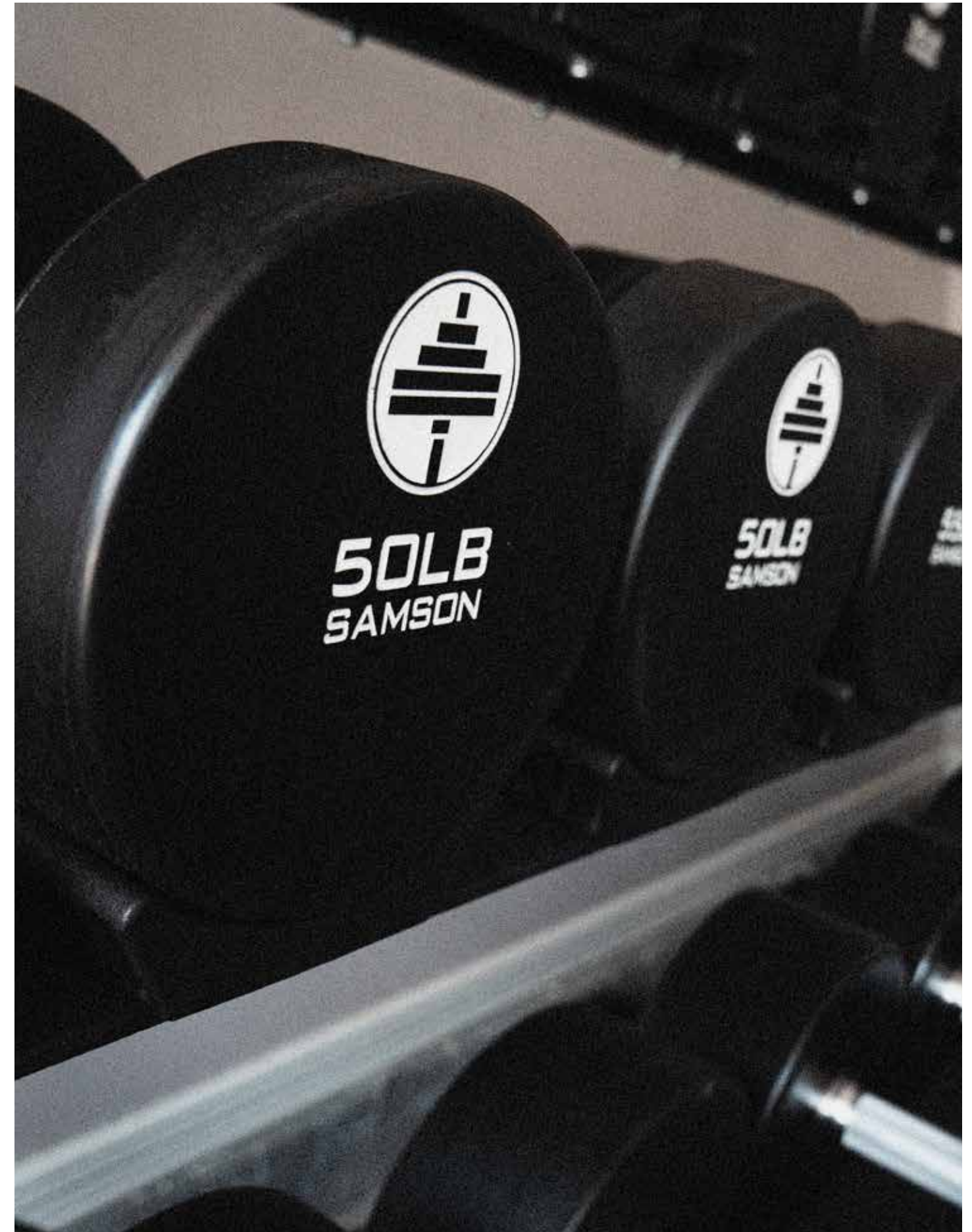

SAMSON GLUTE HAM DEVELOPER

An Industry Standard GHD with adjustable tubing for biomechanically correct positions. Stainless Steel adjustable tubes provide longevity and protect material. An adjustable knee pad allows for training of athletes at different levels.



Depth: 62 in
Width: 32.5 in
Height: 54 in
Mass: 325 lbs



SAMSON GLUTE HAM/REVERSE HYPEREXTENSION

This device is built around our standard GHD to minimize footprint while utilizing the front of our GHD pad for Reverse Hyperextension exercise. Built with anatomically correct hinge points you feel load throughout your whole movement.



Depth: 70 in
Width: 34 in
Height: 56 in
Mass: 378 lbs



SAMSON FREE STANDING HI-LOW CABLE COLUMN

A free standing selectorized weight stack cable column built for a variety of upper body and lower body exercises. This compact design adds maximum versatility for your space. Weight stack starts at 250lbs.

Depth: 40 in
Width: 38 in
Height: 97 in
Mass: 588 lbs



SAMSON HORIZONTAL LEG PRESS

The Horizontal Leg Press is a great machine if space permits to train the lower body. Built with custom cut case hardened rod and sealed ball bearings, it is meant to withstand heavy use. This machine comes with a 600lb selectorized weight stack and a large foot plate with anti-skid powder coat for freedom in stance variation.

Depth: 81 in
Width: 52.25 in
Height: 83.25 in
Mass: 1355 lbs



SAMSON LAT-ROW MACHINE

Our Samson Standard Lat-Row Combo comes standard with a 300lb selectorized, all-steel, weight stack.

Depth: 72 in
Width: 28 in
Height: 96 in
Mass: 640 lbs

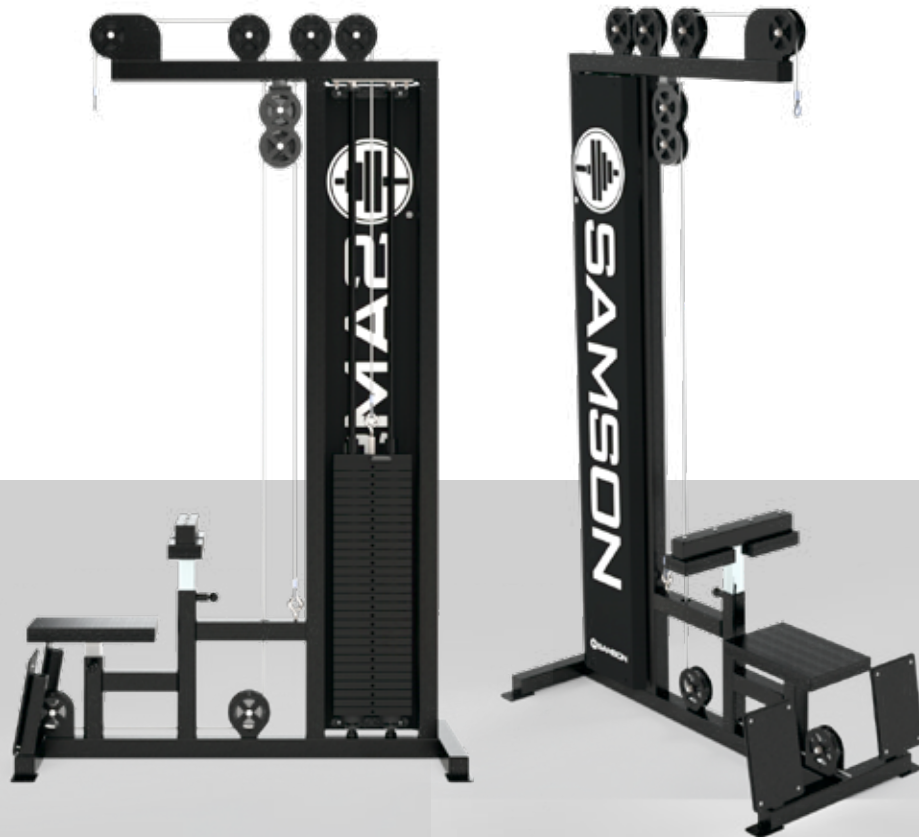

SAMSON BELT SQUAT

Our Standard Belt Squat was built around the purpose of rehabbing athletes back to normal loading and depth. Built alongside Master Level Strength Coach, Don Decker, this piece will add great variation in lower body training.

Depth: 78 in
Width: 65.5 in
Height: 57.75 in
Mass: 658 lbs



SAMSON PILLAR SYSTEM

The Pillar System was created to add machine posts to rooms that can be added onto and modified based on your needs. These are unique to you. Choose any mix of 4 upper and lower body machines to be attached to your "Pillar". Example to the right shows 2 Samson Pillars linked together with Rowing Machines, Lat-Pull Down Machines, Hi-Low Cable Columns, Standing Calf Raise, and a Leg Curl/Leg Extension Machine.

(Specs for Pillar Only)

Depth: 7 in
Width: 7 in
Height: 89 in
Mass: 128 lbs

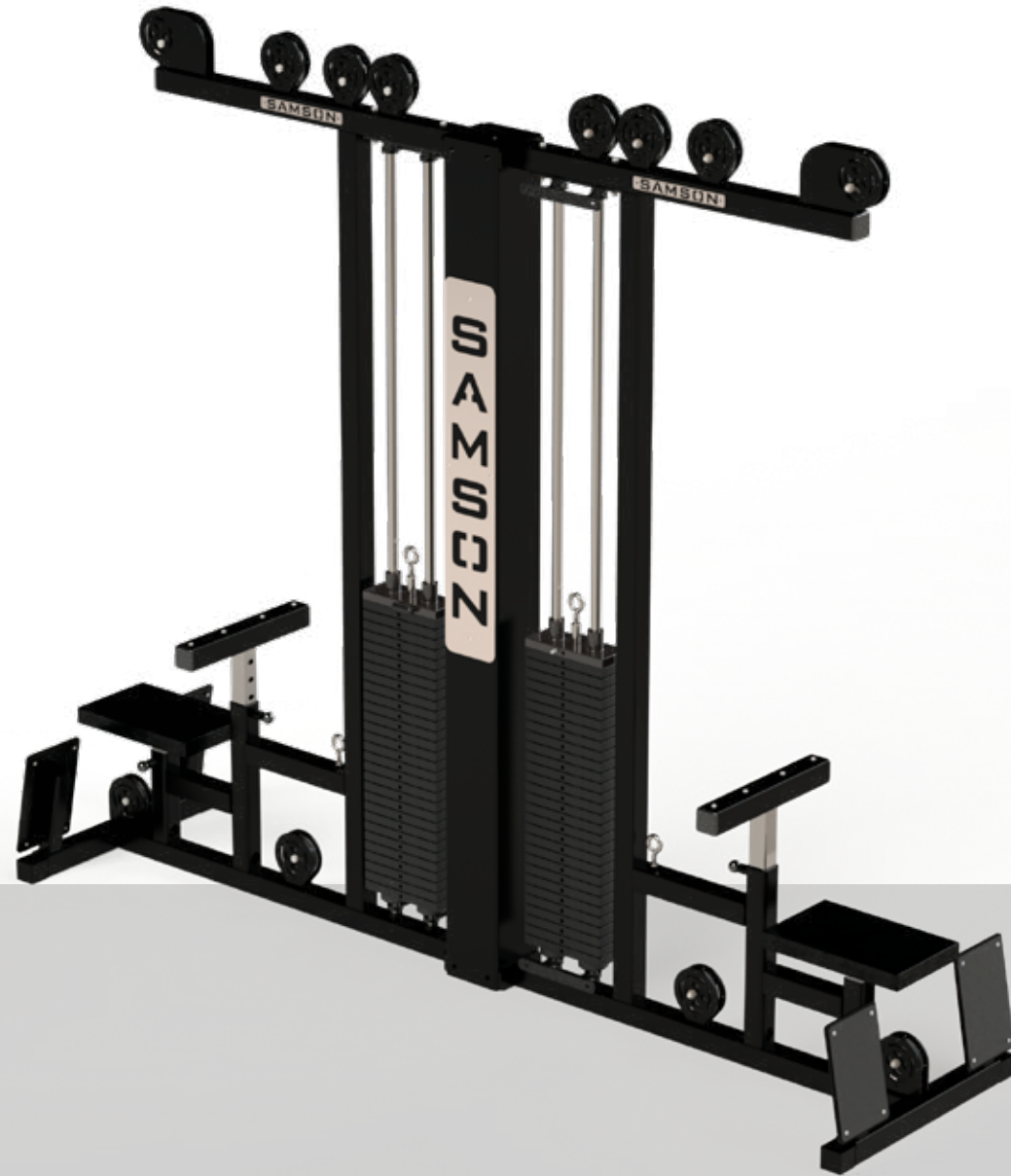
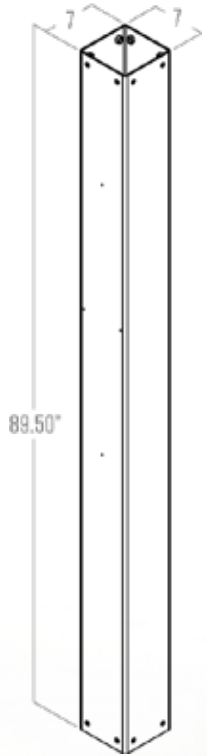

TACTICAL

Tactical Solutions in our industry have grown tremendously in recent years. We took time to study the market to understand and know exactly what we needed to create on our own. Our Samson Brand is built on a strong foundation of providing durable and long term solutions for our customers. Samson Lockers and Samson Outdoor Lifting System® are no different from our Professional Weight Room Solutions. We provide a professional service behind our products that ensures you make the best purchase decision possible. We make ease of purchase happen for our government partners. Utilize your GPC, your ADS rep or our GSA Contract to procure equipment needs!

SAMSON FREEDOM LOCKER



The Samson Freedom Locker allows you to utilize your existing container, or purchase containers from us to easily store your racks, benches, barbells, and weights. Compared to other brands on the market, it is highly configurable to fit your needs. It has a higher capacity with our rack designs. The Samson Lockers are not limited to the foundation of the container, which allows for more mobile rack setups and more freedom of choice for you.

SAMSON OUTDOOR LIFTING SYSTEM (S.O.L.S)



Our Samson Outdoor Lifting System® (S.O.L.S) provides you with a 10' x 10' leveling platform built with Samson Specs at 3"x 3" .188 square tubing frame, 1.5" x 1.5" cross pieces, and a rubber lifting surface. This system is equipped with a 10' x 10' Alaska Structures® Shade tent built to withstand wind speeds of up to 100mph! Take your outdoor training to a new level with this solution.

** Tent Available for Custom Branding **

FACILITIES

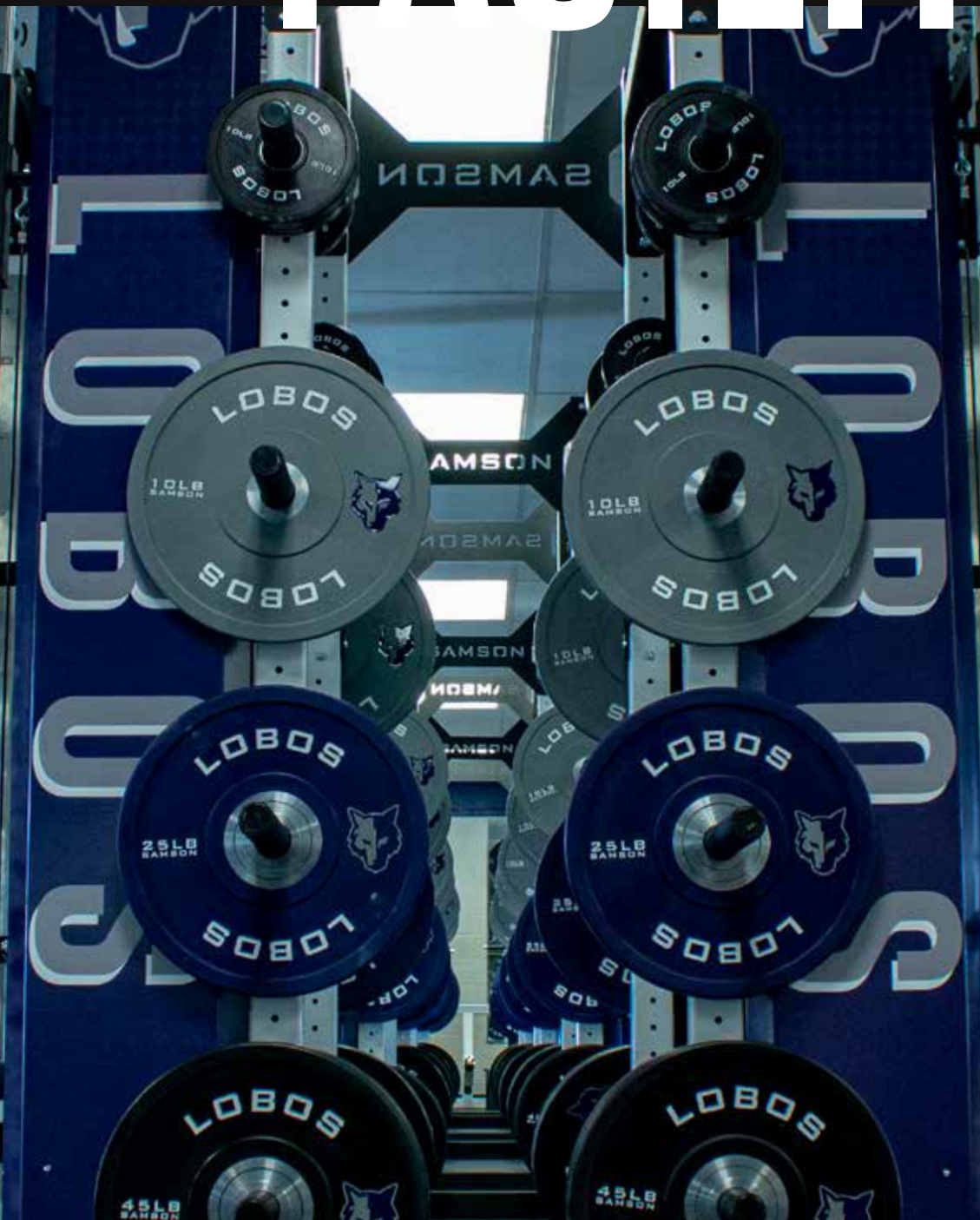

FACILITIES



SOUTHEASTERN OKLAHOMA STATE UNIVERSITY

DURANT, OK



ZACH FEARS
STRENGTH AND CONDITIONING COACH

"Find someone that knows what they are doing, that's not just trying to sell you equipment. Get someone that's set up major rooms and go look at the rooms that they have done. I can tell you right now, Samson will work with you in any way. If you want something customized they are going to do it that exact same way. If you are looking for quality equipment then Samson is your go to!"

SOUTHEASTERN OKLAHOMA STATE UNIVERSITY | DURANT, OK







UNIVERSITY OF WEST FLORIDA

PENSACOLA, FL



KENT MORGAN
DIRECTOR OF SPORTS PERFORMANCE

"We had certain needs in our weight room that I couldn't get elsewhere. Samson immediately sent me some 3D layouts, and from that moment on, I was sold. Those were the racks I wanted, and no other companies I had worked with did anything like that. In this facility, you're basically unlimited as a strength coach on what you can do. I would put it up there with the best in the country. Anyone can walk into our facility and see that nobody else has these racks. They were custom designed especially for all the things I was looking to do - utilizing space, having storage in the racks, and creating a visual effect. We've gotten many recruits already, and a lot of the reason is because of Samson Equipment."

UNIVERSITY OF WEST FLORIDA | PENSACOLA, FL







MORIARTY HIGH SCHOOL

MORIARTY, NM



JOE ANAYA
ATHLETIC DIRECTOR

"I had a history working with Samson... When we got the green light to get this thing done we called Brian. We didn't make any other phone calls, it was straight to Samson...Here we are, he took care of it all. He gave us some ideas we didn't even have... We got the greatest facility we could have ever asked for."

MORIARTY HIGH SCHOOL | MORIARTY, NM







COTTON BOWL

DALLAS, TX



ANDREW KLINGSPORN

"We were the 1st bowl game destination to attempt an on site strength and conditioning facility. Typically the two teams have to either bring their own equipment, or we line them up with surrounding high schools, making logistics a nightmare. Scott and the Samson team stepped in and created a 1st Class, state of the art strength and conditioning facility with custom branding that helped us in regards to marketing leading up to the game. Out of all the decisions we had to make leading up to this event, choosing Samson Equipment to outfit our facility was by far the best. Their product quality and attention to detail are 2nd to none. We highly recommend Scott and the Samson team and dare other bowl games to try and beat what we accomplished!"

COTTON BOWL | DALLAS, TX





NATURAL GAS

SAMSON

GOTTON

GOTTON

GOTTON

GOTTON



GOTTON

BOWL CLASSIC

SAMSON



ANNA HIGH SCHOOL

ANNA, OH



ANNA HIGH SCHOOL BOOSTER CLUB

“Talk to Samson...their knowledge is invaluable. They have seen everything across the country. High school, college and professional level, their advice is invaluable... They were able to work with to find out how many athletes we had and what type of sports we had, and knowledgeable enough to say this is the type of equipment you’ll need and heres a way to lay it out...Find the people that will listen to what your needs are.”

ANNA HIGH SCHOOL | ANNA, OH







ADDRESS HIGH SCHOOL

EL PASO, TX



JEFF WOODRUFF
ATHLETIC DIRECTOR/HEAD FOOTBALL COACH



“There’s a lot of small colleges who would love to have something like this...The people I’ve talked to around the country, colleges specifically, they spoke highly of the product and durability. It holds up...Everyone in El Paso is going to want to build something now, and if you’re not going with Samson you’re just building a building”

ADDRESS HIGH SCHOOL | EL PASO, TX







SAINT MARY'S COLLEGE

MORAGA, CA



MAX BAYER
ASSISTANT ATHLETIC DIRECTOR

"Our new state-of-the-art Sports Performance Center will help us build resilient, confident student-athlete leaders in a positive and inspiring training environment. The atmosphere will be special and we'll have more tools than ever before to develop champions."



SAINT MARY'S COLLEGE | MORAGA, CA



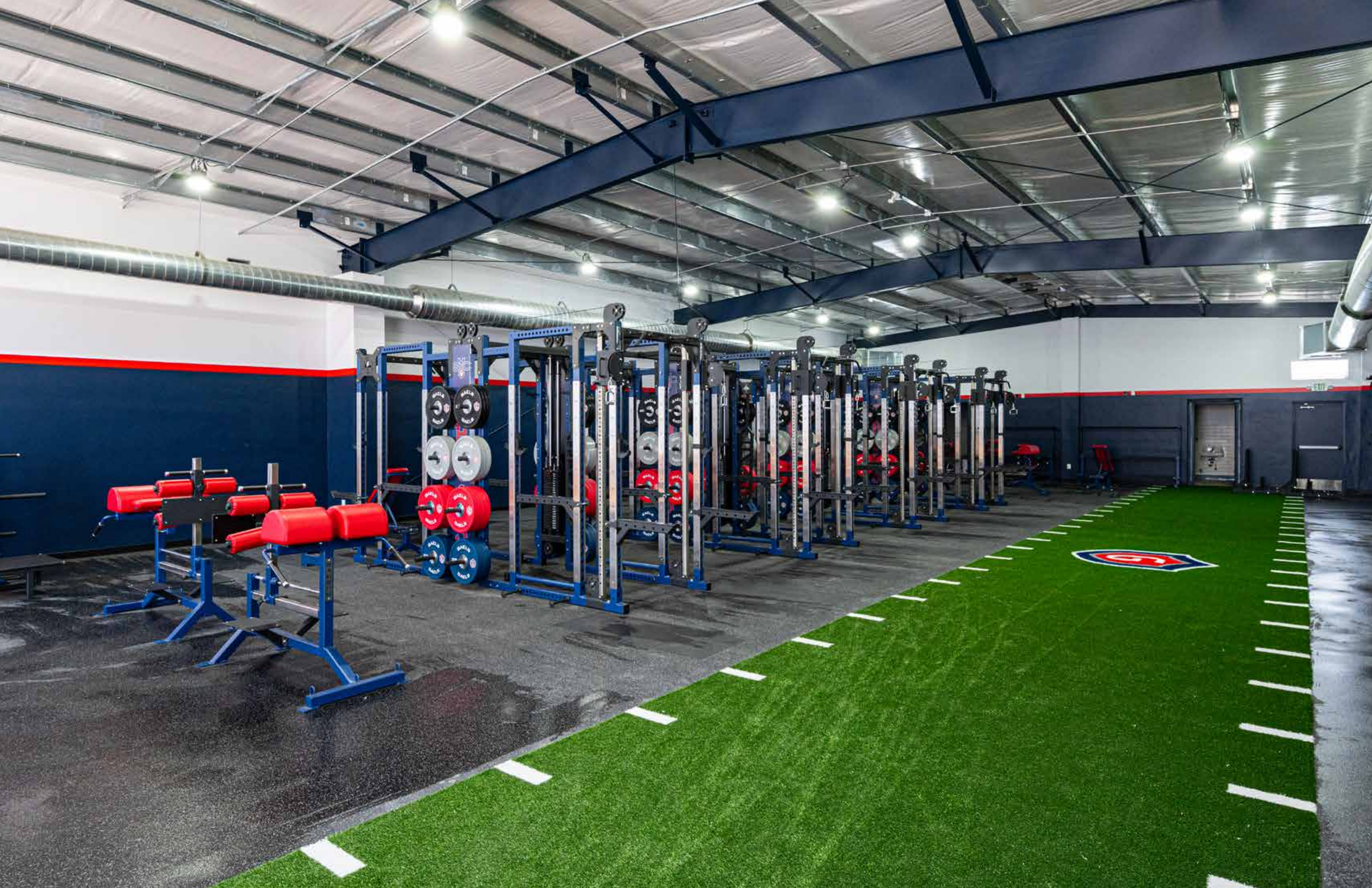



UNIVERSITY OF COLORADO BOULDER

BOULDER, CO

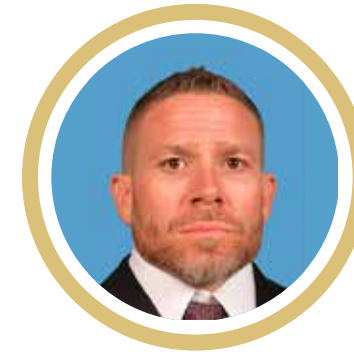

STEVE ENGLEHART
ASSITANT ALTHLETIC DIRECTOR

“Samson worked tirelessly with us on the design of our equipment. Not only did they outfit us with custom-branded racks, DB’s and plates that looked great aesthetically, they went the extra mile to make sure each piece of equipment was designed to meet the functional needs of all our teams and coaches. Their willingness to design custom pieces of equipment that would make huge positive impacts on our training at CU really sets them apart in the industry. We couldn’t be any happier with the finished product and owe a huge thanks to Samson for making our weight room the perfect blend of function and style that will serve us perfectly for years to come.”

UNIVERSITY OF COLORADO BOULDER | BOULDER, CO





BUFFALOES

HOLDRAID

HOLDRAID

HOLDRAID

HOLDRAID

SAMSON
EQUIPMENT

SAMSON

SAMSON

WARNING

WARNING



58TH SPECIAL OPERATIONS WING

KIRTLAND AIR FORCE BASE



JUSTIN SCHWIND
HUMAN PERFORMANCE ADVISOR



“Working with the military it is hard to purchase anything directly. Samson was willing to work with other companies to make the process happen in a timely manner and to get everything we needed. We’ve gone further than I ever imagined or that I’ve ever seen in a weight room. There are things that I never really thought of if I would of just went with a regular joe off the street. With Samson, everything is customizable. It really is crazy to say but your dreams come true. Not just to make it happen but the expertise, and the knowledge from the Samson staff themselves allowed us to get there. You need people with a performance mindset and Samson has that.”

58TH SPECIAL OPERATIONS WING | KIRTLAND AIR FORCE BASE





HUMANS ARE MORE IMPORTANT THAN HARDWARE

58TH SOW



MIAMI UNIVERSITY

OXFORD, OH



JAMES CARSEY
ASSISTANT ATHLETIC DIRECTOR FOR HUMAN PERFORMANCE

"It seemed like they really wanted to do something for us. I think it's that personal touch that really put it over the top. Then once I started looking at the product compared to the other product I was looking at the time, it was a no brainer to go with Samson. It was a great process and I'm super excited."

MIAMI UNIVERSITY | OXFORD, OH



RED HAWKS





LAWRENCE HIGH SCHOOL

LAWRENCE, KS



STEVE RAMPY
HEAD FOOTBALL COACH

“The strongest thing they offered me was the customizing of what our needs were... They just are so helpful in meeting your needs for your physical space, but then on top of that their customer service is second to none. They make it right.”



LAWRENCE HIGH SCHOOL | LAWRENCE, KS







WIDEFIELD HIGH SCHOOL

COLORADO SPRINGS, CO



JON SHUB
ATHELETIC DIRECTOR



“This room is an old room. It’s been here since the 1990s, so overcoming the challenges and the surprises this type of room comes with, Samson was able to help us figure out creative solutions to the problems we had... Widefield is a powerful and proud community, so this hopefully emulates the pride and the commitment to our community.”

WIDEFIELD HIGH SCHOOL | COLORADO SPRINGS, CO





GLADIATORS

GLADIATOR 15

GLADIATOR 11.5

GLADIATOR 9.5

GLADIATOR 15

GLADIATOR 11.5

GLADIATOR 15



EASTWOOD HIGH SCHOOL

EL PASO, TX



MARCUS DUCHENE
ELEV8 WEIGHT ROOM CONSULTING

“What really turned me on to Samson was the ability to customize what we wanted to do and make sure it was going to fit the space... Samson was easy to work with to help build it out”



EASTWOOD HIGH SCHOOL | EL PASO, TX





FIND AN EXCUSE TO WIN

FIND AN EXCUSE TO WIN

FIND AN EXCUSE TO WIN

FIND AN EXCUSE TO WIN

TEACHERS

TESTIMONIALS

Some of the unique things that Samson did in their rack design as well as the NMSU branding they did definitely create conversation for all who enter the new room. The athletes at NMSU have a lot to brag about.

-Don Decker
NEW MEXICO STATE UNIVERSITY | LAS CRUCES, NM

Samson Equipment provided elite equipment at an affordable price. We had a short timeline to complete the weight room and Samson met it effortlessly. They were professional, efficient and able to adjust on the fly. The strength staff had a say in every detail and it led to truly customized equipment that reflected our training philosophy. The graphic shields really made the racks stand out. Would definitely work with Samson Equipment again.

-Captain Kevin Quinn
AIR FORCE ACADEMY | COLORADO SPRINGS, CO

I contacted 3 major strength equipment vendors. As time went on it was evident that only one vendor, Samson was willing to be patient enough with the process to continue the lines of communication and offer ideas at different price points. Samson only offers one level of equipment "top of the line" so there would be no shortcuts. Brian Schroeder took the time to facetime me, view the facility and the upstairs hurdles and to most importantly LISTEN!

-Ted Beyer, Head Strength Coach
RIDGEFIELD HIGH SCHOOL | RIDGEFIELD, WA

"The customer service from Samson was incredible, throughout the entire process, from facility design to install. They were in constant communication and were able to customize all equipment to serve our student athletes' needs. The attention to detail in design and versatility of the equipment will continue to give our student athletes a competitive edge for many years to come."

-Brian Amenta
UNIVERSITY OF MARYLAND, BALTIMORE COUNTY | BALTIMORE, MD

"The Branding and Logos that Samson created for our program really gave our weight room its own unique appeal. The Power Rack stations have allowed our athletes to accomplish so much more from our weight sessions."

-Gary Rundell
MOUNTAIN VIEW HIGH SCHOOL | EL PASO, TX

"Working with Samson was an enjoyable experience, in that, they didn't show you a lot of things and say, "this is what we have", instead they came to us asking, "What do you need?". It was nice not having limitations put on the process of building this weight room."

-Jeffrey Ramirez
DEL VALLE HIGH SCHOOL | AUSTIN, TX

"Opening a new school is a very daunting yet rewarding task, and you want to make sure you get things right from the start. Working with the team at Samson to outfit our weight rooms was the best decision I made. No one can match their product, service, or creativity. What sets them apart from the competition is their ability to design a product based on your needs. Their unique graphics provides an outstanding look to an already great product. There isn't a better weight equipment company out there."

-Cody Moore
BRASWELL HIGH SCHOOL | AUBREY, TX

We placed our first huge purchase with Samson Equipment back in 1985 and are still purchasing from them in 2019, 34 years later. There is a reason for this loyalty. The customization of pieces to fit an institution's facility restrictions and program prescriptions is unparalleled in the industry. If you can dream it, they can make it, and make it amazing.

-Tim McClellan
ARIZONA ARSENAL | MESA, AZ

OUR SPECS. & WARRANTY

SAMSON BUILT FOR STRENGTH WARRANTY:

The steel materials and/or workmanship in SAMSON machines are warranted for Lifetime when used as intended as applicable to the original purchaser (non-transferable). In the event they fail through no abuse or fault of the owner, please notify SAMSON Equipment, Inc. and return the equipment at the owner's expense. SAMSON Equipment, Inc. will repair or replace the equipment at SAMSON'S option, and shall return the same to the owner at SAMSON'S expense.

Customer bears the responsibility of contacting Samson Equipment with the pertinent information as to the condition of the equipment.

Bearings are warranted for 8 years if used as designed and intended and not abused by the owner. All other moveable parts are warranted for 1 year if used as designed and intended and not abused by the owner, as applicable to the original purchaser (non-transferable).

Upholstery/ Powder Coating / Paint is warranted for 18 months if used as designed and intended, and not abused by the owner, as applicable to the original purchaser (non-transferable).

Wood products are warranted for 90 days if used as designed and intended, and not abused by the owner, as applicable to the original purchaser (non-transferable).

Warranty items are subject to inspection by Samson Equipment to determine if warranty-voiding abuse, neglect, or misuse is present. If Warranty-Voiding situation is present, repairs can still be done on a labor and materials required basis. A written estimate and bill will be provided to the customer before non-warranty repairs are done. Customer bears the costs of packaging and return shipping on any non-warranty situation.

Third Party Warranties for products provided but not manufactured by Samson Equipment as warranted by the original manufacturer, such original manufacture's warranty applies solely.

This Samson Built for Strength warranty is an expressed warranty and excludes all other warranties expressed or implied, as applicable to the original purchaser (non-transferable).abused by the owner.

SAMSON BUILT SPECS.

- Most items use ASTM A-500 Gr B 3" x 3" x .188 steel square tubing weighing 7.04 lbs./ft. or ASTM A-500 Gr B 2 1/2" x 2 1/2" x .188 steel square tubing weighing 5.75 lbs./ft. Some items use 2" x 2" x .188 steel square tubing weighing 4.32 lbs./ft. All flat welds are ground, sanded and polished to a smooth finish for appearance. All exposed tube ends are capped.
- All machine cables use 3/16" diameter 7x19 galvanized steel aircraft cable that is nylon coated to 1/4" diameter. Stainless steel thimbles are used for all eyes.
- Heavy duty 40 oz. Expanded Vinyl used on all items requiring upholstery. Choice of colors available. Upholstery corners are stitched, with perimeter double stitching.
- Super 12 lb. density neoprene closed cell padding is used for support. 3/4" plywood is used for support. T-Nut fasteners.
- Baked on Electrostatically Applied Powder Coating having a Specific Gravity of 1.2-1.7g/cm cubed. Cured at 340 degrees for 15 min. after substrate material has reached 340 degrees. Gloss levels to be between 55-65 according to TSO 2813/60 degrees. Available in a variety of basic colors at no additional charge. Applied to a minimum of 3 mils thickness. Surfaces are sand blasted and DA sanded prior to painting.
- 1630 DS precision ground sealed bearings are used at all hinge points. 4 1/2" precision ball bearing pulleys are used on all machines. Samson uses three sizes of Linear Ball Bearing Systems (1 1/2", 1 1/4", & 1" lineal ball bearings); all systems use Rockwell 60 case hardened shafting.

- Spring-loaded pop-pins are used for quick and easy adjusting. Telespar, a snug fitting telescoping square tubing, is used for tight solid feel of stability. All adjustable parts to have brushed finish, made of type 304 stainless steel (with a 400 grit finish) with numbered window system.
- Weight stacks to be made of Steel, no cast iron or other alloy material will be substituted. Steel plates will not break or fracture like alloy or cast iron. All weight stack plates to be painted black with corresponding weight marks clearly visible to the user. Weight plate guide rods are solid 1" round ground steel, Industrial chrome plated. All selector plates are machined steel with machined MDS bushings in every plate and MDS cushioning between every plate. All weights are lifted by 7/8" round solid cold rolled steel selector shafts with bright polished chrome finish. All weight stacks use magnetic selector pin.

