

**SUPER**  <sup>®</sup>

**X9DR3-F**  
**X9DRi-F**

**USER'S MANUAL**

Revision 1.1b

---

The information in this User's Manual has been carefully reviewed and is believed to be accurate. The vendor assumes no responsibility for any inaccuracies that may be contained in this document, and makes no commitment to update or to keep current the information in this manual, or to notify any person or organization of the updates. **Please Note: For the most up-to-date version of this manual, please see our Website at [www.supermicro.com](http://www.supermicro.com).**

Super Micro Computer, Inc. ("Supermicro") reserves the right to make changes to the product described in this manual at any time and without notice. This product, including software and documentation, is the property of Supermicro and/or its licensors, and is supplied only under a license. Any use or reproduction of this product is not allowed, except as expressly permitted by the terms of said license.

IN NO EVENT WILL SUPER MICRO COMPUTER, INC. BE LIABLE FOR DIRECT, INDIRECT, SPECIAL, INCIDENTAL, SPECULATIVE OR CONSEQUENTIAL DAMAGES ARISING FROM THE USE OR INABILITY TO USE THIS PRODUCT OR DOCUMENTATION, EVEN IF ADVISED OF THE POSSIBILITY OF SUCH DAMAGES. IN PARTICULAR, SUPER MICRO COMPUTER, INC. SHALL NOT HAVE LIABILITY FOR ANY HARDWARE, SOFTWARE, OR DATA STORED OR USED WITH THE PRODUCT, INCLUDING THE COSTS OF REPAIRING, REPLACING, INTEGRATING, INSTALLING OR RECOVERING SUCH HARDWARE, SOFTWARE, OR DATA.

---

Any disputes arising between the manufacturer and the customer shall be governed by the laws of Santa Clara County in the State of California, USA. The State of California, County of Santa Clara shall be the exclusive venue for the resolution of any such disputes. Supermicro's total liability for all claims will not exceed the price paid for the hardware product.

---

FCC Statement: This equipment has been tested and found to comply with the limits for a Class A digital device pursuant to Part 15 of the FCC Rules. These limits are designed to provide reasonable protection against harmful interference when the equipment is operated in a commercial environment. This equipment generates, uses, and can radiate radio frequency energy and, if not installed and used in accordance with the manufacturer's instruction manual, may cause harmful interference with radio communications. Operation of this equipment in a residential area is likely to cause harmful interference, in which case you will be required to correct the interference at your own expense.

---

California Best Management Practices Regulations for Perchlorate Materials: This Perchlorate warning applies only to products containing CR (Manganese Dioxide) Lithium coin cells. "Perchlorate Material-special handling may apply. See [www.dtsc.ca.gov/hazardouswaste/perchlorate](http://www.dtsc.ca.gov/hazardouswaste/perchlorate)".

**WARNING:** Handling of lead solder materials used in this product may expose you to lead, a chemical known to the State of California to cause birth defects and other reproductive harm.

---

Manual Revision 1.1b

Release Date: December 19, 2013

Unless you request and receive written permission from Super Micro Computer, Inc., you may not copy any part of this document.

Information in this document is subject to change without notice. Other products and companies referred to herein are trademarks or registered trademarks of their respective companies or mark holders.

Copyright © 2013 by Super Micro Computer, Inc.

All rights reserved.

**Printed in the United States of America**

## Preface

This manual is written for system integrators, PC technicians and knowledgeable PC users. It provides information for the installation and use of the X9DR3-F/X9DRi-F motherboard.

### About This Motherboard

The Super X9DR3-F/X9DRi-F motherboard supports dual Intel® E5-2600(v2) Series Processors (Socket R LGA 2011) that offer QPI (Intel QuickPath Interface) Technology (V.1.1), providing point-to-point connection with a transfer speed of up to 8.0 TG/s. With the PCH C606/C602 chipset built in, the X9DR3/i-F motherboard supports Intel® Management Engine (ME), Rapid Storage Technology, Digital Media Interface (DMI), PCI-E Gen. 3.0 and up to 1866 MHz DDR3 memory. This motherboard is ideal for HPC/Cluster/Database 2U server platforms. Please refer to our Website (<http://www.supermicro.com>) for CPU and memory support updates.

### Manual Organization

**Chapter 1** describes the features, specifications and performance of the motherboard, and provides detailed information about the Intel PCH C606/602 chipset.

**Chapter 2** provides hardware installation instructions. Read this chapter when installing the processor, memory modules and other hardware components into the system. If you encounter any problems, see **Chapter 3**, which describes troubleshooting procedures for video, memory, and system setup stored in the CMOS.

**Chapter 4** includes an introduction to the BIOS, and provides detailed information on running the CMOS Setup utility.

**Appendix A** provides BIOS Error Beep Codes.

**Appendix B** lists Software Installation Instructions.

## Conventions Used in the Manual

Pay special attention to the following symbols for proper system installation and to prevent damage to the system or injury to yourself.

**Warning:** Important information given to ensure proper system installation or to prevent damage to the components



**Note:** Additional information given to differentiate between various models or provides information for correct system setup.

## Contacting Supermicro

### Headquarters

Address: Super Micro Computer, Inc.  
980 Rock Ave.  
San Jose, CA 95131 U.S.A.

Tel: +1 (408) 503-8000

Fax: +1 (408) 503-8008

Email: [marketing@supermicro.com](mailto:marketing@supermicro.com) (General Information)  
[support@supermicro.com](mailto:support@supermicro.com) (Technical Support)

Web Site: [www.supermicro.com](http://www.supermicro.com)

### Europe

Address: Super Micro Computer B.V.  
Het Sterrenbeeld 28, 5215 ML  
's-Hertogenbosch, The Netherlands

Tel: +31 (0) 73-6400390

Fax: +31 (0) 73-6416525

Email: [sales@supermicro.nl](mailto:sales@supermicro.nl) (General Information)  
[support@supermicro.nl](mailto:support@supermicro.nl) (Technical Support)  
[rma@supermicro.nl](mailto:rma@supermicro.nl) (Customer Support)

### Asia-Pacific

Address: Super Micro Computer, Inc.  
3F, No. 150, Jian 1st Rd.  
Zhonghe Dist., New Taipei City 23511  
Taiwan (R.O.C)

Tel: +886-(2) 8226-3990

Fax: +886-(2) 8226-3992

Web Site: [www.supermicro.com.tw](http://www.supermicro.com.tw)

Technical Support:

Email: [support@supermicro.com.tw](mailto:support@supermicro.com.tw)

Tel: +886-(2)-8226-3990

# Table of Contents

## **Preface**

### **Chapter 1 Overview**

1-1	Overview .....	1-1
1-2	Processor and Chipset Overview.....	1-11
1-3	Special Features .....	1-12
1-4	PC Health Monitoring.....	1-12
1-5	ACPI Features.....	1-13
1-6	Power Supply .....	1-13
1-7	Super I/O.....	1-14
1-8	Advanced Power Management.....	1-14
	Intel® Intelligent Power Node Manager (NM) (Available when NMView Software is Installed).....	1-14
	Management Engine (ME) .....	1-14
1-9	Overview of the Nuvoton WPCM450 Controller.....	1-15
	Other Features Supported by the WPCM BMC Controller.....	1-15

### **Chapter 2 Installation**

2-1	Standardized Warning Statements .....	2-1
	Battery Handling.....	2-1
	Product Disposal .....	2-3
2-2	Static-Sensitive Devices.....	2-4
	Precautions .....	2-4
	Unpacking .....	2-4
2-3	Processor and Heatsink Installation.....	2-5
	Installing the LGA2011 Processor .....	2-5
	Installing a Passive CPU Heatsink .....	2-9
	Removing the Heatsink.....	2-10
2-4	Installing and Removing the Memory Modules.....	2-11
	Installing & Removing DIMMs.....	2-11
	Removing Memory Modules .....	2-11
2-5	Motherboard Installation.....	2-16
	Tools Needed .....	2-16
	Location of Mounting Holes .....	2-16
	Installing the Motherboard .....	2-17
2-6	Control Panel Connectors and I/O Ports.....	2-18
	Back Panel Connectors and I/O Ports.....	2-18
	Back Panel I/O Port Locations and Definitions .....	2-18
	Serial Ports.....	2-19

---

	Video Connection .....	2-19
	Universal Serial Bus (USB).....	2-20
	Ethernet Ports .....	2-21
	Front Control Panel.....	2-22
	Front Control Panel Pin Definitions.....	2-23
	NMI Button .....	2-23
	Power LED .....	2-23
	HDD LED.....	2-24
	NIC1/NIC2 LED Indicators .....	2-24
	Overheat (OH)/Fan Fail LED.....	2-25
	Power Fail LED .....	2-25
	Reset Button .....	2-26
	Power Button .....	2-26
2-7	Connecting Cables.....	2-27
	Power Connectors .....	2-27
	Fan Headers.....	2-28
	Chassis Intrusion .....	2-28
	Internal Speaker .....	2-29
	Power LED/Speaker.....	2-29
	TPM Header/Port 80 .....	2-30
	Overheat LED/Fan Fail .....	2-30
	Power SMB (I <sup>2</sup> C) Connector .....	2-31
	IPMB.....	2-31
	T-SGPIO 1/2 Headers .....	2-32
	DOM Power Connector.....	2-32
2-8	Jumper Settings .....	2-33
	Explanation of Jumpers .....	2-33
	GLAN Enable/Disable .....	2-33
	CMOS Clear.....	2-34
	Watch Dog Enable/Disable .....	2-34
	VGA Enable.....	2-35
	BMC Enable .....	2-35
	Management Engine (ME) Recovery .....	2-36
	Manufacture Mode Select .....	2-36
2-9	Onboard LED Indicators .....	2-37
	GLAN LEDs.....	2-37
	IPMI Dedicated LAN LEDs.....	2-37
	Onboard Power LED .....	2-38
	BMC Heartbeat LED .....	2-38

---

2-10	Serial ATA Connections.....	2-39
	Serial ATA Ports.....	2-39
	SCU Ports .....	2-39

**Chapter 3 Troubleshooting**

3-1	Troubleshooting Procedures .....	3-1
3-2	Technical Support Procedures .....	3-5
3-3	Battery Removal and Installation .....	3-6
3-4	Frequently Asked Questions .....	3-7
3-5	Returning Merchandise for Service.....	3-8

**Chapter 4 BIOS**

4-1	Introduction.....	4-1
4-2	Main Setup.....	4-2
4-3	Advanced Setup Configurations.....	4-3
4-4	Event Logs .....	4-24
4-5	IPMI .....	4-26
4-6	Boot.....	4-28
4-7	Security .....	4-29
4-8	Save & Exit .....	4-30

**Appendix A BIOS Error Beep Codes**

A-1	BIOS Error Beep Codes .....	A-1
-----	-----------------------------	-----

**Appendix B Software Installation Instructions**

B-1	Installing Software Programs .....	B-1
B-2	Configuring SuperDoctor® III.....	B-2



# Chapter 1

## Overview

### 1-1 Overview

#### Checklist

Congratulations on purchasing your computer motherboard from an acknowledged leader in the industry. Supermicro boards are designed with the utmost attention to detail to provide you with the highest standards in quality and performance.

Please check that the following items have all been included with your motherboard. If anything listed here is damaged or missing, contact your retailer.

The following items are included in the retail box.

- One (1) Supermicro Mainboard
- Two (2) Serial ATA cables (CBL-0044Lx2)
- Two (2) I-Pass to Serial ATA cables (CBL-097L-03 x2) (for X9DR3-F)
- One (1) I-Pass to Serial ATA cables (CBL-097L-03) (for X9DRi-F)
- One (1) I/O Shield (MCP-260-00042-0N)
- One (1) Quick Reference Guide (MNL-1259-QRG)



**Note:** For your system to work properly, please follow the links below to download all necessary drivers/utilities and the user's manual for your motherboard.

SMCI product manuals: <http://www.supermicro.com/support/manuals/>

Product Drivers and utilities: <ftp://ftp.supermicro.com/>

If you have any questions, please contact our support team at [support@supermicro.com](mailto:support@supermicro.com).

SUPER Motherboard Image

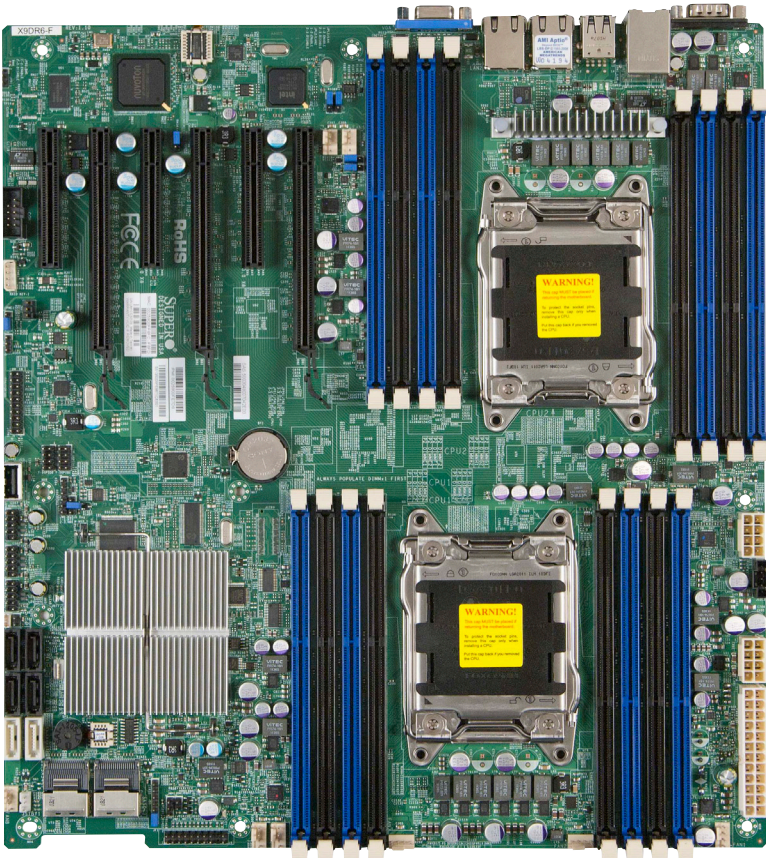

**Note:** All graphics shown in this manual were based upon the latest PCB Revision available at the time of publishing of the manual. The motherboard you've received may or may not look exactly the same as the graphics shown in this manual.

## Motherboard Layout

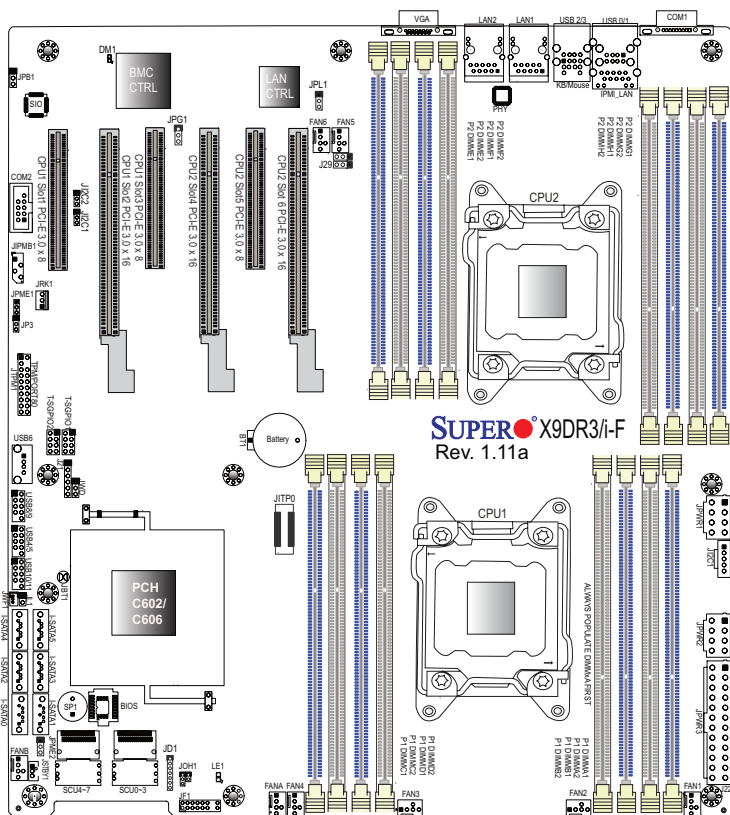

**Note 1:** For the latest CPU/Memory updates, please refer to our Website at <http://www.supermicro.com/products/motherboard/> for details.

**Note 2:** Changing BMC log-in information is recommended during initial system power-on. The default username is ADMIN and password is ADMIN. For BMC best practices, please refer to: [http://www.supermicro.com/products/info/files/IPMI/Best\\_Practices\\_BMC\\_Security.pdf](http://www.supermicro.com/products/info/files/IPMI/Best_Practices_BMC_Security.pdf)

## X9DR3-F/X9DRi-F Quick Reference

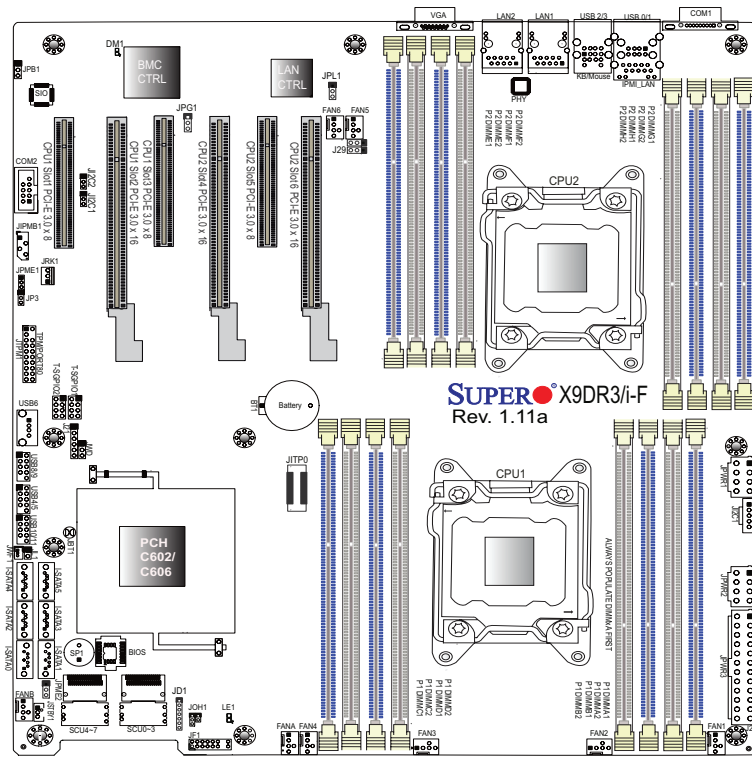

 **Notes:**

- See Chapter 2 for detailed information on jumpers, I/O ports and JF1 front panel connections.
- "■" indicates the location of "Pin 1".
- Jumpers/LED Indicators not indicated are for testing only.
- *Components that are not documented in this manual are reserved for internal use only.*
- Use only the correct type of onboard CMOS battery as specified by the manufacturer. Do not install the onboard battery upside down to avoid possible explosion.

**X9DR3-F/X9DRi-F Jumpers**

<b>Jumper</b>	<b>Description</b>	<b>Default Setting</b>
JBT1	Clear CMOS	See Chapter 2
JPB1	BMC Enabled	Pins 1-2 (Enabled)
JPG1	VGA Enabled	Pins 1-2 (Enabled)
JPL1	GLAN1/GLAN2 Enable	Pins 1-2 (Enabled)
JPME1	Management Engine (ME) Recovery Mode Enable	Pins 1-2 (Normal)
JPME2	Management Engine (ME) Manufacture Mode	Pins 1-2 (Normal)
JWD	Watch Dog Timer Enable	Pins 1-2 (Reset)

**X9DR3-F/X9DRi-F Connectors**

<b>Connectors</b>	<b>Description</b>
BT1	Onboard Battery (See Chpt. 3 for Used Battery Disposal)
COM1/COM2	Backplane COM Port1/Front Accessible COM2 Header
FAN1~6, FAN A, FAN B	CPU/System Fan Headers
I-SATA 0/1	Intel SB SATA 3.0 Connectors 0/1 (Color: White)
I-SATA 2~5	Intel SB SATA 2.0 Connectors 2~5 (Color: Black)
J22 (JPWR3)	ATX 24-Pin Power Connector (See Warning on Pg. 1-6.)
JD1	Speaker/Power LED Indicator
JF1	Front Panel Control Header
JIPMB1	4-pin External BMC I <sup>2</sup> C Header (for an IPMI Card)
JL1	Chassis Intrusion
JOH1	Overheat LED Indicator
JPI <sup>2</sup> C1	Power Supply SMBbus I <sup>2</sup> C Header
JPWR1/2	12V 8-Pin Power Connectors (See Warning on Pg. 1-6.)
JSTBY1	Standby Header
JTPM1	TPM (Trusted Platform Module)/Port 80
JWF1	SATA DOM (Disk on Module) Power Connector
Keyboard/Mouse	PS2 Keyboard/Mouse (optional)
LAN1/LAN2	G-bit Ethernet Ports 1/2
(IPMI) LAN	IPMI_Dedicated LAN
SCU 0~3, 4~7	Storage Control Unit (SCU) Connectors 0~3, 4~7 (SCU 4~7: X9DR3-F only)
SP1	Onboard Buzzer (Internal Speaker)
Slot2, Slot4, Slot6	CPU1 Slot2/CPU2 Slot4/CPU2 Slot6 PCI-Exp. 3.0 x16



Slot1, Slot3, Slot5	CPU1 Slot1/CPU1 Slot3/CPU2 Slot5 PCI-Exp. 3.0 x8
T-SGPIO 1/2	Serial_Link General Purpose I/O Headers
BP USB 0/1, 2/3	Back Panel USB 0/1, 2/3
USB 4/5, USB 6, USB 8/9, USB 10/11	Front Panel Accessible USB Connections
VGA	Backpanel VGA Port

**X9DR3-F/X9DRi-F LED Indicators**

LED	Description	State	Status
DM1	BMC Heartbeat LED	Green: Blinking	BMC Normal
LE1	Standby PWR LED	Green: On	SB Power On

**Warning:** To prevent damage to the power supply or motherboard, please use a power supply that contains a 24-pin and two 8-pin power connectors. Be sure to connect these power supply connectors to the 24-pin power connector (JPWR3) and two 8-pin power connectors (JPWR1, JPWR2) on the motherboard. Failure in doing so will void the manufacturer warranty on your power supply and motherboard.

## Motherboard Features

<b>CPU</b>	<ul style="list-style-type: none"> <li>Dual Intel® E5-2600(v2) Series Processors (Socket R LGA2011); each processor supports four full-width Intel QuickPath Interconnect (QPI) links (with support of up to 25.6 GT/s per QPI link and with Data Transfer Rate of up to 8.0 GT/s per direction).</li> </ul> <p> <b>Note:</b> For Intel E5-2600(v2) processor support, BIOS version 3.0 or above is required.</p>	
<b>Memory</b>	<ul style="list-style-type: none"> <li>Integrated memory controller supports up to 1 TB of Load Reduced (LRDIMM), 512 GB of Registered (RDIMM) or 128 GB of Unbuffered (UDIMM) ECC/Non-ECC DDR3 800/1066/1333/1600/1866 MHz 240-pin 4-channel memory modules in 16 DIMM slots.</li> </ul> <p> <b>Note 1:</b> 1866 MHz memory speed is dependent on Intel E5-2600v2 CPUs.</p> <p><b>Note 2:</b> For the latest memory updates, please refer to the Tested Memory List posted on our website (<a href="http://www.supermicro.com/products/motherboard">http://www.supermicro.com/products/motherboard</a>).</p>	
	<ul style="list-style-type: none"> <li>Virtualization: VT-x, VT-d, and VT-c</li> </ul>	
<b>Chipset</b>	<ul style="list-style-type: none"> <li>Intel® PCH C606/C602</li> </ul>	
<b>Expansion Slots</b>	<ul style="list-style-type: none"> <li>Three (3) PCI Express 3.0 x16 slots (CPU1 Slot2/CPU2 Slot4/CPU2 Slot6)</li> <li>Three (3) PCI Express 3.0 x8 slots (CPU1 Slot1/CPU1 Slot3/CPU2 Slot5)</li> </ul>	
<b>Graphics</b>	<ul style="list-style-type: none"> <li>Nuvoton BMC Video Controller (Matrox G200)</li> </ul>	
<b>Network</b>	<ul style="list-style-type: none"> <li>One Intel I350 Gigabit (10/100/1000 Mb/s) Ethernet Dual-Channel Controller for LAN 1/LAN 2 ports.</li> </ul>	
	<ul style="list-style-type: none"> <li>Nuvoton WP450R Base-board Controller (BMC) supports IPMI_LAN 2.0</li> </ul>	
<b>I/O Devices</b>	<b>SATA Connections</b>	
	<ul style="list-style-type: none"> <li>SATA Ports</li> </ul>	Six (6): Two (2) SATA 3.0 and Four (4) SATA 2.0 Ports
	<ul style="list-style-type: none"> <li>RAID (Linux)</li> </ul>	RAID 0, 1, 5, 10

	<b>SCU (Storage Control Unit) Connections</b>
	<ul style="list-style-type: none"> <li>SCU Ports: 0~3, 4~7 (X9DR3-F) 0~3 (X9DRi-F)</li> <li>RAID Support: RAID 0, 1, 10 (X9DR3-F) RAID 0, 1, 5, 10 (X9DRi-F)</li> </ul>
	<b>Integrated IPMI 2.0</b>
	<ul style="list-style-type: none"> <li>IPMI 2.0 supported by the WPCM450R BMC</li> </ul>
	<b>Serial (COM) Port</b>
	<ul style="list-style-type: none"> <li>Two (2) Fast UART 16550 Connection: 9-pin RS-232 port</li> </ul>
	<b>Super I/O</b>
	<ul style="list-style-type: none"> <li>Winbond Super I/O 83527</li> </ul>
<b>Peripheral Devices</b>	<b>USB Devices</b>
	<ul style="list-style-type: none"> <li>Four (4) USB ports on the rear I/O panel (USB 0/1, USB 2/3),</li> <li>Six (6) USB connections for front access (USB 4/5, USB 8/9, USB 10/11),</li> </ul>
	<ul style="list-style-type: none"> <li>One (1) Type A USB connection for front access (USB 7)</li> </ul>
<b>BIOS</b>	<ul style="list-style-type: none"> <li>16 MB SPI AMI BIOS® SM Flash BIOS</li> </ul>
	<ul style="list-style-type: none"> <li>APM 1.2, PCI 2.3, ACPI 1.0/2.0/3.0, USB Keyboard, Plug &amp; Play (PnP) and SMBIOS 2.5</li> </ul>
<b>Power Management</b>	<ul style="list-style-type: none"> <li>ACPI/ACPM Power Management</li> </ul>
	<ul style="list-style-type: none"> <li>Main switch override mechanism</li> </ul>
	<ul style="list-style-type: none"> <li>Keyboard Wake-up from Soft-Off</li> </ul>
	<ul style="list-style-type: none"> <li>Power-on mode for AC power recovery</li> </ul>
	<ul style="list-style-type: none"> <li>Intel® Intelligent Power Node Manager (Available when the NMView Software is Installed)</li> <li>Management Engine</li> </ul>
<b>PC Health Monitoring</b>	<b>CPU Monitoring</b>
	<ul style="list-style-type: none"> <li>Onboard voltage monitors for 1.8V, +3.3V, 3.3VSB, +5V Standby, 1.35V, 1.5V, Chipset Voltage, and Battery Voltage.</li> <li>CPU 5-Phase switching voltage regulator</li> </ul>



	<ul style="list-style-type: none"> <li>• CPU/System overheat LED and control</li> </ul>
	<ul style="list-style-type: none"> <li>• CPU Thermal Trip support</li> </ul>
	<ul style="list-style-type: none"> <li>• Thermal Monitor 2 (TM2) support</li> </ul>
	<b>Fan Control</b>
	<ul style="list-style-type: none"> <li>• Fan status monitoring with firmware thermal management via IPMI 2.0</li> </ul>
	<ul style="list-style-type: none"> <li>• Low noise fan speed control</li> </ul>
<b>System Management</b>	<ul style="list-style-type: none"> <li>• PECI (Platform Environment Configuration Interface) 2.0 support</li> </ul>
	<ul style="list-style-type: none"> <li>• System resource alert via SuperDoctor® III</li> </ul>
	<ul style="list-style-type: none"> <li>• SuperDoctor® III, Watch Dog, NMI</li> </ul>
	<ul style="list-style-type: none"> <li>• Chassis Intrusion Header and Detection</li> </ul>
<b>Dimensions</b>	<ul style="list-style-type: none"> <li>• 12.00" (L) x 13.00" (W) (304.80 mm x 330.20 mm)</li> </ul>

 **Note:** For IPMI Configuration Instructions, please refer to the Embedded IPMI Configuration User's Guide available @ <http://www.supermicro.com/support/manuals/>.

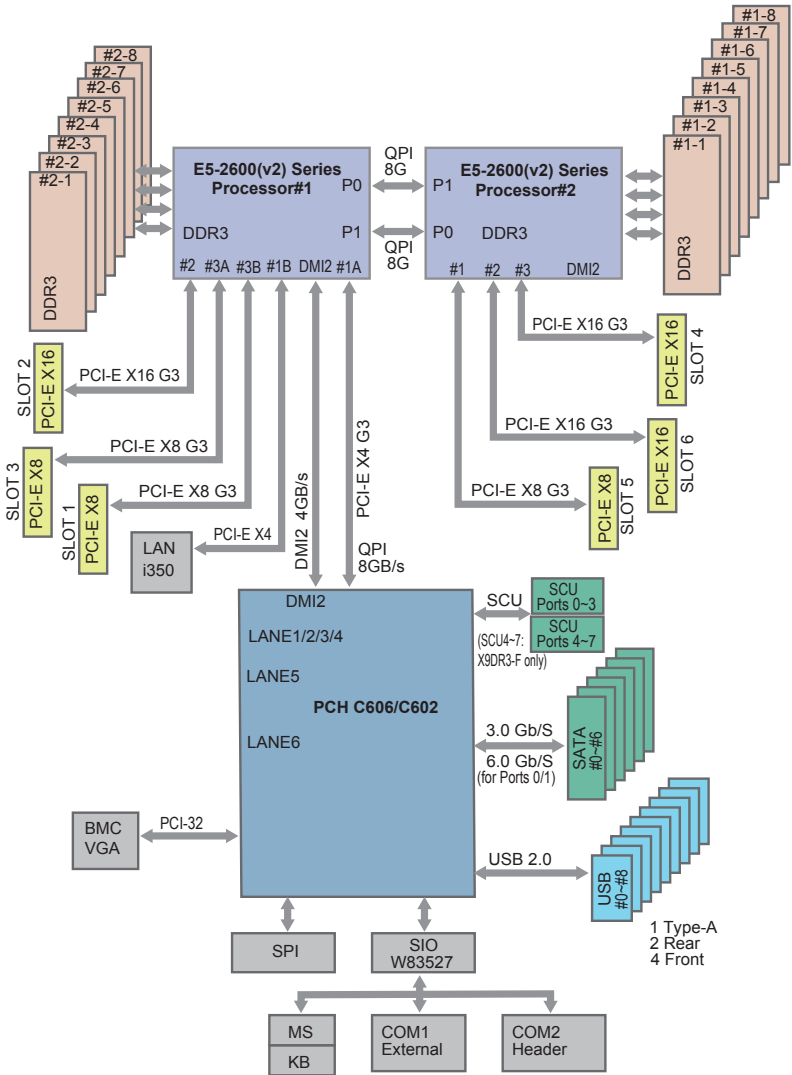

### System Block Diagram

 **Note:** This is a general block diagram and may not exactly represent the features on your motherboard. See the Motherboard Features pages for the actual specifications of each motherboard.

## 1-2 Processor and Chipset Overview

Built upon the functionality and the capability of Intel® E5-2600(v2) Series Processor (Socket R LGA 2011) and the PCH C606/C602 chipset, the X9DR3-F/X9DRi-F motherboard provides the performance and feature sets required for dual\_processor-based HPC/Cluster/Database servers. (See note below for processor support.)

With support of Intel QuickPath interconnect (QPI) Technology, the X9DR3-F/X9DRi-F offers point-to-point serial interconnect interface with a transfer speed of up to 8.0 GT/s, providing superb system performance.

The PCH C606/C602 chipset provides extensive IO support, including the following functions and capabilities:

- PCI-Express Rev. 2.0 support
- PCI-Express Gen. 3 uplink supported by some SKUs
- ACPI Power Management Logic Support Rev. 3.0b or Rev. 4.0
- USB host interface backplane and front access support
- Intel Rapid Storage Technology supported
- Intel Virtualization Technology for Directed I/O (Intel VT-d) supported
- Intel Trusted Execution Technology supported
- Serial Peripheral Interface (SPI) Supported
- Digital Media Interface (DMI) supported
- Advanced Host Controller Interface (AHCI) supported



**Note:** For Intel E5-2600(v2) processor support, BIOS version 3.0 or above is required.

## 1-3 Special Features

### Recovery from AC Power Loss

The Basic I/O System (BIOS) provides a setting that determines how the system will respond when AC power is lost and then restored to the system. You can choose for the system to remain powered off (in which case you must press the power switch to turn it back on), or for it to automatically return to the power-on state. See the Advanced BIOS Setup section for this setting. The default setting is **Last State**.

## 1-4 PC Health Monitoring

This section describes the features of PC health monitoring of the motherboard. This motherboard has an onboard System\_Hardware\_Monitor chip that supports PC health monitoring. An onboard voltage monitor will scan the voltages of CPU, memory, chipset and onboard battery continually. Once a voltage becomes unstable, a warning is given, or an error message is sent to the screen. The user can adjust the voltage thresholds to define the sensitivity of the voltage monitor.

### Fan Status Monitor with Firmware Control

The PC health monitoring chip can check the RPM status of a cooling fan. The onboard CPU and chassis fans are controlled by firmware thermal management via IPMI 2.0.

### Environmental Temperature Control

A thermal control sensor monitors the CPU temperature in real time and will turn on the thermal control fan whenever the CPU temperature exceeds a user-defined threshold. The overheat circuitry runs independently from the CPU. Once the thermal management firmware detects that the CPU temperature is too high, it will automatically turn on the thermal fan control to prevent the CPU from overheating. The onboard chassis thermal circuitry can monitor the overall system temperature and alert the user when the chassis temperature is too high.



**Note:** To avoid possible system overheating, please be sure to provide adequate airflow to your system.

### System Resource Alert

This feature is available when used with SuperDoctor® III in the Windows OS environment or used with SuperDoctor II in Linux. SuperDoctor is used to notify the user of certain system events. For example, you can configure SuperDoctor

to provide you with warnings when the system temperature, CPU temperatures, voltages, and fan speeds go beyond a pre-defined range.

## 1-5 ACPI Features

ACPI stands for Advanced Configuration and Power Interface. The ACPI specification defines a flexible and abstract hardware interface that provides a standard way to integrate power management features throughout a PC system, including its hardware, operating system and application software. This enables the system to automatically turn on and off peripherals such as CD-ROMs, network cards, hard disk drives and printers.

In addition to operating\_system-directed power management, ACPI also provides a generic system event mechanism for Plug and Play, and an operating system-independent interface for configuration control. ACPI leverages the Plug and Play BIOS data structures, while providing a processor architecture-independent implementation that is compatible with Windows 7, Windows Vista and Windows 2008 Operating Systems.

### Slow Blinking LED for Suspend-State Indicator

When the CPU goes into a suspend state, the chassis power LED will start blinking to indicate that the CPU is in suspend mode. When the user presses any key, the CPU will "wake up," and the LED will automatically stop blinking and remain on.

## 1-6 Power Supply

As with all computer products, a stable power source is necessary for proper and reliable operation. It is even more important for processors that have high CPU clock rates.

The X9DR3-F/X9DRi-F motherboard accommodates 24-pin ATX power supplies. Although most power supplies generally meet the specifications required by the CPU, some are inadequate. In addition, two 12V 8-pin power connections are also required to ensure adequate power supply to the system. Your power supply must also supply 1.5A for the Ethernet ports.

**Warning:** To avoid damaging the power supply or motherboard, please use a power supply that contains a 24-pin and two 8-pin power connectors. Be sure to connect these power supply connectors to the 24-pin (JPWR3) and two 8-pin power connectors (JPWR1, JPWR2) on the motherboard. Failure to do so will void the manufacturer warranty on your power supply and motherboard.

It is strongly recommended that you use a high quality power supply that meets ATX power supply Specification 2.02 or above. It must also be SSI compliant. (For more information, please refer to the Website at <http://www.ssiforum.org/>). Additionally, in areas where noisy power transmission is present, you may choose to install a line filter to shield the computer from noise. It is recommended that you also install a power surge protector to help avoid problems caused by power surges.

## 1-7 Super I/O

The Super I/O supports two high-speed, 16550 compatible serial communication ports (UARTs). Each UART includes a 16-byte send/receive FIFO, a programmable baud rate generator, complete modem control capability, and a processor interrupt system. Both UARTs provide legacy speed with baud rate of up to 115.2 Kbps as well as an advanced speed with baud rates of 250 K, 500 K, or 1 Mb/s, which support higher speed modems.

The Super I/O provides functions that comply with ACPI (Advanced Configuration and Power Interface), which includes support of legacy and ACPI power management through an SMI or SCI function pin. It also features auto power management to reduce power consumption.

## 1-8 Advanced Power Management

### **Intel® Intelligent Power Node Manager (NM) (Available when NMView Software is Installed)**

The Intel® Intelligent Power Node Manager (IPNM) provides your system with real-time thermal control and power management for maximum energy efficiency. Although IPNM Specification Version 1.5/2.0 is supported by the BMC (Baseboard Management Controller), your system must also have IPNM-compatible Management Engine (ME) firmware installed to use this feature.



**Note:** Support for IPNM Specification Version 1.5 or 2.0 depends on the power supply used in the system.

### **Management Engine (ME)**

The Management Engine, which is an ARC controller embedded in the PCH, provides Server Platform Services (SPS) to your system. The services provided by SPS are different from those provided by the ME on client platforms.

## 1-9 Overview of the Nuvoton WPCM450 Controller

The Nuvoton WPCM450R Controller, a Baseboard Management Controller (BMC), supports 2D/VGA-compatible Graphic Cores with PCI interface, creating multi-media virtualization via Keyboard/Video/Mouse Redirection (KVMR). The WPCM450R Controller is ideal for remote system management.

The WPCM450R Controller interfaces with the host system via PCI connections to communicate with the graphics cores. It supports USB 2.0 and 1.1 for remote keyboard/mouse/virtual media emulation. It also provides LPC interface support to control Super IO functions. The WPCM450R Controller is connected to the network via an external Ethernet PHY module or shared NCSI connections.

The WPCM450R communicates with onboard components via six SMBus interfaces, PECE (Platform Environment Control Interface) buses, and General Purpose I/O ports.

### Other Features Supported by the WPCM BMC Controller

The WPCM450R supports the following features:

- IPMI 2.0
- Serial over LAN
- KVM over LAN
- LAN Alerting-SNMP Trap
- Event Log
- X-Bus parallel interface for I/O expansion
- Multiple ADC inputs, Analog and Digital Video outputs
- SPI Flash Host BIOS and firmware bootstrap program supported
- Reduced Media Independent Interface (RMII)
- OS (Operating System) Independency
- Provides remote Hardware Health Monitoring via IPMI. Key features
- Provides Network Management Security via remote access/console redirection.
- Supports the following Management tools: IPMIView, CLI (Command Line Interface)

- RMCP+ protocol supported



**Note 1:** For more information on IPMI configuration, please refer to the IPMI User's Guide posted on our website at <http://www.supermicro.com/support/manuals/>.

**Note 2:** The term "IPMI controller" and the term "BMC controller" can be used interchangeably in this section.



---

---

## Chapter 2

### Installation

#### 2-1 Standardized Warning Statements

The following statements are industry-standard warnings, provided to warn the user of situations which have the potential for bodily injury. Should you have questions or experience difficulty, contact Supermicro's Technical Support department for assistance. Only certified technicians should attempt to install or configure components.

Read this section in its entirety before installing or configuring components in the Supermicro chassis.

#### Battery Handling



##### Warning!

There is a danger of explosion if the battery is replaced incorrectly. Replace the battery only with the same or equivalent type recommended by the manufacturer. Dispose of used batteries according to the manufacturer's instructions

電池の取り扱い

電池交換が正しく行われなかった場合、破裂の危険性があります。交換する電池はメーカーが推奨する型、または同等のものを使用下さい。使用済電池は製造元の指示に従って処分して下さい。

##### 警告

電池更換不當會有爆炸危險。請只使用同類電池或製造商推薦的功能相當的電池更換原有電池。請按製造商的說明處理廢舊電池。

##### 警告

電池更換不當會有爆炸危險。請使用製造商建議之相同或功能相當的電池更換原有電池。請按照製造商的說明指示處理廢棄舊電池。

##### Warnung

Bei Einsetzen einer falschen Batterie besteht Explosionsgefahr. Ersetzen Sie die Batterie nur durch den gleichen oder vom Hersteller empfohlenen Batterietyp. Entsorgen Sie die benutzten Batterien nach den Anweisungen des Herstellers.

#### Attention

Danger d'explosion si la pile n'est pas remplacée correctement. Ne la remplacer que par une pile de type semblable ou équivalent, recommandée par le fabricant. Jeter les piles usagées conformément aux instructions du fabricant.

¡Advertencia!

Existe peligro de explosión si la batería se reemplaza de manera incorrecta. Reemplazar la batería exclusivamente con el mismo tipo o el equivalente recomendado por el fabricante. Desechar las baterías gastadas según las instrucciones del fabricante.

#### **אזהרה!**

קיימת סכנת פיצוץ של הסוללה במידה והוחלפה בדרך לא תקינה. יש להחליף את הסוללה בסוג התואם מחברת יצרן מומלצת.

סילוק הסוללות המשומשות יש לבצע לפי הוראות היצרן.

هناك خطر من انفجار في حالة استبدال البطارية بطريقة غير صحيحة فعليك استبدال البطارية فقط بنفس النوع أو ما يعادلها كما أوصت به الشركة المصنعة تخلص من البطاريات المستعملة وفقا لتعليمات الشركة الصانعة

경고!

배터리가 올바르게 교체되지 않으면 폭발의 위험이 있습니다. 기존 배터리와 동일하거나 제조사에서 권장하는 동등한 종류의 배터리로만 교체해야 합니다. 제조사의 안내에 따라 사용된 배터리를 처리하여 주십시오.

#### Waarschuwing

Er is ontploffingsgevaar indien de batterij verkeerd vervangen wordt. Vervang de batterij slechts met hetzelfde of een equivalent type die door de fabrikant aanbevolen wordt. Gebruikte batterijen dienen overeenkomstig fabrieksvoorschriften afgevoerd te worden.

## Product Disposal



### Warning!

Ultimate disposal of this product should be handled according to all national laws and regulations.

### 製品の廃棄

この製品を廃棄処分する場合、国の関係する全ての法律・条例に従い処理する必要があります。

### 警告

本产品的废弃处理应根据所有国家的法律和规章进行。

### 警告

本產品的廢棄處理應根據所有國家的法律和規章進行。

### Warnung

Die Entsorgung dieses Produkts sollte gemäß allen Bestimmungen und Gesetzen des Landes erfolgen.

### ¡Advertencia!

Al deshacerse por completo de este producto debe seguir todas las leyes y reglamentos nacionales.

### Attention

La mise au rebut ou le recyclage de ce produit sont généralement soumis à des lois et/ou directives de respect de l'environnement. Renseignez-vous auprès de l'organisme compétent.

## 2-2 Static-Sensitive Devices

Electrostatic Discharge (ESD) can damage electronic components. To avoid damaging your system board, it is important to handle it very carefully. The following measures are generally sufficient to protect your equipment from ESD.

### Precautions

- Use a grounded wrist strap designed to prevent static discharge.
- Touch a grounded metal object before removing the board from the antistatic bag.
- Handle the board by its edges only; do not touch its components, peripheral chips, memory modules or gold contacts.
- When handling chips or modules, avoid touching their pins.
- Put the motherboard and peripherals back into their antistatic bags when not in use.
- For grounding purposes, make sure that your system chassis provides excellent conductivity between the power supply, the case, the mounting fasteners and the motherboard.

### Unpacking

The motherboard is shipped in antistatic packaging to avoid static damage. When unpacking the board, make sure that the person handling it is static protected.

## 2-3 Processor and Heatsink Installation

**Warning:** When handling the processor package, avoid placing direct pressure on the label area.

 **Notes:**

- Always connect the power cord last, and always remove it before adding, removing or changing any hardware components. Make sure that you install the processor into the CPU socket before you install the CPU heatsink.
- If you buy a CPU separately, make sure that you use an Intel-certified multi-directional heatsink only.
- Make sure to install the system board into the chassis before you install the CPU heatsink.
- When receiving a server board without a processor pre-installed, make sure that the plastic CPU socket cap is in place and none of the socket pins are bent; otherwise, contact your retailer immediately.
- Refer to the Supermicro website for updates on CPU support.

### Installing the LGA2011 Processor

1. There are two load levers on the LGA2011 socket. To open the socket cover, first press and release the load lever labeled 'Open 1st'.

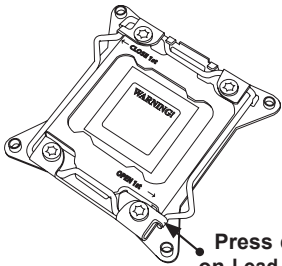
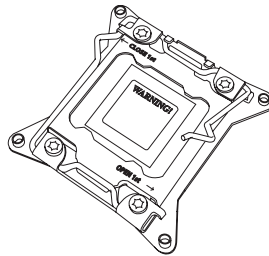
**1****2**

2. Press the second load lever labeled 'Close 1st' to release the load plate that covers the CPU socket from its locking position.

**1**

Press down on Load the Lever labeled 'Close 1st'

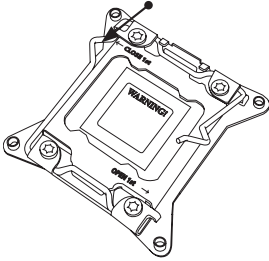

**2**

Pull lever away from the socket

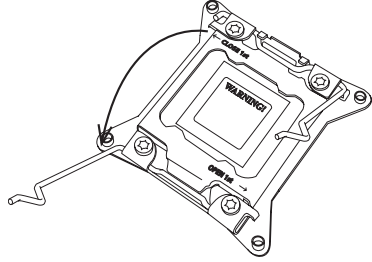

3. With the lever labeled 'Close 1st' fully retracted, gently push down on the 'Open 1st' lever to open the load plate. Lift the load plate to open it completely.

**1**

Gently push down to pop the load plate open.

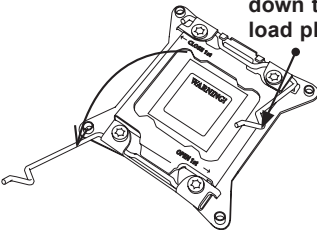

**2**

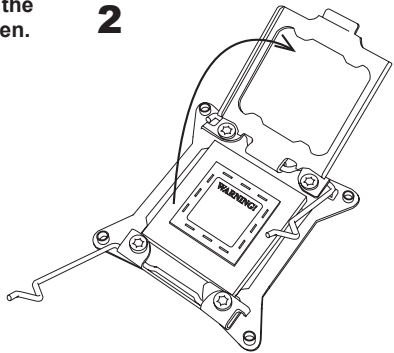

1. Using your thumb and the index finger, remove the 'WARNING' plastic cap from the socket.

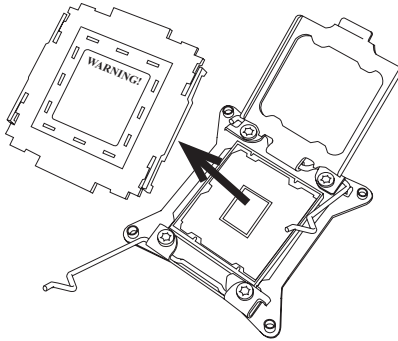

2. Use your thumb and index finger to hold the CPU on its edges. Align the CPU keys, which are semi-circle cutouts, against the socket keys.

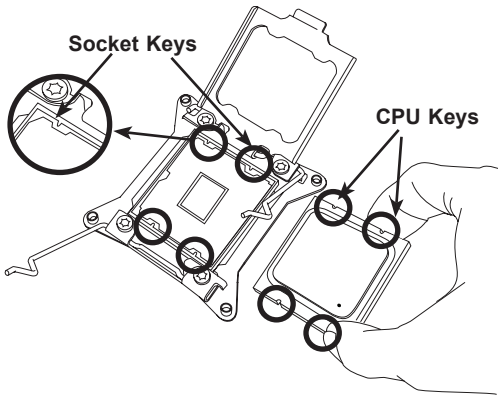

3. Once they are aligned, carefully lower the CPU straight down into the socket. (Do not drop the CPU on the socket. Do not move the CPU horizontally or vertically. Do not rub the CPU against the surface or against any pins of the socket to avoid damaging the CPU or the socket.)

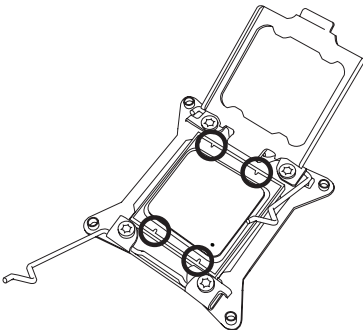

**Warning:** You can only install the CPU inside the socket in one direction. Make sure that it is properly inserted into the CPU socket before closing the load plate. If it doesn't close properly, do not force it as it may damage your CPU. Instead, open the load plate again and double-check that the CPU is aligned properly.

4. With the CPU inside the socket, inspect the four corners of the CPU to make sure that the CPU is properly installed.
5. Close the load plate with the CPU inside the socket. Lock the lever labeled 'Close 1st' first, then lock the lever labeled 'Open 1st' second. Use your thumb to gently push the load levers down to the lever locks.

**1**

Gently close the load plate.

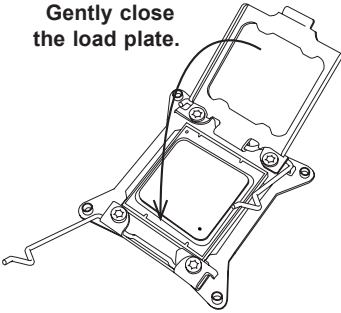

**2**

Push down and lock the lever labeled 'Close 1st'.

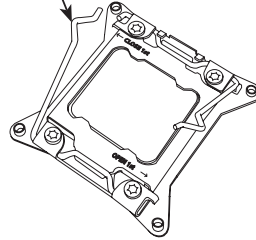

**3**

Lever Lock

Push down and lock the lever labeled 'Open 1st'

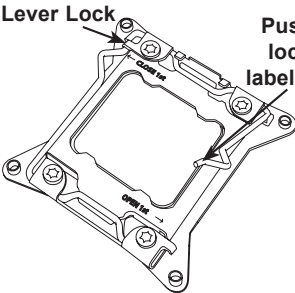

**4**

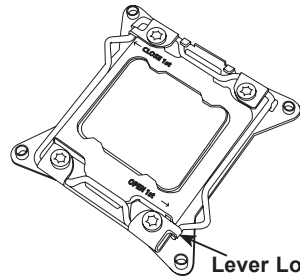



Lever Lock

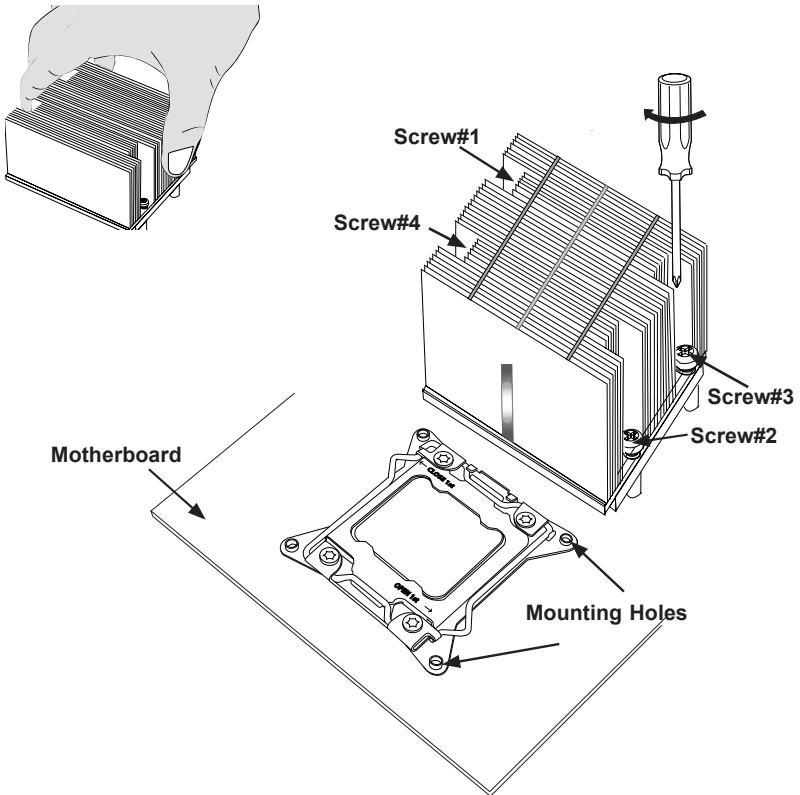

## Installing a Passive CPU Heatsink

1. Do not apply any thermal grease to the heatsink or the CPU die -- the required amount has already been applied.
2. Place the heatsink on top of the CPU so that the four mounting holes are aligned with those on the Motherboard's and the Heatsink Bracket underneath.
3. Screw in two diagonal screws (i.e., the #1 and the #2 screws) until just snug (do not over-tighten the screws to avoid possible damage to the CPU.)
4. Finish the installation by fully tightening all four screws.



 **Notes:** 1. For optimized airflow, please follow your chassis airflow direction to install the correct CPU heatsink direction. 2. Graphic drawings included in this manual are for reference only. They might look different from the components installed in your system.

## Removing the Heatsink

**Warning:** We do not recommend that the CPU or the heatsink be removed. However, if you do need to uninstall the heatsink, please follow the instructions below to uninstall the heatsink to prevent damage done to the CPU or the CPU socket.

1. Unscrew the heatsink screws from the motherboard in the sequence as shown in the illustration below.
2. Gently wriggle the heatsink to loosen it from the CPU. (Do not use excessive force when wriggling the heatsink!)
3. Once the CPU is loosened, remove the CPU from the CPU socket.
4. Remove the used thermal grease and clean the surface of the CPU and the heatsink. Reapply the proper amount of thermal grease on the surface before reinstalling the CPU and the heatsink.

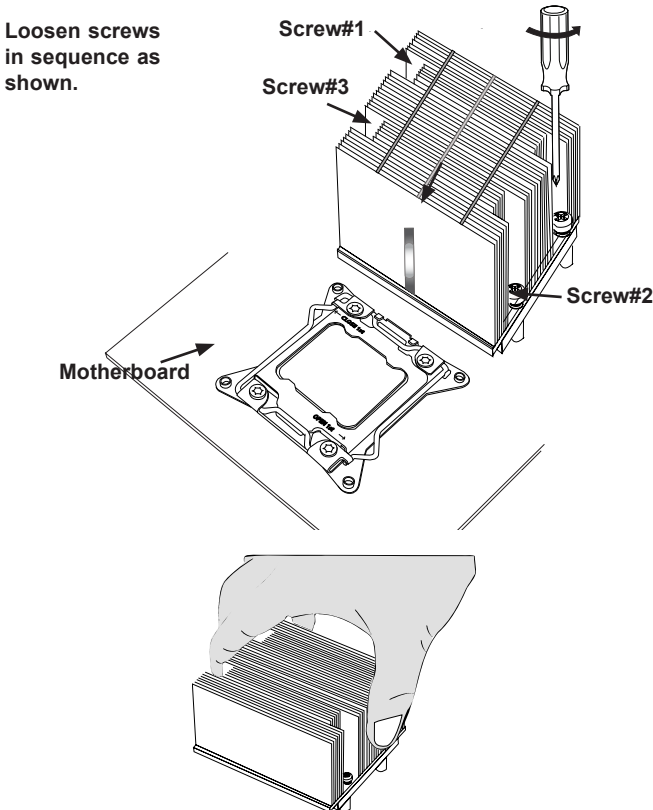

**⚠ Do not reuse thermal grease!**

## 2-4 Installing and Removing the Memory Modules

 **Note:** Check Supermicro's website for recommended memory modules.

### CAUTION

Exercise extreme care when installing or removing DIMM modules to prevent any possible damage.

### Installing & Removing DIMMs

1. Insert the desired number of DIMMs into the memory slots, starting with P1-DIMMA1. (For best performance, please use the memory modules of the same type and speed in the same bank.)
2. Push the release tabs outwards on both ends of the DIMM slot to unlock it.

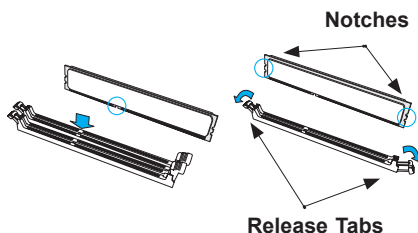
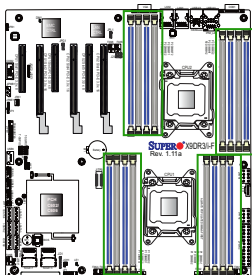

3. Align the key of the DIMM module with the receptive point on the memory slot.
4. Align the notches on both ends of the module against the receptive points on the ends of the slot.
5. Use two thumbs together to press the notches on both ends of the module straight down into the slot until the module snaps into place.
6. Press the release tabs to the locking positions to secure the DIMM module into the slot.

Press both notches straight down into the memory slot at the same time.

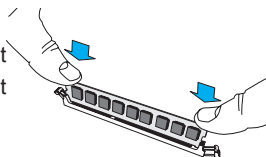

### Removing Memory Modules

Press both notches on the ends of the DIMM module to unlock it. Once the DIMM module is loosened, remove it from the memory slot.

### Memory Support for the X9DR3-F/X9DRi-F Motherboard

The X9DR3-F/X9DRi-F motherboard supports up to 1 TB of Load Reduced (LRDIMM), 512 GB of Registered (RDIMM) or 128 GB of Unbuffered (UDIMM) ECC/Non-ECC DDR3 800/1066/1333/1600/1866 MHz 240-pin 4-channel memory modules in 16 DIMM slots.



**Note:** For the latest memory updates, please refer to the Tested Memory List posted on our website (<http://www.supermicro.com/products/motherboard>).

### Processor & Memory Module Population Configuration

For memory to work properly, follow the tables below for memory installation.

Processors and their Corresponding Memory Modules								
CPU#	Corresponding DIMM Modules							
<b>CPU 1</b>	P1-DIMMA1	P1-DIMMB1	P1-DIMMC1	P1-DIMMD1	P1-DIMMA2	P1-DIMMB2	P1-DIMMC2	P1-DIMMD2
<b>CPU2</b>	P2-DIMME1	P2-DIMMF1	P2-DIMMG1	P2-DIMMH1	P2-DIMME2	P2-DIMM F2	P2-DIMMG2	P2-DIMMH2

Processor and Memory Module Population	
Number of CPUs+DIMMs	CPU and Memory Population Configuration Table (*For memory to work properly, please follow the instructions below.)
<b>1 CPU &amp; 2 DIMMs</b>	CPU1 P1-DIMMA1/P1-DIMMB1
<b>1 CPU &amp; 4 DIMMs</b>	CPU1 P1-DIMMA1/P1-DIMMB1, P1-DIMMC1/P1-DIMMD1
<b>1 CPU &amp; 5-8 DIMMs</b>	CPU1 P1-DIMMA1/P1-DIMMB1, P1-DIMMC1/P1-DIMMD1 + Any memory pairs in P1-DIMMA2/P1-DIMMB2/P1-DIMMC2/P1-DIMMD2 slots
<b>2 CPUs &amp; 4 DIMMs</b>	CPU1 + CPU2 P1-DIMMA1/P1-DIMMB1, P2-DIMME1/P2-DIMMF1
<b>2 CPUs &amp; 6 DIMMs</b>	CPU1 + CPU2 P1-DIMMA1/P1-DIMMB1/P1-DIMMC1/P1-DIMMD1, P2-DIMME1/P2-DIMMF1
<b>2 CPUs &amp; 8 DIMMs</b>	CPU1 + CPU2 P1-DIMMA1/P1-DIMMB1/P1-DIMMC1/P1-DIMMD1, P2-DIMME1/P2-DIMMF1/P2-DIMMG1/P2-DIMMH1
<b>2 CPUs &amp; 10-16 DIMMs</b>	CPU1/CPU2 P1-DIMMA1/P1-DIMMB1/P1-DIMMC1/P1-DIMMD1, P2-DIMME1/P2-DIMMF1/P2-DIMMG1/P2-DIMMH1 + Any memory pairs in P1, P2 DIMM slots
<b>2 CPUs &amp; 16 DIMMs</b>	CPU1/CPU2 P1-DIMMA1/P1-DIMMB1/P1-DIMMC1/P1-DIMMD1, P2-DIMME1/P2-DIMMF1/P2-DIMMG1/P2-DIMMH1, P1-DIMMA2/P1-DIMMB2/P1-DIMMC2/P1-DIMMD2, P2-DIMME2/P2-DIMMF2/P2-DIMMG2/P2-DIMMH2



**Notes:** 1866 MHz memory speed is dependent on Intel E5-2600v2 CPUs. For Intel E5-2600(v2) processor support, BIOS version 3.0 is required.

### Populating UDIMM (ECC/Non-ECC) Memory Modules

Intel E5-2600(v2) Series Processor UDIMM Memory Support											
Ranks Per DIMM & Data Width	Memory Capacity Per DIMM (See the Note below)			Speed (MT/s) and Voltage Validated by Slot per Channel (SPC) and DIMM Per Channel (DPC)							
				2 Slots Per Channel				3 Slots Per Channel			
	1DPC		2DPC		1DPC		2DPC				
	1.35V	1.5V	1.35V	1.5V	1.35V	1.5V	1.35V	1.5V			
SRx8 Non-ECC	1GB	2GB	4GB	NA	1066, 1333, 1600, 1866	NA	1066, 1333, 1600	N/A	1066, 1333, 1600, 1866	N/A	1066, 1333, 1600
DRx8 Non-ECC	2GB	4GB	8GB	NA	1066, 1333, 1600, 1866	NA	1066, 1333, 1600	N/A	1066, 1333, 1600, 1866	N/A	1066, 1333, 1600
SRx16 Non-ECC	512MB	1GB	2GB	NA	1066, 1333, 1600, 1866	NA	1066, 1333, 1600	N/A	1066, 1333, 1600, 1866	N/A	1066, 1333, 1600
SRx8 ECC	1GB	2GB	4GB	1066, 1333	1066, 1333, 1600, 1866	1066, 1333	1066, 1333, 1600	1066, 1333	1066, 1333, 1600, 1866	1066, 1333	1066, 1333, 1600
DRx8 ECC	2GB	4GB	8GB	1066, 1333	1066, 1333, 1600, 1866	1066, 1333	1066, 1333, 1600	1066, 1333	1066, 1333, 1600, 1866	1066, 1333	1066, 1333, 1600

**Note:** For detailed information on memory support and updates, please refer to the SMC Recommended Memory List posted on our website at <http://www.supermicro.com/support/resources/mem.cfm>.

### Populating RDIMM (ECC) Memory Modules

Intel E5-2600(v2) Series Processor RDIMM Memory Support													
Ranks Per DIMM & Data Width	Memory Capacity Per DIMM (See the Note Below)			Speed (MT/s) and Voltage Validated by Slot per Channel (SPC) and DIMM Per Channel (DPC)									
				2 Slots Per Channel				3 Slots Per Channel					
	1DPC		2DPC		1 DPC		2DPC		3DPC				
	1.35V	1.5V	1.35V	1.5V	1.35V	1.5V	1.35V	1.5V	1.35V	1.5V	1.35V	1.5V	
SRx8	1GB	2GB	4GB	1066, 1333	1066, 1333, 1600, 1866	1066, 1333	1066, 1333, 1600	1066, 1333	1066, 1333, 1600, 1866	1066, 1333	1066, 1333, 1600	800	800, 1066
DRx8	2GB	4GB	8GB	1066, 1333	1066, 1333, 1600, 1866	1066, 1333	1066, 1333, 1600	1066, 1333	1066, 1333, 1600, 1866	1066, 1333	1066, 1333, 1600	800	800, 1066
SRx4	2GB	4GB	8GB	1066, 1333	1066, 1333, 1600, 1866	1066, 1333	1066, 1333, 1600	1066, 1333	1066, 1333, 1600, 1866	1066, 1333	1066, 1333, 1600	800	800, 1066
DRx4	4GB	8GB	16GB	1066, 1333	1066, 1333, 1600, 1866	1066, 1333	1066, 1333, 1600	1066, 1333	1066, 1333, 1600, 1866	1066, 1333	1066, 1333, 1600	800	800, 1066
QRx4	8GB	16GB	32GB	800	800, 1066	800	800	800	800, 1066	800	800	N/A	N/A
QRx8	4GB	8GB	16GB	800	800, 1066	800	800	800	800, 1066	800	800	N/A	N/A

**Note:** For detailed information on memory support and updates, please refer to the SMC Recommended Memory List posted on our website at <http://www.supermicro.com/support/resources/mem.cfm>.

*Populating UDIMM (ECC/Non-ECC) Memory Modules*

<b>Intel E5-2600 Series Processor UDIMM Memory Support</b>											
Ranks Per DIMM & Data Width	Memory Capacity Per DIMM  (See the Note below)			Speed (MT/s) and Voltage Validated by Slot per Channel (SPC) and DIMM Per Channel (DPC)							
				2 Slots Per Channel				3 Slots Per Channel			
	1DPC		2DPC		1DPC		2DPC				
	1.35V	1.5V	1.35V	1.5V	1.35V	1.5V	1.35V	1.5V			
SRx8 Non-ECC	1GB	2GB	4GB	NA	1066, 1333	NA	1066, 1333	N/A	1066, 1333	N/A	1066, 1333
DRx8 Non-ECC	2GB	4GB	8GB	NA	1066, 1333	NA	1066, 1333	N/A	1066, 1333	N/A	1066, 1333
SRx16 Non-ECC	512MB	1GB	2GB	NA	1066, 1333	NA	1066, 1333	N/A	1066, 1333	N/A	1066, 1333
SRx8 ECC	1GB	2GB	4GB	1066, 1333	1066, 1333	1066	1066, 1333	1066	1066, 1333	1066, 1333	1066, 1333
DRx8 ECC	2GB	4GB	8GB	1066, 1333	1066, 1333	1066	1066, 1333	1066	1066, 1333	1066, 1333	1066, 1333

**Note:** For detailed information on memory support and updates, please refer to the SMC Recommended Memory List posted on our website at <http://www.supermicro.com/support/resources/mem.cfm>.

*Populating RDIMM (ECC) Memory Modules*

<b>Intel E5-2600 Series Processor RDIMM Memory Support</b>													
Ranks Per DIMM & Data Width	Memory Capacity Per DIMM  (See the Note Below)			Speed (MT/s) and Voltage Validated by Slot per Channel (SPC) and DIMM Per Channel (DPC)									
				2 Slots Per Channel				3 Slots Per Channel					
	1DPC		2DPC		1 DPC		2DPC		3DPC				
	1.35V	1.5V	1.35V	1.5V	1.35V	1.5V	1.35V	1.5V	1.35V	1.5V			
SRx8	1GB	2GB	4GB	1066, 1333	1066, 1333, 1600	1066, 1333	1066, 1333, 1600	1066, 1333	1066, 1333, 1600	1066, 1333	1066, 1333, 1600	N/A	800, 1066
DRx8	2GB	4GB	8GB	1066, 1333	1066, 1333, 1600	1066, 1333	1066, 1333, 1600	1066, 1333	1066, 1333, 1600	1066, 1333	1066, 1333, 1600	N/A	800, 1066
SRx4	2GB	4GB	8GB	1066, 1333	1066, 1333, 1600	1066, 1333	1066, 1333, 1600	1066, 1333	1066, 1333, 1600	1066, 1333	1066, 1333, 1600	N/A	800, 1066
DRx4	4GB	8GB	16GB	1066, 1333	1066, 1333, 1600	1066, 1333	1066, 1333, 1600	1066, 1333	1066, 1333, 1600	1066, 1333	1066, 1333, 1600	N/A	800, 1066
QRx4	8GB	16GB	32GB	800	1066	800	800	800	1066	800	800	N/A	N/A
QRx8	4GB	8GB	16GB	800	1066	800	800	800	1066	800	800	N/A	N/A

**Note:** For detailed information on memory support and updates, please refer to the SMC Recommended Memory List posted on our website at <http://www.supermicro.com/support/resources/mem.cfm>.

### Populating LRDIMM (ECC) Memory Modules

Intel E5-2600(v2) Series Processor LRDIMM Memory Support												
Ranks Per DIMM & Data Width	Memory Capacity Per DIMM (See the Note Below)		Speed (MT/s) and Voltage Validated by Slot per Channel (SPC) and DIMM Per Channel (DPC)									
			2 Slots Per Channel				3 Slots Per Channel					
			1DPC		2DPC		1DPC		2DPC		3DPC	
			1.35V	1.5V	1.35V	1.5V	1.35V	1.5V	1.35V	1.5V	1.35V	1.5V
QRx4 (DDP)	16GB	32GB	1066, 1333, 1600	1066, 1333, 1600, 1866	1066, 1333, 1600	1066, 1333, 1600	1066, 1333, 1600	1066, 1333, 1600	1066, 1333, 1600	1066, 1333, 1600	1066	1066
8Rx4 (QDP)	32GB	64GB	1066	1066	1066	1066	1066	1066	1066	1066	1066	1066

**Note:** For detailed information on memory support and updates, please refer to the SMC Recommended Memory List posted on our website at <http://www.supermicro.com/support/resources/mem.cfm>.

Intel E5-2600 Series Processor LRDIMM Memory Support												
Ranks Per DIMM & Data Width	Memory Capacity Per DIMM (See the Note Below)		Speed (MT/s) and Voltage Validated by Slot per Channel (SPC) and DIMM Per Channel (DPC)									
			2 Slots Per Channel				3 Slots Per Channel					
			1DPC		2DPC		1DPC		2DPC		3DPC	
			1.35V	1.5V	1.35V	1.5V	1.35V	1.5V	1.35V	1.5V	1.35V	1.5V
QRx4 (DDP)	16GB	32GB	1066	1066, 1333	1066	1066, 1333	1066	1066, 1333	1066	1066, 1333	1066	1066
QRx8 (QDP)	8GB	16GB	1066	1066, 1333	1066	1066, 1333	1066	1066	1066	1066	1066	1066

**Note:** For detailed information on memory support and updates, please refer to the SMC Recommended Memory List posted on our website at <http://www.supermicro.com/support/resources/mem.cfm>.



#### Other Important Notes and Restrictions

- For the memory modules to work properly, please install DIMM modules of the same type, same speed and same operating frequency on the motherboard. Mixing of RDIMMs, UDIMMs or LRDIMMs is not allowed. Do not install both ECC and Non-ECC memory modules on the same motherboard.
- Using DDR3 DIMMs with different operating frequencies is not allowed. All channels in a system will run at the lowest common frequency.

## 2-5 Motherboard Installation

All motherboards have standard mounting holes to fit different types of chassis. Make sure that the locations of all the mounting holes for both motherboard and chassis match. Although a chassis may have both plastic and metal mounting fasteners, metal ones are highly recommended because they ground the motherboard to the chassis. Make sure that the metal standoffs click in or are screwed in tightly. Then use a screwdriver to secure the motherboard onto the motherboard tray.

### Tools Needed

- Phillips Screwdriver
- Pan head screws (10 pieces)
- Standoffs (10 pieces, if needed)

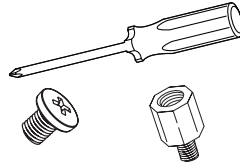

### Location of Mounting Holes

There are ten (10) mounting holes on this motherboard indicated by the arrows.

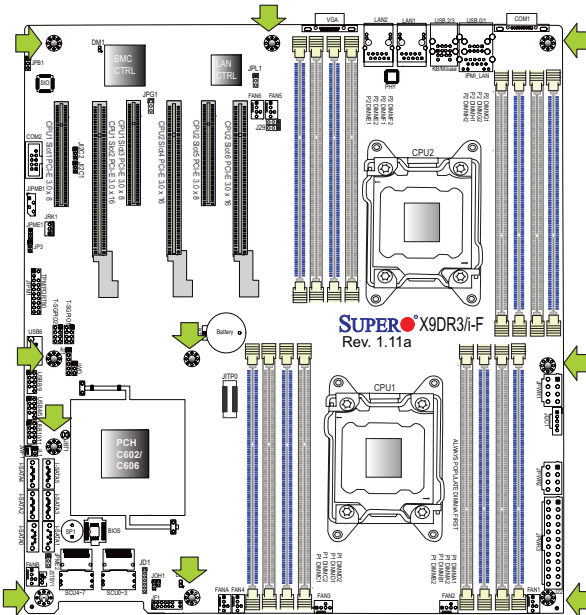

**Caution:** 1) To avoid damaging the motherboard and its components, please do not use a force greater than 8 lb/inch on each mounting screw during motherboard installation. 2) Some components are very close to the mounting holes. Please take precautionary measures to prevent damage to these components when installing the motherboard to the chassis.



## Installing the Motherboard

1. Install the I/O shield into the chassis.

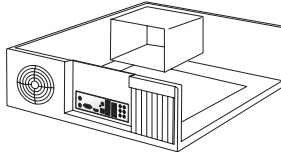

2. Locate the mounting holes on the motherboard.
3. Locate the matching mounting holes on the chassis. Align the mounting holes on the motherboard against the mounting holes on the chassis.
4. Install standoffs in the chassis as needed.

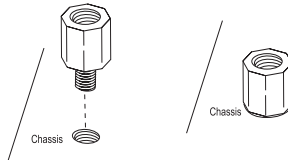

5. Install the motherboard into the chassis carefully to avoid damaging motherboard components.
6. Using the Phillips screwdriver, insert a Pan head #6 screw into a mounting hole on the motherboard and its matching mounting hole on the chassis.

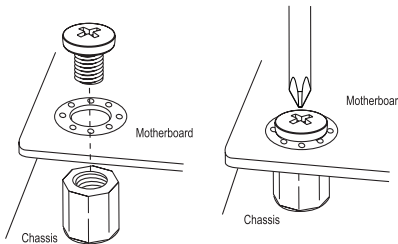

7. Repeat Step 5 to insert #6 screws into all mounting holes.
8. Make sure that the motherboard is securely placed in the chassis.

 **Note:** Images displayed are for illustration only. Your chassis or components might look different from those shown in this manual.

## 2-6 Control Panel Connectors and I/O Ports

The I/O ports are color coded in conformance with the PC 99 specification. See the picture below for the colors and locations of the various I/O ports.

### Back Panel Connectors and I/O Ports

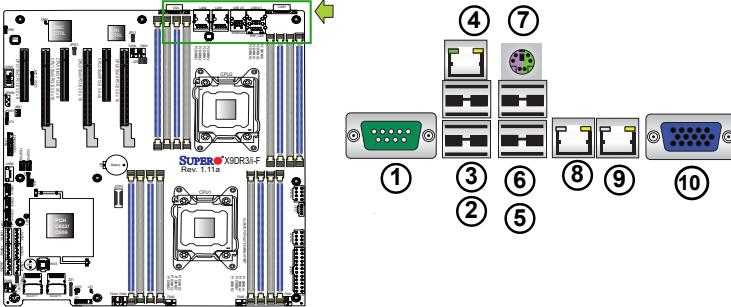

### Back Panel I/O Port Locations and Definitions

1. COM Port 1 (Turquoise)
2. Back Panel USB Port 0
3. Back Panel USB Port 1
4. IPMI_Dedicated LAN
5. Back Panel USB Port 2
6. Back Panel USB Port 3
7. PS2 Keyboard or Mouse (Optional)
8. Gigabit LAN 1
9. Gigabit LAN 2
10. Back Panel VGA (Blue)

## Serial Ports

Two COM connections (COM1 & COM2) are located on the motherboard. COM1 is located on the Backplane I/O panel. COM2, located close to PCI-E Slot1, provides front access support. See the table on the right for pin definitions.

Serial COM) Ports Pin Definitions			
Pin #	Definition	Pin #	Definition
1	DCD	6	DSR
2	RXD	7	RTS
3	TXD	8	CTS
4	DTR	9	RI
5	Ground	10	N/A

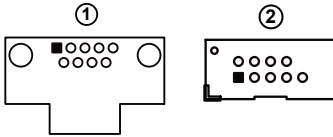

## Video Connection

A Video (VGA) port is located next to LAN2 on the I/O backplane. Refer to the board layout below for the location.

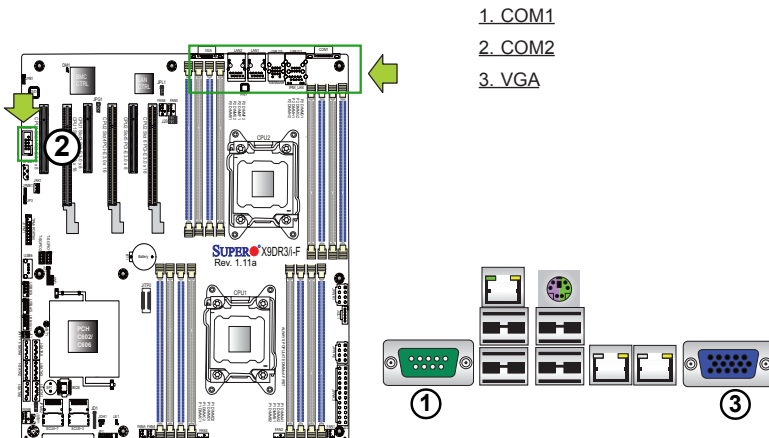

**Universal Serial Bus (USB)**

Four Universal Serial Bus ports (USB 0/1, USB 2/3) are located on the I/O back panel. Please note that BP USB 2/3 can also be used for PS2 Keyboard/Mouse connections. In addition, three USB headers, located close to the IO Hub, provides six front-accessible USB connections (USB 4/5, USB 8/9, USB 10/11). One Type A connector (USB6) also supports front panel USB connection. (Cables are not included). See the tables on the right for pin definitions.

Backplane USB (0/1, 2/3) Pin Definitions	
Pin#	Definition
1	+5V
2	PO-
3	PO+
4	Ground
5	NA

FP USB (4/5, 8/9, 10/11, USB 6) Pin Definitions			
USB 4, 8, 10, 6, 7 Pin # Definition		USB 5, 9, 11 Pin # Definition	
1	+5V	1	+5V
2	PO-	2	PO-
3	PO+	3	PO+
4	Ground	4	Ground
5	NC	5	Key

(NC= No connection)

1. Backpanel USB 0
2. BP USB 1
3. BP USB 2
4. BP USB 3
5. FP USB 4/5
6. FP USB 8/9
7. FP USB 10/11
8. FP USB 6

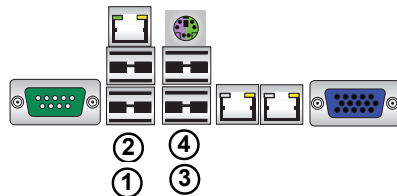
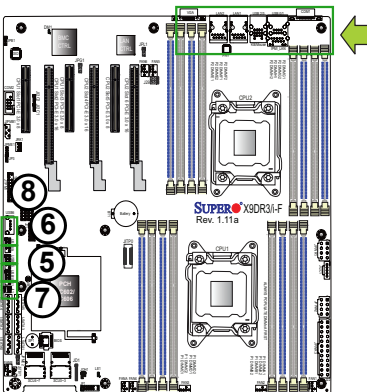

## Ethernet Ports

Two Gigabit Ethernet ports (LAN1, LAN2) are located on the I/O backplane on the motherboard. In addition, an IPMI\_Dedicated LAN is located above USB 0/1 ports on the backplane to provide KVM support for IPMI 2.0. All these ports accept RJ45 type cables. Please refer to the LED Indicator Section for LAN LED information.

LAN Ports Pin Definition			
Pin#	Definition		
1	P2V5SB	10	SGND
2	TD0+	11	Act LED
3	TD0-	12	P3V3SB
4	TD1+	13	Link 100 LED (Yellow, +3V3SB)
5	TD1-	14	Link 1000 LED (Yellow, +3V3SB)
6	TD2+	15	Ground
7	TD2-	16	Ground
8	TD3+	17	Ground
9	TD3-	18	Ground

(NC: No Connection)

1. GLAN1
2. GLAN2
3. IPMI\_LAN

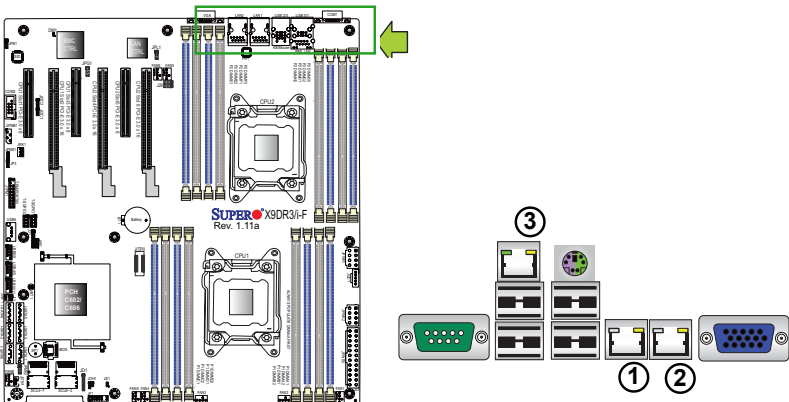

## Front Control Panel

JF1 contains header pins for various buttons and indicators that are normally located on a control panel at the front of the chassis. These connectors are designed specifically for use with Supermicro's server chassis. See the figure below for the descriptions of the various control panel buttons and LED indicators. Refer to the following section for descriptions and pin definitions.

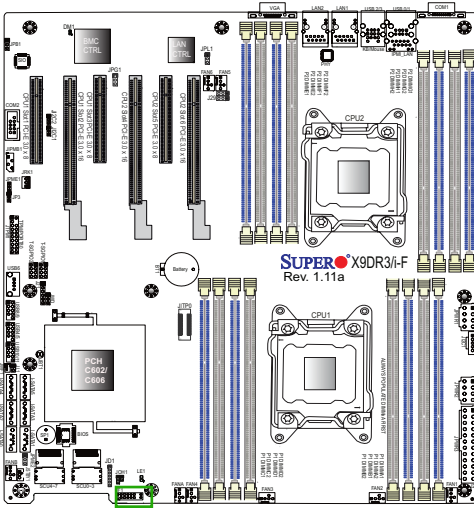

JF1 Header Pins

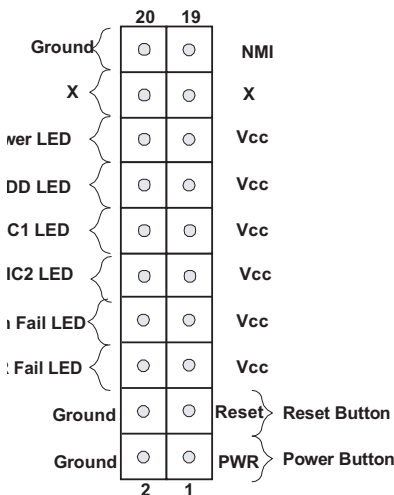

## Front Control Panel Pin Definitions

### NMI Button

The non-maskable interrupt button header is located on pins 19 and 20 of JF1. Refer to the table on the right for pin definitions.

NMI Button Pin Definitions (JF1)	
Pin#	Definition
19	Control
20	Ground

### Power LED

The Power LED connection is located on pins 15 and 16 of JF1. Refer to the table on the right for pin definitions.

Power LED Pin Definitions (JF1)	
Pin#	Definition
15	3.3V
16	PWR LED

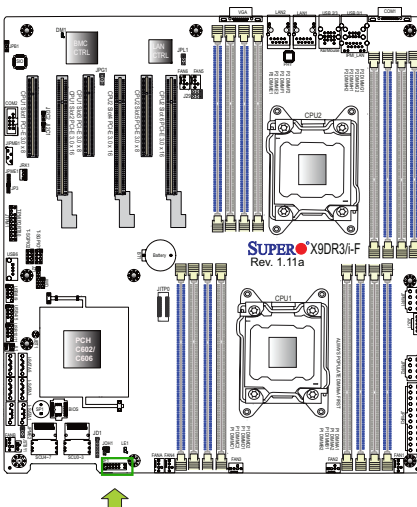

A. NMI

B. PWR LED

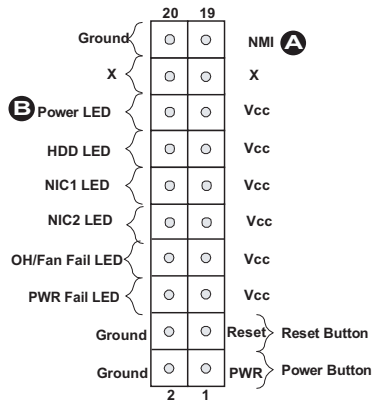

### HDD LED

The HDD LED connection is located on pins 13 and 14 of JF1. Attach a cable here to indicate HDD activity. See the table on the right for pin definitions.

HDD LED Pin Definitions (JF1)	
Pin#	Definition
13	3.3V Standby
14	HD Active

### NIC1/NIC2 LED Indicators

The NIC (Network Interface Controller) LED connection for GLAN port 1 is located on pins 11 and 12 of JF1, and the LED connection for GLAN Port 2 is on Pins 9 and 10. Attach the NIC LED cables here to display network activity. Refer to the table on the right for pin definitions.

GLAN1/2 LED Pin Definitions (JF1)	
Pin#	Definition
9	Vcc
10	NIC 2 LED
11	Vcc
12	NIC 1 LED

- A. HDD LED
- B. NIC1 LED
- C. NIC2 LED

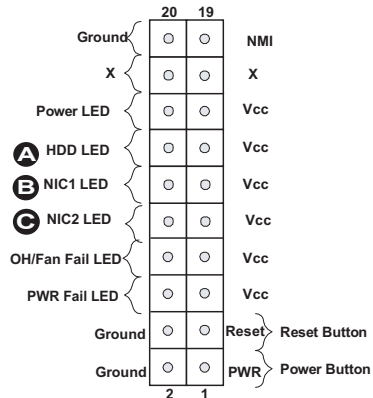
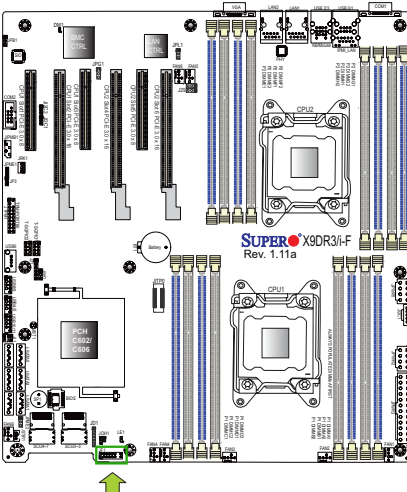



### Overheat (OH)/Fan Fail LED

Connect an LED cable to pins 7 and 8 of JF1 to provide advanced warnings of chassis overheating and fan failure. Refer to the table on the right for pin definitions.

OH/Fan Fail/PWR Fail LED Pin Definitions (JF1)	
Pin#	Definition
7	Vcc
8	OH/Fan Fail LED)

OH/Fan Fail Indicator Status	
State	Definition
Off	Normal
On	Overheat
Flash- ing	Fan Fail

### Power Fail LED

The Power Fail LED connection is located on pins 5 and 6 of JF1. Refer to the table on the right for pin definitions.

PWR Fail LED Pin Definitions (JF1)	
Pin#	Definition
5	3.3V
6	PWR Supply Fail

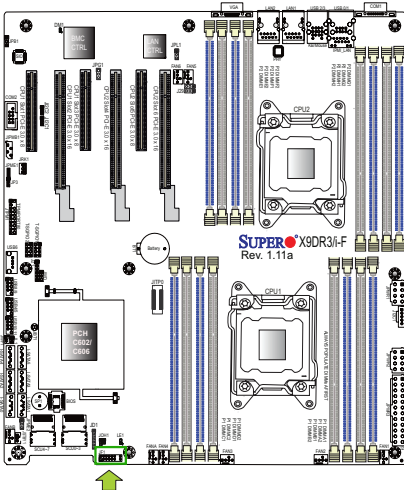

A. OH/Fail/PWR Fail LED

B. PWR Supply Fail

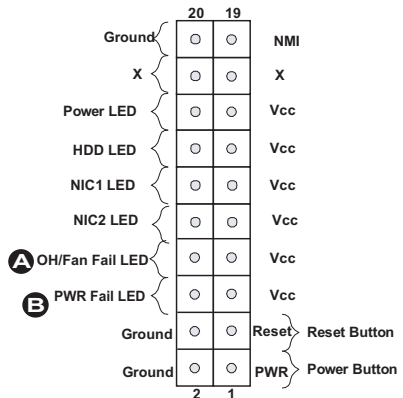

### Reset Button

The Reset Button connection is located on pins 3 and 4 of JF1. Attach it to a hardware reset switch on the computer case. Refer to the table on the right for pin definitions.

Reset Button Pin Definitions (JF1)	
Pin#	Definition
3	Reset
4	Ground

### Power Button

The Power Button connection is located on pins 1 and 2 of JF1. Momentarily contacting both pins will power on/off the system. This button can also be configured to function as a suspend button (with a setting in the BIOS - See Chapter 5). To turn off the power when the system is in suspend mode, press the button for 4 seconds or longer. Refer to the table on the right for pin definitions.

Power Button Pin Definitions (JF1)	
Pin#	Definition
1	Signal
2	Ground

A. Reset Button

B. PWR Button

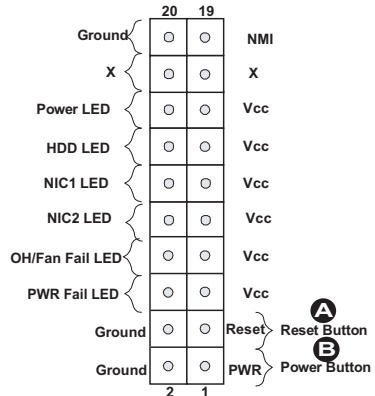
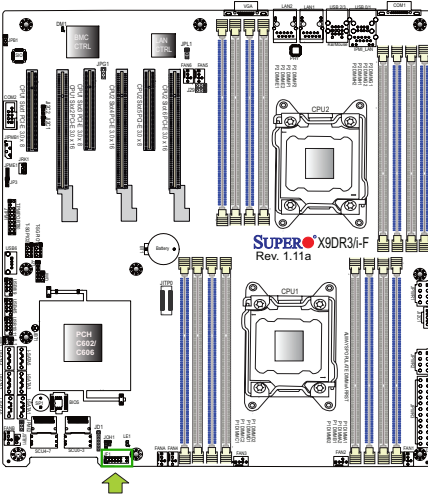

## 2-7 Connecting Cables

### Power Connectors

A 24-pin main power supply connector (J22) and two 8-pin CPU PWR connectors (JPWR1/2) are located on the motherboard. These power connectors meet the SSI EPS 12V specification. These power connectors must also be connected to your power supply. See the table on the right for pin definitions.

**Warning:** To provide adequate power supply to the motherboard, be sure to connect the 24-pin ATX PWR (JPWR3) and two 8-pin PWR connectors (JPWR1, JPWR2) to the power supply. Failure to do so will void the manufacturer warranty on your power supply and motherboard.

ATX Power 24-pin Connector Pin Definitions			
Pin#	Definition	Pin #	Definition
13	+3.3V	1	+3.3V
14	-12V	2	+3.3V
15	COM	3	COM
16	PS_ON	4	+5V
17	COM	5	COM
18	COM	6	+5V
19	COM	7	COM
20	Res (NC)	8	PWR_OK
21	+5V	9	5VSB
22	+5V	10	+12V
23	+5V	11	+12V
24	COM	12	+3.3V

12V 8-pin PWR Connector Pin Definitions	
Pins	Definition
1 through 4	Ground
5 through 8	+12V

(Required)

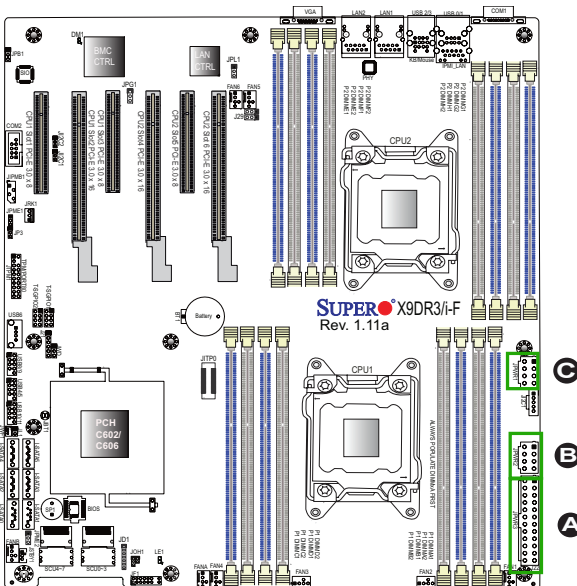

A. J22: 24-pin ATX PWR

(Req'd)

B. JPWR1: 8-pin Processor PWR (Req'd)

C. JPWR2: 8-pin Processor PWR (Req'd)

**Fan Headers**

This motherboard has eight system/CPU fan headers (Fan 1~Fan 10, Fan A, Fan B) on the motherboard. All these 4-pin fan headers are backward compatible with the traditional 3-pin fans. The fan speeds are controlled by firmware thermal management via IPMI 2.0. See the table on the right for pin definitions.

Fan Header Pin Definitions	
Pin#	Definition
1	Ground
2	+12V
3	Tachometer
4	Thermal Management

**Chassis Intrusion**

A Chassis Intrusion header is located at JL1 on the motherboard. Attach an appropriate cable from the chassis to inform you of a chassis intrusion when the chassis is opened.

Chassis Intrusion Pin Definitions	
Pin#	Definition
1	Intrusion Input
2	Ground

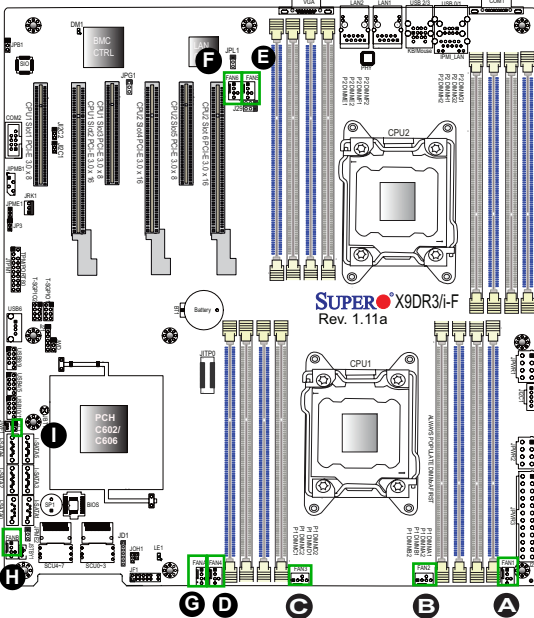

- A. Fan 1
- B. Fan 2
- C. Fan 3
- D. Fan 4
- E. Fan 5
- F. Fan 6
- G. Fan A
- H. Fan B
- I. Chassis Intrusion

## Internal Speaker

The Internal Speaker, located at SP1, can be used to provide audible indications for various beep codes. See the table on the right for pin definitions. Refer to the layout below for the locations of the Internal Buzzer (SP1).

Internal Buzzer (SP1) Pin Definition		
Pin#	Definitions	
Pin 1	Pos. (+)	Beep In
Pin 2	Neg. (-)	Alarm Speaker

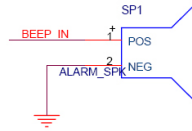

## Power LED/Speaker

On JD1 header, pins 1-3 are used for power LED indication, and pins 4-7 are for the speaker. See the tables on the right for pin definitions. Please note that the speaker connector pins (4-7) are used with an external speaker. If you wish to use the on-board speaker, you should close pins 6-7 with a jumper (Default).

PWR LED Connector Pin Definitions	
Pin Setting	Definition
Pin 1	Anode (+)
Pin2	Cathode (-)
Pin3	Cathode (-)

Speaker Connector Pin Settings	
Pin Setting	Definition
Pins 4-7	External Speaker
Pins 6-7	Internal Speaker (Default)

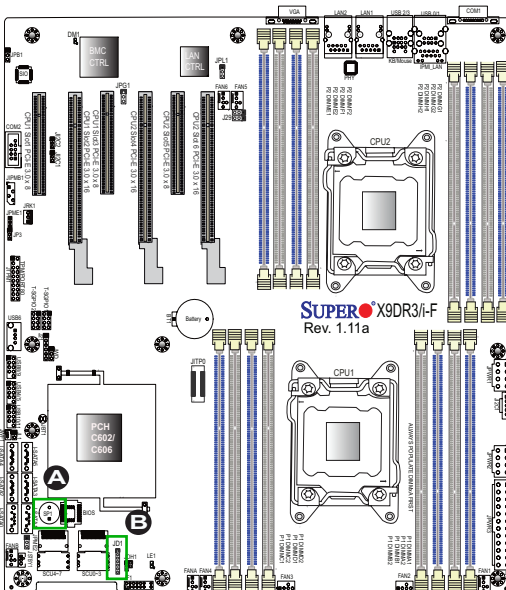

A. Internal Speaker

(Buzzer)

B. PWR LED/Speaker

**TPM Header/Port 80**

A Trusted Platform Module/Port 80 header is located at JTPM1 to provide TPM support and Port 80 connection. Use this header to enhance system performance and data security. See the table on the right for pin definitions.

TPM/Port 80 Header Pin Definitions			
Pin #	Definition	Pin #	Definition
1	LCLK	2	GND
3	LFRAME#	4	<(KEY)>
5	LRESET#	6	+5V (X)
7	LAD 3	8	LAD 2
9	+3.3V	10	LAD1
11	LAD0	12	GND
13	SMB_CLK4	14	SMB_DAT4
15	+3V_DUAL	16	SERIRQ
17	GND	18	CLKRUN# (X)
19	LPCPD#	20	LDRQ# (X)

**Overheat LED/Fan Fail**

The JOH1 header is used to connect an LED indicator to provide warnings of chassis overheating and fan failure. This LED will blink when a fan failure occurs. Refer to the tables on right for pin definitions.

Overheat LED Pin Definitions	
Pin#	Definition
1	VDC
2	OH Active

OH/Fan Fail LED Status	
State	Message
Solid	Overheat
Blinking	Fan Fail

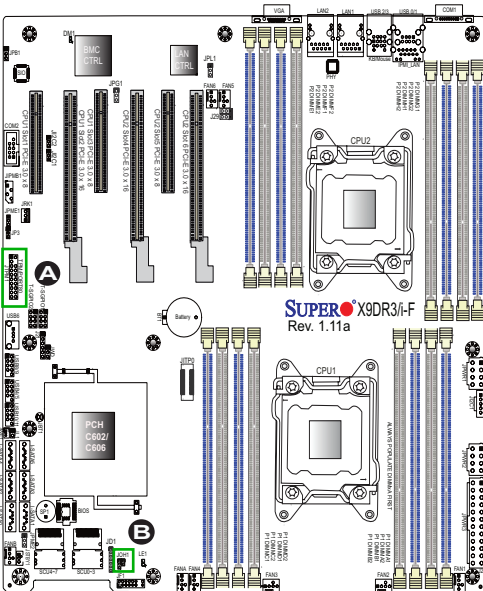

A. TPM/Port 80 Header  
 B. JOH1

## Power SMB (I<sup>2</sup>C) Connector

Power System Management Bus (I<sup>2</sup>C) Connector (J1<sup>2</sup>C1) monitors power supply, fan and system temperatures. See the table on the right for pin definitions.

PWR SMB Pin Definitions	
Pin#	Definition
1	Clock
2	Data
3	PWR Fail
4	Ground
5	+3.3V

## IPMB

A System Management Bus header for IPMI 2.0 is located at JIPMB1. Connect the appropriate cable here to use the IPMB I<sup>2</sup>C connection on your system.

IPMB Header Pin Definitions	
Pin#	Definition
1	Data
2	Ground
3	Clock
4	No Connection

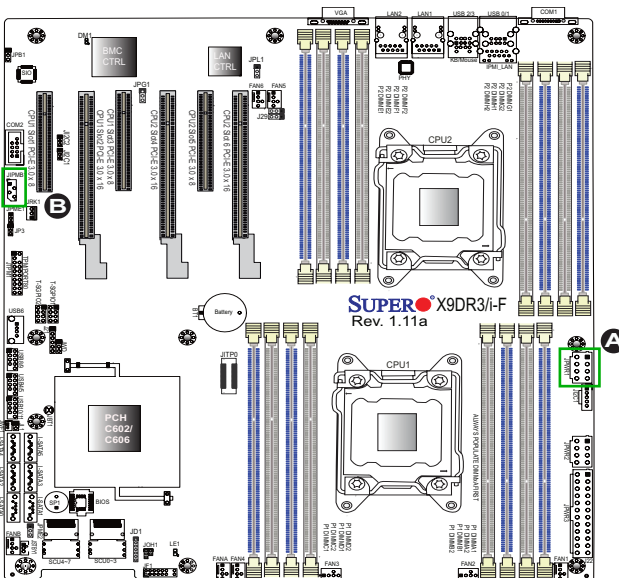

A. J1<sup>2</sup>C1

B. IPMB

**T-SGPIO 1/2 Headers**

Two SGPIO (Serial-Link General Purpose Input/Output) headers are located on the motherboard. These headers support Serial\_Link interface for onboard SATA connections. See the table on the right for pin definitions.

T-SGPIO Pin Definitions			
Pin#	Definition	Pin	Definition
2	NC	1	NC
4	Ground	3	Data
6	Load	5	Ground
8	Clock	7	NC

Note: NC= No Connection

**DOM Power Connector**

A power connector for SATA DOM (Disk\_On\_Module) devices is located at JWF1. Connect an appropriate cable here to provide power support for your DOM devices.

DOM PWR Pin Definitions	
Pin#	Definition
1	+5V
2	Ground
3	Ground

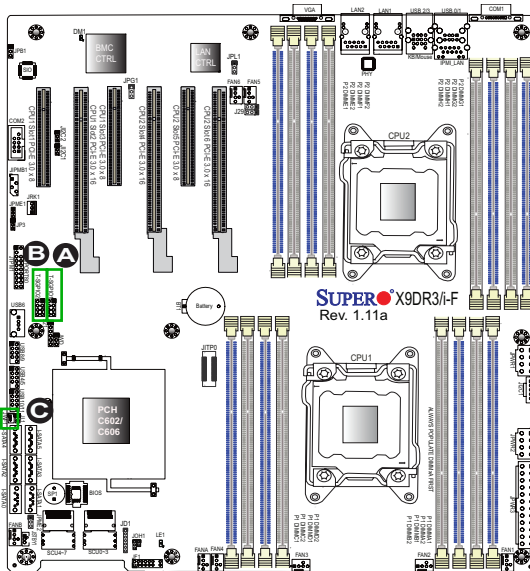

- [A. T-SGPIO1](#)
- [B. T-SGPIO2](#)
- [C. DOM PWR](#)



## 2-8 Jumper Settings

### Explanation of Jumpers

To modify the operation of the motherboard, jumpers can be used to choose between optional settings. Jumpers create shorts between two pins to change the function of the connector. Pin 1 is identified with a square solder pad on the printed circuit board. See the motherboard layout pages for jumper locations.

 **Note:** On two-pin jumpers, "Closed" means the jumper is on and "Open" means the jumper is off the pins.

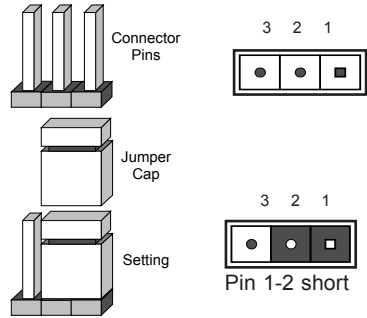

### GLAN Enable/Disable

JPL1 enables or disables the GLAN Port1/ GLAN Port2 on the motherboard. See the table on the right for jumper settings. The default setting is Enabled.

GLAN Enable Jumper Settings	
Jumper Setting	Definition
1-2	Enabled (default)
2-3	Disabled

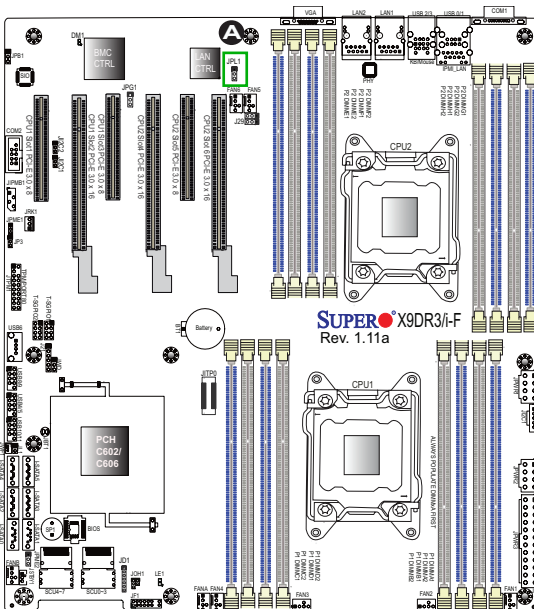

A. GLAN1/2 Enable

### CMOS Clear

JBT1 is used to clear CMOS. Instead of pins, this "jumper" consists of contact pads to prevent accidental clearing of CMOS. To clear CMOS, use a metal object such as a small screwdriver to touch both pads at the same time to short the connection. Always remove the AC power cord from the system before clearing CMOS. ⌚

 **Note 1:** For an ATX power supply, you must completely shut down the system, remove the AC power cord, and then short JBT1 to clear CMOS.

**Note 2:** Be sure to remove the onboard CMOS Battery before you short JBT1 to clear CMOS.

**Note 3:** Clearing CMOS will also clear all passwords.

### Watch Dog Enable/Disable

Watch Dog (JWD) is a system monitor that will reboot the system when a software application hangs. Close pins 1-2 to reset the system if an application hangs. Close pins 2-3 to generate a non-maskable interrupt signal for the application that hangs. See the table on the right for jumper settings. Watch Dog must also be enabled in the BIOS.

Watch Dog Jumper Settings	
Jumper Setting	Definition
Pins 1-2	Reset (default)
Pins 2-3	NMI
Open	Disabled

A. Clear CMOS

B. Watch Dog Enable

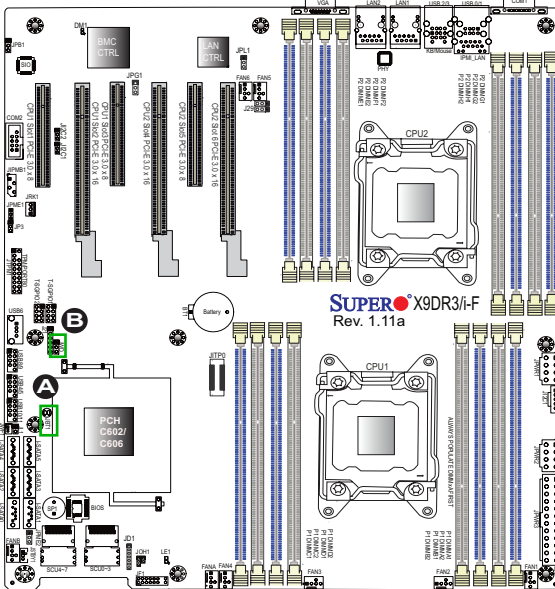

## VGA Enable

Jumper JPG1 allows the user to enable the onboard VGA connector. The default setting is 1-2 to enable the connection. See the table on the right for jumper settings.

VGA Enable Jumper Settings	
Jumper Setting	Definition
1-2	Enabled (Default)
2-3	Disabled

## BMC Enable

Jumper JPB1 allows you to enable the embedded WPCM 450 BMC (Baseboard Management) Controller to provide IPMI 2.0/KVM support on the motherboard. See the table on the right for jumper settings.

BMC Enable Jumper Settings	
Jumper Setting	Definition
Pins 1-2	BMC Enable (Default)
Pins 2-3	Disable

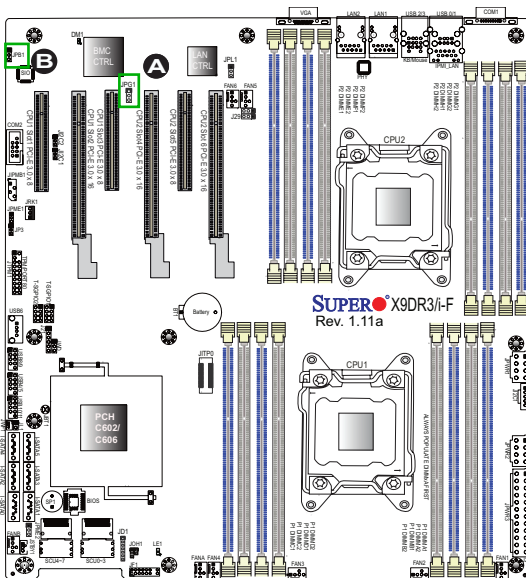

A. VGA Enabled

B. BMC Enabled

**Management Engine (ME) Recovery**

Use Jumper JPME1 to select ME Firmware Recovery mode, which will limit resource allocation for essential system operation only in order to maintain normal power operation and management. In the single operation mode, online upgrade will be available via Recovery mode. See the table on the right for jumper settings.

ME Recovery Jumper Settings	
Jumper Setting	Definition
1-2	Normal (Default)
2-3	ME Recovery

**Manufacture Mode Select**

Close pins 2 and 3 of JPME2 to bypass SPI flash security and force the system to operate in the Manufacture Mode, allowing the user to flash the system firmware from a host server for system setting modifications. See the table on the right for jumper settings.

ME Mode Select Jumper Settings	
Jumper Setting	Definition
1-2	Normal (Default)
2-3	Manufacture Mode

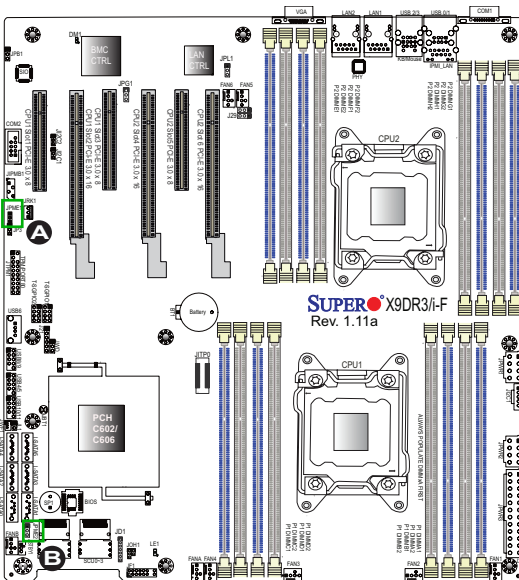

- A. JPME1
- B. JPME2

## 2-9 Onboard LED Indicators

### GLAN LEDs

There are two GLAN ports on the motherboard. Each Gigabit Ethernet LAN port has two LEDs. The Yellow LED on the right indicates connection and activity. The Link LED on the left side may be green, amber or off to indicate the speed of the connection. See the tables on the right for more information.



**Rear View** (when facing the rear side of the chassis)

GLAN Activity Indicator (Right) LED Settings		
Color	Status	Definition
Off	No Connections	
Yellow	Flashing	Active

GLAN Link Speed Indicator LED Settings (Left)	
LED Color	Definition
Off	No Connection or 10 Mbps
Green	100 Mbps
Amber	1 Gbps

### IPMI Dedicated LAN LEDs

In addition to LAN 1/LAN 2, an IPMI Dedicated LAN is also located on the I/O Backplane of the motherboard. The amber LED on the right indicates connection and activity, while the green LED on the left indicates the speed of the connection. See the table on the right for more information.

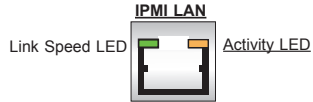

IPMI LAN Link Speed LED (Left) & Connection Activity LED (Right)		
LED	Color/State	Definition
Off	Off	No Connection
Activity	Amber: Blinking	Active
Speed	Green: Solid	100 Mbps

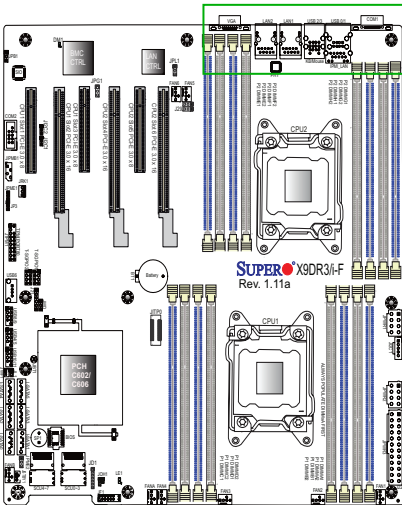

A. LAN1/2 LEDs

B. IPMI LAN LEDs



**Onboard Power LED**

An Onboard Power LED is located at LE1 on the motherboard. When this LED is on, the system is on. Be sure to turn off the system and unplug the power cord before removing or installing components. See the table on the right for more information.

Onboard PWR LED Indicator (LE1) LED Settings	
LED Color	Definition
Off	System Off (PWR cable not connected)
Green	System On
Green: Flashing Quickly	ACPI S1 State

**BMC Heartbeat LED**

A BMC Heartbeat LED is located at DM1 on the motherboard. When DM1 is blinking, BMC functions normally. See the table on the right for more information.

BMC Heartbeat LED Status	
Color/State	Definition
Green: Blinking	BMC: Normal

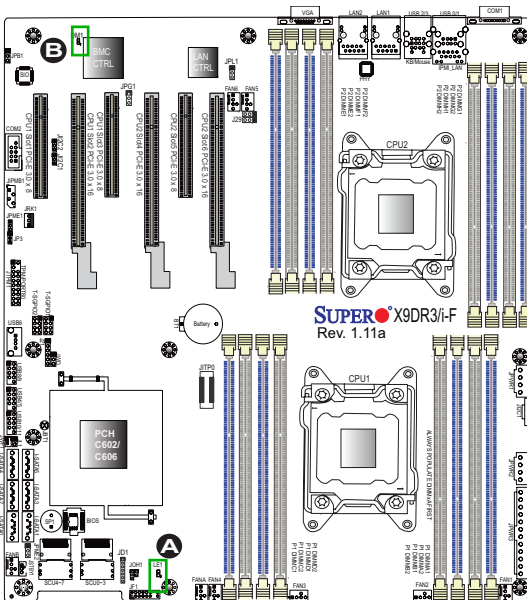

A. PWR LED

B. BMC LED

## 2-10 Serial ATA Connections

### Serial ATA Ports

There are six Serial ATA Ports (I-SATA0~I-SATA 5) located on the motherboard. I-SATA 0/1 support SATA 3.0 and I-SATA 2~5 are SATA 2.0 ports. These ports provide serial-link signal connections, which are faster than the connections of Parallel ATA. See the table on the right for pin definitions.

Serial ATA/SCU Pin Definitions	
Pin#	Definition
1	Ground
2	TX_P
3	TX_N
4	Ground
5	RX_N
6	RX_P
7	Ground

### SCU Ports

Eight SCU (Storage Control Unit) Ports (SCU 0~3, 4~7) are located on the X9DR3-F and four SCU (SCU 0~3) ports are on the X9DR1-F to provide serial link connections. These ports are supported by the Intel PCH. See the table on the right for pin definitions.

 **Note:** For more information on SATA HostRAID configuration, please refer to the Intel SATA HostRAID User's Guide posted on our website @ <http://www.supermicro.com>..

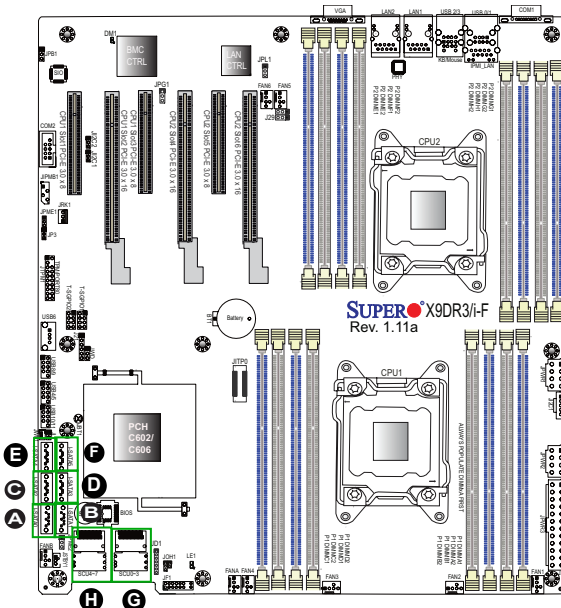

- A. I-SATA0 (SATA 3.0)
- B. I-SATA1 (SATA 3.0)
- C. I-SATA2 (SATA 2.0)
- D. I-SATA3 (SATA 2.0)
- E. I-SATA4 (SATA 2.0)
- F. I-SATA5 (SATA 2.0)
- G. SCU 0~3
- H. SCU 4~7 (X9DR3-F only)

## Notes



## Chapter 3

# Troubleshooting

### 3-1 Troubleshooting Procedures

Use the following procedures to troubleshoot your system. If you have followed all of the procedures below and still need assistance, refer to the 'Technical Support Procedures' and/or 'Returning Merchandise for Service' section(s) in this chapter. Note: Always disconnect the power cord before adding, changing or installing any hardware components.

#### **Before Power On**

1. Make sure that there are no short circuits between the motherboard and chassis.
2. Disconnect all ribbon/wire cables from the motherboard, including those for the keyboard and mouse.
3. Remove all add-on cards.
4. Install CPU 1 first (making sure it is fully seated) and connect the front panel connectors to the motherboard.

#### **No Power**

1. Make sure that there are no short circuits between the motherboard and the chassis.
2. Make sure that the ATX power connectors are properly connected
3. Check that the 115V/230V switch on the power supply is properly set, if available.
4. Turn the power switch on and off to test the system, if applicable.
5. The battery on your motherboard may be old. Check to verify that it still supplies ~3VDC. If it does not, replace it with a new one.

## No Video

1. If the power is on, but you have no video, remove all the add-on cards and cables.
2. Use the speaker to determine if any beep codes exist. Refer to Appendix A for details on beep codes.

## System Boot Failure

If the system does not display POST or does not respond after the power is turned on, check the following:

1. Check for any error beep from the motherboard speaker.
  - If there is no error beep, try to turn on the system without DIMM modules installed. If there is still no error beep, try to turn on the system again with only one processor installed in CPU Socket#1. If there is still no error beep, replace the motherboard.
  - If there are error beeps, clear the CMOS settings by unplugging the power cord and contracting both pads on the CMOS Clear Jumper (JB1). (Refer to Section 2-8 in Chapter 2.)
2. Remove all components from the motherboard, especially the DIMM modules. Make sure that the system's power is on, and memory error beeps are activated.
3. Turn on the system with only one DIMM module installed. If the system boots, check for bad DIMM modules or slots by following the Memory Errors Troubleshooting procedure in this Chapter.

## Losing the System's Setup Configuration

1. Make sure that you are using a high quality power supply. A poor quality power supply may cause the system to lose the CMOS setup information. Refer to Section 2-7 for details on recommended power supplies.
2. The battery on your motherboard may be old. Check to verify that it still supplies ~3VDC. If it does not, replace it with a new one.
3. If the above steps do not fix the Setup Configuration problem, contact your vendor for repairs.

## Memory Errors

When a No-Memory Beep Code is issued by the system, check the following:

1. Make sure that the memory modules are compatible with the system and that the DIMM modules are properly and fully installed. (For memory compatibility, refer to the Memory Compatibility Chart posted on our Website @ <http://www.supermicro.com>.)
2. Check if different speeds of DIMMs have been installed. It is strongly recommended that you use the same RAM speed for all DIMMs in the system.
3. Make sure that you are using the correct type of DDR3 Registered/Load Reduced ECC or Unbuffered ECC/Non-ECC DDR3 DIMM modules recommended by the manufacturer.
4. Check for bad DIMM modules or slots by swapping a single module among all memory slots and check the results.
5. Make sure that all memory modules are fully seated in their slots. Follow the instructions given in Section 2-4 in Chapter 2.
6. Please follow the instructions given in the DIMM Population Tables listed in Section 2-4 to install your memory modules.

## When the System Becomes Unstable

### **A. *The system becomes unstable during or after the OS installation***

The system becomes unstable during or after the OS installation, check the following:

1. CPU/BIOS support: Make sure that your CPU is supported, and you have the latest BIOS installed in your system.
2. Memory support: Make sure that the memory modules are supported by testing the modules using memtest86 or a similar utility.



**Note:** Refer to the product page on our website <http://www.supermicro.com> for memory and CPU support and updates.

3. HDD support: Make sure that all hard disk drives (HDDs) work properly. Replace the bad HDDs with good ones.

4. System cooling: Check system cooling to make sure that all heatsink fans, and CPU/system fans, etc., work properly. Check Hardware Monitoring settings in the BIOS to make sure that the CPU and System temperatures are within the normal range. Also check the front panel Overheat LED, and make sure that the Overheat LED is not on.
5. Adequate power supply: Make sure that the power supply provides adequate power to the system. Make sure that all power connectors are connected. Please refer to our website for more information on minimum power requirement.
6. Proper software support: Make sure that the correct drivers are used.

***B. The system becomes unstable before or during the OS installation***

When the system becomes unstable before or during OS installation, check the following:

1. Source of installation: Make sure that the devices used for installation are working properly, including boot devices such as CD/DVD disc, CD/DVD-ROM.
2. Cable connection: Check to make sure that all cables are connected and working properly.
3. Using minimum configuration for troubleshooting: Remove all unnecessary components (starting with add-on cards first), and use minimum configuration (with a CPU and a memory module installed) to identify the trouble areas. Refer to the steps listed in Section A above for proper troubleshooting procedures.
4. Identifying bad components by isolating them: If necessary, remove a component in question from the chassis, and test it in isolation to make sure that it works properly. Replace a bad component with a good one.
5. Check and change one component at a time instead of changing several items at the same time. This will help isolate and identify the problem.
6. To find out if a component is good, swap this component with a new one to see if the system will work properly. If so, then the old component is bad. You can also install the component in question in another system. If the new system works, the component is good and the old system has problems.

## 3-2 Technical Support Procedures

Before contacting Technical Support, please take the following steps. Also, please note that as a motherboard manufacturer, Supermicro also sells motherboards through its channels, so it is best to first check with your distributor or reseller for troubleshooting services. They should know of any possible problem(s) with the specific system configuration that was sold to you.

1. Please go through the 'Troubleshooting Procedures' and 'Frequently Asked Question' (FAQ) sections in this chapter or see the FAQs on our website (<http://www.supermicro.com/>) before contacting Technical Support.
  2. BIOS upgrades can be downloaded from our website (<http://www.supermicro.com>).
  3. If you still cannot resolve the problem, include the following information when contacting Supermicro for technical support:
    - Motherboard model and PCB revision number
    - BIOS release date/version (This can be seen on the initial display when your system first boots up.)
    - System configuration
  4. An example of a Technical Support form is on our website at (<http://www.supermicro.com>).
- Distributors: For immediate assistance, please have your account number ready when placing a call to our technical support department. We can be reached by e-mail at [support@supermicro.com](mailto:support@supermicro.com).

### 3-3 Battery Removal and Installation

#### Battery Removal

To remove the onboard battery, follow the steps below:

1. Power off your system and unplug your power cable.
2. Locate the onboard battery as shown below.
3. Using a tool such as a pen or a small screwdriver, push the battery lock outwards to unlock it. Once unlocked, the battery will pop out from the holder.
4. Remove the battery.

#### Proper Battery Disposal

**Warning:** Please handle used batteries carefully. Do not damage the battery in any way; a damaged battery may release hazardous materials into the environment. Do not discard a used battery in the garbage or a public landfill. Please comply with the regulations set up by your local hazardous waste management agency to dispose of your used battery properly.

#### Battery Installation

1. To install an onboard battery, follow the steps 1 & 2 above and continue below:
2. Identify the battery's polarity. The positive (+) side should be facing up.
3. Insert the battery into the battery holder and push it down until you hear a click to ensure that the battery is securely locked.

**Warning:** When replacing a battery, be sure to only replace it with the same type.

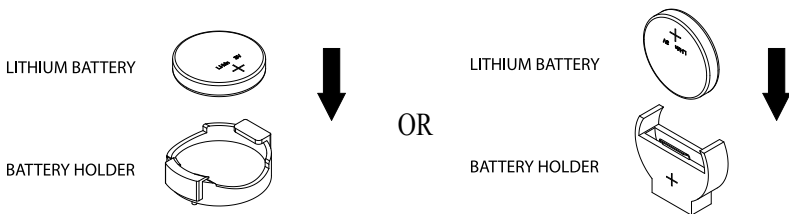

---

## 3-4 Frequently Asked Questions

**Question: What are the various types of memory that my motherboard can support?**

**Answer:** The motherboard supports Registered/Load Reduced ECC or Unbuffered ECC/Non-ECC DDR3 DIMM modules. To enhance memory performance, do not mix memory modules of different speeds and sizes. Please follow all memory installation instructions given on Section 2-4 in Chapter 2.

**Question: How do I update my BIOS?**

It is recommended that you **do not** upgrade your BIOS if you are not experiencing any problems with your system. Updated BIOS files are located on our website at <http://www.supermicro.com>. Please check our BIOS warning message and the information on how to update your BIOS on our website. Select your motherboard model and download the BIOS file to your computer. Also, check the current BIOS revision to make sure that it is newer than your BIOS before downloading. You can choose from the zip file and the .exe file. If you choose the zip BIOS file, please unzip the BIOS file onto a bootable USB device. Run the batch file using the format AMI.bat filename.rom from your bootable USB device to flash the BIOS. Then, your system will automatically reboot.

**Warning:** Do not shut down or reset the system while updating the BIOS to prevent possible system boot failure!



**Note:** The SPI BIOS chip used on this motherboard cannot be removed. Send your motherboard back to our RMA Department at Supermicro for repair. For BIOS Recovery instructions, please refer to the AMI BIOS Recovery Instructions posted at <http://www.supermicro.com>.

**Question: How do I handle the used battery?**

**Answer:** Please handle used batteries carefully. Do not damage the battery in any way; a damaged battery may release hazardous materials into the environment. Do not discard a used battery in the garbage or a public landfill. Please comply with the regulations set up by your local hazardous waste management agency to dispose of your used battery properly. Refer to Section 3-3 on Page 3-6.

### 3-5 Returning Merchandise for Service

A receipt or copy of your invoice marked with the date of purchase is required before any warranty service will be rendered. You can obtain service by calling your vendor for a Returned Merchandise Authorization (RMA) number. When returning the motherboard to the manufacturer, the RMA number should be prominently displayed on the outside of the shipping carton, and the shipping package is mailed prepaid or hand-carried. Shipping and handling charges will be applied for all orders that must be mailed when service is complete. For faster service, you can also request a RMA authorization online (<http://www.supermicro.com/RmaForm/>).

This warranty only covers normal consumer use and does not cover damages incurred in shipping or from failure due to the alternation, misuse, abuse or improper maintenance of products.

During the warranty period, contact your distributor first for any product problems.



## Chapter 4

### BIOS

#### 4-1 Introduction

This chapter describes the AMI BIOS Setup utility for the X9DR3-F/X9DRi-F. It also provides the instructions on how to navigate the AMI BIOS Setup utility screens. The AMI ROM BIOS is stored in a Flash EEPROM and can be easily updated.

#### Starting BIOS Setup Utility

To enter the AMI BIOS Setup utility screens, press the <Del> key while the system is booting up.

 **Note:** In most cases, the <Del> key is used to invoke the AMI BIOS setup screen. There are a few cases when other keys are used, such as <F3>, <F4>, etc.

Each main BIOS menu option is described in this manual. The Main BIOS setup menu screen has two main frames. The left frame displays all the options that can be configured. Grayed-out options cannot be configured. Options in blue can be configured by the user. The right frame displays the key legend. Above the key legend is an area reserved for a text message. When an option is selected in the left frame, it is highlighted in white. Often a text message will accompany it.

 **Note:** The AMI BIOS has default text messages built in. The manufacturer retains the option to include, omit, or change any of these text messages.

The AMI BIOS Setup utility uses a key-based navigation system called "hot keys." Most of the AMI BIOS setup utility "hot keys" can be used at any time during setup navigation. These keys include <F3>, <F4>, <Enter>, <ESC>, arrow keys, etc.

 **Note 1:** Options printed in **Bold** are default settings.

**Note 2:** <F3> is used to load optimal default settings. <F4> is used to save the current settings and exit the setup utility.

#### How To Change the Configuration Data

The configuration data that determines the system parameters may be changed by entering the AMI BIOS Setup utility. This Setup utility can be accessed by pressing <F2> at the appropriate time during system boot.

 **Note:** For AMI UEFI BIOS Recovery, please refer to the UEFI BIOS Recovery User Guide posted @<http://www.supermicro.com/support/manuals/>.

## Starting the Setup Utility

Normally, the only visible Power-On Self-Test (POST) routine is the memory test. As the memory is being tested, press the <F2> key to enter the main menu of the AMI BIOS Setup utility. From the main menu, you can access the other setup screens. An AMI BIOS identification string is displayed at the left bottom corner of the screen below the copyright message.

**Warning:** Do not upgrade the BIOS unless your system has a BIOS-related issue. Flashing the wrong BIOS can cause irreparable damage to the system. In no event shall the manufacturer be liable for direct, indirect, special, incidental, or consequential damage arising from a BIOS update. If you have to update the BIOS, do not shut down or reset the system while the BIOS is being updated to avoid possible boot failure.

## 4-2 Main Setup

When you first enter the AMI BIOS Setup utility, you will enter the Main setup screen. You can always return to the Main setup screen by selecting the Main tab on the top of the screen. The Main BIOS Setup screen is shown below.

The AMI BIOS main menu displays the following information:



### System Time/System Date

Use this option to change the system time and date. Highlight *System Time* or *System Date* using the arrow keys. Enter new values through the keyboard and press <Enter>. Press the <Tab> key to move between fields. The date must be entered in Day MM/DD/YY format. The time is entered in HH:MM:SS format. (**Note:** The time is in the 24-hour format. For example, 5:30 P.M. appears as 17:30:00.)

### X9DR3-F/i

#### SMC Version

This item displays the SMC Version of the BIOS used in the system.

#### SMC Build Date

This item displays the day and time when this version of BIOS was built.

### Memory Information

#### Total Memory

This displays the amount of memory that is available in the system.

## 4-3 Advanced Setup Configurations

Use the arrow keys to select Advanced and press <Enter> to access the following submenu items:

### ► Boot Feature

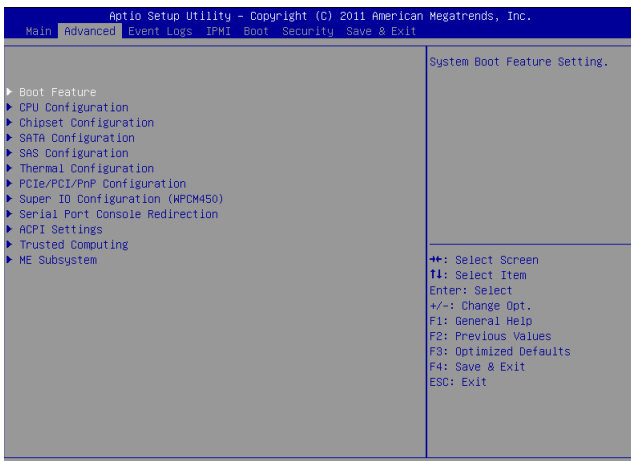

### Quiet Boot

Set this value to allow the bootup screen options to be modified between POST messages or the OEM logo. Select Disabled to allow the computer system to display the POST messages. Select Enabled to allow the computer system to display the OEM logo. The default setting is **Enabled**.

### AddOn ROM Display Mode

This sets the display mode for the Option ROM. Select Keep Current to use the current AddOn ROM Display setting. Select Force BIOS to use the Option ROM display mode set by the system BIOS. The options are **Force BIOS** and Keep Current.

### Bootup Num-Lock

Use this feature to set the Power-on state for the Numlock key. The options are Off and **On**.

### Wait For 'F1' If Error

Select Enabled force the system to wait until the 'F1' key is pressed when an error occurs. The options are Disabled and **Enabled**.

### Interrupt 19 Capture

Interrupt 19 is the software interrupt that handles the boot disk function. When this item is set to Enabled, the ROM BIOS of the host adaptors will "capture" Interrupt 19 at boot and allow the drives that are attached to these host adaptors to function as bootable disks. If this item is set to Disabled, the ROM BIOS of the host adaptors will not capture Interrupt 19, and the drives attached to these adaptors will not function as bootable devices. The options are **Enabled** and Disabled.

## Power Configuration

### Power Button Function

If this feature is set to Instant Off, the system will power off immediately as soon as the user presses the power button. Select 4 Second Override for the system to power off when the user presses the power button for 4 seconds or longer. The options are **Instant Off** and 4 Seconds Override.

### Restore on AC Power Loss

Use this feature to set the power state after a power outage. Select Power-Off for the system power to remain off after a power loss. Select Power-On for the system power to be turned on after a power loss. Select Last State to allow the system to resume its last state before a power loss. The options are Power On, Stay Off and **Last State**.

## ►CPU Configuration

This submenu displays the information of the CPU as detected by the BIOS. It also allows the user to configure CPU settings.

### ►Socket 0 CPU Information

This submenu displays the following information regarding the CPU installed in Socket 0.

- Type of CPU
- CPU Signature
- Microcode Patch
- CPU Stepping
- Maximum CPU Speed
- Minimum CPU Speed
- Processor Cores
- Intel HT(Hyper-Threading) Technology
- Intel VT-x (Virtualization) Technology
- Intel SMX (Trusted Execution) Technology
- L1 Data Cache
- L1 Code Cache
- L2 Cache
- L3 Cache

### ►Socket 1 CPU Information

This item displays if a CPU is installed in Socket 1.

#### **CPU Speed**

This item displays the speed of the CPU installed in Socket 1.

### **64-bit**

This item indicates if the CPU installed in Socket 1 supports 64-bit technology.

### **Hyper-threading**

Select Enabled to support Intel Hyper-threading Technology to enhance CPU performance. The options are **Enabled** and Disabled.

### **Active Processor Cores**

Set to Enabled to use a processor's Second Core and beyond. (Please refer to Intel's web site for more information.) The options are **All**, 1, 2, and 4.

### **Limit CPUID Maximum**

This feature allows the user to set the maximum CPU ID value. Enable this function to boot the legacy operating systems that cannot support processors with extended CPUID functions. The options are Enabled and **Disabled** (for the Windows OS).

### **Execute-Disable Bit Capability (Available if supported by the OS & the CPU)**

Set to Enabled to enable the Execute Disable Bit which will allow the processor to designate areas in the system memory where an application code can execute and where it cannot, thus preventing a worm or a virus from flooding illegal codes to overwhelm the processor or damage the system during an attack. The default is **Enabled**. (Refer to Intel and Microsoft Web Sites for more information.)

### **Hardware Prefetcher (Available when supported by the CPU)**

If set to Enabled, the hardware prefetcher will prefetch streams of data and instructions from the main memory to the L2 cache to improve CPU performance. The options are Disabled and **Enabled**.

### **Adjacent Cache Line Prefetch (Available when supported by the CPU)**

If this feature is set to Disabled, The CPU prefetches the cache line for 64 bytes. If this feature is set to Enabled the CPU fetches both cache lines for 128 bytes as comprised. The options are Disabled and **Enabled**.

### **DCU Streamer Prefetcher (Available when supported by the CPU)**

Select Enabled to support Data Cache Unite (DCU) prefetch to speed up data accessing and processing in the DCU to enhance CPU performance. The options are Disabled and **Enabled**.

### DCU IP Prefetcher

Select Enabled for DCU (Data Cache Unit) IP Prefetcher support, which will prefetch IP addresses to improve network connectivity and system performance. The options are **Enabled** and Disabled.

### Intel® Virtualization Technology (Available when supported by the CPU)

Select Enabled to support Intel Virtualization Technology, which will allow one platform to run multiple operating systems and applications in independent partitions, creating multiple "virtual" systems in one physical computer. The options are **Enabled** and Disabled.



**Note:** If there is any change to this setting, you will need to power off and restart the system for the change to take effect. Please refer to Intel's website for detailed information.

### Clock Spread Spectrum

Select Enabled to enable Clock Spectrum support, which will allow the BIOS to monitor and attempt to reduce the level of Electromagnetic Interference caused by the components whenever needed. The options are **Disabled** and Enabled.

### ► CPU Power Management Configuration

This submenu allows the user to configure the following CPU Power Management settings.

#### Power Technology

Select Energy Efficiency to support power-saving mode. Select Custom to customize system power settings. Select Disabled to disable power -saving settings. The options are Disable, **Energy Efficient** and Custom. If Custom is selected, the following options become available:

#### EIST

EIST (Enhanced Intel SpeedStep Technology) allows the system to automatically adjust processor voltage and core frequency in an effort to reduce power consumption and heat dissipation. **Please refer to Intel's web site for detailed information.** The options are Disabled and **Enabled**.

#### Turbo Mode

This feature allows processor cores to run faster than marked frequency in specific conditions. The options are Disabled and **Enabled**.

### **P-STATE Coordination**

This feature selects the type of coordination for the P-State of the processor. P-State is a processor operational state that reduces the processor's voltage and frequency. This makes the processor more energy efficient, resulting in further gains. The options are **HW\_ALL**, **SW\_ALL** and **SW-ANY**.

### **CPU C3 Report, CPU C6 Report, CPU C7 Report**

This BIOS feature enables or disables C3, C6, and C7 reporting to the operating system. The options for C3 and C7 are **Disabled** and **Enabled**. The options for C6 are **Disabled** and **Enabled**.

### **Package C State Limit**

If set to Auto, the AMI BIOS will automatically set the limit on the C-State package register. The options are **C0**, **C2**, **C6**, **C7**, and **No Limit**.

## **Energy Performance**

This setting allows the user to adjust the fan speed based on performance (maximum cooling) or energy efficiency (maximum energy savings). The options are **Performance**, **Balanced Performance**, **Balanced Energy**, and **Energy Efficient**.

### **Factory Long Duration Power Limit**

This item displays the power limit set by the manufacturer during which long duration power is maintained.

### **Long Duration Power Limit**

This item displays the power limit set by the manufacturer during which long duration power is maintained.

### **Factory Long Duration Maintained**

This item displays the period of time set by the manufacturer during which long duration power is maintained.

### **Long Duration Maintained**

This item displays the period of time during which long duration power is maintained.

### **Recommended Short Duration Power**

This item displays the short duration power settings recommended by the manufacturer.

### **Short Duration Power Limit**

This item displays the period of time during which short duration power is maintained.



---

## ►Chipset Configuration

### ►North Bridge

This feature allows the user to configure the settings for the Intel North Bridge.

### ►IOH (IO Hub) Configuration

#### Intel VT-d

Select Enabled to enable Intel Virtualization Technology support for Direct I/O VT-d by reporting the I/O device assignments to the VMM (Virtual Working Memory) through the DMAR ACPI Tables. This feature offers fully-protected I/O resource sharing across Intel platforms, providing greater reliability, security and availability in networking and data-sharing. The options are **Enabled** and Disabled.

#### Intel® I/OAT

The Intel I/OAT (I/O Acceleration Technology) significantly reduces CPU overhead by leveraging CPU architectural improvements, freeing the system resource for other tasks. The options are Disabled and **Enabled**.

#### DCA Support

Select Enabled to use Intel's DCA (Direct Cache Access) Technology to improve data transfer efficiency. The options are **Enabled** and Disabled.

#### IOH 0 PCIe Port Bifurcation Control

This submenu allows the user to configure the following 8 PCIe Port Bifurcation Control settings for the IOH 0 PCI-Exp port. This feature determines how to distribute the available PCI-Express lanes to the PCI-E Root Ports.

#### IOU1-PCIe Port

This feature allows the user to set the PCI-Exp bus speed between IOU1 and PCI-e port. The options are **x4x4** and x8.

#### Port 1A Link Speed

Select GEN1 to enable PCI-Exp Generation 1 support for Port 1A. Select GEN2 to enable PCI-Exp Generation 2 support for Port 1A. Select GEN3 to enable PCI-Exp Generation 3 support for Port 1A. The options are GEN1, **GEN2**, and GEN3.

### **Port 1B Link Speed**

Select GEN1 to enable PCI-Exp Generation 1 support for Port 1B. Select GEN2 to enable PCI-Exp Generation 2 support for Port 1B. Select GEN3 to enable PCI-Exp Generation 3 support for Port 1B. The options are GEN1, **GEN2**, and GEN3.

### **IOU2 - PCIe Port**

This feature allows the user to set the PCI-Exp bus speed between IOU2 and PCIe port. The options are x4x4x4x4, x4x4x8, x8x4x4, x8x8, and **x16**, and Auto.

### **Port 2A Link Speed**

Select GEN1 to enable PCI-Exp Generation 1 support for Port 2A. Select GEN2 to enable PCI-Exp Generation 2 support for Port 2A. Select GEN3 to enable PCI-Exp Generation 3 support for Port 2A. The options are GEN1, **GEN2**, and GEN3.

### **IOU3 - PCIe Port**

This feature allows the user to set the PCI-Exp bus speed between IOU3 and PCIe port. The options are x4x4x4x4, x4x4x8, x8x4x4, **x8x8**, and x16, and Auto.

### **Port 3A Link Speed**

Select GEN1 to enable PCI-Exp Generation 1 support for Port 3A. Select GEN2 to enable PCI-Exp Generation 2 support for Port 3A. Select GEN3 to enable PCI-Exp Generation 3 support for Port 3A. The options are GEN1, **GEN2**, and GEN3.

### **Port 3C Link Speed**

Select GEN1 to enable PCI-Exp Generation 1 support for Port 3C. Select GEN2 to enable PCI-Exp Generation 2 support for Port 3C. Select GEN3 to enable PCI-Exp Generation 3 support for Port 3C. The options are GEN1, **GEN2**, and GEN3.

### **IOH 1 PCIe Port Bifurcation Control**

This submenu allows the user to configure the following 6 PCIe Port Bifurcation Control settings for the IOH 1 PCI-Exp port. This feature determines how to distribute the available PCI-Express lanes to the PCI-E Root Ports.

### **IOU1-PCIe Port**

This feature allows the user to set the PCI-Exp bus speed between IOU1 and PCI-e port. The options are x4x4 and **x8**.

**Port 1A Link Speed**

Select GEN1 to enable PCI-Exp Generation 1 support for Port 1A. Select GEN2 to enable PCI-Exp Generation 2 support for Port 1A. Select GEN3 to enable PCI-Exp Generation 3 support for Port 1A. The options are GEN1, **GEN2**, and GEN3.

**IOU2 - PCIe Port**

This feature allows the user to set the PCI-Exp bus speed between IOU2 and PCIe port. The options are x4x4x4x4, x4x4x8, x8x4x4, x8x8, and **x16**, and Auto.

**Port 2A Link Speed**

Select GEN1 to enable PCI-Exp Generation 1 support for Port 2A. Select GEN2 to enable PCI-Exp Generation 2 support for Port 2A. Select GEN3 to enable PCI-Exp Generation 3 support for Port 2A. The options are GEN1, **GEN2**, and GEN3.

**IOU3 - PCIe Port**

This feature allows the user to set the PCI-Exp bus speed between IOU3 and PCIe port. The options are x4x4x4x4, x4x4x8, x8x4x4, x8x8, and **x16**, and Auto.

**Port 3A Link Speed**

Select GEN1 to enable PCI-Exp Generation 1 support for Port 3A. Select GEN2 to enable PCI-Exp Generation 2 support for Port 3A. Select GEN3 to enable PCI-Exp Generation 3 support for Port 3A. The options are GEN1, **GEN2**, and GEN3.

**►QPI Configuration****Current QPI Link**

This item displays the current status of the QPI Link.

**Current QPI Frequency**

This item displays the current frequency of the QPI Link.

**QPI (Quick Path Interconnect) Link Speed Mode**

Use this feature to select data transfer speed for QPI Link connections. The options are **Fast** and Slow.

**QPI Link Frequency Select**

Use this feature to select the desired QPI frequency. The options are **Auto**, 6.4 GT/s, 7.2 GT/s, and 8.0 GT/s.

### ►DIMM Configuration

- **Total Memory:** This item displays the total memory size available in the system.
- **Current Memory Mode:** This item displays the current memory mode.
- **Current Memory Speed:** This item displays the current memory speed.
- **Mirroring:** This item displays if memory mirroring is supported by the motherboard.
- **Sparing:** This item displays if memory sparing can be supported by the motherboard.

### ►DIMM Information

#### CPU Socket 1 DIMM Information/ CPU Socket 2 DIMM Information

The status of the memory modules detected by the BIOS will be displayed.

#### Memory Mode

When Independent is selected, all DIMMs are available to the operating system. When Mirroring is selected, the motherboard maintains two identical copies of all data in memory for data backup. When Lockstep is selected, the motherboard uses two areas of memory to run the same set of operations in parallel. The options are **Independent**, Mirroring, Lockstep and Sparing.

#### DRAM RAPL BWLIMIT

This item sets the limits on the average power consumption and the bandwidth of a DRAM module in operation so that the OS can manage power consumption and energy budget of hardware more effectively within a certain window of time. The options are 0, 1, 8, and 16

#### Perfmon and DFX Devices

A PerfMon device monitors the activities of a remote system such as disk usage, memory consumption, and CPU load which will allow an IT administrator to maximize the performance of each computer within the network. A DFX device, usually in the form of a USB adaptor, can be used to enhance audio performance. Select Unhide to display the Perfmon and DXF devices installed in the system. The options are **HIDE** and UNHIDE.

### **DRAM RAPL Mode**

RAPL which stands for Running Average Power Limit is a feature that provides mechanisms to enforce power consumption limits on supported processors. The options are DRAM RAPL MODE0 , **DRAM RAPL MODE1**, and Disabled.

### **MPST Support**

Select Enabled to enable the Message Processing Subscriber Terminal which is used to process short messages. The options are **Disabled** and Enabled.

### **DDR Speed**

Use this feature to force a DDR3 memory module to run at a frequency other than what the system is specified in the specification. The options are **Auto**, Force DDR3-800, Force DDR3-1066, Force DDR3-1333, Force DOR3-1600 and Force SPD.

### **Channel Interleaving**

This feature selects from the different channel interleaving methods. The options are **Auto**, 1 Way, 2 Way, 3, Way, and 4 Way.

### **Rank Interleaving**

This feature allows the user to select a rank memory interleaving method. The options are **Auto**, 1 Way, 2 Way, 4, Way, and 8 Way.

### **Patrol Scrub**

Patrol Scrubbing is a process that allows the CPU to correct correctable memory errors detected on a memory module and send the correction to the requestor (the original source). When this item is set to Enabled, the IO hub will read and write back one cache line every 16K cycles, if there is no delay caused by internal processing. By using this method, roughly 64 GB of memory behind the IO hub will be scrubbed every day. The options are **Enabled** and Disabled.

### **Demand Scrub**

Demand Scrubbing is a process that allows the CPU to correct correctable memory errors found on a memory module. When the CPU or I/O issues a demand-read command, and the read data from memory turns out to be a correctable error, the error is corrected and sent to the requestor (the original source). Memory is updated as well. Select Enabled to use Demand Scrubbing for ECC memory correction. The options are Enabled and **Disabled**.

### **Data Scrambling**

Select Enabled to enable data scrubbing and ensure data security and integrity. The options are **Disabled** and Enabled.

### DRAM RAPL

RAPL which stands for Running Average Power Limit is a feature that provides mechanisms to enforce power consumption limits on supported processors. The options are Mode 0, **MODE1**, and Disabled.

### Device Tagging

Select Enabled to support device tagging. The options are **Disabled** and Enabled.

### Thermal Throttling

Throttling improves reliability and reduces power consumption in the processor via automatic voltage control during processor idle states. The options are Disabled and **CLTT** (Closed Loop Thermal Throttling).

### OLTT Peak BW %

Use this feature to set a percentage of the peak bandwidth allowed for OLTT. Enter a number between 25 to 100 (%). The default setting is **50**.

## ►South Bridge

This feature allows the user to configure the settings for the Intel PCH chip.

### PCH Information

This feature displays the following PCH information.

- **Name:** This item displays the name of the PCH chip.
- **Stepping:** This item displays the status of the PCH stepping.

### All USB Devices

Select Enabled to enable all onboard USB devices. The options are **Enabled** and Disabled. When set to enabled, EHCI Controller 1 and 2 will appear below.

### EHCI Controller 1/ EHCI Controller 2

Select Enabled to enable Enhanced Host Interface (EHCI) Controller 1 or Controller 2 to improve overall platform performance. The options are **Enabled** and Disabled.

### Legacy USB Support (Available when USB Functions is not Disabled)

Select Enabled to support legacy USB devices. Select Auto to disable legacy support if USB devices are not present. Select Disable to have USB devices

available for EFI (Extensive Firmware Interface) applications only. The settings are **Enabled**, Disabled and Auto.

#### **Port 60/64 Emulation**

Select Enabled to enable I/O port 60h/64h emulation support for the legacy USB keyboard so that it can be fully supported by the operating systems that do not recognize a USB device. The options are **Disabled** and Enabled.

#### **EHCI Hand-off**

Select Enabled to enable support for operating systems that do not support Enhanced Host Controller Interface (EHCI) hand-off. When enabled, EHCI ownership change will be claimed by the EHCI driver. The options are **Disabled** and Enabled.

### **►SATA Configuration**

When this submenu is selected, the AMI BIOS automatically detects the presence of IDE or SATA devices and displays the following items.

#### **SATA Port0~SATA Port5**

The AMI BIOS displays the status of each SATA port as detected by the BIOS.

#### **SATA Mode**

Use this feature to configure SATA mode for a selected SATA port. The options are Disabled, IDE Mode, **AHCI Mode**, and RAID Mode. The following are displayed depending on your selection:

##### **IDE Mode**

The following items are displayed when IDE Mode is selected:

##### **Serial-ATA (SATA) Controller 0~1**

Use this feature to activate or deactivate the SATA controller, and set the compatibility mode. The options for Controller 0 are Enhanced and **Compatible**. The default setting for SATA Controller 1 is **Enhanced**.

##### **AHCI Mode**

The following items are displayed when the AHCI Mode is selected:

##### **Aggressive Link Power Management**

Select Enabled to enable Aggressive Link Power Management to support Cougar Point B0 stepping and beyond. The options are **Enabled** and Disabled.

### Port 0~Port 5 Hot Plug

Select Enabled to enable hot-plug support for a port specified by the user so that the user is allowed to change a hardware component or a device without shutting down the system. The options are Enabled and **Disabled**.

### Staggered Spin-up

Select Enabled to enable Staggered Spin-up support to prevent excessive power consumption caused by multiple HDDs spinning-up simultaneously. The options are Enabled and **Disabled**.

## RAID Mode

The following items are displayed when RAID Mode is selected:

### PCH RAID CodeBase

Set this item to Intel or LSI to specify the codebase to be used for RAID support. The options are Intel and LSI.

### Port 0~5 Hot Plug

Select Enabled to enable hot-plug support for a port specified by the user. The options are Enabled and **Disabled**.

## ►SCU (Storage Control Unit) Configuration

If a SCU port is detected in the system, the following items will be displayed.

### SCU Devices

Select Enabled to enable support for PCH SCU (System Configuration Utility) devices. The options are Disabled and **Enabled**.

### OnChip SCU Oprom

Select Enabled to support the onboard SAS Option ROM to boot up the system via a storage device if a SAS device is installed. The options are Disabled and **Enabled**.

### SCU Port 0~7

The SCU devices detected by the BIOS will be displayed.

## ►Thermal Configuration

### Thermal Management

Select Enabled to initialize the PCH Thermal subsystem device. The options are Enabled and **Disabled**.



---

## ME SMBus Thermal Reporting

This feature appears when Thermal Management is set to Enabled. Select Enabled to support ME SMBus (Management Engine System Management Bus) reporting. The options are Enabled and **Disabled**. If set to Enabled, the following items appear:

### PCH Temp Read, CPU Energy Read, CPU Temp Read

Set the above items to Enabled to activate these monitors. The options are **Enabled** and Disabled.

### Alert Enable Lock

Set this item to Enabled to lock all Alert Enable settings. The options are Enabled and **Disabled**. If set to Enabled, the following options appear.

### PCH Alert, DIMM Alert

Set the above items to enabled to activate the corresponding pins. The options are Enabled and **Disabled**.

## ►PCIe/PCI/PnP Configuration

This submenu allows the user to configure the following PCIe/PCI/PnP settings.

### PCI ROM Priority

Use this feature to select the Option ROM to boot up the system when there are multiple Option ROMs available in the system. The options are **Legacy ROM** and EFI Compatible ROM.

### PCI Latency Timer

Use this feature to set the latency timer of each PCI device installed on a PCI bus. Select 64 to set the PCI latency to 64 PCI clock cycles. The options are 32, **64**, 96, 128, 160, 192, 224, and 248.

### Above 4G Decoding (Available if the system supports 64-bit PCI decoding)

Select Enabled to decode a PCI device that supports 64-bit in the space above 4G Address. The options are Enabled and **Disabled**.

### PERR# Generation

Select Enabled to allow a PCI device to generate a PERR number for a PCI Bus Signal Error Event. The options are **Enabled** and Disabled.

### SERR# Generation

Select Enabled to allow a PCI device to generate a SERR number for a PCI Bus Signal Error Event. The options are **Enabled** and Disabled.

### Maximum Payload

This feature selects the setting for the PCIe maximum payload size. The options are **Auto**, 128 Bytes, 256 Bytes, 512 Bytes, 1024 Bytes, 2048 Bytes, and 4096 Bytes.

### Maximum Read Request

This feature selects the setting for the PCIe maximum Read Request size. The options are **Auto**, 128 Bytes, 256 Bytes, 512 Bytes, 1024 Bytes, 2048 Bytes, and 4096 Bytes.

### ASPM Support

This feature allows the user to set the Active State Power Management (ASPM) level for a PCI-E device. Select Force L0 to force all PCI-E links to operate at L0 state. Select Auto to allow the system BIOS to automatically set the ASPM level for the system. Select Disabled to disable ASPM support. The options are **Disabled**, Auto, and Force L0s.

### Onboard LAN Option ROM Select

This feature selects whether to load the iSCSI or PXE onboard LAN option ROM. The options are iSCSI and **PXE**.

### Load Onboard LAN1 Option ROM/Load Onboard LAN2 Option ROM

Select Enabled to enable the onboard LAN1 Option ROM~LAN4 Option ROM. This is to boot the computer using a network device. The default setting for LAN1 Option ROM is **Enabled**. The default setting for LAN2 Option ROM is **Disabled**.

### VGA Priority

Use this feature to specify which graphics controller to be used as the primary boot device. The options are **Onboard** and Offboard (VGA).

### Network Stack

Select Enabled to enable PXE (Preboot Execution Environment) or UEFI (Unified Extensible Firmware Interface) for network stack support. The options are Enabled and **Disabled**.

## ►Super IO Configuration (WPCM450)

### Super IO Chip

This item displays the Super IO chip type.

---

---

## ►Serial Port 0 Configuration/Serial Port 1 Configuration

The submenus allow the user to configure the following settings for Serial Port 0 or Serial Port 1:

### Serial Port

Select Enabled to enable a serial port specified by the user. The options are **Enabled** and Disabled.

### Serial Port Mode

This feature allows the user to set the serial port mode for Console Redirection. The options are **SOL** and COM.

### Device Settings

This feature indicates whether or not a reset is required for a serial port specified.

### Change Settings

This option specifies the base I/O port address and the Interrupt Request address of Serial Port 1 and Serial Port 2. The options for Serial Port 1 and Port 2 are:

**Auto**, IO=3F8h; IRQ=4; IO=3F8h; IRQ=3, 4, 5, 6, 7, 9, 10, 11, 12; IO=2F8h; IRQ=3, 4, 5, 6, 7, 9, 10, 11, 12; IO=3E8h; IRQ=3, 4, 5, 6, 7, 9, 10, 11, 12; and IO=2E8h; IRQ=3, 4, 5, 6, 7, 9, 10, 11, 12.

## ►Serial Port Console Redirection

These submenus allow the user to configure the following Console Redirection settings for a COM Port 0 or COM Port 1 as specified by the user.

### COM 0/COM 1

#### Console Redirection

Select Enabled to use a COM Port selected by the user for Console Redirection. The options are Enabled and Disabled. (The default setting for COM0 is **Disabled**, and for COM1 is **Enabled**.)

### ►Console Redirection Settings

This feature allows the user to specify how the host computer will exchange data with the client computer, which is the remote computer used by the user.

#### Terminal Type

This feature allows the user to select the target terminal emulation type for Console Redirection. Select VT100 to use the ASCII character set. Select VT100+ to add color and function key support. Select ANSI to use the extended ASCII

character set. Select VT-UTF8 to use UTF8 encoding to map Unicode characters into one or more bytes. The options are ANSI, VT100, **VT100+**, and VT-UTF8.

### Bits Per Second

This item sets the transmission speed for a serial port used in Console Redirection. Make sure that the same speed is used in the host computer and the client computer. A lower transmission speed may be required for long and busy lines. The options are 9600, 19200, 38400, 57600, and **115200** (bits per second).

### Data Bits

Use this feature to set the data transmission size for Console Redirection. The options are 7 and **8** (Bits).

### Parity

A parity bit can be sent along with regular data bits to detect data transmission errors. Select Even if the parity bit is set to 0, and the number of 1's in data bits is even. Select Odd if the parity bit is set to 0, and the number of 1's in data bits is odd. Select None if you do not want to send a parity bit with your data bits in transmission. Select Mark to add mark as a parity bit to be sent along with the data bits. Select Space to add a Space as a parity bit to be sent with your data bits. The options are **None**, Even, Odd, Mark, and Space.

### Stop Bits

A stop bit indicates the end of a serial data packet. Select 1 Stop Bit for standard serial data communication. Select 2 Stop Bits if slower devices are used. The options are **1** and 2.

### Flow Control

This feature allows the user to set the flow control for Console Redirection to prevent data loss caused by buffer overflow. Send a "Stop" signal to stop sending data when the receiving buffer is full. Send a "Start" signal to start sending data when the receiving buffer is empty. The options are **None** and Hardware RTS/CTS.

### VT-UTF8 Combo Key Support

Select Enabled to enable VT-UTF8 Combination Key support for ANSI/VT100 terminals. The options are **Enabled** and Disabled.

### Recorder Mode

Select Enabled to capture the data displayed on a terminal and send it as text messages to a remote server. The options are **Disabled** and Enabled.

**Resolution 100x31**

Select Enabled for extended-terminal resolution support. The options are Disabled and **Enabled**.

**Legacy OS Redirection**

Use this feature to select the number of rows and columns used in Console Redirection for legacy OS support. The options are **80x24** and 80x25.

**Putty Keypad**

Use this feature to select function key and keypad setting on Putty. The options are **VT100**, LINUX, XTERMR6, SCO, ESCN, and VT400.

**Serial Port for Out-of-Band Management/Windows Emergency Management Services (EMS)**

This item allows the user to configure Console Redirection settings to support Out-of-Band Serial Port management.

**Console Redirection**

Select Enabled to use a COM Port selected by the user for Console Redirection. The options are **Enabled** and Disabled.

**►Console Redirection Settings**

This feature allows the user to specify how the host computer will exchange data with the client computer, which is the remote computer used by the user.

**Out-of-Band-Mgmt Port**

Use this feature to select the port for out-of-band management. The options are **COM0** and COM1

**Terminal Type**

This feature allows the user to select the target terminal emulation type for Console Redirection. Select VT100 to use the ASCII character set. Select VT100+ to add color and function key support. Select ANSI to use the extended ASCII character set. Select VT-UTF8 to use UTF8 encoding to map Unicode characters into one or more bytes. The options are ANSI, VT100, **VT100+**, and VT-UTF8.

**Bits Per Second**

This item sets the transmission speed for a serial port used in Console Redirection. Make sure that the same speed is used in the host computer and the client computer. A lower transmission speed may be required for long and busy lines. The options are 9600, 19200, 38400, 57600, and **115200** (bits per second).

### Flow Control

This feature allows the user to set the flow control for Console Redirection to prevent data loss caused by buffer overflow. Send a "Stop" signal to stop sending data when the receiving buffer is full. Send a "Start" signal to start sending data when the receiving buffer is empty. The options are **None**, Hardware RTS/CTS, and Software Xon/Xoff.

## ►ACPI Settings

Use this feature to configure Advanced Configuration and Power Interface (ACPI) power management settings for your system.

### ACPI Sleep State

Use this feature to select the ACPI State when the system is in sleep mode. Select S1 (CPU Stop Clock) to erase all CPU caches and stop executing instructions. Power to the CPU(s) and RAM is maintained, but RAM is refreshed. Select Suspend to use power-reduced mode. Power will only be supplied to limited components (such as RAMs) to maintain the most critical functions of the system. The options are **S1 (CPU Stop Clock)** and Suspend Disabled.

### Numa

This feature enables the Non-Uniform Memory Access ACPI support. The options are **Enabled** and Disabled.

### High Precision Timer

Select Enabled to activate the High Precision Event Timer (HPET) that produces periodic interrupts at a much higher frequency than a Real-time Clock (RTC) does in synchronizing multimedia streams, providing smooth playback, reducing the dependency on other timestamp calculation devices, such as an x86 RDTSC Instruction embedded in the CPU. The High Performance Event Timer is used to replace the 8254 Programmable Interval Timer. The options are **Enabled** and Disabled.

## ►Trusted Computing (Available if a TPM device is installed)

### Configuration

#### TPM Support

Select Enabled on this item and enable the TPM jumper on the motherboard to allow TPM support to improve data integrity and network security. The options are Enabled and **Disabled**.

**Current Status Information:** This item displays the information regarding the current TPM status.

#### **TPM Enable Status**

If a security device is detected by the BIOS, this item displays the status of TPM Support to indicate if TPM is currently enabled or disabled.

#### **TPM Active Status**

If a security device is detected by the BIOS, this item displays the status of TPM Support to indicate if TPM is currently active or deactivated.

#### **TPM Owner Status**

If a security device is detected by the BIOS, this item displays the status of TPM Ownership.

#### **►Intel TXT(LT-SX) Configuration**

This feature indicates if the following hardware components support the Intel TXT (Trusted Execution Technology), which helps protect against software-based attacks and ensures protection, confidentiality and integrity of data stored or created on the system.

- **CPU/Chipset TXT Feature** - Displays status of TXT Feature support.
- **TXT Support** - Indicates if TXT support is enabled or disabled. The default setting is **Disabled**.
- **Intel TXT Dependencies** - Displays a list of features that must be supported (and enabled) before Intel TXT(LT-SX) configuration can be enabled.

### **►ME (Management Engine) Subsystem**

#### **Intel ME Subsystem Configuration**

This feature displays the following ME Subsystem Configuration settings.

#### **ME Subsystem**

Select Enabled to support Intel Management Engine (ME) Subsystem, a small power computer subsystem that performs various tasks in the background. The options are **Enabled** and Disabled.

When ME Subsystem is enabled, the following items will display.

- **ME BIOS Interface**
- **ME Version**

## 4-4 Event Logs

Use this menu to configure Event Log settings.

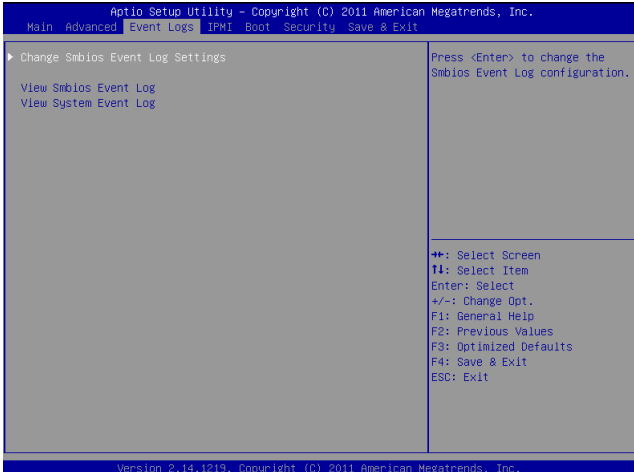

### ► Change SmbIOS Event Log Settings

#### Enabling/Disabling Options

##### Smbios Event Log

Change this item to enable or disable all features of the Smbios Event Logging during boot. The options are **Enabled** and Disabled.

#### Erasing Settings

##### Erase Event Log

This option erases all logged events. The options are **No**, Yes, Next reset, and Yes, Every reset.

##### When Log is Full

This option automatically clears the Event Log memory of all messages when it is full. The options are **Do Nothing** and Erase Immediately.

##### Log System Boot Event

This option toggles the System Boot Event logging to enabled or disabled. The options are **Disabled** and Enabled.



**MECI**

The Multiple Event Count Increment (MECI) counter counts the number of occurrences a duplicate event must happen before the MECI counter is incremented. This is a numeric value ranging from 1 to 255.

**METW**

The Multiple Event Time Window (METW) defines number of minutes must pass between duplicate log events before MECI is incremented. This is in minutes, from 0 to 99.

**View Smbios Event Log**

This feature displays the contents of the SmbIOS Event Log.

**View System Event Log**

This feature displays the contents of the System Event Log.

## 4-5 IPMI

Use this menu to configure Intelligent Platform Management Interface (IPMI) settings.

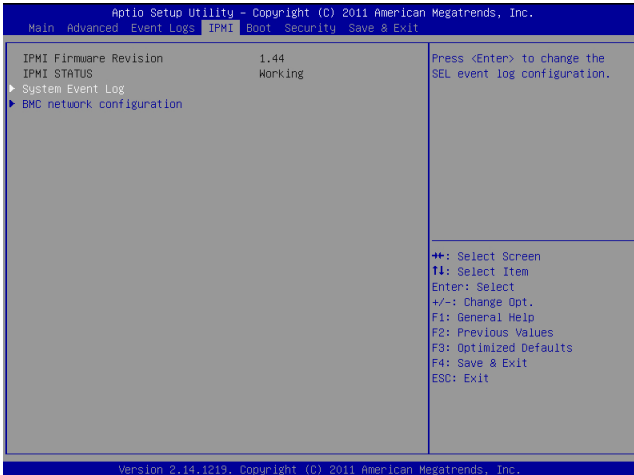

### ► System Event Log

#### Enabling/Disabling Options

##### SEL Components

Select Enabled for all system event logging at bootup. The options are **Enabled** and Disabled.

##### Erasing Settings

##### Erase SEL

Select 'Yes, On next reset' to erase all system event logs upon next system reboot. Select 'Yes, On every reset' to erase all system event logs upon each system reboot. Select No to keep all system event logs after each system reboot. The options are **No**, Yes, On next reset, and Yes, On every reset.

##### When SEL is Full

This feature allows the user to decide what the BIOS should do when the system event log is full. Select Erase Immediately to erase all events in the log when the system event log is full. The options are **Do Nothing** and Erase Immediately.

### Log EFI Status Codes

Select Enabled to log EFI (Extensible Firmware Interface) Status Codes, Error Codes or Progress Codes. The options are Disabled and **Enabled**.



**Note:** After making changes on a setting, be sure to reboot the system for the changes to take effect.

## ►BMC Network Configuration

**LAN Channel 1:** This feature allows the user to configure the settings for LAN Channel 1.

### Update IPMI LAN Configuration

This feature allows the user to decide if the BIOS should configure the IPMI setting at next system boot. The options are **No** and Yes. If the option is set to Yes, the user is allowed to configure the IPMI settings at next system boot:

### Configuration Address Source

This feature allows the user to select the source of the IP address for this computer. If Static is selected, you will need to know the IP address of this computer and enter it to the system manually in the field below. The options are Static and DHCP.

### Station IP Address

This item displays the Station IP address for this computer. This should be in decimal and in dotted quad form (i.e., 192.168.10.253).

### Subnet Mask

This item displays the sub-network that this computer belongs to. The value of each three-digit number separated by dots should not exceed 255.

### Station MAC Address

This item displays the Station Mac address for this computer. Mac addresses are 6 two-digit hexadecimal numbers.

### Router IP Address

This item displays the Router IP address for this computer. This should be in decimal and in dotted quad form (i.e., 192.168.10.253).

### Router MAC Address

This item displays the Router Mac address for this computer. Mac addresses are 6 two-digit hexadecimal numbers.

## 4-6 Boot

This menu allows the user to configure the following boot settings for the system.



### Boot Option Priorities

#### Boot Option #1/ Boot Option #2/ Boot Option #3

Use this feature to specify the sequence of boot device priority.

#### Network Device BBS Priorities, Hard Drive BBS Priorities

This option sets the order of the legacy network devices and Hard Disks detected by the motherboard.

#### ►Delete Boot Option

This feature allows the user to delete a previously defined boot device from which the system boots during startup.

#### Boot Option #1, Boot option #2, Boot Option #3

The settings are **Built-in EFI Shell**, and [any pre-defined boot device].

## 4-7 Security

This menu allows the user to configure the following security settings for the system.



### Administrator Password

Use this feature to set the Administrator Password which is required to enter the BIOS setup utility. The length of the password should be from 3-characters to 8-characters long.

### User Password

Use this feature to set a User Password which is required to log into the system and to enter the BIOS setup utility. The length of the password should be from 3-characters to 8-characters long.

## 4-8 Save & Exit

This menu allows the user to configure the Save and Exit settings for the system.

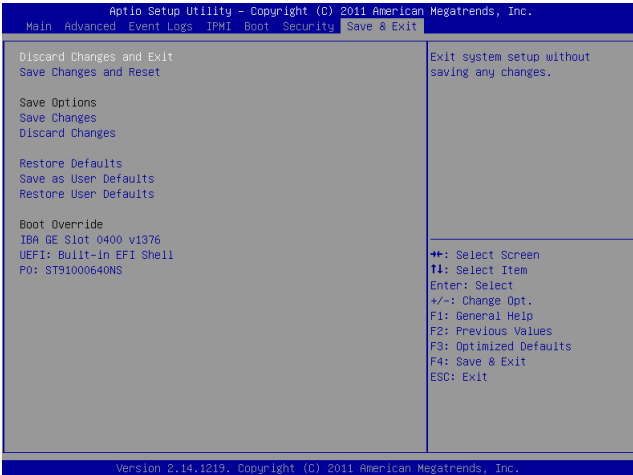

### Discard Changes and Exit

Select this option to quit the BIOS Setup without making any permanent changes to the system configuration, and reboot the computer. Select Discard Changes and Exit, and press <Enter>. When the dialog box appears, asking you if you want to exit the BIOS setup without saving, click **Yes** to quit BIOS without saving the changes, or click No to quit the BIOS and save changes.

### Save Changes and Reset

When you have completed the system configuration changes, select this option to save the changes and reboot the computer, so that the new system configuration parameters can take effect. Select Save Changes and Exit, and press <Enter>. When the dialog box appears, asking you if you want to exit the BIOS setup without saving, click **Yes** to quit BIOS without saving the changes, or click No to quit the BIOS and save changes.

### Save Options

### Save Changes

Select this option and press <Enter> to save all changes you've done so far and return to the AMI BIOS utility Program. This will not reset (reboot) the system. When the dialog box appears, asking you if you want to save configuration, click **Yes** to save the changes, or click No to return to the BIOS without making changes.

**Discard Changes**

Select this feature and press <Enter> to discard all the changes and return to the BIOS setup. When the dialog box appears, asking you if you want to load previous values, click **Yes** to load the values previous saved, or click No to keep the changes you've made so far.

**Restore Defaults**

Select this feature and press <Enter> to load the default settings that help optimize system performance. When the dialog box appears, asking you if you want to load the defaults, click **Yes** to load the default settings, or click No to abandon defaults.

**Save As User Defaults**

Select this feature and press <Enter> to save the current settings as the user's defaults. When the dialog box appears, asking you if you want to save values as user's defaults, click **Yes** to save the current values as user's default settings, or click No to keep the defaults previously saved as the user's defaults.

**Restore User Defaults**

Select this feature and press <Enter> to load the user's defaults previously saved in the system. When the dialog box appears, asking you if you want to restore user's defaults, click **Yes** to restore the user's defaults previously saved in the system, or click No to abandon the user's defaults that were previously saved.

**Boot Override**

This feature allows the user to enter a new setting to overwrite the original setting that was saved for the listed devices.

## Notes



## Appendix A

### BIOS Error Beep Codes

During the POST (Power-On Self-Test) routines, which are performed at each system boot, errors may occur.

**Non-fatal errors** are those which, in most cases, allow the system to continue to boot. The error messages normally appear on the screen.

**Fatal errors** will not allow the system to continue with bootup procedure. If a fatal error occurs, you should consult with your system manufacturer for possible repairs.

These fatal errors are usually communicated through a series of audible beeps. The numbers on the fatal error list correspond to the number of beeps for the corresponding error.

#### A-1 BIOS Error Beep Codes

BIOS Error Beep Codes		
Beep Code/LED	Error Message	Description
1 beep	Refresh	Ready to boot
5 short beeps + 1 long beep	Memory error	No memory detected in the system
5 beeps	No Con-In or No Con-Out devices	Con-In: USB or PS/2 keyboard, PCI or Serial Console Redirection, IPMI KVM or SOL  Con-Out: Video Controller, PCI or Serial Console Redirection, IPMI SOL
X9 IPMI Error Codes		
1 Continuous Beep	System OH	System Overheat

## **Notes**

## Appendix B

### Software Installation Instructions

#### B-1 Installing Software Programs

After you've installed the operating system, a screen as shown below will appear. You are ready to install software programs and drivers that have not yet been installed. To install these programs, click the icons to the right of these items.

 **Note:** To install the Windows OS, please refer to the instructions posted on our Website at <http://www.supermicro.com/support/manuals/>.

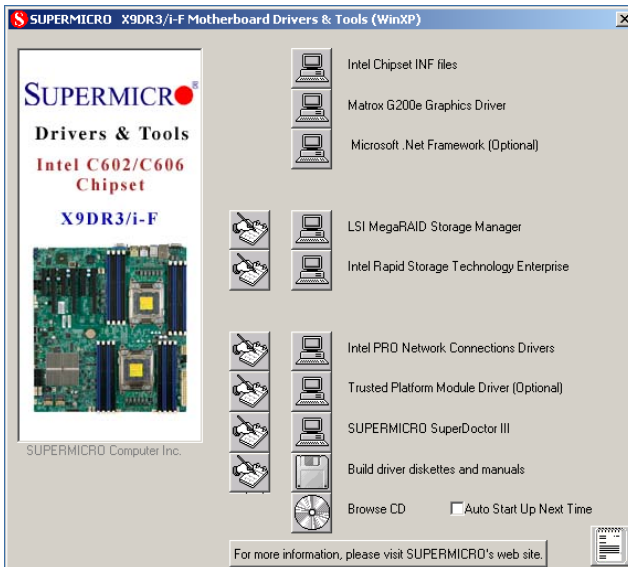

#### Driver/Tool Installation Display Screen

 **Note 1:** Click the icons showing a hand writing on the paper to view the readme files for each item. Click a computer icon to the right of an item to install an item (from top to the bottom) one at a time. After installing each item, you must reboot the system before proceeding with the next item on the list. The bottom icon with a CD on it allows you to view the entire contents of the CD.

**Note 2:** When making a storage driver diskette by booting into a Driver CD, please set the SATA Configuration to "Compatible Mode" and configure SATA as IDE in the BIOS Setup. After making the driver diskette, be sure to change the SATA settings back to your original settings.

**Note 3:** Changing BMC log-in information is recommended during initial system power-on. The default username is ADMIN and password is ADMIN. For BMC best practices, please refer to: [http://www.supermicro.com/products/nfo/files/IPMI/Best\\_Practices\\_BMC\\_Security.pdf](http://www.supermicro.com/products/nfo/files/IPMI/Best_Practices_BMC_Security.pdf)

## B-2 Configuring SuperDoctor III

The SuperDoctor® III program is a Web-based management tool that supports remote management capability. It includes Remote and Local Management tools. The local management is called the SD III Client. The SuperDoctor III program included on the CDROM that came with your motherboard allows you to monitor the environment and operations of your system. SuperDoctor III displays crucial system information such as CPU temperature, system voltages and fan status. See the Figure below for a display of the SuperDoctor III interface.



**Note 1:** The default user name and password are ADMIN.

**Note 2:** In the Windows OS environment, the SuperDoctor III settings take precedence over the BIOS settings. When first installed, SuperDoctor III adopts the temperature threshold settings previously set in BIOS. Any subsequent changes to these thresholds must be made within SuperDoctor, since the SD III settings override the BIOS settings. For the Windows OS to adopt the BIOS temperature threshold settings, please change the SDIII settings to be the same as those set in BIOS.

### SuperDoctor® III Interface Display Screen-I (Health Information)



**SuperDoctor® III Interface Display Screen-II (Remote Control)**

The screenshot displays the SuperDoctor III Remote Management web interface. The top navigation bar includes links for System Info, Health, Info, Performance, Remote Control, Configuration, Administration, System Management, Report, and Help. The main content area is titled "Remote Control" and features a blue virtual remote control device. The remote's screen shows the following text:

```
~Graceful Power Control
Open Console
~Power Control | Enter~
```

Below the remote control image, the interface provides information about graceful power control, requirements, and power control options.

**Graceful power control**

Super Doctor III allows a user to inform the OS to reboot or shut down within a specified time (the default is 30 seconds). Before the system reboots or shuts down, it's allowed to cancel the action.

**Requirements**

Keep Super SD3Service Daemon running at all times on this system.  
Provide TCP/IP connectivity.

**Power control**

 **Note:** The SD III utility and user guide can be downloaded from our website at: <http://www.supermicro.com/products/accessories/software/SuperDoctorIII.cfm>. For Linux, we will still recommend that you use SuperDoctor II.

## Notes

(Disclaimer Continued)

The products sold by Supermicro are not intended for and will not be used in life support systems, medical equipment, nuclear facilities or systems, aircraft, aircraft devices, aircraft/emergency communication devices or other critical systems whose failure to perform be reasonably expected to result in significant injury or loss of life or catastrophic property damage. Accordingly, Supermicro disclaims any and all liability, and should buyer use or sell such products for use in such ultra-hazardous applications, it does so entirely at its own risk. Furthermore, buyer agrees to fully indemnify, defend and hold Supermicro harmless for and against any and all claims, demands, actions, litigation, and proceedings of any kind arising out of or related to such ultra-hazardous use or sale.