

Changes	REV.	SYM.	Date	Changed	Checked	Approved
---------	------	------	------	---------	---------	----------















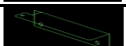





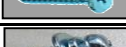

5100T Win10 Upgrade-kit Assembly manual

Written	Jan.16.2019	SK.JIN	Title		Drawing	Page
Checked	Jan.16.2019	SY.LEE	5100T Win10 Upgrade-kit Assembly manual			1
Approved	Jan.16.2019	MY.KO				7

1. Preface

- This is the instruction how to Win10 upgrade.

2. Parts

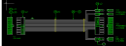
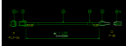
L-1	L-2	P/N	Part Name	Q'ty	Shape	Remark
1		7900002271	UP-KIT:CE H81:W/SPL:WIN10:5100T	1	Shape click to enlarge	
	1	7090000740	UNIT:CE:TG_H81:G1820:4GB:MODEM:WIN10	1		
	2	5621000037	UNIT:P/S:280W:HPS250-GTTWI:ATX	1		
	3	7110000056	UNIT:SPL:10.1":MOLD:DVI:MODE:wo/HANDLE	1		
	4	3353000022	PLUG:MODULAR COUPLER 8P:COPY TYCO:CN	5		
	5	4010022528	BRKT:CE_MOUNT:MX5100T	1		
	6	4010022527	BRKT:FR_CE_LOCK:MX5100T	1		
	7	4140009464	K-ASSY:SUPPORT_SPL_MOLD:MX5100T	1		
	8	4140009465	K-ASSY:SUPPORT_CONER_SPL:MX5100T	1		
	9	45463603	SCR:UNIT_SUPPORT_M3_1.2L:KIOSK	1		
	10	44633302	SCR:TRUSS(+):M4X8:W/ZNMaterial	4		
	11	44651302	SCR:PH(+):S/W:F/W(L):M3x6:W/ZN	3		
	12	45463602	SCR:UNIT_SUPPORT_M3_1.8L:KIOSK	1		
	13	44621302	SCR:FH(+):M3X8:W/ZN	2		
	14	44654303	SCR:PH(+):S/W:F/W(L):M4x8:W/ZN	10		
	15	3328000007	MONITOR_CABLE:DVI-D:3M	1		
	16	3200006537	CABLE_ASSY:10.1_INCH_SPL_PWR:MX5100T	1		
	17	3200007258	CABLE_ASSY:5100T:WIN10:UP-KIT:COMPORT	1		
	18	3266000184	CABLE_ASSY:AUDIO_JACK_I/F:TTW	1		
	19	3200007260	CABLE_ASSY:PWR CTRL IF	1		
	20	3200007278	CABLE_ASSY:CDU:COM2:IF	1		
	21	3400000041	USB_CABLE:AM TO MINIB:STR:3M	1		
	22	3200006923	CABLE_ASSY:MODE_S/W_IF:MX5100T	1		
	23	3200006924	CABLE_ASSY:MODE_S/W_IF:MX5100T (2)	1		
	24	3200006533	CABLE_ASSY:CE_ATX_20P_PWR:MX5100T	1		
	25	3200006535	CABLE_ASSY:P-ON_IF:MX5100T	1		
	26	5721003171	LABEL:USB_CABLE:MX5300	1		

3. Tools

[(+) Screwdriver]



[Nipper]



[Tie]

Written	Jan.16.2019	SK.JIN	Title		Drawing	Page
Checked	Jan.16.2019	SY.LEE	5100T Win10 Upgrade-kit			2
Approved	Jan.16.2019	MY.KO	Assembly manual			7

4. How to 5100T Windows10 upgrade.

1. CE Assembly

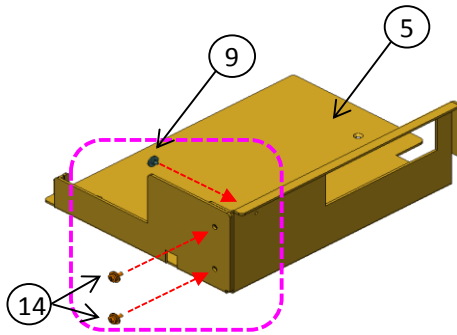
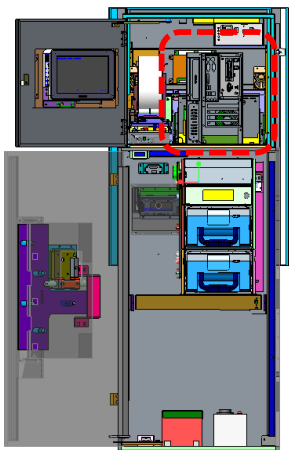

1-1. Assemble CE Brkt using Screw
- fasten 3 points(No.9,14)

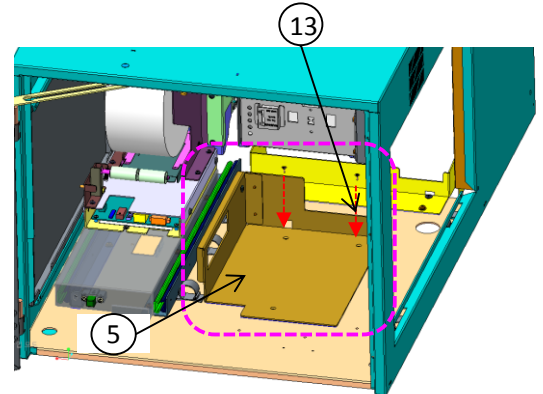

1-2. Install CE brkt Assy in the system
- fasten 2 points(No.13)

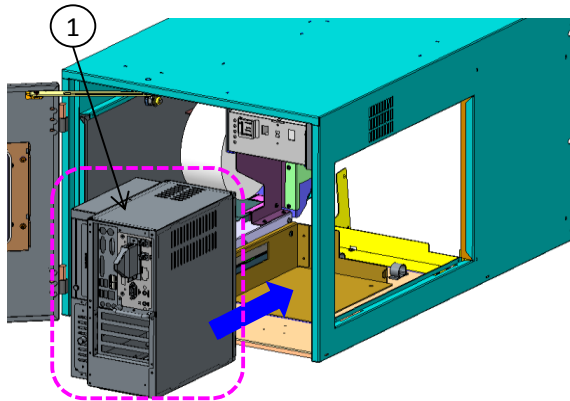

1-3. Install CE Assy in the system

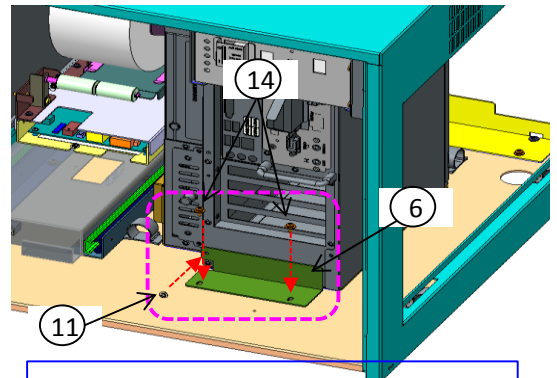

1-4. Install brkt in the system
- fasten 3 points(No.11,14)

Written	Jan.16.2019	SK.JIN	Title
Checked	Jan.16.2019	SY.LEE	5100T Win10 Upgrade-kit Assembly manual
Approved	Jan.16.2019	MY.KO	



Drawing	Page
	3
	7

2. Power Supply Assembly

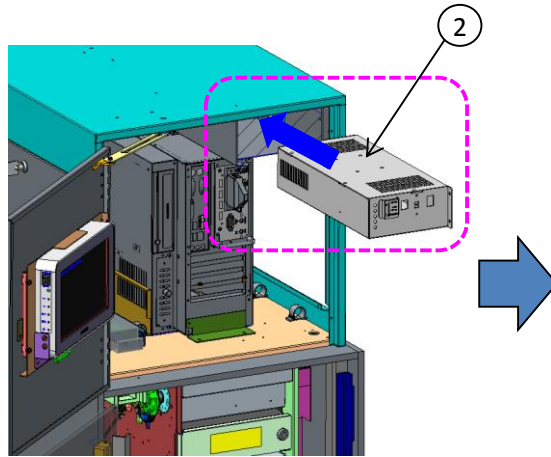
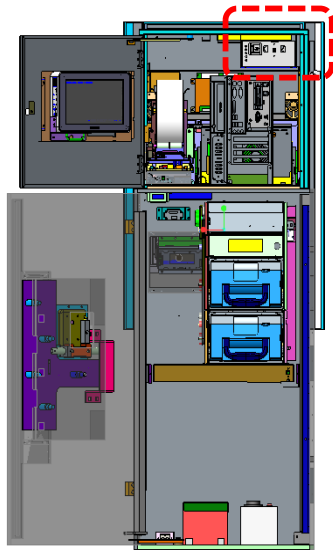

2-1. Install power supply in the system

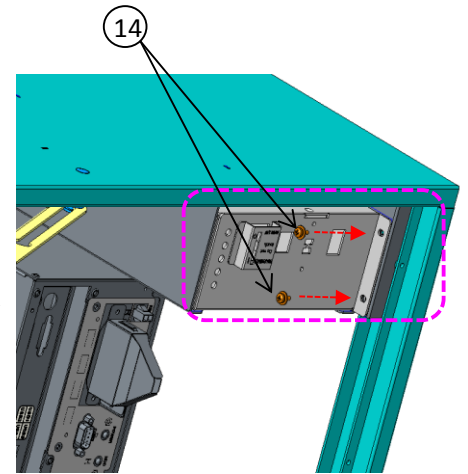

2-2. fasten 3 points(No.14)

3. SPL Assembly

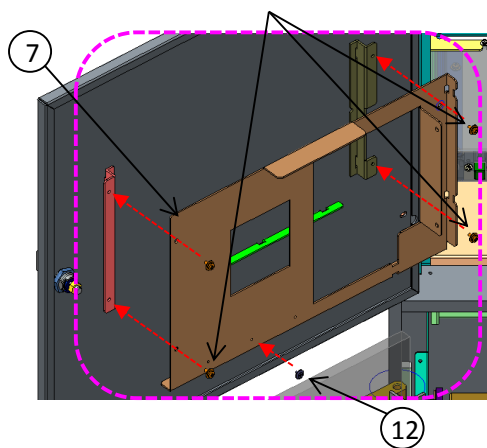
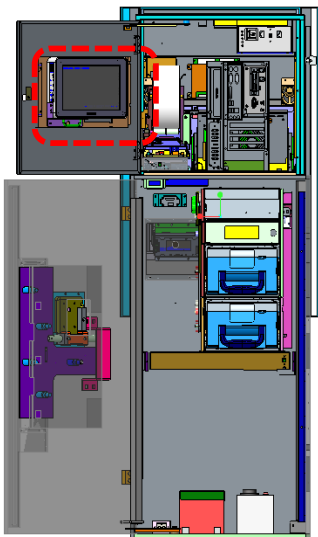

3-1. Install SPL brkt in the system
- fasten 5 points(No.12,14)

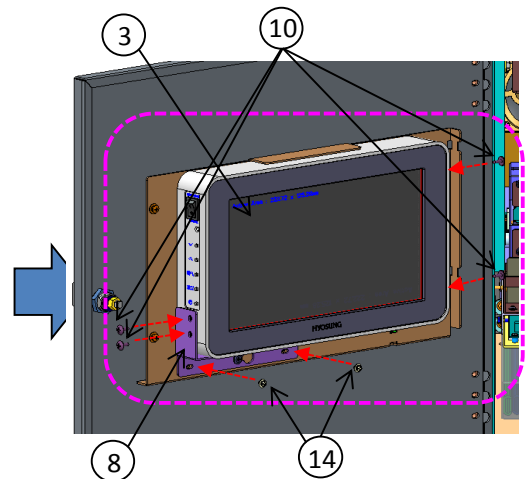

3-2 Install SPL in the system(w/Brkt)
- fasten 6 points(No.10,14)

Written	Jan.16.2019	SK.JIN
Checked	Jan.16.2019	SY.LEE
Approved	Jan.16.2019	MY.KO

Title
5100T Win10 Upgrade-kit Assembly manual



Drawing	Page
	4
	7

4. Cable connect guide(Use tie to Arrange cable.)

4-1. 5100T SYSTEM BLOCK DIAGRAM

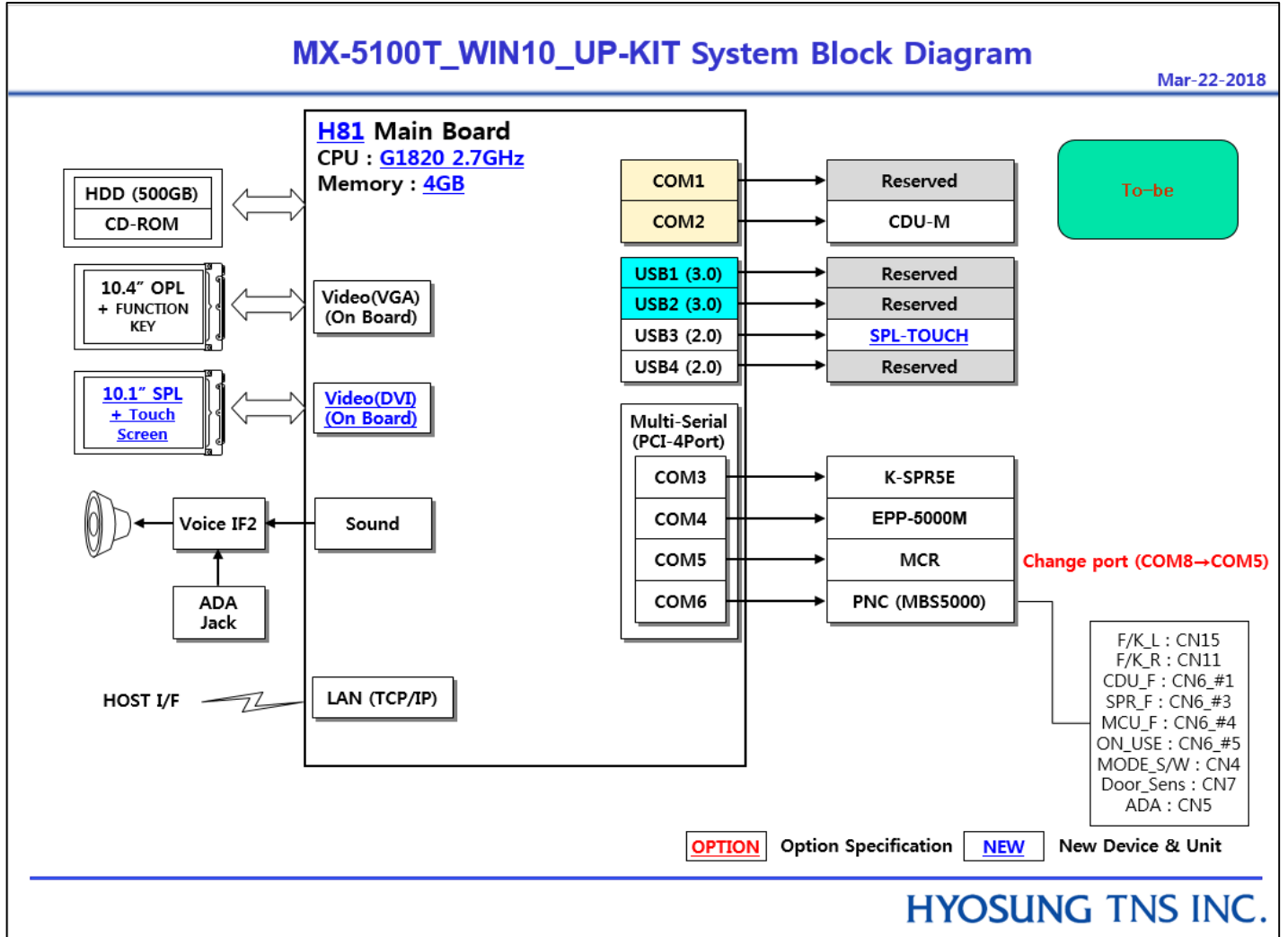

4-2. 5100T SYSTEM BLOCK DIAGRAM, CABLE LINK, CABLE LIST(Click More Info)

- MX-5100T_Win10_Up-kit BlockDiagram_R00(20180322).ppt
- MX-5100T_Win10_Up-kit Cable linking Diagram_R00(20180327).ppt
- MX-5100T_WIN10_Up-kit cable list_R00(20180327).xls

Written	Jan.16.2019	SK.JIN	Title 5100T Win10 Upgrade-kit Assembly manual	HYOSUNG TNS INC.	Drawing	Page
Checked	Jan.16.2019	SY.LEE				5
Approved	Jan.16.2019	MY.KO				7

4-3. New cable Arrange

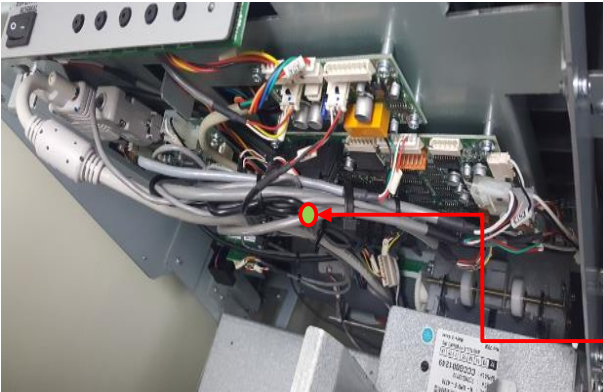

(22)3200006923
(PNC CN_4 to MODE IF)

(23)3200006924
(MODE IF to MODE S/W)

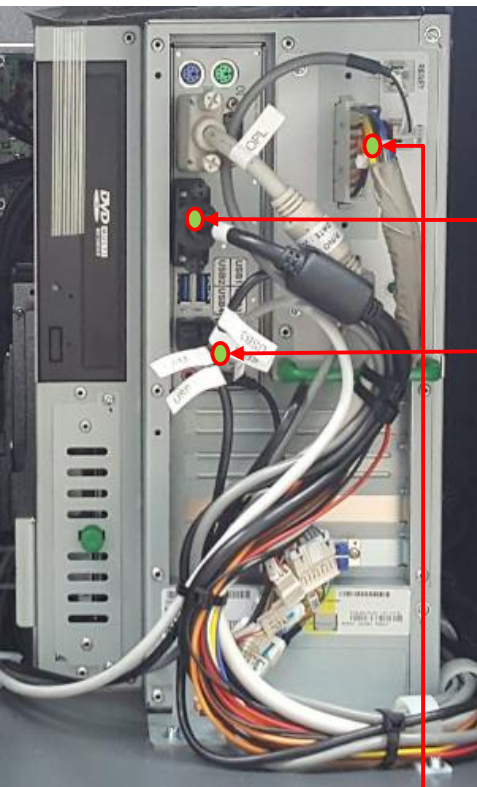

(15)3328000007
(CE DVI to SPL DVI)

(22)3400000041
(CE USB_3 to SPL T/S)



(16)3200006537
(SPL to P/S_SPL)

(24)3200006533
(CE PWR to P/S_3.3V_MBD_12V)

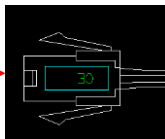
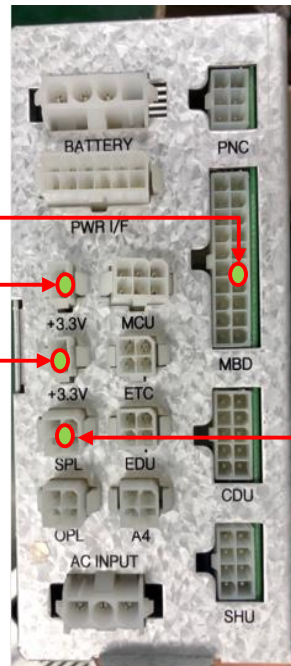

(20)3200007278
(CE_COM2)

(4)3353000022
(MODULAR * 1ea)

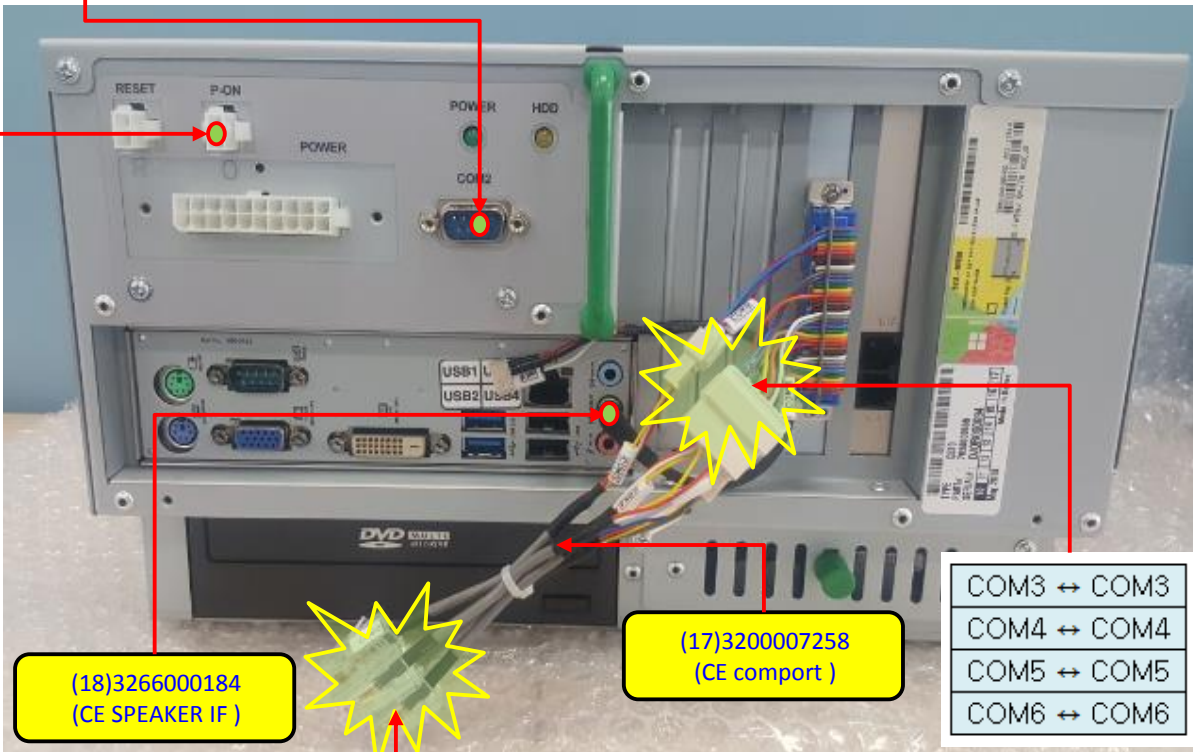

(18)3266000184
(CE SPEAKER I/F)

(17)3200007258
(CE com port)

COM3 ↔ COM3
COM4 ↔ COM4
COM5 ↔ COM5
COM6 ↔ COM6

(4)3353000022
(MODULAR * 4ea)



(25)3200006535
(P/S_P-ON to CE P-ON)

(19)3200007260
(P/S_PWR I/F)

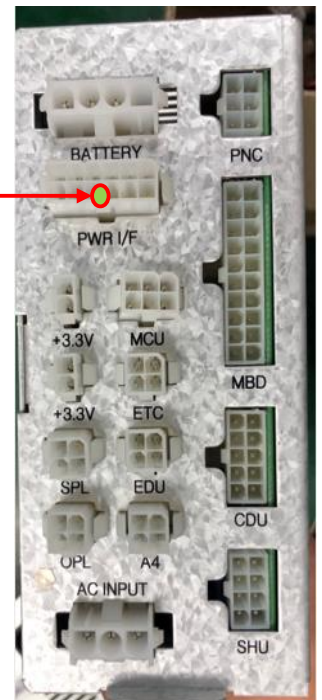

Written	Jan.16.2019	SK.JIN
Checked	Jan.16.2019	SY.LEE
Approved	Jan.16.2019	MY.KO

Title
5100T Win10 Upgrade-kit Assembly manual



Drawing

Page
7
7