

Intel® Desktop Board DH77EB Technical Product Specification

October 2012

Part Number: G53909-003

The Intel Desktop Board DH77EB may contain design defects or errors known as errata that may cause the product to deviate from published specifications. Current characterized errata are documented in the Intel Desktop Board DH77EB Specification Update.

Revision History

Revision	Revision History	Date
-001	First release of the Intel® Desktop Board DH77EB Technical Product Specification	April 2012
-002	Updated the Board Identification Information	June 2012
-003	Specification Clarification	October 2012

This product specification applies to only the standard Intel® Desktop Board with BIOS identifier EBH7710H.86A.

INFORMATION IN THIS DOCUMENT IS PROVIDED IN CONNECTION WITH INTEL® PRODUCTS. NO LICENSE, EXPRESS OR IMPLIED, BY ESTOPPEL OR OTHERWISE, TO ANY INTELLECTUAL PROPERTY RIGHTS IS GRANTED BY THIS DOCUMENT. EXCEPT AS PROVIDED IN INTEL'S TERMS AND CONDITIONS OF SALE FOR SUCH PRODUCTS, INTEL ASSUMES NO LIABILITY WHATSOEVER, AND INTEL DISCLAIMS ANY EXPRESS OR IMPLIED WARRANTY, RELATING TO SALE AND/OR USE OF INTEL PRODUCTS INCLUDING LIABILITY OR WARRANTIES RELATING TO FITNESS FOR A PARTICULAR PURPOSE, MERCHANTABILITY, OR INFRINGEMENT OF ANY PATENT, COPYRIGHT OR OTHER INTELLECTUAL PROPERTY RIGHT. UNLESS OTHERWISE AGREED IN WRITING BY INTEL, THE INTEL PRODUCTS ARE NOT DESIGNED NOR INTENDED FOR ANY APPLICATION IN WHICH THE FAILURE OF THE INTEL PRODUCT COULD CREATE A SITUATION WHERE PERSONAL INJURY OR DEATH MAY OCCUR.

All Intel® desktop boards are evaluated as Information Technology Equipment (I.T.E.) for use in personal computers (PC) for installation in homes, offices, schools, computer rooms, and similar locations. The suitability of this product for other PC or embedded non-PC applications or other environments, such as medical, industrial, alarm systems, test equipment, etc. may not be supported without further evaluation by Intel.

Intel Corporation may have patents or pending patent applications, trademarks, copyrights, or other intellectual property rights that relate to the presented subject matter. The furnishing of documents and other materials and information does not provide any license, express or implied, by estoppel or otherwise, to any such patents, trademarks, copyrights, or other intellectual property rights.

Intel may make changes to specifications and product descriptions at any time, without notice.

Designers must not rely on the absence or characteristics of any features or instructions marked "reserved" or "undefined." Intel reserves these for future definition and shall have no responsibility whatsoever for conflicts or incompatibilities arising from future changes to them.

Intel desktop boards may contain design defects or errors known as errata, which may cause the product to deviate from published specifications. Current characterized errata are available on request.

Contact your local Intel sales office or your distributor to obtain the latest specifications before placing your product order.

Intel, 3rd generation Intel Core processor family, and 2nd generation Intel Core processor family are trademarks of Intel Corporation in the U.S. and/or other countries.

* Other names and brands may be claimed as the property of others.

Copyright © 2012, Intel Corporation. All rights reserved.

Board Identification Information

Basic Desktop Board DH77EB Identification Information

AA Revision	BIOS Revision	Notes
G39073-303	EBH7710H.86A.0041	1,2
G39073-304	EBH7710H.86A.0053	1,2
G39073-400	EBH7710H.86A.0053	1,2

Notes:

1. The AA number is found on a small label on the component side of the board.
2. The H77 chipset used on this AA revision consists of the following component:

Device	Stepping	S-Spec Numbers
Intel H77 Express Chipset	C1	SLJ88

Specification Changes or Clarifications

The table below indicates the Specification Changes or Specification Clarifications that apply to the Intel® Desktop Board DH77EB.

Specification Changes or Clarifications

Date	Type of Change	Description of Change or Clarification
October 2012	Spec Clarification	Updated Table 39. Environmental Specifications to address operating temperature requirements for the board.

Errata

Current characterized errata, if any, are documented in a separate Specification Update. See <http://developer.intel.com/products/desktop/motherboard/index.htm> for the latest documentation.

Intel Desktop Board DH77EB Technical Product Specification

Preface

This Technical Product Specification (TPS) specifies the board layout, components, connectors, power and environmental requirements, and the BIOS for Intel® Desktop Board DH77EB.

Intended Audience

The TPS is intended to provide detailed, technical information about Intel Desktop Board DH77EB and its components to the vendors, system integrators, and other engineers and technicians who need this level of information. It is specifically *not* intended for general audiences.

What This Document Contains

Chapter	Description
1	A description of the hardware used on Intel Desktop Board DH77EB
2	A map of the resources of the Intel Desktop Board
3	The features supported by the BIOS Setup program
4	A description of the BIOS error messages, beep codes, and POST codes
5	Regulatory compliance and battery disposal information

Typographical Conventions

This section contains information about the conventions used in this specification. Not all of these symbols and abbreviations appear in all specifications of this type.

Notes, Cautions, and Warnings



NOTE

Notes call attention to important information.



CAUTION

Cautions are included to help you avoid damaging hardware or losing data.

Other Common Notation

#	Used after a signal name to identify an active-low signal (such as USBP0#)
GB	Gigabyte (1,073,741,824 bytes)
GB/s	Gigabytes per second
Gb/s	Gigabits per second
KB	Kilobyte (1024 bytes)
Kb	Kilobit (1024 bits)
kb/s	1000 bits per second
MB	Megabyte (1,048,576 bytes)
MB/s	Megabytes per second
Mb	Megabit (1,048,576 bits)
Mb/s	Megabits per second
TDP	Thermal Design Power
xxh	An address or data value ending with a lowercase h indicates a hexadecimal value.
x.x V	Volts. Voltages are DC unless otherwise specified.
*	This symbol is used to indicate third-party brands and names that are the property of their respective owners.

Contents

Revision History

Board Identification Information	iii
Errata	iii

Preface

Intended Audience.....	v
What This Document Contains.....	v
Typographical Conventions	v

1 Product Description

1.1 Overview	11
1.1.1 Feature Summary	11
1.1.2 Board Layout	13
1.1.3 Block Diagram	15
1.2 Online Support	16
1.3 Processor	16
1.3.1 Graphics Subsystem	17
1.4 System Memory	19
1.4.1 Memory Configurations	20
1.5 Intel® H77 Express Chipset	22
1.5.1 Direct Media Interface (DMI)	22
1.5.2 Display Interfaces	22
1.5.3 USB	25
1.5.4 SATA Interfaces	25
1.6 Real-Time Clock Subsystem	27
1.7 Legacy I/O Controller	27
1.7.1 Consumer Infrared (CIR).....	27
1.8 Audio Subsystem.....	28
1.8.1 Audio Subsystem Software	28
1.8.2 Audio Subsystem Components	28
1.9 LAN Subsystem	30
1.9.1 Intel® 82579V Gigabit Ethernet Controller	30
1.9.2 LAN Subsystem Software	31
1.9.3 RJ-45 LAN Connector with Integrated LEDs	31
1.10 Hardware Management Subsystem	32
1.10.1 Hardware Monitoring	32
1.10.2 Fan Monitoring	32
1.10.3 Chassis Intrusion and Detection	32
1.10.4 Thermal Monitoring	33
1.11 Power Management	34
1.11.1 ACPI	34
1.11.2 Hardware Support	36

2 Technical Reference

2.1	Memory Resources	41
2.1.1	Addressable Memory.....	41
2.1.2	Memory Map.....	43
2.2	Connectors and Headers.....	43
2.2.1	Back Panel Connectors.....	44
2.2.2	Component-side Connectors and Headers.....	45
2.3	Jumper Block	57
2.4	Mechanical Considerations	59
2.4.1	Form Factor.....	59
2.5	Electrical Considerations.....	60
2.5.1	Power Supply Considerations	60
2.5.2	Power Supervisor	60
2.5.3	Fan Header Current Capability	61
2.5.4	Add-in Board Considerations.....	61
2.6	Thermal Considerations	61
2.7	Reliability	64
2.8	Environmental.....	64

3 Overview of BIOS Features

3.1	Introduction.....	65
3.2	BIOS Flash Memory Organization.....	66
3.3	Resource Configuration	66
3.3.1	PCI Express Autoconfiguration	66
3.4	System Management BIOS (SMBIOS)	67
3.5	Legacy USB Support	67
3.6	BIOS Updates	68
3.6.1	Language Support.....	68
3.6.2	Custom Splash Screen	69
3.7	BIOS Recovery.....	69
3.8	Boot Options.....	70
3.8.1	Optical Drive Boot	70
3.8.2	Network Boot.....	70
3.8.3	Booting Without Attached Devices	70
3.8.4	Changing the Default Boot Device During POST.....	70
3.9	Adjusting Boot Speed.....	71
3.9.1	Peripheral Selection and Configuration	71
3.9.2	BIOS Boot Optimizations	71
3.10	BIOS Security Features	72
3.11	BIOS Performance Features	73

4 Error Messages and Beep Codes

4.1	Speaker	75
4.2	BIOS Beep Codes	75
4.3	Front-panel Power LED Blink Codes.....	76
4.4	BIOS Error Messages	76
4.5	Port 80h Power On Self Test (POST) Codes	77

5 Regulatory Compliance and Battery Disposal Information

5.1	Regulatory Compliance.....	83
5.1.1	Safety Standards.....	83
5.1.2	European Union Declaration of Conformity Statement.....	84
5.1.3	Product Ecology Statements.....	85
5.1.4	China RoHS.....	88
5.1.5	EMC Regulations.....	89
5.1.6	ENERGY STAR* 5.0, e-Standby, and ErP Compliance.....	91
5.1.7	Regulatory Compliance Marks (Board Level).....	92
5.2	Battery Disposal Information.....	93

Figures

1.	Major Board Components.....	13
2.	Block Diagram.....	15
3.	Memory Channel and DIMM Configuration.....	21
4.	Back Panel Audio Connectors.....	29
5.	LAN Connector LED Locations.....	31
6.	Thermal Sensors and Fan Headers.....	33
7.	Location of the Standby Power LED.....	40
8.	Detailed System Memory Address Map.....	42
9.	Back Panel Connectors.....	44
10.	Component-side Connectors and Headers.....	45
11.	Connection Diagram for Front Panel Header.....	54
12.	Connection Diagram for Front Panel USB 2.0 Headers.....	56
13.	Location of the Jumper Block.....	57
14.	Board Dimensions.....	59
15.	Localized High Temperature Zones.....	62
16.	Intel Desktop Board DH77EB China RoHS Material Self Declaration Table.....	88

Tables

1.	Feature Summary.....	11
2.	Components Shown in Figure 1.....	14
3.	Supported Memory Configurations.....	19
4.	DVI Port Status Conditions.....	23
5.	HDMI Port Status Conditions.....	23
6.	DisplayPort Status Conditions.....	24
7.	Audio Formats Supported by the HDMI and DisplayPort Interfaces.....	24
8.	Audio Jack Support.....	28
9.	LAN Connector LED States.....	31
10.	Effects of Pressing the Power Switch.....	34
11.	Power States and Targeted System Power.....	35
12.	Wake-up Devices and Events.....	36
13.	System Memory Map.....	43

Intel Desktop Board DH77EB Technical Product Specification

14.	Component-side Connectors and Headers Shown in Figure 10.....	46
15.	Front Panel Audio Header for Intel HD Audio	47
16.	Front Panel Audio Header for AC '97 Audio.....	47
17.	Front Panel USB 2.0 Headers	47
18.	Front Panel USB 3.0 Connector.....	48
19.	SATA Connectors.....	48
20.	S/PDIF Header	48
21.	Chassis Intrusion Header.....	49
22.	Processor, Front, and Rear Chassis (4-Pin) Fan Headers.....	49
23.	Back Panel CIR Emitter (Output) Header	49
24.	Front Panel CIR Receiver (Input) Header	49
25.	Parallel Port Header	50
26.	PCI Express Full-/Half-Mini Card Connector.....	51
27.	Serial Port Header	52
28.	LPC Debug Connector.....	52
29.	Processor Core Power Connector	53
30.	Main Power Connector.....	53
31.	Front Panel Header	54
32.	States for a One-Color Power LED.....	55
33.	States for a Two-Color Power LED.....	55
34.	Alternate Front Panel Power/Sleep LED Header.....	55
35.	BIOS Setup Configuration Jumper Settings	58
36.	Fan Header Current Capability.....	61
37.	Thermal Considerations for Components.....	63
38.	Tcontrol Values for Components	63
39.	Environmental Specifications.....	64
40.	BIOS Setup Program Menu Bar.....	66
41.	BIOS Setup Program Function Keys	66
42.	Acceptable Drives/Media Types for BIOS Recovery.....	69
43.	Boot Device Menu Options	70
44.	Supervisor and User Password Functions	72
45.	BIOS Beep Codes	75
46.	Front-panel Power LED Blink Codes.....	76
47.	BIOS Error Messages	76
48.	Port 80h POST Code Ranges	77
49.	Port 80h POST Codes	78
50.	Typical Port 80h POST Sequence	82
51.	Safety Standards.....	83
52.	EMC Regulations.....	89
53.	Regulatory Compliance Marks	92

1 Product Description

1.1 Overview

1.1.1 Feature Summary

Table 1 summarizes the major features of the board.

Table 1. Feature Summary

Form Factor	MicroATX (9.60 inches by 9.60 inches [243.84 millimeters by 243.84 millimeters])
Processor	<ul style="list-style-type: none">• 3rd generation Intel® Core processor family and 2nd generation Intel® Core processor family processors with up to 95 W TDP in an LGA1155 socket<ul style="list-style-type: none">– One PCI Express* x16 graphics interface– Integrated memory controller with dual channel DDR3 memory support– Integrated graphics processing (processors with Intel® HD Graphics)– External graphics interface controller
Memory	<ul style="list-style-type: none">• Four 240-pin DDR3 SDRAM Dual Inline Memory Module (DIMM) sockets• Support for DDR3 1600 MHz, DDR3 1333 MHz, and DDR3 1066 MHz DIMMs• Support for 1 Gb, 2 Gb, and 4 Gb memory technology• Support for up to 32 GB of system memory with four DIMMs using 4 Gb memory technology• Support for non-ECC memory• Support for 1.5 V (standard voltage) and 1.35 V (low voltage) JEDEC memory• Support for XMP memory <p>Note: DDR3 1600 MHz DIMMs are only supported by 3rd generation Intel Core processor family processors</p>
Chipset	Intel® H77 Express Chipset consisting of the Intel® H77 Express Platform Controller Hub (PCH)
Graphics	<ul style="list-style-type: none">• Integrated graphics support for processors with Intel HD Graphics:<ul style="list-style-type: none">– High Definition Multimedia Interface* (HDMI*) v1.4a– DVI-I v1.0– DisplayPort* v1.1a• Support for a PCI Express* 3.0 x16 add-in graphics card <p>Note: PCI Express 3.0 is only supported by 3rd generation Intel Core processor family processors</p>
Audio	<ul style="list-style-type: none">• 10-channel (8 + 2) Intel High Definition Audio via the Realtek* ALC892 audio codec

continued

Table 1. Feature Summary (continued)

<p>Peripheral Interfaces</p>	<ul style="list-style-type: none"> • Four USB 3.0 ports: <ul style="list-style-type: none"> – Two USB 3.0 ports are implemented with stacked back panel connectors (blue) – Two front panel USB 3.0 ports are implemented through one internal connector (blue) • Ten USB 2.0 ports: <ul style="list-style-type: none"> – Four ports implemented with stacked back panel connectors (black) – Six front panel ports implemented through three internal headers • Six Serial ATA (SATA) ports: <ul style="list-style-type: none"> – Two SATA 6.0 Gb/s interfaces through the Intel H77 Express Chipset with Intel® Rapid Storage Technology RAID support (blue) – Two internal SATA 3.0 Gb/s interfaces through Intel H77 Express Chipset with Intel Rapid Storage Technology RAID support (black) – One internal SATA connector (multiplexed with an mSATA port, routed to the PCI Express Full-/Half-Mini Card slot) (gray) – One back panel eSATA port (red) • One serial port header • One parallel port header
<p>Expansion Capabilities</p>	<ul style="list-style-type: none"> • One PCI Express 3.0 x16 add-in card connector • Three PCI Express 2.0 x1 add-in card connectors • One PCI Express Full-/Half-Mini Card slot with support for mSATA <p>Note: PCI Express 3.0 is only supported by 3rd generation Intel Core processor family processors</p>
<p>BIOS</p>	<ul style="list-style-type: none"> • Intel® BIOS resident in the SPI Flash device • Support for Advanced Configuration and Power Interface (ACPI), Plug and Play, and SMBIOS
<p>Instantly Available PC Technology</p>	<ul style="list-style-type: none"> • Support for PCI Express* Revision 3.0 • Suspend to RAM support • Wake on PCI Express, LAN, front panel, serial, Consumer Infrared (CIR), and USB ports
<p>LAN Support</p>	<p>Gigabit (10/100/1000 Mb/s) LAN subsystem using the Intel® 82579V Gigabit Ethernet Controller</p>
<p>Legacy I/O Control</p>	<p>Nuvoton W83677HG-i I/O controller for CIR, serial port, parallel port, and hardware management support</p>
<p>Hardware Monitor Subsystem</p>	<ul style="list-style-type: none"> • Hardware monitoring through the Nuvoton I/O controller • Voltage sense to detect out of range power supply voltages • Thermal sense to detect out of range thermal values • Three fan headers • Two fan sense inputs used to monitor fan activity • Fan speed control

1.1.2 Board Layout

Figure 1 shows the location of the major components on Intel Desktop Board DH77EB.

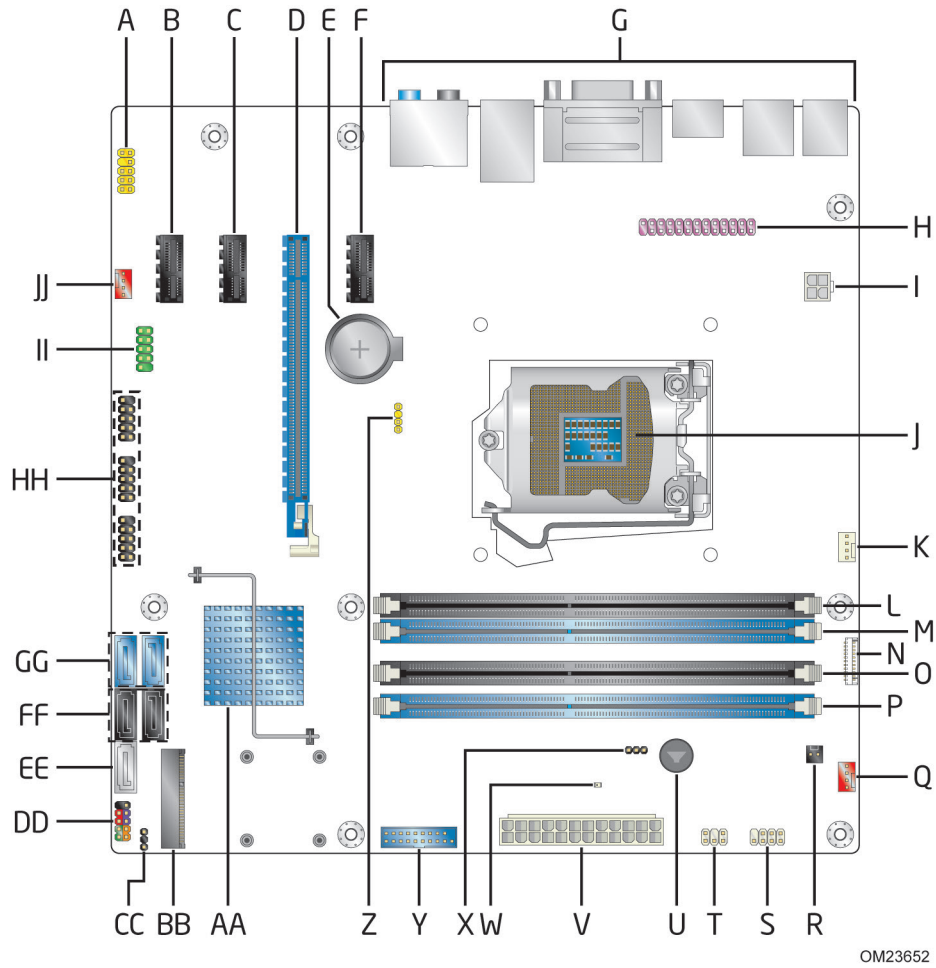

OM23652

Figure 1. Major Board Components

Table 2 lists the components identified in Figure 1.

Table 2. Components Shown in Figure 1

Item/callout from Figure 1	Description
A	Front panel audio header
B	PCI Express x1 add-in card connector
C	PCI Express x1 add-in card connector
D	PCI Express x16 add-in card connector
E	Battery
F	PCI Express x1 add-in card connector
G	Back panel connectors
H	Parallel port header
I	Processor core power connector (2 x 2)
J	LGA1155 processor socket
K	Processor fan header
L	DIMM 3 (Channel A DIMM 0)
M	DIMM 1 (Channel A DIMM 1)
N	Low Pin Count (LPC) Debug connector
O	DIMM 4 (Channel B DIMM 0)
P	DIMM 2 (Channel B DIMM 1)
Q	Front fan header
R	Chassis intrusion header
S	Consumer IR receiver (input) header
T	Consumer IR emitter (output) header
U	Piezoelectric speaker
V	Main power connector (2 x 12)
W	Standby power LED
X	BIOS Setup configuration jumper block
Y	Front panel USB 3.0 connector
Z	S/PDIF out header
AA	Intel H77 Express Chipset
BB	PCI Express Full-/Half-Mini Card slot
CC	Alternate front panel power/sleep LED header
DD	Front panel header
EE	SATA 6.0 Gb/s connector (multiplexed with an mSATA port, routed to the PCI Express Full-/Half-Mini Card slot) (gray)
FF	SATA 3.0 Gb/s connector through the PCH (black)
GG	SATA 6.0 Gb/s connector through the PCH (blue)
HH	Front panel USB 2.0 connectors
II	Serial port header
JJ	Rear chassis fan header

1.1.3 Block Diagram

Figure 2 is a block diagram of the major functional areas of the board.

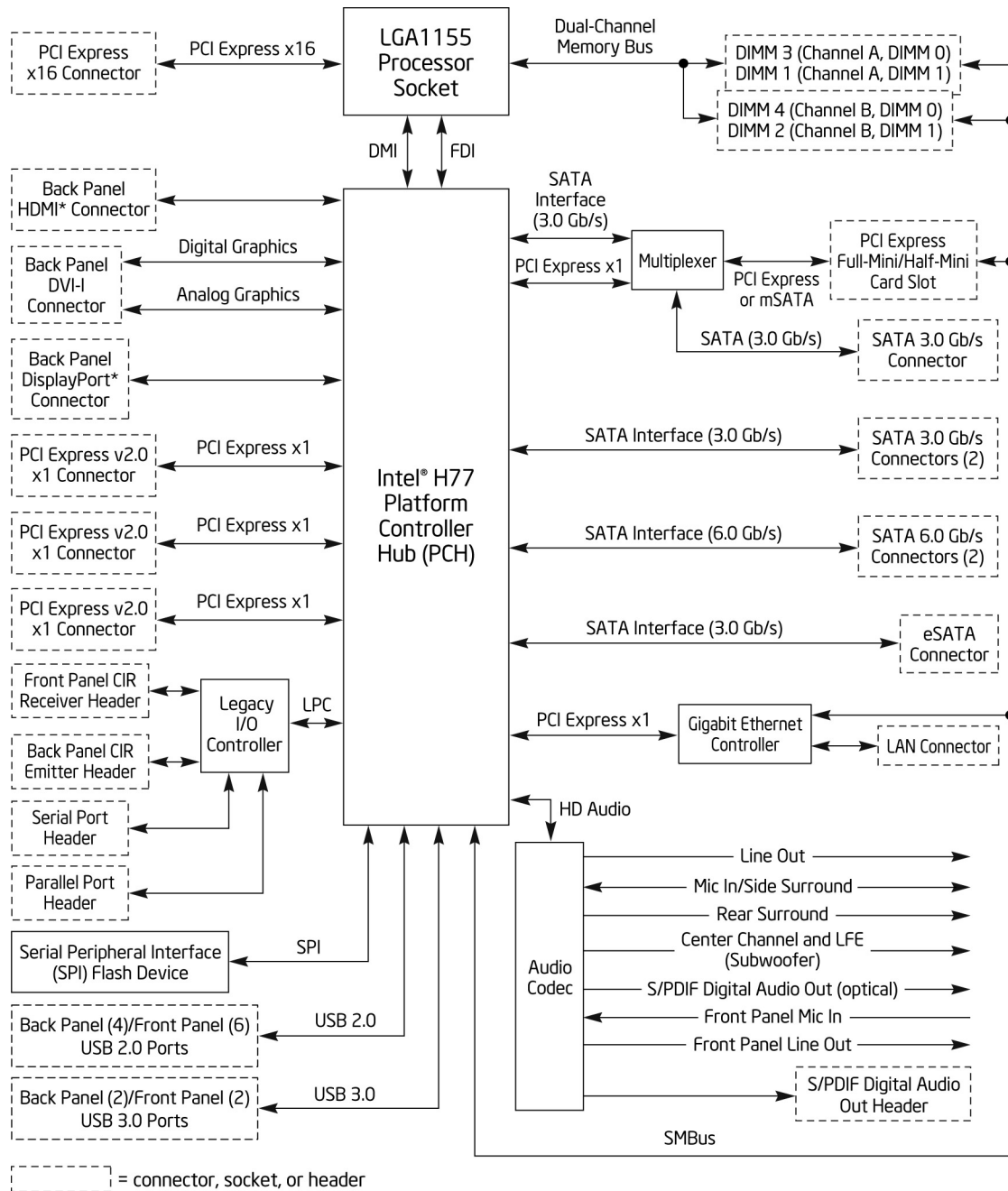

OM23663

Figure 2. Block Diagram

1.2 Online Support

To find information about...

Intel Desktop Board DH77EB
Desktop Board Support
Available configurations for Intel Desktop Board DH77EB
Supported processors
Chipset information
BIOS and driver updates
Tested memory
Integration information

Visit this World Wide Web site:

<http://www.intel.com/products/motherboard/index.htm>
http://www.intel.com/p/en_US/support?iid=hdr+support
<http://ark.intel.com>
<http://processormatch.intel.com>
<http://www.intel.com/products/desktop/chipsets/index.htm>
<http://downloadcenter.intel.com>
<http://www.intel.com/support/motherboards/desktop/sb/CS-025414.htm>
<http://www.intel.com/support/go/buildit>

1.3 Processor

The board supports 3rd generation Intel Core processor family and 2nd generation Intel Core processor family processors.

Other processors may be supported in the future. This board supports processors with a maximum wattage of 95 W Thermal Design Power (TDP). The processors listed above are only supported when falling within the wattage requirements of Intel Desktop Board DH77EB. See the Intel web site listed below for the most up-to-date list of supported processors.

For information about...

Supported processors

Refer to:

<http://processormatch.intel.com>



CAUTION

Use only the processors listed on the web site above. Use of unsupported processors can damage the board, the processor, and the power supply.



NOTE

This board has specific requirements for providing power to the processor. Refer to Section 2.5.1 on page 60 for information on power supply requirements for this board.

1.3.1 Graphics Subsystem

The board supports graphics through either the processor Intel HD Graphics or a PCI Express x16 add-in graphics card.

1.3.1.1 Processor Graphics

The board supports integrated graphics through the Intel® Flexible Display Interface (Intel® FDI) for processors with Intel HD Graphics.



NOTE

If using a processor with integrated graphics, the board will support only two of the integrated graphics interfaces simultaneously: DisplayPort, DVI-I, HDMI. Also, during the Power On Self Test (POST), the board will not output to the DisplayPort if DVI-I or HDMI is used concurrently with DisplayPort.

1.3.1.1.1 Intel® High Definition (Intel® HD) Graphics

The Intel HD graphics controller features the following:

- 3D Features
 - DirectX* 11 (2nd generation Intel Core processor family processors support CS4.0 only) support
 - OpenGL* 3.0 support
 - Shader Model 4.0
- Video
 - High-Definition content at up to 1080p resolution
 - Hardware accelerated MPEG-2, VC-1/WMV, and H.264/AVC Hi-Definition video formats
 - Intel® HD Graphics with Advanced Hardware Video Transcoding (Intel® Quick Sync Video)
 - Note: Intel Quick Sync is enabled with the appropriate software application
 - Blu-ray* S3D via HDMI 1.4a
 - Dynamic Video Memory Technology (DVMT) 5.0 support
 - Support of up to 1.7 GB Video Memory with 4 GB and above system memory configuration

1.3.1.2 PCI Express x16 Graphics

3rd generation Intel Core processor family processors support PCI Express 3.0, 2.x, and 1.x and 2nd generation Intel Core processor family processors support PCI Express 2.x and 1.x:

- PCI Express 3.0 with a raw bit rate of 8.0 GT/s results in an effective bandwidth of 1 GB/s each direction per lane. The maximum theoretical bandwidth of the x16 interface is 16 GB/s in each direction, simultaneously, for a total bandwidth of 32 GB/s.
- PCI Express 2.x with a raw bit rate of 5.0 GT/s results in an effective bandwidth of 500 MB/s each direction per lane. The maximum theoretical bandwidth of the x16 interface is 8 GB/s in each direction, simultaneously, for a total bandwidth of 16 GB/s.
- PCI Express 1.x with a raw bit rate of 2.5 GT/s results in an effective bandwidth of 250 MB/s each direction per lane. The maximum theoretical bandwidth of the x16 interface is 4 GB/s in each direction, simultaneously, for a total bandwidth of 8 GB/s.

For information about

PCI Express technology

Refer to

<http://www.pcisig.com>

1.4 System Memory

The board has four DIMM sockets and supports the following memory features:

- 1.5 V DDR3 SDRAM DIMMs with gold plated contacts, with the option to raise the voltage to support higher performance DDR3 SDRAM DIMMs.
- 1.35 V Low Voltage DDR3 DIMMs (JEDEC specification)
- Two independent memory channels with interleaved mode support
- Unbuffered, single-sided or double-sided DIMMs with the following restriction:
Double-sided DIMMs with x16 organization are not supported.
- 32 GB maximum total system memory (with 4 Gb memory technology). Refer to Section 2.1.1 on page 41 for information on the total amount of addressable memory.
- Minimum recommended total system memory: 1 GB
- Non-ECC DIMMs
- Serial Presence Detect
- DDR3 1600 MHz, DDR3 1333 MHz, and DDR3 1066 MHz SDRAM DIMMs
Note: DDR3 1600 MHz DIMMs are only supported by 3rd generation Intel Core processor family processors
- XMP version 1.3 performance profile support for memory speeds up to 1600 MHz



NOTE

To be fully compliant with all applicable DDR SDRAM memory specifications, the board should be populated with DIMMs that support the Serial Presence Detect (SPD) data structure. This allows the BIOS to read the SPD data and program the chipset to accurately configure memory settings for optimum performance. If non-SPD memory is installed, the BIOS will attempt to correctly configure the memory settings, but performance and reliability may be impacted or the DIMMs may not function under the determined frequency.

Table 3 lists the supported DIMM configurations.

Table 3. Supported Memory Configurations

DIMM Capacity	Configuration ^(Note)	SDRAM Density	SDRAM Organization Front-side/Back-side	Number of SDRAM Devices
1024 MB	SS	1 Gbit	128 M x8/empty	8
1024 MB	SS	2 Gbit	128 M x16/empty	4
2048 MB	DS	1 Gbit	128 M x8/128 M x8	16
2048 MB	SS	2 Gbit	128 M x16/empty	8
4096 MB	DS	2 Gbit	256 M x8/256 M x8	16
4096 MB	SS	4 Gbit	512 M x8/empty	8
8192 MB	DS	4 Gbit	512 M x8/512 M x8	16

Note: "DS" refers to double-sided memory modules (containing two rows of SDRAM) and "SS" refers to single-sided memory modules (containing one row of SDRAM).

For information about...

Tested Memory

Refer to:

<http://support.intel.com/support/motherboards/desktop/sb/CS-025414.htm>

1.4.1 Memory Configurations

The 3rd generation Intel Core processor family and 2nd generation Intel Core processor family processors support the following types of memory organization:

- **Dual channel (Interleaved) mode.** This mode offers the highest throughput for real world applications. Dual channel mode is enabled when the installed memory capacities of both DIMM channels are equal. Technology and device width can vary from one channel to the other but the installed memory capacity for each channel must be equal. If different speed DIMMs are used between channels, the slowest memory timing will be used.
- **Single channel (Asymmetric) mode.** This mode is equivalent to single channel bandwidth operation for real world applications. This mode is used when only a single DIMM is installed or the memory capacities are unequal. Technology and device width can vary from one channel to the other. If different speed DIMMs are used between channels, the slowest memory timing will be used.
- **Flex mode.** This mode provides the most flexible performance characteristics. The bottommost DRAM memory (the memory that is lowest within the system memory map) is mapped to dual channel operation; the topmost DRAM memory (the memory that is nearest to the 8 GB address space limit), if any, is mapped to single channel operation. Flex mode results in multiple zones of dual and single channel operation across the whole of DRAM memory. To use flex mode, it is necessary to populate both channels.

For information about...

Memory Configuration Examples

Refer to:

<http://www.intel.com/support/motherboards/desktop/sb/cs-011965.htm>

Figure 3 illustrates the memory channel and DIMM configuration.

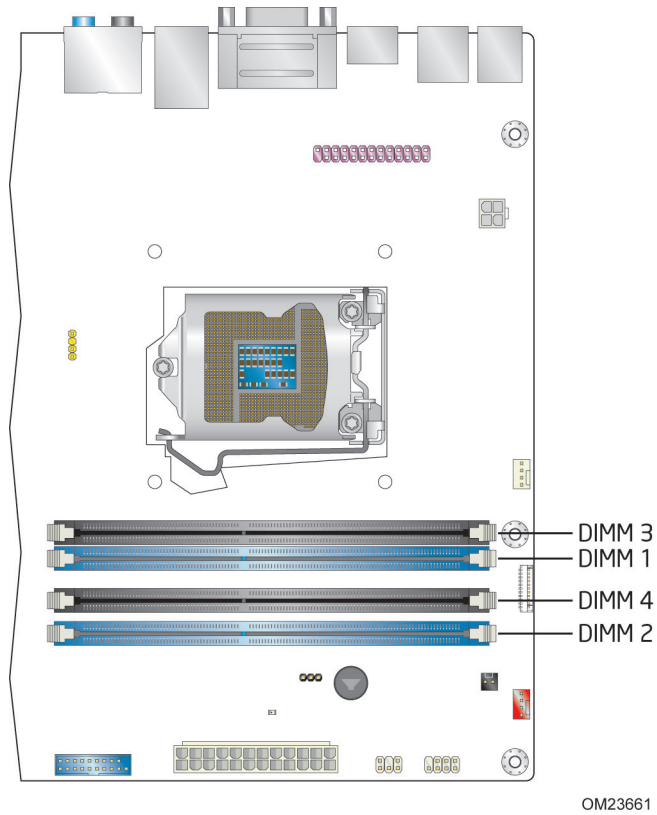

Figure 3. Memory Channel and DIMM Configuration



NOTE

For best memory performance always install memory in the blue DIMM sockets if installing only two DIMMs on your board.

1.5 Intel® H77 Express Chipset

Intel H77 Express Chipset with Intel Flexible Display Interconnect (Intel FDI) and Direct Media Interface (DMI) interconnect provides interfaces to the processor and the display, USB, SATA, LPC, LAN, and PCI Express interfaces. The Intel H77 Express Chipset is a centralized controller for the board's I/O paths.

For information about	Refer to
The Intel H77 chipset	http://www.intel.com/products/desktop/chipsets/index.htm
Resources used by the chipset	Chapter 2

1.5.1 Direct Media Interface (DMI)

Direct Media Interface (DMI) is the chip-to-chip connection between the processor and PCH. This high-speed interface integrates advanced priority-based servicing allowing for concurrent traffic and true isochronous transfer capabilities.

1.5.2 Display Interfaces

Display is divided between the processor and the PCH. The processor houses the memory interface, display planes, and pipes while the PCH has transcoder and display interface or ports.

The PCH receives the display data over Intel FDI and transcodes the data as per the display technology protocol and sends the data through the display interface.

1.5.2.1 Intel® Flexible Display Interconnect (Intel® FDI)

Intel FDI connects the display engine in the processor with the display interfaces on the PCH. The display data from the frame buffer is processed in the display engine of the processor and sent to the PCH over the Intel FDI where it is transcoded as per the display protocol and driven to the display monitor.

1.5.2.2 High-bandwidth Digital Content Protection (HDCP)

HDCP is the technology for protecting high definition content against unauthorized copy or unreceptive between a source (computer, digital set top boxes, etc.) and the sink (panels, monitor, and TVs). The PCH supports HDCP 1.4 for content protection over wired displays (HDMI, DVI, and DisplayPort).

1.5.2.3 Digital Visual Interface (DVI-I)

The DVI-I port supports both digital and analog DVI displays. The maximum supported resolution is 1900 x 1200 (WUXGA). The DVI port is compliant with the DVI 1.0 specification. DVI analog output can also be converted to VGA using a DVI-VGA converter.

Depending on the type of add-in card installed in the PCI Express x16 connector, the DVI port will behave as described in Table 4.

Table 4. DVI Port Status Conditions

PCI Express x16 Connector Status	DVI Digital (DVI-D) Port Status	DVI Analog (DVI-A) Port Status ^(Note 1)
No add-in card installed	Enabled	Enabled
PCI Express x16 add-in card installed	Enabled ^(Note 2)	Enabled ^(Note 2)

Notes:

1. DVI analog output can also be converted to VGA with a DVI-VGA converter.
2. May require BIOS setup menu changes.

1.5.2.4 High Definition Multimedia Interface* (HDMI*)

The HDMI port supports standard, enhanced, or high definition video, plus multi-channel digital audio on a single cable. It is compatible with all ATSC and DVB HDTV standards and supports eight full range channels at 24-bit/96 kHz audio of lossless audio formats such as Dolby* TrueHD or DTS* HD Master Audio. The maximum supported resolution is 1920 x 1200 (WUXGA). The HDMI interface supports the HDMI 1.4a specification.

The HDMI port is enabled for POST whenever a monitor is attached, regardless of the VGA and DVI-I connector status.

Depending on the type of add-in card installed in the PCI Express x16 connector, the HDMI port will behave as described in Table 5.

Table 5. HDMI Port Status Conditions

PCI Express x16 Connector Status	HDMI Port Status
No add-in card installed	Enabled
PCI Express x16 add-in card installed	Enabled ^(Note)

Note: May require BIOS setup menu changes.

1.5.2.5 DisplayPort*

DisplayPort is a digital communication interface that utilizes differential signaling to achieve a high bandwidth bus interface designed to support connections between PCs and monitors, projectors, and TV displays. DisplayPort is suitable for display connections between consumer electronics devices such as high definition optical disc players, set top boxes, and TV displays. DisplayPort output can also be converted to HDMI using a DisplayPort-HDMI converter. The DisplayPort interface supports the 1.1a specification.

DisplayPort’s maximum supported display resolution is 2560 x 1600 at 60 Hz refresh with a 16:10 aspect ratio (WQXGA).

Table 6. DisplayPort Status Conditions

PCI Express x16 Connector Status	DisplayPort Status
No add-in card installed	Enabled
PCI Express x16 add-in card installed	Enabled ^(Note)

Note: May require BIOS setup menu changes.

For information about

DisplayPort technology

Refer to

<http://www.displayport.org>

1.5.2.6 Integrated Audio Provided by the HDMI and DisplayPort Interfaces

The HDMI and DisplayPort interfaces from the PCH support audio. Table 7 shows the specific audio technologies supported by the PCH.

Table 7. Audio Formats Supported by the HDMI and DisplayPort Interfaces

Audio Formats	HDMI	DisplayPort
AC-3 - Dolby* Digital	Yes	No
Dolby Digital Plus	Yes	No
DTS-HD*	Yes	No
LPCM, 192 kHz/24 bit, 8 Channel	Yes	Yes

1.5.3 USB

The PCH contains up to two Enhanced Host Controller Interface (EHCI) host controllers that support USB high-speed signaling. High-speed USB 2.0 allows data transfers up to 480 Mb/s. All ports are high-speed, full-speed, and low-speed capable.

The PCH also contains an integrated eXtensible Host Controller Interface (xHCI) host controller which supports USB 3.0 ports. This controller allows data transfers up to 5 Gb/s. The controller supports SuperSpeed (SS), high-speed (HS), full-speed (FS), and low-speed (LS) traffic on the bus.

The board supports up to 10 USB 2.0 ports and four USB 3.0 ports.

The Intel H77 Express Chipset provides the USB controller for the 2.0/3.0 ports. The port arrangement is as follows:

- Two USB 3.0 ports are implemented with stacked back panel connectors (blue)
- Two front panel USB 3.0 ports are implemented through one internal connector (blue)
- Four USB 2.0 ports are implemented with stacked back panel connectors (black)
- Six USB 2.0 front panel ports implemented through three internal headers



NOTE

Computer systems that have an unshielded cable attached to a USB port may not meet FCC Class B requirements, even if no device is attached to the cable. Use a shielded cable that meets the requirements for full-speed devices.

For information about

Refer to

The location of the USB connectors on the back panel

Figure 9, page 44

The location of the front panel USB headers

Figure 10, page 45

1.5.4 SATA Interfaces

The board provides six SATA connectors, through the PCH, which support one device each:

- Two SATA 6.0 Gb/s interfaces through the Intel H77 Express Chipset with Intel® Rapid Storage Technology RAID support (blue)
- Two internal Serial ATA (SATA) 3.0 Gb/s interfaces through the Intel H77 Express Chipset with Intel Rapid Storage Technology RAID support (black)
- One internal SATA connector (multiplexed with the mSATA port, routed to the PCI Express Full-/Half-Mini Card slot) (gray)
- One back panel eSATA port (red)

The PCH provides independent SATA ports with a theoretical maximum transfer rate of 6.0 Gb/s for two ports and 3.0 Gb/s for four ports. A point-to-point interface is used for host to device connections.

The PCH supports the Serial ATA Specification, Revision 3.0. The PCH also supports several optional sections of the Serial ATA II: Extensions to Serial ATA 1.0 Specification, Revision 1.0 (AHCI support is required for some elements).

The underlying SATA functionality is transparent to the operating system. The SATA controller can operate in both legacy and native modes. In legacy mode, standard IDE I/O and IRQ resources are assigned (IRQ 14 and 15). In native mode, standard PCI Conventional bus resource steering is used. Native mode is the preferred mode for configurations using the Windows* XP and Windows 7 operating systems.



NOTE

Many SATA drives use new low-voltage power connectors and require adapters or power supplies equipped with low-voltage power connectors.

For more information, see: <http://www.serialata.org/>.

For information about

The location of the SATA connectors

Refer to

Figure 10, page 45

1.5.4.1 SATA RAID

The board supports Intel Rapid Storage Technology which provides the following RAID (Redundant Array of Independent Drives) levels via the Intel H77 Express Chipset:

- **RAID 0** - data striping
- **RAID 1** - data mirroring
- **RAID 0+1 (or RAID 10)** - data striping and mirroring
- **RAID 5** - distributed parity

1.5.4.2 Intel® Smart Response Technology

Intel® Smart Response Technology is a disk caching solution that can provide improved computer system performance with improved power savings. It allows configuration of a computer system with the advantage of having HDDs for maximum storage capacity with system performance at or near SSD performance levels.

For more information on Intel Smart Response Technology, go to <http://www.intel.com/support/chipsets/sb/CS-032826.htm>



NOTE

In order to use supported RAID and Intel Smart Response Technology features, you must first enable RAID in the BIOS. Also, during Microsoft Windows XP installation, you must press F6 to install the RAID drivers. See your Microsoft Windows XP documentation for more information about installing drivers during installation. Microsoft Windows 7 includes the necessary RAID drivers for both AHCI and RAID without the need to install separate RAID drivers using the F6 switch in the operating system installation process.

1.6 Real-Time Clock Subsystem

A coin-cell battery (CR2032) powers the real-time clock and CMOS memory. When the computer is not plugged into a wall socket, the battery has an estimated life of three years. When the computer is plugged in, the standby current from the power supply extends the life of the battery. The clock is accurate to ± 13 minutes/year at 25 °C with 3.3 VSB applied via the power supply 5V STBY rail.



NOTE

If the battery and AC power fail, date and time values will be reset and the user will be notified during the POST.

When the voltage drops below a certain level, the BIOS Setup program settings stored in CMOS RAM (for example, the date and time) might not be accurate. Replace the battery with an equivalent one. Figure 1 on page 13 shows the location of the battery.

1.7 Legacy I/O Controller

The I/O controller provides the following features:

- One serial port header
- One parallel port connector with Enhanced Parallel Port (EPP) support
- Consumer Infrared (CIR) headers
- Serial IRQ interface compatible with serialized IRQ support for PCI systems
- Intelligent power management, including a programmable wake-up event interface

The BIOS Setup program provides configuration options for the I/O controller.

1.7.1 Consumer Infrared (CIR)

The Consumer Infrared (CIR) feature is designed to comply with Microsoft Consumer Infrared usage models.

The CIR feature is made up of two separate pieces: the receiving (receiver) header, and the output (emitter) header. The receiving header consists of a filtered translated infrared input compliant with Microsoft CIR specifications, and also a "learning" infrared input. This learning input is simply a high pass input which the computer can use to "learn" to speak the infrared communication language of other user remotes. The emitter header consists of two output ports which the PC can use to emulate "learned" infrared commands in order to control external electronic hardware.

Customers are required to buy or create their own interface modules to connect to Intel Desktop Boards for this feature to work.

1.8 Audio Subsystem

The board supports Intel HD Audio via the Realtek ALC892 audio codec. The audio subsystem supports the following features:

- Advanced jack sense for the back panel audio jacks that enables the audio codec to recognize the device that is connected to an audio port.
- Digital-to-Analog Converters (DAC) with 95 dB SNR (A-weighting) and Analog-to-Digital Converters (ADC) with 90 dB SNR (A-weighting).
- Ten DAC channels support 16/20/24-bit PCM format for 7.1 channel sound playback, plus two channels of concurrent independent stereo sound output (multiple streaming) through the front panel output.
- Two stereo ADCs support 16/20/24-bit PCM format, multiple stereo recording
- Microphone Acoustic Echo Cancellation (AEC), Noise Suppression (NS), and Beam Forming (BF) technology for voice applications.
- Windows 7 Ultimate certification.

Table 8 lists the supported functions of the front panel and back panel audio jacks.

Table 8. Audio Jack Support

Audio Jack	Micro-phone	Head-phones	Front Speaker	Line In	Rear Surround	Center/Sub	Side Surround
FP Green		Default					
FP Pink	Default						
Rear Blue				Default			
Rear Green		Ctrl panel	Default				
Rear Pink							Default
Rear Black					Default		
Rear Orange						Default	

1.8.1 Audio Subsystem Software

The latest audio software and drivers are available from Intel's World Wide Web site.

For information about

Obtaining audio software and drivers

Refer to

Section 1.2, page 16

1.8.2 Audio Subsystem Components

The audio subsystem includes the following components:

- Intel H77 Express Chipset
- Realtek ALC892 audio codec
- Front panel audio header that supports Intel HD audio and AC '97 audio (a 2 x 5-pin header that provides mic in and line out signals for front panel audio connectors) (yellow)
- S/PDIF digital audio out header (1 x 4-pin header) (yellow)

- S/PDIF digital audio out connector on the back panel
- 5-port analog audio input/output stack on the back panel

The back panel audio connectors are configurable through the audio device drivers. The available configurable back panel audio connectors are shown in Figure 4.

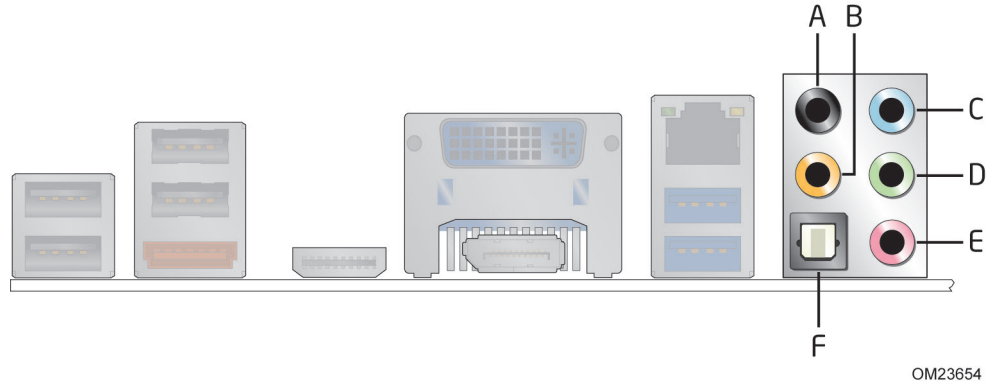

OM23654

Item	Description
A	Rear surround
B	Center channel and LFE (subwoofer)
C	Line in
D	Line out/front speakers
E	Mic in/side surround
F	S/PDIF out (optical)

Figure 4. Back Panel Audio Connectors



NOTE

The back panel audio line out connector is designed to power headphones or amplified speakers only. Poor audio quality occurs if passive (non-amplified) speakers are connected to this output.

For information about	Refer to
The locations of the front panel audio header and S/PDIF audio header	Figure 10, page 45
The signal names of the front panel audio header and S/PDIF audio header	Section 2.2.2.1, page 47
The back panel audio connectors	Section 2.2.1, page 44

1.9 LAN Subsystem

The LAN subsystem consists of the following:

- Intel 82579V Gigabit Ethernet Controller (10/100/1000 Mb/s)
- Intel H77 Express Chipset
- RJ-45 LAN connector with integrated status LEDs

Additional features of the LAN subsystem include:

- CSMA/CD protocol engine
- LAN connect interface between the PCH and the LAN controller
- ACPI technology support
- LAN wake capabilities
- LAN subsystem software

For information about

LAN software and drivers

Refer to

<http://downloadcenter.intel.com>

1.9.1 Intel® 82579V Gigabit Ethernet Controller

The Intel 82579V Gigabit Ethernet Controller supports the following features:

- 10/100/1000 BASE-T IEEE 802.3 compliant
- Energy Efficient Ethernet (EEE) IEEE802.3az support (Low Power Idle [LPI] mode)
- Dual interconnect between the Integrated LAN Controller and the Physical Layer (PHY):
 - PCI Express-based interface for active state operation (S0) state
 - SMBUS for host and management traffic (Sx low power state)
- Compliant to IEEE 802.3x flow control support
- 802.1p and 802.1q
- TCP, IP, and UDP checksum offload (for IPv4 and IPv6)
- Full device driver compatibility

1.9.2 LAN Subsystem Software

LAN software and drivers are available from Intel's World Wide Web site.

For information about

Obtaining LAN software and drivers

Refer to

<http://downloadcenter.intel.com>

1.9.3 RJ-45 LAN Connector with Integrated LEDs

Two LEDs are built into the RJ-45 LAN connector (shown in Figure 5).

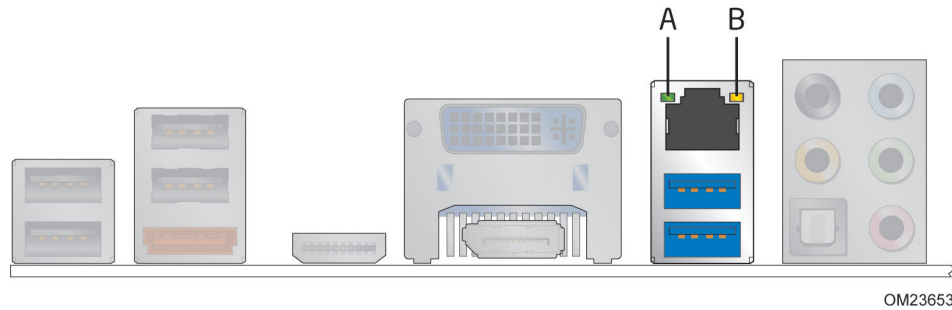

Item	Description
A	Link LED (Green)
B	Data Rate LED (Green/Yellow)

Figure 5. LAN Connector LED Locations

Table 9 describes the LED states when the board is powered up and the LAN subsystem is operating.

Table 9. LAN Connector LED States

LED	LED Color	LED State	Condition
Link	Green	Off	LAN link is not established.
		On	LAN link is established.
		Blinking	LAN activity is occurring.
Data Rate	Green/Yellow	Off	10 Mb/s data rate is selected.
		Green	100 Mb/s data rate is selected.
		Yellow	1000 Mb/s data rate is selected.

1.10 Hardware Management Subsystem

The hardware management features enable the board to be compatible with the Wired for Management (WfM) specification. The board has several hardware management features, including the following:

- Thermal and voltage monitoring
- Chassis intrusion detection

1.10.1 Hardware Monitoring

The hardware monitoring and fan control subsystem is based on the Nuvoton W83677HG-i device, which supports the following:

- Processor and system ambient temperature monitoring
- Chassis fan speed monitoring
- Power monitoring of +12 V, +5 V, +3.3 V, 3.3 Vstandby, V_SM, +VCCP, and PCH Vcc
- SMBus interface

1.10.2 Fan Monitoring

Fan monitoring can be implemented using Intel® Desktop Utilities or third-party software.

For information about	Refer to
------------------------------	-----------------

The functions of the fan headers	Section 1.11.2.2, page 37
----------------------------------	---------------------------

1.10.3 Chassis Intrusion and Detection

The board supports a chassis security feature that detects if the chassis cover is removed. The security feature uses a mechanical switch on the chassis that attaches to the chassis intrusion header. When the chassis cover is removed, the mechanical switch is in the closed position.

For information about	Refer to
------------------------------	-----------------

The location of the chassis intrusion header	Figure 10, page 45
--	--------------------

1.10.4 Thermal Monitoring

Figure 6 shows the locations of the thermal sensors and fan headers.

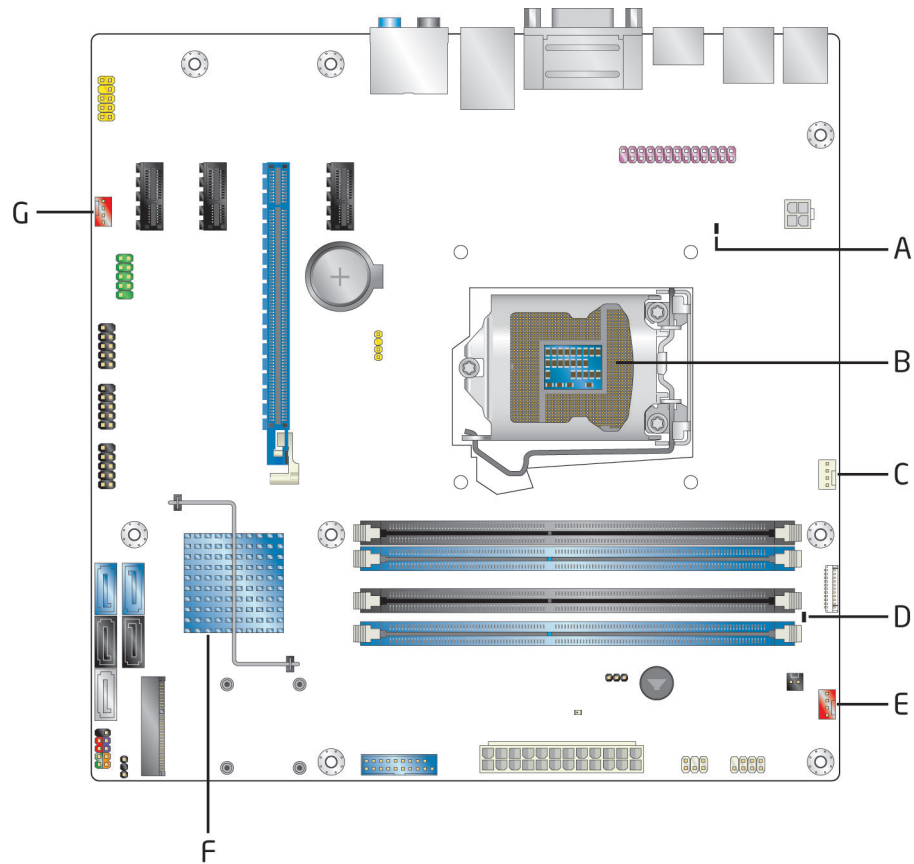

OM23662

Item	Description
A	Thermal diode, located on the VR zone
B	Thermal diode, located on the processor die
C	Front chassis fan header
D	Thermal diode, located on the memory zone
E	Processor fan header
F	Thermal diode, located on the Intel H77 PCH
G	Rear chassis fan header

Figure 6. Thermal Sensors and Fan Headers

1.11 Power Management

Power management is implemented at several levels, including:

- Software support through Advanced Configuration and Power Interface (ACPI)
- Hardware support:
 - Power connector
 - Fan headers
 - LAN wake capabilities
 - Instantly Available PC technology
 - Wake from USB
 - PCI Express WAKE# signal support
 - Wake from Consumer IR
 - Wake from serial port
 - Wake from S5
 - +5 V Standby Power Indicator LED

1.11.1 ACPI

ACPI gives the operating system direct control over the power management and Plug and Play functions of a computer. The use of ACPI with this board requires an operating system that provides full ACPI support. ACPI features include:

- Plug and Play (including bus and device enumeration)
- Power management control of individual devices, add-in boards (some add-in boards may require an ACPI-aware driver), video displays, and hard disk drives
- Methods for achieving less than 15-watt system operation in the power-on/standby sleeping state
- A Soft-off feature that enables the operating system to power-off the computer
- Support for multiple wake-up events (see Table 12 on page 36)
- Support for a front panel power and sleep mode switch

Table 10 lists the system states based on how long the power switch is pressed, depending on how ACPI is configured with an ACPI-aware operating system.

Table 10. Effects of Pressing the Power Switch

If the system is in this state...	...and the power switch is pressed for	...the system enters this state
Off (ACPI G2/G5 – Soft off)	Less than four seconds	Power-on (ACPI G0 – working state)
On (ACPI G0 – working state)	Less than four seconds	Soft-off/Standby (ACPI G1 – sleeping state)
On (ACPI G0 – working state)	More than six seconds	Fail safe power-off (ACPI G2/G5 – Soft off)
Sleep (ACPI G1 – sleeping state)	Less than four seconds	Wake-up (ACPI G0 – working state)
Sleep (ACPI G1 – sleeping state)	More than six seconds	Power-off (ACPI G2/G5 – Soft off)

1.11.1.1 System States and Power States

Under ACPI, the operating system directs all system and device power state transitions. The operating system puts devices in and out of low-power states based on user preferences and knowledge of how devices are being used by applications. Devices that are not being used can be turned off. The operating system uses information from applications and user settings to put the system as a whole into a low-power state.

Table 11 lists the power states supported by the board along with the associated system power targets. See the ACPI specification for a complete description of the various system and power states.

Table 11. Power States and Targeted System Power

Global States	Sleeping States	Processor States	Device States	Targeted System Power ^(Note 1)
G0 – working state	S0 – working	C0 – working	D0 – working state.	Full power > 30 W
G1 – sleeping state	S3 – Suspend to RAM. Context saved to RAM.	No power	D3 – no power except for wake-up logic.	Power < 5 W ^(Note 2)
G1 – sleeping state	S4 – Suspend to disk. Context saved to disk.	No power	D3 – no power except for wake-up logic.	Power < 5 W ^(Note 2)
G2/S5	S5 – Soft off. Context not saved. Cold boot is required.	No power	D3 – no power except for wake-up logic.	Power < 5 W ^(Note 2)
G3 – mechanical off AC power is disconnected from the computer.	No power to the system.	No power	D3 – no power for wake-up logic, except when provided by battery or external source.	No power to the system. Service can be performed safely.

Notes:

1. Total system power is dependent on the system configuration, including add-in boards and peripherals powered by the system chassis' power supply.
2. Dependent on the standby power consumption of wake-up devices used in the system.

1.11.1.2 Wake-up Devices and Events

Table 12 lists the devices or specific events that can wake the computer from specific states.

Table 12. Wake-up Devices and Events

These devices/events can wake up the computer...	...from this state
Power switch	S3, S4, S5 ^(Note 1)
RTC alarm	S3, S4, S5 ^(Note 1)
LAN	S3, S4, S5 ^(Note 1)
USB	S3
WAKE#	S3, S4, S5 ^(Note 1)
Consumer IR	S3, S4, S5 ^(Note 2)
Serial port	S3

Notes:

1. S4 implies operating system support only.
2. Wake from S4 and S5 is recommended by Microsoft.



NOTE

The use of these wake-up events from an ACPI state requires an operating system that provides full ACPI support. In addition, software, drivers, and peripherals must fully support ACPI wake events.

1.11.2 Hardware Support



CAUTION

Ensure that the power supply provides adequate +5 V standby current if LAN wake capabilities and Instantly Available PC technology features are used. Failure to do so can damage the power supply. The total amount of standby current required depends on the wake devices supported and manufacturing options.

The board provides several power management hardware features, including:

- Power connector
- Fan headers
- LAN wake capabilities
- Instantly Available PC technology
- Wake from USB
- PCI Express WAKE# signal support
- Wake from Consumer IR
- Wake from serial port
- Wake from S5
- +5 V Standby Power Indicator LED

LAN wake capabilities and Instantly Available PC technology require power from the +5 V standby line.

**NOTE**

The use of Wake from USB from an ACPI state requires an operating system that provides full ACPI support.

1.11.2.1 Power Connector

ATX12V-compliant power supplies can turn off the system power through system control. When an ACPI-enabled system receives the correct command, the power supply removes all non-standby voltages.

When resuming from an AC power failure, the computer returns to the power state it was in before power was interrupted (on or off). The computer's response can be set using the Last Power State feature in the BIOS Setup program's Boot menu.

For information about	Refer to
The location of the main power connector	Figure 10, page 45
The signal names of the main power connector	Table 30, page 53

1.11.2.2 Fan Headers

The function/operation of the fan headers is as follows:

- The fans are on when the board is in the S0 state
- The fans are off when the board is off or in the S3, S4, or S5 state
- Each fan header is wired to a fan tachometer input of the hardware monitoring and fan control ASIC
- All fan headers support closed-loop fan control that can adjust the fan speed or switch the fan on or off as needed
- All fan headers have a +12 V DC connection
- The fan headers are controlled by Pulse Width Modulation

For information about	Refer to
The location of the fan headers	Figure 10, page 45
The location of the fan headers and sensors for thermal monitoring	Figure 6, page 33

1.11.2.3 LAN Wake Capabilities



CAUTION

For LAN wake capabilities, the +5 V standby line for the power supply must be capable of providing adequate +5 V standby current. Failure to provide adequate standby current when implementing LAN wake capabilities can damage the power supply.

LAN wake capabilities enable remote wake-up of the computer through a network. The LAN subsystem PCI bus network adapter monitors network traffic at the Media Independent Interface. Upon detecting a Magic Packet* frame, the LAN subsystem asserts a wake-up signal that powers up the computer. Depending on the LAN implementation, the board supports LAN wake capabilities with ACPI in the following ways:

- The PCI Express WAKE# signal
- By Ping
- Magic Packet
- The onboard LAN subsystem

1.11.2.4 Instantly Available PC Technology



CAUTION

For Instantly Available PC technology, the +5 V standby line for the power supply must be capable of providing adequate +5 V standby current. Failure to provide adequate standby current when implementing Instantly Available PC technology can damage the power supply.

Instantly Available PC technology enables the board to enter the ACPI S3 (Suspend-to-RAM) sleep-state. While in the S3 sleep-state, the computer will appear to be off (the power supply is off, and the front panel LED is amber if dual colored, or off if single colored.) When signaled by a wake-up device or event, the system quickly returns to its last known wake state. Table 12 on page 36 lists the devices and events that can wake the computer from the S3 state.

The board supports the *PCI Bus Power Management Interface Specification*. Add-in boards that also support this specification can participate in power management and can be used to wake the computer.

The use of Instantly Available PC technology requires operating system support and PCI Express add-in cards and drivers.

1.11.2.5 Wake from USB

USB bus activity wakes the computer from an ACPI S3 state.



NOTE

Wake from USB requires the use of a USB peripheral that supports Wake from USB.

1.11.2.6 WAKE# Signal Wake-up Support

When the WAKE# signal on the PCI Express bus is asserted, the computer wakes from an ACPI S3, S4, or S5 state.

1.11.2.7 Wake from Consumer IR

CIR activity wakes the computer from an ACPI S3, S4, or S5 state.

1.11.2.8 Wake from Serial Port

Serial port activity wakes the computer from an ACPI S3 state.

1.11.2.9 Wake from S5

When the RTC Date and Time is set in the BIOS, the computer will automatically wake from an ACPI S5 state.

1.11.2.10 +5 V Standby Power Indicator LED

The +5 V standby power indicator LED shows that power is still present even when the computer appears to be off. Figure 7 shows the location of the standby power LED.



CAUTION

If AC power has been switched off and the standby power indicator is still lit, disconnect the power cord before installing or removing any devices connected to the board. Failure to do so could damage the board and any attached devices.

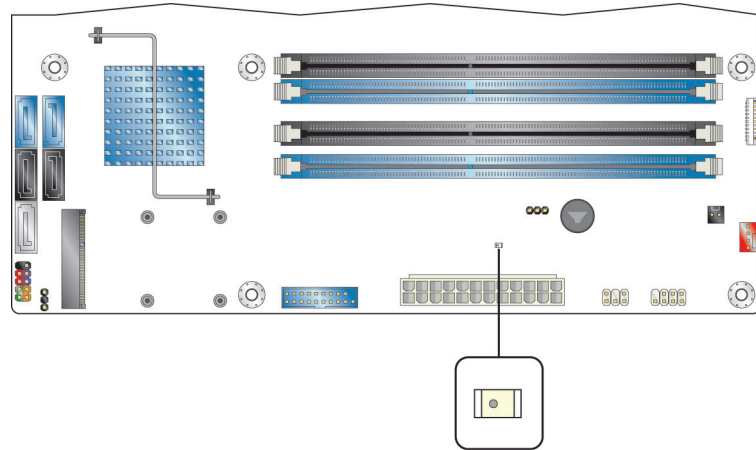

OM23660

Figure 7. Location of the Standby Power LED

2 Technical Reference

2.1 Memory Resources

2.1.1 Addressable Memory

The board utilizes 32 GB of addressable system memory. Typically the address space that is allocated for add-in cards, PCI Express configuration space, BIOS (SPI Flash device), and chipset overhead resides above the top of DRAM (total system memory). On a system that has 32 GB of system memory installed, it is not possible to use all of the installed memory due to system address space being allocated for other system critical functions. These functions include the following:

- BIOS/SPI Flash device (32 Mbit)
- Local APIC (19 MB)
- Direct Media Interface (40 MB)
- PCI Express configuration space (256 MB)
- PCH base address registers PCI Express ports (up to 256 MB)
- Memory-mapped I/O that is dynamically allocated for PCI Express add-in cards (256 MB)

The board provides the capability to reclaim the physical memory overlapped by the memory mapped I/O logical address space. The board remaps physical memory from the top of usable DRAM boundary to the 4 GB boundary to an equivalent sized logical address range located just above the 4 GB boundary. Figure 8 shows a schematic of the system memory map. All installed system memory can be used when there is no overlap of system addresses.

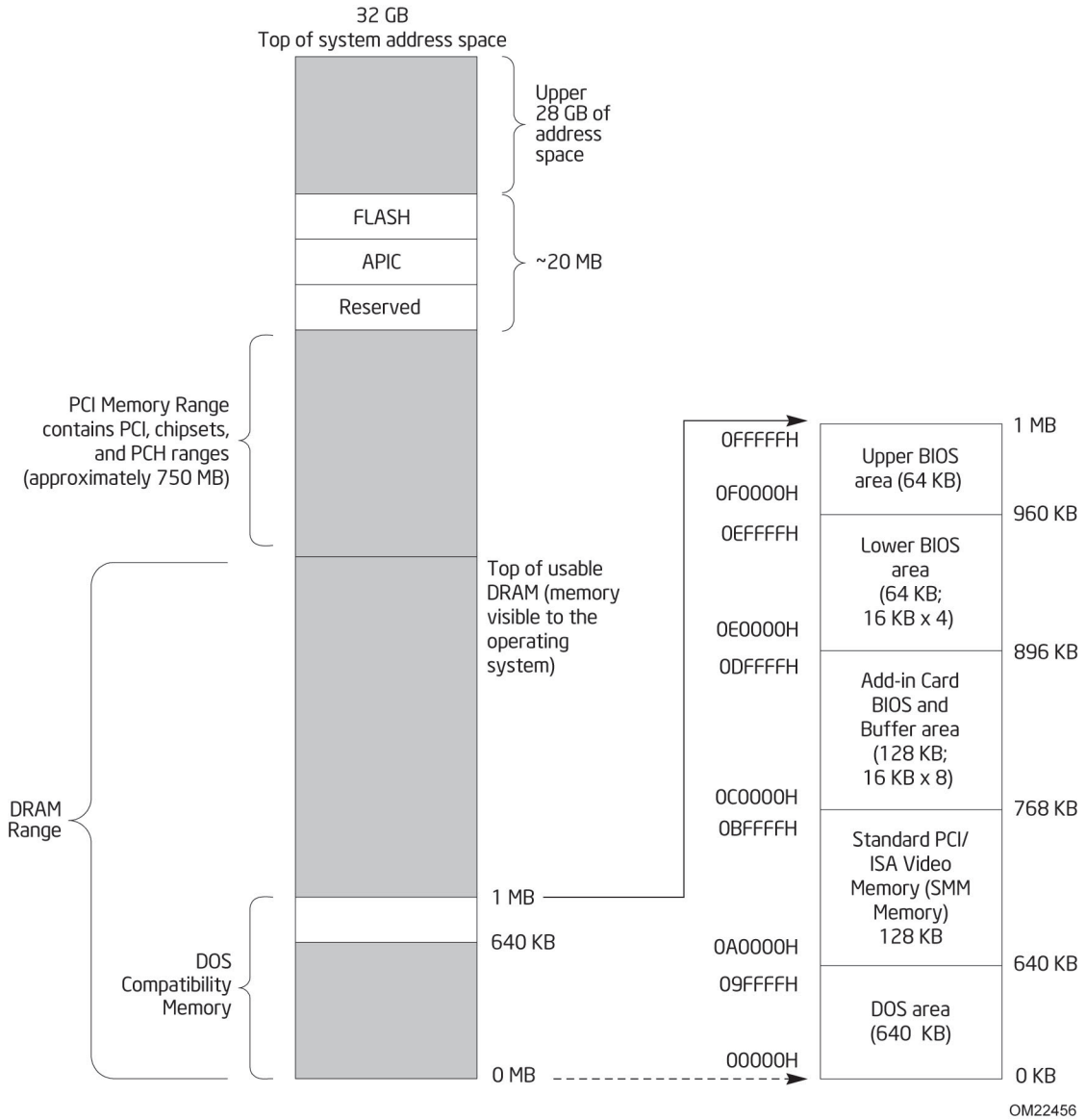

Figure 8. Detailed System Memory Address Map

2.1.2 Memory Map

Table 13 lists the system memory map.

Table 13. System Memory Map

Address Range (decimal)	Address Range (hex)	Size	Description
1024 K - 33550336 K	100000 - 7FFC00000	32764 MB	Extended memory
960 K - 1024 K	F0000 - FFFFF	64 KB	Runtime BIOS
896 K - 960 K	E0000 - EFFFF	64 KB	Reserved
800 K - 896 K	C8000 - DFFFF	96 KB	Potential available high DOS memory (open to the PCI Conventional bus). Dependent on video adapter used.
640 K - 800 K	A0000 - C7FFF	160 KB	Video memory and BIOS
639 K - 640 K	9FC00 - 9FFFF	1 KB	Extended BIOS data (movable by memory manager software)
512 K - 639 K	80000 - 9FBFF	127 KB	Extended conventional memory
0 K - 512 K	00000 - 7FFFF	512 KB	Conventional memory

2.2 Connectors and Headers



CAUTION

Only the following connectors and headers have overcurrent protection: back panel and front panel USB, and serial.

The other internal connectors and headers are not overcurrent protected and should connect only to devices inside the computer's chassis, such as fans and internal peripherals. Do not use these connectors or headers to power devices external to the computer's chassis. A fault in the load presented by the external devices could cause damage to the computer, the power cable, and the external devices themselves.

Furthermore, improper connection of USB header single wire connectors may eventually overload the overcurrent protection and cause damage to the board.

This section describes the board's connectors. The connectors can be divided into these groups:

- Back panel I/O connectors
- Component-side connectors and headers (see page 45)

2.2.1 Back Panel Connectors

Figure 9 shows the location of the back panel connectors for the board.

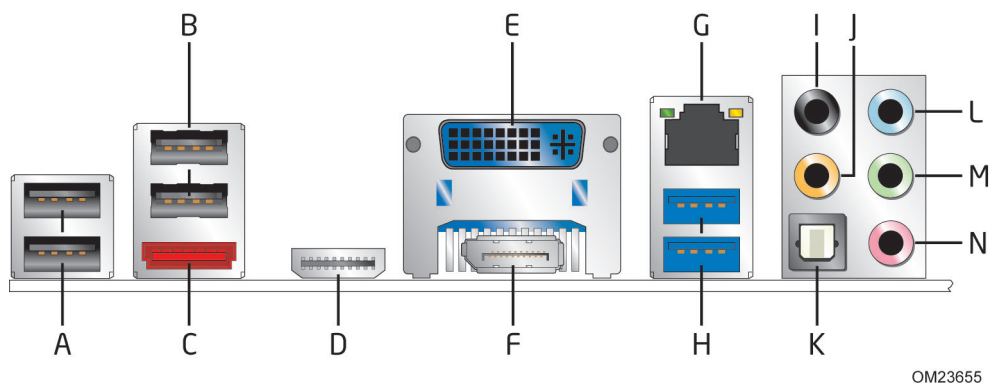

OM23655

Item	Description
A	USB 2.0 ports
B	USB 2.0 ports
C	eSATA connector
D	HDMI connector
E	DVI-I connector
F	DisplayPort connector
G	LAN port
H	USB 3.0 ports
I	Rear surround
J	Center channel and LFE (subwoofer)
K	S/PDIF out (optical)
L	Line in
M	Line out/front speakers
N	Mic-in/side surround

Figure 9. Back Panel Connectors



NOTE

The back panel audio line out connector is designed to power headphones or amplified speakers only. Poor audio quality occurs if passive (non-amplified) speakers are connected to this output.

2.2.2 Component-side Connectors and Headers

Figure 10 shows the locations of the component-side connectors and headers.

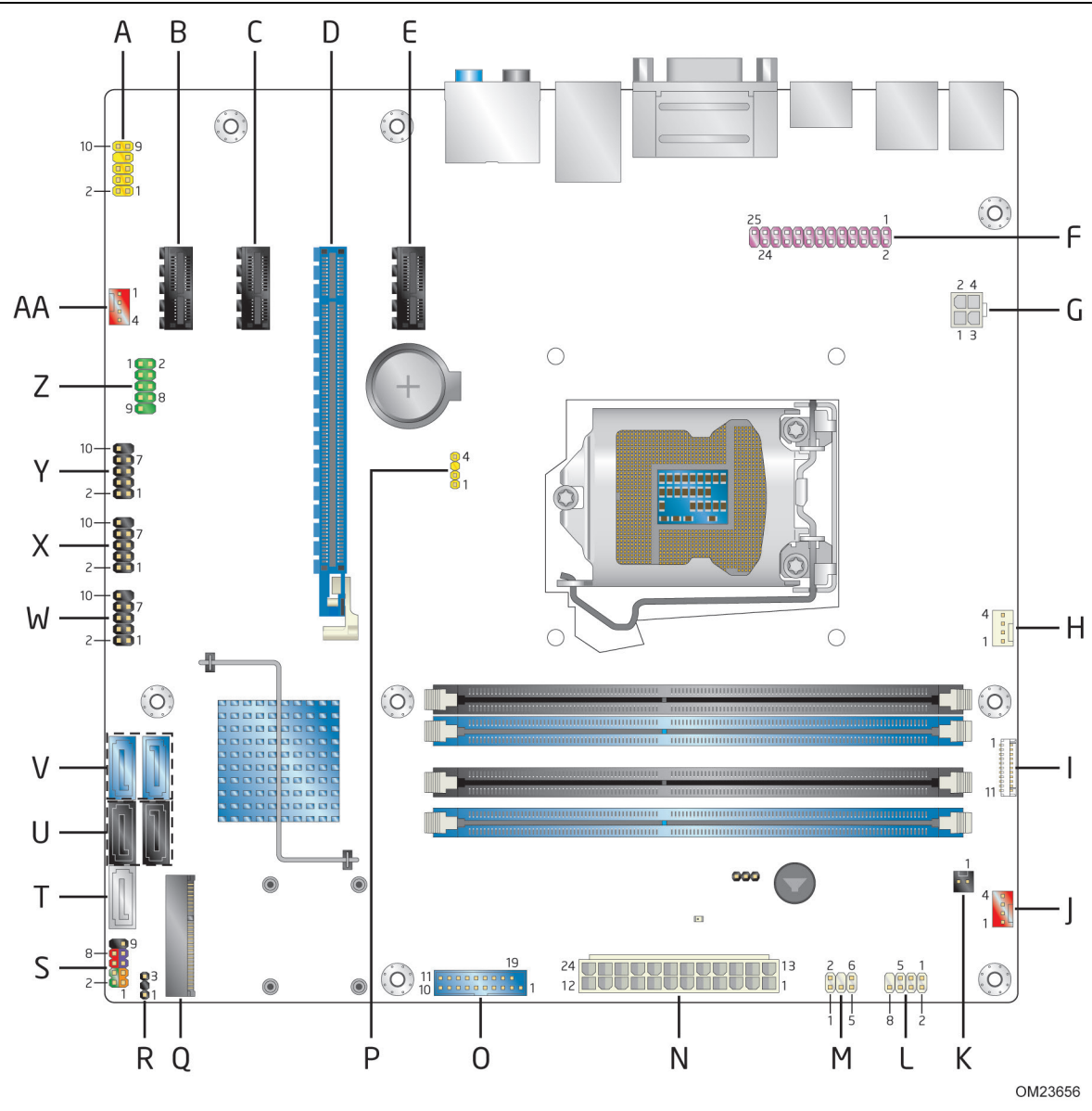

Figure 10. Component-side Connectors and Headers

Table 14 lists the component-side connectors and headers identified in Figure 10.

Table 14. Component-side Connectors and Headers Shown in Figure 10

Item/callout from Figure 10	Description
A	Front panel audio header
B	PCI Express x1 add-in card connector
C	PCI Express x1 add-in card connector
D	PCI Express x16 add-in card connector
E	PCI Express x1 add-in card connector
F	Parallel port header
G	Processor core power connector (2 x 2)
H	Processor fan header
I	LPC Debug connector
J	Front fan header
K	Chassis intrusion header
L	Consumer IR receiver (input) header
M	Consumer IR emitter (output) header
N	Main power connector (2 x 12)
O	Front panel USB 3.0 connector
P	S/PDIF out header
Q	PCI Express Full-/Half-Mini Card slot
R	Alternate front panel power/sleep LED header
S	Front panel header
T	SATA 6.0 Gb/s connector (multiplexed with an mSATA port, routed to the PCI Express Full-/Half-Mini Card slot) (gray)
U	SATA 3.0 Gb/s connector through the PCH (black)
V	SATA 6.0 Gb/s connector through the PCH (blue)
W	Front panel USB 2.0 header
X	Front panel USB 2.0 header
Y	Front panel USB 2.0 header
Z	Serial port header
AA	Rear chassis fan header

2.2.2.1 Signal Tables for the Connectors and Headers

Table 15. Front Panel Audio Header for Intel HD Audio

Pin	Signal Name	Pin	Signal Name
1	[Port 1] Left channel	2	Ground
3	[Port 1] Right channel	4	PRESENCE# (Dongle present)
5	[Port 2] Right channel	6	[Port 1] SENSE_RETURN
7	SENSE_SEND (Jack detection)	8	Key (no pin)
9	[Port 2] Left channel	10	[Port 2] SENSE_RETURN

Table 16. Front Panel Audio Header for AC '97 Audio

Pin	Signal Name	Pin	Signal Name
1	MIC	2	AUD_GND
3	MIC_BIAS	4	AUD_GND
5	FP_OUT_R	6	FP_RETURN_R
7	AUD_5V	8	KEY (no pin)
9	FP_OUT_L	10	FP_RETURN_L

Table 17. Front Panel USB 2.0 Headers

Pin	Signal Name	Pin	Signal Name
1	+5 V DC	2	+5 V DC
3	D-	4	D-
5	D+	6	D+
7	Ground	8	Ground
9	KEY (no pin)	10	No Connect

Table 18. Front Panel USB 3.0 Connector

Pin	Signal Name	Description
1	Vbus	Power
2	IntA_P1_SSRX-	USB3 ICC Port1 SuperSpeed Rx-
3	IntA_P1_SSRX+	USB3 ICC Port1 SuperSpeed Rx+
4	GND	Ground
5	IntA_P1_SSTX-	USB3 ICC Port1 SuperSpeed Tx-
6	IntA_P1_SSTX+	USB3 ICC Port1 SuperSpeed Tx+
7	GND	Ground
8	IntA_P1_D-	USB3 ICC Port1 D- (USB2 Signal D-)
9	IntA_P1_D+	USB3 ICC Port1 D+ (USB2 Signal D+)
10	ID	Over Current Protection
11	IntA_P2_D+	USB3 ICC Port2 D+ (USB2 Signal D+)
12	IntA_P2_D-	USB3 ICC Port2 D- (USB2 Signal D-)
13	GND	Ground
14	IntA_P2_SSTX+	USB3 ICC Port2 SuperSpeed Tx+
15	IntA_P2_SSTX-	USB3 ICC Port2 SuperSpeed Tx-
16	GND	Ground
17	IntA_P2_SSRX+	USB3 ICC Port2 SuperSpeed Rx+
18	IntA_P2_SSRX-	USB3 ICC Port2 SuperSpeed Rx-
19	Vbus	Power

Table 19. SATA Connectors

Pin	Signal Name
1	Ground
2	TXP
3	TXN
4	Ground
5	RXN
6	RXP
7	Ground

Table 20. S/PDIF Header

Pin	Signal Name
1	Ground
2	S/PDIF out
3	Key (no pin)
4	+5 V DC

Table 21. Chassis Intrusion Header

Pin	Signal Name
1	Intruder#
2	Ground

Table 22. Processor, Front, and Rear Chassis (4-Pin) Fan Headers

Pin	Signal Name
1	Ground (Note)
2	+12 V
3	FAN_TACH
4	FAN_CONTROL

Note: These fan headers use Pulse Width Modulation control for fan speed.

Table 23. Back Panel CIR Emitter (Output) Header

Pin	Signal Name
1	Emitter out 1
2	Emitter out 2
3	Ground
4	Key (no pin)
5	Jack detect 1
6	Jack detect 2

Table 24. Front Panel CIR Receiver (Input) Header

Pin	Signal Name
1	Ground
2	LED
3	NC
4	Learn-in
5	5 V standby
6	VCC
7	Key (no pin)
8	CIR Input

Table 25. Parallel Port Header

Pin	Standard Signal Name	EPP Signal Name
1	STROBE#	WRITE#
2	AUTOFD#	DATASTB#
3	PD0	PD0
4	FAULT#	FAULT#
5	PD1	PD1
6	INT#	RESET#
7	PD2	PD2
8	SLCTIN#	ADDRSTB#
9	PD3	PD3
10	GROUND	GROUND
11	PD4	PD4
12	GROUND	GROUND
13	PD5	PD5
14	GROUND	GROUND
15	PD6	PD6
16	GROUND	GROUND
17	PD7	PD7
18	GROUND	GROUND
19	ACK#	INTR
20	GROUND	GROUND
21	BUSY	WAIT#
22	GROUND	GROUND
23	PERROR	PE
24	GROUND	GROUND
25	SELECT	SELECT
26	KEY (no pin)	KEY (no pin)

Table 26. PCI Express Full-/Half-Mini Card Connector

Pin	Signal Name	Additional Signal Name
1	WAKE#	
2	+3.3 V aux	
3	Reserved	
4	GND	
5	Reserved	
6	1.5 V	
7	CLKREQ#	
8	Reserved	
9	GND	
10	Reserved	
11	REFCLK-	
12	Reserved	
13	REFCLK+	
14	Reserved	
15	GND	
16	Reserved	
17	Reserved	
18	GND	
19	Reserved	
20	Reserved	
21	GND	
22	PERST#	
23	PERn0	
24	+3.3 V aux	
25	PERp0	
26	GND	
27	GND	
28	+1.5 V	
29	GND	
30	SMB_CLK	
31	PETn0	
32	SMB_DATA	
33	PETp0	
34	GND	
35	GND	
36	USB_D-	
37	GND	(mSATA) GND
38	USB_D+	

continued

Table 26. PCI Express Full-/Half-Mini Card Connector (continued)

Pin	Signal Name	Additional Signal Name
39	+3.3 V aux	(mSATA) 3.3 V
40	GND	
41	+3.3 V aux	(mSATA) 3.3 V
42	LED_WWAN#	
43	Reserved	NC (mSATA indicator)
44	LED_WLAN#	
45	Reserved	(mSATA) Vendor
46	LED_WPAN#	
47	Reserved	(mSATA) Vendor
48	+1.5V	
49	Reserved	(mSATA) DA/DSS
50	GND	
51	Reserved	(mSATA) Presence Detection
52	+3.3 V aux	

Table 27. Serial Port Header

Pin	Signal Name	Pin	Signal Name
1	DCD (Data Carrier Detect)	2	RXD# (Receive Data)
3	TXD# (Transmit Data)	4	DTR (Data Terminal Ready)
5	Ground	6	DSR (Data Set Ready)
7	RTS (Request to Send)	8	CTS (Clear to Send)
9	RI (Ring Indicator)	10	Not connected

Table 28. LPC Debug Connector

Pin	Signal Name	Pin	Signal Name
1	CK_33M_DEBUG	2	GND
3	PLTRST#	4	LFRAME#
5	LAD0	6	LAD1
7	LAD2	8	LAD3
9	GND	10	GND
11	+3.3 V	12	+3.3 V
13	Key (no pin)	14	+3.3 V

2.2.2.2 Add-in Card Connectors

The board has the following add-in card connectors:

- One PCI Express x16 (3.0/2.x/1.x)
- Three PCI Express x1 (2.x/1.x)
- One PCI Express Full-/Half-Mini Card (with support for mSATA)



NOTE

PCI Express 3.0 is only supported by 3rd generation Intel Core processor family processors.

2.2.2.3 Power Supply Connectors

The board has the following power supply connectors:

- **Main power** – a 2 x 12 connector. This connector is compatible with 2 x 10 connectors previously used on Intel Desktop boards. The board supports the use of ATX12V power supplies with either 2 x 10 or 2 x 12 main power cables. When using a power supply with a 2 x 10 main power cable, attach that cable to the main power connector, leaving pins 11, 12, 23, and 24 unconnected.
- **Processor core power** – a 2 x 2 connector. This connector provides power directly to the processor voltage regulator and must always be used. Failure to do so will prevent the board from booting.

Table 29. Processor Core Power Connector

Pin	Signal Name	Pin	Signal Name
1	Ground	2	Ground
3	+12 V	4	+12 V

Table 30. Main Power Connector

Pin	Signal Name	Pin	Signal Name
1	+3.3 V	13	+3.3 V
2	+3.3 V	14	-12 V
3	Ground	15	Ground
4	+5 V	16	PS-ON# (power supply remote on/off)
5	Ground	17	Ground
6	+5 V	18	Ground
7	Ground	19	Ground
8	PWRGD (Power Good)	20	No connect
9	+5 V (Standby)	21	+5 V
10	+12 V	22	+5 V
11	+12 V (Note)	23	+5 V (Note)
12	2 x 12 connector detect (Note)	24	Ground (Note)

Note: When using a 2 x 10 power supply cable, this pin will be unconnected.

For information about

Power supply considerations

Refer to

Section 2.5.1 on page 60

2.2.2.4 Front Panel Header

This section describes the functions of the front panel header. Table 31 lists the signal names of the front panel header. Figure 11 is a connection diagram for the front panel header.

Table 31. Front Panel Header

Pin	Signal Name	Description	Pin	Signal Name	Description
1	HDD_POWER_LED	Pull-up resistor (750 Ω) to +5V	2	POWER_LED_MAIN	[Out] Front panel LED (main color)
3	HDD_LED#	[Out] Hard disk activity LED	4	POWER_LED_ALT	[Out] Front panel LED (alt color)
5	GROUND	Ground	6	POWER_SWITCH#	[In] Power switch
7	RESET_SWITCH#	[In] Reset switch	8	GROUND	Ground
9	+5V_DC	Power	10	Key	No pin

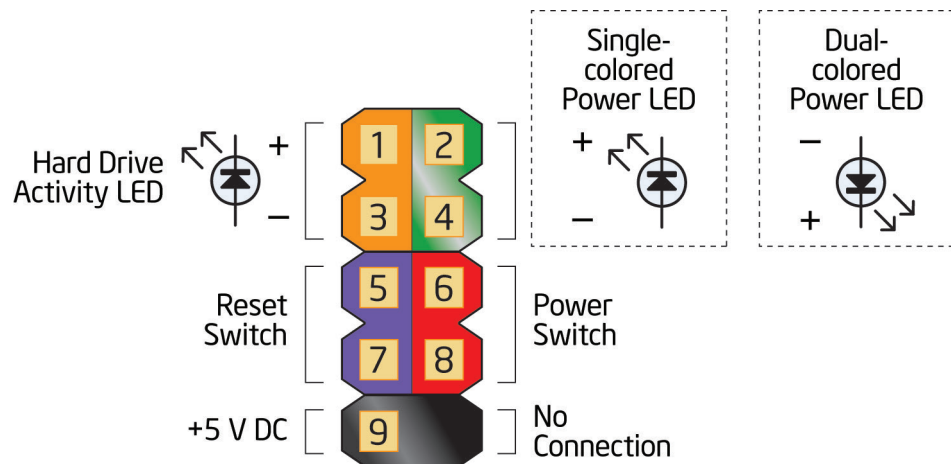

OM20472

Figure 11. Connection Diagram for Front Panel Header

2.2.2.4.1 Hard Drive Activity LED Header

Pins 1 and 3 can be connected to an LED to provide a visual indicator that data is being read from or written to a hard drive. Proper LED function requires a SATA hard drive or optical drive connected to an onboard SATA connector.

2.2.2.4.2 Reset Switch Header

Pins 5 and 7 can be connected to a momentary single pole, single throw (SPST) type switch that is normally open. When the switch is closed, the board resets and runs the POST.

2.2.2.4.3 Power/Sleep LED Header

Pins 2 and 4 can be connected to a one- or two-color LED. Table 32 shows the possible states for a one-color LED. Table 33 shows the possible states for a two-color LED.

Table 32. States for a One-Color Power LED

LED State	Description
Off	Power off/sleeping
Steady Green	Running

Table 33. States for a Two-Color Power LED

LED State	Description
Off	Power off
Steady Green	Running
Steady Yellow	Sleeping



NOTE

The colors listed in Table 32 and Table 33 are suggested colors only. Actual LED colors are chassis-specific.

2.2.2.4.4 Power Switch Header

Pins 6 and 8 can be connected to a front panel momentary-contact power switch. The switch must pull the SW_ON# pin to ground for at least 50 ms to signal the power supply to switch on or off. (The time requirement is due to internal debounce circuitry on the board.) At least two seconds must pass before the power supply will recognize another on/off signal.

2.2.2.5 Alternate Front Panel Power/Sleep LED Header

Pins 1 and 3 of this header duplicate the signals on pins 2 and 4 of the front panel header.

Table 34. Alternate Front Panel Power/Sleep LED Header

Pin	Signal Name	Description
1	POWER_LED_MAIN	[Out] Front panel LED (main color)
2	Key (no pin)	
3	POWER_LED_ALT	[Out] Front panel LED (alt color)

2.2.2.6 Front Panel USB 2.0 Headers

Figure 12 is a connection diagram for the front panel USB 2.0 headers.



NOTE

- The +5 V DC power on the USB headers is fused.
- Use only a front panel USB connector that conforms to the USB 2.0 specification for high-speed USB devices.

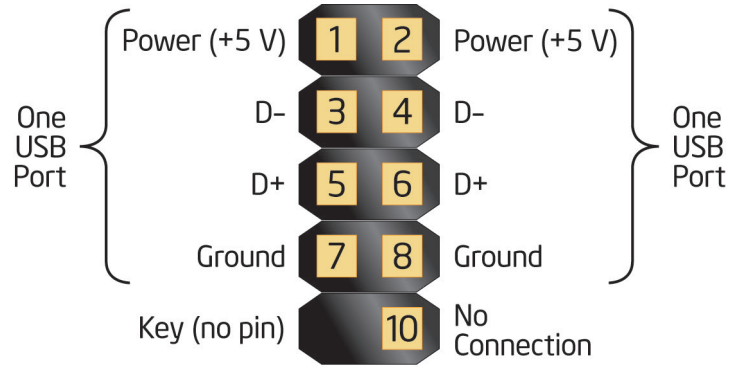

OM20473

Figure 12. Connection Diagram for Front Panel USB 2.0 Headers

2.3 Jumper Block

CAUTION

Do not move the jumper with the power on. Always turn off the power and unplug the power cord from the computer before changing a jumper setting. Otherwise, the board could be damaged.

Figure 13 shows the location of the jumper block. The 3-pin jumper block determines the BIOS Setup program's mode. Table 35 describes the jumper settings for the three modes: normal, configure, and recovery. When the jumper is set to configure mode and the computer is powered-up, the BIOS compares the processor version and the microcode version in the BIOS and reports if the two match.

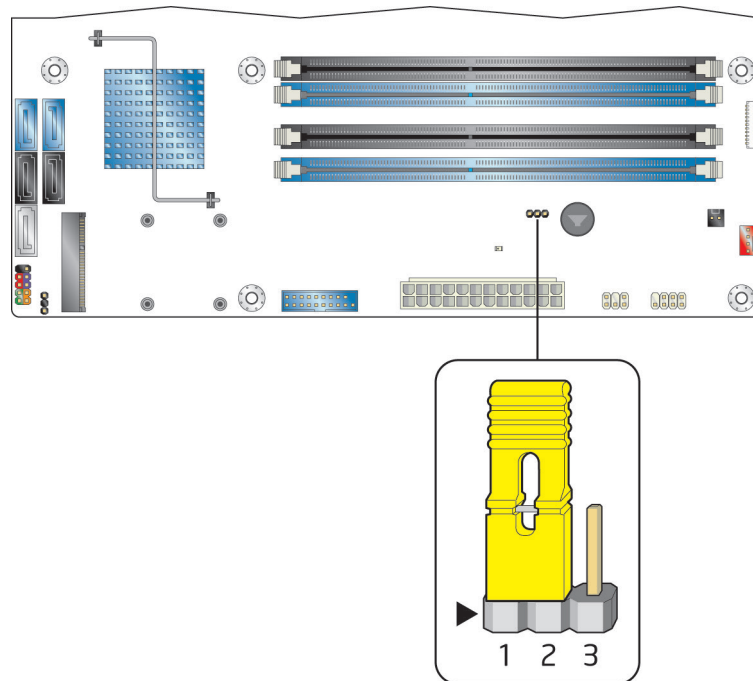

OM23659

Figure 13. Location of the Jumper Block

Table 35. BIOS Setup Configuration Jumper Settings

Function/Mode	Jumper Setting	Configuration
Normal	1-2	The BIOS uses current configuration information and passwords for booting.
Configure	2-3	After the POST runs, Setup runs automatically. The maintenance menu is displayed. Note that this Configure mode is the only way to clear the BIOS/CMOS settings. Press F9 (restore defaults) while in Configure mode to restore the BIOS/CMOS settings to their default values.
Recovery	None	The BIOS attempts to recover the BIOS configuration. A recovery CD or flash drive is required.

2.4 Mechanical Considerations

2.4.1 Form Factor

The board is designed to fit into an ATX-form-factor chassis. Figure 14 illustrates the mechanical form factor for the board. Dimensions are given in inches [millimeters]. The outer dimensions are 9.60 inches by 9.60 inches [243.84 millimeters by 243.84 millimeters]. Location of the I/O connectors and mounting holes are in compliance with the ATX specification.

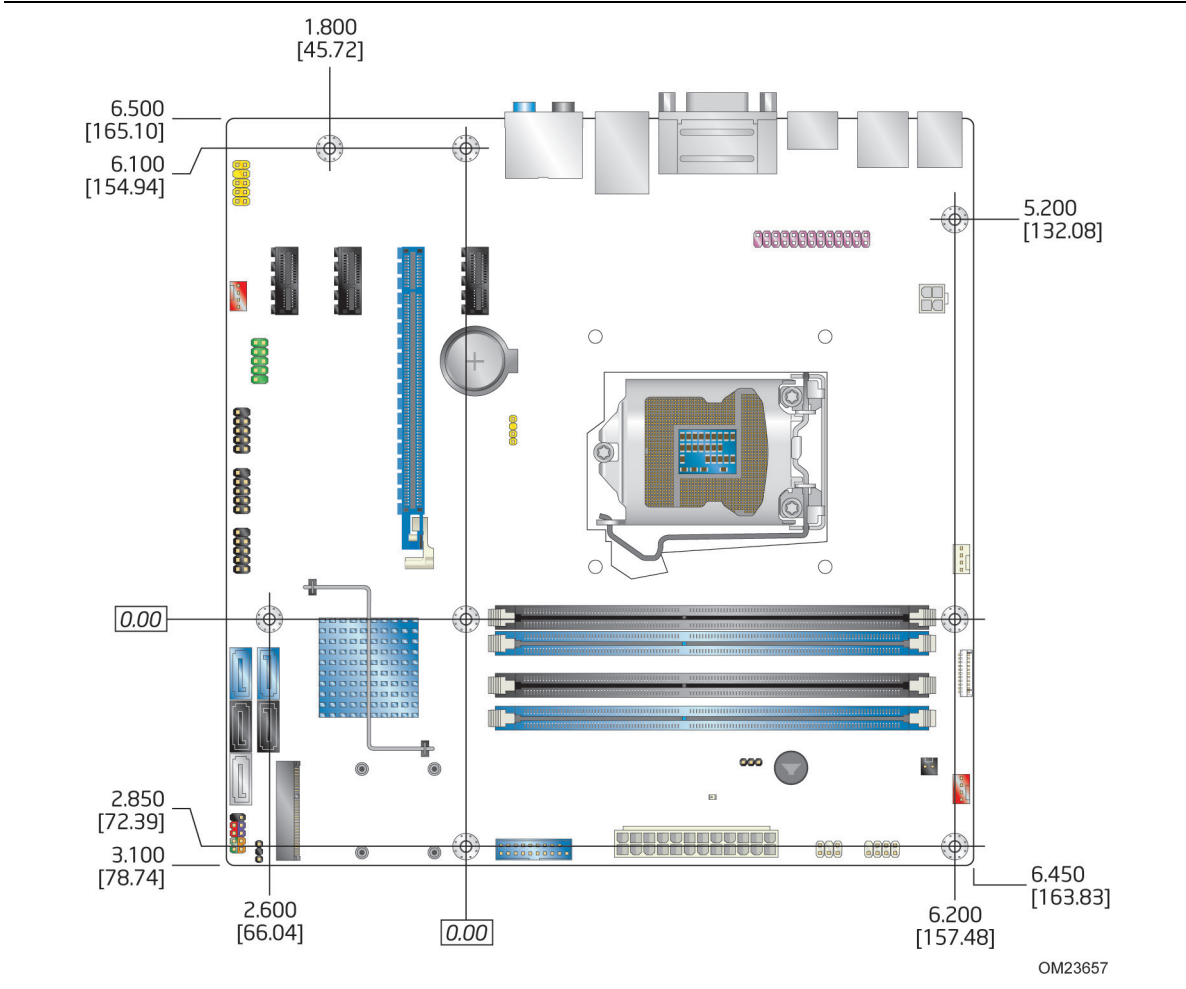

Figure 14. Board Dimensions

2.5 Electrical Considerations

2.5.1 Power Supply Considerations



CAUTION

The +5 V standby line from the power supply must be capable of providing adequate +5 V standby current. Failure to do so can damage the power supply. The total amount of standby current required depends on the wake devices supported and manufacturing options.

Additional power required will depend on configurations chosen by the integrator. The power supply must comply with the indicated parameters of the ATX form factor specification.

- The potential relation between 3.3 V DC and +5 V DC power rails
- The current capability of the +5 VSB line
- All timing parameters
- All voltage tolerances

For example, for a high power system consisting of a supported 95 W processor (see Section 1.3 on page 16 for a list of supported processors), 4 GB DDR3 RAM, one high end video card, one hard disk drive, one optical drive, and all board peripherals enabled, the minimum recommended power supply is 460 W.

For example, for a low power system consisting of a supported 45 W processor (see Section 1.3 on page 16 for a list of supported processors), 2 GB DDR3 RAM, integrated graphics, one SSD, one optical drive, and no extra onboard peripherals enabled, the minimum recommended power supply is a 320 W.

For information about	Refer to
Selecting an appropriate power supply	http://support.intel.com/support/motherboards/desktop/sb/CS-026472.htm

2.5.2 Power Supervisor

This board supports a version of the Power Supervisor feature which adds protection to the 5 VSB power rail by limiting potential electrical overstress events to a non-destructive level.

2.5.3 Fan Header Current Capability



CAUTION

The processor fan must be connected to the processor fan header, not to a chassis fan header. Connecting the processor fan to a chassis fan header may result in onboard component damage that will halt fan operation.

Table 36 lists the current capability of the fan headers.

Table 36. Fan Header Current Capability

Fan Header	Maximum Available Current
Processor fan	2.0 A
Front chassis fan	1.5 A
Rear chassis fan	1.5 A

2.5.4 Add-in Board Considerations

The board is designed to provide 2 A (average) of current for each add-in board from the +5 V rail. The total +5 V current draw for add-in boards for a fully loaded board (all three expansion slots filled) must not exceed the system’s power supply +5 V maximum current or 14 A in total.

2.6 Thermal Considerations



CAUTION

A chassis with a maximum internal ambient temperature of 38 °C at the processor fan inlet is a requirement. Use a processor heat sink that provides omni-directional airflow to maintain required airflow across the processor voltage regulator area.



CAUTION

Failure to ensure appropriate airflow may result in reduced performance of both the processor and/or voltage regulator or, in some instances, damage to the board. For a list of chassis that have been tested with Intel desktop boards please refer to the following website:

http://www3.intel.com/cd/channel/reseller/asmo-na/eng/tech_reference/53211.htm

All responsibility for determining the adequacy of any thermal or system design remains solely with the reader. Intel makes no warranties or representations that merely following the instructions presented in this document will result in a system with adequate thermal performance.



CAUTION

Ensure that the ambient temperature does not exceed the board's maximum operating temperature. Failure to do so could cause components to exceed their maximum case temperature and malfunction. For information about the maximum operating temperature, see the environmental specifications in Section 2.8.



CAUTION

Ensure that proper airflow is maintained in the processor voltage regulator circuit. Failure to do so may result in damage to the voltage regulator circuit. The processor voltage regulator area (shown in Figure 15) can reach a temperature of up to 120 °C in an open chassis.

Figure 15 shows the locations of the localized high temperature zones.

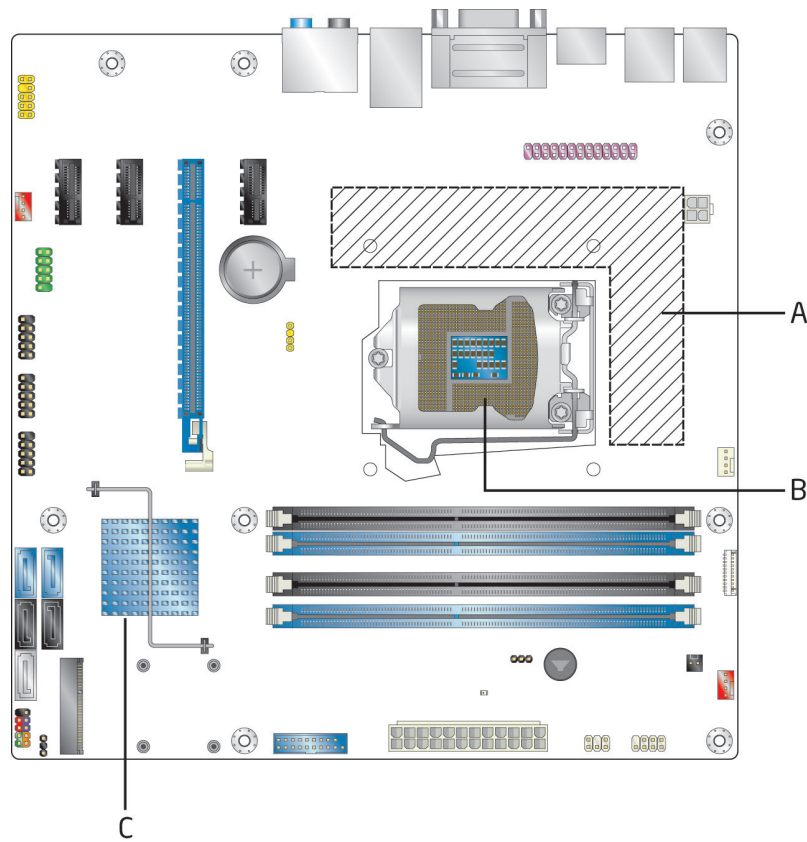

Item	Description
A	Processor voltage regulator area
B	Processor
C	Intel H77 Express Chipset

Figure 15. Localized High Temperature Zones

Table 37 provides maximum case temperatures for the components that are sensitive to thermal changes. The operating temperature, current load, or operating frequency could affect case temperatures. Maximum case temperatures are important when considering proper airflow to cool the board.

Table 37. Thermal Considerations for Components

Component	Maximum Case Temperature
Processor	For processor case temperature, see processor datasheets and processor specification updates
Intel H77 Express Chipset	104 °C

To ensure functionality and reliability, the component is specified for proper operation when Case Temperature is maintained at or below the maximum temperature listed in Table 37. This is a requirement for sustained power dissipation equal to Thermal Design Power (TDP is specified as the maximum sustainable power to be dissipated by the components). When the component is dissipating less than TDP, the case temperature should be below the Maximum Case Temperature. The surface temperature at the geometric center of the component corresponds to Case Temperature.

It is important to note that the temperature measurement in the system BIOS is a value reported by embedded thermal sensors in the components and does not directly correspond to the Maximum Case Temperature. The upper operating limit when monitoring this thermal sensor is Tcontrol.

Table 38. Tcontrol Values for Components

Component	Tcontrol
Processor	For processor case temperature, see processor datasheets and processor specification updates
Intel H77 Express Chipset	104 °C

For information about	Refer to
Processor datasheets and specification updates	Section 1.2, page 16
Intel H77 Express Chipset	http://www.intel.com/products/desktop/chipsets/

2.7 Reliability

The Mean Time Between Failures (MTBF) prediction is calculated using component and subassembly random failure rates. The calculation is based on the Telcordia SR-332, Issue 2; Method I Case 3 50% electrical stress, 55 °C ambient. The MTBF prediction is used to estimate repair rates and spare parts requirements. The MTBF data is calculated from predicted data at 55 °C. The MTBF for the Intel Desktop Board DH77EB is 328,467 hours.

2.8 Environmental

Table 39 lists the environmental specifications for the board.

Table 39. Environmental Specifications

Parameter	Specification		
Temperature			
Non-Operating	-20 °C to +70 °C ^(Note)		
Operating	0 °C to +55 °C The operating temperature of the board may be determined by measuring the air temperature from within 1 inch of the edge of the chipset/PCH heatsink and 1 inch above the board, in a closed chassis, while the system is in operation.		
Shock			
Unpackaged	50 g trapezoidal waveform		
	Velocity change of 170 inches/s ²		
Packaged	Half sine 2 millisecond		
	Product Weight (pounds)	Free Fall (inches)	Velocity Change (inches/s ²)
	<20	36	167
	21-40	30	152
	41-80	24	136
	81-100	18	118
Vibration			
Unpackaged	5 Hz to 20 Hz: 0.01 g ² Hz sloping up to 0.02 g ² Hz		
	20 Hz to 500 Hz: 0.02 g ² Hz (flat)		
Packaged	5 Hz to 40 Hz: 0.015 g ² Hz (flat)		
	40 Hz to 500 Hz: 0.015 g ² Hz sloping down to 0.00015 g ² Hz		

Note: Before attempting to operate this board, the overall temperature of the board must be above the minimum operating temperature specified. It is recommended that the board temperature be at least room temperature before attempting to power on the board.

3 Overview of BIOS Features

3.1 Introduction

The board uses an Intel BIOS that is stored in the Serial Peripheral Interface Flash Memory (SPI Flash) and can be updated using a disk-based program. The SPI Flash contains the BIOS Setup program, POST, the PCI auto-configuration utility, LAN EEPROM information, and Plug and Play support.

The BIOS displays a message during POST identifying the type of BIOS and a revision code. The initial production BIOSs are identified as EBH7710H.86A.

When the BIOS Setup configuration jumper is set to configure mode and the computer is powered-up, the BIOS compares the CPU version and the microcode version in the BIOS and reports if the two match.

The BIOS Setup program can be used to view and change the BIOS settings for the computer. The BIOS Setup program is accessed by pressing the <F2> key after the Power-On Self-Test (POST) memory test begins and before the operating system boot begins. The menu bar is shown below.

Maintenance	Main	Configuration	Performance	Security	Power	Boot	Exit
-------------	------	---------------	-------------	----------	-------	------	------



NOTE

The maintenance menu is displayed only when the board is in configure mode. Section 2.3 on page 57 shows how to put the board in configure mode.

Table 40 lists the BIOS Setup program menu features.

Table 40. BIOS Setup Program Menu Bar

Maintenance	Main	Configura- tion	Performance	Security	Power	Boot	Exit
Clears passwords and displays processor information	Displays processor and memory configuration	Configures advanced features available through the chipset	Configures Memory, Bus and Processor overrides	Sets passwords and security features	Configures power management features and power supply controls	Selects boot options	Saves or discards changes to Setup program options

Table 41 lists the function keys available for menu screens.

Table 41. BIOS Setup Program Function Keys

BIOS Setup Program Function Key	Description
<←> or <→>	Selects a different menu screen (Moves the cursor left or right)
<↑> or <↓>	Selects an item (Moves the cursor up or down)
<Tab>	Selects a field (Not implemented)
<Enter>	Executes command or selects the submenu
<F9>	Load the default configuration values for the current menu
<F10>	Save the current values and exits the BIOS Setup program
<Esc>	Exits the menu

3.2 BIOS Flash Memory Organization

The Serial Peripheral Interface Flash Memory (SPI Flash) includes a 32 Mbit (4096 KB) flash memory device.

3.3 Resource Configuration

3.3.1 PCI Express Autoconfiguration

The BIOS can automatically configure PCI Express devices. PCI Express devices may be onboard or add-in cards. Autoconfiguration lets a user insert or remove PCI Express cards without having to configure the system. When a user turns on the system after adding a PCI Express card, the BIOS automatically configures interrupts, the I/O space, and other system resources. Any interrupts set to Available in Setup are considered to be available for use by the add-in card.

3.4 System Management BIOS (SMBIOS)

SMBIOS is a Desktop Management Interface (DMI) compliant method for managing computers in a managed network.

The main component of SMBIOS is the Management Information Format (MIF) database, which contains information about the computing system and its components. Using SMBIOS, a system administrator can obtain the system types, capabilities, operational status, and installation dates for system components. The MIF database defines the data and provides the method for accessing this information. The BIOS enables applications such as third-party management software to use SMBIOS. The BIOS stores and reports the following SMBIOS information:

- BIOS data, such as the BIOS revision level
- Fixed-system data, such as peripherals, serial numbers, and asset tags
- Resource data, such as memory size, cache size, and processor speed
- Dynamic data, such as event detection and error logging

Non-Plug and Play operating systems require an additional interface for obtaining the SMBIOS information. The BIOS supports an SMBIOS table interface for such operating systems. Using this support, an SMBIOS service-level application running on a non-Plug and Play operating system can obtain the SMBIOS information. Additional board information can be found in the BIOS under the Additional Information header under the Main BIOS page.

3.5 Legacy USB Support

Legacy USB support enables USB devices to be used even when the operating system's USB drivers are not yet available. Legacy USB support is used to access the BIOS Setup program, and to install an operating system that supports USB. By default, Legacy USB support is set to Enabled.

Legacy USB support operates as follows:

1. When you apply power to the computer, legacy support is disabled.
2. POST begins.
3. Legacy USB support is enabled by the BIOS allowing you to use a USB keyboard to enter and configure the BIOS Setup program and the maintenance menu.
4. POST completes.
5. The operating system loads. While the operating system is loading, USB keyboards and mice are recognized and may be used to configure the operating system. (Keyboards and mice are not recognized during this period if Legacy USB support was set to Disabled in the BIOS Setup program.)
6. After the operating system loads the USB drivers, all legacy and non-legacy USB devices are recognized by the operating system, and Legacy USB support from the BIOS is no longer used.
7. Additional USB legacy feature options can be access by using Intel® Integrator Toolkit.

To install an operating system that supports USB, verify that Legacy USB support in the BIOS Setup program is set to Enabled and follow the operating system's installation instructions.

3.6 BIOS Updates

The BIOS can be updated using either of the following utilities, which are available on the Intel World Wide Web site:

- Intel® Express BIOS Update Utility, which enables automated updating while in the Windows environment. Using this utility, the BIOS can be updated from a file on a hard disk, a USB drive (a flash drive or a USB hard drive), or a CD-ROM, or from the file location on the Web.
- Intel® Flash Memory Update Utility, which requires booting from DOS. Using this utility, the BIOS can be updated from a file on a hard disk, a USB drive (a flash drive or a USB hard drive), or a CD-ROM.

Both utilities verify that the updated BIOS matches the target system to prevent accidentally installing an incompatible BIOS.



NOTE

Review the instructions distributed with the upgrade utility before attempting a BIOS update.

For information about	Refer to
------------------------------	-----------------

BIOS update utilities	http://support.intel.com/support/motherboards/desktop/sb/CS-022312.htm
-----------------------	---

3.6.1 Language Support

The BIOS Setup program and help messages are supported in US English. Check the Intel web site for support.

3.6.2 Custom Splash Screen

During POST, an Intel® splash screen is displayed by default. This splash screen can be augmented with a custom splash screen. The Intel Integrator's Toolkit that is available from Intel can be used to create a custom splash screen.



NOTE

If you add a custom splash screen, it will share space with the Intel branded logo.

For information about	Refer to
Intel Integrator Toolkit	http://developer.intel.com/design/motherbd/software/itk/
Additional Intel® software tools	http://developer.intel.com/design/motherbd/software.htm

3.7 BIOS Recovery

It is unlikely that anything will interrupt a BIOS update; however, if an interruption occurs, the BIOS could be damaged. Table 42 lists the drives and media types that can and cannot be used for BIOS recovery. The BIOS recovery media does not need to be made bootable.

Table 42. Acceptable Drives/Media Types for BIOS Recovery

Media Type	Can be used for BIOS recovery?
CD-ROM drive connected to the SATA interface	Yes
USB removable drive (a USB Flash Drive, for example)	Yes
USB diskette drive (with a 1.44 MB diskette)	No
USB hard disk drive	No

For information about	Refer to
BIOS recovery	http://www.intel.com/support/motherboards/desktop/sb/cs-023360.htm

3.8 Boot Options

In the BIOS Setup program, the user can choose to boot from a hard drive, optical drive, removable drive, or the network. The default setting is for the optical drive to be the first boot device, the hard drive second, removable drive third, and the network fourth.

3.8.1 Optical Drive Boot

Booting from the optical drive is supported in compliance to the El Torito bootable CD-ROM format specification. Under the Boot menu in the BIOS Setup program, the optical drive is listed as a boot device. Boot devices are defined in priority order. Accordingly, if there is not a bootable CD in the optical drive, the system will attempt to boot from the next defined drive.

3.8.2 Network Boot

The network can be selected as a boot device. This selection allows booting from the onboard LAN or a network add-in card with a remote boot ROM installed.

Pressing the <F12> key during POST automatically forces booting from the LAN. To use this key during POST, the User Access Level in the BIOS Setup program's Security menu must be set to Full.

3.8.3 Booting Without Attached Devices

For use in embedded applications, the BIOS has been designed so that after passing the POST, the operating system loader is invoked even if the following devices are not present:

- Video adapter
- Keyboard
- Mouse

3.8.4 Changing the Default Boot Device During POST

Pressing the <F10> key during POST causes a boot device menu to be displayed. This menu displays the list of available boot devices. Table 43 lists the boot device menu options.

Table 43. Boot Device Menu Options

Boot Device Menu Function Keys	Description
<↑> or <↓>	Selects a default boot device
<Enter>	Exits the menu, and boots from the selected device
<Esc>	Exits the menu and boots according to the boot priority defined through BIOS setup

3.9 Adjusting Boot Speed

These factors affect system boot speed:

- Selecting and configuring peripherals properly
- Optimized BIOS boot parameters
- Enabling the Fast Boot feature

3.9.1 Peripheral Selection and Configuration

The following techniques help improve system boot speed:

- Choose a hard drive with parameters such as “power-up to data ready” in less than eight seconds that minimizes hard drive startup delays.
- Select a CD-ROM drive with a fast initialization rate. This rate can influence POST execution time.
- Eliminate unnecessary add-in adapter features, such as logo displays, screen repaints, or mode changes in POST. These features may add time to the boot process.
- Try different monitors. Some monitors initialize and communicate with the BIOS more quickly, which enables the system to boot more quickly.

3.9.2 BIOS Boot Optimizations

Use of the following BIOS Setup program settings reduces the POST execution time.

- In the Boot menu, enable the settings for Fast Boot. This option will allow BIOS to skip through various stages of POST and boot quickly to the last detected boot device.
- In the Boot Menu, set the hard disk drive as the first boot device. As a result, the POST does not first seek a diskette drive, which saves about one second from the POST execution time.
- In the Peripheral Configuration submenu, disable the LAN device if it will not be used. This can reduce up to four seconds of option ROM boot time.



NOTE

It is possible to optimize the boot process to the point where the system boots so quickly that the Intel logo screen (or a custom logo splash screen) will not be seen. Monitors and hard disk drives with minimum initialization times can also contribute to a boot time that might be so fast that necessary logo screens and POST messages cannot be seen.

This boot time may be so fast that some drives might be not be initialized at all. If this condition should occur, it is possible to introduce a programmable delay ranging from zero to 30 seconds by 5 second increments (using the Hard Disk Pre-Delay feature of the Advanced Menu in the Drive Configuration Submenu of the BIOS Setup program).

3.10 BIOS Security Features

The BIOS includes security features that restrict access to the BIOS Setup program and who can boot the computer. A supervisor password and a user password can be set for the BIOS Setup program and for booting the computer, with the following restrictions:

- The supervisor password gives unrestricted access to view and change all the Setup options in the BIOS Setup program. This is the supervisor mode.
- The user password gives restricted access to view and change Setup options in the BIOS Setup program. This is the user mode.
- If only the supervisor password is set, pressing the <Enter> key at the password prompt of the BIOS Setup program allows the user restricted access to Setup.
- If both the supervisor and user passwords are set, users can enter either the supervisor password or the user password to access Setup. Users have access to Setup respective to which password is entered.
- Setting the user password restricts who can boot the computer. The password prompt will be displayed before the computer is booted. If only the supervisor password is set, the computer boots without asking for a password. If both passwords are set, the user can enter either password to boot the computer.
- For enhanced security, use different passwords for the supervisor and user passwords.
- Valid password characters are A-Z, a-z, and 0-9. Passwords may be up to 16 characters in length.

Table 44 shows the effects of setting the supervisor password and user password. This table is for reference only and is not displayed on the screen.

Table 44. Supervisor and User Password Functions

Password Set	Supervisor Mode	User Mode	Setup Options	Password to Enter Setup	Password During Boot
Neither	Can change all options (Note)	Can change all options (Note)	None	None	None
Supervisor only	Can change all options	Can change a limited number of options	Supervisor Password	Supervisor	None
User only	N/A	Can change all options	Enter Password Clear User Password	User	User
Supervisor and user set	Can change all options	Can change a limited number of options	Supervisor Password Enter Password	Supervisor or user	Supervisor or user

Note: If no password is set, any user can change all Setup options.

**NOTE**

The BIOS complies with NIST Special Publication 800-147 *BIOS Protection Guidelines / Recommendations of the National Institute of Standards and Technology*. Refer to <http://csrc.nist.gov/publications/nistpubs/800-147/NIST-SP800-147-April2011.pdf> for more information.

3.11 BIOS Performance Features

The BIOS includes the following options to provide custom performance enhancements when using 3rd generation Intel Core processor family and 2nd generation Intel Core processor family processors in an LGA1155 socket.

- Processor Maximum Non-Turbo Ratio (processor multiplier can only be adjusted down)
- Memory multiplier adjustment
- Memory voltage adjustment
- Graphics multiplier adjustment

4 Error Messages and Beep Codes

4.1 Speaker

The board-mounted speaker provides audible error code (beep code) information during POST.

For information about

The location of the onboard speaker

Refer to

Figure 1, page 13

4.2 BIOS Beep Codes

Whenever a recoverable error occurs during POST, the BIOS causes the board's speaker to beep an error message describing the problem (see Table 45).

Table 45. BIOS Beep Codes

Type	Pattern	Frequency
F2 Setup/F10 Boot Menu Prompt	One 0.5 second beep when BIOS is ready to accept keyboard input	932 Hz
BIOS update in progress	None	
Video error	On-off (1.0 second each) two times, then 2.5-second pause (off), entire pattern repeats (beeps and pause) once and the BIOS will continue to boot.	932 Hz When no VGA option ROM is found.
Memory error	On-off (1.0 second each) three times, then 2.5-second pause (off), entire pattern repeats (beeps and pause) until the system is powered off.	932 Hz
Thermal trip warning	Alternate high and low beeps (1.0 second each) for eight beeps, followed by system shut down.	High beep 2000 Hz Low beep 1500 Hz

4.3 Front-panel Power LED Blink Codes

Whenever a recoverable error occurs during POST, the BIOS causes the board's front panel power LED to blink an error message describing the problem (see Table 46).

Table 46. Front-panel Power LED Blink Codes

Type	Pattern	Note
F2 Setup/F10 Boot Menu Prompt	None	
BIOS update in progress	Off when the update begins, then on for 0.5 seconds, then off for 0.5 seconds. The pattern repeats until the BIOS update is complete.	
Video error	On-off (1.0 second each) two times, then 2.5-second pause (off), entire pattern repeats (blink and pause) until the system is powered off.	When no VGA option ROM is found.
Memory error	On-off (1.0 second each) three times, then 2.5-second pause (off), entire pattern repeats (blinks and pause) until the system is powered off.	
Thermal trip warning	Each beep will be accompanied by the following blink pattern: .25 seconds on, .25 seconds off, .25 seconds on, .25 seconds off. This will result in a total of 16 blinks.	

4.4 BIOS Error Messages

Table 47 lists the error messages and provides a brief description of each.

Table 47. BIOS Error Messages

Error Message	Explanation
CMOS Battery Low	The battery may be losing power. Replace the battery soon.
CMOS Checksum Bad	The CMOS checksum is incorrect. CMOS memory may have been corrupted. Run Setup to reset values.
Memory Size Decreased	Memory size has decreased since the last boot. If no memory was removed, then memory may be bad.
No Boot Device Available	System did not find a device to boot.

4.5 Port 80h Power On Self Test (POST) Codes

During the POST, the BIOS generates diagnostic progress codes (POST codes) to I/O port 80h. If the POST fails, execution stops and the last POST code generated is left at port 80h. This code is useful for determining the point where an error occurred.

Displaying the POST codes requires a POST card that can interface with the Low Pin Count (LPC) Debug connector. The POST card can decode the port and display the contents on a medium such as a seven-segment display. Refer to the location of the LPC Debug connector in Figure 1.

The following tables provide information about the POST codes generated by the BIOS:

- Table 48 lists the Port 80h POST code ranges
- Table 49 lists the Port 80h POST codes themselves
- Table 50 lists the Port 80h POST sequence



NOTE

In the tables listed above, all POST codes and range values are listed in hexadecimal.

Table 48. Port 80h POST Code Ranges

Range	Subsystem
0x00 – 0x05	Entering SX states S0 to S5.
0x10, 0x20, 0x30, 0x40, 0x50	Resuming from SX states. 0x10 – S1, 0x20 – S2, 0x30 – S3, etc.
0x08 – 0x0F	Security (SEC) phase
0x11 – 0x1F	PEI phase pre MRC execution
0x21 – 0x29	MRC Memory detection
0x2A – 0x2F	PEI phase post MRC execution
0x31 – 0x35	Recovery
0x36 – 0x3F	Platform DXE driver
0x41 – 0x4F	CPU Initialization (PEI, DXE, SMM)
0x50 – 0x5F	I/O Buses: PCI, USB, ISA, ATA etc. 0x5F is an unrecoverable error. Start with PCI.
0x60 – 0x6F	BDS
0x70 – 0x7F	Output Devices: All output consoles.
0x80 – 0x8F	For future use
0x90 – 0x9F	Input devices: Keyboard/Mouse.
0xA0 – 0xAF	For future use
0xB0 – 0xBF	Boot Devices: Includes fixed media and removable media. Not that critical since consoles should be up at this point.
0xC0 – 0xCF	For future use
0xD0 – 0xDF	For future use
0xF0 – 0xFF	

Table 49. Port 80h POST Codes

Port 80 Code	Progress Code Enumeration
	ACPI S States
0x00,0x01,0x02,0x03,0x04,0x05	Entering S0, S2, S3, S4, or S5 state
0x10,0x20,0x30,0x40,0x50	Resuming from S2, S3, S4, S5
	Security Phase (SEC)
0x08	Starting BIOS execution after CPU BIST
0x09	SPI prefetching and caching
0x0A	Load BSP microcode
0x0B	Load APs microcodes
0x0C	Platform program baseaddresses
0x0D	Wake Up All APs
0x0E	Initialize NEM
0x0F	Pass entry point of the PEI core
	PEI before MRC
	PEI Platform driver
0x11	Set bootmode, GPIO init
0x12	Early chipset register programming including graphics init
0x13	Basic PCH init, discrete device init (1394, SATA)
0x14	LAN init
0x15	Exit early platform init driver
	PEI SMBUS
0x16	SMBUSriver init
0x17	Entry to SMBUS execute read/write
0x18	Exit SMBUS execute read/write
	PEI CK505 Clock Programming
0x19	Entry to CK505 programming
0x1A	Exit CK505 programming
	PEI Over-Clock Programming
0x1B	Entry to entry to PEI over-clock programming
0x1C	Exit PEI over-clock programming
	Memory
0x21	MRC entry point
0x23	Reading SPD from memory DIMMs
0x24	Detecting presence of memory DIMMs
0x27	Configuring memory
0x28	Testing memory
0x29	Exit MRC driver

continued

Table 49. Port 80h POST Codes (continued)

Port 80 Code	Progress Code Enumeration
	PEI after MRC
0x2A	Start to Program MTRR Settings
0x2B	Done Programming MTRR Settings
	PEIMs/Recovery
0x31	Crisis Recovery has initiated
0x33	Loading recovery capsule
0x34	Start recovery capsule/ valid capsule is found
	CPU Initialization
	CPU PEI Phase
0x41	Begin CPU PEI Init
0x42	XMM instruction enabling
0x43	End CPU PEI Init
	CPU PEI SMM Phase
0x44	Begin CPU SMM Init smm relocate bases
0x45	Smm relocate bases for APs
0x46	End CPU SMM Init
	CPU DXE Phase
0x47	CPU DXE Phase begin
0x48	Refresh memory space attributes according to MTRRs
0x49	Load the microcode if needed
0x4A	Initialize strings to HII database
0x4B	Initialize MP Support
0x4C	CPU DXE Phase End
	CPU DXE SMM Phase
0x4D	CPU DXE SMM Phase begin
0x4E	Relocate SM bases for all APs
0x4F	CPU DXE SMM Phase end
	IO BUSES
0x50	Enumerating PCI buses
0x51	Allocating resources to PCI bus
0x52	Hot Plug PCI controller initialization
	USB
0x58	Resetting USB bus
0x59	Reserved for USB
	ATA/ATAPI/SATA
0x5A	Resetting PATA/SATA bus and all devices
0x5B	Reserved for ATA

continued

Table 49. Port 80h POST Codes (continued)

Port 80 Code	Progress Code Enumeration
	BDS
0x60	BDS driver entry point initialize
0x61	BDS service routine entry point (can be called multiple times)
0x62	BDS Step2
0x63	BDS Step3
0x64	BDS Step4
0x65	BDS Step5
0x66	BDS Step6
0x67	BDS Step7
0x68	BDS Step8
0x69	BDS Step9
0x6A	BDS Step10
0x6B	BDS Step11
0x6C	BDS Step12
0x6D	BDS Step13
0x6E	BDS Step14
0x6F	BDS return to DXE core (should not get here)
	Keyboard (PS2 or USB)
0x90	Resetting keyboard
0x91	Disabling the keyboard
0x92	Detecting the presence of the keyboard
0x93	Enabling the keyboard
0x94	Clearing keyboard input buffer
0x95	Instructing keyboard controller to run Self Test (PS2 only)
	Mouse (PS2 or USB)
0x98	Resetting mouse
0x99	Detecting mouse
0x9A	Detecting presence of mouse
0x9B	Enabling mouse
	Fixed Media
0xB0	Resetting fixed media
0xB1	Disabling fixed media
0xB2	Detecting presence of a fixed media (IDE hard drive detection etc.)
0xB3	Enabling/configuring a fixed media

continued

Table 49. Port 80h POST Codes (continued)

Port 80 Code	Progress Code Enumeration
	Removable Media
0xB8	Resetting removable media
0xB9	Disabling removable media
0xBA	Detecting presence of a removable media (IDE, CDROM detection etc.)
0xBB	Enabling/configuring a removable media
	DXE Core
0xE4	Entered DXE phase
	BDS
0xE7	Waiting for user input
0xE8	Checking password
0xE9	Entering BIOS setup
0xEB	Calling Legacy Option ROMs
	Runtime Phase/EFI OS Boot
0xF8	EFI boot service ExitBootServices () has been called
0xF9	EFI runtime service SetVirtualAddressMap () has been called

Table 50. Typical Port 80h POST Sequence

POST Code	Description
21	Initializing a chipset component
22	Reading SPD from memory DIMMs
23	Detecting presence of memory DIMMs
25	Configuring memory
28	Testing memory
34	Loading recovery capsule
E4	Entered DXE phase
12	Starting application processor initialization
13	SMM initialization
50	Enumerating PCI buses
51	Allocating resourced to PCI bus
92	Detecting the presence of the keyboard
90	Resetting keyboard
94	Clearing keyboard input buffer
95	Keyboard Self Test
EB	Calling Video BIOS
58	Resetting USB bus
5A	Resetting PATA/SATA bus and all devices
92	Detecting the presence of the keyboard
90	Resetting keyboard
94	Clearing keyboard input buffer
5A	Resetting PATA/SATA bus and all devices
28	Testing memory
90	Resetting keyboard
94	Clearing keyboard input buffer
E7	Waiting for user input
01	INT 19
00	Ready to boot

5 Regulatory Compliance and Battery Disposal Information

5.1 Regulatory Compliance

This section contains the following regulatory compliance information for Intel Desktop Board DH77EB:

- Safety standards
- European Union Declaration of Conformity statement
- Product Ecology statements
- Electromagnetic Compatibility (EMC) standards
- Product certification markings

5.1.1 Safety Standards

Intel Desktop Board DH77EB complies with the safety standards stated in Table 51 when correctly installed in a compatible host system.

Table 51. Safety Standards

Standard	Title
CSA/UL 60950-1	Information Technology Equipment – Safety - Part 1: General Requirements (USA and Canada)
EN 60950-1	Information Technology Equipment – Safety - Part 1: General Requirements (European Union)
IEC 60950-1	Information Technology Equipment – Safety - Part 1: General Requirements (International)

5.1.2 European Union Declaration of Conformity Statement

We, Intel Corporation, declare under our sole responsibility that the product Intel® Desktop Board DH77EB is in conformity with all applicable essential requirements necessary for CE marking, following the provisions of the European Council Directive 2004/108/EC (EMC Directive), 2006/95/EC (Low Voltage Directive), and 2002/95/EC (ROHS Directive).

The product is properly CE marked demonstrating this conformity and is for distribution within all member states of the EU with no restrictions.



This product follows the provisions of the European Directives 2004/108/EC, 2006/95/EC, and 2002/95/EC.

Čeština Tento výrobek odpovídá požadavkům evropských směrnic 2004/108/EC, 2006/95/EC a 2002/95/EC.

Dansk Dette produkt er i overensstemmelse med det europæiske direktiv 2004/108/EC, 2006/95/EC & 2002/95/EC.

Dutch Dit product is in navolging van de bepalingen van Europees Directief 2004/108/EC, 2006/95/EC & 2002/95/EC.

Eesti Antud toode vastab Euroopa direktiivides 2004/108/EC, ja 2006/95/EC ja 2002/95/EC kehtestatud nõuetele.

Suomi Tämä tuote noudattaa EU-direktiivin 2004/108/EC, 2006/95/EC & 2002/95/EC määräyksiä.

Français Ce produit est conforme aux exigences de la Directive Européenne 2004/108/EC, 2006/95/EC & 2002/95/EC.

Deutsch Dieses Produkt entspricht den Bestimmungen der Europäischen Richtlinie 2004/108/EC, 2006/95/EC & 2002/95/EC.

Ελληνικά Το παρόν προϊόν ακολουθεί τις διατάξεις των Ευρωπαϊκών Οδηγιών 2004/108/EC, 2006/95/EC και 2002/95/EC.

Magyar E termék megfelel a 2004/108/EC, 2006/95/EC és 2002/95/EC Európai Irányelv előírásainak.

Icelandic Þessi vara stenst reglugerð Evrópska Efnahags Bandalagsins númer 2004/108/EC, 2006/95/EC, & 2002/95/EC.

Italiano Questo prodotto è conforme alla Direttiva Europea 2004/108/EC, 2006/95/EC & 2002/95/EC.

Latviešu Šis produkts atbilst Eiropas Direktīvu 2004/108/EC, 2006/95/EC un 2002/95/EC noteikumiem.

Lietuvių Šis produktas atitinka Europos direktyvų 2004/108/EC, 2006/95/EC, ir 2002/95/EC nuostatas.

Malti Dan il-prodott hu konformi mal-provvedimenti tad-Direttivi Ewropej 2004/108/EC, 2006/95/EC u 2002/95/EC.

Norsk Dette produktet er i henhold til bestemmelsene i det europeiske direktivet 2004/108/EC, 2006/95/EC & 2002/95/EC.

Polski Niniejszy produkt jest zgodny z postanowieniami Dyrektyw Unii Europejskiej 2004/108/EC, 206/95/EC i 2002/95/EC.

Portuguese Este produto cumpre com as normas da Diretiva Europeia 2004/108/EC, 2006/95/EC & 2002/95/EC.

Español Este producto cumple con las normas del Directivo Europeo 2004/108/EC, 2006/95/EC & 2002/95/EC.

Slovensky Tento produkt je v súlade s ustanoveniami európskych direktív 2004/108/EC, 2006/95/EC a 2002/95/EC.

Slovenščina Izdelek je skladen z določbami evropskih direktiv 2004/108/EC, 2006/95/EC in 2002/95/EC.

Svenska Denna produkt har tillverkats i enlighet med EG-direktiv 2004/108/EC, 2006/95/EC & 2002/95/EC.

Türkçe Bu ürün, Avrupa Birliği'nin 2004/108/EC, 2006/95/EC ve 2002/95/EC yönergelerine uyar.

5.1.3 Product Ecology Statements

The following information is provided to address worldwide product ecology concerns and regulations.

5.1.3.1 Disposal Considerations

This product contains the following materials that may be regulated upon disposal: lead solder on the printed wiring board assembly.

5.1.3.2 Recycling Considerations

As part of its commitment to environmental responsibility, Intel has implemented the Intel Product Recycling Program to allow retail consumers of Intel's branded products to return used products to selected locations for proper recycling.

Please consult the http://www.intel.com/intel/other/ehs/product_ecology for the details of this program, including the scope of covered products, available locations, shipping instructions, terms and conditions, etc.

中文

作为其对环境责任之承诺的部分，英特尔已实施 Intel Product Recycling Program（英特尔产品回收计划），以允许英特尔品牌产品的零售消费者将使用过的产品退还至指定地点作恰当的重复使用处理。

请参考http://www.intel.com/intel/other/ehs/product_ecology

了解此计划的详情，包括涉及产品之范围、回收地点、运送指导、条款和条件等。

Deutsch

Als Teil von Intels Engagement für den Umweltschutz hat das Unternehmen das Intel Produkt-Recyclingprogramm implementiert, das Einzelhandelskunden von Intel Markenprodukten ermöglicht, gebrauchte Produkte an ausgewählte Standorte für ordnungsgemäßes Recycling zurückzugeben.

Details zu diesem Programm, einschließlich der darin eingeschlossenen Produkte, verfügbaren Standorte, Versandanweisungen, Bedingungen usw., finden Sie auf der http://www.intel.com/intel/other/ehs/product_ecology

Español

Como parte de su compromiso de responsabilidad medioambiental, Intel ha implantado el programa de reciclaje de productos Intel, que permite que los consumidores al detalle de los productos Intel devuelvan los productos usados en los lugares seleccionados para su correspondiente reciclado.

Consulte la http://www.intel.com/intel/other/ehs/product_ecology para ver los detalles del programa, que incluye los productos que abarca, los lugares disponibles, instrucciones de envío, términos y condiciones, etc.

Français

Dans le cadre de son engagement pour la protection de l'environnement, Intel a mis en œuvre le programme Intel Product Recycling Program (Programme de recyclage des produits Intel) pour permettre aux consommateurs de produits Intel de recycler les produits usés en les retournant à des adresses spécifiées.

Visitez la page Web http://www.intel.com/intel/other/ehs/product_ecology pour en savoir plus sur ce programme, à savoir les produits concernés, les adresses disponibles, les instructions d'expédition, les conditions générales, etc.

日本語

インテルでは、環境保護活動の一環として、使い終わったインテルブランド製品を指定の場所へ返送していただき、リサイクルを適切に行えるよう、インテル製品リサイクルプログラムを発足させました。

対象製品、返送先、返送方法、ご利用規約など、このプログラムの詳細情報は、http://www.intel.com/intel/other/ehs/product_ecology (英語)をご覧ください。

Malay

Sebagai sebahagian daripada komitmennya terhadap tanggungjawab persekitaran, Intel telah melaksanakan Program Kitar Semula Produk untuk membenarkan pengguna-pengguna runcit produk jenama Intel memulangkan produk terguna ke lokasi-lokasi terpilih untuk dikitar semula dengan betul.

Sila rujuk http://www.intel.com/intel/other/ehs/product_ecology untuk mendapatkan butir-butir program ini, termasuklah skop produk yang dirangkumi, lokasi-lokasi tersedia, arahan penghantaran, terma & syarat, dsb.

Portuguese

Como parte deste compromisso com o respeito ao ambiente, a Intel implementou o Programa de Reciclagem de Produtos para que os consumidores finais possam enviar produtos Intel usados para locais selecionados, onde esses produtos são reciclados de maneira adequada.

Consulte o site http://www.intel.com/intel/other/ehs/product_ecology (em Inglês) para obter os detalhes sobre este programa, inclusive o escopo dos produtos cobertos, os locais disponíveis, as instruções de envio, os termos e condições, etc.

Russian

В качестве части своих обязательств к окружающей среде, в Intel создана программа утилизации продукции Intel (Product Recycling Program) для предоставления конечным пользователям марок продукции Intel возможности возврата используемой продукции в специализированные пункты для должной утилизации.

Пожалуйста, обратитесь на веб-сайт

http://www.intel.com/intel/other/ehs/product_ecology за информацией об этой программе, принимаемых продуктах, местах приема, инструкциях об отправке, положениях и условиях и т.д.

Türkçe

Intel, çevre sorumluluğuna bağlılığının bir parçası olarak, perakende tüketicilerin Intel markalı kullanılmış ürünlerini belirlenmiş merkezlere iade edip uygun şekilde geri dönüştürmesini amaçlayan Intel Ürünleri Geri Dönüşüm Programı'nı uygulamaya koymuştur.

Bu programın ürün kapsamı, ürün iade merkezleri, nakliye talimatları, kayıtlar ve şartlar v.s dahil bütün ayrıntılarını öğrenmek için lütfen

http://www.intel.com/intel/other/ehs/product_ecology Web sayfasına gidin.

5.1.4 China RoHS

Intel Desktop Board DH77EB is a China RoHS-compliant product.

The China Ministry of Information Industry (MII) stipulates that a material Self Declaration Table (SDT) must be included in a product’s user documentation. The SDT for Intel Desktop Board DH77EB is shown in Figure 16.

关于符合中国《电子信息产品污染控制管理办法》的声明

**Management Methods on Control of Pollution from
Electronic Information Products
(China RoHS declaration)**

产品中有毒有害物质的名称及含量

部件名称 (Parts)	有毒有害物质或元素					
	铅 (Pb)	汞 (Hg)	镉 (Cd)	六价铬 (Cr6+)	多溴联苯 (PBB)	多溴二苯醚 (PBDE)
主板组件 Motherboard Assembly	×	○	○	○	○	○
<p>○ : 表示该有毒有害物质在该部件所有均质材料中的含量均在 SJ/T 11363-2006 标准规定的限量要求以下。</p> <p>○ : Indicates that this hazardous substance contained in all homogeneous materials of this part is below the limit requirement in SJ/T 11363-2006.</p> <p>× : 表示该有毒有害物质至少在该部件的某一均质材料中的含量超出 SJ/T 11363-2006 标准规定的限量要求。</p> <p>× : Indicates that this hazardous substance contained in at least one of the homogeneous materials of this part is above the limit requirement in SJ/T 11363-2006.</p> <p>对销售之日的所售产品,本表显示我公司供应链的电子信息产品可能包含这些物质。注意:在所售产品中可能会也可能不会含有所有所列的部件。</p> <p>This table shows where these substances may be found in the supply chain of our electronic information products, as of the date of sale of the enclosed product. Note that some of the component types listed above may or may not be a part of the enclosed product.</p>						

Figure 16. Intel Desktop Board DH77EB China RoHS Material Self Declaration Table

5.1.5 EMC Regulations

Intel Desktop Board DH77EB complies with the EMC regulations stated in Table 52 when correctly installed in a compatible host system.

Table 52. EMC Regulations

Regulation	Title
FCC 47 CFR Part 15, Subpart B	Title 47 of the Code of Federal Regulations, Part 15, Subpart B, Radio Frequency Devices. (USA)
ICES-003	Interference-Causing Equipment Standard, Digital Apparatus. (Canada)
EN55022	Limits and methods of measurement of Radio Interference Characteristics of Information Technology Equipment. (European Union)
EN55024	Information Technology Equipment – Immunity Characteristics Limits and methods of measurement. (European Union)
EN55022	Australian Communications Authority, Standard for Electromagnetic Compatibility. (Australia and New Zealand)
CISPR 22	Limits and methods of measurement of Radio Disturbance Characteristics of Information Technology Equipment. (International)
CISPR 24	Information Technology Equipment – Immunity Characteristics – Limits and Methods of Measurement. (International)
VCCI V-3, V-4	Voluntary Control for Interference by Information Technology Equipment. (Japan)
KN-22, KN-24	Korean Communications Commission – Framework Act on Telecommunications and Radio Waves Act (South Korea)
CNS 13438	Bureau of Standards, Metrology, and Inspection (Taiwan)

FCC Declaration of Conformity

This device complies with Part 15 of the FCC Rules. Operation is subject to the following two conditions: (1) this device may not cause harmful interference, and (2) this device must accept any interference received, including interference that may cause undesired operation.

For questions related to the EMC performance of this product, contact:

Intel Corporation, 5200 N.E. Elam Young Parkway, Hillsboro, OR 97124
1-800-628-8686

This equipment has been tested and found to comply with the limits for a Class B digital device, pursuant to Part 15 of the FCC Rules. These limits are designed to provide reasonable protection against harmful interference in a residential installation. This equipment generates, uses, and can radiate radio frequency energy and, if not installed and used in accordance with the instructions, may cause harmful interference to radio communications. However, there is no guarantee that interference will not occur in a particular installation. If this equipment does cause harmful interference to radio or television reception, which can be determined by turning the equipment off and on, the user is encouraged to try to correct the interference by one or more of the following measures:

- Reorient or relocate the receiving antenna.
- Increase the separation between the equipment and the receiver.

- Connect the equipment to an outlet on a circuit other than the one to which the receiver is connected.
- Consult the dealer or an experienced radio/TV technician for help.

Any changes or modifications to the equipment not expressly approved by Intel Corporation could void the user's authority to operate the equipment.

Tested to comply with FCC standards for home or office use.

Canadian Department of Communications Compliance Statement

This digital apparatus does not exceed the Class B limits for radio noise emissions from digital apparatus set out in the Radio Interference Regulations of the Canadian Department of Communications.

Le présent appareil numérique n'émet pas de bruits radioélectriques dépassant les limites applicables aux appareils numériques de la classe B prescrites dans le Règlement sur le brouillage radioélectrique édicté par le ministère des Communications du Canada.

Japan VCCI Statement

Japan VCCI Statement translation: This is a Class B product based on the standard of the Voluntary Control Council for Interference from Information Technology Equipment (VCCI). If this is used near a radio or television receiver in a domestic environment, it may cause radio interference. Install and use the equipment according to the instruction manual.

この装置は、情報処理装置等電波障害自主規制協議会（VCCI）の基準に基づくクラスB情報技術装置です。この装置は、家庭環境で使用することを目的としていますが、この装置がラジオやテレビジョン受信機に近接して使用されると、受信障害を引き起こすことがあります。
取扱説明書に従って正しい取り扱いをして下さい。

Korea Class B Statement

Korea Class B Statement translation: This equipment is for home use, and has acquired electromagnetic conformity registration, so it can be used not only in residential areas, but also other areas.

이 기기는 가정용(B급)으로 전자파적합등록을 한 기기로서 주로 가정에서 사용하는 것을 목적으로 하며, 모든 지역에서 사용할 수 있습니다.

5.1.6 ENERGY STAR* 5.0, e-Standby, and ErP Compliance

The US Department of Energy and the US Environmental Protection Agency have continually revised the ENERGY STAR requirements. Intel has worked directly with these two governmental agencies in the definition of new requirements.

Intel Desktop Board DH77EB meets the following program requirements in an adequate system configuration, including appropriate selection of an efficient power supply:

- Energy Star v5.0, category B
- EPEAT*
- Korea e-Standby
- European Union Energy-related Products Directive 2009 (ErP) Lot 6



NOTE









Energy Star compliance is based at the system level not the board level. Use of an Intel Desktop Board alone does not guarantee Energy Star compliance.

For information about	Refer to
ENERGY STAR requirements and recommended configurations	http://www.intel.com/go/energystar
Electronic Product Environmental Assessment Tool (EPEAT)	http://www.epeat.net/
Korea e-Standby Program	http://www.kemco.or.kr/new_eng/pg02/pg02100300.asp
European Union Energy-related Products Directive 2009 (ErP)	http://ec.europa.eu/enterprise/policies/sustainable-business/sustainable-product-policy/ecodesign/index_en.htm

5.1.7 Regulatory Compliance Marks (Board Level)

Intel Desktop Board DH77EB has the regulatory compliance marks shown in Table 53.

Table 53. Regulatory Compliance Marks

Description	Mark
UL joint US/Canada Recognized Component mark. Includes adjacent UL file number for Intel Desktop Boards: E210882.	
FCC Declaration of Conformity logo mark for Class B equipment.	
CE mark. Declaring compliance to the European Union (EU) EMC directive, Low Voltage directive, and RoHS directive.	
Australian Communications Authority (ACA) and New Zealand Radio Spectrum Management (NZ RSM) C-tick mark. Includes adjacent Intel supplier code number, N-232.	
Japan VCCI (Voluntary Control Council for Interference) mark.	
Korea Certification mark. Includes an adjacent KCC (Korean Communications Commission) certification number: KCC-REM-CPU-DH77EB.	
Taiwan BSMI (Bureau of Standards, Metrology and Inspections) mark. Includes adjacent Intel company number, D33025.	
Printed wiring board manufacturer's recognition mark. Consists of a unique UL recognized manufacturer's logo, along with a flammability rating (solder side).	V-0
China RoHS/Environmentally Friendly Use Period Logo: This is an example of the symbol used on Intel Desktop Boards and associated collateral. The color of the mark may vary depending upon the application. The Environmental Friendly Usage Period (EFUP) for Intel Desktop Boards has been determined to be 10 years.	

5.2 Battery Disposal Information



CAUTION

Risk of explosion if the battery is replaced with an incorrect type. Batteries should be recycled where possible. Disposal of used batteries must be in accordance with local environmental regulations.



PRÉCAUTION

Risque d'explosion si la pile usagée est remplacée par une pile de type incorrect. Les piles usagées doivent être recyclées dans la mesure du possible. La mise au rebut des piles usagées doit respecter les réglementations locales en vigueur en matière de protection de l'environnement.



FORHOLDSREGEL

Eksplosionsfare, hvis batteriet erstattes med et batteri af en forkert type. Batterier bør om muligt genbruges. Bortskaffelse af brugte batterier bør foregå i overensstemmelse med gældende miljølovgivning.



OBS!

Det kan oppstå eksplosjonsfare hvis batteriet skiftes ut med feil type. Brukte batterier bør kastes i henhold til gjeldende miljølovgivning.



VIKTIGT!

Risk för explosion om batteriet ersätts med felaktig batterityp. Batterier ska kasseras enligt de lokala miljövårdsbestämmelserna.



VARO

Räjähdyksvaara, jos pariston tyyppi on väärä. Paristot on kierrätettävä, jos se on mahdollista. Käytetyt paristot on hävitettävä paikallisten ympäristömääräysten mukaisesti.



VORSICHT

Bei falschem Einsetzen einer neuen Batterie besteht Explosionsgefahr. Die Batterie darf nur durch denselben oder einen entsprechenden, vom Hersteller empfohlenen Batterietyp ersetzt werden. Entsorgen Sie verbrauchte Batterien den Anweisungen des Herstellers entsprechend.



AVVERTIMENTO

Esiste il pericolo di un esplosione se la pila non viene sostituita in modo corretto. Utilizzare solo pile uguali o di tipo equivalente a quelle consigliate dal produttore. Per disfarsi delle pile usate, seguire le istruzioni del produttore.



PRECAUCIÓN

Existe peligro de explosión si la pila no se cambia de forma adecuada. Utilice solamente pilas iguales o del mismo tipo que las recomendadas por el fabricante del equipo. Para deshacerse de las pilas usadas, siga igualmente las instrucciones del fabricante.



WAARSCHUWING

Er bestaat ontploffingsgevaar als de batterij wordt vervangen door een onjuist type batterij. Batterijen moeten zoveel mogelijk worden gerecycled. Houd u bij het weggooien van gebruikte batterijen aan de plaatselijke milieuwetgeving.



ATENÇÃO

Haverá risco de explosão se a bateria for substituída por um tipo de bateria incorreto. As baterias devem ser recicladas nos locais apropriados. A eliminação de baterias usadas deve ser feita de acordo com as regulamentações ambientais da região.



AŚCIAROŻZNAŚĆ

Існуе рызыка выбуху, калі заменены акумулятар неправільнага тыпу. Акумулятары павінны, па магчымасці, перепрацоўвацца. Пазбаўляцца ад старых акумулятараў патрэбна згодна з мясцовымі заканадаўствам па экалогіі.



UPOZORNĚNÍ

V případě výměny baterie za nesprávný druh může dojít k výbuchu. Je-li to možné, baterie by měly být recyklovány. Baterie je třeba zlikvidovat v souladu s místními předpisy o životním prostředí.



Προσοχή

Υπάρχει κίνδυνος για έκρηξη σε περίπτωση που η μπαταρία αντικατασταθεί από μία λανθασμένου τύπου. Οι μπαταρίες θα πρέπει να ανακυκλώνονται όταν κάτι τέτοιο είναι δυνατό. Η απόρριψη των χρησιμοποιημένων μπαταριών πρέπει να γίνεται σύμφωνα με τους κατά τόπο περιβαλλοντικούς κανονισμούς.



VIGYÁZAT

Ha a telepet nem a megfelelő típusú telepre cseréli, az felrobbanhat. A telepeket lehetőség szerint újra kell hasznósítani. A használt telepeket a helyi környezetvédelmi előírásoknak megfelelően kell kiselejtezni.



注意

異なる種類の電池を使用すると、爆発の危険があります。リサイクルが可能な地域であれば、電池をリサイクルしてください。使用後の電池を破棄する際には、地域の環境規制に従ってください。



AWAS

Risiko letupan wujud jika bateri digantikan dengan jenis yang tidak betul. Bateri sepatutnya dikitar semula jika boleh. Pelupusan bateri terpakai mestilah mematuhi peraturan alam sekitar tempatan.



OSTRZEŻENIE

Istnieje niebezpieczeństwo wybuchu w przypadku zastosowania niewłaściwego typu baterii. Zużyte baterie należy w miarę możliwości utylizować zgodnie z odpowiednimi przepisami ochrony środowiska.



PRECAUȚIE

Risc de explozie, dacă bateria este înlocuită cu un tip de baterie necorespunzător. Bateriile trebuie reciclate, dacă este posibil. Depozitarea bateriilor uzate trebuie să respecte reglementările locale privind protecția mediului.



ВНИМАНИЕ

При использовании батареи несоответствующего типа существует риск ее взрыва. Батареи должны быть утилизированы по возможности. Утилизация батарей должна проводиться по правилам, соответствующим местным требованиям.



UPOZORNENIE

Ak batériu vymeníte za nesprávny typ, hrozí nebezpečenstvo jej výbuchu. Batérie by sa mali podľa možnosti vždy recyklovať. Likvidácia použitých batérií sa musí vykonávať v súlade s miestnymi predpismi na ochranu životného prostredia.



POZOR

Zamenjava baterije z baterijo drugačnega tipa lahko povzroči eksplozijo. Če je mogoče, baterije reciklirajte. Rabljene baterije zavržite v skladu z lokalnimi okoljevarstvenimi predpisi.



คำเตือน

ระวังการระเบิดที่เกิดจากเปลี่ยนแบตเตอรี่ผิดประเภท หากเป็นไปได้ ควรนำแบตเตอรี่ไปรีไซเคิล การทิ้งแบตเตอรี่ใช้แล้วต้องเป็นไปตามกฎข้อบังคับด้านสิ่งแวดล้อมของท้องถิ่น.



UYARI

Yanlış türde pil takıldığında patlama riski vardır. Piller mümkün olduğunda geri dönüştürülmelidir. Kullanılmış piller, yerel çevre yasalarına uygun olarak atılmalıdır.



ОСТОРОГА

Використовуйте батареї правильного типу, інакше існуватиме ризик вибуху. Якщо можливо, використані батареї слід утилізувати. Утилізація використаних батарей має бути виконана згідно місцевих норм, що регулюють охорону довкілля.



小心

如果更換的電池類型不正確，可能會有爆炸的危險。請盡可能將電池送至回收處。請依照當地的環保規範來處理使用過的電池。



주의

배터리를 잘못된 종류로 교체할 경우 폭발 위험이 있습니다. 가능한 경우 배터리는 재활용해야 하며, 수명이 다한 배터리를 폐기할 때는 각 지역의 환경법을 따라야 합니다.



THẬN TRỌNG

Có nguy cơ xảy ra nổ nếu thay pin không đúng loại. Pin cần được tái chế nếu có thể thực hiện được. Việc thải bỏ pin đã sử dụng phải tuân theo các quy định của địa phương về môi trường.



UPOZORNĚNÍ

V případě výměny baterie za nesprávný druh může dojít k výbuchu. Je-li to možné, baterie by měly být recyklovány. Baterie je třeba zlikvidovat v souladu s místními předpisy o životním prostředí.



ETTEVAATUST

Kui patarei asendatakse uue ebasobivat tüüpi patareiga, võib tekkida plahvatusoht. Tühjad patareid tuleb võimaluse korral viia vastavasse kogumispunkti. Tühjade patareide äraviskamisel tuleb järgida kohalikke keskkonnakaitse alaseid reegleid.



FIGYELMEZTETÉS

Ha az elemet nem a megfelelő típusúra cseréli, felrobbanhat. Az elemeket lehetőség szerint újra kell hasznosítani. A használt elemeket a helyi környezetvédelmi előírásoknak megfelelően kell kiselejtezni.



UZMANĪBU

Pastāv eksplozijas risks, ja baterijas tiek nomainītas ar nepareiza veida baterijām. Ja iespējams, baterijas vajadzētu nodot attiecīgos pieņemšanas punktus. Bateriju izmešanai atkritumos jānotiek saskaņā ar vietējiem vides aizsardzības noteikumiem.



DĒMESIO

Naudojant netinkamo tipo baterijas įrenginys gali sprogti. Kai tik įmanoma, baterijas reikia naudoti pakartotinai. Panaudotas baterijas išmesti būtina pagal vietinius aplinkos apsaugos nuostatus.



ATTENZJONI

Riskju ta' splużjoni jekk il-batterija tinbidel b'tip ta' batterija mhux korrett. Il-batteriji għandhom jiġu riċiklati fejn hu possibbli. Ir-rimi ta' batteriji użati għandu jsir skond ir-regolamenti ambjentali lokali.



OSTRZEŻENIE

Ryzyko wybuchu w przypadku wymiany na baterie niewłaściwego typu. W miarę możliwości baterie należy poddać recyklingowi. Zużytych baterii należy pozbywać się zgodnie z lokalnie obowiązującymi przepisami w zakresie ochrony środowiska.