

Designing varactor tuners for radio and tv 88

Hybrid control reaches the plant 98

Calendar spotlights meetings ahead 143

Electronics®

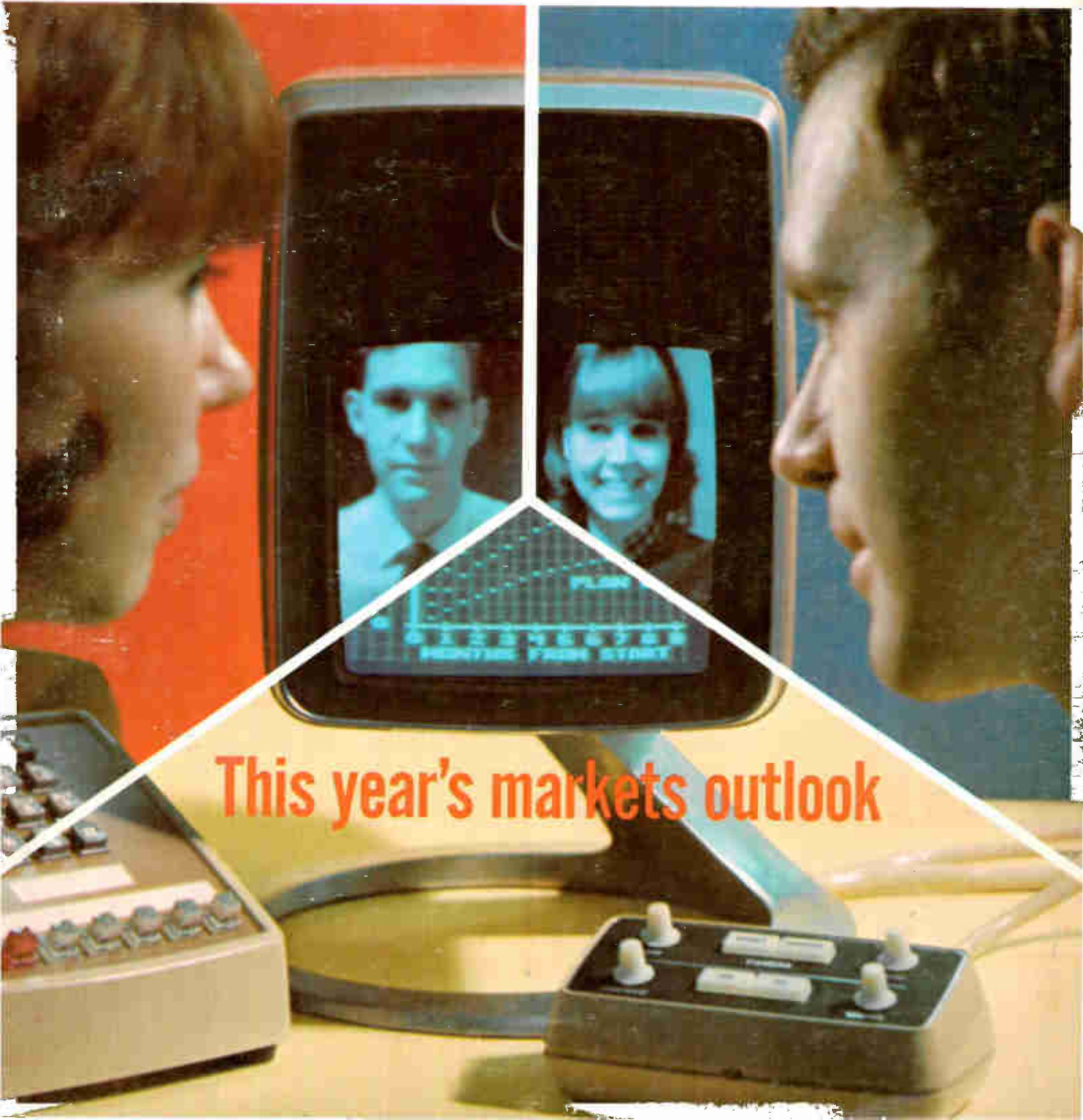

This year's markets outlook

Commucopia

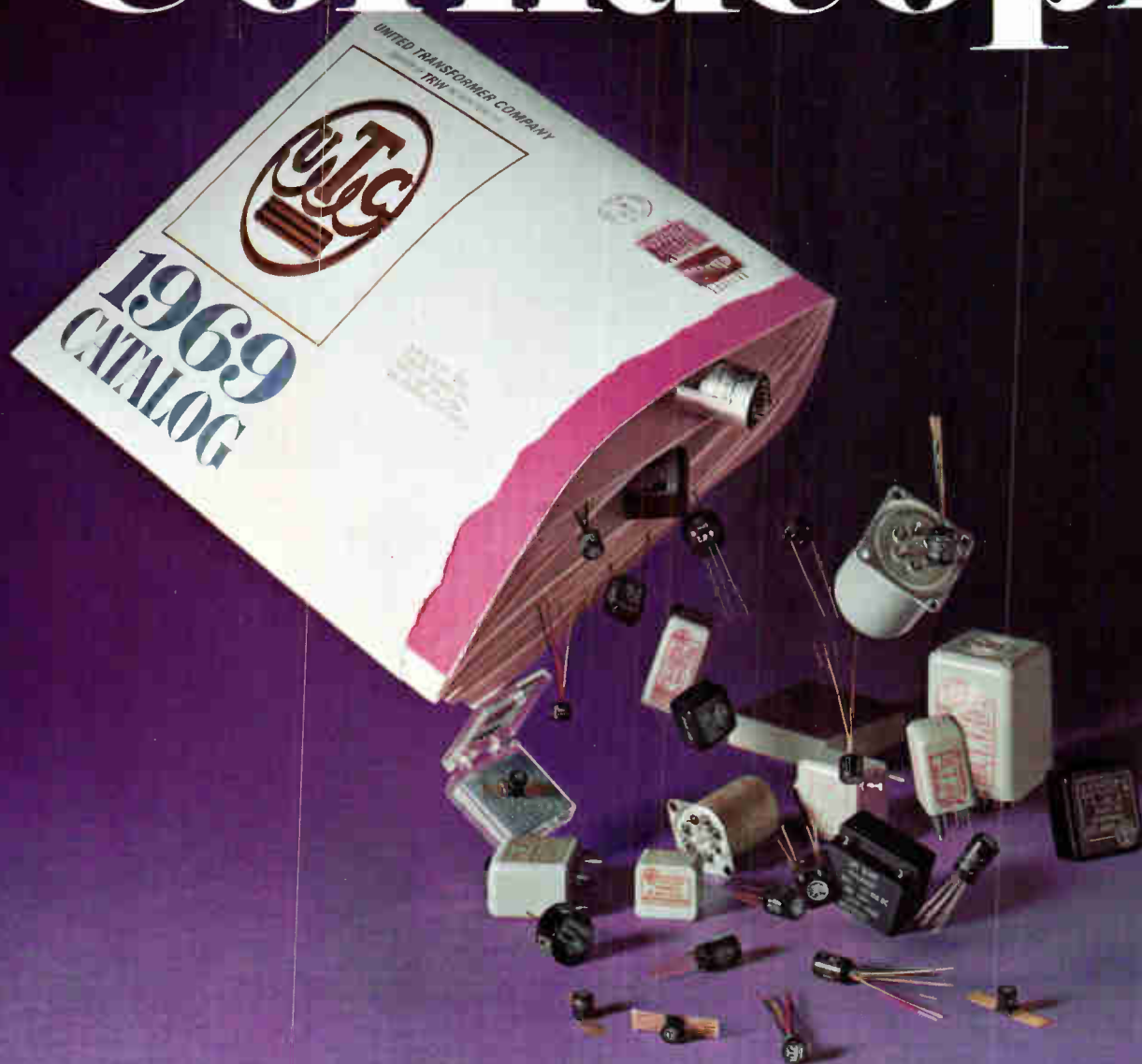

Get UTC's NEW 1969 Catalog—the quick-and-easy locator for transformers and filters.

UTC's 1969 Catalog is the most comprehensive in our history. Over 1350 standard parts, including audio, power and pulse transformers, inductors, electric wave filters, high Q inductors, magnetic amplifiers, saturable reactors, and similar iron-core inductance devices. Many of these new products are listed for the first time.

Eighty-eight clear pages make it easy to locate and specify the part you need: product lines categorized, product selection guide for each line, engineering specifications and applications, new

drawings, new curves, expanded charts.

Also included are: audio and power application circuitry, plus a lucid digest of the new MIL Specs (MIL-T-27C, MIL-F-18327C, MIL-T-21038B).

The "special" you need is probably a "standard" in the NEW UTC Catalog. All items are immediately available from your local distributor. For your copy of the catalog contact: United Transformer Company, Division of TRW INC., 150 Varick Street, New York, N.Y. 10013.

TRW[®]

UNITED TRANSFORMER COMPANY

Circle 900 on reader service card

In 1-1000 MHz work

Voltage tells only half the story



The HP Vector Voltmeter tells all.

"All" means *phase*, the key to every RF measurement. Especially the tough ones like open-loop gain of feedback amplifiers, electrical lengths, resonance characteristics, or filter pass and rejection bands. And this 2-channel millivoltmeter-phasemeter makes them directly, accurately and conveniently.

The Vector Voltmeter covers the frequency range from 1 to 1000 MHz and automatically locks onto the signal anywhere within an octave—no fine tuning required. It's extremely sensitive—full scale 100 μ V. With its 90 dB dynamic range, you can easily measure high gain and high loss networks. It has a 360-

degree phase range with 0.1° resolution.

The 8405A also serves as a "frequency translator." How? By transforming the RF inputs to 20 kHz outputs whose wave shapes, amplitudes and phase relationship remain identical to the original RF signals. You can use these outputs for further analysis with low frequency scopes.

You needn't waste time making a tough RF measurement any longer. The HP 8405A does it faster and more completely than ever before. Application Note 91 tells you how. Just call your HP field engineer for details, or write Hewlett-Packard, Palo Alto, California 94304; Europe: 54 Route des Acacias, Geneva.

MAJOR SPECIFICATIONS, HP 8405A VECTOR VOLTMETER

FREQUENCY RANGE is 1 to 1000 MHz in 21 over-lapping octave bands; automatic tuning within each band.

VOLTAGE RANGE FOR CHANNEL A (synchronizing channel), 300 μ V to 1 V rms (10-500 MHz), 500 μ V to 1 V rms (500-1000 MHz), 1.5 mV to 1 V rms (1-10 MHz).

VOLTAGE RANGE FOR CHANNEL B (input to Channel A required) 100 μ V to 1 V rms, full-scale. Full-scale meter ranges from 100 μ V to 1 V in 10 dB steps. Both channels can be extended to 10 V rms with 11576A 10:1 Divider.

PHASE RANGE of 360° indicated on zero-center meter with end-scale ranges of $\pm 180^\circ$, $\pm 60^\circ$, $\pm 18^\circ$, $\pm 6^\circ$. Phase meter OFFSET of $\pm 180^\circ$ in 10° steps permits use of $\pm 6^\circ$ range for 0.1° phase resolution at any phase angle.

PRICE: \$2750.

Circle 1 on reader service card

HEWLETT  PACKARD

RF TEST EQUIPMENT

04806
← Circle 900 on reader service card

Normal Mode Noise Clouding Your Low-Level DC Measurements?

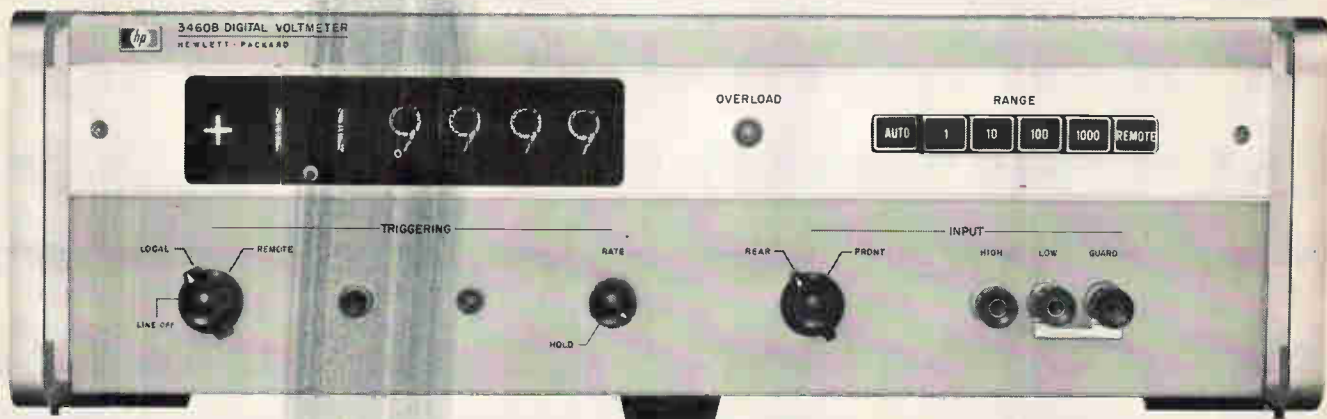

Not Here! The HP 3460B was introduced as a super accurate, 5-digit voltmeter. To make 0.004% of reading accuracy practical, a dual technique was utilized—integrating and potentiometric. The integration technique in itself gave a high common mode rejection of 160 dB at dc.

Now HP has added a filter option which is a programmable filter that cancels out frustrating noise picked up by leads and input devices. This

filter effectively adds 26 dB of ac normal-mode rejection at 60 Hz to rejection provided by integration. Now you can accurately measure low level dc signals with as much as 100% of range (peak) ac riding on the measured dc signal.

Other features of the 3460B include a sixth digit for 20% overranging, automatic polarity selection, four ranges from 1 V to 1000 V, guarded inputs, 15 readings per second (without filter) fully programmable functions with BCD output for systems compatibility.

To make the 3460B a multiple function DVM, add the HP 3461A AC/Ohms Converter-DC Preampfier. Measure 0.1 V dc voltages with 1 μ V sensitivity, 50 Hz to 100 kHz ac measurements with 10 μ V sensitivity, and resistance measurements from 1

k Ω to 12 M Ω with 10 milliohm sensitivity on lowest range.

If you're interested in a precision DVM, look up the 3460B in your HP catalog. If you're interested in adding the filter option to pick low level dc out of noisy environments, call your local HP field office. (Price HP 3460B, \$3800; 3461A, \$2400. 3460B Option 002 or 003 is required for operation with 3461A. Price option 002 or 003, \$150. Filter option prices on request.) Or for a data sheet, write to Hewlett-Packard, Palo Alto, California 94304. Europe: 1217 Meyrin-Geneva, Switzerland.

099/1

HEWLETT  PACKARD
DIGITAL VOLTMETERS

News Features

Probing the News

- 165 **Companies:** GE helps start aerospace company in ghetto
- 171 **Government:** 91st Congress, opening next week, will have great influence on electronics industry

U.S. Reports

- 53 **Fast, alterable read-only memory** can be batch fabricated
- 54 **Circuit design:** Engineer works with computer to make masks
- 56 **Optoelectronics:** Hybrid vidicon goes to war
- 58 **Space electronics:** Apollo 8
- 58 **Communications:** New bird orbits
- 60 **Consumer:** Tune in; I don't know yet
- 62 **For the record**

Electronics International

- 251 **China:** Swedish engineer-diplomat sees Mao-land moving into forefront of science before too long
- 252 **Great Britain:** Digital sonar finds schools of fish near surface
- 253 **West Germany:** Telefunken builds solar cells that don't need the usual solder coating on contacts
- 253 **Japan:** Indium antimonide "IC" generates squares and cubes; Hitachi logs 8,500 hours on Gunn-diode local oscillator

New Products

- 179 **PDP-12:** by PDP-8/1, out of LINC-8
- 181 **Isocons** go to market
- 185 **Microwave review**
- 185 **IC** converts r-f to i-f
- 186 **Delay line** works in X band
- 191 **Instruments review**
- 191 **\$625 pot** has 10-ppm accuracy
- 193 **Multimeter's** readout is digital
- 194 **Filters** break up audio signals
- 196 **Spectrum analyzer** goes to 1,250 Mhz
- 199 **Subassemblies review**
- 199 **A-d converter** does 10 bits/usec
- 200 **Backup power source** is always ready
- 202 **Portable inverter** delivers 300 watts
- 205 **Components review**
- 205 **Triacs** pick a fight with relays
- 208 **Switches** cover 30-to-15,500-Mhz range
- 211 **Production equipment review**
- 211 **Coater** moves wafers with air currents
- 214 **Sputterer** can handle 90 wafers
- 217 **Bonder** does half the searching

Technical Articles

- Consumer electronics** 88 **Overcoming design problems in varactor-diode tuners**
Pushbutton tv tuning—rapidly replacing mechanically variable capacitors in Western Europe—requires cancellation of stray capacitances and diode matching to improve reset accuracy
Hans Keller, Intermetall, Deutsche ITT Industries GmbH.
- Circuit design** 93 **Designer's casebook**
▪ Two one-shots control waveform's pulse width
▪ Power-supply regulator uses fewer parts
▪ Diode adjusts speed of fan that cools a thyatron
▪ Free-running multivibrator is made with NAND gate
▪ Simple gating yields phase-locked pulse bursts
- Hybrid computers** 98 **Analog-plus-logic system gets into the control stream**
Basically a simulation tool, the hybrid computer has found its way into the industrial plant, controlling the flow and pattern of water—up to 6,000 gallons of it—to cool fast-moving slabs of hot-strip steel
Tracy C. Dickson III and John P. Shea Jr., Control Products Division, Bell & Howell Co.
- Marketing** 107 **Electronics markets: 1969**
Electronics' annual market survey indicates the industry will enjoy a modest 6.5% sales increase from 1968
- 111 **The new math of growth**
Sales gains this year will hold at about the 1968 pace, but more important are the further technological advances and the reshaped markets down the road
- Conference calendar** 143 **Spotlighting coming events**
Four-page foldout contains Electronics' guide to major meetings from January through June 1969

Departments

- | | | | |
|----|--------------------------|-----|--------------------------|
| 4 | Readers Comment | 54 | Index of Activity |
| 8 | Who's Who in this issue | 67 | Washington Newsletter |
| 14 | Who's Who in electronics | 218 | New Books |
| 22 | Meetings | 222 | Technical Abstracts |
| 31 | Editorial Comment | 226 | New Literature |
| 33 | Electronics Newsletter | 249 | International Newsletter |

Electronics

Editor-in-Chief: Donald Christiansen

Senior staff editors

Technical: Stephen E. Scrupski
News: Robert Henkel
International: Arthur Erikson

Managing editor: Harry R. Karp
Art director: Gerald Ferguson

Senior associate editor: Joseph Mittleman
Assistant managing editors: Stanley Zarowin, Eric Aiken, H. Thomas Maguire
Senior copy editor: James Chang; Senior staff writer: Howard Wolff

Department editors

Advanced technology: William Bucci, Richard Gundlach
Communications: John Drummond, Raphael Kestenbaum
Computers: Wallace B. Riley, George Weiss
Design theory: Joseph Mittleman
Instrumentation: Owen Doyle, Walter Barney
Military/Aerospace: Alfred Rosenblatt, Paul Dickson
New products: William P. O'Brien
Solid state: George Watson, Stephen Wm. Fields

Domestic bureaus

Boston: James Brinton, manager
Chicago: Frederick Corey, manager
Los Angeles: Lawrence Curran, manager
San Francisco: Walter Barney, manager; Peter Vogel
Washington: Robert Skole, manager; Paul Dickson, William F. Arnold

Foreign bureaus

Bonn: John Gosch
London: Michael Payne
Tokyo: Charles Cohen

Copy editors: Larry Miller, Edward Flinn
Staff writer: Peter Schuyten

Assistant art director: Susan Hurlburt
Production editor: Arthur C. Miller

Editorial research: Anne Mustain

Editorial secretaries: Lorraine Longo, Claire Goodlin, Patricia Gardner,
Barbara Razulis, Terry Kraus, Vickie Green

McGraw-Hill News Service

Director: Arthur L. Moore; Atlanta: Fran Ridgway; Chicago: Robert E. Lee
Cleveland: Arthur Zimmerman; Dallas: Marvin Reid
Detroit: James Wargo; Houston: Barbara LaRouax
Los Angeles: Michael Murphy; Pittsburgh: Louis Gomolak
San Francisco: Margaret Drossel
Seattle: Ray Bloomberg; Washington: Charles Gardner, Daniel B. Moskowitz,
Herbert W. Cheshire, Seth Payne, Warren Burkett, William Small, William D. Hickman

McGraw-Hill World News Service

Bonn: Robert Dorang; Brussels: James Smith; Hong Kong: Wes Perry;
London: John Shinn; Mexico City: Gerald Parkinson; Milan: Ronald Taggiasco, Jack Star;
Moscow: Jack Winkler; Paris: Robert E. Farrell, Stewart Toy
Rio de Janeiro: Leslie Warren; Tokyo: Marvin Petal
Reprints: Susan Nugent
Circulation: Isaaca Siegel

Publisher: Gordon Jones

Electronics: January 6, 1969, Vol. 42, No. 1

Published every other Monday by McGraw-Hill, Inc. Founder: James H. McGraw 1860-1948.

Publication office 99 North Broadway, Albany, N. Y. 12202; second class postage paid at Albany, N. Y.

Executive, editorial, circulation and advertising addresses: McGraw-Hill Building, 330 W. 42nd Street
New York, N. Y. 10036. Telephone (212) 971-3333, Teletype TWX N.Y. 710-581-4235. Cable address:
MCGRAWHILL N.Y.

Subscriptions solicited only from those professionally engaged in electronics technology. Subscription rates:
qualified subscribers in the United States and possessions and Canada, \$8.00 one year, \$12.00 two years,
\$16.00 three years; all other countries \$25.00 one year. Non-qualified subscribers in the U.S. and
possessions and Canada, \$25.00 one year; all other countries \$50.00. Air freight service to Japan \$50.00
one year. Single copies: United States and possessions and Canada, \$1.00; all other countries, \$1.75.

Officers of McGraw-Hill Publications: Joseph H. Allen, President; J. Elton Tuohig, Executive Vice President;
David J. McGrath, Senior Vice President-Operations; Vice Presidents: John R. Callahan, Editorial; Paul F. Cowie,
Circulation; John R. Emery, Administration; John M. Holden, Marketing; David G. Jensen, Manufacturing;
Jerome D. Luntz, Planning & Development; Robert M. Wilhelm, Controller.

Officers of the Corporation: Shelton Fisher, President and Chief Executive Officer; John L. McGraw, Chairman;
Robert E. Slaughter, Executive Vice President; Daniel F. Crowley, Donald C. McGraw, Jr., Bayard E. Sawyer, Senior
Vice Presidents; John J. Cooke, Vice President & Secretary; Gordon W. McKinley, Vice President & Treasurer.

Title © registered in U.S. Patent Office; © Copyright 1969 by McGraw-Hill, Inc. All rights reserved. The contents
of this publication may not be reproduced either in whole or in part without the consent of copyright owner.

Subscribers: The publisher, upon written request to our New York office from any subscriber,
agrees to refund that part of the subscription price applying to copies not yet mailed.
Please send change of address notices or complaints to Fulfillment Manager; subscription
orders to Circulation Manager, Electronics at address below. Change of address notices
should provide old as well as new address, including postal zip code number. If possible,
attach address label from recent issue. Allow one month for change to become effective.

Postmaster: Please send form 3579 to Fulfillment Manager, Electronics,
P.O. Box 430, Hightstown, New Jersey 08520

Readers Comment

Fluidic future

To the Editor:

Sure, fluidics has its problems, and has been oversold and often poorly applied, but the bleak gloom-and-doom flavor you give this field [Nov. 11, 1968, p. 199] is just as incorrect as the overly optimistic views we had a year or two back.

Also, your article quoted me out of context. Besides noting some of the negative aspects of the technology, I described a good number of highly promising developments clearly indicating that the new trend to plug-in modular fluidic systems bodes well for fluidic applications. No mention was made in your article of the new look that is emerging in the fluidics field and of the great stress I placed on the better future this appears to offer.

I feel your article does very little to acquaint electronics engineers with the steadily developing field of fluidics technology. This is a pity because a continuing cross-fertilization of ideas is often claimed to be the mainspring of North American innovation.

Putting the boot to fluidics seems quite fashionable these days and is about as misleading as going the other way. In reality, the position of fluidics and its potential for the future lies, we believe, somewhere between these two extremes.

A. E. Maine

Director of engineering
Aviation Electric Ltd.
Montreal

Cutting the tape

To the Editor:

We read with interest the article "Smaller Cores, Bigger Challenge" [Oct. 28, 1968, p. 112]. Particularly deserving of comment is the statement concerning the possibility of cutting ferrite cores from a green (unfired) ferrite sheet.

Core Memories Inc., a subsidiary of the Data Products Corp., has been producing cores in this manner for about two years, first at our facility in Dublin, Ireland, and now at our Mountain View, Calif.,

Three Series 54/74 circuits that really count.

Decade Counter

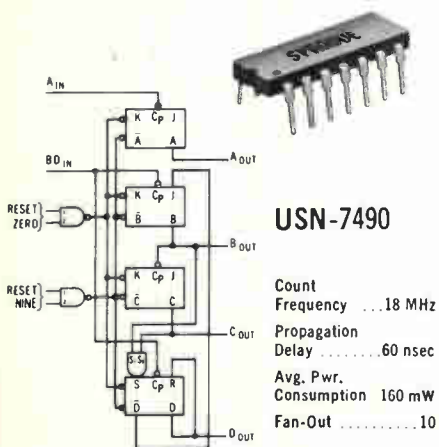

Divide-By-Twelve

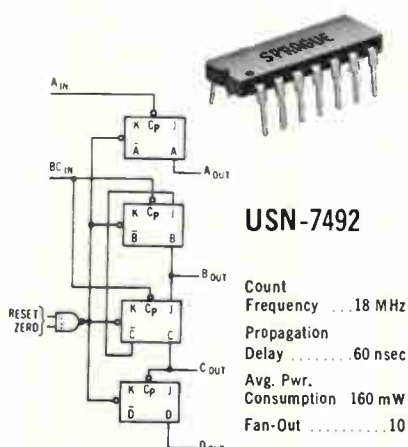

4-Bit Binary

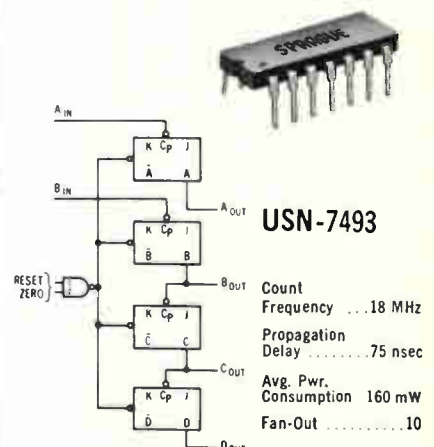

GET ANY OF THESE COUNT MODES

Type Number	Count Mode									
	÷2	÷3	÷4	÷5	÷6	÷8	÷10	÷12	÷16	
USN-7490	✓			✓			✓			
USN-7492	✓	✓			✓			✓		
USN-7493	✓		✓			✓			✓	

Twenty-one standard circuits and nine complex arrays... available now from Sprague, your broad line source for Series 54/74.

Call your distributor or Sprague representative today.
 Or write for data to: Technical Literature Service, Sprague Electric Co.,
 35 Marshall St., North Adams, Mass. 01247.

THE BROAD-LINE PRODUCER OF ELECTRONIC PARTS



Sprague and ® are registered trademarks of the Sprague Electric Co.

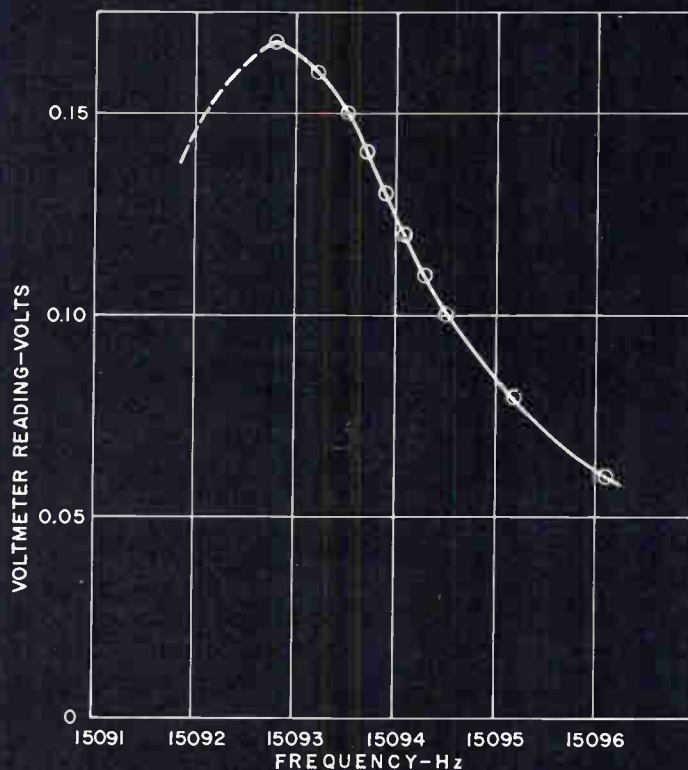

Synthesizer Stability From A Low-Cost Oscillator

This resonance curve is only a few hertz wide at about 15 kHz. You'd expect to achieve this kind of resolution and stability with a frequency synthesizer as a source. But would you expect it from a \$325 oscillator?

The curve shows the high-Q mechanical resonance of a sample of metal alloy. It was plotted from actual data obtained with a GR 1310 oscillator in the closed-loop system shown in the block diagram below.

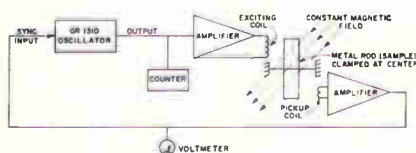

The scheme was submitted by a customer, and it is described more completely in the October, 1968 issue of the *GR Experimenter*. The synchronization capability and the excellent leveling ($\pm 2\%$) of the 1310 combine to make this technique possible.

General Radio makes a whole line of quality oscillators with well-leveled outputs. Each has a distinctive feature to best match your needs. The 1309's (\$325) distortion is less than 0.05%; the 1310 (\$325) has a 2 Hz-to-2 MHz frequency range and a 20-volt output; the 1311 (\$260) offers 1-watt, transformer-coupled output; the 1312 (\$415) has in-line frequency readout and 10 Hz-to-1.1 MHz range; and the

1313 (\$325) gives you single-dial frequency control (no range-switching transients). All have constant output ($\pm 2\%$), and all are covered by a two-year warranty.

For more information, call your nearest GR office, or write General Radio, West Concord, Massachusetts 01781; telephone (617) 369-4400. In Europe: Postfach 124, CH 8034, Zurich 34, Switzerland.

GENERAL RADIO

Prices apply only in the USA.

Readers Comment

plant. The process was developed by Walter Wiechec, head of the firm's ceramics department.

By mixing the ferrite powder with a plastic binder and rolling the mixture to a precisely controlled thickness, an extremely flexible sheet is formed—not at all as brittle as the article suggests. The sheets are then cut into "tapes" about 5/8 inch wide, and these are fed through an automatic machine that cuts a row of up to 12 cores across the tape at a rate of up to 4,000 cores per minute, 40 times the pace of a conventional press.

This technique reduces the cost of cores because it increases yield through better control of core density, lowers tooling expenses, lengthens tool life, and speeds production. And it is particularly suited to producing very small cores (under 18 mils).

William G. Rumble
Engineering department manager
Core Memories Inc.
Mountain View, Calif.

Old hangups

To the Editor:

With reference to Sandia Laboratories' "See-through view" color display [Nov. 25, 1968, p. 50], it may be of interest that Electronics 18 years ago published an article by H. Frank Hicks and me in which we described the principle of electrically controlled color filters [November 1960, p. 112].

Among other things, Hicks de-

clared in his thesis at Rensselaer Polytechnic Institute that it is not possible to obtain saturated colors with one filter stage. I believe this might be the reason for the "weak spots" mentioned in the latest article. And in an article for a British publication in January 1959, I noted thirteen references describing the trials and tribulations experienced in this area by many scientists.

All this, of course, does not and should not take away any credit from the Sandia scientists, Cecil E. Land and Donald G. Schueler, in their ingenious and successful attempt to get around these difficulties by using new materials.

Victor A. Babits
Research management consultant
Palos Verdes Peninsula, Calif.

Vive la difference!

To the Editor:

Concerning the coverage of our Fourier analyzer in your new instruments review [Nov. 11, 1968, p. 239], "gremlins" crept into this release on both your end and ours.

Your error is in the price information. The instrument costs \$2,950—not \$12,950.

For our part, the headline on the original release incorrectly gives the frequency range as 0.25 hertz to 4.95 kilohertz. The latter figure should have been 495 khz.

Steve Cades
Princeton Applied Research Corp.
Princeton, N. J.

Application for

CURRENT-LIMITER DIODES

PROBLEM: Reduce power dissipation in digital output stage with no loss in switching speed.

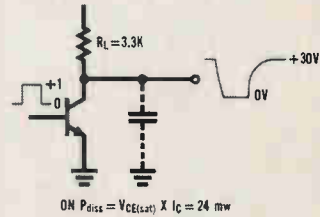

SOLUTION: Replace collector load resistor with a current-limiter diode.

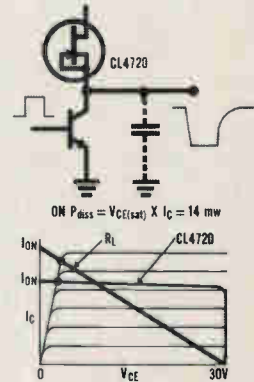

Reduce collector dissipation by 60% with no change in switching times. Turn-on time is controlled by transistor. Turn-off time depends on collector load. Since area under the two characteristic curves is equal, turn-off time does not change.

The CL diode is a new two-terminal circuit element using FET action to provide a constant current over a wide range of applied voltage. Siliconix has nine standard CL Diodes with 20% tolerances. Price at 100 quantity is \$2.25 each. We also offer a custom service for tighter tolerances and temperature coefficients. Write for design data to:



Siliconix incorporated

1140 W. Evelyn Ave. • Sunnyvale, CA 94086
Phone (408) 245-1000 • TWX: 910-339-9216

SUBSCRIPTION SERVICE

Please include an Electronics Magazine address label to insure prompt service whenever you write us about your subscription.

Mail to: Fulfillment Manager
Electronics
P.O. Box 430
Hightstown, N.J. 08520

To subscribe mail this form with your payment and check new subscription renew my present subscription

Subscription rates: qualified subscribers in the U.S.: 1 year \$8; two years, \$12; three years, \$16. Non-qualified: 1 year \$25. Subscription rates for foreign countries available on request.

CHANGE OF ADDRESS

ATTACH LABEL HERE

If you are moving, please let us know five weeks before changing your address. Place magazine address label here, print your new address below.

name

address

city

state

zip code

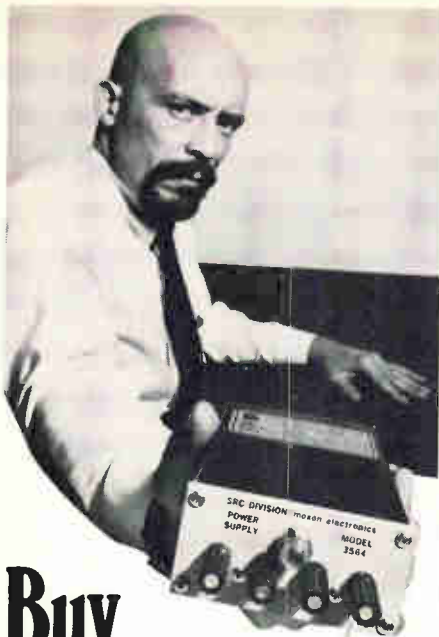

Buy Your Own Power Supply!

\$84.

Our new Model 3564 "Mighty-Mite" is a completely self-contained, all-silicon power supply that delivers 0 to 25V at 200 ma for exciting low level transducers, sensitive IC circuits, or just plain breadboard power. Complete DC and AC isolation has been achieved, with low peak to peak ripple, tight regulation and excellent stability; no small accomplishment in a supply that sells for only \$84 complete. Features include front panel binding post, a heavy-duty six foot power cord and four rubber feet. And in a 1 3/4" x 3 1/2" x 6 1/4" package, the 3564 can be kept in your desk drawer or transported in your pocket. Delivery is from stock.

Complete technical literature on the 3564, as well as the complete family of "Mighty-Mite's" is available from the SRC Division / Moxon Electronics Corp., 2309 Pontius Ave., Los Angeles, California 90064, (213) 477-4573.



Who's Who in this issue



Dickson

Shea

The team that wrote the hybrid computer article on page 98 has had quite a bit of experience in designing control systems. John P. Shea Jr. is the engineering manager of the Control Products division of Bell & Howell. He is responsible for the design of custom and standard control systems employing both analog and digital techniques. Before joining Bell & Howell, he designed automatic production-line systems for the Eversharp Corp. Tracy C. Dickson III, director of process controls for the Control Products division, is in charge of all marketing, manufacturing, and engineering activities for process control instruments and function modules. Before joining Bell & Howell, he worked for Baldwin-Lima-Hamilton in signal conditioning and strain gage applications.

Technical articles are nothing new for Hans Keller, author of the article on varactor-diode tuning on page 88. He's published more than 30 papers in European professional journals. Keller has been with Intermetall, part of ITT's West German operations, since 1958. Until 1964 he was an applications engineer in semiconductor circuit design for industrial and consumer product applications; since then he's been head of electronics development. Keller's degree in electrical engineering is from the Technical University of Aachen.

Well before Labor Day, assistant managing editor Eric Aiken began outlining Electronics' 12th annual markets forecast. The job involved sorting through the voluminous reports and memos submitted by 17 editors and correspondents, and poring over reams of statistics compiled by market research manager David Strassler and his staff. The result, a survey of 1969 prospects for the various sectors of the U.S. electronics market, begins on page 107.

For the cover, art director Jerry Ferguson took photographer Murray Duitz to the Bell Telephone Laboratories' Holmdel, N.J., facility to shoot the several faces of AT&T's Picturephone, which will make its commercial debut later this year.

Wet-sintered-anode Tantalex[®] Capacitors

Buy the best. And save money doing it.

Here's how: Select from the broadest line of tantalum capacitors anywhere. From Sprague. The lower your temperature requirement, the lower your cost.

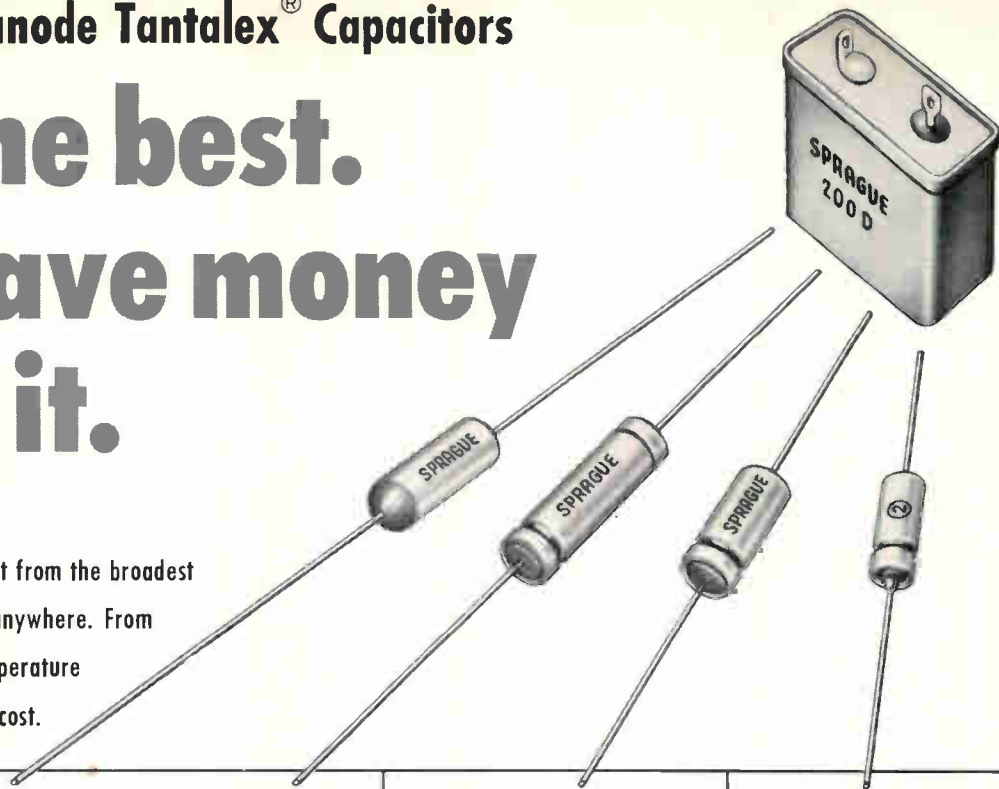

For operation to + 85 C		For operation to + 125 C	For operation to + 175 C
<p>Type 145D</p> <p>Volumetric efficiency up to 210,000 μF-volts per cubic inch. For use in miniature commercial/industrial printed wiring boards, packaged circuit modules, and wherever else cost and space are prime considerations. Elastomer end seal capped with plastic resin insures against electrolyte leakage and lead breakage. Available in voltage ratings from 6 to 75 VDC.</p>	<p>Type 109D</p> <p>A superior design that meets all the basic military requirements for capacitors within this temperature limit. There is no compromise in quality. Voltage ratings from 6 to 150 VDC.</p> <p>For extra large values of capacitance, use Type 200D or 202D package assemblies, which consist of several 109D - type capacitor elements in a hermetically-sealed case.</p>	<p>Type 130D</p> <p>Exceptional electrical stability due to chemical inertness of tantalum oxide film to specific electrolytes used, low diffusion of TFE-fluorocarbon elastomer seal, and special aging for 125C operation. Voltage ratings from 4 to 100 VDC.</p> <p>Dual temperature ratings of Type 200D and 202D package assemblies give you extra high capacitance values for +125 C operation.</p>	<p>Type 137D</p> <p>Proven glass-to-metal hermetic seal qualifies these outstanding capacitors for use in satellites, missiles, and other critical aerospace applications. They have greater volume efficiency than has been previously available for wet-sintered-anode capacitors in this temperature range. Type 137D capacitors exhibit extremely low leakage currents. Available in voltage ratings from 2 to 150 VDC.</p>

CIRCLE 515 ON READERS SERVICE CARD

CIRCLE 516 ON READERS SERVICE CARD

CIRCLE 517 ON READERS SERVICE CARD

CIRCLE 518 ON READERS SERVICE CARD

Select the capacitor type that meets your temperature requirements. That's how to save money. Specify Sprague Tantalex[®] Capacitors. That's how to get the best.

For complete information on Type 145D Capacitors, write for Engineering Bulletin 3750 (Type 109D, Bulletins 3700F and 3700.2; Type 130D, Bulletins 3701B and 3701.2; Type 137D, Bulletin 3703A; Type 200D and 202D, Bulletin 3705B) to the Technical Literature Service, Sprague Electric Company, 35 Marshall St., North Adams, Mass. 01247.



*Sprague' and '©' are registered trademarks of the Sprague Electric Co.

THE BROAD-LINE PRODUCER OF ELECTRONIC PARTS

**With a
memory
like this
you can
forget the
logic**

FROM YOUR TRUTH TABLE

Inputs								Outputs			
A	B	C	D	E	F	G	H	W	X	Y	Z
0	0	0	0	0	0	0	0	0	1	0	1
0	0	0	0	0	0	0	1	0	0	1	1
0	0	0	0	0	0	1	0	0	1	1	0
0	0	0	0	0	0	1	1	1	1	0	0
0	0	0	0	0	1	0	0	0	1	0	0
0	0	0	0	0	1	0	1	0	1	1	1
0	0	0	0	0	1	1	0	0	0	0	0
0	0	0	0	0	1	1	1	1	0	1	0
0	0	0	0	1	0	0	0	1	0	1	1
0	0	0	0	1	0	0	1	1	1	1	1
0	0	0	1	0	1	1	1	1	0	1	1
0	0	1	0	1	1	1	1	1	1	0	1

TO YOUR MM 521

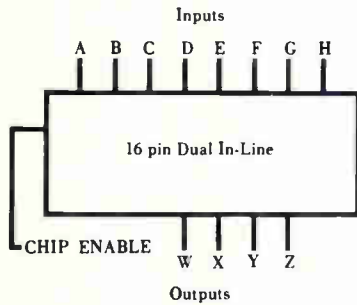

Use the logic easily programmed into our ROM (Read Only Memory) elements. With a minimum of time (typically four weeks), we can set up the simple interconnection metalization pattern your needs dictate and start shipments. Costs about a thousand dollars.

ROM elements are far simpler to make than a new, untried logic design. No logic race conditions; no logic circuit debugging. Our MOS ROM elements are fast, 500 nanoseconds. They operate from ± 12 volt supplies, easily compatible with DTL and TTL.

MM521, 1024 bit element (256 x 4), 16 pin Dual In-Line device, is \$15.00 in 100 quantity. MM522, 1024 bit element (128 x 8), 24 pin Dual In-Line is \$60.00.

Write for a memorable packet of information. National Semiconductor, 2975 San Ysidro Way, Santa Clara, California 95051. (408) 245-4320. TWX: 910-339-9240. Cables: NATSEMICON.

National/MOS

BELDEN...new ideas for moving electrical energy

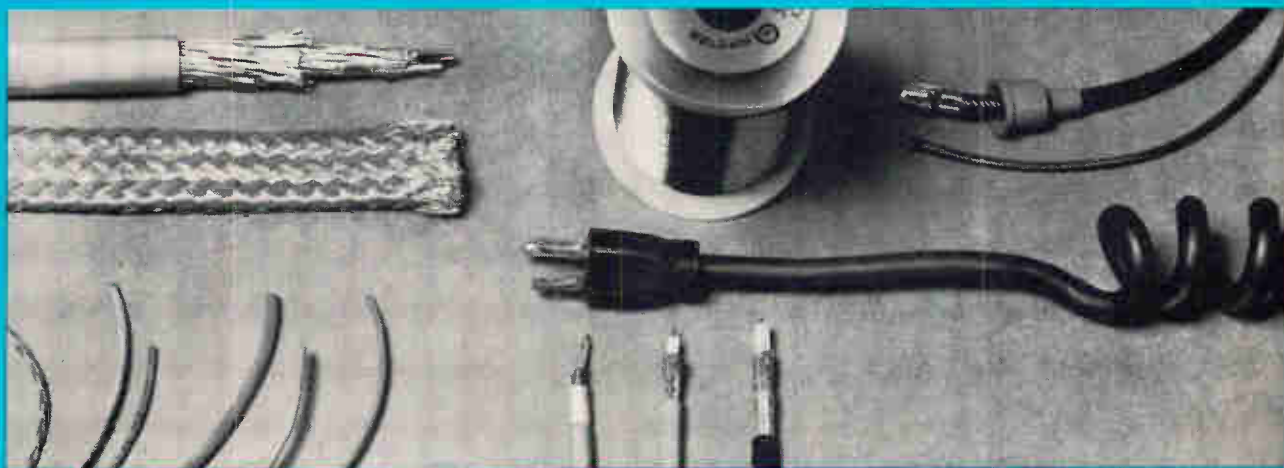
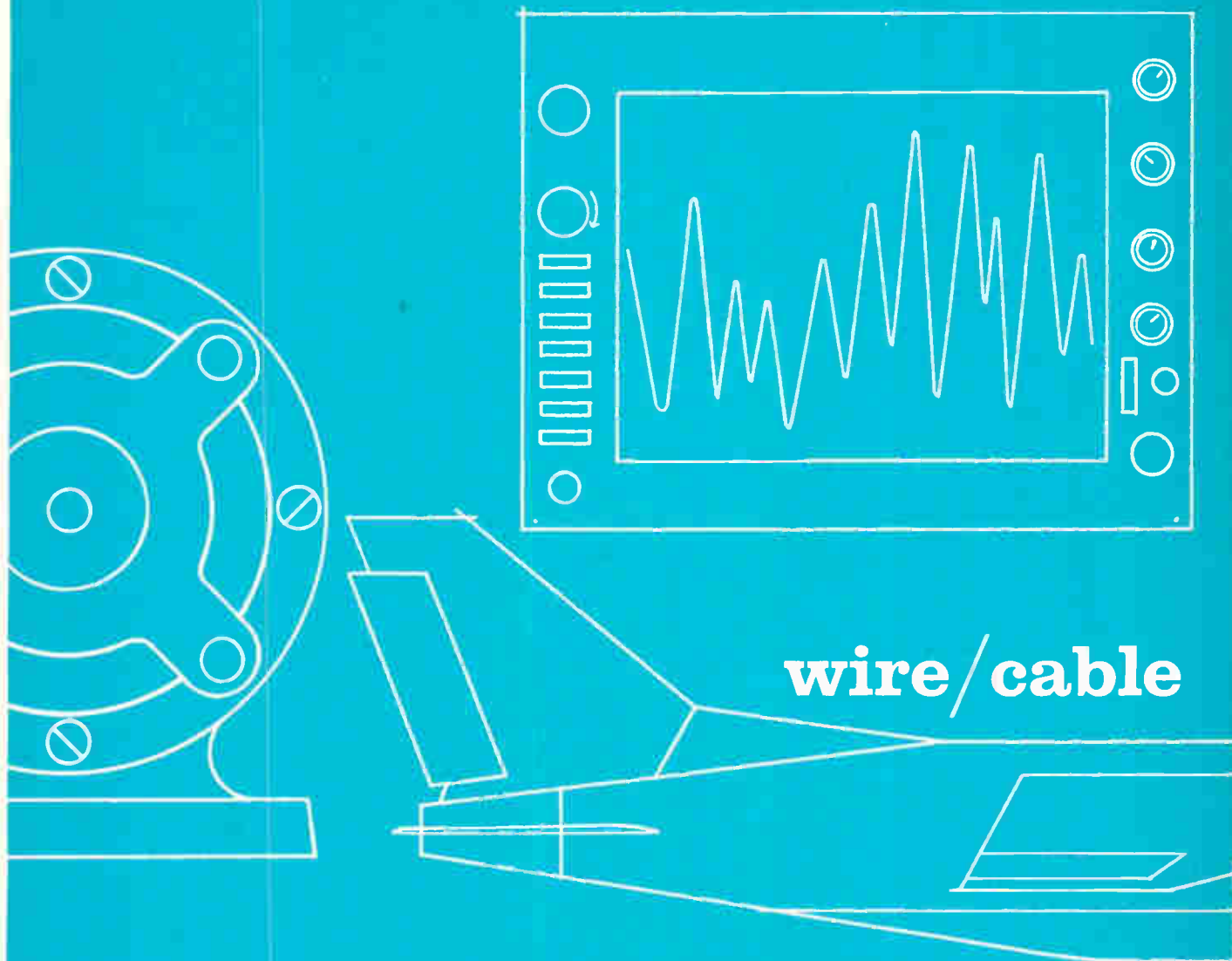

BELDEN

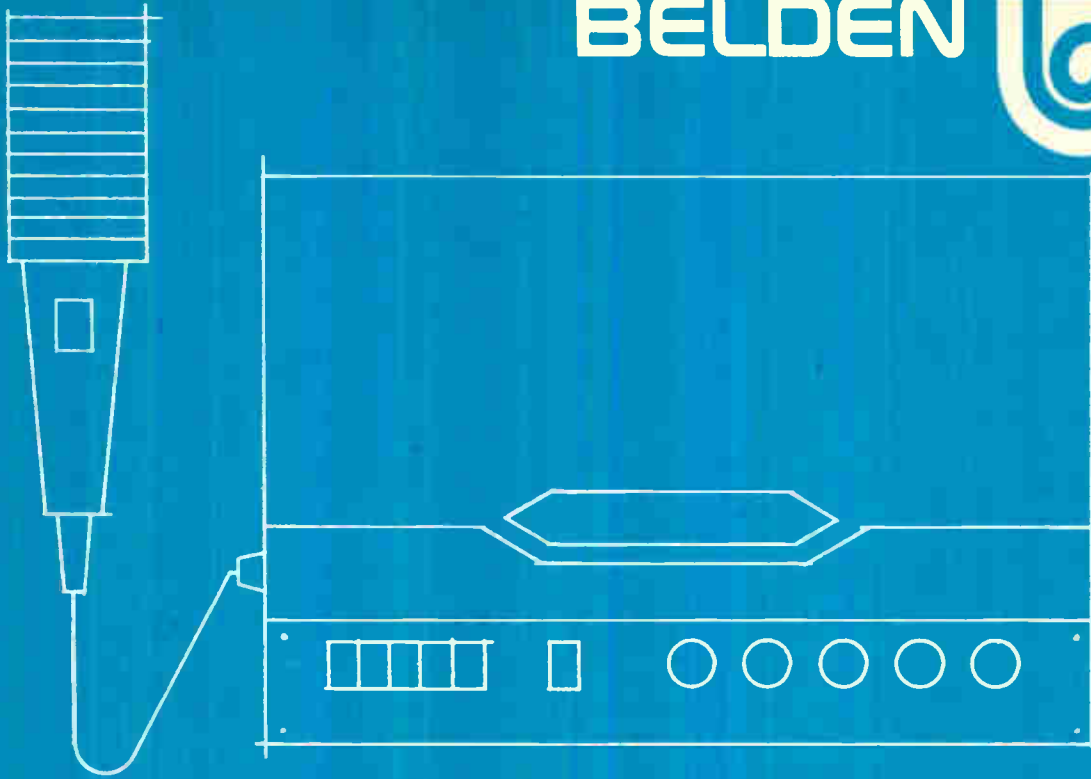

systems turn us on

We have an active imagination when it comes to wiring. Because it's sparked by a lot of savvy about wire and cable and its capabilities. With applied imagination we can create fresh ideas that help a customer get a better value for his dollar. Our Wire Systems Specialists are trained to explore every wire-related aspect of a product—compatibility, production, packaging, operating environment . . . the entire system. And then put their imaginations to work. To eliminate a shielding or stripping problem*. Or save money. Or enhance the product's reliability. And whatever type of wire or cable it takes to turn an

idea into reality . . . well, we make all kinds of wire for all kinds of systems. Why not see what we can imagine for your product? Call or write: Belden Corporation, P.O. Box 5070-A, Chicago, Illinois 60680. And ask for our catalog, and the reprint article, "Key Questions and Answers on Specifying Electronic Cable."

*For example: We've insulated some of our lead wire with silicone. So no glass braid protection is needed. This means that stripper blades will last much, much longer. And a potential health hazard to stripper operators is eliminated.

©-1-8

Microwave
Connectors with

spare pins

ESI makes precision Micro-
wave Transmission Line
Components — among
many other things.*

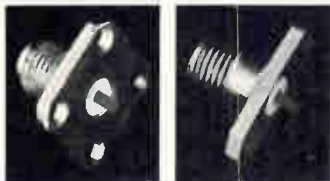

ESM 215-3

ESM 244-3

ESI's standard square base
strip line connector, Cat.
No. ESM 215-3 is similar to
OSM 215-3.

ESI's standard rectangular
base strip line connector,
Cat. No. ESM 244-3 is
similar to OSM 244-3.

ESI standard square base and
rectangular base connectors
come with replacement pin.
Small quantities of each are
in stock.

**Write us about those many
other things, too!*

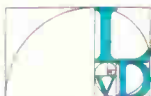

Electro Science Industries
300 S. Geddes St.
Syracuse, N.Y. 13204

Who's Who in electronics

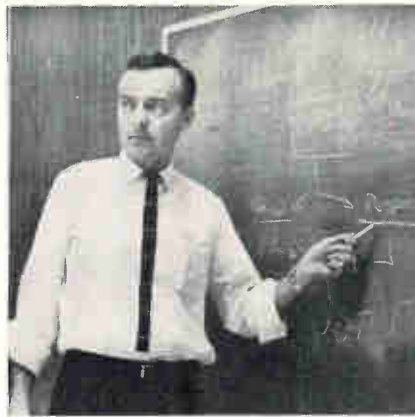

Reynolds

Two years ago, Hewlett-Packard began laying the groundwork for a new division that would build and install automatic test systems. The Systems division finally became a reality several months ago, and H-P named Richard J. Reynolds to be its manager. Reynolds' stated goal was to build and install the computer-controlled test systems in four to six months, about the time it usually takes just to write specifications. And this is what his division has done. So far, in less than six months of operation, the unit has delivered one custom system to Magnavox for the testing of thick-film receiver circuits, and it has four other computerized systems and about 50 custom instruments in its backlog.

Reynolds recalls that H-P's decision to go ahead with the division was based on its belief that there was a demand for a digital computer that could interface with many H-P instruments. During the two years of planning, the company also took into account the need for programable, building-block devices.

Update. The modular approach, says Reynolds, means that a system needn't be considered obsolete because some of its parts become outmoded; it can be expanded and reconfigured as test requirements change. And Hewlett-Packard, adds Reynolds, is in a particularly good position to design custom test systems because of the variety of H-P instruments that can be interfaced with its model 2116B

computer. The test system's computers will use the company's Basic language, which reduces programming to verbal rather than mathematical statements.

The Magnavox system employs products from six H-P divisions and requires only two outside components. "Of course, it's a means of selling more H-P products," Reynolds says, "but additionally, the new division represents an attempt to solve some of the testing and measuring problems that plague our customers and that only a well-designed computational system can relieve."

A babel of control languages—about a dozen—are now in use for computer systems. But a group that will meet early next month in Santa Monica, Calif., may lay the foundation for a standard language. This quest for a golden mean will be carried out by an ad hoc committee being formed within the United States of America Standards Institute (USASI). Its chairman is Millard Perstein, head of the Jovial standards and development project at the System Development Corp., which will be host to the Feb. 4 meeting.

Usually avoiding any flights of fancy, control language, among other things, introduces the user to the computer, provides a job description (compiling or executing, for example), and includes information for accounting purposes. It also tells whether special programs for, say, debugging and editing will be required.

Perstein stresses that his committee's charter is limited. "We're to see if standardization of control languages is desirable and feasible. We're not supposed to develop a standard. There are people who view standardization as tending to stifle development. Some of the pioneers remember attempts 10 years ago to develop a preemptive standard programming language, which failed. That was a mistake."

Perstein believes, however, that



1969 Guide to Machlett Electron Tubes



Planar Triodes.

Grid pulsed to 1 kw at 6 Gc. To 35 kw in pulse modulator service. For communications, radar beacons and navigation.



Magnetic Beam Triodes.

Pulsed ratings to 6 Mw with only 2.5 kw drive. CW ratings to 200 kW with only 0.7 kW drive.



Heavy Duty Tetrodes.

Forced air cooled, water cooled and vapor cooled for broadcasting and communications.



Pulse Modulators.

Shield grid triodes (oxide cathode) to 4.5 Mw, 80 kv peak. High voltage triodes (thoriated tungsten cathode) to 20 Mw with plate voltages to 200 kv peak.



Heavy Duty Triodes.

Includes vapor cooled triodes, to 440 kW CW.



Vacuum Capacitors, Variable.

RMS amperes to 75A; voltage to 15 kv peak. Capacities from 5-750 pF to 50-2,300 pF.



High Power Tetrodes.

Vapor cooled tetrodes to 350 kw CW for communications.

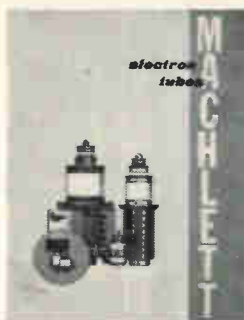

Send for latest condensed catalog

covering the entire line of Machlett electron tubes. Write: The Machlett Laboratories, Inc., 1063 Hope Street, Stamford, Conn. 06907

RAYTHEON

THE MACHLETT LABORATORIES, INC.

A SUBSIDIARY OF RAYTHEON COMPANY



ALSiMAG[®]

Progress Report

NOW

A SUBSTRATE WITH SIX TIMES THE THERMAL CONDUCTIVITY

Since the thermal conductivity of ALSiMag 794 Beryllia Ceramic is about six times that of an alumina ceramic, a Beryllia Substrate can solve many thermal dissipation problems. An engineer may oversimplify when he says: "We can pack the same amount of performance in one-sixth the area" but this new Beryllia ceramic composition does solve a number of circuit problems associated with high circuit density or with the use of higher power resistors. And it has the same favorable electrical characteristics as an ALSiMag alumina ceramic . . . the most widely used of all ceramic substrates.

American Lava Corporation pioneered in the production of thin, flat, precision alumina ceramic substrates with an as-fired surface of 8 micro-inches (CLA) or better as measured on the Talysurf. American Lava also pioneered precision slots, holes and notches for substrates and has shared in the progress on precision metallized patterns.

For many years, Beryllia Ceramic Substrates were limited by production problems. At American Lava, great progress has been made in technical knowledge and skill in processing Beryllia. The new dense ALSiMag 794 Beryllia Ceramic, as shown on the chart at right, has been developed and refined. As a result, American Lava Corporation now produces ALSiMag Beryllia Ceramics in virtually the same wide variety and precision tolerances as alumina ceramics.

ALSiMag 754 was the original ALSiMag Beryllia Ceramic composition. It is in wide use in a large number of applications where it offers advantages in ease of production plus proven performance. But for other requirements, there has been a need for a still finer grained Beryllia ceramic with higher strength and superior electrical, mechanical and thermal characteristics. That composition, ALSiMag 794, with a flexural strength of 33,000 psi, was developed and is now announced after more than a year of volume production which proves its reliability and usefulness.

ALSiMag 794 has grown rapidly in substrate use because of its remarkable ability to dissipate heat. Hand made prototypes are promptly available. Send your operating requirements and sketches or prints and you can quickly evaluate ALSiMag 794 Beryllia Ceramic Substrates for your application.

PROPERTY	ALSiMAG 794
Water Absorption	0 Impervious
Specific Gravity	2.92
Hardness { Mohs' Scale Rockwell 45 N	9 62
Thermal Expansion Linear Coefficient Per °C	{ 25-100 25-300 25-700 25-1000 6.1 x 10 ⁻⁶ 7.5 x 10 ⁻⁶ 8.4 x 10 ⁻⁶ 8.8 x 10 ⁻⁶
Ultimate Tensile Strength, psi	23,000
Compressive Strength	260,000
Flexural Strength (test specimen .070" x .070" 1" span)	33,000
Precision Elastic Limit, psi	14,400
Dielectric Strength 60 Cycle AC Test Discs 1/4" thick	230
Dielectric Constant 1 MC at 25°C	6.1
Loss Factor 1 MC at 25°C	.0008

WARNING—In working with beryllia ceramics personnel should avoid exposure to dust or fume producing operations, such as sawing, grinding, drilling, or processing in moist atmospheres at high temperatures. Specialized equipment is necessary to prevent the dispersal of the dust and fumes into the air.

CODE IDENT. NO. 70371

American Lava Corporation **3M**

PHONE 615 265-3411, CHATTANOOGA, TENN. 37405

A SUBSIDIARY OF **3M** COMPANY

For service, contact American Lava representatives in Offices of Minnesota Mining and Manufacturing Company in these cities (see your local telephone directory): Boston: Needham Heights, Mass. • Chicago: Elmhurst, Ill. • Dallas, Texas • Chagrin Falls, Ohio • Harvard, Mass. • Laurens, S. C. • Los Angeles, Calif. • Metropolitan New York: Ridgefield, N. J. • Up-State New York and Canada: Phoenix, N. Y. • Orange, Conn. • Philadelphia, Penn. • Roanoke, Va. • St. Louis: Lee's Summit, Mo. So. San Francisco, Calif. • 3M International: c/o American Lava Corporation, Chattanooga, Tenn. 37405, U.S.A., 615/265-3411.

67th
YEAR
OF
CERAMIC
LEADERSHIP

TRIMMERS

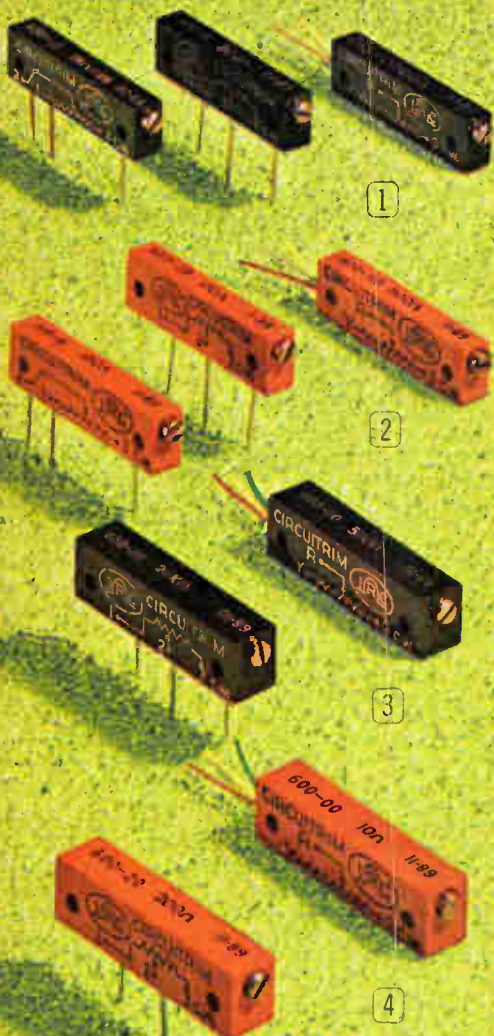

1. **SERIES 450.** Infinite resolution. RJ-12 size. 50 Ω thru 1 meg. 1/2 watt @ 70°C. $\pm 10\%$ tolerance. $\pm 20\%$ available for low-cost needs. Choice of two PC pin arrangements.
2. **SERIES 400.** Wirewound RT-12 C2L or RT-12 C2P size. Also with staggered RT-11 pins for direct replacement while saving space. 1 watt @ 70°C. $\pm 5\%$ tolerance. 10 Ω to 100K.
3. **SERIES 650.** Infinite resolution in RJ-11 size. $\pm 5\%$ tolerance. ± 250 -ppm/ $^{\circ}$ C over range of 100 Ω to 20K. 1 watt @ 70°C.
4. **SERIES 600.** Wirewound RT-11 has MIL quality at industrial prices. Moisture-sealed construction. 1 watt @ 70°C. $\pm 5\%$ tolerance. 10 Ω to 100K.

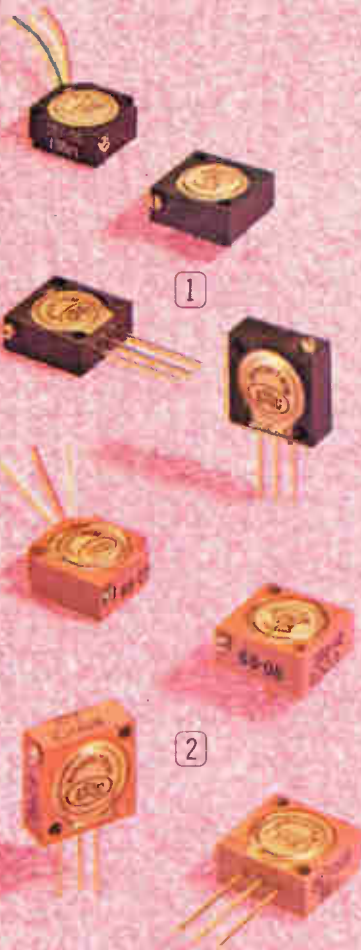

1. **SERIES 255.** RJ-22 styles with infinite resolution. ± 5 , 10, 20% tolerances to meet all your needs. 3/4 watt @ 70°C. 100 Ω to 1 meg.
2. **SERIES 205.** Four RT-22 styles for MIL or high-grade industrial needs. 1 watt @ 70°C. $\pm 5\%$ tolerance. 10 Ω to 50K.

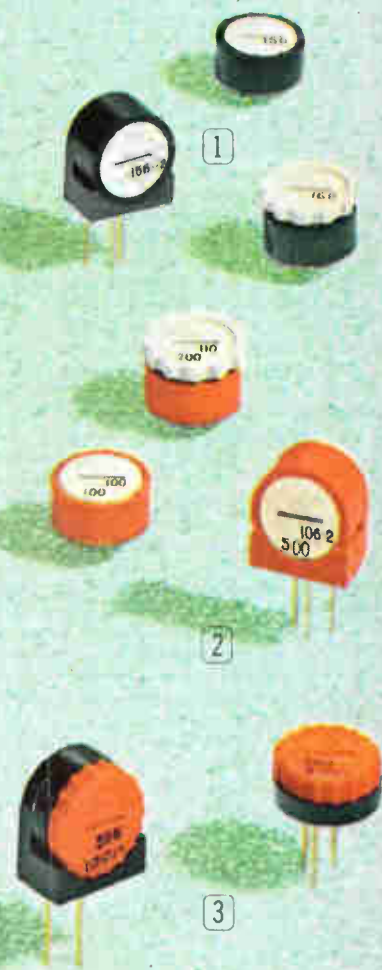

1. **SERIES 150.** Infinite resolution companions to wirewound types. Many configurations. 3/4 watt @ 70°C. ± 5 , 10, 20% tolerances. 100 Ω to 1 meg.
2. **SERIES 100.** Largest 1/2" round selection. Well sealed for MIL or industrial use. Positive stops. Longer winding for better resolution and closer settings. 1 watt @ 50°C. $\pm 5\%$ tol. 10 Ω to 50K.
3. **NEW LOW-COST SERIES 550 and 500.** Most economical 1/2 watt trimmers for commercial and industrial use. Infinite resolution. Series 550 has excellent high-frequency characteristics. $\pm 30\%$ tolerance. 100 Ω to 1 meg. Wirewound Series 500 has best resolution at lowest cost. $\pm 10\%$ tolerance. 10 Ω to 50K. Vertical mounts available.

All styles available from IRC Qualified Industrial Distributors.

Panel mounting versions available for all styles. IRC also offers hundreds of terminations, mounting variations and adjustments.

only IRC offers all popular styles

NOW...



NEW 3/8" MIL TRIMMERS

Infinite resolution or wirewound types

The simplified design of these new IRC 3/8" MIL units provides precision, stability, and economy in a small, board-hugging package.

A proven clutch assembly assures positive drive of the wiper at all times. These trimmers have molded-in pins, and are sealed to resist moisture. Dielectric strength is a full 1,000V A.C.

METAL GLAZE TYPE 750 offers essentially infinite resolution over the full resistance range from 100Ω to 1 megohm. The glass-hard, thick-film resistance element defies catastrophic failure. MIL-R-22097 performance. Rugged epoxy case.

WIREWOUND SERIES 700 in RT-24 size exceeds all MIL-R-27208 requirements. Silver brazed terminations guarantee 0.25% minimum resistance setting and freedom from catastrophic termination failures. Precious metal wiper. Heat-resistant diallyl phthalate case.

CAPSULE SPECIFICATIONS

	METAL GLAZE TYPE 750	WIREWOUND TYPE 700
POWER:	1/2 watt @ 70°C	1 watt @ 70°C
TOLERANCES:	±10, 20%	±5%
RESISTANCE:	100Ω to 1 meg.	10Ω to 50K
TEMP. COEF.:	±250ppm/°C max. (+25°C to +125°C)	±50ppm/°C max.
TEMP. RANGE:	-65°C to +125°C	-65°C to +175°C

Both types are immediately available and at prices that are lower than you would expect. Write for data on these new 3/8" trimmers. Or ask for our new potentiometer catalog.



1

1. 5/16" CUBETRIM® Miniature units provide significant space savings for all PC board applications. Infinite resolution Series 350: 0.3 watt @ 70°C. ±10 and 20% tolerances. 50Ω thru 500K. Wirewound Series 300: 0.6 watt @ 60°C. ±5% tolerance. 50Ω to 20K. Both series available with top or side adjust.



DIVISION OF TRW INC.

401 N. Broad St., Philadelphia, Pa. 19108

Circle 19 on reader service card

Fairchild told everyone what MSI could do.

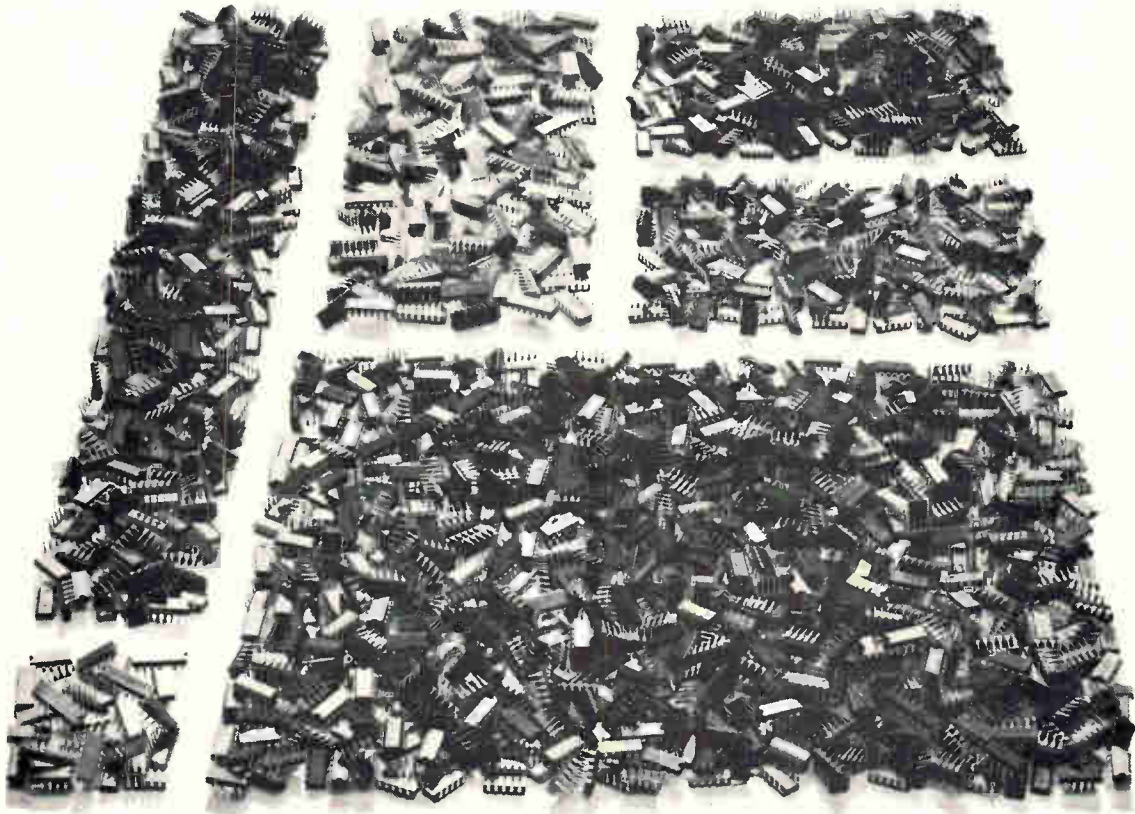

Ever since we introduced medium scale integration in 1967, we've been talking about the systems approach to computer design. Basic, compatible fundamental building blocks that do more jobs than a hundred Integrated Circuits.

Versatile circuits that function like shift

registers, counters, decoders, latching circuits, storage elements, comparators, function generators, etc. We said we had enough MSI device types to build more than half of any digital system you could design. An imaginative company in Boston took us up on it.

We're glad someone was listening.

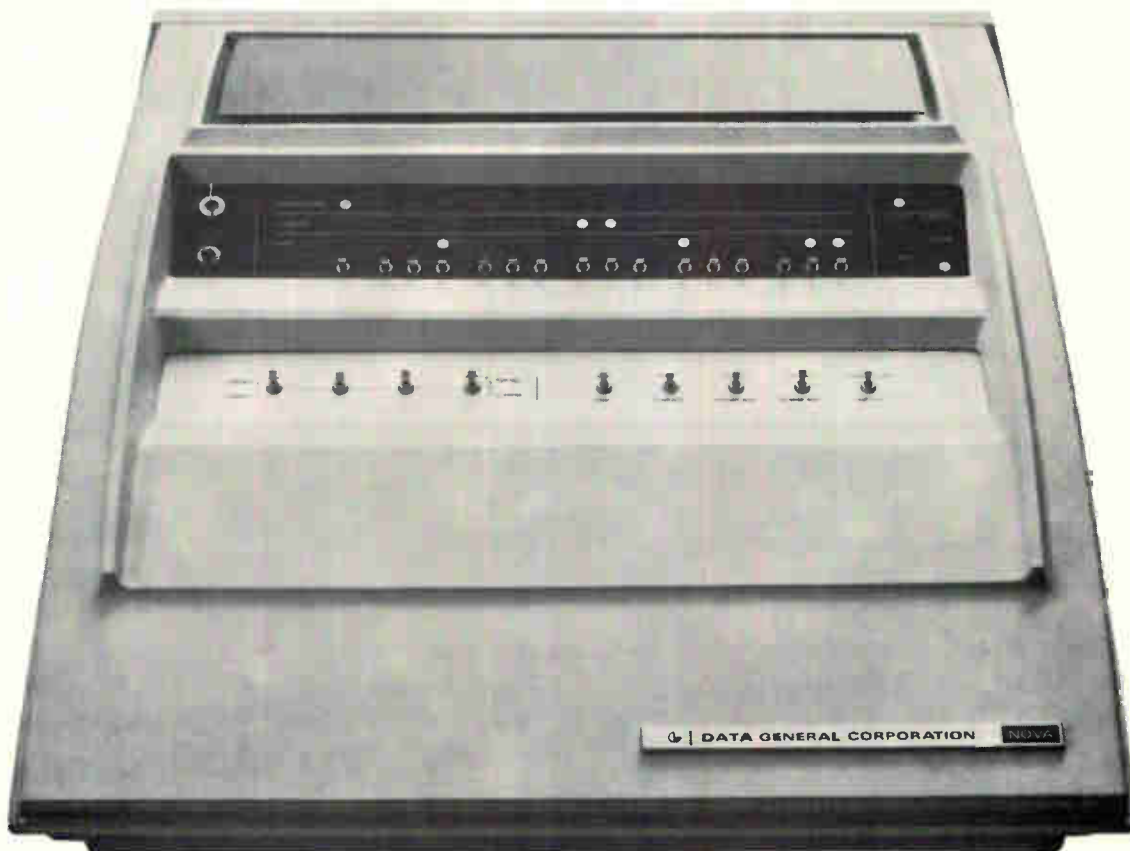

Data General Corporation built a revolutionary computer with Fairchild MSI circuits. The building block approach allowed them to design and build the whole system in six months. And put it in either a desk top console (shown above) or a 5¼-inch high standard 19-inch rack mount package. The central processor fits on two 15-inch by 15-inch plug-in circuit boards.

Another board houses a 4,096-word core memory. A fourth board provides enough space for eight I/O devices. And there's still enough room left for boards that expand the memory capability up to 16K. Any circuit board can be changed in seconds, so the computer has zero down

time. The NOVA is the world's first computer built around medium scale integration. The first general-purpose computer with multi-accumulator/index register organization. The first with a read-only memory you can program like core. The first low-cost computer that allows you to expand memory or build interfaces within the basic configuration. And the first to prove the price/performance economy of MSI circuitry: The NOVA 16-bit, 4K word memory computer with Teletype interface costs less than \$8,000.

If you'd like more information on MSI, use the reader service number on the opposite page. For specs on the NOVA, use the reader service number below.



FAIRCHILD SEMICONDUCTOR / A Division of Fairchild Camera and Instrument Corporation ■ 313 Fairchild Drive, Mountain View, California 94040, (415) 962-5011 ■ TWX: 910-379-6435

Meetings

Bulk-effect is looming large

The promise of bulk-effect and avalanche devices is rapidly being converted to practical performance in microwave circuits, to judge by the papers for the 1969 International Solid State Circuits Conference to be held in Philadelphia, Feb. 19 to 21. Designers are exploiting the high-frequency capability of the devices as they learn to deal with power output, gain, and bandwidth in a sophisticated fashion.

M.E. Hines and C. Buntschuh of Microwave Associates, for example, have developed an X-band power amplifier (they'll disclose the exact power level when they give the paper) that uses Gunn-effect diodes as the active element. The bandwidth exceeds 2 gigahertz with 8 decibel gain, and the authors say that their computer simulations indicate that the bandwidth will exceed 40% with simple compensating networks.

One of the problems with Gunn and other bulk-effect devices has been tuning them. D.C. Hanson of Hewlett-Packard has achieved a wide tuning range in a bulk-gallium-arsenide oscillator by using an yttrium-iron-garnet device to electrically adjust the frequency from 4 to 12 GHz with a power output of at least 4 dbm. Hanson will describe the tuning circuit, which consumes less than 0.75 watt at the maximum frequency, in his paper.

IMPATT (impact avalanche and transit time) diodes will share the spotlight with bulk-effect devices. W.W. Gray, L. Kikushima, N. Morenc, and R.J. Wagner of Hughes Aircraft will discuss their experience in applying IMPATT power sources to modern microwave systems. They've used these diodes as 35 GHz pumps for parametric amplifiers, and as multipurpose drivers with wideband modulation capability for data-link transmission systems. Toyosaku Isobe and Masataka Tokita of Fujitsu will report on their success in phase-locking an IMPATT oscillator to an external frequency-modulated driving signal in their microwave amplifier for

multichannel fm signals.

This year, the conference maintains its stature as the most authoritative meeting in its field with sessions on operational amplifiers, semiconductor memories, and optoelectronics. Attention will also be given to consumer electronics, digital circuits, and solid state power control. In addition to these, computer-aided design, analog circuits, and circuit and device modeling will also be the subjects of in-depth presentations.

The solid state people will reconvene in the evenings for informal discussion sessions on microwave power generation, analog IC's, and custom versus standard large-scale integration. There will be 12 such sessions in all; other topics will be artwork design and implementation, impact of LSI on memory organization and design, electroluminescent diode alphanumeric displays, and insulated-gate FET's. More than 70 panelists are expected to participate in these sessions, which will also include ultrahigh-speed digital techniques, low-noise microwave circuits, microwave phase shifters for phased arrays, and computer-aided circuit design.

For further information, write: 1969 International Solid State Circuits Conference, c/o Lewis Winner, 152 W. 42 St., New York 10036

Calendar

Winter Television Conference, Society of Motion Picture and Television Engineers; Ryerson Polytechnical Institute, Toronto, Jan. 17-18.

Symposium on Reliability, IEEE; Palmer House, Chicago, Jan. 21-23.

Second Hawaii International Conference, Department of Electrical Engineering, University of Hawaii, Honolulu, Jan. 22-24.

Winter Power Meeting, IEEE; New York, Jan. 26-31.

International Symposium on Information Theory, IEEE;

(Continued on p. 24)

VSWR Measurement

VSWR (Reflection Coefficient) can be measured over bandwidths as wide as 2500:1 with Texscan Reflection Coefficient Bridge Kits. Speed of measurement and accuracy make these instruments important tools for both the production line and the laboratory.

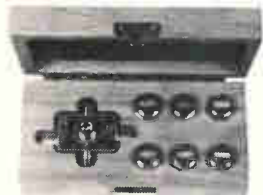
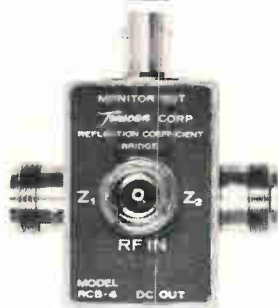

Bridge Kits

contain: 1 Reflection Coefficient Bridge, 2 Standard Loads and 3 Standard Mismatches

KRCB-3 . . .
.5 MHz to 1 GHz

KRCB-4 . . .
.5 MHz to 2.5 GHz



TEXSCAN CORPORATION

2446 N. Shadelana Avenue
Indianapolis, Indiana 46219
Telephone (317) 357-8781
TWX: 810 - 341 - 3184

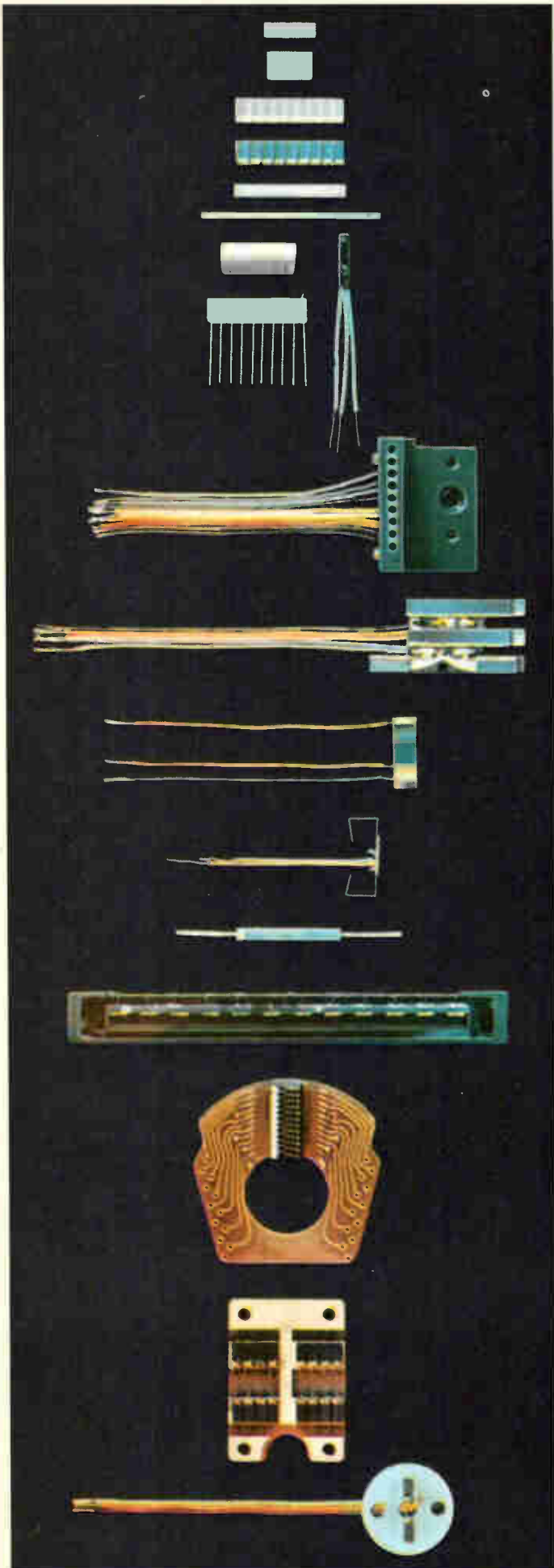

You Supply the Light — Centralab Optoelectronic Devices Will Control:

object counters • punched tape readers • card readers • position indicators • object orienting equipment • liquid level indicators • optomechanical programmers • analog to digital converters • recognition equipment • precision motor speed • film sound track pickups • automatic illumination • TV automatic brightness • exposure meter and aperture • burglar alarms and security systems • doors • infrared detectors • X-ray • ultraviolet • flame failure detectors • smoke and fire detectors

Consult Centralab in the early stages of your design to see how photovoltaic, photoconductive and photoemissive sensors can be used. You'll be assured of a degree of control not possible through other methods. Centralab has experience in all the areas listed above and our devices feature advanced designs and fabrication techniques developed as the world's largest producer of solar cells. If Centralab is there during the planning stages, we can lighten your load.

For more information and a comprehensive catalog on our optoelectronic devices, write Centralab Application Engineering Today.



CENTRALAB

Electronics Division

GLOBE UNION, INC.

5757 NORTH GREEN BAY AVENUE
MILWAUKEE, WISCONSIN 53201

M-6829



Temp-R-Tape® T

One of a series of self-adhering tapes of skived Teflon* TFE. High elongation provides excellent conformability for tight wraps around irregular surfaces.

Temp-R-Tape HM

A series of self-adhering tapes of skived Teflon TFE with lower elongation and higher breaking strength. 2¼ mils to 6½ mils. Good conformability.

Temp-R-Tape C

Extruded Teflon FEP film has extremely high electric strength, highest of all Temp-R-Tapes. Transparent for easy read-through. Excellent conformability.

Temp-R-Tape Kapton*

Made from a polyimide film. Has outstanding thermal endurance. Retains physical and electrical properties at elevated temperatures. *T.M. OF DUPONT

Temp-R-Tape GV

Closely woven glass cloth. Good conformability and flexibility. Strong. Puncture and tear resistant. Excellent abrasion resistance and thermal stability.

Temp-R-Glas®

Glass fabric coated with Teflon TFE. Four thicknesses. Resists Teflon cold flow. Strong. Puncture and tear resistant. Also available without adhesive.

WE MAKE SIX DIFFERENT TYPES OF WIDE TEMPERATURE RANGE ELECTRICAL TAPES.

THAT WAY WE'LL HAVE ONE THAT'S JUST RIGHT FOR YOUR APPLICATION.

Temp-R-Tape is operational from -100 F to +500 F, has excellent electrical and physical characteristics. Pressure sensitive silicone polymer adhesive. Stocked by a national network of distributors capable of technical assistance and fast delivery. Look under CHR in industrial directories or micro-film catalogs. Or write for details and sample. The Connecticut Hard Rubber Company, New Haven, Connecticut 06509.

Subsidiary of U.S. Polymeric, Inc.



Meetings

(Continued from p. 23)

Nevele Country Club, Ellenville, N.Y., Jan. 28-31.

PMA Meteorology Conference, Precision Measurements Association; The Ambassador, Los Angeles, Feb. 3-5.

Transducer Conference (G-IECI), National Bureau of Standards; Twin Bridges Marriott Hotel, Washington, D.C., Feb. 10-11.

Winter Convention on Aerospace and Electronics Systems (Wincon), IEEE; Biltmore Hotel, Los Angeles, Feb. 11-13.

First National Conference on Electronics in Medicine, Electronics, Medical World News, and Modern Hospital Magazines; Statler-Hilton Hotel, New York, Feb. 14-15.

International Solid State Circuits Conference, IEEE; University of Pennsylvania and the Sheraton Hotel, Philadelphia, Feb. 19-21.

Technological Influences on Communications Conference, IEEE; Washington Hilton Hotel, Washington, D.C., Feb. 24-25.

Particle Accelerator Conference, IEEE; Shoreham Hotel, Washington, March 5-7.

International Convention & Exhibition, IEEE; Coliseum and Hilton Hotel, New York, March 24-27.

Second International Laser Safety Conference, Medical Center of the University of Cincinnati; Stouffer's Cincinnati Inn, March 24-25.

Semiconductor Device Research Conference, IEEE; Munich, Germany, March 24-27.

Conference on Lasers & Optoelectronics, IEEE; Southampton, England, March 25-27.

Numerical Control Society; Stouffer's Motor Inn and Convention Center, Cincinnati, April 1-3.

Mathematical Aspects of Electrical Network Analysis, American Mathematical Society; Providence, R.I., April 2-3.

Semiconductor Device Research Conference, IEEE; Munich, West Germany, April 11-14.

Computer Aided Design Conference, IEEE; University of Southampton, England, April 15-18.

(Continued on p. 26)

Programmable.

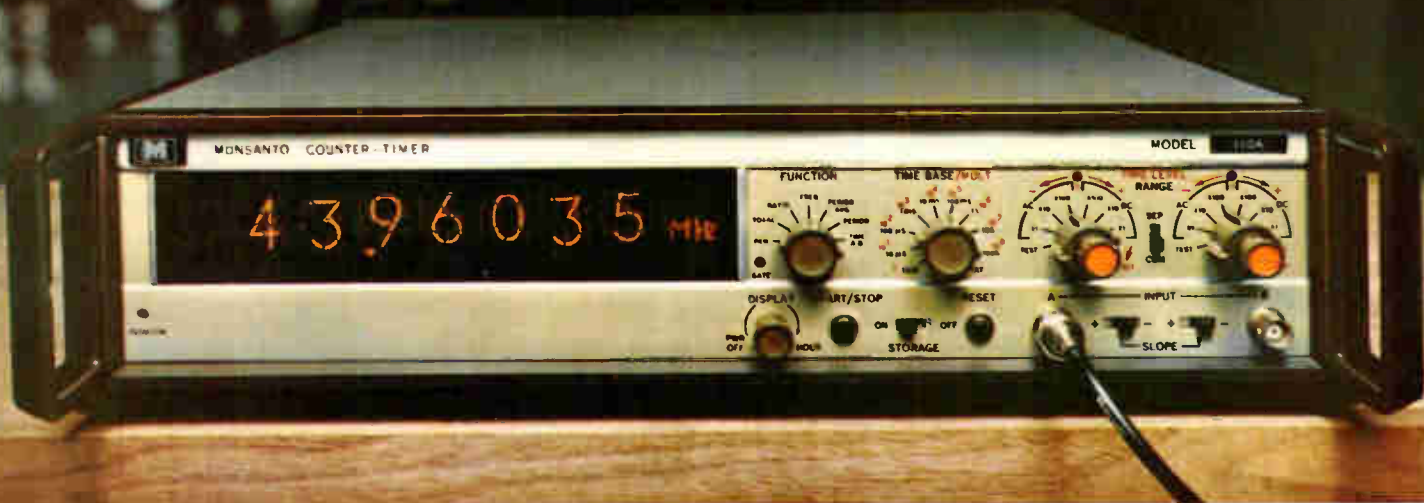

**Universal; extended range
7 nanosecond pulse resolution
Full 50 MHz counting
Programmability, BCD output...**

all for only \$1185.

Our new model 110A offers you a broader range of operational advantages than any other counter/timer in its price range.

Front-panel functions are tailor-made for programming with our Model 501A Programmer (shown at right) or can be readily selected by virtually any contact-closure or logic-level source.

The extended frequency range, dc to 50 MHz, of the Model 110A to-

gether with such advantages as: provision for use of an external time base; internal time base, marker, and gate outputs; the inherent reliability of our "4th generation" integrated circuit design, plus our usual 2-year warranty all combine to assure you the versatility, the reliability, and integrity of performance you have come

MODEL 501A DIGITAL PROGRAMMER



to expect from Monsanto. The price is only \$1185.00, FOB West Caldwell, N. J. Eighth digit optional.

For a demonstration, or for full technical details, call your local Monsanto Field Engineer or contact us directly at Monsanto Company, Electronic Instruments, West Caldwell, New Jersey 07006, (201) 228-3800.

Monsanto

Electronically dispun antennas for telecommunication satellites

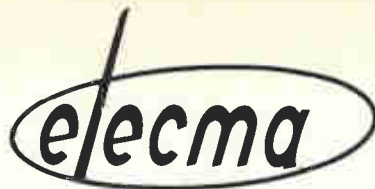

(System developed under CNES contract)

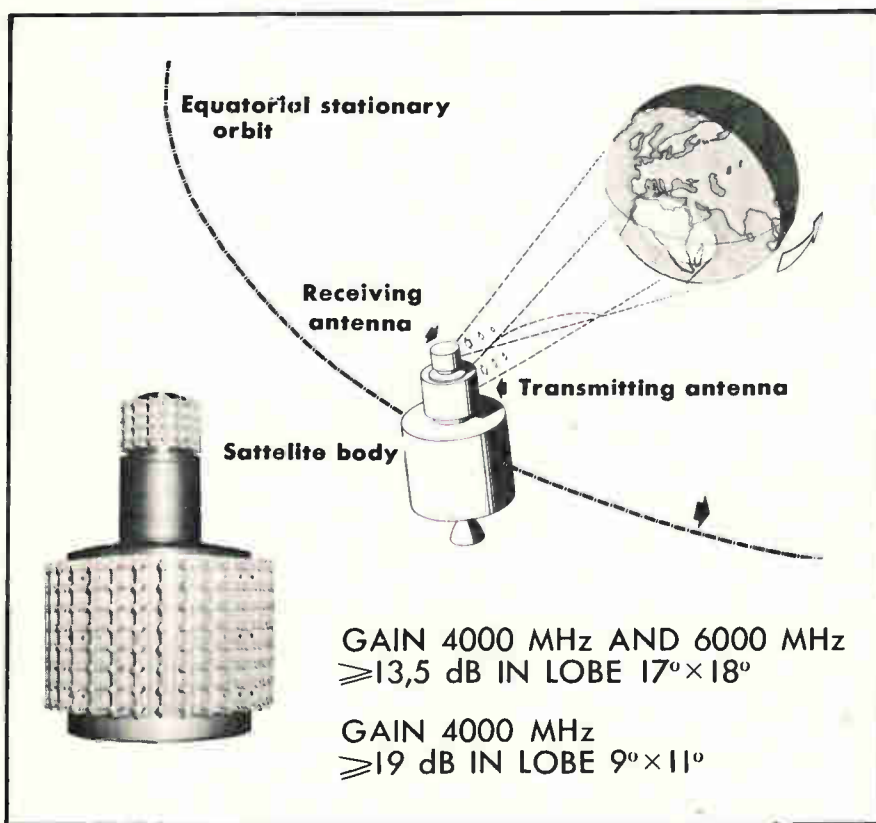

**Airborne antennas, converters,
high efficiency conversers
Sounding rocket equipments
Automatic tracking and telemetry antennas**

ELECMA

DIVISION ÉLECTRONIQUE DE LA SNECMA

22, QUAI GALLIENI 92 SURESNES - FRANCE

Meetings

(Continued from p. 24)

Joint Railroad Conference, IEEE; Queen Elizabeth Hotel, Montreal, April 15-16.

International Magnetics Conference (Intermag), IEEE; RAI Building, Amsterdam, Holland, April 15-18.

International Geoscience Electronics Meeting, IEEE; Twin Bridges Marriott Hotel, Washington, April 16-18.

Conference on Switching Techniques for Telecommunications Networks, IEEE; London, April 21-25.

Southwestern Conference & Exhibition, IEEE; Convention & Exhibition Center, San Antonio, April 23-25.

Electrical & Electronic Measurement and Test Instrument Conference, Instrumentation & Measurement Symposium, IEEE; Skyline Hotel, Ottawa, Canada, May 5-7.

Rocky Mountain Bioengineering Symposium; University of Wyoming, Laramie, May 5-6.

Short courses

Computer Programming for Electrical Engineers and Problem Solving for Electrical Engineers Using Time-Shared Computers, following Wincon, IEEE; Biltmore Hotel, Los Angeles, Feb. 14-15; \$90 fee per course for nonmembers, \$75 fee per course for members.

Magnetic Materials and Engineering Applications, University of Wisconsin, Madison, March 18-19; \$70 fee.

Selected Applications of Computers in Engineering, University of Michigan, Ann Arbor, May 19-30; \$400 fee.

Call for papers

Photo-optical Techniques in Simulators Seminar, Society of Photo-optical Instrumentation Engineers; South Fallsburg, N.Y. Jan. 15 is deadline for submission of abstracts to the seminar committee, c/o SPIE National Office, P.O. Box 288, Redondo Beach, Calif. 90277

Electron, Ion, and Laser Beam Technology Symposium, IEEE; National Bureau of Standards, Gaithersburg, Md., May 21-23. Jan. 31 is deadline for submission of abstracts to Dr. L. Marton, conference chairman, National Bureau of Standards, Washington, D.C. 20234

Cermet

AND THE

Model 3292

MEETS MIL-R-22097

Standard Temperature Coefficient 150 PPM/°C*
over entire resistance range of 10Ω to 1 Meg



Produced in the highest tradition of quality.

Write or call the factory, your local Bourns sales office or representative today for full details.

*100 PPM/°C AVAILABLE



BOURNS, INC., TRIMPOT PRODUCTS DIVISION • 1200 COLUMBIA AVE., RIVERSIDE, CALIF. 92507

Doctors:

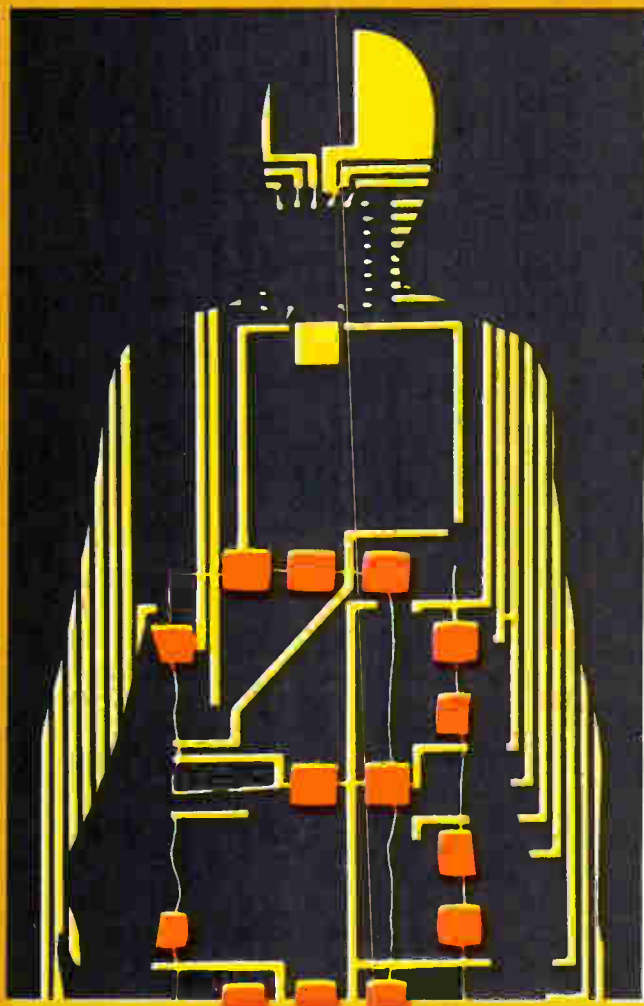

ADVANCE REGISTRATION

FIRST NATIONAL CONFERENCE ON ELECTRONICS IN MEDICINE
February 14-15 Statler-Hilton, New York, N.Y.

Registration Fee: \$125

Name _____

Address _____

City _____

State _____

Zip _____

Hospital or Company _____

Position _____

Please register the above for the **ELECTRONICS IN MEDICINE** Conference

Check enclosed Send invoice

Mail an additional registration form with descriptive brochure.

NOTE: Attendance will be limited and applications will be handled on a first-come, first-served basis.

Make hotel reservations directly with the Statler-Hilton before February 1. Identify yourself as an attendee of this conference. A number of rooms are being held.

Mail registrations and make checks payable to:
FIRST NATIONAL CONFERENCE ON ELECTRONICS IN MEDICINE
330 West 42nd Street, New York, N.Y.

Here's your chance to learn how electronics can help you care for your patients and manage your practice. Tell the nation's leading electronics firms what you really need for diagnosis, therapy, and monitoring. See the latest equipment demonstrated and critiqued.

FIRST NATIONAL CONFERENCE ON ELECTRONICS IN MEDICINE

February 14-15
STATLER-HILTON, NEW YORK, N.Y.

Presented by McGraw-Hill Publications:
ELECTRONICS / MEDICAL WORLD NEWS / MODERN HOSPITAL

CONFERENCE OUTLINE

Computers In Medicine

- Computers join the medical team
- What are computers doing in medicine?
- Diagnosis by computer
- Data processing in the doctor's office
- How to communicate with the computer
- Small computers—new para-medical aids

Engineers:

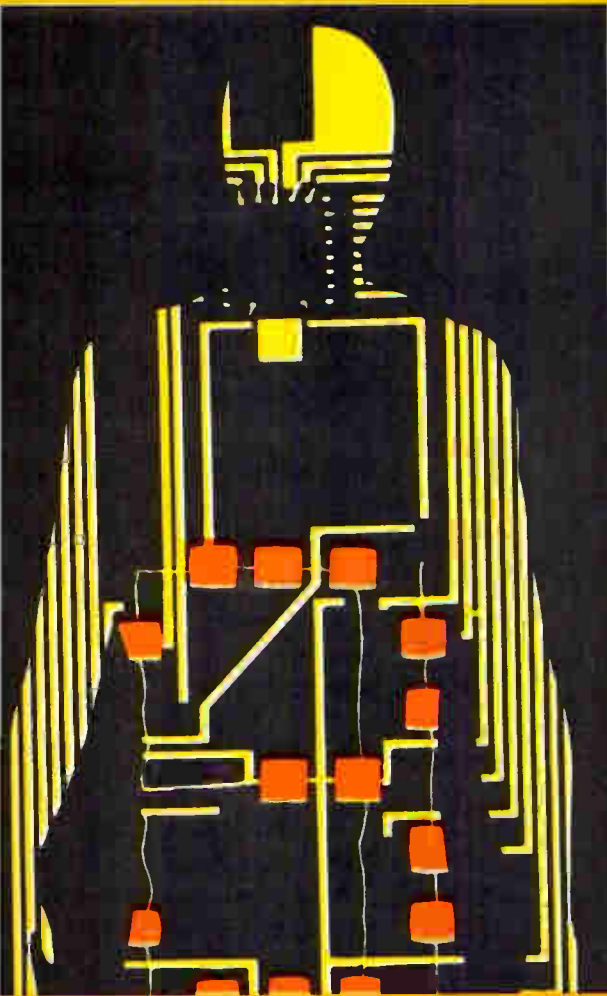

ADVANCE REGISTRATION

FIRST NATIONAL CONFERENCE ON ELECTRONICS IN MEDICINE

February 14-15

Statler-Hilton, New York, N.Y.

Registration Fee: \$125

Name _____

Address _____

City _____

State _____

Zip _____

Company _____

Position _____

Please register the above for the ELECTRONICS IN MEDICINE Conference

Check enclosed Send invoice

Mail an additional registration form with descriptive brochure.

NOTE: Attendance will be limited and applications will be handled on a first-come, first-served basis.

Make hotel reservations directly with the Statler-Hilton before February 1. Identify yourself as an attendee of this conference. A number of rooms are being held.

Mail registrations and make checks payable to:
FIRST NATIONAL CONFERENCE ON
ELECTRONICS IN MEDICINE
330 West 42nd Street, New York, N.Y.

Make the most of this opportunity to help close the communications gap between medicine and electronics. Join the world's leading physicians and medical specialists in bilateral discussions. Help match their real needs to the dynamic capabilities of electronics.

Instrumentation In Medicine

- Is it being designed and used properly?
- Achievements and barriers
- Instrumentation in practical patient management
- Protecting the patient—standards and safety
- Government regulation

Medical-Engineering Relationships

- Why can't doctors and engineers communicate?
- What the hospital administrator wants

Systems Engineering

- Marshalling medical resources through systems
- Prescription for large-scale health care
- Remodelling the surgery department

Demonstrations

- Patient monitoring, and computer-aided diagnosis systems, xerographic mammography techniques, a pulmonary function analyzer, and an electric power monitor will be demonstrated and critiqued by a panel of physicians and engineers.

NEW Calibrated TDR with 35 ps risetime and 12.4 GHz sampling in one easy-to-use plug-in

See More...Do More with the HP 180 Scope System! Now, in one measurement, you can find out what, where, and how much—when you design connectors, circuits, antennas, strip lines and similar components. No interpolation or extrapolation needed. Now HP has combined high resolution time domain reflectometry and 12.4 GHz sampling in the HP 1815A double-size plug-in that fits the standard 180A Oscilloscope mainframe or the 181A Variable Persistence and Storage mainframe.

The 1815A in conjunction with the 1817A remote feed-through sampler and the 1106A pulse generator provides calibrated 35 ps risetime TDR—with capability of resolving discontinuities down to a *quarter of an inch apart*. New signal averaging

circuitry reduces noise and jitter at a ratio of 2 to 1 or more.

And the 1815A not only provides more accurate answers, it provides them faster and easier. Why waste your valuable time? Get direct readouts in reflection coefficient (ρ) and feet (meters optional) for instant answers that previously required time-consuming calculations. Get direct, front panel calibration of dielectric constants for air and polyethylene, or use a variable control to

set the dielectric constant between $\epsilon = 1$ to $\epsilon \cong 4$.

In addition, the 1815A/1817A combination can be externally triggered to provide 12.4 GHz (28 ps) sampling capability. The signal averaging technique allows you to use the entire bandwidth capabilities of the plug-in/sampler — undistorted by noise and jitter.

If you don't need the full capability of the 1815A, a lower cost and lower frequency sampling head (1816A) and tunnel diode pulse generator (1108A) are available for 4 GHz 90 ps risetime sampling and 110 ps TDR (60 ps pulses).

Prices: 1815A, \$1100; 1817 Remote Sampler, \$1500; 1106A Tunnel Diode Pulse Generator, \$550; 1816A Remote Sampler, \$850; 1108A Tunnel Diode Pulse Generator, \$175.

Isn't it time you took a step forward in your oscilloscope measurements? Call your HP field engineer and he'll tell you about the all-solid-state, proven HP 180 scope system, which now includes TDR and sampling. Or, write for data sheet to Hewlett-Packard, Palo Alto, California 94304. Europe: 1217 Meyrin-Geneva, Switzerland.

STEP FORWARD

HEWLETT *hp* PACKARD

OSCILLOSCOPE SYSTEMS

Circle 30 on reader service card



Editorial comment

1969 outlook is bright

The new year is going to be a big one for electronics. The consensus of industry leaders is that over-all sales will rise 6.5% from last year's level to \$25.3 billion [see market report, p. 107]. Market sectors of particular significance include:

- Communications. An expected business spurt of 12% will push sales to an estimated \$1.85 billion, with digital systems, land mobile gear, and telemetry accounting for much of the gain. The industry this year can also expect to feel the first effects of growing pains in the teleprocessing field and changes in the Government's role in regulating communications.

- Computers. Another healthy increase (about 16%) will boost this market to nearly \$4.79 billion. Customers, who are becoming more sophisticated and more receptive to small machines, will encounter more situations in which data systems require communications networks.

- Instrumentation. Despite a slowing of R&D activity in this field due to the Vietnam war, sales are expected to climb 12% to \$769 million. Customers are looking for more automatic features and for equipment that will interface with computer setups, data banks, and the like.

- Industrial electronics. Having finally reached the billion-dollar mark last year, this market is set for a further 12% jump to \$1.15 billion. Industries using high-volume production and in-

spection equipment will be prime customers for electronics gear. And the drive to automate on the part of the steel, machinery, and chemical industries will open up more opportunities.

- Medical electronics. The custom nature of most medical electronics gear will keep unit volume low and prices high. Nevertheless, a \$406.9 million market is expected, up 11%.

- Consumer electronics. Color television will again lead the field with a gain of about 8%. The total market may rise 5% to \$4.4 billion.

- Military/aerospace. If there's a fly in all this ointment, it can be found here. The annual budget briefings scheduled for Jan. 11 will clear up the now-hazy outlook for Federal electronics spending, but this much is already apparent: outlays in this sector, which accounts for about half the total electronics market, will not increase significantly from the 1968 level. Vietnam will continue to create a demand for present-generation military-electronics gear but will curtail development of advanced systems over the near term. And unless the new Administration reverses a recommendation now on the books, NASA's budget will remain at about \$3.85 billion.

But the flattening out of Government electronics buying cannot offset the solid gains due in other areas. In sum, the 1969 prospects for electronics are excellent. ■ ■

Call for objectivity

The scientific community gives much lip service to the ideal of objectivity, though the best engineers not only subscribe to it, but practice it. Unfortunately, one often encounters an all-too-human rejection of objectivity when an engineer's personal advancement is involved. Then self-deception and myopia replace clear thinking.

As a case in point, it is surprising what undue significance an author may attach to having an article describing one of his developments published in a technical journal—or for that matter, rejected.

In a recent issue of the prestigious *Physical Review Letters*, the editor, S.A. Goudsmit, noted that almost every author (not just the young physicist) who submits a manuscript seems to suffer unbearable suspense. "We wish we could

convince the community of physicists that having a Letter accepted is not to be taken as proof of great scientific achievement," Goudsmit said. "In fact, we are often reminded that half the Letters should not have been published, though there is no agreement on which half."

Each Letter published is supposed to contain "important new discoveries or topics of high current interest." But Goudsmit doubts that physicists really produce as many advances of high interest as the number of Letters published in each issue of the journal would indicate, and he suspects that the authors and readers agree. "To get their Letters published is often more important for the authors than it is for the progress of physics," he concluded.

We'll cast our vote for a return to objectivity; it ought to be the badge of our profession. ■ ■



*The
Standard of
Excellence*

S/D D/S converters by CLIFTON

Excellent means — “first class, of great worth, eminently good.” Definite qualities of our ADverter S/D, D/S converters. But we should add one other feature: *not expensive!* (Model SD12A1, \$795 qty. 1-9.)

In fact, their low cost, combined with such other features as: reliable, all solid state circuitry, easily interchangeable

encapsulated sub-modules, no calibration or adjustments, multi-channel capability, wide variety of options, make them superior in many ways to brush encoders.

Although designed especially for the process control and machine tool fields, this system can easily be modified for military applications.

So take advantage of our

application engineering know-how which is yours for the asking. Call our DITRAN division in Burlington, Mass. (617) 272-6210, or your local Clifton sales office. When you consider Litton, Clifton, Ditrans quality, you couldn't do better!

CLIFTON 
DIVISION OF LITTON INDUSTRIES

Pearls by J. E. Caldwell Co., Philadelphia—\$5,600

Electronics Newsletter

January 6, 1969

**1969: the year
MOS takes off . . .**

All signs point to 1969 as the year that MOS starts fulfilling its promises.

Reports from United States and foreign producers and consumers of metal oxide semiconductor circuits indicate that orders will begin to grow rapidly within the next few months. Producers are expanding their MOS manufacturing facilities and customers are quickening their plans to design MOS into new equipment or to retrofit equipment.

Last year, MOS producers assessed the 1968 market at \$20 million. But, they concede now, if the totals hit \$15 million they'll be lucky.

**. . . for both users
and manufacturers . . .**

Looming as major customers for MOS are such firms as Burroughs, Honeywell, the National Security Agency, and some Japanese firms, such as Canon Camera.

The suppliers apparently could be anybody with a respectable MOS capability, including Texas Instruments, American Microsystems, Fairchild, Motorola, General Instrument, and Autonetics.

**. . . some orders
are very large . . .**

American Microsystems has seven large development contracts in the works, all with big production potential. One of these could mature into a purchase running to about a million units a month by July. The Burroughs facility in Plymouth, Mich., is on the brink of a big buy for memory units that buffer a disc memory; Fairchild is believed to have the inside track, although TI and Motorola can't be counted out of the running. The Burroughs' buy, which could come at any time, would be to retrofit its TC-500 computer terminal with MOS to replace DTL.

In addition, Burroughs has given American Microsystems a development contract to design 10 large-scale arrays for a calculator. American, which beat out GI and TI in this competition, doesn't expect a production contract this year.

Honeywell's Computer Control division in Framingham, Mass., is beating the bushes to flush a 512-bit random access memory for terminal equipment—TI seems to have the corner on such a circuit. Again, this order is imminent; one industry source says it could involve up to 100 million bits of storage.

Farther down the road, Control Data is believed to be shopping for very-high-speed MOS memories for computer main frames, although the devices may not form the bulk of the main frame memory. The buy is believed to be about two years away. One industry source says it could reach \$1 million.

Some of the mushrooming MOS action from Japan will also go to TI. Canon will switch from DTL to MOS in a calculator it makes, with TI supplying \$4 million worth of circuits. Other Japanese companies are also buying MOS in substantial amounts—100-bit shift registers in lots of more than 100,000 units, possibly for use in calculators.

**. . . and some
are unusual . . .**

And a sleeper could be the new Viatron Computer Systems, which recently introduced its data-handling System 21 [*Electronics*, Oct. 14, 1968, p. 193]. The system—in which large-scale MOS arrays are the heart—caused a sensation at last month's Fall Joint Computer Conference

Electronics Newsletter

in San Francisco; engineers were backed up in the aisles waiting to view the system. If their marketing plans come true—and many in the industry believe they will—little Viatron may quickly surpass the National Security Agency as the largest customer for MOS. Up till now the super-secret Government agency has been the largest user, with the circuits going to cryptographic computer systems.

This year the security agency will purchase huge lots of MOS circuits for high-speed cryptographic equipment. An all-TI team won a four-way competition for a multimillion-dollar development contract, but a production order expected next year will include other suppliers.

There are also indications that Victor Comptometer is once again looking for a supplier of MOS dice for a calculator despite its disastrous experience with Philco-Ford, which couldn't meet Victor's requirements [*Electronics*, June 24, 1968, p. 25]. In addition, National Cash Register is eyeballing MOS memories for its Century computer series.

... but can MOS producers meet the demand?

However, one potentially big user of MOS devices questions the makers' ability to meet this burgeoning demand. This source says, "We have a request for quotations out now for development lots of MOS arrays—some 10,000 pieces of 50-odd MOS types. Even this is going to strain design and production capacity. When we try to discuss these quantities with possible suppliers, they tell us, 'we would need to divert 75% to 100% of our design people to your problem. If you fail, we could lose six months or more on our competition.'"

Aircraft displays to anticipate danger

Engineers want simplified cockpit displays that show more data on cathode-ray tubes and less on dials and gauges.

Boeing is reviewing crt displays for supersonic transports while United Aircraft is supplying crt situation displays for the AH-56 helicopter.

Meanwhile NASA is preparing for the second generation of cockpit graphics in work being done at its Ames Research Center and the Electronics Research Center. Both are trying to supply display techniques needed for the vertical and short-take-off-and-landing aircraft of the 70's. But at ERC, scientists are trying to develop techniques for so-called adaptive displays.

The most advanced crt displays now contemplated show data only when the pilot calls for it. But at ERC, the future goal is to tell the pilot what he needs to know before he knows he needs it. To do this a computer would be programmed to anticipate dangers—by monitoring sensors it would note, for example, a high nose angle coupled with falling airspeed then flash a stall warning before the pilot becomes aware of it.

Addenda

Sylvania hopes it has found an answer to CBS' electronic video recorder [*Electronics*, Dec. 23, 1968, p. 38] in a movie version of its color slide theater [*Electronics*, May 13, 1968, p. 42]. The company will demonstrate the system at the end of March and expects to have it in its dealers' hands by the summer. Costing \$1,200, the system uses a Kodak Super-8 movie projector and a cassette tape recorder housed in a 23-inch color tv set. . . . David Packard, chairman and chief executive officer of Hewlett-Packard, was named Deputy Secretary of Defense in the Nixon Administration. Packard, 56, who owns some 25% of H-P, will place his \$300 million of securities in trust to avoid conflict of interest.

DIODES

Need Chip diodes? We'll slice them to your spec.

We'll design custom diodes for you, scribe and cut them to your needs and deliver them after a 100% DC test on each chip.

If you're working with hybrid circuits take a look at our capability to supply you with uncased diode chips. We can make them to order and test them to your electrical specs.

Right now, we are supplying chips similar to many popular finished diodes such as 1N3064, 1N3600, 1N4146, 1N4148 and 1N4448. All of these devices are 100% probe tested to DC specs and are checked for AC parameters on a sample

basis. After testing we'll scribe and cut them to your needs and we'll put a suitable backing material on the dice to be compatible with your method of welding or soldering the chips to your substrate.

Typical of the special treatment we can give is the quad N/P diode array we make for a large computer manufacturer. All four devices have a common anode with four separate cathode connections. We can also make quads in the P/N configuration if that's what you need.

Another way we can deliver diodes is as single or multiple chips in a channel pack. We'll give you common anode or common cathode configurations or even hook up some simple circuits such as bridges, ring modulators, etc. Again, all units are 100% tested to your specifications.

If you are looking at chip diodes as space savers in your circuit designs, talk to our sales engineers. You may be surprised at what they can offer you.

CIRCLE NUMBER 300

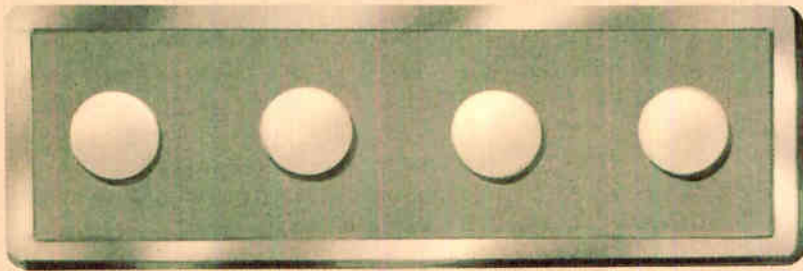

Quad diode array packs four diodes into a minimum of space.

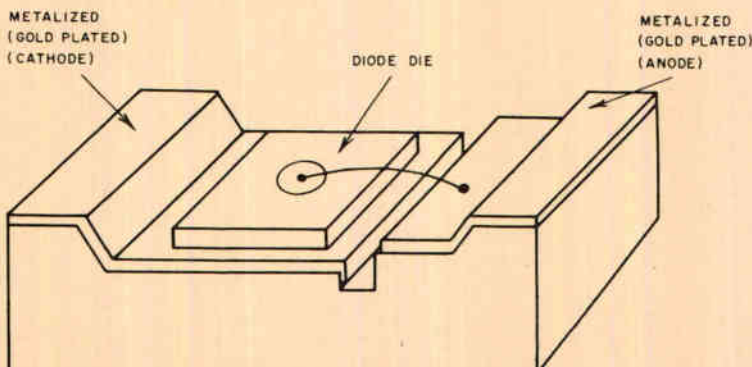

Diodes can be supplied in channel packs for ease of handling.

This issue in capsule

Integrated Circuits

Multiplexer/Demultiplexer arrays cut can count.

Microwave Devices

Beamlead and chip capacitors simplify hybrid circuit design.

Television

'Instant warm-up' heater speeds picture tube turn-on.

Manager's Corner

The path to LSI: Who goes first?

CRTs

Low drain heaters save portable power.

EL Readouts

How etched leads boost EL bar-graph resolution.

INTEGRATED CIRCUITS

Multiplexer/Demultiplexer arrays cut can count.

Two new functional arrays reduce number of gate packages in typical multiplex system from ten to two.

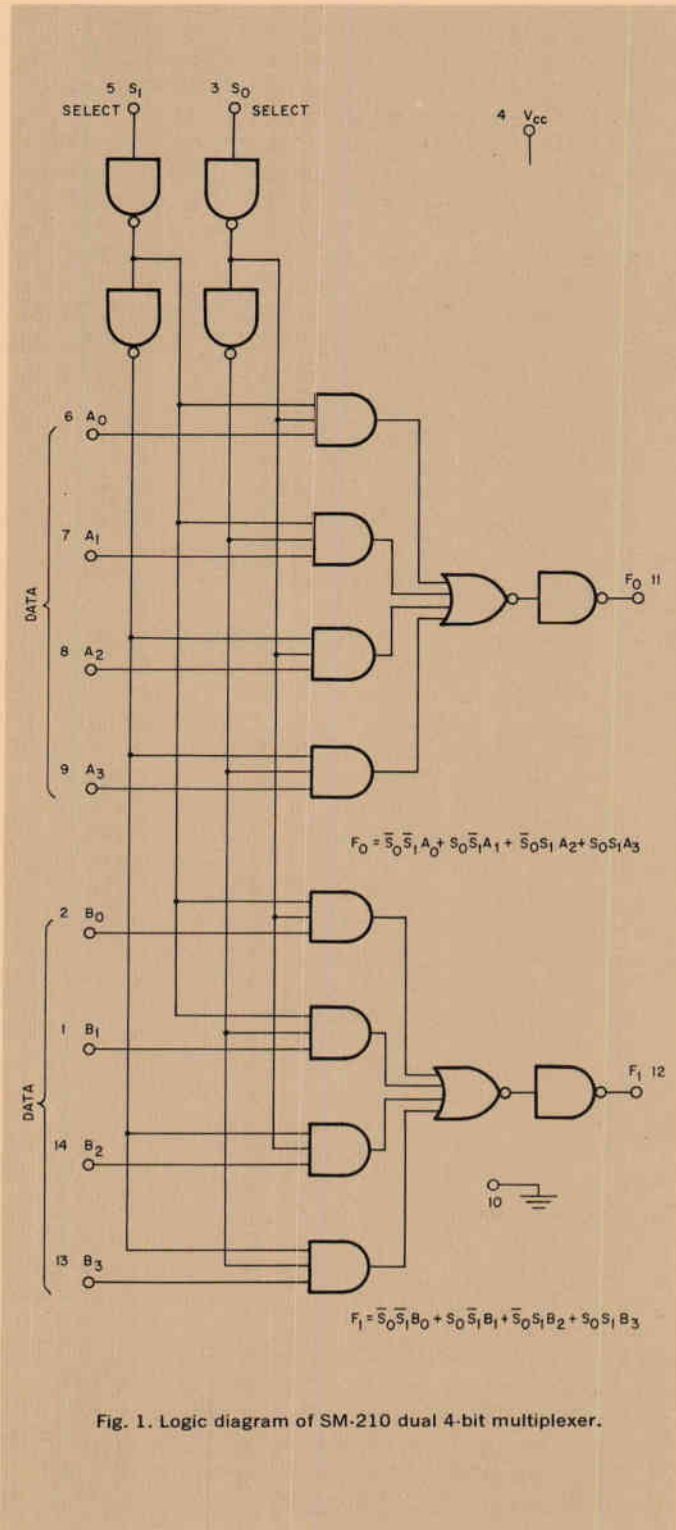

Fig. 1. Logic diagram of SM-210 dual 4-bit multiplexer.

Lower can count, higher speed and less power dissipation are some of the benefits you get from two new functional arrays we have just introduced. The SM-210 is a dual 4-bit multiplexer and the SM-220 is its demultiplexing counterpart. Each replaces up to five gates used in a typical multiplexing operation.

By designing the internal gate structures for speed rather than drive capability we've obtained a high on-chip speed. As a result, propagation delays through several internal gates are comparable to those usually accepted for a single gate. Typically, outputs are produced in less than 12 nanoseconds after the input pulse.

Both devices have the type of inputs and outputs characteristic of SUHL circuits to assure top performance in fan-out, logic swing, capacitance drive, and noise immunity.

Logically speaking, the SM-210 (Fig. 1) is a dual four-bit multiplexer. In each section, two control lines select one of four inputs for presentation at the output. The control lines are common for each section and are buffered from their external connections to prevent excessive loading of drive stages. Data and selection variables are directed to either of two identical quad 3-input AND gates. The results of the "AND"ing are "OR"ed together and double inverted in the output driver stage. The resulting output is the true AND-OR form of the input logic. This means you can drive flip-flops, shift registers, adders and other functions directly, without extra gate inversions.

A typical application of the SM-210 is shown in Fig. 2. This parallel-to-serial converter multiplexes two 16-bit words onto two bus lines. All "A" inputs are bussed into F_0 and all "B" inputs are bussed into F_1 . The selection variables are driven by a four-bit counter. The resultant outputs for each clock pulse are shown in the table. Propagation delay is about 24 nanoseconds from data input to data output and 29 nanoseconds from control input to final output.

This system could be expanded to multiplex two 32-bit words by constructing another identical system and directing its outputs along with F_0 and F_1 into another SM-210.

The SM-220 demultiplexer array performs the inverse operation of the SM-210. It consists of two separate decoding sections. In one section, incoming data may be steered to any one of four identical outputs under control of two selection variables. In the second section, another data input can be routed to either of two identical outputs determined by the state of the selection line.

The logic arrangement of the SM-220 is shown in Fig. 3. In the one-into-four section, four 3-input NAND gates are used, followed by output inverters. Each gate receives the data input along with one of the four possible combinations of the selection bits. The data can be steered to one output only for a particular selection input combination since the connections to each 3-input gate are unique. The output inverter/drivers provide the true states of the input data eliminating the need for extra gate inversions and allowing direct data entry into subsequent stages.

Used as a serial-to-parallel converter, as in Fig. 4, the SM-220 decodes 16 parallel bits onto two bus lines, F_0 and F_1 . The one-to-two section is used in six of the eight SM-220s and the one-to-four section is used in all. The output bits appear in the chronological order of their subscripts, shifting one to the right with each clock pulse. The SG-130 drivers are used to satisfy the input current requirements of the control lines. Propagation delay is about 33 nanoseconds from input to any output. Delay from control input to any output is about 40 nanoseconds.

As you can see, the SM-210 and SM-220 make an ideal pair for multiplexing systems where high speed, low power consumption and a low package count are desired. And where aren't these features important?

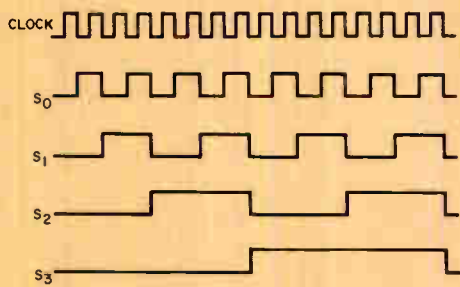
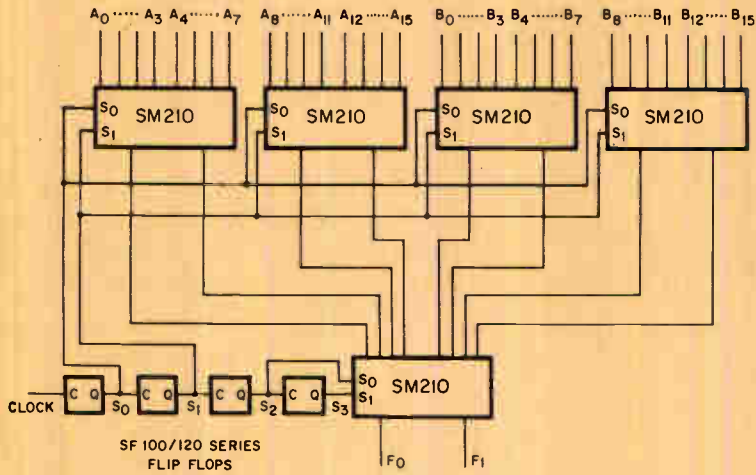

TRUTH TABLE						
CONTROL		INPUTS			OUTPUT	
S ₀	S ₁	S ₂	S ₃	F ₀	F ₁	
0	0	0	0	A ₀	B ₀	
1	0	0	0	A ₁	B ₁	
0	1	0	0	A ₂	B ₂	
1	1	0	0	A ₃	B ₃	
0	0	1	0	A ₄	B ₄	
1	0	1	0	A ₅	B ₅	
0	1	1	0	A ₆	B ₆	
1	1	1	0	A ₇	B ₇	
0	0	0	1	A ₈	B ₈	
1	0	0	1	A ₉	B ₉	
0	1	0	1	A ₁₀	B ₁₀	
1	1	0	1	A ₁₁	B ₁₁	
0	0	1	1	A ₁₂	B ₁₂	
1	0	1	1	A ₁₃	B ₁₃	
0	1	1	1	A ₁₄	B ₁₄	
1	1	1	1	A ₁₅	B ₁₅	

Fig. 2. Application of the SM-210 as a parallel-to-serial converter.

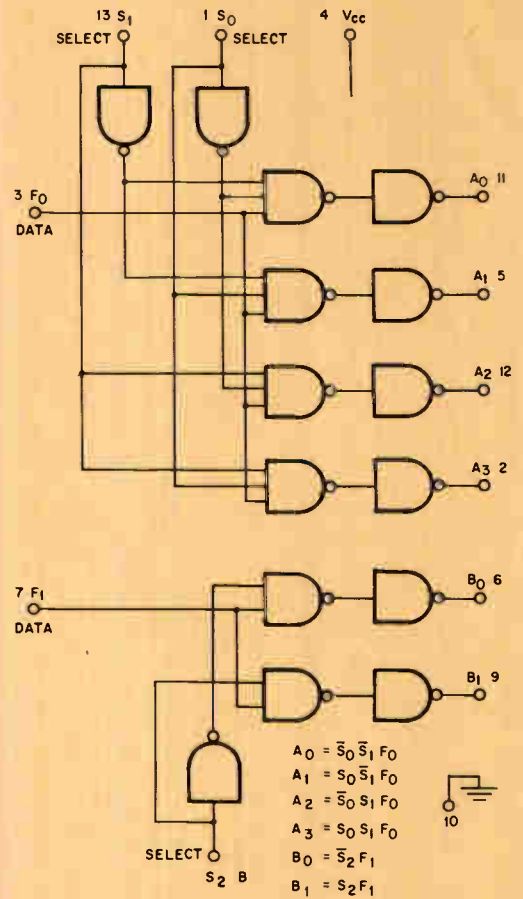

Fig. 3. Logic arrangement of SM-220 demultiplexer.

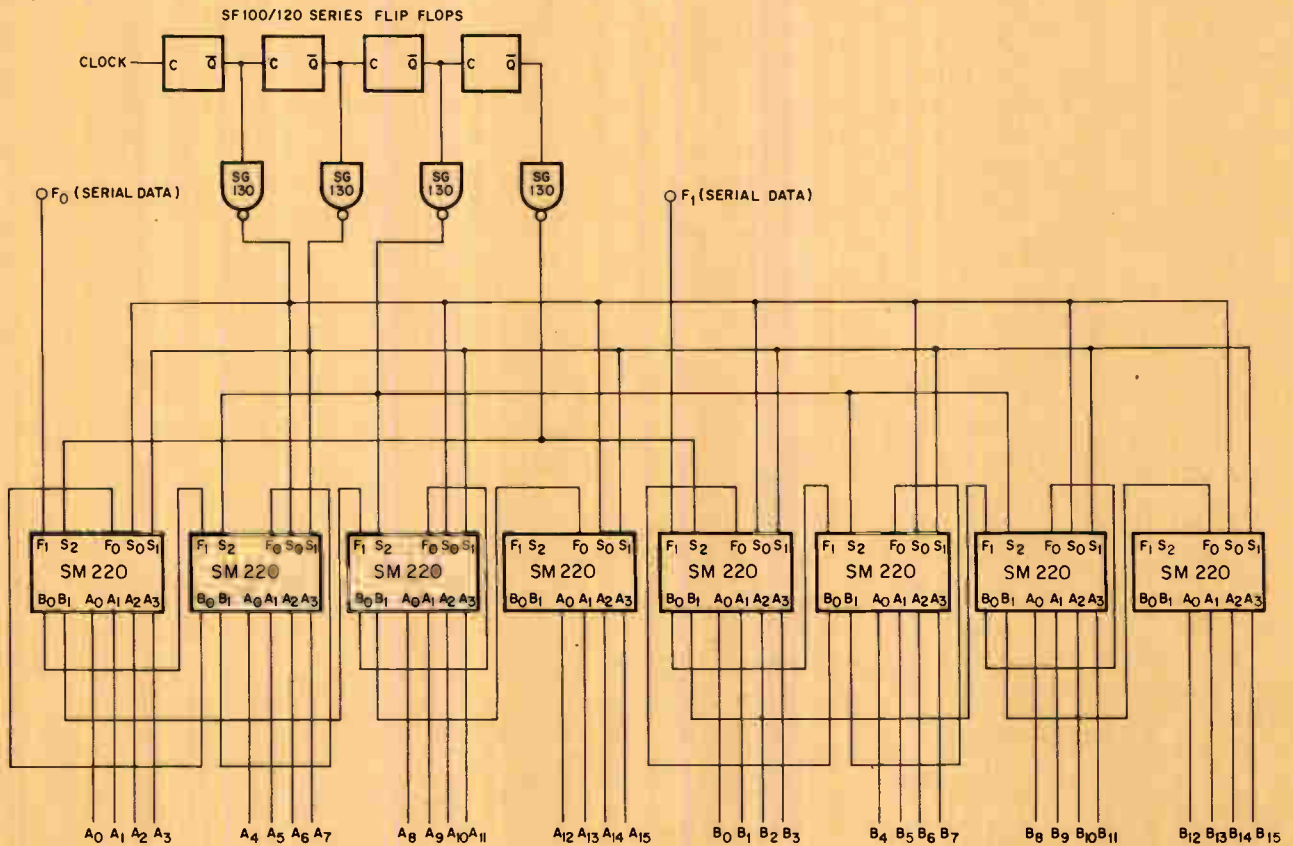

Fig. 4. SM-220 used as a serial-to-parallel converter.

MICROWAVE DEVICES

Beamlead and chip capacitors simplify hybrid circuit design.

New devices are ideally suited to use as series and bypass capacitors in microstrip applications.

Two new silicon-dioxide capacitor designs round out Sylvania's broad line of microwave components for microstrip systems.

The SC-9001 series are beamlead devices designed for series circuit applications such as coupling or blocking capacitors. Their mechanical design allows the gold beamleads to be spot-welded directly across a small gap in the microstrip line.

The SC-9002 series of chip capacitors is perfect for bypass applications. The base of the chip can be bonded directly to the ground plane and the other plate of the capacitor can be

connected to the microstrip line by a flying lead. These chip devices have gold metallization pads for ease of handling and bonding.

Both series of capacitors have an RF insertion loss equal to, or better than, microstrip line itself. Among the many applications for the two new capacitors are microwave switches, video detectors, RF and IF amplifiers and limiters.

Keep watching the pages of IDEAS for further developments in our microstrip components line. We expect to be telling you soon about a new resistor that will bring the benefits of beamlead devices to the microstrip world.

CIRCLE NUMBER 302

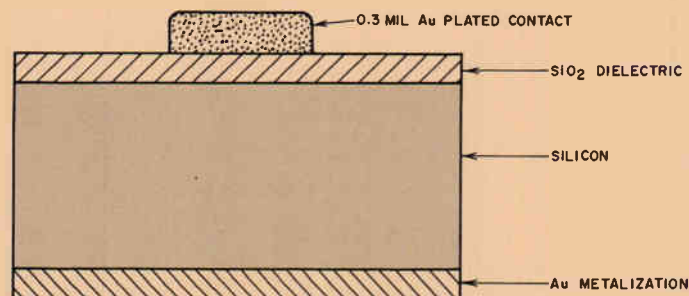

PACKAGE STYLE	CAPACITANCE RANGE
BEAM LEAD PACKAGE 146	0.5 TO 2.2 pF
BEAM LEAD PACKAGE 147	2.2 TO 4.7 pF
BEAM LEAD PACKAGE 148	5.6 TO 47 pF
CHIP PACKAGE 149 - 152	* PACKAGE 149 $0.020'' \times 0.020'' = 6.8$ TO 8.2 pF * PACKAGE 150 $0.030'' \times 0.030'' = 10$ TO 22 pF * PACKAGE 151 $0.040'' \times 0.040'' = 33$ TO 68 pF * PACKAGE 152 $0.050'' \times 0.050'' = 100$ pF

Electrical characteristics:	Beamlead	Chip
Capacitance Range @ 1 MHz	0.5 to 50 pf	6.8 to 100 pf
Temperature Coefficient	200 ppm/°C	200 ppm/°C
Capacitance Tolerance	± 20%	± 20%
Operating Temperature	-55°C to 150°C	-55°C to 150°C
Working Voltage	50 volts min	100 volts min

Characteristics of beamlead capacitors

Type number	Capacitance	Package number
SC-9001A	0.5 to 1.0	146
SC-9001B	1.0 to 2.2	146
SC-9001C	2.2 to 4.7	147
SC-9001DM	5.6 ± 20%	148
SC-9001EM	6.8 ± 20%	148
SC-9001FM	8.2 ± 20%	148
SC-9001GM	10.0 ± 20%	148
SC-9001HM	15.0 ± 20%	148
SC-9001JM	22.0 ± 20%	148
SC-9001KM	33.0 ± 20%	148
SC-9001LM	47.0 ± 20%	148

Characteristics of chip capacitors

Type number	Capacitance	Package number
SC-9002EM	6.8 ± 20%	149
SC-9002FM	8.2 ± 20%	149
SC-9002GM	10.0 ± 20%	150
SC-9002HM	15.0 ± 20%	150
SC-9002JM	22.0 ± 20%	150
SC-9002KM	33.0 ± 20%	151
SC-9002LM	47.0 ± 20%	151
SC-9002MM	68.0 ± 20%	151
SC-9002NM	100.0 ± 20%	152

TELEVISION

'Instant warm-up' heater speeds picture tube turn-on.

Two-second warm-up time more nearly matches CRT to the turn-on characteristics of solid-state TV receivers.

We've come up with a new directly heated cathode design for television picture tubes that approaches the "instant warm-up" characteristics of modern solid-state receivers. And what's more, it requires so little power that it can be driven by a simple link to the horizontal yoke current.

The construction of the new heater-cathode is shown in Fig. 1. The mounting is designed to give maximum thermal isolation for the cathode. The ceramic support is also carefully designed to act as a thermal sink for the cathode support structure. This maintains a relatively uniform thermal gradient along the length of the cathode ribbon. This is very important for long mechanical life of the cathode.

The cathode itself is a ribbon with an oxide-coated button at its center. Since power input requirements are proportional to the mass of the button, the button area is kept to a minimum.

We evaluated the new instant warm-up cathode in a type 12CSP4 monochrome tube and have come up with some remarkable results. Warm-up time, measured in terms of a

visible raster, was as little as 1½ to 2 seconds. The test tubes do not show any microphonic properties, nor does severe shock appear to change electrical characteristics. Emission levels are satisfactory with maximum currents in the range of 1 mA.

The low power requirements, 0.5 V at 0.800 A, enabled us to experiment with unusual sources of power. In a conventional arrangement, a portion of the DC power supply load current could provide the necessary heater current. But this approach would rule out use of the heater as the element by which the video signals are applied to the picture tube. This important feature can be retained if the heater is driven by means of a transformer in the yoke circuit as shown in Fig. 2.

In this circuit, a half-inch diameter ferrite toroid is used as a one-turn transformer. The primary is the ground return lead. The secondary is formed by passing the heater lead from the picture-tube socket through the core and connecting it to the other heater contact.

The result is a very low impedance source for powering the heater.

The toroidal transformer adds a minimum of capacitance to the video circuit, thus requiring no modification of the output stage peaking components. The low-impedance source is capable of supplying the higher-than-rated current needed when the cathode is cold. Measured warm-up time of the picture tube using this circuit was less than two seconds.

Although it's not yet an off-the-shelf item, our new instant warm-up cathode is definitely out of the experimental stage. We're ready to talk about designing it into your tubes. It can give you the selling feature you need for next year's models.

CIRCLE NUMBER 303

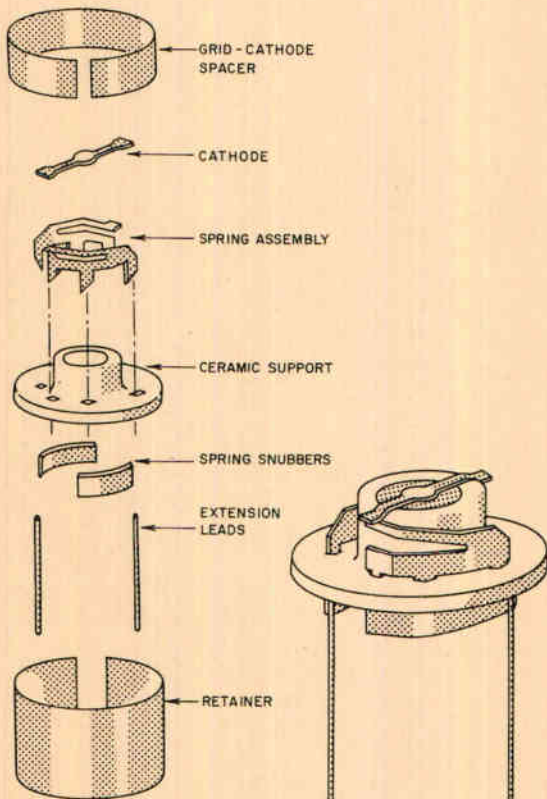

Fig. 1. Construction of the new instant warm-up picture tube cathode assembly.

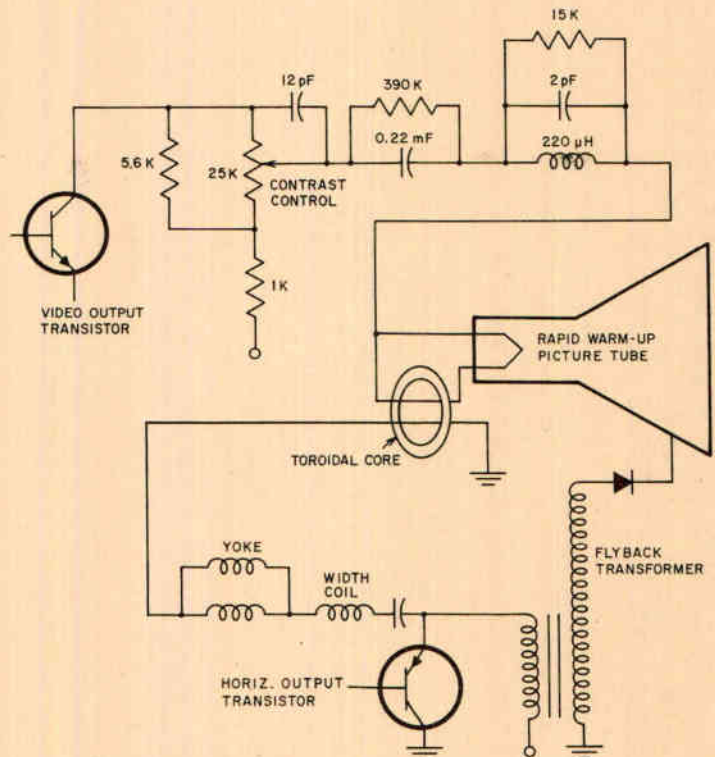

Fig. 2. New heater-cathode can be driven by single-turn transformer from yoke ground lead.

MANAGER'S CORNER

The path to LSI: Who goes first?

Perhaps the best analogy to illustrate the relationship between the design engineer and the integrated circuit manufacturer is that of two children daring each other to perform a certain adventurous act. Each one says "you go first."

As the semiconductor technology advances towards more highly complex circuits, the interface between the design engineer and the IC manufacturer becomes more critical. As the situation exists presently, the design engineer risks the design of a complex system based on the assumption that advanced circuit configurations can be fabricated by the integrated circuit manufacturer. The manufacturer, on the other hand, risks the production of a highly complex integrated circuit based on the assumption that the engineering community will use that package in their system design programs.

This could limit the advancement of LSI as a practical technology. The most apparent question is "who should take the first step." Should the design engineer be willing to take the gamble in hardening his design, hoping that the IC manufacturer can achieve the level of sophistication required to meet his IC specifications; or should the manufacturer go out on a limb and provide a more complex IC chip hoping that the engineering community can work with these more complex building blocks?

Actually, the relationship between the design engineer and the IC manufacturer is critical only if we are considering LSI as the immediate objective. If one looks back on the relationship as it has existed in the past, it is obvious that there is an evolutionary trend present. For example, in the past when an engineer intended to use a flip-flop in his system he merely designed the circuit using discrete components. With the introduction of the monolithic integrated circuit, the IC manufacturer decided to package the flip-flop configuration, thereby offering the design engineer a pretested building block.

In effect, the IC manufacturer made it possible for the engineering community to approach system designs on a higher level. They no longer were restricted to thinking in terms of discrete components since they now had available a wide assortment of functional blocks. The design engineer can now expand his thinking to a point where his general approach to system design assumes the use of these larger building blocks.

As the monolithic technology matured, the IC manufacturer, hoping to serve the engineering community, approached his packaging concept on a larger scale. If flip-flops could be packaged individually, why not complete shift registers and other similar complex circuit functions? Where once an engineer had to design a shift register by using individual IC flip-flops, he can now obtain this fundamental unit ready made.

Once again, the thinking of the design engineer was allowed to expand to a higher level. In approaching complex

system design, the engineer is now armed with larger and more sophisticated building blocks. This frees the engineer from the burden of having to design and test previously established circuit configurations. With larger, pretested building blocks available he can use his talent, experience and creative energies in the development of a more efficient and effective system.

It should be obvious at this point that the evolutionary trend has arrived, quite naturally, at the present state of semiconductor technology—namely, MSI (Medium Scale Integration). MSI is a natural extension of the monolithic technology, and is a stepping-stone on the path to LSI. It is this fact which lends so much importance to Sylvania's approach in satisfying the needs of the engineering community for more complex and sophisticated building blocks.

Rather than make an unrealistic leap into the production of extremely complex circuit configurations, which could possibly result in a retardation of semiconductor developments (i.e., trying to force the design engineer to work with building blocks far more advanced in sophistication than those which he is used to working with), Sylvania has followed the more natural line of evolution. We are providing the design engineer with integrated circuit configurations designed to allow him to expand his thinking at a more practical and realistic pace. In this way the same goals can be achieved. The level of LSI is approached for complex system design, while at the same time the design engineer can use practical building blocks to design and fabricate systems using present-day specifications.

What it all boils down to is the fact that the integrated circuit manufacturer serves as a high-level packager. He follows the activity of the system's design engineer, continuously observing system developments. The integrated circuit manufacturer then attempts to package larger portions of these systems, thereby freeing the design engineer to rise to higher levels of design approaches, and to think in bigger terms.

The relationship between the design engineering community and the integrated circuit manufacturer is, therefore, regenerative. As systems become more complex, the packaging of larger portions of these systems will follow. As these packages or building blocks are made more complex, the result will be the raising of the design engineer's level of thinking. This, of course, is a limitless process and will lead, in the future, to levels of design sophistication which today are unimaginable.

Harry Luhrs

H. M. Luhrs
Product Marketing Manager
Integrated Circuits

CRTs

Low-drain heaters save portable power.

High-efficiency heater-cathodes cut CRT power consumption to six percent of that of conventional units.

Our approach to heater-cathode design really takes the strain off battery-powered equipment. Wherever battery drain is a problem—spacecraft, military field equipment or industrial portable testers—our special design can reduce power requirements to 1/16 of that required by conventional CRTs.

These low-power heater-cathodes operate on as little as 0.21 watts (1.5 V, 140 mA) as compared to 3.78 watts (6.3 V, 600 mA) consumed by conventional heaters. The result is longer battery life (or smaller batteries), longer equipment life, and greater reliability. In addition, the lower power reduces equipment operating temperatures.

The low-power heater-cathode is a tiny pancake-like structure measuring 0.050" in diameter and 0.011" thick.

Compared with conventional units, the low-power assembly has an external radiating surface of 0.0054 square inches versus 0.136 square inches, a ratio of 25:1.

The extremely small mass enhances resistance to shock and vibration, upping reliability in severe environments.

One place where the low-power heater-cathode has been put to good use is in a lightweight, man-portable radar. This application uses two Sylvania low-power CRTs. Another application is in a portable industrial ultrasonic flaw detector. Here, the low-power heater-cathode is used in a CRT with helical-resistor post-deflection acceleration to achieve high writing rates and minimum pattern distortion. The table lists the characteristics of three tubes that make use of the low-power heater-cathode. These are just typical applications since the low-power design is adaptable to practically all present-day CRTs.

The 3BGP—offers high-deflection sensitivity, electrostatic deflection and focus with an optical-quality clear, pressed faceplate. It is a compact direct-view oscilloscope tube with face dimensions of 1½" x 3".

The 3BMP—is a 3" diameter tube with a flat, clear faceplate. It offers post-deflection acceleration, electrostatic deflection and focus.

The feature of the SC-3016 is compactness. It's only 6" long and offers a 1½" circular face. Deflection sensitivity is high with electrostatic focus and deflection.

CIRCLE NUMBER 304

Characteristics of low-heater power CRTs

Key Characteristics	3BGP-	3BMP-	SC-3016	Units
Heater Ratings	1.5V/140mA	1.5V/140mA	1.5V/140mA	Vdc
Anode No. 3 Voltage		6600*		Vdc
Anode No. 2 Voltage	2750*	2200*	2750*	Vdc
Anode No. 1 Voltage	1100*	1500*	1100*	inches
Face Dimension	1½ x 3/1/64	3	1½	inches
Over-all length	9¼	10	6	inches

*Absolute max. rating

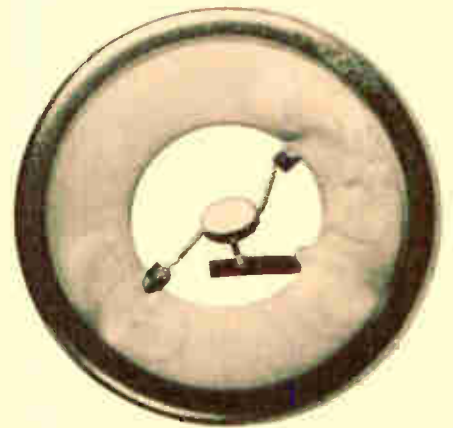

Low power heater-cathode operates on as little as 0.21 watt.

SEE OUR SPECIFICATIONS IN
VSMF
MICROFILM CATALOG FILE

Use Sylvania's "Hot Line" inquiry service, especially if you require full particulars on any item in a hurry. It's easy and it's free. Circle the reader service number(s) you're most interested in; then fill in your name, title, company and address. We'll do the rest and see you get further information by return mail.

BUSINESS REPLY MAIL

No Postage Stamp Necessary if Mailed in the United States

FIRST CLASS
Permit No. 2833
Buffalo, N. Y.

POSTAGE WILL BE PAID BY

Sylvania Electric Products Inc.
Sylvania Electronic Components
1100 Main Street
Buffalo, New York 14209

Dept. D 1 1 1

EL READOUTS

How etched leads boost EL bar graph resolution.

Chemical technique allows 50-line-per-inch spacing of bar graph segments, simplifies printed-circuit board connections.

Our recently developed chemical etch technique for making connections to electroluminescent (EL) devices improves the resulting device in two ways. By the use of this technique, we can now produce EL bar graphs with resolutions as high as 50 lines per inch. At the same time, the etched leads make an ideal way to connect the EL device directly to the necessary circuitry by soldering directly to a printed circuit board or to flex circuits.

The chemical etch method allows us to maintain tight control over lead spacing and lead dimensions. Because of this, we can vary the resolution along the length of a bar graph. This allows us to construct bar graphs having a logarithmic characteristic, or any other function desired. Elements of the bar graph can be as small as 0.050" in width.

Using this technique gives us better capability of stacking or making multiple bar graphs on a single substrate. Again, these can have the same or varying resolutions, widths, lengths, etc.

Chemical etch is just another flexibility added to the already high flexibility of EL display devices. In addition to bar graphs, EL devices are readily adaptable to the display of any type of information. For example letters, numbers,

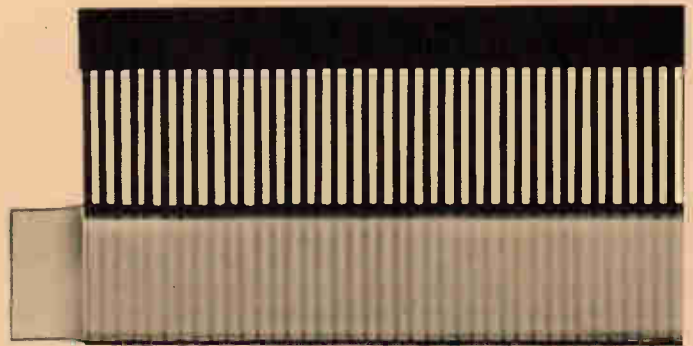

Chemical etch process allows accurate spacing of bar-graph divisions down to 50 lines per inch.

pictorial or analog data displays can be easily designed to meet your specific needs.

New developments in phosphors now enable us to offer EL devices with brightness levels up to 50 foot-lamberts at 250 V, 400 Hz and 25 foot-lamberts at 115 V, 400 Hz. Special glass faceplates allow contrast enhancement to permit viewing under the highest of ambient light conditions.

These features are in addition to the basic characteristics of EL that make it such an ideal display device. EL is a planar display; you don't have to look through a web of non-illuminated characters to see the one that's lit. It is practically immune to catastrophic failure and the spectral characteristic of EL devices closely matches the response of the human eye.

With all these features, isn't EL the best way to solve your display problems? Talk to Sylvania's applications engineers. They will be glad to show you how the flexibility of EL makes it practically certain that a display can be designed to match your exact requirements.

CIRCLE NUMBER 305

This information in Sylvania Ideas is furnished without assuming any obligations.

SYLVANIA

A SUBSIDIARY OF
GENERAL TELEPHONE & ELECTRONICS

NEW CAPABILITIES IN: ELECTRONIC TUBES • SEMICONDUCTORS • MICROWAVE DEVICES • SPECIAL COMPONENTS • DISPLAY DEVICES

D1

NAME _____

TITLE _____

COMPANY _____

ADDRESS _____

CITY _____ STATE _____ ZIP _____

Circle Numbers Corresponding to Product Item

300 301 302 303 304

305

Please have a Sales Engineer call



HOT LINE INQUIRY SERVICE

Need information in a hurry? Clip the card and mail it. Be sure to fill in all information requested. We'll rush you full particulars on any item indicated.

You can also get information using the publication's card elsewhere in this issue. Use of the card shown here will simplify handling and save time.

Meet the MICRO SWITCH Quality Assurance Department

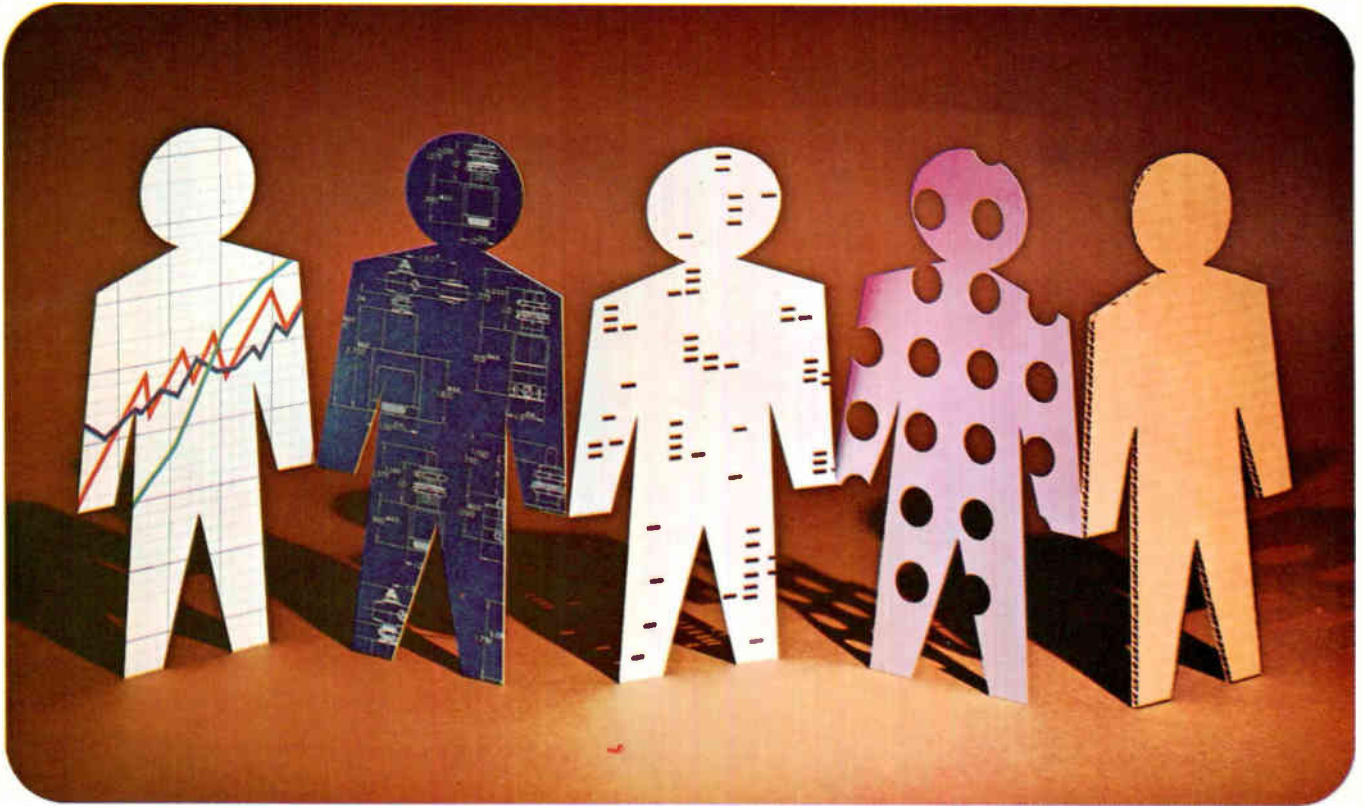

Left to right: vice president, design engineer, computer programmer, punch press operator, and shipping clerk.
Not present for picture: All the other employees of MICRO SWITCH.

Quality Assurance for the customer is everyone's business at MICRO SWITCH. It is the result of a total concern for the details that make up customer satisfaction. It starts with top management and permeates the entire organization, involving every step of manufacture—from raw materials and design on through production and shipping.

The emphasis at MICRO SWITCH is on the prevention of defects, rather than simply their detection.

The Quality Assurance program is designed to assure reliability *before* manufacturing begins. It includes such procedures as: a periodic calibration system for all measuring equipment, a strict vendor rating system, extensive documentation to cover all details in advance, and innovative operator self-checking procedures.

Most important, our experienced, highly trained personnel have a personal concern for customer satisfac-

tion. They know it's the little things that count.

What does this elaborate program mean to you? Dependability. The knowledge that each switch will hold up as well in your equipment as it does in our grueling laboratory tests. We're more careful to make you more sure.

To find out for yourself the many ways MICRO SWITCH is more careful, write for our booklet, "Quality Assurance for our Customers." No obligation, of course.

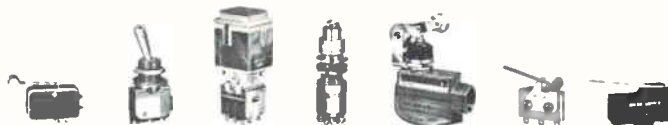

MICRO SWITCH

FREEPORT, ILLINOIS 61032

A DIVISION OF HONEYWELL

HONEYWELL INTERNATIONAL • Sales and service offices in all principal cities of the world. Manufacturing in United States, United Kingdom, Canada, Netherlands, Germany, France, Japan.



**Do you have
the question
to this**  **answer?**

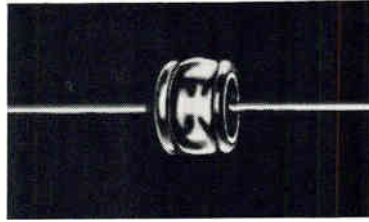

The only limits to the questions answered by the Siemens Gas-filled Surge Voltage Protector are your needs, and your imagination.

Tiny, lightweight, a handful can protect a ton of sensitive electronic equipment, especially supersensitive solid state circuits. They give you tailor-made protection in hundreds of places throughout circuitry. With current carrying capacities up to 5,000 amps. With DC striking voltages from 90V to 1000V. With reaction speeds in the nanosecond range. And with a cost of less than \$1 in quantity.

Lightning strokes, static charges, internal switching, short circuits—all these transient dangers are guarded against by these tiny, tireless sentries—Siemens Gas-filled Surge Voltage Protectors. If you've got a protection question, call Siemens America Incorporated for immediate protection delivery.

Send us your questions!

SIEMENS AMERICA INCORPORATED
350 Fifth Ave., New York, N.Y. 10001 • (212) 564-7674

with your reputation at stake, which resistor line would you specify?

take a close look—there'll be no question



The above illustrations are from unretouched photomicrographs taken of four $\frac{1}{2}$ -watt fixed resistors. Compare the anchoring of the leads, the seal provided by the insulating jacket at the ends, the homogeneity of the resistance material, the sharp color code bands—and decide for yourself.

For more details on Allen-Bradley hot-molded resistors, please write for Technical Bulletin 5000: Allen-Bradley Co., 1201 South Second Street, Milwaukee, Wis. 53204. Export Office: 630 Third Avenue, New York, N. Y., U.S.A. 10017. In Canada: Allen-Bradley Canada Ltd.

A-B hot-molded fixed resistors are available in all standard resistance values and tolerances, plus values above and below standard limits. A-B hot-molded resistors meet or exceed all applicable military specifications including the new Established Reliability Specification. Shown actual size.



QUALITY ELECTRONIC COMPONENTS



ALLEN - BRADLEY

Circle 45 on reader service card



At 12.4 GHz, forget about crosstalk.

This new switch gives 60 db of isolation at 12.4 GHz. You can forget about crosstalk at high frequencies because it's held to an absolute minimum.

Besides excellent isolation across its entire operating range (zero to 12.4 GHz), electrical characteristics are well suited to

high-frequency applications. VSWR at 12.4 GHz is 1.5 max. Insertion loss is only 0.5 db max.

Mechanical characteristics make Amphenol's high-isolation switch easy to use. Switches come with standard N or TNC connectors. They measure a small $2\frac{1}{8}$ " x $2\frac{3}{16}$ " x 1" and can be easily

stacked. Temperature range is from -55° to 85° C. Altitude range goes from zero to 70,000 feet. Shock and vibration performance meets MIL-S-3928B.

For high-isolation, high-frequency switches, talk to Amphenol RF Division, 33 E. Franklin St., Danbury, Conn. 06810.



AMPHENOL
THE BUNKER-RAMO CORPORATION

Allen-Bradley cuts space requirements with new sealed type Z cermet trimmers

Type Z
½-watt trimmer
shown 5 times actual size



this latest addition to the Allen-Bradley line of cermet trimmers...the type Z...affords high performance in an especially compact package

The cermet material—an exclusive formulation developed by Allen-Bradley—provides superior load life, operating life, and electrical performance. For example, the full load operation ($\frac{1}{2}$ watt) for 1000 hours at 70°C produces less than 3% total resistance change. And the temperature coefficient is less than ± 250 PPM/ $^{\circ}\text{C}$ for all resistance values and throughout the complete temperature range (-55°C to $+125^{\circ}\text{C}$).

The Type Z is ruggedly constructed to withstand shock and vibration. The unique rotor design ensures smooth adjustment and complete stability under severe environments. The leads are permanently anchored and bonded. The connection exceeds the lead strength—opens cannot occur. Leads are weldable.

The enclosure is *SEALED*. It is both dust-tight as well as watertight, and can be potted. Mounting pads prevent moisture migration and also post-solder washout. For full specifications on this new spacesaving cermet trimmer, please write Henry G. Rosenkranz, Allen-Bradley Co., 1344 S. Second St., Milwaukee, Wis. 53204. In Canada: Allen-Bradley Canada Ltd. Export Office: 630 Third Ave., New York, N.Y., U.S.A. 10017.

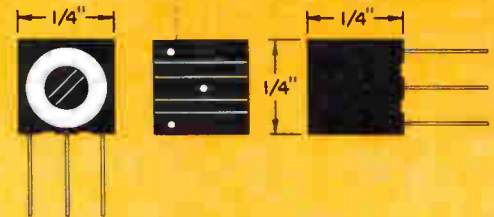

SPECIFICATIONS SUMMARY

Adjustment: Horizontal or vertical.

Temperature Range: -55°C to $+125^{\circ}\text{C}$.

Resistances: 50 ohms through 1 megohm.
Lower resistances available.

Tolerances: $\pm 20\%$ standard, $\pm 10\%$ available.

Resolution: Essentially infinite.

Rotational Life: Less than 2% total resistance change after 200 cycles.

Rotation: 300° single turn.

End Resistance: Less than 3 ohms.



ALLEN - BRADLEY
QUALITY ELECTRONIC COMPONENTS

MEET MIDTEX



Midtex
Slayer of
giant problems



Midtex
Faithful
friend



Midtex
The "service on a
silver tray" people



Midtex
The "we'll tackle
anything" people



Midtex
Cracker of
tough nuts

INDUSTRIAL RELAYS	TYPE 155	TYPE 156	TYPE 157	TYPE 48 Single Coil Latching Action
CONTACTS	U/L Recognized 1, 2, & 3 PDT 5 & 10 amp	U/L Recognized 1, 2, 3 & 4 PDT Low Level to 3 amp	1, 2, & 3 PDT 5 & 10 amp	1 & 2 PDT 10 amp
COILS	6 to 240 VAC 5 to 110 VDC	6 to 240 VAC 6 to 110 VDC	6 to 240 VAC 6 to 110 VDC	6 to 240 VAC 6 to 110 VDC
ENCLOSURES	Open and Dust Cover	Dust Cover and Hermetically Sealed	Open and Dust Cover	Open
TERMINALS	Solder, Plug-in, Wire-wrap, 3/16" Quick Connect	Solder/Plug-in, Printed Circuit, #78 Taper Tab	Solder/Plug-in/ 3/16" Quick Connect	Solder, 3/16" Quick Connect

MERCURY-WETTED CONTACT RELAYS	TYPE 159	TYPE 160	TYPE 161	TYPE 168
CONTACTS	1PDT	Mercury-Wetted, 2 amp max, 500 V max, 100 VA max		1PDT
SENSITIVITY—Bistable Single-Side-Stable	20 mw 40 mw	20 mw 40 mw	30 mw 60 mw	2 mw 5 mw
TERMINALS	PCB pins	PCB pins	PCB pins	Dctal plug



TYPE
153

COAXIAL CRYSTAL CAN

CHARACTERISTIC IMPEDANCES 50 and 75 ohms
RF CHARACTERISTICS:

Frequency	VSWR	Crosstalk
50 MHz	1.05/1	-62 DB
200 MHz	1.06/1	-50 DB
1000 MHz	1.15/1	-35 DB

CONTACTS 2C coaxial or 1C coaxial and 1C auxiliary, 100 watts RF, 2 amp 28 VDC
COILS 6 to 48 VDC
ENCLOSURE Hermetically sealed
TERMINALS RG188/AU Cable or ultra-miniature connectors, Solder hook for auxiliary
MOUNTING Standard varieties of crystal can relay stud, brackets, etc.
ENVIRONMENTAL Mil-R-5757



TYPE
615

ELECTRONIC TIME DELAY

DELAY TYPES Delay on operate Delay on release

DELAY RANGES

0.1 to 1 sec.	1 to 300 sec.
1 to 10 sec.	1 to 60 sec.
1 to 100 sec.	1 to 180 sec.

RESET TIME 25 MS max
REPEATABILITY $\pm 2\%$ at nominal voltage and $\pm 77^\circ\text{F}$
TOTAL TIMING VARIATION $\pm 10\%$ over voltage and temperature range
VOLTAGES AC 120 VAC (105 to 125 VAC) DC 12, 24, 48 VDC $\pm 25\%$
TEMPERATURE RANGE -40°F to $+150^\circ\text{F}$
CONTACTS 2PDT, 10 amp, 120/240 VAC or 24 VDC
TERMINALS Dctal style plug-in, solder, screw

Midtex/AEMCO also designs and manufactures a wide variety of programmers, both standardized and to handle special customer requirements.

Midtex—The broad range relay and timer supplier

MIDTEX 
INCORPORATED
AEMCO DIVISION
10 STATE STREET MANKATO, MINNESOTA 56001
PHONE 507-388-6286
TWX 910-565-2244

No other manufacturer offers as large a selection: hundreds of standard types of control knobs, more than 2,000 "specials". Almost every type, style and color combination is promptly available to you from local distributors and large factory stocks.

Turn to color with the new PANELRAMA knobs shown below...mix or match caps and body colors in almost any combination...to harmonize or contrast with every panel decor.

Or, you can choose elegantly-

styled Designer Series knobs with spun-aluminum caps on body colors of black; light, medium, or dark gray; and off-white. When you need a solid color, select from the nine decorative colors in our 400 series.

For military applications, specify Standard Series control knobs —thousands of quality knobs that meet MS91528. Or, specify the new self-locking push-to-turn knobs and Microverniers...for accurate, precision control settings. And when you need custom-

made knobs, call Raytheon first...to get the advantages of Raytheon quality and fast delivery.

For a catalog, call your distributor or nearest Raytheon regional sales office. Or send the reader service card. *Raytheon Company, Industrial Components Operation, Quincy, Massachusetts 02169.*



Here's why Raytheon knobs control more settings than any other brand.



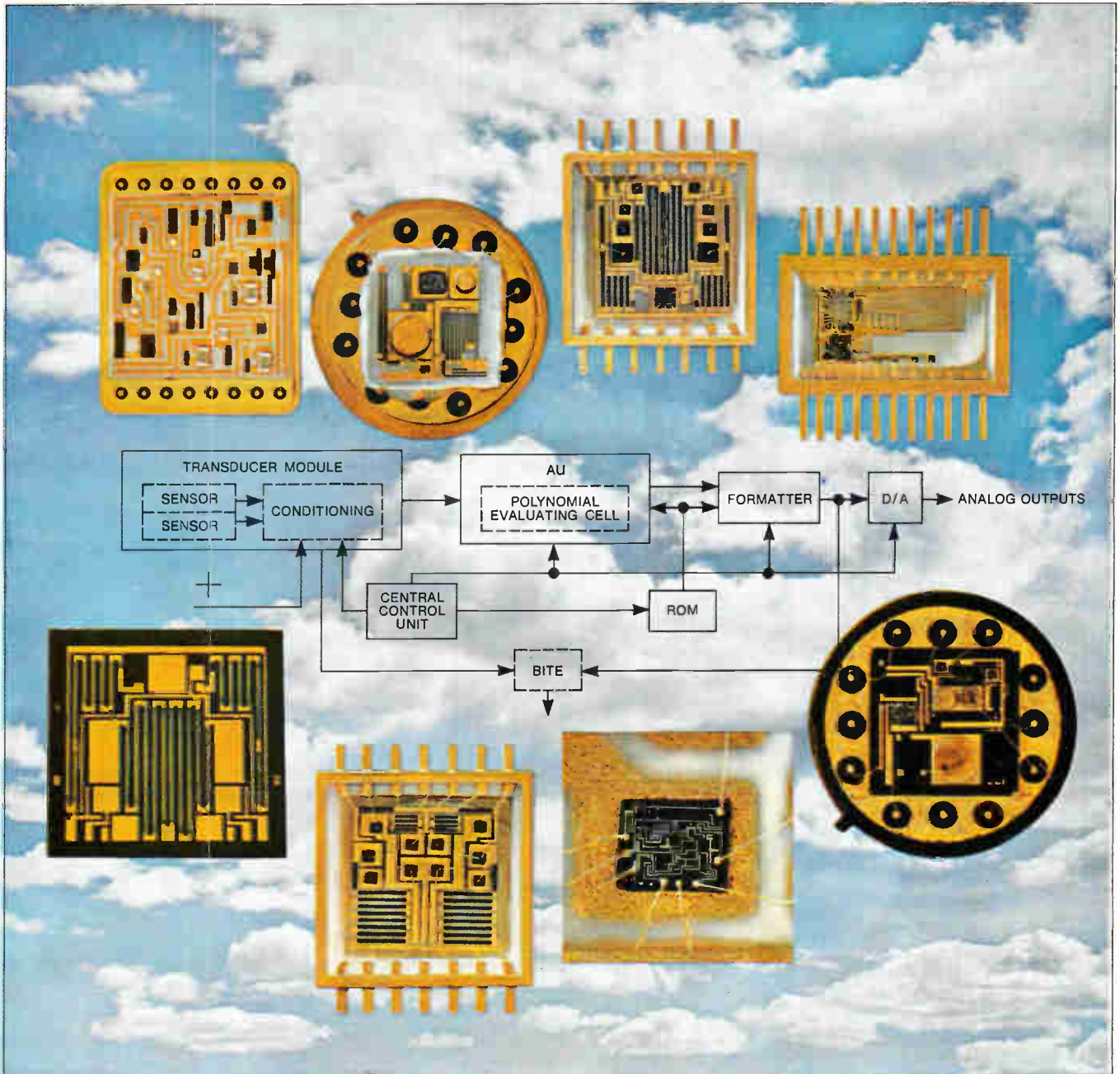

AiResearch has new ways of applying electronics to solve problems.

For example...

... digital air data systems, airborne integrated data systems, multiplexing systems, engine fuel controls, cabin pressure controls, propulsion monitoring systems, and displays.

We don't merely answer specifications. We start with the basic problem itself. We analyze the need, design the system, we build our own electronic components

and circuits, and finally we produce the system itself.

We have found that this kind of total system responsibility demands the highest degree of in-house electronics capability. In our house, this includes development of highly sophisticated electronic circuits through the use of advanced techniques such as thin-film, thick-film, and large

scale integration. The result is optimum weight-saving, miniaturization, and reliability.

Bring us your problem. AiResearch Electronics Systems, 2525 W. 190th Street, Torrance, California 90509.

AiResearch electronics capability starts at home



AiResearch
Electronic Systems

Garrett is one of The Signal Companies

Try A Complimentary Complimentary Pair... On Us

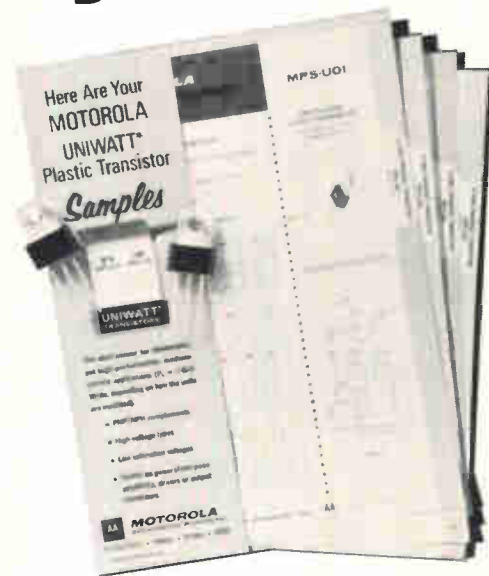

UNIWATT* Plastic Transistors Fill The "Economy" Gap In Medium Power.

UNIWATT... Remember That. Uniwatt, Motorola's new plastic package at last provides a truly economical line of silicon annular† devices fully capable of meeting medium-power requirements to 8 Watts. They fill the power handling gap between versatile TO-92 Unibloc* transistors (310 mW) and high-current Thermopad* (to 90 W) plastic types.

Uniwatt transistors occupy only about half the space of comparable TO-5 metal cans, but handle up to one watt at $T_A = 25^\circ\text{C}$ without heat sinking. Power dissipation is 5 to 8 times that figure when the integral heat sink is chassis mounted.

And yes, we said truly economical. Prices from 46¢ to 76¢ @ 5,000-up are a good example of what we mean. We have them on the shelf. And we deliver whatever your needs whenever you need it.

Type No.	Polarity	V_{CE0} Rating	P_D @ 25°C		h_{FE} @ I_C (min.)	$V_{CE(sat)}$ @ I_C (max.)	f_t @ I_C (min.)	Price (5,000-up)
			T_A	T_C				
MPS-U01 MPS-U51	NPN PNP	30 V	1.0 W	8.0 W	70 @ 150 mA	1.0 V @ 1.0 A	50 MHz @ 50 mA	54¢ 62¢
MPS-U02 MPS-U52	NPN PNP	40 V	1.0 W	6.0 W	50 @ 150 mA	0.4 V @ 150 mA	150 MHz @ 20 mA	46¢ 54¢
MPS-U03 MPS-U04	NPN	120 V	1.0 W	5.0 W	40 @ 10 mA	0.5 V @ 200 mA	100 MHz @ 50 mA	66¢
		180 V						76¢

Now, About That Complimentary Complementary Pair — Write your request on your company letterhead and we will send you a complete set of Uniwatt transistor data sheets — and an NPN MPSU02 and a PNP MPSU52 for prototyping.

*Trademark of Motorola †Annular Semiconductors Patented by Motorola

- where the priceless ingredient is care!



MOTOROLA Plastic Transistors

MOTOROLA SEMICONDUCTOR PRODUCTS INC./P.O. BOX 20912/PHOENIX, ARIZONA 85036

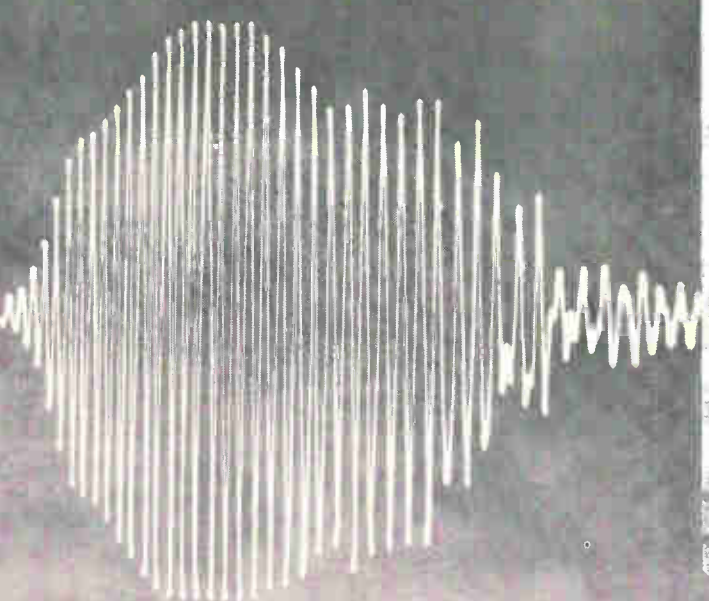

ANALYZE EVEN THE MOST COMPLEX SIGNALS ...

Recent research into the cry of the bat provides us with an unusual opportunity to demonstrate the ability of our Correlation Function Computer and Fourier Analyzer to analyze and sometimes derive unsuspected information from a complex signal.

The experimenter's objective was to characterize the bat's acoustic transmission to shed light on its sonic signal processing mechanisms. Through the use of the Correlation Function Computer, he derived the autocorrelation function of the cry and found that the bat's range discrimination success curve mirrored the envelope of the autocorrelation of its cry. This supports the hypothesis that the bat ranges by crosscorrelating its transmission with the returned echo.

The experimenter next processed the autocorrelation function through a PAR™ Fourier Analyzer to obtain the power spectrum of the cry. This spectrum is being studied to gain additional insight into the acoustic physics of the bat's vocal apparatus.

Whether you are working with bat cries or other phenomenon such as velocities in flowing turbulent fluids, potentials in an active plasma, pressure density in a boiling fluid or current flow across a reverse biased p-n junction, let us familiarize you with this powerful signal processing system. Write Princeton Applied Research Corporation, P.O. Box 565, Princeton, New Jersey 08540, or call (609) 924-6835.

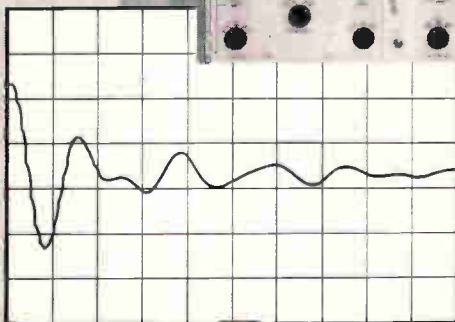
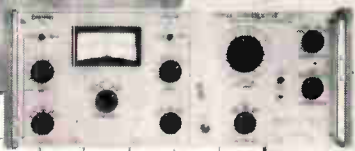

Autocorrelation of bat cry defined by Model 100 Correlation Function Computer (Price: \$8,500.)

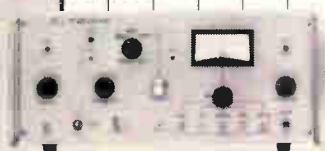

Power spectral density of bat cry transformed from autocorrelation function by Model 102 Fourier Analyzer (Price: \$2,950.)

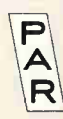

PRINCETON APPLIED RESEARCH CORPORATION

Memory has unforgettable price

Cost per bit of post-and-film system is only 2 cents, less than half that of core and plated-wire types

Almost nobody worries more about saving pennies than designers of computer memories; these systems use thousands upon thousands of elements. Ferrite cores, still the cheapest, generally cost 5 to 8 cents a bit; close behind are plated-wire memories, at 5 to 12 cents a bit. Computer producers think better mass-production techniques can cut prices of both types to between 2 and 4 cents a bit in a few years. But Litton Industries says it already has a memory that costs about 2 cents a bit.

In fact, the memory, which can be batch fabricated, may soon be used. The first candidate will be the L-3050 computer made by Litton's Data Systems division. Officials there say the machine will probably have a fast, alterable read-only memory incorporating the new technique.

The memory is composed of posts and films. Robert Vieth, man-

ager of magnetics and microelectronics research at the Guidance and Control division, explains the makeup of the memory as follows.

Post time. Two layers of Permalloy film are bonded to a glass substrate, with a layer of nonmagnetic material between the Permalloy layers. The Permalloy layer next to the glass is a "hard" film—that is, it's highly anisotropic, and its magnetic hysteresis loop is nearly square in the easy direction and almost linear in the hard direction. The other Permalloy layer is "soft"; it's also anisotropic, but the difference in its magnetic properties in the two directions is less pronounced. The easy directions of the two films are parallel. In this direction, binary 1's and 0's correspond to magnetization one way or the other.

Meanwhile, two sets of grooves are cut into a ferrite block at right angles, leaving a set of posts. Semi-

conductor dicing techniques are used in the cutting process. Drive conductors are then placed in the grooves, and the glass substrate carrying the films is flipped over onto the ferrite, film side down, to complete the sandwich.

Because the memory elements contain both hard and soft films, readout can be either nondestructive or destructive. In the nonde-

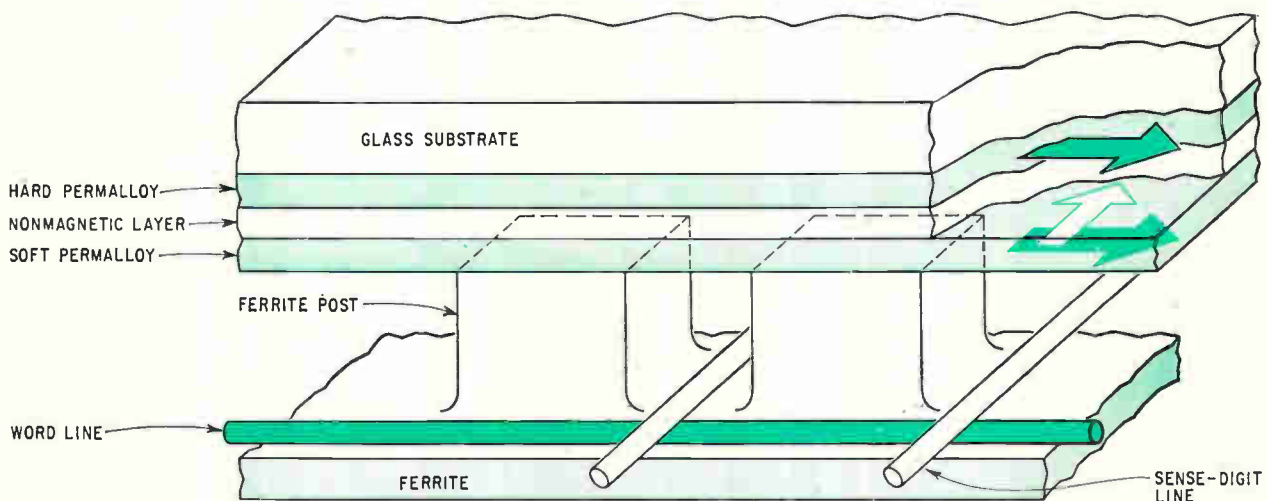
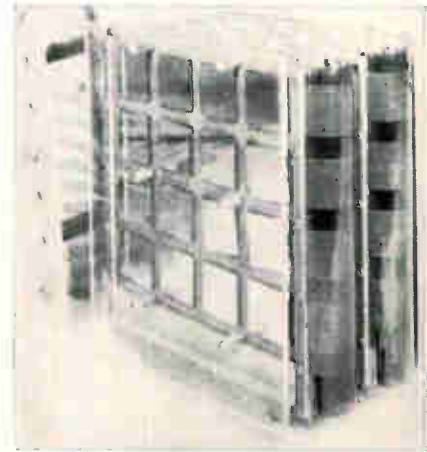

Post and film. Current pulse in the word line of this batch-fabricated memory rotates the magnetization of the "soft" Permalloy film to generate a readout pulse in the sense-digit line. Readout of the economical memory is nondestructive because the magnetization in the "hard" film restores the direction of magnetization in the "soft" film when the pulse is removed. Registration of glass substrate carrying films isn't critical, as photo shows.

U.S. Reports

structive mode, a pulse sufficient to change the magnetic axis of the soft film, but too weak to have much effect on the hard film, swings the magnetization of the soft film to one side. Its motion generates a pulse in the sense wire. After the pulse is withdrawn, the magnetism of the hard film drags the soft film back to its original position, retaining the information stored.

In the destructive mode, a bigger readout pulse affects both the soft and hard films. This would be primarily for writing new information in the memory. A pulse in the sense winding, now doing double duty as a bit line, defines the new direction of the films at the end of the pulse.

The posts define the bit positions on the film, which therefore needn't

be carefully registered on the ferrite array (see photo). The posts also provide a complete path through low-reluctance material for the magnetic flux, and this gets around the problems often encountered in conventional planar thin films.

No creeps. If the planar film is continuous, repeatedly reading and writing in one location tends to destroy data in adjacent locations, a phenomenon called creep. And all the efforts to overcome or avoid creep—including putting the film down in spots or on a cylindrical substrate (plated wire)—lead to other problems.

Norman Grossman, manager of materials engineering at the lab, says each part of the memory can be batch-fabricated, separately

tested, and separately repaired. Film evaporation is easily done in batches, and the ferrites are fired, molded, and separated in groups. The word and digit wires are fabricated in one large plane; they're connected to each other and to the electronics in a proprietary way that eliminates hand wiring and solder joints.

Monolithic. Charles Womack, manager of the Data Systems division's memory section, notes that the memory's relatively low drive currents—40 milliamperes for the digit wire and 150 ma for the word wire—allow use of monolithic integrated circuits as the drive electronics. This would be difficult with cores and plated wires, he says. Cores require 300 ma on the digit wire and 800 ma on the word wire. Plated wires dictate 125 ma on the digit wire and 800 ma on the word wire.

A 1,024-word stack of 32-bit words has already been built. The goal of the in-house effort is to develop an 8,000-word by 33-bit unit, which, Womack believes, will dissipate 20 watts—a third to a fourth less than a similar plated-wire stack and far less than the 160 watts needed for a core stack of comparable size.

Womack also sees greater speeds and higher bit densities for the new memory: a 250-nanosecond read cycle and a 400-ns write cycle, compared with 500-ns read and 700-ns write for plated wire and 500-ns read and 10-microsecond write for cores. Bit densities of 1,760 per square inch have been estimated; this compares with 1,400 bits for plated wire and 1,200 for cores.

Circuit design

Engineer in the loop

The aim of most computer-aided design schemes is to get the engineer out of the loop. But, as some CAD experts are finding to their dismay, that leaves the machine with a lot more responsibility than they'd like. At MIT's Lincoln Laboratory, however, a CAD scheme called the Mask Program succeeds

Electronics Index of Activity

January 6, 1969

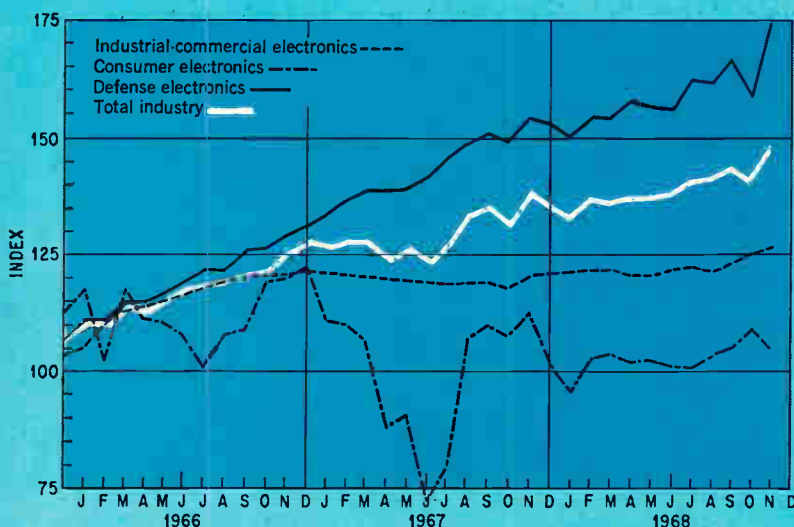

Segment of Industry	Nov. 1968	Oct. 1968*	Nov. 1967
Consumer electronics	105.8	109.5	112.9
Defense electronics	174.2	159.6	150.9
Industrial-commercial electronics	126.7	125.0	121.4
Total industry	148.7	140.9	135.8

Electronics production rose 7.8 index points in November from the prior month and 12.9 points from the year-earlier level. Gains were posted in all sectors except consumer output, which declined 3.7 points in the month and 7.1 points in the year. Defense electronics soared 14.6 points from October and 23.3 points from November 1967. The industrial-commercial index was up 1.7 points in the month and 5.3 points in the year.

Indexes chart pace of production volume for total industry and each segment. The base period, equal to 100, is the average of 1965 monthly output for each of the three parts of the industry. Index numbers are expressed as a percentage of the base period. Data is seasonally adjusted.
* Revised

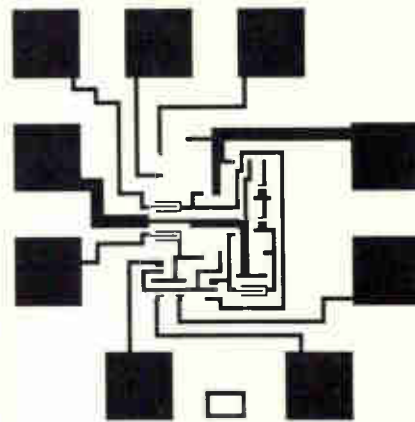
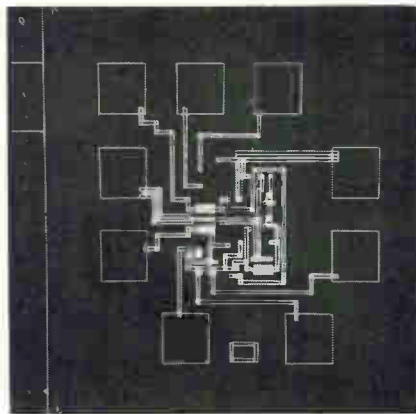

Before your eyes. A Lincoln Lab engineer's sketch grows into a crt-displayed IC pattern (center) as he programs a computer with a data tablet (left). The computer analyzes his composite drawing, designs masks needed to make the IC, then punches paper tape to feed a mask-making artwork generator. The final result is a mask like the one at right, one of a set for an emitter-coupled three-input AND gate.

in using the computer to complement the engineer, not replace him.

"We wanted a system that could make full use of the engineer's experience," says Fontaine K. Richardson, a lab staff member. "It is a rare computer that can tell the difference between a great design and a marginal one, or one which will build itself or give fits to process control personnel."

"It's taken 15 or 16 cuts at the software to bring us to this point," he says. "Using the laboratory's TX-2 computer, a cathode-ray tube display, and a data-entry tablet, we can now design metal oxide semiconductor and bipolar integrated circuits so complex they require 15 masks or more and three layers of metalization interconnection."

In contrast, one of the best known CAD systems in industry can reach only the eight-mask, single-layer-metalization level of complexity.

Free hand. Most CAD operations begin with a detailed circuit diagram or its equivalent in tape or punched cards. But the Mask Program can work from rough rectilinear sketches entered at the data tablet. And while the sketches themselves are in standard symbols, such as the resistor's zig-zag, the computer-generated crt display—continually developing as the engineer completes his sketch—looks like an artist's concept of a chip photograph.

Engineers using the Mask Pro-

gram can readily vary geometry and change component values. Designers can also use the program to delete, rotate, or relocate components. Centering of lines is automatic, and the computer picks the proper line width for a resistance or capacitance.

This contrasts with other CAD systems, in which circuit parameters usually are known before layout begins and the engineer can change them only within narrow bounds. These limits are imposed by the amount of memory needed to hold alternate component definitions and the complexity of the software needed to call them up, says Richardson.

He calls the Mask Program "an infinite drafting table with edges imposed only by the amount of memory available", and the TX-2 has lots; it can store 170,000 words of 36 bits each.

One industry source said after a demonstration, "While other men would be writing up circuit specs and component values, these guys are sketching an IC and getting a set of masks." Such speed is important to Lincoln Lab, which often needs special circuits quickly.

Debugging. Final designs are analyzed by the computer, which generates descriptions of the separate masks needed to construct them. The TX-2's output is a punched paper tape used to drive a David W. Mann Co. 10-times artwork generator [*Electronics*, Dec. 25,

1967, p. 41]. According to Mann's marketing director, Aubrey C. Tobey, this tape output allows artwork generation in a fifth to a hundredth the time needed with drafting tables. "A five- or six-mask set for a simple circuit can be readied in a day or less," he says.

Even before the tapes are cut, the engineer can debug the masks by viewing each one on the display. If he is very cautious, the computer can draw each mask with an x-y plotter for close examination.

From the sketch of a single gate to the final tape might take an hour or two, says Richardson, but the Mask Program isn't limited to simple circuits—though the more complex ones take longer to draw because "we engineers like to be able to change our minds."

Unlike CAD systems sometimes limited to 25 to 35 elements per chip, the Mask Program already allows design of large-scale IC's with double that many gates, each of which contains many elements of its own.

Too big? One of the first LSI circuits to be built with Mask Program is a 16-gate bipolar array with two layers of metalization, and Richardson's group is now about to begin work on a 65-gate dual 4-bit adder. It will have full carry-skip logic to make possible ADD, AND, exclusive-OR, and OR functions. It's expected to require three-layer metalization.

This makes possible what may

be another unique feature of the Mask Program: storage of whole circuits in memory for later use as cells or building blocks in LSI arrays. Such cells can be called out of memory, arranged on the display tube, enlarged or reduced en masse, then interconnected using the data tablet.

This system is so powerful that Richardson envisions using the 65-gate array as a building block and aims to work his way up through a dual 16-bit to a dual 32-bit adder. This is very large-scale integration indeed, so large that one industry spokesman feels that the Mask Program may have outstripped processing technology.

Optoelectronics

Caught in the crunch

The effects of the military's urgent need for low-light-level reconnaissance systems in Vietnam shows up in work under way at Texas Instruments on an unusual vidicon. The company, which only started development of the hybrid tube in June 1967, is now producing the device for a military infrared avionics system.

Because it has to deliver on the contract, TI is currently accepting low yields. But "dramatic improvements" have been made in the past two months, according to Frank L. Skaggs, manager of the project. These improvements, he says, should enable the company by mid-1969 to increase yields to the point where it can reduce the price of the tube and build "a lot more tubes" with just one or two defects. The defects—leaky diodes that show up as small white specks in the display—now run about 10 to 12 per array, or a total of about 20 nanoamperes.

In the 1-inch vidicon, a silicon photodiode array replaces the photoconductive coating normally evaporated on the tube face [*Electronics*, April 29, 1968, p. 39]. Bell Telephone Laboratories first developed the beam-scanned array for its Picturephone system and TI has been doing similar work in the

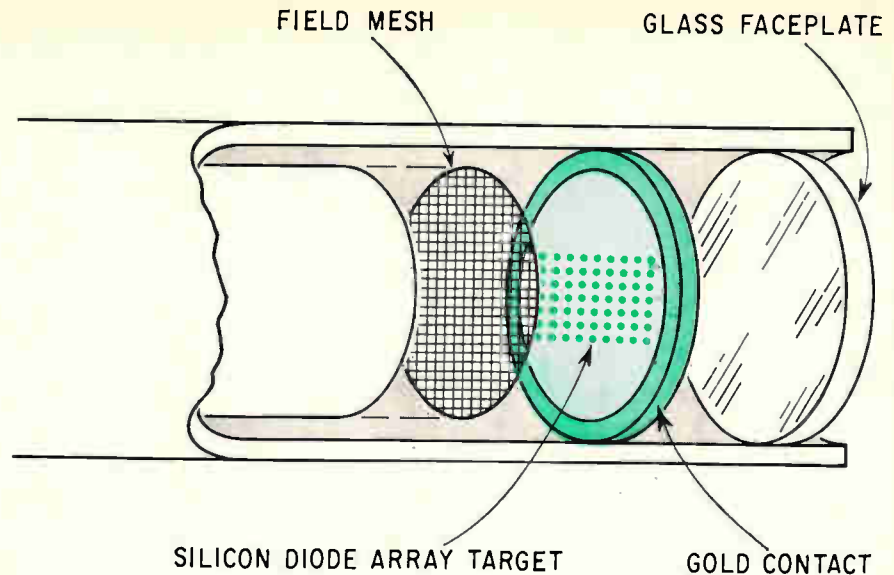

Hybrid tube. Infrared imaging device differs from conventional 1-inch vidicon in that it uses an array of single-crystal silicon photodetectors.

near-infrared region (0.9 to 1.1 microns).

One track. All production tubes are going to the military system, which is also being built by TI. "But we've got several expressions of outside interest," Skaggs comments. Price of a tube with 10 to 12 defects is \$6,500; one with one or two defects costs \$9,800. Because of the high price, TI "won't get out a spec sheet" and has given "no thought to an industrial line now," Skaggs says. The company hasn't achieved broadcast quality with the tubes yet, he adds, but as far as industrial applications go, "we're there."

One silicon vidicon has a resolution of 350 tv lines and an array center thickness of 0.0012 inch. A later tube with a 0.001-inch-thick array has a resolution of 550 horizontal tv lines. The target array must be mounted mechanically and it takes "a few weeks of work before it is properly installed in the tube," Skaggs says.

An array of 468,000 diodes in a 760-by-600 arrangement on a 0.62-by-0.48-inch rectangle is made by a p-type diffusion into the n-type silicon wafer. The 0.3-mil diodes are on 0.8-mil centers, and small islands of gold are placed upon each one to eliminate electron-beam charging of the insulating surface. The beam, which scans the rear of the target array, deposits electrons to drive the diodes to cathode potential. The diodes thus become reversed biased, and the

incident light creates minority carriers (holes in this case) that cause the diodes to lose their charge-storing capability. In the video-producing step, the returning electron beam redeposits electrons to bring the diodes back to cathode potential.

Higher efficiencies. Maximum quantum efficiency of the silicon vidicon is about 25%, peaking between 0.85 and 0.9 micron, but an antireflectance coating increases this to about 40% to 50%. And Skaggs feels that more attention to such factors as surface recombination velocities and the lifetimes of crystal minority carriers can possibly boost the efficiency to 60%. Current reconnaissance systems observe infrared-laser returns from a target with the S-1 cathode in image orthicons, secondary-emission conduction tubes, and direct-view storage tubes, but all of these devices suffer either from low quantum efficiency in the near-infrared region or unstable photocathodes above room temperature.

The silicon vidicon—both the tube and target array—can take 325°C without damage, though it can't operate at such temperatures. There's less lag and smear than in a standard vidicon, and there's no need to protect the tube from sudden high light levels.

Since the tube can take high temperatures, a 325°C bakeout should provide longer tube life, Skaggs feels. TI is working on this. This step should raise tube life to



ALPAC[®]

only
the high current
bridge rectifier
that stacks up —

**Performance
Packaging
Reliability
Price**

This power bridge rectifier is designed to out perform anything on the market. Years of reliable performance, in on-the-line operation, has proven the ALPAC concept. ALPAC is a Semtech design.

ALPAC utilizes a functional aluminum case to guarantee maximum thermal conductivity and light weight — replacing out-moded stud rectifiers and all the miscellaneous hardware associated with it.

ALPAC is easy to use. The devices are fitted with three way, universal terminals (insulated from the case) to minimize production costs.

Internally, ALPAC utilizes the Semtech high performance rectifiers — welded together for mechanical strength.

Average Output Current . . . 25 amps
Peak Inverse Voltage . . . 50 to 600 Volts
Thermal Resistance (Max.) . . . 1.5°C/watt

If you want quality "designed in" you'll buy ALPAC . . . another good idea from Semtech.

For immediate delivery see your representative:

San Francisco—941 E. Charleston, Suite 10, Palo Alto, California 94303 / (415) 328-8025
Chicago—140 N. La Grange Road, La Grange, Illinois 60525 / (312) 352-3227 / TWX: 910-683-1896
Dallas—402 Irving Bank Tower, Irving, Texas 75060 (214) 253-7644
New York—116-55 Queens Blvd., Forest Hills, New York 11375/(212) 263-3115/TWX: 710-582-2959
European Sales—Bourne A. G. Alpenstrasse 1, Zug, Switzerland / (042) 4 82 72/73

SEMTECH
CORPORATION

652 Mitchell Road, Newbury Park, California 91320
(805) 498-2111, (213) 628-5392 / TWX: 910-336-1264

© ALPAC is a registered trade-mark of the Semtech Corporation.

U.S. Reports

10,000 to 20,000 hours—comparable to that of cathode-ray tubes. Present silicon vidicon life is about 5,000 hours.

TI also looked at the possibility of applying large-scale integration to make the camera fully solid state, but "the time frame on this project (the military production contract) precluded our doing this," Skaggs says. TI is also developing a germanium-type array that peaks at about 1.3 microns, but this system has to be cryogenically cooled.

Space electronics

Shot seen 'round the world

It will still take several weeks for the National Aeronautics and Space Administration to complete its evaluation of the Apollo 8 mission. But NASA's scientists—after discussing and dismissing a few very minute problems—will undoubtedly come to the same conclusion reached by the nation's press and public, the trip around the moon was a smashing success.

One reason the average American can confidently attest to the success of Apollo 8 was the image of the mission portrayed on his television set. In a series of unprecedented spectacles, the world's tv viewers were treated to real-time views of the lunar surface, the earth from afar, and life inside the space capsule. In the broad field of electronics serving the three astronauts, the obvious star was the communications system.

Unglamorous tasks. Only part of the success of the unified S-band setup was seen on the television screen; the system was also for the transmission of voice messages, recorded telemetry, and scientific data for the spacecraft. The versatile S-band antenna performed well. A high-gain array consisting of four 31-inch parabolic reflectors clustered around an 11-inch-square wide-beam horn, it was developed by the Textron division of Dalmo Victor in Belmont, Calif.

Engineers at Dalmo Victor feel that their system worked well but are hesitant to go overboard in

congratulating themselves. It is their contention that the system didn't get the workout it deserved.

Dalmo Victor was particularly interested in the antenna's ability to stay homed in on an earth station. Of the antenna's three modes—manual, automatic track, and automatic reacquisition—the latter was used least on the lunar mission. The reacquisition mode allows the spacecraft to stay on the air continuously—an especially challenging feat since the craft rotates about its roll axis in order to keep its outer surfaces at a constant temperature.

Outer limits. During such rolls, the earth station is tracked until the antenna reaches its gimbal's limit, which keeps the array from pointing at the spacecraft and producing false signals. At that point, integrated logic circuitry drives the antenna to the opposite limit and permits it to quickly reacquire the primary ground station as the antenna emerges from the spacecraft shadow. On the Apollo 8 flight, vhf omnirange equipment was used more than Dalmo Victor anticipated and the automatic reacquisition mode could not be fully evaluated.

Despite this reservation, the flight proved that the unified S-band system could handle the varied and complex communications requirements of Apollo from earth to the moon and back.

Communications

Relaying greetings

The Christmas-New Year's season is the busiest time of year for transatlantic communications. And the International Telecommunications Satellite Consortium didn't want to miss this opportunity to start cashing in with their newest satellite, Intelsat 3A.

Launched "beautifully" Dec. 18, the satellite just missed going into commercial operation by Christmas. But the Comsat officials managing the satellite for Intelsat hoped to have it relaying both television signals and voice and data

signals by early last week—in time at least to catch some of the New Year's greeting traffic.

Initial tests and positioning, carried out through Christmas Day, were slowed a little because the earth station at Etam, W. Va., was needed for transmitting Apollo 8 television pictures to Europe. A week after the launch, Comsat officials would not speculate on how the first tests of the satellite were shaping up; the testing is included in Intelsat's contract with TRW, and the buyer obviously wants to be certain that the satellite meets all requirements before giving it a stamp of approval. This is especially so since this is the first commercial satellite made by any firm other than Hughes Aircraft. Furthermore, Hughes has been the only firm until now to build a synchronous satellite.

Language barrier. Another complication is the fact that TRW had a relatively large number of foreign subcontractors working on Intelsat 3A. ITT, one of the four major subcontractors, had three of its foreign subsidiaries—in France, West Germany, and Belgium—providing subsystems. Six other foreign firms—two in France and one each in West Germany, Britain, Switzerland, and Japan—also supplied subsystems.

The satellite, which has a mechanically despun antenna and an effective power of 22 dbw, contains two transponders. Transmissions are received in the 5,920-to-6,420-megahertz band, and are sent back to earth in the 3,695-to-4,195-Mhz band. Intelsat 3A, with 1,200 voice circuits or four television channels, has five times the capacity of the Intelsat 2.

The next in the series of four Intelsat 3 satellites will probably be launched in early February and positioned over the Pacific. Comsat hasn't set a date for the launch of the third satellite, to be placed over the Atlantic Ocean, nor the fourth craft, slated for the Indian Ocean.

The first launch of Intelsat 3, on Sept. 18, failed when the three-stage Delta rocket broke up shortly after liftoff. This means that Comsat has just one "spare" left under

1.39 - 510 MHz

Vital Tool for Advanced RF, VHF, UHF Communications Equipment



TYPE SMFA

AM/FM STD SIGNAL GENERATOR

FEATURES:

- Frequency Range: 1.39-510 MHz in 12 ranges using 12 inch scales
- Frequency Stability: 30 ppm over 15 min.
- Synchronizable over entire range to at least 7 digits using ND30M frequency synthesizer
- Built-in Electronic Fine Tuning (metered): Offsets to ≈ 300 kHz with resolution of ≈ 100 Hz
- Output Voltage: $0.03\mu\text{V} - 2\text{V}$ behind 50 Ω (To 1 V with AM) with automatic leveling to 0.5 dB
- Modulation: AM, FM, FM Stereo, Simultaneous AM & FM; internal or external
 - AM: Modulation accurately set and metered from 0.1%-95%; S/N > 70 dB
 - FM/FM Stereo: Accurately set & metered from 100 Hz - 300 kHz; crosstalk with stereo < 1%; envelope distortion < 1%
- Built-in Modulation Generator: 10 Hz - 100 kHz; 0-6 V

APPLICATIONS

- AM, FM, FM Stereo Receiver Testing
- Telemetry Receiver Testing
- Overload and Sensitivity Tests
- Selectivity Testing
- Cross-Modulation Testing
- Study of Detector Discriminator Performance
- Measurement of Drift

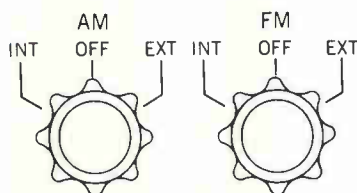

MODULATION MODE

Complete flexibility provided with AM and FM modulation.

Covering the entire RF, VHF, and part of the UHF range (1.39-510 MHz), Type SMFA is a Standard Signal Generator of unmatched specifications. Extremely high resolution is provided using 144 inches of scale with an anti-parallax indicator. Accuracy of $\approx 0.5\%$ can be further improved to 1 (10 $^{-7}$) by synchronizing with our ND30M-Q4 Frequency Synthesizer. Critical selectivity measurements can be made with the electronic incremental tuning feature. No external battery required: It's all built-in and metered. Output voltage continuously variable from $\approx 0.03\mu\text{V}-2\text{V}$; leveled of course.

Exceptional modulation capabilities are included: AM, FM, FM Stereo (use our Type MSC for stereo coding). Simultaneous AM/FM modulation permits vitally important studies of detector and discriminator performance. Measurements at very low, accurate levels possible. Why limit internal modulation to 1 kHz? Type SMFA incorporates a modulation generator, continuously variable from 10 Hz - 100 kHz.

With all of these features, the price of the Type SMFA AM/FM Signal Generator is competitive with the most sophisticated AM generator on the market.

Get The Extra Capability,
Greater Reliability, and
Longer Useful Life Of . . .



ROHDE & SCHWARZ

111 LEXINGTON AVENUE, PASSAIC, N. J. 07055 • 201-773-8010

Inquiries outside the U.S.A. should be made to: Rohde & Schwarz, Muehlhofstrasse 15, Munchen 8, West Germany.

U.S. Reports

the terms of the \$32 million contract with TRW, which calls for two reserve satellites.

Consumer electronics

Fingertip control

Television sets with electronic tuning—one of those little extras that set makers would love to offer the consumer but haven't up to now because of the high cost—will start rolling off the assembly line later this year. Both the F.W. Sickles division of General Instrument and Standard Kollsman Industries are now making the tuners, which allow the tv viewer to simply press a button to get the station he wants. All the channels are preset and the switching action is electronic. [For more on electronic tuning for tv sets, see page 88.]

Although neither company will say which set makers are buying the tuners, Albert Schrob, a GI engineer, says the list is impressive. However, one company, RCA, which makes its own tuners, may be the first to market a set with all-channel varactor-diode tuning.

Until now, the chief obstacle to the application of the tuners has been the diodes. For one thing, they are difficult to make with sufficient capacitance variation to cover the very high and ultrahigh frequency spectrum. For another, the diodes' voltage-capacitance characteristics must be carefully matched with each other, a difficult and costly process.

One approach to these problems is to integrate the diodes on a single substrate, a tack adopted by GI's Microelectronics division, which will provide F.W. Sickles with the IC's. Four matched diodes are integrated on a 50-mil chip, which is packaged in a ¼-inch square eight-lead flatpack.

Richard Adler, one of the developers of the new IC, says that this approach should eventually reduce the cost of the entire tuner.

Currently, the electronic tuners are about twice as expensive as conventional devices. For example, Standard Kollsman's conventional tuners are sold to the set maker

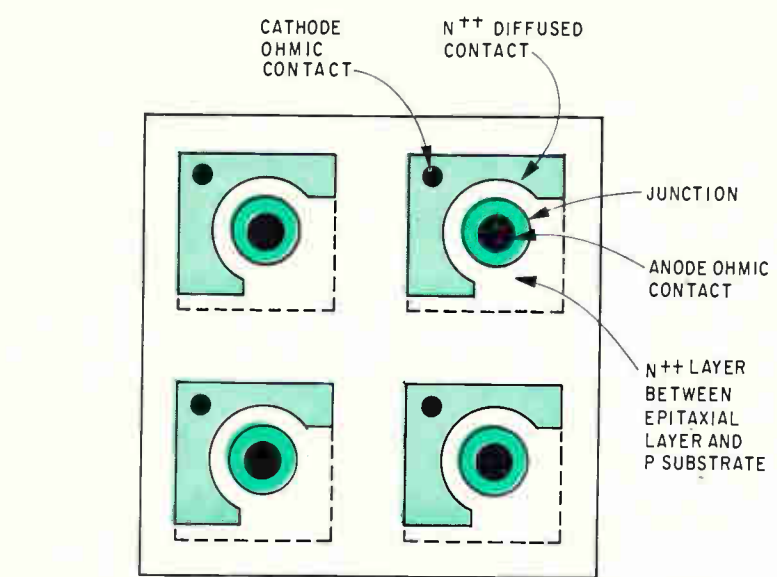

Matching. Four varactor diodes on a single chip designed by General Instrument may lead to development of inexpensive electronic tuning for television.

for \$10; its varactor diode tuners are priced at \$20, although this includes \$5 for the pushbutton bank.

SCR's in tv

The advantages of the switch from tubes to solid state components in color television sets were clear: improved reliability and performance. But these advantages were just as clearly offset by some disadvantages: price rises of from \$100 to \$200. Part of the price rise was due to the need for additional or expensive components to handle the high voltages that are beyond the capability of some solid state devices. RCA, however, has found a way to get rid of one costly component—the high-voltage transistors used in the horizontal deflection system—by replacing it with less expensive silicon controlled rectifiers and diodes. Also eliminated is the expensive power transformer and its complementary filter circuit. The savings, for the consumer, is estimated at \$20.

"The circuit produces as much deflection energy and beam current as the best tube circuits available," says Don E. Burke, one of its developers, "but is less expensive than alternate systems since it operates directly from the rectified power line."

The switch. In conventional hori-

zontal deflection systems, current is transferred to the deflection yoke near the end of each sweep trace by a transistor-controlled switch. The beam retrace results from the energy stored by the yoke inductance and retrace capacitance. The only drawback of this method is that most of the available transistors can't handle the high current that's needed to drive the sweep circuits of large-screen color sets.

In RCA's horizontal deflection circuit, the high current is switched off and on by SCR's and fast turn-off diodes. The retrace yoke current is controlled by a commutating switch that turns off the trace SCR and transfers energy to the yoke.

The energy storage and timing cycles are achieved by retrace inductor L_r , (see diagram) with capacitors C_a , C_r , and C_f . The charge path from the set's power supply to the retrace capacitor, C_r , is through the input inductor. The gate trigger for the trace switch SCR is derived from a secondary winding on the input inductor.

Open and shut. The commutating switch enables the yoke current to reverse for retrace and transfers energy from retrace capacitor C_r into the yoke, for the next trace. The switch is closed by a trigger from the horizontal oscillator just prior to retrace, and opens shortly after retrace is com-

NEW TUNG-SOL® DIGIVAC S/G

TRADE MARK

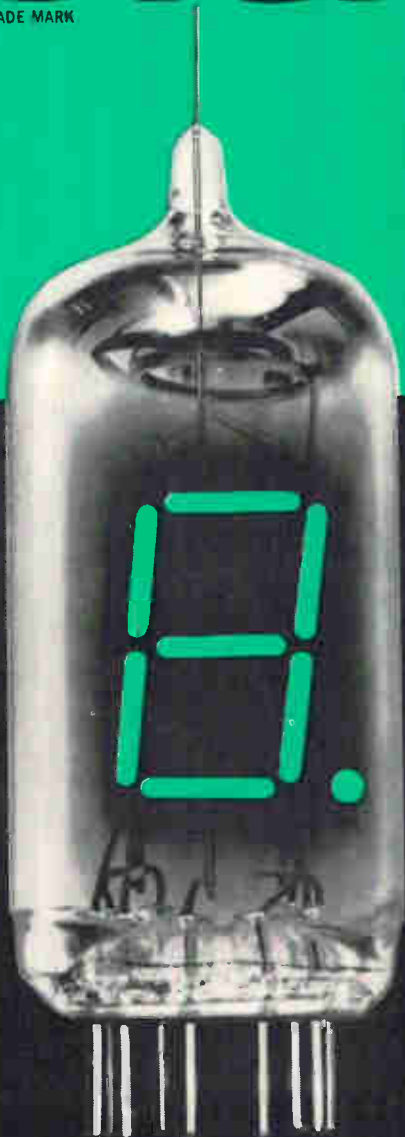

Vacuum Fluorescent
Readout with
Matching Logic

A Significant Second Generation Readout

1. Low cost
2. Single plane display
3. 150° viewing angle
4. Standard 9-pin base
5. High brightness
6. Low power
7. Low voltage
8. Simplicity of design
9. I.C. compatibility
10. Optional decimal
11. 10 numerals; 13 letters
12. Variety of colors with appropriate filtering

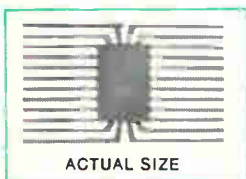

LOGIC FOR TUNG-SOL DIGIVAC S/G

This is a monolithic integrated MTOS circuit. It contains (1) decade counter, (2) storage register, (3) decoder/driver, and (4) appropriate input, output, and command terminals. Two important features are provision for leading zero blanking and false count indication.

Write for complete information.

TUNG-SOL DIVISION
WAGNER ELECTRIC CORPORATION
One Summer Avenue, Newark, N.J. 07104 • Telephone: (201) 484-8500

© T.M. Wagner Electric Corporation

VIDICONS

Prices and Quality have never been better



The quality: brand-new Toshiba and Hitachi, fully guaranteed in factory-sealed cartons.

The price: (distributor cost)

Hitachi 7735-A vidicon \$34.50

Toshiba 7038-H vidicon \$29.50

Hitachi separate mesh vidicon 8507 \$74.50

Replacement vidicon for

Sony and Panasonic 7262 \$29.50

All vidicons sold in lots of 5 (10% more for lesser quantities). Act today. These prices apply for a limited period. Write for GBC's free Encyclopedia of CCTV equipment.

GBC Closed Circuit TV Corp.
74 Fifth Avenue, N.Y. 10011
(212) 989-4433



U.S. Reports

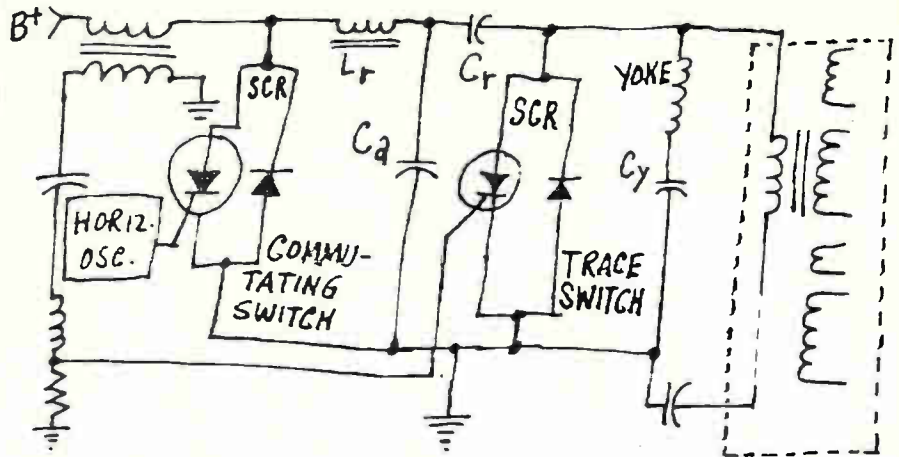

Deflecting with SCR's. RCA's new circuit in horizontal yoke winding eliminates need for costly high-powered transistors and power transformer.

pleted. The input choke stores energy when the commutating switch is closed. The choke current then charges the retrace capacitor when the switch opens. In the complete circuit, the commutating SCR acts as a regulator to maintain the sweep and high voltage within acceptable limits in the presence of a-c line voltage and picture tube beam current variation.

For the record

Showers forecast. Radio astronomers at the Air Force's Cambridge Research Laboratories have hit upon a technique for predicting proton showers 4 to 14 hours before they occur, giving plenty of time to readjust surveillance gear.

Although not as frequent as solar flares and magnetic storms, solar proton showers are far more destructive and harder to predict. In fact, they can totally black out radio communications. And they occur most frequently in the polar regions, where much of the U.S. air defense radar and missile detection systems must penetrate.

The labs' astronomers will continuously monitor radio-frequency output of the sun over a band from 200 megahertz to 15.4 gigahertz. When the sun's r-f output exceeds 1,000 flux units (a flux unit is 10^{-22} watt per square meter per hertz), and when such a burst is accompanied by a dip in power in the

0.6-GHz range, there will probably be a proton event. The new system is expected to be more accurate than the optical techniques used formerly.

Memory reconsidered. Westinghouse is taking another look at its experimental metal-oxide-nitride-oxide semiconductor (MONOS); it thought the memory devices could lead to high-speed MOS flip-flops [*Electronics*, Oct. 28, p. 49]. But now the device looks like it can never be applied to high speed read-write computer applications below the microsecond range. Reason: the 75 to 100 volts required to switch the devices in nanoseconds cause "fatigue" in the nitride layers along with loss of the memory characteristics. One of the developers, Hung C. Lin, says, however, that the principle still shows promise for both read-only memories and lower speed read-write uses. Unknown right now, he says, is whether or not other forms of nitride exhibit the same limitation.

Package deal. The Digital Equipment Corp. is now debugging software for a low-cost system including a PDP-8/I computer and a new graphics display terminal. The system, which uses a Tektronix storage tube, would sell for less than \$20,000. It may be announced officially as early as February. Digital Equipment's aim appears to be a share of sales now going to graphics systems costing from \$40,000 to \$100,000.

Can you spare less than one gram to solve your MIL-STD-704 surge protection problems?

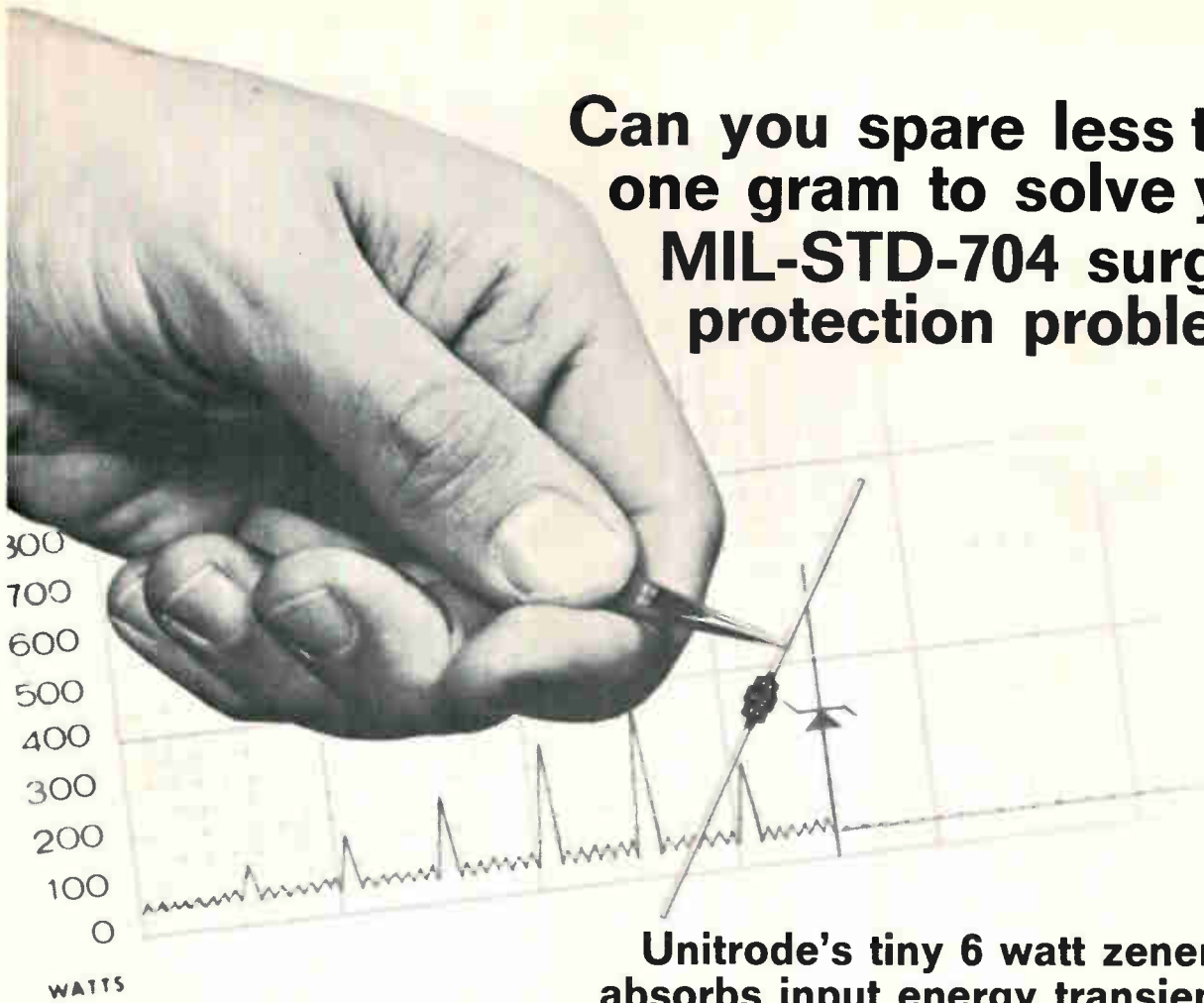

Unitrode's tiny 6 watt zener absorbs input energy transients up to 1000 watts for 1 microsecond.

- 350 watt surge capacity is 600% more than conventional 10 watt . . . 35% more than a 50 watt.
- Weighs less than 1 gram . . . 1/10th of a conventional 10 watt . . . 1/20th of a conventional 50 watt.
- Available in 10 watt rating, stud mounted.
- 6.8 to 100 volt range ■ low leakage current.
- Electrical characteristics remain stable throughout life, exceeding the environmental requirements of MIL-S-19500.

580 Pleasant St., Watertown, Mass. 02172 (617) 926-0404

UNITRODE

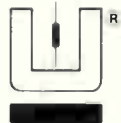

This one won't do it . . .



This one won't do it, either . . .



But this one will,



And so will this one . . .



Because it is built like this on the inside.

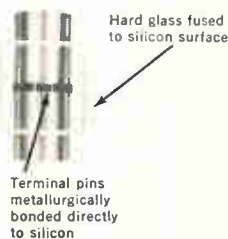

So . . . better get yourself a complete set of specs.



Check off the reply card number now or call Dave Green COLLECT at (617) 926-0404

If you're building any computer except a Computer, you need CT μ L.

CT μ L integrated circuits will give you more speed for less money than any other ICs. They're perfect for process control systems, test instrumentation, central processing units, computer peripheral equipment — just about anything short of an airborne computer.

Keep it in the family.

You can build a complete digital logic system with Fairchild's family of CT μ L devices. We have gates, flip-flops, inverters and memory circuits. A dozen different devices that make a computer easy to package. And, you'll need only about 80 percent as many packages as required with TTL.

You get out of it what you put into it.

The key CT μ L characteristic is non-saturating logic. That means you get fast gate propagation delay (typically 3nsec) with slow rise and fall times (typically 6nsec). So, there's no need for transmission lines or complex packaging. You can build an entire computer with normal two-sided circuit boards. Also, CT μ L can handle signal swings as large as 3V. It also provides typical noise immunity of 500mV.

What we'll do for an encore:

MSI CT μ L will be out before the year ends. CT μ L-II will be out even sooner, offering improvements like gate propagation delay of 1.5nsec. (typical, loaded) and a buffer and

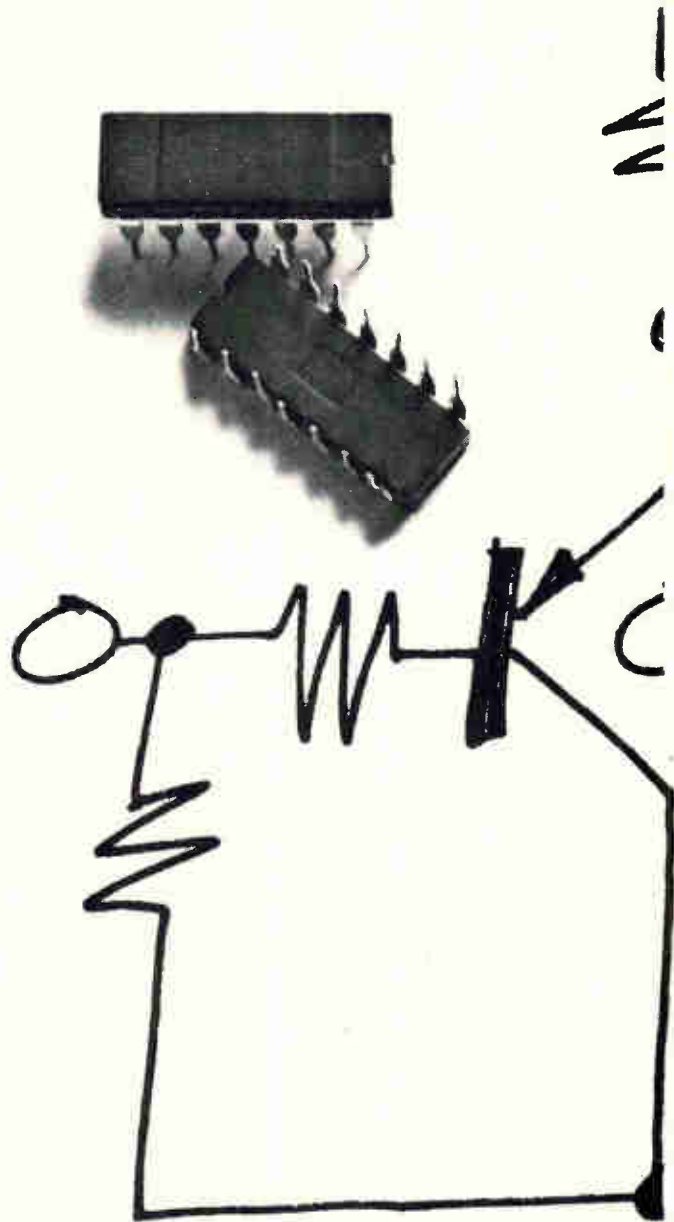

The world's largest manufacturer

inverter with propagation delays of 5nsec, compared with 12nsec in standard CT μ L. And, the new MSI and CT μ L-II circuitry will interface beautifully with all these standard CT μ L devices:

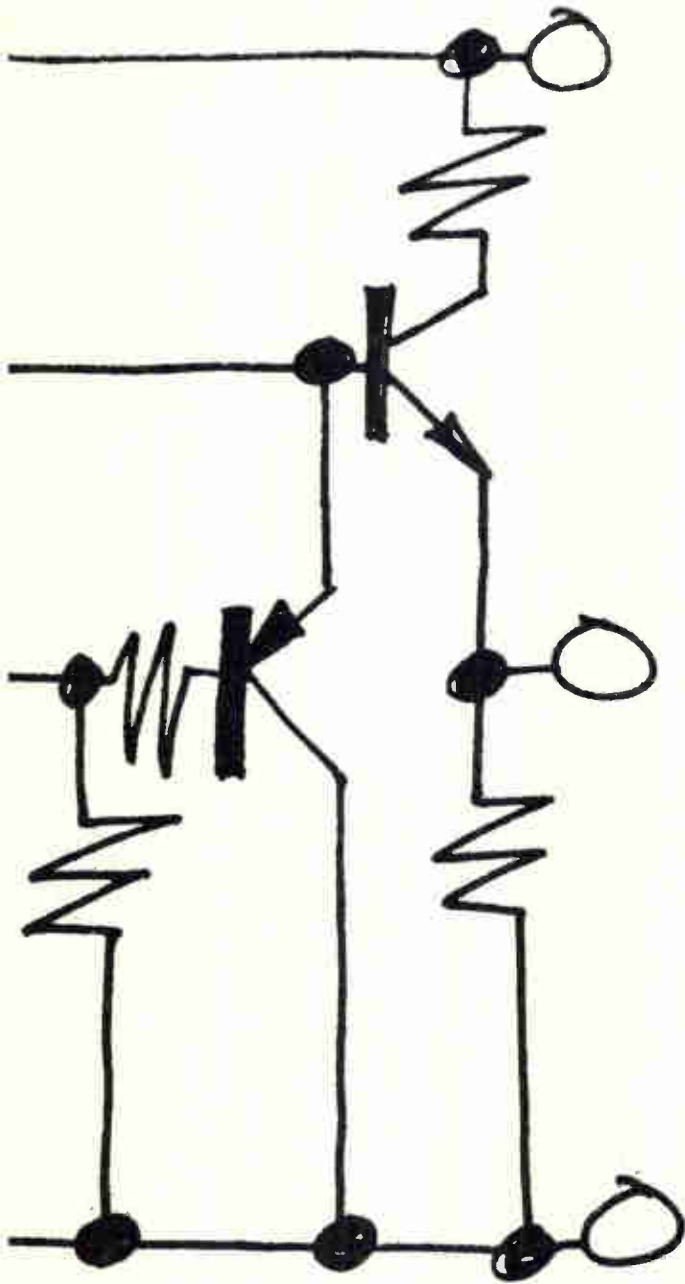

Device	Price (100-999)
9952 Dual NOR Gate	\$1.25
9953 Triple AND Gate	1.25
9954 Dual Four-input AND Gate	1.25
9955 Eight-input AND Gate	1.25
9956 Dual Buffer	1.25
9957 Dual-rank Flip-flop	2.00
9964 Dual Three-input and Single-input AND Gates	1.25
9965 Quad Single-input AND Gate	1.25
9966 Quad Two-input AND Gates, one pair with OR-tie	1.25
9967 JK Flip-flop	2.00
9968 Dual Latch	2.00
9971 Quad Two-input AND Gates with OR-tied pairs	1.25
9972 Quad Two-input AND Gates, one pair with OR-tie	1.25

If you want CT μ L-II in sample quantities, call Fairchild. If you want standard CT μ L in production quantities, call a Fairchild distributor. He has everything you need to build any computer. Even a Computer.



Fairchild Semiconductor / A Division of Fairchild Camera and Instrument Corporation / 313 Fairchild Drive, Mountain View, Calif. 94040 (415) 962-5011 / TWX: 910-379-6435

of LSI admits there's another way:

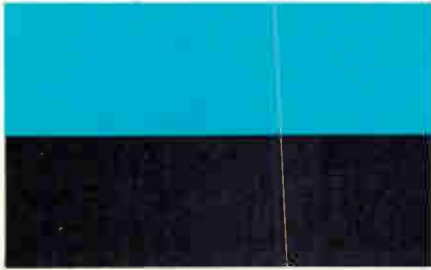
**MICROWAVE IC
PROGRESS
REPORT #5**

PACT proves microstrip is compatible for MIC mixers, filters, hybrids

Before microwave integrated circuits can become a reality this important question must be answered — can present stripline technology be converted to microstrip without a prohibitive performance penalty? Engineers and scientists engaged in Sperry's PACT (Progress in Advanced Component Technology) Program have found the answer, and the answer is yes!

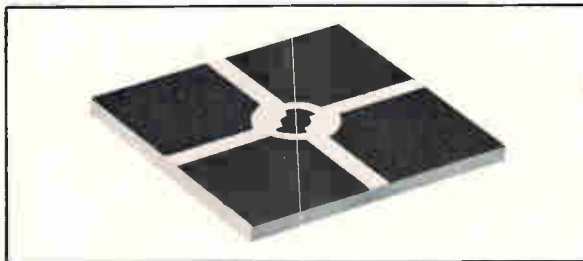
TWO-BRANCH MICROSTRIP 3 DB COUPLER

PACT investigations have already produced couplers, balanced mixers and a number of hybrid circuits, all utilizing the basic microstrip technology. Performance penalties have been negligible, and all indicators point to production availability of entire subsystems deposited on a single substrate.

Like other PACT activities, this effort has depended heavily on the proper selection of materials. For multi-function substrates, such as those capable of carrying entire subsystems, Sperry's choice is a composite of ferrimagnetic and alumina substrates. In some cases all-ferrimagnetic substrates are recommended.

MICROSTRIP BALANCED MIXER CIRCUIT

This approach provides maximum size, weight and cost savings, along with significant increases in thermal and mechanical stability.

PACT has also benefited from the use of the computer as a design aid. For example, the computer was programmed to calculate the electrostatic potentials around a microstrip circuit and determine its impedance. Options were then added to the program to obtain a print-out of actual potentials around the microstrip and to plot equal potential lines.

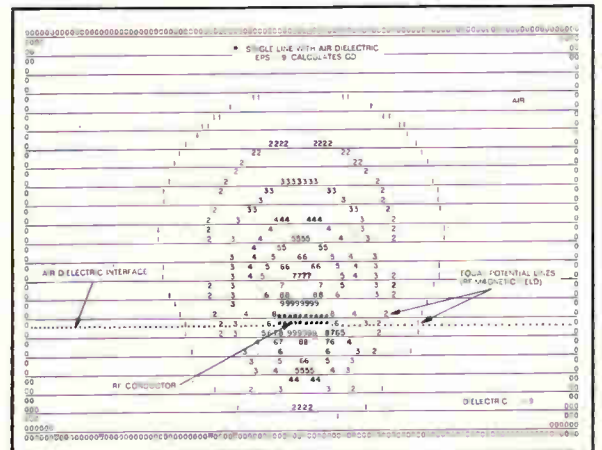
**COMPUTER PLOT OF EQUAL-POTENTIAL SURFACES
(RF MAGNETIC FIELD) AROUND MICROSTRIP LINE
WITH $\epsilon = 9$**

The result is optimum configuration for microstrip circuits prior to their fabrication.

To learn more about Sperry progress in design and fabrication of multi-function MICs for your applications, ask your Cain & Co. representative or write Sperry Microwave Electronics Division, Sperry Rand Corporation, Clearwater, Florida.

*For faster microwave progress,
make a PACT with people
who know microwaves.*

SPERRY

MICROWAVE ELECTRONICS DIVISION
CLEARWATER, FLORIDA

Washington Newsletter

January 6, 1969

Imps job goes to Bolt, Beranek

The Pentagon's Advanced Research Projects Agency will award the contract for the Interface Message Processors (Imps) for its computer network to Bolt, Beranek & Newman of Cambridge, Mass. The contract will cover the fabrication, testing, and integration of processors to connect the network's 35 computers and 1,500 remote consoles, many "incompatible." The coast-to-coast time-sharing network will be the first to unite multilingual computers [Electronics, Sept. 30, 1968, p. 131].

Even though the contract isn't expected to exceed \$2 million, it was hotly contested because of the unique nature of the job. Linking the ARPA network, it is felt, will give a company an entree into complex computer networking jobs both inside and outside Government. A total of 51 companies showed interest in the job, and 14 bid on it.

Decision on 621B due this summer

The Pentagon is expected to make its decision this summer on whether to continue work on the Air Force's 621B navigation satellite system. Hughes and TRW, which are doing \$500,000 parallel studies on the program, will present their preliminary design and analysis studies later this month to the Space and Missile Systems Office (SAMSO).

Original plans were to pick a contractor in fiscal 1969, but the Air Force received only \$500,000 this year, just enough to keep the program alive [Electronics, July 22, 1968, p. 34]. RCA had proposed using this money to take one of its Tacsat tactical ground terminals and test the feasibility of a scheme to derive navigational fixes from the Tacsat communications signal. SAMSO, however, has turned RCA down.

EIA may join talks on phone attachments

Although the Bell System won't like it, the Federal Communications Commission's Common Carrier Bureau will probably invite the Electronic Industries Association ad hoc committee on communications interfaces to sit in on discussions of technical standards for customer-owned phone attachments.

While the FCC allowed the phone company's new tariffs on customer-provided equipment to take effect Jan. 1, detailed technical standards for attachments must still be hammered out. The new rules—which can be changed—will allow businesses to attach switchboards, phones, microwave systems, and intercom systems to the Bell network. What remains as a ticklish point of dispute is the requirement in the new regulations that Bell "furnish, install, and maintain" network control and signaling units that are used for computer switching. The EIA characterizes this as "common carrier featherbedding."

Proposed IC specs could move Pentagon

The Electronic Industries Association is sending out its first draft of proposed general specifications covering all microelectronic devices. The EIA stresses that drawing up specifications is an industry effort that doesn't include the military. The present Pentagon policy is to keep hands off the standardization of IC's [Electronics, April 15, 1968, p. 68], except when used in specific systems, such as Minuteman. But industry acceptance of IC specifications will push the military toward changing its policy.

Meanwhile, the Pentagon is having headaches with Military Standard

Washington Newsletter

883, which sets specifications for the test methods and procedures concerning microelectronics. Contractors are being forced to obtain waivers because some of the specifications are not workable with newly developed IC's. The EIA and the military are working out proposed changes in 883, but they won't be ready for at least a year.

Digital voice tests slated this month

The Defense Communications Agency this month hopes to begin laboratory and hot-line testing of systems for transmitting voice signals digitally. Even if the tests prove successful, though, DCA officials aren't optimistic about putting the systems into operation. Explains one: "There's a dollar problem." The DCA originally had hoped to launch the four-month test program last summer [Electronics, May 13, 1968, p. 30], but the startup was postponed because the agency couldn't get telephone lines from Ma Bell.

One line will link a DCA station in Maryland with Communications & Systems Inc., the Washington, D.C., contractor running the tests, while another will tie the station to the firm's Huntsville facility.

DCA will evaluate systems bought from Radiation Inc., Philco-Ford, and Honeywell in the automatic secure voice communications (Auto-sevocom) section of the agency's Autovon network.

FCC jobs look safe for top 6 appointees

Although under pressure to make some changes, President-elect Richard Nixon will probably retain all six top staff members of the Federal Communications Commission. Three of the six are Democrats: Max D. Paglin, FCC executive director; Henry Geller, general counsel; and Bernard Strassburg, chief of the Common Carrier Bureau. All are long time employees of the FCC. Geller and Strassburg, known as liberals, have been influential in getting the FCC to open up the Bell Telephone System to foreign attachments, through the Carterphone case.

Navy will study standard packaging

The Naval Electronics Systems Command is about to award a contract for a wide-ranging study of standardization in electronics packaging. The 12-month project, which will cover everything from the plug-in circuit board to six-foot enclosures for use aboard ship, is to produce a document advising Navy program managers of the advantages of standardization and apprising them of parts and components already in use that might be chosen over newer proprietary gear. Ideally, the study could save the Navy time and money on electronics parts by reducing inventory and purchasing problems.

Although the prime object is a look at mechanical standardization, the study will also investigate functional standardization, as with the standard hardware program [Electronics, April 15, 1968, p. 171]. The study contract includes a provision that the contractor will have to give several months of presentations on his findings "to sell them to various parts of the Navy," says one spokesman.

Addendum

Signals were mixed when the Air Force finally got the go-ahead to move into contract definition with Awacs [Electronics, Dec. 23, p. 48]. The Air Force Systems Command will select either Boeing or McDonnell-Douglas to build the flying command post late next fall, not late next spring as the service first indicated.

Sorensen modular power supplies

± 0.005% regulation **\$8900**

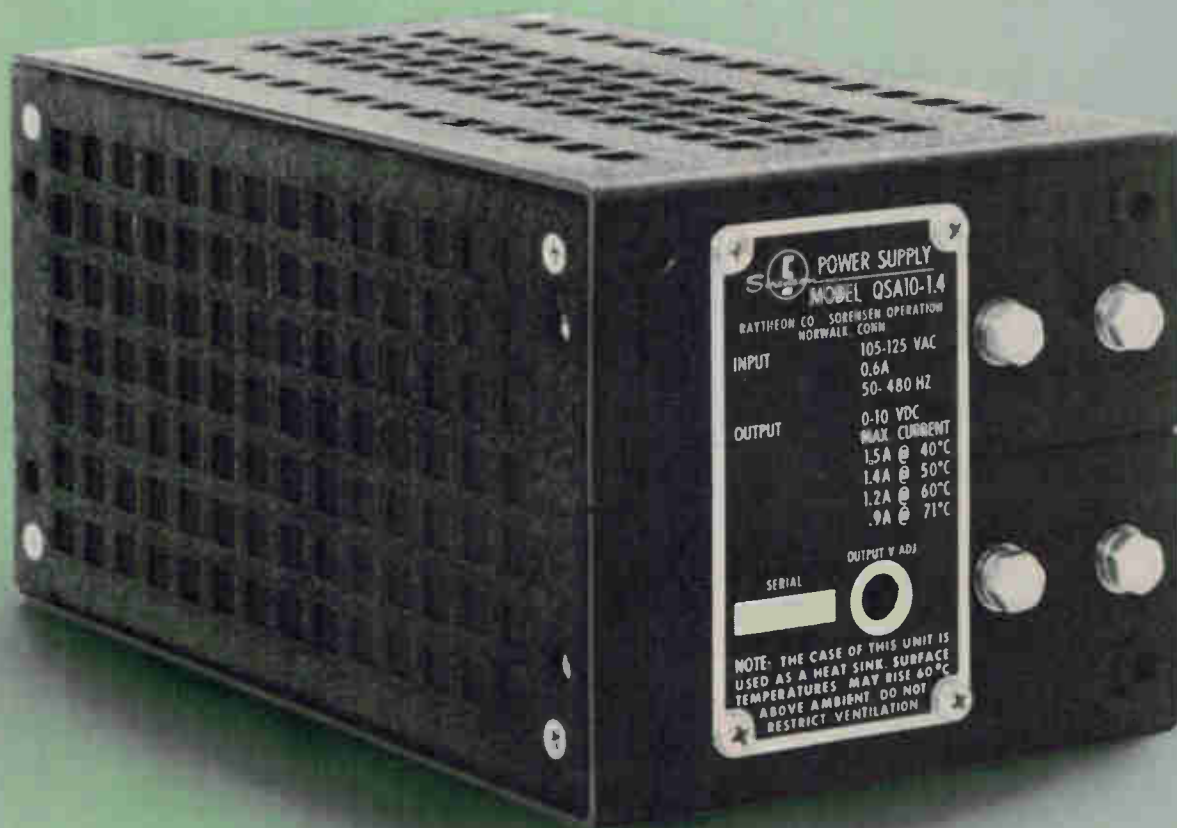

Optional 10 μ sec. overvoltage protection. Requires no external heat sink in ambients to 71° C. 29 models—voltages to 330 Vdc at power levels to 300 watts. Remote programming—remote sensing—series/parallel operation. Overload and short circuit protection. Meets military specifications.

Model QSA 10-1.4, shown actual size, illustrates the compactness of the Sorensen QSA Series. These laboratory-grade, precision power sources are designed for OEM or system applications and utilize the latest solid-state regulating technology to provide a high degree of regulation and stability.

Sorensen produces 29 wide-range models, each with optional overvoltage protection. Other manufacturers require more than 100 models to cover the same area. By producing and stocking fewer models, Sorensen is able to provide better specifications, higher reliability, lower prices and "same-day shipments."

For more information contact your local Sorensen representative or; Raytheon Company, Sorensen Operation, Richards Ave., Norwalk, Conn. 06856. Tel.: 203-838-6571; TWX: 710-468-2940; TELEX: 96-5953.



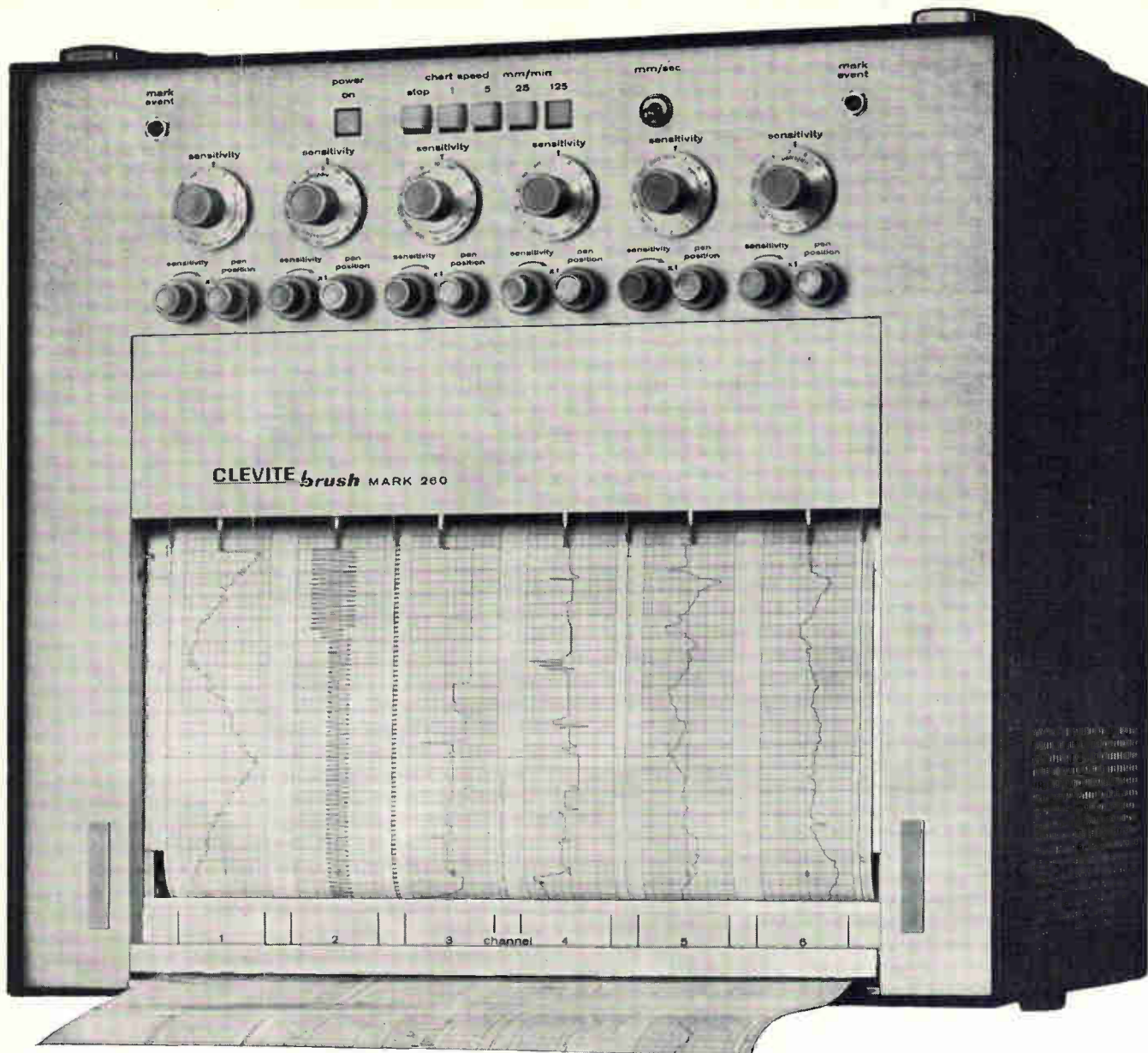

The Mark 260 tells it like it is.

That's because we've taken the fooling out of recording. This high-performance six-channel portable delivers more fact and less fiction than any other make you can buy.

The Mark 260 eliminates the things that can fool you. First, it's accurate — better than 99.5% accurate. It's the only recorder of its type with a foolproof *position feedback* system that enforces accuracy regardless of the pen's position on the chart. Second, its resolution is fully equal to its accuracy. The Brush patented pressure-fluid writing system produces thin, sharply defined traces that cannot smudge and cannot be misread. No fooling about exact reading of point-to-point values; no fooling about even the most complex wave-forms.

And no fooling with recalibration every time you change a setting. Calibration is factory fixed, drift free and constant — no matter how often you change your mode of recording. You can be certain your data is valid . . . you save time and

chart paper. Just plug it in, set it up, and you're in business. No fooling.

Six analog channels and four event channels in a package you can carry and use anywhere. Performance that's better than many recorders twice its size . . . and twice as expensive. That's what the Mark 260 delivers.

More fact and less fooling.

We'd like to send you sample charts that "tell it like it is"— or better yet, demonstrate the Mark 260 right in your plant. Write Clevite Corporation, Brush Instruments Division, 37th and Perkins, Cleveland, Ohio 44114.

CLEVITE BRUSH



The product improvers.

Improved N-channel FET choppers from TI feature lower capacitances for reduced feedthrough plus faster chopping and switching.

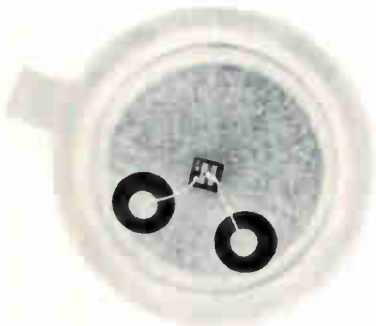

Here's the new look in FET chopper transistors from TI. A new design gives significantly lower C_{iss} and C_{rss} .

These lower capacitances reduce feedthrough of the input signal into the output line. Faster chopping and switching are other results.

In addition to the improved 2N4856A-61A series, this family now includes 2N3970-72, 2N4091-93, and 2N4391-93 FETs, as well.

Use of any or all of these FET "product improvers" will mean big dividends for you...in upgraded performance and reduced costs.

You won't have to wait, either, because production quantities are immediately available.

So don't put off evaluation any longer. Call your TI sales engineer or distributor now. Or, for data sheets, write on your company letterhead to Texas Instruments Incorporated, P.O. Box 5012, MS 980-B Dallas, Texas 75222.

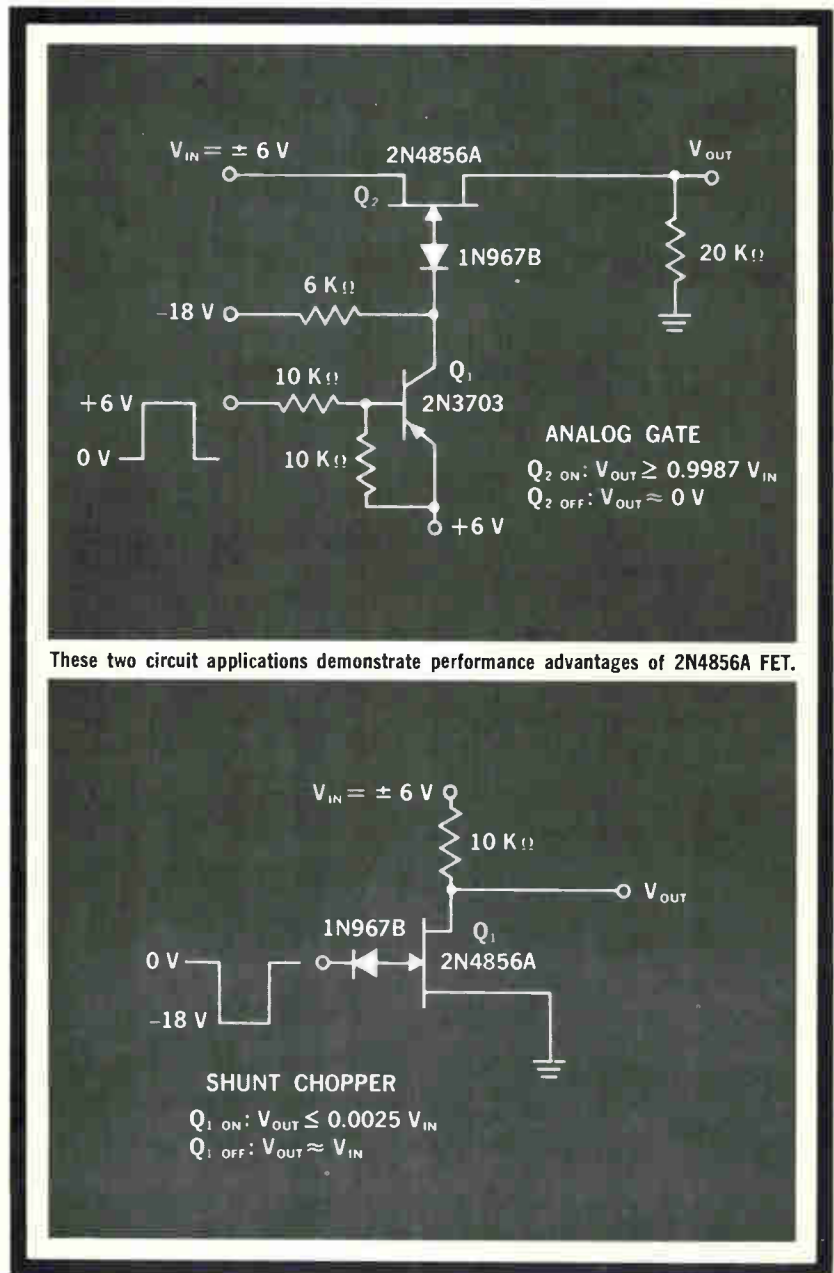

These two circuit applications demonstrate performance advantages of 2N4856A FET.

TEXAS INSTRUMENTS
 INCORPORATED

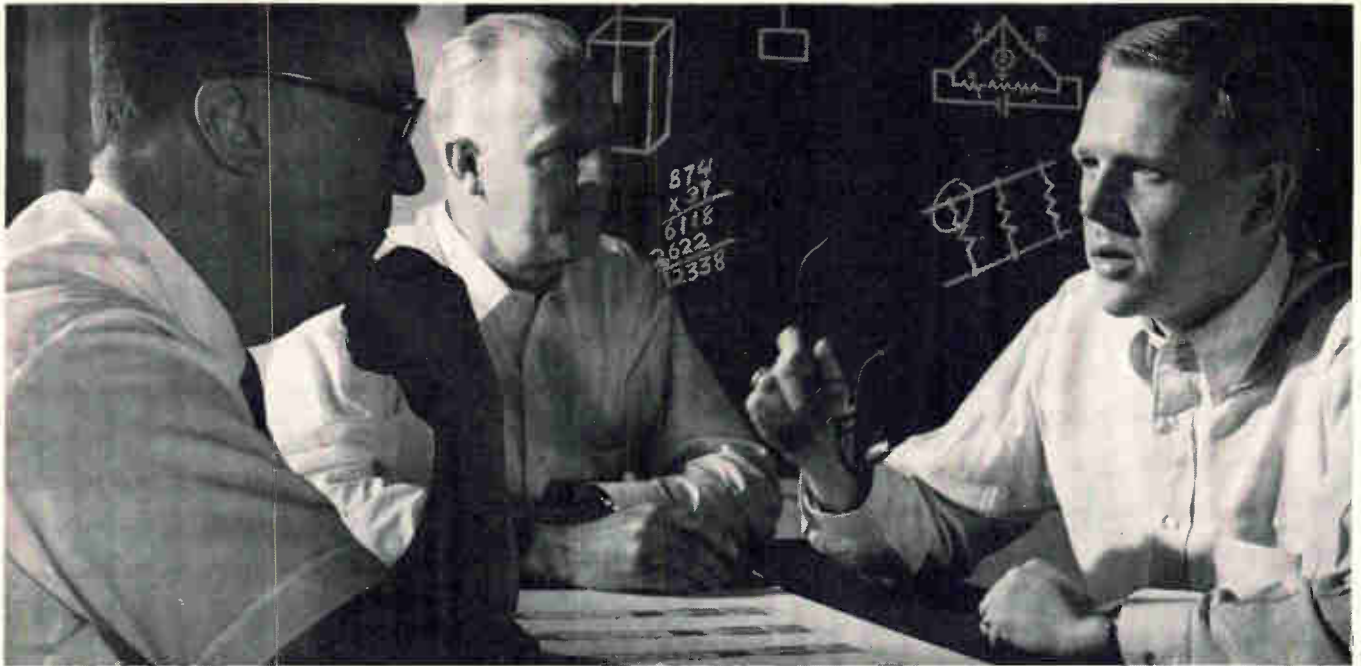

If "custom" instrumentation is the answer, call L&N.

Many measurement problems can't be solved with standard, off-the-shelf products alone. That's why Leeds & Northrup offers "instrumentation a la carte"—your particular measurement problem analyzed by our development engineers and solved with quality L&N products integrated into a facility tailored to your application. Some of our answers . . .

Cryogenic Calibration. Automatically measures resistance of four-lead resistance thermometers up to 2500 ohms and with a readability of 0.0001 ohm or six digits of resistance value. Provides a lighted digital display of the resistance values, as well as automatic digital printing of data.

Recorder Calibration. Consists of nine modules, each one contributing to the calibration of any recorder. Provides accuracy, sensitivity, impedance and resistance tolerances . . . common and differential mode rejection . . . transient response . . . chart-speed accuracy, etc.

Spectrometer Field Measuring. To determine magnetic fields in such applications as magnetic electron spectrometer coils. Consists of a six-dial potentiometer facility combined with a special Grade A manganin shunt immersed in a $\pm 0.001^\circ\text{C}$ constancy temperature bath.

What measurement instrumentation, not generally available, do you require? Tell us. Leeds & Northrup, North Wales, Pa. 19454. We're not just handing you a line.

(Some of our answers.)



LEEDS & NORTHRUP
Pioneers in Precision
 Subsidiaries in Canada, Mexico, England, Italy, Australia.
 Agents throughout the world.

READY NOW

new 5TH EDITION of this world-famous reference:

now contains 50% MORE DATA to include major information developed over the past 12 years. Prepared by an outstanding group of practicing engineers, professors, and industry and government experts, under the direction of the International Telephone and Telegraph Corporation staff.

**OVER 160,000 COPIES SOLD
IN THE FOURTH EDITION**

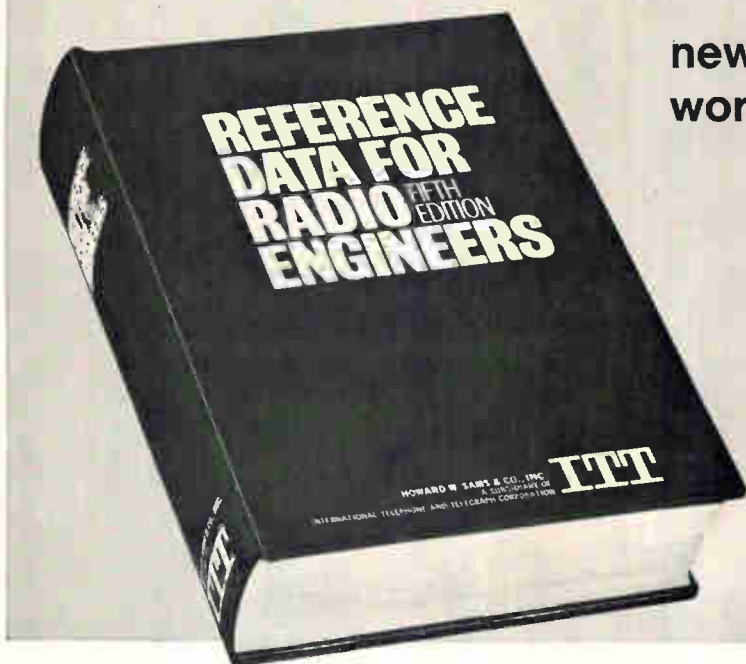

Reference Data for Radio Engineers

CHAPTER CONTENTS

Frequency Data	Transmission Lines
*International Telecommunication Recommendations	Waveguides and Resonators
Units, Constants, and Conversion Factors	Scattering Matrices
Properties of Materials	Antennas
Components or Parts	Electromagnetic-Wave Propagation
Fundamentals of Networks	Radio Noise and Interference
Filters, Image-Parameter Design	Broadcasting and Recording
Filters, Modern-Network-Theory Design	Radar Fundamentals
Filters, Simple Bandpass Design	Wire Transmission
Attenuators	*Switching Networks and Traffic Concepts
Bridges and Impedance Measurements	Digital Computers
Magnetic-Core Transformers and Reactors	*Navigation Aids
Rectifiers and Filters	*Space Communications
Magnetic Amplifiers	Electroacoustics
Feedback Control Systems	Nuclear Physics
Electron Tubes	*Quantum Electronics
Electron-Tube Circuits	Information Theory
Semiconductors and Transistors	Probability and Statistics
Transistor Circuits	*Reliability and Life Testing
*Microminiature Electronics	Miscellaneous Data
Modulation	Fourier Waveform Analysis
	Maxwell's Equations
	Mathematical Equations
	Mathematical Tables

*New chapters on subjects not covered in 4th Edition

1138 PAGES • 1350 ILLUSTRATIONS
plus 41 page index

The new FIFTH EDITION of this widely used reference work has been completely revised and updated. It provides in a single volume comprehensive data on all basic phases of electronics, including tables, formulas, standards, and circuit information—PLUS—all-new data on microminiature electronics, space communications, navigation aids, reliability and life testing, international telecommunication recommendations, switching networks and traffic concepts, and quantum electronics. Includes over 1300 charts, nomographs, diagrams, tables, and illustrations. 45 data-packed chapters. 1138 pages of invaluable information for practicing radio and electronics engineers.

10-Day Free Examination

HOWARD W. SAMS & CO., INC., Dept. EL-1
A Subsidiary of International Telephone and Telegraph Corporation
4300 West 62nd Street, Indianapolis, Ind. 46268

Send me REFERENCE DATA FOR RADIO ENGINEERS for 10-day examination, without cost or obligation.

If I decide to keep the volume, I will send: \$20.00 (plus postage), or \$7.00 (plus postage) in 10 days, and \$6.50 per month for 2 months. Otherwise, I will return the book postpaid within 10 days.
 \$20 payment enclosed. Send my copy postpaid with full 10-day refund privilege. (Include sales tax where applicable.)

Name _____

Company Name _____

Address _____

City _____

State _____

Zip _____

the Least Expensive Expert in the Lab

MIDWESTERN'S MODEL 801 OSCILLOGRAPH is the most logical addition to your data acquisition team, because it provides **total recall** of unerring accuracy in a tangible form and gives you **more features and options at a lower cost** than either of its nearest "competitors" — CEC's Model 5-124 or Honeywell's Model 1508.

Only Midwestern offers you so much instrument for the money:
8-inch chart • 8 to 36 channels • 10 speeds to 128 ips • mercury or xenon lamp • internal damping board • four interval timing • 115 VAC/60 cycle and 220 VAC/50 cycle power • frequency response to 20 KHz • modular construction • optional take-up unit with heated platen.

To add an expert, with no increase in payroll, contact your nearest **Midwestern Instruments** representative... he'll send a graduate from **MI/T.***

*Midwestern Instruments/Telex

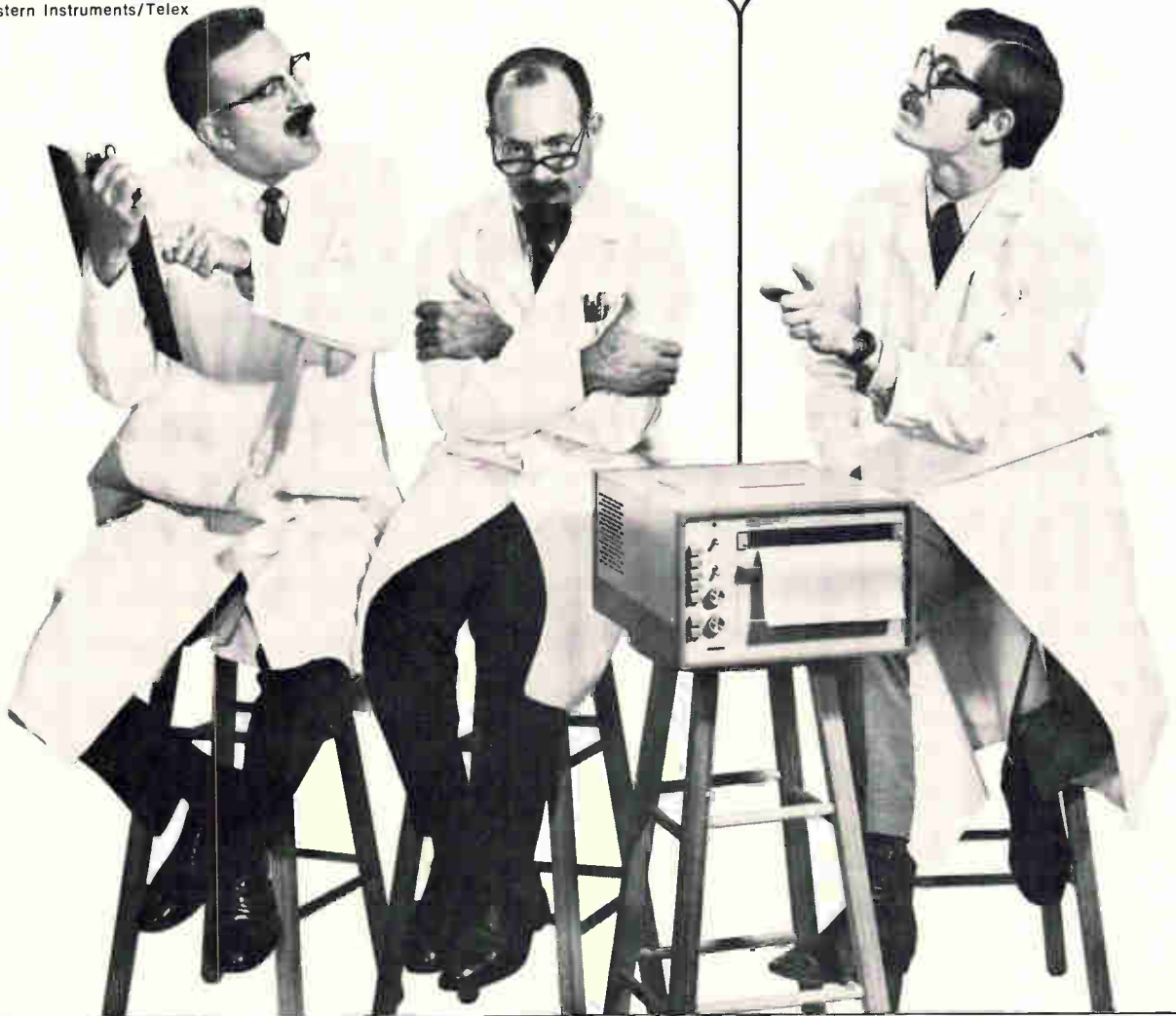

FREE LITERATURE
ON REQUEST

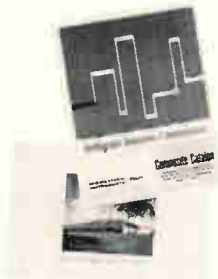

**MIDWESTERN
INSTRUMENTS / TELEX**

A DIVISION OF THE TELEX CORPORATION
6422 E. 41ST STREET TULSA, OKLAHOMA 74135
PHONE 918-627-1111 TWX 918-627-6030 TELEX 49-2489

General Electric introduces a faster, more convenient and less costly technique for production line encapsulating and potting. And the RTV's used in the process are as tough as any previously available.

Called the RTV-800 series, the new liquid silicone rubbers do not need a catalyst to activate them, so no premixing is needed.

They cure at temperatures ranging from 200°F to 450°F, so pot life is far longer than is customary with RTV's. A typical deep section cure would be one hour at 300°F. For really rapid cure, components can be preheated and dipped into the RTV.

These three new products are supplied in both opaque and clear grades, with viscosities ranging from very pourable to pourable. They can be blended with one another to suit your particular encapsulating job.

For more information about these new encapsulating RTV silicones (they also make good short-run molding-

materials), write Section 300, Silicone Products Dept., General Electric Company, Waterford, N.Y. 12188.

TYPICAL PROPERTIES

Uncured	RTV-815	RTV-830	RTV-835
Color	Clear	Beige	Beige
Consistency	Easily pourable	Pourable	Easily pourable
Viscosity, cps	3500	200,000	8000
Specific Gravity	1.02	1.28	1.18
Solids, %	100	100	100
Shelf Life, months	4	4	4
Cured, ± 1 hr. @ 150°C	RTV-815	RTV-830	RTV-835
Hardness, Shore A durometer	35	50	35
Tensile Strength, psi	700	800	500
Elongation, %	150	250	200
Tear Strength, lb/in.	15	100	20

GENERAL  ELECTRIC

**Now. Heat-curing,
no-mixing, high-strength
RTV silicones.**

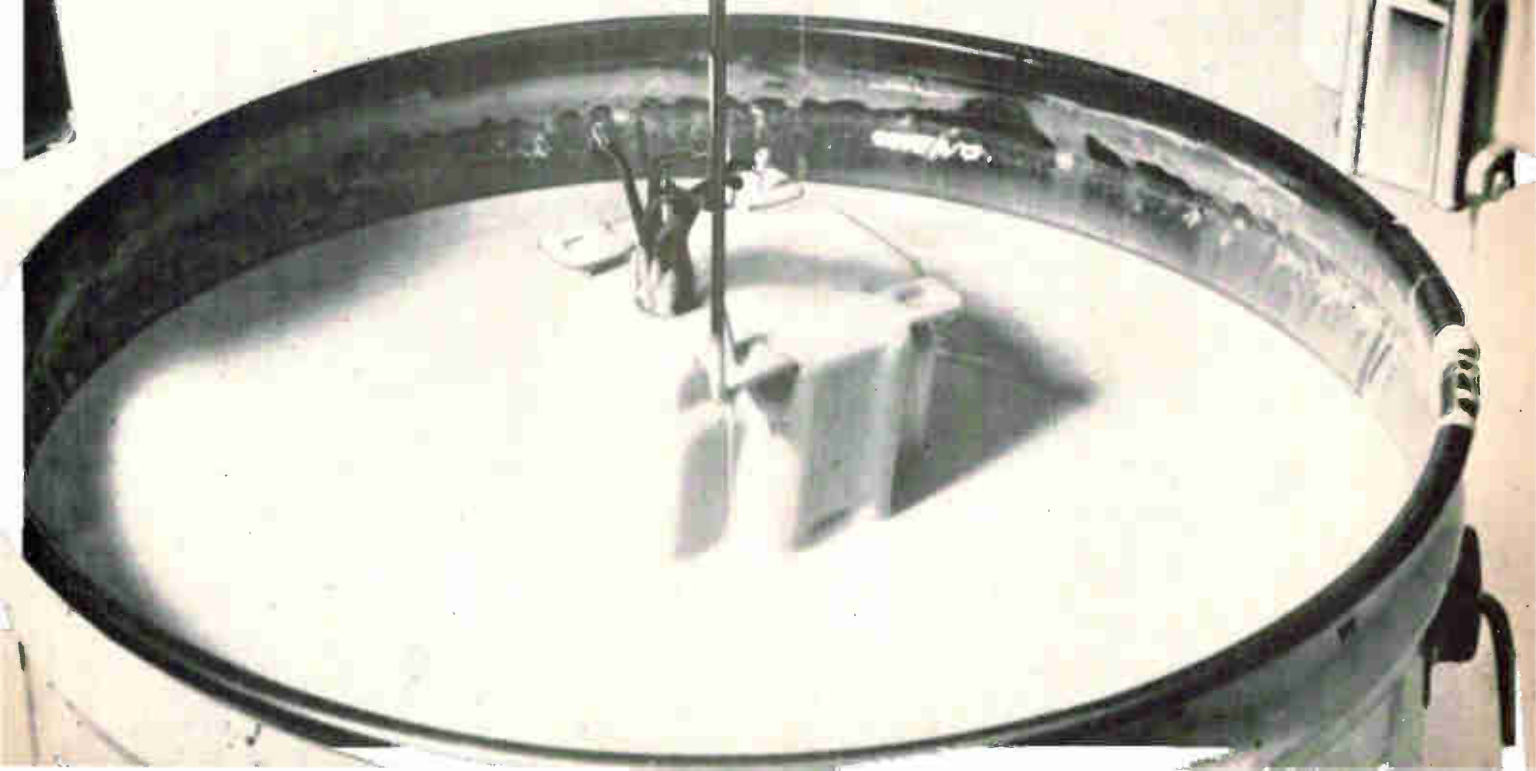

Autonetics plays a vital role in three of the nation's most important defense programs. Here are two of them.

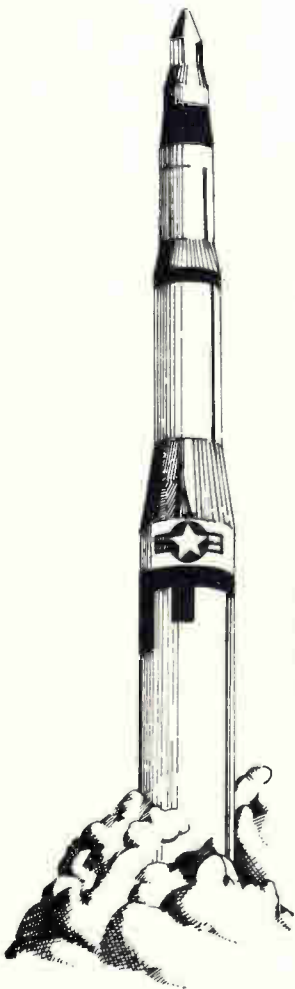

Take the advanced avionics systems we developed for the F-111D and FB-111A aircraft. They're acknowledged to be the most advanced airborne systems around. They give F-111 crews electronic tools never before available to pilots. Yet, with no sacrifice in performance, they fulfill all of the less spectacular (but equally important) requirements established jointly with the Air Force. Major sub-systems are made up of plug-in modules for uncomplicated field replacement. Computer capacity reserve is uncommitted so that future requirements can be accommodated without major retrofiting. There's even an onboard recorder that "remembers" any system malfunction for later use by ground crews. This is a lot of system.



The guidance systems we designed for Minuteman II and III had a tough act to follow. Minuteman I. It's our country's first major weapon system to use microelectronics. Therefore, it weighs less, uses less space but it's more accurate. It has enough additional computer capacity to perform most of its own check-out, simplifying silo test stand requirements. And, it's one of the most reliable weapon systems ever produced. Autonetics is the Air Force's associate prime contractor for guidance and controls. The third?

It's Ships Inertial Navigation System (SINS)—for the Navy's Polaris-Poseidon program—more about this later.

For more information write: Autonetics, 3370 Miraloma Avenue, Anaheim, California 92803.



Autonetics

Division of North American Rockwell

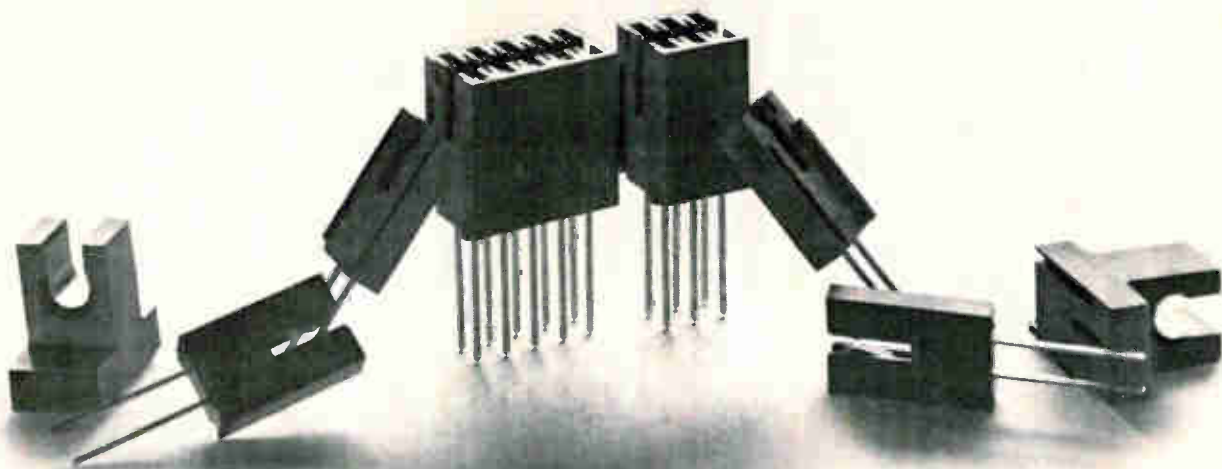

When you make a connector like this, it pays to give it away.

That's exactly what we are doing because it's such a handy design tool.

Sylvania's segmented connector gives you a building block approach to breadboarding and prototyping.

It allows you to build up exactly the single-position circuit-board connector to fit your job.

Just put together as many segments as you need.

Use it for actual circuit wiring and for mechanical layout.

When you have your final design, call Sylvania for fast production on connectors that will meet your exact specifications.

That way, you will get the benefits of Sylvania's long experience in custom connectors. Such benefits as our special gold-dot contact design that minimizes contact resistance and lowers cost.

You also get Sylvania's precision construction that puts connector terminals exactly where they're needed for programmed wiring systems.

For your own do-it-yourself connector design kit write on your letterhead to M. Gustafson, Product Manager, 12 Second Ave., Warren, Pa. 16365. Your kit will be sent by return mail. As a bonus, we'll throw in data sheets on our new off-the-shelf connector line.

CONNECTORS BY
SYLVANIA
GENERAL TELEPHONE & ELECTRONICS

At last, an IC tester that even a company president can use.



It's the new Signetics Model 1100 Integrated Circuit tester series. Never before have such simple-to-use machines performed such complex functions in the hands of a totally unskilled operator (company presidents do forget). In fact, the 1100's were designed to be the most compact, comprehensive, inexpensive, easy to use, production-oriented IC testers on the market. And that's just what they are.

You simply select and insert a single program board, plug in the IC and punch the test button. Instantly, you get complete "go-no-go" assurance, including AC performance capability. With just

a few minutes training, incoming inspection or production personnel can test 5 to 10,000 IC's per day (that's over 2 million per year). On the other hand, engineers can completely test single IC's in seconds. Prices start at \$3,795. See below for information or a demonstration. And if you're a company president, we'll throw in a box of cigars.

SG SIGNETICS CORPORATION
MEASUREMENT/DATA
A subsidiary of Corning Glass Works

For detailed information or a demonstration write Signetics, Measurement/Data, 811 E. Arques Ave., Sunnyvale, Calif. 94086, or contact one of the following:

AUTHORIZED SIGNETICS REPRESENTATIVES (Measurement/Data) Alabama and Tennessee Col-Ins.-Co., Inc. Huntsville (205) 539-1771 California L and M Engineering, Inc. Inglewood (213) 678 5409; Santa Clara (408) 243-6661 Connecticut Datch Associates, Inc. New Haven (203) 524-7291 District of Columbia (see Silver Spring, Maryland) Florida Col-Ins.-Co., Inc., Orlando (305) 423-7615 Georgia Col-Ins.-Co., Inc., Marietta (404) 422-8327 Illinois Carter Electronics, Inc., Chicago (312) 776-1601 Indiana Carter Electronics, Inc., Indianapolis (317) 293-0696 Maryland OED Electronics, Inc., Silver Spring (301) 588-8134 Massachusetts Datch Associates, Inc., Newtonville (617) 527-5394 Minnesota Carter Electronics, Inc., Minneapolis (612) 869-3261 Mississippi/Louisiana Col-Ins.-Co., Inc., St. Louis (504) 833-1116 New Jersey OED Electronics, Inc., Camden (215) 925-8711 New York OED Electronics, Inc., Mt. Vernon (914) 968-2200 J. A. Reagan Co., Inc., Albany (518) 489-4777; Binghamton (607) 723-9661; Newburgh (914) 561-4510; Syracuse (315) 471-7274; Utica (315) 732-3775; Rochester (716) 473-2115 North Carolina Col-Ins.-Co., Inc., Winston-Salem (919) 765-3650 Ohio WKM Associates, Inc., Cleveland (216) 485-5616; Dayton (573) 434-7500 Pennsylvania WKM Associates, Inc., Pittsburgh (412) 892-2953 Michigan WKM Associates, Inc., Detroit (313) 892-2500

A hand is shown holding a stack of several logic cards against a background of a cloudy sky. The cards are dark green or black with intricate white circuit patterns and various components. Some cards have labels like 'BIN/BCD COUNTER' and 'CONTROL LOGIC'. The cards are stacked in a way that they appear to be building up a structure, similar to the 'mountains' mentioned in the text.

You could build mountains out of our logic cards... if you had to

We've got that many. And you could build different kinds of mountains, too.

We've got just that product line versatility. Build T²L SUHL I mountains, or T²L SUHL II mountains, or DTL mountains, or 7400 T²L mountains. We can supply enough for you to go as high as you want. And building mountains is a nice way to look at how our micrologic circuit cards are applied. But if you don't want to think in terms of mountains, you can build mole hills, too.

For more information, write or call:

 **CONTROL LOGIC, INC.** 3 Strathmore Road
Natick, Massachusetts 01760 / Tel: (617) 235-1865

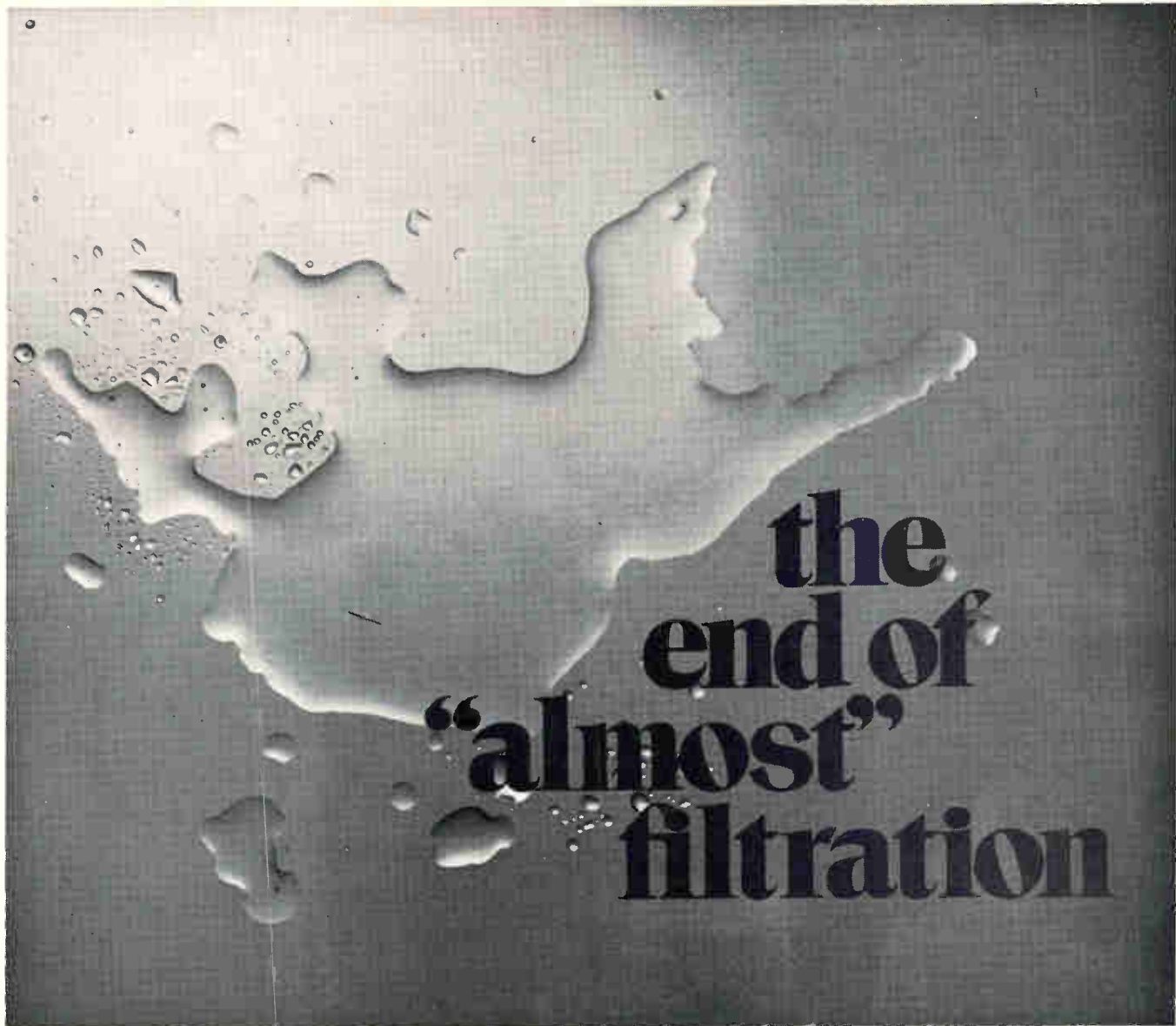

the end of “almost” filtration

You can *almost* remove every particle or microorganism larger than a specific size from fluids with “depth” filters. But the few that sneak through can ruin product quality. So can the many which may be dumped when a depth filter is shocked. And the microorganisms which can grow through. And the pieces of filter material which can break off and contaminate a filtrate.

Millipore filters remove every particle or microorganism larger than specific filter pore size — as small as 0.22 micron. They

have an *absolute* rating — no depth about it. And they contain no fibers or particles to work loose and contaminate a filtrate.

Now Millipore systems (including “depth” filters for *prefiltration*) make *absolute* filtration possible and practical in many industrial applications where a high degree of cleanliness is required.

In electronic production they are *increasing yields* by:

- providing 18 megohm rinse water free of particles to an *absolute* level of 0.45 micron.
- removing *all* particles larger than 1 micron from gases used for purging and drying.
- removing *all* particles from photo resists to sub-micron levels.
- removing *all* particles from coating solutions and wash water for cathode ray tubes.
- removing *all* particles from developers for I.C. masks to sub-micron levels.

Find out how you can put an end to “almost” filtration. Start now by writing for the Millipore Electronic Production Application Guide. Millipore Corporation, Bedford, Mass. 01730.

MILLIPORE

systems for analyzing and processing fluids

From the Leader in Epitaxial Reactors and Cold Wall Furnaces



Only Hugle Industries offers you this large range of models, then makes them available in either semi-automated or fully automated modes. The automatic units feature our exclusive HI integrated circuit process controller. Soft-ware and installation are furnished free with these models.

Choose the model and mode that suits your operation.

HIER I	14-1" wafers or 4-2" wafers	HIER IV	60-1" wafers or 12-2" wafers
HIER II	25-1" wafers or 4-2" wafers	HIER VI	85-1" wafers or 18-2" wafers
HIER III (Thin Film)	14-1" wafers or 4-2" wafers	HIER VII	108-1" wafers or 27-2" wafers

And Our Newest Addition . . . EPI GRANDE (Barrel) 140-1" wafers or 40-2" wafers

Other Hugle Industries' products include: Diffusion Doping Systems D100 Series Epitaxial Doping Systems Model 100 Infrared Microscope Model 1300 Ultrasonic Wire Bonder Model 1400 Beam Lead Bonder Model 2000 Flip Chip Bonder PCD Process Controller.

Call Mr. Dave Davis, Marketing Manager, at (408) 738-1700 for further information.



HUGLE Industries

750 NORTH PASTORIA AVENUE

SUNNYVALE, CALIFORNIA 94086

Got a reference preference?

Looking for a keener Zener?

CALL TRANSITRON, WHERE THE DIODE ACTION IS

Zener Diodes

- Power ratings from 125mW to 50W
- Zener voltages from 2.4V to 200V
- Industrial & military tolerances
- Hundreds of types in stock for fast delivery

Temperature-compensated Reference Diodes

- Temperature coefficient to $\pm 0.0002\%/^{\circ}\text{C}$
- Available in voltages: 6.2, 8.4, 9.0, 11.7, 12.6, 19.0
- Inherent low noise operation
- Industrial and military temperature ranges

Certified Voltage References

- (Guaranteed voltage stability for 1000 hours)
- Stabilities to within $\pm 5\text{ppm}$

Get the Diode facts

Send for this handy new Zener and reference diode selection guide

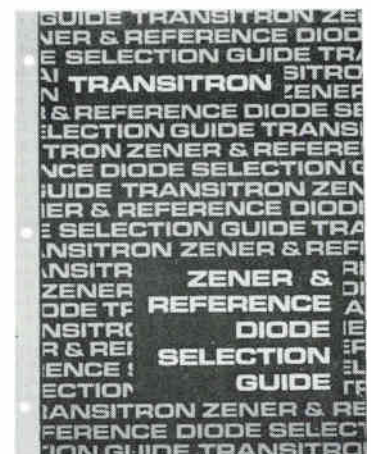

Transitron
electronic corporation
168 Albion Street, Wakefield, Mass. 01880, Tel: 245-4500

Bolt a new METERMATE to any panel meter

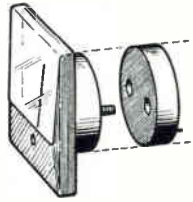

- ... it's a single-ended D.C. voltmeter
- ... it's a high impedance differential voltmeter
- ... it's a log scale D.C. voltmeter
- ... it's a log ratiometer D.C. voltmeter
- ... it's a "you-name-it-we've-got-it" meter

Now standard panel meters read voltage at high source impedances. METERMATES for various functions mount flush at the rear of the meter and fit within the length of the meter terminals — take no extra space, install easily. Ranges are altered simply by changing one external resistor value.

METERMATES are available as individual units or with companion meters in a complete selection of types and ranges. Call your Philbrick/Nexus sales representative for complete specifications, prices and applications assistance. Or write, Philbrick/Nexus Research, 22 Allied Drive at Route 128, Dedham, Massachusetts 02026.



PHILBRICK/NEXUS RESEARCH

A TELEDYNE COMPANY

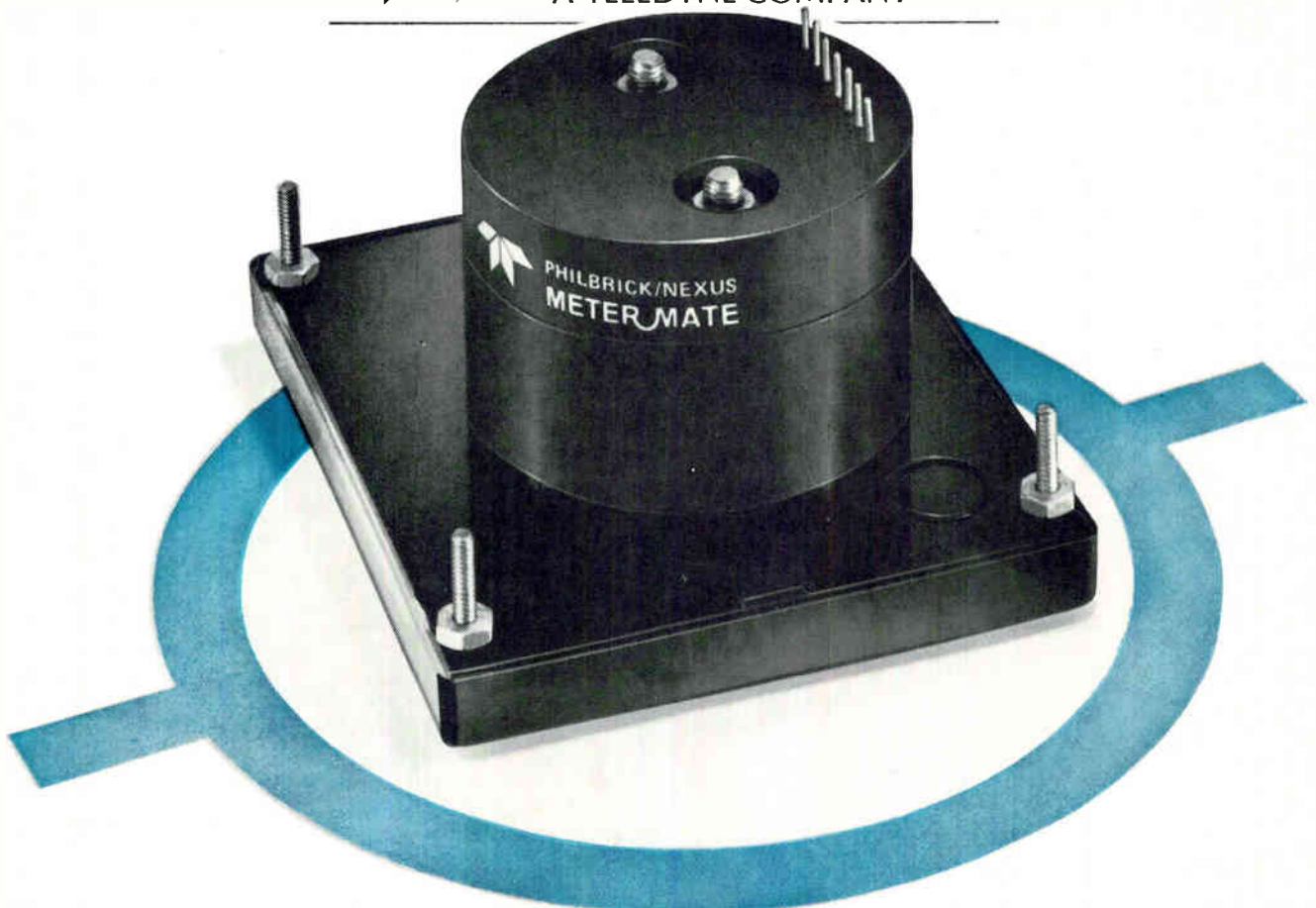

COMPLETE and COMPACT

CEI's NEW MODEL 112

MICROWAVE RECEIVER

- CEI's first complete, single unit microwave receiver with modular tuning heads installed with simple hand tools.
- Receives AM, FM and pulse signals.
- Compact. Fits in a standard 19-inch rack. Only 3 1/2 inches high.
- 4 tuning heads. Cover 1 to 2 GHz, 2 to 4 GHz, 4 to 8 GHz and 8 to 12 GHz. An optional head is available to cover 2 to 4.5 GHz.
- 5 IF bandwidths: 100 kHz, 10 MHz, 20 MHz, and choice of 500 kHz and 1 MHz or 2 and 4 MHz.
- 2 IF outputs: 21.4 MHz and 160 MHz for both wide and narrow band external monitoring.

WATKINS JOHNSON
wj CEI DIVISION
6006 Executive Boulevard
Rockville, Maryland 20852

World's largest selection of receiving equipment for surveillance, direction finding and countermeasures.

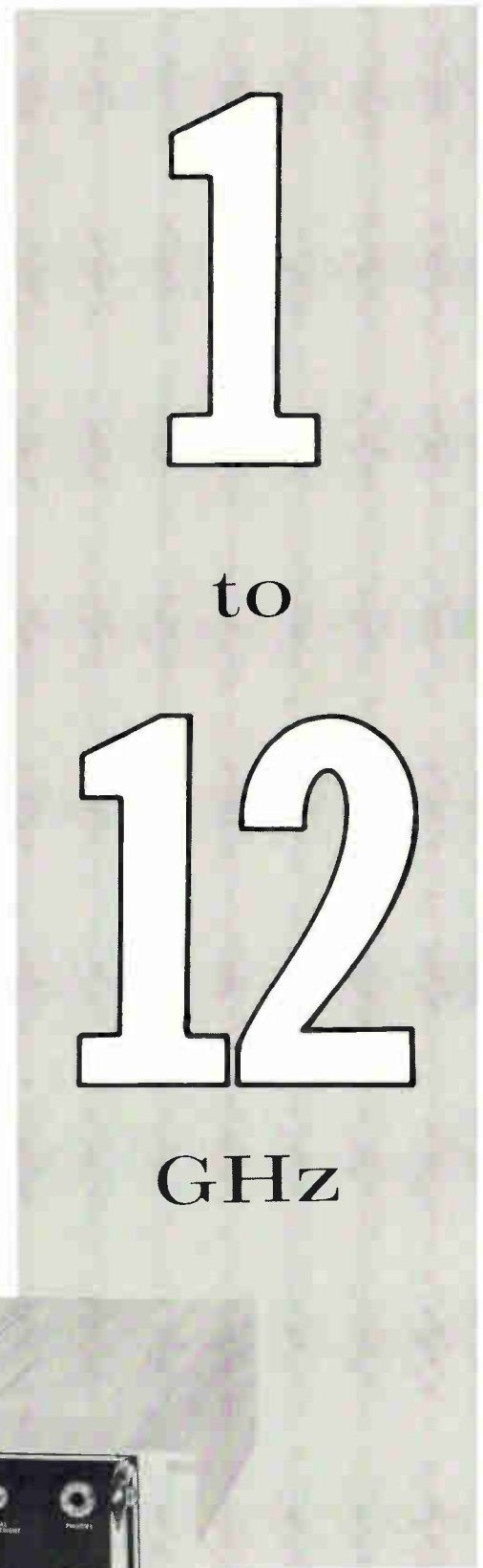

NOW...

from Solitron

RF SILICON POWER TRANSISTORS



RF power transistors are NOW immediately available from Solitron in TO-5, TO-60 and plastic stripline cases. These high reliability silicon devices include the popular 2N3375, 2N3632, 2N4440, 2N5090 and 2N5108. The operating frequency is 100MHz to 1.0GHz, power ratings from 13.5W @ 175 MHz to 1.0W @ 1.0 GHz.

Typical applications include Class A, B and C RF amplifiers, telemetry systems, mobile and airborne communications equipment, commercial and high reliability communications equipment, CATV operations and as RF power oscillators.

THE RF KITS SHOWN ON RIGHT ARE AVAILABLE FOR 175 MHz and 400 MHz OPERATION:

Dial 1-800-327-3243 for a "No Charge" telephone call and further information.

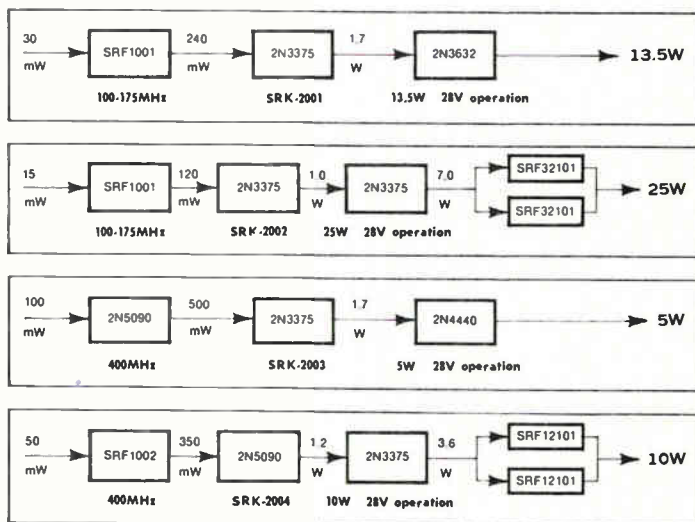

SEMICONDUCTOR DIVISION
Solitron **DEVICES, INC.**
 1177 BLUE HERON BLVD. / RIVIERA BEACH, FLORIDA / TWX: (510) 952-6676

hybrid microcircuits from the “total capability” source

There's a reason why Burroughs is a preferred source for hybrid microcircuits. It's TOTAL CAPABILITY. TOTAL CAPABILITY is the unique ingredient that keeps Burroughs ahead in hybrid circuit leadership and enables you to reduce system size with increased reliability.

Burroughs now offers the entire circuit package* and its components — all designed and fabricated under the eyes of experts in one complete in-house operation, providing economy, high reliability, quality control and prompt delivery.

■ Hermetic Packaging ■ MSI Capability ■ Computer Test Facility ■ Fully Documented to MIL-Q-9858A and MIL-I-45208

Buy your hybrid microcircuits NOW from Burroughs, and discover what Burroughs Total Capability can do for you.

*Call or write Burroughs Corporation, Electronic Components Division,
P.O. Box 1226, Dept. H1, Plainfield, New Jersey 07061.
Tel. (201) 757-5000, or contact your nearest Burroughs
representative or sales engineer.*

*Circuits are available in various configurations with resistors, capacitors, and discrete IC and MSI chips, mounted.

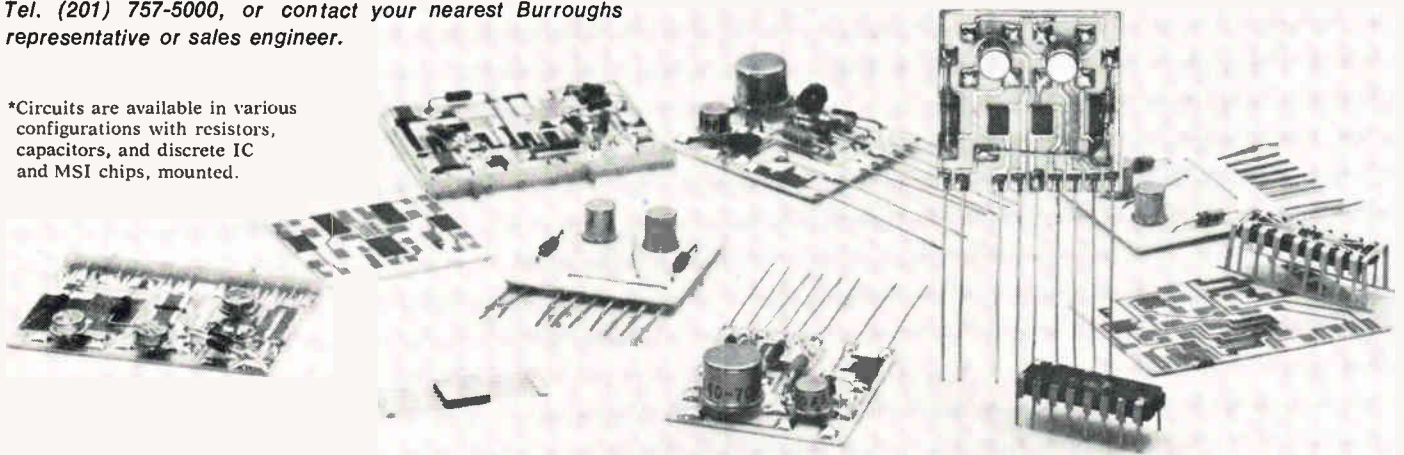

Burroughs 

January 6, 1969 | Highlights of this issue

Technical Articles

**Tuning up with
varactor diodes**
page 88

European radio and tv set manufacturers are rapidly converting to all-electronic tuning with varactor diodes. But American set producers haven't yet made the changeover, largely because the wider frequency range that must be covered here and our overcrowded spectrum pose severe cross-modulation and selectivity problems. Furthermore, suitable diodes are hard to come by. This article discusses—from a European viewpoint—some of the problems in selecting diodes, and recommends some practical approaches to designing electronic radio and tv tuners.

**Hybrid computer
takes over control**
page 98

Made up of conventional analog and logic modules, this system regulates the flow and pattern of water used to cool fast-moving hot-strip steel. The hybrid computer, which up to now has been a simulation and design tool, has thus graduated to industrial process control. An intriguing feature of this machine, which can also be used to control other types of industrial operations, is a hard-wired, logic-implemented matrix for selecting any one of several operating modes for the plant equipment.

Electronics markets: 1969
page 107
The new math of growth
page 111

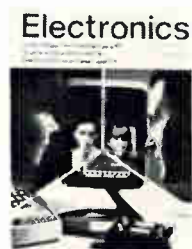

Industry revenue this year will advance at about the same pace it set in 1968. Electronics' annual market survey points to another 6.5% rise, this time to a total of \$25.3 billion. Although the war in Vietnam continues to hurt sales in several fields, another year of technical gains appears in store. Integrated circuits, for example, are coming on strong in more outlets, notably the industrial. And the computer field, which continues to grow at a dizzying pace, will get a further boost from improved peripheral gear. But despite earlier optimism, large-scale arrays are still several years away from commercial availability.

Coming

**IC technology
in Britain**

Articles in this special report on British advances in integrated-circuit design will cover such subjects as computer-generated interconnections, laser mask-making, multilayer techniques, and ion-implanted circuits.

Overcoming design problems in varactor-diode tuners

Pushbutton tv tuning—rapidly replacing mechanically variable capacitors in Western Europe—requires cancellation of stray capacitances and diode matching to improve reset accuracy

By Hans Keller

Intermetall, Deutsche ITT Industries GmbH, Freiburg, West Germany

Throughout Europe, varactor diodes are rapidly replacing variable capacitors as the main tuning element in radio and television sets. And set producers estimate that more than 50% of all tv sets made in 1969 will be tuned with these diodes. In the U.S., however, manufacturers have had trouble producing electronic tuners [see "The American way" at right].

Diode tuning can sharply increase design flexibility. For example, because the diodes require only a preset d-c voltage to select each channel, there's no mechanical link between the user's controls and the channel selector, so the tuner can be placed anywhere in the receiver.

And flexibility is only one of many advantages. The use of preset voltages improves tuning accuracy; fine-tuning isn't needed. And the technique makes it possible to easily design a set that can be remotely tuned, because no high-frequency voltages are present on the line between the tuning voltage trimmers and the diode circuitry. And, for sophisticated applications, wireless remote control can be easily achieved without costly motor-driven variable capacitors.

Rounding up the strays

Variable diodes are stable and virtually immune to temperature variations. They perform well in resonant circuits because of their large capacitance variation and high Q-factor. However, for best tracking throughout the tuning range, diodes with identical characteristics must be used. Manufacturers can usually supply diodes in matched pairs, triads, or quadruplets.

The most widely used method of providing the tuning voltage uses inexpensive trimming poten-

tiometers, individually preset, and a pushbutton switching unit to apply or remove the voltage.

In a typical diode-tuned parallel resonant circuit, on facing page, the tuning voltage is applied to the diode through inductance L and resistor R. Capacitor C_s completes the a-c circuit path. The tunable

The American way

U.S. producers of tv sets, led by RCA and Zenith, are reportedly racing to be first with a varactor diode-tuned set by spring. But of the four independent tuner suppliers—Standard Kollsman, Oak Electro/Netics, Sarkes Tarzian, and General Instrument—only Standard Kollsman and General Instrument have produced varactor-diode tuners. These are now being sampled by the set makers. RCA, for one, will soon use a similar tuner produced in-house.

Some of the difficulties in designing a suitable diode tuner for the domestic U.S. market are attributed to severe cross-modulation problems due to overcrowding of the tv spectrum, as well as the wide tuning range over which the diodes must track. As a result, selectivity requirements are critical. Although most European tv sets are equipped with only about four pushbuttons for the allocated stations, U.S. producers must include 12 buttons for the vhf channels and at least six more for the uhf channels. Switching thus becomes a major cost factor.

"One of our biggest problems," says Edward Midgley, engineering vice president of Standard Kollsman, "is getting suitable varactor diodes."

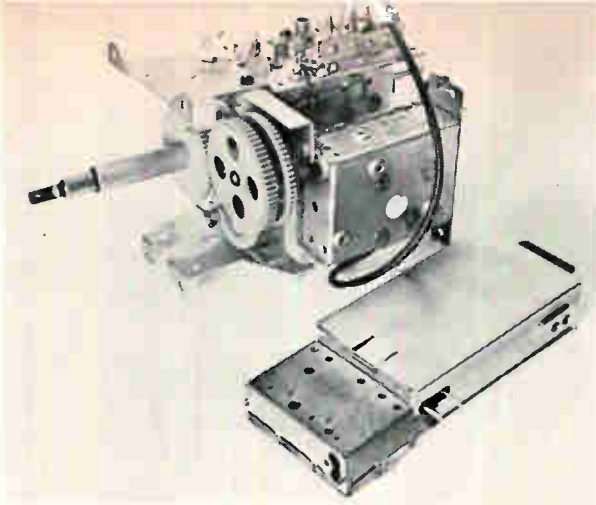

Small and simple. The all-channel varactor tv tuner from Standard Kollsman is far less complex than the conventional electromechanical uhf-vhf device.

frequency range of the circuit is determined by

$$V_f = \frac{f_{\max}}{f_{\min}} = \sqrt{\frac{1 + \frac{C_{\max}}{C_p \left(1 + \frac{C_{\max}}{C_s}\right)}}{1 + \frac{C_{\max}}{C_p \left(H + \frac{C_{\max}}{C_s}\right)}}$$

where C_s and C_p are, respectively, the series and parallel capacitances, and H is the capacitance variation coefficient, given by

$$H = \frac{C_{\max}}{C_{\min}} = \frac{C(V_{\min})}{C(V_{\max})}$$

Of course, there's always some additional shunt stray capacitance in the circuit, resulting from the coil winding and wire leads inductance. As the C_s value approaches infinity, the circuit tuning range becomes

$$V_f = \sqrt{\frac{1 + \frac{C_{\max}}{C_p}}{1 + \frac{C_{\max}}{H \cdot C_p}}}$$

In practice, however, the tunable frequency range, V_f , is known as part of the design problem, as is the approximate parallel capacitance, C_p . Therefore, the preceding equation can be rewritten as

$$C_{\max} = C_p \cdot \frac{V_f^2 - 1}{H - V_f^2}$$

The resistance, R , in series with the d-c tuning voltage, appears as a shunt across capacitor C_s .

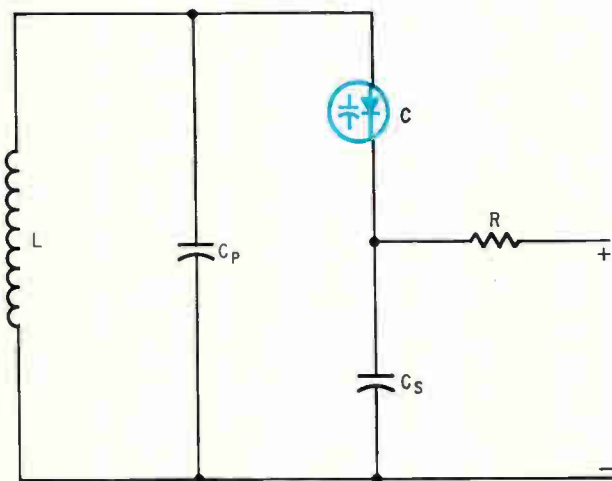

Diode tuning. The circuit's tunable frequency range depends on the diode's capacitance and variation coefficient and on assigned values of C_p and C_s .

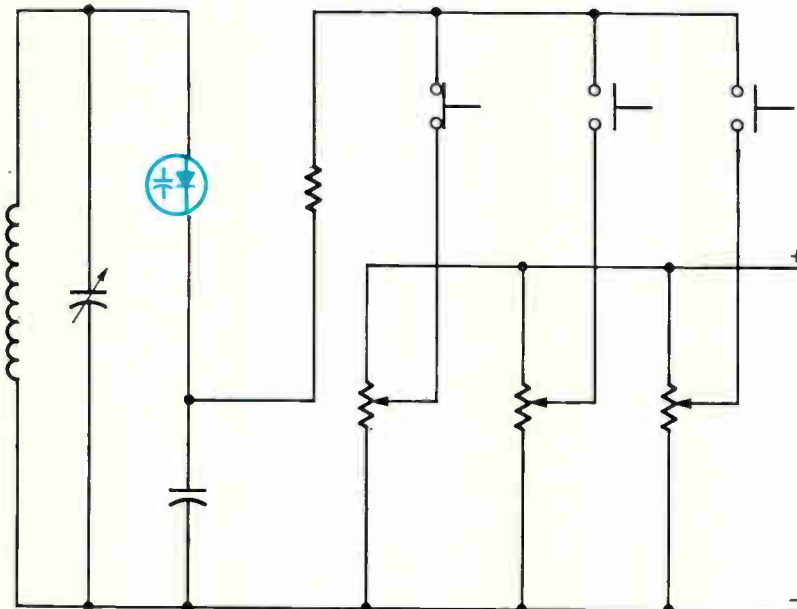

Pushbutton selector. Trimmer potentiometers are used with small pushbuttons to control the required preset voltages for station selection.

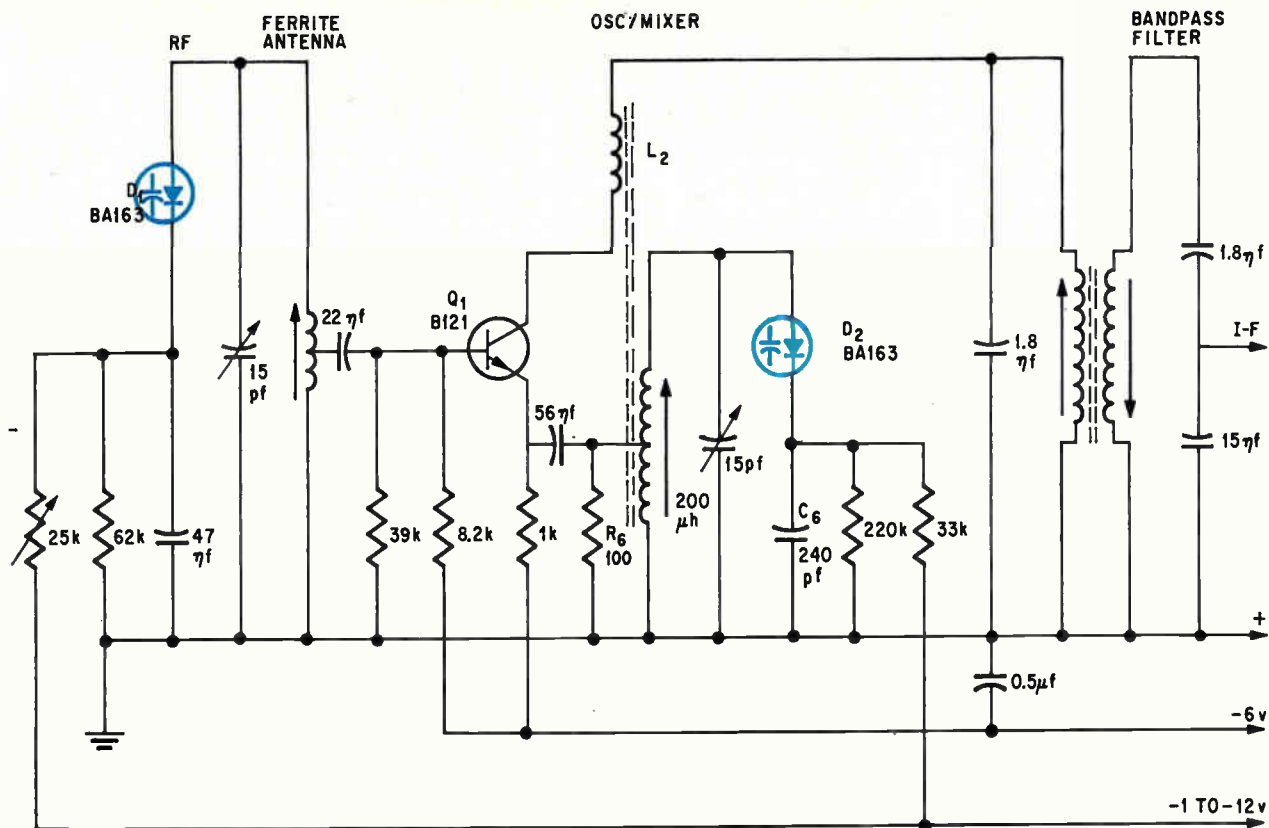

Broadcast band. Designed to cover the 510-to-1610-khz band, the input tank circuit of this a-m tuner has a loaded Q of approximately 180.

The over-all effect is that of an additional resistance in parallel with the tuned circuit. The value of this added resistance, R_x , can be calculated from

$$R_x = R \left(\frac{\omega^2 LC_s}{1 - \omega LC_p} \right)^2$$

From the formula, it can be seen that both the resonance resistance and the circuit bandwidth are frequency-dependent. Therefore, to minimize the effect of R_x , R and C_s must be made as large as possible.

Within practical limits, such a circuit can be adjusted to cover any desired tuning range by trimming the circuit inductance and parallel capacitance in the usual manner. If this doesn't work, the bias voltage can be adjusted.

The current through the resonant circuit will be more or less constant only if the size of the coil corresponds to the wavelength of the signal. But since the coil dimensions cannot be reduced at will, the circuit energy losses, caused by radiation and skin effect, will increase as the frequency goes up. The net result is that the Q factor of the circuit will be seriously reduced.

Saving energy

Energy losses from skin effect, which are high at frequencies above 300 megahertz, can be reduced by using an electrically shorted quarter-wavelength

coaxial line resonator instead of a standard coil. The resonator provides larger conducting surfaces, and the screening action of its outer conductor cuts down on energy losses due to radiation. The important parameters of the resonator are its line length, l , and the characteristic impedance, Z , with which it can be terminated without producing any reflection.

The tuning range for a quarter-wavelength coaxial line resonator is given by

$$V_f = \frac{\tan \frac{l \omega_{\min}}{C_o}}{\tan \frac{l \omega_{\max}}{C_o}} \cdot \frac{1 + \frac{C_{\max}}{C_p \left(1 + \frac{C_{\max}}{C_s} \right)}}{1 + \frac{C_{\max}}{C_p \left(H + \frac{C_{\max}}{C_s} \right)}}$$

where c_o is the velocity of light in the circuit dielectric.

Note that for a given frequency range the capacitance variation coefficient is minimum when the resonator line is made as short as possible and the characteristic impedance as large as possible. In this case the equations on page 89 can be used to design a quarter-wavelength resonator, with close approximation, for any frequency band.

Because the series inductance of the diode forms part of the line, the external circuit can be connected only through a tap on the coaxial line. The effective resonance resistance across the resona-

tor's terminals, therefore, becomes

$$R_p \approx \frac{1}{R_s} \left(\frac{1}{\omega C} + \frac{1}{\omega C_s} - \omega L_s \right)$$

To keep the resonance resistance as large as possible for any given value of C , R_s and L_s , a low-inductance capacitor, C_s , should be placed in series with the tuner diode. The value of this capacitor should be high enough so that the capacitance variation of the diode is just sufficient to cover the desired frequency range. Except for the precautions mentioned, the design and alignment of the coaxial line resonator are the same as for a resonant circuit using an inductance coil.

In designing a diode-tuned front end, the engineer must consider the capacitance variation coefficient and Q-factor of the diodes. The Q factor is determined by

$$Q = \frac{1}{\omega C R_s}$$

where $\omega = 2 \pi f$, C is the junction capacitance, and R_s is the diode's internal series resistance.

Varactor-diode manufacturers will supply, upon request, charts showing capacitance variation versus applied tuning voltage for each device.

Having established the receiver's tuning range and diode characteristics, the next step is to provide the tuning voltages. The typical method uses the circuit at the bottom of page 89.

Consider the front end of a radio set, below, designed to tune in the European medium-wave band (510 to 1,610 kilohertz). A standard 465-khz intermediate frequency is used. The circuit includes a tuned first stage with a ferrite rod antenna, a self-oscillating mixer and tuned oscillator, and a handpass output filter. The input tank circuit, which has the same configuration as that on page 89, is coupled through a tap on the coil to Q_1 's base. The precise location of the tap is important because it determines the power gain and noise level of the stage.

The unloaded Q of the tank circuit, which is about 180, depends largely on the resistive loss of the coil inductance, because the tuner diode D_2 has very low loss resistance. In the oscillator tank circuit the addition of padding capacitor C_6 limits the tuning range to ensure proper tracking of the oscillator and antenna circuits. The padder

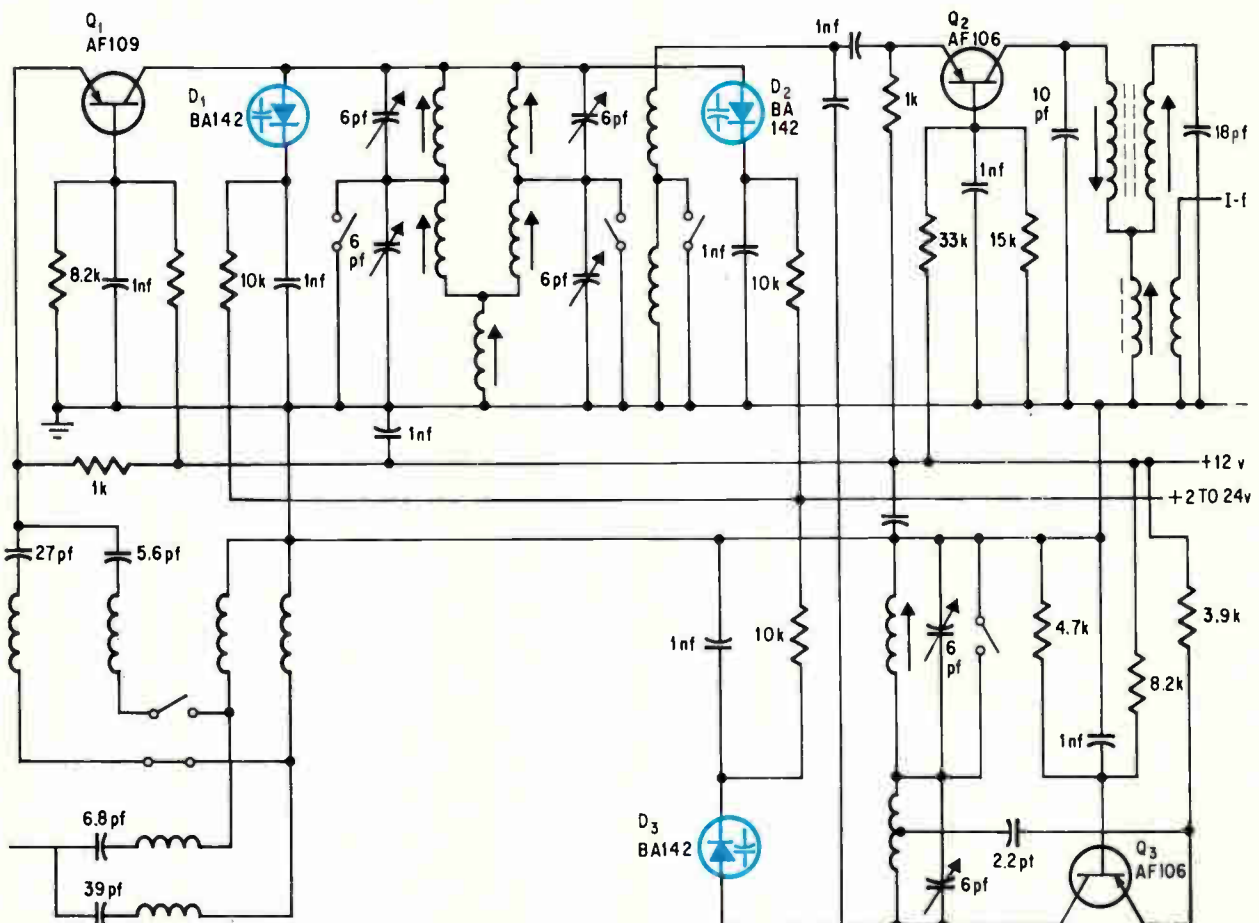

Vhf tv tuner. Two switchable broadband input circuits, together with three varactor diodes and three transistors provide coverage for the 50-to-65 and 170-to-220-Mhz vhf tuning ranges.

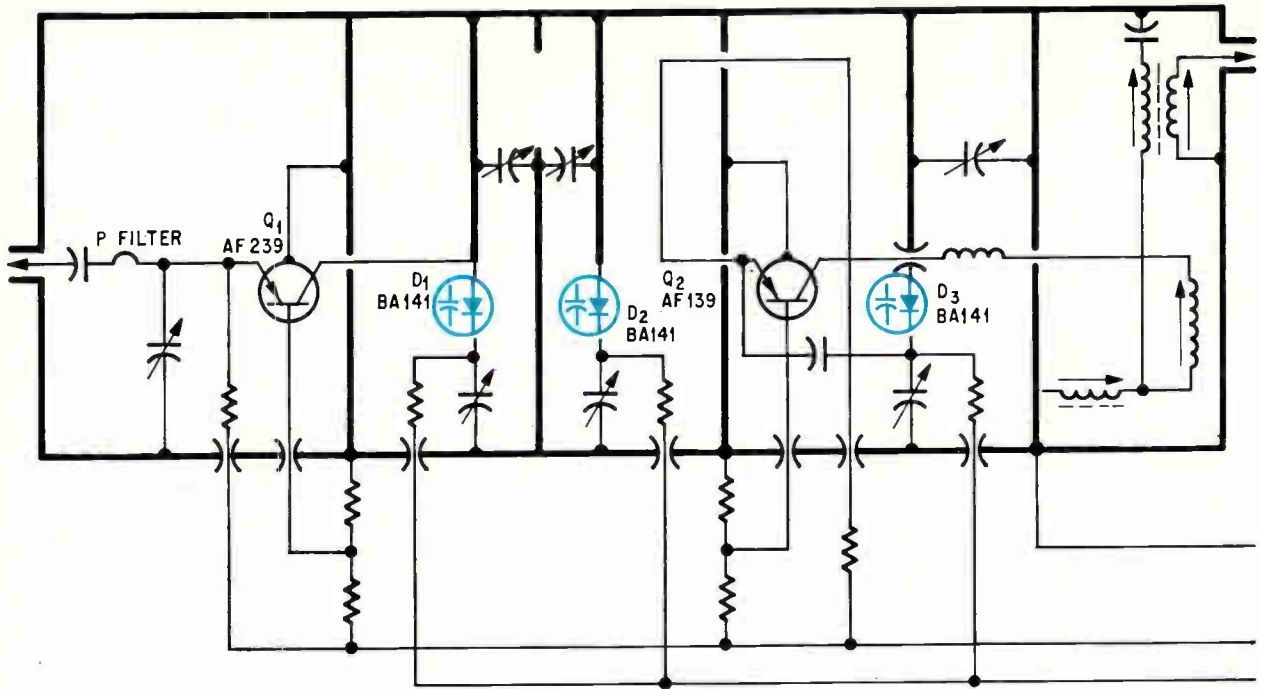

Uhf tv tuner. Using three varactor diodes in quarter-length coaxial line resonators and a self-oscillating mixer, the tuner covers the 170-to-790-Mhz uhf frequency band.

capacity turns out to be approximately equal to that of the tuner diode. Thus, in this design, C_6 has a value of 240 picofarads, which matches the diode's 220-pf capacity range.

The self-oscillating mixer transistor, Q_1 , operating in a common-base mode, sustains oscillation by positive feedback from collector to emitter through a tap on oscillator coil L_2 winding. The coil's turns ratio is selected so that voltage level at Q_1 's emitter will be large enough to sustain oscillation. In this application, the voltage is about 60 millivolts. However, the a-c voltage applied to the diode must never exceed 0.8 volt peak. To ensure a constant oscillator voltage over the diode's tuning range, a 100-ohm resistor, R_6 , is shunted across a portion of the oscillator coil to somewhat dampen the oscillation.

The maximum tuning voltage for the 510-1610 kHz frequency band is 12 volts. The minimum voltage is that necessary to increase the oscillator diode's capacitance to its maximum value of 220 pf.

Since a close tracking tolerance is essential for proper tuning of the radio set, it becomes necessary that diodes D_1 and D_2 be a factory-matched pair. The capacitances are precisely aligned by a relative displacement of the two bias voltages; this must be done by the set manufacturer before the usual LC alignment.

The design procedure for an f-m tuner is basically the same as for the a-m tuner. The use of a matched diode pair is also essential to close tracking tolerances, so the diode's capacitance needn't be calibrated against its bias voltage.

Although varactor diode tuning is now widely

used in f-m receivers, its greatest advantage is in tv tuners where channels can be switched effortlessly. In the typical circuit for a very-high-frequency tuner, on page 91, three diodes are used to tune in all channels in the lower (50 to 65 Mhz) and upper (170 to 220 Mhz) frequency bands. The tuner consists of two switchable broadband input circuits, a preamplifier stage, a double-tuned bandpass filter, a mixer, and an oscillator circuit. The upper and lower frequency bands are selected by mechanically switching the tuning coils.

The i-f output, 36 Mhz, is coupled out from a bandpass filter in the collector circuit of the mixer. For exact tracking, the tuned circuits can be aligned inductively or capacitively. The tuner has a bandwidth of 8 to 9 Mhz and a power gain of 25 db.

In a typical ultra-high-frequency tuner, above, the diodes must be capable of tuning over the entire 470-to-790 Mhz band. The tuner consists of an r-f, amplifier, Q_1 , a self-oscillating mixer, Q_2 , and diodes, D_1 , D_2 , and D_3 in quarter-wavelength coaxial line resonators.

A pi filter in the antenna input is adjusted for minimum reflection. The coaxial line resonator, including diode D_1 , is in the collector circuit of Q_1 , which operates in a common-base mode. This resonator is coupled, inductively and capacitively, to a second resonator with diode D_2 , through a slot in the wall between them.

The self-oscillating mixer transistor, Q_2 , also operates in a common-base mode. Its collector is coupled to the oscillator coaxial line resonator containing D_3 . A combination of inductive and capacitive feedback maintains a very constant oscillator voltage over the frequency range.

Designer's casebook

Two one-shots control waveform's pulse width

By K. Vijaya Raghavan

Indian Telephone Industries Ltd., Bangalore, India

A waveform's pulse width can be doubled for a certain time interval simply by cascading two monostable multivibrators.

Initially, Q_1 and Q_3 are on, and Q_2 and Q_4 are off. Switch S_1 is open and the 2.5-kilohertz sine wave triggers the first monostable. The pulse width out is $0.7C_1 [R_2 \parallel (2R_f + R_1)]$ which approximately

equals $0.7C_1 (R_2 \parallel R_1)$, where R_f is the forward resistance of D_1 and D_2 .

To increase the pulse width, S_1 is closed and opened, triggering the second monostable. Its duration, $0.7 R_3 C_2$, determines how long the wider pulses will be gated out. Q_3 is cut off and Q_4 turned on. The supply voltage at Q_3 's collector reverse biases D_1 and D_2 via D_3 . As the first monostable triggers, its new pulse width, t_a , becomes $0.7C_1 [R_2 \parallel (2R_f + R_1)]$, where R_f is the reverse resistance of diodes D_1 and D_2 . Since $2R_f + R_1$ is much greater than R_2 , t_a is about equal to $0.7C_1 R_2$. If $R_2 = R_1$, the new pulse width is twice the original.

As long as the second monostable is not triggered, D_3 is reverse biased, thus ensuring that the period of the first monostable is independent of the second's circuit parameters.

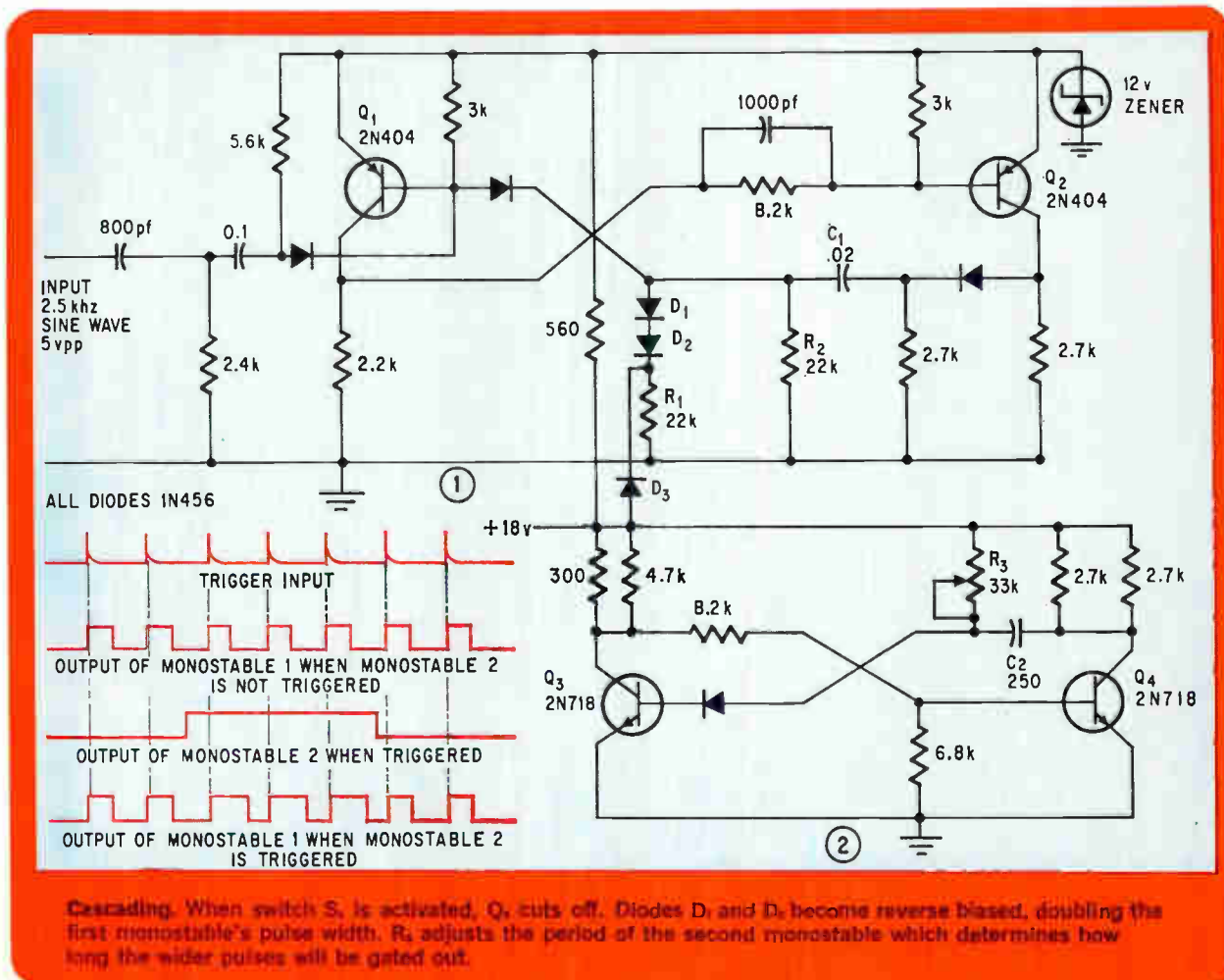

Power supply regulator uses fewer parts

By F.J. Messina

Electro-Mechanical Research Inc., Princeton, N.J.

Series regulators can protect power supplies without added transistors and the silicon controlled rectifier.

As the load increases, so does Q_3 's current. As a result, the conduction in the Darlington pair increases in an effort to support the heavier load.

Voltage regulation continues until Q_3 reaches its maximum current, determined by the zener, R_3 , and Q_3 's base-emitter voltage. This current is divided between I_1 and I_2 , and R_2 is selected so $I_1 \gg I_2$. Then the maximum input current becomes

$$[I_{3(\max)}R_2 - V_{BE(Q1)} - V_{BE(Q2)}]/R_1.$$

The output voltage will continue to drop as the load increases until Q_3 turns off. The Darlington then turn off, deactivating the power supply. The circuit does not turn back on after removal of the overload. The power supply can be reset after the overload is eliminated by a manual, command, or automatic reset.

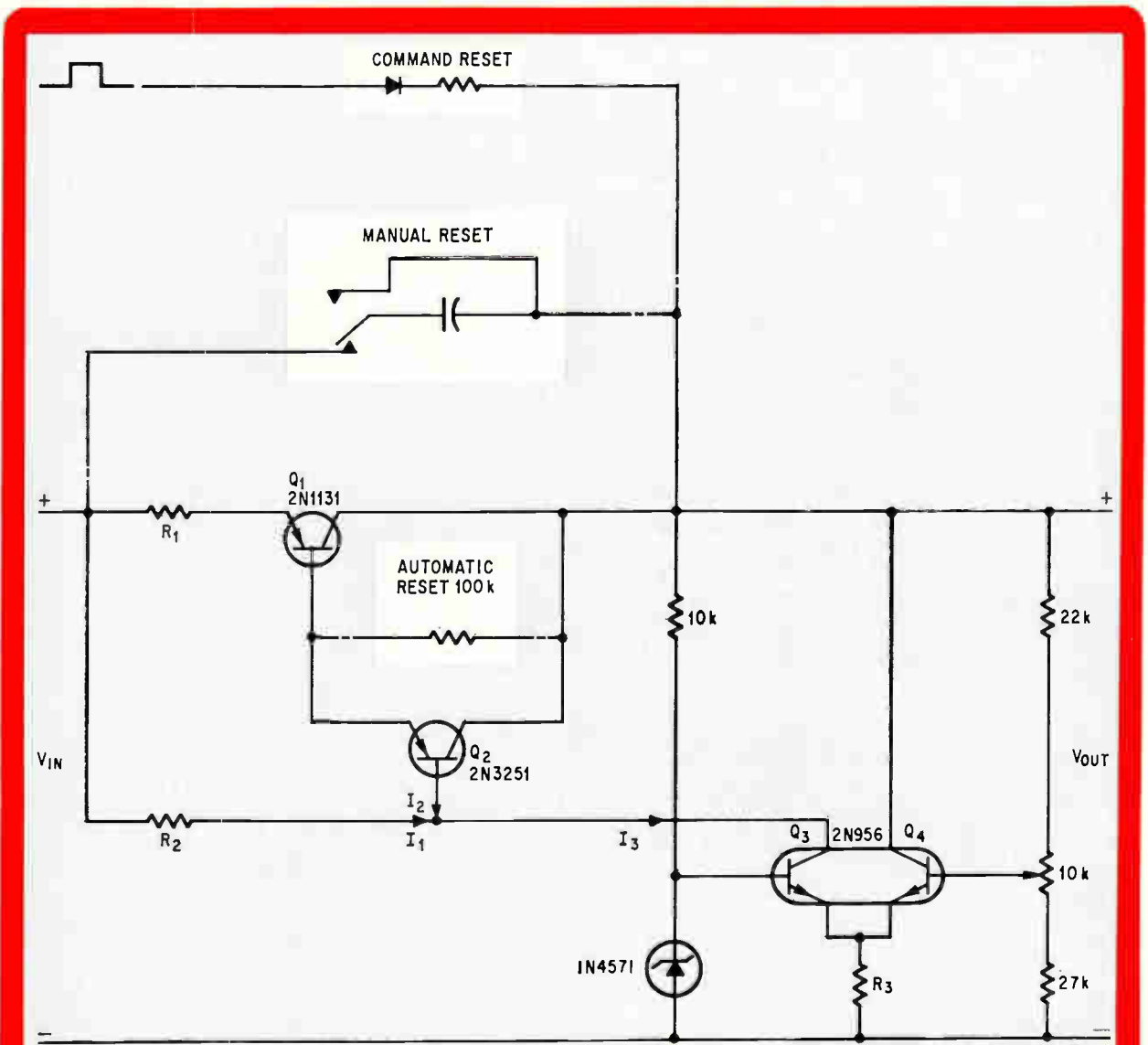

Versatile. The output voltage will drop as the load increases until Q_3 turns off and deactivates the supply. After the overload has been eliminated, any of three methods can be used to turn the supply on again. Each method involves applying a bias to Q_3 so it begins to conduct.

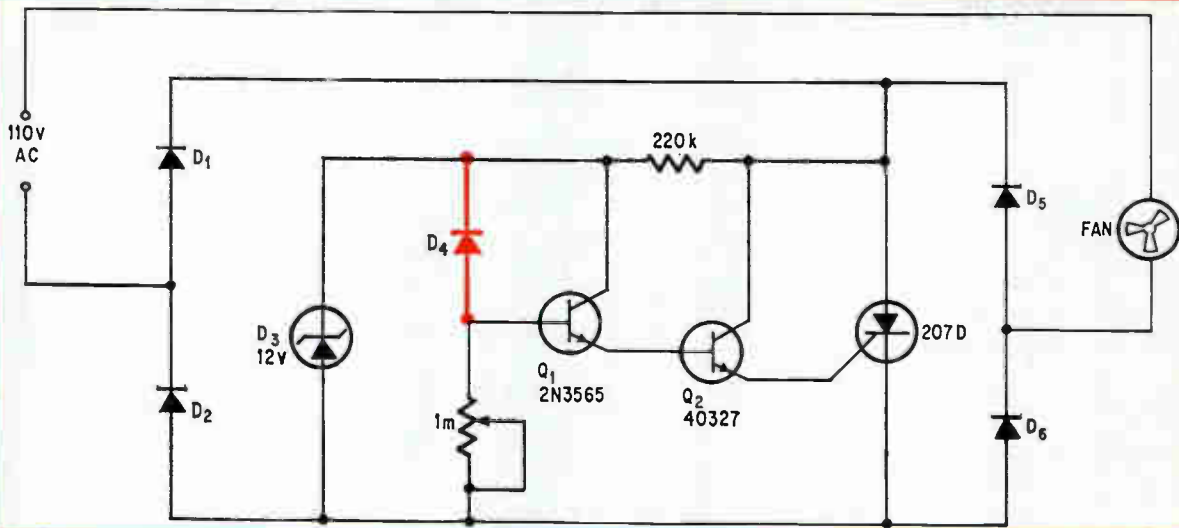

Breezy circuit. The reverse current of the diode is temperature-dependent and is regulated by the potentiometer to vary the firing angle of the SCR, which regulates the current to the fan's induction motor. The circuit allowed very accurate temperature control of the thyristor.

Diode controls speed of fan that cools a thyristron

By Y. Alon and M. Jonas
Hebrew University of Jerusalem

The condensed mercury in high-voltage thyristrons must be kept within specified temperature limits if recurring failures are to be avoided. An ordinary series-connected fan with a simple speed-control

circuit kept part of the bulb within 0.5°C of a constant temperature allowing faultless operation of a 20-kilovolt thyristron for six months.

A germanium diode (D₄) is glued to the outside of the thyristron bulb in the condensed mercury region. The temperature-dependent reverse current of the diode, regulated by the 1-megohm potentiometer, is amplified by Q₁ and Q₂. The resulting gate current varies the firing angle of the silicon controlled rectifier in accordance with the sensed bulb temperature. Controlled current waveforms flow on alternating half-cycles through D₁-D₆ and D₂-D₅, changing the speed of the fan.

Free-running multivibrator is made with a NAND gate

By Orin Q. Flint Jr.
Zeltex Inc., Concord, Calif.

Free-running multivibrators can be assembled quickly by adding a couple of resistors and a capacitor to a quad, 2-input NAND gate. The low-cost multivibrator is self-starting and has rise and fall times of less than 50 nanoseconds, complementary outputs, and a wide frequency range. Fre-

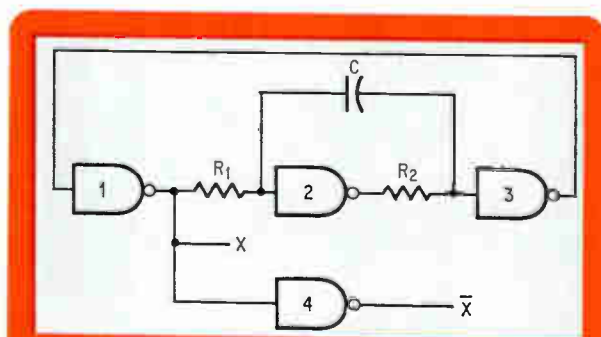

Self-starting. R₁ and C control the frequency. Increasing R₁ reduces the duration of the 1 state over 25% to 60% of the period.

quency and symmetry are independently adjustable.

The device is basically a flip-flop (gates 1 and 3) with a high-frequency bypassed inverter in the loop (gate 2). The inverter makes the loop unstable. The capacitor couples gate 1 to gate 3—allowing regeneration to occur even for fast rise times—and

provides a time delay for the inverter.

C and R_2 control the frequency. R_1 varies the symmetry of the output. When $R_1=R_2=510$ ohms, and C is varied from 10 microfarads to 100 picofarads, the output frequency varies from a few hundred hertz to several megahertz.

Simple gating yields phase-locked pulse bursts

By J. Kalisz

Institute of Nuclear Research, Warsaw-Anin, Poland

An easy way to synchronize a pulse burst uses a delay line generator to produce the high-speed pulse bursts with their phases locked to the start of the gating cycle. High repetition rates together with fast rise and fall times are obtained at low cost. The generator, to cite one possible application,

may be used to trigger the time base of a sampling oscilloscope.

Q_2 and R_1 control the time interval of the oscillations. When the circuit is open and there's no signal at the gate's input, Q_2 is saturated, Q_1 cut off, and no oscillations occur. A negative 1-volt pulse to a matched 50-ohm input by cutting off Q_2 and turning on Q_1 , starts the cycle. The period of oscillation is approximately twice the delay of L_1 . During free-run conditions when S_1 is closed, Q_2 remains cut off. C_1 aids in shaping the output pulse. The circuit worked at a 20-megahertz repetition rate. Bursts of 1 to 10 pulses of 25-nanosecond width are obtained by varying the gating pulse from 40 to 490 usec in 50-nsec increments.

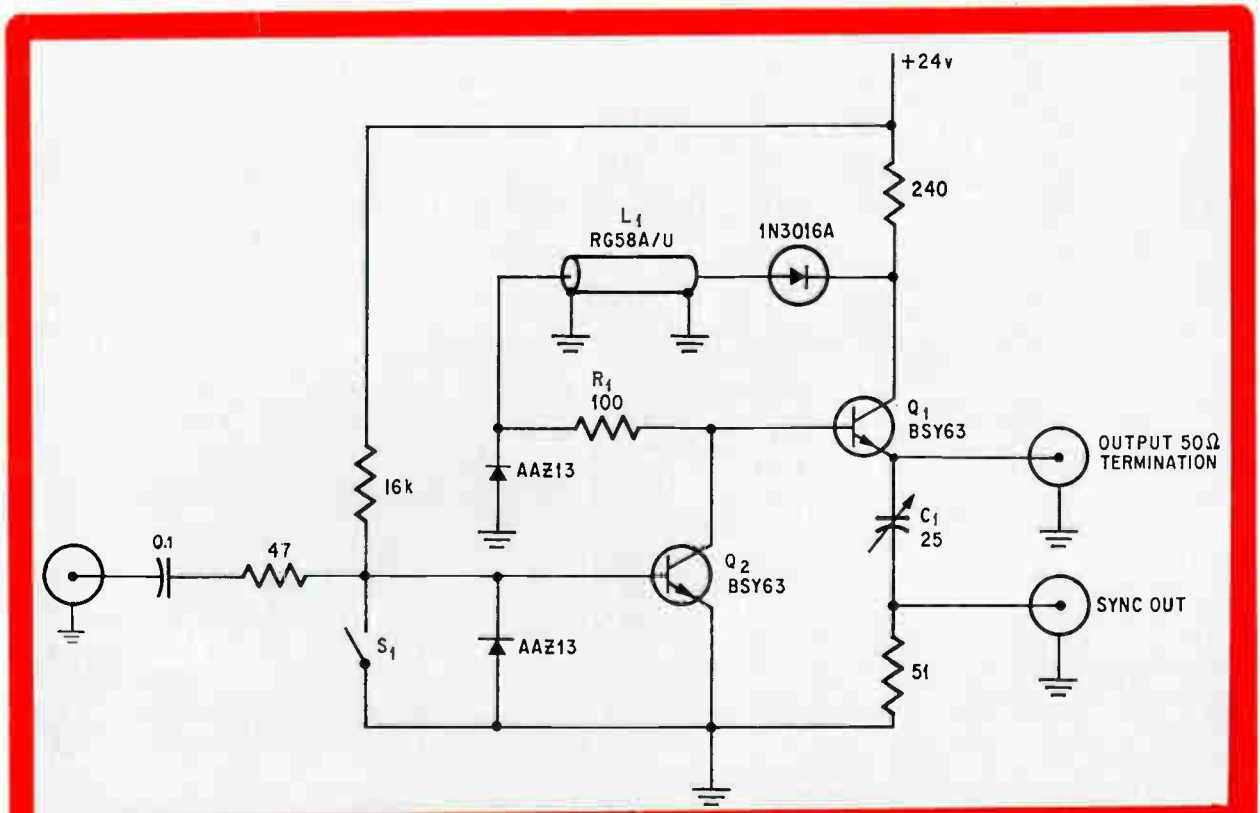

Delay. When the switch is closed and a negative one volt pulse is applied at the input, Q_1 cuts off and Q_2 turns on starting the cycle. The output pulse is fed back through the delay line, L_1 , and triggers the output transistor. The pulses are locked to the start of the gating cycle.

Pick the
BEST IC
for the job

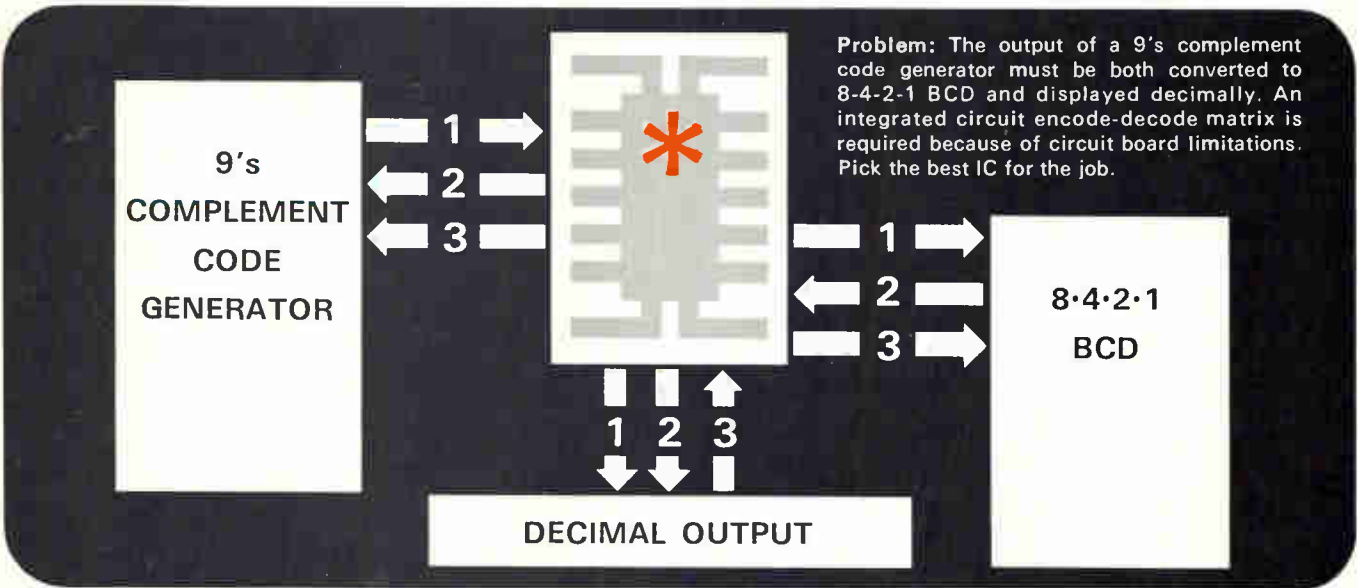

the **BEST** Solution:

THE RADIATION RM-84 DIODE MATRIX



Solve the problem easily. Combine only *four* * RM-84 diode matrices from Radiation and form a 16 x 10 matrix array. Six code conversions can be performed by this single bi-directional array to replace approximately 80 logic elements. The code pattern will be customized quickly from our complete stock of standard matrices.

Radiation diode matrices are dielectrically isolated, eliminating cross-coupling and allowing easy customization. These circuits can be combined with Radiation interface circuits to provide the most economical, convenient and reliable diode logic available.

Contact your nearest Radiation sales office. Ask about our diode matrix line. Let us help you pick The Best IC for The Job.

WE MAKE THE **BEST IC** FOR THE JOB

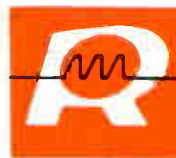

RADIATION
INCORPORATED

SUBSIDIARY OF HARRIS-INTERTYPE CORPORATION
MICROELECTRONICS DIVISION

Analog-plus-logic system gets into the control stream

Basically a simulation tool, the hybrid computer has found its way into the industrial plant, controlling the flow and pattern of water—up to 6,000 gallons of it—to cool fast-moving slabs of hot-strip steel

By Tracy C. Dickson III and John P. Shea Jr.

Control Products Division, Bell & Howell Co., Bridgeport, Conn.

A hot-strip mill is a spectacular operation. In about three minutes, the mill squeezes a 15-to-20-ton slab of cherry-red steel into a thin, wide strip that's thousands of feet long. Using an electronic hybrid control computer, specifically designed to operate a new type of water cooling system on the mill, operators produce a better grade of steel at considerably higher production rates in the Youngstown Sheet & Tube Co.'s Indiana Harbor, Ind., mill #3.

The hybrid computer combines continuous analog calculation intimately meshed with logic-implemented on-off outputs. This control system, constructed from conventional analog and logic modules, operates in an industrial environment and performs some functions that could prove useful in other types of applications.

This hot-slab rolls through seven thickness-reducing stands, glides along a runout table where laminar-flow water cools the steel. The strip, now traveling at 30 miles an hour, winds up as a huge coil. While this operation is taking place, the computer solves a heat-balance equation in its analog section, and sets up a desired cooling water pattern in its logic section, thereby controlling the strip's final temperature.

On the 500-foot-long runout table the final operation is performed—cooling the steel to attain its desired physical properties. The strip's cooling rate after it leaves the last reduction stand affects the steel's grain structure and hence its strength and ductility.

Previous cooling systems were designed merely to provide a sufficient discharge of water. At best, control of flow rate and distribution pattern is fairly coarse. Furthermore, a shroud of steam and

drops of water dancing on the strip's 1,500-1,700°F surface prevents efficient cooling. But the new cooling system, developed by Pittsburgh-based Golden Anderson Specialty Valve Co. and installed at YS&T, can vary the flow rate and pattern to approximately match the cooling requirements of the wide range of products going through the mill.

Using laminar-flow nozzles, the cooling system produces multiple high-energy streams of water which hit the strip with sufficient force to pierce the steam and water blanket formed by previous water and thus produce efficient cooling. The final temperature is between 900-1,300°F, depending on production requirements.

The hybrid computer takes into account such factors as the strip's grade and thickness, its instantaneous speed on the runout table, and its temperature before and after cooling, and the desired coil temperature. Automatically, the computer turns on the correct number of headers and sets their initial rate of flow.

The nozzles are closely adjacent to each other on headers that extend across the width of the strip, the net effect being a sheet of water flowing from each header. The 270-foot-long cooling portion of the runout table is divided into nine main sections and one trim section.

Each main section has four headers delivering water from the top and one header spraying from the bottom. Each of the total of 45 headers in the main sections can be turned on or off by signals from the main part of the hybrid computer. The rate of flow from the turned-on headers is a given section is varied by a pressure-reducing valve operated by a closed-loop controller which receives its setpoint value from the hybrid computer.

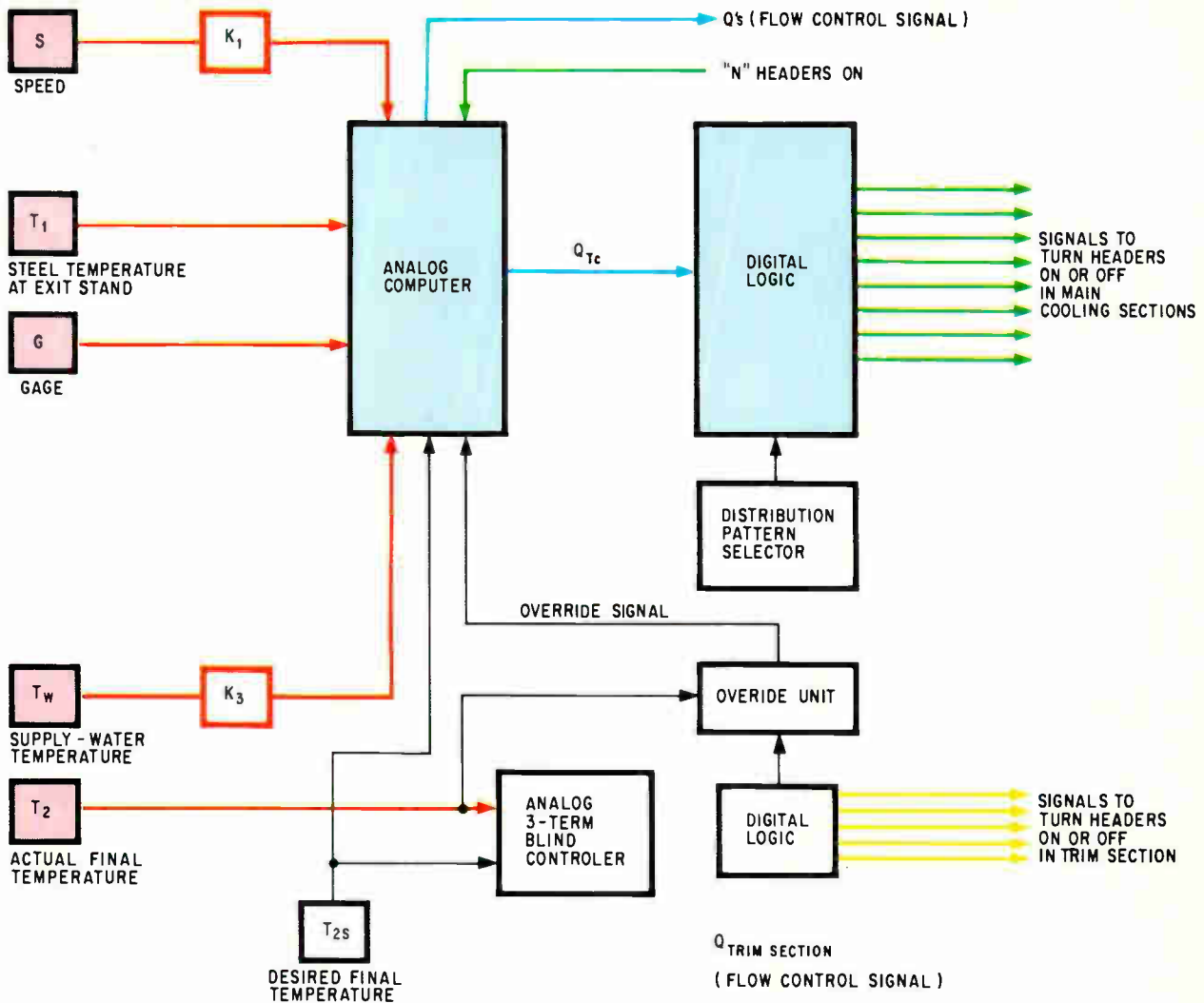

Computer and control. The analog sections of the hybrid computer determine cooling water needs; the logic sets the flow pattern.

The trim section, whose function it is to furnish the final amount of cooling water before the strip reaches the coiler using the section's four top headers and one bottom header, is manipulated by another part of the computer.

If the final actual temperature doesn't match the final desired temperature, the computer proportions the flow rate of the trim-section headers. If that isn't enough, the computer next pulses solenoid-operated switches that turn on (or shut off) more nozzles until the correct amount of water cools the strip to the desired temperature.

The diagram above shows how the major elements of the hybrid computer relate to each other and to the cooling system's headers and flow-control valves.

The analog portion of the hybrid control computer, after it converts, scales, and linearizes the input signals from the mill and from the logic section, calculates how much heat must be removed from the strip and adjusts the total cooling-water-flow-rate accordingly. The logic portion sets up the

water distribution and selects the appropriate headers to turn on.

As the slab is reduced in thickness from stand to stand it also gets longer, forming a strip whose leading edge travels faster and faster relative to the speed of the slab at the first stand. By the time it's caught on-the-fly by the coiling machine, the strip's leading edge is traveling about 1,000 feet a minute. Then the whole mill operation is accelerated until the strip's maximum speed at the coiling machine is about 3,000 feet a minute. As the mill speed increases, a correspondingly greater amount of water must be sprayed on the strip to cool it to the correct temperature. The maximum flow of water is 6,000 gallons a minute.

Operation of the mill's reducing stands is quite complex, and it's handled by a large separate digital control computer. The hybrid computer discussed here is assigned specifically to the control of the cooling system on the runout table. It receives many of its inputs from the mill instrumentation and its commands—pattern selection, for ex-

ample—from the control desk.

A separate hybrid computer was selected for several practical reasons. Because the cooling system is the first of its kind, the equations and heat-transfer criteria for laminar streams were only generally known. Developing the information on the digital computer would have involved complex software and attendant delays in preparing and debugging the programs. Instead, the analog computer in the hybrid system was built with several variable coefficients, K factors, to permit easy adjustment of equations and thus to arrive at a fast determination of the proper cooling data based on actual operating experience.

Conditioning the inputs

As mentioned, inputs to the hybrid computer are related to the mill's operation. The speed, S, of the strip is actually measured by a pulse-type tachometer mounted on the mill's final stand. A frequency-to-analog converter conditions the speed signal and a digital thumbswitch—set by the operator at the control desk and converted to an analog signal inside the hybrid computer—develops a variable factor, K_1 , that scales stand speed to flow per header in gallons per minute.

The temperature of the steel, T_1 , as it leaves the last stand is measured by an infrared-radiation pyrometer. However, the analog computer obtains the temperature signal from a retransmitting slide-wire of a recorder associated with the pyrometer. Since this signal is highly nonlinear, the computer contains a four-segment function generator to provide the linear relationship between signal voltage and temperature that's required in solving the equation.

The final actual temperature, T_{2A} , the temperature of the strip after being cooled by the water, is handled in a manner similar to that for T_1 . This signal goes to the analog controller for the trim section, for it's here that the fine adjustment of cooling water must be accomplished.

The cooling capability of water depends on the supply-water's temperature, T_w , which is measured with a resistance temperature detector. A nonlinear factor, K_3 , modifies this signal to provide the heat removed per gallon of water at the measured temperature.

The strip's gage, its thickness in inches, also is obtained from a retransmission slidewire.

The final desired (or setpoint) temperature of the strip, T_{2S} , is set by the mill operator with a digital thumbswitch on the console in the pulpit (control room) suspended high above the mill. The analog computer controlling the nine main cooling sections converts this digital signal to an appropriate analog equivalent. This analog signal also becomes the setpoint value for the analog controller for the trim section.

Using these process signals, the hybrid control computer calculates the total water flow rate required, Q_{Tc} , and—on a closed-loop basis—adjusts the actual flow rate of water delivered from all

headers, Q_{Tn} , so that, ideally

$$Q_{Ta} = Q_{Tc}$$

where

$$Q_{Ta} = N_T Q_{TH} + N_B Q_{BH} + N_{Trim} Q_{Trim H}$$

and

$$Q_{Tc} = f(T_1 - T_{2S})G \times f(K_3 T_w) \times \frac{1}{f(K_0 + K_1 S)} \times K_2$$

The Q's are in gallons per minute, and the N's are the number of headers on. The subscript T applies to top headers, B to bottom headers, Trim to trim headers. K_0 sets water flow at zero strip speed.

The balance between calculated and actual flow rate could be obtained by many combinations of different values of N's and Q's. For example, under certain conditions, enough cooling water could be obtained with only top headers on and with bottom and trim headers off. Doing so, however, is not desirable from metallurgical or control viewpoints.

Production experience in rolling steel indicates that some water, not necessarily the maximum amount, must always cool the strip's bottom surface. Furthermore, as mentioned earlier, different kinds and gages of steel need different water-distribution patterns. For example, some products might require only the first header in each main cooling section being turned on, thus minimizing the cooling rate of the strip. A pattern where headers come on in numerical order would give the maximum cooling rate,

Turning on the headers

A bidirectional counter, the distribution-pattern selector, and other logic functions turn on the needed number of headers in each cooling section. The analog portion of the hybrid system computes the flow rate for the headers as a function of the strip's gage and speed. The resulting signal goes to the proportional flow controller for each cooling section. Thus, these hybrid-computer operations set the initial flow of water as the strip's leading edge enters the cooling area.

Any difference between actual and calculated flow is detected by an analog deviation comparator whose output drives the bidirectional counter up or down to turn more headers on or off until the total flow equals the calculated flow to within a minimum flow increment. This increment, or dead-band, is automatically adjusted according to the flow rate, which—as mentioned—changes with speed, so that the increment is always more than the minimum flow per header.

The computation of the outputs of the main analog computer—the individual flow rates of the top and bottom headers and the total flow rate—is accomplished with a host of electronic adder/subtractors, multiplier/dividers, comparators, time delays, function generators, coefficient potentiometers, memory units, track-and-hold amplifiers, and the like. All these are arranged to solve the Q_{Tc} equation using procedures that are common in analog computing.

The track-and-hold amplifier performs a particularly interesting function. Recall that temperature, T_1 , is measured at the last reducing stand. If this measurement were sent directly to the analog computer it would provide the correct signal as long as there was steel strip emerging from the stands. When the strip's trailing edge passed under the i-r pyrometer, the signal would drop to ambient temperature. Using an ambient reading for the rest of the time that the strip is being cooled on the runout table would of course be erroneous and the water flow would decrease. To circumvent this, the pyrometer signal is sent through a track-and-hold amplifier. This amplifier transmits the instantaneous measured temperature while the strip remains in the stands and then stores the last measured value after the strip leaves the stand. This stored value remains constant and continues as an input to the analog heat balance calculation until the strip is completely cooled and coiled.

Selecting the pattern

The diagram on the next page shows how the bidirectional counter connects with the up or down signals from the analog comparator. The counter is made of 45 flip-flops connected in series as a shift register.

An up signal puts a logic 1 in the register's left-most position, and each succeeding up signal inserts a 1 in the left position and shifts any resident 1's to the right. A down signal inserts a 0 at the right and shifts any resident 1's to the left. Thus, the number of 1's in the counter, N , equals the number of headers needed to be on. Which

header a particular flip-flop actually turns on depends on the pattern selector associated with the gate circuits, and the driver amplifier associated with each header's solenoid switch.

The diagram on the next page details the AND, OR, and exclusive-OR gate configuration which— together with a coincident square wave from the clock—sends an enabling pulse to an amplifier which then drives a solenoid switch. Each of the five AND gates can receive one input from the counter and one from the pattern selector.

Consider two typical header patterns. One pattern, denoted by the green color, has only the first header, in each top section, spraying water on the steel; the second pattern, denoted by red, uses the first and third headers in each section to cool the strip. The first pattern sends pulse to headers:

1, 5, 9, 13, 17, etc.

The second pattern looks like: 1, 3, 5, 7, 9, etc.

In both patterns, the first flip-flop's output (position 1) goes to the top inputs of AND-gates 1 and 2 in the logic circuit associated with header 1. However, the input from the pattern selector representing pattern 1 goes to the bottom input of AND-gate 1, while the signal for pattern 2 goes to the bottom input of AND-gate 2. Thus the driver amplifier for header 1 will pulse solenoid switch 1 on when flip-flop 1 is in the on state if either pattern 1 or pattern 2 has been selected by the mill operator.

Now consider the two patterns again, but this time the computer turns on the second header in each pattern, header 5 and header 3 respectively. Header 5 is turned on when the signal from counter-position 2, which is the second flip-flop,

Pacer. Hybrid computer, left, commands 270-foot-long cooling table, right.

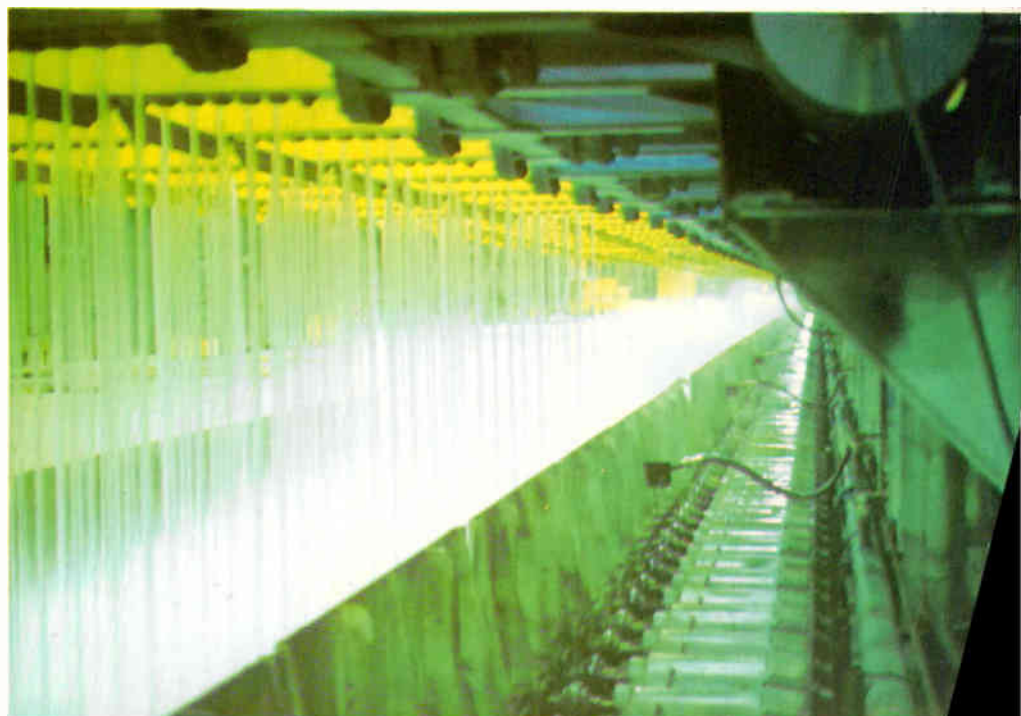

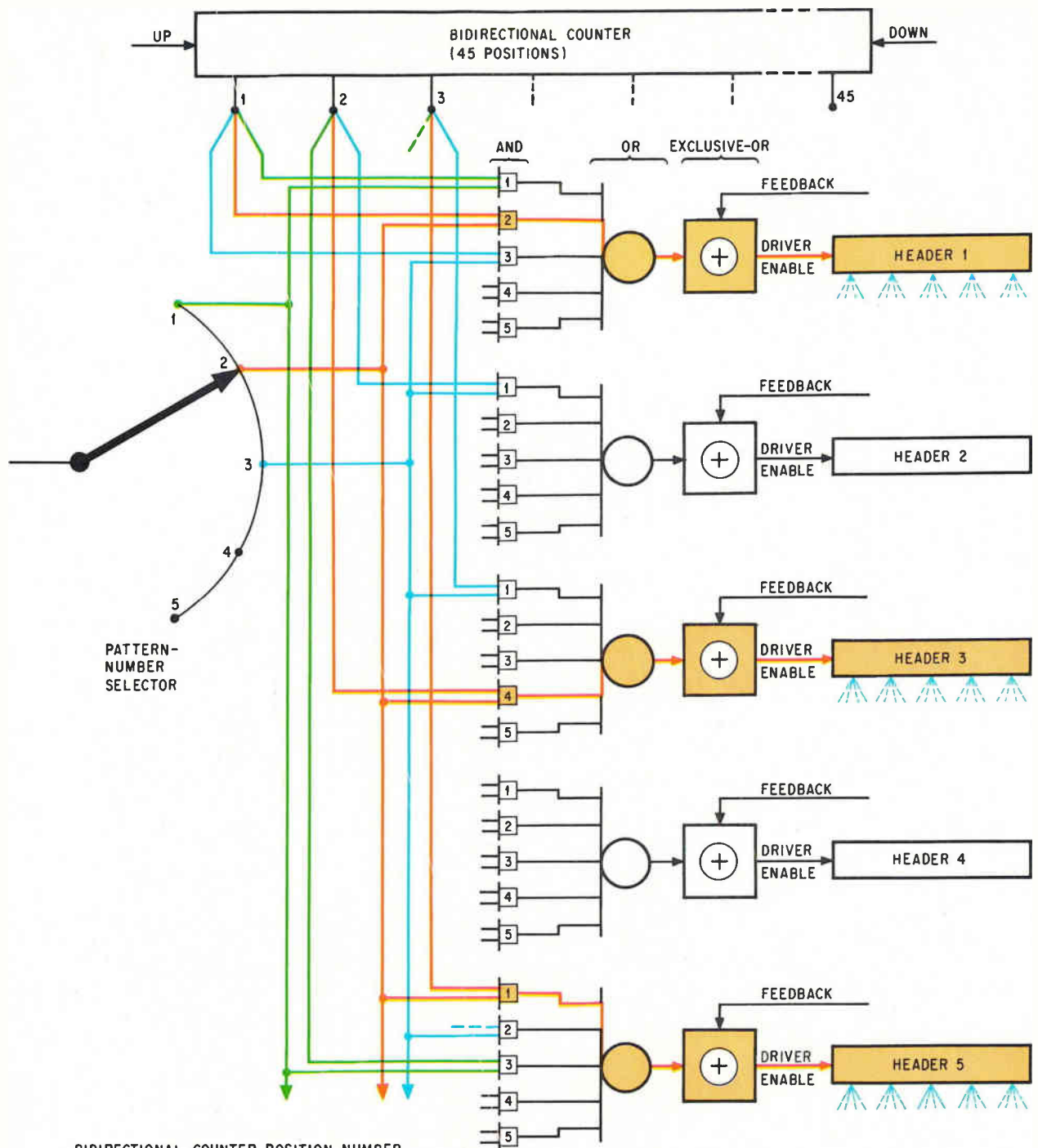

BIDIRECTIONAL COUNTER POSITION NUMBER

	1	2	3	4	5	6	7	8	9	ETC.
PATTERN NUMBER 1	1	5	9	13	19	21				
PATTERN NUMBER 2	1	3	5	7	9	11				
PATTERN NUMBER 3	1	2	3	5	6	7				

HEADER NUMBER

	1	2	3	4	5	6	7	8	9	10	11	12	13	14	15	16
PATTERN NUMBER 1	■	□	□	□	■	□	□	□	■	□	□	□	■	□	□	□
PATTERN NUMBER 2	■	■	□	■	■	■	■	■	■	■	■	■	■	■	■	■
PATTERN NUMBER 3	□	□	□	□	□	□	□	□	□	□	□	□	□	□	□	

Pick and choose. The water-distribution pattern is set by hard-wire connections and logic. When the selector switch and a position on the bidirectional counter enable the same AND gate, the header associated with that gate turns on.

goes to say, the top input of AND-gate 3 in the logic channel for header 5. The first pattern's signal connects to the bottom input of this same gate. Header 3 is turned on when the signal from the second flip-flop goes to the top of one of the AND gates in the circuit for header 3. The second pattern's signal connects to this AND gate's other input terminal.

In this manner, the logic portion of the hybrid computer is wired to accommodate five different patterns for the 36 top and 9 bottom headers in the nine main cooling sections. The diagram shows, in blue, some of the connections for pattern 3. A five-throw, single-pole, switch on the operator's console, connected by five wires to the computer, is all that's used to call up the specific matrix of logic circuits that represent a water-flow pattern.

Backfilling the pattern

The system is also wired to execute a backfill pattern in a given sequence if the selected pattern can't supply enough cooling water or supplies too much. Here's how it works. When the mill operator uses the every-other-top-header-pattern, the first 18 flip-flops in the bidirectional counter handle the odd-numbered headers 1 through 35. Thus the on-pattern is

1, 3, 5, 7, 29, 31, 33, 35

The logic circuit for header 35 receives a signal from flip-flop position 18. Now when more water is needed than can be applied by the trim cooling section, the override signal from the trim control enters the main analog computer. This signal in turn injects an up (or 1) pulse into the bidirectional counter. This shifts a 1 into the counter's position 19. The circuit for header 34, the next header upstream that's off, is wired to accept this signal which—together with an enabling pulse to the same AND gate signifying the second pattern—turns on this header.

If even greater quantities of water were required, an enabling pulse would be sent to header 32, the next one off in the upstream direction. If process conditions were to require less water, the headers would automatically turn off in the sequence 32, 34, 35, 33, 31, etc.

Only one of the five AND gates in the logic circuit for a header at the left can simultaneously have two inputs. Depending on the pattern, none of the five gates may have two inputs. When an AND gate does have simultaneous inputs from both the counter and pattern selector, its output appears at the OR gate.

The output of the OR gate should be all that's needed to actuate the solenoid relay at the output of the driver amplifier. However, the solenoid relay can also be operated manually as a pushbutton switch. The mill operator might want to override the hybrid computer by turning on the header, or he might inadvertently actuate the pushbutton. In either case, the feedback contacts would close

without there being a corresponding logical signal coming from the gate circuits. Therefore, practical consideration requires the insertion of an exclusive-OR function between the conventional OR gate and the driver.

If the OR-gate output calls for the contacts to be closed, and they're open, the feedback signal changes the exclusive-OR gate's output to enable the driver amplifier—in conjunction with a clock signal—to pulse the solenoid. If the OR-gate output calls for open contacts, and they're closed, the exclusive-OR gate changes its state via the feedback signal to release the contacts. In short, the exclusive-OR gate forces the feedback contacts to reach the proper on or off state called for by the logic circuit.

The feedback contacts on each solenoid relay also ground a pair of resistors on the input of an amplifier. This raises the amplifier's analog output voltage by an increment equivalent to an N-value of 1. Other resistor pairs, switched by contacts from other solenoids, are also connected to the output of the amplifier. This amplifier adds up the net input voltage resulting from the closure of the contacts to produce an analog voltage proportional to N, the sum of the number of headers turned on.

Trimming the flow

Finally, the hot-strip mill, like all processes, is subject to disturbances and uncertainties which require that some trim headers always be on. They correct for small variations by maintaining, ideally, an initial flow rate of about half their maximum, so that any need for more or less cooling water can be accommodated simply by changing the header flow rate over a small range.

Larger variations between actual and desired coiling temperature are corrected by the hybrid control computer that turns on or off additional headers in the trim section. The flow rate per header in the trim section is set by a three-mode (proportional band, reset, and rate) controller. The set point signal is desired coiling temperature; the process signal is actual temperature. As flow increases, more trim section headers are turned on by the trim section digital control.

If the trim section is at maximum flow and is calling for more water (or is at minimum flow and is calling for less water) an override signal is generated which changes the overall flow calculation in the appropriate direction. This, in turn, operates headers in the main cooling section and changes the strip temperature to a range where minor variations can be compensated by the trim section. This override correction of Q_{Tc} generates Q_{Tc}' (corrected calculated flow) where

$$Q_{Tc}' = Q_{Tc} \left[1 + \frac{1}{T} \int_{t_1}^{t_2} (T_2 - T_{2s}) dt \right]$$

and where $1/T$ is the time constant for an analog integrator and $(t_2 - t_1)$ is the time the trim section is in the override condition.

COMPATIBILITY with dual in-line IC and discrete solid state devices

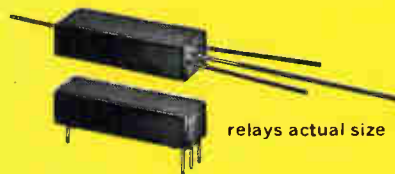

New High-Speed
PICOREED
by Clare

LOWEST PROFILE...LONGEST LIFE
of any dry reed relay

Exclusive new Clare Picoreed relay operates in $500\mu\text{s}$; permits $.250''$ pcb mounting centers; completely compatible with IC solid-state devices

Maintenance-free, hermetically-sealed contacts in molded-epoxy modules provide positive on-off switching for 100,000,000 operations at low-level loads

Build a straight relay-switched circuit or combine relays with dual in-line integrated circuits—you'll get important plus-factors with the Picoreed. Low profile for close board spacing. Long life. Immunity to transients. Sensible cost. The Picoreed's one Form A contact solves important problems of economical and reliable input-output isolation buffering.

Outstanding characteristics of the Picoreed are:

- **High speed.** $500\mu\text{s}$ operate time (including bounce) and 667 Hz repetition rates at nominal coil power. Capable of following 1000 Hz with appropriate coil drive. (See response curves and scope traces.)
- **Low profile mounting.** Your choice of terminal pins for through-board connections, or axial leads for aperture mounting. Pcb mounting on $.250''$ centers is feasible. Relays are not position sensitive.
- **Minimal size.** $.187''$ high, $.250''$ wide, $.781''$ long.
- **Positive on-off switching.** ON impedance (contact resistance) 0.1 ohm initially; 1.0 ohm maximum after life. OFF impedance (insulation resistance) 10 KM ohms minimum with 0.5 pf open contact capacitance.
- **Inherent reliability.** Maintenance-free, hermetically-sealed contacts are built for 100,000,000 operations at low-level loads, 5,000,000 at 28 vdc, 0.125 amp.
- **Environmental.** Withstand vibration 0 to 5 KHz at 20g; shock 100g. Temperature range: -40° to $+85^\circ\text{C}$.

TYPICAL RESPONSE TIMES

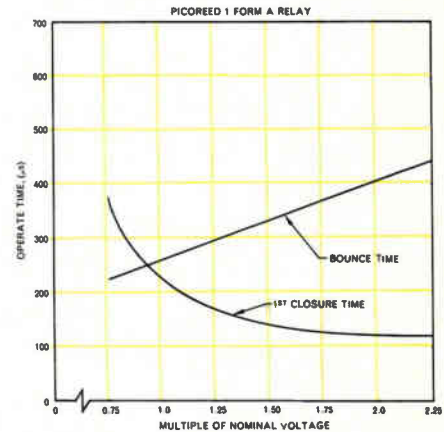

NOTES:

1. Response time measurements made at 50 Hz, 50% duty cycle square-wave coil drive.
2. With diode coil suppression (1N914 or equivalent) release time approximately $100\mu\text{s}$, with nominal voltage zener diode clamping release time approximately $50\mu\text{s}$.

REPETITION RATE CAPABILITIES

Oscillograms below illustrate the ability of the Picoreed to operate at 667 Hz (operate time including bounce typically $500\mu\text{s}$) and to follow 1000 Hz with an appropriate coil drive.

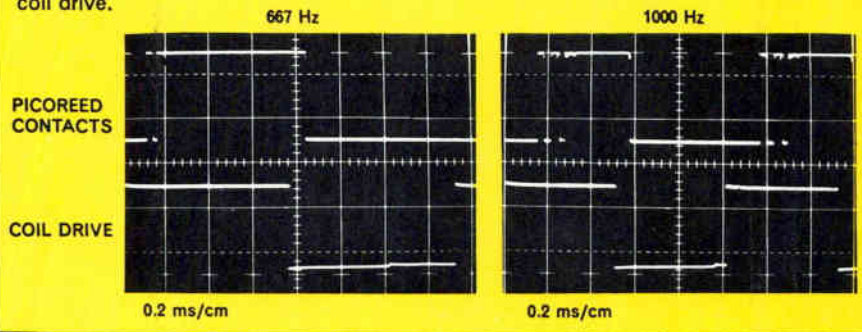

For a sample Picoreed relay, call your nearest Clare Sales Engineer:

East. Needham, Mass. (617) 444-4200; Great Neck, N. Y. (516) 466-2100; Syracuse, N. Y. (315) 422-0347; Philadelphia, Pa. (215) 386-3385; Baltimore, Md. (301) 377-8010; Silver Spring, Md. (Government liaison) (301) 593-0667; Orlando, Fla. (305) 424-9508

Central. Des Plaines, Ill. (312) 827-0151; Minneapolis, Minn. (612) 920-3125; Overland (St.

Louis) Mo. (314) 429-7372; Cleveland, Ohio (216) 221-9030; Xenia, Ohio (513) 426-5485; Cincinnati, Ohio (513) 891-3827; Columbus, Ohio (614) 486-4046; Mission, Kansas (913) 722-2441

Southwest. Dallas, Texas (214) 357-4601; Houston, Texas (713) 528-3811

Pacific Coast and Mountain States. Burlingame, Cal. (415)

697-8033; Encino, Cal. (213) 981-3323; Phoenix, Arizona (602) 264-0645; Seattle, Wash. (206) 455-2410 & 2411

For complete data, circle Reader Service Number, or write Group 1N9, C. P. CLARE & CO., 3101 Pratt Blvd., Chicago, Illinois 60645...and worldwide.

a GENERAL INSTRUMENT Company



LOOK FIRST TO ERIE FOR...

CUSTOM *Hybrid* INTEGRATED CIRCUITS

*When choosing your Custom HYBRID Circuit Source...
Check ERIE'S "Total Package" In-Plant Capability*

There are very specific reasons why ERIE is becoming a preferred source for Custom Hybrid Integrated Circuits. Our distinctly superior *resistor technology* is unique in the industry, as is our in-depth *capacitor technology*. We produce our own *precious metal formulations*, our own *substrates*, *semiconductors* and the best *protective encapsulant* available. Result? Economy, greater reliability, excellent quality control and delivery to meet your schedules. Prototypes available in about two-weeks with production quantities in about six weeks.

Look first to ERIE as *Your Custom Hybrid source*. Our total in-plant capability and experIENCE are unparalleled in the industry.

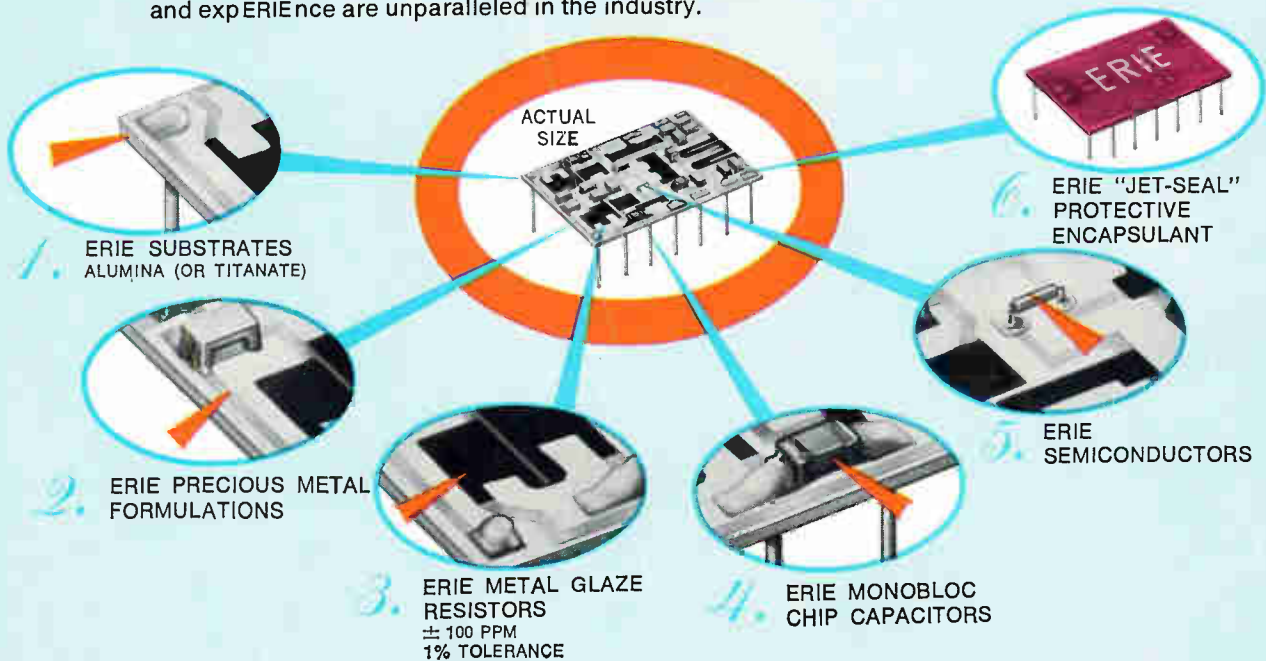

Write today for ERIE "Custom Hybrid I/C" Brochure...

ERIE TECHNOLOGICAL PRODUCTS, INC. • 644 West 12th St. • Erie, Pa. 16512 • Phone (814) 456-8592

Electronics Magazine's 1969 Markets Report

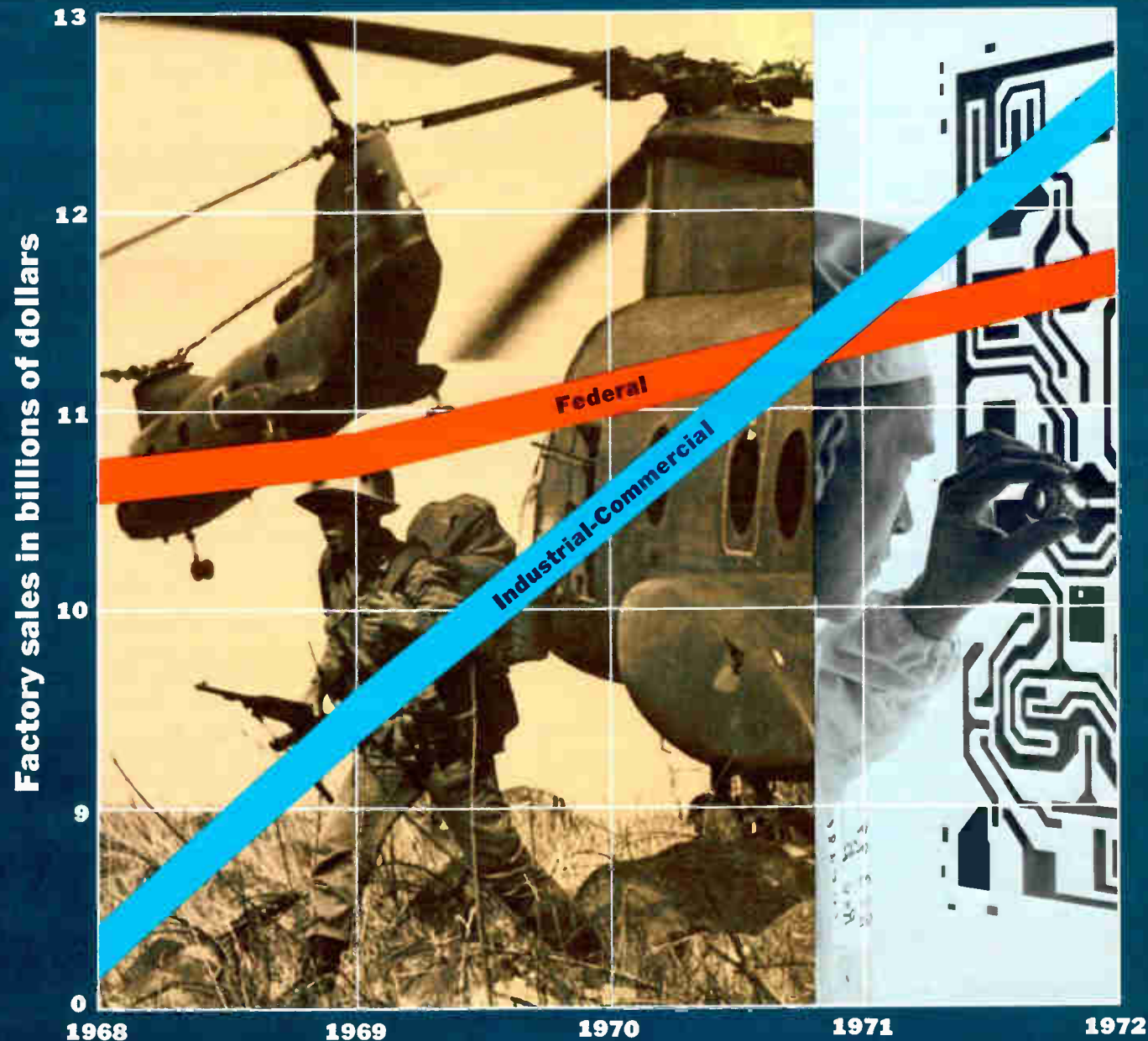

The market estimates in this tabulation are based on a survey conducted by Electronics magazine. Estimates are of U.S. factory sales in millions of dollars. This survey is not directly comparable to those made in previous years; some categories have been added, others deleted to reflect dominant trends in the field.

Component Markets

	1968	1969	1972		1968	1969	1972
	(millions of dollars)				(millions of dollars)		
Antennas and antenna hardware	412.0	430.4	511.4	Relays, total	271.6	287.4	348.1
Capacitors, total	400.7	434.5	516.2	Solid-state relays	17.3	21.4	42.0
Paper capacitors	52.0	54.2	58.0	Electromagnetic relays, total	112.1	117.7	139.1
Film capacitors	57.3	63.6	83.5	Contact meter relays	6.1	6.0	5.0
Electrolytic capacitors	173.0	187.4	244.7	Crystal can relays	34.2	33.3	35.8
Mica capacitors	26.3	29.0	24.1	Dry reed relays	24.5	28.2	39.2
Glass and vitreous enamel capacitors	8.7	9.2	7.5	Mercury wetted relays	15.7	18.0	24.6
Ceramic capacitors	57.4	61.4	64.3	Resonant reed relays	1.5	1.8	3.0
Variable capacitors	26.0	29.7	34.1	Telephone type relays	26.1	26.3	27.0
Connectors, total	354.4	379.5	449.0	Thermal relays	4.0	4.1	4.5
Coaxial connectors, standard size	33.1	35.2	38.5	Other relays	142.2	148.3	167.0
Coaxial connectors, miniature	20.6	23.0	34.5	Semiconductors, total	1,376.1	1,488.4	1,959.2
Cylindrical connectors	128.7	138.1	164.5	Discrete, conventional devices total	596.5	562.9	464.8
Rack and panel connectors	75.2	79.7	90.8	Transistors, total	405.5	375.3	313.3
Printed circuit connectors	45.8	50.3	58.0	Transistors, silicon, bipolar	298.4	284.7	241.0
Special purpose and fused connectors	51.0	53.2	62.7	Transistors, germanium bipolar	86.7	64.1	35.0
Delay lines	18.0	19.3	24.0	Transistors, field effect	15.1	18.7	23.5
Electromechanical devices, total	561.4	586.4	696.9	Transistors, unijunction	5.3	7.8	13.8
Resolvers	10.8	11.5	12.0	Diodes, total	191.0	187.6	151.5
Servo Motors	29.6	31.5	33.6	Germanium diodes	22.7	21.6	8.3
Synchros	30.0	29.5	28.8	Silicon diodes	168.2	166.0	143.2
Rate generators	5.3	5.6	6.3	Discrete, special devices total	277.2	275.7	288.8
Motor generators	14.3	15.1	17.0	Thyristors (SCR's, 4 layer diodes, etc.)	59.7	63.8	89.4
Fractional horsepower motors	411.3	417.0	491.8	Trigger diodes	51.3	50.1	42.3
Solenoids	24.7	26.0	34.4	Tunnel diodes	4.5	5.1	6.9
Encoders and decoders	35.4	50.2	73.0	Microwave diodes, excluding varactors	24.1	22.0	18.7
Electron tubes, total	1,352.2	1,366.1	1,401.1	Microwave transistors	6.4	8.3	21.2
Receiving tubes	244.0	221.3	148.0	Varactor diodes	6.7	7.6	13.1
Power and special purpose tubes, total	296.2	295.5	308.1	Zener diodes	56.9	55.7	46.3
High-vacuum tubes	65.1	61.7	58.0	Multiple devices (duals, diode arrays)	31.2	29.4	21.7
Gas and vapor tubes	17.6	17.0	14.8	Other special devices (temperature sensing, strain gauge, etc.)	36.4	33.7	29.2
Klystrons	41.4	41.0	38.6	Integrated electronics, total	502.4	649.8	1,205.6
Magnetrons	39.8	39.1	37.5	Monolithic IC's total	342.3	425.4	734.2
TWT's including backward wave types	54.4	54.0	59.2	Linear (less than 12 gates)	76.3	89.2	171.6
Light-sensing tubes	37.4	39.6	47.0	Digital (less than 12 gates)	242.9	296.8	435.6
Storage tubes	17.5	18.1	23.0	Single chip subsystems active (shift registers, scratch-pad memories, DDA's, etc.)	23.1	39.4	127.0
Display tubes, except cathode ray	6.2	7.0	9.7	Hybrid IC's total (Semiconductor devices and thin or thick film components combined on a common substrate)	51.3	61.2	92.0
Cathode ray tubes, except TV	16.8	18.0	20.3	Digital	31.4	37.0	54.7
TV picture tubes, black-and-white	119.6	103.3	79.0	Linear	19.9	24.2	38.3
TV picture tubes, color	692.4	746.0	866.0	Integrated arrays, total	52.8	108.0	263.4
Ferrite devices, total	302.7	329.7	375.0	MSI devices (12 to 100 gates)	49.2	100.0	225.0
Computer cores	16.8	19.3	34.0	LSI devices (100 or more gates)	3.6	8.0	38.4
Transformers and chokes, except TV	242.3	260.7	294.0	Operational amplifiers, monolithic	22.8	26.9	41.0
TV ferrite components, including yokes, flybacks	43.6	49.7	47.0	Passive thin or thick film devices	33.2	38.3	74.0
Filters, electronic, total	48.1	52.3	67.8	Optoelectronic devices, total	23.0	27.2	35.7
Active filters	3.4	4.9	18.0	Photovoltaic (solar) cells	5.7	6.5	7.7
Passive filters	44.7	47.4	49.8	Photoconductive cells	8.6	9.5	11.0
Loudspeakers	112.4	114.7	129.0	Light-emitting diodes	0.8	1.2	2.6
Magnetic tape, total	175.7	209.9	305.7	Photodiodes	6.3	7.6	9.7
Audio tape	54.3	62.5	92.0	Special optoelectronic devices (isolators, switches)	1.6	2.4	4.7
Computer tape	63.7	78.2	118.0	Rectifiers, solid state, total	124.1	128.7	151.0
Instrument tape	34.8	39.6	48.3	Rectifiers, silicon	96.2	102.0	121.5
Video tape	22.9	29.6	47.4	Rectifiers, selenium and copper oxide	15.2	13.1	10.5
Microwave components and hardware, total	108.2	116.3	168.0	Rectifier assemblies	12.7	13.6	19.0
(tubes and antennas excluded)				Switches, mechanically actuated, total	162.2	176.8	211.3
Microwave ferrite devices	22.0	23.8	33.0	Coaxial switches	8.3	9.8	12.9
Multicomponent packages, total	221.7	296.4	445.0	Pressure switches	20.2	21.0	23.3
(two or more separate active or passive components in a single package)				Rotary switches	37.4	40.8	56.3
Logic modules	94.3	144.6	208.0	Snap-action switches	51.2	54.3	62.0
Other multicomponent packages	127.4	151.8	237.0	Toggle, mercury, knife, misc.	31.4	33.1	37.8
Printed circuits, total	224.9	257.7	332.4	Stepping switches	13.7	17.8	19.0
Single-layer boards	83.5	93.8	109.0	Transducers, total	110.0	122.1	162.1
Two-layer boards	93.1	100.0	125.0	Pressure transducers	32.4	35.6	48.7
Multi-layer boards	48.3	63.9	98.4	Position transducers	31.9	34.3	46.2
Quartz crystals (including mounts and ovens)	54.4	58.3	67.8	Strain transducers	32.1	37.9	51.2
Resistors, total	410.3	423.0	434.8	Acceleration transducers	13.6	14.3	16.0
Fixed resistors, total	220.5	225.3	229.9	Wire and cable, total	328.6	358.6	394.1
Composition resistors, fixed	90.7	88.3	85.4	Coaxial cable	62.5	68.5	78.7
Deposited carbon resistors, fixed	17.1	15.8	11.2	Flat and flexible printed circuit cable	20.2	26.5	37.6
Metal film resistors, fixed	50.6	54.8	67.3	Hook-up wire	147.2	153.6	139.8
Wirewound resistors, fixed	62.1	66.4	66.0	Magnet wire	98.7	110.0	138.0
Potentiometers, total	164.7	170.7	172.9				
Wirewound potentiometers	79.7	82.0	81.6				
Non-wirewound potentiometers	85.0	88.7	91.3				
Other resistors (including varistors and thermistors)	25.1	27.0	32.0				

Electronics markets: 1969

The new math of growth

Sales gains this year will hold at about the 1968 pace, but more important are the further technological advances and reshaped markets down the road

Once again, the electronics industry anticipates a comparatively modest—by past standards, at any rate—year-to-year gain. Sales this year are expected to rise 6.5% from 1968, to \$25.3 billion.

The war in Vietnam is no less a factor in the near-term outlook than it was a year ago. Pentagon procurement patterns will inevitably have a significant impact upon electronics companies. Likewise, space projects will probably be wounded by further budget slashes. In addition, recurrent international monetary crises, ambivalent behavior of consumers when it comes to big-ticket items like color television and stereo sets, and the uncertainties that attend the installation of a new Administration also figure in the equation.

But the immediate statistical data seems somewhat less important this year than the industry's dynamics and what they portend. Within the next three years, electronics will become an almost \$30 billion industry. And by 1972, industrial and commercial outlets will have overhauled the Government market in terms of dollar volume. The Federal sector isn't going to fall off precipitately as a source of revenue; it will simply decline in relative importance. Clearly, this development augurs well for firms seeking to fatten their profit margins. At the same time, however, the Government's anticipated outlays of \$11.7 billion in 1972 indicate the continued and welcome availability of research and development funds.

Behind the industry's expected surge during the period ahead is the increasing rule of solid state technology. By yearend, integrated electronics of all kinds—monolithic, hybrid, film, arrays, and related wares—will claim a 44% share of semiconductor sales. By 1972, when the field will be doing around \$2 billion worth of business, this penetration is expected to reach a level of 60% or better.

Integrated circuits have already done extremely well in computer and military applications. The former market should continue to be a tower of strength, but the military is showing signs of becoming more selective in its purchases. Taking up much of the slack will be the industrial market. So important have such sales become that at least one semiconductor house has realigned its market-

ing efforts to give better coverage to the Midwest, where numerical controls manufacturers are centered. Down the road, consumer goods loom as another volume market for solid state devices. However, price is of paramount importance in this field, and IC's must first prove their mettle on economic, rather than performance, grounds if they're to find entry.

To survive and thrive from here on out, semiconductor houses are going to have to merchandise their wares and create new markets. In this context, the concerted drumbeating for large-scale integration seems premature by at least a couple of years. Most manufacturers are quietly preparing to offer complex, medium-scale arrays that interface with such proven families of devices as transistor-transistor logic.

Meanwhile, the industry in general and semiconductor houses in particular are increasingly uneasy about the blurring of the lines demarcating traditional spheres of interest. As their assemblies grow in complexity, device makers find themselves invading the territory of systems and set makers. And many of the latter are seeking to develop in-house skills in semiconductor technology. Similarly, communications firms are encroaching upon the once private preserves of computer concerns. If only for reasons of self-interest and preservation, rapprochements must eventually be worked out.

Markets index		125	Government
		126	Communications
110	Military electronics	130	Microwave
114	Solid state	131	Computers
118	Instrumentation	134	Consumer electronics
121	Medical electronics	136	Components
122	Avionics	138	Industrial electronics

Advanced projects begin to take shape

Defense procurement in 1969 will follow the general patterns of the past few years; in the research and development field, however, there will be a discernible shift in emphasis from tactical to strategic projects. Nuclear submarines and the Advanced Manned Strategic Aircraft, for example, are high on the Pentagon's shopping list. In addition, the Sentinel antiballistic missile system is still slated to receive a healthy infusion of funds. Fully three-quarters of the spending on this program, which could run to \$1 billion or more annually, will go to electronics concerns for radar, computers, semiconductor devices, and related items.

In the meantime, if the Vietnam war has done nothing else, it has underscored the crying need for special equipment in brushfire conflicts. As a result, a considerable amount of time and money will be devoted to night-vision gear, countermortar radar, and the like. And if the war were to end tomorrow, there would be little, if any, effect upon electronics suppliers, because of the long-term requirements for tactical equipment and hardware.

Clear sailing

Tomorrow's Navy, which is being developed today, will feature quiet-running nuclear subs as well as a high-speed surface fleet. In November,

the Naval Ships Systems Command awarded a start-up contract worth \$35 million to General Dynamics' Electric Boat division for the so-called "quiet" submarine. Secretary of Defense Clifford estimates the production cost of these craft at \$150 million to \$200 million—about twice the going rate for present nuclear models.

Study contracts have been let for the new multi-mission DX/DXC destroyers. About half the cost of these craft, whose prices are estimated at \$45 million or more, will be accounted for by radars and other electronics equipment. One of the big buys in the DX/DXC program will be for the electronics-laden advanced surface missile system, currently in contract definition. Development and production awards for both programs, which will probably be total-package procurements eventually worth more than \$2 billion, are expected by late summer.

It's all ahead full for the Poseidon submarine-launched ballistic missile, which is replacing the Polaris. By yearend, the missile-equipped nuclear sub fleet will have 69 craft. And the preparedness investigating subcommittee of the Senate's Committee on the Armed Services believes the U.S. is falling behind Russia in this area. As a result, attack sub programs could get even higher priority.



Field tested. The PRC-25 family of tactical radio equipment has been a workhorse in Vietnam. But the Army is now working on the future generations of equipment it will use during the mid-1970's.



Comeback. Most of the Navy's air arm budget is tabbed for new systems. Nonetheless, there's going to be money for upgrading craft like the Grumman E2A.

Moreover, a staff assistant on the defense subcommittee of the House Appropriations Committee reports that his organization is also taking a special interest in missile-carrying nuclear subs. Some members are even agitating for MIRV (Multiple Individual Re-entry Vehicles), though a number of military experts still have grave doubts about the accuracy and reliability of such systems.

The Poseidon is of particular interest to electronics suppliers because of the Navy's standard hardware program for modules in the fire-control system. "What it comes down to is that we don't care what the vendors stuff into a package so long as it does what it's supposed to," says an official at the service's Special Projects Office.

The Navy's very-low-frequency navigation system is set for substantial funding in 1969. Clifford recently gave the go-ahead for a second group of four Omega transmitting stations.

The Navy's air arm is also looking ahead. There'll be money for the VSX, which will eventually replace the Grumman S-2 antisubmarine warfare craft. This project is still in a definition stage, but development and production contracts could be let by June. Likewise, the VFX, an interim replacement for the recently scuttled F-111B, will be funded. The Navy wants it for carrier defense and related applications.

Older programs are also showing life. For example, the E2A, an early-warning radar craft built by Grumman, will be fitted out with APS-111 radar equipment.

Air power

The Air Force is cutting back on its purchases of A7's this year; it plans to use the money it saves to buy more F-4E's. The FX, a version of the Navy's advanced tactical fighter, will be underwritten during the year. The precontract definition phase is still some time away; the service is seeking the best tradeoffs among maneuverability, weapons-carrying capabilities, and speed.

With overland radar accepted, the Air Force will probably move into full-scale development of Awacs (Airborn Warning and Control System) to have it operational by 1970. Requests for procure-

ment are expected shortly. In the meantime, however, the Tactical Air Command is pushing for an interim system called Atacc (Advanced Tactical Airborne Command and Control). Awacs advocates fear that a quick-and-dirty implementation of Atacc could wind up hurting available funding for their project.

A project to be funded at relatively low levels—\$2 million or so for study contracts—could eventually lead to billions of dollars worth of orders for electronics suppliers. It's the I/CNI (Integrated Communications, Navigation, and Identification) system. An Air Force Systems Command study group, with help from the Mitre Corp. and industry, has concluded that the program is technologically feasible.

In the Army now

Army communications programs will cover a number of fronts. The multination integrated tactical trunking and distribution system of Mallard will continue to be a preoccupation. Additional versions of RADA (Random Access Discrete Address) subscriber units will be purchased. In addition, field radios beyond the PRC-25 family are being developed. "The market for lightweight tactical equipment is growing fast," says Richard Shetler, senior vice president at Sylvania Electronic Systems. "We expect volume to reach \$300 million a year by 1975."

Tacfire, a complex computer-based system for automating combat artillery batteries, will be a big buy during 1969. Litton Industries' Data Systems division is prime contractor on the program, which will be operational by 1971. Tacfire automates fire direction and selection by integrating all required data, including trajectory, survey, meteorological, and logistical information.

Although few details are available on most electronic warfare systems, it seems likely that 1969 will be another growth period for this area. Pentagon research emphasis will probably fall on reconnaissance gear, infrared sensors, foliage-penetration radar, countermortar radar, equipment to pinpoint the source of artillery fire, and related items.

IC makers' surge to continue

If and when are finally words of the past for integrated circuits. Monolithic assemblies alone chalked up sales of \$342.3 million last year; volume in this year is estimated at \$425.4—a 24% jump. Integrated electronics of all kinds, including hybrid devices, arrays, film, and related items are expected to do \$649.8 million worth of business this year, an almost 30% improvement over the year-earlier level. What's more the integrated category is zeroing in on the 50% mark in the semiconductor field. By yearend, it should account for better than 44%; by 1972, over 60%.

Discrete semiconductor components, which carried their more exotic descendants through some difficult days, have stabilized somewhat after taking their lumps during the 1966-67 period. But while unit sales will rise, dollar volume will make no headway, declining from last year's \$596.5 million to \$562.9 million. Discretes still account for a substantial enough portion of semiconductor sales that the industry's total revenue gain this year will be held to less than 9%—\$1.49 billion, as against \$1.38 billion.

While military applications will continue to be the big sales guns, other markets are on the point of becoming volume outlets. Commercial, consumer, and industrial customers, for example seem prepared to boost their orders considerably. Computer makers and aerospace concerns continue to rank high on the list of industry prospects.

Where it's at

Albert B. Dall, vice president of the Transitron Electronic Sales Corp., sums things up this way: "Computers continue to be the area with the greatest sales potential, and gains in this field are accelerating. Military business is not growing as much as had been hoped; purchases are getting very selective. Industrial outlets, which are working from a smaller base than the computer industry, should grow at a faster pace." Interestingly enough, this latter development has forced a realignment in Transitron's sales activities. The Midwest, once a Sahara, has become an important territory as numerical control makers move from the suspect to the prospect category.

Nevin Kather, who heads semiconductor operations at the Raytheon Co.'s Components division, is also looking for gains in the industrial-commercial field. "IC's for application in electronic data processing equipment are now competitive with discrete devices," he says. "In addition, high-speed memories are feasible and available." Kather also anticipates that an increasing proportion of the industry's output will be going into automobiles and consumer goods. Similarly, the fast-growing

National Semiconductor Corp., which has made a lucrative specialty out of the high-reliability military market, has also set its sights on instrumentation and calculator makers with counting elements for desk-top machines, digital voltmeters, and related apparatus. "We concentrate almost exclusively on complex elements with four or more levels of logic," says Donald T. Valentine, marketing manager. "This accounts for our dollar growth—the unit cost stays high."

Floyd Kvamme, product marketing manager at National, likes the looks of the MOS market. "Buyers have confidence in the manufacturers," he says. "A few years ago, the static about delivery was deafening. But users are getting their circuits now." Kvamme points out that shift registers, which got a big play in 1967, are now routinely designed into systems. "During 1968, the stress was on read-only memories," he says. "This year, it will be on random-access memories for computer scratchpads." Kvamme ticks off a number of applications for read-only memories, including cash registers, small computers, and character generators for remote terminals.

Another MOS enthusiast is Bill Berg, domestic marketing manager for the Signetics Corp., a subsidiary of Corning Glass Works. "MOS should do well, particularly in memory outlets, this year," he says. "I don't think we'll see high introductory price tags, though. Rather, circuits will be offered

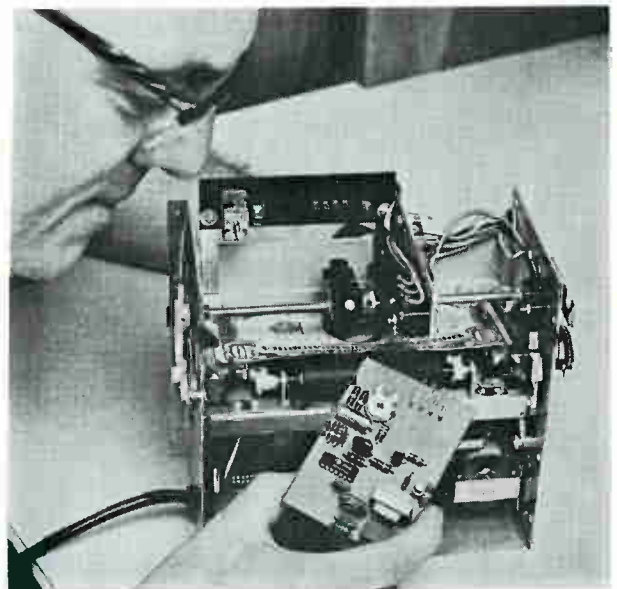

One for the money. Transmarine bill changer, built with IC's from TI is typical of new commercial applications.

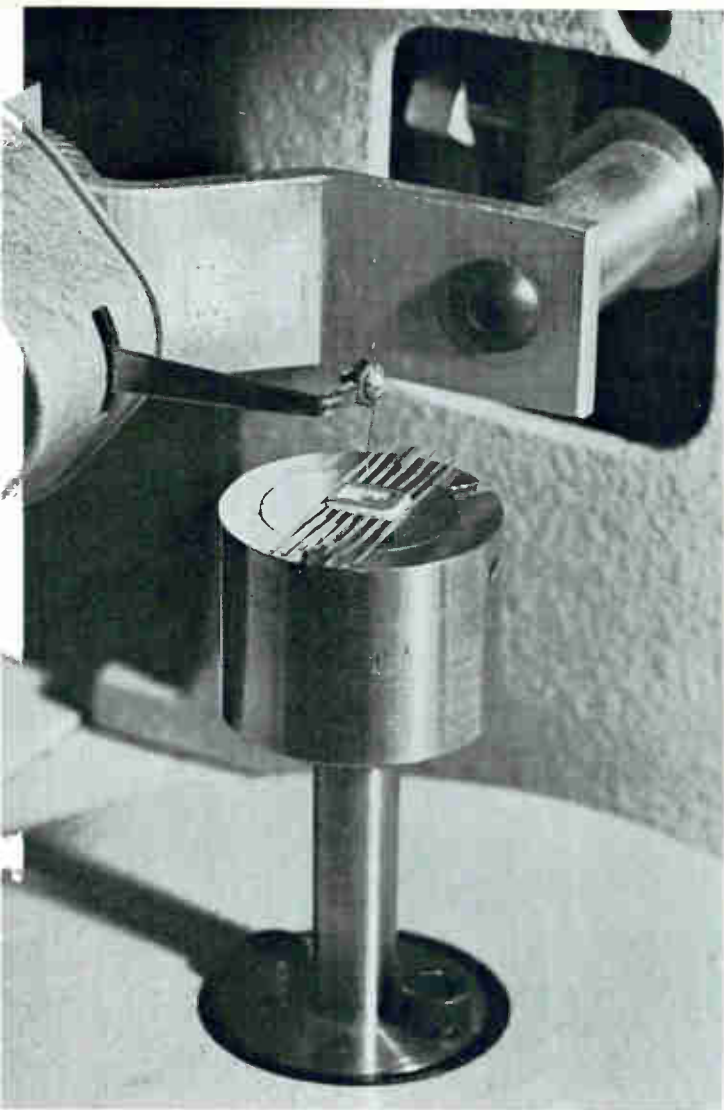

Breakaway. Sylvania spot-checks integrity of lead bonds before encapsulating any IC production runs in plastic.

at a level that can be maintained over a period of time." Berg is also optimistic about prospects in the commercial-industrial sector. "There's a lot of growth potential in peripheral equipment; users have been stuck with discrete devices because of power requirements and voltage considerations," he says. "But this year, we'll see IC's that can handle 200 to 300 volts; dielectric isolation, together with other techniques, will make these devices marketable items."

Widespread consumer applications are apparently not yet in the cards. However, the outlook is improving, and, long-term prospects remain bright. "The consumer field is traditionally slow to embrace new technologies because of the price premiums that are involved," says W. D. Rasdal, assistant manager of the TRW Microelectronics division, an element of the Electronics Group at TRW Inc. "Manufacturers are in no hurry to back away from tubes, much less adopt IC's."

Jim Burns, manager of linear IC marketing at Motorola, agrees with Rasdal's analysis. "When you reach a point where you can match the performance of discrete devices or tubes, it becomes strictly a price fight," he says. "The set maker wants a straight one-to-one rivalry before he'll adopt an IC. He's just not interested in the superior reliability we say we can furnish with linear IC's."

Nonetheless, Clay Tatom, manager of linear IC product planning at Motorola, reports the company is taking dead aim on consumer outlets. Process control improvements leading to price cuts that will let Motorola-made IC's compete with sockets are behind this push. For example, as a result of better yields, an increase in chip size, and greater device density, Motorola was able to slash the quotation on the MC1439C, a commercial op amp, from \$5.50 to \$1.80 in lots of 100.

Burns figures most linear IC's are now being used to replace discretely. He does, however, say some electromechanical devices are being displaced in automotive applications. Burns believes ignition systems will be the next sizable outlet for linears in this field.

Pro and con

There's still a good bit of controversy swirling about plastic packaging of IC's in the semiconductor field. "There's no question but what plastic encapsulation is the big thing," says an official at Texas Instruments. "We ship more devices in plastic than in any other kind of packaging. And the resistance of the military is not affecting the bright outlook to any great extent. The only point on which plastic can be questioned is hermeticity. But in normal applications, there's no problem." TI, of course, has made a very good thing of plastic-packaged logic circuits in the industrial field. It has been particularly aggressive in merchandising these wares to comparatively small manufacturers who have no prior skills in electronics, much less IC's. Frequently, these accounts turn out to be important customers whose business runs to six-figure levels.

Not everyone, however, is as sanguine about plastic as TI. "We've found much of the concern is justified," says Joseph T. Nola, manager of IC market planning at the Semiconductor division of Sylvania Electric Products. "Plastic presents some complex materials and engineering problems; we've done a lot of study in both areas." Sylvania, for example, is checking the relationships of the chip, the bond, and the package, having observed that contraction or expansion of the encapsulant can tear leads from pads. As a standard sampling procedure, the company has a "yank" test in which the wires are gently tugged to see if the bonds hold or break. "We have specifications that a bond must meet before the lot is packaged," says Nola.

Nola estimates about 48% of all transistor-transistor-logic IC's are now sold in plastic. "But the boom awaits solution of moisture, temperature-cycling, and bond-breakage problems," he says.

Stephen F. Guthman, manager of marketing services at Westinghouse's Molecular Electronics division, agrees: "The Government will eventually accept plastic. But it's up to the IC industry to prove its case. It hasn't done so, and plastics won't be accepted in any kind of high-reliability environment this year." Guthman, however, concedes that such devices will continue to thrive in commercial outlets. TRW's Rasdal anticipates that the military will continue to insist upon hermetically sealed packages—even for beam-lead devices, which are virtually sealed chips requiring no package, according to their advocates.

Jerry Gibbs, product marketing manager at Tele-dyne's Amelco Semiconductor division, is looking for more widespread acceptance of plastic-encapsulated IC's during the year. He's disturbed, however, about the semantics that are involved. "Plastic is really a misnomer; silicone is the proper term," he says. "Many misconceptions could be overcome if the industry used this term." Gibbs points to the fact that silicone is inert and—unlike epoxies—has no catalyst. In addition, he says, the material is capable of wider temperature ranges than ceramic.

Motorola's Burns virtually dismisses the whole question, saying: "Plastic-packaged devices—whether digital or linear—were never intended for the military market." However, his colleague Tatom points out certain defense applications in which plastic surpasses other materials. Motorola makes linear IC fuzes for a wide variety of ordnance. The greater impact resistance of the plastic package makes it more attractive in this case. This is because the package is "filled," making for greater lead-bond integrity when projectiles are fired.

About as far as they can go . . .

As IC producers gain experience in their craft, their yields have improved. Exactly how much, however, is a closely guarded secret. When queried on the subject, spokesmen are inclined to give a percentage improvement over last year's unknown. While there's little reason to doubt that the figures have improved considerably, the industry gives the impression of fretting about where its next breakthrough will come from. "Yields are like a staircase," says Westinghouse's Guthman. "They improve, and then stay at a plateau for a while." Raytheon's Kather reports his company's yields have reached the point where "there won't be any substantial improvements without major process innovations." To this end, Raytheon is running further wafer checks, performing a-c, d-c, and testing on the chip.

"Yields are to the point where we can run IC's off the line like discrete transistors," boasts Dall of Transiron. "Even on complex functions like our upcoming 45-megahertz shift register and 60-Mhz counter arrays, yields are already better than on simple assemblies. Problems with arrays may never be as serious as was the case with the first flip-

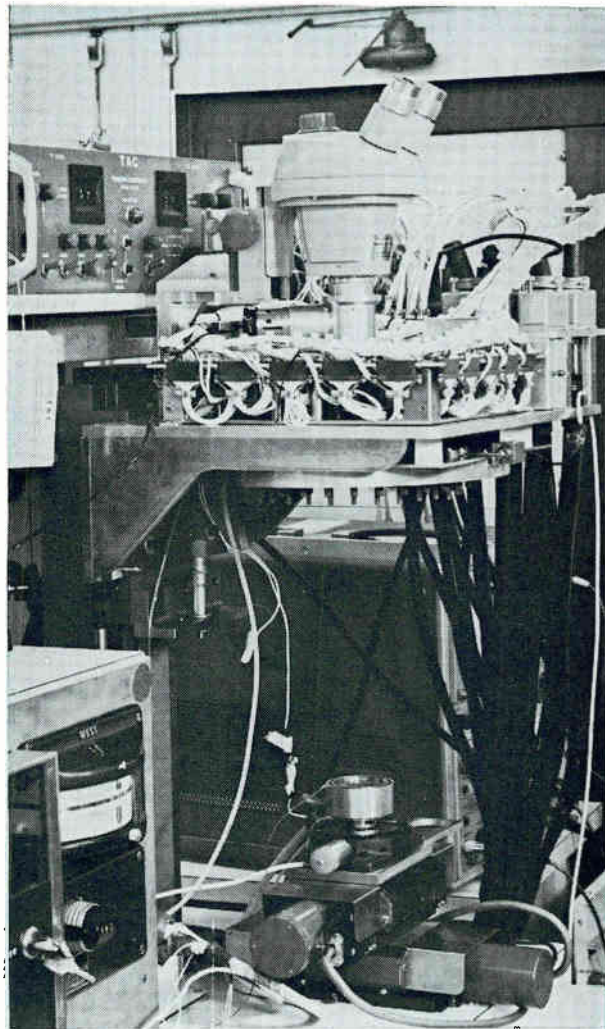

Check point. To enhance IC yields, Raytheon uses set-up which makes a-c, d-c, and temperature tests on the wafer.

flops and related devices."

Gibbs of Amelco believes further improvement in yields will be marginal involving better testing at the wafer stage. But, he says, present equipment is close to the practical limit.

Motorola has turned its attention to boosting reliability via mechanical means—for example, application of spider bonding techniques and automation of the lead bonding process. At TRW, which is heavy in hybrids, Rasdal considers assembly still the over-riding problem. "Over the short haul, we'll sharpen controls," he says. "But long term, we think beam-lead devices will be the big thing helping to automate assembly." Many in the industry agree with his analysis. One engineer is reported to have gone to his boss and said: "I think we should make an objective evaluation of beam leads and flip chips—and then choose beam leads."

Confusion on a large scale

Semiconductor houses continue to beat the drums for large-scale integration while preparing to promote medium-scale arrays. A source at Fair-

child Semiconductor sums things up this way: "Along with most everyone else, we're set to push MSI this year. Sales will be less than 10% of the integrated electronics total. This is because computer makers are the biggest outlets, and they're still designing the next generation of machines. Volume buys at the moment are for gates and flip-flops. However, the important thing is that MSI determines the balance of the new systems. The design emphasis is on maximum complexity—in other words, the most gates per pin and fewest packages per system."

National Semiconductor is also dubious about LSI. "It's the most complex circuit you can make," says Valentine only half in fun. "But by anybody's definition, no true LSI devices will be used in production equipment for three to five years in any meaningful quantity." Again, however, MSI is something else; National has jumped into this area with complex TTL circuits. Later, it will bring out the simple gates that designers need for filling out their systems. Signetics' Berg agrees, "TTL will continue to grab a bigger share of market, and most MSI designs will be compatible."

Way to go

John A King, manager of marketing operations at Sprague Electric's Semiconductor division, says: "We're not home free on LSI as an industry, and we won't be for a long time. Failure modes, thermal considerations, lattice structure, and the like become critical problems as the wafer size grows. And if nothing else does, that's going to hurt." King believes, however, that work in LSI will pay off by fallout at least. "For example, yields on less complex circuits will improve as we solve process control problems on LSI."

"MSI is the way to go. Yields here are improving steadily to the point where we easily can produce circuits with two layer metalization on pilot lines; three-layer metalization is working well in the lab," says Dall of Transitron. "We're confident enough to anticipate introduction of a 64-bit memory chip within the next few months."

"I honestly don't think that anyone will be able to spot the time at which MSI outgrows its label and becomes LSI. As MSI yields improve, chips will gradually grow more complex."

Dall believes the unwary IC maker could get whipsawed selling LSI. He dips into the past to prove his point: "In the days of discrettes, a computer's arithmetic section could be built out of two cards—say, a gate card and a flip-flop card. Then IC's arrived, causing some firms to use a few of them, wired in many different ways in many different circuit board types. Now, LSI is confronted by 100 or more different cards in the more complex and powerful computers. And customers want to take these four or five racks of gear and squeeze them into a shoebox-sized container by exchanging each card type for an LSI wafer. But the seller finds out his prospective customer only wants one or two a year—at a price competitive with conven-

tional IC's. It all adds up to a low-profit, high-risk situation that isn't wholly the fault of the IC house, since if enough attention were paid to system architecture, computer builders could cut card or LSI circuit types by 75%."

Dall believes the real benefit of LSI over the next few years will be as a watershed technology for MSI. "By doing the near impossible with LSI, we'll boost yields and reliability and, maybe, reduce prices as well," he says. "For the moment, there won't be much if any, off-the-shelf LSI. Hybrids using MSI chips will be the LSI of the next couple of years."

"Circuits of 100 gates or more are talked about more than sold; it won't be until the very end of 1970 that these 100 and more gate circuits are introduced," says Berg of Signetics.

But because of the fine geometries required for the MSI that Signetics plans to bring out, masking equipment will be put into use which will provide higher resolution than previously. "We are now producing circuits with 24-lead complexity," says Berg. "It will be late 1969 or 1970 before we move to the next level of complexity of 50 or 60. Twenty-four lead packages will become the standard in IC's as 1969 wears on."

Business side

Prices on any IC family will start down and taper off, but the curve will be much flatter this year because there's not much that can be done to raise yields, says Berg. "We won't see dramatic price cuts anymore; probably prices will go down only by 5% or 10%."

During the year, Berg says, there will be increasing difficulty in getting users to accept product innovations. A new line, he believes, will have to offer something pretty substantial to get accepted.

Because there's not much possibility of cutting costs by improving yields, Berg says that it will be difficult for producers who don't have high volume and high yields to make any money.

"We will see a polarization in the industry which will separate the specialty houses from the broad producers. There will always be room for the small volume specialty house doing a \$2.5 million business, but they can't expect any longer to get into a position comparable to the industry's big five," says Berg.

Berg makes an analogy between the semiconductor industry and the automotive industry. The big automotive manufacturers have the bulk of the market sewed up and it would be impossible for anyone to become a GM, but there are numbers of small "specialty" houses which quite profitably produce special-purpose vehicles.

The polarization of specialty houses and broad-market houses in the semiconductor industry will be greeted warmly by Signetics. Berg says that it will be a relief not to have to make both the investment and those costly errors which are required to put a circuit on the market for only small volume sales. "Let the specialty houses do it," he says.

Sweet notes in instrumental theme

Instrumentation firms anticipate another good, if unspectacular, market this year. Sales are expected to rise 12% to \$769 million from last year's \$684.4 million. The principal reason for the field's come-down from the 20% plus growth rates that characterized the mid-1960's is the war in Vietnam. George Bruns, president of the Systron-Donner Corp., explains things this way: "A big chunk of the money for this war doesn't go to industry for equipment; it's simply spent in Southeast Asia." This sort of Government outlay cuts into military, as well as civilian, research and development activities.

Marketing officials at Systron-Donner, about half of whose business is underwritten by the Government, believe that the dollar value of R&D contracts would be much greater if the war were to end—though, they say, the ratio of military to other work would remain about the same.

Diversion of Government funds to the war effort has forced cuts in the budgets of such agencies as the National Aeronautics and Space Administration and the National Institutes of Health, which have been important instrument customers in the past. Hewlett-Packard's president, William R. Hewlett, says: "An end to the war would stimulate sales of electronic measurement and computation equipment for medical research, air traffic control, space, telecommunications, ground transportation, advanced military projects, urban renewal, and education."

Another depressing influence of as yet unknown magnitude is the 10% surcharge on Federal income taxes. Many instrument companies report that the impost has had no appreciable effect so far, but if it cuts significantly into profits, customers could reduce their spending for instrumentation.

Calling automatics

The moderate gains forecast for 1969 are largely attributable to customers' desire to modernize. They're demanding, for example, measuring equipment that's more automatic. John W. Zevenbergen, marketing vice president at the John Fluke Mfg. Co., reports that more and more of the firm's customers balk at buying "manual" equipment—that is, gear that must be read by a human. He cites Collins Radio as but one account that won't buy any new apparatus that can't be easily interfaced with a digital, automatic system producing computer-compatible data.

"In the future, we'll be concentrating on automatic instrumentation," he says. "About everything we do on a manual basis now we hope eventually to do digitally and automatically."

Robert G. Fulks, engineering group leader at the

General Radio Co., considers this demand trend "part of the continuous process of taking the art out of precision measurements and building it into instruments." General Radio expects growing interest in automatic impedance measurements and automatic calibrating d-c digital voltmeters.

"Computer-controlled measurement systems will really catch on in 1969," Fulks says. "The engineer is beginning to realize that a computer is not necessarily a piece of mystery equipment but a useful component that will reduce his measured results to a form meaningful to his application."

"The field is boiling," asserts Robert Brunner, corporate engineering manager at H-P. "By using software imaginatively to augment hardware, we can give engineers fast access to the parameters that are their real concern but which previously they could only derive after the experiment was over by computation or inference."

Because of the industry's growing ability to digitize and process data fast, it's now possible, for example, to measure impulse response by testing with noise, substantially in real time. Histograms can be generated to show the way circuits or systems depart from center-line performance with overload, temperature, and other factors.

Improved performance at reasonable cost will also play a role in the anticipated market growth by opening new outlets. In counting and timing, for instance, direct methods can now go up to 200 megahertz. And with scaling and heterodyne techniques, converters can go to 50 gigahertz. Timing resolution on the order of 1 nanosecond will also be available. As a result of such gains, Wavetek, for one, expects more widespread use of instruments previously considered exotic. Spectrum analyzers, for instance, are becoming workaday items of test equipment.

Export sales are another factor in growth; Hewlett predicts continuing high levels of international business for his company. Orders from customers outside the U.S. are now running 23% ahead of year-earlier levels at H-P. And Fred Katzman, director of the electronics department of Monsanto's Electronic Instruments division, is also sanguine about overseas prospects. He expects his firm to ship 20% or more of its production overseas.

Two-way stretch

Integrated circuits will expand their inroads into instrument designs next year, and will have a profound effect in the marketplace. Says Systron-Donner vice president Frank Marble: "The spurt we anticipate is directly attributable to the fact that we've gone for IC's. This has permitted us to market a low-priced instrument in a high-priced market."

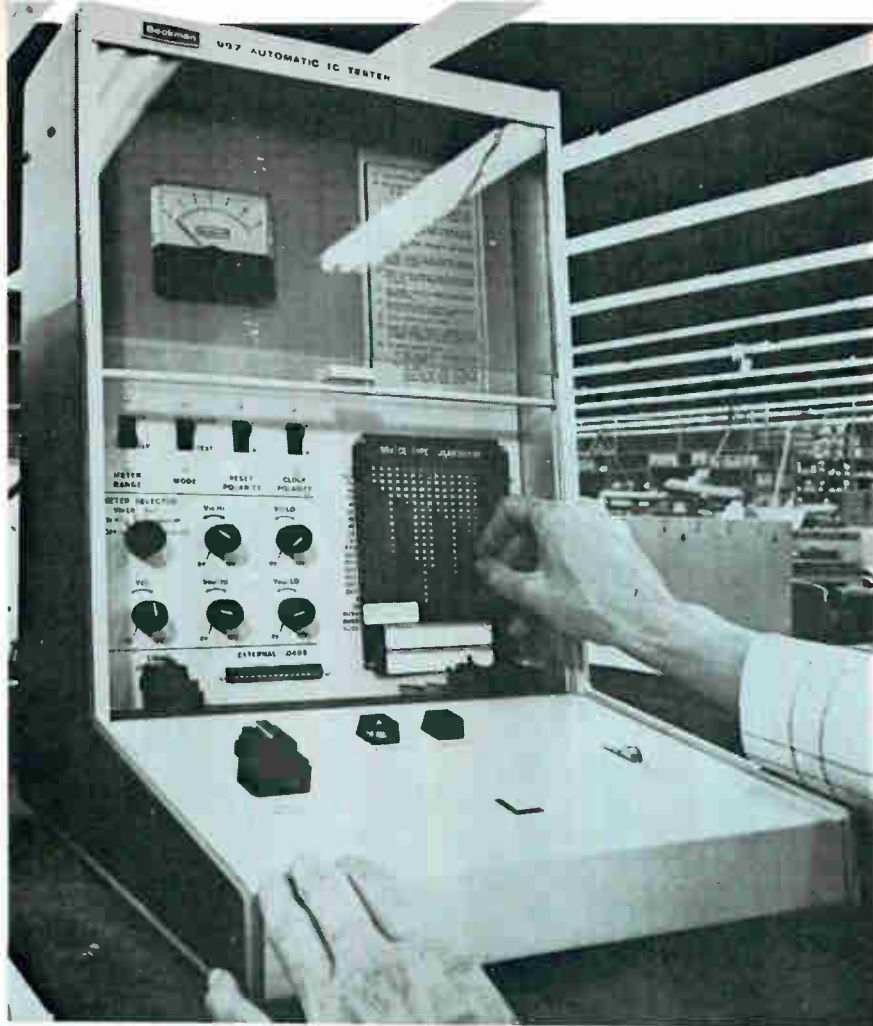

Niche. Instrumentation houses and semiconductor firms are seemingly preoccupied with elaborate IC testers; but economy models like this Beckman unit continue to appeal to laboratories and smaller equipment makers.

Cheap labor and discrete components cannot match the cost or performance of instruments made with IC's."

The success of IC's in instrumentation, in fact, is partly responsible for the trend to greater automaticity in measurements. The continuing rise in labor costs and decline in the cost of digital logic will make it practical to automate more and more measurements, notes Fulks of General Radio.

IC's are intensifying competition too. It's possible for the counter manufacturer to do less circuit designing and to simply assemble devices designed by component manufacturers. "This is swinging garage doors open all over the country," says a Beckman official. Wavetek agrees. "With circuit design innovations available to everyone, it will be up to the manufacturer to use ingenuity in packaging the IC's to maintain a competitive edge," a source there declares.

Shakeout

Though IC's will make it easy to get into the instrument business, it's not going to be easy to stay in. "We are seeing increasingly sophisticated instruments with more and more engineering investment," Monsanto's Katzman says. "This can be hard on the small supplier. We'll witness more and more consolidations."

The prevalence of IC's is affecting instrument

manufacturers in another way, creating a huge market for testers. And as IC's become cheaper, there's greater pressure to test them more cheaply. "That doesn't necessarily mean simpler and less costly testers. It may, in many cases, mean more elaborate, faster, and surer testers," says H-P's Brunner. He anticipates a trend toward comparative performance testing in lieu of parameter checking.

Large-scale integration poses particularly knotty problems for test-set manufacturers because of the vast number of parameters involved. H-P views the problem as one of making many dynamic measurements rapidly and interpreting the results automatically. "It's hard to see how these systems can be of the 'economy' variety, although they can and will be reasonably priced," says Brunner.

One example of what will be involved in checking future LSI circuitry is the apparatus H-P has devised to check the company's new calculator, the read-only memory of which is a single, sealed array. A computer-controlled system checks the entire 32,768 bits of the memory in seconds, notes if errors exist (and where), and then makes as many as 1.2 million bit comparisons in about two minutes.

Officials at Beckman agree that there will be a good market for complex test systems among big IC makers, who need to know more about their output than do their customers. But, they say, econ-

Time check. Monsanto counter/timer is used to test switching time of thermal relay; increasingly such equipment is being combined in computer-based systems that measure more parameters with greater accuracy.

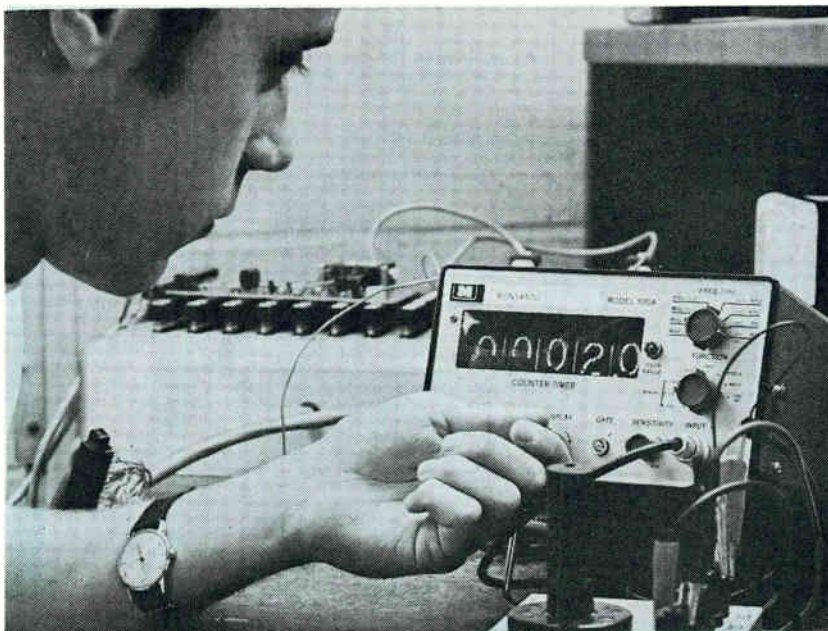

omy models will continue to appeal to small and medium-size companies, which are more concerned with midrange operating capability than with operation near the outside limits.

So far, only one firm appears to have come up with anything that fills the LSI bill—the North American Electronic Systems division of the Educational Computer Corp. Last fall, the company began offering an LSI test console for between \$30,000 and \$35,000, depending on the test modules. The computerless system isn't programmed conventionally as are the huge, experimental setups being developed by semiconductor houses; instead, it uses a matrix board and diode pins to generate word patterns. It's up to the user to decide which checks best meet his needs. Alfred J. Homann, vice president and chief engineer at NAES, believes the system provides an economical solution to the dilemma of designers who want to test short runs of different circuits, each of which requires individual word drivers.

Status symbols

Digital panel meters are expected to come into their own in 1969. Says one marketing source: "Any original-equipment manufacturer with a digital device looks better than one with analog apparatus. Customers are paying a premium to get a digital function—it's the thing to do."

Whatever the reasons, this market has huge potential, and competition is intense. New firms are invading the field, and those already in will introduce improved versions of their wares. So far, sales are somewhat slow largely because of the cost and size of the meters. But these drawbacks are diminishing. "It's never going to replace the \$14 analog panel meter, of course, but among hand-calibrated, high-accuracy meters, the digital unit is going to be moving in rather quickly," says Alan Dallas of

Honeywell's Test Instruments division.

"There'll be fairly rapid growth in volume now that they're below the \$200 price level," says Robert Turner, a vice president of Tyco Laboratories, Inc. Prices should continue to drop drastically; in fact, experts predict levels of about \$100 to \$125 a year from now. "The DPM is now a direct threat to the pointer meter," says Turner.

One indication of the intensity of competition in this field is the fact that Tyco encapsulates its digital panel meters in plastic to discourage other manufacturers from trying to analyze their innards.

Other advances in components will also start to be felt this year. Ferrites and such gallium-arsenide assemblies as light-emitting diodes and bulk-effect oscillators are being looked over with increasing interest by instrumentation houses. "Last year saw the development of efficient light-emitting diode structures and of Gunn-effect high-frequency oscillators that appear to be quiet, stable, and reliable. We're sure these developments have important consequences," says Brunner.

Monsanto this year expects to introduce commercially a counter with light-emitting diodes for the numerical display market.

Improved versions of conventional devices can sometimes have near-revolutionary effects, Brunner points out. "Transistors that perform far into the gigahertz region are becoming really useful now that we can incorporate them in chip form directly as transmission-line elements of hybrid microcircuits. These circuits operate at low voltage and can be voltage-tunable. And being small, they afford a wider range of tradeoffs. We have begun to see their effect in new sweep-signal generators and spectrum analyzers. We'll be seeing solid state instruments that'll be more reliable, smaller, and more easily programable than present gear, and which will provide improved electrical performance."

Long-term prognosis still favorable

Even enthusiasts have stopped predicting a run-away boom for medical electronics. What's in store is another healthy gain of about 11% as sales rise from \$366.3 million last year to \$406.9 million in 1969. Manufacturers will be turning out systems that do everything from handling hospitals' routine administrative chores to monitoring cardiac cases and speeding diagnoses. But a number of obstacles preclude a volume market any time soon.

Buyers can expect somewhat higher price tags on the medical electronics apparatus they buy this year. Aside from inflationary pressures, the industry's low volume is the most frequently cited reason for rising prices. "Medical electronics gear is usually a lot less complicated than, say, a color television set," says William Hagan, director of medical electronics at Baxter Laboratories. "But it still costs a lot more."

Service requirements are also running up costs. "Our customers demand—as is their right—a lot in the way of support," says Dean Morton, medical products manager at Hewlett-Packard's Waltham division. "We think we're doing a good job. But everyone has a way to go, and service costs."

And now the Food and Drug Administration is seeking enactment of a bill permitting it to police electronic equipment used in the medical field. There's no consensus concerning the need for Federal controls in this area, but most observers agree regulation would push up prices and, perhaps, drive some smaller companies out of the field.

Communications gap

Another difficulty is that physicians are all too often unable to express their requirements in precise technical terms, while engineers are wont to over-solve medical problems. "It's not really a matter of what can be measured fastest and easiest with the latest in aerospace technology," says one M.D. "We're after systems the physician will find useful."

Ignorance of the market is also holding a lot of companies back. The head of medical engineering at one company sums up his problem this way: "We could invent the resurrection pill, have them stacked all over the place, and still not be able to sell because we just don't know the market. It's that much different from the aerospace business."

John Truxal, chairman of the National Academy of Engineering's committee on the interplay of engineering in medicine and biology, believes cognizant Government agencies should be doing more to stimulate the market. "There's no set-up inside NIH (National Institutes of Health) to foster the development of electronic devices—nothing like at NASA or the Pentagon," he says. "NIH should be trying to convince industry to come into this un-

familiar market. Companies either have to be given big contracts or the prospect of profit."

Joining the larger, old-line instrument companies and specialties firms that have been in the medical field a good while are pharmaceutical houses. Early this year, for example, Hoffman-LaRoche, a drug company, will offer a doppler-effect blood pressure monitor.

Cardiac monitoring units are being designed and built in increasing quantities by old timers and newcomers. At the November meeting of the American Heart Association, H-P's Waltham division unveiled an arrhythmia detector, which inspects the waveform of a patient's heartbeat and compares it

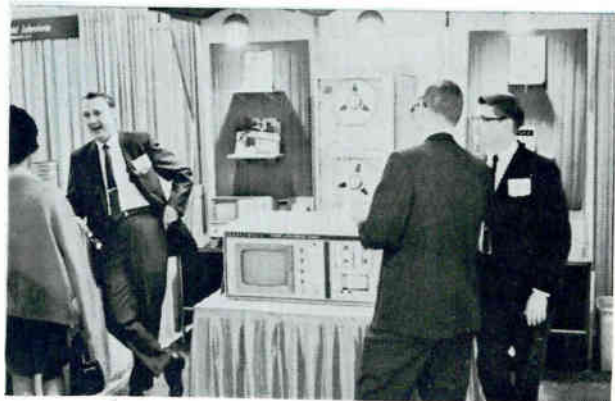

Heart of the matter. Sales of cardiac monitors like this Honeywell system will jump an estimated 30% during 1969.

to a "healthy" version stored in the instrument's memory. At the same show, Westinghouse's new medical department introduced a cardiac monitor.

Honeywell, Inc. is taking orders for its new monitoring system and will have a blood-pressure module ready by July. Baxter Labs introduced a monitoring system in 1968, and this year plans to offer plug-ins that measure arterial blood pressure, peripheral blood pressure, and fetal heart rate.

NAE's Truxal points out that preventive medicine is another area where electronics can play an important role. "Multiphasic screening is coming on strong," he says. Mass screening demands that instruments be developed that can test for various diseases quickly and simply. One such instrument may be the doppler-effect spirometer which Statham says will be ready early this year. According to the company, the device will measure all respiratory parameters, including tidal volume and minute-to-minute volume in three minutes.

Commercial markets start to soar

The sky's the limit again for avionics suppliers. Not only will this year's sales top the strong showing made in 1968, but the gains should come across the board—in general aviation, commercial transports, and even space systems. And supporting the anticipated sales success is a solid base of technological progress.

The general-aviation fleet will be increased by another 15,000 or so craft—close to the peak level of 1966. The outlook in this area is further enhanced by the fact that owners are outfitting their planes with more sophisticated systems, according to Victor Kayne, vice president of the Aircraft Owners and Pilots Association. He says 25% of today's pilots have instrument ratings, against only 15% five years ago.

Deliveries of commercial aircraft to domestic airlines will total only about 70 during 1969, according to Air Transport Association data. But activity will pick up toward the end of the year as Boeing begins to ship its jumbo jet 747's and McDonnell Douglas and Lockheed make the first deliveries of their DC-10 and L-1011 airbuses.

The anticipated growth in both the commercial and general-aviation fields promises to have a tremendous impact upon the Federal Aviation Administration Agency, not only in 1969 but also in the years to come. As traffic in the skies increases, so does the agency's problem of directing it safely and efficiently.

But despite the near breakdown of the U.S. air traffic control system last summer, there seems to be no particular sense of urgency at the FAA. The agency continues to sink millions of dollars into installations designed years ago and considered already obsolete by many observers. For example, work will finally start this year on the Automated Radar Terminal System (ARTS-3). An offshoot of the FAA's Terminal Radar Control (Tracon), ARTS-3 features radarscopes that provide automatic alphanumeric readouts on an aircraft's ground speed, altitude, and identification. The system, which is supposed to alleviate traffic jams around busy airports, will be hooked up to the computers in the nation's en route air traffic control network.

As it happens, though, work is still in progress on the latter project. The first installation, at Jacksonville, Fla., won't be turned on until March. When completed, it will have television-type displays with alphanumeric readouts, as well as computer-processed radar data. The en route network won't be finished before 1973 at the earliest. And by that time, all of the 20 or so centers will be overtaxed, necessitating further stop-gap capacity expansions.

As usual, things look better aloft. For example, 1969 will be the year commercial airlines embrace inertial navigation systems. Pan American World Airways will be flying AC Electronics' Carousel 4 aboard Boeing 747's by yearend, and several other carriers including TWA, United, and Finnair will be using operational systems on stretched 707's and DC-8's. Other airlines are waiting to see just how economical inertial gear—at \$100,000 a crack—will prove to be.

To make inertial navigation more attractive, AC Electronics is looking at new ways of applying it. For example, the company is studying the possibility of tying the precision velocity and attitude outputs into automatic landing systems and area navigation displays. And both AC and Litton Industries, the other commercial supplier of inertial systems, are working on lower-cost versions of present models.

Within the past year, considerable interest has been expressed in a guidance system whose accuracy would be somewhere between that of gyro-stabilized tables and the \$100,000 inertial gear. Two such "poor man's stable tables," dubbed Heading and Attitude Sensors—HAS-1 and 2—are being breadboarded at a number of concerns. HAS-1 is essentially a better-performing replacement for vertical and directional gyros; HAS-2, which would be more accurate and expensive, provides inertial-sensor position outputs. Both could be used with ground-based aids to drive area navigation displays and tie in with signals from instrument landing systems.

Airline interest centers largely on the HAS-1 system. And approval of a specification making an installation interchangeable with a fully inertial system meeting Arinc's 561 spec is expected at the May meeting of the Airlines Electronic Engineering Committee.

American Airlines is seriously considering HAS-1 for its DC-10's, says Lee C. Keene, the carrier's director of avionics engineering. And there's the possibility, he says, of retrofitting the airline's 707 fleet. American is hoping for a price tag between \$15,000 and \$20,000.

Lockheed is investigating HAS-2 for the L-1011, says John A. Gorham, the firm's assistant division engineer for flight guidance and control systems. The company asked for proposals for a dual HAS-2 system late last year, and it hopes to select a design by early spring. The system is basically a Shuler-tuned inertial platform with a third vertical gyro, according to Gorham. It will provide such inertial data as latitude and longitude displacement. Lockheed hopes costs can be kept under \$30,000.

OF NYCXPPA NYCCBPA RAAXXPA MIAAXMPA NYCMRPA VWLXXPA
 ,DIGICOM N778PA NYXXTPA
 FLIGHT NO. 211
 ROUTE 3
 FIX 14-14
 TIME 1557
 FLIGHT LEVEL 370
 MESSAGE 390
 3
 3051617
 AAI 116 AGP 117

REQ	CRUISE			
FL	370			
RAT	-27.3			
ENG	1	2	3	4
N-1	99.9	102.0	101.3	102.0
N-2	94.0	95.9	88.7	89.3
EGT	401.3	400.2	400.0	406.9
EPR	1.739	1.775	1.772	1.785
FF	3000	3105	3110	3195



Less talk, more action. Prototype digital communications systems like this Bendix equipment flying on Pan American aircraft transmit routine flight and engine-performance data to crt displays or teletypewriters, cutting voice traffic.

Area navigation, talked about for 20 years, may finally become a workaday cockpit routine starting this year. A half-dozen airlines were flying systems last year, and by spring the FAA will issue a technical equipment standard. And because of increasingly congested airways the agency will probably authorize the use of area navigation over selected routes.

Faster track

Area navigation systems permit aircraft to deviate from established routes—a feature that can make for considerable savings in time. Planes equipped with on-board computers can operate along just about any path without losing their way—provided they're within range of signals from ground-based very-high-frequency omnirange and distance-measuring equipment. The ground stations also handle signals from instrument-landing system transmitters to put an aircraft directly on the glide path to a safe landing.

Eastern Airlines is currently checking Decca Systems' Omnitrack on its DC-9 shuttle flights between New York and Washington. American is testing Butler National Corp.'s Vector Analog Computer system on two 727's operating between New York and Chicago. And United is flying a system developed by Hughes Aircraft.

Area navigation could get a boost from efforts to promote the use of short takeoff and landing (STOL) aircraft for city-to-suburbs and even city-to-city flights. Last November the FAA recommended that 25 STOL ports be built in the New York, Washington, Los Angeles, and San Francisco areas to relieve congestion around terminals.

Digital data communications may be standard

in commercial aircraft by 1971, says B.F. McLeod, director of electronic engineering at Pan Am, which is now flying a system from Bendix Avionics in a 707. Both the airlines and the FAA are interested in digital techniques because they promise to help reduce the staggering volume of air-to-ground voice communications. Routine reports a pilot now makes orally to his line or to an FAA ground station could be sent automatically over a digital link. In addition, engine performance parameters could be monitored and sent automatically to terminal stations as a maintenance aid.

Pan Am's tests will determine the best hardware arrangement and operational procedures for the job. And checks on how an aircraft's operational environment affects digital transmissions will determine the data rate and error-control techniques that are to be used.

This year, Pan American plans to install systems that can be interrogated from ground stations in at least five more planes. The next step will be to outfit the airline's entire fleet, with priority to be given to the new 747's.

Pan Am would like to carry out its experiments via vhf satellite circuits, but conventional and extended-range equipment will be used if a space-craft link isn't available. Commercial carriers have long talked about orbiting a vhf satellite for their own use. Such a craft would give them more reliable digital data links, as well as better-quality voice communications, than are possible with long-range high-frequency equipment.

Last year, the Communications Satellite Corp. proposed the orbiting of two satellites—one over the Atlantic, the other over the Pacific—in a system that would cost \$50 million to \$55 million over

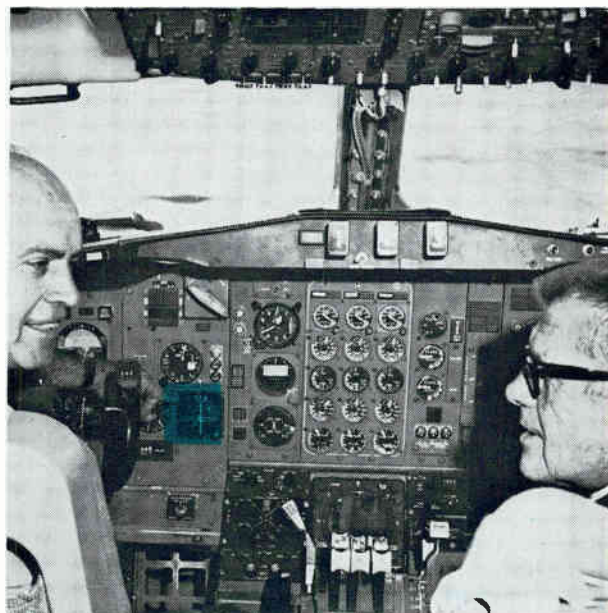
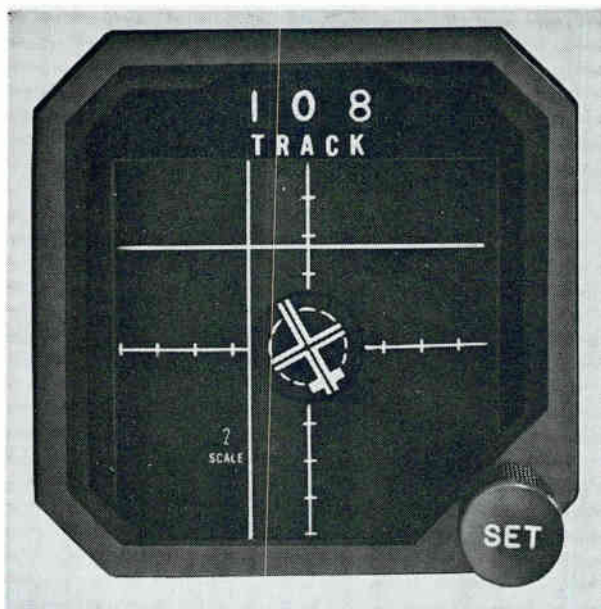

Time saver. Many commercial airlines are test-flying area navigation systems like this built by Butler; the hope is that such equipment will cut down on the amount of time wasted both en route and around terminal areas near jetports.

its five-year lifetime. A decision would have to be made now for a 1970 launch, but with industry earnings down and the FAA not committed to share the cost, the outlook for this project is dubious.

Another factor delaying an aeronautical services satellite is the industry's quickened interest in an L-band system. Some observers believe this band would afford better transmission reliability and quality. But aside from the fact that the gear must prove itself operationally, present airborne communications systems and ground stations have been developed only to handle vhf.

Testing time

Further work will be done during the year on collision avoidance systems (CAS). Under the aegis of the ATA, six months of flight tests will begin this June on systems built by: Bendix Avionics; McDonnell Douglas; Martin-Marietta; and the team of Sierra Research and Wilcox Electric.

Although the airlines version of a CAS will probably cost, at least initially, anywhere from \$30,000 to \$50,000, a general-aviation version might go for only a third as much, according to Frank C. White, ATA's manager of communications and data processing. In five years, he says, with further improvements in integrated-circuit techniques, the price for a general-aviation model might be under \$3,500.

Commercial carriers will be paying more attention this year to computer-controlled automatic equipment to shop-test such electronics gear as autopilots and flight directors. The 20 man-hours it might take to check out an autopilot drops to less than two when automatic equipment is used, says William Smoot of Arinc Research.

A British company, Hawker-Siddeley, sold one

of the first commercial automatic systems to American Airlines in 1967. Last year, Collins Radio got into the act, supplying equipment to United. Other carriers expected to buy systems, which carry price tags of \$250,000 and more, include Pan Am, Continental, and TWA.

And the first commercial flight tests of all solid state digital air data equipment will begin this spring. American Airlines will test two systems—one from Conrac and the other from Garrett AiResearch—for three to six months aboard 707's.

The digital systems, which are slated to replace electromechanical devices, read out such information as altitude, true airspeed, mach number, and temperature. The solid state sensors are expected to be more reliable than their electromechanical counterparts, thereby lowering maintenance costs, says American's Keene. His company is looking into the possibility of retrofitting its 707's with the systems, which go for \$20,000.

Digital air data systems have been specified for the DC-10. But Lockheed decided in November to order analog air data computers for its airbus.

The airlines will continue equipping their planes with all-weather landing systems, although their efforts don't seem to be matched by the FAA's pace of ground-station installations. By the end of the year, about 1,640 commercial aircraft will have been fitted out at a cost of \$65 million, according to ATA. Right now, perhaps 1,000 are equipped.

According to one industry source, the hope behind the airlines' installation of equipment—which ATA estimates costs \$40,000 per aircraft—is that the FAA will be pressured into putting in the more precise instrument landing systems and approach and runway lighting that are needed.

Changing of the guard makes civilian agencies cautious

"If you find out what the Federal Government plans to spend on electronics in 1969, please let us know," says a Senate Appropriations Committee staff member. This is a fair sample of the general feeling in Washington as President Johnson gets ready to present the fiscal 1970 budget—which President-elect Nixon and a Democratic Congress will have to work into mutually satisfactory shape.

On balance, nobody in Washington expects any significant changes in civilian outlays for electronics this year. "We'll be spending about the same for electronics—perhaps a little more," says a source at the Atomic Energy Commission. "This is about the same pattern as in 1968." The comment is typical in that agencies in the market for electronics are playing it close to the vest in discussing new programs. Officials seem convinced that it doesn't pay to rock the boat when a new captain is climbing aboard.

Aside from the military, the FAA, and NASA, the big electronics buyers in Government continue to be the AEC, the Department of Transportation, and the Department of Health, Education and Welfare. For example, the AEC's calendar 1969 budget of about \$72 million includes an estimated total of \$25 million for computers. The agency, one of the Government's largest computer users, is increasing its expenditures for this purpose by about 25% a year. "And we don't see any end to this," says a source. However, outlays for reactor control and instrumentation equipment, as well as radiation detection and monitoring apparatus, will not increase quite as rapidly.

Although the AEC is among the Government's most active purchasers of computers, it is not the largest by a long shot. For example, the General Services Administration figures it will buy or lease between \$400 million and \$500 million worth of machines this year. And the Office of Education will start working toward the first model of a system that could have great impact on the use of computers in public schools.

The system, known as Cues (for computer utilities for educational systems), will be built around a large processor at a central site serving up to 100 high schools and junior colleges in a 100-mile radius. Initially, the setup will teach the 200,000 or so students in the Washington school system how to use computers in solving problems in such fields as science and math. It will also be used for vocational training of students in programing in at least the Fortran and Cobol languages.

Until several weeks ago, there was some question about President-elect Nixon's thoughts on the

future of oceanology. But in a letter to Edward Wenk Jr., executive secretary of the President's National Council on Marine Resources and Ocean Engineering, Nixon made it clear that the council would continue to exist and that a Federal program for studying and exploiting the oceans would be established. Exactly what form this effort will take—whether a full-scale "wet NASA" or a small, independent agency to coordinate various oceanographic efforts—remains to be seen. The important thing about the letter as far as the electronics industry is concerned is that there will not be any pressure from the top to cut down on present programs.

During the fiscal year ending June 30, a total of \$516 million is being spent on 13 Federal marine science programs. This figure includes naval oceanographic work and Pentagon research, which amounts to \$150 million. Roughly 40% of all oceanographic expenditures go for electronics. Some programs—for example, sea research buoys—have an even higher electronic content.

There will also be sizable Government outlays in transportation and medicine during 1969. In ground transportation, several automatic highway traffic control projects will reach the field-test stage, but most electronics projects will remain paper studies.

In medicine, no profound spending shifts are anticipated; bioengineering and automation of hospital work will continue to be emphasized. For example, the National Institute of General Medical Sciences of the National Institutes of Health has appointed a 12-man advisory committee to spur R&D for completely automating clinical labs.

Cops and robbers

State and local law enforcement efforts will probably get a major boost this year through the Government's new Law Enforcement Assistance Administration. This agency is authorized to spend up to \$400 million in two years, but only \$63 million was appropriated for its first year by Congress. An estimated 10% of the \$29 million allocated for "action grants" will be used to improve communications.

An official of the International Association of Chiefs of Police says: "Communications are a top-priority need at local departments." There's always interest in sophisticated equipment such as vehicle teleprinters and locator systems, but such apparatus is still a way down the road. "The big budget item for police departments involves personnel," says the association official. "Even if an outfit can't get all it wants, up-to-date gear allows it to make better use of the men it has."

Growth signal is loud and clear

Digital systems will pace the 1969 communications market, providing a healthy boost to dollar volume. At the same time, sales of telemetry and land-mobile equipment will spurt. Revenues in the former category will jump from last year's estimated \$191.4 million to \$220.0 million; in the latter grouping sales are expected to go from \$184.1 million to \$207.5 million.

The spurs to growth in these three key fields include: the opening of the telephone network to data modems supplied by non-Bell companies as a result of the Carterphone decision; the proliferation of signaling and warning systems for transit authorities, police, and fire departments; and the armed forces' impatience over the laggard pace of the conversion of air-to-ground communications networks to L and S bands.

Information explosion

One jubilant east coast marketing executive says this about the new data ruling: "We could only sell modems on private lines before. Now the whole world's open to us. Customers are going to discover there are lots and lots of ways to reduce their costs that they didn't know about."

Paul A. Frakenberg, vice president of the Ultronic Data Communications Products division at Sylvania, also expects a sizeable market to result from the ruling. "It costs about \$40 a month to lease the Bell System's 1,200-band modem. We sell our version for \$475 and for under \$400 in quantity. A maintenance contract costs about \$5 a month. We've got something to sell now and it's going to be the same at other companies."

Surprisingly enough, even Ma Bell has some positive things to say about the prospective competition. "With more companies in on the act, the technology will probably move ahead faster. The biggest impact isn't going to be felt this year and when it comes it will be in the low-speed field—the hottest market right now because of time-sharing," says William B. Quirk, marketing director for data communications services at AT&T.

Another important factor is the relatively modest cost of the lower speed modems. "Some companies may offer teleprinters with built-in modems," says Quirk. "Of course, it's a different story with higher speed units. They're more complex, and expensive, and it's not so easy to wash through their price in a package deal."

ITT, until recently prohibited from selling modems for the switched network in the U.S., is now eyeing this market. While the company is circumspect about its plans, Frank Barnes, senior vice president and product group manager for telecommunications, says: "This could be the year for data

communications. We've reaching a sort of critical mass, mostly because so many people are using computers and because channels are so available."

This year Bell will market its new 3,600-bit-per-second data modem for the switched network. The set contains an adaptive automatic equalizer, a device that improves transmission quality, allowing more information to be sent over a channel. Bell will also introduce a new solid state teletypewriter and a low-cost modem to be used with this equipment. Several versions of the new sets will use integrated circuits for the first time.

General Telephone & Electronics, Sylvania's parent company, is exploiting duobinary techniques to increase speed; late in 1969 it will market a 4,800-bit-per-second set for private voice lines. Earlier, GT&E will offer a modem with options for either 2,400 bits per second or 40.8 kilobits per second.

And this year General Tel will be installing its new version of Bell's T1 carrier, a 1.5 megabit pcm system. "There are some advantages in coming in second," says Clarence C. Crow, director of systems engineering. "Our system takes advantage of technology developed since Western Electric first introduced T1. Our equipment is smaller and about 50% of its circuitry is either monolithic or hybrid IC's."

Meanwhile, Bell has announced plans to scrap its development effort on T4—a long distance, 284-megabit pcm system—and to start work on T5—a 564-megabit system. At the same time, it's installing



Lofty. Mobile radios like this solid state unit for helicopters from RCA should sell well during 1969.



School days. The Bell System and General Telephone will offer Teleclass and Tele-teaching systems during 1969, permitting students to get instruction over their phones at home.

the new L4 carrier system, a continuous-wave coaxial facility that transmits 32,400 telephone conversations. L4 will be able to handle digital, as well as analog, signals. Work is under way on a faster L5 system, which will also have digital capabilities.

This year, the Bell System's Picturephone could go commercial. Says Wilfred Rinkor, marketing director of customer telephone services at AT&T: "In February we're starting a trial of Mod 2—the version we're going with—between Westinghouse's New York and Pittsburgh offices. If everything goes well there's an outside chance we'll offer service commercially in 1969. Of course, it will be on a limited basis—a kind of dress rehearsal."

For the first time, Bell's willing to quote prices. Rinkor says that local Picturephone service would have to cost about \$100 a month initially. "Our job now is to get marketing information—to find out how many people in a corporation, for instance, would need the service and whether companies are willing to pay for it. We're going to have to go slowly because the capital commitments are awe-

some even for the Bell System."

If Picturephone catches on quickly, Bell will have to telescope its timetable for high-speed long-distance pcm systems. Engineers generally agree that digital techniques are the most economical means of transmitting visual telephone signals over toll facilities.

Meanwhile, Sylvania's Ultronic division is expanding its data service to brokerage houses. The company sells a drum-type computer data transmission system to provide stock quotations to firms throughout the U.S. and in Canada. During 1969, it will be selling general-purpose computers that will provide expanded services such as information retrieval and calculations. It will also introduce new cathode-ray-tube equipment to replace the Nixie tubes used in its display units.

Digital transmission technology will benefit from an end to the Vietnam War, says Charles Mack, chief of advanced technology at Philco-Ford's Communications and Electronics division. "One of the first things we'll probably see when Government

funds are released will be an improvement of military communications systems. That means there'll be an increase in secure, digitalized voice systems." The Defense Communications Agency will test one of Philco's modems this year. Designed for use over a voice channel with a vocoder, the unit transmits 9,600 bits a second.

Even further ahead, Electronic Communications, Inc. is exploring new coding techniques to increase the amount of digital information that can be sent via a given channel; it is also working on the design of digital filters. "We're doing things now that aren't going to pay off immediately, but they're pivotal for future complex, high-capacity systems," says Paul Hansel, vice president of engineering.

Sales of telemetry equipment will rise this year thanks to NASA's Apollo and unmanned satellite programs and the military's conversion to microwave. One engineering executive, however, sounds a sour note: "The switchover has been slow because many of the customers have changed specifications and demanded performance that's stretched the state of the art. Things would have moved a lot faster if the requirements hadn't been changed."

On the move

Vehicular applications for communications gear are growing so fast that companies which have eschewed the field are now eyeing it. Philco-Ford is one such firm. Meanwhile, RCA looks forward to another year like 1968 when its mobile volume grew by 50%. Edward J. Hart, manager of the company's commercial communication systems department, attributes RCA's success in part to its solid state line.

The 1969 mobile market also looks good to Sylvania Electric Products, which developed KarTrak—an automatic identification system for railroad freight cars, which uses optical scanning, and digital transmission. This system will be able to locate any freight car in the country by "reading" multi-colored stripes on its side. The railroad industry is investing \$20 million labeling two million units of rolling stock; it expects to finish the job by next January. In the meantime, Sylvania expects to sell KarTrak systems in volume lots.

In addition, KarTrak may be used in other applications, for instance, on subways and buses. Jack Barriger, manager of transportation systems at Sylvania, says: "Industry hasn't standardized on a bus system yet, so there's great potential for KarTrak." Right now the system's being tested in experiments on the Garden State Parkway in New Jersey. And this month Sylvania is testing its system—as are three other manufacturers of signaling systems—in Czechoslovakia. "If KarTrak is accepted, this could open up the European market to us," says Barriger.

Brighter picture

Last year's rather gloomy picture for suppliers of television broadcasting gear has changed. "We're looking for a \$10 million increase in 1969," says

Andrew F. Inglis, division vice president of RCA's Broadcast and Communications Products division. "We've hit the bottom of the trough. The color slump is over, and stations are making greater profits. All of the economic indicators point to increased income—and more equipment buying."

Specifically, Inglis sees a move to update color transmitters and, to a lesser extent, antennas. "Many vhf stations have been on the air for over 10 years and are still operating with their original equipment," he says. "Since the FCC will probably approve remotely controlled vhf transmitters these stations will have to buy new equipment to meet the higher specs. Otherwise they won't be able to take advantage of this new development."

RCA will market a new generation of vhf transmitters this year that offer a two-to-one improvement in performance specs and an order of magnitude increase in reliability. There's also an increase in price. For example, a new 30-kilowatt transmitter will cost about \$250,000 while the older version went for about \$180,000.

The uhf market doesn't promise anywhere near as dramatic an increase, but it should continue to be strong. "The resale value of existing uhf stations has been increasing steadily," says Inglis. "Broadcasters continue to have faith that uhf is going to develop."

However, the educational market—an important outlet for uhf—won't do so well this year, largely because of the war-caused squeeze on Government funds. Leonard Frakwitz, national sales manager for visual communications equipment at Sylvania, says: "We're expecting an 8% to 12% increase, but that's not going to bring us up to the substantial level of 1967. However, if the Yarborough bill—which seeks as much as \$800 million for educational systems and materials—is passed it might help the market somewhat in 1969." Sylvania will introduce new closed circuit television cameras this year. All will be vidicon types.

A sleeper in the tv market is the growing trend to multiple antenna installations like those planned for the World Trade Center now being built in New York City. By summer, the five vhf television stations in Chicago will have antennas installed atop the new John Hancock Building. The installation alone will cost \$1.3 million. However, since stations can't move their transmitters overnight and can't afford to be off the air for an appreciable time, they'll buy new equipment. Thus, the total investment in transmitting equipment and antennas in Chicago alone will reach \$3 to \$4 million.

Video tape recorders will continue to move—especially now that there's a trend to lower-priced units. Last year, RCA's TR 50 sold so well that the company brought out an improved version priced at \$65,000-\$10,000 higher than its predecessor. This model, the TR 60, is a high-band unit. As such it can record a signal modulated on a carrier about 4 megahertz from the color signal's subcarrier.

Cable antenna television has reached a crossroads, according to Lee Zemnick, executive vice

president at the Jerrold Corp., now a subsidiary of General Instruments. "The CATV market can't expand further unless we get real relief in the rules. The time's come for that to happen," he says.

Leonard Frakwitz of Sylvania says: "There's an increasing need for CATV operators to originate more programs. The FCC has some restrictions on the revenue they can get from such service. However, this situation is being resolved slowly but surely." In 1969, Sylvania will put a priority on marketing originating equipment. The package prices will vary according to the completeness, running up to \$60,000.

Jerrold will be turning out its Starline 20 CATV system, which handles 20, rather than 12, channels, in 1969. The company will also introduce solid state antenna site gear and Flexitap—a unit that makes it possible to build a CATV system and later tap off up to three outlets without cutting cable and interrupting service.

With CATV maturing, reliability and performance demands have jumped appreciably according to Jerrold's Zemnick. "We're now dealing with markets that have gotten class A pictures from rooftop antennas. But we're running cable over long distances, exposing it to many changes in temperature. We have to offer the best pictures and a highly reliable system to boot. So a large chunk of our budget is spent on the environmental testing of CATV gear."

Progress and problems

The once private preserves of computer and communications companies will continue to blur during the year. One Philco-Ford executive says: "The Government is going to take more and more of an interest in this problem. We may have to have a new industry—an information utility."

Late last year Collins Radio announced that it would begin offering computer services and computer-controlled process technology to industry and government. These services would involve the transmission of information—presumably with Collins modems.

Meanwhile Bell continues to install electronic switching central offices; early this year it will begin evaluating its electronic store-and-forward message switching system. By yearend, it will have about 69 working ESS central offices, 26 more than last year's total.

But while electronic stored-program systems appear to be the way to go, some critics remain hesitant. An east coast expert says: "Nobody knows at this stage whether they'll come out in the wash economically. We've got to have reliability. Regardless of who develops these systems, telephone companies can't afford to go through four or five generations like the computer companies did when they were getting started."

General Telephone doesn't have any stored-program systems slated for installation in 1969, but the company is working on several versions. One is an electronic traffic service position console that

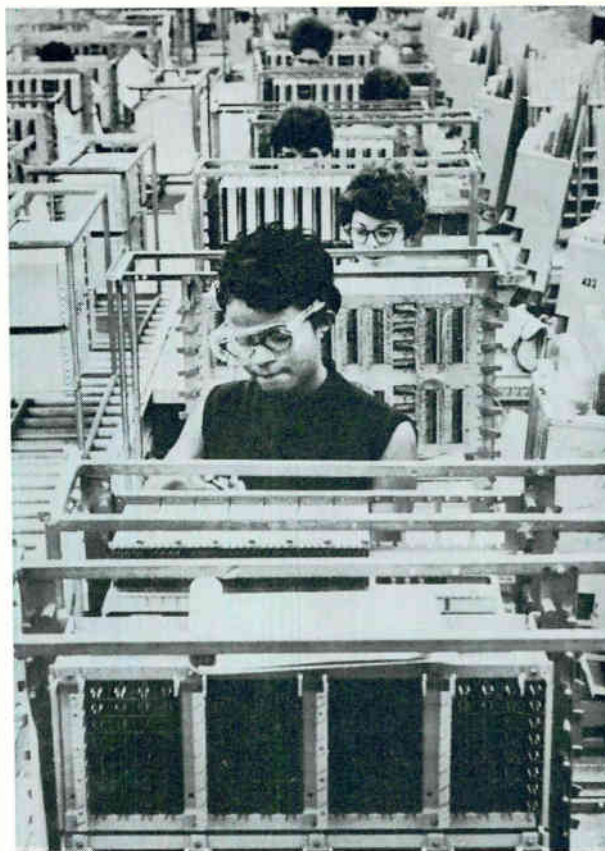

On the line. During 1969, the Bell System will continue to install electronic switching central offices. By 1970, it will have 69 working systems—26 more than last year.

will perform a number of functions to ease the tasks of the operator. "We're desperate for trained operators today," says Crow. "Electronic systems can help us with the problem."

Services

Other services to be offered in 1969 over the once limited telephone network include an apartment door answering service. Designed for older units that would be expensive to rewire, this service allows a caller to dial three digits in the lobby. His signal is routed through a central office back to the phone of the person he wishes to visit in the building. After talking with the caller, the householder can then "push the buzzer" using his telephone. The service will be marketed widely for the first time this year.

AT&T will also be introducing Teleclass—a cabinet with a telephone card dialer that allows a teacher to instruct up to 20 students in their homes by talking to them individually or all together over a phone. GT&E will offer a similar system.

And this is the year when IC's will be making a real debut in the telephone business. The Bell System is manufacturing beam leaded assemblies slated for use in, among other things, ESS, Touch Tone telephones, PBX's, carrier systems, and traffic service positions.

Still dancing to Pentagon's tune

This year shapes up as another wait-and-see period for the microwave field—a part of the electronics industry that deals almost entirely with the military. “If I flipped a coin, it would probably stand on edge,” says a marketing man, assessing the outlook in defense markets.

Last year at this time, microwave firms anticipated the Sentinel antiballistic missile system and the F-111 and A7A aircraft would be volume outlets for their wares. But now that the first two have been caught in the switches of budget cuts and the third begins to look like a stretched-out project, they're not so sure.

Fortunately for the industry, some earlier developments—particularly in electronic countermeasure equipment—bore fruit in 1968. For example, the use of radar-controlled anti-aircraft guns and missiles in North Vietnam forced increases in the procurement of backward-wave oscillators and traveling-wave tubes.

The ecm market should continue to be relatively strong in 1969. Howard B. Foster, Parametric Industries Inc.'s western regional sales manager, says: “Ecm already represents about 30% of our business. Even if the F-111 and A7A are cut to the bone, the delay time involved before the Pentagon could replace these aircraft with new programs like FX or VFX means a retrofit market.”

Peace and the action

At least one major microwave firm is making its plans on the assumption there will be a June halt to the Vietnam war. This company expects microwave tube sales to drop \$15 or \$16 million—about 10% below the 1968 level. However, management has a contingency plan which anticipates a 4% to 5% gain in tube volume should the war continue.

Sales of low-powered traveling-wave and klystron tubes were around \$58 million in 1968. There will probably be a 12% to 14% drop this year, since solid state devices are finally beginning to make inroads on microwave tube territory. Solid state assemblies already appear in military systems, such as Westinghouse's APQ-120 radar, as well as in community antenna television repeaters, tv relays, and other remotely operated equipment for which reliability is a critical design consideration. However, where maintenance is no particular problem but, instead, large amounts of power are needed, the progress of the solid state will be slow. Glamour items, such as Gunn devices, fall into this last category.

Even Varian Associates, which is readying both avalanche diodes and ferrite-tuned Gunn effect devices for market, shows little optimism about their sales potential. “It's going to be late in 1969 before

these oscillators have much impact on the marketplace,” says Norman Heistand, marketing manager for tube and electron devices at Varian. “The industry is still in the throes of product development and can't expect any real volume before the end of 1969.”

Caution seems to be the watchword next year for bulk effect devices. Says one source: “Transistors have lots of potential left in both power and frequency range. It will be more than a year before the bulk effect device is an economical alternative.”

Norman Chasek, president of the International Microwave Corp., admits that the growth of limited space charge accumulation devices (LSA) will also be slow: “For high-frequency operation, say in the millimeter wave region, you can buy gallium arsenide with the proper doping characteristics, but there's no market here. At lower frequencies, like L, S, C, and X bands, there are outlets but no GaAs.”

With communications satellites so often in the news, the high powered twt market should be solid. However, the volume still isn't there. As a result suppliers have to depend on military outlets. But Varian's Heistand says: “The satellite market is just beginning, and it's from this source that much of microwave industry's income will flow—when funds become available.” This suggests a boom will follow the end of fighting in Vietnam. In 1969, however, it's a very iffy foundation for market estimates. As a result, Heistand isn't making firm predictions for the high-powered communications twt market.

In a different sector of the satellite communications field, Microwave Associates Inc. just signed a contract worth about \$500,000 for equipment to relay signals to and from an Iranian ground station. This relatively small program serves as a reminder that there's more to the communications satellite business than spacecraft and antennas, particularly in underdeveloped countries.

Nonetheless, the “what if's” in the 1969 market equations indicate a record year for antacids as marketing managers' worries mount. For example: “It's hard to plan for production of twt's for the A7A's ecm gear,” says one edgy manager. “LTV says it won't be cut, but most of the intelligence we've been able to gather suggests that at least some slashes are due. And I have to be able to jump both ways.”

What it comes down to is that microwave firms are still almost completely dependent upon Pentagon largesse. When a budget squeeze is on, they sweat. “And don't think microwave ovens or anything commercial will save us,” says one marketing manager. “There still isn't enough here to fill your hat. And all the money goes to tube makers.”

Gravy train still rolling along

Generation gaps are beginning to look like a thing of the past—at least in the computer field. From a hardware standpoint, machines built with vacuum tubes, discrete semiconductor components, and integrated circuits represent three distinct divisions. Then, too, successively higher levels of programming language and operating software have been developed. Nonetheless, there's a consensus that most technological advances from here on out will fall into the evolutionary, rather than revolutionary, category.

The evolutionary trends that will buoy the industry are already well established. Makers of computers and related apparatus expect to ring up sales of \$4.79 billion in 1969—a 16% improvement over the \$4.13 billion worth of business done during 1968.



Best sellers. Small computers like this PDP-8/L, built by the Digital Equipment Corp., have become the hottest thing around in the world of electronic data processing.

Burroughs, for one, points out that large data banks, remote-access systems with thousands of terminals, and elaborate management-information systems are facts of life today. Such equipment requires a high degree of parallel processing, hierarchical memory organizations, advanced operating systems, and fail-safe management—all of which were just words a couple of years ago.

“Customers are no longer impressed with catchwords,” says Kenneth Olsen, president of the Digital Equipment Corp. “They want to know how much they will have to pay to get a particular level of data-processing or problem-solving capability.” The “level” may go up, and the “how much” may come down, but in context there are no longer any grounds for talking in terms of generations—implying, as they do, order-of-magnitude breakthroughs.

One of the distinguishing characteristics of the computer market during the late 1960's will be its receptivity to small machines. Among others, the bantamweights appeal to users who previously couldn't afford a computer and manufacturers of systems that could be more efficient or more powerful using a computer as a subassembly. Designers of large time-shared networks also use small computers as remote terminals and extended core memory systems, in which the vast monitor programs required can be stored.

Great and small

As recently as last year, the Digital Equipment Corp. was termed “not a dominant figure in the electronic data-processing field.” This is no longer the case; reliable estimates indicate DEC ranks number five in total number of installations. The company itself claims to be third, taking into account its order backlog.

Two recent product entries, from the Data General Corp. and from the Viatron Computer Systems Corp., attest to the potential of small and ultra-small computers. In particular, the financial backing of these two companies suggests that the market amounts to a lot more than “visions of sugar-plums” in the designers' heads.

Overall, the computer industry should continue to grow at a 15% to 20% annual rate for the next several years. Shortages of technically trained personnel—in programming and related services—are potentially the most serious obstacle to achieving such growth. In addition, some observers fret about what they consider a lack of involvement and understanding for computer problems, on the part of their customers' managements.

During 1969, communications nets will become increasingly important parts of information processing systems, thereby enhancing the markets for

Computer aided.
During the year,
there should be
greater use of
service installations
like this reservation
system built by
Univac for
United Air Lines.



interface hardware, models, and buffer memories. The networks will also contribute to the mushrooming growth of the small computer market.

Another distinguishing feature of this year's computer market—and one that harks back to the field's early days—is the number of customers who will be buying computers for the first time. "Our model 110, designed specifically for first-time users, has been getting a good reception in the marketplace," says Robert P. Henderson, vice president for marketing at Honeywell's Electronic Data Processing division.

And Paul W. Lappetito, assistant marketing vice president at National Cash Register says: "More than half the orders for our Century series are from first-time users. This confirms the existence of a broad base of potential customers ready for the right combination of price and performance."

Price tags on computers and related equipment are expected to remain at relatively stable levels during 1969. Most observers attribute this to the greater use of integrated circuits which tend to reduce costs. But there's another side to the coin. "Although IC's are significantly less expensive than discrete components, quality control and product testing are more difficult," says Curtis W. Fritze, vice president for corporate planning at the Control Data Corp.

Then, too, main frame hardware represents a comparatively small part of the total outlay for a computing installation. "In most cases, the optional equipment ordered to go with a processor costs about as much as the basic processor itself," says Nick J. Mazzaresse, a vice-president of DEC. "This hardware cost is only about half the total which includes programing outlays. Then you have to service, maintain, and operate the system. By the time you're through you find out the price of a processor is really only one-fifth or one-sixth of the total cost of a data processing system."

Time sharing, long heralded as "the wave of the future," is now a fact of life. Several of the top computer manufacturers offer time-sharing services as a sideline, and a good number of independent time-sharing networks have sprung up all over.

The growth in this market has proved salutary for just about everyone in the computer field. For example, the manufacturers of large central processors are moving everything they can produce and looking for new worlds to conquer. At the moment, NCR is doubling the number of its time-sharing data centers, and Univac is also expanding its net, as well as improving the capability of its 1108 computer. Control Data Corp., which has long specialized in the heavyweights, recently unveiled its mammoth 7600 machine. Honeywell expects volume sales for its 4200 and 8200 machines during 1969, and General Electric anticipates a comparable spurt for its 600 series.

Command performance

Software houses have done, and will continue to do, well. Faster IC's and memories will produce an improvement in performance as great as 40%, according to some estimates. As a result, better programing—particularly operating system software—and improved peripherals will be needed.

In this latter area, Ampex predicts magnetic tape with a density of 1,600 characters per inch will soon be commercially available; at the moment the standard is 800. Moreover, says the company, speeds of 200 inches per second will be commonplace. In ferrite-core memories—both internal and peripheral—cycle times have already dipped from 1 microsecond to 500 nanoseconds; further decreases to 250 nsecs are in the offing this year.

However, the raw speed of a processor or of any particular hardware assembly isn't going to be the only major consideration. Users want ever faster throughput. Thus, overall system design and

software efficiency loom large as well.

"None of the new processors that have been introduced recently have been dramatically different—from a performance standpoint," says Mazzaresse. "Computer makers are just going to chip away for awhile until someone comes up with a breakthrough. This will probably occur in peripheral equipment rather than processors."

Late in 1967, CDC and Scientific Data Systems tried pricing software separately from hardware to determine whether such a policy would prove economically feasible. IBM also plans to take a flyer at this dual pricing policy. It appears that applications software can be separately priced without much difficulty; but executive software, that controls the minute-by-minute operation of a system, generally has to be included with the hardware, which isn't very efficient without it.

Along technical lines, monolithic IC's seem to have become standard items in computers. The use of such assemblies will become even more common in 1969. Gradually there will be more applications of medium- and large-scale integration.

CDC is the only major computer maker sticking with discrete components in its large processors. But the company claims to have achieved a packing density comparable to that of MSI. This is accomplished by using cordwood packaging in which components are turned on end and supported between two printed-circuit cards rather than mounted flat on one card. Thus, the cooling problems that limit the density of otherwise closely-packed components are sidestepped. The company claims that the discrete components in its new giant, the 7600, are packed as closely as the integrated and hybrid circuits in its medium-scale 3500 and certain peripheral apparatus.

But Honeywell, already an extensive user of IC's, expects to expand the number of applications in

its wares. It considers IC's an important price stabilizer. Univac will also use more IC's during 1969, but the firm doesn't anticipate high-volume applications of MSI until 1971 or later.

Amplex is looking for faster memory speeds with cycle times as short as 250 nsec during 1969. Nonetheless, ferrite cores will continue to dominate the scene for some time to come. Semiconductor arrays, which have already had an impact on read-only memory technology will extend their influence, while plated wires and thin films will be the order of the day in extremely high-speed systems.

CDC maintains ferrite cores can now perform nearly as well as thin films—at much lower costs. Burroughs, which has a vested interest, takes an opposite tack. Honeywell, which expects ferrite cores to dominate this year, points to its own and other organizations' continuing research in thin films, plated wires, and optical techniques—implying that great things can be expected from these fields before too long. NCR, of course, is locked in with rods for its Century computers, and will continue with these assemblies. Univac expects plated rods to replace cores slowly over the next three or four years.

Fast registers, to be built from IC's in 1969, will move into the domains of MSI and LSI. However, these will not be available in significant quantities before the early 1970's.

The growth rate of peripherals during the past several years has been considerably higher than that of the computer industry as a whole. The development of time-sharing and of communication networks is contributing to such gains, which will continue in future years. Most new peripheral devices slated for 1969 debuts will be in the remote category.

Electronic apparatus—for example, the familiar cathode-ray tube display—will record gains. But the physical requirements of moving an input or output medium—like punched cards and printed paper—or for gaining access to a large block of storage will prevent electro-mechanical equipment from being wholly displaced for many years to come.

Upcoming electronic peripherals include, according to Honeywell, nonimpact printers, optical scanners, and advanced art displays—all of which will have some degree of mechanical motion, even if it's only a key on a keyboard. "We keep hoping for a big breakthrough in peripherals," says Olsen of DEC. "But we really expect only slow, steady improvements in reliability and price."

During the year, CDC looks for developments involving data services equipment for both in-house installations and service bureaus. Such apparatus will be used for ticket buying, hotel room reservations, credit checks, and similar applications. Meanwhile, Univac anticipates an improved understanding of all aspects of data processing—better trade-offs between hardware and software in a computer system, as well as better human engineering of the equipment.

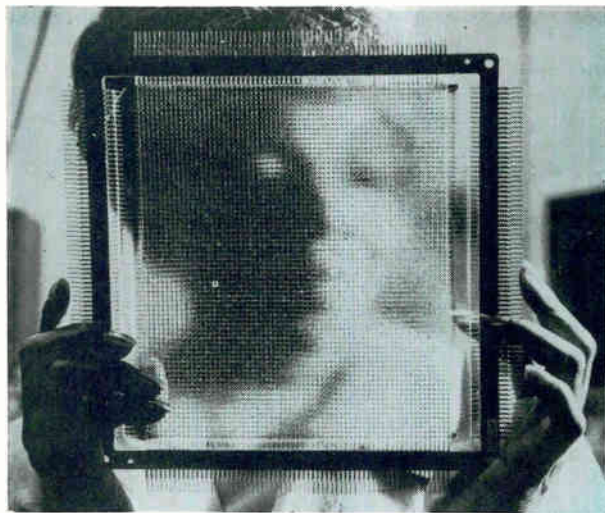

Mementos. Memory plane of NCR's new Century computer series holds 4,608 bits of information on tiny rods.

Technology gains to outstrip the growth in dollar volume

Color television receivers will again set the pace—albeit a slower one—in the consumer electronics field this year. Sales of color sets will reach \$2.2 billion, about 8% ahead of the 1968 level. Overall, the consumer market should register a 5% gain to \$4.4 billion from the \$4.17 billion of 1968.

The design of monochrome tv sets, which are in for another dismal sales year, is pretty much frozen, and few improvements are in the offing. But color sets are down for a number of innovations. For instance, solid state chassis with modular sub-assemblies that can be removed quickly for easy service will be reaching the marketplace in volume. RCA joined the industry's solid state pioneer, Motorola, last fall, and Zenith, among others, is reportedly ready to take the plunge. By yearend, most of the name brands should be in the solid state fold.

Plug-in components, including integrated circuits, will be important additions in many 1970 color tv lines. Sylvania pioneered this development, and most other manufacturers are now designing sockets into their receivers. Zenith, for example, offered a plug-in color demodulator on some late-season drop-ins last year; the company will follow up with plug-in pc boards on its 1970 color models.

By springtime, some American-made color sets may be sporting electronic push-button tuning features. RCA, for one, will use a varactor diode tuner produced in-house. And at least two other firms reportedly will be using comparable units supplied by Standard Kollsman. In addition, the industry's first integrated uhf/vhf tuner, unveiled last year by Oak Electro/Netics, will be installed in some of the 1970 color lines. A follow-on version with a detented uhf section is already set for some 1971 models, according to industry sources.

Automatic fine-tuning circuitry, previously available only in top-of-the-line sets, will be incorporated in modestly priced receivers largely as a result of consumers' insistence. However, automatic chroma and tint controls will not be available until such time as broadcasters standardize the color-burst phase relationship. And efforts to produce a 110° deflection color tube won't bear fruit this year because the principal supplier, the Corning Glass Works, is still having trouble producing the envelope.

Sweet music

The second most important sector of the consumer field, covering phonographs and hi-fi equipment, is also set for a good year in 1969. Hi-fi sales

are expected to jump 15% from last year to \$110 million. "Consumers are buying more big-ticket goods than they did a few years ago," says a spokesman for one manufacturer. "They want quality and seem willing to pay for it." Domestic producers will, however, continue to face stiff competition from abroad. In particular, Japanese producers of equipment and components are making inroads.

Battery-operated phonographs with radios, units styled for the youth market, will claim a bigger chunk of the market this year. In the main, this equipment will be imported and sold under domestic labels, and will incorporate monolithic IC amplifiers as well as transistors. Nevertheless, self-contained stereo receivers with tuner, phono-preamplifier, and power amplifier in a single housing will again dominate the sales picture in this sector. A good portion of such units will be equipped with cassette and reel-to-reel tape recorders.

IC amplifiers will predominate in the i-f strips of f-m stereo sets. And crystal and ceramic filters will be widely used, replacing the once standard i-f

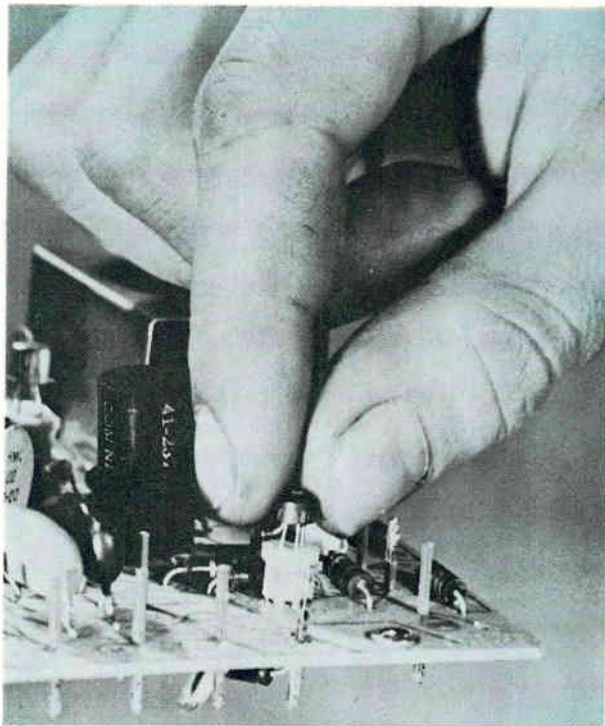

Socket to me. Plug-in semiconductor devices like this one from Sylvania will be widely used in 1970 tv sets.

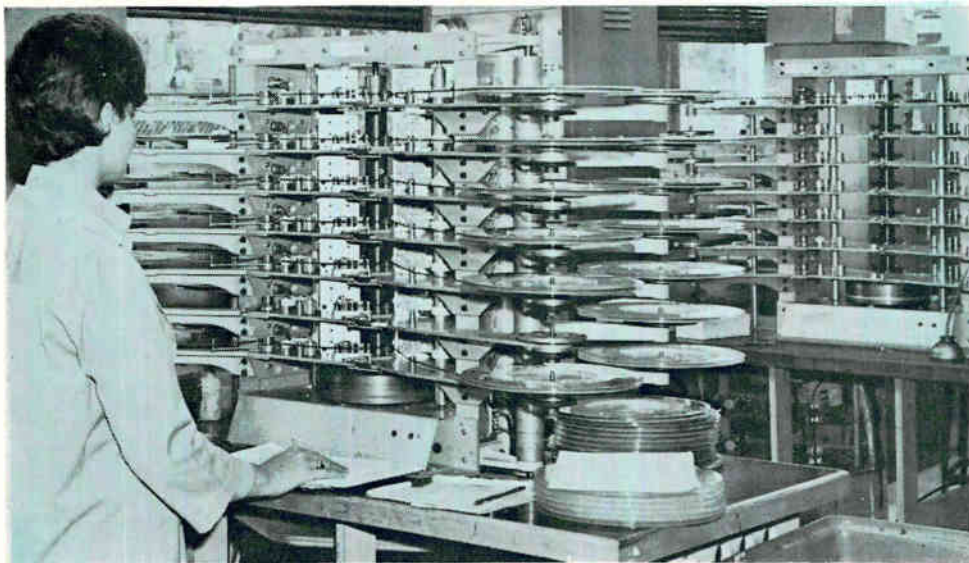

Record year. The booming demand for tape players in consumer outlets is keeping things busy on duplicating lines like this one at Dubbings Electronics.

transformer in top-of-the-line goods. Double-balanced hot-carrier diode mixers will show up in the front ends of some sophisticated receivers, but MOS FET's will continue to be the more common mixer element.

Makers of audio tape recorders should enjoy a banner year, with sales expected to jump 16% to \$188.2 million. The big reasons for this surge: the low cost and convenience of cassette units; the availability of self-threading, open-reel recorders; and the great variety of prerecorded tapes that can be bought for open-reel, four-track and eight-track cartridge and cassette player/recorders. The automobile industry's promotion of cartridge units as optional equipment for new cars is also providing a big boost.

But the market is far from stable. "Perhaps within five years, the cassette will completely displace the eight-track stereo player as a mass-market item," says Irving E. Lempert, engineering section manager at Westinghouse Electric's Consumer Products division. He believes the shift will come "when car makers opt for cassettes as an industry standard." However, many observers are inclined to insert an "if" in that statement. "There's no change in the wind here," says a highly placed source at General Motors. And Ford recently signed another three-year agreement with Motorola for eight-track cartridge players.

Home entertainment

Video tape recorders for use in the home are still an iffy proposition despite enthusiastic drum-beating in certain quarters. The big drawbacks are cost—up to \$50 for an hour's worth of recording—and limited picture resolution.

The vtr picture is also clouded by the advent of the Columbia Broadcasting System's EVR (electronic video recording) system. These units will be offered both as separate attachments that, when hooked up to standard tv sets, play prerecorded

programs on the screen, and in combination with receivers. Additional, albeit indirect, competition for vtr's will come from the home movie/tv combinations Sylvania will introduce later this year.

The material presented with EVR is originally recorded on motion picture film or video tape and then transferred to special 8.75-mm film by CBS Labs. An hour's worth of material can be put on a 7½-by-½-inch cartridge; processing costs \$20.

Later this year, the first EVR playback units will start rolling off Motorola's assembly lines. Priced between \$700 and \$800, they're destined for educational and industrial applications. A trim consumer model will be out later in the year with a price tag of about \$500. Farther down the road, Motorola, which has a two-year exclusive on EVR, will turn out an EVR/tv combination set; it's expected that economies will be achieved with designs using tv circuits to perform certain electronic video recording functions.

Car makers are fast becoming major outlets for electronics suppliers. Within the past couple of years, for example, the industry has switched virtually en masse from relay-operated voltage regulators to IC designs. Rear-window defrosters now sport electronic timing circuits, and mechanical cruise-control systems have gone electronic as well. Turn signals are giving way to sequential flashers. And Ford is using a tiny computer in its prototype antiskid system.

Though it's difficult to pinpoint upcoming developments with any precision because of the auto firms' predilection for cloak-and-dagger secrecy, the shape of the field's near-term electronics future is already apparent. GM will offer an antiskid control system as optional equipment on some 1970 models, and will also introduce the first silicon IC voltage regulator. Other electronic wares earmarked by the industry for 1970 or 1971 delivery include speedometers, fuel pumps, variable-speed windshield wipers, and liquid-level detectors.

Strong demand to continue for high-performance items

Improved performance at a price will again be the key to success for components suppliers, many of whom are clinging to markets threatened by integrated circuits. Parts makers who can fill this bill should continue to do well. Demand promises to be strong across the board in military, industrial, consumer, and commercial outlets. And original-equipment manufacturers have long since worked off the swollen inventories of components that led to a sickening slide in demand two years ago.

Resisting decline

Though IC's have made some inroads in the market for discrete resistors, the boom in demand for such equipment as desktop computers should provide enough of an offset for sales to rise to \$423.0 million in 1969 from \$410.3 million in 1968.

Desktop machines use a lot of IC's, primarily in their logic circuitry. Power sections still require fixed-value resistors. And metal-film resistors continue to be used in fabricating hybrid microcircuits; monolithic technology cannot yet produce high-precision devices. Since the computer field is expected to continue its headlong expansion during 1969, there will undoubtedly be an increase in demand for metal-film resistors.

These resistors will also be improved. For example, higher temperature coefficients, better tolerances, and better power-handling capabilities are within reach. Thus, a 20-pulse-position-modulation assembly is feasible for volume applications in analog computers. The metal-film resistor is popular because it offers more resistance per volume than its principal rival, the wirewound resistor.

Aware of the strong competition from metal-film

units, producers of wirewound resistors are building better mousetraps. During 1968, they further miniaturized their wares, got the tolerances down to 0.0025% from 0.01%, and achieved stabilities ranging from 20 parts per million a year to 20 ppm every three years.

Capacious market

Last year was one of the best that capacitor manufacturers have ever enjoyed, and 1969 shapes up as equally good. Sales should rise from an estimated total of \$400.7 million to \$434.5 million. Fixed ceramic dielectric and variable capacitors lead the sales parade. Jack Goodman, vice president of JFD Electronics, says: "These smaller capacitors have high r-f current and voltage features, as well as values ranging from 1 to 3,500 picofarads. They're widely used in communications, telemetry, and medium-power transmitter.

New ceramic formulas are largely responsible for the improved characteristics. Ceramic capacitors have fused leads that don't have to be soldered and stand up well to the temperature extremes encountered in space. Such units will continue to move in on mica, fixed glass dielectric, and vitreous enamel capacitors.

Dollar volume of tantalum capacitors should increase during 1969 even though unit prices have dropped to competitive levels. Likewise, high r-f current capacitors will continue to be widely used in the outputs of cathode-ray tubes, as well as medium-power transmitters.

Challenge round

IC's continue to play a role in the operational amplifier field. But units made with discrete components are still very much in demand. To meet the challenge of IC competition, manufacturers are offering better performance at lower cost. For example, Analog Devices now has a new op amp, the model 118, with lower bias current and better frequency response than its general-purpose 111. The 118 sells for \$11, the 111 for \$13.

Similarly, with the model 230, the company has almost halved the price of a previous chopper-stabilized op amp while improving the performance [Electronics, May 27, 1968, p. 181]. The 230 is priced at \$67 per 100, as against \$125 for the 210. The new unit is half the size and has superior current-drift characteristics.

Models with IC's also boast improved quality. Analog Devices' 801 unit, for example, was designed to compete with the standard 709 op amp. The new unit has: a bias current of 4 nanoamps,

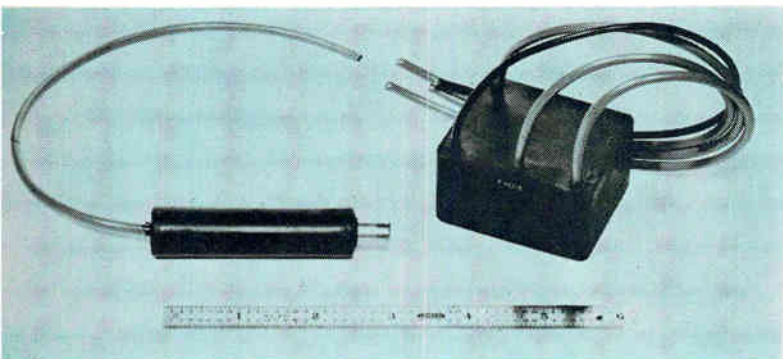

Rule of three. Voltage tripler, an encapsulated network of diodes and capacitors, eliminates rectifier tubes and secondary coils in flyback transformers of tv receivers.

compared with 500 nanoamps for the 709; open-loop gain of 15,000, as against the 709's 25,000; and an input impedance of 25 megohms, compared with 0.15 megohm for the 709.

Triple play

Like most other components, diodes and related specialty devices should continue to grow. Among the best bets for success is a network of discrete diodes and capacitors called a voltage tripler that will be in many 1969 television receivers. Set makers are using the network to step up the voltage on the picture tube from 8,000 volts to 25,000 volts, eliminating some of the secondary coils in the fly-back transformer. The tripler also eliminates the need for a high-voltage rectifier tube and a focus rectifier tube. In addition, it reduces the X-radiation effects that have proved a major problem in some color sets.

Although widely used in Europe, the tripler is new in the U.S. Manufacturers using it can build almost completely solid state receivers that require only high-voltage rectifier and picture tubes.

Triplers have a longer life expectancy than conventional assemblies because of cooler operation and lower power drain. Besides tv, prospective applications include high-voltage power supplies for electrostatic copiers, precipitators, and filters, as well as other crt equipment in the industrial and military fields. Prices are competitive with those of vacuum tubes and selenium assemblies. Triplers are supplied by such domestic firms as ITT, Varo, Sempeck, and Atlantic Semiconductor, as well as European concerns such as Siemens.

Aside from the voltage tripler, such special devices as log diodes will be in demand during 1969—especially for equipment that requires multipliers. In addition, silicon diodes should move ahead of germanium units. The operating advantages of the silicon diode—more speed, better thermal effects, broader operating range, and longer life—have always been popular, but high costs have tended to limit its application. Now, says Jerry Kalman, vice-president of marketing at Computer Diode, "Prices have been reduced and values increased. As the computer market continues its growth throughout 1969, more and more of these devices will be used." Other volume applications will be in automobile alternators and radios.

Transformation

Computers are playing a larger roll in the design of new components. A case in point is Varo's new ferroresonant transformer. The computer helped Varo design a unit that requires less core material, less copper, and a smaller resonant capacitor than conventional units. And, the company reports, these savings were obtained without degradation of performance.

An important development in the semiconductor sector is RCA's perfection of a technique to build extremely high-power transistors. This achievement makes transistors, for the first time, a direct rival

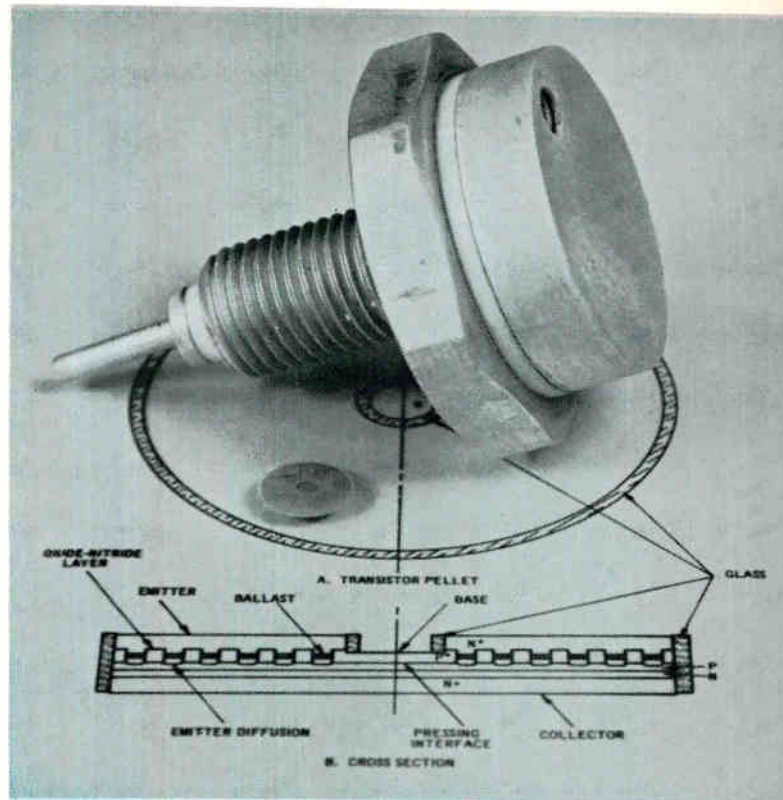

Big time. Semiconductor engineers at RCA have developed experimental transistors putting out 800 watts of power; even larger outputs at high frequencies are anticipated.

of the high-power vacuum tube.

Although the technology is still experimental, engineers have produced breadboard models that have generated radio waves oscillating at 1 megahertz with a power of 800 watts—over three times the power generated by many radio stations. Considerably higher powers and frequencies are expected during 1969.

Units are formed on two separate silicon wafers—the emitter base and the base collector. The wafers are then fused, or laminated, under heat and pressure into a monolithic structure. The features of an overlay structure, including ballast resistors to guard against secondary breakdown, are retained in the new devices. After lamination, the entire wafer is hermetically sealed in glass. Individual hermetically sealed pellets are separated and can be mounted in nonhermetic packages for various applications.

The active regions of the device are in the center plane of the semiconductor pellet; in conventional devices, the active regions are generally at the surface. This geometry provides an emitter contact area that has a solid and continuous surface suitable for heat sinking.

The pellet, 250 mils in diameter, contains 222 emitter sites. A larger pellet, now under investigation, is about 330 mils in diameter and contains 330 emitter sites.

IC's to gain a foothold

Having broken into the billion-dollar class this past year, the industrial electronics field appears ready to improve upon its performance. Sales are expected to hit \$1.15 billion, a 12% gain from the 1968 level.

The little integrated circuit promises to be the big news in the industrial sector this year. IC's have finally made it to the market, permitting the design of original new products, offering clever ways to redesign old wares, and serving as means for companies—from component makers to end users of electronic equipment—to expand their businesses.

One of the effects of this IC proliferation will be the disturbance of some historic—and comfortable—marketing traditions. Thus, for a while at least, component houses and product makers won't be looking at sales to the continuous-processing industries as a barometer of business conditions.

Starting from a lower base, admittedly, manufacturing firms are pouring capital into their plants at a faster rate than are, for example, chemical and petroleum companies. Processing companies already boast of a capital investment of between \$60,000 and \$100,000 per employee. But other manufacturing plants are rapidly approaching these levels, and a significant amount of this investment is going for electronic controls, excluding numerical controls, to program and operate machinery.

The best prospects are in the industrial sub-market composed of makers and users of high-volume production and inspection machinery. One supplier estimates the total electronic and electrical control sales in this area at about \$500 million dollars—with an annual growth rate of 25% to 30%. And electronic equipment, using integrated circuits, discrete components, and silicon controlled rectifiers, can vie for about \$100 million worth of the action. This amount includes the value added to the basic electronics to produce functional equipment and systems ready for installation by the customer.

Since similar production and inspection machinery can be found in many kinds of manufacturing plants, electronics suppliers may have to revise their marketing viewpoints and tactics. Instead of hawking their wares in a vertical market, they'll search out all possible outlets for electronic control in, say, package inspection machinery.

Some producers of manufacturing machinery have elected to develop their own circuits and build their own electronic equipment starting at the integrated-circuit or discrete-component level. This requires an engineering staff well versed in electronics technology. But since most machinery makers are mechanically inclined, there's a strong tendency to farm out the electronics development and production to companies skilled in providing func-

tional modules and systems. To an extent then, machinery makers are putting their sales in the hands of their electronics suppliers.

Target areas

OEM (original-equipment makers) outlets should prove a growth area for electronics companies. The Digital Equipment Corp, for example, has set its sights on machinery-control portion of the OEM market. It wants to sell functional modules—products that put IC's and other electronic components into a form the customer can use.

Allan T. DeVault, module product line manager at DEC, notes that with their greater reliability and smaller size, packaged functions made with IC's can command a premium price up to 2½ times that of an equivalent relay-type control system. However, most electronic machine control systems sell for about 1½ times the tab on conventional apparatus. DeVault looks forward a few years to the time when prices of IC control-function modules reach the point where the modules compete head-on with relay-type machine controls.

Just how fast the portion of the industrial electronic market that's centered around the IC will grow in the next few years is indicated by data compiled by Texas Instruments. According to the Dallas-based semiconductor giant, total industry sales for digital-type industrial IC's during 1968 came to about \$83 million; in 1969, the level is

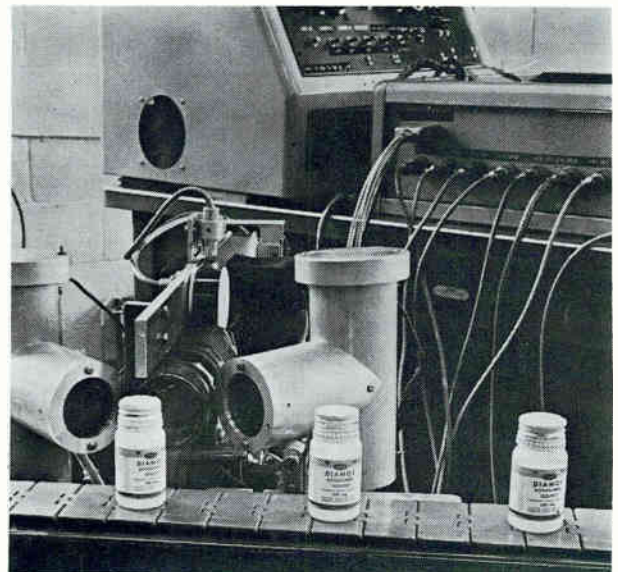

Fallout. Industrial concerns are trying to capitalize on their technological know-how; this American Cyanamid system "reads" luminescent product codes on bottle labels.

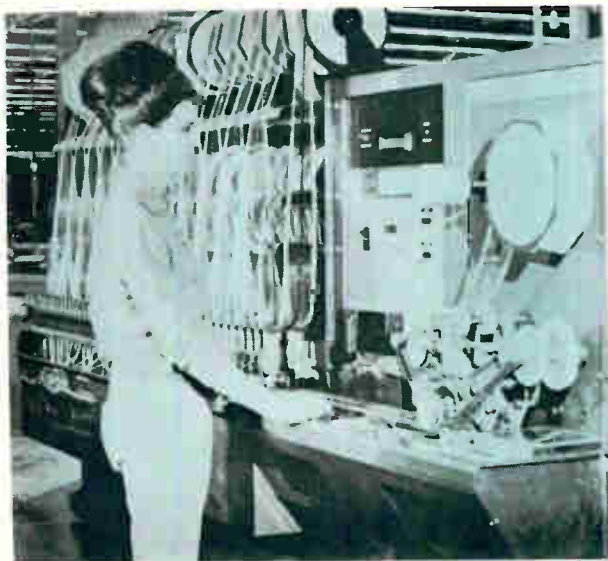

In turn. Component sequencer takes up to 39 different values of resistors and diodes at GE and places them in order on reels for installation on pc boards.

expected to double to \$160 million, and 1970 volume may double again to \$320 million.

While these figures are impressive, they don't tell the whole story. The number of circuits and packages will increase even faster than dollar sales. Unit prices are sure to tumble this year and maybe again next year as production capacity expands. In fact, J. Fred Bucy, TI vice president, says his company will cut prices 25% on high-volume, low-complexity devices like flip-flops and gates during the first quarter this year.

Maximum effort

One of the reasons for such growth is the component makers' diligence in helping their customers get started—even arranging for deliveries at a time the customer can pay for the packages. TI's application group alone will account for a large part of the increased IC usage by industrial companies. This organization has helped design motor controls, machine-tool controls, stock market equipment, draw-and-speed indicators (for the paper industry), digital measuring systems, and the like for machinery makers whose products used to be made of gears, levers, relays, and vacuum tubes.

Because of its massive efforts, TI claims that 80% of the recently designed products using digital IC's employ transistor-transistor-logic techniques. When these products get into production this year, according to TI, TTL will account for more than half of the logic-package sales to industry.

Interestingly, major process-control suppliers have substantially ignored IC's integrated circuit in their present products. In fact, any kind of electronics seems to find the going hard in conventional process-control equipment. Sales of pneumatic controls still outpace their electronic counterparts,

mainly because—for a particular installation—the electronic versions don't offer distinctive benefits to offset the lower cost and historic acceptance of pneumatics. Pragmatic customers, it seems, buy process controls, not the glamor of electronics.

This is not to imply that users of process-control equipment haven't gained from semiconductor technology. Lower costs and better performance have resulted from specific equipment designed around IC's. Much of this gain is offered by smaller, possibly more energetic companies that sell peripheral items used in process control but not listed in the catalogs of major suppliers.

For example, Deltron Inc. of North Wales, Pa., provides a line of IC annunciators—devices that visibly indicate normal conditions of process variables. The company's sales manager, Robert Lewis, says that the use of IC's dropped the price of annunciators about 10%. Less metal work and easier assembly are the big reasons. Because of the annunciator's smaller size, the customer needs less space on very expensive panel boards to keep the operator informed of process conditions.

Lower product cost isn't always the goal. IC's can lead to better performance. Gabriel J. Luhovy, chief engineer of Transmation Inc., of Rochester, N.Y., says linear IC's afford a higher open-loop gain per dollar than discrete-component devices. Because of the higher gain, it's feasible to use more feedback in the circuits, resulting in instruments with better linearity, regulation, and temperature compensation. Thus, for a modest increase in price, the customer can get a 0.1% instrument instead of the usual 0.25%.

Honorable discharge

Because the integrated circuit is an offshoot of Government-funded development work, the devices tend to reflect military requirements. But the fast switching speed of IC's, needed, for example, in airborne digital computers, can prove troublesome in industrial electronic equipment. Says Luhovy: "IC makers have gone overboard in making wide-band devices. Industry doesn't need 100-megahertz bandwidths. Rather, 50 kilohertz should be adequate. Further, IC makers ought to place more emphasis on a better noise figure—a couple of decibels at 1 hertz—and more reliability in plastic-packaged IC's."

Transmation—which does its own designs—doesn't use plastic-packaged IC's in its products. But such conservatism is by no means universal. Don Metz, a staff engineer at Litton Industries' Louis Allis division, selected plastic-packaged TTL IC's—with help from TI's application group—for the firm's Dynapar Custom 600 draw-and-speed indicator. He says these assemblies work reliably in the heat, humidity, and sulfur-laden air around paper-making machines.

For products built around a few packages, the quality of the IC—not the chance to pinch pennies—is of paramount importance. When a 709-type operational amplifier can be bought for less than

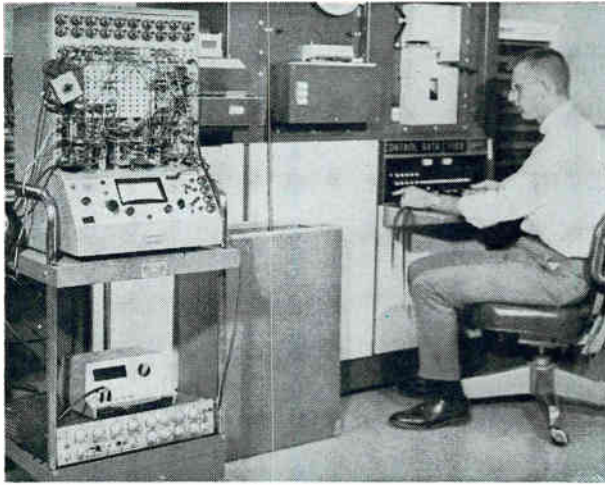

First phase. AAI's experimental work on adaptive control may lead to commercial systems for process applications.

\$2, saving a few cents isn't going to mean much on a product that winds up costing the end user more than \$100. To industrial electronic engineers like Luhowy, reliability applies to the IC and to suppliers—those who deliver on time.

Major process-control suppliers' avoidance of integrated circuits may be a sometime thing, a reflection of unwillingness to redesign old products. More than likely, market strategy is centered around the future introduction—and the future may be very close—of products in which IC's can implement some of the control ideas and concepts that up to now have been within the province of large and expensive digital control computers. Thus, without having to know much about such complex techniques as feedforward control, adaptive control, self-tuning, time-sharing, and the like, the user will be able to derive the benefits of these methods through new kinds of control devices.

Mead Bradner, technical director at the Foxboro Co., provides some clues to what might "appear in the next couple of years" in process-control equipment. He anticipates new types of hybrid controller packages that will be time-shared, will combine analog and digital techniques—high gain analog for low-level inputs and digital integration—and will come in modules to service four, six, or eight loops. "The control system will use integrated circuits," he states.

Breakouts

But while control companies are keeping their ideas simmering on the back burner, other firms are moving theirs to the front of the stove. Significantly, some of the biggest buyers of electronic equipment are now starting to sell both hardware and process-control know-how. Just as these companies have capitalized on research efforts by licensing their processes, they will sell their hard-won process-control knowledge in the form of special products and systems containing unique func-

tions implemented with IC's and other electronic packages.

Late last year, for example, the American Cyanamid Co. announced the formation of its Decision Making Systems department, whose initial venture will be to apply photoluminescence technology in industry. Using photoluminescent inks, which Cyanamid makes, the department will market machinery and electronics for printing, detecting, and processing coded information in invisible ink. Scanning and logic circuits, energized by ultraviolet light shining on the ink, will detect labels and sort packages during both production and final inspection operations.

Applied Automation Inc., formed in mid-1968 by Phillips Petroleum, will merchandise expertise in processing and process control. While a lot of its revenue will come from systems studies for customers, the firm also plans to sell electronic hardware it has already developed or is working on. AAI engineers continue to study and apply adaptive control with the stored-program digital computer. And it's not unlikely, they hint, that someday they'll be able to implement such complex schemes on functional cards rather than through software programming.

In addition to analyzers for measuring the composition of process streams, AAI will sell functional cards it developed for some Phillips computer control jobs. These cards, built from IC's, will perform such input-output functions as filtering, high-low limit detection, and storage of signals during multiplexing.

Numbers game

But what of numerical control? Historically, NC has been considered a major adjunct to metalworking. With 14,000 such systems in operation, there's a new push coming. According to Louis Rader, vice president and general manager of the General Electric Co.'s Industrial Process Control division, numerical control, which got its start as stand-alone equipment, will someday constitute only one part of an integrated approach to running a factory. Eventually, these systems will include a process-control computer, NC, materials-handling gear, and telemetering. Anticipating the need for such an integrated setup, GE designed its recently announced Mark Century 7500 numerical-control system from logic packages that can be used throughout a wide range of factory-control equipment. The packages are, of course, made of integrated circuits.

Probably the most notable nonmetalworking application of numerical control is at the Ford Motor Co.'s glass plant in Nashville, Tenn. This facility turns out 800 tons of automotive and commercial glass every day. The NC system—the largest ever built by General Electric—performs on-line, cutting glass with no reduction in production line speed. Taking into account the location of imperfections, it cuts the glass to tight specifications with a minimum of loss and waste.

NASA tightens its belt another notch

Unless the Nixon Administration arrives with a set of proposals for some new starts in space, as well as the will and the cunning needed to get them through an unsympathetic Congress, 1969 will be another comparatively slow year for space spending. Few planners really expect a last-minute reprieve. As a matter of fact, most anticipate that hardware outlays will slip below this year's levels.

The National Aeronautics and Space Administration has little money to spend during the first six months of the year, and the second half scarcely looks brighter. Less than 35% of the agency's fiscal 1969 budget of \$3.85 billion will be spent through June 30; most of the money went last year, and what's left will go largely for studies and services. At the moment, NASA plans on submitting a fiscal 1970 budget of \$3.875 billion. Officials hope to boost this amount once Nixon takes office.

There are few surprises at the agency's Office of Space Science and Applications (OSSA). "New starts" will be ideas that have been around for a season or two. Says an official with eight years on the job: "You can't expect anything too imaginative when our primary concern is to keep existing programs alive. Ideas will flourish—as they did a few years ago—when we can get some more money."

Flight plans

One of the programs OSSA will try to get off the ground during the second half is the earth resources technology satellite. If Congress approves, contracts for two spacecraft could go out later this year. Officials estimate that the whole program, including studies and launch vehicles, will cost \$47.7 million, \$18 million of which will be requested in fiscal 1970. OSSA would also like some low-level study funds for "omnibus" ERTS programs to be run during the late 1970's. The rationale is that there will eventually be a need for big earth resources satellites for dozens of unrelated tasks.

NASA men would also like to resurrect another pet project of theirs, the 1973 Mars probes—now known as Project Viking—which have suffered so at the hands of budget-cutters that a go-ahead at this point would amount to a new start. OSSA has a list of eight experiments to be placed on Mars with soft landers; to get started, officials want at least the \$20 million that was cut out of the last budget.

Just about every project office is jockeying for seed money to get started on programs for the early 1970's. Among the ideas now being considered: Applications Technology Satellites H and J; advanced Nimbus and synchronous-orbit meteorological spacecraft, as well as biosatellites and new geodesy vehicles.

Funds will be requested for studies and early design work for 1973 missions to Mercury, as well as swing-by missions to outer planets during the 1976-79 period. This so-called "grand tour" of Jupiter, Saturn, Uranus, and Neptune will be pushed hard because the planets won't be back in line again for another 179 years.

Funds for the Office of Advanced Research and Technology in 1969 will remain at about the same level—\$156 million—as this year. Electronics research will get around \$35 million worth of the action, though officials at the Electronics and Control division would dearly love to boost the ante to \$38 million. Frank J. Sullivan, who heads this activity, says the money will be used for a variety of projects, including stepped-up efforts in avionics. In particular, pilot warning indicators and clear air turbulence detection systems will receive attention. Both laser backscatter and laser doppler techniques will be investigated for CAT applications, and prototype hardware will be tested.

Straight up

A major effort will be devoted to developing vertical/short-takeoff-and-landing systems at NASA's Electronics Research Center in Cambridge, Mass. Says Sullivan: "If we can develop efficient and reliable V/STOL aircraft, we can pave the way to generally improved air transportation." V/STOL elements due for attention during 1969 include:

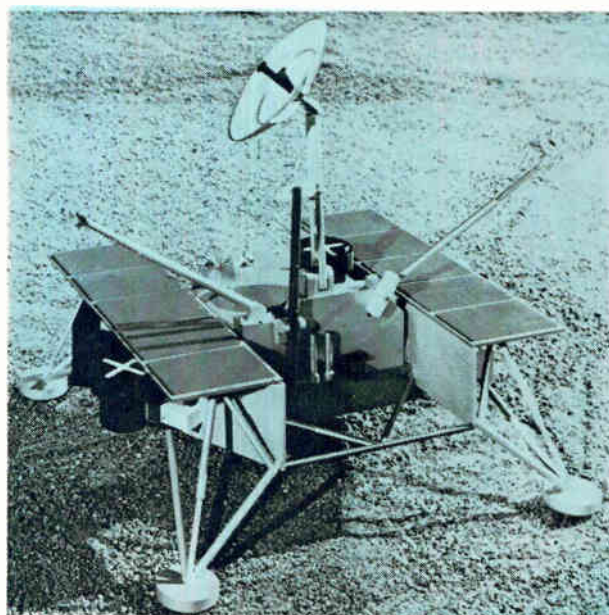

Model. Space agency's 1973 Mars missions may include soft landers like this—if the project is finally approved.

inertial navigation systems, displays, and on-board data processing gear, as well as associated air traffic control electronics. Work on L-band communications, including antenna configurations and transmission techniques, also figures in ERC's 1969 plans.

Space electronics projects on tap include optical techniques for orbital observatories, high-data-rate communications to and from orbiting vehicles, and advanced sensors for earth applications work. Data processing aboard satellites will be examined, as will video compression methods and schemes to increase channel capacity. Sullivan says, "Our data studies will range from simple casting out of redundant bits in transmissions through examination of transmissions of holograms from a spacecraft orbiting a planet."

Electronic component and device research will have a practical cast in the coming year. According to Sullivan, there will be an effort to apply such recent developments as large-scale integration, Gunn-effect devices, and lasers in space systems. "But our principle project during the year will involve microelectronic reliability," he says. ERC is charged with the responsibility of devising more efficient ways to develop electronic systems. "The burden of hardware verification falls on the user—usually at a time when the designer is off on another project," Sullivan says. "We want to foster better communications among designer, fabricator, and user." ERC will issue suggestions for coordinating systems work, contracting with electronics firms for detailed studies.

The trend away from hardware procurement perhaps is most evident in NASA's manned space flight program. The office in charge of the program estimates that only 10% to 15% of its \$2.1 billion budget will go for hardware, and that only a small amount of this will be for electronics. Says Walter S. Grosyck of the program's control directorate: "Even if Congress came through with a \$4.7 or \$4.8 billion appropriation, we'd still not be able to spend much on hardware in the next year and a half. Our funds will have to go for items already contracted for, services for Apollo, and studies of new endeavors. We work with long lead times and we can't get major hardware purchases back into the pipeline in the next year."

Funds for Apollo will continue to dwindle while outlays for the drastically reduced Apollo Applications Program (AAP) rise. About \$1 billion will be spent in the first half of 1969, with most of it earmarked for Apollo bills and about 10% for AAP. During the second half, the proportion will be reversed—albeit on shorter rations.

The first of four projected AAP missions is slated for 1971. In the fiscal 1969 budget request, \$439.6 million was sought for AAP but only \$253.2 million was authorized. Unless a substantial increase is forthcoming, officials predict the once grandiose scheme will either have to be further limited or stretched out considerably.

Faced with a generally grim year for new proj-

ects, the Office of Manned Space Flight will attempt to get some new projects in the works. NASA now plans two lunar revisits a year during the early 1970's and wants money to study ways to extend stays beyond 24 hours and produce vehicles permitting astronauts to venture beyond a quarter of a mile—the current limit—from their spacecraft. In addition, there will be a new line item requesting funds for a national space station. But funds will only cover studies and preproduction work.

The Office of Data and Tracking Acquisition anticipates spending around \$280 million in 1969. About \$200 million is for the organization's existing network; the balance would be largely devoted to equipment replacement. Only \$20 million is earmarked for new stations with 210-foot dishes in Spain and Australia. RFP's have been issued.

Comrades in arms

Military space programs will get less than \$2.0 billion in 1969. Spending for the Air Force's Manned Orbiting Laboratory—the largest armed forces' project—is expected to peak during 1969 at about \$600 million.

The general budget squeeze, however, has kept many Pentagon space projects in limbo and put others in the stretched-out category. The fate of certain Pentagon programs will not be clear until the fiscal 1970 budget is unveiled. For example, such ambitious projects as the Air Force's integrated communications, navigation, and identification system and 621-B navigation satellite are in the balance. But the Defense Satellite Communications System is down about \$200 million in 1969 as contracts are let for six spacecraft.

In the civilian sector, Comsat will be spending heavily during 1969. Almost half of the \$32 million budgeted for six Intelsat 3 satellites will be paid to TRW Inc. and its subcontractors, and large installments of the \$72 million due the Hughes Aircraft Co. for four Intelsat 4's will be made. Unless the FCC denies Comsat's request for two new ground stations, contracts will be signed early in the year for installations on Guam and in Alaska. The new stations will have 97-foot steerable dishes and be designed to incorporate modifications for operation with the Intelsat 4 series.

Two major undertakings—an Aeronautical Services Satellite program and a U.S. domestic satellite program—are still as doubtful as they were a year ago. However, the former may get a definite no within the next few weeks; the latter has the approval of the President's task force on telecommunications.

Another big question mark involves the nature of permanent arrangements for Intelsat, which Comsat is managing on an interim basis. Renegotiation of the temporary agreement begins Feb. 24; until the matter is settled, Comsat will not know exactly where it stands within Intelsat.

Reprints of this report are available at \$1 each. © Copyright 1968, Electronics © A McGraw-Hill publication

January

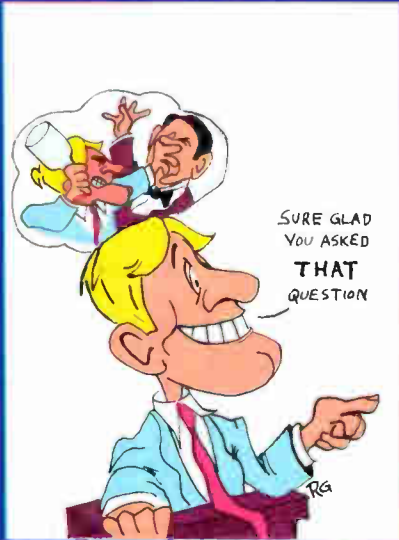

Reliability Symposium
January 21-23
Palmer House, Chicago

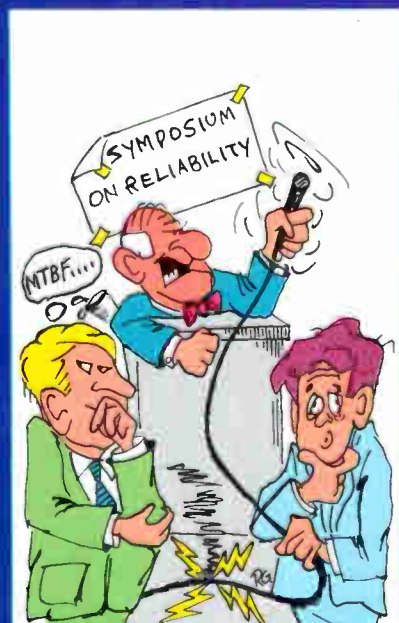

February

Transducer Conference
February 10-11
Washingtonian Motel and
National Bureau of
Standards, Washington



**Aerospace and Electronic
Systems Winter Convention
(Wincon)**
February 11-13
Biltmore Hotel, Los Angeles

**International Solid State
Circuits Conference**
February 19-21
University of Pennsylvania and
Sheraton Hotel, Philadelphia

March

**National Association of
Broadcasters**
March 23-26
Sheridan Park Hotel and
Shoreham Hotel,
Washington

**IEEE International
Convention & Exhibition**
March 24-27
Coliseum and
New York Hilton Hotel,
New York



ferences: January-June

April

**Midwest Symposium on
Circuit Theory**
April 21-22
University of Texas, Austin



**National Telemetry
Conference**
April 22-24
Washington Hilton Hotel,
Washington

**Southwestern IEEE
Conference & Exhibition**
April 23-25
Convention Center
and Palacio Del Rio Hotel,
San Antonio, Texas

**Electronic Components
Conference**
April 30-May 2
Shoreham Hotel, Washington

May



**International Microwave
Symposium**
May 5-8
Marriott Motor Hotel,
Dallas

**Spring Joint Computer
Conference**
May 14-16
Sheraton Boston Hotel and
the War Memorial Auditorium,
Boston

**National Aerospace Electronics
Conference (NAECON)**
May 19-21
Sheraton Dayton Hotel,
Dayton, Ohio

**Laser Engineering
& Applications Conference**
May 26-28
Washington Hilton Hotel,
Washington

June

**Spring Conference on
Broadcast & Tv Receivers**
June 9-10
Marriott Motor Hotel,
Chicago

**International
Communications Conference**
June 9-11
University of Colorado,
Boulder

Computer Conference
June 17-19
Leamington Hotel,
Minneapolis, Minn.

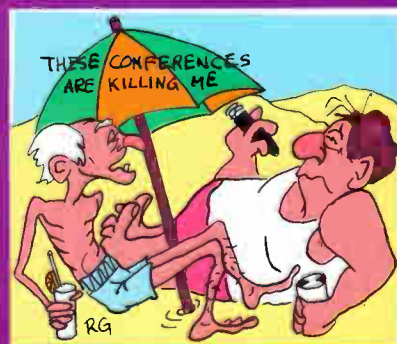

**Electromagnetic
Compatibility Symposium**
June 17-19
Berkeley Carteret Hotel,
Asbury Park, N. J.

**Electronics
guide**

Major 1969 conferences: January-June

January

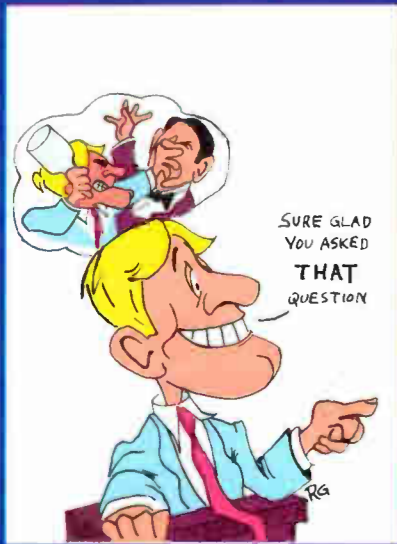

Reliability Symposium
January 21-23
Palmer House, Chicago



February

Transducer Conference
February 10-11
Washingtonian Motel and
National Bureau of
Standards, Washington



**Aerospace and Electronic
Systems Winter Convention
(Wincon)**
February 11-13
Biltmore Hotel, Los Angeles

**International Solid State
Circuits Conference**
February 19-21
University of Pennsylvania and
Sheraton Hotel, Philadelphia

March

**National Association of
Broadcasters**
March 23-26
Sheridan Park Hotel and
Shoreham Hotel,
Washington

**IEEE International
Convention & Exhibition**
March 24-27
Coliseum and
New York Hilton Hotel,
New York



April

**Midwest Symposium on
Circuit Theory**
April 21-22
University of Texas, Austin

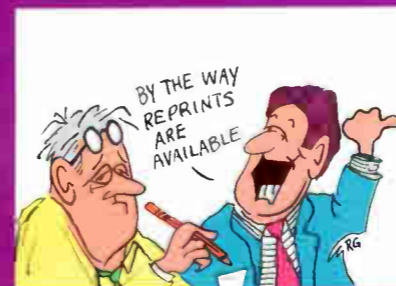

**National Telemetry
Conference**
April 22-24
Washington Hilton Hotel,
Washington

**Southwestern IEEE
Conference & Exhibition**
April 23-25
Convention Center
and Palacio Del Rio Hotel,
San Antonio, Texas

**Electronic Components
Conference**
April 30-May 2
Shoreham Hotel, Washington

May



**International Microwave
Symposium**
May 5-8
Marriott Motor Hotel,
Dallas

**Spring Joint Computer
Conference**
May 14-16
Sheraton Boston Hotel and
the War Memorial Auditorium,
Boston

**National Aerospace Electronics
Conference (NAECON)**
May 19-21
Sheraton Dayton Hotel,
Dayton, Ohio

**Laser Engineering
& Applications Conference**
May 26-28
Washington Hilton Hotel,
Washington

June

**Spring Conference on
Broadcast & Tv Receivers**
June 9-10
Marriott Motor Hotel,
Chicago

**International
Communications Conference**
June 9-11
University of Colorado,
Boulder

Computer Conference
June 17-19
Leamington Hotel,
Minneapolis, Minn.

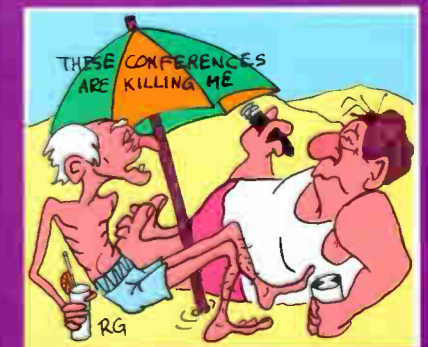

**Electromagnetic
Compatibility Symposium**
June 17-19
Berkeley Carteret Hotel,
Asbury Park, N. J.

Transducer Conference

A potpourri of 14 papers on measurement and conversion techniques will be served up, some new, some review, and most electronics-oriented. MIT's Prof. Kurt Lion will lead off with "Transducers: Problems and Prospects," and W.V. Miller of TRW Systems will describe a new development, a frequency-modulated electric-to-fluidic transducer. The schedule includes tour of the National Bureau of Standards.

First National Conference on Electronics in Medicine

February 14-15
Statler-Hilton, New York

Aimed at both engineers and physicians, this meeting will be sponsored by a trio of McGraw-Hill publications: Electronics, Medical World News, and Modern Hospital. The meeting will provide a forum where medical scientists and practitioners can gather with electronics engineers to discuss the problems and progress of medical care and the application of electronic technology to medicine. The program will include the presentation of papers, panel discussions, and equipment demonstrations.

International Solid State Circuits Conference

If previous gatherings of the solid state people are any indication, the Philadelphia conference should be a lively affair. The evening panel

discussions, which are often marked by arguments, will cover, among other topics, microwave power generation, analog IC's, custom versus standard LSI, the impact of LSI on memory organization and design, and electroluminescent - diode alphanumeric displays. Progress in devices and applications will be reported in sessions on operational amplifiers, bulk-effect and avalanche circuits, semiconductor memories, and many other subjects.

IEEE International Convention and Exhibition

The biggest electronics conference in the country will have a slightly modified format this year. For one thing, the directors of the IEEE show have reduced the number of technical sessions from last year's 70 to 52 to give the more than 65,000 visitors more time to look over the 800 exhibits. However, those technical sessions scheduled will cover a broader range of topics than before. Among other changes: a series of applications sessions and the presentation of two short courses.

The Changing Interface: an IC/systems seminar

March 28
Park-Sheraton, New York

A meeting sponsored by Electronics magazine will explore the new relationships developing among components manufactur-

ers, circuit design engineers, and systems houses. The need for a critical look stems from the growing complexity of IC technology. Presentations by men from each side of the interface will be followed by panel discussions.

Midwest Symposium on Circuit Theory

Both theoretical and practical subjects get an airing at this annual meeting, though in recent years, the papers have leaned more to the practical, dealing with such things as computer-aided design and integrated-circuit technology. The symposium, held in a different location each year, is guided by a steering committee of members from Midwestern universities and industries acting in cooperation with the circuit theory group of the IEEE. The first symposium was held at the University of Illinois in the spring of 1955.

SWIEECCO

Attendance is expected to be around the 4,000 mark at this conference. There will be 100 exhibitors and about 20 sessions. Many of the papers presented will deal with biomedical electronics because this is a sectional meeting and there are a large number of medical facilities in the area—Brooks Army Medical Center, Texas Medical Center, and the Southwest Research Center, to name a few. The meeting will coin-

cide with fiesta week in San Antonio, and the convention's organizers hope to see engineers from Latin America participating in the program; all papers will be presented in both English and Spanish over closed-circuit television.

International Microwave Symposium

New advances in microwave technology are being stressed this year, although there'll also be the traditional coverage of standard theory and techniques. Magnetoelastic and acoustic devices will be discussed, reflecting the recent interest in praetersonics. Millimeter-wave discussions, formerly limited to detectors, will be broadened this year. For example, a paper has been solicited on a 94-gigahertz radar. And there'll be a new look at Gunn-effect devices and avalanche diodes. Familiar subjects include ferrite materials and components, filters, switches, fabrication techniques for integrated circuits, and transmission lines.

National Aerospace Electronics Conference

To mark its 21st year, Naecon will take a look at the 21st century. Airborne communications, navigation and guidance systems, integrated electronics, and laser applications will get lots of attention. So will the avionics problems related to the designs of future swept-

wing, supersonic transports and V/STOL aircraft.

Laser engineering

Potential applications of picosecond pulses, parametric oscillators, and laser-acoustic interactions are among the new topics the conference will cover this year; the added features reflect substantial engineering done recently. Also being solicited are papers on modulation and detection, the latter being another area that's seen considerable progress lately. Other topics will include communications techniques and the components of communication systems, ranging, information processing, and measurement methods.

Computer Conference

Biomedical applications will be a major topic at this year's conference. Hospitals need equipment for continuous monitoring of patients and for data retrieval. Physicians and engineers at the conference will discuss the success of prototype systems in hospitals, deficiencies to be remedied, and future requirements for the automation of hospital services. The over-all theme of the conference will be real-time systems; other topics include graphic displays, programing techniques, and modeling analyses of time-shared systems. Several papers, most presented by professors, will cover the use of queuing theory to relieve congestion in time-shared systems.

Thou shalt not invert.

Not when you have AND, OR, NAND and NOR functions available in one logic family.

With the recent addition of seven new

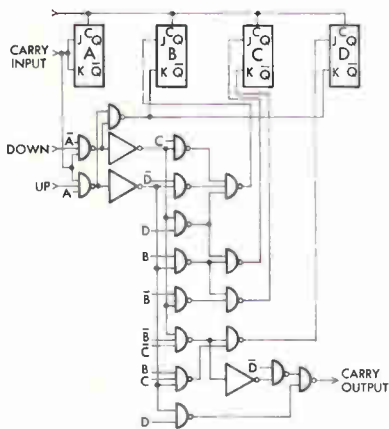

DTL implemented up-down counter

gates to the line, Utilogic II now allows you to implement functions simply, any way you choose — with AND, OR, NAND or NOR elements. No other logic family permits this flexibility.

It's possible to eliminate inverters, commonly required in DTL designs. The Utilogic II implementation of the Up-Down Counter shown below requires 11% fewer packages than the typical DTL version. In terms of comparative system costs based on 1000-up pricing, the Utilogic II implementation saves you 30% in parts cost alone.

The new circuits include dual 4-input expandable, triple 3-input and quad gates in both OR and NAND logic functions, plus a triple 2-input expandable OR gate and a diode expander.

All the new circuits are immediately available in volume in a 14-pin dual-in-line silicone package in the SP (0°C to 75°C) and LU (10°C to 55°C) operating temperature

ranges. Utilogic II, as you recall, has three times greater noise margins and double the fan-out of any other available logic family. And its performance has been proven by over 15 million elements in the field. For our Utilogic II Handbook write Signetics, 811 East Arques Avenue, Sunnyvale, California 94086. Bless you.

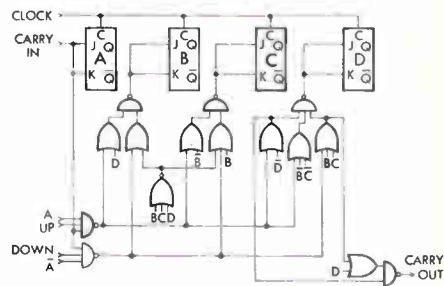

UTILOGIC II implemented up-down counter

Signetics Integrated Circuits 

A SUBSIDIARY OF CORNING GLASS WORKS

SIGNETICS SALES OFFICES: Wakefield, Massachusetts (617) 245-8200; Trumbull, Connecticut (203) 268-8010; Poughkeepsie, New York (914) 471-3292; Syracuse, New York (315) 469-1072; Fort Lee, New Jersey (201) 947-9870; Radnor, Pennsylvania (215) 687-2660; Silver Spring, Maryland (301) 946-6030; Clearwater, Florida (813) 726-3734; Winter Park, Florida (305) 671-5350; Oayton, Ohio (513) 433-4133; Minneapolis, Minnesota (612) 920-3256; Rolling Meadows, Illinois (312) 259-8300; Richardson, Texas (214) 231-6344; Garden Grove, California (714) 636-4260; Burbank, California (213) 846-1020; Redwood City, California (415) 369-0333.

DISTRIBUTORS: Avnet Electronics Corp., Burlington, Mass. (617) 272-3060; Cescio Electronics, Ltd., Montreal, Quebec, Canada (514) 735-5511. Compar Corporation at the following locations: Huntsville, Alabama (205) 539-8476; Los Angeles, California (213) 245-1172; Burlingame, California (415) 347-8244; Hamden, Connecticut (203) 288-9276; Clearwater, Florida (813) 446-2991; Orlando, Florida (305) 855-3964; Park Ridge, Illinois (312) 692-4125; Baltimore, Maryland (301) 484-5400; Newton Highlands, Mass. (617) 969-7140; Minneapolis, Minnesota (612) 922-7011; St. Louis, Missouri (314) 542-3399; Albany, New York (518) 489-7408; Endwell, New York (607) 723-8743; Woodbury, New York (516) 921-9393; Fairport, New York (716) 271-2230; Syracuse, New York (315) 471-3356; Winston-Salem, North Carolina (919) 723-1002; Seattle, Washington (206) 763-1711. Hamilton Electro Sales, Culver City, Calif. (213) 870-7171; Cherry Hill, N. J. (609) 662-9337; Hammond Electronics, Orlando, Florida (305) 241-6601; Kierulff Electronics, Seattle, Wash. (206) 763-1550; G. S. Marshall, San Marino, Calif. (213) 684-1530; Milgray-Delaware Valley, Inc., Philadelphia, Pa. (215) 228-2000; Pioneer Standard Electronics, Rockville, Maryland (301) 427-3300; Schley Electronics, Watertown, Mass. (617) 926-0235; Semiconductor Specialists, Inc., Elmhurst, Illinois (312) 279-1000; Terminal-Hudson Electronics, New York, New York (212) 243-5200; Universal Electronics, Inc., Houston, Texas (713) 781-0421; Wesco Electronics, Inc., Los Angeles, Calif. (213) 685-9525; Palo Alto, Calif. (405) 968-3475.

DOMESTIC REPRESENTATIVES: Compar Corporation at the following locations: Scottsdale, Arizona (602) 947-4336; Denver, Colorado (303) 781-0912; Southfield, Michigan (313) 357-5369; Haddonfield, New Jersey (609) 429-1526; Albuquerque, New Mexico (505) 265-1020; Albany, New York (518) 489-7408; Endwell, New York (607) 723-8743; Fairport, New York (716) 271-2230; Syracuse, New York (315) 471-3356; Rocky River, Ohio (216) 333-4120; Fairborn, Ohio (513) 878-2631; Dallas, Texas (214) 363-1526; Houston, Texas (713) 667-3420. Ozark Electronic Marketing, Inc., St. Louis, Missouri (314) 423-7200.

INTERNATIONAL SALES: France, Germany, Italy, Belgium, Holland, Luxemburg, Spain—Sovcor Electronique, 11, Chemin de Ronde, Le Vesinet. (S.-&D.) France. United Kingdom, Ireland, Sweden, Denmark, Norway, Switzerland, Austria, Portugal—Electrosil Ltd., Lakeside Estate, Colnbrook-Bypass Slough, Buckinghamshire, Great Britain. Australia—Corning, 1202 Plaza Building, Australia Square, Sydney, N.S.W. 27-4318. Canada—Corning Glass Works of Canada, Ltd., Leaside Plant, Ontario, Canada (416) 421-1500. Israel—Talvion, P.O. Box 3282, Tel-Aviv, Israel 236-666. Japan—ASAHI Glass Co., Ltd., Corning Products Sales Dept. No. 14, 2-Chome Marunouchi, Chiyoda-ku, Tokyo, Japan 211-0411.

Eight good reasons for specifying Sperry C and X band traveling wave amplifiers

If you're working on radar, communications or ECM systems at C or X band frequencies, investigate Sperry's newest developments — the STC-5210 (4 to 7 GHz) and the STX-5220 (7 to 11 GHz). Here are eight good reasons why these tubes belong in your system:

1. Output Power: These tubes deliver 200 watts CW minimum across their entire bandwidth and 250 watts CW minimum across any 25% of the band.

2. Extended Bandwidth: The STX-5224 delivers 200 watts minimum from 7 to 11 GHz, 100 watts minimum to 12.4 GHz and 50 watts minimum to 13.4 GHz.

3. Efficiency: The STC-5210 and STX-5220 have a minimum beam efficiency of 21%.

4. Pulse Performance: More than 350 watts of output across C band and 300 watts across X band. Both at 5% duty cycle.

5. Matched Power Supplies: Simplify your applications task — take delivery with the tube/power supply interface already made. Sperry's power supply comes in a 4" x 7" x 15" package weighing just 22 lbs. It's all solid-state, 82% efficient, and qualified to MIL-E-5400, Class II. Your choice of 400 cycle AC or 28 VDC input.

6. Weight: Tubes weigh 6 lbs.; power supplies weigh 22 lbs., maximum.

7. Cooling: Specify conduction or forced air cooling at no additional cost.

8. Environmental Qualification: Tubes and power supplies are designed to meet the most stringent MIL requirements.

Get more information on these outstanding TWT amplifiers. Contact your Cain & Co. man or write Sperry Electronic Tube Division, Gainesville, Florida.



SPERRY
ELECTRONIC TUBE DIVISION
GAINESVILLE, FLORIDA



MICROWAVE PROS!



Tell us about your engineering degree(s) and your five or more years of microwave tube experience. Let us tell you about exciting work, educational opportunity and pleasant living in one of America's most attractive university cities. Resume, please, to Walt Thomas, Director of Industrial Relations. (An equal opportunity employer, M&F.)



"THE FLINT SKINS" ARE NOW AVAILABLE
IN 0.10, 0.25, 0.50 AND 1.0% TOLERANCES

They have a molded silicone body that's denser and thicker than any conformal coating. It's totally impervious to moisture and has outstanding dielectric. Silicones are a natural for precision molding, too, making a perfect shape for machine handling in any automated operation.

In fact, they have all the good characteristics of the "Flint" family plus the impact resistance of cross linked poly. But Clarostat's modern mass production techniques make them so miserly in price, maybe we should call them "The Skin Flints"?

Ask for the new Flint Skins as Clarostat series SC
1, 3, 5, 10 watts surpassing mil-specs RW 70U, 74U, 78U, 79U.

CLAROSTAT Dept. 101
Dover, N.H. 03820

Tear out this page.

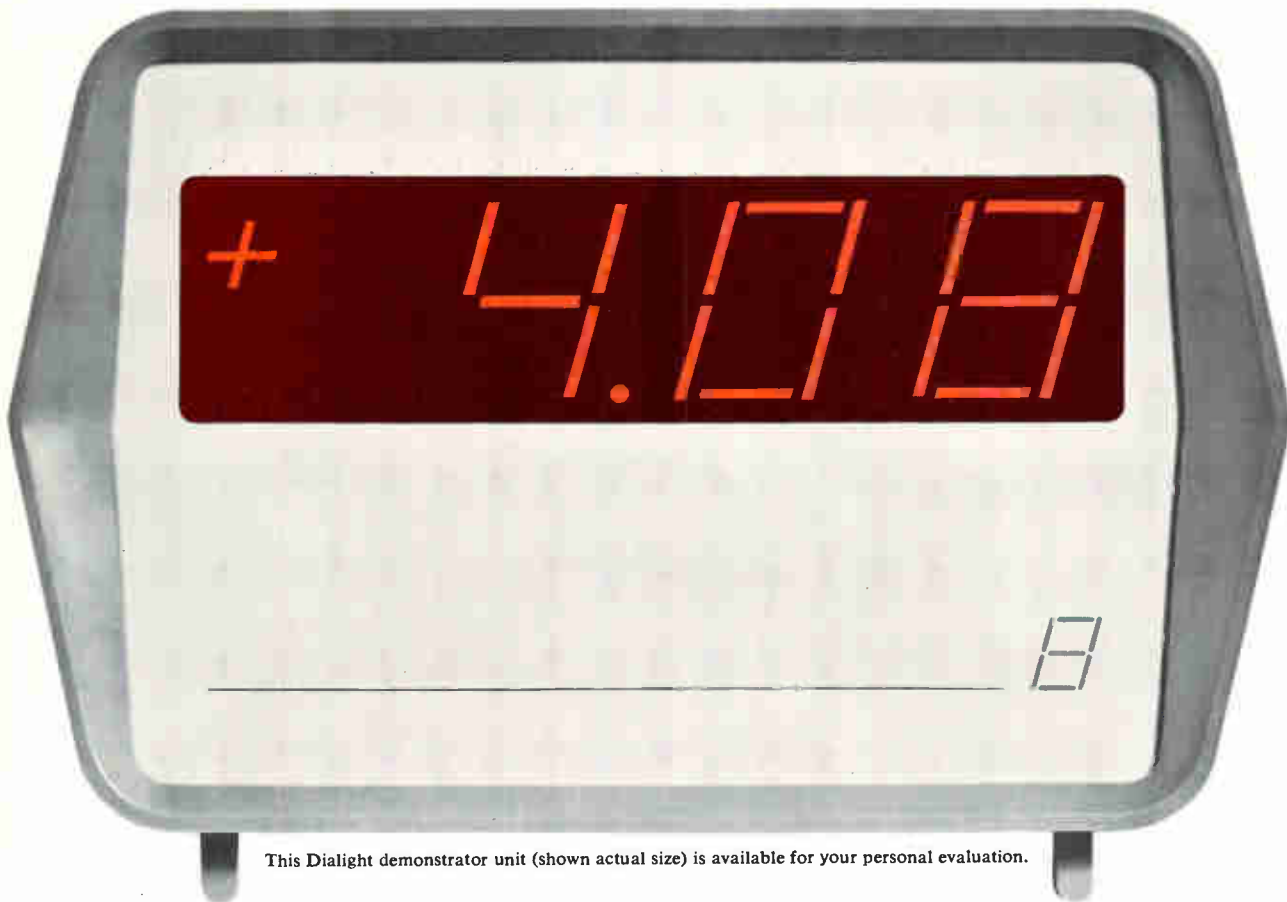

This Dialight demonstrator unit (shown actual size) is available for your personal evaluation.

*Place it next to any readout
you're now considering.
Then walk back 30 feet and
prove to yourself that low-cost
Dialight readouts are easier to read.*

The only way to be sure is to compare Dialight readouts with others. This little test will give you a rough idea of the difference. But it's not quite as convincing as the actual demonstration we'll be happy to provide you with on request.

Dialight readout modules cost as little as \$3.99 each (less lamps in 1000 lot quantities). They operate on 6, 10, 14-16, 24-28 volts AC-DC, 150-160 volts DC and 110-125 volts AC. Caption modules are available; each is capable of displaying up to six messages at one time.

Windows are of non-glare type in a choice of colors.

Options: universal BCD to 7-line translator driver, 10-line to 7-line converter for decimal input, RFI-EMI suppression screen. Custom translators available.

To arrange to borrow a Dialight demonstrator unit, write us on your company letterhead.

For copy of our current catalog, circle reader service number below. Dialight Corporation, 60 Stewart Ave., Brooklyn, N.Y. 11237. (212) 497-7600.



DIALIGHT

Circle 150 on reader service card

Circle 151 on reader service card →

free



Digital Equipment Corporation, Maynard, Mass. 01754

Please send free copy of:

- 250 page Control Handbook (1969 edition) describing industrial modules, applications, system design concepts.
- 500 page Logic Handbook (1968 edition) including a logic primer, description of all Digital modules, application uses, and an A to D conversion handbook.
- Both.

name

title

company

address

city

state

zip

digital
COMPUTERS • MODULES

USC REMI* JOINS THE NAVY

*Removable REntrancy Miniature Connector



US Components
Printed Circuit Connectors
RWG-37F WG-37M
(Actual size) (Actual size)



A modern Navy torpedo is a complex seagoing craft in itself. It requires an extremely reliable electro-mechanical "crew" to seek out and destroy enemy subs.

When Westinghouse Electric Corporation was assigned the job of building the wire-guided Mark 48 torpedo, it selected USC REMI* two-unit printed circuit connectors RWG-37F and WG-37M to serve on board. Westinghouse designed these USC REMI* connectors into its vital analog and amplifier circuits of its intricate guidance systems.

Major manufacturers such as Westinghouse know connectors can make a big difference in how well a completed product or system performs. That's why they specify USC where ER** helps simplify designs, save space, enhance reliability and reduce assembly costs.

Makes USC connectors worth investigating, doesn't it?

**USC Established Reliability can do!



No. of Contacts: 37
Wire Sizes Accommodated: Female Connector, AWG #14 to #30 and MIL-W-16878A #16 to #37. REMI Contacts are ordered separately. Crimping by MIL-T-22570A (WEP) Class I or II tools.
Military Specifications: (Contacts) MIL-C-23216, MIL-C-26636, MS3190. (Connectors) MIL-C-23353, MIL-C-21097. (Latest revisions) U. S. Patent No. 2,979,6

1320 ZEREGA AVENUE • BRONX, N.Y. 10462 or use TWX: 710-593-2141 • Tel. 212-824-1600 TELEX: 1-2411 • or Cable: COMPONENTS N.Y.

This cartridge-loaded recorder revolutionary packs up to 130 million digital bits.

Our new five pound MTR-8500 not only records seven times more than competitive models, but does so with virtually no errors. Thanks to a unique new design technique called High Density Digital Recording (HDDR, patent pending), you can pack 6,000 bits per track inch. And although we guarantee an error rate of 1×10^8 , we've yet to drop a single bit using HDDR.

The new 8500 cartridge-loaded unit is ideal for reconnaissance, surveillance and electronic countermeasure applications. It records almost a half hour at $1\frac{7}{8}$ ips and can record and reproduce at various tape speeds. Power consumption is only 20 watts, and it will operate on 28 volt aircraft systems.

Best of all, the new MTR-8500 complete with HDDR is available now for use in such rugged environments as 0-130°F, 100% humidity and altitudes up to 150,000 feet. For more complete information write Leach Corporation, Controls Division, Department E, **LEACH** 717 North Coney Avenue, Azusa, California 91702. (213) 334-8211.

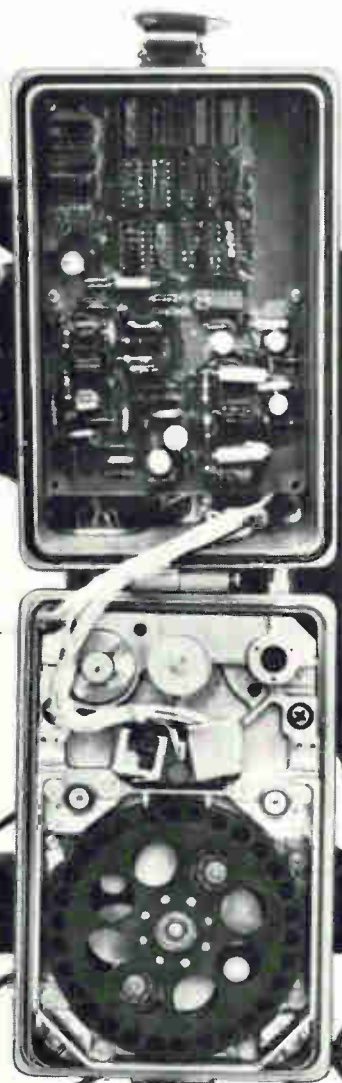

The Single Source For Reliable Protection For Every Type Of Electronic And Electrical Circuit And Device

BUSS QUALITY

SMALL DIMENSION FUSES AND FUSEHOLDERS

Include dual-element "slow-blowing" fuses, single-element "quick-acting" fuses and signal or visual indicating type fuses . . . in sizes from 1/500 amp. up . . . PLUS: a companion line of fuseholders.

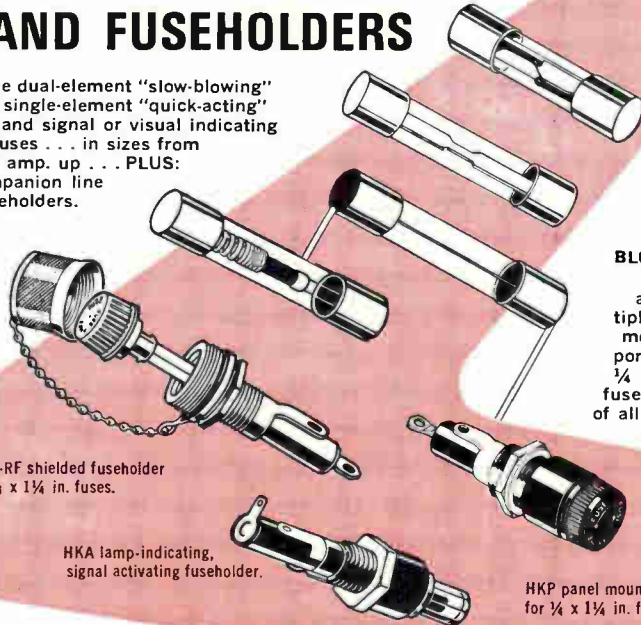

HMR-RF shielded fuseholder for 1/4 x 1/4 in. fuses.

HKA lamp-indicating, signal activating fuseholder.

HKP panel mounted fuseholder for 1/4 x 1/4 in. fuses.

THE COMPLETE LINE OF SIGNAL-INDICATING ALARM-ACTIVATING FUSES

For use on computers, microwave units, communication equipment, all electronic circuitry.



BUSS GLD-1/4 x 1/4 in. Visual-Indicating, Alarm-Activating.

BUSS GBA-1/4 x 1/4 in. Visual-Indicating.



BUSS Grasshopper Fuse, Visual-Indicating, Alarm-Activating.



BUSS MIN-13/32 x 1/2 in. Visual-Indicating.

BUSS MIC-13/32 x 1/2 in. Visual-Indicating, Alarm-Activating.



BUSS ACH Aircraft Limiter, Visual-Indicating.



FNA FUSETRON Fuse 13/32 x 1/2 in. slow-blowing, Visual-Indicating, Alarm-Activating. (Also useful for protection of small motors, solenoids, transformers in machine tool industry.)

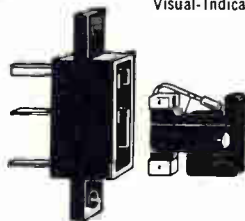

BUSS GMT and HLT holder, Visual-Indicating, Alarm-Activating.

FOR FUSES AND FUSEHOLDERS OF UNQUESTIONED HIGH QUALITY FOR EVERY PROTECTION NEED INSIST ON . . .

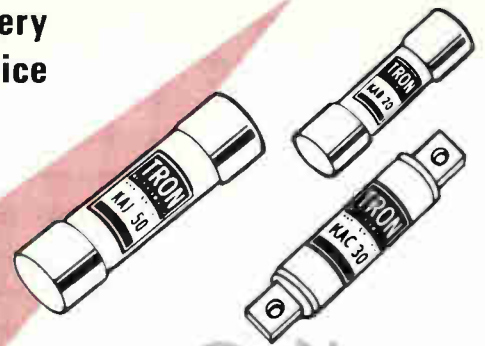

TRON Rectifier Fuses

For the Safe Protection of Solid State Devices

Provide extremely fast opening on overload and fault currents, with a high degree of restriction of let-thru current. Many types and sizes available. Ampere ratings from 1/2 to 1000 in voltages up to 1500.

BLOCKS FOR BUSS FUSES

All types available for every application. Single pole, multiple pole, small base, full base, molded base, laminated base, porcelain base for fuses from 1/4 x 5/8 inches up. Also signal fuse blocks and special blocks of all types.



SUB-MINIATURE FUSES

Ideal for space tight applications, light weight, vibration and shock resistant. For use as part of miniaturized integrated circuit, large multi-circuit electronic systems, computers, printed circuit boards, all electronic circuitry.

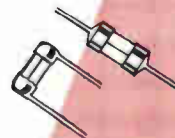

TRON

Sub-Miniature Pigtail Fuses - Body size only .145 x .300 inches.

Glass tube construction permits visual inspection of element. Hermetically sealed. Twenty-three ampere sizes from 1/100 thru 15.

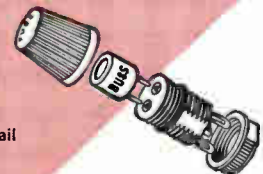

BUSS Sub-Miniature GMW Fuse and HWA Fuseholder.

Fuse size only .270 x .250 inches. Fuse has window for visual inspection of element. Fuse may be used with or without holder. 1,200 to 5 amp. Fuses and holders meet Military Specifications.

FOR MORE INFORMATION ON THE COMPLETE BUSS LINE, WRITE FOR BUSS FORM SFB

BUSSMANN MFG. DIVISION, McGraw-Edison Co., St. Louis, Missouri 63107

SUPPLIED THE ECONOMICAL WAY THRU DISTRIBUTORS

BUSS QUALITY

FUSES



For electrical contacts,
as in mini-fashion,

It pays to see a specialist

Like a successful model-on-the go, Deringer is an on-the-go company which concentrates all efforts on providing our customers with the best in electrical contacts, contact sub-assemblies and assemblies. When you consider the many factors involved in designing the optimum electrical contact for a specific application, the advantages of specialization are important to you. So contact Deringer. We'll send one of our "go-go" specialists right away.



METALLURGICAL CORPORATION

1250 Town Line Road (Rt. 60) Mundelein, Illinois 60060

Circle 155 on reader service card

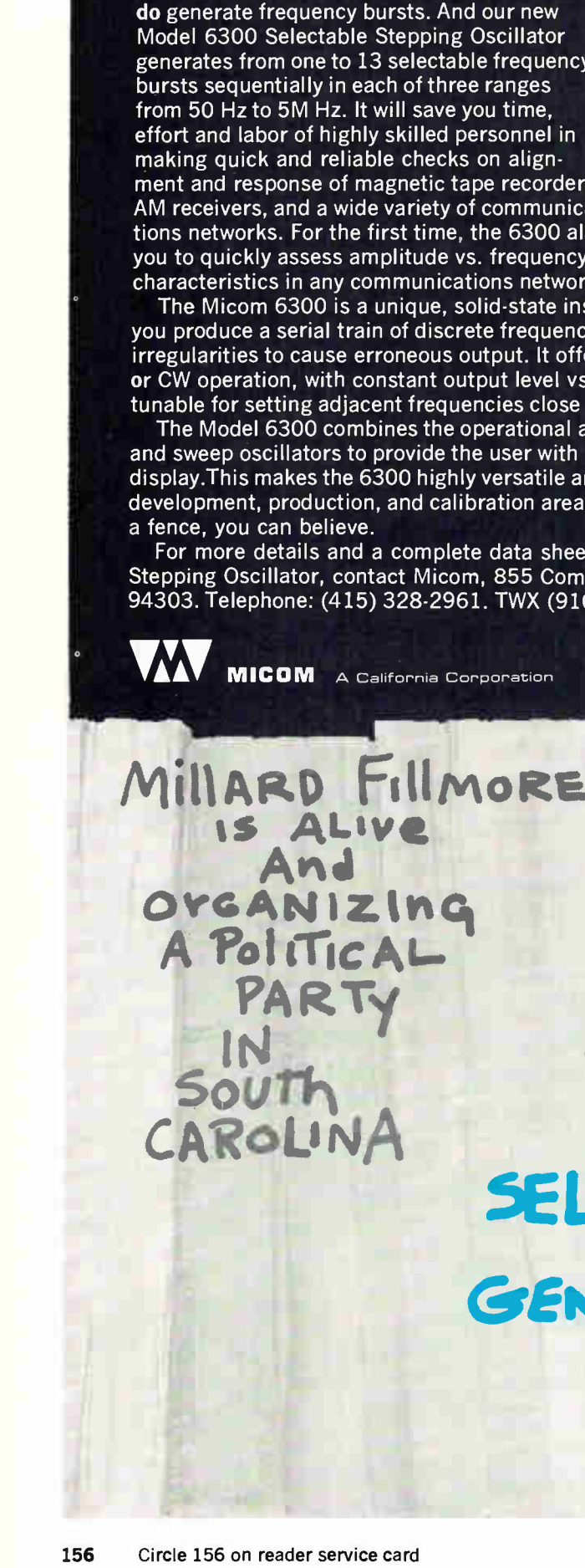

We're not sure about Millard, Dick or Judy, but Selectable Stepping Oscillators certainly do generate frequency bursts. And our new Model 6300 Selectable Stepping Oscillator generates from one to 13 selectable frequency bursts sequentially in each of three ranges from 50 Hz to 5M Hz. It will save you time, effort and labor of highly skilled personnel in making quick and reliable checks on alignment and response of magnetic tape recorders, AM receivers, and a wide variety of communications networks. For the first time, the 6300 allows you to quickly assess amplitude vs. frequency characteristics in any communications network or system.

The Micom 6300 is a unique, solid-state instrument that lets you produce a serial train of discrete frequencies, without spikes or irregularities to cause erroneous output. It offers transient-free stepping or CW operation, with constant output level vs. frequency. Frequencies are tunable for setting adjacent frequencies close together or even overlapping them.

The Model 6300 combines the operational advantages of manually tunable and sweep oscillators to provide the user with a virtually simultaneous frequency display. This makes the 6300 highly versatile and economical for use in research and development, production, and calibration areas. Some things you see written on a fence, you can believe.

For more details and a complete data sheet on our Model 6300 Selectable Stepping Oscillator, contact Micom, 855 Commercial Street, Palo Alto, California, 94303. Telephone: (415) 328-2961. TWX (910) 373-1179.



MICOM A California Corporation

MILLARD FILLMORE
IS ALIVE
AND
ORGANIZING
A POLITICAL
PARTY
IN
SOUTH
CAROLINA

JUDY W.
HAS A CRUSH
ON
TINY TIM

DICK TRACY
SLEEPS
WITH A
NIGHT LIGHT

**SELECTABLE STEPPING
OSCILLATORS
GENERATE FREQUENCY
BURSTS**

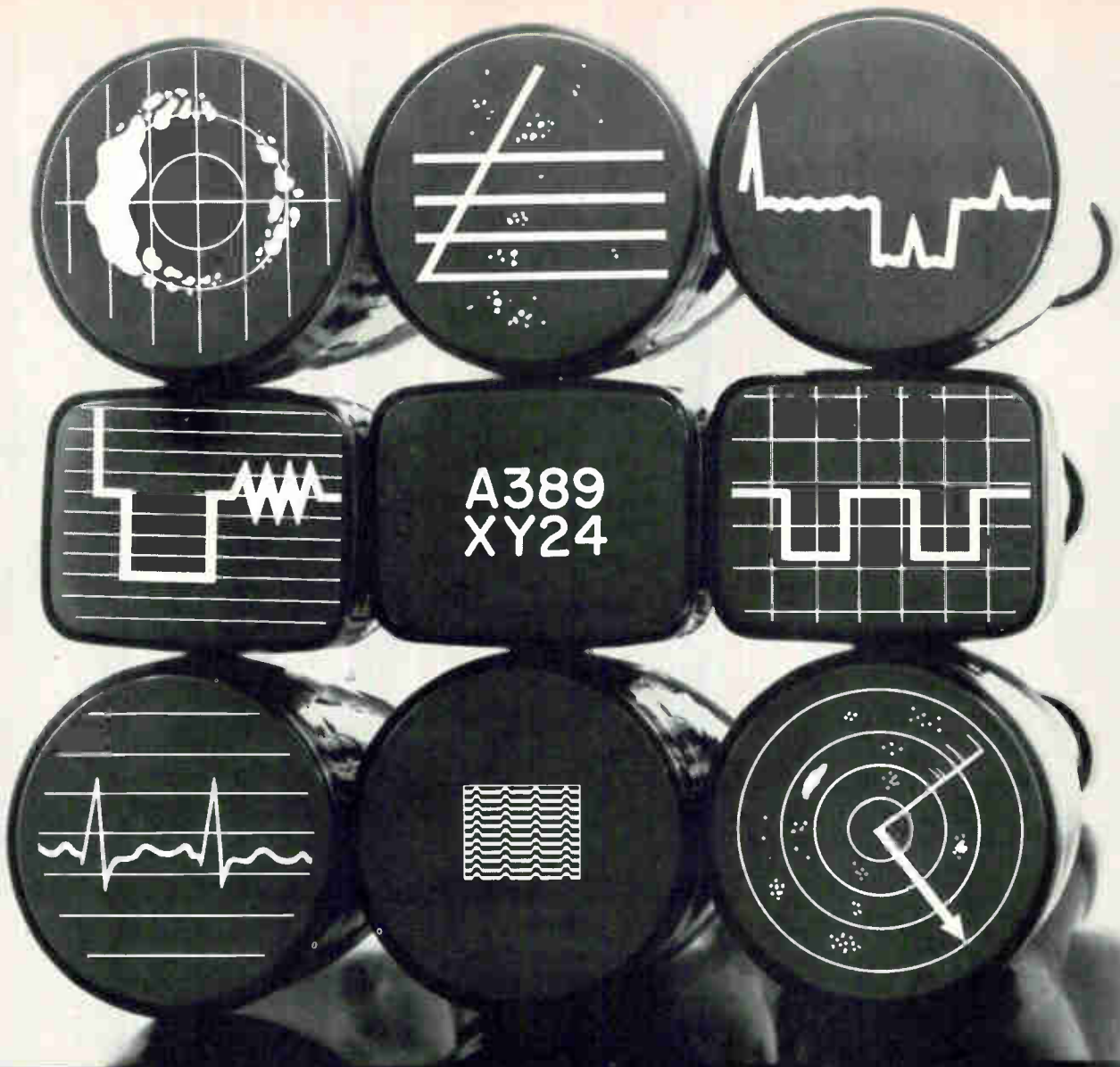

We offer over 200 talking pictures. Pick one that speaks your language.

Our CRT's have been articulate right from the start. Our first, thirty years ago, told us we were onto a good thing. Some people didn't believe it, but that one spoke our language.

Since then we've gone on to develop and produce CRT's that make up an electronic United Nations.

One speaks to the weather-

man. Another to a heart specialist. There's one that sits on a desk and talks to bookkeepers or accountants. And one that communicates with aircraft control tower personnel. One that strikes up a conversation with geologists. And even one that displays nuclear explosion data to anyone who cares.

That's asking a lot from a CRT.

But then we've always done that. And we'll go right on doing it. Because even as our customers tell us, there's almost no limit to what a CRT can talk about.

Want to start a conversation with a CRT? Call or write us to arrange a meeting... anytime.

Electronic Tube Division,  General Atronics, Philadelphia, Pennsylvania 19118



GENERAL ATRONICS

Circle 157 on reader service card

Let us throw you a curve

If you've problems with LC circuits, Magnetics' new Iso-Q contour curves speed ferrite pot core selection.

No more squinting at tangles of curves on log paper to find the ferrite pot core size you need. Magnetics' new Iso-Q contour curves let you zero in on your target size in seconds. We've plotted over 100 of these time-savers to handle more than 90% of normal design

requirements. They're all contained in our new Ferrite Cores Catalog, first of its kind in the industry.

Magnetics' high purity ferrites cover frequencies up to 2 megahertz. Linear temperature coefficients on 750, 1400 and 2000 permeability materials are guaranteed from -30° to $+70^{\circ}\text{C}$. Flat temperature coefficient on 2300 perm material is guaranteed from $+20^{\circ}$ to $+70^{\circ}\text{C}$.

Magnetics' wide selection of ferrites comprises eight international standard sizes and five additional sizes—175 part numbers for design freedom. We can give you quick

delivery from our large inventory that includes both gapped and un-gapped cores in your most asked-for sizes. Of course, we provide one-piece clamping hardware for most sizes. Finally, we offer you a complete choice of tuning assemblies, bobbins and shapes—toroid, E, U and I.



Get your set of our new Iso-Q Curves. You'll like their curvilinearity. Magnetics Inc., Butler, Pa. 16001



MAGNETICS inc.
®

Tape, Powder, Bobbin, Ferrite Cores • Laminations • Photo-etched Parts • Specialty Metals • Engineered Control Systems

158 Circle 158 on reader service card

Circle 159 on reader service card →

If you thought all Daystrom pots were squares

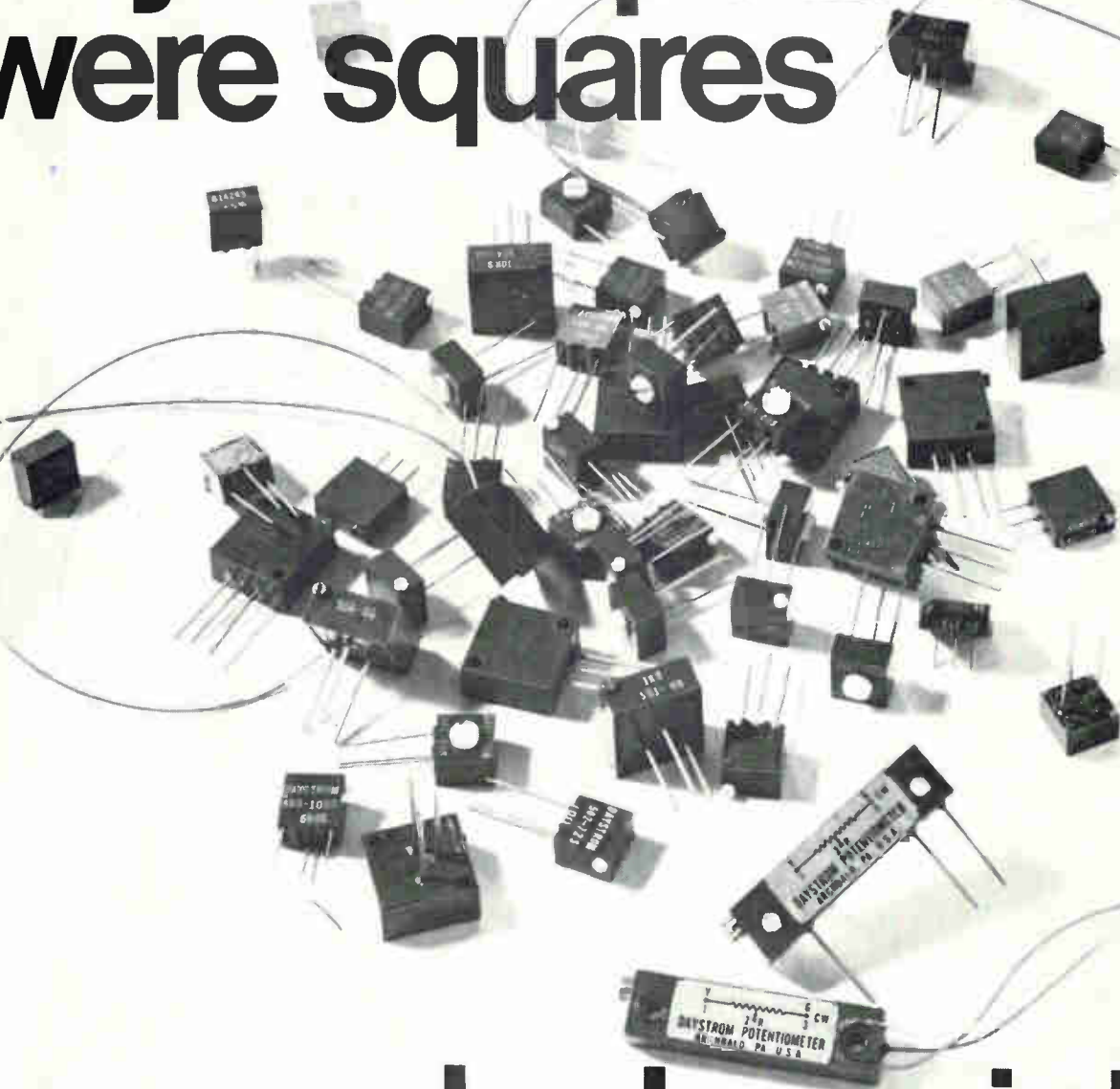

...look again!

Rectilinear components are still a necessary requirement in many circuit applications. That's why Weston has rounded out its high-performance potentiometer line with two new rectilinear models. RT-12 styles 534 and 535 are designed for both general-purpose and military applications. They feature the same $\pm 5\%$ tolerance, 10 ohm to 50K range, and slip clutch stop protection that are standard with Daystrom Squaretrim® units, plus 24-turn adjustability and

humidity proofing. Also new this year . . . models 553 half-inch and 543 three-eighth-inch Squaretrim potentiometers in military and commercial versions. Save board space as well as money with our field proven 501 Series multi-turn and 504 Series single-turn $\frac{1}{16}$ " Squaretrims offering values to 20K in a 0.02 cubic inch case. All Squaretrim Diallyl-Phthalate cased pots give you Weston's patented "wire in the groove" construction and your choice of flexible leads,

pin and screw configurations. Whether your trimmer needs are military, industrial or commercial, you'll find the answer in this complete new low-cost line. Write today for data sheets and evaluation samples. DAYSTROM potentiometers are another product of WESTON COMPONENTS DIV., Archbald, Pennsylvania 18403, Weston Instruments, Inc., a Schlumberger company

WESTON®

Have you talked to an analyst about your identification problem?

The problems of marking and identifying electrical and electronic components can drive a production engineer right up the old wall. "How can you print several color bands on a miniature diode?" "Is there an ink that'll dry on contact and meet Mil specs?" "How can you get fast, smudge-proof marks on things like ceramics, plastics and chrome?" "How can you simultaneously mark the tops and sides of transistors at high rates of speed?"

A Markem analyst thrives on problems like these. He can help you solve them by supplying the best machines, specialty inks, printing elements and other supplies. He can help by being there whenever you need service, whenever an operator needs training. And he can help by showing you how to get better identification for less money. For example, we recently introduced an Instant Type Former which lets you make metal type in-plant, as needed. No waiting for delivery . . . You can form new type inserts in less than a minute by simply "dialing" the legend.

Have a Markem analyst visit your plant to look into your marking operation. His ideas could save you a lot of grief. And a lot of money. Call your local Markem Sales office or Bernie Toomey at 603-352-1130. Write for our new "Problem Solver" booklet. Markem Corporation, 305 Congress St., Keene, N.H. 03431.

MARKEM®

Circle 160 on reader service card



A sampling*

Category	Type	Description	Experience
Discretes	HRN1030	General Purpose, Insulated Gate, Switch	4 years
	HRN8318D	General Purpose, Gate Diode Protected, Switch	4 years
Multiplexers	HRM8014D	General Purpose Quad, Gate Diode Protected	3 years
	HRM2206	8-Channel Switch, Gate Diode Protected	2 years
D-A & A-D Converters	HRM8013	4-Channel Multiplexer with Drive Logic	3 years
	HRM8068 HRM2302	Dual DPDT Analog Switch with Drive Logic A/D and D/A Converter Elements	3 years 2 years
Counters	HRM F/2	Low Cost Frequency Divider	1 year
	HRM2034	Seven Stage Binary Counter	2 months
Combinational Logic	HRM2304	Triple 3 Input, Dual 2 Input NOR Gates	2 years
Shift Registers	HRM2026	Dual 2 ϕ 25 Bit Shift Register	3 months
Arithmetic	HRM2032	Differential Digital Analyzer	new

THE TOMORROW MOSFETS. TOMORROW

We call our line "The Tomorrow MOSFETS" because they have features that, someday, all MOSFETS will probably have.

Features like lower threshold voltage with the ability to operate at higher voltage levels; lower channel resistance; and the lowest 1/f noise in the industry.

These features result in more design freedom, in faster operating speeds, in lower power consumption, and in the elimination of level translators.

But there's another reason we call them The Tomorrow MOSFETS.

They're built for tomorrow. The longer they're used, the more

You can see from the sampling up above that the oldies are still the goodies.

And that's just a sample. We have more where those came from.

Write Hughes, MOSFETS, 500 Superior Ave., Newport Beach, Calif. 92663. Phone (714) 548-0671. TWX (714) 642-1353.





Educating electronics personnel is too big a problem to have only one solution.



Of course, you're sold on the importance of providing continuing education for your electronics personnel. So rapidly do new developments take place in electronics that knowledge begins to lose its value almost as soon as it is acquired. Valuable men can become outmoded and unproductive almost overnight. And the shortage of technical manpower at both the professional and supporting levels makes it imperative that you utilize fully every man you have.

Perhaps your company conducts in-plant programs of instruction. Or pays all or part of the cost

of evening classes in nearby technical institutes, colleges and universities. Whatever your educational program, we believe it will be more flexible and more effective if you supplement it with CREI Home Study Programs in Electronics.

We've prepared a brochure that tells how CREI Programs can help you update, upgrade and reorient electronics personnel. Use coupon below to send for a copy today.

Founded 1927



Accredited Member of the National Home Study Council



CREI, Home Study Division, McGraw-Hill Book Company

Dept. WTC-03, 3224 Sixteenth Street, N.W.
Washington, D.C. 20010

I want more information on CREI Programs in Electronics and how they can supplement our educational program for electronics personnel. Please send me, without obligation, your descriptive brochure.

Name _____

Title _____

Firm Name _____

Address _____

City _____ State _____ Zip _____



15-MHz, Dual-Trace Portable Oscilloscope

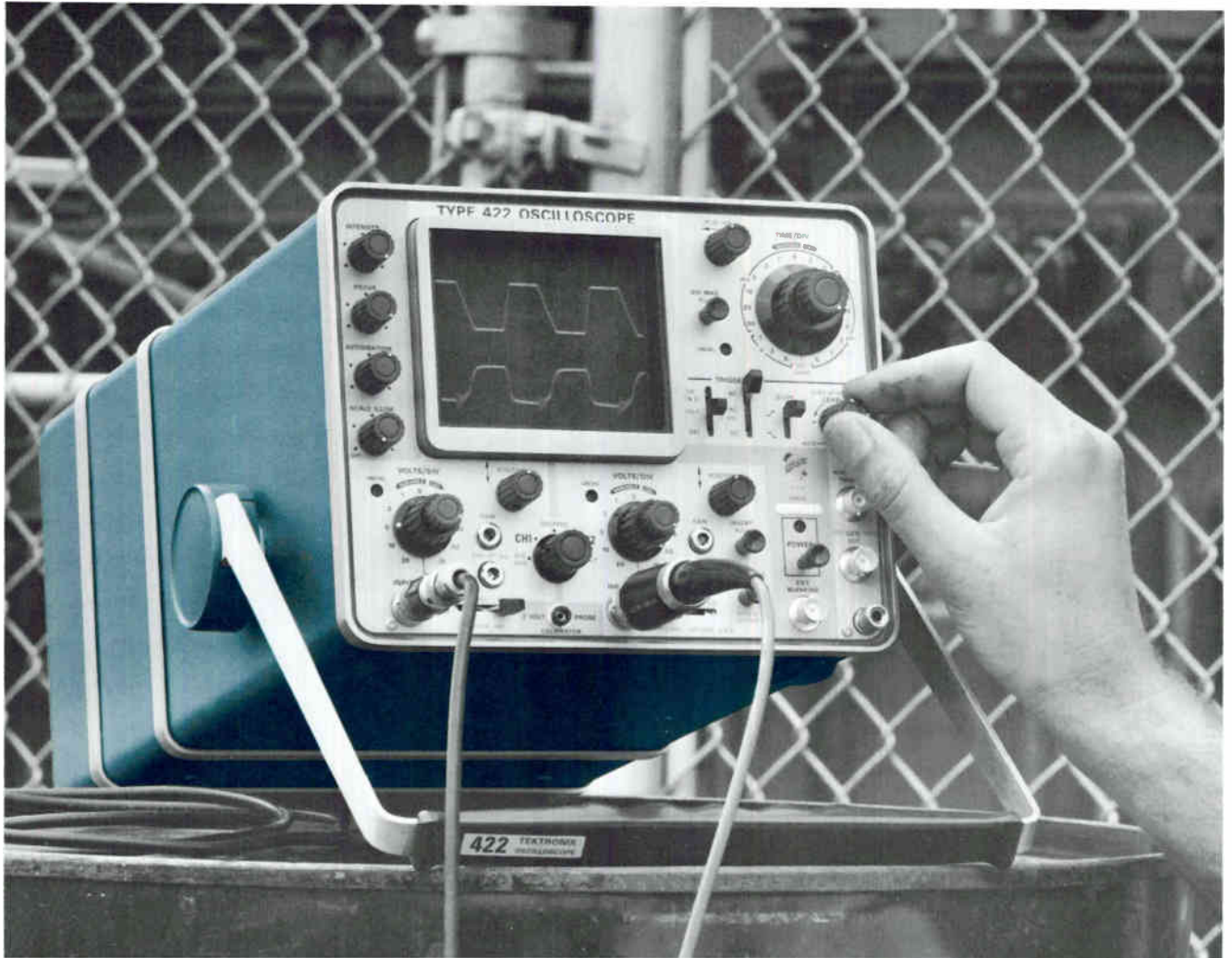

AC, DC or Battery Powered!

Your waveform measurements no longer need be compromised by adverse field conditions or the absence of a convenient power connection. The Tektronix Type 422 Portable Oscilloscope brings the precision of the laboratory "on site" to meet your measurement requirements.

This compact, rugged oscilloscope combines small size and light weight with 15-MHz, dual-trace performance! Two models are available. One is pow-

ered from AC; the other from AC, DC, or internal rechargeable batteries. The AC version weighs less than 22 pounds including accessories and operates from 115 or 230 VAC $\pm 10\%$, 45 to 440 Hz, 40 watts. The AC/DC version (MOD 125B) with built-in battery recharger weighs 30 pounds including accessories and batteries and operates from an internal 24-volt rechargeable battery pack; from 115 or 230 VAC $\pm 20\%$, 45 to 440 Hz, 27 watts; or from 11.5 to 35 VDC, 23 watts.

please turn page for additional information 

TEKTRONIX PRODUCT REPORT - PORTABLES

Making the Measurement . . . with the Tektronix Type 422

Portable Oscilloscope

PERFORMANCE

Dual vertical input amplifiers cover major use areas with 23-ns rise-time and DC-to-15 MHz bandwidth over the 10 mV/div to 20 V/div deflection range. For observing low level signals, 1 mV/div deflection factor with 5-Hz to 5-MHz bandwidth is provided on Channel 2. Sweep rates are 0.5 s/div to 0.5 μ s/div, extending to 50 ns/div with the X10 magnifier. Easy-to-use trigger logic provides stable triggering to above 15 MHz. A Tektronix 4-inch rectangular CRT presents sharp, bright displays on an 8 x 10 div viewing area (0.8 cm/div). A parallax-free, illuminated graticule contributes to accurate measurements. Two miniature 10X attenuator probes are included and are stored in the front panel protective cover.

RUGGED CONSTRUCTION

The Type 422 is ruggedly constructed to withstand shock, vibration and other extremes of environment. Electrical specifications are valid over an ambient temperature range of -15° C to $+55^{\circ}$ C (AC version), -15° C to $+40^{\circ}$ C (AC/DC version).

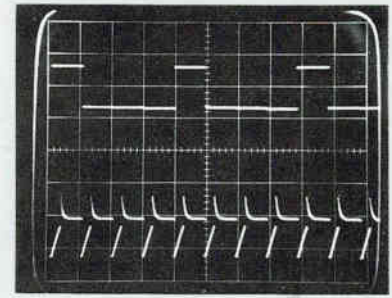

Dual-trace performance of the Type 422 Portable Oscilloscope permits convenient waveform comparison.

OPTIONAL ACCESSORIES

CAMERA . . . The C-30A, a compact, lightweight trace-recording camera, mounts directly to the Type 422 and provides photographic prints in 10 seconds.

SCOPE-MOBILE® CART . . . The Type 200-2 has an adjustable tray which friction-locks in any position from 0° to 60° .

PROBES . . . A full complement of voltage and current probes are available. Two P6012 10X miniature general-purpose probes are included as standard accessories. The P6019 current probe and 134 amplifier illustrated below permits 1 mA/div current measurements up to 15 MHz with the Type 422.

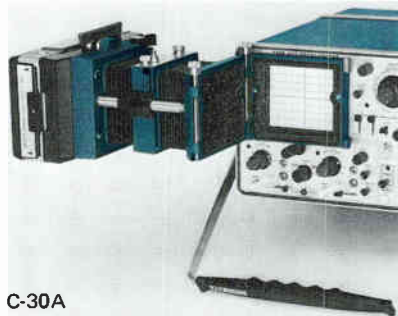

C-30A



200-2



P6019/134

Your Tektronix Field Engineer will demonstrate the performance of the Type 422 Portable Oscilloscope in your application. Please call him, or write: Tektronix, Inc., P.O. Box 500, Beaverton, Oregon 97005.

Type 422 Oscilloscope (AC version)	\$1425
Type 422 MOD 125B Oscilloscope (AC/DC without batteries)	\$1775
Battery Pack for Type 422 MOD 125B (order 016-0066-02)	\$ 125
C-30A Camera	\$ 450
P6019/134 Current Probe and Amplifier	\$ 275
Type 200-2 Scope-Mobile® Cart	\$ 75

U.S. Sales Prices FOB Beaverton, Oregon



Tektronix, Inc.

committed to progress in waveform measurement

Building a business in the ghetto spells Progress with a capital letter 'P'

Working in their spare time, managers from the General Electric Co. have helped set up a black-controlled aerospace firm in Philadelphia

By Peter J. Schuyten

Staff writer

The question was startlingly direct. It was put to Mark Morton, a General Electric vice president and general manager of the firm's Missile and Space division, last April during one of his regular breakfast meetings with the Rev. Leon Sullivan, a leader of Philadelphia's Negro community. For five years they had been getting together to plan job-training programs for the city's minority groups, but at this particular session, Sullivan broached the idea for a far broader effort. What, he asked, would GE do to help start an aerospace firm in Philadelphia's black ghetto.

The answer was quick and positive. So was the action.

Fast start

In the words of another GE executive, Charles Dates, manager for reentry systems, "We were astonished by the rapidity with which things got moving. Morton said he would make people and skills available, and that's when we come in."

The result: Progress Aerospace Enterprises, a company with 94 employees and 39 trainees. Operating with GE subcontracts, it's doing work for the Air Force and NASA, work that includes the calibrating and checking of test equipment and the assembling of cables, harnesses, and consoles.

The initial GE contribution consisted of executives who volunteered to work with PAE. Says one: "It was just like the Army. Only here the volunteers were screened for prejudice." And there was precious little time for even the screen-



The dream . . . Progress Aerospace Enterprises' prime movers are the Rev. Leon Sullivan, a leader of Philadelphia's Negro community; Mark Morton, GE vice president and general manager; and Ben Sallard, general manager of Progress.

ing. Dates points out that "from that breakfast last April to the first delivery of hardware took less than six months. In that time procedures had to be established, a facility had to be located, and personnel had

to be found and trained."

Nicholas Dragann, GE's special projects manager, worked with PAE general manager Ben Sallard to get things moving. He recalls: "Our initial task was to determine what

EUROPE'S STRONGEST GROUP IN SOLID STATE DEVICES CAN DELIVER THESE IC'S RIGHT NOW



TTL INTEGRATED CIRCUITS - FH FAMILY

(compatible with SUHL II series)

Fastest of our TTL series with a stage delay of 6 ns, the FH family offers the best speed/power compromise for the exacting demands of computers, high-speed telecommunications, and instrumentation. High fan-out and the ability to drive large capacitive loads are special features of this family, combined with a high logic swing, low output impedance, and inherent short-circuit protection.

MAJOR CHARACTERISTICS

High noise margin	typ. 1 V
Average propagation delay	typ. 6 ns
Very high fan-out over full temperature range	version A - min. 9
Full industrial temperature range	version B - min. 5
Popular package for easy mounting	0 °C - 75 °C
	dual-in-line

RANGE OF STANDARD CIRCUITS

DESIGNATION	TYPE NUMBER
single NAND gate	FHH101A FHH101B
dual NAND gate	FHH121A FHH121B
quadruple NAND gate	FHH141A FHH141B
single expandable AND-OR-NOT gate	FHH161A FHH161B FHH181A FHH181B
JK flip-flop (AND inputs)	FHJ101A FHJ101B
JK flip-flop (OR inputs)	FHJ121A FHJ121B
AND-OR-NOT expander	FHY101A FHY101B

WE OFFER FULL DIGITAL CAPABILITY!

- We also make an extensive range of IC's for medium and high-speed applications: the DTL FC family and the TTL FJ family, which are compatible with the 200-series and the 74N series.
- We design **higher-order circuits** for large-volume requirements compatible with any one of these digital families.
- We can make ultra-high-speed current-mode logic in the 2 to 3 ns range to suit your needs; emitter-emitter coupled logic for example.
- We have a well-established process for making complex MOS circuits with excellent performance throughout life.
- We achieve high noise immunity with digital circuits. Our 12 V circuitry has a noise margin of 5 V, and a speed of several hundred ns.

PHILIPS

PHILIPS ELECTRONIC COMPONENTS AND MATERIALS DIVISION - EINDHOVEN, THE NETHERLANDS

distributed and sold in the U.S. by: AMPEREX ELECTRONIC CORPORATION Providence Pike, SLATERSVILLE, Rhode Island
230 Duffy Avenue, HICKSVILLE, New York 11802 • 801 E. Charleston Avenue PALO ALTO California 94303 • 360 E. North Avenue, NORTHLAKE, Illinois 60164.

**...and Amperex
your American source
for Philips IC's
has monolithic IC
specialists
as close to you
as your telephone:**

on the East Coast:

**Phone Cranston, R. I.
401-737-3200
or
Hicksville, N.Y.
516-931-6200**

in the Midwest:

**Phone Northlake, Ill.
312-261-7878**

on the West Coast:

**Phone Palo Alto, Cal.
415-327-0461**

Amperex
TOMORROW'S THINKING IN TODAY'S PRODUCTS

For immediate action, data sheets, etc., write:
**AMPEREX ELECTRONIC CORPORATION
SEMICONDUCTOR AND MICROCIRCUITS DIVISION
SLATERSVILLE, RHODE ISLAND 02876**

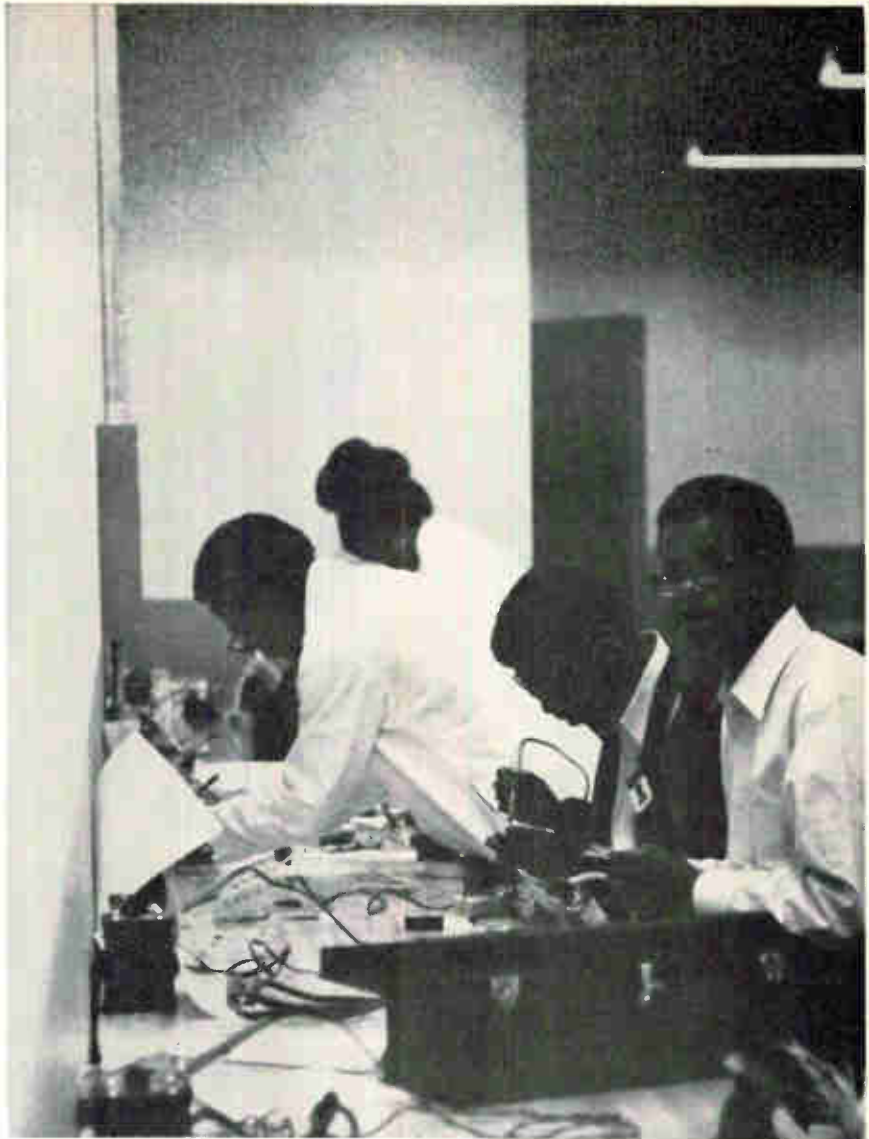

... becomes a reality. Some of Progress Aerospace's 90-plus employees. The Philadelphia firm, organized with the help of General Electric, does subcontract work for NASA and the Air Force. Some early work was completed ahead of schedule.

type of activity the new company should go after and then to figure out what type of work we could subcontract to them. After we set up a base for what the product should be, we had to figure out equipment, personnel, and facility needs—everything from walk-in ovens to where the ladies' room should be."

Because no one had ever done anything quite like this before, much of the planning had to be done on a trial-and-error basis. Says Dragann: "At first, PAE's managers, all of whom left secure jobs at GE, tried to do most of the work—like setting up procedures and devising job classifications—on their own. But they soon found they

needed help and that's when we began taking a more active role."

Now GE's role is shrinking, and it will gradually phase itself out entirely. "Of course, since PAE is one of our vendors, we'll have to keep a close watch on their procedures, but then we do that with all our vendors and so does everyone else," observes Robert Norwood, finance manager of the re-entry systems department.

Along with publicity and national attention, GE has received letters from other large aerospace contractors requesting information on the project. Such firms as Martin-Marietta, Boeing, North American Rockwell, Lockheed-Georgia, and Hughes Aircraft have all shown an

Custom Magnetic Processing with Standard Components

RFL Automagnetic® Systems — New Concept in Magnetic Processing

The RFL Automagnetic System now makes it possible to completely automate your production permanent magnet processing operation at a minimum cost. This new concept affords maximum flexibility for manual, automatic and programmable operations. Complete processing of magnets, meter movements, magnetic assemblies and a wide range of relative applications can all be achieved automatically by using *standard* RFL magnetizing, treating, and measurement equipment. Each instrument can be used individually for production, field and laboratory applications.

BASIC COMPONENTS

A typical Automagnetic System would consist of a Model 3260 Magnet Charger, a Model 990 Magnetreater®, a Model 750 Gaussmeter, and a Model 3356 Automatic Module Enclosure. The configuration of a system will vary according to specific customer requirements.



OPERATION OF THE SYSTEM

The magnet material to be processed is placed in the magnetizing/treating and measuring fixture which is interconnected to the Model 3260 Magnet Charger and Model 990 Magnetreater. The magnet is then charged to saturation. The Model 750 Gaussmeter, will indicate the magnet saturation flux density. Simultaneously, the gaussmeter output is fed to the input of the control circuitry of the Model 990 Magnetreater. When the information is received, the treating cycle will automatically begin. (In some instances other sensing apparatus may be used for a means of control.) A series of continuously increasing amplitude pulses treat the magnet to a preset level and the process is automatically terminated. During this entire operation, the value of the magnet's flux density may be monitored on the gaussmeter. A System Status Panel, using indicators will show that the operation is complete and is ready for another process. Other conditions such as Calibrate, Operate, Non Saturate, Overtreat and Incomplete can be incorporated on this status panel. Failure to reach the pre-

Circle 168 on reader service card

set level results in the operation of an Incomplete signal indicating the possibility of a flaw in the material or improper control settings.

APPLICATIONS

The RFL Automagnetic System is primarily used for production processing of magnets and magnetic assemblies. Typical production assembly processing includes TWT magnets, Bar and C shaped magnets and other basic magnet configurations. The Automagnetic System is particularly suited for processing magnets in assemblies that require field strength adjustments. Typical of these applications are: precision adjustment of D-C meters, torque motors, accelerometers, permanent magnet field motors and other designs embodying permanent magnets. Basically any magnet or magnet assembly requiring magnetic adjustment can be processed with the RFL Automagnetic System.

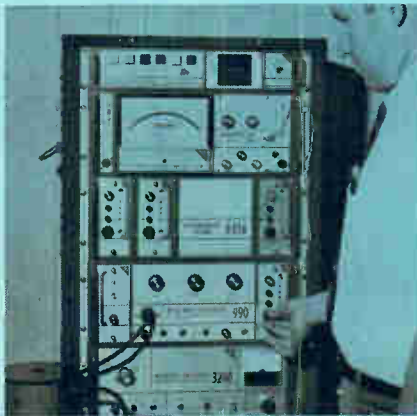

RFL's Magnetic Applications Engineering Staff will design at no cost, the necessary fixturing interconnection wiring and any additional apparatus for specific customer requirements. For detailed information on Automagnetic Systems contact:



RFL Industries, Inc.
Instrumentation Div. • Boonton, N. J. 07005
Tel: 201-334-3100 / TWX: 710-987-8352 / CABLE: RADAIRCO, N. J.

... No complaints yet from other GE vendors ...

interest in the PAE concept.

Open door. There have been a few letters asking if PAE was an equal opportunity employer. It is; both blacks and whites work there.

One group that hasn't been heard from yet is GE's other vendors, from whose pie PAE is taking a slice. Says one GE spokesman, "There may be some opposition on the part of our vendors, but we haven't heard any complaints yet."

In its role as adviser to the new company, GE has discovered that most of the problems that have cropped up thus far are similar to those encountered when setting up, say, a new subsidiary or new division.

For instance, Edward Curtis, GE's manager of personnel relations and the man who wrote the new firm's job specifications, says, "We were keying PAE's personnel requirements to our own, so we left out certain jobs we shouldn't have, and other classifications had to be revised." Curtis' department is currently conducting a full review of all of PAE's requirements in order to anticipate future needs.

Not all the problems were that standard, though. For example, Curtis' department had geared PAE's salary scales to those of GE, without taking into account that along with, say, a \$2 hourly rate, GE provides another 50 cents an hour in benefits that PAE couldn't afford to give.

Staying aboard

Among the pleasant surprises has been the low dropout rate from the PAE training program. Sallard has been drawing his technicians mainly from the hard-core unemployed. After receiving their initial two or three weeks of orientation and training at PAE, the trainees move on to advanced instruction at GE's facility in Valley Forge, Pa. PAE pays GE for this service. Final training for specific jobs is completed at PAE. "So far," says Dragan, "only two out of 60 people have left the program. We expected a much higher rate."

Most GE men feel that the PAE project has gone so well to date that within six months the new

'... All the jollies end
in 2 or 3 months ...'

company will be able to go it alone. "For the most part, we've accomplished our original goals on time," says Dates. "In some cases—in producing its first piece of hardware, for instance—PAE was even ahead of schedule." The next step, according to the timetable, is to get contracts from other firms in the aerospace industry.

Most of the GE personnel involved in the project feel that once PAE starts getting contracts from other aerospace vendors, something Sallard and his staff are working on right now, the fledgling firm will more or less be on its feet. "That'll be the ultimate satisfaction for most of us, seeing PAE performing completely on its own," says one of the GE people. "And maybe our wives will get to see a little bit more of us when that happens."

Damper. At least one GE manager, however, is guarded in his optimism. "We're still on the honeymoon," he says. "The backslapping is still going on, and it's all a little removed from the hard realism of the aerospace business. But all the jollies will end in two or three months when PAE has to deliver its first hardware in quantity."

But when asked whether he thought the undertaking would succeed, this manager replied, "Of course it will, because we won't let it not succeed."

Indeed, its commitment to PAE's success is such that after all the fanfare, GE cannot afford to let the project fail. Dragann and his team will have to prepare Sallard and his staff for the hard realities of aerospace competition. And that may be the key to the ultimate success of PAE.

Quite naturally, because of PAE's early progress, Dragann and others are convinced that the project can be a prototype for future programs, the kind that the Nixon Administration says it intends to promote. "We've all been hearing about different approaches to socio-economic problems. This approach is one of the best any of us has seen yet and has perhaps the best chance to succeed," says the optimistic Dragann.

republic makes aluminum strip conductor

the electrogage® way

Republic Foil has been one of the leaders in developing aluminum strip for coil applications and led the industry in guaranteeing tight gauge control. Experience gained from producing Electrogage precision slit strip conductor for a number of years has led to the development of superior quality edge contoured strip. Electrogage edge contoured strip offers a uniformly curved edge from surface to surface free of any protrusions which could affect insulation values.

Both Electrogage contoured strip and precision slit strip conductor are carefully monitored for gauge and conductivity throughout fabrication.

Each master coil of end product is measured and certified for conductivity. *Write for a copy of our new 8-page Bulletin SC.*

THE LEADING MANUFACTURER OF A COMPLETE LINE OF PLAIN & ETCHED CAPACITOR FOIL



REPUBLIC® FOIL INC.

General Offices, Danbury, Conn. 06813: Tel. 203-743-2731

BRANCH SALES OFFICES

Chicago, Ill. 312-545-2142 • Salisbury, N. C. 704-633-6020 • Cleveland, Ohio 216-871-6268
WEST COAST — Electrical Specialty Co., 213 E. Harris Ave., So. San Francisco, California
2820 E. 12th Street, Los Angeles, California 90023

PLANTS • Danbury, Conn. • Salisbury, N. Carolina • Somerville, Mass.

Report from

**BELL
LABORATORIES**

A simple, better microphone

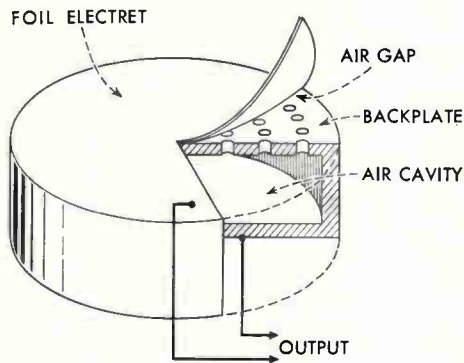

Essentials of the new microphone: The microphone's diaphragm is a charged dielectric foil upon which a thin metal layer has been deposited; it is called a foil electret. The electret touches a metal backplate in several places and, due to surface irregularities, air pockets form between the electret and the backplate. The backplate is perforated so that the air layer can communicate with the larger cavity, increasing the vibration amplitude (and thus the sensitivity) of the system.

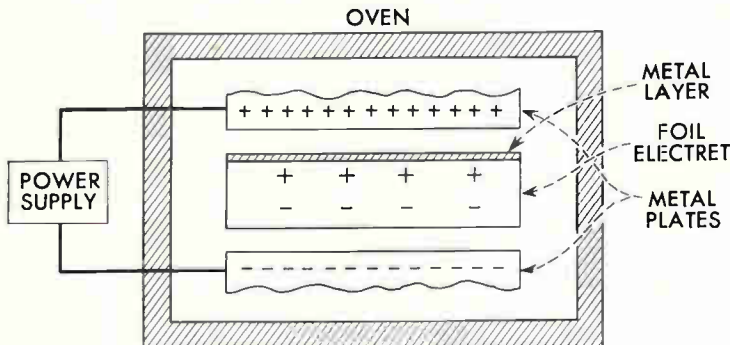

Simplified cross-sectional diagram showing how microphone "electrets"—permanently charged dielectric foils—are made. The metallized foil is heated to about 200°C while between a pair of charged metal plates which create an electrostatic field of between 10 and 100 kV/cm. Charges, identical in sign to the adjacent plates, migrate from the plates to the electret, where they remain after cooling. This method of foil electret preparation was announced by Bell Laboratories in 1962.

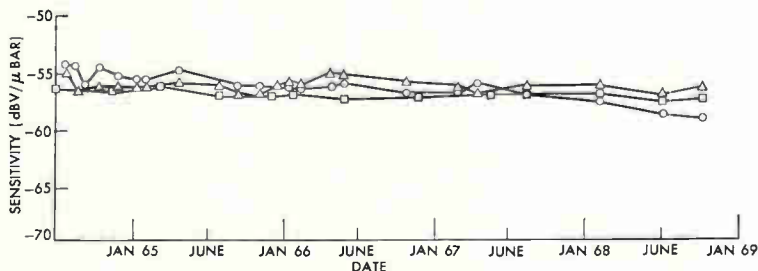

Sensitivity of electret microphones using fluorocarbon foils is nearly constant. Extrapolated lifetime is about 100 years.

A new kind of condenser microphone with several valuable features has been invented by Gerhard M. Sessler and James E. West of Bell Laboratories. It has the excellent sound fidelity of former types of condenser microphones, but does not need a d-c supply, and has much lower electrical impedance; this permits good low-frequency response without the need for special circuits.

Like previous designs, the new microphone depends on a varying capacitance—produced as sound vibrations impinge on one flexible plate of a capacitor. But there's a difference: here, the flexible plate is a "foil electret"—a thinly metallized sheet of fluorocarbon or polycarbonate. The electret contains a permanent static charge. As the electret moves, it varies the electrostatic field across the air gap (drawing). This produces a varying voltage at the output. Thus, the microphone needs no d-c supply.

In any capacitor, the thinner the dielectric, the higher the capacitance. Dielectric films can be made 0.00012 to 0.001 inch thick. So, the capacitance of the electret microphone is about triple that of conventional types of condenser microphones, and the impedance is comparably lower. This simplifies accompanying circuitry.

The microphone is inexpensive, exceptionally rugged, and immune to wide temperature fluctuations.

As the graph (left) shows, the microphone's sensitivity remains essentially constant for very long periods. This is due to an inherent compensation only possible with thin-film electrets: as the charge on the electret decays—and measurements indicate that it will take about 100 years to fall 50 percent—electrostatic attraction between electret and backplate is reduced. This diminishes the restoring force on the electret, allowing it to vibrate at greater amplitude. Electrical output remains, therefore, nearly constant.

As with all promising devices the electret microphone is being evaluated by our development and systems engineers. Because of its simple construction and low cost it may well find application in future telephones.



Bell Telephone Laboratories
Research and Development Unit of the Bell System

High stakes on Capitol Hill

By Robert Skole

Washington bureau manager

As the 91st Congress convenes this week, it not only will be facing crucial national and international issues—but on a more parochial level will have to find answers to some of the most ticklish and significant questions facing the electronics and aerospace industries. As a matter of fact, the 91st could have a greater influence on these industries than any Congress of recent years.

Adding a note of uncertainty to the outcome of those questions is the fact that this is the first time since 1824 that a new President's party does not control at least one House. Because of this, and because of the uncertainties of how the factions within the two parties will line up on crucial issues, predictions about the outcome on most questions must be cautious.

The significant issues—excluding Defense, the Vietnam War, and NASA (see Market Report, page 141)—range from the future of Comsat to the future of consumers, and from air pollution to air traffic. Almost every governmental agency or department is affected to one degree or another.

Moving. Atop a heap of questions

concerning transportation is what to do about the supersonic transport. Federal Aviation Administration officials are optimistic the Boeing Co. has worked all the bugs out of the fixed swept-wing design.

Boeing must submit its final design plans by Jan. 15. When accepted, the program will head into the more expensive prototype stage. Boeing and the FAA say that an appropriation of \$300 million for fiscal 1970 will be necessary to meet the costs of the first year of this stage. This is roughly a 50% increase over annual costs during the design stage.

The SST may face a rough trip through a budget-minded Congress. Sen. William Proxmire (D., Wis.), who has been chairman of the Joint Economic Committee, has already urged President-elect Nixon to stop the SST spending. Proxmire suggests getting Uncle Sam out of the marketplace; he continually points out that President-elect Nixon has often urged that free enterprise should get a larger role in national policy-making. The Wisconsin Senator—one of the few in Congress who appears concerned over the SST's

technical and noise problems that have yet to be solved—might possibly call for hearings this year on the question of how the aircraft's contract was handled. Although stepping down as chairman of the full committee, he will remain chairman of the subcommittee on economy in government. He would like to find out why Boeing got the contract on the basis of a swing-wing proposal, as opposed to Lockheed's fixed-wing design, and then dumped the swing-wing for the fixed version.

Adding to the speculation that the SST might be in for a rough flight are the pre-election Nixon statements that the plane could be one of the programs cut back if there is need for belt-tightening.

Stacked up

Another major aviation issue facing Congress is how to clear up the air traffic jams over busy terminals. The FAA, which will be getting a new administrator, will probably be taken over the coals for not pushing air traffic control systems with greater technical improvements. The FAA will also come under fire for its slow motion

How bills might fare

Here's a breakdown of electronics and aerospace issues facing the 91st Congress—which opens next week—that are likely to reach a vote.

- Revision of U.S. patent law, making it compatible with those of other industrialized nations.
- Funding of supersonic transport with \$300 million in fiscal year 1970 to build prototype.
- Limiting overhead charges by companies and universities working on Federal R&D projects.
- Giving Food and Drug Administration regulatory powers over medical treatment devices.
- Establishing 20-man National Medical Devices

Standards Commission.

- Providing Department of Commerce with \$500,000 to study converting U.S. to metric system.
- Amending Comsat's charter, clarifying Comsat's right to build own satellites, and changing Comsat's board of directors.
- Appropriating a record high Defense budget, including start of design and production work on advanced manned strategic aircraft, airborne radar warning network, and new fighter aircraft.
- Increasing Department of Transportation research and development funds for rail propulsion systems, high-speed air cushion trains, linear induction motor test vehicle, ground traffic control.

JFD UNICERAM

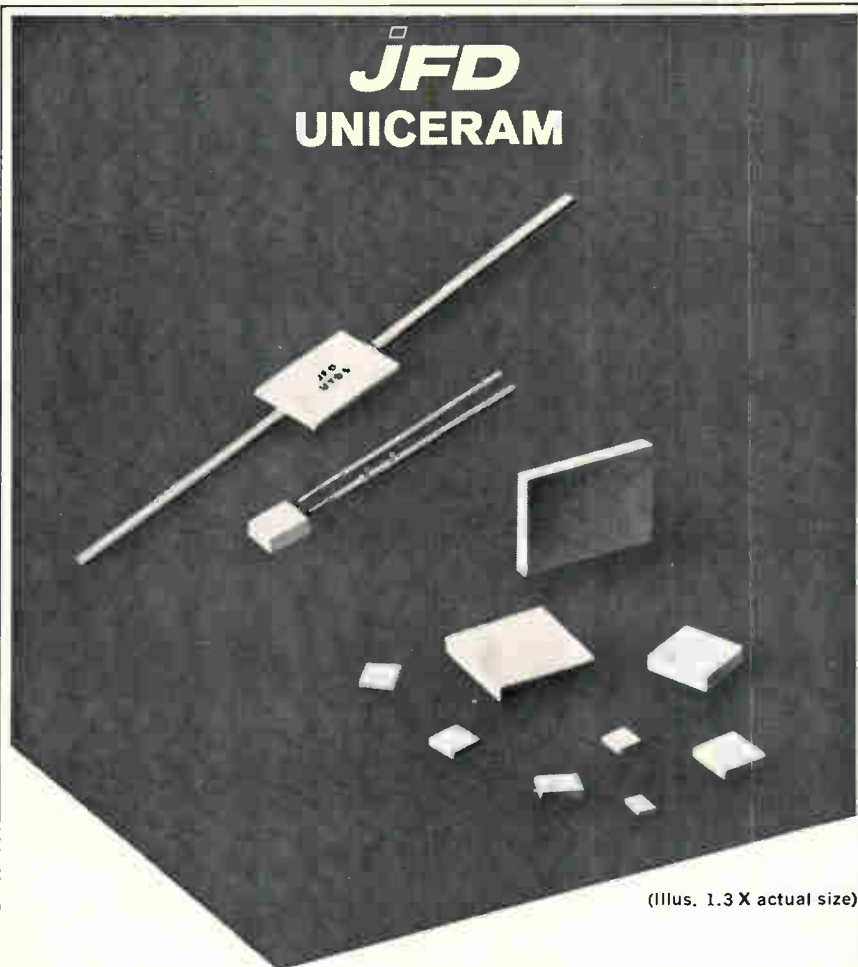

(Illus. 1.3 X actual size)

HIGH Q AND HIGH K CERAMIC FIXED CAPACITORS

UNICERAM HIGH Q

JFD High Q monolithic ceramic fixed capacitors in wafer and leaded configurations offer the ultimate in 'Q'. A high ratio of capacitance per unit volume results in an exceptionally stable, smaller-sized-package than competitive units. 'Q' at 1 MHz for values of 1000 pf or less is 5000 min.

Over 1000 glass encapsulated and unencapsulated miniature models, in 5 square case sizes, are offered with capacitance values of 0.5 to 3000 pf. The highly reliable and stable glass encapsulated models meet applicable requirements of MIL-C-11272B.

Write for catalogs UNM-H/Q-67-A and UNM-H/K-67.

UNICERAM HIGH K

JFD High K wafer series ceramic monolithic capacitors offer high capacitance per unit volume. Capacitance range offered in this series is 10 pf to 1.5 mfd.

This High K wafer series is a quality 'Industrial Grade' ceramic multi-layer construction available in 5 squares and 12 rectangular sub-miniature and miniature metalized-edged configurations — inherently impervious to moisture and contamination. Each unit meets or exceeds applicable portions of MIL-C-11015C and MIL-C-39014.

Uniceram High Q and High K wafer capacitors are ideally suited to hybrid integrated circuitry, as well as discrete component designs. Their metalized-edge construction assures easy soldering to printed circuit boards.

"TODAY'S COMPONENTS BUILT FOR TOMORROW'S CHALLENGES"

JFD JFD ELECTRONICS CO. / COMPONENTS DIVISION
15th Ave. at 62nd St. • Brooklyn, N.Y. 11219 / Phone 212-331-1000

Offices and subsidiaries in principal cities, world-wide.

... Legislators to hear demands to clean up ...

in getting collision avoidance systems in operation.

On the ground, the two East Coast high-speed train demonstration projects will finally get into operation this year about a year and a half late, which is typical of the speed at which American railroads move. Once the systems are working—and if, indeed, they do work properly—Congress can be expected to be touched for more money.

The FAA can be expected to get about \$37 million in fiscal 1970 for research and development—about the same it got for the current year. However, a system of aviation user charges might be allowed by Congress, which would make more money available for long-range research activities, such as new radar and beacon systems.

Pollution problems. Congress will be called on to provide both tax incentives for pollution abatement and Federal grants for solid waste disposal.

Although Congress will be placed under great pressure from industry to give tax breaks for firms installing equipment to reduce air and water pollution, there will be strong arguments raised by conservationists and liberals that taxpayers' money should not help big business clean up a situation it should never have created in the first place. One technical problem that would have to be overcome is how to determine whether equipment is strictly for pollution abatement. Another argument against the tax break is that such a program would discourage process changes and improved manufacturing methods that might result in less pollution. If the tax break were allowed, there would be a bigger market for electronic monitoring and control equipment.

Sen. Edmund Muskie (D., Me.) who is chairman of the air and water pollution subcommittee, will be getting much attention this year when he holds hearings on a bill to provide Federal grants to local governments for solid-waste disposal equipment. Muskie's fast rise to national eminence as Vice Presidential candidate will add much

weight to this proposal. He unsuccessfully introduced a similar bill several years ago, and it called for an appropriation of \$900,000. If Congress approves a new bill, it will eventually mean a good piece of business for electronic control and monitoring equipment.

There will probably be moves in Congress to create a single separate agency dealing with environmental control. Right now, the Air Pollution Control Administration is part of the Department of Health, Education and Welfare, while the Water Pollution Control Administration is part of the Interior Department.

President-elect Nixon has called for "coordinating" all Federal programs to eliminate "duplication and red tape." If water pollution control is moved back into HEW, this can make life a lot easier for systems salesmen.

However, manufacturers of electronic equipment might come under fire in this Congress in hearings by the House science, research, and development subcommittee, headed by Rep. Emilio Q. Daddario (D., Conn.), and the air and water pollution subcommittee, headed by Sen. Muskie. The hearings will take a look at ways to assess the environmental impact of new products before the products are introduced on the market. Although the hearings will primarily touch on air and water pollutants, there is a good likelihood that the subcommittees will look at radiation-emitting products, such as microwave ovens, radars, and color television receivers.

Comsat up in the air

Since 1962, when the act establishing Comsat was passed, the company has never been in a greater state of flux. First, the President's Task Force on Communications is reporting suggestions, which, if implemented, would change most elements of the corporation's way of doing business. Second, negotiations will open in February, for the long-awaited permanent arrangements for the International Telecommunications Satellite Consortium (Intelsat). The negotiations may last a year.

There is sure to be at least one bill affecting Comsat submitted to Congress in the early days of this ses-

KH Oscillators excel in many important parameters

(and now may cost you less!)

Consider the medium-priced Krohn-Hite Model 4100 Push-Button Variable Oscillator. When compared to others in its price class, the \$550 Model 4100 is a leader in those significant performance parameters that mean the difference between a true oscillator and other instruments regardless of price.

The accompanying chart demonstrates these wide differences in published manufacturer's specifications. Compare them for yourself. Note that there is no relationship between price and performance.

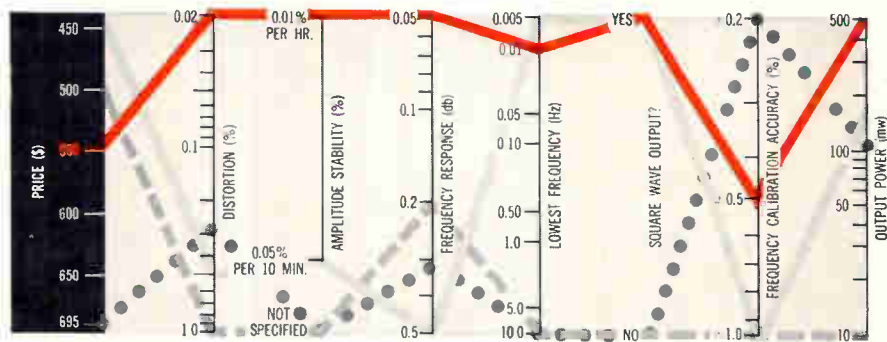

IMPORTANT OSCILLATOR PARAMETERS are plotted for four competing solid-state instruments. The plot for the K-H Model 4100 (color) is compared to other units with lower and higher price tags. Relative position of each parameter was determined by its value to the instrument user, not by its number. Thus the lowest price has

been placed near the top of the chart . . . and 0.02% distortion placed higher than 1.0%. Logarithmic scales are used throughout. All units have 1 MHz maximum frequencies. Note that although the Model 4100, is relatively low on the price scale, it excels in other parameters.



MODEL 4100 SOLID STATE PUSH-BUTTON VARIABLE OSCILLATOR covers 0.01 Hz to 1 MHz, with simultaneous sine- and square-wave outputs. Size: 8½"W x 5¼"H x 14½"D. Price: \$550.

Write for Model 4100 Data.



580 Massachusetts Ave., Cambridge, Mass., U.S.A. 02139
Telephone: (617) 491-3211

Oscillators / Filters / AC Power Sources / DC Power Supplies / Amplifiers

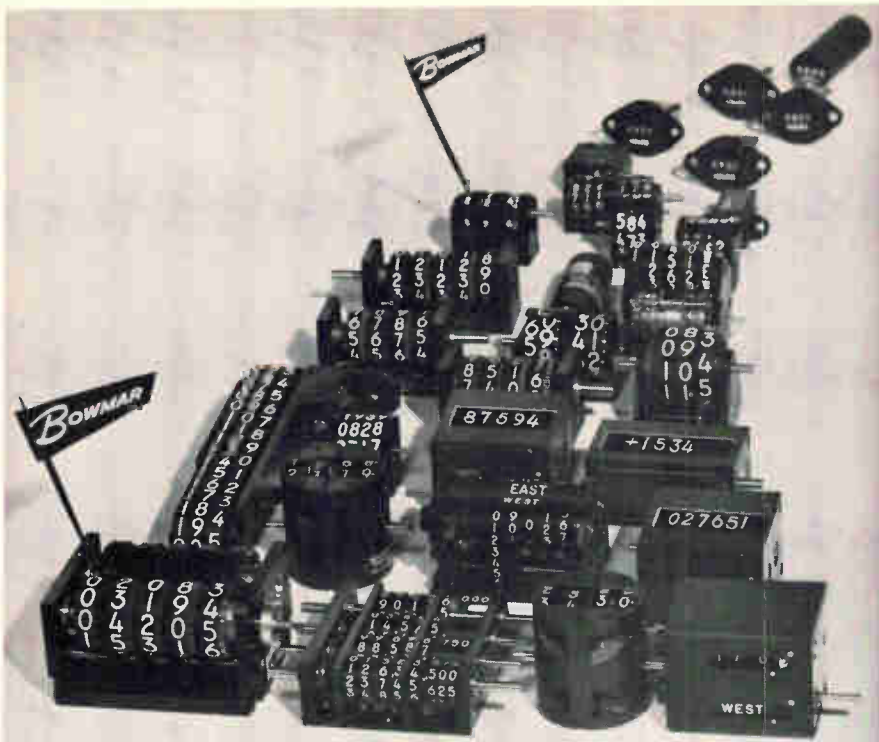

**In the name of design freedom
...join Bowmar's
counter revolution!**

While others have been trumpeting the merits of standards, we've spent the past 18 years quietly meeting the mechanical counter needs of the world's 100 toughest customers. Now, with thousands of field-proven configurations in our B-line™ design library, we can't stay quiet any longer.

**WE'RE STARTING A
COUNTER REVOLUTION!**

Bowmar's B-line™ design library, which includes all popular counter configurations, enables us to compare favorably in price and delivery with many "off the shelf" counters. B-line also offers you unique design freedom. You don't have to design

around our counters; we'll design around your requirements . . . quickly and economically. If you want complete design liberation, simply give us the inputs and outputs, and we'll supply your entire counter/display package.

Our B-line™ counters and display assemblies have met the toughest reliability and life demands of military, NASA, commercial aviation, and heavy industry.

Be a counter-revolutionary! Strike a blow for design freedom by adding Bowmar to your qualified bidder list.



**The shortest distance between
output and display
is the Bowmar B-line***

* Call (219) 747-3121 for engineering assistance



INSTRUMENT CORPORATION
8000 BLUFFTON ROAD □ FORT WAYNE, INDIANA 46809

**... Can the carriers
clip Comsat's wings? ...**

sion. The bill would permit the company to change its "mix" (or ratio) of public and carrier board members. The bill was prompted by the sale by International Telephone and Telegraph Co. of 316,000 shares of Comsat stock in June, and another 400,000 shares in December.

ITT announced it was unhappy with Comsat's aggressive efforts to gain more responsibilities for providing international communications services. The bill, to be introduced by Sen. John Pastore, (D., R.I.), would allow the board of directors to better reflect share ownership. The big issue behind the bill is whether ITT and other carriers will be able to cut Comsat down to size by changing the entire charter.

Comsat was originally conceived as a "carrier's carrier"—a wholesaler of raw transmission services. But the company has assumed other functions: the Federal Communications Commission, for example, has temporarily sanctioned ownership by Comsat of 50% of ground terminals. Also, Comsat would like to sell services—"retail" directly to users of communications services—thus cutting out the existing carriers. As it looks now, the carriers will be pushing hard to get Congress to clip Comsat's wings.

The Task Force Report, however, proposes that Comsat would assume all international transmission facilities of all carriers—cable, radio, and satellite. This would mean taking over the facilities of ITT, RCA International, Western Union International, and the voice circuits of AT&T. It also proposes that Comsat should build the "pilot" domestic satellite system—but be barred from owning the eventual operational domestic system. The report also proposed that Comsat should be barred from owning either domestic transmission facilities of any kind, or satellite production facilities. Its research and development facilities should examine only broad technical issues.

All these points in the report will probably get before Congress

in the debate over Pastore's controversial bill.

Consumerism. The 91st Congress, like the 90th, will undoubtedly be faced with a long list of consumer-protection bills. Although few Republican presidents have won any laurels for their efforts to police business and industry, Nixon will probably take a "liberal" attitude toward consumer-protection—for the sake of some harmony with Congress, if for no other reason.

One of the major bills that Congress will probably act on will be a comprehensive measure covering guarantees and product servicing. The proposed legislation will emerge from the Senate Commerce Committee—which is chaired by Sen. Warren Magnuson (D., Wash.), who used as one of his campaign slogans during this past election, "Keep the big boys honest." The legislation will be the result of what President Johnson calls for in his State of the Union message; what his consumer-adviser Betty Furness recommends in her special report on guarantees; the outcome of hearings by Sen. Philip Hart (D., Mich.) on auto repairs, and the Federal Trade Commission's investigation of auto warranties.

The bill that eventually emerges will have a significant effect on the consumer electronics business, particularly the design of new products. If manufacturers are forced to really live up to their guarantees—and provide service as contracted for by the purchaser—there obviously will be a demand for designers to turn out products that not only are more reliable, but also are easier to service. Some television receiver manufacturers already emphasize serviceability in their advertising.

In another consumer-protection area, there might be some moves in this Congress to toughen the Radiation-Protection Law, which squeaked through the 90th Congress. Sen. Ralph Yarborough (D., Tex.), chairman of the labor subcommittee, was most unhappy that the bill did not provide for protection of workers using radiation-emitting equipment.

And the Food and Drug Administration will try again to gain regulatory power over medical devices.

Now, three standard LOGICATOR models give you new flexibility in designing your logic indicators. The basic DA-3305 electromagnetically positions the readout drum directly from **computer-level voltages**. The companion DA-3306 contains **built-in drive**. The DA-3307 contains both **drive and memory** to store computer data at microsecond speed, freeing the computer for other work between reading changes. Only LOGICATOR displays provide this versatility.

The LOGICATOR display is also the only indicator with **excellent readability** under all light conditions . . . combining printed-drum legibility with exclusive back-lighting . . . ideal for airborne instrumentation requiring Mil-E-5400 Class 2 performance. Features such as 1 million cycle life, fast response, 1 watt power consumption, and inherent magnetic memory make LOGICATOR displays your logical choice in computer indicators. Make a **B-line*** for Bowmar.

Only LOGICATOR[®] computer displays solve your readability, drive, and memory problems.

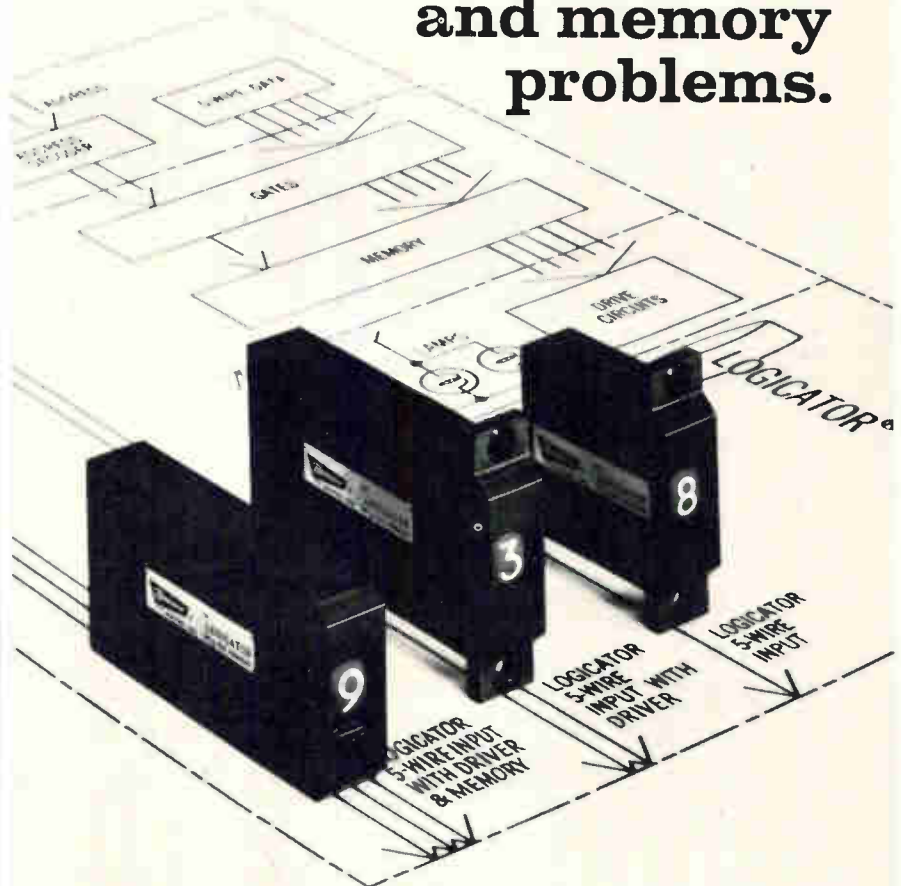

**The shortest distance
between computer and display
is the Bowmar B-line***

*Call (219) 747-3121 for engineering assistance



INSTRUMENT CORPORATION
8000 BLUFFTON ROAD □ FORT WAYNE, INDIANA 46809

**Our new
high energy
silicon power
transistors.
15 Amperes.
80 to 120 Volts.**

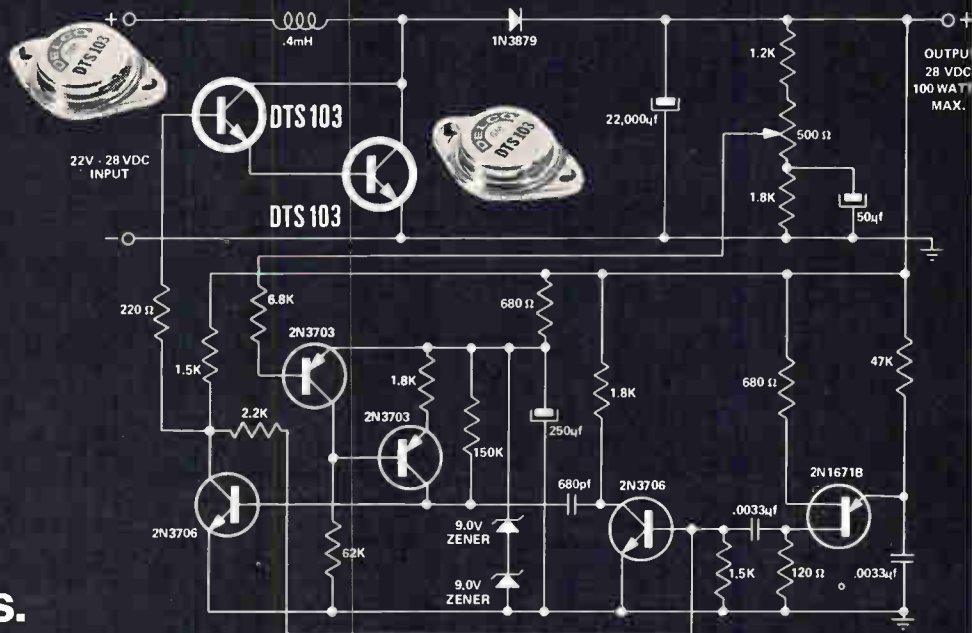

For Switching.

The Delco Radio DTS-100 series. NPN. Triple diffused. Rugged.

All the experience gained from our very high voltage silicon power line has gone into the development of these new transistors.

They were especially designed for the extreme under-the-hood environment of our I.C. voltage regulator. We found these devices ideal for applications requiring high efficiency switching or high power amplification.

The Delco triple sequential diffusion gives the DTS-100 series the high

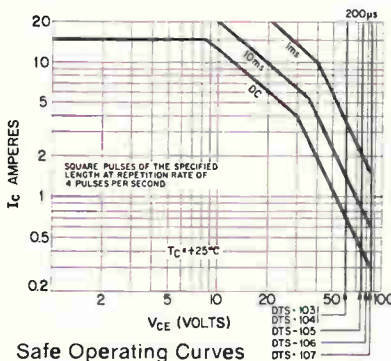

energy reliability that's needed for very tough switching jobs—resistive or inductive. The 28-volt shunt regulator above, for example, is amply handled by the DTS-103 (V_{CEX} of 80 volts). For complete data on this circuit, ask for our application note No. 42.

In the direct coupled audio amplifier above right, the DTS-107 displays the excellent frequency response, gain linearity and transconductance of this family. This circuit is covered in our application note No. 43.

Our solid copper TO-3 package provides maximum thermal capacitance to absorb peak power pulses. Its low thermal resistance ($0.75^{\circ}\text{C/W Max.}$) assures the extra reliability you expect from Delco.

Like more information? Just call us or your nearest Delco Radio distributor. All our distributors are stocked to handle your sample orders.

SEMICONDUCTOR DISTRIBUTORS: EAST—BALTIMORE, MD. 21201, Radio Electric Service Co., 5 North Howard Street, (301)-539-3835 BINGHAMTON, N.Y. 13902, Federal Electronics, Inc., P. O. Box 1208, (607)-748-8211 CLIFTON, N.J. 07015, Eastern Radio Corporation, 312 Clifton Avenue, (201)-471-6600 NEWTON, MASS. 02195, The Greene Shaw Co., Inc., 341-347 Watertown St., (617)-969-8900 NEW YORK, NEW YORK 10036, Harvey Radio Co., Inc., 2 West 45th St., (212)-582-2590 PHILADELPHIA, PENN. 19123, Almo Industrial Electronics, Inc., 412 North 6th Street, (215)-922-5918 PITTSBURGH, PENN. 15328 RPC Electronics, 620 Alpha Drive, RIDC Park, (412)-782-3770 WOODBURY, L.I., N.Y. 11797, Harvey Radio Company, Inc., 60 Crossways Park West, (516)-921-8700 **SOUTH**—BIRMINGHAM, ALA. 35233, Forbes Distributing Company, Inc., 1416 Fourth Ave., South, (205)-251-4104 MIAMI, FLORIDA 33142, Mountain Electronics, Division of Mountain National Co., 3730 Northwest 36th St., (305)-634-4556 RICHMOND, VA. 23220, Meridian Electronics, Inc., 1001 West Broad Street, (703)-353-6648 WEST PALM BEACH, FLA. 33402, Mountain Electronics, Division of Mountain National Co., 1000 N. Dixie Highway, (305)-833-5701 **MIDWEST**—CINCINNATI, OHIO 45237, United Radio, Inc., 7713 Reinhold Drive, (513)-761-4030 CLEVELAND, OHIO 44125, The W. M. Pattison Supply Co., Industrial Electronics Division, 4550 Willow Parkway, (216)-411-3000 INDIANAPOLIS, IND. 46225, Graham Electronics Supply, Inc., 122 South Senate Avenue, (317)-634-8486 KALAMAZOO, MICH. 49005, Electronic Supply Corp., P.O. Box 831, (616)-4626 KANSAS CITY, MO. 64111, Walters Radio Supply, Inc., 3635 Main

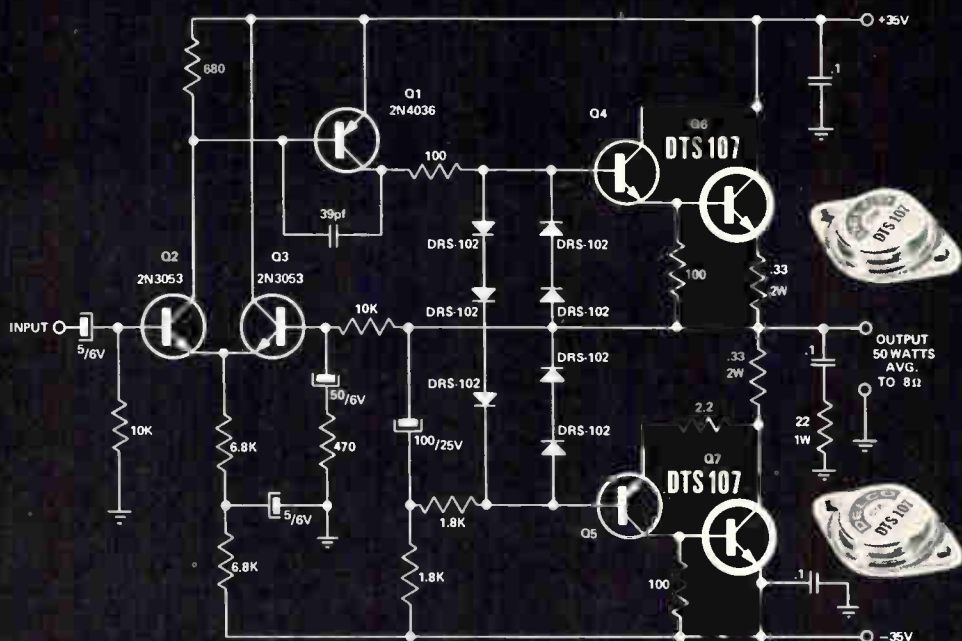

For Audio Amplification.

	Ic Cont. Amps.	Ic Pulsed Amps.	V _{CEX} @ .5mA Volts	V _{CEO} @ .25mA Volts	V _{CEO(SUS)} @ 250mA Volts	h _{FE} @ 5A	h _{FE} @ 20A (Min.)	V _{CE(sat)} @ 10A (Max.)	f _t MHz (Min.)	P _t Watts (Max.)
DTS-103	15	20	80	60	60	20-55	5	1.8	4	125
DTS-104	15	20	80	60	60	50-120	10	1.5	4	125
DTS-105	15	20	100	80	75	20-55	5	1.8	4	125
DTS-106	15	20	110	90	80	20-55	5	1.8	4	125
DTS-107	15	20	120	100	85	20-55	5	1.8	4	125

FIELD SALES OFFICES

Union, New Jersey* 07083
Box 1018 Chestnut Station
(201) 687-3770

Syracuse, New York 13203
1054 James Street
(315) 472-2668

Santa Monica, Calif.* 90401
726 Santa Monica Blvd.
(213) 870-8807

Detroit, Michigan 48202
57 Harper Avenue
(313) 873-6560

Chicago, Illinois* 60656
5151 N. Harlem Avenue
(312) 775-5411

Kokomo, Ind. 46901
700 E. Firmin
(317) 459-2175 Home Office

*Office includes field lab and resident engineer for application assistance.



MARK OF EXCELLENCE



DELCO RADIO
DIVISION OF GENERAL MOTORS
KOKOMO, INDIANA
THE KOKOMOANS ARE IN POWER

Street, (816)-531-7015 MINNEAPOLIS, MINNESOTA 55401, Stark Electronics Supply Co., 112 3rd Ave., North, (612)-332-1325 SKOKIE, ILL. 60076, Merquip Electronics, Inc., 7701 N. Austin Ave., (312)-282-5400 ST. LOUIS, MO. 63144, Electronic Components for Industry Co., 2605 South Hanley Road, (314)-647-5505 WEST—ALBUQUERQUE, N. M. 87103, Sterling Electronics, Inc., 1712 Lomas Blvd., N. E., (505)-247-2486 DALLAS, TEXAS 75201, Adleta Electronics Company, 1907 McKinney Ave., (214)-742-8257 DENVER, COLO. 80219, L. B. Walker Radio Company, 300 Bryant Street, (303)-935-2406 HOUSTON, TEXAS 77001, Harrison Equipment Co., Inc., 1422 San Jacinto Street, (713) 224-9131 LOS ANGELES, CAL. 90015, Radio Products Sales, Inc., 1501 South Hill Street, (213)-748-1271 LOS ANGELES, CAL. 90022, Kierulff Electronics, Inc., 2585 Commerce Way, (213)-685-5511 OKLAHOMA CITY, OKLAHOMA 73102, Radio, Inc., 903 North Hudson, (405)-235-1551 PALO ALTO, CAL. 94303, Kierulff Electronics, Inc., 3969 East Bayshore Road, (415)-968-6292 PHOENIX, ARIZ. 85005, Sterling Electronics, Inc., 1930 North 22nd Ave., (602)-258-4531 SAN DIEGO, CAL. 92101, Milo of California, Inc., 2060 India Street, Box 2710, (714)-232-8951 SEATTLE, WASH. 98108, Kierulff Electronics, Inc., 5940 6th Ave., South, (206)-763-1550 TACOMA, WASH. 98402, C & G Electronics Company, 2502 Jefferson Ave., (206)-272-3181 TULSA, OKLAHOMA 74119, Radio, Inc., 1000 South Main Street, (918)-587-9124 CANADA—SCARBOROUGH ONTARIO, Lake Engineering Co., Ltd., 123 Manville Rd., (416)-751-5980

DUMP CIRCUITS

Magnetic circuit breakers lend themselves to SCRAM circuits, panic button circuits, or any such application where it is desired to quickly and reliably remove the load from the power source.

APL type breakers can be had with standard 50 ma AC coils which have about 420 ohms impedance. Operated directly from 115 volts AC the coil current of Pole B will reach 275 ma for a few milliseconds. (Pole A is in the other side of the line and provides time delayed protection against overloads.) Somewhat lower pushbutton currents can be obtained, if necessary, by the use of circuit breakers with impedances up to 11K ohms. These would be non-standard, but our non-standard costs are modest indeed.



**APL
MAGNETIC
CIRCUIT BREAKER**
Double Pole with
auxiliary signal contacts

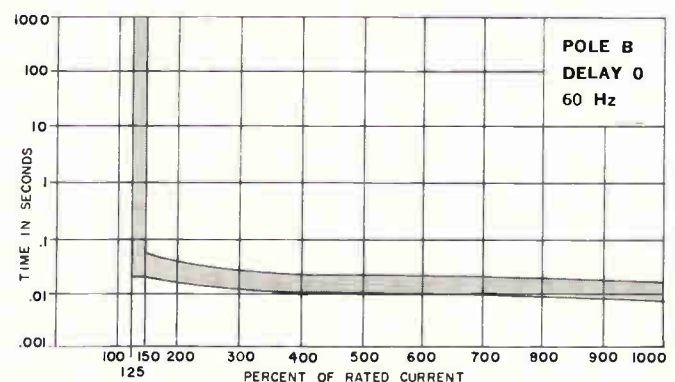
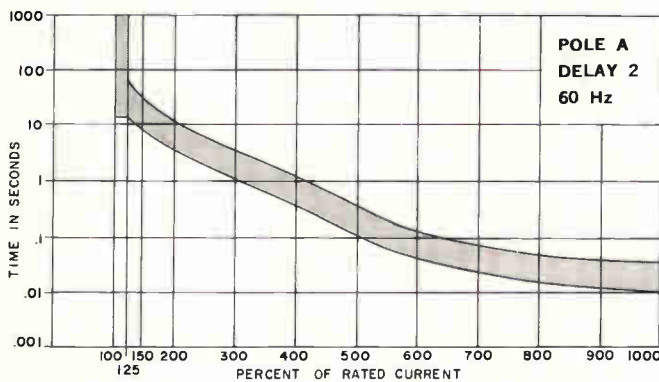
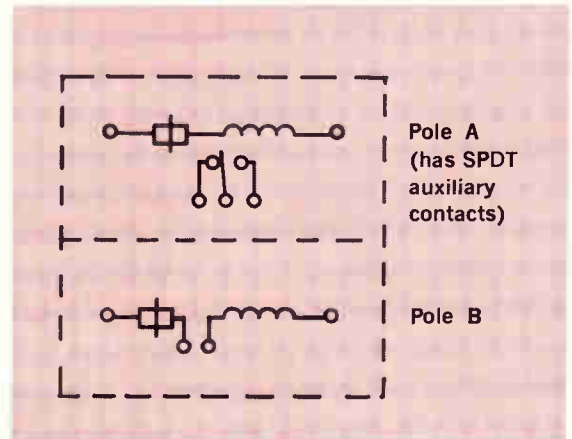
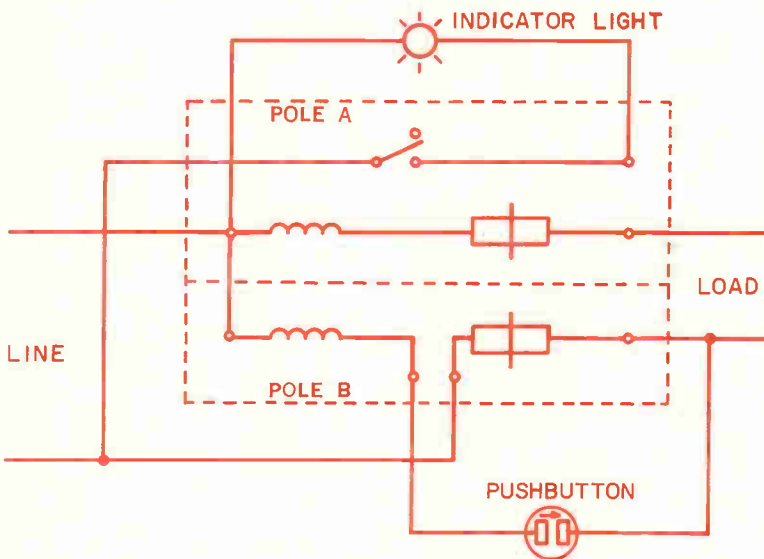

AIRPAX ELECTRONICS

CAMBRIDGE DIVISION, CAMBRIDGE, MARYLAND 21613
Phone (301) 228-4600 TWX 710 865-9655 TELEX 8-7715

At last—a computer with a heart

“Less impersonal” machine patiently guides even a novice user along; it reprograms itself, is easy to talk to, and does its processing in real time

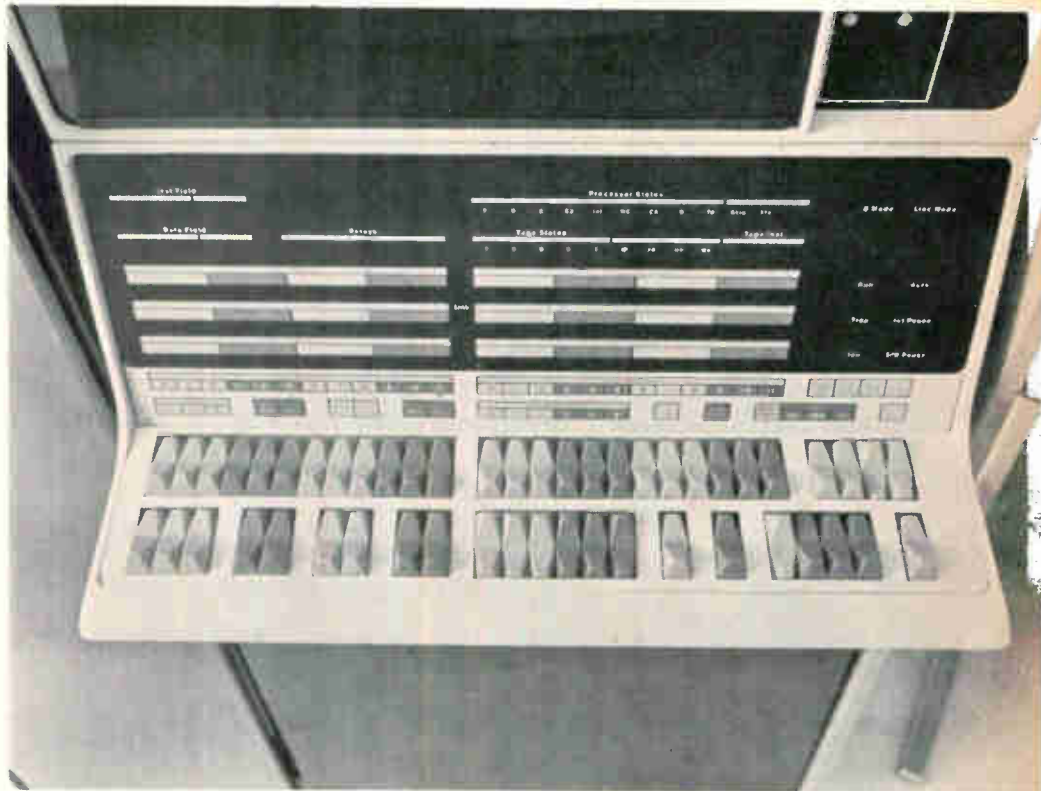

Family resemblance. Operator console combines features of PDP and LINC series. The upper banks of switches are for loading instructions and data manually; those below are for executing special functions.

Four summers ago, a few dozen biologists, biochemists, and other experimenters in the life sciences went to MIT for six weeks to get acquainted with a special new computer—one they could become as familiar with as they were with the microscope.

The machine, called LINC for Laboratory Instrument Computer and developed with Government funds, was designed to be easy to talk to and work along with, even for a novice.

The Digital Equipment Corp. decided to develop the machine further and market it, and this developmental work evolved along a path paralleling that of DEC's more

powerful PDP-8. This week, DEC announces the PDP-12, which combines the analytic capabilities of the PDP-8/I and the interactive characteristics of the LINC-8. The company is aiming at markets where dialogue with an unskilled user is crucial, such as hospital information systems, computer-aided design, and inventory control.

Electronic tutor. “The PDP-12 is designed to lower the barriers between men and computers—to make the computer less impersonal and more of an electronic aide-de-camp, technician, or tutor,” says Edward A. Kramer, PDP-12 marketing manager.

But DEC also has another goal

in mind: cutting into the time-shared computer market. Says Kramer: “The price of the PDP-12 is low enough to compete with consoles in many time-sharing applications, and there is the additional advantage of always having an open port—time-shared computers haven't proven to be as readily shareable as many users had expected. We hope to sell to people who would like to trade their position in a queue for some stand-alone computation.

“PDP-12's spotted around a plant may be more economical and flexible than a large time-shared computer plus its peripheral consoles.” Kramer adds that spotting com-

... heavy emphasis on graphics and dialogue makes things easier for unskilled user ...

puter power where it's needed eliminates the cost of cable connections.

Very like a hybrid

First deliveries of the new machine will be in late February or early March. The most powerful and most comprehensive PDP-12 will sell for \$27,900, down from \$38,500 for the LINC-8.

Despite the price cut, DEC says, the buyer gets more computer. "The usefulness per dollar ratio is about double that of the LINC-8," according to Richard J. Clayton, PDP-12 product line manager.

He also points out the user needn't buy more than he wants. Although the model A has hard-wired options, models B and C are available with fewer items of peripheral equipment.

The model C includes only memory, central processor, teletypewriter, sense switches, index registers, and enclosure and sells for just \$14,900; tape, cathode-ray tube display, analog-to-digital conversion gear, and the like can be added as desired.

The PDP-12 replaces the LINC-8 and includes its heavy emphasis on graphics, its ability—almost like that of a hybrid computer—to manipulate data and experimental conditions in real time, and its capacity for question-and-answer dialogue with the user.

New architecture. The PDP-12 is a 12-bit machine and can use software that's been written for either the LINC-8 or PDP-8/I; this totals about 400 programs that are already debugged. DEC thus expects the PDP-12 to have immediate applications far beyond those of the LINC's, which were designed to aid biomedical experimentation and research.

Although the PDP-12 has most of the characteristics of the LINC's, it uses a new architecture much like that of the PDP-8/I, says Clayton. "This architecture requires about 10% more hardware than used in the PDP-8/I to enable the computer to obey both PDP-8/I and LINC-8 instruction sets." The processor can thus operate in

either LINC or PDP-8/I mode on user or program command.

The machine has a standard 2,096-word core memory with a 1.6-microsecond cycle time. This makes possible 312,400 additions per second. Multiplication, which takes about 9 microseconds, is built into the machine and needn't be programed, as it was in the PDP-8.

Display logic can fill the 11-inch (diagonal) crt display with 400 alphanumeric characters—without flicker, DEC says—or 1,000 points of graphic data. The display is refreshed from the core memory.

Following orders. Clayton notes that most characters can be defined with only 6 bits. Character words, therefore, are stacked; characters are stored in the first six and last six bits of a core-word lo-

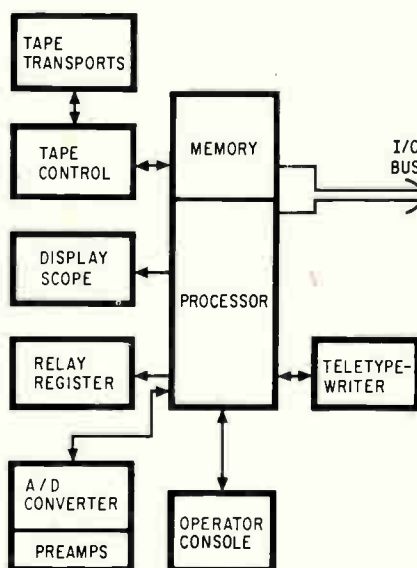

Flexible. System organization permits processor to execute programs with PDP-8 or LINC coding, or both.

eration. "To generate a character, the processor selects between the first half or second half of a word as it's read out of core," says Clayton. "This makes for more efficient use of memory. The PDP-12 can manipulate such six-bit bytes directly."

Processor architecture also is more economical in its use of core. The LINC-8 computed in either a LINC or PDP-8 type proc-

essor, and the encoding and decoding needed to move a problem from one processor into the other and out again used up about a fourth of the LINC-8's 4,096 words of core. With the PDP-12's "unified dual mode processing system," these kilobits of memory are freed, and program assembly proceeds whether the program is in LINC-8 or PDP-8 order codes.

Morton E. Ruderman, manager of biomedical marketing at DEC, says the new machine will be easy for unskilled users to work with mainly because it has "the most powerful order code of any 12-bit computer, and one more powerful than those of many 16- and 18-bit machines." The PDP-12 has 43 basic orders, and the variations on them can add up to instructions numbering in the hundreds, Ruderman says.

Name and number. As the machine is turned on, the crt lights up with the query "Execute program?" The answer will be the name and number of the tape-sorted program, which the user can type into the machine from the teletypewriter. If the user doesn't know the program designation he can request a display of the names of those available by asking for the "library list."

After the computer finds the program, it transfers the tape to the core memory and starts work. Relays and data converters are built in; the 16-channel a-d converter has eight channels equipped with level-setting potentiometers, which can be used for manual programming or control of parameter inputs. It's possible, for example, to call up a cursor and use one of the knobs to help trace a waveshape or graph displayed on the crt. At the same time, the display can be made to show the numerical value of any point on the displayed curve.

The PDP-12 is built with TTL monolithic integrated circuit logic modules. It is self-contained, requiring no special power sources. Internal power supplies develop all needed operating levels from 115-volt, 60-hertz single-phase line power at 20 amperes. Other voltages and frequencies are available.

Digital Equipment Corp., 146 Main St., Maynard, Mass. 01754 [338]

Isocons make their move

After 20 years as a lab curiosity, tv image tubes that can see in the dark appear on the market

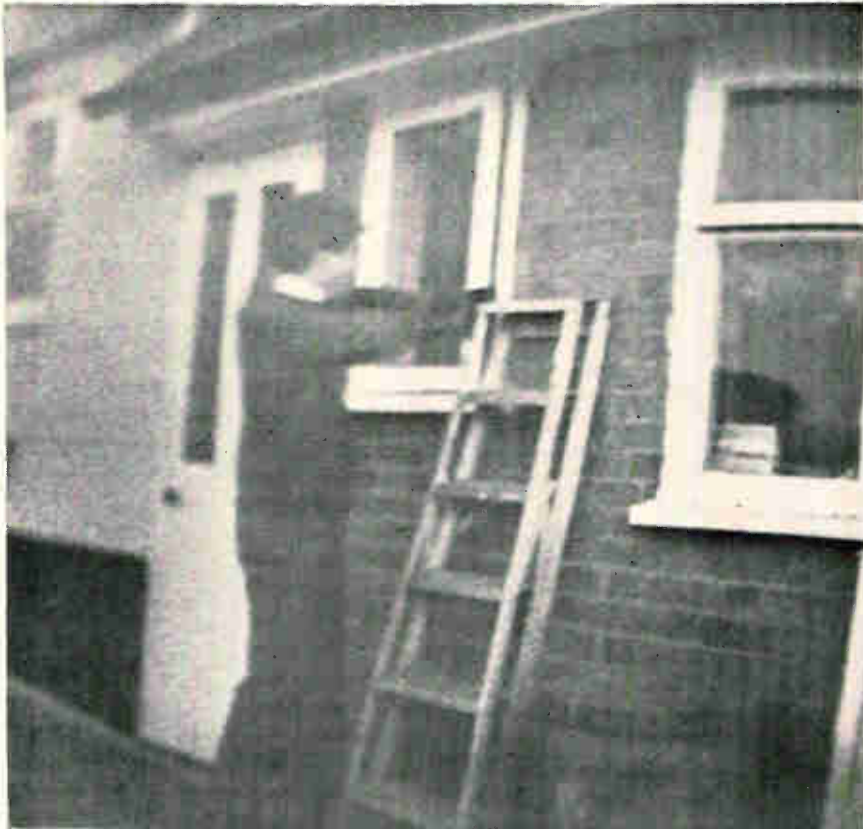

No privacy for the workingman. Since the isocon responds to as little as 10^{-6} foot-candles, it can be used in tv cameras that keep watch at night.

A star twinkling in the sky and a crook breaking into a house are both low-level performers. The star—because it's far away—and the crook—because he prefers working at night—send out light that is too weak to be picked up by conventional tv cameras. But now both of these reluctant performers may find themselves appearing more and more on tv screens.

The reason is the rebirth of the isocon, an extremely sensitive image tube. Truman was president when the first isocon was built by P.K. Weimer at RCA. But about the same time that the isocon appeared, another image tube, the

orthicon, was also being developed.

The tubes look alike and, to a point, work in the same way. In both, a beam of electrons is bounced off a glass membrane, and in both the reflected beam contains information about the scene being televised. But in the orthicon, the reflected beam goes straight to a photomultiplier; in the isocon, the beam is split into two components, and only one component goes to the multiplier.

Engineers found the orthicon much easier and cheaper to build. So despite being able to work at much lower light levels, the isocon stayed on the lab bench while the

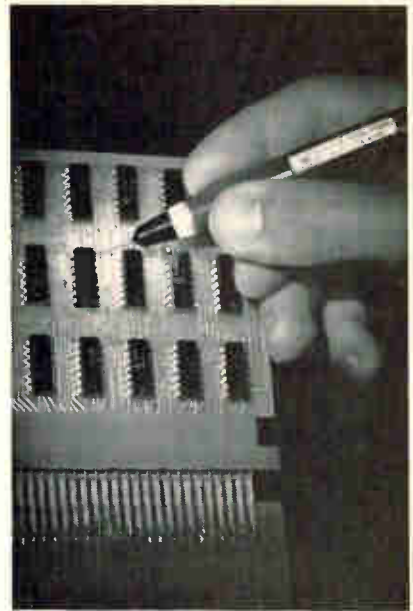

This probe lights up when a pulse goes by.

Even a pulse as short as 30 ns—positive or negative—will cause this logic indicator to flash a signal. You can trace pulses, or test the logic state of TTL or DTL integrated circuits, without taking your eyes off your work. In effect, the probes act like a second oscilloscope at your fingertips.

No adjustments of trigger level, slope or polarity are needed. A lamp in the tip will flash on 0.1 second for a positive pulse, momentarily extinguish for a negative pulse, come on low for a pulse train, burn brightly for a high logic state, and turn off for a low logic state.

The logic probe—with all circuits built into the handpiece—is rugged. Overload protection: -50 to $+200$ V continuous; 120 V ac for 10 s. Input impedance: 10 k Ω . Price of HP 10525A Logic Probe: \$95, quantity discounts available.

Ask your HP field engineer how you could put this new tool to work in logic circuit design or troubleshooting. Or write Hewlett-Packard, Palo Alto, Calif. 94304; Europe: 54 Route des Acacias, Geneva.

02825A

HEWLETT  PACKARD

HICKOK CRO 5000 25 MHz Oscilloscope (all solid state)

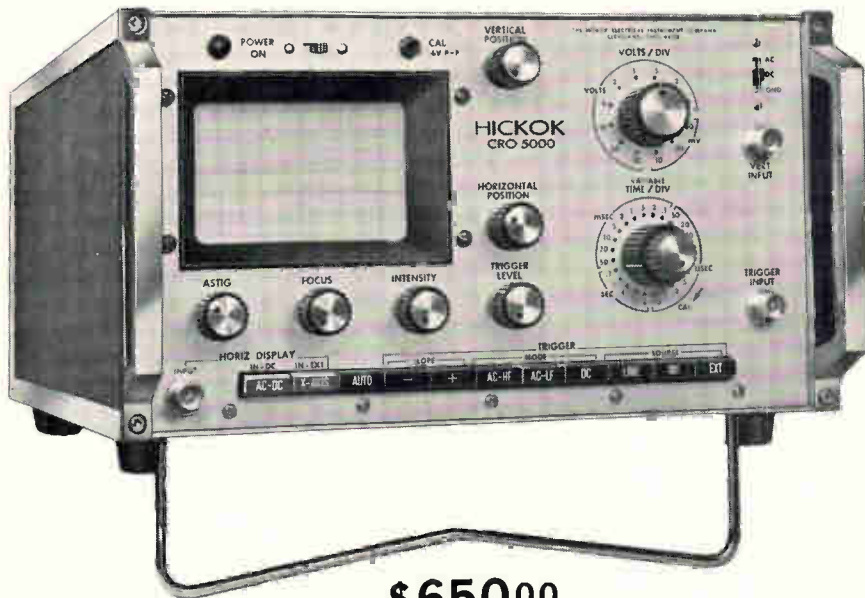

\$65000

This high-precision laboratory oscilloscope equals the basic performance of higher priced, sophisticated 'scopes, yet meets the industry need for such performance in the \$600 price range. Emphasis has been placed mainly upon those characteristics most important in precise measurements, eliminating some of the more exotic and somewhat superfluous functions found in higher priced instruments. The result is an all-solid-state instrument in the medium price range with extraordinary stability, sensitivity, bandwidth, sweep-speed range, trigger capability, reliability, and ruggedness.

- 25MHz vertical bandwidth (to 3db down points)
- Usable to 50MHz
- All solid state for high stability and reliability
- 12 calibrated vertical attenuator ranges
10 mv/div to 50 volts/div ($\pm 3.0\%$ accuracy)
- 24 calibrated sweep ranges
0.05 microseconds/div to 2 sec/div ($\pm 3.0\%$ accuracy)
- Vertical delay line assures viewing of full leading edge of pulses
- "Sweep Delay" of up to 40 divisions
- Sweep speed continuously variable between ranges
- X-axis channel bandwidth DC — 5MHz
- 4" flat-faced CRT, 6 x 10 division graticule
- 3.8 kv HV provides sharp, bright trace
- Vertical amplifier will handle overloads, with negligible distortion of waveforms increased to 5 times screen height
- Internal 1.0% calibration squarewave
- Fast, convenient push-button selection of trigger modes
- Positive, solid triggering on all displays
- Small — 11 $\frac{1}{4}$ " W, 6 $\frac{7}{8}$ " H, 19" D; 24 pounds

HICKOK ELECTRICAL INSTRUMENT COMPANY, 10514 Dupont Ave., Cleveland, Ohio 44108

... the brighter the scene,
the higher the charge ...

orthicon went into tv cameras.

Over the years engineers have refined and modified the orthicon, but the tube could never be made to detect illumination levels less than a few foot-candles. So interest turned back to the isocon.

In the last few months RCA has started selling "developmental type" isocons. Also, the English Electric Valve Co. has introduced two models.

Angling in. Both orthicons and isocons gather light from the scene to be televised and focus the light on a photocathode. The electrons generated are collected on a thin glass membrane, the target. Secondary electrons come off the target and are collected on a positively charged mesh between the photocathode and the target. This results in the target being positively charged; the brighter the portion of the scene associated with a given section of the target, the higher the charge at that section of the target.

At the other end of the tube, be it orthicon or isocon, is an electron gun. A magnetic field sweeps the gun's beam over the back surface of the target. Some electrons in the beam hit the target and neutralize some of its charge; others, the scattered electrons, bounce off the target, while others are repelled before they get there. The scattered and the repelled electrons form a beam that travels back towards the gun.

Here's where the difference is. In the orthicon, the beam from the gun approaches the target perpendicularly, and both the scattered and the repelled electrons return along the same narrow-diameter path. At the end of the tube a photomultiplier collects them and generates an output signal.

So the orthicon modulates negatively—maximum input to the multiplier corresponds to dark areas of the scene. Besides, the lower the light level, the higher the noise.

In the isocon, a magnetic field bends the beam so it approaches the target at an angle. The repelled electrons come back along a narrow path, but the scattered electrons spread out and return over

... X-rays can be taken
with less radiation ...

a much wider road.

In front of the multiplier is an aperture-electrode system that separates the scattered from the repelled electrons, and feeds the scattered electrons into the multiplier.

Modulation is positive, and noise decreases as the light level goes down.

Logging in. The bending and separating systems push isocon prices to two or three times those of orthicons. The RCA tubes cost from \$1,500 to \$6,000, and focusing and alignment assemblies add \$800 to \$2,500.

But the money buys a tube that can almost see in the dark. For example, one RCA isocon, the C21095, has a log-log plot of output versus illumination that goes linearly from 0.02 microamp to 2.0 μ amps when illumination goes from 2×10^{-5} to 2×10^{-3} ft-c.

English Electric offers two models, the P850 for \$4,700 and the shorter, less-sensitive P880 for \$4,200. The tubes are being sold in the U.S. by the Visual Electronics Corp.

The log-log output curve of the P880 linearly goes from 0.001 amp to 4.0 amps when illumination goes from 10^{-6} to 2×10^{-3} ft-c.

Both RCA and English Electric expect that the isocon will be used in night reconnaissance systems, particularly in aircraft. The British tube was developed for military systems, and there has been much classified work done with isocons by the U.S. Army.

Another application is night security systems for banks, factories, and similar institutions.

Doctors and radiologists may also find use for the tubes since their high sensitivity allows X-rays to be taken with much lower doses of radiation.

Astronomers are also working with the isocon; the British model is being tested on telescopes at the Royal Observatory in Herstmonceux.

RCA, Camera Tube Marketing, Lancaster, Pa. [339]

Visual Electronics Corp. 356 W. 40th St., New York, N.Y. 10018 [340]

Hickok

1050 DIGITAL SET-POINT CONTROLLER



1050 Controller
\$230

The Model 1050 Digital Set-Point Controller, when used with the Hickok DMS 3200 Digital Measuring System, can start and/or stop the operation of any peripheral function at pre-determined measurement values, as selected by the operator. Set-points are absolute, assuring start or stop functions at specific values with zero set-point error.

When used with the DMS Main Frame and the appropriate DP Series plug-in digital measurements of voltage, frequency, period, resistance, capacity, events (and with appropriate transducers, pressure, flow, temperature, strain, etc.) can be used to activate external mechanical feeds, drives, print-outs, reject hoppers, feed motors, fuel adjustments, blowers, tabulation recorders, etc.

- Front-panel upper and lower set-points provide absolute values at which external control circuitry is activated
- Designed for operation with Hickok DMS 3200 Digital Measuring System — just interconnect and operate
- Will operate with other devices having 10-line decimal outputs
- Three-digit control is standard; two controllers may be operated in tandem to provide six-digit control
- Front-panel indicator lamps show operator if measurements are falling within "accept" band
- Low-voltage, low-power data inputs
- Control outputs are from relay closure contacts — 1.5 amperes rating
- All solid state design for long-term reliability
- Integrated circuits used for most circuitry
- Modular construction for maintenance ease
- Small — only 6½"W, 6⅞"H, 7¾"D; 6¼ pounds

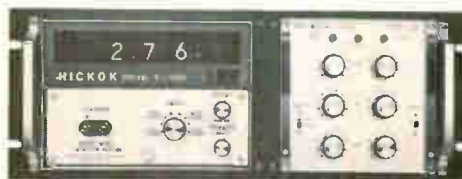

DMS 3200 and 1050 Controller rack-mount to provide single package



Two Model 1050 Controllers can provide 6-digit set-point control

HICKOK ELECTRICAL INSTRUMENT COMPANY, 10514 Dupont Ave., Cleveland, Ohio 44103

Meet a new kind of T²L. It's twice as fast.

Introducing Ray III. The fastest TTL on the market. Samples available now.

Ray III halves the best T²L speed-power product you previously could get. It has a 5½ nanosecond maximum propagation delay with only 22 mW dissipation per gate. Where older T²L flip flop frequencies reach about 50 MHz, Ray III hits 100 MHz. It's pin- and function-compatible with Ray I and Ray II, our standard T²L series. And we've added clamp diodes to all gates and active pull-down networks to improve noise immunity.

By April our distributors will be stocking 19 logic functions: expanders, inverters, gates, flip flops. All available in commercial or mil-type temperature ranges, in flatpacks and DIP cases. And by mid year we'll be producing even more functions as well as Ray III MSI. Send for data sheets, designer's handbook and list of distributors from the company that gets the ideas — and delivers them.

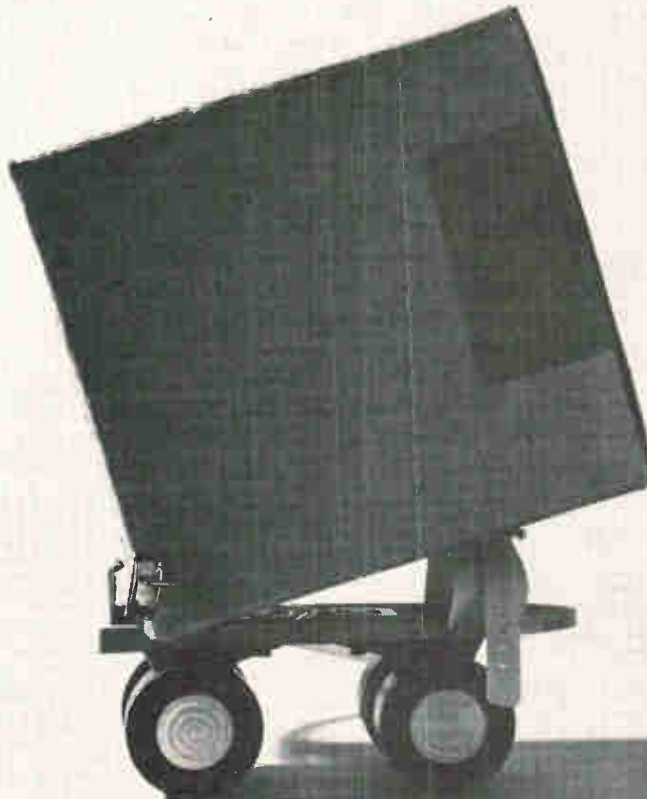

Samples available from distributors:

RG 3220/3222 Quad 2-Input NAND Gate. RF 3200/3202 AND-Input JK Flip Flop. RF 3210/3212 OR-Input JK Flip Flop.

New microwave products

IC produces i-f on the spot

Inputs from 1,435 to 1,535 Mhz are knocked down by a 5-ounce converter with a drain of only 2 watts

Missionaries aren't the only ones looking for a way to make on-the-spot conversions. Engineers at Varian Associates' LEL division have been looking, too, and now they think they've found a way.

The conversion these engineers want is from r-f to i-f. Their integrated-circuit converter takes up only 2½ cubic inches and weighs

5 ounces, so it's small and light enough to be packed with small microwave antennas, such as the dipoles in phased-array radars. Because a receiver that down-converts at the antenna has only i-f signals flowing in it, it's less susceptible to interference.

The device's size and weight also make it a good bet to appear in air-

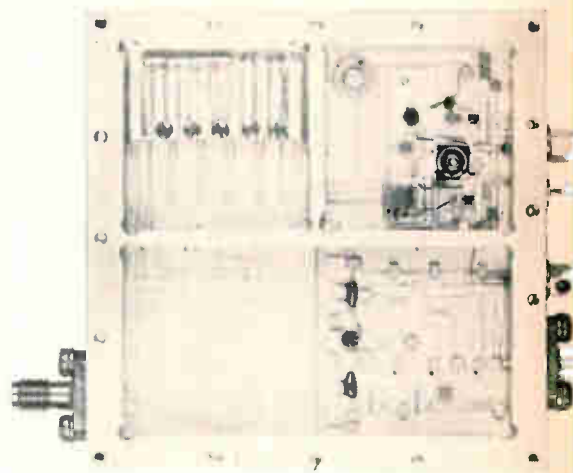

Down, then out. R-f input is converted and amplified in IC's lower half. Upper part has the oscillator.

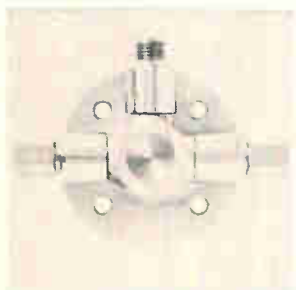

Coaxial power divider DA-C36 is for use from d-c to 10 Ghz. An integral panel permits it to be fastened securely to any standard chassis or any other similar flat surface. The divider has a nominal resistive loss of 3 db, with output symmetry of 0.2 db max. Vswr in any arm is below 1.35 over the full frequency range. Microlab/FXR, Microlab Road, Livingston, N.J. [401]



Integrated mixer model MWT-9375 employs three-arm branch hybrid design that saves weight and space. The device operates at a center frequency of 9,375 Mhz with a 10% bandwidth. Input vswr is 1.50 to 1 maximum and input to local-oscillator isolation is 15 db. Maximum noise figure is 7.5 db with a 1.5 db i-f. Raytheon Co., 152 Floral Ave., Murray Hill, N.J. 07974. [402]



Two channel S-band (2.2-2.3 Ghz) telemetry multicoupler model S-201 allows simultaneous operation of two 50-w transmitters into a single antenna. With channels separated by 25 Mhz, the unit provides 24-db isolation with 0.6-db passband insertion loss. The unit measures 1.90 x 2.35 x 5.70 inches, weighs 0.65 lb. Wavecom Inc., 9181 Gazette Ave., Chatsworth, Calif. 91311. [403]



Compact, lightweight voltage variable attenuator AM7000 is useful where low vswr and system accuracy are requirements. It is available with standard p-i-n diodes or optional p-n types for greater switching speed. Frequency range is 1 to 4 Ghz. Insertion loss is 2 db max. Vswr is 2 max. Alpha Industries Inc., 381 Elliot St., Newton Upper Falls, Mass. 02184. [404]



Broadband thermocouple mount model 550 covers from 8.2 to 12.4 Ghz. The thermocouple sensor is field replaceable requiring no special tool or adjustments. The mount weighs less than 8 oz and has passed typical MIL specs for shock and vibration. Price is \$145; delivery, 2 weeks after receipt of order. MSI Electronics Inc., 34-32 57th St., Woodside, N.Y. 11377. [405]

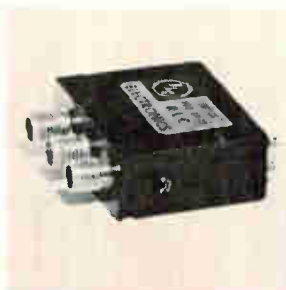

Remote Miti-Min coaxial switch series SRM is a single pole, two position type for use over the range of d-c to 12.4 Ghz. Insertion loss is 0.4 db max.; vswr, 1.5 max.; isolation, 60 db min.; r-f power rating, 50 w average; r-f connectors, RSM female; life, 1 million cycles min.; price \$125. RLC Electronics Inc., 25 Martin Place, Port Chester, N.Y. 10573. [406]

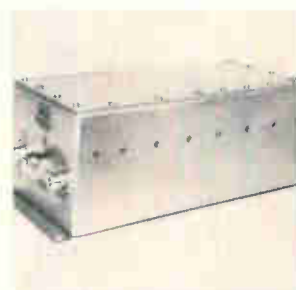

Varactor multiplier model UHM-2 (TX)-3580/500-32 is a solid state device that has a 32 times multiplication ratio with an output bandwidth of 500 Mhz. Input frequency is 104 to 119.7 Mhz and output frequency is 3.33 to 3.83 Ghz. Nominal power is 20 mw for an input driving signal of 100 mw. Applied Research Inc., 76 S. Bayles Ave., Port Washington, N.Y. 11050. [407]



Heterodyne converter model 635 is designed to plug into the portable model 616 frequency counter and boost the range from 225 Mhz to 3.3 Ghz. The plug-in features a converter frequency range from 0.1 Ghz to 3.3 Ghz, with continuous tuning in 0.1-Ghz steps from 0.2 Ghz to 3.2 Ghz. CMC, Div. of Pacific Industries, 12970 Bradley Ave., San Fernando, Calif. [408]

A new way to
dependable,
compact,
low-cost, digital
**COUNT AND
CONTROL**

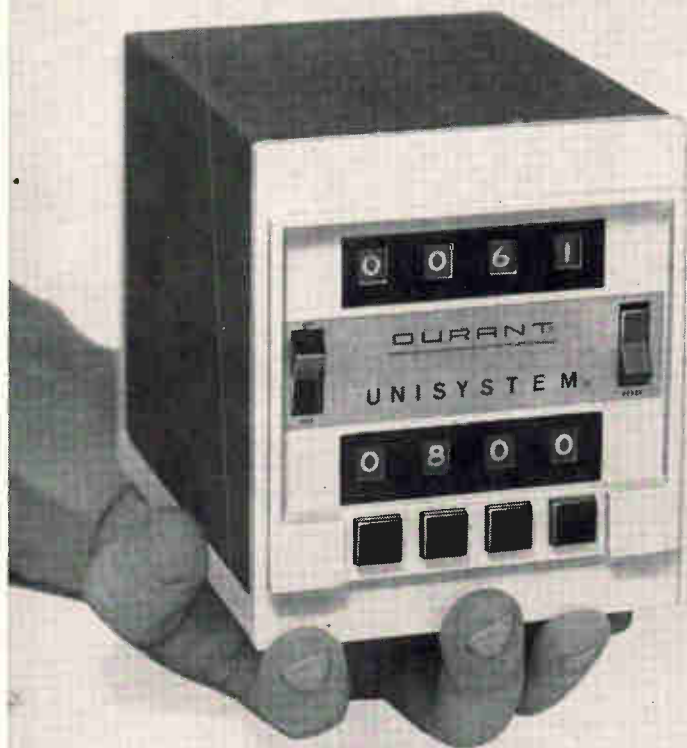

DURANT 49600 UNISYSTEM

The answer to a need for fast, accurate count or control in most industries — machine tool, textile, wire, boxboard, electrical, paper, lumber, printing, food, chemical, and other industries. Controls fluid metering, batching, testing, cutting, packaging; counts cartons, coil turns, lineal lengths, and units per bundle. Exceptionally dependable; count always retained in case of power failure.

Compact size permits space-saving desk mount or panel mounting. Choose 2, 3 or 4-digit predetermining and count levels. Also available in Splash and Dustproof models. Speed ranges from 0 to 30 cps (1800 cpm). Large, easy-to-read visual display

Easy push-button setting of predetermined number — preset value always retained, always visible. Instant electric reset from panel front, remote reset, or automatic cycle repeat. Setup and connecting is easy, too... rear panel terminals allow 49600 to be readily applied to a variety of operating functions.

See it demonstrated at your desk! Write for specifications.

DURANT
MANUFACTURING COMPANY

622 North Cass Street
MILWAUKEE, WISCONSIN
In Europe: Durant (Europa) N.V. Barneveld, Netherlands

borne radars and radios, telemetry systems, and transponders.

Mixing it up. LEL engineers make the converter on two 1-by-2-inch substrates. On one are a mixer and an i-f amplifier; on the other are a crystal oscillator, a multiplier, and a five-section comb filter.

The mixer combines the r-f input, whose frequency can be 1,435 to 1,535 megahertz, with a filtered signal from the crystal oscillator. The i-f signal from the mixer goes to an amplifier whose output is the output of the converter.

It takes 9 volts to run the converter, and maximum drain is 2 watts. Input and output impedance are both 50 ohms, and the voltage standing-wave ratio is 1.5. The maximum noise figure is 8 decibels, and the frequency stability is 0.01%.

I-f frequencies available are 30, 60, and 265 Mhz, and possible bandwidths are 10, 20, and 100 Mhz. Gain ranges from 15 to 30 db.

Putting it down. LEL engineers make the converter the same way they make other microwave IC's. A resistive layer of chromium-chrome oxide is coated with gold. Resistive and conductive paths are etched, and active devices and discrete capacitors and inductors are bonded to the substrate.

Chip capacitors are used in the r-f section.

The converter's price is about \$2,000, and delivery time is 3 to 4 months.

LEL Division, Varian Associates, Akron St., Copiague, N.Y. 11726 [409]

New microwave

**Crystalline units
delay Ghz signals**

Film-sapphire-film devices
handle 100 milliwatts c-w;
losses down 50 to 75 db

The brute-force approach is the common way to delay a microwave signal—pass it through a predetermined length of coaxial cable. Crystalline delay lines by compari-

0455

The Olympus MG was designed to make photography a simple part of any metallographer's routine. The only attachments you need to take a picture are the optional 35mm or Polaroid film backs; the shutter, flat-field photo eyepiece are built in.

Flat-field achromats (as standard equipment) ensure your photos will be accurately focused across the entire field. And by building the bright-field illuminator's transformer into the base, we stabilized the instrument, preventing vibration that might blur your shots.

Since observation is also part of your routine, we made the MG as easy to see through as it is to shoot with. Its high-eyepoint, wide-field eyepieces are comfortably angled, at a convenient height above the bench. All controls, including the objective turret, coaxial fine and coarse focus knobs and coaxial stage movements are clustered handily nearby.

The MG is adaptable, too, with accessories available for polarized, dark-field, oblique and transmitted-

light illumination, plus a wide range of eyepieces and objectives.

Yet the price of the MG is about what you'd expect to pay for an equivalent metallograph without its camera facilities. And if you don't need those facilities, the MG's other features are available for even less in the compact MGK.



Model MGK

Details and prices on both models—and on the other upright and inverted Olympus Metalscopes—are yours for the asking.

Olympus Model MG

Inverted Flat-Field Metallograph

This camera comes with a built-in flat field microscope.



"50 years of precision in microscopy"

OLYMPUS CORPORATION OF AMERICA
 PRECISION INSTRUMENT DIVISION / Dept. E, 2 Nevada Drive, New Hyde Park, N.Y. 11040
 Send information on the Olympus Model MG, with camera facilities, the Olympus Model MGK,
 Olympus upright metallograph microscopes. My applications include:

Name _____
 Title _____
 Organization _____
 Address _____
 City _____ State _____ Zip _____

The still is just the start in a distilled water system.

You get "the works" from Barnstead, including a *still* to purify the water (½ to 1000 and more gallons per hour) . . .

. . . a *storage tank* to keep it pure . . . contaminant-free *pipng* and faucets to put distilled water on tap wherever you need it . . . plus *controls, purity meters and accessories.*

Barnstead does the whole job, from raw-water analysis, design and construction to supervision of installation, and service.

And by supplying a complete system, lined with pure block tin (shown being applied to a Barnstead storage tank in the photo below) — we can *guarantee* water of a specific purity delivered right to the points of use.

Like this one-source approach? Write for details on Barnstead distilled water systems. Barnstead Still and Sterillizer Co., 225 Rivermoor Street, Boston, Massachusetts 02132.

(That's why it'll pay you to look into Barnstead.)



Barnstead

Ritter Pfaudler Corporation

son are more sophisticated. Only inches in length, they offer space and weight advantages over bulky piles of cable. However, high loss factors and low power ratings have, so far, kept these devices out of gigahertz systems.

The latest additions to the delay-line family of Andersen Laboratories Inc. are designed to get into the Ghz systems. The crystalline devices operate at any specified frequency between 7 and 11 Ghz. They provide delay times of 200 to 2,000 nanoseconds, and bandwidths up to 20%. Input/output isolation is 100 decibels. They can handle 100 milliwatts continuously and 50 watts peak, and spurious signals are below 20 db. Performance meets MIL-E-54000 Class II.

Presently the loss is between 50 and 75 db, but this will be down



Slowdown. A piezoelectric film at the input converts an electrical signal into a slower-moving acoustic one.

to 35 db by the middle of 1969, says Walter Crofut, head of microwave systems at Andersen. With the new units, the company's line covers the range from 100 megahertz through X band.

A sound film. At the input of the delay lines is a piezoelectric film which converts electrical energy into acoustical energy, thus slowing down the signal. The sound wave travels through a delay medium—usually sapphire—and then to the output where another piezoelectric film converts the energy back to electrical form.

Specified delay times are accurate to within 10 nsecs, but Crofut says that the actual error is negligible in devices whose delay mediums are cut from the same crystal.

The new devices sell for \$3,000 each. A prototype takes 6 weeks, after which the production units can be delivered as needed.

Andersen Laboratories, Inc., 1280 Blue Hills Ave., Bloomfield, Conn. [410]

SCIENCE/SCOPE

The giant new Intelsat IV satellite ordered by Comsat Corp. for International Telecommunications Satellite Consortium from Hughes will have 25 times more communications capacity than any satellite now in operation. It will be able to handle 6,000 two-way telephone calls or 12 color TV broadcasts simultaneously. A unique feature will be Intelsat IV's ability to focus its power into two "spotlight" beams and point them at any selected areas.

The airborne radar system for the F-X fighter is being developed by Hughes under one of two \$11-million contracts awarded by the U.S. Air Force. Winner of the competition will be selected after both radar prototypes have been flight tested and the results evaluated. The F-X will be the world's most advanced single-place, twin-engine air superiority fighter in the 1975 time period.

The U.S. Army TOW wire-guided anti-tank missile has been ordered into production under a \$141-million contract awarded to Hughes. It is designed for use either as a man-carried tripod-mounted weapon or mounted on a variety of existing vehicles. It will also be launched from the Army's new Cheyenne helicopter. The Army recently demonstrated TOW to nearly 100 high-ranking military representatives of 11 foreign nations at Grafenwoehr, Germany.

A multiplexed passenger-entertainment system for the DC-10 is being built by Hughes under a \$12-million contract from McDonnell Douglas. It will give the DC-10 passenger the choice of monaural or stereophonic high fidelity music or multilingual sound tracks for in-flight movies by pressing a button at his seat. Multiplexing will save miles of wiring and up to 400 pounds of weight.

Telecasts live and in 12 languages for Europe were relayed from the Olympics in Mexico by two Hughes-built satellites. NASA's ATS III and Comsat's Early Bird were used to transmit video and audio segments separately to two ground stations in Europe. The games reached Japanese viewers via microwave to a portable ground station installed by Hughes near San Jose, Calif., then via Intelsat II.

Hughes has immediate openings for engineers in several major new programs. We especially need Circuit Designers, Engineering Programmers, and Weapon Systems Analysts. Requirements: engineering degree, at least two years of experience, U.S. citizenship. Please send your resume to: Mr. J.C. Cox, Hughes Aircraft Company, Culver City, California. Hughes is an equal opportunity employer.

Advanced materials technology research at Hughes has resulted in four processes for producing thermosetting polyferrocene resins suitable for laminate fabrication...a method of molding boron and graphite fibers into high-strength high-modulus composites for evaluation in spacecraft and missile components...new knowledge about color center formations, which could lead to extremely stable white thermal control coatings for spacecraft.

U.S. will be first to use laser rangefinders on tanks as the result of a \$2.7 million contract awarded Hughes by the U.S. Army's Frankford Arsenal. Initial production order -- first for a completely militarized laser -- is for 243 rangefinders for the M-60 battle tank.

Creating a new world with electronics



Circle 189 on reader service card

increase ic yield

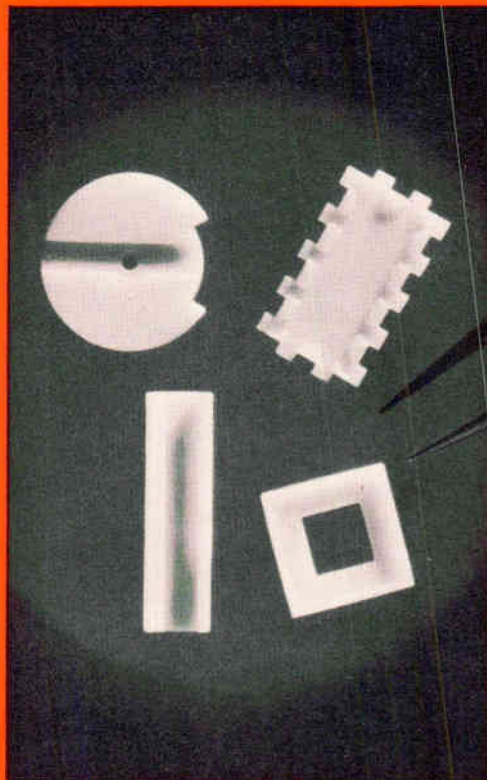

With Coors microceramics. Parts and complete packages. Of alumina and beryllia. Strong, chemically inert, dimensionally stable. Unaffected by age or environment. Part-to-part uniformity from 1st to nth. Precision-ground or as-fired surfaces. Easy to metallize, by you, by us. Most any size, any shape. Fast delivery. Prototype quantities, millions, or anything in between. Get higher yield, more profit. Start with the most reliable circuit packaging. Coors microceramics. Send for data pack.

Coors Porcelain Company
Golden, Colorado 80401

Coors CERAMICS

New instruments

All together now: a microvolt potentiometer

Julie Labs offers a completely self-contained device costing \$625 and accurate to within 10 parts per million

Second-sourcing doesn't necessarily mean supplying identical copies. Julie Research Laboratories, for instance, went a prime supplier one better when it successfully bid to become a Government agency's second source for a microvolt potentiometer. For about the same price charged by the other supplier, Julie offered a com-

pletely self-contained instrument. Instead of the separate indicator, power source, current reference, and galvanometer offered by the first source, Julie built all of them as part of the main frame. And the company is now putting the potentiometer on the market.

It's the second product from Julie—known as a maker of high-

priced instruments—on the medium-priced market. The first, a differential voltmeter, was introduced last October. The new potentiometer costs \$625 and its accuracy is 10 parts per million, compared with 1 ppm for the firm's expensive line, which sells for \$3,000 to \$4,000.

Two versions. There are two



Differential potentiometer 7564 combines a precision potentiometer, a solid state null detector, a guarded power supply, a precision volt-box, and a thermally-lagged standard cell, all in a compact case. It measures voltage from 0.5 μ v to 1,600 v. Emf value is displayed at a central readout window with a resolution of $\pm 0.5 \mu$ v. Leeds & Northrup Co., North Wales, Pa. [361]



Time interval detector model 101 reduces the complexity and man-hours normally required for detection of chatter or intermittent contact openings and closings during environmental testing of electromechanical devices. Times from 0.1 μ sec to 9.99 msec can be detected. Accuracy is $\pm 0.1 \mu$ sec. Prices start at \$420. Digital Networks, P.O. Box 817, Pomona, Calif. 91769. [362]



Test sine generator model F312A employs the Wien bridge oscillator technique to achieve low distortion sine wave output over a 10 hz to 10 Mhz frequency span. A wideband a-c voltmeter provides accurate monitor of the output signal which is capable of delivering 3.16 v rms into 50 or 600 ohms. Price is \$695. Data Royal Corp., 8014 Armour St., San Diego, Calif. 92111. [363]



Combination FET and conventional transistor tester TF151 is easy to use. Flip the function control knob in the middle to the left and the unit is a regular in and out of circuit transistor tester; testing for beta gain and I_{cbo} out of circuit leakage. Flip the knob to the right and the unit tests FET's for transconductance in or out of circuit. Sencore Inc., Addison, Ill. [364]



Rotating electrostatic voltmeter model 12008 measures magnitude and polarity of electrostatic fields up to 500,000 v/meter. Range switch adjusts sensitivity from 0-500 v/meter to 0-500,000 v/meter in 4 decades steps. Individual recorder outputs are available for each decade output. Comstock & Wescott Inc., 765 Concord Ave., Cambridge, Mass. 02138. [365]



Transistor curve tracer PM6507, with magnetically deflected crt, can display 2 to 8 characteristic curves from any four terminal semiconductor device, including power transistors. The dynamic curves may be run over a broad power range, to 20 amps max collector current, 500 v collector-emitter voltage. Philips Electronic Instruments, 750 S. Fulton Ave., Mt. Vernon, N.Y. [366]



Audio frequency meter 503 is a portable unit that measures sine or square wave frequencies to 50 khz. Accuracy is $\pm 1\%$. It accepts signals of less than 1 v to 120 v rms without sensitivity adjustment. Built-in overload protection to 250 v rms is featured. Price is \$129 complete with test leads and operator's manual. Maricopa Controls, 8013 E. Roosevelt, Scottsdale, Ariz. [367]

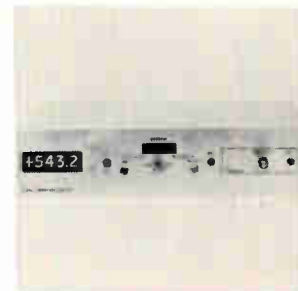

Digital temperature indicator DT-600R provides precise readings over the full range of the input thermocouple. Linearization is accomplished by digital sampling techniques that provide dynamic linearization throughout the thermocouple range. Price is from \$1,350; delivery, 3 to 4 weeks after receipt of order. Anadex Instruments Inc., 7833 Haskell Ave., Van Nuys, Calif. [368]



ELIMINATE SECONDARY PROCESSING BY USING HAMILTON PRECISION STRIP AND FOIL

When you use strip or foil produced by Hamilton Precision Metals, you eliminate surface preparation, dimensional gaging and physical property testing in your plant. That is because Hamilton produces the material to your specifications exactly—it is ready to use in the "as received" condition.

Every lot of Hamilton strip and foil is produced under rigid control of mechanical properties through alloy analysis, annealing and heat-treating; the closest dimensional control by means of X-Ray and Beta-Ray gages; superior surface finish through the use of diamond lapped work rolls and process cleanliness.

This same technical "know-how" goes into the processing of every one of our 7 proprietary metals, 12 pure metals and 112 commercial alloys rolled in thicknesses from 0.060" down to 0.000070" in widths up to 12" and continuous coils to 1000 lbs.

Write, wire or phone giving us the material you desire and the properties you need. We'll tell you how fast we can get it to you—in quantity! Or, write for our latest catalog containing our capabilities and engineering data on all our materials.



HAMILTON PRECISION METALS

Division of Hamilton Watch Company, Lancaster, Pa. 17604
Telephone 717-394-7161 TWX 717-560-4417

models of the new instrument, the NVS-503A, which measures 10 nanovolts to 500 millivolts in six ranges, and the NVS-1103A, measuring 11 μV to 1.1 volts in six ranges. Both have a maximum error of $\pm 0.05\%$ of full scale or ± 0.1 microvolt, whichever is larger, and both can be used as a voltage source to generate a reference level that's accurate within $\pm 0.04\%$ of full scale or $\pm 0.1 \mu\text{V}$, whichever is greater. The instruments can operate for a month without calibration.

Input isolation from the case is better than 10^9 ohms, and the input resistance is infinite at null. When the instrument is used as a source, the output impedance is 50 ohms for all ranges. An internal mercury battery pack provides 200



Comprehensive. Entire voltage-measuring system is built into main frame.

hours of continuous duty. Size is $3\frac{1}{2}$ by 19 by $5\frac{1}{2}$ inches.

Polarity is reversible for both "measure" and "generate" modes. The instrument—both potentiometer and null detector—dissipates less than 0.5 watt and the null detector can be removed from the main frame and used in other measuring systems.

Dennis Cope, Julie's sales manager, describes the potentiometer as "a very compact and handy" voltage measuring system. "It will be useful in any standards lab or testing lab," Cope predicts, "and could be used for production-line testing—it's a very rugged little instrument." It's particularly suited to measuring voltages of low-power circuits, he notes, because it operates potentiometrically and thus has no insertion loss.

Julie makes all the critical resistors used in the instrument, and this is a major factor in reducing costs while maintaining acceptable accuracy, according to Cope. Manufacturing the resistors to the firm's own standards of precision "eliminates a lot of trimming," he says. "We can provide a very

stable instrument with a minimum number of parts."

Delivery time is three to four weeks.

Julie Research Laboratories Inc., 211 W. 61st St., New York 10023 [369]

New instruments

Dutch multimeter says it digitally

Instrument from Philips handles a-c and d-c, measures up to 1 megohm

Latest from the Low Countries for design engineers is a digital multimeter made by Philips' Gloeilamp-enfabrieken. Called the PM2420, the meter is a three-digit instrument and costs \$420 in the Netherlands.

The instrument has a floating input and can handle voltages up to 500 volts above ground. It measures d-c voltages in five ranges from 100 millivolts to 1,000 volts, and a-c voltages in four ranges from 300 mv to 300 volts rms.

Maximum resolution is 100 microvolts for d-c measurements and



Well protected. The PM 2420 takes overloads up to 1,000 volts.

1 mv for a-c checks. Accuracies are 0.5% of range \pm one digit and 1.0% of range \pm one digit, respectively.

The meter's five d-c current ranges go from 100 microamps to 1 amp, with resolution of 100 milliamps and accuracy of 1.5% \pm one

How'd you like to drill carbon plates 6 times faster? Pinpoint accuracy—even for unskilled operators with the new multi-spindle

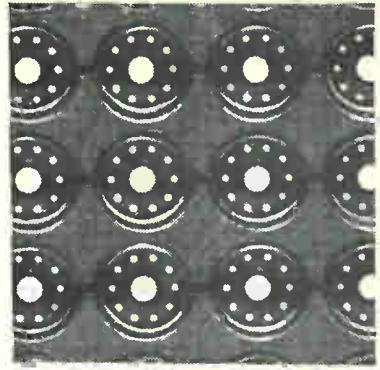

Engravograph®

Speed transistor mounting! Now anyone can drill six carbon plates in one operation from one template with registration and depth of hole controlled to a plus-or-minus .001" tolerance.

Drill up to 1600 holes per minute. Save time, labor... and especially costs.

For details write: Dept. 175.

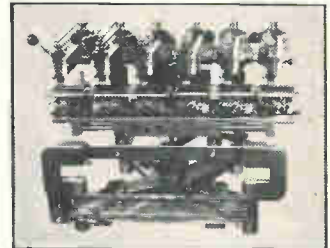

new hermes engraving machine corp.

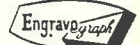

20 Cooper Sq., N.Y., N.Y. 10003 • Chicago, Atlanta, Los Angeles, Dallas, Montreal, Toronto, Mexico City

Circle 262 on reader service card



OUT OF SIGHT! A Deutsch DBA 70 connector may be operating away from your line of vision, but you don't have to see it to connect or disconnect properly. There's nothing to turn, twist or thread. Just push to engage; pull to disconnect. Mating is grope-free, trouble-free! Environmentally-sealed, the DBA 70 stands up under temperatures ranging from -67° to 392° F. It meets all the performance and reliability requirements of NAS 1599 and works in absolute harmony with the rest of our Integrated Termination System. Out of sight? Maybe! Out of reach? Never! Just pick up the phone and call your friendly Deutschman.



DEUTSCH

ELECTRONIC COMPONENTS DIVISION

Municipal Airport • Banning, California 92226 • Telephone • Area Code 714 • 818-6711 • TWX 714-811-7210

this is our filter line: ∞

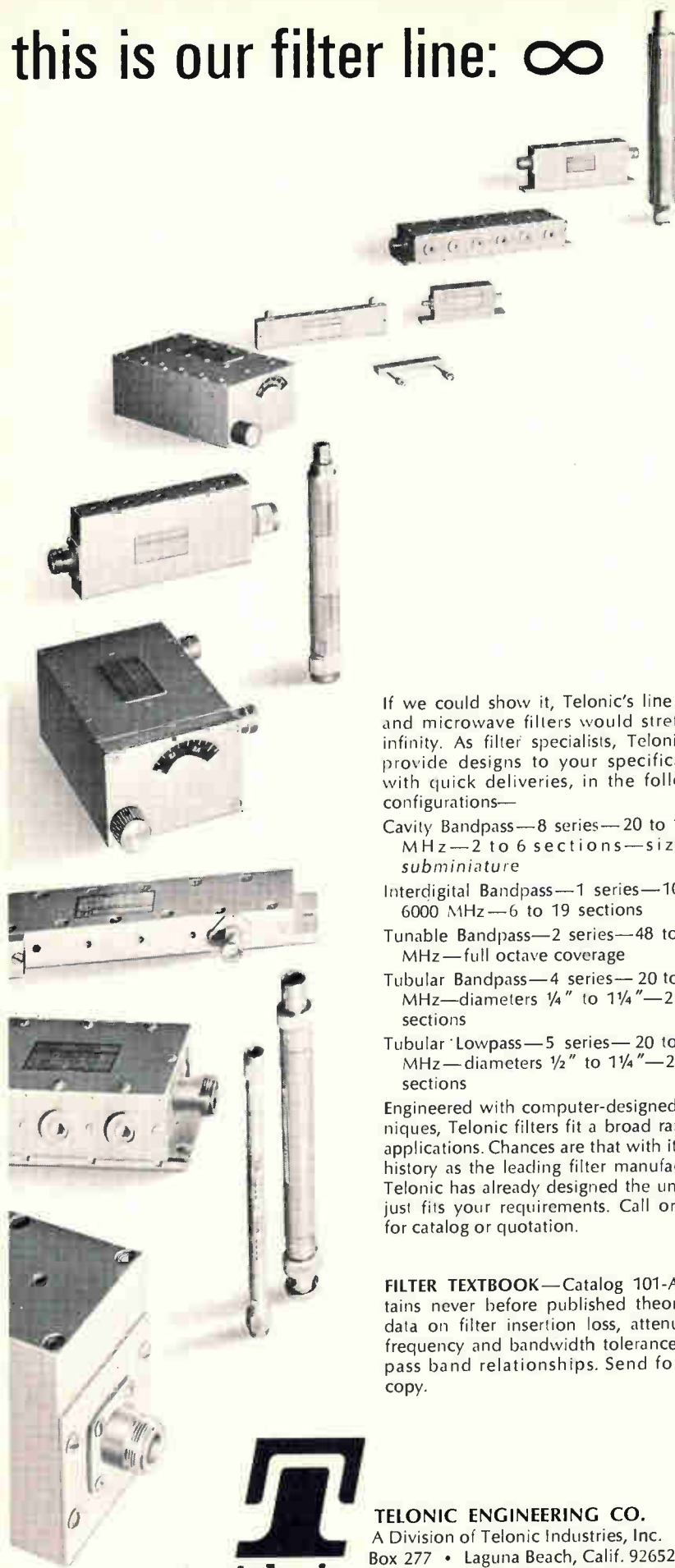

If we could show it, Telonic's line of RF and microwave filters would stretch to infinity. As filter specialists, Telonic can provide designs to your specifications with quick deliveries, in the following configurations—

Cavity Bandpass—8 series—20 to 12,000 MHz—2 to 6 sections—sizes to *subminiature*

Interdigital Bandpass—1 series—1000 to 6000 MHz—6 to 19 sections

Tunable Bandpass—2 series—48 to 4000 MHz—full octave coverage

Tubular Bandpass—4 series—20 to 2700 MHz—diameters 1/4" to 1 1/4"—2 to 12 sections

Tubular Lowpass—5 series—20 to 3000 MHz—diameters 1/2" to 1 1/4"—2 to 12 sections

Engineered with computer-designed techniques, Telonic filters fit a broad range of applications. Chances are that with its long history as the leading filter manufacturer, Telonic has already designed the unit that just fits your requirements. Call or write for catalog or quotation.

FILTER TEXTBOOK—Catalog 101-A contains never before published theory and data on filter insertion loss, attenuation, frequency and bandwidth tolerances, and pass band relationships. Send for your copy.



TELONIC ENGINEERING CO.
A Division of Telonic Industries, Inc.
Box 277 • Laguna Beach, Calif. 92652
Phone—(714) 494-9401 • TWX-910-596-1320

digit. The four a-c ranges go from 300 μ a to 300 ma rms; resolution is 1 μ a and accuracy is 2.0% \pm one digit.

The PM 2420 also measures resistance in five ranges from 100 ohms to 1 megohm.

There's an additional digit provided for over-range protection. The meter also has a polarity indicator and an overload signal.

The meter can stand overloads up to 1,000 volts on the higher d-c ranges, and 300 volts rms on all a-c ranges. For the two lowest d-c ranges, the instrument can take 150 volts.

Generated internally is a 9.99-volt signal that can be used to calibrate the meter. Philips says that the PM 2420 is very stable; one calibration a day is enough.

Industrial and Scientific Div., Philips' Gloeilampenfabrieken, Eindhoven, Netherlands [370]

New instruments

Active filters sift sounds

Audio spectrum analyzer
marketed for voice-pattern,
sonar, and noise studies

The sonar echo is difficult to analyze because its characteristics can vary if its analog waveform is sampled at different times. Yet the analysis is potentially very rewarding; the return signals could be as important in identifying a ship to a properly programed computer as a reference in Jane's.

A filter bank that prepares a signal for analog-to-digital conversion by breaking up the frequency bands into a number of segments and analyzing the energy level in each has been announced by Kinetic Technology Inc., a company formed last spring to manufacture active filters. Designated the SB-55, the system was designed for sonar analysis, voice pattern studies, and noise analysis.

The heart of the audio spectrum analyzer is a fourth-order (two-pole pair) Butterworth filter that

... better performance
with discretives, but ...

produces a flat passband with no ripple. The filter is electronically tunable from 80 hertz to 12 kilohertz, in three decades. At any frequency setting, the bandwidth is adjustable from 0.5% to 100%. Each filter has two single-tuned sections that can be adjusted to achieve the flat top and sharp skirt characteristic of the Butterworth response.

Size tradeoff. Kinetic Technology currently uses its own active filters, which have two sets of gain-filter-attenuation stages, limited to some extent by the characteristics of the linear MOS circuits used. The operational amplifiers themselves generate 250 microvolts of noise, and the relatively slow slew rates keep peak response to a maximum of 20 khz. Discrete components, while improving response, would make the filter bank unmanageably large; in its hybrid state, with five channels per rack panel, the 64-channel system fills two racks.

To obtain the fast-varying d-c voltage that's fed to the a-d converter, the signal is passed through both a full-wave rectifier, which gives a d-c level proportional to the energy out of the filter, and an RC filter that integrates the d-c signal to eliminate ripple. The rectifier has a 66-decibel dynamic range, giving the output an accuracy of 10 bits.

Function generators, which produce an output voltage equal to either the logarithm of the input, or to the input raised to a power between +10 and -10, are also available. This section of the system weights the spectrum to accommodate nonlinear signals.

Price of the SB-55 is \$1,500 per channel; this breaks down to \$950 for the attenuator-filter-detector-integrator segments, \$235 for the log generator, and \$315 for the exponent generator. The generators are optional. Also as an optional feature, a scaler network having a 10-bit accuracy can be supplied.

Kinetic Technology will start making deliveries in March.

Kinetic Technology Inc., 17,465 Shelburne Way, Los Gatos, Calif. 95030 [371]



Unlocking the Future

**Electrical
electronics
engineering**

4 FLOORS OF EXHIBITS
NEW YORK COLISEUM

48 TECHNICAL SESSIONS
NEW YORK HILTON

Monday through Thursday

- 48 TECHNICAL SESSIONS at the New York Hilton. Hours: 10:00-12:30; 2:00-4:30.
- FOUR FLOORS OF EXHIBITS at the N. Y. Coliseum including over 600 firms. Hours: 10 a.m.-8 p.m. 4 Days.
- GALA ANNUAL BANQUET—Wednesday 7:15 p.m. N. Y. Hilton Grand Ballroom — \$18.00.
- FREE SHUTTLE BUSES between the Hilton and the Coliseum — every few minutes.
- REGISTRATION — Good all days — Technical Sessions and exhibits. In and out privileges. — IEEE Members \$3.00. Non-members \$6.00. Ladies \$1.00. High School Students \$3.00 if accompanied by an adult — One student per adult. Thursday only — limit of 3 students per adult.
- REG-IDENT CARD speeds request for exhibitors' literature. Ask for one when registering.
- ESCALATORS/EXPRESS ELEVATORS to the Fourth Floor.

IEEE '69  **INTERNATIONAL**
CONVENTION & EXHIBITION
MARCH 24-27, 1969

Circle 307 on reader service card

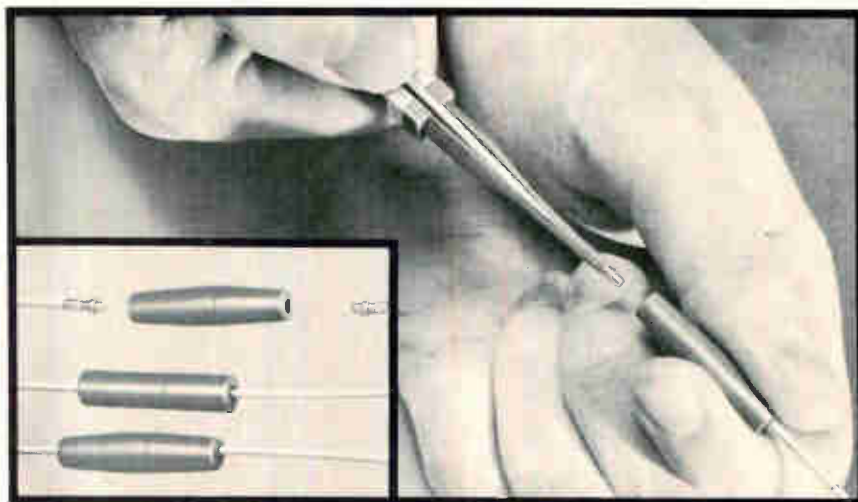

Nicer than Splice!

We know you aren't out to win any beauty contests when making wire-to-wire connections. But you'd get the prize anyhow with Deutsch Jiffy Junctions! Their soft, form-fitting, wire-hugging rubber cylinders flex, insulate, seal. Better than the wires themselves? Snap your wires in place and forget all about them. They won't shake loose, pull apart or turn brittle. Jiffy Junctions make one-to-one unions. Multi-Junctions for three-to-one combinations. As important members of your Integrated Termination System (ITS) they're Deutsch little sisters — both nicer than splice!



DEUTSCH

ELECTRONIC COMPONENTS DIVISION

Municipal Airport • Banning, California 92220 • Telephone: Area Code 714 • 849-6701 • TWX: 714-841-7210

COPYRIGHT, 1968 DEUTSCH ELECTRONIC COMPONENTS DIVISION

LOWER PRODUCTION COSTS with the TRW LASER IC TRIMMER

Clean...

Accurate...

Efficient...

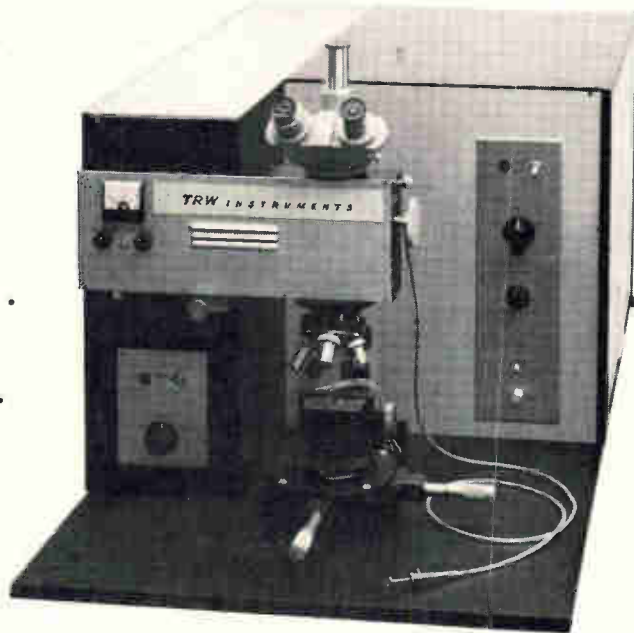

Speed up production processes by laser annealing or vaporizing to increase or decrease resistance in thin-film microcircuit packages — monolithic, compatible monolithic, chip-and-film hybrids.

The Model 84A Laser IC Trimmer utilizes a totally concealed pulsed argon laser for the trimming process. A trinocular microscope provides safety interlocked viewing and is adaptable for TV viewing.

Laser Spot Size:	10 or 15 microns
Spot Energy Density:	Continuously variable from approximately 25 to 500 joules/cm ²
Working Distance:	6.5 mm or greater
Illumination:	Selectable viewing contrast 400 to 460 and 540 to 700 nanometers through viewing optics.
Price:	\$12,750 f.o.b. El Segundo, Calif.
Delivery:	90 days

Write or call our factory or office nearest you for complete specifications.

TRW INSTRUMENTS

EM-19

Factory: 139 Illinois Street, El Segundo, California 90245 • (213) 535-0854
Branch Offices: Carle Place, New York (516) 333-1414
Los Altos, California (415) 948-2887 • Woodland Hills, California (213) 887-9374

TRW

New instruments

Spectrum analyzer goes to 1,250 Mhz

Frequency-base scope has absolute calibration in voltage and db scales

Every electronics lab needs at least one oscilloscope. Right? Wrong, say engineers at the Hewlett-Packard Co.'s Microwave division. A lab should have at least two scopes, they say—one with a time base and the other with a frequency base.

The ubiquitous time-base scope is easy to operate and has very fast sweep times. Frequency-base units, usually called spectrum analyzers, aren't as simple to work and have a comparatively narrow operating range.

But things may be different now; H-P is building a spectrum analyzer that it calls a frequency-domain twin of the standard time-base scope.

The key to this instrument is H-P's new plug-in unit, the 8554L r-f section. Combined with the 8552A i-f section and the 140S display section, the 8554L makes an analyzer with a wide operating range—1 to 1,250 megahertz—and with absolute amplitude calibration in either a voltage or decibel scale.

Versatile scanning. According to H-P, no other analyzer can operate anywhere near 1,250 Mhz; the best the older H-P instruments could do was 40 Mhz. Amplitudes from 0.3 microvolt to 8.0 volts can be read on the scope face. When the instrument is set to log display, 60 db of calibrated dynamic range, in a span from -120 db to +10 db above 1 milliwatt, are shown on the scope. The frequency response is ± 1 db, and for most types of measurements, accuracy is 1.0 to 1.5 db.

The horizontal scan is also adjustable. The entire 0-to-1,250 Mhz scan can be shown, or the operator can select any center frequency in the range, then pick one of 10 calibrated scans, from 2 kilohertz to 100 Mhz per division. Or repeti-

tive scan can be turned off, and the operator can manually interrogate an incoming signal.

The displayed center frequency is within 10% of the frequency indicated on the dial of the 8552A. And the frequency difference between two points on the display can be read to within 10%.

The bandwidth is also adjustable among seven calibrated values, from 300 hertz to 300 khz. If the bandwidth chosen is too narrow for the selected scan width and rate, a red warning light comes on.

The scan can be from 10 seconds to 0.1 millisecond per division, and the scan can be internally or externally triggered, or synchronized with line frequency or the video envelope. A front-panel push-button puts the device into a single-scan mode for use with a camera or plotter. The scan voltage itself can be supplied externally.

Versatile testing. The scope allows for fast determination of the Fourier coefficients of a high-fre-

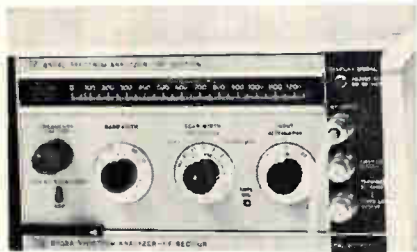

Pick the middle. The knob on the left is used to select the center frequency of the scan.

quency signal; the amplitude and frequency are simply read off the scope. The level and shape of a pulse spectrum, as well as the absolute and relative levels of individual communication channels, can be quickly measured.

The system is intended primarily as an aid in r-f circuit design. Among other tests, it can measure the flatness, harmonic content, and spectral purity of an oscillator, the gain, frequency response, and distortion of an amplifier, and the response of a filter.

The price of a complete system is \$6,000. The 8554L by itself costs \$3,300; deliveries of the plug-in unit will start in March.

Hewlett-Packard Co., Microwave Division, 1501 Page Mill Rd., Palo Alto, Calif. 94304 [374]

IF PRINTOUT IS YOUR PROBLEM, MDS DIGITAL STRIP PRINTERS ARE YOUR ANSWER

The MDS 1200 and 1600 Digital Strip Printers are both high-speed parallel entry recorders (12 or 16 column capacities) featuring

- 40, 30 or 20 lines per second print speed
- all solid state
- simple maintenance
- competitive pricing, 120-day warranty

The print drum can be set at any of three indexed positions without making electrical changes, and is cantilever-mounted so that roll or fanfold paper can be easily slipped into position without being threaded.

"Down-time" is by far the exception and not the rule!

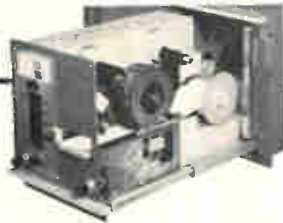

Easy does it! The complete mechanism slides forward for full inspection and quick, easy paper loading!

Ask for the MDS folder file—or
MEET YOUR MAN FROM MDS

MOHAWK
DATA SCIENCES CORPORATION

OEM MARKETING

122 E. Ridgewood Ave. • Paramus, N.J. 07652

Telephone 201/265-7333

Every MDS Office is an OEM Marketing Office

Digital Strip Printers • Buffered Tape Units

High-Speed and Low-Speed Line Printers

Card Punches and Readers

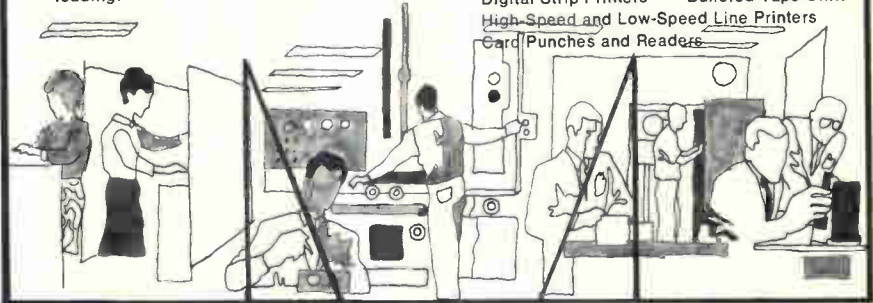

Circle 263 on reader service card



Small Wonder!



But you don't have to wonder why the Deutsch RSM is the most-wanted of all sub-miniature push-pull connectors. No other unit handles more wires in less space. Or treats them so gently while still maintaining excellent electrical engagement. Push-pull, quick-disconnect coupling. And—quick delivery! Call your local Deutschman for more details. This "small wonder" is another component of ITS... the Deutsch Integrated Termination System.



DEUTSCH

ELECTRONIC COMPONENTS DIVISION

Munich, Airport • Banning, California 92220 • Telephone Area Code 714 • 849-6701 • TWX: 714-641-7210

COPYRIGHT, 1968 DEUTSCH ELECTRONIC COMPONENTS DIVISION

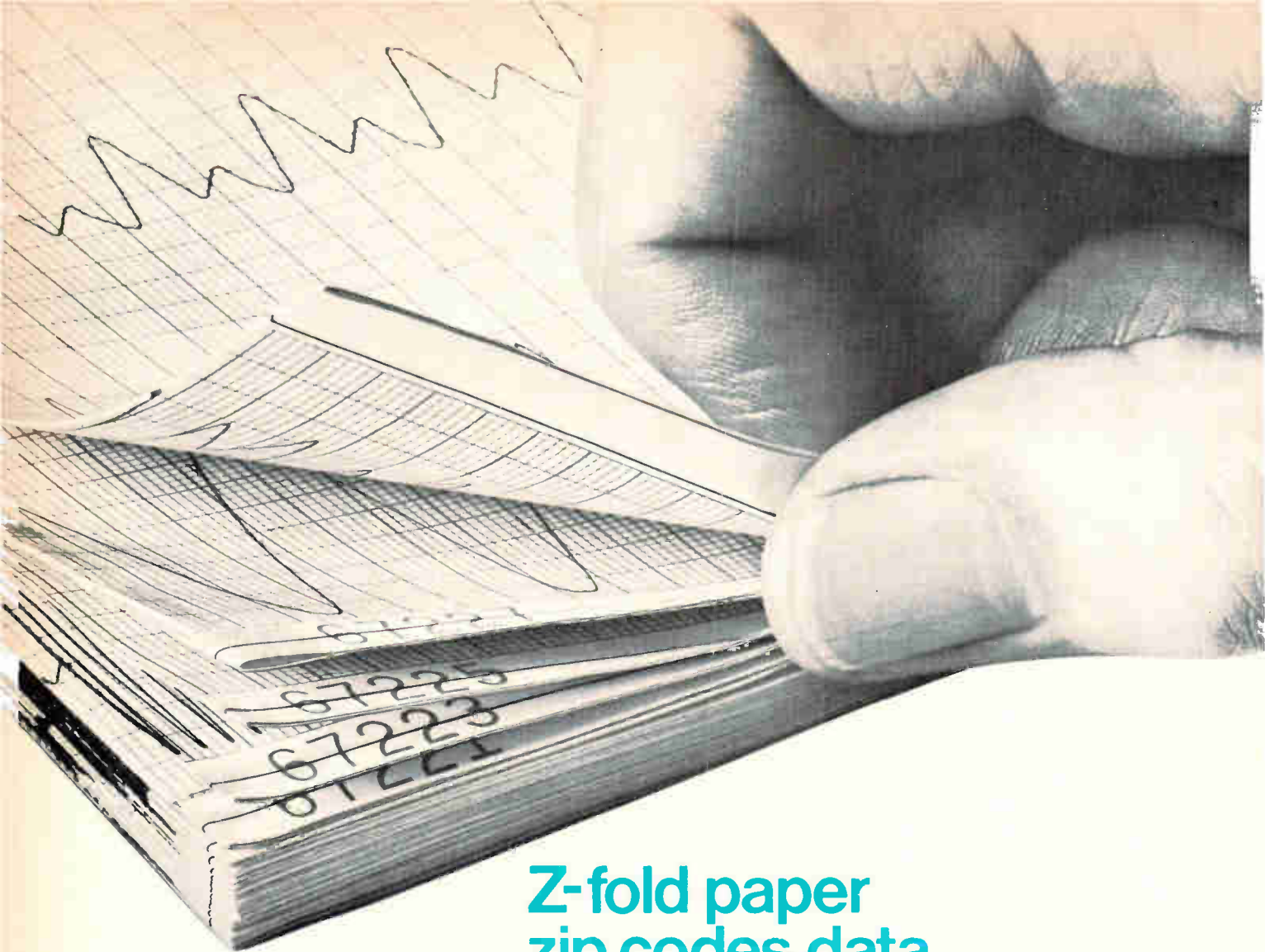

Z-fold paper zip codes data for quick retrieval

Data recorded on Z-fold paper by the Hewlett-Packard 7800 Series Rectilinear Recorder is instantly retrievable. Each page is numbered to simplify reference to recorded data. Z-fold chart packs store easily in their original cartons.

Contactless pen tip sensing and a *modulated pressure ink system* produce traces of equal density from all signals and throughout the recorder's variable speed ranges of .025 to 200 mm. per second. *You get blue ink reproducibility compatible to diazo or any similar process.*

Designed with modular, solid-state electronics, the 7800 Systems provide high-resolution, permanent, rectilinear recording of up to eight variables from dc to 150 Hz.

Eight 8800 Series Preamplifiers provide signal conditioning to the driver-amplifiers which drive the recording pens. The recording system is available with eight different or eight identical preamplifiers of your choice. Frequency



response of the recorder is 150 Hz for 10 div p-p deflection and 58 Hertz maximum for full scale deflection. Maximum ac or dc non-linearity is 0.5% full scale. Additional features include: choice of chart paper in Z-fold packs or rolls; 14 electrically-controlled chart speeds; built-in paper take-up; ink supply warning light; disposable plug-in ink supply cartridge that may be replaced while the recorder is in operation and modular construction for easy maintenance.

For complete information on the 7800 Series, optional and related equipment, contact your local HP Field Office or write Hewlett-Packard, Waltham Div., 175 Wyman St., Waltham, Mass. 02154. In Europe: 1217 Meyrin-Geneva, Switzerland.

HEWLETT **hp** PACKARD

RECORDING SYSTEMS

Circle 198 on reader service card

17802B

Converting 10 bits in 1 microsecond

Successive approximation gives a-d device high speed and high resolution for real-time processing jobs

Speed versus resolution is an almost universal tradeoff, and analog-to-digital converters are no exception. Those that work very fast—at 4 to 5 megahertz—have a resolution of only 6 to 8 bits. Those with a resolution of 14 or 15 bits dawdle along at 15 kilohertz.

Until recently, this tradeoff was tolerable, but now, says James

Pastoriza, president of Pastoriza Electronics Inc., digital processing of radar data, real-time interaction with data processing equipment, and new forms of pulse or wave-shape analysis require converters of both high speed and high resolution.

A new fad. That's why the firm has developed its FAID-10 converter,

which takes only a microsecond to complete a 10-bit conversion.

"The FAID-10 is a complete converter module," says Richard A. Ferrero, sales manager. "Everything is on one board." This includes the reference power supply, high-speed switches, resistor network, comparison amplifier, and integrated-circuit TTL.

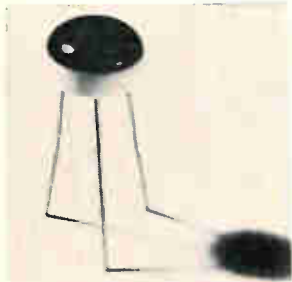

Silicon monolithic voltage regulators 2103, 2104 and 2105 include internal short-circuit protection, with a thermal feedback circuit to prevent excessive operating temperature. Each is designed for a positive regulated output at +15 v, and contains its own voltage reference element for voltage regulation to 0.1%. Philbrick/Nexus Research, Allied Drive, Dedham, Mass. [381]

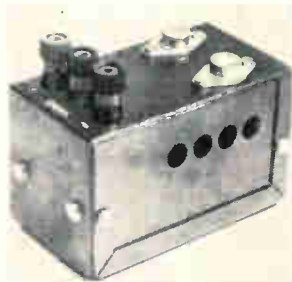

Regulated power supply model 15-15-100 uses silicon solid state throughout. It provides two outputs, nominally +15 v and -15 v d-c, separately adjustable over a $\pm 10\%$ range, and regulated to within 0.05% for both load and line variations. Output is 100 ma max. from each output terminal. Accelerated Electronics Industries Inc., 233 Orchard St., New Haven, Conn. 06511. [382]

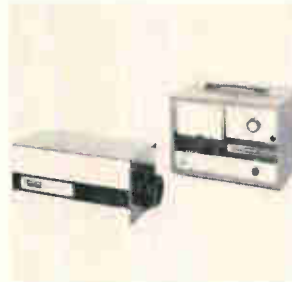

YAG laser system 400Y comes in over 12 different configurations to fill many needs. From several hundred mw of continuous green light at 5,300 angstroms for underwater tv, holography and aerial mapping, to over 20 w of continuous infrared power at 10,600 angstroms for materials fabrication work, are offered. Control Data Corp., 535 Broad Hollow Road, Melville, N. Y. [383]

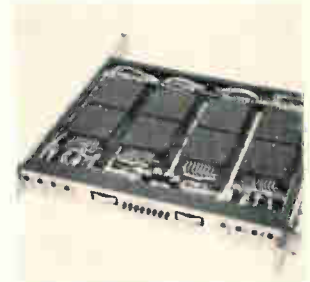

Fully assembled power systems use standard IC power components and accessories. They consist of a thin-line rack adapter, which can accommodate up to 8 power modules, 8 overvoltage protectors, 8 individual power control panels, a metering panel with 2 meters, fuses and selector switch, 4 connecting cables and 2 chassis slides. Lambda Electronics Corp., Melville, N.Y. [384]



Modular power supplies series AN3000 measure $2\frac{3}{4} \times 6 \times 3\frac{1}{8}$ in. over-all, and provide all voltages necessary for the operation of practically any combined analog-digital, discrete, hybrid, or integrated circuitry. All four models in the series use silicon semiconductors and operate from 0° to 70°C. Prices, \$94.50 to \$124.50. Analogic Co., Newton St., Waltham, Mass. [385]

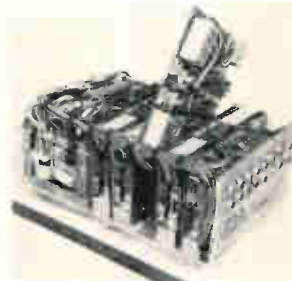

Subminiature, switching type airborne power supply features efficiencies of 60 to 70% through use of latest type IC's. It is capable of 25 amps at ± 5 v. It can operate at full load at ambient temperatures as high as +115°C and down to -55°C without de-rating. Unit is $2.5 \times 4 \times 6.2$ in. It meets MIL-I-6181. Bergen Laboratories, Inc., 60 Spruce St., Paterson, N.J. [386]



Plug-in analog multiplier model AM701 combines solid state integrated circuitry with the proven magnetoresistor bridge to obtain analog multiplication. It accepts ± 10 -v signals and delivers ± 10 -v output at 5 ma with a one quadrant accuracy of $\pm 0.40\%$ of full scale. Price in lots of 1 to 24 is \$98.50 each. American Aerospace Controls Inc., Farmingdale, N.Y. [387]



Regulated d-c power supplies are available in two models: PSR-12-25 with output from 0 to 25 v d-c, 0 to 500 ma, and PSR-12-50 with output of 0 to 50 v d-c, 0 to 250 ma from input of 105 to 125 v 60 hz. Line regulation is 0.01% +2 mv, load regulation is 0.01%. Ripple is less than 100 microvolts. Electro Products Laboratories Inc., 6125 Howard, Chicago. [388]

**WHY SETTLE FOR LESS?
GET TOP
PERFORMANCE
WITH
DELTA'S FABULOUS
MARK® TEN**

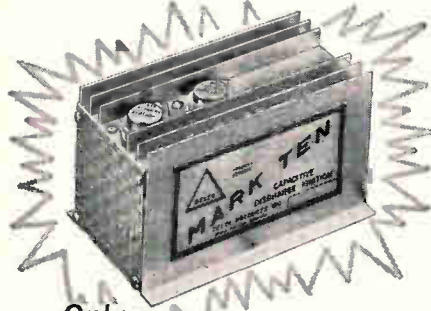

Only
\$44.95 CAPACITIVE
ppd. DISCHARGE
IGNITION SYSTEM

Deltakit - Only
\$29.95 ppd.

You read about the Mark Ten in the April issue of Popular Mechanics!

Now discover why even Detroit has finally come around. In 4 years of proven performance and reliability, the Mark Ten has set new records of ignition benefits. No wiring. And works on literally any type of gasoline engine. Buy the original, the genuine, the real McCoy—Mark Ten. From Delta. The true electronic solution to a major problem of engine operation.

READY FOR THESE BENEFITS?

- ▲ Dramatic Increase in Performance and in Fast Acceleration
- ▲ Promotes more Complete Combustion
- ▲ Points and Plugs last 3 to 10 Times Longer
- ▲ Up to 20% Mileage Increase (saves gas)

LITERATURE SENT BY RETURN MAIL
BETTER YET—ORDER TODAY!

DP 7-B

DELTA PRODUCTS, INC.

P.O. Box 1147 E • Grand Junction, Colo. 81501

Enclosed is \$_____. Ship prepaid.
Please send: Ship C.O.D.

Mark Tens (Delta Kit) @ \$29.95
(12 Volt Positive or Negative Ground Only)

Mark Tens (Assembled) @ \$44.95

6 Volt: Negative Ground only.
 12 Volt: Specify Positive Ground
 Negative Ground

Car Year _____ Make _____

Name _____

Address _____

City/State _____ Zip _____



Closing the gap. Converter has both high speed, 1 megahertz, and high resolution, 10 bits.

FAD-10 uses a successive-approximation rather than a cyclical technique, with each comparison (or bit) completed within 100 nanoseconds. Thus 10 bits take about a microsecond for an operating speed around 1 Mhz.

For a given switching-speed and a full-range signal, successive approximation requires fewer conversions—and thus less time—than the cyclical technique.

Comparisons. In the FAD-10, input current is compared with up to 10 reference currents. The first current is the largest, the second is half the first, the third is a quarter as large, and so on. The comparison amplifier rejects each current in succession until one is found smaller than the input. FAD-10 then adds succeeding smaller references to close the difference between input and supply currents.

Since successive approximation is used, each conversion takes place in a fixed time. With the cyclical technique, conversion time depends on the ratio between the data being converted and the level of the previously converted signal. The speed of a cyclical converter depends on how much and how quickly its input changes in amplitude.

Ferrero says that in multiplexed applications, where sampling is done at a set clock rate, the cyclical technique can be a disadvantage but that successive approximation lends itself to a fixed-rate multiplexing.

No buffering. The use of TTL IC's makes FAD-10's output levels compatible with today's fastest commercial computers. Pastoriga notes that with most memory systems capable of storage in the 1-microsecond range, the FAD-10 could be used to convert analog

data for direct consumption by a core memory. No buffering would be required, so the scheme could save money for main-frame builders and their customers.

Radar pulse analysis represents another potentially large market, according to Pastoriga. Accurate digital processing of returned pulses requires good resolution in a converter that will have completed its job before the next pulse arrives. And with some radar systems using pulse repetition rates of hundreds of kilohertz to boost average power, something like FAD-10 has become a necessity, Pastoriga says.

He lists as other application areas the input stages of fast Fourier computers, the converter sections of fast character-recognition systems, and digital filtering sections of doppler radar systems.

Specifications

Input voltage range	0 to +10 v
Input impedance	2.5 kohm
Trigger	50-nsec pulse
Differential linearity	± 0.5 lsb
Output code	10-bit parallel binary
Output levels	0, less than 0.5 v 1, more than 2.5 v
Price	\$2,975

Pastoriga Electronics Inc., 385 Eliot St.,
Newton, Mass. 02164 [389]

New subassemblies

**System steps in
when power fails**

Battery-driven source

assures continuous

250-kva input

The advent of real-time data systems has brought with it the need for power sources that can't fail. Many users of these data units have met this need by installing uninterruptible power systems (UPS)—battery-powered sources of three-phase power that supply energy to a load when the commercial power's voltage or frequency is out of tolerance.

A recent entry in the UPS market is the Avtel Corp., a division of Airtronics Inc. Bruce Ballard, the division's marketing director, says

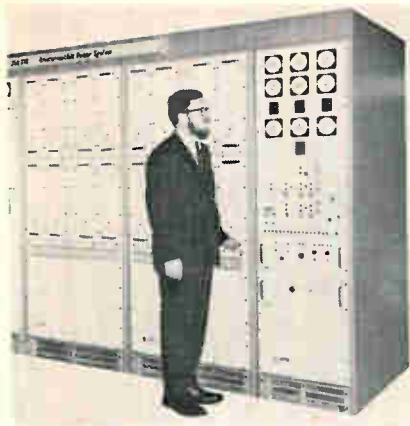

Always ready. The 250-kva system has battery chargers that are run from the commercial power lines.

that Avtel will be competing with four companies, but he feels that his firm's new 250-kilovolt-ampere system tops the opposition in many critical areas and is still competitively priced.

That competitive price is 70 cents to \$1 per volt-ampere, which means the Avtel system costs around \$200,000. This sounds steep but Ballard points out that many potential customers just can't tolerate power failures, no matter how short their duration. Avtel has already sold one system for use in a computer message-switching application. Other places the system might be needed are at radar and communication centers, in airline reservation systems, and in hospital data-gathering systems.

UPSmanship. Avtel's system takes up, including room for the operator, 250 square feet of floor space. Ballard says that this is about one fourth the area needed by competitors.

Like competitive units, the Avtel system has a bank of batteries that drives a solid state inverter, which in turn generates the system's output. The system also has battery chargers which are driven by commercial lines, or whatever else is being used as primary source.

Ballard says that the Avtel inverter design is one of the principal features that sets the 250-kva system apart from competitors. Silicon controlled rectifiers are used by most manufacturers of UPS to generate the a-c output. Avtel also uses SCR's, but in a manner different from its competitors.

One competing system, says Bal-

NEW DELTA DESIGN!

MODEL 3000 FET VOM

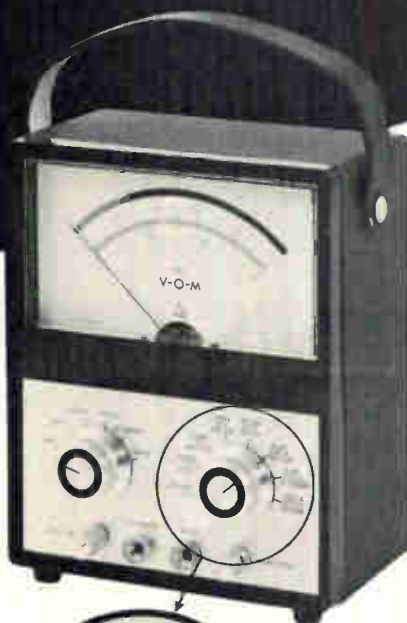

A unique and efficient instrument bridging the gap between a multimeter and a digital voltmeter!

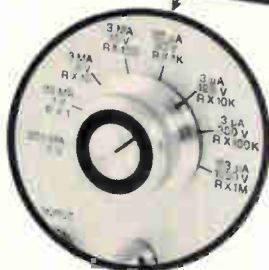

Delta, pioneer of the famous Mark Ten® CD System, now offers a compact, versatile, and extremely sensitive VOM which combines FETs and ICs for extreme accuracy. Compact (6½" W x 8" H x 3½" D), portable, wt. 3¾ lbs. In full production at only

\$74.95
ppd.

Would you believe:

1. Mirror scale 200 μ A D'Arsonval meter
2. Integrated circuit (IC) operational amplifier for extreme accuracy
3. FET input stage with current regulator
4. Two stage transistor current regulator and Zener diode on OHMS for absolute stability and accuracy
5. Voltage clippers for protection of input stage
6. Fully temperature compensated for low low zero drift
7. Ten turns ZERO and OHMS adjust potentiometers
8. Epoxy glass circuit boards and metal case
9. Enclosed switches
10. Uses readily available type AA cells
11. Uses standard test leads for maximum flexibility and ease of measurement
12. 10 Megohms input impedance

Available in Kit form: Feedback network with pre-selected components to eliminate all final calibration. Ready to use when assembled!

Kit:
Only **\$59.95** ppd.



DELTA PRODUCTS, INC.

P. O. Box 1147, Grand Junction, Colorado 81501

I enclose \$_____ Please send postpaid:

_____ Model 3000 FET VOMs @ \$74.95 assembled

_____ Model 3000 FET VOMs @ \$59.95 kit form

Name _____

Address _____

City/State _____ Zip _____

DP 8-7

Set-Point Control $\pm 1\%$

...made easy with Sensitak Models 11&12 Solid-State/Dry Reed Relays

- Overvoltage or Undervoltage
- Latch or On-Off types
- Isolated dry reed load contacts
- Operate on 1 Vdc and/or 1 mA
- -20°C to $+70^{\circ}\text{C}$ ambient

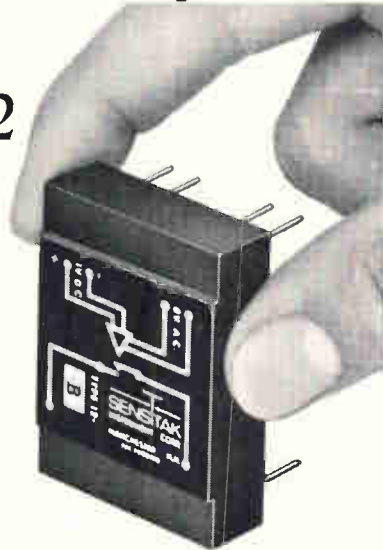

OVER/UNDER VOLTAGE MONITOR (metering relay)

For precise monitoring of a nominal 48 volt dc line connect overvoltage Model 12A and undervoltage Model 12B relays and an 8 Vac Model 13 power supply with both inputs across the 46 to 50 Vdc line through appropriate series resistors. Load switch on 12A closes when the input is 49 volts or more, and opens when the input falls below 49 volts. Load switch of 12B opens when the input is 47V or more, and closes when the input falls below 47V.

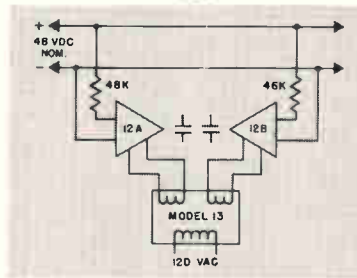

PRECISE OVERLOAD RELAY

Precise overload protection is provided by connecting a Model 11A overvoltage latching relay to a Model 13 power supply through a N.C. pushbutton switch. The input voltage powers the load through an NPN transistor connected so it is normally conducting. Potentiometer R is adjusted so the relay contacts latch when the load current exceeds 1 ampere. This removes the saturating bias from the transistor, thereby removing power from the load. Reset by momentarily depressing switch S.

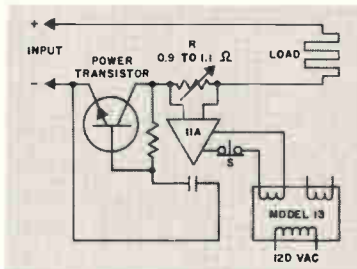

PRECISE LOGIC VOLTAGE MONITOR (wide or narrow differential)

This logic circuit monitors input variations from 20 to 80 Vdc. The load switch of a Model 11A overvoltage latching relay closes at 50 Vdc and remains closed while the input varies over a wide range. The 22K series resistor causes the reed switch of overvoltage on-off relay Model 12A to close at 23 volts, thus supplying primary power to the 11A which remains in standby until latched by a 50 volt input signal. The load switch of the 11A remains closed until the input drops below the 23 volt set point of the 12A at which time the switch on the 12A opens, thus unlatching the 11A.

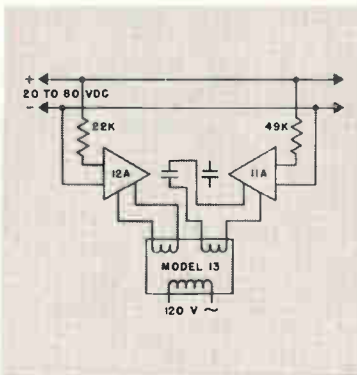

Get 4-page Bulletin B/10611. Write to:



SENSITAK INSTRUMENT CORP.

A WHOLLY-OWNED STRUTHERS-DUNN SUBSIDIARY
531 Front Street, Manchester, N.H. 03102

Telephone: 603-627-1432

8S-8114

202 Circle 202 on reader service card

lard, needs a large filter on the inverter output to get rid of unwanted harmonics. Another, he says, uses SCR's in a way that requires that the output be fed through a ferroresonator. "This is fine if the frequency and voltage are exactly right, but if the line fails and you have to go to battery operation, you need a big bank of batteries, which means more floor space and more cost."

Avtel's approach is to fire the SCR's in the inverter so that a 24-step waveform is generated. "These are proportional," Ballard explains, "so that the first harmonic we see on the output, without any filtering, besides the fundamental harmonic is the 23rd. By using a minimum of filtering on the output, we allow the unit to be insensitive to reactive loads. We can use a much smaller filter and the system is impervious to voltage and frequency changes."

Ballard also points to some specs when explaining why he feels Avtel has the best in show. The voltage transient is 5% when the load changes by 50%; there's no transient when the load is switched from UPS power to commercial power. The system's acoustic noise is low, says Ballard, so it can be used in a laboratory.

The first system that Avtel sold had lead-acid batteries but the system can also use nickel-cadmium and lead-acid calcium types.

Avtel Corp., 1130 E. Cypress St., Covina, Calif. [390]

New subassemblies

Inverter delivers 300 watts at 60 hz

Solid state device can be power source in the field or backup in the laboratory

Like a veteran song-and-dance man, the 1057 inverter can be the star of a small road company or the understudy in a big production.

Built by the Wilmore Electronics Co., the 1057 is a solid state device

Electronics | January 6, 1969

that converts d-c inputs, from 11 to 14.5 volts, into a 115-volt, 60-hertz signal. Output is 300 watts and frequency stability is 0.25%.

One type of customer that Wilmore built the inverter for is the engineer who works in such fields as oceanology or geology, where equipment ruggedness and portability is at a premium. The 1057 is powerful and stable enough to drive instruments such as oscilloscopes, videotape recorders, and



Cleanup. An optional plug-in filter cuts harmonic distortion of the inverter's output to under 5%.

seismographic devices. And in a pinch, it can even run motors and other gear usually driven by a small generator. The 25-pound unit is 7 by 7 by 11 inches.

Homebody. But Wilmore believes engineers who stay indoors will also find use for the 1057. When fitted with an optional automatic-switchover connection and a battery charger, the converter can be used as a backup source in a laboratory or operating room.

The company says the device's switching-mode waveshaper provides a three-level approximation of a sine wave that has the same ratio of peak to rms voltage as a normal sine wave. Where this approximation isn't close enough, Wilmore can supply a plug-in filter that's 85% efficient and reduces harmonic distortion to under 5%.

For input variations in the 11-to-14.5 volt range or a change of no load to full load, the out-put varies by no more than $\pm 5\%$.

In quantities of one to four, the 1057 costs \$200; delivery time is less than 30 days. Wilmore Electronics Co., Box 2973, West Durham Station, Durham, N.C. 27705 [391]

less than \$180 per function...



HEATH Universal Digital Instrument

Now you only need one instrument, the Heath EU-805A, to perform all these functions: Frequency, Period, Time Interval, Events count, Ratio, Integrating DVM, and Voltage Integrator. Combining in one package a DC-12.5 MHz Multi-Purpose Counter/Timer with a 0.05% accuracy Digital Voltmeter, the new Heath/Malmstadt-Enke UDI offers you unmatched versatility at less than \$180 per function! An original modular design based on TTL IC's plug-in cards protects the instrument from obsolescence.

The UDI features convenient fast cycling on slow time bases, continuous summing function, memory, 0.1 s to 30 s display time, 6 digit readout plus over-range.

The identical high-sensitivity (10 mV) input comparators provide 1 M Ω impedance, complete range of trigger controls (including Automatic Mode), oscilloscope monitoring of triggering point and four levels of input attenuation. Input pulse resolution is better than 50 ns. Time bases range from 1 us to 10 s and short term stability is better than 5 in 10⁹. Accuracy ± 1 count.

DVM section has Automatic Polarity, 5 x 10⁹ Ω input impedance on separate 1 V range (10 M Ω on the others), four ranges from 1 V to 1000 V, 10 μ V resolution, 0.1 s to 10 s integrating time and V-F output available at rear panel.

The UDI is obviously the instrument you need and it is obviously priced right: \$1250. Less DVM order EU-805D at \$940. DVM conversion pack costs \$340.

Many cards from the UDI may be used in the Heath/Malmstadt-Enke Analog Digital Designer EU-801A:

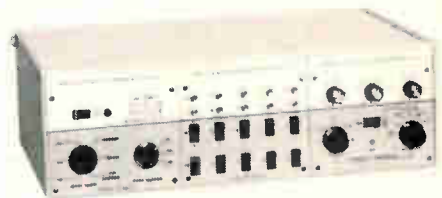

The ADD permits the design of various analog and digital circuits and instruments, by plugging-in logic cards into its power, binary and timing modules. Solderless connections are made with ordinary wire and component leads.

For full information send for the FREE NEW Scientific Instrumentation Catalog. An abridged Manual is available for \$3.50.

HEATH COMPANY, Dept. 580-04
Benton Harbor, Michigan 49022

In Canada, Daystrom Ltd.

- Please send Free New Scientific Instrumentation Catalog.
- Please send Manual EUA-800A, a special 250 pg. condensation of the manuals which accompany Heath Digital equipment ... \$3.50.

Name _____

Address _____

City _____ State _____ Zip _____

Prices & specifications subject to change without notice. EK-264





OVERHEAD CHOPPER:

Rent test instruments from Electro Rents.

Immediate Shipment from East
or West Coast Facilities.

Cut project hold-ups: with complete inventories, staff and Metrology Labs now on both coasts, we can deliver all the test equipment you need—anywhere—inside of 24 hours. **Cut**

down-time: gear arrives in-calibration, NBS-traceable, ready to plug in, functioning up-to-spec. **Cut extra overhead:**

While you're renting, we take care of maintenance, repairs, replacements.

Cut capital expense: for the short haul, you're money ahead when you rent from us. Make sense? Make haste: call, wire, or write for our brochure.

WEST COAST (Main Office & Laboratories)

4131 Vanowen Place, Burbank, Calif. 91504 • Phone: (213) 843-3131

EAST COAST (Warehouse & Laboratories)

17 Park Place, Paramus, New Jersey 07652 • Phone: (201) 265-7500

Other locations: San Francisco, San Diego, Albuquerque, Denver, Phoenix, Dallas

Los Angeles: "Call TWX 910-498-2238"

San Francisco: "Call TWX 910-338-0202"

Electro Rents

Multichip triac package replaces relays

Single epoxy case holds six devices for applications in tv sets, home appliances, and automotive controls

Packaging costs have been a big drawback in making semiconductors for control jobs. It's common for packages to cost three times as much as the chip, says Harry Goff, a vice president of the Electronic Control Corp. ECC has an answer, though. It's putting six 1.6-amp triacs in one epoxy package. And to make things simpler as

well as less expensive for the user, the triggering devices for the triacs can be included in the package. The company calls this combination a Quadrac.

The problem of sealing the triacs in a plastic package has been overcome by the use of substrate-mounted semiconductors. The company applies what it calls a "unique

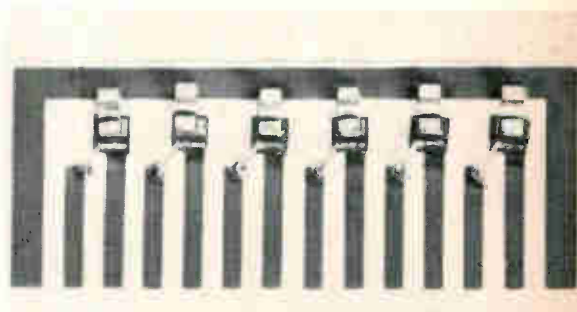

All in one. Six Quadracs mounted on a single substrate are ready to challenge electromechanical relays.

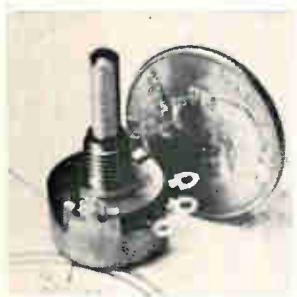

Low-noise commercial potentiometer model 381 is a 5/8-inch 1-w device with 1% dynamic noise and 5% maximum independent linearity. Resistance range is 100 ohms to 5 megohms linear, 500 ohms to 2 megohms tapered. Resistance tolerance is $\pm 10\%$ through 0.5 megohm, $\pm 20\%$ over 0.5 megohm. Voltage coefficient is 0.008%/v max. Clarostat Mfg. Co., Dover, N.H. [341]



Single-turn resistance trimmers type AFR are designed for 0.1-inch p-c grids. Rated at 1/2 w, the units' design includes a hot-molded resistor track and low resistance collector track bridged by a single moving contact brush. Fifteen models cover the resistance range of 100 ohms to 5 megohms, $\pm 20\%$. Price (1-9) is \$3. Ohmite Mfg. Co., 3601 Howard St., Skokie, Ill. 60076. [342]



Small, rugged up to 165 w, 400 hz Thin-Tran power transformers are designed to meet MIL-T-27B Class V for operating temperatures to 155°C. The thin shape of the units (1 3/8-inch thick) is achieved by use of widely distributed, shallow windings of high temperature wires. Price is from \$139. Arnold Magnetics Corp., 11264 Playa Court, Culver City, Calif. 90230. [343]

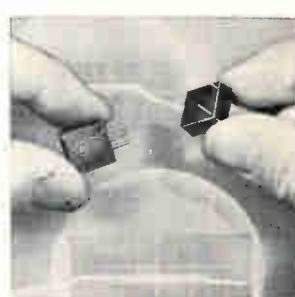

Miniature suppressor LVP-6 protects printed circuits from transient voltages. Connected to the d-c input of the printed circuit, it is effective against very slow rising as well as very fast rising voltages. It can be provided with nominal clamping voltages from 6 to 25 v with tolerance of 5, 10 or 20%. Price (100 lots) is under \$3. Dale Electronics Inc., P.O. Box 180, Yankton, S.D. [344]



All-purpose, compact vacuum relay H-11/S2 is for h-v applications commonly associated with radar, communications, pulse-forming networks and medical electronic systems. Specs include spst contacts, rated operating voltage of 12 kv in air and 18 kv in oil. Price (1-9) is \$110 each. High Vacuum Electronics Inc., 538 Mission St., South Pasadena, Calif. 91030. [345]

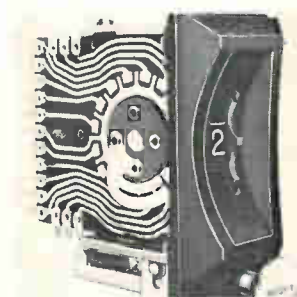

Precision thumbwheel switches series TIR offer a convenient push-button instant-reset-to-zero feature. Uses include industrial and military applications requiring presetting of thumbwheel switches from a zero position. The instant reset feature saves time and avoids errors. Single module prices begin at \$14.75. Chicago Dynamic Industries Inc., 1725 Diversey Blvd., Chicago [346]



Cermet-element adjustment pot model 3009 is a 20-turn E-Z-Trim type measuring 0.75 x 0.19 x 0.35 inch. Data code traceability and $\pm 0.05\%$ settability are featured. Resistance range is 10 ohms to 1 megohm. Power rating is 0.75 w at 25°C. Temperature coefficient is ± 150 ppm/°C max. Price (500 lots) is \$1.45 each. Bourns Inc., 1200 Columbia Ave., Riverside, Calif. [347]

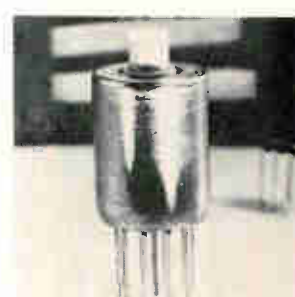

Ten-position continuous turn rotary switch type 3 is designed for use with IC's. Basically a single-pole configuration, the switch is also available with stops to limit rotation to 2 through 10 positions. It offers up to 1/2 amp at 28 v d-c, 0.1 amp at 120 v a-c noninductive. It measures 1/8 inch in diameter, 0.687 inch high including leads. Oak Mfg. Co., Crystal Lake, Ill. [348]

Interference or Information?

With active filters, the choice is yours.

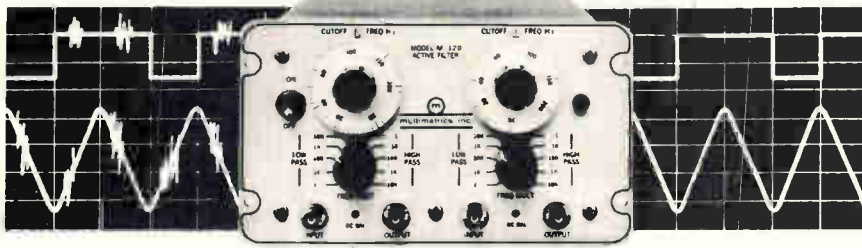

Here are examples of what we think effective signal conditioning should be:

Series AF-100-20Hz to 2MHz.
Series AF-200-0.2Hz to 20kHz.

High pass, low pass, band pass and band reject. Continuously adjustable cutoff frequency. Selectable frequency response flatness (Time Domain/Butterworth). Unity pass band gain. Attenuation slope of 24



db/octave and 48 db/octave. Series AF-400-.01Hz to 99.9kHz. Digitally tuned.

Series AF-500-0.2Hz to 20kHz. Empirically tuned.

Series AF-300-.001Hz to 200kHz. Fixed frequency modules. Especially if small size is a big consideration. So look into active filtering. And separate the waves from the noise.



multimetrix, inc.

401 Concord Avenue, Bronx, N. Y. 10454 (212) 665-6484

Circle 264 on reader service card

NATIONAL®

Regenerative Gate* SCR

lowest switching losses

Operates to 20 KHz with switching losses lower than any other high power SCR available. Ideal for inverters, choppers, DC to DC converters, cycloconverters. Only the Regenerative Gate* SCR gives 600 amperes/ μ sec. di/dt with low power gate drive. 110 ampere rating available with 200 volts/ μ sec. minimum dv/dt and 10 μ sec. maximum turn-off time.

*A NATIONAL® exclusive, Patent Pending.

NATIONAL
ELECTRONICS, INC.

a varian subsidiary

PHONE: (312) 232-4300 • GENEVA, ILLINOIS 60134

REQUEST BULLETIN



... tv makers plan to use them in remote controls ...

glass passivation technique" in which the wafer is completely covered with glass that's then removed from all areas except junctions. These remain filled with glass to provide the necessary sealed protection.

Savings. The technique reduces packaging costs, and ECC is also realizing labor economies by manufacturing its devices in Matamoros, Mexico.

Goff describes the device as a direct replacement for mechanical relays in many applications. The substrate fits directly into slotted printed-circuit boards and can be hand- or flow-soldered. Made of alumina with precious-metal contacts, it comes in 1- or 2-inch-by-0.850-inch configurations.

At least two major television manufacturers plan to replace the electromechanical relays in the remote-control systems of their 1970 color sets with the new device. One is now paying 68 cents each for U.S.-made relays, while the other is laying out 40 cents for devices imported from Hong Kong. According to Goff, ECC will be supplying Quadrac modules to both firms at a cost of about 40 cents per function.

Easy assembly. The semiconductor controls, besides matching or undercutting the prices for electromechanical relays, are expected to save the set makers considerable labor expenses and other costs. The remote-control systems require six relays now, with all the attendant soldering and connection steps, but the semiconductor module can be installed in a single assembly step.

Car makers are also eyeing the Quadrac module as a replacement for relays, variable resistors, and switches. As one auto industry spokesman puts it, "What we need is a multifunction unit with all of the triacs in one cheap and rugged package."

ECC expects its device to find a place in a wide range of switching and timing applications in home appliances. The cost in applications where more than a single switching function is required is

TURN to Grayhill
When Only Excellent is Adequate

**for MINIATURE
 PUSH BUTTON SWITCHES**

- WIPING, SNAP ACTION and BUTT CONTACTS.
- SPST, SPDT, DPST, DPDT.
- PUSH-PULL — LIGHTED.
- 25,000 to 1,000,000 OPERATIONS.

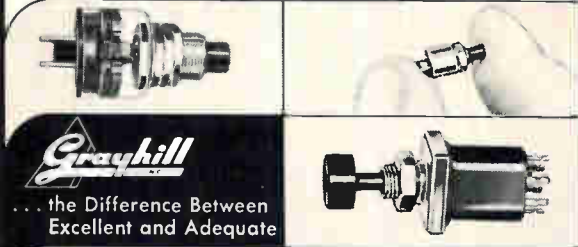

Grayhill
 ... the Difference Between
 Excellent and Adequate

- Select Materials**
- Contacts — Fine Silver
 - Springs — Tinned Music Wire
 - Housing — Molded Phenolic per MIL-M-14
 - Shorting Bar & Terminals — Fine Silver or Silver Plated Copper Alloy

- Typical Specifications:**
- ¼ Amp. to 10 Amps., 115 VAC Resistive
 - Contact Resistance 10 Milliohms
 - Insulation Resistance — 25,000 to 900,000 Megohms

All fully described in Engineering Catalog G-304-A
 Write



523 Hillgrove Avenue
 LaGrange, Illinois 60525
 Area Code 312, Phone 354-1040

"PIONEERS IN MINIATURIZATION"

Circle 265 on reader service card

**Measure phase
 easily,
 directly,
 and accurately**

ACCURACY $\pm 1^\circ$ WITH LARGE SIGNAL-TO-REFERENCE RATIOS ... $\pm 0.5^\circ$ WITH SMALL SIGNAL-TO-REFERENCE RATIOS ■ CONTINUOUS 0° TO 360° READINGS ■ EXPANDED SCALES FOR ACCURATE AND EASY READING ■ ACCURACY INDEPENDENT OF ANGLE ■ DIGITAL RATIO-METRIC READOUT AVAILABLE ■ ACTON LABS' 329B PHASE METER.

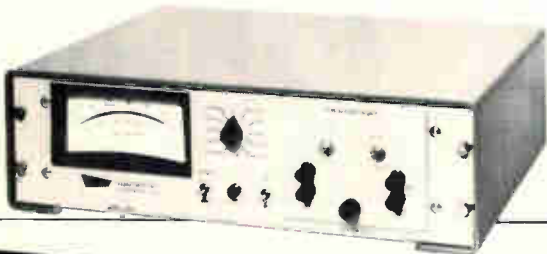

BOWMAR ACTON LABORATORIES, INC.
 A Subsidiary of Bowmar Instrument Corporation
 531 Main Street ■ Acton, Mass. 01720 ■ (617) 263-7756

Circle 266 on reader service card

*-100°F to +350°F
 temperature
 chamber
 for only
 \$335!*



**FROM ASSOCIATED — a full-range
 lab-designed temperature chamber
 at the lowest price anywhere.**

Only Associated — the country's leading environmental testing laboratory would engineer this full-range low-high temperature chamber at a price every lab can afford. Designed for development, quality control and production test of small parts and assemblies, Model RW-1100 offers many big chamber features in a compact, economical bench unit, including:

- temperature range from -100°F to $+350^\circ\text{F}$
- one-half cubic foot work space
- door-mounted temperature readout
- solid-state temperature controller
- control stability to $3/4^\circ\text{F}$
- liquid CO_2 cooled

Catalog M-7 has complete data. Call or write today for your copy.

**ASSOCIATED TESTING
 LABORATORIES INC.**



200 Route 46, Wayne, New Jersey • (201) 256-2800
 West Coast Office:
 6100 Wilmington Ave., Los Angeles, Calif. 90001 • (213) 589-9196

Circle 207 on reader service card

207

PROGRAM VOLTAGE OR PROGRAM CURRENT WITH KEPCO AUTO-CROSSOVER POWER SUPPLIES

By PROGRAM, we mean the exercise of intentional control over the output of your power supply — a regulated supply that remains quiescent — unmoving, stable until it receives your command signal.

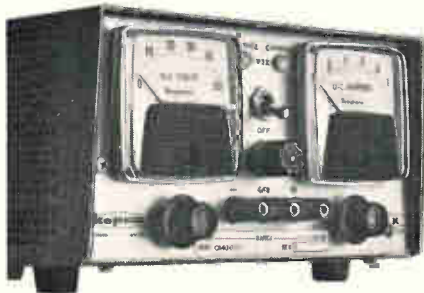

Model CK-36—1.5M voltage/current regulator showing Kepco's exclusive mode indicator lights—VIX®. This half-rack power supply delivers 0—36V @ 0—1.5A.

You can signal with analog voltage or current or resistance or conductance. Or, you can get fancy and use digital control. Kepco's 6 CK models offer complete control over both voltage (0—2V to 0—60V) and current (0—8A to 0—0.5A) the half-rack design may be bench mounted or installed in a single or dual 19" rack adapter. Write Dept. AP-14 and we'll tell you about the 16 programming terminals available on all models.

**with KEPCO
IT'S CONTROL!**



131-38 SANFORD AVE. • FLUSHING, N.Y. 11352
(212) 461-7000 • TWX # 710-582-2631

lower than or competitive with that of most conventional single-pole relays, according to ECC. The company can supply SCR's in the same configuration. And on special order, more than six chips can be packaged together.

Electronic Control Corp., 1010 Pamela Drive, Euless, Texas [349]

New components

Fast switching in the K-band

Series of 27 switches
boasts nanosecond speed;
work up to 15,500 Mhz

When it comes to making switches, engineers at the G-L Microwave Corp. don't take any chances on slighting someone. Instead of bringing out one or two new devices, the company has introduced a line of 27 single-pole-single-throw switches covering a range from 30 to 15,500 megahertz. All, according to the company, feature low insertion loss and fast switching speeds.

The S1110L, for example, handles signals ranging from 30 to



One of 27. This model, the S15459L, switches 5,400-to-5,900-Mhz signals in 50 nsec. Vswr is 1.25.

1,000 Mhz; its insertion loss is 0.6 decibel, and switching speed is 5 nanoseconds. This switch has 50 db of isolation, and a voltage standing-wave ratio of 1.30; it handles 10 watts average and 30 watts peak.

At the other end of the line is the S115016L. This switches sig-

ESC DELAY LINES SOLVE

high density packaging problems

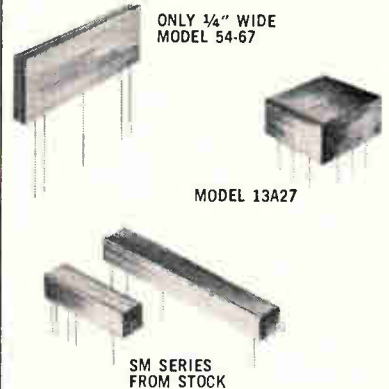

An example of ESC's sophisticated design capability is our Model 54-67 (size: 3"L x 1/4"W x 1/2"H). Used in an airborne application, this rugged flat pack unit has a time delay of 29 usec. with a tap at 11 usec. The rise time is 1.8 usec. maximum with an impedance of 400 ohms and an attenuation of 2 db maximum.

Our Model 13A27 (size: .490"L x .490"W x .370"H) is transfer molded and illustrates a low cost, high production run unit. Designed for printed circuit board use in a computer application, the 13A27 has become one of a series of "custom standards" to a valued ESC customer. It has a time delay of 7 nsec. with taps at 4, 2 and 1 nsec.

The SM series of subminiature nanosecond delay lines provides a high figure of merit in a small volume without compromising reliability. Standard items range from 10 to 1,200 nsec. at impedance levels of 100, 200 and 500 ohms. Available off-the-shelf in two standard sizes: 1" x 0.32" x 0.32" and 2" x 0.32" x 0.32", both with 1/2" leads.

All ESC delay lines conform to MIL-D-23859A.

Write for complete catalog.

ESC ELECTRONICS CORPORATION

a subsidiary of Simmonds Precision

534 Bergen Blvd., Palisades Park,
New Jersey 07650 • (201) 947-0400

World's Leading Designer and Producer
of Delay Lines

... video signals turn
a diode off and on ...

nals in the 15,000-to-15,500-Mhz range at a speed of 50 nsec. Its isolation is 0.9 db and its vswr is 1.50. Average power which can be handled is 5 watts; peak is 100 watts.

The S112L has the lowest insertion loss—0.3 db—and the lowest vswr—1.15. The fastest switches turn on or off in 5 nsec, and the slowest in 100 nsec. Also, some models can take 6 kilowatts peak.

Blocks. All the G-L switches are strip-line devices. The switching element is a diode which goes from the blocking to the conducting state when a video signal passes through it.

The on-state bias is +50 milliamps or -50 volts; off-state values are +25 ma or -18 volts.

Nine models of the switch come in packages that are 3½ by 2 inches by ½ inch; the others, higher-frequency devices for the most part, are in packages 2½ by 1½ inches by ½ inch.

The company says the devices can be used anywhere it's desired to turn microwave power off and on at high speed; chopping a wave or blanking an antenna are two examples.

Prices vary from model to model but typical unit price for small quantities is \$145. Delivery time is 2 to 3 weeks.

Specifications

Model number	Frequency range (Mhz)
S1110L	30-1,000
S112L	100-250
S112H	100-250
S125L	250-500
S125H	250-500
S151L	500-1,500
S151H	500-1,000
S11020L	1,000-2,000
S11011H	1,020-1,100
S11416H	1,400-1,600
S11724L	1,700-2,400
S11040L	1,000-4,000
S12223H	2,200-2,300
S12080L	2,000-8,000
S17040L	2,000-4,000
S13337H	3,300-3,700
S14450H	4,400-5,000
S14450HF	4,400-5,000
S14080L	4,000-8,000
S15459L	5,400-5,900
S15459H	5,400-5,900
S17484L	7,400-8,400
S18012L	8,000-12,400
S18596L	8,500-9,600
S11012L	10,000-10,250
S113514L	13,500-14,500
S115016L	15,000-15,500

G-L Microwave Corp., 825 Black Oak Ridge Rd., Wayne, N.J. 07470 [350]

PROBINGnAGIANS!*

**BARNES 039 SERIES DIP
CARRIERS/CONTACTORS
AND SOCKETS FOR
MSI/LSI PACKAGES**



Here are the Big Ones from Barnes! Use them with DIP MSI/LSI packages up to 40 leads, lead spacing of 0.100" and row spacing of 0.500" or 0.600". They eliminate lead deformation in handling, test and shipping, assure reliable electrical contact with positive retention. Carriers and contactors insure correct device polarization. Wiping type contacts in sockets prevent distorting DIP lead taper. Write for the big story.

*We still make the Lilliputians too.



Lansdowne, Pa. 19050 • 215/MA2-1525

barnes / THE FIRST WORD IN CARRIERS, CONTACTORS AND SOCKETS FOR I.C.'S

Circle 268 on reader service card

NORTON Magnetic Tape Heads



SERIES 2000

Crosstalk—60 DB
+75°C Temperature Operation

Send now for complete technical literature.

NORTON

ASSOCIATES, INC.

10 Di Tomas Court, Copiague, N.Y. 11726
Phone: 516 598-1600

**T.C. of ± 20ppm/°C,
std. tolerance of 1%
in new models of DIPLOHMATIC
POWER RESISTORS
with welded terminations**

MOD. 280
2W

MODEL 281
3W

MODEL 881—5W
MODEL 882—7W

PRECISION WOUND on ceramic cores, with welded terminations. Ceramic sleeves, zircon sand filled. Values from 1Ω. Available in standard tolerances of ± 1% to 0.1%. Production delivery 2 to 4 weeks. Price from 36¢ in 100 quantity.

FREE 12-PAGE CATALOG shows full line of wire-wound Diplohmatic resistors, 1 to 40W, also trimming potentiometers. Representatives in principal cities. Write Diplohmatic Division—

HARRY LEVINSON CO.

1211 E. Denny Way, Seattle, Wash. 98122
Tel. (206) 323-5100 TWX 910-444-2154

Pick a Taylorclad® copper-clad laminate ...and relax.

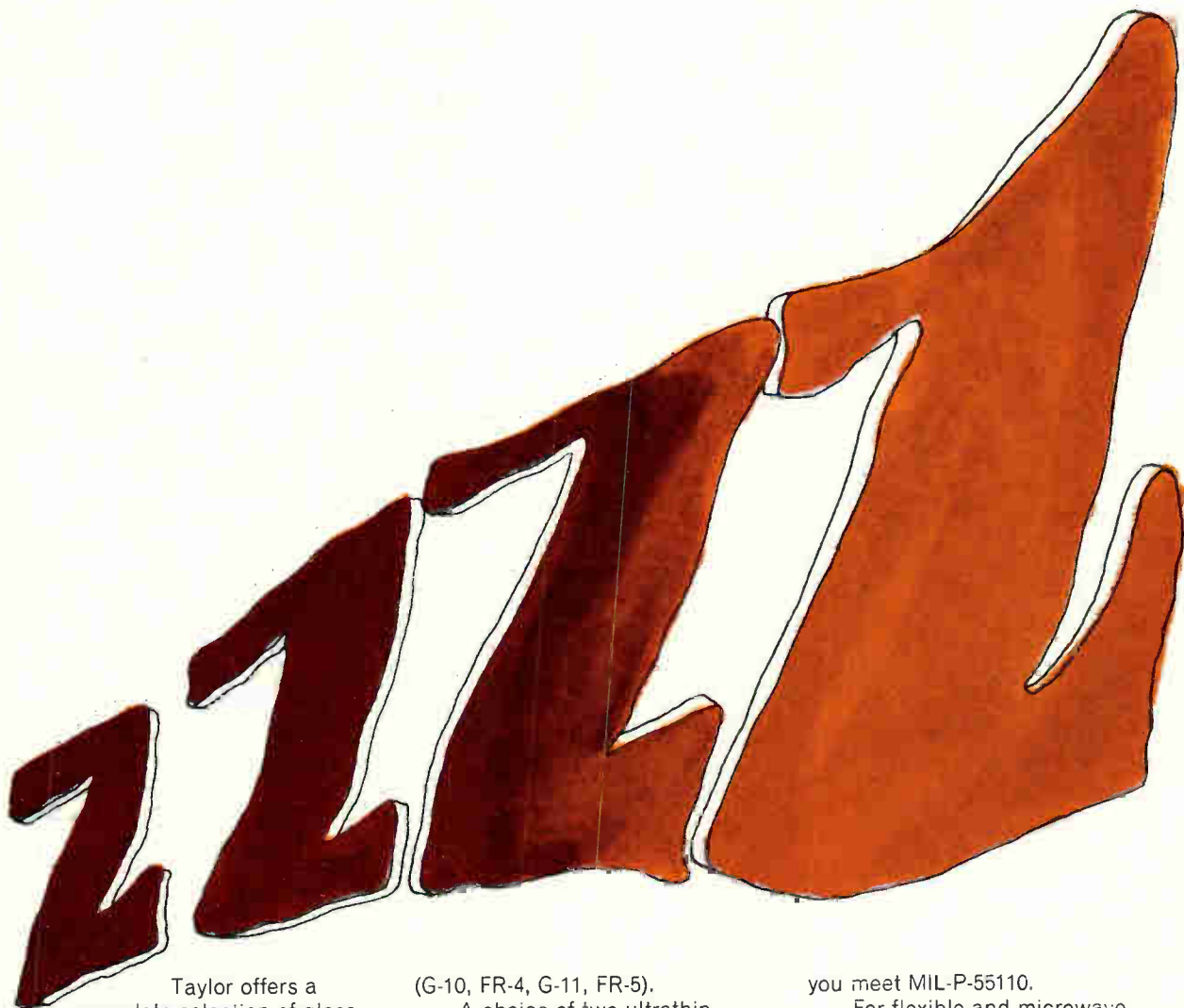

Taylor offers a complete selection of glass epoxy grades (rigid board and ultrathin) to meet Military, NEMA, and IPC specs.

Four glass epoxy rigid board grades to choose from—GEC 500 E (G-10), GEC 111 E (G-11); flame retardant grades: Fireban 600 E (G-10, FR-4), Fireban 1011 E

(G-10, FR-4, G-11, FR-5).

A choice of two ultrathin grades—GEC 550 (G-10) and Fireban 650 (FR-4).

Forms include sheets or whatever size panels you require. Prepregs are also available.

What else does Taylor offer you? Uniformly reliable products that mean processability to help

you meet MIL-P-55110.

For flexible and microwave applications, Taylor also offers a wide selection of flexible materials, including Kapton*, and Teflon*-glass copper-clads.

Ask about the choice of 7 different colors and other details on these quality Taylorclad products.

*TM Du Pont

Taylor corporation

See our exhibit at the NEPCON
West Show, Booth No. 362.

A subsidiary of Alco Standard Corporation
Valley Forge, Pa. 19461 • 215-666-0300
La Verne, Calif. 91750 • 714-593-1341
In Canada: Small Fibre Stampings, Ltd.
Scarborough, Ont. 416-751-6655
Manufacturer of Tayloron® Laminated Plastics,
Taylorite® Vulcanized Fibre, Tayloron® Prepregs,
Taylor Fabricated Parts

Air makes the going great for IC slices

Pneumatic currents of a photoresist-coating machine handle 1,360 units an hour without surface contact

Contact is fine for lovers and switches, but not for integrated circuits during fabrication. Now there's a new way to keep the IC wafers away from surrounding surfaces: a coating machine that transports them on air currents through the photoresist process and returns them to their carriers automatically. No handling is required.

The device is made by the Industrial Modular Systems Corp., whose president, C. Arthur Lasch Jr., says it offers a wide range of possibilities for introducing new production techniques to wafer fabrication. The air currents permit abrupt speed changes at any point along the conveyor system, and transportation of parts through fluids

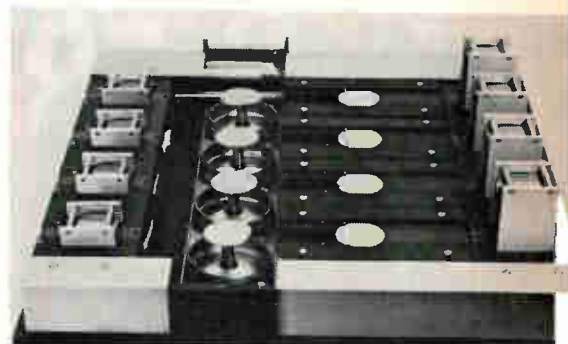

Airborne. Wafers at right move toward raised chucks for photoresist coating.



Automatic centrifugal tinning apparatus is for spin-coating p-c boards. It utilizes the advantages of hot tinning to form the intermetallic compound layer essential to reliable solder joints, and then a centrifugal force to remove excess solder and control layer thickness accurately. Results achieved meet with NASA specs. Electrovert Inc., 86 Hartford Ave., Mount Vernon, N.Y. [421]



Automatic tester model DA provides rapid test and sort of diodes. It will measure leakage currents as low as 1 na and peak inverse voltages up to 2,000 v. Forward voltage is measured with currents up to 10 amps. Standard test time is 16 msec, making it desirable to interface the tester with mechanical handlers. Lorlin Industries Inc., 30 Pandanaram Road, Danbury, Conn. [422]



Flip chip bonder model 2000 incorporates IC logic control. High production rates are due to the use of an automatic dice back up operation and positive alignment achieved through the use of an optical mirror system. Total cycle time of a complete bonded chip is less than 5 sec. Unit handles sizes from 1/4 to 3 sq. in. Hugle Industries, 750 N. Pastoria Ave., Sunnyvale, Calif. [423]

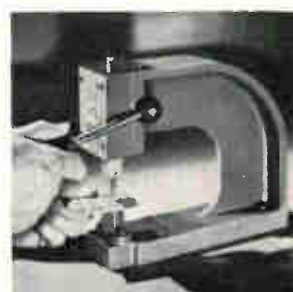

Staking machines called Accu-Ram are for eyeletting a variety of sizes including the 0.021 inch i-d used in printed circuitry. Two models, one hand actuated and the other pneumatically driven, feature a highly accurate ram and compensators to assure consistent mechanical fit to 0.0005 inch, and a limited travel spindle. Mark Eyelet & Stamping Inc., Wolcott, Conn. [424]



Circuit scrubber and cleaning machine model 500 is designed for cleaning copper and gold, or solder plated circuit boards. It uses 3 sets of adjustable non-loading abrasive brushes in its scrubbing section to produce simultaneous, two-sided cleaning action as well as a variety of surface finishes. General Products Laboratory, 111 Lock St., Nashua, N.H. 03060. [425]



Automatic wafer cleaner model 900 is designed to improve yields by removal of contamination between various steps in the processing of silicon semiconductor slices. The timed cycle includes a slow spin with deionized-water spray while blanketed with nitrogen, followed by a high-speed spin with dry nitrogen blowoff. Macronetics Inc., 220 California Ave., Palo Alto, Calif. [426]



Semiautomatic operational amplifier tester model 5102 is useful for production line checking. It will test both the dynamic and static characteristics, including common mode rejection and power supply rejection of linear integrated circuits as well as discrete operational amplifiers. Price is \$1,400. Philbrick/Nexus Research, Allied Drive, Dedham, Mass. 02026. [427]

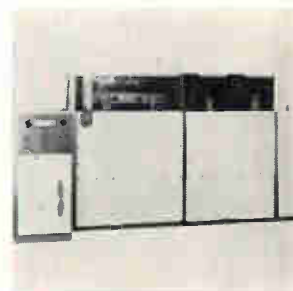

Medium-size conveyerized spray etcher model V-20 is for production of printed circuits and small metal parts. It provides automated double-sided etching of material 20 inches wide and of continuous length. The system's 44 spray nozzles, 4 inches apart on 4 manifolds on top and 4 on the bottom give complete acid coverage. Pemco, 4930 West 35th St., Minneapolis 55416 [428]

TRYGON HAS THE POWER

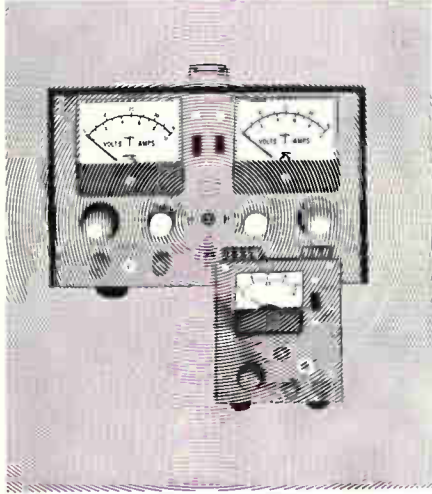

**to deliver these
two great laboratory
supplies immediately.**

Trygon's economy EAL and precision DL-series laboratory power supplies are available—right now—from 36 sales offices, nationwide. So when we say you'll have them, you can depend on it. You can also depend on them.

The versatile DL Series gives you two independent dual-range supplies (0-20V @ 1 amp or 0-40V @ 0.5 amps) in one half-rack package. And you can run them independently, in series or in parallel (from 20V @ 2 amps up to 80V @ 0.5 amps. All for \$249, only a few dollars more than comparable single-output units.

The compact EAL fits in a corner of your bench and your budget (only \$99) and comes in the four most commonly used laboratory voltage ranges: 0-10VDC @ 1.0 amp, 0-20VDC @ 500 mA, 0-32 @ 300 mA, and 0-50 @ 250 mA.

Both the EAL and the DL come complete with combination volt/ammeters and both give you .01% regulation, .05% stability.

Put Trygon power to work for you. Today. For the name of the sales office nearest you, call us collect.



TRYGON POWER SUPPLIES

111 Pleasant Avenue, Roosevelt, L.I., N.Y. 11575
Trygon GmbH 8 Munchen 60, Haidelweg 20, Germany
Write for Trygon 1968 Power Supply Handbook.

Prices Slightly Higher in Europe

... in an hour, out come
1,360 coated wafers ...

and in a wide variety of temperature ranges.

No standing. The company is negotiating with a semiconductor company to develop a handling system that will operate at diffusion-oven temperatures and, according to Lasch, "result in big differences in semiconductor device characteristics." Moving the wafers throughout the entire furnace by air would eliminate diffusion variations that result when the wafers stay at a particular spot in the furnace. Lasch says the wafers could be brought up to temperature rapidly, permitting shallower diffusion for higher-frequency operation.

In addition to the machine, called the 6604, the company is developing an etcher and a photoresist stripper that will use the air-transport mechanism. Lasch says any industry that requires transportation of parts or material through an unusual environment or requires delicate handling can use air bearings. With this technique air currents at relatively low pressure (typically 65 pounds per square inch) arrive at the transportation surface through a single row of 10- by 20-mil holes; the air ducts bend in the direction in which the part will move.

Change in direction. As air passes through the holes to the surface, its flow tends to diverge from the transportation surface of the conveyor. However, a phenomenon first described by Henri Coanda and called the wall attachment effect forces a change in the direction of flow so that the air current flows parallel to, and just above, the transport surface. In fact, a vacuum is created on the bottom of the air flow. This vacuum combined with the atmospheric pressure acting on the top of the air current deflects the flow. Semiconductor wafers are supported by the air current and move with it; the speed of parts moving along the conveyor is determined by the pressure of the flow.

The machine, which can handle 1,360 units an hour, costs \$15,000. It has four vacuum chuck spindles fed from four wafer carriers, each

**SUPERIOR
COAXIAL
ATTENUATORS**

**continuously
variable
broadband**



attenuators

Each Model in Ψ Series 953 and 973 operates in frequency ranges up to 3½ octaves wide with only small changes in characteristics.

MODEL	RANGE FREQ. (GHz)	RANGE IN dB
953-3	1-11	3
953-10	2.5-11	10
953-20	4-11	20
973-10	1.3-11	10
973-20	2.5-11	20
973-40	4-11	40

They are available as either level set or calibrated units. The direct reading insertion loss scales are individually calibrated. They also feature . . .

- Non-contacting control device
- Stainless steel connectors
- Small phase shift
- High stability
- Optional panel mounting versions

Using the simple control, insertion loss is continuously variable, and the scale is almost linear in dB.



Designers and
Manufacturers of Precision
Microwave Equipment

**WEINSCHEL
ENGINEERING**
Galthersburg, Maryland



Perfect your CCTV system with **COSMICAR[®]** lenses

Shown are a few selected at random from COSMICAR lenses ranging from 8.5mm to 1,000mm and zooms.

COSMICAR is also prepared to custom-make lenses of any specifications.

Please write today to:



COSMICAR OPTICAL CO., LTD.

(Former name: ICHIZUKA OPTICAL CO., LTD.)

568, Shimoochiai, 2-chome, Shinjuku-ku, Tokyo Cable Address: "MOVIEKINO TOKYO"

Circle 271 on reader service card

OBSERVABLE UP TO 10kV!!

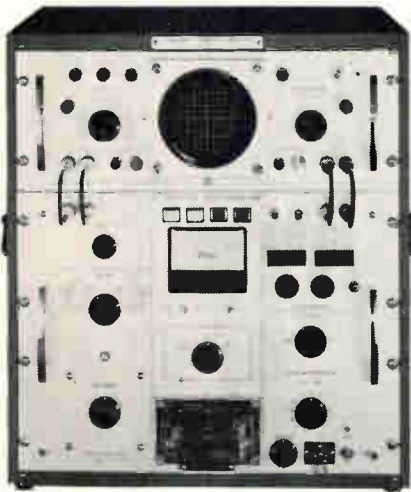

MODEL **583** CURVE TRACER

Internal Test Voltage Supply:

Rectified half wave of power line frequency and sine wave.

Range 0~30V peak, max. 10A peak Low Voltage
 0~300V peak, max. 1A peak
 0~3kV peak, max. 0.1A peak High Voltage
 0~10kV peak, max. 0.1A peak

Gate DC Power Supply:

0~10V continuously variable, 1A max.



kikusui

KIKUSUI ELECTRONICS CORP.

3-1175, SHINMARUKO-HIGASHI, KAWASAKI-CITY, KANAGAWA-PREF., JAPAN. CABLE ADDRESS: "KIKUSUIDE" KAWASAKI

Circle 272 on reader service card

THUMBWHEEL SWITCHES



- | | |
|---|--|
| <input type="checkbox"/> COMPACT | <input type="checkbox"/> MODULAR |
| <input type="checkbox"/> POSITIVE OPERATION | <input type="checkbox"/> WIDE RANGE OUTPUT |
| <input type="checkbox"/> SIMPLE, CLEAN INSTALLATION | <input type="checkbox"/> EDGE LIGHTING AVAILABLE |
| <input type="checkbox"/> ECONOMICAL | |

Send for further information

TECH LABORATORIES, INC.

Palisades Park, New Jersey

Phone: 201 — 944-2221 • TWX: 201 — 947-4730

Circle 213 on reader service card



THE NEW SHAPE IN PLASTIC TUBING

*may fit
your problem
exactly*

FLEXITE Shrinkdown Plastic Tubing shrinks 50% in diameter upon application of moderate heat to form a tight-fitting sheath around objects of irregular shape. It's being used to solve many different problems . . . like insulating electrical connections; protecting delicate components; strengthening assemblies; binding things together; resisting corrosion, heat or moisture; preventing wear, vibration and noise. What problems do you have that a tight sheath of tough plastic might solve? Markel offers Shrinkdown in three distinct types to meet a broad range of needs. Your call or letterhead request will bring samples and data.



L. FRANK MARKEL & SONS, INC.
Norristown, Pa. 19404 • Phone: 215/272-8960
INSULATING TUBINGS AND SLEEVINGS
HIGH TEMPERATURE WIRE AND CABLE

of which holds 25 wafers. The wafers are moved from the carriers on air bearings to the vacuum chuck, upon which they are automatically centered. The photoresist is applied and the chuck spins to provide uniform coating. When the process is finished, the wafers are moved on air bearings to empty carriers for storage and handling.

Pushbuttons on the front panel control the process.

The system comes complete with power supplies and—mounted on separate printed-circuit cards—spin-motor controls, valve drivers, and logic circuits.

Industrial Modular Systems Corp.,
10440 N. Tantau Ave., Cupertino, Calif.
95014 [429]

New production equipment

Sputtering system coats 90 wafers

Both target and substrate
are held vertically;
coating uniformity is $\pm 5\%$

A target that turns may help transform sputtering from a laboratory technique into a production-line process. Until recently, says John Flood, sales manager at the Norton Co.'s Vacuum Equipment Division, sputtering has been a low-volume operation. But now a technique to speed up this versatile method for depositing thin films has been found. According to Flood, Norton's new system handles six times as much substrate as older units.

Sputtering is a process in which high-speed electrons strike some target material and knock off flakes, which deposit on a substrate. In most sputtering systems, both target and substrate are horizontal; but everything is on the up and down in Norton's new system.

The target, a thin metal plate, is held vertically, and can be rotated during the operating cycle. So if there's a different material on each side, the operator can change

NEW
**ultra
miniature**
**I/C POWER
SUPPLY**
**80%
SMALLER!**

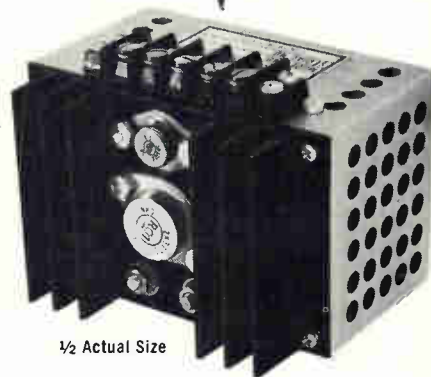

1/2 Actual Size

Powertec's new, ultra-miniature power supply is only 4"x3"x2 5/8" including heatsink.

POWERTEC 9-D SERIES power supplies are specifically designed for use in light weight chassis with IC or other digital logic. Output voltages are available from 3 to 30 volts with .05% regulation.

INPUT: 115 VOLTS 47-440HZ

TYPICAL OUTPUTS:

3 V at 6 A

5 V at 5 A

15 V at 2 A

THE POWERTEC 9-D SERIES is currently available from stock. Detailed specifications and price are available upon request.

CUSTOM POWER SYSTEMS

Powertec's experts are capable of solving your most difficult power conversion requirements.



POWERTEC DIVISION
9168 DeSoto Street
Chatsworth, California 91311

TRW SPACE SAVING SOLID TANTALUM CAPACITORS

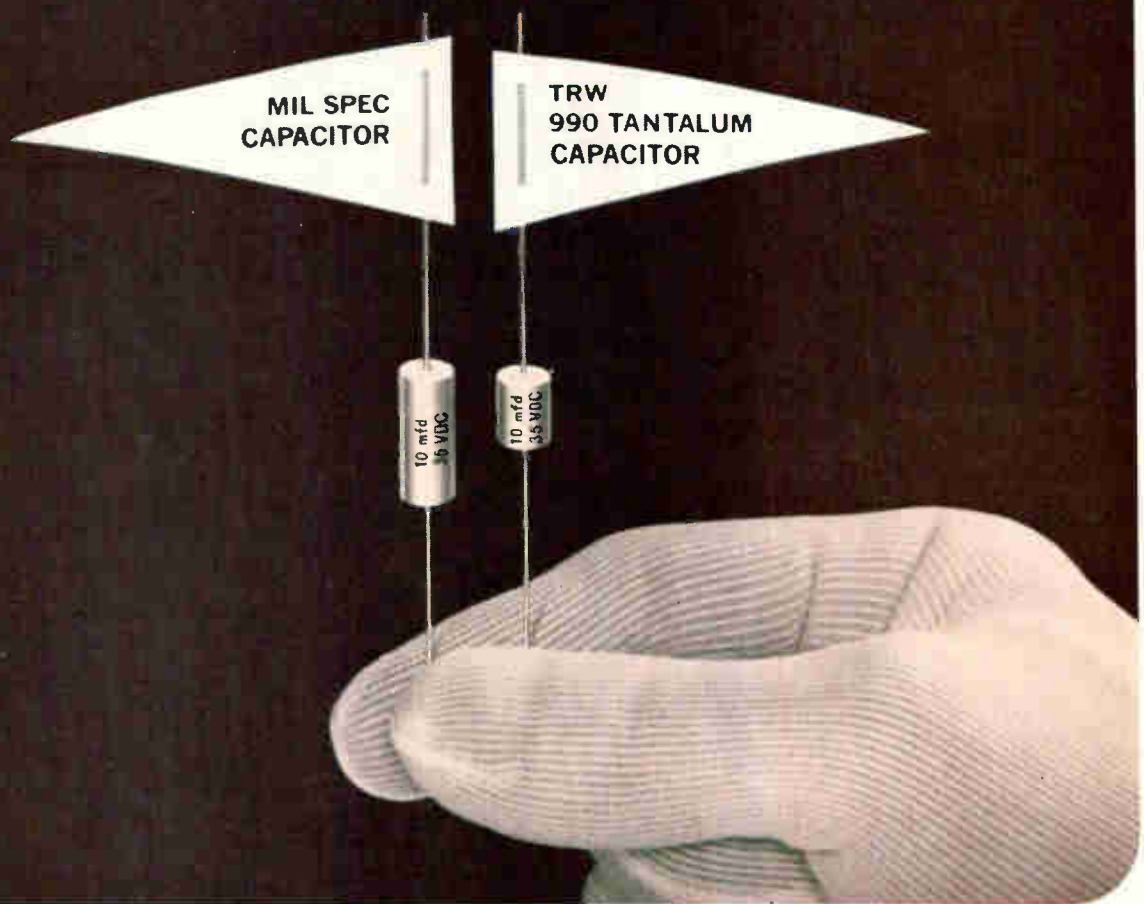

MIL spec performance...in half the space!

Type 990 miniature solid tantalums typify TRW's creative engineering. They're *designed* to fit in half the space. *Designed* to give better shock and vibration resistance. *Designed* to MIL

specs. They're *designed* to be the best hermetically sealed tantalums you can buy. Values from 8.2 to 330 mfd, 6 to 35 V.

Get the TRW tantalum story on space-savers like the 990,

on standard MIL types and tantalum hi rel capability. Contact TRW Capacitor Division, TRW INC., Box 1000, Ogallala, Nebraska. Phone (308) 284-3611. TWX: 910-620-0321.

TRW

Service...Engineering...Experience

MAKE THE **BIG** DIFFERENCE
BETWEEN A YOKE SPECIALIST
AND A YOKE SUPPLIER



1" ID 12 oz. Single Gap
Shielded Dynamic/Static
Focus Coil

Syntronic Yoke Specialists have more yoke knowledge and provide more engineering assistance than anyone else in the field.

The most extensive line of deflection yokes available is offered by Syntronic... in production quantities or custom designed to special requirements. See the BIG Difference for yourself the next time you specify a yoke.

Syntronic

INSTRUMENTS, INC.

100 Industrial Road, Addison, Illinois Phone 312, 543-6444

Circle 274 on reader service card

Snowflakes Look Alike...

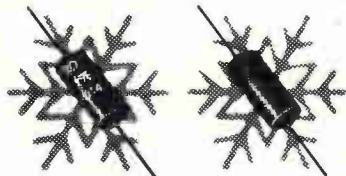

...So Do Resistors!

But One Is 6 Ways Better!

Like snowflakes, precision wire-wound and metal film resistors only look alike.

Kelvin precision wire-wound resistors offer:

1. **Lower Noise** (db's quieter — no current noise).
2. **Better Long Term Stability** (.003% /year).
3. **Lower Temperature Coefficients** (to ± 1 ppm) at much less cost.

Metal films are good but, Kelvin precision wire-wounds are 6 ways better. Want the other 3 ways? Please call us!



KELVIN

5919 Noble Ave., Van Nuys, Calif.
Phone: (213) 782-6662

216 Circle 295 on reader service card

ECONOMICAL Thin Film!

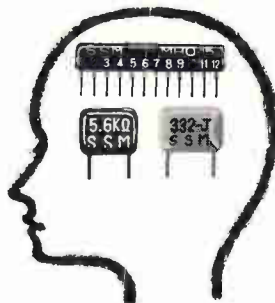

What's needed for memory system is everlasting high accuracy. SSM's components are the very ones satisfying superior reliability.

- Plate-ohm: evaporated metal film resistor
- Pla-module: thin film modulated C-R circuit
- Pla-con: organic thin film capacitor by plasma reaction

SUSUMU INDUSTRIAL CO., LTD.

Minami Bldg. 1-12 Ebisuminami
Shibuya-ku, Tokyo, Japan
TEL: Tokyo (03) 712-5990
TELEX: No. 246-6270

Circle 275 on reader service card

the material being sputtered by turning the target. He doesn't have to shut down the system.

Norton says this feature can cut cycle time in half.

And anything that eliminates the need to take off the bell jar increases reliability. Anytime the cover is off, there's the danger of oxidizing and contaminating the film.

Five turning faces. Substrates are also mounted vertically, on a five-sided holder which can be rotated during the operating cycle.

The holder weighs 7 pounds and is conduction-cooled by water circulating through the pedestal on which the holder is mounted.

Each side of the holder frames a removable copper faceplate which has small pegs positioned to hold substrates of specific size



Target ready. A technician positions the target. On his right is the five-sided substrate holder

and shape. So when an operator wants to work on a different substrate, he switches faceplates. Plates are available that handle substrates ranging in diameter from $\frac{3}{4}$ inch to 2 inches.

The system, for example, can coat up to 90 substrates, 1 inch in diameter, in a cycle. The volume varies according to the diameter of the wafer. Norton says that the coating uniformity is $\pm 5\%$ over the entire area of the substrate.

The system costs \$25,000 and delivery time is 8 to 10 weeks.

Norton Co., Vacuum Equipment Div.,
160 Charlemont St., Newton, Mass.
02161 [430]

Electronics | January 6, 1969

New production equipment

Bonder searches automatically

Ultrasonic machine can step back chip by as little as 0.02 inch

Locating the spot on a substrate to connect leads takes time and slows down the action on the production line.

But an ultrasonic wire bonder made by Kulicke and Soffa Industries Inc. cuts this search time in half, if the bonding pattern is symmetrical. The operator manipulates the chip until he centers the spot where one end of a wire is to be bonded; the bonder, called the 484, will find the spot where



Easy off. The ultrasonic generator is mounted in the top part of the system so it can be removed quickly.

the other end is to be connected.

Kulicke and Soffa says the 484 is the first bonder with this feature, which the company calls automatic setback. The setback distance, changed by switching cams, can be set from 0.02 to 0.125 inch.

The system can bond most kinds of wire, including 0.0015-inch-diameter gold.

The ultrasonic generator itself is mounted on the top part of the system, so it can be replaced in a matter of seconds.

Kulicke and Soffa Industries Inc., Fort Washington, Pa. 19034 [431]

Q. What's So *SPECIAL* about

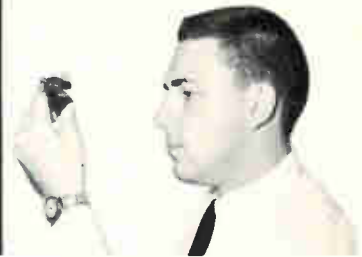
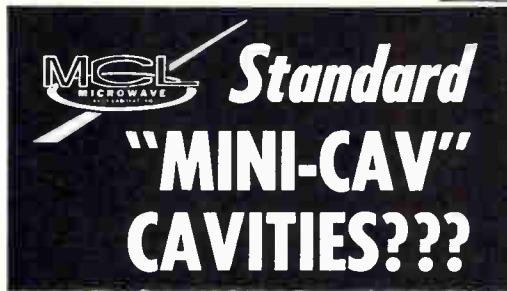

A. They meet some of the *TOUGHEST* performance vs. size and weight requirements of contemporary electronic equipment design.

Look At These Examples*:

Model 9015 CW Oscillator

Freq. Range: 4300 MHz
Power Output: 2 MW min.
Max. VSWR Output: 1.7:1
Output Impedance: 50 ohms

Power Input Requirements
80 VDC @ .015 amp. max.
6.3 VAC @ .275 amp. max.

Diameter: 5/8" Length: 2 17/32"
Weight: 2.5 Oz. (approx.)
Temp. Range: -55°C to +100°C

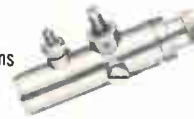

Model 9009A Plate Pulsed Oscillator

Freq. Range: 4300 MHz
Power Output: 1.0 KW min.
Max. VSWR Output: 1.4:1
Output Impedance: 50 ohms

Duty Cycle:
.000085 to .00029

Power Input Requirements
2900 VDC peak @ 2.5 amps. peak
6.0 VAC @ .93 amp.

Diameter: 1 3/8" Length: 3 9/16"
Weight: 12 oz. (approx.)



Model 9018 Plate Pulsed Oscillator

Freq. Range: 4300 Mhz
Power Output: 250 watts peak max.
Max. VSWR Output: 1.5:1
Output Impedance: 50 ohms

Power Input Requirements
800 VDC ± 50 V peak @ 1.1 amps. peak max.
6.3 VAC @ .475 amp. max.

Diameter: 1.0" Length: 2.0"
Weight: 10 oz. (approx.)

*The MINI-CAV line consists of more than a dozen cavity varieties, including CW amplifiers and triplers and grid pulsed and plate pulsed oscillators.

Model 8207 Plate Pulsed Oscillator

Freq. Range: 940-980 Mhz
Power Output: 6.0 KW peak
Max. VSWR Output: 1.2:1
Output Impedance: 50 ohms

Duty Cycle:
.001

Power Input Requirements
3500 VDC @ 5.0 amps. peak max.
6.3 VAC @ 1.2 amps.

Diameter: 1.5" Length: 5 9/16"
Weight: 20 oz. (approx.)

Conduction cooled. Frequency drift less than 1.0 MHz per 15-minute operation.

Before Tackling Another Miniaturization Project . . .

Ask your MCL sales engineer about designing it around "MINI-CAV" standard cavities. He'll show you why they lick their size and weight in the toughest MIL and commercial specs—giving you an honest bonus in lower final costs, shorter production cycles, reduced "slipstick" time—and lower intake of headache pills! And, write for your free copy of MCL's catalog of "Dynamic Disciplines" engineered products: standard and custom high power tetrode cavities, tetrode and klystron amplifier systems, subsystems, test equipment and accessories.

MICROWAVE CAVITY Laboratories, Inc.



10 North Beach Avenue
La Grange, Illinois 60525

Phone: (312)—354-4350

Western Union Telex: 25-3608

Frequency Changers

from ...
250 VA
Laboratory
option shown



to ...
50 KVA
Unitized,
weatherproof
option shown

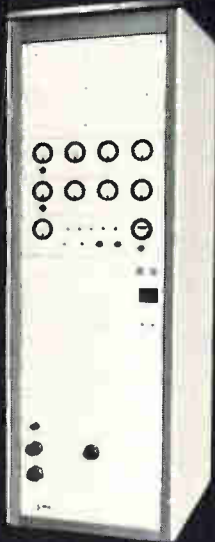

(with 65 models in-between)

SUPERIOR SPECIFICATIONS

Less than 2% THD.
Constant voltage/current.
Regulation better than 1% from
combined effects of line load,
and temperature.
Efficiencies in excess of 90%.
Compact, approaches 4 KVA/Ft³.

VERY WIDE SELECTION

250 VA to 50 KVA in 67 basic
models, 4 frequencies, 11 power
levels, and 27 standard options.

FAST DELIVERY

Popular sizes and frequencies
shipped from stock.

Avtel also produces Inverters and
Uninterruptible Power Systems
to 1 million VA. See our catalog
in eem, page 1759, or send for
complete details.



**AVTEL
CORPORATION**
Division of Airtronics, Inc.

1130 E. Cypress St. • Covina, Calif. 91722
Phone (213) 331-0661 • TWX (910) 584-1311

New Books

Bigger and better

Reference Data for Radio Engineers,
Fifth Edition
ITT Federal Laboratories
Howard W. Sams & Co., \$20

Here's a book that for 25 years has provided the busy engineer with fast access to equations, graphs, tables, and other data. Of previous editions, 350,000 copies have been sold. But if the background is impressive, the state of the art is even more so. For now, 12 years after the last revision, this engineer's bible has been expanded and improved.

The latest edition contains 50% more information than its predecessor, and is easier to read on its larger—about an inch all around—completely retypeset pages. And its index contains more than twice as many entries as the previous edition. For instance, the topic of microwaves, subdivided only into the subjects of links and tubes in the old edition, is now divided into 18 separate subtopics from amplification through wavelength. Just about all of the previous edition's 38 chapters have been expanded, and five have been retitled. Further, new chapters have been added on the subjects of: international telecommunications recommendations; microminiature electronics; switching networks and traffic concepts; navigation aids; space communications; quantum electronics; and reliability and life testing.

Geared to meet the needs of design and systems engineers, most of the new chapters discuss definitions and terminology before launching off into the specifics of design and application.

The chapter on microminiature electronics covers such topics as design considerations, film materials and processes, photoresist applications, packaging, and the applications of linear integrated circuits.

Another of the new chapters, the one on telecommunication recommendations, is a compendium of the major positions of two international committees dealing with telephone, telegraph, and data-transmission circuits and equip-

LOW COST INDUSTRIAL Servo Amplifier

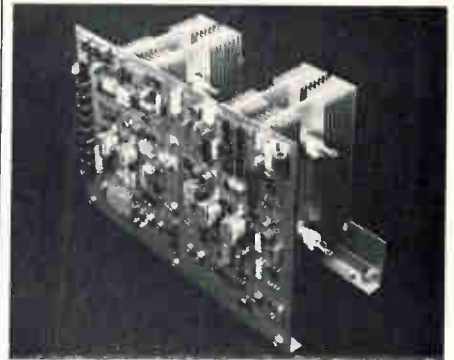

FULL WAVE, 1-5 HP

This new A580 Servo Drive is designed for control of speed or position of 1 to 5 HP DC motors. The A580 amplifier features high gain and frequency response with exceptional linearity, is modular in form, measures 7 x 10 x 4½, and can be supplied panel or rack mounted with auxiliaries. When low cost must be combined with rigid performance you'll find the Westamp A580 will more than satisfy your requirements. Available in 4 weeks.

HIGH POWER SERVO AMPLIFIERS

WESTAMP

1542 FIFTEENTH STREET
SANTA MONICA, CALIF. 90404
PHONE: (213) 393-0401

Circle 278 on reader service card

TOP TALENT: ANOTHER PROFIT PLUS

Scientists, engineers and administrators find in our Phoenix environment new intellectual stimulus — as well as new dimensions of personal fulfillment and enjoyment. That's why recruiting and keeping top talent is never a problem in this land of year-round sunshine — where our vigorous business climate and tax structure encourage profits/growth.

For FREE 40-page brochure, "PHOENIX: Environment for Science-Oriented Industries," write Stanton Allen, Manager, Economic Development Dept., Room E-32, Chamber of Commerce, Phoenix, Arizona 85004.

**dynamic
Phoenix**

PROFIT CENTER OF THE SOUTHWEST

CARBON COMPOSITION AND WIRE-WOUND POTENTIOMETERS

Other LESA products for electrical industries:

- Fractional HP Electric Motors
- Record Players and Record Changers
- Phonographic Piezo-electric Cartridges

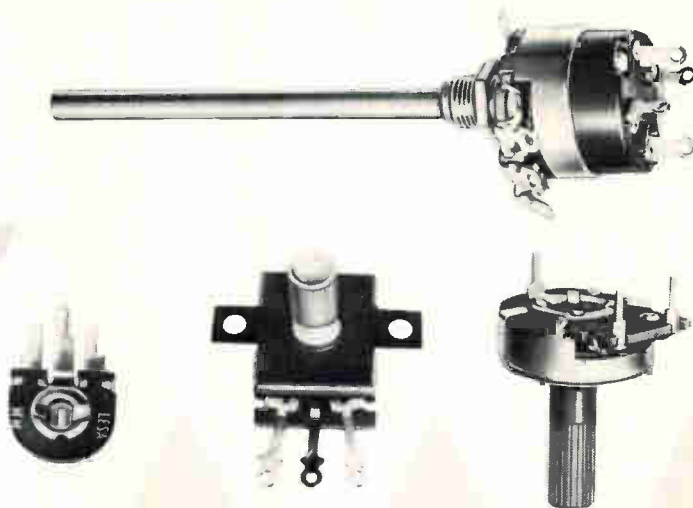

LESA

LESA OF AMERICA CORP. - 521 Fifth Avenue - NEW YORK, N.Y. 10017 (U.S.A.) - Tel. 212 697-5838
 LESA COSTRUZIONI ELETTROMECCANICHE S.p.A. - Via Bergamo, 21 - MILANO (Italia) - Tel. 554.341
 LESA DEUTSCHLAND GMBH - Wiesentalstrasse, 10 - 78 FREIBURG i/Br. (Deutschland) - Tel. (0761) 44 0 10
 LESA ELECTRA S.A. - Viale Portone, 27 - 6500 BELLINZONA (Svizzera) - Tel. (092) 5 53 02
 LESA FRANCE S.A.R.L. - 19, Rue Duhamel - 69 LYON 2 (France) - Tel. (78) 42 45 10

Circle 280 on reader service card

PRESENTING THE ONE AND ONLY...

high frequency oscilloscope with both a 100 MHz capability and sweep switching in one instrument. We call it the 766 H/F. You can call it what you wish. Charley. Archibald. Brigitte. But whatever you name it remember it's one of our 700 series of scopes, famous for their quality, accuracy and versatility. And it's available now through our reps.



DUMONT 766 H/F offers the reliability of silicon solid state circuitry, no-fan low power consumption, greater display area, fully interchangeable X and Y plug-ins, internal graticule and of course, 100 MHz capability and sweep switching. It is also available in a horizontal version for rack mounting, the 767 H/F.

DUMONT

OSCILLOSCOPE LABORATORIES, INC.

Anybody think to tell them it uses our 79-02A and 74-17A plug ins?

Yep. All about our complete line of rack or bench low frequency, high sensitivity, low cost scopes, and full line of scope accessories.

Let's send 'em our new catalog. That'll tell them everything.



We should have named it Melvin.

DUMONT Oscilloscope Laboratories, Inc.
 40 Fairfield Place, West Caldwell, N. J. 07006

- Have a sales representative call, quietly.
- Send your new catalog, you pay postage.

NAME _____

TITLE _____

COMPANY _____

ADDRESS _____

CITY _____ STATE _____ ZIP _____

Solve all Resistor problems fast...

TALK TO THE SPECIALIST... LECTROHM

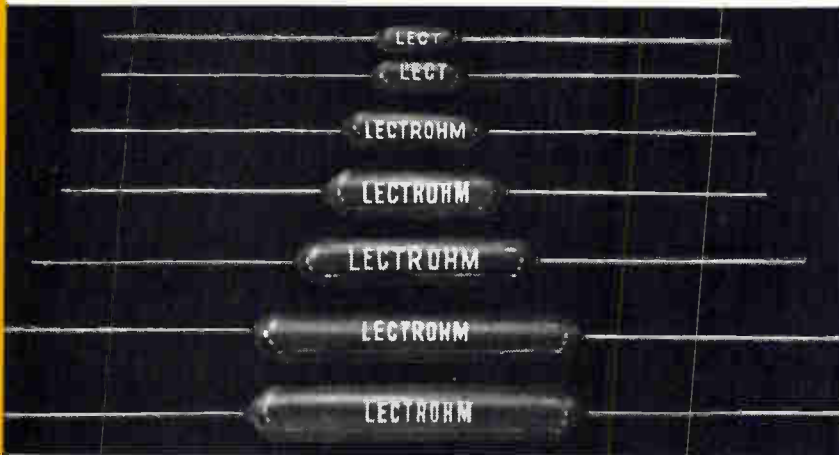

With LECTROHM's entire production facilities devoted to the manufacture of quality power, wire-wound resistors, we are in the unique position to provide quick, economical solutions to all resistor problems. As specialists in the field, LECTROHM knows resistors.

Whether your products require "standard" or "custom" styles — fixed or adjustable types, vitreous enamel or silicone coated — there is a LECTROHM resistor to match those needs precisely. To meet your production schedules, large stocks of standard styles in popular values are always available for immediate shipment, with special facilities geared to fast delivery on small orders of special values.

Whatever your resistor problems entail, you will do better talking to the specialist — talk to LECTROHM. You'll be time and money ahead, everytime.



FREE!

Full line
LECTROHM
catalog.

Send for your
copy today!



Vitreous Enameled
Fixed Resistors



Vitreous Enameled
Adjustable Resistors



Type FP Resistors

Lectrohm, Inc.

A subsidiary of



COOK ELECTRIC

5562 Northwest Highway, Chicago, Ill. 60630

New Books

ment. The chapter on quantum electronics covers in fair detail the different types of masers and lasers, while the chapter on space communications describes ground-to-spacecraft, spacecraft-to-ground, and spacecraft-to-spacecraft systems.

The chapter on reliability and life testing includes a summary of reliability specifications, a table on the failure rates of components, and a discussion of confidence levels and limits, distribution functions, component reliability, and the derivation of the theoretical distributions used. The switching networks and traffic concepts section describes both single and multistage switching networks and contains traffic equations and tables. And if the new chapter on navigation aids contained nothing more than its excellent glossary of navigation terms, it would be a welcome addition.

The updating of the older chapters has, in some cases, resulted in a vast expansion of the material presented. The chapter on digital computers, for example, has jumped from nine pages to 38 larger pages and even has a section on debugging computer programs. And the chapter on antennas now include a section on such frequency-independent units as log periodical and on scanning systems. New charts appearing in the chapter entitled Filters, Modern Network-Theory Design cover the relative attenuation for one- and eight-pole networks, and the delay and phase distortions of the Butterworth response shape.

A section on toroidal and ferrite-pot-core audio filter coil design has been added to the chapter on magnetic-core transformers, and the chapter that was originally called Broadcasting has been updated to include sections on CATV, instructional and color tv, and sound and video tape recording. Material on earth-space communications, line-of-sight propagation at optical frequencies, and the effect of nuclear explosions on radio-wave propagation has been included in a chapter that's been renamed Electromagnetic-Wave Propagation.

Recently published

Systems and Transforms with Applications in Optics, Athanasios Papoulis, McGraw-Hill Book Co., 474 pp., \$19.50

Explores the relationship between systems and optics. Covers the general theory of systems and transforms in one and two dimensions, including singularity functions, Hankel transforms viewed as Fourier transforms, sampling expansions, and stochastic processes. Aimed at developing analytical techniques and showing their relevance in a large number of applications. For graduate students in engineering and optics.

Digital Systems Logic and Circuits, Basil Zacharov, American Elsevier Publishing Co., 160 pp., \$3.95

Intended for the engineering or science student with some knowledge of electronics. Covers number systems, simplification of Boolean expressions, transistor implementation of logic operations, magnetic-core logic, and switching matrices. Describes AND, OR, and flip-flop circuits and how they perform digital computer functions.

Advanced Linear-Programming Computing Techniques, William Orchard-Hays, McGraw-Hill Book Co., 355 pp., \$12.50

Geared to the needs of the practitioner. Details the dual simplex algorithm, post-optimal ranging algorithms, and parametric algorithms. Emphasis is placed on algebra and logic. Organized into definitions, theorems, algorithms, and techniques.

Geometric Optics, Allen Nussbaum, Addison-Wesley Publishing Co., 132 pp., \$7.50

Simplifies the traditional algebraic approach to analyzing lens systems by using matrix techniques. Covers the theory of aberrations, and includes a few Fortran programs to show how some sample problems can be solved. College and trade school text.

Error Detecting Logic for Digital Computers, Frederick F. Sellers Jr., Mu-Yue Hsiao, Leroy W. Bearson, McGraw-Hill Book Co., 295 pp., \$15.00

Defines the logical building blocks in a computer and the kinds of failures. Develops the equations, proofs, and logic needed for detection schemes. Parity and residue checking are emphasized for arithmetic units. Includes error detection in counters, data paths, combinational and sequential logic, and memory and storage, with a final chapter on problems and checks on the system level. More than 100 references. For the engineer and researcher.

Annual Review of Information Science and Technology, Vol. 3, Carlos A. Cuadra, Encyclopaedia Britannica Inc., 457 pp., \$15.00

Edited review of 1967 meeting proceedings of the American Society for Information Science. Discusses progress and cost effectiveness of information systems in such areas as education and medicine. Notes recent developments in computer graphics, medium and large scale multiaccess computer systems, and storage systems. Evaluates proposals for universal code of recorded knowledge and classification scheme for mechanized searching. Investigates language structure and its simplification.

Frequency Modulation Receivers, A.B. Cook and A.A. Liff, Prentice-Hall Inc., 527 pp., \$15.00

Discusses all circuits in an fm receiver. Descriptions cover the vacuum tube, transistor, field effect transistor, and integrated circuits. Emphasizes operational aspects of fm receivers, covering both past and present practices. Each section ends with a detailed summary and is augmented by practical sample problems. Reference for communication and broadcast engineers and an aid for service technicians.

Reed Relays that deliver more of what you need most...

VERSATILITY ■ RELIABILITY ■ ECONOMY



Standard and Miniature Reed Relays



Special Design Reed Relays

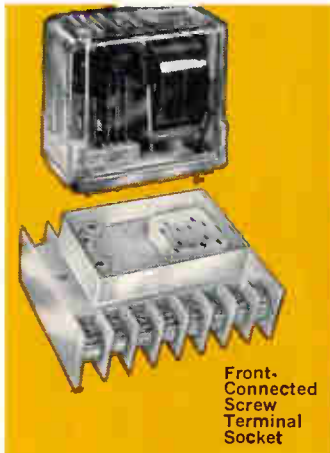

Front-Connected Screw Terminal Socket

Automatic Controls' Reed Relays — standard, miniature, or your special designs — offer individually supported reed switches, magnetic foil wrapped coils, non-magnetic terminals, and rhodium plated contacts, providing peak performance and reliability. Standardized contact configurations assure off-the-shelf delivery and maximum economy. For more of what you need most — specify Automatic Controls' Reed Relays everytime!

NEW from Automatic Controls... Front-Connected Screw Terminal Socket.

Accommodates the Automatic Controls' "family" of general purpose plug-in relays and time delay relays.

Automatic Controls

Division



COOK ELECTRIC

200 East Daniels Rd., Palatine, Ill. 60067



FREE!
Automatic Controls
Industrial
Relay Booklet.
Send for your copy
today!

Avoiding traps

Degradation of Gunn-effect GaAs devices

S.V. Jaskowski, M.A. Seitz, and P.H. Wackman, Marquette University, Milwaukee

Gallium arsenide has been fashioned into a variety of semiconductor devices—tunnel diodes, coherent-light emitters, bulk-effect microwave generators. In general, though, these devices don't last very long.

Marquette University's College of Engineering, in investigating this problem in connection with Gunn-effect oscillators, found that the addition of a highly doped n^+ buffer zone greatly increases longevity.

N -type, continuous-wave GaAs Gunn oscillators were used in the study. They were deposited epitaxially with a 10-to-50-micron-thick-layer of carrier concentration in the range of 10^{14} to 10^{15} per

cubic centimeter.

Over a period of 18 months, conventional devices, which have a tin electrode directly alloyed to the high-resistivity n^- active region, deteriorated seriously. Specifically, the voltage threshold needed to initiate oscillation increased, power output dropped, noise increased, and the oscillation frequency declined.

The net effect of this degradation was that the devices eventually ceased to operate in any mode—pulsed microwave, quenched, pure Gunn transit time, or impact ionization. Failure was caused by two things: heat generated in the device and, more significantly, a trapping mechanism.

Heat causes realloying of the contacts into the bulk material. At the same time, atoms of tin from the electrode diffuse into the bulk material, not because of excessive heat but because the atoms tend to move toward a region of low con-

centration. The tin atoms create donor and acceptor levels in the forbidden gap of the GaAs—traps that permanently remove carriers from the conduction band. In time, enough traps are created so that the number of available carriers drops below the level critical for Gunn oscillation.

But, if a highly doped n^+ buffer zone is placed between the bulk material and the electrode, the traps can't get into the active region. All of the devices with this buffer-zone design were still operating when the Marquette tests ended.

Texas Instruments is now using this new design for all their bulk-effect GaAs devices. It's been found that just about any kind of contact material can be used.

An extra dividend is that the buffer-zone devices are less susceptible to burnout. In the conventional design, the contact, alloyed directly on the active layer, pro-

SOLVE NOISE AND FILTERING PROBLEMS WITH CERAMAG® FERRITE BEADS



- Ceramag® ferrite beads are low cost, easy to install, and save space.
- Effective r.f. decoupling, shielding and parasitic suppression without sacrificing low-frequency power or signal level.
- Installed by simply sliding one or several over conductor leads.
- Beads can, but need not, be grounded.
- Sizes from .040" ID — .100" OD — 100" L.
- Sample quantities available.



STACKPOLE
CARBON COMPANY
Electronic Components Division
St. Marys, Pa. 15857

CERAMAG® FERRITE MATERIALS CONSISTENT IN PERFORMANCE, QUALITY



- Select from over 30 grades.
- Available in toroids; cup, insert and thread cores; bobbins; sleeves; transformer cores; deflection yokes; and rectangular solids.
- A wide range of sizes held to exact tolerances.
- Maximum permeability and high Q.
- Tooling available for hundreds of parts.
- Offers the advantage of complete moldability.
- Write for bulletin.



STACKPOLE
CARBON COMPANY
Electronic Components Division
St. Marys, Pa. 15857

GUARANTEED UNIFORMITY IN ELECTRICAL, PHYSICAL CHARACTERISTICS

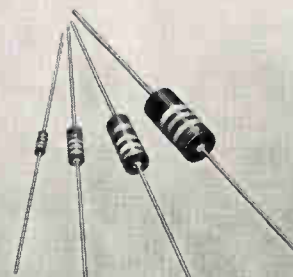

- Available in 2, 1, 1/2 and 1/4 watt sizes.
- Uniform from resistor to resistor, order to order.
- 100% tested for resistance value.
- Same day shipment on 9 orders out of 10.
- Solderability, load life and humidity-temperature characteristic checked.
- Impregnated to assure moisture resistance.
- Write for literature.



STACKPOLE
CARBON COMPANY
Electronic Components Division
Kane, Pa. 16735

duces a thin high-resistivity region. If it's biased in the wrong direction, the field intensity is enough to burn out the device. The buffer, however, completely eliminates this effect.

Presented at the Seventh Annual Reliability Physics Symposium, Washington, Dec. 2-4, 1968.

Groovy projection

A new approach to color television display and color selection using a sealed light valve
William E. Good
General Electric Co.
Syracuse, N.Y.

A sealed light source using a single electron gun and raster can improve color fidelity and brightness in a television projection system. Unlike other projectors, which require either two or three sets of guns and rasters to produce a color image, the new system produces the red, green, and blue

picture elements simultaneously eliminating registration and convergence problems.

The basic system contains a light source, a set of input slots, a fluid surface, a schlieren lens, output bars, a projection lens, and an electron gun. Grooves or diffraction gratings written within each picture element represent color and brightness. To minimize interactions, the red and blue gratings must be written at right angles to the green grating.

A reflector collects as much as half the light from a 500-watt sealed-beam xenon light source. The sealed construction protects the optical surface of the light source from the arc.

The associated circuitry is no more complex than that of a conventional color tv monitor without the deflection yoke and convergence circuitry. Even so, the primary colors produced are very close to those of a phosphor-type

color tube. The projector is capable of a 50-to-1 contrast ratio, with a resolution limited only by the 525-line National Television System Committee standards. The color display can go up to 6 by 8 feet, with front or rear projection.

Presented at NEC, Chicago, Dec. 9-11.

Big waves

Amplification of magnetostatic surface waves by interaction with drifting charge carriers in crossed electric and magnetic fields
Ernst Schlomann
Raytheon Research Division,
Waltham, Mass.

Magnetostatic waves propagating in ferrites are an unusual type of electromagnetic radiation. Most of the energy density is associated with the magnetic field, and almost none with the electric. These waves are used in microwave-frequency delay lines because their phase and group velocities are much smaller

ENVIRONMENT PROOF ROTARY SWITCHES

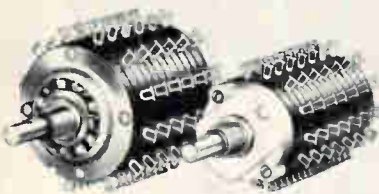

Series 600 1 1/4" Dia. — Series 100 1 1/8" Dia.

- Both index mechanism and electrical sections are completely enclosed.
- Corrosive atmospheres, dust, dirt and moisture are permanently sealed out, lubricants sealed in.
- Solder or quick-connect terminals molded permanently into position minimize production damage.
- Standard index angles include 15°, 30°, 36°, 60° and 90°, special angles available on request.
- Write for engineering bulletin.



STACKPOLE
COMPONENTS COMPANY
P. O. Box 14466
Raleigh, N. C. 27610

UNEXCELLED QUALITY FOR LESS THAN 4¢

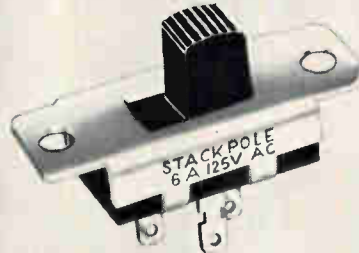

- Listed by UL AND CSA, 1 to 10 amps at 125V AC.
- 7960 slide switch combinations—23 basic types.
- New rugged solder lug terminal, designed for use with quick connectors.
- Uniform quality assured by automated assembly.
- Electro-silver plated terminals and contacts—shorting and non-shorting.
- Phenolic or nylon triggers in a variety of colors.
- Write for engineering literature.



STACKPOLE
COMPONENTS COMPANY
P. O. Box 14466
Raleigh, N. C. 27610

UNIQUE DESIGN ADDS VALUE AND APPEAL

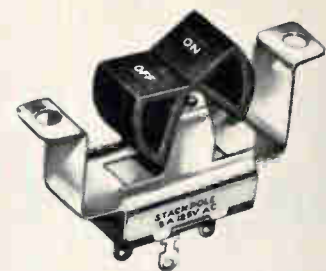

- 23 rocker switch configurations, including 2-3 positions, spring return and center-off.
- Variety of rocker designs available in a spectrum of colors and hot-stamped lettering.
- Listed by UL AND CSA, 1 to 10 amps at 125V AC.
- Solder lug, space saver, quick-connect or printed circuit terminals.
- Field-proven quality same as famous Stackpole slide switches.
- Prices start at less than 15¢.
- Write for engineering literature.



STACKPOLE
COMPONENTS COMPANY
P. O. Box 14466
Raleigh, N. C. 27610

VARISTORS PROTECT YOUR CIRCUITS

Silicon Varistors



SiC Varistors



Si diodes, Si rectifiers,
Si transistors, Se rectifiers,
CdS photo cells, Power supplies.

Sanken®

TELEX: 0272-2323 (SANKLE TOK)
CABLE: SANKLE TOKYO Phone: 986-6151

1-22 8 NISHI-IKEBUKURO,
TOSHIMA-KU, TOKYO
SANKEN ELECTRIC CO., LTD.

Technical Abstracts

than those of ordinary electromagnetic waves.

One way in which the magneto-static waves propagate is along the surface of a magnetic crystal. It's possible to amplify these surface waves, instead of just allowing them to pass through passively as in a delay line. In a microwave delay line, this gain reduces the insertion loss.

Amplification is achieved by allowing the waves to interact with charge carriers drifting through a semiconducting layer placed in contact with the crystal. A d-c voltage is applied to the semiconductor in the direction of propagation. And a d-c magnetic field is set up in the plane of the crystal surface perpendicular to the direction of propagation.

Low-loss magnetic materials, such as yttrium iron garnet, can be used with high-mobility semiconductors such as indium antimonide. At room temperature, a carrier density of 2.5×10^{17} per cubic centimeter and a semiconductor film thickness of 3,000 angstroms produces a net gain when the d-c current per unit width of the film exceeds 2.2 amperes per centimeter. This corresponds to a dissipation per unit area of approximately 75 watts per square centimeter.

Presented at the 14th Annual Conference on Magnetism and Magnetic Materials, New York, Nov. 18-21.

Light manufacturing

The laser as a manufacturing tool for the semiconductor industry
R.M. Lumley and S.S. Charschan
Western Electric Co.
Princeton, N.J.

Feasibility studies of using lasers in semiconductor production have encompassed areas such as mask generation and inspection, welding, component trimming, scribing, substrate separation, and thin-film shaping.

Resolutions of a micron or less should be possible when a laser is used to generate a photomask. One technique generates a mask by moving a thin film under a laser beam and selectively vaporizing areas of the film by turning the beam on and off. Another method

MATSUO

Highly Reliable Capacitors

POLYESTER FILM CAPACITORS.

Type MXT

Type MFK

Type MFL

Type SW

Type MXT In plastic tube.
Capacitance Range: .001 MFD to .47 MFD.
Voltages: 100v, 200v, 400v, 600v DC.

Type MFK Dipped flat shape, non-inductive construction.
Capacitance Range: .01 MFD to .47 MFD.
Voltages: 100v, 200v, 400v, 600v DC.

Type MFL Dipped flat shape.
Capacitance Range: .001 MFD to .22 MFD.
Voltages: 50v, 100v, 200v DC.

Type SW Super wrap with epoxy endfill.
Capacitance Range: .01 MFD to .47 MFD.
Voltages: 100v, 200v, 400v, 600v DC.

METALLIZED POLYESTER FILM CAPACITORS.

Type FNX-H Mylar wrapped semi-wal with epoxy end seal.
Capacitance Range: 1 MFD to 10 MFD
Voltages: 100v, 200v, 400v, 600v DC.

SOLID TANTALUM CAPACITORS.

Type TAX

Type TSX

Type TSL

Type TAX MIL-C-26655A hermetically sealed.

Type TSX-TSL Sealed with epoxy resin.
Capacitance Range: .22 MFD to 330 MFD.
Voltages: 6v, 10v, 15v, 20v, 25v, 35v, 50v DC.

for further details, contact:

MATSUO ELECTRIC CO., LTD.

3-chome, Sennari-cho, Toyonaka-shi, Osaka, Japan
Cable Address **NCC MATSUO OSAKA**
TWX-523 4164 OSA.

exposes a photographic film with the laser radiation. Or a laser beam can heat and vaporize a thin-film material in ambient, rather than vacuum, conditions and deposit it on an adjacent substrate.

Photomasks can be quickly and accurately inspected with a laser technique called spatial filtering. The mask is illuminated by laser light; if the mask is perfect and the light falls upon the proper spatial filter, no light will pass through. However, if the mask is imperfect, the spatial filter blocks portions of the diffraction pattern that correspond to the pattern of the perfect mask; light from portions that aren't identical passes through. This light can be used to determine the number and type of defects in the mask.

Lasers can be used for microwelding if their beam power densities are controlled so that the heat will melt but not vaporize. Many dissimilar metals can now be welded without physical contact. Such microwelding has been used in bonding beam-leaded integrated circuits.

It's also feasible to trim thin-film and other components with a laser. Pulsed ruby lasers are currently being used to trim deposited carbon resistors through glass envelopes. A pulsed argon-ion laser is about to be used to adjust IC's after the devices have been encapsulated and while they're operating.

Great promise is being shown in separating materials, especially brittle ones, with a laser beam. Laser beams are scribing semiconductor wafers at up to 60 inches a minute, about as fast as diamond dies can scribe silicon. And because there's no pressure on the material, the technique should give more uniform results with much less breakage.

Thin-film circuits can be separated from their substrates by using a laser for controlled fracturing. This technique relies on surface heating of the material to generate stresses strong enough to fracture it.

Presented at NEC, Chicago, Dec. 9-11.

ELECTRONICS TODAY

6 MAJOR BOOKS FROM MCGRAW-HILL

1 STANDARD HANDBOOK FOR ELECTRICAL ENGINEERS, 10th Edition.
Edited by DONALD G. FINK and JOHN M. CARROLL.

This new book continues the tradition of its preceding nine editions. In one volume it provides basic data on design and application for all components and systems employed in the generation, transmission, distribution, control, conversion and application of electricity. Primarily concerned with power, it also covers Wire Communication, Electronic Data Processing and Industrial Electronics. New and sophisticated techniques for computer control of power generation and distribution appear along with conventional data on wiring sizes and switchgear. **2,506 pp., \$32.50**

2 MICROWAVE SEMICONDUCTOR DEVICES AND THEIR CIRCUIT APPLICATIONS. By H. A. WATSON.

This book covers the development of microwave solid-state circuits and microwave semiconductor devices. The early chapters survey important background material necessary to understand the operation of the devices described in later chapters. Besides excellent references, the author has included an extensive list of principal symbols. **636 pp., \$22.50**

3 SOURCEBOOK OF ELECTRONIC CIRCUITS. By JOHN MARKUS.

Over 3,000 different electronic circuits, each complete with values of all components, are logically arranged here in 100 chapters for easy reference. With each circuit is a concise description of its significant features, performance data, and operating characteristics, as an aid in choosing quickly the circuit that most closely meets current needs. **896 pp., \$18.50**

4 SIMULATION: The Dynamic Modeling of Ideas & Systems With COMPUTERS. Edited by JOHN McLEOD.

Starting with a general discussion of the subject, this important new book covers a wide range of topics, from simulation in aerospace to the design of models for various technical and engineering situations. The thirty articles which comprise most of the book represent the best current thinking on simulation. **368 pp., \$15.00**

5 REGULAR MATRIX TRANSFORMATIONS. By GORDON M. PETERSEN.

Examines matrices by investigating the properties of their elements. Determines the relative strengths of two matrices or whether a matrix is stronger than a given set of matrices. Self-contained, ideal for home study; offers much new material. **152 pp., \$8.00**

6 INTRODUCTION TO FEEDBACK SYSTEMS. By H. R. MARTIN.

Covers the fundamentals of linear automatic control theory. Special chapters deal with root locus, introduce analogue and digital computers, discuss testing and test equipment and offer a selection of fully worked examples. **304 pp., \$15.00**

AT YOUR BOOKSTORE
or direct from publisher

10 DAYS FREE EXAMINATION

McGraw-Hill Book Co., Dept. 23-L-15 • 330 West 42nd Street, New York, N.Y. 10036
Send me the book(s) circled below for 10 days on approval. In 10 days I will remit for book(s) I keep, plus a few cents for delivery costs, and return others postpaid. Include local sales tax if applicable.

1 20973-4	2 68475-3	3 40443-4
4 45433-0	5 94024-7	6 94085-8

Name (print) _____

Address _____

City _____

State _____

Zip Code _____

Offer good in the U.S. and Canada only.

23-L-15

New Literature

Power supplies. Sorensen Operation, Raytheon Co., Richards Ave., Norwalk, Conn. 06856, has released a 12-page illustrated catalog covering 173 d-c power supplies, a-c line voltage regulators, and high voltage d-c power supplies.

Circle 446 on reader service card

Industrial control. Diversified Electronics Inc., P.O. Box 6231, Evansville, Ind. 47712, has published a catalog on industrial control products consisting of voltage band monitors, phase sequence and phase loss monitors, and a phase indicator. [447]

Photocell-lamp modules. Clairex Electronics Inc., 1239 Broadway, New York 10001. A 12-page bulletin covers an expanded line of Photomod photocell-lamp modules. [448]

Reed switches. Gordos Corp., 250 Glenwood Ave., Bloomfield, N.J. 07003. Detailed specifications for a full line of magnetic reed switches are given in an eight-page catalog. [449]

Laser components. Oriol Optics Corp., 1 Market St., Stamford, Conn. 06902. A four-page brochure offers specifications

and prices on a wide line of 10.6-micron optical components for use with CO₂ lasers. [450]

High-impact resin. Isochem Resins Co., Cook St., Lincoln, R.I. 02865, has published a technical bulletin on Isochemrez 408SA high-temperature, high-impact resin, which is now fortified with Super Airout air release agent. [451]

Automation center. Microsystems Technology Corp., 203 Middlesex Turnpike, Burlington, Mass. 01803, offers a brochure detailing services, capabilities, and equipment of its computerized design and production automation center. [452]

High-voltage wire. ITT Wire and Cable Division, Pawtucket, R.I. 02862. A four-page brochure describes the high-voltage and high-temperature capabilities of the company's silicone wire. [453]

Data generator. Datapulse Division, Systron-Donner Corp., 10150 W. Jefferson Blvd., Culver City, Calif. 90230. Advance specifications bulletin 214 covers model 214 data generator, a 13-channel pattern generator with a 10-Mhz stepping frequency. [454]

Transistor testing. Teradyne Inc., 183 Essex St., Boston 02111, has available a 12-page illustrated brochure on its T217 automatic transistor test instruments. [455]

Shaft hardware. James Millen Mfg. Co., 150 Exchange St., Malden 48, Mass. 02148. An eight-page bulletin, listing both standard-size and miniature shaft hardware, includes such items as dials, knobs, couplings, shaft locks, and shaft bearings. [456]

Nickel cadmium batteries. Nife Inc., 21 Dixon Ave., Copiague, N.Y. 11726. Complete specifications for a line of long-rate nickel cadmium alkaline batteries are covered in bulletin AG-424. [457]

Adjustable toroids. Vanguard Electronics Division of Wyle Laboratories, 930 W. Hyde Park Blvd., Inglewood, Calif. 90302. Applications and operating characteristics of miniature high-frequency adjustable toroids are described in a specifications brochure [458]

Tiny display lights. Pinlites Inc., 1275 Bloomfield Ave., Fairfield, N.J. 07006,

CERMET TRIMMERS



Series 340 Top Adjust 1/4" x 1/4" x .220"
Cermet Trimmer

NEW FROM CTS

\$1.25 ea. in 1,000 lots down to
93c ea. in 50,000 lots.

50 Ω through 500K Ω .

\pm 20% tolerance.

3/4 watt @ 25°C; 1/2 watt @ 85°C, derated to no load @ 150°C.

Single turn.

Prototype Quantities From Stock.
Production Quantities: 4-6 weeks.

Order from: CTS of Berne, Inc., Berne, Indiana 46711.
(219) 589-3111.



CTS CORPORATION
Founded 1896



Series 360 Side Adjust 7/16" x 17/64" x 25/64"
Snap-in Type Cermet Trimmer

NEW FROM CTS

\$1.04 ea. in 1,000 lots down to
80c ea. in 50,000 lots.

50 Ω through 1 megohm.

\pm 20% tolerance.

1 watt @ 25°C; 1/2 watt @ 85°C, derated to no load @ 125°C.

Single turn.

Prototype Quantities From Stock.
Production Quantities: 4-6 weeks.

Order from: CTS of Berne, Inc., Berne, Indiana 46711.
(219) 589-3111.



CTS CORPORATION
Founded 1896

manufacturer of microminiature digital display readouts and tiny incandescent lamps, has published its 1969 catalog. [459]

Heat sink. Astrodyne Inc., 207 Cambridge St., Burlington, Mass. 01803. Bulletin NC-524 covers a heat sink with low thermal resistance and side-panel mounting. [460]

Metal-forming service. Hydroforming Division, Perfection Mica Co., 740 Thomas Dr., Bensenville, Ill. 60106, has issued catalog H-68 describing a new low cost ferrous and nonferrous metal-forming service with short delivery cycles. [461]

Aluminum electrolytic capacitors. Sangamo Electric Co., Pickens, S.C. Axial lead, aluminum electrolytic capacitors that are said to make tantalum foil capacitors obsolete are described in bulletin 2240A. [462]

Microwave components. Kevlin Mfg. Co., 26 Conn St., Woburn, Mass. 01801. A 20-page catalog covers solid state switches, miniature coaxial hybrids, couplers and mixers, and rotary couplers, plus a line of associated microwave components. [463]

Micrologic cards. Control Logic Inc., 3 Strathmore Rd., Natick, Mass. 01760, has available a 44-page catalog dealing with 5-Mhz micrologic circuit cards and accessories. [464]

Piezoelectric transducers. PCB Piezotronics Inc., 3311 Walden Ave., Depew, N.Y. 14043, offers a catalog illustrating and describing a line of piezoelectric transducers for measuring dynamic pressures. [465]

Interval timers. Hi-G Inc., Spring St. and Rt. 75, Windsor Locks, Conn. 08098. Bulletin 161 covers three series of interval timers that include both solid state and electromechanical output configurations. [466]

Electromagnetic shielding. Emerson & Cuming Inc., Canton, Mass. 02021, has issued a folder on Eccoshield r-f shielding materials, showing a wide variety of approaches to shielding requirements. [467]

MOS shift registers. Texas Instruments, 13500 N. Central Expressway, Dallas 75222, offers a 20-page application report that describes MOS static shift registers and tells how to use them in

bipolar logic systems. [468]

Digital servo. Theta Instrument Corp., 22 Spielman Rd., Fairfield, N.J. 07006. An instrument servomechanism with digital outputs is described in six-page bulletin 66-11D. [469]

Semiconductor screening. Associated Testing Laboratories Inc., 200 Rt. 46, Wayne, N.J., 07470, has available two-page bulletin T-18 giving a detailed description of the capabilities of its new semiconductor screening facility. [470]

Bench etcher. Chemcut Corp., 500 Science Park, State College, Pa. 16801. Data sheet E-16 contains features and technical specifications of bench-type model 315 conveyORIZED horizontal spray etcher. [471]

Signal averager. Fabri-Tek Instruments Inc., 5225 Verona Rd., Madison, Wis. 53711. A four-page catalog explains what signal averaging is and how it works and describes the low-cost model 1010 signal averager. [472]

Stepping motors. Computer Devices Inc., 11925 Burge St., Santa Fe Springs, Calif. 90670, has prepared a 16-page

CERMET TRIMMERS



Series 165-3/8" x 3/8" x 13/64" Cermet Trimmer

NEW FROM CTS

\$3.25 ea. in 1,000 lots down to
\$2.56 ea. in 50,000 lots.

50 Ω through 1 megohm.

$\pm 20\%$ tolerance.

1/2 watt @ 85°C derated to no load @ 150°C.

25 turns.

Prototype Quantities From Stock.
Production Quantities: 4-6 weeks.

Order from: CTS of Berne, Inc., Berne, Indiana 46711.
(219) 589-3111.

 **CTS CORPORATION**
Founded 1896



Series 190-3/4" x .160" x .310" Cermet Trimmer

NEW FROM CTS

\$1.24 ea. in 1,000 lots down to
98c ea. in 50,000 lots.

50 Ω through 500K Ω .

$\pm 20\%$ tolerance.

1/2 watt @ 85°C derated to no load @ 125°C.

20 turns.

Prototype Quantities From Stock.
Production Quantities: 4-6 weeks.

Order from: CTS of Berne, Inc., Berne, Indiana 46711.
(219) 589-3111.

 **CTS CORPORATION**
Founded 1896

NEW O.E.M.

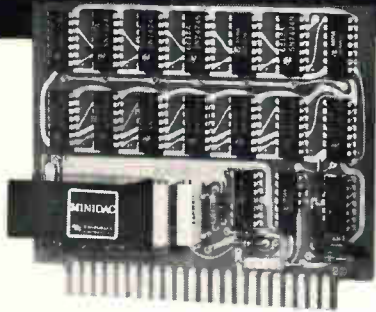

3 3/4" x 4 1/2" x 1/2"

A-to-D Converter

Pastoriza offers the first utility converter for systems applications . . . priced for quantity sales.

Having first introduced the modular A-to-D and D-to-A converter, Pastoriza Electronics now offers an unprecedented innovation: A printed circuit card A-to-D converter featuring . . .

High Performance

- 12 bits conversion in 8 microseconds.
- 10 bits conversion in 4 microseconds.
- 8 bits conversion in 2 microseconds.

Low Cost

Priced competitively with any ADC available today, and designed for volume production.

Open Book Concept

No black magic in the design — circuitry is accessible and repairable.

User Confidence

Design and component information is supplied to insure ease and confidence in customer application.

This complete single-card A-to-D converter includes reference supply and comparison amplifier, using dual in-line integrated circuit logic with a MINIDAC D-to-A module. It accepts 0 to +10 volts input range, and provides up to 12 bits resolution.

Write for eye-opening facts on this newest modular A-to-D utility converter.

PASTORIZA
ELECTRONICS, INC.

385 Elliot St., Newton, Mass. 02164 • 617-332-2131

New Literature

brochure describing state-of-the-art stepping motors. [473]

Data acquisition systems. Datatron Inc., 1636 E. Edinger Ave., Santa Ana, Calif. 92705. A technical brochure describes two recently introduced analog/digital data acquisition and recording systems. [474]

EMI measurements. Hewlett-Packard Co., 1501 Page Mill Rd., Palo Alto, Calif. 94304. A 26-page application note discusses the principles of electromagnetic interference measurements and shows how modern calibrated spectrum analyzers can be used as tuned r-f microvolts with visual display to speed these measurements. [475]

Instrument modules. Monsanto Electronic Instruments, 620 Passaic Ave., West Caldwell, N.J. 07006, has issued a technical bulletin on its fourth-generation series 100 system-compatible instruments and the series 500 accessories. [476]

Vhf tuner. Telefunken Sales Corp., South St., Roosevelt Field, Garden City, N.Y. 11530. Brochure 6701134 describes a television vhf tuner using variable capacitance diode tuning. [477]

Connectors. AMP Inc., Harrisburg, Pa. An expanded series of rectangular pin and socket connectors for rack and panel/cable applications is described in 52-page catalog No. 940. [478]

Circulators and drivers. E&M Laboratories, 7419 Greenbush Ave., North Hollywood, Calif. 91605. High-speed switchable circulators and drivers are described in a four-page short-form catalog. [479]

Cable assemblies. General Reliance Division, General Relay Corp., 20 Mercer St., Dover, N.J. 07801, has available a four-page, two-color booklet entitled "Custom Cable and Molded Cable Assemblies." [480]

Echo suppressor. Lenkurt Electric Co., 1105 County Rd., San Carlos, Calif. 94070. A four-page brochure describes the 931C echo suppressor, which eliminates the echo encountered in satellite, transoceanic, and transcontinental circuits. [481]

MOS integrated circuits. National Semiconductor Corp., 2975 San Ysidro Way, Santa Clara, Calif. 95051, offers a report describing its quality and reliability program, including recent test results on its integrated MOS products. [482]

Industrial static switching. Jordan Controls Inc., 5607 W. Douglas Ave., Milwaukee 53218, has released a 66-page

High Voltage Rectifiers

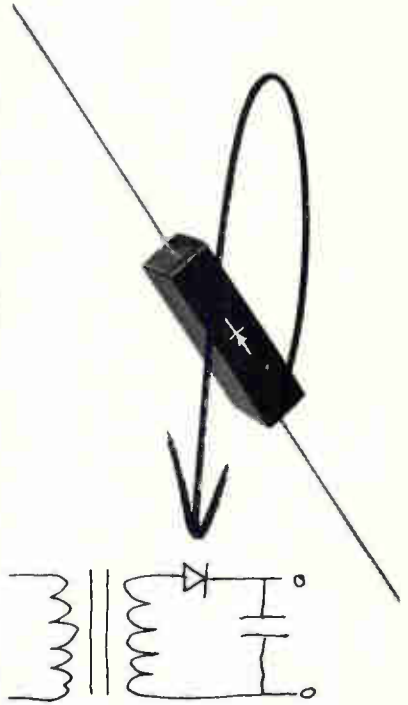

New! From Varo.

Silicon Rectifiers At Selenium Prices!

At last, economical high voltage silicon rectifiers. Ideal for use in all high voltage, low current applications.

- 5,000-40,000 Volts
- 5, 10, 25 milliamp ratings
- Standard and Fast Recovery
- In 1/4" square package.

These are the high voltage rectifiers that make completely solid state television circuits possible. Equally well suited for use in other cathode ray tube applications, electrostatic power supplies and voltage multipliers.

Only \$1.32

10,000V, 5mA rating. Quantity of 1,000. Complete details, applications, and price list available.



SEMICONDUCTOR DIVISION
2203 WALNUT STREET, GARLAND, TEXAS 75040
(214) 272-3561

New Literature

handbook on industrial static switching techniques and applications. [483]

Microwave filters. DeMornay-Bonardi Division of Datapulse Inc., 1313 N. Lincoln Ave., Pasadena, Calif. 91103. Technical data sheet DB-282 describes waveguide bandpass and band-reject filters. [484]

Wire and cable. Garrett Wire & Cable Corp., 24 Central Dr., Farmingdale, N.Y. 11735, has released a 36-page catalog listing nine major wire and cable groups and related products. [485]

Dipping material. Isochem Resins Co., Cook St., Lincoln, R.I. 02865, has released a data sheet on Clear Dip, a dipping material that has optical clarity, excellent thixotropy, and long pot life. [486]

P-c connectors. U.S. Components Inc., 1320 Zerega Ave., Bronx, N.Y. 10462. An illustrated eight-page catalog shows newly developed connectors in two-unit, grid-spaced, printed-circuit designs. [487]

IC terminology. Sylvania Electric Products Inc., 100 First Ave., Waltham, Mass. 02154, has published a pocket dictionary for most of the terms used in the integrated-circuit field. [488]

Silvered-mica capacitors. Sprague Electric Co., 35 Marshall St., North Adams, Mass. 01247. Bulletin 1010A covers a line of dipped single-film, silvered-mica capacitors for entertainment and commercial equipment. [489]

Brushless d-c motors. Siemens America Inc., 350 Fifth Ave., New York 10001. A four-page brochure describes a line of miniature brushless d-c motors with solid state controls. [490]

Rotary switches. Electro Switch Corp., King Ave., Weymouth, Mass. 02188. Bulletin 30 covers the series 24 solenoid-drive rotary switches for remote control up to 30 amps, 600 volts. [491]

Corona detectors. Hipotronics Inc., Brewster, N.Y. 10509. A two-page brochure discusses corona detectors designed for wire and cable industry applications and over-all industrial use. [492]

Portable vibration meter. Reliance Electric Co., 24701 Euclid Ave., Cleveland 44117, has issued data sheet P-2524 on the model 638 vibration meter for in-plant measurement. [493]

Discrete devices. Fairchild Semiconductor, 313 Fairchild Dr., Mountain View, Calif. 94041, has published the 1969 catalog giving a complete listing of its discrete devices, including diodes, FET's, and power transistors. [494]

TDK CIRCULATOR



The 200-series circulators and isolators are designed for VHF and UHF service of up to 1,000MHz. They are compact, high-performance, and low cost circulators developed by TDK under the guidance of the NHK Technical Research Laboratory.

Each 200-series circulator is of lumped-element type, and has its internals secured reliably for improved shock resistance and magnetically shielded by the case. The internals are net-like center conductors, YIG ferrites ferrimagnets and matching capacitors, all made of premium-quality materials selected from the wide variety of magnetic and dielectric materials manufactured by TDK Electronics.

Write to MH & W for full technical data and information on applications
Representative in U.S.A. & Canada for Ferrite Core for communications



MH&W INTERNATIONAL CORPORATION

280 Midland Avenue Saddle Brook N.J. 07662
Phone N.J. 201 791 6277 N.Y. 212 244 0695



TDK ELECTRONICS CO., LTD.
2-14-6 Uchikanda, Chiyoda-ku, Tokyo, Japan

It's one thing to make a low cost digital tape unit, it's something else to make a low cost digital tape unit without compromise. Tally did.

From bare bones to full dress, Tally's new low price Series 4000 computer compatible digital tape units were built from the ground up with no compromises in design.

Series 4000 digital tape units are available and in production now. You can order the transport only with servo and capstan electronics. Or you can order the full dress version with read/write data electronics and complete interface logic.

Performance? Just Check All these Key Features.

- High speed rewind with servo controlled tape tension (another no compromise) takes 1½ minutes for a full 10½ inch reel of tape.
- Compact design handles full 10½ inch reels yet uses only 26½ inch panel space in a standard 19 inch rack. Hinged transport for easy access and front-end service.



- DTL logic or 7 and 9 channel formats. Special read only version can handle both formats without head change.
- Tape deck constructed from a rugged temperature stabilized precision casting. (Unique in the low cost field.)
- No periodic mechanical adjustments. (Another no compromise design feature.)
- Low mechanism forces and single capstan drive handle tape gently for long tape life.

Simply write or call our man Tom Tracy for more data. Tally Corporation, 1310 Mercer Street, Seattle, Washington 98109. Phone: (206) 624-0760. In the U.K. and Europe, address Tally Limited, 6a George Street, Croydon, Surrey, England. Phone: MUN-6836.

TALLY

Electronics index

Volume 41, 1968

NOTES: EA (Electronics Abroad); ED (Editorials); EI (Electronics International); ER (Electronics Review); NP (New Products)

- AMPLIFIERS**
Active filters ER p. 45 Feb. 19
Active filters: Part 5 Applying the operational amplifier p. 98 Dec. 9
Amplifier bridges cost-specs gap NP p. 176 Jan. 8
Amplifier flattens ripple in d-c regulator p. 106 Apr. 15
Amplifier not bothered by 100°C change NP p. 235 Aug. 5
Amplifying data without noise NP p. 156 Feb. 5
Beyond microwave IC's—new technique called praeterionics ER p. 66 Nov. 11
Boosting color tv's i-f performance p. 130 Mar. 4
Boosting op-amp output with two transistors p. 110 June 10
Bootstrapping bias supply increases IC voltage capacity p. 90 Oct. 28
Bridge amplifier provides isolation p. 83 Sept. 30
Bridge and amplifier monitor d-c level p. 99 June 24
Corrected version p. 71 Sept. 2
Designers beat 3-way stretch NP p. 191 Mar. 18
Differential amplifier governs magnetic brakes and clutches p. 75 May 13
Differential amplifier uses two IC's p. 120 Nov. 11
Doubling-up IC amplifiers makes sense NP p. 217 Jan. 8
Dynamic tests for op amps use synchronous modulation p. 118 Aug. 5
80-watt amplifier covers 225 to 400 Mhz NP p. 115 Dec. 23
Everything—including sink—in one package NP p. 211 Feb. 19
FET and IC keep oscillator linear p. 84 Aug. 19
Full compensation added to op amps NP p. 184 May 27
Giving IC op amps a powerful boost NP p. 154 Feb. 5
Great Britain: Cooling with gas—parametric amplifier EA p. 245 May 27
Great Britain: Sound thought—preamplifier for hi-fi EI p. 309 Nov. 11
Grounded-base amplifier mates npn to pnp p. 89 Feb. 5
High-precision preamp built from 3 transistors p. 58 Dec. 23
IC audio amplifier puts out 5 watts NP p. 111 Nov. 25
IC op amp compressed into flatpack NP p. 115 Nov. 25
IC's poaching on op amp preserves NP p. 109 Apr. 29
Integrating agc ER p. 46 Feb. 5
Isolated success—dielectric isolation technique for developing linear IC operational amplifier ER p. 44 Jan. 22
Japan: Big gainer—IC i-f amplifiers EA p. 146 Apr. 29
Japan: Steady gains—Hybrid IC amplifier for S band EI p. 147 Nov. 25
Linear IC's: Part 6 Compensating for drift p. 90 Feb. 5
Low-distortion limiter uses IC operational amplifier p. 120 Oct. 14
Low-drift op amp for less NP p. 181 May 27
- Modulating current supplied by op amp p. 107 Aug. 5
Op amp boosts pick-up voltage p. 108 Aug. 5
Op amp combines squelch and agc NP p. 209 June 10
Operational amplifier simulates inductance p. 99 Sept. 16
Operational amplifier with four transistors in the input stage—high-gain transistors ER p. 54 Nov. 11
Optics aid pulse amplifier NP p. 132 Apr. 29
Power circuits key to trim package NP p. 157 Aug. 19
Process trainer gives operators true picture p. 131 Jan. 22
Protecting data from the ground up p. 58 Apr. 29
The 709 gets a high-speed successor NP p. 95, 177 June 24
Splendid isolation—dielectric approach yields premium, competitive op amp NP p. 187 Feb. 5
Squelch gate reduces amplifier's standby gain p. 83 Dec. 9
Stripped for action—magnetic amplifier uses a zener diode in place of the demodulator ER p. 32 Apr. 1
30-Ghz amplifier has 600-Mhz bandwidth NP p. 149 Sept. 2
Too-fast converter finds its niche NP p. 242 Aug. 5
Transistor replaces resistor and improves amplifier p. 92 Jan. 8
Uncoupling r-f amplifiers ER p. 39 Mar. 4
UJT protects op amp from voltage transients p. 83 Nov. 25
Voltage comparator is made with op amps and logic gates p. 91 July 8
Wescon preview: IC testers, op amps star p. 191 Aug. 5
Tester takes to any op amp p. 192 Aug. 5
Improving on the 709 p. 195 Aug. 5
Wideband amplifier has 2 magnetrons NP p. 198 Mar. 18
- ANTENNAS**
Australia: Five-array antenna for Post Office EA p. 249 Jan. 8
Great Britain: Clearing the dishes—Cassegrain antenna EA p. 255 June 10
Great Britain: Good steer—wideband steerable arrays EA p. 145 Apr. 1
Hong Kong: Tailoring antennas EA p. 318 Mar. 4
Motor gives reverse twist to the Intelsat 3 antenna p. 71 Apr. 1
Sighting in on narrow light beams p. 106 Mar. 18
Solid state radar—Half step ER p. 43 May 27
Way up there—log-periodic dipole antenna ER p. 60 Oct. 14
West Germany: Ghost chaser—tv antenna will have a unique radiation pattern EA p. 270 Aug. 5
- ASTRONOMY**
East Germany: New stage for stars EA p. 147 Apr. 1
Radio Astronomy Explorer (RAE-A) ER p. 50 July 22
- AUTOMOTIVE**
Back on the road—highway traffic control research site ER p. 62 Aug. 5
Computerized automobile diagnostic centers ER p. 50 July 22
Devices meter auto pollutants NP p. 244 Nov. 11
Electronic traffic control: can it make the grade? p. 157 Apr. 15
France: Freeing the freeway—analyzer spots bottlenecks as fast as they develop EA p. 247 Jan. 8
Impatt impact—microwave radar "trap" ER p. 37 Apr. 29
Japan: Data-transmission network to handle auto registrations EA p. 172 Sept. 2
Japan: New way to skin a cat—bulldozer remote control for untrained operators EA p. 277 Apr. 15
Keeping in touch—program called Pulse ER p. 60 Nov. 11
Lots of radio on just one IC p. 124 Aug. 5
Monitor warns of car light that fails NP p. 213 Sept. 16
Sorting out the tires p. 125 Mar. 18
Treading softly—computer weeds out defective tires and grades acceptable ones ER p. 50 Feb. 19
West Germany: Feeling the heat—system measures the temperature of engine pistons EI p. 146 Nov. 25
West Germany: Fixing the brake—electronic antiskid system EI p. 271 Oct. 14
West Germany: In a scrape—radio-controlled scoop loader for radioactive debris EA p. 211 Feb. 5
West Germany: Road test—Daimler-Benz test track loaded with electronics EA p. 196 Jan. 22
West Germany: Top grade—grader has Nivomatic blade-control system EA p. 247 Jan. 8
- AVIONICS**
Accelerometer has cut-rate price NP p. 185 June 10
Aeronautical Services Satellite—Breaking the logjam ER p. 48 May 27
Aeronautical Services Satellite—Speculative proposal ER p. 44 Sept. 2
Air Force malfunction system—First AIDS ER p. 50 May 27
Air Force plans new weather monitor p. 151 June 24
Air traffic control: the waiting game p. 111 Sept. 2
Airborne military transceiver finds room in crowded spectrum p. 133 Apr. 15
Airbus makers go two ways on avionics p. 157 Aug. 5
Airplane altimeter goes all-electric NP p. 168 July 8
Altitude alert ER p. 62 Sept. 16
...and reacting faster—MAP system cuts a pilot's reaction time ER p. 40 Jan. 22
Australia: New approach for glide path arrays EA p. 255 Mar. 18
AWACS wins approval—Crisis of identity ER p. 54 Sept. 30
CAT by the tail ER p. 44 Apr. 29
- Dash dashed ER p. 74 Nov. 11
Designers up in air over specs p. 165 Sept. 16
Discretionary LSI: airborne digital computer ER p. 47 June 24
Done with magnets—magnetic fluid accelerometer ER p. 54 Mar. 18
Dropliner navigation system is redesigned from a to d p. 78 July 22
Electronics Markets 1968: Aviation's growth sends 1968 prospects soaring p. 120 Jan. 8
Entertainment system for DC-10 ER p. 56 Dec. 9
FAA priorities irk critics p. 155 Feb. 19
FAA readies new checkout system p. 127 Feb. 5
Flight control—electronic systems for the SST ER p. 64 Aug. 5
Follow the bouncing ball—non-mechanical inertial reference instrument ER p. 58 Oct. 14
France: Inside job—high-frequency transceiver EA p. 163 July 22
Geiger fuel gauge for aircraft ER p. 72 Nov. 11
Great Britain: Missing link—quadruplicated control system EA p. 164 July 22
Great Britain: Sharper look—transponders' market EI p. 212 Sept. 30
Great Britain: Thin solar cells EI p. 145 Nov. 25
Guidance for \$2,000—computer to guide an air-to-surface missile ER p. 52 Nov. 25
Height of sophistication in in-flight monitoring p. 78 May 13
High lighting: electroluminescent panels for aircraft ER p. 46 June 10
Image-intensifying electronic devices' study—Getting the picture... ER p. 39 Jan. 22
International: Aerospace tutorial—NATO's Advisory Group for Aerospace R&D EA p. 246 May 27
Italy: Landing system instruments ordered EA p. 249 May 27
Luxembourg: Institute to train air-traffic control specialists EA p. 249 Jan. 8
Making a point: digital airborne computers use floating-point arithmetic ER p. 48 June 10
Mexico: One umbrella—a nationwide air-traffic control system EI p. 210 Sept. 30
Modular air computer ER p. 44 May 27
Module tester will help speed repairs on aircraft navigation and radio equipment ER p. 60 June 24
Multiplexing the LSI way—telemetry module ER p. 45 June 10
Navigation converter talks two languages—computer device NP p. 151 Feb. 5
Netherlands: computer—controlled "Air-lord" EA p. 164 July 22
Night sight ER p. 56 Aug. 19
Outside wiring—new approach to discretionary wiring ER p. 47 June 24
Potential of phased-array radar spurs increasing R&D activity p. 94 Sept. 2
A question of priority ER p. 52 Mar. 18
Radar system—Happy landings ER p. 48 Apr. 29

RCA's integrated very-high-frequency omni-range and instrument landing system ER p. 48 Sept. 30
Real-time reservation—computerized reservation system ER p. 51 Aug. 5
Recorded voice alerts pilots NP p. 171 Feb. 19
Simulators go to the head of the class p. 163 Apr. 15
SST multiplexing ER p. 58 June 24
Standing up to abuse—IC operates on 28 volts ER p. 55 Oct. 14
Sweden: Automatic tester checks Vigen electronics EA p. 148 Apr. 1
Systems engineering for the airlines ED p. 31 Aug. 5
TFX—Back to the drawing board ER p. 60 Apr. 15
Talking by the numbers ER p. 44 Dec. 23
Testing on the wing p. 81 Apr. 29
Touching down—helicopter landing system ER p. 48 June 24
Vibrating angular rate sensor may threaten the gyroscope p. 130 June 10
A weight saver for jumbo jets NP p. 232 Nov. 11
West Germany: Back in the air EA p. 172 Sept. 2
West Germany: Double coverage—air traffic control radar EA p. 260 June 10
West Germany: Fit to be tied—kibitzing capsule for electronic gear EA p. 276 Apr. 15
West Germany: Glide guide—Setac landing equipment EA p. 161 July 22
West Germany: Low ceiling EA p. 198 May 13
West Germany: A sad Red Baron EI p. 308 Nov. 11

BUSINESS
Age of protest—computer manufacturers challenge Air Force on contract award ER p. 48 Jan. 8
Airbus makers go two ways on avionics p. 157 Aug. 5
All-purpose scapegoat ED p. 23 Jan. 8
Australia: AWA will develop and produce IC's EA p. 261 June 10
Automation: good barometer for markets ED p. 31 Dec. 23
Bell Canada's R&D arm, Northern Electric, develops reach p. 125 May 13
British invade a common market NP p. 216 Mar. 4
Business and the urban crisis—McGraw-Hill special report p. C1-C16 Feb. 5
A case of self-deception ED p. 31 Sept. 2
Control Data Corp.'s preliminary agreement to acquire Electronic Associates Inc. ER p. 56 Mar. 4
Control Data Corp. sales ER p. 56 Feb. 5
Copying may not work ED p. 23 Mar. 18
Data Automation Co. buys 45% interest in Carterphone Communications Corp. ER p. 56 Dec. 9
Election issues for electronics p. 139 Oct. 28
EIA—Soaring sales ER p. 60 Mar. 18
Electronics Markets 1968 p. 101 Jan. 8
State of the mart: gains slowed by war priorities p. 105 Jan. 8
The prospects are solid p. 109 Jan. 8
Growing—but still in the incubator (medical electronics) p. 113 Jan. 8
A funny thing happened on the way to prosperity (television) p. 114 Jan. 8
Computer-assisted instruction stepping up in class p. 116 Jan. 8
Growth rate a Vietnam casualty p. 118 Jan. 8
Aviation's growth sends 1968 prospects soaring p. 120 Jan. 8
Too hot not to cool down? (computers) p. 123 Jan. 8
Signal gains in store for 1968 (communications) p. 126 Jan. 8
Still tied to Pentagon purse strings (microwave) p. 129 Jan. 8
The fiscal squeeze tightens (space electronics) p. 130 Jan. 8
New member of the billion-dollar club (industrial electronics) p. 132 Jan. 8
Selective gains for the resourceful (components) p. 135 Jan. 8
Europe: Fairchild readying a new assault on market EI p. 202 Dec. 9
European electronics markets: 1969-report p. 65 Dec. 23
It's got to be good
West Germany p. 71 Dec. 23
United Kingdom p. 72 Dec. 23
France p. 76 Dec. 23
Italy p. 79 Dec. 23
Sweden p. 81 Dec. 23
The Netherlands p. 83 Dec. 23
Belgium p. 85 Dec. 23
Switzerland p. 86 Dec. 23
Spain p. 87 Dec. 23
Denmark p. 88 Dec. 23
Norway p. 89 Dec. 23
Fairchild Camera & Instrument Corp. to sell its memory-products group to Data Products Corp. ER p. 56 Feb. 5
Fairchild shakeup ER p. 52 July 8
C. Lester Hogan, new president and chief executive officer ER p. 45 Aug. 19
Fairchild-Motorola Act Two ER p. 40 Sept. 2
Fairchild vs. Motorola ER p. 60 Sept. 16

Hogan takes hold at Fairchild p. 119 Sept. 30
Fairpak finale ER p. 58 Nov. 11
Federal budget—An uncertain guide for suppliers p. 137 Feb. 19
France: CSF trims down EA p. 224 July 8
France: Gathering clouds EI p. 199 Dec. 9
France: Hard times EA p. 256 June 10
France: Powerful partner—government acquires one-quarter holding in CFT EA p. 193 Jan. 22
French firm enters U.S. market for nuclear instrumentation p. 157 May 27
From another Iron Mountain—"Technological innovation in civilian public areas" ED p. 23 Jan. 22
GE—Deficit mending ER p. 38 Apr. 29
General Precision Equip. Corp. merger with Singer Co. proposed ER p. 44 May 13
Good business: an international approach ED p. 31 July 22
Great Britain: Comeback for Dynatel Ltd. EA p. 185 Aug. 19
Great Britain: The taxman cometh EA p. 145 Apr. 1
Heading toward a record ED p. 23 Jan. 8
Hewlett-Packard vs. GAO, continued ER p. 50 Feb. 5
Honeywell Inc. will move the operations of its Test Instruments division ER p. 66 June 10
Indonesia: East is east—and cheaper EI p. 309 Nov. 11
International: Entrenched privilege—moves to cut the outflow of capital from the U.S. may have little impact on overseas plant investments EA p. 197 Jan. 22
IBM: Federal Center broadens horizons p. 145 June 24
International outlook ED p. 31 Sept. 30
Italy: Elsi plant to be run by STET EI p. 206 Dec. 9
Italy: Raytheon-Elsi decision near EA p. 237 Sept. 16
Japan: Ending to its four-year-long hassle with TI EA p. 200 May 13
Japan: Giant chasers EA p. 205 June 24
Japan: Matsushita Electrical Industrial Co.'s subsidiary in Australia EA p. 257 Mar. 18
Japan: NTT ordered to punish the engineers who designed the repeater stations EA p. 261 June 10
Laser Systems Corp. purchases Lear Siegler Inc.'s Laser Systems Center ER p. 66 June 10
Life or death at Sperry Gyroscope ER p. 62 July 8
LMI report: a little knowledge ED p. 23 Apr. 15
Moving into ghettos ER p. 45 May 27
Name dropping—Sen. Proxmire plans to disclose which companies have substantial government-owned equipment and which have been misusing the equipment ER p. 48 Jan. 8
The other jobs were easy ED p. 23 Feb. 5
Philco-Ford—Robert Hunter, top man ER p. 62 Oct. 14
RCA sells medical electronics agreement back to Hoffmann-LaRoche ER p. 56 Sept. 30
Russia—an open market p. 126 Dec. 9
Sales leadership: new optimism at two companies ER p. 38 May 13
Singer Co. and General Precision Equipment Corp. merger agreement ER p. 64 May 27
Solitron Devices Inc. moves to take over Amphenol ER p. 54 Mar. 4
Soviet Union: Contract with the Italians for computer peripheral equipment EI p. 272 Oct. 14
Soviet Union: Getting a ruble's worth EI p. 310 Nov. 11
Spain: Brave new band—export drive EA p. 209 June 24
Sperry Rand getting out of semiconductor business ER p. 48 Jan. 22
Stop-loss order ER p. 60 Oct. 28
Tenneco Inc. will sell Watkins-Johnson Co. ER p. 56 Mar. 4
TRW Inc. will take control of Clevite Corp. ER p. 64 May 27
Tyco Labs. Inc. to purchase Digital Devices Inc. ER p. 66 June 10
Unpackaged chips market picks up ER p. 47 Apr. 15
Value engineering: getting your money's worth p. 31 July 8
War puts agencies on short rations p. 151 Feb. 19
Watchdog at bay—Government's Renegotiation Board under industry attack again ER p. 42 Jan. 22
West Germany: Mating game EA p. 211 Feb. 5
West Germany: Quick recovery EI p. 308 Nov. 11
West Germany: Saba GmbH and GT&E merger EA p. 321 Mar. 4
West Germany: Siemens AG moving up on IBM EA p. 223 July 8
Zenith suit ER p. 66 June 10
CAPACITORS
Capacitor slows down stabilized power supply p. 123 Nov. 11
Chip capacitors tested automatically NP p. 217 June 10

French chip in leadless capacitors NP p. 128 July 22
One capacitor makes IC a pulse-width modulator p. 71 Sept. 2
Resonance effects yield in-circuit capacitance checks p. 119 Oct. 14
Rule of thumb for ripple calculations p. 87 Aug. 19
Single-sheet capacitors NP p. 214 Aug. 5
Transistor and relay regulate high voltages p. 70 July 22
Wescon preview: IC testers, op amps star p. 191 Aug. 5
This dielectric keeps it cool p. 207 Aug. 5

COLOR TELEVISION
Austria: Color tv production center EI p. 272 Oct. 14
Boosting color tv's i-f performance p. 130 Mar. 4
Camera focuses on low cost NP p. 195 July 8
CBS nominates a convention hopeful—lightest portable color tv camera p. 74 Aug. 19
Color-tv demodulator goes IC NP p. 221 June 10
Color tv display system suitable for use as a studio monitor ER p. 65 Apr. 15
Color tv scores big gains with small screens p. 136 June 10
Doing it in color—all-solid state color models p. 107 June 24
Dusting process brightens picture NP p. 192 Mar. 18
Electronics Markets 1968: Selective gains for the resourceful p. 135 Jan. 8
Finland: PAL color tv system adopted EA p. 321 Mar. 4
France: Broken color line EA p. 236 Feb. 19
Graphite coatings are hard and porous NP p. 230 Nov. 11
Great Britain: Mortal coils—etched coils for scanning deflection EA p. 238 Sept. 16
Great Britain: Reins damp tv outlook EI p. 146 Nov. 25
Japan: Color it otherwise—"separated white" concept could lead to practical successors to the shadow-mask tube EA p. 194 Jan. 22
Japan: Color tv sales EA p. 249 Jan. 8
Japan: Facsimile palette—still color photos by facsimile EA p. 257 June 10
Japan: Telechromatic—color-facsimile transmissions EA p. 193 Jan. 22
Japan: Three-shot gun—Trinitron EA p. 145 Apr. 29
MOS IC's process color video signals NP p. 133 July 22
One-tube color camera ER p. 47 Dec. 9
... others go solid—component producers pushing for tubeless tv ER p. 56 July 8
Portable color cameras in the picture NP p. 133 May 13
Radiating worry ER p. 56 Apr. 15
Radiation standards ER p. 52 Oct. 28
Setting the stage for flat-screen tv p. 92 Apr. 15
Corrections p. 228 May 27
Shortcuts in tv camera design make for big cuts in price p. 134 Nov. 11
Silicon power transistor for color tv sets ER p. 58 June 24
Slide view—color tv system that can screen color slides ER p. 42 May 13
Some push tubes...RCA offering nine-pin miniature tubes; GE pushes its Compactron tubes ER p. 54 July 8
Soviet Union: Color tv behind schedule EI p. 206 Oct. 28
Toward tubeless tv—high-voltage rectifier ER p. 42 Mar. 4
West Germany: Fading color line EA p. 258 June 10

COMMUNICATION SATELLITES
Aeronautical Services Satellite—Breaking the logjam ER p. 48 May 27
Aeronautical Services Satellite—speculative proposal ER p. 44 Sept. 2
APT to grow ER p. 58 May 27
ATS-F—loaded mission p. 103 Dec. 23
Bridging the gap—role of the military satellites ER p. 64 July 8
Canada: Bouchette, earth station EI p. 272 Oct. 14
Canada: Domestic satellite ruffles feathers EA p. 239 Sept. 16
Canada: Satellite in sight EA p. 277 Apr. 15
Central America: regional two-satellite communications network EI p. 148 Nov. 25
Comsat gains ER p. 74 Nov. 11
Great Britain: Goonhilly Downs station will be rebuilt ER p. 249 May 27
Great Britain: "Skynet" military communications satellite network contract EA p. 320 Mar. 4
Growing flock of birds ER p. 56 Mar. 18
Intelsat 3 antenna—motor gives reverse twist p. 71 Apr. 1
Intelsat 4 countdown nears zero p. 139 June 24
Intelsat 4: Fourth generation ER p. 68 Oct. 14

Kenya: First commercial communications satellite ground station in Africa EA p. 321 Mar. 4
LES-6 Communication satellite ER p. 52 Sept. 30
NASA selects GE and Fairchild to carry out parallel design studies for Applications Technology Satellites F and G ER p. 56 Sept. 30
Nimbus B will be replaced ER p. 50 July 22
Philippines: Satellite communication ground station EA p. 262 June 10
Photo finish—Comsat and Intelsat 3 race for Olympic Games ER p. 64 Sept. 16
A single voice — Task Force suggests Comsat serve as the nucleus of a new company that would take over the international transmission facilities of all existing U.S. carriers ER p. 58 Nov. 25
Soviet Union: Network for socialist countries EA p. 248 Jan. 8
Spain: Telephone network will extend direct dialing to European countries in '69 EA p. 249 May 27
Symphonic satellite—Fiddling with Symphonie ER p. 46 Apr. 29
Tacsat: big bird ER p. 44 May 27
Unspun—gravity-gradient system may limit the life of ATS-D ER p. 48 July 22

COMMUNICATIONS
ARPA network will represent integration on a large scale p. 131 Sept. 30
Airborne military transceiver finds room in crowded spectrum p. 133 Apr. 15
AT&T has asked the FCC to require the use of a protective device between non-Bell equipment and phone lines ER p. 55 Sept. 16
Band splitting ER p. 56 Feb. 19
Canada: Fixed positions—hydrographic survey system EA p. 222 July 8
Car 54—Where are you?—mobile radio power transistor NP p. 186 Feb. 5
Car 54, wofbr akl yih?—police flight eavesdropping NP p. 125 Sept. 4
Channel sharing ER p. 52 Mar. 4
Circulator suppresses echoes in 4-GHz band NP p. 179 Sept. 30
Cleaning the spectrum ER p. 54 Feb. 19
CBS nominates a convention hopeful—lightest portable color tv camera p. 74 Aug. 19
"Competition is good... sometimes" ED p. 31 Dec. 23
CAI edges slowly into the classroom p. 163 Aug. 5
Converter handles high-speed-spin signals NP p. 238 Aug. 5
Cutting noise in data sampling p. 70 May 13
Different type—adapting a typewriter to a computer ER p. 58 Aug. 5
Elbow room—recommendations about what to do to relieve the crowded frequency spectrum ER p. 56 Aug. 5
Electronics Markets 1968: Signal gains in store for 1968 p. 126 Jan. 8
Every data bit counts in transmission cleanup p. 77 Jan. 22
Fast talk ER p. 56 June 10
FCC begins to get the message p. 153 Jan. 8
FCC contract to Stanford for communication research ER p. 50 July 22
Federal libraries cast a long shadow p. 123 July 8
Ferrites' attraction is magnetic and growing p. 104 Oct. 14
France: Carpitron tube sold for use in Brittany's Intelsat 3 ground stations EI p. 136 Dec. 23
France: Inside job—high-frequency transceiver ER p. 163 July 22
France: Lowdown—new low-level altimeter EA p. 185 Aug. 19
France: The right address—address generator EA p. 271 Aug. 5
Great Britain: Asbestos-like plastic for new pivot assembly EA p. 261 June 10
Great Britain: Bulldog spirit EA p. 317 Mar. 4
Great Britain: Comeback for Dynatel Ltd. EA p. 185 Aug. 19
Great Britain: Gem of a delay EA p. 254 Mar. 18
Great Britain: IC to change college curricula EA p. 207 June 24
Great Britain: Magnetic modulator EA p. 237 Feb. 19
Great Britain: Out of the trunk—mobile transceiver the size of an ordinary car radio EI p. 206 Oct. 28
Great Britain: Unto the breach—line fly-back period used for audio EI p. 211 Sept. 30
Ground-station market flies high p. 105 Nov. 25
Hands-off attitude—regulating telepresence ER p. 40 Dec. 23
Hungary: Communications network improvement program EA p. 321 Mar. 4
Illinois Central RR's 800-mile microwave radio communications system ER p. 56 Mar. 4
Italy: microwave link EI p. 136 Dec. 23
Italy: Unkind cut—telephone monitor cuts off long-distance calls EA p. 280 Apr. 15

Japan... and diodes today for millimeter-wave phone setup EI p. 210 Sept. 30
Japan: Double talk—two phone conversations on one line EA p. 235 Sept. 16
Japan: Facsimile palette—still color photos by facsimile EA p. 257 June 10
Japan: Fast check—nationwide check-clearing facility EA p. 162 July 22
Japan: Improving a loser—glass fiber promises less signal noise EI p. 133 Dec. 23
Japan: Mitey mike—electret capacitor microphone EI p. 133 Dec. 23
Japan: On call—DEX-II exchange EA p. 161 July 22
Japan: Steady gains—Hybrid IC amplifier for S-band EI p. 147 Nov. 25
Japan: Telechromatic—color-facsimile transmissions EA p. 193 Jan. 22
Japan: Topics (total on-line program and information control system) EI p. 205 Oct. 28
Japan: Twice the fax EI p. 201 Dec. 9
Japan: Wave of the future... millimeter-wave phone experiment EI p. 209 Sept. 30
Keeping in touch—program called Pulse ER p. 60 Nov. 11
Keyboard with Ascii output costs \$500 NP p. 201 June 10
Laser series III Light wave of the future: optical pcm p. 123 Sept. 16
Latin America: Conference call—telecommunications network EA p. 184 Aug. 19
Loran receiver—new role planned NP p. 168 Aug. 19
Los Angeles Police Dept. contract for facsimile identification network ER p. 56 Feb. 5
Lots of radio on just one IC p. 124 Aug. 5
Luxembourg: broadcast station EA p. 214 Feb. 5
Mexico: One umbrella—a nationwide air-traffic control system EI p. 210 Sept. 30
Mexico nears finish line in the first Olympic event p. 95 Apr. 1
Multiplexing the LSI way: telemetry module ER p. 45 June 10
Opening up the spectrum ER p. 68 Nov. 11
Op amp combines squelch and agc NP p. 209 June 10
Pioneer D: convolutional coding technique cuts errors ER p. 36 Apr. 1
Portable telephone always gets call NP p. 218 Mar. 18
Power-line filters need specific specs p. 112 June 24
Project Mallard: for the birds ER p. 54 Feb. 19
Receiver tuned to needs of new nations NP p. 216 Mar. 18
Ring up a computer ER p. 52 July 8
Saving money on data transmission as signals take turns on party line p. 119 Apr. 15
School work—experimental computer-assisted instruction system has conventional tv sets and pushbutton telephones ER p. 56 Feb. 5
Security guard system uses magnetically encoded ID cards ER p. 63 Apr. 15
Sighting in on narrow light beams p. 106 Mar. 18
Signal analysis with a 20-hertz bandwidth NP p. 228 Aug. 5
A single voice—Task Force suggests Comsat serve as the nucleus of a new company that would take over the international transmission facilities of all existing U.S. carriers ER p. 58 Nov. 25
Sound out of sight—Portamike ER p. 61 May 27
Space transmission method uses electric-optic crystal ER p. 47 Aug. 19
Spain: Telephone network will extend direct dialing to European countries in '69 EA p. 249 May '69
Speeding diplomacy's messages—ITT system for State Department p. 173 June 10
SST multiplexing ER p. 58 June 24
A switch for the teletypewriter market NP p. 158 Feb. 5
Sylvania would rather switch—tactical telephone exchange p. 119 Aug. 19
Taking noise out of weak signals p. 80 July 8
Talking by the numbers ER p. 44 Dec. 23
Taming the CO₂ laser ER p. 54 Apr. 15
Too-fast converter finds its niche NP p. 242 Aug. 5
Transmission of weather maps over ordinary telephone lines with isographic plotter ER p. 38 Apr. 1
Tuning bar replaces radio dial NP p. 185 Jan. 8
Uhf triodes aim to plant tricolor NP p. 167 Feb. 5
Unjamming the spectrum ED p. 23 Mar. 18
Wave of optimism for millimeter waves p. 151 Mar. 18

West Germany: Bright tune—tuning-indicator circuit for stereo receiver EA p. 246 Jan. 8
West Germany: Fax afield—portable facsimile EA p. 208 June 24
West Germany: System that transmits still images over standard telephone lines EA p. 248 May 27
West Germany: Tunnel talk EA p. 316 Mar. 4
Yugoslavia: Ground station designed to link with satellite for telephoning EI p. 272 Oct. 14
COMPUTERS
Active filters see Filters
Adder on a chip: LSI helps reduce cost of small machine p. 119 Mar. 18
ARPA network will represent integration on a large scale p. 131 Sept. 30
Australia: Information Electronics Ltd. first Australian-owned computers company EA p. 164 July 22
Australia: Japanese computer maker in Sydney EA p. 249 Jan. 8
Automated technician ER p. 60 May 27
Automating all along the line p. 88 Nov. 25
Average-as-you-go computer bows NP p. 194 Feb. 19
Blowup—details from a cart ER p. 37 Dec. 23
Bowling-Pin money: computerized scoring for bowling ER p. 46 Jan. 22
British challenger uses big words NP p. 180 Feb. 19
Budget-price magnetic-tape transport NP p. 173 July 8
Calculating on MOS—off-line peripherals for clerical functions ER p. 48 Sept. 30
Census Bureau depends on electronics to make its 1970 national nose count p. 103 July 22
A challenge from the power industry ED p. 31 Nov. 11
Circular words ER p. 48 June 24
Computer-aided design Part 13: Defining faults with a dictionary p. 64 Jan. 22
Part 14: Start with a practical IC model p. 94 Mar. 4
CAI edges slowly into the classroom p. 163 Aug. 5
Computer-oriented system speeds testing of circuits and components p. 72 July 22
Computer program club ER p. 46 Sept. 2
Computer with peripherals will rent for \$40 a month NP p. 193 Oct. 14
Coupler makes many matches NP p. 266 Nov. 11
Cranking out masks—computer-controlled masking camera does step-and-repeat work ER p. 38 Jan. 22
Czechoslovakia: Computers now operating EA p. 262 June 10
Czechoslovakia: Gamma 140 computer EA p. 200 May 13
Czechoslovakia: Head of the class—teaching machine ER p. 205 June 24
Data banks overdrawn EA p. 53 Feb. 19
Data converter accepts 20 channels NP p. 119 Dec. 23
Data recorder has light touch NP p. 260 Nov. 11
Data services ER p. 46 Sept. 2
Data system for thin purses NP p. 117 Apr. 1
Deficit mending at GE ER p. 38 Apr. 29
Design-a-day channel filter—computer-aided technique NP p. 191 Jan. 8
Diagnostic computer programs make TTC-(X) maintenance easier p. 122 Aug. 19
Different type—adapting a typewriter to a computer ER p. 58 Aug. 5
Digital comparator: smoothing difference signals for control NP p. 165 Sept. 30
Discretionary LSI—airborne digital computer ER p. 47 June 24
Doppler navigation system is redesigned from a to d p. 78 July 22
Double thinking—dual environment ER p. 64 June 10
Down the drain—joint calculator venture dropped ER p. 66 July 8
Drafting computers ER p. 44 Mar. 4
Drawing on computers ER p. 39 Mar. 4
Dual on line ER p. 56 Feb. 19
East Germany: Computer craze ER p. 198 May 13
Electronic traffic control: can it make the grade? p. 157 Apr. 15
Electronics Markets 1968: Computer-assisted instruction stepping up in class p. 116 Jan. 8
Electronics Markets 1968: Too hot not to cool down? p. 123 Jan. 8
An emerging solution ED p. 23 May 27
Fast-computer market at stake in emitter-coupled logic race NP p. 109 Dec. 23
FFT—shortcut to Fourier analysis p. 124 Apr. 15
FFT hardware: the time-saver p. 92 June 24
Federal libraries cast a long shadow p. 123 July 8

First with the fastest—Motorola will soon offer this large-scale integrated eight-bit adder ER p. 46 Apr. 15
France: The right address—address generator EA p. 271 Aug. 5
France: Travelers' check—magnetic-card system EA p. 163 July 22
GSA schema for cutting data-transmission costs ER p. 44 May 13
Going overboard—sea reading ER p. 50 June 24
Graphics may return control to the engineer ED p. 31 Aug. 5
Graphics terminal displays attractive figure: under \$10,000 NP p. 141 Dec. 9
Great Britain: Changing stations—computers will handle the computations needed to simulate reactor characteristics EA p. 271 Aug. 5
Great Britain: Computer combine EA p. 146 Apr. 1
Great Britain: Computer quiz EA p. 222 July 8
Great Britain: Logic choice—TTL packages in ICT's new processors for small- and medium-size computers EA p. 195 Jan. 22
Guidance for \$2,000—computer to guide an air-to-surface missile ER p. 52 Nov. 25
Hard line on software ED p. 23 May 27
Hempstead Bank will install computerized purchasing system ER p. 56 Feb. 5
Hewlett-Packard joins the time-sharing crowd ER p. 44 May 13
Hybrid computers I Three-way dialogue yields solutions in depth p. 86 Sept. 30
II Choosing a simulation system p. 91 Sept. 30
III Devising industrial control systems p. 132 Oct. 4
Illiac cutback ER p. 56 Oct. 14
Improving the mask-maker's image p. 78 Feb. 5
Incompatibles engaged—first time-sharing network using incompatible computers comes a step closer to reality ER p. 62 Sept. 16
Industrial control computers solve some problems, but cause others p. 129 May 27
IEEE product preview Computer aide designed p. 201 Mar. 4
Quality combined with automation p. 210 Mar. 4
IC operation keyed to Hall effect NP p. 169 Sept. 16
International: Aerospace tutorial—NATO's Advisory Group for Aerospace R&D EA p. 246 May 27
IBM keyboard-to-magnetic-tape units ER p. 64 May 27
Italy: Computer concentration EA p. 199 May 13
Italy: Gassed up—computer simulates what goes on in gas transmission network EA p. 269 Aug. 5
Japan: Back to back—Facom 230-60 computer with two main central processors back-to-back EA p. 149 Apr. 1
Japan: Calculated move—Fujitsu adds three computers EI p. 269 Oct. 14
Japan: Calculating components—desk calculator components EI p. 148 Nov. 25
Japan: Computer to control a thermal power plant EA p. 186 Aug. 19
Japan: Fast count—desk-calculator output surges EA p. 257 June 10
Japan: Giant chasers EA p. 205 June 24
Japan: King-size cassette EA p. 254 Mar. 18
Japan: LSI calculator EI p. 307 Nov. 11
Japan: Tooling around—computerized numerical control system EI p. 270 Oct. 14
Japan: Topics (total on-line program and information control system) EI p. 205 Oct. 28
Keeping track of the action—multicolored dynamic projections speed commands or management decisions p. 92 Aug. 5
Keyboard with Ascii output costs \$500 NP p. 201 June 10
Logic trainer has movable modules NP p. 145 Sept. 2
Lower-priced systems ER p. 44 May 13
Making a point—digital airborne computers use floating-point arithmetic ER p. 48 June 10
Medical literature analysis and retrieval will be upgraded and expanded to integrate and automate all the functions of the library ER p. 60 June 24
Memories Back in action—error-correcting technique ER p. 48 Feb. 19
Buffer talks fast but keeps still NP p. 218 Apr. 15
Core assault—hybrid LSI memory ER p. 49 June 24
Cores challenged by plated wire NP p. 216 Oct. 14
Fairchild Camera & Instrument Corp. to sell its memory-products group to Data Products Corp. ER p. 56 Feb. 5

Forward march—Century Series designs include a second generation thin-film rod memory and a new disk file design ER p. 49 Mar. 18
Fruit of the loom—lower cost braided-wire memory ER p. 52 Jan. 8
Great Britain: Minding the store—Manchester will describe an integrated-circuit associative memory EA p. 272 Aug. 5
Great Britain: Through the looking glasses—optical read only memory EA p. 255 June 10
Hardy memories for the Army ER p. 42 July 22
Honeywell memory disk pact uses chromium dioxide coatings ER p. 48 Jan. 22
Japan: Finished goods—woven memories for Univac machines EA p. 236 Sept. 16
Japan: Memorable memory EA p. 245 Jan. 8
Laser encodes diode memory ER p. 37 Dec. 23
Laser recording ER p. 50 Mar. 18
Low-budget films ER p. 31 Apr. 1
Memories shot from guns p. 98 Feb. 5
Memory stacks up as a rugged item NP p. 176 July 8
MOS memory to sell for 10 cents a bit NP p. 189 Sept. 30
New terminals in display picture p. 159 Jan. 8
Nova can't lose its instructions p. 76 Dec. 9
Nova read-only storage section p. 147 Sept. 30
Opening the MOS gate—Read-only memories ER p. 45 Feb. 19
Pointing the way—positioning a read-write head ER p. 66 Oct. 14
Putting the squeeze on radar signals p. 86 Jan. 22
A quick-change braid memory NP p. 148 Dec. 9
Read-only memory uses bipolar IC's NP p. 165 Aug. 19
Remembering the MOS ER p. 38 Apr. 29
Shift registers launch MOS standard line NP p. 235 Oct. 14
Tape memory price and package trimmed NP p. 250 Nov. 11
Three-wire design speeds up memory NP p. 127 Apr. 29
Total recall on one board NP p. 144 Dec. 9
Toward MOS memories ER p. 49 Oct. 28
Unlocking memories—ceramic disk memory set for new applications ER p. 57 Sept. 16
Memory technology—Special report Memories: practice and promise p. 104 Oct. 28
I Staying ahead of the game p. 106 Oct. 28
II Scant room for improvement p. 109 Oct. 28
III Smaller cores, bigger challenge p. 112 Oct. 28
IV Lower costs for longer words p. 115 Oct. 28
V Plated wire: a long shot that's paying off p. 124 Nov. 11
VI Rods look like wires, act like cores p. 128 Nov. 11
VII Weaving wires for aerospace jobs p. 131 Nov. 11
VIII MOS arrays come on strong p. 54 Dec. 23
Modular air computer ER p. 44 May 27
Monitoring panels by the numbers NP p. 172 Feb. 5
Music: Signal gains for electronic music p. 93 Apr. 29
Navigation converter talks two languages—computer device NP p. 151 Feb. 5
Need an LSI array with 96 gates? Orders filled in six weeks p. 121 July 22
Netherlands: Computer-controlled "Airlord" EA p. 164 July 22
Netherlands: Philips gets computer order EA p. 261 June 10
Netherlands: Philips unveils computer EA p. 222 July 8
"No" on software ER p. 58 Oct. 28
Not quite LSI—computer takes it from design to module ER p. 53 Aug. 5
Nova can't lose its instructions p. 76 Dec. 9
Nova, third-generation small computer to make its debut in December p. 147 Sept. 20
Numbers game—MTBF system criticized ER p. 46 Jan. 8
Office machine—computers for small design shops ER p. 60 Aug. 5
Opening a new deck—magnetic computer cards are processed by fluidic mechanism ER p. 48 Mar. 18
Outside wiring—new approach to discretionary wiring ER p. 47 June 24
PDP-8/1: bigger on the inside yet smaller on the outside p. 92 Sept. 16
Pacing ultrahigh-speed computers p. 165 Mar. 4

Package deals—shopping for software ER p. 38 May 13
Patents—Upsetting decision ER p. 52 Dec. 9
Picture that—graphical data processor ER p. 37 May 13
Punched cards on the ropes? NP p. 193 Apr. 15
Readout tubes face a challenger NP p. 160 Oct. 28
Real-time reservation ER p. 51 Aug. 5
Ring up a computer ER p. 52 July 8
Sales leadership—new optimism at two companies ER p. 38 May 13
Sidestepping the System 360 goals—IBM model 25 computer NP p. 156 Jan. 22
Simulators go to the head of the class p. 163 Apr. 15
Single logic configuration compares 8-bit numbers p. 101 Sept. 16
Sorting out the tires p. 125 Mar. 18
South Africa: Hands off—steel mill controlled by computer ER p. 197 May 13
Soviet computer program has as many downs as ups p. 165 Mar. 18
Sovlet Union: Computer finds gold in Siberia EA p. 224 July 8
Soviet Union: Contract with the Italians for computer peripheral equipment EI p. 212 Oct. 14
Soviet Union: Export wares EA p. 274 Feb. 5
Spotting faults—visual inspection of IC's by computer ER p. 48 Mar. 4
Subway: Hamburg, Germany, testing control systems for automated subway p. 124 Aug. 19
Sweden: Computer plots instant patient data EA p. 183 Aug. 19
Switch contacts minimize contamination NP p. 147 Aug. 19
Testing on the wing p. 81 Apr. 29
Threshold logic will cut costs, especially with boost from LSI p. 94 May 27
Too-fast converter finds its niche NP p. 242 Aug. 5
Treading softly—computer weeds out defective tires and grades acceptable ones ER p. 50 Feb. 19
Triple play speeds a-d conversion p. 69 Apr. 29
Turned off on real time—no computer for IC processing ER p. 64 Apr. 15
Utilities go slow on automation p. 125 Sept. 30
Voting: Enhancing the voice of the people ED p. 31 Nov. 25
Voting—A night to forget ER p. 50 Nov. 25
Walk-in model—CDC 7600 ER p. 45 Dec. 9
Wang offers grown-up calculator NP p. 215 Apr. 15
West Germany: Fixing the brake—electronic antiskid system EI p. 271 Oct. 14
West Germany: Meeting a knead—computerized baking EI p. 270 Oct. 14
West Germany: Siemens AG moving up on IBM EA p. 223 July 8
Where are you?—Chicago bus identification system ER p. 60 Mar. 18
Widetrack trend is accelerated NP p. 152 Dec. 9
CONSUMER ELECTRONICS
All-purpose scapegoat ED p. 23 Jan. 6
Bartenders, electronic, for the home ER p. 66 June 10
Coating extends life span of tape duplicating heads NP p. 189 Feb. 5
Color tv camera focuses on low cost NP p. 195 July 8
CATV—Untangling cable tv ER p. 52 June 10
F-m stereo tuner—Interesting, but expensive ER p. 44 Sept. 30
A funny thing happened on the way to prosperity p. 114 Jan. 3
Great Britain: Sound thought—pre-amplifier for hi-fi EI p. 309 Nov. 11
Hi-fi—Schottky problems for hi-fi makers ER p. 58 June 24
Home color video tape recording ER p. 47 Feb. 19
Industry nips at consumers' watchdog p. 170 Aug. 5
IC audio amplifier puts out 5 watts NP p. 111 Nov. 25
IC's in tv's ER p. 56 July 8
Japan: Electronic watch EA p. 209 Feb. 5
Japan: Good tip—low-distortion phonograph pickup EA p. 170 Sept. 2
Japanese cook up cool oven with fins NP p. 240 Apr. 15
Kitchen danger—potential hazards from microwave ovens ER p. 43 Sept. 30
Lots of radio on just one IC p. 124 Aug. 5
Mexico: Manana is today in Mexico p. 185 Nov. 11
Moog music ER p. 41 Mar. 4
Music: putting electronic organs in tune with natural sound p. 100 June 24
Music: Signal gains for electronic music p. 93 Apr. 29
Microwave mini-oven ER p. 39 Apr. 29
... others go solid—component producers pushing for tubeless tv ER p. 56 July 8
Packing 33 channels on ¼-inch tape NP p. 113 Apr. 1

Pin money computerized scoring for bowling ER p. 46 Jan. 22
Portable color cameras in the picture NP p. 133 May 13
Radiating worry ER p. 56 Apr. 15
Radiation standards ER p. 52 Oct. 28
Real-time reservation—computerized reservation system ER p. 51 Aug. 5
Recipes for IC's—food blenders ER p. 54 Aug. 19
7-inch record plays for two hours on each side ER p. 65 Apr. 15
Slide view—color tv system that can screen color slides ER p. 42 May 13
Some push tubes . . . —RCA offering nine-pin miniature tubes; GE pushes its Com-pactron tubes ER p. 54 July 8
Speakers—plastic replaces paper in new speaker shape that lowers cost NP p. 190 Feb. 5
Taiwan: Consumer electronics plant EI p. 272 Oct. 14
Tv tuner tuned to ease of repair NP p. 247 Mar. 4
Test-set kit for plant or shop NP p. 188 Jan. 6
There's no overcharge for fast-charged batteries—diodes protected by thermal switches prevent nickel-cadmium cells from rupturing during fast recharge p. 97 Jan. 22
Transceiver puts an FET up front NP p. 252 Mar. 4
Tuner for all channels ER p. 46 Feb. 19
Tuning bar replaces radio dial NP p. 185 Jan. 8
Uni-Key—ceramic disk memory set for new applications ER p. 57 Sept. 16
Varactor diodes search f-m band NP p. 248 Mar. 4
Vtr travels for on-the-spot recording NP p. 131 Apr. 1
Video tape recorders: Longitudinal or helical scan? p. 80 Apr. 1
Waiting for a home vtr? Don't hold your breath p. 102 Sept. 30
West Germany: Bright tune—tuning-indicator circuit for stereo receiver EA p. 246 Jan. 8
COUNTERMEASURES
Air Force gets new, economy BUIC p. 159 Sept. 16
Awacs—on the flight line, but . . . ER p. 54 June 24
Awacs—Waiting for Awacs ER p. 46 July 22
AWACS wins approval—Crisis of Identity ER p. 54 Sept. 30
A question of priority ER p. 52 Mar. 18
Sentinel orders ER p. 68 Oct. 14
CRYSTALS
Climate for growth is inside cathode NP p. 278 Nov. 11
Crystal gives precision to a stable multi-vibrator p. 121 Nov. 11
Crystal growing ER p. 74 Nov. 11
Field detector works in real time p. 118 June 24
Filter on a slice—monolithic crystal filter ER p. 45 Sept. 30
Frequency stabilized with oven in an oven NP p. 169 May 13
In phase—new way to test crystals ER p. 48 Apr. 15
Japan: Crystal clear—X-ray crystallography ER p. 169 Sept. 2
Japan: Desaturated—Schottky diode in transistor-transistor logic circuit keeps inverter transistor from saturating EA p. 209 Feb. 5
Japan: Quick curtain—polycrystalline isolation technique EI p. 209 Sept. 30
Storing light and current in crystals p. 104 July 8
System grows 50,000-chip crystals NP p. 215 June 10
CYBERNETICS
Automating all along the line p. 88 Nov. 25
DETECTION
Air Force gets new, economy BUIC p. 159 Sept. 16
Alarming vibrations—getting the "feel" of the enemy ER p. 42 Dec. 23
AWACS wins approval—Crisis of Identity ER p. 54 Sept. 30
Detecting data errors boosts transmission accuracy p. 91 Jan. 8
Dynamic tests for op amps use synchronous modulation p. 118 Aug. 5
Field detector works in real time p. 118 June 24
Follow the bouncing ball—non-mechanical inertial reference instrument ER p. 58 Oct. 14
Great Britain: Insect early warning EA p. 186 Aug. 19
Great Britain: Instrument spots defects in metal tubing EA p. 148 Apr. 29
Great Britain: Laser as an eavesdropping device EA p. 164 July 22
Guarding industry's electrical loads p. 86 Jan. 8
Height of sophistication in in-flight monitoring p. 78 May 13
Infrared camera takes a big picture NP p. 221 Aug. 5
Infrared detector ready for civilian life NP p. 172 Sept. 30
Japan: Traffic control by noise sensor EA p. 150 Apr. 1

Night sight ER p. 56 Aug. 19
Night watch—preventing crib death ER p. 40 Apr. 29
Pattern-recognition logic analyzes infrared signals p. 112 Nov. 11
Photoacoustic senses ultraviolet NP p. 136 Sept. 2
Photocell sensitive to ultraviolet NP p. 163 June 24
Portable unit sees millionth-of-a-gauss NP p. 207 Oct. 14
Probe lights up to verify IC logic state NP p. 275 Nov. 11
Recombination radiation—New way to look at it ER p. 51 Nov. 25
Scanner puts it on the line NP p. 121 Dec. 23
Security guard system uses magnetically encoded ID cards ER p. 63 Apr. 15
Sensing the fire before it erupts NP p. 165 Jan. 22
Starry-eyed mosaic—solid state photo-mosaic device ER p. 54 May 27
Storing light and current in crystals p. 104 July 8
West Germany: Underarm protection—personal alarm system EI p. 135 Dec. 23
X-rays can find wafer imperfections p. 165 May 27
DIODES
Batch view—Light-emitting diode arrays ER p. 52 Feb. 19
Bright idea—monolithic array of gallium-arsenide light-emitting diodes ER p. 53 Oct. 14
British Gunn shoots at X band NP p. 173 Feb. 19
Calculating Gunn-diode output p. 148 Nov. 11
Cubic zener has low drift NP p. 200 May 27
Diode from Japan crowds the Halls NP p. 246 Apr. 15
Diodes in multivibrator lessen frequency variations p. 92 July 8
Diodes prevent overload by limiting input's slope p. 69 Jan. 22
Diodes—they also serve p. 90 Feb. 19
Diodes put out more milliwatts NP p. 117 Dec. 23
Fabrication advances boost potential of avalanche diodes p. 96 July 8
Great Britain: Behind the Gunn EA p. 245 May 27
Great Britain: Gunned-up pulses EA p. 171 Sept. 2
Gunn diodes—first of a series ER p. 39 Sept. 2
Impatt impact—microwave radar "trap" ER p. 37 Apr. 29
IEEE product preview: Shifting into the future p. 188 Mar. 4
Isolation problems get an airing—planar air technique p. 75 Apr. 29
Japan: . . . and diodes today for millimeter-wave phone setup EI p. 210 Sept. 30
Japan: Desaturated—Schottky diode in transistor-transistor logic circuit keeps inverter transistor from saturating EA p. 209 Feb. 5
Japan: One to make ready—diode oscillator EI p. 269 Oct. 14
Laser encodes diode memory ER p. 37 Dec. 23
Lighting up in a group p. 104 Mar. 4
A little millimeter radar ER p. 40 Mar. 4
Meeting specifications—after radiation NP p. 197 May 27
MOS used as capacitor in diode package NP p. 265 Mar. 4
Ohmmeter and diode measure dwell angle p. 105 Aug. 5
Photoresistor coupler switches in 1 ms NP p. 212 Aug. 5
P-i-n diodes turn on microwave bands faster p. 67 Apr. 29
Schottky-barrier mixer diode—GaAs on sapphire ER p. 51 July 8
Schottky diodes—gold diffusion alternative ER p. 58 Oct. 28
Schottky problems for hi-fi makers ER p. 58 June 24
Silicon diodes go to 150 kilovolts NP p. 136 Jan. 22
Solid state module makes for light reading p. 74 Sept. 2
Stripped for action—magnetic amplifier uses a zener diode in place of the demodulator ER p. 32 Apr. 1
There's no overcharge for fast-charged batteries—diodes protected by thermal switches prevent nickel-cadmium cells from rupturing during fast recharge p. 97 Jan. 22
Through channels—Uhf tuner EA p. 210 Feb. 5
Transistor and zener monitor calibration p. 102 June 24
Transistor and zener protect series regulator p. 92 July 8
Transistor increases zener's power capability p. 99 Sept. 16
Tuning Gunn diodes ER p. 44 Sept. 30
Tuning a laser over 50 gigahertz ER p. 41 Sept. 2
Tunnel diode speeds pulse frequency modulation p. 73 Jan. 22
Two impatts: less noise or less money NP p. 169 Oct. 28

Zener can take 1,000 watts NP p. 220 Mar. 4
Zener power supply answers current problem p. 71 Jan. 22
Zener simulates muscle signals p. 111 June 10
Zener triggers a-c alarm circuit p. 122 Nov. 11
Zeners and SCR fire gas discharge tube p. 71 July 22
DISPLAYS
Batch view—light-emitting diode arrays ER p. 52 Feb. 19
Braided characters—low-cost cathode-ray tube display units ER p. 56 Mar. 4
Bright idea—monolithic array of gallium-arsenide light-emitting diodes ER p. 53 Oct. 14
Controlling the view—EL display ER p. 56 Nov. 11
Cool view—thermochromics, materials which change color when their temperatures change ER p. 38 Apr. 1
Curve tracer shows scale and beta NP p. 149 Oct. 28
Deflected by digits ER p. 54 Sept. 30
Drawn to light—display uses stripe domains ER p. 52 Feb. 5
Electroluminescent displays—New light on the subject ER p. 47 Jan. 8
Four-color cathode-ray-tube display system with single electron gun ER p. 40 Apr. 1
France: Place on panels sought for meters NP p. 120 Apr. 29
Fruit of the loom—lower-cost braided-wire memory ER p. 52 Jan. 8
Graphics terminal displays attractive figure: under \$10,000 NP p. 141 Dec. 9
Happy medium—advanced remote display station ER p. 50 Feb. 19
IEEE product preview: Digits for everyone p. 202 Mar. 4
Japan: Elfin tubes—In the groove EA p. 243 May 27
Keeping track of the action—multicolored dynamic projections speed commands or management decisions p. 92 Aug. 5
Light reading—photoconductive arrays on single substrates ER p. 50 Aug. 19
Lighting own way—light-emitting diode array ER p. 48 Apr. 15
Lighting up in a group p. 104 Mar. 4
A new 'scope—and a wider scope NP p. 239 Nov. 11
New terminals in display picture p. 159 Jan. 8
Now you see it—electro-luminescent photo-conductor image converter ER p. 51 Oct. 28
On display—A. B. Dick Co. Videograph Series ER p. 60 July 8
Plasma display panel with inherent memory ER p. 39 July 22
Real-time reservation—computer-generated cathode-ray-tube displays ER p. 52 Aug. 5
See-through view—color panel ER p. 50 Nov. 25
Solid-state display nears market p. 95 July 22
Solid state module makes for light reading p. 74 Sept. 2
Thermocouple data digitized NP p. 186 Sept. 16
Through a glass brightly p. 95 Feb. 5
TTL enters a numbers game NP p. 223 Nov. 11
Utilities go slow on automation p. 125 Sept. 30
Wave analyzer has 85-db dynamic range NP p. 137 July 22
EDITORIALS
After Vietnam p. 23 Apr. 15
All-purpose scapegoat p. 23 Jan. 8
An emerging solution p. 23 May 27
Automation: good barometer for markets p. 31 Dec. 23
The best salesman p. 31 Sept. 30
A case of self-deception p. 31 Sept. 2
A challenge for the power industry p. 31 Nov. 11
Charting innovation—Bardeen, Shockley and Brattain, the transistor trio p. 23 Feb. 19
"Competition is good . . . sometimes" p. 31 Dec. 23
Copying may not work p. 23 Mar. 18
Down with the upkeep p. 31 Aug. 19
The earth: a neglected spacecraft p. 23 Apr. 1
Enhancing the voice of the people p. 31 Nov. 25
For NASA: days of decision p. 31 Oct. 14
From another Iron Mountain p. 23 Jan. 22
Getting your money's worth p. 31 July 8
Good business: an international approach p. 31 July 22
Graphics may return control to the engineer p. 31 Aug. 5
Hard line on software p. 23 May 27
Heading toward a record p. 23 Jan. 8
International outlook p. 31 Sept. 30
Japan chooses its IC road p. 23 May 13
A little knowledge p. 23 Apr. 15
McNamara's parting shot is almost on target p. 23 Apr. 29

One-way street to a dead end p. 23 Mar. 4
The other jobs were easy p. 23 Feb. 5
Overhead needs a realistic ceiling p. 31 Oct. 28
Pinning the blame p. 23 June 10
Survival kit p. 31 Sept. 16
Show and tell p. 23 Mar. 4
Systems engineering for airlines p. 31 Aug. 5
A 'testy' attitude p. 23 June 10
Unjamming the spectrum p. 23 Mar. 13
Vintage year in Europe? p. 31 Dec. 9

EDUCATION
Business and the urban crisis—McGraw-Hill special report p. C1-C16 Feb. 5
CAI edges slowly into the classroom p. 163 Aug. 5
Czechoslovakia: Head of the class—teaching machine EA p. 205 June 24
Electronics Markets 1968: Computer-assisted instruction stepping up in class p. 116 Jan. 8
Great Britain: Computer quiz EA p. 222 July 8
Great Britain: IC to change college curricula EA p. 207 June 24
Keyboard education ER p. 60 Mar. 18
The other jobs were easy ED p. 23 Feb. 5
Programmed learning system, the AVS-10 video ER p. 50 June 24
Programing executives for overseas p. 183 Oct. 14
RCA instruction system hooked into a computer ER p. 42 Apr. 1
School work—experimental computer-assisted instruction system has conventional tv sets and pushbutton telephones ER p. 56 Feb. 5
Simulators go to the head of the class p. 163 Apr. 15
Workshops to acquaint college and university teachers with recent advances in d-c measurement ER p. 66 July 8

ELECTRON BEAMS
Micron-size transistors ER p. 56 Oct. 28
Probing study: electron microprobe ER p. 54 Oct. 28
Space transmission method uses electric-optic crystal ER p. 47 Aug. 19

MAGNETICS
A tv film special—electron-beam recorder ER p. 51 Mar. 4

FIELD EFFECT TRANSISTORS
An old-timer comes of age p. 120 Feb. 19
Analog gate's output is cleaned up by FET p. 81 Nov. 25
Everyman's test set for semiconductors NP p. 200 Jan. 8
FET and IC keeps oscillator linear p. 84 Aug. 19
FET converter is self-oscillating p. 62 Dec. 23
FET keeps long staircase steps flat p. 94 Mar. 18
FET oscillator helps dolphins understand people p. 85 Feb. 5
FET reaches for the high ground NP p. 131 Apr. 29
FET's resistance change trips heater control p. 65 Apr. 29
FET tester keeps out the 'zot' NP p. 149 May 13
FET voltmeter reads transients p. 109 June 10
Flexible thin-film transistors stretch performance, shrink cost p. 100 Aug. 19
Gate-to-source resistor stabilizes FET regulator p. 104 Apr. 15
Ion-implant serendipity ER p. 55 Nov. 11
Japan: Forbidding FET EI p. 200 Dec. 9
MOS FET devices invade tube preserve NP p. 151 Sept. 30
Nordic trigger pulled by light NP p. 170 Dec. 9
Si₃N₄ for MOS FET's ER p. 46 May 27
Switzerland: Microwave FET's? EI p. 199 Dec. 9
Transceiver puts FET up front NP p. 252 Mar. 4

FILTERS
Active filter cuts frequency, and cost NP p. 188 Mar. 18
Active filters ER p. 45 Feb. 19
Active filters
Part 1: The road to high Q's p. 109 May 27
Activating the passive RC network p. 114 May 27
Part 2: Using the gyrator p. 114 June 10
Part 3: Negative-impedance converters p. 82 Sept. 2
Part 4: Approaching the ideal NIC p. 105 Sept. 16
Part 5: Applying the operational amplifier p. 98 Dec. 9
Bandpass filter covers 7 octaves NP p. 168 Sept. 30
Bandpass filters go off-shelf in vhf NP p. 174 May 13
Cutting noise in data sampling p. 70 May 13
A design-a-day channel filter NP p. 191 Jan. 8
Filter on a slice—monolithic crystal filter ER p. 45 Sept. 30
Parallel-T bandpass filter produces voltage gain p. 103 Sept. 16
Power-line filters need specific specs p. 112 June 24

Reluctant Inductance—IC gyrators ER p. 54 Dec. 9
Simple method eliminates excess inductors in filters p. 58 Dec. 23
Space transmission method uses electric-optic crystal ER p. 47 Aug. 19
Third-order active filter uses three transistors p. 122 Oct. 14

GENERATORS
Fabrication advances boost potential of avalanche diodes p. 96 July 8
Pulse generator is supply and temperature independent p. 106 May 27
Pulse generator takes to the field NP p. 123 Nov. 25
R-f generator has digital readout NP p. 110 Dec. 23
Signal generators use phase lock to sweep NP p. 195 Mar. 18

GRAPHIC TECHNIQUE
No need to juggle equations to find reflection—just draw three lines p. 93 Oct. 28

GUIDED MISSILES
Guidance for \$2,000—computer to guide an air-to-surface missile ER p. 52 Nov. 25
No metric Maverick ER p. 46 July 22
Uniform electronic modules for fire-control system at Poseidon missile p. 171 Apr. 15

GUNN EFFECT
Budding germanium ER p. 40 May 13
Calculating Gunn-diode output p. 148 Nov. 11
Cooling it—higher microwave power is possible with better heat sinking ER p. 52 Feb. 5
Diodes put out more milliwatts NP p. 117 Dec. 23
Double cavity widens Gunn range NP p. 269 Nov. 11
France: Keeping up—Gunn oscillator EA p. 246 May 27
Great Britain: Behind the Gunn EA p. 245 May 27
Great Britain: Gunned-up pulses EA p. 171 Sept. 2
Gunn diodes—first of a series ER p. 39 Sept. 2
Gunn-effect oscillators aim at klystron markets NP p. 157 June 24
Gunn in the West ER p. 54 Mar. 18
In step—solid state phased-array radars ER p. 47 Feb. 5
Japan: 50-mw Gunn oscillators NP p. 203 May 27
Tuning Gunn diodes ER p. 44 Sept. 30

HALL EFFECT
Diode from Japan crowds the Halls NP p. 246 Apr. 15
Great Britain: Up the Hall—transducer EA p. 212 Feb. 5
IC operation keyed to Hall effect NP p. 169 Sept. 16

INDUSTRIAL ELECTRONICS
Accentuating the negative—processing machine uses microwaves to dry movie film ER p. 48 Mar. 4
All-purpose scapegoat ED p. 23 Jan. 8
Australia: Electronics sales EA p. 172 Sept. 2
Banks—Hempstead Bank will install computerized purchasing system ER p. 56 Feb. 5
Bell Canada's R&D arm, Northern Electric, develops reach p. 125 May 13
Blind controller eyes special situations NP p. 231 Apr. 15
A challenge from the power industry ED p. 31 Nov. 11
Copying may not work ED p. 23 Mar. 18
Crime-fighting—Wesco '68 p. 137 Aug. 5
Data converter accepts 20 channels NP p. 119 Dec. 23
Election issues for electronics p. 139 Oct. 28
Electronic desk for executives ER p. 56 Feb. 19
Electronic traffic control: can it make the grade? p. 157 Apr. 15
Electronics Markets 1968: State of the mart; gains slowed by war priorities p. 105 Jan. 8
New member of the billion-dollar club p. 132 Jan. 8
European electronics markets: 1969—report p. 65 Dec. 23
It's got to be good p. 71 Dec. 23
Switzerland: State of the mart; gains slowed by war priorities p. 105 Jan. 8
New member of the billion-dollar club p. 132 Jan. 8
United Kingdom p. 72 Dec. 23
France p. 76 Dec. 23
Italy p. 81 Dec. 23
Sweden p. 83 Dec. 23
The Netherlands p. 85 Dec. 23
Belgium p. 86 Dec. 23
Switzerland p. 87 Dec. 23
Spain p. 88 Dec. 23
Denmark p. 89 Dec. 23
Norway p. 90 Dec. 23
Fairchild shakeup See Business
Fare price—IBM system will automatically deduct fares from a magnetically coded card ER p. 58 July 8
FAA priorities irk critics p. 155 Feb. 19
Federal budget—An uncertain guide for suppliers p. 137 Feb. 19
Fluidics stays barely above water p. 199 Nov. 11

France: Gathering clouds EI p. 199 Dec. 9
France: Travelers' check—magnetic-card system EA p. 163 July 22
GE raising prices of some of its devices ER p. 64 Sept. 16
Going directly to the director—M/C device NP p. 168 Jan. 22
Good business: an international approach ED p. 31 July 22
Great Britain: Tripling the guard—ferrite device for shutdown system EA p. 318 Mar. 4
Green light, red faces—explanation of failure of card security system at Democratic National Convention ER p. 57 Sept. 16
Guarding industry's electrical loads p. 86 Jan. 8
Heading toward a record ED p. 23 Jan. 8
Hybrid computers III Devising Industrial control systems p. 132 Oct. 14
India bids for self-sufficiency p. 117 Sept. 2
Indonesia: East Is east—and cheaper EI p. 309 Nov. 11
Industrial control computers solve some problems, but cause others p. 129 May 27
IEEE product preview
Chopping out line noise p. 199 Mar. 4
Digital meter has its limits p. 206 Mar. 4
ISA preview: the heat is on NP p. 172 Sept. 16
IBM: Federal Center broadens horizons p. 145 June 24
Inverter packs regulated wallop NP p. 208 Feb. 19
Japan: Ending to its four-year-long hassle with TI EA p. 200 May 13
Japan: Fast check—nationwide check-clearing facility EA p. 162 July 22
Japan: New way to skin a cat—bulldozer remote control for untrained operators EA p. 277 Apr. 15
Japan: Tooling around—computerized numerical control system EI p. 270 Oct. 14
Japanese IC technology—a closeup p. 98 May 13
Keeping data on the straight and narrow NP p. 201 Feb. 19
Keeping in touch—program called Pulse ER p. 60 Nov. 11
Keeping track of the action—multicolored dynamic projections speed commands or management decisions p. 92 Aug. 5
Mexico: Manana is today in Mexico p. 185 Nov. 11
Moving into ghettos ER p. 45 May 27
Music: putting electronic organs in tune with natural sound p. 100 June 24
Music: Signal gains for electronic music p. 93 Apr. 29
NASA's technology utilization program—Hard selling technology p. 111 Jan. 22
Netherlands: Nationwide network to check air pollution EA p. 320 Mar. 4
Netherlands: A self-service gasoline station EA p. 262 June 10
Numerical control—It's in the cards to start new line NP p. 212 Mar. 18
Office machines—computers for small design shops ER p. 60 Aug. 5
The other jobs were easy ED p. 23 Feb. 5
Oven—Frequency stabilized with oven in an oven NP p. 169 May 13
Pattern-recognition logic analyzes infrared signals p. 112 Nov. 11
Power-line filters need specific specs p. 112 June 24
Printer types 60 characters a second NP p. 169 June 24
Printing—Dvm-printer costs less than \$1,000 NP p. 154 May 13
Printing—first electronic printing calculator ER p. 56 Feb. 19
Printing—Photographic printer controlled by UJT-SCR timer p. 96 Mar. 18
Process trainer gives operators true picture NP p. 131 Jan. 22
Rate counter talks user's language NP p. 209 Mar. 18
Reacting fast to reactions NP p. 204 Feb. 19
Reed switches form a nonmechanical lock p. 92 Oct. 28
Reporting "breakthroughs" ER p. 40 Dec. 23
Russia—an open market p. 126 Dec. 9
Saving money on data transmission as signals take turns on party line p. 119 Apr. 15
Security guard system uses magnetically encoded ID cards ER p. 63 Apr. 15
See the sea—88-passenger hydrofoil Dolphin ER p. 40 Jan. 22
Semiconductor firms' captive lines capture defense contractors' fancy p. 129 July 8
Sensing the fire before it erupts NP p. 165 Jan. 22
Servo potentiometer charts many courses NP p. 235 Apr. 15
Servocontrol dons civies NP p. 246 Aug. 5
Sorting out the tines p. 125 Mar. 18
South Africa—Hands off—steel mill controlled by computer ER p. 197 May 13

Soviet Union: 1969 outlook for electronics EI p. 136 Dec. 23
Subway: Hamburg, Germany, testing control systems for automated subway p. 124 Aug. 19
Switzerland: Quartz-controlled, IC wristwatch was a hands-down winner at International Chronometric Competition EA p. 321 Mar. 4
Sylvania would rather switch—tactical telephone exchange p. 119 Aug. 19
Taiwan: a changing image p. 165 June 10
Tantalum hike ER p. 56 Jan. 8
TTL makers switch their sales pitch NP p. 147 July 8
Treading softly—computer weeds out defective tires and grades acceptable ones ER p. 50 Feb. 19
Triple play speeds a-d conversion p. 69 Apr. 29
Uni-key—ceramic disk memory set for new applications ER p. 57 Sept. 16
Unpackaged chips set for gains p. 117 May 13
Utilities go slow on automation p. 125 Sept. 30
Videocomp typesetter from RCA ER p. 54 Mar. 4
Vin automatic ER p. 74 Nov. 11
Voting: Enhancing the voice of the people ED p. 31 Nov. 25
Voting—A night to forget ER p. 50 Nov. 25
War puts agencies on short rations p. 151 Feb. 19
Watchdog at bay—Government's Renegotiation Board under industry attack again ER p. 42 Jan. 22
Weld watcher ER p. 62 June 10
West Germany: Hanover Industrial Fair EA p. 147 Apr. 29
West Germany: In a scrape—radio-controlled scoop loader for radioactive debris EA p. 211 Feb. 5
West Germany: Meeting a knead—computerized baking EI p. 270 Oct. 14
West Germany: Quick recovery EI p. 308 Nov. 11
West Germany: Top grade—grader has Nivomatic blade-control system EA p. 247 Jan. 8

INFORMATION RETRIEVAL
ARPA network will represent integration on a large scale p. 131 Sept. 30
Census Bureau depends on electronics to make its 1970 national nose count p. 103 July 22
Computer with peripherals will rent for \$40 a month NP p. 193 Oct. 14
Data banks overdrawn ER p. 53 Feb. 19
Detecting data errors boosts transmission accuracy p. 91 Jan. 8
Dial a book ER p. 66 July 8
Federal libraries cast a long shadow p. 123 July 8
Keeping track of the action—multicolored dynamic projections speed commands or management decisions p. 92 Aug. 5
Laser recording ER p. 50 Mar. 18
Medical literature analysis and retrieval will be upgraded and expanded to integrate and automate all the functions of the library ER p. 60 June 24
Opening a new deck—magnetic computer cards are processed by fluidic mechanism ER p. 48 Mar. 18
Readout tubes face a challenger NP p. 160 Oct. 28

INSTRUMENTS
Accelerometer has cut-rate price NP p. 185 June 10
Airplane altimeter goes all-electric NP p. 168 July 8
Brain probe thin-film strain gage ER p. 50 June 10
Canada: Airborne magnetometer EI p. 206 Oct. 28
Complex math in modular form NP p. 138 Jan. 22
Connector withstands high temperature NP p. 189 June 10
Computing counter can measure rpm NP p. 195 June 10
Counter—It's what's inside that really counts NP p. 180 July 8
Counter extended to 100 megahertz NP p. 230 Mar. 4
Counter range extended to 18 Ghz NP p. 141 Jan. 22
Curve tracer shows scale and beta NP p. 149 Oct. 28
Defense Dept. studying the reliability of self-destruct mechanisms for electronic espionage gear ER p. 48 Apr. 29
Dial 99 for 1100011—decimal-to-binary converter NP p. 134 Jan. 22
Digital voltmeter logs in decibels NP p. 224 Mar. 4
East Germany: New stage for stars—planetarium projector EA p. 147 Apr. 1
Electronics Markets 1968: Growth rate a Vietnam casualty p. 118 Jan. 8
Energetic Identification—induced electron emission spectrometer ER p. 48 Dec. 9
For low cost, count on RTL (resistor-transistor logic modules) p. 74 Jan. 22
French firm enters U.S. market for nuclear instrumentation p. 157 May 27
Frequency counter extended into uhf NP p. 141 Sept. 2

Gated semiconductors clean a-c switching p. 105 May 27
Getting beneath the surface of multilayer ICs p. 84 July 22
Great Britain: Up the Hall—a Hall-effect transducer EA p. 212 Feb. 5
Gunn, John B., an IBM researcher granted a U.S. patent ER p. 56 Feb. 5
High-rise hybrids cut package size NP p. 223 Mar. 18
Impatt: 1968—year of the Impatt NP p. 165 Feb. 5
IEEE product preview
Make, buy, and now sell IC's p. 187 Mar. 4
Reliability registers high p. 189 Mar. 4
Tabs ease bonding p. 190 Mar. 4
Regulation at the site p. 192 Mar. 4
Japan: A-c up to 100 watts is controlled by IC NP p. 208 Sept. 16
Lighting own way—light-emitting diode array ER p. 48 Apr. 15
Logic signals pull a discrete switch NP p. 183 Feb. 5
Making it: Ovonic switch ER p. 49 Nov. 25
Meeting specifications—after radiation NP p. 197 May 27
MOS FET devices invade tube preserve NP p. 151 Sept. 30
MOS multiplexer switches can do well at high frequencies p. 152 Nov. 11
MOS used as capacitor in diode package NP p. 265 Mar. 4
Photoresistor coupler switches in 1 ms NP p. 212 Aug. 5
Remembering the MOS ER p. 38 Apr. 29
Semiconductor gages make sense in most transducer applications p. 109 Mar. 18
Sixths for MOS FET's ER p. 46 May 27
Solid-state display nears market p. 95 July 22
Solid state module makes for light reading p. 74 Sept. 2
Solid state radar—Half step ER p. 43 May 27
Solid state thyatron challenges tubes NP p. 159 July 8
Solid view—replacing the vidicon ER p. 53 Oct. 14
Switches combine speed and power NP p. 159 May 13
The transistor: Two decades of progress—special report p. 77 Feb. 19
The improbable years p. 78 Feb. 19
Fingers in the die p. 93 Feb. 19
A worthy challenger for r-f power honors p. 98 Feb. 19
A discrete transistor that's a power-house p. 105 Feb. 19
Fabrication control is key to micro-wave performance p. 109 Feb. 19
A switch in time p. 116 Feb. 19
An old-timer comes of age p. 120 Feb. 19
Transistors: a chapter ends, but the story continues p. 126 Feb. 19
The triac—from trickle to triumph in three years NP p. 169 Feb. 19
Tuner for all channels ER p. 46 Feb. 19
Two photoresistors share the light NP p. 182 Jan. 8
Unlocking the gates for UJT's p. 56 Apr. 1
Unpackaged chips set for gains p. 117 May 12
SPACE ELECTRONICS
Aeronautical Services Satellite—Breaking the logjam ER p. 48 May 27
Aeronautical Services Satellite—Speculative proposal ER p. 44 Sept. 2
Aerospace Industry keeps its cool p. 175 Oct. 14
Astronomy—Radio Astronomy Explorer (RAE-A) ER p. 50 July 22
Australia: U.S. space base EA p. 186 Aug. 19
APT to grow ER p. 58 May 27
ATS-F—loaded mission p. 103 Dec. 23
Budget trims some space programs p. 117 Jan. 22
Canada: Bouchette, earth station EI p. 272 Oct. 14
Comsat labs to share new home p. 133 Oct. 28
Drawn to magnetics—memory being developed for NASA ER p. 46 Dec. 9
The earth: a neglected spacecraft ED p. 23 Apr. 1
Election issues for electronics p. 139 Oct. 28
Electronics Markets 1968: The fiscal squeeze tightens p. 130 Jan. 8
Fast talk ER p. 56 June 10
For NASA: days of decision ED p. 31 Oct. 14
Great Britain: Thin solar cells EI p. 145 Nov. 25
Ground-station market flies high p. 105 Nov. 25
Growing flock of birds ER p. 56 Mar. 18
International: Changes loom for Europe's space efforts EA p. 200 May 13
JPL up in the air over space role p. 101 Apr. 1
NASA—Happy birthday? ER p. 50 Sept. 30
NASA at the crossroads ED p. 23 June 24
NASA budget—first slice ER p. 58 Mar. 18
NASA budget cuts . . . means less space ER p. 54 June 24
NASA future earthbound by economics p. 169 Oct. 14
NASA seeks to fill post-Apollo void p. 145 Feb. 19
NASA will launch the second of four Orbiting Astronomical Observatories ER p. 72 Nov. 11
NASA's technology utilization program—Hard selling technology p. 111 Jan. 22
Navigation converter talks two languages—computer device NP p. 151 Feb. 5
New year in space—Surveyor 7 and Apollo 5 ER p. 54 Jan. 8
Nimbus B will be replaced ER p. 50 July 22
Pioneer D—convolutional coding technique cuts errors ER p. 36 Apr. 1
Precursor—NASA test and training satellite ER p. 64 May 27
750 largest company presidents to rate the space program in eight basic areas ER p. 56 Jan. 8
Sighting in on narrow light beams p. 106 Mar. 18
Space transmission method uses electric-optic crystal ER p. 47 Aug. 19
Starry-eyed mosaic—solid state photo-mosaic device ER p. 54 May 27
Surveyor 7's spectacular performance ER p. 48 Jan. 22
Symphonie satellite—Fiddling with Symphonie ER p. 46 Apr. 29
Viking is here ER p. 40 Dec. 23
Wave of optimism for millimeter waves p. 151 Mar. 18
STANDARDIZATION
Cleaning the spectrum ER p. 54 Feb. 19
Designers up in air over specs p. 165 Sept. 16
Great Britain: Reading the meter EI p. 204 Dec. 9
Industry nips at consumers' watchdog p. 170 Aug. 5
IC registration revisited p. 159 Mar. 18
Kitchen danger—potential hazards from microwave ovens ER p. 43 Sept. 30
Laser safety issue burning bright p. 193 Nov. 11
Pinning the blame ED p. 23 June 10
Radiation standards ER p. 52 Oct. 28
SYSTEMS ENGINEERING
Defense Department states reform of systems engineering management p. 153 Sept. 16
Electronic traffic control: can it make the grade? p. 157 Apr. 15
Systems engineering for the airlines ED p. 31 Aug. 5
TELEMETRY
Cutting noise in data sampling p. 70 May 13
FFT—shortcut to Fourier analysis p. 124 Apr. 15
Great Britain: Comeback for Dynatel Ltd. EA p. 185 Aug. 19
Pioneer D: convolutional coding technique cuts errors ER p. 36 Apr. 1
Wave synthesizer accurate to .01% NP p. 143 Aug. 19
TELEVISION
All-solid state design overtakes large-screen monochrome tv sets p. 104 June 24
Bahamas: to start tv broadcasts in 1969 EA p. 249 Jan. 8
Between the lines—raster modification for tv ER p. 37 Jan. 22
Cameras that wink can produce 3-D tv p. 132 Mar. 18
CATV—Untangling cable tv ER p. 52 June 10
FCC gets CATV ER p. 60 June 24
A funny thing happened on the way to prosperity p. 114 Jan. 8
Great Britain: contract for tv transmitters EA p. 172 Sept. 2
Great Britain: Reins damp tv outlook EI p. 146 Nov. 25
Great Britain: Unto the breach—line fly-back period used for audio EI p. 211 Sept. 30
Image-intensifying electronic devices study: Getting the picture ER p. 39 Jan. 22
IC's in tv's ER p. 56 July 8
Japan: An eye for curves—tv reader converts curves on charts into series of digital values EA p. 245 Jan. 8
Japan: Crystal clear—X-ray crystallography ER p. 169 Sept. 2
Japan: Facsimile palette—still color photos by facsimile EA p. 257 June 10
Japan: Playback platter EA p. 315 Mar. 4
Japan: Pocket video—tv set with 2-inch screen EA p. 243 May 27
Japan: Sayonara to flybacks—piezoelectrics for tv EA p. 315 Mar. 4
Japan: Sound vision—ultrasonic tv ER p. 169 Sept. 2
Japan: Through channels—Uhf tuner EA p. 210 Feb. 5
Japan: Topics (total on-line program and information control system) EI p. 205 Oct. 28
Japan: World's highest tv tower EA p. 262 June 10
Lights out—black-face cathode ray tube ER p. 45 Jan. 8
Millimeter tv ER p. 48 Apr. 29
New terminals in display picture p. 159 Jan. 8
One-shot rainbow—one-gun, one-phosphor color cathode-ray-tube ER p. 37 Jan. 22
. . . others go solid—component producers pushing for tubeless tv ER p. 56 July 8
School work—experimental computer-assisted instruction system has conventional tv sets and pushbutton telephones ER p. 56 Feb. 5
SCR helps video signal gate a-c power line p. 66 Apr. 29
Solid view—replacing the vidicon ER p. 53 Oct. 14
Some push tubes . . . RCA offering new-in-miniature tubes: GE pushes its Compaction tubes ER p. 54 July 8
Technique that replaces photo-conductive coatings (usually antimony trisulfide) in standard tv camera vidicon tubes with a silicon diode array ER p. 39 Apr. 29
A tv film special—electron-beam recorder ER p. 51 Mar. 4
Tv tuner tuned to ease of repair NP p. 247 Mar. 4
Tiny transformer wants tv job NP p. 216 Aug. 5
Toward tubeless tv—high-voltage rectifier ER p. 42 Mar. 4
Tuner for all channels ER p. 46 Feb. 19
Turkey: tv will be introduced EA p. 241 Feb. 5
Uhf triodes aim to plant tricolor NP p. 167 Feb. 5
Underwater eyes: laser-television system ER p. 45 June 10
Up camera—tv periscope ER p. 42 July 22
West Germany: Ghost chaser—tv antenna will have a unique radiation pattern EA p. 270 Aug. 5
West Germany: The low road—two-transistor circuit EA p. 237 Feb. 19
West Germany: System that transmits still images over standard telephone lines EA p. 248 May 27
TESTING
Capacitance bridge test is automatic—to a point NP p. 141 Aug. 19
Chip capacitors tested automatically NP p. 217 June 10
Circuit tester does double duty NP p. 160 Dec. 9
Computer-oriented system speeds testing of circuits and components p. 72 July 22
Converter handles high-speed-spin signals NP p. 238 Aug. 5
Curve tracer shows scale and beta NP p. 149 Oct. 28
Curve tracer tests logic IC quickly p. 98 June 24
Dynamic IC testing made easy p. 74 Sept. 30
Dynamic tests for op amps use synchronous demodulation p. 118 Aug. 5
Everyman's test set for semiconductors NP p. 200 Jan. 8
FET tester keeps out the 'zot' NP p. 149 May 13
Finding a FRIEND: IC tester ER p. 58 June 10
Finding leaky IC's on p-c boards p. 127 June 24
FDR: a new deal for faultfinders p. 96 Aug. 19
Getting beneath the surface of multilayer IC's p. 84 July 22
Height of sophistication in in-flight monitoring p. 78 May 13
In phase—new way to test crystals ER p. 48 Apr. 15
Industry nips at consumers' watchdog p. 170 Aug. 5
IC testers: stepping up in class NP p. 192 May 27
IC testing tries to keep up with gains in IC technology p. 88 May 13
Japanese-made IC probe—Saying sayonara to U.S. testers NP p. 204 Jan. 8
Large-scale problems in LSI testing p. 99 Nov. 25
LST arrives at terminal before LSI NP p. 160 Feb. 5
Linear IC tester checks 22 values NP p. 223 Apr. 15
Measuring up to standards NP p. 191 Feb. 19
Meeting specifications—after radiation NP p. 197 May 27
Module tester will help speed repairs on aircraft navigations and radio equipment ER p. 60 June 24
On-the-spot tests for relay links NP p. 196 Jan. 8
Outside testing ER p. 50 Mar. 18
Pinning the blame ED p. 23 June 10
Putting the stress on IC reliability p. 149 May 27
Radar testing with less weight NP p. 158 Aug. 19
Radiation testing guidelines p. 122 June 10
Scanner puts it on the line NP p. 121 Dec. 23
Skipping the hard part of radiation hardening p. 122 Mar. 4
Sonar sub-systems testing ER p. 66 June 10
Sorting out the tires p. 125 Mar. 18
Spectrum analysis for only \$1,300 NP p. 193 June 10
Spotting faults—visual inspection of IC's by computer ER p. 48 Mar. 4
Stretching video pulse keeps indicator on p. 90 Mar. 4
Test-set kit for plant or shop NP p. 188 Jan. 8
Tester measures resistance of multilayer p-c boards p. 100 Sept. 16
Tester takes all comers NP p. 184 Sept. 30
Testing on the wing p. 81 Apr. 29
A 'testy' attitude ED p. 23 June 10
Transistor sorter stepping up performance classifications NP p. 121 Apr. 1
Tremble tester has 3% accuracy NP p. 230 Aug. 5
Using a universal pulser for a-c checks of IC flip-flops p. 120 May 27
Wescon preview: IC testers, op amps star p. 191 Aug. 5
Fast testing without frills p. 191 Aug. 5
Tester takes to any op amp p. 192 Aug. 5
Comparing with the best p. 193 Aug. 5
See-as-you-go IC tester p. 194 Aug. 5
Miniflows spotted inexpensively p. 197 Aug. 5
West Germany: Road test—Daimler-Benz test track loaded with electronics EA p. 196 Jan. 22
X-rays can find wafer imperfections p. 165 May 27
THIN FILMS
Filter on a slice—monolithic crystal filter ER p. 45 Sept. 30
Flexible thin-film transistors stretch performance, shrink cost p. 100 Aug. 19
Low-budget films ER p. 31 Apr. 1
Memory technology—report IV Low costs for longer words p. 115 Oct. 28
V Plated wire: a long shot that's paying off p. 124 Nov. 11
VI Rods look like wires, act like cores p. 128 Nov. 11
VII Weaving wires for aerospace jobs p. 131 Nov. 11
Nordic trigger pulled by light NP p. 170 Dec. 9
TIMERS
Clockmaker counts on IC's NP p. 193 Sept. 16
Great Britain: Light hands—electronic clock uses light for "hands" EI p. 134 Dec. 23
Motorless timer has long life span NP p. 173 May 13
Photographic printer controlled by UJT-SCR timer p. 96 Mar. 18
West Germany: New twist on time—plezo-electric mechanism EI p. 204 Oct. 28
TRANSISTORS
All-solid state design overtakes large-screen monochrome tv sets p. 104 June 24
Ballasting a mercury-arc lamp with a solid-state circuit p. 130 Aug. 5
Boosting op-amp output with two transistors p. 110 June 10
Bridge and transistor are exclusive-or gate p. 88 Aug. 19
Car 54—Where are you?—mobile radio power transistor NP p. 186 Feb. 5
Charting innovation ED p. 23 Feb. 19
Current, currency—a dual gain NP p. 220 Jan. 8
Curve tracer shows scale and beta NP p. 149 Oct. 28
Darlington transistors widen multivibrator's range p. 82 Nov. 25
Ferrites: Part 2 Circulators for vhf and up p. 84 Nov. 25
For low cost, count on RTL p. 74 Jan. 22
Germanium for LSI—monster array of 12,800 pnp transistors ER p. 52 Aug. 5
Great Britain: More with the MOST EA p. 253 Mar. 18
Great Britain: Up the Hall—a Hall-effect transducer EA p. 212 Feb. 5
Grounded-base amplifier mates npn to pnp p. 89 Feb. 5
High-grain transistors ER p. 54 Nov. 11
High-precision preamp built from 3 transistors p. 58 Dec. 23
High-voltage transistor switches fast NP p. 131 Nov. 25
Hybrid microwave developed for MERA ER p. 64 Sept. 16
Japan: Isolationist EI p. 204 Oct. 28
Japan: Oriental etchings—silicon transistor production process EA p. 269 Aug. 5
Meeting specifications—after radiation NP p. 197 May 27
Micron-size transistors ER p. 56 Oct. 28
Opening the MOS gate—read-only memories ER p. 45 Feb. 19
Power sealed in TO-3 case NP p. 169 Dec. 9
Power transistor's r-f gain measured by brief pulse p. 104 Apr. 15

Semiconductor gages make sense in most transducer applications p. 109 Mar. 18
Silicon power transistor for color tv sets ER p. 58 June 24
Silicon transistor power upped ER p. 46 Sept. 2
Single transistor rectifies agc signal p. 90 Jan. 8
Spider bonding technique ER p. 58 Sept. 16
Stepping up performance classifications—transistor sorter NP p. 121 Apr. 1
Thin-film transistors don't have to be drifters p. 88 Mar. 18
Third-order active filter uses three transistors p. 122 Oct. 14
The transistor: Two decades of progress—special report p. 77 Feb. 19
The improbable years p. 78 Feb. 19
Fingers in the die p. 93 Feb. 19
A worthy challenger for r-f power honors p. 98 Feb. 19
A discrete transistor that's a power-house p. 105 Feb. 19
Fabrication control is key to micro-wave performance p. 109 Feb. 19
A switch in time p. 116 Feb. 19
An old-timer comes of age p. 120 Feb. 19
Transistors: A chapter ends, but the story continues p. 126 Feb. 19
Transistor and relay regulate high voltages p. 70 July 22
Transistor and zener monitor calibration p. 102 June 24
Transistor and zener protect series regulator p. 92 July 8
Transistor circuit cancels inductive load effects p. 83 Dec. 9
Transistor increases zener's power capability p. 99 Sept. 16
Transistor replaces bleeder and regulates power supply p. 70 Jan. 22
Transistor replaces resistor and improves amplifier p. 92 Jan. 8
Transistor speeds up charging circuit p. 105 Aug. 5
TTL circuit has extra noise immunity NP p. 153 Aug. 19
TTL enters a numbers game NP p. 223 Nov. 11
Unijunction transistor controls stable one-shot p. 89 Jan. 8
UJT protects op amp from voltage transients p. 83 Nov. 25
Unlocking the gates for UJT's p. 56 Apr. 1
Unpackaged chips market picks up ER p. 47 Apr. 15
West Germany: The low road—two-transistor circuit EA p. 237 Feb. 19

TUBES
Coaxial tube works in C-band NP p. 230 Oct. 14
Deflected by digits ER p. 54 Sept. 30
Dusting process brightens picture NP p. 192 Mar. 18
Electron tube that can bake a cake in under four minutes ER p. 56 Mar. 4
France: Carpitron tube sold for use in in Britanny's Intelsat 3 ground station EI p. 136 Dec. 23
Graphite coatings are hard and porous NP p. 230 Nov. 11
Great Britain: instrument spots defects in metal tubing EA p. 128 Apr. 29
Great Britain: Shining example—image intensifier EA p. 271 Aug. 5
HP still selling tube designs ER p. 64 Oct. 14
Image-intensifying tubes—Bright future ER p. 50 June 10
Italy: First manufacturer of color tv picture tubes EA p. 248 May 27
Japan: Color it otherwise—"separated white" concept could lead to practical successors to the shadow-mask tube EA p. 194 Jan. 22
Japan: Elfin low-price tubes—In the groove EA p. 243 May 27
Japan: Three-shot gun—Trinitron EA p. 145 Apr. 29
Japan: 12-inch shadow-mask picture tube EA p. 248 Jan. 8
Keeping cool—projection cathode-ray tube ER p. 39 July 22
Klystron is tunable automatically NP p. 191 July 8
Laser's tubes a snap to change NP p. 144 May 13
Lights out—black-face cathode ray tube ER p. 45 Jan. 8
MOS FET devices invade tube preserve NP p. 151 Sept. 30
One-shot rainbow—one-gun, one-phosphor color cathode-ray-tube ER p. 37 Jan. 22
Photomultiplier dynode gives gain of 30 NP p. 226 Nov. 11
Readout tubes face a challenger NP p. 160 Oct. 28
Real-time reservation—computer-generated cathode-ray-tube displays ER p. 52 Aug. 5
Solid state thyratron challenges tubes NP p. 159 July 8
Some push tubes—RCA offering nine-pin miniature tubes; GE pushes its Compactron tubes ER p. 54 July 8

Technique that replaces photo-conductive coatings (usually antimony trisulfide) in standard tv camera vidicon tubes with silicon diode array ER p. 39 Apr. 29
Uhf triodes aim to plant tricolor NP p. 167 Feb. 5

ULTRASONICS
Infrared technique for ultrasonic flip-chip bonder NP p. 177 Feb. 19
Japan: Sound vision—ultrasonic tv EA p. 169 Sept. 2

VARIABLES
Great Britain: Thin slices of silicon hold high promise ER p. 170 Sept. 2
Varactor diodes search f-m band NP p. 248 Mar. 4

VIDEO RECORDERS
Coating extends life span of tape duplicating heads NP p. 189 Feb. 5
Getting a peak—CBS unveils EVR ER p. 38 Dec. 23
Golfers, burglars, how's your style? NP p. 160 Jan. 22
Home color—video tape recording ER p. 47 Feb. 19
Japan: Playback platter EA p. 315 Mar. 4
Laser recording ER p. 50 Mar. 18
Video tape recorders: longitudinal or helical scan? p. 80 Apr. 1
Vtr travels for on-the-spot recording NP p. 131 Apr. 1
Waiting for a home vtr? Don't hold your breath p. 102 Sept. 30

Author Index

Aasnaes, H. B. & T. J. Harrison, Triple play speeds a-d conversion p. 69 Apr. 29
Aghassi, J. J. et al, Here's a good switch: radiation-resistant thyristors p. 65 Apr. 1
Aiken, E., From help wanted to jobs wanted p. 157 Mar. 4
Solid-state display nears market p. 95 July 22
TTL makers switch their sales pitch NP p. 147 July 8
Al-Moufti, M. N. et al, Calculating Gunn-diode output p. 148 Nov. 11
Antonelli, D. et al, Zener simulates muscle signals p. 111 Jun 10
Arnold, W., Defense Department slates reform of systems engineering management p. 153 Sept. 16
Arnold, W. F. & P. A. Dickson, Laser safety issue burning bright p. 193 Nov. 11
Augustine, C. F., Field detector works in real time p. 118 June 24
Avera, C. B., SCR's monitor discharge rate p. 86 Aug. 19
Baade, O., One capacitor makes IC a pulse-width modulator p. 71 Sept. 2
Ball, J. V., There's no overcharge for fast-charged batteries p. 97 Jan. 22
Barney, W., Curve tracer shows scale and beta NP p. 149 Oct. 28
Graphics terminal displays attractive figure: under \$10,000 NP p. 141 Dec. 9
Hogan takes hold at Fairchild p. 119 Sept. 30
MOS bandwagon starts rolling NP p. 173 Mar. 18
Need an LSI array with 96 gates? Orders filed in six weeks p. 121 July 22
New terminals in display picture p. 159 Jan. 8
Barone, A., P-I-n diodes turn on microwave bands faster p. 67 Apr. 29
Barone, F. J., & C. F. Myers, Getting beneath the surface of multilayer IC's p. 84 July 22
Bates, A. M., Memories IV Lower costs for longer words p. 115 Oct. 28
Becker, R., Inexpensive comparator reacts in 100 nanoseconds p. 70 Sept. 2
Beeh, R. C. M., Improving the mask-maker's image p. 78 Feb. 5
Beierwaltes, W. T., Wave analyzers: a bright future p. 62 July 22
Bell, L. S., High-current switch is driven by an IC p. 120 Nov. 11
Berger, P. et al, CBS nominates a convention hopeful p. 74 Aug. 19
Bessen, A., Pattern-recognition logic analyzes infrared signals p. 112 Nov. 11
Bildstein, P., Third-order active filter uses three transistors p. 122 Oct. 14
Birnbaum, B., Gate-to-source resistor stabilizes FET regulator p. 104 Apr. 15
Blaskeslee, T. B., Computer-oriented system speeds testing of circuits and components p. 72 July 22
Bodow, J., Guarding industry's electrical loads p. 86 Jan. 8
Boysel, L. L., Adder on a chip: LSI helps reduce cost of small machine p. 119 Mar. 18
Bray, K. J., FET keeps long staircase steps flat p. 94 Mar. 18

Breikss, I. P., IC's in action: Part 9—Digital techniques shrink recorder p. 93 Jan. 8
Brinton, J., Air Force gets new, economy BUIC p. 159 Sept. 16
Air Force plans new weather monitor p. 151 June 24
Computer with peripherals will rent for \$40 a month NP p. 193 Oct. 14
Sylvania would rather switch p. 119 Aug. 19
Brody, P. & D. Page, Flexible thin-film transistors stretch performance, shrink cost p. 100 Aug. 19
Brooks, D. A., Unijunction transistor controls stable one-shot p. 89 Jan. 8
Brower, R., Taking noise out of weak signals p. 80 July 8
Bucci, W. J., Laser research takes a practical turn p. 110 Sept. 16
Wave of optimism for millimeter waves p. 151 Mar. 18
Budlong, J. P., Bridge and amplifier monitor d-c level p. 99 June 24
Corrected version p. 71 Sept. 2
Budych, I., Amplifier flattens ripple in d-c regulator p. 106 Apr. 15
Burkett, R., Feedback protects spacecraft's power supply p. 91 Jan. 8
Burkhardt, H. et al, Nova can't lose its instructions p. 76 Dec. 9
Busby, E. S., Feedback circuit keeps motor's torque constant p. 72 Sept. 2
Byers, K. G., Jr. & H. W. Denny, Measuring impedance with insertion loss p. 61 Apr. 1
Byrd, M. R. et al, Super-ECL speeds signals p. 124 Oct. 14
Caggiano, A. C., Operational amplifier simulates inductance p. 99 Sept. 16
Calkins, R., Dynamic tests for op amps use synchronous demodulation p. 118 Aug. 5
Candel, G. W., Sine waves become square, with symmetrical switch p. 74 May 13
Caplan, S. et al, Lighting up in a group p. 104 Mar. 4
Carley, D. R., A worthy challenger for r-f power honors p. 98 Feb. 19
Chan, W. & P. Mogensen, MOS multiplexer switches can do well at high frequencies p. 152 Nov. 11
Chapman, R., UJT protects op amp from voltage transients p. 83 Nov. 25
Cinque, G. M., Simple logic configuration compares 8-bit numbers p. 101 Sept. 16
Clausen, H. & R. B. Rusert, Isolation problems get an airing p. 75 Apr. 29
Cofer, J. W., Jr., Saving money on data transmission as signals take turns on party line p. 119 Apr. 15
Cohen, J. M., An old-timer comes of age p. 120 Feb. 19
Avoiding IC system design pitfalls p. 110 Aug. 5
Collins, J. D., Putting the squeeze on radar signals p. 86 Jan. 22
Converse, M. E., Multiplier stages replace power-supply transformer p. 84 Dec. 9
Corey, F. & J. D. Drummond, Industry nips at consumers' watchdog p. 170 Aug. 5
Cowell, R. B., Charts simplify prediction of noise from periodic pulses p. 62 Sept. 2
Power-line filters need specific specs p. 112 June 24
Curran, L., Airbus makers go two ways on avionics p. 157 Aug. 5
Automating the whole shooting match p. 171 Mar. 4
Beam leads vs. flip chips
Part 1: In search of a lasting bond p. 72 Nov. 25 68
Part 2: Rival preloading schemes head for a market showdown p. 88 Dec. 9 68
Design-it-yourself trend invades LSI technology NP p. 105 Apr. 1
Designers up in air over specs p. 165 Sept. 16
Davis, T. J., Analog gate's output is cleaned up by FET p. 81 Nov. 25
deCastro, E. D. et al, Nova can't lose its instructions p. 76 Dec. 9
DeLoach, E. R., Transistor and zener monitor calibration p. 102 June 24
DeMaria, A. J., Mode locking opens door to picosecond pulses p. 112 Sept. 16
de Miranda, W. R. R., Visual inspection of IC's boosts reliability at little cost p. 104 Aug. 19
de Pian, L., Active filters Part 2: Using the gyrator p. 114 June 10
de Pian, L. & A. Meltzer, Active filters Part 3: Negative-impedance converters p. 74 Sept. 2
Part 4: Approaching the ideal NIC p. 105 Sept. 16
Demrow, R. I., Narrowing the margin of error p. 108 Apr. 15
Protecting data from the ground up p. 58 Apr. 29
Denny, H. W. & K. G. Byers, Jr., Measuring impedance with insertion loss p. 61 Apr. 1
Dickson, P. A., ARPA network will represent integration on a large scale p. 131 Sept. 30

Census Bureau depends on electronics to make its 1970 national nose p. 103 July 22
Comsat labs to share new home p. 133 Oct. 28
Federal Center broadens IBM horizons p. 145 June 24
Federal libraries cast a long shadow p. 123 July 8
Ground-station market flies high p. 105 Nov. 25
Hard selling technology p. 111 Jan. 22
Loaded mission for ATS-F p. 103 Dec. 23, 68
NASA future earthbound by economics p. 169 Oct. 14
Simulators go to the head of the class p. 163 Apr. 15
Dickson, P. A. & W. F. Arnold, Laser safety issue burning bright p. 193 Nov. 11
Domanski, S., Circuit divides pulses without binary counters p. 81 Sept. 30
Donnelly, F. E. Jr. et al, Motor gives reverse twist to the Intelsat 3 antenna p. 71 Apr. 1
Doyle, O., Busbar blocks high-frequency noise NP p. 135 Aug. 19
TTL enters a numbers game NP p. 223 Nov. 11
Drummond, J. D., Color tv scores big gains with small screens p. 136 June 10
Doing it in color p. 107 June 24
Waiting for a home vtr? Don't hold your breath p. 102 Sept. 30
Drummond, J. D. & F. Corey, Industry nips at consumers' watchdog p. 170 Aug. 5
Dunn, V. E., Circulators for vhf and up p. 84 Nov. 25
Eberle, A. C. & R. S. Snyder, Power multi-vibrator gives linear motion to control rods p. 69 July 22
Edwards, R., Fabrication control is key to microwave performance p. 109 Feb. 19
Elad, E., FET's resistance change trips heater control p. 65 Apr. 29
Ellermeyer, W., Voltage comparator is made with op amps and logic gates p. 91 July 8
English, M., Voltage regulator built from two AND gates p. 57 Dec. 23, 68
Fadner, W. L. Zener triggers a-c alarm circuit p. 122 Nov. 11
Fedde, G. A., Memories V Plated wire: a long shot that's paying off p. 124 Nov. 11
Fein, A. E., Detecting data errors boosts transmission accuracy p. 91 Jan. 8
Ferguson, J. G. et al, Keeping track of the action p. 92 Aug. 5
Fields, S. W., The triac—from trickle to triumph in three years p. 169 NP Feb. 19
Fields, S. W. & P. J. Schuyten, Signal gains for electronic music p. 93 Apr. 29
Finnell, J. T., Jr. & F. W. Karpowich, Guidelines for radiation testing p. 122 June 10
Skipping the hard part of radiation hardening p. 122 Mar. 4
Fitzsimmons, C. K., Transistor replaces bleeder and regulates power supply p. 70 Jan. 22
Flores, R. A., Memories VII Weaving wires for aerospace jobs p. 131 Nov. 11
Foodman, H. W. et al, CBS nominates a convention hopeful p. 74 Aug. 19
Francis, P. A. & K. R. Whittington, Low-cost Schmitt trigger made with digital IC p. 88 Mar. 4
Franklin, D. F., Diodes prevent overload by limiting input's slope p. 69 Jan. 22
Freilich, A., Boosting op-amp output with two transistors p. 110 June 10
Frey, A. H. & R. E. Kavanaugh, Every data bit counts in transmission cleanup p. 77 Jan. 22
Fugit, B., Collector clamping improves threshold detector p. 81 Sept. 30
Gates, W. D., Vibrating angular rate sensor may threaten the gyroscope p. 130 June 10
Gay, M. J., et al, Lots of radio on just one IC p. 124 Aug. 5
Gilmartin, M. J., et al, The time-saver: FFT hardware p. 92 June 24
Girard, F. L., Finding leaky IC's on pc boards p. 127 June 24
Glasgal, R., Dual-Quad IC gives flip-flop a fast recovery p. 86 Feb. 5
Low-distortion limiter uses IC operational amplifier p. 120 Oct. 14
Golden, F. B., Darlington transistors widen multivibrator's range p. 82 Nov. 25
Gomez, E., et al, The time-saver: FFT hardware p. 92 June 24
Gosch, J., Automated subway: Hamburger special p. 124 Aug. 19
Graunas, R. P. et al, Motor gives reverse twist to the Intelsat 3 antenna p. 71 Apr. 1
Gray, D. I., This SCR is not for burning p. 96 Sept. 30
Greenberger, H. et al, Keeping track of the action p. 92 Aug. 5
Greenlee, L. E., Bridge rectifier clips dangerous voltages p. 89 Mar. 4

FREE

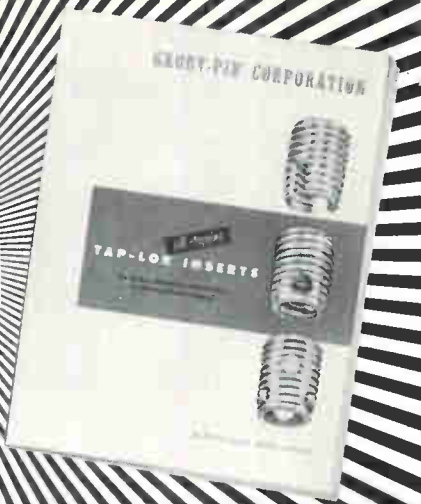

FASTENER KNOW-HOW

Here's complete design and application data on self-tapping TAP-LOK® inserts . . . the quickest, most practical and economical way to put strong threads in soft materials. Get your copy of this helpful 12-page catalog by writing: Groov-Pin Corporation, 1121 Hendricks Causeway, Ridgefield, N.J. 07657, WH-5-6780.

FASTENER DIVISION **GROOV-PIN CORP.**

Circle 276 on reader service card

Lead Frames for I. C. Packaging

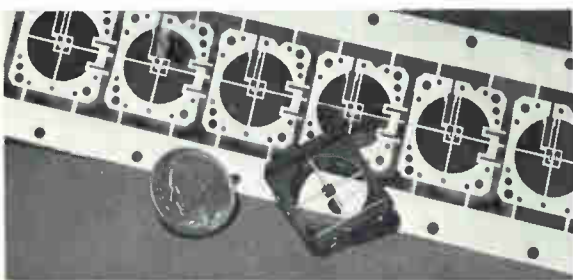

Etched lead frames for integrated circuits. Any configuration can be made adequately framed for support. Leads are flat ribbons down to 0.002 inches wide and from .002, .004, .005 and .010 inches thick. We etch kovar, nickel, alloy 42, copper, aluminum and other metals for microcircuit packaging.

Nickel, copper, silver, and gold plating on lead frames. Thinnest plating is 15 micro inches, thickest is 250 micro inches. We can go beyond this for special orders.

Etching or photoforming to tolerances of ± 0.000039 . Call or write sales manager Bill Amundson for more information.

BUCKBEE-MEARS COMPANY

245 E. 6th Street, St. Paul, Minn. 55101 / (612) 227-6371



Circle 277 on reader service card



Sharp started something big.

We did just that, when we produced the world's first IC calculators. Being the largest maker, Sharp offers a complete line of easy-to-use models. Their lightning-speed, utter silence and compact lightness, sets them apart from all conventional calculating methods.

See our whole range and make a logical choice.



CS-22A

IC

Fourteen digit 6 decimal place capacity. Fully automatic decimal and half-cent round off system. Automatic credit balance. Two working registers plus a full-function memory bank. Memory indicator, over-capacity error light. Silent, versatile and elegant. Just 8.8 lbs.



CS-17B

Silently adds and subtracts in 31 milliseconds. Multiplies and divides in less than 364 milliseconds. Performs successive multiplication and division automatically by a constant. Full capability for exponent and mixed calculation. Automatic decimal system. Two registers. 12 digit 6 decimal place capacity. Easy-to-read display panel. Only 8.8 lbs.

SHARP

HAYAKAWA ELECTRIC CO., LTD. Osaka Japan
U.S. Subsidiary: SHARP ELECTRONICS CORP. 178 Commerce Road Carlstadt, New Jersey

Circle 243 on reader service card

243



EMPLOYMENT OPPORTUNITIES

Rewarding, permanent careers in Connecticut for
**APPLICATIONS ENGINEERS • LOGIC DESIGNERS •
 CIRCUIT DESIGNERS • PACKAGING, Electronic Design
 Engineers • SYSTEMS ENGINEERS • TEST ENGI-
 NEERS • RELIABILITY/MAINTAINABILITY ENGINEERS
 • PROGRAMMERS • SYSTEMS DESIGN & ANALYSIS
 (Software) • MECHANICAL DESIGN ENGINEERS**

There's no limit to personal growth at this dynamic, expanding multi-product company. We are seeking creative, aggressive, responsibility-minded individuals who want to put their career in high gear. Have you experience or interest in one of the following product areas?

- Airborne Integrated Data Systems • Digital Flight Controls • Airborne Environmental Control Systems • Aircraft Signal Multiplexers • Electronic Engine Controls • Special Purpose Computers, Airborne Sensors and Indicators • Inertial Gyros • Biomedical Products • Guidance & Control Systems • Graphic Display Systems • Special Purpose Automatic Check-Out Equipment

An Equal Opportunity Employer

IF SO, then you should interview with us at your earliest convenience. Please forward your resume, stating present salary, to Mr. R. E. Wellington, Personnel Department, Hamilton Standard, Windsor Locks, Conn. 06096.

**Hamilton
Standard**

**U
A**
DIVISION OF UNITED AIRCRAFT CORPORATION

TECHNICIANS, ENGINEERS and SPECIALISTS

Our unique system can place you anywhere you want to be in this country or overseas. Register now with our Technical Division, staffed with consulting engineers who can serve you BEST. Fee paid.

BAILEY EMPLOYMENT SYSTEM

Dept. GWC
 900 Chapel St., New Haven, Conn. 06510
 Resume or telephone (203) 772-2100

CIRCLE 966 ON READER SERVICE CARD

EMPLOYMENT SERVICES

**Florida/Nationwide EEs, MEs, IEs . . . Elec-
 tronic, Aerospace, Industrial, Sales & Mfg.
 \$9-18,000. Tech Div Brodeur Personnel Ser-
 vice, Inc., 3947 Blvd., Center Drive, Jack-
 sonville, Fla. 32207**

"Put Yourself in the Other Fellow's Place"

TO EMPLOYERS — TO EMPLOYEES

Letters written offering Employment or applying for same are written with the hope of satisfying a current need. An answer, regardless of whether it is favorable or not, is usually expected.

MR. EMPLOYER, won't you remove the mystery about the status of an employee's application by acknowledging all applications and not just the promising candidates.

MR. EMPLOYEE you, too, can help by acknowledging applications and job offers. This would encourage more companies to answer position wanted ads in this section.

We make this suggestion in a spirit of helpful cooperation between employers and employees. This section will be the more useful to all as a result of this consideration.

McGRAW-HILL, INC.

330 West 42nd St.,

Classified Advertising Dept.

New York, N. Y. 10036

Looking for a better job?



Ask Electronics' computer all about it

Electronics magazine feels an obligation to help its readers find positions in the electronics technology which will make the greatest contribution to their profession and to society — jobs in which electronics men themselves will be happiest.

Electronics has joined with a nation-wide talent search company—National Manpower Register, Inc.—to form the computerized Electronics Manpower Register.

Your qualifications and job requirements will be pro-

grammed into a GE 265 computer, direct-linked to the Manpower Register's offices in New York. The computer, once your resume form (bottom of page and following page) is received, will continuously compare all your data with the specific manpower needs of electronics companies. When a match is made, you will be contacted directly or through an affiliated agency. The company and you will be brought together on a confidential basis.

Continued on next page

Electronics Manpower Register

It is important that your information be complete and that you type or print legibly

IDENTITY

PRESENT OR MOST RECENT EMPLOYER

Name

Date

Parent company

Home address

Your division or subsidiary

City

State

Zip

Location (City/State)

Home phone

Do you subscribe to Electronics

or see a library or pass-along copy

GEOGRAPHICAL PREFERENCE (Check appropriate boxes and complete all blanks)

I will NOT relocate I will consider opportunities in: North East Mid Atlantic South Midwest Southwest Calif. Northwest

Prefer: Metro. area Medium town Rural area

Other: _____

EDUCATION

Degree

Major field

Year

College or University

EMPLOYMENT INFORMATION

FOR OFFICE USE ONLY

--	--	--	--	--	--

REGISTRATION NUMBER

INITIAL OF LAST NAME

Position desired

Present or most recent position

From

To

Title

Duties and accomplishments

HAVE YOU REGISTERED WITH THIS SYSTEM PREVIOUSLY? Yes No

CONTINUED ON OTHER SIDE

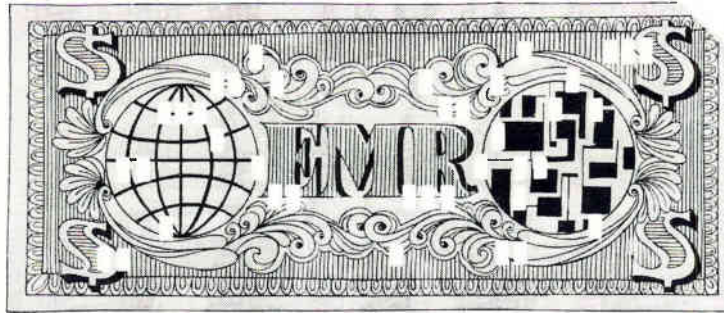

The cost of all this to you? Absolutely nothing. No fees or charges at any time.

Other advantages of EMR:

- Your resume is sent only to those companies that have a genuine requirement for your particular skills.
- There is no general "broadcasting" in the hope "someone will be interested."
- Your identity is protected because your name is released only according to your prior instructions. Your name can be deleted on request.
- EMR's service is nationwide. You may be considered for job opportunities anywhere in the U.S.

The Electronics Manpower Register is a powerful tool and should be considered when you are seriously seek-

ing a new position. And, although you may be reasonably happy in your present position, chances are that you might have that ideal job in mind.

This is why EMR makes good sense for you. If that job does turn up, you'll be there.

To get your name in the EMR file, just fill out the resume form and return to:

Electronics Manpower Register
 330 West 42nd Street
 New York, N. Y. 10036

Please enclose a copy of your resume if you have one. A detailed brochure further describing EMR will be sent to you.

Electronics Manpower Register A computerized employment opportunity service

CONTINUED FROM OTHER SIDE				
Previous Position	Employer	City/State	From	To
Duties and accomplishments				
Previous Position	Employer	City/State	From	To
Duties and accomplishments				
GENERAL INFORMATION				
(Summarize your over-all qualifications and experience in your field. List any pertinent information not included above.)				
Current annual base salary	Total years of experience	Date available (within four months)	U.S. Citizen <input type="checkbox"/>	Non U.S. Citizen <input type="checkbox"/>
My identity may be released to:	Any employer <input type="checkbox"/>	All but my present employer <input type="checkbox"/>	Have you security clearance? Yes <input type="checkbox"/> No <input type="checkbox"/>	If yes, What level
Mail (with a copy of your resume, if you have one) to:				
Electronics Manpower Register ELECTRONICS 330 West 42nd St. New York, N. Y. 10036			NO FEES OR CHARGES	
EMR-10				

MARTIN MARIETTA CAREERS IN ELECTRONICS

Appropriate Engineering Degree Required

CIRCUIT DESIGN

Experienced linear circuit designers will be assigned creative work in laser seekers, high frequency video amplifiers, servo systems for gimbaled heads, missile control sub assemblies, low light level TV guidance. Must have knowledge of hybrid, monolithic techniques, transistor and integrated circuits, control theory and servo design.

COMPONENTS

Electronic engineers to work with circuit designers in establishing optimum device requirements and selecting conventional medium and large scale integrated circuits, semiconductors to resist high dynamic and nuclear environments. Assignments will involve analytical, experimental and consultant-type evaluation.

ELECTRONIC MANUFACTURING RESEARCH

Supervisory positions are available for experienced electronics manufacturing engineers to head groups engaged in development of improved processes for fabrication and assembly of electronic packages. Sub systems include welded and soldered modules, flexible circuits, multi-layer printed circuit boards, flat cables.

MICROELECTRONICS PHOTOMASK SPECIALIST

Senior laboratory photomasking specialist is required to set up and provide technical direction to a new microelectronics laboratory photomask fabrication area. Monolithic integrated circuits (including MOS) and thick as well as thin film will be fabricated in a new phototype facility.

Qualified candidates are requested to write in confidence to:

JOHN A. PAVEY

Chief, Professional Staffing

MARTIN MARIETTA CORPORATION
P. O. Box 5837
Orlando, Florida 32805

MARTIN MARIETTA

An Equal Opportunity Employer

CIRCLE 967 ON READER SERVICE CARD



SEARCHLIGHT SECTION

• CLASSIFIED ADVERTISING • BUSINESS OPPORTUNITIES
• USED OR SURPLUS EQUIPMENT

AUTOTRACK MOUNT



360 degree azimuth, 210 degree elevation sweep with better than 1 mil. accuracy. Missile velocity acceleration and steering rates. Amplydne and servo control. Will handle up to 20 ft. dish. Supplied complete with control chassis. In stock—immediate delivery. Used world over by NASA, USAF, MP-61-B, Type SCR-584. Nike Ajax mounts also in stock.

PULSE MODULATORS

MIT MODEL 9 PULSER 1 MW—HARD TUBE
Output 25kv 40 amp., 30kv 40 amp. max. Duty cycle .002, .25 to 2 microsec. Also 5 to 5 microsec. and 1 to 1.5 microsec. Uses 6C21. Input 115v 60 cycle AC. Mfr. GE. Complete with driver and high voltage power supply. Ref: MIT Rad. Lab. Series, Vol. 5, p. 152.

2 MEGAWATT PULSER

Output 30 kv at 70 amp. Duty cycle .001. Rep rates. 1 microsec 600 pps. 1 or 2 msec 300 pps. Uses 5048 hydrogen thyratron. Input 120/208 VAC 60 cycle. Mfr. GE. Complete with high voltage power supply.

250 KW HARD TUBE PULSER

Output 16 kv 16 amp. Duty cycle .002. Pulses can be coded. Uses 5D21, 715C or 4PR60A. Input 115 v 60 cy. AC \$1200 ea.

18 MEGAWATT PULSER

Output 150KV at 120 amps. Rep rate: 50-500 PPS. Pulse length: 5 msec. 15KV 120 amp. into pulse transformer. Rise time 1.5 msec. Filament supply 5V 80 amp. incl. 17.5KV 1.5 amp DC power supply. Input: 220V 60 cy AC.

INDICATOR CONSOLES

AN/SPA-4A, PPI 10", range to 300 ml.
VJ-1 PPI 12", Range to 200 ml.
VL-1 RFI 12" to 200 ml. 60K ft.

HIGH VOLTAGE POWER SUPPLIES

100 KV, 200MA, DC, \$5500; 27 KV, 100MA, DC, \$2200; 15KV, 2 amp. DC, \$3800; 12KV, 1200MA, DC, \$1400; 8KV, 800MA, DC, \$975.

SCR 584 AUTOTRACK RADARS

Our 584s in like new condition ready to go, and in stock for immediate delivery. Ideal for telemetry research and development, missile tracking, satellite tracking. Fully Desc. MIT Rad. Lab. Series Vol. 1, pps. 207-210, 228, 284-286. Comp. Inst. Bk available \$25.00 each.

WELDING HAND TOOL

TW 17 A
\$ 48.00



Replaceable Tips—Adjustable Pressure
AC and Stored Energy Power Supplies

EWALD Instruments Corporation

Kent, Conn. 06757
CIRCLE 970 ON READER SERVICE CARD

Remember . . .

MAIL MOVES

THE COUNTRY

but . . .

ZIP CODE MOVES

THE MAIL

Mr. Used Equipment Dealer:

When you advertise in the Searchlight Section . . . You have hired your most persuasive salesman:

He's efficient . . . He thrives on long hours . . . His territory is the entire nation . . . and overseas . . . He doesn't see buyers of used and new surplus equipment: They see him—regularly. They depend on him.

He is Searchlight—The section of this publication where wise dealers advertise and list their stocks for sale.

SEARCHLIGHT SECTION

Classified Advertising Dept.
Post Office Box 12 • New York, N. Y. 10036

SONAR SYSTEMS IN STOCK

AN/FQS-1A, AN/UQS-1B, Q11Ba scanning sonars.
Rochelle salt hydrophones 6 ft.

MICROWAVE SYSTEMS

200-2400 mc. RF PKG

Continuous coverage, 30 Watts Cw nominal output. Uses 2C30A. Price \$375.

I BAND RF PKG.

20 KV peak 990 to 1040 MC. Pulse width .7 to 1.2 micro sec. Rep. rate 180 to 420 pps. Input 115 vac incl. Receiver \$1200.

200-225 mc RADAR SYSTEM

1 Megawatt output, 500 nautical mile range for long range detection of medium and high altitude jet aircraft as well as general search. AN/TPS-28

SURVEILLANCE DRONE RADAR SYSTEM

X-Band tracking system with plotting boards. Type AN/MPQ-29. Drone also in stock.

5 MEGAWATT C-BAND

Klystron RF package delivering nominal 5 megawatt pulse RF. Complete with pulser and power supply.

500 KW I BAND RADAR

500 kw 1220-1350 msec. 160 nautical mile search range P.R.I. and A scopes. MITI thyratron mod 5326 magnetron. Complete system.

AN/GPG-1 SKY-SWEEP TRACKER

3 cm. automatic tracking radar system. Complete package with indicator system. Full target acquisition and automatic tracking. Input 115 volts 60 cycle New. In stock for immediate delivery Entire System 6' long, 3' wide, 10' high. Ideal for Infrared Tracker, Drone Tracker, Missile Tracker, R. & D.



C Band Autotrack

1 Megawatt 10 ft. Parabola. Sperry.

RADAR SYSTEMS GROUND AND AIRBORNE, AUTOMATIC TRACKING ANTENNA SYSTEMS, NIKE AJAX, NIKE HERCULES M-33, MSO-1A, MFS-19, MFS-9, SCR 584, TPS-1D, TPS-28, FAA-ASR-2, AIRBORNE SYSTEMS, APN-84, APN-102, APS-20, APS-27, APS-45, DPN-19, DIGITAL COMPUTERS, IBM 650, IBM 704

LARGEST INVENTORY OF RADAR AND MICROWAVE EQUIPMENT IN THE WORLD.
RADIO RESEARCH INSTRUMENT CO.

45 WEST 45TH ST. N. Y. 10036 212-JU 6-4691

CIRCLE 968 ON READER SERVICE CARD

ELECTRON TUBES

KLYSTRONS • ATR & TR • MAGNETRONS
SUBMINIATURES • C.R.T. • T.W.T. • 5000.
6000 SERIES

• SEND FOR NEW CATALOG A2 •

A & A ELECTRONICS CORP.
1063 PERRY ANNEX
WHITTIER, CALIF.
696-7544

CIRCLE 969 ON READER SERVICE CARD

SURPLUS IBM EQUIPMENT

FREE catalog of powers supplies, light & switch panels, semiconductors, test equipment, IC's, optics, etc.

GADGETEERS SURPLUS ELECTRONICS, Inc.
5300 Vine St. Cincinnati, Ohio 45217

CIRCLE 971 ON READER SERVICE CARD

Tips on cooling off hot transistors

See how circuit designers use IERC heat dissipators to protect semiconductors...improve circuit performance and life.

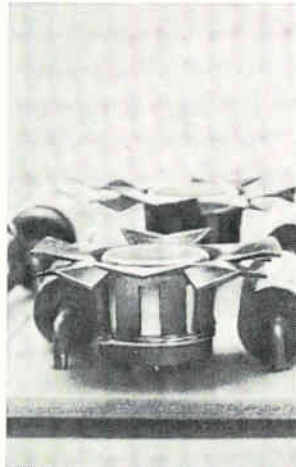
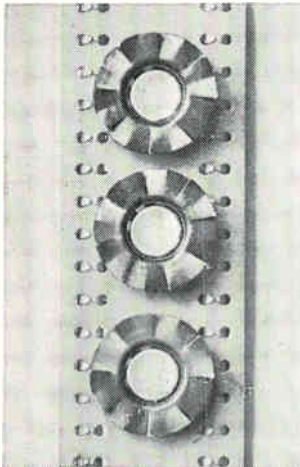

Fan-top dissipators for TO-5 and TO-18 cases drop temperatures dramatically; cost just pennies. T-shape adds almost nothing to board height; allows components to snuggle close to transistors. Spring fingers provide fast, press-on installation.

To cool off low-to-medium power transistors in TO-5 and TO-18 cases, use IERC's efficient LP's. Patented, staggered-finger design maximizes radiation and convection efficiency, radiates heat directly to ambient. Available in single or dual mounting for thermal mating of matched transistors.

IERC Thermo-Link Retainers provide efficient thermal links between transistors and chassis or heat sinks. (Also, excellent dissipation when used on p-c boards.) Integral BeO washers reduce capacitance up to 2/3. Fast, no-snap installation; transistors are firmly held.

New! Dissipators and retainers for plastic and epoxy transistors. 3 new series for RO-97A, RO-97 and X-20's. Permit a jump of 10% to 33% in operating power.

Free 8-page short form catalog discusses IERC's complete line of dissipators, retainers and tube shields. Gives specifications, prices, how to order. Send for your copy today.

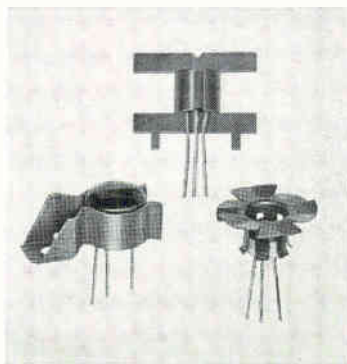

Special insulating coating — Insulube 448, a special non-hygroscopic finish developed by IERC, combines excellent dielectric properties, 50 K megs insulation resistance, and high heat emissivity. Also protects against salt spray, fungus, etc.

Tough heat dissipating problem? IERC engineers welcome your letter-head inquiry for specific information or assistance in selecting heat dissipators.

ierc
SEMICONDUCTOR
HEAT DISSIPATORS

International Newsletter

January 6, 1969

Soviets slate show for foreign IC gear

About a half-hundred U.S. firms will soon receive an unusual invitation—a bid to show integrated circuits and IC production equipment at a special exhibition in Moscow's Sokolniki Park this spring. **All the major semiconductor producers can expect invitations, say Soviet sources.**

The show—Mashintegralschema—reflects a new tack in Soviet procurement of hardware from Western countries. Unlike normal Moscow trade shows, **the IC Salon will be limited to invited foreign companies and Soviet specialists in semiconductors.** The purpose is to bring foreign sellers and Soviet buyers together in relatively quiet circumstances, something that can't be done in the bustle of a show open to the public.

Both the Soviet Chamber of Commerce and Western businessmen (few Americans were asked) hailed the first "invitation-only" salon—held for automotive equipment in November. **The IC salon, though, could come a cropper because of the U.S. embargo on strategic materials.**

Budget hangups threaten ELDO

The staff of ELDO is operating under a pall of gloom once again because of the failure of the organization's council to come up with a budget. Said one staff member after the latest Paris council meeting: "We're right back where we were before the November Bonn meeting" at which a \$626 million austerity budget was outlined. Council president General Robert Aubiniere went even further and declared that if a decision wasn't forthcoming before the end of February, ELDO might not be able to continue in its present form.

The failure of the Paris meeting was underlined by the reluctance of Britain and Italy to approve the austerity proposal. The British said they could afford only \$24 million of the \$40 million they were assessed; the Italians balked at the elimination of the Europa rocket's made-in-Italy apogee motor as part of the austerity program.

Germans ponder computer utility

The West German Post Office, already the largest user of computers in Western Europe, is taking a hard look at the feasibility of a nationwide data-processing network. **Intended mainly for small companies that can't afford their own computers, the proposed utility would spot computers in industrial centers and tie subscribers into them over existing lines.**

The agency is expected to have details on the extent and cost of the computer grid worked out sometime this spring. The computers for the grid, presumably, would be independent of the 38 third-generation machines that the post office now has in service at 10 data-processing centers and money-order-handling facilities around the country.

Plessey may become UK leader in NC

Rebuffed in its bid to take over the giant English Electric Co., the Plessey Co. has been looking for strong, small companies to take into its fold. **Apparently one of the first will be Controls and Communications Ltd., a \$10.5 million firm particularly strong in numerical controls and radio communications. Insiders say a merger between the two firms is an almost-sure thing.**

Picking up C&C apparently would move Plessey up into the top spot among British NC producers, now led by Ferranti Ltd. Although these companies don't divulge their NC business volume, market watchers

International Newsletter

figure Plessey and C&C together account for more than half of NC sales in the UK.

The merger is the sort of thing that the Wilson Government and its Industrial Reorganisation Corp. have deemed good for Britain and may even be speeded with some IRC money. Nearly all of Plessey's NC hardware is made under a license from Bunker-Ramo; C&C, by contrast, developed its own designs.

Rx for overtalk: cable the sea

Nippon Telegraph and Telephone Public Corp. may enlist submarine cables in its effort to keep up with Japan's fast-growing communications demand.

The government-owned carrier, which runs the world's densest microwave-link network, will put a multichannel sea cable into service next September between Muroran and Mori, both on Uchiura Bay on Hokkaido, the northernmost main Japanese island. The 22.5-mile link will have a repeater about every $3\frac{3}{4}$ miles. NTT says the cable, with 900 channels, will set a world record for submarine cable capacity.

If the Muroran-Mori link passes muster, NTT intends to switch aggressively to submarine cables for domestic communications. Most of the country's population is concentrated on the coast and the underwater links avoid costly cable-laying in the mountainous countryside.

Toshiba tools up for NC venture

Fujitsu Ltd., Japan's leading producer of numerical control equipment, almost surely will face formidable new competition this year.

Toshiba Machine Co., currently a Fujitsu NC customer, plans to set up a joint venture with Kearney and Trecker, an American machine-tool producer, to build Milwaukee-Matic machining equipment. The new company intends to use domestic NC's in its machines but Fujitsu might see most of the business going to Toshiba Machine's parent firm, Tokyo Shibaura Electric Co. (Toshiba), which is thinking about a deal with General Electric that would give it the right to build GE's numerical control systems in Japan. Many Milwaukee-Matics come fitted out with GE controls.

Toshiba Machine hopes to get government approval of the joint venture by April or May. The new company would import Milwaukee-Matics until a plant can be built. Mitsui and Co., one of Japan's largest trading companies will hold a 5% share in the venture. Toshiba Machine will hold 45% and K&T 50%.

Addenda

West German engineer Georg Greger, inventor of the Lectron instruction kit marketed in the U.S. by Raytheon, has three other kits nearly ready for production: digital circuitry, a Geiger counter, and a low-voltage oscilloscope. Raytheon will build and sell all three under license . . . Norway's small but vigorous electronics industry picked up a new company this week, Telox A/S. The company will specialize in communications and navigation systems and will team up with Hughes Aircraft, Sweden's L.M. Ericsson, and Denmark's Terma Elektronisk Industri on the Scandinavian satellite communications ground station . . . Matsushita Research Institute reports it has developed light-emitting gallium arsenide diodes with an external efficiency of 2%. The figure was obtained at a device current of 5 milliamps and matches the performance reported earlier by Bell Telephone Labs.

China poised for 'great leap' into the forefront of science

Swedish engineer-diplomat reports strong technological progress, but says pace of production lags far behind scientific achievements

The natural habitat of the China-watcher is Hong Kong, but the species can be found in almost any capital in the world. Stockholm, for instance, is the present headquarters of Jon Sigurdson, an electronics engineer who's been an observer of Chinese science ever since he served at Sweden's embassy in Peking in the mid-sixties.

Sigurdson last month had much good to say about Red Chinese science. In a report published by Sweden's prestigious Royal Academy of Sciences, he predicted that China would move up into the "front line of science within the foreseeable future." But he noted that a place in the forefront of scientific progress does not insure a place among the leaders in industrial production.

Sigurdson hammers home that point with some facts about computers. "A breakthrough was scored in large, fast models around 1965," Sigurdson says, "and the computer industry in China is now, at most, five years behind that of Western countries." But he guesses that production is perhaps only a dozen machines a year—although precise figures can't be had.

Inference. Little is known about the country's most modern machine, except that it's a transistorized digital computer and presumably represents a real advance over the earlier Chinese computers, which were versions of Russian-designed analog machines. Even more significant, Sigurdson points out, is the fact that the latest computer indicates a Chinese components industry sophisticated enough to produce quality hardware.

The machine's transistors are germanium, the material most com-

monly used for semiconductors in China. But the Chinese are up on their silicon technology, too. When Sigurdson wrote his report last year, he noted that production of integrated circuits had not yet begun. But he now believes the Chinese have started turning out IC's.

In fact, Sigurdson's view is that the minions of Mao can produce

almost anything. He says the Chinese will "definitely" be able to launch a satellite within a decade. But again he points out that the ability to build one unit doesn't mean the builders can organize series production.

Factories first. At the moment, Sigurdson says, the emphasis in China is on developing process-control equipment for chemical and

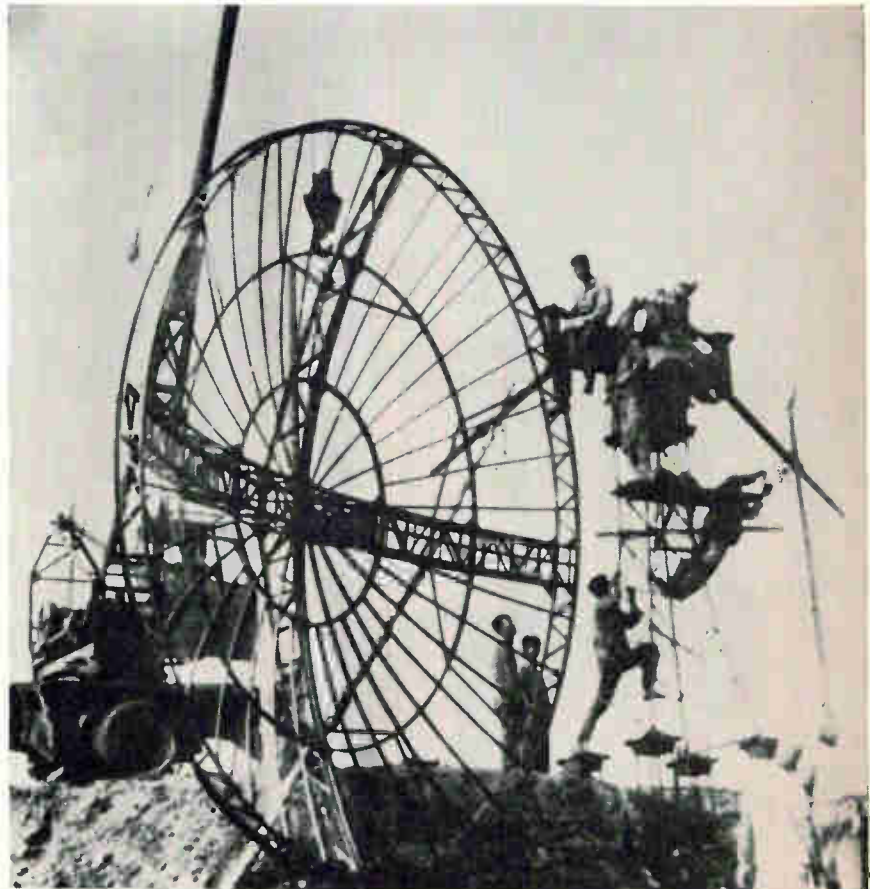

Teacher's helpers. "Acting in accordance with the teachings of Chairman Mao" (with some additional tutoring by scientists from the University of Sydney, Australia), Chinese technicians are building a 40-dish radiotelescope that stretches 1.9 miles.

petrochemical plants. And there's a push to get electronic controls into the metal-working industries; but this effort, Sigurdson says, is "still in its beginning stages."

Another sector that's been getting particular attention is telecommunications, and Chinese electronics engineers have been having a fling at instrumentation. One notable achievement: an electron microscope with a magnification of 200,000.

And the Chinese have under construction what Sigurdson says is "one of the best" radiotelescopes anywhere. Made up of a 1.9-mile-long chain of 40 antenna dishes with diameters between 20 feet and 30 feet, the telescope will be able to track celestial bodies over a 12-hour period.

The Chinese are getting some help on the radiotelescope from scientists from Australia's University of Sydney. But dependence on outsiders has been on the wane since the onset of the Cultural Revolution in 1966. For all the havoc the still-continuing revolution has wreaked on the country's economy, it has also brought new respect for Chinese scientific achievements and has forced foreign-trained scientists to concede that Chinese-made hardware has some worth, Sigurdson feels.

Looking out. Despite the stress on home-grown technology, Peking keeps a close watch on developments abroad. At the city's Institute of Scientific and Technical Information, there's a special section that collects catalogs of foreign manufacturers. In addition, the institute gets more than 7,000 foreign technical and scientific publications, and a great deal of this material is translated and distributed to the Chinese technological community. In 1965, for example, the Chinese published 262 books on electronics, and 40 on automation.

The Chinese still import many advanced instruments—particularly from Japan and West Germany. And despite American efforts, some U.S.-made equipment slips into China.

This bootleg instrument business is on the decline, Sigurdson thinks. Over the past 18 months, Japan's

Ministry of International Trade and Industry has been squeezing the flow, presumably at the behest of Washington. Because of this, however, there's been a switch in Japan toward exports of know-how, and small groups of Japanese experts have been going to China recently to train engineers and technicians there.

Great Britain

Schools systems

Pity the poor Loch Ness monster. It may be on the way to dropping in status from an infamous mystery to just another unusual sea creature.

If it does, much of the credit—or blame—will go to a research team at Birmingham University and the digital sonar it has developed. In initial tests, the sonar picked up in the deep Scottish lake targets too big and too fast to be ordinary fish. One, for example, checked out as several yards long and was moving 18 miles an hour along the range axis—all the while diving at about 450 feet a minute.

And if the Birmingham sonar could be bad news for the Loch Ness monster, it should be even worse for herring and other fish that school relatively near the surface. The sonar was conceived mainly to ferret them out; most fish-finding sonars search straight down to the bottom.

The researchers worked out their digital-sonar scheme to get around the expensive analog circuitry required for "within pulse" sonars. In these types—the first sonars with a wide, out-front scan fast enough to detect schools of fish—the outgoing beam is as wide (say 60°) as the sector to be scanned. Echoes are picked up on an array of transducers, and the phase of signals from each element is shifted rapidly to determine the bearings of the sound echoes. The entire sector covered by the beam can thus be scanned electronically during the return-pulse duration.

The Birmingham researchers, led by David Creasey, worked their

variation on this basic scheme by putting into hardware an idea of Donald Nairn, now with the Admiralty: use digital computing techniques, rather than phase shifting, to figure the bearing of echoes picked up on an array. After the successful tests in the Loch Ness, the experimental system has been taken out to sea for further tryouts. Along with possible monsters, the sonar resolved in bearing and range a 1-inch sphere at 50 yards and a 7-inch sphere at more than 200 yards. At the same time, the sonar picked up the edge of the loch, more than 2 miles away. Creasey says no conventional sonar can match this performance.

Half-dozen. The Birmingham sonar operates at 47.5 kilohertz and scans a 60° sector with seven transducers spaced about one wavelength apart. Phase differences between echoes arriving at adjacent transducers are measured and the six measurements used to make sure the incoming signal is valid and to determine its bearing.

Signals from the transducers are first amplified and then applied to gates. The positive-going zero-crossing of the amplifier output for transducer number one, for example, opens gate number one, and the same condition at amplifier number two closes it. Thus the six gates are switched on and off successively as the echo moves along the array.

How long each gate stays open depends upon the phase difference between signals at adjacent transducers. A count of the time a gate stays open is made by means of a 6.08-megahertz clock pulse used to quantize the time into one of 128 levels. The level is fed to a digital counter, which stores it.

On the average. To make the validity check, each set of six quantized gate samples stored in the counters is averaged and each sample compared to the average. If the sum of the deviations lies below a preset threshold, the set is accepted. When three successive sets are accepted, the value—whose magnitude depends on the bearing of the incoming signals—is fed to a cathode-ray tube display. It takes about 250 microseconds to process

three sets of samples, so the duration of the sonar pulse must be at least this long.

The digital technique, Creasey concedes, has a major drawback compared with an analog "within pulse" system. Only the target returning the strongest echo is displayed by the digital sonar, but analog systems can pinpoint several targets within their scan sectors. But Creasey is certain that the system's potentially lower cost—the components for its digital circuits cost less than \$500—more than offsets the drawback. The cost of logic packages is dropping so fast, he points out, that the digital sonar one day could be built for a price fishermen will pay.

West Germany

A lighter contact

Once they're up in orbit, the solar cells that power satellites are riding dry as well as high, making any protection against ground humidity just wasted weight.

Most cells do, in fact, pack some spare avoirdupois: a layer of solder to protect the contacts—a layer of titanium and a layer of silver deposited on the photovoltaic silicon—against electrochemical corrosion that can occur when the silver and titanium are next to one another in a humid atmosphere.

To be sure, solderless cells are fabricated and stored for long periods in relatively dry areas like Southern California. But if the cells are destined for a satellite slated for a Cape Kennedy launch, they need elaborate safeguards against the moisture-laden sea breezes until the satellite is up and away.

A new and simple safeguard against humidity, however, has been worked out by AEG-Telefunken at the behest of the European Space Research and Technology Center (Estec) at Noordwijk, the Netherlands, where it's damp. Telefunken's technique: put down a layer of palladium between the titanium and silver layers. The palladium layer shifts the electro-

chemical potential between the titanium and silver layers to a range where the titanium, which ordinarily corrodes, doesn't.

Hot and cold. In laboratory tests, the new solderless cells have worked without losing any efficiency for 600 hours at temperatures to 90°C and humidities up to 100%. Furthermore, the cells still can convert photons into electrons after exposure to temperatures of 400°C. This suits them particularly for deep-space missions, where temperatures are higher than for earth orbits. Cycling between -196°C and +150°C doesn't faze the cells.

What's more, thermocompression bonds or resistance welds can be made on the new contacts; both are better than soldering. In the solderless cells, a tear strength greater than 700 grams is achieved for a bond area measuring only one-third millimeter square. This small bonding area greatly reduces the temperature stresses in solar-cell contacts. Better still, the bonds or welds point to considerable savings in fabrication costs, compared with soldering, although Tele-

funken still hasn't figured out how much the savings might be.

One, two, three. A typical solderless solar-cell contact is made by successively depositing onto the cell's silicon surface a 350-angstrom film of titanium, a 50- to 200-angstrom layer of palladium, and finally a 5-micron layer of silver. These three layers are put down in one evaporation run with the silicon substrates at temperatures near 150°C. No special equipment or techniques are needed for the palladium, so the advantages of this trio of layers can be had using equipment that's already around.

Japan

On the square

There's long been a need for a simple device that can square or cube an analog input function, and a way to meet this need has been found by the Denki Onkyo Co.

What Denki has done is build a sort of functional integrated cir-

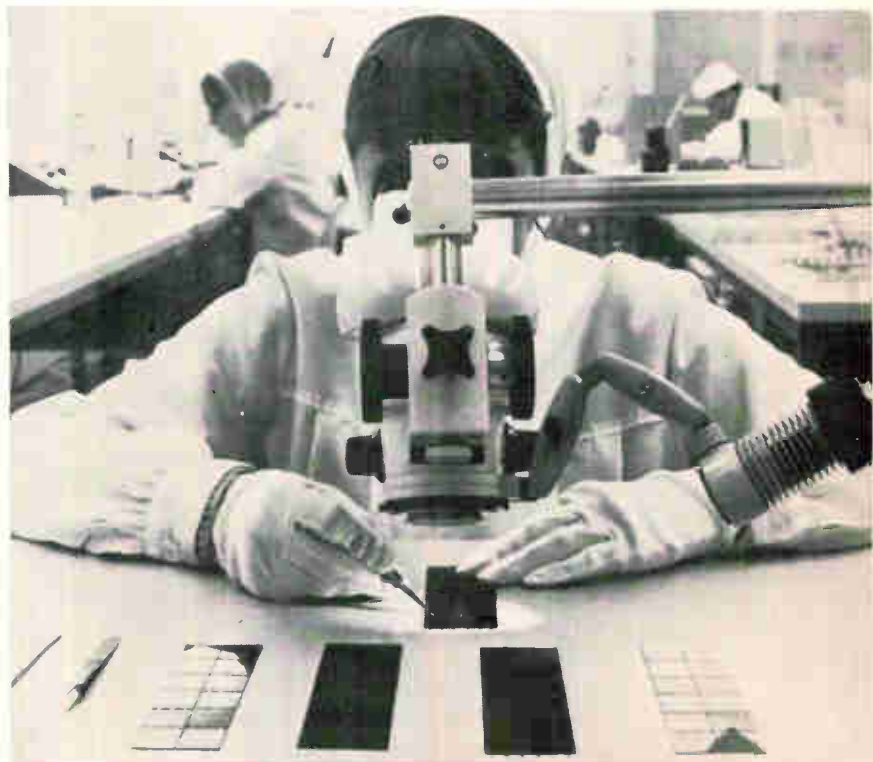

Cell block. Technician at AEG-Telefunken checks connections on plates of solar cells made with solderless contacts.

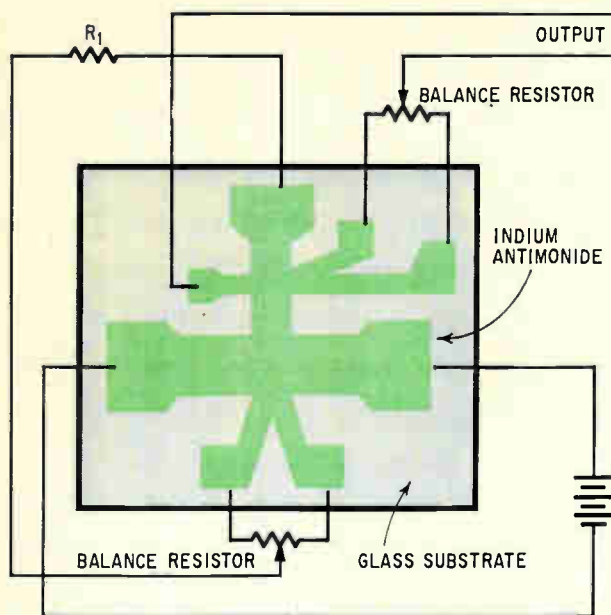

Bootstraps. Hall voltage developed across horizontal arm drives current through vertical arm, whose Hall voltage thus becomes a function of the square of the magnetic field.

cuit—a slice of single-crystal indium antimonide on a very thin glass substrate. The InSb is shaped to form a multiple Hall element, and the interaction of the Hall currents and voltages in effect multiplies by itself the value of the input, a magnetic field.

Straightforward. Unlike most new bulk semiconductor devices, Denki's functional IC is easy to understand. The square-law version combines a pair of Hall elements at right angles to one another [see diagram]. One is fed with a constant-current power supply and thus generates a Hall voltage when there's a magnetic field applied. This Hall voltage drives current through the second Hall generator. But it, too, lies in the magnetic field, so its output voltage is proportional to the square of the applied field.

Higher-order functions can be had by repeating the process. Denki already has cubic-law circuits, obtained by using the output of the second Hall generator to drive current through a third. The precision of the squaring units is about 0.2% if the magnetic field is kept below 3 kilogauss. For cubing units, the figure is 0.2% with the same proviso. And Denki thinks satisfactory levels of precision are possible with higher-power units.

To fabricate the functional IC, Denki cements a 6-micron-thick

slice of single-crystal InSb to a glass substrate 100 microns thick. The Hall-generator pattern is then etched into the InSb using conventional photoresist techniques.

Small gap. The thin glass substrate keeps the air gap in the magnetic circuit small and thus helps solve one problem that pops up when the devices are put to work in practical circuits—getting adequate sensitivity. The narrowness of the air gap between the InSb and magnetic field partly compensates for the loss in sensitivity that goes with a large load resistance. The over-all circuit needs this resistance to make negligible the changes in resistance caused by the magnetostrictive effect of the Hall elements upon one another.

Another source of trouble is the voltage imbalance that develops if the voltage takeoff contacts aren't directly opposite one another. Denki zeroes this out by means of a split contact with a tapped resistance across it.

Gunn for hire

Many of the world's major semiconductor producers have announced with considerable fanfare during the past year that they were ready to sell "commercial" Gunn-effect diodes. But there are conspicuous absentees from the

list of Gunn-oscillator houses; until last month Hitachi Ltd. seemed to be one of them.

The company should, however, have been on the list long ago. While its competitors were readying themselves to peddle Gunn diodes, Hitachi was using them as local oscillators in television-relay links built for Nippon Hoso Kyokai, the Japan Broadcasting Corp. Hitachi says the diodes have operated continuously for 8,500 hours at 13 gigahertz. Rated power output is 50 milliwatts.

Achievers. The company's engineers say the diodes have an edge over reflex klystrons, the tubes generally used for the local oscillators in K-band microwave links. The frequency deviation of the diodes caused by changes in temperature, for example, is only 160 kilohertz per degree Centigrade at 13 Ghz.

They also show better linearity for frequency modulation than the reflex klystrons, whose frequency swing is usually 20 megahertz per volt. With a varactor diode biased at 4 volts modulating the Gunn diode, this sensitivity is 30 Mhz/volt. It's even better with a diode bias of 6 volts.

The Gunn-diode local oscillators are fabricated from gallium arsenide with impurity levels of about 10^{15} atoms per cubic centimeter. This makes electron mobility in the GaAs crystal $8,000 \text{ cm}^2/\text{v-sec}$, close to the theoretical limit. Hitachi worked out the method for purifying GaAs crystals to this level in a joint program with the Electrical Communication Laboratory of the Nippon Telegraph and Telephone Public Corp., the state-owned communications carrier.

Outgoing. Hitachi also plans to develop transmitter oscillators using Gunn diodes. In tests so far, the oscillators have been run at 8.7 Ghz with output power of 400 milliwatts. Much higher frequencies can be had at the usual penalty—a drop in output power that approximates the $1/f^2$ power frequency relationship predicted by theory. At 25.3 Ghz, for example, the diode's output goes down to 51 mw.

Electronics advertisers

January 6, 1969

Acton Laboratories, Inc. Impact Adv., Inc.	207	Deutsch Company Smith & Hemmings	193, 195, 197	I R C, Inc. Gray & Rogers, Inc.	18, 19
Airpax Electronics, Inc. Welch, Mirabile & Co., Inc.	178	Dialight Corporation Michel Cather, Inc.	150		
Airtronics, Inc., Powertec Div. Frost, Shaffer, Gauthier	214	Digital Equipment Corp. Kalb & Schneider, Inc.	151		
Allen-Bradley Co. Fensholt Adv. Agcy.	45, 47	Dumont Oscilloscope Laboratories, Inc. Keyes, Martin & Co.	219		
■ American Lava Corp., Sub. of Minnesota Mining & Mfg. Co. Designers, Inc.	17	Durant Manufacturing Co. Franklin Mautner Advertising	186	■ J F D Electronics Co., Components Div. Delphi Adv., Inc.	172
■ Amperex Electronics Corp., Div. of North American Philips Co. Sam Groden, Inc.	167				
■ Amphenol Corp. Marsteller, Inc.	46	Elco Corp. Fien and Schwerin, Inc.	258	Kelvin Stoneham & Summers Adv.	216
Associated Testing Laboratories, Inc. Murray Heyert Associates	207	ELECM Service Publicite	26	■ Kepco, Inc. Weiss Advertising	208
Automatic Control Div., Cook Electric Co. Sander Rodkin Adv. Agcy., Ltd.	221	Electro-Rents Wyman/Anderson-McConnell Adv. Agcy., Inc.	204	Kikusui Electronics Corp. General Adv. Agcy., Inc.	213
Avtel Corp. Tri-Tech/Services	218	E/MC—Medical Electronics Seminar Slesar & Kanzer, Inc.	28, 29	Krohn-Hite Corp. L. K. Frank Co., Inc.	173
		Erie Technological Products Co., Inc. Altman-Hall Associates	106		
■ Barnes Corp. Industrial Public Relations, Inc.	209	ESC Electronics Corp. Comar Adv. Agcy., Inc.	208	■ Leach Corp. Jay Chiat & Associates	153
■ Barnstead Subsidiary of Ritter Pfaudler Corp. Creamer, Trowbridge, Case & Basford, Inc.	188			Lectrohm, Inc., a Subsidiary of Cook Electric Co. Sander Rodkin Adv. Agcy., Ltd.	220
Belden Corporation Fensholt Adv., Inc.	12, 13	Fairchild Semiconductor, Inc. Chiat/Day, Inc.	20, 21, 64, 65	LDV Electro Science Industries V.C. Graphics, Inc.	14
Bell Telephone Laboratories N.W. Ayer & Son, Inc.	170			Leeds & Northrup Gaynor & Ducas, Inc.	72
Bourns, Inc., Trimpot Div. The Lester Co.	27	Garrett Corp., AiResearch Mfg. Div. J. Walter Thompson Co.	50	Lesam of America Corp. Zam & Kirshner, Inc.	219
■ Bowmar Instrument Corp. Impact Adv., Inc.	174, 175	GBC, Closed Circuit TV Corp. Gilbert and Felix, Inc.	62	Levinson Co., Harry Pollock & Loth, Inc.	209
■ Brush Instruments, Div. of Clevite Corp. Carr Liggett Adv., Inc.	70	General Atronics Corp. Garceau Hallahan & McCullough, Inc.	157		
Buckbee-Mears Co. Midland Assoc., Inc.	243	General Electric Co., Silicone Products Div. Ross Roy of New York, Inc.	75	McGraw-Hill Professional and Reference Book Div.	225
■ Burroughs Corp., Electronic Components Div. Conti Adv. Agcy., Inc.	86	General Radio Co. Horton, Church & Goff, Inc.	6	■ Machlett Laboratories, Div. of Raytheon Co. Fuller & Smith & Ross, Inc.	15
■ Bussman Mfg. Div. of McGraw Edison Co. Henderson Adv. Co.	154	■ Grayhill, Inc. Merchandising Adv., Inc.	207	■ Magnetics, Inc. Lando Adv. Agcy., Inc.	158
		Groov-Pin Corp. Feeley & Wheeler, Inc.	243	Markel & Sons, L. Frank George Moll Adv., Inc.	214
				Markem Corp. Creamer Trowbridge Case & Basford, Inc.	160
Centralab Div. of Globe-Union, Inc. The Brady Company	23	Hamilton Watch Co. Beaumont, Heller & Sperling, Inc.	192	■ Matsuo Electric Co., Ltd. Daiyusha, Inc. Adv.	224
Clare & Co., C.P. Reincke, Meyer & Finn Adv., Inc.	104, 105	Hayakawa Electric Co., Ltd. Dai-Ichi International, Inc.	243	Metal Removal Co., The Advertising Producers Associates	16
Clarostat Manufacturing Co. Horton, Church & Goff, Inc.	149	■ Heath Co., Sub. of Schlumberger, Ltd. Advance Advertising Service	203	□ Metrimex Hungexpo	4E
■ Clifton Precision Products Co., Div. of Litton Industries Ivey Adv., Inc.	32	■ Hewlett Packard, Colorado Springs Div. Tallant/Yates Adv., Inc.	30	Micom, Inc. Lennen & Newell, Inc.	156
Communication Electronics, Inc. William C. Estler—Public Relations	84	■ Hewlett Packard, Frequency & Time Div. Lennen & Newell, Inc.	181	■ Micro Switch Division of Honeywell N. W. Ayer & Son, Inc.	43
Connecticut Hard Rubber Co. Chirurg & Cairns, Inc.	24	■ Hewlett Packard, Loveland Div. Tallant/Yates Adv., Inc.	2	■ Microwave Cavity Laboratories, Inc. Art Brown Writing Service	217
□ Contelec Werbegraphik	8E	■ Hewlett Packard, Microwave Div. Lennen & Newell, Inc.	1	Midtex/Aemco Chuck Ruhr Assoc. Adv.	48
Control-Logic, Inc. Van Christo Assoc., Inc.	79	■ Hewlett Packard, Waltham Div. Culver Adv., Inc.	198	■ Midwestern Instruments White Adv. Agcy., Inc.	74
Coors Porcelain Co. Tallant/Yates Adv., Inc.	190	■ Hickok Electrical Instrument Co. Parsells Advertising Service	182, 183	Millipore Corp. Czyryca/Design, Inc.	80
Cosmic Optical Co., Ltd. Matsushita, Inc.	213	Howard W. Sams & Co., Inc. George Brodsky Adv., Inc.	73	Mohawk Data Sciences Corp./OEM Marketing MacFarland Associates, Inc.	197
CREI, Home Study Div. of the McGraw-Hill Book Co. Henry J. Kaufman & Associates	162	Hughes Aircraft Co. Foote, Cone & Belding	161, 189	Monsanto Co. Michel-Cather, Inc.	25
■ CTS Corporation Reincke, Meyer & Finn, Inc.	226, 227	Hugle Industries, Inc. Tom Jones Adv. and Packaging	81	Motorola Semiconductor Products, Inc. Lane & Bird Adv., Inc.	51
				Moxon Electronics Corp., SRC Div. Alden Adv. of California, Inc.	8
■ Dale Electronics, Inc., Sub. of Llonel Corp. Swanson, Sinkey, Ellis, Inc.	3rd Cover			Multimetrix, Inc. David Silver Adv., Inc.	206
Delco Radio Division of General Motors Corp. Campbell-Ewald Co.	176, 177	IEEE (Institute of Electrical & Electronic Engineers) Alpaugh Advertising	195		
Delta Products, Inc. Noble De Roin & Associates	200, 201	International Electronic Research Corp. Van Der Boom, McCarron, Inc. Adv.	248	■ National Electronics, Inc. Connor-Sager Associates	206
Deringer Metallurgical Corp. R. B. Advertising	155			National Semiconductor Corp. Hall Butler Blatherwick, Inc.	10, 11
				New Hermes Engraving Machine Corp. Lester Harrison Adv., Inc.	193

North American Rockwell, Autonetics Div. 76 Campbell-Ewald Co.	
■ Norton Assoc., Inc. 209 J. J. Coppo Co.	
Olympus Corp. 187 Kameny Assoc., Inc.	
Pastoriza Electronics Co. 228 L. K. Frank Co., Inc.	
Philbrick/Nexus Research 83 Culver Adv., Inc.	
Philips Eindhoven, Nederland 166 Media International	
□ Philips N.V. Pit/Ema Div. 2E Marsteller International S.A.	
Phoenix Chamber of Commerce 218 Jennings & Thompson Adv.	
Princeton Applied Research Corp. 52 Mort Barish Assoc., Inc.	
Radiation, Inc. 97 W. M. Zemp & Assoc., Inc.	
Radio Corporation of America 4th Cover, 257 Al Paul Lefton Co.	
Raytheon Co., Components Div. 49 Fuller & Smith & Ross, Inc.	
Raytheon Semiconductor 184 Botsford, Constantine & McCarty, Inc.	
■ Republic Foil, Inc. 169 The Graphic Group	
RFL Industries, Inc., 168 Instrumentation Div. Josephson, Cuffari & Co.	
Rohde & Schwarz 59 Fletcher-Walker-Gessell, Inc.	
Sanken Electric Co., Ltd. 224 Seikosha Adv., Inc.	
□ Schneider R.T. 7E Noirclerc Publicite	
■ Semtech Corp. 57 Burrell Advertising	
Siemens America 44 Clinton E. Frank, Inc.	
Signetics Corp., 78, 147 Sub. Corning Glass Works Cunningham & Walsh, Inc.	
Siliconix, Inc. 7 Graphics West	
Solitron Devices, Inc., Transistor Div. 85 Haselmire Pearson Adv., Inc.	
Sorensen Operation, Raytheon Company 69 Urrutia & Hayes, Inc.	
Sperry Rand Corp., 66 Sperry Microwave Electronics Div. Neals & Hickok, Inc.	
Sperry Rand Corp., 148 Sperry Electronic Tube Div. Neals & Hickok, Inc.	
Sprague Electric Co., The 5, 9 Harry P. Bridge Co.	
■ Stackpole Carbon Co., 222, 223 Electronic Components Div. Meek & Thomas, Inc.	
Struthers-Dunn, Inc. 202 Harry P. Bridge Co.	
Susumu Industrial Co., Ltd. 216 Sanko Sha Adv. Agcy. Co., Ltd.	
Sylvania Electric Products, Inc., 35 to 42 Electronic Components Group Doyle, Dane, Bernbach, Inc.	
Sylvania Electric Products Inc., 77 Parts Div. Doyle, Dane, Bernbach, Inc.	
■ Syntronic Instruments, Inc. 216 Burton Browne Adv.	
Tally Corp. 230 Bonfield Assoc., Inc.	
Taylor Corp. 210 Gray & Rogers, Inc.	
TDK Electronics Co., Ltd. 229 Chuosenko Co., Ltd.	
■ Tech Laboratories, Inc. 213 Lewis Adv. Agcy.	

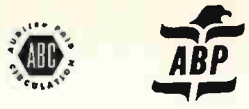

■ Tektronix, Inc. 163, 164 Dawson, Turner & Jenkins, Inc.	
Telonic Engineering Co. 194 Jansen Associates, Inc.	
Texas Instruments Incorporated 71 Components Group Don L. Baxter, Div. of Albert Frank- Guenther Law, Inc.	
Texscan Corporation 22 Burton Browne Advertising	
Transitron Electronic Corp. 82 Larcom Randall Adv., Inc.	
TRW Electronics, Capacitors Div. 215 Fuller & Smith & Ross, Inc.	
TRW Instruments 196 Fuller & Smith & Ross, Inc.	
■ Trygon Electronics, Inc. 212 Kameny Assoc., Inc.	
■ Tung-Sol Div., Wagner Electric Corp. 61 Feeley & Wheeler, Inc.	
■ United Transformer Co., 2nd Cover Div. of TRW, Inc. Fuller & Smith & Ross, Inc.	
■ Unitrode Corp. 63 Silton Brothers, Inc.	
U. S. Components 152 Delphi Adv., Inc.	
■ Varo, Inc. 228 Tracy-Locke Co., Inc.	
□ Watkins-Johnson Co. 3E William C. Estler Public Relations	
■ Weinschel Engineering Co. 212 E.G. White Adv., Inc.	
Westamp, Inc. 218 Siegmeister-Grant	
■ Weston Instruments, Inc. 159 Archbald Div. Arndt, Preston, Chapin, Lamb & Keen, Inc.	

Classified Advertising
F.J. Eberle, Manager

EMPLOYMENT OPPORTUNITIES . . . 244-247
Bailey Employment System . . . 244
Hamilton Standard Div. of . . . 244
United Aircraft Corp. 244
Martin Marietta Corp. 247

EQUIPMENT
(Used or Surplus New)
For Sale

A & A Electronics Corp. 247
Ewald Instruments Corp. 247
Gadgets Surplus Electronics Inc. 247
Radio Research Instrument Co. 247

■ For more information on complete product line see advertisement in the latest Electronics Buyer's Guide
□ Advertisers in Electronics International

Electronics Buyers' Guide
George F. Werner, General Manager [212] 971-2310
Robert M. Denmead, Midwest Regional Manager [312] MO 4-5800
Regina Hera, Directory Manager [212] 971-2544
Thomas M. Egan, Production Manager [212] 971-3140

Circulation Department
Isaaca Siegel, Manager [212] 971-6057

Research Department
David Strassler, Manager [212] 971-6058

Advertising Sales Staff

Frank E. LeBeau [212] 971-6464
Advertising Sales Manager

Wallis Clarke [212] 971-2187
Assistant to sales manager

Donald J. Austermann [212] 971-3139
Promotion Manager

Warren H. Gardner [215] LO 8-6161
Eastern Advertising Sales Manager

Atlanta, Ga. 30309: Michael H. Miller, 1375 Peachtree St., N.E. [404] 892-2868

Boston, Mass. 02116: William S. Hodgkinson McGraw-Hill Building, Copley Square [617] CO 2-1160

Cleveland, Ohio 44113: William J. Boyle, 55 Public Square. [216] SU 1-7000

New York, N.Y. 10036
500 Fifth Avenue
James R. Pierce [212] 971-3615
John A. Garland [212] 971-3617
Michael J. Stoller [212] 971-3616

Philadelphia, Pa. 19103:
Jeffrey M. Preston
Warren H. Gardner,
6 Penn Center Plaza,
[215] LO 8-6161

Pittsburgh, Pa. 15222: Warren H. Gardner,
4 Gateway Center, [412] 391-1314

Rochester, N.Y. 14534: William J. Boyle,
9 Greylock Ridge, Pittsford, N.Y.
[716] 586-5040

Donald R. Furth (312) MO 4-5800
Midwest Advertising Sales Manager

Chicago, Ill. 60611: Kenneth E. Nicklas
Ralph Hanning, 645 North Michigan Avenue,
[312] MO 4-5800

Dallas, Texas 75201: Richard P. Poole, 1800
Republic National Bank Tower,
[214] RI 7-9721

Houston, Texas 77002: Robert Wallin,
2270 Humble Bldg. [713] CA 4-8381

Detroit, Michigan 48226: Ralph Hanning,
856 Penobscot Building
[313] 962-1793

Minneapolis, Minn. 55402: 1104 Northstar
Center [612] 332-7425

St. Louis, Mo. 63105: Kenneth E. Nicklas,
The Clayton Tower, 7751 Carondelet Ave.
[314] PA 5-7285

James T. Hauptli [415] DO 2-4600
Western Advertising Sales Manager

Denver, Colo. 80202: Joseph C. Page, David
M. Watson, Tower Bldg., 1700 Broadway
[303] 255-5484

Los Angeles, Calif. 90017: Ian C. Hill,
John G. Zisch, 1125 W. 6th St.,
[213] HU 2-5450

Portland, Ore. 97204: James T. Hauptli,
Thomas McElhinny, 218 Mohawk Building,
222 S W. Morrison Street,
Phone [503] 223-5118

San Francisco, Calif. 94111: James T. Hauptli,
Thomas McElhinny, 255 California Street,
[415] DO 2-4600

Pierre Braude Tel: 225 85 88: Paris
European Director
Paris: Denis Jacob
88-90 Avenue Des Champs-Elysees, Paris 8
United Kingdom and Scandinavia
London: Oliver Ball, Tel: Hyde Park 1451
34 Dover Street, London W1
Milan: Robert Saidel
1 via Baracchini Phone 86-90-656
Brussels: F.I.H. Huntjens
27 Rue Ducale Tel: 136503
Frankfurt/Main: Hans Haller
Elsa-Brandstroem Str. 2
Phone 72 01 81
Geneva: Denis Jacob
1, rue du Temple Phone: 31 95 60
Tokyo: Takeji Kinoshita 1 Kotohiracho
Shiba, Minato-Ku Tokyo [502] 0656
Osaka: Ryoji Kobayashi 163, Umegae-cho
Kita-ku [362] 8771

Business Department
Wallace C. Carmichael, Manager [212] 971-3191
Stephen R. Weiss, Production Manager [212] 971-2044
Thomas M. Egan, Assistant Production Manager [212] 971-3140
Dorothy Carmesin, Contracts and Billings [212] 971-2908
Frances Vallone, Reader Service Manager [212] 971-2865

The Inside Story of Handling Current at High Speeds

Now, RCA introduces the multiple-emitter chip, a concept using RCA "overlay" techniques, in 2N5038 and 2N5039—multi-epitaxial silicon transistors for high-speed switching circuits. On the inside is the pellet with 12 discrete emitter sites, interconnected by a 12-pronged heat-conducting copper slug. The use of individual emitter sites provides the excellent 20-ampere current handling capabilities of these devices by increasing the emitter periphery. The copper slug assures good temperature and voltage distribution among the emitter sites across the pellet, and further contributes to the current handling, *while adding significantly to the forward second breakdown capability of the device.* These concepts (discrete emitters and copper slug) eliminate the non-uniform current injection normally associated with high current interdigitated transistor structures.

For the design engineer, 2N5038 and 2N5039 represent the right combination of mechanical structure and performance characteristics. They have low saturation voltage (1.0 volt max. at 12 A for 2N5038 and at 10 A for 2N5039) and fast saturated switching times (turn-on less than $0.5 \mu\text{s}$ and turn-off less than $2 \mu\text{s}$).

Available in production quantities, 2N5038 and 2N5039 are useful in a wide variety of applications including: dc-to-dc converters (at 25 KHz, 250 watts and 85% eff. may be achieved) and high frequency switching regulators (up to 50 KHz, 700 watts output, with 95% eff.). Both units make good linear amplifiers at frequencies up to 5 MHz.

Call your RCA representative today for more information or see your RCA Distributor. For technical data, write: RCA Electronic Components, Commercial Engineering, Section No. 1N-1-1, Harrison, N. J. 07029.

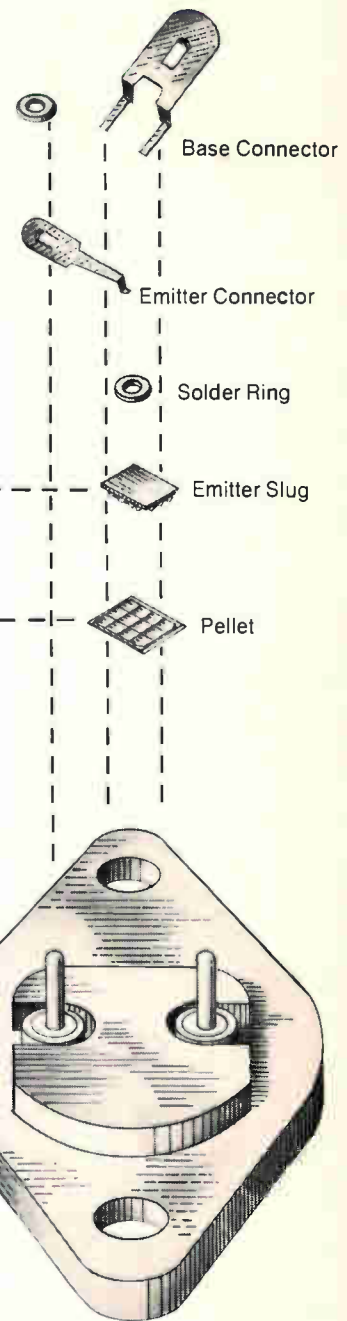

Elco p.c. connectors separate the men from the noise.

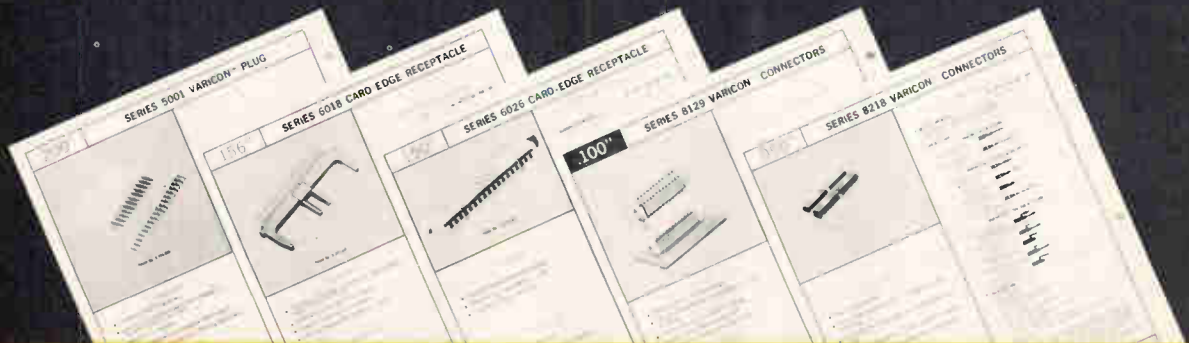

• TRADE-MARK

**YOU CAN'T OUT-SHOUT THE FACTS. WE'RE NO. 1
IN THE FIELD, AND HERE'S WHY...**

We offer the most. And best. And you cannot gainsay that truth. The most in designs, types, sizes, and reliability—via the industry's standard for excellence . . . Elco Varicon* Connectors and Contacts. For the most basic to most highly exotic electrical/mechanical requirements. Plugs, receptacles, and contacts without insulators. With tails for wire wrap, crimp, taper tab, solder. From 2 to 25,000 contacts, depending on model or size of metal plate, at .050", .100", .125", .150", .156", .200" spacing. For contact-to-contact, or contact-to-printed-circuitry applications. Write, wire, call or TWX us for our Printed Circuit Connector literature. It speaks quietly in a voice everyone can hear. Elco Corporation, Willow Grove, Pa. 19090; 215-659-7000; TWX 510-665-5573.

ELCO
Corporation



SEE US AT NEPCON BOOTHS 351-353
FEBRUARY 11-12-13

P.S.—FREE SAMPLE? Let us know after you read our literature.
We'll be delighted to send you one.

Electronics reader service

Warning: The Post Office now requires your ZIP CODE on all mail. Please include your ZIP CODE number when filling out your reply card.

Use these handy post cards for more detailed information on: products advertised, new products, new literature.

Circle the number on the Reader Service post card that corresponds to the number at the bottom of the advertisement, new product item, or new literature in which you are interested.

Please print clearly. All written information must be legible to be efficiently processed.

If someone has beaten you to the post cards, you may obtain the needed information by writing directly to the manufacturer, or by sending your name and address, plus the Reader Service number, to Electronics Reader Service department.

All inquiries from outside the U.S. that cannot reach Electronics before the expiration dates noted on the Reader Service post card, must be mailed directly to the manufacturer. The manufacturer assumes all responsibilities for responding to inquiries. Electronics merely provides and clears requests for information from inquirer to manufacturer.

Correct amount of postage must be affixed for all mailings from outside the U.S.

To subscribe to or to renew Electronics

Fill in the "For Subscriptions" area on the card if you desire to subscribe to or renew your present subscription to Electronics. Send no money. Electronics will bill you at the address indicated on the Reader Service post card.

Multi-product advertisements

For information on specific items in multi-product advertisements which do not have a specific Reader Service number indicated write directly to manufacturer for information on precise product in which you are interested.

1 *For employment inquiries fill in home address. January 6, 1969 Card Expires March 6, 1969

Name _____ title _____

Company* _____

Address _____

City _____ State _____ Zip Code _____

1 20 39 58 77 96 115 134 153 172 191 210 229 248 267 286 305 324 343 362 381 400 419 438 457 476 495 514 962

2 21 40 59 78 97 116 135 154 173 192 211 230 249 268 287 306 325 344 363 382 401 420 439 458 477 496 515 963

3 22 41 60 79 98 117 136 155 174 193 212 231 250 269 288 307 326 345 364 383 402 421 440 459 478 497 516 964

4 23 42 61 80 99 118 137 156 175 194 213 232 251 270 289 308 327 346 365 384 403 422 441 460 479 498 517 965

5 24 43 62 81 100 119 138 157 176 195 214 233 252 271 290 309 328 347 366 385 404 423 442 461 480 499 518 966

6 25 44 63 82 101 120 139 158 177 196 215 234 253 272 291 310 329 348 367 386 405 424 443 462 481 500 900 967

7 26 45 64 83 102 121 140 159 178 197 216 235 254 273 292 311 330 349 368 387 406 425 444 463 482 501 901 968

8 27 46 65 84 103 122 141 160 179 198 217 236 255 274 293 312 331 350 369 388 407 426 445 464 483 502 902 969

9 28 47 66 85 104 123 142 161 180 199 218 237 256 275 294 313 332 351 370 389 408 427 446 465 484 503 951 970

10 29 48 67 86 105 124 143 162 181 200 219 238 257 276 295 314 333 352 371 390 409 428 447 466 485 504 952 971

11 30 49 68 87 106 125 144 163 182 201 220 239 258 277 296 315 334 353 372 391 410 429 448 467 486 505 953 972

12 31 50 69 88 107 126 145 164 183 202 221 240 259 278 297 316 335 354 373 392 411 430 449 468 487 506 954 973

13 32 51 70 89 108 127 146 165 184 203 222 241 260 279 298 317 336 355 374 393 412 431 450 469 488 507 955 974

14 33 52 71 90 109 128 147 166 185 204 223 242 261 280 299 318 337 356 375 394 413 432 451 470 489 508 956 975

15 34 53 72 91 110 129 148 167 186 205 224 243 262 281 300 319 338 357 376 395 414 433 452 471 490 509 957 976

16 35 54 73 92 111 130 149 168 187 206 225 244 263 282 301 320 339 358 377 396 415 434 453 472 491 510 958 977

17 36 55 74 93 112 131 150 169 188 207 226 245 264 283 302 321 340 359 378 397 416 435 454 473 492 511 959 978

18 37 56 75 94 113 132 151 170 189 208 227 246 265 284 303 322 341 360 379 398 417 436 455 474 493 512 960 979

19 38 57 76 95 114 133 152 171 190 209 228 247 266 285 304 323 342 361 380 399 418 437 456 475 494 513 961 980

1 *For employment inquiries fill in home address. January 6, 1969 Card Expires March 6, 1969 14

Name _____ title _____

Company* _____

Address _____

City _____ State _____ Zip Code _____

1 20 39 58 77 96 115 134 153 172 191 210 229 248 267 286 305 324 343 362 381 400 419 438 457 476 495 514 962

2 21 40 59 78 97 116 135 154 173 192 211 230 249 268 287 306 325 344 363 382 401 420 439 458 477 496 515 963

3 22 41 60 79 98 117 136 155 174 193 212 231 250 269 288 307 326 345 364 383 402 421 440 459 478 497 516 964

4 23 42 61 80 99 118 137 156 175 194 213 232 251 270 289 308 327 346 365 384 403 422 441 460 479 498 517 965

5 24 43 62 81 100 119 138 157 176 195 214 233 252 271 290 309 328 347 366 385 404 423 442 461 480 499 518 966

6 25 44 63 82 101 120 139 158 177 196 215 234 253 272 291 310 329 348 367 386 405 424 443 462 481 500 900 967

7 26 45 64 83 102 121 140 159 178 197 216 235 254 273 292 311 330 349 368 387 406 425 444 463 482 501 901 968

8 27 46 65 84 103 122 141 160 179 198 217 236 255 274 293 312 331 350 369 388 407 426 445 464 483 502 902 969

9 28 47 66 85 104 123 142 161 180 199 218 237 256 275 294 313 332 351 370 389 408 427 446 465 484 503 951 970

10 29 48 67 86 105 124 143 162 181 200 219 238 257 276 295 314 333 352 371 390 409 428 447 466 485 504 952 971

11 30 49 68 87 106 125 144 163 182 201 220 239 258 277 296 315 334 353 372 391 410 429 448 467 486 505 953 972

12 31 50 69 88 107 126 145 164 183 202 221 240 259 278 297 316 335 354 373 392 411 430 449 468 487 506 954 973

13 32 51 70 89 108 127 146 165 184 203 222 241 260 279 298 317 336 355 374 393 412 431 450 469 488 507 955 974

14 33 52 71 90 109 128 147 166 185 204 223 242 261 280 299 318 337 356 375 394 413 432 451 470 489 508 956 975

15 34 53 72 91 110 129 148 167 186 205 224 243 262 281 300 319 338 357 376 395 414 433 452 471 490 509 957 976

16 35 54 73 92 111 130 149 168 187 206 225 244 263 282 301 320 339 358 377 396 415 434 453 472 491 510 958 977

17 36 55 74 93 112 131 150 169 188 207 226 245 264 283 302 321 340 359 378 397 416 435 454 473 492 511 959 978

18 37 56 75 94 113 132 151 170 189 208 227 246 265 284 303 322 341 360 379 398 417 436 455 474 493 512 960 979

19 38 57 76 95 114 133 152 171 190 209 228 247 266 285 304 323 342 361 380 399 418 437 456 475 494 513 961 980

1 *For employment inquiries fill in home address. January 6, 1969 Card Expires March 6, 1969 14

Name _____ title _____

Company* _____

Address _____

City _____ State _____ Zip Code _____

1 20 39 58 77 96 115 134 153 172 191 210 229 248 267 286 305 324 343 362 381 400 419 438 457 476 495 514 962

2 21 40 59 78 97 116 135 154 173 192 211 230 249 268 287 306 325 344 363 382 401 420 439 458 477 496 515 963

3 22 41 60 79 98 117 136 155 174 193 212 231 250 269 288 307 326 345 364 383 402 421 440 459 478 497 516 964

4 23 42 61 80 99 118 137 156 175 194 213 232 251 270 289 308 327 346 365 384 403 422 441 460 479 498 517 965

5 24 43 62 81 100 119 138 157 176 195 214 233 252 271 290 309 328 347 366 385 404 423 442 461 480 499 518 966

6 25 44 63 82 101 120 139 158 177 196 215 234 253 272 291 310 329 348 367 386 405 424 443 462 481 500 900 967

7 26 45 64 83 102 121 140 159 178 197 216 235 254 273 292 311 330 349 368 387 406 425 444 463 482 501 901 968

8 27 46 65 84 103 122 141 160 179 198 217 236 255 274 293 312 331 350 369 388 407 426 445 464 483 502 902 969

9 28 47 66 85 104 123 142 161 180 199 218 237 256 275 294 313 332 351 370 389 408 427 446 465 484 503 951 970

10 29 48 67 86 105 124 143 162 181 200 219 238 257 276 295 314 333 352 371 390 409 428 447 466 485 504 952 971

11 30 49 68 87 106 125 144 163 182 201 220 239 258 277 296 315 334 353 372 391 410 429 448 467 486 505 953 972

12 31 50 69 88 107 126 145 164 183 202 221 240 259 278 297 316 335 354 373 392 411 430 449 468 487 506 954 973

13 32 51 70 89 108 127 146 165 184 203 222 241 260 279 298 317 336 355 374 393 412 431 450 469 488 507 955 974

14 33 52 71 90 109 128 147 166 185 204 223 242 261 280 299 318 337 356 375 394 413 432 451 470 489 508 956 975

15 34 53 72 91 110 129 148 167 186 205 224 243 262 281 300 319 338 357 376 395 414 433 452 471 490 509 957 976

16 35 54 73 92 111 130 149 168 187 206 225 244 263 282 301 320 339 358 377 396 415 434 453 472 491 510 958 977

17 36 55 74 93 112 131 150 169 188 207 226 245 264 283 302 321 340 359 378 397 416 435 454 473 492 511 959 978

18 37 56 75 94 113 132 151 170 189 208 227 246 265 284 303 322 341 360 379 398 417 436 455 474 493 512 960 979

19 38 57 76 95 114 133 152 171 190 209 228 247 266 285 304 323 342 361 380 399 418 437 456 475 494 513 961 980

Reprint service

All Electronics editorial matter available in reprint form:

For reprints of special reports and feature articles see list on right side of this page. Send your order to Electronics Reprint Department at the address indicated. To expedite mailing of your order for single reprints please send cash, check or money order with your order. Allow 3-4 weeks for delivery.

Bulk reprints of editorial matter can be ordered from current or past issues. The minimum quantity is 100 copies. Price quoted on request: call 212-971-2274, or write to address below.

Warning: The Post Office now requires your ZIP CODE on all mail. Please include your ZIP CODE number when filling out your reply card.

3

Business reply mail

No postage stamp necessary if mailed in the United States

Postage will be paid by

Electronics
Reader service department
Box 444
Hightstown, N. J. 08520

First class
Permit no. 42
Hightstown, N. J.



2

Business reply mail

No postage stamp necessary if mailed in the United States

Postage will be paid by

Electronics
Reader service department
Box 444
Hightstown, N.J. 08520

First class
Permit no. 42
Hightstown, N. J.



1

Business reply mail

No postage stamp necessary if mailed in the United States

Postage will be paid by

Electronics
Reader service department
Box 444
Hightstown, N.J. 08520

First class
Permit no. 42
Hightstown, N. J.



To order reprints or for further information, please write to: **Electronics Reprint Department, 330 West 42nd Street, New York, N.Y. 10036.**

You may order any of the below listed reprints by key number. Discounts on quantities over 10.

- Key no. R-01 **Computer-aided Design: Part I, The Man-machine Merger.** 16 pages. \$1.25.
- Key no. R-02 **Vietnam Communications Network Growing Into Southeast Asia's Best.** 3 pages. 25¢.
- Key no. R-04 **Multilayer Circuit Boards: Sharpening An Imperfect Art.** 7 pages. 50¢.
- Key no. R-05 **Topology Cuts Design Drudgery.** 12 pages. 50¢.
- Key no. R-06 **Report on Japanese Technology: Sony.** 20 pages. 50¢.
- Key no. R-010 **Special Report on Large Scale Integration.** 54 pages. \$1.50.
- Key no. R-011 **Medical Electronics (1967).** 8 part series, 44 pages. \$1.25.
- Key no. R-012 **Special Report on Gallium Arsenide** 17 parts. 32 pages. \$2.00
- Key no. R-013 **European Electronics Markets 1968** 24 page forecast report with a 6 page foldout. \$1.00
- Key no. R-014 **U.S. Electronics Markets 1968.** 32 page forecast report with 4 page foldout. \$1.00.
- Key no. R-015 **1967 Electronics Index to Technical Articles and Authors Free.**
- Key no. R-016 **Special Report on The Transistor: Two Decades of Progress.** 48 pages. \$1.50.
- Key no. R-017 **Special Report on Ferrites.** 16 pages. \$1.00.
- Key no. R-87a **The Packaging Revolution in Microelectronics. Parts I through VI.** 64 pages. \$2.00.
- Key no. R-79 **MOS Integrated Circuits.** 12 pages. 50¢.
- Key no. R-78 **The Overlay Transistor.** 15 pages. 50¢.
- Key no. R-75 **Biotelemetry.** 2 part series, 16 pages. 50¢.
- Key no. R-64 **Field Effect Transistors. Parts I, II, and III.** 64 pages. \$1.00.

OM-3 Power Supply (Darcy Industries, Behlman Division)
...one of 414 different models using Dale HLT Resistors.



"We standardized on
Dale Industrial Wirewounds"

Darcy Industries, Behlman Division, meets 414 power supply requirements with one Dale HL style

"In our OM power supplies, we use Dale HLT resistors to assure balance between power transistors and to help provide long-term stability in the series regulator circuit. With 414 models in this DC silicon module design, we needed to standardize on a single resistor type. Dale responded quickly to our design needs for a specific tapped resistor and has met our quality and delivery requirements—a total combination difficult to find in a single vendor."

*Darcy Industries, Behlman Division
Santa Monica, California*

DALE INDUSTRIAL WIREWOUNDS

Tubular Silicone coated lug (HL), tapped (HLT), adjustable (HLA) and lug with lead (HLW) styles. Meet MIL-R-26 and MIL-R-19365C. 5-225 watts, .1 ohm to 1.3 megohms. Tolerance $\pm 5\%$, $\pm 10\%$. Non-inductive styles available.

Flat Silicone coated standard (HL) and miniature (HLM) styles. Meet MIL-R-26. 10-95 watts, .1 ohm to 150K ohms. Tolerance $\pm 5\%$, $\pm 10\%$. Miniature size has patented mounting for limited space, high vibration areas.

Axial Lead (CW) Silicone coated. 1.25-13 watts, .1 ohm to 273K ohms. Tolerance $\pm 5\%$, $\pm 10\%$. For applications requiring near precision performance at low cost.



For faster response to your industrial resistor needs, call Dale ... 402-564-3131

For Resistor Catalog A, Circle 181



for optimum value in industrial resistors

DALE ELECTRONICS, INC., 1300 28th Ave., Columbus, Nebraska 68601

Printed in U.S.A.

New! Multi-Color Performance from RCA Single-Gun CRT's

How many colors do you want in CRT read-out? RCA can give you two, and the shades between, from a single-gun CRT. What's more you have a choice of tube size for the display of all types of visual information — waveforms, alphanumeric, pictorial or any combination of these three.

Here's your answer to air-traffic control systems, military IFF systems, stock market quotation displays, airline and other transportation status boards. Utilize RCA's new capability in teaching machines, electronic test instruments, computer read-out equipment—anywhere a multi-color display makes understanding easier.

The RCA multi-color CRT is made with two phosphor layers. The multi-color performance is obtained through the application of different anode voltages.

Whatever your choice of colors and display, the read-out is as sharp and bright as black and white. And the single electron gun means simple back-up circuitry.

For more information on RCA multi-color CRT's and other RCA Display Devices, see your RCA Representative. For technical data, write: RCA Electronic Components, Commercial Engineering, Section No. A-19Q-2, Harrison, N. J. 07029.

RCA

