

Snap diodes sharpen pulses 105
Core arrays simplify calculator 118
New circuits for tv and audio 133

Electronics®

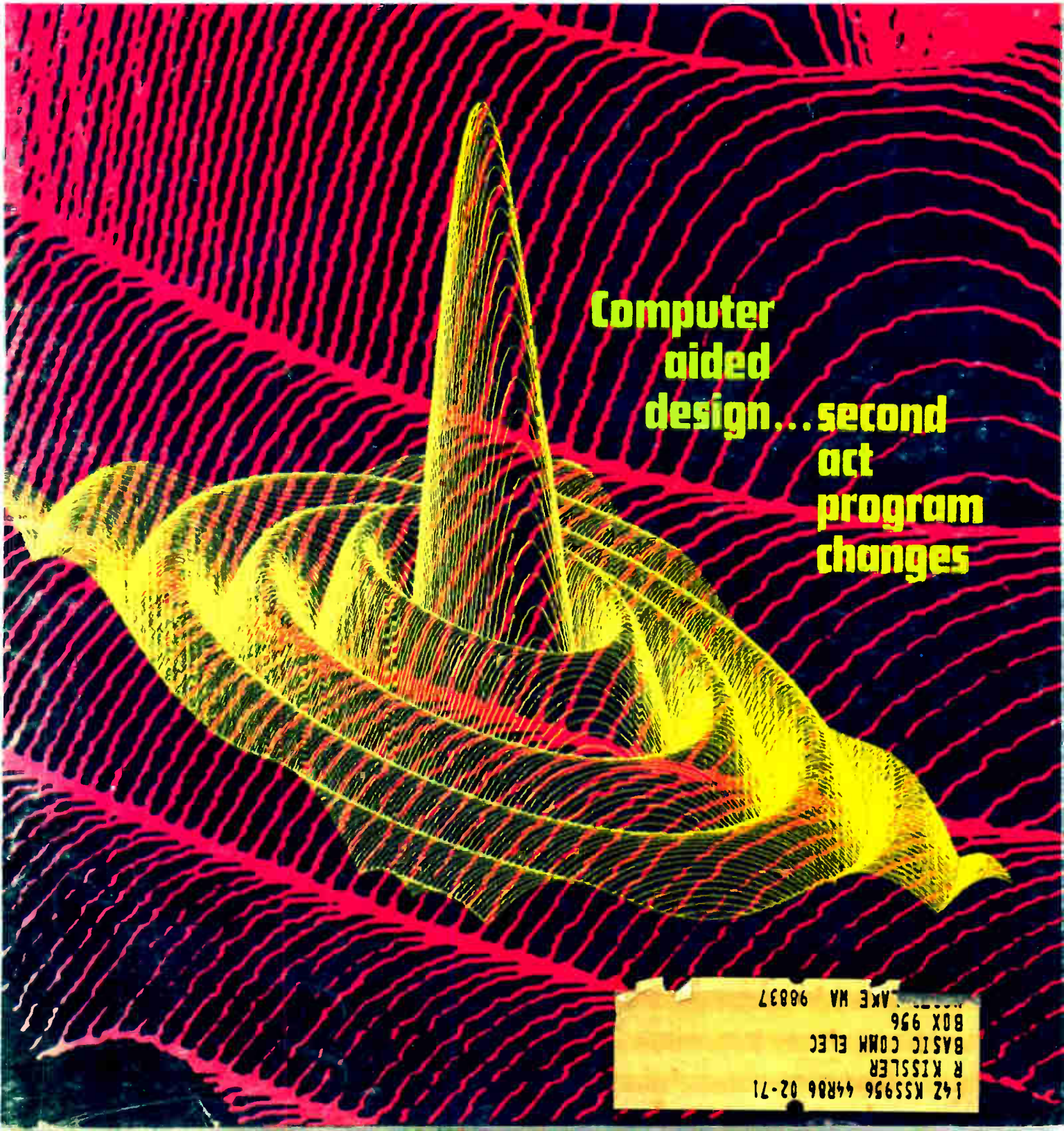

**Computer
aided
design... second
act
program
changes**

142 K55956 4486 02-71
R KISSLER
BASIC COMM ELEC
BOX 956
LAKE WA 98037

The easy way to sort R-L-C components

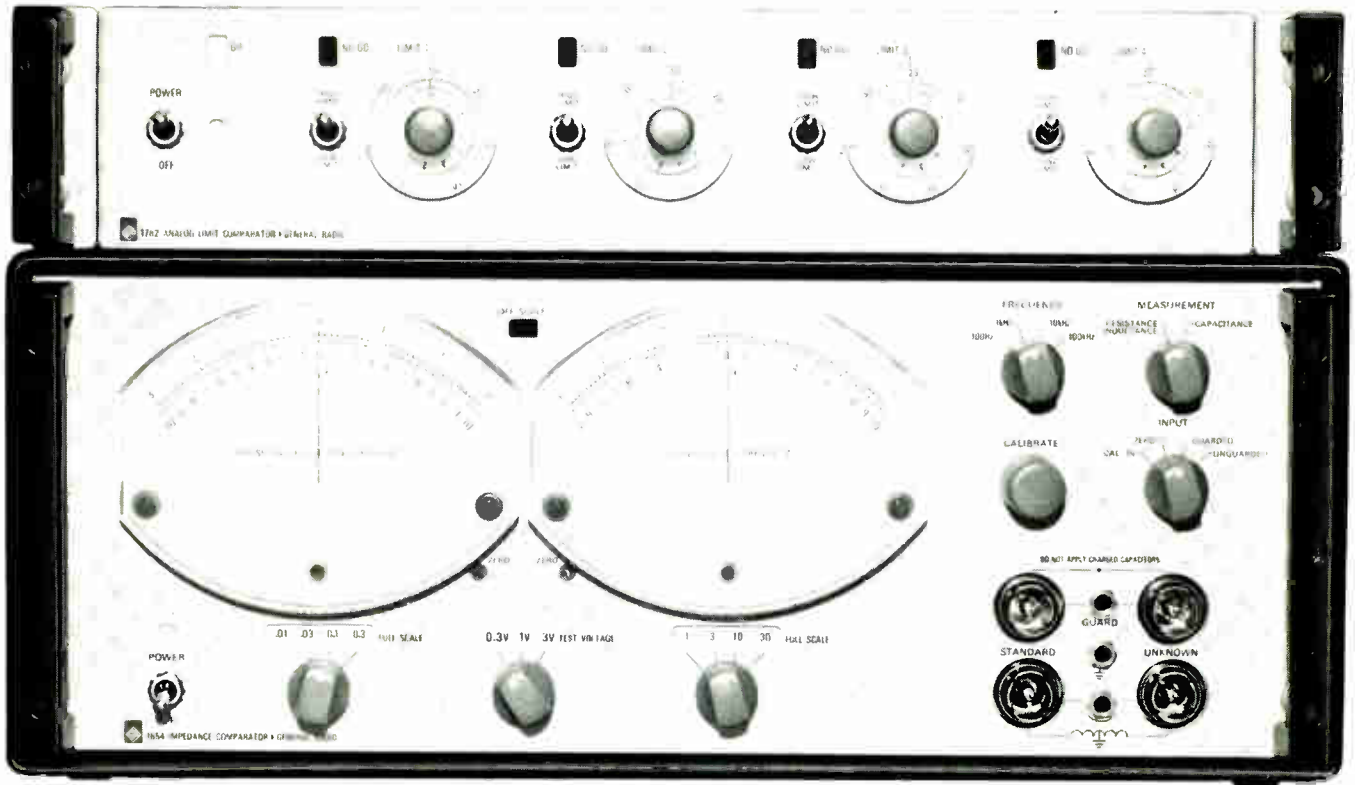

FAST

Measure and sort R-L-C components as rapidly as you can move your hands, using the new 1654 Impedance Comparator and 1782 Analog Limit Comparator. With the optional relay-equipped models of the 1782 you can attain automatic sorting rates as fast as 10,000 components per hour.

FLEXIBLE-VERSATILE

The same setup works for either R, L, or C components because the 1654 measures in terms of impedance difference. Setup is easy. Just connect your production sample or standard to one side of the bridge and your unknowns to the other side. On two large meters read the differences in magnitude and phase-angle between the sample and unknown; for relatively pure components the readout effectively is in terms of ΔR , ΔL , ΔC , ΔQ , or ΔD . Comparison precision is 30 ppm. Manual sorting decisions can be based on the 1654's meter readings or on the 1782's GO/NO GO lights. Or, you don't have to look at anything if you use the relay-equipped models with automatic sorting devices.

The 1782 has four independent limits, each settable to either a high or low limit of either $\Delta\theta$ or ΔZ . Resolution of GO/NO GO limit settings is one percent of full scale and several 1782's can be used with a 1654 for multiple-limit sorting.

LOW COST

One of the best features of this component-sorting system is the price. For \$1250 you can get the basic 1654 Impedance Comparator (rack model) for manual use where meter readout is acceptable. Analog output voltages are available to drive recorders, DVM's, or limit devices. For an additional \$570 you can add the 1782 Analog Limit Comparator and have four preset GO/NO GO limits. Or, for \$645 you can get a 1782 equipped with relays for automatic sorter control. Thus, for \$1250, \$1820, or \$1895 you get a sorting system that can't be beaten in price or performance. Prices apply only in the U. S. A.

Condensed Specifications 1654 Impedance Comparator

Measuring Ranges (dependent upon frequency and voltage) R - 2 Ω to 20 M Ω ; C - 0.1 pF to 1000 μ F; L - 20 μ H to 1000 H.

Test Voltage Across Unknown: 0.3, 1, or 3 V, switch selectable.

Internal Test Frequencies: 100 Hz, 1, 10 and 100 kHz.

For complete information, write General Radio Company, W. Concord, Massachusetts 01781; telephone (617) 369-4400. In Europe: Postfach 124, CH 8034, Zurich 34, Switzerland.

GENERAL RADIO



Circle 900 on reader service card

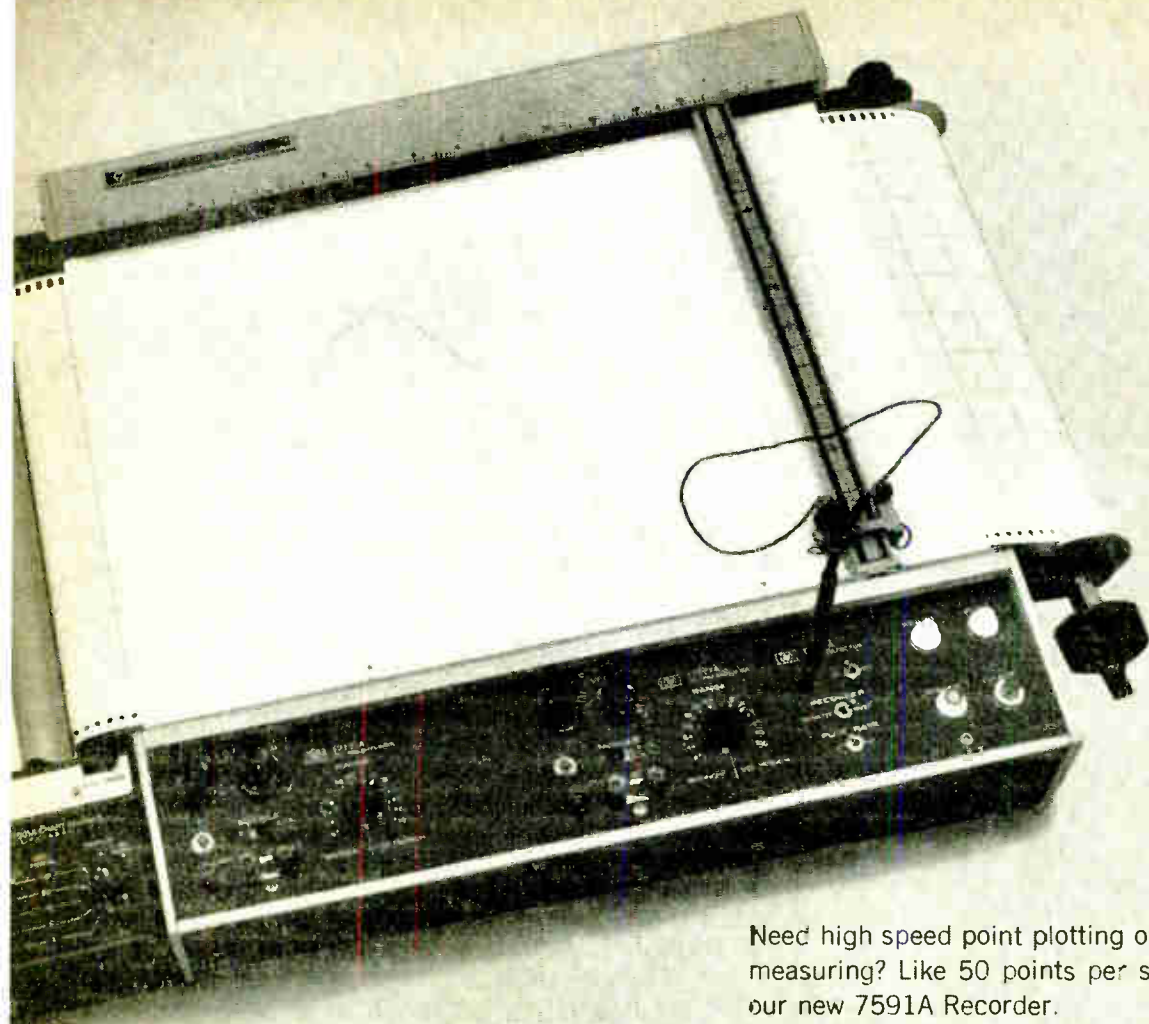

**Get
to the
point
...fast!**

Need high speed point plotting of the data you're measuring? Like 50 points per second? Then try our new 7591A Recorder.

Fifty points/second is a new high in closed-loop data transfer... exactly the type dynamic response needed for such jobs as plotting data from a multi-channel pulse-height analyzer. The null detector accepts analog inputs, positions the X and Y servos, and actuates the plotter... with unequalled speed and accuracy.

Moreover, the 7591A's plug-in design gives you exceptional versatility at a realistic price. The recorder shown here has an incremental chart advance attached to resolve tightly grouped points or permit comparison of groups of recorded data. Z-Fold Adapter available as well.

7591A Point Plotting System with in-input plug-ins and chart advance, ready-to-play, from \$2685.

Your local HP field engineer can point out all the advantages of HP recorders and accessories. Or write Hewlett-Packard, Palo Alto, California 94304; Europe: 1217 Meyrin-Geneva, Switzerland.

HEWLETT  PACKARD

GRAPHIC RECORDERS

Circle 1 on reader service card

BEST SHORT-TERM STABILITY IN A RUBIDIUM FREQUENCY STANDARD... \$7500.

That says it.



No if's, and's or but's. Just the facts. The Hewlett-Packard 5065A sets a new mark for short-term stability (rms) in a rubidium frequency standard: less than 7×10^{-12} , 1 second averaging; 2.2×10^{-12} , 10 sec. avg.; and 7×10^{-13} , 100 sec. avg.—verified against the HP hydrogen maser. Yet this 37-pound, portable atomic standard costs you only \$7500.

More facts. The 5065A has a built-in frequency synthesizer that lets you change time scales as much as 1×10^{-7} by convenient thumbwheel dialing—no extra cost. Fine frequency control resolution is 2×10^{-12} . Signal-to-noise ratio is greater than 87 dB.

Long-term stability is better than 2 parts in 10^{11} per month. And the standard has passed environmental tests for humidity, magnetism, vibration, shock and electromagnetic compatibility under military specifications.

Options featured: Option 01 is a Time Standard which has a clock pulse rate of 1 pulse/second, a rise time of less than 50 nsec and jitter of less than 20 nsec. Clock movement is 24 hours. Option 02 is a Standby Power Supply.

The price—again—of this portable, rugged Rubidium Standard is only \$7500. Option 01 costs \$1500;

Option 02, \$300. Or you can get Option 03, shown above, which combines both for \$1800.

Now you can get all three frequency standards from Hewlett-Packard—quartz, cesium or rubidium. Get more facts by calling your HP field engineer, or writing Hewlett-Packard, Palo Alto, California 94304; Europe: 54 Route des Acacias, Geneva.

HEWLETT  PACKARD

FREQUENCY STANDARDS

02805

News Features

Probing the News

- 133 **Consumer electronics:** New circuits brighten color tv picture
139 **Recorders:** Tape equipment fights for markets
145 **Audio:** IC's still stalled in hi-fi and radio outlets

U.S. Reports

- 51 **Computers:** Race on to supply machines for Congress
51 **Communications:** Digital ship-to-ship talk
53 **Companies:** Signetics GI licensing deal
54 **Military electronics:** Navy wants early say in design
54 **Integrated electronics:** CMOS for smaller a-d converter
56 **Space electronics:** A-d converter that can handle a billion bits a second
58 **Government:** Army purchasing on the griddle again
60 **Government:** Dissent on telecommunications report
63 **Contracts:** 621B needs some selling

Electronics International

- 203 **Japan:** Calculators steal spotlight at Tokyo business show amid predictions of lower priced and programed machines
204 **Switzerland:** Longines Witthauer uses light emitting diodes for digital readout in solid state stop watch
205 **France:** Severe European component shortage hits French manufacturers where it hurts
206 **Great Britain:** Army to replace klystron-based line-of-sight communicator with unit using Gunn diode oscillator in receiver

New Products

- 153 **In the spotlight**
153 Masking camera for LSI circuits focuses on speed and resolution
157 **Microwave review**
157 Price stressed in transistor line
160 Mixers suppress unwanted signals
163 **Instruments review**
163 Seismic-data echoes eliminated
169 **Subassemblies review**
169 Amplifier avoids spikes problem
172 Yag laser delivers 250 watts c-w
175 **Components review**
175 Dvm tube displays six decades
178 Phototube covers 1,100-6,000 Å
181 **Semiconductor review**
181 IC regulator controls kilovolts
184 Memory requires no external logic

Title R registered U.S. Patent Office; © copyright 1969 by McGraw-Hill Inc. All rights reserved, including the right to reproduce the contents of this publication in whole or in part.

Technical Articles

- Applications technology** 90 **Computer-aided design, act two: Admission price exceeds forecasts (cover)**
Synthesizing and optimizing designs by computer are now attainable goals; however, even champions of the technique are apt to admit refinements in programing, modeling, and graphics will be needed to achieve them
Joseph Mittleman, Associate editor
- Circuit design** 99 **Designer's casebook**
▪ Unity-gain amplifier in probe needs only two conductors
▪ Circuit improves thermistor's linearity and boosts output
▪ Unijunction circuit prevents damage to transistors
▪ Op amp logic circuit eliminates diode bulk resistance effects
- Solid state** 105 **Simpler digital circuits in a snap**
The fast switching characteristics of charge controlled diodes cut components count in circuits for sharpening and delaying pulses and generating pulse trains
Bernard Siegal, Microwave Associates (West)
- Circuit design** 110 **Linearity corrector does double duty**
Forward-biased FET serves dual purpose in gamma correction circuit by compensating for nonlinearity while providing temperature stability
Robin Williams, New York University
- Memory technology** 114 **Delay lines—key to low cost in keyboard machines**
Robert A. Tracy, Friden Inc.
- 118 **For sophisticated calculators, core arrays are worth the price**
Thomas E. Osborne, Hewlett-Packard
- 119 **Exotic storage applications often revive old memories**
Robert W. Reichard, Honeywell Inc.
- 122 **Military masses its cores for battlefield conditions**
Bryan W. Rickard, Electronic Memories Inc.

Departments

- | | | | |
|----|--------------------------|-----|--------------------------|
| 4 | Readers Comment | 53 | Index of Activity |
| 8 | Who's Who in this issue | 75 | Washington Newsletter |
| 15 | Who's Who in electronics | 187 | New Books |
| 26 | Meetings | 188 | Technical Abstracts |
| 35 | Editorial Comment | 192 | New Literature |
| 37 | Electronics Newsletter | 201 | International Newsletter |

Electronics

Editor-in-Chief: Donald Christiansen

Senior staff editors

Technical: Stephen E. Scrupski
News: Robert Henkel
International: Arthur Erikson

Managing editor: Harry R. Karp
Art director: Gerald Ferguson

Senior associate editor: Joseph Mittleman
Assistant managing editors: Eric Aiken, H. Thomas Maguire, Howard Wolff
Senior copy editor: Frederick Corey

Department editors

Advanced technology: William Bucci, Richard Gundlach
Communications: John Drummond, Raphael Kestenbaum
Computers: Wallace B. Riley, George Weiss
Design theory: Joseph Mittleman
Instrumentation: Owen Doyle, Walter Barney
Military/Aerospace: Alfred Rosenblatt; Paul Dickson (Aerospace)
New products: William P. O'Brien
Solid state: George Watson, Stephen Wm. Fields

Domestic bureaus

Boston: James Brinton, manager; Gail Farrell
Los Angeles: Lawrence Curran, manager; Ralph Selph
San Francisco: Walter Barney, manager; Peter Vogel
Washington: Ray Connolly, manager; Paul Dickson

Foreign bureaus

Bonn: John Gosch
London: Michael Payne
Tokyo: Charles Cohen

Copy editor: Edward Flinn
Staff writer: Peter Schuyten

Assistant art director: Charles Ciatto
Production editors: Susan Hurlburt, Arthur C. Miller

Editorial research: Anne Mustain

Editorial secretaries: Lorraine Longo, Claire Goodlin, Barbara Razulis, Vickie Green, Bernice Pawlak

McGraw-Hill News Service

Director: Arthur L. Moore; Atlanta: Fran Ridgway; Chicago: Robert E. Lee
Cleveland: Arthur Zimmerman; Dallas: Marvin Reid
Detroit: James Wargo; Houston: Barbara LaRoux
Los Angeles: Michael Murphy; Pittsburgh: Louis Gomolak
San Francisco: Margaret Drossel
Seattle: Ray Bloomberg; Washington: Charles Gardner, Daniel B. Moskowitz,
Herbert W. Cheshire, Seth Payne, Warren Burkett, William Small, William D. Hickman

McGraw-Hill World News Service

Bonn: Robert Dorang; Brussels: James Smith; Hong Kong: Wes Perry;
London: John Shinn; Mexico City: Gerald Parkinson; Milan: Ronald Taggiasco, Jack Star;
Moscow: Jack Winkler; Paris: Robert E. Farrell, Stewart Toy
Rio de Janeiro: Leslie Warren; Tokyo: Marvin Petal
Reprints: Gail Niles

Circulation: Isaaca Siegel

Publisher: Gordon Jones

Assistant to the publisher: Wallace C. Carmichael

Electronics: June 9, 1969, Vol. 42, No. 12

Published every other Monday by McGraw-Hill, Inc. Founder: James H. McGraw 1860-1948.
Publication office 99 North Broadway, Albany, N. Y. 12202; second class postage paid at Albany, N. Y.

Executive, editorial, circulation and advertising addresses: McGraw-Hill Building, 330 W. 42nd Street
New York, N. Y. 10036. Telephone (212) 971-3333, Teletype TWX N.Y. 710-581-4235. Cable address:
MCGRAWHILL N.Y.

Subscriptions solicited only from those professionally engaged in electronics technology. Subscription rates:
qualified subscribers in the United States and possessions and Canada, \$8.00 one year, \$12.00 two years,
\$16.00 three years; all other countries \$25.00 one year. Non-qualified subscribers in the U.S. and
possessions and Canada, \$25.00 one year; all other countries \$50.00. Air freight service to Japan \$50.00
one year. Single copies: United States and possessions and Canada, \$1.00; all other countries, \$1.75.

Officers of the Corporation: Shelton Fisher, President and Chief Executive Officer; John L. McGraw, Chairman;
Robert E. Slaughter, Executive Vice President; Daniel F. Crowley, Donald C. McGraw, Jr., Bayard E. Sawyer, Senior
Vice Presidents; John J. Cooke, Vice President & Secretary; Gordon W. McKinley, Vice President & Treasurer.

Title © registered in U.S. Patent Office; © Copyright 1969 by McGraw-Hill, Inc. All rights reserved. The contents
of this publication may not be reproduced either in whole or in part without the consent of copyright owner.

Subscribers: The publisher, upon written request to our New York office from any subscriber,
agrees to refund that part of the subscription price applying to copies not yet mailed.
Please send change of address notices or complaints to Fulfillment Manager; subscription
orders to Circulation Manager, Electronics at address below. Change of address notices
should provide old as well as new address, including postal zip code number. If possible,
attach address label from recent issue. Allow one month for change to become effective.

Postmaster: Please send form 3579 to Fulfillment Manager, Electronics,
P.O. Box 430, Hightstown, New Jersey 08520

Readers Comment

Myth hunter

To the editor:

The statement on the cover of the April 28 issue "System engineering—men, methods, myths" implies there is "myth" involved in systems engineering. I avidly headed for Mr. Kestenbaum's article (p. 68). What a sad realization developed. No admission of "myth" existed anywhere. But it didn't take long to find some.

In the third paragraph, the implication is made concretely that every job can be done right the first time. I would hope that all the University of Arizona students would not enter into the world of reality too enmeshed in that concept.

A quote is made at another point: "Often you deliberately sacrifice performance and accuracy in subelements to achieve the level of cost effectiveness and perfor-



Systems engineers at work.

mance required by the total system." A collection of words that gives here, retains there, and pleases all. If he means use 10% resistors instead of 1% in routine circuits, yes. If he means buy a "moderately accurate" accelerometer where a reliable measurement is needed, no! I would advise that any manager agreeing to this

Something *New* Has Been Added!

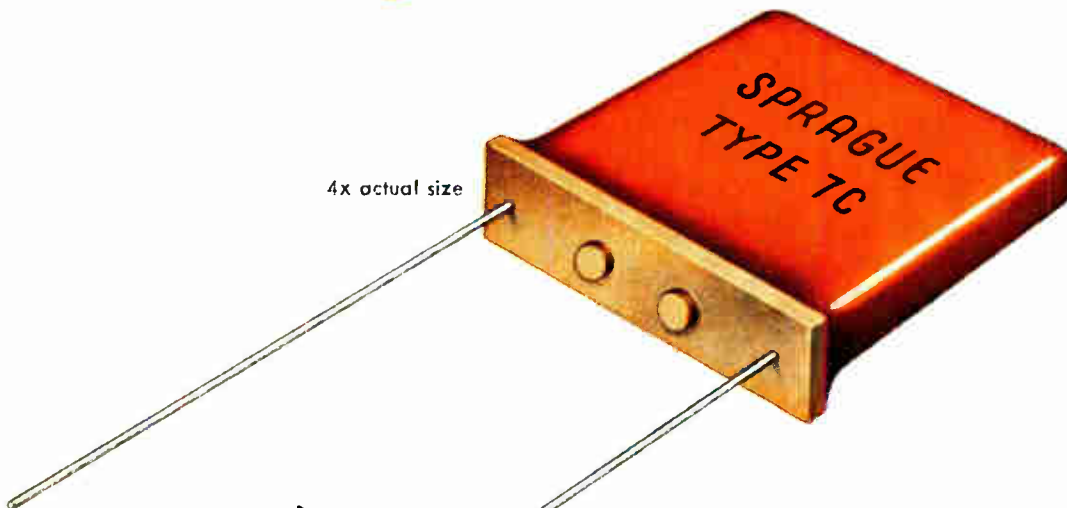

Improved SPRAGUE MONOLYTHIC[®] CERAMIC CAPACITORS

now have a phenolic terminal base

Type 7C Radial-lead Capacitors are made with alternate layers of sprayed ceramic dielectric material and screened metallic electrodes, fired into a solid homogeneous block and coated with a tough phenolic resin. Their new bossed terminal base construction provides these advantages: (1) No resin run-down on leads. (2) Uniform lead spacing is automatically maintained. (3) No dirt and moisture entrapment; degreasing fluid flows freely between capacitor and board.

Body Code	EIA Characteristic	Operating Temperature Range	Maximum Cap. Change over Temp. Range	WVDC	Capacitance Range	Capacitance Tolerance
082	NPO	-55 C to +125 C	+60ppm/°C	50 100 200	51 pF to .024 μF	±20% ±10% ±5% ±2%
075	N750	+25 C to +85 C	-750 ± 120 ppm/°C	50 100 200	.001 μF to .082 μF	±20% ±10% ±5% ±2%
		-55 C to +125 C	Meets MIL-C-20 Char. UJ			
067	X7R	-55 C to +125 C	±15%	50 100	.0018 μF to 1.5 μF	±20% ±10%
023	Z5U	+10 C to +85 C	+22% ₀ -56%	50	.01 μF to 3.3 μF	+80,-20% ±20%

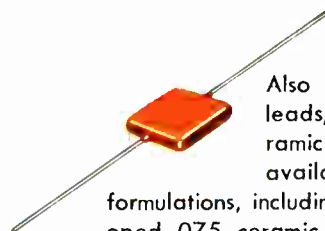

Also made with axial leads, Monolythic[®] Ceramic Capacitors are available in four body formulations, including a newly-developed 075 ceramic material, as described in the adjacent chart.

For complete technical data write for engineering bulletins on Monolythic Ceramic Capacitors to: Technical Literature Service, Sprague Electric Co., 35 Marshall St., North Adams, Mass. 01247.

SPRAGUE COMPONENTS

CAPACITORS	PULSE TRANSFORMERS	CERAMIC-BASE PRINTED NETWORKS
TRANSISTORS	INTERFERENCE FILTERS	PACKAGED COMPONENT ASSEMBLIES
RESISTORS	PULSE-FORMING NETWORKS	BOBBIN and TAPE WOUND MAGNETIC CORES
INTEGRATED CIRCUITS	TOROIDAL INDUCTORS	SILICON RECTIFIER GATE CONTROLS
THIN-FILM MICRO CIRCUITS	ELECTRIC WAVE FILTERS	FUNCTIONAL DIGITAL CIRCUITS

49C-0107P1



[®] 'Sprague' and '®' are registered trademarks of the Sprague Electric Co.

THE BROCKER

Here's our newest, most attractive addition to the family: the JC rocker-handle circuit breaker. It's much too nice to hide on the back panel of your equipment: put it out front, and save yourself the price of an on-off switch.

Along with the front panel sales appeal you get the advantages of hydraulic-magnetic protection: precise ratings from 0.020 to 30 amp, job-matched time delays, optional special-function internal circuits, and a five-year warranty that's rather attractive in its own right. Write for Bulletin 3380.

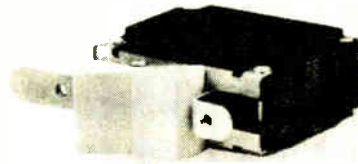
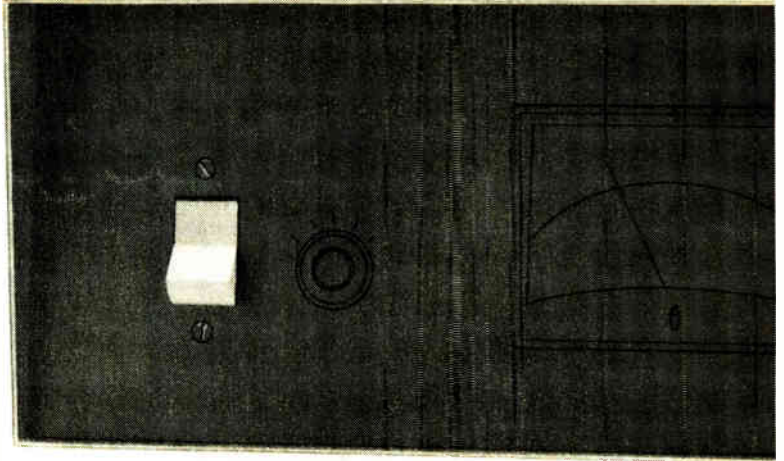

The 'old' original...

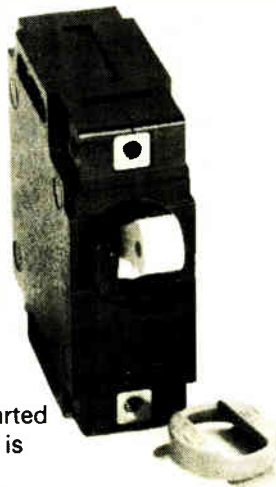

The breaker that started it all, our Series JA is fast becoming the first choice of OEM's. Available in multi-pole models with different specifications for each pole. Write for Bulletin 3350.



...and a snappy newcomer.

An especially convenient mounting design lets you snap the JB breaker right into the panel cutout, prewired or not. Secure enough to meet Mil-Std-202 for shock and vibration resistance.

The JB can be ordered with mounting-boss color caps that add sparkle and readability to multibreaker panels. Write for Bulletin 3360.

4275



HEINEMANN 2804 Brunswick Pike
Trenton, N. J. 08602

NEW FROM EG&G The HA-100 Hybrid Op Amp designed for use with SGD-100 and SGD-444 Silicon Photodiodes

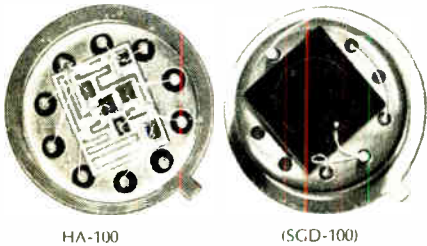

HA-100

(SGD-100)



HAD-130
combination amplifier
(HA-100)
and photodiode
(SGD-100)

The new HA-100 is a truly functional operational amplifier intended to enhance the versatility of EG&G's SGD-100 and SGD-444 photodiodes. It provides low current/high gain (1500 minimum open loop gain) amplification with excellent linearity at low currents. The frequency range of the HA-100 extends from D.C. to 200 kHz. Provision for an external feedback resistor facilitates optimum resistance selection for each application. With a feedback resistance of 15 megohms, the HA-100 demonstrates high sensitivity (15V/ μ W) and a transient response of 15 μ sec. Packaged in a standard TO-5 configuration, the HA-100 is priced at \$175 in small quantities.

The HA-100 Op Amp is also available mounted in an integral package (TO-5) with the SGD-100 photodiode and is referred to as the HAD-130 Op Amp-Photodiode. Priced at \$295, it out-performs the commonly used S-1 photomultiplier tube in most low to medium frequency, low light level detection and measurement applications. Where size, power, reliability and/or cost are important factors, the EG&G silicon photodiodes and operational amplifiers offer an excellent alternative to photomultiplier tubes.

For further information, contact EG&G, Inc., 166 Brookline Avenue, Boston, Mass. 02215. Phone: 617-267-9700. TWX: 617-262-9317. On west coast telephone 213-464-2800.



Circle 214 on reader service card

Readers Comment

approach stay away from the missile system world.

Systems engineering is a management term for ease in reference. It attempts to put boundaries around very indefinite areas, each with its own variables and assumptions. To propel it as a science removes the student from basics. The model is representative, and the diagrams serve to depict all the terms; it serves as a technique to generate understanding and communication from a point of reference. But, it is a very inexact method to predict an end result. As a phrase, it is about as descriptive as Guidance Simulation, Automation, Instrumentation, Availability and Reliability, Systems Readiness and Accuracy, and Control System Analysis, for a few.

I wouldn't want to scare the student into a hopeless state. With a good working knowledge of basic physics, some chemistry, a lot of electronics, applicable mathematics, and an appreciation for semantics—you are ready to work your way through any part of the maze. And if the job gets done correctly the first time, it must have been fairly simple to begin with. But it will not happen.

R.W. Berkhemer
Johns Hopkins University/APL
Field Office USNSMES
Port Huene, Calif.

A bit too fast

To the editor:

Your article about the Mullard amplifier that beats the heat [May 12, p. 240] does me too much honor. My integrated circuit pulse generator and duration modulator will switch at speeds up to several megahertz, not several gigahertz. In fact, all references to gigahertz should be to megahertz.

Brian Attwood
Mullard Ltd.
Mitcham,

▪ A slight case of garbled figures sent by cable and reconstructed incorrectly in New York.

New from the **SPEC-TROLL!**

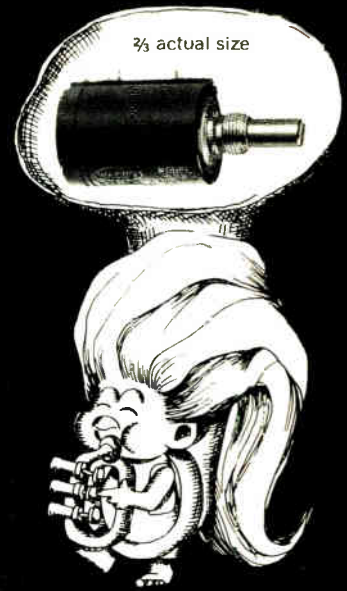

A 10-TURN INDUSTRIAL WIREWOUND POT WORTH BLOWING OUR HORN ABOUT!

Selling for only \$4.39 in quantity, our new Model 532 features "designed-in" reliability to give you top pot performance at bargain prices. The 532 offers:

- Longer element for "lighter" resolution.
- Precious metal contacts for minimum noise characteristics.
- Improved vibration-resistant slider design and dual slip ring contacts.
- Rugged mechanical stops for dependability.
- Passivated stainless steel shaft.
- A tough industrial design that can handle most of the requirements associated with MIL-R-12934.

Brief Specs

Size:	$\frac{3}{8}$ " diameter
Resistance Range:	15 ohm to 180K
Resistance Tolerance:	$\pm 5\%$
Independent Linearity:	$\pm 0.25\%$
Power Rating:	3 watts @ 40°C

The model 532 is available through your local Spectrol distributor. For full specs, circle the reader service number. Qualified respondents may obtain a sample free of charge through their Spectrol representative.



Spectrol Electronics Corporation
A subsidiary of Carrier Corporation
17070 East Gale Avenue
City of Industry, Calif. 91745
Phone: (213) 964-6565
TWX: (910) 584-1314

Circle 7 on reader service card

Who's Who in this issue



Osborne

Four experienced engineers contributed to *Electronics'* latest installment on memory technology. Tom Osborne, who wrote the piece on cores for calculators (page 118), joined Hewlett-Packard in 1965 as a consultant. At the time, he headed his own firm, the Logic Design Co. where he developed a floating-point calculator on which the 9100A is based. Robert Tracy, author of the article on delay lines that begins on page 114, holds both a B.A. and an M.S. in physics from the University of Michigan. Before coming to Friden, he was with Burroughs where he did R&D work on materials, fabrication processes, components, and computer subsystems. Bryan Rickard, who did the rundown on military core memories that starts on page 122, is a transplanted Englishman. Prior to joining EMI four and a half years ago, he worked on general-purpose airborne computers at Great Britain's General Electric. Robert W. Reichard, responsible for the piece on exotic applications for old memories, is an MIT man with both a B.S. and M.S. to his credit. He's had a 10-year career with Honeywell.



Tracy

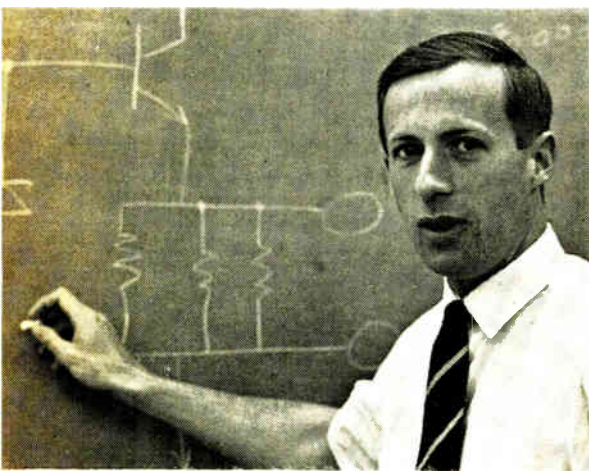

Rickard



Reichard

Williams

An instructor at New York University, Robin Williams, who wrote the article on linearity correction (page 110), is working toward a Ph.D. He earned his master's degree from NYU and bachelor's at Imperial College in London. Williams has worked for Philips in England and the U.S., and the work on which his story is based was done at the company's research labs.



Siegal

Versatility marks the engineering career of Bernie Siegal, author of the article on pulse-switching diodes (page 108). Holder of a B.S. from Cornell and an M.S. in semiconductor physics from San Jose (Calif.) State College, he's done R&D work on microwave tubes. Siegal now concentrates on applications.

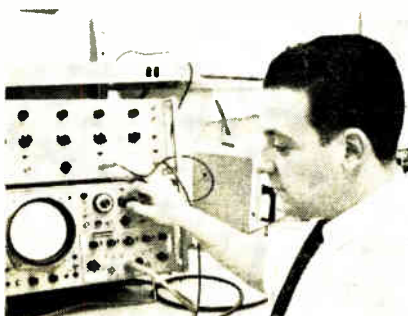

Associate editor Joseph Mittleman authored the cover story on computer-aided design (page 90). Joe, who won a B.S. from the City College of New York, also holds an M.S. from George Washington University. A professional technical editor for the last six years, Joe has worked for Airborne Instrument Laboratory and Jansky and Bailey as a research engineer in circuit design, network theory, feedback systems, antenna design, and radio-frequency interference. He's also the author of *Circuit Theory Analysis*, a standard work in the field. On the CAD article, Joe had assistance from a number of *Electronics'* field correspondents, including Jim Brinton in Boston, Walt Barney and Peter Vogel in San Francisco, and Larry Curran in Los Angeles.

the little things that count... in the Big Time.



Sub-miniature and miniature **events counters** and **elapsed time indicators**... with such high reliability that they set the industry's standards. With such myriad capabilities that they lend themselves perfectly to state-of-the-art applications: Space exploration; communications equipment; aircraft controls; computer technology; automated systems; laboratory procedures. Think of your own applications. If you require a little counter to tell you *how many*... or a little timer to tell you *how long*... chances are you're ready for the Big Time.

For additional information, contact:

SPACE AND SYSTEMS
DIVISION



GENERAL TIME
Progress in the World of Time

1200 HICKS ROAD, ROLLING MEADOWS, ILL. 60008 / (312) 259-0740

BITE INDICATORS • ROTARY SWITCHES • TRIMMER POTENTIOMETERS • ELAPSED TIME INDICATORS • EVENTS COUNTERS



Fairchild announces the future. Available today.

Part No. M μ L 4027



Bipolar



Random access



You're looking at the technology that's going to be used for the largest, least expensive bipolar and MOS memories. And it's here now to give you a fast start on economical high-performance scratchpad and buffer memories.

The product is the new Fairchild μ L4027 Bipolar 128-Bit Read/Write Random Access Memory. Inside, we've used bipolar technology to give you read and write times of 35ns. And we've used face-down bonding and multi-layer ceramic to eliminate flying-wire leads and increase both performance and reliability. The 128 bits are organized as 64 2-bit words with uncommitted collectors that allow easy word or bit expansion. Addressing is through

eight X and eight Y coincident-select lines to simplify memory organization. All outputs are CCSL-compatible.

The completed memory comes in a 1" x 1" hermetic ceramic plug-in package that saves you weight and space. And it's yours for less than 52¢/bit (\$100, 1-24; \$66, 25-99; \$66, 100-999).

So write for the complete specs and application notes. Or pick up several units from your Fairchild distributor. The technology is for the future; the product is here today.

Fairchild Semiconductor / A Division of Fairchild Camera and Instrument Corporation
 Mountain View, California 94040
 (415) 962-5011/TWX: 910-379-6435



128 bit bipolar memory

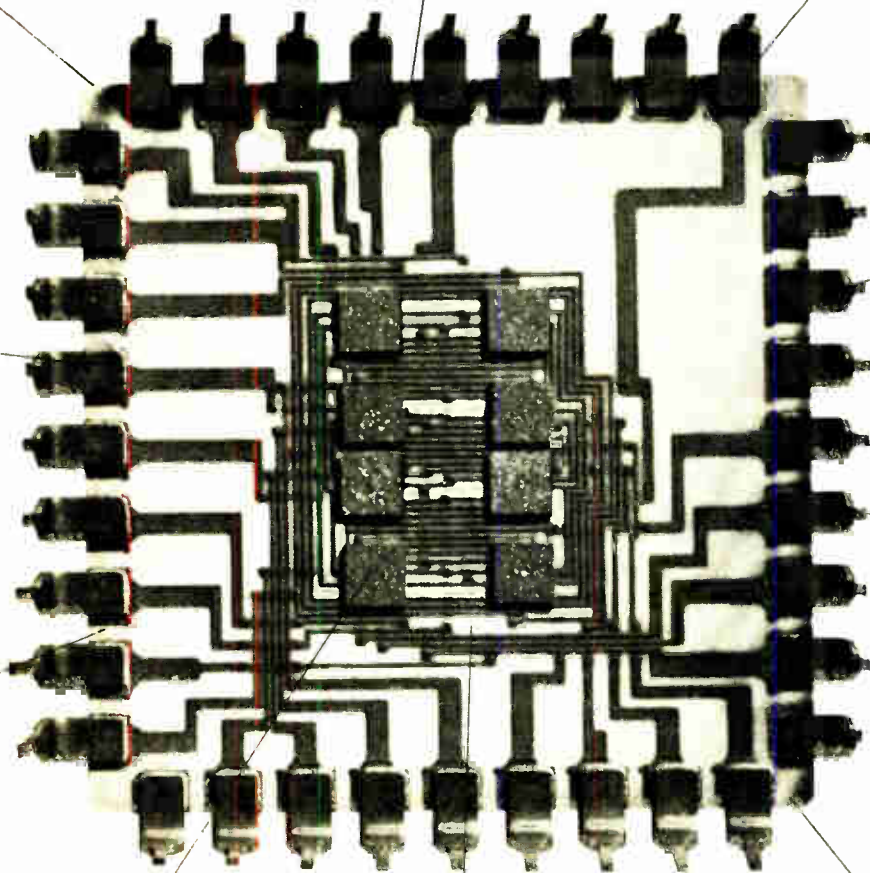

*128 bits -
(64 2-bit words)*

*35 ns
read & write times*

*52¢
per bit*

*CCSL
compatible.*

Face-down bonding

Multi-layer ceramic

*Easy word
or bit size
expansion*



Look What You Can Do Now With High Voltage, TO-3 Silicon Power!

That's right! . . . you can now put standard, inherently-economical, TO-3 packaged silicon power transistors — the 2N5629-31 series — right to work in high voltage operation in your rugged, audio/servo amplifiers, inverters, converters, choppers and switching and series pass regulators.

You can now reduce the size, cost and complexity of input, output and filtering components without the use of large, cumbersome — and costly — silicon power stud packages. Plus, reduce required current and keep your circuitry more compact, lighter and easier to cool through elimination of step-down componentry.

Performance? How about: 200-watt power dissipation . . . 16-ampere collector current . . . 1-volt saturation voltage . . . 20 to 100 beta at 8-amperes . . . 140-volt rating!

The 2N5629 series is a nimble switch, too, with f_T a minimum of 1 at 1 ampere and 20 volts. And, there's no "punch-through" (second breakdown) in your designs because Motorola's diffusion process allows acceptance of high voltages even in the most demanding designs.

The new unit's operating temperature range extends from -65° to 200°C , making them ideal replacements for germanium types in today's "brute power" systems.

Scan these specs on the 2N5629-31 series and its 10-ampere companion — then contact your franchised Motorola distributor or the factory about evaluation or production quantities of either economical, high power silicon transistor!

Write today for new data sheets!

Circle 510 on reader service card

Highlight Parameters	2N5629, 30, 31	2N5632, 33, 34
Polarity	NPN	
High $V_{CE(sat)}$	100, 120, 140 V	
High $I_{C(cont.)}$	16 A	10 A
Fast Switching — f_T @ 1 A/20 V (min)	1 MHz	
Low $V_{CE(sat)}$ @ $I_C = 10$ A (max)	1 V	2 V
High P_D @ 25°C	200 W	150 W

— where the priceless ingredient is care!



You've Just Discovered State-of-the-Art, 50 A Silicon Power Complements!

And you can now discover how easy it is to put extra performance in — and take the cost and circuit complexity out of — those rugged, new-design audio/servo amplifiers . . . with the highest-rated, TO-3 PNP/NPN complements in the business: the 60 and 80-volt, 2N5683-86 series!

A pair of these in your designs gives you *unprecedented* power in compact, low-silhouette packaging — 300 watts of DC to 50 amperes! Plus, you realize a higher degree of frequency stability through elimination of expensive, impedance-matching driver transformers. And you're ensured lighter, simpler, less-costly heat sinking in all designs through low thermal resistance — θ_{JC} of only 0.583° C/W maximum.

When you're looking for heavy muscle in switching applications, there's no power/speed trade-off with either polarity . . . at 50 watts, the units furnish a high minimum f_T of 2 MHz minimizing switching losses.

Both series ensure efficient, low-power-loss performance — 1.0 volt maximum saturation voltage at 25 amperes and provide the capability to swing down in voltage without the loss of current gain to 2 volts at 25 amperes, important in low distortion, audio amplifiers.

Motorola's exclusive EpiBase* die fabrication process affords minimum user cost while maintaining long-term reliability and stability.

More than 30 PNP/NPN silicon power complements are available for today's cost and performance-conscious designer from 1 to 50 amperes and 5 to 250 watts . . . they're immediately available for evaluation from your franchised Motorola distributor or in production quantities from the factory!

Write for data now!

Circle 511 on reader service card

Highlight Parameters	2N5683, 84	2N5685, 68
Polarity	PNP	NPN
High I_C (cont.)	50 A	
Low $V_{CE(sat)}$ @ $I_C = 25$ A (max)	1 V	
High P_D @ 25°C	300 W	
Fast Switching — f_T @ 5 A/10 V (min)	2 MHz	
High h_{FE} @ $I_C = 25$ A	15-60	

*Trademark of Motorola, Inc.

MOTOROLA

Silicon Power Transistors

Motorola Semiconductor Products Inc. / P.O. Box 20912 / Phoenix, Arizona 85036



The new Fluke 893A will retire lots of good old Fluke voltmeters.

They won't be the only ones to go!

All kinds of differential voltmeters are likely to find quick retirement when you check out the new solid state Fluke Model 893A AC/DC Differential Voltmeter. Here's a low cost differential voltmeter with infinite resistance at null to 1100 volts, dc accuracy of 0.01%, ac accuracy of 0.05%, and integral battery pack operation.

Available in both half and full rack models, price is \$995 for either. Battery operation can be added at any time for only \$100. Grounded recorder output is available for \$50 more.

Ranges are 1, 10, 100, and 1000 volts ac and dc with 10% overranging. Resolution is 1 ppm of range. Reference regulation is the best available. Reference stability is 15 ppm/hr.

Using the instrument in the battery mode assures portability and complete isolation from the effects of power line interference. In the ac mode, the useful frequency range is 5 Hz to 100 KHz with a 1 mv accuracy. In the TVM mode, input resistance is 100 megohms, so you get the same advantages of low source loading as with older vacuum tube differentials.

Other user features include large, in-line readout with 360° rotation of voltage dials, virtual immunity to damage by accidental overload, and automatic decimal switching with range.

Ready to make the change?

We'd like to help. Your friendly Fluke sales engineer (listed in EEM and EBG) has all the facts as well as demo equipment. Call him or contact us directly if it's more convenient.



Fluke, Box 7428, Seattle, Washington 98133. Phone: (206) 774-2211.

TWX: 913 449-2850.

In Europe, address Fluke Nederland (N.V.), P.O. Box 5053, Tilburg, Holland.
Telex: 814 8073. In the U.K., address Fluke (Great Britain) Corp., Garnett Close,
Willford, Walsley, England. Phone: Walsley 27769. Telex: 934583.





GI's Sack

As an astrologer might say it: this could be the best of all possible times to become the head of a large semiconductor company's hybrid operation. But the reason has nothing to do with stars; it's found in the ascension of large scale integrated hybrids. And for Edwin Sack, vice president of General Instrument's Integrated Circuits division, there's an additional plus: the job has almost no rules or preconceived notions attached to it because it's a brand new position.

GI's hybrid group, while it was part of the MOS setup, had been restricted to custom military circuits. But this is going to change. "I'm thinking in terms of where GI should grow," says the 39-year-old Sack, "and I believe that one area is LSI hybrids. With this technique, we're not limited to a specific technology or a specific chip size—we can employ the best of each technique."

To this end, Sack, who was the general manager of Westinghouse's Molecular Electronics division and left before Westinghouse decided to move the facility to Canada, has set up a bipolar IC facility strictly for the use of the hybrid division [*Electronics*, May 26, p. 37]. The first bipolar IC's will be operational

amplifiers for a hybrid voltage regulator circuit. "This is just a starting point," says Sack. "Eventually, we'll be using MOS devices, bipolar chips, and thick- and thin-film techniques in a single package. This way we won't have to force a single technology to do something it isn't meant to do."

In the next four or five years, Sack says, the electronics industry will see the emergence of very complex systems in hybrid form in which a beam-lead-like process will play an important part. "It's not only because we need beam leads for reliability and ease of assembly, but also because they provide a means by which we can repair a circuit."

Sack points out that GI has conducted tests with beam-lead devices where the chip has been bonded and removed seven times without affecting the operating characteristics of the circuit.

Movement into new markets lies ahead for Litton Industries' Guidance and Control Systems division if Joseph F. Caligiuri has his way. And chances are he will, because



PUTTING CURRENT-LIMITER DIODES TO WORK

PROBLEM: How to provide a *low noise* voltage reference with only two components?

SOLUTION: A Siliconix CL diode in series with a resistor.

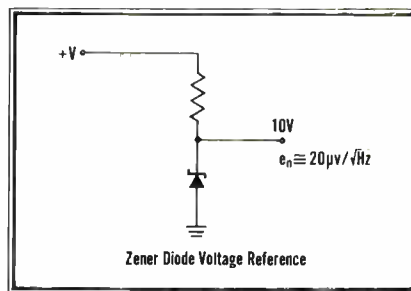

The zener diode voltage reference circuit has a typical noise voltage of $20 \mu\text{V}/\sqrt{\text{Hz}}$.

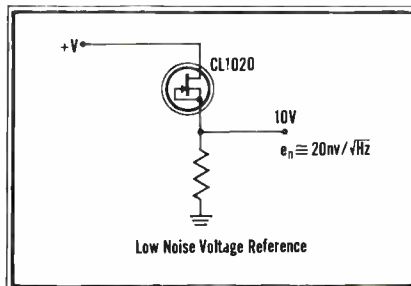

This CL diode circuit results in a 60 dB reduction in noise voltage—from $20 \mu\text{V}/\sqrt{\text{Hz}}$ to $20 \text{ nV}/\sqrt{\text{Hz}}$ at 100 Hz.

For further information and immediate applications assistance, call the number below. Ask for extension 19.

Siliconix
incorporated

1140 W. Evelyn Ave. • Sunnyvale, CA 94086
Phone (408) 245-1000 • TWX: 910-339-9216

* Applications power . . . a broad product line, an in-depth applications team at your service!

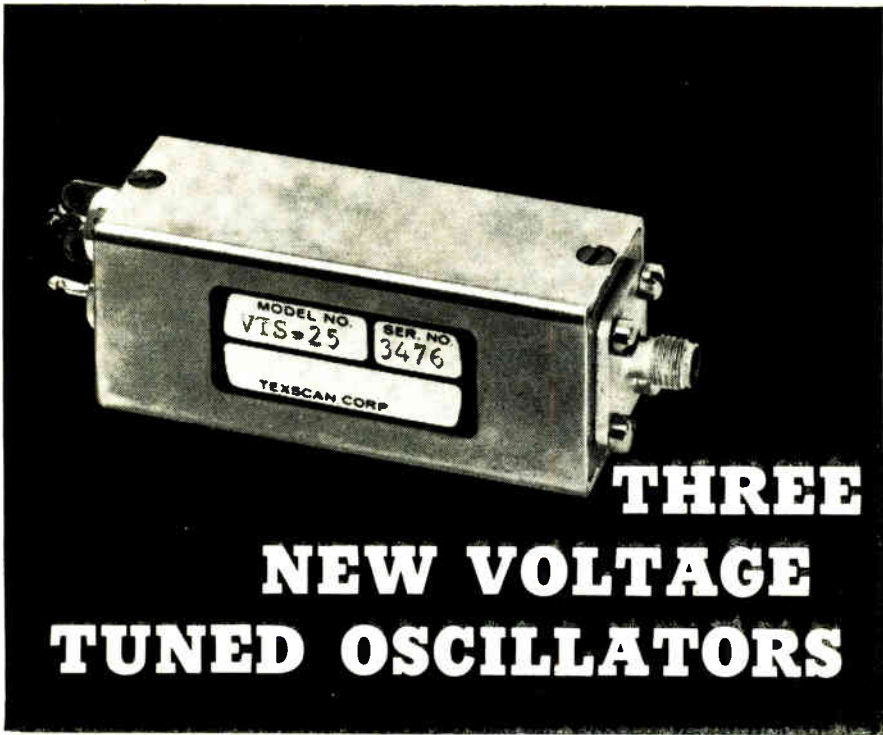

Texscan's VTS series of oscillators are solid state, fundamental RF sources, and voltage tunable over a full octave. They feature exceptionally good voltage versus frequency characteristics and power output capability.

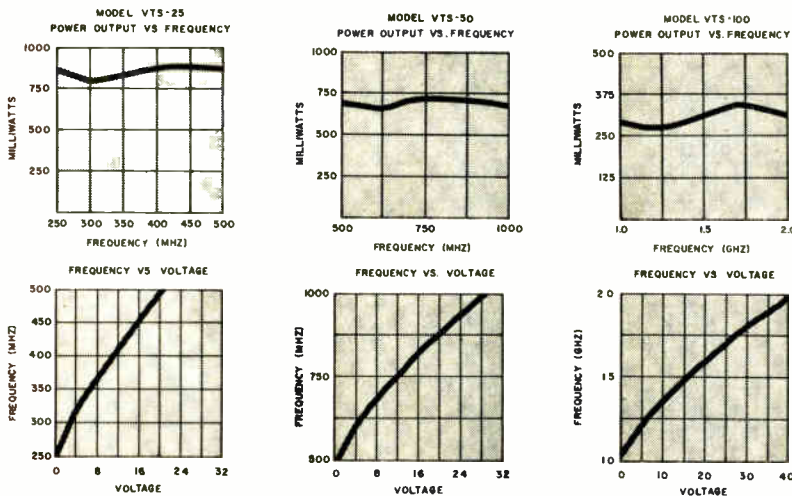

Inquiries for special tuning ranges, power outputs, and mounting flanges are invited.

Model No.	VTS-25	VTS-50	VTS-100
Frequency Range	250-500 MHz	500-1000 MHz	1 - 2 GHz
Power Output Into 50 Ohm	750 MW	500 MW	250 MW
Non-Harmonic Spurious Rejection	50db	50db	50db
Tuning Voltage	+0.5 to +20 VDC	+0.5 to +28 VDC	+0.5 to +40 VDC
Physical Size	1" x 1" x 2½"	1" x 1" x 2½"	1" x 1" x 2½"
Price	\$195.00	\$195.00	\$275.00

TEXSCAN CORPORATION
 2446 N. Shadeland Avenue
 Indianapolis, Indiana 46219
 Telephone (317) 357-8781
 TWX: 810 - 341 - 3184

he's the division's new vice president of engineering.

"Historically, Litton has done very well in the aircraft inertial navigation field, but the company's tremendous technology allows a great expansion into weapons delivery systems," says Caligiuri, who comes to Litton from Sperry Gyroscope, where he was chief engineer on antisubmarine warfare and inertial systems.

"The first thing I did on arriving was to put a new business staff together, and we are carefully assessing expansion into marine, missile and terrestrial navigation systems, as well as the electro-optical area," he adds. The division's short-term prospects admittedly hinge on several upcoming contract awards. Litton's bid to supply guidance subsystems for the Minuteman 3 program, for example, could be pivotal.

Toe to toe. Caligiuri says: "The division has put together a real hard-hitting team to go after this contract, and I get the feeling that our competition is nervous and concerned about us. I'm sure we're at the top of the list, but the big boys are really out there fighting for it. If Litton gets this contract, it will be very significant in our future."

Caligiuri is also awaiting the outcome of another imminent contract award, for a carrier aircraft inertial navigation system (Cains). Initially to be used in F-14, S-3A and E-2C aircraft, Cains should have broad application in future Navy aircraft.

Although determined to move the division into new waters, Caligiuri says that the technologies in which the company is already firmly ensconced will continue to be supported. "There's no question that aircraft and avionics will still be very important for us. We're looking at the competition, and seeing what it takes to make us competitive.

"Our business mix will be in new programs more than in the past, but we do see growth out there in the future, and our five-year projection is very ambitious," Caligiuri adds.

LR series high-performance power supplies regulation—0.0005%, ripple—35 μ v

For test equipment and lab use—
rack or bench
0-20, 0-40,
0-120,
0-250 VDC,
from 60 ma.
to 1.8 amps.

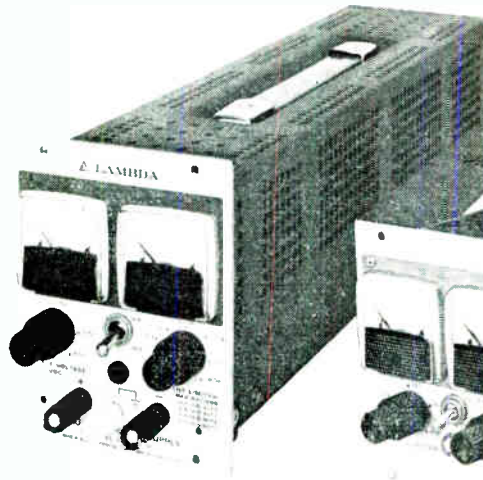

1/4 rack models

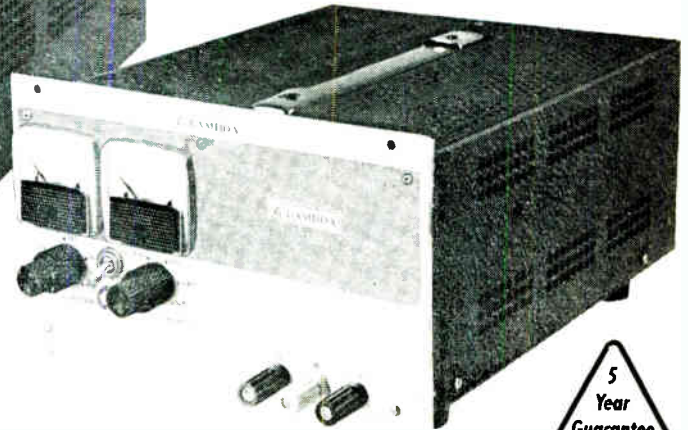

1/2 rack models

**ONE
DAY
DELIVERY
ALL
MODELS**



Features and Data

- 0.0005% plus 100 μ regulation.
- 35 μ V rms, 100 μ p-to-p ripple.
- AC Input: 105-132 VAC, 47-440 Hz (Ratings based on 55-65 Hz; derate current 10% at 50 Hz.) 205-265 VAC on request at no extra charge ("V" option).
- 2 meters monitor both voltage and current simultaneously and continuously.
- Accuracy—0.01% plus 1mV
- Stability—0.001% plus 100 μ V for 8 hours
- Temperature coefficient—0.001% plus 10 μ V/°C
- Multi-Current-Rated.

- Guaranteed for 5 years. The only 5-year guarantee that includes labor as well as parts. Guarantee applies to operation at full published specifications at end of 5 years.
- Only 5 1/4" high. Convenient 1/4 and 1/2 rack sizes for rack or bench use.
- All silicon-designed for maximum reliability.
- Convection Cooled—no blowers, no external heat sinks.
- Auto Series/Auto Parallel with Master-Slave tracking.
- Constant Voltage/Constant Current
- Completely protected—short-circuit proof—continuously adjustable, automatic current limiting.
- Overvoltage protection available for all models up to 70 VDC.
- Remotely Programmable

LR Series 1/4-rack models		Size: 5 3/16" x 4 3/16" x 1 5 1/2"				
Model	Voltage Range	MAX. AMPS AT AMBIENT OF: 1				Price
		30 C	40 C	50 C	60 C	
LR-602-FM	0-20 VDC	1.1	.95	.80	.64	\$265
LR-603-FM	0-40 VDC	.60	.50	.42	.33	265
LR-605-FM	0-120 VDC	.23	.20	.17	.14	295
LR-606-FM	0-250 VDC	80ma	72ma	65ma	60ma	310

LR Series 1/2-rack models		Size: 5 3/16" x 8 3/8" x 10 5/8"				
Model	Voltage Range	MAX. AMPS AT AMBIENT OF: 1				Price 2
		30 C	40 C	50 C	60 C	
LR-612-FM	0-20 VDC	1.8A	1.6A	1.3A	1.1A	\$305
LR-613-FM	0-40 VDC	1.0A	0.9A	0.75A	0.6A	305
LR-615-FM	0-120 VDC	0.33A	0.29A	0.25A	0.21A	320
LR-616-FM	0-250 VDC	100ma	90ma	80ma	70ma	340

NOTES:

- 1 Current rating applies over entire voltage range. Ratings based on 55-65 Hz operation. Derate current 10% for 50 Hz input.
- 2 Prices are for metered models. LR Series models are not available without meters

Accessories

Rack Adapter LRA-1 Price \$60.00 • 5 1/4" H x 16 1/2" D

Rack Adapter LRA-2 Price \$35.00 • 5 1/4" H

OVERVOLTAGE PROTECTION ACCESSORIES			
For Use With	Model	Adj. Volt Range	Price
LR-602-FM, LR-612-FM	LH-OV-4	3-24 V	\$35
LR-603-FM, LR-613-FM	LH-OV-5	3-47 V	35

Prices F.O.B. factory, Melville, N. Y. All specifications and prices subject to change without notice.

 **LAMBDA**
ELECTRONICS CORP.
515 BROAD HOLLOW ROAD, MELVILLE, L.I., NEW YORK 11746
TEL. 516-694-4200. TWX: 510-224-6484 CABLE: VEECOVAC PLAINVIEW NY

See additional equipment inside

Circle 17 on reader service card

How to write a great ad.

Tell people what you will do for them. How you're different. This is most important.

Be under the proper headings so people can find you fast. Maybe you should be under both "Heating" and "Plumbing."

Your services are more important than your name.

**Emergency Service
Day or Night**

BARRY'S HEATING & PLUMBING

Since **BHP** 1921

**COMMERCIAL,
INSTITUTIONAL, RESIDENTIAL,
INSTALLATION & REPAIRS**

<p>Complete line of:</p> <ul style="list-style-type: none"> • Kitchens • Laundries • Sewage Systems • Water Pumps • Heating Systems • Pipes and Drains 	<ul style="list-style-type: none"> ★ Master Lic. #103241 ★ References ★ Estimates ★ Delayed Payment Plans ★ Ample Parking
---	--

phone **555-2368**

77 Locust Lane. (Between Main and Central, one mile from RR. Station).

Tell people about your special services...repairs...rentals.

Use your logotype to gain recognition. Give facts about your qualifications, reliability, etc.

List products you carry.

Tell how easy it is to deal with you...credit, parking, hours, delivery.

Give telephone number and address, of course; and if you're hard to locate, directions and perhaps a map.

There...you've written a great ad. Now place it where people will be looking for you...in the Yellow Pages.



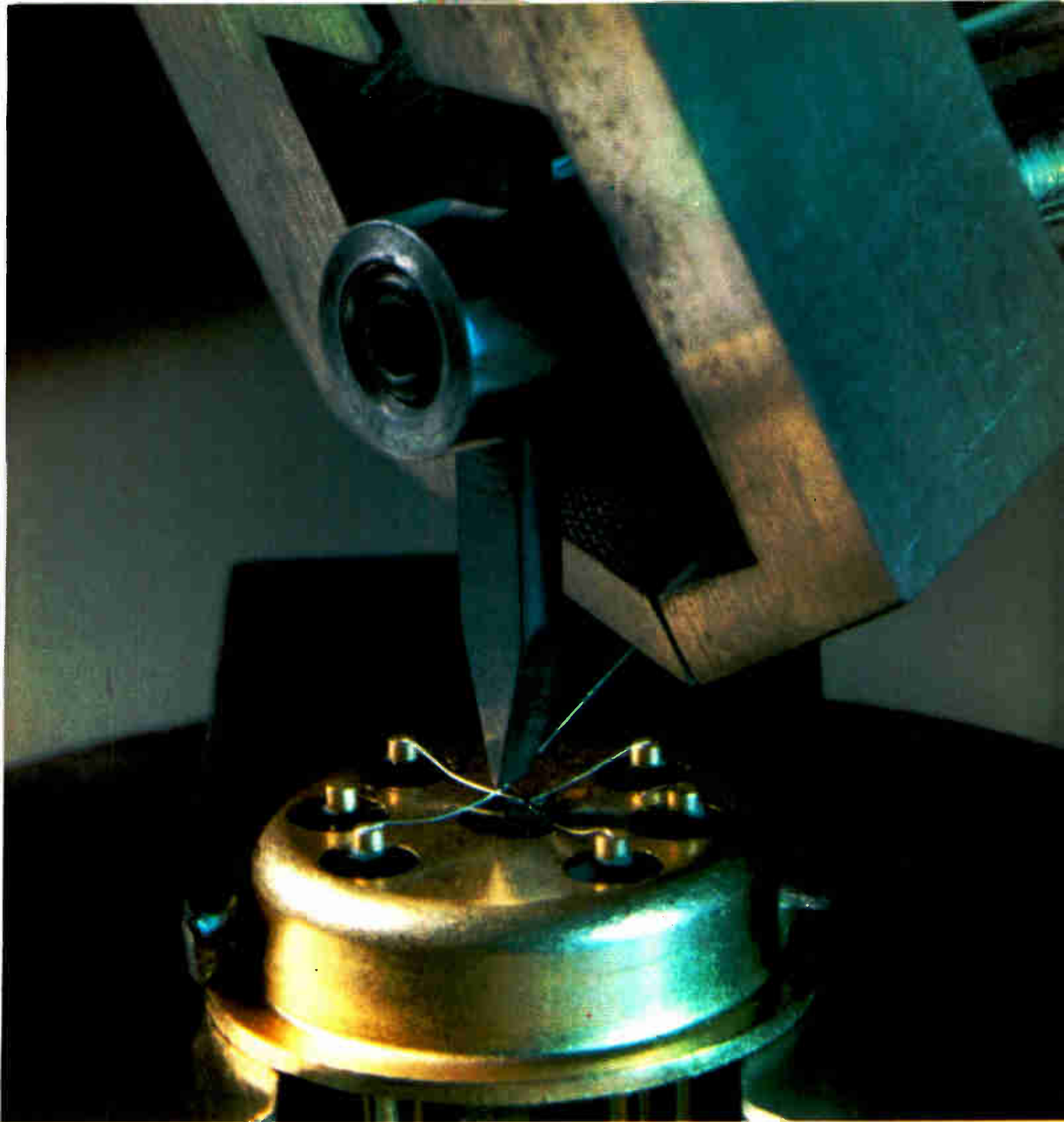

Craftsmanship in hard materials...an industry standard

HIGH PRECISION TUNGSTEN CARBIDE BONDING TOOLS, SUCH AS THE ONE SHOWN IN THIS 13X MAGNIFICATION OF AN ULTRASONIC LEAD BONDING OPERATION, WERE PIONEERED AND INTRODUCED AS PRODUCTION DEVICES BY TEMPRESS . . . IN 1963, THE TEMPRESS CAPILLARY TUBE, AN INDUSTRY STANDARD . . . IN 1967, THE ULTRASONIC BONDING TOOL, AN INDUSTRY STANDARD. The techniques and the specialized machinery developed to produce such precision products from ultra-hard materials have not been duplicated; quite probably will not be, for they are a result of the unique combination of Tempress people and the

Tempress philosophy. To meet its responsibilities, Tempress maintains a continuing expansion program, limited only by strict adherence to the Tempress Standard of Excellence. (It requires as long as 11 months to train an operator for certain operations.) The same uncompromising standard is applied to Tempress Automatic Scribing Machines and to the entire growing family of Tempress miniature assembly tools and production equipment.



TEMPRESS

Tempress Industries, Inc., 930 University Ave., Los Gatos, Calif. 95030

Circle 21 on reader service card

For longer lasting attachments in weldable coppermetals go with **ANACONDABILITY**

Anacondability is more than just the industry's finest weldable coppermetals. It's also the latest technical information . . . prompt engineering assistance . . . constantly high product quality, plus a wider selection of weldable coppermetals and welding rod alloys for trouble-free welding,

and permanent joints.

Anacondability, in effect, is Anaconda's total capability in research, production, distribution and customer service . . . the difference that distinguishes Anaconda coppermetals from all others. **Anacondability solves difficult joining problems.**

Anaconda metallurgists, aware of the importance

of weldable coppermetals in today's new technologies, are constantly seeking to add weldability to the properties of more and more coppermetals.

Boron Deoxidized Copper is one example of a product developed to fulfill a particular need—the need for a high conductivity metal resistant to



oxygen penetration when brazed at high temperatures.

Anaconda coppermetals need only minimum preparation for welding, and are readily joined with conventional processes and relatively simple procedures. In many instances they can also be adapted to

joining by newer techniques like electron and laser-beam welding, diffusion bonding, cold welding, friction welding, etc.

For complete technical information on weldable alloys for specific jobs, send for

Anaconda's new Coppermetal Data Sheets. Write to: Anaconda American Brass Company, 414 Meadow St., Waterbury, Connecticut 06720. In Canada: Anaconda American Brass Limited, Ontario.

2.8.26

Circle 23 on reader service card

Think copper, think **ANACONDA**[®]
AMERICAN BRASS COMPANY

automate

**Unique Gardner-Denver Grid-Drill™
drills electronic circuit boards
at a rate of 130 cycles per minute—at total
positioning accuracies of less than $\pm.0006$ "**

No other production machine drills so many holes so accurately in so short a time as this new n/c Gardner-Denver Grid-Drill. Perfect for multi-layer and through-hole plating, for computers of this generation—and the next.

Handles as many as four stacks of panels as large as 15" x 20" each. Drills hole sizes from .010" to .125". Fingertip control adjusts spindle speed from 10,000 to 50,000 rpm. Each spindle is programmed for "use" or "not use," allowing the use of one, all, or any combination of spindles for each cycle. Individual spindles are located in "packages," the spacing and number of which are dependent on the type and volume of work. Packages are customized to your application.

How's this for accuracy? Table location, over a 20" travel, is accurate within $\pm.0006$ ". Repeatability of positioning—within .0003". Spindle runout—within .0005" TIR.

Production rate, including table movement, spindle programming and drilling, is as high as 130 cycles with each spindle per minute.

Gardner-Denver is also the maker of the famous automatic Wire-Wrap® machine. Both machines spectacularly increase production—and lower the cost—of electronic equipment. Call for further information, or write for Bulletins 14-121 and 15-1.



GARDNER-DENVER

Gardner-Denver Company, Quincy, Illinois 62301





New High Voltage High Power Rectifiers

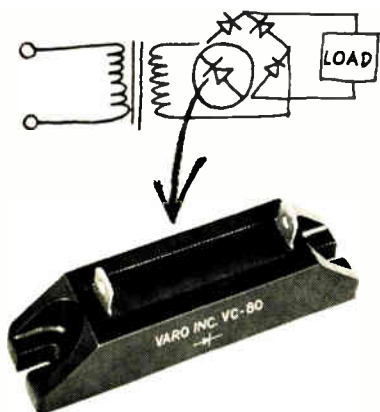

VC Series from Varo.

Our new VC Series rectifiers may be tiny (3" long, 3/4" high, 3/4" wide), but they're plenty tough enough to stand up under high voltage, high power conditions.

They have voltage ratings of from 2 KV to 8 KV, current ratings of 1 to 2 amps, and they're available with an optional 300 nanoseconds recovery time.

Varo VC Series rectifiers are made to handle the biggest jobs. Like X-ray power supplies, radio and radar transmitters, and things like the new microwave oven power supplies.

And they'll handle most of the new high voltage, high power system demands that'll be coming along in the future, too.

The new VC Series from Varo.

It's the kind of thing we know you've come to expect from us.

\$4.18 EACH

VC-80 (8,000 Volts — 1 Amp).
1,000 quantity.



SEMICONDUCTOR DIVISION
1000 N. SHILOH ROAD, GARLAND, TEXAS
75040 (214) 272-4551

Meetings

Small portion, but tasty

Although avionics plays a small role in the technical program, several papers at this year's Aircraft Design and Operations Meeting may attract considerable interest among suppliers of electronic systems. Most of these papers are included in a confidential session on New Developments in Military Aircraft to be held on the last day of the meeting. The conference, sponsored by the American Institute of Aeronautics and Astronautics, will run from July 14 to 16 in Los Angeles.

Perhaps the most interesting paper, with respect to potential for new military funding, is "A High-Accuracy Navigation Satellite System." One of its authors is Lt. Col. F.M. Charette, of the Air Force's Space and Missile Systems Organization (Samsco), who has been concerned with the development of Samsco's 621-B navigation satellite system. Several small contracts have been let recently for developing antijam receivers for this system, which could eventually result in simpler and cheaper navigation sets for aircraft and ships.

Watch it. In another paper, the Norden/United Aircraft Corp. will describe radar techniques that would enable a helicopter to detect and avoid obstacles. The company

has been developing a radar that operates in the millimeter-wave area.

There will also be a session devoted to summarizing some of the relatively new avionics developments in both civil and military aviation.

McDonnell Douglas, which is supplying one of the aircraft collision avoidance systems to be tested soon by the Air Transport Association, will discuss the time-frequency technology it has developed for this purpose. The Autonetics division of North American Rockwell will relate the outcome of tests it has been running—thus far with only limited success—on an infrared system that detects clear air turbulence. United Aircraft will describe the terrain-following system it has built for the C-5A transport. And United Airlines and Hughes Aircraft will describe their work on equipment for area navigation, an important technique that the airlines would like to use to speed up their movement through the air lanes.

In still another session, a speaker from Autonetics will describe the integration testing of the D version of the F-111 avionics system.

For further information, contact the Meetings Dept., AIAA, 1290 Sixth Avenue, New York, N. Y. 10019.

Calendar

Federal Research and Development in the 70's—its Need and Scope, National Security Industrial Association, State Department West Auditorium, Washington, D.C., June 11-12.

Consumer Electronics Show, Consumer Products Division of Electronic Industries Association; New York Hilton and Americana Hotels, New York, June 15-18.

Data Processing Conference and Business Exposition, Data Processing Management Association; Queen Elizabeth Hotel, Montreal, Canada, June 16-19.

Congress of the International Federation of Automatic Control

(IFAC), IEEE; Warsaw, Poland, June 16-21.

Computer Group Conference, IEEE; Leamington Hotel, Minneapolis, Minn.; June 17-19.

Electromagnetic Compatibility Symposium, IEEE; Berkeley Cartaret Hotel, Asbury Park, N.J., June 17-19.

Properties and Use of MOS Structures, Center of Nuclear Studies; Grenoble, France; June 17-20.

National Cable Television Association Convention and Exposition; San Francisco Hilton Hotel; June 22-25.

(Continued on p. 28)

This Sierra L-F wave analyzer costs \$2,295.

(For about the same money, others can give you a fraction of its accuracy: ± 3 Hz).

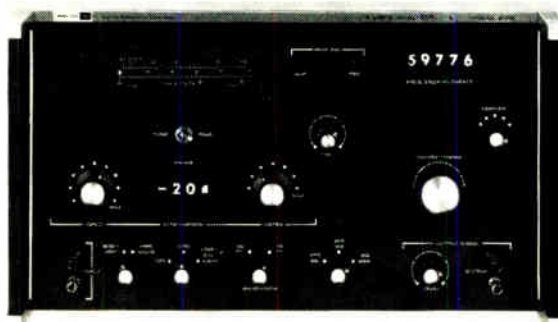

(...and about half its range of 20 Hz to 110 kHz)

Short of spending another \$2,000, you cannot buy the accuracy of a Model 301B L-F Wave Analyzer. Nor its broad tunable coverage of the low-frequency spectrum. Nor its convenience and all-around usefulness.

Consider, for example, the benefits of up-to-date readout techniques. Model 301B displays tuned frequency on a five-digit counter, driven by solid-state circuitry. A second digital display presents the algebraic sum of the two attenuator settings, doing away with calculations. A lighted pointer on direct-projected meter scales gives you parallax-free readings of voltage and dBm.

As a wide-range wave analyzer, Model 301B delivers precise data on individual components of complex signals. You can accurately measure fundamental frequencies, harmonic voltages, intermodulation products, and other noise and signal voltages too small to be indicated by other means.

Built-in signal generator

By looping pulse outputs back to the 301B input, you can produce a harmonic signal every 100 Hz or 1 kHz (READ or TUNE position). A built-in 1-MHz clock frequency assures the accuracy of all generated pulse harmonic frequencies in this mode. By tuning the set to any harmonic frequency and locking on AFC, you can operate it as a frequency synthesizer throughout the entire range. In this function, it provides a restored sig-

nal of high frequency accuracy at the restored output terminals.

Among other Model 301B features: dual-selectable bandwidths of 10 and 100 Hz; a meter recording output; an optional bridging line transformer (Model 129-600) that makes measurements of true dBm on 600-ohm lines possible with only 0.1 dB bridging loss.

Product File 369 discloses everything about this remarkable economic development. Write Philco-Ford, 3885 Bohannon Drive, Menlo Park, California 94025. Or call (415) 322-7222, ext. 329.

SUMMARY SPECIFICATIONS

Frequency	
Range	20 Hz to 110 kHz
Accuracy	(20 Hz to 110 kHz) 1 Hz ambiguity, ± 2 Hz error
Input Level Range	
Voltage (Full scale).....	30 μ v to 300 v in 1, 3, 10, 30 sequences
dBm (ref 600-ohm line and 0 dB on meter scale).....	+50 to -90
Input Level Accuracy.....	± 0.5 dB
Selectivity	
Narrowband	10 Hz (6-dB points) 60 Hz (60-dB points)
Wideband	100 Hz (6-dB points) 600 Hz (60-dB points)

PHILCO 
SIERRA ELECTRONIC OPERATION
Philco-Ford Corporation
Menlo Park, Calif. 94025

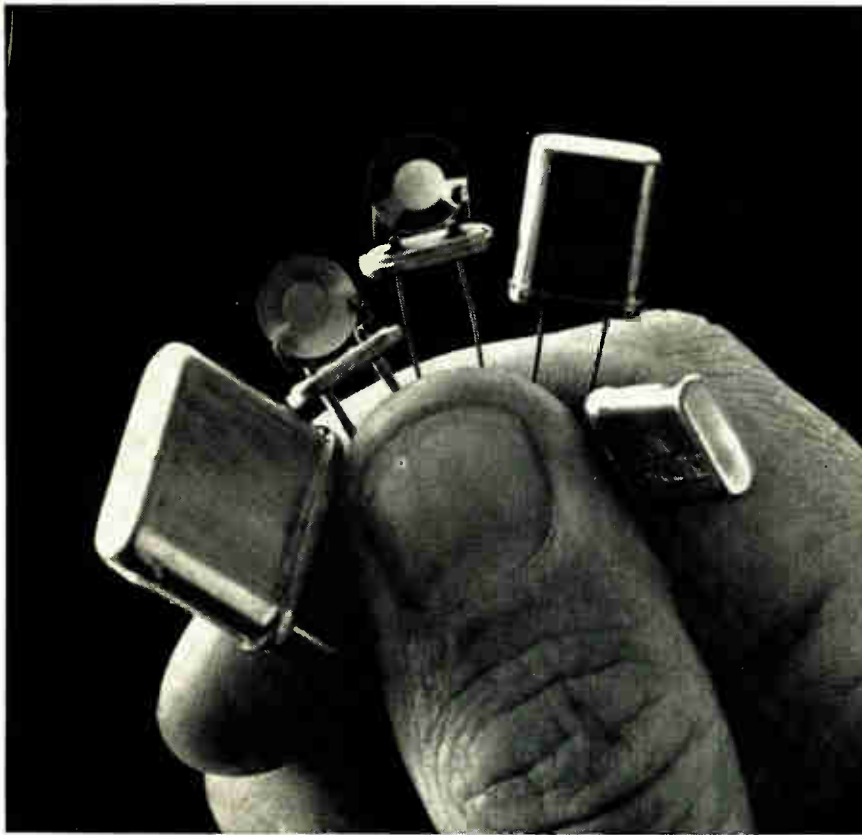

How are Sherold crystals a cut above the competition?

With frequency.

The right frequency. Consistently and with the low-cost quantity production that comes from top-quality crystal technology. Whether you order a few hundred or a few hundred thousand crystals from Sherold, you know you'll get exactly what you ordered — fast and accurate right down to the last MIL spec on the last crystal. We manufacture a variety of crystals from 4 kHz to 175 megaHz in numerous packages, as well as crystal filters and discriminators. In prototypes, short orders and long runs. In addition, Sherold has several plants geographically located to give you specialized local crystal technology assistance. Each has in-house facilities to meet and beat high shock and vibration MIL specs. Whether you're looking for a high-volume, off-the-shelf crystal or a prototype design, tell us about it. We'll give you a quote. With speed. Write Sherold Crystal Products Group, Tyco Laboratories, Inc., 1510 McGee Trafficway, Kansas City, Mo. 64108. Or phone (816) 842-9792. TWX 910-771-2181.

TYCO

Meetings

(Continued from p. 26)

Summer Power Meeting, IEEE; Dallas, Texas; June 22-27.

Electronic Distance Measuring and Atmospheric Refraction, International Association of Geodesy; Boulder, Colo.; June 23-27.

Parallel Processor Systems, Technologies and Applications, Department of Defense, Naval Research; Navy Postgraduate School, Monterey, Calif.; June 25-27.

Conference on Applications of Continuous System Simulation Languages, Association for Computing Machinery, IEEE; Sheraton-Palace Hotel, San Francisco; June 30-July 1.

Aviation and Space Conference, American Society of Mechanical Engineers; Statler Hilton Hotel, New York; June 30-July 2.

Computer Science and Technology Conference, University of Manchester Institute of Science and Technology; London, England; June 30-July 3.

Conference on Applications of Continuous Systems Simulation Languages IEEE, Association for Computing Machinery; Sheraton Palace Hotel, San Francisco; June 30-July 1

Conference on Environmental Effects on Antenna Performance, Institute for Telecommunication Sciences, Cooperative Institute for Research In Environmental Sciences, Air Force Cambridge Research Laboratories; University of Colorado, Boulder, Colo.; July 7-18.

Conference on Measurement Education, IEE; University of Warwick, Warwickshire, England; July 8-10.

Conference on Nuclear and Space Radiation Effects, IEEE; Pennsylvania State University, University Park, Pa.; July 8-11.

International Conference on Medical and Biological Engineering, International Federation for Medical and Biological Engineering, Joint Committee on Engineering in Medicine and Biology, IEEE, Instrument Society of America, American Society of Mechanical Engineers, American Institute of Chemical Engineers; Palmer House, Chicago; July 20-25.

Annual Conference on Engineering in Medicine and Biology, International Federation for Medical and Biological Engineering, Joint Committee on Engineering in Medicine and Biology, IEEE, Instrument Society of America,

(Continued on p. 30)

NEW



New Allen-Bradley hot-molded Type GD dual variable resistor shown actual size

**TWO
IN
ONE**

Allen-Bradley hot-molded dual variable resistor

Here's the most compact two section variable resistor currently available—the new Allen-Bradley dual Type GD. It's one-half inch in diameter and only a fraction of an inch longer than the popular single section Type G control. The case is dust-tight as well as watertight. ■ Both resistance tracks in the dual Type GD are solid, hot-molded elements, which provide long operating life. As with the single Type G, the noise level is low initially and actually decreases with normal use. Adjustment is smooth at all times with virtually infinite resolution. And low inductance permits operation at frequencies far beyond the usable range of wirewound controls. ■ In addition to standard application, these new dual Type GD controls are ideally suited for use in compact attenuators. ■ Dual Type GD controls are available with nominal resistance values from 100 ohms to 5.0 megohms. For complete specifications on tolerances, tapers, and options, please write Henry G. Rosenkranz, Allen-Bradley Co., 1201 South Second Street, Milwaukee, Wis. 53204. Export Office: 1293 Broad Street, Bloomfield, N.J., U.S.A. 07003. In Canada: Allen-Bradley Canada Limited.



ALLEN-BRADLEY
QUALITY ELECTRONIC COMPONENTS

WHY GAMBLE!

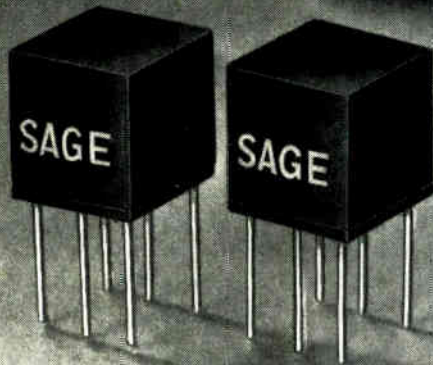

When your design calls for high reliability miniature transformers look to

THE NEW SAGE MICROCUBE LINE

When Sage makes it, you can count on advanced design, highest quality and complete dependability. These new Microcube Miniature Transformers, featuring highly efficient laminated cores and sealed construction, are no exception. Specify Sage when you require . . .

- A MINIATURE BROADBAND AUDIO TRANSFORMER that utilizes minimum space and standard grid spacing. Sage can supply them with power ratings of up to 50 milliwatts at 1KHz; frequency response of ± 2 DB from 400 Hz to 250 KHz; 5% maximum distortion; primary impedance "Standard" to 25K ohms, "Special" to 100K ohms.
- A PLUG-IN PULSE TRANSFORMER with very fast rise times. Sage manufactures a microcube transformer with rise times to 50 nanoseconds; ET constants to 5000 volt microseconds; high pulse impedance with low droop.
- ONE SIZE PACKAGE STANDARDIZATION. Sage can provide miniature inductors in the microcube configuration featuring inductances to 50 henries, highest Q and excellent stability.

Give us the opportunity to discuss your requirements. SAGE ELECTRONICS CORP., Box 3926, Rochester, N.Y. 14610; Tel: (716) 586-8010

A Leader in Micromagnetics

SAGE

ELECTRONICS

SUBSIDIARY OF GULTON INDUSTRIES, INC.

Meetings

(Continued from p. 28)

American Society of Mechanical Engineers, American Institute of Chemical Engineers; Palmer House, Chicago; July 20-25.

Conference on Instrumentation Science, Instrument Society of America; Hobart and William Smith College, Geneva, N.Y.; July 28-Aug. 1.

Seminar on Case Studies in System Control, IEEE; University of Colorado, Boulder; Aug. 4.

Joint Automatic Control Conference, IEEE; University of Colorado, Boulder, Colo.; Aug. 5-7.

Third Annual Contemporary Filter Design Seminar, University of Missouri, Columbia, Mo.; Aug. 5-8.

Short courses

Built-In Test and Continuous Monitoring, New York University, United Engineering Center, New York; June 16-20; \$265 fee.

Modern Digital Systems Design, Texas A&M University, Department of Electrical Engineering, College Station; June 16-20; \$150 fee.

Computer Applications for Vibration Problems in Engineering; University of Wisconsin, Department of Engineering, Madison; Aug. 11-15; \$200 fee.

Call for papers

Vehicular Technology Conference, IEEE, Columbus, Ohio, Dec. 4-5. Aug. 1 is deadline for submission of abstracts to Robert E. Fenton, Department of Electrical Engineering, Ohio State University, Columbus 43210.

Conference on Signal Processing Methods for Radio Telephony, IEE; London, England, May 19-21, 1970. Aug. 25 is deadline for submission of papers to the IEE Conference Department, Savoy Place, London, W.C.2.

Winter Power Meeting, IEEE; Statler Hilton Hotel, New York, Jan. 25-30, 1970. Sept. 15 is deadline for submission of papers to J.W. Bean, technical program chairman, 1970 Winter Power Meeting, 345 E. 47 Street, New York 10017.

Allen-Bradley cuts space requirements with new sealed type Z cermet trimmers

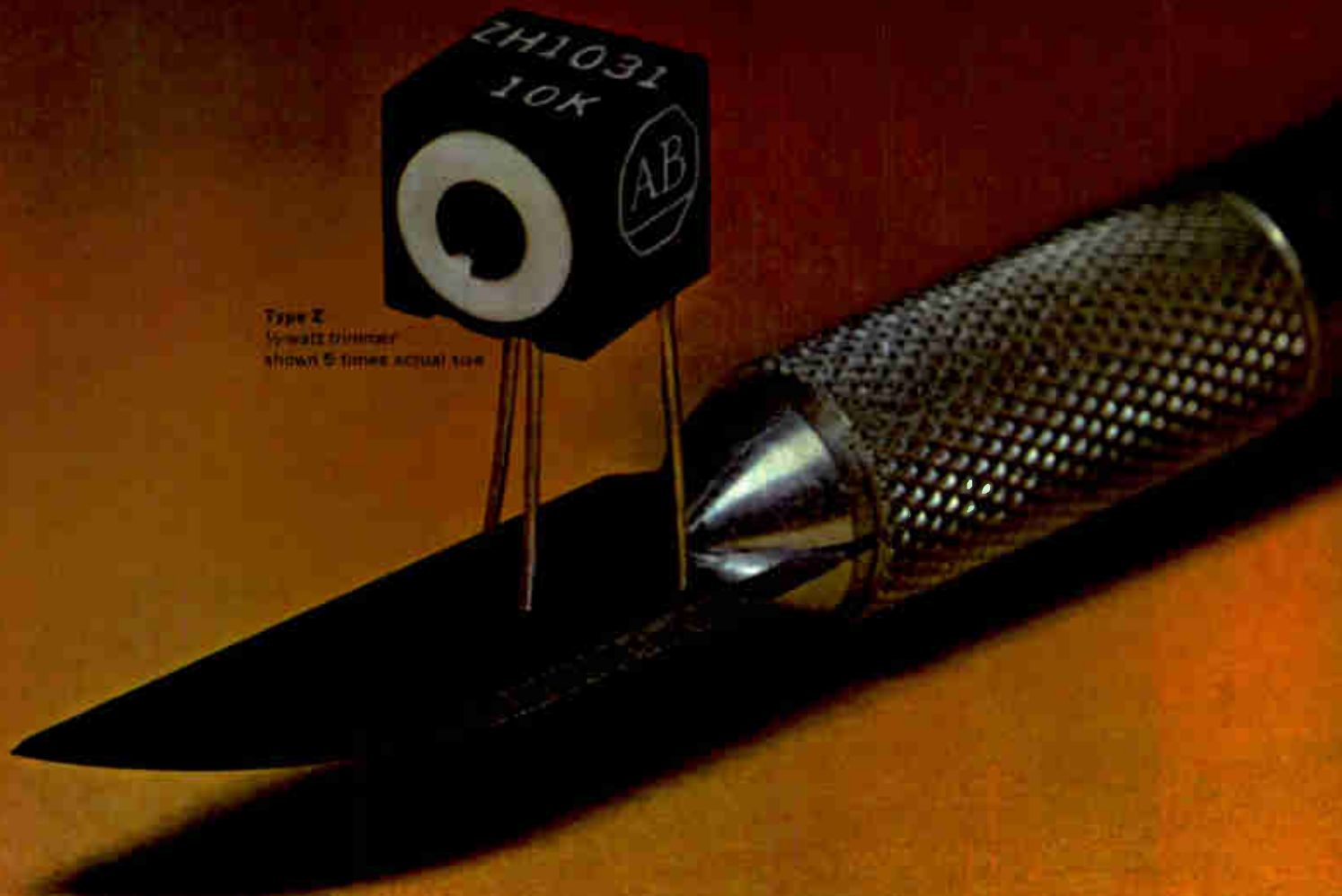

this latest addition to the Allen-Bradley line of cermet trimmers...the type Z...affords high performance in an especially compact package

The cermet material—an exclusive formulation developed by Allen-Bradley—provides superior load life, operating life, and electrical performance. For example, the full load operation ($\frac{1}{2}$ watt) for 1000 hours at 70°C produces less than 3% total resistance change. And the temperature coefficient is less than ± 250 PPM/°C for all resistance values and throughout the complete temperature range (-55°C to +125°C).

The Type Z is ruggedly constructed to withstand shock and vibration. The unique rotor design ensures smooth adjustment and complete stability under severe environments. The leads are permanently anchored and bonded. The connection exceeds the lead strength—opens cannot occur. Leads are weldable.

The enclosure is *SEALED*. It is both dust-tight as well as watertight, and can be potted. Mounting pads prevent moisture migration and also post-solder washout. For full specifications on this new spacesaving cermet trimmer, please write Henry G. Rosenkranz, Allen-Bradley Co., 1201 S. Second St., Milwaukee, Wis. 53204. Export Office: 1293 Broad Street, Bloomfield, N.J., U.S.A. 07003. In Canada: Allen-Bradley Canada Ltd

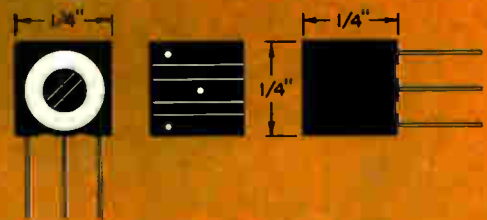

SPECIFICATIONS SUMMARY

- Adjustment:** Horizontal or vertical.
- Temperature Range:** -55°C to +125°C.
- Resistances:** 50 ohms through 1 megohm. Lower resistances available.
- Tolerances:** $\pm 20\%$ standard, $\pm 10\%$ available.
- Resolution:** Essentially infinite.
- Rotational Life:** Less than 2% total resistance change after 200 cycles.
- Rotation:** 300° single turn.
- End Resistance:** Less than 3 ohms.



You've
 never seen
 a dry reed
 relay
 like this
 new one
 from P&B

JDT Series Dry Reed Relay

An entirely new magnetic structure makes possible an exceptionally low seated height of only 0.275 inch for high density board packaging. Circuit boards employing JDT relays may be spaced on 0.5 inch centers.

This design minimizes magnetic flux dispersion, resulting in a very efficient magnetic circuit. This decreases coil power requirements and often permits direct operation of JDT relays in low-power semiconductor logic circuits. An interfacing amplifier may be eliminated in many applications.

Terminals are similar to those on IC packages, permitting spot testing on either side of a circuit board. The dual in-line terminals on 0.1 inch centers simplify circuit board design. The reed switches are rated at 10 watts maximum resistive (50V or 0.5A DC maximum) switching.

A solid state time delay circuit may be incorporated in this small package. Or a Darlington amplifier can be included to compensate for low current applications. However, the number of available poles for switching is reduced by the addition of either of these circuits.

The JDT is completely encapsulated in epoxy, giving protection against environmental contamination. The Series is presently available in many combinations of Forms of A, B and C.

Get full information today by calling your local P&B representative or call direct to Potter & Brumfield Division of American Machine & Foundry Company, Princeton, Indiana. 812-385-5251.

SPECIFICATIONS

Power:

JDT 4000 Series: 310mw nominal
 JDT 8000 Series: 600mw nominal

Operate Time:

4 milliseconds maximum @ nominal voltage
 @ 25°C, including bounce

Temperature Range:

-50° to +85°C

Expected Life:

Approximately 20 million operations (resistive)

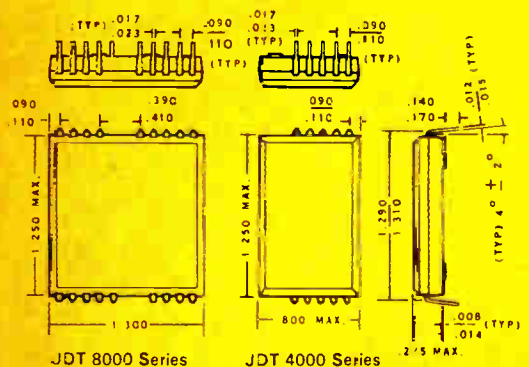

Introducing Potter & Brumfield's unique

dual thin-line dry reed relays

mounted height is only 0.275"

power requirements: only 75mw per pole

combinations of Forms A, B and C are available

Single lot prices are as low as \$7.65
for 4-pole version (JDT 4000 Series)
with 6 or 12-volt coils.
The 8-pole relays (JDT 8000 Series)
start at \$12.95. Quantity discounts
apply. Order sample quantities
today for evaluation in
your most sophisticated design.

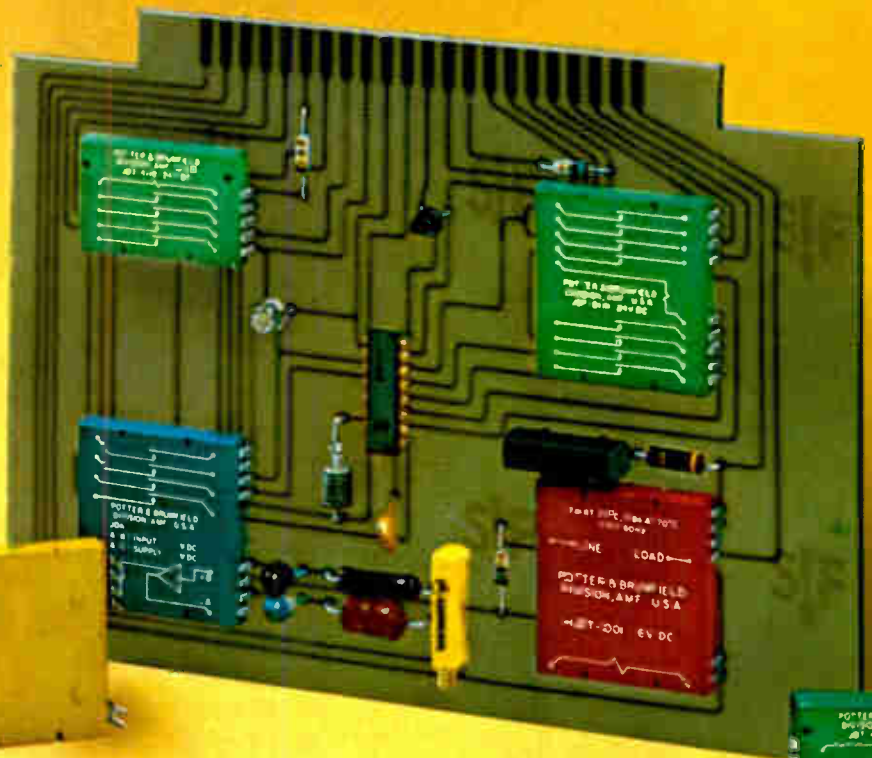

AMF

POTTER & BRUMFIELD

Circle 33 on reader service card

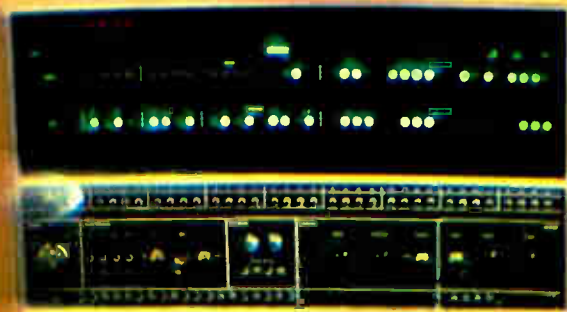

Ultramation: up to 50% better price/performance in a medium-scale computer system

The H632 — first member in the Honeywell Series 32 family of medium-scale computer systems — offers 15% to 50% better price/performance than any computer in its class.

That's Ultramation . . . the ultimate in automation by Honeywell computers.

The field-proven H632 is a 32-bit I/C system that can grow from 8K to 132K words using plug-in modules; from one central processor and one I/O processor to four each.

It's ideal for such on-line real-time applications as trainer/simulators, ground support/checkout, research, and

tracking/navigation. And it has a complete line of peripherals and subsystems.

The H632 offers you special processor capabilities in multi-processor configurations, optimum use of available memory space, and plenty of software. A system-oriented instruction set includes bit, boolean, and halfword operations. Delivery is six months A. R. O.

Find out how much you can save in a medium-scale computer system with a 1740-hour MTBF. For summary brochure on the H632 write Honeywell, Computer Control Division, Framingham, Massachusetts 01701.

Honeywell
A U T O M A T I O N

Editorial comment

Are we ready for IC standards?

Lots of talk but little apparent action has characterized the many attempts to generate workable standards for IC's. Perhaps the fault lies in the broad scope of all efforts to date. Standards may not be needed at all the levels proposed. Documents have been drawn up by equipment manufacturers, the Electronic Industries Association, the Aerospace Industries Association, and Government agencies, but few are in use.

Another impediment to IC standardization is the failure of users to press for registration, and manufacturers have studiously avoided registering any devices with the EIA. Further, IC makers resist the suggestion that specifications ought to include detailed instructions on how the devices are manufactured. And they balk when complex screening requirements are included in the specifications. C.H. Zierdt Jr., chairman of EIA's Committee on Specifications and Standards, notes that attempts to get IC standards are still blocked by Department of Defense policies against coordinating military specifications. Part of the reason device makers have disdained the registration procedure, he says, is the presumed marketing advantage of the claim that "our XXX-series devices are better than anyone else's." (This factor didn't deter transistor makers from entering the market with A & B versions

of standard types and occasionally inventing new type numbers when it suited their purposes.) One thing that no standards committee has yet proposed is a simple registration code to identify families of IC's. The EIA is reluctant to reserve series of numbers so that devices of the same family could carry sequential numbers regardless of when individual IC's within the family were developed.

In the meantime, the lack of registered IC's doesn't seem to be retarding the expected benefits of standardization, namely, device interchangeability, price competition, and off-the-shelf availability. On the other hand, the industry's concerted attempts to achieve formal standards have yielded a good deal of informal standardization. For example, device makers tend to follow closely, if not exactly, the test procedures set forth in MIL-STD 883, and some data sheets are based on EIA's formats.

The industry is about to get another crack at a "general specification for microelectronic devices," when Zierdt's committee submits its final draft for consideration this month. The proposal will have a commendable new feature: it will provide for the specification of any one of four device quality levels (level I requires visual inspection only; level IV includes sampling tests as well as 100% inspection requirements). ■

Safety in the streets

Research and development is a new tool for the Justice Department—one that could be misused. It ought to be directed toward the immediate prevention of crime in the streets, not toward long-range sociological studies.

Prior to 1969 the Justice Department had no vehicle to carry out R&D. Then last year Congress created the Institute of Law Enforcement and Criminal Justice, a subsidiary of the Justice Department, and gave it \$3 million for R&D. In fiscal 1970, the Institute is asking for \$20.9 million.

Congressman James Scheuer (D., N.Y.), who was instrumental in founding the Institute, hopes the bulk of the appropriation will be directed toward hardware development. In a book to be released this month*, Scheuer devotes the first five chapters to the description of needed hardware for the detection and prevention of crime. He believes R&D should be carried out by triumvirates consisting of a law enforcement agency (such as a metro-

politan police department), a university, and a private company.

No firm figures have been set on how much of the \$20.9 million will be directed toward electronics programs. Nevertheless, the new director of the Institute, Henry S. Reuth, is seen by his associates as a "Nixon pragmatist," and is expected to encourage adaption of existing hardware such as transceivers that can be attached to a patrolman's helmet or pocket. One Justice Department official, informed that the military already has comparable transceivers in use for pilot rescue in Southeast Asia, said "I suspect one of the first things we'll do is to get together with Pentagon scientists to see what they've got."

Scheuer's "three-cornered" approach to R&D, coupled with Justice's pragmatism, could accelerate safety in the streets. ■

*To Walk the Streets Safely, by James H. Scheuer, Doubleday and Co., Inc., 1969

**Small, compact size,
yet large capacity;
long life.**

HP RELAYS — High reliability, compact size, long life. Complete standardization and simplification. Both solder and plug-in types available for AC and DC applications. Both types are interchangeable with U.S. components, including pin configurations.

HC RELAYS, HM RELAYS — Especially designed to meet market demand for EDP, computer, process control and many other applications. Features: UL Approval, Extra-long life: Mechanical — 10⁸ / Electrical — 10⁵. High reliability — gold flashed silver-cadmium oxide contacts. Compact size — 1.2 cu. in. AC & DC types. Large control capacity: 3A for 4C, 5A for 2C.



HP RELAYS



HP2-S
S-series — for direct solder tab connection or used with AMP-connectors.

HP2-R
R-series — for plug-in to standard sockets.

FEATURES: UL Approval Long life, high reliability, superior contact performance. DPDT, 3PDT & 4PDT types available at all voltage levels. Both solder and plug-in types available for AC and DC HP applications at 6, 12, 24, 48, & 120 volts. Complete standardization & simplification allow minimized sizes and lowest prices. Totally interchangeable with U.S. components, including pin configurations.

SPECIFICATIONS:

Max. switch-off current10A AC
Max. switch-on current20A AC
Max. contact current10A
Max. contact voltage250V AC
Max. contact power120W
(at DC 24V), 2.5 KVA
Max. pull-in/drop-out time15 ms
Shock resistance10G
Mech. lifeOver 10,000,000

HP 3 RELAYS

Brand new series — 3-pole versions of HP relays, for both AC & DC high power applications.

Circle 36 on reader service card

HC RELAYS

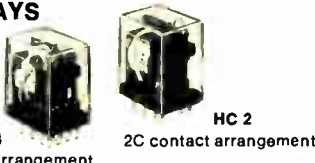

HC 4
4C contact arrangement

HC 2
2C contact arrangement

Especially designed to meet market demand for EDP, computer, process control and many other applications.

FEATURES: UL Approval Extra-long life: Mechanical — 10⁸ / Electrical — 10⁵. High reliability — gold flashed silver-cadmium oxide contacts. Compact size — 1.2 cu. in. AC & DC types Large control capacity: 3A for 4C, 5A for 2C.

SPECIFICATIONS:

Shock vibration resistance10-5G, 55 Hz
Coil voltage6 to 115 VAC, 6 to 110 VDC
Pull in/Drop out time13/10 ms
Temperature range-50° to +50°C
Coil power @ 25°C:
AC=1.20V amps nom.; 0.77V amp min.
DC=0.90 watt nom.; 0.58 watt min.

HM RELAYS

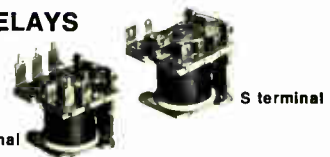

P terminal

S terminal

FEATURES: Minimum 15g contact pressure High life Low price Contact material: gold flashed silver SPDT types available with both P and S terminals at 3V, 6V, 9V, 12V, 18V, 24V, 35V, 42V, and 60V.

SPECIFICATIONS:

Max. switch-off current3A
Max. switch-on current10A
Max. contact current6A
Max. contact voltage250V
Max. contact power90W/1 KVA
Mechanical life20,000,000
Pull-in/Drop-out time12/8 ms
Vibration resistance5G, 55 Hz

Call or write for details:

REMVAC COMPONENTS, INC.
37-55 61st Street, Woodside, Long Island, New York 11377 • (212) TW 9-6100
Agents for U.S. sales of components manufactured by
Matsushita Electric Works, Ltd.

Electronics Newsletter

June 9, 1969

Motorola to offer frequency synthesizer on an ECL chip

The ubiquitous digital integrated circuit may become yet more so when Motorola unveils its emitter-coupled logic frequency synthesizers by the end of this year. The circuits are aimed squarely at the communications market up to 150 megahertz, and will include a voltage-controlled oscillator, a phase-frequency detector, a charge pump which sets the control voltage for the VCO, and presettable down-counters.

Unlike the analog circuits now used in receivers, the digital version will produce a square-wave output and thus create undesirable higher-order harmonics. But Motorola engineers say that a filter will take care of these and that the new IC's still do away with filters used in the analog circuit.

Add S-3A, Awacs to '69 doubtful list

One of the biggest guessing games now going is what new military systems will be started this year. And guessing is about all anyone can do since the Nixon Administration is understood to be willing to trade one or more new-program starts to get the Safeguard ABM through Congress. Among programs that may be on the block is the Navy's S-3A antisubmarine aircraft (VSX). Cancellation could get the Pentagon off an embarrassing hook since a Navy selection board picked Lockheed over General Dynamics just about the time the Army canceled Lockheed's Cheyenne attack helicopter production order because of technical problems. Another program that could be expendable is Awacs, the airborne warning and control system, for which Boeing and McDonnell Douglas are competing.

Some industrial officials also worry about the F-15, the new Air Force interceptor, which is now slated to go to a contractor late this year. The traditional question crops up: does the U.S. need both the F-15 and the Navy's F-14 now being designed by Grumman? Both aircraft are designed to fill the gap left by the trouble-plagued F-111 program, but some wonder why the F-14 couldn't follow the lead of the McDonnell Douglas Phantom, originally developed for the Navy but then purchased in large quantity by the Air Force.

And for some unexplained reason, the request for proposals for the new Air Force strategic bomber, AMSA, continues to slip. Latest word is the rfp will go out late this month, but even this doesn't look very firm.

ICNI to carry Air Force ideas

The "thin-thread" integrated communications, navigation, and identification (ICNI) system, for which bids are due tomorrow, will be an Air Force test bed during the seventies for the development of new operational hardware, modulation schemes, and signal structures of the Air Force Avionics Laboratory at Wright-Patterson AFB, according to Richard Alberts.

Only one contract will be awarded for the initial two-year program designed to demonstrate, with aircraft rather than satellites, the feasibility of the different systems studies made to date. And at the same time, the demonstrations could help convince any Pentagon skeptics that the integration of the basic ICNI functions into a single system, which couldn't be operational until the 1980's, is desirable.

Electronics Newsletter

P-3C's lltv is first for aircraft use

The low-light-level television system on the Navy's P-3C antisubmarine warfare aircraft is probably the first for operational use on any plane. The first two units, which use an image-intensifier, image-orthicon system supplied by General Electric's Aircraft Equipment division, were delivered last month. They replace the high-power searchlight on earlier P-3's. The tv system will enable the P-3C to detect surfaced subs under starlight conditions.

SST funding still stalled

Persistent Washington reports that the Nixon Administration is prepared to let the supersonic transport program die of economic starvation have rattled hopeful avionics suppliers. Unfunded in Lyndon Johnson's budget, the Boeing SST needs \$200 million during fiscal 1970, which starts July 1, 1969, to move from design into construction of a \$1.1 billion prototype.

Washington sources say the President has decided to put off a budget request to the Congress until he gets a reading on the reaction to his plan to extend the income-tax surcharge and repeal the 7% investment tax credit.

Hughes ocr's await stamp of approval

Hughes Aircraft Co.'s Vacuum Tube Products division is awaiting Post Office approval of a \$600,000 contract for 50 optical code readers to process business-reply mail. The scanners would go on sorting machines in Chicago, the world's busiest business-reply center. Hughes spokesmen say the initial installation would pay for itself in 18 months because no sorting machine operators are needed. The cost of ensuing scanners could be made up in about half that time, says Hughes.

Unlike most ocr's, which are passive, the Hughes scanner is an active device. Several scans are taken of the envelopes' bar codes and the system then sorts the mail by company. In demonstration runs, the system has averaged only one error in 10,000 sortings.

NASA software study delayed by semantics

More than half the \$490,000 in grants planned for the NASA Electronic Research Center's Sofix (software fix) program have been assigned, and the remainder should be awarded by month's end. Sofix is to be a minimum five-year effort aiming to make development of software as well planned and controlled as that of computer hardware [*Electronics*, March 31, p. 36].

Addenda

Comsat's planned global communications system will be completed by the end of the month with the positioning of three Intelsat 3 satellites. The most recent bird is being moved into synchronous orbit over the Pacific; the Intelsat 3 now over the Pacific will be moved to the Indian Ocean. . . . Sylvania Electronic Systems-East has submitted to NASA's Lewis Research Center a midterm design review of an antenna for a direct-broadcast television satellite due to fly in the 1975 period. Sylvania is keeping details of the \$99,000 study under wraps until mid-June but does state that the system would be capable of broadcast to individual time zones; also home tv sets could be modified for only \$100 to \$150 to pick up the signal. . . . Indications are that other makers of Texas Instruments' series 54/74 transistor-transistor logic would go along with TI's price cut—an average reduction of 30% in OEM prices.

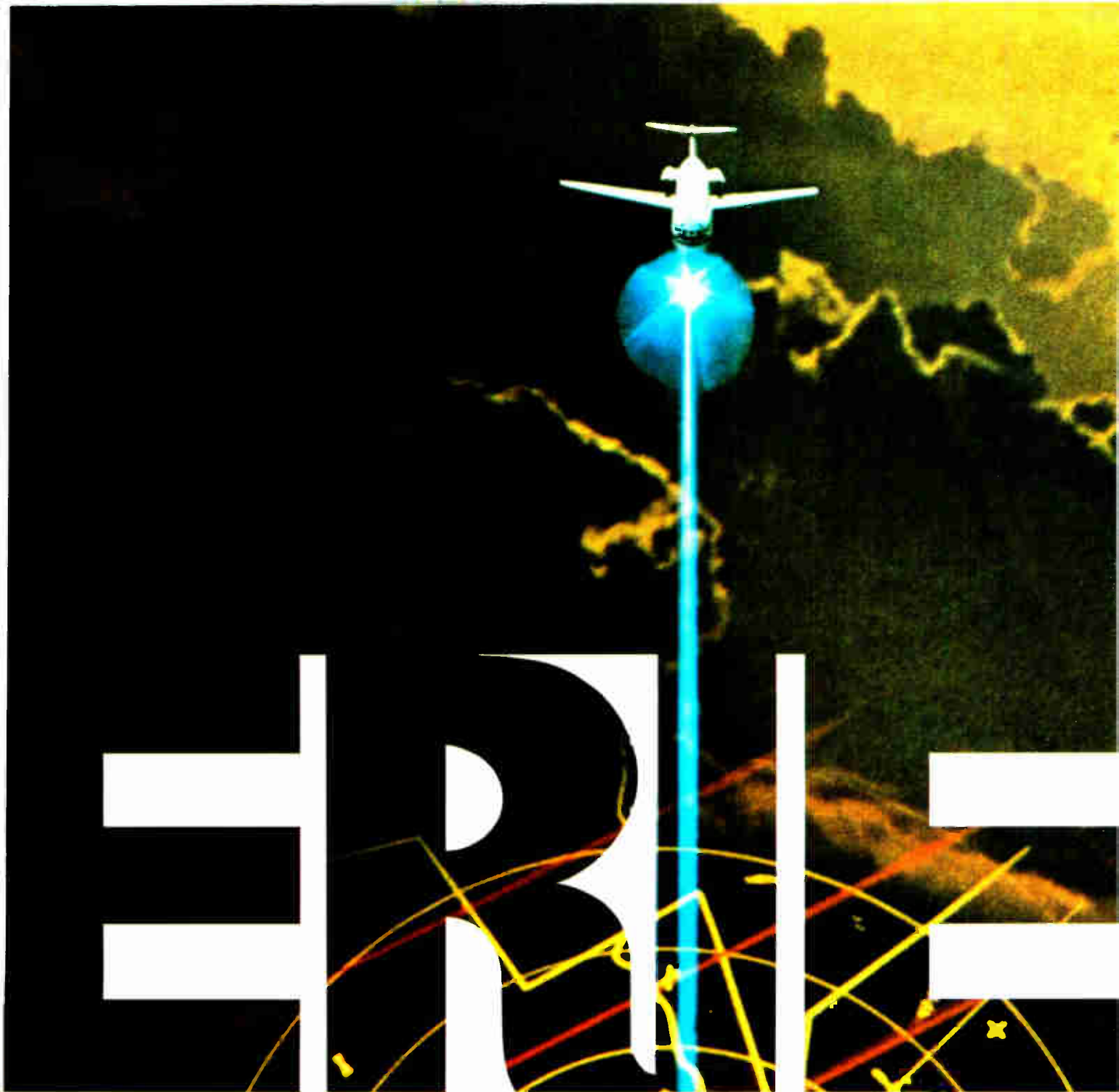

When you want radar as pure and coherent as a laser beam...

Symbolic electronic signal undistorted by EMI —
photographed by Howard Sochurek

bring ERIE in early.

31,000 feet...heavy traffic...ugly weather over the Plains. It isn't his time for "noise" in the radar. But, no sweat! RCA's exciting new AVQ-30X Weather Radar is up front, sweeping the sky...protected from EMI by 35 special ERIE filters. No other airplane radar has ever approached the single or dual system reliability of the AVQ-30. From the start, RCA has called on the outstanding research and component capability of ERIE TECHNOLOGICAL to help in the development of this great new unit. Proof, once again, that it pays to bring ERIE in early.

ERIE TECHNOLOGICAL PRODUCTS, INC.

644 West 127th Street, Eng. Ph. 18512
19141 455-8207

Are you a creative software designer?



Like to join Hughes in California?

You'll be doing conceptual design of new-generation aerospace software systems. For an advanced, real-time computer system.

You'll be part of a small team of exceptional software/hardware specialists. But also part of a growing, highly diversified company where good work and creative thinking are recognized and rewarded.

It's a great spot to grow professionally. And Southern California isn't such a bad spot for your family to grow up, either.

Requirements: Degree (MS preferred) in engineering, mathematics, or physics. At least three years' experience with software systems, assembler and compiler languages, simulation systems, and use of large-scale computers.

Please airmail resume today to:

Mr. Robert A. Martin
Head of Employment
Hughes Aerospace Divisions
Dept. 38
11940 W. Jefferson Blvd.
Culver City, Calif. 90230

An equal-opportunity employer—
M & F. U.S. citizenship is required



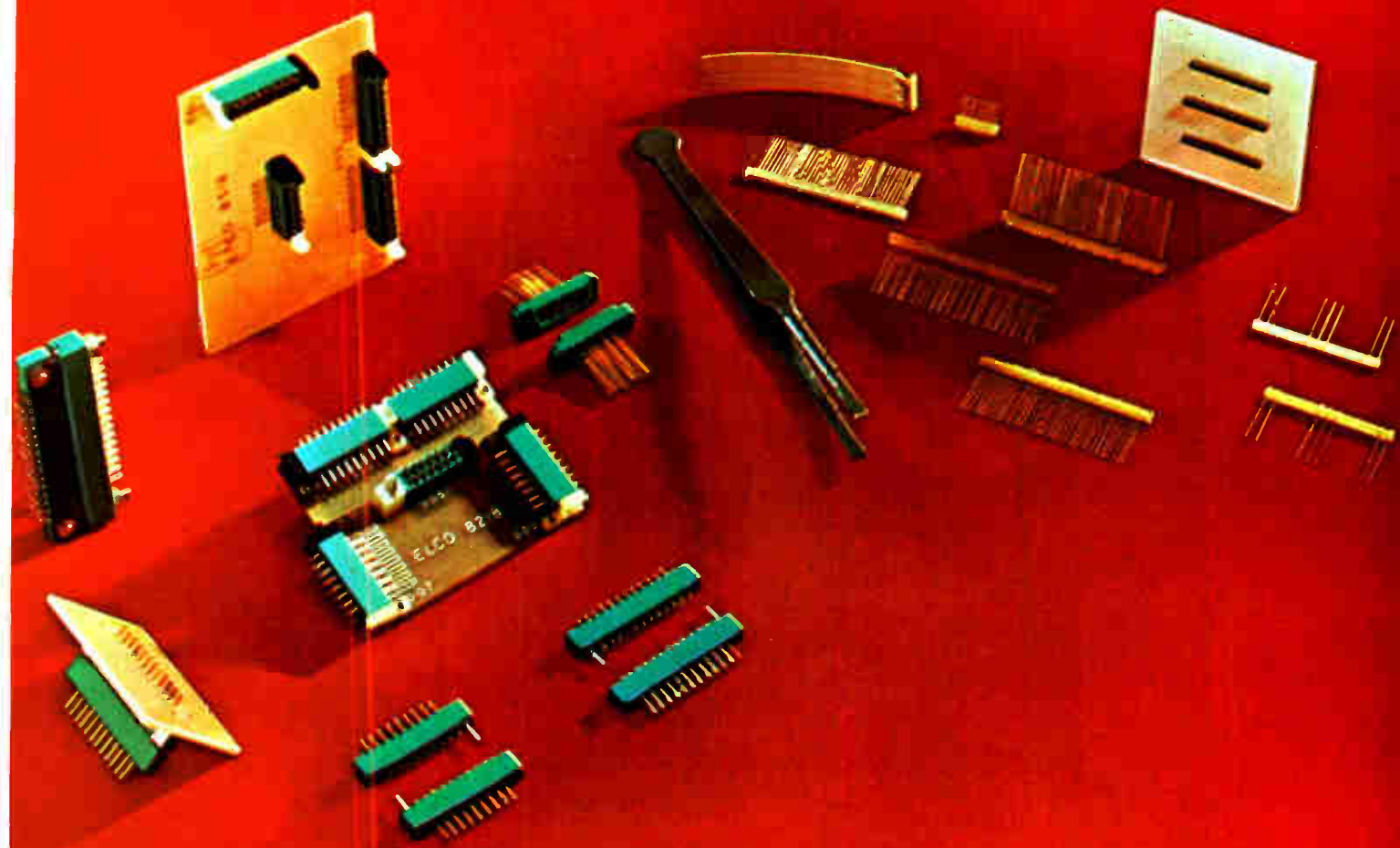

Miniature, subminiature connectors, yes.

Miniature, subminiature contacts, no.

Microelectronics can give you a pain in the tweezers. You have to be perfect. And you have to be perfect in places so small that a flea would have trouble scratching his back.

Actually, the electronics part isn't too hard, what with piezoelectric this's and thin-film that's to work with.

But, inevitably, there comes the day when all the this's and that's have to be put together. It's a problem. Mechanically. Electrically.

You don't want to put a big fat plug on a skinny little mini-circuit.

So you need miniature or subminiature connectors. Those we have. By the catalogfull.

But you sure don't need undernourished contacts. You need all the strength you can get, all the contact area you can get, all the hang-togetherness you can get.

Those we give you. Every miniature in our catalog is made with our patented Varicon™ contacts (you probably already know about them). Our newer subminiatures are made with Bi/Con™ contacts (which

is sketched at the left).

See the four mating surfaces?

Four mating surfaces, coined so that they're exceptionally hard and smooth.

Four mating surfaces, held together snugly by the spring-like action of the design. And by the innate characteristics of the phosphor-bronze.

Four mating surfaces, strengthened by a reinforcing web.

Four mating surfaces, on a contact that floats in its insulator to make sure that the four mating surfaces mate.

No comparably sized contact can match the Bi/Con's dimensional, electrical, and mechanical characteristics.

And no subminiature contact can match the Bi/Con's incredibly low price, either.

For more information, write, wire, call or TWX us for our Microelectronics catalog. Elco Corporation, Willow Grove, Pa. 19090.

(215) 659-7000, TWX 510-665-5573.



Circle 41 on reader service card

ELCO Varicon® miniatures
Bi/Con® subminiatures

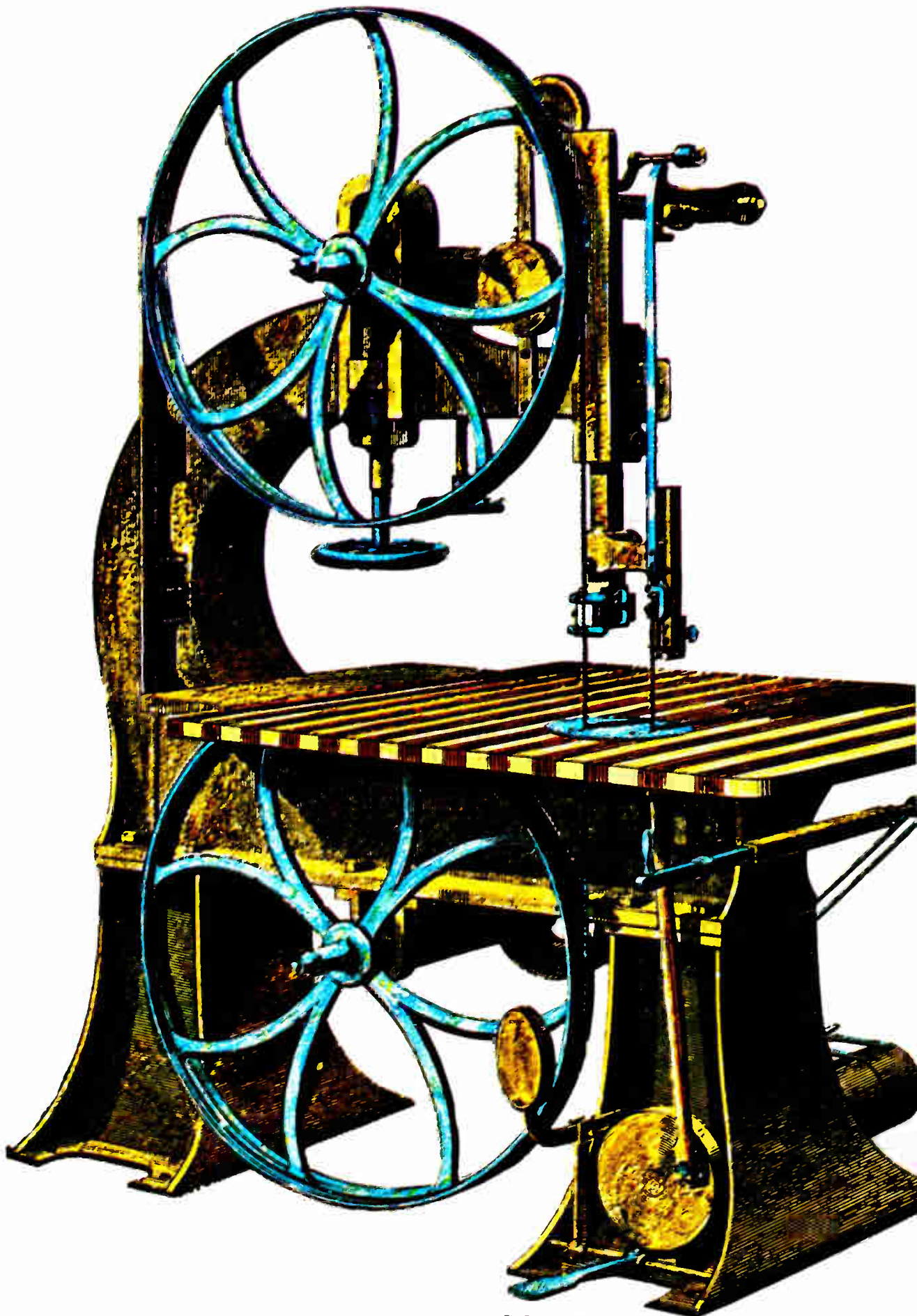

The Bettmann Archive Inc.

MAGNETICS BY ARNOLD



CUT SOME FANCY CURVES! Operating an old-time bandsaw was no push-over. Today, it's a snap of the switch and a motor does it for you...easily, smoothly, steadily. A motor that's probably actuated by an Arnox[®] hard ferrite permanent magnet. What's more, Arnold's magnetic materials perform a similarly efficient job for a lot of other machine tools—including the computer-driven ones.

Forward-looking manufacturers always look to Arnold for high-quality magnetic materials, design, technology, components. Magnetic cores. Powder cores. Laminations. You ask. We'll supply. The best in magnetic materials.



ARNOLD

SPECIALISTS IN MAGNETIC MATERIALS

The Arnold Engineering Company, Main Office: Marengo, Ill.
Branch Offices and Representatives in Principal Cities.

Other Arnold products offer a lot of potential both in machine tool operation and control: MPP and powdered iron cores • Tape and Bobbin cores • Alnico and Arnox[®] permanent magnets • Supermendur transformer cores.



Write for your free guide to the only complete line of magnetic materials.

Plastic ICs

IN TOUGH ENVIRONMENT



95% humidity off Louisiana coast



90°F / 90% humidity in jungle



125° in Sahara desert



- 50°F at Northslope, Alaska

What do these oil exploration sites have in common?

Tough environments and reliable TI plastic ICs.



Conquering the elements is a major requirement of electronic equipment used in geophysical service...

where tough environments demand rugged equipment and components.

Storage temperatures range from -50°F in the arctic to more than 150°F in the desert, operating temperatures from freezing to a searing 130°F .

Tropical rains and salt spray send humidities soaring to 100%.

Modules have even been submerged while crossing jungle streams.

And just transporting the equipment to job sites requires battle with some of the roughest terrain in the world.

Rugged TI plastic ICs have won this battle with heat, cold, humidity and

shock. Approximately 800 TI plastic ICs are used in each of the 150 DFS-III's™—digital seismic field systems—sold by TI's Industrial Products Group to geophysical crews on every continent and ocean. With DFS-III, these field workers instantly collect important seismic data in computer format to help uncover possible oil traps far below the earth's surface.

Out of the 100,000 plastic ICs in service on DFS-III field units, less than 0.03% have failed in up to three years duty. This performance has made DFS-III the industry standard for reliability.

Performance of TI plastic ICs has also established new standards of reliability for many other equipments. Over 1700 TI customers have combined the reliability and low cost of plastic

ICs to the benefit of their systems. Both the number and the diversity of plastic IC applications are growing dramatically.

Reliability Summary

A Texas Instruments reliability summary

For the latest information on the performance you can expect from TI plastic ICs, send for the new Reliability Summary just off the press.

Circle 246 on the Reader Service card for your free copy... or write direct to Texas Instruments Incorporated, Post Office Box 5021, MS 980, Dallas, Texas 75222.



TEXAS INSTRUMENTS
INCORPORATED

together for the first time in one package



the \pm hybrid voltage regulator internally preset to ± 15 VDC

If you use Op Amps, General Instrument's Complementary/Dual Polarity IC Voltage Regulator (NC 572) is made for you. For the first time, + and - 15 V regulators are combined in one IC package providing two isolated and independent control sections of complementary polarity. The NC 572 also provides a combination of features that are superior to those available in any individual positive or negative voltage regulator . . .

For example:

- Output voltages are internally preset to the most popular Op Amp supply voltages, +15 and -15 VDC. Where required, the output voltage can be externally adjusted to any value from ± 13 to ± 38 VDC or factory preset to any voltage within this range.
 - Its high efficiency performance is demonstrated by a minimum required output/input voltage differential of only 1V for the positive regulator and 2V for the negative regulator.
 - Other features include: line regulation of 0.0005% V_o/V_{in} , load regulation of 0.0005% V_o/mA , input isolation of 74 dB min., and a full military operating temperature range.
 - The unit price at 1-24 pcs. is \$30.80; at 500-999 pcs., \$24.20 each.
- The \pm NC 572 hybrid voltage regulator in one 16-lead TO-8 style package is now in stock and immediately

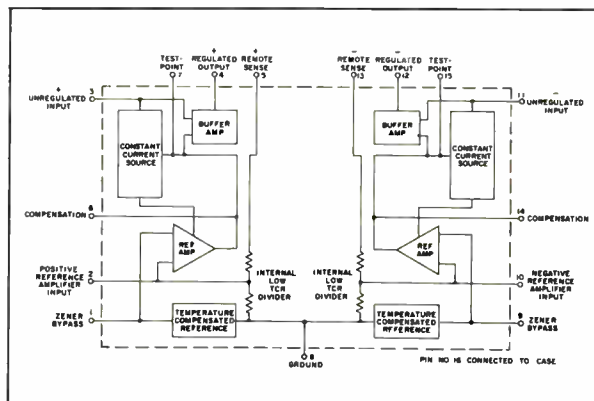

Functional Diagram

available from your authorized General Instrument Distributor.

For complete information, call (516) 733-3244 or write, General Instrument Corporation, Dept. I, 600 West John Street, Hicksville, N.Y. 11802.

(In Europe write to: General Instrument Europe, S.P.A., Piazza Amendola 9, 20149, Milano, Italy. In the U.K. to, General Instrument U.K., Ltd., Stonefield Way, Victoria Road, South Ruislip, Middlesex, England.)



GENERAL INSTRUMENT CORPORATION • 600 WEST JOHN STREET, HICKSVILLE, L. I., NEW YORK

Small wonder:



**Our new "4th generation"
12.5 MHz universal counter/timer**
Wonderful versatility.
Wonderful small package.
Wonderful small price.

With the new Model 100A you can measure average frequency, frequency ratio, single period or time interval, or count total events. It has a crystal-controlled clock, Monsanto integrated circuit construction, and built-in compatibility with a rapidly growing assemblage of accessory modules.

With its \$575 price tag, FOB West Caldwell, New Jersey, you can have big-league counter/timer performance at costs never before possible. Small wonder we are selling and delivering Model 100A's just as fast as we can build them. Accessory modules are also comparably modestly priced.

For a demonstration of our "Small Wonder," the Model 100A universal counter/timer, or for full technical details call your local Monsanto Field Engineer, or contact us directly at: Monsanto Company, Electronic Instruments, West Caldwell, New Jersey 07006, (201) 228-3800.

Monsanto

SWITCH CRAFT FORUM

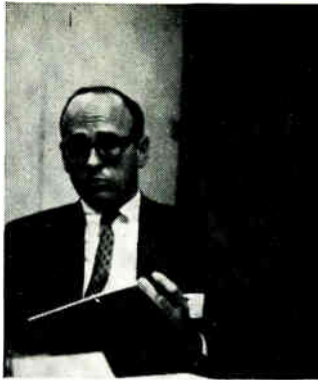

on the new
DW
"Multi-Switch"®*

I can tell you right now, if the new DW "Multi-Switch" doesn't save on space and cost, and offer plenty of versatility it's going to be a dud!

That's the point. Switchcraft designed this compact pushbutton switch to do both. It's not just a scaled down version of an existing "Multi-Switch".

I'll buy your design philosophy so long as you haven't sacrificed the versatility and quality we've been accustomed to on your larger switches. And, don't forget economy.

Let's tackle your points one by one, and see how the new Series 65000 DW "Multi-Switch" shapes up!

We've guaranteed versatility by using simplified modular construction. Essentially, the switch consists of a frame up to 18 stations long, latch bar for function control and switching modules that provide up to 2C (DPDT) circuitry.

Fig. 1

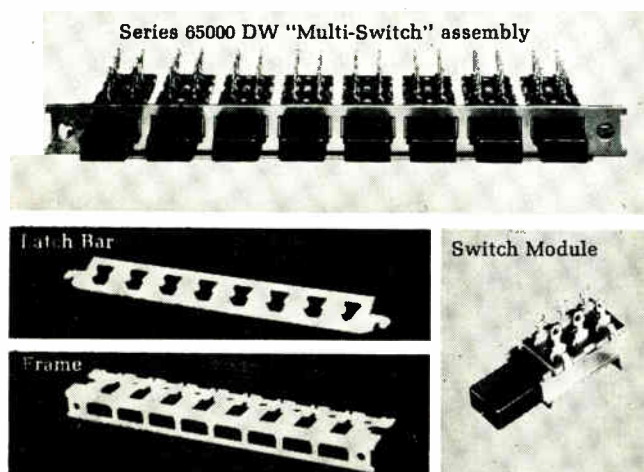

Fig. 1 shows how these elements are combined to complete the switch. The latch bar and mating actuator configuration determine the functional operation, such as: Interlock, All-lock, Non-lock, and even special functions. The push-to-lock, push-to-release function is also available and can be combined with Interlock, All-lock, Non-lock on the same switch frame without any interaction between the various functions.

We don't have space to cover all the versatility details, such as, printed circuit terminals, pushbutton engraving, accommodation for mounting with Tinnerman nuts, etc. JUST CIRCLE THE READER SERVICE NUMBER FOR NEW PRODUCT BULLETIN #174.

*Patent applied for

An example of quality construction is the rigid frame, and double-wipe contactors used for extreme reliability. Fig. 2 shows how the "U" shaped contactor provides positive contact and minimizes "bounce". Also, the molded nylon pushbutton actuators are an integral part of the module. They can't be lost or pilfered. Our quality story ties right into economy. You can't buy a better made, compact multiple-station pushbutton switch for the money.

Fig. 2

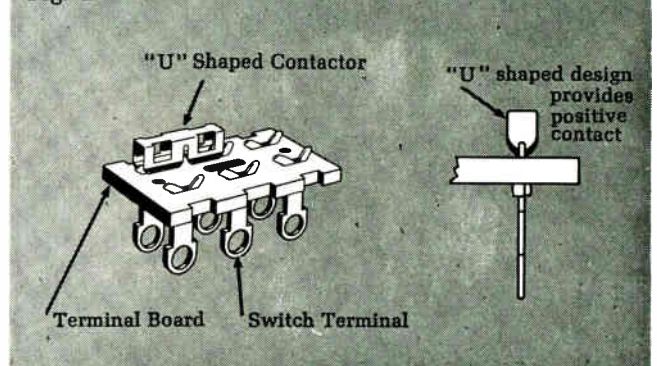

We'll accept the commercial, only because you have the reputation to back it up. The design looks great, but what about ratings and special circuit applications?

Typical ratings for silver-plated contactors would be 3 amps. A.C., 0.5 amps. D.C. 125v. non-inductive. For dry circuit applications, gold flashed contactors and terminals could be furnished. As usual, we're glad to engineer specials to accommodate your volume requirements.

I'll probably have more questions after we get a few samples on test. In the meantime, I'd like certain members of my staff to get complete engineering details on the DW "Multi-Switch" switch.

Just have them drop us a request on your company letterhead for complete technical scoop. Also, we'll add their name to our TECH-TOPICS mailing list to receive this engineering-application magazine every-other month. Over 10,000 engineers find the application stories very interesting and useful in their work.

*Patent applied for

SWITCHCRAFT
INC.

5539 North Elston Avenue • Chicago, Illinois 60630

Electronics | June 9, 1969

Through this ordinary voice grade line pass 9600 bits every second.



Unbelievable? There's nothing to it, really. The Codex Model AE-93 Modem transmits 9600 cps over one voice grade Type 3002, C-2 conditioned line. And with accuracy as good as 2400 bps equipment. So one leased line can do the work of four.

An Automatic Adaptive Equalizer conditions the data. You press a button to start equalization. Three and a half seconds later, the AE-96 is ready to transmit data. It monitors the line and compensates for line changes — 8 times per second. No hours of setup, and no need for manual adjustment.

Codex's AE-96 is in use, and on the production line. Meets EIA RS232B Interface Standards, and MIL STD. 188B.

Want literature? Test results? Full details? Write Richard Young, Marketing Manager, Data Transmission, Codex Corporation, 150 Coolidge Ave. Watertown, Mass. 02172. Phone: (617) 926-3000 TELEX: 922-443.

codex
corporation

Circle 49 on reader service card

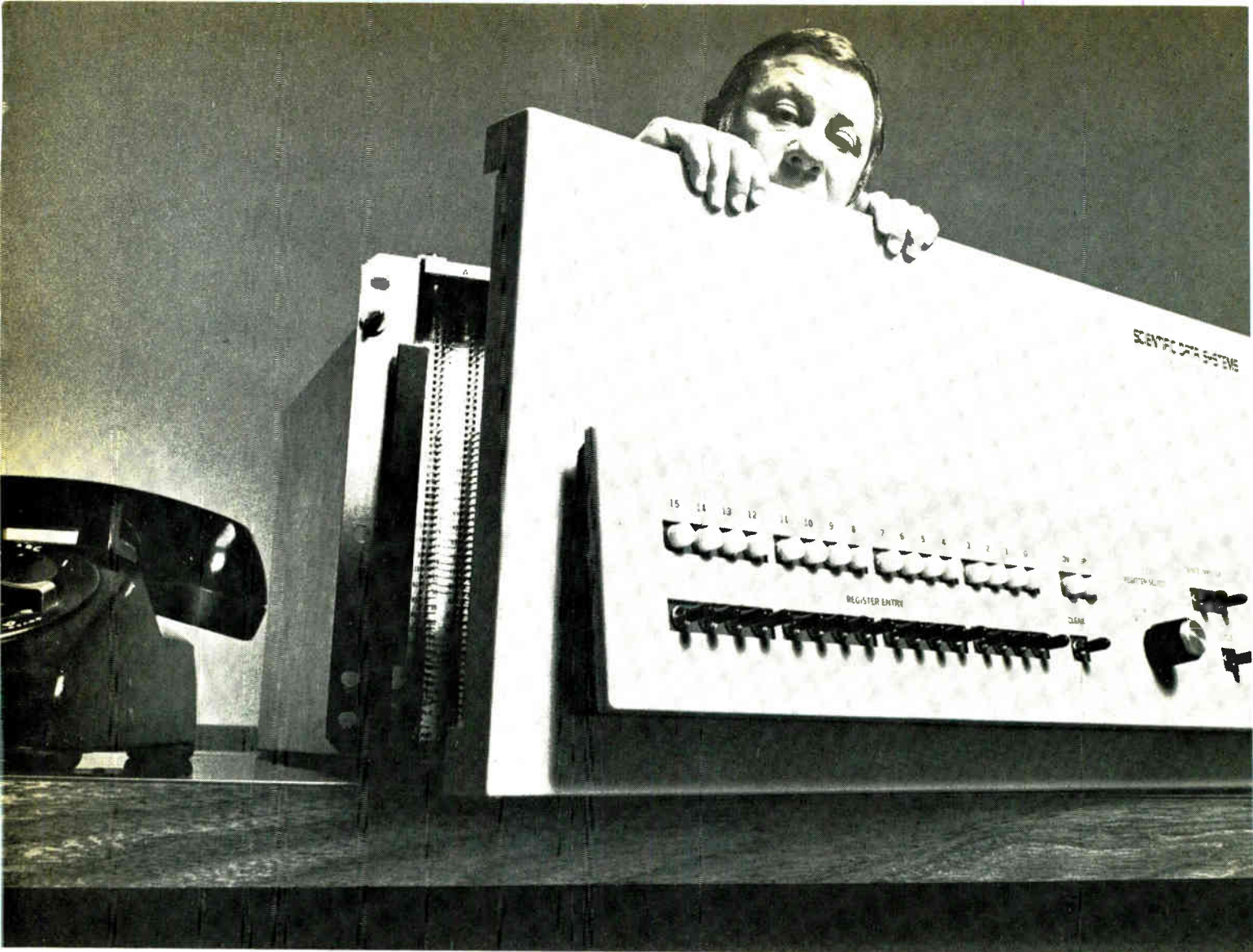

Our new mini-computers have built-in programmers.

Most small computers are designed for programmers. Ours are designed for people.

Just tell our 16-bit machines what you want done. The CE16 and CF16 will do it, because their "built-in programmers" (a comprehensive set of sophisticated instructions) let any engineer use them with ease. For example, the single instruction "scan memory" makes our machines compare a given number with the contents of the entire memory.

The CE16 and CF16 have 125 other heroic instructions that specify comprehensive maneuvers. So you give fewer instructions and use far less core memory than with any other small computer. Problem run times are shortened and Input/Output operations are simplified.

The CE16 and CF16 are designed to control and exchange information with a large number of external devices while doing related computation. Their "automatic I/O" enables them to talk back and forth between memory and a group of interrupting peripherals, in order of priority,

without needing attention from the on-going program.

Automatic I/O isn't a high priced option. Neither is a teletype, nor three priority interrupts, one of which is indefinitely expandable. They're all standard. The only thing you might pay extra for is speed. The CF16 can do a fully signed software multiply in 42 micro-seconds. But it costs a little more than the CE16 which takes 126 micro-seconds (which isn't bad) for the same job.

Don't take our word for all this. Drop us a line asking for:

- A brochure with straight from the shoulder specs so you can compare.
- A representative with more information than could fit in a brochure.
- Or a meeting between our sales engineer and one from any competitor you want, at your office. The competition can even bring a programmer along. We won't have to.

SDS
Scientific Data Systems,
El Segundo, California

The Hill wants a computer—but whose?

Responsibility for the system will fall to the GAO; Budget Bureau links would speed accurate data on Federal spending to puzzled Congressmen

As Congress hovers delicately on the brink of entrance into the computer age, manufacturers' men in the capital are busily trying to wedge a foot in the door. What they're after is not so much the business—although hardware rentals alone for a management information system linking each member to the Budget Bureau's comparable system would run between \$65,000 and \$75,000 monthly—but rather the prestige attached to being the company that automated the Congress.

Still, even though passage of a bill to bring computers to the Hill seems assured now that it has been favorably reported out of the House Government Operations Committee, there still has been no action on specifications. The General Accounting Office, Congress' fiscal watchdog, would be responsible for the system—yet it has neither a computer nor any extensive experience with one. All Congress has said so far is that it wants the most modern equipment, an observation akin to favoring motherhood.

Fast figure. What Congress wants in its link with the Budget Bureau management information system is fast, accurate data on federal spending. Queries, says one Budget Bureau source, could be directed to specific appropriations. "A Congressman might ask, for example, how much was appropriated, or how much has been spent to date and how much is left. It could be broken down by specific appropriations measures or by individual projects within a given appropriation."

In view of strong criticism of Defense Department spending, cost overruns, and imprecisely defined

budget items, little opposition to the bill is anticipated. And backers want it passed quickly since the Budget Bureau has been working a year and a half on its system, and Congress wants to be able to guarantee that the two systems will work together. However, Budget officials say their effort is still largely in the study stage with a contract out to consultants McKinsey & Co.

The Budget Bureau anticipates spending between \$5 million and \$6 million on its system, and Congress could spend at least as much in the long run, especially if a hassle develops on how much access it should have to data from the Budget Bureau, which reports to the Executive branch.

Cranking up. Meanwhile, several specific computer operations already under way could play an important role in the proposed Congressional system. Among them:

- The Library of Congress is developing an information system to keep track of the status of Congressional legislation.

- The GAO has produced a computer-generated key work index to the decisions of the Comptroller-General.

- The Air Force has developed project LITE (for legal information through electronics), a computerized file of essential data relating to rules regarding Pentagon procurement.

According to backers of the bill, the new system could help reduce the budget by billions a year with, paradoxically, much of the savings coming out of electronics-laden programs. The House report on the bill says: "Decisions could be made on costly defense systems when

they begin to exceed original cost estimates rather than after additional millions or even billions in tax funds were obligated."

Adds a committee staff member: "Such programs as the F-111, C-5A, and Cheyenne are going to be used in the debate to get computers into Congress."

Communications

Hear this now

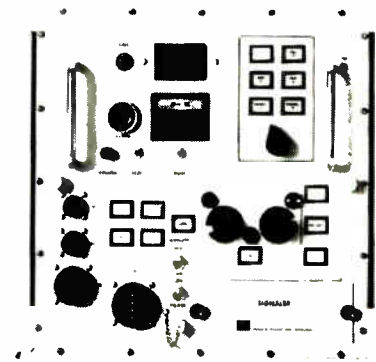

Fast. Digital calling system automatically sets up links for voice communication.

Navy radio operators must sometimes wonder if anybody out there cares. Attempting to set up a voice radio link can be a frustrating affair: 60% to 80% of all calls are delayed from 50 seconds to 3 minutes. And that's a long time in battle. Even after the operator gets through, there's still at least a 20% chance that either he or his party will mess up the security procedure known as authentication and thus have to start the whole business

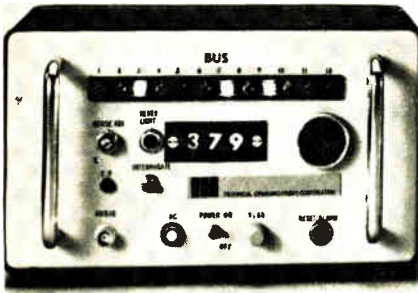

Watchdog. This module assures privacy when used with TCC's digital ship-to-ship communications system.

over again.

The statistics come from studies by the Technical Communications Corp. of Lexington, Mass., which also claims to have some answers to the problems of tactical radio operation. One is a system that automatically sets up two-way voice links—often using a single pushbutton—and handles authentication, too.

No hang-on. Called the digital selective calling system, the scheme cuts the delay probability by 5% to 30% and reduces the delay time to between 3 and 30 seconds. Since authentication is part of the ring-back procedure, there's no chance for human error.

The signalers grew out of Navy-funded studies at TCC in the early '60's aimed at finding the best modulation technique for a random access tactical communications system. Instead of suggesting a modulation format, TCC concluded that random access wasn't necessary and also wasted bandwidth. Also, it found that 50% to 80% of circuit time was taken up with so-called supervision—the mechanics of establishing the link and maintaining security. Often, messages accounted for only 20% of traffic time.

TCC also noted that the Navy's channel utilization seemed inefficient; some frequencies were overloaded, while others were dedicated to certain tasks and nearly never used.

TCC's president, Arnold M. McCalmont, drew the obvious conclusion that a system which could cut

supervision time would speed up communications. He also drew the less obvious one that since most calls were between two parties rather than from one party to many, time could be saved and channel utilization could be improved by giving each user multiple access to only two or three channels—regardless of mission.

Push to talk. Out of this came the digital signaler. Now instead of sending out a voice call sign and awaiting a reply, a radioman selects a two-digit address and pushes a button (addresses of frequently called parties can be preset). A digital encoder and an audio-frequency modem convert the address to a binary code which is sent over an ordinary radio channel.

At the other end of the link a similar signaler "guards" the channel—in other words, awaits its own binary address code. When the code appears, the signaler flashes a light and beeps to indicate an incoming call. It also displays the caller's numerical address. In response, the radioman presses the authenticate button, and as he does, his signaler sends back a much modified version of his address code. The ring-back tells the caller not only that he has reached another party, but also that he has reached the party desired.

Thus the signaler eliminates repeated voice calls, garbled responses, and the time taken to look up—and often mistake—authentication signals. It also finds circuit space whenever possible.

Calls pass over either of two radio channels, and the operator can select the free one. If both are busy, and the message is important enough, the user can press a pre-empt button that signals other users to vacate a circuit. The signalers in the circuit will give each user a countdown as well as an initial tone signal; thus they know not only that they must get off the air, but also how long they can stay on—usually less than 10 seconds.

Busy users can watch a hold light that signals an attempt to contact them. The hold feature also includes a display of the caller's address so that return is swift.

Step two. Through it's only now

entering sea trials, the digital signaler is only the first in a two-part plan TCC has for aiding naval communications. In the second part, the patch panels now used to connect remote radio-telephone stations with particular transmitters and receivers would be replaced with a computer-controlled switching system like a small electronic telephone exchange.

This switching system would be the heart of the Somada communications system (for self-organizing, multiaccess, discrete address). From a digital signaler, the user would go through the same steps already outlined, but with potentially far more addresses and many different frequencies at his command.

Frequencies would be allocated by the computer, and the user normally wouldn't know what frequency he was talking on, or whether his message were being relayed via satellite or through a random access discrete address system. Somada's key advantage, according to McCalmont, is its flexibility; the transmission medium could be anything from vlf radio to laser beams, and the mix could be changed when necessary. Less recabling would be needed when new communication gear is installed; only the computer-controlled switching system would be affected. This will allow the Navy to update communications gear in an evolutionary way, adding new gear as needed, ship by ship, and at less cost than is now possible.

Finally, he estimates that a Somada system will use the radio spectrum 66% more efficiently than present schemes—"We would use fewer frequencies more intensively," he says, and adds that even the digital signaler alone could double frequency-utilization efficiency.

To top it off, the program so far has been inexpensive as defense programs go. Only about \$500,000 in off-again, on-again, Vietnam-afflicted funding has been spent. Compared with concepts like RADA, which have much the same goals—but which already have cost more and promise lavish use of bandwidth—TCC's digital signaler/Somada scheme looks like a bargain.

Electronics Index of Activity

June 9, 1969

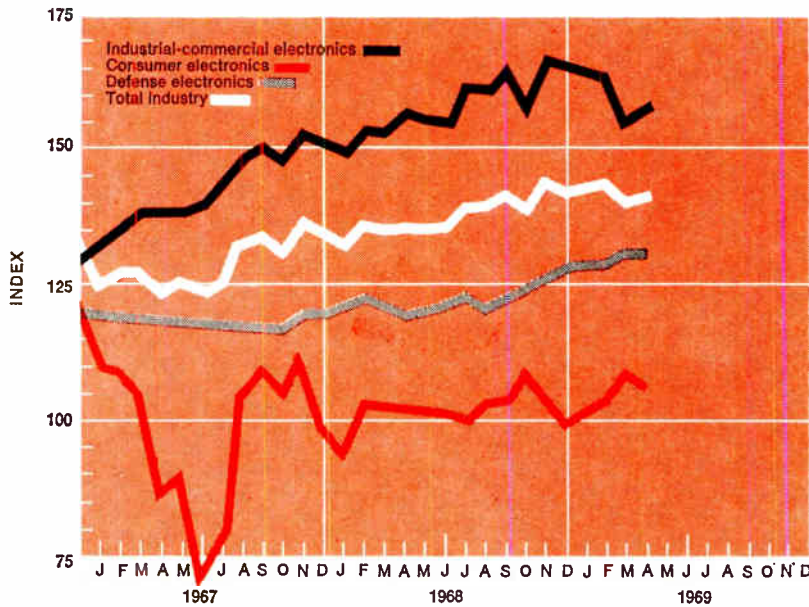

Segment of industry	April 1969	March 1969*	April 1968
Consumer electronics	107.1	110.8	101.8
Defense electronics	158.6	163.3	153.3
Industrial-commercial electronics	131.5	130.1	120.3
Total industry	141.9	144.6	134.9

Electronics production in April was down for the first time in six months, slipping 2.7 points from the revised March figure to 141.9. However, the overall index continued to run ahead of the year-ago figure by 7 points. Contributing to the April decline were the consumer sector, off 3.7, and defense, down 4.7. Only industrial-commercial continued its uninterrupted 1969 climb by rising 1.4 index points.

The downcurve coincided with a report from the Electronic Industries Association on consumer electronics sales showing totals for the first quarter up from the first quarter of 1968. Television totals rose to 3,363,965 from 2,796,074, with color sets accounting for 1,604,962 of the 1969 total. And the home radio market was 8.3 million units compared to 6.2 million.

Indexes chart pace of production volume for total industry and each segment. The base period, equal to 100, is the average of 1965 monthly output for each of the three parts of the industry. Index numbers are expressed as a percentage of the base period. Data is seasonally adjusted. Revised*

Companies

Licking the platter

Signetics and the General Instrument Corp. might have been made for one another like Jack Spratt and his wife. Signetics, the fourth-largest integrated circuit maker, lacked a sufficiently large product line to grow as fast as it wished: GI, which at one time practically owned the MOS market, had been staggered by production difficulties and personnel defections, and desperately needed a second source on a couple of large contracts. The solution the two companies came up with: let Signetics share GI's MOS technology.

The agreement signed by the two companies late last month provides for the exchange of sufficient technical information to allow mutual second-sourcing of metal-oxide-semiconductor circuits. Signetics actually gives up nothing,

neither money nor technology, because its own MOS effort is miniscule. By signing the agreement, it not only establishes itself in the MOS business, but also wins access to GI's biggest customers—principally the National Cash Register Co., which will use a GI 256-bit dynamic shift register in its century computer series.

Wanted. NCR reportedly demanded a second source on its contract, and it was this order that provided the impetus for the agreement with Signetics. But GI officials are well aware that inviting Signetics to help out may be like inviting the camel into the tent. Signetics has a reputation as a reliable producer, and it could conceivably grab a sizable share of GI's custom business. (The agreement is unique in this respect, for there are no other second-source orders on custom circuits outside the military). With at least two huge production orders

in house, GI apparently felt that the risk was worth taking.

"The second source always has to learn how to make the parts," pointed out one semiconductor maker, "and it always turns out that the first source doesn't tell them everything."

Nonetheless, even before the contract was signed, Signetics sent a task force to GI's Hicksville, N.Y., plant to work out details for the technology transfer. It has had a small MOS contingent since January, working under Donald C. McKenzie. The company will make MOS circuits in its new 70,000-square foot plant in Orem, Utah.

Signetics is getting into the market at a ripe time. Although 1968 was a disappointing year for MOS, with total sales estimated at just over \$13 million, MOS orders have been exploding in 1969, and most manufacturers expect the market to double this year. The mere entry of a new and reliable producer

U.S. Reports

may increase the market.

Selective. Signetics will probably not second-source the whole GI line, because it has grown haphazardly as custom products were altered slightly for inclusion in the catalog. Also, the circuits operate at voltages too high for direct interface with bipolar logic. Under new president William C. Hittinger and new microelectronics boss J. Leland Seely, GI has been re-vamping that line; it recently introduced a silicon nitride passivation process to obtain low-voltage operation, directly compatible with bipolar circuits.

The NCR contract was for high-voltage circuits. But Signetics will get the nitride process as well, under terms of the agreement.

Military electronics

Early help

The Navy's operational test and evaluation force (Optevfor) in Norfolk, Va., has asked to be cut in on early design review conferences for new hardware systems. The reason: Optevfor is anxious to counter the so-called designed by geniuses for use by idiots syndrome that tends to foul up certification of systems for fleet use.

The syndrome is common to much military hardware and hinges more on poor design rather than on workmanship; it also plays a part in the overly complex documentation for system maintenance by enlisted technicians.

Disclosure of the Optevfor request was passed to industry at the closed Systems Performance Effectiveness Conference sponsored by the Naval Material Command. Passing the word was Cdr. Jerrold M. Zacharias, back from Vietnam and now attached to the Attack Air Warfare section of Optevfor, where hardware faces its biggest hurdle—certification for fleet use.

Shortcomings. At the meeting in Washington, Zacharias cites, among others, the following electronics systems deficiencies:

- Ignorance of human engineering that produces ambiguous and

obscure labeling of control switch functions; poor visibility, readability, and interpretability for instruments; lighting panels with no intermediate intensity ranges; and, in the case of one missile, clustering of five toggle switches so close that all five can be covered by a pilot's gloved hand. Quick reaction conditions requiring use of this switch bank, said Zacharias, "often resulted in inadvertent disablement of the entire missile system."

- Design changes in another missile which affected system receiver sensitivities; inability of the elevation tracker in a fire control system to keep up with a ship's roll in any weather since the hardware was designed for ships with an eight-second roll period though the test ship has a four-second roll period; modifications to a data processor in a sonobuoy evaluation, and a computer program change in a carrier landing system lead to the testing of equipment that is "no longer representative" of production models.

- Total absence of maintenance documents or the presentation of documents so complex—no less than engineering drawings and block diagrams in one case—that fault location by technicians is slowed, mean-time-to-repair increased, and equipment given low test marks because of it.

Zacharias, citing his service as commander of a Grumman A-6A Intruder squadron before the North Vietnam bombing halt, hinted that the plane's avionics problems were more plentiful than previously indicated despite the high public praise given the aircraft's capability for all-weather operations over high-threat targets.

"Failure of any component, even the radar altimeter, during the mission into a high threat area can cause the flight to abort," he said. He specifically cited such complex subsystems as the inertial navigation system, digital ballistics computer, and search and track radars.

Industry registrants later were inclined to construe his comments on A-6A failures as directed principally at bugs in Litton's digital integrated attack navigation equipment (Diane), now corrected.

Integrated electronics

One-way road

While some companies are combining technologies to produce faster and more accurate analog-to-digital converters, Ragen Semiconductor, a division of Ragen Precision Industries, is applying a single technology—complementary metal oxide semiconductors—to produce a smaller one.

Under a contract with the Air Force Avionics Laboratory at Wright-Patterson Air Force Base, Ragen is developing a monolithic CMOS a-d converter with a resolution of 12 bits, and an accuracy of 0.1% of full scale. There are integrated circuit a-d converters, but these consist of one or more packages of bipolar or p-channel MOS circuits and one package containing a monolithic or thick-film precision ladder network. Ragen's unit will be contained in one 28-lead ceramic package with one, or at most two chips. The problem here is that seven capacitors are required, and if they pose a size problem when constructed on the circuit chip using MOS devices, then they can be made on a second chip employing thin-film techniques.

Another difference. But reducing the a-d converter to one package is not Ragen's only claim to innovation; the precision ladder network is being replaced by a self-calibrating logic circuit which provides automatic compensation to maintain the accuracy of the device over a temperature range from -55°C to $+125^{\circ}\text{C}$.

Essentially, the circuit consists of high- and low-voltage comparators, a ramp generator, an oscillator, and a counter. The comparators are set to voltages proportional to the positive and negative inputs. Next a positive voltage ramp is generated and applied to the comparators. When the negative comparator switches, a 12-stage binary ripple counter begins counting pulses from the oscillator. When the positive comparator switches, the counter stops. Thus the number of pulses counted is a measure of the voltage, and

NEW FLAT PAK DESIGN ONLY 0.1" THICK

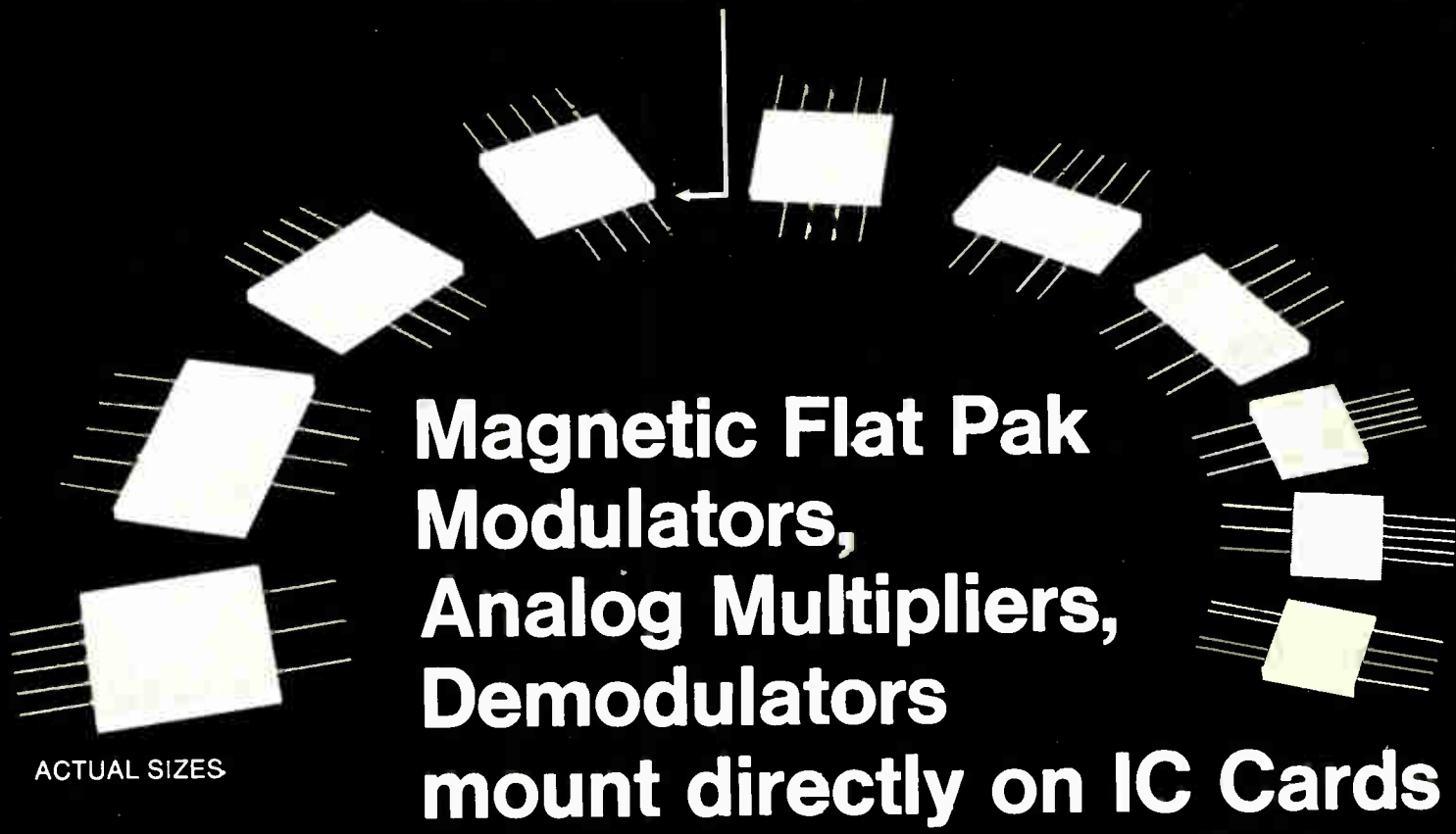

Magnetic Flat Pak Modulators, Analog Multipliers, Demodulators mount directly on IC Cards

ACTUAL SIZES

- Hybrid assemblies mount directly on IC cards.
- Space saver design . . . typical dimensions 0.1" thick x 0.5" x 0.75".
- Rugged design, extreme reliability. MTBF design goal 0.25 per million hours.
- Extremely low drift over -55 to +125°C range.
- Not affected by high intensity nuclear radiation.
- Capable of operating on carrier frequencies as high as five Mhz.
- One or more isolated or floating input signals may be used for modulating, multiplying, dividing, squaring or extracting a root.
- No external nulling or offset adjustments.
- No additional components or compensation required.
- No external operational amplifiers required.
- Standard ± 15 V DC power supplier unless otherwise specified.

TYPICAL FUNCTION PERFORMED BY THESE COMPACT MODULES

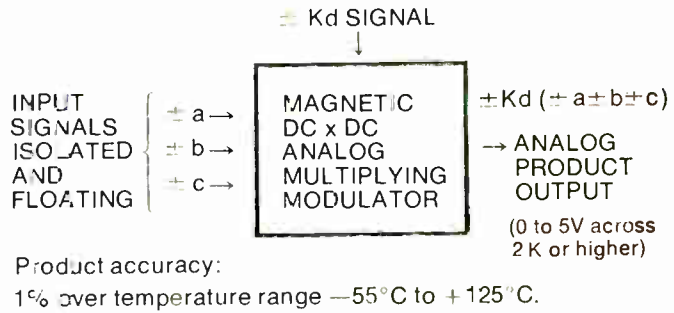

TYPE NUMBER	IMM 1199-1	IMM 1210-1	IMM 1212-1	IMM 1214-1
Reference Carrier Voltage and Frequency	10 V RMS @ 1800 Hz	10 V RMS @ 400 Hz	5 V RMS @ 25 KHz	5 V RMS @ 100 KHz
Input Control Signal Range	0 to ±1.5 ma DC	0 to ±300 ma DC	0 to ±5 V DC	0 to ±10 V DC
DC Resistance of Input DC Signal Winding	8 K ohms	30 K ohms	10 K ohms min	< 5 K
AM Phase Reversing AC Output Range	0 to 5 V RMS @ 1800 Hz	0 to 5 V RMS @ 400 Hz	0 to 5 V RMS @ 25 KHz	0 to 5 V RMS @ 100 KHz
Differential Gain RMS mv AC Output/ua DC Sig. Input	4 mv RMS /ua DC	16.5 mv RMS /ua DC	1 V RMS / 1 V DC	0.5 V RMS / 1 V DC
AC Output Null (Noise Level) RMS	1/2% f.s.	1/2% f.s.	0.5% f.s.	0 to 5 V RMS @ 100 KHz
Output Impedance External Load	> 50 ohms	< 50 ohms	< 50 ohms	< 50 ohms
Excitation (Carrier Winding) Impedance	4 K ohms	25 K ohms	10 K ohms	1 K ohms
Zero Point Drift over Temp. Range Referred to DC Input Terminals	0.25% f.s.	0.5% f.s.	0.5% f.s.	1% max
Hysteresis in Percent of Max. Input DC Signal	0.2% f.s.	0.5% f.s.	0.5% f.s.	0.5% f.s.
% Harmonic Distortion in Output Wave	5%	10%	< 5%	< 5%
Temperature Range	-55°C to +125°C	-55°C to +125°C	-55°C to +125°C	-55 to 100°C
Frequency Response	DC to 200 Hz	DC to 100 Hz	DC to 2.5 KHz	DC to 10 KHz
Overall Dimensions (in inches)	0.1 x 1.0 x 1.0	0.1 x 1.0 x 1.0	0.1 x .75 x .625	0.1 x .75 x .625
Type of Mounting	Flat Pak Terminals	Flat Pak Terminals	Printed Circuit Flat Pak	Printed Circuit Flat Pak

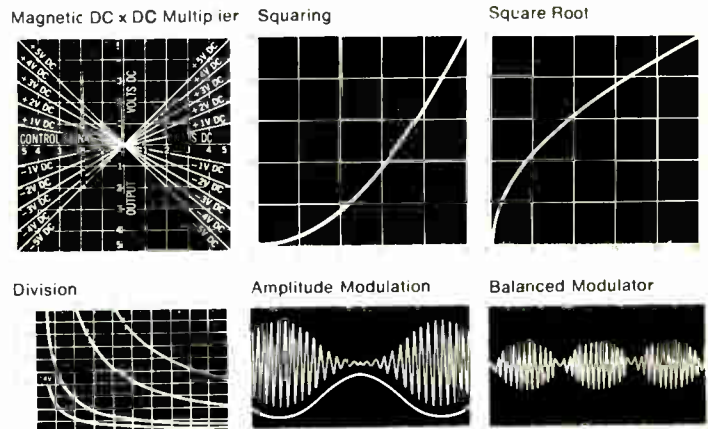

There is No Substitute for Reliability
GENERAL MAGNETICS, INC.
 135 Bloomfield Avenue,
 Bloomfield, New Jersey 07003

Circle 55 on reader service card

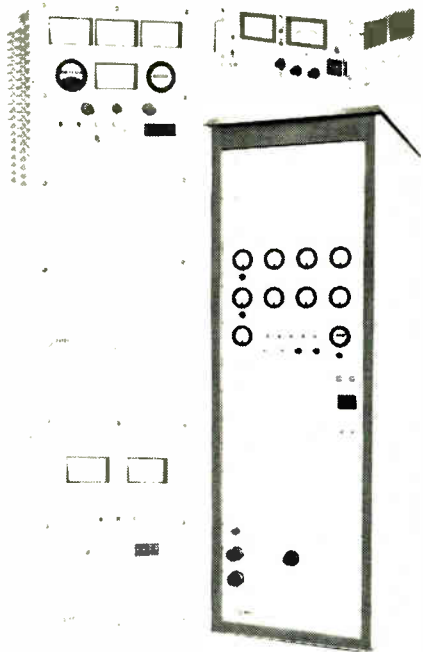

Almost-off-the-shelf solid state frequency changers for custom applications.

Avtel Solid State Frequency Changers are built from pre-assembled, pre-tested modules. We offer 46 models in our CR and TR Series with 31 standard options in power ranges from 250 VA to 50 KVA. Chances are a million to one that we have a model ready to assemble that will meet your special design requirements.

Our CR and TR Series feature:

- Uninterruptible power, optional on all models.
- Four frequency ranges and 13 power levels.
- Less than 2% THD.
- Adjustable voltage/current.
- Regulation better than 1% from combined effects of line load and temperature.
- Efficiencies in excess of 85%.
- Compactness approaching 3 KVA per cubic foot.
- High mean-time-between-failure.
- Low mean-time-to-repair.
- Most popular models in stock.

We also manufacture Inverters and Uninterruptible Power Systems to one million VA. Send for complete details.



1130 East Cypress St. • Covina, California 91722
Phone (213) 331-0661 • TWX (910) 584-1311

U.S. Reports

appears as a binary number at the output of the counter.

According to Albert Medwin, general manager of Ragen Semiconductor, CMOS was chosen because of its high speed (higher than p-channel MOS but lower than bipolar devices) and low power consumption. Initial specifications call for a maximum power consumption of 300 milliwatts, a 280-kilohertz bit rate, and a-c or d-c inputs with a swing of ± 7.5 volts. Medwin says that the Air Force is interested in a one-package a-d converter because it would eliminate noise in getting data from a transducer that might be located at the tip of a wing, and at the same time save weight.

As an example, Medwin points out, the Boeing 747 has about 300 remote transducers. Their outputs are transmitted along twisted-pair lines to a central location, and because they might be on the order of a few millivolts, they are very susceptible to noise. The a-d converter requires only one signal wire and uses a common lead as the other. And the power supply leads don't have to be fed to each converter from a central location; they can be strung from unit to unit around the plane.

Space electronics

Speed merchant

About 99% of the digital transmissions from spacecraft can be handled with data rates of less than 10 million bits per second, says Robert Gottfried, assistant laboratory manager in the Data Systems Laboratories at the TRW Systems Group's Electronic Systems division. To handle that other 1%, an effort is under way there to develop analog-to-digital converters that can handle at least 600 million bits per second—and possibly 1 billion bits per second.

TRW officials expect to have a brassboard—the step beyond a breadboard—of the 600-megabit encoder in about two months and an engineering model by early next year. Gottfried says the ultrahigh-

speed a-d converters will be needed to digitize signals from a video source having a very wide bandwidth (30 megahertz) and to digitize analog signals as soon as possible onboard a spacecraft to facilitate downstream data management before transmission to a ground station. This could include data compression, digital filtering and digital transmission.

TRW officials foresee their a-d converter being used to digitize signals picked up by television cameras in meteorological satellites and earth resources satellites, among other imaging systems. Gottfried notes the availability of high-speed logic has been a big help in making these high-speed a-d converters possible. "But we need more than logic. The system organization, types of devices used, heat removal, and packaging all have to be considered concurrently to come up with an overall solution to the problems involved in such high speeds," he says. "At these rates, the system layout becomes as much a building block as the logic. The interconnections are transmission lines, and we want to minimize their lengths so that we don't get reflections." One way TRW engineers have chosen to simplify interconnections and minimize power requirements is to design their own LSI bipolar array combining linear and digital circuitry, thereby mechanizing the converter's comparators, strobe gates, flip-flops, current source switches, and current sources.

No waiting. The LSI design is about ready to be made into hardware at TRW Systems' Microelectronics Center. Gottfried says, however, that the brassboard won't have to wait on the arrays; it will be mechanized with high-speed emitter-coupler logic (Motorola's MECL 3) and with such discrete linear components as wideband 2-gigahertz transistors, hot-carrier diodes, and wideband transmission line transformers with delays of one nanosecond or less.

The 600-megabit encoder using available ECL and discrete linear devices has two sections, one following the other. The first, which consists of comparators, flip-flops,

Pick the
BEST IC
 for the job

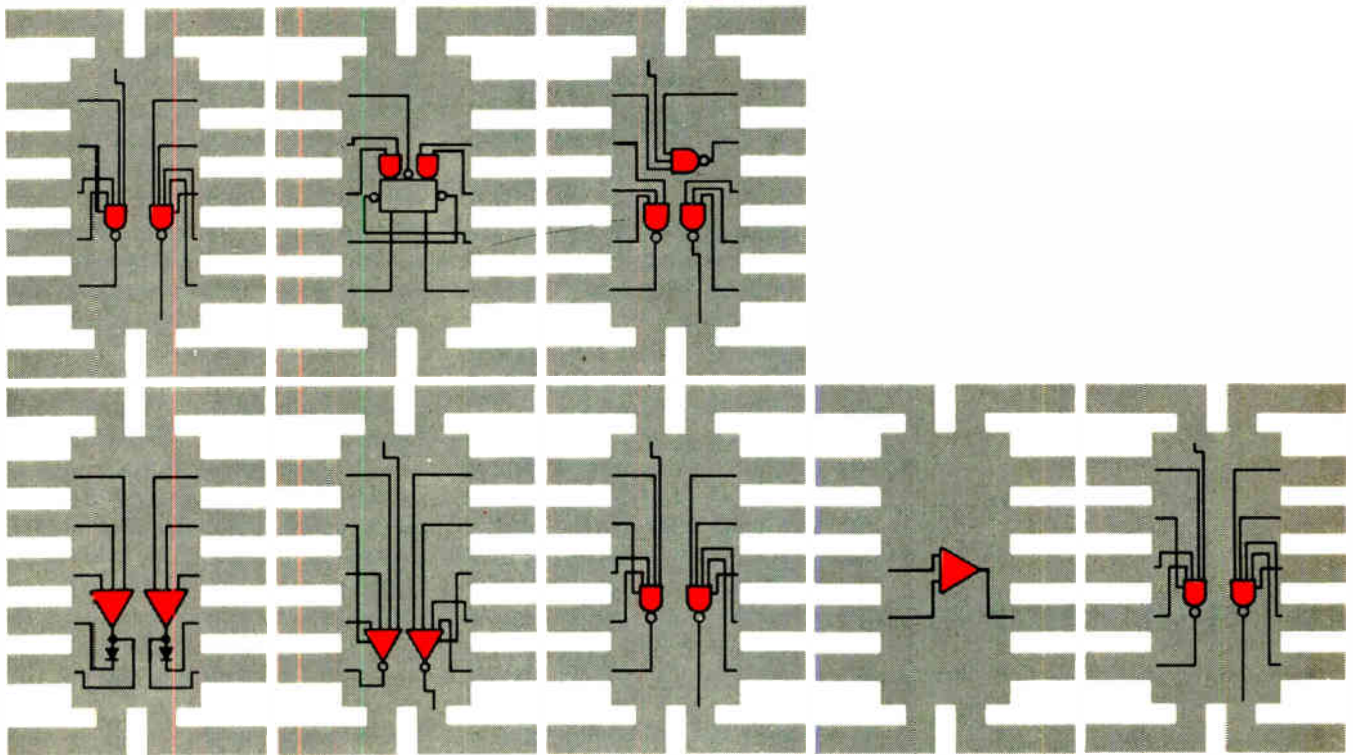

Best line of defense against radiation environment

Radiation offers the circuit designer two orders of magnitude improvement in hardening levels over conventional PN junction devices. This is accomplished by dielectric isolation, thin-film resistors over oxide, small-device geometries, shallow diffusions and other special IC design techniques. So when you pick the Best IC for a radiation environment application, doesn't it make sense to come to the leader in hardened circuit technology?

Our line of defense consists of 930 series DTL, a level shifter, a line driver and a linear 709. These are not prototype circuits. We can deliver Dual 4 Input; Dual 4 Input Power or Triple 3 Input Gates; Clocked Flip-Flop; Dual 4 Input Buffer; Dual Level Shifter; Dual Line Driver and 709 Operational Amplifiers. With the exception of the Dual Level Shifter and Dual Line Driver, all are plug-in replacements for their non-hardened 930 Series and 709 counterparts. The Hardened Dual Line Driver is a pin-for-pin replacement for Radiation's standard RD 209 Line Driver.

Want more information? Contact your nearest Radiation Sales Representative. He'll give you complete details and help you pick the Best IC for the Job.

WE MAKE THE **BEST IC** FOR THE JOB



RADIATION
 INCORPORATED

SUBSIDIARY OF HARRIS INTERTYPE CORPORATION
 MICROELECTRONICS DIVISION

RADIATION SALES OFFICES: P. O. Box 476, Lexington, Mass. 02173, (617) 862-1055 • 600 Old Country Road, Garden City, N.Y. 11530, (516) 747-3730 • 2600 Virginia Ave. N.W., Washington, D.C. 20037, (202) 337-4914 • 6151 W. Century Blvd., Los Angeles, Calif. 90045, (213) 670-5432 • Saratoga, Calif., (408) 253-5050 • P. O. Box 37, Melbourne, Fla. 32901, (305) 727-5430 • International Sales: Marketing Department, P. O. Box 37, Melbourne, Fla. 32901, (305) 727-5412



BUILDING BLOCKS for your system

Model No.	Frequency (MHz)	Small Quan. Price
4208	50-125	\$250.00
4209	125-250	325.00
4210	250-500	400.00
4211	500-1000	475.00

Delivery: 30 days or less

10 milliwatts power output
 • +0.003% frequency stability over -20°C to +65°C
 • 45-db spurious and harmonic rejection
 • no restriction on load VSWR • 15 VDC at 30 to 65 mA
 • reverse-polarity protected
 • 3-mm female RF connector
 • 2.8 to 4.9 cu. in.
 • 2.4 to 4.5 oz.

Optional features: Greater frequency stability • wider temperature range
 • higher power output • frequency trimmer
 • adjustable power output • greater reduction of spurious and harmonic outputs.

Crystal-controlled microwave sources up to 18 GHz



ZETA LABORATORIES, INC.

616 National Avenue, Mountain View, CA 94040
 Telephone (415) 961-9050

U.S. Reports

and d-a converters, determines the three most significant bits of data in the video signal. The d-a converter processes the digital data for acceptance by the linear comparators in section number two. These units determine the three least significant bits in the video signal and transfer them to flip-flops in the second part of the second section. The flip-flops in each section store the bits of interest and transfer them to a decoder and buffer, which puts them into proper format to be swept out serially and transmitted to the ground by pulse-code modulation.

Cutback. But to get the 100 million 6-bit samples per second required for the 600-megabit data rate, two parts of both sections one and two are interleaved; each has seven channels. Gottfried says this requires some 600 discrete linear and conventional integrated circuit parts, affording acceptable weight, volume, and power consumption levels for spacecraft applications. But converting the encoder design to LSI will reduce the parts count to about 28 and cut power requirements by a factor of 10 to 15.

Gottfried calls the converter's organization a serial-parallel feed-forward design. He describes this as a hybrid combining all-parallel encoder techniques with an all-serial successive approximation feed forward scheme. "Each function," Gottfried says, "is literally strobed into the next without interposed logic and delays. It is a desirable configuration from both the standpoint of packaging and adaptability to LSI."

Government

Harsha treatment

In mid-May, Rep. William H. Harsha (R., Ohio) fired a broadside at the Army Electronics Command for its handling of a procurement from Packard-Bell. At the time [*Electronics*, May 26, p. 71] a Harsha aide commented: "He has excellent sources and can be expected to periodically reveal more information in this area."

Now the Congressman has made his second assault on the Army Electronics Command, this time attacking a \$75 million procurement of which he estimated, "conservatively, at least \$30 million was wasted." The next day he returned to the House floor and spoke of going beyond his original charges of "inordinate stupidity" or "incredible indifference" by the Army with more severe language carrying a clearly implied threat of prosecution of Army officials.

To say that the Congressman is upset is an understatement. His attack on the Army Electronics Command represents a new departure in the current flap over the military and industry. According to one of his aides: "He is an ex-marine who is a strong advocate of a strong defense posture. He is an able prosecutor." Harsha himself states he has no truck with those making a fuss over the military-industrial complex; he has tied his attack to his feelings on free enterprise and concern that the military is making itself an easy target for critics who would weaken U.S. defense posture.

Harsha is currently working on stiff legislation that should be ready by mid-June. His office confirms the fact that the barrage has just begun and that since the Army has made no corrections Harsha will continue to make periodic revelations. Says one Harsha staff member of the bill: "It will cut directly to the heart of the whole military procurement mess." And of the Congressman's mood at this time, "He sees this as deadly serious business and he has a substantial body of data with which to continue to make charges."

Army replies. Specifically, the first charges centered about a transponder test set (ANA/PM-123) purchased from Packard-Bell. The Army has worked up a rebuttal stating that Harsha made three invalid assumptions:

- The Army did not require "urgent delivery" on the items.
- It had adequate data for competitive procurement.
- The lowest bidder would have been a qualified bidder.

In quick order the Army insists

True to our tradition, we've got something great to tell you about this month.

Raytheon now has an op amp that draws less power than any other you can buy. Anywhere. It works within specifications with supplies as low as ± 3 volts. We call it the RM4132, and it's sitting on our distributors' shelves, right now, waiting for you to come and give it a home.

This graph plots power and current against supply

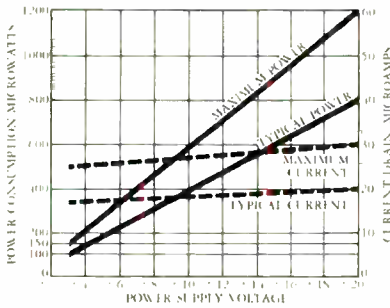

voltage, and we guarantee that 150 μ W figure at ± 3 V! Maximum input bias is 10 nA, max input offset current is 2 nA, with no more than 0.1 nA/ $^{\circ}$ C drift.

It has typical unity-gain frequency response of 150 kHz. And small signal open loop gain is 94 dB minimum.

The RM4132 is internally frequency compensated. It's pin-for-pin compatible with the 709, 741, 107, 4131 and like that.

And the full military version costs only \$30 for 100-999.

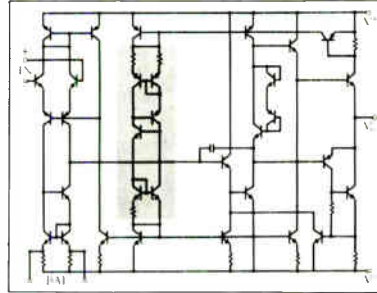

How do we do it? It's simple. This patent-pending little current regulator holds the amplifier quiescent current to 20 μ A from ± 3 to ± 20 volts, and never

shows more than $\pm 10\%$ current variation across our whole -55 to $+125^{\circ}$ C temperature range. And those little bitty batteries seem to last forever. So immortalize your system with an RM4132 from the company that's getting the ideas and delivering the goods. Raytheon Semiconductor, Mountain View, California. (415) 968-9211.

Don't let your system run down.

Our new RM4132 microwatt op amp keeps your cells young and active.



Bobbins

All Sizes

Thousands of standard bobbin dies are on hand for quick production at low cost. Bobbins can be made to specifications in minimum time with patented "Plastilokt"® construction.

All Uses

Transformers, solenoids, FHP motors, relays, chokes—especially applicable in lower volume production runs, prototype use and where UL requires class "B" applications.

All Materials

From low cost dielectric kraft through acetate, vulcanized fibre, phenolic kraft and asbestos to Mylar*, Nomex* and Kapton*. No costly tooling or mold charges necessary.

Send for FREE Bobbin Catalog

BUCKEYE BOBBIN

AND MFG. DIVISION
PRECISION PAPER-TUBE CO.

781 Sharon Drive, Westlake, Ohio 44145
Phone: (216) 871-0020 (Cleveland suburb)

*Reg. TM DuPont Co.

U.S. Reports

the requirements were urgent, that it did not have adequate procurement data for a competitive buy, and that competitive data was not available.

Finally, the Army contends that the equipment was required in Southeast Asia. According to a spokesman for the Army Electronics Command, Harsha's criticism of the command for buying 85% of its equipment on a noncompetitive basis is being worked out.

Next case. The second blast centers around an Army program started in 1962 to develop a secure forward-area pulse-code-modulation terminal identified as SCL-4357. Harsha alleges the contract was given to the fourth lowest bidder: Raytheon (General Dynamics was the lowest). He alleges that follow-ons and associated contracts were given to Raytheon over the years on a noncompetitive, sole-source basis and having finally totaled \$75 million. Harsha says that after "overwhelming pressure from the electronics industry" the equipment was finally opened to competitive bidding on the first of last month. Raytheon came in with a bid for \$4,130 after having sold the set for as much as \$13,800 and as low as \$8,000 per unit.

When the four bids were opened, Raytheon was next to the highest with Honeywell Tampa offering to build the set for \$3,092. Raytheon lost, and Harsha charges the company with taking a "luxury ride through the Army Electronics Command's taxpayer-provided wonderful wonderland."

If nothing else, Harsha is having little visible effect on the Pentagon. A Pentagon spokesman, asked for an official statement on the Raytheon allegations, said it wouldn't be ready for a week.

Government

Dissent

First reading of James D. O'Connell's dissent to the final report of the President's Task Force on Communications Policy has communications equipment makers uptight.

Some, in fact, are furious, claiming that O'Connell, director of the White House Office of Telecommunications Management, goes down the line for Ma Bell, supporting vertical integration in the industry—for example, Western Electric's role as manufacturing arm for AT&T—and discouraging competition. While most details of the Task Force's recommendations have been published, the nature of the O'Connell position has not been known until now.

Some of the points of controversy in O'Connell's disagreement with the Task Force recommendations fall in these areas:

▪ On competition: "There are two general themes which run through most of the report," the OTM director notes. "The first is the need for more competition; the second, the need for greater innovation. I have no disagreement whatever with these objectives, but I disagree with the philosophy that these are ends in themselves. . . . It is one conclusion of this dissent that all proposals for increasing or decreasing competition in this industry be examined . . . in the light of past history." What does history show? O'Connell says: "Adverse effects upon the public interest during the years of intense competition in the telephone industry."

▪ On innovation: "No case for lack of innovation in telecommunications has been made in the Task Force report." In a separate appendix, O'Connell lists telecommunications innovations to support his case; virtually all are products of the Bell system.

▪ On vertical integration: "Basic issues in respect to vertical integration have not been clearly set forth in the report. It is important to recognize that the achievement of reliable and economical service involves research, development, manufacturing, installation, and maintenance. More extensive development of separate manufacturing capabilities appears justified only to the extent that it would inevitably result in significant improvements in service to all classes of users. In this context it is not an end in itself, nor are we able to determine with confidence that the

What kind of counter can you expect to get for only \$395?

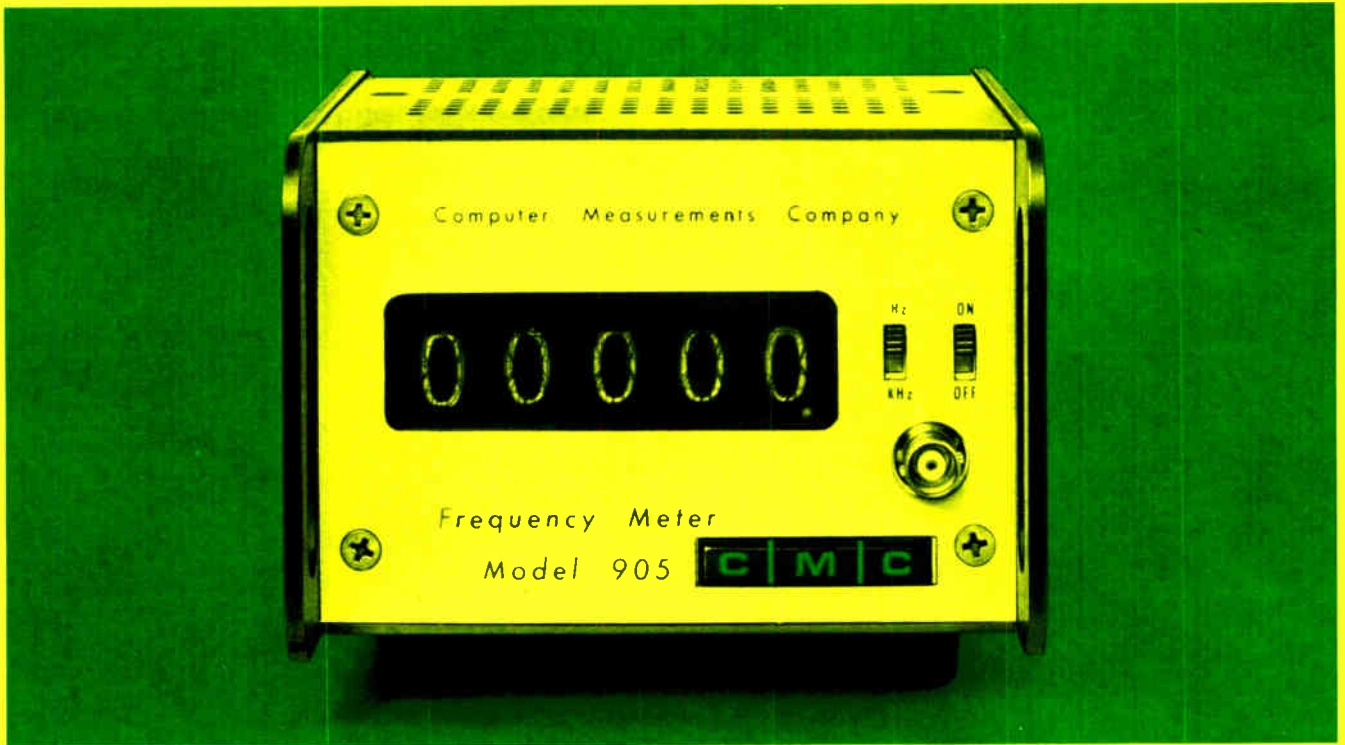

Why not mail this coupon and find out!



- 15-MHz IC Performance
- 5-Digit Readout
- 1-MHz Crystal Oscillator
- Measures only 3½" x 5" x 7" deep
- Weighs only 3½ pounds

Now, CMC offers you its new Model 905 for 35% less than you would pay for a comparable instrument from the industry's big gun and 20% less than you would pay from that other company that makes a big noise about its little counters! Fact is, you can't do better anywhere, so why not order yours now? At least, insist on a demonstration and all the facts. Just tear out the card and drop it in the mail today.

Not interested in low-cost counters, but need a standard one? Just flip the page.

COMPUTER MEASUREMENTS COMPANY



A Division of Pacific Industries

- Okay, I'll buy one. Tell your local Rep to deliver a Model 905 ASAP.
- I'm from Missouri. Tell your Rep to bring one around and show me.
- Keep a leash on your salesman until I've read the data sheet you're going to send me.
- Send me your Condensed Catalog and put my name on your mailing list.

Name _____

Title _____

Company Name _____

Address _____

City _____

State _____

Zip _____

MODEL 901

200-MHz in a new IC counter

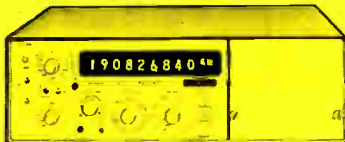

MODEL 901 \$2475

Gate times are 1 μ sec to 100 seconds in decade steps. A special feature of the display control is a fast reset of 10 μ sec to accommodate those requiring maximum data gathering abilities.

Input sensitivity of the 901 is 10mV for both A and B amplifiers.

The readout has nine decades with automatically positioned decimal point, large readout tube with units symbols, and an overflow lamp.

Printer output in the form of BCD in the 1-2-4-8 code is a standard feature.

Remote programming of the entire front panel controls, except trigger levels and attenuators, is an optional feature.

Time Interval mode offers resolution to 10 nanoseconds. Gate output, useful in determination of the amplifier trigger points in the Time Interval mode, is a standard feature of the 901.

CIRCLE NO. 101

Frequency Extender Plug-ins



MODEL 931 \$825

Turret type, positive switching 100 MHz to 1.3 GHz Heterodyne Converter. Sensitivity is 50 mV across its entire range.

MODEL 935 \$875

Continuous tuning 100 MHz to 3.3 GHz Heterodyne Converter. Sensitivity is 50 mV across its entire range.

SERIES 700

High-performance in an economy line



MODEL 727 \$1725.00

UNIVERSAL COUNTER-TIMER

Model 727 directly measures frequency from 0 Hz to 50 MHz, single period from 1 μ sec to 10⁸ seconds and time interval from 0.3 μ sec to 10⁸ sec, multiple period multipliers of 1 to 10⁷ in decade steps. Oscillator stability ± 3 parts in 10⁷ per month. Seven decade in-line readout. Memory is standard.

CIRCLE NO. 102



MODEL 738/735 \$1650.00

100-MHz DIRECT READING FREQUENCY METER WITH 500-MHz PLUG-IN

Frequency from 10 Hz to 100 MHz measured directly. Seven decade readout. Extends to 500 MHz in 50-MHz steps with Model 735 turret-type, positive-switching, heterodyne converter provided free with the purchase of the basic instrument.

CIRCLE NO. 103



MODEL 786 \$1255.00

SOLID-STATE DUAL PRESET COUNTER-CONTROLLER

Absolute accuracy, 100 mV sensitivity, 100 kHz recycling rate. Six decades with count capacity to 999,999. "Count" and "Reset" contact closures at rear panel for remote operation.

CIRCLE NO. 104

SERIES 600

An all-silicon, solid-state line



MODEL 608 \$740.00

Measures frequency and period, determines frequency ratio and totalizes. Frequency, period and frequency ratio measurement ranges: 2 Hz to 15 MHz. Period average and multiple ratio: 1, 10 and 100. In-line long-life biquinary display. Five decades are standard, a sixth is optional.

CIRCLE NO. 105



MODEL 609 \$1195.00

Measures frequency, period, multiple period average, frequency ratio, time interval, and totalizes. Frequency measurement range: 0 to 5 MHz. Period: 0 to 1 MHz. Multiple period average measurement from 0 to 20 MHz, from 10⁰ to 10⁷ periods in decade steps. 1 MHz crystal time base; stability ± 2 parts in 10⁷ per month. Six decade in-line biquinary display, automatically positioned decimal point.

CIRCLE NO. 106



MODEL 614 \$1300.00

Preset Multi-function Counter extends applications to normalizing and multiplication by any preselected constant. Gate time presets to any interval from 10 μ sec to 100 seconds. Gate time presets by remote selection. Direct displays as mph, rpm, ms, per N periods, etc. 614 also measures frequency and period and totalizes. Frequency range: 2 Hz to 2.5 MHz. Period and frequency ratio ranges: 2 Hz to 500 kHz. Preset count circuitry operates dependably at frequencies through 300 kHz—up to three times as fast as other variable gate time counters. 100 kHz crystal time base; stability ± 2 parts in 10⁸ per week. Standard five decade in-line biquinary display (sixth optional) with automatically positioned decimal point.

CIRCLE NO. 107



MODEL 616 \$1975.00

Model 616 provides low-cost direct frequency measurement from 10 Hz to 225 MHz by means of a unique prescaler built into the instrument. It can be rack-mounted. All-silicon semiconductor circuitry assures dependable operation over wide temperature ranges. 1 MHz crystal time base; stability ± 2 parts in 10⁷ per month. Seven decade in-line display is standard — eighth decade optional. Standard automatic decimal and display storage.

CIRCLE NO. 108

MODEL 633 \$300.00 MODEL 631 \$775.00 MODEL 635 \$825.00



Model 633, 1 μ sec resolution Time Interval Plug-in with range from 1 μ sec to 10 sec.

Model 631, turret-type, positive switching 100 MHz to 1.3 GHz Heterodyne Converter.

Model 635, continuous tuning, 200 MHz to 3.3 GHz Heterodyne Converter.

FIRST CLASS
Permit No. 140
San Fernando,
Calif.

BUSINESS REPLY CARD

No postage stamp necessary if mailed in the United States

POSTAGE WILL BE PREPAID BY

COMPUTER MEASUREMENTS COMPANY

12970 BRADLEY AVENUE

SAN FERNANDO, CALIFORNIA 91342

For full product information, circle the appropriate reader service number. For a demonstration of any of these products on your premises at your convenience, call your local CMC representative or call CMC direct.

COMPUTER MEASUREMENTS COMPANY



A Division of Pacific Industries

12970 Bradley Avenue
San Fernando, California 91342
Phone (213) 367-2161
TWX 910-496-1487

Printed in U.S.A. 125/HP469

objective of improved service would be achieved."

Contrast. Particularly irritating to industry sources is O'Connell's contrast of the satellite communications with the telephone industries.

Of the first, he says: "A large part of the aerospace industry has been developed with major financial support of the Government, where the market predominantly consists of the Department of Defense and NASA, where the market for commercial communications satellites form only a small share of total requirements, and where present aerospace industry capacity is more than amply sufficient to provide for commercial needs." Conclusion: creation of new manufacturing facilities for space hardware by Comsat or a new international corporation is unjustifiable.

But in the case of Bell, he says, "When one considers the past history of development to meet the needs of the telephone industry, it is clear that a major factor in the success, rapid progress, and low cost of telephone service in this country has been due to vertical integration, and the great improvements in planning and economies of scale which makes this possible."

Says one telecommunications executive opposed to the O'Connell views: "Thank God he's going to retire soon. I just hope his successor is able to clean house over there"—a clear reference to the former telephone company staffers now in the OTM director's shop.

Contracts

Salesmanship

Although it's one of the Air Force's key advanced technology efforts, the high-precision 621B tactical navigation satellite program is not moving as fast as it could. The program's manager, the Space and Missile Systems Organization (Samsco) apparently still must sell the program to Pentagon officials.

The going would be much easier if the Air Force could show a clear, critical need for the system. An industry source points out that the Navy's Transit satellite program was sold on just such a basis, with the admirals insisting the Transits



Did he have wave filters in mind?

Чебышёв

Above is the original Russian spelling of Chebyshev, the name of a nineteenth century mathematician to whom modern network theory owes a debt of gratitude. His well known polynomials were published in "Oeuvres" Vol. 1, St. Petersburg, 1899, for use in studying the construction of steam engines. Obviously, he didn't have wave filters in mind.

When Chebyshev Polynomials are applied to modern filter synthesis they produce ladder networks with controlled pass band ripple, and roll-off which is more rapid than that produced by "classical" networks such as the image parameter "constant K".

The illustration below shows the improved sharpness at cutoff and increased roll-off rate for a one section Chebyshev Filter. Admittedly, this is a simplified example, but it provides an easily understandable comparison between "old" and "new" design methods.

When the use of more sophisticated tools such as elliptic functions and Bessel Polynomials are added to the Chebyshev Polynomials, Modern Network Synthesis becomes a powerful vehicle for the realization of today's computer and space oriented filtering problems.

ADC staff specialists are skilled in the art of Modern Network Synthesis. The classical, modern or computer approach to network design is used as each may fit a particular application. Facilities include those for design, prototype sampling, testing, and production.

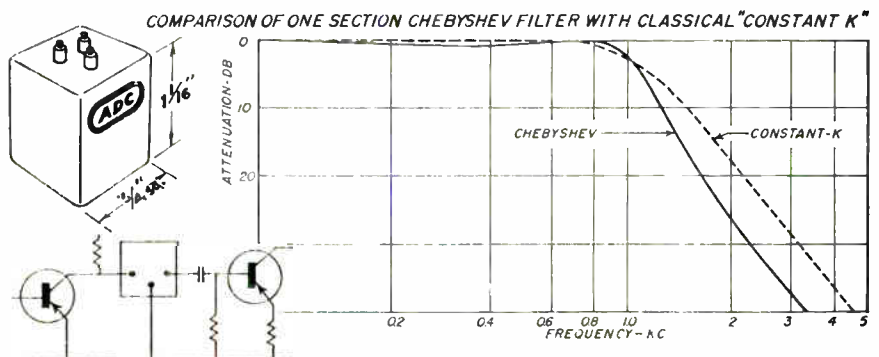

If modern network theory and its application interests you, we'll be glad to send you a copy of "General Approaches to Wave Filter Design"—no charge, no obligation.



ADC PRODUCTS

A DIVISION OF MAGNETIC CONTROLS CO.
6405 CAMBRIDGE STREET ■ MINNEAPOLIS, MINN. 55426

Who put 500KHz-1MHz in a tiny TO-5 COLDWELD CRYSTAL PACKAGE?

(who else but BULOVA!)



Who else could offer such a broad range of low frequency output from a series of masterfully miniaturized packages? Now Bulova produces a coldweld-enclosed crystal built to an even tighter spec — in a smaller container — at a lower price!

In the TO-5 can, for example, with the frequency range of 500 KHz to 1 MHz, you get a tolerance of $\pm .015\%$ (from -55°C to $+ 105^{\circ}\text{C}$, or to specification), and aging is 1×10^{-7} per week (10^{-8} after four weeks), after one week stabilization at 75°C . All this with a coldweld seal to eliminate the problems from contamination and frequency shift caused by solder flux and heat.

What's more, Bulova supplies an entire line of high precision crystals in a selection of packages. Virtually the entire frequency spectrum is available, from 2 KHz to 140 MHz for oscillator and filter applications, in every type of package: glass sealed, solder-seal, metal holders, and, of course, coldweld.

For more data, call 212-335-6000, see EEM Section 2300, or write —



BULOVA FREQUENCY CONTROL PRODUCTS
Electronics Division of Bulova Watch Company, Inc.
61-20 Woodside Ave., Woodside, N. Y. 11377 (212) 335-6000

Go Bulova, and leave the designing to us!

were crucial to the success of the Polaris fleet ballistic missile program.

To establish the need, Samsco plans to award two study contracts — each for less than \$100,000. One study will determine what avionics could be eliminated from an aircraft if 621B were operational. This could certainly give the system's proponents some cost-benefit ammunition since it's apparent that navigation functions handled in the satellite would not have to be duplicated in the aircraft. For the other contract, Samsco will turn to the requirements of its colleague, the Navy, to find out how the navigation satellites could improve aircraft carrier operations.

Samsco has already let two contracts for antijam receivers, a crucial hardware item in a military navigation satellite system. TRW and Hughes Aircraft got the awards — about \$175,000 each — but Hughes called on Magnavox to build its receiver. There's not much difference in the receiver designs; the main desire is to start getting test data by the end of the year to help the overall system provide the best service.

Serious attempts at designing receivers probably won't begin until late 1970. And, Samsco has budgeted some \$2 million in fiscal 1970 for a demonstration program using aircraft and an applications technology satellite.

For the record

The Naval Air Systems Command hopes to award a production contract by the month's end for micro-miniature digital TACAN navigation systems. Some 200 systems will be ordered initially, according to the Navy, followed by 500 systems in each of the next five or six years — a total of 1,000.

Three bidders are crossing their fingers for the award — Hoffman Electronics of El Monte, Calif.; IIT Avionics of Nutley, N.J.; and General Dynamics Electronics of San Diego. The front runner could be Hoffman. Unlike its competitors, the firm has already delivered production models of its system and has some 11,000 hours of flying time on British military aircraft and on aircraft in this country.

Electrical Engineers:

At IBM Lexington, the biggest electronic challenges come in small packages.

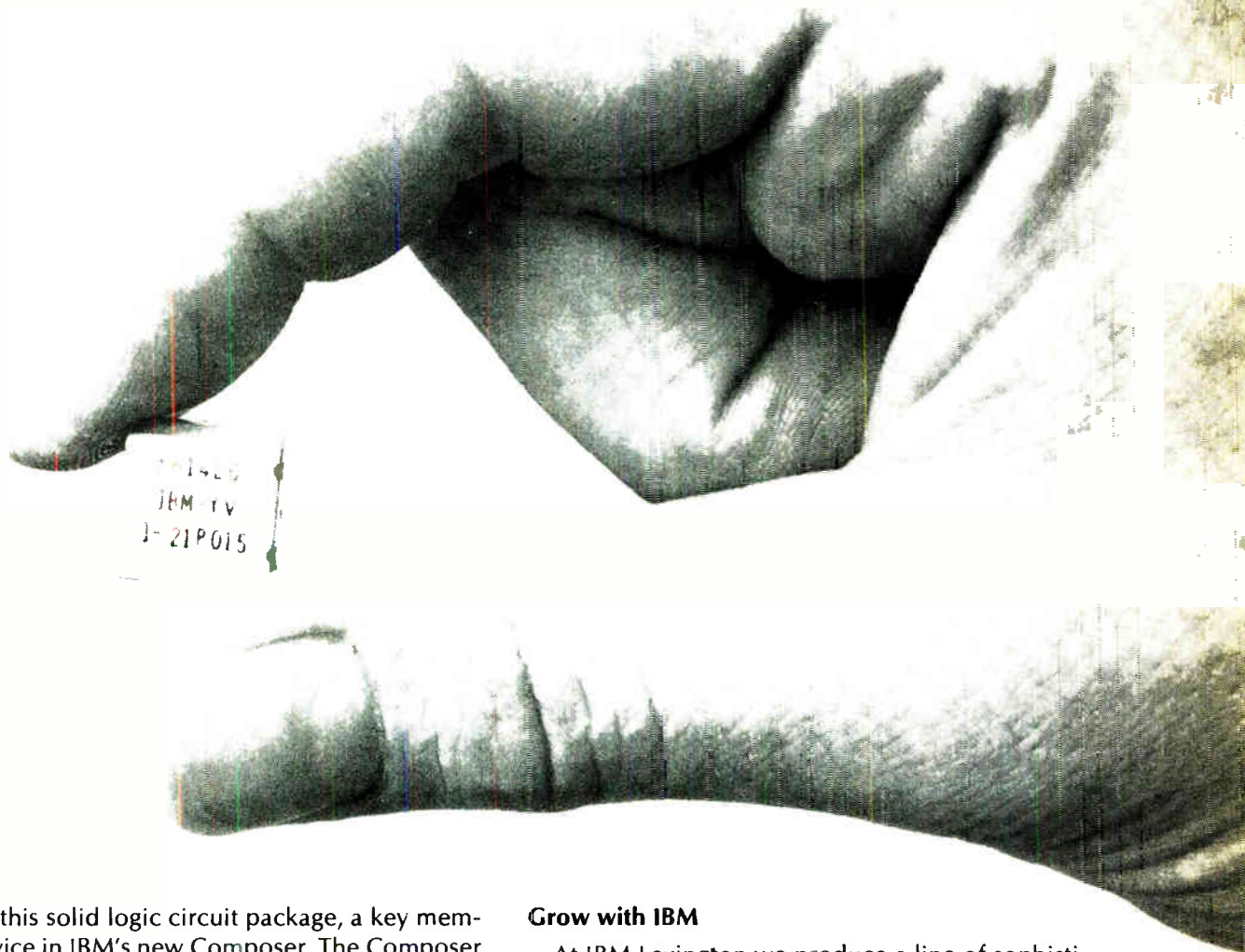

Like this solid logic circuit package, a key memory device in IBM's new Composer. The Composer electronically sets, justifies and corrects type for printing. It was developed at IBM Lexington, Kentucky, and is just one example of the electronic challenges and opportunities you'll find here.

What you'd do

We have immediate openings for electrical engineers with a B.S. or M.S. degree. If you qualify, there are opportunities in several areas:

Semiconductors: You'd work with solid state semiconductor devices, optimizing their capabilities in practical applications.

Design: You would be involved with logic design, logic circuit design, analog and digital circuit design, and digital logic design.

Testing: You would test electronic and electro-mechanical equipment—both manufactured products and the test equipment itself.

Grow with IBM

At IBM Lexington we produce a line of sophisticated office products: electric typewriters, dictating equipment, printers. And the line is constantly growing. In fact, we develop one major new product at Lexington about every 18 months.

Progress like this has made IBM a leader in the world's fastest growing major industry—information processing. Maybe your ideas can help solve some of the problems we face in electronics, and you can grow with us.

Write to us now

If you're interested, send your resume to Dave Evans, IBM Corporation, Department CD 1062, New Circle Road, Lexington, Kentucky 40507.

An Equal Opportunity Employer

IBM®

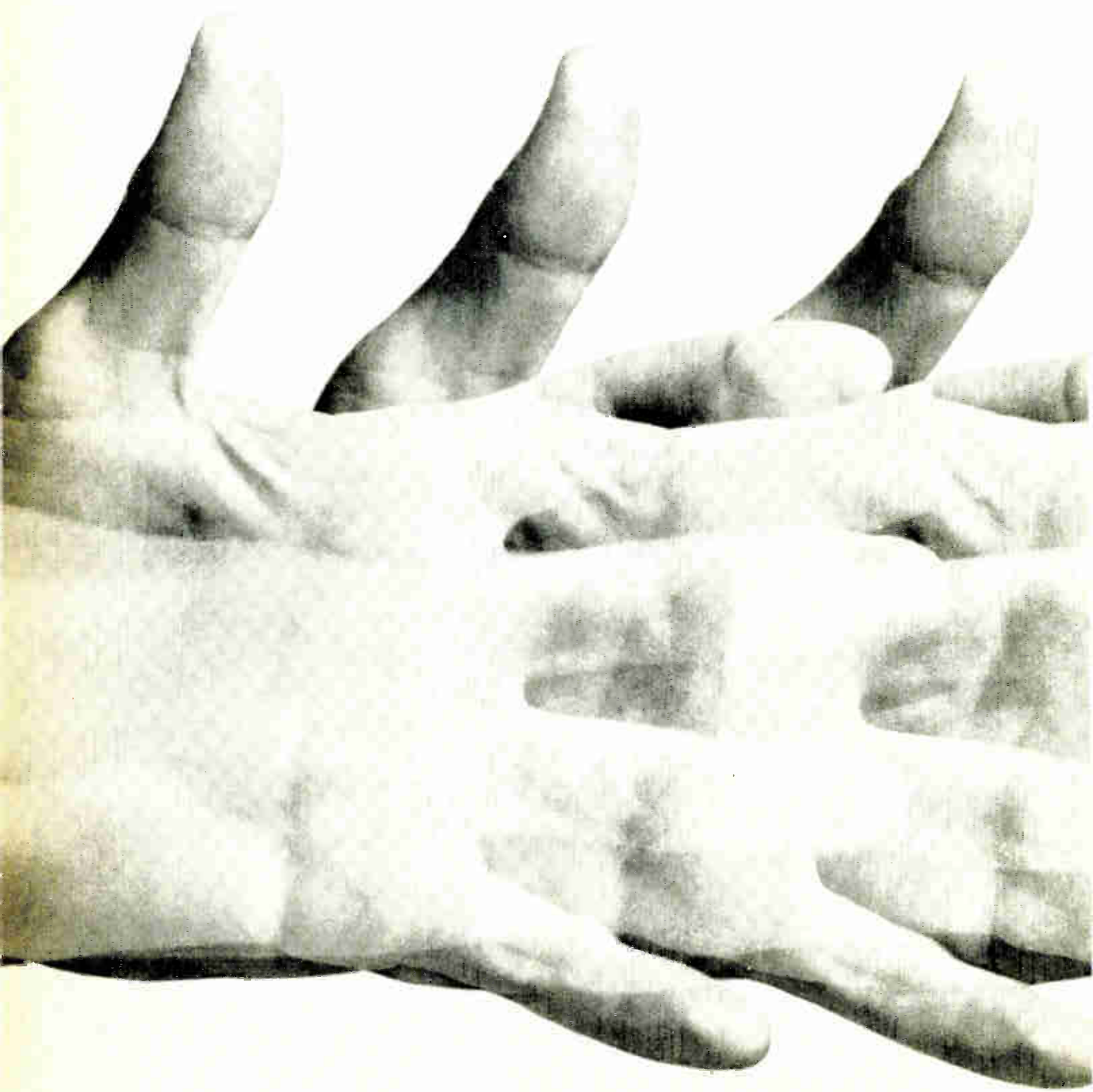

THE C

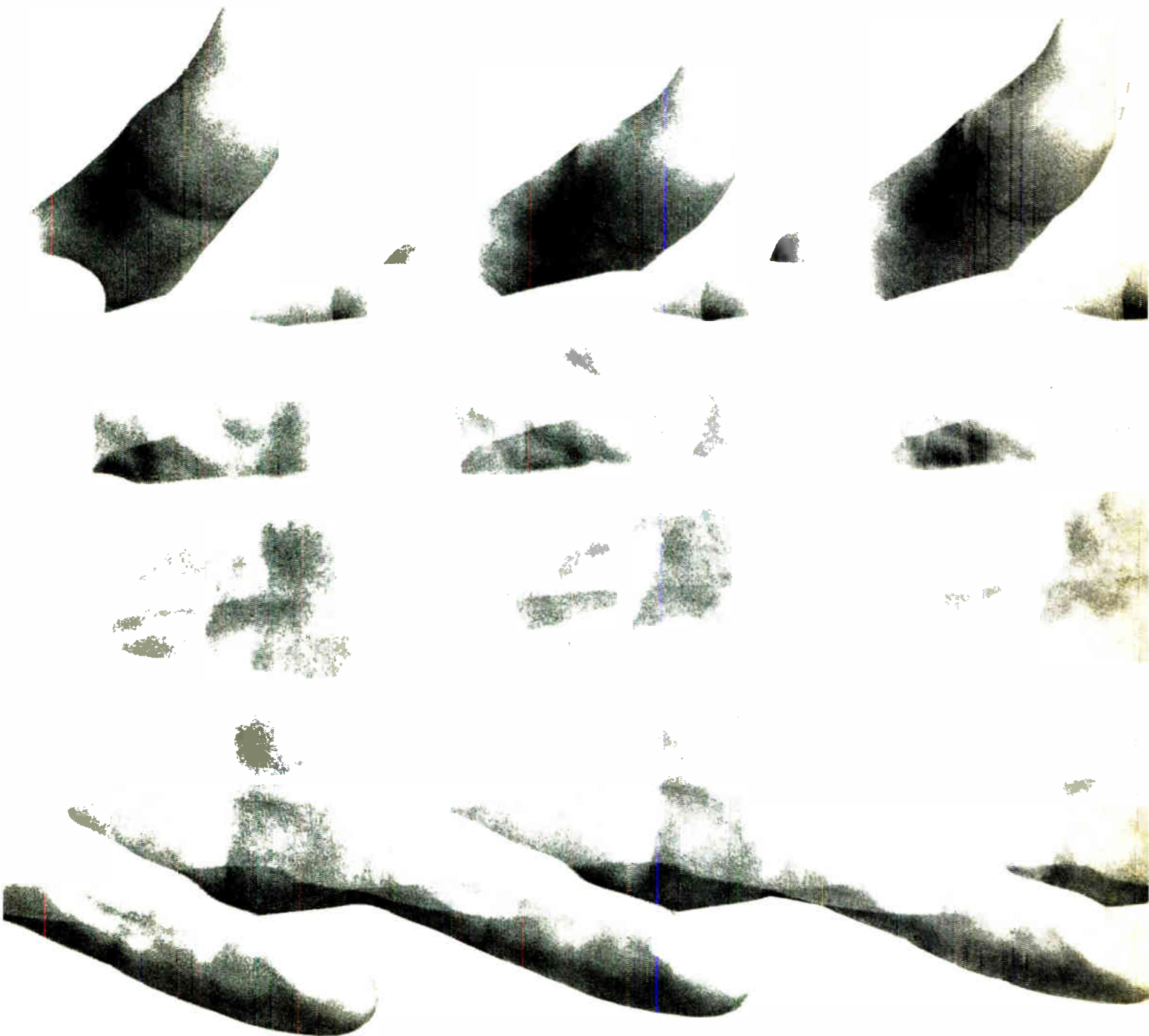

AREAT

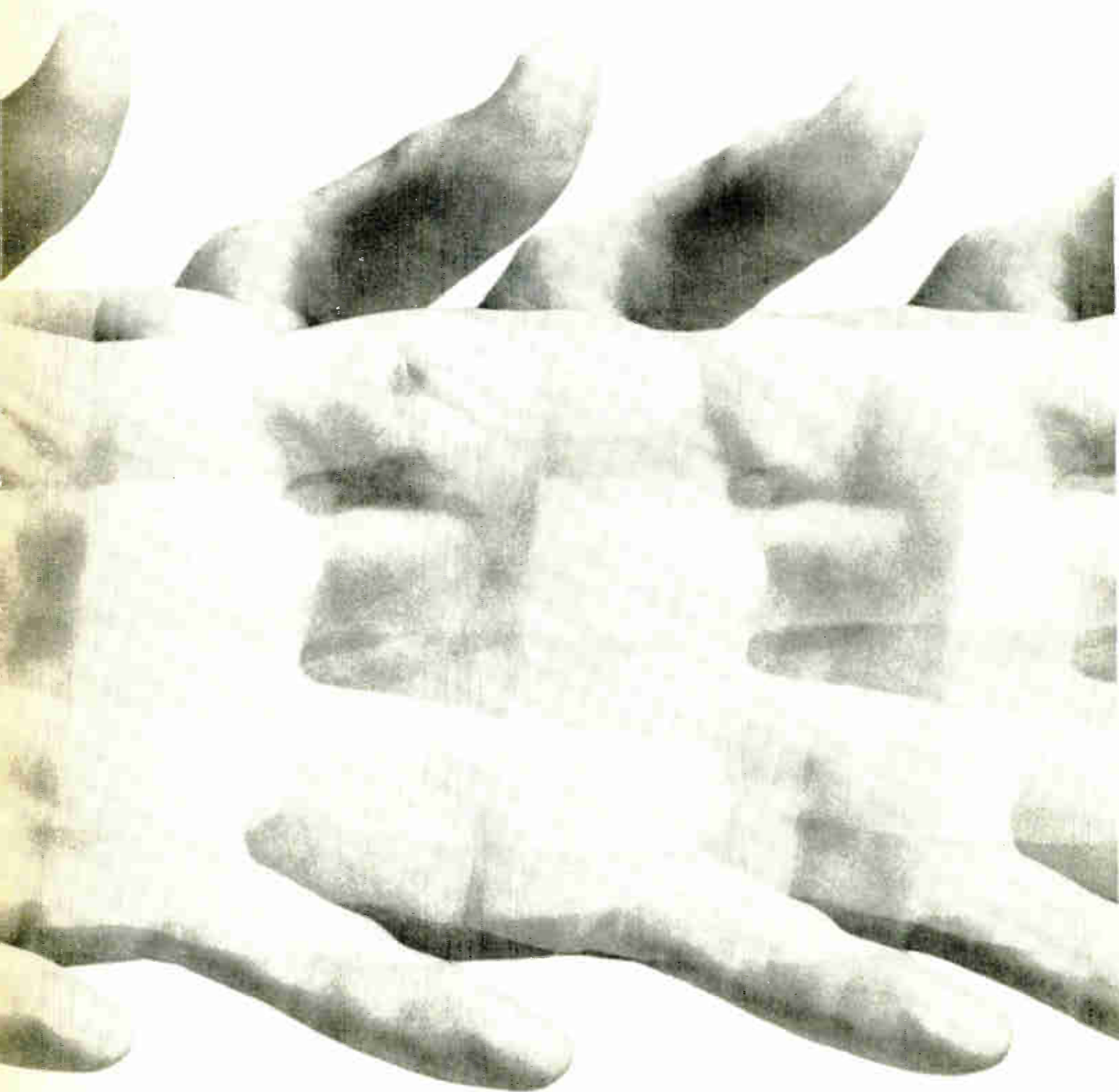

FAIRCH

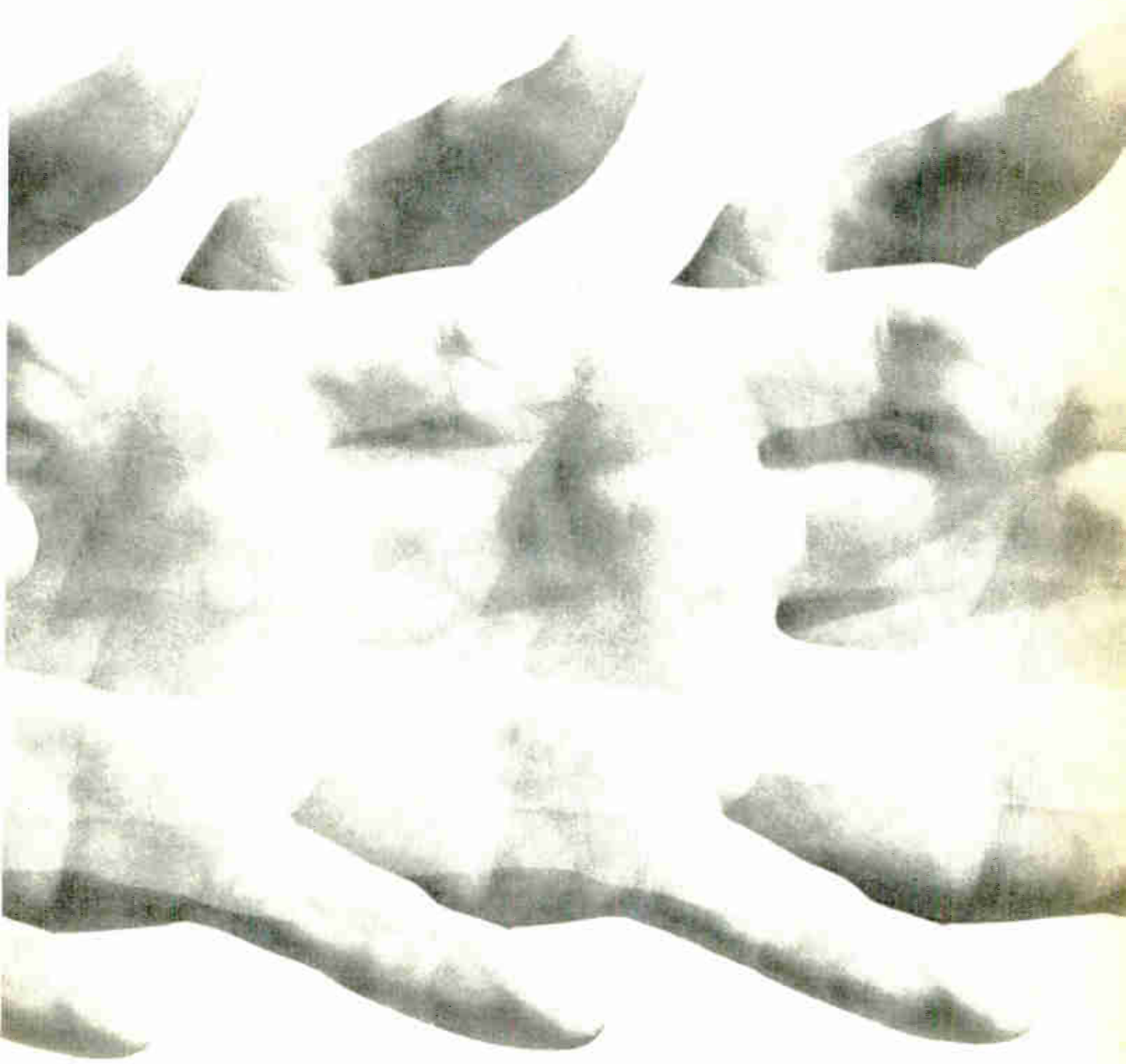

WILD PO

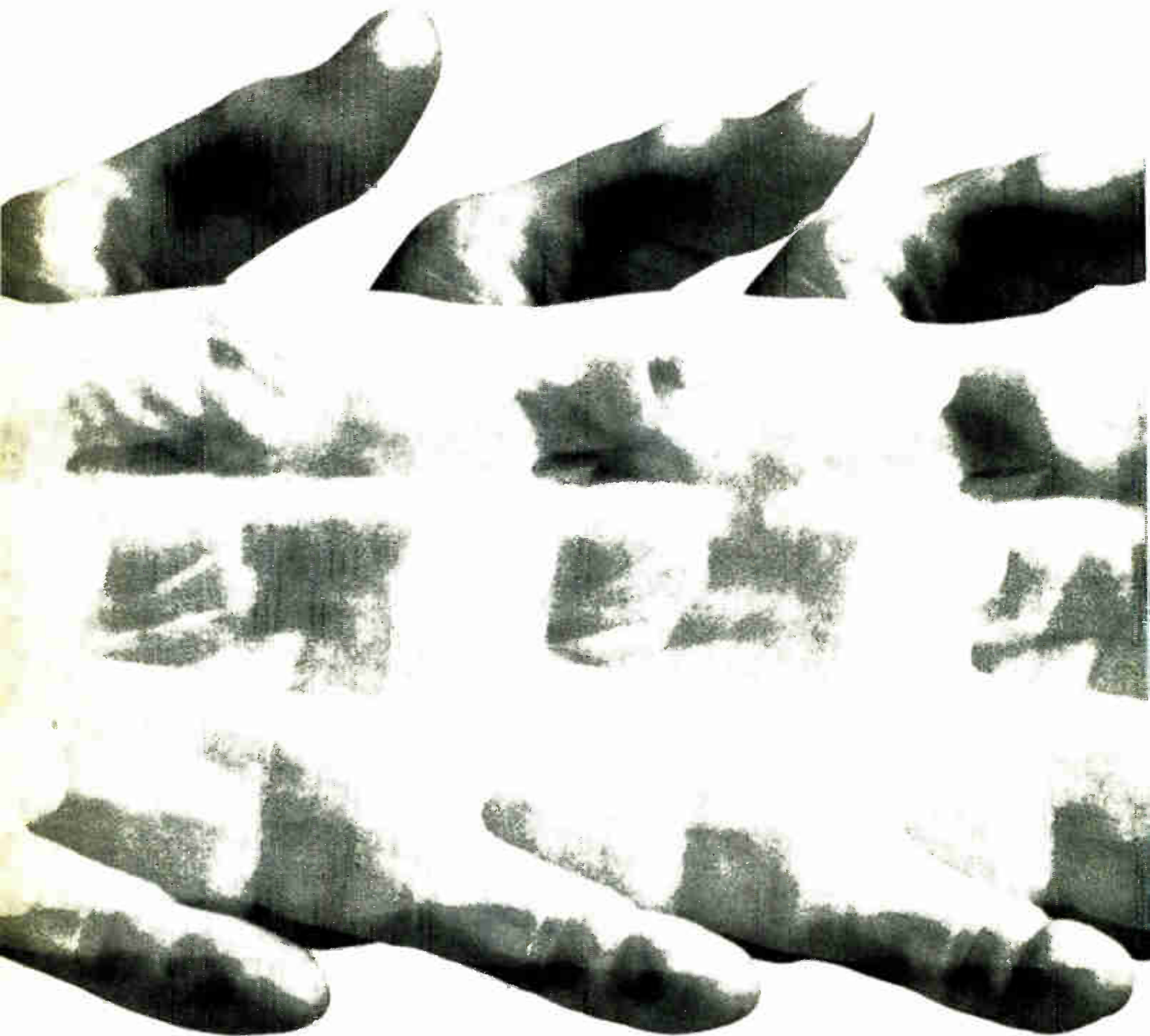

DWVERO

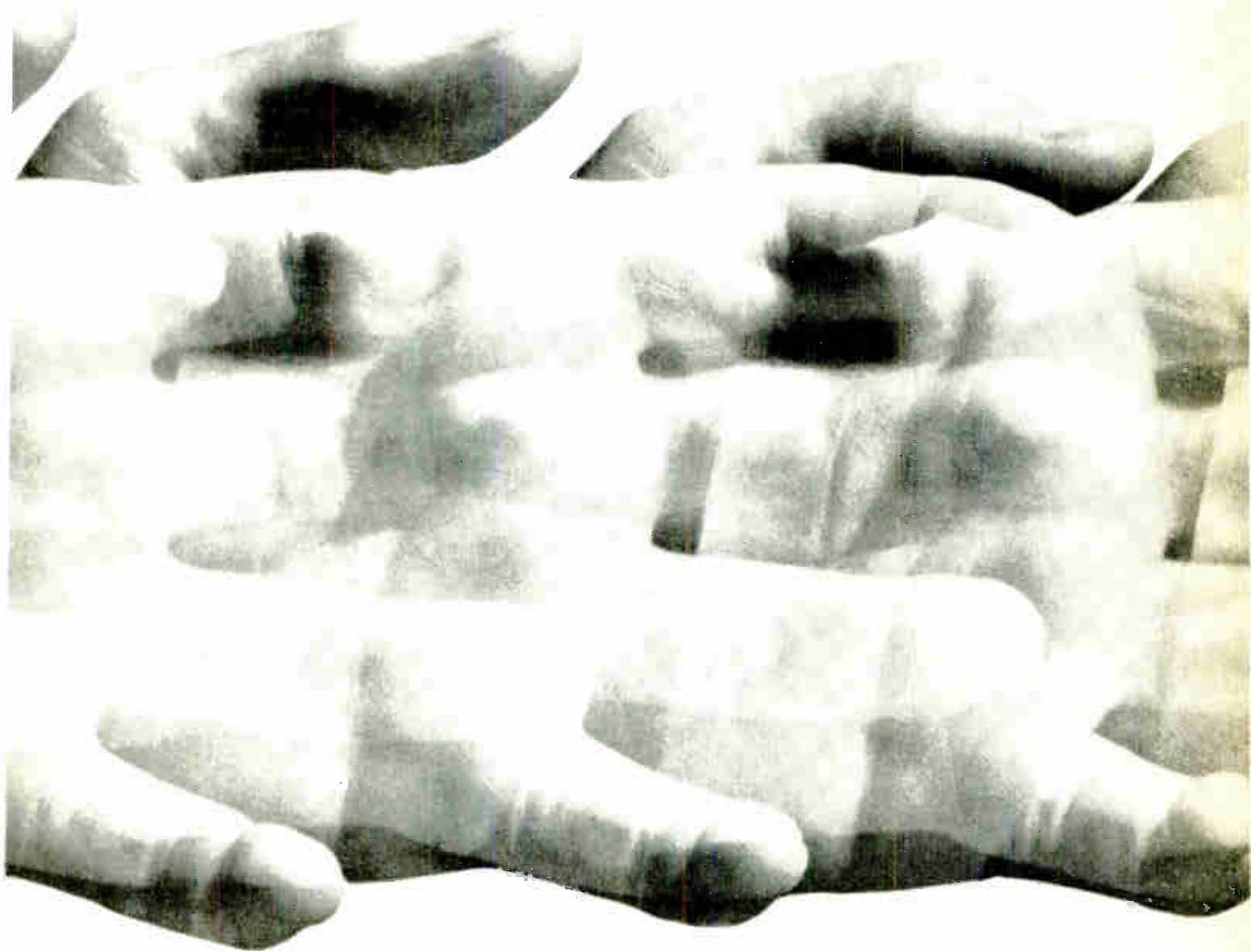

GRAB

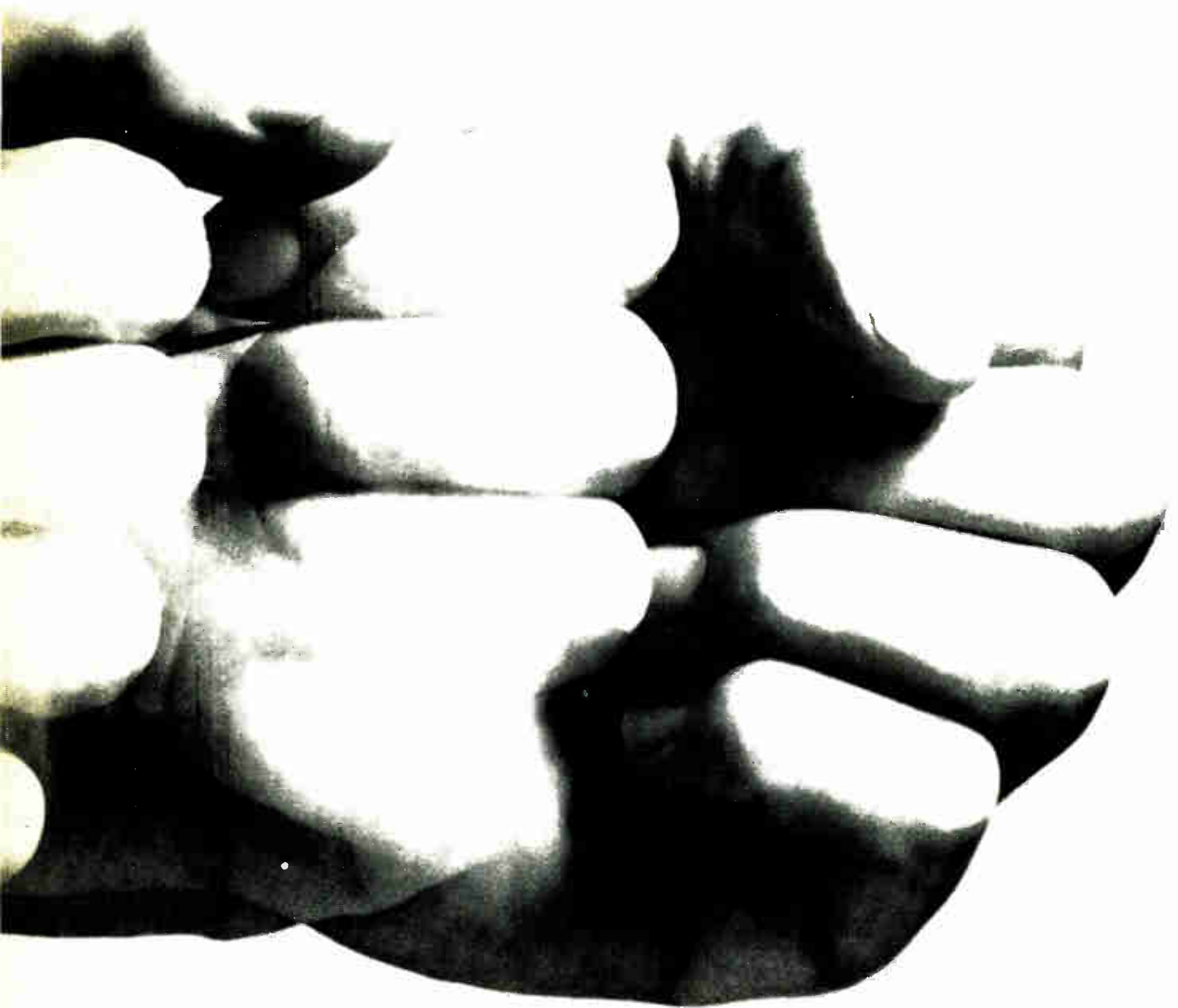

We're out to brute force the power business.
 Across the board: NPNs. PNPs. NPN/PNP
 complementary pairs.

High voltage devices. Devices no one else
 can make.

And second-source devices we can make
 better than anyone else.

Every month you'll see new power products.

Competitively priced. Available in volume,
 off distributor shelves.

All on the preannounced schedule below.

To make a public announcement like this,
 you've got to be either superconfident or crazy.

Crazy, we're not.

The Great Fairchild Power Grab is on.

JULY

NPN POWER SWITCHES AND AMPLIFIERS



THE GREAT FAIRCHILD POWER GRAB

AUGUST

PNP COMPLEMENTARY POWER SWITCHES AND AMPLIFIERS



THE GREAT FAIRCHILD POWER GRAB

SEPTEMBER

NPN/PNP COMPLEMENTARY POWER SWITCHES



THE GREAT FAIRCHILD POWER GRAB

OCTOBER

TO-66/TO-3 PLASTIC POWER TRANSISTORS



THE GREAT FAIRCHILD POWER GRAB

NOVEMBER

HIGH VOLTAGE PLASTIC POWER AMPLIFIER TRANSISTORS



THE GREAT FAIRCHILD POWER GRAB

THE GREAT FAIRCHILD POWER GRAB



HELIAX ELLIPTICAL WAVEGUIDE

twelve
ways
to
beat
the
clock...

by eliminating planning and installation
complications of rigid waveguide...

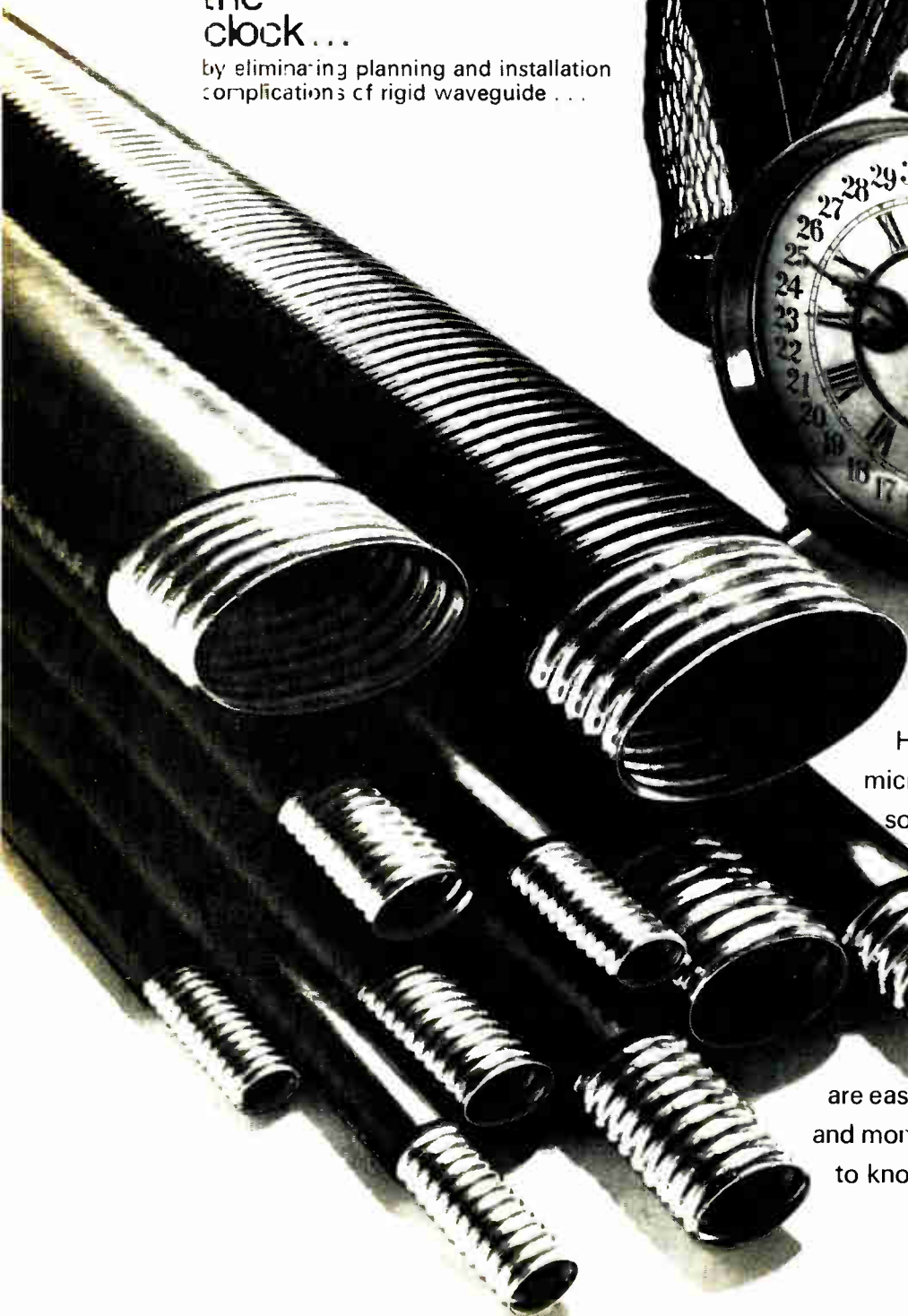

Yes, we have twelve sizes of HELIAX® elliptical waveguide for the microwave spectrum: 10 in stock, 2 more soon. Coverage from 1.7 to 15.2 GHz.

Andrew's unique corrugated construction makes the difference.

Makes HELIAX copper waveguide stronger, more flexible. Long continuous lengths are easily fitted to your layout. You save time and money all down the line. Wouldn't you like to know more? Communicate with Andrew.

10-68



ANDREW

CONTACT THE NEAREST ANDREW OFFICE OR ANDREW CORPORATION, 10500 W. 153rd STREET, ORLAND PARK, ILLINOIS 60462

Washington Newsletter

June 9, 1969

**DIA now calls
the shots on
client hardware**

Suppliers of "spook shops" had better look to the Defense Intelligence Agency, a Pentagon outfit, rather than the Central Intelligence Agency for future determination and coordination of intelligence policy, as well as money for electronics intelligence hardware. The National Security Agency's policy role—never great—is also being downgraded and its efforts restricted to continuing its crypto/communications efforts, including circuit buys. The downgrading of CIA to the number-two spot stems from recommendations made in an unreleased report by one of the Nixon task forces established shortly after his election. Headed by the Itek Corp.'s Franklin A. Lindsay, a cum laude alumnus of the intelligence plant, the task force operated under cover of studying "reorganization of the executive branch." Insiders report the then President-elect was disturbed by the CIA's strong influence on, and often faulty inputs to, his predecessors; he wanted to shake up "the Company." As a result, he bought the Lindsay group's recommendations. A secondary reason for not releasing the study is that university specialists on the committee panicked at the link.

**Federal agencies
eye think tank**

Federal regulatory agencies, having only limited R&D capabilities of their own, are toying with the idea of setting up a joint think tank modeled after the Rand Corp. Among those considering the idea are the FCC, the FAA, and the Civil Aeronautics Board.

Already dubbed IRA, for Institute for Regulatory Agencies, it would perform functions other than R&D, too. These would include serving as a training center, as a computer custodian, and perhaps, as an impartial council to render technical decisions for the agencies. Advocates of the idea believe they could attract highly qualified people because such a setup could bypass Civil Service salary limitations.

As envisioned, member agencies would derive benefits from IRA in direct proportion to the amount of money they contribute.

**Space station
seen as joint
NASA-DOD effort . . .**

NASA's office of Manned Space Flight is going ahead with plans for a National Space Station on the assumption that major elements in the program will be joint ventures with the Pentagon. According to a high-ranking space-agency official, the launch complex for the reusable vehicles, which will support the station, and the vehicles themselves are now considered NASA/Air Force undertakings. In addition, other parts of the program will be candidates for joint funding. The Manned Space Flight Office is also investigating inside sources of money for the mammoth program. Says the same official: "Reusable craft could be sent on special sorties to put satellites in orbit. If this proves feasible, we may be able to get funds from the unmanned space people."

**. . . as NASA counts
on project as step
to Mars**

While it won't appear as a line item in the space budget for some years to come, work on a manned Mars mission is already under way at NASA. The agency is taking a building-block approach in developing the necessary systems without publicly specifying the ultimate mission. There has been a recent flurry of "trial balloons" from NASA on a manned Mars program, but no attempt will be made now to gain official approval for such a project. At this stage of development though, program approval

Washington Newsletter

isn't vital since NASA is going ahead with such elements as the Nerva nuclear propulsion unit, the space station, and unmanned probes like the Viking.

Industry proposals are due this month on space station studies, and such a system represents a big step toward landing on Mars. While a Mars mission isn't being advertised as a reason for the station, this prospect definitely figures in the plans of those working on the project. The space station would enable NASA to develop and test, under zero gravity for long time periods, the systems and apparatus needed for a manned flight to Mars, including life support, human factors, nuclear power and propulsion, and long-life electronics hardware.

Two vie for OTM post

Philco-Ford's Charles C. Mack and Washington consultant Fred W. Morris Jr. are being touted as leading candidates to succeed James D. O'Connell as director of the White House Office of Telecommunications Management. O'Connell is expected to retire this summer [see related story on p. 60].

Mack, chief scientist for Philco's Communications-Electronics division in Willow Grove, Pa., appears to have more industry support than Morris, a former associate chief of the OTM.

The OTM was chartered for the purpose of advising the Executive branch on communications policy, coordinating Federal efforts, and directing frequency allocation.

Blount hires Faught as R&E consultant

Political bickering has blocked the appointment of the Nixon Administration's candidate for Assistant Postmaster General for Research and Engineering. Harold Faught, an executive with Westinghouse in Pittsburgh, is Postmaster General Winton M. Blount's choice for the job of administering the Post Office's \$50 million-plus research budget. But Senator Hugh Scott (R., Pa.), apparently miffed over Blount's refusal to clear Faught, a fellow Pennsylvanian, through him, is blocking the appointment.

Not to be outdone, Blount has taken on Faught as a \$98-a-day consultant and put him in charge of the Research and Engineering office. Consultants don't have to be approved by the Senate.

Military contractors shun public spotlight

Contractors, hoping to keep out of the public eye in light of the current uproar over the so-called military-industrial complex, were conspicuously absent from last month's Navy League meeting in Washington. Unlike previous years when there were scores of hospitality suites, this year's meeting had but a handful. And more than one civilian attending the session cringed in his seat when House Armed Services Committee chairman L. Mendel Rivers (D., S.C.) unleashed a strongly worded attack on critics of the defense establishment.

A further indication that contractors are laying low was suggested by the last minute cancellation of a two-day symposium on the "Influence of Microelectronics on Management Decisions," sponsored jointly by the Defense Department and the National Security Industrial Association. NSIA scratched the meeting just one week before the May 27 opening after only 56 registrants signed up. NSIA, conceding that the present unpopularity of things military probably affected registration, says it needed at least 400 attendees to get the program off the ground.

2760 watts and 7" panel height?

Yes! With the Sorensen DCR Series

\$900⁰⁰

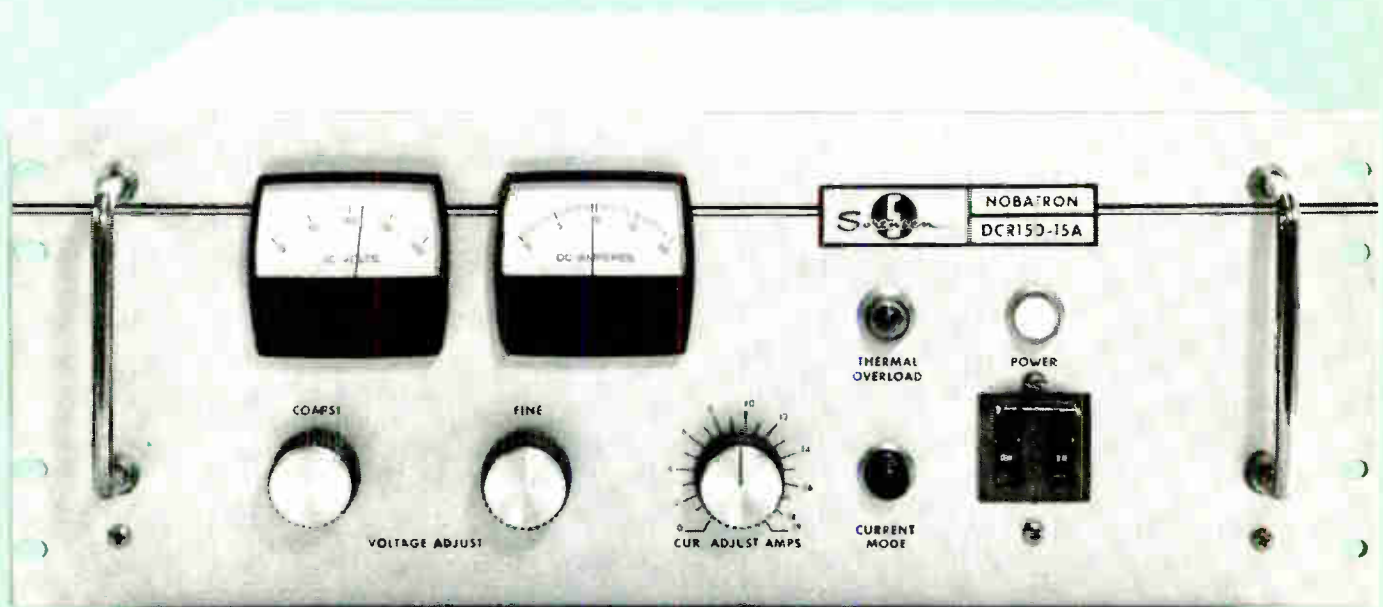

The multi-temperature rated DCR Series (115% I_o @ 30°C/100% I_o @ 55°C/65% I_o @ 71°C) contains eleven models which are available from stock in the 7" high package utilized by model DCR 150-15A. They cover the voltage ranges of 0-20, 40, 60, 80, 150 and 300Vdc at currents to 144A.

Features include: ■ =0.075% voltage regulation and current regulation with automatic crossover ■ optical overvoltage protection ■ compliance with MIL- -26600 and MIL-I-6181D ■ 25,000 hour MTBF.

The versatile and proven performance

of these models make them ideal for industrial or scientific applications such as: life testing or production aging of semiconductor devices, forming electrolytic capacitors, controlled charging and discharging of batteries, precision electroplating and controlling magnetic devices.

For more information contact your local Sorensen representative or; Raytheon Company, Sorensen Operation, Richards Avenue, Norwalk, Connecticut 06856.

Tel: 203-838-6571;
TWX: 710-468-2940;
TELEX: 96-5953



TTL.

PDQ.

RSVP: Your National distributor

Gates

DM8000N (SN7400N)	Quad 2-Input, NAND gate
DM8001N (SN7401N)	Quad 2-Input, NAND gate (Open Collector)
DM8003N (SN7403N)	Quad 2-Input, NAND gate (Open Collector)
DM8010N (SN7410N)	Triple 3-Input, NAND gate
DM8020N (SN7420N)	Dual 4-Input, NAND gate
DM8030N (SN7430N)	Eight-Input, NAND gate
DM8040N (SN7440N)	Dual 4-Input, Buffer
DM8050N (SN7450N)	Expandable Dual 2-Wide, 2-Input AND-OR-INVERT gate
DM8051N (SN7451N)	Dual 2-Wide, 2-Input AND-OR-INVERT gate
DM8053N (SN7453N)	Expandable 4-Wide, 2-Input AND-OR-INVERT gate
DM8054N (SN7454N)	Four-Wide, 2-Input AND-OR-INVERT gate
DM8060N (SN7460N)	Dual 4-Input expander
DM8086N (SN7486N)	Quad Exclusive-OR-gate

Flip Flops

DM8501N (SN7473N)	Dual J-K MASTER-SLAVE flip flop
DM8500N (SN7476N)	Dual J-K MASTER-SLAVE flip flop
DM8510N (SN7474N)	Dual D flip flop

Counters

DM8530N (SN7490N)	Decade Counter
DM8532N (SN7492N)	Divide-by-twelve counter
DM8533N (SN7493N)	Four-bit binary counter
DM8560N (SN74192N)	Up-down decade counter
DM8563N (SN74193N)	Up-down binary counter
DM8520N	Modulo-n divider

Decoders

DM8840N (SN7441N)	BCD to decimal nixie driver
DM8842N (SN7442N)	BCD to decimal decoder

Shift Registers

DM8570N	Eight-bit serial-in parallel-out shift register
DM8590N	Eight-bit parallel-in serial-out shift register

Miscellaneous

DM8200N	Four-bit comparator
DM8210N	Eight channel digital switch
DM8220N	Parity generator/checker
DM8820N	Dual line receiver
DM8830N	Dual line driver
DM8800H	Dual TTL to MOS translator
DM8550N (SN7475N)	Quad latch

TTL devices for industrial applications. Stocked in depth—available immediately, through National distributors. For our TTL Specification Guide and pricing, write or call National Semiconductor, 2975 San Ysidro Way, Santa Clara, California 95051. (408) 245-4320. TWX: 910-339-9240. Cables: NATSEMICON.

National/TTL

P.S. We've got low power TTL too. Meets 883 mil standards; off-the-shelf availability.

United Aircraft

produces... stocks... sells

semiconductor dice

Some call 'em "chips," some call 'em "dice," and others call 'em "wafers"—but if you make hybrid circuits... or communications and microwave equipment... we've got the semiconductor devices to fit most of your needs. For example:

Hybrid Applications

Small signal, P-N diodes, N-P diodes, zener diodes, switching diodes, tantalum nitride resistor networks, silicon dioxide capacitors, TTL integrated circuits. And for...

Microwave Applications

High frequency, medium-power and high-power devices for communication and microwave stripline substrates.

In addition, we'll be happy to provide schedules and methods for the bonding, proper care and handling of these devices.

And we're ready to give you excellent service and fast delivery on any quantity—from a few devices to several million a month!

Contact us for full details.

Electronic Components DIVISION OF **U A**[®]

TREVOSE, PENNSYLVANIA Tel. 215-355-5000 TWX: 510-667-1717

West Coast Office: 128 E. Katella Ave., Orange, Calif. (714) 639-4030

DESIGNERS AND PRODUCERS OF • RF AND MICROWAVE TRANSISTORS
• CUSTOM HYBRID CIRCUITS • MONOLITHIC INTEGRATED CIRCUITS



KEPCO'S LINEAR HIGH-POWER JQE REGULATORS

(28 well-behaved models)

Typical Full Rack Model

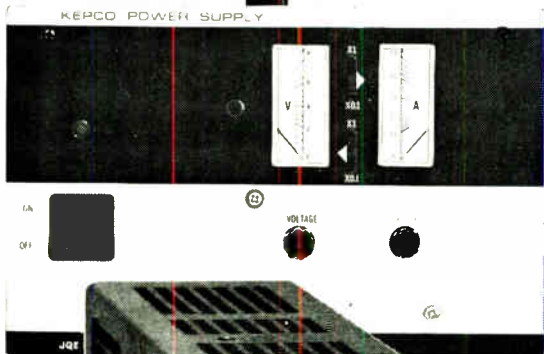
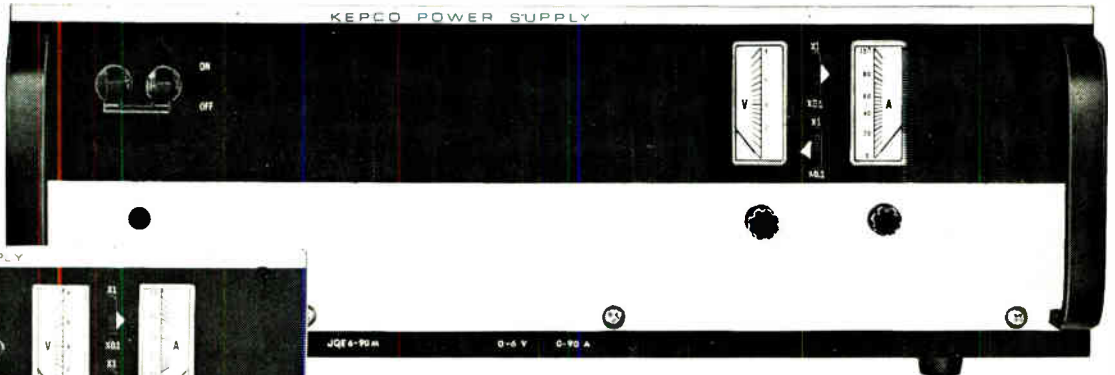

Typical 1/2 Rack Model

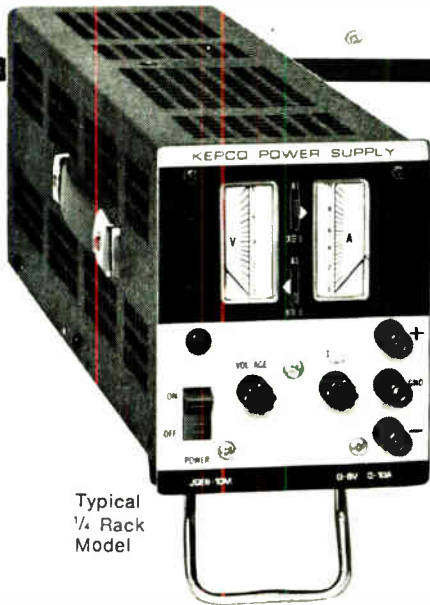

Typical 1/4 Rack Model

A linear regulator offers many advantages

- Precision operational programmability
- Compatibility with digital control
- Readily set-up to control current
- A fast programming option
- Very low ripple
- No EMR interference
- No switching, no SCR's

MODEL	DC OUTPUT RANGE		RACK SIZE	PRICE
	VOLTS	AMPS		
JQE 6-10M	0-6	0-10	1/4	\$289.00
JQE 6-22M	0-6	0-22	1/2	520.00
JQE 6-45M	0-6	0-45	1/2	625.00
JQE 6-90M	0-6	0-90	Full	977.00
JQE 15-6M	0-15	0-6	1/4	289.00
JQE 15-12M	0-15	0-12	1/2	520.00
JQE 15-25M	0-15	0-25	1/2	625.00
JQE 15-50M	0-15	0-50	Full	977.00
JQE 25-4M	0-25	0-4	1/4	289.00
JQE 25-9M	0-25	0-9	1/2	520.00
JQE 25-18M	0-25	0-18	1/2	625.00
JQE 25-36M	0-25	0-36	Full	977.00
JQE 36-3M	0-36	0-3	1/4	289.00
JQE 36-6M	0-36	0-6	1/2	520.00

MODEL	DC OUTPUT RANGE		RACK SIZE	PRICE
	VOLTS	AMPS		
JQE 36-13M	0-36	0-13	1/2	625.00
JQE 36-25M	0-36	0-25	Full	977.00
JQE 55-2M	0-55	0-2	1/4	300.00
JQE 55-4.5M	0-55	0-4.5	1/2	520.00
JQE 55-9M	0-55	0-9	1/2	625.00
JQE 55-18M	0-55	0-18	Full	977.00
JQE 75-1.5M	0-75	0-1.5	1/4	300.00
JQE 75-3M	0-75	0-3	1/2	520.00
JQE 75-6.5M	0-75	0-6.5	1/2	625.00
JQE 75-13M	0-75	0-13	Full	977.00
JQE 100-1M	0-100	0-1	1/4	300.00
JQE 100-2.5M	0-100	0-2.5	1/2	520.00
JQE 100-5M	0-100	0-5	1/2	625.00
JQE 100-10M	0-100	0-10	Full	977.00

Kepco's linear regulator controls voltage (or current) by closing a feedback loop around a fully dissipative power stage—driven by a high gain integrated d-c amplifier.

The highly efficient heat-transfer abilities of Kepco's linear power stage obsoletes the complexities of conventional dissipation limiting schemes: switching preregulators, SCR's, resonant circuits, mechanical tracking; and does away with their concomitant performance limitations: line frequency restrictions, programming speed limits, radio frequency and audio frequency radiation....

The Kepco linear regulator assumes the *entire* burden of dissipative regulation, relieving you of unwanted use-restrictions. Using modern materials and methods, the linear regulator is able to do its job in less space (up to 30% smaller), lower cost (compare the prices), and higher operating temperatures (+71°C with no derating of any sort).

with KEPCO...IT'S CONTROL!

For complete specifications write Dept. V-14



5 GE silicone problem solvers.



Invisible seal against moisture. Translucent GE RTV-615 silicone rubber used on this underwater connector assures clear identification of terminals, and improved dielectric strength under high voltage. RTV has excellent electrical properties.



Mold life doubled. New RTV-630 silicone molds last twice as long as conventional silicones in molding epoxy parts for electronic modules. Tear strength of 100 psi (die B) makes "630" the toughest RTV yet... without sacrificing flexibility.



Durable marking labels made of GE silicone rubber withstand temperature extremes, aging, moisture, chemicals, fire. RTV adhesive/sealant keeps flexible labels in place permanently on cable, industrial equipment.



Beats heat and cold. Electrical heating strip on pipes keeps temperatures constant, indoors and out. GE silicone rubber "jacket," sealed with RTV, has high dielectric strength, resists aging, corona, from -65° to 600°F.



Cheaper than gaskets. GE RTV-109 silicone rubber seals plate assemblies of food slicer to keep juices out. Non-toxic, inert RTV-109 is applied easily, forms permanent, moisture-proof bond. Contact GE for FDA data on RTV-109.



And 500 others waiting in the wings.

Chances are you're wrestling with a design problem that could be solved with a GE silicone.

But *which* GE silicone? We have over 500 varieties to choose from. And thousands of success stories to back them up.

Let's make a deal. You tell us what your problem is, and we'll help you solve it.

Without fail.

Write to Section N6311, Silicone Products Department, General Electric Company, Waterford, New York 12188.

GENERAL  ELECTRIC



**New tiny
product.**

**Old giant
guarantee.**

Meet JR.
The world's first
Guaranteed Forever
miniaturized power supply.
Five times smaller. 50%
better efficiency.
Competitively priced.
Write for complete catalog.
acdc electronics, inc.
2979 North Ontario St.,
Eurbank, Calif. 91504.

Union Carbide / San Diego proves again that great technology breeds great products

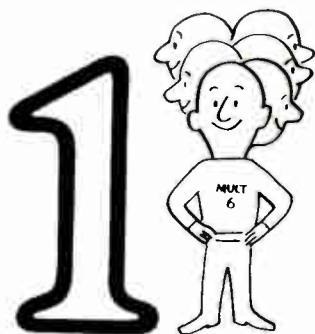

MULT6 MOS IC MULTIPLEXER

The MULT6 (UC 6410) features exceptionally low leakage ($I_{dss} = 200 \text{ pA}$), exceptionally low capacitance ($C_{rss} = 1.0 \text{ pf}$), high voltage breakdowns (-40 V). 6 MOS P-Channel enhancement transistors on a single chip. The last word in reliability for multiplexers, decommutation, logic, interfacing. Or use as a group of six electrical switches for a variety of functions.

(For information circle 320)



SRD-25 MOS IC SHIFT REGISTER

The new MOS Dual 25 Bit Dynamic Shift Register (UC7330) that solves your DTL and TTL interface problems. The only FULLY BIPOLAR COMPATIBLE shift register available today. Inputs can be driven by DTL or TTL. Output can drive DTL or TTL. Union Carbide's low threshold P-Channel technology assures low voltage power supplies ($V_{dd} = -10 \text{ V}$, $V_{gg} = -16 \text{ V}$), low power dissipation (typ. 0.4 mw/bit at 1 MHz).

(For information circle 322)



ROM1K MOS IC READ ONLY MEMORY

The world's best 1024-bit static MOS Read Only Memory, the UC6500. Three dimensional on-chip decoding. Four efficient word and bit organizations. Static operation. Bipolar compatible output. Low access time, less than $1.0 \mu\text{sec}$. Full MIL operating temperature range, -55°C to $+125^\circ\text{C}$. Chip inhibit capability. Dip or flat pack. And it's as fast as core, costs less than core, uses less power than core, and is 50 times denser than core.

(For information circle 321)

ALL FROM UNION CARBIDE, THE DISCOVERY COMPANY

Union Carbide's Electronics Division is a total supplier to the Electronics Community. For more information on Semiconductors, IC's and Modular Operational Amplifiers (circle 323), Capacitors (circle 324), Crystal Products (circle 325), Laser Systems (circle 326), and Water Quality Instruments (circle 327).

ELECTRONICS DIVISION
SEMICONDUCTOR DEPARTMENT



P.O. Box 23017, 8888 Balboa Avenue, San Diego, California 92123
TWX: 910-335-1211. Tel.: (714) 279-4500.

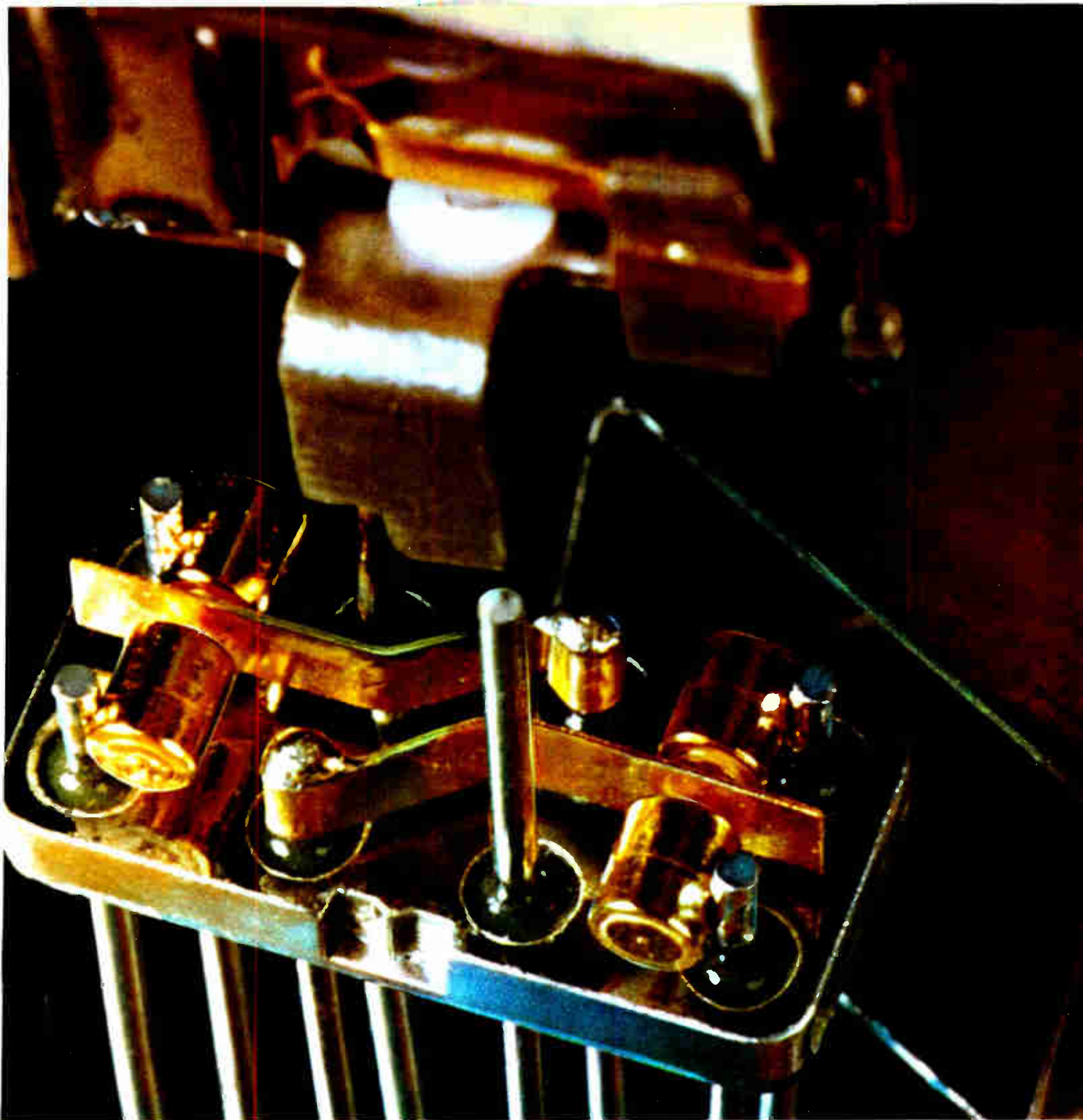

ENLARGED 16 TIMES

mite-size relays with macro-size contacts

Couch 2X relays are true 1/7-size, yet the contacts are as large or larger than many full and half-size crystal can units. Couch 2X relays meet MIL-R-5757D/19 and /30 specs in 1/25th of a cu. in. Design simplicity and oversize contacts assure the ultimate in performance. Each relay is fully tested. Ideal for missile and aerospace switching applications or wherever reliability in small space is of prime importance. Available in many terminal styles and a wide choice of mountings. S. H. Couch Division, ESB Incorporated, 3 Arlington St., North Quincy, Mass. 02171.

Write for Data Sheets No. 9 and No. 10 today.



ACTUAL SIZE

	2X (DPDT)	1X (SPDT)
Size	0.2" x 0.4" x 0.5"	same
Weight	0.1 oz. max.	same
Coil Operating Power	100 mw or 150 mw	70 mw or 100 mw
Coil Resistance	60 to 4000 ohms	125 to 4000 ohms
Temperature	-65°C to 125°C	same
Vibration	20G	same
Shock	75G	same

RUGGED ROTARY RELAYS  Dynamically and Statically Balanced

S. H. COUCH DIVISION
ESB INCORPORATED



Circle 85 on reader service card



SMALL DIMENSION FUSES and FUSEHOLDERS

FOR THE PROTECTION OF ALL TYPES OF
ELECTRONIC & ELECTRICAL CIRCUITS & DEVICES

The complete BUSS line of fuses includes dual-element "slow-blowing," single-element "quick-acting" and signal or visual indicating types... in sizes from 1/500 amp. up—plus a companion line of fuse clips, blocks and holders.









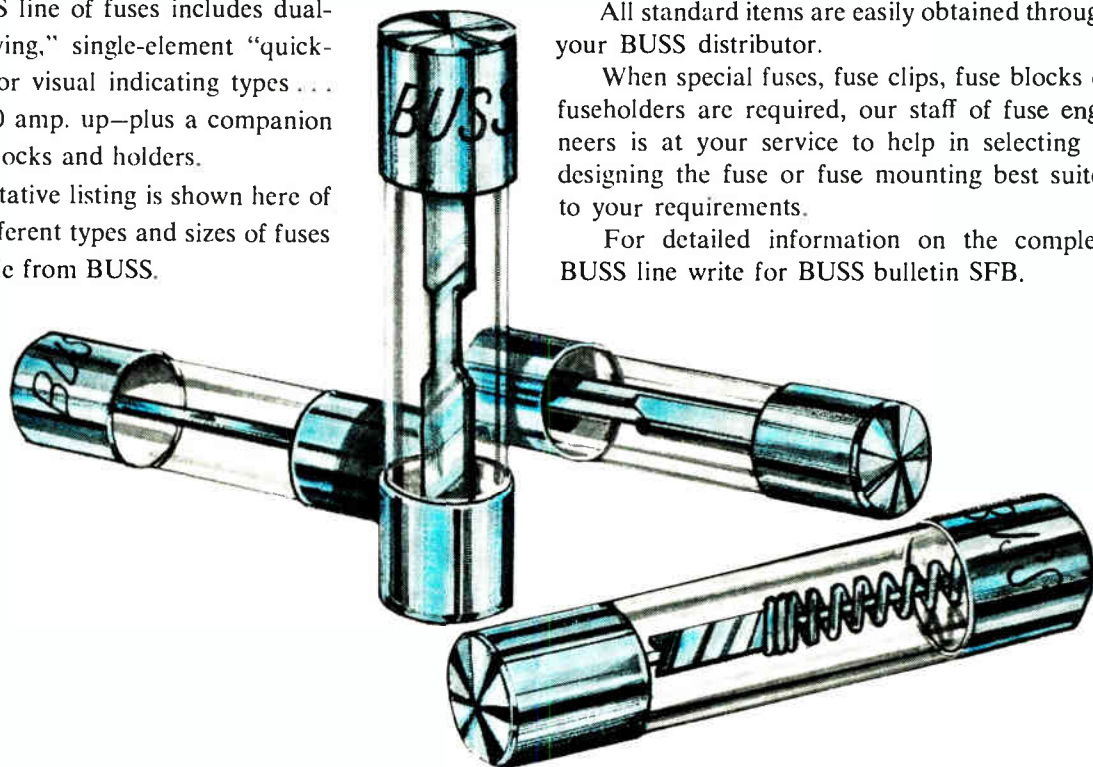























Only a representative listing is shown here of the thousands of different types and sizes of fuses and holders available from BUSS.

All standard items are easily obtained through your BUSS distributor.

When special fuses, fuse clips, fuse blocks or fuseholders are required, our staff of fuse engineers is at your service to help in selecting or designing the fuse or fuse mounting best suited to your requirements.

For detailed information on the complete BUSS line write for BUSS bulletin SFB.



							
Buss AGX Fast Acting Fuses	Buss AGC and MTH Glass Tube Fuses	Fusetron FNM Fibre Tube Fuses	Fusetron FNA Indicating Fuses	Buss In-the-Line or Panel Mounted Fuse/Holder	Buss Panel Mounted Holders	Buss Screw or Solder Terminal Fuse Blocks	Buss Porcelain Base Fuse Blocks
							
Buss AGC Glass Tube Fuses	Buss Indicating Fuses	Buss Sub-miniature Fuses and Holders	Tron Sub-miniature Pigtail Fuses	Buss HPC Holders	Buss Lamp Indicating Holders	Buss Silicon Rectifier Fuse Blocks	Buss Indicating Aircraft Fuses
							
Fusetron MDL Fuses	Buss ABC Ceramic Tube Fuses	Buss GMT Fuse and HLT Holder	Buss High Voltage Fuses	Buss Space Saver Holders	Buss Shielded Holders	Fusetron ACK Stud Mounted Fuses	Limitron KTK High Interrupting Capacity Fuses
							
Buss GJV Pigtail Fuses	Buss SFE Standard Fuses	Fusetron Type N Fuses and Holders	Buss In-the-Line Holders	Buss HLD Visual Indicating Holders	Buss Signal Fuse Blocks	Tron Rectifier Fuses	Buss Miniature Glass Tube Fuses

BUSSMANN MFG. DIVISION, McGraw-Edison Co., ST. LOUIS, MO. 63107

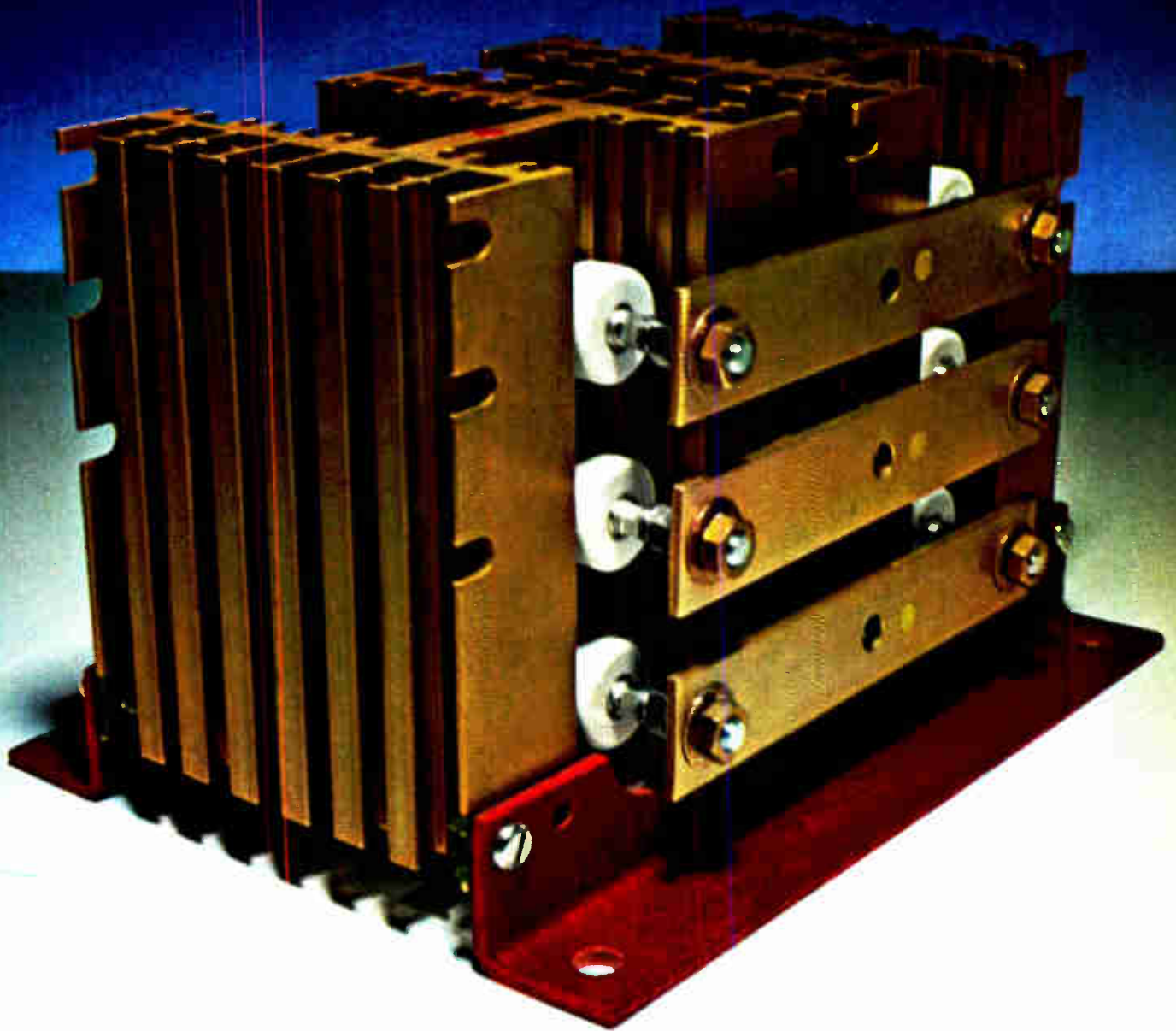

Try me.

Whether you build stacks or buy 'em... we'll show you how Westinghouse Gold-Line rectifier assemblies yield more power per dollar.

Send for the proof.

After you've tried our assemblies, you'll ask yourself why you bother to build.

Because Westinghouse Gold-Line rectifier assemblies give you simplified design and standardization; fewer parts; bonus output amps.

And you'll save on inventories, parts, labor, testing, rejects and down-ratings. What's more, we guarantee the current rating of Gold-Line rectifier pre-assembled packages. They're compact in de-

sign with a wide range of distinct current and voltage ratings and circuit configurations.

Let us analyze your real costs, and prove that Westinghouse can save you money. But first write for our 54-300 catalog and our 54-021 price list. You'll see how our stacks stack up. Then you'll try us. Write Westinghouse Semiconductor Division, Youngwood, Pa. 15697.

You can be sure... if it's **Westinghouse**



**What this country
needs is a good
nickel cigar...
and a $\frac{3}{8}$ " square
industrial
cermet
trimmer.**



Helipot has the trimmer for \$3.50 list...
now available in local stock.

(But you'll have to find the cigar.)

Beckman

INSTRUMENTS, INC.
HELIPOT DIVISION
FULLERTON, CALIFORNIA • 92634

INTERNATIONAL SUBSIDIARIES: AMSTERDAM, CAPE TOWN, GENEVA, GLENROTHES,
SCOTLAND, LONDON, MEXICO CITY, MUNICH, PARIS, STOCKHOLM, TOKYO, VIENNA

Technical Articles

**CAD, act two:
Admission price
exceeds forecasts
page 90**

Electronics



Computer-aided design, though growing up, has yet to come of age. Programing, graphics, and modeling are among the problems that must still be solved before the computer's potential—the synthesizing and optimizing of designs—can be fully realized. For all the difficulties involved in mastering CAD technology and techniques, a good deal of progress is being recorded and users are nearing the point where they can achieve quick solution of electronic problems. On the cover is a computer-generated plot, representing the broadside far-field radiation pattern of a uniformly illuminated, continuous circular aperture, produced at Norden. It affords the designer a 3-D look at and hence control over the beam width and side lobe level.

**Simpler digital
circuits in a snap
page 105**

Charge-controlled switching diodes, long used by microwave engineers in frequency-multiplier circuits, can also be applied to advantage in digital configurations. They can, for example, prove useful in simple circuits that perform such functions as pulse sharpening, pulse delay, pulse-width conversion, and impulse generation.

**Linearity corrector
does double duty
page 110**

Compensating for the nonlinearities of vacuum tube circuits, using temperature-dependent elements like diodes and bipolar transistors can be a tricky proposition. But by using the output characteristic of a field effect transistor in a relatively simple arrangement, the designer can provide the necessary correction, as well as achieve temperature stability.

**Renewing
old memories
page 114**

The tenth installment of *Electronics'* series on memory technology covers four topics. Leading off is a discussion of how delay lines, among the oldest forms of memory, are still economically viable for applications in keyboard machines. Next comes an analysis of the design freedom random-access cores offer to engineers working on electronic calculators and other small machines. In the number-three slot is a piece on how exotic storage applications can revive technologies left for dead. Last but not least, is a detailed look at the ways the military ruggedizes memory systems to withstand severe environments.

**Pulse-code modulation's
tower of Babel**

Coming

With the advent of communications satellites, pulse-code modulation offers a practical and economical means of sending voice, television, and data from one nation to another. For information to be intelligible, however, systems must be compatible. At this point, they're not; *Electronics* is surveying what's being done around the world in this vital area.

Computer-aided design, act two: Admission price exceeds forecasts

Synthesizing and optimizing designs by computer are now attainable goals, but even the enthusiasts are willing to concede that improvements in programing, modeling, and graphics are required to reach them

By Joseph Mittleman

Senior associate editor

Computer-aided design has been something less than a smash hit during its comparatively brief run. Nonetheless, it's showed enough star quality to whet the electronics industry's interest in what it might do for an encore. Already, CAD, as it's billed, has played an active role in such diverse productions as electro-optical lenses, integrated circuits, active filters, printed-circuit boards, large-scale arrays, and microwave equipment. But for all the ballyhoo and build-up, these have been bit parts.

Practitioners are beginning to appreciate the magnitude of the obstacles in achieving the computer's promoted potential—the synthesizing and optimization of design. Programing, modeling, and graphics are among the inter-related problems proving tougher to handle than enthusiasts first thought to be the case. Moreover, the very fact that CAD techniques are still more art than science, coupled with the high costs of machine time and the gross amounts of memory required, have produced a certain confusion and disillusionment. As a result, users are by and large doing their own thing with a lamentable lack of fruitful communication.

The expectation gap manifests itself in various ways, some of which are self-defeating. "CAD is just a tool to be used well or ineptly," says Nathan Sokal, president of Design Automation, at Lexington, Mass., consulting firm that, among other things, develops computer models for its clients. "Properly used, it can be a big help. Unfortunately, however, there's a tendency to compute rather than think. I've seen machines used where an average engineer could handle things by referring to a schematic. There seems to be a general fascination

with electronic data processing, seven-decimal printouts, graphics, and the like."

Whether or not this is true in all cases, CAD has clearly been puttering away at relatively unsophisticated tasks. For example, existing circuits and systems have been analyzed, parameter sensitivities studied, and component tolerances set with the help of computers. Another application that's becoming more common is review of simulated designs before they're released for production.

Circuit designers do have several general network-analysis programs at their disposal. But they're letting processors optimize parameter choices only in special cases. And while researchers would like to combine analysis routines with mathematical programing techniques, they're finding that since the former are generally constrained by speed, such methods are not suitable for the repetitive steps used in design.

The thing of it is that communicating with a computer is a tricky and demanding proposition; the machines can only "think" straight and need models to understand the problem. It's true that plenty of general-purpose CAD programs are now available—ECAP, Sceptre, Circus, and Net-1, to name a few. But general-purpose routines, users are fast learning, are no cure-all. As a rule, such programs have to be modified to meet special requirements—a process that chews up inordinate amounts of memory. Other beefs against the breed center on the fact that they cannot be operated repetitively while varying a particular parameter for a given set of values. Moreover, such programs run on only one machine, generally requiring accessory equipment; and more often than not,

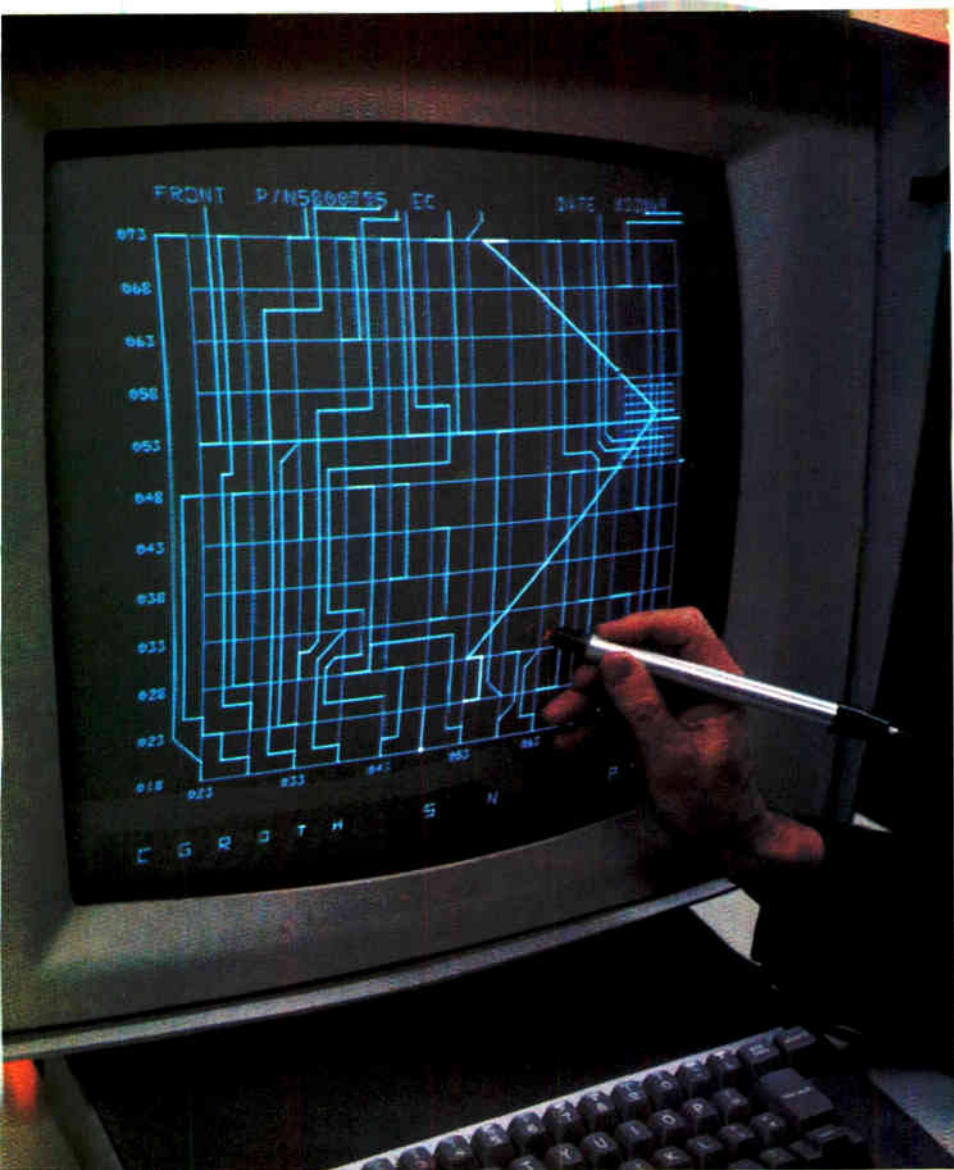

Modification. Editing a printed-circuit layout is handled by an IBM engineer using a light pen. Here, he is modifying one wire in a group. Once satisfied with the position of the wire, he closes the pen switch, fixing it as a permanent part of the group. A new temporary wire becomes available each time one is fixed in place. This technique is used to make engineering changes in an established design or to rapidly modify an existing design before getting into production cycle.

they're too large for medium-sized processors. Finally, general-purpose programs are limited by device models, and can't easily be changed in response to special circumstances.

"For analysis and modeling, we used Net-1 and ECAP; we also have tried some filter and microwave stripline design programs," says Willard W. McLeod, chief engineer at the Radar and Electronics Lab of Raytheon's Missile Systems division. "But there's been no real interaction by the designer with the computer. And there still isn't." When this unit set goals for design automation, it decided to pursue high payoff, labor-saving applications, rather than Ph.D. replacement. Most programs are simply aimed at saving dog-work—drafting is one example. "Not glamorous but very effective," says McLeod. The advantages are realized in errors, rather than jobs, eliminated.

General-purpose programs are by no means a washout; a number of companies have been using them to good effect. David Lynn, manager of CAD at Motorola, reports his company is using both general-purpose and in-house programs for circuit design. Sceptre a nonlinear transient analysis program used in batch mode, is quite flexible, he says,

since it allows a variety of circuit models to be used. However, Lynn points out, a user pays for this flexibility in memory and modeling time. Motorola also uses ECAP for a-c analysis. Lynn likes ECAP because it can be used in a time-shared system and affords modeling flexibility. But he notes, while ECAP will handle such characteristics as conductance and resistance that are constant and linear, it won't accommodate nonlinearities, for which solutions are unknown and must be derived numerically or graphically.

A number of companies, Motorola among them, have developed a nonlinear transient analysis program, called FINC (for fast integration of nonlinear circuits). Also available is a program for nonlinear d-c analysis. Both are on-line interactive routines that can be used on time-sharing systems.

Availability is the biggest advantage enjoyed by ECAP, Sceptre, and others of their ilk. CAD-minded concerns didn't have to spend time or money developing them. And though Sceptre consumes a good deal of central processor time, it's still a cheaper proposition than do-it-yourself routines.

But cost is not necessarily a prime consideration for companies trying to get ahead. Motorola's semi-

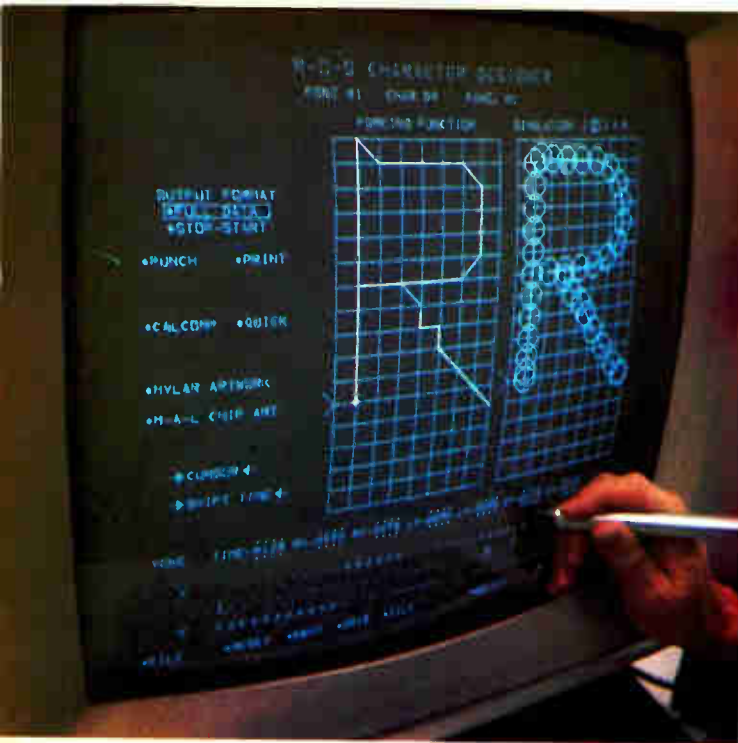

Character generation

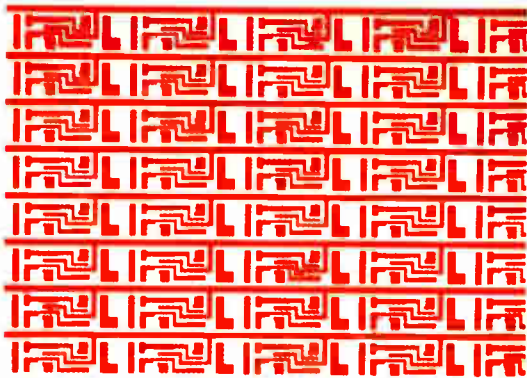
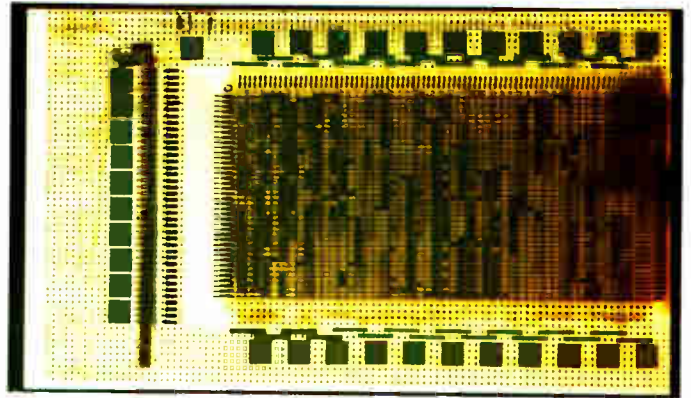

Graphic design. Cathode-ray tube displays the letter R being designed as a font in an experimental IBM character generator at Kingston, N.Y.

Letters are written on the phosphor coating on the left side of the screen with a light pen. Forcing functions form the letter at the right side of the screen. Once the forcing function sequence is established, a red mask is generated, which when reduced photographically, is used to make the integrated circuit for each character. Integrated circuits are mounted on a printed-circuit board and inserted in a character generator. There are 16 IC's per board.

conductor division, for example, is working on a-c optimization with an eye to such functions as bandwidth shaping on a linear bandpass amplifier, using gradient techniques. "We're not fully operative yet with optimization," Lynn says. "But it's simpler to take our own programs and use them as sub-routines than it is to use general-purpose programs in this way.

Activity report

One reason firms are now depending on their own resources is that little in the way of CAD software has been developed since 1966. Such progress as has been made falls into the refinement category. Since Net-1 became available, for example, there have been 18 sets of changes to its approximately 32,000 instructions, including a major overhaul to the math. Familiarity, however has fostered some gains, and Sceptre is being applied to new sets of problems—among them systems simulations. ECAP is also being used for block function simulation.

In the wings, however, is Net-2; it's due by year's end. The man responsible for Net-1, Allan Malmberg, now with Braddock, Dunn, and McDonald in El Paso, Tex., is developing it under contract from the Army's Harry Diamond Labs. Net-2 is ear-

marked for use with IBM's System 360 machines and the Control Data Corp.'s 6600.

At this point it is believed that Net-2 will include nonlinear d-c and transient analysis, frequency analysis, flexible general-purpose modeling "of anything that can be described by an equation," statistical analysis, Monte Carlo simulation, maxima-minima search, and logic simulation using binary numbers rather than voltages and currents.

In the meantime, DSL-90 (digital simulation language as applied to the IBM 7090 computer) has been available for systems situations for some time. Relatively new is CSMP (continual system modeling program, for IBM's System 360 and 1130 machines) as is GPSS (general purpose system simulation). The systems simulation programs probably get as much of a workout as circuit simulation software.

Economics explain this as part of the status quo in CAD. A major use of programs involves review where there's a finished design to check or emulate. Integrated circuits are, however, an exception to this rule. Since it's impossible to breadboard a monolithic assembly CAD enters the cycle at an early stage and there's pressure on engineers to use simulation to help predict performance. But the time when an engineer will sketch a circuit on

Radar design. Norden's computer program for a phased-array radar antenna generates the data from which this far-field pattern is plotted. Once the desired pattern is established, the equipment can be built. In this way the engineer can determine whether the radar will work properly without having to build it first. Thus, time and money are both used to advantage.

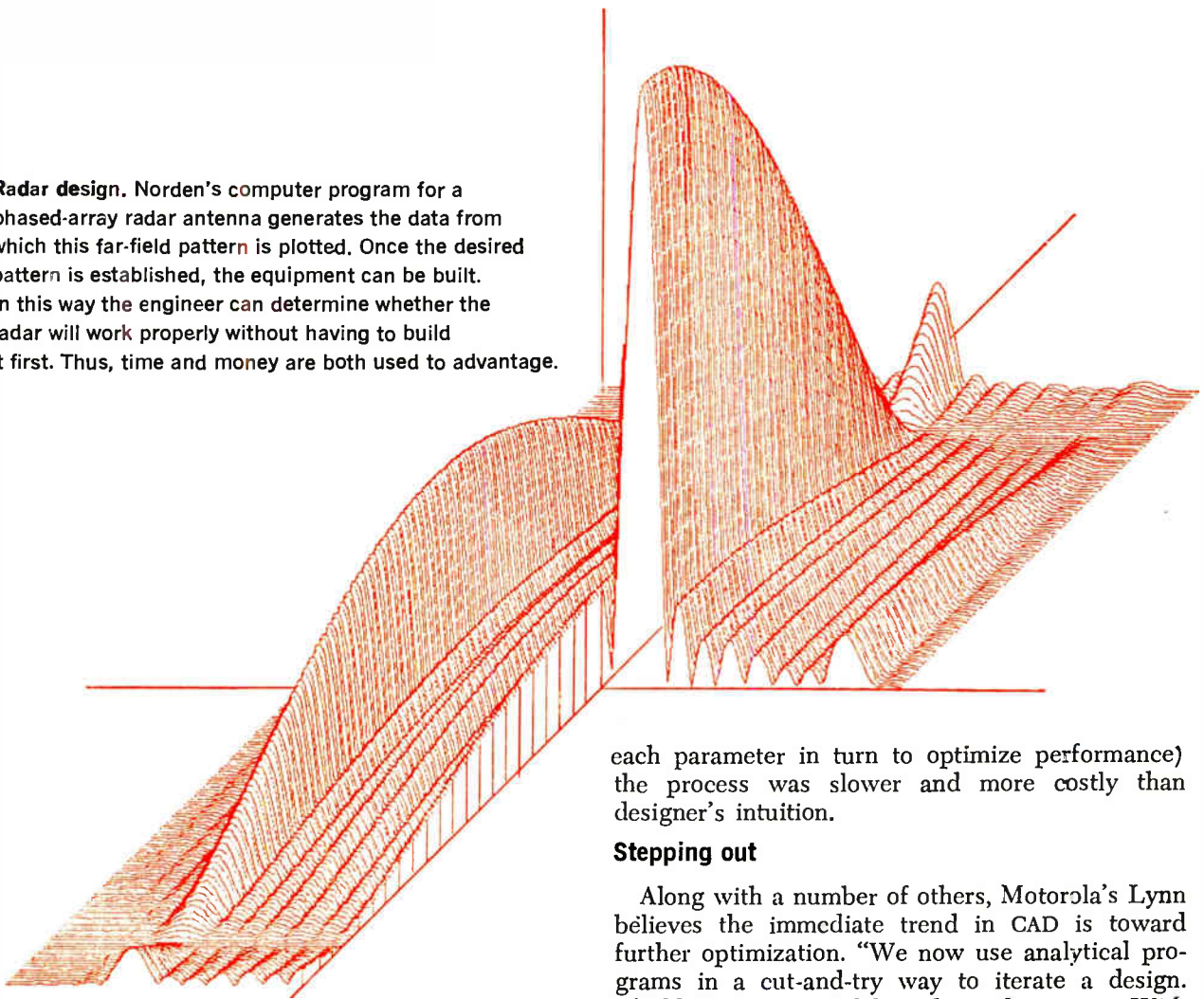

a tablet and get masks from the other end of the computer is several years off. Such systems, though they indicate the direction which computer-aided design is moving, aren't yet commercially or technologically feasible.

John B. Campbell, manager of the simulation branch in Raytheon's Missile Systems division, summarizes the situation this way: "Time-shared (general-purpose) programs are usually weak; they fall apart or require runs so long that they're uneconomical for work toward circuits of practical size." Thus, Raytheon tends to use more of what could be called computational rather than design aids. The rationale is that machines can help the engineer by allowing him to increase the number of exploratory designs before settling on one. However, no graphics, time sharing, or interaction are involved. Commercial use of direct design programs is a long way down the road because of job complexity, Campbell continues. "Although some programs can design a simple RC circuit in seconds, practical circuits, which may have hundreds of R's and C's, run all too long." And, the company has found in actual practice, when the search method was tried (under computer control, varying

each parameter in turn to optimize performance) the process was slower and more costly than designer's intuition.

Stepping out

Along with a number of others, Motorola's Lynn believes the immediate trend in CAD is toward further optimization. "We now use analytical programs in a cut-and-try way to iterate a design. It's like sitting in a lab and tweaking pots. With optimization we might have 10 elements—all of them varying at once and the machine doing the tweaking."

The first operating programs in this area will, however, probably handle only parts of a circuit. Designers will start with a specific configuration, allow some subset of element values to vary, and generate an optimized parameter. If they're concerned with, say, noise margins, they'll wind up with an optimized value though other parameters may not be tops. Even within such limitations, however, the technique will be several cuts above wholly cut-and-try methods.

After the ability to optimize a single characteristic is mastered, designers will go for two or more at a time. Eventually, programs may permit the computer to grow circuit elements. The machine will be able to tell a designer he needs a capacitor across a certain node if the gradient across the node pair becomes large enough and the limits of the gradient error have been programmed into the computer. But the consensus is there's still plenty to be done in analytical and optimization programs before the era of element growing arrives.

Moreover, there's still a long way to go in analytical programs for complex assemblies. In an-

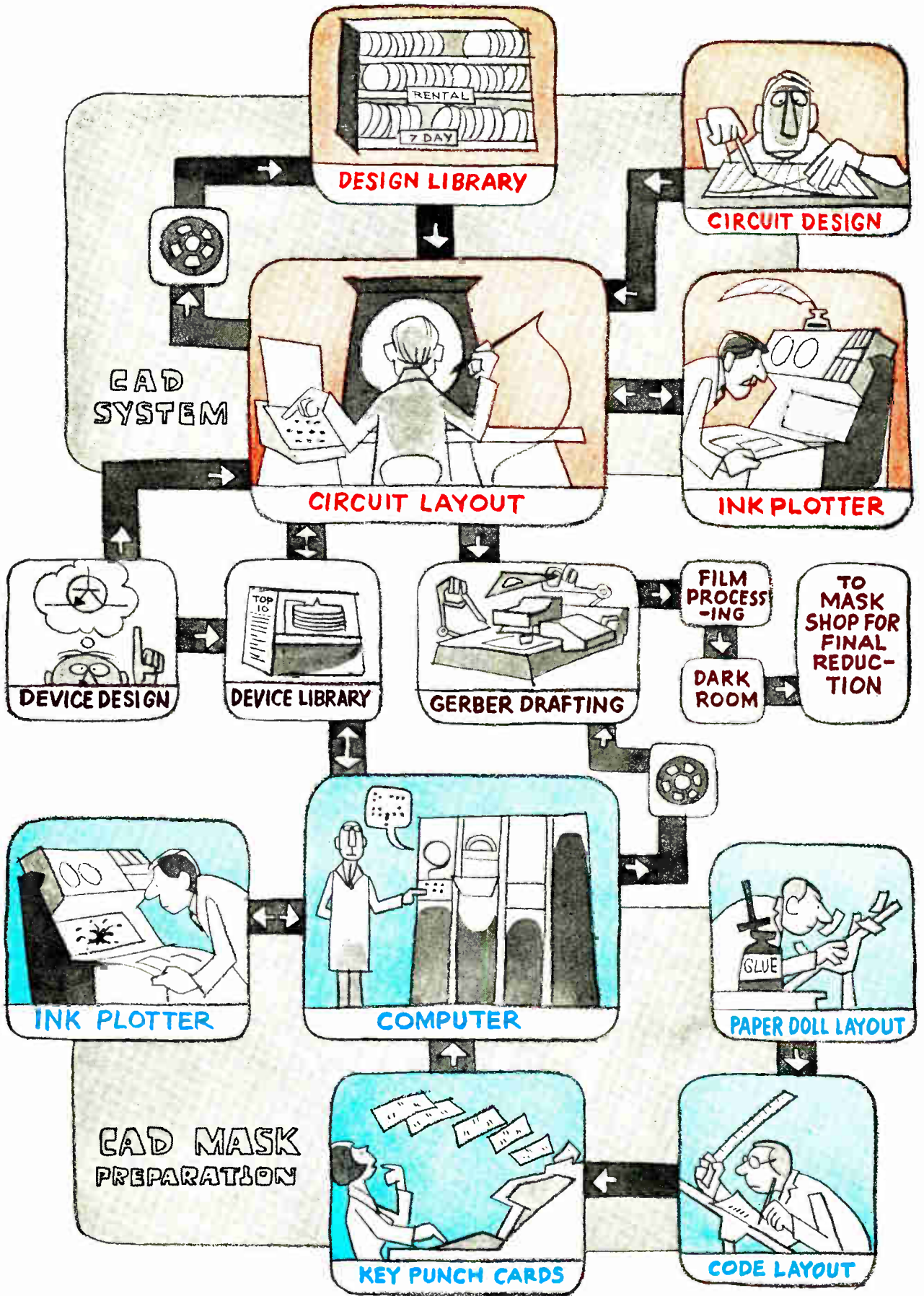

IC design. Steps for an integrated-circuit mask and system are characterized by Motorola's Semiconductor Products division as shown in this cartoon sequence.

alyzing logic circuits, most designers are interested in one gate—or maybe two with the second acting as a load on the first—and establishing d-c characteristics and delay times. Once this has been done, some attention can be paid to macromodeling for large arrays. Already, however, some work is being done along these lines.

Charles Meyer, manager of integrated-circuit modeling and diagnostics at Motorola, recognizes three levels of circuit simulation. Basic is detailed circuit analysis, in which the designer concerns himself with effects such as parasitics. Second comes analog simulation of arrays with complexities up to 100 gates. Here, a designer is still studying wave shapes but he can put enough of them together to make a macromodel that is faithful at the terminals, affording a waveshape simulation of the entire system. Finally, there's Boolean simulation in which a gate is allowed to be a one or a zero and different delays can be specified for each element if the gate changes states.

Meyer uses company-generated programs and his group is continually adding to its store, anticipating further improvements, particularly fault modeling—diagnosing which gate on a chip is in the wrong. Meyer considers macromodeling a useful tool and believes it can keep pace with device sophistication. He's especially optimistic about its prospects of growing along with MOS complexity because such devices are unilateral, requiring less interconnection between gates than bipolar circuits.

Going it alone

Raytheon's McLeod reports his unit has recently added a number of general-purpose programs like Circus and Sceptre to its repertoire since getting a bigger (Univac 1180) computer. "Each program gets individualized because of the men who are users," he says. "Most of our in-house programs aim at specific goals and hardware. An example is MASD (machine aids to SAM-D). This is a scheme whereby logic diagrams will be punched into the processor. Ultimately all the interconnection, wiring-bookkeeping will be done by machine.

When the program gets on line, the programmer-engineer will specify special logic arrangements; MASD will come up with parent plates, cabling schemes, logic-card layout, and gate arrangement. Another area of interest is computer generation of test routines, which are now being done manually. It should, company officials believe, be possible to generate the appropriate checks from the logic diagram. Work is underway as part of RATS (Raytheon automatic test system).

But McLeod is less sanguine on the immediate prospects in another key area. "Interactive design of IC's and LSI devices isn't yet practical—too costly—though it is coming," he says. In Raytheon's LSI approach there are a small number of basic chips which are applicable to nearly all circuit types. They just have to be interconnected. This

can easily be done using computer-stored wiring rules. "In analog circuits however, there are many impressaries and in such a field, characterized by low volume and thick-film work, it will stay this way," says McLeod. "The payoff for graphics and interactive programs here is even further away than that for digital circuits."

Aside from more practical analytical routines and techniques and working optimization programs, most sources agree what's needed to improve computer-aided design are simply better models—particularly for nonlinear elements. Bipolar circuits models, for example, don't yet include such factors as high current effects, current crowding, two-dimensional current flow in base regions, or base-width modulation.

For the moment, however, a lot of users would settle for better—or at least consistent—analytic routines. "With numerical analysis (using general-purpose programs), you often and unexpectedly get either no answer or an inaccurate one," says Design Automation's Sokal. Transient analysis can present similar problems and then some. When working with integrated sets of differential equations, the step size for integration must be small to be accurate. If the steps are too big, the program blows up. But there must be some stop time, say, after 1 millisecond. If the program is using 1 nanosecond, time constants with steps shorter than 1 nanosecond, this means large, possibly infinite amounts of machine time."

Frequency analysis is plagued by numerical inaccuracy though there's no record of anyone's being bitten by infinite runs. Nonlinear analysis can also be troublesome. Where radical changes in circuit performance—switching in particular—or large assemblies are involved, there can be difficulty in converging to a correct d-c solution.

Wanted: new rules

Researchers have separate but approximately equal problems with CAD. Their big job is to develop new computer algorithms that can be used to design networks. What they'd appreciate is software that allows network parameters to be varied one at a time during a run to get the best design. Given this, researchers would graphically feed initial circuit data to the machine and simply describe the performance desired, along with the constraints. The computer would then work over the information and provide some sort of maximized performance output.

To do this, the computer must operate the same way that an engineer would if he were doing the work manually. The machine would examine the data at several check points and allow the designer to alter the performance specs or change the constraints. Once the details of the program are worked out, the major requirement is speed. It is not unusual for the computer to evaluate performance 100 times for each maximization. Ideally, the designer wants machine time under a minute.

At present, programs for linear network analysis do perform rapidly. The residual hand-up involves which routines to combine to get a frequency response. For example, should the designer go after the critical frequencies of a network and evaluate directly? Or, should he operate on the defining equations and obtain the response at the next frequency point by iterative techniques? The latter would be based on an initial guess using the response at the lower frequency point to provide an input for the next guess.

However, nonlinear networks have not as yet proved susceptible of rapid performance evaluation. Among the reasons are a lack of good circuit models that clearly represent the nonlinear device; quite often models are much too complicated to describe to the computer. In addition, many time steps are required in a numerical integration as a result of high-frequency parasitics present in the network. Ignoring these can increase the step size, but it also results in instability of the algorithm. Finally, large matrices have to be manipulated at each integration—a time-consuming task.

Clearly, new algorithms for integration are required. These must provide stable operation for a reasonable time step and reduce the matrix manipulations required. These latter are controlled through techniques now being developed. The idea is to take advantage of the zeros in a matrix to cut down manipulation. The technique also permits matrix partitioning so a number of analyses can be handled simultaneously.

For purely practical purposes, Raytheon's McLeod wants improved algorithms. "We need them for better p-c board layouts," he says. "Computers can often come up with somewhat lower parts densities than men can or force one to use costly multilayer boards. Also the algorithms now available do only about 80% of the work, leaving the rest to the engineer."

Getting the picture

Making all man-machine communications as easy as possible rates high on any list of CAD priorities. As a result, there are high hopes for the application of graphics at both the input and the output ends of the cycle. However, many engineers believe that insufficient progress is being made in this area. At the moment, only a few CAD algorithms have graphics capabilities—despite no technical bar to more widespread use.

One reason for the lag, however, is that graphics require large memories, necessitating large machines. However, as better and more efficient programs are written, the processor size can be reduced. Moreover, there is no universal language like Fortran for graphics so programs cannot be conveniently exchanged.

Engineers would like to have present graphics capabilities extended to include such exotica as three-dimensional displays. Advances of this sort would, of course, prove invaluable in the design of integrated circuits and multilayered printed-

circuit boards since hidden lines could be observed and necessary alterations made with minimum fuss.

For all the problems, more manufacturers than ever are now relying on graphics for development work on IC's and printed-circuit boards. One is Motorola. Lester Hazlett, manager of CAD graphics at the company's Semiconductor Products division says, "The graphics terminal installed at the Mesa, Ariz., plant is still a research tool. However, three design groups have used it to make real circuits to prove out the system." Hazlett believes the set-up is now ready to be used as an on-line, interactive tool.

At the moment, Motorola's graphics capability includes a Control Data Corp. 1700 computer and disk unit driving a Digigraphics cathode-ray tube. The division's total CAD facility includes: Another CDC 1700 complete with disk unit, magnetic tape apparatus, printer, and card reader, a Gerber 2032 automatic drafting machine with light head for making masks up to 100 times actual size, and a Computer Industries plotter that makes ink drawings on paper.

Two years ago, Motorola wasn't doing any integrated graphics work but when the automatic drafting machine arrived it was immediately put to work solving mask-making problems for IC designs. "Historically, mask making has taken about one-third of the time required from device conception to production," says Hazlett. "We wanted better turn-around time than that." In addition to saving time on this part of the job, Motorola was interested in CAD as a way to eliminate the errors inherent in manual mask design—a concern made even more imperative by the trend to large-scale integration.

All of the application programs used by Hazlett's 14-man group in their graphics work were developed at the company. Almost all are written in Fortran. The group did some of the work Norden has done with its Cadic system, but Motorola customized the implementation.

Raytheon's McLeod reports good progress in this area as well. "Some of our most successful programs are for circuit layout—say, printed-circuit boards using output from a computer to drive a Gerber plotter. From rough artwork to finished one-to-one sized masks it's now a matter of about 10 days. It used to be weeks," he says. "There's also an in-house capability of driving a D. W. May Co. IC pattern generator with punched tape. In no case does the computer design the logic. Instead, machine instructions are created by key-punch operators or programmers from stylized logic diagrams. But from this point on, the production process can be automated all the way through to wire-wrapping."

"It's true, graphics have been an engineer's toy but it has proven very useful in monitoring and output devices. The principles of interactive graphics are sound; it's just immature as an input device," says Hazlett. "We've already done a job in just eight hours that would normally take eight

Surprise package

Defense contractors in the aerospace and electronics fields, using computer-aided design techniques may eventually find themselves hoist with their own petard. On most military projects, documentation is a must. Unfortunately, however, the formats specified for paperwork are not particularly compatible with CAD methodology. As a result, a number of companies have been compiling their documentation artificially in parallel with virtually unrelated design processes. For example, certain specs call for a four-to-one film enlargement of a printed-circuit board for quality assurance. Firms whose plotters automatically generate one-to-one artwork have to take it to job shops with precision enlargers to satisfy a requirement that hasn't caught up with technology.

A number of studies are being made of the problem. But most sources in industry feel the one acceptable answer is a complete restructuring of doc-

umentation so it can be run off as a part of the computer's output. In the meantime, small favors are being gratefully accepted. "Take the case of parts lists," says one engineering executive. "They can now be attached to engineering drawings rather than lettered out. Such small changes make design alterations much easier and save time."

Over the longer term, yet another joker may show up. Electronics concerns are already vying for contracts on the basis of unique software packages and hardware installations. The best bet is second-sourcing will wind up being a tricky proposition since no two electronic data processing capabilities are really alike. The military may well have trouble farming out production awards to concerns other than the original designer. Technique, it seems, is becoming part and parcel of the design itself and, perhaps, as important an element as system or device performance.

weeks. The finished result is a complete drawing, cutting, and peeling operation."

Rudy Thun, manager of microelectronics at the Radar and Electronics Lab at Raytheon's Missile Systems division, is less sanguine. He says: "Graphics are not too critical, all you want is a display of parameters unless you're doing layout work. They're useful in viewing system block diagrams, placement, mask checking, and sometimes in wire or conductor routing. But it's usually just as easy to print it out. Graphics are nice, but costly. Not just for themselves, but also software development."

Thun's reservations are based on empiric evidence. "We've found general approaches to CAD don't help much," he says. "Our experience has shown us the value of the empirical developments of automation for those blocks of the design process which save labor—the mindless, repetitive, or error-prone portions. Routing, pinning, mask making, are examples."

The future of crt-type interactive graphics, however, appears inhibited by a lack of better hardware. Users want improved size and speed. Some would like a work surface as big as a drafting board, as well as resolutions down to a couple of mils instead of the 10 mils now possible. "We'd like to draw lines that are an order of magnitude longer before the graphics line flickers," says one engineer. "As we get more information on the screen than it can handle, the speed drops from 40 hertz to about 20 hz and the flicker becomes objectionable."

Achieving a desired design for a given network requires a lot of computation, which pre-empts the processor, followed by long time pauses. When operating in the time-shared mode further delays are probable because the machine is also serving other users. Conversely, it becomes impractical for the computer to carry every CAD run through to

completion because others on the line will have to wait. But with graphics, fast turn-around times are a must. There's no particular problem in this area with batch processing, but then such techniques are not always as effective as graphics.

Killing time

One big factor against graphics centers on the use of typewriter terminals. Most engineers are simply not typists; if they hunt and peck or make mistakes, valuable computer time is lost. Advocates of batch processing argue that this is never the case with their favorite technique—once all the cards are punched correctly.

But Motorola's Meyer, who uses both batch-processing and time-shared systems, inclines toward the latter. He's after interaction for testing, in which a network is entered using the typewriter and the program compiles all the faulty modes of a test sequence using his special device design knowledge.

Time-sharing with remote terminals probably does offer the most sensible and most economic solution for the average company interested in CAD. But many answers remain to be found. And users can't realistically expect that the near future holds breakthroughs that will advance the state of the art by orders of magnitude.

However, a number of top minds at corporate research centers and universities are working on these difficulties. A key aspect of the solution will be gaining a better understanding of how best to combine performance evaluation and optimization. IBM is working along these lines on a project called PLAN (problem language analyzer). PLAN is not geared to any specific area such as circuit analysis; it's conceptual and can be applied in a general way. The idea is to make it easier for a designer to use a computer without learning programming.

Large-scale integration is the semiconductor industry's response to demands for more complex electronic chips. Economics will play a key role in acceptance, and engineering costs are perhaps the most easily variable item in this category. Since it is expensive to develop an LSI chip, the problem comes down to finding ways of making small runs of custom chips at acceptable costs.

Micromatrix—a Fairchild Semiconductor invention—represents one approach, being intended to serve markets ranging from a few hundred chips to the crossover point of pure custom work.

Micromatrix is a two-dimensional matrix of basic multigate building blocks or cells; each cell contains a set of components (diode cluster, inverters, and the like) that may be individually specialized by cell intraconnections to become one of a variety of fundamental logic building blocks—nand gate or flip flop. By means of a two-layer metalization process, the cells may be interconnected to form a complex subsystem logic function.

Not all the components in any array may practically be implemented in a subsystem; Fairchild's experience indicates that 80 percent usage is a fair efficiency figure for logic partitioning. A pure custom circuit, however, will usually employ 100 percent of the components on the chip.

One of the ground rules is that customization is permitted only at the interconnection level, not at the device level. No testing is performed at the cell level. Checks are run only after fabrication when metalization is complete.

Micromatrix makes for lower cost and shorter turn-around time for complex large scale integrated circuits than conventional custom design. CAD in this case is primarily applied for device simulation, test synthesis and analysis, and optimum lay out of the matrix cells on the micromatrix wafer.

Second fiddle

Micromosaic, a Fairchild Semiconductor approach to the need to reduce costs of engineering and manufacture for large-scale, custom integrated circuits. It's exclusively MOS. (However, development work is under way to extend the technique to bipolar circuits.) Computer programs are used for device modeling, test synthesis and analysis, cell placement and layout, interconnection masks generation and final checks.

Low customer costs and quick turn-around time are also the objectives of micromosaic. Logic diagram input to finished device time is presently two to three months, but Robert Ulrickson, department head, systems and arrays engineering says: "Within one year, only one month will be required from the initial customer logic to finished device."

From a customer's logic design, Fairchild codes the circuit network in Fairsim language to produce a logic simulation of the network. Logical delay is used to sequence the signal transmission to this device model. Logic transitions are assumed to be instantaneous, which means that input threshold and noise immunity cannot be simulated directly.

The operation of the simulator is accomplished this way: 64 elements of memory are reserved for a time wheel corresponding to the logic element delay range of 0 to 63. The program scans each position of the time wheel and upon encountering the entry is directed to a list of logic elements whose delays have timed out and whose outputs are ready to change.

The program then transmits the new output along the fan-out net as inputs to other logic elements. Next, it simulates all affected elements to determine if their outputs will change state; if they do it places the proper flag in the time wheel at the slot their output is due to change after their delay. The scanning of the time wheel elements then resumes. The time wheel also updates total elapsed system time before recycling.

The output consists of a network listing, a signal cross-reference listing, and a simulation. The network is described in terms of available logic elements. The signal cross-reference provides a method for checking the network coding. All signals are listed; corresponding to each signal is a list of all elements that are driven by this signal. The fan-out number shown on the printout corresponds to the number of elements that are connected to a node, and takes into account no other electrical consideration. Any signal which is not defined as the output of a logic element is assumed to be an output, and is so labeled. Simulation output provides the basic output of Fairsim that is the CAD equivalent of a multitrace oscilloscope.

After computer simulation of the device, cell and pad assignment are made from a library of 44 cells. Ulrickson says: "Fairchild can add new cells as new functions are demanded by the customer. New cells will take about one month to design; but all the cells in the library have standard geometries so that old cells do not have to be recharacterized upon the introduction of a new cell." There were only 20 cells a year ago.

Subsequent to computer cell and pad assignment, human constraints may alter the computer-generated geometry. From the final cell placement and interconnection patterns stored in the computer, graphics and masks are generated. After the customer's logic diagram is translated into Fairsim, the operation is completely automated with the exceptions of human intervention to improve cell placement and interconnections.

Raytheon's Thun looks to CAD for a hand in checkouts. "One area that must be fostered is test programs. Once a manufacturer could test parts before putting them into a circuit. But the first IC's made components control impossible and moved quality control all the way to the end of the production line," he says. "As circuits become ever more complex, the burden is becoming heavier very rapidly. Computer tests should inject a little more honesty into IC and LSI sales. With computers handling checking, both manufacturers and users will have to stick to the rules—and the rules will be tight enough to choke off lots of specmanship."

Designer's casebook

Unity-gain amplifier in probe needs only two conductors

By James F. Teixeira

Sylvania Electronic Systems, Waltham, Mass.

The need frequently arises to design a probe with a unity gain, high input impedance amplifier. Such an amplifier, when placed in the probe, functions by isolating the probe tip from the cable connecting the probe to the measuring instrument. Ordinarily, a coaxial cable is used for this purpose, but the designer is limited by the two-conductor nature of this cable type as will be shown.

One possible circuit uses a field effect transistor and a bipolar transistor (top) where input bias resistors R_1 and R_2 are bootstrapped to increase the input impedance to the FET, but this circuit requires three wires for power, output, and ground.

A modified version of this circuit shown below requires only two conductors. The bias voltage is developed across resistor R_2 which is bypassed for a-c signals by C_2 . The load resistor R is located at the measuring instrument.

The circuit exhibits low output impedance and can easily drive several feet of coaxial cable. The input impedance of this amplifier is tens of megohms. The amplifier draws about 1.5 milliamps.

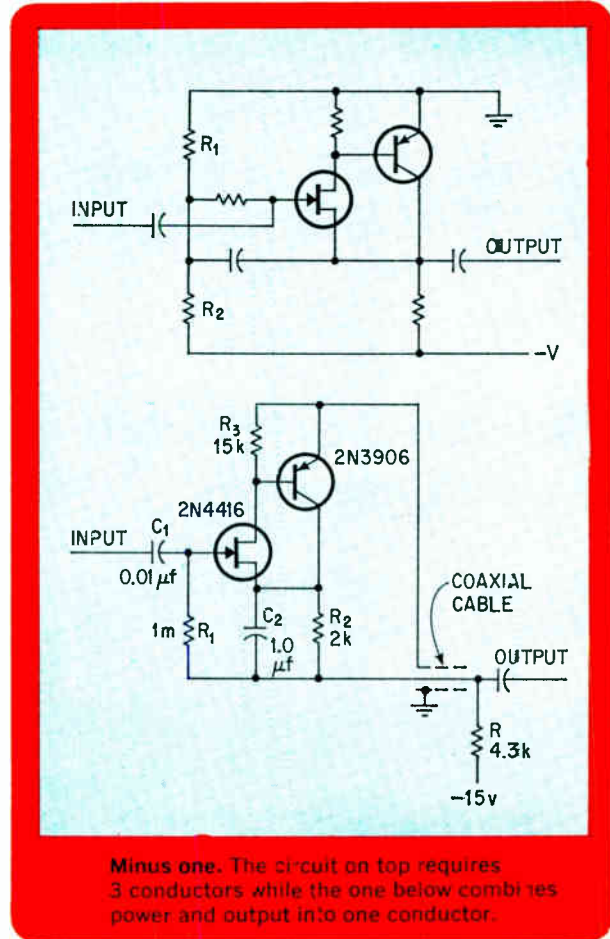

Circuit improves thermistor's linearity and boosts output

By J. M. Nemchik and R. J. Fritsch

Carnegie-Mellon University, Pittsburgh

Although being inexpensive and easy to use, thermistors are inherently non-linear and can supply only very small output signals due to their sub-milliwatt power ratings.

The circuit shown overcomes these problems. Its

output voltage is a linear function of temperature over a range of -20°C to $+70^{\circ}\text{C}$ and is given by the equation: $V_{out} = -V_o R_t / (R' + R_t)$. The output voltage is boosted by a factor R_t/R' , or in this example 150.

This function is linear at about the temperature at which $R_t = R'$. Thus the value of R' should be made equal to the thermistor resistance at the center of the desired temperature range.

R_1 , R_2 , R_3 and the diode form a regulated d-c power supply delivering a voltage $V_o = -0.067$ volts. If the value of R' is chosen correctly, the current through R_1 will be a linear function of temperature over a wide range. The op amp supplies to the meter a voltage proportional to the thermistor

current at a low output impedance.

An upper limit on the value of V_o is imposed by the maximum power rating of the thermistor, P_T . V_o is given by: $V_o \leq \sqrt{R_T P_T}$. This voltage is supplied by the regulator and divider combination R_1 , R_2 , R_3 and the zener diode.

Feedback resistor R_f determines the gain of the circuit; normally, the center of the temperature range would appear at center scale on the output voltmeter. The value of R_f is then determined by $R_f = V_{fs} R' / V_o$ with V_{fs} being the full scale voltmeter reading.

R_3 is adjusted so that $V_o = -0.067$ volts. The output impedance of the circuit is 50 ohms.

The maximum power dissipated by the thermistor in the circuit is 2.5 microwatts.

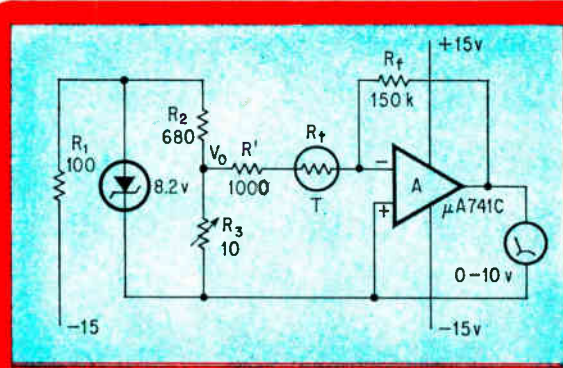

Right choice. If R' is chosen correctly, the thermistor's current will be linear over a wide temperature range.

Unijunction circuit prevents damage to transistors

By John Durnin and Michael DeCicco
Burroughs Corp., Plainfield, N.J.

Destruction of current-limiting transistors in voltage regulators stemming from excessive power dissipation can be prevented by using the circuit shown. The circuit is activated only when the associated power supply exceeds its specified current capability.

Current-sensing resistor R_1 is initially adjusted to prevent unijunction transistor Q_3 from operating

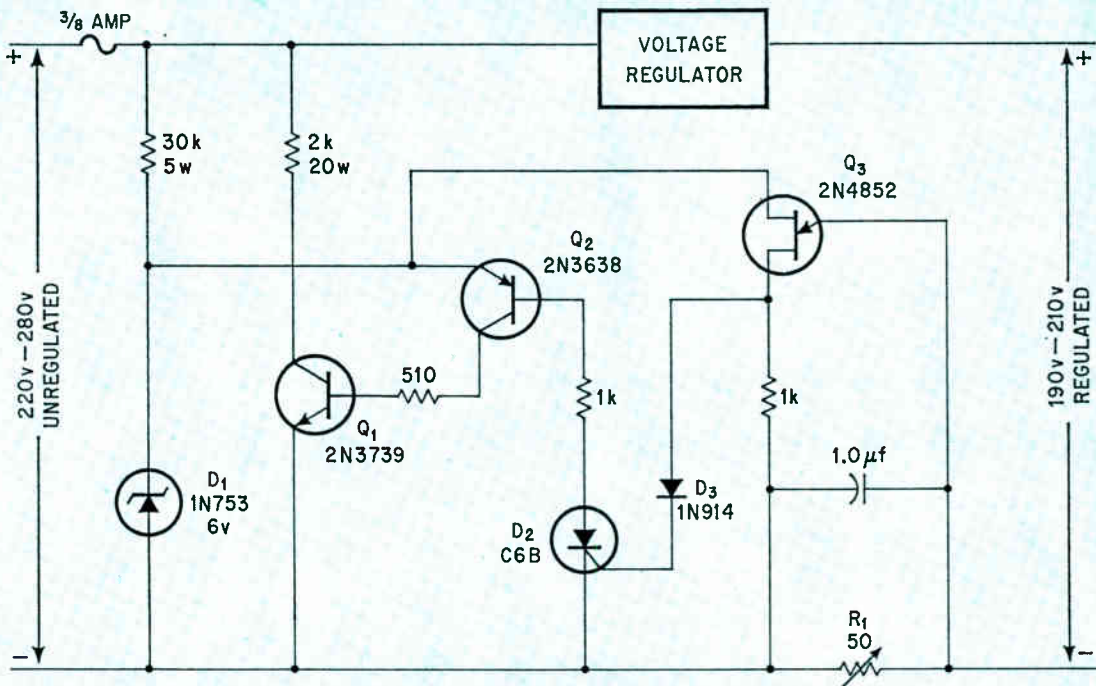

Protection. When the power supply's maximum current is exceeded, Q_1 fires and gates the silicon controlled rectifier on. D_1 's anode voltage drops, biasing Q_1 on, which in turn switches Q_3 on. The amount of current drawn by Q_3 is sufficient to open the fuse and prevent current flow to the regulator.

until the maximum current output of the power supply is exceeded. As the current surpasses the maximum rating, the voltage across R_1 increases, biasing Q_3 on. Q_3 's positive output turns on D_2 , a silicon controlled rectifier. D_2 's anode voltage drops, biasing Q_2 on. Q_2 's collector places a positive volt-

age on Q_1 's base, turning it on. The amount of current drawn by Q_1 is sufficient to open the fuse and stop current flow to the voltage regulator.

D_1 provides the bias voltage for Q_2 and Q_3 . D_3 prevents negative pulses from inadvertently turning D_2 off.

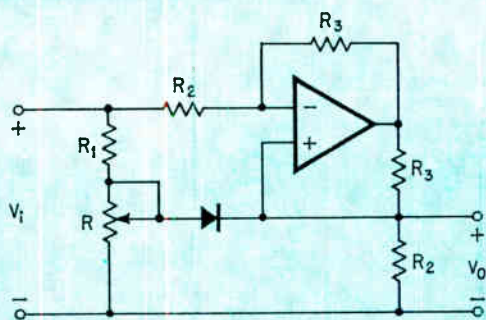

LOGARITHMIC AMPLIFIER

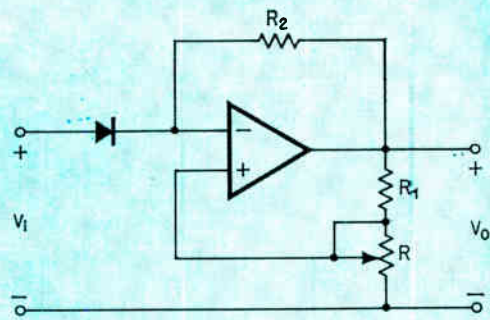

ANTI-LOGARITHMIC AMPLIFIER

TYPICAL VALUES
 OP AMPS - μ A702
 $R_1 = 500\Omega$ $R_2 = R_3 = 1k$
 $R = 20\Omega$

Cancels effects. The logarithmic and antilogarithmic amplifiers yield an exponential relation between the forward current and voltage in a diode, even when the diode operates over a large forward current where its bulk resistance may not be negligible.

Op amp log circuit eliminates diode bulk-resistance effects

By Sergio Franco

University of Illinois, Urbana

Silicon diodes find wide application in analog circuits such as logarithmic and anti-logarithmic amplifiers, multipliers, and dividers because of the exponential relationship between forward current (I_f) and forward voltage (V_f). But this relationship holds only when the diode is operated over small forward currents (less than 1 milliamp) where the ohmic component generated by the bulk resistance of the diode is negligible.

Sometimes, however, it is desirable to work with larger forward currents to extend the current signal range or increase the circuit speed. Then the bulk resistance may not be negligible and the

I-V relationship may no longer be exponential. The op amp circuits shown maintain the logarithmic relationship of the diode by canceling the bulk resistance effect.

The log relation of a diode is $V_f = A \log I_f + B + rI_f$ where r is the diode's bulk resistance. In the circuit, a voltage equal to rI_f is developed across R and subtracted from V_f , so that the relationship between I_f and the difference ($V_f - rI_f$) is exponential. To determine the setting of the trimpot R , the input-output characteristics of either circuit are plotted on semi-logarithmic paper, and R is varied until a straight line is obtained.

In the first circuit, $I_f = V_i/R_2$ and $V_o = V_f - rI_f$, therefore $V_o = [A \log (V_i/R_2) + B]$. R_1 must be smaller than R_2 . If after adjusting R , $2R_1 + R = R_2$, then $R = r$.

In the second circuit $I_f = V_o/R_2$ and $V_i = V_f - rI_f$. Therefore $V_o = R_2 \exp [(V_i - B)/A]$. If after adjusting R , $R_1 + R = R_2$, then $R = r$.

Because of the common mode rejection of the op amps, the reference terminals need not be grounded.

Take a look... this counter



speaks for itself

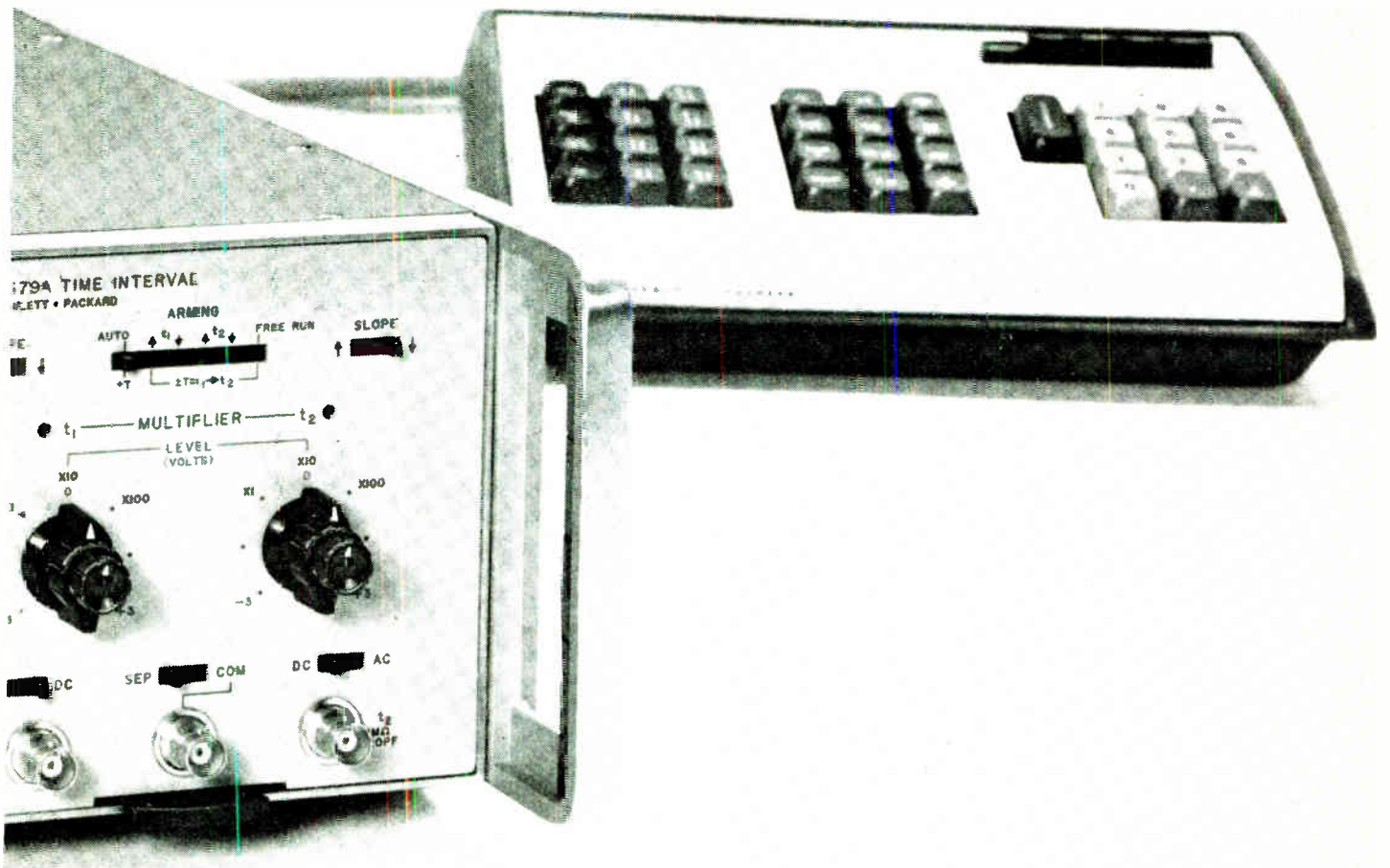

A word from the new HP 5360A Computing Counter:

Measurement and computation

The revolutionary new Hewlett-Packard 5360A Computing Counter, the most significant advance in counter technology since 1952, uses built-in interpolation with computation to eliminate the traditional ± 1 count ambiguity. It combines an IC period-measuring counter and an internal computer in a compact, easy-to-use package. Lets you measure frequency 1000 times faster, much more accurately and over a wider range than ever possible before. Basic measurements, 0.01 Hz to 320 MHz are automatic, with period and time interval resolution to 0.1 ns — a resolution never before offered in a counter. The 5360A's computing capability lets you automatically and in real time solve equations whose variables are the counter's measurements!

Fast and true

Take speed — the 5360A's up to 100 times more accurate than previous counters for the same speed. Take accuracy — it's 3 to 1000 times faster for the same accuracy. The previous ± 1 count accuracy limitation is decreased by a factor of 1000 by interpolators and digital computation within the 5360A.

Widest range

Besides the basic 0.01 Hz to 320 MHz measurement range, the 5360A accepts all the heterodyne converters of the popular HP 5245L, 5246L and 5248L Counters and lets you make spurious-free measurements to 18 GHz. Basic measurements without prescalers, too.

Finest resolution

No previous direct-reading digital instrument has given you the 0.1 ns resolution available in the 5360A for time interval and period measurements. In addition, with the 5379A Time-Interval Plug-in (not required for period measurements) you get more versatile input controls than ever before, automatic error detection and measurement of positive or negative intervals down to zero seconds, at rates over 1000 measurements per second.

Pulsed RF measurement

With none of the tedious transfer oscillator manipulation and calculation, the 5360A will measure pulsed signals up to 320 MHz with pulse length as short as 1 microsecond — and do it automatically and directly. Using the frequency converter plug-ins, you can measure pulsed carriers all the way to 18 GHz. And you can even measure a single burst of signal, which you can't do with transfer oscillators.

Computation

The 5360A and its accessory plug-in program module (available now) or its keyboard (available later this year) let you get direct answers in final form, real-time solutions to equations... without additional costly processing equipment and interface design. Two simple examples are direct readout measurements of phase or the rms value of a series of measurements.

Easy to use

Front-panel controls provide new dimensions of versatility, yet the 5360A is easy to use. There's a new minimum in the need to manipulate controls. Range selection, for example, is automatic over the entire frequency range, no matter what the setting of the Measurement Time switch. The 5360A gives you a fixed-decimal display, with automatic blanking — your reading is always in the same position, with up to three digits to the left of the decimal, up to 11 digits in resolution... all via internal calculation. It's virtually impossible to read the 5360A incorrectly.

Questions?

The 5360A Computing Counter with the 5365A Input Module costs \$6500. The 5367A Time-Interval Plug-in costs \$750. Accessory keyboard, approximately \$1000. Accessory plug-in program module, \$190.

For all the information on this break-through instrument in counter technology, call your local HP field engineer. Or write for our fully illustrated brochure and data sheet: Hewlett-Packard, Palo Alto, California 94304; Europe: 1217 Meyrin-Geneva, Switzerland.



ELECTRONIC COUNTERS

02907

Simpler digital circuits in a snap

Fast switching property of charge-controlled diodes cuts component count in circuits for sharpening and delaying pulses and generating pulse trains

By Bernard Siegal

Microwave Associates (West), Inc., Sunnyvale, Calif.

Charge-controlled switching diodes, familiar to the microwave engineer in frequency-multiplier circuits, are not as well known to digital circuit designers. But when designed specifically for digital applications, such diodes can be very useful in simple circuits that perform such functions as pulse sharpening, pulse delay, pulse width conversions, and impulse generation.

The diode has an intrinsic region (a PIN construction) that creates long minority carrier lifetime and a controlled release of stored charge during reverse biased conditions. During forward bias, the minority charge carriers injected into the intrinsic layer have a long recombination time. The diode appears as a low impedance, typically less than 1 ohm. A sudden reversal of current will start to remove the stored charge and the diode appears as a low impedance until all the stored charge has been removed—then it switches rapidly to a high impedance state, typically greater than a megohm. The time required to go from low to high impedance, usually called the turn-off or transition time, may be from tens to hundreds of picoseconds, depending on how the diode is made.

In a circuit for sharpening a pulse's leading edge on page 106, the diode is connected across the load. Current from the bias supply stores charge in the junction causing it to appear as the low impedance. When the input pulse is applied as a reverse bias, the stored charge starts to disappear and when it has been completely extracted, the diode switches to the high impedance state and the output voltage suddenly rises, producing a sharply rising pulse. The output pulse then drops at the same time as the input, and thus the output pulse is narrower than the input pulse by the delay time.

The delay time is

$$t_d = \tau \ln \left[1 + \frac{I_B (1 - e^{-t_F/\tau})}{I_p} \right]$$

where I_p is the reverse-bias pulse current, τ is minority carrier lifetime, I_B is bias current, and t_F is the time interval that bias is applied. If I_b is less than about $0.2I_r$, the delay time is, within 10%,

$$t_d = \tau I_B / I_p$$

The trailing edge can also be sharpened by placing the diode in series with the load; both the leading and trailing edges can be sharpened by a combination of series and shunt connected charge-controlled diodes.

The inherent delay of the diode can also be put to use in a simple nanosecond delay circuit which has a fast output risetime and little time jitter between input and output.

The coupling capacitors produce excessive droop if the input pulse is too wide, but this can be overcome by using Schottky-barrier diodes for d-c isolation instead of the capacitors. Though this is an added expense, the diodes add less parasitic circuit inductance, require less physical space, and remove restrictions on pulse widths and repetition rates.

Sensitive area

The complex circuitry usually needed for pulse area limiters or pulse-amplitude-to-width converters can be replaced by a simple circuit in most cases. In the circuit on page 107 the input pulse of varying amplitude and width will be limited to a maximum time-current area given by

$$A_{t_{c\max}} = t_r I_r = \tau I_F$$

Input pulses having time-current areas less than $A_{t_{c\max}}$ will pass through the circuit unaffected, but those with greater area will pass through until the critical area is reached and then be isolated from the output by the reverse biased diode.

The same circuit can be used in other ways: as a wideband pulse-counting f-m discriminator with

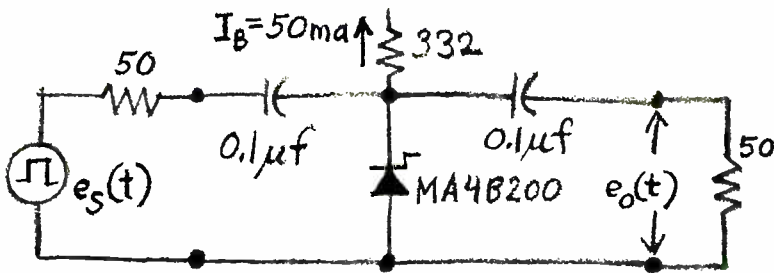

Leading edge sharpener. When placed across the load, the charge-controlled diode presents a low impedance, holding the output voltage low, until all its stored charge is removed and then switches into a high impedance state. As shown at the right, the input risetime is about 12 nsec; the output risetime is less than 1 nsec.

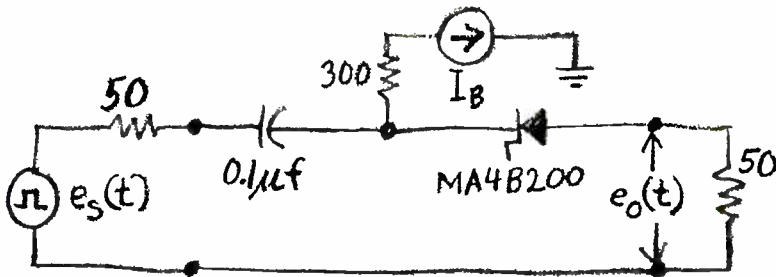
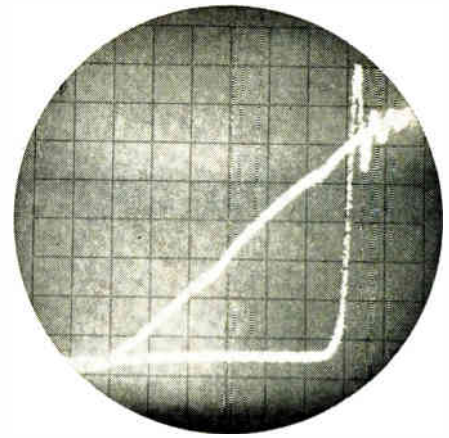

Trailing edge sharpener. When placed in series with the load, the diode reduces the output voltage when it switches into the high impedance state. Traces at right show the fall time of the input pulse is about 5 nsec while the output has less than 1-nsec fall time.

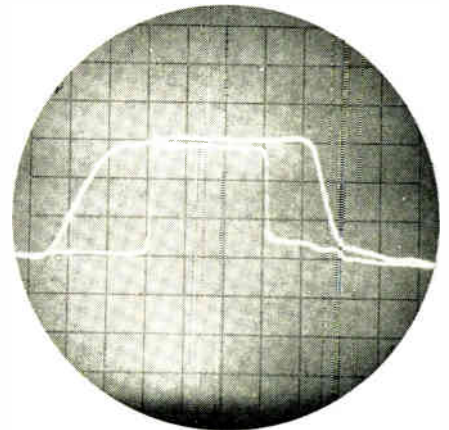
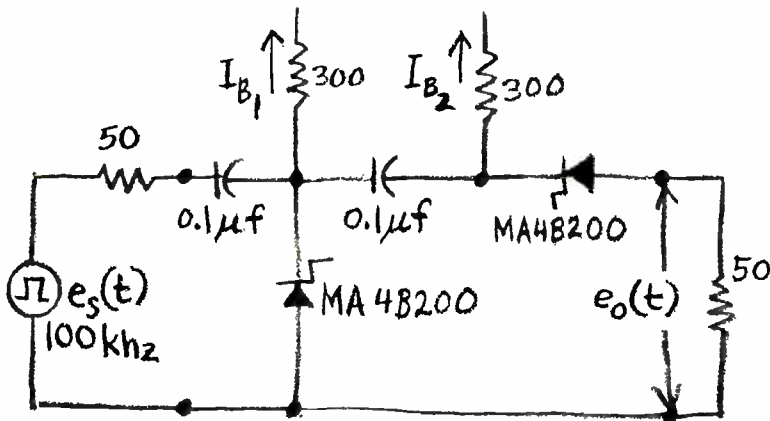
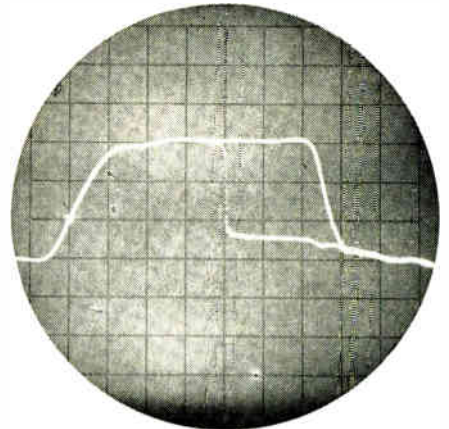

Pulse Squarer. A combination of diodes will sharpen both the leading and trailing edges. The same circuit can be used to produce variable pulse width control and pulse position control by varying the bias currents, as indicated by the lower two traces. All scope settings are 10 nsec per division for horizontal axis and 5 volts per division for vertical axis.

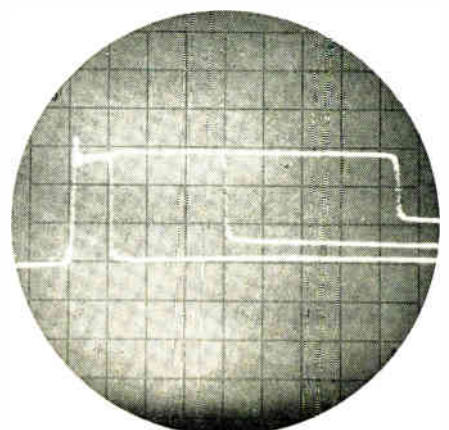
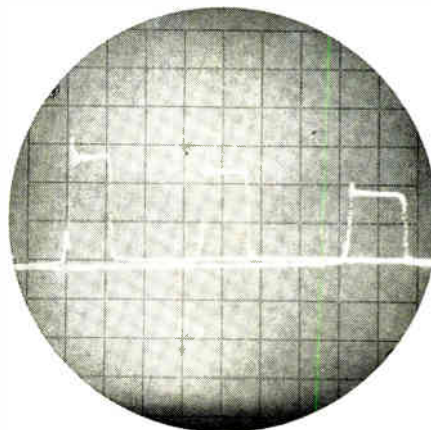

good linearity and as an amplitude-to-pulse-width converter.

Since a series of varying amplitude and width input pulses will produce a series of constant area output pulses, the time average of the output will be proportional to the input pulse frequency, but not the input amplitude. The result is the f-m discriminator circuit.

Analog signal amplitude-to-pulse-width conversion can be obtained by applying a fixed amplitude and width pulse at the input and varying the forward current. The input pulse, which might be considered a clock pulse, must have sufficient width to handle the maximum value of the now varying I_F . If τ and I_r are fixed, then

$$t_r(t) = \left(\frac{\tau}{I_r} \right) I_F(t)$$

$I_F(t)$ can range from a very slowly varying d-c current to an a-c signal in the kilohertz range.

On an impulse

The trend toward higher clock rates in computer circuitry has required the design of complex circuits providing high frequency, narrow width pulses. Although there are many ways of obtaining the desired pulses, an easy method is to convert a high frequency sinusoid to an impulse. This can be easily accomplished with a picosecond pulse shaping diode.

In addition to use a clock pulse generator, the circuit can find other important applications. The narrow width impulse, when observed in the frequency domain, will produce a frequency picket (harmonics) of relatively constant amplitude. In the time domain, the impulses can be used as time markers for accurate calibration of high speed equipment. If a suitable high power diode is used, this circuit can drive microwave tubes, such as magnetrons, to produce very narrow r-f pulses for radar and ecm systems.

If the diode is coupled to a sinusoidal source, as on page 108, and a d-c bias supply adjusted so that when the diode makes the transition from low impedance to high, there is some current through the inductor, then a voltage impulse will appear across the diode. The width of the impulse t_o is dependent on the diode drive inductance L_d and load resistance R_L :

$$t_o = \frac{\pi \sqrt{L_d C_{TR}}}{\sqrt{1 - \left(\frac{L_d}{4R_L^2 C_{TR}} \right)}}$$

where C_{TR} is the diode's total capacitance at a reverse d-c voltage.

In actual practice, the sinusoidal source will have some fixed impedance and will be affected by a highly reactive load.

A more practical version of the circuit is on page 108. The value of inductance will be determined by the desired t_o , R_L , and the diode's C_{TR} . Since the diode package has inductance associated

with it, L'_d , the sum of L_d and the package inductance L_p , must be used in the above equation instead of L_d . The value of the d-c isolation capacitor, C_i , is chosen to have negligible impedance for the desired t_o . The minimum obtainable impulse width for a given diode is:

$$t_{o \min} = \pi \sqrt{L_p C_{TR}}$$

For a typical diode having $L_p = 2$ nh and $C_{TR} = 4$ pf, $t_{o \min}$ is approximately 400 psec. The main purpose of C_T is to resonate the combination of L_d , diode, and R_L so that the input impedance is purely resistive. An empirical relation for C_T is:

$$\frac{N^2 C_{TR}}{2} \leq C_T \leq N^2 C_{TR}$$

where N is the ratio of the input frequency half period to the impulse width;

$$N = \frac{t_i}{2t_o}$$

If a high quality capacitor is used for C_T , then it

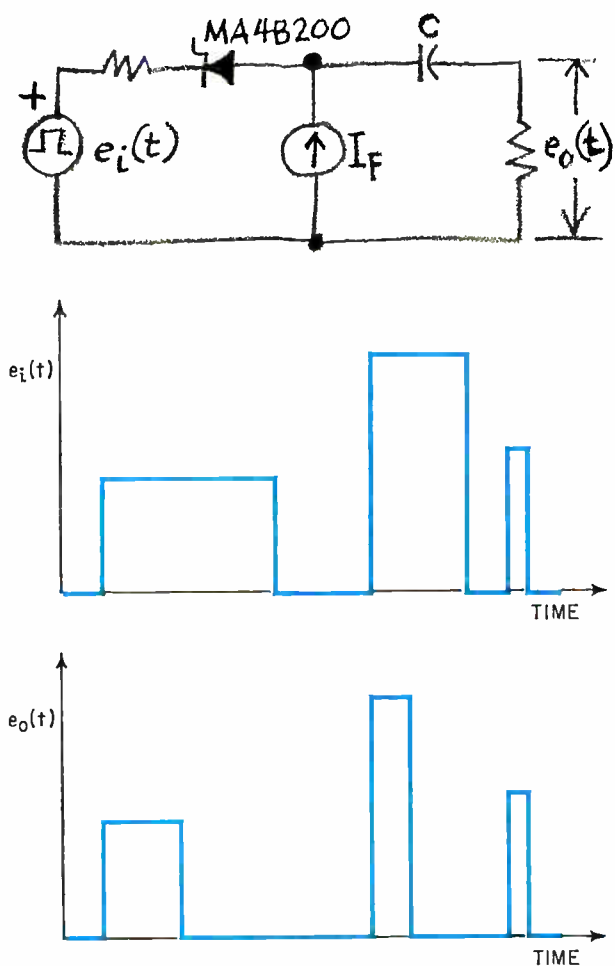

Pulse area limiter. The bias current I_F sets the stored charge and thus the area of the output pulse. Input pulses less than a critical area are passed unchanged, but pulses of greater area are limited to a fixed area, with the same amplitude but of less width.

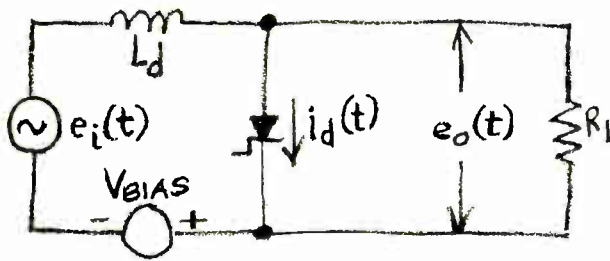

Impulse generator. When driven with a sinusoidal source, the diode produces an impulse output for each input cycle. The output occurs when the diode switches to the high impedance state with a current flowing through the inductor which produces an induced voltage across the inductor. A more practical circuit is shown in which the input matching is included.

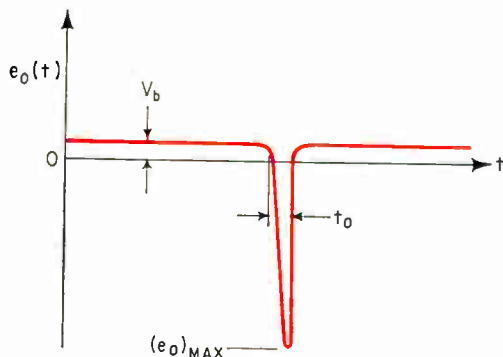
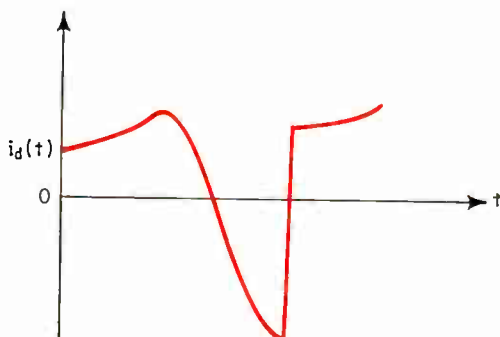
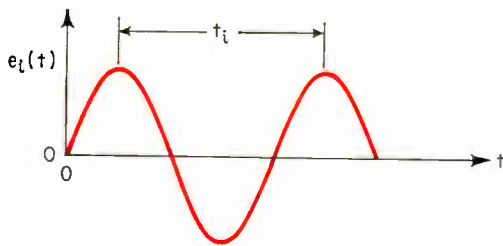

also serves to isolate the signal source from the impulse.

The matching and bias section provides a good match from the source impedance R_g to the input impedance, R_{in} , of the impulse generator section. The value of R_{in} has been empirically found as:

$$R_{in} = \frac{t_o}{\pi C_{TR} N}$$

A simple, single stage, L-C low pass filter circuit will usually provide adequate matching and source isolation. For the matching circuit shown

$$L_m = \frac{\sqrt{R_{in}(R_g - R_{in})}}{2\pi f_i}$$

$$C_m = \frac{1}{2\pi f_i R_g} \sqrt{\frac{R_g - R_{in}}{R_{in}}}$$

where f_i is the input frequency.

The bias inductor L_b is necessary to isolate the bias resistor R_b from the input frequency while still providing to a d-c path for the bias current.

Either fixed or self bias can be used. Although fixed bias can be used to control the impulse, the less expensive self-bias method is usually favored. The value of the bias resistor is:

$$R_b = \frac{2\tau}{N^2 C_{TR}}$$

Since minority carrier lifetime, τ , is the only major temperature sensitive parameter of diode a bias resistor with the same temperature coefficient as τ would stabilize the circuit over very wide temperature extremes.

The input frequency has some minimum value:

$$f_{i \min} \gg \frac{1}{2\pi\tau}$$

This condition is necessary to prevent a significant loss of stored charge due to recombination with the junction.

The series combination of L_d and L_p will form an inductive voltage divider that reduces the impulse amplitude from theoretical value. If $e_{o \max}$ is required to be very large, then both the diode's reverse breakdown voltage and package inductance must be considered. ■

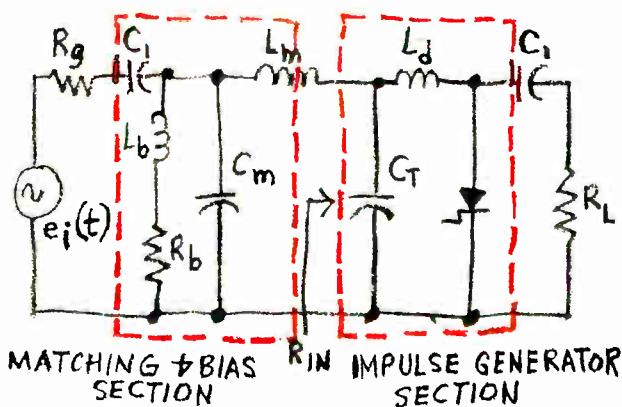

winning form



from the form-factor specialists at Damon

Getting a true AFC lock-on can be a problem with a discriminator that produces extraneous zero-crossings. That's a problem you can forget with the new **Damon Model 6283MDA Monolithic Discriminator**. You also get a highly symmetrical characteristic — even beyond peaks — resulting in improved performance with noisy signals. Plus a monolithic multi-resonator for excellent stability over a wide temperature range. All in a compact one cubic inch package.

The high-reliability Model 6283MDA has a center frequency of 10.2 MHz \pm 100 Hz, and peak separation of 10 KHz nominal.

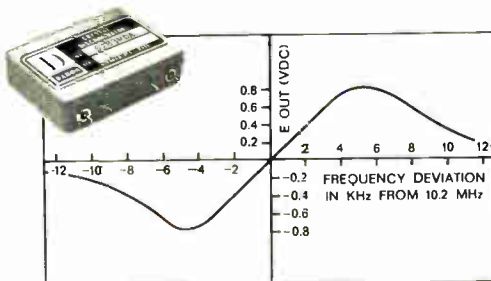

Sensitivity: 0.2 volts/KHz \pm 10%. Linearity: $<$ 5% over $f_r \pm 2$ KHz. Input: 2 volts P-P square wave. Supply: 12.5 volts at 22 ma.

Whatever your signal-shaping needs — from a narrow-band discriminator characteristic to a broad band-pass — rely on the form-factor specialists at Damon. Write: Electronics Division, Damon Engineering, Inc., 115 Fourth Avenue, Needham, Mass. 02194, or call (617) 449-0800.

 **DAMON**

Circle 109 on reader service card

Linearity corrector does double duty

Forward-biased FET serves dual purpose in gamma-correction circuit by compensating for nonlinearity while providing temperature stability

By Robin Williams

New York University

As most designers of linear circuits would attest, compensating for the nonlinear performance of vacuum tube circuits by using such temperature-dependent nonlinear circuit elements as diodes and bipolar transistors can be a complex task.

But there is a relatively simple alternative. The designer can, by using the output characteristic of a field effect transistor in a simple arrangement, provide the necessary correction while, at the same time, achieve the required temperature stability.

Consider, for example, a design of a television camera. Because the modulated light output from a tv receiver's cathode-ray tube is nonlinear with respect to the applied intensity-modulation video signal, the designer includes a compensating circuit just ahead of the camera's video processing circuitry. Called a gamma-correction circuit, it compensates for the receiver crt's nonlinearity. Without this compensation, the intensity variations appearing on the crt would differ from those of the original scene.

Gamma correction requirements are even more stringent for color tv than for black and white. Not only must the circuit provide the correct nonlinearity, it must be temperature-stable to reproduce the colors with consistency. Moreover, in addition to being capable of compensating for differences in camera pickup tubes, the gamma-correction circuit must have an adjustable transfer characteristic; a single potentiometer must be able to provide gamma variations of $\pm 10\%$, with the end points of the transfer curve remaining fixed as the gamma control is varied.

The transfer characteristic should be

$$E_{out} = (E_{in})^\gamma$$

where $\gamma = 1/2.2$ nominally.

Although a FET has a biasing point at which its drain current, I_d , does not vary with temperature over a wide range of drain-to-source voltage, V_{ds} , this point cannot be used. For the transistor's nonlinear output characteristic to resemble the gamma

curve, the drain-to-source voltage must be variable over a 10-volt range. But such a voltage swing is too great for gamma correction. However, by forward biasing the gate of the FET, the required nonlinearity can be exhibited with a signal level of only 1 volt or less.

When the gate of a FET is forward biased—positive for an n-channel device and negative for p-channel—the resulting drain current versus drain-to-source voltage characteristic for

$$0 < |V_{ds}| < 1 \text{ volt}$$

is similar to the gamma-correction curve common to tv systems. Moreover, it is possible to obtain an almost zero temperature coefficient for this characteristic.

With the forward biasing, about 0.65 volt for a type 2N3823, the drain current will remain constant as temperature is increased. The reason: any

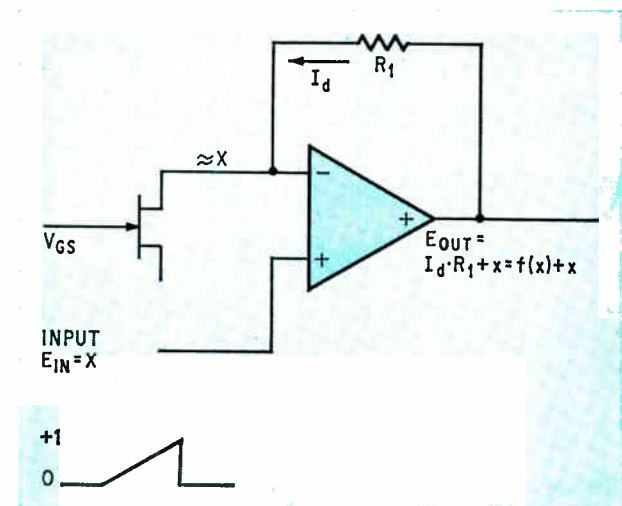

Basic circuit. With an input at the noninverting terminal of the op amp, the output voltage is the sum of the drop across R_1 and x , the FET's drain-to-source voltage.

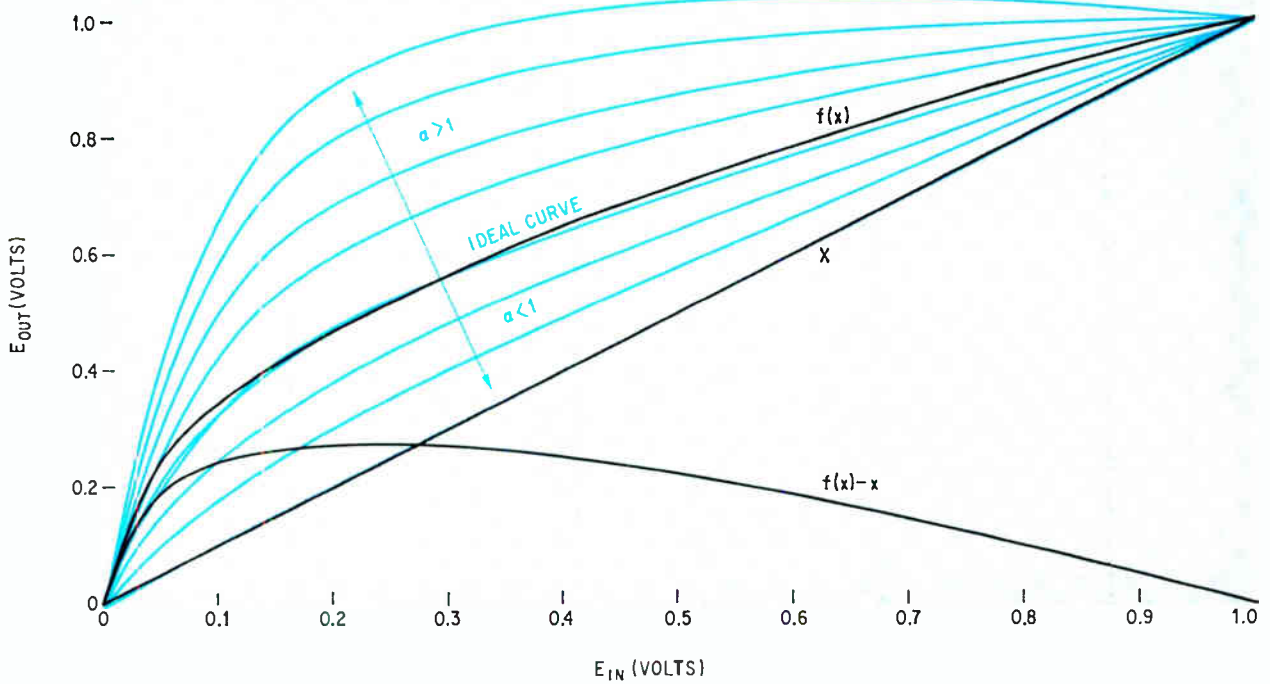

Transfer characteristics. Subtracting linear curve x from gamma curve $f(x)$ produces difference curve $f(x)-x$. These curves are shown in black. In color are plots that show actual performance characteristics of an experimental gamma correction circuit.

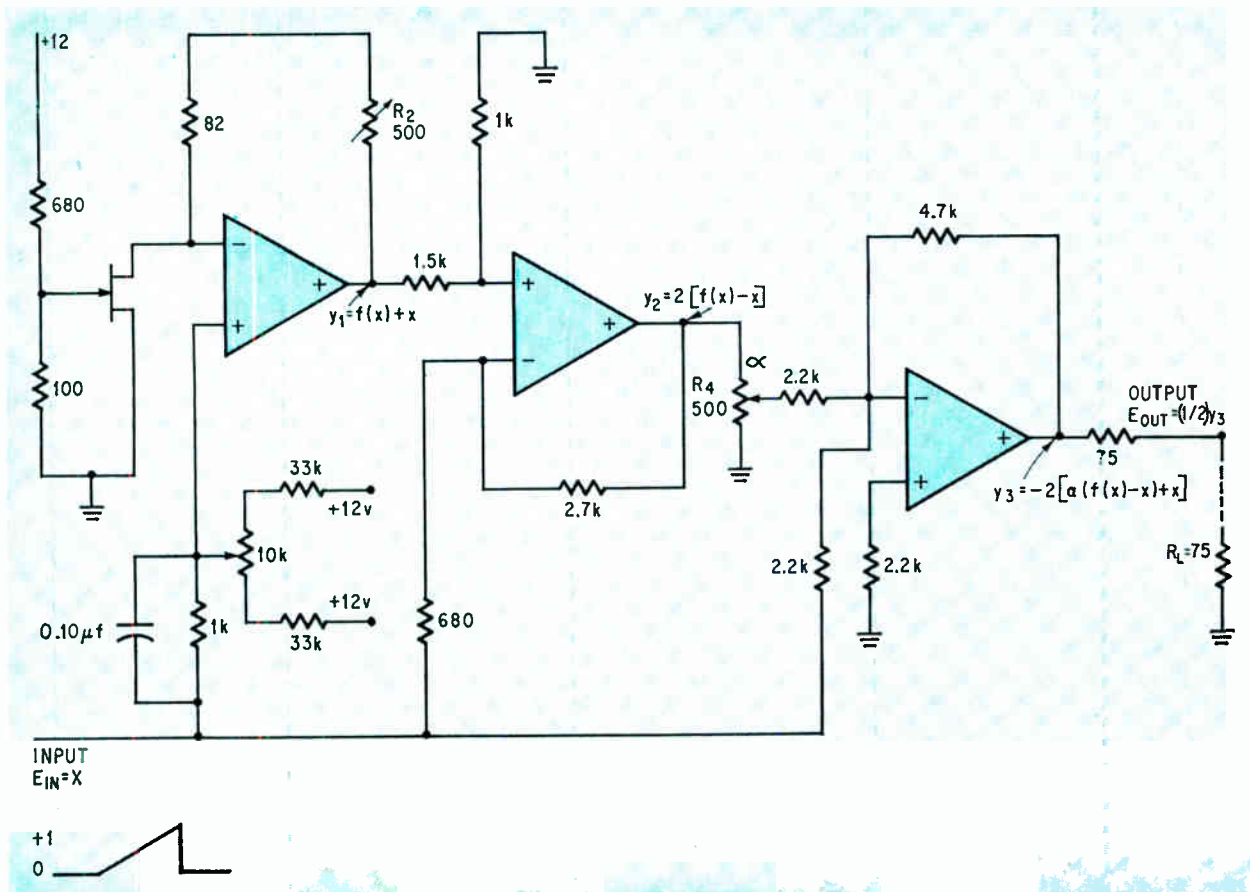

Gamma corrector. A single potentiometer, R_1 , establishes the value of α and provides a wide range of gamma control.

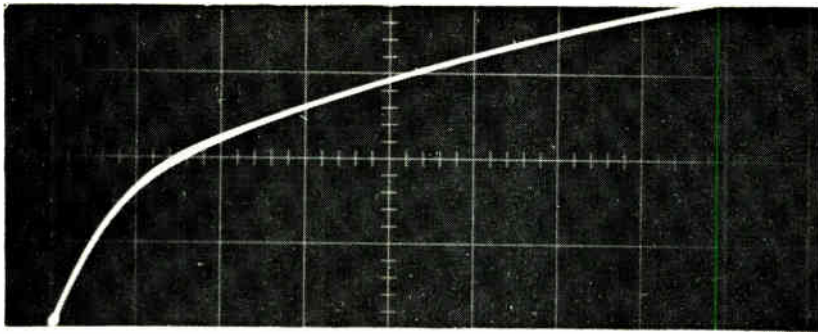

Superimposed. Composite transfer characteristic curve derived by superimposing curves from three 2N3823 FET's used alternately in first stage of experimental gamma-correction circuit. The vertical scale was set at 1 v/cm and the horizontal at 0.125 v/cm.

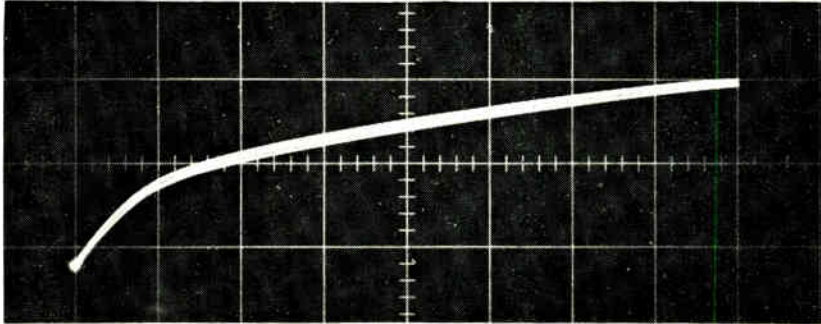

Stability. Composite curve reflects temperature stability of correction circuit.

reduction of the majority carriers is compensated by an increase in the conductivity of the channel. This increase stems from injection of minority carriers from the forward-biased gate.

However, a better approximation of the gamma curve can be obtained by biasing the gate at 0.9 volt. But this would result in the drain current increasing as the temperature is increasing. This can be nullified by introducing a resistance in the gate supply voltage path, thereby creating a negative feedback effect. The gate-to-source voltage, V_{gs} , will then decrease with increasing temperature because of the increasing gate current, and will cause the drain current to decrease. These effects will usually be cancelled because of the small range of V_{ds} . A value of about 100 ohms for the gate-voltage source impedance and 0.9 volt V_{gs} for $V_{ds} = 0$ provides good compensation.

A basic circuit using the I_d versus V_{ds} characteristic for gamma correction, shown on page 110, generates $E_{out} = f(x) + x$, where $f(x)$ is the I_d versus V_{ds} characteristic and the input x is equal to V_{ds} for an ideal amplifier. For an n-channel FET, the bias V_{gs} is set to a positive potential (about 0.9 volt) where the $I_d - V_{ds}$ characteristic is temperature compensated with a bias resistor. The input signal is applied to the operational amplifier's non-inverting input and the output voltage is then obtained by adding the two voltage drops, x and $I_d R_1$. Thus, with $I_d = f(x)$ and assuming the operational amplifier is ideal, this yields $E_{out} = f(x) + x$. E_{out} can be scaled by choosing an R_1 value.

The ideal gamma-correction transfer characteristic is almost equal to $f(x)$. But in practice, it is necessary to subtract one x term and adjust the gamma curve to match the characteristics of individual camera pickup tubes or other nonlinear de-

vices. The approach taken is to form a family of curves, with each having a different value of gamma but with fixed end points.

This is achieved by introducing a variable α and by forming the function

$$\alpha [f(x) - x] + x$$

As α varies, the over-all gamma varies.

Firstly, x is subtracted from the gamma curve $f(x)$ to form $f(x) - x$ as shown on page 111. Then, it is added to α times $f(x) - x$, where $0 < \alpha < 2$, to form $\alpha [f(x) - x] + x$. The end points of this curve are independent of α because when $x = 0$ and when $x = 1$, $f(x) - x$ is 0. When $\alpha = 1$, then $\alpha [f(x) - x] + x = f(x)$ —the ideal gamma curve. This approach led to the development of the over-all gamma-correction circuit on page 111.

The output from the first stage of this circuit $y_1 = f(x) + x$, and the linear term x are fed into another operational amplifier to generate $y_2 = 2 [f(x) - x]$ in the second stage. With a third op amp, $y_3 = 2 [(f(x) - x) + x]$ is generated. The loaded output voltage $E_{out} = \frac{1}{2} y_3$. The over-all gamma-control potentiometer is R_1 , which sets the value of α and provides a wide range of gamma control. When $\alpha = 0$, the output is x , and therefore linear. As α is increased the output curve becomes increasingly nonlinear, passing through the approximate gamma curve $f(x)$ when $\alpha = 1$. Positive polarity signals can be handled with the low-capacitance n-channel 2N3823. The semiconductor industry is not yet marketing a p-channel device having the required low capacitance to handle negative polarity signals with the required bandwidth. Until such time a device is available, an inverter stage would be required.

The graphs in color on page 111 were plotted with several settings of R_1 . This control can

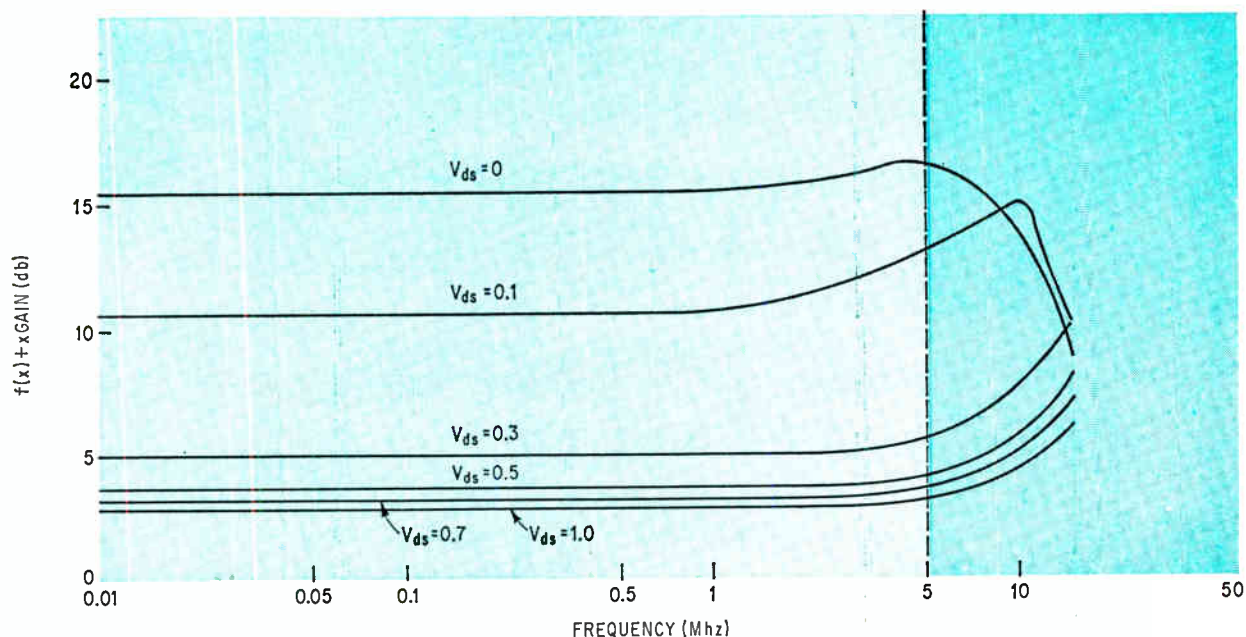

Biasing. Incremental gain curves show effect of bias from 0 to 1 volt.

easily change the circuit's function. By inserting two resistors—one on each side—in series with R_4 , the range of the gamma control could be limited. The end points, however, would remain fixed as the gamma control is varied.

Differing FET's will require different gate-biasing voltages. However, by selecting FET's having approximately the same gain, g_m , the circuit values given for the over-all gamma-corrector on page 111 will yield the transfer characteristics shown in the top oscilloscope trace opposite. The transfer curves of the first stage, FET plus operational amplifier, are superimposed for three different 2N3823 FET's, each from a different manufacturer. Only the end points were adjusted for each FET. Also, the transfer characteristic has a near-zero temperature coefficient. The transfer characteristics of the first stage, $f(x) + x$ versus x , for temperatures of 0°, 25°, 50°, and 75°C are superimposed in the other trace. Variations across this temperature range were found to be slight.

Measuring frequency response

In measuring the voltage gain of the gamma circuit as a function of frequency, a d-c voltage and a small sinusoidal voltage are applied to the input, and the resulting a-c output of the first stage is measured. The d-c voltage biases the FET to some part of the I_d - V_{ds} output curve, and the voltage gain at the bias point is calculated as the ratio of the output, $f(x) + x$, to input, x .

The voltage gain was measured as a function of frequency for several d-c bias voltages, and the results are shown above. Since the frequency response of the second and third stages is flat to greater than 10 megahertz the plots are representative of the whole circuit; the frequency response

varies with the d-c bias voltage. By changing the value of the 150-picofarad compensation capacitor in the operational amplifier circuit, the peaking effects can be altered.

If the circuit is to be used in the normal way in a tv camera, the signals will differ from the ones used. There will be an averaging effect of the voltage gains at the various V_{ds} biasing values, depending upon the signal level, which will tend to give an over-all flatter frequency response at low signal levels than the graphs indicate. However, because of the harmonic distortion created by the nonlinearity of the circuit, the frequency response cannot be measured in this manner.

Peaking in the frequency-response curve are caused by the FET's capacitance. An RX meter was used to measure the output impedance of the FET for various gate voltages with $V_{ds} = 0$. The capacitance will increase as the gate is brought more and more toward forward bias. It may increase to 45 pf at about 0.4 volt, remain relatively constant to 0.65, and then rapidly increase to over 100 pf at about 0.7 volt as the gate becomes forward biased. When the gate voltage reaches 0.9 volt, the resistance is less than 50 ohms, making direct measurement of capacitance virtually impossible because of the circuit's high dissipation factor. The capacitance can be measured indirectly, however, merely by substituting a parallel resistor-capacitor combination for the FET. At $V_{ds} = 0$, the capacitor value required to achieve the same frequency response as the FET circuit is about 5,000 pf.

The amount and frequency of peaking depends on the time constant of the FET channel. The lower the FET's capacitance, the better the frequency response of the over-all circuit. ■

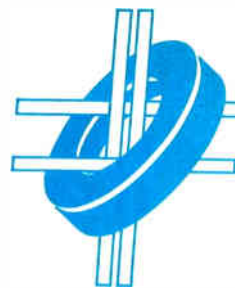

Delay lines—key to low cost in keyboard machines

By Robert A. Tracy

Friden Inc., Palo Alto, Calif.

Although the delay line is one of the oldest forms of memory, it still remains a viable technology, appearing today in small serial computers and electronic calculators, as well as in communication networks, television, and radar systems. The original mercury lines were supplanted by devices of quartz or similar glassy material, and by magnetostrictive wires; now a newer type—the surface delay line—is making waves among engineers.

In essence, a delay line is a short-term information storage device that takes advantage of a mechanical vibration's very low propagation velocity relative to the velocity of electrical signals. It's used wherever volatility of stored data and relatively long access time aren't disadvantages.

There are three basic types of passive delay lines in use today. The oldest is the solid delay line, a prism of glass material in which signals are internally reflected at several faces while propagating from an input to an output transducer. Next is the wire line, in which a mechanical vibration is induced by a magnetostrictive transducer. The newest form is the surface delay line, in which the signals travel across the surface of the material rather than through its volume. And there are active delay lines of semiconductor material. In these devices a sound wave creates electrical effects that, in the presence of an electric field, react upon the sound wave to amplify it.

All passive delay lines are subject to certain fundamental limitations. One of these limitations is associated with the way sound attenuates as it is propagated through a material. For a given frequency f , the ratio of the amplitude at the end to that at the beginning of a time interval Δt is a double inverse exponential:¹

$$\frac{\text{Amplitude at } (t + \Delta t)}{\text{Amplitude at } t} = (e^{-A_1 f \Delta t}) (e^{-A_2 f^4 \Delta t})$$

A_1 and A_2 are constants. The term with the first power of frequency gives the effect of hysteresis in the material's stress-strain characteristics. This hysteresis arises from the energy lost when the

material undergoes a strain—even a strain well below its elastic limit. The lost energy is dissipated in the form of heat, and, as the first-power term shows, is a function of frequency.

The fourth-power term gives the effect of scattering caused by the material's polycrystalline structure. In materials used for digital delay line memories, this term is usually negligible. It can be shown that when only the first-power term is considered, the maximum number of bits that a piece of material can store will be independent of the length of time the bits remain in the material.² That is, as Δt increases, f must decrease proportionally. (This isn't the same as saying the storage capacity is independent of the length of the material in inches.)

The material's storage capacity is inversely proportional to the constant A_1 :

$$N_0 = \frac{\pi \sqrt{3}}{A_1}$$

The number N_0 may be used as a figure of merit for the material; some typical values are given in the table:

Memory materials

Material	A_1	N_0
Ni-Span C.....	.33	1.6×10^4
Beryllium copper.....	.14	3.9×10^4
Fused quartz.....	.015	36.3×10^4
Low-TC glass.....	.693	$.78 \times 10^4$

Even though the capacity is independent of the delay time, the latter is controllable. The most important variable is the temperature, which changes the physical length of the line and the modulus of elasticity of the material. The thermal coefficient of delay is the average of the thermal coefficients of expansion and of elasticity;³ obviously if these are equal in magnitude and opposite in sign, the delay is constant with variations in temperature. This ideal condition is approached most closely in

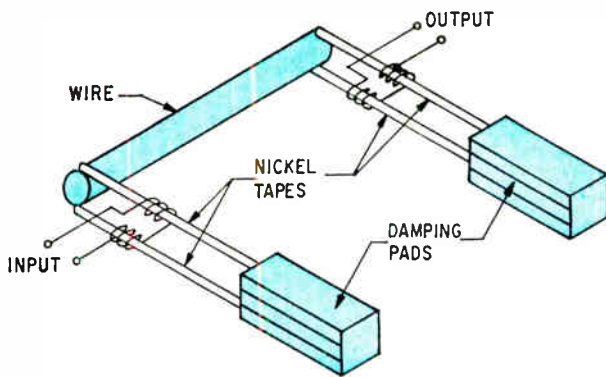

Twist. Current pulse in the input coil creates a tensile or compressive stress in the nickel tape, which twists the wire. This torsional stress travels down the wire, and transfers to the tapes at the other end. Output coil generates a signal as tape stresses pass through it.

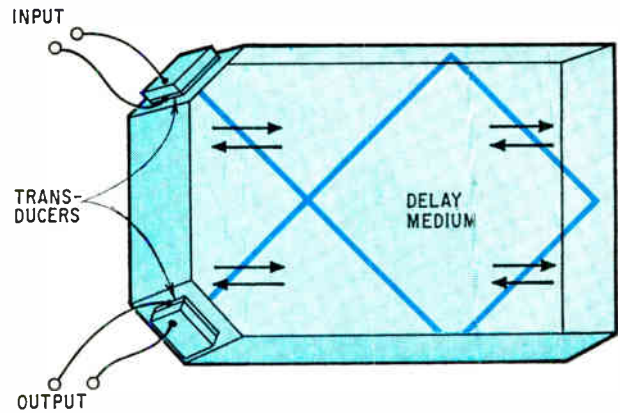

Solid. Input transducer generates a wave in the block of glass that is internally reflected several times, producing a long delay time in a small piece of material, before arriving at the output transducer.

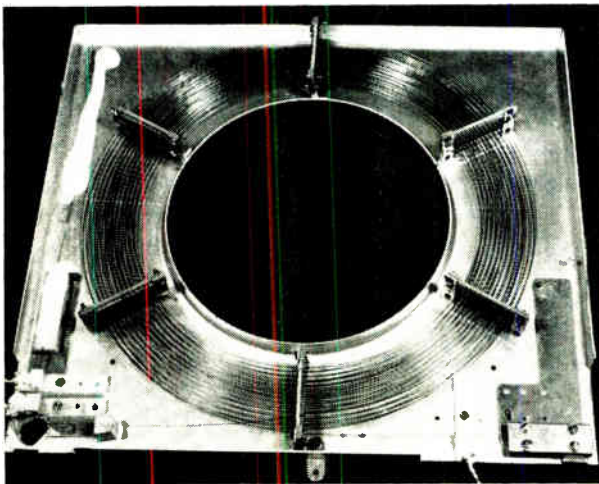

Pass through. This coil of beryllium copper wire circulates 20,000 bits at 1.5 megahertz with a signal-to-noise ratio of 20.

zero-TC glass made by Corning Glass Works and others, and in International Nickel Co.'s trademarked Ni-Span C, an alloy of nickel, chromium, titanium and a minute amount of carbon.

When the temperature can't be controlled, the maximum capacity of a delay line is

$$N_{\max} = \frac{k}{\frac{d\tau}{\tau} \Delta T}$$

where k is the fraction of a period the bit is allowed to deviate from perfect timing, $d\tau/\tau$ is the thermal coefficient of delay, and ΔT is the temperature variation. Both Ni-Span C and Corning 8875 glass are often chosen for delay lines because they have very low coefficients of thermal delay.

Transducers also restrict delay line performance, but this is more a matter of fabrication difficulty than a fundamental limitation.

The typical wire delay line vibrates in the torsion mode, as at top left. The transducers are tapes made of a magnetostrictive material, such as nickel; coils are wound loosely around these tapes. A current pulse in the input coil generates a magnetic field, which causes a magnetostrictive change in the length of the tape inside the coil. If the tape shortens, this action generates a tensile stress; if it lengthens, the stress is also generated, but in this case it's compressive. Either way, the stress creates a strain pulse that is propagated away from the coil in both directions. At one end, this pulse is absorbed in the damping pad; at the other, it is converted into a torsion wave in the wire. Two tapes oppositely stressed by properly connected coils have a push-pull action. This torsion wave travels to the other end of the delay wire and is reconverted into an electrical signal by another pair of tapes and coils.

Sometimes only one magnetostrictive tape or a direct torsion-mode transducer is used. For example, the twenty-thousand bit wire delay line [photo at left] is constructed of beryllium copper with a single tape transducer at the transmitting end and a plated torsion mode transducer⁴ at the receiving end. The line operates at 1.5 megahertz and has a signal-to-noise ratio of 20.

A current passing through the wire exerts control over the delay by heating the wire. The temperature can be increased or decreased to compensate for external variations; thus the delay can be kept constant or can be varied as desired.

The frequency limit of wire delay lines is about 4 or 5 Mhz. At higher frequencies solid delay lines are more practical, because the material is easier to control and the transducers easier to make.

In a glass, darkly

In a solid delay line shown above, the transducers are made of piezoelectric ceramic, such as lead-zirconate-titanate, that has been polarized in a strong electric field. The polarization direction

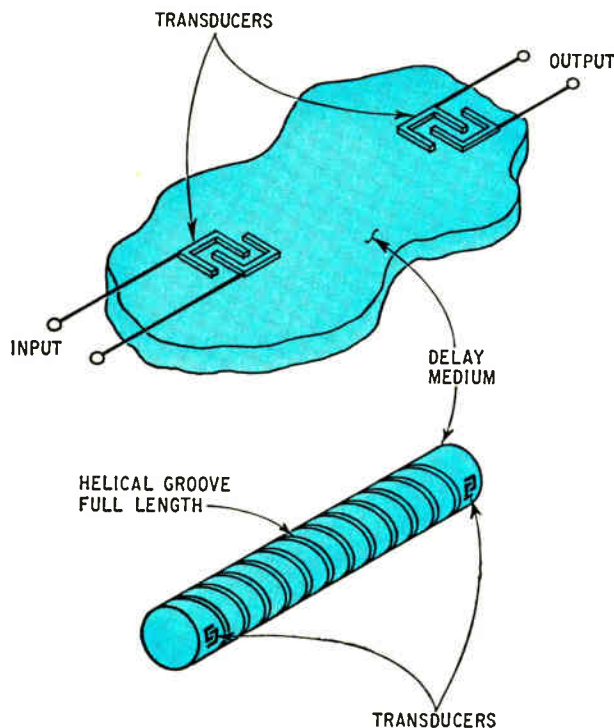

Surface effect. Sound waves that resemble water waves travel across the surface of this medium, either flat or helical, from one transducer to the other.

determines whether the vibration mode is shear, longitudinal in tension, or longitudinal in compression. The shear mode parallel to the reflective faces is usually preferred; it's less likely to generate new modes when it's reflected at the various surfaces.⁵

A typical solid delay line is Corning Glass Works' Type 9283. This uses the zero-temperature-coefficient glass and stores 2,048 bits at 8 Mhz. It operates reliably from 0° to 55°C without temperature compensation.

Fabrication problems limit the ceramic transducers used in these solid delay lines to thicknesses that operate only up to 20 Mhz. From 20 to 50 Mhz, quartz crystal transducers are employed. Recently, thin-film transducers of zinc oxide and cadmium sulfide have been developed that may be used from 50 Mhz to beyond 1 gigahertz.

On the surface

These transducers are also potentially applicable to a relatively new form of delay line of a solid material. Two kinds of surface-wave delay lines are shown above at left.

These ultrasonic surface waves, called Rayleigh waves, are very similar to water waves.⁶ In a thin layer of material, the waves disperse or "break," much like ocean waves approaching a beach. But in material significantly thicker than the ultrasonic signal's wavelength, the losses are very low and the velocity of propagation is comparable to that of shear waves in the solid material. The losses are also very small on a convex surface, but become



Line of action. The 1150 printing calculator's operation depends on the delay line in the foreground.

very high on concave surfaces.

Surface-wave delay lines are potentially very expensive and can store a large quantity of data. A single flat surface with vacuum-deposited transducers, as shown in the upper part of the sketch, could be fabricated for between \$1 and \$5. Its capacity obviously depends on its physical size, which is limited primarily by the difficulty of supporting the surface in such a way that no part of it can ever become even minutely concave. If that happened, the surface wave would be absorbed.

The helical configuration could store 10,000 words of 16 bits each in a one-inch diameter rod three inches long, at a cost of perhaps \$20. The higher cost arises from cutting the groove to establish the helical configuration—for example, with an etching technique similar to that used in making integrated circuits.

In a delay-line memory, as the stored information appears at the output, it is immediately reloaded at the input. Thus it continuously recirculates with a time address rather than a physical location address. This time address—the moment at which a particular bit appears at the output—is in step with the data. Only when the data appears at the output of the delay line is it available for use; and only at that moment can new data be loaded in its place.

An example of a typical delay-line application is the Friden 1150 electronic printing calculator, shown above at right. The time addresses in the delay line are divided into six registers. The arith-

1	19	12	5	23	16	9	2	20	13	6	24	17	10	3	21	14	7	25	18	11	4	22	15	8
---	----	----	---	----	----	---	---	----	----	---	----	----	----	---	----	----	---	----	----	----	---	----	----	---

Interlacing. While calculator processes bit in position 1, six more bits go by. In the seventh position is bit 2, showing up just when the calculator is ready for it. While the calculator is working on bit 4, the delay line completes a full cycle, bit 1 is recirculated and bit 5 appears in the seventh slot after 4. This continues until bit 25 comes up; bit 1 reappears for new processing seven positions beyond 25.

metic unit shifts data within these registers, transfers it between registers, loads new data for storage, and unloads the stored data in the registers for output, as well as performing the standard arithmetic functions.

The cost of the delay line is minimized in the 1150 by permitting the time delay to vary with temperature and from machine to machine—thus bypassing critical design and fabrication problems. The home signal precedes the data propagated through the line; when it emerges, it opens a gate that starts the counter to provide timing and address information. When the last data has emerged from the line for either processing or recirculation, a signal from the address counter turns off the clock pulses that drive the counter. The dead time left over after the turnoff signal and before the home signal comes around again may be of any length without affecting machine operation.

Content-addressed memories have long been sought after for the more powerful computing machines, but most forms have been too expensive to be feasible. Delay lines provide a limited content addressing capability in a very simple way as shown below. In the search mode, the recirculating data passes through a search register in which it is compared with a tag that identifies the specific data. When a match is found, the immediately following data is directed into a buffer register.

The Friden 5610 Computer uses this limited content-addressing technique in its program storage line. This gives the machine a programing capability with which it can execute sequential program steps, including both unconditional and

conditional branching.

Interlacing, or gearing, is a third mode of memory operation with delay lines; it allows the use of high speed delay lines in a lower speed computer, greatly reducing access time. An interlaced delay line memory containing n bits produces several bits during each machine cycle, of which only the first bit is used. The number of bits per machine cycle and the total number of bits in the memory are selected so that a precession occurs as the delay line recycles, until access to all bits has been obtained, as shown above. Interlacing of registers is used in the Friden 1150.

Delay lines perform many other memory functions besides those in computers. For example, they appear as buffers in communications terminals, computer operated displays, and other peripheral equipment. And completely outside the computer field, new television and instrumentation applications are appearing at an increasing rate; radar systems, in which delay lines made their first appearance nearly 30 years ago, are continually finding new applications for them.

Keeping pace with expanding utilization of delay lines are advances in design,⁷ materials, and transducers. And significant strides are being made in understanding the behavior of phonons—the fundamental science of delay lines. Even delay lines that provide internal amplification have been built.⁸ One of these has single crystals of cadmium sulfide interspersed between conventional delay lines; the crystals transduce the signal from one line to the next and amplify it at the same time. They act like amplifiers inserted in a transmission line ■

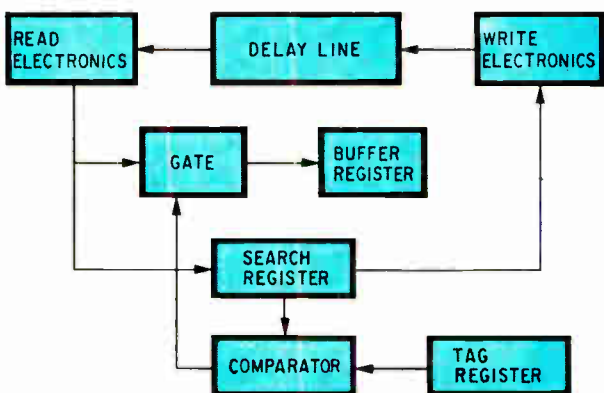

Associative. A delay line has a limited content-addressable capability because it is constantly recirculating all its data, even when it's not doing anything with it.

References

1. W.P. Mason, "Physical Acoustics," Academic Press, 1964, Vol. 1, Part A, p. 445.
2. R. Dickinson, "Wire Delay Line Materials," Friden, Inc., internal report, 1968.
3. G.G. Scarrott and R. Naylor, "Wire-Type Acoustic Delay Lines for Digital Storage," Proceedings, Institution of Electrical Engineers, Part B, Supplement 3, 1956, p. 497.
4. Z. Kitamura, H. Terada, and S. Hidaka, "The Magnetostrictive Film Transducer for Ultrasonic Delay Lines," IEEE Transactions on Magnetics, Sept. 1966, p. 206.
5. D.L. Arenberg, "Ultrasonic Solid Delay Lines," Journal of the Acoustical Society of America, Jan. 1948, p. 1.
6. Igor A. Viktorov, "Rayleigh and Lamb Waves: Physical Theory and Applications," Plenum Press, 1967.
7. G.L. Heiter and E.H. Young, Jr., "A 100-Mhz, 1,024-Bit Recirculating Ultrasonic Delay-Line Store," Digest, International Solid State Circuits Conference, 1968, p. 108.
8. A.R. Hutson, J.H. McFee, and D.L. White, "Ultrasonic Amplification in CdS," Physical Review Letters, 1960, p. 359.



For sophisticated calculators, core arrays are worth the price

By Thomas E. Osborne

Hewlett-Packard Co., Palo Alto, Calif.

A random-access memory costs more than a serial memory, but the design freedoms and simplifications it allows in electronic calculators and other small machines more than make up the difference.

Serial memories were characteristic of those first-generation electronic calculators that began to appear on the market about 1963. These memories—usually magnetostrictive delay lines, though a few rotating magnetic disks were used—were substantially faster than their mechanical forebears.

The designers at that time considered using core memories, the only form of random-access memory then available, but they invariably decided in favor of delay lines on a cost-comparison basis. The cost differential was partly in the storage medium and partly in the peripheral circuitry—but partly also in the designer's imagination.

First, the designers saw cores as hundreds of tiny components that had to be strung with two, three or even four wires. They compared these with a delay line—a single piece of wire coiled up, with transducers capable of imparting a high-frequency acoustic signal at one end and of sensing it, after a propagation delay, at the other.

A second factor counting against core memories was the large number of relatively expensive high-current transistors required by their drivers. The delay line needs only a single driver—and it's not a high-current device. Also, the core array employs many sense amplifiers, while the delay line requires only one. And for all the drastic price reductions transistors and core arrays have undergone in the past few years, a delay line is still cheaper.

Furthermore, most manufacturers of core memories were apparently slow to supply samples and reluctant to build the small arrays required in electronic calculators. On the other hand, the delay-line manufacturers were quick to quote very low prices and to back them up with samples.

However, the designer of an electronic calculator doesn't design a memory; he designs a system containing a memory. He must therefore choose a form of memory that permits him to meet his specifications at a reasonable cost. Since the design philosophies of the core calculator and delay-line calculator are quite different, it's hard to say which type of memory results in the lowest system cost in a

given application. But generalizations and estimates that take into account the limits of the two technologies can be made.

In general, then, it can be said that a calculator requiring less than 500 bits of storage favors the delay-line memory, while the calculator with more than 1,000 bits of storage favors the core memory. The 500-to-1,000-bit territory, between these two categories is the area of contention.

One factor affecting the crossover: the cost per bit of a core array decreases more rapidly as the memory size increases than that of a delay-line memory. But what establishes the core's economy is the fact that sophisticated calculators capable of automatically executing highly complex operations require more than 1,000 bits of storage; and in devising such stores, the freedom offered by a core memory results in a more efficient design.

It would take a great deal of space to elaborate fully upon all the efficiencies the use of a core memory affords a design. For one thing, the core memory is free from the delay line's unyielding timing requirements. Information transported throughout a delay-line system must be rigidly scheduled, and this rigidity significantly influences the functions and design philosophy of the calculator. A design with a core memory is free from all but minor timing restrictions.

Calculator designers have indeed capitalized upon these freedoms to produce more sophisticated devices. Their products can do floating-point arithmetic, carry out complex arithmetic functions, and be easily programmed to execute a sequence of operations. Since a core memory is nonvolatile, it can retain information when power is removed from the system; this is not true of a delay-line memory. Another important advantage of the core memory over the delay line is its inherently higher speed—especially in machines with a large storage capacity.

From a practical viewpoint, little is gained by going to higher speeds in nonprogrammable calculators. Almost all electronic calculators can perform any single operation in 2 seconds or less; some can do it in milliseconds.

But with programmable calculators capable of executing hundreds of arithmetic operations in

sequence automatically, speed becomes important.

The Hewlett-Packard 9100A calculator, a machine with a core memory, can solve a common problem 50 times faster than can a delay-line calculator. For example, where a typical delay-line machine needs about 7 minutes to solve a typical problem involving a set of transcendental equations—whose coefficients involve logarithms, trigonometric functions, and the like—by making a series of successive approximations, the HP 9100A can do the job in 7 seconds.

If the memory in the HP 9100A were programmed to simulate the operation of a serial delay line, its bit rate would be 4 megahertz—four times faster than most magnetostrictive delay lines.

Of course, calculators with serial memories will continue to handle calculations under the step-by-step control of human operators. In fact, these machines will continue to take the largest share of the market for electronic desk calculators. And for now, their serial memories will be delay lines.

But for stored-program machines capable of carrying out complex calculations automatically, random-access memories—currently ferrite-core arrays—will get the nod.

But both delay lines and core memories will eventually be supplanted by integrated-circuit arrays—shift registers in place of delay lines as serial memories, and flip-flop registers in place of cores as random-access memories. ■

Memories XXIII



Exotic storage applications often revive old memories

By Robert W. Reichard

Computer Control Division, Honeywell, Inc., Framingham, Mass.

As hazardous as predicting the future of the computer industry is deprecating its past—because supposedly “dead” technologies, that perhaps originally were ahead of their time, sometimes come to life again. Even so, computer memories have generally evolved in an orderly manner, for economic reasons; the few mavericks that have had an impact have done so primarily because of special applications, of one sort or another.

The pace of technology and the requirements of applications have caused a proliferation of memory technologies. This proliferation has been so broad that no memory form can be pigeonholed in a particular type of application; there have always been, and will always be, wide areas of overlap. This overlapping has been largely responsible for the success of some technologies and the demise of others; in addition, the more widely a technology can be used, the more likely it is to pay off.

One prime example of an old technology's new life is the rebirth of the 2½-D core memory after a decade of disuse. This memory form is an elementary coincident-current memory which contains, on one drive-current axis, as many drive circuits as there are bits in the word; these circuits are logically enabled or disabled to write a 1 or a 0 respectively. This technology was considered state-of-the-art 13 years ago,¹ although some of its char-

acteristics—such as a mean time between failures of well under 100 hours—appear ludicrous today.

With the wisdom of hindsight, the 3-D memory can be considered an improvement on the 2½-D, which required more drive circuits. A 2½-D memory containing n -bit words requires $(n + 1)$ sets of selection and drive circuits, whereas a 3-D memory requires only two sets of circuits regardless of the number of bits per word.

But the renaissance of the 2½-D came about for several reasons. Among these reasons is the much smaller size of standard cores now than 10 to 15 years ago; through these tiny cores the 2½-D needs only three wires to be threaded, instead of the four that the usual 3-D design needs. There is another reason: circuits, on the whole, are cheaper and much more reliable than they used to be, permitting a degree of prodigality in their use that would have been unthinkable in the middle 1950's.²

Nor are 2½-D memories alone in enjoying such a resurrection. Not long ago engineers at Bell Telephone Laboratories built a memory out of quartz delay lines.³ For their application—a signal-processing system for the U.S. Navy—only this rather antiquated technology provided the high access rate that the application required. Although the unit's maximum latency was 750 microseconds, the data

was retrieved in blocks, with a new 48-bit word made available every 25 nanoseconds; the system thus resembled a magnetic drum with an enormously high bandwidth.

Evolution, not revolution

The development of memories that are faster, cheaper, larger in capacity, smaller in physical size, and more reliable is compelled to obey the force of economy. Trying to improve all these parameters simultaneously, while staying within the bounds of economy, results in evolutionary, rather than revolutionary, change.

Yet, as the exception proves the rule, occasionally a product has appeared that offered an extraordinary improvement in one characteristic at the expense of two or three others; some of these memories have been profitable to their developers, but none lasted very long or were built in large numbers. For example, the Ampex Corp. built some memories several years ago that were very large, very complex, and very costly. The company sold them to only a few non-government customers besides the military agency that funded their development; they were the only memories then available that had microsecond cycle times, and the users needed that speed at almost any price.

Such innovations, while lacking a wide market, often contribute to the industry's viable base, from which more useful products later evolve. Furthermore, sometimes their unique advantages can be developed for a particular value.

Magnetic logic, for example, was quite a fad at one time, but declined in interest for various reasons—manufacturing problems, among others. But those who persisted in studying it found its requirements for little or no standby power and its insensitivity to radiation made it ideal for applications whose unusual requirements insulated them from the pressures of the marketplace.

Most of these applications, of course, are in the aerospace industry. Even so, during the interval between fad and fruition, multiaperture devices for magnetic logic proliferated; however, few of these saw even isolated uses, and one company actually went out of business as a result of its overcommitment in this area.

Tradeoffs

Military applications, also on occasion, require memories whose attributes would be unacceptable elsewhere. Thus a system that is intrinsically slow is nevertheless often suitable because it dissipates less power or is more reliable than more conventional systems. For example, a militarized core memory typically has an access time about one-quarter the full cycle time, instead of about one-half, as is the case in commercial versions; this is so because, to keep its semiconductor circuits as reliable as possible, it works with low voltages whose waveforms have long risetimes, thus slowing them considerably. [The ferroelectric memory described in *Electronics*, May 12, p.116, is another

such intrinsically slow device.] In other memories small size and light weight may be required, even at high cost.

A divergence of technology has also occurred in the telephone industry, which enjoys a built-in market. The telephone companies don't need expert salesmen to tout their wares; on the contrary, the telephone markets are highly predictable and can be precisely characterized. It's therefore possible to manufacture memories for telephone exchanges that wouldn't be commercially marketable; the application requires extraordinarily high reliability and minimal maintenance, but performance and physical size are only minor considerations. Examples of such developments include the twistor, made of a flat metallic ribbon wound around a cylindrical wire; and the ferrite-plate memory, essentially a large collection of cores in a monolithic unit. Because the telephone companies could predict the need for these memories far in advance, they had plenty of time to finance them, to develop them and to recover the investment—situations that are rarely present in the commercial arena.

End use of a product also creates divergence in technology. On the one hand, where a product is to be sold on the open market, it must be modular and capable of being used with various combinations of optional accessories; on the other hand, where a product is to be used as a subassembly in a large number of identical units, its attributes can be optimized for that particular application.

Imaginative designers will always continue to produce revolutionary ideas. Some of these ideas have never been seriously tried out. Others have been tried and failed. Their originators have often been influenced by trends in other technologies. Semiconductor developments, for example, led to the idea of the tunnel-diode memory, which has never breached the cost barrier; low-temperature physics generated interest in cryogenic stores.

Likewise, pure intuition has produced concepts with biological analogs. For example, a neuristor structure has been proposed that, like nerve fibers in animals, propagates signals without attenuation, and that conceivably could be interconnected in large networks like the human nervous system. Another similar structure is the cryosistor, which operates at very low temperatures and depends on unusual ionization phenomena in semiconductors at those temperatures.

It's always wise to keep an eye on the reasons for the failure of those ideas that didn't quite make it; advances in technology may obviate them, and at the same time make a previously impractical idea quite valuable. Also, evaluation may show how to avoid committing the same mistakes again.

Historical analysis should never be used to discredit a new idea; the latter's time may not yet have come. For example, storage at a molecular level—such as storing images in crystals using Bragg-angle holography—has been an idea of basic researchers for a long time. One of these days somebody may perfect this technique or invent

Memory categories

Address-related	Environment-related
Random access	Temperature tolerant
Sequential access	Humidity tolerant
Interlaced access	Electromagnetic radiation resistant
Pushdown storage	Shock and vibration resistant
Content-addressable	Corrosion resistant
	Pressure tolerant
Data-related	Support-equipment related
Serial format	Limited power dissipation
Parallel format	Non-volatile (no standby power)
Electrically alterable read-only	Limited size
Mechanically alterable read-only	Limited weight
Fixed read-only	Reliability
Content-addressable	Cost
Data rate-related	Modularity
Fast read, fast write	
Fast read, slow write	
Slow read, fast write	

some other molecular device, permitting a system engineer to design a memory surpassing any previous units in capacity and compactness.

Similarly, researchers should continue working with neuron-like devices. These are basically serial storage elements, and in that respect are elementary; the unsolved problems are in clocking, input-output, and multiple branching, and these problems are by no means necessarily unsolvable.

Great temptation

The proliferation of memory technologies creates a great temptation to try to categorize the wide variety of application requirements into mutually exclusive groups. This is difficult, even though the table shown above seems to indicate it's easy. It's equally difficult to establish a relationship between the various memory technologies, past and present, and each of the groups. It's nevertheless helpful to try this pigeonholing procedure, as background.

Plated-wire memories illustrate the problem. These are usable in each of several categories: as scratchpads (high-speed, small-capacity read-write memories); as main storage units (medium-speed, large-capacity read-write memories); and as micro-program units (high-speed, medium-capacity electrically alterable read-only memories). Thus they can't be made to fit in any one category.

Each grouping of technologies in the table is supposedly independent of all the others. Within each group, the various categories indicate the different approaches that have been required or could conceivably be required.

Under the heading "Address-related," for example, the random-access category is the basic mode required in most computers. The push-down store is also sometimes known as the last-in first-out memory. It is related to the content-addressable store, from which data is retrieved in terms of content rather than location. Both approaches have

been proposed for use in the same memory in one recent application.⁴ The sequential mode, or first-in first-out mode, is most useful in simple data accumulations. In these sequential memories data can be stored or retrieved from any given block only in the order in which it was stored. The interlaced mode is one where data is read out at a different rate or in a different format than that in which it is written. An example of this is Raytheon's Cortic radar signal processor.⁵

In the data-related categories, the serial and parallel formats are self-evident. The mechanically alterable read-only form would be most useful as a catalog that could be expediently changed when necessary, but only by mechanical process. Electrically alterable read-only memories are similar, except that their alterations, when necessary, must be quicker than the mechanical form permits; obviously the electrically alterable form must also incorporate safeguards against accidental alteration by the wrong person at the wrong time. An example of a fixed read-only store would be a mathematical table or a dictionary.

The fast-read, fast-write data rate is probably the best known and most often used, and therefore can be considered a norm. But it's not always the best for specific applications. A fast-read, slow-write memory would be more suitable in a data gathering application, as in an automatic tester. A memory of this description has been built that reads conventionally in about 250 nanoseconds but takes 100 times as long to write, using a degaussing process, because in its application—telephone switching—writing new data occurs only rarely and when it does occur it's a radical event.

A slow-read, fast-write memory would be required in an application where the output rate is limited by other factors. Such an application is storing digitized television pictures quickly in an unmanned spacecraft and transmitting them slowly back to earth. Such variations from the norm permit independent design of read and write circuits.

The environment-related constraints may affect the memory directly, or may only require it to be isolated from them to some extent. For example, military equipment is subject to wide temperature variation, which can be compensated for directly with special magnetic cores or indirectly with heated core stacks or temperature-compensated power supplies.

Some memories are subject to unexpected exposure to electromagnetic radiation. For example, magnetic thin-film memory design, which isn't seriously affected by temperature fluctuations, must take the earth's magnetic field into account. And more than once the cause of an intermittent system failure has been traced to a high-powered airport radar that periodically swept across the computer.

Ambient pressure can be as low as zero in outer space or as high as several thousand pounds per square inch in ocean deeps. Obviously, the same piece of memory equipment won't have to withstand both extremes, but one or the other may have

to be accounted for in a design.

Support equipment directly affects the memory design, and strongly depends on the memory's application. For example, a memory in a spacecraft has very limited power available to it, and both it and its power supply are subject to stringent size and weight constraints. Furthermore, their reliability must be predictable and very high. As a result, spacecraft memories bear very little resemblance to commercial equipment.

Since these design parameters usually differ subtly from one system to the next, development costs can't be spread out over a lengthy production run. As a result, costs of such systems are often an

order of magnitude higher than those of commercial equipment of similar performance. ■

References

1. M.A. Alexander, M. Rosenberg, and R. Stuart-Williams, "Ferrite core memory is fast and reliable," *Electronics*, Feb. 1956, p. 158.
2. R.W. Reichard and W.F. Jordan Jr., "A Compact Economical Core Memory with All-Monolithic Electronics," *Conference Proceedings, American Federation of Information Processing Societies*, Vol. 32 (Spring Joint Computer Conference), 1968, p. 253.
3. P.S. Fuss, "1.36-million-bit High-speed Delay Line Memory," *Electronic Communicator*, May, 1968.
4. R.B. Derickson, "A Proposed Associative Push-down Memory Concept," *Computer Design*, March, 1968.
5. John D. Collins, "Putting the squeeze on radar signals," *Electronics*, Jan. 22, 1968, p. 86.

Memories XXIV

Military masses its cores for battlefield conditions

By Bryan W. Rickard

Electronic Memories Inc., Hawthorne, Calif.

Up in the air or down to earth, a military environment for electronic equipment usually implies a wide temperature range and high humidity in which the equipment must operate reliably, while withstanding severe vibration and shock. These conditions are particularly severe for computer memories, since they must handle all the programs and data for a variety of tasks—often in the midst of battle.

To achieve reliability under these conditions, the cores in military memories are usually made of lithium ferrite, and the core mats are mounted on rigid frames, instead of being suspended in midair by their selection wires. Furthermore, all exposed conducting materials are coated with a moisture-resistant material to avoid shorting by contamination, and all cabling is securely tied down.

In general, the military core memory is designed and built in accordance with the appropriate military specifications for use in aircraft, missiles, ships, or ground-based equipment. These specifications insure that the materials, parts, and processes used are consistent with the military's basic requirements for human engineering, utility, value, and quality control.

Lithium ferrite's wide temperature range is a result of its crystalline structure, in which monovalent lithium replaces divalent and trivalent ions

in a complex bonding structure [*Electronics*, Oct. 28, 1968, p. 112]. But lithium cores can't solve all the temperature problems of military memories. Drive currents through even the best lithium cores must be temperature compensated. Since the coercive force of the material decreases as the temperature goes up, the drive currents must also decrease, at approximately the same rate. These currents are usually controlled by temperature-sensitive resistors or diodes mounted in the stack. As the temperature increases, these devices control the drive circuits to admit less current through the drive lines.

But using these devices creates a subsidiary problem—namely, making sure that all cores controlled by a given drive line are at the same temperature as the monitoring device, or nearly so. A great many factors can affect the temperature gradient within a memory, some of which are discussed below:

- Operating duty cycle is one of the more obvious factors. The more often a memory is cycled, the more often its cores switch; each switching action requires energy input, most of which is dissipated in the form of heat. If the rate of energy input is greater than the rate of heat dissipation, the memory's temperature rises.

- Within a given cycle of the memory, the ampli-



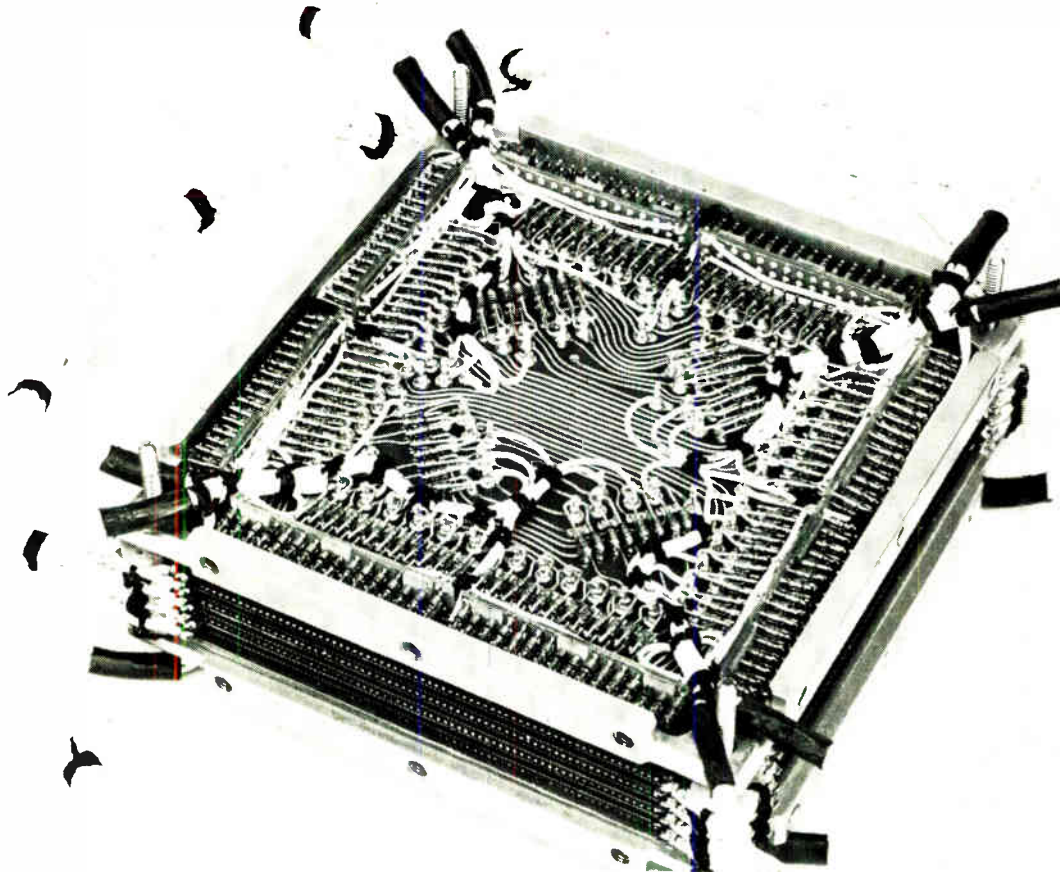

Battle ready. This memory stack, designed to withstand the stresses and strains of military applications, can store 4,096 words of eight bits each. Current-steering diodes are visible on the top layer.

tude and duration of the drive current pulse also affect the rate of energy input. The minimum pulse needed to switch the cores establishes lower bounds on amplitude and duration.

- For a drive current pulse of given amplitude and duration, the size of the wires that thread the cores determines the energy input to the memory, and therefore the rate of heat dissipation.

- Operating data patterns affect the heat input to the memory in two ways. Firstly, a preponderance of 0's in the data pattern increases the heat input, because cores into which a 0 is written are kept from switching by current in an inhibit winding. The inhibit current is about the same magnitude as either of the two selection currents, but it passes through a much longer wire. This wire cannot be made very large in diameter because it has to pass through very small cores along with several other wires. Its small size and its length therefore make its resistance rather high, and current through this resistance will therefore generate a good deal of heat.

Secondly, since reading and writing 1's in a data pattern switch the cores, and hysteresis converts some switching energy into heat, a preponderance of 1's increases the amount of this converted energy. However, this is a relatively minor factor as far as temperature gradient is concerned,

except when a fast memory repeatedly cycles at a single address, creating hot spots wherever 1's are stored in the word at that address.

- Air pressure and air flow affect the temperature gradient in some memories, but generally are less important considerations for military memories, since many of these depend on conductive cooling. Heat developed within a conductively cooled stack is conducted through the metallic structure to a heat sink, from which it reradiates to the environment. By using conductive cooling, structural limitations that might inhibit the access of air to the memory can be ignored; its use also eliminates the danger of dust and other contaminants brought in by air currents, which eventually would block the air flow; and in some circumstances such as spaceborne and high-altitude applications, there is no air.

- Rapid ambient temperature change may cause a temporary failure by creating large thermal gradients within a stack—even though it may operate satisfactorily under equilibrium conditions. For example, when an aircraft scrambles from an arctic base, its equipment bay's temperature increases rapidly as it absorbs heat from the engine; the sudden heat from the firing of weapons is another factor. This kind of problem can be a particularly difficult one to diagnose,

because of its transient nature. To avoid it, the cores must have the widest possible temperature coefficient—generally less than 1 milliampere per degree Centigrade, and their thermal conductance must be high.

▪ Internal thermal conductance—core to core, and core to temperature sensor—should be as high as possible, both to keep the internal temperature even and to avoid difficulties with rapid ambient changes. Establishing a high conductance in these areas more or less assures high conductance from cores to heat sink, which limits the cores' upper temperature extreme but has little relevance to internal gradient. High thermal conductance is obtained by bonding the cores on metal frames, and by joining the frames with accurately fitted spacers or side plates that contact the frames over a large area. The drive wires also conduct heat as well as electricity. Heat conduction paths are also necessary on or past the end boards, which carry selection diodes and interconnecting printed circuits; these boards are usually made of epoxy glass, which is a material that has a very low thermal conductivity.

A well-designed military-memory stack can withstand shocks of over 1,000 times the force of gravity applied in a few milliseconds, and sustained vibration of over 30 g's—in spite of the fact that the crushing strength of a ferrite core is only about 50 grams—about the same as that of a glass bead of the same size. The mechanical structure is very rigid and has no resonant frequency within the range of excitation frequencies encountered in most turbine- and rocket-powered craft.

Each core is bonded to the planes in such a way that a pull of several grains—many thousands of times the weight of a single core—is required to detach it.

Weak link

The magnet wire on which the cores are strung is a potential source of mechanical failure. It is subject to fatigue; it is weakened by chemical changes that occur when it is soldered; and it may be kinked and scratched during stringing. When the memory vibrates, the wire may rub against the cores, causing wear. Careful design and construction are necessary to guard against these vulnerable points.

The military core memory is also protected against atmospheric hazards. Humidity and contamination could be responsible for both open-circuit and short-circuit failures in a memory. Open circuits can result from metal corrosion that breaks a conducting path; short circuits can occur when moisture and contaminants build up on adjacent conductors until they come in contact.

Coating all uninsulated circuits with a material impervious to moisture prevents the electrolytic build-up, but does not necessarily prevent corrosion. Even though the coating ordinarily withstands the kinking and twisting that often occurs when the fine copper wire is threaded through

several hundred cores of rather abrasive material, it nevertheless may develop crazing and pinholes through which moisture can attack the metal when a high d-c voltage is present.

To prevent these failures, arrays are manufactured in extremely clean surroundings. Production-line personnel handle the fine wire with extreme care to avoid damaging the insulation. And the completed memory is thoroughly tested at temperature extremes, to insure that they meet the appropriate military specifications.

The general-purpose memory contains many diodes—either individual glass-encapsulated diodes, which are very rugged and reliable, or integrated assemblies of several diodes in a single multilead package, which promise to make even higher reliability.

When the diodes are installed in the stack, care is taken to avoid stress on the interface between the diode leads and glass body, and to keep the soldering heat at a minimum.

Outlook

Adequate environmental performance has already been achieved in militarized memory stacks, to the extent that no dramatic improvements in the necessary characteristics are likely to occur. On the contrary, recent trends indicate that exposure requirements will become less rather than more severe over the next few years, permitting a relaxation in the specifications.

In the past, military memory system organization has lagged behind commercial development by several years, possibly because military agencies prefer to use time-proven techniques. Therefore today's trends in commercial core memories, such as 2½-D organization and the use of smaller, faster cores, haven't yet appeared widely in the military market, but they will probably be accepted in due time. The reputation of the military for pushing advanced developments doesn't extend to the field of core memory technology.

In addition to the general-purpose 3-D core stack, the military also requires many different specialized memories for various purposes. These include magnetically pure systems, which must be completely devoid of external magnetic fields to avoid interfering with other nearby magnetic equipment—for example, those instruments in a spacecraft which are designed to measure the magnetic field of the moon or another planet. Other examples of specialized memories are those with nondestructive readout, those that operate at ultra-high speeds, and those that dissipate ultra-low power. Many of the design and production considerations apply to these as well as to general-purpose memories; and the engineering and production know-how obtained from meeting the more sophisticated requirements often can increase performance at the general-purpose level. Conversely, specialized memory production wouldn't be possible without the foundation supplied by experience with standard general-purpose memories. ■

Signetics lays it on the linear:

1. Today, we're going linear. In a very big way.

2. We can supply the linears everybody wants—op amps, sense amps, RF/IF amps, video amps, differential amps, comparators.

3. Effective immediately, prices are down. Down on 709's, down on 710's, down on 711's. (Eye-opening example: full Mil 5709's, 5710's, 5711's in T05's—only \$3.75, 100 up!)

4. Our silicone dual-in-lines are now the lowest-priced in the entire industry. (You can find N5709A's, N5710A's, N5711A's for just \$1.68, 100 up, at your Signetics distributor.)

5. Our whole line is getting bigger by the week. (Watch these pages for news of what's new!) And, in the meantime, send for our comprehensive linear package. It really lays things on the line.

Signetics 

Signetics Corporation/811 E. Arques Ave., Sunnyvale, California 94086/A subsidiary of Corning Glass Works

Electronics Profit.

How McGraw-Hill's new
Electronics/Management Center
can help you improve it.

We've created a unique information system for the management of companies in and around electronics.

We call it the Electronics/Management Center.

E/MC combines the specialized experience of the publishers of *ELECTRONICS* Magazine, with the broadly-based facilities of McGraw-Hill, one of the world's largest corporations devoted to increasing man's knowledge.

In thirty years of electronics experience, we've accumulated the background and talents to produce the problem-solving tools you need. The kind that are essential when living with lasers, making your way through the implications of Large-Scale Integration, and meeting the technical revolutions yet to come.

Supplement To Internal Systems

For your company, we'll plan, execute, and analyze custom projects—to meet an objective of general, technical, or marketing management. Or to establish a new objective.

Our system is sufficiently diverse to serve as a prime and total information source. Or, it can supplement the most sophisticated company capability. In fact, it may be more efficient to "buy" certain kinds of information from us than it is to "make" it yourself.

Often, we can be faster. Or less

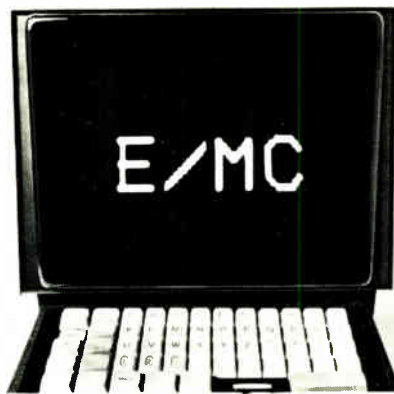

expensive. Always, we can be more objective.

Independent Technical Group

In technical matters, we can provide important assistance without adding overhead or over-loading your present staff. We offer the services of a national organization of university-based scientists and engineers with a long list of accomplishments.

Full Marketing Assistance

We can help you reduce marketing risks, too.

It's difficult to move around the electronics industry without bumping into both customers and competitors in the same corridor. We can probe new market potentials without revealing your identity. Or conduct research in an area not too familiar to your own staff.

We can do it in a neat package that combines access to the market with complete maintenance of confidence.

We can also supply those complex services you'd like to have created outside if you could find someone who speaks your language. Services like seminars, to educate customers, or train technical and marketing staffs, or develop management skills.

Weekly News Service

Management will also find our weekly news service an invaluable working tool. In minimum reading time each week, the *Electronics/Management Advisory Service* can keep your company current on the important electronics developments around the world. Market changes, prices, contracts, finances, significant trends, even a telephone number to call for person-to-person consultation—all the essentials to provide an information base on which to make top management decisions. For the next week. Or the next five years.

If you believe, as we do, that better information can help make your company more profitable, and you would like to know more about our services, write to: Electronics/Management Center, 330 West 42nd Street, New York, New York 10036.

E/MC

Electronics/Management Center
A McGraw-Hill Information Service

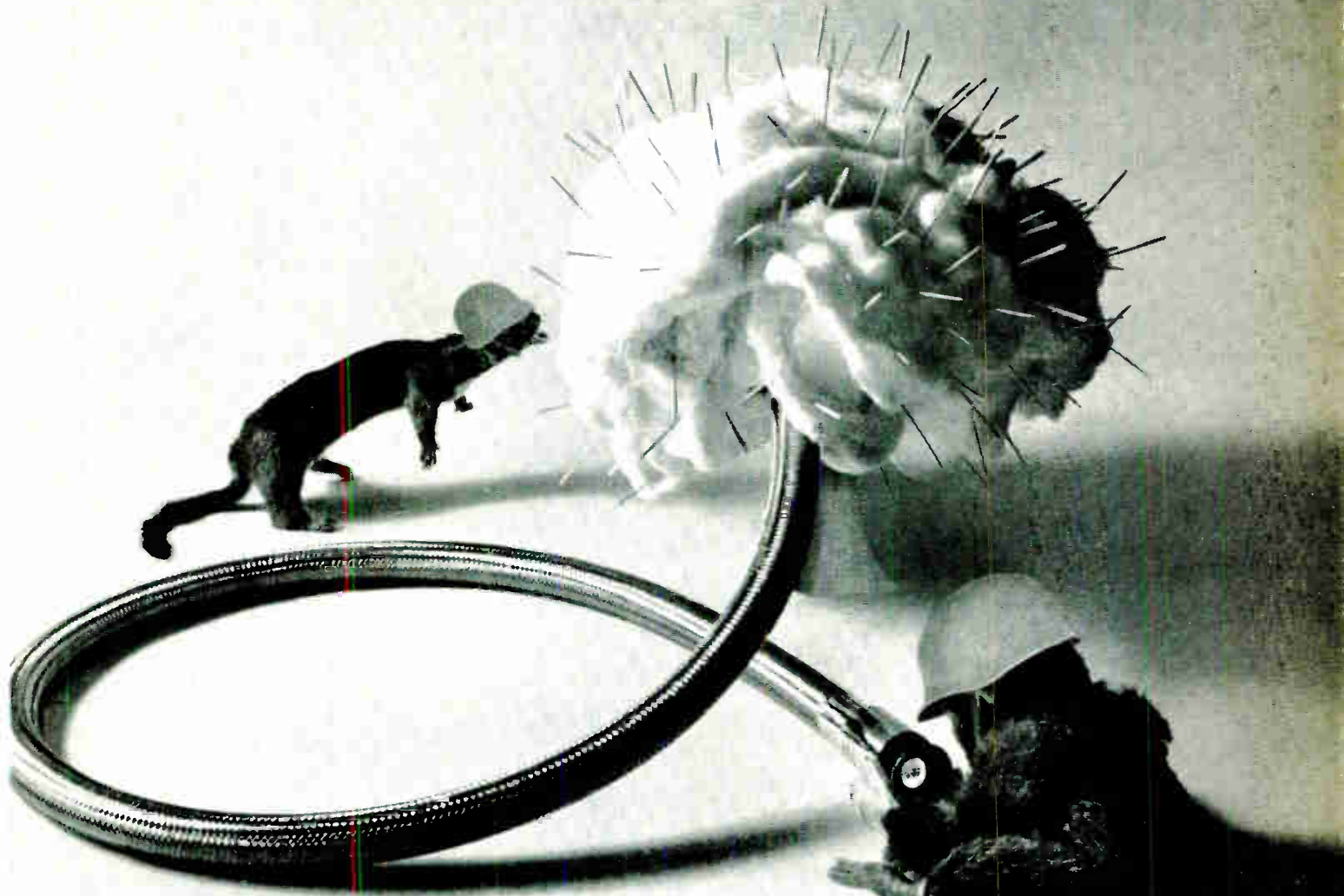

What does the monkey of today use to track the elusive weasel all around the prickly mulberry bush?

A flexible Bendix imagescope. An image transfer device that monitors remote events and inspects otherwise inaccessible areas. It doesn't beat around the bush. But beats into it . . . and under it . . . and over it. In fact, the Imagescope can bend, twist, and "weasel" its way into many hard-to-see places. And because it can be optically coupled to an image intensifier device, it can bring a picture right into the cockpit of a tank, or a helicopter, or a fighter plane. This rugged but flexible, device can carry a picture of what's there to any lengths because it consists of a coherent bundle of glass fibers. The Imagescope breaks up an image into thousands of minute parts, conducts each separately within the individual fiber, and then reassembles them at the other end. There you can attach it to any photo-optical system: Vidicon or still camera. The Bendix Imagescope has so many uses that it can "pop" into any mulberry bush to identify any weasel.

For more information about the Bendix weasel-tracking Imagescope, call or write: Mosaic Fabrications Division, The Bendix Corporation, Galileo Park, Sturbridge, Mass. 01518 • (617) 347-9191

Bendix **Electronics**

do more testing...

- ... more ways
- ... more efficiently
- ... more economically
- ... faster
- ... automatically

AUTOTEST

... Automatically Tests When Discrete Instruments Can't
... Computers Shouldn't

Autotest is a new approach to automatic testing of your product or system. It offers precise, high-speed testing with unmatched flexibility and economy. The Autotest Control Unit uses a punched tape program (EIA Code) to feed the solid state BCD data storage which, in turn, routes the appropriate command signals for each measurement to the Instrumentation Bank. The Instrumentation Bank is extremely versatile and modular in that it can contain any programmable equipment with suitable interface. It can be assembled and re-assembled with different instruments making it immediately "Custom Designed" for that task. The result: simplified program preparation, reduced equipment costs, easily designed for a wide variety of measurement and test problems. AUTOTEST.



713

mi **MARCONI**
INSTRUMENTS
DIVISION OF ENGLISH ELECTRIC CORPORATION

111 CEDAR LANE □ ENGLEWOOD, NEW JERSEY 07631
TELEPHONE: (201) 567-0607

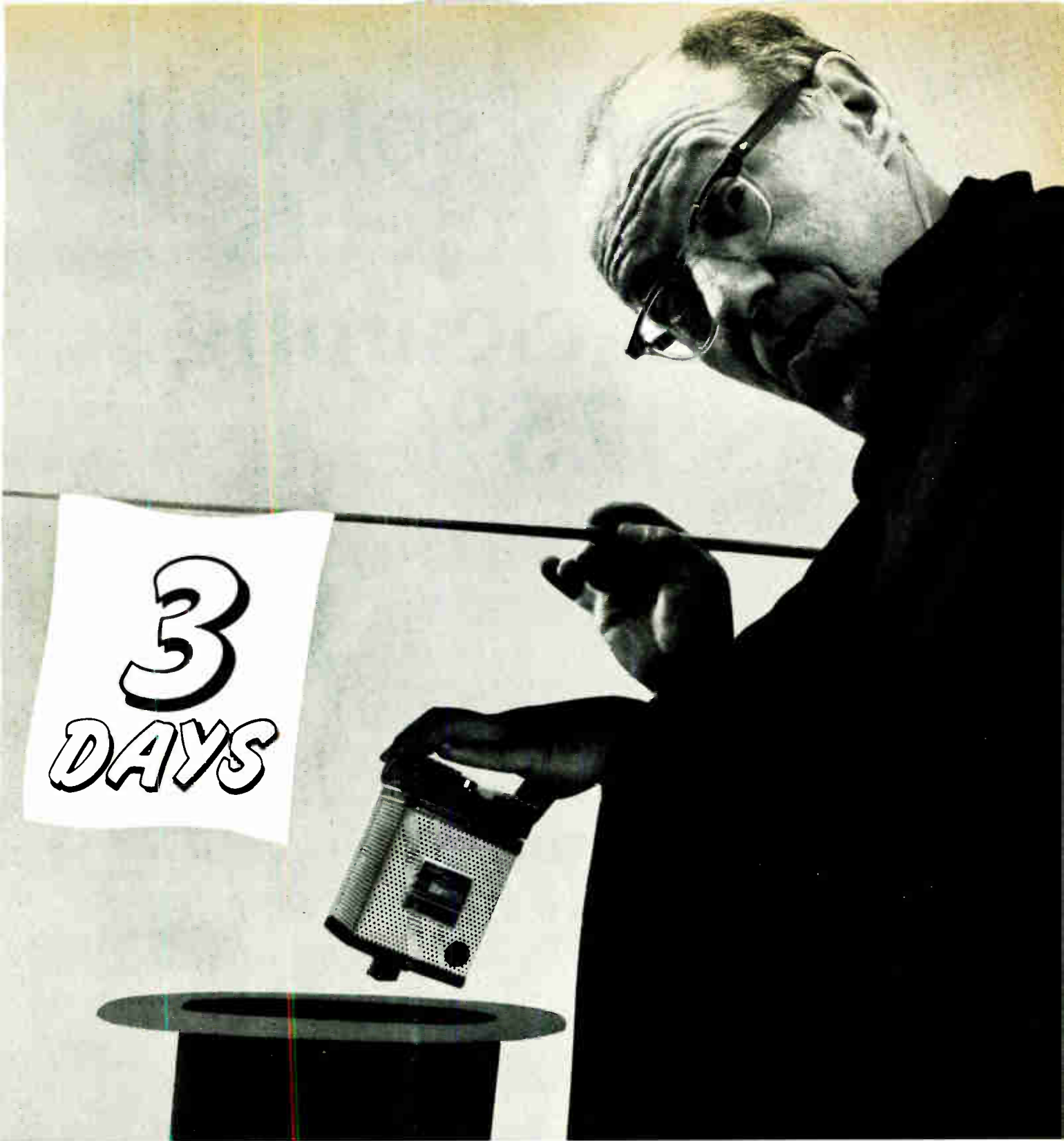

Magic... Acopian style!

We ship any of our 82,000 different AC to DC plug-in power supplies in just 3 days!

Next time you need power supplies in a hurry, contact Acopian. We offer 82,000 different AC to DC plug-in power supplies, any of which will be shipped to you in just three days! Choose the exact DC output you need. Singles or duals. Regulated or unregulated. Whether you need one power supply or several, your order will be shipped in just three days! That's our promise. For your copy of our latest catalog, contact your local Acopian rep, call us at (215) 258-5441, or write to Acopian Corp., Easton, Pa. 18042.



“FREON[®] solvents stopped rejects and cut cleaning costs 97.5%”

—Miles J. Valles, Cinch Manufacturing Co.

Cinch Manufacturing requires that its subminiature connectors be free of all contaminants when examined under a 12-power microscope. Miles J. Valles, Cinch's manufacturing engineer, explains why they use FREON solvents:

“We really didn't have any success in cleaning until we decided to use FREON. We would have to clean many of the parts six or seven times. We find that the FREON solvent removes the contaminants completely with one cleaning. And we have had no rejects from the standpoint of cleanliness since we started using FREON.”

FREON solvents give Cinch Manufacturing greater efficiency and at much lower cost.

“Combined savings in the multiple cleaning and inspection operations have cut our costs in these areas by 97.5% when compared to previous methods.”

FREON also helped to improve working conditions at Cinch. With other cleaners, the people in cleaning and adjacent areas complained of “odors, headaches and even broke out in rashes.” With FREON, this problem has been eliminated.

FREON helped to speed up production as well. No drying time is necessary with FREON—the parts move immediately from the cleaning operation to inspection. Costly time and space requirements have been eliminated. Also eliminated was a problem with delivery schedules.

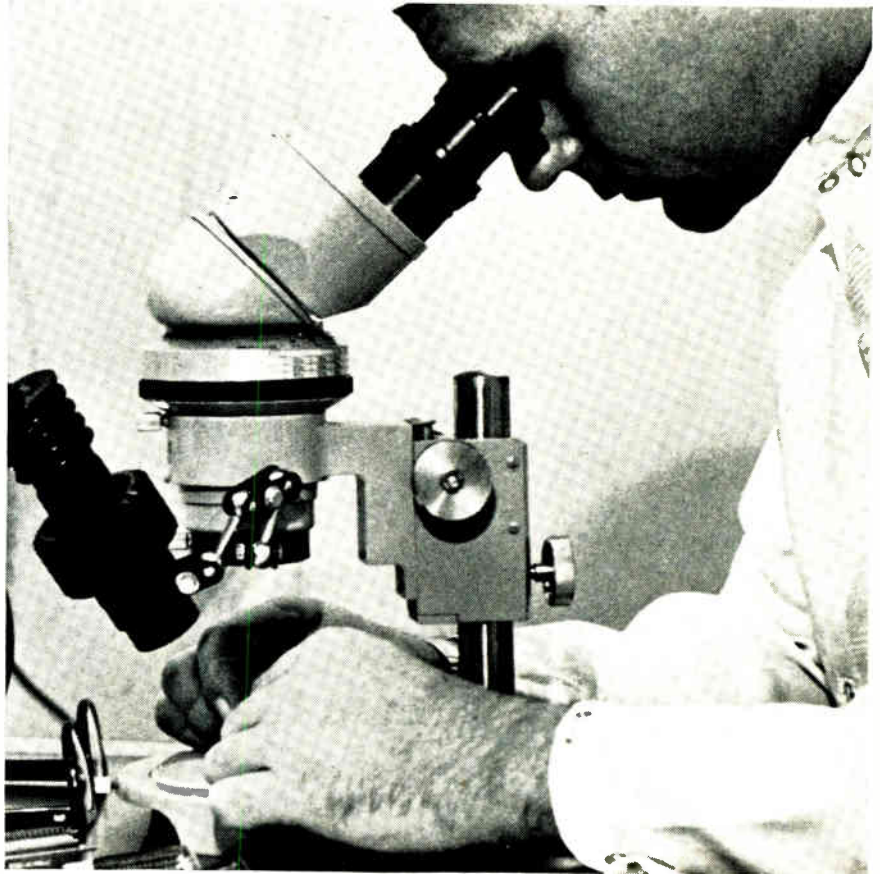

Mr. Valles inspects a cleaned part under the microscope.

“Prior to using FREON it was difficult to accurately predict the time necessary to properly cleanse our connectors in various stages of production. Since the use of FREON we can accurately plot our production schedule and we've literally trimmed weeks from our former production cycles.”

Find out how FREON can do the

job for you. Write today to Du Pont Company, Room 7751, Wilmington, Del. 19898. (In Europe, Du Pont de Nemours Int., S.A., FREON Products Div., 81 Route de l'Aire, CH-1211 Geneva 24, Switzerland.)

DU PONT **FREON[®]**
solvents
REG. U.S. PAT. OFF.

**Meet Datapoint.
It's 20 times faster
than other multipoint recorders.
And infinitely more versatile.**

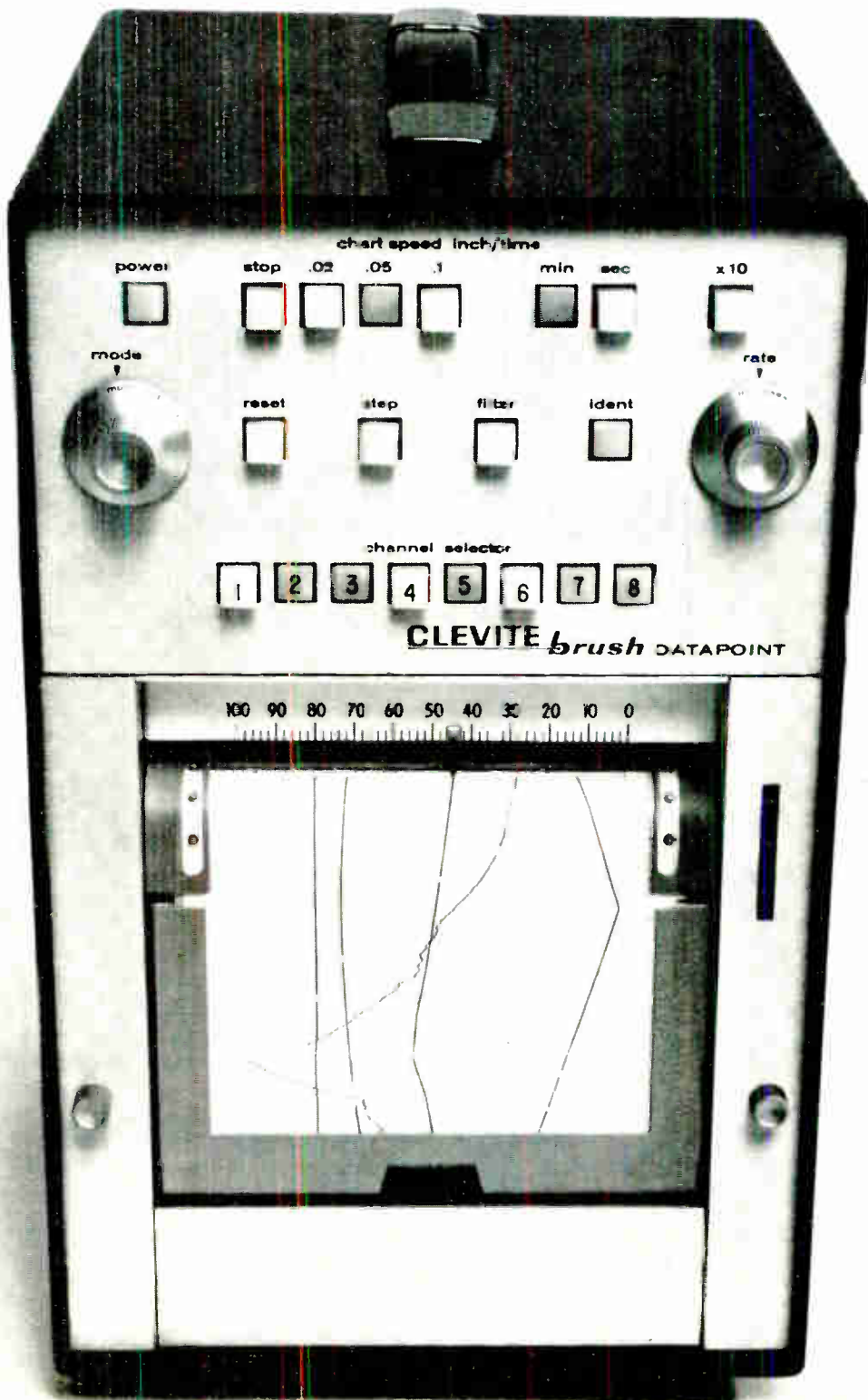

This new high-speed multipoint recorder by Brush runs off as many as 20 samples per second on 2 to 8 channels. So it's great for monitoring fast-changing variables in temperature, flow, pressure, strain, chemical processes, displacement dynamics and the like.



Datapoint handles mixed inputs from high and low level inputs. All on one chart. Recordings come out clear, crisp, uncluttered. And Z-folded. You've got a choice of 12 chart speeds, pushbutton controlled.

About that versatility. Datapoint works in three modes: multipoint sampling, intensified sampling, for channels of high dynamic content, or continuous single channel recording. So you get much more than just a fast multipoint recorder. Without paying more to get it.

And Datapoint is accurate, too. A full 99.5%, enforced by a non-contact position-feedback system. It's a first in this type of recorder. (But a proven success in countless Brush direct writing oscillographs.)

Speed. Versatility. Accuracy. These make Datapoint a new concept in recording. There's never been anything like it. You'll find more proof in the Datapoint brochure. Send for your copy today. Clevite Corporation, Brush Instruments Division, 37th and Perkins, Cleveland, Ohio 44114.

CLEVITE BRUSH

JAN2N3055/ JANTX2N3055

NOW FROM BENDIX.



The new Bendix JAN2N3055 and JANTX2N3055 silicon mesa power transistors conform to all characteristics of Mil-S-19500/407. Both offer you improved maximum ratings and greater optimum power handling capabilities for switching and regulator applications. Increased power ($P_T = 117W$), coupled with optimum "turn-on" and "turn-off" times (on = $6\mu\text{sec}$; off = $12\mu\text{sec}$) create a more desirable device for your military, audio amplifier and public address system applications.

Our JANTX2N3055 undergoes 100% screening to assure compliance with high-reliability requirements, as well as total "burn-in" processing. Both models are Safe Operating Area (SOAR) specified to prevent second breakdown—like our commercial 2N3055.

The JAN2N3055 and the JANTX2N3055. Two more reasons why we're called the real power in power. Two more reasons for you to call us.

Contact your nearest Bendix sales office for comprehensive data. Or, if you prefer, write us direct: The Bendix Corporation, Semiconductor Division, Holmdel, New Jersey 07733.

ELECTRICAL RATINGS

Symbol	Characteristics
$V_{(BR)CEO}$	60V (min)
I_C	15A
P_T (@ $T_C = 25^\circ\text{C}$)	117W
θ_{JC}	1.5°C/W (max)
Turn-on time	$6\mu\text{sec}$ (max)
Turn-off time	$12\mu\text{sec}$ (max)

Bendix **Electronics**

Chicago—(312) 637-4633; Denver—Electronic Component Sales, (303) 771-6200; Detroit—(313) 548-2120; Greenwich, Conn.—(203) 869-7797; Holmdel, N.J.—(201) 946-9400; Horseheads, N.Y.—(607) 732-1882; Lexington, Mass.—(617) 861-8350; Los Angeles—(213) 776-4100; Merriam, Kansas—Mid-America Marketing, (913) 432-8678; Minneapolis—(612) 926-4633; Orlando, Fla.—(305) 423-6048; Richardson, Texas—P. J. Scanlon Co., (214) 213-4661; Rochester, N.Y.—(716) 266-5550; Runnemede, N.J.—(609) 933-2550; Seattle—Ray Johnston Co., Inc. (206) 542-5170; Timonium, Maryland—(301) 828-6877; Export—Cable: "Bendixint," 605 Third Avenue, New York, (212) 973-2121; Ottawa, Ont.—Computing Devices of Canada, P.O. Box 508 (613) 829-1800; San Juan, Puerto Rico—Southern International Sales Co. 723-3879.

Circle 132 on reader service card

New circuits brighten color tv picture

Electronic tuning, automatic chroma and tint controls, the generally greater use of IC's and new tube sizes are among the things to watch for in the period ahead

Color television, which overhauled monochrome the first time last year, will continue to dominate the consumer market largely because circuitry advances have appreciably improved reliability and performance. This is a direct result of manufacturers' long-awaited move toward solid state. To take but one example, Sylvania now offers sets that are about 75% solid state; tubes are used only in the deflection, video and color output, and subcarrier oscillator sections.

A number of important innovations will be introduced this year, although not all will be included in the 1970 lines to be marketed this fall. Among the things to look for: electronic tuning or switching; automatic chroma and tint controls; instant-on color; automatic fine tuning features for bottom-of-the line models; brighter picture tubes; tubes with wider deflection angles for thinner consoles; new tube sizes; and more widespread use of integrated circuits.

First fruits

An all-IC receiver has already been announced in Japan, but most observers believe that it won't be marketed for several years. The prototype was developed jointly by five set makers and eight components suppliers. Total outlay on the project, which took three years to complete, reportedly approached \$500,000.

In general, manufacturers are striving to design and produce sets that can be serviced more easily by run-of-the-mill technicians. One reason for this is the lack of qualified servicemen. But it's turned out to be a good marketing gimmick as well. Motorola, with its Quasar line, gets credit for having started the ball rolling three years ago;

now, other companies, including Zenith and Sylvania, are following their rival's lead.

No hands. Perhaps the most useful development earmarked for 1970's color models, which will be unveiled this summer and fall, is the so-called TAC (total automatic color) circuit for the Magnavox line. The circuit, which eliminates the need for picture and color adjustments once the set is tuned, combines automatic fine tuning, automatic color control, and automatic tint control features on a single printed-circuit board measuring approximately 4 x 5 inches. The importance of the circuit lies in the fact that it automatically eliminates variations in tint or color saturation from station to station, as well as from program to program.

Though details are still a closely-guarded secret, it's known that the color burst is automatically gain- and phase-controlled by a logic circuit. This latter determines the optimum signal level for color saturation and maintains the proper phase shift for tint consistency before it is phased- and frequency-locked with the receiver's 3.58-megahertz subcarrier, which demodulates it to recover the color signal.

Split decision. Over the years, the inconsistency of color tv pictures has been a bugaboo of broadcasters and set producers alike. The latter have contended that irregularities were due to transmission phase errors and such other factors as differences in video tape recorder performance, camera colorimetry, and even studio equipment settings. The party line was that there wasn't much set makers could do in the way of designing automatic color-correction circuits

until tighter broadcast standards were adopted.

To this end, an ad hoc committee including representatives from the Electronics Industries Association, the National Association of Broadcasters, the Society of Motion Picture and Television Engineers, and AT&T was formed to investigate the problem and make appropriate recommendations. The committee's report is due the end of this month. In view of the Magnavox development, which effectively limits hue and saturation errors, it's probably a better than even-money bet that the committee will decide to toss

Associate editor John Drummond previews the technology advances in consumer goods to be unveiled at private dealer showings, the IEEE Spring Conference on Broadcast Receivers, and the Consumer Electronics Show in New York June 15-18. He opens with a look at what's in store for color television receivers.

Improvements in both video and audio tape recorder technology are the subject of the article beginning on page 139.

The story starting on page 145 outlines what's new in the wonderful world of high-fidelity and audio equipment.

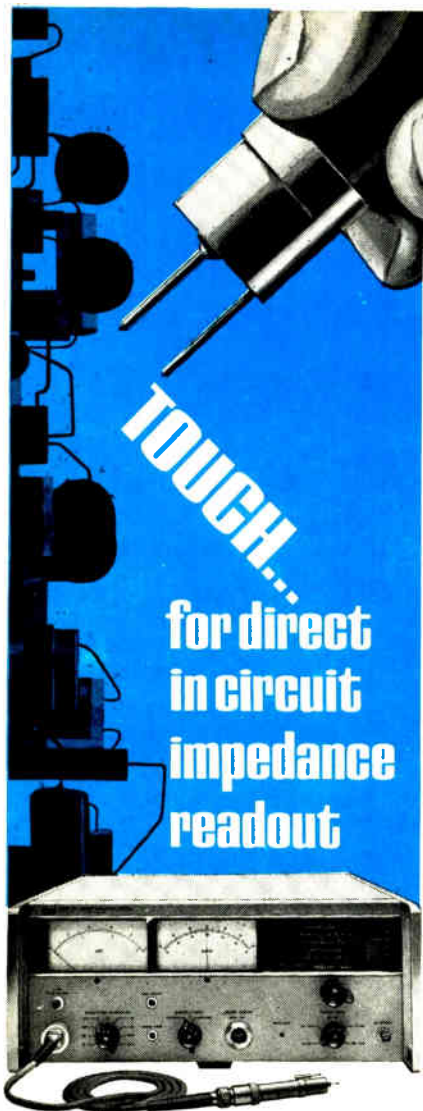

Hewlett-Packard 4815A RF Vector Impedance Meter simplifies impedance measurements. It's fast and simple. No tedious nulling and balancing, you just touch and read positive and negative impedance directly. Measure components, networks or probe right into active circuits in their normal operating environment. Application Note 86 describes many applications of the 4815A RF Vector Impedance Meter. For your copy and complete specifications contact your local Hewlett-Packard field engineer or write: Hewlett-Packard, Green Pond Road, Rockaway, New Jersey 07866. In Europe 1217 Meyrin-Geneva, Switzerland.

Pertinent Specifications:

Frequency Range: 500 kHz to 108 MHz, continuous.
 Impedance Range: 1 ohm to 100,000 ohms.
 Phase Range: 0 to 360°.
 Price: \$2,650.

HEWLETT *hp* PACKARD
 IMPEDANCE INSTRUMENTS

1095

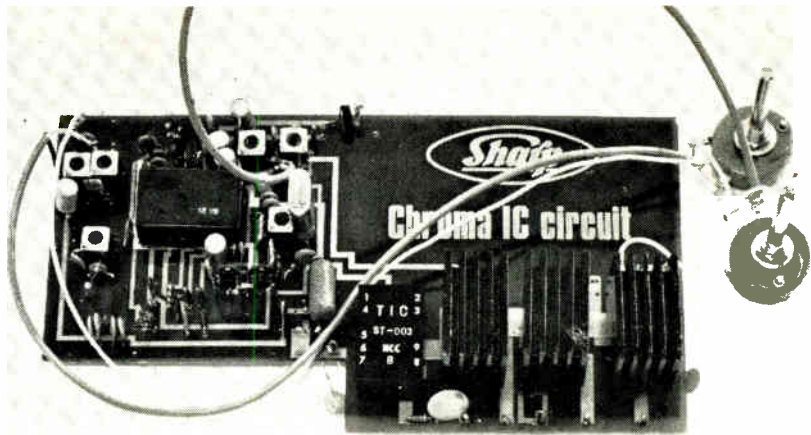

On the shelf. Color chroma circuits are part of an all-IC receiver made by a Japanese consortium; the set won't be marketed for several years.

the problem back into the lap of the set makers.

Electronic pushbutton tuning also promises to be a splashy sales feature on new sets. Unlike standard set-ups, which have mechanical switching contacts, electronic tuners use bias voltages to change channels. Such systems have no moving parts, thereby enhancing reliability [*Electronics*, January 6, p. 88]. In addition, some sources claim stability is improved as a result of using electronic assemblies. Others, however, dispute this.

Two distinct types of electronic tuners will be on the market by Christmas. One uses switching diodes, the other varactor diodes. RCA will shepherd the former version to market, while the latter will

be introduced by at least two set makers—Zenith and Panasonic—and probably several more.

Single purpose. RCA's switched-diode version is designed for operation on vhf only; a standard solid state unit will be used for the uhf channels in the company's sets. The vhf tuner uses 48 PIN diodes in the r-f, interstage, and oscillator circuits to switch in preselected coils that tune in the tv channels on a command signal triggered by pushing a button.

The novel approach of using PIN diodes for electronic tuning was worked out at the RCA Laboratories in Princeton, N.J., for the company's Consumer Products division. A PIN diode is essentially an r-f switch that's equivalent to a

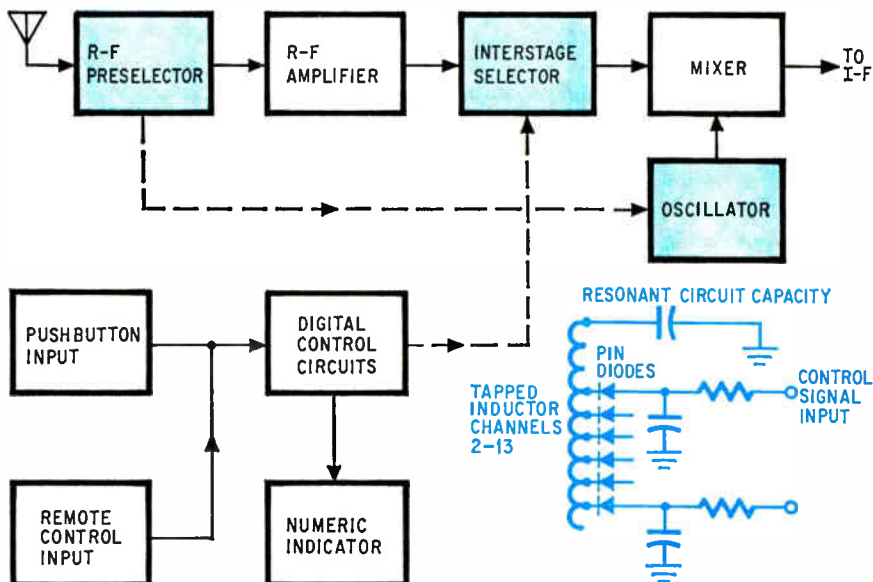

Switchover. RCA's tuner uses 48 PIN diodes in the r-f, interstage, and oscillator circuits to switch preselected coils that bring in vhf channels.

circuit made up of a junction capacitance shunted by an adjustable junction conductance. Its excellent switching characteristics—attributable to low forward resistance and low reverse capacitance—are controlled by a direct current. A forward current turns it on, and a reverse current turns it off. In the RCA application, the diodes are in series with an isolation resistor and the tapped inductor which, together with the required capacitance, forms the tuned circuit for each channel.

The control signal for channel selection is initiated by pushing a button. It's held down, permitting the circuit to be sequenced by a ring counter until the desired channel is tuned in. A numeric indicator provides a visual check on the station tuned in. While forward bias is being applied to the appropriate diode elements, reverse bias is simultaneously applied to the other diodes in the circuit to keep them turned off. Digital logic memory circuitry is used to keep the set on the channel selected by the viewer.

RCA's competitors will offer standard voltage-variable diode (varactor) circuitry to do the same tuning job. These work off preset voltages, selected by separate buttons. It's anticipated that the first such tuners will be made by Standard Kollsman and General Instruments. ITT, a leading varactor diode supplier will soon begin producing in volume in the U.S. to fill the expected demand from domestic tuner producers [*Electronics*, May 26, p. 163]. Most observers believe that electronic tuners will completely replace standard units within five years, and a number of firms, including ITT, are trying to get a jump in what looks like a potentially big market.

Signal achievement

To simplify the task of tuning in uhf stations, Sylvania has come up with a signal-seeking remote control unit that uses logic circuitry to achieve bidirectional search with a single pushbutton. It sweeps the entire uhf band in about 25 seconds, automatically reverses at the high end, and stops at the low. A muting circuit muffles sound during search, and the automatic frequency control is simultaneously

If it's easy for us to make difficult pots:

Like this attitude controller feedback pot in the Gemini space capsule.



Think how easy it is for us to make the standard ones.

Like these PRECISION WIREWOUND AND CONDUCTIVE PLASTIC POTENTIOMETERS, 7/8" to 3" diameters.

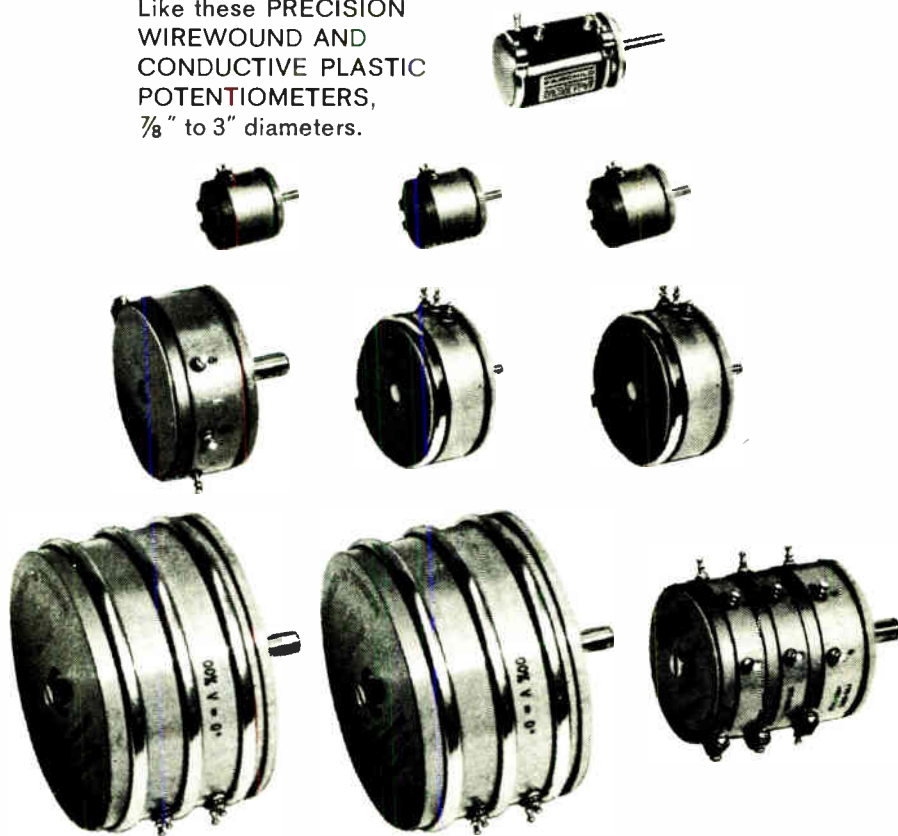

Let Fairchild prove it to you.

Call or write us today.

FAIRCHILD

CONTROLS

A DIVISION OF FAIRCHILD CAMERA AND INSTRUMENT CORPORATION
225 PARK AVENUE, HICKSVILLE, L. I., NEW YORK
TELEPHONE: (516) 938-5600 • TWX: (510) 221-1854
CABLE: FAIRCON-HICKSVILLE, NEW YORK, U. S. A.

take
the mess
out of
breadboarding
with
elite 1

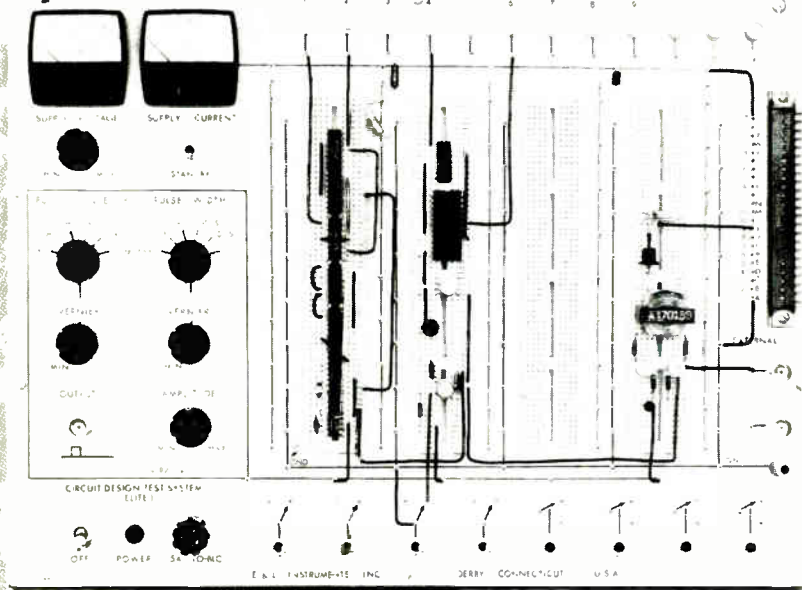

This unique instrument takes all the scavenging and soldering out of design, while conveniently accommodating any combination of IC's and Discrete Components.

BUILT-IN FEATURES:

- Precision Pulse Generator, Variable-Freq., Ampl. and Width.
- Variable Power Supply.
- Neon Lamp Display with Drivers.

ADVANTAGES:

- Total breadboarding without soldering.
- Complete breadboard interconnections with solid #22 wire.
- Breadboarding with any combination of IC's and Discrete's.
- Convenient desk-top operation.

AS A UNIVERSAL INTERFACE

... use the elite 1 for all DESIGNING, TESTING, and BURN-IN; and reduce your breadboarding to merely — insert components, interconnecting with #22 wire and monitoring circuit responses via built-in display.

\$650.00 complete



EL Instruments Incorporated

61 First Street, Derby, Connecticut 06418 Telephone 203-735-8774

overridden during this cycle.

To tune in a uhf station, the viewer presses a button on the set or remote unit, sending an r-f signal that's picked up by the set's remote receiver. After amplification and detection, the control signal activates a relay that switches the a-c line power to a d-c rectifier. The d-c output is applied to a search amplifier and relayed through a low-voltage regulator, as well as to the drive motor through a timing circuit and reverse amplifier. The timing circuit provides a $\frac{3}{4}$ of a second delay before the reverse relay closes; this delay provides directional control.

Time factor. Once the relay closes and the direction of search—forward or reverse—has been established by the length of time the uhf detector remains energized by the transmitter, the detector de-energizes upon release of the control pushbutton. Power is applied to a second low-voltage rectifier to start the search operation.

An adjustable gain control circuit establishes a threshold that prevents the search mechanism from stopping on images and spurious signals. Muting is accomplished by increasing the impedance in the B+ source for the set's sound IC until the circuit cuts off. The switching on of a pair of clamping transistors establishes the fixed manual bias for the tuner at low impedance and overrides the output from the automatic frequency control amplifier.

Screening new tubes

Several new types and sizes of color tubes will be available, albeit in limited quantities, by the Christmas shopping season. RCA says it has developed a new 23-inch diagonal tube that produces a picture 100% brighter than those of the units now used in the company's large-screen sets. The tubes, to be installed only in top-of-the-line receivers, will be shown to dealers in June, but can't be bought until late fall.

As it happens, there's no practical way to gauge the true qualities of the new tube itself. An RCA source acknowledges much of the projected brightness will be attributable to a new gun, an opaque coating around the triad color dots, an improved color demodulator,

the use of a silicon controlled rectifier horizontal deflection system [Electronics, January 6, p. 60], and a solid state chassis that's designed to drive the picture tube at higher-than-normal power levels.

At the moment, the domestic color tube market is mature and, to an extent at least, suffering from overcapacity. The leading lights in the field are RCA and Sylvania, which together fill about two-thirds of all orders. Their dominant position is as much attributable to the value of the applications engineering services they offer as it is to the excellence of the products they have for sale.

Hang-up. Sylvania, which developed the rare earth phosphor used in present high-intensity color tubes, has announced its intention to produce the industry's first 110° color tube early next year—pending availability of the envelope. The Corning Glass Works, which supplies most of the glass for these units is reportedly still working out development kinks [Electronics, January 6, p. 134].

In the meantime, Sylvania's plans call for production of the industry's largest tube—a 25-inch viewable 90°, square-corner design—as well as a new 21-inch viewable square-corner model. Drawings of these tubes are already in the hands of color set makers.

Holland's Philips has also entered the race to produce a 110° color picture tube. The company has announced it's working on a square-cornered design that will be offered to original-equipment manufacturers next year; samples will be made available to interested producers this fall. Two sizes will be offered: a 25-inch viewable square-cornered design that's about 3½ inches shorter than current 23-inch models and a 21-inch viewable diagonal unit. Both tubes have an aspect ratio of 4:3.

To attract set makers, Philips will offer a matching deflection yoke and circuitry for dynamic convergence of the beams around the edges of the tube. Domestic interests aren't too worried about possible competition from Philips. The doubling of import duties on color tubes to 24%, scheduled to go into effect this September, will, they believe, price Philips' offerings out of the U.S. market.

International Catalog

your electronics buying guide
for precision made radio crystals
and electronic equipment—

free!

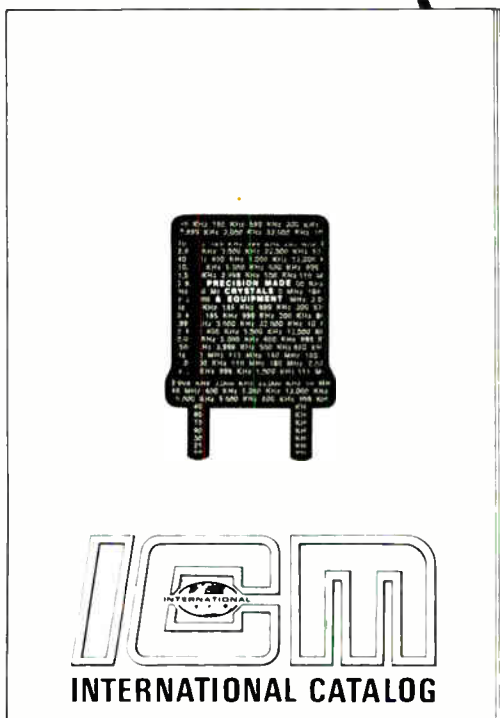

INTERNATIONAL CRYSTAL MANUFACTURING CO., INC.

10 North Lee • Oklahoma City, Oklahoma 73102

**Rush
FREE
catalog**



NAME _____ PLEASE PRINT

ADDRESS _____

CITY _____ STATE _____ ZIP _____

BIG ADVANCES Come in Small Packages

Now... Reeves has developed the highly accurate subminiature heaterless Mini-RIG Integrating Gyro... and the full capability for packaging it as a self-contained sub-system.

The Mini-RIG development represents a major advance in reliability, cost reduction and performance, in the field of subminiature high-volume inertial sensors.

Only one inch by two inches in size, the Mini-RIG can stabilize short-mission-time inertial platforms or serve as an inertial sensor in strap-down applications. Automated gyro assembly techniques have reduced final assembly time from the normal one month to **one work-day!** This, in turn, has minimized the possibility of contamination and maximizes reliability. Reeves has full

packaging capability, too. For example, the illustration shows a typical compact three axis rate package especially designed for aircraft missile and satellite system applications. It is system-engineered to provide the necessary accuracy and to meet the most stringent environmental requirements of outer space. Within its 30 cubic inch volume are three Mini-RIG Rate integrating gyros **plus** all necessary electronic modules to operate the entire package.

What are your special needs for subminiature gyro packages and sub-systems? Reeves can meet them! Our engineers working within the Total Systems Concept, will isolate the problem areas and provide the most practical solutions for them.

For complete data and application information call (516) 746-8100 ext. 540, or write Component Division, Reeves Instrument, Garden City, N.Y. 11530.

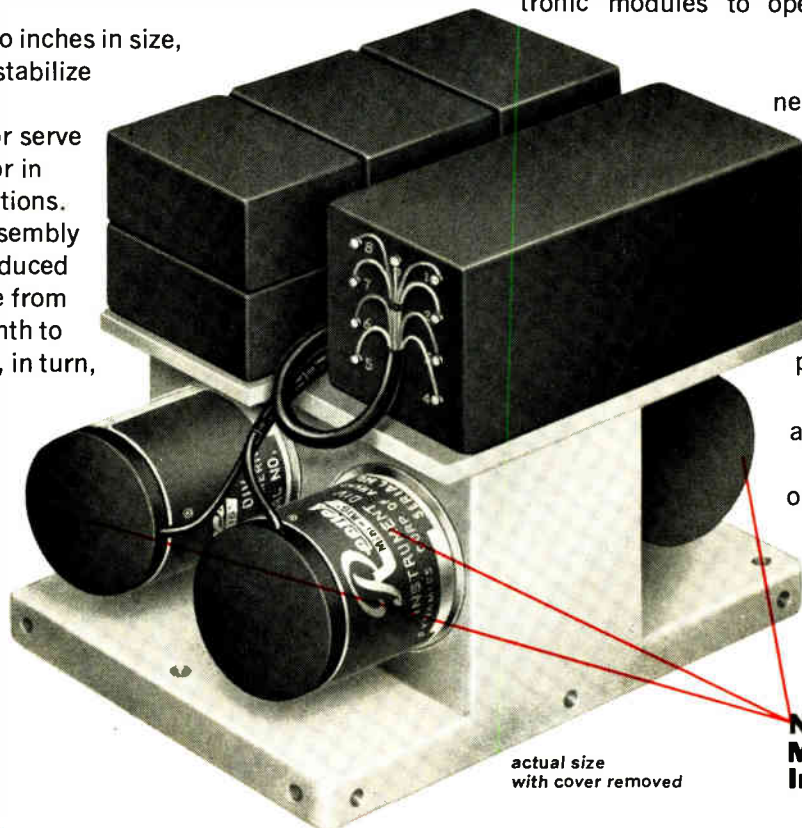

actual size
with cover removed

**NEW! REEVES
Mini-RIG®
Integrating Gyro.**

Reeves®

INSTRUMENT DIVISION



DYNAMICS CORPORATION OF AMERICA | GARDEN CITY, NEW YORK 11530

Tape equipment fights for markets

Color video recorders for the home are still a way off, but EVR looks solid in educational/industrial outlets; showdown near for cassette and cartridge units

Tape recorders, in both video and audio versions, appear set for some significant design changes during the period ahead. However, the prospects of a home vtr are apparently no brighter now than they were a year ago when Arvin Industries' prototype color unit [*Electronics*, Feb. 19, 1969, p. 47] stalled along the road to the consumer market. As often happens, the jump from prototype to production proved longer than anticipated. A possible reason: the technology involved in fixed-head video recording [*Electronics*, September 30, 1968, p. 102] is still a chancy proposition. At this point, it appears Arvin's color video recorder won't make its scheduled 1969 appearance.

Likewise, Sony has shied away from discussing marketing plans for the cartridge-loaded color vtr it has developed [*Electronics*, May 12, p. 239]. In fact, the company would now like to license others to make and market the unit, reducing the chances of the unit's appearing in two years as was predicted earlier. Sony's recorder uses helical-scan technology.

Undaunted, Matsushita (Panasonic) has just unveiled a multiple-speed helical-scan vtr that can provide up to 42 hours of continuous recording from a 2,400-foot reel of standard 1/2-inch video tape. The unit will go on sale in Japan this month and will be offered in U.S. markets this fall. The unit measures about 17 x 17 x 11 inches and weighs about 50 pounds. The price, including a monitor and tv camera, will be under \$2,000.

Sylvania, known to be developing a movie version if its successful color-slide theatre, also appears to be running into problems. While the company has never publicly admitted it has such a product under development, insiders say the movie/tv combination, built around a special Kodak Super 8 projector, is scheduled for production next year.

Home away from home. The prospects that CBS' electronic video recording system will make it as a low-cost home unit aren't very bright either since EVR is essentially a film-playback device which has no recording capability. However, EVR will undoubtedly enjoy

success in educational/industrial outlets because of high program-packing density. Its 7-inch cartridge holds up to 750 feet of 8.75-millimeter film which provides 52 minutes of programming at a speed of 6 inches per second. The dual film track accommodates 180,000 picture frames.

Although EVR plays back prerecorded film through a standard tv receiver, the present design can't handle color, thereby reducing its appeal as a consumer item. CBS says it will demonstrate a color system by yearend, but the probable price tag—about \$1,000 as against \$800 for monochrome units—effectively removes it from the mass-market class.

To reduce costs and tap consumer outlets, the EVR player could be designed into the tv set—in much the same way that a tape deck piggybacks on the audio system of an amplifier. For example, the tv receiver's deflection system could drive the EVR's flying-spot scanner in a direct hookup, eliminating this system from the player. Similarly, the video output from the phototube could be applied

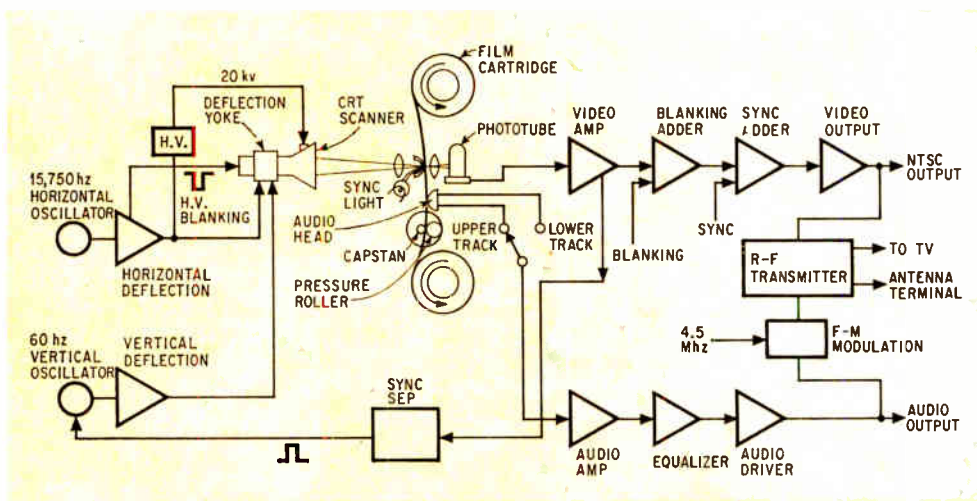

Misnomer. At this point, the CBS electronic video recorder is still a film playback device with no recording capability. However, as mass consumer markets open up, it will be designed into television receivers in much the same way tape decks hitch rides on the audio sections of amplifiers.



EMI
four
stage
magnetically
focused
image
intensifier
9694

...offers an overall light gain of 10^6 with a typical background of 10^{-10} lumens/cm². (light equivalent input.)

Typical operating voltage for these conditions is 40KV The background indicated is for a tube having bi-alkali photocathodes,—tubes are also available with a range of S-20 cathodes for use out to 8,000 Angstroms. Input and output windows are flat Zinc crown glass, 50 mm diameter. Type 9693 is available with sapphire input window for use in the UV. Developmental types are now being made with fibre optic windows. All present types are furnished with P-11 phosphors throughout although other types of phosphors are under investigation □ Tubes are normally supplied potted in silicon rubber and a number of variations are available. A complete package, including electromagnet, divider chain, high voltage power supply and magnet supply is offered. A permanent magnet is also available □ An extensive technical manual, as well as useful application notes, are available on request. Write on your company letter-head to:

GENCOM DIVISION
Whittaker
CORPORATION

80 Express Street • Plainview, N. Y. 11803
516 - 433-5900



In store. A brisk battle between Philips with its cassette and Lear Jet with its Stereo 8 cartridge system is developing in audio tape recorders.

directly to the receiver's video driver. This would obviate the need for the r-f transmitter that feeds the set's antenna terminals. In addition, the output from the audio tape head could be preamplified and applied to the receiver's audio driver, getting rid of the 4.5-megahertz f-m modulator which now feeds the r-f transmitter.

Both CBS and Motorola, which is making players, are thinking along such lines. But they're holding off since there's still no real mass market for EVR. What's more, there won't be until entertainment EVR films can be offered for sale or rental. The feeling is that this pros-

pect is at least several years away. In the meantime, CBS is making money on its worldwide film-processing facilities, while Motorola and other licensees expect to profit making and selling the player.

Film file

The EVR's playback unit employs a cathode-ray-tube flying-spot scanner light source to project the film as it moves past a light gate through an optical path onto a phototube that converts it to an electrical signal. The crt scanner is driven by a deflection yoke whose vertical and horizontal sweep currents are provided by 60-

hertz and 15,750-hz oscillators—the frequency timing for the 525-line tv standard.

The film, which has no sprocket holes, is transported at 6 inches per second by a drive system which uses a capstan and pressure roller in a manner similar to that of a standard tape recorder. Automatic threading is achieved by air jets in the feed reel which pick up the lead end of the film and guide it through the threading path to the takeup reel. The tape transport system is driven by a synchronous motor that locks to the line frequency to eliminate hum bars. Vertical stability, which is independent of the line-power frequency, is achieved by a sync pulse that's picked off the film. The pulse, in the form of a light window, is located between the two adjacent picture tracks.

Double duty. The high voltage for the crt is produced in a manner similar to that of a standard tv set, but regulation is not required since the unregulated raster serves as a constant load that draws only a very small current. A photoresistor circuit monitors the light level and automatically adjusts beam current to maintain constant bright output.

The video output from the phototube is processed to add blanking and sync and then pulse-clamped to remove hum components. After amplification, it modulates the frequency for the unused channel to produce the r-f signal that's applied to the tv set's antenna terminals.

The audio signal that's picked off the sound track is amplified and pre-emphasized to achieve the standard 75-microsecond rolloff figure for f-m sound. It then modulates the 4.5-Mhz oscillator to generate the intercarrier sound signal for the transmitter.

Sound and fury

After color television, audio tape recorders are probably the hottest item in consumer outlets. What's more, a high-stakes game is now being played by the two top contenders—Philips with its cassette and Lear Jet with its Stereo 8 cartridge system—for market dominance. The rivalry now shaping up looks potentially vicious in view the fact that Lear's Stereo 8 has all but smothered Fidelipack's

New from MetroData Systems, Inc.

DL 620A

A COMPLETE 18-CHANNEL DIGITAL DATA ACQUISITION SYSTEM

for only
\$3,900

The compact and lightweight design, plus low power requirements, makes the DL 620A an extremely versatile unit. Ideal for general purpose recording of analog or digital data on magnetic tape both in the laboratory and remote installations... or portable airborne applications.

This complete 18-channel data acquisition system weighs only 18 lbs. and needs minimal power of 35 watts. Features include a presettable crystal controlled clock; ability to accept either analog or direct digital data; high Z differential analog input stage; selectable recording rates; cartridge magnetic tape system with associated drive; plus all necessary logic and power supplies. Data recovery options include; tape-to-tape, tape-to-computer, and real-time.

For the complete story on the Model DL 620A and associated equipment write MetroData Systems, Inc., P. O. Box 1307, Norman, Oklahoma 73069.

metrodata systems, inc.



TRW Presents Low Frequency Varicaps®



High Capacitance... High Q... Low Noise

New TRW Varicaps make direct low frequency electronic tuning possible for the first time...from the high end of the broadcast band to 5 MHz and beyond.

Three high capacitance, single chip devices are available; PQ2150 at 150 pF, PQ2300 at 300 pF, and PQ2500 at 500 pF. All have less than

1 μ A leakage, Q factor greater than 150, and 5:1 capacitance ratio over a 2 to 90 V sweep

Ideal for electronic tuning in receivers, ADFs, NAVCOM systems, low frequency VCOs, TCXOs, and field strength instruments, these single element Varicaps provide inherent low noise and high stability.

Contact any TRW Distributor for complete information. TRW Semiconductors is a Subsidiary of TRW INC.

TRW®

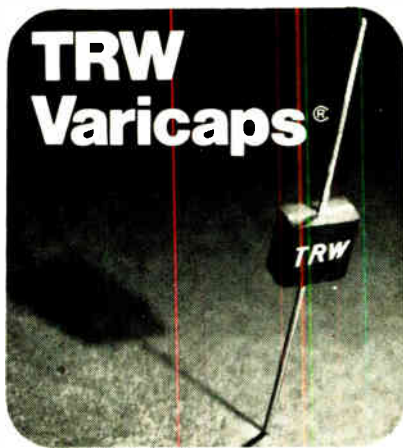

Immediately available from TRW distributors

CALIFORNIA—Los Angeles Area

AVNET CORPORATION
10916 Washington Blvd (213)870-6141
Culver City, Calif 90230 (213)836-4711

K-TRONICS, INC

5645 E. Washington Blvd
Los Angeles, Calif 90022 (213)685-5888

SANTA MONICA BELL ELECTRONICS CORP

306 E. Alondra Blvd
Gardena, Calif 90247 (213)321-5802

WESTATES ELECTRONICS CORP

20151 Bahama Street
Chatsworth, Calif 91311 (213)341-4411

CALIFORNIA—San Francisco Area

ELMAR ELECTRONICS INC.
2288 Charlston Road
Mountain View, Calif 94091 (415)967-3611

KIERULFF ELECTRONIC INC

3969 E. Bayshore Road
Palo Alto, Calif 94303 (415)968-6292

DISTRICT OF COLUMBIA

ELECTRONIC WHOLESALERS, INC
2345 Sherman Avenue NW
Washington, D C 20001 (202)485-5200

CRAMER ELECTRONICS, INC

692 Lofstrand Land
Rockville, Md 20850 (301)424-2700

FLORIDA

CRAMER/FLORIDA, INC (305)566-7511
4141 N. E 6th Avenue (305)947-6517
Ft. Lauderdale, Florida Enterprise 1776

ELECTRONICS WHOLESALERS INC

345 Graham Avenue
Orlando, Florida (305)841-1550

MASSACHUSETTS

CRAMER ELECTRONICS, INC
320 Needham Street
Newton, Mass 02164 (617)969-7700

NEW JERSEY

EASTERN RADIO CORP
312 Clifton Avenue
Clifton, New Jersey 07015 (201)471-6600
New York, New York (212)CH4-2268

NEW YORK

CRAMER/ESCO INC
96-10 23rd Avenue
Elmhurst, New York 11369 (212)478-4000

TERMINAL-HUDSON ELECTRONICS, INC

236 W. 17th Street
New York, New York 10011 (212)234-5200

OHIO

ELECTRONIC MARKETING CORP (EMC)
814 W. 3rd Avenue
Columbus, Ohio 43212 (614)299-4161

PENNSYLVANIA

ALMO INDUSTRIAL ELECTRONICS INC
Roosevelt Blvd at Blue Grass Rd
North East, Industrial Park
Philadelphia, Penn 19114 (215)676-6000

TEXAS

HALL-MARK ELECTRONICS CORP.
9100 Markville Drive
Dallas, Texas 75231 (214)231-6111

TRW®

Available from all other TRW distributors coast-to-coast

... hybrid tape systems that will play cartridges or cassettes are on tap ...

four-track system—the first such design on the market.

Jim Gall, vice president of marketing at Lear Jet, contends there's room in the huge consumer market for both. But his counterpart, Wybo Semmelink, vice president of North American Philips' Home Entertainment division, thinks otherwise. His conviction is shared by many industry marketing experts and a number of retailers who are betting on cassettes.

On the road. The cassette is not only challenging the Stereo 8 for leadership in home entertainment outlets but also going after the huge auto market. At least one major producer—Panasonic—is reported to be starting production of a cassette player for cars. And a recent announcement from Ampex that it intends entering the auto cassette field with monaural and stereo systems should further stimulate the market. Detroit, for the time being at least, is sticking by the Stereo 8. But by next year auto makers will begin offering the motorist a choice. When this happens, it seems likely that the industry will adopt the cassette exclusively within five years.

Last year, 5 million cassette and cartridge type players were sold. In 1969, the figure is expected to jump to nearly 7 million units. In terms of dollar volume, this amounts of over \$400 million. So the game is well worth the candle.

Bantamweight. The cassette is basically a miniature reel-to-reel machine with the tape supply and takeup reels in a small lightweight plastic enclosure. It uses a 1/8-inch-wide tape that's transported past the record/playback head at 1 7/8 inches per second.

The frequency response of most portable cassettes is in the 150-hz to 7,500-hz range, though expensive units can provide responses of from 40 hz to about 10,000 hz—just below the hi-fi threshold. Frequency limitation is due largely to the slow speed, which affords a playing time of up to two hours with some tape packs. Increasing the speed to, say, 3 3/4 inches per second would solve the problem al-

though tape consumption would rise and the size of the package would be appreciably increased. However, the response can be enhanced without altering the present format by the use of improved tapes like Du Pont's chromium-dioxide offering and the new gamma ferric-oxide tape from Japan's TDK Electronics. Unfortunately, there are still drawbacks. The use of Du Pont tape, for example, requires a different bias frequency.

Stereo 8, unlike the cassette, is an endless loop system which works with a single spool for both tape takeup and supply. It uses 1/4-inch-wide tape that plays back at 3 3/4 inches per second and provides a frequency response comparable to that of standard open reel-to-reel machines playing at the same speed. A major drawback of Stereo 8 is that it's a playback only machine, and hence requires more expensive prerecorded tapes. At present, the only company making an 8-track machine with recording capabilities is Sony. But Lear Jet will probably soon have such a unit. Another drawback of the endless loop system is that it can't be operated fast forward as can the cassette; neither can it be rewound. It can only be played in a forward direction at normal speed.

Coming attractions. There'll be many innovations in the basic designs of Stereo 8 and cassette units this year. For one thing, there'll be an endless loop cassette cartridge which its producer, TDK Electronics, says will have a frequency response of from 30 hz to 20,000 hz. Aside from this improvement, the main benefit of the endless loop is that the machine will continue playing until it's turned off by the user.

Aiwa is reported to be readying a hybrid system that will play 4-track or 8-track tapes, as well as cassettes. In addition, it will have automatic reversing features, something present designs don't have. Other companies are also planning to unveil adapters that can be used to turn a standard Stereo 8 unit into cassette machines.

If you don't see what you want here...



ask for it.

We make all kinds of recorders, including Unicon[®], first practical laser recording system. Result? We're able to recommend the recorder (or recorder system) that's best for you—objectively, professionally. Just send the coupon below. Or, call us at 3170 Porter Drive, Palo Alto, California 94304; (415) 321-5615.



TO: Precision Instrument Company
3170 Porter Drive, Palo Alto, California 94304

OK Help me select the recorder that's best for my application.

Name _____

Company Organization _____

Address _____ Phone _____

City _____ State _____ Zip _____

I'M INTERESTED IN:

- Digital
- Analog
- Video

FOR USE:

- in aircraft
- in lab
- in field

- in land vehicle
- on board ship.

IC's still stalled in audio outlets

But the growing pre-eminence of Japanese producers in hi fi and radio may trigger a shift; popularity of f-m stereo programming stimulates sales of combination units

Prepackaged music-reproduction equipment will get an increasing share of attention at this spring's Consumer Electronics show, as well as at the more exclusive High Fidelity Show this fall, as erstwhile component manufacturers follow the trend towards integrated compact systems. As things now stand, status-seeking hi-fi buffs will be hard-pressed to find separate components—tuners, preamps, power amps, and the like—to show off.

Much of the streamlining will be attributable to more widespread use of semiconductor components. Integrated circuits, however, with but a few notable exceptions, have failed to make much of a dent in the hi-fi radio/audio field. In general, manufacturers seem quite content to stick with discrete devices to meet their performance and price objectives. "Consumer goods houses are, as a rule, reluctant to make a big commitment to advanced technologies," says a West Coast source. "They're in no hurry to back away from discrettes, much less make a switch to IC's."

Another reason for set and audio-component makers' laggard pace in integrated electronics involves costs. Once suppliers succeed in matching the performance characteristics of discrete semiconductor devices and they'll find themselves marketing largely on price. "Our potential customers simply aren't too interested in the superior reliability we say we can offer with linear IC's," says the sales manager at a leading semiconductor house.

Exceptions. Some few manufacturers have, however, traveled the IC road with fair success. H.H. Scott was among the first to venture in this direction two years ago, building IC's into its receiver i-f amps. Sylvania too has used IC's in

the limiter stages of top-of-the-line units to enhance capture ratio and achieve a spurious-signal response rejection to 125 db. In the front end, however, the company has stuck with dual-gate field effect transistors and silicon transistors for the output stage to achieve an ear-splitting 200 watts (EIA) of power for audiophiles.

For the moment, domestic concerns will emphasize external system features, rather than behind-the-scenes advances in technology. Fisher, for example, will concentrate on putting more power in smaller packages, while Scott will try to cash in on "cleaner" sound at lower price levels. Harmon Kardon, once a poor third in the popular-price market, will be vying for a top spot with sleeker styling. Marantz will introduce its first compact stereo—made in Japan, the locus of much of the audio field's current problems. CM Laborator-

ies, which last autumn unveiled a prototype crystal-controlled, digital-readout tuner, hopes to have its brainchild in dealer showrooms in time for the holiday shopping season. The firm's rivals, however, suggest the unit still requires further debugging and is not yet ready for release to production.

Meanwhile Sylvania will attempt to consolidate a position in the exclusive hi-fi component market with newly designed stereo preamplifier a-m/f-m tuner combinations featuring muting defeat pushbutton, automatic stereo defeat pushbutton, and an f-m front end using a dual-gate MOS FET r-f amplifier and a junction FET mixer. The planned-on capture ratio, 1.6 db, is a bid for the lowest level in the industry. The tuners will combine silicon controlled rectifiers varactor diodes, and IC's for state-of-the-art performance advantages.

Japanese producers are expected

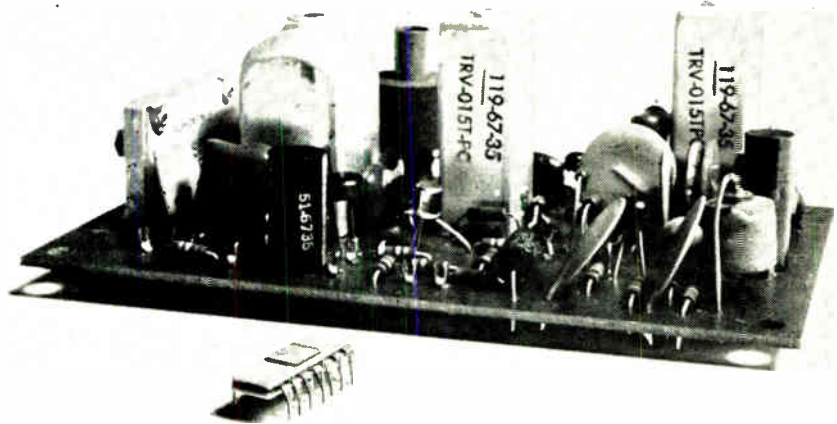

Rare bird. IC's are still used sparingly in audio systems; this device, which replaces a 3 x 5 assembly in a Scott tuner, is among select few.

GLASS ENCLOSED
AMPERITE
Thermostatic
DELAY RELAYS

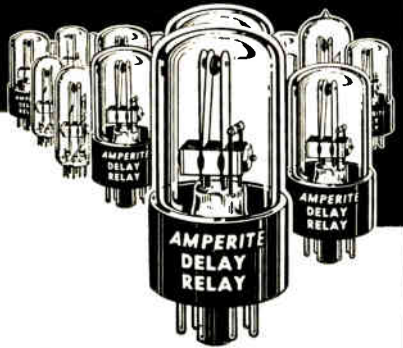

Offer true hermetic sealing
-assure maximum stability and life!

Delays: 2 to 180 seconds . . . Actuated by a heater, they operate on A.C., D.C., or Pulsating Current . . . Being hermetically sealed, they are not affected by altitude, moisture, or climate changes . . . SPST only—normally open or normally closed . . . Compensated for ambient temperature changes from -55° to +80° C. . . Heaters consume approximately 2 W. and may be operated continuously . . . The units are rugged, explosion-proof, long-lived, and—inexpensive!

TYPES: Standard Radio Octal, and 9-Pin Miniature.
List Price, \$4.00

PROBLEM? Send for Bulletin No. TR-81

AMPERITE
BALLAST
REGULATORS

Hermetically sealed, they are not affected by changes in altitude, ambient temperature (-50° to +70° C.), or humidity . . . Rugged, light, compact, most inexpensive.

List Price, \$3.00

Write for 4-page Technical
Bulletin No. AB-51

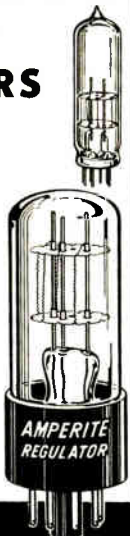
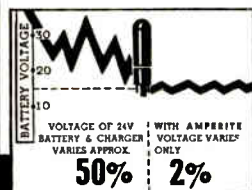

AMPERITE
600 PALISADE AVE., UNION CITY, N.J.
Telephone: 201 UNION 4-9503

In Canada: Atlas Radio Corp., Ltd.,
50 Wingold Ave., Toronto 10

to use large lots of integrated circuits in their new designs. So advanced are they in this area, a prototype of the first stereo receiver using all thick-film IC's has already been previewed. Although the set will not be in production until next year at the earliest, it illustrates the success of such efforts in Japan.

The all-IC receiver is the result of a cooperative effort by eight Japanese manufacturers including such well-known Matsushita, Toshiba, and Sony. The receiver will use nine IC's as follows: f-m tuner, a-m tuner, i-f amplifier, f-m limiter, multiplex, pre-amp, tone control, power amplifier, and power supply.

Eclipsing. The Japanese, who are slowly wrestling the hi-fi market from American producers, will offer an expanded line this fall. "The rivalry will be intense," says a New York dealer. "Frankly, we don't see how Scott, Fisher, Harman Kardon, Marantz and the rest can compete successfully with giants like Panasonic, Sony, Sansui, Toshiba, or Hitachi, to name a few." William Glasser, Scott's vice president and sales manager, admits that the fight for survival will be fierce. However, he believes, the engineering talents at American companies in general and his company in particular will turn the tide.

The engineering manager of a New York based hi-fi equipment

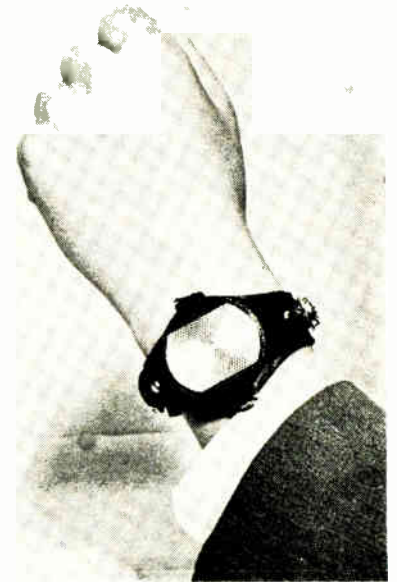

New reality. Japan's Kodama is set to produce an all-IC wristwatch radio a la Dick Tracy in a year or so.

producer see things a little differently: "Let's face it, our labor costs won't allow us to compete on an equal basis. It won't be long before we'll take a page out of the book written by the television set makers and turn, as they have done, to the East for relief."

In fact, the trend has already begun to swing in this direction. Harman Kardon which made the first move overseas is being joined by

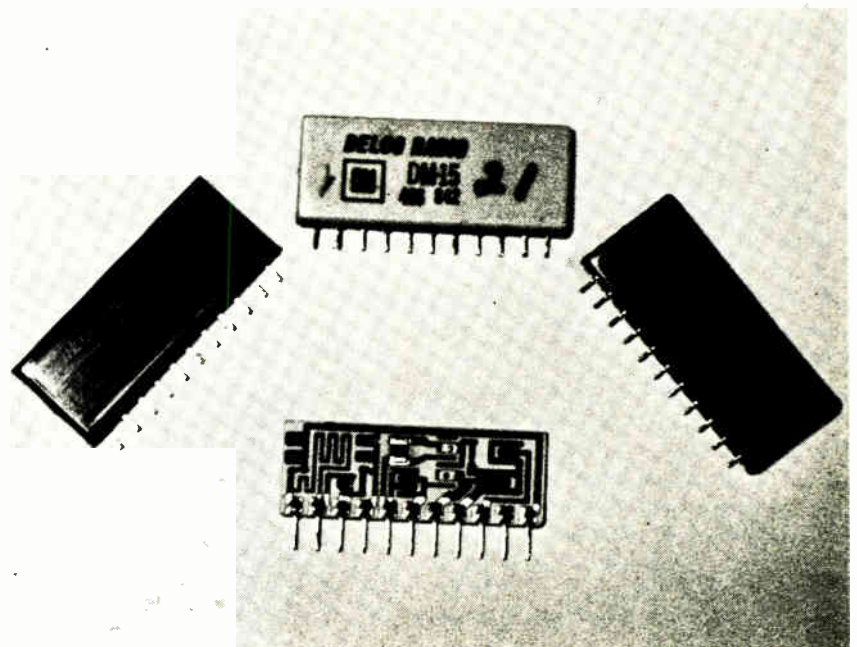

Components. Delco is making these IC's for the radios in GM's 1970 cars; only tuning and decoupling circuits are needed to complete the picture.

Looking for an All-Around Voltmeter?

Hewlett-Packard gives you a broad choice of multi-function meters that do not have to be pampered. Choose the versatility that fits your needs for ac volts, dc volts, current and resistance measurements. The exclusive individually calibrated taut-band meter used in these voltmeters gives you reliability, repeatability and high accuracy.

Make 90% of your day-to-day ac/dc measurements with laboratory precision using the hp model 410C Voltmeter. Measure dc from 15 mV to 1500 V full scale, current from 1.5 μ A full scale, resistances from 10 Ω to 10 M Ω , and ac volts to 700 MHz. The hp-developed photoconductor chopper amplifier gives the 410C high sensitivity, low drift, and low noise. Price of hp 410C is \$475. Vacuum tube version, hp 410B is \$300.

Low cost fully-portable multi-function meter—that's the all-solid-state, battery-operated hp model 427A Voltmeter. It costs only \$225. Option 01 gives both battery and line operation for an additional \$25. Measure dc voltages from 100 mV to 1 kV full scale; ac voltages from 10 mV to 300 V full scale at frequencies to 1 MHz (to 500 MHz with the 11096A High Frequency Probe, price \$45); resistance from 10 Ω to 10 M Ω . Ac and dc accuracy is $\pm 2\%$. FET's in the input circuit give you 10 M Ω input impedance—minimal circuit loading.

Highly sensitive dc and resistance measurements are made with hp 412A DC Vacuum Tube Voltmeter. With its 1 mV full scale dc voltage sensitivity and 1 Ω midscale ohms sensitivity, and its simplicity of

operation, the 412A is ideal for production line testing. Measure dc with 1% full scale accuracy. Price of 412A is \$450.

Extreme accuracy and hands-free operation distinguish the "Touch and Read" 414A DC Autovoltmeter. Automatic ranging and polarity indication occurs in less than 300 ms. Measuring accuracy for dc voltage is $\pm(0.5\%$ of reading $+0.5\%$ of full scale)—the best available in any analog voltmeter. Resistance accuracy is $\pm(1\%$ of reading $+0.5\%$ of full scale) on an easy-to-read linear scale. Price is \$690

For full details on these and other Hewlett-Packard Voltmeters, see your hp catalog or contact your nearest hp field engineer. Or, write to Hewlett-Packard, Palo Alto, California 94304. Europe: 1217 Meyrin-Geneva, Switzerland.

HEWLETT  PACKARD
ANALOG VOLTMETERS

098/15



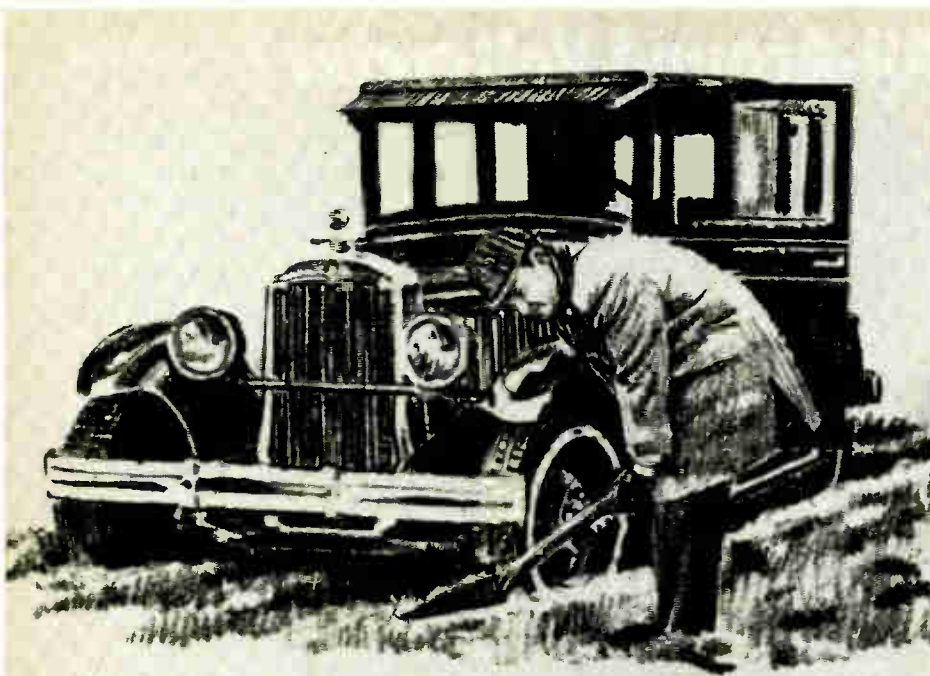

Slot supplies have you in a rut? GET OUT OF IT!

Replace obsolete, narrow-range slot supplies with POWER/MATE CORP.'s UniPower Series. These nine all-purpose, wide voltage range power supplies can replace thousands of narrow-range slot supplies and give you these big advantages: current output up to 34 amps • adjustable to any range from 0-34 volts • regulation to 0.005% • ripple a low 250 microvolts. The wide voltage range of the UniPower Series simplifies your power supply requirements because you can stock fewer units. In addition, these modules can be mounted in standard size racks or on any of three surfaces and in any position!



UNI-30F

The UniPower Series of Nine

- Uni-76 — 0-34 volts, 0.5 amps — \$76.00
- Uni-88 — 0-34 volts, 1.5 amps — \$99.00
- Uni-30C — 0-30 volts, up to 5 amps — \$134.00
- Uni-30D — 0-30 volts, up to 8 amps — \$151.00
- Uni-30E — 0-30 volts, up to 12 amps — \$174.00
- Uni-30F — 0-30 volts, up to 18 amps — \$205.00
- Uni-30G — 0-30 volts, up to 24 amps — \$265.00
- Uni-30H — 0-30 volts, up to 34 amps — \$315.00
- UniTwin-164 — dual output 0-25 volts, 0.75 amps — \$164.00

MODEL	CURRENT vs. VOLTAGE OUTPUT													
	0-6V	8	10	12	14	15	16	18	20	22	24	26	28	30
Uni-76	0.05 amp throughout range													
Uni-88	1.5 amps throughout range													
Uni-30C	5.0	4.6	4.4	4.2	4.1	4.0	3.8	3.6	3.4	3.2	3.0	2.8	2.6	2.5
Uni-30D	8.0	7.6	7.3	6.9	6.6	6.4	6.2	6.0	5.7	5.3	5.0	4.7	4.4	4.0
Uni-30E	12.0	11.2	10.8	10.3	9.8	9.5	9.2	8.8	8.3	7.9	7.4	6.9	6.4	6.0
Uni-30F	18.0	16.9	16.2	15.5	14.8	14.4	14.0	13.3	12.6	11.9	11.2	10.5	9.8	9.0
Uni-30G	24.0	22.5	21.6	20.6	19.1	18.6	17.7	16.7	15.8	14.8	13.8	12.9	12.0	
Uni-30H	34.0	31.9	30.5	29.2	27.8	27.1	26.4	25.0	23.7	22.4	21.0	19.7	18.3	17.0

SPECIFICATIONS: Regulation — up to $\pm 0.005\%$ or 1 MV for line and load; Ripple — Less than 250 microvolts; Response Time — Less than 20 microseconds; Overload and Short Circuit Protection — Solid state, instantaneous recover, and automatic reset. Cannot be damaged by prolonged short circuit or overload.

FREE: Send for complete catalog. Write to:



POWER/MATE CORPORATION

163 CLAY STREET, HACKENSACK, NEW JERSEY 07601
PHONE: (201) 343-6294 TWX: (710) 990-5023

none other than the highly respected Marantz. The latter has turned to Standard Radio of Japan and Mitsubishi for components and speakers.

Radio revival

A sudden consumer interest in f-m stereo radio programming undoubtedly accounts for the growing popularity of combination a-m/f-m sets. This year, close to 40% of all radios produced will have f-m tuning features. Cassette-radio combinations, which barely made an impression when first introduced about two years ago, will be plentiful. Multiband sets, until recently popular only in Europe, will be produced for U.S. outlets in increasing numbers.

All-IC radios will be plentiful for the first time, now that the recently concluded pact between Texas instruments and Japanese producers has opened the flood gate. Toshiba will offer sets with a FET front end, using IC's for most of the other functions. Sony will introduce a multiband radio using one IC and a FET in the mixer stage. A thermistor will be included for temperature stability.

Offbeat. An honest-to-goodness "Dick Tracy Wristwatch radio" will be produced and marketed by a small Japanese company called Kodama. The radio weighs 60 grams, has a 40-mm diameter, and is 25 mm thick; it's powered by three rechargeable nickel-cadmium battery cells that afford over four hours of playing time. Kodama says the set will be priced at around \$40 in retail outlets.

But the biggest change is due from Kokomo, Indiana where Delco Radio is producing an auto radio with as many as five hybrid IC's for the 1970 General Motors cars. In the a-m portion of the receiver, one IC serves as the r-f amplifier and converter; another as the i-f amplifier, automatic gain control, and detector; and another as an audio preamplifier and driver. A single discrete transistor provides the power output.

Additionally, f-m sets will have an IC amplifier and limiter; the stereo multiplex units will feature a demodulator with stereo indicator and muting functions. The latter circuit, the most complex of the group, has 62 distinct elements. ■

ANOTHER BOURNS FIRST...

10 MIL-SPEC TRIMPOT POTENTIOMETERS

MIL-R-27208



RT10



RT11



RT12



RT22



RT24



RT26*

MIL-R-22097



RJ11



RJ12



RJ22



RJ24*

AVAILABLE FROM YOUR LOCAL BOURNS DISTRIBUTOR!

Bourns is the world's largest manufacturer of Adjustment potentiometers with 22 years of leadership. Bourns is also the largest manufacturer of MIL-Spec potentiometers backed by a total of 10 RT and RJ models in our line.

The 6 RT and 4 RJ models not only meet the specifications of MIL-R-27208 and MIL-R-22097, but each is designed and manufactured to consistently exceed each facet of these requirements.

As in the past, you can depend on Bourns to deliver the potentiometer you need. In this tradition of service, we now offer the MIL-Spec unit you may need for your next critical application with 10 RT and RJ models.

Circle 149 on reader service card

Full data is available from the factory, local field office, representative or your stocking distributor.

* Not yet stocked in depth by distributors.



BOURNS, INC., TRIMPOT PRODUCTS DIVISION
1200 COLUMBIA AVENUE, RIVERSIDE, CALIFORNIA 92507
714 684-1700 • TWX: 910 332-1252 • CABLE: BOURNSINC



Phototransistor arrays for

If you're using metal packaged transistors, you'll appreciate the price of Fairchild's new phototransistor arrays — it's a third of what you're used to paying.

If you're using solar cells, the price you'll pay is about the same but you get a free pre-amplifier with each detector — built in, so assembly is simpler and reliability is higher. And the Fairchild phototransistor arrays are guaranteed to +65°C at 95% relative humidity.

For your tape readers, get the Fairchild FPA700. 9 transistors on 100 mil centers. But only \$14 in 100 quantities. For your card readers, we have the FPA710. 12 transistors on 250 mil centers. \$20 in 100 quantities. And if your application isn't quite standard, we can give you the same kind of

OFF

card and tape readers.

CARD READER

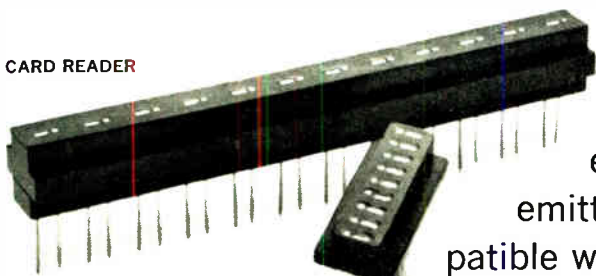

TAPE READER



low price on custom arrays. Fast. The Fairchild arrays come in rugged, easy-to-mount packages, with separate emitter and collector leads. They're fully compatible with DTL, RTL or TTL circuits so they're ideal for your computer peripherals, optical encoders or data collection systems. And you can get

them now from your Fairchild distributor. Fairchild Semiconductor ■ A Division of Fairchild Camera and Instrument Corp. ■ Mountain View, Calif. 94040 (415) 962-5011 ■ TWX: 910-379-6435

FAIRCHILD
SEMICONDUCTOR

Oh, you'll put it together, all right, and after a while, it'll work, more or less. Then you'll take the prototype to engineering for board design, get it back, attach the components, test it, make a few compromises, try it again. What you have then is an engineering model.

Then the manufacturing design. Back to engineering for debugging. More testing. Parts procurement. Incoming inspection. Telephone calls. Late deliveries. More testing. Heartache.

Final release and the module is ready for manufacture. Maybe.

All this time, an already designed, fully debugged, guaranteed, computer-tested, solid state module sits on Digital's shelf. Fifty engineers in offices around the country wait for your call to help. Application notes, installation drawings, catalogs sit in our mail room.

Power supplies, hardware, racks are piled high in the stock room.

M Series modules are the most complete, fully compatible, fast, all IC, TTL, inexpensive solid state logic available anywhere. With a few million modules in our recent history, and a few million dollars worth of test equipment, we really know how to put them out.

Read all about them in the new Logic Handbook. Free.

digital
COMPUTERS · MODULES



Hold it, right there.

DIGITAL EQUIPMENT CORPORATION.
Maynard, Massachusetts 01754. Telephone
(617) 897-5111 / Cambridge, Mass. New
Haven / Washington, D.C. Parsippany, Palisades
Park, N.J. / Princeton, N.J. Rochester, N.Y. / Long
Island, N.Y. / Philadelphia / Pittsburgh / Cleveland /
Dayton / Huntsville / Cocoa, Fla. / Chicago / Denver /
Ann Arbor / Salt Lake City / Houston / Albuquerque /
Los Angeles / Palo Alto / Seattle. INTERNATIONAL
Carleton Place and Toronto, Ont. / Montreal,
Quebec, Edmonton, Alberta, Canada / Reading and
Manchester, England / Paris, France / Munich and
Cologne, Germany / Oslo, Norway / Stockholm,
Sweden / Sydney and West Perth, Australia

Masking camera for LSI circuits focuses on speed and resolution

Step-and-repeat instrument produces IC masks measuring 250 by 250 mils in single exposure and brightens the picture for use of king-sized wafers

IC makers are in a squeeze. Demand for their new LSI devices is growing fast, and this means quick masking and production—particularly when it comes to manufacturing custom devices.

At the same time, their designers are honing device geometries, packing more components on each square mil, and increasing over-all size of the integrated circuits. And because the key to low-cost circuit integration is batch processing, production engineers are urging the use of wafers 3 inches and more in diameter to raise the number of circuits per batch. This, they contend, would reduce costs and perhaps increase wafer yield, too.

A possible way out, says the David W. Mann Co., is its 1680 step-and-repeat masking camera. Aubrey C. Tobey, director of marketing, claims the 1680 is unique in its combination of features:

- It's the first masking camera able to make IC masks that measure as much as 250 by 250 mils in a single exposure, using 10× art-

work to get these IC's that measure a quarter-inch square.

- Its plate-holding stage moves beneath the lens barrel across a 4-by-4-inch range, enough to make photomasks for wafers even larger than 3 inches in diameter.

- It's the first camera to use the Nikon Ultramicronikor 10-power, wide-field reducing lens. Not only can the lens reduce artwork to actual size in a single step, it does so with a resolution of 650 line pairs per millimeter over almost all of the 9-mm.-diameter field. This translates into geometries of 0.1 mil even with emulsion plates, and resolution of lines smaller than 0.2 mil even at the edge of an exposure.

- It can have up to six lens assemblies, and a plate holder capable of holding six mask plates. With a multibarrel 1680, users could make six photomask sets simultaneously.

Thus the 1680 holds out the promise of providing the makers of large-scale-integrated devices with both quality and speed.

Previously, different parts of a mask had to be exposed separately to come up with one that is 250 mils or so on a side. This is photo-composition. It can be likened to taking a single snapshot in four sections and then piecing it together like a jigsaw puzzle. It does, however, have advantages: the total field the lens has to illuminate is small and resolution can be relatively high, 0.1 mil or so. But the process is time consuming, and there is always the risk, although small, of mismatches.

Passing the buck. The 1680, doing the whole job in a single exposure, eases things considerably. No match-up problems are encountered unless the IC is larger than a quarter inch on a side. And resolution is about as good as that of the best small-field lenses available.

But in reality, however, the 1680 merely represents a transfer of problems from the IC houses to the Mann company's engineers. For the Nikon lenses to do the job, a new

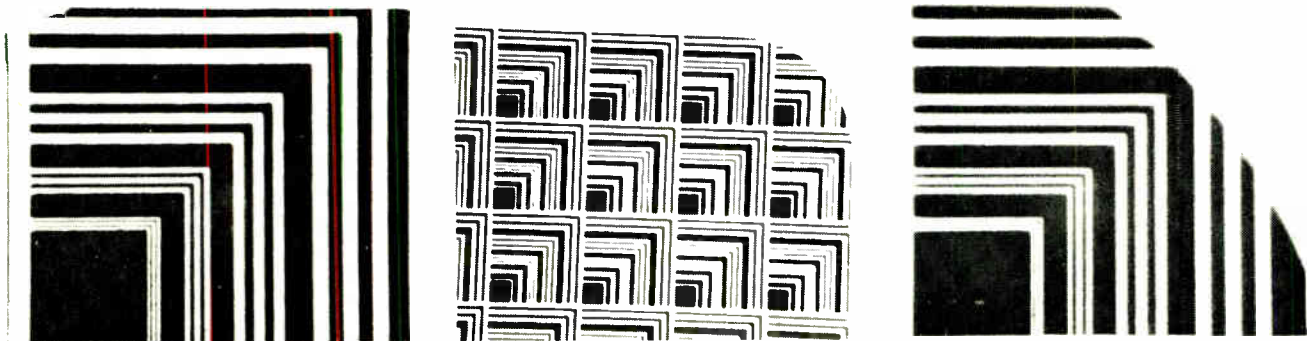

A matter of resolution. Test pattern, center, demonstrates step-and-repeat process of camera. Magnified cell, left, is from the center of the pattern. Widths of the lines are 0.05, 0.1, 0.2, 0.3, and 0.4 mil. Cell at right is from upper right corner, at the edge of the 9-mm.-diameter field of view, where resolution usually falls off.

NOW!

5VDC at 1A

IC POWER SUPPLY

for... **\$24.00** IN SINGLE QUANTITY

The LIC5-1A is another of Elasco's new series of low-cost, high-quality plug-in power supplies. This power supply is designed to power approximately 25 IC's. The unit delivers 5 volts D.C. at 1 Ampere with regulation and ripple specifications commensurate with integrated circuit requirements. The power supply is manufactured to mount in a standard 5¼" basket, and is available with an overvoltage protection option.

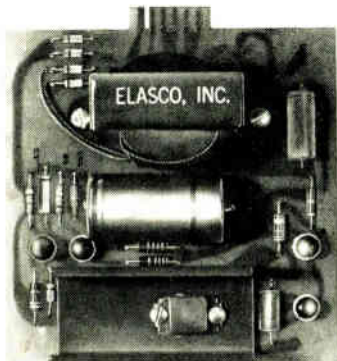

The LIC5-1A power supply is designed for mounting either on a chassis or in a 5¼" IC Basket. As many as 9 units can be mounted in a standard Elasco basket.

FEATURES

- ▲ SHORT CIRCUIT PROOF
- ▲ 71°C OPERATION
- ▲ LOW COST OVERVOLTAGE OPTION
- ▲ DELIVERY: STOCK TO 2 WEEKS

WRITE FOR BULLETIN
269 FOR DATA ON THE LIC5-1A
POWER SUPPLY



ELASCO INCORPORATED

5 NORTHWOOD RD., BLOOMFIELD, CONN. 06002
(203) 242-0708

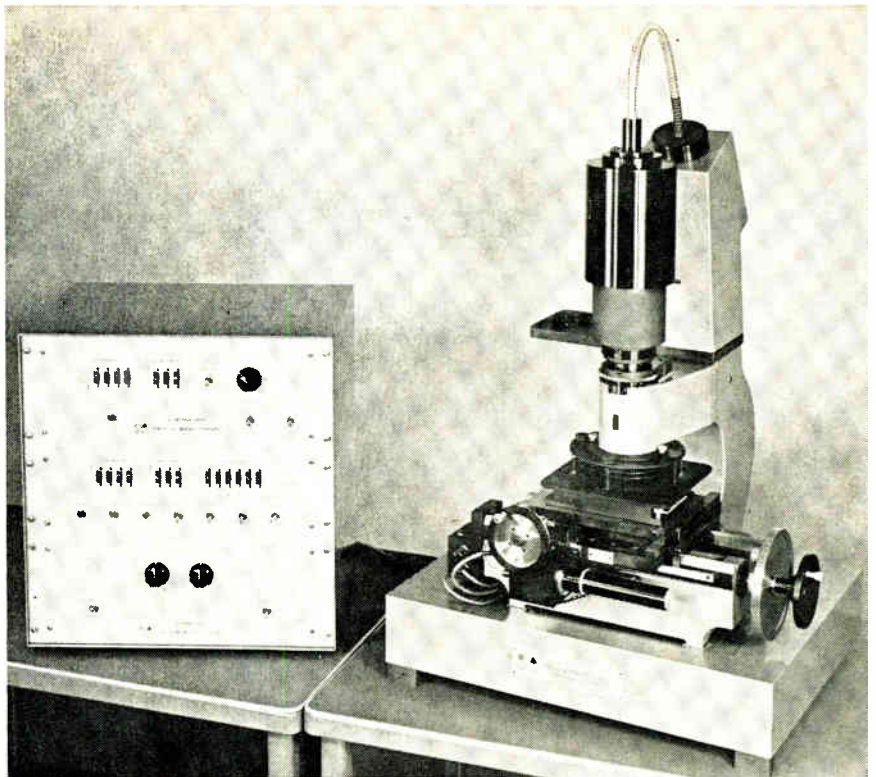

Mask maker. Precision camera helps produce fine-geometry IC's. Switches in control unit, left, set variables such as spacing, number of exposures.

illumination system was necessary to supply the light to expose the mask plate over the full 250-by-250-mil area—and expose it evenly. The Mann company's engineers use a xenon flash lamp, with fiber optics to carry the light to the Nikon lens.

Assuming that the artwork, 10 times the actual size (the masking camera's "input"), is correct and that the lens and illuminating system are operating properly, there still remains the problem of repeatability—exposing a mask pattern over a large plate area; that is, if the 3-inch wafers now becoming available are to be used. To make each mask plate match the others in its set, it is necessary to position the plate beneath the lens, or lenses, prior to each exposure. This requires accuracy.

In the 1680, the stage is servo-positioned to within 0.00005 inch in x and y axes. To do this, says Tobey, two linear optical encoders, which he calls a microset scale, are used. Positioning accuracy, he points out, is about as good as—and often better—than that possible with a laser interferometer.

Spotting the stage. In fact, the encoder is made with an interferometer in a sealed and controlled environment. It consists of thin

parallel lines drawn on glass plates, with the interferometer used as a "ruler" to space the lines. The width of the lines equals the space between them. In the stage assembly, two pairs of these plates (one for x-axis and the other for y-axis positioning) are placed face to face and a light beam is focused through them. As one plate moves over another, less and less light is able to pass through until finally none does. As movement continues, the spacing opens again until maximum light is allowed through. Each light peak triggers a counter circuit and a servosystem uses the counter to spot the stage.

Since the glass has a minute thermal expansion coefficient, the microset scale is almost immune to environmental changes. This means that it is even more accurate than the laser, whose line spacings can vary with temperature.

A single-barrel model of the 1680 costs about \$65,000; delivery time is about three months. The four- and six-barrel models are priced at \$145,000 and \$175,000 respectively, and delivery time is about seven or eight months.

The David W. Mann Co., a division of the GCA Corp., 174 Middlesex Turnpike, Burlington, Mass. 01804 [338]

Laboratory or General Purpose

Triplett meets
the need
precisely

Whatever your testing needs, wherever you're working, there's a Triplett portable tester to meet the requirements — as perfectly as the skills of dedicated craftsmen can guarantee. For example, here are four winners from Triplett's great 630 Series:



**MODEL 630-A
LABORATORY V-O-M**

- 1 $\pm 1\frac{1}{2}\%$ DC, $\pm 3\%$ AC accuracy.
- 2 One selector switch minimizes chance of incorrect settings and burnouts.
- 3 Rugged $5\frac{1}{2}$ " suspension meter movement with $4\frac{1}{2}$ " mirrored scale.

\$71⁰⁰



**MODEL 630-APL
LABORATORY V-O-M**

- 1 $\pm 1\frac{1}{2}\%$ DC, $\pm 3\%$ AC accuracy.
- 2 One selector switch minimizes chance of incorrect settings and burnouts. Polarity reversing for DC.
- 3 Suspension meter movement diodes protected against instantaneous overloads.

\$71⁰⁰



**MULTI-PURPOSE V-O-M
MODEL 630-PL**

- 1 One selector switch minimizes chance of incorrect settings and burnouts. Polarity reversing for DC.
- 2 4.4 Ohms center scale, 0.1 ohm to 100 megohms resistance.
- 3 Meter movement diode protected against instantaneous overloads.

\$61⁰⁰



**MULTI-PURPOSE V-O-M
MODEL 630**

- 1 One selector switch minimizes chance of incorrect settings and burnouts.
- 2 4.4 Ohm center scale, reads from 0.1 ohm up to 100 megohms resistance in 4 ranges.
- 3 20,000 ohms per volt DC sensitivity; 5,000 AC.

\$61⁰⁰

See your Triplett representative or distributor for free demonstration.

TRIPLETT ELECTRICAL INSTRUMENT CO.



BLUFFTON, OHIO 45817

One for the road.

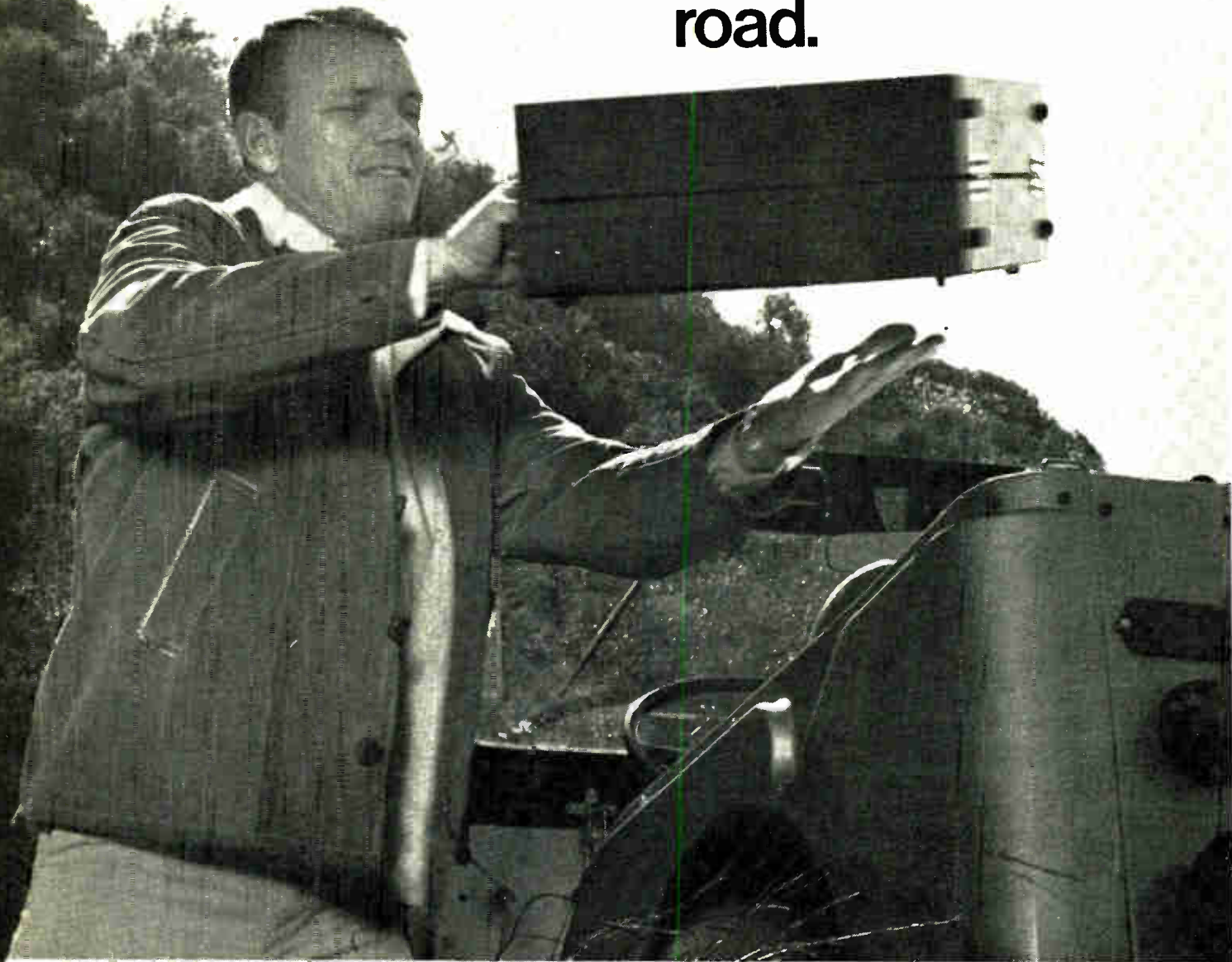

417—the lightweight recorder for heavy duty field use

Hit the road with the rugged, portable Lockheed 417. Take it where the data is—around the plant, around the lab, around the campus or around the world.

Weight: only 28 lbs. with battery—50 lbs. under any comparable recorder. Measures 14" x 15" x 6" (fits under a plane seat).

Runs on 110/220v AC/DC or internal battery. Power consumption as low as 10w.

Accuracy matches large rack machines. Has phaselock servo for precise speed control. Records on 7 channels. IRIG compatible.

Tagged as low as \$7,000.

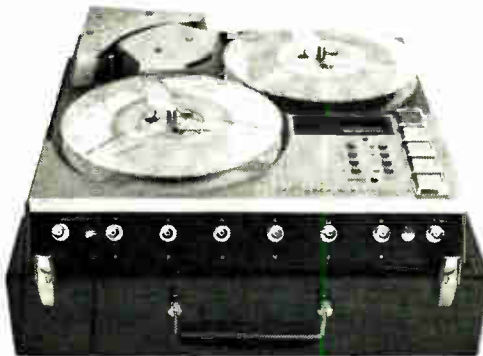

Exclusive low-mass differential capstan drive gives precision recording even in rough field conditions. Simplified, maintenance-free mechanism works under vibration and in any position.

Frequency response: 100 kc direct, 10 kc FM.

Send for our catalog containing full details on the 417—one of a family of precision data recorders for land, ocean, air and space application. Write: Boyd McKnight, Dept. #E-60, Lockheed Electronics Company, Edison, New Jersey.

Have questions on data recording? Call (201) 757-1600.

LOCKHEED

Lockheed Electronics Company. A Division of Lockheed Aircraft Corporation

Motorola launches low-price transistor line

Devices designed for oscillator and amplifier applications in communications, telemetry systems at low-gigahertz frequencies

It's a familiar pattern at Motorola's Semiconductor Product division: it is seldom first with a new technology, but when the time is ripe, the division unveils a broad product line with prices that are lower than the competition's. So it is with the division's first move into microwave componentry, with seven transistors designed for oscillator and amplifier applications in the

low gigahertz regions.

These devices represent the leading edge of a broad line of microwave products, including small-signal and power transistors, integrated circuits and passive components for hybrid circuit designers (*Electronics*, May 26, p. 38). Bruce Kennedy, product manager for microwave hybrid circuits, says that the most significant thing

about the new transistors for oscillator applications is their power output at a low price. For example, the MM8008 puts out more than one-half watt in the 1.68 Ghz radio-sonde band.

Motorola officials say the three oscillator-type transistors (the other two are the MM8010 and the MM8011), will be used in telemetry equipment and as local oscillators



Y-function circulators series 5000 are manufactured using the latest thin-film techniques. They cover the range from 1 to 12.4 Ghz in 10% bandwidths. Isolation is 20 db minimum, insertion loss 0.5 db maximum, and vswr is low. Units are 1.50 x 1.25 x 0.50 in. and weigh less than 1.5 oz. Prices (1-5) are from \$200 to \$250 each. Microphase Corp., 35 River Road, Cos Cob, Conn. [4011]

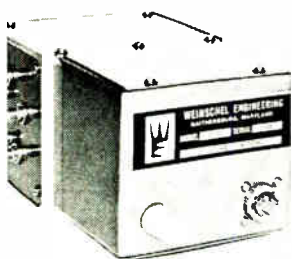

Motorized coaxial r-f switch model 1532 is a 5-to-1 port device with input to output capability in either direction. Characteristics include a broadband frequency range of d-c to 18 Ghz, greater than 120 db isolation between adjacent ports, and a switching repeatability range of better than 0.005 db at d-c to 0.03 db at 18 Ghz. Weinschel Engineering, Gaithersburg, Md. [4022]

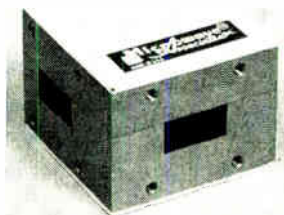

Miniature X-band, waveguide 3-port junction circulator MA-8K269 weighs approximately 16 oz. It features isolation of 20 db minimum, with low loss of 0.3 db maximum, over the frequency range of 8.2 to 12.4 Ghz. It has a vswr of 1.20 max. and a peak power of 10 kw. The unit is suited for use in broadband transceiving. Microwave Associates, Burlington, Mass. [4033]



A complete family of 100-w c-w traveling-wave tubes covers all frequency bands from 1 through 18 Ghz. Each unit provides a gain of at least 30 db. Typical noise figure is 35 db, and insertion loss is about 70 db. Efficiency is high — up to 15% depending on band and tube model. Average weight of the tubes is about 6 lbs. Varian TWT Division, 611 Hansen Way, Palo Alto, Calif. [4048]



Phase-locked microwave source offers low-noise performance at selected bands from 3.6 to 14.3 Ghz. Key specifications include: harmonic rejection, greater than 60 db in-band, greater than 50 db out-of-band; frequency stability, to ± 5 ppm; output power, 10 or 50 mw minimum; f-m response, 25 khz to greater than 10 Mhz. Micromega, 4134 Del Rey Ave., Venice, Calif. [4055]

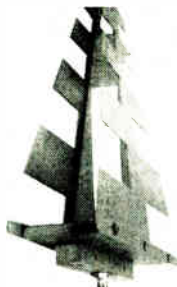

Low-profile log periodic antenna AN112F covers the 1-12.5 Ghz frequency range. Antenna pattern measurements have shown only a single main lobe with a 15 db front-to-back ratio over the band for both vertical and horizontal planes. Outline dimensions of the antenna are 8 x 6 1/2 x 1 3/4 in. It weighs under 1 lb. Price is \$175. Electro/Data Inc., 3121 Benton St., Garland, Texas. [4066]



Automatically swept superheterodyne receiver model MR-101 covers the frequency range from 1 to 2 Ghz. Through the use of microstrip circuit techniques, the over-all receiver is contained in a package 2 1/4 x 4 5/8 x 3/4 in. The receiver provides a 1 Mhz video output with crystal calibration markers at 125 Mhz intervals. HRB-Singer Inc., Science Park, State College, Pa. [4077]



Solid state noise sources RFN/25 use avalanche-mode semiconductors as the generating source. They generate random gaussian-distributed noise in the range of 10 khz to 18 Ghz. Noise is generated in the semiconductor by the application of a low power d-c supply causing a plasma flow in the reverse avalanche region. Solitron Microwave, 37-11 47th Ave., Long Island City, N.Y. [4088]



Generation Gap



The Wang 700 Calculator is a whole lot smarter than its predecessors.

It's the first of a new breed, a third generation programmable calculator. The difference is more revolutionary than evolutionary. It's ten times faster and more powerful than the best of the 2nd generation machines. It handles far longer programs (learns on a built-in 8192-bit core and stores permanently up to 10 blocks of 960 steps each on snap-in magnetic tape cassettes), has many more data storage registers (up to 120), and provides more hardware operations (like logs to base e and base 10, π , e^x , 10^x , etc.), than any existing calculator or so-called desk-top computer.

Execution speeds for various functions range from 300 μ sec for + and - to 250 msec for trig functions. A dual Nixie-type display produces 12 digit answers plus 2-digit (-98 to +99) exponents each register.

The Wang 700 has commands for loops, branches and subroutines, unmatched power for matrix and array operations. Exclusive integrated circuit design concentrates all these capabilities into a self-contained, convenient desk-top package. It's the logical heir to Wang leadership in high performance problem-solving.



Dept. 6H, 836 North St., Tewksbury, Massachusetts 01876 • Tel. 617 851-7311

Call today!

(201) 272-7160	(301) 588-3711	(314) 727-0256	(505) 255-5775	(612) 881-5324	(714) 234-5651
(203) 288-8481	(301) 821-8212	(315) 463-9770	(512) 454-4324	(614) 488-9753	(716) 381-5440
(205) 881-5360	(303) 364-7361	(317) 631-0909	(513) 531-2729	(615) 523-8648	(717) 236-4782
(206) 525-2000	(304) 344-9431	(404) 633-6327	(515) 288-5991	(616) 454-4212	(805) 962-6112
(212) 682-5921	(305) 563-8458	(412) 366-1906	(516) 437-2500	(617) 851-7311	(808) 536-5359
(213) 776-2985	(305) 841-3691	(414) 442-0160	(517) 835-7300	(702) 322-4692	(813) 877-6590
(214) 361-7156	(309) 674-8931	(415) 692-0584	(518) 463-8877	(703) 595-6777	(816) 444-8388
(215) 642-4321	(312) 297-4323	(502) 426-1116	(601) 982-1721	(703) 359-6320	(918) 747-0018
(216) 333-6611	(313) 352-2144	(504) 729-6858	(608) 244-9261	(713) 668-0275	(919) 272-5683

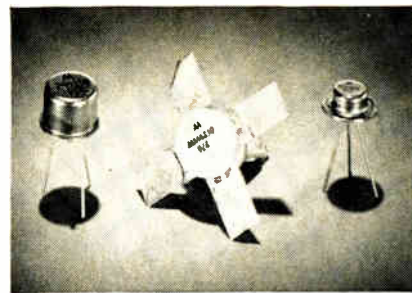

Package trio. The new devices come in TO-39 case, left; SOE (stripline-opposed emitter), center; and TO-107.

in microwave receivers. They can also be used as amplifiers. When working as oscillators, the minimum specified power outputs at 2 Ghz are: MM8008, 300 milliwatts; MM8010, 200 milliwatts; and MM8011, 100 milliwatts. All three are housed in the wide-flange TO-107 package with the collector grounded. Kennedy says packaging is a big factor in Motorola's ability to get prices below comparably rated devices that sell for \$80 to \$90 in coaxial packages.

The MM8008 will sell for \$17.50 in quantities of 100; the MM8010, \$12; the MM8011, \$7.50.

Amplifier units. Four other entries in the lineup are expected to find wide usage as Class C amplifiers. Two of these, the MM4430 and MM4429, come in the division's ceramic stripline-opposed emitter package, featuring low-inductance ribbon leads and isolated terminals. At 28 volts, the MM4430 offers a minimum power output of 2.5 watts at 1 Ghz with a 6-db gain. The MM4429 has the same ratings except for power output, which is 1 watt. The price of the MM4430 is \$19 each in quantities of 100; the MM4429 sells for \$9.

Rounding out the amplifier line are the 2N5108 and the MM8009, both housed in TO-39 packages. Output of the 2N5108 at 1 Ghz is 1 watt with a gain of 5 db and a breakdown voltage of 55 volts; the MM8009 is similarly rated, except that its 1-Ghz output is 0.9 watt and its breakdown voltage is 50 volts. Either can double as an oscillator, putting out 300 milliwatts typically at 1.68 Ghz. The 2N5108 price in 100 lots is \$9.25; the MM8009 sells for \$7.50.

Motorola Semiconductor Products Inc., P.O. Box 20924, Phoenix, Ariz. 85036 [409]

IRRAVIN²

INSULATED WIRE

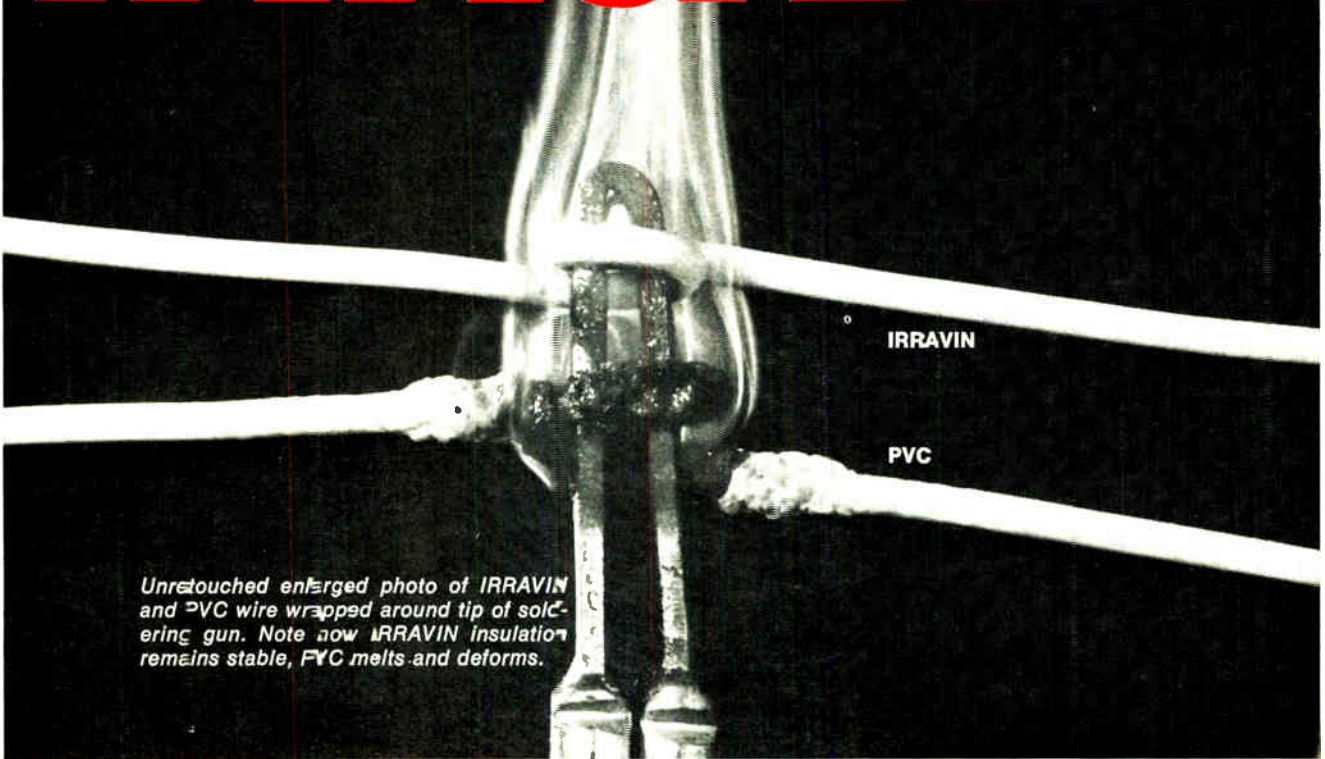

Unretouched enlarged photo of IRRAVIN and PVC wire wrapped around tip of soldering gun. Note how IRRAVIN insulation remains stable, PVC melts and deforms.

Hot problem...cool solution.

IRRAVIN insulation won't melt, flow or shrink back.

This photo was made to demonstrate the solder iron resistance of IRRAVIN insulated hook-up wire, compared with ordinary PVC insulated hook-up wire. It's proof that low-cost IRRAVIN wire suits applications where heat, even direct hot solder iron contact, is encountered. IRRAVIN insulation won't shrink back, or deform. It stays in place to maintain insulation integrity.

IRRAVIN wire can be soldered in snug spaces, even when terminals are

closely set. This, in addition to a small O.D., means space-savings, reduced rework and production time, less scrap.

To get the same product advantages of IRRAVIN wire you would have to specify wire that costs a lot more, two to three times more in fact! With IRRAVIN wire you not only save on time, space and waste... you save on the initial cost too!

Don't just take our word for it. See for yourself with a sample.

It's yours FREE! Write ITT Wire and Cable Division, Surprenant Products, International Telephone and Telegraph Corporation, Pawtucket, Rhode Island 02862. In Europe: ITT Europe-Components Group, Lister Road, Basingstoke, Hants, England.

IRRAVIN—the wire that stops the grumbles.



Have a good application?
Enter our Pot-O-Gold Contest.
Write for your entry form today.

WIRE AND CABLE **ITT**

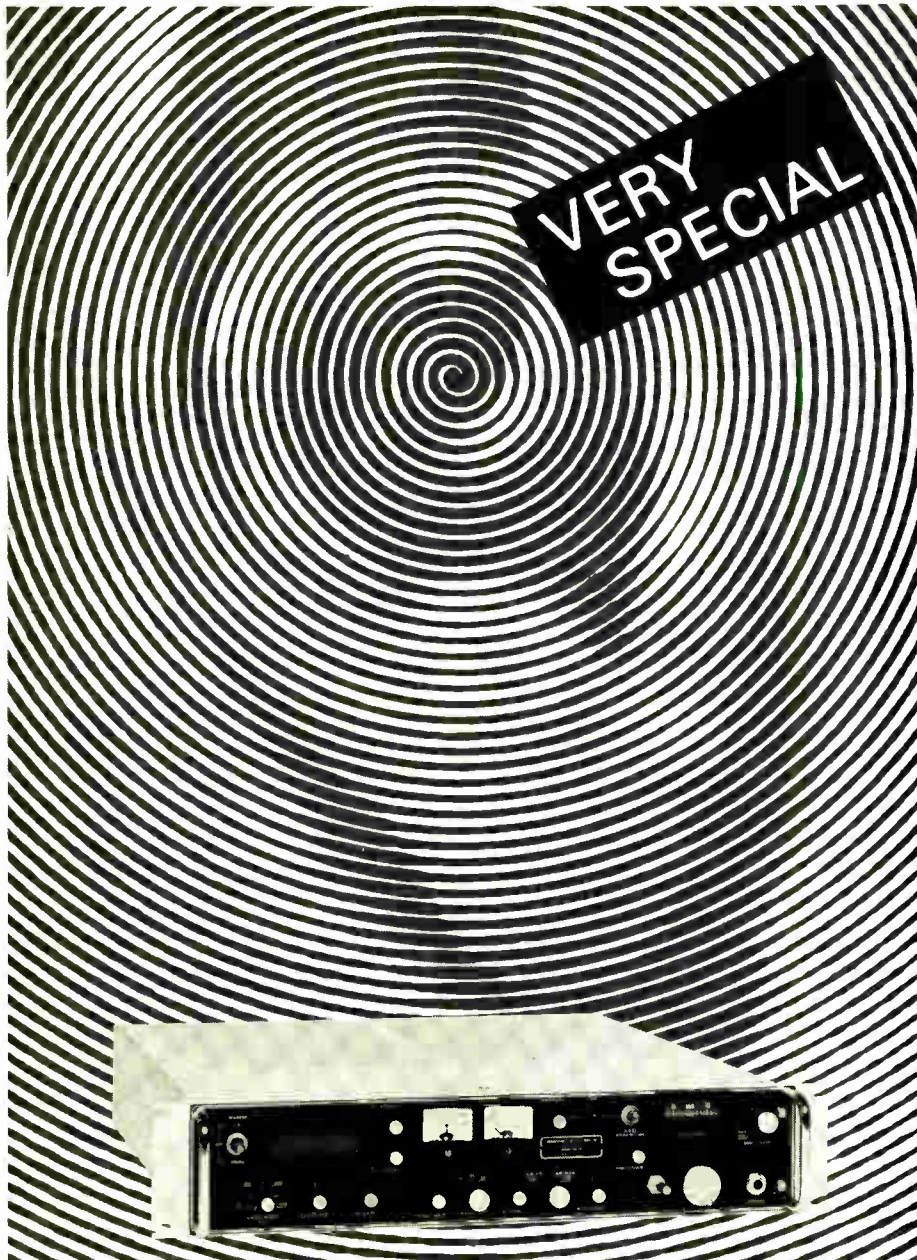

VERY SPECIAL

W-J's new Type 555 VHF Receiver offers a wealth of special features in a unit designed for specialized surveillance and monitoring applications.

It receives AM, FM and CW signals in the 90 to 180 MHz range and, since FM signals normally encountered in this band are of low deviation, incorporates a high slope FM detector. Separation of closely spaced signals in this congested band is accomplished by IF filters with very steep skirts. A 50 kHz wide band position is provided by a crystal filter. Mechanical filters provide bandwidths of 10 kHz and 20 kHz.

The receiver includes an integral signal monitor with a dispersion adjustable from

0 to 300 kHz and a resolution of 2.5 kHz. The monitor has a center frequency marker to indicate the center of the IF band for precise tuning. Markers are provided in 50 kHz increments on both sides of the center frequency marker for accurate determination of spacing of interfering signals.

Other features: a carrier operated relay and an independently variable beat frequency oscillator, plus Digital Automatic Frequency Control capability when the receiver is connected to an external counter such as W-J's DRO-302A.

There's more! Ask the receiver specialists at Watkins-Johnson Company's CEI Division, 6006 Executive Blvd., Rockville, Md. 20852.



CEI DIVISION

World's largest selection of receiving equipment for surveillance, direction finding and countermeasures.

New microwave

Mixers suppress unwanted signals

No preselectors needed with device that uses image phasing techniques

A series of mixers developed by Varian's LEL division minimizes unwanted image signals without using any preselectors. The image phasing techniques used in the MSS-2 family of miniature mixers give image suppression in excess of 20 db over a 10% bandwidth. Optional intermediate-frequency phasing networks are offered as an integral part of each unit.

The general design of the mixers provides a capability toward octave band coverage, LEL says. The units work well as single sideband modulators with modulating signals from audio to microwave.

The i-f frequency range goes up to 180 megahertz on standard units, can go up to 1,000 Mhz on special types. The local-oscillator drive requirements are 4 to 10 milliwatts in the absence of bias. Without a combiner, the i-f output impedance is 150-200 ohms; with a combiner, it is 90 ohms. Noise figures range from 9 db at L band to 10 db at C band.

Model MSS-2-1500 covers 1400-1600 Mhz; MSS-2-1700, 1575-1875 Mhz; MSS-2-2250, 2100-2400 Mhz; MSS-2-3000, 2800-3200 Mhz; MSS-2-4000, 3700-4200 Mhz; and model MSS-2-5650, 5250-5900 Mhz.

With the requirements of MIL-E-5400 in mind, the mixers are made with solid aluminum cases and temperature-stable dielectric material. If replacement in the field should be necessary, replaceable Schottky barrier diodes are designed into the units.

All of the devices use SMA-type connectors and all are 5½ inches wide and 1 inch high. The largest unit is 4 inches long. The price is \$980 for one, or \$975 each for a quantity of 2 to 4 units. Delivery time is 45 days.

Varian LEL Division, Akron St., Copiague, N.Y. 11726 [410]



Best DVM on the market. For all practical purposes.

It's the simplest way to measure DC levels . . . visually and with BCD outputs. The 404 is an extremely accurate DVM at a very reasonable price. It's portable. Easy to operate. Has four full digits with a fifth overrange. Accuracy of $0.02\% \pm$ one digit. The 404 offers input flexibility

of five voltage ranges with an ultra-high input of 1,000 megohms on 1-volt range. And high noise rejection with differential input and integration techniques providing common mode rejection greater than 100 db at 60 Hz. It has BCD outputs and remote programming for system compatibility. And it costs only \$595. That's a lot of DVM for a relatively small investment. Call or write us for a

demonstration today. We'll have a 404 operating in your lab tomorrow. Practically. Tyco Instruments Division, Tyco Laboratories, Inc., Hickory Drive, Waltham, Mass. 02154. (617) 891-4700.

**For \$595,
this can lead to
almost anything.**

tyco

ADAC

A Versatile New Computer-Controlled Data Acquisition and Control System

...starting at less than \$30,000!

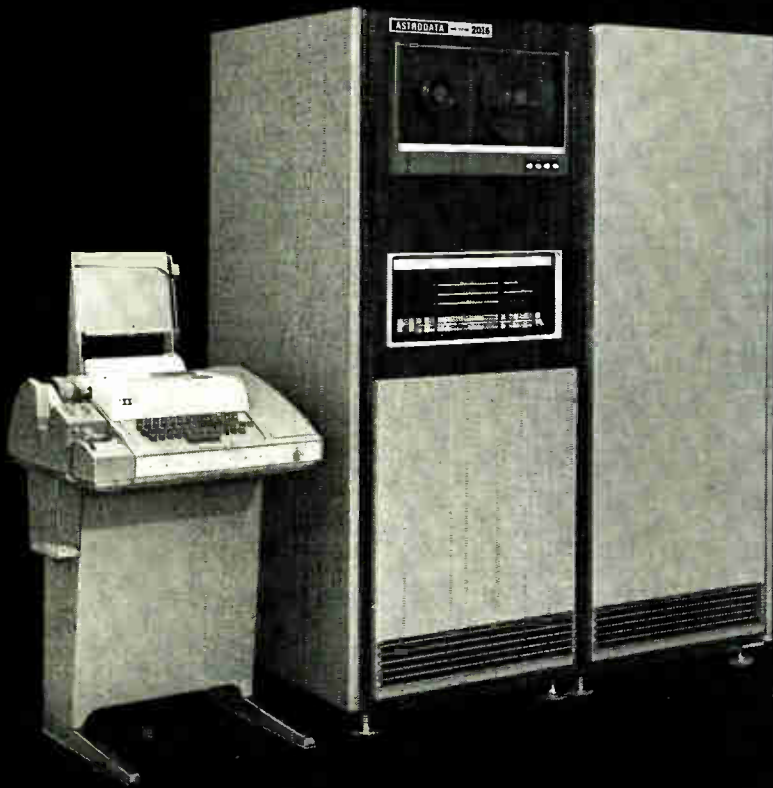

...with
plug-in
expandability!

Start with the basic ADAC, and you have a compact, hard-working system which will acquire analog data from a variety of sources, and process and store the data in an integral general-purpose digital computer for a broad range of recording and control applications. And all this at a price well below other currently available models.

Now, expand ADAC to provide for added inputs and a variety of recording and monitoring devices. It's easy with Astrodata's unique new *Intercoupler*. In most cases, your "custom" output requirements probably already exist as standard designs for ADAC. Inexpensive, too — little or no engineering charges and volume production techniques reduce expansion costs to the minimum.

Whatever your particular application... seismic studies, spacecraft checkout, nuclear reactor monitoring and control, petrochemical process analysis and control, etc.... ADAC can easily and inexpensively be your solution. Get full details today on this new, versatile data acquisition and control system.

Write or call...



Astrodata Inc., 240 E. Palais Rd., Anaheim, Calif.; (714) 772-1000.

Circle 162 on reader service card

Echoes at sea are weeded out

By controlling a filter with an autocorrelator, instrument takes noise out of seismic data

Sea-going surveyors and prospectors usually face a month or two lag between the time they gather data and the time they get to process it. The room-size computers that handle seismic data just can't be put on a ship.

Land-based processing will be around for awhile, says the head of Real Time Geophysics Inc., Warren Moon. But Moon's company

has built an instrument that gives surveyors and prospectors a rough idea of what their data means as it comes aboard.

Real Time's MW-1 Dereverberator, a specialized autocorrelator and filter, removes one type of noise—echoes—from seismic data. "This is by no means a substitute for on-shore processing," says Moon, "but getting rid of the echoes lets you

make some decisions on the spot. For example, whether to take more data from a given area."

"Suppose the computer indicates that there may be oil at some spot," points out Moon, "but you're still not certain enough to drill." He says it could cost over \$500,000 to go back to that spot in order to collect more data.

The MW-1 also helps out on land



Digital pulse control generator model 200 provides control of pulse width and pulse count for use in logic circuits and on/off cycling of electronic components. Accuracy and resolution are 0.1% for pulse duration while pulse count remains absolute. Range is 1 μ sec to 0.99 sec with 50-ohm output impedance. D.T.I. Corp., 2201 S. Grand Ave., Santa Ana, Calif. [361]



Solid state digital pH meter is for accurate pH and millivolt measurements in laboratory applications. It features a 4-digit Nixie-tube readout that displays $\frac{3}{4}$ -in. red numerals on a black background. The display is readable to 0.01 pH or 1 mv through the full 1 to 14 pH and 1400 mv ranges. Price is \$695. Beckman Instruments Inc., 2500 Harbor Blvd., Fullerton, Calif. [362]

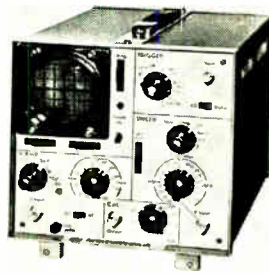

Portable oscilloscope S1302 with a delayed trigger action is suited for the efficient maintenance of computers. It features a dual-beam crt and optional plug-in Y amplifiers having bandwidths of 15 to 30 Mhz. Unit can operate on its internal batteries where an a-c outlet is not convenient. Motorola Communications & Electronics Inc., 1301 Algonquin Rd., Schaumburg, Ill. [363]

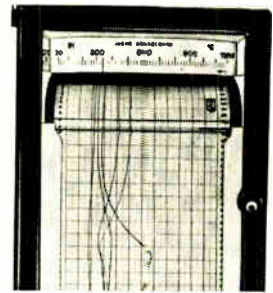

Twelve-channel point recorder NSK can handle 3 separate input variables. It is available as a single color recorder for one measuring point, a multicolor recorder for 2, 3, 4, or 6 measuring points, or as a multicolor recorder for a maximum of 12 measuring points. System accuracy factors of 1% and 0.5% are available. Elnik Instruments Inc., 100 Hudson St., Hackensack, N.J. [364]

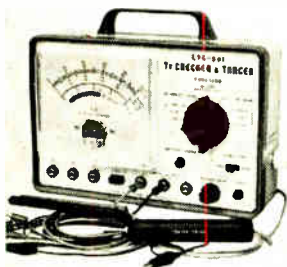

Multifunction instrument model LTC-901 is used for both in-circuit and out-of-circuit transistor checking. Beta and I_{CBO} of transistors as well as diode quality may be determined. A special section of the instrument performs the function of a signal tracer for both a-f and r-f applications. Price is \$69. Leader Instruments Corp., 24-20 Jackson Ave., L.I.C., N.Y. 11101. [365]

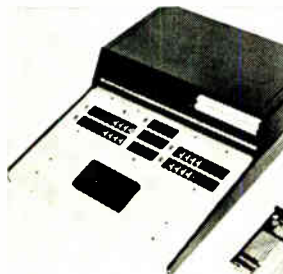

IC tester model 1740C features card programming capability with the added flexibility of thumb-wheel switches. It is designed for use in areas where both high speed testing and evaluation of IC parameters is needed such as incoming inspection, wafer sorting, and final inspection. Unit weighs about 40 lbs. Miracle-Hill Electronics Inc., 320 Martin Ave., Santa Clara, Calif. [366]

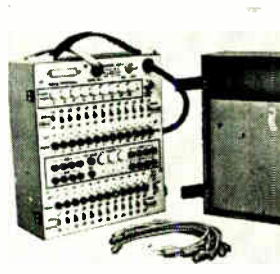

Portable data interface test set model 505-1 permits immediate isolation of trouble conditions in business machine circuits. It enables observation of many points simultaneously through convenient lamp readouts. The unit requires 117 v a-c power, and its 3,000 ohm test jack provides a maximum EIA load to any isolated lead. Pulse Communications Inc., Falls Church, Va. [367]

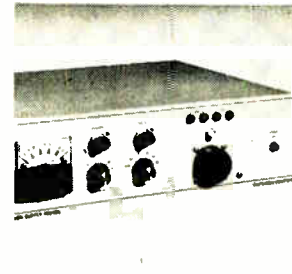

Power supply tester MPST-06 can simulate the full range of loading conditions faced by computer power supplies in actual use. It has a voltage slew rate of 5 v/ μ sec and a typical current slew rate of 2.5 amps/ μ sec. It can be used in either a rack or bench setup. Price is under \$1,000; delivery, 30 to 45 days. Raytheon Computer, 2700 S. Fairview St., Santa Ana, Calif. [368]

**this
man
is
headed
for
trouble**

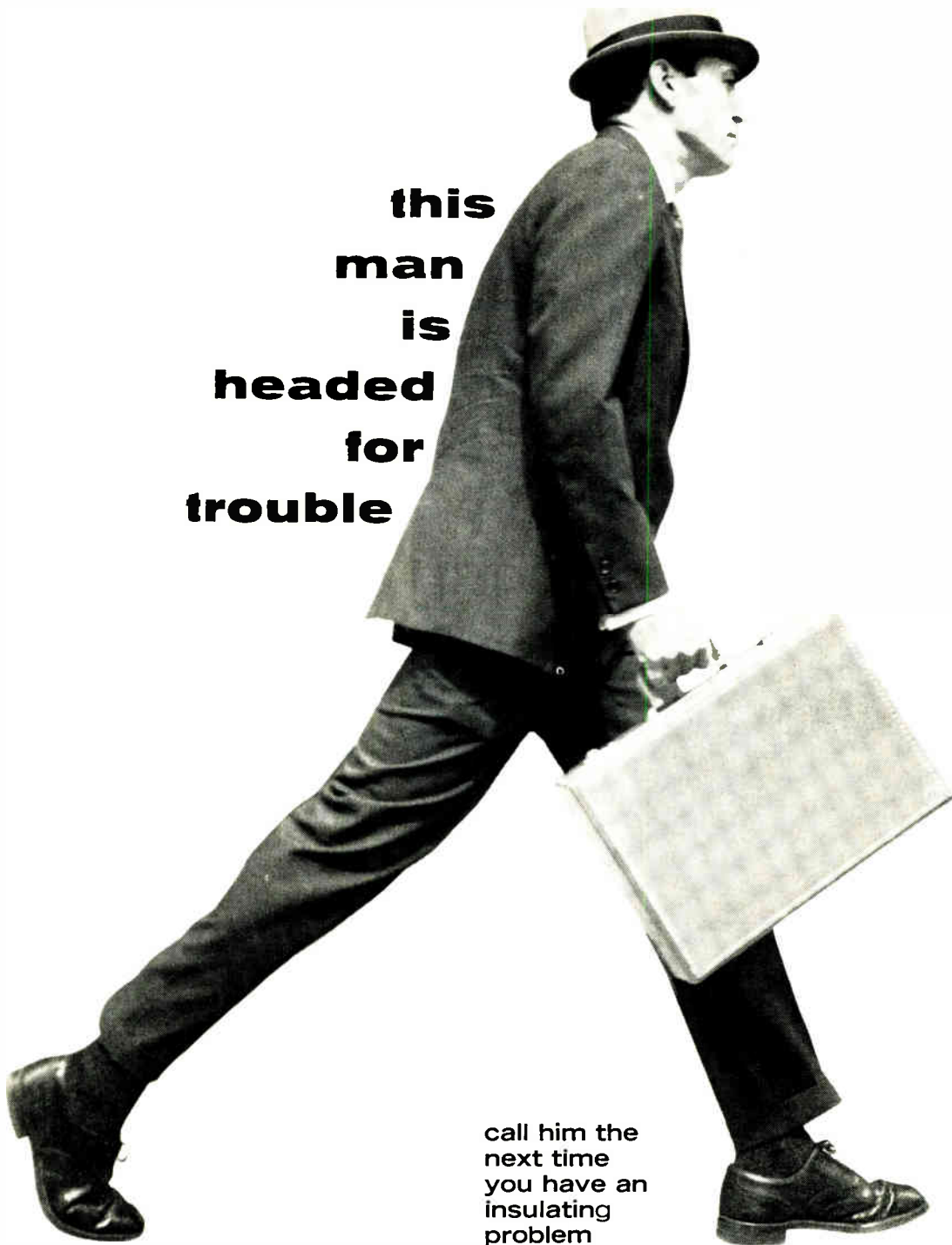

**call him the
next time
you have an
insulating
problem**

ONE SOURCE for EXCELLENCE
in Insulating Tubings and Sleeveings
High Temperature Wire and Cable



L. FRANK MARKEL & SONS, INC.
NORRISTOWN, PA. 19404 • 215-272-8960

When it comes to electrical insulating problems, there's a man near you who makes a business of solving them. He's the Markel sales representative in your area. He not only knows the answers . . . he can deliver them! He handles what is probably the world's broadest line of insulating tubings and sleeveings . . . more than 3500 different types and sizes in all. But if one of these doesn't meet your needs exactly, we'll make one for you that does. The next time you have an insulating problem, call your nearest Markel "trouble-shooter." You'll find his name and phone number on the opposite page.

**There's a Markel
trouble-shooter near
you!**

NORTHEAST REGION

NEW ENGLAND

R. P. Mahan Co., Inc., Wellesley, Mass.—617-237-1040
Watertown, Conn.—203-274-2363
†Green Shaw Co., Newton, Mass.—617-969-8900

EASTERN NEW YORK STATE

Barco Sales, Schenectady, N.Y.—518-393-2729

WESTERN NEW YORK STATE

Gislason Sales, Inc., Rochester, N.Y.—716-454-4741

**NEW YORK CITY, LONG ISLAND,
WESTCHESTER COUNTY, NO. NEW JERSEY**

Harold B. Heft, Lynbrook, L.I., N.Y.—516-599-3351
Cedar Grove, N.J.—201-239-5623

**EASTERN PENNSYLVANIA, SO. NEW JERSEY,
MARYLAND, DISTRICT OF COLUMBIA**

C. H. Newson & Associates, Phila., Pa.—215-CH 8-3377
†Smith of Philadelphia, Phila., Pa.—215-GA 5-6869
†Electronic Wholesalers, Inc., Washington, D.C.—202-483-5200
Baltimore, Md.—301-646-3600
†Commercial Plastics & Supply Corp., Phila., Pa.—215-223-8600
Hyattsville, Md.—301-864-6226

WESTERN PENNSYLVANIA

P.E.I. Sales Corp., Munhall, Pa.—412-462-6300

NORTHCENTRAL REGION

OHIO

Electrolock, Inc., Chagrin Falls, Ohio—216-247-4245
Dayton, Ohio—513-277-3221
†Electric Parts & Service Co., Cleveland, Ohio—216-881-6044

MICHIGAN

Lloyd George Agency, Northville, Mich.—313-474-1505
Benton Harbor, Mich.—616-925-3244
Gross Point Farms, Mich.—313-TU 6-2647
†McNaughton-McKay Electric Co., Detroit, Mich.—313-834-7600

INDIANA, ILLINOIS, SOUTHERN WISCONSIN

J. J. Glenn & Co., Chicago, Ill.—312-847-6400
Elm Grove, Wis.—414-352-7262

MINNESOTA, NORTHERN WISCONSIN

Fred Peterson Co., Minneapolis, Minn.—612-927-4453
†D. A. Schultz Co., Minneapolis, Minn.—612-339-7701

MISSOURI

Hippler Sales Co., Webster Groves, Mo.—314-961-8499
†D. A. James Co., St. Louis, Mo.—314-MI 4-0411

KANSAS, MISSOURI

Ray Deane, Kansas City, Mo.—816-942-0130

SOUTH REGION

VIRGINIA, NORTH & SOUTH CAROLINA

Harry T. Altman Co., Charlotte, N.C.—704-399-8926
†Electronic Wholesalers, Inc., Winston-Salem, N.C.—919-725-8711
†Cramer Electronics, Raleigh, N.C.—919-832-6441
†Commercial Plastics & Supply Corp., Raleigh, N.C.—919-834-2511

GEORGIA

Estes Associates, Inc., Decatur, Ga.—404-373-8266
†Cramer of Atlanta, Chamblee, Ga.—404-451-5421
†Commercial Plastics & Supply Corp., Atlanta, Ga.—404-577-2600

FLORIDA

J. F. Griffin & Co., N. Palm Beach—305-848-4617
Altamonte Springs, Fla.—305-831-1080
†Cramer of Florida, Fort Lauderdale—305-566-7511
†Hughes Supply, Orlando, Fla.—305-841-4710
†National Wire & Cable Co., Orlando—305-423-2491

ALABAMA, TENNESSEE, MISSISSIPPI

Jackson & Assoc., Chattanooga, Tenn.—615-267-4260
†Electronic Wholesalers, Inc., Huntsville, Ala.—205-539-5722

LOUISIANA, SOUTH MISSISSIPPI

Mitchell White Engineering Co., Inc., Metairie, La.—504-833-3731
Industrial Distributors, Inc., Metairie, La.—504-833-3731

TEXAS, ARKANSAS

Cline and Son, Inc., Arlington, Texas—817-261-2255

OKLAHOMA

John H. Cole Co., Oklahoma City, Okla.—405-235-2447

WEST REGION

COLORADO

Ward Electric Supply Co., Denver—303-222-3541
Plasticrafts, Inc., Denver, Colo.—303-433-8801

ARIZONA, NEW MEXICO

AR/TEC, Inc., Scottsdale, Ariz.—602-947-6304

UTAH

Electric Parts & Insulation Co., Salt Lake City, Utah—801-486-0773

CALIFORNIA

Insulation Supply Co., Los Angeles, Calif.—213-747-5416
Redwood City, Calif.—415-369-7357
National Wire & Cable Co., Los Angeles, Calif.—213-225-5611
San Mateo, Calif.—415-344-3066
Vanderveer Industrial Plastics, Inc., Los Angeles, Calif.—213-269-0625
Western States Wire & Cable Co., Los Angeles, Calif.—213-264-1291
Burlingame, Calif.—415-342-7201

WASHINGTON, OREGON

C. E. Riggs, Inc., Portland, Ore.—503-266-3286
Seattle, Wash.—206-623-5707
Spokane, Wash.—509-624-7554

CANADA

H. P. Ruggles Co., Burlington, Ontario—416-632-1403
West Montreal, P.Q.—514-486-5640

†Jobber

For areas not covered by the above
representatives, call or write:



L. FRANK MARKEL & SONS, INC.
NORRISTOWN, PA. 19404 • 215-272-8960

by pointing out the data that looks the most interesting. By processing this data first, scientists may be able to discard some data, thereby saving on computer costs.

And for scientists who can't afford all the electronics equipment needed for seismic exploring, the MW-1 offers a compromise.

Sea ear. The collecting of seismic data starts with a bang. A dynamite explosion or other high-energy source sends sound waves to the ocean floor. Some waves bounce off while others go through the floor and bounce off the top of one of the sedimentation layers stacked beneath the floor.

A floating hydrophone picks up all the reflected waves; the lower the sedimentation layer off which a wave bounces, the longer it takes

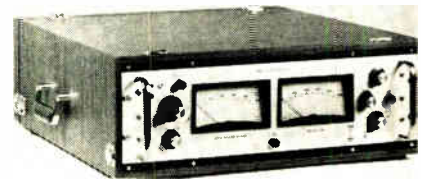

Two outs. Both the autocorrelation function and the echoless version of the input are MW-1 outputs.

for the wave to travel back to the surface. Using the data picked up by the hydrophone, scientists profile the sedimentation layers. These profiles point to oil and mineral deposits.

But not all reflections go straight back to the hydrophone. The ocean acts as an echo chamber and some of the reflections bounce back and forth between the ocean's top and bottom. So the hydrophone's output comprises direct reflections, which are what the scientists are after, plus echoes and some other types of noise.

The MW-1 eliminates the echoes. The key to its operation is the fact that direct reflections are random while echoes are periodic. And pulling random signals out of periodic noise is the job for the autocorrelation function.

Hold up. The MW-1 sends the hydrophone's output through an analog-to-digital converter, which takes 1,000 8-bit samples in 1, 2, 3 or 5 seconds. The digitized hydrophone signal goes to a pair of

dc voltage standards

THE FACTS ARE
IN THE
CARDS

ACCURACY

GOOD

Model 351 0.003% Accuracy

BETTER

Model 353 0.002% Accuracy

BEST

Model 355 0.001% Accuracy

COHU MEETS THE TEST

We could have said, "COHU BEATS THE REST," but the technically knowledgeable engineer will see the 0.001% of the Model 355 and ask "WHY STATE THE OBVIOUS?"

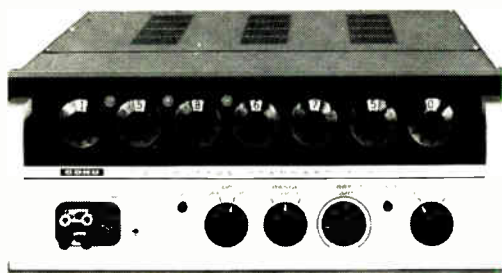

So, to get the DC Voltage Standard YOU need, it's obvious:

ASK COHU FOR IT



BOX 623, SAN DIEGO, CALIFORNIA 92112 • PHONE 714-277-6700 • TWX 910-335-1244

... 1,000 points for the curve
in 11½ seconds or less ...

memories; each is 1,000 bits long, 8 bits high and made with MOS shift registers. The signal in each memory is cycled through that memory 1,000 times. In the feedback loop of one memory is a 1-bit delay line. So during each cycle, the signal in one memory slips back 1 bit relative to the signal in the other memory.

After each cycle the contents of each memory pass through a digital-to-analog converter. The outputs of the two converters are multiplied together and the product is integrated, producing one point on an autocorrelation curve. One thousand iterations means a 1,000-point curve of the MW-1's input's autocorrelation function.

Using the amplitude and period of this function, the MW-1 calculates the ocean's reflection coefficient and reverberation trap depth (the distance from the ocean surface to ocean's solid floor).

Echoless. And the MW-1 uses autocorrelation to set the parameters of a filter whose output is the dereverberated, i.e. echoless, version of the signal from the hydrophone.

The autocorrelation function, reflection coefficient, trap depth, and dereverberated response are available as outputs of the instrument. The coefficient and depth are also displayed on meters. Five volts is the maximum value of the outputs.

All the MW-1's calculations are made in 1½ seconds. So if the sampling time is set at 5 seconds, the total processing time is 11½ seconds—5 seconds to load, 1½ seconds to calculate, and 5 seconds to unload.

When the sample time is 1 or 2 seconds, the MW-1's response is 5 to 150 hertz; at the 3- and 5-second settings, response is 5 to 100 hertz.

The MW-1's circuit boards are coated with salt- and moisture-resistant material.

The instrument is 19 by 5¼ by 19 inches, weighs 40 pounds, and draws less than 100 watts. The price is \$19,500. Delivery time is 90 days.

Real Time Geophysics Inc. 163 Morse St., Norwood, Mass. 02062 [369]

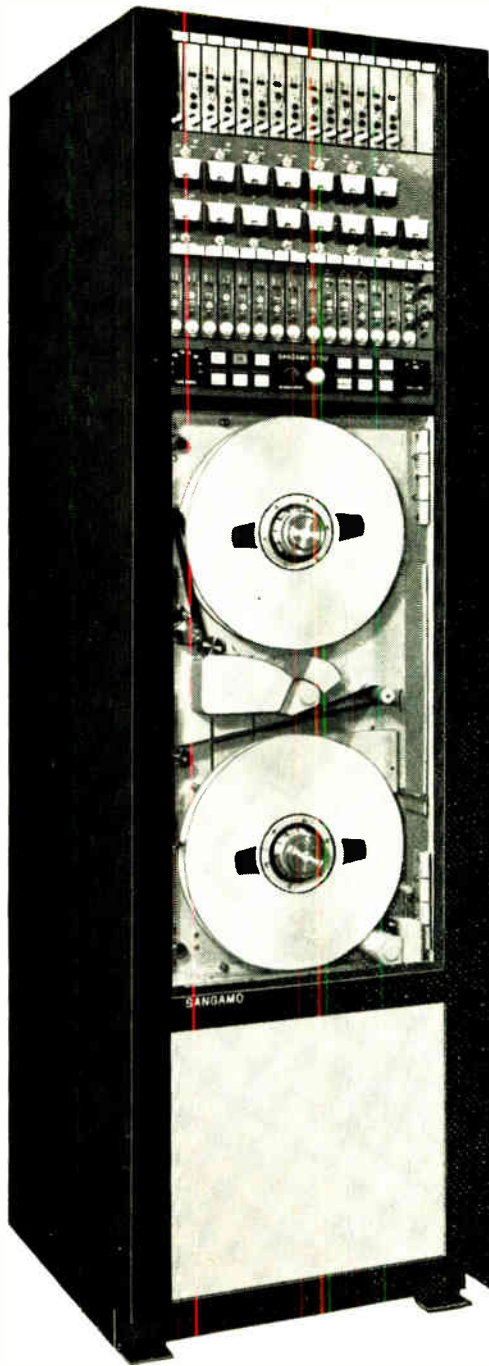

SANGAMO'S 4700 RECORDER / REPRODUCER EXCELS ALL OTHERS IN TAPEABILITY

YOU BE THE JUDGE

The 4700 challenges any other IRIG laboratory system to offer $\frac{1}{4}$, $\frac{1}{2}$, 1, and 2-inch tape widths as a standard feature. Moves tape with low static and dynamic skew, under low tension, low flutter, low mass drive, with exclusive vacuum guiding and cleaning—all at eight speeds from 15/16 to 120 ips. Eliminates the need for a second transport for those reel-to-reel/loop dubbing applications by employing a set of dual IRIG heads—another tapeability feature of the 4700.

DATA ACQUISITION ADVANTAGES

Analog and digital data formats are easily accepted by off-shelf

IRIG channel electronics with improved stability, drift, and linearity characteristics. Choose any combination of Direct, FM, PDM, constant bandwidth FM, serial PCM and parallel PCM solid state electronics for all eight transport speeds. For data requiring isolation from long lines, choose FM modulators with differential inputs for both bi-polar or unipolar operation to 80 KHz.

SUPERB RELIABILITY

Excellent MTBF and MTR figures have resulted in an exceedingly small spare parts kit and no extra charge for Sangamo's one-year warranty on parts and service.

The long life expectancy of the 4700 offers the user the best price/usage ratio.

TO BE MORE PRECISE, SPECIFY THE 4700

Can we arrange a demonstration? Contact one of our application engineers, Information Systems Division, Department E-6. TWX: 910-242-0533. Phone: 217-544-6411.

SANGAMO
Information Systems
Springfield, Illinois 62705

The innovators
in tape
instrumentation

D569-3

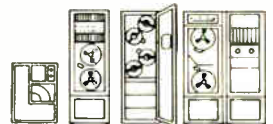

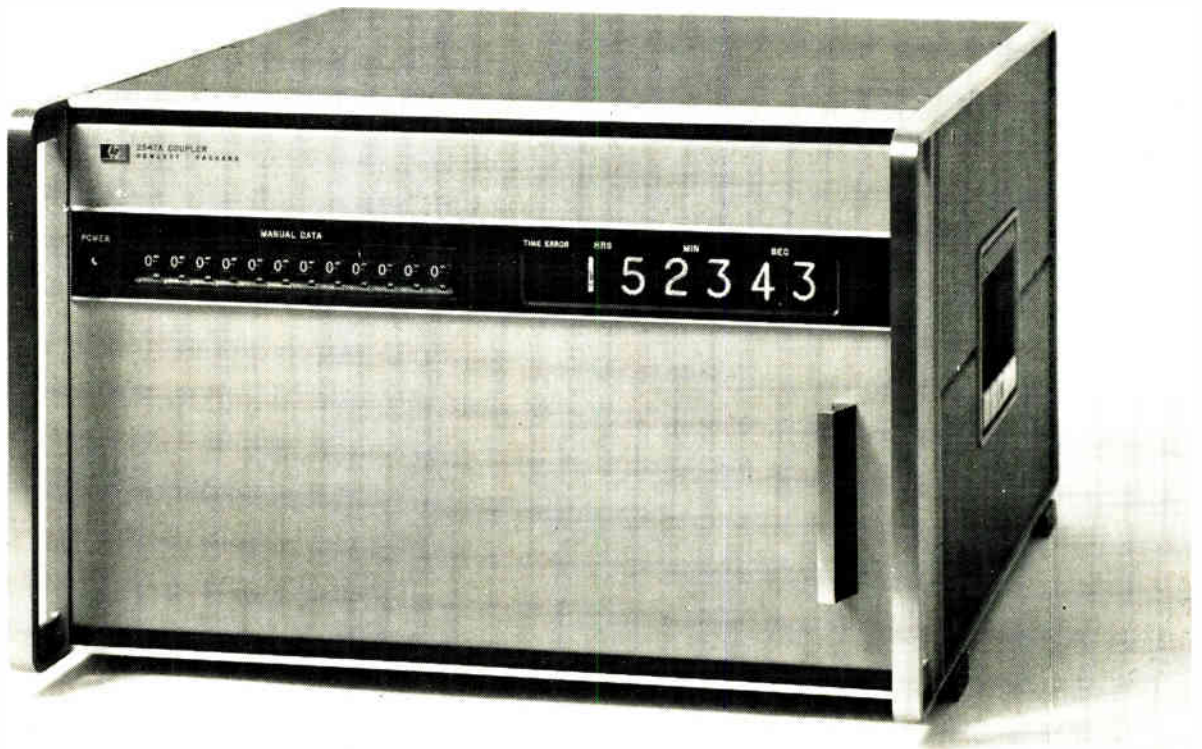

The Middle Man

This is the Hewlett-Packard 2547A Coupler—a specialist at translating digital data for recorders. It takes the place of special circuits you've been building to record your DVM and counter measurements.

Whether you have one measuring instrument or six, this coupler feeds measured data to your choice of recorder—like a tape punch, card punch, teleprinter or magnetic tape deck. And you can run a printer simultaneously to see what's going on. Later on, if you want to change your recorder, just plug in a new card.

You can add other options any time you want: digital clock for time of day, manual data panel for entering fixed data along with measurements.

If you need a systems middle man to automate your recording, call your local HP field engineer. Ask him for our new Coupler Applications Note describing 15 unusual uses of the 2547A with measuring and recording instruments. Or write Hewlett-Packard, Palo Alto, California 94304; Europe: 1217 Meyrin-Geneva, Switzerland.

06827A

HEWLETT  PACKARD

DATA ACQUISITION SYSTEMS

Trading stability for better noise protection

Solid-state differential amplifier avoids the spikes characteristic of mechanical-chopper inputs

It is well known that differential amplifiers having mechanical-chopper inputs operate with better stability than solid-state devices under the stress of temperature changes over long periods. But designers at Dana Laboratories, Inc., are willing to give up some stability to eliminate the noise spikes associated with mechanical choppers. Accepting this tradeoff,

they've developed what they call the first all-silicon solid-state programmable-gain differential amplifier on the market.

Their model 2865 is designed for high-speed, low-level-data acquisition systems in which high common-mode rejection, low noise, and protection against radio-frequency interference are important considerations. Barton Weitz, Dana's

product marketing manager, expects the unit to be used for control applications such as power stations, where 1,000 samples or more per second are taken.

Dana's main competitor in this field, Preston Scientific Inc., uses mechanical choppers and some germanium transistors in its model 8300-RC floating differential amplifier. While the choppers give Pres-



Static inverter model N2D converts 28 v d-c to 400 hz sine wave voltages of either 115 or 26 v a-c. With continuous full load operation at 160° F, it supplies an output power of 20 v-a. Modular design provides a package as small as 2½ x 3 x 3¼ in. which weighs less than 2.1 lbs. Price is \$218. Abbott Transistor Laboratories Inc., 5200 W. Jefferson Blvd., Los Angeles 90016 [381]

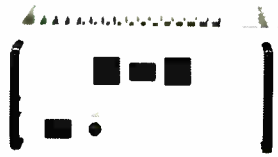

Disk drive synchronization system model DS360 provides precise speed/phase and indexing control of magnetic disk files used in computer systems. It permits an unlimited number of individual disk drives to be synchronized with a time displacement error between drives of less than 100 nsec. Sequential Information Systems Inc., 66 Saw Mill River Rd., Elmsford, N.Y. [382]



Six encapsulated modules series AA1100 are for linear addition of signals and interconnection of operational elements such as multipliers, dividers, followers etc. They range from 1° static accuracy with 100 khz bandwidth (3 db) for \$30 to 0.05% accuracy with 2 Mhz bandwidth at \$135. Quantity discounts are available. GPS Instrument Co., 14 Burr St., Framingham, Mass. [383]

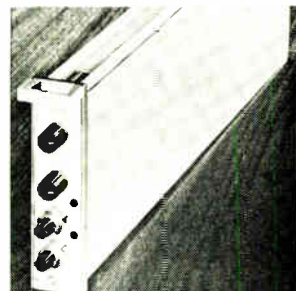

Triple mode differential amplifier model 7350 is designed to work from a wide variety of signal sources such as strain gauges, thermocouples, and piezoelectric transducers. It features a wide dynamic range of 60 db, ±20 v common-mode operating level, and isolated charge calibration circuitry. Dynamics Instrumentation Co., 513 Monterey Pass Rd., Monterey Park, Calif. [384]



High speed digital multiplier model MPY-10 accepts a 9 bit 2's complement number and an 8 bit magnitude number and outputs a 10 bit truncated 2's complement product with a maximum delay of 250 nsec. No output control signals are required and interface is TTL, DTL compatible. Price is \$985; delivery, 4-6 weeks. Unigon Industries Inc., 200 Park Ave., New York 10017 [385]



Analog multipliers models 103 and 104 offer full scale accuracy better than 0.1% for full 4 quadrant operation. The transfer function of the 103 is +XY/10, whereas the 104 is -XY/10. Both units may be used to multiply, divide, square, and square root by appropriate pin interconnections. Price (1-9) is \$325. Hybrid Systems Corp., 95 Terrace Hall Ave., Burlington, Mass. [386]

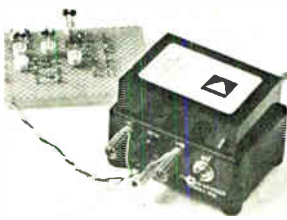

Manifold model 950 accepts plug-in d-c power supplies, and provides a safe and inexpensive source of ±15 v d-c power for breadboarding and general laboratory use. It comes with 4 feet of 3-wire line cord, on-off switch, fuse, socket for accepting the encapsulated supply, and 4 output terminals. Single units list for \$16. Analog Devices Inc., 221 Fifth St., Cambridge, Mass. [387]

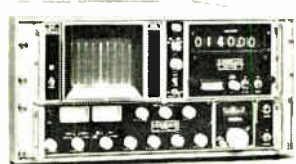

Scanning receiver system RS-160 uses a varactor-tuned preselector that covers 30-300 Mhz in four plug-in heads. It can be used in manual or sweep modes. A signal monitor displays the entire band or any portion of it, and a digital readout gives a direct frequency display and digital automatic frequency control. CEI div. of Watkins-Johnson Co., 6006 Executive Blvd., Rockville, Md. [388]



Model 41A Microwattmeter with new 12.4 GHz head

SOMETHING NEW IN POWER MEASUREMENTS UP TO 12.4 GHz

Our new power detector head measures down to -60 dBm, has a dynamic range of 70 dB, and offers all these other advantages:

- No zeroing (except for fractional microwatt measurements).
- Insensitivity to shock and handling drift.
- Overload protection to 300 mW cw.
- One head for all power levels, to save you time and money.
- Accuracy to ± 0.5 dB (including power detector).
- 200 KHz to 12.4 GHz range for easy low frequency calibration and noise power measurements.
- Doubles as detector for slotted line vswr measurements.

Ask for a demonstration of our 41A Microwattmeter with the new 12.4 GHz head, or send for a data sheet.

Prices: 41A Microwattmeter — \$600; 41-4B 12.4 GHz head — \$250.

**BOONTON
ELECTRONICS**
CORPORATION

ROUTE 287
PARSIPPANY, N.J. 07054
Telephone: 201-887-5110
TWX: 710-986-8241

... light-sensing diode triggers FET switches ...

ton a zero stability of 0.05% over 6 months compared with Dana's 0.01% for 200 hours, the Dana instrument eliminates the noise spikes that are typical with mechanical choppers, and that are a particular source of error in the operation of analog-to-digital converters.

In the Dana unit, switching is done with field effect transistors instead of relays. By isolating the amplifier from the gain selection circuitry, a photocoupler combined with the switching technique prevents degradation of the amplifier's 120-decibel common-mode rejection ratio (CM_{rr}) from d-c to 60 hertz.

Sends a beam. The photocoupler comprises a light-emitting and a light-sensing diode. The light-emitting diode generates a beam that's picked up by the sensing diode, and this triggers the FET switches that select the proper gain resistor. Use of the photocoupler protects the differential amplifier's guard band.

The 120-db CM_{rr} is for all gain settings with up to 1,000 ohms source unbalance. In addition, the amplifier's operating voltage is 300 volts.

The model 2865 has a settling time of 335 microseconds and an over-load recovery time of 560 microseconds, and Dana officials say these times make it easily compatible with data acquisition systems requiring "well over 1,000 samples per second." And the unit's noise level of 2 millivolts rms referred to the output on a gain of 1,000 allows it to resolve changes of 1 part in 5,000.

The instrument has four standard gain positions: 1, 10, 100, and 1,000. Options include eight selectable positions and a variable bandwidth.

The amplifier has a comparatively high input impedance—10,000 megohms in parallel with less than 0.001 microfarad.

The model 2865 costs \$1,545, and delivery takes 60 to 90 days.

Dana Laboratories Inc., 2401 Campus Drive, Irvine, Calif. 92664 [389]

Now from Philco!

10 standard MOS shift registers --instantly available!

Just pick up your phone. Ask us for MOS dynamic shift registers. You'll make your selection from the broadest line on the market, including the longest (256 bits) and the fastest (standard 5MHz clock rate) commercially available.

Best of all, you'll get them *now*. The Philco MOS shift registers listed here are all being made today in volume production at our Lansdale plant, which is one of the largest MOS facilities in the country. They're standard products, fully tested and proved, and ready to ship immediately from stock.

Another standard Philco MOS device instantly available is the 1024-bit read-only memory, programmed as a sine look-up table.

These are the first of a growing line of standard Philco MOS devices. We're the place to look when you want MOS *now*. Write or call MOS Marketing, Microelectronics Division, Philco-Ford Corporation, Blue Bell, Pa. 19422; telephone 215-646-9100.

These standard MOS dynamic shift registers and sine look-up table are available, now!

Device	Description	Package
pL5R32C(1)	Dual 8/16-bit shift register	TO-5
pL5R40C(1)	Dual 20-bit shift register	TO-5
pL5R96C(1)	Dual 48-bit shift register	TO-5
pL5R100C(1)	Dual 50-bit shift register	TO-5
pL5R128C(2)	Dual 64-bit shift register	TO-5
pL5R128AC(3)	Dual 64-bit shift register	TO-5
pL5R250C(2)	250-bit shift register	TO-5
pL5R250AC(3)	250-bit shift register	TO-5
pL5R256C(2)	256-bit shift register	TO-5
pL5R256AC(3)	256-bit shift register	TO-5
pM1024	1024-bit read-only memory (sine look-up table)	Flat pack

(1) Clock rate 500KHz (2) Clock rate 2MHz (3) Clock rate 5MHz

the NOW people in MOS

PHILCO





Pert Mag, the PERMAG girl, says:

"Handling is chore-less with Magnets!"

And Permag has just the right magnet for your material handling problem. Permag offers permanent magnets, assemblies, electrical alloys, flexible magnets, soft magnetic materials and ferrites. Also, special precision grinding and cutting. And full magnetizing and engineering facilities. Distributor of Gordos Reed Switches.

PERMAG

PERMAG SIERRA CORP.
3721 HAVEN AVENUE, MENLO PARK, CALIFORNIA 94025
Telephone Area Code (415) 369-0303

PERMAG PACIFIC CORP.
5441 WEST 104th ST., LOS ANGELES, CALIFORNIA 90045
Telephone Area Code (213) 776-5656 TWX [910] 328-6547

PERMAG SOUTHWEST CORP.
2720 TAYLOR STREET, DALLAS, TEXAS 75226
Telephone Area Code (214) 748-6909

PERMAG CENTRAL CORP.
1213 ESTES AVE., ELK GROVE VILLAGE, ILL. 60007
Telephone Area Code (312) 956-1140

PERMAG MAGNETICS CORP.
formerly EMPIRE MAGNETICS
3130 SOUTH AVENUE, TOLEDO, OHIO 43609
Telephone Area Code (419) 385-4621

PERMAG NORTHEAST CORP.
50 THAYER ROAD, WALTHAM, MASSACHUSETTS 02154
Telephone Area Code (617) 484-0550

PERMAG CORP.
88-06 VAN WYCK EXPRESSWAY, JAMAICA, N.Y. 11418
Telephone Area Code (212) 657-1818 TWX [710] 582-2952

Circle 216 on reader service card

The geniuses who perfected the Dalic selective plating process certainly had electronic manufacturers in mind.

If Sifco's Dalic process of electroplating had just one reason for existence, one might say it was to make life pleasanter for electronic manufacturers, their operations more profitable. ■ Pleasanter, because the Dalic process is designed to be an integral part of the electronic manufacturer's setup, ready for plating jobs anytime. ■ Profitable, too, because—being portable—it saves masking, dismantling and processing time . . . saves sending parts out and waiting for them to come back. ■ With Sifco's exclusive Dalic process, makers of electronic equipment can spot-plate gold, silver,



rhodium or other metals directly onto conductive surfaces . . . without disturbing the assembled components. ■ The Dalic electroplating process consists of power pack, tools and electrolyte solutions. Applying metal coatings with this "package" is easily mastered with a minimum of training and no previous experience. ■ The thickness of deposited metals can be accurately controlled to as fine as 0.000010 inches. ■ Additional information on the Sifco Dalic process for electronic equipment sent on request.

Sifco Metachemical

935 East 63rd St. • Cleveland, Ohio 44103
Phone 216/881-8600 and 216/431-0306
TWX 810-421-8464

DIVISION OF
SIFCO
INDUSTRIES, INC.

Circle 172 on reader service card

New subassemblies

Yag laser delivers 250 watts c-w

Unit sells for \$25,000; frequency doubler can extend applications

The power goes up and the price goes down for commercially available yttrium aluminum garnet lasers. The latest entry is from Laser Nucleonics Inc., which has introduced a 250 watt continuous output model. It sells for \$25,000.

The largest previously reported commercial yag laser output was 200 watts, and that laser was priced at \$35,000.

A frequency doubler, lithium niobate housed in a temperature-controlled oven, is offered as an option with the Laser Nucleonics unit. This extra costs approximately \$2,000. Thus the 1.06 micron output of the yag laser can be doubled to the green part of the spectrum, and this in effect doubles the applicability of the unit. The com-

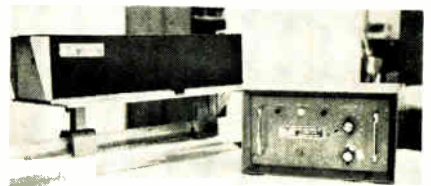

Power tool. Yag laser, left, shown with controller, has highest power announced for a commercial model.

pany says it is marketing the laser for metal working jobs, Raman spectroscopy, optics alignment, holography, hole drilling, resistor trimming, welding, underwater detection, and other tasks.

According to the company, a new kind of pumping technique, using krypton lamps, is designed into the system. The lamps are guaranteed for a minimum of 100 hours.

Delivery time is 60-90 days.

Laser Nucleonics Inc., 123 Moody St., Waltham, Mass. 02154 [390]

Today's solution to machine and process control.

New SENSIPAK™ Logic Control Modules combine the plug-in simplicity and screwdriver hook-up of relays with the decision making capability of a computer.

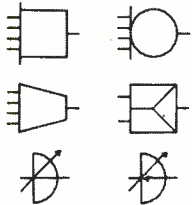
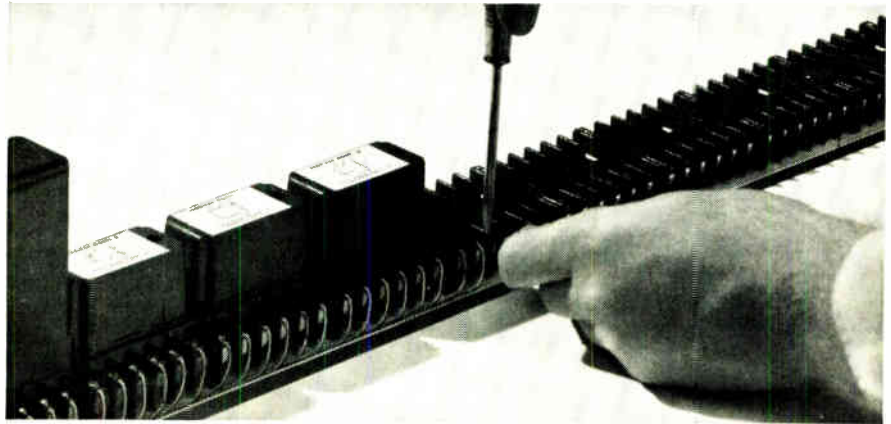

And, Or, Nor, Memory, and Delay

SENSIPAK Logic Control Modules are based on the standard English logic elements. High noise immunity solid-state circuitry is combined with totally-isolated, positive-acting dry reed switch outputs to give you the best possible logic system for the industrial environment.

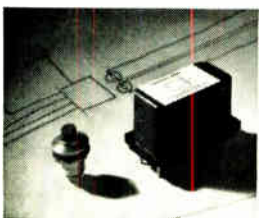

Self Logic Terminals

Every logic module has the unique "self-logic" feature. Connect its terminals to a primary information device such as a pushbutton switch, photocell or thermistor. The logic module then supplies signal voltage

to its own input. It becomes a self-contained control system.



High Current Switches

Switch power loads directly. The SENSIPAK family includes modules with capabilities to switch 10 Amps at up to 240 VAC. There's no need to add on extra amplifiers, power relays or motor starters. You save money with an all-SENSIPAK system.

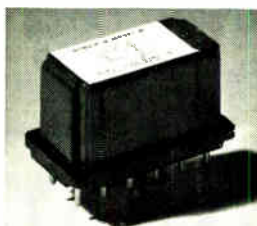

Adjustable Time Delays

SENSIPAK adjustable ON and OFF Delays are available in three ranges:

0 to 2, 2 to 20, and 20 to 200 seconds. They're adjustable so you can set up just the sequencing you need. And if your control program changes, a simple screwdriver adjustment changes the timing.

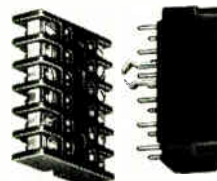

Simple Plug-In; Screwdriver Hookup



All SENSIPAK modules plug into the standard Struthers-Dunn industrial socket. And a key slot makes sure they go in only one way. Sockets are wired with nothing more than a screwdriver. You get easy installation in the panel shop and on the line.

Full details in Catalog 10100. Send for it today! See how far ahead you can be with the control people.



SENSITAK INSTRUMENT CORPORATION

A wholly-owned Struthers-Dunn Subsidiary

531 Front Street, Manchester, N. H. 03102 Telephone: 603-669-5922

Here's the DVM they won't dare mention



\$695

Model 350

Why?

Is it because it offers equal or superior performance at a savings of typically \$500?

The 350 performs to:

An ACCURACY of .01% of reading \pm .01% of full scale

A RESOLUTION of 100 microvolts standard (1 microvolt option)

An INPUT IMPEDANCE of 1000 megohms

And, available options include mV, ACV, ohms and ratio.



**DATA
TECHNOLOGY
CORPORATION**

Hard to believe? Try us!
Call collect: (415) 321-0551 x 216

1050 East Meadow Circle
Palo Alto, California 94303

Six-decade display tube for advanced dvm's

Single-plane readout provides legibility in small area; drive and decoding electronics for unit can be time-shared

Designers of such instruments as digital voltmeters are always looking for ways to reduce the space required to display information. This is particularly true now that the drive electronics for most display instruments has become microminiaturized. To meet the designers' needs, Industrial Electronic Engineers Inc. has developed a line of display tubes that

not only fulfills the size requirement, but provides good legibility with low power and at a low cost per decade.

Called NIMO, (numerical indicator multiple oscilloscope), the line started out with single-decade and four-decade units. Now, a six-decade tube is being introduced. The company expects the new tube, designated the model SS, to

attract a great deal of attention from dvm designers, since most advanced dvm's have six digits of display. At present, a decimal point isn't included in the model SS, but is expected to be added within six months.

The tube alone, a cathode-ray tube equipped with 10 electron guns (one for each digit from 0 to 9, with the horizontal sweep cir-

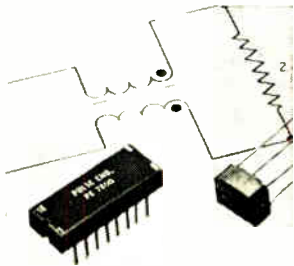

Balun transformers, designed to reduce noise in computer memory circuits, come in a 4-transformer module compatible with IC's as well as in discrete miniature cases. They feature ratios of primary inductance to leakage inductance as high as 6,600:1. Units with primary inductances of 20 μ h to 2,000 μ h are in stock. Pulse Engineering Inc., 560 Robert Ave., Santa Clara, Calif. [341]

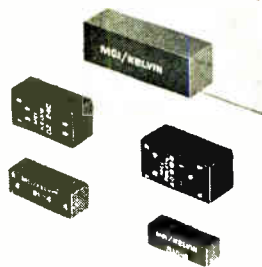

Reed relay series meets or exceeds all applicable sections of MIL-R-5757. Features include 1 amp and 3 amp contacts (10 w to 50 w), switching speeds to 0.5 msec, coil voltages to 48 v d-c. Quality control is operated to conform to MIL-Q-9858. Typical applications include data switching, low level power switching, and relay logic. Kelvin, 5919 Noble Ave., Van Nuys, Calif. 91401. [342]



Rapid installation T0-5 and T0-18 Teflon transistor sockets eliminate chassis hole chamfering and loose parts. Called Beltline, the sockets use a belt or band of metal around the outside diameter. Moderate pressure forces the socket through the belt and chassis hole, and the Teflon expands to lock the socket in place. U.S. Terminals Inc., 7502 Camargo Rd., Cincinnati [343]



Solid state thyatrons series 75 afford low power consumption. Made of a high gain amplifier and a thyristor, both of which offer greatly increased reliability over the gas thyatron, units operate from -20° to $+90^{\circ}$ C, with filament voltage of 6 to 15 v a-c or d-c and 1 amp max. current rms, 10 amps half-cycle max. at 60 Hz. Kurman Instruments Corp., 15 Burke Lane, Syosset, N.Y. [344]



Miniature pi section filters are 50 v d-c rfi/emf noise suppression devices using ceramic capacitive elements. Units are designed for low pass operation from 10 khz to 10 Ghz over a temperature range of -55° to 125° C. An attenuation of 70 db is obtained at the higher frequencies. Prices start at \$13.35 in production lots. USCC, 2151 N. Lincoln St., Burbank, Calif. 91504. [345]

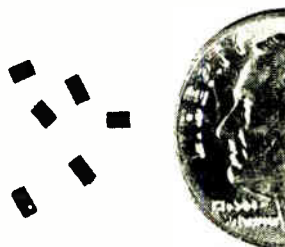

Microminiature solid cermet chip resistors series 150 and 151 offer a wide range of uses in breadboard designs, hybridizing of circuits, and stripline applications. A wide resistance range from 200 ohms to 350 kilohms, with a rating of $\frac{1}{8}$ w at 125° C, is available. Resistance tolerance as low as $\pm 1\%$ can be provided. CTS Microelectronics Inc., West Lafayette, Ind. 47906. [346]

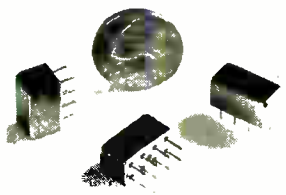

Dpdt all welded relay designated MiniG series is a 0.150 grid device rated at 2 amps. These $\frac{1}{5}$ size relays meet or exceed all applicable requirements of MIL-R-5757. Electron beam welding assures uniform seals and contamination-free relays. Price is \$18 each (\$9.95 in lots of 1,000); availability, 30 to 60 days. HiG Inc., Spring St. & Route 75, Windsor Locks, Conn. [347]

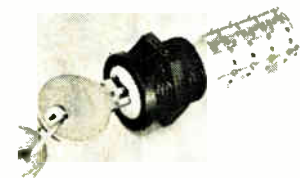

Key operated rotary switch is available in three different models featuring 30° , 36° , and 45° indexing. By use of the key, it becomes impossible for unauthorized personnel to operate the switch, nor can the switch be inadvertently operated. Each of the three models offers a broad selection of poles and positions. Janco Corp., 3111 Winona Ave., Burbank, Calif. 91504. [348]

FREE Engineering Handbook on Electromagnetic Delay Lines

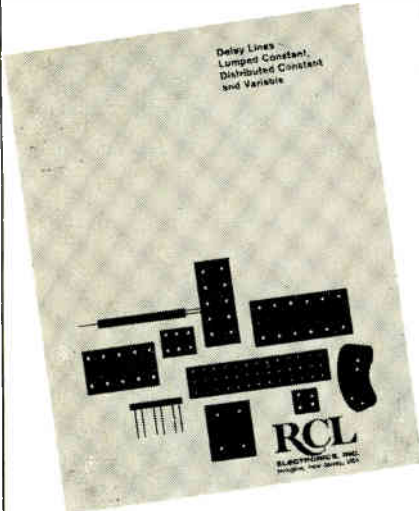

We've reserved
a copy
for your desk . . .

Terms . . . engineering
definitions . . . how to
specify delay lines . . .
characteristics of various
types . . . specifications
. . . they're all included in
this concise, easy-to-read
handbook . . . yours for
the asking.

**LUMPED CONSTANT . . .
DISTRIBUTED CONSTANT
. . . VARIABLE**
all three types are covered
in this reference
handbook.

RCL

RCL ELECTRONICS, Inc.,

General Sales Office:

Seven Hundred
South Twenty First Street
Irvington, New Jersey 07111

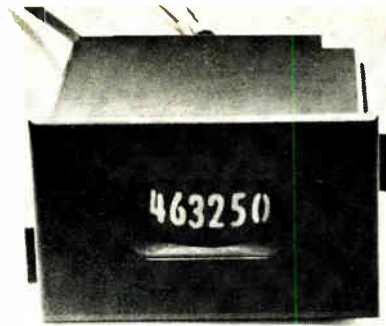

Readout. Six-decade display requires low voltage, is compatible with IC's.

cuitry determining in which decade or decades the digit is displayed) is priced at \$17.50 each in quantities of 1,000, or about \$2.90 per decade. Edward Brady, Industrial Electronic's manager of engineering, says this is less expensive than the \$3.95 per decade in comparable lots for a Nixie tube displaying a character one-half-inch high. The model SS character is 3/8-inch high.

Only a 10- or 12-volt power supply is needed to control the model SS, and this is compatible with the diode-transistor logic integrated circuits used in the tube's decoding circuitry.

Easy on eye. Brady says the NIMO's single-plane display makes it more legible than a tube in which digits are arranged one behind the other. Also, he says, the tube can be dimmed or brightened.

The model SS can be purchased by itself, or with deflection circuitry, data-decoding logic, mounting hardware, and power supplies as a complete six-decade display, or as the tube and deflection yoke together.

According to Brady, the SS requires only two decades worth of electronics—the decoder forms one set while the deflection circuitry, counter, and peripheral electronics form a second. The drive and decoding electronics can be time-shared in the model SS, he points out. A multiplexer converts four-line binary-coded decimal data to four-line multiplexed BCD form so that a single decoder can be used by all six decades.

The SS is available with green, blue, or red phosphors. Delivery time is 90 days.

Industrial Electronic Engineers Inc.,
7720 Lemona Ave., Van Nuys, Calif.
91405 [349]



"Black Magic" FROM Plastic Capacitors

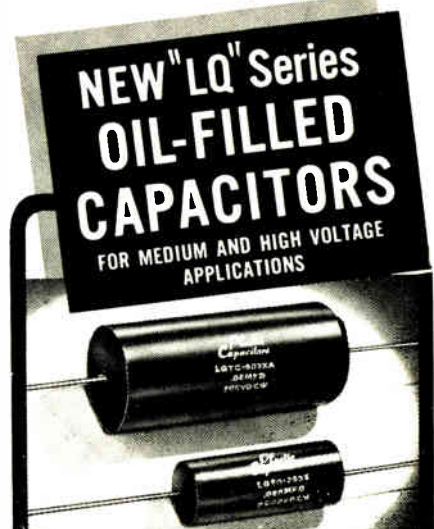

- Voltage range, 1000 to 10,000 volts DC
- Power Factor, 0.5% at 60 and 1000 Hz.
- Peak to Peak Ripple Voltage, 20% of DC Voltage Rating
- Designed for continuous operation of 10,000 hours at 65°C
- Black phenolic shell, epoxy end fill
- Axial wire lead terminations
- Excellent corona characteristics

Here's new "Black Magic" from PC, delivering more power and reliability at extremely low cost. Compact size and stability increase their versatility.

Quality construction assures peak performance. Intensive testing to insure field performance applications unlimited.

Write for free samples and complete engineering data today!



Plastic Capacitors

INC.

2620 N. Clybourn • Chicago 14, Ill.
DI 8-3735

Realism



Kodak



Six kinds of Kodak Irtran infrared-transmitting polycrystalline materials serve builders of optical equipment. Occasionally the hot-pressing does not go as well as it should for optical quality. Then part or all of the product fails to deserve the trademarks "Kodak Irtran." After the hammer has smashed it, it becomes mere chunks of purified MgF_2 , ZnS , CaF_2 , MgO , $ZnSe$, or $CdTe$ of nearly full density for the compound.

The chunks are not worthless, however. For evaporation applications they are worth more the way they are than as powders. They don't blow out of the boat when the power hits them. Evaporation is under better control. Spillage do

foul the chamber and the vacuum pumps is less of a worry.

We figure the magnesium fluoride, zinc sulfide, calcium fluoride, and magnesium oxide are worth \$40 per pound, the zinc selenide and cadmium telluride \$100 per pound. Buyers often conceal both why they want the stuff and their surprise that we don't charge more.

To ask what's on hand phone 716-325-2000, ext. 12170, or write Kodak Apparatus Division, Special Products Sales, Rochester, N.Y. 14650. Prices subject to change without notice. Minimum order \$25. Prices quoted for making up to special sizes and shapes.

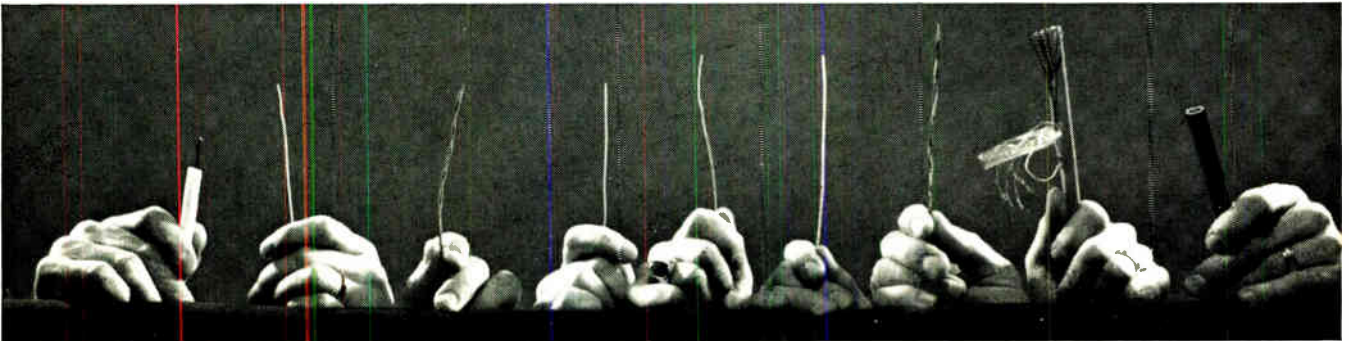

Confessions of a polyethylene producer

We have made a lot of polyethylene in our time. That our time is not over would be apparent from taking a ride around Longview, Tex., where we make it. Much of that polyethylene, coated in and on communication cable, may have found its way into your business. Even if the thought fails to stir you deeply, please check now whether the subject deserves a bit of attention.

Be advised that polyethylene now faces a fight for this market against a material known as TENITE Polyallomer M7853-146E. The only advantages on the challenger's side are little things like more feet of insulation for less money and less thickness, significantly higher tensile strength, 200 times the

resistance to cut-through (which translates into freedom from worry during twisting of conducting pairs, cable bundling, and cable-shielding operations), 5 to 10 times the number of megohms per 1000 feet of 12-mil coating on 19-AWG wire, as measured in 75C water for 200 hours at 600 v a-c. There used to be two separate oxidative deterioration problems, both now eliminated. Polyethylene retains the advantage of a lower brittleness temperature.

TENITE Polyallomer—fortunately for us, for cable users, and for cable makers—just as easily comes out of that Longview plant. For a more detailed comparison, ask Eastman Chemical Products, Inc., Kingsport, Tenn. 37662 for "Propylene Polymers for Insulation of Communication Cable."

Very nice. But for hot news try the following:

The KODAK High Speed Duplicating Plate is now on sale. If you don't know where to find it, ask Industrial Photo Methods, Eastman Kodak Company, Rochester, N.Y. 14650.

The "High Speed" is new. For computer-generated artwork, if desired.

"Duplicating" is new. It means that whether a computer or person is drawing, no negative step intervenes from light on the artwork to clear on the plate, dark on the artwork to dark on the plate.

"Plate" is new. It means you can have the "high speed" and the "duplicating" on glass. Glass—that old no-shrink, no-stretch miracle. Glass all the way. Starting with KODAK Orange Scribing Plates, now available without special-order arrangements (that's new, too) for the finest lines and the sharpest edges. Then the new KODAK High Speed Duplicating Plate, followed by KODALITH Ortho Plate, KODAK High Resolution Plate, and KODAK Metal-Clad Plate. And on to Kodak photoresists.

"Made together to work together" the saying goes.

MINIATURE ATTENUATORS

**SPACE
QUALIFIED
OFF
THE SHELF**

**UP TO 2 WATTS
AVERAGE POWER**



1/3 LESS COST

Rugged μ Series 3 and 4 miniature fixed coax attenuators identical in materials and construction to off-the-shelf units have met the stringent requirements for space flight—and now they're priced to put standards-lab performance within the reach of cost-conscious systems designers. These superior attenuators operate at up to 2 Watts average power (1 kW peak) without performance loss. Frequency ranges of DC-18.0 GHz are available with standard dB values up to 80 dB. VSWR up to 12.4 GHz is less than 1.35 for the Series 3 and less than 1.50 up to 18.0 GHz for the Series 4.

Prices now start at \$50 (Series 3) and \$95 (Series 4). For complete specs and prices, contact your local μ representative, or write:

 Designers and
Manufacturers of Precision
Microwave Equipment
**WEINSCHEL
ENGINEERING**
Gaithersburg, Md. 20760
Tel: (301) 948-3434
TWX: 710-828-9705

New components

Detector covers 1,100-6,000 Å

Wide-band photomultiplier
for laboratory, space jobs
has 10% quantum efficiency

In space experiments, each detector must yield as much data as possible. This was the design goal for a multiplier phototube that will fly later this year aboard the Orbiting Geophysical Observatory and that is also being marketed for laboratory and rocket experiments.

The photomultiplier is the first to provide—in a single unit—a response from 1,100 angstroms in the far ultraviolet to 6,000 Å in the visible, according to EMR-Photoelectric, the company that developed the 541N-09.

It has a typical quantum effi-

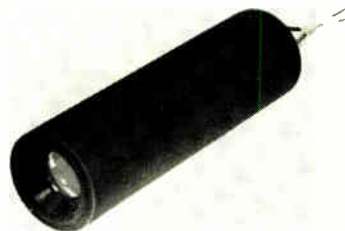

ciency of 10% over the major portion of the band. Designed for stellar spectroscopy studies, it is also expected to be used for solar and geophysical spectroscopy. Typical dark current characteristics range from 1.0×10^{-10} amperes at a current amplification of 10^7 to 1.5×10^{-12} amps at 10^5 . The tube has a typical anode luminous sensitivity of 20 a/lm at a current amplification of 10^6 , and a typical cathode luminous sensitivity of 20 μ a/lm.

The phototube has 14 venetian-blind dynodes of silver magnesium and copper beryllium. It is 4 inches long unpotted, weighs 71 grams, and has a magnesium fluoride window. The price is \$3,100.

EMR-Photoelectric, P.O. Box 44, Princeton, N.J. 08540 [350]

CONDUCTIVE ADHESIVE FOR EMI/RFI SHIELDING



ECCOSHIELD® PST is a pressure sensitive, conductive adhesive-backed metallic tape for shielding components, waveguides or seams in enclosures. Simply put in place and press. Electrical contact between adjacent surfaces and the tape is positive because unique design provides a continuous back-to-front conductive path. Send for free sample.

Circle 512 on reader service card

FAST-CURING EPOXY FOR HIGH SPEED POTTING



STYCAST® 1240 is a low viscosity epoxy system designed for potting units at high production rates. It cures rapidly without high exotherm. Protects heat-sensitive components, and units can be handled minutes after potting.

Circle 513 on reader service card

CLEAR EPOXY COATING FOR HIGHEST TEMPERATURE

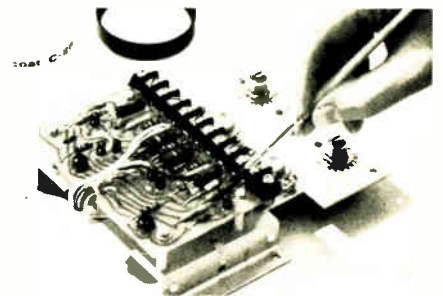

ECCOCOAT® C-26 is the ultimate in a clear epoxy coating. Use for semiconductors, glass packages, IC's, thick and thin film devices, PC boards, components, etc. Apply with brush or spray; 10^{14} ohms/square at 500°F.

Circle 514 on reader service card

Emerson & Cuming, Inc.



CANTON, MASS.
GARDENA, CALIF.
NORTHBROOK, ILL.
Sales Offices
in Principal Cities

EMERSON & CUMING EUROPE N.V., Oevel, Belgium

business trips rule out evening classes?



here's a practical way to update your knowl- edge of electronics

Are irregular hours, travel and family obligations keeping you from attending classes—even though you worry about becoming technically obsolescent? Check into the Special Programs in Electronics for Engineers developed by CREI, the Home Study Division of the McGraw-Hill Book Company.

These are not simply courses, but comprehensive programs in advanced electronics offering major electives in such fields as:

Communications Engineering, Aeronautical and Navigational, Television Engineering, Automatic Control Engineering, Missile and Spacecraft Guidance, Radar and Sonar Engineering, Nuclear Instrumentation and Control, Computers.

Industry-recognized CREI Programs make it possible for you to catch up on new developments in electronics through study in your own home, at your own pace,

your own schedule. Free book gives complete information and details of technical material covered. For your copy, mail coupon below or write: CREI, Home Study Division, McGraw-Hill Book Company, Dept. 1866H, 3224 Sixteenth St., N.W., Washington, D.C. 20010.

Founded 1927



Accredited Member of the National Home Study Council



CREI, Home Study Division, McGraw-Hill Book Company
Dept. 1866H, 3224 Sixteenth St., N.W.
Washington, D.C. 20010

Send me free brochure describing CREI Programs in Electronics for Engineers.

NAME _____ AGE _____

ADDRESS _____

CITY _____ STATE _____ ZIP CODE _____

COMPANY _____

TITLE _____

Get Fast, Low-Cost Total Harmonic Distortion Measurements

There are several ways you can make total harmonic distortion measurements:

1. Eyeball approach using oscilloscope which is accurate enough for *some* applications.
2. Point-by-point measuring using wave analysis which is often too slow, involves needless expense for unused capability and requires you to calculate THD.
3. Plot information using spectrum analysis which is again needlessly expensive for the job... and you still must calculate THD.

OR, you can use HP 333A or 334A distortion analyzers and cut your measurement time from minutes to seconds. Simply set your level, tune, and flip the auto-nulling switch to AUTOMATIC. The instrument does the rest! It automatically and accurately completes the nulling—typically > 80 dB rejection. It will also track drifting and unstable signals!

Use the all-solid-state HP 333A or 334A where you need fast measurement of harmonic distortion of fundamentals between 5 Hz and 600 kHz—harmonics up to 3 MHz. Measure voltage up to 3 MHz.

Not only do these analyzers save you money by cutting measurement time, their initial cost is less than other measurement methods. HP 333A costs \$865 and HP 334A is \$895.

Both instruments have a high pass filter that can be switched-in to provide pure distortion measurements of signals greater than 1 kHz without 60 cycle and harmonics. With

the 334A RF detector, you can measure audio envelope distortion from 550 kHz to 65 MHz.

HP 331A and 332A Distortion Analyzers have all these features except automatic nulling and high-pass filters. (Price HP 331A, \$650; HP 332A, \$680.) HO5-332A and HO5-334A meet FCC requirements on broadcast distortion measurements. (Prices on request)

Cut your distortion measurement time with fast, low cost HP 333A or 334A. Consult your HP Instrumentation Catalog for full specifications on distortion analyzers. Order the instrument of your choice by calling your nearest HP order desk. For data sheets, write Hewlett-Packard, Palo Alto, California 94304. Europe: 1217 Meyrin-Geneva, Switzerland.

099/3
HEWLETT  PACKARD
SIGNAL ANALYZERS

Circle 180 on reader service card

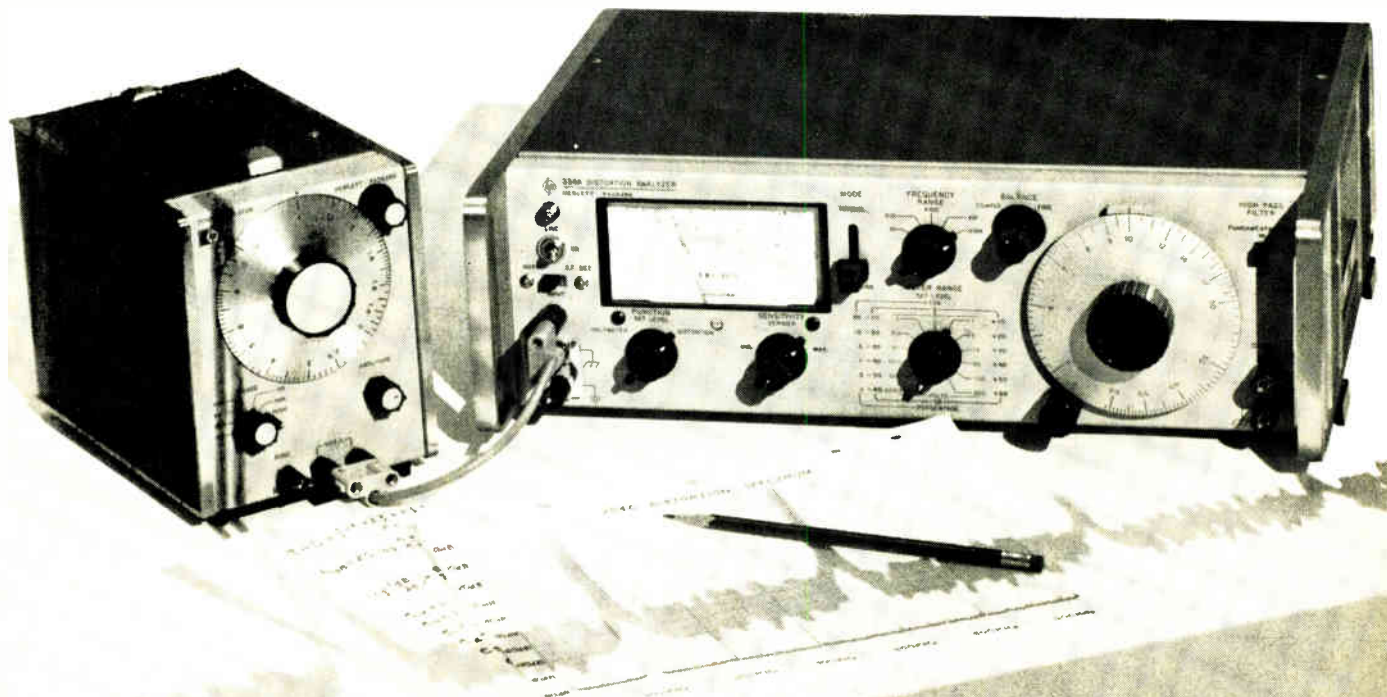

IC regulator rides easy on high voltage

Fully floated device generates 'preregulated' voltage referenced to output, not ground; can control thousands of volts

For their regulator needs, power-supply manufacturers have for years dismissed integrated circuits as too low-voltage. But at least one—Lambda Electronics Corp.—has reconsidered; Lambda is using a monolithic IC regulator, Motorola's MCI566, in power supplies that include several 150-volt, 4.5-ampere models.

By floating the IC, the MCI566

can regulate voltages many times its breakdown voltage. In fact, the voltage that the IC regulates is limited only by the breakdown voltage and safe operating area of the discrete output pass transistors.

The MCI566 can, for instance, provide a 300-volt, 0.5 ampere output with 0.01% regulation. More dramatically, albeit less practically, the IC's designers have oper-

ated it in combination with a 6BQ6 vacuum tube to get a 2,000-volt regulated output. And using high-voltage transistors as the output devices, they've regulated 1,000 volts at 200 milliamperes. (This was only a demonstration; the discrete output transistors were outside the "safe operating area" and prone to second breakdown.)

The versatile Motorola circuit

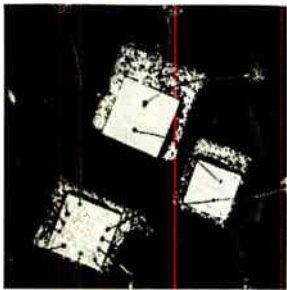

Hybrid driver circuit SH2200 features a 50v output and a sinking current of 500 ma at 6 v. It provides a combination of 4 input NAND gates and an inhibit (NOR) input. It can interface with all other current sinking logic circuits. Prices range from \$3.75 to \$17.95 depending on quantity and package selected. Fairchild Semiconductor, 313 Fairchild Dr., Mountain View, Calif. [436]

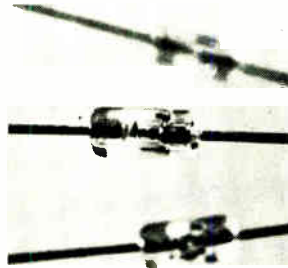

Schottky switching diode MA4-A200 is a planar passivated silicon device utilizing a combination of 2 Schottky barriers and a p/n junction. It has the high breakdown voltage (greater than 25 v) and operating temperature characteristics of silicon, plus the low turn-on voltage of germanium. Package is ODS-54. Microwave Associates Inc., 999 E. Arques Ave., Sunnyvale, Calif. [437]



JEDEC series 1N5461A-1N5476A diodes are available in 16 types to cover the range from 6.8 pf to 100 pf with a tolerance of $\pm 10\%$. The Q of over 600 at the lower capacitance values suits the devices for sharp response in tuning circuits at 500 Mhz and above. Price (1-99) is \$6.75 each; delivery 2 to 3 weeks. MSI Electronics Inc., 34-32 57th St., Woodside, N.Y. 11377. [438]

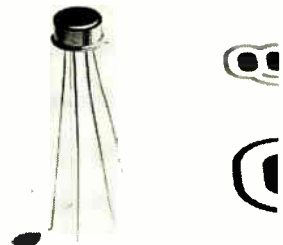

Dual transistors 2N2913-20 offer a low noise figure of 3 db max. at 1 khz, breakdown voltages as high as 60 v, V_{BE} matching of ± 3 mv max., and V_{BE} tracking accuracy of $10 \mu v/^{\circ}C$ at 100 μa . A high current gain of 150 minimum is provided at 10 μa . Prices (100-999) range from \$1.75 for the 2N2913 to \$7.30 for the 2N2920. Qualidyne Corp., 3699 Tahoe Way, Santa Clara, Calif. [439]

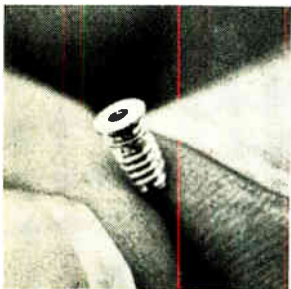

Noise-free, low-voltage GaAs diodes that use the Gunn effect principle are for use in X-band production and lab systems in airborne and missile use. The VSX-9201 will deliver a typical output of 45 mw; the VSX-9205, 8 w. Tuning range at this power is ± 500 Mhz from any specified center frequency from 8.5 to 11.9 Ghz. Varian Associates, 611 Hansen Way, Palo Alto, Calif. [440]



FET switches 2N4091, -2, and -3 can also be utilized as low-level choppers, video and r-f amplifiers or high-gain and low noise amplifiers. They find application in microvolt amplifiers and meters, tv equipment and various audio equipment. On-resistance is 30 ohms; switching time, 40 nsec; leakage, 200 pa. National Semiconductor Corp., San Ysidro Way, Santa Clara, Calif. [441]

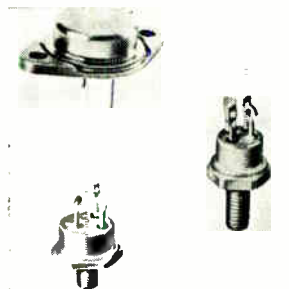

Power transistors feature high-frequency capability (f_t is rated up to 40 Mhz minimum), fast switching speeds (typical storage time ranges from 400 nsec at 2 amps to 330 nsec at 60 amps), and sustaining voltage rated up to 200 v. Power range is 20 to 150 w and peak collector current ratings, from 10 through 75 amps. Westinghouse Semiconductor Division, Youngwood, Pa. [442]

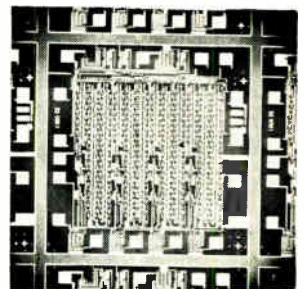

MOS shift register comes in a quad configuration. It consists of a monolithic silicon chip that contains 4 separate 32-bit dynamic serial registers with a common clock and common power lines. The EA1200 operates to 3 Mhz with a 2-phase 24 v clock. The 1201 operates to 1 Mhz with a low power single-phase 9 v clock. Electronic Arrays Inc., 501 Ellis St., Mtn. View, Calif. [443]

The Connector Thing

in which Microdot solves the case of the two missing funny things.

Our story opens in the walnut paneled office of Microdot's Group Elder Statesman, Eldredge Oldadt. We find the graying, self-styled, self-made bureaucrat pacing the Bigelow on the floor and making clicking noises with his tongue.

In the morning's interoffice mail, he'd come across the inventory report. Everything tallied—except in two places. He'd gone over and over the figures, but the answer was always the same. Two pieces were missing. One Lepra/Con. One Golden Crimp.

When he was able to gain some self-control, he sat behind his desk, head in hands, and wept. He wept for the missing Lepra/Con, that wonderful ultraminiature, 50 ohm coax connector with that magnificent all-crimp assembly. Such a beautiful little thing.

And then he'd thought of the Golden Crimp. The 3-piece Golden Crimp. So compact. 1.693 lightweight grams. And now? Gone. Lost. Stolen? Perhaps.

Slowly the door creaked open to reveal a hefty Oriental with a Fu Manchu moustache. Behind him covered what Oldadt took to be a Chinese busboy.

"Sorry to enter without knocking." The Oriental moved to a nearby chair, and the busboy cringed into another. "But much is revealed when one enters room this way. There is much in the sky besides sparrows." A wide smile spread across the visitor's enigmatic countenance.

"You must be the security consultant."

"Charlie Chum, your humble servant."

"And he's your number one son, right?"

"Wrong. He is my busboy?"

"Well, Charlie...if I may call you Charlie."

"Certainly. Is it not correct to light candles under the temple bell?"

"Er...yes...now to business..."

"As you say in your country, OK Joe."

There was something about this man from the East that Oldadt just couldn't figure out. Something enigmatic.

"Charlie, there are two connectors missing."

"Yes, I know."

Astounded, Oldadt could not believe his ears. "But how could you know? I only found out about it a few hours ago!"

"Not so hard when mind trained in detective work. Since busboy and myself came into room you have held two fingers of your right hand together. Either the number two was on your mind, or you were about to administer Cub Scout salute."

"Remarkable, but how did you know they were connectors?"

"Wild guess?"

"Charlie, we've got to get them back. I've got to have them. I've got...."

"Please do not gnash teeth. Keep pants on, buster. First must have description."

For the second time that morning Oldadt fought for control. Leaning back in his chair, he fingered his slide-rule tie-clip nervously.

"Well, first of all, a Lepra/Con is missing. It's the smallest all crimp 50 ohm coax available. I don't know whether it was a screw-on or slide-on version, since we make both kinds."

"Continue, please."

"It could be one of many configurations, such as: right angle, or straight plugs, bulk-head or plain jacks, front or rear mount, or printed circuit receptacles...they're all available in screw-on or slide-on versions. All very reliable because, their contacts are completely protected."

"I see, and what about other connector?"

"The Golden Crimp?"

"Yes, is it not the year of the Golden Crimp?"

"Well, we'd like to think so. It comes in three pieces. Not seven or eight pieces like the others. It's .620" x .242" diameter by .250" hex.

"Question. What are the three pieces?"

"Contact assembly, inner crimp sleeve and the housing."

"What, no sealing sleeves, no pieces of teflon dielectric insulators, no retaining rings?"

Once again Oldadt was amazed at
(continued on next page)



[more Connector Thing]

the Oriental's perception. How enigmatic it all was.

"Yes, that's right. Just three small pieces. Why you can assemble one in less than one-and-a-half minutes. It is capable of operating at 200° C., has a contact resistance of 4 milliohms max., and an insulation resistance of 5K megohms min."

Charlie Chum raised himself from his chair and began shuffling around the office. He went to the indoor plant, plucked a leaf, and began chewing the stuff. He smelled the picture frame by the window, scratched the desk-top with a nail, got down on the floor and listened to the carpet, then gnawed a small hole in one of the office chairs. Seeming well satisfied, he returned to his chair. He and the busboy exchanged enigmatic smiles.

"Would you ask secretary. Miss Brenda, to come into office?" Oldadt reached for the intercom. "Also would like for you to have Mr. Bart Sellital, your product manager, also come to office"

Quickly, Oldadt ordered his two employees to his office. As the two entered, Charlie Chum rose, smiled enigmatically at the busboy, and said, "Case closed?"

"But what do you mean? Where's the missing connectors? Where's the Leptra/Con? And where's the Golden Crimp?"

"Please to admire beautiful young secretary's dangly earrings."

"Well I'll be!"

"Bart Sellital, did you give me some hot earrings?" Sellital looked at his feet, and Brenda burst into tears. Oldadt sat spellbound in his chair, his mouth open, still trying to put all the pieces together. At the door with his busboy, Charlie Chum turned to the astounded Group Elder Statesman and said, "It is like the cherry blossoms in spring; they are pink, but a long way from lemonade."

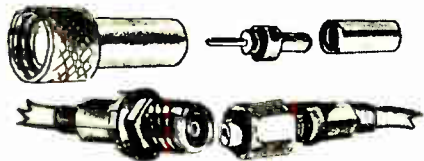

Golden Crimp and Leptra/Con are registered trade marks of Microdot Inc.



MICRODOT INC.

220 Pasadena Ave., So. Pasadena, Calif. 91030

Circle 183 on reader service card

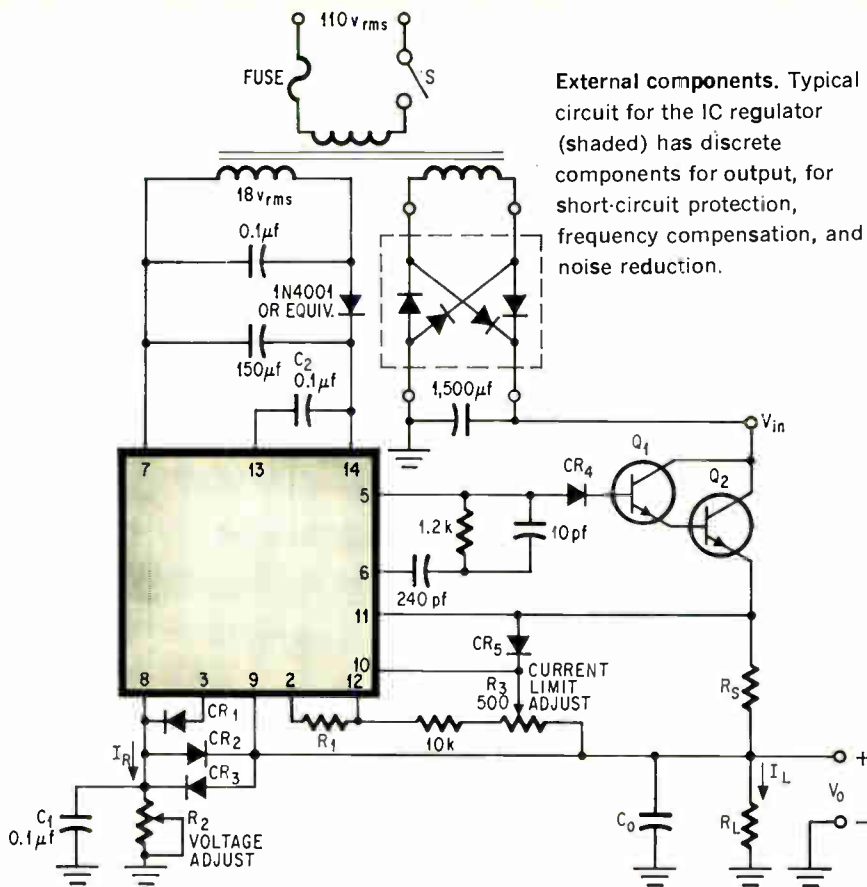

External components. Typical circuit for the IC regulator (shaded) has discrete components for output, for short-circuit protection, frequency compensation, and noise reduction.

requires no external zeners, and can still deliver full loop gain for any value of output voltage. This is because it is full-floated; it derives its operating power from its own power winding and it generates "preregulated" voltage that's referenced to the output rather than to ground. The negative (substrate) side of the MC1566 is 7.25 volts lower than the output voltage, and the preregulator keeps the positive side of 18.5 volts above the substrate—11.25 volts above the output. The IC voltage with respect to ground doesn't matter, since the device is floating around the output voltage.

The MC1566 can regulate the voltage of either load or line. It can also regulate current. As a voltage regulator, it controls within 0.01% + 1 millivolt. As a current regulator, the IC controls to 0.1% + 1 milliamper. Output current and output voltage are adjustable down to zero.

The MC1566 is operable over the full military temperature range of -55 to +150°C. A commercial version, the MC1466, has a temperature range of 0 to 75°C.

The auxiliary supply voltage, V_{aux} , which powers the IC, must be

electrically isolated from the unregulated high-voltage supply. The instantaneous value of V_{aux} should be no greater than 35 volts to prevent breakdown. And for proper internal regulation, V_{aux} should be no less than 20 volts. The auxiliary current is typically 7 ma.

The output voltage, V_o , is derived from the product of I_R and R_2 . If 8.5 kilohms is selected for R_1 , I_R will be 1 ma, and V_o in volts will equal the value of R_2 in kilohms.

Other values of I_R can be used as long as the 750 milliwatt maximum package dissipation isn't exceeded (for each milliamper increase in I_R , dissipation increases by 4 mw.) It should also be remembered that the 3 microampere bias current for the voltage control amplifier must come from the reference current. For this diversion to have negligible effect, I_R should be at least 100 times larger than the bias current.

The regulator comes in a 14-lead dual in-line package. In 100-or-greater quantities, unit price is \$24.50 for the MC1566, \$8.50 for the MC1466.

Motorola Semiconductor Products, Box 20912, Phoenix, Ariz. 85036 [444]

PERFORM WITH CHAMPIONS



ONLY
\$44.95 ppd.



BUY THE BEST **MARK TEN**[®] CAPACITIVE DISCHARGE IGNITION SYSTEM

DELTAKIT only **\$29.95**
ASSEMBLE IT YOURSELF!

Now discover for yourself the dramatic improvement in performance of your car, camper, jeep, truck, boat—any vehicle! Delta's remarkable electronic achievement saves on gas, promotes better acceleration, gives your car that zip you've always wanted. Find out why even Detroit has finally come around. In four years of proven reliability, Delta's Mark Ten has set new records of ignition benefits. No re-wiring! Works on literally any type of gasoline engine.

COMPARE THESE PROVEN BENEFITS...

- ▲ Dramatic Increase in Performance and in Fast Acceleration
- ▲ Promotes more Complete Combustion
- ▲ Points and Plugs last 3 to 10 Times Longer
- ▲ Up to 20% Mileage Increase (saves gas)

Order Your **MARK TEN** Today
Shipped Postpaid at once . . .



P.O. Box 1147 E - Grand Junction, Colo. 81501

Enclosed is \$_____ Ship ppd. Ship C.O.D.

Please send:

- Mark Tens (Deltakit[®]) @ \$29.95
(12 VOLT POSITIVE OR NEGATIVE GROUND ONLY)
 Mark Tens (Assembled) @ \$44.95
 6 Volt: Negative Ground only
 12 Volt: Specify Positive Ground
 Negative Ground

Car Year _____ Make _____

Name _____

Address _____

City/State _____ Zip _____

New semiconductors

Memory within a memory

Tiny storage unit eliminates need for external logic circuit

By incorporating a tiny six-bit read-only memory in the logic circuitry, American Micro-systems Inc. has enabled its 2,560-bit ROM to operate as part of an even larger system with no extra logic.

The huge ROM, designated the MA01M, was originally designed as a character generator, and AMI expects it to find its greatest use in generating vectors to compose USASCII characters.

Such circuits are generally not compatible with other ROM's, because their synchronous circuit delays are not equal to one bit time of the driving clock. The integral six-bit ROM solves this timing problem by generating a pulse from three chip address lines to set a d-c flip-flop that connects or disconnects the output; since there are three binary-value address lines, the MA01M can be used with as many as seven (2^3-1) other chips to make a 2,048-by-10 ROM module. (The chip structure is 256-by-10 bits.)

Word selection is through eight micro-address lines; the decoded address is applied to the ROM circuitry, whose outputs are read into a 10-bit d-c storage register. (This amounts to one bit of delay, since the 10 bits are read-in in parallel.) Outputs of the storage register are connected to low-impedance push-pull line drivers, each of which can drive a TTL gate with no interface circuitry.

The memory is described as a dynamic register with a two-phase clock. John A. Read, senior member of AMI's technical staff who designed the MA01M, says that it is "quasi-static." If the two phases of the clock are of equal duration, then the circuit behaves as a straight dynamic memory. But if one of the phases is made a sharp spike, then data will be held in the

d-c storage register for nearly two clock times. The circuit produces an output only when data is clocked out of the register.

No inversion. AMI uses a thick oxide process on 1-0-0 silicon to get low-level operation. Field oxide inversion threshold is 20 volts. Read says that the power supplies of +5 volts and -12 volts do not provide enough swing to cause unwanted inversion.

Internal high-voltage clocks are necessary to transfer data from the memory to the storage register; these 13-volt clocks are generated by internal amplifiers from the 5-volt inputs.

All of this logic and control circuitry adds enough delay to the chip so that AMI could not quite realize its original goal of 500-nanosecond access time at 125°C. Read says that while room-temperature access time is about 450 nsec, the high-temperature figure is 700 nsec.

The customer puts his own code on the chip by filling out a deck (52 cards, 55 words per card) of punched cards, from which AMI generates both the oxide thinning mask and a test tape. Instead of coding through final metalization, AMI codes by selectively thinning over gate areas.

The MA01M, which comes in a 40-lead ceramic dual in-line package, is available six weeks after the customer delivers his desired pattern.

For quantities up to 10, the price is \$250; 11-49, \$175; 50-199, \$140; and 200-999, \$110.

Specifications

Operating temperatures -55° to +125° C.
Storage temperatures -65° to +150° C.

Typical electrical characteristics at 25° C.

Supply voltages	+5.0 v, -12 v, ±10%
Positive supply current	40 ma
Negative supply current	5 ma
Power dissipation	260 mw typical
Clock 1	+4.0 v
Clock 0	+4.0 v
Logic input 1	+4.0 v
Logic input 0	+0.4 v
Output 1	+4.5 v
Output 0	+0.3 v
Access time	450 nsec
Readclock pulse width	200 nsec

American Micro-systems Inc., 3800
Homestead Rd., Santa Clara, Calif.
95051 [445]

THUMBWHEEL SWITCHES



- COMPACT
- POSITIVE OPERATION
- SIMPLE, CLEAN INSTALLATION
- ECONOMICAL
- MODULAR
- WIDE RANGE OUTPUT
- EDGE LIGHTING AVAILABLE

Send for further information

TECH LABORATORIES, INC.

Palisades Park, New Jersey
Phone: 201 — 944-2221 • TWX: 201 — 947-4730

Circle 218 on reader service card



COMPET: Brain Child

Compet CS-12D. Sharp's high budget-priced time-saver for fast-moving engineers and scientists. So small you can carry it anywhere. Yet the all IC construction (advanced MOS-ICs, by the way) provides instant answers to a wide range of calculations with maximum efficiency. Moreover, our newly developed glare-free soft lighting green display panel makes figures easier to read and eliminates eye strain.

Fast. Silent. Dependable. Compact. Try it. One operation will tell the story!



CS-12D



12 digit, 6 decimal place capacity. Automatic decimal system. Minus sign indicator. Performs constant calculation. Only 6.5 lbs.

SHARP

HAYAKAWA ELECTRIC CO., LTD. Osaka, Japan

U.S. Subsidiary: SHARP ELECTRONICS CORP. 178 Commerce Road Carlstadt, New Jersey

"Sharp Has a Way of Making it Better"

Circle 185 on reader service card

185

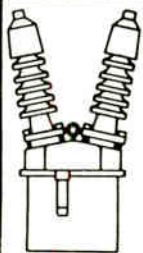

ABC MANUFACTURING CO.
RESEARCH DIVISION
VALLEY STREAM, N.Y.

TITLE	
DRAWN BY	DATE
CHECKED BY	SCALE
APPROVED BY	DWG. NO.
PROJECT NO.	

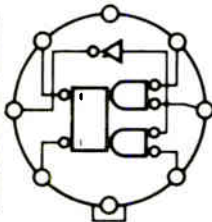

LET STANPAT PREPRINT ALL YOUR REPETITIVE SYMBOLS

sharp, crisp reproduction every time!

STANPATS are made specifically for use on drawings. Inferior imitations create endless problems. STANPAT will preprint your own repetitive items for instant drafting. Every sheet is guaranteed to meet your exact requirements. Adhesion is instant . . . reproduction is always perfect. Unbelievable? Send today for free samples—judge for yourself. Use quick-reply coupon below.

Send a copy of your own repetitive details . . . we'll send you a quote!

Telephone: 516 883-8400

faithfully serving the architect and engineer for over 25 years



STANPAT PRODUCTS INC.

Dept. J6, 366 Main St., Port Washington, N.Y. 11050

Send free samples and literature. Quote on my attached art.

Name _____ Title _____
Company _____
Address _____
City, State, Zip Code _____

Circle 219 on reader service card

PRE-ENGINEERED POWER!

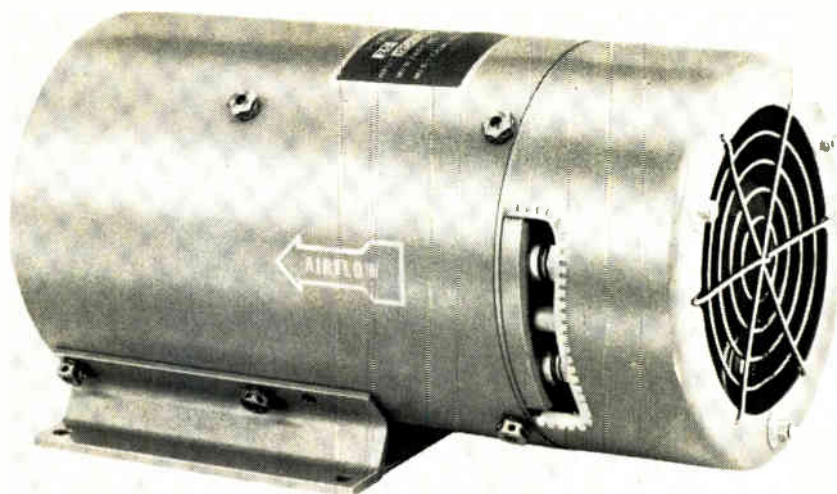

28G5P 47-65 Hz input (also style 28GP for 400 Hz), high-efficiency 28 V.D.C. output; lightest, most compact static unit.

Here are two readily available ways to get dependable 28 V. D. C. high-current power

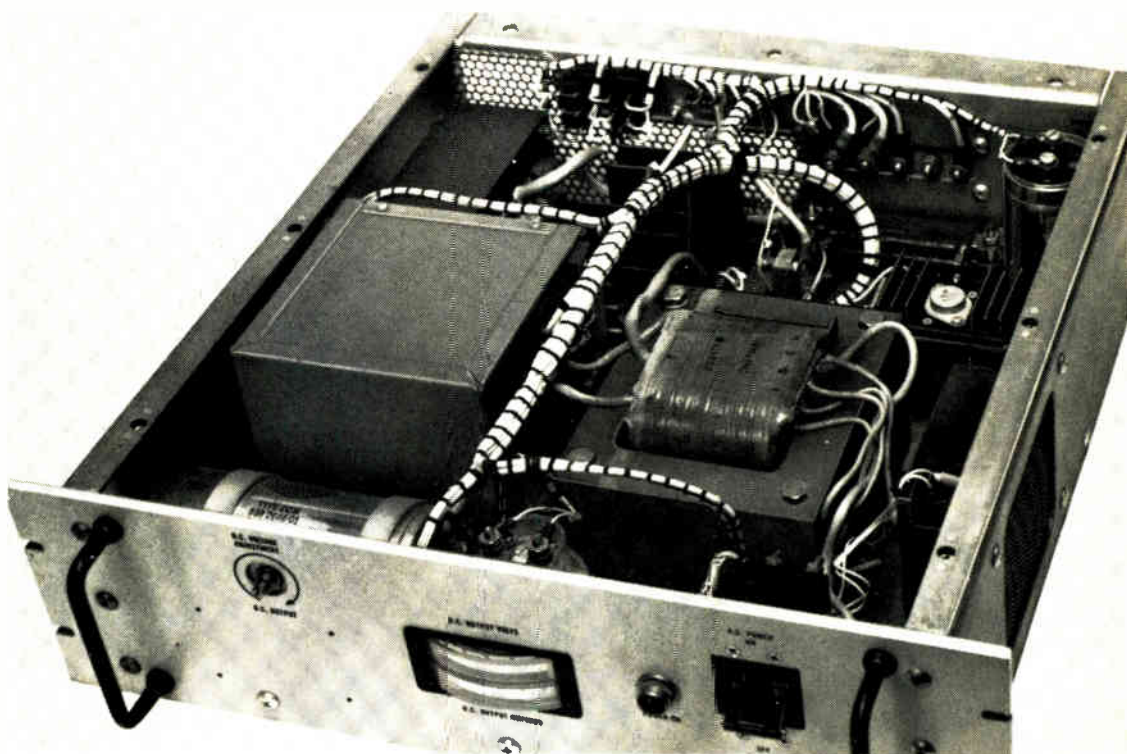

CR27.5 High-current, adjustable, 1% regulation, 28 V.D.C. output, 50-60 Hz unit. Withstands substantial overloads.

Tung-Sol pre-engineered standard power supplies meet lots of special requirements. You'll find they offer many cost/efficiency/size-weight/availability advantages. No more shoe-horning in at the last minute with a make-do power unit. No more high-cost custom or do-it-yourself designs. In all likelihood, Tung-Sol's done it before ... and can meet the specific requirements of your circuitry.

Tung-Sol pre-engineered power supplies reflect unique production abilities and in-house capabilities in solid-state components, transformers and electromagnetics which contribute added performance-value to your equipment. Units meet EMI and MIL Specs.

Talk to one of our experienced factory engineers. He's backed by a versatile line of pre-engineered, readily available, standard power supplies. Tung-Sol Division, Wagner Electric Corporation, 630 West Mt. Pleasant Ave., Livingston, N.J. 07039. Telephone (201) 992-1100.

TUNG-SOL*

Helps you do more
...with less

*Registered trademark Wagner Electric Corporation

New Books

Micro coverage

Microwave Components
P.A. Matthews and I.M. Stephenson
Chapman and Hall Ltd., 196 pp., \$9.50

To adequately provide an insight into such an expansive field as microwave components, systems, and measurements would require several large volumes, yet the authors try to do this in a book that totals only 196 pages. And in so doing, the authors' treatment of most individual devices is often much too brief to be satisfying. However, they do manage to include some of the newer measurement tools such as time-domain reflectometry, sampling oscilloscopes and wideband, electronic swept sources.

Although the book is lacking somewhat in depth and omits some of the newer innovations, it does make for easy reading, and it does provide a basic overview of microwave components and some of the measurement techniques. And, it does touch upon some of the more classical aspects of microwave systems.

It is the authors' contention that sufficient theory is included in the first two chapters for the reader to be able to appreciate the principles involved in the discussions that follow. Unfortunately, it's difficult to gain much insight about microwave components from Maxwell's equations for free space. Indeed, the authors might have done better to leave the theoretical material to textbooks and devote some space to comparisons of waveguide, coaxial, microstrip and stripline modes of transmission. And, there could have been some mention of the newer modes, slot line and coplanar.

Particularly disturbing, in light of the emerging field of microwave integrated circuits, is the lack of a discussion of the newer microwave components and where they fit in the over-all picture. The section on filter design, for example, doesn't mention stripline filters or voltage-tunable yig-filter techniques. And the chapter on nonreciprocal components makes no mention of yig; it boils down to just a brief review of old material on ferrites, mainly for waveguide devices. It includes

neither planar-ferrite thin-film technology nor mentions the meander-line phase shifter or circulators that are now printed directly onto a ferromagnetic substrate.

One chapter looks at a few over-all microwave systems that use waveguide and coaxial components, but there's no mention that this now can be accomplished by connecting microwave transistors and diodes in chip form to other passive devices on a small substrate using microstrip techniques.

Recently published

Electronic Spectra of Transition Metal Complexes, D. Sutton, McGraw-Hill Book Co., 200 pp., \$8.50

Essentially a nonmathematical approach to the subject, this book provides a review of some aspects of the electronic theory of atoms and ions as a basis for the discussion of energy levels of electrons in complexes. The construction of energy-level diagrams is discussed, and the spectra of octahedral complexes are analyzed in detail. It is intended for use by undergraduate students.

Introduction to Control Theory for Engineers, Allan Sencicle, Hart Publishing Co., 240 pp., \$10

Intended to provide a basic understanding of control system theory for engineering students, the book covers such topics as analog systems, analog computing units, transient analysis and frequency-response analysis of control systems. An introduction to nonlinear systems is also included.

Control Systems for Technicians, G.T. Bryan, Hart Publishing Co., 324 pp., \$12.50

A survey of automatic control systems, the book's major topics include system components, remote transmission, position control systems, speed- and process-control systems, digital techniques and computers, and machine-tool control.

Transmission Lines and Waveguides, Lamont V. Blake, John Wiley & Sons, 310 pp., \$9.95

Written in textbook fashion with problems and exercises at the end of each chapter, this book introduces some fundamentals involved in the transmission of electrical power and signals on lines, the basic equations applicable to two-line transmission lines, and the Smith chart. Other chapters deal with the hollow-pipe waveguide, the special uses to which sections of transmission lines are adaptable, and transmission-line measurements.

Music by Computers, H. von Foerster, J.W. Beauchamp, Editors, John Wiley & Sons, Inc., 139 pp., \$14.95

The book is based on papers presented at the 1966 Fall Joint Computer Conference. The three main topics covered are computer hardware and software for the generation of sound; compositional techniques; and aesthetics, or the problem of judgment entering perception. Four records are included to illustrate all examples in the text.

think digital

ELFIN®
2.99*

MS-4000-B
3.85*



MS SERIES
4.97*



RK SERIES
4.97*

Think ELFIN® — the new single plane, segmented neon readout indicator that provides brighter displays and wider viewing. Only 0.41" dia. ELFIN® displays 0-9, + and — some alpha symbols and decimal.

MS-4000-B miniature encased readout with the flat single-plane viewing, uses 100,000 hr. #683 T-1 subminiature incandescent lamps. Plug-in feature expedites replacement.

ALCO's RK numeric and symbol readouts have a unique in-line design to provide clear displays without focusing problems. The precision machined 1-piece aluminum case also serves as a heat sink.

The MS Mosaic numeric segmented indicators are available in 2 sizes and use either 6, 14 or 24V lamps for flexibility in design.

*10C0 Lot prices

ALCO

ELECTRONIC PRODUCTS, INC.

Lawrence, Massachusetts 01843
Circle 187 on reader service card

The
Trend
is TTL.

Series 74F MSI flatpacks
**1 WEEK
AROUND**
(Same day shipment on 250 pieces or less)



Faster deliveries on all TTL circuits—made possible by greatly expanded manufacturing capability. Get full information on the IC types you need. Call your TI representative—now!

TEXAS INSTRUMENTS
INCORPORATED

FAMOUS MAGNELINE® QUALITY

**NEW
COMPACT
SIZE!**

**NEW
LOW PRICE!**



Shown actual size

Patwin's Series 18000 indicators operate from pulsed DC voltages in decimal form to display digits or symbols. They have the same reliability, readability and memory as other MAGNELINE models but are more compact and lower in price. The new indicators are only .29" wide and .92" high yet digit size is a full ¼ inch. Unit price is \$33.80 in quantities of 100.

The Series 18000 has many applications in aviation and general instrumentation, especially where extreme reliability and low maintenance cost are important. Open construction of the unit gives instrument designers a wide choice of mounting methods. Full information available from Patwin, 41 Brown Street, Waterbury, Connecticut 06720. Telephone (203) 756-3631.

PATWIN®
DIVISION OF UNITED-CARR
UNITED-CARR INCORPORATED • A SUBSIDIARY OF TRW INC

**WATERBURY,
CONNECTICUT 06720**

188 Circle 188 on reader service card

Technical Abstracts

Upside down

Filtering, frequency multiplexing, and other microwave applications with inverted-common-collector transistor circuits

David K. Adams and Raymond Y.C. Ho
Stanford Research Institute,
Menlo Park, Calif.

Ground the collector? Whatever for? Transistors in the grounded-emitter configuration make better high-gain amplifiers below the transistor's f_T and the common-base circuit does quite well above, so why use the common-collector configuration?

The answers to these questions are seen with a transistor in the grounded-collector mode—a mode virtually unused at lower frequencies—that produces active microwave elements suitable for integrated circuits. For example, the inverted-common-collector transistor circuit can perform like a high-Q inductance to achieve stable multiplexers, impedance-matching networks, and amplifiers.

A major feature of the inverted-common-collector circuit is its ability to synthesize a stable inductance with unlimited Q at high frequencies. By placing a R-L circuit having a low Q in a grounded-collector transistor's base, the transistor's emitter impedance looks like an inductance in series with a negative resistance. The inverted-common-collector configuration rotates any impedance in the base up to 90° as viewed from the emitter. For example, a resistance in the base would show up as an inductance in the emitter, whereas an inductance would look like a negative resistance, and a capacitance would look like a positive resistance. Moreover, the synthesized inductance and negative resistance are insensitive to temperature and current variations over a considerable range; they tend to be properties of the transistor's geometry and doping profiles which are relatively insensitive to such variations. However, the positive resistance is inversely proportional to transistor current and sensitive to temperature changes.

Active filter bandwidths from 0.1% to 10% and tuning ranges up

The Material
of Unlimited Uses...



SOLDERING "UNSOLDERABLES"

...is but one of the thousands of uses for advanced low-melting-temperature alloys such as Cerroseal[®] 35. Cerroseal 35 melts between 238° and 260° F., and can be used with ordinary soldering techniques. When soldered with this versatile alloy, "toughies" such as glass-to-metal, ceramic-to-metal and metal-to-metal seals stay tight even in a deep vacuum. Other Cerro[®] Alloys, including specials made to your individual specs, are perfect for joining ultra-delicate parts like integrated circuits which cannot be heat-sunk during soldering. Low-temperature soldering as cool as 117° F. can also be accomplished with certain Cerro Alloys.

For detailed information contact Cerro Alloy Dept., Cerro Copper & Brass Company, Stamford, Conn. 06907... R. S. Darnell (203) 327-0550.

In Europe, contact Mining & Chemical Products Ltd., Alperton, Wembley, Middlesex, England.

CERRO[®]

Circle 220 on reader service card

Technical Abstracts

to 40% have been achieved using the inverted-common-collector configuration. Although little detuning over temperature was noticed, insertion loss varies. The noise figure of the active filter is higher than that of an ideal passive filter, but this doesn't necessarily mean that the active filter is no better than a lossy passive filter coupled to an amplifier—it depends on the specific application.

Among other things, the configuration lends itself to multiplexer applications. It provides the compact high-Q elements that are essential for the output multiplexer filters. And it offers a high degree of base-to-emitter isolation, which buffers the sharp-selectivity output filter in the emitter circuit from the input coupling terminals at the base. This allows many transistors to be paralleled and enables the output of each individual terminal to be tuned to a different frequency without interaction. With suitable band partitioning, about 100 contiguous channels could be multiplexed using this technique. And, if desired, additional active stages of filtering can be added to improve selectivity.

Presented at the International Microwave Symposium, Dallas, May 5-7.

On films

A vanadium oxide film "switching element"

T.N. Kennedy
Rensselaer Polytechnic Institute,
Troy, N.Y.

F.M. Collins
AirCo-Speer Research Laboratories,
Niagara Falls, N.Y.

Transition metal oxides, long used commercially as thermistors, look like good bets for economical thin-film switches. Vanadium-dioxide film resistors have been fabricated, and they have been switched on and off at frequencies up to 500 kilohertz by increasing or decreasing voltage. Potential uses are in sensitive infrared detectors, temperature sensors, and nonlinear circuit modulators.

As input voltage is increased, the vanadium oxide heats up. And at 68°C, the resistivity decreases from about 20 ohm-centimeters to

push with ALCOSWITCH

These miniature push button switches control heavy currents with outstanding reliability and consistent performance. Snap-action mechanism allows quick make-and-break along with solid silver contacts for efficient switching operations.

LIGHTED MODELS

The illuminated push button Series MSPN have over 50 varied colored buttons and sizes to fit your specific applications. Versatile DPDT model with isolated lamp terminals.

WATERPROOF

The "E" Series is made to rigid specifications exceeding industry standards. Miniature in size, but exceptional in performance. Available as momentary, or Push-ON or Push-OFF, in one, two and 4PDT models.

Whether you need one or one thousand switches you have a greater variety to choose from when you specify an ALCOSWITCH.

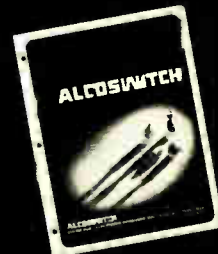

SEND FOR COMPLETE
ALCOSWITCH CATALOG

ALCO

ELECTRONIC PRODUCTS, INC.

Lawrence, Massachusetts 01843

Circle 189 on reader service card

The
Trend
is TTL.

SN7496N MSI 5-bit shift register
**2 WEEKS
AHEAD**
(Same day shipment on 250 pieces or less)



Faster deliveries on all TTL circuits—made possible by greatly expanded manufacturing capability. Get full information on the IC types you need. Call your TI representative—*now!*

TEXAS INSTRUMENTS
INCORPORATED

Make your own break.

You can take a lot of the chance out of your future by including yourself in the Electronics Manpower Register.

When you do, your experience and talents become part of a nationwide computerized placement service.

Our computer is programmed to give every registrant the same

look for every opening. With your prior approval, you'll be considered for every opportunity that matches your resume.

All you have to do is send one to:

Electronics Manpower Register
Electronics
330 West 42nd Street
New York, N.Y. 10036

R&D SEARCH SERVICES

Are your Scientific and Engineering professionals doing work at which they are amateurs?

- NERAC's information specialists can save your technical talent from time-consuming literature searches which precede each R&D project.
- NERAC's specialists are trained to find information. Their ties with over 150 centers, agencies, libraries, and institutes insure you comprehensive coverage. Their technical backgrounds insure their ability to communicate with your people.
- For fast, efficient service, contact:

PHONE: (203) 429-5151

NERAC, BOX U-41N
THE UNIVERSITY OF
CONNECTICUT
STORRS, CONN. 06268

Technical Abstracts

0.1 ohm-centimeter. This occurs in a microsecond.

Films were deposited on an alumina substrate by r-f sputtering, then samples were prepared by dicing 100-by-50-mil sections and evaporating gold pads onto each. During testing, the film showed a resistance of about 500 kilohms until a critical voltage was reached. At that point resistance dropped to about 20 kilohms and remained low over a wide range of temperature changes. The thin-film "switches" could handle currents up to 10 milliamperes.

The switching speed of the vanadium-oxide resistors was tested in relaxation-oscillator circuit.

While all devices tested could easily be made to switch up to frequencies of 100 khz, some reached 500 khz. These relatively high switching speeds apparently are possible because small amounts of heat are lost or gained during transitions from high-to-low or low-to-high resistivity.

Shifting of the film-transition temperature by incorporating lattice impurities is now being investigated. And the film-deposition process is also being looked at further to determine among other things, the effect of film thickness on switching.

Although only relatively few samples were prepared, electrical characteristics of the films were reasonably uniform. For example, the threshold voltage of six different resistors prepared by the same process from the same sputtered film varied no more than $\pm 10\%$ of the average value—180 volts.

Presented at the Electronic Components Conference, Washington, April 30-May 2.

On the beam

Computer-generated graphic segments in a raster display
Richard A. Metzger
Rome Air Development Center
Rome, N.Y.

Renewed emphasis is being placed on raster displays for computer output. Such displays offer the advantages of simplicity, easy remote operation for multiple-station users, low cost per station, having a capa-

MORE THAN JUST ANOTHER OVEN



**(FOR ONE THING,
IT GOES TO +1200°F.)**

That's hot enough for heat-treating and annealing. Solid-state instrumentation with built-in time proportioning offers performance to meet the strictest requirements . . . makes this Blue M Ultra-Temp Oven suitable for research and pilot plant work as well as for production applications.

If you're after even better performance, need absolute control reliability, and don't find these extremely high temperatures essential, then consider the Blue M Ultra-Temp Ovens equipped with the patented POWER-O-MATIC 60® Saturable Reactor Proportioning Control. These go to +1050°F. (+565°C.), yet offer accuracy so exacting that they are especially recommended for processing resistors, transistors, rectifiers, and diodes.

If you have thought that all ovens are alike, remember the Blue M Ultra-Temp. We'll even help remind you. Write: Blue M Engineering Company, A Division of Blue M Electric Company, Corporate Headquarters, Blue Island, Illinois 60406.



Circle 221 on reader service card

Technical Abstracts

bility for mixing output with standard television sources, and of having good position repeatability for computer generated data. However, to use a raster display as a computer output, a conversion to video data is required.

Data generated by the raster-type display is governed by the timing of the raster sweeps. For a dot to be generated on the screen, the beam must be unblanked the instant it traverses a specified address. The raster format's address structure can be considered as an address-coordinate grid where the individual scan lines represent the y address and the points along the line represent the x address.

Every picture element, which has a corresponding x-y coordinate address, occurs at a given time interval after the beginning of a frame. Since each point on the line must be scanned before the beam arrives at the address, digital-to-video conversion can be considered a position-to-time conversion.

One means of implementing the conversion is with a bit-per-element converter. With this approach, input data consisting of x and y addresses, character code and control bits are delivered to the buffer memory and process control. The memory stores the character, vector, and control data while the address bits are transferred to the sync and comparator section, which provides the over-all timing.

Controlled by the sync and comparator section, the data is transferred from the buffer memory to the character generator where a dot pattern is formed for the symbol to be displayed. The pattern is then transferred to the video memory. For a graphic segment, a dot is generated at each of a series of coordinate addresses with the group of dots forming the figure.

The video memory contains one bit of digital storage for each picture element. Loading of the video memory is achieved during retrace when the beam is blanked. Each bit is read out as the beam traverses the corresponding point on the display surface.

Presented at the Spring Joint Computer Conference, Boston, May 14-16.

Circle 191 on reader service card →

variety with ALCOSWITCH

The greater the variety, the more flexibility you have when designing a miniature ALCOSWITCH into your quality equipment. The broad ALCOSWITCH line offers over a hundred different models.

Miniature Toggle Switches are available in five series including high performance waterproof types, locking handles, and switches with 15/32" bushings.

Miniature Push Button Switches include the new illuminated series, top-grade SPDT-DPDT-4PDT types, 15/32" bushings, and economy priced miniatures.

1/2" Dia. Miniature Adjustable-Stop Rotary Switches are built to meet the highest reliability standards and are available with or without their own specially mated knobs.

Whether you need one or one thousand switches you have a greater variety to choose from when you specify an ALCOSWITCH.

SEND FOR
20-PAGE
ALCOSWITCH
CATALOG



ALCO

ELECTRONIC PRODUCTS, INC.

Lawrence, Massachusetts 01843

The
Trend
is TTL.

SN7441AN MSI Nixie* driver

**4 WEEKS
AHEAD**

(Same day shipment on 250 pieces or less)



Faster deliveries on all TTL circuits—made possible by greatly expanded manufacturing capability. Get full information on the IC types *you* need. Call your TI representative—*now!*

TEXAS INSTRUMENTS
INCORPORATED

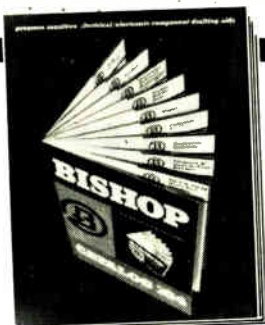

FREE CATALOG

68-page Manual of Time-Saving Problem-Solving Electrical / Electronic Drafting Aids

Featuring illustrated technical information on printed wiring artwork production techniques. Thousands of pressure-sensitive shapes, symbols and tapes for faster, more accurate master artwork.

- T0-5 Patterns
- T0-18 Patterns
- Flatpack Patterns
- Integrated Circuit Patterns
- Pads
- Connectors
- Fiducials
- Tapes
- Tees
- Elbows
- Letters and Numbers and many, many more...

From Bishop, the specialist in electrical/electronic component drafting aids.



Write for free copy:
Bishop Graphics, Inc.
7300 Radford Avenue
North Hollywood, California 91605
Phone: (213) 982-2000



actual size
Model A1-21

**Mite-size
miniature 7/16" indicator**

These tiny indicators are compact, rugged, versatile and easy to read. They feature a microminiature moving coil core magnet mechanism. A1-21 Indicators operate in -55°C to +85°C environments and are sealed against dirt and dust. Choice of pointer or flag display in a wide variety of electrical sensitivities and functions. Size: 7/16" in diameter, 31/32" in length. Weight: 11.5 grams. Write today for complete information.

AMMON

AMMON INSTRUMENTS, INC.
345 Kelley St., Manchester, N.H. 03105

New Literature

Photoelectric controls. Autotron Inc., 3627 N. Vermilion, Danville, Ill. 61832. Thirty-six page catalog 69 lists 284 pre-engineered photoelectric controls. Circle 446 on reader service card.

Hybrid expansion system. Honeywell Computer Control Division, Framingham, Mass. 01701. A 16-page brochure describes the series 16 hybrid expansion system designed for TR-48 analog computer users. [447]

Hybrid IC's. Sprague Electric Co., 35 Marshall St., North Adams, Mass. 01247. Thin-film hybrid microcircuits for d-to-a applications are featured in technical paper TP 69-1. [448]

Color videotape recorder. Ampex Corp., 401 Broadway, Redwood City, Calif. 94063, has available a brochure describing the VR-660C portable color video tape recorder for closed circuit tv production and monochrome broadcaster use. [449]

IC connector harnesses. Spectra-Strip Corp., P.O. Box 415, Garden Grove, Calif. 92642, offers a data sheet describing the applications and features of a line of IC interconnectors. [450]

Operational amplifiers. National Semiconductor Corp., 2950 San Ysidro Way, Santa Clara, Calif. 95051. An operational amplifier guide provides basic specifications on a line of military and commercial IC op amps. [451]

Hybrid IC's. Hybridyne Inc., 1950 Cotner Ave., Los Angeles 90025. A data pack describes a family of thin-film resistors, resistor network, and chip hybrid IC's [452]

Thin film materials. Materials Research Corp., Orangeburg, N.Y. 10962. Over 90 different metallic and ceramic materials may be selected from a nine-page catalog/price list for use as sputtering targets and vapor deposition slugs, feed wires, powders or granules. [453]

Waveguide and components. Dielectric Communications, Division of Sola Basic Industries, Raymond, Maine 04071, has issued a 58-page application manual, 70-2, which contains a complete line of WR-650 through WR-2300 large waveguide and waveguide components. [454]

On-line color monitor. Hunter Associates Laboratory Inc., 9529 Lee Highway, Fairfax, Va. 22030. A four-page bulletin announces the D44 continuous-reading color monitor designed for the production line. [455]

Heat sealing. GTI Corp., 310 Chestnut St., Meadville, Pa. 16335. Information

80 MHz WIDEBAND RF POWER AMPLIFIER



MODEL RF-805

- 10 Watts Output into 50Ω
- 0.1 Volts In — 22.5 Volts Out
- .05 MHz to 80 MHz Broadband
- Low Distortion
- Solid State
- Flat 47 db Gain

The RF-805 is a solid state amplifier, broadband from .05 to 80 megahertz, which produces ten watts with -30 db harmonic and intermodulation distortion. Lower distortion is available at lower output levels. Gain is 47 db minimum, constant within 1 db, so that full output is developed with less than 0.1 volt at the 50 ohm input. Accurate output metering and overload protection is provided.

The RF-805 will raise the power of most manual and swept tuned signal generators and thus extend the usefulness and versatility of available signal generators. Receiver testing, wattmeter calibration, antenna testing, RFI testing, attenuator measurements, and filter and component testing will be aided with the use of this equipment.



R F COMMUNICATIONS, INC.
1680 University Avenue • Rochester, N. Y. 14610

Circle 224 on reader service card

FREE! CATALOG ON SEMI-CONDUCTOR PROCESSING EQUIPMENT

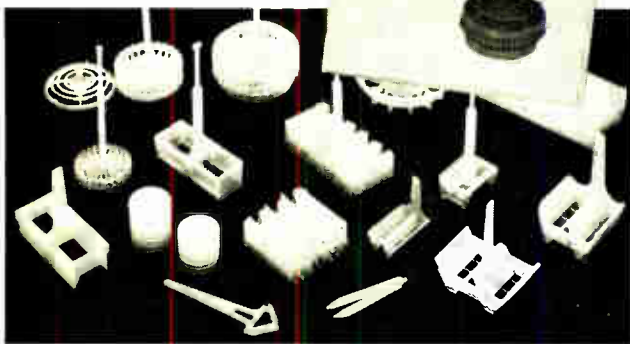

Get full information on a wide variety of products for handling substrates, wafers, and crystals. Fluoroware carriers, baskets, and trays are precision-molded from FEP Teflon*, a material that is almost 100% inert and useable at extreme temperatures.

Write for the "Semi-conductor Processing Equipment Catalog," including information on the new Fluoroware spin dryer.

*DuPont Trademark

FLUOROWARE.
Chaska, Minnesota 55318 • Phone 612-448-3131

Circle 223 on reader service card

Going to IC's? Or Higher IF's?

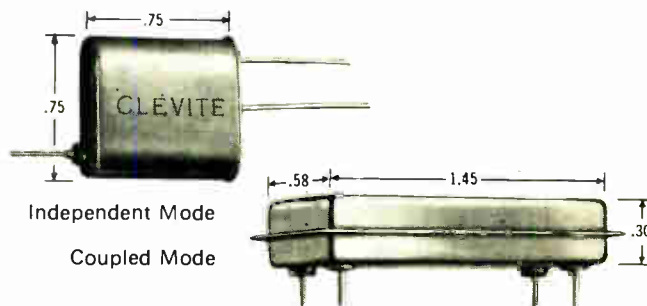

Go two ways with Monolithic Quartz Uni-Wafer® Filters

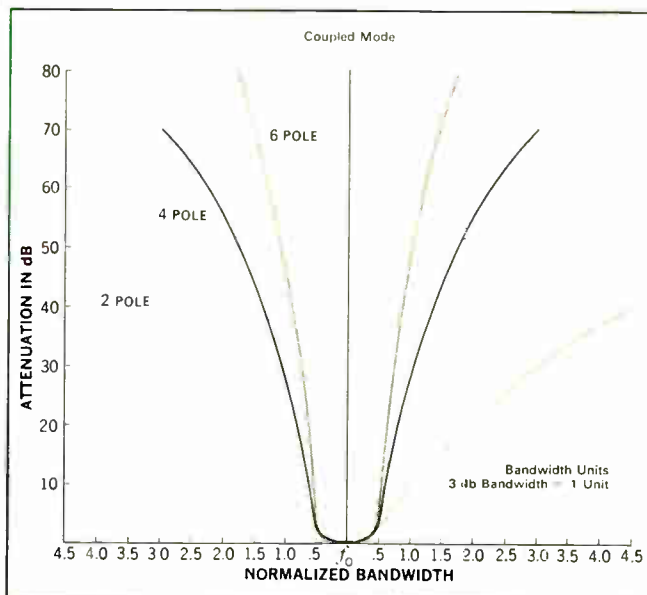

Go independent mode. Go coupled mode. You can go either mode with monolithic Clevite Uni-Wafer® filters. They're smaller and more reliable (fewer interconnections) than conventional filters.

Clevite Uni-Wafer filters are ideal for matching IC circuitry in communications receivers operating in the VHF and UHF frequency ranges as well as in telemetry, radar and aerospace systems.

They are 2, 4 and 6 pole crystal filters with a choice of center frequencies ranging from 8 MHz to 75 MHz. They've been developed using Clevite's advanced engineering techniques and Clevite's original thin film approach to quartz filters. In this concept, arrays of resonators are achieved on a single quartz wafer with resonator isolation and spurious suppression controlled by the trapped energy principle.

So if you're going to IC's or higher IF's, go Clevite Uni-Wafer filters. They're available in both independent and coupled mode.

For more information and complete specification data, write: Clevite Corporation, Piezoelectric Division, 232 Forbes Road, Bedford, Ohio 44146.

CLEVITE

Circle 193 on reader service card

193

The
Trend
is TTL.

Series 54H 6 ns TTL (flatpacks or ceramic DIP)

**4 WEEKS
AHEAD**
(Same day shipment on 250 pieces or less)



Faster deliveries on all TTL circuits—made possible by greatly expanded manufacturing capability. Get full information on the IC types *you* need. Call your TI representative—*now!*

TEXAS INSTRUMENTS
INCORPORATED

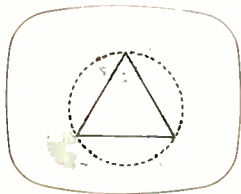

COLOR TELEVISION IN EUROPE

Color television came to Europe in the summer of 1967. The takeoff in West Europe is expected to be considerably faster than it was in the United States, as European television is controlled almost entirely by governments and financed by taxpayers. Thus there is no need to persuade cost-conscious sponsors to foot the bill for programming. Secondly, Europe's late entry

enabled manufacturers to learn from more than a decade of American experience, resulting in sets that are markedly superior to our own.

From among the score of companies involved in West Europe, we have singled out four for detailed discussion: Philips, Thorn, Rank, and AEG-Telefunken. For a copy of this 56-page booklet, address Dept. E.

LOEB, RHOADES & CO.

42 WALL STREET, NEW YORK 10005

MEMBERS NEW YORK STOCK EXCHANGE & OTHER PRINCIPAL EXCHANGES



New Literature

on sealing double stud and epoxy diodes, soldering silicon dice, silicon slice alloying, window assembly, and encapsulation of photo semiconductors is presented in an applications manual. [456]

Component mounting pads. Bivar Inc., 1500 S. Lyon St., Santa Ana, Calif. 92705, offers a brochure describing Permopads, a line of Nylon molded components mounting pads, and applications as production aids for p-boards. [457]

Cable connectors. Hewlett-Packard Co., 1501 Page Mill Road, Palo Alto, Calif. 94304. How to design cable connectors for minimum impedance discontinuity, using time-domain reflectometry for performance evaluation, is described in a 17-page application note. [458]

Hybrid voltage regulators. Silicon Transistor Corp., East Gate Blvd., Garden City, N.Y. 11532, offers a data sheet on a series of high power hybrid voltage regulators hermetically sealed in power transistor packages similar to the TO-3 outline. [459]

Metals and alloys. Techalloy Co., Rahns, Pa. 19426. Technical data and pricing information on more than 90 metals and alloys, produced in wire, rod and strip forms, are included in a 54-page booklet. [460]

Rotary switches. Cherry Electrical Products Corp., 1650 Old Deerfield Rd., Highland Park, Ill. 60035. An eight-page brochure illustrates and describes thumbwheel and leverwheel rotary switches. [461]

Portable transceiver. Hallicrafters Co., 600 Hicks Rd., Rolling Meadows, Ill. 60008, offers a two-page data sheet on an all-environment, portable transceiver operated by flashlight batteries. [462]

Current drivers. Datapulse Division, Systron-Donner Corp., 10150 W. Jefferson Blvd., Culver City, Calif. 90230. Model 310 current drivers, featuring dual-channel remote output from 5 ma to 1 amp, are described in a data sheet. [463]

Finger strips and rings. Instrument Specialties Co., Little Falls, N.J. 07424. An eight-page catalog describes finger strips and rings micro-processed from beryllium copper for rfi/emi shielding. [464]

Digital intercoupler. Daedalus Computer Products Inc., Box 248, North Syracuse, N.Y. 13212. A two-page specification sheet on the model 210 digital intercoupler includes the electronic instrument devices used for input and the readout equipment that can be connected to the intercoupler. [465]

WANTED: ELECTRONICS MANUFACTURER

who desires to fill a
dependable supply of
government contracts

Excellent opportunity for growth-minded electronics manufacturer to locate in Texas and help meet the needs of the government and the third fastest-growing state. Stable, productive labor. Incomparable tax advantages. Lowest living costs. For 1968 Texas Fact Book, write or call the:

TEXAS INDUSTRIAL COMMISSION

Central Information Source for all of Texas
Box JJ-E, Capitol Station
Austin, Texas 78711
Telephone 512/475-4331

Circle 225 on reader service card

The only total portable, laboratory quality oscilloscope.



Model
S1301A

And only \$665.

Goes anywhere you need it. And at \$665,* there's no need for scope sharing. Operates from optional internal battery or 110/220 vac 50 to 400 Hz line. Compact 8½" x 9" x 15" size, weighs less than 20 lbs.

Features include: 20 MHz bandwidth; 17 nsec rise time; 18 sweep speeds; internal voltage calibrator; and triggering stability over 30 MHz.

Write for Bulletin TIC 3316 to Motorola Communications & Electronics Inc., 4501 W. Augusta Blvd., Chicago, Ill. 60651.



MOTOROLA
Precision Instrument Products

*Exclusive of options.

Circle 226 on reader service card

TRANSTECTOR

CIRCUIT PROTECTOR



prevents transients from
causing "unexplainable" circuit failures.

Don't blame circuit failures on bad luck.

Voltage transients can cause circuits to fail or suffer undetected and progressive damage.

Transtector* circuit protector, a new solid state device, senses transients within nanoseconds, absorbs the surge and resets itself. Gives continuous protection for tubes, transistors, diodes and integrated circuits.

Find out about Transtector Systems from M&T Chemicals Inc., 3025 W. Mission Rd., Alhambra, California 91803.

*Trademark of M&T Chemicals Inc.

Phone (213) 283-9278

M&T Chemicals Inc. 
SUBSIDIARY OF AMERICAN CAN COMPANY

Circle 227 on reader service card

JUDSON INFRARED DIVISION

Announcing a New Source for Infrared Detectors



Judson Infrared Detectors

Judson Research and Mfg. Co. has the capability and experience to design and produce photovoltaic InSb detectors in both single, multi-element and both conventional and side looking dewars. We would like the opportunity to quote on your requirements and to demonstrate our capability in producing a superior InSb detector for your system.



JUDSON
RESEARCH AND MFG. CO.
CONSHOHOCKEN, PENNA.
19428

Circle 195 on reader service card

195

Why some people just can't wait to get to Utica...

There are engineers like Albert Killian, for example. Itching to get involved in beyond-the-art projects like the E-2C. Champing at the bit over the prospects of working with over two million dollars worth of the latest microcircuit fabrication equipment... ranging from precision 15"-zone diffusion furnaces stable within $\pm 1^\circ\text{C}$ from 900-1300°, to automated vacuum deposition equipment for film-circuit fabrication. And fighting the fierce muskellunge on Saturdays.

Millie and the kids have their reasons, too. For all seasons. Utica holds forth a lot of attrac-

tions. Skiing (water and snow), boating, golf, picnics, good schools and quiet streets. Spectator-wise, there's big-time college football nearby and professional sports, too. And a host of historical sites.

But mainly, the reason for the rush to Utica is Albert and his

work. What he can do in General Electric at Aerospace Electronics. Like design of a custom 10-bit IC D/A converter accurate to .05% from -55 to +100°C. And other challenges ranging from clock pulse amplifiers to memory switch subassemblies to MHz and GHz amplifiers... not to mention MOSFET arrays.

Know what? You could be doing what the Killians are doing. Right now. At Aerospace Electronics.

What's keeping you? Why not write to Mr. William L. Stanton, Aerospace Electronics, Sect. 59H, General Electric Company, General Road, Utica, New York 13503. An Equal Opportunity Employer (M/F). U.S. Citizenship Required.

AEROSPACE ELECTRONICS
AIRCRAFT EQUIPMENT DIVISION
GENERAL  ELECTRIC



Looking for a better job?

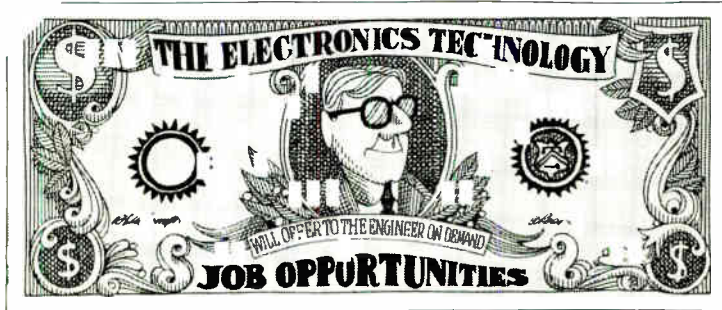

Ask Electronics' computer all about it

Electronics magazine feels an obligation to help its readers find positions in the electronics technology which will make the greatest contribution to their profession and to society — jobs in which electronics men themselves will be happiest.

Electronics has joined with a nation-wide talent search company—National Manpower Register, Inc.—to form the computerized Electronics Manpower Register.

Your qualifications and job requirements will be pro-

grammed into a GE 265 computer, direct-linked to the Manpower Register's offices in New York. The computer, once your resume form (bottom of page and following page) is received, will continuously compare all your data with the specific manpower needs of electronics companies. When a match is made, you will be contacted directly or through an affiliated agency. The company and you will be brought together on a confidential basis.

Continued on next page

Resumes acceptable only from applicants residing within the United States	Electronics Manpower Register It is important that your information be complete and that you type or print legibly	Resumes acceptable only from applicants residing within the United States	
IDENTITY	PRESENT OR MOST RECENT EMPLOYER		
Name	Date	Parent company	
Home address		Your division or subsidiary	
City	State	Zip	Location (City/State)
Home phone	Do you subscribe to Electronics <input type="checkbox"/> or see a library or pass-along copy <input type="checkbox"/>		
GEOGRAPHICAL PREFERENCE (Check appropriate boxes and complete all blanks)			
I will NOT relocate <input type="checkbox"/> I will consider opportunities in: <input type="checkbox"/> North East <input type="checkbox"/> Mid Atlantic <input type="checkbox"/> South <input type="checkbox"/> Midwest <input type="checkbox"/> Southwest <input type="checkbox"/> Calif. <input type="checkbox"/> Northwest			
Prefer: <input type="checkbox"/> Metro. area <input type="checkbox"/> Medium town <input type="checkbox"/> Rural area Other: _____			
EDUCATION			
Degree	Major field	Year	College or University
EMPLOYMENT INFORMATION			
Position desired			
Present <input type="checkbox"/> or most recent <input type="checkbox"/> position			
From	To	Title	
Duties and accomplishments			
HAVE YOU REGISTERED WITH THIS SYSTEM PREVIOUSLY? Yes <input type="checkbox"/> No <input type="checkbox"/>			
			FOR OFFICE USE ONLY REGISTRATION NUMBER <input type="checkbox"/> INITIAL OF LAST NAME
			CONTINUED ON OTHER SIDE

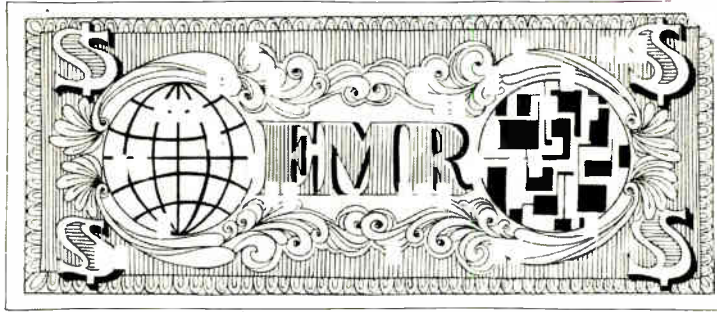

The cost of all this to you? Absolutely nothing. No fees or charges at any time.

Other advantages of EMR:

- Your resume is sent only to those companies that have a genuine requirement for your particular skills.
- There is no general "broadcasting" in the hope "someone will be interested."
- Your identity is protected because your name is released only according to your prior instructions. Your name can be deleted on request.
- EMR's service is nationwide. You may be considered for job opportunities anywhere in the U.S.

The Electronics Manpower Register is a powerful tool and should be considered when you are seriously seek-

ing a new position. And, although you may be reasonably happy in your present position, chances are that you might have that ideal job in mind.

This is why EMR makes good sense for you. If that job does turn up, you'll be there.

To get your name in the EMR file, just fill out the resume form and return to:

Electronics Manpower Register
330 West 42nd Street
New York, N. Y. 10036

Please enclose a copy of your resume if you have one. A detailed brochure further describing EMR will be sent to you.

Electronics Manpower Register

A computerized employment opportunity service

CONTINUED FROM OTHER SIDE				
Previous Position	Employer	City/State	From	To
Duties and accomplishments				
Previous Position	Employer	City/State	From	To
Duties and accomplishments				
GENERAL INFORMATION (Summarize your over-all qualifications and experience in your field. List any pertinent information not included above.)				
Current annual base salary	Total years of experience	Date available (within four months)	U.S. Citizen <input type="checkbox"/>	Non U.S. Citizen <input type="checkbox"/>
My identity may be released to: Any employer <input type="checkbox"/>	All but my present employer <input type="checkbox"/>	Have you security clearance?	Yes <input type="checkbox"/> No <input type="checkbox"/>	If yes, What level
Mail (with a copy of your resume, if you have one) to:				
Electronics Manpower Register			NO FEES	
ELECTRONICS			OR	
330 West 42nd St.			CHARGES	
New York, N. Y. 10036			EMR-16	



EMPLOYMENT OPPORTUNITIES



We have been placing B.S., M.S. and Ph.D.

ELECTRONIC ENGINEERS

in fee paid positions throughout the U.S. since 1959. Send resume today or request confidential application. We are graduate engineers, working full time . . . for you.

ATOMIC PERSONNEL, INC.

Suite L, 1518 Walnut St., Phila., Pa. 19102
AN EMPLOYMENT AGENCY FOR ALL TECHNICAL FIELDS

CIRCLE 952 ON READER SERVICE CARD

— RATES —

DISPLAYED: The advertising rate is \$79.00 per inch for all advertising appearing on other than a contract basis. Contract rates quoted on request.

An advertising inch is measured 7/8" vertically on a column—3 columns—30 inches to a page.

UNDISPLAYED: \$3.60 per line, minimum 3 lines. To figure advance payment count 5 average words as a line. Box numbers—count as 1 line.

Discount of 10% if full payment is made in advance for 4 consecutive insertions.

Not subject to Agency Commission.

Send new ads to:

ELECTRONICS

Class. Adv. Div., P.O. Box 12, N.Y., N.Y. 10036

electronic engineer

The Sperry Rand Research Center has a challenging position for an electronic engineer in the design and building of circuits for operating plasma panel displays. A good all-around circuit designer interested in digital circuit design will be considered. A knowledge of basic computer logic circuitry is desired and familiarity with high voltage electronic components. The individual selected will assist Ph.D. scientists in the laboratory construction of such circuits.

Please send resume of education and background experience in confidence to Mr. R. C. Davis, Employment Manager.



SPERRY RAND RESEARCH CENTER

SUDBURY, MASSACHUSETTS 01776

An Equal Opportunity Employer

CIRCLE 953 ON READER SERVICE CARD

ELECTRON TUBES

KLYSTRONS • ATR & TR • MAGNETRONS
SUBMINIATURES • C.R.T. • T.W.T. • 5000-
6000 SERIES

• SEND FOR NEW CATALOG A2 •

A & A ELECTRONICS CORP.
1083 PERRY ANNEX
WHITTIER, CALIF.
698-7544

CIRCLE 954 ON READER SERVICE CARD

Ministuid DISPENSER

AIR OPERATED

for miniature potting
and encapsulating

Available in 3 sizes
6cc - 12cc - 30cc



\$34.00

PHILIP FISHER COMPANY
7 CAMERON ST., WELLESLEY, MASSACHUSETTS 02181

CIRCLE 955 ON READER SERVICE CARD

Remember . . .

MAIL MOVES

THE COUNTRY

but . . .

ZIP CODE MOVES

THE MAIL

SEARCHLIGHT SECTION

AUTOTRACK MOUNT



360 degree azimuth, 210 degree elevation sweep with better than 1 mil. accuracy. Missile velocity acceleration and slewing rates. Amplidyne and servo control. Will handle up to 20 ft. dish. Supplied complete with control chassis. In stock—immediate delivery. Used world over by NASA, USAF, MP-61 B. Type SCR 584. Nike Ajax mounts also in stock.

PULSE MODULATORS

MIT MODEL 9 PULSER 1 MW—HARD TUBE

Output 25kv 40 amp., 30kv 40 amp. max. Duty cycle .002, 25 to 2 microsec. Also 5 to 5 microsec. and 1 to 5 microsec. Uses 6C21. Input 115v 60 cycle AC. Mfr. GE. Complete with driver and high voltage power supply. Ref: MIT Rad Lab. Series, Vol. 5, p. 152.

2 MEGAWATT PULSER

Output 80 kv at 70 amp. Duty cycle .001. Rep rates, 1 microsec 600 pps. 1 or 2 msec 300 pps. Uses 5948 hydrogen thyratron. Input 120/208 VAC 60 cycle. Mfr. GE. Complete with high voltage power supply.

250 KW HARD TUBE PULSER

Output 16 kv 16 amp. Duty cycle .002. Pulses can be coded. Uses 5D21, 715C or 4PR60A. Input 115 v 60 cy. AC \$1200 ea.

18 MEGAWATT PULSER

Output 150KV at 120 amps. Rep rate: 50-500 PPS. Pulse length: 5 msec. 15KV 120 amp. into pulse transformer. Rise time 1.5 msec. Filament supply 5V 80 amp. incl. 17.5KV 1.5 amp DC power supply. Input: 220V 60 cy AC.

INDICATOR CONSOLES

AN/SPA-42 PPI 10" range to 300 ml.
VJ-1 PPI 12" Range to 200 ml.
VL-1 RHI 12" to 200 ml. 60K ft.

SCR 584 AUTOTRACK RADARS

Our 584s in like new condition ready to go, and in stock for immediate delivery. Ideal for telemetry research and development, missile tracking, satellite tracking. Fully Desc. MIT Rad. Lab. Series, Vol. 1, pps. 207-210, 228, 284-286. Comp. Inst. Bk available \$25.00 each.



Radio-Research Instrument Co.

45 W. 45th St., New York, N.Y. 10036 ■ 212-586-4691

CIRCLE 956 ON READER SERVICE CARD

ANTI-AIRCRAFT GUN MOUNT

Will handle 6,000 lbs. rapid slew through 360° azimuth, 180° elevation. Mobile.

MICROWAVE SYSTEMS

200-2400 mc. RF PKG

Continuous coverage, 30 Watts Cw nominal output. Uses 2C39A. Price \$575.

L BAND RF PKG.

20 KW peak 990 to 1040 MC. Pulse width .7 to 1.2 micro sec. Rep. rate 180 to 420 pps. Input 115 vac incl Receiver \$1200

200-225 mc RADAR SYSTEM

1 Megawatt output 200 nautical mile range for long range detection of medium and high altitude jet aircraft as well as general search. AN/TTS 28

SURVEILLANCE DRONE RADAR SYSTEM

X-Band tracking system with plotting boards. Type AN/M1Q-29. Drone also in stock.

5 MEGAWATT C-BAND

Klystron RF package delivering nominal 5 megawatt pulse RF. Complete with pulser and power supply.

500 KW L BAND RADAR

500 kw 1220-1359 msc. 160 nautical mile search range P.R.I. and A scopes. MITI thyratron mod 5J26 magnetron. Complete system.

AN/GPG-1 SKY-SWEEP TRACKER

3 cm. automatic tracking radar system. Complete package with indicator system. Full target acquisition and automatic tracking. Input 115 volts 60 cycle.

New. In stock for immediate delivery. Entire System 6' long, 3' wide, 10' high. Ideal for Infrared Tracker, Drone Tracker, Missile Tracker, R. & D.

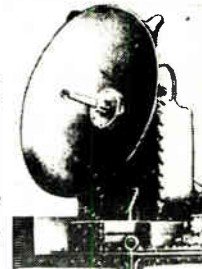

C Band Autotrack

1 Megawatt 10 ft. Parabola. Sperry.

40 KW TRANSMITTER

4 to 21 MHz. 40 kw Telegraphy, 30 kw Voice, can be SSB. New condition. Two systems in stock. Excellent for source, broadcast or point-to-point.

the one stop memory shop.



electronic memories



No one offers quite the range of things we do: cores, stacks and systems; aerospace, military and commercial.

All here.

Electronic Memories, Inc.,
12621 Chadron Avenue,
Hawthorne, California 90250
(213) 772-5201.

International Newsletter

June 9, 1969

Japanese ready hybrids for stereo

Watch for a wave of Japanese stereo radio and hi-fi sets built around thick-film hybrid circuits.

Eight such sets—one with a maximum power output of 180 watts—have been developed in a joint project funded by 17 Japanese components and set makers. The one-year project, which ended last month, was headed by Miyoshi Haradome of Nihon University.

Twelve companies developed circuits for the prototype receivers and two already are set to sell hybrids that came out of the project. Sanken Electric Co. has announced 50-watt power amplifiers and power supplies; Tokyo Shibaura Electric Co. (Toshiba) has a 30-watt hybrid power amplifier very close to mass production.

Plessey to produce plated-wire memory

The Plessey Co. will start delivering 250-nanosecond plated-wire memories this fall. The memories use nickel-iron plating on beryllium-copper wire and operate with destructive readout under control of TTL circuits [*Electronics*, Oct. 16, 1967, p. 231]. Modules range in capacity up to 16,384 words of 50 bits.

First production units are tagged for the 1900A series computers of International Computers Ltd. Plessey also has orders for the memories from a half-dozen other major European computer manufacturers.

A non-destructive-readout version of the memory is well along in development at Plessey.

Japanese calculator bound for Germany

Matsushita Communications Industrial Ltd. has confirmed reports that it has an export contract with West Germany's Olympia. The Japanese firm has agreed to ship 30,000 desk calculators to the German firm over a 12-month period starting next month; the machines will be sold under the Olympia brand.

This marks Matsushita's entry into the desk-calculator field. The firm neither sells a calculator on its home grounds nor does it expect to do so in the near future. Japanese sources expect that Olympia will reduce in-house production and rely on its Japanese supplier.

Although Matsushita won't discuss specifications for the calculator, industry sources say it is a four-function (add, subtract, multiply, and divide) unit with a 12-digit display. The machine is designed to handle 24-digit calculations by displaying alternately each half of register content; it has two memories.

Hawker Siddeley covers the infrared spectrum

By year-end, England's Hawker Siddeley Dynamics Ltd. plans to unveil a low-cost infrared thermal imaging system designed for industrial applications.

The price tag, now estimated at about \$5,000, is about half that planned for a prototype medical imager developed by E.M.I. Electronics Ltd. Moreover, it undercuts by a good two thirds the prices of the Swedish companies that have long dominated Britain's medical market. Hawker Siddeley's entry is a low-resolution system aimed directly at industrial outlets where medical accuracy is not required. Temperature resolution is 1°C, and the 30-line picture repeats at 16 frames per second.

International Newsletter

Message-switching gear gets smaller

Standard Telephones & Cables plans to have off-the-shelf computer-controlled message-switching systems ready to market by the end of the year. The equipment, aimed at the as-yet-untapped European market of medium-size companies, handles from 12 to 36 channels. So far, computer-controlled message systems have been limited for the most part to large outfits—like airlines—with many and far-flung branch offices.

First of the new STC systems, the 600ADX, will use a PDP-8 computer with a 65,000-word disk store backing up the basic 4,096-word memory. The back-up store, plus the applications package, is based on the large message-switching systems that STC has been selling for the past two years. Rental charges will start at \$1,800 monthly for the 12-channel version of the new equipment.

East Germans set to make color sets

East Germany will soon start production of Secam color-tv sets.

Under a license agreement just signed in Paris, state-owned East German firms have obtained the right to build tubes and receivers developed by the Compagnie Francaise de Television. CFT, also, has pledged technical support, and presumably will send technicians to East Germany. Color transmissions there are likely to start on Oct. 7, the country's 20th Anniversary.

West German industry officials expect color tv will start slowly in East Germany. Their reasoning: at present, black-and-white sets sell for \$500 in East Germany. If the usual European 2.5-to-1 ratio between prices of color and black-and-white sets holds for East Germany, color sets there will cost around \$1,250. East German workers' pay averages around \$175 a month.

Yugoslavs look West for color-tv know-how

Anticipating an eventual lusty color-tv market in East Europe, West Germany's Kuba-Imperial GmbH and Yugoslavia's Elektronska Industrija have agreed to exchange know-how in color-set production. The agreement runs for at least two years and most likely will be extended.

Elektronska Industrija, based in Nis, is Yugoslavia's biggest tv set producer. Kuba-Imperial, itself a large set maker, is a subsidiary of the General Electric Co.

Kuba-Imperial will help set up production lines, train personnel, and deliver color-set chassis for further assembly. The goal is for the Yugoslav firm to build, on its own, both PAL and Secam color sets. PAL is the color-tv system developed in West Germany, and Secam is the color-tv system developed in France.

Two for the money in Japan's N/C retrofit market

Japan's tight employment market has expanded outlets for labor-saving devices to the point where at least two firms have decided it's worthwhile to seek retrofit orders for equipping conventional machine tools with numerical-control systems. The two companies—Superior Electric Co. of the U.S. and Fujitsu Ltd. of Japan—are now offering extensive lines of open-loop systems for retrofit and, from all reports, making a go of it.

Such rework may well prove a one-shot proposition with no real long-term potential, according to Kawasaki Heavy Industries, an integrated manufacturing enterprise that's handling actual installations for Fujitsu. But at worst, the company believes, experience gained in this area could help controls producers when they develop new generations of labor-saving production systems.

Japanese show off calculators some with program, others low-priced

Spring business show in Tokyo leads some industry sources to predict prices of \$280 and wider popularity of printout devices

A new wave in the electronics industry may be in the making. After viewing the lineup of inexpensive and programmed calculators featured at Japan's spring business show in Tokyo, some in the industry predict it won't be too long before calculators with price tags of less than \$280 make their debut.

Also on display in profusion for the first time were calculators with printers. One effort in this direction is a dot-type discharge printer shown by Canon that uses a matrix of styluses to print by discharge on special paper.

The lowest-priced calculator on display was a twelve-digit model, developed by the Casio Computer Co. Ltd., at \$305.56. It multiplies and divides by a constant, and has a single, although limited, memory for accumulating sums. The Nippon Electric Co. and Hitachi Ltd. provide the calculator's MOS circuitry which ranges to LSI. The cost was reduced by discarding the decimal point from all calculations except division, thus trimming the amount of control circuits. Operation of the decimal point during division is automatic—dividing 4 by 3 results in 1.33.

Of interest among the other low-priced calculators is the fact that Toshiba's calculators have 16-digit registers, although only 12 digits are displayed. (The MOS IC's used were evidently designed for a larger calculator.) One advantage is that overflow is less frequent. The Canon calculator is the only low-priced one with a delay line used for registers—the others have MOS shift registers.

New calculators with programs

were shown by Sony, Casio, and the Sanyo Electric Co. Hayakawa showed its auxiliary program units, which were announced last autumn and first hit the market at the end of last year.

Sony's new 15-digit calculator, which will go on sale in September for about \$920, uses about 250 DTL packages rather than hybrid logic used in earlier calculators [*Electronics*, May 29, 1967, p. 213]. There are also 79 transistors and 117 diodes. Sony says use of magnetostriction delay lines enables the machine to provide high performance at relatively low cost. The delay line provides a total of 15 registers. The length of the delay line is the same as in the earlier calculator, which keeps the cycle

time the same and doesn't slow down calculation. To accomplish this, pulses less than one third the width of those in the earlier calculator were used. Pulse width is now slightly more than one microsecond, with spacing between pulses just a bit greater than the pulse width.

A rare line. The biggest problem in producing the memories for the new Sony calculator is the transducer used for writing. The pickup head is no special problem, nor are associated electronics. The line itself must be more stable to ensure operation with shorter width pulses, and requires a more stringent selection of materials. The result, however, was an improved line with more than three times



On display. Japanese calculators stole the thunder at Tokyo business show; printouts, programing, and lower prices were featured.

the memory capacity at a slight cost increase.

The Sony calculator has three registers for arithmetic operations, one for totals, four for use as memories, and four for storing programs, with three additional registers acting as either memories or storage—depending on the number of program steps. The calculator has a maximum of 111 steps.

Uses a sample. The calculator is programmed by running through a sample program, during which successive operations are stored. Variables are either inserted manually from keyboard or stored in memory. Constants can be stored as part of the program. They can also be stored in memory, but this wastes memory capacity. The calculator has displays for each of the program instructions, so the calculator can be run through program for checking. Individual steps can be corrected individually if necessary. Aside from normal steps for programs of this type, the Sony program also includes a jump. (By making use of this jump and inserting the appropriate number for control from the keyboard, programs for two separate sequences can be stored at once.)

Sony says that the large number of memories provided in its calculator makes it possible to obtain full use of the program feature, because intermediate results can be stored. It says programmed calculators with fewer memories can't perform as well. All the normal operations are possible with the Sony calculator. It measures 280-by-145-by-40-millimeters. Weight is 16.4 pounds, and power drain is 32 watts.

Casio has announced its 14-digit AL-2000, which will go on sale this July. It is an improved version of the AL-1000, which is programmed by code numbers through the keyboard. The new calculator can be programmed either by storing steps as one goes through a sample program, or by code, as in previous models. The program is checked against a display tube, which is operated in special mode. One through nine on the tube have the usual meaning, these same numbers when combined with the dec-

imal point in the tube refer to 11, 12, 13, etc. The numbers refer to a program code, which can include up to 30 steps; and steps may be divided between two separate program sequences if desired. This calculator has two memories to store numbers as well as constants. It is expected to cost around \$900.

Like the Sony machine the Casio machine has a selection of 14 different instructions, which are stored in four bits—the storage capacity needed for one decimal digit.

Dual memory. Sanyo has developed a 16-digit, two-memory calculator with up to 64 program steps. Constants can be stored in the program; however, it uses MOS shift registers, and all storage evaporates when power is turned off. Two memory registers allow the program steps to be divided into separate program sequences. It has a printout device rather than display tubes.

Price for the calculator, which goes on sale in July, is \$1,319.44. (A similar machine without the program feature costs \$1,097.22.)

Hayakawa Electric Co. showed its memorizers, which operate with Compet models 22, 32, 33, and printing calculator 50. Model 33, a variation of model 32, omits the automatic square root and sells for \$736.11.

When hooked up to a calculator, the model 30 memorizer, which lists at \$305.56, provides 30 program steps. The model 60, at \$444.44, has 60 steps. The units each have a total of 16 instructions, require six bits of core memory per instruction, and store constants in program. Displayed instructions allow the program to be checked at each step. It has a power drain of 27 watts.

Hayakawa says that with its memorizers, owners can retrofit their calculators for programming or attach them only as needed. On the other hand, a memorizer is more expensive to operate than a built-in program, since two of everything is required: for example, two power supplies. Look for Hayakawa to announce a calculator with a built-in program capability later this year.

Switzerland

Watch out



Good timing. Light-emitting diodes produce readout in stop watch.

If you've been accustomed to shrugging off the Swiss as makers of good cheese, chocolate, and 21-jeweled watches, you'd better start yodeling another tune. For deep in the picture-postcard mountains north of Geneva, those descendants of Wilhelm Tell have developed a solid state stop watch that not only uses integrated circuit logic but also a light-emitting-diode digital readout.

About the size of a cigaret pack, this little gem, dubbed Telesprint, is the latest creation of the 32-man staff of Longines Wittnauer's sports timing devices group which is located in the remote little hamlet of St. Imier.

Aimed primarily at the sporting crowd, Telesprint can be operated manually or actuated from a distance by such triggering devices as starting gates or photo cells. It runs for between two and three hours on rechargeable nickel cadmium batteries or for about 10 hours when connected to a small battery pack similar to a photographer's flash unit power supply. Timing is to 0.01 second; the device can also be used for split-action timing.

At the heart of the stop watch is a quartz crystal oscillator which is used as a time base. Equally interesting is the use of Hewlett-Packard's light-emitting diodes for digital readout. These gallium arsenide diode-matrix devices can be easily

read in daylight from a distance of several feet as well as at extremely wide vertical and horizontal off-axis viewing angles.

Because of power consumption, the Telesprint display can be turned off during a timing and turned on again when a reading is desired.

Although Telesprint is intended primarily for sports timing, Longines officials have already talked with spokesmen for the National Aeronautics and Space Administration in the U.S. about possible use of the stop watch in space applications where precise timing is also a necessity.

No firm price has been set for Telesprint, but a Longines spokesman says that in the U.S. it may sell for about \$700.

France

Components shortage

Consumer demand in Germany, France and elsewhere, coupled with the growing electronics needs of basic industries, has created severe shortages in components ranging from copper wire to semiconductors.

"We have orders for 1,000 color sets which we can't fill because we lack the components to make them," says Guy Desborde, director of the television department of the Thomson-Brandt Group, France's largest tv producer with 30% of the market. With the exception of speakers and picture tubes, just about every component in a color tv set is in short supply, he says.

Marc Schneider, vice president of Société Schneider Radio-Television, says he first noticed the situation at the end of 1968. "At first we lacked transistors," he says, "but the shortage is now spreading to resistors, capacitors and other classic components."

Responding to pressure at home, such German companies as Siemens, Telefunken, and Intermetal, which traditionally export components to France, have shut off ex-

ports and started importing French components—in a sense, throwing salt on the wound. At the big components show held in Paris every spring, "we usually have several dozen German companies who stop by, wanting to sell us components," says an official of the French Electronics Trade Association. "This year," he says, "we saw only one." Holland's Philips Gloeilampenfabrieken is also understood to have dried up its normal flow of components towards its French consumer products subsidiary, La Radiotechnique.

Christmas gift. In France, electronics industry sources generally agree the root of the problem lies in the phenomenal consumer demand that developed before Christmas. It was primed by the 12% average wage hikes that French workers won in last summer's strikes and was fed by consumer fears of a franc devaluation. "Everybody thought there would be a production slowdown after last May's revolt," says an official of SCS-France, the French subsidiary of Italy's Societa Generale Semiconduttori. "But tv sales were never as strong as at the end of 1968."

Some 18,000 color tv sets were sold in France during the first quarter of this year against only 7,000 in the same period of 1968. This growth accentuates the demand for components because a color set "takes three to four times as many components," as a black and white set, says one French manufacturer. And the lack of one little component can stop the whole assembly line.

Growing trend. Equally important, say industry officials, is the growing trend for non-electrical industries to use electronic components. Transistors are showing up in clocks and windshield wipers. Machine tools, process control equipment, and other products are making increasing demands on the output of component makers. And electronic equipment makers who formerly used tubes and relays are switching more and more to semiconductors—the area in which European components supplies are the tightest.

Declining prices over the past

few years made semiconductor manufacturers wary of investing in new production capacity. However, as demand has risen, prices have stabilized; but producers now can no longer keep up with market demand.

Full stream. The Toulouse plant of Motorola Semiconductor Products Inc. is operating at maximum capacity during two shifts. A third shift is virtually impossible in France because willing night workers can't be found, says Henri Marziale, Motorola's sales manager in France. "We are constantly increasing our capacity," says Marziale, "but the present market situation is making us expand more rapidly than we had planned." He figures the present semiconductor shortages could last as long as two more years, as tv sets and other products become more and more transistorized.

Motorola's French plant has not previously made germanium transistors for television tuners but has now started turning them out due to heavy customer demand. Other manufacturers are more wary about expanding. An SCS official says, "It's risky. We want to produce just enough and no more—otherwise in a year we'll have a surplus and prices will start falling again."

Share fear. The French Electronics Trade Association shares this fear. Component delivery delays of three months and longer are making customers place the same orders with several suppliers to protect themselves. "It's difficult to say how much people are buying for their present needs and how much they're hedging against the future," says an association official, who fears components makers could be overproducing by the end of this year.

Several European governments have been taking measures to cool consumer spending. The French, for example, have cut credit payments on color tv sets from a maximum of 24 months to only 18 months.

Anxious to eliminate the components shortages but, at the same time, forestall overproduction, the French Trade Association has launched a study of market forces

and hopes within a few weeks to come up with a plan to accomplish both feats. "We need a quick decision," says an official. "It takes time to build components plants."

Great Britain

Gunn channel

For 14 years the British army has been using truck-borne electron tube equipment for line-of-sight radio-telephone communications between forward battle positions and military encampments in the rear. Next year this will all change: the Army is retiring its bulky, rather antiquated system in favor of a solid state transceiver. The odds-on choice is a unit that uses a local oscillator based on a Gunn diode in the receiver section.

Compared to older klystron-based systems, the new transceiver, developed by John Johnson for the government's Signals Research and Development Establishment, is smaller, lighter by about 50%, and requires less power to operate over the same 25-mile line-of-sight range. For example, a klystron consumes 100 watts of power supplied by a power pack weighing 45 pounds; its solid state replacement uses only 15 watts and can run directly from a 12- or 24-volt battery pack. Further, the 14-year-old communicator has only four telephone channels at 4 gigahertz while the successors have a capacity of 16-pulse-code-modulated channels at 8 Ghz.

Currently, three breadboard models measuring 15 x 9 x 8 inches are being evaluated by the British Ministry of Defense, but Johnson has revamped the component layout to reduce the transceiver's size to 15 x 4½ x 4½ inches for production models.

Dish it out. The antenna for the system is an 18-inch dish with 27-decibel gain. The dish is carried on top of a telescopic mast which can be raised 40 feet.

The transceiver, apart from the local oscillator, is fairly conventional. The transmitter power re-

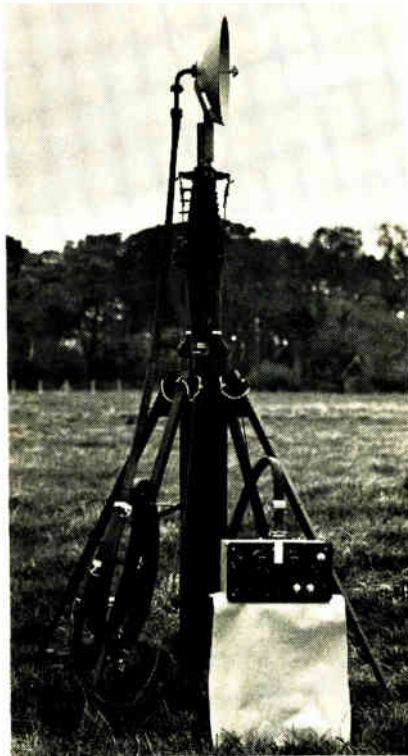

Line of sight. Gunn diode featured in receiver portion of new transceiver

quirement is beyond the capability of a Gunn diode so a varactor harmonic multiplier chain, which meets the army's all-solid-state specification, is used. A 7-watt input gives 0.25 watt output.

The receiver is an orthodox superhet using a triline rate-race ring mixer which has a noise figure of 7 db. The mixer takes 2 milliwatts of local oscillator power through a 3-db line attenuator from a standard Mullard Gunn diode. The receiver has a bandpass of 1 megahertz—sufficient for a frequency-modulated carrier with a maximum information switching rate of 600 kilobits per second, the equivalent of 16 pcm telephone channels. To minimize jamming, the receiver should be tuned through a range of 250 Mhz.

Keystone. The local oscillator resonates at 50 Mhz below signal frequency. Johnson has mounted the Gunn diode within a quarter-wave coaxial resonator; it's the combination of methods he has devised to tune the resonator over the 250-Mhz range that he believes is the unique feature of the system.

The diode is inside the center

post of the resonator, but is not fixed to it. To provide for initial adjustment of the diode within the center post, the local oscillator body has a movable and lockable end-plate coupled to a shaft that extends through the local oscillator body into the center post. The diode is attached to the shaft, and when its desired frequency is reached, the end-plate is locked.

Preliminary preset tuning adjustment to the nominal frequency is obtained by tuning-screw adjustments. The frequency of the Gunn diode oscillator can be phase-locked by a varactor diode. But to minimize heat problems, the varactor is separated from the cavity by a half wavelength; at that distance it's the same electrically as if it were right in the cavity.

Discovery. To vary the characteristic impedance of the cavity, the diameter ratio of the two coaxial elements—inner and outer conductors—has to be varied. Electrically, this can be achieved by moving only part of the wall of the outer conductor relative to the inner conductor. Physically, it is not easy to arrange for a sizable portion of an outer diameter to close in evenly and regularly on an inner diameter, but because Johnson had to obtain tuning over only a narrow frequency band he found that satisfactory electrical variation was possible by moving only a small segment of the outer diameter wall toward the inner conductor.

The segment is small enough—20°—to move in and out as a single shutter block, extending over the length of the cavity, with its edge parallel to the center post axis. In this way, ground-plane capacitance of the center conductor increases uniformly as the shutter moves toward it.

With the cavity diameters used by Johnson, 50 mils of movement of the shutter toward the center post give 250-Mhz tuning. The relationship is highly nonlinear, and in the production versions for operational use it will be linearized relative to the screw adjustment by the profile of a taper in the mechanical linkage between screw and shutter. Mechanical tolerances have to be tight—about 0.5 mil.

Electronics advertisers

June 9, 1969

A C D C Electronics	83	Electronic Memories	200	Mosaic Fabrications Div., The Bendix Corp.	127
Chiat/Day, Inc. Adv.		Chiat/Day, Inc.		Van Christo Associates Inc.	
Acopian Corp.	129	E/MC Electronics/Management Center	126	Motorola Communications & Electronics Inc.	195
Mort Barish Assoc.		Slesar & Kanzer, Inc.		Griswold Eshleman Company	
ADC Products	63	Emerson & Cuming Inc.	178	Motorola Semiconductor Products Incorporated	12-13
John Gompper & Assoc.		Edwin F. Hall		Lane & Bird Adv. Inc.	
Adret Electronique	32E	Erie Technological Products Co., Inc.	39	M & T Chemicals Inc.	195
Perez Publicite		Arthur Schmidt International, Inc.		Marsteller Inc.	
Alcatel	9E	Fairchild Controls	135	National Semiconductor Corp.	78-79
Agence Rene Sicard		Dunwoodie Assoc., Inc.		Hall Butler Blatherwick Inc.	
Alco Electronic Products, Inc.	187, 189, 191	Fairchild Semiconductor, Inc.	10, 11, 66 to 73, 150, 151	Omron Tateisi Electronics Company	6E-7E
Marketronics Adv.		Chiat/Day, Inc.		Dai-Ichi International Inc.	
Allen-Bradley Co.	29, 31	Ferisol	202B	Onan Division of Studebaker Corp.	19E
Fensholt Adv. Agcy.		Agence Domenach		Campbell Mithun Inc.	
American Telephone & Telegraph Co.—Yellow Pages	20	Fluke Manufacturing Co., John Bonfield Assoc.	14	Oltronic Svenska	21E
Cunningham & Walsh, Inc. Adv.		Fluoroware	193	Patwin Electronics	188
Ammon Instruments, Inc.	192	Colle & McVoy Adv. Agcy., Inc.		Graceman Advertising Inc.	
Culver Adv., Inc.		Gardner-Denver Co.	24, 25	Permag Corporation	172
Amperite Co.	146	Buchen Adv., Inc.		Schneider, Allen, Walsh Incorporated	
H. J. Gold Co.		Gencom Division—Whittaker Corp.	140	Philco Ford Company, Microelectronics Division	171
Anaconda American Brass Co.	22, 23	A. D. Adams Adv., Inc.		The Aitkin-Kynett Company Inc.	
Wilson, Haight & Welch, Inc.		General Electric Co., Silicone Products Div.	82	Philco Ford Corporation	
Andrew Corp.	74	Ross Roy of New York, Inc.		Sierra Electronics Operation	27
Fensholt Adv., Inc.		General Electric Co.	29E	Hal Lawrence Inc.	
Arnold Engineering Co.	42, 43	Robert S. Cragin, Inc.		Plastic Capacitors Inc.	176
Buchen Adv., Inc.		General Instrument Corp., Semiconductor Products Div.	46	Sander Rodkin Adv. Agency Ltd.	
Astrodata, Inc.	162	Norman Allen Assoc.		Potter & Brumfield Div., American Machine & Foundry Corp.	32-33
Jansen Assoc., Inc.		General Magnetics, Inc.	55	Grant, Schwenck & Baker Incorporated	
Ates Componenti Elettronici, S.P.A.	20E	Carpenter, Matthews & Stewart, Inc.	2nd Cover	Power/Mate Corporation	148
Publicitas		General Radio Co.		Caroe Marketing Inc.	
Avtel Corp.	56	Horton Church & Goff, Inc.		Precision Instrument Co.	144
Tri-Tech/Services		Hayakawa Electric Co., Ltd.	185	Hal Lawrence Inc.	
Beckman Instruments, Inc., Helipot Div.	88	Dai-Ichi International, Inc.		Precision Paper Tube Co.	60
N.W. Ayer/Jorgensen/MacDonald, Inc.		Heinemann Electric Co.	6	T. W. Blakeslee Advertising	
Bendix Corp., Semiconductor Products Div.	132	Thomas R. Sundheim, Inc.		Radiation Inc.	57
MacManus, John & Adams, Inc.		Hewlett Packard, Frequency & Time Div.	2, 102, 103, 104	W. M. Zemp & Associates Inc.	
Bishop Graphics, Inc.	192	Lennen & Newell, Inc.		Radio Corporation of America	4th Cover
J. R. Bloome Co.		Hewlett Packard, Loveland Div.	147, 180	Al Paul Lefton Co.	
Blue M Electric Co.	191	Tallant/Yates Adv.		Raytheon Semiconductor	59
South Suburban Advertising		Hewlett Packard, Palo Alto Div.	168	Botsford, Constantine & McCarty Inc.	
Boonton Electronics Corp.	170	Lennen & Newell, Inc.		RCL Electronics Incorporated	176
The Creative Group		Hewlett Packard, Rockaway Div.	134	Morvay Advertising Agency	
Bourns, Inc., Timpot Div.	149	Culver Adv., Inc.		Reeves Instrument Division	138
Lester Co., The		Hewlett Packard, San Diego Div.	1	Duncan-Brooks Inc.	
Brush Instruments Div. of Clevite Corp.	131	Lennen & Newell, Inc.		Remvac Components Inc.	36
Carr Liggett Adv., Inc.		Honeywell, Computer Control Div.	34	Caroe Marketing Inc.	
Bulova Watch Co., Electronics Div.	64	Creamer, Trowbridge Case & Basford, Inc.		R F Communications Inc.	193
Caroe Marketing, Inc.		Hughes Aircraft Co.	40	Beachner Advertising Agency	
Bunker-Ramo Corp., The	3rd Cover	Foote, Cone & Belding		Rohde & Schwarz	18E
Marsteller, Inc.		I B M Corporation	65	Sage Electronics Corporation	30
Bussmann Mfg. Div. of McGraw Edison Co.	86	Ogilvy & Mather, Inc. Adv.		Mathison Advertising Inc.	
Henderson Adv. Co.		International Crystal Mfg. Co.	137	Sangamo Electric Company	167
Cerro Copper & Brass Co.	189	Robert V. Freeland & Assoc.		Winius Brandow Co.	
Feeley & Wheeler, Inc.		Ithaco, Inc.	208	Schlumberger Ltd. EMD	2E
Clevite Corp., Piezoelectric Div.	193	Hart-Conway Co., Inc.		Schlumberger SIS	202A
Carr Liggett Adv., Inc.		ITT Wire and Cable		Sodipa	
CMC, A Div. of Pacific Industries	61, 62	MacManus, John & Adams, Inc.		Schlumberger SOMV	4E
Jones, Maher, Roberts, Inc.		Judson Research & Mfg. Co.	195	T. B. Browne Ltd.	
Codex Corp.	49	Williams and Avery Adv. Agcy.		Schneider R. T.	31E
Creamer, Trowbridge, Case & Basford, Inc.		Keppo, Inc.	81	Noirclerc Publicite	
Cohu Electronics, Inc.	166	Weiss Advertising		Scientific Data Systems	50
Control Products Div., Texas Instruments Incorporated	208	Lambda Electronics Corp.	17, 18, 19	Doyle, Dane, Bernback Inc.	
Horton, Church & Goff, Inc.		Michel Cather, Inc.		Sercel	14E
Cosmicar	28E	Lockheed Electronics Co.	156	Termost Technique	
C.R.C.	12E	McCann-Erickson, Inc.		S. H. Couch Division, ESB Incorporated	85
IRP		Loeb, Rhoades & Co.		Culver Advertising Inc.	
CREI, Home Study Div. of the McGraw-Hill Book Co.	179	Doremus & Co.		Sifco Metachemical	172
Henry J. Kaufman & Assoc.		LTT	10E, 11E	The W. N. Gates Company	
CTS Corp.	210	Promotion-Vente-Publicite		Signetics Corp.	
Reincke, Meyer & Finn, Inc.		Marconi Instruments	128	Sub. Corning Glass Works	125
Damon Engineering, Inc.	109	McCarthy, Scelba & DiBiasi Adv. Agcy., Inc.		Cunningham & Walsh Inc.	
L. K. Frank Co., Inc.		Marconi Instruments Ltd	8E	Siliconix Inc.	15
Data Technology, Instrument Div.	174	Taylor Advertising Ltd.		Graphics West	
Coakley Heagerty, Inc.		Markel & Sons, L. Frank	164-165	Sogie	23E
Delta Products, Inc.	184	George Moll Adv. Inc.		Etudes et Creations Publicitaire	
Noble De Roin & Assoc.		Metrodata Systems Inc.	141	Solartron Electronics Group Ltd.	3E
Digital Equipment Corp.	152	Robert V. Freeland & Associates		T. B. Browne Ltd.	
Kalb & Schneider, Inc.		Microdot Incorporated	182-183	Solartron Electronics Group Ltd., Digital Instrumentation	13E
Dow Corning International Ltd.	16E, 17E	Gumpertz, Bentley & Dolan Advertising		T. B. Browne Ltd.	
Marsteller International S.A.		Monsanto Company	47	Solartron Electronics Group Ltd., Hybrids	15E
DuPont de Nemours & Co., Freon Div.	130	Michel Cather, Inc.		T. B. Browne Ltd.	
N. W. Ayer & Son, Inc.		Morgan Group, The	24E	Sorensen Operation Raytheon Company	77
Eastman Kodak Co., Technical Corporate Adv.	177	Scientific Advertising & Marketing Ltd.		Urrutia & Hayes Inc.	
Rumrill Hoyt, Inc.		Mosaic Fabrications Div., The Bendix Corp.		Space & Systems Div.	
Ebauches S.A.	25E	Van Christo Associates Inc.		General Time Inc.	9
Claude Langel		Motorola Communications & Electronics Inc.		Alden Adv. Agcy, Inc.	
E G & G Incorporated	7	Griswold Eshleman Company		Spectrol Electronics Corp.	7
Culver Adv., Inc.		Motorola Semiconductor Products Incorporated		J M R Incorporated	
EL Instruments, Inc.	136	Lane & Bird Adv. Inc.		S. P. Elettronica	26E-27E
Froehlich Adv. Services		M & T Chemicals Inc.		Studio Sergio Rosata	
Elasco, Inc.	154	Marsteller Inc.			
Elco Corp.	41				
Schaefer Adv., Inc.					

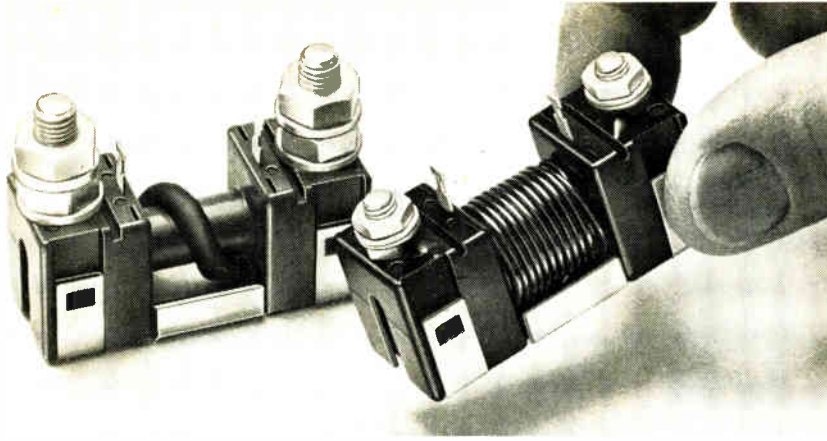

New current & voltage sensor cuts circuit protection costs.

This new electro-magnetic device senses excessive current or voltage overloads. It provides a low-level output switching (10 watts max, 50 V DC or 24 V AC) to activate warning devices or magnetic circuit breakers. The 2SC can respond in one millisecond in instantaneous configurations or provide up to 100 sec delay at 200% overload when the hydraulic/magnetic time-delay feature is specified. Requiring only one-fifth the power of a breaker, it reduces wiring costs substantially. The output switching is hermetically sealed.

Available in ratings from 0.001 to

100 amps and 3 to 60 volts, this T.I. development meets demands for remote and multi-channel sensing in data process equipment, aircraft, military communications, machine tool and other automatic machinery. KLIXON® 2SC sensors cost about 35% less than equivalent breakers, but are two to three times more accurate, thanks to a patented calibration technique.

Bulletin CIRB 36 contains complete data. Write for your copy today to T. I. Control Products Division, Attleboro, Mass. 02703, or phone (617) 222-2800, Ext. 368.



TEXAS INSTRUMENTS INCORPORATED

Circle 228 on reader service card



Someone builds
an amplifier
that's just a
little bit better...

***Ithaco's
the One!***

ITHACO builds and stocks a complete line of low-noise preamplifiers and compatible postamplifiers. Existing designs can be rapidly adapted to your special requirements at reasonable cost.

Some of the things we do best are reflected in our line of standard products

- bandwidths from .0001Hz to above 1 MHz
- state-of-the-art noise performance at any impedance level
- voltage or charge inputs; single ended or differential
- fully automatic, Auto-Gain*, computer-oriented, data acquisition systems

*Registered trademark

Typical application for Ithaco's amplifiers include:

Shock & Vibration—Acceleration, velocity, displacement, dynamic strain

Acoustics—In air or underwater

Seismic—Long and short period systems

Scientific—Infra-red, bio-medical . . . any dynamic phenomena

O.E.M.—In any quantity

Write or phone for complete specifications, prices, and application information:

607 272-7640

ITHACO INC.

413 TAUGHANNOCK BLVD., ITHACA, N. Y. 14850

Sprague Electric Company	5
Harry P. Bridge Company	
Stanpat Products Inc.	185
Morton Advertising Inc.	
□ Ste Jules Richard	22E
PVP	
Struthers Dunn Inc.	173
Harry P. Bridge Company	
Switchcraft Inc.	48
Buti-Roberts Advertising	
■ Tech Laboratories Inc.	185
Lewis Advertising Agency	
Tempress Research Company Inc.	21
Hal Lawrence Inc.	
■ Texas Industrial Commission	195
The Pitluk Group	
Texas Instruments Incorporated,	
Components Group	44-45, 188-190 192-194
Albert Frank-Guenther Law Inc.	
□ Texas Instruments France	5E
Dumesnil Publicite	
■ Texscan Corporation	16
Burton Browne Advertising	
Triplett Electrical Instrument	
Company	155
Burton Browne Advertising	
TRW Semiconductors Inc.	142-143
Fuller & Smith & Ross Inc.	
■ Tung-Sol Division,	
Wagner Electric Corporation	186
Feeley & Wheeler Inc.	
Tyco Laboratories Inc.,	
Instruments Division	161
Kenyon & Eckhardt Inc. Adv.	
Tyco Laboratories Inc.,	
Sherold Crystal Products Group	28
Kenyon & Eckhardt Inc. Adv.	
United Aircraft Electronic Components	80
Cunningham & Walsh Inc. Advertising	
Union Carbide Corporation,	
Semiconductor Dept.	84
Windfield Inc. Adv.	
University of Connecticut	190
Utah Industrial Promotion Commission	209
David W. Evans & Associates	
■ Varo Inc.	26
Tracy-Locke Inc.	
Wang Laboratories	158
Impact Advertising Inc.	
Watkins-Johnson Company	160
Williams C. Estler Advertising	
■ Weinschel Engineering Company	178
E. G. White Advertising Inc.	
Westinghouse Electric Corporation,	
Semiconductor Div.	87
Pritchard Wood Associates Inc.	
Zeta Laboratories Inc.	58
Frank Haylock	

Classified & Employment Advertising

F.J. Eberle, Manager
212-971-2557

EMPLOYMENT OPPORTUNITIES . . . 196-199

Atomic Personnel, Inc. 196

General Electric Co, Aerospace Electronics 199

Sperry Rand, Research Center. 199

EQUIPMENT (Used or Surplus New) For Sale

A&A Electronics Corp. 199

Fishman, P. Co. 199

Radio Research Corp. 199

- For more information on complete product line see advertisement in the latest Electronics Buyer's Guide
- Advertisers in Electronics International

Electronics Buyers' Guide

George F. Werner, General Manager
[212] 971-2310

Robert M. Oenmead,
Midwest Regional Manager

[312] MQ 4-5800

William A. Capuzzi,
New York, New England District Manager

[212] 971-3793

Regina Hera, Directory Manager

[212] 971-2544

Thomas M. Egan, Production Manager

[212] 971-3140

Circulation Department

Isaac Siegal, Manager [212] 971-6057

Research Department

David Strassler, Manager [212] 971-6058

Advertising Sales Staff

Frank E. LeBeau [212] 971-6464
Advertising Sales Manager

Wallis Clarke [212] 971-2187
Assistant to sales manager

Donald J. Austermann [212] 971-3139
Promotion Manager

Warren H. Gardner [215] LO 8-6161
Eastern Advertising Sales Manager

Atlanta, Ga. 30309: Michael H. Miller, 1375
Peachtree St., N.E.
[404] 892-2868

Boston, Mass. 02116: William S. Hodgkinson
McGraw-Hill Building, Copley Square
[617] CO 2-1160

Cleveland, Ohio 44113: William J. Boyle, 55
Public Square, [216] SU 1-7000

New York, N.Y. 10036
500 Fifth Avenue
James R. Pierce [212] 971-3615
John A. Garland [212] 971-3617
Michael J. Stoller [212] 971-3616

Philadelphia, Pa. 19103:

Jeffrey M. Preston
Warren H. Gardner,
6 Penn Center Plaza,
[215] LO 8-6161

Pittsburgh, Pa. 15222: Warren H. Gardner,
4 Gateway Center, [412] 391-1314

Rochester, N.Y. 14534: William J. Boyle,
9 Greylock Ridge, Pittsford, N.Y.
[716] 586-5040

Donald R. Furth [312] MO 4-5800
Midwest Advertising Sales Manager

Chicago, Ill. 60611: Kenneth E. Nicklas
Ralph Hanning 645 North Michigan Avenue,
[312] MO 4-5800

Dallas, Texas 75201: Richard P. Poole, 1800
Republic National Bank Tower,
[214] RI 7-9721

Houston, Texas 77002: Robert Wallin,
2270 Humble Bldg. [713] CA 4-8381

Detroit, Michigan 48226: Ralph Hanning,
856 Penobscot Building
[313] 962-1793

Minneapolis, Minn. 55402: 1104 Northstar
Center [612] 332-7425

St. Louis, Mo. 63105: Kenneth E. Nicklas,
The Clayton Tower, 7751 Carondelet Ave.
[314] PA 5-7285

James T. Hauptli [415] DO 2-4600
Western Advertising Sales Manager

Denver, Colo. 80202: Joseph C. Page, David
M. Watson, Tower Bldg., 1700 Broadway
[303] 255-5484

Los Angeles, Calif. 90017: Ian C. Hill,
John G. Zisch, 1125 W. 6th St.,
[213] HU 2-5450

Portland, Ore. 97204: James T. Hauptli,
Thomas McElhinny, 218 Mohawk Building,
222 S.W. Morrison Street,
Phone [503] 223-5118

San Francisco, Calif. 94111: James T. Hauptli,
Thomas McElhinny, 255 California Street,
[415] DO 2-4600

Pierre Braude Tel: 225 85 88: Paris
European Director

Paris: Denis Jacob
88-90 Avenue Des Champs-Elysees, Paris 8
United Kingdom and Scandinavia

London: Oliver Ball, Tel: Hyde Park 1451
34 Dover Street, London W1

Milan: Robert Saidel, Roberto Laureri Jr.
1 via Baracchini Phone 86-90-656

Brussels: F.I.H. Huntjens
27 Rue Ducale Tel: 136503

Frankfurt/Main: Hans Haller
Elsa-Brandstroem Str. 2
Phone 72 01 81

Geneva: Denis Jacob
1 rue du Temple Phone: 31 95 60

Tokyo: McGraw-Hill
Publications Overseas Corporation,
Kasumigaseki Building 2-5, 3-chome,
Kasumigaseki, Chiyoda-Ku, Tokyo, Japan
[581] 9811

Osaka: Akihiko Kamesaka, McGraw-Hill
Publications Overseas Corporation, Kondo
Bldg., 163, Umegae-cho Kita-ku [362] 8771

Business Department

Stephen R. Weiss, Production Manager
[212] 971-2044

Thomas M. Egan,
Assistant Production Manager [212] 971-3140

Dorothy Carmesin, Contracts and Billings
[212] 971-2908

Frances Vallone, Reader Service Manager
[212] 971-2865

100 years after the Golden Spike . . . Utah is still the state of innovative minds

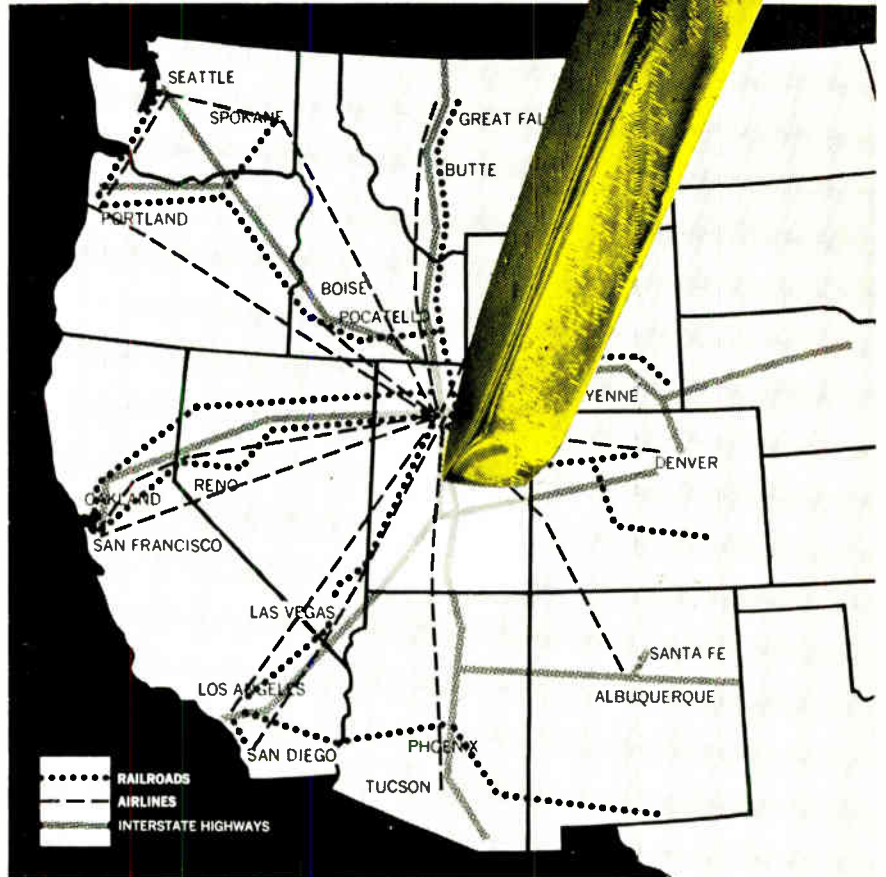

Just a century after conquering a continent at Promontory, Utah, men of caliber and vision have turned their minds and energy toward new technological conquests in Utah.

The idea of iron rails spanning the continent must have seemed as remote to a "forty-niner" as the notion of man soaring to the moon seemed to many only ten years ago.

Just as Utah gained its niche in the annals of rail transportation, so too Utah is becoming a center for space-age technology.

Univac, Eimac, General Instrument, Thiokol, Signetics, Hercules, Litton, Marquardt.

Datacap and I-T-E Imperial are just a few of the companies that have discovered Utah for technical talent and plant development.

They all give high grades for Utah's productive labor; They find recruiting easy from Utah's pool of Technical Talent;

Utah also offers:

- Guaranteed Engineering Talents •
- Productive, Trainable Workers •
- High Educational Achievement •
- Favorable, Balanced Taxes •
- Stable, Uncongested Communities.

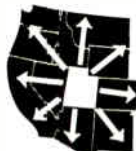

Win the WEST .. from
UTAH!

For more information, call or write:

Governor Calvin L. Rampton
Dept 119 / State Capitol
Salt Lake City, Utah 84114

Name

Company

Type of Business

Address

City, State, Zip

new mil-performance square cermet trimmers from CTS

Now . . . with CTS Cermet Multi-Turn Square Trimmers you get Characteristic C Mil-spec performance for all military applications. All new series 165 (style RJ24) and series 175 (style RJ22) meet tough Characteristic C of Mil-R-22097C. These same environmental characteristics are available . . . at lower cost . . . for commercial and industrial applications.

Both small $\frac{3}{8}$ "-square series 165 and compact $\frac{1}{2}$ "-square series 175 trimmers assure infinite resolution over a 20 ohm to 2.5 megohm range . . . and power rating of $\frac{1}{2}$ watt @ 85°C. TC ± 150 ppm/°C for 2k ohms and above. $-0 +175$ ppm/°C from 50 ohms through 250 ohms and $-0 +250$ ppm/°C from 500 ohms through 1k ohm. All available at no extra cost.

Low cost*, proven quality, and top performance—combined with **fast distributor delivery**—make CTS your best industrial trimmer choice. Can't use one of our standard series? Ask how we can solve specific application problems. Call or write for complete details to CTS of Berne, Inc., Berne, Indiana 46711. Phone (219) 589-3111.

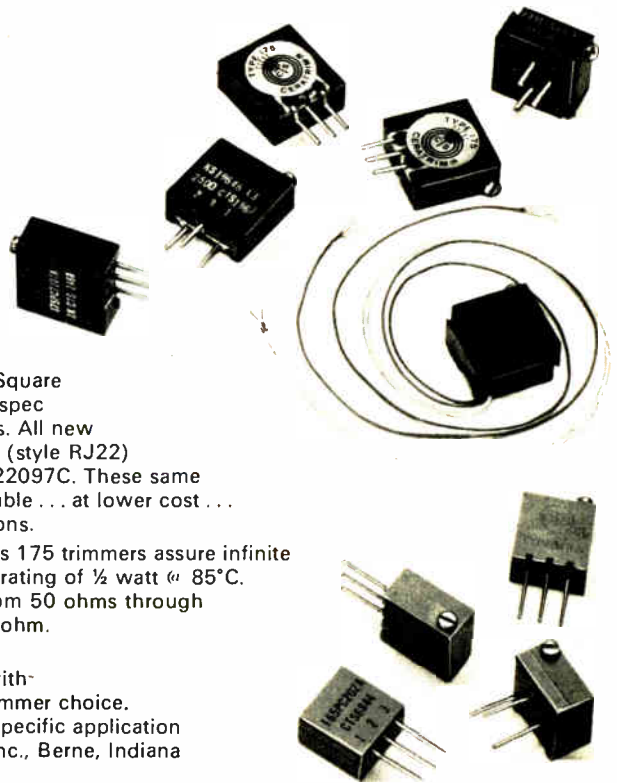







*Check these prices for 4-6 week production delivery. (Small quantities from stock)

Quantity	Series 165		Series 175	
	25-49 (each)	1000 (each)	25-49 (each)	1000 (each)
Commercial ($\pm 20\%$ Tol.)	\$4.55	\$3.25	\$4.20	\$2.95
MIL-type ($\pm 10\%$ Tol., Char. C)	5.30	3.80	5.10	3.65

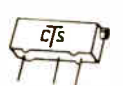

CTS CORPORATION
Elkhart, Indiana

Other CTS Cermet Trimmers include:

 Series 185 1- $\frac{1}{4}$ " x .290" x .364" multi-turn	 Series 190 $\frac{3}{4}$ " x .160" x .310" multi-turn	 Series 340 $\frac{1}{4}$ " x $\frac{1}{4}$ " square x .270" high—single-turn	 Series 360 $\frac{1}{16}$ " x $\frac{1}{16}$ " x $\frac{1}{16}$ " x $\frac{1}{16}$ " single-turn	 Series 385 $1\frac{1}{32}$ " round x .225" high—single-turn	 Series 660 $\frac{3}{16}$ " round x $\frac{1}{4}$ " high— single-turn	 Series 630 $\frac{1}{8}$ " round x $1\frac{1}{32}$ " high— single-turn
--	---	--	--	--	---	--

With Film-Met, only the case is the same.

Inside, it's a whole new trimmer.

The element* is made by an exclusive Amphenol patented process. We use a vacuum deposition chamber to evaporate 100% metal alloys onto insulating substrates—then protect them against oxidation with noble metal overlays.

The result is trimmer performance neither wirewounds nor cermets can match. Only Film-Met™ offers both infinite resolution and a low temperature coefficient of 100 ppm/°C. (50 ppm/°C is available on request.)

Film-Met trimmers have excellent high frequency and pulse characteristics and low contact resistance variation. Their low thermal and current noise features are comparable to metal film fixed resistors.

The new Amphenol Film-Met trimmer line isn't designed to replace wirewounds and cermets in every application. What Film-Met performance does is eliminate circuit design compromise. By adding these trimmers to our line of cermets and wirewounds, we can now match your performance needs perfectly.

To see how Film-Met trimmers perform, contact your local Amphenol distributor or sales engineer. Or write to Amphenol Controls Division, Janesville, Wisconsin.

This could be what you've been waiting for. A whole new trimmer!

Film-Met™ by Amphenol

*U.S. Patent No. 3,353,134; also foreign patents.

Film-Met



AMPHENOL
THE BUNKER-RAMO CORPORATION

Circle 901 on reader service card

First 200 MHz IC Amplifier Array

RCA-CA3049 for -55° to 125° C operating temperature, \$1.95 (1,000 units)

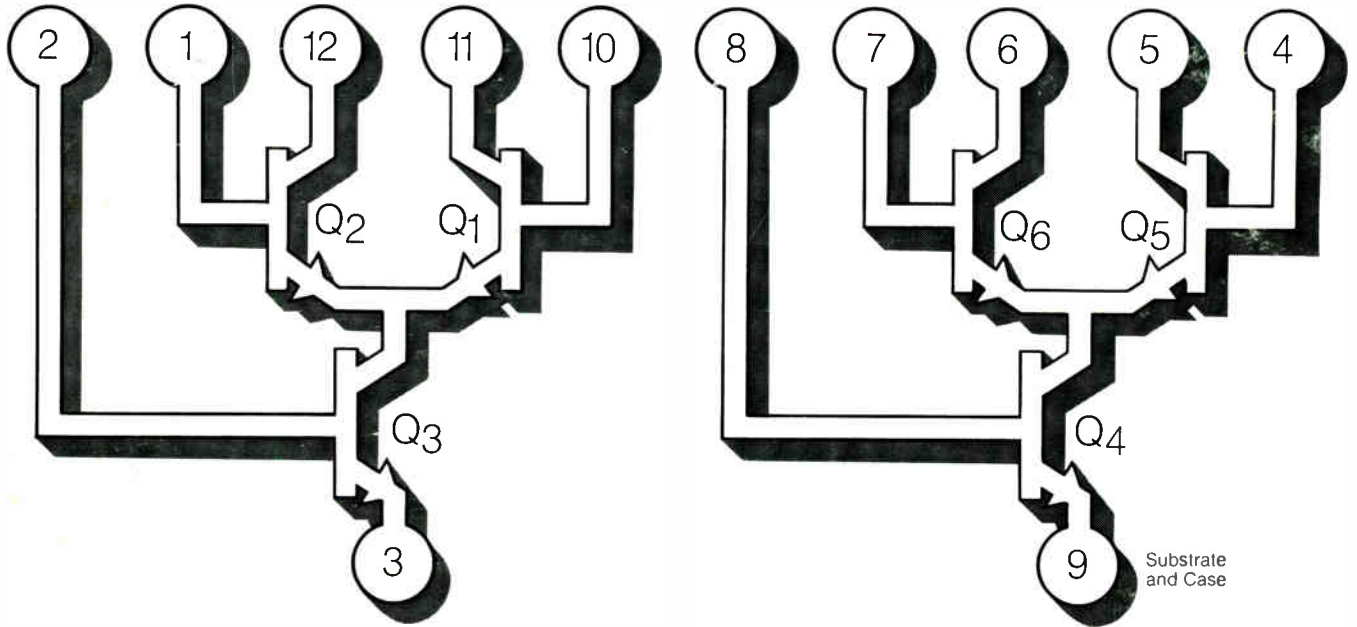

Here's another of RCA's growing family of "building block" IC's—usable as high-speed sense amplifiers, low noise IF and RF amplifiers, balanced mixers, wideband amplifiers, oscillators, and many more.

It's the RCA-CA3049—a pair of differential or cascode amplifiers on a single chip. Each amplifier provides a transducer power gain of 23 dB (typ.) in a cascode connection at 200 MHz with a current of only 2 mA. This unit—useful to 500 MHz—marks another "first" for RCA stemming from new high-frequency IC design and production techniques.

Ask your local RCA Representative or your RCA Distributor for details. Or for complete technical information, write RCA Electronic Components, Commercial Engineering, Section ICN6-1, Harrison, N. J. 07029.

RCA Linear Arrays for Design Flexibility

RCA-CA3018	Two isolated transistors plus Darlington pair	\$.98 (1000 units)
RCA-CA3018A	Same unit with performance characteristics controlled from $10 \mu\text{A}$ to 10 mA	1.35 (1000 units)
RCA-CA3026	Dual independent diff amps for DC to 120 MHz	1.25 (1000 units)
RCA-CA3045	3 isolated transistors and 1 diff pair for -55° to $+125^{\circ}$ C operation, DC to VHF (DIC package)	1.50 (1000 units)
RCA-CA3046	Same as CA3045 but in dual-in-line plastic package (0° C to $+75^{\circ}$ C operation)	.98 (1000 units)
RCA-CA3050	Two Darlington-connected diff amps with diode bias string: -55° to $+125^{\circ}$ C, DC to 20 MHz operation (DIC)	2.25 (1000 units)
RCA-CA3051	Same circuit for 0° C to $+75^{\circ}$ C operation (DIP)	1.65 (1000 units)

RCA
Integrated
Circuits

Circle 902 on reader service card