

Canton Observer

Volume 2 Number 23

Monday, January 24, 1977

Canton, Michigan

24 Pages

Twenty-Five Cents

Year-round class may be coming to 4 schools

By GLENN BUNTING

The Plymouth Board of Education held another discussion workshop Tuesday night, to air suggestions about a three-year growth projection of 3,400 students in the Plymouth Community School District.

The board appears ready to officially propose a \$30 million bond issue that would provide for five new elementary and two middle schools, at its Feb. 28 meeting, according to Raymond K. Hoedel, assistant superintendent for business.

The \$30 million figure, which would give the school district the distinction of seeking the highest bond issue in the state, represents an approximate increase of 1.26 mills.

The additional mills would mean an extra \$25.20 annually for a homeowner with an assessed property value of \$40,000; and an increase of \$37.80 for a \$60,000 piece of property.

THE PROPOSED 1977 bond issue would add roughly 5,700 seats to the present capacity, which would handle the estimated five-year growth of 5,400 students, according to the board's preliminary projections.

Because no new buildings could be completed or opened for at least two years even if voters approved the bond issue, the board must implement interim measures to meet pressing needs, Hoedel said.

Some alternatives suggested were to place Eriksson, Field, Hulsing, Pioneer and Bird elementary schools on a 45-15 program, intensify busing efforts, and add six self-contained portables to Eriksson, Field and Hulsing. All these actions were proposed for either July 1977 or '78.

Other options discussed included implementing a 7 a.m. to 7 p.m. school day at the high school level, shifting ninth graders to middle schools and converting Central Middle School to an alternate high school.

Board president Joe Gray raised objections to transferring Central. "I hate to see Central go to a high school," he said. "With its present facilities, Central serves as an excellent middle school. I'd rather see East go that route."

Marcia Borowski agreed. "The purpose of an alternate high school is to offer the student body smallness and closeness," she said. "Central's too big—the kids would feel lost and faceless."

REPRESENTATIVES from Lakepoint subdivision fear that if Central is converted, it will become Lakepoint High School, one board member reported.

Supt. John M. Hoben confirmed it would never happen, saying "there's no way Central would become an area high school. If anything, it would be an annex."

Ms. Borowski added: "We shouldn't commit ourselves to converting Central. Instead, let's keep East open as an option and remain flexible on this."

Hoben reiterated how costly it would be to the district if the bond issue fails the first time out. "With conservative estimates placing increased building costs at six per cent annually, it's imperative that the bond issue passes in April," he said.

In addition to convincing voters to support the record bond issue, the board faces possible rejection from the state's municipal finance commission, which may feel a proposed five-year bond would be too lengthy, Hoben warned.

If the proposed five-year plan was not accepted, the board would have the option of selling the bond issue in two series, Hoben said.

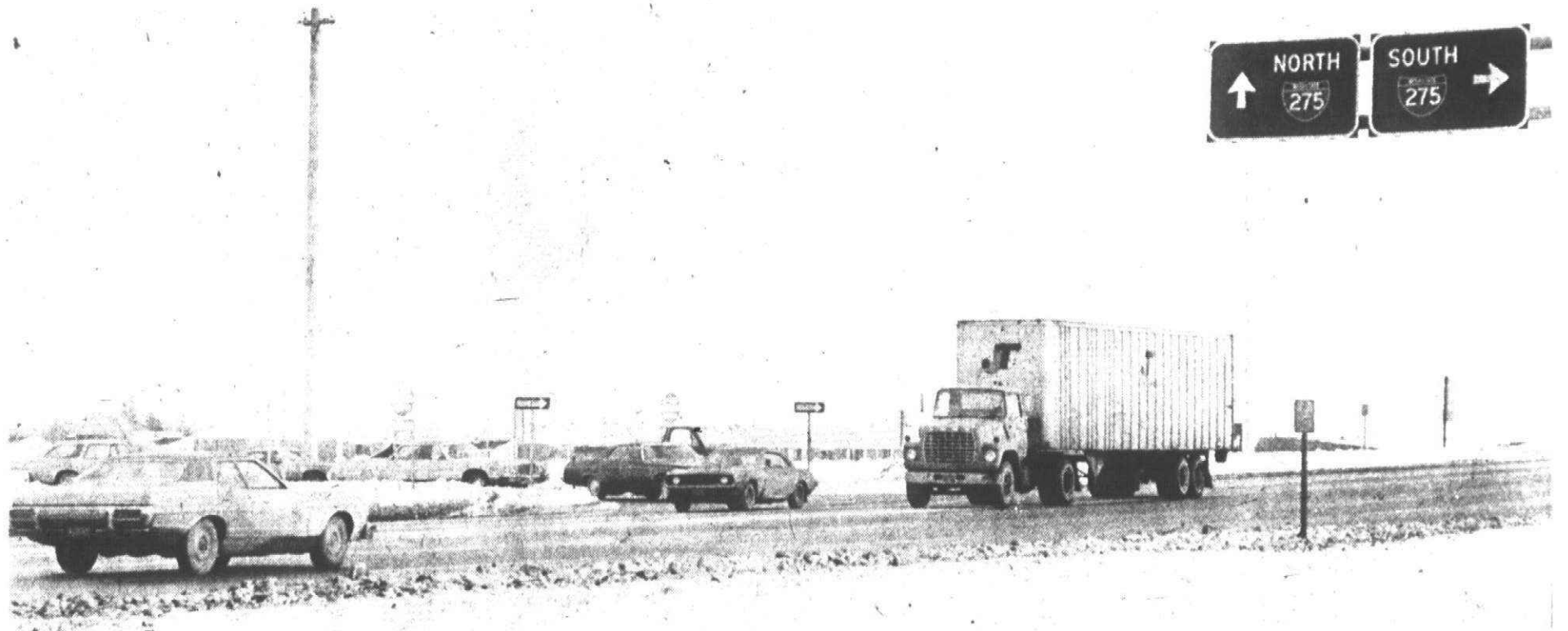

Trying to make a left-hand turn off I-275 on Michigan and Ann Arbor Road is next-to-impossible these days, but help is on the way. (Staff photo by Gary Caskey)

'Forget study—just try turnin'

A little plain, old, country-boy talk helped Plymouth and Canton Townships avoid a bureaucratic state highway department delay in some new traffic lights at off-ramps of I-275. Plymouth Township had requested Wane County Commissioner Royce Smith to speak to the highway department about having traffic control signals put up on Ann Arbor Road at the new I-275 exit ramps. Canton Town-

ship wanted the lights at the exit ramps on Michigan Avenue.

Smith said he talked to Jerald McCarthy, the deputy director of highways, and was told the highway department would study the traffic patterns to see if signals were necessary. However, Smith was unwilling to accept that answer.

"I just talked to McCarthy like one

country-boy to the other," Smith stated. "I told him, 'You don't need to study any traffic patterns. All you have to do is get off I-275 at either of those two roads and try to make a left-hand turn.'"

According to Smith, McCarthy took his advice and experienced some difficulty in making the turn.

"The next thing I heard from

McCarthy," laughed Smith, "was that there was a definite need for lights on both roads, and they would be put up within 90 days."

Smith said that if the highway department would have gone through the process of studying the traffic patterns, there was no telling how long it would have been before the lights were in operation.



When Curley Gray started cutting hair, the ditty, "Shave and a haircut, two bits" wasn't nostalgic. (Staff photo by Gary Caskey)

Curley finds shear joy

By GLENN BUNTING

After being a barber for nearly 60 years and trimming "damn near a million heads," Donald L. Gray says it's about time he hung up the old scissors.

"I really want to quit," said the owner of Curley's Barber Shop on 137 W. Liberty in Plymouth's Old Village. "I hope to retire the shop to my son and go on social security."

Gray's barber shop is a landmark in Plymouth. Born in 1904, he opened the little shop in 1927 when haircuts went for two bits. "There was some kind of competition going on then," Gray recalled.

Me and another barber set the price at 25 cents, but a couple of guys at the Mayflower Hotel charged 15 cents. That was during the depression days and ever since the cost of a haircut has never stopped climbing."

Gray still considers his shop pretty competitive. "A \$7 haircut here will get you the same thing some shops charge \$12 and \$15 for," he said.

GRAY WAS BORN into a family of 16 where his nickname Curley originated.

"When I was a youngster I had real curly hair, so we decided to name the shop Curley's. Today, I'm the only one in the family who isn't bald. Most of my regular customers don't call me by anything but Curley."

Gray says he's ready to retire to the good life. His son Don has been working in the shop for the last 25 years and has had the operator's permit in his name since 1973.

The elder Gray is hoping his son will quit his job at Ford and take over the shop full-time. "He could modernize the place and start from scratch," the shop owner said of his son. "Nowadays, you have to go to a training school and learn all that new jazz, but I'd like to see him take over the shop."

As of late, Curley's business has relied on old customers he's been serving for years. Gray even offers door-to-door service for oldtimers who have been placed in convalescent homes or can't get out of the house.

"A lot of guys who've been getting haircuts here since the place opened can't move around as much, so they give me a call and I work them into my schedule," Gray said.

CURLEY'S BARBER shop still gives shaves upon request, but the demand isn't anything like it was several years ago. "I used to give 20 shaves on a Saturday," Donald said. "Now I'm lucky if I give 20 in a year."

Gray realizes the day of a barber having more customers than he knows what to do with is over. "There used to be five barbers on this end of the street alone, but not anymore," he said.

"We don't get the number of kids that we used to. Now an aunt, a mother or a sister will do it. And with all these styling shops opening up and advertising hair care—it's driving us right out of the business."

Gray says some customers are a lot fussier about their hair than others. "We get these old guys that come in with a lot of hair on the side but none

on top. They want it cut so you can comb it across the bald part. It looks so silly—we just sit back and laugh."

Gray started his career in the early

1920s when he went to a training school in Davenport, Ohio. After graduation, he moved around the country, cutting hair in Illinois, Missouri and Detroit, before coming to Plymouth.

Morality course starts in Observer

Observer Newspapers will publish a Courses by Newspaper series on modern morality beginning with the edition of Thursday, Feb. 3 in cooperation with Schoolcraft College.

The joint announcement was made by Tim Richard, editorial director of the newspapers, and Ronald Griffith, dean of community services at the college.

Entitled "Moral Choices in Contemporary Society," this 16-part series explores the complex—and often controversial—moral dilemmas that confront Americans in the conduct of their public and private lives.

The articles can be read individually by readers; they will be used as the textbook for a course at Schoolcraft; or persons may organize their own discussion groups.

TOPICS DISCUSSED will include abortion, political, business and science ethics, sexual conduct, the family and moral education.

Among the 11 outstanding scholars who wrote the series are:

Daniel J. Callahan, founder and director of the Institute of Society, Ethics and Life Sciences; Kenneth B. Clark, professor emeritus in psychology at City University of New York and research director of the Northside Center for Child Development; Lon Fuller, the Carter professor of general jurisprudence at Harvard University (now emeritus); Hans Jonas, the Alvin Johnson professor of philosophy at the New School for Social Research.

Philip Rieff, the Benjamin Franklin professor of sociology at the University of Pennsylvania; Christopher Lasch, professor of history at the University of Rochester; Jean Lipman-Blumen, director of the women's research project at the National Institute of Education; Martin E. Marty, professor of the history of mod-

ern Christianity and dean of the Divinity School at the University of Chicago.

Robert W. Tucker, professor of political science at Johns Hopkins University who holds a joint position with the School of advanced International Studies; Ernest van den Haag, a psychoanalyst who is adjunct professor of social philosophy at New York University and a lecturer at the New School for Social Research; and John P. Sisk, professor of English literature at Gonzaga University.

CIVIC GROUPS, service clubs, unions, religious and youth organizations and local libraries are encouraged to form their own discussion groups based on the Courses by Newspaper series.

To simplify program planning, these groups may obtain a "Source Book" of program ideas and resources for \$2.50 from Schoolcraft College or by writing Publisher's Inc., 243 12th Street, Drawer P, Del Mar, CA, 92014.

For any additional information on this series and the Courses by Newspaper program, contact the Schoolcraft College community services office at 591-6400 ext. 264.

Courses by Newspaper was developed in 1973 by university extension of the University of California, San Diego. It is funded by the National Endowment for the Humanities.

"Moral Choices in Contemporary Society" is the sixth in a continuing series of timely features prepared by Courses by Newspaper. This marks the first time either Observer Newspapers or Schoolcraft College has participated.

The series will run in Thursday editions from Feb. 3 to May 19. It will appear in the Livonia, Plymouth, Canton, Redford, Garden City and Westland Observers.

Stein doubts sincerity

Is politics in growth fight?

By CRAIG PIECHURA

It was almost a year ago that the Canton Township Planning Commission adopted a new master land use plan.

Today, the elected officials who supported that plan are gone, and so presumably is the plan itself.

But the taint of politics concerning growth and land use continues.

Unlike the hot and heavy words that followed November's election, talk of recalling supervisor Harold Stein is muffled these days, although backers of former supervisor Robert Greenstein, and Peter Bundarin, the Republican candidate for supervisor in November admit they are "keeping a close eye" on the new supervisor. That eye is focused directly at growth control.

Although Stein, under the pressure of a newly formed citizen's group agreed to set up a subcommittee to study growth control options, it was done with reservations.

The supervisor suspects the citizen's group demanding a curb on residential building is a thinly-disguised recall committee.

Not so, say the co-chairpersons of the group, Sue Koch and Stan Bucher. But Stein remains unmoved by their protestations.

The day after Stein held a press conference to respond to the "Citizen for Growth Control" petition drive press conference demands, he referred to his press conference as "real" and the citizen's group as "phony."

Koch and Bucher, say "the biggest obstacle" confronting the citizen's group is convincing people that it is not politically affiliated.

"First he tried to talk me out of continuing this committee of ours, saying that since he formed the township growth committee we didn't need ours. But we don't intend to let our committee die."

"I don't pretend to be an expert on growth control. That's why I've been spending my time calling the National Research Committee and studying pamphlets on growth patterns from

timidate them into doing something."

Carman and Donahue headed the nearly-successful "Committee to Reelect the Greenstein Team" during the last election.

Donahue did not deny that he helped Bucher arrange the press conference, but said that while he often disagrees with Stein, he doesn't think Stein has done "anything yet" that warrants recall.

analysis

Wayne State's library. We're not ready to make a final ultimatum. We're studying and researching."

Mrs. Koch has applied for a spot on the township's growth control study, which is a new subcommittee under the land use committee. Stein set up the growth subcommittee the Monday after Ms. Koch held her press conference.

Part of the reason behind suspicion that the growth control group is politically-manipulated, is that Koch was a campaign worker for Bundarin. Bucher was an avid Greenstein supporter. Their prior affiliations have caused some people to suspect that the two unsuccessful candidates have formed a coalition to unseat Stein.

Bundarin said he is aware that people suspect him of pulling strings behind the scene and he denies it.

"This committee (growth control) will never have anything to do with recall," Bundarin said Thursday. "Because of those suspicions (Jim) Donahue, (Tom) Carman, and myself will not attend the public meeting at the high school. It's a conscious attempt to keep this growth committee exactly what it is. I would never show up at the meeting and try to in-

"Let's just say we're keeping our eyes and ears wide open," Donahue said. "I'm not pleased with some of the stunts he's pulled with the police chief, but I can't see in either issue where he's done something that would call for a recall."

"But I'd be lying to myself if I didn't say that if Stein does do something that a majority of us feel is illegal he'd better be prepared to stand charges. He's being watched."

Bundarin said that he thinks Stein is smart enough to avoid any direct confrontation with his political opposition.

"Right now the ball's on his side of the field," Bundarin said. "The facts have been laid out on the rate of growth and the impending \$30 million bond issue to pay for the schools we're going to have to build. If Mr. Stein doesn't heed the interests of the people then he'll let people know that he doesn't pay attention to what they want."

"If Harold Stein passed a workable growth control ordinance he'd be re-elected for the rest of his life," Bundarin continued. "If I was intent on recalling him, I wouldn't push the growth issue."

inside

FOR ALL TIME

The historical recollections of 12 longtime residents were recorded for posterity during the bicentennial year by the Dunning-Hough Library. The library has now turned the oral history tapes over to the Plymouth Historical Museum for its archives. Page 2B.

Amusements	4B
Bowling	9A
Classified Ads	Sec. 1C
Sports	6-9A
Suburban Life	1B
The Stroller	5A

With federal funds

Expanded sewer, water planned

The Plymouth Township Board of Trustees tomorrow night will consider recommendations to expand water and sewer facilities using funds from the federal 1977 Community Development program.

The board will be asked to approve recommendations from Supervisor Thomas Notebaert and Clerk Helen Richardson at Tuesday's regular meeting which begins 8 p.m. in the township hall at Lilley and Ann Arbor Roads.

At the Dec. 21 meeting, the board approved an expenditure of approximately \$88,000 for sanitary sewer crossings on Ann Arbor Road. Notebaert and Mrs. Richardson are going to ask the trustees to approve using the township's share of the fed-

eral block grant to pay for those sewer improvements.

Under the stipulations of the grant, application for funds can only be made under certain categories. They are: urban renewal and neighborhood development; model cities; water and sewer facilities; neighborhood facilities; public facilities loans; open space; and rehabilitation loans.

"I think we stand the best chance of getting the money if we apply under sewer and water," said Mrs. Richardson. "Some of the categories don't apply to us. And of the ones that do, our sewer and water needs are the most pressing. She added that the township's share of the federal funds would be about \$80,000.

In 1975 the township received

\$32,000 under the grant and used the money to improve the recreation site on Ann Arbor Trail for the improvement of neighborhood parks. Under the 1976 community development program, the township applied for funds for storm sewers on Haggerty and Ann Arbor Roads. Mrs. Richardson said she has verbal approval for \$66,000 for those improvements.

ALSO DURING Tuesday's meeting, the board will hear a report on the status of the Evans Products land split request. The issue had been tabled at the meeting of Oct. 26 to allow the board time to study certain problems with the sewer facilities on the property along Eckles Road.

At that meeting the attorney for Evans had wanted the township to accept dedication of the sewer, so Evans could sell a portion of the land. However, the trustees were reluc-

tant to take on the sewer because it was 40 years old and in need of repair. They did not want to commit the township to heavy repair and maintenance expenses.

The question of the land split has all the elements of a prolonged struggle because Evans has to have the sewers accepted by the township before the land can be sold.

TRUSTEE RICHARD GORNICK is expected to give a verbal progress report on his committee's study of the charter township question. Since Supervisor Thomas Notebaert took office, he has made no secret of his desire to see Plymouth Township move toward becoming a charter township. And he appointed Gornick to chair a committee formed to look into the advantages and disadvantages of charter townships. The committee's final report is due in February.

Metric workshop scheduled

Metric Workshop, a two credit hour class scheduled for five Friday-Saturday blocks of time, will be offered at Madonna College, Livonia, during the winter term. Classes will meet from 6:30-9:30 Friday evenings and 9 a.m. to noon on Saturdays.

Distance and speed will be discussed Feb. 4-5, size, weight, and mass of objects on Feb. 25-26, and temperature, work, and power on March 18-19.

The sessions April 1-2 will be devoted to review and practice in conversion to metric.

Instructor for the workshop will be Sister John Francis Moore, professor of physics and mathematics at Madonna.

Enrollment is open to those who do not wish college credit as well as to Madonna students. The non-credit fee is \$20. Registration may be completed at the Student Services Center, Madonna College, 36600 Schoolcraft, Livonia.

Schools may create more voting polls in Canton Township

Four more voting precincts may be established in Canton Township for school elections to avoid some of the unusually long lines in past elections.

The Plymouth Board of Education tonight (Monday) will be asked to increase the number of school voting precincts in Canton from nine to 14.

Canton Clerk John Flodin has worked closely with Florence Beier, community relations director for the school district, in making plans to split school precincts. The expense for the splitting of precincts is being shared by the township and school district.

The meeting Monday will begin at 7:30 p.m. in the cafeteria of Plymouth Canton High, 8415 Canton Center Road.

THE SCHOOL BOARD also will be asked to appoint a financial consultant and an architect for the 1977 bond issue.

In another item related to population growth, the school board will be asked to approve a resolution which would be the first scheduling at other schools besides Miller Elementary where it now is operating as a pilot project.

The board is considering the necessity of year-round school for Eriksson, Field and Hulsing elementaries in Canton, Bird Elementary and Pioneer Middle schools in Plymouth. The expansion of the year-round program is being eyed as a means of meeting growth demands for the next two years until new school buildings can be constructed—if the proposed \$30 million bond issue is approved by voters in April.

"It is apparent to us that alternatives will be necessary in the next two years to accommodate the very substantive growth that is anticipated," says Supt. John M. Hoben. "It also is the feeling of the central administrative staff and of a select group of building administrators that the 45-15 concept does provide the optimum of educational opportunities with the least amount of disruption to the educational program."

INTRODUCTION OF AN intramural program at the Centennial Educational Park also will be before the board with an administrative record to budget \$1,800 for the first year, pilot program effort.

Man-size **ECONOMY** TRACTOR loader today...

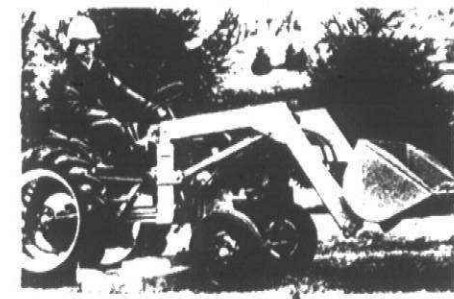

lawn tomorrow!

Compact tractor that's more than a lawnmower. All-gear drive gets more horsepower to wheels, saves gasoline. Loader lifts 1/2 ton, dumps over 6-ft. truck sides. 60" rotary mows up to 3 acres per hour. Frame-mounted tools: 32" tiler, 5' sickle, 48" snow blower. Power-angling dozer fits loader. Three point hitch and all rear tools.

SAXTONS GARDEN center inc.

PRICES START AT \$1,970⁰⁰

587 W. Ann Arbor Trail PLYMOUTH - 453-6250

Daily 9-6 Fri. 9-8 Sat. 9-5

Livonia Building Materials Drywall Special

3/8" Sheetrock 4'x8'

\$189 each

Cash & Carry

While present supply lasts.

Mon.-Fri. 8-5

Sat. 8-12

12770 Farmington Rd. S. of Schoolcraft

937-0478

421-1170

Keep your fuel bills down and comfort up

INSULATE

CALL YOUR INSULATION DEALER



Consumers Power Company

Beat the Blahs with our January Specials

FROSTINGS

PERMS

Reg. \$25 **\$17.50**

Reg. \$25 **\$17.50**

PRECISION HAIRCUTTING by RON SHANE

Eight stylists to serve you

Mon. 9-5

Tues. thru Fri. 9-9

Sat. 9-7

Appointment Not Always Necessary

Entri hair Stylist

Sheldon at Ann Arbor Road

155-3100 Plymouth

Perkos

SHOES FOR THE FAMILY

33426 WEST FIVE MILE AT FARMINGTON RD.—LIVONIA

SHOE SALE OF THE YEAR

Thousands of shoes for Men, Women and children... Many on racks for quick self serve selection

UP TO 60% OFF

For Women

NATURALIZERS
REG. 20.00 to 30.00
NOW 9.62 to 19.23

HUSH PUPPIES
REG. 18.00 to 29.00
NOW 7.69 to 20.19

LIFESTRIDE
REG. 18.00 to 25.00
NOW 7.69 to 15.38

For Men

PEDWIN
REG. 20.00 to 35.00
NOW 9.62 to 22.12

ROBLEE
REG. 25.00 to 46.00
NOW 12.59 to 29.80

HUSH PUPPIES
REG. 19.00 to 37.00
NOW 9.62 to 24.04

ZIPPER BOOTS
YOUTH BOYS MEN'S \$7.69

BUSTER BROWN SHOES

Reg. 13.00 to 23.00

NOW 6.73 TO 14.42

PHONE 427-3477

HOURS: Mon., Tues., Wed. and Sat. 9:30 a.m. - 8 p.m. Thurs. and Fri. 9:30 a.m. - 9 p.m.

Group Piano

THE KIDS WILL LOVE IT

CALL 427-0040

New Sessions Starting Soon

HAMMELL MUSIC, INC.

15630 MIDDLEBELT RD. (North of Five Mile) LIVONIA

427-0040

937-1040

Jacobson's Open Thursday and Friday Evenings Until 9:00 Saturday Until 5:30 P.M.

WHITE SALE



Save on Melody sheets by Martex

Soft beige sheets with a lilting pattern of meadow flowers and greenery are beautifully made of polyester/cotton percale that never needs ironing. Flat or fitted sheets: twin size, \$6; full size, \$8; queen size, 11.50; king size, \$15; pillowcases, 5.50 pr.; bolster cases, 6.50 pr.

Comforters: twin, \$37; full/queen, \$47; dual, \$65



Sumergrade "Supreme" pillow

Our finest pillow filled with imported white goose down for deep, soft sleeping comfort. Ticking is white with a damask design. Standard 22"x28" pillow, \$36; queen 22"x31", \$43; king 22"x39", \$56

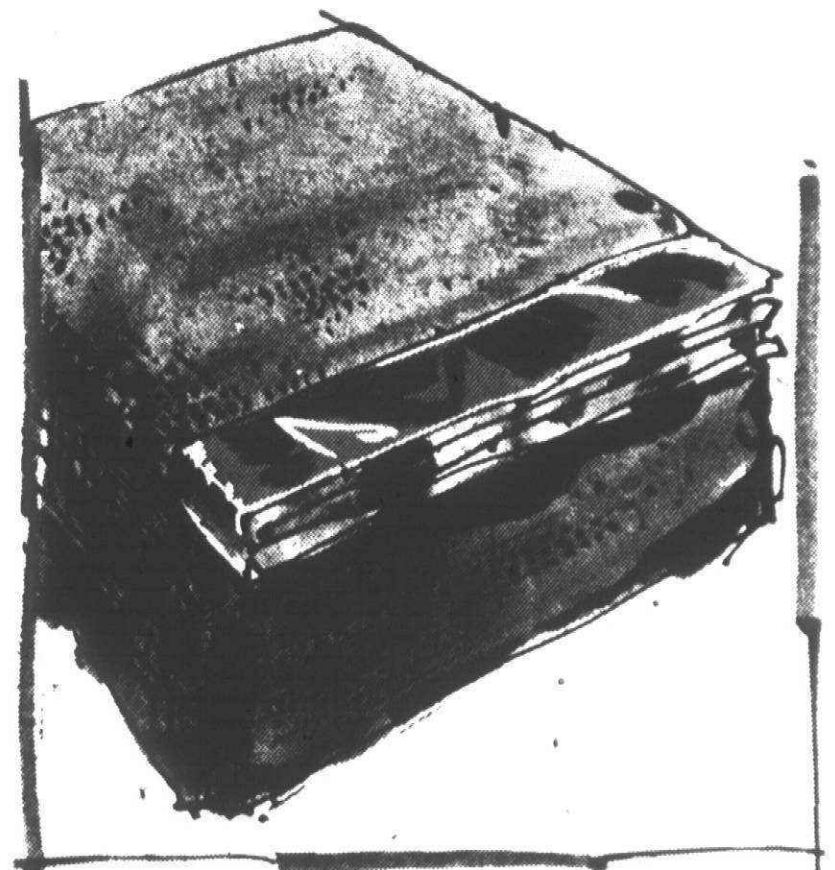

Modernaire II blanket by Faribo

Good value in a thermal weave blanket of non-pilling Acrilan® acrylic yarns. "Wear Dated"® for three years normal wear, by Monsanto. In blue, white, camel, yellow, green, terracotta, gold or peach. Twin size blanket, \$12; full size, \$14; queen size, \$17; and king size, \$20

Jacobson's

Liberty at Maynard - Ann Arbor

Dial 422-4540 Toll Free from Plymouth

PLEASE PARK IN THE ADJOINING ENCLOSED MAYNARD STREET AUTO RAMP JACOBSON'S WILL GLADLY VALIDATE YOUR PARKING TICKET

Local clergy can't justify death order

By PATRICK TOUHEY
(Second in a series)

In an opinion survey of law enforcement officials published in the last issue, a majority of those questioned favored a state constitutional amendment to provide for the death penalty.

Although a few expressed doubts about the wisdom of granting the state the right to take a life, in the end, the moral question was placed in a practical, legal framework of how best to deal with certain types of crime and criminals.

But the question is only partially a legal one. It is also a moral question.

WHEN THE Observer asked local clergy members whether they would be in favor of capital punishment, the overwhelming response was the exact opposite of that of the legal profession.

"I would not be in favor of the death sentence," said Rev. Sam Stout of the First United Methodist Church. "The taking of a human life, under any circumstances, is an awesome responsibility, and it can never be completely justified, not even in war."

Stout said a society that resorts to executing those people who violate its laws, is only expressing failure to find better alternatives.

"There seems to be a need on the part of the society in general to dramatize a justice it doesn't have. There is a need to select a few here and a few there and punish them," he remarked.

"I think we have to find better ways and more humane ways to deal with people who don't fit into society."

FR. ROBERT KELLER of Our Lady of Good Counsel Catholic Church, also felt society had to take more responsibility for the individual failings of its members.

"Capital punishment is not necessarily the only answer," he com-

mented. "We should ask ourselves how we are helping to assimilate people into society in a productive manner." He said the death penalty did not serve the purpose of true justice.

"In the Christian tradition, I would say it is not the kind of justice we are seeking. Execution is treating the symptom rather than the cause. I am not in favor of it, nor will I ever be."

The Rev. Philip McGee, of the First United Presbyterian Church of Plymouth, felt capital punishment violated the nature of the human spirit.

"I realize people have very real fears," he said, "but I also realize

fear can cause over-reaction. There is always the hope that a person can and will change. For us to take judgment into our own hands—even judges—and say whether a man should live or die is a frightening thing. I do not think it is wise to set ourselves up as the judges of the worth of a human life."

The Rev. Jeff Goldsmith, pastor of Geneva Presbyterian Church in Canton, was in the process of doing research for a sermon he was planning to give on capital punishment when contacted and said that although he hadn't worked his position out as thoroughly as he wanted to, his gut reaction was one of strong opposition.

"There is no way around it," he stated, "when we execute a person we are committing murder. It's brutal and repulsive to me."

He said he was aware that providing for the protection of society was important, but felt there were better ways than the death penalty for providing it.

"How can we kill a person outright?" he asked. "We are talking about someone created by God, just like we all are. The thought of it disturbs and saddens me greatly."

The one dissenting view was presented by Rev. Leonard Koeninger of St. Peter's Evangelical Lutheran Church. He spoke to the issue of capital punishment from the official church position and as an individual.

"We believe capital punishment is not morally wrong. God has given the state the right to impose the sentence of death. It is a duty and a responsibility of the government."

Patterson hits parole abuse

Oakland County Prosecutor L. Brooks Patterson has a lot to say about the state parole laws, and none of it is good. He claims that by releasing dangerous criminals prematurely, the parole system is working against the best interest of the people.

Patterson made his remarks in an after-dinner speech at the annual Plymouth Jaycees Distinguished Service Awards banquet. He told those present that the parole system was a failure.

"We are being raped, robbed, and murdered by the same people over and over again," he said. "The parole system is an abysmal failure."

His main complaint was criminals who had been convicted of violent crimes were being released from prison by the parole board to rape, rob, and kill again.

To substantiate his claim, he cited 16 pages of documented cases of crimes committed by criminals who

had been paroled before they had served their minimum sentence.

PATTERSON TOLD the audience that his interest in parole abuse started when he was working on a case involving a murdered policeman.

As the circumstances surrounding the killing unfolded, Patterson said, it was discovered that the murderers were parolees. One of them had been sentenced to 15 to 25 years for murder and was released after serving only seven and one-half years.

"If those men had been made to serve just their minimum sentence, that police officer would still be alive today," he said.

According to Patterson he started keeping a record of all violent crimes that were committed by convicted criminals who were out on parole. He said there have been 11 in Oakland County alone since 1973.

The fault, Patterson alleges, lies in the parole laws, which allow prisoners

to accumulate "good time"—a certain number of days taken off their sentence for each month they serve.

To document this, Patterson produced statistics which showed that a man sentenced to 20 to 35 years in jail could, by receiving maximum good time, only serve 10 years—or 50 per cent less than the minimum number of years. A man sentenced to 30 to 45 years could be released after 13, 63 per cent less time than the minimum stipulation.

"The system defeats itself," he stated. "The longer the sentence, the higher the per cent of reduction."

Patterson's solution is to change the parole laws so people convicted of violent crimes—rape, murder, and armed robbery—are required to serve their full minimum sentence. He said in 1973 he introduced just such a bill into the state legislature. But it has yet to be reported out of committee.

"The bill I introduced four years ago has died in committee twice," he said. "The legislature has refused to act. And I don't think it is too much to ask. Just make the violent criminal serve his minimum sentence."

Two female felons flee DeHoCo Friday

Two inmates of the Women's Division of the Detroit House of Corrections (DEHOCo) leaped over a fence to freedom Friday. One of the escapees was serving a life sentence for two first degree murders.

According to Martha Wheeler, director of the prison, Constance Hanes, 37, of Flint, a white female, and Sharon Halferty, 35, of Quincy, also white, left their cottages to visit the residence store on the prison grounds. They reportedly jumped over a fence and hopped into a dark green van driven by an unidentified white male.

"It appears they had made prior arrangements to be met," stated Ms. Wheeler, "but I don't know how or when." She added this was the fourth escape for Ms. Hanes and the second for Ms. Halferty.

Ms. Wheeler said Ms. Hanes first came to the prison in 1969 to serve three life sentences and one 50-60 year

sentence. She was convicted of two first degree murders, assault with intent to murder, and armed robbery.

Her fellow escapee, according to Ms. Wheeler, had been in prison "off and on" since 1967. She was serving her sentence for receiving stolen property, attempted breaking and entering and attempted check passing.

The Michigan State Police were notified of the escape, but late Friday, the women were still at large.



Vets not veterans

Homeowner groups in Canton Township have warned its members that the truck soliciting used furniture from subdivision residents represents a commercial venture called "Vets" in Detroit and has no affiliation with any military veteran's group or administration. Representatives from the Carriage Hills Homeowner's Association say that the truckdrivers have not, to their knowledge, misrepresented themselves, but say that slogans on the truck such as, "I served America" could be misleading. (Staff photo by Bob Woodring)

New sewer rate higher April 1st

To go with your 39 per cent water increase last year is an upcoming 20 per cent sewer rate increase coming April 1, 1977.

And that's no April Fool's joke. The public works committee announced the rate hike in a meeting Tuesday afternoon in the City-County Building in Detroit.

Using an explanation similar to the reason given for the water increase, the director of the department of public works, George Bingham, said there are two reasons for the rate hike in wastewater disposal.

Bingham told the people at the hearing a "cost-plus factor" is needed in the sewer budget to eliminate the deficit to pay for operating expenses. Once the "revolving fund" is established in the next two years, Bingham said rates may be lowered or stabilized. He said it is hoped the department will have enough money on hand, with the revolving fund, to pay a quarter's worth of bills at one time.

The rate increase will be \$159.48 per million gallons used; up from the present \$140.96 per million gallons of wastewater disposal.

Measured in "per thousand cubic feet," the new rate is \$1.193—raised from the current rate of \$1.0545 per thousand cubic feet.

Canton's deputy treasurer Mike Gorman was at the public hearing Tuesday to tell the board of public works that Canton officials aren't convinced the hike is necessary.

Gorman said many neighboring communities also oppose the hike.

"If they could show us a similar community that needed a 15 per cent overcharge to meet its water needs, then we might not have such a problem with it," Gorman said. "But they

hired a big consultant firm that compiled a fancy, thick report which may impress a lot of people, but, in my mind, still doesn't justify the amount of increase imposed."

Gorman said while he and representatives from surrounding communities made their objections known, "I felt like we were banging our heads against a brick wall." The only effect their protest might have, Gorman said, was that the county can't say they were unaware of dissent in the communities serviced by sewers.

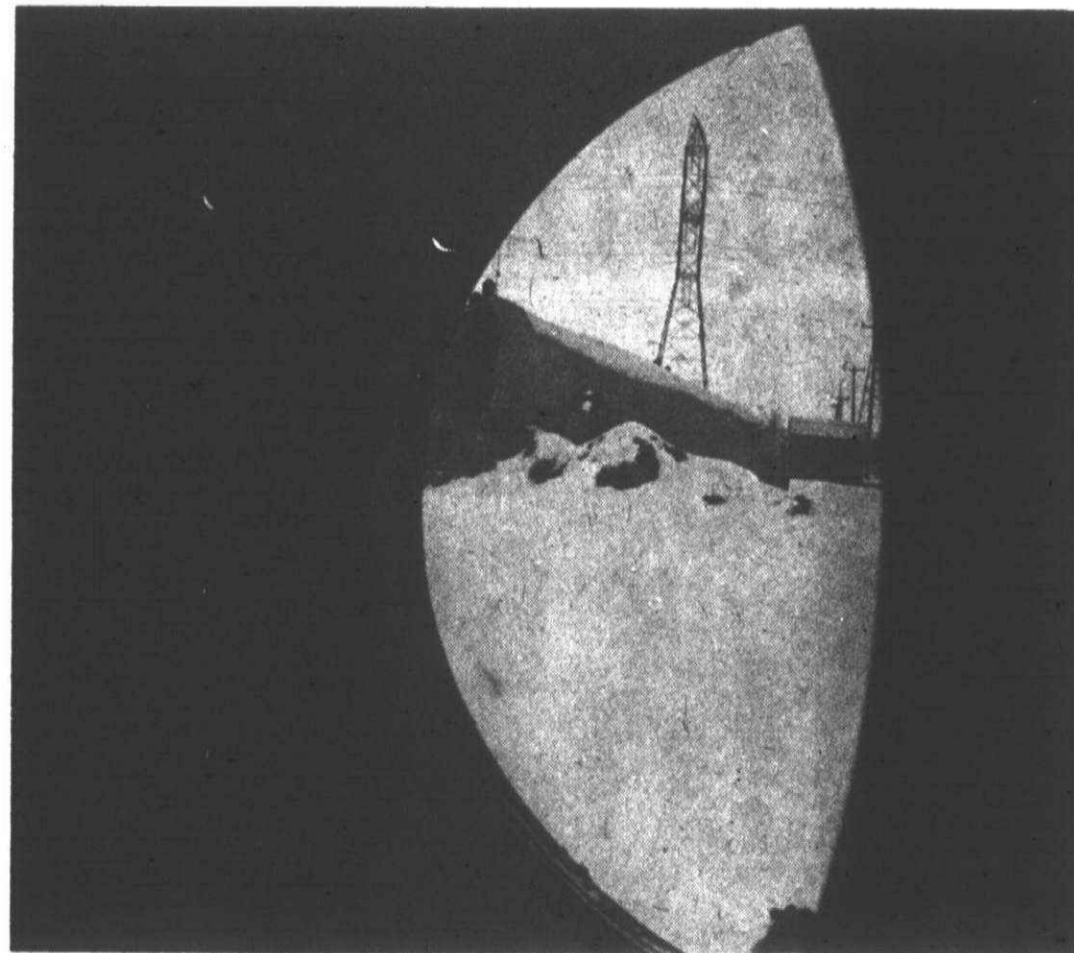

Sewers may look pretty in artsy photos like this, but your sewer bill won't be a pretty sight with the new rate hike. (Staff photo by Gary Caskey)

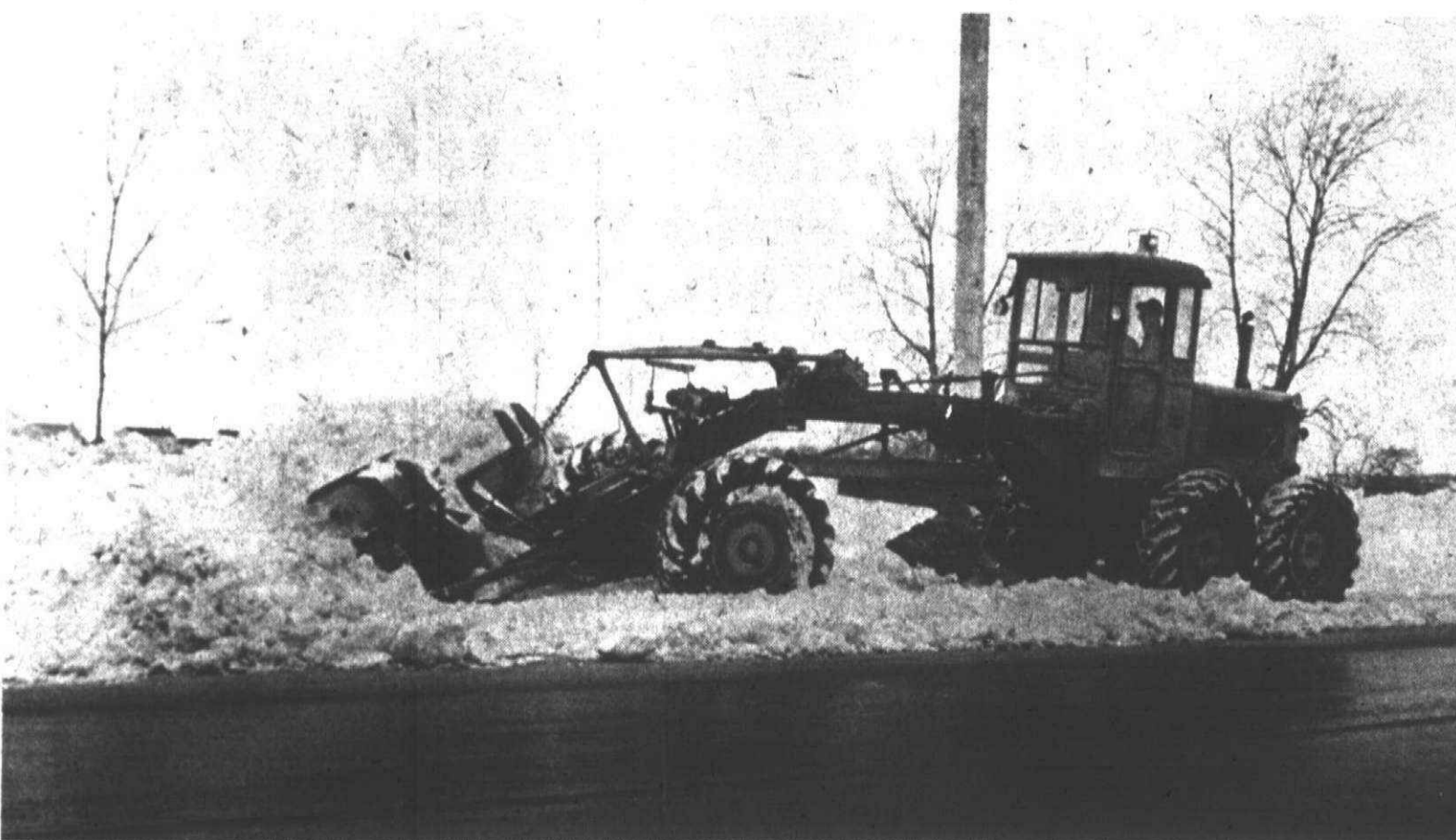

Some shovel

The snow of two weeks ago hasn't disintegrated around the roads yet. A county election worker spent a good part of Friday morning moving the snow bank back from the

roadway with his monstrous plow. Prodigious sun, please return, all is forgiven. (Staff photo by Gary Caskey)

Canton Observer

Co-Publishers
Henry M. Hogan, Jr. Philip H. Power

HOME DELIVERY SERVICE
Newsstand per copy 25¢
Carrier monthly, \$1.00



RED MARK SALE

ENTIRE INVENTORY OF
WINTER FASHIONS
SPECIALLY MARKED IN RED
MOST ITEMS AT OR BELOW COST

TO MAKE ROOM FOR NEW SPRING ARRIVALS,
EVERY ITEM IN STORE WILL BE SOLD
AT UNHEARD OF PRICES

ALL SALES FINAL • NO LAYAWAYS, RETURNS OR EXCHANGES

Starts Monday, January 24 thru Saturday, January 29

ALL WINTER COATS and JACKETS REDUCED 50% to 75%

Claudette's FASHION

(Corner of Ann Arbor Rd. at Sheldon Rd.)
44515 ANN ARBOR ROAD • PLYMOUTH
459-1010

Hours: Monday thru Saturday 10-9



From our readers Hedging by Stein evident in articles

Editor:
Subject: Police Chief-Supervisor Harold Stein?

According to your recent front page article entitled "Police Suggest a Pay Cut," you indicate that Mr. (Harold) Stein said at the meeting of 12-28-76, that he is the chief of police. Also, when questioned at length at the 1-10-77 township board meeting I attended as to this statement, he didn't really deny it, but implied that since he is supervisor he is chief law enforcement officer of the township and that these two jobs go hand-in-hand.

He didn't seem to feel that way when Robert Greenstein held these two positions, so there seems to be two sets of rules.

Under the charter township act, the township board has the ultimate authority in determining who should be police chief (Crier: 10-27-76). Mr. Stein has never been appointed to this position by the board of trustees to my knowledge. Former supervisor Robert Greenstein, and founder of the Canton Police Department, was named to the position of police chief by a unanimous vote of the board (Canton Observer: 5-25-75).

Mr. Stein hasn't the experience, training, educational background or legal right to issue police chief directives.

Prior to the November 2, 1976 election:

Mr. Stein stated (Observer 9-2-76) that if he won the supervisor's spot he would not assume the role of police chief and supervisor.

Stein's position paper says, "If we are to have quality police protection, I want well-qualified professional people, as well as a police chief." (Detroit News 7-23-76).

Many Stein supporters sent letters to all the local papers objecting to Greenstein's supervisor-police chief position. The local papers objected in editorials, etc., to same.

Attorney Noel Culbert and Carrie Young, objected so strongly to the supervisor-police chief roles that they wrote to Attorney General Frank Kelley for an action to remove Greenstein from the office of supervisor.

AFTER THE November election:

Stein, Canton Chamber push for name change

Canton's Chamber of Commerce unanimously agreed on a resolution to go on record as being in favor of a name change for the Plymouth Community School District—namely, Plymouth-Canton Community Schools.

In a letter to the Plymouth Community School Board, chamber of commerce president Al Daly said: "We hope our input will have a direct impression on the board when this decision is brought before them in the near future."

The decision to revive support for

Trustee Lynne Goldsmith made the motion to fire Mr. Greenstein from office of police chief with the statement: "I would consider the office of chief of police to be one held by a man with experience. In order to get politics out of the police department, I feel that the most political person in the township should not be chief." (Eagle 11-25-76).

A police study was formed to study the police department and advise the board on any changes or improvements that might be made. Results will not be ready for several months.

Mr. Stein said (Observer 12-9-76) that he would not include members of the Wayne County Sheriff's Department on the police study group. At board meeting (1-10-77) Stein said there would be a Wayne County officer assigned to this group.

Mr. Stein said the reserve unit would continue functioning "as is" until the police study is completed. He also said Mr. Carl Silvers, who had been coordinator of the reserves unit, would direct its operation until the study was completed (Detroit News 11-26-76).

SINCE HE MADE those statements, Mr. Stein has:

Fired Greenstein from police chief position. Promoted Carl Silvers to interim police chief on 11-24-76. Gives directives (police chief?) to the police department. Cut road patrols from four to two; cutting the number of officers in half (Eagle 12-9-76). Has under consideration a one-car patrol (Observer 1-10-77). Demoted interim Police Chief Carl Silvers to commander on 1-10-77.

My conclusion from the above events would be that Mr. Stein is slowly terminating the Canton Police Department, even before the board-appointed police study group presents its results.

It seems like the Stein Slate is so indebted to the Wayne County Sheriff's union, since they were the largest monetary and physical campaign supporters they had prior to the election, that they are obligated to contract for their (the sheriff's) services.

MARTHA MILLER
Canton Township

the name change was made at a recent board of directors meeting, so that Canton may officially become a part of the school district's name.

CANTON SUPERVISOR Harold Stein also supports the name change. He suggested, half-in-jest, that the school district's name be switched to "Canton-Plymouth School District." The reaction by Plymouthites to Stein's suggestion was not immediately known, but one can be certain they were not moved by the advice.

Academy praises police

Orville H. Kappen, school coordinator of the Criminal Justice Institute, cited 14 Canton police officers for their outstanding performances in the school's last basic police recruit class.

Although written scores alone do not make a police officer, Kappen noted the overall high scores achieved by the Canton force as a group.

The written exam scores showed Canton cops on top with 88 per cent, followed by State police (75 per cent) and other state academies (74 per cent).

"The Canton police officers were significantly above all other regional and Michigan State Police academies.

I must congratulate the township administration for the screening process that is bringing high caliber people into the service," he said.

Kappen said he was so impressed with the performance of the Canton recruits that he felt a special need to inform former police chief Carl Silvers about the achievements. Silvers is now a command officer.

The letter of commendation from Kappen represents a slight twist of irony, since a request by the Canton Police Officers Association (CPOA) to send seven more reserves for full training was denied two weeks ago by the Canton board.

Liquor license of lounge in limbo

A three-year-old plan to build a motel and restaurant complex at the corner of Ford and Lotz may be revitalized, if the developers can assure township officials of their good intentions and overcome ill will generated by the developers' failure to use a liquor license previously granted to them.

Canton board members last meeting unanimously agreed to table a request from Wilbert M. Tucker and Ronald J. Makino of Tucker Realty Co. for site plan approval of a proposed \$600,000 restaurant and lounge.

The developers say they plan to construct a 101-unit motel, after the 54,000-square-foot restaurant and lounge are completed.

Township officials agreed to reconsider the developers' site plan request, after they determine the status of a liquor license granted to Tucker in April 1974, when the township had only two liquor licenses to grant.

Board members had granted the license, provided the entire motel and restaurant complex be constructed at one time.

But Tucker never constructed the complex. The liquor license was never used, and site plans approved for the original complex expired.

A representative of Tucker Realty Co., who knew little about the fate of

the original construction plans, showed board members different plans for the motel and restaurant complex than those approved by a previous board some years ago.

Although township officials appeared pleased with the proposed site plans, several board members noted Tucker's plans to construct the complex some years ago—plans which never materialized.

Although the township now has about nine liquor licenses to grant, it had only two when officials granted a license to Tucker. The number of liquor licenses available to a municipality is based on its population.

"The reaction after (granting the license) was that we had been had," recalled Trustee Brian Schwall, who noted the developers' current plans to construct the restaurant, lounge and motel in two phases.

"I think we have a legal problem here. Granting the liquor license in 1974 was dependent on building the whole thing. What are you going to do with a lounge without a liquor license?"

Trustee Eugene Daley moved to table the matter in order to determine the legal status of Tucker's liquor license.

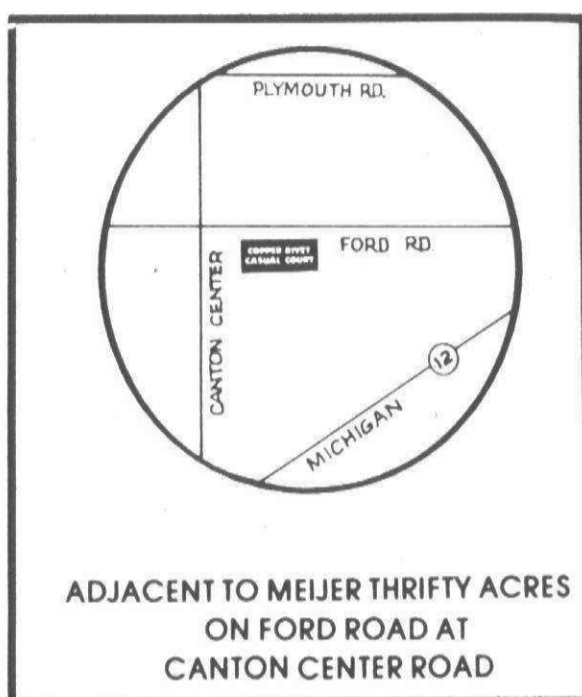

2 GREAT STORES! 1-BIG SALE!



OUR ENTIRE STOCK OF WOMEN'S
FASHION SPORTSWEAR
Fashions from Collegelawn, Mushroom, Tomboy,
Plushbottoms, Happy Legs, Stuffed Shirts and
Jeans, Bananas, White Stag, Aspen, Mountain
Goat, and other famous name brands.

SALE ENDS WEDNESDAY JAN. 26, 1977



OUR ENTIRE STOCK!

10% to 50% off

ORIGINAL PRICE

SAVE AT LEAST 10% OFF OUR ORIGINAL PRICE WOMENS' OR MEN'S NAMEBRAND FASHION SPORTSWEAR

COPPER RIVET

OUR ENTIRE STOCK OF MEN'S
FASHION SPORTSWEAR

All famous name brands. Save on everything in the store
Suits, Co-Ordinates, Blacks, Shirts, Sweaters, Outerwear,
Jeans, Accessories, and more.
Save on the names you know and trust. Don't miss this
great opportunity to save.

SALE ENDS WEDNESDAY JAN. 26, 1977

STORE HOURS: MON. THRU SAT., 10 a.m. to 10 p.m. SUN. 11 a.m. to 6 p.m.

• FREE GIFT WRAPPING • LAY AWAY BANK AMERICARD AND MASTER CHARGE WELCOME



6 FREE LESSONS for beginning Organ Students

No Instrument Necessary



CLASSES Start TUESDAY, JANUARY 25 7:30 P.M.

phone for information

HAMMELL MUSIC, INC.

15630 MIDDLEBELT RD. LIVONIA
North of Five Mile

427-0040

937-1040



The Stroller:

*Snow—
good 'n
bad*

By W. W. EDGAR

"The damn snow—what a mess it makes. Just take a look at it along the curbs of the city streets. It is nothing but an eyesore and I'll be glad when we can get rid of it."

"Look at that snow. Isn't it beautiful as it stretches out across the vacant land and sparkles in the morning sunlight."

"This heavy snow is just what we need. It is the best thing for our plants, roses and the like. It is a cover that keeps them warm and we'll let the real benefit of it next spring and summer."

"I'll take the cold any time. Just get rid of the snow and slush and the slippery sidewalks."

These are just a few of the remarks The Stroller has heard in recent days and they offer real proof that winter is the most controversial of the four seasons.

Sure, one hears complaints about the spring rains, and at times the floods that raise havoc. And there are times when folks shake their heads in distress with the hot sun in the summer months.

In the fall when Mother Nature turns autumn leaves to gold and paints the scenery in a fashion the greatest artists and painters couldn't duplicate, you might hear a few complaints.

HERE AND THERE you will hear complaints when the leaves start to fall and the squirrels gad about in search of nuts to fill their storehouses for the winter. But now, with the coming of the mechanical helper—the leaf blower—there no longer is ground for complaint at this most colorful season of the year.

That brings us back to winter and the howls that go up about the grime and slush on the sidewalks; the piles of dirty snow along the curbs and the danger it brings to motorists who of-times have trouble starting their cars, or even in driving.

One of the strange things about winter—and the controversy is that there are bitter complaints on both sides. People damn the winter when there is no snow just as they did out in Colorado when the ski slopes were bare—even for the president's vacation.

They also damn conditions when there is snow. First, it is the trouble of snow removal from the sidewalks and driveways of our homes; then removal from the streets so that the motorists can go and come from their daily occupations.

Once the way is cleared and conditions would seem to be returned to normal, then comes the complaint of the eyesore of the dirty snow and slush.

Strangely, there is one day and night when the complainants keep quiet and wish for snow. That's Christmas Eve, when every one is quiet and wish for a white Christmas.

YEARS AGO, when The Stroller arrived in Detroit, in the middle of winter, he had his first sight of snow in a metropolitan area and, like many others, he didn't like what he saw.

Then came a turning point. Being a "rookie" on the sports staff he was given the "Odd" assignments, among them covering the ski contests out at Rochester, Michigan.

He had never seen any one skiing back in his hometown—not even in the foothills of the mountains. The chief activity was sledding down the hillsides.

Ski contests? They were something else. So out he went to Rochester and the first sight of the skiers coming down the long slides and taking off into the air amazed him. It wasn't long until he looked forward to Sunday afternoons and the trip to the ski slides to watch the Hall boys, natives of Ishpeming, take their turn and vie for jumping honors.

And, despite the complaints, The Stroller enjoys the winter and longs for another sight of the Hall boys coming down the slide on a Sunday afternoon in Rochester. It was a sight to behold.

FREE FLICKS

Jan. 22—Movies for children will be shown on the fourth Saturday of each month at the Plymouth Community Cultural Center. The movies run from 10 a.m. to noon. Hot dogs and cokes will be available for a nominal charge.

OIL PAINTING & ACRYLICS

Jan. 24—For those who have some experience in painting with oil and acrylics, informal sessions will be meeting at the Cultural Center on Mondays from 10 a.m. to 1 p.m.

DUPLICATE BRIDGE

Jan. 25—Duplicate bridge meets every Tuesday evening at 7:30 p.m. at the Cultural Center.

COMMUNITY CHORUS

Jan. 25—Community Chorus, the men's and women's choral group, meets Tuesdays in the vocal room at East Middle School, 1042 S. Mill.

BREVITIES



ALL PAWNS INVITED

Jan. 25—The Chess Club meets every Tuesday evening from 7:30 to 11:30 p.m. at the Cultural Center. Novice to advanced players are invited to attend. Instruction is provided for beginners. For more information, please call Conrad Drake at 397-1881.

WINTER SIGN-UP

Jan. 25—As if enough isn't going on in the Cultural Center Tuesday night, there will be a special evening registration there from 6:30 to 8:30 p.m. The deadline for class registration is Friday at 5 p.m. This registration is for the winter program of leisure activities offered by the Plymouth Recreation Department.

EVENING REGISTRATION

Jan. 25—There will be a special evening registration for the winter program of leisure activities offered by the Cultural Center from 6:30-8:30 p.m. at the Center. Deadline for class registration is Jan. 28, at 5 p.m.

PLYMOUTH-NORTHVILLE AARP

Jan. 26—The first meeting of 1977 of the Plymouth-Northville chapter of AARP will be held at noon at the First Presbyterian Church of Plymouth. After the meeting, David Sasse of the Michigan State Police will show a film entitled "Senior Power."

LWV LAND USE MEETING

Jan. 26—The League of Women Voters will have a meeting on land use at the home of Fran DeMott, 512 W. Dunlap, Northville at 8 p.m. Claude Coates, who handles environmental planning for Vilican-Leman Assoc., will speak on how environmen-

tal quality and planning are dealt with in community planning and development.

CAYCE STUDY GROUP

Jan. 27—Edgar Cayce Study Groups will present the topic "Reincarnation and Karma" beginning 8 p.m. in Clarenceville High School, 20155 Middle Belt, Livonia. Open to the public at no charge.

PAINT FOR FUN

Jan. 27—Paint for fun invites those who are interested in oil painting to meet every Thursday for an informal session from 1 to 3:30 p.m. at the Cultural Center. The class is free to all who attend.

PARTY BRIDGE

Jan. 27—Party bridge takes place at the Cultural Center each Thursday from 1 to 4 p.m.

Now. Only 1 mg tar.

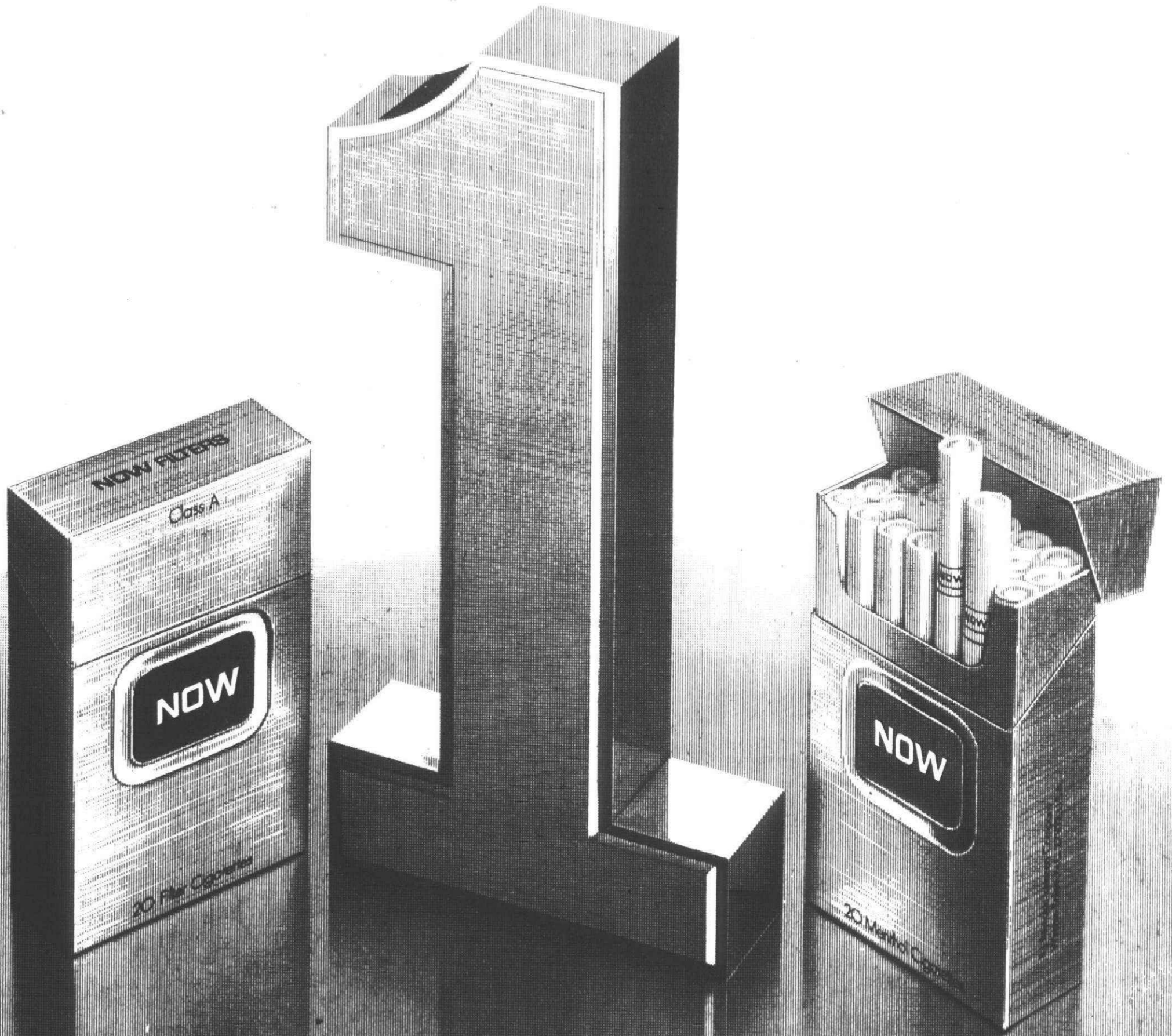

This is more than just low 'tar.' This is ultra-low 'tar.' This is Now, a cigarette with only 1 mg 'tar.' If you want to be sure you're getting ultra-low 'tar,' count all the way down to Now's number 1.

The ultra-low tar cigarette.

Warning: The Surgeon General Has Determined That Cigarette Smoking Is Dangerous to Your Health.

FILTER, MENTHOL: 1 mg. "tar", .1 mg. nicotine av. per cigarette, by FTC method.

**Semi-Annual
Clearance**

Sale

Boys' and Girls' apparel

**Save! Save!
Save!**

**20%-30%-40%-50%
OFF**

Sizes Infant to 16

Bambi Shop

Shelden Center
Plymouth at Farmington Roads

GA1-6400

Cream Allen Park, 50-20

Rock wrestlers roll on

Plymouth Salem's wrestling team continued its rampage in this week's dual meets with a 50-20 smothering of Suburban Eight League foe Allen Park Thursday night at the Plymouth gym.

Two days earlier, the Rocks crushed Garden City West 51-13 as part of a double dual meet at Westland John Glenn.

This conference victory against Allen Park

raised Salem's record to 4-1 in league play and 10-3-1 overall. The Rocks battle Redford Union (a team that beat Allen Park) next week.

"I thought we would have a tough time with Allen Park," said Salem coach Ron Krueger. "We haven't beaten them in the last two years."

"But we had a good lineup in against them and I even juggled a

little to replace our missing people (with injuries).

"Allen Park had troubles too," Krueger said. "They couldn't replace injuries and had to forfeit the last three weights."

Jerry Ottenhoff, Dave Champion and Bob Dasher were the recipients of the Allen Park forfeits.

Salem lost only three of the 13 matches and

two of those setbacks were to first and second place finishers in the Plymouth Invitational last week.

Randy Vipperman started the Rocks with a 1-20 pin in the 100-pound competition. After Mark Ross lost, Steve Ernst pinned his opponent in 2:45.

Rene Leist and Jim Ross followed with identical 5-3 decision victories before Dave

Waite lost at 134.

Steve Scruggs wrestled at 140 and easily won 19-5. Carl McNulty competed at 147 and pinned Keith Spagnol at 3:42.

Jeff Fidge replaced an injured Tom Chaitalis at 157 but the three forfeits at the end turned the match into a rout.

Matt Wilkens lost at 167 but the three forfeits at the end turned the match into a rout.

WEEKEND

FLING

TWO PEOPLE TWO NIGHTS ONLY \$74.75 COMPLETE

including

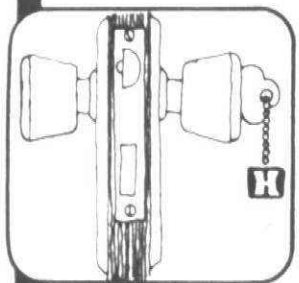

Three days and two nights' occupancy in a luxurious room for two *Friday and Saturday nights or Saturday and Sunday nights)



Gift of welcome — your choice of champagne or fruit basket for your room

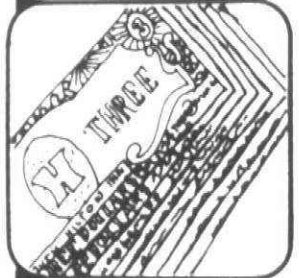

\$24.00 in Plymouth Hilton "fling money" to spend as you wish in the Hotel, at nearby golf or tennis facilities, on entertainment such as movies and Greenfield Village/ Henry Ford Museum, Northville Downs (in season)



Complete use of Hotel facilities, including health club, indoor pool, whirlpool, sauna and game room

Please send me details and directions for a Weekend Fling.

Name _____
 Address _____
 City _____ State _____ Zip _____

Plymouth Hilton Inn
 5 Mile & Northville Roads
 Plymouth, Michigan 48170
 For Reservations, call 313/459-4500

Netters nip Churchill; demolish Allen Park

By BETTY DeLANO

The Plymouth Salem girls varsity volleyball team raised its season record to 3-0 last week when they beat Allen Park on Wednesday night and Livonia Churchill on Thursday.

The Rocks beat Churchill in two close games, 17-15, after going into overtime, and 15-12 in the second game.

Livonia Churchill was number one in the Western six last year and made the competition extremely tough for the Rocks.

During the first game, Salem pulled out to an 11-7 lead but let the Chargers catch up to a 14-14 tie with only one

second remaining on the clock.

After three minutes of overtime play, Salem came out of the first game victorious over Churchill at 17-15.

The second game wasn't quite as thrilling. Salem took the lead in the beginning of the game and didn't let the Chargers catch up. The game ended with only a minute-and-a-half left on the clock and another Salem victory at 15-12.

"The girls have matured quite a bit over the past year and they handled the pressure of a good team like Churchill very well," said Salem coach Brian Gilles.

Wednesday night's game against Allen Park went rather rapidly. Salem showed excellent defensive strategy against the Jaguars and made it obvious through the score of 15-2.

Senior Carol Simonetti led the Rocks in serving in the second game with five points for six serves while senior Peggy Moore and junior Kathy Dillon both added three.

Salem took every advantage the Jaguars opened up for them to take the win at 15-5.

"We had control of the ball and the game during the entire match," said Gilles.

Salem junior varsity didn't quite have enough

to over power Allen Park on Wednesday when the Rocks lost to the Jaguar JV, 15-9 and 16-14.

On Thursday night, the Rocks showed definite improvement on past games played this season according to Salem JV coach Cathy Himes. "We may have lost at 13-6 and 15-13, but we played very well as a team. There were a lot of excellent plays in the game and I think the girls are doing very well," Himes said.

Salem plays Livonia Stevenson tonight (Monday) at Salem. The JV starts at 7 p.m. and the varsity at 8 p.m.

Men's basketball results

The Side Street Pub captured its sixth straight victory Monday night by downing Morrell Builders 64-50 in Plymouth Men's Basketball action.

Side Street led all the way as Mark Reed and Rick Neu paced the attack with 16 points each.

The second game was an exciting contest as the ever-improving Wagenschutz team topped Air Tite Insulators by a 70-60 score.

Air Tite jumped into an early 10-0 first quarter lead but the hot shooting of Brent Boegler led a Wagenschutz comeback. Boegler hit the first 12 Wagenschutz points as his squad ral-

lied to an 18-16 deficit after the first quarter.

The game see-sawed in the second quarter but in the third stanza Wagenschutz started to pull away. Mark Falvo was Wagenschutz leading scorer with 27 points—17 of which came from the foul line. Boegler finished with 24.

Dave Van Wagoner topped Air Tite with 17.

Jim Szczechowski paced Morrell with 19.

The final game of the evening saw league-leading Side Street fall from the ranks of the undefeated as Century 21 pulled out a 62-50 victory.

Century 21 maintained a two-point lead through three quarters of play before romping to victory. Side Street's shooting went cold in the fourth period as the league leaders hit for only five points in a five-minute span.

The Century 21 victory creates a three-way tie for second place in the standings. Side Street remains on top with a 6-1 record. Wagenschutz,

Century 21 and Air Tite are tied at 4-2 while Little Caesar holds down fifth place with a 2-4 mark. Morrell Builders checks in at 1-5 and Richardson's owns the cellar at 1-6.

THE HIGH SCHOOL boys intramural basketball standings are as follows: Navarones 4-0, Plymouth Sports Shop 3-1, All Stars 3-2, Team No. 3 2-2, Team No. 6 3-3, Team No. 5 1-3, L & M Accounting 1-3, and Marauder's 1-4.

J.V. wins

The Plymouth Canton junior varsity basketball team won another game Friday night by beating Farmington Harrison 36-41 at the Plymouth gym.

The Chiefs, coached by Wayne Weimer, currently hold a 6-5 record for the year.

Canton dominated play from the start, breezing to a 27-16 lead at halftime. The Chiefs iced the game away in the third quarter out-scoring the Hawks 15-9.

Kurt Herbert led the Chief JV attack with 14 points. Mike Morin followed with 12 and Mike Leary added 11.

All members of the Chiefs 12-member squad saw action in the game.

The Plymouth Canton freshmen squad beat its neighbors from Plymouth Salem Friday afternoon 54-42. The Chiefs are coached by first-year mentor Dave Van Wagoner.

Save \$65 on RCA's Colorama TV Picture tube replacement

SALE \$134.95* Reg. \$200

- No charge for installation. Repairs to chassis are extra.
- RCA Colorama picture tubes fit most any make TV -19"-21"-25" at \$65 savings now.

*If tube fails within 2 yrs. we'll replace it for labor cost only.

INCLUDES PICK-UP, DELIVERY AND FREE TV CHECK

STA-RITE TV

28915 Joy Rd. WESTLAND 525-5450

SCHMALZREITSONS
Funeral Home

Dignity and Good Taste
Distinguish Every Phase of Our Service

1345 SOUTH BAY
NORTHVILLE, MICHIGAN 48161
CALL FOR A FREE CATALOG

Why Pay More! Why Pay More!

MEIJER
thrifty acres

ANIMAL WORLD ENCYCLOPEDIA

Encyclopedia of the Animal World

THIS WEEK VOLUME #19

\$1.99 ea.

VOLUME #1 ONLY 99¢ EA.

VOLUMES #2 - 18 ONLY \$1.99 EA.

Book Dept.

PRICES GOOD THRU SAT. JAN. 29, 1977

MEIJER THRIFTY ACRES — 45001 FORD RD. AT CANTON CENTER RD.

SHOP MONDAY THRU SATURDAY 9 A.M. TO 10:30 P.M. SUNDAY 9 A.M. TO 7 P.M.

GET PROFESSIONAL
carpet cleaning results (AT DO-IT-YOURSELF PRICES)

RINSE VAC RENT FOR ONLY \$12 A DAY

CLEANS CARPETS. CLEANER KEEPS THEM CLEANER LONGER

TOWN 'N' COUNTRY Hardware & Fireplace

27740 FORD ROAD • GA 2-2750
3 1/2 Blks. W. of Inkster Rd.
• OPEN DAILY 9-8 CLOSED SUNDAYS

Prince & Pauper
4915 N. WAYNE RD.
WAYNE (3 BLKS. S. OF MICH.) 728-1783

COMPLETE DINNER
MON. THRU WED.

20% OFF WITH THIS COUPON

Why Pay More! Why Pay More! Why Pay More!

MEIJER
thrifty acres

PLUMBING FIX-UP SALE!

PRICES GOOD MON. JAN. 24 THRU SAT. JAN. 29, 1977

MEIJER RESERVES THE RIGHT TO LIMIT SALES ACCORDING TO SPECIFIED LIMITS.
NO SALES TO DEALERS, INSTITUTIONS OR DISTRIBUTORS.

<p style="text-align: center;">PEERLESS FAUCET</p> <p>PEERLESS LAUNDRY FAUCET WITH BLADE HANDLES • Model 9230 REG. \$16.37</p> <p style="text-align: right;">\$14.37</p>	<p style="text-align: center;">Why Pay More!</p> <p>PEERLESS FAUCET • Single lever kitchen faucet with sprayer • Model 8500</p> <p style="text-align: right;">REG. \$28.99 \$26.77</p>
<p style="text-align: center;">PEERLESS BAR SINK FAUCET • Two hole • Model 9220 REG. \$22.57</p> <p style="text-align: right;">\$19.33</p>	<p style="text-align: center;">PEERLESS LAVATORY FAUCET • 2 handle with pop-up • Model 9620 REG. \$21.64</p> <p style="text-align: right;">\$19.99</p>
<p style="text-align: center;">PLUMBING & HEATING REPAIR BOOK</p> <p style="font-size: small;">Detailed instructions & illustrations on how to install various plumbing systems</p> <p>OUR REG. \$3.19</p> <p style="text-align: right;">\$2.46</p>	<p style="text-align: center;">Why Pay More!</p> <p>PLUMBING KIT 60 pc. assortment of washers, packing and screws to repair most plumbing leakage problems: toilet seats, etc.</p> <p style="text-align: right;">REG. \$2.11 \$1.27</p>
<p>BUBBLE-FLO™ SHOWER HEAD Made of lifetime plastic with flow adjustment. Gives invigorating spray. Fits 1/2" IPS standard shower arms.</p> <p style="text-align: right;">REG. \$5.99 \$4.97</p>	<p>WATER SAVER TANK BALL Made of longlasting rubber. Eliminates toilet noises. Easy to install.</p> <p style="text-align: right;">65¢</p>
<p>DRAIN CLEANOUT AUGER</p> <p>• Does the job with less effort • 8 foot • 1/4" spiral head</p> <p style="text-align: right;">REG. \$1.83 \$1.47</p>	<p>SILENT SAM TOILET REPAIR KIT Contains Ballcock, rubber tank ball, toilet tank float lift wires, float rod and fill tube.</p> <p style="text-align: right;">REG. \$5.69 \$3.99</p>
<p style="text-align: center;">FAUCET HANDLES</p> <p style="font-size: small;">Fits any faucet. An elegant replacement handle made of durable Lucite. Includes stem adapter and wrench.</p> <p style="text-align: right;">REG. \$2.97 \$2.47</p>	<p>DELUXE REPLACEMENT BASKET Heavy gauge stainless steel. Fits all standard 3 1/2" basket strainer drains.</p> <p style="text-align: right;">REG. \$1.47 \$1.27</p>
<p>4" FLEXIBLE DRYER VENT HOSE • 8 foot REG. \$3.94</p> <p style="text-align: right;">\$3.29</p>	<p>QUALITY FLARING TOOL Holds tubing securely for flaring or threading.</p> <p style="text-align: right;">REG. \$9.36 \$6.99</p>

MEIJER THRIFTY ACRES — 45001 FORD RD. AT CANTON CENTER RD.

SHOP DAILY 8 a.m. to 10:30 p.m. SUN. 9 a.m. to 7 p.m.

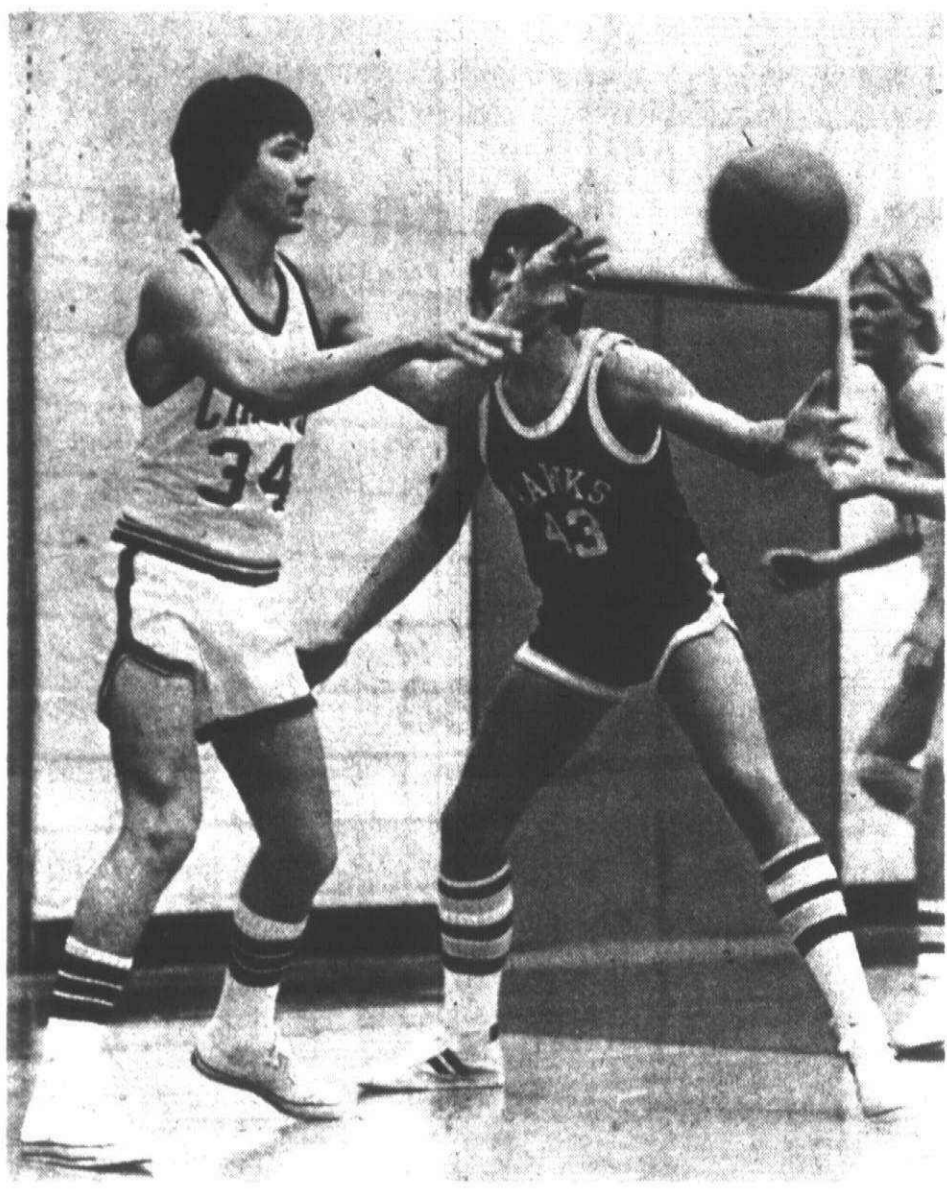

Canton's Mike Albright picks up an assist with this pass during Western Six League action against Farmington Harrison Friday night. The Chiefs lost the contest 74-62. (Staff photo by Gary Caskey)

Canton can't handle zone; Harrison breezes, 74-62

By DENNIS O'CONNOR

Farmington Harrison's stingy 1-2-2 zone defense proved to be the deciding factor in its 74-62 victory over Plymouth Canton in a crucial Western Six League basketball contest played at the Centennial Park gym Friday night.

This contest was important for the Hawks because the road victory helped them keep pace with league-leading Livonia Churchill which easily beat Walled Lake Western.

The Chargers hold a perfect 5-0 record after the first half of the league season while Harrison maintains the second spot at 4-1.

The loss to the Chiefs spelled equal importance to their chances for the Western Six title. This setback on Canton's home court not only cost the Plymouth squad a chance to tie for second place in the standings, but now it all but ends any hopes for a league crown.

Canton holds a 5-7 overall record and a mediocre 2-3 mark in conference play. Harrison is 6-5 overall.

THE CHIEFS started the game quickly wearing down the Hawks' man-to-man defense. Canton raced to a 17-12 lead after the first quarter and maintained that margin for the first four minutes of the second period.

Harrison then switched to its 1-2-2 zone defense and riddled the Chiefs the rest of the way. The Hawks finally grabbed the lead for good with one minute left in the half and took a 28-27 advantage at intermission.

Harrison nearly doubled its total offensive output of the first half in the third quarter alone as the Hawks blew

Canton off the court with a 27-14 spurt.

The Hawks built its margin in as many as 20 points midway in the final quarter as the game was never in doubt.

"WE'VE HAD some trouble on the road and I knew we had to have this one. The kids knew it too," said Harrison coach Bob Suttef.

"We were afraid to try a zone because we thought Canton had a good shooting team. But they hurt us on their drives to the basket when we were in the man-to-man."

"We had a hard time penetrating and couldn't use the baseline because they were so big," said Canton coach Casey Cavell. "Harrison played the zone well—I can't take anything away from them. The only good thing about it was that we forced them to go to it."

"I can't blame our kids," the Canton mentor said. "They worked their butts off trying to penetrate the zone but Harrison played a good defensive game. I didn't think they would be that powerful."

FARMINGTON HARRISON—PLYMOUTH CANTON
 Farmington Harrison (24): Lou Valaj 5, 3-3, 13; Bert Barsch 1, 1-2, 3; Bryant Gilbert 3, 1-1, 11; Paul Burkman 9, 3-6, 21; Larry Pamp 7, 2-2, 16; Greg Marbak 1, 1-4, 6; Paul Kolbe 0, 0-0, 0; John Cagle 2, 0-1, 4; Pat Driscoll 0, 0-0, 0; Doug Howard 0, 0-0, 0; John Hague 0, 0-0, 0; Pete Lambert 0, 0-0, 0; Al Shay 0, 0-0, 0. Totals: 30, 14-20, 74.
 Plymouth Canton (42): Bob Mandie 7, 0-0, 11; Steve Wendland 0, 0-0, 0; Mike Albright 2, 2-2, 6; Mike Ley 0, 0-0, 0; Kevin Randazzo 0, 0-0, 0; Butch King 4, 3-4, 11; Doug Smith 1, 0-1, 2; Keith Fueling 5, 0-2, 10; Russ Mandie 1, 0-0, 4; Randy Ruess 3, 7, 8, 17. Totals: 25, 12-17, 62.
 Totals Fouls: Plymouth Canton 16; Farmington Harrison 15. Fouled Out: None.
 Farmington Harrison 12 16 27 19 —74
 Plymouth Canton 17 10 14 21 —62

In sloppy game Rock cagers destroy AP

By FRED DeLANO

Winless Allen Park was strictly no match for unbeaten Plymouth Salem Friday night as the Rocks hit on 58 per cent of their shots from the floor in rolling to an easy 64-42 Suburban Eight basketball triumph.

This road victory on the Jaguars' floor brought Plymouth to an 11-0 mark for the season, whereas Allen Park is 0-11.

The game completed the first round of Sub 8 action and at the halfway point the Rocks have a two-game bulge over Livonia Bentley at 7-0 to second place Bentley's 5-2. Not in any of the last three title winning seasons has Salem enjoyed that much of a lead in turning the corner for home.

Although the win over hapless Allen Park added no particular luster to the record, the Rocks now have a chance to impress the state's prep pollsters when they invade Dearborn Fordson for an important non-league test Tuesday night.

The perennially powerful Tractors again are in the running for the Great Lakes Conference title, and on their own court will be particularly difficult to subdue.

TOM ELLINGHAUSEN and Chris DeBear led Salem's offensive barrage at Allen Park with 20 and 14 points respectively, but actually their shooting percentages were more important than the point totals.

Ellinghausen canned eight of his 12 shots and DeBear pumped in seven out of 10. Ellinghausen also grabbed 11 rebounds as the Rocks dominated that department, 32-16.

From the floor, Salem made good on 28 of 48 attempts for its impressive 58 per cent team mark, but there were two statistics which detracted from the Plymouth performance and which—if repeated at Fordson—could spell doom.

These included the fact that the Rocks were guilty of an atrocious 25 turnovers and could make good on only eight of 19 chances at the free throw line. Those are not the hallmarks of an unbeaten team that would like to think of itself as a contender for state honors.

THE PLYMOUTH starters found themselves frustrated in the first quarter by an Allen Park quintet which disdained to attack. The Jaguars didn't take their first shot at the bucket until there was only 3:13 left and it was another half-minute before Gene Vacca got their first two-pointer.

The result was a misleading 10-5 Salem edge after eight minutes, but in the second quarter the Rocks blitzed their way to 20 points with hard, intense basketball that foretold the romp it was to become.

From a 30-21 edge at halftime the Rocks stretched their margin to 45-31 for three periods and outscored the Jaguars, 19-11, in the final quarter.

"We went at it low-key and used all 13 men in trying out a variety of personnel combinations," said coach Fred Thomann. "Our starters didn't play more than five minutes of the third period and not more than four of the last one."

The preliminary game wasn't that easy. Salem's Jayvees won, 53-51, to run their record to 9-2.

Su 8 standings now read: Salem, 7-0; Bentley, 5-2; Trenton and Dearborn, 4-3; Belleville and Edsel Ford, 3-4; Redford Union 2-5, and Allen Park, 0-7.

Salem—Allen Park
 Plymouth Salem (64): Tom Ellinghausen 8, 4-7; 20; Chris DeBear 14, 4-14; Mike Christie 3, 1-2, 7; Rich Hewitt 3, 0-2, 6; Bruce Gerish 2, 2-2, 8; Kevin Rouse 2, 0-0, 4; Matt Etienne 1, 0-0, 2; Doug Agnew 1, 0-1, 2; Dave Monk 1, 0-0, 2; Steve Horton 0, 1-1, 1. Totals: 28, 8-19, 64.

Allen Park (42): Ron Herczak 5, 6-12, 16; John Froehner 3, 2-5, 12; Lew Andrews 1, 3-4, 5; Jim Doyle 1, 2-3, 4; Gene Vacca 2, 0-1, 4; Tom Shoulters 0, 1-4, 1. Totals: 14, 14-30, 42.
 Total Fouls: Salem 23; Allen Park 18. Fouled Out: None.
 Plymouth Salem 10 20 15 19 —64
 Allen Park 5 16 10 11 —42

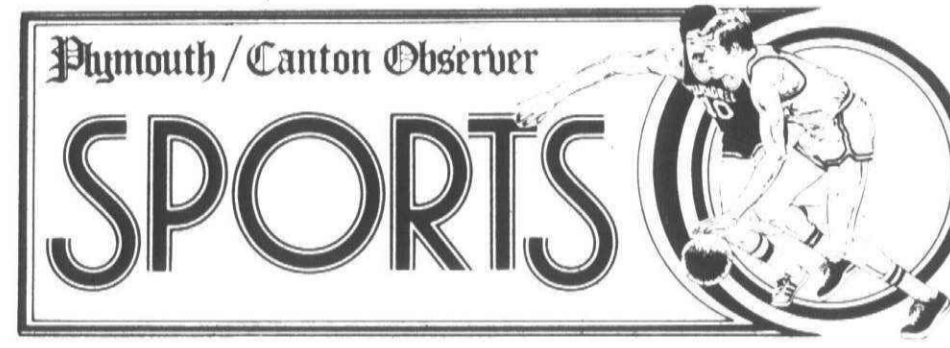

Donnelly, Sellman earn 7th in sectional

Jim Sellman and Kathryn Donnelly placed seventh in Bronze Dancing competition in last weekend's Midwestern Figure Skating Championships held at the Cincinnati Gardens in Cincinnati, Ohio.

This skating pair competed among the top skaters in the United States in this sectional competition.

Donnelly and Sellman qualified for the sectional with a third place finish in regional competition three weeks earlier.

Kathryn, 13, is the daughter of Michael and Carol Donnelly of 11050 N. Beck Road.

Jim, 16, is the son of Bernard and Carol Sellman who reside at 1051 Hartsough.

Both skaters have been dancing together for 10 months and are members of the Plymouth Figure Skating Club.

PHA hosts puck tourney this weekend

The Plymouth Hockey Association (PHA) announced that it will host the Michigan Amateur Hockey Association District Five playoffs starting Jan. 30 and lasting through Feb. 5.

All the games will be played on weeknights or Saturday and Sunday day games at the Plymouth Cultural Center.

The playoffs include the Midget B League, the Squirt, A and B Leagues, and the Squirt Open League.

Admission is \$1 for adults, \$50 for children five to 12 and free for kids under four years of age.

For further information on the tourney see future Observer Sports Sections.

Prince & Pauper
 4915 N. WAYNE RD.
 WAYNE (3 BLKS. S. OF MICH.) 728-1783

COMPLETE DINNER
 MON. THRU WED.

20% OFF WITH THIS COUPON

TELEVISION SERVICE SPECIAL ONLY \$3

We will pick up your television set, bring it to our shop and have it checked by our TV experts. You will then be notified by telephone of the cost of repair. If you decide not to have it repaired we will return it to your home. All for only \$3.

C. B. SALES & INSTALLATION
 • JOHNSON • RCA • REGENCY • COURIER
 Antennas and Accessories

ISTA-RITE TV
 28915 JOY RD. WESTLAND PHONE 525-5450

GARAGE DOOR OPENERS

Genie

MODEL GS 450
\$168⁸⁸
 INSTALLED
 SOLID STATE CONTROLS
 \$177 DIGITAL CONTROLS
 1 YEAR WARRANTY

ANTENNA SERVICE CO.
 WESTLAND 326-7575 PONTIAC 335-9079

Suspended Ceiling Super Specials Gold Bond

Roma 30^c sq. ft.*
 10x12 room \$36.00

Parquet 34^c sq. ft.*
 10x12 room \$40.80

* Price includes white metal

WE STOCK 25 FLAVORS OF SUSPENDED CEILINGS. SEE OUR LARGE IN-STORE DISPLAYS.

SALEM LUMBER CENTER
 Home of Old Fashioned Service
 30650 PLYMOUTH ROAD
 BANKAMERICARD • MASTER CHARGE
 Ph. GA 2-1000

ATTENTION HOCKEY FANS!

HERE IS YOUR CHANCE TO WIN TWO RED WING TICKETS:

For your chance at a free ticket goal, all you have to do is send a post card with your name and address, including your zip code, to RED WINGS TICKETS, The Observer & Eccentric Newspapers, 36251 Schoolcraft Road, Livonia, MI 48150. The Observer & Eccentric will then pick names for winners from your entries. Some weeks, additional post card winners will be chosen for other Olympia events. When your name appears as a winner in our classified section, call 261-8600, ext. 209, to claim your tickets. Monday winners must call by 5 p.m. Tuesday and Thursday winners must call by 5 p.m. Friday. Tickets will be sent to winners through the mail well in advance of the game. (Sorry, no substitutions.)

The Observer & Eccentric Classified Ads

644-1070 IN OAKLAND COUNTY
 852-3222 IN ROCHESTER/AVON

Swimmers swamp Hawks

By BILL COLLINS

With each successive meet, Plymouth Canton's rise to prominence takes on a more distinctive shape. After disposing of Farmington Harrison 94-78 for the first time in Canton history, the Chiefs firmly established themselves as a force to be dealt with in the Western Six League.

The Canton win was its third in four matches against conference foes. Only one loss to Northville kept them from going undefeated in league competition.

"The Harrison meet was a challenge that was presented to the team, they accepted it, and went on to win," said Canton Coach William Faunce.

"It was a commendable performance by the squad as we won seven of

11 events. Particularly outstanding was Kevin Harris' effort," added Faunce.

Harris seemingly is unable to swim in a meet where he doesn't demolish a school record. His last outing was a case in point. The senior captain won the 200-yard freestyle in 1:50.3, lowering his old standard by three seconds, and he tied his own school mark in the 100-yard freestyle at :50.1.

Sophomore Bob Cline emerged victorious in the 200-yard individual medley in 2:20.8.

The turning point in the meet occurred when Canton placed first and second in the 50-yard freestyle. The Chiefs grabbed a lead for good when Dave Tanner and Jamie Greenwood finished back-to-back.

Scott Wales won the diving com-

petition with a 208.80 mark. With that triumph, he clearly makes himself the favorite to win his forte in the league meet.

Steve Wood, another consistent member of the squad, paid his dues to the cause by winning the 100-yard butterfly in :59.3.

Canton will start round two of its dual meets against Western Six conference rivals Thursday against Walled Lake Western.

"At this point in the season we are getting closer to achieving the two goals we set for ourselves as a team this year. First, to improve on our dual meet record, and secondly, to raise our standing in the league. I definitely think they are in reach of the team before the year is over," commented Faunce.

Chargers hand Canton 5th loss

The Plymouth Canton wrestling team lost its third straight Western Six League dual meet Thursday night falling to Livonia Churchill 36-23 at the Chargers' gym.

The Chiefs hold a 7-5 record overall and 1-3 in conference play. Canton battles Livonia Stevenson tomorrow night in a non-league match.

"It was a good match to watch," Canton coach Dan Chrenko said about the Churchill defeat. "We wrestled to an 18-17 score until the 167-pound match."

The Chiefs lost three of those last four matches as sickness or injury plagued Canton's chances for a victory. George Hamblin and Chuck Walker were out with injuries and Dennis Howell had the flu all week. 128-pound Jeff Rey was also out with a twisted ankle.

"It was a case of Churchill beating us in our weak weights," Chrenko said. "We wrestled three first-year kids in those late matches."

Despite the loss, Chrenko was pleased with his team's performance saying "it was the first time since Christmas that we wrestled well." Scott Collins at 147 and Craig Lee at 114 were the standouts for Canton. Lee pinned his opponent in a swift 1:03 while Collins demolished Tom Taylor 9-0. Taylor was a regional qualifier in a lighter weight class last season.

The best match of the night featured the top two 107-pound wrestlers in the conference as Churchill's Bill Jack defeated Canton's captain Bill Heedum 5-2 in a close match.

Canton's junior varsity squad, directed by Dan Riggs, raised its season record to 6-1-1 with a hard-fought 35-24 victory over the Churchill JV in the preliminary match.

RESULTS

100 pounds—Greg Thornhill (Ch) defeated Danny March (Ca), 5-0.

107 pounds—Bill Jack (Ch) defeated Bill Heedum (Ca), 5-2.

114 pounds—Craig Lee (Ca) pinned Bob Riddle (Ch), 1:03.

121 pounds—Bill Riddle (Ch) major decisioned Mark Bartlett (Ca), 13-1.

128 pounds—Matt Major (Ca) and Brian Hornoff (Ch) tied, 6-6.

134 pounds—Kevin Smellie (Ch) defeated Dave March (Ca), 4-0.

140 pounds—Terry Clifton (Ca) defeated Rich Stroyan (Ch), 6-0.

147 pounds—Scott Collins (Ca) major decisioned Tom Taylor (Ch), 9-0.

157 pounds—George Zentz (Ch) and Kyle Heaton (Ca) tied, 2-2.

167 pounds—Mark Swartzott (Ch) pinned Bret Ramage (Ca), 1:21.

180 pounds—Terry Madden (Ch) pinned Rich Burger (Ca), 1:06.

193 pounds—Scott Caldwell (Ca) pinned Rick North (Ch), :54.

HWT—Mark Dwitt (Ch) won by forfeit.

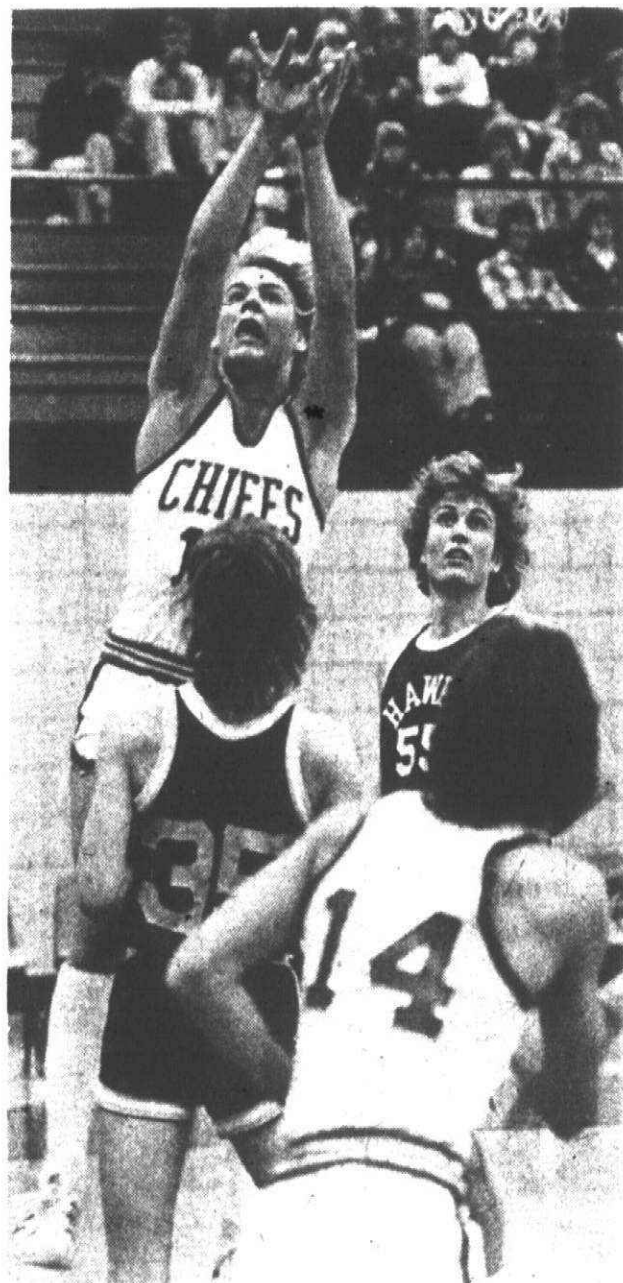

Rienas sinks 2

Randy Rienas pops in two of his 17 points against Harrison Friday night, but his efforts were in vain as the Chiefs lost to the Hawks in this Western Six League battle. (Staff photo by Gary Caskey)

Ready?

The cold weather lingers on but, for members of the Plymouth Canton Junior Baseball League, the work never stops in preparation for the upcoming summer season.

Registration for the 1977 season takes place on the last three Saturdays of March at the Plymouth Canton High School cafeteria.

For further details on the registration procedure see future Observer sports sections.

Why Pay More! Why Pay More! Why Pay More!

Sale on Guitars

Record Dept.

STANDARD SIZE FOLK GUITAR

36 1/2" L x 13 1/4" W x 3 1/2" D.
Steel reinforced neck with maple top, nato sides, & back. Special satin mahogany hand rubbed finish.

\$14⁸⁸

INTERMEDIATE SIZE FOLK GUITAR OUTFIT

Steel reinforced neck with maple top, sides & back. Decorative sound hole. 37 1/2" L x 13 3/4" W x 3 1/2" D. Also includes carrying bag, neck cord, instruction book with chord chart & pick.

\$22⁸⁸

SOLID BODY ELECTRIC GUITAR OUTFIT

Steel reinforced adjustable neck & bridge. Volume and tone controls. 38 1/2" L x 12" W x 1 1/4" D. Also includes carrying bag, neck cord, instruction book, with chord chart & pick.

\$33⁸⁸

BEGINNER AMPLIFIER

- 2 inputs
- Solid state
- Wood case

\$22⁸⁸

MEIJER RESERVES THE RIGHT TO LIMIT SALES ACCORDING TO SPECIFIED LIMITS
NO SALES TO DEALERS, INSTITUTIONS OR DISTRIBUTORS.

PRICES GOOD THRU SATURDAY JANUARY 29, 1977.

MEIJER THRIFTY ACRES — 45001 FORD RD. AT CANTON CENTER RD.

SHOP MON. THRU SAT. 8 a.m. to 10:30 p.m.; SUN. 9 a.m. to 7 p.m.

Keep Smiling

Meet the many faces of DETROITBANK CORPORATION

The familiar Indian head, symbol of Detroit Bank & Trust for more than 40 years, has taken on a whole new meaning.

Today, it stands for DETROITBANK Corporation and all of its subsidiaries. To serve your banking needs, there are more than 95 banking offices throughout the Detroit metropolitan area including Livonia, Southfield, Troy and Warren.

You'll find the subsidiaries of DETROITBANK Corporation are dedicated to helping you with all your financial needs through the competent, experienced help of DETROIT BANK-ers. They provide a complete range of banking, mortgage, equipment leasing, commercial loan and trust services in Michigan, the nation, and the world.

Just look for the Indian head symbol wherever you go, work or live. We've made it easier than ever for you to get to know a DETROIT BANK-er better.

DETROITBANK CORPORATION

you ought to know a DETROIT BANK-er better

The Indian head leads you to Detroit's first family of banks.

DETROITBANK CORPORATION CONSOLIDATED BALANCE SHEET DECEMBER 31, 1976

ASSETS	
Cash and due from banks.....	\$ 210,641,000
Time deposits with other banks.....	460,369,000
U. S. Treasury securities.....	194,294,000
U. S. Government agency securities.....	73,134,000
State and municipal securities.....	565,889,000
Other securities.....	57,069,000
Total securities.....	890,386,000
Federal funds sold and securities purchased under agreements to resell....	77,714,000
Commercial loans.....	857,385,000
Real estate mortgage loans.....	607,889,000
Consumer installment loans.....	187,978,000
Total loans.....	1,653,252,000
Less valuation portion of reserve for loan losses.....	19,686,000
Net loans.....	1,633,566,000
Premises and equipment.....	36,836,000
Customers' liability on acceptances.....	9,645,000
Other assets.....	62,065,000
TOTAL.....	\$3,381,222,000
LIABILITIES	
Demand deposits.....	\$ 776,914,000
Savings and personal time deposits.....	1,822,451,000
Other time deposits.....	166,925,000
Deposits in foreign offices.....	77,093,000
Total deposits.....	2,843,383,000
Federal funds borrowed and securities sold under agreements to repurchase....	174,055,000
Commercial paper outstanding and other borrowed funds.....	47,922,000
Acceptances outstanding.....	9,645,000
Other liabilities.....	70,060,000
Total liabilities.....	3,145,065,000
SHAREHOLDERS' EQUITY	
Preferred stock—no par value; 500,000 shares authorized, none issued.....	—
Common stock—\$10 par value; 4,500,000 shares authorized, 4,433,216 shares issued in 1976, 3,370,483 shares issued in 1975.....	44,332,000
Surplus.....	114,373,000
Retained earnings.....	84,060,000
Total.....	242,765,000
Less treasury stock—182,282 shares at cost.....	6,608,000
Total shareholders' equity.....	236,157,000
TOTAL.....	\$3,381,222,000

BOARD OF DIRECTORS

- E. A. Cafiero
President—Chrysler Corporation
- Walker L. Cislak
Retired Chairman—The Detroit Edison Company
- Frank A. Colombo
Retired Executive Vice President—The J. L. Hudson Company
- Rodkey Craighead
President
- Hugh C. Daly
Vice Chairman—American Natural Resources Company
- Louis A. Fisher
Director
- Walter B. Ford II
Chairman—Ford & Earl Design Associates, Incorporated
- Edward J. Giblin
President—Ex-Cell-O Corporation
- Oscar A. Lundin
Retired Vice Chairman—General Motors Corporation
- Donald R. Mandich
Executive Vice President—The Detroit Bank and Trust Company
- James McMillan
Director
- Paul S. Mirabito
President—Burrhoughs Corporation
- E. Joseph Moore
President—Detroit Ball Bearing Company of Michigan
- Paul W. O'Walley
Chairman and President—Essex International, Incorporated
- Raymond T. Perring
Retired Chairman
- H. Lynn Pierson
Retired Chairman—Dura Corporation
- Robert F. Roelofs
President—Macomb County Community College
- Alan E. Schwartz
Senior Partner—Honigman, Miller, Schwartz and Cohn
- W. Warren Shelden
Director
- C. Boyd Stockmeyer
Chairman
- Arbie O. Thalacker
Chairman—Detrox Chemical Industries, Incorporated
- Cleveland Thurber
Counsel—Miller, Canfield, Paddock and Stone
- Herbert B. Trix
Director—The Standard Products Company
- William R. Yaw
President—Wabeek Corporation

On December 31, 1976 securities having a par value of \$115,116,000 were pledged where permitted or required by law to secure liabilities and public and other deposits totaling \$70,540,000 including deposits of the State of Michigan of \$5,824,000. Standby letters of credit amounted to \$17,577,000 as of the same date.

DETROITBANK CORPORATION

Trenton trips tankers

Parents' Night for the Plymouth Salem swimmers turned out to be a sad affair as the Rocks lost their first Suburban Eight League meet of the season 95-77 to the Trenton Trojans Thursday night at the Plymouth pool.

This setback gives the Rocks a 1-1 record in the conference and 7-3 overall.

"It was a pretty good meet," said Salem coach Byron Williams. "They (Trenton) were stronger than us and a very respectable team. I don't think they are as strong as (defending Sub-8 champion) Dearborn but they had a lot of depth.

"We didn't swim badly. Trenton was just tougher than us."

The Rocks took the majority of the first place finishes with six victories in the 11 events. Salem also followed with five second place finishes but Trenton's depth prevailed at the end.

SENIOR RON Finley performed in his usual great fashion, coming in

with double victories in the 50 free-style and 100 backstroke events.

The 50 free time of :22.8 beat Trenton's top swimmer, Pete Stanton, by one-half a second. Finley's time was good enough for state qualification.

This means that the potential all-American has qualified for state competition in all but one individual event—the 100 breaststroke.

Finley's 100 backstroke time of :55.0 was his best time of the season and increased his hold on the state's best time in that event.

Tom Rubadue was a surprise double winner for the Rocks with victories in the 100 and 200 freestyle races. Rubadue clocked at 1:54.0 in the 200 and :51.9 in the 100.

Rob Kuebler swam his best time of the year in the 100 butterfly, winning that race in :59.1.

The 400 freestyle relay ended the night with a Rock victory as Tim Ying, Craig Finley, Mike Etienne and Rubadue swam a solid 3:30.6.

IN THE POCKET

By W.W. EDGAR

It isn't generally known, but the high averages and the phenomenal scoring you see on TV when the touring pros are in action are not accomplished under the same conditions under which our area leagues bowl.

As a matter of fact, the pro bowlers carry their own maintenance men with them to condition the lanes before a meet. They do not observe the ABC rule that calls for the spreading of oil from gutter to gutter. And because of this, the scores you see rolled by the pros are not approved by the ABC governing body of bowling.

This thought comes to mind when one observes that the five finalists in a recent program all averaged better than 230 to reach TV competition.

The best averages posted in our metropolitan area do not go above 220. Just thought you'd like to know.

THIS IS ANOTHER great year for the veteran bowlers who still compete in the weekly leagues. For instance Mary Mohacs, who was the bowling queen a decade ago, is now topping the averages in two leagues.

And this week Dick Preston, who has been around for more than a few

seasons, rolled a 673 in the Wonderland Classic. He was just a pin short of leading the circuit.

The pacemaking role was shared by George Bashara and Tom Hay, who counted 674.

The team captained by Jerry Redtz contributed a 3120 on games of 1087, 1097 and 936, while the entire league averaged better than 193.

ONE OF THE REAL JOYS of a bowler comes when he or she can take a change from the home lanes and do well in another house.

Juniors didn't play

The Observer Sports section prematurely announced the upcoming junior basketball game with the C League boys. This contest was not played at halftime last Friday.

This exhibition battle is scheduled as the half-time presentation of this Friday's Plymouth Canton-Walled Lake Western varsity basketball game.

HIGHLAND APPLIANCE
NEW STORE NOW OPEN
 33600 PLYMOUTH ROAD
 JUST WEST OF FARMINGTON RD.
 LIVONIA
261-7810

NOW OPEN
FRY'S HARDWARE
 145 HAGGERTY at CHERRY HILL
981-1922
 MAC-O-LAC PAINTS
 SCOTTS LAWN CARE
 WINDOW REPAIRS
 MON.-SAT. 9 A.M.-6 P.M.
 SUN. 10-2

JANUARY SALE
25% OFF
 GAMES • TRUCKS • MODELS
 DOLLS • STUFFED ANIMALS
 CRAFTS
 Save even more on our
Red Tagged Toys
40% OFF
 • Serving Platters
 • Woodenware bowls, servers, salt & pepper, chip 'n dip, etc.
 • Mirrors
 • Mirrographics
 • Baskets • Plant Pots • Mugs
 • Macrame Plant Hangers
 & many other gifts to choose from!

25% OFF STATUES
EARLY AMERICAN LAMPS
METAL WALL SCULPTURES

LIVONIA HARDWARE
 True Value
 5 MILE ROAD at FARMINGTON ROAD
 PHONE 937-1611 GA 2-1155
 OPEN DAILY 9 a.m. - 9 p.m. SUNDAY 10-3

OPEN DAILY 10-10; SUNDAYS 11-6 GOOD NOW THRU SAT.

Kmart ... gives satisfaction always

BIG DISCOUNTS

BARN BOARD PANELING
 Our Reg. 9.28 **5.97** Thru Sat.
 4 ft. x 8 ft. x 1/2 inch paneling. Easy to install. Your choice of colors brown or gray.

CEILING TILES
 Our Reg. 14' **11c** Thru Sat.
 12" x 12" plain white perforated tiles. Easy to install.

MELAMINE TUB KIT
 Our Reg. 36.88 **29.97** Thru Sat.
 Complete do-it-yourself tub kit. 5x5 ft. melamine finished panels.

PLYWOOD HANDI-PANEL
 Our Reg. 4.44 **3.88** Thru Sat.
 2 ft. x 4 ft. x 1/2 in. Handi-panel plywood.

TRI-DOOR BATHROOM ENCLOSURE
 Our Reg. 53.96 **39.88** Thru Sat.

LIQUID NAILS
 Our Reg. 94' **68c** Thru Sat.
 11 oz. cartridge. All-purpose panel adhesive.

Z-BRICK
 Our Reg. 4.97 **2.88** Thru Sat.
 Antique standard red Z-Brick, 6 sq. ft. per package.

CAFE DOORS
 Our Reg. 18.88 **13.97** Thru Sat.
 Sanded and ready to finish doors in packaged pairs. Your choice of size, 30", 32", & 36".

ROLLED INSULATION
 Our Reg. 6.47 **5.97** Thru Sat.
 3 1/2" x 15 rolled insulation. Easy to install. Saves on heating.

CORK TILE
 Our Reg. 2.37 **1.88** Thru Sat.
 8 Sq. Ft., 12 x 24" natural look cork tile. Soundproofs your walls.

NOTICE OF PUBLIC HEARING
TOWNSHIP OF PLYMOUTH

ON A PROPOSED AMENDMENT TO THE ZONING ORDINANCE, BEING ORDINANCE NO. 47 OF THE TOWNSHIP OF PLYMOUTH, WAYNE COUNTY, MICHIGAN

Notice is hereby given that a PUBLIC HEARING, PURSUANT TO THE PROVISIONS OF THE Rural Township Zoning Act, being Act 184, P.A. 1943, as amended, will be held by the Plymouth Township Planning Commission, on its own motion, on Wednesday, February 16, 1977 at 7:30 (+) Eastern Standard Time, at the Plymouth Township Hall, located at 42350 Ann Arbor Road, for the purpose of considering and action upon a proposed amendment to the Zoning Ordinance, being Ordinance No. 47 of the Township of Plymouth, Wayne County, Michigan relative to the Amendment of Article 23.1, ZONING BOARD OF APPEALS, Membership, Terms, Removals.

The text of the proposed Amendment is available for inspection by members of the public during regular business hours at the Township Clerk's Office, Plymouth Township Hall.

PLYMOUTH TOWNSHIP PLANNING COMMISSION
 DORIS RITCHIE, Secretary

Publish January 24 and February 10, 1977

NOTICE OF PUBLIC HEARING
PLANNING COMMISSION
TOWNSHIP OF PLYMOUTH

TO REZONE FROM: R-1 to O-S
 DATE OF HEARING: February 16, 1977
 TIME OF HEARING: 7:30 P.M.
 PLACE OF HEARING: 42350 Ann Arbor Road

NOTICE IS HEREBY GIVEN that the Plymouth Township Planning Commission has received a petition to rezone the following described property from R-1, One Family Residential District, to O-S, Office Service District: (No. 354 Warren)

Lot 2, Rocker Estates Subdivision located in the southwest 1/4 of Section 35, T.15., R.8E, Township of Plymouth, Wayne County, Michigan.

NOTICE IS FURTHER GIVEN that the proposed Amendment to the Map and Text may be examined at the Township Hall, 42350 Ann Arbor Road from 8:30 A.M. to 5:00 P.M. each day, Monday through Friday until the date of the Public Hearing.

TOWNSHIP OF PLYMOUTH PLANNING COMMISSION
 DORIS RITCHIE, Secretary

Publish: January 24 and February 10, 1977

AVAILABLE ONLY AT: FORD ROAD AT SHELDON ROAD

AVAILABLE ONLY AT: ANN ARBOR RD. NEAR HAGGERTY ROAD • FORD ROAD AT SHELDON ROAD

SALE PRICES GOOD NOW THRU SATURDAY

K Mart

OPEN DAILY 10-10; SUNDAY 11-6

K MART'S ADVERTISED MERCHANDISE POLICY

Our firm intention is to have every advertised item in stock on our shelves. If an advertised item is not available for purchase due to any unforeseen reason, K Mart will issue a Rain Check on request for the merchandise to be sold at the sale price whenever available or will sell you a comparable quality item at a comparable reduction in price. Our policy is to give our customers satisfaction always.

S. S. KRESGE CO.

HERE'S PROOF YOU SAVE MORE!

DOORBUSTERS

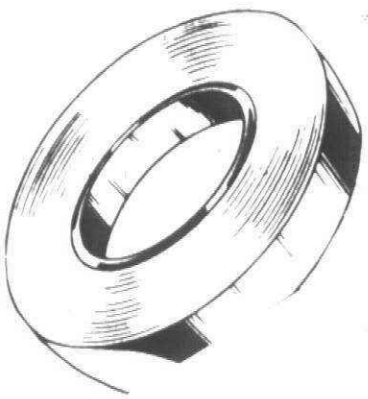

MASKING TAPE

Our Reg. 57¢ Thru Sat.

44¢

¾" x 60 yard roll. Handy for painting, wrapping, general use.

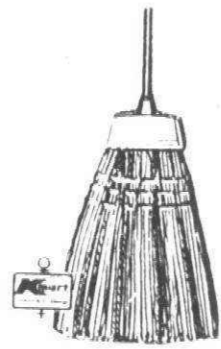

CORN BROOM

Our Reg. 2.97 Thru Sat.

1.99

Indoor-outdoor 12" all purpose corn broom with painted handle.



PUNCH BALLS

Our Reg. 43¢ Thru Sat.

3/\$1

Blow up punch balls. Variety of colors to choose from.



TYPEWRITING TABLE

Our Reg. 19.96 Thru Sat.

\$13

Durable wood look typewriting table.



JEWELRY CLEANER

Our Reg. 96¢ Thru Sat.

57¢

8 oz. K-Mart Jewelry cleaner

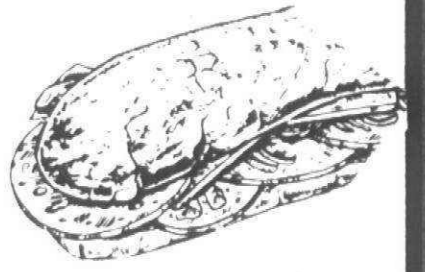

SUB-SANDWICHES

Our Reg. 59¢ Thru Sat.

2/\$1

Submarine Sandwiches are available in our Deli.

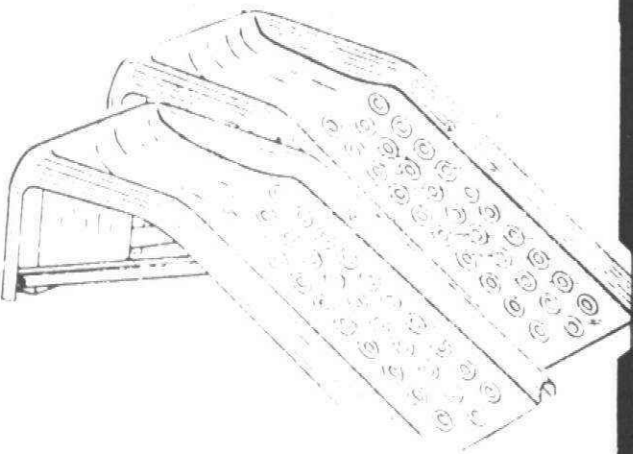

CAR RAMP

Our Reg. 24.88

18.88

Thru Sat.

Safe, sturdy, built-in-wheel cradle and slip resistant incline. In our Auto Dept.

LADIES COATS AND JACKETS

Our Reg. 39.96/54.96
Thru Sat.

\$20-\$35

CLEARANCE

Assorted styles and fabrics. Clearance sale! Shop now and save in our Ladies Fashion Dept.

CHARGE IT! WE HONOR

JOHNNY WEST CLOSE-OUT SALE

Sale price
Thru Sat.

1.96-4.87

Johnny West and the gang, with accessories, costumes and utensils. While 200 last per store.

SAVE on Prescriptions at Pharmacy

AT MOST K-MARTS

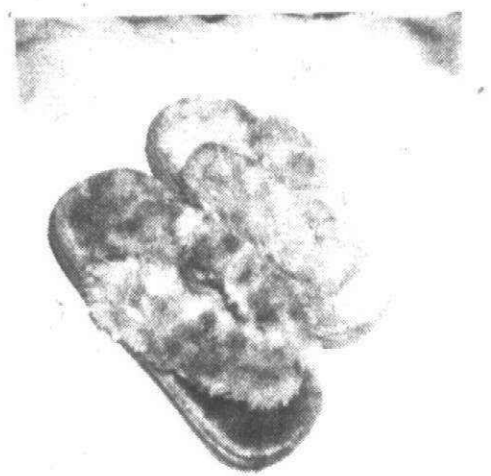

LADIES SLIPPERS

Our Reg. 2.00

\$1

Thru Sat.

Ladies furry thong style slippers. Available in our Footwear Dept.



SHEER SCARVES

Our Reg. 3/1.00

4/\$1

Thru Sat.

Square and rectangular sheer scarves in an assortment of colors.

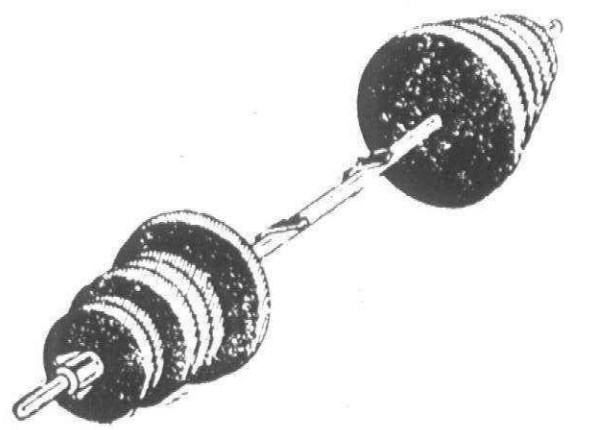

BARBELL SET

Our Reg. 21.88

18.88

Thru Sat.

Plastic coated, 110-lb. barbell set. Available in our Sporting Goods Dept. Shop and Save!



WET MOP

Our Reg. 1.97 Thru Sat.

1.50

Cotton/polyester wet mop with painted handles.



DRESS SHIRTS

Our Reg. 7.66 Thru Sat.

6.66

Mens short sleeve knit dress shirt. 100% polyester knit.



SPORT SHIRTS

Our Reg. 5.96 Thru Sat.

4.96

Mens short sleeve permanent press sport shirts.



DRESS SHIRTS

Our Reg. 7.66 Thru Sat.

\$4

Clearance sale on our mens long sleeve dress and sport shirts.



HOUSE PAINT

Our Reg. 7.47 Thru Sat.

6.47

Premium indoor wall paint. Fast drying and washable.

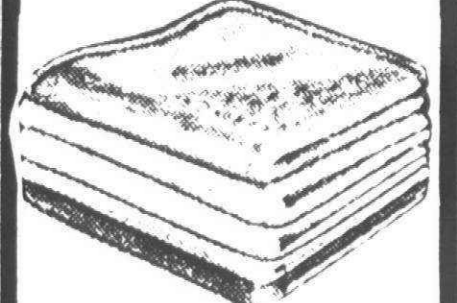

WASHCLOTHS

Our Reg. 21¢ Thru Sat.

16¢

Soft terry washcloths, 11x11" cotton, in solid colors.

AVAILABLE ONLY AT: ANN ARBOR RD. NEAR HAGGERTY RD. • FORD ROAD AT SHELDON ROAD



Fasching party set for Feb. 5

The third annual fasching party sponsored by the German-American Club of Plymouth is scheduled for 8 p.m. Feb. 5 in the Plymouth Cultural Center, 525 Farmer Street, Plymouth.

"Persons of all ethnic backgrounds are invited to enjoy the fun of the pre-Lenten celebration," said Gus Oesterle, president of the club. "There will be all-German wine, beer and food—sausage, pickles, potato salad, sauerkraut and rolls."

Music for dancing will be supplied by the "Melodias." According to club members Maria Mulzer and Helen Oesterle, the band can be heard every day on the German Hour on radio. It also played for the Vienna Ball in Cobo Hall, Detroit.

For Maria Mulzer of Canton Township, the fasching party and stories of fasnacht brought back memories of her childhood in the Black Forest area of Germany. She said the fasching celebration actually begins the 11th hour of the 11th day of the 11th month. It is then that the prince and princess and their attendants are chosen.

"THINGS QUIET down over Christmas but start up again after the new year," said Maria. The prince and princess and their court must be unmarried.

"They visit all the local clubs and are greeted with great ceremony. Their arrival is announced by trumpeters."

Mrs. Mulzer has been in this country for seven years. She said the beginnings of the fasching parties go back to the early 18th century in Germany.

"In the north it is called a festival. In the south—Bavaria and the Black Forest—it is fasching.

"It is a time for spoofing politicians," she said. "Television comedians, and people in the parades and at parties tell jokes and make fun of government officials. The Monday before Ash Wednesday is a holiday. The big parades are carried on television.

"There are floats and tons of candy and pretzels are thrown to the children lining the parade route. It all ends Tuesday night, fasnacht with the big parties."

MARIA MULZER said everyone wears costumes and masks to the

fasching balls. At midnight, they take off their masks.

"If you don't want to unmask, you just leave."

She said that in some places they put a person in clown costume in a casket and carry him out, marking the end of the festivities.

"The children have their own balls on the Sunday afternoon before the parade. I remember after the war," she reminisced. "They threw oranges to the children at the parade. We would collect whole bags full of things. They carried the pretzels on long sticks."

Some of the costumes are very expensive and are handed down in families. Mrs. Mulzer said her brother's costume is worth about \$200.

"It has a wooden mask which distorts your voice when you speak. Some people rent costumes for the ball."

Most of those attending the local fasching party wear costumes but it is not necessary. "I still don't know if I can persuade Gus to go in costume," said Helen Oesterle.

Maria and Horst Mulzer won second place for their costumes at last year's party. Maria made the costumes—they were dressed as Mr. and Mrs. Ladybug.

"I still haven't an idea for this year," she said.

THE GERMAN-AMERICAN Club of Plymouth has members from the surrounding communities, Livonia, Plymouth, Northville, and Westland. It is a social and cultural club which meets the third Thursday of each month in the Plymouth Oddfellows Hall on Elizabeth Street at Ann Arbor Trail.

They are seeking new members and anyone wishing more information can call the president, 455-7789.

Oesterle, the president lives in Canton Township. Roger Feller, vice president is from Northville; Joe Gates of Plymouth is treasurer; Mary Ploughman of Plymouth is secretary; Maria Mulzer and Fritz Sanders of Livonia are the auditors.

Tickets for the fasching party are \$6.50 per couple. They may be purchased from members of the club or from Finlan Insurance on Main Street.

"It's a good idea to buy them early," warned Helen Oesterle. "We've had a sellout each year."



Beth Simescu (left) and Joan Healy presented Dunning-Hough Library's bicentennial gift to Archie Stobie and Evelyn Edgar. (Staff photo by Elinor Graham)

Museum archives receives gift

Beth Simescu and Joan Healy presented Dunning-Hough Library's bicentennial gift to the Plymouth Historical Museum last week with the hope that the program would continue.

"It is a never-ending program," said Mrs. Simescu. "The library wanted to see it begun. We can't continue it now, but will work with others in an advisory capacity."

The gift to the museum was tapes of conversations with 12 longtime Plymouth residents. The oral history of the community contained on the tapes is a valuable addition to the

archives department of the museum. Evelyn Edgar, head of the department, and Archie Stobie, museum director, accepted the gift with the promise to carry on the project.

The taping was done during the spring and summer months.

Beth Simescu and Joan Healy spoke of the research that went into an interview before the actual taping began. Once the project was endorsed by the Community Bicentennial Commission, a resource group was established and several persons attended a class in-

structed by Patricia Pilling to learn the art of interviewing and taping.

Originally, several high school students were involved, but Mrs. Simescu and Mrs. Healy were responsible for all the recordings.

THE 12 PERSONS whose memories now are a permanent record of the history of the area are Roy Fisher, George Burr, Perry Richwine, Roswell and Nancy Tanger, Ernest Allison, Margaret Dunning, Frank Henderson, Jack Wilcox, Ruth Garlett and Clara Alexander.

"We have a long list of others we'd

like to tape," said Mrs. Simescu. It should be done. I was shocked to hear Roy Fisher had died but grateful we had his interesting recollections on tape. These things can't wait."

The gift to the museum included the original tapes and a set of copies. Another set will be kept in the library.

There is a tape player in the museum's archives for listening, and the library has four cassette players for in-library listening.

Students and researchers can use the tapes for study at both the library and the museum.



MR. AND MRS. HARVEY THOMAS

Thomases wed 60 years

Mr. and Mrs. Harvey Thomas of 356 Roe Street, Plymouth, will celebrate their 60th anniversary Jan. 31. They were married Jan. 31, 1917 in Plymouth.

When they were first married, Thomas worked for the Daisy Company.

"My pay was \$9 a week," he said, "for 55 hours a week. We worked 10 hours a day, five days a week, and five hours on Saturday. Some weeks we'd get paid by the piece and I'd get as much as \$13." He still has some of his pay envelopes from 1916 and 1917 with the amounts on the envelopes.

He recalled that he bought his wedding cigars from George Springer, the only policeman in town.

"George rolled the cigars in a little shop behind his house on Mill Street," he said. "They were called Plymouth Mails."

He pointed out the spot on Main Street where the livery stable once stood. Young men could rent a horse

and buggy for \$1 an evening when they were courting.

"You could take a drive into the country but you couldn't stay late. You usually had to get home by 10 o'clock."

He recalled the day a 7-year-old boy drowned in Tonquish Creek. "It was just about where the alley is now, back of Cloverdale. He was washed down to Wing Street."

In a lighter vein he told of the gala days on the site where the Mayflower Hotel now stands, and the medicine shows that set up shop there every year.

The Thomases have four sons and a daughter. Their family includes Mr. and Mrs. Clarence Thomas of Plymouth, Mr. and Mrs. Leland Thomas of Belleville, Mr. and Mrs. Morris Thomas of Plymouth, Mr. and Mrs. Doyle (Eunice) Maddock of Westland, and Sidney Thomas of Plymouth. They have 10 grandchildren and 22 great-grandchildren.

'Rumpelstiltskin' stomping good play

Drama is an elective course for sixth graders at Central Middle School. Those who take the course are immediately involved in all phases of drama.

The latest production of Margo Panko's students is "Rumpelstiltskin."

Besides making their own costumes, the young thespians constructed an elaborate spinning wheel used on the set. After several performances for their fellow-students, they took their show on the road.

"We usually take our plays to our feeder schools," said Mrs. Panko. "This time we are branching out a little. For the first time, we are going to St. Peter's Lutheran Day School. We also took it to Hulsing."

More than 20 students were part of the travelling show.

Jim Fee, Mark Roehrig, Mike Funckhauser and Matt Marcinkiewicz were from 6-2.

Darin Bollinger, Ceila Stuart, Ron Rienas, Laura Aldrin, Erick Faatz, Theresa Wertanen, David Schelling, Lisa Bundarin, Tad Hall and Greg Williams represented grade 6-3.

Others were Joe Hockenbury, 6-1; Barry McNamara and David Rivera, 6-4; Lisa Woodward and Amy Norton, 6-7; Laurie Wells, 6-8; and Mickey Madsen and Brian Krabbenbos, 6-10.

Parents of the students supplied transportation for the 1:30 p.m. performances at Hulsing, Starkweather, Fiegel, Tanger, St. Peter's, Allen and Farrand elementary schools.



Erick Faatz plays the role of Rumpelstiltskin.

Celia Stuart plays the part of Marilyn, the miller's daughter.



Students at St. Peter's Lutheran Day School Gave their full attention to the play. (Staff photos by Gary Caskey)



Horst and Maria Mulzer are looking forward to the Feb. 5 fasching 3 Zy. Their ladybug costumes won a prize last year. (Staff photo)



Cookie time

It's Girl Scout cookie time again, and the girls begin their sales pitch after Feb. 1. Patti Buno (left), Karen Overhiser and Kelly Tucker don't expect much difficulty in selling their share for that old favorite, the peanut butter pattie, is back this year. Pattie belongs to Junior Troop 201, which meets in West Middle School. Her leaders are Rainy Kirchoff and Nancy Harrison. Senior Karen is a member of Troop 501. They meet in First Presbyterian Church of Plymouth, and their adviser is Carol Raycraft. Kelly's Cadette Troop 626 meets in St. John's Episcopal Church, and her leaders are Ruth McMahon and Martha Bentley. (Staff photo by Gary Caskey)

Clubs in Action

MT. HOPE CO-OP NURSERY
The Mt. Hope Co-operative Nursery in the church, 30330 Schoolcraft, west of Middle Belt, is taking applications for three and four-year-olds for the fall term beginning in September.

Interested persons can contact Mrs. Nancy Wood, 14254 Alexander, Livonia.
MAYFLOWER GARDEN CLUB
The Mayflower Garden Club of Plymouth will meet at 9:15 a.m. Jan. 27 in the

home of Mrs. Robert Johnston, 9002 Morrison, Plymouth. Mrs. Howard Tripp will be co-hostess.
Members will discuss ideas and crafts for the rest of the year. They will adjourn for lunch at Northville Charley's.

CANTON NEWCOMERS CLUB
The Canton Township Newcomers Club will have its February meeting at a luncheon in the Roman Forum on Ford Road. The luncheon will be at 12:30 p.m. preceded by hospitality at noon. Guest speaker will be Beverly Henderson of Interior Reflections.
Reservations for the luncheon can be made by calling Mrs. Thomas Cifrodella of Palisades Court. For information concerning nursery facilities call Mrs. Thomas Skorka, Palisades Drive.

the discussion of revision of the by-laws, and the spring leadership training schedule.
At least 30 per cent of the 90 troops in the association must be represented at the meeting for delegates to be selected. Refreshments will be served. For further information, call Ruth Dostie, 453-7544.

PLYMOUTH NEWCOMERS CLUB
Members of the Plymouth newcomers Club will meet for lunch Feb. 3 in the Mayflower Meeting House. Hospitality at 11:30 a.m.; lunch at noon. Betty Andrews, assistant dean of Community Services at Schoolcraft College will speak on "Women in Transition-The Middle Years."
Reservations and cancellations should be made by Feb. 1 with Lois DeBell, 459-9315. Cost of luncheon is \$5. Babysitting reservations should be made 24 hours in advance with Kim Lee, 453-1289.
All newcomers, prospective members and guests may attend.

GIRL SCOUT ASS'N MEETING
Girl Scout leaders and troop committee members from the Plymouth-Canton-Northville area will meet at 7 p.m. Feb. 2 in West Middle School, 44401 W. Ann Arbor Trail, Plymouth. Girls 14 and older may attend.
The agenda will include election of delegates to the Huron Valley Girl Scout Council Meeting in April.

BEAUTY SALON



It's not too late to save. Perms still 1/2 off.
For a limited time you can still save 50% on one of our best perms. Call today for a
\$20 Salon Perm now 9.95
\$25 Body Wave now 12.50
\$30 Deluxe Perm now 15.00

If you want value, come see us.
Use Your Wards Charge-all Credit.

MONTGOMERY WARD

**Wonderland Center
Plymouth at Middlebelt 427-1600**

EthanAllen winter Furniture Sale!

Substantial reductions from regular prices on an exciting selection of our most popular furnishings...including this handsome Antiqued Pine bedroom!



the Hearthside
An Ethan Allen Gallery

LIVONIA • 15700 Middlebelt Rd. • PHONE 422-8770
UTICA • 50170 Van Dyke • PHONE 739-6100
SOUTHFIELD • 15600 W. 12 Mile Rd. • PHONE 557-1800
OPEN MON THURS FRI TIL 9 • TUES WED SAT TIL 5:30

ONLY A FEW DAYS LEFT!!!

AT THE *Dancer's Fashions*

GREAT \$100,000 GOING OUT OF BUSINESS SALE

ALL SALES FINAL—NO REFUNDS—NO EXCHANGES

LADIES WOOL COATS Reg. \$79 \$14⁹⁹	EVERYTHING	PANT SUITS \$50.00 \$14⁸⁸
LADIES T-TOPS VALUES TO \$12.00 \$2⁸⁸ UP	<h1 style="font-size: 2em;">50% OFF</h1> <p>AND MORE</p>	SAVE ON SUMMER SHORTS, TOPS
LADIES SLACKS VALUES TO \$18.00 \$5⁸⁸ to \$8⁸⁸		LADIES' DRESSES FROM AS LOW AS \$3⁸⁸
<p>HOURS <i>Dancer's Fashions</i> BANKAMERICARD AND MASTER CHARGE WELCOME</p> <p>M, TH, F 10-9 METRO PLACE MALL T, W, S 10-6 WAYNE, MICH.</p>		

From Your House

By LORI BRICKMAN 981-0237

The Plymouth Community Arts Council is looking for assistance in the continuance of its school art program.
Many parents new to the Canton area may not be familiar with the eight-year-old series of art exhibits in the schools carried on by the "Picture Ladies." But your children are aware of the program and are becoming more proficient in visual media appreciation.
The PCAC's goal is to help the elementary students in the Plymouth-Canton schools know and enjoy art. Once a month, volunteers take portfolios of reproductions and visit four or five classrooms in each school. Each presentation is based on a theme such as animals, sports, Van Gogh, women artists, etc.
In the first grade, the children are primarily aware of color and what they can find in a picture. When the students have reached the fifth grade, they are ready to learn more about the artist's life and why and how the picture was painted.
APPROXIMATELY 20 minutes is spent discussing five or six paintings. At the end of the sessions, a picture is left in each classroom for the students to "live with." The pictures are rotated each week.
A month later, the picture lady returns with a new portfolio.
Nancy Hayes, chairperson of the project, said, "Our volunteers are not required to have a vast knowledge of art history. It is a learning experience for us as well as the children."
Biographical information and notes concerning the pictures are included with each set of paintings.
The scope of the picture ladies' territory has been increased by the opening of the three new schools in Canton.
An introduction and training session is planned for 1

SUPER

drug stores

2 LOCATIONS

In Plymouth 240 N. MAIN 455-6860
Open Mon.-Sat. 9-9 Sun 10-7

In Canton 5780 SHELDON RD. 455-2820
Open Mon.-Sat. 9-10 Sun 10-7

40th ANNUAL WINTER SALE

Colonial House of Furniture
19532 W. McNichols
Open Mon., Thurs., Fri. til 9 KE2-7900

STAN'S

BUSHELS OF FOOD VALUES!

SALE DATES JAN. 24-30

T-BONE or PORTERHOUSE STEAKS
\$1.79 LB.

ECKRICH POLISH \$1.29 LB.
KIELBASA
SPARTAN 1-LB. 69¢
BOLOGNA PKG.
SPARTAN All Pork SAUSAGE 79¢ LB.
LINKS
SPARTAN 1-LB. 69¢
HOT DOGS PKG.

PORK STEAK
89¢ LB.

Campbell CHICKEN NOODLE SOUP 10 3/4-oz. CANS \$1.00
VELVET Creamy or Crunchy 32 \$1.19
PEANUT BUTTER 30-oz. JAR \$1.49
HOT COCOA MIX 10-1/2 oz. **69¢**
Salada 4 MINUTE FUDGE MIX 171 oz. **\$4.49**

TIDE LAUNDRY DETERGENT 171 oz. **\$4.49**

PRIMA SALSAS 32 oz. **99¢** MEAT or MUSHROOM

QUAKER MAID ANTI-FREEZE \$2.99 GAL.

BANQUET Frozen PIES Chicken, Turkey, Beef 4 8-oz. Pkgs. **89¢**

CUBE STEAKS \$1.29 LB.

Michigan RED DELICIOUS or MacINTOSH 3 LBS. **49¢**

Country Style SPARE RIBS 99¢ LB.

Homemade Bulk PORK SAUSAGE 89¢ LB.

SIRLOIN STEAKS
\$1.59 LB.

Exotic TABLE FERNS in 4" CLAY POTS
Values to \$3.00 FOR **2 \$3.00**

Fresh BROCCOLI Lg. '18' size **49¢**

RED POTATOES 5 LBS. **49¢**

Van Camp TUNA 6 3/4 oz. **39¢**

DOG FOOD 10¢ per can

VERNORS DIET & REG. -N.R. 8 PAK 10 OZ. **\$1.09** SAVE 70 UNIT

Heinz KETCHUP 32 oz. **79¢**

• THURS. & FRI. ONLY—JAN. 27 & 28 •

• 38000 ANN ARBOR RD. • LIVONIA • Mon.-Sat. 9-9 • SUN. 10-5 • 464-0330

We Reserve the Right to Limit Quantities

LRTG meeting features 'Iceman'

The Theatre Guild of Livonia-Redford is inviting the public to attend its next general membership meeting Friday, Jan. 28. After an 8 p.m. business meeting, the Guild will present a portion of Eugene O'Neill's "The Iceman Cometh," lasting approximately one hour. Leonard Bradley of Detroit, is directing and playing the leading role of Hickey. This is a repeat dual performance for Bradley, who was responsible for the critically acclaimed three-hour production of "Iceman" at the Group Theatre. That presentation was the Midwestern premiere of this drama originally produced on Broadway in 1946.

The typical O'Neill story deals with people facing defeat. The setting is the "Last Chance Saloon" on Manhattan's lower west side in the 1920s. The patrons of the bar have one thing in common, they are clinging desper-

ately to pipedreams. Hickey, the salesman, strolls through the room, prodding the sleepers, seemingly little more than a do-gooder in celluloid collar, until he reveals his tragedy.

Members of the cast include Kevin McGee of Livonia; Barry Collins and William Unger of Detroit; Ron Kruman, Clawson; Betty Kenney, Birmingham; Paul Cook, Royal Oak, and Max Wolf of Berkley.

There is no admission charge for this program which will be presented in the Guild Playhouse, 15138 Beech Daly, south of Five Mile, Redford.

Awareness theater at EMU

The Theatre Company of Ann Arbor will give a free performance on the campus of Eastern Michigan University at 8 p.m. Thursday, Jan. 27 in the Roosevelt Auditorium.

The company, which focuses on women, will perform a potpourri of their own original material in repertory, including excerpts from their two recent productions of "Mad Madonnas" and "Bitch, You Crazy!"

The Theatre Company of Ann Arbor has been described as a kaleidoscope, a statement about women today; theatre that recognizes the need to examine women in social, political and economic institutions. The company is known as being entertaining and funny while being serious and moving.

Its most recent production, "Bitch, You Crazy!" is a collection of experimental and improvisational pieces developed or adapted by the company. Some pieces were written by company members, while others are adaptations of works by contemporary writers, including Rita Mae Brown, Judy Grahn, and Alan Alda. In the show, as in its other productions, the company strives to portray the voices of women and their experiences in a social context broader than that normally seen in traditional theater.

Jazz buffs treated

Jazz musicians Bess Bonnier and Joe Laduka will perform Monday at 8 p.m. in the Sisson Room of Fair Lane Conference Center at the University of Michigan-Dearborn.

Ms. Bonnier, a jazz pianist, has long been considered one of Detroit's best jazz musicians. She has performed at some of Detroit's leading entertainment spots, including Jack Brokensha's, the Vineyards, Top of the Pontch and Charlie's Crab.

Joe Laduka, on bass and guitar, is a native Detroit who studied with Joe Fava. He formerly was with a group called Cordova and has performed at the Money Tree in downtown Detroit.

The evening of jazz is sponsored by U of M-Dearborn's cultural events committee and is open to the public without charge. Anne Parks, assistant professor of music history, is chairman of the committee's music series.

GLIMPSES

NEW RELEASES

CARRIE (R). Sissy Spacek plays Carrie, a teenage girl with the power of telekinesis—the ability to move objects by psychic power. She exacts a terrifying revenge on those who offend her.

THE ENFORCER (R). Violence and gun play in the "Dirty Harry" manner as Clint Eastwood shoots it out with a terrorist gang in San Francisco in this third film in the series.

KING KONG (PG). The big ape is back again with his same old destructive but sensitive personality. Jessica Lange plays the love in his life. Revised version with some tongue-in-cheek dialogue.

NETWORK (R). Fierce satire attacking the television industry and mass media generally. Top performances by Peter Finch, Faye Dunaway and William Holden in fast paced, grimly humorous film.

NICKELODEON (PG). Director Bogdanovich recalls the madcap, early days of movie making. Ryan and Tatum O'Neal, Burt Reynolds, Stella Stevens and Jane Hitchcock survive the perils and have some fun.

THE PINK PANTHER STRIKES AGAIN (PG). More clowning with Inspector Clouseau (Peter Sellers) who fumbles his way to victory. This time against the demented ex-chief inspector who would destroy the world unless he's given Clouseau, dead or alive.

THE SEVEN PER CENT SOLUTION (PG). Sherlock Holmes and Sigmund Freud join forces, but the result is less than stimulating. However, location photography in Vienna and Robert Duvall's performance as Dr. Watson are excellent.

THE SHAGGY D.A. (G). If you're looking for a "G" film, this is about the only one in town. A Disney movie about a politician with an unusual affliction.

SILVER STREAK (PG). Gene Wilder, Richard Pryor, Patrick McGeehan and Jill Clayburgh make tracks in this comedy-thriller about murder and mayhem on a train, and sometimes off.

A STAR IS BORN (R). Long-awaited remake with Barbra Streisand and Kris Kristofferson as rock stars (rather than movie stars) whose careers head in different directions.

BACK AGAIN

OBSESSION (PG). Suspenseful romance with Cliff Robertson as man who falls in love with woman who looks just like his dead wife. Some bizarre consequences are the result.

ONE DEAD OVER THE CUCKOO'S NEST (R). Academy Award winner with Jack Nicholson in confrontation with authority in a mental hospital.

TAXI DRIVER (R). Robert DeNiro in terrific performance as he wheels through the rotten part of the Big Apple. Acting honors also to young Jodie Foster as a hooker.

2001: A SPACE ODYSSEY (G). Outstanding special effects illuminate Stanley Kubrick's dazzling sci-fi movie through space and time.

MOVIE RATING GUIDE

- G General audiences admitted.
- PG Parental guidance suggested. All ages admitted.
- R Restricted. Adult must accompany person under 18.
- X No one under 18 admitted.



Getting Around

By ETHEL SIMMONS

Dinner Theatre again at old Botsford Inn

The Coach House of the cozy old Botsford Inn in Farmington Hills is the setting for the R G Production of "I Do! I Do!" which opens in dinner theater format Wednesday.

Over lunch in the dining room of the inn—dating back to 1836, director Edgar A. Guest III of Birmingham talked about the show produced by Michael Goodman.

"It's a comfortable show," he said. "People recognize themselves or moments in their lives. That is the charm of this play."

Guest continued, "It's kind of a gentle play—very, very rich and full of humor. It's a difficult challenge for the actors, since there are only two of them, and they are on stage virtually all the time."

The stars are Nancy Gurwin and Phil Marcus Esser. Guest has the highest praise for both Ms. Gurwin, who has appeared in several dinner theater productions at the Botsford, and Esser, who starred in "Jacques Brel" and "Personals" at Mercy College dinner theater.

Guest describes Esser as "a very strong performer, which you have to be to work with Nancy. She has a tendency to want to take over on stage."

"I DO! I DO!" containing more than 20 musical and dance numbers is written by Tom Jones and Harvey Schmit, who wrote the longest-running play in the American theater. "The Fantasticks."

Mary Martin and Robert Preston starred in the original Broadway production of "I Do! I Do!"

The musical in two acts takes a couple from the ages of 20 to 60 or 65. Guest explained, "It goes from their marriage day to the day they move out of the house after their children are grown up, retirement age."

Guest said Ms. Gurwin is only offstage to change clothes and Esser does his dressing on or offstage. "He's always taking his pants off."

One of the fascinating aspects of the show is that the characters literally age before your eyes, he said. How do the actors do this?

"ONE IS A TRICK of the actors' trade. They just think older. In the second act, the authors have written a very interesting theatrical trick. The show pauses and the actors step down to make-up tables and in front of the audience age."

"There is no age make-up in the show until this time."

"The authors are saying, 'Isn't love wonderful?'" Guest pointed out. "It's a show about love in its many manifestations."

A song in the first act says love is what makes it sort of fun, what makes all the hardships worthwhile.

"The theme is: With enough love, you can survive almost any disaster."

"Similarities between 'Fantasticks' and 'I Do! I Do!' are that both are romantic shows. The audiences identify like crazy," Guest said.

"The authors understand the human heart, and that's what makes their shows successful," he said.

Curtain time

Visit to a Small Planet by Gore Vidal presented by Will-O-Way Repertory Theatre at 8:30 p.m. Friday-Saturday, Feb. 4, 5 at Will-O-Way Apprentice Theatre, 775 W. Long Lake Road, Bloomfield Hills. Call 644-4418 for ticket information.

\$1 films at UM-D

A series of popular films will be open to the public for \$1 each at the University of Michigan-Dearborn this winter. The Office of Student Life sponsors the series in UM-D's Recreation Organization Center.

Monty Python's "And Now For Something Completely Different" will show Wednesday at 9 p.m. Burt Reynolds stars in "Hustle" on Feb. 23 at 9 p.m., while Woody Allen appears in "Sleeper" on March 16 at 9 p.m. "Eiger Sanction," headlining Clint Eastwood, will be featured April 13 at 9 p.m.

ROMAN CHARIOT

Restaurant and Lounge
FEATURING ITALIAN AND AMERICAN DINING
Friday & Saturday
"The Fabulous BANJO PALS"
BANQUET FACILITIES
32826 FIVE MILE RD.
425-8530

Prince & Pauper

4915 N. WAYNE RD.
WAYNE (3 BLKS. S. OF MICH.) 728-1783
COMPLETE DINNER
MON. THRU WED.
20% OFF WITH THIS COUPON

BEEF KEBOB \$2.99

Incl. Baked Potato, Salad, Hot Bread
FEATURED MONDAY, TUESDAY & WEDNESDAY
Mr. Steak
AMERICA'S STEAK EXPERT
on Wayne Rd. just South of Westland Shopping Center
Open til 9 p.m.

SAND BOX

Entertainment 7 nights a week appearing UNITY Mickey returns February 1
No Cover- No Minimum
Lunch daily from 11:00
261-0080
SCHOOLCRAFT & INKSTER
In the Buckingham Shopping Center

DINING AND ENTERTAINMENT GUIDE
ON THE TOWN

TEN YEN CHINESE Restaurant
(Open 7 Days)
CANTONESE, HONG KONG, MANDARIN, JAPANESE & AMERICAN FOODS
正宗粵菜 • 歡迎光臨
Special Businessmen's Luncheon
Over 120 Dinner Selections • Carry-Out • Special rates for big parties
PRIVATE BANQUET ROOM AVAILABLE
8997 WAYNE RD. at Ann Arbor Trail 425-8910

Adams Towne House
421-5060 2 Blocks E. of Merriman 30843 Plymouth
Returning for another extended engagement
Tuesday-Saturday FREE ENTERPRISE featuring Alice Morgan nightly
Special Buffet: Tues., Wed., & Thurs. 5-9:30
• Roast Beef • Fish \$425
• Ribs • Potatoes
• Chicken • Beverage
• Over 20 items on our salad bar
2:00-9:00 featuring a special \$5.00 menu
Now Open Sunday

The Jolly Miller Lounge
LIVE ENTERTAINMENT NITELY FEATURING the Music of CIGAN
[BEFORE OR AFTER DINNER — 'TILL 2:00 AM]
Plymouth Hilton Inn
5 MILE & NORTHVILLE ROADS call (313) 459-4500 FOR MEETINGS AND BANQUET PLANNING
ENTICING CONTINENTAL MENU dine at TEMPTING SALAD BAR
The Jolly Miller Restaurant
NITELY 5:30 TO 11 PM SUNDAY 4 PM TO 10 PM

BONANZA
ATMOSPHERE ON A BUDGET
Budget Specials—A BUILD YOUR OWN SALAD—Budget Specials
Every MONDAY SALAD BAR (9 ITEMS AND 4 DRESSINGS)
SR. CITIZENS' DAY 11 'til closing
BEEF CHOPPET \$1.39
VEAL CUTLET \$1.39
PETITE STRIP STEAK \$1.69
FREE BEVERAGE TO ALL OUR SENIOR CITIZENS
ABOVE ENTREES INCLUDE POTATO, TEXAS TOAST & SALAD BAR
SOUTHFIELD 25610 W. 8 MILE RD. AT BEECH-DAILY RD. IN K-MART PLAZA
BELLEVILLE 2053 RAWSONVILLE RD. OFF I-94 IN K-MART PLAZA
LIVONIA 33456 W. 7 MILE RD. AT FARMINGTON RD. IN K-MART PLAZA
HOURS: MON.-THURS. 11 to 8, FRI. & SAT. 11 to 9 SUNDAY 11 to 8

OCCO / a life game process
PRESENTS:
the inner game of **MONEY**
SPEND AN EVENING LEARNING HOW TO PLAY IT
LEARN TO DEVELOP A PRODUCTIVE RELATIONSHIP WITH MONEY THAT TRANSCENDS MERE MATERIAL GAIN
UNDERSTAND HOW TO MAKE ROOM FOR MONEY IN YOUR LIFE
PREVIEWS: 7:00pm & 9:00pm (EACH of the following evenings)
DATES: January 20 & 21 January 24 & 25
PLACE: Howard Johnsons & Holiday Inn 2380 Carpenter Rd. (US 23 & Washtenaw) Ann Arbor 30375 Plymouth Rd. Livonia
Preview Admission: \$2.00
During the preview, you will play the Game with REAL MONEY, and you could leave with more than you came with!
If you come away from this experience wanting more, you will have the first opportunity to register for one of our 8-hour INNER GAME OF MONEY WORKSHOPS to follow.
508 E. DUTTON KALAMAZOO, MI. 49001 (810) 343-0012

Merit Adds Merit 100's.

MERIT taste science applied to new low tar 100mm cigarette with impressive results.

The MERIT breakthrough technology that produced a whole new taste standard in low tar smoking has now been applied to a 100mm cigarette.

New MERIT 100's. Only 12 mg. tar. Yet packed with 'Enriched Flavor' tobacco. Tobacco fortified with certain key flavor-rich ingredients isolated in cigarette smoke and *proven* to deliver taste way out of proportion to tar.

If you smoke but haven't chosen to take advantage of the MERIT breakthrough because you prefer a longer length cigarette, you'll be interested.

© Philip Morris Inc. 1977

Kings: 9 mg. tar, 0.7 mg. nicotine—
100's: 12 mg. tar, 0.9 mg. nicotine av. per cigarette by FTC Method.

Warning: The Surgeon General Has Determined
That Cigarette Smoking Is Dangerous to Your Health.

Because now you have your MERIT, too.
Read the test results for yourself.

Test Data Conclusive

New 12 mg. tar MERIT 100's were taste-tested against a number of major 100mm brands ranging from 17 mg. to 19 mg. tar.

Thousands of smokers were tested*. The results: *overall, they liked the taste of MERIT 100's as much as the higher tar 100mm brands tested.*

MERIT and MERIT MENTHOL. King Size and new 100's.

The taste barrier for low tar smoking has been broken again.

*American Institute of Consumer Opinion. Study available free on request.
Philip Morris Inc., Richmond, Va. 23261.

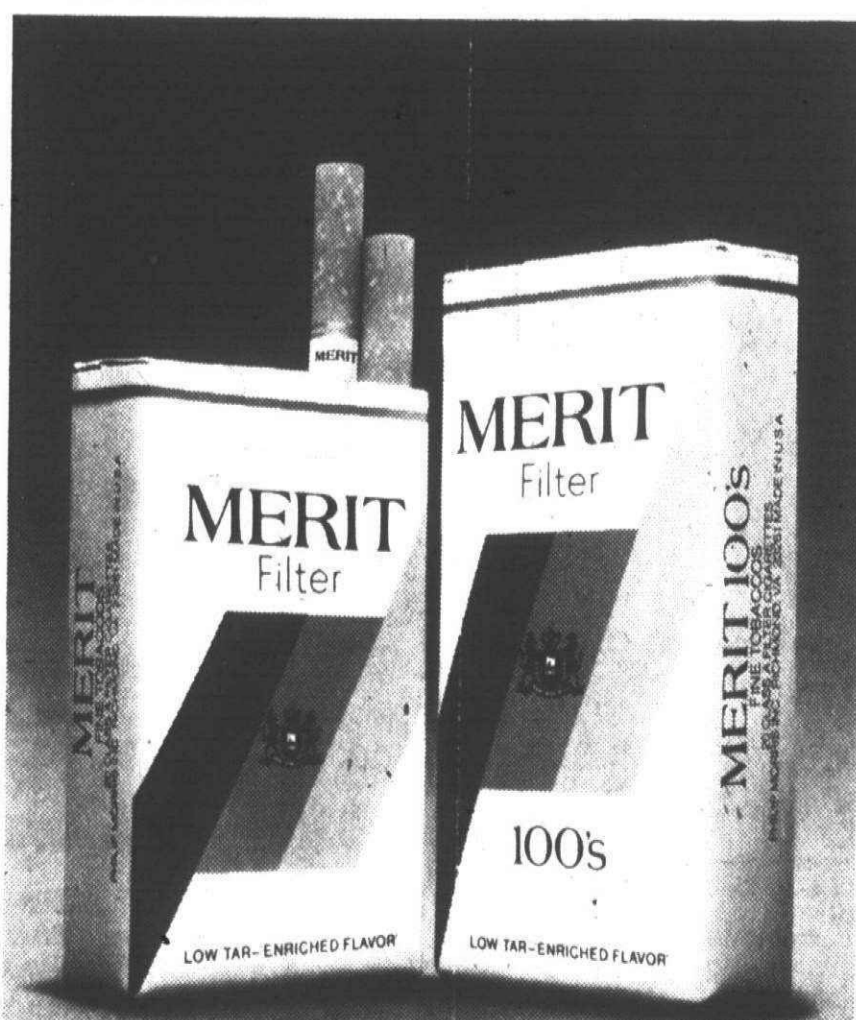

MERIT & MERIT MENTHOL. KINGS & 100's.

MERIT 100's

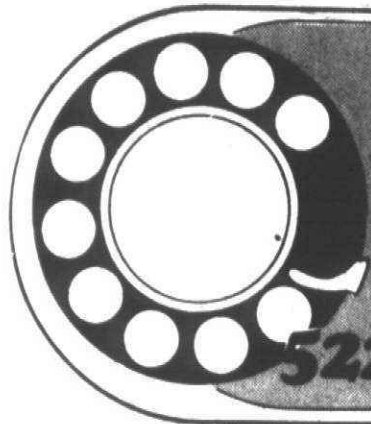

522-0900

Canton Observer

Classified Want Ads



Monday, January 24, 1977

(C1C)

312 Livonia

RENT PROBLEMS? Think thrifty and buy your own home. This 3 bedroom split level has many appealing features. Large country kitchen. Carpeted throughout. Completely fenced yard. Attractively decorated. Possible assumption. **\$27,500**

Thompson-Brown

SUPER VALUES
SPACIOUS luxury living is obtained in this HUGE 4 bedroom colonial with FANTASTIC family sized kitchen with all modern conveniences, huge family room with natural fireplace formal dining room, carpeting throughout. Attached 2 car garage. This home is vacant ready to be occupied. Super value at only \$59,000. Take advantage of the low interest rates now available.

BE THE FIRST this home has to be the Best Buy in Livonia. Super large 3 bedroom ranch home with a most FANTASTIC family room you have ever seen. Large living room, modern kitchen, excellent carpeting throughout, built-in pool, you own it to yourself to see this beautiful home for only \$36,900.

VALUE VISTA SHOW OF HOMES ON DISPLAY
525-7700

Century 21

Gene Darke Realty

Builder's Closeout
LIVONIA WOODED AREA. Custom built colonial in scenic 3 Mile Farmington Rd. area. 3 bedrooms, family room, fireplace, carpeting throughout, attached 2 car garage. 1200' lot and 10 year builder's warranty. \$55,900 Open Sunday 2:30 PM.

Century 21

HALLMARK INC. 307-2300

312 Livonia

RAMBLING RANCH
Huge modernized 3 bedroom ranch home on a 100 ft. treed lot in North Livonia. A few of the features include a formal dining ell, family room, heated sun room, heated exercise room, 2 baths, natural fireplace, extra insulation and a 2 car attached garage. Asking \$45,500.
HARRY S.

WOLFE COMPANY

33235 Seven Mile 427-0733

THREE bedroom full brick ranch full basement, carpet throughout, corner lot, black wood privacy fence, 2 1/2 car garage, brick front matching house, 4 years old. \$36,000.
476-4036

GENTLEMAN FARMER
Over 2,000 sq ft of gracious living in this custom 3 bedroom brick ranch home on almost 3 acres of wooded land. A must see home with barn, corral, workshop and more. Horses welcome. Land Contract Terms. Asking \$81,900.
HARRY S.

WOLFE COMPANY

33235 Seven Mile 427-0733

LOOK OF ELEGANCE
Situating on a 100 ft. lot in Northwest Livonia is this beautiful 4 bedroom pillared colonial. Highlights include a formal dining room, country size kitchen with built-ins, family room with natural fireplace, 2 1/2 baths, Florida Room, finished basement, with bar, and a 2 car attached garage. Asking \$74,900.
HARRY S.

WOLFE COMPANY

33235 Seven Mile 427-0733

312 Livonia

FAMILY ROOM
Huge 24 ft family room highlights this 3 bedroom aluminum sided ranch home. For this low price you get a modern kitchen, new carpeting throughout, and a nice fenced yard. Only \$25,900.
HARRY S.

WOLFE COMPANY

33235 Seven Mile 427-0733

COLONIAL, 3 bedrooms, family room, fireplace, rec room, many extras. mid 50's. 425-4971

ALMOST HALF ACRE
Excellent buy on this charming 3 bedroom brick ranch with large kitchen, fireplace in family room, fruit trees and large pines on this country lot. Priced at \$42,900.

Red Carpet REALTORS

522-3500

BRICK RANCH
With full basement and 2 car garage on a tree lined street. Tastefully carpeted throughout. Large finished recreation room, 3 bedrooms, modern kitchen with built-in dishwasher. Exceptionally large fenced backyard. \$31,900.

TOWERING TREES
1/4 ACRES
And a charming rambling brick ranch. Exceptionally sharp. The site is a dream. A full basement with rec room for the kiddies to romp and a delightful family room with natural fireplace, 3 bedrooms, 1 1/2 baths, large family kitchen decorated to a T. Two car attached side entrance garage. Excellent assumption. \$56,900.

FAMILY ROOM-FIREPLACE
FIRST OFFERING. Spectacular brick ranch in move-in condition, attached 2 car garage and full basement and landscaped to perfection. A 3 bedroom home with large country kitchen with built-ins, 1 1/2 baths. The 17 x 12 Florida room is outstanding. Immaculate condition. \$54,900.

SNOW WHITE
Setting on a large lot, we offer you this all aluminum sided 3 bedroom home with a cozy family room, a large kitchen and attached garage. All this on a treed lot for \$18,900.

FAMILY ROOM-FIREPLACE
Attractive brick ranch styled to today's livings. A tiled basement. An oversized 2 car garage and a delightful 18 ft family room with natural woodburning fireplace. Large modern kitchen with built-ins. Three good size bedrooms, 1 1/2 baths. Tastefully carpeted. Exceptionally clean. \$45,900.
HARRY S.

WOLFE COMPANY

32398 Five Mile GA 15660

CLASSIFICATION INDEX

- AUTOMOTIVE**
850 Autos for Sale
852 Antique Cars
854 American Motors
856 Buick
858 Cadillac
860 Chevrolet
862 Chrysler
864 Dodge
866 Ford
870 Jeep
872 Lincoln
874 Mercury
876 Oldsmobile
878 Plymouth
880 Pontiac
824 Sports & Imported Cars
882 Thunderbird
884 Volkswagen
816 Auto-Trust Parts & Service
818 Auto Rentals & Leasing
819 Auto Financing
820 Autos Wanted
822 Trucks for Sale
823 Vans
800 Recreational Vehicles
802 Snowmobiles
804 Airplanes
806 Boats & Motors
808 Vehicle & Boat
810 Insurance Motor
812 Motorcycles
814 Mini Bikes
814 Campers & Motorhomes
- EMPLOYMENT, INSTRUCTION**
518 Education-Instruction
500 Help Wanted
510 Help Wanted Couples
502 Help Wanted-Dental
507 Help Wanted-Part Time
508 Help Wanted-Domestic
504 Help Wanted-Office
506 Help Wanted-Sales
520 Secretarial-Business Services
512 Situations Wanted-Female
514 Situations Wanted-Male
516 Situations Wanted-Male & Female
- MERCHANDISE FOR SALE**
702 Antiques
706 Appliances
700 Auction Sales
712 Buildings for Sale
718 Building Materials
714 Business & Office Equipment
- 724 Camera Supplies
703 Crafts
720 Farm Produce
721 Flowers & Plants
722 Hobbies Coins & Stamps
744 Horses Livestock & Equipment
708 Household Goods-Oakland County
709 Household Goods-Wayne County
738 Household Pets & Equipment
716 Lawn/Garden & Farm Equipment
710 Misc. for Sale-Oakland County
711 Misc. for Sale-Wayne County
726 Musical Instruments
740 Pet Service
704 Rummage Sales
730 Sporting Goods
728 Stereo Hi-Fi & Tape Decks
734 Trade or Sell
736 Wanted to Buy
732 Wearing Apparel
- NOTICES & SERVICES**
468 Death Notices
604 Announcements & Notices
626 Bingo
610 Birth of Thanks
618 Child Care
614 Death Notices
628 Entertainment
616 Mail for Rent
612 in Memoriam
622 Income Tax & Insurance
606 Legal Notices
616 Mail for Rent
600 Personal
624 Professional Services
608 Transportation
- REAL ESTATE FOR RENT**
400 Apartments to Rent
422 Commercial-Industrial to Rent
426 Condo/Co-ops
428 Duplexes to Rent
410 Flats to Rent
414 Florida Rentals
402 Furnished Apartments to Rent
406 Furnished Houses to Rent
428 Garages to Rent
404 Houses for Rent
432 Living Quarters to Share
418 Mobile Homes to Rent
- 424 Office-Business Space to Rent
420 Rooms to Rent
412 Townhouses-Condominiums to Rent
420 Rooms to Rent
412 Townhouses-Condominiums to Rent
416 Vacation Rentals
434 Wanted to Rent/Resort Property
436 House-Sitting Service
- REAL ESTATE FOR SALE**
311 Home for Sale
302 Birmingham-Bloomfield
351 Bus & Professional Bldg for Sale
304 Farm Sale
318 Bloomfield
309 Northville-Nov
308 Rochester-Troy
306 Southfield-Lathrup
319 Homes for Sale-Wayne County
312 Livonia
314 Plymouth-Canton
318 Redford
316 Westland-Garden City
320 Other Suburban Homes for Sale
321 Real Estate Service
330 Apts for Sale
360 Business Opportunities
348 Commercial-Lots
352 Commercial-Industrial
322 Condominiums for Sale
324 Co-ops for Sale
344 Country Homes
326 Duplexes for Sale
350 Farms for Sale
336 Florida Property for Sale
354 Income Property for Sale
356 Investment Property for Sale
340 Lake & Resort Property for Sale
342 Lakefront Homes for Sale
364 Listings Wanted
338 Lots & Acreage for Sale
332 Mobile Homes for Sale
358 Mortgages-Land Contracts
346 Northern Property
334 Out of Town Property
368 Real Estate to Exchange
362 Real Estate Want
328 Townhouses for Sale

312 Livonia

GREAT AREA
Start the New Year right in this good looking 3 bedroom tri-level with family room, 1 1/2 baths, attached garage, and screened porch. Priced at only \$39,500. For all the details call 522-3500.
RED CARPET REALTY

314 Plymouth Canton

PLYMOUTH CANTON AREA
RANCH COLONIAL QUAD-LEVEL
3 and 4 bedrooms, 1 1/2 baths, insulated windows, screens, family room fireplace, 2 car garage. Many extras. \$42,900.

CANTON 87

South of Cherry Hill on Laley Rd. DEMBS BUILDING CO. 397-1030

6 MONTHS NEW
CANTON Quad level, \$8000 as times has interest mortgage. BEST-TER HERRY For app call

Realty World

CHAPMAN BROS W. 459-3700

FANTASTIC

BEAUTIFULLY DECORATED
Builder's Model Home Available for immediate occupancy. This lovely Quad Level includes 3 bedrooms, 1 1/2 baths and giant family room. Immediate occupancy with low 8 1/2% mortgage. Other models also available including colonials and ranches. Call Bill Webb. 981-1900

PLYMOUTH CANTON AREA COLONIAL

3 bedrooms, 1 1/2 baths, insulated windows, screens, family room with fireplace, 2 car garage. Many extras. \$42,900.

CANTON 87

South of Cherry Hill on Laley Rd. DEMBS BUILDING CO. 397-1030

PLYMOUTH CANTON AREA QUAD LEVEL

3 and 4 bedrooms, 1 1/2 baths, insulated windows, screens, family room with fireplace. Many extras. \$42,900.

CANTON 87

South of Cherry Hill on Laley Rd. DEMBS BUILDING CO. 397-1030

PLYMOUTH TWP 4 bedroom colonial family room fireplace

1 1/2 baths, 2 1/2 car garage, decorated. Large lot, extras \$47,500. 453-8158

In this sharp Carriage Hills colonial, 4 bedrooms, 2 1/2 baths, family room with natural fireplace, full basement, dining room, 2 car attached garage. Only \$54,900.

Century 21

Hartford West, Inc. 453-7600

SHARP NEW LISTING

Immaculate 3 bedroom brick colonial, master bedroom 24 x 13, formal dining room, family room natural fireplace, terrace and 2 car attached garage. Assume this 7 1/2% mortgage at \$55,900.

Century 21

HARTFORD S. 261-4200

TWO BEDROOMS 1 car garage. Close to schools and shopping. \$2,500 moves you in. \$15,500 land contract. After 5:30 PM. 522-3319

THERE IS NO DOUBT
That you will love this sharp 3 bedroom Ranch with carpeting throughout. Completely remodeled. 2 car garage, very clean. Going for \$36,000.

Century 21

CANTON Colonial, 4 bedrooms, 1 1/2 baths, family room with fireplace, dining room. By owner. 453-1916

NEW LISTING

EXCELLENT SMALL FAMILY 2 Bedroom
Home with Spacious Rooms and Quality Wood work. Graceful arches from the Living Room lead to DEN and Formal Dining Room-BRIGHT, CHEERFUL AIR. Kitchen has unusual built-in Buffet with serving counter and Glass Doored Display cabinet-Arched ALCOVE makes a perfect Breakfast Nook! Full Basement has separate Furnace room with Laundry Tubs and Fruit Cellar with floor to ceiling Shelves. \$32,900.

Redford Township-QUICK OCCUPANCY on this CLEAN, well kept 2 Bedroom Home in a quiet, well established neighborhood. Family kitchen with Dining Area overlooking fenced, Extra Deep rear yard has new Easy-Care Flooring and Built-in Dishwasher. Living Room, Hall and Bedrooms completely carpeted. Lower level tiled and Panelled with extra room suitable for office. Future Patio or Screened Summer Room could rise from existing cement pad overlooking 18' Pool with side door access to Kitchen! \$22,900.

EYE ON THIS SHINGLED EXTERIOR catches the eye on this 2 bedroom home close to the heart of downtown Plymouth! Enclosed front porch will stretch the living area with windows on 3 sides bringing the outside in. Updated flooring and wood cabinets in kitchen-utility area off kitchen and covered back porch entry. Full basement-1 car garage-fenced rear yard. \$29,900.

3.5 ACRES WITH "HORSE PRIVILEGES" are yours with this impressively pillared 4 bedroom Colonial home in a fine Plymouth country setting. Wet plaster, marble foyer, and side entrance 2 1/2 car garage add quality to an informally planned, wonderful family home geared to making the most of a relaxing environment. \$87,900. 453-8200

How long have you waited for a secluded building site in a choice wooded location? The magic mix of a PERFECT LOCATION and a high, "perkable" SITE-WITH-A-VIEW! It's here today but likely to be gone tomorrow. Promptness pays. A call to 453-8200 will bring you directions and details.

1005 W. Ann Arbor Trail Plymouth

453-8200

314 Plymouth Canton

Beautiful
custom built colonial in new Sunflower Village Subdivision. This home offers 4 bedrooms, 2 baths, carpeted throughout, central air, beautiful full wall fireplace in lovely family room, custom drapes, stay kitchen, no wax floors, redwood deck, 2 1/2 car attached garage, professionally landscaped. Owner is being transferred, needs quick sale. Priced at only \$69,900.

Century 21

Boardwalk Div. 459-3600

CITY OF PLYMOUTH 3 bedroom ranch finished basement, central air, appliances, 2 car garage. \$38,900. Owner 453-9947

COUNTRY-LIKE LIVING

In Plymouth Twp. A large 4 bedroom home on 1.40 acres with 20 x 40 above ground pool. Home also features den or 5th bedroom, recreation room, 2 full baths and 2 car garage. Excellent land contract terms available. A wonderful family home for \$69,900.

JL HUDSON

Real Estate Co. 453-2210

316 Westland Garden City

WESTLAND M-2 zoning, 23 acres, Cherry Hill and Newburgh Area. House and garage on property. \$60,000. Flexible terms available. Call 456-6700.

Thompson-Brown

LIVONIA SCHOOLS
Don't miss out on this beautiful 3 bedroom brick Tri-Level with 1 1/2 baths, family room, large family kitchen, 2 car garage, clean and sharp throughout. Price cannot be beat at only \$32,900. VALUE VISTA SHOW OF HOMES ON DISPLAY. 525-7700

Century 21

Gene Darke Realty

TONQUISH

Fantastically decorated split level, 3 or 4 bedrooms, plus spacious den or office. Large foyer, 1 1/2 baths, family room with fireplace, patio, 2 car garage. Best buy \$38,900.

Castelli

525-7900

THREE bedroom brick front, enclosed finished patio, drapes & carpeting, 2 1/2 car garage. \$25,900. Westland. 427-4511

Century 21

Gene Darke Realty

Norwood

No. 10 Inc. 459-2800

1ST OFFERING
Spacious 4 to 5 bedroom tri-level with 1 and 1 1/2 baths, 2 car garage, pool and a great yard. Walk to schools and Westland Shopping Center. Move right in! \$19,900. By owner. 427-4162

McKEON, INC.

REAL ESTATE

500 S. Main Street Plymouth, Mich 48170

NEW LISTING

EXCELLENT SMALL FAMILY 2 Bedroom
Home with Spacious Rooms and Quality Wood work. Graceful arches from the Living Room lead to DEN and Formal Dining Room-BRIGHT, CHEERFUL AIR. Kitchen has unusual built-in Buffet with serving counter and Glass Doored Display cabinet-Arched ALCOVE makes a perfect Breakfast Nook! Full Basement has separate Furnace room with Laundry Tubs and Fruit Cellar with floor to ceiling Shelves. \$32,900.

Redford Township-QUICK OCCUPANCY on this CLEAN, well kept 2 Bedroom Home in a quiet, well established neighborhood. Family kitchen with Dining Area overlooking fenced, Extra Deep rear yard has new Easy-Care Flooring and Built-in Dishwasher. Living Room, Hall and Bedrooms completely carpeted. Lower level tiled and Panelled with extra room suitable for office. Future Patio or Screened Summer Room could rise from existing cement pad overlooking 18' Pool with side door access to Kitchen! \$22,900.

EYE ON THIS SHINGLED EXTERIOR catches the eye on this 2 bedroom home close to the heart of downtown Plymouth! Enclosed front porch will stretch the living area with windows on 3 sides bringing the outside in. Updated flooring and wood cabinets in kitchen-utility area off kitchen and covered back porch entry. Full basement-1 car garage-fenced rear yard. \$29,900.

3.5 ACRES WITH "HORSE PRIVILEGES" are yours with this impressively pillared 4 bedroom Colonial home in a fine Plymouth country setting. Wet plaster, marble foyer, and side entrance 2 1/2 car garage add quality to an informally planned, wonderful family home geared to making the most of a relaxing environment. \$87,900. 453-8200

How long have you waited for a secluded building site in a choice wooded location? The magic mix of a PERFECT LOCATION and a high, "perkable" SITE-WITH-A-VIEW! It's here today but likely to be gone tomorrow. Promptness pays. A call to 453-8200 will bring you directions and details.

1005 W. Ann Arbor Trail Plymouth

453-8200

SERVING ALL OF WESTERN WAYNE COUNTY SINCE 1922

GARLINGS INC.

199 N Main Plymouth

Remodeled 2 bedroom alum. sided home on 1/2 acre lot, lots of trees, 1 1/2 car garage. Land Contract terms. \$27,900.

Horses allowed. 2 acres with this all brick 3 bedroom home, family room with fireplace, dining room, full basement, attached 2 car garage, central air. \$59,500.

New 3 bedroom ranch in downtown Plymouth, family room, full basement, carpeted, attached 2 car garage. \$45,000.

Four acres with this custom 3 bedroom ranch, 2 1/2 car garage, carpet thru-out, very secluded but still close to everything. \$65,900.

453-4800 MULTI-LIST SERVICE 427-7797

We Can Guarantee The Sale Of Your Home!

Call today for details.

- HI THERE!!**
I'm a sharp 3 bedroom Colonial near Cherry Hill and Meridian. I have a full tiled basement, and new ceramic tile and plumbing, my kitchen has a new wicker floor and my appliances are negotiable. I also have a large living room and an attached garage. My lot is large and my new owner can move right in. Help, I need the patter of little feet. Call today and ask for Tom or Lou.
721-8400
- DEARBORN PROPER**
3 bedroom bungalow, featuring newly remodeled kitchen and bath, new furnace, all new wiring and circuit breakers, carpet and drapes thru-out, great area for living in, garage and full basement, extra bonus Good assumption, and low, low, taxes. Call and ask for JEAN PROCH. \$31,900.
721-8400
- WESTLAND**
Brick and aluminum ranch with huge country kitchen featuring pantry and doorwall off dining area. Beautiful hardwood floors, 3 bedrooms, immaculate condition. HURRY ON THIS ONE! Call and ask for CHERYL RYBA \$28,200.
721-8400
- A HOME TO BE PROUD OF**
This executive family home has it all including 3 1/2 baths, huge entertainment center with fireplace, formal dining room and finished recreation room. This large 1 1/2 story home sits on a 100x180 lot and backs up to a ravine. Exclusive Westland area near Joy and Newburgh offers Livonia schools and so many extras you must see it to believe it. All offered for only \$55,900. Call Tom or Lou today at:
721-8400

- ATTENTION HORSE LOVERS**
Beautiful home on a hill top, 4 horses can be stabled on this \$9,400. Barn, 3 bedrooms, room for 2 more upstairs, fireplace, dining room, 2 car garage. MANY EXTRAS!! CALL VANA BEGIN.
455-5200
- FISHERMEN ATTENTION!!!**
2 bedroom ranch located in Green Oak Township. Access to chain of Lakes, boat well, private drive, land contract terms. DICK RANDAZZO.
455-5200
- DEFINITELY, SOMETHING TO GET EXCITED ABOUT!**
and we're excited. She's well built too. We're speaking of our 3 bedroom ranch located in Livonia. Great lot, fenced yard. ONLY \$45,000. ***
455-5200
- TODAY YOUR WISH COMES TRUE**
COLONIAL with 3 bedrooms, located in Canton. Fireplace in family room, large patio, 2 car garage, nicely decorated. \$45,900.
455-5200
- ANKLE DEEP IN DAYDREAMS?**
3 bedroom ranch located in Canton on 1.6 acres of land. Fireplace, redwood patio, garage. \$30,900.
455-5200

- PRICED TO ENJOY!** Westland 3 bedroom brick ranch. Large country kitchen with doorwall to a spacious patio, 1 1/2 baths, full basement, 2 1/2 car garage. All for \$32,400.
476-9100
- FLORIDA ROOM**, Cherry Hill/Middlebelt area of Inkster. 3 bedroom brick ranch with full basement, country kitchen and 2 1/2 car garage. \$23,500.
476-9100
- NO PLACE LIKE HOME** Farmington Hills. Quick occupancy on this Cape Cod home featuring 3 bedrooms, large kitchen, family room, natural wood burning fireplace, new carpet thru-out. All backing to wooded area. \$38,900.
476-9100
- BEAUTIFUL START** Southfield. Near 2 bedroom ranch on a large corner lot. Steel siding, central air, country atmosphere. \$23,500.
476-9100
- ROOM TO SPARE** Livonia. 4 bedroom older home in Clarenceville School district. Great investment for the business minded person! Nice sized lot with additional vacant property adjacent. Walk to Livonia Mall. \$44,000.
476-9100

- GREAT LOCATION**
On this beautiful 3 bedroom brick ranch with large country kitchen fireplace in family room, 1 1/2 baths, central entry hall and attached garage. Asking \$22,900.
- Red Carpet Norwood**
No. 1, Inc. 464-2800
- ONLY \$29,900**
100% remodeled 3 bedroom brick ranch in move-in condition. Lovely dining area with large bay window, 2x2x8 heated garage, brick BBQ in nice back-yard. This bargain won't last.
- Red Carpet Kimberley Oaks** 3 bedroom Tri-Level. Professionally decorated. Treed Lot. Fully carpeted. 12x20 Family Room with beamed ceiling and fireplace. 2 baths. 2 car garage. walking distance to schools. Assume 7 1/2% mortgage. Owner asking \$49,900. Buyers only. 261-9452
- Red Carpet**
Exceptional buy on this charming 3 bedroom brick ranch on a 100x100 ft. lot. Extra large kitchen with doorwall off dinette. Good assumption. New listing, won't last at this price.
476-9100

Robert Bake-Realtor

Slightly vaulted ceilings and a glimpse of three lovely levels make an agreeable first impression at this SUPERBLY TIDY 4 BEDROOM QUAD LEVEL. Formal dining, large, excellent kitchen, 2 1/2 baths, a plump 18' x 14.6 foot family room and fireplace, fully usable lower level and premium lot on a quiet cul-de-sac. Accommodating occupancy terms. Priced \$54,900. 453-8200

Add a PLYMOUTH TOWNSHIP ADDRESS AND OVERSIZED LANDSCAPED YARD to the considerable assets of this neat 3 bedroom, 1 1/2 bath NEWLY OFFERED BRICK COLONIAL. The friendly fireplace draws one to its well placed family room off informal dining area. There are recently replaced no wax floors in kitchen and foyer, central air, and an attached 2 car garage. At \$47,900 you'll wish to call 453-8200 to arrange a showing.

3.5 ACRES WITH "HORSE PRIVILEGES" are yours with this impressively pillared 4 bedroom Colonial home in a fine Plymouth country setting. Wet plaster, marble foyer, and side entrance 2 1/2 car garage add quality to an informally planned, wonderful family home geared to making the most of a relaxing environment. \$87,900. 453-8200

How long have you waited for a secluded building site in a choice wooded location? The magic mix of a PERFECT LOCATION and a high, "perkable" SITE-WITH-A-VIEW! It's here today but likely to be gone tomorrow. Promptness pays. A call to 453-8200 will bring you directions and details.

1005 W. Ann Arbor Trail Plymouth

453-8200

JOIN THE WINNING TEAM!

Call Fred Madley, recruiting director at 455-5200 for an interview for a Sales Position in the west region.



316 Westland Garden City
4 ACRES
 Near 2 bedroom \$29,900
Classic
 478-5500

316 Westland Garden City
 Low Down Payment
 On land contract 80 x 110 ft lot
 Frame home at \$349 Middlebelt Rd
 Call for information
Red Baron
 422-8220

316 Westland Garden City
STARTERS
 Just a little Down will feather your nest in this attractive aluminum sided home featuring carpeting throughout and in moving condition. Full price \$17,900. Call 522-8300

316 Westland Garden City
JUST UNDER ONE ACRE
 Imagine a 3 bedroom brick ranch with immediate occupancy at this price. Home offers super kitchen, 1 1/2 baths, 2 1/2 car garage.
 Custom built brick ranch features a full basement, carpeting throughout plus of course - a 2 1/2 car garage \$40,900 Call 522-8300

316 Westland Garden City
WESTLAND BARGAIN ONLY \$27,500
 Imagine a 3 bedroom brick ranch with immediate occupancy at this price. Home offers super kitchen, 1 1/2 baths, 2 1/2 car garage.

318 Redford
 BY OWNER - 3 bedrooms, formal dining room, finished basement, 2 1/2 car garage, fenced patio. Beautifully decorated. Desirable area.
 \$29,500 Call 537-8216

318 Redford
 SHARP 2 bedroom, carpeting, fenced yard, aluminum storms and screens. Best Buy in Redford. Newly decorated. Vacant. VAN EPPS
 538-6444 422-2108

302 Birmingham Bloomfield
BEVERLY HILLS by owner. 5 bedroom colonial, central air, formal dining room, first floor laundry, library, family room, fireplace, wet bar, 2 1/2 baths, 2 half baths, large fenced lot. \$90,900 646-0985

304 Farmington West Bloomfield
Farmington Hills
 Move into this sprawling ranch with three bedrooms, two and one half baths, and kidney shaped pool. Phillipine Mahogany kitchen with cupboards galore. Fully carpeted and ready for you. Call us for list of extra bonus features \$72,900

(LIVONIA SCHOOLS)
BRICK RANCH
 Sharp 3 bedroom home in Westland's Park Trail Sub. Fireplace in large living room, formal dining room, beamed family room, full basement, 2 car attached garage, central air, low interest assumption available or \$3,900 down

Integrity
 Realtors
 WESTLAND 3 bedroom, aluminum sided, covered patio, fenced. \$20,900 \$899 move in. D.A. Ross Realty 326-8300

Integrity
 Realtors
Countrified
 on an oversized lot, 3 bedroom ranch and move-in condition, carpeting throughout and best of all - just \$22,900 Call 522-8300

Red Carpet
 REALTORS 522-3500
 Livonia Schools
 Opportunity of a lifetime on this 2 bedroom aluminum sided ranch, carpeting throughout, partitioned basement, garage plus extra large shed. Great assumption \$149 monthly. A steal at \$29,900

WOLFE COMPANY
 32398 Five Mile GA 15660
 LOW TAXES 2 bedroom brick ranch, 2 car garage. Must sell to close. Estate. 12916 Wornier. 537-4900

Century 21
 Boardwalk Div 459-3600
\$22,500
 will buy you this 4 bedroom, 1 1/2 story home, located in Wayne with 1 1/2 car garage. Home has extra insulation, kitchen and bath has just been newly remodeled, new roof on house and garage. Super deal. For more information call

Century 21
 Boardwalk Div 459-3600
\$26,500
 Extra Sharp 3 bedroom brick 1 1/2 story home located in Inkster. Full finished basement with wet bar, formal dining room with bay window, kitchen has all built-ins, lovely plush carpeting throughout, custom drapes stay in 14x14 breezeway. This is a super sharp home. See it for yourself.

Century 21
 Boardwalk Div 459-3600
302 Birmingham Bloomfield
 IN-TOWN BIRMINGHAM large Colonial 4 bedroom home, 2 car garage. Mint condition. By Owner \$65,000 Call

(REDFORD TWP.)
SCENIC VIEW
 Charming brick and aluminum bungalow on wide lot in lovely area with view of park. 2 bedrooms, expansion attic, basement, recreation room, gas heat, 2 car garage.
\$3,200 DOWN

SUPER BUY
 Immaculate ranch, 3 bedroom brick, large kitchen, carpeting, electric fireplace in living room, basement, patio, gas grill, enormous 2 1/2 car garage \$29,900

Castelli
 525-7900
 GARDEN CITY, Cherry Pointe Sub, large colonial 3 bedroom, 1 1/2 baths, family room with fireplace, attached 2 car garage. \$22-2171

Castelli
 525-7900
 WESTLAND 2 bedroom, excellent condition, enclosed patio, garage. \$20,900. D.A. Ross Realty 326-8300

WOLFE COMPANY
 32398 Five Mile GA 15660
 LOW TAXES 2 bedroom brick ranch, 2 car garage. Must sell to close. Estate. 12916 Wornier. 537-4900

Century 21
 Boardwalk Div 459-3600
\$26,500
 Extra Sharp 3 bedroom brick 1 1/2 story home located in Inkster. Full finished basement with wet bar, formal dining room with bay window, kitchen has all built-ins, lovely plush carpeting throughout, custom drapes stay in 14x14 breezeway. This is a super sharp home. See it for yourself.

Century 21
 Boardwalk Div 459-3600
302 Birmingham Bloomfield
 IN-TOWN BIRMINGHAM large Colonial 4 bedroom home, 2 car garage. Mint condition. By Owner \$65,000 Call

Century 21
 Boardwalk Div 459-3600
302 Birmingham Bloomfield
 IN-TOWN BIRMINGHAM large Colonial 4 bedroom home, 2 car garage. Mint condition. By Owner \$65,000 Call

Weldon Clark
 REALTORS
 27492 Five Mile Livonia 425-7300

Castelli
 525-7900
 GARDEN CITY, Cherry Pointe Sub, large colonial 3 bedroom, 1 1/2 baths, family room with fireplace, attached 2 car garage. \$22-2171

Castelli
 525-7900
 WESTLAND 2 bedroom, excellent condition, enclosed patio, garage. \$20,900. D.A. Ross Realty 326-8300

WOLFE COMPANY
 32398 Five Mile GA 15660
 LOW TAXES 2 bedroom brick ranch, 2 car garage. Must sell to close. Estate. 12916 Wornier. 537-4900

Century 21
 Boardwalk Div 459-3600
\$26,500
 Extra Sharp 3 bedroom brick 1 1/2 story home located in Inkster. Full finished basement with wet bar, formal dining room with bay window, kitchen has all built-ins, lovely plush carpeting throughout, custom drapes stay in 14x14 breezeway. This is a super sharp home. See it for yourself.

Century 21
 Boardwalk Div 459-3600
302 Birmingham Bloomfield
 IN-TOWN BIRMINGHAM large Colonial 4 bedroom home, 2 car garage. Mint condition. By Owner \$65,000 Call

Century 21
 Boardwalk Div 459-3600
302 Birmingham Bloomfield
 IN-TOWN BIRMINGHAM large Colonial 4 bedroom home, 2 car garage. Mint condition. By Owner \$65,000 Call

Century 21
 Boardwalk Div 459-3600
302 Birmingham Bloomfield
 IN-TOWN BIRMINGHAM large Colonial 4 bedroom home, 2 car garage. Mint condition. By Owner \$65,000 Call

EARL KEIM REALTY
 from the HELPFUL PEOPLE!

STARTER HOME
 Fantastic buy on this 3 bedroom brick ranch, spacious kitchen, carpeting throughout, large fenced yard, carpet only, \$24,500. FHA or GI E.O. down

Castelli
 525-7900
 BY OWNER 3 bedroom ranch, newly decorated, fully carpeted, 2 car garage, Livonia schools. \$24,500 or \$9,000 assumes 422-8681

ROSS
 GALLERY OF HOMES
 535-5400

ALUMINUM
 Large family home with 3 bedrooms, could be 4, finished rec room that is carpeted and with a bar \$26,900 Call 525-4200

Integrity
 REALTORS
 FACE BRICK RANCH central air, 2 1/2 car garage, finished carpet, full basement. Owner transferred. \$31,900 937-2675

LAURENCELLE REAL ESTATE
 549-7400
 BIRMINGHAM Unique 2 story home on wooded double lot. Near Quaker Lake. Large 4 bedroom, 2 1/2 baths. Walk to school, church & downtown Birmingham. \$15,000. By appointment only. 647-8279

LAURENCELLE REAL ESTATE
 549-7400
 BIRMINGHAM Unique 2 story home on wooded double lot. Near Quaker Lake. Large 4 bedroom, 2 1/2 baths. Walk to school, church & downtown Birmingham. \$15,000. By appointment only. 647-8279

WELDON CLARK
 REALTORS
 27492 Five Mile Livonia 425-7300

Integrity
 REALTORS
 BIRMINGHAM 3 bedroom, 2 1/2 baths, family room with fireplace, formal dining room, large dinette, built-ins, first floor laundry, fully carpeted, heated pool, garage. \$74,900

Integrity
 REALTORS
 THREE bedroom brick bungalow in a fine area of Redford, aluminum trim, fully carpeted, screened terrace, 2 car garage. \$29,900

Integrity
 REALTORS
 LIVONIA RANCH, don't miss this attractive Kimberly Oaks home, 3 bedrooms, 1 1/2 baths, carpeting, built-ins, recreation room with bar, office and lavatory, garage. \$47,900

Integrity
 REALTORS
 SEEING IS BELIEVING! Come see this 3 bedroom Redford ranch with a family room, fully carpeted, built-ins. \$22,900

Integrity
 REALTORS
 HILLTOP 3 bedroom home in Hartland on large country lot, 1 1/2 baths, family room, full basement, large 2 car garage, excellent condition. \$54,900. Tollfree 1-800-552-0315

Integrity
 REALTORS
 JUST LISTED, deluxe Colonial featuring 3 spacious bedrooms, 18x14 family room, with fireplace, 11x10 kitchen, 11x11 dining area, 1 1/2 baths, full basement, 2 1/2 car attached garage, 100x211 lot. \$84,500. Huron Valley Schools. 363-7117

Integrity
 REALTORS
 ATTENTION ANTIQUE LOVERS, stain glass windows will catch your eye from every direction. There are 4 sets of French Doors, an open staircase with wrap around balcony leading to 3 bedrooms and bath! Just for extras, there is a fireplace, full basement with finished recreation room, patio, formal dining room and lake frontage on Whitmore Lake. A rare find for \$74,500. Toll Free 1-800-552-0315

WELDON CLARK
 REALTORS
 27492 Five Mile Livonia 425-7300

Integrity
 REALTORS
 BIRMINGHAM 3 bedroom, 2 1/2 baths, family room with fireplace, formal dining room, large dinette, built-ins, first floor laundry, fully carpeted, heated pool, garage. \$74,900

Integrity
 REALTORS
 THREE bedroom brick bungalow in a fine area of Redford, aluminum trim, fully carpeted, screened terrace, 2 car garage. \$29,900

Integrity
 REALTORS
 LIVONIA RANCH, don't miss this attractive Kimberly Oaks home, 3 bedrooms, 1 1/2 baths, carpeting, built-ins, recreation room with bar, office and lavatory, garage. \$47,900

Integrity
 REALTORS
 SEEING IS BELIEVING! Come see this 3 bedroom Redford ranch with a family room, fully carpeted, built-ins. \$22,900

Integrity
 REALTORS
 HILLTOP 3 bedroom home in Hartland on large country lot, 1 1/2 baths, family room, full basement, large 2 car garage, excellent condition. \$54,900. Tollfree 1-800-552-0315

Integrity
 REALTORS
 JUST LISTED, deluxe Colonial featuring 3 spacious bedrooms, 18x14 family room, with fireplace, 11x10 kitchen, 11x11 dining area, 1 1/2 baths, full basement, 2 1/2 car attached garage, 100x211 lot. \$84,500. Huron Valley Schools. 363-7117

Integrity
 REALTORS
 ATTENTION ANTIQUE LOVERS, stain glass windows will catch your eye from every direction. There are 4 sets of French Doors, an open staircase with wrap around balcony leading to 3 bedrooms and bath! Just for extras, there is a fireplace, full basement with finished recreation room, patio, formal dining room and lake frontage on Whitmore Lake. A rare find for \$74,500. Toll Free 1-800-552-0315

WELDON CLARK
 REALTORS
 27492 Five Mile Livonia 425-7300

Integrity
 REALTORS
 BIRMINGHAM 3 bedroom, 2 1/2 baths, family room with fireplace, formal dining room, large dinette, built-ins, first floor laundry, fully carpeted, heated pool, garage. \$74,900

Integrity
 REALTORS
 THREE bedroom brick bungalow in a fine area of Redford, aluminum trim, fully carpeted, screened terrace, 2 car garage. \$29,900

Integrity
 REALTORS
 LIVONIA RANCH, don't miss this attractive Kimberly Oaks home, 3 bedrooms, 1 1/2 baths, carpeting, built-ins, recreation room with bar, office and lavatory, garage. \$47,900

Integrity
 REALTORS
 SEEING IS BELIEVING! Come see this 3 bedroom Redford ranch with a family room, fully carpeted, built-ins. \$22,900

Integrity
 REALTORS
 HILLTOP 3 bedroom home in Hartland on large country lot, 1 1/2 baths, family room, full basement, large 2 car garage, excellent condition. \$54,900. Tollfree 1-800-552-0315

Integrity
 REALTORS
 JUST LISTED, deluxe Colonial featuring 3 spacious bedrooms, 18x14 family room, with fireplace, 11x10 kitchen, 11x11 dining area, 1 1/2 baths, full basement, 2 1/2 car attached garage, 100x211 lot. \$84,500. Huron Valley Schools. 363-7117

Integrity
 REALTORS
 ATTENTION ANTIQUE LOVERS, stain glass windows will catch your eye from every direction. There are 4 sets of French Doors, an open staircase with wrap around balcony leading to 3 bedrooms and bath! Just for extras, there is a fireplace, full basement with finished recreation room, patio, formal dining room and lake frontage on Whitmore Lake. A rare find for \$74,500. Toll Free 1-800-552-0315

WELDON CLARK
 REALTORS
 27492 Five Mile Livonia 425-7300

Integrity
 REALTORS
 BIRMINGHAM 3 bedroom, 2 1/2 baths, family room with fireplace, formal dining room, large dinette, built-ins, first floor laundry, fully carpeted, heated pool, garage. \$74,900

Integrity
 REALTORS
 THREE bedroom brick bungalow in a fine area of Redford, aluminum trim, fully carpeted, screened terrace, 2 car garage. \$29,900

Integrity
 REALTORS
 LIVONIA RANCH, don't miss this attractive Kimberly Oaks home, 3 bedrooms, 1 1/2 baths, carpeting, built-ins, recreation room with bar, office and lavatory, garage. \$47,900

Integrity
 REALTORS
 SEEING IS BELIEVING! Come see this 3 bedroom Redford ranch with a family room, fully carpeted, built-ins. \$22,900

Integrity
 REALTORS
 HILLTOP 3 bedroom home in Hartland on large country lot, 1 1/2 baths, family room, full basement, large 2 car garage, excellent condition. \$54,900. Tollfree 1-800-552-0315

Integrity
 REALTORS
 JUST LISTED, deluxe Colonial featuring 3 spacious bedrooms, 18x14 family room, with fireplace, 11x10 kitchen, 11x11 dining area, 1 1/2 baths, full basement, 2 1/2 car attached garage, 100x211 lot. \$84,500. Huron Valley Schools. 363-7117

Integrity
 REALTORS
 ATTENTION ANTIQUE LOVERS, stain glass windows will catch your eye from every direction. There are 4 sets of French Doors, an open staircase with wrap around balcony leading to 3 bedrooms and bath! Just for extras, there is a fireplace, full basement with finished recreation room, patio, formal dining room and lake frontage on Whitmore Lake. A rare find for \$74,500. Toll Free 1-800-552-0315

EARL KEIM of Dearborn, Inc. **LIVONIA OFFICE**
 15707 FARMINGTON RD., LIVONIA
 261-1600
 OUR OFFICE HOURS
 Mon thru Fri 9:00 to 9:00
 Sat and Sun 9:00 to 6:00

Integrity
 REALTORS
 BIRMINGHAM 3 bedroom, 2 1/2 baths, family room with fireplace, formal dining room, large dinette, built-ins, first floor laundry, fully carpeted, heated pool, garage. \$74,900

Integrity
 REALTORS
 THREE bedroom brick bungalow in a fine area of Redford, aluminum trim, fully carpeted, screened terrace, 2 car garage. \$29,900

Integrity
 REALTORS
 LIVONIA RANCH, don't miss this attractive Kimberly Oaks home, 3 bedrooms, 1 1/2 baths, carpeting, built-ins, recreation room with bar, office and lavatory, garage. \$47,900

Integrity
 REALTORS
 SEEING IS BELIEVING! Come see this 3 bedroom Redford ranch with a family room, fully carpeted, built-ins. \$22,900

Integrity
 REALTORS
 HILLTOP 3 bedroom home in Hartland on large country lot, 1 1/2 baths, family room, full basement, large 2 car garage, excellent condition. \$54,900. Tollfree 1-800-552-0315

Integrity
 REALTORS
 JUST LISTED, deluxe Colonial featuring 3 spacious bedrooms, 18x14 family room, with fireplace, 11x10 kitchen, 11x11 dining area, 1 1/2 baths, full basement, 2 1/2 car attached garage, 100x211 lot. \$84,500. Huron Valley Schools. 363-7117

Integrity
 REALTORS
 ATTENTION ANTIQUE LOVERS, stain glass windows will catch your eye from every direction. There are 4 sets of French Doors, an open staircase with wrap around balcony leading to 3 bedrooms and bath! Just for extras, there is a fireplace, full basement with finished recreation room, patio, formal dining room and lake frontage on Whitmore Lake. A rare find for \$74,500. Toll Free 1-800-552-0315

REDFORD
 Clean 3 bedroom face brick ranch. Full basement, 2 baths, central air, garage. Well located just off Grand River. Close to everything! Immediate Occupancy! \$27,900 Call 477-1111 (430148)

GARDEN CITY
 Mediterranean style home. Beautifully landscaped with in-ground pool. Finished basement with kitchen. Full bath in basement, insulated garage - electric garage door opener. \$39,900 Call 274-9510 (43280)

WESTLAND
 Exceptionally sharp 3 bedroom ranch. Full basement and excellent floor plan that includes dining room, 1 1/2 baths, family room with fireplace, professionally finished deck and privacy fence. Assumable mortgage. \$35,500 Call 455-7000 (43866)

LIVONIA
 Good Occupancy! Spacious 3 bedroom, 1 1/2 bath brick ranch. Recreation room, lovely floor plan, excellent storage space. \$36,900 Call 525-0990 (42957)

LIVONIA
 This 4 bedroom Colonial must set on the largest lot in subdivision, 2 1/2 baths, central air, finished basement, 2 car garage attached plus beautiful landscaping. \$58,900 Call 261-0700 (43598)

LIVONIA
 "So Convenient" to transportation, shops, schools, and everything! 3 bedroom brick ranch - 2 full baths, basement, garage, large living room. Low traffic street. \$32,900 Call 261-0700 (43728)

LIVONIA
 Super location in beautiful Heartstone convenient to the Livonia Mall. 3 bedroom, 1 1/2 bath ranch, modern kitchen, carpeted throughout, lower level family room each feature natural wood burning fireplaces. Situated on a large ravine lot. It's breathtaking! Call Harvey Beadle 477-6100 (105)

LIVONIA
 Super sharp, tastefully decorated 4 bedroom quad level located in a very desirable neighborhood. Fantastic heated Florida room overlooks professionally landscaped yard. Rear entrance 2 car garage attached with automatic door opener. Beautiful family room with natural fireplace and parquet tile floor. Good simple assumption! \$55,900 Call 261-0700

SOUTHFIELD
 A decorator's dream! Marble sills, like-new carpet, new no-wax kitchen floor, new marble foyer, extra insulation, brick patio. Many extras! \$49,900 Call 261-2600 (43093)

SOUTHFIELD
 Super clean and sharp - 3 bedroom brick ranch on a wide lot. Large family room, side patio adjacent to garage, carpeting throughout. Country Atmosphere! \$35,900 Call 261-2600 (43241)

LIVONIA
 Immediate Occupancy, Good Assumption! 4 bedroom, 1 1/2 bath Colonial with raised living room, family room, 2 1/2 car garage, basement, above ground pool. Priced below market value! Owner transferred, house is vacant! \$40,900 Call 851-1900 (43588)

LIVONIA
 Room to Roam! Spacious brick ranch on extra large lot with natural fireplace and family room. \$43,900 Call 261-2600 (42329)

LIVONIA
 A Real Charmer! Three bedroom, 1 1/2 story immaculate, remodeled home on a large lot. Superbly landscaped with brick circular drive. \$37,900 Call 455-7000

LIVONIA
 Super location in beautiful Heartstone convenient to the Livonia Mall. 3 bedroom, 1 1/2 bath ranch, modern kitchen, carpeted throughout, lower level family room each feature natural wood burning fireplaces. Situated on a large ravine lot. It's breathtaking! Call Harvey Beadle 477-6100 (105)

LIVONIA
 Super sharp, tastefully decorated 4 bedroom quad level located in a very desirable neighborhood. Fantastic heated Florida room overlooks professionally landscaped yard. Rear entrance 2 car garage attached with automatic door opener. Beautiful family room with natural fireplace and parquet tile floor. Good simple assumption! \$55,900 Call 261-0700

LIVONIA
 Room to Roam! Spacious brick ranch on extra large lot with natural fireplace and family room. \$43,900 Call 261-2600 (42329)

SOUTHFIELD
 A decorator's dream! Marble sills, like-new carpet, new no-wax kitchen floor, new marble foyer, extra insulation, brick patio. Many extras! \$49,900 Call 261-2600 (43093)

SOUTHFIELD
 Super clean and sharp - 3 bedroom brick ranch on a wide lot. Large family room, side patio adjacent to garage, carpeting throughout. Country Atmosphere! \$35,900 Call 261-2600 (43241)

LIVONIA
 Immediate Occupancy, Good Assumption! 4 bedroom, 1 1/2 bath Colonial with raised living room, family room, 2 1/2 car garage, basement, above ground pool. Priced below market value! Owner transferred, house is vacant! \$40,900 Call 851-1900 (43588)

LIVONIA
 Room to Roam! Spacious brick ranch on extra large lot with natural fireplace and family room. \$43,900 Call 261-2600 (42329)

LIVONIA
 A Real Charmer! Three bedroom, 1 1/2 story immaculate, remodeled home on a large lot. Superbly landscaped with brick circular drive. \$37,900 Call 455-7000

LIVONIA
 Super location in beautiful Heartstone convenient to the Livonia Mall. 3 bedroom, 1 1/2 bath ranch, modern kitchen, carpeted throughout, lower level family room each feature natural wood burning fireplaces. Situated on a large ravine lot. It's breathtaking! Call Harvey Beadle 477-6100 (105)

LIVONIA
 Super sharp, tastefully decorated 4 bedroom quad level located in a very desirable neighborhood. Fantastic heated Florida room overlooks professionally landscaped yard. Rear entrance 2 car garage attached with automatic door opener. Beautiful family room with natural fireplace and parquet tile floor. Good simple assumption! \$55,900 Call 261-0700

LIVONIA
 Room to Roam! Spacious brick ranch on extra large lot with natural fireplace and family room. \$43,900 Call 261-2600 (42329)

SOUTHFIELD
 A decorator's dream! Marble sills, like-new carpet, new no-wax kitchen floor, new marble foyer, extra insulation, brick patio. Many extras! \$49,900 Call 261-2600 (43093)

SOUTHFIELD
 Super clean and sharp - 3 bedroom brick ranch on a wide lot. Large family room, side patio adjacent to garage, carpeting throughout. Country Atmosphere! \$35,900 Call 261-2600 (43241)

LIVONIA
 Immediate Occupancy, Good Assumption! 4 bedroom, 1 1/2 bath Colonial with raised living room, family room, 2 1/2 car garage, basement, above ground pool. Priced below market value! Owner transferred, house is vacant! \$40,900 Call 851-1900 (43588)

LIVONIA
 Room to Roam! Spacious brick ranch on extra large lot with natural fireplace and family room. \$43,900 Call 261-2600 (42329)

LIV

304 Farmington West Bloomfield

SPARKLING NEW

Tons of space offered with this over 2,500 sq. ft. colonial with a unique styling of its own. Complete with 4 large bedrooms and walk-in closet, dressing room and full bath off master, 2 1/2 baths, first floor utility, formal dining room, beautiful family room featuring natural fireplace and walnut wcf bar for entertainment. A custom kitchen with all the improvements, plush carpeting throughout, a full basement, 2 1/2 car attached garage. All this plus an oversized lot \$87,500. Another Custom Home by Utz Builders.

HARRY S.

304 Farmington West Bloomfield

COUNTRY living 1/2 acre clean 3 bedroom brick ranch. 1 1/2 baths. Large kitchen, family room, fireplace. Full basement. 4th bedroom. Storage garage. Attached 2 car garage. patio. Walk to everything. \$54,900.

306 Southfield Lathrup

OWNER \$43,900

VERY NICE 4 bedroom brick ranch. Family room, fireplace, 2 1/2 baths, 2 1/2 car garage, approx. 1/2 acre lot. Across the street from MacArthur Elementary. Great for kids. French 1/2 Mile area. 2510 Fredrick 357-0387

COUNTRY SCENE in the city in this extra sharp 3 bedroom brick ranch also features family room, large kitchen, full basement, attached garage, lot is almost 1/2 acre. Telephone 10 Mile area in Southfield. \$89,900. Excellent. Handled by Amad Sales, Robertson, Inc. 549-5405

Lovely Lathrup Village BEAUTIFUL MANSARD roofed colonial with 4 bedrooms, 2 1/2 baths, family room, plus study. Large lot. \$62,900.

NEVER BUILT Ranch with 3 bedrooms, 2 full baths, family room with natural fireplace and beamed ceiling. First floor laundry room. Super floor plan. \$58,500. 681-6600 358-5522

308 Rochester-Troy

DUTCH COLONIAL - Troy, 4 bed. finished basement, central air, firewood deck, walk to school. \$89,500. 889-5612

BY OWNER Cape Cod on 2 acres, north of Rochester, 100% electric heat, 7 year old, 3 large bedrooms, 3 1/2 baths, country kitchen with built-in walk-out basement to large patio, maintenance free exterior, 2 1/2 car attached garage with automatic door opener. Extras include circular front drive, 2 fireplaces, thermopane windows and double insulation throughout, rot vinyl antennae burglar and fire alarm systems, intercom system, high sevens Call 652-3011

Rochester Farms Immed. Occupancy \$55,845

Tienken, 1 Mile East of Avon Colonial Style Home with 2100 square feet of living and bonus space plus full basement and 2 car side entry garage on a lovely cul-de-sac lot. Ask about lot 133. (Others from \$52,490) OPEN EVERYDAY 652-4550 or 851-5700

311 Homes For Sale Oakland County

HUNTINGTON WOODS 5 year old colonial, 3 bedrooms, 2 1/2 baths, family room, 2 car garage. \$41,388. 338-1161

BI-LEVEL 3 bedroom bath and 1 1/2 level, finished basement with built-in bar, 2 1/2 car garage. \$37,900. By owner. 437-2404 or 437-1834

LAKE PRIVILEGES

On Commerce Lake. Nicely decorated 3 bedroom aluminum sided ranch built in 1968. Dated, fenced yard. 60 X 108 lot. \$21,500.

JAMES C. CUTLER REALTY, 349-4030

320 Other Suburban Homes For Sale

BERKLEY HOME must sell. Unique 3 bedroom, 1 1/2 bath, master bedroom, all appliances plus dishwasher, finished basement completely carpeted, 2 car garage, assumable mortgage. \$200 monthly payment \$27,900. 548-6998

BRIGHTON AREA offers an excellent family home in Colonial Village with 4 bedrooms. This colonial style has a large corner lot with basement garage and a nice screened porch. You'll enjoy the 2 1/2 fire-placed family room and extra roomy kitchen. Close to X-way transportation and ready for immediate possession. See it and you'll buy it! \$51,900. Call 476-8790.

336 Florida Property For Sale

WESTPALM

One bedroom decorated, furnished, accept 1977 Lincoln, Cadillac or Regency as part payment. Call Tom Balamian. 338-7161

PORT CHARLOTTE lots, Part S.L. Lucie lot. Sells for equity plus 10% Assume mortgage at 7% Long term investment. 367-0355

338 Lots And Acreage For Sale

TORCH LAKE - 80 acres with quarter mile frontage on county road access. Beautiful hills and woods all or part Terms. 337-9010

TWO acres in Limestone Township on M-47 between Munsing and Tenny. 10 x 44 mobile home included. \$44,500 cash. Reply to Oscar Gibbons, Box 187, Tenny, Michigan 49891.

FREEDOM ROAD Orchard Lake road area. 3 1/2 Acres. Zoned high density. 3 1/2 Acres. Sewers and water in. 455-7251

81 ACRES of gently rolling wooded land in Northville Township. Ridge for development. 2.800 foot frontage on paved road. Terms available at \$48,000. Call 281-5980.

348 Cemetery Lots

ACACIA PARK choice lots, val. at \$500 each. Make offer. Not sold separately. 474-3919

PARKVIEW MEMORIAL Livonia. Several lots available \$190 each. Days: 253-4000. Evenings: weekends. 478-9210

350 Farms For Sale

BYRON AREA - 101 acres, 4 out-buildings and site. Needs some repair. 4 bedroom farm house has been remodeled down stairs, with 1 1/2 baths, Franklin fireplace. \$80,000 cash or terms available. Phillips Realty, Linden, Michigan. 1-735-4222. Evenings Charlie 1-284-302

LARGE FARMHOUSE, several out-buildings, 7 acres, Plymouth Schools, \$63,500, contract terms. Also 4 bedroom Colonial 2.3 mile. 696 So. Lyon Schools. Also new spec homes, like to choose from or will build a home on your parcel or ours. All American Real Estate 437-8111

351 Busi. & Professional Bldg. For Sale

ROCHESTER AREA, home zoned general business, approximately 2400 sq. ft. frontage on 2 block. \$48,000. 651-6560 448-0000

352 Commercial And Industrial

PLYMOUTH RD.-LIVONIA Owner must sacrifice Zoned M-1. 80 x 315 ft. on property rented. Red Baron 422-8220

Must sell 4,800 sq. ft. industrial building, ready to finish. 22,000 sq. ft. of space. Heavy traffic. 15 Mile Road. 476-8700.

400 Apartments To Rent

Immediate Occupancy We Love Children Single's Welcome

BOTSFOUR PLACE

Grand River 8 Mile Area Behind Botsford Hospital IN FARMINGTON

1 BEDROOM for \$239
2 BEDROOM for \$279
3 BEDROOM for \$350

Quiet prestige address, swimming pool and refrigerator, all utilities except electricity included. Laundry facilities. No pets. Good security. Playground on premises. 2 blocks from schools. Warm apartments.

For information phone 477-8464
27883 Independence Farmington Hills

OLD REDFORD AREA Newly decorated 2 bedrooms with carpeting and drapes. Quiet building. Immediate occupancy. \$185 a month plus security. Total welcome. 338-9375

ONE bedroom apartment W. University Dr. Near Center. High \$175 per month. Plus security deposit in Rochester. 651-0422

OAKLAND VALLEY APTS

1 & 2 bedroom luxury apartments. Automatic dishwashers, self-cleaning ovens, frost free refrigerators, sunken living rooms.

From \$222 MONTHLY
11 AM to 6 PM
2800 Patrick Henry Dr. Near Oakland University
373-2196

BIRMINGHAM Adams Ct Apartments in town location. 1 bedroom with appliances, including all utilities except electricity. Call manager 644-6784

8 MILE-Grand River area, 3 room apartment. \$150 monthly, couples only. One child, pay own utilities. 477-8650

400 Apartments To Rent

DELUXE

1-2 Bedroom Apartments
Air Cond., Pool, Carport

Manager 533-5213
557-0770

TWYCKINGHAM VALLEY Apartments. 2227 W. 12 Mile. Spacious 1 bedroom, carpeting and pool. New Whirlpool Appliances. Central Air. Carport. \$285 Monthly. 267-5809

WESTLAND Merriman and Palmer 1 bedroom apartment. Clean. No children or pets. \$145. 455-0454

TODAY'S ADDRESS

TROY

THE GOLDEN CORRIDOR AT YOUR DOORSTEP

2859 Troy Center Dr. between Crooks & 175

East of Somerset Mall
Troy's first elevator service apartment building. One and two bedroom apartments from \$235 to \$340. Immediate Occupancy.

Village Green Of Troy

Office hrs. daily & Sat 9 am to 6 pm
Closed Thurs & Sun
362-0320

WAYNE-WESTLAND AREA beautiful 1 bedroom carpet drapes appliances \$190 728-3953

400 Apartments to rent

Plymouth Hills Apts.

City of Plymouth
764 S. Mill near Ann Arbor Trail New 1 & 2 bedroom from \$205 including washer, dryer, refrigerator, electric range, carpet, air conditioning. No pets. 455-4721

WESTLAND AREA

Attractive 1 and 2 bedroom apts from \$200 monthly. Decorated carpet and air conditioned. Country Court Apts. 721-4500

BLOOMFIELD HILLS

Lovely 1 and 2 bedroom apartments from \$235 monthly. Includes wall to wall carpeting, garbage disposal, dishwasher, TV antenna, central air, carpet, use of clubhouse with sauna, exercise room, swimming pool and playground for children. Close to shopping, commuter train and I-75 X-way. OPDYKE HILLS APARTMENTS At Opdyke & Fox Hills Rd. (Betw. Sugar Lake & S. Blvd.) 338-0243

RED WING TICKET WINNER

Mike Maske
9211 Lucerne
Redford, MI 48239

WOLFE COMPANY

12338 Five Mile GA 1-5860

PILLARED COLONIAL

No. 1 West Bloomfield Twp. 3 year old 9 room 4 bedroom, 2 1/2 bath colonial. Property offers first floor laundry room and den plus formal dining room built in bar in family room, high corner lot, landscaped garage and Earl American decor. Attractive wallpaper, lastely decorated Owner transferred. Immediate occupancy. 2 1/2 mortgage Act now \$84,900

NEVER BUILT Ranch with 3 bedrooms, 2 full baths, family room with natural fireplace and beamed ceiling. First floor laundry room. Super floor plan. \$58,500. 681-6600 358-5522

Lovely Lathrup Village BEAUTIFUL MANSARD roofed colonial with 4 bedrooms, 2 1/2 baths, family room, plus study. Large lot. \$62,900.

Rochester Farms Immed. Occupancy \$55,845

Tienken, 1 Mile East of Avon Colonial Style Home with 2100 square feet of living and bonus space plus full basement and 2 car side entry garage on a lovely cul-de-sac lot. Ask about lot 133. (Others from \$52,490) OPEN EVERYDAY 652-4550 or 851-5700

320 Other Suburban Homes For Sale

BERKLEY HOME must sell. Unique 3 bedroom, 1 1/2 bath, master bedroom, all appliances plus dishwasher, finished basement completely carpeted, 2 car garage, assumable mortgage. \$200 monthly payment \$27,900. 548-6998

BRIGHTON AREA offers an excellent family home in Colonial Village with 4 bedrooms. This colonial style has a large corner lot with basement garage and a nice screened porch. You'll enjoy the 2 1/2 fire-placed family room and extra roomy kitchen. Close to X-way transportation and ready for immediate possession. See it and you'll buy it! \$51,900. Call 476-8790.

336 Florida Property For Sale

WESTPALM

One bedroom decorated, furnished, accept 1977 Lincoln, Cadillac or Regency as part payment. Call Tom Balamian. 338-7161

PORT CHARLOTTE lots, Part S.L. Lucie lot. Sells for equity plus 10% Assume mortgage at 7% Long term investment. 367-0355

338 Lots And Acreage For Sale

TORCH LAKE - 80 acres with quarter mile frontage on county road access. Beautiful hills and woods all or part Terms. 337-9010

TWO acres in Limestone Township on M-47 between Munsing and Tenny. 10 x 44 mobile home included. \$44,500 cash. Reply to Oscar Gibbons, Box 187, Tenny, Michigan 49891.

FREEDOM ROAD Orchard Lake road area. 3 1/2 Acres. Zoned high density. 3 1/2 Acres. Sewers and water in. 455-7251

81 ACRES of gently rolling wooded land in Northville Township. Ridge for development. 2.800 foot frontage on paved road. Terms available at \$48,000. Call 281-5980.

348 Cemetery Lots

ACACIA PARK choice lots, val. at \$500 each. Make offer. Not sold separately. 474-3919

PARKVIEW MEMORIAL Livonia. Several lots available \$190 each. Days: 253-4000. Evenings: weekends. 478-9210

350 Farms For Sale

BYRON AREA - 101 acres, 4 out-buildings and site. Needs some repair. 4 bedroom farm house has been remodeled down stairs, with 1 1/2 baths, Franklin fireplace. \$80,000 cash or terms available. Phillips Realty, Linden, Michigan. 1-735-4222. Evenings Charlie 1-284-302

LARGE FARMHOUSE, several out-buildings, 7 acres, Plymouth Schools, \$63,500, contract terms. Also 4 bedroom Colonial 2.3 mile. 696 So. Lyon Schools. Also new spec homes, like to choose from or will build a home on your parcel or ours. All American Real Estate 437-8111

351 Busi. & Professional Bldg. For Sale

ROCHESTER AREA, home zoned general business, approximately 2400 sq. ft. frontage on 2 block. \$48,000. 651-6560 448-0000

352 Commercial And Industrial

PLYMOUTH RD.-LIVONIA Owner must sacrifice Zoned M-1. 80 x 315 ft. on property rented. Red Baron 422-8220

Must sell 4,800 sq. ft. industrial building, ready to finish. 22,000 sq. ft. of space. Heavy traffic. 15 Mile Road. 476-8700.

400 Apartments To Rent

Immediate Occupancy We Love Children Single's Welcome

BOTSFOUR PLACE

Grand River 8 Mile Area Behind Botsford Hospital IN FARMINGTON

1 BEDROOM for \$239
2 BEDROOM for \$279
3 BEDROOM for \$350

Quiet prestige address, swimming pool and refrigerator, all utilities except electricity included. Laundry facilities. No pets. Good security. Playground on premises. 2 blocks from schools. Warm apartments.

For information phone 477-8464
27883 Independence Farmington Hills

OLD REDFORD AREA Newly decorated 2 bedrooms with carpeting and drapes. Quiet building. Immediate occupancy. \$185 a month plus security. Total welcome. 338-9375

ONE bedroom apartment W. University Dr. Near Center. High \$175 per month. Plus security deposit in Rochester. 651-0422

OAKLAND VALLEY APTS

1 & 2 bedroom luxury apartments. Automatic dishwashers, self-cleaning ovens, frost free refrigerators, sunken living rooms.

From \$222 MONTHLY
11 AM to 6 PM
2800 Patrick Henry Dr. Near Oakland University
373-2196

BIRMINGHAM Adams Ct Apartments in town location. 1 bedroom with appliances, including all utilities except electricity. Call manager 644-6784

8 MILE-Grand River area, 3 room apartment. \$150 monthly, couples only. One child, pay own utilities. 477-8650

400 Apartments To Rent

DELUXE

1-2 Bedroom Apartments
Air Cond., Pool, Carport

Manager 533-5213
557-0770

TWYCKINGHAM VALLEY Apartments. 2227 W. 12 Mile. Spacious 1 bedroom, carpeting and pool. New Whirlpool Appliances. Central Air. Carport. \$285 Monthly. 267-5809

WESTLAND Merriman and Palmer 1 bedroom apartment. Clean. No children or pets. \$145. 455-0454

TODAY'S ADDRESS

TROY

THE GOLDEN CORRIDOR AT YOUR DOORSTEP

2859 Troy Center Dr. between Crooks & 175

East of Somerset Mall
Troy's first elevator service apartment building. One and two bedroom apartments from \$235 to \$340. Immediate Occupancy.

Village Green Of Troy

Office hrs. daily & Sat 9 am to 6 pm
Closed Thurs & Sun
362-0320

WAYNE-WESTLAND AREA beautiful 1 bedroom carpet drapes appliances \$190 728-3953

400 Apartments to rent

Plymouth Hills Apts.

City of Plymouth
764 S. Mill near Ann Arbor Trail New 1 & 2 bedroom from \$205 including washer, dryer, refrigerator, electric range, carpet, air conditioning. No pets. 455-4721

WESTLAND AREA

Attractive 1 and 2 bedroom apts from \$200 monthly. Decorated carpet and air conditioned. Country Court Apts. 721-4500

BLOOMFIELD HILLS

Lovely 1 and 2 bedroom apartments from \$235 monthly. Includes wall to wall carpeting, garbage disposal, dishwasher, TV antenna, central air, carpet, use of clubhouse with sauna, exercise room, swimming pool and playground for children. Close to shopping, commuter train and I-75 X-way. OPDYKE HILLS APARTMENTS At Opdyke & Fox Hills Rd. (Betw. Sugar Lake & S. Blvd.) 338-0243

RED WING TICKET WINNER

Mike Maske
9211 Lucerne
Redford, MI 48239

Century 21

VINCENT N LEE
EXECUTIVE TRANSFER SALES
478-5904

TIRED OF HUNTING? Don't give up, see this spacious 3 bedroom brick ranch. Fireplace in family room, first floor utility, carpeting and 2 car attached garage. Well maintained. IDEAL if you want COUNTRY. IDEAL if you want COUNTRY. TRULY ATMOSPHERE.

ELLIS 476-1700

NEVER BUILT Ranch with 3 bedrooms, 2 full baths, family room with natural fireplace and beamed ceiling. First floor laundry room. Super floor plan. \$58,500. 681-6600 358-5522

Lovely Lathrup Village BEAUTIFUL MANSARD roofed colonial with 4 bedrooms, 2 1/2 baths, family room, plus study. Large lot. \$62,900.

Rochester Farms Immed. Occupancy \$55,845

Tienken, 1 Mile East of Avon Colonial Style Home with 2100 square feet of living and bonus space plus full basement and 2 car side entry garage on a lovely cul-de-sac lot. Ask about lot 133. (Others from \$52,490) OPEN EVERYDAY 652-4550 or 851-5700

320 Other Suburban Homes For Sale

BERKLEY HOME must sell. Unique 3 bedroom, 1 1/2 bath, master bedroom, all appliances plus dishwasher, finished basement completely carpeted, 2 car garage, assumable mortgage. \$200 monthly payment \$27,900. 548-6998

BRIGHTON AREA offers an excellent family home in Colonial Village with 4 bedrooms. This colonial style has a large corner lot with basement garage and a nice screened porch. You'll enjoy the 2 1/2 fire-placed family room and extra roomy kitchen. Close to X-way transportation and ready for immediate possession. See it and you'll buy it! \$51,900. Call 476-8790.

336 Florida Property For Sale

WESTPALM

One bedroom decorated, furnished, accept 1977 Lincoln, Cadillac or Regency as part payment. Call Tom Balamian. 338-7161

PORT CHARLOTTE lots, Part S.L. Lucie lot. Sells for equity plus 10% Assume mortgage at 7% Long term investment. 367-0355

338 Lots And Acreage For Sale

TORCH LAKE - 80 acres with quarter mile frontage on county road access. Beautiful hills and woods all or part Terms. 337-9010

TWO acres in Limestone Township on M-47 between Munsing and Tenny. 10 x 44 mobile home included. \$44,500 cash. Reply to Oscar Gibbons, Box 187, Tenny, Michigan 49891.

FREEDOM ROAD Orchard Lake road area. 3 1/2 Acres. Zoned high density. 3 1/2 Acres. Sewers and water in. 455-7251

81 ACRES of gently rolling wooded land in Northville Township. Ridge for development. 2.800 foot frontage on paved road. Terms available at \$48,000. Call 281-5980.

348 Cemetery Lots

ACACIA PARK choice lots, val. at \$500 each. Make offer. Not sold separately. 474-3919

PARKVIEW MEMORIAL Livonia. Several lots available \$190 each. Days: 253-4000. Evenings: weekends. 478-9210

350 Farms For Sale

BYRON AREA - 101 acres, 4 out-buildings and site. Needs some repair. 4 bedroom farm house has been remodeled down stairs, with 1 1/2 baths, Franklin fireplace. \$80,000 cash or terms available. Phillips Realty, Linden, Michigan. 1-735-4222. Evenings Charlie 1-284-302

LARGE FARMHOUSE, several out-buildings, 7 acres, Plymouth Schools, \$63,500, contract terms. Also 4 bedroom Colonial 2.3 mile. 696 So. Lyon Schools. Also new spec homes, like to choose from or will build a home on your parcel or ours. All American Real Estate 437-8111

351 Busi. & Professional Bldg. For Sale

ROCHESTER AREA, home zoned general business, approximately 2400 sq. ft. frontage on 2 block. \$48,000. 651-6560 448-0000

352 Commercial And Industrial

PLYMOUTH RD.-LIVONIA Owner must sacrifice Zoned M-1. 80 x 315 ft. on property rented. Red Baron 422-8220

Must sell 4,800 sq. ft. industrial building, ready to finish. 22,000 sq. ft. of space. Heavy traffic. 15 Mile Road. 476-8700.

400 Apartments To Rent

Immediate Occupancy We Love Children Single's Welcome

BOTSFOUR PLACE

Grand River 8 Mile Area Behind Botsford Hospital IN FARMINGTON

1 BEDROOM for \$239
2 BEDROOM for \$279
3 BEDROOM for \$350

Quiet prestige address, swimming pool and refrigerator, all utilities except electricity included. Laundry facilities. No pets. Good security. Playground on premises. 2 blocks from schools. Warm apartments.

For information phone 477-8464
27883 Independence Farmington Hills

OLD REDFORD AREA Newly decorated 2 bedrooms with carpeting and drapes. Quiet building. Immediate occupancy. \$185 a month plus security. Total welcome. 338-9375

ONE bedroom apartment W. University Dr. Near Center. High \$175 per month. Plus security deposit in Rochester. 651-0422

OAKLAND VALLEY APTS

1 & 2 bedroom luxury apartments. Automatic dishwashers, self-cleaning ovens, frost free refrigerators, sunken living rooms.

From \$222 MONTHLY
11 AM to 6 PM
2800 Patrick Henry Dr. Near Oakland University
373-2196

BIRMINGHAM Adams Ct Apartments in town location. 1 bedroom with appliances, including all utilities except electricity. Call manager 644-6784

8 MILE-Grand River area, 3 room apartment. \$150 monthly, couples only. One child, pay own utilities. 477-8650

400 Apartments To Rent

DELUXE

1-2 Bedroom Apartments
Air Cond., Pool, Carport

Manager 533-5213
557-0770

TWYCKINGHAM VALLEY Apartments. 2227 W. 12 Mile. Spacious 1 bedroom, carpeting and pool. New Whirlpool Appliances. Central Air. Carport. \$285 Monthly. 267-5809

WESTLAND Merriman and Palmer 1 bedroom apartment. Clean. No children or pets. \$145. 455-0454

TODAY'S ADDRESS

TROY

THE GOLDEN CORRIDOR AT YOUR DOORSTEP

2859 Troy Center Dr. between Crooks & 175

East of Somerset Mall
Troy's first elevator service apartment building. One and two bedroom apartments from \$235 to \$340. Immediate Occupancy.

Village Green Of Troy

Office hrs. daily & Sat 9 am to 6 pm
Closed Thurs & Sun
362-0320

WAYNE-WESTLAND AREA beautiful 1 bedroom carpet drapes appliances \$190 728-3953

400 Apartments to rent

Plymouth Hills Apts.

City of Plymouth
764 S. Mill near Ann Arbor Trail New 1 & 2 bedroom from \$205 including washer, dryer, refrigerator, electric range, carpet, air conditioning. No pets. 455-4721

WESTLAND AREA

Attractive 1 and 2 bedroom apts from \$200 monthly. Decorated carpet and air conditioned. Country Court Apts. 721-4500

BLOOMFIELD HILLS

Lovely 1 and 2 bedroom apartments from \$235 monthly. Includes wall to wall carpeting, garbage disposal, dishwasher, TV antenna, central air, carpet, use of clubhouse with sauna, exercise room, swimming pool and playground for children. Close to shopping, commuter train and I-75 X-way. OPDYKE HILLS APARTMENTS At Opdyke & Fox Hills Rd. (Betw. Sugar Lake & S. Blvd.) 338-0243

RED WING TICKET WINNER

Mike Maske
9211 Lucerne
Redford, MI 48239

Century 21

VINCENT N LEE
EXECUTIVE TRANSFER SALES
478-5904

TIRED OF HUNTING? Don't give up, see this spacious 3 bedroom brick ranch. Fireplace in family room, first floor utility, carpeting and 2 car attached garage. Well maintained. IDEAL if you want COUNTRY. IDEAL if you want COUNTRY. TRULY ATMOSPHERE.

ELLIS 476-1700

NEVER BUILT Ranch with 3 bedrooms, 2 full baths, family room with natural fireplace and beamed ceiling. First floor laundry room. Super floor plan. \$58,500. 681-6600 358-5522

Lovely Lathrup Village BEAUTIFUL MANSARD roofed colonial with 4 bedrooms, 2 1/2 baths, family room, plus study. Large lot. \$62,900.

Rochester Farms Immed. Occupancy \$55,845

Tienken, 1 Mile East of Avon Colonial Style Home with 2100 square feet of living and bonus space plus full basement and 2 car side entry garage on a lovely cul-de-sac lot. Ask about lot 133. (Others from \$52,490) OPEN EVERYDAY 652-4550 or 851-5700

320 Other Suburban Homes For Sale

BERKLEY HOME must sell. Unique 3 bedroom, 1 1/2 bath, master bedroom, all appliances plus dishwasher, finished basement completely carpeted, 2 car garage, assumable mortgage. \$200 monthly payment \$27,900. 548-6998

BRIGHTON AREA offers an excellent family home in Colonial Village with 4 bedrooms. This colonial style has a large corner lot with basement garage and a nice screened porch. You'll enjoy the 2 1/2 fire-placed family room and extra roomy kitchen. Close to X-way transportation and ready for immediate possession. See it and you'll buy it! \$51,900. Call 476-8790.

336 Florida Property For Sale

WESTPALM

One bedroom decorated, furnished, accept 1977 Lincoln, Cadillac or Regency as part payment. Call Tom Balamian. 338-7161

PORT CHARLOTTE lots, Part S.L. Lucie lot. Sells for equity plus 10% Assume mortgage at 7% Long term investment. 367-0355

338 Lots And Acreage For Sale

TORCH LAKE - 80 acres with quarter mile frontage on county road access. Beautiful hills and woods all or part Terms. 337-9010

TWO acres in Limestone Township on M-47 between Munsing and Tenny. 10 x 44 mobile home included. \$44,500 cash. Reply to Oscar Gibbons, Box 187, Tenny, Michigan 49891.

FREEDOM ROAD Orchard Lake road area. 3 1/2 Acres. Zoned high density. 3 1/2 Acres. Sewers and water in. 455-7251

81 ACRES of gently rolling wooded land in Northville Township. Ridge for development. 2.800 foot frontage on paved road. Terms available at \$48,000. Call 281-5980.

348 Cemetery Lots

ACACIA PARK choice lots, val. at \$500 each. Make offer. Not sold separately. 474-3919

PARKVIEW MEMORIAL Livonia. Several lots available \$190 each. Days: 253-4000. Evenings: weekends. 478-9210

350 Farms For Sale

BYRON AREA - 101 acres, 4 out-buildings and site. Needs some repair. 4 bedroom farm house has been remodeled down stairs, with 1 1/2 baths, Franklin fireplace. \$80,000 cash or terms available. Phillips Realty, Linden, Michigan. 1-735-4222. Evenings Charlie 1-284-302

LARGE FARMHOUSE, several out-buildings, 7 acres, Plymouth Schools, \$63,500, contract terms. Also 4 bedroom Colonial 2.3 mile. 696 So. Lyon Schools. Also new spec homes, like to choose from or will build a home on your parcel or ours. All American Real Estate 437-8111

351 Busi. & Professional Bldg. For Sale

ROCHESTER AREA, home zoned general business, approximately 2400 sq. ft. frontage on 2 block. \$48,000. 651-6560 448-0000

352 Commercial And Industrial

PLYMOUTH RD.-LIVONIA Owner must sacrifice Zoned M-1. 80 x 315 ft. on property rented. Red Baron 422-8220

Must sell 4,800 sq. ft. industrial building, ready to finish. 22,000 sq. ft. of space. Heavy traffic. 15 Mile Road. 476-8700.

400 Apartments To Rent

Immediate Occupancy We Love Children Single's Welcome

BOTSFOUR PLACE

Grand River 8 Mile Area Behind Botsford Hospital IN FARMINGTON

1 BEDROOM for \$239
2 BEDROOM for \$279
3 BEDROOM for \$350

Quiet prestige address, swimming pool and refrigerator, all utilities except electricity included. Laundry facilities. No pets. Good security. Playground on premises. 2 blocks from schools. Warm apartments.

For information phone 477-8464
27883 Independence Farmington Hills

OLD REDFORD AREA Newly decorated 2 bedrooms with carpeting and drapes. Quiet building. Immediate occupancy. \$185 a month plus security. Total welcome. 338-9375

ONE bedroom apartment W. University Dr. Near Center. High \$175 per month. Plus security deposit in Rochester. 651-0422

OAKLAND VALLEY APTS

1 & 2 bedroom luxury apartments. Automatic dishwashers, self-cleaning ovens, frost free refrigerators, sunken living rooms.

From \$222 MONTHLY
11 AM to 6 PM
2800 Patrick Henry Dr. Near Oakland University
373-2196

BIRMINGHAM Adams Ct Apartments in town location. 1 bedroom with appliances, including all utilities except electricity. Call manager 644-6784

8 MILE-Grand River area, 3 room apartment. \$150 monthly, couples only. One child, pay own utilities. 477-8650

400 Apartments To Rent

DELUXE

1-2 Bedroom Apartments
Air Cond., Pool, Carport

Manager 533-5213
557-0770

TWYCKINGHAM VALLEY Apartments. 2227 W. 12 Mile. Spacious 1 bedroom, carpeting and pool. New Whirlpool Appliances. Central Air. Carport. \$285 Monthly. 267-5809

WESTLAND Merriman and Palmer 1 bedroom apartment. Clean. No children or pets. \$145. 455-0454

TODAY'S ADDRESS

TROY

THE GOLDEN CORRIDOR AT YOUR DOORSTEP

2859 Troy Center Dr. between Crooks & 175

East of Somerset Mall
Troy's first elevator service apartment building. One and two bedroom apartments from \$235 to \$340. Immediate Occupancy.

Village Green Of Troy

Office hrs. daily & Sat 9 am to 6 pm
Closed Thurs & Sun
362-0320

WAYNE-WESTLAND AREA beautiful 1 bedroom carpet drapes appliances \$190 728-3953

400 Apartments to rent

Plymouth Hills Apts.

400 Apartments To Rent

BLOOMFIELD HILLS 1 bedroom contemporary townhouse with sun living room 2 story studio ceiling immediate possession \$325 330-3000

412 Townhouses- Condos. To Rent

TOWNHOUSE 3 bedroom, 1 1/2 baths, basement, garage, heat, \$375. Mature adults. Between Crooks and Coolidge. North of 14 Mile. 642-6033

418 Mobile Homes To Rent

GMC MOTORHOME. 36 ft. Completely self-contained. Sleeps 6. 626-6096

424 Office-Business Space To Rent

OFFICE SPACE AVAILABLE for lease 100-200 sq. ft. Woodward Ave. Bloomfield Hills location. 642-3333

500 Help Wanted

LIVONIA MANUFACTURER has immediate opening for experienced MILL HAND. BRIDGEPORT MILLS. Must be on set-up. Will be working overtime schedule. Apply in person or call 281-8060

500 Help Wanted

NEED CASH? TEMPORARY WORK Men and women needed for temporary LIGHT PACKAGING WORK in Plymouth. Day and evening shifts available. If interested, call 2944-7500

500 Help Wanted

GUARDS FULL & PART TIME All shifts available GOOD PAY Excellent benefits 255-2600

500 Help Wanted

CLEANING lady needed for furniture store. Steady full time position Monday - Friday. Apply in person. Lasky Park Furniture, 2905 Plymouth Rd. Livonia

500 Help wanted

FOOD VENDING Route Salesmen. Day shift. 276-3883

BROOKVIEW VILLAGE APTS

Palmer Rd. - W of Hannan Plymouth School District 1 1/2 bedroom apartments and 2 bedroom 1 1/2 bath townhouses. Each unit completely air conditioned, carpeted, gas heat. All appliances. WESTINGHOUSE WASH DRYER. Large walk in closets. Lower units in townhouses with private patios and doorways. Ample parking. Gas utility included. Walking distance to elementary school. \$400 month call 349-6458

WEST BLOOMFIELD AREA

Approximately 1900 sq. ft. fireplace, formal dining, 2 large bedrooms, garage, basement. Includes appliances. March 1 thru September 30. Available for purchase thereafter. \$550 per month. 851-2128

MOON LAKE RENTAL TOWNHOUSES

ON PRIVATE LAKE IN WEST BLOOMFIELD • Bloomfield Hills Courts • Golf course, tennis courts, fishing • Clubhouse & swimming pool • Wine cellar, bar, greenhouses • Attached garage with opener • Quiet with no common walls • On Long Lake Rd. 1 Mile W of Middlebelt 626-4888

426 Convalescent-Retirement Homes

NURSE has room for 2 private patients. Ambulatory care in home. Home cooking home atmosphere. Laundry, personal care. 642-2658

428 Garages To Rent

LARGE GARAGES, 12x55, 9 Mile Farmington Rd. 474-2290

430 Wanted To Rent

THREE RESPONSIBLE WOMEN need 2 or 3 bedroom house or flat. Fenced yard, have pets. In Northville. Novi, Farmington area. Call between 7-10 PM. 478-0325, 422-0009

402 Furnished Apts. For Rent

GARDEN CITY 1 bedroom, marble couples, no children, no pets. \$190 monthly. \$190 security. \$30 cleaning. Immediate occupancy. 421-1515

COUNTRYSIDE TOWNHOUSES

2 bedrooms with full basement for family living near Oakland University and 1 1/2 from 1900. Equal housing opportunity. 373-1200

432 Commercial Industrial To Rent

WAREHOUSE STORAGE. 1800 sq. ft. \$400 month. 860 sq. ft. \$150 month. 9 Mile Farmington Rd. 474-2290

434 Florida Rentals

BOCA RATON CONDO - Exclusive Boca West Club, golf, tennis, and pool. Adults preferred. 3 week minimum. Pictures available. 335-9721

436 Living Quarters To Share

RESPONSIBLE, employed, straight female to share with same 3 bedroom home in Birmingham. Please call Paul. 345-3425

438 Wanted To Rent

3 ADULTS would like 3 bedroom, preferably 2 baths, family room, for rent. 2 or 3 bedrooms, 2 1/2 baths, full kitchen, central air, 2 car garage. Call after 6 PM. 626-3228

MONTHLY LEASES

LUXURY completely furnished 1 and 2 bedroom apartments. Linens, dishes, color TV available. Near 14 Mile & Woodward. Call 325-8000

MAPLE RISE TOWNHOUSES

From \$139 per month. Lower rates for senior citizens. If you qualify. Maple North at Beck Rd. W. 13 PM. 624-0038

440 Office-Business Space To Rent

WILL lease up to 800 sq. ft. of office space, including available, superb location. All or part of 212 Daines, Birmingham. 355-0100

442 Office-Business Space To Rent

NEED limited office space in West-ern Wayne County, preferably Livonia. Willing to share office space or receptionist. 425-5481

444 Office-Business Space To Rent

ROOMMATE SERVICE Tell us what you want • Someone to move in • Move in with someone • Start a place with a roommate 334-6673

446 Office-Business Space To Rent

APARTMENT Westland - Livonia area. Working woman to share with 2 children. \$130 monthly plus utilities. 322-5242

MONTHLY LEASES

COMPLETELY FURNISHED lovely 1 and 2 bedroom apartments. Linens, dishes, TV, air, ex. part. weekly. ALSO Weekly leases available. ROYAL CHAMBER APARTMENTS 344-1402

MONTHLY LEASES

COMPLETELY FURNISHED lovely 1 and 2 bedroom apartments. Linens, dishes, TV, air, ex. part. weekly. ALSO Weekly leases available. ROYAL CHAMBER APARTMENTS 344-1402

448 Office-Business Space To Rent

NEED limited office space in West-ern Wayne County, preferably Livonia. Willing to share office space or receptionist. 425-5481

450 Office-Business Space To Rent

NEED limited office space in West-ern Wayne County, preferably Livonia. Willing to share office space or receptionist. 425-5481

452 Office-Business Space To Rent

NEED limited office space in West-ern Wayne County, preferably Livonia. Willing to share office space or receptionist. 425-5481

454 Office-Business Space To Rent

NEED limited office space in West-ern Wayne County, preferably Livonia. Willing to share office space or receptionist. 425-5481

456 Office-Business Space To Rent

NEED limited office space in West-ern Wayne County, preferably Livonia. Willing to share office space or receptionist. 425-5481

458 Office-Business Space To Rent

NEED limited office space in West-ern Wayne County, preferably Livonia. Willing to share office space or receptionist. 425-5481

460 Office-Business Space To Rent

NEED limited office space in West-ern Wayne County, preferably Livonia. Willing to share office space or receptionist. 425-5481

404 Houses To Rent

BURT RD SCHOOLCRAFT area. 2 bedroom full basement carpeting on living room. Fenced yard. \$290 month. Pine-Roads. 333-1311

406 Houses To Rent

HIRSHINGHAM schools. spacious 4 bedroom. (Colonial 2 1/2) baths. garage landscaped half acre. Best subdivision near Somerset. Furnished or unfurnished. 647-5813

408 Houses To Rent

BEVERLY HILLS - Birmingham area. office suites, from 240 to 1000 sq. ft. 14 Mile W. Woodward, utilities, carpeting, plus deposit and half electric. Ask for Mary. Days, 337-1785, After 6, 335-3347

410 Houses To Rent

PROFESSIONAL MALE to share house. Huntington Woods area. 341-3630

412 Houses To Rent

ROOMMATE SERVICE Tell us what you want • Someone to move in • Move in with someone • Start a place with a roommate 334-6673

414 Houses To Rent

PROFESSIONAL MALE to share house. Huntington Woods area. 341-3630

416 Houses To Rent

ROOMMATE SERVICE Tell us what you want • Someone to move in • Move in with someone • Start a place with a roommate 334-6673

418 Houses To Rent

ROOMMATE SERVICE Tell us what you want • Someone to move in • Move in with someone • Start a place with a roommate 334-6673

420 Houses To Rent

ROOMMATE SERVICE Tell us what you want • Someone to move in • Move in with someone • Start a place with a roommate 334-6673

422 Houses To Rent

BOCA RATON CONDO - Exclusive Boca West Club, golf, tennis, and pool. Adults preferred. 3 week minimum. Pictures available. 335-9721

424 Houses To Rent

BOCA RATON CONDO - Exclusive Boca West Club, golf, tennis, and pool. Adults preferred. 3 week minimum. Pictures available. 335-9721

426 Houses To Rent

BOCA RATON CONDO - Exclusive Boca West Club, golf, tennis, and pool. Adults preferred. 3 week minimum. Pictures available. 335-9721

428 Houses To Rent

BOCA RATON CONDO - Exclusive Boca West Club, golf, tennis, and pool. Adults preferred. 3 week minimum. Pictures available. 335-9721

430 Houses To Rent

BOCA RATON CONDO - Exclusive Boca West Club, golf, tennis, and pool. Adults preferred. 3 week minimum. Pictures available. 335-9721

432 Houses To Rent

BOCA RATON CONDO - Exclusive Boca West Club, golf, tennis, and pool. Adults preferred. 3 week minimum. Pictures available. 335-9721

434 Houses To Rent

BOCA RATON CONDO - Exclusive Boca West Club, golf, tennis, and pool. Adults preferred. 3 week minimum. Pictures available. 335-9721

436 Houses To Rent

BOCA RATON CONDO - Exclusive Boca West Club, golf, tennis, and pool. Adults preferred. 3 week minimum. Pictures available. 335-9721

438 Houses To Rent

BOCA RATON CONDO - Exclusive Boca West Club, golf, tennis, and pool. Adults preferred. 3 week minimum. Pictures available. 335-9721

440 Houses To Rent

BOCA RATON CONDO - Exclusive Boca West Club, golf, tennis, and pool. Adults preferred. 3 week minimum. Pictures available. 335-9721

442 Houses To Rent

BOCA RATON CONDO - Exclusive Boca West Club, golf, tennis, and pool. Adults preferred. 3 week minimum. Pictures available. 335-9721

444 Houses To Rent

BOCA RATON CONDO - Exclusive Boca West Club, golf, tennis, and pool. Adults preferred. 3 week minimum. Pictures available. 335-9721

446 Houses To Rent

BOCA RATON CONDO - Exclusive Boca West Club, golf, tennis, and pool. Adults preferred. 3 week minimum. Pictures available. 335-9721

448 Houses To Rent

BOCA RATON CONDO - Exclusive Boca West Club, golf, tennis, and pool. Adults preferred. 3 week minimum. Pictures available. 335-9721

450 Houses To Rent

BOCA RATON CONDO - Exclusive Boca West Club, golf, tennis, and pool. Adults preferred. 3 week minimum. Pictures available. 335-9721

452 Houses To Rent

BOCA RATON CONDO - Exclusive Boca West Club, golf, tennis, and pool. Adults preferred. 3 week minimum. Pictures available. 335-9721

454 Houses To Rent

BOCA RATON CONDO - Exclusive Boca West Club, golf, tennis, and pool. Adults preferred. 3 week minimum. Pictures available. 335-9721

456 Houses To Rent

BOCA RATON CONDO - Exclusive Boca West Club, golf, tennis, and pool. Adults preferred. 3 week minimum. Pictures available. 335-9721

458 Houses To Rent

BOCA RATON CONDO - Exclusive Boca West Club, golf, tennis, and pool. Adults preferred. 3 week minimum. Pictures available. 335-9721

460 Houses To Rent

BOCA RATON CONDO - Exclusive Boca West Club, golf, tennis, and pool. Adults preferred. 3 week minimum. Pictures available. 335-9721

462 Houses To Rent

BOCA RATON CONDO - Exclusive Boca West Club, golf, tennis, and pool. Adults preferred. 3 week minimum. Pictures available. 335-9721

464 Houses To Rent

BOCA RATON CONDO - Exclusive Boca West Club, golf, tennis, and pool. Adults preferred. 3 week minimum. Pictures available. 335-9721

466 Houses To Rent

BOCA RATON CONDO - Exclusive Boca West Club, golf, tennis, and pool. Adults preferred. 3 week minimum. Pictures available. 335-9721

468 Houses To Rent

BOCA RATON CONDO - Exclusive Boca West Club, golf, tennis, and pool. Adults preferred. 3 week minimum. Pictures available. 335-9721

470 Houses To Rent

BOCA RATON CONDO - Exclusive Boca West Club, golf, tennis, and pool. Adults preferred. 3 week minimum. Pictures available. 335-9721

472 Houses To Rent

BOCA RATON CONDO - Exclusive Boca West Club, golf, tennis, and pool. Adults preferred. 3 week minimum. Pictures available. 335-9721

474 Houses To Rent

BOCA RATON CONDO - Exclusive Boca West Club, golf, tennis, and pool. Adults preferred. 3 week minimum. Pictures available. 335-9721

476 Houses To Rent

BOCA RATON CONDO - Exclusive Boca West Club, golf, tennis, and pool. Adults preferred. 3 week minimum. Pictures available. 335-9721

478 Houses To Rent

BOCA RATON CONDO - Exclusive Boca West Club, golf, tennis, and pool. Adults preferred. 3 week minimum. Pictures available. 335-9721

480 Houses To Rent

BOCA RATON CONDO - Exclusive Boca West Club, golf, tennis, and pool. Adults preferred. 3 week minimum. Pictures available. 335-9721

482 Houses To Rent

BOCA RATON CONDO - Exclusive Boca West Club, golf, tennis, and pool. Adults preferred. 3 week minimum. Pictures available. 335-9721

484 Houses To Rent

BOCA RATON CONDO - Exclusive Boca West Club, golf, tennis, and pool. Adults preferred. 3 week minimum. Pictures available. 335-9721

486 Houses To Rent

BOCA RATON CONDO - Exclusive Boca West Club, golf, tennis, and pool. Adults preferred. 3 week minimum. Pictures available. 335-9721

488 Houses To Rent

BOCA RATON CONDO - Exclusive Boca West Club, golf, tennis, and pool. Adults preferred. 3 week minimum. Pictures available. 335-9721

490 Houses To Rent

BOCA RATON CONDO - Exclusive Boca West Club, golf, tennis, and pool. Adults preferred. 3 week minimum. Pictures available. 335-9721

492 Houses To Rent

BOCA RATON CONDO - Exclusive Boca West Club, golf, tennis, and pool. Adults preferred. 3 week minimum. Pictures available. 335-9721

494 Houses To Rent

BOCA RATON CONDO - Exclusive Boca West Club, golf, tennis, and pool. Adults preferred. 3 week minimum. Pictures available. 335-9721

496 Houses To Rent

BOCA RATON CONDO - Exclusive Boca West Club, golf, tennis, and pool. Adults preferred. 3 week minimum. Pictures available. 335-9721

498 Houses To Rent

BOCA RATON CONDO - Exclusive Boca West Club, golf, tennis, and pool. Adults preferred. 3 week minimum. Pictures available. 335-9721

500 Houses To Rent

BOCA RATON CONDO - Exclusive Boca West Club, golf, tennis, and pool. Adults preferred. 3 week minimum. Pictures available. 335-9721

502 Houses To Rent

BOCA RATON CONDO - Exclusive Boca West Club, golf, tennis, and pool. Adults preferred. 3 week minimum. Pictures available. 335-9721

504 Houses To Rent

BOCA RATON CONDO - Exclusive Boca West Club, golf, tennis, and pool. Adults preferred. 3 week minimum. Pictures available. 335-9721

506 Houses To Rent

BOCA RATON CONDO - Exclusive Boca West Club, golf, tennis, and pool. Adults preferred. 3 week minimum. Pictures available. 335-9721

508 Houses To Rent

BOCA RATON CONDO - Exclusive Boca West Club, golf, tennis, and pool. Adults preferred. 3 week minimum. Pictures available. 335-9721

510 Houses To Rent

BOCA RATON CONDO - Exclusive Boca West Club, golf, tennis, and pool. Adults preferred. 3 week minimum. Pictures available. 335-9721

512 Houses To Rent

BOCA RATON CONDO - Exclusive Boca West Club, golf, tennis, and pool. Adults preferred. 3 week minimum. Pictures available. 335-9721

514 Houses To Rent

BOCA RATON CONDO - Exclusive Boca West Club, golf, tennis, and pool. Adults preferred. 3 week minimum. Pictures available. 335-9721

516 Houses To Rent

BOCA RATON CONDO - Exclusive Boca West Club, golf, tennis, and pool. Adults preferred. 3 week minimum. Pictures available. 335-9721

518 Houses To Rent

BOCA RATON CONDO - Exclusive Boca West Club, golf, tennis, and pool. Adults preferred. 3 week minimum. Pictures available. 335-9721

520 Houses To Rent

BOCA RATON CONDO - Exclusive Boca West Club, golf, tennis, and pool. Adults preferred. 3 week minimum. Pictures available. 335-9721

522 Houses To Rent

BOCA RATON CONDO - Exclusive Boca West Club, golf, tennis, and pool. Adults preferred. 3 week minimum. Pictures available. 335-9721

524 Houses To Rent

BOCA RATON CONDO - Exclusive Boca West Club, golf, tennis, and pool. Adults preferred. 3 week minimum. Pictures available. 335-9721

526 Houses To Rent

BOCA RATON CONDO - Exclusive Boca West Club, golf, tennis, and pool. Adults preferred. 3 week minimum. Pictures available. 335-9721

528 Houses To Rent

BOCA RATON CONDO - Exclusive Boca West Club, golf, tennis, and pool. Adults preferred. 3 week minimum. Pictures available. 335-9721

500 Help Wanted
PINJUMPER
AMF 82/70's
Nights and weekends Over 18. Experience preferred. Apply in person at...

500 Help Wanted
MAN NEEDED
For delivery work in Greater Detroit area. Must have good driving record. Apply in person...

500 Help Wanted
BRIDGEPORT OPERATOR
Experienced only. Late Hands. Apply in person at Matton Tool & Mfg. Co. 12990 Wayne Rd. Livonia...

502 Help Wanted
Dental-Medical
ENTHUSIASTIC, accurate, and speedy Medical Transcriptionist for Home Health Agency in NW-3600...

502 Help Wanted
Dental-Medical
NURSES/AIDES for all shifts Hanon Convalescent Home, Plymouth 453-0180

504 Help Wanted
Office-Clerical
PERSONNEL CLERK
Assist Personnel Manager with record keeping, telephone, appointments. Must be neat, personable, outgoing, and discreet. Downtown Detroit location 5 days including Saturday. Call Mr. Conner appointment. 962-3299

504 Help Wanted
Office-Clerical
SECRETARIES
Excellent companies in NW and NE suburban locations. Good typing and shorthand skills preferred. Good potential and benefits. Salary commensurate with abilities. Fee Paid. Equal opportunity employers.

504 Help Wanted
Office-Clerical
SECRETARY for sales office. Southfield location. Good typing. Knowledge of office experience. Necessary. Call for interview. 558-0866

504 Help Wanted
Office-Clerical
TYPISTS
Earn Good Pay
The Kelly Girl Way
Work a schedule tailored to your ability, time and needs. Call today to work in your area. 522-4026 or apply at 2549 E. 9 Mile, just west of Middlebelt.

MAYFLOWER LANES
26600 Plymouth Rd
1/2 Mile W. of Beach Road
JUNIOR BUYER
Leading company in the distribution industry is looking for a Jr. Buyer to work in their purchasing department. Experience should include purchasing & data processing as it relates to inventory control. Salary based upon experience. Send resume to: Mr. Don Murray, Treasurer, Nelson Company, 332 E. Lincoln, Royal Oak, Mich. 48067

MACHINIST
All Around Machinist with at least 3 years experience. Primarily Bridgeport, some Lathe, some Shaping Top pay, Blue Cross, over-time.
Jorgensen Tool
12489 Hartel, Livonia
525-0880

DeVlieg Operators
Nights only, 55 hr. work Mon thru Thurs 12 hrs. Fri 7 hrs. Top wages, profit sharing, vacations, paid insurance. Apply:
Galaxy Boring
41150 Joy Rd. Plym.
BUS BOYS, all shifts. Apply in person. Palace Restaurant, 12881 Greenfield, near Schoolcraft.

NURSES
PART-TIME - Midnights and afternoons. If you desire more of an opportunity to develop your abilities with total patient care, we will provide you with a unique atmosphere to develop your potential. Call: 474-2073 after 5 PM. For more details.

EXECUTIVE SECY
World wide conglomerate needs top notch secy with strong skills. Terrific location, offices and opportunity. \$175 - \$225 Call today, 562-8900.
Your New Boss Pays Our Fee! HARRIET SORGE PERSONNEL

DICTAPHONE OPERATOR
Mature gal to handle all dicta-phone transcribing and filing. Maintenance. Must excel in typing skills and spelling, shorthand helpful. Permanent position with fringe benefits in fast moving, detail oriented manufacturer's representative office. Salary commensurate with ability. Call Mr. Pawluch between 11 AM & 4 PM at: 355-3400

NEED SECRETARY with short-hand and dictaphone skills. 5 PM daily, for Southfield area 5 office. Phone: 354-1619

WITT SERVICES
HAS IMMEDIATE TEMPORARY OPENINGS
Interesting Assignments
IN ALL AREAS
DAY, WEEK, or LONGER
SECRETARIES
STENOGRAPHERS
TYPISTS
ACCOUNTING CLERKS
GENERAL OFFICE SKILLS

RED WING TICKET WINNER
Mrs V England
19151 Norborne
Redford, MI 48240
But you must call the Promotion Dept. of The Observer & Eccentric, Jan. 25, 1977 to claim your TWO FREE RED WING TICKETS. 261-8600, ext 243.

BUS BOYS
FULL-TIME ONLY
Apply in person, 8-5
No phone calls, please
Nugget Restaurant
30685 W 12 Mile Rd. Farmington

MAINTENANCE HELPER
Full-time for apartment complex. No experience necessary. 18 years or older. Apply: 25, 14170 Shadywood Dr. Wycoff Rd. Plymouth. No phone calls, please.

WEST DEARBORN area, experienced Dental Assistant wanted, full-time for Orthodontic office. Good pay, opportunity for advancement and fringe benefits. Call between 8:30 AM - 5 PM. 561-1060

Immediate part-time shift position available for an ASCP registered or registry eligible MEDICAL TECHNOLOGIST. We offer excellent starting salary based on experience and a fully paid benefit program.

SMALL firm, 27 years in business needs gal for general office work. 9 Mile and Lahser area. Southfield, Phone: 353-4491

SECRETARY
Southfield corporate office is seeking a secretary with good shorthand and typing skills and a minimum of 2 years experience. Statistical typing experience helpful. Company offers excellent benefit package. Salary commensurate with experience. Interested applicants may call 355-1100, ext. 223. An Equal Opportunity Employer

OFFICE MANAGER 1, 50% OWNER of an existing Medical related personal employment agency in the area. Salary \$12,000 yearly, investment \$13,000. Office experience, bookkeeping or secretary skills necessary. License desirable but not essential. 628-0706

Production Control Clerk
Manufacturer in Farmington. Experienced in general office procedures with good math aptitude. Full-time position with excellent benefits. Call for interview: 476-7100, Ext. 296. An Equal Opportunity Employer

GENERAL OFFICE
Girl Friday for evenings and weekends only
American Charter Furniture
652-3565 or 652-3572
ESTATE Firm. Commercial Real Estate Firm. Northland area. Good typist, shorthand. Call Mr. Murphy. 559-3000

Production & Machine Operators
We're now taking applications
S. M. Co.
800 Junction Plymouth

TEMPORARY ASSIGNMENT
Need ladies for telephone work. All shifts. Dearborn area. Call WIT SERVICES for interview. 967-0336

EXPERIENCED HAIRDRESSER
wanted clientele preferred. Mr. Drew's Salon, Farmington 851-0390

AVONDALE Convalescent Home has full-time & part-time openings for RN or LPN on 11 PM-7:30 AM shift. Salary commensurate with experience. Nurse aides on all shifts. Call for details, 651-4422

ACCOUNTING CLERK Typist, sales promotion company has position available in accounting department. Requires some accounting experience or bookkeeping training. Typing ability preferred. Please call for appointment: 272-8900. An Equal Opportunity Employer

SECRETARY
Large modern Detroit area teaching firm, complex has an opening for highly skilled SECRETARY to work at a management level for administrative personnel. This position offers an exciting and rewarding challenge, career development and a congenial working environment. Our starting salary is highly competitive with a fully paid benefit program including family Blue Cross-Blue Shield and dental insurance benefits. The necessary requirements are: typing 90 WPM, shorthand 90-100 WPM and previous secretarial experience functioning in a responsible capacity for department head or director. Send complete resume, stating salary expectations, to: Box 604, Observer & Eccentric Newspapers, 36251 Schoolcraft, Livonia, Michigan 48150. An Equal Opportunity Employer

SECRETARY
Seeking a secretary with good shorthand and typing skills and a minimum of 2 years experience. Statistical typing experience helpful. Company offers excellent benefit package. Salary commensurate with experience. Interested applicants may call 355-1100, ext. 223. An Equal Opportunity Employer

SECRETARY
Large modern Detroit area teaching firm, complex has an opening for highly skilled SECRETARY to work at a management level for administrative personnel. This position offers an exciting and rewarding challenge, career development and a congenial working environment. Our starting salary is highly competitive with a fully paid benefit program including family Blue Cross-Blue Shield and dental insurance benefits. The necessary requirements are: typing 90 WPM, shorthand 90-100 WPM and previous secretarial experience functioning in a responsible capacity for department head or director. Send complete resume, stating salary expectations, to: Box 604, Observer & Eccentric Newspapers, 36251 Schoolcraft, Livonia, Michigan 48150. An Equal Opportunity Employer

File Job Troy \$600/Mo.
No previous work experience necessary and no typing required. Love it! Troy offers need energetic file clerk to work in busy building area. Terrific work hours. PERMANENT STAFF. Personnel: 388-8900

TURRET LATHE
Centerless Grinder
EXPERIENCED
Set Up & Operate
26202 W 3 Mile Rd. Redford, Mich

COCKTAIL WAITRESS, must be over 18 and have experience. Good salary and working conditions. Full-time evenings. Westland area. Call between 12-5 PM. 261-9640

EXPERIENCED HAIRDRESSER
wanted clientele preferred. Mr. Drew's Salon, Farmington 851-0390

AVONDALE Convalescent Home has full-time & part-time openings for RN or LPN on 11 PM-7:30 AM shift. Salary commensurate with experience. Nurse aides on all shifts. Call for details, 651-4422

ACCOUNTING CLERK Typist, sales promotion company has position available in accounting department. Requires some accounting experience or bookkeeping training. Typing ability preferred. Please call for appointment: 272-8900. An Equal Opportunity Employer

SECRETARY
Large modern Detroit area teaching firm, complex has an opening for highly skilled SECRETARY to work at a management level for administrative personnel. This position offers an exciting and rewarding challenge, career development and a congenial working environment. Our starting salary is highly competitive with a fully paid benefit program including family Blue Cross-Blue Shield and dental insurance benefits. The necessary requirements are: typing 90 WPM, shorthand 90-100 WPM and previous secretarial experience functioning in a responsible capacity for department head or director. Send complete resume, stating salary expectations, to: Box 604, Observer & Eccentric Newspapers, 36251 Schoolcraft, Livonia, Michigan 48150. An Equal Opportunity Employer

SECRETARY
Large modern Detroit area teaching firm, complex has an opening for highly skilled SECRETARY to work at a management level for administrative personnel. This position offers an exciting and rewarding challenge, career development and a congenial working environment. Our starting salary is highly competitive with a fully paid benefit program including family Blue Cross-Blue Shield and dental insurance benefits. The necessary requirements are: typing 90 WPM, shorthand 90-100 WPM and previous secretarial experience functioning in a responsible capacity for department head or director. Send complete resume, stating salary expectations, to: Box 604, Observer & Eccentric Newspapers, 36251 Schoolcraft, Livonia, Michigan 48150. An Equal Opportunity Employer

File Job Troy \$600/Mo.
No previous work experience necessary and no typing required. Love it! Troy offers need energetic file clerk to work in busy building area. Terrific work hours. PERMANENT STAFF. Personnel: 388-8900

File Job Troy \$600/Mo.
No previous work experience necessary and no typing required. Love it! Troy offers need energetic file clerk to work in busy building area. Terrific work hours. PERMANENT STAFF. Personnel: 388-8900

MANAGER experienced only. For Farmington Hills restaurant lounge. Call for interview: 851-0994

LAUNDRY ATTENDANT
Part-time 25 hour per week position. Mon-Fri. Beverly Manor, 34500 Meadowbrook Rd., Novi. 477-2000

EXPERIENCED HAIRDRESSER
wanted clientele preferred. Mr. Drew's Salon, Farmington 851-0390

AVONDALE Convalescent Home has full-time & part-time openings for RN or LPN on 11 PM-7:30 AM shift. Salary commensurate with experience. Nurse aides on all shifts. Call for details, 651-4422

ACCOUNTING CLERK Typist, sales promotion company has position available in accounting department. Requires some accounting experience or bookkeeping training. Typing ability preferred. Please call for appointment: 272-8900. An Equal Opportunity Employer

SECRETARY
Large modern Detroit area teaching firm, complex has an opening for highly skilled SECRETARY to work at a management level for administrative personnel. This position offers an exciting and rewarding challenge, career development and a congenial working environment. Our starting salary is highly competitive with a fully paid benefit program including family Blue Cross-Blue Shield and dental insurance benefits. The necessary requirements are: typing 90 WPM, shorthand 90-100 WPM and previous secretarial experience functioning in a responsible capacity for department head or director. Send complete resume, stating salary expectations, to: Box 604, Observer & Eccentric Newspapers, 36251 Schoolcraft, Livonia, Michigan 48150. An Equal Opportunity Employer

SECRETARY
Large modern Detroit area teaching firm, complex has an opening for highly skilled SECRETARY to work at a management level for administrative personnel. This position offers an exciting and rewarding challenge, career development and a congenial working environment. Our starting salary is highly competitive with a fully paid benefit program including family Blue Cross-Blue Shield and dental insurance benefits. The necessary requirements are: typing 90 WPM, shorthand 90-100 WPM and previous secretarial experience functioning in a responsible capacity for department head or director. Send complete resume, stating salary expectations, to: Box 604, Observer & Eccentric Newspapers, 36251 Schoolcraft, Livonia, Michigan 48150. An Equal Opportunity Employer

File Job Troy \$600/Mo.
No previous work experience necessary and no typing required. Love it! Troy offers need energetic file clerk to work in busy building area. Terrific work hours. PERMANENT STAFF. Personnel: 388-8900

File Job Troy \$600/Mo.
No previous work experience necessary and no typing required. Love it! Troy offers need energetic file clerk to work in busy building area. Terrific work hours. PERMANENT STAFF. Personnel: 388-8900

TRUCK DRIVING
Building Maintenance
Person needed for part-time job nights. May develop into full-time. Requires two years experience driving a truck and operating a hi-lo and one year experience in general maintenance.

WITNESS wanted, experienced only. Apply in person, Carman's, North, 50 W. Tenen, Rd. in Rochester.

EXPERIENCED HAIRDRESSER
wanted clientele preferred. Mr. Drew's Salon, Farmington 851-0390

AVONDALE Convalescent Home has full-time & part-time openings for RN or LPN on 11 PM-7:30 AM shift. Salary commensurate with experience. Nurse aides on all shifts. Call for details, 651-4422

ACCOUNTING CLERK Typist, sales promotion company has position available in accounting department. Requires some accounting experience or bookkeeping training. Typing ability preferred. Please call for appointment: 272-8900. An Equal Opportunity Employer

SECRETARY
Large modern Detroit area teaching firm, complex has an opening for highly skilled SECRETARY to work at a management level for administrative personnel. This position offers an exciting and rewarding challenge, career development and a congenial working environment. Our starting salary is highly competitive with a fully paid benefit program including family Blue Cross-Blue Shield and dental insurance benefits. The necessary requirements are: typing 90 WPM, shorthand 90-100 WPM and previous secretarial experience functioning in a responsible capacity for department head or director. Send complete resume, stating salary expectations, to: Box 604, Observer & Eccentric Newspapers, 36251 Schoolcraft, Livonia, Michigan 48150. An Equal Opportunity Employer

SECRETARY
Large modern Detroit area teaching firm, complex has an opening for highly skilled SECRETARY to work at a management level for administrative personnel. This position offers an exciting and rewarding challenge, career development and a congenial working environment. Our starting salary is highly competitive with a fully paid benefit program including family Blue Cross-Blue Shield and dental insurance benefits. The necessary requirements are: typing 90 WPM, shorthand 90-100 WPM and previous secretarial experience functioning in a responsible capacity for department head or director. Send complete resume, stating salary expectations, to: Box 604, Observer & Eccentric Newspapers, 36251 Schoolcraft, Livonia, Michigan 48150. An Equal Opportunity Employer

File Job Troy \$600/Mo.
No previous work experience necessary and no typing required. Love it! Troy offers need energetic file clerk to work in busy building area. Terrific work hours. PERMANENT STAFF. Personnel: 388-8900

File Job Troy \$600/Mo.
No previous work experience necessary and no typing required. Love it! Troy offers need energetic file clerk to work in busy building area. Terrific work hours. PERMANENT STAFF. Personnel: 388-8900

TOP PAY
Housewives, students, work in our Livonia office - telephone soliciting. Mornings from 9 AM to 1 PM, or evenings 5 to 9 PM. Hourly plus bonus program. Call: 522-5064

EXPERIENCED HAIRDRESSER
wanted clientele preferred. Mr. Drew's Salon, Farmington 851-0390

EXPERIENCED HAIRDRESSER
wanted clientele preferred. Mr. Drew's Salon, Farmington 851-0390

AVONDALE Convalescent Home has full-time & part-time openings for RN or LPN on 11 PM-7:30 AM shift. Salary commensurate with experience. Nurse aides on all shifts. Call for details, 651-4422

ACCOUNTING CLERK Typist, sales promotion company has position available in accounting department. Requires some accounting experience or bookkeeping training. Typing ability preferred. Please call for appointment: 272-8900. An Equal Opportunity Employer

SECRETARY
Large modern Detroit area teaching firm, complex has an opening for highly skilled SECRETARY to work at a management level for administrative personnel. This position offers an exciting and rewarding challenge, career development and a congenial working environment. Our starting salary is highly competitive with a fully paid benefit program including family Blue Cross-Blue Shield and dental insurance benefits. The necessary requirements are: typing 90 WPM, shorthand 90-100 WPM and previous secretarial experience functioning in a responsible capacity for department head or director. Send complete resume, stating salary expectations, to: Box 604, Observer & Eccentric Newspapers, 36251 Schoolcraft, Livonia, Michigan 48150. An Equal Opportunity Employer

SECRETARY
Large modern Detroit area teaching firm, complex has an opening for highly skilled SECRETARY to work at a management level for administrative personnel. This position offers an exciting and rewarding challenge, career development and a congenial working environment. Our starting salary is highly competitive with a fully paid benefit program including family Blue Cross-Blue Shield and dental insurance benefits. The necessary requirements are: typing 90 WPM, shorthand 90-100 WPM and previous secretarial experience functioning in a responsible capacity for department head or director. Send complete resume, stating salary expectations, to: Box 604, Observer & Eccentric Newspapers, 36251 Schoolcraft, Livonia, Michigan 48150. An Equal Opportunity Employer

File Job Troy \$600/Mo.
No previous work experience necessary and no typing required. Love it! Troy offers need energetic file clerk to work in busy building area. Terrific work hours. PERMANENT STAFF. Personnel: 388-8900

File Job Troy \$600/Mo.
No previous work experience necessary and no typing required. Love it! Troy offers need energetic file clerk to work in busy building area. Terrific work hours. PERMANENT STAFF. Personnel: 388-8900

DESIGNER
Tool and fixture design 5 years experience. Must have some machine, electrical and hydraulic background. Machine shop experience helpful. Excellent salary and fringes including pension. Apply in person.

EXPERIENCED HAIRDRESSER
wanted clientele preferred. Mr. Drew's Salon, Farmington 851-0390

EXPERIENCED HAIRDRESSER
wanted clientele preferred. Mr. Drew's Salon, Farmington 851-0390

AVONDALE Convalescent Home has full-time & part-time openings for RN or LPN on 11 PM-7:30 AM shift. Salary commensurate with experience. Nurse aides on all shifts. Call for details, 651-4422

ACCOUNTING CLERK Typist, sales promotion company has position available in accounting department. Requires some accounting experience or bookkeeping training. Typing ability preferred. Please call for appointment: 272-8900. An Equal Opportunity Employer

SECRETARY
Large modern Detroit area teaching firm, complex has an opening for highly skilled SECRETARY to work at a management level for administrative personnel. This position offers an exciting and rewarding challenge, career development and a congenial working environment. Our starting salary is highly competitive with a fully paid benefit program including family Blue Cross-Blue Shield and dental insurance benefits. The necessary requirements are: typing 90 WPM, shorthand 90-100 WPM and previous secretarial experience functioning in a responsible capacity for department head or director. Send complete resume, stating salary expectations, to: Box 604, Observer & Eccentric Newspapers, 36251 Schoolcraft, Livonia, Michigan 48150. An Equal Opportunity Employer

SECRETARY
Large modern Detroit area teaching firm, complex has an opening for highly skilled SECRETARY to work at a management level for administrative personnel. This position offers an exciting and rewarding challenge, career development and a congenial working environment. Our starting salary is highly competitive with a fully paid benefit program including family Blue Cross-Blue Shield and dental insurance benefits. The necessary requirements are: typing 90 WPM, shorthand 90-100 WPM and previous secretarial experience functioning in a responsible capacity for department head or director. Send complete resume, stating salary expectations, to: Box 604, Observer & Eccentric Newspapers, 36251 Schoolcraft, Livonia, Michigan 48150. An Equal Opportunity Employer

File Job Troy \$600/Mo.
No previous work experience necessary and no typing required. Love it! Troy offers need energetic file clerk to work in busy building area. Terrific work hours. PERMANENT STAFF. Personnel: 388-8900

File Job Troy \$600/Mo.
No previous work experience necessary and no typing required. Love it! Troy offers need energetic file clerk to work in busy building area. Terrific work hours. PERMANENT STAFF. Personnel: 388-8900

504 Help Wanted Office-Clerical
TV, DATA, MIST or mag card operator for Southfield law firm...

504 Help Wanted Office-Clerical
CLERK-TYPIST, PART-TIME, regular permanent part-time position...

504 Help Wanted Office-Clerical
PURCHASING TECHNICIAN To coordinate city department purchases...

506 Help Wanted Sales
FULL OR PART-TIME, Southfield area (Name your own hours)...

506 Help Wanted Sales
INTERESTED IN SELLING REAL ESTATE?
Get complete details on positions open in Chamberlains...

506 Help Wanted Sales
FURNITURE SALESPERSON
Furniture sales experience required. Will be responsible for Furniture Leasing and sales...

506 Help Wanted Sales
LOOKING FOR A FUTURE?
No experience necessary. Fast growing nationwide West Wholesale looking for self-motivated people...

506 Help Wanted Sales
OPPORTUNITY
SALES MANAGEMENT
For qualified college graduates or equivalent business experience...

506 Help Wanted Sales
LOOKING FOR experienced applicant salesmen, full or part-time...

Learn PBX Westland \$600/Mo.
Great chance in nice suburban location to be trained on switchboard...

504 Help Wanted Office-Clerical
SOUTHFIELD OFFICE - 3 Mile Telephone area Part-time permanent Typing bookkeeping and payroll...

506 Help Wanted Sales
SECRETARY
Excellent opportunity for mature individual with good typing and shorthand skills...

506 Help Wanted Sales
SALESPERSON
Male preferred to be trained to sell Sewing Machines, Vacuum Cleaners & related items...

506 Help Wanted Sales
SINGER COMPANY
Northland Shopping Center - Southfield, Michigan
SALES AGENT Train 2 years at full salary with highly respected Life Insurance Company...

506 Help Wanted Sales
ATTENTION! JOBS
18 positions must be filled immediately. Guaranteed salary \$780 monthly...

506 Help Wanted Sales
TEAM BUILDING
Company expansion 2 Livonia locations have several new positions open...

506 Help Wanted Sales
INTERESTED IN SELLING REAL ESTATE?
Get complete details on positions open in Chamberlains greater Western-Wayne offices...

506 Help Wanted Sales
REAL ESTATE
Opportunity Knocks
For the right individual to join the newest of CENTURY 21's 3,000 offices nationwide...

CLAIMS SECRETARY For Aviation Insurance Company, Premier resident of Northern suburbs...

504 Help Wanted Office-Clerical
TYPIST 45 wpm needed to work in a medical laboratory...

506 Help Wanted Sales
LEGAL SECRETARY
For Southfield Law Office. Short-hand Required. 569-0373

506 Help Wanted Sales
SALES OPPORTUNITY
Build your future through a career in Real Estate Sales. Attend Career Seminar at Bateman Rocher...

506 Help Wanted Sales
BIG MONEY
For ambitious people who want to receive full training and complete insurance program...

506 Help Wanted Sales
Wanted - PROFESSIONAL SALESPERSON
American Charter Furniture 652-3565 or 652-3572

506 Help Wanted Sales
Century 21
HARTFORD 5 261-4200
FINELL Industries International Corp. needs men or women experienced sales or will train...

506 Help Wanted Sales
SALES PERSON
Experienced office supply and/or office furniture salesperson for outside sales. Must have proven track record...

506 Help Wanted Sales
FREE REAL ESTATE TRAINING
If you qualify for this unique opportunity, we will train you absolutely FREE for a career in real estate sales...

EXECUTIVE SECRETARY needed for growing company. Steno and typing skills a must. Must have sense of humor and the ability to do the impossible...

504 Help Wanted Office-Clerical
RECEPTIONIST-TYPIST
Train on PBX for new offices of local Southfield law firm. Attractive personable woman with good typing and clerical skills...

506 Help Wanted Sales
EXPERIENCED SALESPERSON
Prime Mkt. Birmingham Second shift. Call between 9 AM and 4 PM. 272-1863

506 Help Wanted Sales
CENTURY 21
Libby & Assoc. South, Inc. 642-8100
CONTEMPORARY WOMEN'S apparel shop in Birmingham wants skilled full-time salesperson...

506 Help Wanted Sales
SALES PEOPLE, DISTRIBUTORS
Demonstrating coffee service to the masses. Will turn into sales. Full part-time. Mr. Shear 399-8444

506 Help Wanted Sales
REAL ESTATE
Highest commissions, good plan for high earner. Will train in Michigan's finest Real Estate School. If you are willing to work, you are able to earn extremely high income...

506 Help Wanted Sales
Century 21
Gene Darke Realty
SALES People wanted for new office in Livonia. Top commission, bonus plan, paid vacation...

506 Help Wanted Sales
NORWOOD
No. 1, Inc. 464-2800
MOONLIGHTERS WANTED
Sales or management experience helpful. Phone for interview. 477-9764

506 Help Wanted Sales
THE DURBIN COMPANY REALTORS
AMBITION is all you need to succeed in a sales career. Get out of life - all that you put into it. Large company looking to expand Western Wayne County office...

LEGAL Secretaries
We have many fine openings for experienced legal secretaries. Free paid by employer. Ask for Grace HILLSTROM & ROSS AGENCY Southfield 557-3007

504 Help Wanted Office-Clerical
TYPISTS STENOS SECRETARIES KEYPUNCH OPERS.
Apply 9 am-3 pm Mon thru Fri 2869 S Mile at Beech Daly 29256 Ryan Rd at 12 Mile MANPOWER TEMPORARY SERVICES An Equal Opportunity Employer

506 Help Wanted Sales
ACCOUNTANT EXPERIENCED ONLY
To work part-time for Livonia CPA firm. Call 478-1063

506 Help Wanted Sales
INTERIOR DESIGNER in Birmingham area would like qualified individual to join forces with me in my studio. Must have drawing ability to handle studio & office. Send resume to Box 622, Observer & Eccentric Newspapers, 36251 Schoolcraft, Livonia, Michigan 48150

506 Help Wanted Sales
SALES & MANAGEMENT OPPORTUNITY
United Tea Kwon Do Inc. the leading martial art school is looking for a branch manager. You must have sales experience & ability to work with people. To find out more about this challenging position, phone 9AM-9PM. 966-5421

506 Help Wanted Sales
INSIDE SALES \$13,000 - \$18,000
For industrial distributor. Must have sales personality and paper work experience. Prefer industrial or mechanical background. Fully paid benefit program. Great career potential. Send background information to: Inside Sales P.O. Box 2808-0, Livonia, Mich 48154

506 Help Wanted Sales
REAL ESTATE
Full-time sales people needed in our West Livonia Office. For info call JOHN HALSER TODAY

506 Help Wanted Sales
FREE REAL ESTATE TRAINING
If you qualify for this unique opportunity, we will train you absolutely FREE for a career in real estate sales...

506 Help Wanted Sales
FREE REAL ESTATE TRAINING
If you qualify for this unique opportunity, we will train you absolutely FREE for a career in real estate sales...

PERMANENT PART-TIME Staff Typist for Birmingham CPA Firm. Call Mr. Fogel or Mr. Gordon 642-6733

504 Help Wanted Office-Clerical
TYPISTS
Applications are now being taken for a person to do bookkeeping. Please send a complete resume to Long Plumbing Co. 190 E. Main St. Northville 48167. All applications will be kept strictly confidential. An Equal Opportunity Employer

506 Help Wanted Sales
GENERAL OFFICE work, typing and phone work. Full-time. Must know office procedures. Salary based on experience. Southfield 357-5680

506 Help Wanted Sales
DICTAPHONE SECRETARY
Good typing and general office skills for a very busy sales office. Telephone & 12 Mile area. For appointment, Phone USI 642-1590

506 Help Wanted Sales
ACCOUNTANT EXPERIENCED ONLY
To work part-time for Livonia CPA firm. Call 478-1063

506 Help Wanted Sales
AMBITION IS ALL YOU NEED TO SUCCEED IN A SALES CAREER. Get out of life - all that you put into it. Large company looking to expand Western Wayne County office...

506 Help Wanted Sales
NORWOOD
No. 1, Inc. 464-2800
MOONLIGHTERS WANTED
Sales or management experience helpful. Phone for interview. 477-9764

506 Help Wanted Sales
FREE REAL ESTATE TRAINING
If you qualify for this unique opportunity, we will train you absolutely FREE for a career in real estate sales...

506 Help Wanted Sales
FREE REAL ESTATE TRAINING
If you qualify for this unique opportunity, we will train you absolutely FREE for a career in real estate sales...

Accounting Service
RICHARD P. FRENCH & ASSOCIATES
Bookkeeping, Accounting & Tax Service
Specializing in Small & Mediumsize Businesses
Call 455-7750 for a Presentation

Building & Remodeling
CARPENTER BUILDER
CONTRACTING REMODELING COMMERCIAL INDUSTRIAL Residential Maintenance
Ray's Construction 261-4230

Carpentry
H&H MODERNIZATION
RESIDENTIAL-COMMERCIAL
Additions • Garages • Porches • Basements • Decks • Storefronts • Homes
All phases of carpentry work. Licensed & free estimates. 535-8336 273-6271

Carpet Repair
CHUCK'S CARPET REPAIR
Any repair, large or small, residential or comm'l. 464-3815

Firewood
Seasoned Firewood
Oak - Maple \$30.00
Kindling \$2.00
FREE DELIVERY TO MOST AREAS
Bundle of kindling free with each face cord. Meadowbrook Landscaping 624-8180

Heating
Call MARVIN WOOD 532-8471 to Find & fix your heating problems. Licensed, insured, reasonable. AIR CARE HEATING - Furnaces, air cleaners, humidifiers, gas, oil service, sheet metal work. 410-5734

Painting & Decorating
VAN CAMP
Interior Painter & Wallpaperer. FREE ESTIMATES 477-9478

Plastering
PLASTERING-Succo work & dry wall repairs. Also texturing of all kinds. Lic. Ins. Fast service. 957-8374

Sewer Cleaning
J & A SEWER CLEANERS
SINK LINES, DRAINS, TUBS. No Extra Charge for Sun. Holidays. 427-6997

Aluminum Siding
LOW PRICES
Alum. siding Trim Gutter 835-8610, Eves. 24 Hrs. 272-8096

Remodeling
REMODELING ATICS COMPLETE BASEMENT MODERNIZATION
PANELING-Ceilings EXPOSED WOOD BEAMS PORCH ENCLOSURES WOOD DECKS
Complete Carpentry Service Free Estimate & Design G. NIEMELA, BUILDER 642-5664

Wood Decks
WOOD DECKS
647-5033 386-0119
Quality Carpentry at reasonable prices. Residential & Comm'l. Additions, roof repairs, etc. Lowest prices on Basements. CARPENTER who teaches Industrial Arts & teaches weekend jobs. Licensed & insured B4R. 538-9499

Draperies
DRAPERIES GALORE
Custom - 15 yrs experience. Buy direct from workroom, eliminate middle man. To find out more about a fraction of the cost. Complete installation. Carol or Ula. 421-8668

Furniture
LEONARD'S FLOOR SANDING
28 years experience. Quality work. Reasonable prices. 474-1163

Income Tax
INCOME TAX preparation. Accounting student with 6 years experience. By appointment only. Plymouth. 455-4368

European Touch
WALLPAPERING-PAINTING
Custom Wallpaper Available. Free Estimate. Insured. 549-3680

Plumbing
CUSTOM PLUMBING & Heating
Repairs, new installations, boiler repairs, everything in plbg & heating. Lic 24 hr serv 555-9341, 537-0117

Sewing Machine Repair
ALL MAKES REPAIRED
FREE ESTIMATES
A.W. Anderson Co. 623 North Main, Rochester 652-2566

Basement Waterproofing
BASEMENT WATERPROOFING
All Outside Digging Guaranteed 477-3977, 861-0247

Brick, Block & Cement
LEONARD MASONRY
Specializing in Fireplaces, Chimneys, Porches. Reasonable Prices. Free Estimates. 349-6444

Business Machine Repair
TYPEWRITER & ADDING
Machines professionally repaired. Reasonable rates. Free estimates. Audette's Office Equip., 4619 Ann Arbor Rd. Plymouth. Present this Ad for 10% discount. 455-5510

Electrical
ELECTRICIAN LICENSED
Home repairs & repairs. Ranges, dryers, fixtures. Free estimates. Reasonable rates. 544-7986

Garages
GARAGE DOORS
REPAIRED OR REPLACED. Electric Operators. 425-8437

Insulation
BURT'S INSULATION
Warmer Winters, Cooler Summers. Fiberglass blown in Attics. Free Estimates. Call anytime. 555-7995

Honest Prices
Using Pittsburgh Paint I can decorate your house inside and out or just 1 room. Custom mixing. Don't paint until you get a free estimate from me. 352-8972

Plumbing
GUS PLUMBING & HEATING
Specialize in faucet repair, water heaters, disposals, sewer & drain cleaning, boilers & furnaces. Valuation work. 24 hour service. 477-3526

Snow Removal
LA COURRE SNOWPLOWING and Lawn maintenance. Commercial Residential. Snow Removal. 357-1928

Chimneys
REPAIRED or Built. New Screened Cleaned. Roof Leaks Stopped. GUARANTEED. 6A-7-3981

Building & Remodeling
REMODELING ADDITIONS
Engineered & Designed to complete your home. FREE ESTIMATES. R. BARGER 284-1113

Carpet Cleaning
STEAM CLEANING SPECIAL
\$25 Living Room or Sofa. Master Charge - BankAmericard. ACTION CARPET CLEANING. 421-5380 559-0050

Firewood
MIXED HARDWOOD
\$25 Face Cord. Free Delivery. 477-6923 538-2653

Garages
GARAGE DOORS
REPAIRED OR REPLACED. Electric Operators. 425-8437

Insulation
BURT'S INSULATION
Warmer Winters, Cooler Summers. Fiberglass blown in Attics. Free Estimates. Call anytime. 555-7995

Honest Prices
Using Pittsburgh Paint I can decorate your house inside and out or just 1 room. Custom mixing. Don't paint until you get a free estimate from me. 352-8972

Plumbing
GUS PLUMBING & HEATING
Specialize in faucet repair, water heaters, disposals, sewer & drain cleaning, boilers & furnaces. Valuation work. 24 hour service. 477-3526

Snow Removal
LA COURRE SNOWPLOWING and Lawn maintenance. Commercial Residential. Snow Removal. 357-1928

Bestway Builders
HAS GONE INTO COMPLETE HOME SERVICE
PAINTING WATERPROOFING REMODELING CARPENTRY HEATING ADDITIONS COMPLETE HOME CLEANING LICENSED & INSURED FOR FREE EST. CALL 537-5375

Carpet Laying
CARPET INSTALLATION
New & Used carpeting installed. Repairs, relayed, restretched. Free estimates. All workmanship guaranteed. Will beat any price. Also full steam cleaning and restoring of carpeting and upholstery. Call Scott. 546-2177

Firewood
MIXED HARDWOOD
\$30.00 per Face Cord BIRCH - \$40.00 per Face Cord DELIVERED LOCALLY CANNEL COAL \$c per lb. Your Container \$2.99 per 50 lb. Bag KINDLING \$1.89 per Bundle HOURS: MON.-SAT. 8-7 SUN. 9-4 NOBLE'S 474-4922

Handyman
HOME REPAIRS
of any type. Fast service, reasonable prices. Call Jim. 642-0679

Insulation
BURT'S INSULATION
Warmer Winters, Cooler Summers. Fiberglass blown in Attics. Free Estimates. Call anytime. 555-7995

Honest Prices
Using Pittsburgh Paint I can decorate your house inside and out or just 1 room. Custom mixing. Don't paint until you get a free estimate from me. 352-8972

Plumbing
GUS PLUMBING & HEATING
Specialize in faucet repair, water heaters, disposals, sewer & drain cleaning, boilers & furnaces. Valuation work. 24 hour service. 477-3526

Snow Removal
LA COURRE SNOWPLOWING and Lawn maintenance. Commercial Residential. Snow Removal. 357-1928

Snow Removal
LA COURRE SNOWPLOWING and Lawn maintenance. Commercial Residential. Snow Removal. 357-1928

Finished Basements
Call BOB REEDY 647-5033

Carpet Laying
CARPET INSTALLATION
New & Used carpeting installed. Repairs, relayed, restretched. Free estimates. All workmanship guaranteed. Will beat any price. Also full steam cleaning and restoring of carpeting and upholstery. Call Scott. 546-2177

Firewood
MIXED HARDWOOD
\$30.00 per Face Cord BIRCH - \$40.00 per Face Cord DELIVERED LOCALLY CANNEL COAL \$c per lb. Your Container \$2.99 per 50 lb. Bag KINDLING \$1.89 per Bundle HOURS: MON.-SAT. 8-7 SUN. 9-4 NOBLE'S 474-4922

Handyman
HOME REPAIRS
of any type. Fast service, reasonable prices. Call Jim. 642-0679

Insulation
BURT'S INSULATION
Warmer Winters, Cooler Summers. Fiberglass blown in Attics. Free Estimates. Call anytime. 555-7995

Honest Prices
Using Pittsburgh Paint I can decorate your house inside and out or just 1 room. Custom mixing. Don't paint until you get a free estimate from me. 352-8972

Plumbing
GUS PLUMBING & HEATING
Specialize in faucet repair, water heaters, disposals, sewer & drain cleaning, boilers & furnaces. Valuation work. 24 hour service. 477-3526

Snow Removal
LA COURRE SNOWPLOWING and Lawn maintenance. Commercial Residential. Snow Removal. 357-1928

Snow Removal
LA COURRE SNOWPLOWING and Lawn maintenance. Commercial Residential. Snow Removal. 357-1928

507 Help Wanted Part Time

DISABLED MAN wants part-time (approximately 16 hrs. per week) assistance in Farmington Hills. Must be physically strong, good moral character and local resident. Call Mon. or Tues. evening between 7-9 P.M. 349-7392

RETIREE and stock work Westland Mall and Southland Mall 9-12 5 days Call 862-3299

\$5 PER HOUR WORK PART-TIME 3 hours afternoons. No phone calls. Apply 1299 Ridge Rd. Canton 477-8829

EDUCATIONALLY DISADVANTAGED Farmington High School or College student, one custodial assistant position, 15 hours a week \$2.30 per hour Call Farmington Library 477-1313

WANTED part-time help, male, for sweeping in automobile dealerships 5 days per week 478-8747

DEPENDABLE HOUSEWIFE to assist in cleaning of new homes. Hours 9-3 P.M. \$2.30 hourly. Call after 5 P.M. 455-8174

SECRETARY - SOUTHFIELD, recent secretarial experience with heavy typing Grammatron skills and own car. Necessary Approx. \$10.00 per hour. Call 341-6801

YOUNG MAN wanted to clean and service restaurant equipment. Mornings. Call J & S Electric 477-8829

SALESPERSON 3 to 4 days per week 3:30 P.M. to 6:30 P.M. Apartment Forst, 180 E. Brown Birmingham 644-9340

JANITORS - Men Women experienced part-time Six days per week 8 AM to 3 PM Middlebrook Schoolcraft Area Call 9 AM till noon 831-9301

TELEPHONE SOLICITORS Fan factory openings for experienced mature women. Hours 5 P.M. - 9 P.M. Guarantee Southfield office 353-9174

CLERK typist part-time, medical billing corporation of doctors, evening helpful. West side \$8.00 an hour. Between 10-4 P.M. 851-3177

RED WING TICKET WINNER

Mrs. Daniel Hand 1316 A. Auburnville Livonia MI 48150

But you must call the Promotion Dept. of The Observer & Eccentric by 5 P.M. Tuesday, January 25, 1977, to claim your TWO FREE RED WING TICKETS. 261-8600, ext. 243

CONGRATULATIONS!

PHOTOGRAPHER needs you! Do not miss extra money. Telephoning from your home at your convenience 476-1537

EXPERIENCED PART-TIME for Veterans Hospital Monday evening all day Friday and half day Saturday CR 4-2331

MATURE WOMAN must enjoy meeting public counter clerk 15:20 hours. Forgotten Laundry and Dry Cleaner 9 Mile and Lakeside 356-9236

A HARD WORKING, intelligent student wanted for part-time to do work in our Troy store. 15:25 hours week. Apply in person at The House of Fabrics, 1223 Lahser S. of Grand River, Redford.

A VERY RELIABLE, hardworking person needed mornings for janitorial and cleaning work in our Troy store at Rochester and Big Beaver Rds. Apply in person at The House of Fabrics, 1223 Lahser S. of Grand River, Redford.

PART-TIME SECRETARY, experienced to work 4 hours per day, 3 days per week. Hours flexible. Call Barry Bremen 352-0620

YOUNG MAN 18 & over for afternoons and weekends 476-7054

PART-TIME help wanted for janitorial service. Prefer men who are mature and have buffing machine experience. Will train if necessary. Must be able to work evening hours. Only dependable men. Good references need apply. Call 261-6048

GAS ATTENDANT - Part-time mornings. Apply in person. Georges Gulf 31385 Joy Rd., Westland. 9:30-3:30 hours. Own transportation. 689-1381

TWO 4 WIVES put your home talents to use. earn our customers' homes and clean extra money. We desire women over 28 to work in your general area. Must be dependable, bondable. have car. 477-5307

APPLICATIONS NOW being accepted for Delivery Personnel. Must have own transportation. Apply Little Caesars 4240 Ford Rd. at Lilley.

508 Help Wanted Domestic

EXPERIENCED CLEANING Lady with own transportation for Rochester - Avon area. References desired. 693-6574

BABY SITTER wanted, Birmingham area. Your home. AM - 5 PM. Monday thru Friday. References. 355-2729

HOUSEKEEPER one day per week. references required. 112 Mile. Telegraph area. 355-2729

NENE BABY SITTER for 2 girls near Memorial School Garden City. 261-4718

FORD RD-Beech Day! Want mature woman to babysit, my home. 7-30 AM-5 PM. \$75 per week. Call after 6:30 PM. 662-1166

PART-TIME young adult Aide-Companion for paralyzed man. Weekends only. Live in. Driving req. West. Livonia area 425-4729

MATURE woman to take care of infant. Mon-Fri. 7:30 AM to 12:00 PM. Own transportation. References. After 5. 879-9546

BABY SITTER needed for remainder of winter months. Should be able to drive. 453-2429

MIDDLE-AGED lady to live in for a family of 4 children. Should be able to drive. 338-6801

COMPANION for elderly widow. Must love cooking, driving and light housekeeping. Please call 8:30 AM - 5 PM. 642-1100

BABY SITTER wanted Monday-Friday 3:30 to 5:30 PM. Own transportation. references after 6 PM. 642-1491

EXPERIENCED baby sitter wanted part-time or weekends for 4 month old child. Own transportation. Farmington Hills area. 851-8297

MATURE woman to care for 19 month old Monday Tuesday. Wednesday \$23 per day. Own transportation. 8:30 to 11:30 AM. Southfield. 354-3256

BABY SITTER my home, your transportation over 10. call after 7 P.M. weekends only. 261-8821

EXPERIENCED WOMAN for house cleaning, own transportation. references. 2 days weekly 12 Mile. Telegraph area. Call weekdays only. VAI-4900

BABY SITTER wanted my home, own transportation. 8PM-3:30AM. specializing in beginning children. Rd. Haggerty area. References. 981-0451

COUPLE WANTED

To assist Manager of Apartment complex (7 Mile - Telegraph Area) with maintenance & cleaning. Wages, Apartment & Hospitalization. 538-2158

RELIABLE woman light housecleaning 12 days a week. References. Birmingham area. Own transportation. 855-1536

MATURE LIVE-IN Mother's helper. Housework and sitting for 2 children. Nice living quarters plus small salary 2 days off a week. Must stay in evenings. Call before 6PM. 453-1514

LIVE IN housekeeper. W. Bloomfield area. Mature woman to care for house and 2 children - ages 11 and 8. Good wages, paid vacation, room and board. Call 5 PM. 881-9174

CLEANING WOMAN full-time. Farmington area. Must have own transportation. 476-9777

BABY SITTER needed days, 2 children 2 1/2 & 8 years. Westland. Your transportation. Must be dependable. 326-1995

EXCHANGE ROOM and board for elderly widow. Garden City 721-4129

BABY SITTER NEEDED 10 AM - 7:30 PM. Joy Middlebelt area. Your home or mine. 422-0968

RESPONSIBLE ADULT to Care for Older Women Mon-Fri. 8AM-4PM. Birmingham Call after 4 PM. 642-1874

TEACHER desires responsible baby sitter part-time. Phone after 5PM. 326-7996

DEPENDABLE CLEANING lady wanted to clean 3 model homes once a week \$25 per hour. Call between 9AM-5PM. Wed thru Fri. Ivan Frankel Construction Co. 626-7600

WANTED RELIABLE older woman as sitter in my home. Monday thru Friday 8AM-5PM. For 2 boys - ages 4 years and 1 year. Call after 6 PM. 652-1674

ROCHESTER AREA - professional couple seeks mature lady as housekeeper to care for 2 young children. Monday thru Friday 9 AM to 6 PM. Position available Feb. 1st. Previous experience desired. 652-1996

MOTHER'S HELPER-college student or high school student or part-time. \$4 PM to \$30 PM. Mon thru Fri. begin Feb 1. Own transportation. 2 children. 4 & 8 years old. Good pay. 851-3671

508 Help Wanted Domestic

WORKING MOTHER needs baby sitter for 2 boys 9 and 10. Your home Saturdays, some days & some nights. Redford Township area. Call 353-4961

508 Help Wanted Domestic

EXPERIENCED CLEANING Lady with own transportation for Rochester - Avon area. References desired. 693-6574

BABY SITTER wanted, Birmingham area. Your home. AM - 5 PM. Monday thru Friday. References. 355-2729

HOUSEKEEPER one day per week. references required. 112 Mile. Telegraph area. 355-2729

NENE BABY SITTER for 2 girls near Memorial School Garden City. 261-4718

FORD RD-Beech Day! Want mature woman to babysit, my home. 7-30 AM-5 PM. \$75 per week. Call after 6:30 PM. 662-1166

PART-TIME young adult Aide-Companion for paralyzed man. Weekends only. Live in. Driving req. West. Livonia area 425-4729

MATURE woman to take care of infant. Mon-Fri. 7:30 AM to 12:00 PM. Own transportation. References. After 5. 879-9546

BABY SITTER needed for remainder of winter months. Should be able to drive. 453-2429

MIDDLE-AGED lady to live in for a family of 4 children. Should be able to drive. 338-6801

COMPANION for elderly widow. Must love cooking, driving and light housekeeping. Please call 8:30 AM - 5 PM. 642-1100

BABY SITTER wanted Monday-Friday 3:30 to 5:30 PM. Own transportation. references after 6 PM. 642-1491

EXPERIENCED baby sitter wanted part-time or weekends for 4 month old child. Own transportation. Farmington Hills area. 851-8297

MATURE woman to care for 19 month old Monday Tuesday. Wednesday \$23 per day. Own transportation. 8:30 to 11:30 AM. Southfield. 354-3256

BABY SITTER my home, your transportation over 10. call after 7 P.M. weekends only. 261-8821

EXPERIENCED WOMAN for house cleaning, own transportation. references. 2 days weekly 12 Mile. Telegraph area. Call weekdays only. VAI-4900

BABY SITTER wanted my home, own transportation. 8PM-3:30AM. specializing in beginning children. Rd. Haggerty area. References. 981-0451

COUPLE WANTED

To assist Manager of Apartment complex (7 Mile - Telegraph Area) with maintenance & cleaning. Wages, Apartment & Hospitalization. 538-2158

RELIABLE woman light housecleaning 12 days a week. References. Birmingham area. Own transportation. 855-1536

MATURE LIVE-IN Mother's helper. Housework and sitting for 2 children. Nice living quarters plus small salary 2 days off a week. Must stay in evenings. Call before 6PM. 453-1514

LIVE IN housekeeper. W. Bloomfield area. Mature woman to care for house and 2 children - ages 11 and 8. Good wages, paid vacation, room and board. Call 5 PM. 881-9174

CLEANING WOMAN full-time. Farmington area. Must have own transportation. 476-9777

BABY SITTER needed days, 2 children 2 1/2 & 8 years. Westland. Your transportation. Must be dependable. 326-1995

EXCHANGE ROOM and board for elderly widow. Garden City 721-4129

BABY SITTER NEEDED 10 AM - 7:30 PM. Joy Middlebelt area. Your home or mine. 422-0968

RESPONSIBLE ADULT to Care for Older Women Mon-Fri. 8AM-4PM. Birmingham Call after 4 PM. 642-1874

TEACHER desires responsible baby sitter part-time. Phone after 5PM. 326-7996

DEPENDABLE CLEANING lady wanted to clean 3 model homes once a week \$25 per hour. Call between 9AM-5PM. Wed thru Fri. Ivan Frankel Construction Co. 626-7600

WANTED RELIABLE older woman as sitter in my home. Monday thru Friday 8AM-5PM. For 2 boys - ages 4 years and 1 year. Call after 6 PM. 652-1674

ROCHESTER AREA - professional couple seeks mature lady as housekeeper to care for 2 young children. Monday thru Friday 9 AM to 6 PM. Position available Feb. 1st. Previous experience desired. 652-1996

MOTHER'S HELPER-college student or high school student or part-time. \$4 PM to \$30 PM. Mon thru Fri. begin Feb 1. Own transportation. 2 children. 4 & 8 years old. Good pay. 851-3671

512 Situations Wanted Female

MATURE BABY Sitter, two days per week for 1 toddler. Own transportation, references. Call after 8PM. 477-5684

PERSONALIZED Maid Service assigned to you on a "We Care Basis". We meet all State and Federal requirements regarding later laws to you. Same girl each week. No lunch time or retaining week. Our clients have peace of mind with our service. 477-5307

DAY CARE for pre-schooler, my little home, playmates, 10 years experience. 5AM - 6PM, Wayne, Joy Rd. area. 852-2889

DEPENDABLE WOMAN washes housecleaning work. 225 daily. Own transportation. Troy-Birmingham area only. 852-7289

PEOPLE Person Mature woman with responsibility for general office work. Experienced 9 AM - 5 PM. Prefer NW area. 422-5004

EXPERIENCED woman washes cleaning work, 9-3, \$25.00 weekly. References. MA 63636

EARLY YEARS Child Care Center. Openings for children ages 2-6 years. Day Care & pre-school. Farmington, 478-7840. 291-768

BEST MADS brings the best to you. Experienced personnel. Fully insured. Transportation furnished. 968-0151

514 Situations Wanted Male

MAN experienced and licensed in property and casualty insurance. Seeking position. Knowledge of agency operations, marketing, underwriting, and other areas. 464-7766

CARPENTRY WORK WANTED. Basement kitchen cabinets etc. Very reasonable. Ask for Chuck 349-5789. 422-2429

ST. COLUMBAN BAPTIST every Mon. 1775 Melton, N. of 14 Mile. between Woodward and Coolidge. Early Bird at 7 PM. 642-3365

Farmington Ems Trustee. Begin Thursday 11:30 AM - 3 PM. Public invited. 23666 Orchard Lake Rd. between 9 Mile-10 Mile. 261-8821

BINGO every Tuesday, 7 PM. Farmington Area Advisory Council. Farmington Hills, 28000 Nine (9) Mile. at Middlebelt. 855-1536

MONDAYS 7:30 PM. BETH ABRAHAM HILLEL. (Between Middlebelt & Inkster) 478-7840

BINGO EVERY Mon. 7 PM. 32520 Cherry Hill, E. of Veno. Hall in Shopping Center, by St. Mary's Orthodox Church. 478-7840

EVERY TUESDAY 7 PM. ST. MAURICE CHURCH. 2777 SCHOOLCRAFT. LIV AT INKSTER. 478-7840

WEDNESDAY 7:15 PM. Brother Rice High School. 7013 W. Maple Rd. between Maple & 14 Mile. 478-7840

622 Income Tax & Insurance

ATTENTION! College students. Have your 1040 done very expensively. Call the Tax Man. Mon - Fri. 9:30 until 5:07 AM. 968-0151

626 Bingo

NORTHWEST COMMUNITY ASSOCIATION FOR RETIRED CITIZENS. WED. 7 P.M. 27777 SCHOOLCRAFT AT INKSTER. LIVONIA. 478-7840

EVERY THURSDAY. Regular Bingo. 7:10-9:30 PM. Lighting Game. 6:30 PM. 555 S. Wayne Rd. Westland. 478-7840

ST. COLUMBAN BAPTIST every Mon. 1775 Melton, N. of 14 Mile. between Woodward and Coolidge. Early Bird at 7 PM. 642-3365

Farmington Ems Trustee. Begin Thursday 11:30 AM - 3 PM. Public invited. 23666 Orchard Lake Rd. between 9 Mile-10 Mile. 261-8821

BINGO every Tuesday, 7 PM. Farmington Area Advisory Council. Farmington Hills, 28000 Nine (9) Mile. at Middlebelt. 855-1536

MONDAYS 7:30 PM. BETH ABRAHAM HILLEL. (Between Middlebelt & Inkster) 478-7840

BINGO EVERY Mon. 7 PM. 32520 Cherry Hill, E. of Veno. Hall in Shopping Center, by St. Mary's Orthodox Church. 478-7840

EVERY TUESDAY 7 PM. ST. MAURICE CHURCH. 2777 SCHOOLCRAFT. LIV AT INKSTER. 478-7840

602 Lost & Found

FOUND: small all white male dog. Spitz Huskie type. Vicinity of Ann Arbor Trail & Wayne Rd. 261-1661

LOST: White Felt Christmas table cloth with sequins. Reward 647-7432

LOST: Pointer, female, Jan 16th, white & tan, 5 Mile - Inkster Rd. area. Reward. GA 1-5560

LOST YOUR PET? In Bloomfield area. Call Bloomfield Twp. Animal Shelter, Mon-Fri. 9 AM-5 PM. Also nice Pets for Adoption \$44-\$61

616 Hall For Rent

COMMUNITY ROOM. 1200 sq. ft. available to local civic groups. WOODLAND CENTER, Plymouth & Middlebelt. 422-4100

LIVONIA K of C Hall. Capacity 275. Ample parking, air conditioning. Rentals for all occasions. 534-9867 or 454-0500

FREE SPACE. For all functions. LINCOLN INN. 386-5000

622 Income Tax & Insurance

ATTENTION! College students. Have your 1040 done very expensively. Call the Tax Man. Mon - Fri. 9:30 until 5:07 AM. 968-0151

626 Bingo

NORTHWEST COMMUNITY ASSOCIATION FOR RETIRED CITIZENS. WED. 7 P.M. 27777 SCHOOLCRAFT AT INKSTER. LIVONIA. 478-7840

EVERY THURSDAY. Regular Bingo. 7:10-9:30 PM. Lighting Game. 6:30 PM. 555 S. Wayne Rd. Westland. 478-7840

ST. COLUMBAN BAPTIST every Mon. 1775 Melton, N. of 14 Mile. between Woodward and Coolidge. Early Bird at 7 PM. 642-3365

Farmington Ems Trustee. Begin Thursday 11:30 AM - 3 PM. Public invited. 23666 Orchard Lake Rd. between 9 Mile-10 Mile. 261-8821

BINGO every Tuesday, 7 PM. Farmington Area Advisory Council. Farmington Hills, 28000 Nine (9) Mile. at Middlebelt. 855-1536

MONDAYS 7:30 PM. BETH ABRAHAM HILLEL. (Between Middlebelt & Inkster) 478-7840

BINGO EVERY Mon. 7 PM. 32520 Cherry Hill, E. of Veno. Hall in Shopping Center, by St. Mary's Orthodox Church. 478-7840

EVERY TUESDAY 7 PM. ST. MAURICE CHURCH. 2777 SCHOOLCRAFT. LIV AT INKSTER. 478-7840

WEDNESDAY 7:15 PM. Brother Rice High School. 7013 W. Maple Rd. between Maple & 14 Mile. 478-7840

628 Entertainment

SPIRITUAL READER. Qabalist & Seer. Identify your quest. Funds for charity. Parties and private consultations. References. Marie. 546-9590

BLUE MENAGERIE BAND. MUSIC FOR ALL AGES. The experienced musicians play at your wedding. Days. 525-6224. 937-4642

FULL VARIETY of excellent music & entertainment. Experienced in providing the finest in music for all social occasions. 731-6861

702 Antiques

WANTED quality antique art objects. no junk. Call after 6:30-7:30 PM. 626-2722

ROUND OAK 42" Pedestal table, 2 leaves and 4 pressed back modern chairs. 349-5850

OAK DINING TABLE, round top pedestal base with claw feet. finished. Victorian. \$350. 646-0465

DIME SLOT machine. Beauty. \$600. 478-3371

JOAN GASAWAY and EVIE BRANT at Tel-Twelve Antique Show. China, crystal, jewelry and fine antique. Will also buy.

ANTIQUE trunks, wooden coat racks, vanity set, floor lamp, mantel clock, children's chairs, 652-2444

WEEKLY FLEA MARKET. Every Wednesday 4 PM to 1 PM. Methodist Church, 5005 Chicago Rd. Warren. 653-7233

706 Appliances

LIKE NEW matched Kenmore washer & gas dryer. Kenmore. Anxious must sell. 478-0329

PACKAGE DEAL - \$450 takes all 1 upright freezer, G.E. refrigerator, electric stove, 2 speed washer. Bendix electric dryer. 646-2427

WESTINGHOUSE 19 Cu Ft refrigerator. Harvest Gold. Excellent condition. 3 years old. \$275. 422-3273

SIDE-BY-SIDE refrigerator, J.I. Hudson, like new. After 5PM. 421-5055

REFRIGERATOR Coldspot. Frostless, automatic ice maker, matching GE. 46" 2 oven. \$104. 454-0578

TWO used refrigerators. 522-3803

BROWN TONE Frigidaire refrigerator. \$125. Brown tone Frigidaire washer and dryer. \$150. Excellent condition. 444-0578

FREEZER 15 cu ft upright. Montgomery Ward, good condition. \$145. 947-7044

KERMORE CLASSIC Gas Range. Helix. excellent condition. Thermador electric wall oven, surface unit, stainless steel. 642-7490

WHIRLPOOL WASHER and dryer. Best offer. 261-4442

GAS DRYER, good operating condition. \$35. Washer has new parts. Needs reassembling. \$15. 645-5918

FRIGIDAIRE refrigerator. 40 in. matching refrigerator. \$150. \$200 for both. 455-1952

GE. 62 cu ft. freezer. chest. 2 years old. Kenmore 30 in gas stove. excellent. reasonable. 537-6222

708 Household Goods Oakland County

SIX Dining Room chair seat cushions. beige-white design. size 18 inches length. 12 to 20 inches width. 2 sofas. Contemporary style. 90 inch nylon Scotchguard gold stripe fabric, fruitwood legs. 968-2017

DINETTE SET 2 years old. 35 x 48 white formica top. 15 x 14 inch chrome legs. 4 green floral design chairs. 968-2017

TWO Chancellor colonial wood chairs. Also new from Wiggs. \$150 each. 968-2017

MATTRESS & BOX SPRINGS. Factory rejects. Twin size set. \$149. Full. \$209. Queen. \$249. King. \$299. (15 Mile). Troy. 588-1800

QUEEN size bed drapes 2 deaks, lamps, etc. Days. 382-2211.

744 Horses, Livestock & Equipment
 REGISTERED APALOOSA mare in foal \$700 Ask for Kathy 525-3624

802 Snowmobiles
 SKI DOO 1971 Nordic 640 electric start excellent condition \$600 Call after 6 PM 459-3415
 TWO XR400 Suzuki snowmobiles, low miles, very good condition \$1,100 After 6 PM 455-2496

1971 1972 Nitro 440 speedster and track \$300 firm 454-2284

SNOW TWISTER 1971 800cc FA Number 76 track rebuff engine, extra fast \$1,000 or best offer. Cash only After 6 PM 481-0275

WALDER 1972 good condition new skis extra set of tracks \$400 478-7556

YAMAHA 1972 SKI new track \$363-6827

YAMAHA SL 890 50 hrs. Eke new starter new double trailer and package like new best offer After 6 PM 646-1522

812 Motorcycles, Go-Karts-Mini Bikes
 HONDA 1970, 750 w/h side car. Evons. 477-4482

TRIUMPH BONNEVILLE 1976 Must sell sacrifice! Excellent condition. \$1600 After 6 PM 459-6593

HARLEY DAVIDSON 1948 clean, all new, desperate make offer. 464-2717

814 Campers And Motorhomes
 FOR RENT 1976 Winnebago 19 motorhome Fully equipped Reasonable 455-8356

1975 GMC 27 Motorhome for rent For more information call 425-3315

PONTIAC 350 engine, 2 barrel clean, runs good, stored 4 years. \$230 Dave 455-6519

REAR SEAT for 1976 Van green \$75 422-5108

TWO 14 INCH Chevy mags, with like new G-78 tires \$50 453-9363

GOODYEAR POLYESTER 4 ply white sidewall tires E78x14, set of four \$75. Call after 6 PM 464-1803

SNOW TIRES (2) G-78 x 15, belt and whitewalls, excellent condition, mounted on Chevy rims \$50 464-7521

FOUR 15x8 wagon wheels, 5 bolt mountings \$100 645-9808

816 Auto-Truck Parts & Service
 Tires-Unroyal Fast Track Glass Belted, E78x14 W/W Mounted and balanced on GM Wheels. New. Reasonable 626-7432

SNOW TIRES-2 Goodyear, G78 15 642-7462

820 Autos Wanted
 NOW!
 OUT OF TOWN BUYER ON PREMISES AT FISCHER BUICK
 and he is paying highest dollar in town for any sharp used car truck or van

821 Junk Cars Wanted
 HIGH\$\$ HIGH\$\$ WANTED
 \$25 - \$50 ON ALL JUNK CARS
 Must Have Title CITY AUTO RECOVERY 40111 Schoolcraft 453-3411 261-9120 PLYMOUTH
 GET TOP Dollar for your car or truck 7 Am to 11 Pm. 728-8948

820 Autos Wanted
 WE BUY USED CARS & TRUCKS
 ALL MAKES & MODELS
 Free Appraisal Top Dollar Paid for Sharp Cars & Trucks
 CRESTWOOD FORD 32850 Dodge Rd 421-5700

820 Autos Wanted
 Dick Morris WILL BUY YOUR USED CAR
 We offer top dollar for any make or model used car.
 Don't sell your car until you have our offer.
 Dick Morris Chev. USED CAR MGR. 624-4500 WALLED LAKE
 Haggerty Rd between Pontiac Trail & Maple Rd

822 Trucks For Sale
 FORD 1 TON PICKUP, automatic, power steering, low miles. Avis Ford Telegraph at 12 Mile 354-3100

TRAIL DUSTER, 1976, Big six, 4 wheel drive, automatic with power steering, radio, heater, and just 11,000 miles. As close to new as you'll find! \$4,995 with Chrysler bank terms to all Colony Chrysler - Plymouth, 111 Ann Arbor Rd 453-2255

FORD 1976 F150, 4-wheel drive pickup. Loaded 23,000 miles \$4,795 or best offer 453-8737, 278-6420

MAZDA 1973 pickup 4 cylinder excellent condition extras 721 9802 Eves 261-7208

FORD PICKUP 1972 S250, automatic, good condition \$3,900 or best offer 522-1171

DODGE 1961, good condition \$900 FORD 1969 1 ton stake automatic, overload springs, \$1,400 476-3906

1972 Ford Window Van Automatic transmission, power assists only \$2,595

LEO CALHOUN FORD 41001 Plymouth Rd 453-1327

CHEVY 1977, 4 wheel drive, 1 ton pickup Must sell Going into Air Force 455-1815

RANCHERO 1975, V8, automatic, power steering, brakes 16,000 miles, excellent condition \$3,475 After 5 PM 322-1815

823 Vans
 CUSTOM VAN many extras, must see to appreciate. Must sell After 6 PM 477-5795

FORD VAN 1970 Radio, heater, automatic, good running condition. Full price \$695 COOK FARR FORD 10 Mile at Greenfield, 399-6900 Call about our exclusive warranty

FORD VAN 1975, custom interior, 6 cylinder, standard transmission, \$4,500 487-5547, 261-3040

CHEVY 1976 Panel Air, power steering, power brakes, automatic V8 cruise \$4,800 421-7447

CHEVROLET 1975, power steering, power brakes, automatic, long wheel base, make offer. Good light industrial and pleasure van. Under 20,000 miles After 6 PM 478-3043

PLYMOUTH 1976 Voyager, power steering, brakes, automatic rear heater, cruise control 522-0902

1972 E-100 VAN 6 cylinder engine, standard trans, automatic, rear economy with this one only \$1,095

LEO CALHOUN FORD 41001 Plymouth Rd 453-1327

3 DODGE VANS 1973 & 1975's, all in excellent condition, some 6 cylinder, some V8. Priced to sell from \$2,495

Jack Demmer ford 37300 Michigan Ave PA 1-2600

BEAUVILLE 1968 Sports Van Air tilt wheel, cruise control, 8 passenger, many extras \$3,800 or best offer 474-4593

DODGE 1975 T200 custom interior, 318 power steering, brakes, am fm stereo tape. Best offer 642-8334

1976 FORD TEC VAN Fully equipped for traveling or camping, only 5,500 miles automatic transmission, power steering, power brakes, raise up top. Save a bundle at \$7,195

LEO CALHOUN FORD 41001 Plymouth Rd 453-1327

FORD F250 Explorer cap 1970 air, automatic, power steering, brakes, twin tanks \$695 474-4593

RAM CHARGER 1975 Power brakes, power steering, radio, heater, carpeted, chrome wheels, extra wide snow tires. Power angling plow \$6000 531-6720

1976 DODGE CLUB CAB 100 Pickup 35,000 miles, automatic transmission, power steering, power brakes. A bargain at \$3,395

LEO CALHOUN FORD 41001 Plymouth Rd 453-1327

FORD 1969 3/4 ton stake truck, heavy duty \$1,150 421-2620

DODGE 1970 1/2 ton pickup \$780 331-6720

FORD 1968 1/2 ton pickup, complete, all new parts, 45 ft box, 429-CJ engine, 4 speed transmission, top cover \$3,000 464-0364

823 Vans
 GMC RALLY STX, 1976 12 passenger bus, 2,500 miles, front air conditioning, automatic power steering and brakes, cruise control, tilt wheel, 2 tone, 980 Art Moran Pontiac-GMC Telegraph, North of 12 Mile 353-9000

FORD WINDOW VAN 1974 automatic, power steering, exceptionally nice. Avis Ford Telegraph at 12 Mile 354-3100

DODGE VAN 1974, automatic radio, heater, carpeted \$3,195 O'Hara Datsun 35655 Plymouth Rd 425-3311

DODGE ROYAL SPORTSMAN WED VAN 1975, AM/FM radio, 8 cylinder, automatic power steering and brakes, 8 passenger new tires, 30,000 miles \$4,695 Bill Brown Ford 35000 Plymouth Rd at Wayne Rd 421-7000

DODGE TRADESMAN CUSTOM WED VAN 1976, 8,800 miles and new as you'll find. V8, automatic power steering, AM-FM stereo tape! See it, drive it, and you'll buy it for just \$4,995. New car bank terms. Colony Chrysler - Plymouth, 111 Ann Arbor Rd 453-2255

1973 PONTIAC GRAND PRIX 2 door, V-8, automatic, air conditioning, power steering and brakes, AM/FM stereo radio, bucket seats \$2,792

1975 FORD COUNTRY SQUIRE 6 PASS. STATION WAGON Automatic, power steering and brakes, radio, wood grain \$2,475

1975 CHEVROLET BEAUVILLE SPORT VAN 20 V-8, air, power steering and brakes, radio, rally wheels, radial tires, auto. transmission \$4,885

1970 CHRYSLER 300 2 door, V-8, automatic, full power, tilt wheel, cruise control, stereo, vinyl top, extra nice car \$1,495

1975 BUICK REGAL LANDAU 2 door, V-8 air conditioning automatic, power steering and brakes, AM/FM stereo radio, only 6,555 miles \$4,250

1976 RIVERNA LANDAU Air conditioning, full power, stereo, tilt wheel, cruise control, 60/40 trim, wire wheel covers \$5,688

DEMO SALE

YOUR CHANCE TO REALLY GET A LOT FOR SO LITTLE...

41 TO CHOOSE FROM

DEMOS

76 BOBCAT RUNABOUT, Auto \$2995
 76 MONARCHS From \$3,495
 76 MERCURYS, all with air. From \$4,695
 76 COMETS, many extras. From \$2,895

HURRY THEY WON'T LAST LONG!

WE HAVE A LARGE SELECTION OF 1977 MODELS ALL MODELS AND COLORS ON DISPLAY FOR IMMEDIATE DELIVERY!

BRING YOUR BEST DEAL FROM ANY LINCOLN-MERCURY DEALER AND WE WILL BEAT IT!

USED CARS

1976 MERCURY BOBCAT DEMOS 4 cylinder and V-6's automatics from \$2,995

1975 FORD TORINO ELITE Triple black power, stereo, air, low miles \$3,995

1975 LINCOLN TOWN COUPE Absolutely perfect, including air, reclining seat, tape, cruise, tilt etc. rose with matching velour interior. Stock #064 \$6,495

1973 CAPRI SUNROOF Automatic, 2,000 engine, dark brown with matching interior \$2,195

1976 CONTINENTAL TOWN COUPE - DEMO Special edition, only 25 manufactured, triple gold, quad sounds and all the other goodies you can put on a car. \$2,995 SAVE

1977 COUGAR XR-7 Full power, air, stereo, decor, good rally wheels, 900 miles, new car warranty \$6,495

PAT MULLIGAN
 DETROIT'S #1 LINCOLN-MERCURY DEALER
 20200 GRAND RIVER AT EVERGREEN KE 2-4000

SAVINGS GALORE!

SPECIAL OF THE WEEK:
 1975 GMC 3/4 TON SIERRA GRANDE CAMPER SPECIAL
 Automatic, power steering and brakes, Meyers plow, deluxe camper top, 12,000 miles.
 Only \$5995

TRUCK SPECIALS

1971 CHEV. IMPALA 4 door hardtop, automatic, power, air, vinyl roof, one owner, sharp \$1,595

1975 MONTE CARLO Automatic, power, air, rally wheels, AM/FM radio, 2 to choose from \$3,995

1976 MONTE CARLO Air, power, vinyl roof, AM/FM stereo, twin comfort seats, tilt wheel, power door locks \$4,795.

1976 CAPRICE CLASSIC 4 door, automatic, power, air, tinted glass, extra sharp \$4,495

1974 NOVA Automatic, 6 cylinder, automatic, power steering, bright red. Extra sharp \$2,495

1975 FORD GRAN TORINO 4 door, automatic, power, air, vinyl roof, sharp \$3,095

1973 NOVA HATCHBACK V8, automatic, custom interior, a real buy \$2,195

1976 GREMLIN X Bright orange, automatic, power, stereo, sharp \$2,995

1971 MAVERICK 8 cylinder, automatic, radio, vinyl top, 40,000 miles. Great transportation \$695

SPORTS CARS

1976 CORVETTES 2 to choose from, automatic, power, air, stereo \$4,995

1976 CAMARO RALLY SPORT Automatic, power, air, stereo, aluminum wheels. Extra sharp \$4,995

1973 CAMARO Automatic, power, air, vinyl roof, rally wheels \$2,995

1971 PORSCH 914 5 speed \$2,395

1976 PONTIAC TRANS AM 4 speed, stereo, sharp \$4,995

1974 GMC PICKUP V8, automatic, power, camper top. Great value \$2,395

1976 CHEVY 1/2 TON PICKUP with Camper top, V8, automatic, power, 4,000 miles, new car warranty \$4,395

1975 CHEVY 1/2 TON PICKUP V8, automatic, power, 21,000 miles Sharp \$3,195

1975 CUSTOMIZED CHEVY VAN Loaded! Showroom condition \$5,395

1974 CHEVETTE MALIBU 2 door hardtop, V8, automatic, power, vinyl roof, AM/FM radio. Extra sharp \$2,495

1973 DODGE CHARGER V8, automatic, power, air, Sharp \$1,995

LIVONIA'S ONLY CHEVROLET DEALER

Tennison

32570 Plymouth Rd. Phone 425-6500

BOB SAKS OLDSMOBILE

BUY A USED CAR WITH CONFIDENCE!

125 USED CARS TO CHOOSE FROM

1976 OLDS 98 REGENCY COUPE Automatic, all power, tilt wheel, cruise, stereo, rear window defroster, vinyl roof, air \$6,495

1974 TORONADO BROUGHAM Automatic, all power, tilt, cruise, stereo, rear window defroster, air, padded vinyl roof, low mileage \$4,195

1975 FORD GRAN TORINO 4 door, V8, automatic, power steering, power brakes, radio, heater, white walls, vinyl roof, factory air, only 19,000 miles, showroom new \$2,995

1974 BUICK REGAL CENTURY SPORT COUPE V8, automatic, power steering, power brakes, radio, heater, white walls, vinyl roof, factory air, low mileage, winter ready \$3,295

1975 PLYMOUTH GOLD DUSTER 6 cylinder, automatic, power steering, power brakes, AM/FM radio, vinyl roof, air conditioning, only 9,000 actual miles. \$2,995

1975 OLDS 98 REGENCY V8, automatic, power steering, power brakes, AM/FM stereo, factory air conditioning, power windows, extra sharp Oldsmobile's best built convertible \$4,895

1975 OLDS 88 ROYALE CONVERTIBLE V8, automatic, power steering, power brakes, AM/FM stereo, factory air conditioning, power windows, extra sharp Oldsmobile's best built convertible \$4,895

1975 OLDS 98 REGENCY Last of the big cars. Fully factory loaded, very low miles, showroom new \$5,395

1975 OLDS TORONADO BROUGHAM Completely loaded, very low miles, extra sharp, padded vinyl roof, AM-FM stereo \$4,995

'76 ROYAL OLDS 88 4 door hardtop, V8, automatic, power steering, power brakes, AM/FM stereo, heater, white walls, rear window defroster, vinyl roof, factory air \$4,995

1974 AMC MATADOR 2 door sport coupe, 6 cylinder, automatic, power steering, power brakes, vinyl roof, good gas saver \$1,995

1976 CUTLASS SUPREME BROUGHAM 2 door, hardtop, V-8, automatic, power steering and brakes, AM/FM stereo, vinyl roof, factory air conditioning, rear window defroster, new car warranty, very low miles \$5,395

1975 BUICK LIMITED 225 COUPE Loaded with all factory options air conditioning, AM-FM stereo, vinyl roof, only 12,000 easy miles, showroom new \$5,595

1973 OLDS CUSTOM CRUISER 9 passenger, loaded, air conditioning, AM/FM radio, sharp, sharp car \$2,395

1975 CUTLASS SUPREME V-8, automatic, transmission, power steering and brakes, air conditioning, vinyl roof, radio, heater, white wall tires, AM-FM stereo, hurry on this one! \$3,995

1971 VW Station Wagon Automatic, winter ready \$1,395

1971 MERCURY MONTEREY 4 door, hardtop, V8, automatic, power steering, power brakes, air, radio, heater, white walls, vinyl roof, low mileage, excellent transportation \$1,495

1975 OLDS 88 ROYALE CONVERTIBLE V8, automatic, power steering, power brakes, AM/FM stereo, factory air conditioning, power windows, extra sharp Oldsmobile's best built convertible \$4,895

1976 CUTLASS SUPREME BROUGHAM Air, AM/FM, power windows, power steering and power brakes, steel belted radial tires, showroom new with very low mileage! \$8,395

1975 CAMARO SPORTS COUPE V8, automatic, power steering, power brakes, bucket seats, sports console, vinyl roof, factory air, radio, heater, white walls \$4,395

1974 OLDS CUSTOM CRUISER STATION WAGON Air conditioning, 9 passenger, loaded, AM/FM stereo, only \$3,295

1972 DELTA 88 ROYALE SPORTS COUPE V8, automatic, power steering, power brakes, factory air conditioning, AM-FM stereo, tinted glass, vinyl roof, winter ready! \$1,995

BOB JEANNOTTE

THE 10-COUNTY PORTING AWARD WINNER

New 1977 GRAND PRIX Turbo Hydraulic, V-8, power steering, ing, power disc brakes, steel belted white side walls, full standard factory equipment \$4,333

1976 PONTIACS SAVE HUNDREDS!! 10 IN STOCK TO CHOOSE FROM

1977 SUNBIRD With Full Standard Factory Equipment Less Factory Rebate \$3,099 -200 \$2,899

NEW 1977 FIREBIRDS 12 TO CHOOSE FROM ALL MODELS COLOR & EQUIPMENT Starting From \$3,899

1977 CATALINA COUPE AIR CONDITIONING Turbo Hydraulic power steering, power brakes, automatic \$4,598

'77 ASTRE Full Standard Factory Equipment Less Factory Rebate \$2,992 -200 \$2,792

PRICES INCLUDE PREP. AND DELIVERY CHARGES. Keep That Great Old Feeling With Genuine GM Parts 174 WEST ANN ARBOR RD. DETROIT AREA PLYMOUTH AREA OPEN MON. & THURS. TIL 2:00 P.M.

963-7192 • 453-2500

Grand Prix SALE OVER 100 TO CHOOSE FROM

• Sport Mirror • Landau Top • Air conditioned • Tinted Glass • Lamp Group • Electric Rear Window Defroster • Accent Stripes • Deluxe Wheel Covers • Power Steering • AM/FM Radio • Power Brakes • Steel Belted radial tires • Hydraulic

\$5393 Stk #933

ART MORAN
 PONTIAC • GMC TRUCKS
 353-9000 29300 TELEGRAPH RD. Just North of 12 Mile

O'HARA DATSUN LARGE SELECTION OF DEMOS Save Up to \$1500

All models available. Prices start at:

\$2987 DATSUN B-210 "Honey Bee" 2 dr. sedan
 AM radio, rear defogger, power assist brakes, 4 speed synchro transmission, body stripe, freight and dealer prep.
 E.P.A. 41 MPG highway, 29 MPG city
 Mileage may vary with individual driving habits

O'HARA DATSUN YES, WE HAVE 280 Z's LARGE SELECTION! F.10's front wheel drive PICKUPS 6 ft. & 7 ft. beds Immediate Delivery

O'HARA DATSUN 35655 PLYMOUTH RD. Livonia (between Wayne & Levan) 425-3311

ASK ABOUT OUR 100% 12 MO.-12,000 MILE USED CAR POWER TRAIN WARRANTY*
 AT GRAND RIVER AND DRAKE 478-0500 JUST 2 MILES WEST OF FARMINGTON

MARK CHEVROLET USED CAR DEPT.

CHUCK MILAZZO has been named "Used Car Salesman of the Month" for his outstanding sales efforts during the month of December.

"The Sales Professionals"

Mark CHEVROLET
 33200 MICHIGAN AVE. WAYNE 722-9147

WE NEED VANS!!

See Us First For Top Dollar on Used Vans Any Year Any Make

TEL-TWELVE DODGE 2625 W 12 Mile - Telegraph 354-6600

1973 PONTIAC GRAND PRIX 2 door, V-8, automatic, air conditioning, power steering and brakes, AM/FM stereo radio, bucket seats \$2,792

1975 FORD COUNTRY SQUIRE 6 PASS. STATION WAGON Automatic, power steering and brakes, radio, wood grain \$2,475

1975 CHEVROLET BEAUVILLE SPORT VAN 20 V-8, air, power steering and brakes, radio, rally wheels, radial tires, auto. transmission \$4,885

1970 CHRYSLER 300 2 door, V-8, automatic, full power, tilt wheel, cruise control, stereo, vinyl top, extra nice car \$1,495

1975 BUICK REGAL LANDAU 2 door, V-8 air conditioning automatic, power steering and brakes, AM/FM stereo radio, only 6,555 miles \$4,250

1976 RIVERNA LANDAU Air conditioning, full power, stereo, tilt wheel, cruise control, 60/40 trim, wire wheel covers \$5,688

824 Sports And Imported Cars

LANCIA BETA COUPE 1975. The line machine. Only 6,000 miles. Air conditioning, 5 speed, stereo & more. Super special \$3,900. Art Moran Pontiac GMC. Telegraph North of 12 Mile. 353-9000

CAPRI 1973 like new 20,000 miles. Decor group, automatic, V-6. \$1,800. 464-7179

CORVETTE 1968 best offer. Call after 5:30 PM. 479-1147

FIAT 1974 X-19. \$1,500. Blue. AM-FM stereo, slightly damaged left rear fender. 336-2863. 322-0033

DATSUN 1977. 280-Z. 2+2. Silver. \$8,000. 478-3220

DATSUN 1974. 210. 32,000 miles. AM-FM stereo, radials, rear wiper, low defogger, good condition. \$2,900. 478-3220

MERCEDES BENZ 1975. 300 D. 25 MPG. private. 477-3532

71 DATSUN 240Z
\$1,995
OPEN SATURDAY
LIVONIA VOLKSWAGEN
11301 Plymouth Rd. 425-4400
Between Wayne & Farmington Rds.

1976 MGB
8,000 miles, wire wheels, burgundy.
\$4,495.
Auburn Motors.
338-4531

CORVETTE 1975 white all power 20,000 miles. 369-8022

JAGUAR XJ12L 1974 sable with sunroof interior immaculate maintenance and service 18,000 miles. new set of Michelin 235V-80-15 radials \$10,000. 616-1506

CAPRI 1976. 6 cyl. 2 door. AM-FM stereo. Decor group. Z-barb. Excellent condition. \$3,500. 478-8262

1974 TOYOTA COROLLA
Red. 34,000 miles, automatic, radio. \$2,695
OPEN SATURDAY
LIVONIA VOLKSWAGEN
34501 Plymouth Rd. 425-4400
Between Wayne & Farmington Rds.

TOYOTA 1971 automatic, AM-FM, new tires \$700. 474-1728

CAPRI 1974. 4 speed, 4 cylinder. AM-FM, reclining seat, low mileage. Well maintained. \$2,100. 582-2542

1975 TOYOTA SR5
4 cylinder, 5 speed, AM-FM stereo, radio, radial tires, styled steel wheels, tinted glass, electric rear window defogger. Like new. \$2,795
Jack Demmer Ford
37300 Michigan Ave.
PA 1-2600

FIAT 1973 128 sedan 2 door, fair condition. 422-5961

OPHEL MANTA 1975. New snow tires. AM-FM stereo, tape deck. Must sell. 425-4734

EXECUTIVES CAR
1975 DATSUN 280 Z. 2+2. automatic. AM-FM stereo, tape, factory air conditioning, steel belted radials with mag wheels, low miles. A must see car. Only \$5,795. Call after 5:00. 557-1997

VOLVO 1972. 164. Burgundy. Ma. room. mint condition. many extras. \$3,350 or best offer. 689-6327

CORVETTE 1976. Yellow. Black interior. air stereo, automatic. Extras. 1500 miles. Warranted. Immaculate. \$4,995. 381-3224

852 Classic Cars

FORD 1936. 4 Door. Best Offer. 10 AM-5 PM. 453-1880. After 5 PM. 453-8072

854 American Motors

GREMLIN X-1973. automatic. power steering, radio, heater. \$1,295. O'Hara Datsun. 35655 Plymouth Rd. 425-3311

AMC REBEL 1970. 4 door. one owner. 43,000 actual miles. Small V-8. automatic. power steering, radio. And good body. Runs great. good tires. top \$795 to first buyer. Colony Chrysler. Plymouth. 111 Ann Arbor Rd. 453-2255

854 American Motors

HORNET SPORTABOUT WAGON 1976, perfect condition throughout. 6 automatic, power, factory air. Reduced to \$3,145. Colony Chrysler. Plymouth. 111 Ann Arbor Rd. 453-2255

HORNET 1975. Hatchback, silver with Levi trim. 304 automatic. power steering & brakes, air stereo and others. 352-3235

JAVELIN 1975. 4 door. automatic. good. \$550. Call after 6 PM. 425-2478

PACER 1975. red. 25,000 miles. \$2,900. 455-2941

PACER 1975. DI. model. loaded everything. \$3,500. 425-6822

PACER 1975. deluxe. power, automatic. air stereo. loaded. spotless. \$1,500. 567-4110

856 Buick

CONVERTIBLE 1974. white on red. 40,000 miles. nice shape. loaded. \$3,600 or best offer. Call for appointment. 646-8962

BUICK 1969 special station wagon. good tires. needs muffler. \$550. 464-1386

VEGA 1975 Hatchback. 4 speed. radio. 18,000 miles. Excellent condition. \$1,850. CR 85121

NOVA 1969. 6 cylinder, in driving condition. \$100. 837-0090

MALIBU CLASSIC 1974. blue with white Landau top. AM-FM, air, white buckets. \$2,650 or best offer. 356-2922

CHEVELLE 1971. blue. 2 door. V8. automatic. new brakes and battery. good condition. \$650. 459-6238

VEGA 1974. GT Hatchback. FM radio. 4 speed. rear defogger. new battery. good tires. 29,000 miles. \$1,300. After 6 PM. 421-6132

VEGA 1974. Hatchback. automatic. AM radio. low miles. excellent condition. \$1,400. 21-000 actual miles. 477-3374

IMPALA 1973. 2 door. automatic. air. New brakes, battery, steel belt. tires, shocks. extras. 644-7672

CHEVY 1974. Custom Impala. 2 door. hardtop, radio and heater. automatic. power. \$1,795. COOK FARR FORD. 10 Mile at Greenfield. 399-6600. Call about our exclusive warranty.

858 Cadillac

COUPE DE VILLE 1973. 2 door. all power. excellent condition. \$3,500. After 6 PM. 728-6211

SEIDAN DeVille 1970. Excellent condition. low mileage. New battery. tires and exhaust. \$1,600. 322-3658

FLEETWOOD BROUGHAM 1975. Dark blue like new. 6250 miles. loaded extras including wire wheel covers & CB See & drive to appreciate. \$10,900. From Harrison. 813 giria area. 425-4738

COUPE DeVille 1974. sunroof. all power. air. AM-FM stereo. with tape. 27,000 miles. Private. 334-9444

ELDOURADO 1976. 4 door. coupe. Insbruck Blue. air stereo. power steering. brakes, doorlocks, wiper. 4 way seat, tilt telescope. wheel, speed control, deicer, cloth interior. show room condition. \$8700. 474-3626

COUPE DeVille 1974. excellent condition. white red leather interior. loaded. \$4,495. Days. 583-9300. Eves. 531-9784

COUPE DeVille 1970. Climate control. tilt and telescope wheel. full power. AM-FM stereo. new tires. \$1,200. 531-0720

ELDOURADO 1976. full power stereo. Firethorn exterior. 8,200 miles. \$8,990. Call after 4 PM. 643-9141

860 Chevrolet

CAPRICES 4 door. loaded. factory official cars. 3,000 miles. Roger Penske Chev. 355-1000

MONTE CARLO 75's. 3 to choose from. Roger Penske Chev. 355-1000

NOVAS 1976. low mileage cars. automatic, power steering and brakes. Roger Penske Chev. 355-1000

VEGAS 75. only 3 left to choose from. automatic, radio, economy specials. Only \$1,795. Roger Penske Chev. 355-1000

NOVAS 1973. 1 TUDOR. 1 FOUR DOOR. Both clean. one owner. 8 cylinder. automatic with power and factory air conditioning radial white wall tires. Your choice \$2,495. Bank terms. Colony Chrysler. Plymouth. 111 Ann Arbor Rd. 453-2255

MONTE CARLO 1973. fully loaded. 8 track stereo, sunroof. good condition. many extras. \$2,700. 326-1333

VEGA 1972. Hatchback. 4 speed. new Goodrich radial tires. new exhaust system. am-fm stereo, radio. good condition. \$495. firm. 455-2882

VEGA 1973. GT Kamback. automatic. AM-FM radio. needs some body work. \$800. or best offer. 464-7343

CAMARO 1974. 350. clean inside and out. low mileage. asking \$2,800. 422-0282

860 Chevrolet

MONTE CARLO 1976. Landau. Many options. 7,000 miles. new appearance mag. radials. executive's wife's car. Must sell. \$4,950. or best offer. 397-0119

IMPALA 1968. never damaged. \$750 or more. inside automatic. air. power steering. nearly new tires. like new. 453-7564

MONTE CARLO 1975. air conditioning. AM-FM radio. beautiful copper finish with matching vinyl roof. 29,000 miles. \$4,195. Bill Brown Ford. 35000 Plymouth Rd. at Wayne Rd. 421-7000

VEGA 1974. stick shift. very clean. \$850. After 6. 399-8775

IMPALA 1974. 4 door. power steering. brakes. air. vinyl top. \$1,300. 422-2864

860 Chevrolet

MALIBU 1973. Air. power steering. power brakes. AM-FM. 8 track tape. Excellent condition. Rear defogger. \$2,195 or best offer. CR 85121

NOVA 1974. custom. many extras. asking \$2,500. After 5 PM. 538-0357

VEGA 1975. Hatchback. 4 speed. radio. 18,000 miles. Excellent condition. \$1,850. 425-4392

NOVA 1969. 6 cylinder, in driving condition. \$100. 837-0090

MALIBU CLASSIC 1974. blue with white Landau top. AM-FM, air, white buckets. \$2,650 or best offer. 356-2922

CHEVELLE 1971. blue. 2 door. V8. automatic. new brakes and battery. good condition. \$650. 459-6238

VEGA 1974. GT Hatchback. FM radio. 4 speed. rear defogger. new battery. good tires. 29,000 miles. \$1,300. After 6 PM. 421-6132

VEGA 1974. Hatchback. automatic. AM radio. low miles. excellent condition. \$1,400. 21-000 actual miles. 477-3374

IMPALA 1973. 2 door. automatic. air. New brakes, battery, steel belt. tires, shocks. extras. 644-7672

CHEVY 1974. Custom Impala. 2 door. hardtop, radio and heater. automatic. power. \$1,795. COOK FARR FORD. 10 Mile at Greenfield. 399-6600. Call about our exclusive warranty.

862 Chrysler

CORDOBAS 1975. 4 to choose from. All sharp cars with loads of goodies. All have factory air conditioning. Your choice \$4,195. Full 2 year warranty. Colony Chrysler. Plymouth. 111 Ann Arbor Rd. 453-2255

CHRYSLER 1970. new tires. new battery. 90,000 miles. air. many extras. \$875. 476-5173

CORDOBA 1975. Loaded, excellent condition. \$4,500. Evenings call. 681-5031

NEW YORKER Brougham. 4 door. Triple blue. full power. cruise control. air. Excellent condition. \$3,588. 589-0541

864 Dodge

IMPALA 1973 station wagon. 24,300 miles. \$2,400. 422-1196 or 322-4036

VEGA 1975. 4 speed. \$1,500. 455-7409

VEGA 1975. 2 Door Sedan. 27,000 miles. stock. \$1,700. Grand 8 Auto Sales. 477-2090

864 Dodge

COLT 1973. dependable. runs great. 25 mpg. some fender rust. 90,000 miles. \$750. 474-1078

DODGE DART 1964. California car. small V-8. 2 door. needs work. \$225. Call before 4:30 PM. 253-6318

866 Ford

FORD ELITE 1976. AM-FM stereo. air conditioning. 351 engine. automatic. power. beautiful cream with vinyl roof. \$4,495. Bill Brown Ford. 35000 Plymouth Rd. at Wayne Rd. 421-7000

TORINO SQUIRE 1970. 53,000 miles. Power brakes, power steering, air. automatic. clean inside. needs body work. \$350. 664-6472

COUNTRY SQUIRE 1972. power steering. power brakes. air. 10 passenger. excellent condition. 43,000 miles. 453-7245

COUNTRY SQUIRE 1973. loaded. AM-FM stereo. tires like new. original owner. 54,000 miles. After 6 PM. 255-7448

TORINO Station Wagon 1975. V8. automatic. air. all power. good condition. \$3,500. 455-8468

TORINO 1971. 50,000 miles. automatic. power steering. power brakes. vinyl top. good condition. \$1,099. 589-4036

MICHIGANS #1 Ford Dealer WHY? We Sell For Less! Large Savings On All Models
STARK HICKEY WEST
24760 W. 7 Mile
538-6600

LTD 1969 Brougham. air. loaded. Z-barb. reasonable offer accepted. new tires. low miles. 261-0394. 981-0255

LTD 1975. Landau. 4 door. Florida Car. Air. Iwan comfort seats. vinyl interior. 24,000 miles. \$3,300. 425-8078

LTD 1969. 1972. full power. many new parts. runs like new. very rusty. \$325 or offer. 453-9363

ELITE 1974. very good condition. stereo. air. cruise. \$3,300. After 6 PM. 545-2178

866 Ford

MAVERICK 1971. 2 door. automatic. exceptionally nice. excellent transportation. \$995. Avis Ford. Telegraph at 12 Mile. 354-3100

FORD 1971. Station Wagon. air. power steering. luggage rack. low mileage. \$750. Good condition. 421-6271

MUSTANG 1968. GT Fastback. 390 balanced and blue. printed. power steering. brakes. automatic. \$3,600. 54,000 miles. extras. best offer. 477-7380

TORINO 1971. 2 door. excellent condition. power steering. radio. automatic. \$750. 981-1225

866 Ford

1971 PINTO
2 door, automatic, radio, heater. \$645
PAT MILLIKEN FORD
9600 Telegraph
Between Plymouth & W Chicago
255-5840

ATTENTION

In doubt about buying a car? Can get you financed on all makes & models 67-77. Must be working. Ask for DAN HARKEY. 421-5870

CHARGER SE 1974. Power steering. brakes. Low mileage. vinyl top. air. \$2,395. Call between 6 PM & 10 PM. 537-1338

POLARA 1973. 4 door. custom hardtop. 400 cu in motor. new muffler system. new battery. good tires. \$1,850 or best offer. 356-5592

866 Ford

MAVERICK 1971. 2 door. automatic. exceptionally nice. excellent transportation. \$995. Avis Ford. Telegraph at 12 Mile. 354-3100

FORD 1971. Station Wagon. air. power steering. luggage rack. low mileage. \$750. Good condition. 421-6271

MUSTANG 1968. GT Fastback. 390 balanced and blue. printed. power steering. brakes. automatic. \$3,600. 54,000 miles. extras. best offer. 477-7380

TORINO 1971. 2 door. excellent condition. power steering. radio. automatic. \$750. 981-1225

MARK CHEVROLET
Proudly Welcomes



RON SIMONS
TO OUR USED CAR DEPT. TEAM OF SALES PROFESSIONALS

Ron extends an invitation to all of his friends and former customers to visit him at Mark Chevrolet and see their large selection of fine quality used cars and trucks including the area's only used truck showroom.



33200 MICHIGAN AVE.
WAYNE 722-9147

866 Ford

FORD ELITE 1975. Very low miles. Velour interior. like new \$3,195

COOK-FARR FORD
10 Mile at Greenfield. 399-6600
Call about our exclusive warranty

MUSTANG II 1974. V-6. power steering. power brakes. AM-FM. 8 track quad. 427-8318

FORD 1970. Custom 4 door. New shocks, brakes. tune up. Runs great. some rust. 562-3669

PINTO RUNABOUT 1974. Well maintained. Automatic, good tires. Excellent second car offer for student. \$1,392. 478-7640. 427-7389

FORD 1969. 302 automatic. power steering. 52,000 miles. \$425. 422-0547

GRAN TORINO Wagon. 1974. 351 automatic. radio. roof rack. radial ply tires. rustproofed. low mileage. \$2,500. After 6 PM. 646-0084

866 Ford

MAVERICK 1971. 2 door. automatic. exceptionally nice. excellent transportation. \$995. Avis Ford. Telegraph at 12 Mile. 354-3100

FORD 1971. Station Wagon. air. power steering. luggage rack. low mileage. \$750. Good condition. 421-6271

MUSTANG 1968. GT Fastback. 390 balanced and blue. printed. power steering. brakes. automatic. \$3,600. 54,000 miles. extras. best offer. 477-7380

TORINO 1971. 2 door. excellent condition. power steering. radio. automatic. \$750. 981-1225

MARK CHEVROLET
Proudly Welcomes



RON SIMONS
TO OUR USED CAR DEPT. TEAM OF SALES PROFESSIONALS

Ron extends an invitation to all of his friends and former customers to visit him at Mark Chevrolet and see their large selection of fine quality used cars and trucks including the area's only used truck showroom.



33200 MICHIGAN AVE.
WAYNE 722-9147

866 Ford

MAVERICK 1973 Grabber. 2 door. White & black. AM-FM. tinted glass. steel styled wheels. radial tires. low miles. excellent condition. \$2,500. After 4:30 PM. 422-8590

FORD ELITE 1975. Very low miles. Velour interior. like new \$3,195

COOK-FARR FORD
10 Mile at Greenfield. 399-6600
Call about our exclusive warranty

MUSTANG II 1974. V-6. power steering. power brakes. AM-FM. 8 track quad. 427-8318

FORD 1970. Custom 4 door. New shocks, brakes. tune up. Runs great. some rust. 562-3669

PINTO RUNABOUT 1974. Well maintained. Automatic, good tires. Excellent second car offer for student. \$1,392. 478-7640. 427-7389

FORD 1969. 302 automatic. power steering. 52,000 miles. \$425. 422-0547

GRAN TORINO Wagon. 1974. 351 automatic. radio. roof rack. radial ply tires. rustproofed. low mileage. \$2,500. After 6 PM. 646-0084

866 Ford

MAVERICK 1971. 2 door. automatic. exceptionally nice. excellent transportation. \$995. Avis Ford. Telegraph at 12 Mile. 354-3100

FORD 1971. Station Wagon. air. power steering. luggage rack. low mileage. \$750. Good condition. 421-6271

MUSTANG 1968. GT Fastback. 390 balanced and blue. printed. power steering. brakes. automatic. \$3,600. 54,000 miles. extras. best offer. 477-7380

TORINO 1971. 2 door. excellent condition. power steering. radio. automatic. \$750. 981-1225

MARK CHEVROLET
Proudly Welcomes

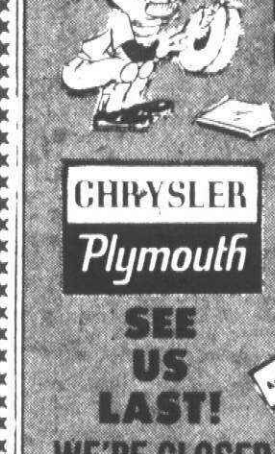

RON SIMONS
TO OUR USED CAR DEPT. TEAM OF SALES PROFESSIONALS

Ron extends an invitation to all of his friends and former customers to visit him at Mark Chevrolet and see their large selection of fine quality used cars and trucks including the area's only used truck showroom.



33200 MICHIGAN AVE.
WAYNE 722-9147

BOB SAKS OLDSMOBILE

1976 OLDS 98 REGENCY COUPE Automatic, power steering, power brakes, factory air, vinyl roof, AM-FM stereo, rear defogger, power door locks, power windows, power seats, tilt, cruise, tinted glass, pin striping. \$1K 7185-A \$6,474	1976 TORONADO DEMO 6 way power seats, power door locks, tint glass, power trunk, body side moldings, door edge guards. \$1K 773 \$6,990
1976 REGENCY SEDAN DEMO 6 way power seats, power door locks, tint glass, power trunk, body side moldings, door edge guards. \$1K 773 \$6,895	1976 DELTA "88" DEMO 2 door, V8 turbo-hydraulic, power steering, power brakes, radio, air conditioning, white walls. Demo \$1K 054 \$4,860

SERVICE OPEN AT 7:30 A.M.
WE SERVICE ALL G.M. CARS
AT GRAND RIVER AND DRAKE—JUST 2 MI. W. OF FARMINGTON

'200 REBATE ON ALL 1977 SUNBIRDS & ASTRES

'77 DEMO'S NOW ON SALE ALL MODELS

ALL FACTORY STANDARD EQUIPMENT			
'77 ASTRE 2 DOOR COUPE 13069 —\$200 REBATE \$2,869	'77 BONNEVILLE 2 door \$4,433	'77 GRAND PRIX J 2 door \$4,335	'77 SUNBIRD 2 door \$3,277

BOB SELLERS PONTIAC
DETROIT'S VOLUME PONTIAC DEALER
22520 GRAND RIVER, EAST OF TELEGRAPH
OPEN MON. & THURS. TIL 9:00
KE 5-7600

think small SAVE BIG

MR. COLONY SEZ CATCH THESE DEALS!

CHRYSLER Plymouth

SEE US LAST! WE'RE CLOSER THAN YOU THINK!

'77 VOLARE \$3165	'77 CORDOBA \$4586
'77 FURY \$3294	'77 NEW YORKER \$5711

Don Marino's COLONY CHRYSLER Plymouth
111 ANN ARBOR RD. 3 Blocks W. of (M-14) I-275 Interchange
PLYMOUTH 453-2255

RENTALS DAILY-WEEKLY MONTHLY WO 2-5830

STU EVANS SELLS FOR LESS

STU MERCURY EVANS LINCOLN

GET OUR DEAL BEFORE YOU BUY

- MERCURY
- LINCOLN
- COUGAR
- CAPRI
- MONARCH
- MARQUE
- COMET
- BOBCAT
- MONTEGO

LARGE INVENTORY

1975 CHRYSLER CORDOBA
Double power, air conditioning, tinted glass. Landau top.
\$4,495

1976 COUGAR XR7
Full factory equipment, stereo, air conditioning, electric rear window defogger, white wall tires, landau top.
\$4,895

1975 THUNDERBIRD
Full power, air, stereo, triple silver, with leather interior. 17,000 miles.
\$5,995

1973 MONTEGO GT
2 door hardtop, V8, automatic, power steering and brakes, vinyl top, white wall tires. 35,000 actual miles. Sharp.
\$2,195

1975 MARK IV'S
Some with sun roof. All low mileage. Loaded including tape deck, AM/FM, air conditioning, speed control. Priced sensibly.
\$3,595

1975 OLDS CUTLASS SUPREME
V8, automatic, power steering and brakes, factory air, AM/FM tape player, tinted glass, radial tires. Red with white landau top, white interior.
\$3,995

1976 CAPRI II
4 speed transmission, radio, radial tires, 2300 LT engine, low mileage.
\$3,395

1974 FORD VAN
V8, automatic, power steering, AM/FM tape stereo, factory air conditioning, tinted glass.
\$7,395

1973 THUNDERBIRD LANDAU
Beautiful Aztec yellow, exceptionally clean, stereo, air conditioning, full power, vinyl top.
\$3,995

1975 CORVETTE
Automatic, power steering and brakes, air conditioning, stereo, T top, beautiful jet black with silver interior.
\$7,395

Home of Lovable Louie
LOU LARICHE CHEVROLET
48875 PLYMOUTH RD. PLYMOUTH, MICH.
PHONE 453-4600

32000 FORD ROAD (near Merriman) GARDEN CITY 425-4300

MAZDA BUY MAZDA

Now before Spring and get FREE AIR CONDITIONING on any MAZDA car or truck in stock! Hurry while selection is great

LIVONIA MAZDA SAAB, INC.
34501 Plymouth Rd.
Livonia
425-5400

FOR THIS WEEK!

Pay More! Why Pay More! Why Pay More! Why Pay More! Why Pay More! Why Pay More!



Food Club

LARGE OR SMALL CURD
COTTAGE CHEESE

24 oz. wt.
carton

68¢ SAVE 35¢



CREAMY OR CRUNCHY

JIF
PEANUT BUTTER

28 oz.
wt. jar

\$1.28 SAVE 25¢

DOWNY FROZEN
WAFFLES
45¢

DIARY FRESH PINCONNING
STYLE COLBY CHEESE

MIDGET
LONGHORN

16 oz.
wt.
pkg. **\$1.29**

SQUEEZE OR SOFT
PARKAY
MARGARINE
55¢

MRS.
BUTTERWORTH
SYRUP

36 fl.
oz.
bottle **\$1.19**

SIPSEY VALLEY ORANGE,
ROOT BEER OR
STRAWBERRY
SOFT DRINKS
39¢

EVERFRESH FROZEN
GLAZED
DOUGHNUTS
68¢

PILLSBURY
BUTTERMILK
BISCUITS
10¢

BETTY CROCKER
FAMILY FUDGE
BROWNIE MIX
22-1/2 oz.
68¢

MINUTE MAID
FROZEN

ORANGE JUICE

12 fl. oz. can

39¢ SAVE 24¢



GRAPE, GRAPEFRUIT,
ORANGE, OR LO-CAL ORANGE

WAGNER
BREAKFAST DRINKS

54 fl.
oz. bottle

59¢ SAVE 14¢



RICH'S FROZEN
BREAD
DOUGH

5 pt.
5 lb.
pkg. **89¢**

REGULAR OR WITH
MINI-MARSHMALLOWS
INSTANT
SWISS MISS
COCOA MIX
79¢

Food Club
MINIATURE
MARSHMALLOWS

16 oz.
wt. (1 lb.)
pkg. **44¢**

GAYLORD

MARGARINE

QUARTERS
16 oz.
wt. pkg. **4/\$1**

SALUTO FROZEN
SASSY & SPICY
PIZZA

18 oz.
wt. pie

\$1.47 SAVE 60¢

DEL MONTE
CATSUP

38 oz.
wt. bottle

88¢



m MEIJER COUNTY LINE MEDIUM SHARP CHEESE Any Size Piece **10¢ OFF** WITH COUPON GOOD 1/24 THRU 1/29/77 DEPT. 419

m MEIJER ORE IDA FROZEN REGULAR OR CRINKLE CUT FRIES 5 lb. pkg. **\$1.55** WITH COUPON GOOD 1/24 THRU 1/29/77 DEPT. 418

m MEIJER HENRIS YOGONAISE OR YOGO WHIP SALAD DRESSING 32 fl. oz. jar (qt.) **30¢ OFF** WITH COUPON GOOD 1/24 THRU 1/29/77 DEPT. 417

m MEIJER BUGLES 7 oz. wt. box **2/\$1** WITH COUPON GOOD 1/24 THRU 1/29/77 DEPT. 419

m MEIJER WITH DEODORANT MINI PADS KOTEX 24 ct. box **99¢** WITH COUPON GOOD 1/24 THRU 1/29/77 DEPT. 412

PRICES GOOD MON. JAN. 24 THRU SAT. JAN. 29, 1977. MEIJER RESERVES THE RIGHT TO LIMIT SALES ACCORDING TO SPECIFIED LIMITS. NO SALES TO DEALERS, INSTITUTIONS OR DISTRIBUTORS.

MEIJER THRIFTY ACRES — 45001 FORD RD. AT CANTON CENTER RD.

SHOP MONDAY THRU SATURDAY 8 A.M. TO 10:30 P.M. — SUNDAY 9 A.M. TO 7 P.M.

Why Pay More! Why Pay More! Why Pay More! Why Pay More! Why Pay More! Why Pay More!

Why Pay More! Why Pay More! Why Pay More! Why Pay More! Why Pay More! Why Pay More!

Why Pay More! Why Pay More! Why Pay More! Why Pay More! Why Pay More! Why Pay More!



GOLD MEDAL FLOUR

5 lb. bag

55¢

SAVE 20¢



ORTEGA TACO SHELLS OR TOSTADA SHELLS

10 ct. 4 oz. wt. box

3/\$1

SAVE 32¢-47¢

CHEF BOY-AR-DEE MEATLESS, WITH MEAT OR WITH MUSHROOMS SPAGHETTI SAUCE

15 oz. wt. can

43¢

MUELLERS VERMICELLI OR REGULAR OR THIN SPAGHETTI

16 oz. wt. pkg.

38¢

OLD EL PASO MILD TACO SAUCE OR HOT SAUCE

8 oz. wt. bottle

2/\$1

VAN CAMP NEW ORLEANS STYLE KIDNEY BEANS

15 oz. wt. can

26¢

KRAFT 1000 ISLAND DRESSING

16 fl. oz. bottle

69¢

OLD EL PASO TACO MIX

1-1/4 oz. wt. pkg.

4/\$1

OLD EL PASO REFRIED BEANS

16 oz. wt. can

3/\$1

HUNTS MANWICH SAUCE

NEW SIZE CAN

27-1/2 oz. wt. can

75¢

SAVE 20¢



WHITE OR ASSORTED KLEENEX FACIAL TISSUE

200 ct. box

45¢

SAVE 10¢

BEET SUGAR

5 lb. bag

59¢ WITH COUPON

Food Club SALAD OLIVES WITH PIMENTO

10 oz. wt. jar

66¢

Food Club FRESH PAK POLISH OR KOSHER DILL PICKLES

48 fl. oz. jar

78¢

FRENCH'S BIG TATE MASHED POTATO FLAKES

28 oz. wt. box

69¢

ORANGE, COLA CREAM SODA OR ROOT BEER

O'SO SOFT DRINKS

12 fl. oz. non-returnable bottles

8/\$1

SAVE 12¢



EVAPORATED PET MILK

13 fl. oz. can

29¢

MEIJER BUSH WITH BACON BAKED BEANS
28 oz. wt. can
48¢
WITH COUPON
GOOD 1/24 THRU 1/29/77
DEPT. 417

MEIJER BEET SUGAR
5 lb. bag
59¢
WITH COUPON
GOOD 1/24 THRU 1/29/77
DEPT. 419



10¢ OFF LABEL LIME LIQUID DISH DETERGENT SWEETHEART
22 fl. oz. bottle
29¢

FURNITURE POLISH LEMON OR WOOD SCENT PLEDGE
14 oz. wt. can
\$1.19

PRICES GOOD MON. JAN. 24 THRU SAT. JAN. 29, 1977. MEIJER RESERVES THE RIGHT TO LIMIT SALES ACCORDING TO SPECIFIED LIMITS. NO SALES TO DEALERS, INSTITUTIONS OR DISTRIBUTORS.

MEIJER

• WELCOMES U.S.D.A. GOVERNMENT FOOD STAMPS
• RESERVES THE RIGHT TO LIMIT TO REASONABLE QUANTITIES

Why Pay More! Why Pay More! Why Pay More! Why Pay More! Why Pay More! Why Pay More!

Why Pay More! Why Pay More! Why Pay More! Why Pay More! Why Pay More! Why Pay More!

Why Pay More!

From the Tender, lovin' meat people

Why Pay More!



BONELESS OLD VIRGINIA HAM

WHOLE FULLY CURED - VERY LEAN -

\$1.18 lb.

(WATER ADDED BY MANUFACTURER)



MEIJER FINEST U.S.D.A. CHOICE

BONELESS CHUCK SHOULDER ROAST 98¢ lb.



SATISFACTION GUARANTEED or Double Your Money Back

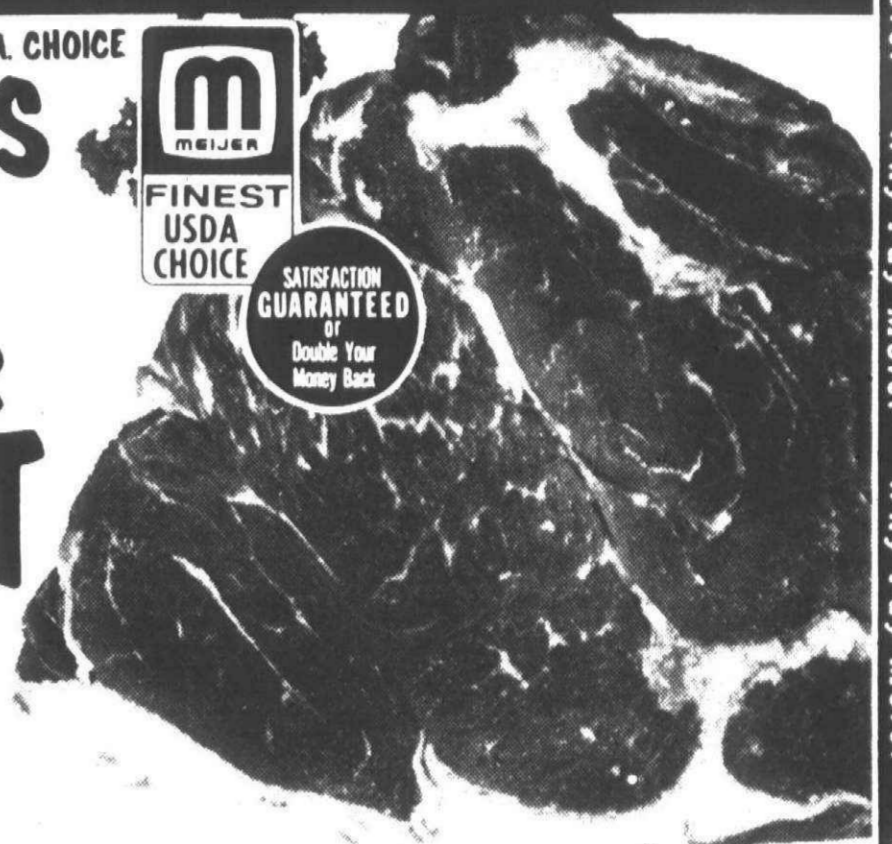

VEAL SALE THE FINEST

STRALING BROTHERS GRAND PRIX de Veau

- VEAL BLADE SHOULDER STEAK \$1.69 lb.
- VEAL BLADE SHOULDER ROAST \$1.49 lb.
- VEAL RIB CHOPS \$1.99 lb.
- VEAL BREAST 99¢ lb.



BONELESS CHUCK SHOULDER STEAK \$1.08 lb.

SATISFACTION GUARANTEED or Double Your Money Back

CAPTAIN FRESH PAN READY WHITE FISH

A VERY TASTY FISH \$1.59 lb.

ARMOUR COOKED, SLICED HAM \$1.29 6 oz. wt. pkg.

ARMOUR FROZEN FRYER THIGHS 39¢ lb.

1 lb. BEST KOSHER BOLOGNA CHUBS \$1.79

Food Club LINK SAUSAGE 89¢ pkg.

ARMOUR SLICED REG. OR THICK BOLOGNA OR COOKED SLICED SALAMI 99¢ lb.

Food Club SLICED REGULAR, THICK, OR GARLIC BOLOGNA 69¢ 12 oz. wt. pkg.

- WHOLE RING BOLOGNA per lb. 88¢
- ARMOUR HOT DOGS per lb. 79¢
- FOOD CLUB ALL BEEF FRANKS per lb. 79¢
- HERRUD CHUNK JUMBO BOLOGNA per lb. 68¢
- HERRUD BEEFEATER BEEF FRANKS per lb. 98¢
- HERRUD TWIN PAC BEER SALAMI 12 oz. wt. pkg. \$1.29
- OSCAR MAYER PORK SAUSAGE LINKS per lb. \$1.69
- OSCAR MAYER SLICED BACON per lb. \$1.69
- OSCAR MAYER REGULAR OR BEEF SLICED BOLOGNA 12 oz. wt. pkg. \$1.09
- OSCAR MAYER SLICED HARD SALAMI 8 oz. wt. pkg. \$1.58
- ECKRICH SKINLESS FRANKS per lb. 99¢
- ECKRICH REGULAR OR THICK SLICED BOLOGNA per lb. \$1.49
- ECKRICH MAPLE, REGULAR OR BEEF SMOK-Y-LINKS 10 oz. wt. pkg. 99¢

Herrud SMOKED OR POLISH SAUSAGE 89¢ 14 oz. wt. pkg.

Herrud BOLOGNA, SALAMI, OR COMBINATION FAMILY PAC \$1.39 20 oz. wt. pkg.

ARMOUR OLD FASHION LOAF LIVER CHEESE LOAF SLICED REG. BOLOGNA SLICED BEEF BOLOGNA COOKED SALAMI PICKLE PIMENTO LOAF 6 oz. wt. pkg.

YOUR CHOICE 49¢

Herrud SLICED BOLOGNA OR SKINLESS REGULAR OR BEEF FRANKS 79¢ lb.

Herrud NEW ENGLAND OR HONEY LOAF 79¢ 8 oz. wt. pkg.

ARMOUR ALL BEEF HOT DOGS 69¢ 12 oz. wt. pkg.

ARMOUR SMOKEES 89¢ 12 oz. wt. pkg.

Why Pay More! Why Pay More! Why Pay More! Why Pay More! Why Pay More! Why Pay More!

— EARLY AMERICAN —

CAST IRON COOK-WARE

COLLECT ALL 12 PIECES!

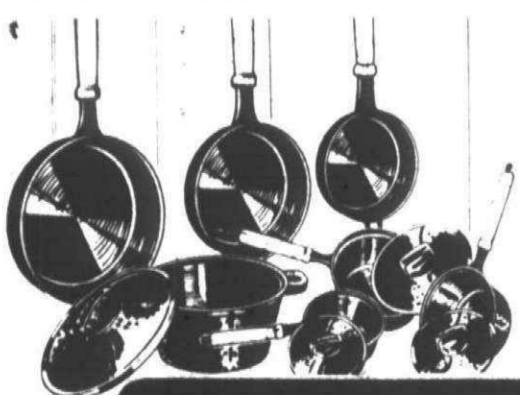

THIS WEEK'S FEATURE



10" OPEN SKILLET \$3.49

With \$5.00 purchase excluding prescriptions, tobacco, and alcoholic beverages

JOIN OUR 8 WEEK PLAN

SCHEDULE SUBJECT TO AVAILABILITY OF PRODUCT

WEEK	FEATURE ITEM	PURCHASE PRICE WHEN NOT FEATURED	FEATURE PRICE *
JANUARY 24	10" OPEN SKILLET	\$4.99	\$3.49
JANUARY 31	2 QT. COVERED SAUCEPAN	\$4.99	\$3.49
FEBRUARY 7	6" OPEN SKILLET	\$2.99	\$1.49
FEBRUARY 14	1 QT. COVERED SAUCEPAN	\$3.99	\$2.49
FEBRUARY 21	10" OPEN SKILLET	\$4.99	\$3.49
FEBRUARY 28	2 QT. COVERED SAUCEPAN	\$4.99	\$3.49

* With \$5.00 purchase excluding prescriptions, tobacco, and alcoholic beverages

PRICES GOOD MON. JAN. 24 THRU SAT. JAN. 29, 1977. MEIJER RESERVES THE RIGHT TO LIMIT SALES ACCORDING TO SPECIFIED LIMITS. NO SALES TO DEALERS, INSTITUTIONS OR DISTRIBUTORS.

Why Pay More! Why Pay More! Why Pay More! Why Pay More! Why Pay More! Why Pay More!

m in the jewelry/small appliance department

"LITTLE MAC" BURGER MACHINE BY HAMILTON BEACH
 Convertible grid is round for hamburger, square for sandwiches. Cooks in 60 seconds. Non-stick cooking surface. #2108.



by Hamilton Beach
Scovill
\$12⁹⁹

CROCK SLOW COOKER BY HAMILTON BEACH
 Slow cooks, casseroles, curries, stews, etc. Crockery liner. 4 qt. capacity. Low, high temp. Gingham decor. #448C.



\$10⁹⁹

3-SPEED HAND MIXER BY HAMILTON BEACH
 Three speed fingertip control. Chrome-plated beaters for long life and easy clean-up. Beater ejector button. #87.

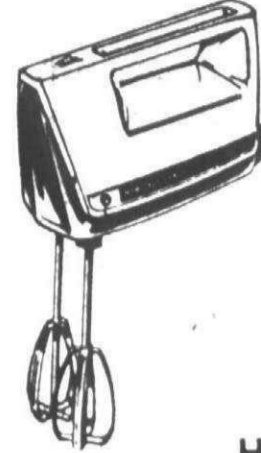

\$7⁴⁴

by Hamilton Beach
Scovill

STEAM-SPRAY-DRY IRON BY HAMILTON BEACH
 39 vents. Spray feature gives you extra steam penetration. #885.



Save \$4.00 REG. \$18.97 **\$14⁹⁷**

Clearance!
CROCKERY COOK POT BY GRANDINETTI
 3 1/2 quart. Healthy exterior. Healthy economical way to cook. Hi-lo heat control. #532W.



\$10⁹⁹

NEW CHILTON FRY BUCKET/DEEP FRYER
 Non-stick interior. Earth brown exterior. #88-82.



Save \$4.00 REG. \$14.97 **\$10⁹⁷**

SUNBEAM COFFEEMASTER DELUXE DRIP COFFEEMAKER
 Brews 4 to 10 cups. Drip method. Super-fine filter. Thermostat controlled. #15-213.



\$25⁹⁷

SUNBEAM GLASS CARAFE
 Replacement carafe glass for Sunbeam drip coffeemaker. #94-180.



REG. \$2.77 **\$2⁴⁷**

SONIC IV STEREO HEADPHONES
 Frequency response: 15-23,000 Hz. 15 ft. coiled extension cord. 4 speakers. Built-in crossover networks.



Save \$11.09 REG. \$29.97 **\$18⁸⁸**

SOUNDESIGN
 Save \$50.00
 REG. \$199.88
\$149⁸⁸



SOUNDESIGN DELUXE AM/FM/FM STEREO RECEIVER WITH 8-TRACK TAPE PLAYER-RECORDER WITH TWO SPEAKERS
 8-track play/record mechanism, auto-stop after program 4 in record. Dual recording level meters. Includes FM dipole antenna, two microphones. #5437-46.

Captain Kelly by Gillette
GILLETTE CAPTAIN KELLY EARLY WARNING SMOKE DETECTOR
 Easy to install. Operates on AC household current. Includes an "on" indicator light. Operates on photoelectric principle. Solid state circuitry. UL listed. #9410.



REG. \$36.97 - Save over \$9.00 **\$27⁸⁷**

HOOVER CONVERTIBLE UPRIGHT VACUUM
 Fingertip switch. Large throw-away bag. 3-position handle. Instant rug adjustment. Edge cleaning suction power. Non-marking guard. Converts easily for cleaning attachments. #U4089.



Save \$17 REG. \$66.88 **\$49⁸⁸**

WEST BEND
WEST BEND 10 CUP ELECTRIC COFFEE/BEVERAGE SERVER
 Keeps up to 10 cups of coffee, tea or other beverages serving hot. Includes glass carafe cover, keep warm plate. #5914.



REG. \$9.97 - Save \$2.00 **\$7⁹⁷**

WEST BEND
WEST BEND 9 CUP AUTOMATIC COFFEEMAKER
 Lightweight aluminum makes 5 to 9 cups of delicious coffee. Harvest gold finish. #9450.



REG. \$9.97 **SAVE \$3.00 \$6⁹⁷**

WEST BEND
WEST BEND 30 CUP PARTY PERK
 Brews coffee, keeps it hot automatically. Makes any amount from 12 to 30 cups. Touch-pour spout. Light glows when coffee's ready. #Avocado 1868; Gold 1869; Pol. Alum. 11838.



\$11⁹⁷

GENUINE MR. COFFEE FILTERS
 • Box of 200 filters



\$1²⁹

G.E. DIGITAL ELECTRIC ALARM CLOCK
 Large electronic style lighted digits. Your choice! #8138-603.



\$14⁸⁸



EAR PIERCING CLINIC: SAT. JANUARY 29 - 11:00 a.m. TO 5:00 p.m.
 Wear the fashionable jewelry of today's new look! We'll pierce your ears...in a simple, painless procedure with Surgical sterile studs. Ear piercing takes less than 2 minutes and is completely painless. Includes 24K gold over surgical grade stainless studs and clasps. Non-allergenic. All work done by trained personnel.

\$6⁹⁵

25% off any 10K-12K-14K gold pierced earrings in stock that are purchased during clinic hours on above dates.

Beautiful NECKLACE
 for your special Valentine!



Choose one of these attractive gold or silver tone necklaces with assorted designs.

YOUR CHOICE! \$1⁸⁷ ea.

Jewelry Dept.

THE WASHING MACHINE
 The appliance that organizes your shower. Just pour in your shampoo, conditioner, and liquid Clean & Rich, and then push a button when you need them.



#WMG101 or 102.

ALSO AVAILABLE IS LIQUID CLEAN & RICH™ LIQUID BODY SHAMPOO MADE ESPECIALLY FOR THE WASHING MACHINE. WHITE ALMOND OR AZURE BLUE AT "WHY PAY MORE" PRICES.

\$16⁹⁷

GILLETTE SUPERMAX 2 STYLER-DRYER
 800 watts. Two powerful settings, dry for fast drying & style for gentle drying. 3 attachments: detangling & styling comb, straightening & shaping comb & finished styling brush. #9180-9190.



\$15⁶³

SCHICK
SCHICK PROJEX 1500 WATT DRYER
 Adjustable speed. Nozzle design provides high air velocity for super-fast job. Built-in safety feature protects against overheating. #PJ1500.



REG. \$24.88 **\$19⁹⁷**

CORDLESS WALL CLOCKS BY BURWOOD
 (1) #7427 Kitchen Wares
 (2) #7053 Mushrooms
 (3) #7299 Kitchen Utensils



YOUR CHOICE! \$11⁹⁷ ea.

G.E. SNOOZE ELECTRIC ALARM CLOCK
 Distinctive oval design. Alarm wakes you again and again. #7406-206.



REG. \$7.47 - Save \$2.50 **\$4⁹⁷**



MEIJER
 thrifty acres

photo department

KODAK INSTAMATIC X-35 CAMERA OUTFIT
 An electric eye camera that takes beautiful color pictures.



Save \$5.00
 REG. \$42.97 **\$37⁹⁷**

KODAK LOW LIGHT MOVIE CAMERA OUTFIT
 • Model XL320



OUR REG. \$89.88
 SAVE \$10.91 **\$78⁹⁷**

KODAK MOVIE DECK PROJECTOR
 Automatic threading and rewind, fast forward, slow motion and normal speeds. #D455.



SAVE \$20.00

FUJICOLOR II COLOR PRINT FILM
 For better color prints in any light, brighter colors and better details. Your choice of 110-20 (pocket size), 126-20 (instant load) or 135-20.



YOUR CHOICE! 99¢

NATIONAL SEMICONDUCTOR MATHEMATICIAN SCIENTIFIC CALCULATOR
 • Model 4510



REG. \$19.97 **\$13⁹⁷**

DELUXE FOAM SLR CASE
 • By Marsand
 • Model RSL-40



Save \$10.00
 REG. \$39.97 **\$29⁹⁷**

PRICES GOOD MONDAY JAN. 24 THRU SATURDAY JAN. 29, 1977. MEIJER RESERVES THE RIGHT TO LIMIT SALES ACCORDING TO SPECIFIED LIMITS. NO SALES TO DEALERS, INSTITUTIONS OR DISTRIBUTORS. Page 5

YOU DON'T NEED CASH! USE EITHER OF THESE CONVENIENT CREDIT CARDS!

your **BANKAMERICARD** welcome

master charge THE INTERBANK CARD

Topco Sale!

 <p>COMPARE AND SAVE</p> <p>TOPCO THIS WEEK ONLY!</p> <p>48¢</p> <p>BUFFERIN TABLETS • 100 count REG. 84¢</p>	 <p>COMPARE AND SAVE</p> <p>TOPCO THIS WEEK ONLY!</p> <p>78¢</p> <p>TOPCO BUFFERED ASPIRIN • 100 count REG. 69¢</p>	 <p>COMPARE AND SAVE</p> <p>TOPCO THIS WEEK ONLY!</p> <p>44¢</p> <p>SINE AID TABLETS • 50 count REG. \$1.81</p>	 <p>COMPARE AND SAVE</p> <p>TOPCO THIS WEEK ONLY!</p> <p>59¢</p> <p>TOPCO SINUS TABLETS • 50 count REG. 98¢</p>	 <p>COMPARE AND SAVE</p> <p>TOPCO THIS WEEK ONLY!</p> <p>77¢</p> <p>CONTAC COLD CAPSULES- 10 count REG. 79¢</p>	 <p>COMPARE AND SAVE</p> <p>TOPCO THIS WEEK ONLY!</p> <p>77¢</p> <p>TOPCO COLD CAPSULES • 10 count REG. 54¢</p>	 <p>COMPARE AND SAVE</p> <p>TOPCO THIS WEEK ONLY!</p> <p>77¢</p> <p>MAALOX LIQUID ANTACID • 12 fl. oz. REG. 96¢</p>	 <p>COMPARE AND SAVE</p> <p>TOPCO THIS WEEK ONLY!</p> <p>88¢</p> <p>TOPCO MAL-A-GEL LIQUID ANTACID • 12 fl. oz. REG. 78¢</p>
 <p>COMPARE AND SAVE</p> <p>TOPCO THIS WEEK ONLY!</p> <p>88¢</p> <p>ONE-A-DAY MULTIPLE VITAMINS PLUS IRON • 100 count REG. \$1.97</p>	 <p>COMPARE AND SAVE</p> <p>TOPCO THIS WEEK ONLY!</p> <p>49¢</p> <p>TOPCO ADULT MULTIPLE VITAMINS PLUS IRON • 100 count REG. \$1.28</p>	 <p>COMPARE AND SAVE</p> <p>TOPCO THIS WEEK ONLY!</p> <p>77¢</p> <p>LISTERINE MOUTHWASH • 14 fl. oz. REG. 65¢</p>	 <p>COMPARE AND SAVE</p> <p>TOPCO THIS WEEK ONLY!</p> <p>77¢</p> <p>TOPCO MOUTHWASH • 16 fl. oz. REG. 56¢</p>	 <p>COMPARE AND SAVE</p> <p>TOPCO THIS WEEK ONLY!</p> <p>77¢</p> <p>JOHNSON & JOHNSON BABY SHAMPOO • 16 fl. oz. REG. \$1.28</p>	 <p>COMPARE AND SAVE</p> <p>TOPCO THIS WEEK ONLY!</p> <p>77¢</p> <p>TOPCO BABY SHAMPOO • 16 fl. oz. REG. 88¢</p>	 <p>COMPARE AND SAVE</p> <p>TOPCO THIS WEEK ONLY!</p> <p>77¢</p> <p>BAN ANTI-PERSPIRANT ROLL-ON • 2.5 fl. oz. REG. \$1.01</p>	 <p>COMPARE AND SAVE</p> <p>TOPCO THIS WEEK ONLY!</p> <p>49¢</p> <p>TOPCO ANTI-PERSPIRANT ROLL-ON • 2.5 fl. oz. REG. 88¢</p>
 <p>COMPARE AND SAVE</p> <p>TOPCO THIS WEEK ONLY!</p> <p>49¢</p> <p>WERNETS DENTU-CREME • 5.1 oz. net wt. REG. \$1.24</p>	 <p>COMPARE AND SAVE</p> <p>TOPCO THIS WEEK ONLY!</p> <p>39¢</p> <p>TOPCO DENTURE CREAM • 5 oz. net wt. REG. 68¢</p>	 <p>COMPARE AND SAVE</p> <p>TOPCO THIS WEEK ONLY!</p> <p>99¢</p> <p>CREST TOOTHPASTE • 7 oz. net wt. REG. 93¢</p>	 <p>COMPARE AND SAVE</p> <p>TOPCO THIS WEEK ONLY!</p> <p>99¢</p> <p>TOPCO FLUORIDE TOOTHPASTE • 7 oz. net wt. REG. 52¢</p>	 <p>COMPARE AND SAVE</p> <p>TOPCO THIS WEEK ONLY!</p> <p>49¢</p> <p>GILLETTE TRAC II BLADES • 9 count REG. \$1.71</p>	 <p>COMPARE AND SAVE</p> <p>TOPCO THIS WEEK ONLY!</p> <p>49¢</p> <p>TOPCO TWIN II BLADES • 9 count REG. \$1.47</p>	 <p>COMPARE AND SAVE</p> <p>TOPCO THIS WEEK ONLY!</p> <p>49¢</p> <p>GILLETTE FOAMY SHAVE CREAM • 11 oz. net wt. REG. 66¢</p>	 <p>COMPARE AND SAVE</p> <p>TOPCO THIS WEEK ONLY!</p> <p>49¢</p> <p>TOPCO SHAVE CREAM • 11 oz. net wt. REG. 59¢</p>

in the pharmacy department



Continues to Advertise Prescription Drug Prices!

THESE PRICES MAY NOT BE APPLIED ON A PER UNIT BASIS FOR OTHER THAN QUANTITIES INDICATED.

10 Examples of Our Low Rx Prices

PRICES GOOD THRU FEB. 5, 1977

ACTIFED SYRUP • 4 fl. oz. • 30 tablets • Triprolidine Hydrochloride and Pseudoephedrine Hydrochloride \$1.29	QUINIDINE SULFATE • 3 gr. • 100 tablets \$6.99	DARVON COMPOUND • 65 mg. • 30 capsules \$1.99	LANOXIN • (Digoxin 0.25 mg.) • 100 tablets 79¢	ACTIFED TABLETS • 30 tablets • Triprolidine Hydrochloride and Pseudoephedrine Hydrochloride \$1.33
PENICILLIN VK • 24 tablets • 250 MG \$1.77	SELSUN SHAMPOO • (Selenium Sulfide Lotion) 4 fl. oz. \$2.09	AMPICILLIN CAPSULES • 250 mg. • 30 capsules \$1.97	TETRA-CYCLINE HCL • 100 capsules • 250 MG \$1.99	PAPAVERINE HYDROCHLORIDE • 150 MG • 100 capsules \$3.99

in the school supplies department

FILE FOLDERS • 9" x 12" • Third cut • 100 count \$3.88	2 DRAWER FILE CABINET Black, 14" deep, 15" wide, Approximately 28" high. \$22.88
BOXED ENVELOPES 2/88¢ • 6 1/4" size - 100 count	DATA CENTER BINDER 11" x 8 1/2". Bifold binder with 1" plastic "Pinchless" slide-ring fixture holding 3 tabbed file pockets, blank planning calendar, & plastic pencil holder. \$2.44
CHECK FILE Holds all standard checks up to IBM size. Includes 12 monthly index cards. Follow block, pull-out removable drawer. \$2.44	BAGGED PENCILS • #2 lead, Mfg. overrun and misprints • 17 count • Eraser tip 2/88¢
MEMO PAD • 5" x 8" • 80 sheet count 28¢	FORMAL WHITE THANK YOU NOTES 4 / \$1 • 10 count
NOTES • Cute, Floral or Thank You - 14 ct. 3 / \$1	

 <p>BRAN SLIM TABLETS • 54 count \$2.59</p>	 <p>DEXATRIM • 28 count REG. \$3.39 \$2.79</p>
 <p>EMPIRIN COMPOUND TABLETS • 100 count 99¢</p>	 <p>ORNEX CAPSULES • 20 count \$1.19</p>
 <p>TRIND DM SYRUP • 4 fl. oz. \$1.68</p>	

Page 5 PRICES GOOD MON. JAN. 24 THRU SAT. JAN. 29, 1977. MEIJER RESERVES THE RIGHT TO LIMIT SALES ACCORDING TO SPECIFIED LIMITS. NO SALES TO DEALERS, INSTITUTIONS OR DISTRIBUTORS.

MEIJER THRIFTY ACRES — 45001 FORD RD. AT CANTON CENTER RD.

SHOP MONDAY THRU SATURDAY 8 A.M. TO 10:30 P.M. — SUNDAY 9 A.M. TO 7 P.M.

Why Pay More! Why Pay More! Why Pay More! Why Pay More! Why Pay More! Why Pay More! Why Pay More! Why Pay More! Why Pay More! Why Pay More!

FABRICS
1/2 OFF

Save 50% on discontinued and seasonal fabrics. Buy and save on fashions for home sewing. Several blends, designs & color combinations.

"While Quantities Last"

Domestics Dept.

LOOK FOR THE BRIGHT RED CLEARANCE SIGNS IN ALL DEPARTMENTS. THEY POINT TO DISCONTINUED MERCHANDISE, OVERSTOCKS, SOME ONE OF A KIND ITEMS, ALL AT SPECIAL SAVINGS. WHILE THEY LAST!

MEN'S KNIT DRESS PANTS

Sale on several patterns and colors of our famous maker knit dress pants. Not all styles in all sizes.

Clearance! While Quantities Last!
OUR REG. \$10.96 to \$12.96

\$8⁹⁶
pr.

Men's Dept.

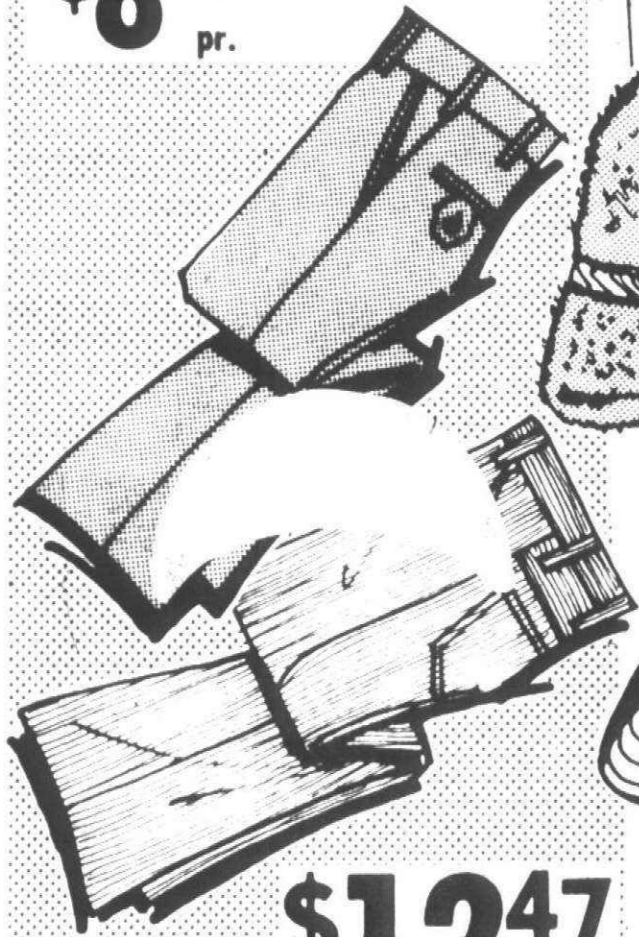

\$12⁴⁷
pr.

MEN'S FASHION CORDUROY PANTS

Sale on several styles of our famous maker corduroy pants. Not all styles in all sizes. Choose now and save.

Clearance! While Quantities Last!
OUR REG. \$14.97 to \$15.97

Men's Dept.

CLEARANCE MEN'S HATS & CAPS

Choice of many styles.

While Quantities Last.
OUR REG. \$2.97 to \$4.97

\$1⁵⁰
ea.

Men's Dept.

MEN'S DRESS SHIRTS

Huge savings on long sleeve dress shirts.
Sizes 14 1/2 to 17.

Save over 40%
OUR REG. \$6.96
Save \$3.00

\$3⁹⁶

Men's Dept.

BOYS' OUTERWEAR

Save on these jackets at clearance prices. While they last. Broken sizes and styles. Not all sizes and styles in all stores.

OUR REG. \$11.88 to \$16.00

\$9⁰⁰ to \$12⁰⁰



Astro

MEN'S, BOYS' & YOUTHS' BASKETBALL SHOES

Assorted colors, duck uppers, pull proof eyelets. Not all sizes in all colors. Men's sizes 6 1/2 to 12. Boys' sizes 2 1/2 to 6. Youths' sizes 11 to 12.

OUR REG. \$4.96

\$2⁷⁷
pr.

Shoe Dept.



BOYS' DENIM SUIT

2 pc. denim suits of 50% cotton - 50% polyester. For dress-up or casual. Sizes 8-16.

OUR REG. \$12.00

\$10⁰⁰

Boys' Dept.



GIRLS' FASHION TOPS

Large assortment. Long sleeve, or short sleeve knits, blouse styles. Sizes 4-14.

Final Clearance!
\$1⁰⁰
ea.

GIRLS' JACKETS & DRESS COATS

Sizes 4 to 14.

SAVE 40% to 60% OFF ORIGINAL PRICE

While Quantities Last!
ORIG. \$10.47 to \$30.97

\$6⁰⁰ to \$12⁰⁰



Girls' Dept.



YOU DON'T NEED CASH! USE EITHER OF THESE CONVENIENT CREDIT CARDS!



A. FOR THE "MOTHER TO BE"

Your choice of any maternity blouse or slacks in our large selection priced from:
REG. \$6.97 to \$10.47 - Save \$1.50 with coupon

\$5.47 **\$8.97**
ea. TO ea.
WITH COUPON

B. LADIES' SPORT BRIEFS

• Control garments for an active life
• White only

SIZES S-M-L SIZE XL
\$1.87 **\$1.97**
pr. pr.

C. LADIES' BODY SHIRTS

Choose from long sleeve styles in assorted prints with a button front and collar. Available in sizes S-M-L.

\$5.00
ea.

D. LADIES' POLYESTER GABARDINE FASHION PANTS

100% polyester with zip front and decorative trim or fashion pockets. Choose from assorted colors. Sizes 5-15.

\$8.97
pr.

E. LADIES' LONG ENKALURE GOWNS

• In gorgeous fashion colors
• Sizes S-M-L

Special Purchase

\$4.77
ea.

Ladies' Dept.

B. LADIES' SPORT BRIEFS

S-M-L XL
\$1.87 **\$1.97**
pr. pr.

BIG SAVINGS ON

C. LADIES' BODY SHIRTS

\$5.00
ea.

D. LADIES' POLYESTER GABARDINE PANTS

\$8.97
pr.

E. LADIES' ENKALURE GOWNS

\$4.77
ea.

A. MATERNITY BLOUSE OR SLACKS

\$5.47 **\$8.97**
TO
WITH COUPON



INFANTS' SLEEP & PLAY SETS

• Stretch terry
• Gift boxed
• Sizes R-L

\$1.99
set

Infants Dept.

m MEIJER **50¢ COUPON**
SPRINGCREST SUPPORT PANTY HOSE
Our Reg. \$1.77
\$1.27
pr.
WITH COUPON
GOOD 1/24 THRU 1/29/76
Coupon limited to one per item DEPT. 350

m MEIJER **\$1.50 COUPON**
MATERNITY BLOUSE OR SLACKS
Reg. \$6.97 to \$10.47
Any in stock
\$1.50 OFF
WITH COUPON
GOOD 1/24 THRU 1/29/76
Coupon limited to one per item DEPT. 340

m MEIJER **10¢ COUPON**
DAYTIME 30'S DISPOSABLE DIAPERS
PAMPERS
10¢ OFF
WITH COUPON
GOOD 1/24 THRU 1/29/76
Coupon limited to one per item DEPT. 210/041

Win IN THE Homecare Sweepstakes

GRAND PRIZE AMC PACER protected by the AMC Buyer Protection Plan and filled with \$1,000 worth of groceries.
274 other fabulous prizes

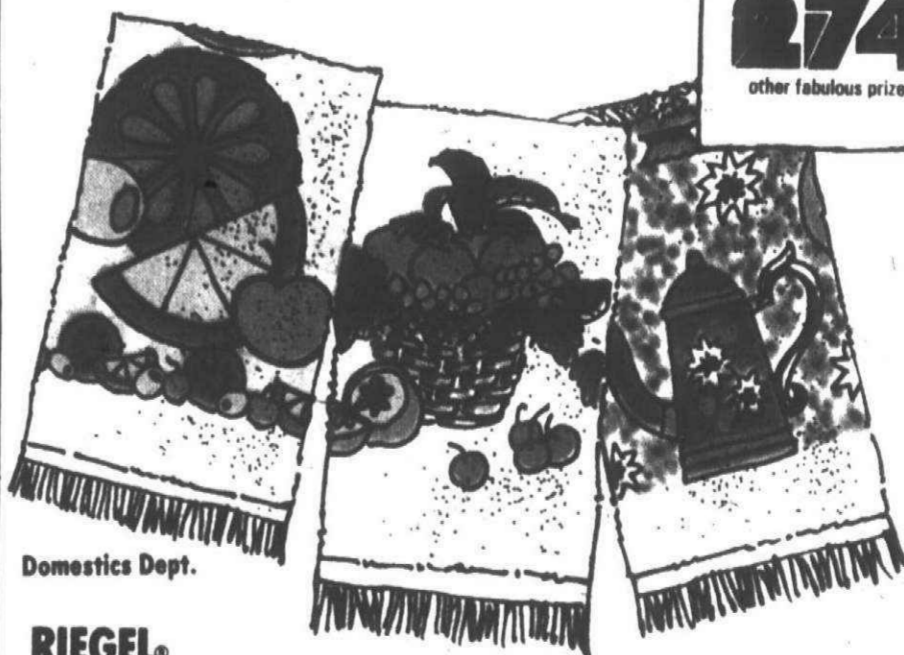

Domestics Dept.

RIEDEL HOMEKARE KITCHEN PRODUCTS

Win in the Homecare Sweepstakes. Win a fabulous array of prizes, including a 1977 AMC Pacer car filled with groceries. See details in the store.

COCKTAIL CHECK KITCHEN TOWEL REG. 87¢ **DISH CLOTH OR POT HOLDER** REG. 49¢ **BOUNTIFUL OR COUNTRY CLASSIC KITCHEN TOWEL** REG. \$1.27 **DISH CLOTH OR POT HOLDER** REG. 69¢

69¢ 39¢ 99¢ 54¢

FIBERFILL II BED PILLOWS

By DuPont® filled with Fiberfill® II polyester. 20" x 26" finished size. Attractive fine quality ticking.

REG. \$5.27 - Save \$1.30

\$3.97
ea.

Domestics Dept.

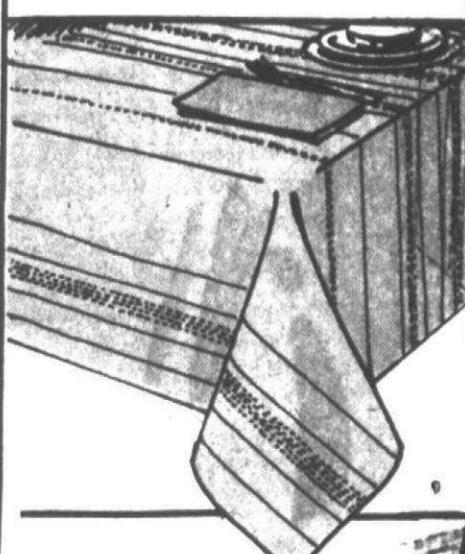

CREWEL KITS

16" x 20" crewel stitchery kits in a choice of 4 designs.

REG. \$3.99 - Save \$1.00

\$2.99
kit

Domestics Dept.



YOU DON'T NEED CASH! USE EITHER OF THESE CONVENIENT CREDIT CARDS!



FAMILY FASHIONS



F. MEN'S SPORT COATS
SAVE \$7.09
\$16⁸⁸



I. MEN'S SPORT SHIRTS
"NEW SPRING COLORS"
\$3⁹⁶ ea.
Save \$1.00

G. MEN'S GOLF JACKETS
\$6⁸⁸

J. MEN'S PRE-WASHED JEANS
Save \$2.00 pr.
\$7⁹⁷ pr.

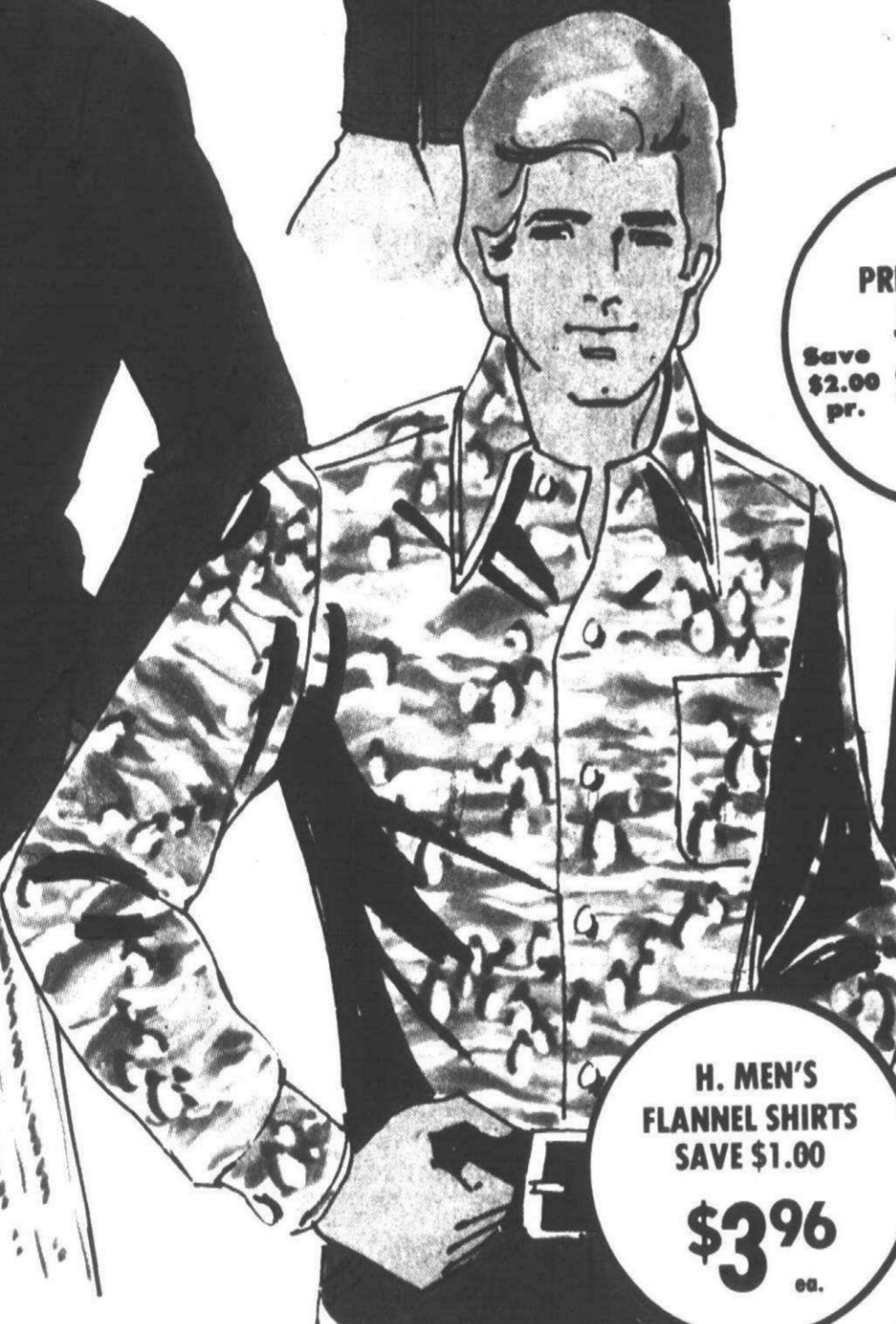

H. MEN'S FLANNEL SHIRTS
SAVE \$1.00
\$3⁹⁶ ea.

F. MEN'S SPORT COATS
100% polyester double knit. Year round weight in solids and patterns. Sizes 36 to 46 Regular or 38 to 46 Long.
REG. \$23.97
SAVE \$7.09
\$16⁸⁸ ea.

G. MEN'S UNLINED GOLF JACKETS
• Features full raglan sleeve
• Button-up convertible collar
• Reversible rain flap pocket
• 65% cotton 35% polyester
• Sizes S-M-L-XL
\$6⁸⁸ ea.

H. MEN'S SCENIC FLANNEL SHIRTS
Look sharp and stay warm in these 100% cotton scenic flannel shirts.
REG. \$4.96
SAVE \$1.00
\$3⁹⁶ ea.

I. MEN'S SPORT SHIRTS
NEW SPRING COLORS
• Short sleeve 100% polyester in assorted solid colors
• Sizes S-M-L-XL
\$3⁹⁶

J. MEN'S PRE-WASHED JEANS
The popular "Super Blues" by Mr. Leggs. 80% cotton, 20% polyester. Fade naturally. Shrinkage controlled. Soft and comfortable. Sizes 30 to 40.
REG. \$9.97
Save \$2.00 pr.
\$7⁹⁷ pr.

Men' Dept.



FRUIT OF THE LOOM
UNCONDITIONALLY GUARANTEED

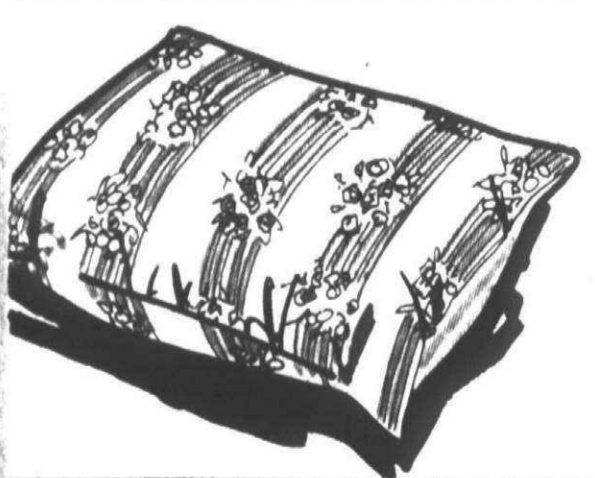

VERSAILLES TABLE CLOTH
100% cotton in solid colors. Soil release, permanently pressed.
52" x 52" REG. \$4.69
52" x 70" REG. \$6.29
60" x 84" OVAL OR OBLONG REG. \$9.97
\$3⁹⁷ \$4⁹⁷ \$8⁴⁹
67" ROUND REG. \$10.97
NAPKINS REG. \$7
\$8⁹⁷ 67¢



PRINTED FABRICS
Select your sewing needs from this assorted special grouping of 44"-45" wide printed fabrics in poly/cotton, all cottons and other blends. Full bolts.
REG. \$1.19
89¢ yd.
Domestics Dept.

SPORTSWEAR FABRIC
Select from this special grouping of 58"-60" sportswear fabrics. Plaids and checks in this assorted grouping.
REG. \$2.39
\$1⁶⁹ yd.
Domestics Dept.

MEN'S FRUIT OF THE LOOM T-SHIRTS
50¢ COUPON
Sizes S-M-L-XL - pkg. of 3
Reg. \$3.69
\$3¹⁹
WITH COUPON GOOD 1/24 THRU 1/29/76
Coupon limited to one per item DEPT. 551

MEN'S FRUIT OF THE LOOM BRIEFS
50¢ COUPON
Sizes 30-42, 3 pair pkg.
Reg. \$3.39
\$2⁸⁹
WITH COUPON GOOD 1/24 THRU 1/29/77
Coupon limited to one per item DEPT. 552

MEN'S FRUIT OF THE LOOM BOXERS
50¢ COUPON
Sizes 30-44, 3 pair pkg.
Reg. \$4.59
\$4⁰⁹
WITH COUPON GOOD 1/24 THRU 1/29/77
Coupon limited to one per item DEPT. 553

MEN'S FRUIT OF THE LOOM ATHLETIC SHIRTS
50¢ COUPON
Sizes M-L-XL - pkg. of 3
Reg. \$3.39
\$2⁸⁹
WITH COUPON GOOD 1/24 THRU 1/29/77
Coupon limited to one per item DEPT. 554

PRICES GOOD MONDAY JAN. 24 THRU SATURDAY JAN. 29, 1977. MEIJER RESERVES THE RIGHT TO LIMIT SALES ACCORDING TO SPECIFIED LIMITS. NO SALES TO DEALERS, INSTITUTIONS OR DISTRIBUTORS. Page 9

CHARGE ANYTHING IN THE STORE EXCEPT FOOD, LIQUOR AND SUPERMARKET ITEMS

YOU DON'T NEED CASH! USE EITHER OF THESE CONVENIENT CREDIT CARDS!





thrifty acres

m in the building supplies department

SPINDLES BY GERBER
 Prefinished in walnut or fruitwood. 8" size. Available in Early American, Spanish or Mediterranean.

REG. \$1.69
\$1.29 ea.

• PRE-FINISHED MATCHING SHELVING ALSO AVAILABLE AT "WHY PAY MORE" PRICES



3 AUTHENTIC STYLES

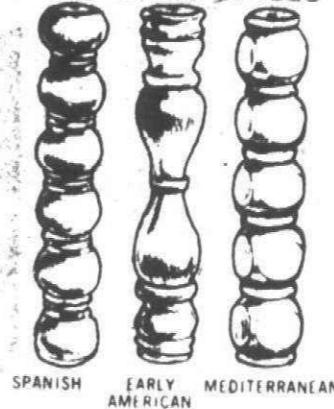

COMFORT HEATER

An authentic replica of stoves from the 18th and 19th century. All cast iron construction with polished nickel trim.

PARLOR STOVE

Cast iron with nickel-plated trim. Provides lots of heat with wood or coal.

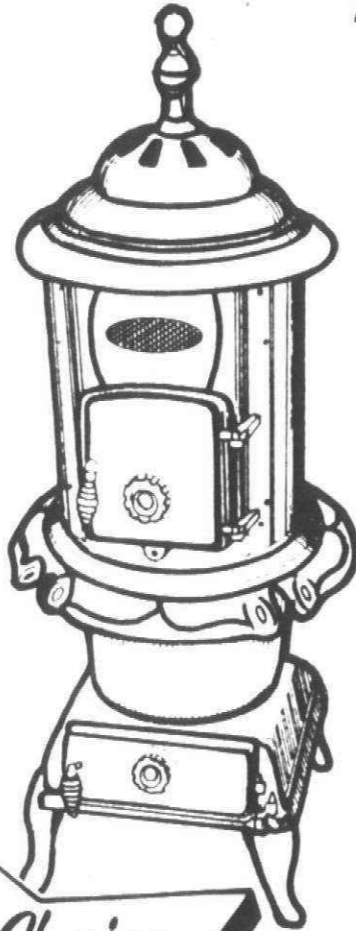
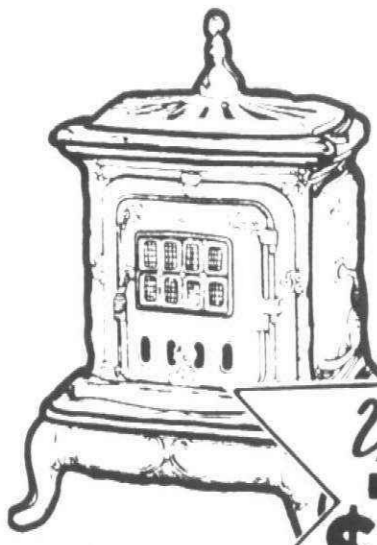

Your Choice
\$199.95 ea.



SAVE
\$1.00 sq. yd.

SHAG CARPET

100% continuous filament nylon in an attractive zig-zag design. Rubber back for do-it-yourself installation.

REG. \$4.99
\$3.99 sq. yd.

CUT LOOP CARPET

Hi-low style in attractive colors. High density rubber back. For easy do-it-yourself installation. Cut to order in 12' widths.

REG. \$5.95
\$4.95 sq. yd.

m in the paint department

MAGICOLOR INTERIOR LATEX SATIN PLUS WALL PAINT

• Choice of several colors



\$7.99 gal.

MAGICOLOR LATEX SEMI GLOSS LUSTER PLUS WALL PAINT

• Choice of several colors



\$8.97 gal.

m in the hardware department

U.S.M. HEAVY DUTY POP RIVET TOOL

Sets 1/8" and 3/16" rivets. Durable - longer handle for greater leverage. Use for snowmobile tracks. #K-111.

AFTER AD \$12.97

18" BOLT CUTTER

Hardened cutters, alloy steel jaws. All steel tubular handles with rubber grips. #275.

AFTER AD \$12.97

ARROW HEAVY DUTY STAPLE GUN TACKER

Shoots a staple wherever you'd drive a nail. Uses 6 staple sizes, including ceiling. #T-50.



Your Choice
\$9.97 ea.

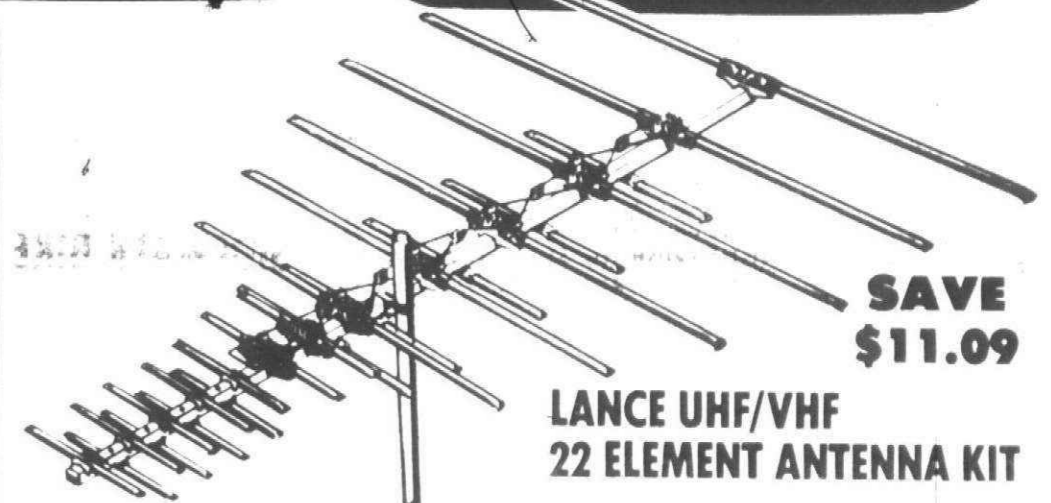

SAVE
\$11.09

LANCE UHF/VHF 22 ELEMENT ANTENNA KIT

REG. \$39.97

\$28.88

For color and black and white television. For fringe area - range up to 100 miles. #LC39.

AR-20 AUTOMATIC ROTOR - REG. \$42.37.....\$29.95



SAVE
\$5.31

1/2 TON POWER PULL

• 10 ft. lift
 • 1/2" cable
 • Model 150C

REG. \$20.19
\$14.88



SKILSHOP 1/4" CORDLESS DRILL WITH REVERSE

Double reduction gearing for high torque performance. Recharges overnight. Charger included.

\$19.99

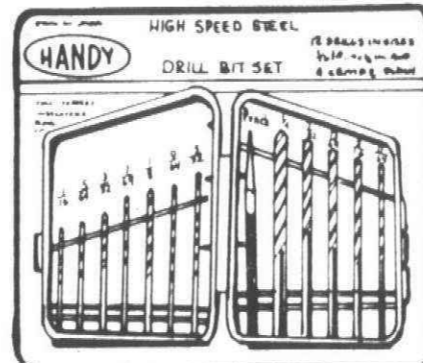

HIGH SPEED STEEL DRILL BIT SET

Full jobber's length. 12 bits sizes 1/16" to 1/2", and a center punch. In unbreakable plastic case. #860100.

AFTER AD \$5.97
\$4.88

STANLEY

24" STANLEY ALUMINUM LEVEL

• Model H1297



\$5.97

STANLEY

RIPPING CHISEL

18" heavy duty in offset pattern. Extra wide flout with beveled nail slot. #H818.



\$2.97

m in the auto supply department



STEEL AUTO RAMP

One piece durable, all steel construction. Weight capacity of 5,000 lbs.

\$17.76 pr.



MECHANIC'S CREEPER

Wood with sponge rubber headrest, covered with oil resistant durable vinyl covering. Low silhouette style.

\$5.76

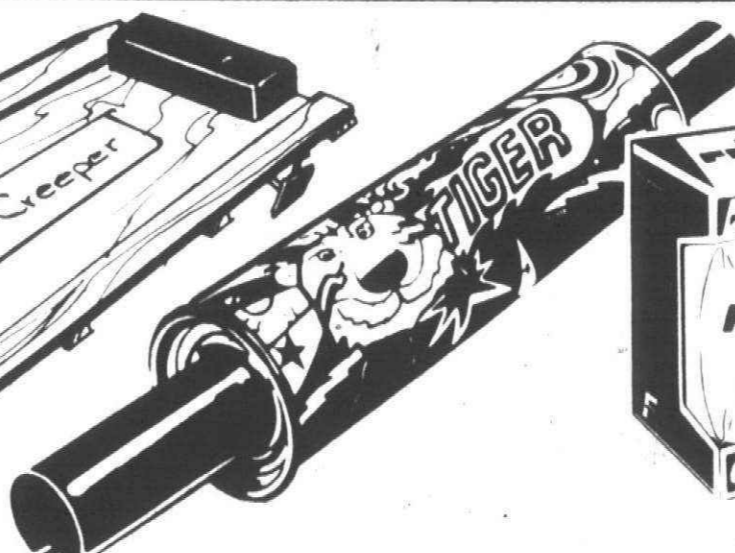

TIGER MUFFLERS

REG. \$10.56

\$7.77



FRAM OIL FILTERS

• Sizes to fit most cars

\$1.97 ea.



MEIJER PENNZOIL, QUAKER STATE, VALVOLINE, HAVOLINE, TOPCREST, SHELL, MOBIL, KENDALL, CASTROL OR APCCO
75¢ COUPON
MOTOR OIL
 STRAIGHT WEIGHTS OR MULTI-GRADES
75¢ OFF
 WITH COUPON ON PURCHASE OF 5 QUARTS
 GOOD 1/24 THRU 1/29/77
 Coupon limited to one per family. DEPT 860

m in the paint department

GLIDDEN SPRED SATIN LATEX WALL PAINT

• Choice of several colors
REG. \$9.77



\$7.97
gal.

OVER 900 CUSTOM TINTS AVAILABLE AT. **\$8.47** gal.

GLIDDEN SPRED LATEX ENAMEL WALL PAINT

Special one coat coverage formula. Easy to apply. Clean up with soapy water. Choice of several colors.



REG. \$11.38

\$8.97
gal.

OVER 900 CUSTOM TINTS AVAILABLE AT. **\$9.47** gal.

- MEIJER BEST 2" NYLON BRUSH REG. \$1.84 ... \$1.49
- MEIJER BEST 3" NYLON BRUSH REG. \$2.96 ... \$1.99
- MEIJER BEST 4" NYLON BRUSH REG. \$4.76 ... \$2.99
- MEIJER BETTER 2" NYLON BRUSH REG. \$1.3689
- MEIJER BETTER 3" NYLON BRUSH REG. \$2.14 ... \$1.69
- MEIJER BETTER 4" NYLON BRUSH REG. \$3.74 ... \$2.49
- MEIJER GOOD 2" NYLON BRUSH REG. .9969
- MEIJER GOOD 3" NYLON BRUSH REG. \$1.54 ... \$1.19
- MEIJER GOOD 4" NYLON BRUSH REG. \$2.49 ... \$1.49
- MEIJER BEST 1 1/2" BRISTLE BRUSH REG. \$1.1999
- MEIJER BEST 2" BRISTLE BRUSH REG. \$1.83 ... \$1.29
- MEIJER BEST 3" BRISTLE BRUSH REG. \$2.97 ... \$1.99
- MEIJER BEST 4" BRISTLE BRUSH REG. \$4.57 ... \$2.99
- MEIJER BETTER 2" BRISTLE BRUSH REG. \$1.2389
- MEIJER BETTER 3" BRISTLE BRUSH REG. \$1.51 ... \$1.29
- MEIJER BETTER 4" BRISTLE BRUSH REG. \$3.35 ... \$1.99
- 1 1/2" POLYESTER BRUSH REG. \$2.08 ... \$1.49
- 2" POLYESTER BRUSH REG. \$2.67 ... \$1.79
- 3" POLYESTER BRUSH REG. \$4.67 ... \$2.99
- 4" POLYESTER BRUSH REG. \$6.44 ... \$3.99

m in the toy department

RADIO "FLYER" WAGON

By Radio Steel. Safe T design handle grip. Heavy gauge steel construction. Solid rubber tires. Ages 1 1/2 to 4. #80.
REG. \$9.47

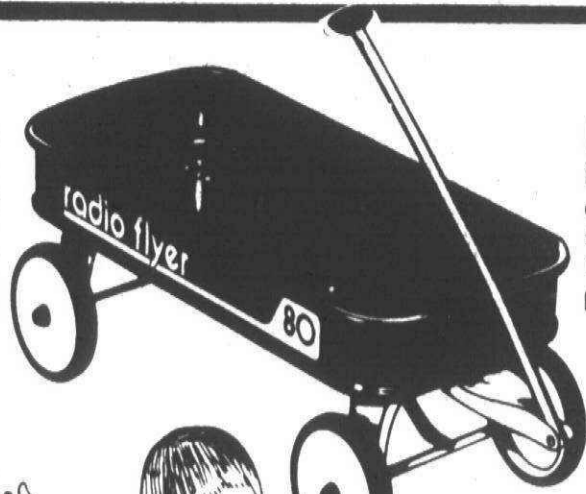

\$7.97

BIG WHEEL

By Louis Marx. Bigger, better, wide track rear tires. New heavy duty brake. Ages 3 to 7. #5045.

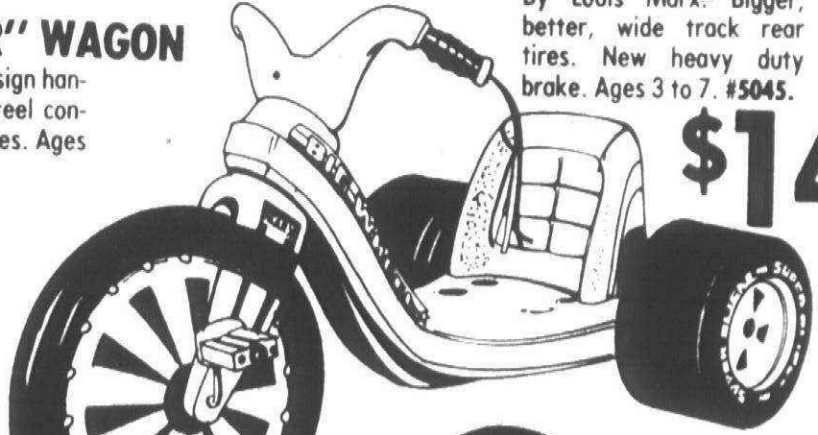

\$14.97

Why Pay More!

little tikes



SNUGGLE BUG

By Little Tikes. Maded of double wall polyethylene, in authentic lady bug colors. #4640.
REG. \$12.47

\$8.88



Your Choice
\$5.96
ea.

OLLIE RIDEM

By Little Tikes. "Foot Power Driven". Has red mop hair, tightly fashioned eyes and big red nose. Strong hand grip and plastic wheels. #7330.
REG. \$6.97



REG. \$44.96

\$36.88

Why Pay More!

TIKE WAGON

By Little Tikes. Can't rust, scratch, cut or bend. Colors: Robin egg blue/red. Ages 1 to 4. #4400.
REG. \$7.96 - Save \$2.00



10" TRIKE

By A.M.F. Econopak frame, sturdy rear step deck. Limerick green finish. Matching steel seat. #E-901.
REG. \$11.96

\$9.88



13" MOTOCROSS

By Hedstrom. A realistic motorcycle look with strength and durability. Green in color. Partially assembled. #9629.
REG. \$34.96 - Save \$5.00

SAVE \$5.00

\$29.96

m in the pets and crafts department

TROPICAL FISH OF THE WEEK!

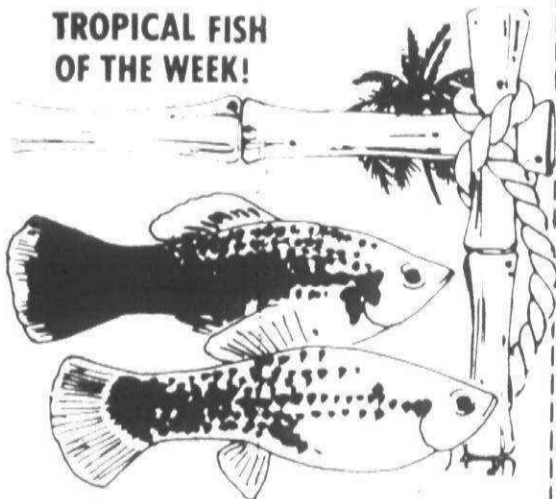

MARIGOLD VARIATUS

REG. 87¢

2 / \$1
pr.

FISH AVAIL. WED. AFTERNOON THRU SAT.

AQUARIUM GRAVEL

All regular colors and rainbow. Fluorescent Red and Green excluded. 5 lb. bag.
REG. \$1.11



79¢ \$11.88

Why Pay More!

AQUOLOGY POWER I FILTER

Pumps 120 gallons an hour. Extra quiet. For fresh or salt water.

SAVE OVER \$4.00

REG. \$15.97

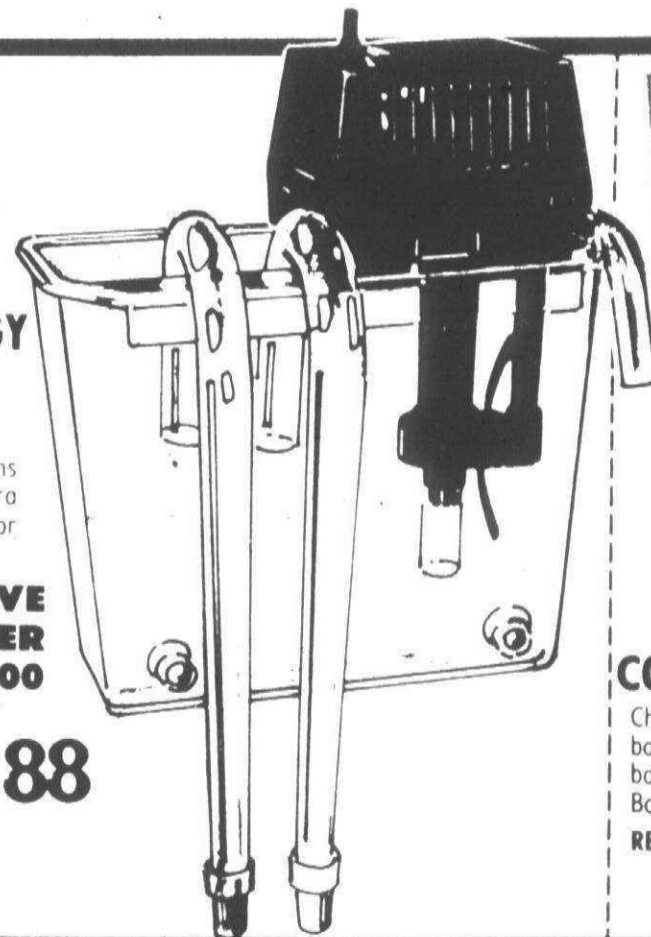

COUNTRY PAINTING CRAFT BOOKS

Choose from any of the \$1.42 books in stock and save, books such as "Just A Stroke Book I & II"
REG. \$1.42



99¢

m in the school supplies department



Save \$11.00

DESK \$48.88
REG. \$59.88

LETTER FILE

- 11 3/4" x 4 1/2" x 10"
- Impact resistant polypropylene
- Heavy construction
- Metal hinges, draw bolt closure
- Recessed handles
- Includes file folders



\$2.44

JUMBO LETTER FILE

- 13" x 9-11/16" x 10 1/4"
- Impact resistant polypropylene
- Metal hinges and draw bolt closure
- Recessed handle
- Includes file folders

\$3.88

4 DRAWER FILE CABINET

- 18" deep
- 15" wide
- 52" high

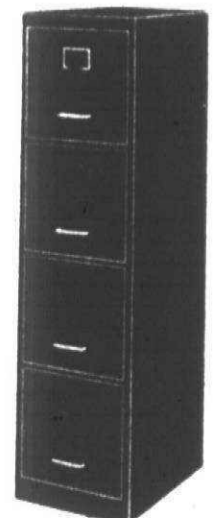

\$38.88



BIC MEDIUM POINT PENS

• 10 count pkg.

99¢



THEME BOOK

- 4 subject
- 80 sheets

2 / \$1

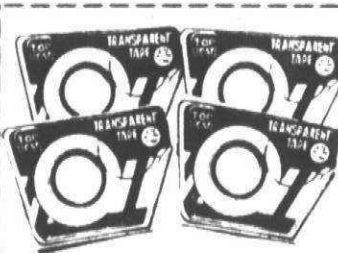

TOPCREST CELLO TAPE

• 1/2" x 800"

4 / \$1

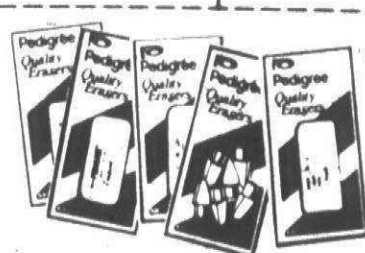

ERASERS

• Stick, green, pink, combination, gum or cap.

19¢

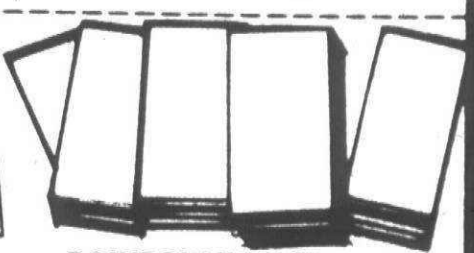

RAINBOW TABLET

• 3" x 5" colored paper

5 / \$1

PRICES GOOD MON. JAN. 24 THRU SAT. JAN. 29, 1977. MEIJER RESERVES THE RIGHT TO LIMIT SALES ACCORDING TO SPECIFIED LIMITS. NO SALES TO DEALERS, INSTITUTIONS OR DISTRIBUTORS.

YOU DON'T NEED CASH! USE EITHER OF THESE CONVENIENT CREDIT CARDS!

Why Pay More! Why Pay More! Why Pay More! Why Pay More! Why Pay More! Why Pay More! Why Pay More! Why Pay More!



SEMI-ANNUAL PLANT SALE!

in the garden center

TRUCK LOAD OF FRESH PLANTS ARRIVING DIRECT FROM FLORIDA, CALIFORNIA AND AROUND THE COUNTRY

Special Purchase

A wide variety of plants in 4" pots specially grown for Meijer. Choose from Philodendron, Pothos, Jade, Gold Dust Croton, Diffenbachia, Algerian Ivy and more.

YOUR CHOICE 99¢ ea.

WEeping FIG
(Ficus Benjamin) Elegant tree grows 2-5' tall in 6" pot. 14" to 18" tall.

DWARF PARLOR PALM
(Neanthe Bella Palm) Ideal plant for any low light area. Approx. 12"-18" tall.

UMBRELLA TREE
(Schefflera) Fast growing tree reaches 6' or more. 6" pot, 14" to 18" tall.

RUBBER TREES
(Ficus Decora) Upright plant with broad shiny leaves. Grows to 5' or taller.

YOUR CHOICE \$3.99 ea.

"JADE TREES"
Beautiful lush green plant that takes on the appearance of a miniature tree.

\$12.99 ea.

WEeping FIG
(Ficus Benjamin). Grows 5' tall. Needs bright sun. Approx. 36" - 44" tall.

REG. \$24.95 - Save \$4.96

UMBRELLA TREE
(Schefflera) One of our most popular plants. Grows full but tall.

REG. \$22.97 - Save \$2.98

YUCCA CANES
A real conversation piece. 3 cane plants in 10" pot. Canes are 3', 2' & 1'.

YOUR CHOICE \$19.99 ea.

AFRICAN VIOLETS
• In 4" pots
• In full bloom

\$1.77

EXOTIC BARK PLANTS
A variety of vine plants growing on 18" bark slabs.

YOUR CHOICE \$4.99 ea.

NORFOLK ISLAND PINE
(Aravcaria) a true foliage plant that resembles a pine tree. 36" - 48" tall.

OUR REG. \$24.95

\$19.99

Special Purchase

Ornamental Grafted Cactus. Unusual grafted cactus together in Japan - complete with decorator pot.

YOUR CHOICE \$1.99 ea.

in the floral department

CACHE POTS
Available in 3 sizes: Small 6" dia. x 5 1/4" high - style 4000. Medium 7 1/4" dia. x 6 1/4" high - style 4001. Large 8 1/4" dia. x 7 1/4" high - style 4002. Assorted colors.

#4000 Reg. \$4.47... Save \$1.00... **\$3.47**
#4001 - Reg. \$5.97... Save \$1.50... **\$4.47**
#4002 - Reg. \$7.47... Save \$1.50... **\$5.97**

PLANTER POLE
Made of real wood. A good looking piece of furniture. Allows your plants to grow. Style 67A67.

OUR REG. \$19.99
Save \$2.11

\$17.88

PLANT HUTCH
3 shelf white Plant Hutch. Very functional and decorative too. #47A7

OUR REG. \$19.99
Save \$5.00

\$14.99

ALUMINUM OR GLASS WATER SPRAYER
Sprays a mist that helps plants grow.

YOUR CHOICE 88¢ ea.

PLANT HUTCH
Gold color 3-shelf plant hutch. Style 47A507.

OUR REG. \$22.99
Save \$3.02

\$19.97

GLASS POT
20 1/2 oz. clear crystal pot.

58¢

PLANTER POLE
Attractive brass planter pole with protective caps at both ends. Holds three plants. Style #53A33.

\$5.88

PLANT STAND
4 shelf bakers' rack in an attractive painted white finish.

OUR REG. \$24.99
Save \$5.02

\$19.97

WOODEN FLOWER CART WITH GARDEN TOOLS
Decorative and useful cart holds 3 tools and a pair of scissors. 3 tiny floral pots filled with dry flowers. Style #154.

OUR REG. \$4.46

\$3.97

HANGING WICKER BASKET
Ideal for holding plants, dried flowers or any other decorative use.

OUR REG. \$2.97
Save \$1.00

\$1.97

PLANTERS
Available in 4 sizes and assorted colors. Style: Heidelberg

4 1/4" x 4" - Reg. \$2.97... Save 70%... **\$2.47**
5 1/2" x 4 1/2" - Reg. \$5.97... Save \$1.50... **\$4.47**
6" x 5 1/2" - Reg. \$8.97... Save \$2.00... **\$6.97**
7" x 6 1/4" - Reg. \$11.97... Save \$3.00... **\$8.97**

MACRAME PLANT HANGER
Reg. \$3.79 and up

\$1.00 OFF
WITH COUPON
GOOD 1/24 THRU 1/29/77

Coupon limited to one per family. DEPT. 610

PLANTERS
4 1/4" diameter x 4" high in assorted colors. Style: Munich

OUR REG. \$3.97
Save \$1.00

\$2.97

PLASTIC PLANTER
Reg. \$1.47 and up

50% OFF
WITH COUPON
GOOD 1/24 THRU 1/29/77

Coupon limited to one per family. DEPT. 610

Page 12 PRICES GOOD MONDAY JAN. 24 THRU SATURDAY JAN. 29, 1977 MEIJER RESERVES THE RIGHT TO LIMIT SALES ACCORDING TO SPECIFIED LIMITS. NO SALES TO DEALERS, INSTITUTIONS OR DISTRIBUTORS.

MEIJER THRIFTY ACRES — 45001 FORD RD. AT CANTON CENTER RD.

SHOP MONDAY THRU SATURDAY 8 A.M. TO 10:30 P.M. — SUNDAY 9 A.M. TO 7 P.M.

(m) in the housewares department

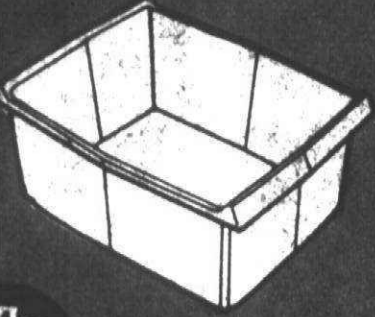

Why Pay More!

RECTANGULAR SERVING TRAY

12 1/2" x 18 1/2" x 2 1/2"
* Green, Yellow or Chocolate
OUR REG. \$1.27

Your Choice
99¢ ea.

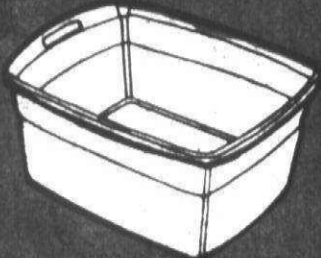

12 1/2" x 18 1/2" x 2 1/2"
* Green, Yellow or Chocolate
OUR REG. \$1.27

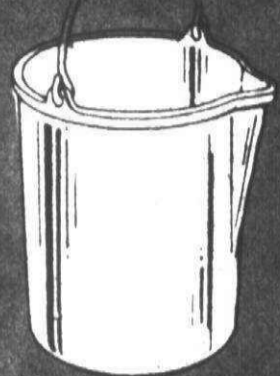

E-Z POUR PAIL
15 quart
* Green or yellow

\$1.37

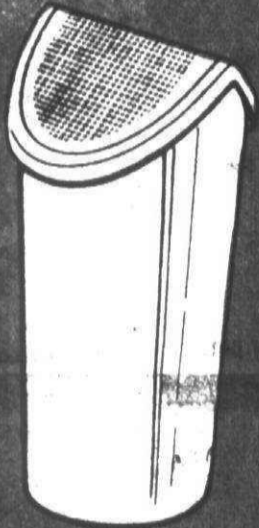

SWING TOP WASTE BIN
* Round
* 27" overall size
* 15" inside
* In orange
OUR REG. \$1.27

\$1.67

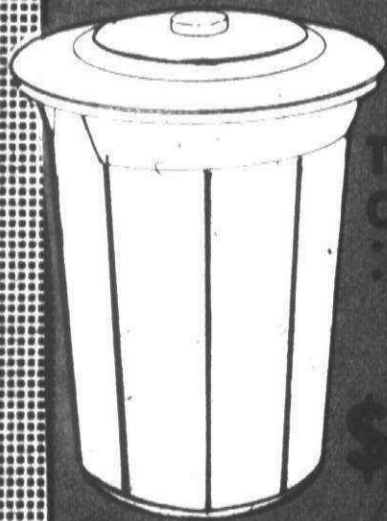

TRASH CAN
27 gallon
* Available in grey

\$6.47



PORCELAIN SOUP POT
1 1/2 qt.
OUR REG. \$2.97

Save \$2.00

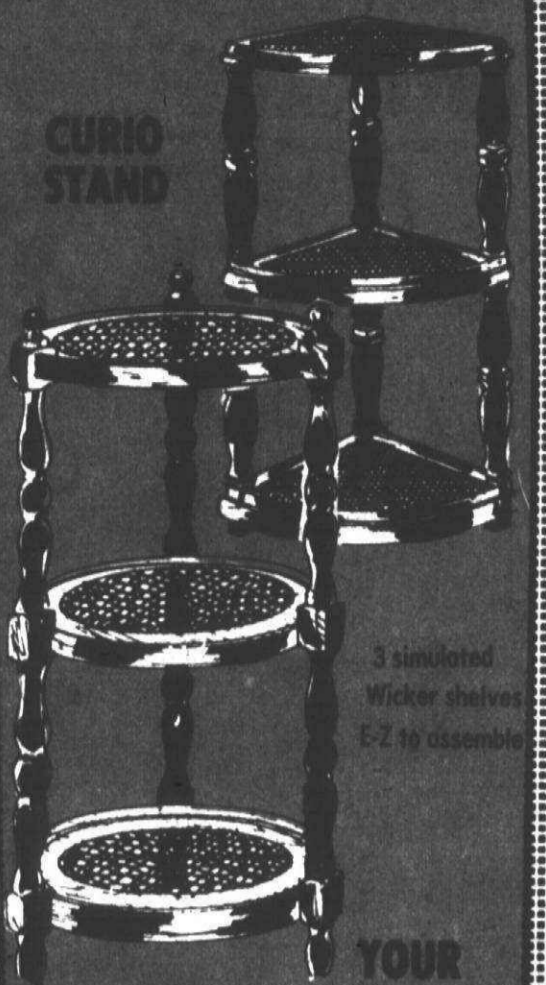

CURIO STAND
3 simulated wicker shelves
E-Z to assemble

YOUR CHOICE
ROUND: 31 1/2" high - 15 1/2" shelf - Walnut finish
CORNER: 31 1/2" high - 13 1/2" wide - Nutmeg Oak finish

\$17.88
AFTER AD \$19.27



SPECIAL CLOSEOUT PURCHASE:
WEXFORD WHISKEY DECANTER
BLUE SPRING 10 1/2 OZ. PITCHER
AVOCADO HERITAGE HILL 12 OZ. PITCHER
54 OZ. FAIRFIELD CANDY DISH WITH COVER
* Avocado or blue

Your Choice
66¢ ea.

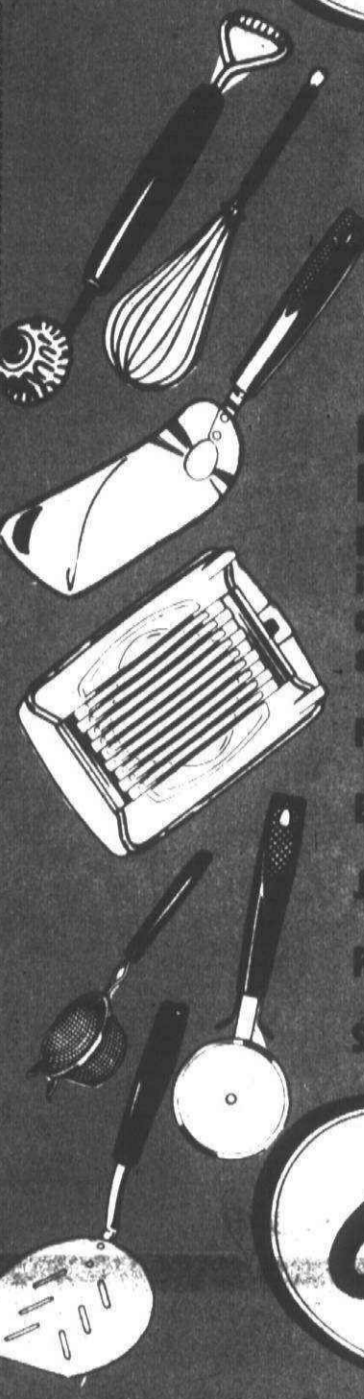

Why Pay More!

AS ADVERTISED ON TELEVISION

EKO KITCHEN HELPERS

EGG WHISKS
in 8", 10" and 12" size

FLEXIBLE SPATULA

EGG SLICER

JUMBO TURNER

PIZZA CUTTER

STRAINER

Your Choice
66¢ ea.



thrifty acres



6 PC. BEVERAGE SETS

* By Libbey
* 12 oz. capacity
* Heavy base tumblers
* Choice of 4 designs

\$1.99 set

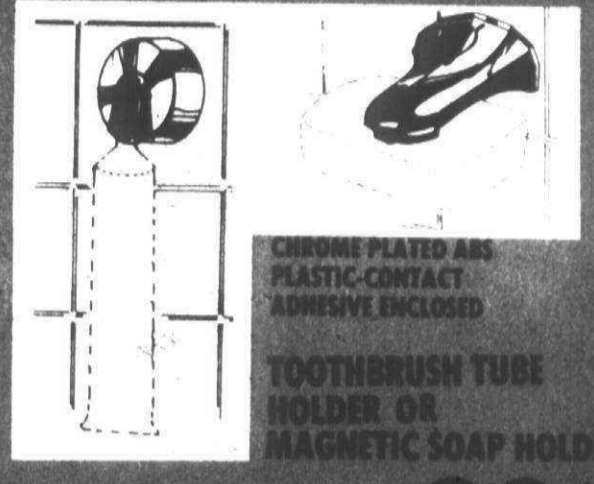

CHROME PLATED AIR PLASTIC-CONTACT ADHESIVE ENCLOSED

TOOTHBRUSH TUBE HOLDER OR MAGNETIC SOAP HOLDER

YOUR CHOICE **88¢**

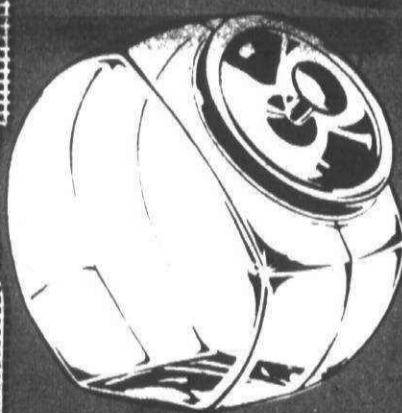

TOMBOW COOKIE JAR
* By Anchor Hocking

OUR REG. \$3.47
\$2.27

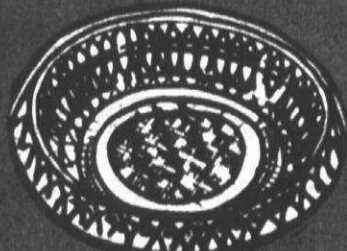

PLASTIC BREAD BASKET

Available in colors
OUR REG. \$1.27
47¢

Why Pay More!

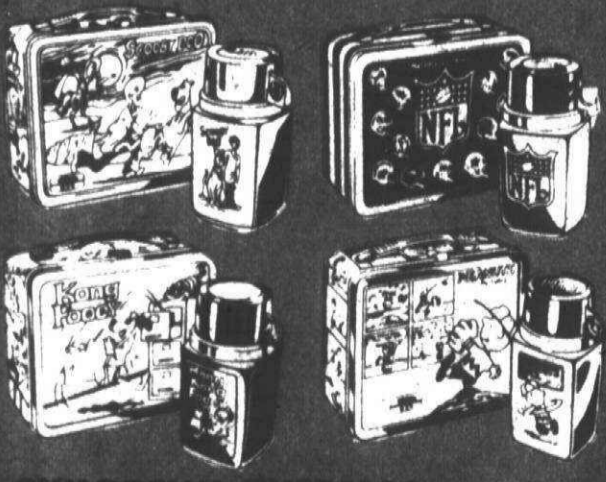

CHILDREN'S FRIENDS

OUR REG. \$2.28
\$1.28

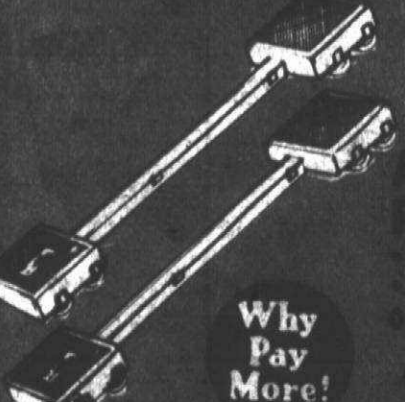

Why Pay More!

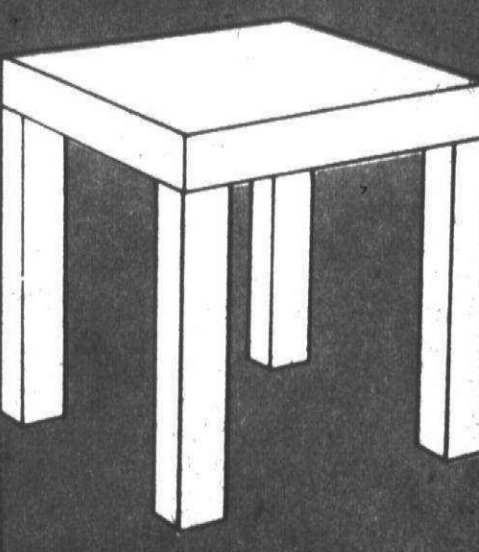

PARSONS TABLES
17" x 17" x 28"
* Available in white, yellow or blue
* Easy to assemble

OUR REG. \$2.88
\$2.88

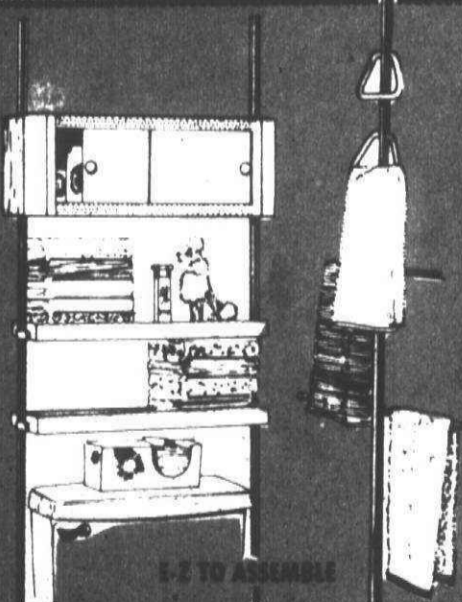

BATHROOM SPACING UNIT
Showercap with Cabinet, 2 shelves, Chrome-plated poles extend to 8"

OUR REG. \$15.47
\$11.47
Save \$4.00

Towel Pole with 2 Rings and 2 Bars, Chrome-plated poles extend to 8"

OUR REG. \$5.97
Save \$1.50
\$4.47



WOOD KITCHEN TOOLS
YOUR CHOICE!

7/\$1

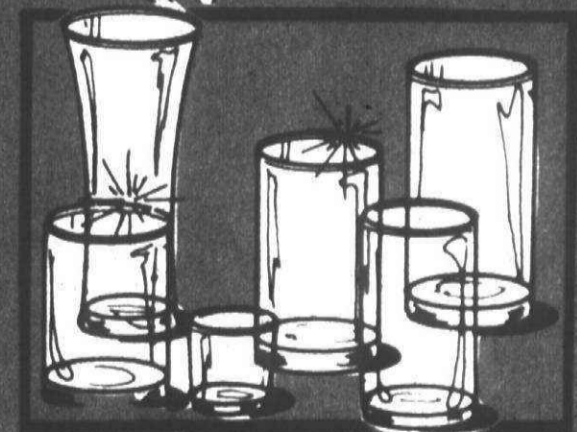

41 PC. HOME PARTY SET
Heavy base tumblers ideal for the home bar and entertaining. Set includes 8 each: Juice, 10 oz Beverage Flipper, Rocks, 12 oz Beverage Tumbler.

Clearance! **\$6.47**



Why Pay More!

SHAMPOO AND BATH SPRAY
* Assorted colors
OUR REG. \$1.27

88¢

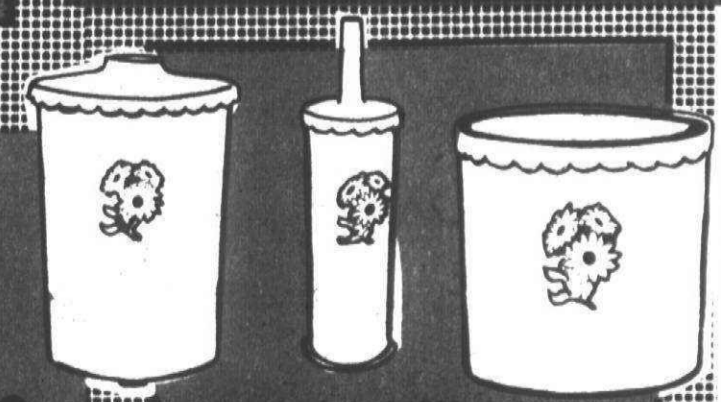

FESTIVAL DAISY DESIGN BATHWARE
In shades of white or blue

TOILET BRUSH \$1.77
TOILET BRUSH \$1.57
TOILET WASHNET \$1.97
TOILET BRUSH \$1.97

WAREHOUSE CLEARANCE

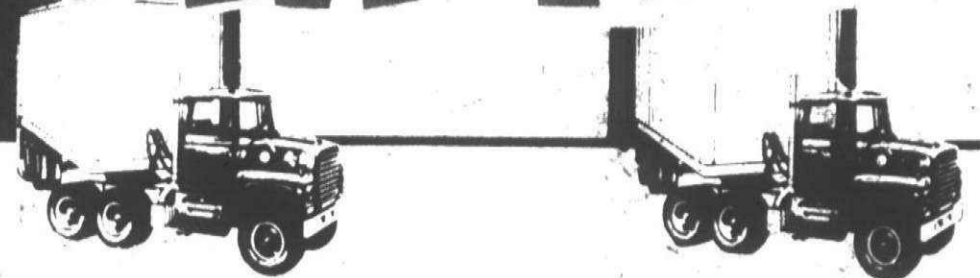

BICYCLE
CLEARANCE! WHILE QUANTITIES LAST!

AND STOCK REDUCTION SALE!

GUARANTEE
Meijer Thrifty Acres guarantees for a period of five years the entire frame against manufacturing defects and faulty workmanship. The balance of the bicycle is guaranteed by Meijer to the extent of the manufacturer's warranty enclosed in the carton. For additional information ask our sales personnel. Warranties also do not cover ordinary wear and tear or accidental breakage.

PRICES SLASHED

EVERY BIKE IN STOCK ON SALE!

SILVER THUNDER 20" BOYS' MX DRAGSTER
By Huffy.
OUR ORIG. \$92.97



SAVE \$35⁵³

\$57⁴⁴

SAVE \$10⁰⁰

THUNDERSTORM 42 20" BOYS' "HMX" STYLE DRAGSTER
By Huffy. Model 9042
OUR REG. \$59.97



\$49⁹⁷



20" GIRLS "HMX" STYLE DRAGSTER

By Huffy. Thunder Rose 3. Single speed. Coaster brake. Cross-braced handlebars. Waffle grips. Knobby tires. Number Plaque. Wide fenders. HMX style saddle. Model 9043
OUR REG. \$59.97

SAVE \$10⁰⁰

\$49⁹⁷

Save \$22⁰⁰ OR MORE
OFF OUR REGULAR PRICES ON
• All 26" & 27" Men's & Ladies' 3-Speed Bicycles
• All 27" Men's 10-Speed Bicycles



SAVE \$20⁰⁰

BOYS' 20" "THUNDER ROAD 60"
Boys' single speed 20" bicycle by Huffy. Twin cantilevered frame, crossbar pad, wide light weight fenders. Rat trap pedals, HMX style saddle, 20" x 2.125" stagger black knobby tires and coaster brake. Model 2060
OUR REG. \$84.97

\$64⁹⁷

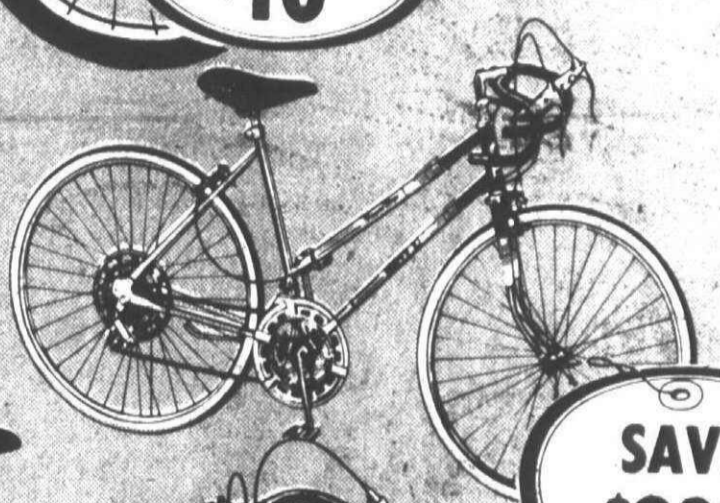

SAVE \$23⁰⁰

MEN'S OR LADIES' 26" "SUPER STAR" 10-SPEED

By Huffy. With stem-mounted shift levers, reflective pedals. Men's frame - 22". Ladies' frame - 19". BMA-6 Model 2692-2693.

OUR REG. \$92.97
\$69⁹⁷

Save \$11⁰⁰ OR MORE
OFF OUR REGULAR PRICES ON
All 26" Men's & Ladies' 3-Speed Bicycles



SAVE \$17⁹⁹

LADIES' OR MEN'S "INDEPENDENCE" 26" 10-SPEED

Bicycle by Huffy. Frame size: Men's 22" and Ladies' 19". White finish. Model 2690-2691.

\$63⁸⁸

OUR REG. \$81.87



LADIES' 26" "SCOUT" 10-SPEED

By Huffy. Frame size: Men's - 22" available in limited quantity. Ladies' - 19". Model 2695.

OUR REG. \$96.97
\$73⁶⁷

Save \$700 OR MORE
OFF OUR REGULAR PRICES ON ALL
• Boys' & Girls' 20" Motocross Dragsters
• 24" Girls' 3-Speed Bicycles
• 24" Boys' 10-Speed Bicycles
• Men's & Ladies' 26" Single & 3-Speed bicycles



SAVE \$8⁹⁰

BOYS' OR GIRLS' 20" "STAR SPANGLER"

Single Speed Bicycle by Huffy. Coaster brake, hi-rise handlebars, reflective pedals, extra wide fenders. Model 2018-2019.

OUR REG. \$50.87

\$41⁹⁷



SAVE \$21³⁰

BOYS' OR GIRLS' 19" CONVERTIBLE "SMALL WONDER"

Convertible sidewalk bicycle by Huffy. Converts from Boys' to Girls'. Coaster brake, touring style handlebars and saddle, training wheels. #2900.

OUR REG. \$43.97

\$38⁹⁷

Save \$500 OR MORE
OFF OUR REGULAR PRICES ON
on all 19" Sidewalk Bikes and
20" Boys' & Girls' Dragsters

IN CARTON SALES - SPORTING GOODS DEPARTMENT

Page 14 PRICES GOOD MONDAY JAN. 24 THRU SATURDAY JAN. 29, 1977. MEIJER RESERVES THE RIGHT TO LIMIT SALES ACCORDING TO SPECIFIED LIMITS. NO SALES TO DEALERS, INSTITUTIONS OR DISTRIBUTORS.

MEIJER THRIFTY ACRES — 45001 FORD RD. AT CANTON CENTER RD.

SHOP MONDAY THRU SATURDAY 8 A.M. TO 10:30 P.M. SUNDAY 9 A.M. TO 7 P.M.