

Canton Observer

Volume 2 Number 47

Monday, April 18, 1977

Canton, Michigan

32 Pages

Twenty-Five Cents

©1977 Suburban Communications Corporation. All Rights Reserved

New 45-15 tracks place Miller in bind

By PATRICK TOUHEY

An attempt to determine a logical schedule for the buildings going on year-round school this July has run into a snag which could reduce the district's state aid money.

School Supt. John Hoben is looking closely at a schedule which would allow the schools going on 45-15 in July to finish their academic year at the same time as buildings on the traditional nine-month calendar.

The snag, however, is Miller Elementary which has been on 45-15 for two years in a pilot program. Re-aligning Miller's schedule with the five additional year-round schools could result in Miller students not meeting the state requirement for 180 instructional days per year.

Hoben is currently searching for a way to avoid the loss of class time at Miller and still begin year-round schedules in the five other schools in July.

HOBEN HAS ASKED the Plymouth-Canton Board of Education to consider a change in the present staggered tracking system used at Miller when the other schools in the district start classes on a year-round basis.

Under the Miller system, there are four tracks (groups) of students who attend classes for 45 school days (nine weeks) and then have a break for 15 days (three weeks). Each group of students begins and ends its school year at a different time. During the year, the groups are staggered in such a way that three groups are in school at any given time. One group is always on break.

Hoben has proposed that all classes for all 45-15 schools begin on July 11. But two of Miller's groups will still be finishing the current school year on that date. One of them won't finish until the first week in August and the other group won't be done until the last week in August.

If Miller and the other five schools, started the 1977-78 academic year on July 11, these two groups of students would lose between three and seven weeks of instruction in the current year. And it would have to be made up.

STATE LAW REQUIRES that schools provide a full 180 class days or 900 instructional hours. If they don't, they are not eligible for state money.

Although Hoben admits he doesn't have any answers yet, he said there are several possible solutions. One would be to petition the state board of education to waive the 180-day requirement.

A second approach would be to require the students to make up the lost time by going longer hours each day or by attending class on weekends.

Neither alternative is particularly attractive. School officials say the chances of the state board granting the waiver are extremely thin. And Miller parents are upset by the situation their children are in.

"I'm very pleased with the 45-15 schedule," said Cindy Monks, "but I'm afraid the switch is going to cause some real problems for the kids. I don't see how they can lose or make up that much time."

Gerri Guzik, also a Miller parent is a little stronger in her criticism of the proposal. "I can't take my child out of school for two months, but the school board can consider doing it. Who do they think they are?"

"I don't think they know what they are doing or where they are going.

They are trying to do too much too fast."

Hoben acknowledges the problem is a thorny one but defends the plan because he says it has some advantages. Primarily, it would provide more flexibility for students. With all the groups starting at the same time, the separation between groups would be eliminated. A child could move from one group to another, if necessary, with a minimal amount of lost instruction.

With the staggered groups at Miller, students are locked in with the group they start with, Hoben said. In addition, the proposed change would enable the schools to have a more uni-

(Continued on page 4A)

Stein wants cost of sheriff patrol

Township officials continue to hammer away at members of a Wayne County Board of Commissioners subcommittee, hoping to convince them to change their minds on funding for the Sheriff's road patrol in seven out-county townships.

Faced with a projected \$12 million deficit for the year, the full board of commissioners voted to terminate the money for the 28-man patrol on June 30, which amounts to about \$1 million. Many of the townships affected by the decision, including Plymouth Township, have no other form of police protection.

In the second meeting in two weeks with the public safety and judiciary committee Wednesday, representatives of the municipalities argued against the termination of the patrol. The committee has the responsibility of advising the full board on the matter.

"I think we got their attention this time, and they are giving some second thoughts to our problems," said Plymouth Township Supervisor Thomas Notebaert. "But we still have a long way to go."

Since the decision was made to end the funds for the patrol, the commissioners' position has remained essentially unchanged. At a meeting two weeks ago, one commissioner said it was time the townships "grew up" and got their own police departments.

However, Notebaert and Canton Township Supervisor Harold Stein believe that the introduction of some new information might have softened the committee's attitude.

Retired Michigan State Police Direc-

tor Fred David, a Plymouth Township resident, attended the meeting at Notebaert's request. He furnished statistics to the commissioners which indicated that much of the crime in the townships was related to the metropolitan parks.

"**WE GET A LOT** of people from Detroit who come out to Hines Park and then commit crimes," said Stein. "They're not even our own residents, and the county still wants us to pay for the road patrol. Does that sound right to you?"

In addition, Stein argued that the involved townships paid \$9 million to the county in taxes. "They should be able to tell us how much of that goes for the road patrol. No one is taking exception to paying, but you have to know what you're paying for."

Although the commissioners had said they would have a detailed breakdown of what the patrol cost was for the townships, Stein was not pleased with the figures they supplied. Committee members had previously suggested the townships contract with the sheriff's department for the amount of protection they needed.

"I still don't know how much of our money goes to the sheriff," commented Stein hotly. "I have to be able to go to my constituents and say it costs so much and ask them if they want it, not. Until I can do that, I'm not making any decisions."

Notebaert, too, shared some of Stein's perceptions. "It seems things get less clear everytime we meet." No date has been set, but another meeting is scheduled.

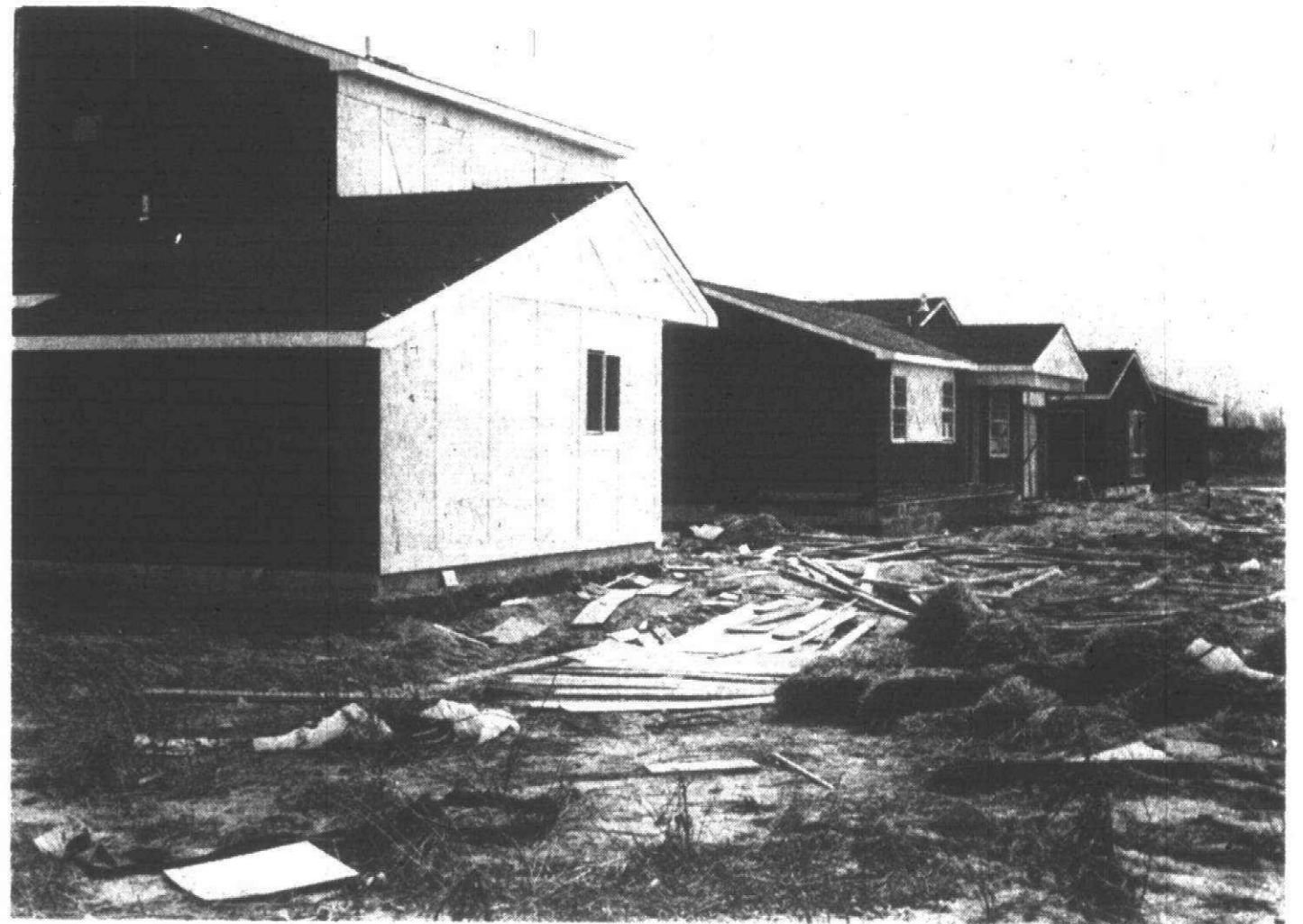

Can a 1,600-square-foot home with two-car garage find harmony with these 1,100-square-foot, one-car garage homes in Canton? (Staff photo)

Smaller homes built

Bank, builder picketed

People often cite "incompatibility" as their reason for seeking divorce. Homeowners in Canton's Willow Trail subdivision cite incompatibility as their reason for fighting construction of new homes with smaller square footage and one-car garages.

Michigan National Bank, owner of 120 remaining lots in the subdivision, is the main target of the residents' criticism. A Michigan National Bank branch office under construction at Ford and Sheldon was picketed Wednesday afternoon by about 50 people who want the bank to build compatible homes on remaining lots in the subdivision.

Thirty-seven homes in the \$50,000 price range were built and sold in Willow Trail subdivision by David Nelson of Phoenix Homes who went into bankruptcy last year. But before he went bankrupt, Nelson signed a covenant with the homeowners promising "to assure the beauty, betterment, protection and harmony of external design and appearance of the residences to be built on lots in the subdivision" in the future.

An architectural control committee established under the covenant expired Dec. 31, 1976 and neither Michigan National nor B.L. Smokler and Co. developers have agreed to renew the agreement.

Willow Trail residents became concerned, said Tom McNamara, president of the subdivision homeowner association, when they saw an 1,100-square-foot model open. Then Smokler began building the small house with one-car garage and brick on the front only, on one of three lots purchased from the bank.

Smokler spokesman Manny Bush said the company has an arrangement with the bank to buy more homes if desired.

"But even if Smokler builds all 50 of the homes they have an option on, the bank is the one who has the responsibility to uphold the original covenant," says Peter Bundarin, attorney for the Willow Trail Homeowner Assoc. "The bank is trying to pass the buck to Smokler."

Bundarin argues that because the bank has become the major property holder in the subdivision, it must reinstate the architectural control committee and live up to the terms of the original covenant.

And, because the 37 homes already built range between 1,500-2,000 square feet, and feature two-car garages, anything substantially less than that is illegal, Bundarin said.

Michigan Bank officials state that all comments on the dispute would come from their attorney, Peter Alter. He could not be reached for comment Friday.

The head of the homeowner group, McNamara, said the association is not attempting to ban homes that cost less than \$50,000 from Canton "we're just saying we want our subdivision finished with like-sized homes and construction materials."

McNamara said future Canton subdivisions could accommodate less expensive or less expansive homes.

He said the association is ready to fight the case in court if necessary. But the association's attorney, Bundarin, says he would like to avoid the

lengthy and uncertain legal route.

"The best way to go about it is bring this to the attention of the bank so they'll become aware of the problems the Willow Trail people are having with these smaller, incompatible homes."

"I understand that after Wednesday's picketing, officials of the bank wanted to know what was going on," Bundarin said. "They don't want all those potential customers to be pick-

eting their soon-to-open bank."

The homeowner group also scheduled a picket yesterday at Smokler's model homes on Saltz, south of Ford and east of Lilley.

"That's what I like about Canton," McNamara said. "People want it to be developed right and they're not about to be pushed around. We've got a new township and people are interested and involved. They don't just sit back and gripe."



Michigan National Bank owns 120 lots in Willow Trail subdivision. The bank's soon-to-open Canton branch was marched upon Wednesday by women and children protesting three Smokler homes being built with smaller garages and square feet than their homes. Adrian Loukotka holds the sign and Lisa Schnapps. (Staff photo by Gary Caskey)

Carter's Blue Cross cap could nudge teacher talks

By EMORY DANIELS

Jimmy Carter may be the latest facilitator in the teacher contract talks in Plymouth-Canton Community Schools.

President Carter unwittingly entered the local contract talks when he addressed the nation Friday morning and proposed a 10 per cent price lid on hospital cost increases.

The timing for the local contract talks, was especially significant because there is a chance both sides might meet at the table today (Monday).

Carter's hospital price lid proposal might be a catalyst locally because the major issue now preventing a settlement appears to be whether there should be a "cap" on medical insurance premiums.

The school board is asking teachers to accept a proposal to share any increase the costs of medical insurance premiums if they exceed \$100 per month for family coverage.

Carter's proposal, if approved by Congress, would limit Blue Cross-Blue Shield premiums to an increase of no more than nine per cent a year.

The proposed economic controls on medical costs might break the current deadlock at the bargaining table.

ALTHOUGH BOTH sides are actually in disagreement on four issues, the key difference is on a proposal to "cap" health insurance premiums.

The board's offer is that once family membership premiums exceed \$100 per month, the added amount will be shared 50-50 by the board and the individual teacher. For example, if medical premiums for families climbed to \$110 a month in 1979, the school district would pay \$5 and the individual teacher would contribute \$5.

The Plymouth Education Association (PEA) has rejected the proposal, arguing it would cause problems for future bargaining teams and represents a rollback from agreements of previous years.

The school board argues premiums won't exceed the \$100 level until at least the third year of the three-year contract presently being negotiated, and then would be a nominal amount for teachers to pay. The board would like the teacher contribution to be deducted from cost-of-living payments.

On April 1, 1977, Blue Cross-Blue Shield premiums increased by about 34 per cent to raise the cost of family coverage from \$72 to \$94.

WHEN ASKED about the local impact of Carter's proposal on the stalemated talks, Supt. John M. Hoben was noncommittal.

"We'll have to look at the details of the President's proposal. But it might be significant. Right now we can't even get to the bargaining table, so maybe this will help."

Hoben did some quick calculations and estimated that if Carter's proposal goes into effect, family coverage will cost \$103.40 per teacher in the third year of the contract. "If the PEA would accept the board's proposal, that would mean the added cost to teachers would be a maximum of \$7.60 for 1979. That's not much money. Maybe a clamp on rising medical costs would give enough assurance to teachers that premiums won't get out of hand that we can reach agreement on this issue."

The board doesn't describe its proposal on medical premiums as being a cap.

"The board isn't asking to have health insurance capped, but merely

asking that if costs continue to rise at the current rate that the board and the PEA share the responsibility," Norm Kee, chief negotiator for the board, said.

NO TALKS OCCURRED last week because teachers were on vacation for Easter break.

Kee and Derald McKinley, PEA chief negotiator, however, left town with expectations that a meeting might be arranged for today.

If the sides don't meet, a critical stage could be reached as the PEA has called for a general membership meeting for 5 a.m. tomorrow (Tuesday) in the Penn Theatre.

McKinley says the purpose of the meeting will be to inform teachers of the status of negotiations. Administrators, however, are worried a strike vote might be taken because the meeting is being held in the morning. The usual practice has been for the teachers to hold meetings in the afternoon, after the school day has ended.

Late last week, reports were also spreading that other teacher unions which don't have contracts yet are calling general membership meetings early this week. There are some 19 school districts in the metropolitan Detroit area currently negotiating contracts with teachers.

CARTER'S PROPOSED lid on medical costs is seen as a key part to the administration's anti-inflation program.

The lid is expected to save the federal government and private insurance firms about \$2.6 billion a year. The controls also will lower costs for Medicare and Medicaid.

Hospital costs have been rising about 15 per cent a year with patient rates now between \$150 to \$200 a day.

inside

Amusements	4B
Bowling	13A
Brevities	5A
Classified ads	1C
Clubs in Action	2B
Obituaries	2A
Sports	9A
Suburban Life	1B
The Stroller	8A
The View	1B

SPORTY SPIKERS

A sport growing in popularity among local women is volleyball—power volleyball, that is. In fact it's so popular, that some residents will play in a softball game or soccer match and then report for a strenuous volleyball doubleheader. See story and photo's in today's Life Section on Page 1B.

All 3 candidates back tax, bond

All three candidates for the Plymouth-Canton Board of Education support the millage renewal and bond issue on the April 23 ballot.

Although the candidates won't be running for the school board until the June 13 annual election, all three urge residents to vote "yes" on both the renewal and the bond issue.

Those who have filed for the school board are Arlene Calahan of Canton, Steve Harper of Plymouth Township, and Mary Jane Mulaski of Canton.

MRS. CALLAHAN says she "strongly supports both ballot issues and really hope they pass."

"I support the millage renewal simply because the school district needs the money. To defeat the millage would only take money, which cannot be replaced, away from our programs. Teachers would get laid off and class sizes would increase."

The bond issue is needed, she said, "so we can keep up with growth in Canton. And it's wise to pass the bond issue now. With inflation, construction costs are going up. If we wait one or two years it will cost us much more to build what we need and is provided for in this bond program. It's just wise financially to pass the bond issue

now. It's like buying a home—if you have the money, you would buy now and not wait for costs to go up."

The renewal proposal is to approve five mills for operating, which are now being levied, for another six years. The bond issue is to borrow \$29.75 million for new buildings and renovations to existing buildings. To pay off the loan, one mill would be levied. Some \$19.75 million would be borrowed in August, 1977, if the issue is approved and the other \$10 million would be borrowed in two years—if the state board of education approves the sale.

MRS. MULASKI says she supports both ballot issues.

"The five mills we've been paying all along and aren't going to miss it by renewing. It's not an additional tax. But we need those five mills to cover existing operation expenses."

"The one mill for new schools also is needed. More and more people are moving into Canton which means more children, and we must be prepared to educate them."

"The school district has looked into other options, such as renting empty buildings but the closest space available is in Garden City. So we've no choice but to vote yes."

"Nobody wants taxes to go up but the additional children are coming and we have to educate them. The school administrators are being flexible in the construction program and bond planning to avoid over-building. This is important to remember."

HARPER, WHO IS chairman of the

citizens election committee, predictably endorsed both ballot proposals.

On the renewal, he commented: "Those five mills amounts to 10 per cent of the operating budget. When you consider 85 per cent of the budget goes for salaries, we must lay off a lot of people if the renewal fails—some 75 to 90 employees. With 800 to 1,200 new students coming in the fall, class sizes will go to unreasonable levels if we have to lay off faculty. And there would be substantial reductions in all types of programs."

"Defeat of the renewal also would have serious impact on the resale values of homes in this community."

On the bond issue, Harper pointed out that 5,000 additional students are expected by 1980. "If we put every single building in the school district on year-round school, we could handle 8,000 students with existing classrooms. But by 1979, we'd reach the point where more buildings are needed. The problem is that we aren't sure now we can—even if we wanted to—put every building on 45-15."

"So we must get the bonds now. By going for a large amount, we qualify for the state bond fund and obtain a lower interest rate and the ability to pay off the loan over a longer period of time. And so we can borrow \$30 million for one mill. Without the state bond fund, it would cost us one mill to borrow \$15 million. So we can get twice the money for the same millage rate and have the opportunity to do some long-range planning but yet build only what we must to meet the growth up to 1981."

Plymouth-Canton OBITUARIES

INGVALD GILBERTSON

Funeral services for Mrs. Gilbertson, 56 of Warren, Canton, were held recently at Maney-Burrell-Turovski Funeral Home with burial at Holy Sepulchre. Officiating was Pastor Norman Schellhase.

Mrs. Gilbertson died April 6 at Providence Hospital. Survivors include: wife, Alice; sisters, Mrs. Ellen Gilbertson, Mrs. Helga Rostvit, Mrs. Inger Stahl, and Mrs. Agnes Stahl.

ANGELA HIEGER

Funeral services for infant Hieger, two months, of Canton were held recently in the Ross B. Northrop & Son Funeral Home, Northville, with burial at Rural Hill Cemetery, Northville. Officiating was the Rev. Fr. McAllister, chaplain at St. Joseph Hospital, Ann Arbor.

Angela died April 9 in St. Joseph Hospital. Survivors include: parents, Mr. and Mrs. Robert Hieger; sister, Amanda; grandparents, Mr. and Mrs. Daniel Shemon of Ypsilanti, Mr. and Mrs. Richard Hieger of Northville Township.

PAUL J. PETRITS

Funeral services were held recently for Mr. Petrits, 59, of Tucson, Ariz.

Mr. Petrits, who died March 28, lived in Plymouth on Thornridge Drive from 1966-74. Born in Detroit, he was a professional musician and a member of the Detroit Federation of Musicians. Survivors include: wife, Jean; daughters, Mary Ann, Sue, Nancy; son, Paul—all residing in Tucson.

Police get boy, lose handcuff

The Michigan State Police have a runaway juvenile with poetic tendencies in custody but are still missing half a handcuff.

Last week, Trooper John McAllen, of the Northville post, picked up a young man who had run away from home. While he was in the process of taking the youth back to the station, he got a radio message to check on a possible burglary at a nearby building.

"We knew he had the kid with him," said Sgt. Gary Sauer of the Northville post, "but he was the nearest man within seven miles. So we told him to check it out."

According to Sauer, McAllen opened the trunk of the patrol car and handcuffed the youth to the latch to keep him from escaping while the officer investigated the building. However, when he came back to the car, the

youngster—and the handcuffs—were gone.

"Apparently, McAllen didn't realize the boy could reach the tire iron," Sauer said. "But he could, and used it to bash the handcuffs open."

Several hours later, the youngster called the police post and told them half their handcuff was in a certain mailbox. When officers arrived on the scene, they found the cuff—and a poem explaining how the youthful offender had made good his escape.

"No doubt, the kid is very creative," commented Sauer. "But we've got him in custody again, and he's going to stay there until he tells us where the other half of the handcuff is."

The youth, who is being held at the juvenile detention center, has thus refused to give the police that information.

Lions elect officers

The Lions Club of Plymouth has elected a slate of officers for directors for 1977-78.

John Roose has been elected president, Lou Morton, secretary, and Les Cavell, treasurer. Dave Cook is the new first vice-president, Dale Dauderman second vice-president, and Noble Kheder, third vice-president. Bob Richardson was elected Lion Tamer, and Fred Robinson Tale Twister.

Elected to one-year terms as directors were Fred Eisenlord, Bill Fehlig, Frank Tanner and Bob Erdelyi. Elected for two-year terms as directors were Skip Dorrington, Don Francoeur, Larry Green and Don Phillips.

The Lions Club meets on the first and third Thursdays of each month at 6:30 p.m. in the Mayflower Hotel.

CANTON Italian BAKERY
7393 Lilley Road
at Warren, Canton
KING'S ROW CENTER

New Owner—Come In and Visit!
TUESDAY ONLY
LARGE CHEESE & PEPPERONI PIZZA \$2.99
459-9544
MON-FRI 8:30-6:30
SAT 9:30-7:00

\$1,200 How much will do it for you?

Commercial Credit's been helping people for more than sixty years. So whatever you need. A few hundred. Or even as much as \$1,500. Just call us about a loan. We'll find ways to help.

COMMERCIAL CREDIT

Personal Loans

a financial service of CONTROL DATA CORPORATION

Detroit • 21559 W. 8 Mile Road • 538-7000
Plymouth • 6064 Sheldon Road • 459-2400
Credit Life Insurance Available to Eligible Borrowers



We've got the skills so you can have the style

the Cutting Quarters

459-0640 585 WANN ARBOR TR. PLYMOUTH, MICH.

Home Buyers Deserve Expert Help...



...they can count on Detroit & Northern

Because we specialize in home financing, you get the best help available when you talk to one of our home loan specialists. He'll tell you about our many loan plans and options and how to determine how costly a home you can afford. At D&N there is a loan plan right for every budget. Our home loan rates are competitive, but beyond that, the home buyer can expect much more at D&N.

Several Options ...

We've been lending money to home buyers since 1889, and our experience shows in the service we render our customers. For example, at D&N we have several term options to help meet each borrower's particular needs. The term of the loan, along with the down payment amount and interest rate determine your monthly payment. Depending on the age and condition of the home, a term of up to 30 years may be selected. Ask a D&N home loan specialist to explain how your monthly payment is affected by the term you choose.

For your security, D&N offers mortgage life insurance. This protection provides for the full payment of your loan in the event of death. Disability insurance is available, too, providing for the payment of your monthly loan if the family breadwinner should become disabled.

Loan Payment Convenience ...

In addition to security, D&N offers some real conveniences, too. To make your monthly payment as easy as possible, we have a plan called "Transmatic." With this plan, your mortgage payment is automatically deducted from your checking account and transferred to D&N on a set date each month. Using the "Transmatic" plan, you needn't worry about forgetting to make a payment when you are on vacation or out of town. A special trip and writing an additional check each month are eliminated when you choose "Transmatic."

Handling Details ...

Many of the details involved in closing the deal will be handled by Detroit & Northern. We will arrange for an appraisal of the property, which will assist in determining the amount of the loan. If a survey is required, D&N will arrange for it. In addition, we can arrange for title insurance. D&N will perform the routine credit checks and handle the recording of your purchase. At the "closing," Detroit & Northern will assemble the various mortgage and legal documents and review them with you.

Continuing Service ...

After receiving your Detroit & Northern home loan, you will enjoy the continuing services we provide homeowners. D&N will handle the payment of your property taxes, hazard insurance, mortgage life and disability insurance. For your records at the end of each year we will send you an analysis of your escrow account and a statement outlining each financial transaction.

AT DETROIT & NORTHERN YOU ARE CONSIDERED A FRIEND AND NEIGHBOR. WE VALUE YOUR BUSINESS. BEFORE BUYING A HOME, SEE A DETROIT & NORTHERN HOME LOAN EXPERT. HE'S A PROFESSIONAL.

DETROIT & NORTHERN SAVINGS

37 OFFICES THROUGHOUT MICHIGAN

NEW CANTON OFFICE
6006 NORTH SHELDON RD.
(AT FORD RD.)
459-9100



PHYSICIANS AND SURGEONS OF THE FOOT

Announce the relocation of their office for the practice of

FOOT SURGERY & PODIATRIC MEDICINE

to

CANTON PROFESSIONAL PARK
8548 NORTH CANTON CENTER ROAD
CANTON, MICHIGAN 48187 455-2400

"We have the Best Prices on LIQUID PROTEIN"

Herbs & Spices • Natural Grains and Nuts
Dannon Yogurt • Minerals • Meatless Foods
Diet Foods • Vitamins • Pure Juices
Natural Snacks • Allergy Foods • Ginseng
Natural Ice Cream and much, much more!

"the natural place to shop"

10% OFF ON ALL PRODUCTS WITH THIS AD

friends of nature health food center
459-5433

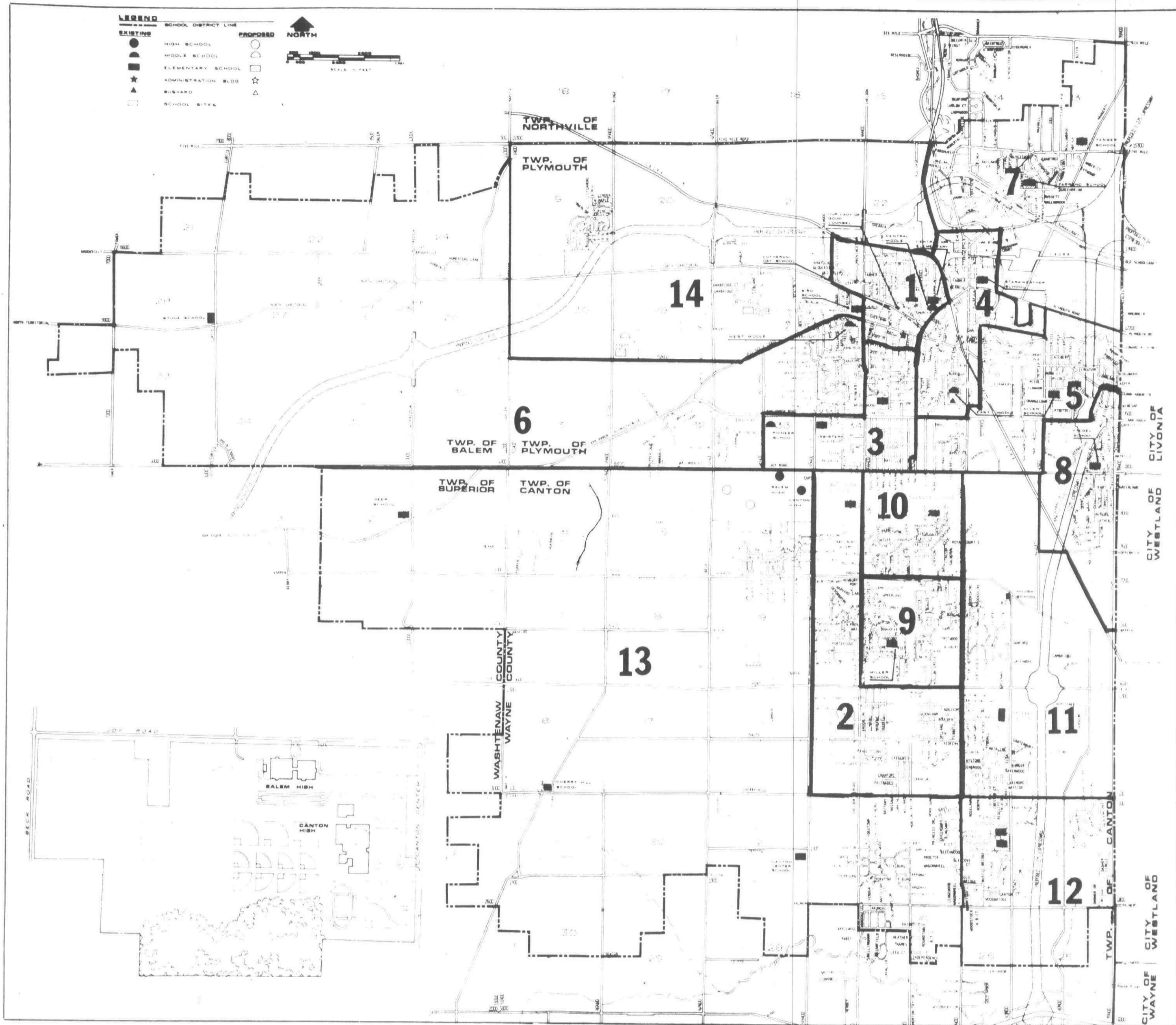

Voting precinct map

Plymouth-Canton Community Schools

The following is the location of voting places for the April 23 millage renewal-bond issue election of Plymouth-Canton Community Schools:

PRECINCT 1
Central Middle School. The first precinct consists of all of City Precinct No. 3 and City Precinct No. 5.

PRECINCT 2
Gallimore Elementary. The second precinct consists of all of Canton Precinct No. 1 and Canton Precinct 10.

PRECINCT 3
Isbister Elementary. The third precinct consists of all of City Precinct No. 4 and all of Plymouth Township Precinct No. 5.

PRECINCT 4
Starkweather Elementary. The fourth precinct consists of all of City Precinct No. 1 and City Precinct No. 2.

PRECINCT 5
Allen Elementary. The fifth precinct consists of all of Plymouth Township Precincts 3, 4 and 9.

PRECINCT 6
West Middle School. The seventh precinct consists of all of Plymouth Township Precincts 6 and 12 and all territory of the school district located in Salem Township.

PRECINCT 7
Farrand Elementary. The seventh

precinct consists of all of Plymouth Township Precincts 1, 2 and 8 and all territory of the school district located in Northville Township.

PRECINCT 8
Fiegel Elementary. The eighth precinct consists of all of Canton Precincts 3, 6 and 11 and all of Plymouth Township Precinct 10.

PRECINCT 9
Miller Elementary. The ninth precinct consists of all of Canton Precincts 5 and 13.

PRECINCT 10
Hulsing Elementary. The 10th precinct consists of all of Canton Precincts 7 and 12.

PRECINCT 11
Eriksson Elementary. The 11th precinct consists of all of Canton Precincts 9 and 14.

PRECINCT 12
Field Elementary. The 12th precinct consists of all of Canton Precinct No. 5.

PRECINCT 13
Canton High School. The 13th precinct consists of all of Canton Precincts 8 and 16 and all territory of the school district in Superior Township.

PRECINCT 14
Bird Elementary. The 14th precinct consists of all of Plymouth Township Precincts 7 and 11.

Cost analyst enters Schoolcraft contest

Karl M. Sjogren, a cost analyst for the Ford Transmission and Chassis Division in Livonia, will seek a seat on the Schoolcraft College board of trustees in the June 13 election.

Sjogren, 23, of 20338 Brentwood, Livonia, is a resident of the Clarenceville School District.

He earned an associate of arts degree at Schoolcraft, a BA in business and pre-law with high honors at Michigan State University and a master of business administration degree in finance at MSU.

"HAVING BEEN president of the student senate and a graduate of Schoolcraft gives me a unique insight into many of the problems facing the college," Sjogren said.

He supports the June 13 property tax proposal to raise the limitation by 0.8 mills.

He said he is "concerned about the needs of the 'traditional' student as well as those of the mature student returning to school. As a trustee, I will work to ensure that the college meets community needs on an efficient and fiscally responsible basis."

AS A SCHOOLCRAFT student, Sjogren served on the college council, an advisory body to the president composed of students, faculty, staff and administrators.

He was a member of Phi Theta Kappa and the swimming team and was selected as an outstanding college athlete of America in 1972 and 1973.



KARL M. SJOGREN
Former student runs

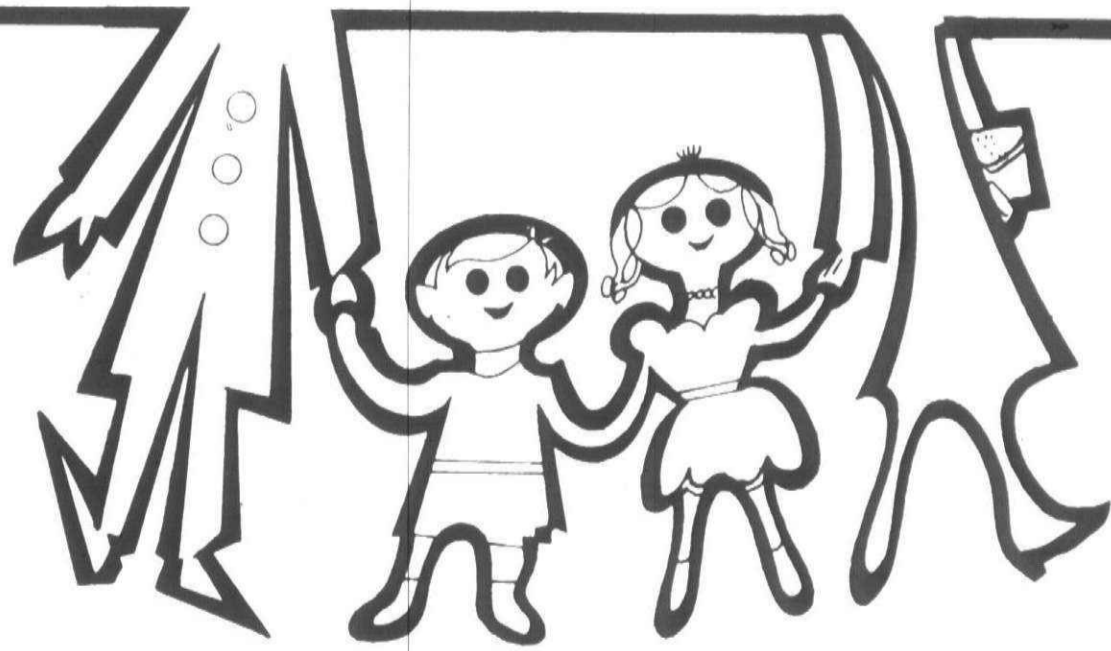

GETTING THEM READY FOR LIFE IS NO EASY TASK

Teaching kids how to handle money wisely in one of the most important things you'll ever do

Your "Family Credit Union" can make you're job easier'

Plymouth Community Federal Credit Union. Serving the folks who live or work in the Plymouth-Canton-Northville Community.

Plymouth Community Federal Credit Union

500 SOUTH HARVEY
453-1200



at your family credit union

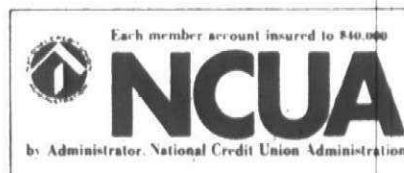

Hours: Mon., Thurs., 9:00 to 5:30--Fri., 9:00 to 7:00--Sat., 9:00 to 1:00
Drive-in Hours: Mon.-Fri., 9:00 to 7:00--Sat., 9:00 to 3:00

GARAGE DOOR OPERATORS

Genie 450D
 CRYPTAR II DIGITAL CONTROLS
\$175.00 installed
 1 Year Warranty—Any Suburb
ALLIANCE AUTOMATIC DOOR CO.
 358-3833 SOUTHFIELD

What's New? Read the Want Ads

COUPON

BIG AND TALL

SPECIAL GROUPS SPORT SHIRTS
 originally \$25
Now \$7.99

SPRING JACKETS
 Originally \$30 to \$50
Now From \$12.99

FARMINGTON HILLS
 KENDALWOOD CENTER
 12 MILE-FARMINGTON RD.
553-3830

BLOOMFIELD-PONTIAC AREA
 Miracle Mile Center
332-8305

6 GREAT STORES

JACK STEVENS

COUPON

WESTLAND MEATS, INC.
 featuring **ALEXANDER & HORNING PRODUCTS**

A SPRING BEEF SALE
USDA IOWA GRAIN FED CHOICE & PRIME CUT BEEF

JUICY NEW YORK STRIP STEAK
\$3.59 LB.

FRESH LEAN GROUND BEEF
 10 LB. BAG **89¢ LB.**

TENDER BONELESS N.Y. SIRLOIN STEAK
\$2.69 LB.

ROUND BONE OR ENGLISH CUT ROAST
\$1.19 LB.

BONELESS, ROLLED ROTISSERIE ROAST
\$1.99 LB.

BEEF SIDES & HINDQUARTERS
 FOR YOUR FREEZER
 CUSTOM CUT, WRAPPED & FROZEN
FREE!

TOP ROUND STEAK
\$1.99 LB.

LEAN TENDER CUBE STEAK
\$2.29 LB.

BLADE CUT POT ROAST
89¢ LB.

FROM THE DELI
 ALEXANDER & HORNING'S
HARD SALAMI - WHOLE OR HALF **75¢ 1/4 LB.**
RING BOLOGNA **\$1.39 LB.**

WESTLAND MEATS, INC.
 WESTLAND CENTER
 ARCADE E-5
421-2730

This announcement is neither an offer to sell nor a solicitation of an offer to buy any of these securities. The offering is made only by the Prospectus.

9 3/4 %

CREDITTHRIFT Investment Notes
 Series A

Available in denominations of \$100 or more.

- Annual interest on Notes can be left to compound quarterly for payment at maturity only. A ratable portion of the interest is taxable annually by the Internal Revenue Service.
- You may also choose to have interest mailed to you monthly (on notes of \$5,000 or more) or quarterly.

Maturity	Effective Annual Interest Rate*	
	(If interest is paid quarterly or monthly)	(If interest is compounded quarterly and paid at maturity only)
10 years	9.75% 10.11%	
5 years	8.75% 9.04%	
2 years	7.75% 7.98%	

*Pre Tax

The net proceeds from the Investment Notes, Series A, will be used by CREDITTHRIFT to retire certain outstanding indebtedness, and the balance, if any, will be added to the general funds of CREDITTHRIFT.

Here's how you can obtain a copy of the Prospectus.

Phone a licensed representative of CFC Investment Inc. today and ask for a Prospectus. The representative(s) serving this area is listed below. Or, phone the toll-free number below.

PHONE TOLL-FREE
800-457-3741
 (In Indiana, 800-742-3784)

CREDITTHRIFT FINANCIAL INC.

In Wayne:
Kathleen Harper
 35630 Michigan Avenue
 Phone: 721-4900

In Livonia:
Robert E. Bussart
 32160 Plymouth Road
 Phone: 422-1505

Wholly-owned subsidiaries of CREDITTHRIFT Financial, Inc. include CREDITTHRIFT of America, Inc., The Morris Plan Company of California, Allen and Stein, and American Security Corporation.

Rite CARPET

Featuring America's Finest Carpet Mills. Largest Selection in the Area. Choose from Lees, Wunda Weve, Bigelow or Cabin Crafts.

7 Mile at Middlebelt across from Livonia Mall
 476-8360

8497 W. Grand River Outside Brighton Mall
 1-227-1314

LAWN MOWER TUNE UP
GET READY FOR SPRING!

TOWN 'N' COUNTRY
 Hardware & Fireplace
 27740 Ford Road • GA2-2750
 3 1/2 BLKS. W. OF INKSTER RD.
 NEW HOURS: M-F 9-8 SAT. 9-6 CLOSED SUN.

ARBOR DRUG CENTERS, INC.

TWO LOCATIONS TO SERVE YOU

REDFORD PLYMOUTH & INKSTER
WESTLAND MIDDLEBELT & ANN ARBOR TRAIL

7 STORES TO SERVE YOU
 • for Nearest Store Location call 336-4700

\$500
How much will do it for you?

Commercial Credit's been helping people for more than sixty years. So whatever you need. A few hundred. Or even as much as \$1,500. Just call us about a loan. We'll find ways to help.

COMMERCIAL CREDIT
 Personal Loans
 a financial service of
CONTROL DATA CORPORATION

Detroit • 21559 W. 8 Mile Road • 588-7000
 Plymouth • 6084 Sheldon Road • 459-2400
 Credit Life Insurance Available to Eligible Borrowers

From our readers

Use a little horse sense; schools must cut frills

Editor: With the school millage coming up for a vote, I feel I must have my say.

First of all, on 30 acres of vacant land, our state equalized value is about \$30,000, making our taxes for 1976 on this property \$1,764. The state value was raised from 1975, so therefore, the schools got more money. In subdivisions, there are about two houses per acre with assessed values of about \$15,000 on each, to make a total of \$30,000 per acre. Some homes have no children, so why is there a need for more millage?

The high-rise apartments for senior citizens are built as such, because they are cheaper to maintain as well

as to build. Why then can't we have at least three-story schools, where the same roof would cover three floors, the same foundation would just have to be changed a little, the heating problems would be greatly reduced, and the maintenance would be far cheaper than for one-story buildings spread over 30 or more acres of land. Are our children too good to climb stairs, as I, my father and mother did in Central Middle School which was the high school we graduated from? My children also graduated from there. Do we think so much less of our senior citizens that we make them go up in a high-rise building and make young children, who are able to

climb stairs and need the exercise, stay at ground level?

We would like to have many things different, but, if we cannot afford it, we have to live within our means. We cannot go and say to our employer, 'I want a new Cadillac, so give me a raise big enough that I can get it.' Why then should the schools not be made to live within their means? I went into Canton High School last June for a graduation. I was sick to see the wasted taxpayers' money in that building. They have what is called a "bull pen" in one area. I don't know what this is for, unless, as the name implies, teachers go there to "talk." Or maybe it's the students.

I do not have a college degree, nor do I need one, to use a little common sense to see that our school system has become a Frankenstein monster. We can no longer control it. It controls us. I hope that every voter will think before he marks his ballot.

They do not have to close schools, lay off teachers, shut down buses or

use a lot more scare tactics to get people to pass the millage. All they have to do is use a little "horse sense," as we farmers say, cut down on their expenses and live within their means as we the people have to. Then they would not need the millage.

Let us not make taxes so high that our children, grandchildren and great-grandchildren will not be able to enjoy life. Let us not be like the ostrich, who buries his head in the sand and thinks he's hidden, while all but his head is in plain view. Let us leave something to our loved ones besides taxes they cannot pay. Let us leave them a school system that lives within its means.

If necessary, weed out the school system the same as we weed a garden. Cull out the non-producers, the same as farmers cull cows that don't produce enough. Again, I ask each and every voter, think before you mark your ballot.

ROGER BORDINE
 Fifth generation Canton Resident

Canton can't waste time by just studying growth

Editor:

It was recently reported by the news media that Canton Township had received initial approval from the Wayne County Community Development Block Grant Program for \$23,000 to catalog innovative growth management techniques.

On March 17, the Canton Growth Committee, appointed by Harold Stein to study growth control alternatives, authorized its chairperson to write a letter to the board of trustees outlining its position on the township's application for block grant funding.

Let me share with you some of the portions of that letter. . . . such a study could delay action for an extended period of time and press Canton near a crisis stage in terms of inability to maintain adequate services.

. . . we question if it (the study) is truly needed as desperately as is immediate citizen input. . . and a specific growth plan and ordinance for Canton.

. . . we are somewhat reticent to endorse your proposal unless some interim growth control technique was activated during the time the study was being completed.

I AM OPPOSED to the study for

two reasons. First, the information to be gathered already exists in three 1,500 page volumes, "Management and Control of Growth," funded in 1975 by the U.S. Department of Housing and Urban Development. How can a \$23,000 study match this in scope and detail?

Second, Canton Township can ill afford to waste more time studying the growth problem. There exists numerous growth management techniques. What we are short of in Canton is commitment on the part of our elected officials to respond to the growth problem with boldness and decisiveness.

The \$23,000 could be better spent on hiring a nationally-known growth management advocate expert to articulate a growth management program for Canton and a law firm capable of defending the program in court.

Canton residents, if you too are convinced something decisive must be done about uncontrolled growth, make your feelings known by contacting Supervisor Harold Stein and the board of trustees.

THOMAS YACK
 Member, Growth Management Committee

Who's behind Harold Stein?

Editor:

In response to Janet Lindbergh's "fairy tale," let's get a few things straight.

It is no longer a fight between three individuals over a public office. It is a fight between the people of Canton and the present supervisor.

We are trying to make Canton a better place to live. We are also trying to get Harold Stein to act on the critical needs of Canton. This he is either incapable of doing, or just will not do.

In the beginning of his term, all we heard was, "Give me time, I've only been in office a few days." If he had really cared about this township, he would have attended the meetings long before he took office. Which makes me wonder who is really behind Harold Stein?

There has to be someone feeding Stein his information. If he had only realized how inadequate he was before he took office, we wouldn't have two ZBAs, numerous study committees, attorney opinions coming from every direction, lawsuits and the wasting of taxpayers' money with an audit.

there have been more of those than regular meetings.

Let's stop blaming Bob Greenstein for Harold Stein's mistake. I might add that for every special meeting that is called each trustee is paid \$40. When you consider all the special meetings that have been held, it adds up to a lot of taxpayers' money.

In closing, I would like to add that the McDonald banquet room was not Bob Greenstein's doing. It was the doing of the (Phil) Dingledey administration. It is obvious that once again a Stein supporter has not checked her facts. Also, Bob Greenstein has attended approximately three meetings since leaving office.

DEE BASHOR
 Canton Township

Discipline is needed

Editor:

Regarding the Feb. 17 absenteeism article, isn't it amazing? Our educators and school officials feel they finally have the explanation for the student attendance problem in our schools (sociological, peer pressure etc.). It is even more amazing these educated people ran right over one of the most obvious reasons of all—supervision with some degree of discipline.

Doesn't the "Sin City" nickname tell us something?

MARY A. BERGER
 Plymouth

New tracking snags Miller

(Continued from page 1A)

form ending date. People coming into or leaving the district would be more "in step with the rest of the world."

It would also get rid of the problems students face when they leave a 45-15 program and go to a middle school on a nine-month calendar or to the high school.

With the staggered method of track-

ing, some tracks would still be finishing the year's instruction when the traditional schools were starting the new academic year.

"We don't have any answers," said Hoben. "But it's ludicrous to put the whole district on a disjointed schedule for one school. We just have to keep working. Nothing is definite as of now."

Extraordinary Savings!

6 Days Only!

Pillow-back Chaise Lounge or Chair and Ottoman . . .

Reg. from \$249 to \$364

Your Choice **\$169.**

We have an excellent group of fabrics. However, our yardage is limited in several patterns, so shop early!

WIGGS
 Open Mon., Thurs. & Fri. 'til 9

phone: 644-7370

TELEGRAPH RD. (at Long Lake Rd.) BLOOMFIELD HILLS

BREVITIES



ARTS FESTIVAL

April 17—The Livonia Artist Club will present its 16th annual Festival of Arts at 1 p.m. in the Carl Sandburg Library on Seven Mile west of Middlebelt Road. The public is invited.

THE GIFTED ONE

April 23—The Plymouth Association for the Academically Talented will meet on Thursday at 8 p.m. in the library at East Middle School. Mrs. Dorothy Knopper, parent and educator, will speak about the challenge of the gifted child. All interested persons are welcome.

ST. KENNETH SENIORS

The Senior Citizens of St. Kenneth Catholic Church will meet at noon April 19 in the Parish Hall on Hagerty Road.

Members are asked to supply their own brown bag lunch. Dessert and coffee will be provided. Guest speaker will be Gary McLean. The topic will be wills and inheritance taxes. The group will play cards after the business meeting and the program.

MOVIES FOR CHILDREN

April 23—will be the final showing of children's movies. The movies run

from 10 a.m. to noon. Hot dogs and cokes are available for a nominal charge. This seasonal program will begin again in September.

OSTOMY CHAPTER MEETS

April 21—The Ann Arbor area Ostomy Chapter will meet on Thursday at the senior citizens guild, 502 W. Huron St., in Ann Arbor. The program will focus on highlights of the conference and election of officers.

K of C SQUARE DANCE

April 23—Allemande left your corner. Do-Sa-Do your partner and promenade her, you know where and I don't care. The caller is already practicing for Saturday night's square dance from 8-11 p.m. at the Council Hall on 150 Fair St. in Plymouth. If you're experienced or a beginner, grab your partner and sashay over to the council hall for an evening of fun and laughs. Coffee and soft drinks will be available. Donation is \$3.50 per couple.

SPRING ARTS & CRAFTS SHOW

Applications for the third annual Plymouth Spring Arts and Crafts show, which will be held the weekend of May 20, are available at the Plymouth Recreation Office, 525 Farmer Street. For more information call 455-6620.



Smiling senators

U.S. Rep. Carl Pursell (R-Plymouth) presents a framed copy of the State of Michigan seal to the new State Sen. R. Robert Geake (R-Northville) at Geake's swearing-in ceremony recently in Livonia City Hall. Geake was elected March 23 in a landslide victory to the 14th senatorial district seat left vacant

when Pursell moved up to the U.S. Congress. The 14th District includes Plymouth and Plymouth Township. State Supreme Court Justice James Ryan of Redford Township was on hand to administer the oath of office.

College News

CMU HONOREES

Seven Plymouth students have been named to the honors list for the fall semester at Central Michigan University. They are: George L. Adler, of Caprice; Terry E. Brennan, of Barchester; Glenda K. Haut, of Partridge; Debra J. Rowland, of Lexington; Dale R. Schrader, of Thornridge; Martha J. Vorech, of Hartsough; and John A. Wee, of River Oaks. Honors students were chosen from the top 10 per cent of each academic class. In addition, to qualify for honors a student had to have completed 12 or more letter-graded hours of on-campus credit and have a grade point average of at least 3.50 (out of a possible 4.0).

KALAMAZOO COLLEGE

Two Plymouth students are involved in a special career development program at Kalamazoo College. During the spring quarter they will be able to gain work experience in a field related to their academic interest. Elizabeth Moehle, a sophomore, will work in the Library of Congress, Washington, D.C. as a student clerk. Gail Schulteiss, also a sophomore, will work for the Plymouth Center for Human Development, Northville.

Wednesday
April
20th



Plymouth's Midnight MADNESS SALE!

8 o'clock
P.M.
til
Midnight

LET'S GET AQUAINTED!

Free
BAG OF POPCORN
Free
CUP OF VERNOR'S
Free
BALLOONS FOR THE KIDS



FROM 8 P.M. TO MIDNIGHT:
WEDNESDAY APRIL 20TH.

OPEN: MONDAY THRU SATURDAY: 9 A.M. TO 10 P.M.
SUNDAY: 11 P.M. TO 6 P.M.

FAMILY DISCOUNT DRUG

1400 SHELDON RD. AT ANN ARBOR RD.
PHONE: 453-5807 or 453-5820

JEANS SALE

OVERALLS

Reg. \$25.99
4 HOUR SALE! Only **\$12.99**

LADIES TOPS

UP TO \$19.99 Reg.
ON SALE **\$5.00**

JEAN STYLE PANTS

UP TO \$19.99 Reg.
BRUSHED DENIM & CORDS
Special **\$2.99**

MEN'S SHIRTS

UP TO \$22.00 REG.
ON SALE **\$2.99 & \$5.00**

MANY OTHER GOOD BUYS!

SLAK SHAK

FASHIONS FOR MEN-WOMEN-CHILDREN
853 W. ANN ARBOR TRAIL
PLYMOUTH • 455-7819 & 453-9819

Special

SAVINGS!
LAST CHANCE TO SAVE
Final Reductions
on Men's & Women's
Sportswear

COATS, SLACKS
SWEATERS, LEISURE SUITS
AND TOPS

UP TO **50% OFF**

Plus **10% OFF** ON ALL SPRING & SUMMER MERCHANDISE!

NAWROT INC.
PENDLETON SHOP
(IN FOREST PLACE MALL)
470 FOREST • 459-0440
PLYMOUTH



BOSTON

including:
More Than A Feeling / Peace Of Mind
Foreplay / Long Time / Rock & Roll Band
Smokin' / Hitch A Ride

Yardbirds Great Hits

For Your Love
Heart Full Of Soul
Still I'm Sad
I'm Not Talking
Shapes of Things
The Train Kept A Rollin'
I Wish You Would
I Ain't Done Wrong
I Ain't Got You
I'm A Man

KANSAS Leftoverture

including:
Carry On Wayward Son
Miracles Out Of Nowhere / Cheyenne Anthem
Magnum Opus / Questions Of My Childhood

\$3.99 Records
\$4.99 Tapes

CHICAGO X

Another Rainy Day In New York City
If You Leave Me Now / Once On This Train
You Are On My Mind / Ship Tight

JEFF BECK LIVE

WITH THE JAN HAMMER GROUP
including:
Scandinavia / Blue Wind
Don't Look Back In Search Of A Son
Step A Moment / Firebird Jam

Maynard Ferguson Conquistador

including:
Gonna Fly Now / Theme From "Rocky"
Major Motion / Theme From "Star Trek"
Sax Like An Eagle / The Fly

\$1.00 OFF ANY CBS Records and Tapes.
(Except those Artists mentioned in ad)

PLYMOUTH RECORD & TAPES

770 PENNIMAN • PLYMOUTH • 453-6580

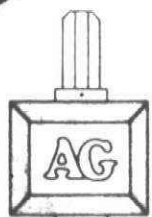

The Art Gallery Inc.

ORIGINAL GRAPHICS • PRINTS
CUSTOM FRAMING • WALL DESIGN

TONIGHT...
20% DISCOUNT
ON CUSTOM FRAMING
plus
SPECIAL DISCOUNT

ON Selected Pieces Plus

Many New FRAMED PRINTS for under \$15

459 S. MAIN
PLYMOUTH
459-5454

THE GREEN THUMB

PLANTS • GIFTS • BASKETS
FLOWERS

all at
FANTASTIC SAVINGS OF
10 to 50%

505 FOREST • PLYMOUTH • 459-2323
(Enter through SIDEWAYS or use Back Entrance)



The Mad Hatter had his party...
We're having our Madness
April 20th!
Children's Apparel
Boys' & Girls'
Sizes Infant thru 14

'The Clothes Tree'

643 N. MILL, Plymouth
in Old Village
Hours: Daily 10-5
Friday 11 8:00 p.m.



Reg. \$1.99 lb.
WHITEFISHlb. **\$1.39**
Reg. \$4.89 lb.
KING CRAB LEGS ...lb. **\$3.99**
Reg. \$1.99
FRESH OYSTERS ...pt. **\$1.49**

578
STARKWEATHER
PLYMOUTH
Behind
BILLS MARKET
455-2630

Wednesday
April
20th



Plymouth's Midnight MADNESS SALE!

8 o'clock
P.M.
til
Midnight

MADNESS TO
MIDNIGHT

SUITS
Were Reg. to \$165 **\$79⁹⁷ • \$89⁹⁷ • \$99⁹⁷**

Better DRESS SLACKS **\$15⁹⁷ 2⁰ F \$30⁰⁰ R**
Reg. \$27.50

Damaged & Soiled
LEATHER COATS More than **50% OFF**

Selected Group
DENIM TOPS & BOTTOMS .. UP **50% OFF** TO

Long Sleeve
SPORT SHIRTS Reg. \$20.00 **\$3⁹⁷**

ALTERATIONS AT COST
Parking in Rear of Store - Overflow Parking Behind Penn Theatre

LENTY

CUSTOM CLOTHING

798 PENNIMAN AVE. & MAIN ST. CORNERS
PLYMOUTH, MICHIGAN • 453-0790



Hurry Down...

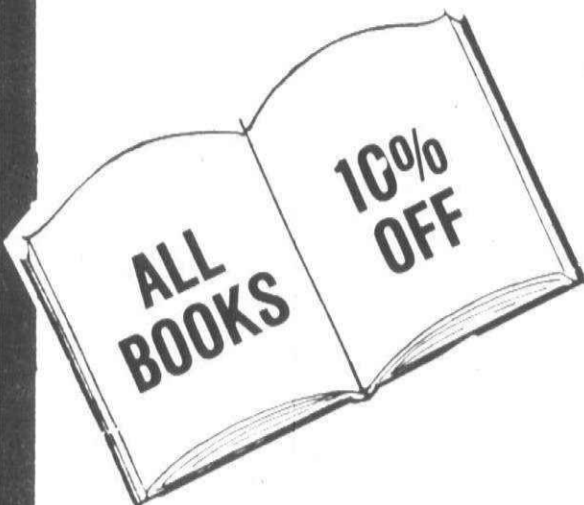

ENTIRE
STOCK
10%
OFF

Open 10 to 9
Mon. - Sat.



10 to 5
Sunday

LITTLE PROFESSOR BOOK CENTER
1456 SHELDON ROAD
at Ann Arbor Road
Plymouth • 453-3300

Kobeck's
Stride Rite Bootery

Sheldon at Ann Arbor Rd.
Plymouth • 459-1070
9:30 to 5:30 Fri. till 8:30

**25% OFF
ALL JEWELRY**

50% OFF
ALL
VIVITAR FILTERS



**40% OFF
ALL CAMERA BAGS
& GADGETS**

CANON F-1



BODY
ONLY

\$349⁵⁰



**KODAK
18
OUTFIT
\$19⁷⁵**

**KODAK
608
OUTFIT
\$28⁷⁵**

**KODAK
340
OUTFIT
\$149⁵⁰**

Nikkor Lenses
AT
DEALER
COST



OLYMPUS OM-1D

WITH F1.8
\$249⁵⁰
WITH F1.4
\$289⁵⁰
PLUS OM-1D FACTORY REBATE

**25% OFF
ALL PHOTO ALBUMS**

**25% OFF
ALL PICTURE FRAMES**

PRICES PREVAIL DURING SALE HOURS
8-12 MIDNIGHT ONLY. ON IN STOCK MERCHANDISE ONLY
CASH N CARRY - SALE IN PLYMOUTH STORE ONLY

Colonial Card & Camera

44473 Ann Arbor Road
at Sheldon Road
Plymouth 455-2930

37629 Five Mile Road
in Chatham Village
Livonia 464-3637

MIDNIGHT MADNESS
AT

KRESGE'S



DENIM
**HALTER
TOPS**
\$1⁴⁷
Reg. 2.47

IRREGULAR
**VELOUR
TOWELS**
2/\$3 Reg. 2.57

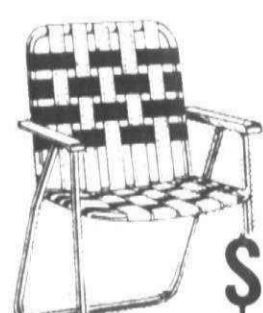

LAWN
CHAIRS
\$4³³
Reg. 7.04

PAPER
PLATES
100
Ct. **63¢**

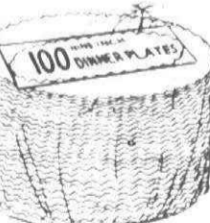

360 S. MAIN STREET • PLYMOUTH

The
Sewing Basket
(formerly Barb's Fabrics)

20% OFF
ALL FABRICS

SPECIAL TABLES

50%
Savings and more!

44465 ANN ARBOR ROAD at SHELDON
PLYMOUTH SQUARE • 453-5350

A FIRST...

SUPER ONE-NIGHT

SAVINGS
during our
ALL
AROUND
TOWN
SALE



Don't miss this one opportunity
to save up to

50%
Make it a real night on the town...
start your MIDNIGHT MADNESS
shopping at

CricketBox

44461 ANN ARBOR ROAD
PLYMOUTH • 455-3332

HOURS: DAILY MON-WED SAT 9:30-6:00 THUR-FRI 9:30-9:00

WAYSIDE

820 W. ANN ARBOR TRAIL
PLYMOUTH • 453-8310

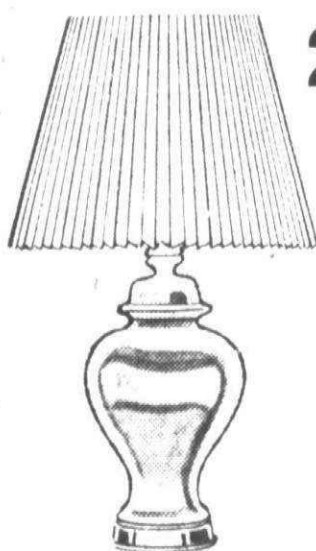

20% OFF
ON ALL
LAMPS
IN STOCK

sideways
COME SEE
OUR
SUPER
BUY!

505 FOREST • PLYMOUTH

SHOE SALE

BASEBALL
(Wilson, Hyde, Puma)
BASKETBALL
(Converse, Hyde)
TRACK
(Brooks, Adidas, Puma, Converse)
BOWLING
(Hyde, Voit, AMF)
GOLF
(Converse)
TENNIS
(Converse)

SPORT POSTERS Reg. \$2.50 SALE **\$1⁹⁵**

TRANSFERS ON T-SHIRT Reg. \$3.95 SALE **\$2⁴⁵**

**BASEBALL BATTING
GLOVES** Reg. \$6.25 SALE **\$4⁹⁵**

25%
to
40%
OFF

ALL OTHER PRICES 10% OFF LIST PRICE

**Plymouth
Sport Shop, Inc.**

863 W. ANN ARBOR TRAIL
PLYMOUTH • 455-1550
HOURS: MON. THRU THURS. 10-5:30 FRI. 10-8 SAT. 9-5



Lenox tapers
by the box
20% off

Selection of crystal
candle holders
50% off

All pictures
&
mirrors
10% off

Pick O' The Wick

800 W. ANN ARBOR TRAIL
PLYMOUTH • 455-6070
HOURS: Daily 9:30-5:30 Fri. 9:30-9

The
Final Touch

We have run a
storewide sale
for two weeks
and now comes the
frosting on the cake...



THE LAST NIGHT
of our
SALE
with MADNESS PRICES
UP
TO

50% OFF

Sportswear
Lingerie
Jewelry
Accessories

Aboard the Mayflower Hotel
PLYMOUTH • 455-3311
HOURS: Daily 9-8 Sat. 9-6

Wednesday
April
20th



Plymouth's Midnight MADNESS SALE!

8 o'clock
P.M.
til
Midnight

live it up
indulge in...

...OUR SPRING
FASHION CLEARANCE -
UP TO ONE HALF
OFF ON SKIRTS, PANTS,
TOPS, DRESSES AND ...

... a red
rose to you
for stopping by

me and mr jones

MADNESS

LEVI DENIM JEANS Reg. to \$16 **\$10⁹⁹**
Limit 2 Per Customer

SUITS Inc. Phoenix Reg. to \$145 **\$49⁹⁹**

DRESS SLACKS Name Brand Reg. to \$20 **\$7⁹⁹**

Short Sleeve KNIT SPORT SHIRTS Inc. Donnegal Reg. to \$18 **\$4⁹⁹**

DRESS SHIRTS Name Brand Reg. to \$12 **\$4⁹⁹**

ALTERATIONS AT COST

Girls' JEANS Reg. \$11.00 to \$16.00 **1/2 OFF**

Summer NIGHT GOWNS Reg. \$8.00 to \$10.00 **NOW \$6⁰⁰ and \$7⁰⁰**

STOREWIDE DISCOUNTS ON ALL MERCHANDISE

Famous Maker BLOUSES Sleeveless, Short or Long Sleeves **\$5⁰⁰**

Women's SLACKS Petite or Regular Lengths Were \$13.00 to \$21.00 **1/2 OFF**

Minerva's Dunning's

WOMEN'S - CHILDREN'S - LINGERIE
500 FOREST
PLYMOUTH GL 3-0080

Free Parking rear of store - Hours: Daily Mon. thru Sat. 9-6 P.M. Sun. 9-5 P.M.

FREE STEAK DINNER AT THE
CROW'S NEST
FOR THE FIRST 25 CUSTOMERS
LIMIT 1 PER FAMILY

PREP SLACKS **SAVE 70%**

MENS' SLACKS **SAVE 50%**

MENS' & BOYS' SPORTSWEAR **SAVE 50%**

MENS' SPORT COATS **SAVE 25%**

MENS' & BOYS' AS IS ITEMS **1/2 PRICE**

John Smith
OF PLYMOUTH

336 S. MAIN • PLYMOUTH

Kay's Midnight Madness Sale

Separates, Pantsuits & Dresses, Sportswear After 5 Fashions
UP TO 60% OFF

ALL LEATHER COATS 25% OFF

All Sales Final

Kay's
of Plymouth

846 West Ann Arbor Trail GL 3-7855
Monday thru Saturday 9:30-6
Friday Night 'til 9 p.m.

USE YOUR BANKAMERICARD, MASTER CHARGE OR OPEN A KAY'S CHARGE

SAVE \$60

Reg. \$169⁹⁵
ONLY \$109⁹⁵

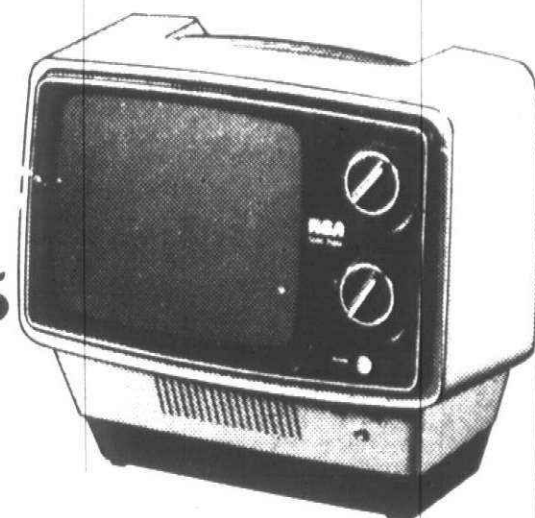

RCA AC/DC PORTABLE 9" diagonal Model AU 097

COMES COMPLETE WITH SUN SHIELD, EARPHONE, CIGARETTE LIGHTER POWER CORD AND RECHARGABLE BATTERIES. BUILT IN CHARGER 3 WAY POWER.

"PLYMOUTH'S ONLY RCA DEALER"

DiVeto Electronics

909 WING STREET (At Forest)
PLYMOUTH • 453-3377

10-9 WEEKDAYS

10-6 SATURDAYS

SALE

BLACK & DECKER ELECTRIC ROTARY MOWERS

Rear Bagger Cordless Reg. \$229.95 **NOW \$169⁹⁵**
Rear Bagger Cord Type Reg. \$179.95 **NOW \$139⁹⁵**

GI GAS CANS Reg. \$11.95 **\$6⁹⁵**

AGRICO LAWN FUNGICIDE Reg. \$8.95 **\$4⁹⁵**

DRIED DECORATIVE FLOWERS Reg. 99¢ Bunch **Tonight 29¢**

PENN SWIM SENTRY POOL CHLORINE Reg. \$7.96 **\$3⁹⁵**

50-LB. BAG of WHITE MARBLE DECORATIVE STONE Reg. \$2.49 **NOW 99¢** in your container

Wonder Gro GOLFERS PRIDE LAWN FOOD Reg. 50 LB. BAG \$13.95 **\$7⁹⁵** COVERS 10,000 SQ. FT.

—While Supply In Stock Lasts—

SAXTONS GARDEN center inc.
587 W. Ann Arbor Trail
PLYMOUTH - 453 6250

Mon, thru Thurs. 9-6 • Fri. 9-6 • Sat. 9-5 • Sun. 10-2

Sale on denim Collection

Includes

Skirts
Gauchos
Jeans
Vests
Jackets
Pre Teen & Junior

ALL

20% off

Special Group of Merchandise **70% OFF**

Purchases are eligible for weekly \$10 Gift Certificate Drawing

459-3920
821 PENNIMAN
PLYMOUTH

YOUNG GENTLEMEN'S CLOTHING



The "Good Stuff" Sale!

All Young Men's PRE-WASHED Blue Jeans

Reg. \$14.98 to \$21.00 **only \$12⁰⁰**

ALL SEASONAL MERCHANDISE

Mens' Boys' Childrens' **20% Off**

Please, these prices good only tonight 8-12

NORMAN'S SHOES & APPAREL

868 W. ANN ARBOR TRAIL • PLYMOUTH • PHONE 455-2342
HOURS: DAILY 9 to 6 • FRIDAY 9 to 9





The Stroller

World's worst cynic

By W.W. EDGAR

Sorting through the bird baths, flower boxes and other garden ornaments the other afternoon while getting ready to dress up the spacious lawn. The Stroller came upon an old familiar piece that caused him to chuckle. It was the popular ornament many folks stick into the middle of the flower gardens and reads:

The kiss of the sun for pardon

The song of the bird for mirth

One is nearer God's heart in a garden

Than anywhere else on earth

Reading the words again he was reminded of one of the world's worst cynics—an elderly chap named Old Jim Daugherty, whom the Stroller met during his early days in the suburbs.

Old Jim owned a piece of property not far from the plot on which the Stroller built his home, and Jim spent every weekend on the bank of the tiny stream that flowed through his "home."

No week-end was complete without a visit to Old Jim just to hear him unleash many of his cynicisms, and he protected no one. He was quite a character.

On this particular weekend during The Stroller's visit, Old Jim had an unexpected caller. It was a gentleman of the cloth—the minister of the Presbyterian church.

He had come to make the acquaintance of Old Jim as he relaxed along the bank of the tiny stream and to invite him to church services.

WITH THE pomp and dignity of his station in life the minister told Jim that he would find enjoyment at the services, meet a lot of nice people,

and it would do his soul some good. "Not me," Old Jim countered. "You won't get me to church and leave my haven here even for only a few hours."

Stunned by the flat refusal, the minister asked Jim why he was so adamant.

"I just think it is a waste of time," Old Jim said, "and I'll tell you why." The minister threw back his shoulders as if to ward off a blow and stood mute as Old Jim continued. "I've been to church, and it was far from being enjoyable."

Then he explained the entire hour of service. "We were asked to sing a hymn," he explained. "None of us could sing. We were like a bunch of cattle at meal time. We were off-key and I couldn't wait until we finished."

"Then the choir sang—or attempted to—and it wasn't much better. It certainly wasn't enjoyable."

Old Jim was just getting started. The minister uttered nary a word.

"In the midst of the hour a girl got up and sang a solo. She was off-key, too."

"I guess her father made a donation to the church. I don't know any other reason why she was invited to sing—just to keep the old man happy. I guess."

Old Jim really struck home when

he continued his explanation of his church experience.

"Finally, the minister got up." Old Jim recalled, "and started telling us stories that I have heard many times before. I heard them when I was a kid—and there was no reason for me to sit there and listen to them again."

"When he was finished we were asked to sing another hymn. This was worse than the first time. I guess everyone was anxious to leave. I know I was and now I'd rather spend my Sunday mornings right here."

"I am close enough to the church to hear the bells chime, and the music sounds fine in the summer air. Meanwhile, I am down on my knees working in God's good earth. I will be rewarded later on."

"As a fact Rev., I am one of God's helpers and I am doing a job I like to do. Sometimes I hum along with the music of the church bells. I am out here on many a Sunday morning alone. And I am having a joyous time."

"I don't have to get up and mumble through a hymn and be off-key with all the others. And I don't have to listen to a fellow telling me a lot of old stories. I'm closer to God out here than I would be in church." With that the minister walked away.

He had met one of the world's worst cynics.

Area commissioners named to new jail panel

Four Wayne County Commissioners representing districts in western areas of the county have been appointed to a special subcommittee to oversee construction of the new jail pro-

posed for downtown Detroit.

Included are Thomas Presnell (D-Westland), Royce E. Smith (D-Belleville), Edgar L. Harris (D-Taylor), and Richard E. Manning (D-Redford), the new subcommittee's chairman.



Save \$65 on RCA's Colorama TV Picture tube replacement

SALE \$134.95* Reg. \$200

- No charge for installation. Repairs to chassis are extra.
- RCA Colorama picture tubes fit most any make TV -19" -21" -25" at \$65 savings now.
- If tube fails within 2 yrs. we'll replace it for labor cost only.

INCLUDES PICK-UP, DELIVERY AND FREE TV CHECK

STA-RITE TV

28915 Joy Rd. WESTLAND 525-5450

SUPER
drug stores

2 LOCATIONS

In Plymouth 240 N. MAIN 455-6860 Open Mon-Sat 9-9 Sun 10-7	In Canton 5780 SHELTON RD. 455-2820 Open Mon-Sat 9-10 Sun 10-7
--	--

April 23 & 24
25th Anniversary

SALE MOWERS & TILLERS



CLOWNS!
COFFEE & DONUTS
BALLOONS
Drawing for
12" PIONEER SAW
& WEED EATER
Drawing will be held May 1st at 3:00. You need not be present to win. Winner will be notified by phone. Winners names will be posted in store for the month of May. No purchase necessary.

SNAPPER LAWN BOY TORO PIONEER SAW

Saturday, April 23, meet...

Toro Representative-Ron Gibbs • Snapper Representative-Ron Petri
• Lawn Boy Pioneer-Bob Apple

Also CLEARANCE ON BIKE ACCESSORIES All Tires In Stock **\$100 EA.**

WHITE'S Sales & Service
7777 SHELTON, CANTON
Between Warren & Joy

453-5287 Sat. 10-6; Sun. 10-4

From now on, you've got a choice.

It's us. Or rust.

Most new cars start to rust through in a couple of years. But the next new car you buy doesn't have to. Because now there's Ziebart rustproofing. We've just opened a brand new location close to you. Bring your new car in. We'll rustproof it and give you a money-back guarantee against rust-through for 5 years or 50,000 miles. Give us a call. We'll tell you more.

231 PLYMOUTH ROAD
(1 1/2 BLKS. E. OF MAIN STREET)
PLYMOUTH • 459-6080



NEW ACTION WEAR FROM **Catalina**



Smashing new colors



Look of luxury

Arthur Ashe Action Wear
Smashing new colors and fabrics. Color-coordinated active sportswear. Super spring colors: white, maize/blue, grey/red. Shirts, shorts, and accessories. **Shirts and shorts from \$13.**

La Paz Classic Spring Jacket
All these features: fly front; three-way knit collar, cuffs, and waistband; floating shoulder; two button-down flap pockets; and a bi-swing back with a mesh yoke. Lined, completely washable. In spring shades of light blue, navy, oyster, tan, and yellow. **Sizes 38R - 46R, \$30. Longs, \$32.**



BANK AMERICARD AND MASTER CHARGE WELCOME
• FREE GIFT WRAPPING • LAY AWAY

STORE HOURS: MON. THRU SAT., 10 a.m. to 10 p.m.; SUN. 12 noon to 6 p.m.
ADJACENT TO MEIJER THRIFTY ACRES ON FORD ROAD AT CANTON CENTER ROAD

SPRING SPECTACULAR

Tools not incl.



HANG-A TOOL 3.97
Tool organizer includes 6 hangers, 4 mounting brackets. 50-in. steel rod. 8850

MARK FORE VATCO



AUTO RAMPS 19.99 Pair
Holds 5000 lbs. eleven inches off the ground—safely. Heavy-gauge steel construction, movable chock. CR2

meior



3.99

HOME GARDEN SPRINKLER
Unmatched efficiency in gentle rain-like water distribution. 369C



HOMELITE XL CHAIN SAW

- Automatic Chain Oiling
- 10' bar chain
- Easy starting
- Lightweight - 7.2 lbs.

84.95

Reg. \$114.95



OSCILLATING SPRINKLER 6.77
Provides even watering over large areas. Dial any of 4 rectangular patterns.

60 FT. RUBBER/VINYL GARDEN HOSE



10.88

Nylon-reinforced vinyl stays flexible even in the coldest weather, strong in the hottest sun, is lightweight and easy to handle. Shutoff at nozzle without bursting.

HT-756-6G

LIVONIA HARDWARE

5 MILE ROAD
AT FARMINGTON ROAD

True Value HARDWARE

PHONE 937-1611 GA 2-1155

DINERS CLUB BANKAMERICARD

OPEN DAILY 9 a.m. - 9 p.m. SUNDAY 10-3

With Stevenson

Canton gains split

By DENNIS O'CONNOR
Sports Editor

John Young was the hitting and pitching hero in Plymouth Canton's 8-6 victory over Livonia Stevenson in the second game of a doubleheader played Friday afternoon at Central Middle School.

This triumph gained a split for the Chiefs, as the Spartans grabbed the first contest, 4-1.

Young, who is the Chiefs' starting catcher, was stationed in leftfield in this second contest. The Canton senior compiled three hits and knocked in six runs to lead the Chiefs' onslaught.

But not only was Young spectacular with his bat, but he also came in to pitch in the seventh inning to preserve the victory for starter Doug Smith.

Smith was cruising along with a comfortable 8-2 lead going into the final inning before he began to tire. Smith allowed two Spartans runs in the seventh to cut the margin to 8-4. And he left the mound with the bases



Monday, April 18, 1977

(P.C.) 9A

loaded and nobody out.

But Young came in and responded with two quick strikeouts to ease the pressure.

After one Spartan batter blooped a single to centerfield to score two runs, Young bore down and struck out the final batter to pick up the save.

CANTON OPENED the scoring with two runs in the first inning. After Rob Mandle and Young hit back-to-back doubles for one tally, Smith, Jeff Campbell and Doug Bricker all

walked to force in another.

Canton added three more in the second when Craig Lee and Scott Collins scored ahead of Young's towering three-run homer in left-centerfield.

Mandle singled, stole second and scored on Young's double for another run. Four base-on-balls and a Smith single scored the final two runs in the sixth inning.

The Chiefs' eight-hit attack was led by Young's three extra base hits. Mandle added two singles.

The Chiefs' offensive attack wasn't as potent in that first game however, as Canton mustered only two hits.

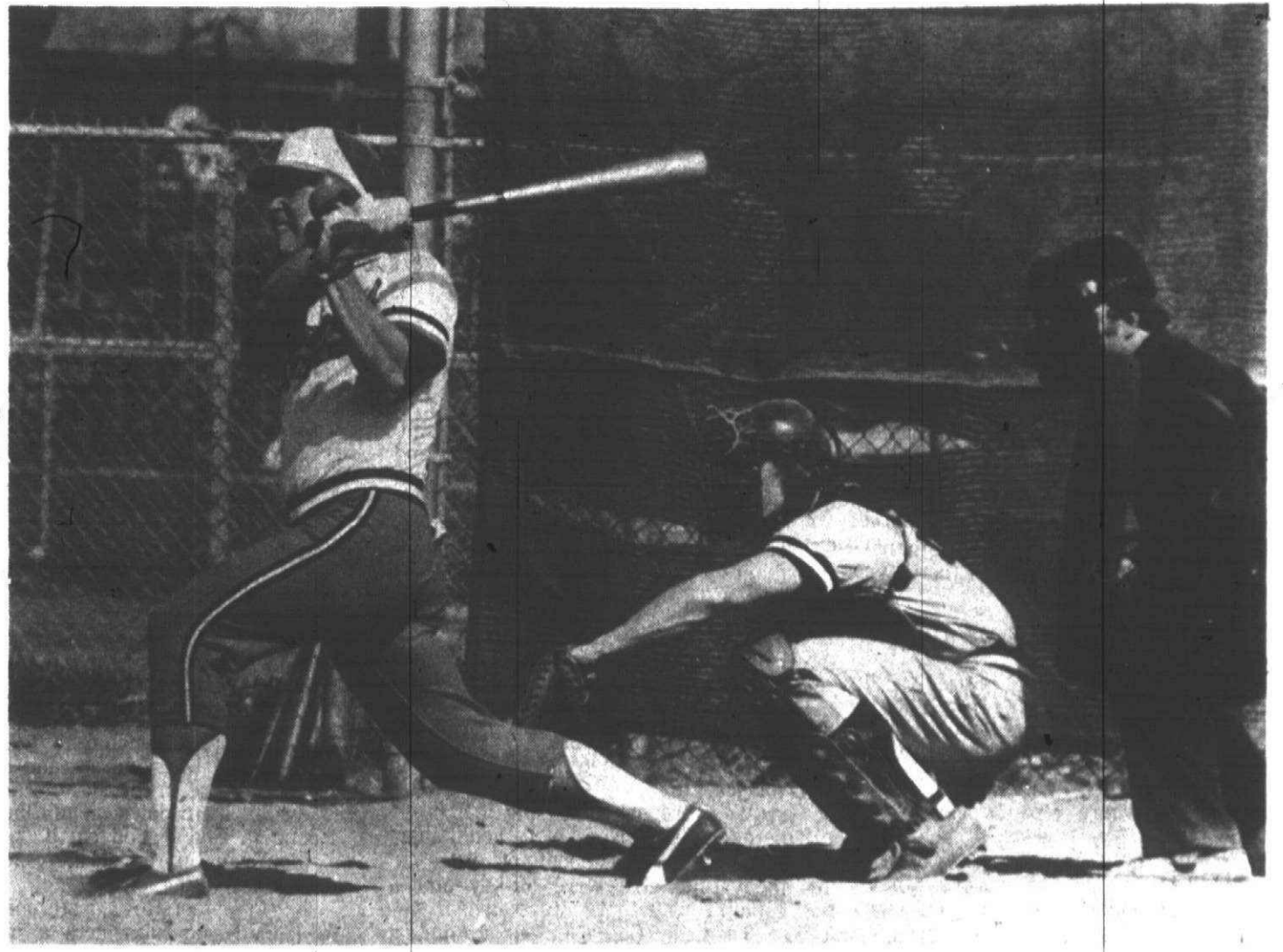

The home run swing of Canton's John Young over Stevenson in the second game of Friday's doubleheader. (Staff photo by Gary Caskey).

ADVERTISEMENT FOR BIDS TOWNSHIP OF PLYMOUTH

The Township of Plymouth, Wayne County, Michigan, will receive sealed bids for the following 1977 vehicle:

One (1) Intermediate sized car for Building Department Bids will be received at the Township Clerk's office, 42350 Ann Arbor Road, Plymouth, Michigan 48170 until 8:00 P.M. Tuesday, April 26, 1977, at which time bids will be opened and read aloud.

Specifications will be on file at the Township Clerk's office and the Township Board reserves the right to reject any and all bids.

HELEN RICHARDSON, CLERK
Township of Plymouth

Publish: April 18, 1977



NOTICE OF BUDGET HEARING CITY OF PLYMOUTH, MICHIGAN

Notice is hereby given that a Public Hearing on the proposed 1977-78 Budget of the City of Plymouth will be held in the Commission Chamber of the City Hall, 201 S. Main Street, Plymouth, on MONDAY, APRIL 25, 1977, at 7:30 P.M. Said proposed Budget includes Federal Revenue Sharing Funds to be used for Capital Improvement Projects at various locations within the City, as set forth in the following Budget Summary:

Fund	Budgeted Amount	Percent of Fed. Funds
General Fund	\$2,555,000	0%
Major Street Fund	135,485	0%
Local Street Fund	177,170	0%
Capital Improvement Fund	197,500	100%
General Debt Service Fund	111,105	0%
M.V.H. Debt Retirement Fund	28,030	0%
Cultural Center Fund	404,295	0%
Parking Fund	95,725	0%
Sewer Fund	221,895	0%
Water Fund	532,125	0%
Equipment Fund	190,770	0%
Cemetery Fund	60,260	0%
Road Special Assessment Fund	197,690	0%

All interested persons are invited and urged to attend this public hearing, at which time ample opportunity will be given for all citizens to appear and be heard. All requests for added municipal services or improvements or curtailments in any items of service; or other municipal functions, should be presented at this hearing, in order that consideration may be given same before approval of the 1977-78 Fiscal Year Budget by the City Commission.

Copies of said proposed Budget are on file and available in the Office of the City Clerk during regular office hours.

Paul V. Brumfield, City Clerk

Publish: April 18, 1977

CHARTER TOWNSHIP OF CANTON BOARD PROCEEDINGS

A special meeting of the Township Board of the Charter Township of Canton was held at 7:00 P.M. on Tuesday, March 29, 1977 at 128 Canton Center Road.

Members present: Bradley, Daley, Flodin, Goldsmith, Myers, Schwall, Stein

Members absent: None

The following items were added to the agenda:

1. Discussion of procedures used in hiring of firemen and cadets.

2. Discussion of ZBA issue.

A motion was made by Schwall and supported by Myers and unanimously carried that the agenda with additions be accepted.

A motion was made by Flodin, supported by Stein and unanimously carried that the township purchase two sirens for \$10,000, with 50% of the cost being shared by civil defense.

A motion was made by Flodin and supported by Bradley and unanimously carried that the clerk be directed to write a letter to the Plymouth School Board stating the township's position relative to acquiring the Canton Center school, and discuss the purchase of the property.

A motion was made by Bradley and supported by Schwall and unanimously carried that township attorney Bert Burgoyne be requested to furnish an opinion as to whether the township has an immunity of the Zoning Ordinance, relative to height restrictions in the construction of the new township administration building.

A motion was made by Schwall and supported by Flodin and carried that the township purchase the Dimension PBX electronic communications system from the Michigan Bell Telephone Co. with federal grant money if possible, and further that the money be paid at time of installation in the amount of \$36,283.97.

A motion was made by Stein and supported by Bradley to purchase 4 new typewriters and service maintenance agreement.

A motion was made by Schwall and supported by Flodin and unanimously carried to table the motion.

A motion was made by Schwall and supported by Flodin and carried to waive the bidding procedure.

Yes: Bradley, Daley, Flodin, Goldsmith, Schwall, Stein

No: Myers

A motion was made by Stein and supported by Bradley and carried to purchase four typewriters out of the water department budget, in the amount of \$2988.00, and that a service agreement contract be purchased in the amount of \$1,015.30 per year.

Yes: Bradley, Daley, Flodin, Goldsmith, Schwall, Stein

No: Myers

A motion was made by Flodin and supported by Goldsmith and carried that the township proceed with the condemnation proceedings of approximately 2 acres adjacent to fire station No. 1 for additional parking.

Yes: Daley, Flodin, Goldsmith, Schwall, Stein

No: Bradley, Myers

A motion was made by Stein and supported by Bradley to hire a full-time police administrator. A motion was made by Schwall and supported by Myers to amend the motion to expand the services of the township police department. Schwall and Myers withdrew the motion and support.

Stein and Bradley withdrew the original motion.

A motion was made by Schwall and supported by Myers and carried that the Board adopt option No. 5 of the police study report, as the most viable; which is as follows:

Re-Organize. This appeared to be the most logical and desirable option available to us and could be achieved with a minimum of disruption utilizing the present manpower and training already provided them. It would also be the least costly and could be expanded upon as monies became available.

Yes: Bradley, Flodin, Goldsmith, Myers, Schwall, Stein

No: Daley

A motion was made by Stein and supported by Bradley and unanimously carried that the Board declare its intent to hire a full-time police administrator, and direct the police commission to report to the Board its recommendations for qualifications, criteria, evaluation proceedings, job description and recommend salary. It was decided to hold a police commission meeting on Thursday, March 31, 1977 at 4:00 P.M. at 128 Canton Center Road.

Trustee Schwall requested that the procedures used in hiring the 6 firemen and 3 cadets be discussed at the meeting of April 5, 1977.

A motion was made by Stein and supported by Daley and unanimously carried to adjourn at 11:15 P.M.

Harold Stein, Supervisor
John W. Flodin, Clerk

Publish: April 18, 1977

OPEN DAILY 10-10; SUNDAYS 11-6 GOOD NOW THRU SAT.

Kmart
... gives satisfaction always

BIG DISCOUNTS



DOUBLE ROLL OF WALL PAPER

Our Reg. **5⁹⁷**

Make an old room look new with prepeasted vinyl wallpapering.

Our Reg. **9⁹⁷**



DOOR/WINDOW METAL AWNINGS

Our Reg. **7⁴⁴**

White, easy-care 36" aluminum awning comes with hardware. Ready to hang. Save!

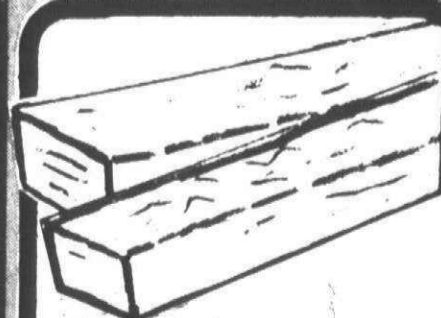

SAVE! ON 2"x4"x7' BUILDING LUMBER

Our Reg. **59¢** EA.

Get in on the savings on building lumber today! Save big in our building materials dept.

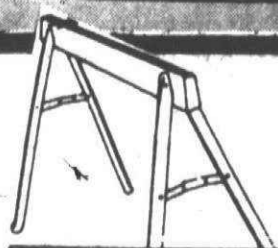

GRIP HORSE STEEL BRACKETS

Our Reg. **5⁹⁷**

30" legs. Holds up to 1600 lbs. with crosspiece. Heavy-gauge steel.



LOUVERED CAFE DOORS

Our Reg. **13⁹⁷**

Unfinished, quality ponderosa pine doors. Easy to install. 30", 32", 36" sizes.



GABLE MT. ATTIC FAN

Our Reg. **29⁸⁸**

Thermostatically controlled attic vent. Ready-to-install. 1190 CFM. mounted behind power shutter.



SEAL-DOWN SHINGLES

SALE PRICE **16⁹⁵** per sq.

Self-sealing shingles. 3 bundles per square covers 100 sq. ft. White. Charge it!

K MART'S ADVERTISED MERCHANDISE POLICY
Our firm intention is to have every advertised item in stock on our shelves. If an advertised item is not available for purchase due to any unforeseen reason, Kmart will issue a Rain Check on request for the merchandise to be purchased at the sale price whenever available or will sell you a comparable quality item at a comparable reduction in price. Our policy is to give our customers 100% satisfaction always.
S.S. KRESGE CO.

**CHARGE IT!
WE HONOR**



TIMBERS FOR LANDSCAPING

Our Reg. **3⁹⁷**

Cresote-dipped rustic timbers for landscaping 4 x 6 x 8 foot. Savings for you!



FIBERGLASS INSULATION

Sale Priced! **5⁹⁷** roll

Easy to install! Kraft faced insulation. Each roll is 3' x 15' 56 lineal foot.



4-MIL. ROLL OF POLY PLASTIC

Our Reg. **1⁹⁷**

3x50-ft. roll of 4-mil. all-purpose polyethylene plastic. Shop and Save the Kmart way!

AVAILABLE ONLY AT: FORD ROAD AT SHELDON ROAD

Rocks throw away two; fall to Glenn, 5-4, 5-1

By DENNIS O'CONNOR

Lackluster efforts combined with shoddy fielding plays resulted in Plymouth Salem's doubleheader baseball loss to Westland John Glenn Friday afternoon.

The double setback dropped the Rocks' overall record to 2-5 for the season.

Salem opens its Suburban Eight League play Tuesday against Allen Park. And if tomorrow's game resembles anything like Friday's action, the Rocks are surely in for a tough time in defending their conference title.

Salem junior Doug Holloway was one pitch away from hurling his first varsity victory in the first game when the roof fell in.

Holloway was coasting along with a 4-2 lead

going into the final stanza. Glenn had runners on first and second base with two outs and Brian Borke at the plate. Borke, who earlier hit a solo home run off Holloway, laced a full count pitch to centerfield to score one run.

On the relay, Borke attempted to take second. Salem's third baseman Dave Nidsgorski tried to throw Borke out, but the throw went into rightfield, scoring the tying run.

The score remained deadlocked until the second extra inning when Glenn scored the deciding run off Salem reliever Tom Chiatialis.

In the second game, more Rocks errors, both mentally and physically, wasted an outstanding pitching performance by Barry Brueckner.

With the score tied at 1-1, Glenn capitalized on

two bad throws by reserve catchers Doug Rowe and John Lewelling to score twice in both the sixth and seventh innings to sweep the doubleheader.

Rowe and Lewelling were forced into duty when starting catcher Mike Stevens injured his thumb late in the first game.

A FRUSTRATED Salem coach Brian Gilles just didn't know what to think after both losses.

"This is typical of what's been happening this year," Gilles said.

"We are inconsistent. First we get the hitting and then we get the pitching. That was the sad part. We had two good pitching performances out there."

"This club just doesn't have a leader. They're not hungry out there. They play like individuals and have no pride."

"It's a matter of pride—and we just don't have it. I don't know what to do. I can't go out and catch the ball for them."

Gilles went onto to say that he hopes for a turnaround with the league schedule starting soon.

"I still think this is a good ballclub," Gilles said. "We have to turn it around. Maybe these losses will help."

Brueckner threw a five hitter in the second game, striking out nine and walking only one batter in going the distance.

Holloway yielded to Chiatialis in the seventh of the first game but gave six and one-third innings of fine pitching.

Joe Goodsir and Benny Wilcox led the Rocks' hitting attack in the first contest. Goodsir collected three hits while Wilcox adeed two.

Salem JV comesback to split with Glenn

The Plymouth Salem junior varsity baseball team split its second doubleheader of the season Friday afternoon as the Rocks battled John Glenn to a standoff.

The Rockets came from behind in the final inning to pull out a 6-5 first game victory. Salem came back in the nightcap to post a 4-2 triumph.

The Rocks currently

hold a 2-2 record for the year.

Barry Owens got the decision in both Salem games. Owens relieved John Holdsworth in the first contest and gave up the winning hit in the bottom of the seventh inning.

The Rocks held a 5-3 lead going into the final inning of play.

Owens went all the way in the second con-

test against the good Glenn squad, yielding only two runs.

Salem jumped into the early lead when it scored three runs in the first inning. Dave Wilcox tripled home two runs and Chris Hannan sacrificed for the other.

Wilcox also came through with a clutch single in the seventh to score Paul Woodard with the final tally.

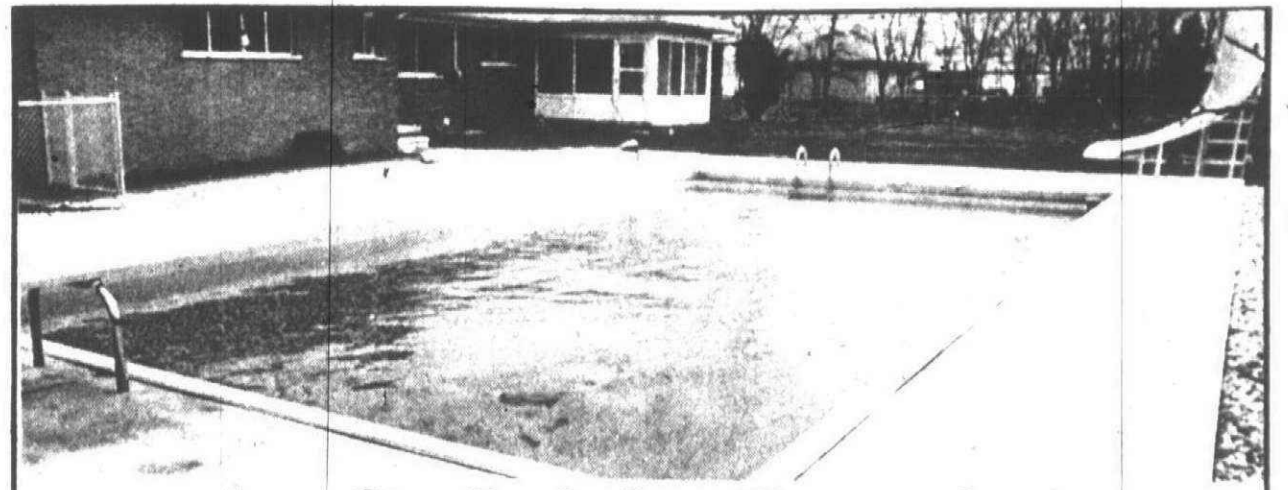

Aqua Star Pools Cost Thousands of Dollars Less Than Competitive Models!!

EXAMPLE: **16 X 36 SWIM AREA, 3'10" TO 7'10" DEPTH**

INCLUDES ALL NECESSARY EQUIPMENT, PUMP, FILTER, S.S. LADDER, SKIMMER, MAIN DRAIN, VACUUM EQUIPMENT, AND MORE, ALL TOP QUALITY ACCESSORIES.

INSTALLED, \$3999⁰⁰ PRE-SEASON PRICE LIMITED TIME ONLY **BIG SAVINGS ON DO-IT-YOURSELF KITS, TOO!**

Thousands of dollars less than overpriced cement pools—and your Aqua Star Pool will last years longer!

Aqua Star in-ground pools, unlike expensive gunite pools, can be easily installed in two or three days, and are warranted not to crack in cold weather. Wolmanized* wood is used for the pool wall and decking—a material that is not only strong and

decay-proof, but flexible enough to withstand seasonal ground changes.

Aqua Star's pool liner is flexible, durable vinyl, the most popular material used today. It's available in a tile border, with pebble bottom design or optional Hawaiian blue marble design (you must see this), and carries a limited warranty of 10 years. A swimming pool is a once-in-a-lifetime pool!

NEW 30-YEAR LIMITED WARRANTY

Now Aqua Star Pools carry a new 30-year limited warranty on the Wolmanized* wood construction of pool walls and decking—the most important part of the pool. Proof positive that an Aqua Star Pool is an outstanding investment.

BANK TERMS AVAILABLE

Financing is available with low monthly payments at current bank rates. In most cases, there is no money required as down payment. Call today for complete details.



aqua star pools

28875 JOY RD. WESTLAND

CALL 425-8830

MON. THRU SAT. 10 TO 6 SUN. 12 TO 5

3 blks. E. of Middlebelt

Civitan's to host tennis showdown

Tennis professionals Rod Laver and Bjorn Borg will compete in the second-annual Civitan Tennis Classic which will be held tonight at Crisler Arena in Ann Arbor starting at 7:30 p.m.

Proceeds from this event will benefit the Michigan Special Olympics and the Civitan International Foundation.

A host of other local media celebrities and Detroit Lion football players will also be on hand.

Jimmy Launce of WJR radio will be the master of ceremonies.

Proceeds from this event will benefit the Michigan Special Olympics and the Civitan International Foundation.

ACE CB RADIO
6865 MIDDLEBELT GARDEN CITY
522-7800 HRS: M-F 6 p.m.-9 p.m. SAT. 9-9 SUN. 1-4 P.M.
23 & 40 CHANNEL CB RADIOS
EXPERT FCC LICENSED SERVICE QUALIFIED
• EQUIPPED TO SERVICE • MOBILE ANTENNA MATCHING & CHECKOUT
• MOBILE INSTALLATIONS
HAM RADIO OPERATOR OWNED

Special PRICE
BLACK DIAMOND Reg. NOW
EDGING, 20 Ft. Strip \$13.95 \$12.95
Also
ORTHO SPRING FERTILIZER SALE
HURRY!
Plymouth Nursery
9900 PLYMOUTH-ANN ARBOR ROAD-M-14
(7 Miles East of U.S. 23 and 5 Miles West of Sheldon)
Open Daily 9-6-Sunday 10-5 p.m.
453-5500

Livonia Building Materials
Drywall
1/2" sheetrock 1/2" sheetrock
4x8 2.39 2.49
4x10 3.19 3.39
4x12 3.79 3.98
Other sizes available
Mon.-Fri. 8-5 Sat. 8-12
12770 Farmington Rd. S. of Schoolcraft
937-0478 421-1170

Scott's Lawn Pro
AUTHORIZED RETAILER
Now there's a fertilizer that combines the two things lawnowners want most—quick green-up and long-lasting results. It's Scott's (R) High Nutrient Lawn Fertilizer, the best fertilizer they've ever made. Its high density formula produces a deep green lawn you'll be proud to own. Will not burn grass—just use as directed.
SCOTT'S BEST LAWN FERTILIZER
5,000 sq. ft.-Wgt. 14 lbs.
Reg. \$9.95 NOW \$7.95
High Density Formula
SAXTONS GARDEN center inc.
587 W. Ann Arbor Trail
Plymouth 453-6250
Hours: Daily 9-6 Fri. 9-8 Sat. 9-5

For Incisive Comment At Its Best, Read Philip Power's 'Observation Point' Weekly On The Editorial Page

LOOSE RUG CLEANING
in our plant, free pick-up and delivery
Ferguson Carpet Cleaners
32485 Schoolcraft Livonia
525-1220 or 525-1221

Gerald Curtis, Attorney at Law, 18411 Twelve Mile, Lathrop Village, Michigan No. 77 701 437 DM
STATE OF MICHIGAN IN THE CIRCUIT COURT FOR THE COUNTY OF WAYNE
JO ANN CLARKE, Plaintiff vs. LAWRENCE CLARKE, Defendant
GERALD CURTIS (p 12411) Attorney of Plaintiff
ORDER TO ANSWER
At a session of said Court held in the City-County Building, City of Detroit, County of Wayne, State of Michigan on April 12, 1977
PRESENT: HONORABLE JOHN M. WISE, CIRCUIT JUDGE
On reading and filing an Affidavit for an Order to Answer and it appearing to the Court that an action was started on January 17, 1977, by JO ANN CLARKE against LAWRENCE CLARKE, to obtain a Judgement of Divorce:
IT IS HEREBY ORDERED:
1. LAWRENCE CLARKE shall answer or take such other action as may be permitted by law on or before July 6, 1977. Failure to comply with this Order will result in a Judgement by Default against the above named Defendant for the relief demanded in the Complaint filed in this Court.
JOHN M. WISE
CIRCUIT JUDGE
Publish: April 18, 25, May 2 and 9, 1977

Surety Federal Savings
OUR 5TH ANNIVERSARY IN PLYMOUTH...
... A NEW METRIC LOOK
The Surety Federal Savings Office on Sheldon near Ann Arbor Road has installed a new time and alternating celsius, fahrenheit temperature sign.
The sign is controlled by a mini-computer and is the only one of it's kind in the Plymouth area.
Free Metric Conversion tables are available to anyone visiting the branch during the celebration.
The Metric Conversion Tables convert our presently used units of measure to the new metric system.

FREE GIFT When you open or add to a Surety Federal Savings Account
Premium Offer Good April 18 through April 29, 1977. Due to Federal Regulations, premium offer is limited to one gift per family.
\$200 deposit or more chooses
(A) Westclox Dunmar Drouse Alarm
(B) Paneho Gonzales Tennis Balls
(C) Beacon 72 x 90 Blankets
\$1,000 deposit or more chooses
(D) GE Electric Sentry Plug In Timer
(E) GE AM Portable Radio
(F) Corning Ware Set
\$5,000 deposit or more chooses
(G) Morgan Silver Dollar
(H) Timex Watches men and women
(I) Norelco Flame Fighter
Free coffee and pastries during the celebration
SAVINGS OFFICE HOURS
Monday thru Thursday 10 am-5 pm
Friday 10 am-8 pm
455-5010

4 DAYS ONLY!

MONDAY APRIL 18 THRU THURS. APRIL 21, 1977

TIMES

MANUFACTURERS

24

COUPONS

SAVINGS

WORTH

60¢

Beginning today and ending Thursday, April 21, 1977, bring in any national manufacturers' cents-off coupons, and we will redeem them for 2 times their value. Customer must purchase coupon product in specified size. We will refund up to but not more than the total price of the item.

THIS OFFER GOOD ON NATIONAL MANUFACTURERS' COUPONS ONLY AND NOT MEIJER OR ANY RETAILER COUPONS. *COFFEE OR "FREE" *COFFEE COUPONS EXCLUDED DUE TO UNCERTAINTY OF SUPPLY.



MEIJER THRIFTY ACRES — 45001 FORD RD. AT CANTON CENTER RD.

SHOP MONDAY THRU SATURDAY 8 A.M. TO 10:30 P.M. — SUNDAY 9 A.M. TO 7 P.M.

Why Pay More! Why Pay More! Why Pay More! Why Pay More! Why Pay More!

Why Pay More! Why Pay More! Why Pay More! Why Pay More! Why Pay More!

In The Pocket

By W.W. EDGAR

Emotions ran high last week in Cobo Hall when the doors of the Detroit Bowling Hall of Fame were opened to admit five new members including three veterans who were charter members of the all star leagues that were organized 40 years ago.

Heading the list was Cass Schlaff, now 75 years old, who captained the Pepsi-Cola team when it won the ABC title in 1950.

Despite his age Schlaff still bowls in a league each week at Cloverlanes and says he still gets a great kick out of topping the pins.

The other veterans were Hank Gavie, who bowled with several teams in the all-star league and Dorothy Aldred who once held the world record for women's bowling. The others inducted were Ed Browalksi, a veteran bowling writer and the late Fred Smith, the first lefthander ever to become an ABC titlist.

ROSEMARY PRE-UTER has every reason to feel proud of her record for the season. She is a member of the Bonanza team that clinched the title in the Bowlerettes circuit, one of the strongest in the country.

While she is proud of the honor, another Plymouth housewife is waiting patiently for the

women's city tournament to finish.

She is Marge Kropacek, who with Carol Gaddis as a partner, is leading the actual doubles with only two more weeks to go. She is keeping her fingers crossed.

ANOTHER WHO is still going is Mary Mohacs, who is leading the averages in the Ladies Major. She is averaging 193, while her team captain, Cora Fiebig, is second at 190.

"This is not a rivalry," Cora insists, "I am just happy that we both are on the same team."

ONE OF THE BEST showings of the season was that of Marion Landers, who carries a 135 average at Garden Lanes. During the week, she turned in a 560 in the Ladies Classic. That's 148 pins over her average.

Marilyn Lucek paced the group with a 622, while Mohacs landed second with 613. May Lackey had a 611 and Jan Dimmer a 593.

CLOSE FINISHES are becoming an old story at Westland Bowl. This week, Jim Wrublewski had a 246 in 640 to beat Jim Johnson by a single pin. Jim Wodarski used an opening 266 for a 634 and third place. Mark Hammell took single-game honors with a 279 in 623.

DORIS MACKORKINDALE walked off with

top honors in the Livonia Ladies Classic. She won the final of the three game set, 195-37-232 and the series, 540-111-651.

In the other games Pat Coombe took the opener, 190-30-220, and Jopan Lewis won the second 200-35-235.

IT ISN'T OFTEN that a young bowler can go 97 pins over her average but Betty Antzk did it last week at Woodland Lanes. With an average of 121 she rolled a 218 game in a 515 series.

In the meantime Pat Weinrauch, who carries a 144 average, joined the split conversion club by topping the 4-6-7.

AT FARMINGTON LANES Carl Kropp paced the men in the Thursday mixed league with a 225 in 612. On the women's side of competition for the week, Diana Lawson showed the way with a 216 in 630 and Mary Lou Schneider had a 209 in 587.

BOB CASSAR broke the 700 barrier at Wonderland Lanes when he linked games of 244, 266 and 203 for a 713 to pace the Classic. This gave him a 22-pin edge on his nearest rival, John McKeever who had a 691.

Alexa Cassel had little trouble leading the women as she posted a 651.

SCORING TOOK A BOOST at Mayflower Lanes. Glenn Bruneel

was the top man with a 257 in 648, while Mel Kramer fashioned a 266 in 630. Mary Lou Wesman showed the way to the women with a 232 in 607.

DOUBLE CENTURY figures were the order of the day at Westland. Chuck Anderson had games of 214, 243 and 201 in 658 and T.C. Welmat linked counts of 200, 222, and 219 for 641. Jim Novak was next with 222, 201 and 202 for 635.

In the ladies league, Sandy Marsh had a 614 that included games of 203 and 220. And Dolly Young had a 234.

CONRAD EONTRIGN reached the high point of his bowling career at Bel-Aire Lanes when he broke the 700 barrier with a 605 count that included games of 248 and 245 to pace the Lady of Sorrows League.

Other pacemakers included Jim Timmerman who showed the way in the classic with a 672, and Leona Bergman, who led the parade in the Old Homestead League with a 600. Steve Killian came back to the winners circle in the Thursday mixed league when he posted a 611. Carol Parker topped the women with a 585 and Eve Len had a 225 in 535.

In the Tuesday men's league, Dave Lynch registered a 250 to set the pace with a 669.

Receive a \$100 gift certificate when you buy a Whirlpool Power Guard II air conditioner.

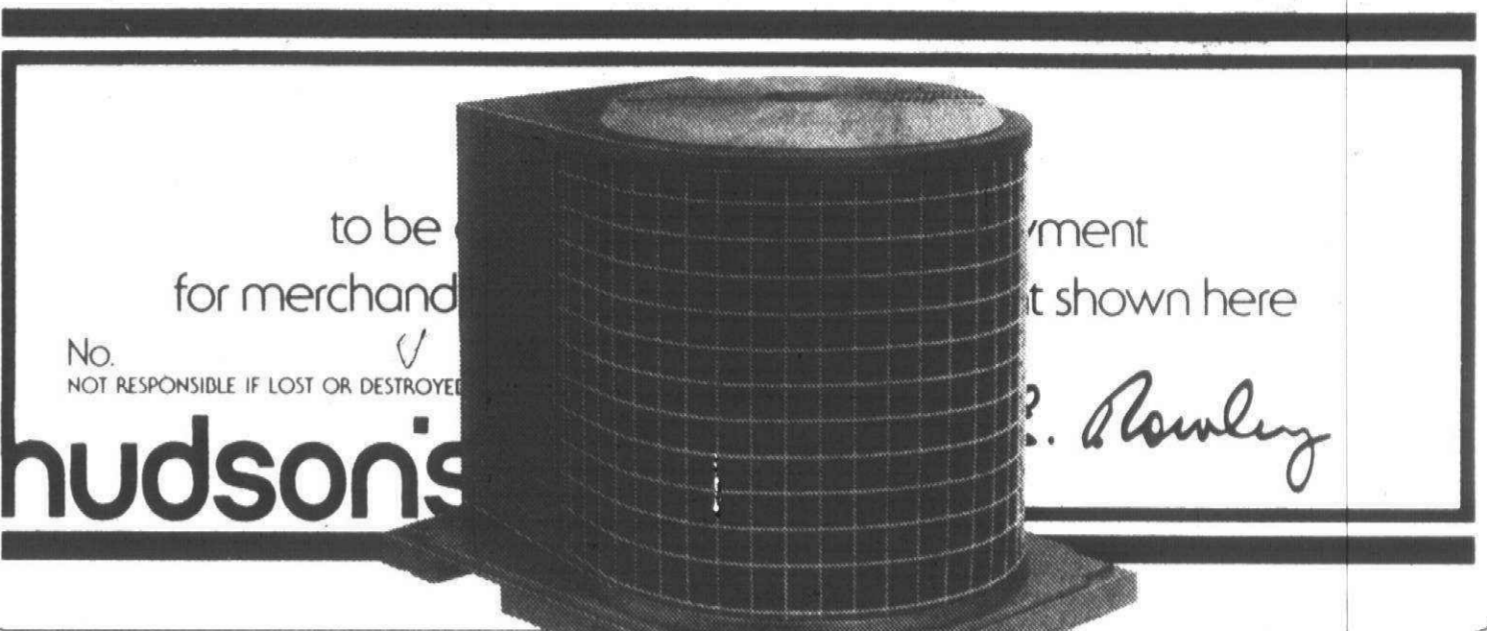

Whirlpool offers you the best pre-season deal EVER!

From now until April 30th, you can purchase a Whirlpool Power Guard II air conditioner and receive a \$100 J. L. Hudson's gift certificate.* You save two ways since Power Guard II air conditioners have special features that make them up to 38% more efficient than our deluxe series systems. Features like Solid State Variable Speed Fan Control, desirable top discharge design, and an EER rating of up to 9.4 make Power Guard II a wise choice for those hot, humid days ahead. And efficient cooling will mean a lower electricity bill and more money in your pocket.

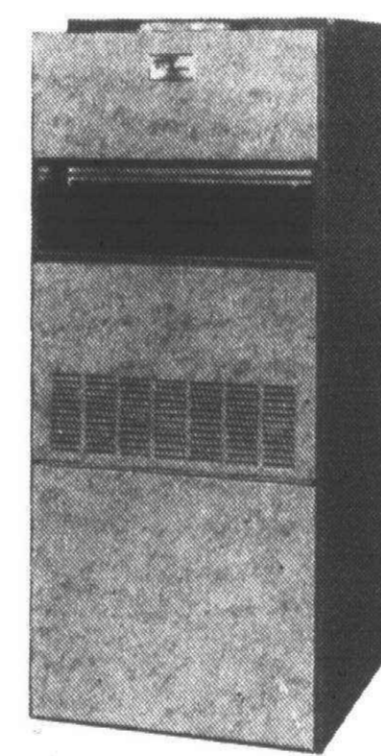

Whirlpool ABCC financing available. (No payments until July) The time to prepare your home for summer comfort is here, and Whirlpool can lighten the financial load with ABCC financing. You make your first payment in July. Check with these Whirlpool dealers for all the facts.



- | | | | |
|--|---|---|---|
| Dearborn Heating & Cooling Co.
5040 Greenfield
Dearborn, Michigan 48126
582-6608 | Harrison Refrigeration & Air Cond.
12944 Farmington Road
Livonia, Michigan 48150
525-9050 | Moore Furnace Company
Wonderland Shopping Center
Livonia, Michigan 48150
421-1840 | Olson Heating & Air Cond., Inc.
141 North Mill
Plymouth, Michigan 48170
453-2434 |
| Drayton Heating Company
4800 Hatchery Road
Drayton Plains, Michigan 48020
673-2379 | Zilka Heating & Cooling Inc.
2595 Orchard Lake Rd
Pontiac, Michigan 48053
682-1210 | Kulin Bros. Heating & Refrig., Inc.
11048 Ranch Home Court
Utica, Michigan 48087
739-3009 | Robert L. Lussenden
Plbg. Heating Air Cond. Electrical
30740 W. Twelve Mile Road
Farmington, Michigan 48018
626-1808 |

Criminal justice program expanding

Madonna College in Livonia has received a grant of \$275,000 from the Law Enforcement Assistance Administration, U.S. Department of Justice, to enroll 300 students during the academic year 1976-77 in the Madonna criminal justice program. The grant provides for tuition support up to \$400 per term for persons

employed in law enforcement, corrections, or related fields. Qualified applicants who would like to apply for a grant for Term II, beginning in January, should contact Ziegler or Alan Eichman, director of the Criminal Justice program, at Madonna College, telephone 425-8000.

special

3 days only

CASH & CARRY SAVINGS

April 18 • 19 • 20

SECRETARIAL DESK
Basic desk is 60"x30". Return is 42"x18". Features plastic walnut laminated top to resist scratching. Please specify right or left return. Available in black or tan.
Reg. \$265.88
SPECIAL CASH & CARRY \$225⁰⁰

SECRETARIAL POSTURE CHAIR

Vinyl back fabric seat, polished chrome base. Available in black or brown.
Reg. \$54.88
SPECIAL CASH & CARRY \$48⁰⁰

TWO DRAWER FILE
Executive-style 29" high lateral file. Full suspension drawers. Security locks. Walnut textolite top. Black or tan.
Reg. \$129.88
SPECIAL CASH & CARRY \$109⁰⁰

STORAGE CABINET
Rugged steel cabinet comes with adjustable shelves and single handle locking system. 72" x 36" x 18". Black, tan or grey.
Reg. \$81.88
SPECIAL CASH & CARRY \$69⁰⁰

STACKING CHAIRS
Polished chrome frame. Assorted colors. Vinyl seat and back.
With Arms: Reg. \$24.88, **SPECIAL CASH & CARRY \$21⁰⁰**
Without Arms: Reg. \$21.88, **SPECIAL CASH & CARRY \$19⁰⁰**

*Desk and storage cabinet must be picked up at our Green/8, Troy, Greenfield, Ann Arbor, Southland stores

MACAULEY'S

Troy Commons & Wonderland

If you hate pests, you'll love Terminix.

Nobody hates pests like Terminix hates pests. For professional pest control with complete satisfaction call your Terminix man. Ask about safe, economical regular treatment to assure a sanitary home or business.

384-6900

Woodland Lanes, Livonia Under New Ownership

Al and Bill Winkel, present owners of Bel-Aire Lanes in Farmington and Monte Carlo Lanes in Detroit, have recently purchased Woodland Lanes in Livonia. We hope you'll enjoy our clean and friendly atmosphere.

MONDAYS
1:00 PM SENIOR CITIZENS MIXED — (Bow today — golf tomorrow)
7:30 PM GUYS & DOLLS (4) 3-6-9-League Automatic strikes—3,6,9th frame ea. game
8:30 PM MEN'S DOUBLES (4 games—80% from 400—good competition—fast bowling)

TUESDAYS
9:30 AM WOODLAND BOWLERETTES (4) (everyone welcome—all averages)
4:00 PM BOYS & GIRLS—8-16 (100% handicap—high and low averages)
7:30 PM KEGLERETTES (4 ladies—any average, beginners welcome)
7:30 PM MIXED DOUBLES—(4 games—just the two of you)

WEDNESDAYS
1:00 PM Daytime Mixed (something new)
1:00 PM LEARN TO BOWL CLASSES (Learn the right way)
7:30 PM Mixers "4" (9 pin no tap league — bowl a 300)
7:30 PM YOUNG ADULTS—18 to 25 (Bowling & pizza — meet friends here)

THURSDAYS
1:00 PM LADIES' FOURSOME (keep trim and fit)
7:30 PM FAMILY FOURSOME—(MOTHER, DAD, SON, DAUGHTER (Good family fun)
7:30 PM MEN'S 4-700 TEAM MAXIMUM—(Handicap 80% to 700, 100% over 700)

FRIDAYS
12 NOON SENIOR CITIZENS MIXED (Continue your winter program)
7:30 PM KINGS & QUEENS—(start the weekend right — everyone welcome)
7:30 PM LADIES' DOUBLES—(3 games handicap 80% from 350)

SATURDAYS
10:00 AM JUNIORS AND BANTAM (Any average — 100% handicap)

SUNDAYS
7:30 PM HITS AND MISSES MIXED (End the weekend mixing pins)

BEL-AIRE LANES

MONDAYS
Begining May 16
8 P.M. MEN'S TRIO LEAGUE — Better Bowlers

TUESDAYS
Begining May 17
6:30 P.M. FAMILY TOWNSOME — Youngster/Adult Combo
8:00 P.M. FOUR GAL FUN LEAGUE
8:00 P.M. GUYS-GALS MIXED LEAGUES

WEDNESDAYS
Begining May 11
10:00 A.M. LADIES' MORNING COFFEE LEAGUE
1:00 P.M. LADIES AFTERNOON SWINGERS
8:15 P.M. FOUR MAN FUN LEAGUE

Begining May 4
3:45 STUDENTS' LEAGUE — Grade School Boys and Girls

THURSDAYS
Begining May 10
7:30 P.M. HIGH SCHOOL STUDENT'S Mixed League
8:00 P.M. KINGS & QUEENS Mixed League

FRIDAYS
Begining May 13
8:00 P.M. MIXED WEEKENDERS LEAGUE

SATURDAYS
Begining May 14
8:00 P.M. MIXED SWINGERS LEAGUE

SUNDAYS
Begining May 15
8:00 P.M. MIXED LOST WEEKENDERS FUN LEAGUE

33775 PLYMOUTH RD. • 522-4515 • LIVONIA

24001 ORCHARD LAKE ROAD • 476-1550 • FARMINGTON

AVAILABLE ONLY AT: ANN ARBOR RD. NEAR HAGGERTY ROAD • FORD ROAD AT SHELDON ROAD

SALE PRICES GOOD NOW THRU SATURDAY



Kmart

OPEN DAILY 10-10; SUNDAY 11-6

K MART'S ADVERTISED MERCHANDISE POLICY

Our firm intention is to have every advertised item in stock on our shelves. If an advertised item is not available for purchase due to any and every reason, K Mart will issue a Rain Check on request for the merchandise to be purchased at the same price whenever available. We will not accept comparable quality items at a comparable price from any other retailer in order to meet our customers' satisfaction.

S. S. KRISGE CO.

HERE'S PROOF YOU SAVE MORE!



MYSTERY BOOKS
Our Reg. 1.82 Thru Sat.
137 Ea.
Enjoy the mysteries of Nancy Drew and Hardy Boys in hard back covers. Save!



DRY ROASTED PEANUTS
Our Reg. 1.03 Thru Sat.
77¢
12-oz. jar dry roasted peanuts. No sugar or oil added. Tasty treat anytime.
*Net Wt.



Cotton Denim

ACCESSORY CASES
Our Reg. 87¢ Thru Sat.
57¢ Ea.
Your choice in purse accessories. Eyeglass case, smoke tote, or coin purse.



4 PLATE HOLDERS
Our Reg. 1.17 Thru Sat.
87¢
Woven rattan. Holds 9" size paper plate. Package of 4. Useful year round.



DUNCAN YO YO
Our Reg. 97¢
74¢ Ea.
Everyone can enjoy yo yo fun! Molded acetate plastic in your choice of colors.



BABY STROLLER
Our Reg. 19.97 Thru Sat.
15⁴⁴
Fold it up and carry it like an umbrella. Aluminum frame, nylon seat, rubber tires.



WOMEN'S ROPE BOTTOM SANDAL
Our Reg. \$3 Thru Sat.
2⁴⁴ Pr.
Spring into a light-weight sandal. Urethane material. Teak or navy. Women's sizes.

SAVE! MEN'S SHORT SLEEVE SPORT SHIRT
Our Reg. 5.96 **4⁸⁸**
Special savings on great looks for men. Sport shirt in solid colors with one pocket.

MEN'S SHORT SLEEVE DRESS SHIRT
(Not Pictured) Polyester/Knit
Our Reg. 7.66 **5.88**

PERMANENT PRESS
NO IRONING NECESSARY

CHARGE IT! WE HONOR 



TURTLE WAX SUPER HARD SHELL CAR WAX KIT
Our Reg. 2.28 Thru Sat.
1⁸⁸
You will get a super hard shell finish on your next car wax job. Shop at Kmart and save!



CHRIS EVERT® TENNIS RACKET
Our Reg. 14.96 Thru Sat.
10⁹⁶
6-ply, European ash with leather grip. Cross nylon strung. A prestige racket. Save!

SAVE on Prescriptions at Pharmacy
AT MOST K-MARTS

WOMEN'S PANTSUITS
Our Reg. 9.96 **\$8**
Short or long sleeve tops with matching pants in junior, misses' and half-sizes. Charge it!

RAIN SLICKERS
Our Reg. 6.96 **\$5**
Smart looking rain jacket in your choice of hood or no hood. Yellow, green, or blue. Women's sizes. Similar to illustration.



5-FUNCTION L.E.D. WATCHES
OUR REG PRICE **20% OFF**
Women's elegantly or men's handsome designed, light emitting diode watches. Hours, seconds, month, and date.



DROP CLOTH
Our Reg. 28¢ Thru Sat.
18¢ Ea.
Plastic all purpose drop cloth. Indoor/outdoor use. 9x12'. Stock up and save!



EXTENSION CORD
Our Reg. 13.96 Thru Sat.
8⁹⁶
All-weather, 16-gauge 100 ft. extension cord. UL listed. Meets all OSHA requirements.



STORAGE UNIT
Our Reg. 10.77 Thru Sat.
7⁸⁸
Metal 4-tier unit for garage or basement. 60x36x12" size. Gray enamel finish.



DAISY® SWEEPER
Our Reg. 12.58 Thru Sat.
9⁹⁶
Two-way sweeping action with Daily® sweeper. Ideal for quick clean up.



SLIDE SORTER
Our Reg. 5.47 Thru Sat.
3⁹⁷
Focal® sorter-viewer holds 80, 2x2 35mm slides. 17 1/2 x 20 1/2" screen. Folds. Charge it and save!



First Alert SMOKE DETECTOR
Our Reg. 32.88 Thru Sat.
28⁸⁸
Battery-run First Alert® operates if household power fails. A wise investment for your home.

AVAILABLE ONLY AT: ANN ARBOR RD. NEAR HAGGERTY RD. • FORD ROAD AT SHELDON ROAD

The VIEW
from
461 SOUTH MAIN

"CHILDREN OF NOVEMBER," the documentary film about children with asthma and the National Asthma Center in Denver, Colo. will be shown twice next Sunday in Geneva United Presbyterian Church.

First showing will be right after church at noon. The second will be at 7:30 p.m.

Lorne Green narrates the story in the film and the children are true asthmatics at the center.

Bobbie Williams, who is pioneering the first March for Breath in this area, says response to her plea for walkers has been tremendous. Mrs. Williams' son Eric spent several months at the center. Although diagnosed as an intractable asthmatic, when he was released, his condition was under control. Last fall, for the first time in his life, Eric played football with his classmates.

The showing of the film will be free. Mrs. Williams says she hopes persons who have volunteered to help with the walk for asthma will be able to attend. "Also, anyone who is interested



by
ELLIE GRAHAM

and wants to learn more about asthma should come," she said.

Others wishing to spend a few hours marching for breath can call Bobbie Williams at 453-1808 for more information.

LEE HOSEY and Eleanor Catlett met for the first time at the Presbyterian Church's annual White Breakfast.

"The only Hosey I ever knew was a friend of mine in Virginia who married a man named Hosey," said Mrs. Catlett.

"My mother-in-law came from Virginia," replied Mrs. Hosey.

Further conversation revealed that Eleanor Catlett and Luella Ballentine had been neighbors in Blacksburg, Va. To make it more interesting, the senior Mr. and Mrs. Andrew Hosey were coming to town to visit their son and daughter-in-law for Easter.

"We invited the Catletts over when they were here," said Mrs. Hosey. "It was a wonderful reunion. They hadn't seen each other for years."

MR. AND MRS. PERRY RICHWINE will host the Detroit College of Law class of 1927 for a 50th class reunion May 4.

A chronicle of Detroit history, forgotten lifestyles and vintage memories will pervade the Hyatt Regency in Dearborn when the class of '27 meets at 2 p.m. Those bygone days of the '20s when streetcars moved through downtown Detroit and the Charleston rocked the local nightspots, will be remembered. The number of guests invited will include more than 30 graduates of that year from the Detroit area and as far west as California.

Although the years have taken their toll on these classmates through deaths and illnesses, an active and vibrant community of practicing attorneys and retirees engage in their profession and enjoy their leisure time.

Ten members of the class are practicing in downtown Detroit as they have been for 50 years.

These DLC graduates had seen history taking shape throughout Detroit from a legal as well as social perspective.

For the class of 1927, May 4 should prove another memorable afternoon in their lives.

ROBERT SINCOCK has been discharged from St. Joseph Mercy Hospital in Ann Arbor and is convalescing at his home on Penniman Avenue. His round table cronies are anxiously awaiting his return to the morning coffee sessions.

PLYMOUTH-CANTON Parents Without Partners will have a general meeting the evening of April 21 in the American Legion Hall, 888 N. Sheldon Road.

THE PLYMOUTH CANTON Hockey Association will meet at 7:30 p.m. April 28 in the cafeteria of Central Middle School to elect new officers.

PAUL SZILAGI, son of Mr. and Mrs. Robert Szilagi of Sheridan Avenue, Plymouth, has been elected to Beta Gamma Sigma fraternity at Western Michigan University in Kalamazoo.

He was formally received into the society March 23. Election to Beta Gamma Sigma is the highest scholastic honor a student in the College of Business can achieve, according to WMU officials.

Szilagi graduated from Plymouth-Salem High School in 1974.

ANN PREVOST and Frank Kelsey had high scores at last Thursday's party bridge game in the Plymouth Cultural Center.

With the spring weather and players returning from southern vacations, there have been as many as 10 tables in play at the center.

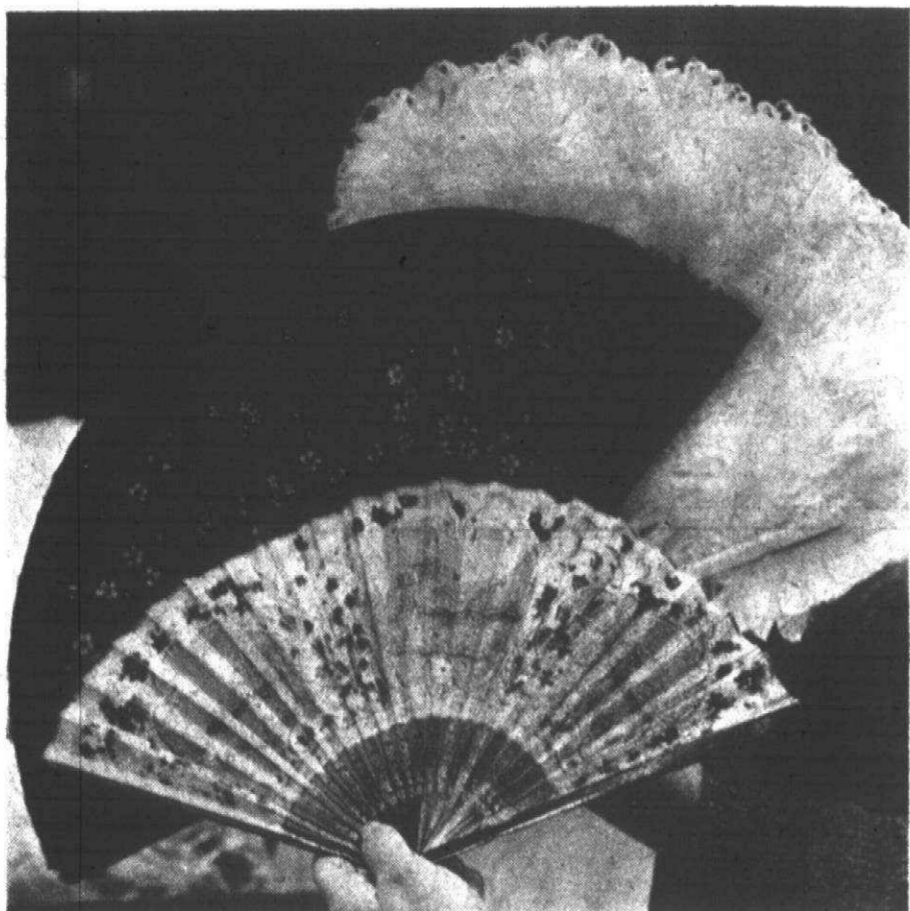

Fans and Parasols

There's a new exhibit at the Plymouth Historical Museum. Above are three lovely old fans—one made of paper and decorated with violets, a black silk fan, and, in the background, white ostrich plumes. (At right) Pat O'Reilly with frilly white parasol and Pat Scott arranged the collection in a museum showcase. (Staff photos by Gary Caskey)



GS leaders vote to boycott meeting

Girl Scout leaders representing 60 area troops have voted to boycott the April 20 general meeting of the Detroit Girl Scouts Council at Cobo Hall.

The move is in protest over the recent endorsement of the Equal Right Amendment by the Girl Scouts national board of directors and the Detroit council.

As part of the protest, the leaders will use the April 20 date to signal the start of a petition drive to give parents of registered Girl Scouts the opportunity to speak up on the endorsement issue.

Claiming that the endorsement is unprecedented in Girl Scout history, they said they feel it is in direct violation of the organization's national charter.

Fathers as well as mothers will be encouraged to join the protest, according to Marie McGee, chairman of the newly-formed Keep Girl Scouts Nonpolitical committee, which will coordinate the petition drive.

KGSN was formed as the result of a meeting called two weeks ago by Mrs. McGee and three other scouting volunteers in Livonia—Carolyn Rogman, Rita Dahn and Carol Skamiera. They acted after learning the Detroit council had joined the national board in endorsing ERA.



Monday, April 18, 1977



(C) 1B

NEIGHBORHOOD CHAIRMEN have been informed of the Detroit council action, but an official announcement to the general membership is still forthcoming.

According to Jan Griffis, public relations representative, the announcement was to be published in the April issue of the council's monthly newsletter, which leaders in this area have not yet received.

"We felt we had to speak up because of the principle involved," a

KGSN statement said.

"We feel that by endorsing one side of a highly-controversial issue, the national board and the Detroit council board have violated the Girl Scout congressional charter which specifically states that the Girl Scout movement shall be nonpolitical."

The decision to boycott the April 20 meeting was done regretfully, the committee added, because 40 Girl Scouts from this area are among those who will be honored that night for having achieved first class rank.

"It is not our intention to detract in any way from the high honor due these girls," the statement said. "Rather, we congratulate them, because to be a first class scout is to be a first class person."

"However, the seriousness of the endorsement action made the boycott necessary. It was the best way we know to effectively inform both boards that many of us are not in agreement with the action or the rationale used in making the decision that ultimately allows politicians to

use the good name of the Girl Scouts to further outside political interests.

"WE ARE CONCERNED about the future. Statements made by several national board members indicate it is their belief that Girl Scouts can no longer be nonpolitical, but must speak up on public issues which the national board's political issues committee feels 'will have impact on the lives of our girls as they mature into womanhood.'"

"We respect this point of view, and if they feel this course is vital to the growth of this organization, we suggest they initiate steps to amend the charter accordingly."

"In the meantime they, like the rest of us in Girl Scouting, are bound by the same charter, laws and promise that have been in effect for the past 62 years. No amount of legal finagling alters that fact."

But even in this "family" dispute, the Girl Scout sense of humor prevails, Mrs. McGee said.

"When this is all over," she smiled, "I'm going to recommend that a public speaking badge be added. The only requirement will be to make an endorsement or position statement without appearing to be political."

Power Puffs unruffled by doubleheader

Palise's Power Puffs ended the volleyball season Wednesday night with a doubleheader in Central Middle School gymnasium.

"We were dead tired," said manager Sharon Palise. "We won the first game 3 out of 5, and the second five straight. But we still ended up in second place for the season."

The two wins in Plymouth and Northville Parks and Recreation League competition were in spite of strenuous pre-game activities by some of the players—softball and soccer practice.

The five members of the team who showed up for the games were Sherrie Law, Nancy Weiss, Trudy Watkins, Joyce Hainer and Sharon.

None had put in a restful day to prepare for the two games.

Sherrie Law is a housewife and mother of three children. Besides keeping her household going, she is active in scouting and brownies. She has been with the team for seven years.

JOYCE HAINER, a Canton resident, has been on the team for five years. She works at the Fairlane Center where she books and manages parties for the center. Joyce plans wedding receptions and banquets. Menus, music, decorations and decorations are her responsibility.

Nancy Weiss is married and has two children. She is a member of the Birmingham Police Department. Nancy and Joyce are sisters and both

attended softball practice before their doubleheader.

Trudy Watkins, 19, is the youngest member of the team. She is a graduate of Plymouth Salem High School and works at Meijer's Thrifty Acres.

"She's a terrific player," said Sharon.

Trudy coaches a girls soccer team and during practice sessions she joins her team in the scrimmages. On Wednesday evening, just before the two volleyball games, Trudy and her team had a practice game with a team of 10-year-old boys.

Captain Sharon and her family have lived in Canton Township for a year and a half and she says, "We love it." She and her husband have two daughters and a son. Lisa, 13, was a member of Pioneer Middle School's undefeated volleyball team this year. She has filled in on her mother's team a couple of times.

"THIS WAS THE first year the men let Lisa and I handle the ball in the family picnic volleyball game," laughed Sharon.

Sharon is vice-president and publicity chairperson for Apple Run branch Woman's National Farm and Garden Association. She is busy painting, papering and decorating their new house. In the fall, she goes into the canning business, preserving more than 300 jars of vegetables and fruit for her family.

After managing a team for eight

years, Sharon has seen women's volleyball change from "jungle" to "power" play.

"We follow the USVBA rules now." She went on to explain the bump-set-spike format of power volleyball. "It is now a much more controlled game. The old game was less organized. Now everyone knows just what to do."

When the ball is served by the opposing team, the player who receives the ball must keep her hands together when she bumps the ball to the setter. The setter is supposed to slow it down and pass it to the spiker who volleys it over the net.

"There is no more slapping and hitting. The shots are cleaner," said Mrs. Palise.

THE POWER PUFFS were among the 40 teams invited to play in the 10th annual Great Lakes Volleyball Tournament earlier this year.

"We didn't do very well," admitted Sharon. Teams from Canada and the Great Lakes states competed in the tourney.

The cost of playing volleyball in a league has increased. Before moving to Canton, Sharon's team played in a Redford Township Parks and Recreation League where there was no charge.

"Earl Keim Real Estate sponsored us last year. They gave us \$100 which paid the \$35 fee and bought some new balls."

"This year there was a mixup and we had no sponsor. The league fee went up to \$60 and we had to pay it ourselves."

The top team in the league was Plymouth No. 4.

Those who played in the last game of the season were Darlene Regan, Marge Verdue who works for John

Sandmann, athletic director for the Plymouth-Canton Community Schools, Mary Ann Riggs, Phyllis Maycock, Ruda Sturis, Ursula Veit, who also attended soccer practice before the game, and Sue Riggs, a substitute teacher in the Livonia schools.

Most of them will be playing softball for Century 21 this spring and early summer.



Power Puffs do a victory dance.



Top team in the league—(kneeling, from left) Marge Verdue, Phyllis Maycock, Mary Ann Riggs, and Ruda Sturis; (standing, from left) Sue Riggs, Ursula Veit and Darlene Regan.



The Power Puffs came in second—(front row, from left) Sherrie Law, Sharon Palise and Trudy Watkins; (back row, from left) Nancy Weiss and Joyce Hainer. (Staff photos)

Clubs in Action

ANNUAL POPS CONCERT

Tickets for the annual Plymouth Symphony Orchestra Pops Concert sponsored by the Plymouth Symphony League will go on sale April 12.

Tickets and seating plan will be in Bed 'n Stead in the Forest Place Mall—\$3.50 for adults and \$1.75 for students.

Theme for the cabaret-style concert will be College Night at the Pops. A limited number of tickets are available.

MOTHERS OF TWINS

Northville-Plymouth Mothers of Twins Club will meet at 7:30 p.m. April 18 in the home of Karen Schorrenberg, 14435 Ramblewood, Livonia.

Mrs. Kathryn Martin will share her experience as a mother of two sets of twins who are now adults.

ALPHA OMICRON PI

April 21—The Northwest Suburban Alumnae Chapter of Alpha Omicron Pi will meet with the Dearborn Alumnae Chapter at 7:30 p.m. in the home of Mrs. Max Powell, 920 Grace, Northville. Members are asked to bring hand-crafted items or baked goods to be auctioned at the meeting. Alumnae wishing to attend may call Mrs. William O'Shea, 35979 Middleboro, Livonia.

GERMAN-AMERICAN CLUB

The German-American Club of Plymouth will meet at 8 p.m. April 21 in the Plymouth Cultural Center on Farmer Street.

Plans for the Freundschaft (Friendship Dinner) will be finalized.

DELTA ZETA

Delta Zeta alumnae of western Wayne County will meet at 8 p.m. April 21 in the home of Mrs. William Luftus of Livonia. Guest speaker will be Lucille McKinney, handwriting analyst, who will discuss what handwriting reveals.

Mrs. Carl Holmes of Dearborn will be co-hostess for the meeting. Members are asked to bring old magazines for nursing center residents.

FARRAND MOTHER & DAUGHTER

Farrand Elementary School PTO will sponsor a fashion show for mothers and daughters in the school from 7:30-9 p.m. April 26.

Mothers will model fashions from Nawrot Pendleton Shop in Forest Place Mall and the girls will wear fashions from the Little Angels Shoppe.

There will be no admission charge but the PTO will be collecting non-perishable food items for the local FISH organization.

There will be prizes and refreshments.

LADIES GOLF

Registration for the Plymouth Newcomers Club Golf League closes April 30. Golfers do not have to be members of the club. For more information call Jackie LaChapelle, 455-7456.

BAKE SALE

Apple Run branch Woman's National Farm and Garden Association will have a bake sale in the Harvard Square Kroger store from 10 a.m. to 4 p.m. April 23.

PILGRIM GARDEN CLUB

Nancy Jones of Plymouth Nursery will be guest speaker at the April 28 meeting of the Pilgrim Garden Club.

Because of the timeliness of her subject—"Maintaining the Health and Elegance of Shrubs"—husbands will be invited to the meeting which begins at 7:30 p.m. in Hulsing Elementary School Media Center. Guests may attend for a \$1 donation.

PLYMOUTH CHILDREN'S NURSERY

The Plymouth Children's Nursery, a cooperative preschool nursery at Wren and Haggerty roads, is planning spring round-ups at 1 p.m. April 29 and May 13.

Children and parents will have an opportunity to see the facilities at the school and talk to teachers and co-op members.

For further information call Barb Palmer, 455-4088, or Linda Luke, 455-0863.

FREUNDSCHAFT DINNER

The German American Club of Plymouth will have a spring Friendship Dinner April 23 in the Odd-fellows Hall, 344 Elizabeth Street Plymouth.

There will be three serving times—5, 6:30, and 8 p.m.

Menu will include German Knachwurst, bratwurst, sauerkraut, German potato salad, rolls, coffee and apple and cherry kuchen. All tickets will be sold in advance only. Tickets are available from club members, at Finlan Insurance (453-6000), or Gus Festerle (455-7789).

PLYMOUTH-NORTHVILLE AARP

The American Association of Retired Persons will meet at noon April 27 in First Presbyterian Church of Plymouth. A sack lunch at noon will be followed by a singalong, a business meeting, and the program for the day. A representative of Consumers Power Company will speak about "Alternate Sources of Energy." His talk will be illustrated by slides. The meeting is open to the public.

MT. HOPE CO-OP NURSERY

Mt. Hope Cooperative Nursery in the church at 30330 Schoolcraft, west of Middle Belt, is taking applications for 3 year olds for the fall term beginning in September.

Classes meet from 9:15 to 11:15 a.m. on Tuesday and Thursday. Interested persons should contact Nancy Wood, 14254 Alexander, Livonia. Tuition is \$14 per month.

Distinctive
American Traditional
Furnishings for the Home

**Colonial House
of Furniture**
19532 W. McNichols
Open Mon., Thurs., Fri. til 9
KE2 7900

Why Pay More! Why Pay More! Why Pay More! Why Pay



thrifty acres

25% OFF

Our entire selection of Gaucho sets. Choose from an assorted selection of Spring 'n' Summer styles. Mostly junior styles, some misses. While quantities last!



**\$8.50
TO
\$16**

Clearance!

OUR REGULAR
\$11.37 to \$21.87

GAUCHOS

Ladies' Department

PRICES GOOD THRU SATURDAY APRIL 23, 1977

MEIJER THRIFTY ACRES — 45001 FORD RD. AT CANTON CENTER RD.
SHOP MON. THRU SAT. 8 a.m. to 10:30 p.m. SUN. 9 a.m. to 7 p.m.



Dress: McCall's 5534

Jumpsuit: McCall's 5421
Blouse: McCall's 4617

Suit: McCall's 5432
Blouse: McCall's 5158

NEW AT MEIJER! The Burlington/Klopman Dressmaker Shop

FASHION FABRICS

The brand new collection of fashion fabrics from BURLINGTON/KLOPMAN...performance-tested **knits** and **wovens** of Dacron® polyester. They're all here and all together for one stop shopping...even an exciting assortment of model garments to help make your fabric selection a snap! And the BURLINGTON/KLOPMAN warranty ☆ assures you get what you pay for or BURLINGTON/KLOPMAN makes good. Warranted quality...easy-care fashion...all beautifully coordinated and waiting for you in our DRESSMAKER SHOP.

*FULL WARRANTY

If not satisfied with fabric quality and performance, return with sales slip for refund to Burlington/Klopman Retail Fabrics, Dept. G, a division of Burlington Industries, 1345 Avenue of the Americas, New York 10019.



thrifty acres

in the domestics department

MEIJER THRIFTY ACRES — 45001 FORD RD. AT CANTON CENTER RD.

STORE HOURS: MON. thru SAT., 10 a.m. to 10 p.m.; SUN. 12 noon to 6 p.m.

'Salute to Musicals' is Sunday



Plymouth Community Chorus members (from left) Linda Groat, Harriet Wehrheim and Dolores Roth spread the word about their April 24 concert in Geneva United Presbyterian Church. (Staff photo by Gary Caskey)

Cast in rehearsal for PTG comedy

The cast of the Plymouth Theatre Guild's next production, "A Gentleman and a Scholar," is in rehearsal. Opening night will be May 13 in the auditorium of Central Middle School, 640 Church Street, Plymouth.

Curtaintime will be 8:30 p.m. for the four performances, May 13, 14, 20 and 21.

"A Gentleman and a Scoundrel" was written by Jack Sharkey. There are three character in the play. The lead is a dual role, Fred Dickson-Rick Laredo, played by Thomas Hinks of Plymouth Township. Carole

McNulty of Livonia will be Jenny Correll, and Mike Nelson of Westland has the role of Basil Pronker.

Dale Feldpausch of Farmington Hills will direct the comedy. Patricia Bray of Northville is production stage manager.

Thelma Parrish of Westland and Clemie Cyburt of Canton Township are in charge of ticket sales. Admission will be \$3 for adults and \$2 for children. Persons wishing to make reservations for individuals or groups can call Mrs. Cyburt, 453-4140; Robyn McLean, 349-4136; or Patti Troth, 453-3305.

Bingo games at Madonna

Weekly bingo games will begin at Madonna College of Livonia Friday, April 22.

It is the first time a Michigan college has used bingo in fund-raising since the state legislature amended the state lottery law in 1976 to include private colleges among educational institutions allowed to profit from the act.

Madonna received its license for bingo last week from state lottery commissioner, Gus Harrison.

"People's natural recreational interest in bingo and our convenient, air conditioned site, were too good a combination for use to pass up," said Sister Mary Lauriana, vice president for planning and development at Madonna.

"As are other independent colleges, Madonna is always extending its source of funding to underwrite educational programs, provide scholarships for deaf and other worthy students, and to keep costs down."

The bingo games will be held in the Activities Center at the corner of Schoolcraft and Levan Roads. They will begin at 7 p.m. each Friday. Special events such as hard card cover-all, quickies, early bids, pot-of-gold and college cup are included.

Refreshments will be available.



Lange-Darling

Mr. and Mrs. John R. Lange of Bloomfield Hills, formerly of Plymouth, announce the engagement of their daughter, Jacqueline, to Dennis L. Darling, son of Mr. and Mrs. Robert Darling of Schwartz Creek.

Miss Lange is a graduate of Michigan State University. Her fiancé has an MA from Michigan State and is with an engineering firm in Gaithersburg, Md.

A July wedding is planned.

The Plymouth Community Chorus has chosen a nostalgic theme for its annual spring concert at 4 p.m. April 24 in Geneva United Presbyterian Church, 5835 Sheldon Road, just north of Ford Road, in Canton Township.

William Grimmer, conductor and founder of the chorus, will direct "A Salute to American Musicals" Sunday afternoon. Grimmer's assistant is Sara Humphrey and the accompanist is James Wagner.

Narrator will be Peter Humphrey.

The program will consist of many top hits from Broadway musicals. There will be choral selections from Lerner and Loewe's "Gigi" and "My Fair Lady"; a "Showboat Medley" by Kern and Hammerstein II; songs from "South Pacific" by Rodgers and Hammerstein; a tribute to Sigmund Romberg; and selections from "West Side Story."

Admission to the concert will be \$2 for adults and \$1 for senior citizens and children under 12. Tickets can be purchased at the door or by calling 453-0539 or 453-4526.

The chorus will conclude its current season with informal concerts for the Northville Senior Citizens April 26; Tongish Creek Manor May 9; Westland Convalescent Center May 23; and a final "Concert of Classical Music" June 5.

Historical museum open 3 days

The Plymouth Historical Museum, Main Street at Church is open

three days a week—Thursday, Saturday and Sunday.

Admission is \$1 for adults, 50 cents for 12-17-year-olds, and 25 cents for five to 11-year-olds.

Doors open at 1 p.m. and guides are available until the museum closes at 4 p.m.

Group visits can be arranged by calling the museum, 455-8940.

Panel views accounting

Careers in Accounting will be the topic of a panel discussion scheduled for the open forum to be sponsored by the Schoolcraft College Women's Resource Center at 8 p.m. Thursday.

Representatives from the American Society of Women Accountants will lead the program in Room B200 of the Liberal Arts building on Schoolcraft's Livonia campus. The session is free and the public is invited.

Free classes for deaf

Deaf and hearing-impaired persons 50 and older are offered spring and summer courses free of charge through Madonna College's interpreting department and a project funded through the Department of Health, Education and Welfare.

Classes begin April 18 and can be taken for two credits or non-credit.

Among the classes still open to enrollment are arts and crafts, tele-typewriting, nutrition, cooking for two, and leadership training. Interpreting services will be available in each class.

Arts and crafts is being offered

from 2-5 p.m. Tuesdays at St. John's Deaf Center in Warren.

The teletypewriting class is offered from 1-3 p.m. Mondays at Ladywood High School in Livonia. It teaches students basic skills in typing and knowledge of TTYs. A guest speaker will give a demonstration on maintenance, services and other TTY information.

The nutrition class will be held at Madonna College with Sandy Silverman acting as interpreter.

For more information call 425-800. Registration is 9 a.m.-5 p.m. daily in the administration building on Schoolcraft and Levan, Livonia.

YMCA CAMP
Livonia Family Y
14255 Stark Rd.
261-2161

Your youngsters can have the time of their lives at a YMCA camp this summer. Check today at your YMCA — the summer camp people.

Come on over to our house!
Michigan's Largest
Ethan Allen Dealer
the Hearthside
Livonia Utica Southfield

FREE DECORATING BOOKLET

come in for AN ADVENTURE IN CREATIVE DECORATING

April is National Home Decorating Month. To celebrate, we offer you a free, 32-page full color decorating ideas booklet. Every page is jam-packed with fascinating tips and hints to make your decorating adventure more rewarding. Beautify your home and have a creative adventure while doing it. Pick up your free copy now. Booklets cannot be mailed, so stop in today! No obligation, of course.

LOSE UP TO 30 LBS. IN 4 WEEKS

With Weight Loss Center's medically supervised Liquid-Protein Program

The easiest way to lose weight is a program where there are no food decisions to make, no calories to count, is hunger free, and most important, offers a maintenance program that allows you to maintain your weight-goal while enjoying your favorite foods.

Weight loss Center's Liquid-Protein nondiet offers all this with-out loss of energy, without drugs, injections or exertion.

Start now, you could lose 30 pounds or more, in the next four weeks.

CALL NOW FOR FREE CONSULTATION ABSOLUTELY NO OBLIGATION

weight loss medical centers

LIVONIA TROY WARREN
421-8710 528-2325 758-5100

KENT'S DECORATING CENTERS
HEADQUARTERS FOR HOME DECORATING NEEDS

15367 Newburgh 464-2700
25655 Joy Road (at Beach) 274-0082
19514 W. 7 Mile Rd. (4 blocks east of Evergreen) 532-8672

STAN'S

SALE DATES APRIL 18-24

FREEZER SPECIALS
CUSTOM CUT, WRAPPED & FROZEN AT NO EXTRA CHARGE

- U.S.D.A. Choice Primal Round 65 Lbs.**
Round Steak 24 lbs.
Rump Roast 18 lbs.
Sirloin Tip Steak 10 lbs.
Beef Stew 2 lbs.
Heel of Round Roast 8 lbs.
Ground Beef 5 lbs.
\$1.25 lb.
- U.S.D.A. Choice Primal Beef Chuck 85 Lbs.**
Blade Chuck Roast 25 lbs.
Center Chuck Roast 18 lbs.
Arm Cut Chuck Roast 17 lbs.
BBQ Ribs 4 lbs.
Boneless Chuck Roast 5 lbs.
Ground Beef 11 lbs.
79¢ lb.
- U.S.D.A. Choice Primal Beef Rib 20 Lbs.**
Rib Steak or Rib Roast 15 lbs.
Ground Beef 3 lbs.
\$1.39 lb.
- U.S.D.A. Choice Primal Beef Side**
1 Beef Loin Approx. 40 lbs.
1 Beef Round Approx. 65 lbs.
1 Beef Rib Approx. 20 lbs.
1 Beef Chuck Approx. 85 lbs.
210 lbs.
\$1.09 lb.
- U.S.D.A. Choice Primal Beef Loin 40 lbs.**
Sirloin Steak 14 lbs.
T-Bone Steak 9 lbs.
Porterhouse Steak 8 lbs.
Ground Beef 3 lbs.
\$1.49 lb.

Whole BEEF RIBS
Sliced & Wrapped For Your Freezer • No Charge • Average Weight 20#
\$1.39 LB.

Delmonico STEAKS \$2.79 LB.

Delmonico RIB EYE ROAST \$2.59 LB.

SMOKED PORK CHOPS \$1.39 LB.

Ocean PERCH FILLETS \$1.19 LB.

RIB STEAKS \$1.59 LB.

CUBE STEAKS \$1.59 LB.

Standing RIB ROAST \$1.49 LB.

GRAPEFRUIT 10¢ EA.

STRAWBERRIES 99¢ QT.

LETTUCE 39¢

Melody Farms SHERBET 1/2 GAL. 59¢
SAVE 40¢ UNIT

ROYAL CROWN COLA 6 12 OZ. CANS \$1.19
SAVE 30¢ UNIT

Spartan SALTINES 1-LB. BOX 37¢

Frozen TREESWEET ORANGE JUICE 4 6-OZ. CANS \$1.00
Melody Farms LO-FAT CHOCOLATE MILK Plastic GAL. \$1.29

DOUBLE COUPONS ON WEDNESDAY
All Manufacturers Coupons Honored

Tues. thru Thurs. Only **NESBIT'S 8 16-OZ. BTL. 99¢**
Save \$1 Unit Limit 1 with \$5.00 Purchase While Supply Lasts

THURS. & FRI. ONLY - APRIL 21 & 22

Bulk PORK SAUSAGE 89¢ LB.

Country Style SPARE RIBS 99¢

BANANAS 18¢ LB.

We Reserve the Right to Limit Quantities

● 38000 ANN ARBOR RD. ● LIVONIA ● 464-0330 ●
● MON.-SAT. 9-9 ● SUN. 10-5 ●



LOUISE SNIDER

Cinderella story—delightful film

"The Slipper and the Rose" (G) is a generously endowed film: Lush costumes and settings, exterior scenes shot on location in Austria, pleasing (if not immortal) music, smart choreography and a wealth of talent.

Richard Chamberlain sings and dances as The Prince, newcomer Gemma Craven is an appealing, fresh-as-the-dew Cinderella, and a host of excellent British stars including Kenneth More, Dame Edith Evans and Margaret Lockwood, comprise the supporting cast.

This is a delightful family movie. Lest anyone think the Cinderella story too soppy and sentimental, be assured this version has been enlivened with considerable humor and even wit.

Michael Hordern is the candid King who forever is reminding his Chamberlain to speak plain English and stop being such a flatterer. When the King needs to raise money to pay for a great ball, he says he will institute a new tax, "a tax on snobbery."

The effusive Chamberlain quickly begins praising the King's genius, till the King retorts that the new tax will most certainly apply to him.

MARGARET LOCKWOOD is the Stepmother, so mean you just want to hiss every time she appears. In contrast, Annette Crosbie is an atypical Fairy Godmother. She's a very practical, efficient person who frets that she is being run ragged because there are so many people in the world who need her help.

Moreover, she works in ordinary, everyday clothes, no gossamer and sparkles and wands. After all, she insists, that's "a ridiculous way" for a grown woman to dress.

Almost everyone in this movie has a chance to poke fun at some stereotype and play a role for a few laughs. I was a little concerned that my 10-year-old movie companion, who watches plenty of fast-paced television programs, might be bored with some of the longer song and dance routines, but she wasn't. She found them delightful.

"The Slipper and the Rose" is a welcome change of pace for viewers of any age.



RICHARD CHAMBERLAIN

'Raggedy Ann' too saccharine

"Raggedy Ann and Andy" (G) is mostly an animated movie with some live acting interspersed. The individual characters and sequences were drawn by different artists resulting in wide variations in style and effect.

Many of the animated sequences, especially at the beginning, have a soft, watercolor-like quality which is just too sweetie-poo. Indeed the first half-hour is slow and saccharine. It lacks the crispness that many children have become accustomed to from television, whether watching commercials or "Sesame Street."

Called a "musical adventure," there is lots of singing in the movie but nothing really memorable or toe-tapping. The story develops around a collection of dolls in a child's room. When a new French doll, Babette, is added, trouble starts.

The pirate doll, who is entranced by Babette, captures her and sails away. Raggedy Ann and Andy pursue in an attempt to rescue Babette. The pace picks up as we follow their adventures. Preschoolers and children in the early primary grades probably will enjoy these episodes.

THEY MEET a gluttonous Greedy in a Taffy Pit and King Koo Koo in Looney Land. But the most endearing character they encounter is a baggy-kneed camel who chases visions of a dazzling camel caravan in the sky.

When they finally overtake the pirate ship, the movie throws its one bold punch. Instead of a weeping Babette and a barbarous Captain, we find the Captain in irons and a fiery Babette driving the crew like Captain Bligh.

You know that can't last. Eventually, everyone returns home and the status quo is restored.

GLIMPSES

NEW RELEASES

AIRPORT 77 (PG). A disaster film that combines air and sea operations by crashing a 747 into the ocean and then trying to raise the plane or lower the ocean—something like that.

BLACK SUNDAY (R). Slick thriller of inflated terrorism from a blimp at the Super Bowl. Robert Shaw and Marthe Keller are the capable adversaries. Fine acting by Bruce Dern as berserk pilot.

DEMON SEED (R). Violent computer violates Julie Christie. A self-starter with its own programming plans, computer runs amok in real time.

THE DOMINO PRINCIPLE (R). Gene Hackman is the trigger man in a nameless organization's attempt at political assassination. Muddled but predictable plot.

THE EAGLE HAS LANDED (PG). World War II suspense-adventure story about a group of German paratroopers who attempt to kidnap Winston Churchill. Michael Caine, Donald Sutherland and Robert Duvall star.

FELLINI'S CASANOVA (R). A lavish and lengthy production that abounds with grotesqueries, one of which is Donald Sutherland's strange make-up, as Fellini interprets Casanova's memoirs.

G General audiences admitted.

PG Parental guidance suggested. All ages admitted.

R Restricted. Adult must accompany person under 18.

X No one under 18 admitted.

Gamma rays, marigolds at Madonna

"The Effect of Gamma Rays on Man-in-the-Moon Marigolds," the Pulitzer Prize-winning play by Paul Zindel, makes a one-night appearance at Madonna College.

The play will be presented at 8 p.m. Wednesday.

Staged by the Attic Theatre Group, and sponsored by Madonna's cultural

affairs committee, "Marigolds" has received favorable reviews from local critics since its recent run at Greentown's Attic Theatre.

The play delves the life of a mother and her two daughters and their struggle to survive. It is a play about the cruelty of hopes shattered and despair.

Beatrice Hundorfer, Mother, boards not-quite-dead old people to help pay the bills. Daughter Ruth is on the outgoing side of life; a high schooler whose popularity is enhanced by her cheerleading. Younger sister Ruth is a studious, quiet girl into science. Her project of growing flowers exposed to radiation is the basis for the play's title.

These three souls wrestle and eventually overcome the elements of survival.

Tickets can be purchased at the switchboard in the Administration Building, or by calling 425-8000, ext. 21. Admission is \$2 and \$1 for students. Madonna College is at Schoolcraft and Levan, Livonia.

Schoolcraft sets music school try-outs

Auditions for Schoolcraft's summer music school program will be held May 14 and June 4.

The music school, along with the summer music festival, is scheduled for June 27 through July 22. It is open to junior high, high school and college musicians.

A number of tuition scholarships

are available, and these will be awarded by the faculty on the basis of audition performance and financial need.

This will mark the 11th year of the music school's existence, and will again be under the direction of Richard Saunders, SC's director of fine arts and conductor of the student and faculty orchestras.

Music school faculty includes members of the Detroit Symphony Orchestra and Schoolcraft music faculty.

Saunders said the student orchestra will study and perform major works selected for their educational and musical value. Students will perform works by George Gershwin, "An American in Paris," Shostakovich, Symphony No. 5, and Mendelssohn.

Symphony No. 4.

Students will be instructed in chamber music and orchestral music performance styles. In addition, they will receive instruction in music history and theory and will perform weekly recitals and concerts.

Interested students should call Saunders at 591-6400, ext. 342 for information and application forms.

'Boys in the Band' plays The Theatre

"The Boys in the Band" will be the final production of The Theatre's sixth season.

The play, written by Mart Crowley, will be presented weekends and Sundays through May 1. Weekend per-

formances are at 8:30 p.m. with Sunday curtains at 7:30 p.m. on the Margrove College Campus.

"The Boys..." is Crowley's first play and was one of the more controversial offerings of the 1968 theater season. It also was one of the most popular having run for 1,000 performances in New York.

Crowley's play is one of the first serious ventures about homosexuals and the gay life. It is set in the New York apartment of a young man named Michael, who is throwing a

birthday party for Harold, who, like Michael and the rest of the partiers, happens to be homosexual.

Into the party, an old college friend of Michael's arrives; a straight man from whom Michael wishes not to reveal his coming out of the closet.

These efforts fail, however, and provide some humor and tension-filled moments.

The production is directed by David L. Regal, acting chairman of the Performing Arts Department at University of Detroit/Marygrove. Regal also

directed the "House of Blue Leaves" production earlier this year.

On stage will be Warren Reinecker, Michael, Joseph Zubrick, Hank, Paul Gruber, Emory, Charles Van Hoose, Harold, Michael Ceresko, Donald, Michael Woods, Larry, James Bowen, Bernard, Robert R. Beaupre, as the Cowboy, and John Powers as Alan.

Tickets are \$3.50 general, \$2.50 for students and senior citizens.

For information and reservations, call 341-1838 or 927-1130. The Theatre is at 8425 W. McNichols, Detroit.

Restaurant show slated

"New Horizons in Hospitality," the 11th annual Michigan and Great Lakes Restaurant Equipment and Food Service Exposition sponsored by Michigan Restaurant Association (MRA), will be held Oct. 4 and 5, during National Restaurant Month.

Exposition Chairmen Jerry O'Connor and Fred Teich announce that the event will return to Cobo Hall in Detroit's Civic Center, Hall B.

O'Connor is president of the Fogcutter restaurant in Port Huron. Teich is vice-president and general manager of food services for J. L. Hudson Co., headquartered in Detroit.

Detroit Federation of Musicians will hold its 15th annual Musicians Ball in Roma's of Livonia, Monday, May 9.

Four Detroit orchestras will provide the music for big band sounds. Bands will include those of Jimmy Wilkins, Carl Edson (directed by Chet Bogan),

and Warner Ruhl. Dinner music will be provided by the Eddie Desantis Singing Strings.

Ticket prices include beer and setups, buffet dinner, continuous music and free parking. Dinner will be served between 8 and 10 p.m. Tickets are available from the DFM, 19161

Schaefer, Detroit 48235, or by calling 345-6200. The price is \$10 per person on or before May 5, and \$15 on or after May 6.

The ball starts at 7:30 p.m. There are no reserved seats. Roma's of Livonia is at 2777 Schoolcraft, between Inkster and Middlebelt.

Musicians will throw a ball

DINING AND ENTERTAINMENT GUIDE ON THE TOWN

TEN YEN CHINESE Restaurant
(Open 7 Days)
CANTONESE, HONG KONG, MANDARIN, JAPANESE & AMERICAN FOODS
正宗粵菜 • 歡迎光臨
Special Businessmen's Luncheon
Over 120 Dinner Selections • Carry-Out • Special rates for big parties
PRIVATE BANQUET ROOM AVAILABLE
8997 WAYNE RD. at Ann Arbor Trail 425-8910

EL CAMINO
Mon.-Sat. 11 AM-12 Midnight
Sun. 1 PM-10 PM
Elegant Mexican Cuisine
Carry Out Service available
33605 Plymouth Rd.
(west of Farmington)
261-2370

UN-WIND, RELAX, EASE OFF, LAY BACK AND LET THE DAY GO AWAY WITH 2 DRINKS FOR THE PRICE OF 1 FROM 4 P.M. TO 7 P.M. MONDAY THRU FRIDAY. KEEP ROLLING FROM 9 TIL 2 AS THE JOLLY MILLER PRESENTS: JOHN MALLON AND ALL OF US MONDAY THRU SATURDAY THE PLACE TO BE.

Double Bubble

The Jolly Miller Lounge
Monday to Saturday 11 a.m. til 2 a.m. Sundays noon til midnight

Plymouth Hilton Inn
5 MILE & NORTHVILLE ROADS call (313) 459-4500 FOR MEETINGS AND BANQUET PLANNING

Adams Towne House
421-5060 2 Blocks E. of Merriman, 30843 Plymouth
Bring the family to enjoy Adam's exceptional buffet.
• Roast Beef • Fish
• Ribs • Potatoes
• Chicken • Vegetables
• Plus a trip to our salad bar stocked with 20 items
\$4.25 adults
\$2.95 children under 10
Tuesday, Wed., Thurs. 5:00-9:30

NATIVE CHINESE & AMERICAN DISHES NOW OPEN
WESTLAND'S NEWEST RESTAURANT
Luncheons Served Daily-Carry Out
Businessmen's Luncheon Specials
FAMILY DINNERS ARE OUR SPECIALTY
YUAN-MEE
8040 Middlebelt at Ann Arbor Trail
ARBOR PLACE SHOPPING CENTER
422-5370
FRI., SAT., 11-3 A.M. SUN. THRU THURS. 11-11

BONANZA
ATMOSPHERE ON A BUDGET

Budget Specials—A BUILD YOUR OWN SALAD—Budget Specials

Every MONDAY	SR. CITIZENS' DAY 11 'til closing	Every TUESDAY
BEEF CHOPPET \$1.49	VEAL CUTLET \$1.49	FAMILY NIGHT 4 'til closing
PETITE STRIP STEAK \$1.79		RIB EYE STEAK \$1.99
FREE BEVERAGE TO ALL OUR SENIOR CITIZENS		CHOPPED BEEF \$1.99

ABOVE ENTREES INCLUDE - POTATO, TEXAS TOAST & SALAD BAR

SOUTHFIELD 25610 W. 8 MILE RD. AT BEECH-DALY RD. IN K-MART PLAZA	BELLEVILLE 2053 RAWSONVILLE RD. OFF I-94 IN K-MART PLAZA	LIVONIA 33456 W. 7 MILE RD. AT FARMINGTON RD. IN K-MART PLAZA
--	--	---

HOURS: MON.-THURS. 11 to 8, FRI. & SAT. 11 to 9 SUNDAY 11 to 8

Just blame it on spring fever

from your house

By Lori Brickman
981-0237



Spring is in the air, and after a long, hard winter we deserved every day of last week's record-breaking temperatures. Forgiven are those who, suffering from spring fever, were seen gazing out of office windows.

Spring fever was probably the reason Kim McLand and Steve Whiteley were inadvertently omitted from the Geneva confirmation class members listed in last Monday's column.

Kim is the daughter of Mr. and Mrs. James McLand of Franciscan Court West in Canton Township. At present, swimming is a favorite pastime for the young lady while her educational future includes college and a teaching career.

Steve, also from Canton, is the son of Mr. and Mrs. Ronald Whiteley of Leann Street. He is active in a variety of sports and is planning to be an oceanographer.

DURING A RECENT business meeting of the Royal Holiday Senior Citizens, president Irene Simmons announced plans to resign from the organization.

Mrs. Simmons and her husband, John, are building a home near Clearwater, Fla. Upon its completion, the sale of their present home on Warren Road, they will leave the community.

After the meeting, the bingo enthusiasts tried their luck. Ruth Fisher, Robert Dirks, Alma Michalak and Helen Pimberton were just a few of those to share the wealth as winners.

JUDY PRINCE is a very active lady in the Canton community. She is an area Girl Scout coordinator, a founding member of Adoption for Spe-

cial Kids (ASK), is raising a family of six, and working part-time as a real estate saleswoman.

Judy is undergoing tests in Oakwood Hospital, Dearborn, room 927D. Why not send a get-well wish to someone who is helping make Canton a nice place to live?

MEMBERS OF THE Plymouth Branch American Association of University Women met in the home of Bobbi Abbott on Foxthorne for their monthly potpourri meeting.

As the name implies, the group discusses a number of different and interesting topics. On this occasion, Lee Halsey from the Health Shoppe in Plymouth, was the featured speaker. She explained the value of a well-balanced diet in a fast-paced society such as ours. She listed necessary vitamins and how they can be obtained in their natural form.

Members exchanging health food recipes were Laurina Badendiek, Kathy St. Clair, Janet Repp, Caroline Teichmann, Barbara Hansen and Marilyn Robison. The evening's refreshments included a nutritional coffee cake served by the hostess and enjoyed by her guests.

THE PLYMOUTH CHILDBIRTH Education Association has moved to Geneva Presbyterian Church to accommodate an increase in membership. The first meeting in the church on Sheldon Road was last Tuesday evening.

Prior to their move, the non-profit organization met in private homes. This became unworkable as the enrollment grew and program offerings expanded. Classes in Caesarean births as well as Lamaze and other childbirth techniques are arranged.

"Although we have elected new officers for 1977, volunteers are needed for committee assignments and other responsibilities," said member Carolyn Ziegler. "Our meetings are the second Tuesday of each month at 8 p.m. and all interested families are welcome."

AAUW to mark 25th anniversary

The Plymouth branch American Association of University Women will celebrate its 25th anniversary April 23 with a luncheon meeting in the Mayflower Meeting House.

Coralyn Riley, Peggy Fisher and Elaine Kirchgatter have planned the program. The various accomplishments and activities of the group will be reviewed in a special audiovisual report. The AAUW chorus, directed by Faith Schweiss, will provide a medley of hit songs from the past 25 years.

Jan Carney will arrange floral cen-

terpieces for the tables and Janet Repp will be in charge of name tags and physical arrangements.

Cheryl Holmberg, corresponding secretary, has mailed invitations to charter members and past presidents of the Plymouth branch. Two division board consultants of the state AAUW, Barb Medwedeff and Mary Jo Lomas have been invited.

The cocktail hour will begin at noon with the luncheon and program following at 12:30 p.m. A short business meeting will conclude the anniversary party.

NEWS RELEASE

A Message to the Vehicle Owner

The U.S. Environmental Protection Agency in carrying out the Clean Air Act has contracted with Olson Laboratories, Inc., Livonia, Michigan to conduct emission tests on vehicles registered within 15 miles of the city limit of Livonia.

Olson Laboratories would like your participation in our testing program.

We have been authorized by the EPA to offer the following incentives:

- \$50 Savings Bond
- Return of the vehicle with a full tank of fuel.
- If the vehicle owner so chooses, the use of a late model, fully insured loaner vehicle during the time that your car is undergoing testing.

We will keep your car 5-8 days. It will remain in our possession during this time and will be tested under normal street and highway conditions. Your car will be fully insured while in our possession.

If you wish to participate, please call 122-3160 between 8 A.M. and 5 P.M. Monday thru Friday and Olson Laboratories Procurement personnel will determine if your vehicle is suitable for inclusion in the test program.

Your cooperation and participation will make a substantial contribution to cleaner air.

THE FOLLOWING GENERAL MOTORS 1976 MODEL CARS ARE NEEDED:

ALL MUST HAVE AUTOMATIC TRANSMISSIONS. ALL VEHICLES MUST BE LESS THAN 1 YEAR OLD AND HAVE LESS THAN 15,000 ACCUMULATED MILEAGE.

Make	Vehicle Size	Engine Size	Carburator
Buick	I	260	2
Cadillac	F	500	1
Chevrolet	SC	85	1
	F	100	1
	C	305	2
	I	100	1
	F	350	2
	F	350	1
Oldsmobile	I	350	1
	F	350	1
Pontiac	F	100	2

FS full size I intermediate C compact SC subcompact X number of carburetor venturics (barrels) transmission

OPEN THURSDAY AND FRIDAY EVENINGS UNTIL 9:00

wear the soft split skirt suit when the weather is in doubt. Of lightweight water-repellent polyester and cotton blend poplin, it's one of the easiest ways we know to zip through a busy day. Tan, with tie-belted longer jacket, turnback cuffs, big zipper, mandarin neckline. 6-14 sizes. \$105

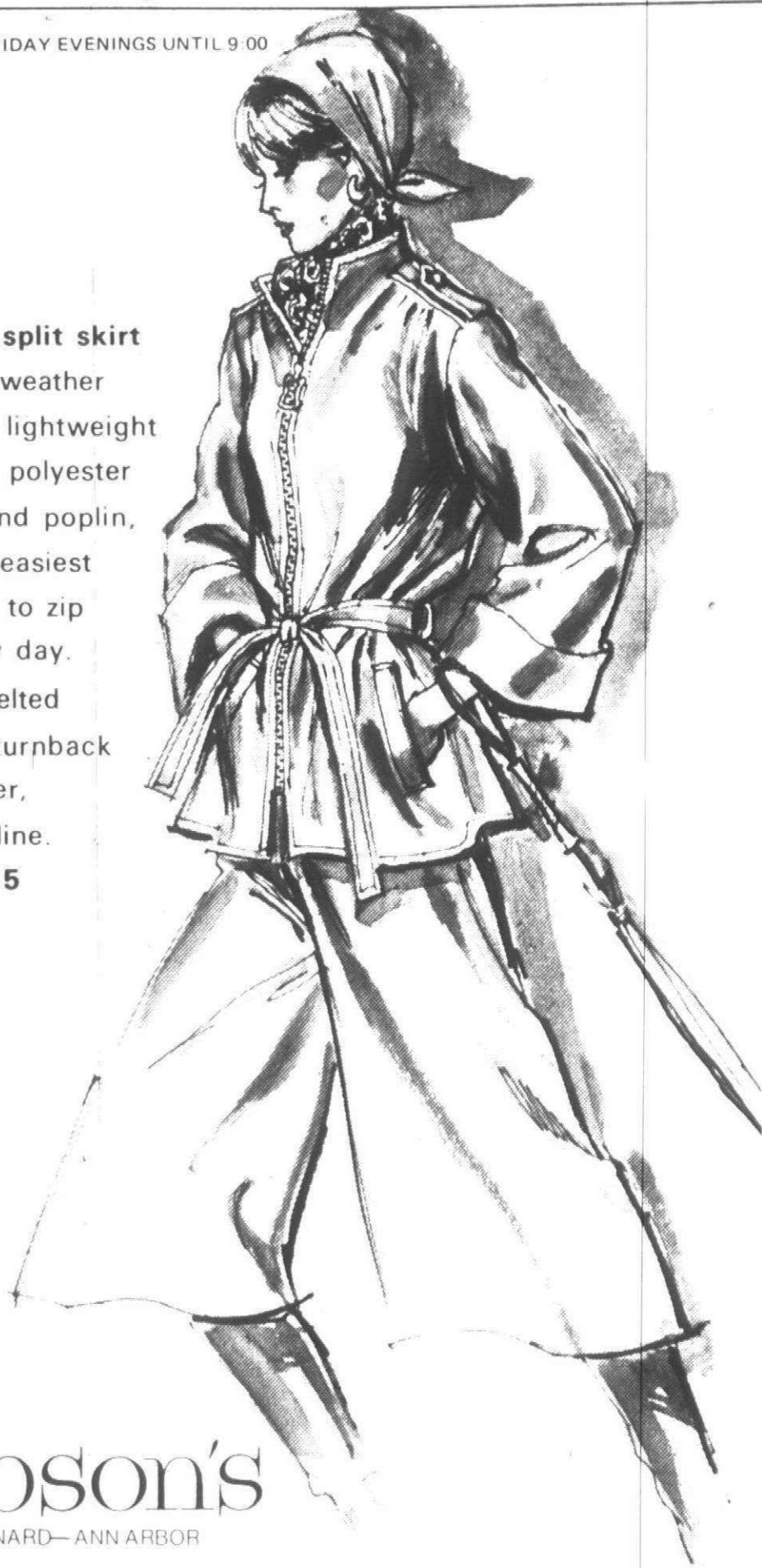

Jacobson's

LIBERTY at MAYNARD-ANN ARBOR

FREE PARKING IN THE ADJACENT RAMP WE WILL VALIDATE YOUR TICKET

An employee carrying this card is no stranger.

When strangers knock on your door saying they're from Consumers Power, how do you know they're telling the truth?

Easy. Ask for an Identification Card. If they do not have one, they're not from Consumers Power. So don't let them in. Unfortunately, some people try to get into homes by passing themselves off as our employees.

Consumers Power employees all carry Identification Cards so they can prove their identity right on the spot for your safety.

I'm a Consumers Power chief meter man and I go into homes every day. When someone answers the door, I tell them I'm from Consumers Power. But you know what? When they ask me for my Identification Card, I like it. Because it's exactly what my family would do.



"TEN THOUSAND WORKING PEOPLE BRINGING ENERGY TO YOU."

KENNETH BLACKBURN
Chief Meter Man
South Central
Region

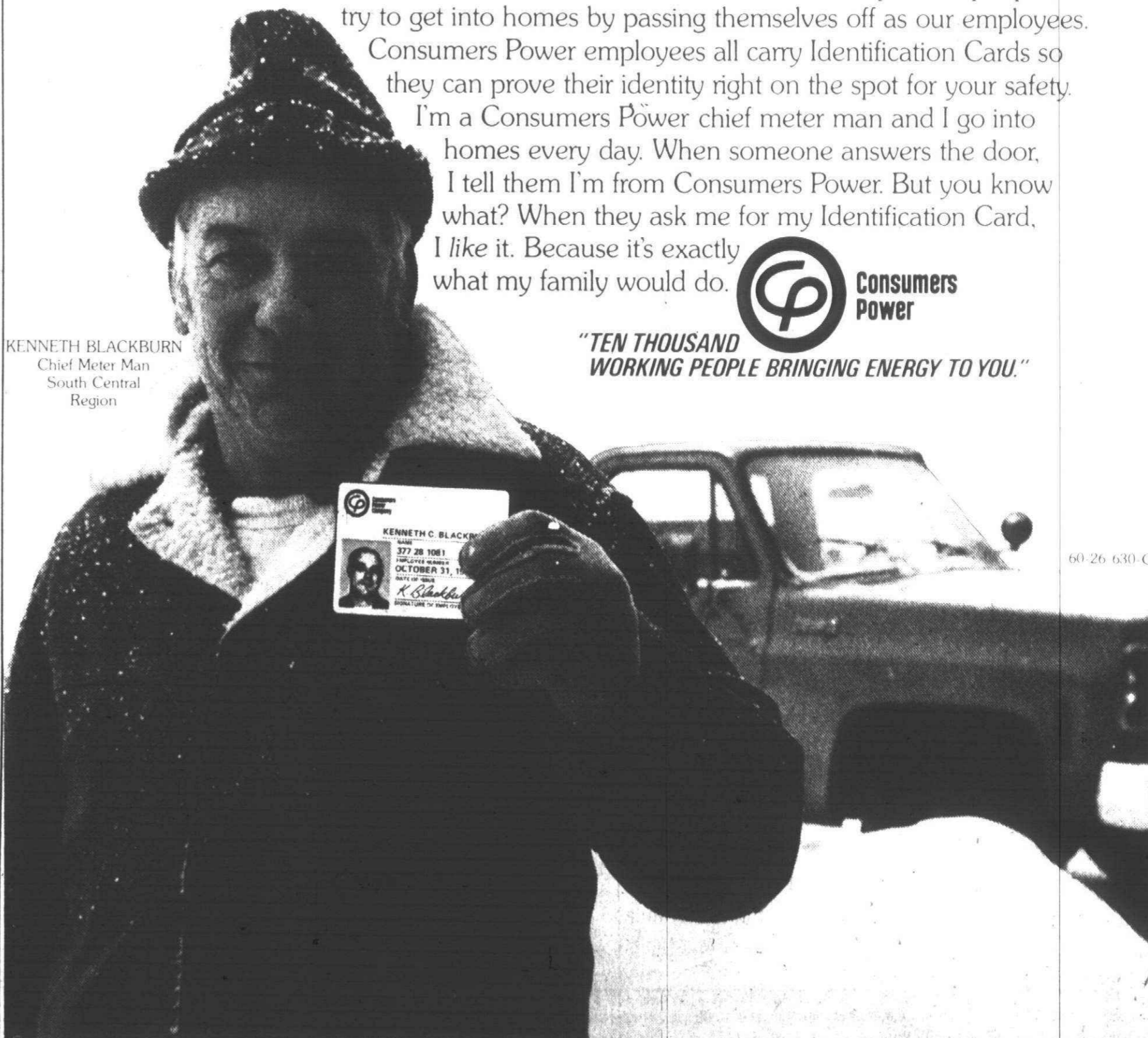

Summer HAIRSTYLES for easy living...

Let us find a hairstyle that reflects your personality and lets you enjoy all your outdoor activities!



Precision haircutting by Ron SHANE

Mon. 9-5
Tues. thru Fri. 9-9
Sat. 9-4

hair Stylist

Sheldon at Ann Arbor Road
155-3100 Plymouth

STAN'S

GARDEN & PRODUCE CENTER
38001 ANN ARBOR RD.
Across from Stan's Market

Winter Hours: Mon.-Sat. 10-7 Sun. 10-5

HEAD LETTUCE 3/\$1.00

GREEN PEPPERS 5 for \$1.00

CUCUMBERS 5 for \$1.00

VINE-RIPE TOMATOES 49¢ LB.

MICHIGAN PEAT 40-lb. BAG 99¢

YELLOW ONION SETS 39¢ lb.

ORTHO 24-4-8 LAWNFOOD 20-lb. BAG \$4.99

Stan's Nursery Stock has arrived Complete Selection of Yews, Pflitzers, Junipers, Arborvitae, Trees, etc.

THURS. & FRI. ONLY-APRIL 21 & 22

STRAWBERRIES 88¢ qt. 18¢ lb.

Merit Sparks Low Tar Boom!

'Enriched Flavor' tobacco seen as major factor in unprecedented smoker move to low tar.

Since its introduction, MERIT has become one of the most popular new cigarettes in twenty years.

A popularity largely responsible for a significant growth in low tar smoking.

The reason: 'Enriched Flavor' tobacco. *Tobacco that delivers extra flavor without the usual corresponding increase in tar.*

The kind of flavor smokers can switch to—and stick with.

Here are the taste-test results which show why smokers are switching to MERIT. If you smoke, you'll be interested.

© Philip Morris Inc. 1977

Kings: 8 mg. tar, 0.5 mg. nicotine av. per cigarette, FTC Report Dec. 76
100's: 12 mg. tar, 0.9 mg. nicotine av. per cigarette by FTC Method.

Warning: The Surgeon General Has Determined That Cigarette Smoking Is Dangerous to Your Health.

Tests Prove Taste

MERIT and MERIT 100's were both tested against a number of higher tar cigarettes. The

results proved conclusively that 'Enriched Flavor' tobacco *does* boost taste without the usual increase in tar.

Overall, smokers reported they liked the taste of both MERIT and MERIT 100's as much as the taste of the higher tar cigarettes tested.

Cigarettes having up to 60% more tar! Only one cigarette has 'Enriched Flavor' tobacco.

And you can taste it.

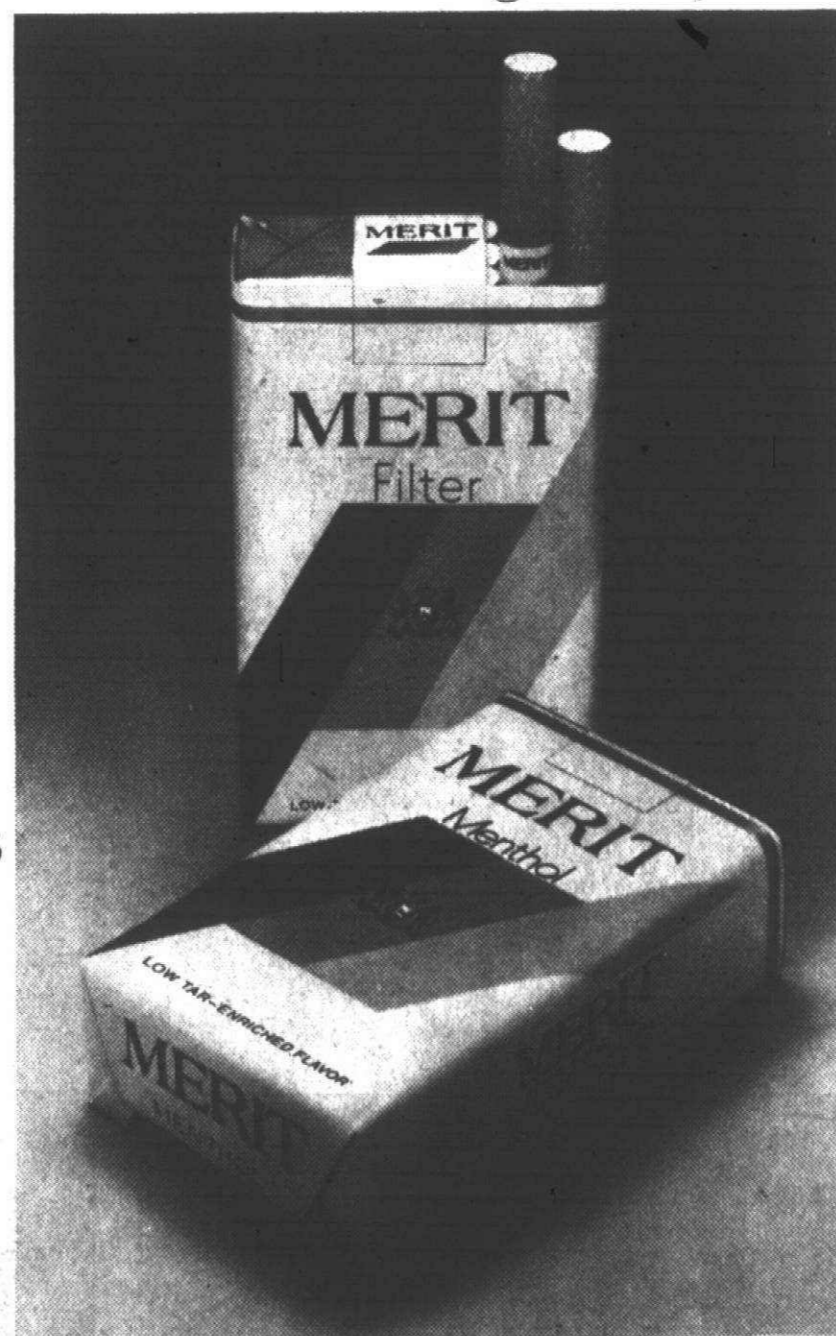

REGULAR and MENTHOL

MERIT

Kings & 100's

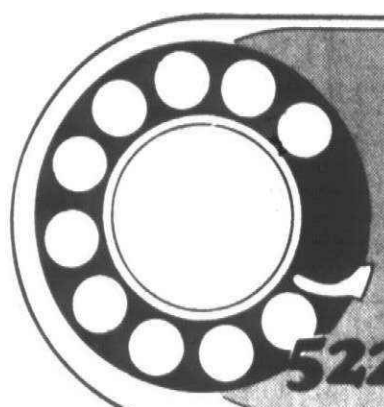

522-0900

Canton Observer

Classified Want Ads



Monday, April 18, 1977

(C) 1C

312 Livonia

COUNTRY SETTING
(No 13) Enjoy comfort and convenience in this sprawling 3 bedroom ranch on nearly 1/2 acre. Has all new carpeting throughout, fireplace in living room, formal dining or family room, 2 1/2 car garage and an unbelievable price of only \$34,400.

Century 21
VINCENT N. LEE
EXECUTIVE TRANSFER SALES
553-3408

Bldr's. Closeout
LIVONIA WOODED AREA - Custom built colonial in scenic 5 Mile Farmington Rd area. 3 bedrooms, family room, fireplace, carpeting throughout, attached 2 car garage, 1507 Loveland, 10 year builder's warranty. \$55,500. Open Sunday 2-5 PM.

CENTURY 21 HALLMARK INC.
937-2300

CHARMING BRICK RANCH
1/2 ACRE
Enjoy outdoor living on your own 1/2 acre lot with this almost new 3 bedroom brick ranch plus fireplace in family room, country kitchen, full basement. \$42,900.

Realors Carpet
REALTORS 522-3500

Sharp as a Tack
Beautiful 3 bedroom brick ranch, tastefully decorated, like new carpeting throughout, family room, full basement, with office room or extra bedroom, 2 1/2 car garage with carport. Hurry. Won't last. Priced at \$38,900. 255-5330. John Cole Realty.

We're Putting You On
To a great opportunity to own this lovely 3 bedroom home, nice carpeting, large country kitchen, natural fireplace, and bath and a half, convenient location to schools and shopping. Only \$21,900. FHA and VA terms. 255-5330.

The Big Steal
Jesse James had a gun but he never made out like this. Excellent 3 bedroom brick, 1 1/2 baths, family room, with woodburning fireplace, country kitchen, carpeting throughout, attached 2 1/2 heated garage, assume mortgage. \$39,900.

1ST UNITED
255-5330
JOHN COLE REALTY
25105 WEST 6 MILE
REDFORD, MICHIGAN
KE 7-5313

AUTOMOTIVE

850 Autos for Sale
854 Antique Cars
854 American Motors
856 Buick
858 Cadillac
860 Chevrolet
862 Chrysler
864 Dodge
866 Ford
870 Jeep
872 Lincoln
874 Mercury
876 Oldsmobile
878 Plymouth
880 Pontiac
882 Sports & Imported Cars
884 Thunderbird
886 Volkswagen
816 Auto-Truck Parts & Service
818 Auto Rentals & Leasing

819 Auto Financing

820 Autos Wanted
822 Trucks for Sale
823 Vans
800 Recreational Vehicles
802 Snowmobiles
804 Airplanes
806 Boats & Motors
808 Vehicle & Boat Storage
810 Insurance Motor
812 Motorcycles
814 Cars
814 Campers & Motorhomes

504 Help Wanted-Office-Clerical

506 Help Wanted-Sales
520 Secretarial-Business Services
512 Situations Wanted-Female
514 Situations Wanted-Male
516 Situations Wanted-Male & Female

MERCHANDISE FOR SALE

702 Antiques
706 Appliances
700 Auction Sales
712 Bicycles for Sale
718 Building Materials
724 Camera Supplies
703 Crafts

CLASSIFICATION INDEX

REAL ESTATE FOR RENT
400 Apartments to Rent
422 Commercial-Industrial to Rent
426 Condo/Co-op to Rent
416 Vacation Rentals
430 Wanted to Rent
410 Flats to Rent
414 Florida Rentals
402 Furnished Apartments to Rent
406 Furnished Houses to Rent
428 Garages to Rent
404 Houses to Rent
432 Living Quarters to Rent
418 Mobile Homes to Rent
424 Office-Business Space to Rent

420 Rooms to Rent

412 Townhouses- Condominiums to Rent
420 Rooms to Rent
412 Townhouses- Condominiums to Rent
416 Vacation Rentals
430 Wanted to Rent
434 Wanted to Rent Resort Property
436 House Sitting Service

319 Homes for Sale

312 Livonia- Wayne County
314 Plymouth-Canton
318 Redford
316 Westland-Garden City
320 Other Suburban Homes for Sale
321 Real Estate Service
330 Apts. for Sale
360 Sports Opportunities
348 Cemetery Lots
352 Commercial-Industrial
322 Condominiums for Sale
324 Co-ops for Sale
344 Country Homes
326 Duplexes for Sale
350 Farms for Sale
336 Florida Property for Sale
354 Income Property for Sale

356 Investment Property for Sale

340 Lake & Resort Property for Sale
342 Lakefront Homes for Sale
364 Listings Wanted
338 Lots & Acreage for Sale
332 Mobile Homes for Sale
364 Listings Wanted
338 Lots & Acreage for Sale
332 Mobile Homes for Sale
358 Mortgages-Land Contracts
346 Non-Res Property
334 Out of Town Property
368 Real Estate to Exchange
362 Real Estate Wanted
328 Townhouses for Sale

312 Livonia

QUALIFIED BY QUALITY
North Livonia has this 4 bedroom plus den brick colonial with natural fieldstone front. Bay window, stained natural woodwork, self-cleaning range, luxury tile and carpeting, 1st floor laundry, family room with beamed studs, stereo ending, and brick wall fireplace with natural wood stained bookshelves, wood thermo windows, side entrance garage. Trade in your present home. Don't delay, call One Way 324,600.

One Way
BEST BUY Around! Meet by owner or turn over to Real Estate for higher price. 4 bed, 4 bed rooms, 1 1/2 bath, heat, humidifier, stove, refrigerator, dishwasher, 2 1/2 car garage, newly decorated, must see. \$29,900. 414-3329

OLDIE BUT GOODIE
CHARMING completely remodeled Ranch offering 3 bedrooms, carpeting throughout, 2 car garage and a GREAT PRICE. \$26,000.

CENTURY 21 CORNERSTONE
478-4660
BY OWNER. This level, prime Livonia area 3 bedrooms, 1 1/2 baths, formal dining room, fireplace. Attached garage, new kitchen with appliances. Immaculate yard with new pool. \$47,900. Call after 4 PM. 464-6402

312 Livonia

PRESTIGE AREA
Tastefully decorated 4 bedroom colonial, family room with fireplace, slate foyer, attached 2 car garage with opener, pantry in kitchen, Call NANCY AUSMAN for more details.

Realors Carpet
CENTURY 21
Hartford West, Inc. 453-7600

312 Livonia

LIVONIA - 2 bedroom home with family room, 14x16, 2 car garage, also 11x17 workshop, in the rear of the garage. \$29,900. Ashley & Cox Real Estate. 349-2790

THREE bedroom aluminum-sided Ranch. 2 car garage, finished basement, standard lot, conventional mortgage. \$34,900. 522-3729

\$22,900
Just listed cute ranch or retiree all brick ranch that offers a full basement, completely fenced yard, extra low taxes in convenient location in Livonia.

Red Carpet
REALTORS 522-3500
LIVONIA, 3 bedroom colonial corner lot, family room with natural fireplace, 2 1/2 car attached garage, basement. \$53,900. 625-6606

LIVONIA LARGE FAMILY HOME
You must see this large 4 bedroom aluminum ranch on over an acre. Family room, 2 full baths, family kitchen, 2 car garage plus another 1 1/2 car garage. Asking \$45,900.

EXCELLENT STARTER
Very clean and sharp 3 bedroom aluminum bungalow with large 24x24 garage. All appliances negotiable. Big lot. Asking \$26,900.

1ST UNITED Weldon Clark
REALTORS 425-7300
27492 Five Mile Livonia

312 Livonia

EXCEPTIONAL custom home, 3 bedroom brick ranch on large treed lot, custom built stone wall in foyer, fieldstone fireplace, field stone wall in full finished basement, 2 full baths, formal dining room, large country kitchen, attached garage, by owner. \$39,900. After 5 PM. 534-8504

Extra Large Lot
LIVONIA, older 1 1/2 story, 4 bedroom, newly decorated inside, plenty of room for the large family room, large country kitchen, attached garage. Call and ask for GARY DITMORE. \$44,900.

Century 21
Boardwalk Div. 459-3600
FOUR bedroom Colonial Formal dining room, family room fireplace, 1 1/2 baths deck gas grill. Early occupancy 1422 Edgewood. \$60,900. 522-4572

LIVONIA owner wants action on this well kept 3 bedroom brick ranch, country kitchen, large family room, well planned basement with rec room, 2 1/2 car garage. \$37,500.

WOLFE LOVE
422-9278
32398 Five Mile GA 1-5660
TRIPLE LEVEL, 2 1/2 car garage, 3 bedroom, dining room, large treed private yard. \$45,500. Owner. 425-0125

312 Livonia

BRIGHT & CHEERFUL
In excellent condition and in a good area, we have this terrific 3 bedroom, 2 full baths, all brick tri with a large modern kitchen, a gorgeous family room, this beauty is carpeted throughout and has a 2 car garage. \$44,900. HARRY S.

WOLFE LOVE
422-9278
SIX MILE - Livant, by owner, 3 bedroom brick ranch, 1 1/2 baths, family room, fireplace, carpet throughout, 2 car attached garage. Immediate occupancy. \$53,900. 464-9655

1st OFFERING
COLONIAL CHARM
Lovely 3 bedroom colonial located on a large treed lot with 1 1/2 baths, large family room with natural fireplace and garage for only \$31,900.

Century 21
Boardwalk Div. 459-3600
LIVONIA-sharp 3 bedroom brick ranch, natural fireplace, modern country kitchen with disposal and built in dishwasher, new roof, 87 x 100 lot, and full basement. \$34,500. Buyers only. 261-7242

Going Fishing
LIVONIA owner wants action on this well kept 3 bedroom brick ranch, country kitchen, large family room, well planned basement with rec room, 2 1/2 car garage. \$37,500.

WOLFE LOVE
422-9278
25200 5 MI 533-7272
THREE bedroom Ranch, brick and aluminum attached 2 car garage, family room, fireplace, finished basement, 1 1/2 baths, central air, large patio, 4 yrs. old. \$54,900. 625-4407

312 Livonia

BY Owner - 3 bedroom brick ranch, big kitchen, 1 1/2 baths, full finished basement, 1 bedroom in basement, 2 1/2 car garage. \$5-1343

Family Room FIREPLACE
LIVONIA, truly mint condition, 3 bedroom all brick ranch, 2 1/2 car garage, kitchen opening into beautiful family room with fireplace. Park like yard. \$38,900.

1st OFFERING
COLONIAL CHARM
Lovely 3 bedroom colonial located on a large treed lot with 1 1/2 baths, large family room with natural fireplace and garage for only \$31,900.

Century 21
HARTFORD SOUTH
464-6400
THREE BEDROOM brick ranch, 2 car attached garage, dishwasher, 1 1/2 baths, family room with fireplace, central air, pool. \$45,500. 425-8368

NEED 5 BEDROOMS?
ATTRACTIVE, large home, convenient location with room for hospitality or income. Double lot with 2 car garage. \$44,900.

TEPEE REALTY
25200 5 MI 533-7272
THREE bedroom Ranch, brick and aluminum attached 2 car garage, family room, fireplace, finished basement, 1 1/2 baths, central air, large patio, 4 yrs. old. \$54,900. 625-4407

312 Livonia

LIVONIA \$42,900, 3 bedroom brick ranch, 2 car garage, central air, 28 ft. above ground pool. 261-1079

EVER POPULAR
Very nice, well kept 3 bedroom brick ranch home on an extra deep lot featuring a large kitchen, full finished basement with a full bath and a large patio. Good assumption. \$34,900. HARRY S.

WOLFE COMPANY
33235 Seven Mile 427-0733
LIVONIA Pride of owner, \$39,900. 3 bedroom ranch, 1 1/2 baths, family room, all new kitchen, finished rec room in basement, air conditioning, office, all new 6 panel doors, heated workroom behind garage, raised patio with new canvas awning last year. All new landscaping. You must see this one to appreciate its value. Beautiful Rosedale Gardens. Call after 4 PM. 425-9518

RAMBUNG RANCH
Spaciousness abounds in this beautiful 3 bedroom brick ranch home. Featuring all aluminum trim and professional landscaping, central air, family room with fireplace, 1 1/2 baths, beautifully finished rec room with full bath, 2 car attached garage and much more. Offered at \$62,900.

HARRY S. WOLFE COMPANY
33235 Seven Mile 427-0733

312 Livonia

LIKE PRIVACY?
That's what you'll have with this delightfully landscaped privacy lot. Featuring 2000 plus sq ft of living space, 4 or 5 bedrooms, 2 1/2 baths, formal dining room, large kitchen, family room with fireplace, beautiful rec room with library, 2 1/2 car garage and lots of storage space. Owner transferred. Just listed at \$69,900. Don't delay, call One Way 322,600.

One Way

CONGRATULATIONS!
Jerry Pociask
Sales Associate
Chamberlain's Plymouth/Office is proud to announce that Jerry Pociask is the top Sales Associate for March. Give this sales leader a call about your home plans. TODAY!

Chamberlain's REALTORS
Plymouth/Normalville Office
19605 Maple
Plymouth, Michigan 48170
455-5200

The buyer finders.

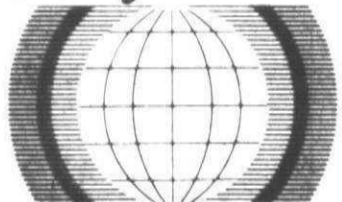

REALTY WORLD

C. W. ALLEN, Inc.
15337 Farmington Road
421-2100

The buyer finders.

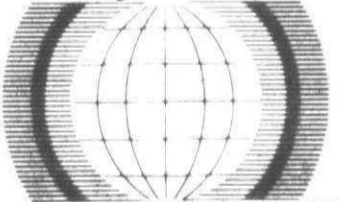

"Serving You Over 29 Years"

"Serving You Over 29 Years"

"REALSCOPE"

a way to make buying or selling a house faster, easier, more pleasant.

You don't need lots of lookers to sell your home... Just 1 buyer.

And Realscope is just one reason you need Realty World. Realscope. A photographic tour of your home's most salable features that helps us separate the buyers from the lookers in our offices, not your living room. When it's because they know what they want and are prepared to do something about it. Realscope helps make selling your home fast and convenient. At Realty World, we think that's the way it should be.

"a WORLD of Difference"



LIVONIA

4 bedrooms, in Kingsbury Heights Subdivision. Super sharp large home with Central Air, 2 1/2 baths, family room, recreation room and large modern kitchen - \$72,900.

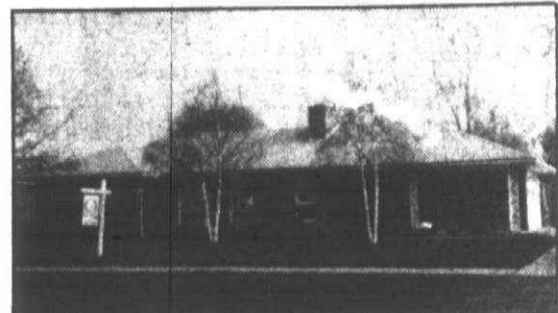

LIVONIA

Custom home in lovely 105 x 206' lot. Well built 2 bedroom home with fireplace, dining room, 20' utility room and gas heat. Room for expansion. \$42,900.



REDFORD TOWNSHIP

IMMACULATE, this 3 bedroom home 22' living room with fireplace, large family kitchen, basement and gas heat. Good area near 8 Mile Road. 70'x298' lot. \$35,900.

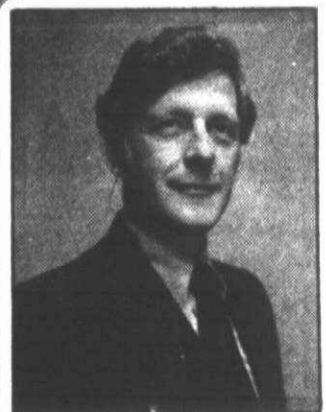

CHARLES W. ALLEN, JR. BROKER



MARYLOU KUCZEK



HAROLD A. PRYOR



ALICE MURNIGHAN

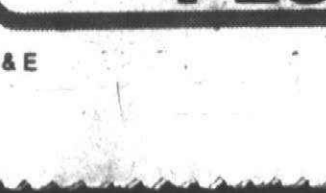

DAN McMULLEN

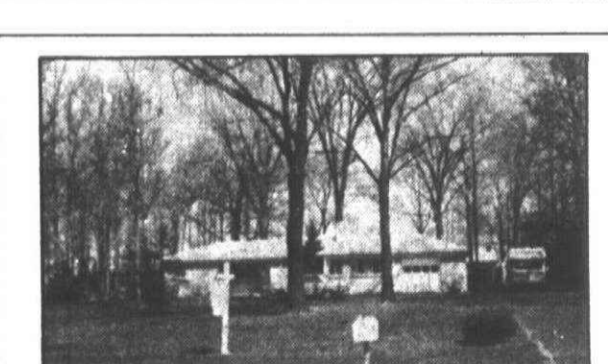

LIVONIA

Showplace in the trees. Large 3 bedroom home with family room 2 baths, fireplace and rear screened porch. 120'x340' lot \$53,900.



DEARBORN HEIGHTS

Bright, sunny home with bay window in kitchen, plus 3 bedrooms, basement and garage makes this a good value at only \$24,500.



INVESTMENT

For you, only \$26,500, for this 2 family in Redford area, 5/5 with separate heat and utilities. Good condition, will go FHA.

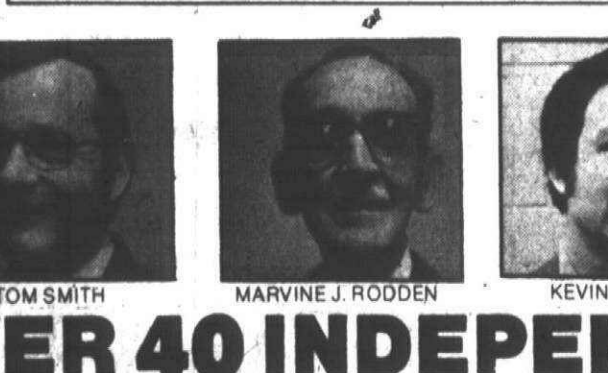

TOM SMITH

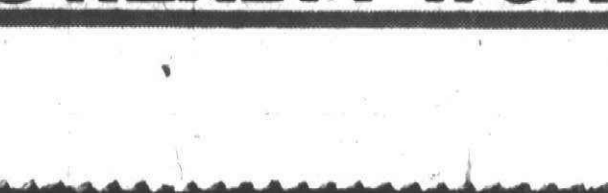

MARVINNE J. RODDEN

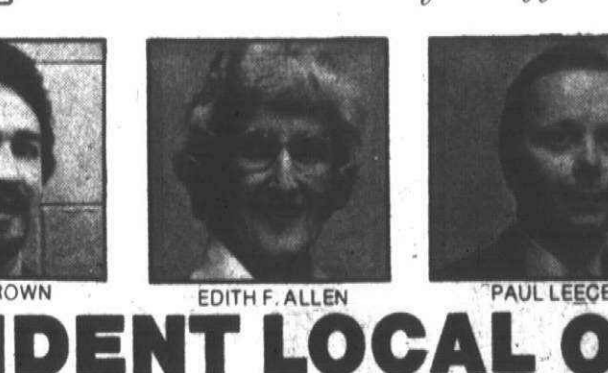

KEVIN BROWN

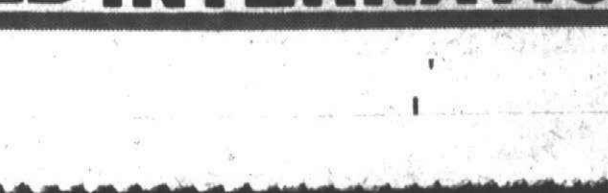

EDITH F. ALLEN



PAUL LEECE

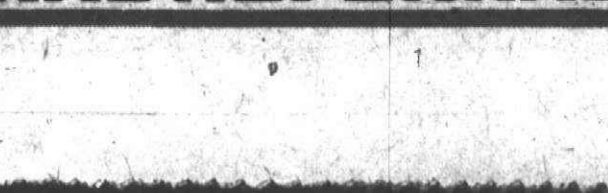

ALICE KELLY



CARL WAGNER

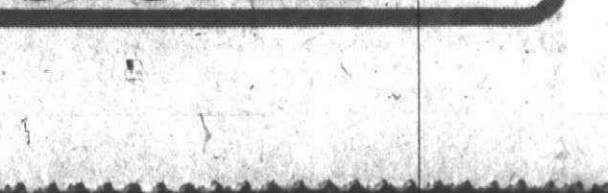

BARBARA LYNN

SIMON SILVER

OVER 40 INDEPENDENT LOCAL OFFICES TO SERVE YOU! PLUS REALTY WORLD INTERNATIONAL REFERRAL SYSTEM

<p>312 Livonia BY OWNER Livonia Open Sat. and Sun. 2 to 5PM. 1438 Sunbury. Tri-level, 3 bedrooms, 1 1/2 bath, paneled family room, brand new carpeting and decorated throughout. 1 1/2 car garage. Immaculate condition. \$41,900. 261-9317</p> <p>FIRST OFFERING Built in 1970 and still like new, don't miss this attractive all brick 4 bedroom ranch, with a very nice kitchen, with built-ins, a 22 x 13 living room, an 18 ft family room with brick wall fireplace, this home is immaculate throughout, it's maintenance free, sitting on a 1/2 acre site with a sunken pool. \$59,900.</p> <p>HARRY S. WOLFE COMPANY 32398 Five Mile GA 1-5660</p>	<p>312 Livonia FAMILY ROOM-FIREPLACE An all brick 1 1/2 baths, with 3 nice size bedrooms, a 19 ft kitchen modern, an 18x17 family room with wood burning fireplace, carpeting throughout, a full basement, central air conditioning, an attached 2 car garage, and a large lot. \$42,900.</p> <p>HARRY S. WOLFE COMPANY 32398 Five Mile GA 1-5660</p>	<p>312 Livonia SIX & Levan, sharp 4 bedroom colonial, 1 1/2 baths, large lot. \$59,900. 261-2359</p> <p>LIVONIA Cape Cod, by owner, 3 bedrooms, 2 full baths, 2 car garage. \$45,500. 261-8198</p> <p>HOUSE BEAUTIFUL Only 4 years old is this outstanding 3 bedroom brick ranch home. Featuring a 24 ft. dream kitchen, large patio, full basement, 2 car garage and an excellent assumable mortgage. Asking \$37,900.</p> <p>HARRY S. WOLFE COMPANY 32325 Seven Mile 427-0733</p>	<p>312 Livonia FARMINGTONJOY RD Real Sparkler Custom 3 bedroom brick ranch, extra sharp. 1 1/2 baths, 2 1/2 car garage. Air conditioned. Finished basement. This one has everything. \$41,500. HARRISON MOORE. 427-9030</p> <p>HOT NEW LISTING Call now to see this lovely 3 bedroom brick ranch home with full finished rec. room, 4 th bedroom, lavatory and summer kitchen. Beautifully landscaped plus a 2 car brick front garage. Good assumption. \$34,500.</p> <p>HARRY S. WOLFE COMPANY 32325 Seven Mile 427-0733</p>	<p>312 Livonia A DREAM Ranch in Livonia - 3 bedrooms, 1 1/2 bath, 2 1/2 car garage. Loads of extras! \$48,000. By Owner. Buyers only. 425-3207</p> <p>STARK GARDENS Like new 4 bedroom brick colonial, 1 1/2 baths, and a great floor plan, with formal dining room, a large kitchen, with dinette and built-ins, a cozy family room with fireplace and attached 2 car garage. \$53,900.</p> <p>HARRY S. WOLFE COMPANY 32398 Five Mile GA 1-5660</p>	<p>312 Livonia 4 BEDROOM COLONIAL in Denmar Estates we offer you this attractive all brick 4 bedroom, 2 1/2 baths colonial, with a formal dining room, a dream kitchen, with built-ins, a large family room with fireplace, with doorwall to patio, a full finished basement and 2 car attached garage. \$69,900.</p> <p>HARRY S. WOLFE COMPANY 32398 Five Mile GA 1-5660</p>	<p>314 Plymouth Canton LARGE FAMILY NEEDS Are answered in this lovely Brick colonial with 3 bedrooms plus two more in the basement, nice family room with fireplace, large kitchen, all carpeted except kitchen, attached 2 car garage and large beautifully landscaped lot. A place for everyone and a great place to live. An exceptional value at only \$49,900.</p> <p>J. L. HUDSON Real Estate Co. 453-2210 Plymouth-Canton Area COLONIAL \$38,990 3 bedrooms, 2 car garage, bath and a half, approx. 1900 sq ft. Many extras. Immediate occupancy.</p> <p>CANTON 87 South of Cherry Hill on Lally Rd. DEMBS BUILDING CO. 397-1030</p>	<p>314 Plymouth Canton SUPER HOME! POSSIBLE 4 bedroom bi-level, 1 1/2 baths, family room, and 2 car garage. Nice area! WONT LAST. Owner says sell! Only \$36,500.</p> <p>ELLIS 476-1700</p> <p>HOLIDAY PARK Sharp 3 bedroom brick ranch, large family kitchen and dining area, rec room, 2 1/2 car garage and more. Asking \$38,900.</p> <p>HARTFORD S. 261-4200</p> <p>BY OWNER, well maintained 3 bedroom aluminum sided bungalow. garage air. Solarian kitchen floor, dishwasher, attractively decorated, full basement, close to school & shopping. \$36,900. 459-9389</p> <p>CANTON TWP QUAD LEVEL 4 bedrooms, 2 1/2 car attached garage, 2 baths, family room with fireplace. \$47,490 45 Day Occupancy Call Gary Coogan Re Lot #59 Between 18 Mon-Sun Closed Thurs 397-0550</p>	<p>314 Plymouth Canton BY OWNER 4 bedroom colonial, circular stairway, 1 1/2 baths, family room, fireplace, formal dining, basement, patio, attached garage. \$58,000. 459-5584</p> <p>BY OWNER Prestigious Notting-ham Forest Sub. Immaculate 4 bedroom Quad. 2 1/2 baths, attached 2 1/2 car garage. Central air, air purifier, power humidifier. Custom draperies, carpeting throughout. Large patio, formal dining room, beautifully decorated. \$49,000. By appointment. 459-1797</p> <p>9459 SOUTHWORTH \$49,900 Rambling ranch, 1/2 acre treed lot, 3 bedrooms, beamed ceiling in living room with fireplace, formal dining area. Large kitchen, 1 1/2 baths, family room, attached 2 car heated garage. Privacy backyard with pool.</p> <p>Norwood No. 3, Inc. 425-1500 THREE bedroom Colonial 1 1/2 baths, fireplace, family room, attached garage, large lot, tiled basement, central air, pool, extras. \$46,500. 397-1199</p> <p>4 Bedroom Colonial 2 full baths, separate dining room, family room, fireplace, full basement, 2 car garage. Many more extras. Only \$55,500. Call and ask for KAREN SWYSTUN.</p> <p>Century 21 Boardwalk Div. 459-3600</p> <p>CANTON ranch, all brick, 3 bedroom, 2 bath, large sunny living room, dining room, family room with fireplace, patio, attached garage with opener, air conditioning. \$35,900. 453-9369</p> <p>CANTON TWP RANCH 3 BEDROOM RANCH FULL BASEMENT FAMILY ROOM ONLY 10 LEFT \$34,990 FOR INFORMATION 397-1030 Model Open 1 to 7 CANTON 3 bedroom brick ranch, 2 car attached garage, 1 1/2 baths, new Solarian kitchen floor, family room with fireplace. Wooded lot. \$43,900. 459-9680</p> <p>CANTON TWP Immediate Occupancy New 3 bedroom ranch with family room, fireplace, 1 1/2 baths, 2 car attached garage, full basement. \$48,990 Call Gary Coogan Re Lot #46 Between 18 Mon-Sun Closed Thurs 397-0550</p> <p>TRILEVEL, 3 bedrooms, large kitchen with built-ins, family room with fireplace, 2 baths, 2 1/2 car garage. Plymouth Township. \$47,900. 453-2675</p> <p>BEST BUY IN PLYMOUTH 4 bedroom colonial, central air, custom drapes go along with this beauty, carpeting throughout, dish washer in kitchen, fireplace in large family room, beautiful terrace leads out to a professionally finished patio and landscaped yard, underground sprinkler system, 2 car attached garage. Must see this one! For more details call</p> <p>Century 21 Boardwalk Div. 459-3600</p>
---	--	--	---	---	---	---	--	---

We Can Guarantee The Sale Of Your Home!
Call today for details.

<p>APRIL SHOWERS! BRING Spring Flowers, and this darling 1 1/2 story house located in Redford. 3 bedrooms, formal dining room, carpet throughout, 1st floor utility room, cyclone fenced yard, 1 1/2 car heated garage, new furnace. CALL TODAY.</p> <p>455-5200</p>	<p>REALLY REDUCED in Dearborn Heights. This 3 bedroom brick and aluminum ranch contains central air, finished basement with fireplace, and tasteful decor with plush carpeting. Also a 2 1/2 car garage. FHA VA terms. Owner anxious. \$30,900.</p> <p>476-9100</p>	<p>WESTLAND 3 bedroom brick ranch in desirable Tonguehook offering beautiful finished basement, recreation room with fireplace, carpeting throughout, new in living room. Immaculate condition, attached 2 car garage. All for only \$41,900. Call to see and ask for DOREEN MORGAN.</p> <p>721-8400 GARDEN CITY</p>
<p>INDULGE YOURSELF Custom Built Beautiful Colonial located in a Mature Area of Plymouth. 4 bedrooms, 2 1/2 baths, formal dining room, kitchen with dinette, premium carpeting throughout, natural fireplace in family room, patio, 2 car attached garage. TONY KILMAN.</p> <p>455-5200</p>	<p>FARMINGTON HILLS Large rambling Colonial features 3 bedrooms, remodeled country kitchen, fireplace, 2 full baths, full basement and low taxes. Can't beat it at \$25,900.</p> <p>476-9100</p>	<p>4 bedroom aluminum 1 1/2 story home, featuring a home for a large family with formal dining room, full basement, and an extra room upstairs for either a sewing room for the lady of the house or a hobby room for the man of the house! 1 1/2 car garage, 45x150 Lot, with fruit trees all over backyard! Large front porch, cyclone fence and many extras. Don't miss this one a real must see! \$29,800. Call for an appointment to see and ask for BILL WINTERSTEEN.</p> <p>721-8400 FHA VA 0 DOWN Owners will pay the points on this 3 bedroom brick ranch in Chery Hill school district, also has full basement and garage. Only \$23,900.</p> <p>721-8400 START HERE!! Perfect starter home with low assumption and \$207.00 payments in Dearborn Heights, features 3 bedrooms, bright sunny kitchen, full tiled basement and 2 car garage. All for Only \$25,900.</p> <p>721-8400 INKSTER 2 bedroom home, with large fenced lot. Close to schools, ideal for anyone who likes to work in the yard! Outside needs tender loving care. Nice neat, clean starter home. Only \$11,900.</p> <p>721-8400</p>
<p>IT WORKS BOTH WAYS She can have the home of her dreams at a price he can afford. 3 bedrooms, kitchen with entry dinette, Brand New Carpeting will be installed in hall and living room. Buyer can pick the color. \$25,500.</p> <p>455-5200</p>	<p>LIVONIA Seven Mile Middlebelt. Lovely 3 bedroom Bi Level. Central air, newly decorated kitchen, family room with wet bar, attached 1 1/2 car garage. An irresistible \$34,900.</p> <p>476-9100</p>	<p>FARMINGTON HILLS 2 or 3 bedroom ranch. Includes large double lot, new roof, and large 2 car garage. Priced to sell at \$23,000. Call STEVE LEIBHAN.</p> <p>476-9100</p>
<p>SWEET AND SIMPLE IN BEAUTIFUL NORTHVILLE 3 bedrooms, formal dining room, kitchen with dinette, wool carpeting throughout, enclosed patio. \$34,900.</p> <p>455-5200</p>	<p>LIKE A DREAM... in Farmington Hills. Over an acre of beautiful trees and ravine with running stream surrounds this beautiful brick Colonial. Aluminum trim, 3 bedrooms, family room, formal dining room, 2 1/2 baths. \$59,400.</p> <p>476-9100</p>	<p>IDEAL STARTER HOME Looking for an IDEAL STARTER HOME in Plymouth? Then you MUST see this charming, clean, 2 bedroom home, new aluminum siding. Priced to sell at unbelieveably low \$20,900!! CALL VANA BEGIN IN.</p> <p>455-5200</p>

JOIN THE WINNING TEAM!
Call Fred Madley, recruiting director at 455-5200 for an interview for a Sales Position in the west region.

Chamberlain REALTORS

EARL KEIM REALTY from the HELPFUL PEOPLE!

ENJOY THE SUMMER in this air conditioned home with attic fan. Brick Ranch 3 bedrooms-1 1/2 baths on main floor-2 car garage-awnings dining ell-curtains, and drapes all for \$37,500. 261-1600

FIREPLACE LOVERS! You'll admire the beauty of this home's heart centered Living Room-3 bedroom Face Brick and Aluminum Ranch on nearly a 1/2 acre fenced lot. Full basement-1 1/2 Baths-18x12 Florida Room easily converted to all year round Family room with wide open view-Wool carpeting. Immediate Possession possible. \$39,900. EKR-Livonia 261-1600

BY THE FIREPLACE you can forget the problems at your business, relaxing in front of this Full Brick wall fireplace-paneled 28 foot Family room with beamed ceiling also features 3 bedrooms-1 1/2 Baths-Full Basement-carpeting and Drapes-2 car brick front garage-Priced right at \$46,900. 261-1600

IS YOUR FAMILY GROWING--BUT YOUR HOUSE ISN'T? Everyone can have their own room in this 5 bedroom 2 story Brick in Livonia-built in 1958 offers huge Living room-kitchen-Separate dining room-Family room-2 fireplaces(one is electric)-garage. Country setting on this 80 foot lot-walk to Elementary. \$49,900. EKR-Livonia 261-1600

WHAT A VIEW! You'll be enchanted with the view of 1/4 acres of rolling landscape with winding stream and overlooking Northville golf club. This 14 year old face brick ranch is immaculate and has central air-beautifully finished recreation room in the basement with bar-3 bedrooms and den with large windows to enjoy view while relaxing or dining-2 car garage-Come and see this. \$56,900. EKR-Livonia 261-1600

EARL KEIM of Dearborn, Inc. **LIVONIA OFFICE**
15707 FARMINGTON RD., LIVONIA
261-1600

OUR OFFICE HOURS
Mon thru Fri 9:00 to 9:00
Sat and Sun 9:00 to 6:00

NATIONWIDE member FIND A HOME

<p>REDFORD Super home! Super kitchen! Super assumption! Don't delay come and see this 3 bedroom brick ranch with 2 car garage today. \$30,900. Call 274-9510 (45109)</p>	<p>LIVONIA 4 bedroom brick double wing Colonial with side entrance garage and first floor laundry in an outstanding neighborhood. Heated in-ground swimming pool, large family room with fireplace. \$68,900. Call 261-0700 (45693)</p>	<p>LIVONIA A super sharp home, decor rich and elegant in an excellent area. Landscaping pleasing with trees. Also a garden. Recreation room with gas log fireplace. 3 bedroom all brick ranch with 2 car garage. \$39,000. Call 261-0700 (45541)</p>	<p>LIVONIA Country atmosphere prevails. 1 1/2 story Cape Cod style home on large lot featuring 4 bedrooms, 1 1/2 baths, large family room with natural fireplace, garage. \$35,900. Call 261-0700 (45673)</p>
<p>SOUTHFIELD Extra large, no maintenance home, marble sills, large basement, 3 full bathrooms, lovely family room with doorwall. A real family home. \$45,900. Call 261-2600 (42964)</p>	<p>SOUTHFIELD Immediate occupancy, 3 bedroom brick Colonial with attached garage, doorwall off dining area, 1 1/2 baths, central air, built-ins in kitchen. \$33,800. Call 261-2600 (45278)</p>	<p>REDFORD Spotted 3 bedroom ranch features large modern kitchen with pantry, full basement, large workman's garage, new drive, home and landscaping impeccable!!! \$29,900. Call 261-2600 (45926)</p>	<p>SOUTHFIELD Super clean and sharp, 3 bedroom brick ranch on a wide lot. Large family room. Side patio adjacent to garage. Carpeting throughout. Country atmosphere. \$35,900. Call 261-2600 (43241)</p>
<p>SOUTH LYON 3 bedrooms, 1 bath, lavatory, 1 living room with fireplace, dining and kitchen with breakfast. Home in very good condition. A fine family home in an excellent neighborhood. \$55,000. Call 477-1111 (45347)</p>	<p>REDFORD The ultimate custom built brick ranch with desirable Western Golf Club location. Features 3 extra large bedrooms, 2 1/2 baths, beautiful Florida room, super den, extra insulation, attic fan, fabulous custom drapes and curtains, plush carpeting. Much more! \$72,900. Call 477-1111 (45624)</p>	<p>LIVONIA Custom built extra clean and sharp 4 bedroom tri-level home located across from wooded area in desirable N.W. Livonia location. Large family room with full wall fireplace. Main floor laundry and many other features. \$52,900. Call 261-0700 (45200)</p>	<p>LIVONIA Executive Colonial in Blue Grass Farms. 4 bedrooms, Library, 2 1/2 baths, 1st floor laundry, formal dining, family room with fireplace, circular drive, much more home! \$76,500. Call 525-0990 (46024)</p>
<p>PLYMOUTH Cape Cod, beautiful brick with aluminum trim, 4 bedrooms 2 full baths, huge kitchen with all appliances, completely carpeted and full basement, aluminum, huge oversized garage. Much more! \$55,900. Call 455-7000 (44940)</p>	<p>CANTON Large 4 bedroom Colonial with all the important things that a family needs. Good location, good school, large lot, vegetable garden. \$59,500. Call 851-1900</p> <p>FARMINGTON HILLS Three acres, a real doll house with aluminum siding, fully carpeted, newly redecorated with 2 bedrooms. Perfect for young couple that wants room to roam. \$115,000. Call 455-7000 (44148)</p> <p>GARDEN CITY Mom and Dad will love the huge 15x11 bedroom with sitting room in this nicely decorated 3 bedroom home with full basement and bar. 2 1/2 car garage in Garden City. \$28,900. Call 274-9510 (45268)</p>	<p>PLYMOUTH Lake Pointe Village, 4 bedroom Tri-Level with formal dining room, spacious living room, 2 car garage. Home is prepped for central air. Has loads of storage. Close to neighborhood park and excellent for the lucky family. \$46,900. Call 261-0700</p> <p>REDFORD Move right in to this nice clean starter home on a lovely wooded double lot. Good assumption and low payments. \$21,000. Call 261-2600 (45275)</p>	<p>NORTHFIELD Over 1 acre, Sharp 3 bedroom split level, unique decor. 2 1/2 car garage, swimming pool. Great home for the country squire. \$59,000. Call 455-7000 (44879)</p>

314 Plymouth Canton

TRAILWOOD, by owner 4 bed-rooms plus den, Kopeck colonial, custom drapes, shutters, carpet & built-ins. Appointment. 455-2219
PLYMOUTH TOWNSHIP - Low maintenance, energy saving home with convenience & quality plus 3 bedrooms, 1 1/2 baths, family room with fireplace, central air. Custom cabinets, drapes, wiring. Beautifully landscaped patio with gas bar-b-q, 2 1/2 car garage, finished basement. All you need do - is move in \$51,900. 293-2727. 455-3185

DESIGNED FOR WARM HEATED HOSPITALITY AND COMFORT. 4 bedroom, 2 1/2 bath Colonial well maintained central air and air cleaner. All drapes and curtains included. Family room. Full finished basement. 2 car attached garage. \$77,900. Call 261-5966

NEW LISTING Beautiful custom quality 3 bedroom ranch in Plymouth Township. Finished basement. Family room. Modern kitchen. Attached 2 car garage and much more. Asking \$53,500. Call 261-5080

TOWNSHIP sharp brick home, 3 bedrooms, full basement, 2 car garage, desirable area, large tree. Lot \$41,500. After 6 P.M. 455-1305

CANTON Reduced for Fast Sale. Owner must sell this great 2 story, 4 bedroom Colonial. Family room, fireplace, dining room, 2 1/2 baths, carpeting throughout. The best area \$57,900

CENTURY 21
 STEINHAUER, INC.
 326-3400

316 Westland Garden City
 CHERRY HILL/VENOV SACRIFICE
 Owner transferred, must sell this 3 bedroom brick and aluminum colonial. 1 1/2 baths, family room with fireplace, carpeted throughout. Immediate occupancy \$31,900. Owner will discount for cash. HARRISON MOORE. 427-9030

FAMILY ROOM
 Welcome Spring in this immaculate 3 bedroom brick ranch that features a delightful family room with doorwall leading to lovely patio and gas grill. Large 2 car garage and more for only \$32,900

Red Carpet REALTORS 522-3500
 GARDEN CITY 3 bedroom brick ranch, basement, 2 1/2 car garage, fenced. \$29,900 \$900 down. D.A. Ross Realty. 226-8300

WESTLAND COLONIAL
 4 bedrooms, full basement, family room, fireplace, 1 1/2 baths, attached 2 car garage. Ask for KAREN A SWYSTUN

Century 21
 Boardwalk Div. 459-3600

SERVING ALL OF WESTERN WAYNE COUNTY SINCE 1922

GARLINGS INC.

199 N. Main Plymouth REALTOR

Beacon Hill, the prestige subdivision of Plymouth area. Large four bedroom Colonial on one acre. \$159,000. Please call for details and list of extras.

Zoned General Business in downtown Plymouth. Presently used as a large 4 bedroom residence. Terms available. \$41,000.

Glenview Estates, large 3500 sq. ft. Quad level with 3 or 4 bedrooms, 3 1/2 baths, 2 fireplaces, custom thru-out. Call for details.

Three bedroom aluminum sided ranch on dead end street in Plymouth Township, large country kitchen, carpet thru-out garage. Only \$29,900

453-4800 MULTI-LIST SERVICE 427-7797

Robert Bake-Realtor

NORTHVILLE
 FIRST OFFERING! CITY OF NORTHVILLE. This well located home is a pleasure to see. A brick one story home with recently installed aluminum trim. 3 bedrooms, 2 full baths, fireplace, kitchen with large breakfast area, full basement, and 2 car attached garage. \$47,900. 453-8200

NEW ON THE MARKET! An outstanding Plymouth Township one story condominium with 2 generous bedrooms, 2 1/2 baths, a large kitchen arrangement, full basement, and covered parking. Up-graded carpeting, Central Air Conditioning, Electronic air purifier, and an enclosed patio are among its many extras. ESPECIALLY WELL DECORATED! \$38,300. 453-8200

THE APPEAL OF A DUTCH COLONIAL is accepted by all and this local example has endless surprises and sophisticated appointments. 3 or 4 bedrooms, 2 1/2 baths, marble foyer, formal dining room, a study, a magnificent kitchen, a Garden Room, first level laundry, family room with fireplace, full basement, and side entrance oversized/heated 2 1/2 car garage. CENTRAL AIR, ELECTRONIC AIR PURIFIER, UNDERGROUND SPRINKLERS, HEATED INGROUND POOL, and a location in PLYMOUTH TOWNSHIP that's respected by all. Call 453-8200 today.

1005 W. Ann Arbor Trail Plymouth 453-8200

316 Westland Garden City

BLVD. GARDENS
 Immaculate 3 bedroom brick ranch with aluminum trim, new carpeting throughout, aluminum sided 2 1/2 car garage with heat and electric. Livonia schools \$32,900

Castelli
 525-7900
 OWNER TRANSFERRED 3 bedrooms, 2 1/2 car garage. Beautifully finished basement with bar. Large outdoor gas grill. \$29,900. Call owner. 326-1298

LAND CONTRACT
 Terms available on this 3 bedroom aluminum sided bungalow. Country kitchen, dining room, 2 1/2 car garage plus 2 1/2 acres. Only \$29,900

Castelli
 525-7900
 ASSUMPTION
 Livonia schools, 3 bedroom bungalow, carpeting, 2 car garage. \$205 month, 7% interest. Full price \$19,700

Castelli
 525-7900
 WESTLAND - by owner 3 bedroom ranch, completely decorated. Finished basement with wet bar. 1 1/2 baths \$28,900. Open Sun 1-5. 326-6781

Century 21
 Boardwalk Div. 459-3600
 Sharp Brick Ranch
 3 bedrooms, carpeted throughout, built-in oven and range in large kitchen, all drapes stay, full basement with bar, huge backyard, super house at a super price. Westland at only \$28,500

Century 21
 Boardwalk Div. 459-3600
 WESTLAND - By owner 3 bedroom brick ranch. Attached garage, full finished basement. Many extras \$33,900. LO 1-0112

Great Assumption
 Three bedroom face brick ranch with country kitchen and full finished basement. Only \$27,500. Call 525-4200

Integrity
 REALTORS
 Garden City
 Sparkling new aluminum sided, five spacious rooms, and a wife pleasing kitchen - make this home on an extra large lot, today's best buy at \$25,200. Call 522-8300

Integrity
 REALTORS
 GARDEN CITY, by owner. Aluminum sided 2 bedroom, full basement, 2 1/2 car garage, fenced lot. \$27,900. 722-8915. 525-7739

316 Westland Garden City

BY OWNER 3 bedroom maintenance free brick ranch, professionally finished basement, possible 4th bedroom attached 1/2 bath, central air, 2 1/2 car garage, \$29,400. Extras \$26-9664. 533-6564

NEEDS PAINT
 Three bedroom brick ranch with basement, fenced yard, country kitchen. Good closet space, neighborhood of well kept homes. Priced right \$26,000

TEPEE REALTY
 25200 S. M. 533-7272
ROOM TO SPARE
 IMMACULATE 3 bedroom brick ranch with den or fourth bedroom, featuring carpeting throughout, 20' covered terrace and of course a 2 1/2 car garage. \$36,900. Call 522-8300

Westland By owner Brick ranch 3 bedrooms, 1 1/2 baths, full finished basement, fenced backyard, \$27,800. 728-2263

LIVONIA SCHOOLS Westland 3 bedroom brick ranch. Family room, completely remodeled kitchen with built-ins. Carpeting throughout, custom drapes, finished basement. Gas furnace, 12 ft. pool, fenced, covered patio. Open Sunday 2-6. \$34,900. 522-2143

FAMILY COMFORT REASONABLY PRICED this 3 bedroom, 1 1/2 bath Colonial with plenty of storage including a large cedar closet. Electric garage door opener. Walk to schools \$29,900. Call 261-5080

Thompson-Brown
 BIRCHWOOD 35408. 3 bedroom brick ranch, low assumption, low taxes. \$23,500. 728-1681

FIRST TIME OFFERED Mint 3 bedroom brick ranch with finished basement, 1 1/2 bath, 2 car garage. Beautifully landscaped lot. A Great Buy at \$35,900. FIRST FORMAL REALTY, INC. 478-3400

WESTLAND 2 bedroom, 2 car garage on large lot \$14,900. After 5:30 P.M. 901-1638, or days, ask for Joan. 487-3295

GREAT BUY - ON A "BI" BILEVEL that is offering 3 bedrooms, Xtra large kitchen with built-ins. Fireplace in family room, 1 1/2 baths, carpeting thru-out. Attached garage at a low \$44,500.

CENTURY 21
 CORNERSTONE 478-4660
Castelli
 525-7900

316 Westland Garden City

WESTLAND ASSUMPTION
 \$2400 Moves you in this 3 bedroom Ranch. Carpeting, immaculate condition. Oversized 2 1/2 car garage. Payments only \$246. Seller has bought another home. \$23,900

CENTURY 21
 STEINHAUER, INC.
 326-3400
318 Redford
 \$1,000 DOWN
 WESTLAND New 4 bedroom Colonial. 1 1/2 baths, basement \$31,500. Will take trades.
 D. A. Ross Realty 326-8300

DELIGHTFUL 1/2 ACRE
 Only \$25,900
 Neat and tidy 4 bedroom bungalow with lovely large kitchen, beautiful rock garden and patio plus 2 garages on property.

Red Carpet REALTORS 522-3500
 CHANGE you don't want to miss! Grand River-Telegraph. 2 bedroom Ranch, huge living room with fireplace. 2 1/2 car garage with huge lot. Ideal for starter or elderly couple. Low assumption. 528-4668

BY OWNER 3 bedroom, 1 1/2 story home. New shag carpeting, roof, driveway, fence. Move in condition. 2 1/2 car garage, large lot. Close to schools & churches. Excellent assumption after 5 P.M. 528-3654

Country Living
 in the city. Situated in convenient Redford Twp. Sharp and clean 4 bedroom home, dining room, carpeting, 4th bedroom can be converted to a den, 2 air conditioners stay, lot size is 70x287. Lots of room! Good assumption available. Priced at only \$27,900. Call

Century 21
 Boardwalk Div. 459-3600
 REDFORD TWP. 16104 Norborne, by owner, 3 bedroom brick, 1 1/2 baths, 2 1/2 car garage, corner lot, \$37,500. Conventional mortgage. 537-7446

ALMOST new 3 bedroom home, large bathroom, utility room, gas heat, close to schools, Grand River-Inkster area. \$74,239

FANTASTIC
 Brick 3 bedroom tri-level aluminum trim, enormous kitchen, 1 1/2 baths, large family room with fireplace and doorwall to patio. Central air, 2 car aluminum sided garage, immaculate. S Redford

FARMINGTON HILLS
 Tired of the unusual? Call today to see this beautiful Spanish style quad level. 4 bedrooms, 3 1/2 baths, fantastic kitchen with all built-ins, and oak cabinetry, unique floor-to-ceiling fireplace in the ballroom sized family room. There is much more and the owner wants an offer this week. Host John Kare 477-6300 or 348-9664 (H-62)

LIVONIA
 More than you'd expect... you may have passed by this modest looking home without realizing the exceptional value it offers. The 21 foot living room offers new shag carpeting plus a lovely dining area. 2 large bedrooms, all nicely decorated, full basement, gas heat, garage, big lot. Let us show you what you can get for only \$31,900. Call Bette Haskings 477-6300 or 535-0152 (W-79)

WESTLAND
 Super buy! Only 4 years old. 4 bedrooms, 1 1/2 baths, lovely family room with natural fireplace, nice carpeting, kitchen built-ins, full basement, attached garage and a 16 x 32 swimming pool with redwood decks. To see this brick and aluminum Colonial \$38,900. Call Bob Smith 477-6300 or 476-0837 (S-87)

500 people to know
Westdale REALTORS
 One of the nation's largest
 21023 FARMINGTON 477-6300

McKEON, INC.
 REAL ESTATE
 500 S. Main Street Plymouth, Mich 48170

A RARE COMMODITY-A Large 4 bedroom family home with dramatic FLAIR! Light brick exterior trimmed with shutters and wrought iron. Large entry foyer is 2-stories high with balcony on upper level! Master bedroom with walk-in closet, dressing area, PLUS private bath. Main bath up is roomy with 2-bowl vanity. Family kitchen is centrally located between paneled family room (with fireplace and doorwall to patio) and formal dining room. Also large formal living room and 1/2 bath on main level. 2-car attached garage, full basement, fenced yard. \$56,500.

A BEAUTIFULLY EASY-TO-LIVE-IN Kind of a home with an airy, open design. Large tiled foyer with easy access to laundry, 1/2 bath, formal living room with arch to dining room, and carpeted, open stairway to 4 bedrooms and 2 FULL BATHS. Master bedroom has twin closets and private bath. Pretty wallcoverings enhance the U-shaped kitchen with all BUILT-IN appliances and serving island to informal dining area. Paneled family room has brick fireplace and doorwall to NEW Covered Wood Deck! 2-car attached garage, full basement PLUS CENTRAL AIR. \$64,900.

ATTRACTIVE INCOME PROPERTY-with 1 large unit on main level with 3 bedrooms, living and dining rooms plus family kitchen. Smaller lower unit includes fireplace in the living room. Large, high lot has many mature plantings, shading the Spanish-style stucco exterior with red tile roof! Zoned R-2-A. \$42,000.

453-6800

318 Redford

3 BEDROOM brick ranch, 1 1/2 baths, 1 1/2 car garage, full basement, new carpeting, built-in dishwasher. 927-1418

Would You BELIEVE?
 Three bedroom brick ranch with built-ins, master bedroom with full bath and walk-in closet. PLUS a full finished basement. A real beauty at \$35,900. Call 525-4200

Integrity
 REALTORS
 THREE BEDROOM Brick, 150' frontage, 2 car attached garage, family room, 1 1/2 bath, \$41,900. Anytime 535-3220. 624-1224

ENTERTAINMENT POSSIBILITIES 5 bedroom, 3 1/2 bath brick home overlooking Golf Course. Huge game room in finished basement. Family room, formal dining room, 2 car attached garage. Call 261-5080 for further details \$62,900

Thompson-Brown
 BY OWNER, neat brick bungalow, east of Telegraph, Plymouth Rd area. Low taxes, 2 1/2 car garage. Conventional only. Buyers only. 531-0619

SMART & THRIFTY is this well insulated 3 bedroom home with hardwood floors, wet plaster walls, finished rec room, patio and fenced yard. Convenient to shopping and transportation. Asking \$25,900. Don't delay, call One Way 522-6000

One Way
 REDFORD TWP. beautiful custom built ranch on over 2 acres, 2 fireplaces, ravine and stream, must see to appreciate. Owner \$38,6693

THRIFTY THIRTIES
 For this large 1 1/2 story home. Featuring 4 bedrooms, full finished basement, carpeting thru-out, rec room. Breezeway with attached garage. GREAT YARD for children's pleasure and your leisure. DON'T MISS IT! \$30,900

CENTURY 21
 CORNERSTONE 478-4660
 OPEN SUN 1-5. Sharp 3 bedroom brick ranch, full basement, 2 1/2 car garage, maintenance free. 16658 Woodworth, \$33,500. 534-7225

318 Redford

FHA - VA SPECIALIST
 DO YOU HAVE \$500 to \$1000 AND GOOD CREDIT? WE HAVE MANY 2 & 3 BEDROOM HOMES IN REDFORD. CALL FOR INFORMATION
CENTURY 21
 GOLD KEY HOMES
 27349 W 7 Mile Redford 255-2100

THREE bedrooms plus family room, 2 car garage, fully carpeted. By owner. After 5 P.M. & week ends. 927-0458

319 Homes For Sale Wayne County
 DEARBORN HILLS 4 bedroom Colonial on 50x145 lot. Living room with fireplace, dining room, modern kitchen, central air. Finished rec room, new carpeting. 2 car attached garage. \$73,900. 277-2805

CONGRATULATIONS!
 Chamberlain's Westland/Garden City Office is proud to name Jean Proach TOP SALES ASSOCIATE for MARCH. Give this sales leader a call about your home plans, TODAY!

Chamberlain REALTORS
 Westland/Livonia Office: 34215 Ford Road Westland, Michigan 48185 721-8400

319 Homes For Sale Wayne County

Central Air
 is only one of the features you will enjoy this summer in this 3 bedroom brick ranch located in Wayne. Beautifully decorated and very clean. 2 full baths, all new carpeting throughout, gas Bar-B-Q grill, 2 1/2 car attached garage with automatic door opener, and much more. All for only \$32,500. Hurry and call

Century 21
 Boardwalk Div. 459-3600
 WEST DEARBORN 3 bedroom bungalow, 2 car garage, 2 baths, carpeting throughout, many extras \$33,000. 459-3847

302 Birmingham Bloomfield
 DEARBORN HILLS 4 bedroom Colonial on 50x145 lot. Living room with fireplace, dining room, modern kitchen, central air. Finished rec room, new carpeting. 2 car attached garage. \$73,900. 277-2805

BEVERLY HILLS 1 1/2 story brick, 3 bedrooms, 1 1/2 baths, breezeway, 2 car attached garage, double lot, gas grill, \$49,500. 642-8867

302 Birmingham Bloomfield

QUARTON LAKE ESTATES BY OWNER
 Unique French Colonial architecture. Living room with fireplace, 4 bedroom, 2 full baths, 2 half baths, formal dining room, breakfast room, den, foyer, basement rec-room, oak panelling, slate roof, 2 car attached garage. July 1 possession \$125,000. Buyers only. By appointment only. 642-9888

FOX CROFT, Maple, Telegraph, 3 bedroom Ranch, 1 1/2 baths, family room, patio, large lot, trees. Assumable 6 1/2% mortgage. Buyers only. 651-4192

WEST LIVING 4 bedroom, 2 1/2 bath, 3 year old Colonial, full basement, double garage. Large family room with fireplace, generous closets, air conditioned, in cul-de-sac. Owner transferred. Bloomfield Hills Schools. \$79,000. 626-1613

302 Birmingham Bloomfield
 SUPER SHARP 3 bedroom ranch home in fine Livonia area, carpeting, large country kitchen, recreation room, nice assumption, hobbyist will delight in the oversized garage, fenced yard. \$41,900

ABSOLUTELY SPOTLESS 3 bedroom Livonia ranch home, fully carpeted, the finished basement with wet bar is an entertainer's paradise. 2 car garage. \$39,900

CUTE AS CAN BE 3 bedroom Livonia ranch with a remodeled kitchen to delight mom! Fully carpeted and it is new, tiled basement, fenced yard, garage. \$27,500

A GREAT OPPORTUNITY to be in Livonia at a modest price. 3 bedroom ranch in nice condition, carpeting, just \$21,900

Martin, Ketchum & Martin REALTORS
 522-0200

GO THE MODERN WAY
HARRY S. WOLFE COMPANY
 TWO LIVONIA LOCATIONS
 32398 FIVE MILE RD.
52nd ANNIVERSARY
 ONCE AGAIN THE LEADER
 IN LIVONIA HOME SALES IN 1976
52nd ANNIVERSARY
 GA 1-5660 IN LIVONIA HOME SALES IN 1976 GA 7-0733

THINKING ABOUT SELLING? ... THINK ABOUT THIS
 Interest rates have been lowered and buyers are anxious to purchase NOW! We have many qualified buyers who need a home. In all price ranges. Call now for a market appraisal on your home.

BEGINNERS PARADISE

QUICK SALE
 On an extra large lot we offer you this excellent buy. A 3 bedroom ranch with a modern kitchen, also another room for study or den, new furnace, check this one out. \$19,900

CAREFREE
 Situated on a quiet court is this 2 bedroom, 1 1/2 bath unit featuring a large kitchen with built-ins, and dishwasher, king size bedrooms, family room, private patio, central air, carport and pool. Good assumption \$26,500

CANTON CONDOMINIUMS
 We have 2 outstanding 3 bedroom, 1 1/2 bath units in beautiful condition. Featuring a large living room and dining ell, wet bar, and outstanding terms. Mid \$20's

SHARP RANCH
 This lovely 3 bedroom brick ranch will delight the whole family. Extras include a finished basement with bath, extra insulation, and garage. Truly a home in A-1 condition. Only \$27,500.

INEXPENSIVE BUT POPULAR

FAMILY STYLE
 All brick with 3 bedrooms master bedroom with privacy bath a dream kitchen with built-ins a warm cozy family room with fireplace this immaculate home sets on a huge lot with towering trees also equipped with central air conditioning \$38,900

SLEEPY HOLLOW
 Situated in a quiet treeed area is this spacious contemporary brick ranch home featuring a 20 ft. living room, formal dining room, king size master bedroom, full tiled basement and an excellent assumption. Offered at \$39,900

A REAL WINNER
 All brick wet plaster hard wood floors, this beautiful ranch has 3 bedrooms a modern kitchen a full finished basement and a garage and in an excellent area \$32,900.

4 BEDROOMS RANCH
 Built in 1972 and all brick with 4 bedrooms. A modern kitchen, carpeting throughout out a new 2 1/2 car garage great family home priced to sell \$32,900.

COZY COLONIAL
 Nice clean 3 bedroom brick home in a quiet area. Featuring a large bright kitchen with doorwall, 1 1/2 baths, full basement, and an attached garage. Asking \$33,900

CITY FARMER
 Come and see this beautiful one owner one of a kind custom brick home on over a HALF Acre. With 3 bedrooms, formal dining room, wet plaster, charming kitchen, full basement, central air, all aluminum trim, and a 2 car garage. City Farmer's Delight! \$36,500

COUNTRY ATMOSPHERE

SPACIOUS LIVING
 You have first chance this week to see this attractive Cape Cod, with a walk out basement, 3 large bedrooms, a sharp modernized kitchen, 2 natural fireplaces attached garage all this and a beautiful 1/4 acre site \$49,900

RAVINE-STREAM
 This freshly decorated doll house with a picturesque setting features a modern kitchen, full basement, enclosed patio, and a 2 car attached garage. Asking \$44,900

5 BEDROOMS
 This is a five bedroom custom built home on a 1/2 acre lot, 2 1/2 baths, a 20 x 15 family and fireplace, 2 1/2 car attached garage and full finished basement. \$39,900.

CUSTOM BUILT
 Large bedrooms in this all brick ranch with a formal dining room with French doors to enclosed patio a large modern kitchen a 20x16 living room an attached 2 car garage, all this on a 135x134 lot with trees truly a country setting. \$49,900.

BEAUTIFUL HALF ACRE
 Beautiful one owner one of a kind custom brick home on over a half acre. With 3 bedrooms, formal dining room, wet plaster, charming kitchen, full basement, central air, all aluminum trim, and a 2 car garage. City Farmer's Delight! Only \$36,500.

SPRING FEVER
 Call to see this outstanding 3 bedroom ranch home situated on a country size lot in a rural area. Super sharp and decorated to perfection. This home features a 22 ft. family room with natural fireplace, modern kitchen with built-ins, dishwasher and refrigerator and an attached garage. Only \$39,900!

"ASK ABOUT OUR GUARANTEE SALES PROGRAM"
HARRY S. WOLFE CO.
 GA 7-0733
GA 1-5660

302 Birmingham Bloomfield

BEVERLY HILLS, owner. Elegant 3 bedroom colonial. Separate dining, sun room, new kitchen, beautiful double lot. Birmingham schools. \$65,900. 661-3571

Thompson-Brown

BIRMINGHAM, in-town. Charming with open contemporary feeling. 3 bedrooms, 1 1/2 baths with extensive updating. Large rooms with newer built-in kitchen, furnace, carpeting throughout. Must see to appreciate. \$64,900. 661-9287

Bloomfield Hills

BLOOMFIELD HILLS, Fox Hills Sub. Colonial 4 large bedrooms, 2 1/2 baths, family room with fireplace, main floor, finished basement with wet bar, new carpeting, beautifully landscaped yard. 332-9302

Bloomfield Hills

THREE BEDROOM all brick ranch on beautifully landscaped acre lot in Bloomfield Hills. All basement, finished rec. room, fireplace, dining room, kitchen, 2 1/2 car attached garage. \$58,900. By owner. 334-6790

Bloomfield Hills

BLOOMFIELD Orchards near I-75, 237 Birmingham, like new 4 bedroom, 1 1/2 bath brick, ranch, fireplace, rec. room, patio, carpets, drapes, stove, refrigerator, attached garage, fenced immediate possession. Reduced to \$36,900. Mr. Stevens. 832-4688

Bloomfield Hills

ON Fairway in Birmingham, charming red brick Cape Cod, cedar shake roof, screened porch, 4 bedrooms, 2 full baths, fireplace, custom interior woodwork, extensive slate floor & walkway. All on beautiful sloping lot. \$78,500. Open season July 1st 1431 Fairway Dr. Buyers only. 661-1824

Bloomfield Hills

BLOOMFIELD HILLS, By Owner. New \$125,000 3 bedroom, 2 1/2 bath wooded lot complements 3 bedroom, 2 1/2 bath Contemporary. Beautifully landscaped, large windows areas. Bloomfield Hills schools, lake privileges on Upper Long Lake. Open house Sat. 10 AM - 12 PM. 1911 Wake Robin off Long Lake Shores. East of Middlebelt, north of Long Lake. 338-2436

Bloomfield Hills

CAPE COD, WING LAKE. BY OWNER. BIRMINGHAM HILLS SCHOOLS. 4 bedrooms, 2 fireplaces, family room, country kitchen with finished basement, 3/4 acre landscaped, mature trees. For appointment, phone Mrs. Thr. 831-0011

304 Farmington West Bloomfield

LAKE PRIVILEGES. Traditional brick ranch home sitting proudly on large wooded site overlooking beautiful Darb Lake. 3 bedroom, 2 1/2 bath, large fireplace, 3 spacious bedrooms, large fireplace family room, formal dining room, country kitchen with butcher block counters and built-ins. West Bloomfield schools. A real value at \$78,500. Call 363-8307.

OLD ORCHARD

WEST BLOOMFIELD ranch, 3 bedroom, 1 1/2 baths, family room, Birmingham schools, big wooded lot. \$54,900. 661-1431

FARMINGTON HILLS

FARMINGTON HILLS, Holly Hill Farms. 4 bedrooms, 2 1/2 baths, 3 car garage, contemporary 2 story, has everything. \$89,900. 851-5485

LAKE PRIVILEGES

4 bedroom, 2 1/2 bath tri-level, family room, fireplace, library, 2 car garage. A really fine home. See all should see without delay. Choice West Bloomfield location. \$74,500.

WEST POTOMAC GREENS

2 story pillared Colonial with side entrance garage on large corner lot. 95x135. Priced at \$61,340, with 8 1/2% financing available. For more information, regarding lot #1, call Bev Moresky. 661-1230, 661-2500

PULTE

Homes of Michigan, Inc. WEST BLOOMFIELD. Open House Sun 2 - 5. Beautiful 5 bedroom sun. ft. of living area. Many extras must be seen to be appreciated. By owner. \$93,900. 861-6188

Over 1 Acre

Unique Cape Cod in a beautiful area. 7 rooms include dining room, 3 bedrooms, 1 1/2 baths, plus a 2 car garage. \$46,900. To see, call 325-4200

Integrity

WEST BLOOMFIELD, by owner. Colonial, 4 acre, 34 bedrooms, 1 1/2 baths, basement, 2 1/2 car garage, family room with fireplace, central air, walking distance to schools. \$68,500. 851-4619

NEW on Market Farmington Hills

3 bedroom ranch, fireplace, sun deck, large tree, finished basement, 2 1/2 car attached garage. Central air, electric, air cleaner. \$56,900. 853-0577

COMFORTABLE FAMILY HOME

on large lot in beautiful area of Farmington. Featuring 3 large bedrooms, country kitchen, large living room with fireplace, attached 2 car garage. This won't last at \$45,900. Call 553-8700

FARMINGTON MEADOWS

sparkling clean 3 bedroom tri-level, huge family room with fireplace, electric carpeting and drapes. Close to elementary school, convenient area. Excellent shopping, churches. Good assumption. Better hurry! \$47,900. Call 553-8700

FARMINGTON HILLS

By owner. Farmington Hills, Canterbury Commons, colonial with 4 bedrooms, 2 1/2 baths, living room, separate dining room, family room with fireplace, large family room, open to fifth bedroom, 26x26 tile area. \$82,500. By appointment. 851-0673

ELEGANT SPACIOUS & CLEAN

3 bedroom ranch with 2 1/2 baths, hardwood floors, stone front, finished garage, gas BBQ, 1st floor laundry, automatic garage door opener, 30 x 12 terrace, pecan paneled ceiling, custom quality home, model condition. \$81,900. Call 553-4790

WILDFIELD

By owner. Tri-Level on 3/4 acre, living, dining, family room, 3 bedrooms, 2 1/2 baths, patio. Buyers Only. \$81,500

Farmington Hills, Kendallwood

By owner. Farmington Hills, Kendallwood N. & Tri-Level, 3 bedrooms, 2 1/2 baths, fireplace, all appliances, gas grill, electric garage door opener, well landscaped. Sun. 7:30 - 9:00 AM. 553-0228

304 Farmington West Bloomfield

SUPERBLY MAIN-TAINED 4 bedroom colonial in independent Community. 1st floor laundry, air conditioning, sprinklers, backs to commons, super master suite, truly a quality home priced right. Good assumption and occupancy. \$86,500. Call 553-8700

Thompson-Brown

FARMINGTON 3 bedroom ranch, 9 Mile and Middlebelt area. Super starter home, extra insulation, new carpeting, cute kitchen, possible assumption. Only \$25,900

Century 21

ROBEY PROPERTIES 851-7711

THREE bedroom brick, Ranch Dining area, finished basement, 2 1/2 car garage. Fenced yard, sun trees. \$38,500. 477-6519

COUNTRY SETTING

No 11 Owner transfer forces the sale of this 3 year old quality built, 6 rooms, 3 bedroom home with family room and fireplace, central air, and oversized attached garage. 132x140 ft. lot. Early occupancy. Reduced to only \$44,900. ML 04068. 477-6519

Century 21

VINCENT N LEE EXECUTIVE TRANSFER SALES 553-3408

THIRTEEN MILE AREA 4 bed room, 2 1/2 bath Piled Colonial. Fireplace in Living Room and Family room. Carpeted floors. 2600 sq ft. Large Treed Lot. \$69,900. Call 9AM - 5PM daily. 642-3040

3 BEDROOM

Brick ranch in desirable Farmington Hills, for only \$58,500. Home also has slate floor, marble tiles, drapes and carpeting. Large lot with fruit shade trees. Family room and screened terrace, add extra living area. Century 21. Gene Darke 2 Realtors. 851-6700

INDEPENDENCE COMMONS

Beautiful 3 bedroom quad level home. Professionally decorated & landscaped. All the extras. For sale by owner. \$114,900. 474-4584

EXEC HOME

A beautiful setting among the trees in rolling terrain of Farmington Hills. For gracious entertaining around the heated granite pool or large family room. See all the extras to fully appreciate the quiet area for peaceful enjoyment. Known by appointment. Century 21. Gene Darke 2 Realtors. 851-6700

CUSTOM BUILT

(No 61) Quality construction as apparent throughout this large 4 bed room, 2 1/2 bath home. The finer appointments include all wool carpeting, custom woodwork treatments, first floor library and more. This lovely hilltop home also features a large formal dining room, fully equipped kitchen and first floor laundry. Home and area are in finest strong pride of ownership. Area of property appreciation. \$85,900. ML 42775

Century 21

VINCENT N LEE EXECUTIVE TRANSFER SALES 553-3408

CRANBROOK VILLAGE RANCH

Lovely 3 bedroom brick home in Southfield with 1 1/2 baths, finished rec. room, large living room, attached fireplace, attached garage. \$41,900. 509-0106

IMMEDIATE OCCUPANCY

Custom 3 bedroom, 2 1/2 bath home with trees and stream, fully carpeted fireplace, large deck, insulated windows, 1st floor laundry, walk out basement, price reduced. 9 Mile. Telegraph. 352-1382

OWNER TRANSFERRED

Immediate possession, 3 bedroom, bath and a half tri-level, with family room and 2 car garage. Priced for quick sale. So call now. \$34,900.

CRANBROOK

Assoc. Inc Realtors. 681-6600 358-5522

SOUTHFIELD 11 Mile-Greenfield area

Attractive 3 bedroom ranch, large living room, finished basement, attached garage. Extras \$36,250. After 5PM. 557-8069

SOUTHFIELD

By Owner. 2 story 3 bedrooms, 2 1/2 baths, fireplace, living/dining room, 2 car garage with adjacent finished room. Appliances, carpeting, finished full basement with work bench, fruit cellar and shower. Excellent neighborhood near schools. 4 1/2 acre, many extras, excellent condition. \$39,500. After 6PM. 571-265-6312

SOUTHFIELD, 1981 MELROSE

off Evergreen, north of 8 Mile, brick ranch, 2 car garage, \$30,000. Good assumption available. LOVE rec. room. Just listed. 422-9278

FIVE bedroom house, den, family room, living room, full dining room, central air. \$68,900. Days 864-8900. Evenings 567-8658

PICTURESQUE SETTING

IMMACULATELY maintained ranch with large L shaped living, dining room with fireplace, central air, Florida room, 1 1/2 baths, 2 car garage, excellent neighborhood. \$42,500

TEPEE REALTY

25200 5 MI 333-7272

SOUTHFIELD Tanglewood Sub

4 bedroom, 2 1/2 bath, brick colonial, attached garage, heated granite ground pool, finished basement. Tired 50's. 567-3349

MID OF RENTING? You could live as expensively in this 3 bedroom brick ranch, have your own patio, and much more privacy. Conveniently located.

LAVERNE EADY & ASSOCIATES

626-4711 275-4422

ATTRACTIVE 4 bedroom quad

306 Southfield Lathrup

4 Bedroom Brick Ranch

(No 6) Located in Northern Southfield, this lovely 4 bedroom brick ranch features a modern decor, a fully equipped kitchen & newly landscaped lot. Transfer forces the sale. Just \$32,900. ML 41815

Century 21

VINCENT N LEE EXECUTIVE TRANSFER SALES 553-3408

BY OWNER. 4 bedroom tri-level, 2600 square feet, spacious foyer, living room, dining room, kitchen, 2 1/2 baths, large family room, beautifully landscaped with patio. Birmingham schools. \$66,900. Appointment. 647-8658

South'd. Beauty

Lovely starter or retiree home in good location, 12 and Southfield area. 3 bedrooms, 2 car garage, nice landscaping. A real value at only \$29,900. 477-6519

Century 21

Hartford 414, Inc. 478-6000

308 Rochester-Troy

TROY 2 bedroom home on large lot, garage, aluminum siding, near schools, shopping. 175 By owner. \$69,889. 669-6889

SPACIOUS English Tudor

in Adams & Long Lake area, 4 acre, 2 1/2 bath, fireplace, large family room with cathedral beamed ceiling & oversized fireplace, 2 car garage, 1st floor laundry, carpeted, too many extras to mention. \$65,900. 546-0878

320 Other Suburban Homes For Sale

SHELBY TWP 6 year old, one of a kind, 3300 sq ft custom built, 10 rooms, 2 1/2 baths. Colonial fireplace includes 2 fireplaces, 3x22 game room, family room, 2 1/2 baths, living room, dining room, half bath, 2 1/2 car garage, basement on 1/2 acre lot, lake privileges. \$32,900. 739-1924

STARTER HOME For \$29,900

Built in 1973. Aluminum and cedar main entry. Three bedrooms, 2 1/2 baths, central air, 2 1/2 car garage, 1/2 acre lot, goes with this Historic farm house, featuring 4 bedrooms, library, large barn, milk barn and other outbuildings. Brick construction. Possible split lot. \$29,900. 478-7440

LAVERNE EADY & ASSOCIATES

626-4711 275-4422

30 Day Occupancy OR SOONER! IN BRIGHTON

Come see these brand new homes in AIRWAY RANCH with everything you're looking for in 3 bedrooms, 1 1/2 baths, family room with fireplace, 2 car attached garage, full basement, appliances, choice of carpeting, and much more. We've got you to compare our BRIGHTON COLONY, or the FAIRWAY RANCH with everything you've seen in the area. \$51,500 colonial and \$51,000 ranch with best conventional terms available. Call GRANADA HOMES at 229-2080 or Brighton or 838-3536 in Detroit.

HUNTINGTON WOODS

Beautiful spacious colonial, 4 bedrooms including master bedroom suite, 3 1/2 baths, central air, large family room, formal dining room, full breakfast area, 2 car detached garage, automatic sprinkler system. \$65,500. Appt only. Days 391-0573. Evenings 546-7733

ADAMS RD. AREA

CHARNWOOD HILLS Large Ranch in excellent condition. On exceptionally beautiful large 4 bed room, 2 1/2 bath, 2 fireplaces, 2 1/2 car garage, large separate activities room, brick patio, screened porch. Extra large garage. By Owner. \$72,500. 879-6618

BY OWNER spacious Colonial ranch

Great Oaks Golf Course view, 3 bedroom, 2 bath, living room, formal, 4 1/2 acre, fully carpeted, utility room, basement 2 years old. After 6 PM. 851-6285

17 MILE CIRCLE area, custom built colonial

3 bedrooms, 2 1/2 baths, family room with fireplace, kitchen with dining area, 1st floor laundry, dining room, 2 1/2 car garage, 2 full baths, 2 1/2 baths, finished full basement with wet bar, 2 1/2 car garage, deck, tennis, basketball, volleyball court, automatic mortgage. Convenient to schools. 643-8956

TROY 3 bedroom brick/aluminum ranch

2 1/2 baths, 2 car attached garage, full basement. \$39,790

TROY Brick aluminum Colonial

4 bedrooms, 1 1/2 baths, family room, fireplace, central air, 2 car attached garage. Energy conscious, allergy free home. \$49,290

SQUARE LAKE JOHN R

Contemporary level, elegant decor, 3 bedrooms, 1 1/2 baths, family room, fireplace, 2 1/2 car attached garage. Beautiful lot, extras. \$56,900

JOHN R LONG LAKE

Colonial 4 bedroom colonial. Dining room, family room, fireplace, 1st floor laundry, professionally finished basement, 2 car attached garage. \$59,900

ALSO Beautiful 4 bedroom, 2 1/2 bath Colonial. \$71,900

COOK REALTY CO. 939-4700

BUCKINGHAM WOODS 1

Appealing Cape Cod, 4 bedrooms, 2 1/2 baths, dining room, fireplace, 1st floor, basement rec. room, 2525 Warwick, Troy. 649-5329

ROCHESTER Brick Ranch

basement opens to terrace, dining area, 3 1/2 bedrooms, 2 1/2 baths, family room and fireplace, \$80,000.

TROY by owner 3 bedroom tri-level built in 1973, family room, attached 2 car garage, 1 1/2 baths, etc. extras. see lot. \$47,200. \$24-1571

309 Northville-Novl

NOVI - attractive 2 bedroom home on 90x120 lot, stove and refrigerator included. \$17,000. Ashley & Cox Real Estate. 453-6012

NORTHVILLE COMMONS

311 Homes For Sale Oakland County

BY Owner - North Ranch Oak 3 bedroom brick ranch, aluminum trim, draperies, carpeting, built-in kitchen, finished basement, centrally located. \$39,490. 549-7575

OAKLAND County near 1860, Mt Ford Rd. By owner 1.900 sq. ft. large lot, garage. \$45,000. 437-2678

CAPE COD OAKLAND MANOR SUB

5 BEDROOM, 2 1/2 baths, finished basement, attached 2 car garage. Pool. Walking distance to Shrine School & Church. 100 Foot lot with trees. Ideal family home. By Owner. \$62,600. Days 334-0567. Even. 542-8879

BEVERLY HILLS SUB

Royal Oak Spacious 3 bedroom Colonial. Full and 1/2 bath, fireplace, dining room, family room, Florida room, family room, modernized kitchen, 2 car attached garage with door opener, carpets and drapes throughout. \$59,900. 675-0186

HUNTINGTON WOODS

13153 Balfour, story & a half brick, full basement, 3 bedrooms, 1 1/2 baths, table space in kitchen, separate living room, 2 car garage, fenced yard. \$41,500. By owner. 547-8564

HUNTINGTON WOODS

STUNNING custom contemporary Ranch. Over 1 Acre professionally landscaped lot. 4 Bedrooms, 3 full baths, family room, study, pool. ALL EXTRAS! \$135,000

424-8575 661-1206

HUNTINGTON WOODS

By owner. Large 3 bedroom colonial, 2 1/2 baths, fireplace, large family room with cathedral beamed ceiling & oversized fireplace, 2 car garage, 1st floor laundry, carpeted, too many extras to mention. \$65,900. 546-0878

320 Other Suburban Homes For Sale

SHELBY TWP 6 year old, one of a kind, 3300 sq ft custom built, 10 rooms, 2 1/2 baths. Colonial fireplace includes 2 fireplaces, 3x22 game room, family room, 2 1/2 baths, living room, dining room, half bath, 2 1/2 car garage, basement on 1/2 acre lot, lake privileges. \$32,900. 739-1924

STARTER HOME For \$29,900

Built in 1973. Aluminum and cedar main entry. Three bedrooms, 2 1/2 baths, central air, 2 1/2 car garage, 1/2 acre lot, goes with this Historic farm house, featuring 4 bedrooms, library, large barn, milk barn and other outbuildings. Brick construction. Possible split lot. \$29,900. 478-7440

LAVERNE EADY & ASSOCIATES

626-4711 275-4422

30 Day Occupancy OR SOONER! IN BRIGHTON

Come see these brand new homes in AIRWAY RANCH with everything you're looking for in 3 bedrooms, 1 1/2 baths, family room with fireplace, 2 car attached garage, full basement, appliances, choice of carpeting, and much more. We've got you to compare our BRIGHTON COLONY, or the FAIRWAY RANCH with everything you've seen in the area. \$51,500 colonial and \$51,000 ranch with best conventional terms available. Call GRANADA HOMES at 229-2080 or Brighton or 838-3536 in Detroit.

HUNTINGTON WOODS

Beautiful spacious colonial, 4 bedrooms including master bedroom suite, 3 1/2 baths, central air, large family room, formal dining room, full breakfast area, 2 car detached garage, automatic sprinkler system. \$65,500. Appt only. Days 391-0573. Evenings 546-7733

ADAMS RD. AREA

CHARNWOOD HILLS Large Ranch in excellent condition. On exceptionally beautiful large 4 bed room, 2 1/2 bath, 2 fireplaces, 2 1/2 car garage, large separate activities room, brick patio, screened porch. Extra large garage. By Owner. \$72,500. 879-6618

BY OWNER spacious Colonial ranch

Great Oaks Golf Course view, 3 bedroom, 2 bath, living room, formal, 4 1/2 acre, fully carpeted, utility room, basement 2 years old. After 6 PM. 851-6285

17 MILE CIRCLE area, custom built colonial

3 bedrooms, 2 1/2 baths, family room with fireplace, kitchen with dining area, 1st floor laundry, dining room, 2 1/2 car garage, 2 full baths, 2 1/2 baths, finished full basement with wet bar, 2 1/2 car garage, deck, tennis, basketball, volleyball court, automatic mortgage. Convenient to schools. 643-8956

TROY 3 bedroom brick/aluminum ranch

2 1/2 baths, 2 car attached garage, full basement. \$39,790

TROY Brick aluminum Colonial

4 bedrooms, 1 1/2 baths, family room, fireplace, central air, 2 car attached garage. Energy conscious, allergy free home. \$49,290

SQUARE LAKE JOHN R

Contemporary level, elegant decor, 3 bedrooms, 1 1/2 baths, family room, fireplace, 2 1/2 car attached garage. Beautiful lot, extras. \$56,900

JOHN R LONG LAKE

Colonial 4 bedroom colonial. Dining room, family room, fireplace, 1st floor laundry, professionally finished basement, 2 car attached garage. \$59,900

ALSO Beautiful 4 bedroom, 2 1/2 bath Colonial. \$71,900

COOK REALTY CO. 939-4700

BUCKINGHAM WOODS 1

Appealing Cape Cod, 4 bedrooms, 2 1/2 baths, dining room, fireplace, 1st floor, basement rec. room, 2525 Warwick, Troy. 649-5329

ROCHE

302 Help Wanted Dental-Medical

MEDICAL OFFICE MANAGER Excellent opportunity. Experienced with full knowledge of medical office, assisting skills and knowledge of insurance forms. 425-0000

MEDICAL ASSISTANT for busy Dermatologist office, benefits. 261-6600

RN-LPN Afternoon and midnight shifts. Full-time. Good starting salaries. Modern facilities. Will consider part-time. See Mrs. Ferguson

Nightingale West 3845 Newburgh Rd. Westland, N. J. Joy Rd. An Equal Opportunity Employer

RECEPTIONIST wanted for doctor's office. Also willing to do clerical work. Apply in person. Eiman Clinic, 7151 Franklin, near Livonia, Detroit

FRONT DESK Office Assistant. Pleasant girl with experience. Award Westland Dental Practice. 422-5560

WANTED: office girl. Duties consist of reception and clerical assisting. Experience not necessary. 9AM-5PM. Southfield, 557-2818

RNs and LPNs STUDENT NURSES NURSES' AIDES Immediate positions available on all shifts in a new area. Call Nursing Director

CAMBRIDGE NURSING CENTER, WEST 255-1010

DENTAL HYGIENIST - Experienced. Part-time in pleasant office. Farmington area. 477-0208

MEDICAL ASSISTANT Southfield Internist office. Experienced in EKG, X-Ray, Lab. 273-3480

RECEPTIONIST Southfield Internist office. Experienced in Blue Cross - Blue Shield. 273-3480

NURSES' AIDES OR ORDERLY ALL SHIFTS Full or Part-Time Apply in person

FRANKLIN MANOR CONVALESCENT CENTER 352-7390

DENTAL ASSISTANT Experienced, full-time, highly professional office awaits team member. Salary open. Livonia-Redford area. 422-6310

MEDICAL ASSISTANT for Birmingham Internist clinic in basic lab work and typing needed. 821-2440

OPHTHALMIC ASSISTANT needed for busy Ophthalmologist's office. Good salary and fringe benefits. Eight Mile-Telegraph area. Extension 258-4310

PERSONNEL PLACEMENT COUNSELOR Medical experience is required. Prior personnel experience a definite plus. Salary open. Work toward management position. \$4 DR. PERSONNEL AGENCY Northland Medical Bldg. 569-5254

MED. TECH. Full-time, Farmington Pediatric's office 4 day work week. Excellent starting salary and fringe benefits. Please send resume to Pediatric Associates of Farmington, 2313 Orchard Lake Rd., Farmington, Mich. 48024

RELIEF Nurses needed Monday through Friday, 8:30 AM to 4:30 PM. To give experienced total care to patients in their homes. BS in RN preferred. No travel necessary. Call Mrs. Landis 358-3121

DENTAL HYGIENIST for Westland Office. Full or part time. No Saturdays. Call 728-2616

RNs Full-time, day & afternoon shifts. Apply in person. WILLIAMSBURG

Convalescent Ctr. 21017 Middlebelt, Farm. Between Grd River & B. Mile

DENTAL HYGIENIST, preferably for Tuesday Schoolcraft, Telegraph area. 354-6680

DENTAL ASSISTANT, part-time. Livonia specialty practice. Week days only. No Saturdays. No travel. Experienced. Preferred. Will train. Send handwritten resume to Box 256, Oberlin, Eclectic Newspapers, 36251 Schoolcraft, Livonia, Michigan 48150

DENTAL Hygienist wanted, part-time. No travel. No Saturdays. Dearborn Hills area. 278-4470

There's no better way to find the person you're looking for to do that particular job.

OBSERVER & ECCENTRIC BUSINESS DIRECTORY

506 Help Wanted Sales

FREE REAL ESTATE TRAINING If you qualify for this unique opportunity, we will train you absolutely FREE for a career in real estate sales whereby you could earn up to \$20,000 first year. For more information, call

GARY COOK 851-6000 THE DURBIN COMPANY REALTORS

502 Help Wanted Dental-Medical

Certified Social Worker Full-Time Apply in Person Ardmore Acres Hospital

19810 Farmington, Livonia MEDICAL Transcriptionist, experienced, excellent pay. Southfield area. Call 557-8711

EXPERIENCED Nurse's Aide to care for elderly lady in her home. Bloomfield Hills area. Spanish speaking preferable. 426-1851

DENTAL hygienist wanted, part time for Bloomfield area. 338-4140

NURSE AIDES Midnight Shift Full-time, experienced. Pontiac, but not necessary. Apply in person

WILLIAMSBURG Convalescent Center 21017 Middlebelt, Farm. Between Grd River & B. Mile

MODELS & ACTORS, full or part-time. Experience not necessary. Models & Actors Referrals Service, 21700 Northwestern, Tower 14, Suite 1120, Southfield 557-0990

NURSES AIDES Weekend positions now available. Full-time positions, days and night shifts. Mature persons. See Mrs. Mayville

Nightingale West 3845 Newburgh Rd. Westland, N. J. Joy Rd. An Equal Opportunity Employer

TYPIST for Troy physician. Dictated. Full-time. Type 60 w.p.m. Non-smoker. Exercise and fitness oriented. Full-time, Monday through Friday. Send resume to Ruth Lewis, 1551 W. Big Beaver, Troy, Mich. 48064

NURSES AIDES - all shifts, full or part-time. Pontiac, but not necessary. Convalescent Center, 105 Hagerty Rd., Plymouth

RN'S NEW HIGHER STARTING RATES We have shifts to meet your needs. Part-time positions available on the day, afternoon and midnight shifts. Full-time positions available on the afternoon and midnight shift

LPN'S Patient care only. Part-time positions available on the day, afternoon and midnight shift. Full-time positions available on the afternoon and midnight shift. Part-time positions consist of 2 days a week with every other week being full-time. Applications accepted with approved references. Apply to Personnel Dept. PONTIAC OSTEOPATHIC HOSP. 50 Perry St., Pontiac, Mich. 48058 338-7271, Ext. 262

RN'S Full-time positions available. Excellent benefits & wages. Good working conditions. Apply in person, University Convalescent & Nursing Home, 28550 Five Mile Rd., Livonia Between Inkster & Middlebelt Roads

OPHTHALMOLOGIST'S OFFICE - Full-time. Completely familiar with insurance. Blue Shield, Medicare, Medicaid. Ophthalmologist's office. Good salary and fringe benefits. Eight Mile-Telegraph area. Extension 258-4310

ATTENTION RNS & LPNS Avondale Convalescent Home - A skilled nursing facility. Home of 110 beds. Full or part-time position open for RN or LPN interested in skilled long term care. Call for details. 851-4422

RNS or LPNS Full-time, 3PM-11PM shift. Apply to Dorvin Convalescent & Nursing Center, 29270 Morlock, Livonia, near the Livonia Mall. 476-0550

NURSE AIDES FULL OR PART-TIME MIDNIGHT SHIFT Apply in person between 9 & 4 PM

FRANKLIN MANOR CONVALESCENT CENTER 352-7390

DENTAL TECHNICIAN Experienced fishers & waders for medical & bridge lab in Southfield area. 357-1820

502 Help Wanted Dental-Medical

RN for busy surgeon's office. Full-time. Must be fully experienced in all phases of office work and completely familiar with Blue Shield, Medicare and Medicaid. Excellent working conditions. 2400 Plymouth area. Reply Box 248, Observer & Eccentric Newspapers, 36251 Schoolcraft, Livonia, Michigan, 48150

NURSES' AIDES ALL SHIFTS APPLY IN PERSON CAMELOT HALL 35100 Ann Arbor Trail LIVONIA

RN'S-LPN'S AIDES Needed immediately. Full-time and full-time positions. Call Health Care RN Owned & Operated 589-2585

NURSES AIDES ORDERLIES All shifts. Experienced preferred, but will train. Apply at Dorvin Nursing & Convalescent Center 29270 Morlock, Livonia 476-0550

RNS or LPNS 11 PM-7 AM, two or three nights a week. Apply at Dorvin Convalescent Nursing Center, 29270 Morlock, Livonia, near the Livonia Mall. 476-0550

504 Help Wanted Office-Clerical SECRETARY SOUTHFIELD AREA

Aggressive sales firm looking for responsible SECRETARY to start immediately. Typing, telephone contact and clerical experience with ability. Salary commensurate with ability. Call Wednesday, April 20 559-7410

FULL SERVICE BUILDING SECRETARY, 25 years or older. Life insurance office, rate book experience helpful. Must be typing skills and ability to communicate. Salary commensurate with experience. 649-0006

SECRETARY for Executive Office in large Troy company 2 years experience and good skills. Qualifies you for this ideal job in Somerset area. Salary \$6.50 with top benefits and fee paid

EXPERIENCED Legal Secretary with good skills for nice Southfield firm. 50% of job is administrative. Company has benefits, nice hours and pays the fee. Salary \$700 to \$800. Contact Mrs. J. Siler 453-8500

RECEPTIONIST with good grammar skills for Birmingham company. Apply at Fania Sea Swim Center, 23660 Front River, 3 blocks E. of Telegraph. 474-4800

FRONT DESK Clerk - full-time, afternoons. PBX and typing skills essential. Must enjoy meeting people. Bostford Inn. 474-4800

SECY. WITH S/H BEGINNER No experience. Fast growing for self-starter. 9600 Jean. 559-4760

KAY TURNER PERSONNEL-101 18280 W. 10 Mile Rd. SOUTHFIELD

GENERAL OFFICE Telephone Receptionist - type 50 w.p.m. excellent. Must be unusually bright person. Must be good with numbers. Start approx \$130 weekly. Apply Tuesday, 2:5 PM, 12821 Capital, Oak Park

SALES SECRETARY Ability to compose, excellent typing, filing & record keeping skills. Shorthand or dictaphone. Many fringe benefits. Salary commensurate with experience. Contact Personnel at 548-9330

CLAIMS TYPIST Multi-line insurance company has opening for a Claims Typist. Position involves typing of Claims Drafts, other various Claims documents. Competitive salary with excellent benefits. INSURANCE CO. Contact Mrs. Forkin or Mr. Hine. 649-4300

LEGAL SECRETARY - mature, experienced with excellent skills. Must be typing. 557-4000

SECRETARY Good typing and shorthand skills. Key to this position is secretary in our district sales office. You will be performing a variety of secretarial and clerical duties.

We offer an excellent starting salary, a full range of benefits including company paid group life and health insurance and profit sharing.

Full Charge BOOKKEEPERS Southfield-Troy

TYPIST Oak Park Southfield-Troy

ASSISTANT BOOKKEEPERS Southfield-Royal Oak Birmingham

RECEPTIONIST Detroit Ranging in salary from \$450 month to \$1100 month. Call

ACCOUNTING CLERK with Airline. Home Billing experience. Good salary & travel benefits. ELKIN TOURS 358-5566

SECRETARIES & PBX for Southfield, Troy & Eastern Suburbs. Start immediately. If you have good skills, call Pat 356-1618

RECEPTIONIST Receptionist - Secretary needed here. General office duties and heavy phone contact offers you the chance to run this office in convenient suburban spot. Call 562-8900

Your New Boss Pays For! HARRIET SORGE PERSONNEL SECRETARY RECEPTIONIST needed. Experience necessary. Please call at 559-3772. anzyceanyzacczsgitttyzcczavtse has permanent openings available as well as daily assignments for GUARDS. Top wages & fringe benefits. Apply 22150 Greenfield, Oak Park. 986-1992

SALES SERVICE ASSIST. Office work to do a convincing suburban wholesaler needs your sales experience and clerical skills to handle inventory. Fee Paid: \$650 up. Call Joan Hartz 509-0400

Snelling & Snelling PERSONNEL GENERAL OFFICE Pleasant surroundings, diversified office. Positions offered by Royal Oak manufacturer. Experience, poise and ability, good business machine skills essential. Computer experience knowledge desirable. Full-time, good benefits. Reply to: Box 278, Observer & Eccentric Newspapers, 36251 Schoolcraft, Livonia, Michigan 48150

BLOOMFIELD Prestige firm, gorgeous offices, great location. Outgoing personality plus just light shorthand merits \$650 - \$750 start. Call 643-9000

Your New Boss Pays For! HARRIET SORGE PERSONNEL RECEPTIONIST, Corporate Office in Southfield needs High School Grad with pleasant telephone manner, accurate typing, neat appearance. Call Sharon at 338-1782

504 Help Wanted Office-Clerical

CLERICAL CLERK-good starting job for a plump Southfield company. Will train but must have 60 wpm typing, familiar with office duties. \$450 - \$475 to start. Company pays our fee. GOOD PROFESSIONAL PERSONNEL 357-4810

TYPIST - Experienced, Mature, 60-70 wpm. 15 Mile and Haggerty. 646-6666

CLERICAL \$6500 Bright gal needed for top spot! Good math aptitude. Call 476-3360

SHARROW GAL \$6000 Light bookkeeping and reception duties will fill your day!

ADMINISTRATIVE SECY. To assist this financial entrepreneur with your professional skills and figure. Full-time, plus office. Benefits plus \$11,500 await you! Call Sheri Day 569-0400

Snelling & Snelling PERSONNEL SUBURBAN STAR to \$10,000 Career oriented secretary. Bookkeeping, typing, filing, etc. Reply TRAINER SPECIAL \$5200 Your new career is about to begin! Typing necessary. Call 478-3500

SALES SECRETARY, \$7000 plus fringe suburban office ready to hire. No shorthand! 478-3500

ACCOUNTING CLERK \$200 For rapidly expanding Southfield Company. Minimum of 2 years experience. Accounts Payable & Receivable plus some college accounting courses. Fully paid benefits with dental & cost of living. Employer paid fee. 525-7870

SHARROW & ASSOCIATES LEGAL secretary, Birmingham. Experience desired but not necessary. Nice place to work. \$150-\$200. 645-0750

SECRETARY Suburban Wayne County Medical Clinic has 2 full-time positions open for Clerical Assistants. Applicants need typing skills of 60 WPM, good grammar & spelling & a working knowledge of machine transcription. Full benefits, salary based on skills. PLEASE CALL 562-5233

OFFICE MESSENGER & general office clerk. Must be good typist. Able to read & O.D. O.D. No. 2129, Livonia, Mich. 48151

SECRETARY-RECEPTIONIST Needed for corporate office of a franchising organization. Paid fringe benefits. Must be good typist. Speedwriting, record keeping and/or knowledge of adding machine helpful. Located on Greenfield across from Northland. For interview, call Mrs. J. Siler 453-8500

RECEPTIONIST with good Monday thru Fri 12 - 9 PM. Apply at Fania Sea Swim Center, 23660 Front River, 3 blocks E. of Telegraph. 474-4800

GENERAL OFFICE Telephone Receptionist - type 50 w.p.m. excellent. Must be unusually bright person. Must be good with numbers. Start approx \$130 weekly. Apply Tuesday, 2:5 PM, 12821 Capital, Oak Park

SALES SECRETARY Ability to compose, excellent typing, filing & record keeping skills. Shorthand or dictaphone. Many fringe benefits. Salary commensurate with experience. Contact Personnel at 548-9330

CLAIMS TYPIST Multi-line insurance company has opening for a Claims Typist. Position involves typing of Claims Drafts, other various Claims documents. Competitive salary with excellent benefits. INSURANCE CO. Contact Mrs. Forkin or Mr. Hine. 649-4300

LEGAL SECRETARY - mature, experienced with excellent skills. Must be typing. 557-4000

SECRETARY Good typing and shorthand skills. Key to this position is secretary in our district sales office. You will be performing a variety of secretarial and clerical duties.

We offer an excellent starting salary, a full range of benefits including company paid group life and health insurance and profit sharing.

Full Charge BOOKKEEPERS Southfield-Troy

TYPIST Oak Park Southfield-Troy

ASSISTANT BOOKKEEPERS Southfield-Royal Oak Birmingham

RECEPTIONIST Detroit Ranging in salary from \$450 month to \$1100 month. Call

ACCOUNTING CLERK with Airline. Home Billing experience. Good salary & travel benefits. ELKIN TOURS 358-5566

SECRETARIES & PBX for Southfield, Troy & Eastern Suburbs. Start immediately. If you have good skills, call Pat 356-1618

RECEPTIONIST Receptionist - Secretary needed here. General office duties and heavy phone contact offers you the chance to run this office in convenient suburban spot. Call 562-8900

Your New Boss Pays For! HARRIET SORGE PERSONNEL SECRETARY RECEPTIONIST needed. Experience necessary. Please call at 559-3772. anzyceanyzacczsgitttyzcczavtse has permanent openings available as well as daily assignments for GUARDS. Top wages & fringe benefits. Apply 22150 Greenfield, Oak Park. 986-1992

SALES SERVICE ASSIST. Office work to do a convincing suburban wholesaler needs your sales experience and clerical skills to handle inventory. Fee Paid: \$650 up. Call Joan Hartz 509-0400

Snelling & Snelling PERSONNEL GENERAL OFFICE Pleasant surroundings, diversified office. Positions offered by Royal Oak manufacturer. Experience, poise and ability, good business machine skills essential. Computer experience knowledge desirable. Full-time, good benefits. Reply to: Box 278, Observer & Eccentric Newspapers, 36251 Schoolcraft, Livonia, Michigan 48150

BLOOMFIELD Prestige firm, gorgeous offices, great location. Outgoing personality plus just light shorthand merits \$650 - \$750 start. Call 643-9000

Your New Boss Pays For! HARRIET SORGE PERSONNEL RECEPTIONIST, Corporate Office in Southfield needs High School Grad with pleasant telephone manner, accurate typing, neat appearance. Call Sharon at 338-1782

504 Help Wanted Office-Clerical

NEED ambitious helper for busy office. Phone work, filing, and some typing. 26015 Glendale, Redford. 357-4810

PERMANENT part-time office work. Mature. Apply: Youth Center Store, Tel - Twelve Mall, Southfield. 357-4810

SECRETARY with promotional head of Detroit firm. Excellent typing and shorthand. \$750 to start. Fee paid. LOIS RAY PERSONNEL 559-0560

SECRETARY WANTED, for Southfield office. Organization. Strong typing skills, light bookkeeping, good people skills. Salary negotiable from \$10 weekly. Blue Cross, Life insurance, other benefits. Rewarding work in pleasant surroundings. Call office manager at Affirmative Action Employer 557-5533

KEYPUNCH OPERATOR Southfield area, full-time, afternoons. 129 or Univac. experienced only. Call Eileen. 355-3848

Don't Let Your Office Skills Get Rusty

Keep your skills in shape with temporary assignments through KELLY SERVICES. You're free to work where you want and for as long as you want. One day to months. We have immediate openings. Come in today.

LIVONIA 522-0220 SOUTHFIELD 642-9650 BLOOMFIELD HILLS 398-2680 MADISON HTS.

KELLY GIRL A Division of Kelly Services. Not an agency. Never a fee. Equal Opportunity Employer M/F. FULL-TIME. Must be at least 20 years old, clean neat appearance. Average typing skills required. Calls accepted only between 10AM-2PM weekdays. Oak Park 346-6465

CLERK-Typist for small insurance company. diversified work. pleasant atmosphere and many benefits. Northland area. Mrs. Bastie 968-2500

Acc's. Receivable Clk. Experienced to assist in Accounting Department. Must be mature and have an aptitude for figures. Novi area. Call Miss Harrier weekdays between 10 AM-3 PM. 349-5000

RECEPTIONIST for small insurance company. diversified work. pleasant atmosphere and many benefits. Northland area. Mrs. Bastie 968-2500

RECEPTIONIST must type, general office experience. Good with figures. 29200 Vassar, Suite #41, Livonia, Monday-Friday, 9AM-1PM. 388-8900

STENOGRAPHER, IBM Executive typewriter, shorthand essential, law office, Honeywell Bldg., Southfield. 352-3900

RECEPTIONIST must type, general office experience. Good with figures. 29200 Vassar, Suite #41, Livonia, Monday-Friday, 9AM-1PM. 388-8900

TELEPHONE RECEPTIONIST National printing ink manufacturer seeks experienced Telephone Receptionist for its corporate headquarters located near Schoolcraft & Telegraph. Strong typing skills essential. Purchasing background helpful but not mandatory. Call 338-6800 ext. 10

FLINT INK CORPORATION 25111 Glendale Ave. Detroit, Michigan An Equal Opportunity Employer

RECEPTIONIST-CASHER Some previous office experience necessary. Typing skills. Conveniently located office. The person we want must be interested in gradually assuming increased responsibilities and increasing value and income. To apply, phone Mr. General Finance Corp. 334-1205

LEGAL SECRETARY wanted to take over small firm in W. Bloomfield. Exciting and challenging position for well qualified individual with good skills including shorthand. Located Southfield. From 9 to 5 PM. 851-9660

SECRETARY Fast growing company in Farmington Hills is in need of Secretary who is diversified Shorthand 80, typing, 60. Not a pressure job but friendly job. Excellent benefits, salary starts at \$7,800. Company pays our fee. CALL BARBARA GOOD PROFESSIONAL PERSONNEL 357-4810

TYPIST - Part-time. Experienced typist, mornings, afternoons, or evenings. Saturday or Sunday. Farmington area company. Send resume with wage requirements and references to: Box 274, Observer & Eccentric Newspapers, 36251 Schoolcraft, Livonia, Michigan 48150

LEGAL Secretary, minimum 1 year experience with legal terms and procedures. Will be working with 3 attorneys. 50% of job with dictaphone experience. Call for appointment. The Hartford Inn Personnel Dept. 484-0700 ext. 307-308. An Equal Opportunity Employer

PAUNDIT CORP. 755 W. Big Beaver Rd. SUITE 2206 Troy, Mich. 48064 313-382-2570 An Equal Opportunity Employer

BOOKKEEPER General Office Typing, good office experience and full charge bookkeeping. Birmingham firm. \$750. Fee paid

LOIS RAY PERSONNEL 559-0560

LEGAL SECRETARY Active Southfield firm specializing in Insurance Defense and Subrogation, requires well organized, experienced Legal Secretary. Good typing, dictaphone, knowledge of pleadings & Legal Procedures required. 557-4000

FILE Clerk Maintain files, sort & deliver incoming and inter-office mail. Light typing responsibilities. Must be good typist. Some office experience desirable. Northwest Detroit 532-2600 ext. 43

SUBURBAN SECRETARY - \$700 fee paid for large Southfield firm. Good S.H. typing. 557-4000

TYPIST This suburban firm will pay super salary for sharp gal who types 50 w.p.m. Really great hours. RECEPTIONIST \$600 - Farmington. Great job for sharp gal who takes meeting people. Light typing. TOWN & COUNTRY EMPLOYMENT CENTER 474-1717

KEYPUNCH OPR We have a day position available for a keypunch operator with a minimum of 1 year experience on IBM 129 and/or Univac 710. For further information please contact Personnel Department

ALEXANDER HAMILTON LIFE INSURANCE CO. OF AMERICA 12 Mile & Farmington Rd. 553-2000

FULL-TIME position for person with one-two years experience in general typing. Good typing. Birmingham. Ask for Mrs. Valdes. 642-8000

504 Help Wanted Office-Clerical

SECRETARY wanted (Part-time Business Office) near downtown Birmingham. Write Box 268, Observer & Eccentric Newspapers, 36251 Schoolcraft, Livonia, Michigan 48150

RECEPTIONIST, for a new sales office. Must be good typist. Pleasant surroundings. 357-4771

SHAW - BARTON Advertising Company needs girl for One Girl Office. Must be good typist, with bookkeeping necessary. Answering phone, filing also included but no bookkeeping. Call H. M. Brown, 943-0116, 2820 W. Maple, Troy. 444-1440

RECEPTIONIST If you have an outgoing personality, smiling face and some typing no shorthand necessary \$493 month. Call Jackie Kaye 644-4600

SNELLING & SNELLING AGENCY FULL-TIME typist for physician's office. Dictaphone experience desired but not mandatory. Non-smoker, physical fitness oriented. Send resume to: Mrs. M. J. W. Big Beaver, Troy, Mich. 48064

SECRETARY Must have bookkeeping, typing, filing, and shorthand experience. Novice. Call Miss Horner weekdays between 10 AM - 3 PM. 349-5000

Diversified Office Duties in North-West Area Auto Dealership, Auto Dealer Assistant & General Clerical Work. Must be good typist. Pleasant working conditions and insurance benefits. Phone 335-7377

AUTO BILLER North-West Area Dealer. Permanent full-time employment, must be good typist. Pleasant working conditions and insurance benefits. Phone 335-7377

GENERAL OFFICE, Posting to general ledger and operating accounts, trial balance and general ledger. Must be good typist. Monthly reports. Other office duties. Send qualifications to Business Manager, Madona's College, 36600 Schoolcraft, Livonia, Michigan 48150

GENERAL OFFICE Purchasing Clerk with light typing, filing and use of business machines. Send resume to Business Manager, Madona's College, 36600 Schoolcraft, Livonia, Michigan 48150. An Equal Opportunity Employer

Division of Kelly Services. Equal Opportunity Employer M/F. PART-TIME - Garden City. Must type, light bookkeeping, one girl office. 427-2920. Call for appointment. 525-0737

GENERAL OFFICE, Requires logical thinking, 10 key calculator. Typing experience. Position has variety of functions. Full benefits. Soap On Tools Corporation, 23460 Woodward, Park Dr. Farmington, Michigan. An Equal Opportunity Employer

Large training and communications company requires mature, experienced secretary. Strong shorthand and typing skills required. CALL MRS. KLEE AFTER 1PM 871-1200

EXPERIENCED Bookkeeper familiar with Payroll and Sales Tax, for Southfield CPA office. Full-time. Please send resume to: PERMANENT STAFF PERSONNEL 388-8900

EXECUTIVE SECRETARY, Administrative Assistant, for V.P. Birmingham Sales Incentive career position. Full charge position with excellent shorthand, typing and

507 Help Wanted Part Time WOMEN WANTED for interesting phone work... SALES OFFICE Part-time Clerical with dictaphone, typing experience...

507 Help Wanted Part Time PART-TIME clerical help, 3 day week, Monday, Wednesday, Friday... PART - TIME TELLERS EXPERIENCE PREFERRED...

510 Help Wanted Couples HUSBAND & WIFE to do General Cleaning of luxurious condominium building...

508 Help Wanted Domestic BABY SITTER needed by Christian woman, Mon. thru Fri. 5:30 AM - 3 PM... BABY SITTER-housekeeper, mature, non-smoker...

508 Help Wanted Domestic BABY SITTER wanted, my home, 4 days, Westland area... GENERAL HOUSEWORK A good, honest, dependable lady...

508 Help Wanted Domestic RESPONSIBLE PERSON to live-in, 3 days, child care, housekeeping \$106 per week... LIVE-IN housekeeper, mature woman, child care responsibilities...

512 Situations Wanted Female CLEAN your apartment, town house or condo, Livonia... SECRETARIAL SERVICE in my home IBM Selectric typewriter...

BLUE GRASS FARMS Growers of Nursery Sod TOP SOIL LANDSCAPING EVERGREENS SEEDING SODDING FERTILIZER SAND PEAT FILL DIRT STONE

553-3300 PART-TIME light janitorial work, Mondays, Wednesdays, Fridays... HOUSEWIVES put your home to use cleaning our customers' homes...

37601 Five Mile Rd. at Newburgh PART-TIME, 4 nights per week, telephone people needed in our Southfield office...

BABY SITTER needed for 3 year old boy Monday thru Friday... HOUSEKEEPER for elderly Gentle man, live-in, 7 nights, 1 day off...

BABY SITTER for 3 year old, in my home, Monday thru Friday... MATURE, dependable person to live-in housekeeping...

WANTED, reliable baby sitter for one day weekly... BABY SITTER to watch 6 & 2 year old children in my home...

MATURE, dependable person to live-in housekeeping... MATURE woman to care for my home and 9 year old...

YOUNG lady desires cleaning in your home... BOOKKEEPER, Secretary, 10 yrs experience in all phases of office duties...

BLUE GRASS FARMS (continued) COMMERCIAL & RESIDENTIAL 16185 NEWBURGH RD 464-2080

Home Service Guide

Aluminum Cleaning COMPLETE HOME IMPROVEMENT Aluminum, vinyl, roofing and gutters... CLEANED & WAXED, aluminum siding, brick, concrete...

Brick, Block & Cement CEMENT WORK Basement & Garage floors Walks Patios-Driveways... BRICK & BLOCK WORK Porch & chimney repairs...

Building & Remodeling ALL HOME IMPROVEMENTS GARAGES - All Styles... BESTWAY BUILDERS 464-3770

Carpet Cleaning FOR REASONABLE Prices & Quality work in Carpet, Furniture, wall, windows and general house cleaning... HOLLAND'S Carpet Cleaning Steam clean your average living room...

Firewood MIXED HARDWOOD 2 cords, \$40-1 cord \$23.00... FLOOR SERVICE LAYING SANDING-Finishing Staining specialty...

Landscaping AA-1 MERION Blue Grass Farms one cutting SOD daily at 51825 W. Eight Mile Rd... NATURE'S IMAGE Custom Landscaping, Professional Lawn Maintenance...

Lawn Maintenance RESIDENTIAL & COMMERCIAL Lawn Maintenance Programs... D.K. WALTON Lawn Service Spring cleanup Power Raking...

Painting & Decorating STOP! 22 YEARS PAINTING EXP Hygrade Painting & Decorating Co. Residential interior, exterior...

Aluminum Siding ALUMINUM SIDING Quality work & affordable prices... TRIM-TRIM-TRIM Also aluminum siding & gutters...

CEMENT WORK ALL KINDS To save money, deal directly with owners... ITALIAN CEMENT CO. LICENSED-INSURED BONDED FREE ESTIMATE...

BESTWAY BUILDERS 464-3770 ADDITIONS Rough or Finished Roofs, Patios, Pools... BEST WORK BEST PRICE CALL NOW...

MODERN CARPET CLEANING ON SPRING SPECIAL NOW! Carpet cleaning, shampooing, methods We Do A Job!... STEAM CLEANING SPECIAL 825 LIVING ROOM Furniture-Draperies...

FIREWOOD MIXED HARDWOOD 2 cords, \$40-1 cord \$23.00... FLOOR SERVICE LAYING SANDING-Finishing Staining specialty...

LANDSCAPING AA-1 MERION Blue Grass Farms one cutting SOD daily at 51825 W. Eight Mile Rd... NATURE'S IMAGE Custom Landscaping, Professional Lawn Maintenance...

LAWN MAINTENANCE RESIDENTIAL & COMMERCIAL Lawn Maintenance Programs... D.K. WALTON Lawn Service Spring cleanup Power Raking...

PAINTING & DECORATING STOP! 22 YEARS PAINTING EXP Hygrade Painting & Decorating Co. Residential interior, exterior...

ALUMINUM SIDING Quality work & affordable prices... TRIM-TRIM-TRIM Also aluminum siding & gutters...

CEMENT WORK ALL KINDS To save money, deal directly with owners... ITALIAN CEMENT CO. LICENSED-INSURED BONDED FREE ESTIMATE...

BESTWAY BUILDERS 464-3770 ADDITIONS Rough or Finished Roofs, Patios, Pools... BEST WORK BEST PRICE CALL NOW...

MODERN CARPET CLEANING ON SPRING SPECIAL NOW! Carpet cleaning, shampooing, methods We Do A Job!... STEAM CLEANING SPECIAL 825 LIVING ROOM Furniture-Draperies...

FIREWOOD MIXED HARDWOOD 2 cords, \$40-1 cord \$23.00... FLOOR SERVICE LAYING SANDING-Finishing Staining specialty...

LANDSCAPING AA-1 MERION Blue Grass Farms one cutting SOD daily at 51825 W. Eight Mile Rd... NATURE'S IMAGE Custom Landscaping, Professional Lawn Maintenance...

LAWN MAINTENANCE RESIDENTIAL & COMMERCIAL Lawn Maintenance Programs... D.K. WALTON Lawn Service Spring cleanup Power Raking...

PAINTING & DECORATING STOP! 22 YEARS PAINTING EXP Hygrade Painting & Decorating Co. Residential interior, exterior...

ALUMINUM SIDING Quality work & affordable prices... TRIM-TRIM-TRIM Also aluminum siding & gutters...

CEMENT WORK ALL KINDS To save money, deal directly with owners... ITALIAN CEMENT CO. LICENSED-INSURED BONDED FREE ESTIMATE...

BESTWAY BUILDERS 464-3770 ADDITIONS Rough or Finished Roofs, Patios, Pools... BEST WORK BEST PRICE CALL NOW...

MODERN CARPET CLEANING ON SPRING SPECIAL NOW! Carpet cleaning, shampooing, methods We Do A Job!... STEAM CLEANING SPECIAL 825 LIVING ROOM Furniture-Draperies...

FIREWOOD MIXED HARDWOOD 2 cords, \$40-1 cord \$23.00... FLOOR SERVICE LAYING SANDING-Finishing Staining specialty...

LANDSCAPING AA-1 MERION Blue Grass Farms one cutting SOD daily at 51825 W. Eight Mile Rd... NATURE'S IMAGE Custom Landscaping, Professional Lawn Maintenance...

LAWN MAINTENANCE RESIDENTIAL & COMMERCIAL Lawn Maintenance Programs... D.K. WALTON Lawn Service Spring cleanup Power Raking...

PAINTING & DECORATING STOP! 22 YEARS PAINTING EXP Hygrade Painting & Decorating Co. Residential interior, exterior...

ALUMINUM SIDING Quality work & affordable prices... TRIM-TRIM-TRIM Also aluminum siding & gutters...

CEMENT WORK ALL KINDS To save money, deal directly with owners... ITALIAN CEMENT CO. LICENSED-INSURED BONDED FREE ESTIMATE...

BESTWAY BUILDERS 464-3770 ADDITIONS Rough or Finished Roofs, Patios, Pools... BEST WORK BEST PRICE CALL NOW...

MODERN CARPET CLEANING ON SPRING SPECIAL NOW! Carpet cleaning, shampooing, methods We Do A Job!... STEAM CLEANING SPECIAL 825 LIVING ROOM Furniture-Draperies...

FIREWOOD MIXED HARDWOOD 2 cords, \$40-1 cord \$23.00... FLOOR SERVICE LAYING SANDING-Finishing Staining specialty...

LANDSCAPING AA-1 MERION Blue Grass Farms one cutting SOD daily at 51825 W. Eight Mile Rd... NATURE'S IMAGE Custom Landscaping, Professional Lawn Maintenance...

LAWN MAINTENANCE RESIDENTIAL & COMMERCIAL Lawn Maintenance Programs... D.K. WALTON Lawn Service Spring cleanup Power Raking...

PAINTING & DECORATING STOP! 22 YEARS PAINTING EXP Hygrade Painting & Decorating Co. Residential interior, exterior...

ALUMINUM SIDING Quality work & affordable prices... TRIM-TRIM-TRIM Also aluminum siding & gutters...

CEMENT WORK ALL KINDS To save money, deal directly with owners... ITALIAN CEMENT CO. LICENSED-INSURED BONDED FREE ESTIMATE...

BESTWAY BUILDERS 464-3770 ADDITIONS Rough or Finished Roofs, Patios, Pools... BEST WORK BEST PRICE CALL NOW...

MODERN CARPET CLEANING ON SPRING SPECIAL NOW! Carpet cleaning, shampooing, methods We Do A Job!... STEAM CLEANING SPECIAL 825 LIVING ROOM Furniture-Draperies...

FIREWOOD MIXED HARDWOOD 2 cords, \$40-1 cord \$23.00... FLOOR SERVICE LAYING SANDING-Finishing Staining specialty...

LANDSCAPING AA-1 MERION Blue Grass Farms one cutting SOD daily at 51825 W. Eight Mile Rd... NATURE'S IMAGE Custom Landscaping, Professional Lawn Maintenance...

LAWN MAINTENANCE RESIDENTIAL & COMMERCIAL Lawn Maintenance Programs... D.K. WALTON Lawn Service Spring cleanup Power Raking...

PAINTING & DECORATING STOP! 22 YEARS PAINTING EXP Hygrade Painting & Decorating Co. Residential interior, exterior...

ALUMINUM SIDING Quality work & affordable prices... TRIM-TRIM-TRIM Also aluminum siding & gutters...

CEMENT WORK ALL KINDS To save money, deal directly with owners... ITALIAN CEMENT CO. LICENSED-INSURED BONDED FREE ESTIMATE...

BESTWAY BUILDERS 464-3770 ADDITIONS Rough or Finished Roofs, Patios, Pools... BEST WORK BEST PRICE CALL NOW...

MODERN CARPET CLEANING ON SPRING SPECIAL NOW! Carpet cleaning, shampooing, methods We Do A Job!... STEAM CLEANING SPECIAL 825 LIVING ROOM Furniture-Draperies...

FIREWOOD MIXED HARDWOOD 2 cords, \$40-1 cord \$23.00... FLOOR SERVICE LAYING SANDING-Finishing Staining specialty...

LANDSCAPING AA-1 MERION Blue Grass Farms one cutting SOD daily at 51825 W. Eight Mile Rd... NATURE'S IMAGE Custom Landscaping, Professional Lawn Maintenance...

LAWN MAINTENANCE RESIDENTIAL & COMMERCIAL Lawn Maintenance Programs... D.K. WALTON Lawn Service Spring cleanup Power Raking...

PAINTING & DECORATING STOP! 22 YEARS PAINTING EXP Hygrade Painting & Decorating Co. Residential interior, exterior...

ALUMINUM SIDING Quality work & affordable prices... TRIM-TRIM-TRIM Also aluminum siding & gutters...

CEMENT WORK ALL KINDS To save money, deal directly with owners... ITALIAN CEMENT CO. LICENSED-INSURED BONDED FREE ESTIMATE...

BESTWAY BUILDERS 464-3770 ADDITIONS Rough or Finished Roofs, Patios, Pools... BEST WORK BEST PRICE CALL NOW...

MODERN CARPET CLEANING ON SPRING SPECIAL NOW! Carpet cleaning, shampooing, methods We Do A Job!... STEAM CLEANING SPECIAL 825 LIVING ROOM Furniture-Draperies...

FIREWOOD MIXED HARDWOOD 2 cords, \$40-1 cord \$23.00... FLOOR SERVICE LAYING SANDING-Finishing Staining specialty...

LANDSCAPING AA-1 MERION Blue Grass Farms one cutting SOD daily at 51825 W. Eight Mile Rd... NATURE'S IMAGE Custom Landscaping, Professional Lawn Maintenance...

LAWN MAINTENANCE RESIDENTIAL & COMMERCIAL Lawn Maintenance Programs... D.K. WALTON Lawn Service Spring cleanup Power Raking...

PAINTING & DECORATING STOP! 22 YEARS PAINTING EXP Hygrade Painting & Decorating Co. Residential interior, exterior...

ALUMINUM SIDING Quality work & affordable prices... TRIM-TRIM-TRIM Also aluminum siding & gutters...

CEMENT WORK ALL KINDS To save money, deal directly with owners... ITALIAN CEMENT CO. LICENSED-INSURED BONDED FREE ESTIMATE...

BESTWAY BUILDERS 464-3770 ADDITIONS Rough or Finished Roofs, Patios, Pools... BEST WORK BEST PRICE CALL NOW...

MODERN CARPET CLEANING ON SPRING SPECIAL NOW! Carpet cleaning, shampooing, methods We Do A Job!... STEAM CLEANING SPECIAL 825 LIVING ROOM Furniture-Draperies...

FIREWOOD MIXED HARDWOOD 2 cords, \$40-1 cord \$23.00... FLOOR SERVICE LAYING SANDING-Finishing Staining specialty...

LANDSCAPING AA-1 MERION Blue Grass Farms one cutting SOD daily at 51825 W. Eight Mile Rd... NATURE'S IMAGE Custom Landscaping, Professional Lawn Maintenance...

LAWN MAINTENANCE RESIDENTIAL & COMMERCIAL Lawn Maintenance Programs... D.K. WALTON Lawn Service Spring cleanup Power Raking...

PAINTING & DECORATING STOP! 22 YEARS PAINTING EXP Hygrade Painting & Decorating Co. Residential interior, exterior...

ALUMINUM SIDING Quality work & affordable prices... TRIM-TRIM-TRIM Also aluminum siding & gutters...

CEMENT WORK ALL KINDS To save money, deal directly with owners... ITALIAN CEMENT CO. LICENSED-INSURED BONDED FREE ESTIMATE...

BESTWAY BUILDERS 464-3770 ADDITIONS Rough or Finished Roofs, Patios, Pools... BEST WORK BEST PRICE CALL NOW...

MODERN CARPET CLEANING ON SPRING SPECIAL NOW! Carpet cleaning, shampooing, methods We Do A Job!... STEAM CLEANING SPECIAL 825 LIVING ROOM Furniture-Draperies...

FIREWOOD MIXED HARDWOOD 2 cords, \$40-1 cord \$23.00... FLOOR SERVICE LAYING SANDING-Finishing Staining specialty...

LANDSCAPING AA-1 MERION Blue Grass Farms one cutting SOD daily at 51825 W. Eight Mile Rd... NATURE'S IMAGE Custom Landscaping, Professional Lawn Maintenance...

LAWN MAINTENANCE RESIDENTIAL & COMMERCIAL Lawn Maintenance Programs... D.K. WALTON Lawn Service Spring cleanup Power Raking...

PAINTING & DECORATING STOP! 22 YEARS PAINTING EXP Hygrade Painting & Decorating Co. Residential interior, exterior...

ALUMINUM SIDING Quality work & affordable prices... TRIM-TRIM-TRIM Also aluminum siding & gutters...

CEMENT WORK ALL KINDS To save money, deal directly with owners... ITALIAN CEMENT CO. LICENSED-INSURED BONDED FREE ESTIMATE...

BESTWAY BUILDERS 464-3770 ADDITIONS Rough or Finished Roofs, Patios, Pools... BEST WORK BEST PRICE CALL NOW...

MODERN CARPET CLEANING ON SPRING SPECIAL NOW! Carpet cleaning, shampooing, methods We Do A Job!... STEAM CLEANING SPECIAL 825 LIVING ROOM Furniture-Draperies...

FIREWOOD MIXED HARDWOOD 2 cords, \$40-1 cord \$23.00... FLOOR SERVICE LAYING SANDING-Finishing Staining specialty...

LANDSCAPING AA-1 MERION Blue Grass Farms one cutting SOD daily at 51825 W. Eight Mile Rd... NATURE'S IMAGE Custom Landscaping, Professional Lawn Maintenance...

LAWN MAINTENANCE RESIDENTIAL & COMMERCIAL Lawn Maintenance Programs... D.K. WALTON Lawn Service Spring cleanup Power Raking...

PAINTING & DECORATING STOP! 22 YEARS PAINTING EXP Hygrade Painting & Decorating Co. Residential interior, exterior...

ALUMINUM SIDING Quality work & affordable prices... TRIM-TRIM-TRIM Also aluminum siding & gutters...

CEMENT WORK ALL KINDS To save money, deal directly with owners... ITALIAN CEMENT CO. LICENSED-INSURED BONDED FREE ESTIMATE...

BESTWAY BUILDERS 464-3770 ADDITIONS Rough or Finished Roofs, Patios, Pools... BEST WORK BEST PRICE CALL NOW...

MODERN CARPET CLEANING ON SPRING SPECIAL NOW! Carpet cleaning, shampooing, methods We Do A Job!... STEAM CLEANING SPECIAL 825 LIVING ROOM Furniture-Draperies...

FIREWOOD MIXED HARDWOOD 2 cords, \$40-1 cord \$23.00... FLOOR SERVICE LAYING SANDING-Finishing Staining specialty...

LANDSCAPING AA-1 MERION Blue Grass Farms one cutting SOD daily at 51825 W. Eight Mile Rd... NATURE'S IMAGE Custom Landscaping, Professional Lawn Maintenance...

LAWN MAINTENANCE RESIDENTIAL & COMMERCIAL Lawn Maintenance Programs... D.K. WALTON Lawn Service Spring cleanup Power Raking...

PAINTING & DECORATING STOP! 22 YEARS PAINTING EXP Hygrade Painting & Decorating Co. Residential interior, exterior...

ALUMINUM SIDING Quality work & affordable prices... TRIM-TRIM-TRIM Also aluminum siding & gutters...

CEMENT WORK ALL KINDS To save money, deal directly with owners... ITALIAN CEMENT CO. LICENSED-INSURED BONDED FREE ESTIMATE...

BESTWAY BUILDERS 464-3770 ADDITIONS Rough or Finished Roofs, Patios, Pools... BEST WORK BEST PRICE CALL NOW...

MODERN CARPET CLEANING ON SPRING SPECIAL NOW! Carpet cleaning, shampooing, methods We Do A Job!... STEAM CLEANING SPECIAL 825 LIVING ROOM Furniture-Draperies...

FIREWOOD MIXED HARDWOOD 2 cords, \$40-1 cord \$23.00... FLOOR SERVICE LAYING SANDING-Finishing Staining specialty...

LANDSCAPING AA-1 MERION Blue Grass Farms one cutting SOD daily at 51825 W. Eight Mile Rd... NATURE'S IMAGE Custom Landscaping, Professional Lawn Maintenance...

LAWN MAINTENANCE RESIDENTIAL & COMMERCIAL Lawn Maintenance Programs... D.K. WALTON Lawn Service Spring cleanup Power Raking...

PAINTING & DECORATING STOP! 22 YEARS PAINTING EXP Hygrade Painting & Decorating Co. Residential interior, exterior...

ALUMINUM SIDING Quality work & affordable prices... TRIM-TRIM-TRIM Also aluminum siding & gutters...

CEMENT WORK ALL KINDS To save money, deal directly with owners... ITALIAN CEMENT CO. LICENSED-INSURED BONDED FREE ESTIMATE...

BESTWAY BUILDERS 464-3770 ADDITIONS Rough or Finished Roofs, Patios, Pools... BEST WORK BEST PRICE CALL NOW...

MODERN CARPET CLEANING ON SPRING SPECIAL NOW! Carpet cleaning, shampooing, methods We Do A Job!... STEAM CLEANING SPECIAL 825 LIVING ROOM Furniture-Draperies...

FIREWOOD MIXED HARDWOOD 2 cords, \$40-1 cord \$23.00... FLOOR SERVICE LAYING SANDING-Finishing Staining specialty...

LANDSCAPING AA-1 MERION Blue Grass Farms one cutting SOD daily at 51825 W. Eight Mile Rd... NATURE'S IMAGE Custom Landscaping, Professional Lawn Maintenance...

LAWN MAINTENANCE RESIDENTIAL & COMMERCIAL Lawn Maintenance Programs... D.K. WALTON Lawn Service Spring cleanup Power Raking...

PAINTING & DECORATING STOP! 22 YEARS PAINTING EXP Hygrade Painting & Decorating Co. Residential interior, exterior...

ALUMINUM SIDING Quality work & affordable prices... TRIM-TRIM-TRIM Also aluminum siding & gutters...

CEMENT WORK ALL KINDS To save money, deal directly with owners... ITALIAN CEMENT CO. LICENSED-INSURED BONDED FREE ESTIMATE...

BESTWAY BUILDERS 464-3770 ADDITIONS Rough or Finished Roofs, Patios, Pools... BEST WORK BEST PRICE CALL NOW...

MODERN CARPET CLEANING ON SPRING SPECIAL NOW! Carpet cleaning, shampooing, methods We Do A Job!... STEAM CLEANING SPECIAL 825 LIVING ROOM Furniture-Draperies...

FIREWOOD MIXED HARDWOOD 2 cords, \$40-1 cord \$23.00... FLOOR SERVICE LAYING SANDING-Finishing Staining specialty...

LANDSCAPING AA-1 MERION Blue Grass Farms one cutting SOD daily at 51825 W. Eight Mile Rd... NATURE'S IMAGE Custom Landscaping, Professional Lawn Maintenance...

LAWN MAINTENANCE RESIDENTIAL & COMMERCIAL Lawn Maintenance Programs... D.K. WALTON Lawn Service Spring cleanup Power Raking...

PAINTING & DECORATING STOP! 22 YEARS PAINTING EXP Hygrade Painting & Decorating Co. Residential interior, exterior...

512 Situations Wanted Female

WOMAN wishes baby-sitting, your transportation, reasonable references. Livonia 441-3076

602 Lost & Found

LOST: Vicinity 7 Mile, Telegraph. White miniature poodle. Needs return answers to Mopsy 548-4378

702 Antiques

ANTIQUE Breakfront china cabinet. ANTIQUES MARKET SPRINGFIELD OAKS

708 Household Goods Oakland County

EUROPEAN wood loveseat and chair, gold velvet cushion seats. 1 1/2 years old. \$500

709 Household Goods Wayne County

NINE piece blond dining room set. 150. 2 bedroom twin beds. complete.

710 Misc. For Sale Oakland County

SWIMMING POOL, vinyl lined. End table, tea cart, child's round table, 4 ft. heater, filter, redwood deck, slides, accessories, best offer.

712 Bicycles For Sale

BICYCLES: 26 in boy's Schwinn. 26 in boy's, 24 in girl's Schwinn. \$25 each. 400-2507

726 Musical Instruments

CELLO, student, excellent. all wood. bow, case like new. \$250 complete. 453-8237

732 Wearing Apparel

PASTEL, Mint Blotie, appraised by Chudak of Birmingham. \$500

604 Announcements & Notices

Artists and galleries applications available for Detroit Art Festival on Harmony Park, June 25-26

606 Legal Notices

AUCTION: One mechanic's tool chest and tools, used April 19

703 Crafts

APPLICATIONS are now being taken for St. Andrew's of Livonia 17th annual Bazaar and Craft Show

704 Rummage Sales

LUTHERAN CHURCH 20201 Southfield Road (service drive), south of 8 Mile Friday, April 22, 9 AM till noon

514 Situations Wanted Male

PAINTING WORK desired by college student. Interior. Exterior. Experienced conscientious worker. References. Free estimates. Call after 4 PM

616 Hall For Rent

LIVONIA K of C Hall Capable 2755. Ample parking, air conditioning. Rentals for all occasions

624 Professional Services

NEED information you are unable to find? Both small and large assignments accepted. Call Barb after 5 PM. 865-6028

626 Bingo

EVERY WEDNESDAY 7PM 29600 W 9 Mile W Middlebelt 478-1117

628 Entertainment

WANTED: Band to play for bowling banquet for June 18 at Roma's of Livonia. 1970's music. 522-6764

518 Education Instructions

EXPERIENCED tutoring in high school or introductory college chemistry, physics and math is cheaper than you think. Call 548-2468

628 Entertainment

EVERY THURSDAY EARLY BIRD 7 PM Knights of Columbus. 870 N. Main. Closed on Wednesdays

628 Entertainment

WANTED: Band to play for bowling banquet for June 18 at Roma's of Livonia. 1970's music. 522-6764

628 Entertainment

WANTED: Band to play for bowling banquet for June 18 at Roma's of Livonia. 1970's music. 522-6764

628 Entertainment

WANTED: Band to play for bowling banquet for June 18 at Roma's of Livonia. 1970's music. 522-6764

628 Entertainment

WANTED: Band to play for bowling banquet for June 18 at Roma's of Livonia. 1970's music. 522-6764

628 Entertainment

WANTED: Band to play for bowling banquet for June 18 at Roma's of Livonia. 1970's music. 522-6764

628 Entertainment

WANTED: Band to play for bowling banquet for June 18 at Roma's of Livonia. 1970's music. 522-6764

628 Entertainment

WANTED: Band to play for bowling banquet for June 18 at Roma's of Livonia. 1970's music. 522-6764

IBM KEYPUNCH

Learn Now - Work in Weeks DAY & EVENING CLASSES. FREE Placement Assistance

628 Entertainment

WANTED: Band to play for bowling banquet for June 18 at Roma's of Livonia. 1970's music. 522-6764

628 Entertainment

WANTED: Band to play for bowling banquet for June 18 at Roma's of Livonia. 1970's music. 522-6764

628 Entertainment

WANTED: Band to play for bowling banquet for June 18 at Roma's of Livonia. 1970's music. 522-6764

628 Entertainment

WANTED: Band to play for bowling banquet for June 18 at Roma's of Livonia. 1970's music. 522-6764

628 Entertainment

WANTED: Band to play for bowling banquet for June 18 at Roma's of Livonia. 1970's music. 522-6764

628 Entertainment

WANTED: Band to play for bowling banquet for June 18 at Roma's of Livonia. 1970's music. 522-6764

628 Entertainment

WANTED: Band to play for bowling banquet for June 18 at Roma's of Livonia. 1970's music. 522-6764

628 Entertainment

WANTED: Band to play for bowling banquet for June 18 at Roma's of Livonia. 1970's music. 522-6764

608 Personals

CLUBS, Schools, Churches or Fund Raising have a Psychic lecture and demonstration

628 Entertainment

WANTED: Band to play for bowling banquet for June 18 at Roma's of Livonia. 1970's music. 522-6764

628 Entertainment

WANTED: Band to play for bowling banquet for June 18 at Roma's of Livonia. 1970's music. 522-6764

628 Entertainment

WANTED: Band to play for bowling banquet for June 18 at Roma's of Livonia. 1970's music. 522-6764

628 Entertainment

WANTED: Band to play for bowling banquet for June 18 at Roma's of Livonia. 1970's music. 522-6764

628 Entertainment

WANTED: Band to play for bowling banquet for June 18 at Roma's of Livonia. 1970's music. 522-6764

628 Entertainment

WANTED: Band to play for bowling banquet for June 18 at Roma's of Livonia. 1970's music. 522-6764

628 Entertainment

WANTED: Band to play for bowling banquet for June 18 at Roma's of Livonia. 1970's music. 522-6764

628 Entertainment

WANTED: Band to play for bowling banquet for June 18 at Roma's of Livonia. 1970's music. 522-6764

602 Lost & Found

LOST: brown and black mixed dog. black and white dog. black and white dog. black and white dog.

628 Entertainment

WANTED: Band to play for bowling banquet for June 18 at Roma's of Livonia. 1970's music. 522-6764

628 Entertainment

WANTED: Band to play for bowling banquet for June 18 at Roma's of Livonia. 1970's music. 522-6764

628 Entertainment

WANTED: Band to play for bowling banquet for June 18 at Roma's of Livonia. 1970's music. 522-6764

628 Entertainment

WANTED: Band to play for bowling banquet for June 18 at Roma's of Livonia. 1970's music. 522-6764

628 Entertainment

WANTED: Band to play for bowling banquet for June 18 at Roma's of Livonia. 1970's music. 522-6764

628 Entertainment

WANTED: Band to play for bowling banquet for June 18 at Roma's of Livonia. 1970's music. 522-6764

628 Entertainment

WANTED: Band to play for bowling banquet for June 18 at Roma's of Livonia. 1970's music. 522-6764

628 Entertainment

WANTED: Band to play for bowling banquet for June 18 at Roma's of Livonia. 1970's music. 522-6764

602 Lost & Found

LOST: car keys Plymouth Rd. near Industrial Dr. and 2nd St. Daily. 837-2734

628 Entertainment

WANTED: Band to play for bowling banquet for June 18 at Roma's of Livonia. 1970's music. 522-6764

628 Entertainment

WANTED: Band to play for bowling banquet for June 18 at Roma's of Livonia. 1970's music. 522-6764

628 Entertainment

WANTED: Band to play for bowling banquet for June 18 at Roma's of Livonia. 1970's music. 522-6764

628 Entertainment

WANTED: Band to play for bowling banquet for June 18 at Roma's of Livonia. 1970's music. 522-6764

628 Entertainment

WANTED: Band to play for bowling banquet for June 18 at Roma's of Livonia. 1970's music. 522-6764

628 Entertainment

WANTED: Band to play for bowling banquet for June 18 at Roma's of Livonia. 1970's music. 522-6764

628 Entertainment

WANTED: Band to play for bowling banquet for June 18 at Roma's of Livonia. 1970's music. 522-6764

628 Entertainment

WANTED: Band to play for bowling banquet for June 18 at Roma's of Livonia. 1970's music. 522-6764

602 Lost & Found

LOST: smooth Fox Terrier, white dog with black head and black spot on side. Last seen 12 Mile and Drake Rd. area March 18. \$100 reward.

628 Entertainment

WANTED: Band to play for bowling banquet for June 18 at Roma's of Livonia. 1970's music. 522-6764

628 Entertainment

WANTED: Band to play for bowling banquet for June 18 at Roma's of Livonia. 1970's music. 522-6764

628 Entertainment

WANTED: Band to play for bowling banquet for June 18 at Roma's of Livonia. 1970's music. 522-6764

628 Entertainment

WANTED: Band to play for bowling banquet for June 18 at Roma's of Livonia. 1970's music. 522-6764

628 Entertainment

WANTED: Band to play for bowling banquet for June 18 at Roma's of Livonia. 1970's music. 522-6764

628 Entertainment

WANTED: Band to play for bowling banquet for June 18 at Roma's of Livonia. 1970's music. 522-6764

628 Entertainment

WANTED: Band to play for bowling banquet for June 18 at Roma's of Livonia. 1970's music. 522-6764

628 Entertainment

WANTED: Band to play for bowling banquet for June 18 at Roma's of Livonia. 1970's music. 522-6764

602 Lost & Found

LOST: smooth Fox Terrier, white dog with black head and black spot on side. Last seen 12 Mile and Drake Rd. area March 18. \$100 reward.

628 Entertainment

WANTED: Band to play for bowling banquet for June 18 at Roma's of Livonia. 1970's music. 522-6764

628 Entertainment

WANTED: Band to play for bowling banquet for June 18 at Roma's of Livonia. 1970's music. 522-6764

628 Entertainment

WANTED: Band to play for bowling banquet for June 18 at Roma's of Livonia. 1970's music. 522-6764

628 Entertainment

WANTED: Band to play for bowling banquet for June 18 at Roma's of Livonia. 1970's music. 522-6764

628 Entertainment

WANTED: Band to play for bowling banquet for June 18 at Roma's of Livonia. 1970's music. 522-6764

628 Entertainment

WANTED: Band to play for bowling banquet for June 18 at Roma's of Livonia. 1970's music. 522-6764

628 Entertainment

WANTED: Band to play for bowling banquet for June 18 at Roma's of Livonia. 1970's music. 522-6764

628 Entertainment

WANTED: Band to play for bowling banquet for June 18 at Roma's of Livonia. 1970's music. 522-6764

602 Lost & Found

LOST: smooth Fox Terrier, white dog with black head and black spot on side. Last seen 12 Mile and Drake Rd. area March 18. \$100 reward.

628 Entertainment

WANTED: Band to play for bowling banquet for June 18 at Roma's of Livonia. 1970's music. 522-6764

628 Entertainment

WANTED: Band to play for bowling banquet for June 18 at Roma's of Livonia. 1970's music. 522-6764

628 Entertainment

WANTED: Band to play for bowling banquet for June 18 at Roma's of Livonia. 1970's music. 522-6764

628 Entertainment

WANTED: Band to play for bowling banquet for June 18 at Roma's of Livonia. 1970's music. 522-6764

628 Entertainment

WANTED: Band to play for bowling banquet for June 18 at Roma's of Livonia. 1970's music. 522-6764

628 Entertainment

WANTED: Band to play for bowling banquet for June 18 at Roma's of Livonia. 1970's music. 522-6764

628 Entertainment

WANTED: Band to play for bowling banquet for June 18 at Roma's of Livonia. 1970's music. 522-6764

628 Entertainment

WANTED: Band to play for bowling banquet for June 18 at Roma's of Livonia. 1970's music. 522-6764

602 Lost & Found

LOST: smooth Fox Terrier, white dog with black head and black spot on side. Last seen 12 Mile and Drake Rd. area March 18. \$100 reward.

628 Entertainment

WANTED: Band to play for bowling banquet for June 18 at Roma's of Livonia. 1970's music. 522-6764

628 Entertainment

WANTED: Band to play for bowling banquet for June 18 at Roma's of Livonia. 1970's music. 522-6764

628 Entertainment

WANTED: Band to play for bowling banquet for June 18 at Roma's of Livonia. 1970's music. 522-6764

628 Entertainment

WANTED: Band to play for bowling banquet for June 18 at Roma's of Livonia. 1970's music. 522-6764

628 Entertainment

WANTED: Band to play for bowling banquet for June 18 at Roma's of Livonia. 1970's music. 522-6764

628 Entertainment

WANTED: Band to play for bowling banquet for June 18 at Roma's of Livonia. 1970's music. 522-6764

628 Entertainment

WANTED: Band to play for bowling banquet for June 18 at Roma's of Livonia. 1970's music. 522-6764

628 Entertainment

WANTED: Band to play for bowling banquet for June 18 at Roma's of Livonia. 1970's music. 522-6764

BOB SAKS OLDSMOBILE. GRAND RIVER AT DRAKE RD. 478-0500. FARMINGTON HILLS. We Use Genuine GM Parts Designed Especially For You. We Work on GM Cars Only. So It Makes Sense That We Know More About Them. We Frequently Attend School At The GM Training School.

BOB SAKS OLDSMOBILE. GRAND RIVER AT DRAKE RD. FARMINGTON HILLS. 478-0500. The house you're waiting for is waiting for you - in the pages of The Observer & Eccentric Classified Ads.

Pets 'N' Particulars. 2230 MOONEYAVE. Across from Farmington Place. OPEN MON.-SAT. 8-6. 474-6008. Master Charge - BankAmericard.

738 Household Pets
FREE PUPPIES Elkhound and Shepherd-Collie
SIAMSESE Kittens Elegant lillian point male Champion sire...

738 Household Pets
SIBERIAN Huskie, AKC pups make offer
BEAGLE, approx. 1 year old, good with children, needs good home...

800 Recreational Vehicles
FOR RENT PACE ARROW Motor-home, full equipment, sleeps 9...

812 Motorcycles, Go-Karts-Mini Bikes
TRIUMPH 1973, 750 Tiger Custom paint, seat, sissy bar, excellent condition...

814 Campers And Motorhomes
STEP Bumper for a 1976 Chevy pickup Excellent condition \$45...

821 Junk Cars Wanted
ANY AUTOS or trucks wanted, \$500 dollar paid, free towing, additional dollars for running condition...

STU EVANS SELLS FOR LESS 1977 MERCURY MONARCH 2 dr. 'Our protection size car' \$3702 Includes 200-IV '6' engine, 4 speed manual overdrive transmission...

740 Pet Services
SHEAR MAGIC PET SALON All Breed Dog Grooming
30083 Ann Arbor Rd. Livonia (Across from Stan's Market)

818 Insurance, Motor
AUTO INSURANCE Motorcycles Insurance Check our low rates...

818 Insurance, Motor
AUTO INSURANCE Motorcycles Insurance Check our low rates...

818 Insurance, Motor
AUTO INSURANCE Motorcycles Insurance Check our low rates...

818 Insurance, Motor
AUTO INSURANCE Motorcycles Insurance Check our low rates...

BOB SAKS OLDSMOBILE MEANS TOTAL VALUE AND DEPENDABILITY 125 USED CARS TO CHOOSE FROM 1973 PONTIAC FIREBIRD SPORTS COUPE \$3,295

SPRING SAVINGS SPREE! 40 CARS IN STOCK! NEW '77 SUNBIRD \$3,278 NEW '77 GRAND PRIX-J \$4,335

GET SET TO GO! SPECIAL OF THE WEEK: 1972 FORD COUNTRY SQUIRE WAGON 10 PASSENGER, automatic, power, air conditioning...

1975 BUICK ESTATE WAGON 9 passenger, air, power, stereo, rack \$3995

ARMSTRONG Buick-Opel 525-0900 30500 PLYMOUTH RD., LIVONIA

DETROIT'S LARGEST SELECTION OF FULL SIZE MERCURYS • LINCOLNS • MARK V'S '77 MARQUIS Immediate Delivery \$4,978

FISCHER BUICK TROY MOTOR MALL 643-7660 VW'S WANTED TOP DOLLAR PAID IMMEDIATE CASH

Junk Cars Wanted FREE PICK UP 739-3333 268-1090 HIGH\$ HIGH\$ WANTED

WE BUY USED CARS ALL MAKES & MODELS ALSO TRUCKS COMPLETE SELECTION OF CLEAN USED CARS

Bob Saks 478-0500 Farmington We Are Buying Now ALL MAKES & MODELS HIGH DOLLAR

Leo Calhoun Ford, Inc. 453-1100 Always Bigger Cash

EXAMPLE: BRAND NEW '77 GMC Widebody 1/2 Ton Pickup Radio, heavy duty springs Stock # 407

ART MORAN'S PONTIAC/GMC Excellent Savings on All GM's In Stock

ART MORAN'S PONTIAC/GMC 353-9000 FORD 1973, Ranger XLT 1/2 Ton Pickup V-8 power, air cond.

PAT MULLIGAN'S HOME OF THE BIG 'M' 20200 GRAND RIVER West of EVERGREEN OPEN TIL 9:00 MON, AND THURS. KE 2-4000

822 Trucks For Sale

DODGE D-100 ADVENTURE PICKUP. 1976. power steering and brakes. automatic, air, cruise control. AM-FM stereo. very low mileage. make offer. Town & Country Dodge, Grand River & Orchard Lake Rd., Farmington 474-6668

1976 BLAZER CHEYENNE 4-WHEEL DRIVE

Automatic transmission, power steering and brakes, factory air. AM-FM stereo tape. Black leather. \$6,295 LEO CALHOUN FORD 4101 Plymouth Rd 453-1327

FORD 1972 F-250 pickup, V8. New clutch. \$225. 427-8332 DODGE power wagon, 4 door, 4 speed. New paint, cloth, brakes, shocks. Ashton custom push bumper. 36,000 original miles. \$1,600 or best offer. After 3PM. 522-6143

DODGE 1973 Club Cab Pickup. Runs good, new brakes, radiator, carburetor, water pump and tires. \$1,400 FORD '76 1969 Custom cab, air conditioning package, weekend camping unit. Steel belted radial tires. \$600. Can be seen at 14272 Northville Rd. off Hines Dr. After 5 weekdays. 453-5863

1974 FORD F-100 302, V-8, 4 speed, AM-FM radio, rear step bumper, dark metallic blue. A-1. \$2,495 Jack Demmer Ford 37300 Michigan Ave. PA 1-2600

GMC 1971 1/2 ton pickup, power brakes, radio, 18 inch camper, trailer hook-up. \$1,200 FORD 1976 1975 power brakes automatic, 17,000 miles. 425-4763 GMC 1969 1/2 ton pickup, good condition, 60,000 miles. V-8. \$600 or best offer. 682-2784

GMC 1976 Sierra Classic, 1/2 ton pickup, 8 ft. bed, 350 V-8 automatic, air, power steering, power brakes. Ziebart \$4,600 673-8140 GMC 1974 1/2 ton pickup, High Sierra, loaded, like new. 8,000 miles. \$4,795 352-3821

BOB SAKS OLDS USED TRUCK SPECIALS 74 Chev Custom C-20 Pickup, V-8, auto, power steering, power brakes, air dual tanks, radio, very low mileage. \$3,495 74 Chev K-5 Blazer, V-8, auto, power steering and brakes, 4 wheel drive, air, K-5 pkg with power angle and tie snow blade. Winter ready. \$4,495 75 Ford F-100 Custom Pickup, V-8, auto, power steering, radio, heater, white walls. \$3,995 76 Chev Beauville Van, Low miles, air, a perfect family special. \$6,295 77 Dodge Sportsman Maxi Window Van, 1976, 4 speed, 300 V-8, auto, power steering, power brakes, air conditioning, cruise control, double heater, only 3,000 miles, showroom new. \$5,495 76 GMC Suburban Sierra Grande, 9 passenger, loaded, showroom new. \$6,295

BOB SAKS OLDS Grand River at Drake 478-0500 FORD 1978 F-250 4 wheel drive, 9,900 miles with Meters shown and contracts 9:50PM. 474-5154 GMC 1972 1/2 ton pickup with small camper, excellent condition, low mileage, reasonable. 427-8842 FORD F-150 4 wheel drive pickup truck, 1976, loaded \$4,700 or best offer. Call 463-8377 or 453-3533 CHEVY 1971, V-8 dump 1 ton, A-1 condition, auto, power steering, mixer on wheels, scaffold, 2 wheel bars, misc tools. Make offer. 427-2248 CHEVY SUBURBAN 1968, 6 cylinder, stick shift, new clutch \$650 476-1583 DODGE 1973 1/2 Ton Pickup 6 cylinder, automatic, power steering and brakes, radio, good old truck. \$1,790. Colony Chrysler Plymouth 11 Ann Arbor Rd. 453-2252

823 Vans

CHEVY 1976 Van V-8, automatic, power steering and brakes, air conditioning, AM-FM stereo and tape, fully customized, low miles, priced to sell. SOUTHFIELD DODGE 354-6600 DODGE VANS 1974's 1976's, 5000 to choose from. Come see and drive. Town & Country Dodge, Grand River & Orchard Lake Rd., Farmington 474-6668

BEAUVILLE 1976 5 passenger power steering brakes, 9 months old no van. 525-5714 FORD VAN 1972 \$1100 Nice condition. 449-2214 FORD WINDOW VAN 1969 automatic, good condition. \$700 464-3542 FORD 1976 Van, completely carpeted. Extras \$4000. 522-9921 CHEVY 1976 3/4 ton G-20 panel van, loaded under warranty. Mr. Lund 644-6614. 851-7200

CHATEAU 1975, 8 passenger, cap tan, new way glass, 351 automatic, power steering, brakes, top package, auxiliary tank, 2 tone tan, rust proofed. \$4,995 524-8777 CHEVY 1975 1/2 ton, power steering, brakes, air conditioned, 3 way refrigerator, stove, carpeted, car air, tinted windows, low mileage, extra. \$5,500. 464-4212 FORD 1974, Econoline, custom steering, low mileage. V-8. 453-5850 CHEVY 1974, Econoline, custom steering, low mileage. V-8. 453-5850

DODGE 1971 Van, 8000 ton automatic, power steering. Carpeted interior. \$1,475 481-9095 FORD CHATEAU window van, 1974, E200 Custom 2 tone, power steering, radial tires and snows. \$3,300 427-8399 DODGE 1974 Tradesman 100, power steering, power brakes, 318 cubic inch engine, 19,000 miles, interior. \$3,395 588-7106 FORD Van E-250 cargo, heavy duty, AM-FM stereo, tape, power brakes, 300 V-8 automatic, good condition. \$1,500 851-0700

824 Sports And Imported Cars

VOLVO 144GL 1974, excellent condition, power steering, power brakes, AM-FM cassette stereo, automatic, many extras. A great buy. 478-2760

DATSUN 240Z 1972, automatic, air conditioning, AM-FM radio, 33,196 O'Hara Datsun, 35655 Plymouth Rd. 425-3311 DATSUN 1974 B-210 4 speed, AM-FM radio, \$1,895 O'Hara Datsun, 35655 Plymouth Rd. 425-3311 DATSUN 280Z 1975, 4 speed, AM-FM radio, sharp \$5,385 O'Hara Datsun, 35655 Plymouth Rd. 425-3311

824 Sports And Imported Cars

VOLVO 144GL 1974, excellent condition, power steering, power brakes, AM-FM cassette stereo, automatic, many extras. A great buy. 478-2760

DATSUN 240Z 1972, automatic, air conditioning, AM-FM radio, 33,196 O'Hara Datsun, 35655 Plymouth Rd. 425-3311 DATSUN 1974 B-210 4 speed, AM-FM radio, \$1,895 O'Hara Datsun, 35655 Plymouth Rd. 425-3311 DATSUN 280Z 1975, 4 speed, AM-FM radio, sharp \$5,385 O'Hara Datsun, 35655 Plymouth Rd. 425-3311

824 Sports And Imported Cars

JAGUAR XJ-12-L, 1974, 38,000 miles, excellent condition, must sell. Andrew 846-5141 TOYOTA 1976, Corolla lift-back 1973 Mazda RX2. Both excellent condition. Call for details. 455-5090

PEUGEOT 1975, 504 Sedan, Diesel, mint condition. Weekdays, call 979-5400

CORVETTE Coupe 1971, air, bonnet, yellow, 4 speed, AM-FM, air, 22,000 miles, mint condition, original owner. \$6,000. 353-1336

DATSUN 1973, 1200 coupe, automatic, 1970 or best offer. 474-3905 CAPRI 1974, V6, 4 speed, 28,000 miles, good shape. \$2,100 522-2671 MERCEDES Benz 1976, 300 D, fully maintained, excellent condition. 852-2323

1973 TOYOTA CELICA 4 cylinder, 4 speed, radio, yellow with vinyl top. Sharp! \$2,495 Jack Demmer Ford 37300 Michigan Ave. PA 1-2600

PIAT 1973, this weeks special at \$995. Avts Ford. Telephone at 12 Mile. 354-3100 MGB ROADSTER 1973, only 18,000 miles. Sharp. Avts Ford. Telephone at 12 Mile. 354-3100 DATSUN 280-Z 1975, 4 speed, air, new tires, 34,000 miles. Mint condition. 273-2823 or 453-1755

FIAT 1975 Spyder, 5 speed, 24,000 miles. All power, 60-40 seat, cruise, tilt, AM-FM 8 track stereo, rear defroster, undercoated, showroom condition. \$4,975. 453-1094 ELECTRA 1975, 4 door, loaded with extra equipment. Wife's car. \$4,300. 427-7574

REGAL 1973, Air, automatic, power brakes, steering, stereo, 44,000 miles Radials, \$2,100. After 5PM. 427-4431

LESABRE CUSTOM - 1976, 4 door, air, low mileage. Must sell. After 5 PM. 525-7943

CENTURY 1974, Luster Hardtop coupe, loaded, very good shape in excellent condition. 68,000 miles. Asking \$2,300. Come look it over and make offer. Call 255-1894

1973 BUICK 225 ELECTRA Dark blue, white vinyl roof fully equipped. Was \$2,695. Now \$2,245. REDFORD CHRYSLER-PLYMOUTH 2226 Grand River KE 1-2400

BUICK 1973, Regal, 4 door, air, 410 wheel, power steering, radio, AM-FM radio, 19,000 miles. Asking \$2,300. 459-1628

BUICK Limited 1973, All options, undercoated, original owner. Perfect condition. \$3,900. Days. 455-4343

BUICK 1970 Limited, 4 door, power brakes, power steering, air, 3-way seat, four doors, good condition. \$550. 465-1836

ELECTRA Limited 1971, 4 door, power air, cruise, level ride, \$1,700. 357-2324

ELECTRA 1970, 225 2 door, Power & Air, New Tires. Very good condition. \$995. 981-0033

ELECTRA 1973, 4 door, power steering, power brakes, power windows, air, shocks, new radials, very good condition. \$2,132

REGAL 1976 Landau custom coupe, mint condition, AM-FM stereo, AM-FM radio, power windows, top, mag's, etc. \$4,800. After 5 PM. 522-7888

BUICK 1974, Electra, fully loaded, excellent condition. 464-6320

REGAL 1973, air, loaded, excellent condition. \$2,650. 844-2523

PACE CAR 1973, Custom Custom with special striping, 2 door, AM-FM radio, AM-FM stereo, all power, air, cruise, AM-FM 8 track, loaded. Warranty \$590. 464-2767

CENTURY Custom, 1974, air, cruise, radials, light blue, 14,000 miles. Very good condition. 474-6563

RIVIERA 1969 AM-FM stereo, steel belted tires, original owner. 349-5281 \$595

BUICK Estate Wagon 1976, air, all power, rack, wood, loaded, cruise, etc. 18,000 miles, mint condition. \$4,400. 626-4038

LE SABRE 1975, custom, excellent condition, 4 door, air, vinyl top, stereo, 22,000 miles. \$2,795. 404-4111

LESABRE, custom, 1975, 4 door, 350 power steering, brakes, AM-FM stereo, extras \$3,395. 464-2767

SKYHAWK 1976, sports package, \$3,500. 459-1107

ELECTRA 1969, good transportation, reasonable. 427-8842

CENTURY 1975, custom, V-8, air, power steering, radio, white walls, excellent condition. \$3,350. 851-0700

854 American Motors

GREMLIN X 1974, automatic, leather, new tires and brakes, clean. \$4,700. After 6PM. 389-9861

AMBASSADOR 1972, Brougham, air, stereo, power steering, brakes. Super condition in and out. 355-3234

JAVELIN 1972, bucket seats, power brakes, power steering, automatic transmission. \$500. 425-3780

HORNET 1976, 6 cylinder, automatic, power steering, very clean. \$400. 261-4119

GREMLIN 1973, X, power steering, power brakes, AM-FM radio. \$1,000 or best offer. 455-3217

GREMLIN - 1976, 6 cylinder, 3 speed, radials, AM-FM 8 track. \$2,550. After 6 PM. 453-7187

GREMLIN 1973, 3 speed, good condition, snow tires. \$1,095. Call after 6 PM. 455-9563

856 Buick

BUICK 1973, 4 door, what a beauty. Only 35,000 miles. Only \$1,895. North Bros. 421-1376

SKYLARK 1972, a pretty beauty with nice cloth interior. Automatic with air. No rust. \$1,695. Call Mon-Sat after 5PM. 474-8126

SEVILAR 1976, 4 door, 2800, air, \$3,900. Extras. 379-7219

SKYLARK 1976, 2 door, hardtop, mint condition, throughout, 20,000 easy miles. Full warranty. \$2,850. 455-3375

SKYLARK 1976, 2 door, hardtop, mint condition, throughout, 20,000 easy miles. Full warranty. \$2,850. 455-3375

SEVILAR 1976, 4 door, 2800, air, \$3,900. Extras. 379-7219

REGAL 1976, landau, V-8, special AM-FM stereo, 60-40 seat, cruise, tilt, AM-FM 8 track stereo, rear defroster, undercoated, showroom condition. \$4,975. 453-1094

ELECTRA 1975, 4 door, loaded with extra equipment. Wife's car. \$4,300. 427-7574

REGAL 1973, Air, automatic, power brakes, steering, stereo, 44,000 miles Radials, \$2,100. After 5PM. 427-4431

LESABRE CUSTOM - 1976, 4 door, air, low mileage. Must sell. After 5 PM. 525-7943

CENTURY 1974, Luster Hardtop coupe, loaded, very good shape in excellent condition. 68,000 miles. Asking \$2,300. Come look it over and make offer. Call 255-1894

1973 BUICK 225 ELECTRA Dark blue, white vinyl roof fully equipped. Was \$2,695. Now \$2,245.

REDFORD CHRYSLER-PLYMOUTH 2226 Grand River KE 1-2400

BUICK 1973, Regal, 4 door, air, 410 wheel, power steering, radio, AM-FM radio, 19,000 miles. Asking \$2,300. 459-1628

BUICK Limited 1973, All options, undercoated, original owner. Perfect condition. \$3,900. Days. 455-4343

BUICK 1970 Limited, 4 door, power brakes, power steering, air, 3-way seat, four doors, good condition. \$550. 465-1836

ELECTRA Limited 1971, 4 door, power air, cruise, level ride, \$1,700. 357-2324

ELECTRA 1970, 225 2 door, Power & Air, New Tires. Very good condition. \$995. 981-0033

ELECTRA 1973, 4 door, power steering, power brakes, power windows, air, shocks, new radials, very good condition. \$2,132

REGAL 1976 Landau custom coupe, mint condition, AM-FM stereo, AM-FM radio, power windows, top, mag's, etc. \$4,800. After 5 PM. 522-7888

BUICK 1974, Electra, fully loaded, excellent condition. 464-6320

REGAL 1973, air, loaded, excellent condition. \$2,650. 844-2523

PACE CAR 1973, Custom Custom with special striping, 2 door, AM-FM radio, AM-FM stereo, all power, air, cruise, AM-FM 8 track, loaded. Warranty \$590. 464-2767

CENTURY Custom, 1974, air, cruise, radials, light blue, 14,000 miles. Very good condition. 474-6563

RIVIERA 1969 AM-FM stereo, steel belted tires, original owner. 349-5281 \$595

BUICK Estate Wagon 1976, air, all power, rack, wood, loaded, cruise, etc. 18,000 miles, mint condition. \$4,400. 626-4038

LE SABRE 1975, custom, excellent condition, 4 door, air, vinyl top, stereo, 22,000 miles. \$2,795. 404-4111

LESABRE, custom, 1975, 4 door, 350 power steering, brakes, AM-FM stereo, extras \$3,395. 464-2767

SKYHAWK 1976, sports package, \$3,500. 459-1107

ELECTRA 1969, good transportation, reasonable. 427-8842

CENTURY 1975, custom, V-8, air, power steering, radio, white walls, excellent condition. \$3,350. 851-0700

856 Buick

ELDORADO 1974, Cabriolet, leather, new tires and brakes, clean. \$4,700. After 6PM. 389-9861

DE VILLE, d Elegance 1975, loaded, excellent condition. Call after 4PM. 455-9028

DE VILLE Convertible 1968, loaded, superb condition. Call after 4PM. 455-9028

ELDORADO 1976, convertible, stereo, tape, cruise, tilt wheel, 2nd bar, tilt defroster system, window defogger, outside thermometer, mirror, space saver tire, beige & buckskin, hard top. 474-0216

COUPE DeVILLE 1974, many extras, new tires, sharp. \$4,995. 967-3464

DEVILLE Convertible 1968, leather, leather interior. Owner. 553-2468

DEVILLE 1972, 4 door, full power, 35,000 miles. \$2,350. After 3PM. 645-5180

SEBAM 1968, loaded, good tires. \$450. 225-5000

ELDORADO 1975, loaded, white on white, red leather, 36,000 miles. 349-7124

ELDORADO 1974, loaded, full power, must sell. \$4,450. or best offer. After 5 PM. 626-3753

COUPE DeVILLE 1974, 26,000 miles. Many extras. \$4,795. Invt. 464-3223 or evenings. 455-3375

SEBAM DeVILLE 1973, excellent condition. Full power. \$3,500. Call before 5. 453-8448

860 Chevrolet

IMPALA 1974, 4 door, power brakes, steering, air, white side walls, 30,000 miles. \$2,900. 427-2128

CAPRICE 1974, Classic 4 door, Full defroster, undercoated, showroom condition. \$4,975. 453-1094

CHEVELLE Malibu 1974, Classic, air, stereo, power steering, brakes, rustproofed. 49,000 miles. Mint condition. \$5,000 or best offer. 464-3268

1975 EL CAMINO CLASSIC V-8, automatic, power steering and brakes, AM-FM radio, fiberglass cap, radial tires, 2 tone paint, 15,000 miles. Like new. \$2,495

CAMARO 1976, air conditioning, stereo, T top convertible, 7,000 miles. Like new. North Bros. 421-1376

SHARP, Black 1976 NOVA, Air, full power, AM-FM radio. Loaded. Call after 6PM. 478-2792

CAPRICE 1974, Classic 4 door, Full power, 16,000 miles. Like new. Florida owner. \$3,475. 527-5899

MONTE CARLO 1971, AM-FM stereo, Power locks, seats, trunk. Air, extras. \$1,400. 455-2425

NOVA 1970, good condition inside & out, 2 door, automatic, small V-8. Florida owner. \$2,475. 527-5899

MONTE CARLO 1973, many extras, excellent condition. \$2,300 or best offer. Must sell. Call Andy. 349-3000

CAPRICE 1973, Estate Wagon, 3 seats, 49,000 miles, one owner. AM-FM radio, power steering and brakes, power windows, radials, beautiful condition. \$2,295. Art Moran, Pontiac-GM, Telegraph North of 12 Mile. 453-9000

MALIBU 1974, power steering, power brakes, AM-FM stereo, rear defroster, radial tires. \$2,800. 256-7228

CAPRICE 1974, wagon, 9 passenger, power locks, stereo, power steering, good condition, make offer. 425-1027

IMPALA 1976, station wagon, 9 passenger, air, cruise control, tilt wheel, power door locks, air, shocks, luggage rack, steel wheel, tires 13,000 miles. private. 474-2816

CHEVROLET Camaro, 1976, automatic transmission, power steering, radio and heater, silver blue, only 6,000 miles. \$3,800. 453-1901

MONZA Town Coupe 1976, automatic, air, stereo, vinyl roof, Ziebarted Sharp. \$3,150. 534-4343 or 453-0886

VEGA 1973, automatic, low mileage. \$1,700. 351-6680

SOUTHFIELD DODGE 354-6600

1973 VEGA WAGON Automatic radio \$1,095 LEO CALHOUN FORD 4101 Plymouth Rd 453-1327

VEGA 1974, Hatchback, AM-FM stereo, tape, automatic, one owner car, 30,000 miles. Roger Penske Chev. 355-1000

860 Chevrolet

MONTE CARLO 1974, Automatic, power, air, buckets and console. AM-FM tilt, locks. \$3,500-1000 Roger Penske Chev. 355-1000

CAMAROS 1970-1976, 8 to choose with air. 685-1605

IMPALA 1971, power steering, power brakes, vinyl top, good condition. \$800. 352-4296

CAMARO 1969, Rally Sport, new alignment, tires, tune-up, little rust. \$550 or best offer. 281-2218

MONTE CARLO 1972, excellent condition, V-8, air, AM-FM, power steering, brakes, snows, new tires. Best offer. Weekdays after 6PM. 425-8451

MALIBU Classic 1976, 2 door, power steering, power brakes, automatic, air, whitewall radials, tinted glass, am radio, rear speaker. Fire-thorn Red, saddle vinyl interior. Low mileage. \$4,995. 427-3778

CHEVROLET 1968 Impala, runs good. Call after 5 P.M. 626-3230

CHEVROLET CAPRICE 1976, 4 door, silver with red cloth interior, vinyl roof, full power, air conditioning, auto radials, 5,000 miles. factory warranty. \$4,800. 476-4281

CAMARO 1974, V-8, stock, AM-FM 8 track stereo, new tires, low mileage. \$2,475. 981-0056. 561-3721

CAPRICE 1974, Light green with vinyl top, AM-FM stereo, power steering, power brakes, excellent condition. \$4,995. 427-3778

MONZA 1976, air, AM-FM, rust proofed, rear defog, 4 speed. \$4,000. 437-3720

CAMARO 1974, Z28, all factory options, many custom parts, excellent condition. \$5,100. 453-2227

1976 CAMARO Automatic, power steering and brakes, power windows, tilt wheel stereo, tape, factory air, rally wheels, 11,000 miles. \$4,195

Hines Park LINCOLN-MERCURY 453-2424 425-2444

MONTE CARLO 1974, power steering, power brakes, stereo, air, Landau. \$3,000. 439-0103

864 Dodge
DART 1972, 6 cylinder, automatic, vinyl top, steering, air conditioning, vinyl top, 1977. After 6 PM 397-1326

866 Ford
GRAN TORINO 1972, power brakes, steering, AM-FM stereo, air, vinyl top, 1977. 322-3634

74 Mustang Fastback
V-6 automatic, power steering, factory air, AM-FM stereo. \$2,495

LEO CALHOUN FORD
4101 Plymouth Rd. 453-1327

1975 PINTO
SQUIRE WAGON
4 speed, radial white wall tires. \$2,495

LEO CALHOUN FORD
4101 Plymouth Rd. 453-1327

1974 ELITE
Automatic, power steering and brakes, cruise control, split seats. \$3,295

LEO CALHOUN FORD
4101 Plymouth Rd. 453-1327

1975 FORD
LTD WAGON
10 passenger, air, automatic, power steering and brakes, deluxe rack, 19,000 actual miles. \$3,895

LEO CALHOUN FORD
4101 Plymouth Rd. 453-1327

1973 PINTO
2 door, automatic, radio, hardtop, white side walls, plenty of m.p.g. \$745

1974 MUSTANG
2 door, radio, hardtop, heater, white side wall tires. Plenty of m.p.g. \$1,945

866 Ford
GRAN TORINO 1976, wagon, air, stereo, all option goods, low mileage, excellent condition, \$4,700. Call after 6 PM. 522-1022

1972 Gran Torino
Brougham
2 door, hardtop, automatic, air, stereo, white side walls, April special, \$995

PAT MILLIKEN
FORD
9600 Telegraph
Between Plymouth & W. Chicago
255-5840

1975 PINTO
SQUIRE WAGON
4 speed, radial white wall tires. \$2,495

LEO CALHOUN FORD
4101 Plymouth Rd. 453-1327

1974 ELITE
Automatic, power steering and brakes, cruise control, split seats. \$3,295

LEO CALHOUN FORD
4101 Plymouth Rd. 453-1327

1975 FORD
LTD WAGON
10 passenger, air, automatic, power steering and brakes, deluxe rack, 19,000 actual miles. \$3,895

LEO CALHOUN FORD
4101 Plymouth Rd. 453-1327

1973 PINTO
2 door, automatic, radio, hardtop, white side walls, plenty of m.p.g. \$745

1974 MUSTANG
2 door, radio, hardtop, heater, white side wall tires. Plenty of m.p.g. \$1,945

866 Ford
GRAN TORINO 1976, wagon, air, stereo, all option goods, low mileage, excellent condition, \$4,700. Call after 6 PM. 522-1022

1972 Gran Torino
Brougham
2 door, hardtop, automatic, air, stereo, white side walls, April special, \$995

PAT MILLIKEN
FORD
9600 Telegraph
Between Plymouth & W. Chicago
255-5840

1975 PINTO
SQUIRE WAGON
4 speed, radial white wall tires. \$2,495

LEO CALHOUN FORD
4101 Plymouth Rd. 453-1327

1974 ELITE
Automatic, power steering and brakes, cruise control, split seats. \$3,295

LEO CALHOUN FORD
4101 Plymouth Rd. 453-1327

1975 FORD
LTD WAGON
10 passenger, air, automatic, power steering and brakes, deluxe rack, 19,000 actual miles. \$3,895

LEO CALHOUN FORD
4101 Plymouth Rd. 453-1327

1973 PINTO
2 door, automatic, radio, hardtop, white side walls, plenty of m.p.g. \$745

1974 MUSTANG
2 door, radio, hardtop, heater, white side wall tires. Plenty of m.p.g. \$1,945

874 Mercury
MERCURY 1972, Montego Village, 9 passenger wagon, runs like a dream and equipped for a KING including air \$1,250. One year written warranty. Call Chrysler Plymouth, 111 Ann Arbor Rd. 453-2255

MONARCH 1977, 2,000 miles, 2 door, power steering, power brakes, air, V-6 automatic, AM-FM stereo with tape player. Call 522-2500

MONTEREY 1972, 2 door, automatic, power steering, air, AM-FM stereo, tape. \$3,300. After 5 PM. 522-0109

COUGAR XR7 1977, 2 door, automatic, power steering, air, AM-FM stereo, tape. \$3,300. After 5 PM. 522-0109

COUGAR XR7 1977, 2 door, automatic, power steering, air, AM-FM stereo, tape. \$3,300. After 5 PM. 522-0109

COUGAR XR7 1977, 2 door, automatic, power steering, air, AM-FM stereo, tape. \$3,300. After 5 PM. 522-0109

COUGAR XR7 1977, 2 door, automatic, power steering, air, AM-FM stereo, tape. \$3,300. After 5 PM. 522-0109

COUGAR XR7 1977, 2 door, automatic, power steering, air, AM-FM stereo, tape. \$3,300. After 5 PM. 522-0109

COUGAR XR7 1977, 2 door, automatic, power steering, air, AM-FM stereo, tape. \$3,300. After 5 PM. 522-0109

COUGAR XR7 1977, 2 door, automatic, power steering, air, AM-FM stereo, tape. \$3,300. After 5 PM. 522-0109

COUGAR XR7 1977, 2 door, automatic, power steering, air, AM-FM stereo, tape. \$3,300. After 5 PM. 522-0109

876 Oldsmobile
BEFORE YOU BUY
SEE
SUBURBAN
OLDS
For Metropolitan
Detroit's Largest
Inventory
of 1976 and 1977
Oldsmobiles
Troy Motor Mail
Birmingham Bloomfield Hills
643-0070

VISTA Cruiser 1976, 9 passenger, power steering, stereo, radio, 1976. Excellent condition. \$750. Call 453-2255

DELTA 88 1976, Royale coupe, saddle metallic, lots of extras, 11,200 miles. Call 453-2255

CUTLASS SUPREME 1976, full loaded, 10,000 miles. \$2,200. 852-7625

CUTLASS 1974 Supreme, 4 door, AM-FM radio, power steering, door locks, air conditioning, defogger. 422-7285

CUTLASS Supreme 1976, 7700 miles, landau roof, air, power steering, power brakes, side wall, radio, AM-FM, 1976. Excellent condition. \$2,600. Call 453-2255

CUTLASS 1974, 4 door, AM-FM radio, power steering, door locks, air conditioning, defogger. 422-7285

CUTLASS 1974, 4 door, AM-FM radio, power steering, door locks, air conditioning, defogger. 422-7285

CUTLASS 1974, 4 door, AM-FM radio, power steering, door locks, air conditioning, defogger. 422-7285

CUTLASS 1974, 4 door, AM-FM radio, power steering, door locks, air conditioning, defogger. 422-7285

CUTLASS 1974, 4 door, AM-FM radio, power steering, door locks, air conditioning, defogger. 422-7285

880 Pontiac
FIREBIRD 1977, air conditioning, stereo, 1-top convertible, 6,000 miles, silver bullet. Must see! North Bros. 421-1376

TRANS AM 1976 4 speed, white with saddle interior. Full power, fully loaded. Excellent condition. 11,800 miles. AM-FM stereo. 453-2255

FIREBIRD HO 1967, beautiful condition, \$800. Call before 2 PM and weekends. 528-7259

BONNEVILLE 1969, good condition, make offer. 453-3733

CATALINA 1971, Power steering, brakes, air, snows & wheels, fuel, wife's car. \$1,000. Clean. 476-5147

CATALINA 1968, Power, radials, tinted glass, 48,000 original miles. Best offer over \$400. 332-2664

CATALINA 1974, 455 engine, loaded, perfect condition. 459-0545

CATALINA 1976 4 door, 400 V-8, air, excellent condition. \$3,150. 538-4859

TRANS AM 1976 Silver burgundy, automatic, air, stereo, tape, door locks. 453-2255

1972 PONTIAC LeMANS
2 door hardtop, automatic, power, air conditioning, vinyl top, 43,000 miles. Sharp. \$2,150.

ASTRE SAFARI 1976, power steering, automatic, A.M. 5 am, 1976. 459-9323

880 Pontiac
VENTURA Hatchback, 1973, 350 V-8, air, power steering, brakes, AM-FM cassette, excellent. Evenings, weekends. 464-8382

THUNDERBIRD 1974, loaded, very good condition, \$3,500. T-BIRD Classic re-built engine, needs restoration. \$650 or best offer. 428-2855

T-BIRD 1974, unemployed, must sell before April 22, most options, must condition, best offer. 428-2855

T-BIRD 1974, gold & black air conditioning, power windows, rear defogger, excellent condition, best offer over \$3900. 476-7845

T-BIRD 1975, full power, white on white, \$2,200. Call 729-4690. 729-3549

1974 THUNDERBIRD
Full power, air, stereo, cruise control. \$3,695

LEMANS 1973 Sport Coupe, power steering, automatic, rear defogger, steel belted tires. \$1,500. Call before 2 PM. 326-2368

FIREBIRD 1968, automatic, con- vertible, automatic, rear defogger, 8 track, best offer. 626-7245

FIREBIRD 1975, AM-FM stereo, air, tilt wheel, 30,000 miles, power steering, brakes, \$258. 425-4541

SAFARI 1976 9 passenger wagon, low miles \$4,200. 642-8093

TRANS AM 1976, automatic, engine work, all or parts. Automatic, power steering, power brakes, \$258. 425-4541

882 Thunderbird
THUNDERBIRD 1974, loaded, very good condition, \$3,500. T-BIRD Classic re-built engine, needs restoration. \$650 or best offer. 428-2855

T-BIRD 1974, unemployed, must sell before April 22, most options, must condition, best offer. 428-2855

T-BIRD 1974, gold & black air conditioning, power windows, rear defogger, excellent condition, best offer over \$3900. 476-7845

T-BIRD 1975, full power, white on white, \$2,200. Call 729-4690. 729-3549

1974 THUNDERBIRD
Full power, air, stereo, cruise control. \$3,695

LEMANS 1973 Sport Coupe, power steering, automatic, rear defogger, steel belted tires. \$1,500. Call before 2 PM. 326-2368

FIREBIRD 1968, automatic, con- vertible, automatic, rear defogger, 8 track, best offer. 626-7245

FIREBIRD 1975, AM-FM stereo, air, tilt wheel, 30,000 miles, power steering, brakes, \$258. 425-4541

SAFARI 1976 9 passenger wagon, low miles \$4,200. 642-8093

TRANS AM 1976, automatic, engine work, all or parts. Automatic, power steering, power brakes, \$258. 425-4541

GRAND PRIX 1976, S.J. Metallic Red, stereo tape, sunroof, climate control, padded roof. \$45,126. 811-2805

884 Volkswagen
VW 1966, Station wagon, low mileage, good mechanical and interior. Some rust. \$200. 421-6896

1973 VW BUG
AM-FM stereo, 4 speed, sharp. \$1,395

1975 VW SCIROCCO
Silver metallic, paint 12,000 miles. AM-FM stereo, alloy wheels. In stock. 3 others in stock. 478-2193

TOM SULLIVAN
VOLKSWAGEN
OPEN SATURDAY
25400 W. 8 Mile. 333-9900

CORVETTE 1975, Silver, 4 speed. T-top loaded, air, AM-FM stereo, excellent. \$3,050 or offer. 533-7509 or 538-5844

FIAT 1975, 1200 spider, orange convertible, stereo, 23,000 miles, good condition. 349-9000

VW's wanted
TOP DOLLAR PAID
IMMEDIATE CASH

TOM SULLIVAN
VOLKSWAGEN
OPEN SATURDAY
25400 W. 8 Mile. 333-9900

VALVO 1960, ES, 1973, excellent condition, 10,000 miles, 2028, overdrive, fuel injected, 4 speed and overhead, dark green, call leather upholstery, original only. \$600 firm. Written inquiries only. John Berkey, 74 West Long Lake Road, Bloomfield Hills, Mich. 48301. 349-9000

VW BUS 1976, air, good tires, 43,000 miles, automatic, regularly maintained, extras after 6 PM. 628-8211

Mr. Colony Sez: CATCH THESE DEALS!
YOU'LL FIND IT HERE!
1977 ARROW \$3,099
1977 FURY \$3,394
1977 VOLARE \$3,165
1977 CONDOBA \$4,586

CALHOUN COUNTRY TRUCK ROUND-UP
SUPER SAVINGS
on all TRUCKS and VANS in stock
38 TO CHOOSE FROM
FOR EXAMPLE
NEW 1976 SUPER CAB RANGER XLT
with AIR CONDITIONING, power steering, am radio, light group, tinted glass, step bumper, gauges, dual tanks.
#5550 Model \$4939
OPEN MONDAY & THURSDAY TIL 9 P.M.

LEO CALHOUN
453-1100
41001 PLYMOUTH RD.
"Where Customers Bring Their Friends"

WE'LL GIVE YOU THE RIGHT PRICE!
MID SIZE LUXURY \$7253 PER MO. \$4,177
AFFORDABLE \$77 CENTURY Automatic, power steering, AM/FM, Landau top, V-6 \$11093 PER MO.
77 SKYLARK-S 2 DOOR \$65.27 PER MO. \$3,678
77 ELECTRA Power windows, air, AM/FM & more! \$5,977

HINES PARK'S SPRING DEMO SALE
NOW THRU THE END OF THE MONTH GREAT SAVINGS ON '77 COUGAR - '77 MERCURY MONARCH & '76 CAPRI DEMOS
SEE US NOW FOR SPECIAL DEALS ON '77 LINCOLN DEMOS
George Kolb's Hines Park LINCOLN-MERCURY
40601 Ann Arbor Rd., Plymouth (at the I-275 interchange) 453-2424
OPEN MON. & THURS. TIL 9 P.M.

GREENFIELD/JEEP THE AMERICAN MOTORS KING SAYS: "I don't care where you've been or what you've been offered on any car - don't sign any order with any dealer until you see our deal!"
13600 GREENFIELD AT SCHOOLCRAFT 837-8200
BUY DIRECT AND SAVE
GO RIVER SOUTHFIELD SCHOOLCRAFT GREENFIELD 13600 GREENFIELD

Why Pay More! Why Pay More! Why Pay More! Why Pay More! Why Pay More! Why Pay More! Why Pay More!



thrifty acres

BOYS' KNIT SHIRTS

A special purchase! These short sleeve knit shirts are made of 50% polyester/50% cotton in a range of styles, colors and patterns. Sizes 14-20.

AFTER AD \$4.97

\$3.77

MEN'S ORLON® ACRYLIC DRESS SOCKS

High quality orlon® blends in solid colors. Size 10-13.

SAVE 20¢ PR.

OUR REG. 88¢

68¢ pr.

MEN'S SWEATSHIRTS

Long sleeve 50% cotton/50% Acrilan® acrylic. Choose from many colors. Sizes S-M-L-XL.

SAVE \$1.00

OUR REG. \$4.47

\$3.47

MEN'S TANK TOPS

All with solid body and contrast trim. Sizes S-M-L-XL.

ONLY

\$1.58

WHITE SALE

m in the domestics department



SEERSUCKER

44"-45" seersucker in beautiful spring patterns and designs. Machine washable. Full bolts.

OUR REG. \$1.59 YD.

\$1.19 YD.

DOTTED SWISS

Great for spring sewing! 44"-45" wide. Popular colors in polyester and cotton. Full bolts. Machine washable.

99¢ YD.

WHITE FABRICS

Special purchase of an all white group of assorted blend fabrics. 36"-45" wide. Machine washable. Slight irregulars. 1 to 10 yard lengths.

2 YDS. \$1

COLORAMA KNITS

Special purchase of 45"-60" assorted synthetic knits, fancy and solid. Machine washable. 1 to 8 yard lengths.

69¢ YD.

Why Pay More!



MEN'S "FRUIT OF THE LOOM" UNDERWEAR

Quality underwear styled for comfort and good fit. 100% cotton for absorbency. Crew neck T-shirts, live elastic waist band briefs.

T-SHIRTS SIZES S-M-L-XL PKG. OF 3 REG. \$3.69

BRIEFS SIZES 32-42 PKG. OF 3 REG. \$3.39

Men's Underwear MEANS SAVINGS!

Your Choice **\$2.99** PKG. OF 3



BOYS' "FRUIT OF THE LOOM" UNDERWEAR

100% absorbent cotton.

T-SHIRTS SIZES 8-16 REG. \$2.69

BRIEFS SIZES 8-16 REG. \$2.49

BOYS' FRUIT OF THE LOOM BRIEFS
SIZES 8-16 PKG. OF 3
REG. \$2.49 **\$2.19**
WITH COUPON
GOOD 4/18 THRU 4/23/77
Coupon limited to one per family. DEPT. 580

BOYS' FRUIT OF THE LOOM T-SHIRTS
SIZES 8-16 PKG. OF 3
REG. \$2.69 **\$2.19**
WITH COUPON
GOOD 4/18 THRU 4/23/77
Coupon limited to one per family. DEPT. 581

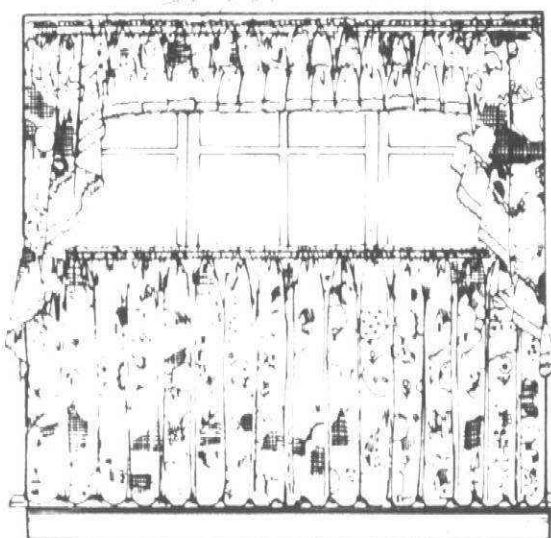

NOVELTY TAILORED TIER CURTAINS

"Hills and Dale" scenic print on Polyester/Avril. Machine washable.

60" x 36" REG. \$4.07

VALANCE REG. \$2.77

RUFFLED TRIMMED SWAG REG. \$5.27

\$3.27 PR. **\$2.27** PR. **\$4.27** PR.



DETROIT TIGER BATH TOWEL

100% cotton. Conventional looped terry.

WASH CLOTH

87¢

BATH TOWEL

\$2.27

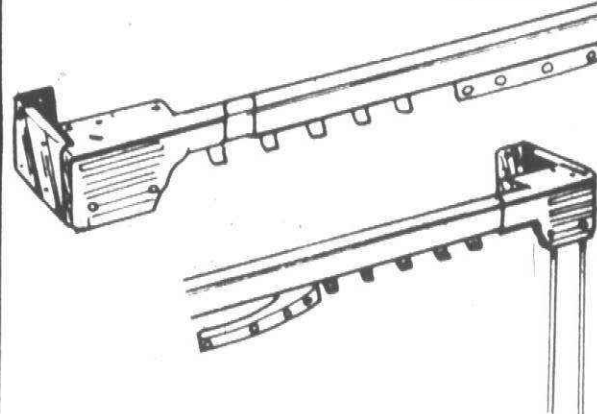

TRAVERSE RODS

By Newell. Style Monarch. A heavy-duty, quiet, smooth-operating® traverse rod. Adjustable to the following lengths.

30" - 50" **\$3.57**

66" - 120" **\$5.97**

50" - 86" **\$4.97**

84" - 150" **\$7.97**

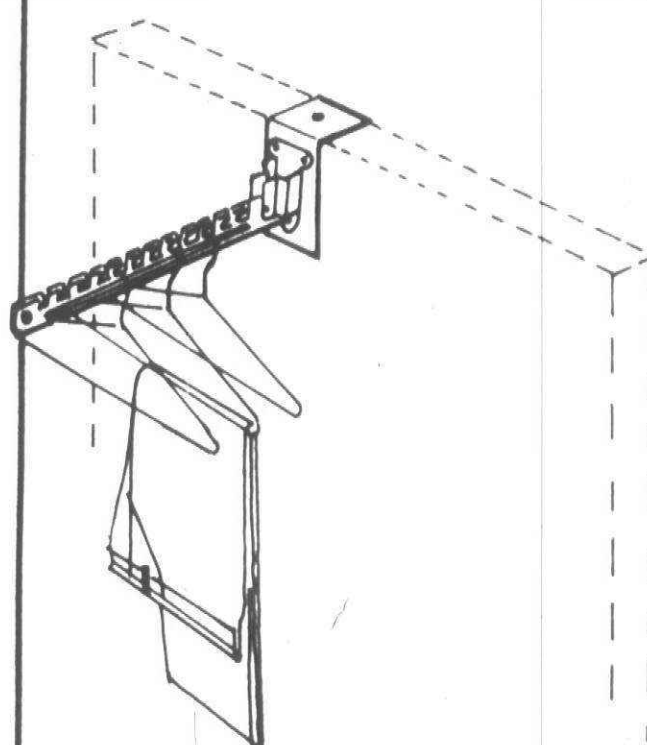

OVER DOOR CLOTHES HANGER

OUR REG. \$1.17

88¢

m in the housewares department



GASWARE CASE SALT
16 oz. Beer
16 oz. Soda
12 oz. Cold
Stack up now for the Summer Season.
REG. \$8.97



Why Pay More!



SAVE \$1.50 CASE
CASE OF 12
\$2.47



CLOSEOUT PURCHASE!
ICELANDIC BEVERAGEWARE
Cordial • Wine Rocks • Goblet • Ice Tea

4 FOR \$1

ROCKINGHAM TEA POT
• 6 cup capacity.



OUR REG. \$2.97
SAVE \$1.00
\$1.97

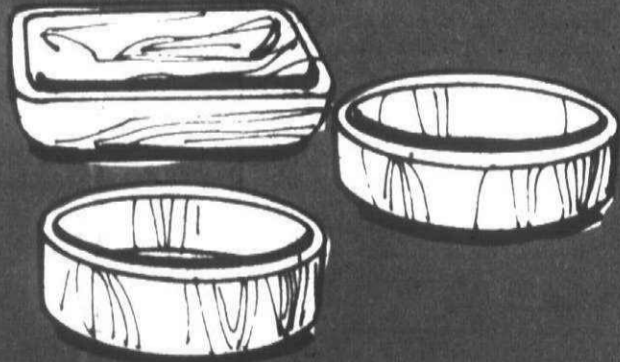

LAUAN WOOD SALAD BOWLS
Choose from round or square. Also ideal for other entrees, main, etc.

OUR REG. \$7.97
3 FOR \$1



WASTE BASKETS
• 50 quart size
• Round 44 qt. size

YOUR CHOICE **\$2**

Why Pay More!

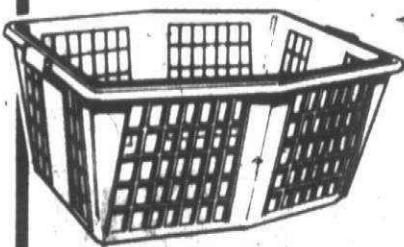

LAUNDRY BASKET
• 2 bushel size.

\$2

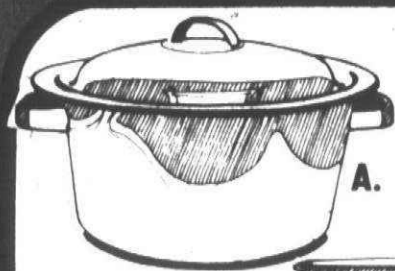

PORCELAINWARE SALE

A. COVERED STOCK POT
11 qt. size. Rugged porcelain on steel construction. Easy to clean, dishwasher safe. Brown sugar color.

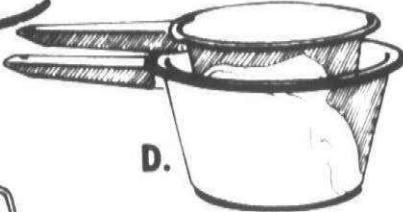

B. TEA KETTLE
• 2 qt. size.



C. COVERED SAUCE PAN
• 2 qt. size

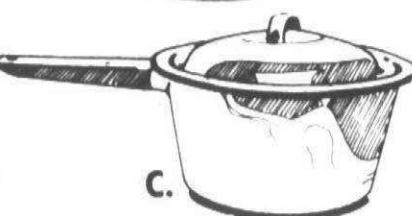

D. 2 PC. SAUCE PAN SET
OUR REG. \$2.47

YOUR CHOICE **\$1.77**

20 PC. STONEWARE DINNERWARE SETS

Sepia, Floral, Glorioso, Daisy Delight. Service for 4. Oven safe, dishwasher safe. Set includes 4 each: Dinner Plates, Salad Plates, Cups, Soup Bowls, Saucers

OUR REG. \$28.97

YOUR CHOICE **\$19.88** SET



Sepia



Floral



Glorioso



Daisy



STONEWARE SOUP MUGS
Colorful soup designs.
OUR REG. \$1.97

\$1.47

MATCHING STONEWARE 5-PC. COMPLETER SETS

Includes Platter, Vegetable Bowl, Covered Sugar and Creamer.

OUR REG. \$17.97
SAVE \$5.00

\$12.97



thrifty acres

Why Pay More!

FLUTED COFFEE FILTERS

100 ct. pkg. Fits Mr. Coffee, West Bend, etc.

2 \$1

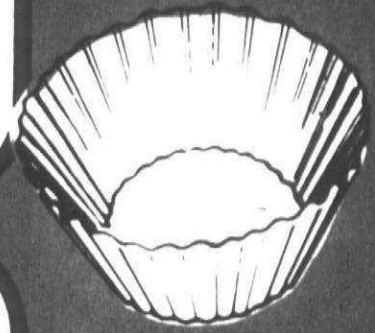

THERMOS VACUUM BOTTLE

• Steel case
• Pint size
OUR REG. \$2.97

\$1.77

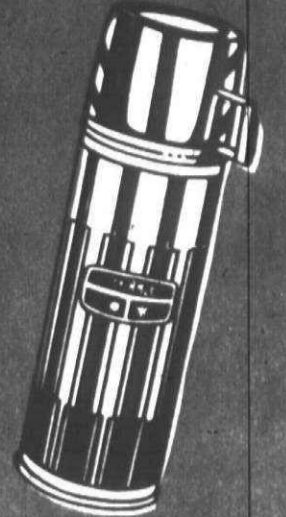

METAL WASTEBASKETS

Several popular designs to choose from. Ideal for children's room, den or family room.

OUR REG. \$1.77

\$1.47

OUTDOOR DRYER

182 ft. drying space. Galvanized steel. Unassembled for easy handling.

OUR REG. \$15.97
SAVE \$4.00

\$11.97

Why Pay More!

STEEL TEE-POST

Painted or galvanized steel. Furnished with cadmium hardware, plastic capped ends and ground sockets. 8 evenly spaced "S" hooks. 84" length.

OUR REG. \$6.47

\$4.97

PLASTIC CLOTHES PINS

• 20 count

OUR REG. 59¢

49¢ PKG.

WOODEN CLOTHES PINS

• 50 ct. pkg.

OUR REG. 77¢

64¢ PKG.

ROUND WOODEN CLOTHES PINS

• 50 ct. pkg.

64¢ PKG.

COTTON CLOTHESLINE

• 50 ft. OUR REG. 97¢

77¢

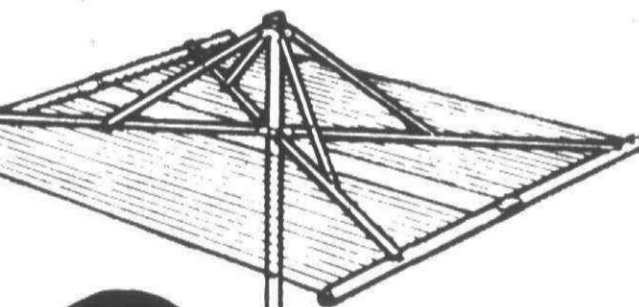

GALVANIZED CLOTHES PROP

84 inch with rope support tip and plastic foot base.

OUR REG. 87¢

57¢

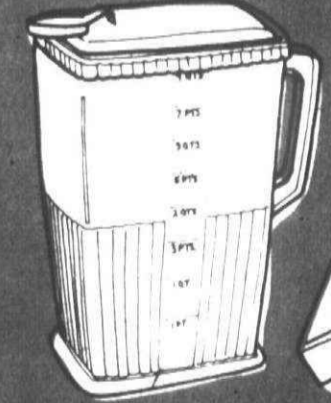
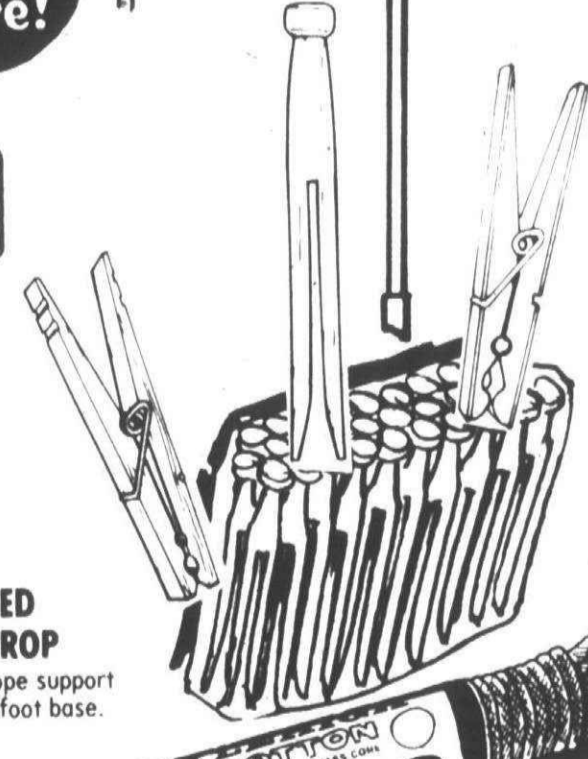

GALLON DECANTER
OUR REG. 87¢

YOUR CHOICE

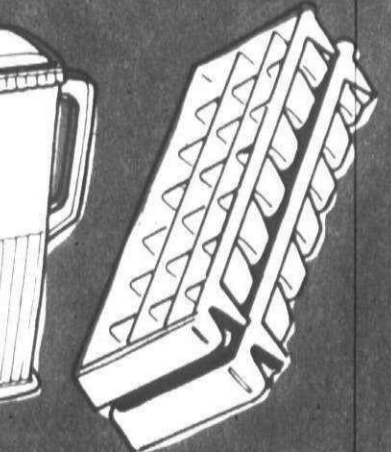

ICE CUBE TRAY
• 21 cube
OUR REG. 87¢

59¢

4 PIECE KING SIZE TV TABLE SET

Four 22" x 16" trays. Baked on enamel finish, brass color frames. Wild flower design.

OUR REG. \$9.97
SAVE \$2.00

\$7.97



Why Pay More!

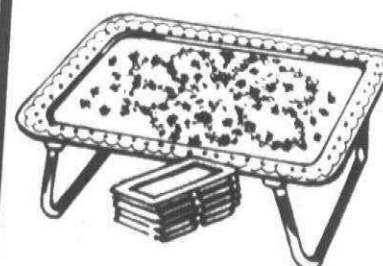

LAP TRAYS

Legs fold, tables stack for storage. Baked on enamel finish. (Slight irregulars.)

OUR REG. 97¢

77¢



SAVE! GARMENT RACK

67" high x 33" wide x 18" deep. Hat shelf and shoe rack.

OUR REG. \$7.47

\$5.88

SAVE \$1.50



UTILITY TABLE W/OUTLET

3 large shelves. 3-way electrical outlet. Casters.

OUR REG. \$6.97

SAVE \$1.00

\$5.97

PRICES GOOD MON. APRIL 18 THRU SAT. APRIL 23, 1977.

MEIJER RESERVES THE RIGHT TO LIMIT SALES ACCORDING TO SPECIFIED LIMITS. NO SALES TO DEALERS, INSTITUTIONS OR DISTRIBUTORS.

CHARGE ANYTHING IN THE STORE EXCEPT FOOD, LIQUOR AND SUPERMARKET ITEMS



YOU DON'T NEED CASH! USE EITHER OF THESE CONVENIENT CREDIT CARDS!



m in the gifts and lamps department



WALL PLAQUES

- Wood comic wall plaques
- 10 1/2" x 4 1/4" size
- #Style X1331

97¢ ea.



PICTURES

Four different country scenes framed under glass. Hanging hardware included. Over all size 20" x 26".
AFTER AD \$14.97

\$12.47 ea.

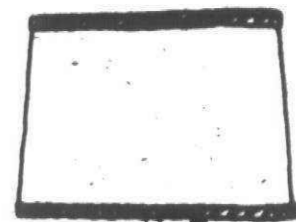

PINUP LAMPS

- Woodtex Pinup in walnut or pine
- YOUR CHOICE!

AFTER AD \$12.97

\$9.97 ea.

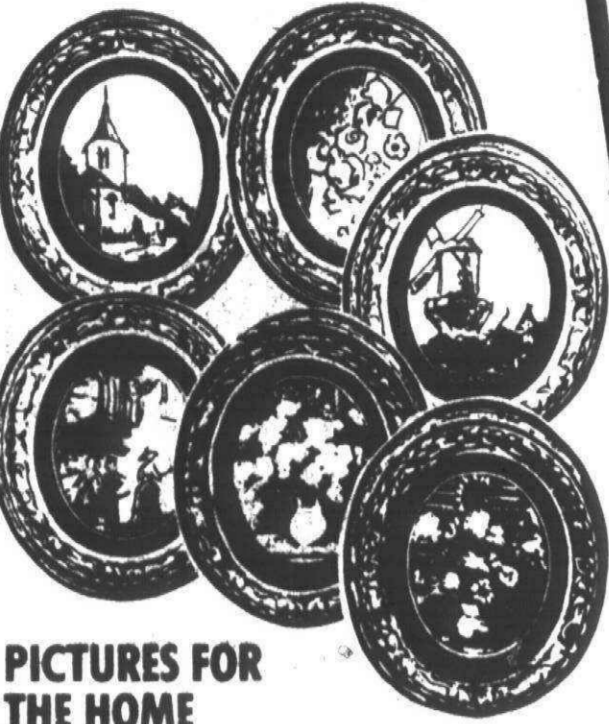
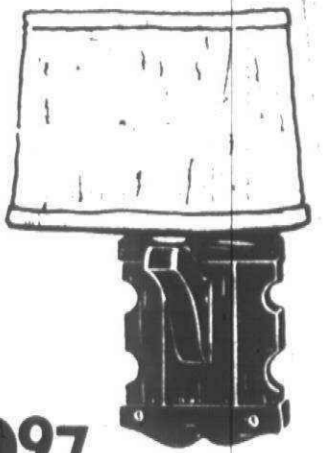

PICTURES FOR THE HOME

Antique Florentine finish plastic frame with glass front. Assorted pictures. 9 1/2" x 8 1/2". #Style X2069. REG. \$1.47

\$1 ea.

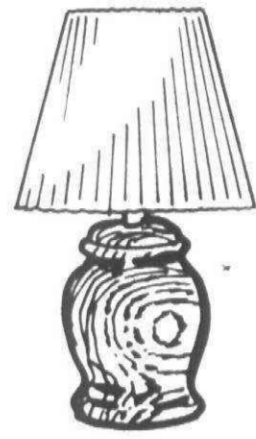
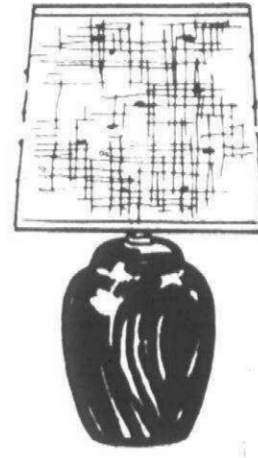
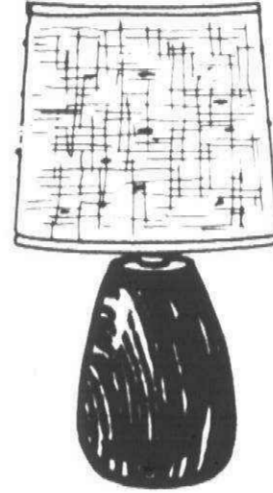

BOUDOIR LAMPS

- Woodtex Boudoir in 6 styles
- YOUR CHOICE!

AFTER AD \$9.97

\$7.97 ea.

SAVE \$2.00 TO \$5.00 ON BALL GLOVES

Choose from any glove in our entire stock. Famous brands such as Wilson, Spalding, King, Louisville Sluggers and Continental Leisure.

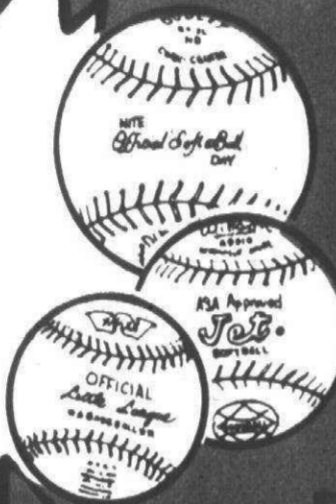

WORTH OFFICIAL LITTLE LEAGUE BASEBALL

Wilson J1 Softball

DUNELP OFFICIAL SOFTBALL



ANY IN STOCK COUPON

BALL GLOVE

Our Reg. up to \$11.97 (NOT ALL STYLES IN EVERY STORE)

\$2.00 OFF

WITH COUPON

GOOD 4/18 THRU 4/23/77

Coupon limited to one per family. DEPT. 490

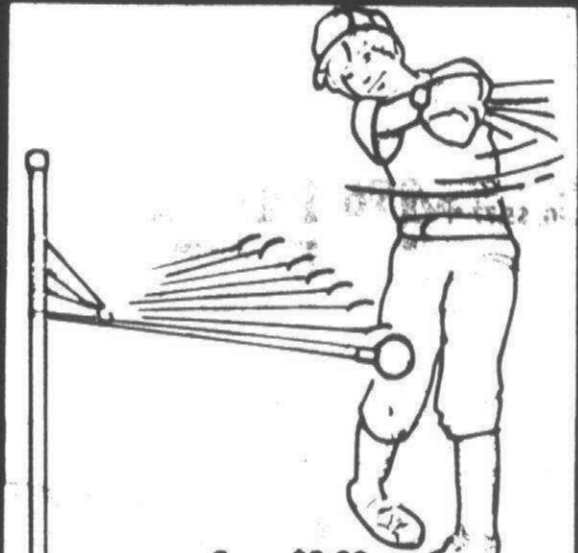

"JOHNNY BENCH" BATTER UP

Unique low cost training device. Simulates a pitched ball with varied speeds and angles. Helps batter develop a level swing & improved timing. Adjustable. #100.

REG. \$13.97

ANY IN STOCK COUPON

BALL GLOVES

Our Reg. \$11.98 to \$19.97 (NOT ALL STYLES IN EVERY STORE)

\$3.00 OFF

WITH COUPON

GOOD 4/18 THRU 4/23/77

Coupon limited to one per family. DEPT. 490



m in the sporting goods department



LADY TENSOR ALUMINUM TENNIS RACKET

By Tensor. Tempered aluminum alloy frame. Strung with impregnated nylon, leather grip. Lightweight. #A-760.

REG. \$18.97

CUSTOM ALUMINUM TENNIS RACKET

By Tensor. Tempered aluminum alloy frame. Strung with impregnated nylon, leather grip, nylon throat. #A-750.

REG. \$18.97

YOUR CHOICE!
\$15.97 ea.

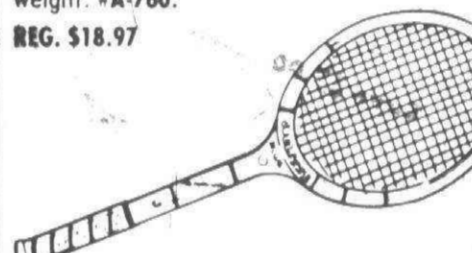

"PROFESSIONAL" WOOD TENNIS RACKET

By Jollette. 9-ply hardwood, 2-fiber laminations. Leather grip and cross twist nylon string. #1202-3.

REG. \$9.97

"CHALLENGER" WOOD TENNIS RACKET

By Jollette. 7-ply hardwood racket, fiber throat, nylon twist string and leather grip. #1202-11.

REG. \$7.97

Save \$1.00
\$6.97



CHROME-PLATED STEEL TENNIS RACKET

Reinforced welded throat and shoulders, vinyl leather grip and nylon strings. #2800GT.

REG. \$8.97

Save \$3.00
\$5.97



CROWN ALUMINUM FRAME RACQUETBALL RACKET

With leather grip, nylon string and vinyl bumper. #0338.

REG. \$9.97

Save \$2.00
\$7.97

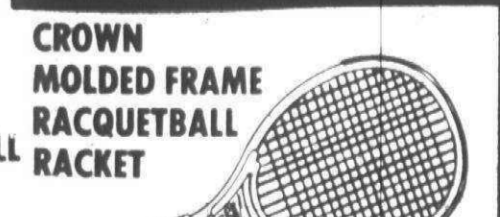

CROWN MOLDED FRAME RACQUETBALL RACKET

With leather grip, red & white cross braided nylon string. #3980.

REG. \$15.97

Save \$2.00
\$13.97



ANY IN STOCK COUPON

BALL GLOVES

Our Reg. \$19.98 to \$24.97 (NOT ALL STYLES IN EVERY STORE)

\$4.00 OFF

WITH COUPON

GOOD 4/18 THRU 4/23/77

Coupon limited to one per family. DEPT. 490



LITTLE LEAGUE BASEBALL OR SOFTBALL WOOD BAT

By Hillerich & Bradsby (Louisville Slugger)

NOT ALL STYLES IN EVERY STORE

\$1.00 OFF

WITH COUPON

GOOD 4/18 THRU 4/23/77

Coupon limited to one per family. DEPT. 490



SEAMCO #539 OFFICIAL N.R.C. RACQUETBALLS

• Two per can - 2 1/4" sorb energy at the

REG. \$2.97

\$1.97 can

"LEACH" RACQUETBALL RACKET

(NOT ALL STYLES IN EVERY STORE)

\$11.97

WITH COUPON

GOOD 4/18 THRU 4/23/77

Coupon limited to one per family. DEPT. 491

PRICES GOOD MON. APRIL 18 THRU SAT. APRIL 23, 1977. MEIJER RESERVES THE RIGHT TO LIMIT SALES ACCORDING TO SPECIFIED LIMITS. NO SALES TO DEALERS, INSTITUTIONS OR DISTRIBUTORS.

MEIJER THRIFTY ACRES — 45001 FORD RD. AT CANTON CENTER RD.

SHOP MONDAY THRU SATURDAY 8 A.M. TO 10:30 P.M. — SUNDAY 9 A.M. TO 7 P.M.



In the paint dept...

Spring house paint sale!



GLIDDEN SPRED HOUSE PAINT

Latex is so easy to apply you'll feel like a pro. Flat finish resists peeling. Dries fast to reduce dirt pickup. Choice of several colors.

\$947

OVER 900 CUSTOM TINTS AVAILABLE AT 50¢ ADDITIONAL CHARGE PER GALLON. REG. \$11.88 gal.



In the



HAVE FUN MAKING

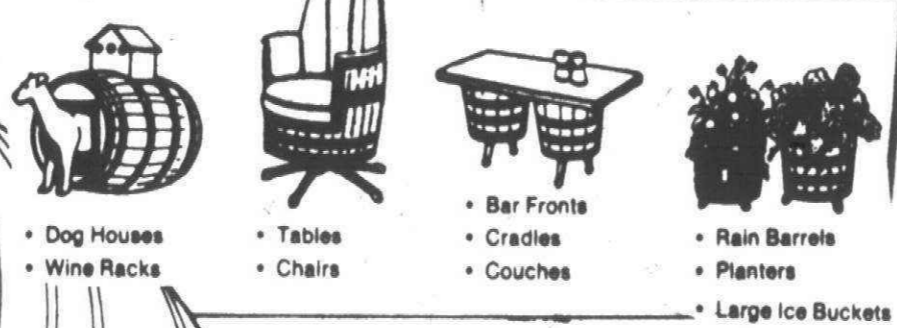

BARREL IDEA & INSTRUCTION BOOKLET

"How To" with whiskey barrels. Ideas and plans on whiskey barrel projects.

69¢



OAK BARRELS (ONCE USED) MAKE YOUR OWN BARREL FURNITURE

Save \$4.00

New shipment of 1" thick oak barrels, for do-it-yourself projects. 36" high - 28" diameter. Both ends in tact. Tight and sound. Heavyweight. 6 steel bands. Use your imagination, make chairs, tables, stools, planters, rain barrels, tables, party room bars and dog houses.

AFTER AD \$16.95

\$12⁹⁵ ea.

More! Why Pay More! Why Pay More! Why Pay More! Why Pay More! Why Pay More! Why Pay More! Why Pay More! Why Pay More!

Page 8 — PRICES GOOD MON. APRIL 18 THRU SAT. APRIL 23, 1977. — MEIJER RESERVES THE RIGHT TO LIMIT SALES ACCORDING TO SPECIFIED LIMITS. — NO SALES TO DEALERS, INSTITUTIONS OR DISTRIBUTORS.

MEIJER THRIFTY ACRES — 45001 FORD RD. AT CANTON CENTER RD.

SHOP MONDAY THRU SATURDAY 8 A.M. TO 10:30 P.M. — SUNDAY 9 A.M. TO 7 P.M.

m in the hardware department

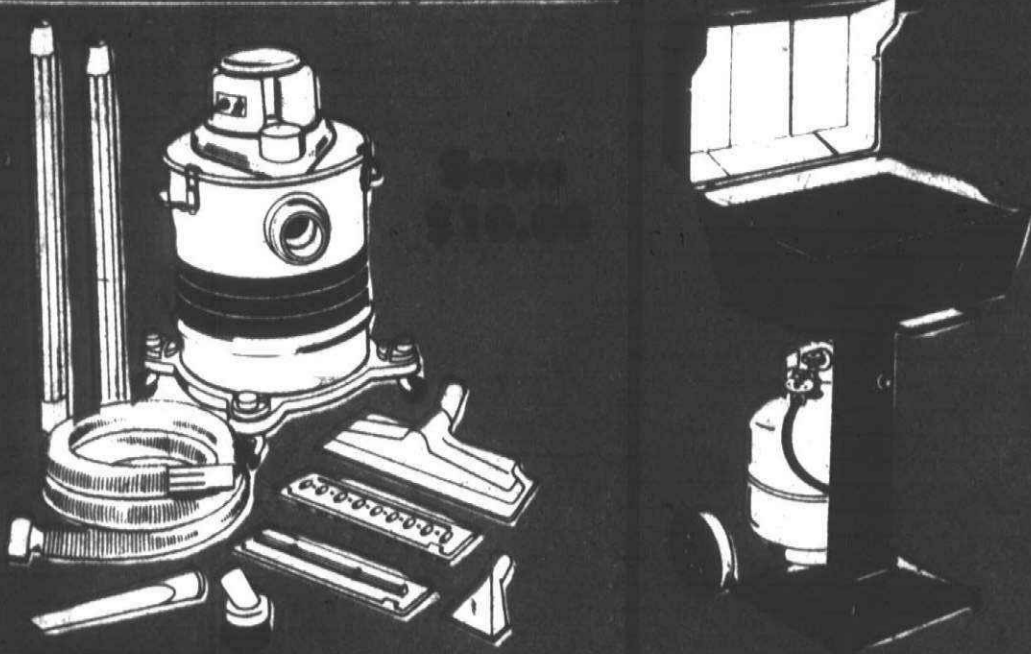

Why Pay More!

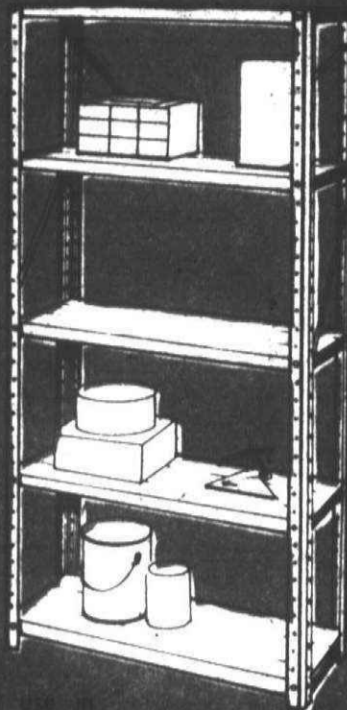

Poulan

Now! After 3 years intensive engineering - more quality for less cost than any chain saw in the world today

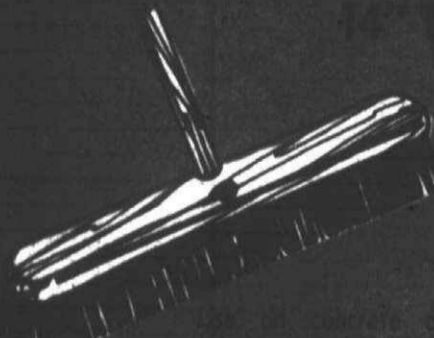
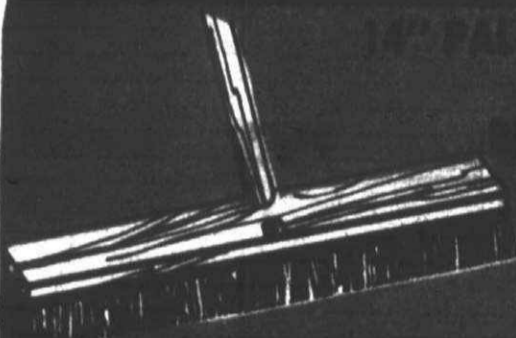
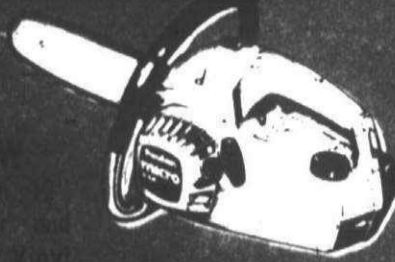
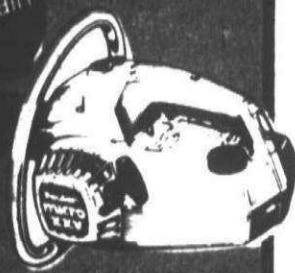

m in the building supplies department

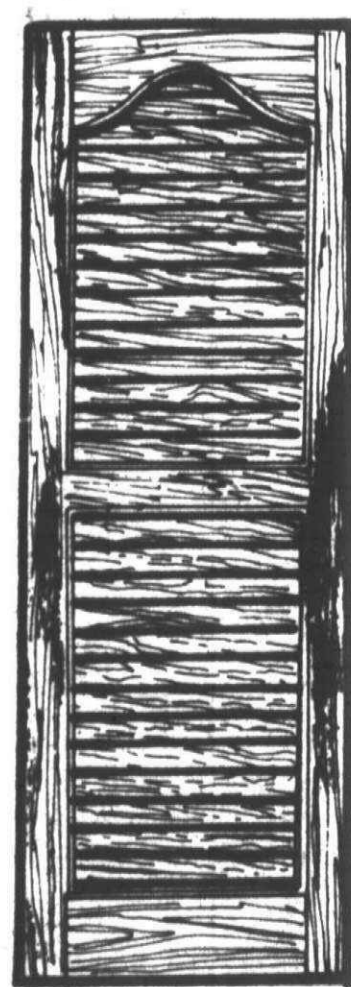

SAVE \$2.00 PER PAIR - BLACK EXTERIOR SHUTTERS

• Jamestown wood grain acrylic shutters.

SIZES:

- 14" x 35"
- 14" x 39"
- 14" x 47"
- 14" x 51"
- 14" x 55"
- 14" x 59"
- 14" x 80"

\$2.00 OFF EACH PAIR

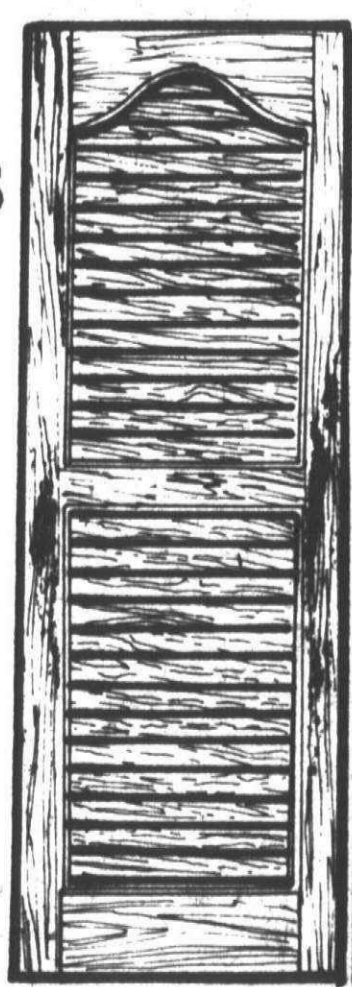

PRICES GOOD MON. APRIL 18 THRU SAT. APRIL 23, 1977.

MEIJER RESERVES THE RIGHT TO LIMIT SALES ACCORDING TO SPECIFIED LIMITS.

NO SALES TO DEALERS, INSTITUTIONS OR DISTRIBUTORS.

Page 9

CHARGE ANYTHING IN THE STORE EXCEPT FOOD, LIQUOR AND SUPERMARKET ITEMS



YOU DON'T NEED CASH! USE EITHER OF THESE CONVENIENT CREDIT CARDS!



m in the plumbing department

SEWER & DRAIN PIPE



SALE

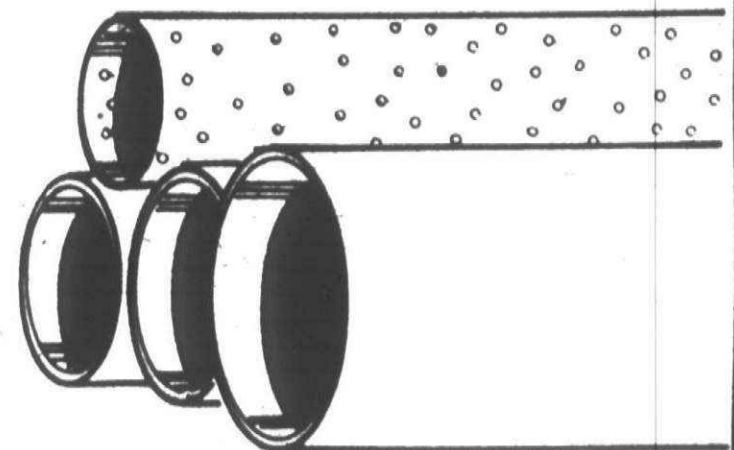

4' DIA. - 10' LENGTHS

- Perforated and solid
- 1500 lb. crush with coupling

\$3.77 PER 10' LENGTH

4" - 90 DEGREE ELBOW

\$1.17 ea.

4" WYE

\$1.41 ea.

4" - 45 DEGREE ELBOW

89¢ ea.

4" TEE

\$1.67 ea.

Why Pay More!

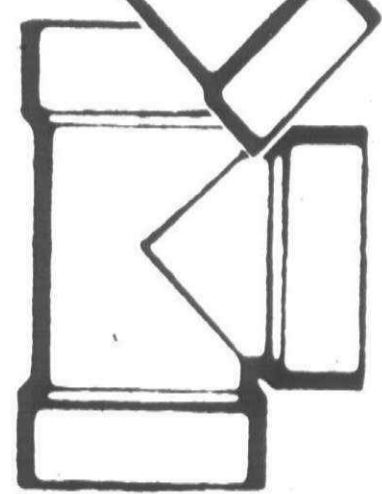
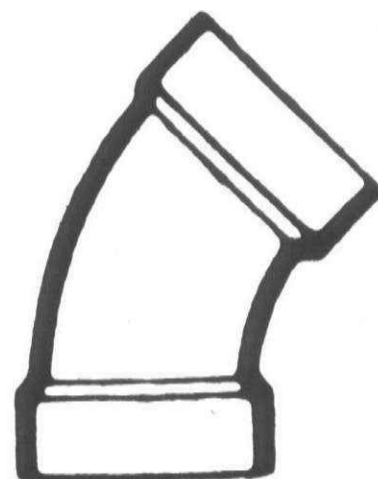
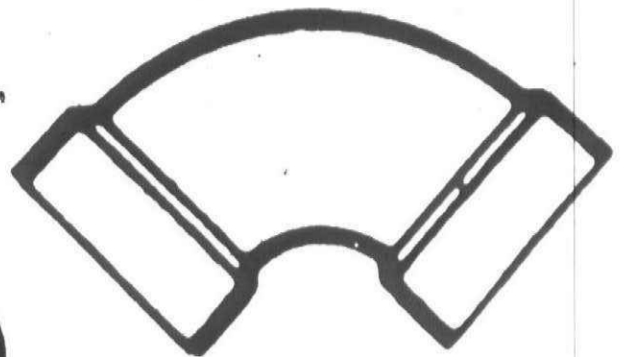

m in the auto supply department

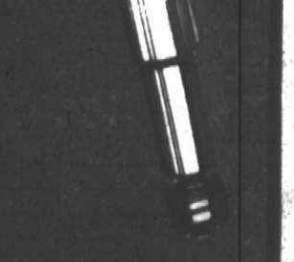
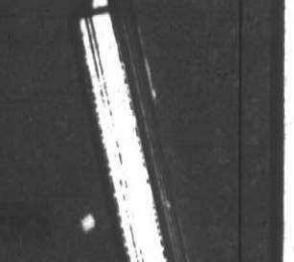
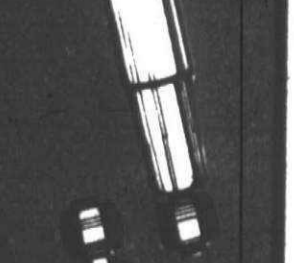
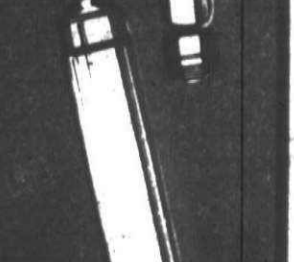
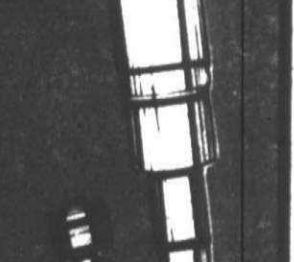
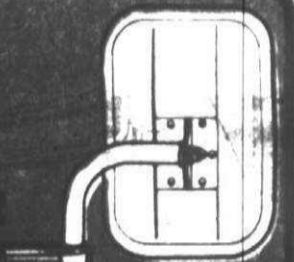
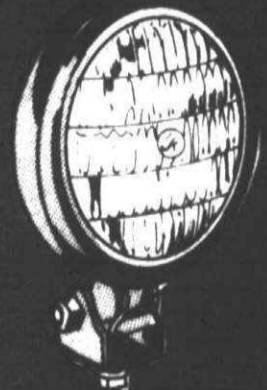

m CUSTOM TRAILER HITCHES
 SIZES TO FIT MOST CARS
 OUR REG. \$14.88 & UP
\$5.00 OFF
 WITH COUPON
 GOOD 4/18 THRU 4/23/77
 Coupon limited to one per family. DEPT. 860

m ANY IN STOCK TRAILER BALL
 1-7/8 OR 2" - REG. \$2.68 & UP
\$1.00 OFF
 WITH COUPON
 GOOD 4/18 THRU 4/23/77
 Coupon limited to one per family. DEPT. 860

Why Pay More! Why Pay More! Why Pay More! Why Pay More! Why Pay More! Why Pay More! Why Pay More!



HI SPORTSMAN I CB BICYCLE BASE AND AM RADIO
By Power Two-way communication. Built-in speaker-mic. Crystal controlled transmitter. Vinyl carry case.

\$19⁹⁸



G.E. AM CLOCK RADIO
Compact styling. Wake to music. Large easy to read clock face. #7-4725

\$13⁹⁷



G.E. PORTABLE CASSETTE RECORDER
Five pushbuttons. DTC cassette recorder. End of tape shut off. #5-3081
OUR REG. \$27.97

\$19⁹⁷



G.E. TUNABLE SCANNING/FM/AM PORTABLE RADIO
Receives FM/AM and scans 4 PS hi frequencies. No crystals required. Two-way power. #7-2995

\$87⁸⁸



The Schick hot lather machine
Just plug in. Then wait for the signal (a light that goes on when it's hot), and push. Piping hot lather. Packaged in a box with regular refill cartridge.

\$9⁹⁷



GILLETTE SUPERMAX 2 ADJUSTABLE STYLING DRYER
200 to 900 watts of power. #9160

\$17⁹²



G.E. WALKIE TALKIES
(Hand Held CB Channel 14). Visual transmit indicator. Large side mounted transmit control. Range up to 1 mile. 36" telescoping chrome antenna. Carry strap. #3-5960

\$18⁹² PAIR



SOUNDESIGN 8 TRACK STEREO TAPE PLAYER WITH WIDE-RANGE SPEAKERS
#4126-14

\$46⁸⁸



WAHL HOME HAIRCUTTING KIT
2 comb attachments. Complete with clipper blade guard, barber comb, oil, head cleaner, oil and instruction book. #650

\$6⁹⁷



SUPER CURL COMPACT PORTABLE CURLER
By Gillette. Cordless. Fast and easy to use. Heats in about 2 minutes. Compact, portable design. Unique telescoping rod. #9330

\$9⁹⁶



WEST BEND 30 CUP PARTY PERK
Brews 12 to 30 cups of coffee and keeps it hot for hours, automatically. "Serve" light signals when coffee's ready. #11658

\$10⁹⁷



CERTRON 8 TRACK HEAD CLEANERS
Cartridge style. Keeps your 8 track unit in good clean condition!
OUR REG. 97¢

SAVE 30¢

67¢ EA.



SUNBEAM CARAFE GLASS
Replacement carafe glass for Sunbeam drip coffee maker. #94-180

\$2⁴⁷



AMERICAN ELECTRIC SLOW COOKER
5-qt. removable crockery casserole. Thermomatic control cooking memory. GE Lexan lid and case with no-heat handles. #5000

OUR REG. \$19.97

\$13⁹⁷



G.E. 2-SLICE AUTOMATIC TOASTER
Toast selector light to dark. Gleaming chrome finish. Small compact design. Extra high toast lift. Snap open crumb tray. Heat resistant carrying handles. #1-17

\$13⁹⁷



PRESTO ELECTRIC SINGLE BURNER RANGE
Compact. Heating element tilts up for easy cleaning. #PRIP

OUR REG. \$17.97

\$14⁹⁷



SUNBEAM COFFEEMASTER DELUXE DRIP COFFEEMAKER
Brews 4 to 10 cups by drip method. Super-fine filter. Carafe holds coffee or warming tray. Thermostat control. Removable basket. Also heats water. Compact. #13-213

\$25⁹⁷



WESTCLOX AUTOMATIC NITE 'N DAY PROGRAM TIMER
(Electric) Program it to turn lights, radio, TV on or off automatically, even when you're away. Set and forget. Unit resets automatically. Plugs directly into wall outlet. #28817
OUR REG. \$8.97
SAVE \$2.00

\$5⁹⁷



EQUITY KEYWOUND ALARM CLOCK SPECIALS!
Easy to read luminous dot dial with luminous hands. Attractive designs. 2 styles. #1165/6 or #2865/6
OUR REG. \$6.97
SAVE \$2.00

\$4⁹⁷ EACH



SUNBEAM JEWEL SELF-CLEANING SHOT OF STEAM IRON
Features spray, safety signal light, stainless steel water tank, water level gauge, safety heel rest, 61 vents. Spray steam and dry. #12-71

\$21⁸⁶



SUNBEAM "BURST OF POWER" MIXMASTER MIXER
Touch a button for instant extra power. Avocado (#3-72) or Harvest Gold (#3-73).

\$15⁹⁷

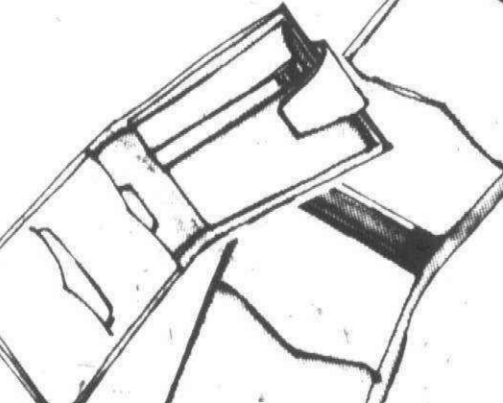

AMITY WALLET
ANY IN STOCK
\$2 OFF
WITH COUPON
GOOD 4/18 THRU 4/23/77
Coupon limited to one per family. DEPT. 841



SMOKE SHOP SPECIAL!
WHITE OWL INVINCIBLE CIGARS
Special package of 2 5-packs. (Total of 10 cigars)
FOR ONLY **79¢**



BIC BUTANE LIGHTER SPECIAL!
Buy a lighter and get a Bic shaver. Free! A Bic pack!
OUR REG. \$1.27
SAVE \$1.00



BISSELL SWEEPMASTER DUAL POWERED LITE VAC WITH POWER FOOT
Two powerful motors for top efficiency. One motor powers the brush that combs out deep-down dirt. Second motor provides strong suction. Compact. #3046-1

OUR REG. \$59.88
SAVE \$10.00

\$49⁸⁸



WARING 12 SPEED - 2 WAY MIXER
Finger-tip control, push-button beater ejector. 3 qt. and 1 1/2 qt. glass bowls. 150 watt motor. White. #HS-151

SAVE \$5.00

\$16⁸⁸



TOASTMASTER "INSTANT HEAT" ELECTRIC HEATER
Automatic thermostat. Multi-position heat selector. 1500 watts maximum. #9A2
OUR REG. \$26.97

SAVE \$5.00

\$21⁹⁷

EAR PIERCING CLINIC SAT. APRIL 23 11:00 a.m. to 5:00 p.m.

\$7.45

A specially trained nurse will painlessly pierce your ears and insert a pair of non-allergenic posts of 24K gold applied directly to surgical grade stainless steel. Minors must be accompanied by a parent or guardian.

FREE!
8 fl. oz., bottle of Steri-Quik solution with each ear piercing performed on this date. While quantities last!



1 BOTTLE FREE



MOTHER'S RINGS

Three very beautiful and distinct styles of Mother's Rings. All are available in your choice of 10K or 14K yellow or white gold with from 1 to 10 synthetic stones.

\$36 TO \$127

(SPECIAL ORDER NOW FOR DELIVERY BY MOTHER'S DAY!)

Mead envelopes Security

80 envelopes

SECURITY ENVELOPES

- 6 1/4 size
- 80 count

57¢



MEIJER
thrifty acres

Learn how to trim your food budget without lowering your standard of eating.

START YOUR 20 VOLUME SET TODAY BUY A NEW VOLUME EACH WEEK UNTIL YOU HAVE THE COMPLETE SET.

THIS WEEK VOL. #10 FOR ONLY \$1.99

Book Dept.

VOL. #1 ONLY 49¢ ea. VOLUMES #2-9 ONLY \$1.99 ea.

GAF COMPACTIBLE 200 CAMERA

With 135 film and auto flash. 200 ASA. 1/125 to 1/2000. 1/2" x 3/4" film. 200 ASA. 1/125 to 1/2000. 1/2" x 3/4" film.

\$5.88

GAF HUSH-A-MATIC™ SLIDE PROJECTOR

With full remote control and pop-up editor. #2680.

REG. \$99.88

Save \$20.00

\$79.88

LEDGER BOOKS

10 1/2" x 8" 80 count. Your choice of each-day book, single-entry, double-entry and record-entry books.

\$1.27

CLEARANCE! CHILDREN'S MATH BOOKS

- Grades two, three, five and six.

2/\$1

Why Pay More!

KODAK EK6 INSTANT CAMERA

REG. \$55.47

\$43.88

• KODAK EK4 INSTANT CAMERA \$33.83

KODAK XL360 MOVIE OUTFIT

• Low light - power zoom

REG. \$199.97

\$188

ADULT PERPETUAL DIARY

• With statistics, cash account and address section

48¢

CHEESE NOTE PADS

- 50 sheets
- 5 1/2" x 8 1/2"

2/88¢

FUJICA POCKET CAMERA OUTFIT

• Includes camera, lens cap, battery, and carrying case.

REG. \$199.00

\$139.88

DA-LITE FLYER 40" x 40" BEADED PROJECTION SCREEN

REG. \$13.87

Save \$2.00

\$11.87

PENTEL ROLLING WRITER

Liquid ink rolls on for expressive writing. Writes smoother than a ball point and makes carbons. Red, black or blue.

2/88¢

METRIC CONVERTER

Incorporates 16 conversions from U.S. standards to metric system and vice versa.

88¢

PEDIGREE DRAWING PENCILS

19¢

ROYAL METRIC CONVERSION CALCULATOR

- with two independent memories #92M
- REG. \$24.97

Save \$5.00

ROYAL FINANCIAL CALCULATOR

- 4 memory registers for fixed programs.
- 8 financial programs - trend, trade-margin, purchase and sell pricing. #94F.
- REG. \$24.97

Save \$5.00

Your Choice \$19.97

INSTANT REPLAY PHOTO ALBUM

\$1.57

LETTER DESK TRAYS

Your choice of black, beige, yellow or orange colors.

\$1.57

CLEARANCE! Save \$4.00 LLOYD'S CHECKBOOK SLIDE RULE CALCULATOR

- With four key memory
- Model E614
- REG. \$19.97

\$15.97

ROYAL CHECKBOOK PORTABLE TYPEWRITER

• Rugged all steel construction

REG. \$19.97

Save \$3.00

\$16.97

WIREBOUND INDEX CARDS

- 3" x 5" ruled
- 64 cards

2/88¢

MAVERICK PLAYING CARDS

Your choice of poker, bridge or glint face.

2/\$1

TOPCREST CELLO TAPE

• 1/2" x 300"

4/\$1

CLEARANCE! DAISY PARTY TABLEWARE

- 9 oz. Cold Cup, 40 ct.
- 9 1/2 oz. Hot Cup, 24 ct.
- 9" plate, 50 ct.
- 7" plate, 30 ct.

2 pkgs. / \$1

CLEARANCE!

SPECIAL GROUP OF PAPER TABLE PARTY GOODS

- PLATES 3 pkgs. / \$1
- HOT CUPS 4 pkgs. / \$1
- LUNCHEON & BEVERAGE NAPKINS ... 3 pkgs. / \$1
- TABLE COVERS 2 pkgs. / \$1

PRICES GOOD MON. APRIL 18 THRU SAT. APRIL 23, 1977. MEIJER RESERVES THE RIGHT TO LIMIT SALES ACCORDING TO SPECIFIED LIMITS. NO SALES TO DEALERS, INSTITUTIONS OR DISTRIBUTORS. Page 11

YOU DON'T NEED CASH! USE EITHER OF THESE CONVENIENT CREDIT CARDS!

BANKAMERICARD welcome

master charge THE INTERBANK CARD

m
MEIJER
thrifty acres

herbal essence shampoo
herbal essence creme rinse
Ultra Blue
Lady Clairol

Kleenite
DENTURE CLEANSER
• 9 oz. net wt.
\$1.14

LAVORIS
MOUTHWASH
Lavoris
mouthwash
4 purple

mudd
ZAPS ZAPS
MUDD CREAM
5.2 oz. net wt. Acne medication.
OUR REG. \$2.47
\$1.99

TYLENOL
acetaminophen tablets
safe fast pain relief without aspirin
Why Pay More!
TYLENOL TABLETS
• 250 ct.
\$2.89

BARNES-HIND
WETTING SOLUTION
2 fl. oz. For hard contact lenses.
\$1.32

DR. SCHOLL'S
EXERCISE SANDALS
Available in 4 colors:
• Natural Wheat (new)
• Chocolate (new)
• Striking Blue
• Blue Dream
• Natural White
• Vibrant Cherry
Scholl
OUR REG. \$13.99
\$9.88

VICKS
COUGH SYRUP
• 6 fl. oz.
\$1.19

BEABY MAGIC
SHAMPOO
• 7 fl. oz.
77¢

Fostex
CAKE
MEDICATED SKIN CLEANSER
PIMPLES, BLACKHEADS,
OILY SKIN, ACNE
NET WT. 3 1/2 OZ.
FOSTEX CAKE
3.75 oz. net wt. Medicated skin cleanser for pimples, blackheads, oily skin and acne.
94¢

DEGEST 2
Soothing drops for red, irritated eyes.
New & Improved
15 ml. sterile
Why Pay More!
DEGEST 2
15 ml. Soothing drops for red, irritated eyes. New and improved.
\$1.69

Toni
Conditioner
• 16 fl. oz.
77¢

Vaseline
Wipe 'n Dipe
Baby Oil Wipes
• 50 count
99¢

BRAN TABS
LAXATIVE FOR REGULARITY
• 50 count
OUR REG. \$1.59
\$1.19

Keri Lotion
FOR DRY SKIN CARE
13 fl. oz. For dry skin care.
Why Pay More!
KERI LOTION
13 fl. oz. For dry skin care.
\$2.99

Schick
INJECTOR Plus Platinum
15 count.
OUR REG. \$2.29
\$1.29

BEABY MAGIC
powder
• 9 fl. oz. or
• Powder - 9 oz. net wt.
77¢ EACH

ALPHA KERI
OIL
8 fl. oz. Bath oil for dry skin care.
Why Pay More!
ALPHA KERI OIL
8 fl. oz. Bath oil for dry skin care.
\$2.09

ALPHA KERI
SOAP
4 oz. net wt. Soap for dry skin care.
90¢

MEIJER
ONE-A-DAY PLUS MINERALS
60 COUNT
75¢ OFF
WITH COUPON
GOOD 4/18 THRU 4/23/77
Coupon limited to one per family. DEPT 049/449

ARRID
EXTRA DRY ANTI-PERSPIRANT
• 12 oz. net wt.
\$1.66

CORICIDIN
TABLETS
60 count. For cold and flu symptoms.
\$1.59

SNUG
DENTURE CUSHIONS
\$1.19

FEEN-A-MINT
GUM
• 84 ct. **\$1.49**

FEEN-A-MINT
PILLS
• 60 ct. **\$1.19**

m in the floral department

HANGING PLANTER BRACKETS
Available in black wrought iron style.
YOUR CHOICE **\$1 EA.**

#B161
#B111 (swivels).

PLANT TUB
Reinforced fiberglass tub available in white, avocado, butterscotch.
• #121 - 12" AFTER AD \$7.97 SALE **\$5.97**
• #141 - 14" AFTER AD \$8.47 SALE **\$6.47**
• #161 - 16" AFTER AD \$10.97 SALE **\$8.97**

"CIRCLE IN THE SQUARE" PLANTERS
White with floral decoration water drainage tray for proper moisture control. The perfect accent for any room.
• J35F - 3 1/2" OUR REG. 79¢ SALE **59¢**
• J45F - 4 1/2" OUR REG. 89¢ SALE **69¢**
• J55F - 5 1/2" OUR REG. 99¢ SALE **89¢**

m in the garden center

PLANT OF THE WEEK
AFRICAN VIOLETS
Patented Rescued Violets. Many varieties.
\$1.77

FRESH CUT FLOWERS ALWAYS AVAILABLE **\$1.97**

BUD VASE
Crystal Fern. 7 oz. size. Floral Dept.
54¢

Why Pay More! Why Pay More! Why Pay More! Why Pay More! Why Pay More! Why Pay More!

PORK IS A KEY SOURCE OF MANY ESSENTIAL NUTRIENTS

Today's pork is superior due to scientific breeding and feeding by the producer and closer trimming by meat packers and retailers. This means more lean pork per pound with more body-building proteins and less fat. With less fat and fewer calories, pork plays a particular role in the diet for weight control. In fact, in recognition of the nutritional qualities of pork, the Weight Watchers organization has ruled that pork is acceptable for their members use. Whether it is barbecued pork roast, ham, bacon or left over pork in a sandwich, you can be sure of the same outstanding nutritive values that means so much to the health and well-being of old and young alike.



PORK SHOULDER BLADE

ROAST

68¢ LB.

Herrud BONELESS HAM PORTIONS
VERY LEAN \$1.38 lb.
 CENTER SLICES \$1.78 lb.
REGULAR BONE IN WHOLE SMOKED HAM
 SLICED OR CUT UP FREE! **79¢ lb.**

HAMBURG
 FRESH GROUND **66¢ lb.**

	PORK SHOULDER BLADE STEAK	78¢ lb.
	BONELESS ROLLED PORK ROAST	78¢ lb.
	PORK (CUTLETS) CUBED STEAK	98¢ lb.
	PORK (CHOP SUEY MEAT) CUBES FOR KABOBS	98¢ lb.
	COUNTRY STYLE (FROM THE SHOULDER) SIDE PORK	88¢ lb.
	MEJER'S OWN LEAN BREAKFAST SAUSAGE	68¢ lb.

ARMOUR LUNCH MEAT

- SLICED SALAMI
- SLICED REG. BOLOGNA
- SLICED THICK BOLOGNA
- OLD FASHION LOAF
- LIVER CHEESE LOAF
- BEEF OR REG. SLICED BOLOGNA
- COOKED SALAMI
- PICKLE PIMENTO LOAF

1 lb. pkg. **74¢ WITH COUPON**
 6 oz. wt. pkg. **\$1.14 WITH COUPON**
 6 oz. wt. pkg. **34¢ WITH COUPON**

MEJER'S A SELECTION OF **ARMOUR LUNCH MEATS**
 6 oz. wt. pkg. to 1 lb. pkg.
15¢ off pkg. WITH COUPON
 GOOD 4/18 THRU 4/23/77
 DEPT 988

ARMOUR FROZEN BEEF LIVER STEAKS
 (SKINNED AND DEVEINED)
59¢ lb.

SLICE YOUR OWN AND SAVE!
SLAB BACON
69¢ lb.

CAPTAIN FRESH PAN READY WHITE FISH
\$1.69 lb.

ARMOUR DINNER FRANKS
 2 lb.
\$2.19
 LOOK IN PKG FOR 25 COUPON TOWARD NEXT PURCHASE

Herrud SMOKED OR POLISH STYLE SAUSAGE
 14 oz. wt. pkg.
89¢

Food Club CHIPPED MEATS
 • CHICKEN • TURKEY
 • CORNED BEEF • BEEF
 • PASTRAMI • HAM
 3 oz. wt. pkg. **3/\$1 WITH COUPON**
 GOOD 4/18 THRU 4/23/77

MEJER'S 6 VARIETIES **CHIPPED MEATS**
 3 oz. wt. pkg.
3/\$1 WITH COUPON
 GOOD 4/18 THRU 4/23/77
 DEPT 429

PESCHKE PARTI PAC 12 oz. wt. pkg. **99¢**
 ARMOUR SMOKEES 12 oz. wt. pkg. **99¢**
 PESCHKE REG. OR THICK SLICED BOLOGNA 12 oz. wt. pkg. **69¢**
 ARMOUR PAN SIZE SLICED BACON 12 oz. wt. pkg. **\$1.09**
 FOOD CLUB REG. OR BEEF SKINLESS FRANKS per lb. **69¢**

HERRUD SLICED BOLOGNA, SALAMI, OR COMBO PAC FAMILY PAC 20 oz. wt. pkg. **\$1.39**
 HERRUD NEW ENGLAND OR HONEY LOAF 8 oz. wt. pkg. **89¢**
 HERRUD REG. OR BEEF SKINLESS FRANKS per lb. **89¢**
 HERRUD BEEFEATER BEEF FRANKS per lb. **\$1.08**
 HERRUD CHUNK JUNDO BOLOGNA per lb. **79¢**

OSCAR MAYER LINK PORK SAUSAGE per lb. **\$1.69**
 OSCAR MAYER SLICED BACON per lb. **\$1.69**
 ECKRICH SKINLESS FRANKS per lb. **\$1.19**
 ECKRICH REG., THICK, OR BEEF SLICED BOLOGNA 12 oz. wt. pkg. **\$1.19**
 FALARSKI BOCKWURST per lb. **\$1.29**

ECKRICH MAPLE, REG. OR BEEF SMOK-Y-LINKS
 10 oz. wt. pkg.
25¢ off WITH COUPON

MEJER'S ECKRICH MAPLE REG. OR BEEF **SMOK-Y-LINKS**
 10 oz. wt. pkg.
25¢ off WITH COUPON
 GOOD 4/18 THRU 4/23/77
 DEPT 429

From the Tender, lovin' meat people

Fresh Top Fresh Top Fresh Top Fresh Top Fresh Top Fresh Top Fresh

LUSCIOUS RED RIPE CALIFORNIA STRAWBERRIES
QUART 88¢

PRODUCE ITEM OF THE WEEK
FRESH ARTICHOKES
 LARGE 20 SIZE **29¢ EACH**
 NUT LIKE FLAVOR - SERVE HOT OR COLD WITH SAUCE OF YOUR CHOICE
 FREE RECIPES AVAILABLE

ROYAL PURPLE EGGPLANT
28¢ lb.

DELICIOUS AND NUTRITIOUS
GOLDEN RIPE BANANAS
19¢ LB.

PRICES GOOD MON. APRIL 18 THRU SAT. APRIL 23, 1977. MEJER RESERVES THE RIGHT TO LIMIT SALES ACCORDING TO SPECIFIED LIMITS. NO SALES TO DEALERS, INSTITUTIONS OR DISTRIBUTORS.

Top Fresh Top Fresh Top Fresh Top Fresh Top Fresh Top Fresh Top Fresh Top Fresh

Why Pay More! Why Pay More! Why Pay More! Why Pay More! Why Pay More! Why Pay More!



DEAN
FRUIT ON THE BOTTOM
YOGURT

8 oz. wt. cup
18¢ SAVE 15¢



GAYLORD
VANILLA OR NEOPOLITAN
ICE CREAM

gallon carton
\$1.29 SAVE 56¢ WITH COUPON

FRIGO SHREDDED CHEDDAR CHEESE
8 oz. wt. pkg. **77¢**

QUARTERS KEYKO MARGARINE
16 oz. wt. pkg. **36¢**

IMITATION MOZZARELLA PIZZA PAL
16 oz. wt. pkg. **99¢**

SALUTO FROZEN PEPPERONI PIZZA
21 oz. wt. pkg. **\$1.79**

BRADY FRAMS FROZEN IQF STRAWBERRIES
16 oz. wt. pkg. **79¢**

TREESWEET FROZEN ORANGE JUICE
16 fl. oz. can **69¢**



FROZEN
GREEN PEAS

16 oz. wt. pkg. **4/\$1** SAVE 84¢ ON

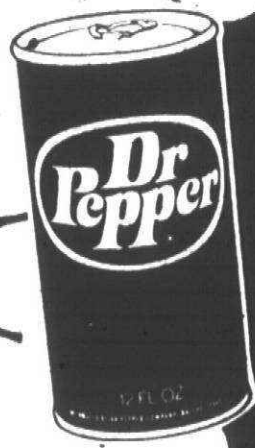

REGULAR AND SUGAR FREE
DR. PEPPER

8 pk. 12 fl. oz. cans
\$1.29 SAVE 70¢



SWANSON FROZEN HUNGRY-MAN LASAGNA OR SLICED BEEF DINNER
17-17-3/4 oz. wt. pkg. **\$1.07**

SCHAFER HILLBILLY BREAD
20 oz. wt. loaf **2/\$1.09**

- 23 oz. wt. box DUNCAN HINES BROWNIE MIX **97¢**
- 15 fl. oz. bottle PINE SOL **79¢**
- 32 fl. oz. bottle STEP SAVER FLOOR CARE **\$1.53**
- 12 oz. wt. can FAVOR LEMON FURNITURE WAX **98¢**
- 8 oz. wt. tube PILLSBURY CRESCENT ROLLS **39¢**
- 12 oz. wt. pkg. KRAFT MEDIUM CHEDDAR CHEESE **\$1.19**
- 8 oz. wt. can KRAFT GRATED PARMESAN **\$1.48**

WIN SCHULER BAR SCHEEZE
8 oz. wt. cup **77¢**

GREEN GIANT FROZEN BROCCOLI IN CHEESE SAUCE
10 oz. wt. pkg. **49¢**

GREEN GIANT FROZEN CAULIFLOWER IN CHEESE SAUCE
10 oz. wt. pkg. **49¢**



RAINBARREL
FABRIC SOFTENER

48 fl. oz. bottle
\$1.29 SAVE 50¢

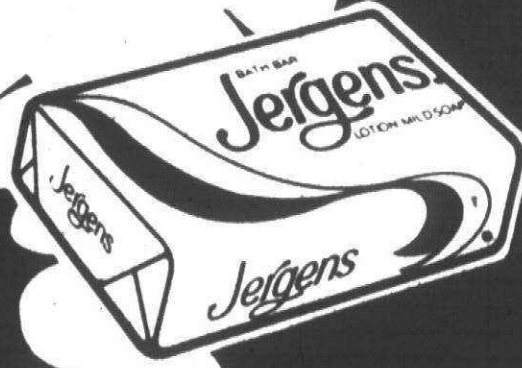

JERGENS
REGULAR BAR
SOAP

3 oz. wt. bar
10¢

BORDEN INSTANT ORANGE DRINK
27 oz. wt. jar
20¢ OFF WITH COUPON
0000 4/18 THRU 4/23/77
DEPT. 416

GENERAL MILLS BUGLES
7 oz. wt. box
2/\$1 WITH COUPON
0000 4/18 THRU 4/23/77
DEPT. 418

- 12 oz. wt. pkg. REMES FROZEN EGG NOODLES **57¢**
- 5 oz. wt. pkg. - 2 ct. LA CHOY FROZEN SHRIMP EGG ROLL **66¢**
- 6 fl. oz. can TOP FROST FROZEN GRAPEFRUIT JUICE **24¢**
- 16 oz. wt. pkg. NI LINER FROZEN COD FILLET **\$1.19**

FOOD CLUB ORANGE JUICE
Half Gallon
14¢ off WITH COUPON
0000 4/18 THRU 4/23/77
DEPT. 419

GAYLORD VANILLA OR NEOPOLITAN ICE CREAM
Gallon Carton
\$1.29 WITH COUPON
0000 4/18 THRU 4/23/77
DEPT. 418

PRICES GOOD MON. APRIL 18 THRU SAT. APRIL 23, 1977. MEIJER RESERVES THE RIGHT TO LIMIT SALES ACCORDING TO SPECIFIED LIMITS. NO SALES TO DEALERS, INSTITUTIONS OR DISTRIBUTORS.

MEIJER THRIFTY ACRES — 45001 FORD RD. AT CANTON CENTER RD.

SHOP MONDAY THRU SATURDAY 8 A.M. TO 10:30 P.M. — SUNDAY 9 A.M. TO 7 P.M.

Why Pay More! Why Pay More! Why Pay More! Why Pay More! Why Pay More! Why Pay More!

Why Pay More! Why Pay More! Why Pay More! Why Pay More! Why Pay More! Why Pay More!

Why Pay More! Why Pay More! Why Pay More! Why Pay More! Why Pay More!



NABISCO
OREO COOKIES

19 oz.
wt. pkg.

78¢

SAVE
44¢

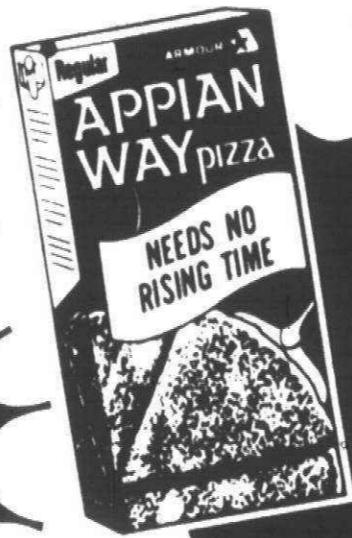

APPIAN WAY
PIZZA MIX

12-1/2 oz.
wt. box

35¢

GAYLORD

**PORK
AND
BEANS**

15-1/2 oz.
wt. can

22¢

**THANK-YOU
TOMATO
JUICE**

32 fl.
oz. (qt.)
btl

38¢

**MUELLER
LASAGNE**

16 oz.
wt. (1 lb.)
pkg.

49¢

**CREAMETTE
EXTRA WIDE
EGG NOODLES**

16 oz.
wt. (1 lb.)
bag

47¢

**7 SEAS
VIVA
ITALIAN
DRESSING**

8 fl.
oz. btl.

38¢

**SIPSEY VALLEY
ROOT BEER, ORANGE,
OR STRAWBERRY
SOFT
DRINKS**

48 fl. oz.
non-return
bottle

39¢

EDON

ASSORTED

1 PLY - 4.5" X 4.5"

TOILET TISSUE

280 sheets
4 roll pkg.

48¢

SAVE
15¢



**SNOWDRIFT
SHORTENING**

48 oz.
wt. can
(3 lb.)

\$1.19

SAVE
44¢

Food Club

**FREEZE DRIED
INSTANT COFFEE**

8 oz.
wt. jar

\$2.99

**NESTEA
INSTANT TEA**

3 oz.
wt. jar

\$1.49

**STAYFREE
MINI
PADS**

48 ct.
box

\$1.69

- 4 pk. - 5 oz. wt. can
HUNTS
SNACK PACK 69¢
- 12 oz. wt. can
FOOD CLUB IMPORTED
CORNED BEEF **85¢**
- 12 fl. oz. bottle
FRANK
RED HOT SAUCE **59¢**
- 32 fl. oz. bottle
HENRI CREAMY
GARLIC DRESSING **\$1.39**
- 17 oz. wt. can
GREEN GIANT
THREE BEAN SALAD **57¢**
- 3 oz. wt. can
O & C FRENCH FRIED
ONIONS **37¢**
- 16 oz. wt. can
FOOD CLUB WHITE WHOLE OR SLICED
POTATOES **22¢**

Food Club

**GROUND
BLACK
PEPPER**

8 oz.
wt. can

89¢

LESTOIL

28 fl.
oz. btl.

89¢

**GLADE SOLID
EARLY SPRING, SUNNY LEMON,
COOL LIME, SCOTCH PINE
AIR FRESHENER**

6 oz. wt.
container

39¢

FRESHLIKE

VEGETABLES

12 to 16
oz. wt. can

25¢

- CREAM STYLE CORN
- WHOLE KERNEL CORN
- SHINACH
- FRENCH STYLE GREEN BEANS
- CRINKLE SLICED BEETS
- CRINKLE SLICED CARROTS
- VEG-ALL MIXED VEGETABLES

**FRESHLIKE
WHOLE GREEN BEANS OR GARDEN**

PEAS

14-14-1/2
oz. wt.
can

29¢



- 2 oz. wt. pkg.
MARTHA WHITE
SPUD FLAKES 10/¢1
- 5/8 oz. wt. pkg.
PILLSBURY BROWN OR HOME-STYLE
GRAVY MIXES 10/¢1
- 25 oz. wt. jar
MUSSELMAN CHUNKY
APPLESAUCE 55¢
- 13 1/2 oz. wt. box
DUNCAN HINES BANANA NUT, SPICY
APPLE RAISIN, OR DOUBLE CHOC. CHIP
MOIST 'N EASY CAKES 69¢
- 13 oz. wt. box
DUNCAN HINES BLUEBERRY
MUFFIN MIX 75¢

M MEIJER **25¢ COUPON**

**LYSOL SPRAY
DISINFECTANT**
14 oz. wt. can

25¢ off
WITH COUPON
GOOD 4/18 THRU 4/23/77

Coupon limited to one per family. DEPT. 410

M MEIJER **14¢ COUPON**

**WAXTEX
WAX
PAPER**
100 ft. roll

35¢
WITH COUPON
GOOD 4/18 THRU 4/23/77

Coupon limited to one per family. DEPT. 410

M MEIJER **15¢ COUPON**

**HELLMANN'S
SPIN BLEND
SALAD
DRESSING**
32 fl. oz. jar

15¢ off
WITH COUPON
GOOD 4/18 THRU 4/23/77

Coupon limited to one per family. DEPT. 417

M MEIJER **30¢ COUPON**

**GERBER
STRAINED OR
GERBER JUNIOR
HI-MEAT
DINNERS**
4-1/2 oz.
wt. jar

30¢ off
WITH COUPON
ON 6 JARS
GOOD 4/18 THRU 4/23/77

Coupon limited to one per family. DEPT. 989

PRICES GOOD MON. APRIL 18 THRU SAT. APRIL 23, 1977. MEIJER RESERVES THE RIGHT TO LIMIT SALES ACCORDING TO SPECIFIED LIMITS. NO SALES TO DEALERS, INSTITUTIONS OR DISTRIBUTORS.

MEIJER

• WELCOMES U.S.D.A. GOVERNMENT FOOD STAMPS
• RESERVES THE RIGHT TO LIMIT TO REASONABLE QUANTITIES

Why Pay More! Why Pay More! Why Pay More! Why Pay More! Why Pay More!

Why Pay More! Why Pay More! Why Pay More! Why Pay More! Why Pay More!

m in the garden center

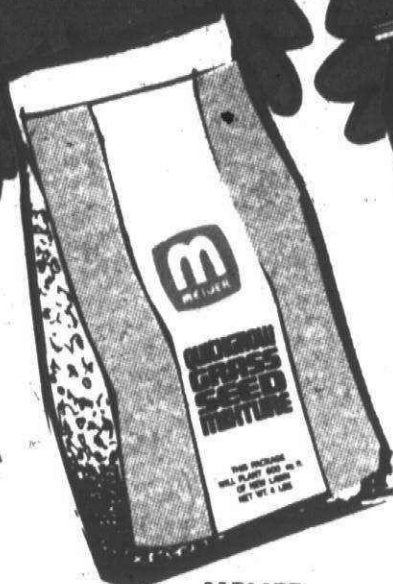

MEIJER GRASS SEED
 2 LB. SHADY GRASS SEED MIXTURE \$2.47
 5 LB. GRASS SEED MIXTURE \$3.97
 2 LB. KENTUCKY BLUE GRASS SEED \$2.47
 3 LB. FESCUE GRASS SEED \$2.97
 4 LB. KENTUCKY BLUE GRASS SEED . . . \$3.67
 1 LB. MERION BLUE GRASS SEED \$2.97

MEIJER BEST GRASS SEED
 Our finest blend of grass seed contains both Kentucky Blue grass and Fescue to give that deep green carpet appearance.
 1 LB. COVERS 600 SQ. FT. REG. \$1.57
 5 LB. COVERS 3000 SQ. FT. REG. \$7.47

MEIJER QUICK-GROW GRASS SEED
 A blend of annual and perennial rye grass germinates in 7 to 10 days. Also use as a nurse crop with other grasses. 4 lbs.
 REG. \$1.97 **\$1.47**

MEIJER GARDEN FERTILIZER
 • 5-10-5 analysis
 • 20 lb. bag
 REG. \$2.47 **\$1.97**

MEIJER GOOD WEED-N-FEED
 10-6-4 fertilizer blended with leaf weed control. An economical way to green up your lawn and make it weed free. 20 lb. bag covers 5000 sq. ft.
 REG. \$3.67 **\$3.17**

MEIJER BEST WEED-N-FEED
 Premium quality fertilizer. Contains two weed killing agents to kill viney & broad leaf weeds. 20 lb. bag covers 5000 sq. ft.
 Save \$1.00
 REG. \$7.97 **\$6.97**

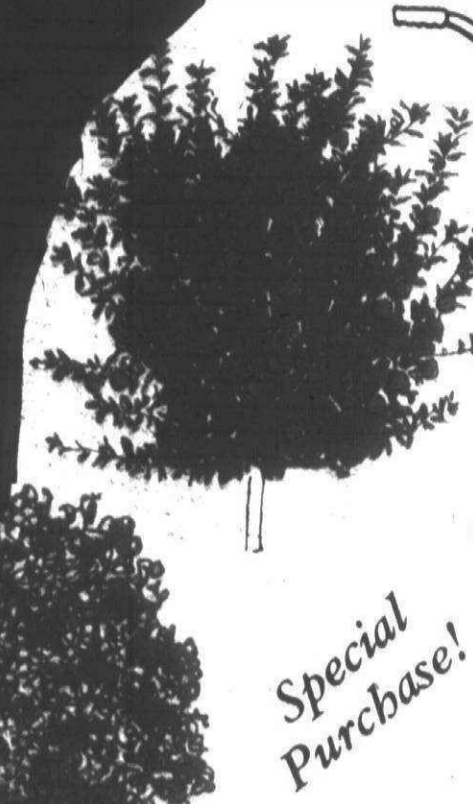

24" DROP SPREADER
 By Precision. 75 lb. hopper capacity. 10" wheels. "Accu-Rate" low control system. #248-10.
 REG. \$22.97
\$19.97

TRUE TEMPER HOSE REEL & UTILITY CART
 By True Temper. 200 ft. 5/8" hose capacity. Detaches to mount to house.
SAVE \$5.00
 OUR REG. \$24.57
\$19.57

PACKAGED FLOWERING SHRUBS
 Lilacs, Mock Orange, Pussy Willow, Snowball, Spirea, Weigela, Althea, Dogwood, Hydrangeas and many more
99¢

PACKAGED FRUIT TREES
 A complete selection of Apples, Peaches, Cherries, Pears and more.
\$3.67 to \$5.97

PACKAGED DWARF FRUIT TREES
 • Apple, Cherry or Peach
\$4.99 to \$5.99

FRUIT TREES
 Choose from popular varieties of apples, peaches, plums, cherries, etc.
 9-16" DWARF FRUIT TREES REG. \$9.97
 11-16" STD. FRUIT TREES REG. \$8.97-\$9.97
Save \$3.00 to \$4.00
ALL \$5.97

Why Pay More!
TRUE TEMPER

SMALL HANDLE GARDEN & FLOWER TOOLS BY TRUE TEMPER

A. DIGGING TROWEL
 B. TRANSPLANTING TROWEL
 C. HAND CULTIVATOR
 D. WEEDING HOE
 E. POINTED HOE

OUR REG. \$12.99
\$9.97

LANDSCAPERS SPECIAL!
SOUTHERN BARK
 • 3 cubic feet
 REG. \$4.27 **\$3.27** bag

PACKAGED ORNAMENTALS
 Flowering Crabs, Purple Leaf Plum or Red Bud.
\$3.97

PERENNIALS
 A wide selection of packaged perennials. You plant them only once and they come up year after year.
69¢ and up

ROSES
 • All two year old field grown
\$1.47 and up

NYLON REINFORCED GARDEN HOSE
 Solid brass coupling. Multi-ply construction. Green cover 1/2" x 50'. #508-12-50.
 REG. \$5.27 **\$4.27**

VINYL GARDEN HOSE REG. \$2.97
 • Opaque
 • 100% vinyl
 • 1/2" x 50'
 • Model 5400
\$2.47

WATER NOZZLE
 Long-lasting stem and nut of polymer. Non-corrosive body. #501-C.
 REG. 97¢ **77¢**

ALL PURPOSE UTILITY HANGER REG. \$2.97
 Chrome plated tubular steel. Hangs up garden hose, lawn spreader, mower, ladder, etc.
\$2.57

HOSE HANGER
 By Keller. Holds up to 100 ft. of garden hose. Steel with green enamel finish.
 REG. 77¢ **59¢**

VINYL HOSE 5/8" x 50'	\$4.87	DELUXE NYLON REINFORCED HOSE 5/8" x 50'	\$9.97
NYLON REINFORCED HOSE 5/8" x 50'	\$6.77	DELUXE NYLON REINFORCED HOSE 5/8" x 75'	\$12.97
NYLON REINFORCED HOSE 5/8" x 75'	\$9.17	RUBBER HOSE 5/8" x 50'	\$14.97
		3 TUBE SPRINKLER 50'	\$4.17

YOU DON'T NEED CASH! USE EITHER OF THESE CONVENIENT CREDIT CARDS!

your **BANKAMERICARD** welcome

master charge THE INTERBANK CARD

SPRING WHITE SALE

PULL OUT FOR SAVINGS
IN OUR DOMESTICS DEPT.



SPRING WHITE SALE

PULL OUT FOR SAVINGS
IN OUR DOMESTICS DEPT.



PRICES GOOD THRU SAT.
APRIL 23, 1977

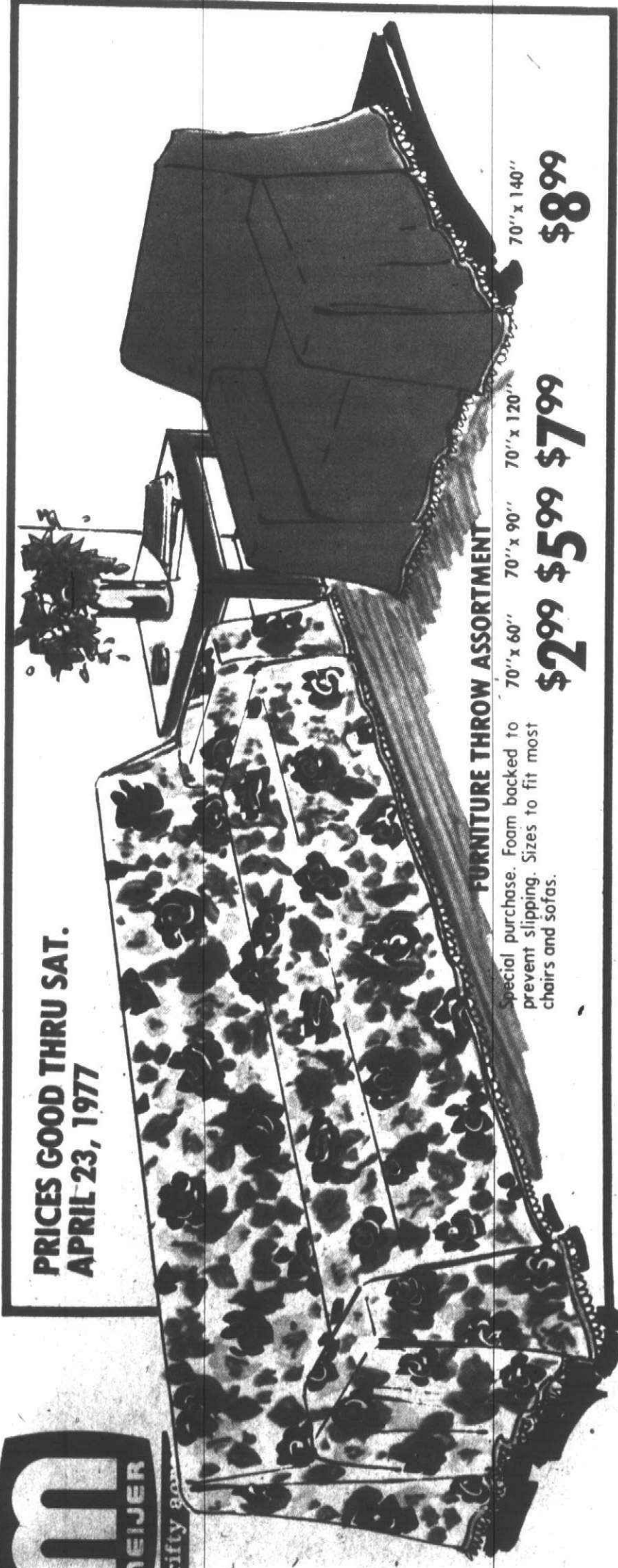

FURNITURE THROW ASSORTMENT

70" x 60" \$299 \$599 \$799
70" x 90" \$899
70" x 140"

special purchase. Foam backed to prevent slipping. Sizes to fit most chairs and sofas.

CAPE COD TIER CURTAINS
50% Celanese Fortrel® Polyester/50% Avrije Rayon. Machine washable. Solid colors of white, yellow, celery and brown.

62" x 24" OR 62" x 30" \$237 pr.

62" x 36" VALANCE \$257 pr. \$197 ea.

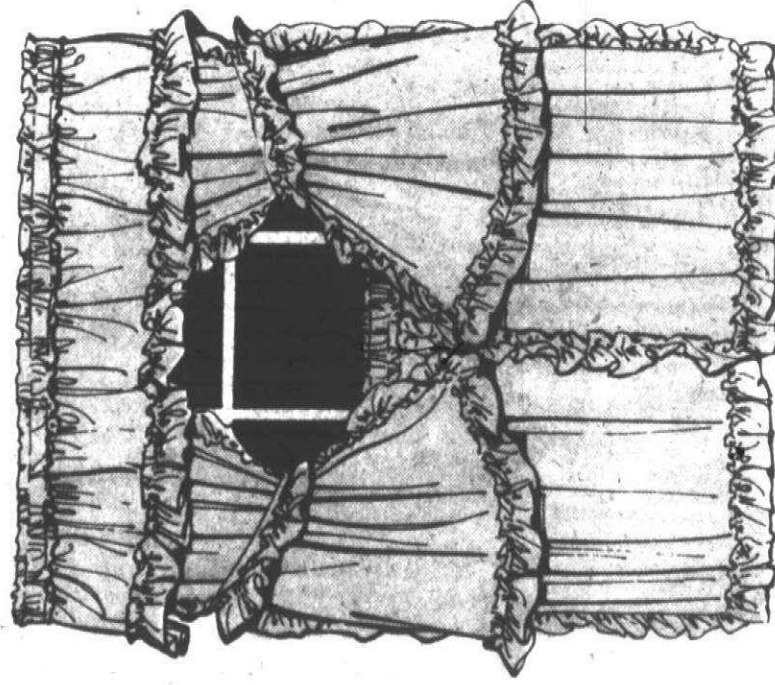

KITCHEN TOWEL
REG. \$1.33

88¢

DISH CLOTH OR POT HOLDER
REG. 88¢

58¢

OVEN MIT
REG. \$1.33

88¢

VEGETABLE PATCH KITCHEN ENSEMBLE
Choose a green artichoke, red apple, yellow pear, or an orange mushroom pattern.

\$327

MATCHING PUSH PILE RUG WITH NON-SKID RUBBER BACK
REG. \$3.87

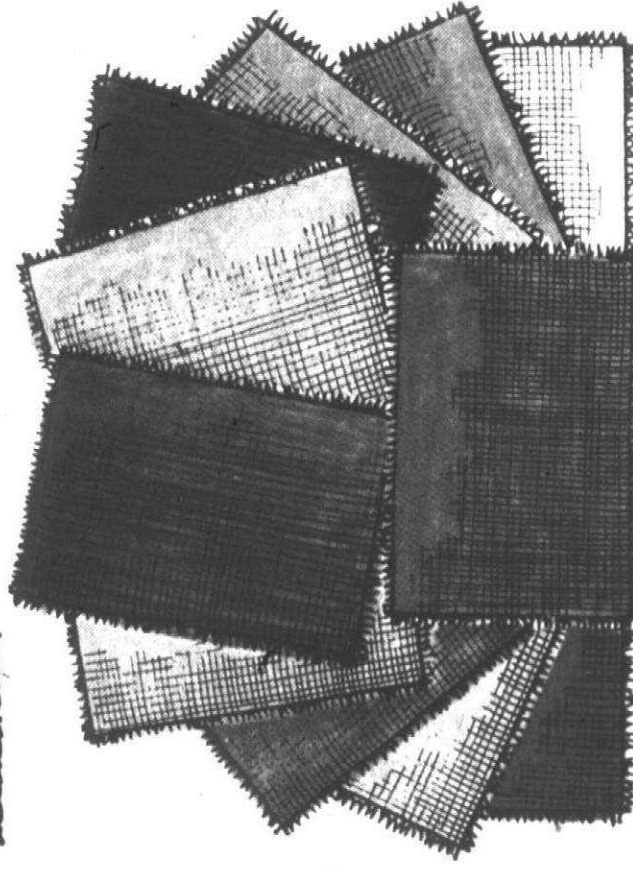

FASHION LOOP PLACE MATS

• Assorted colors
REG. 79¢

2/\$100

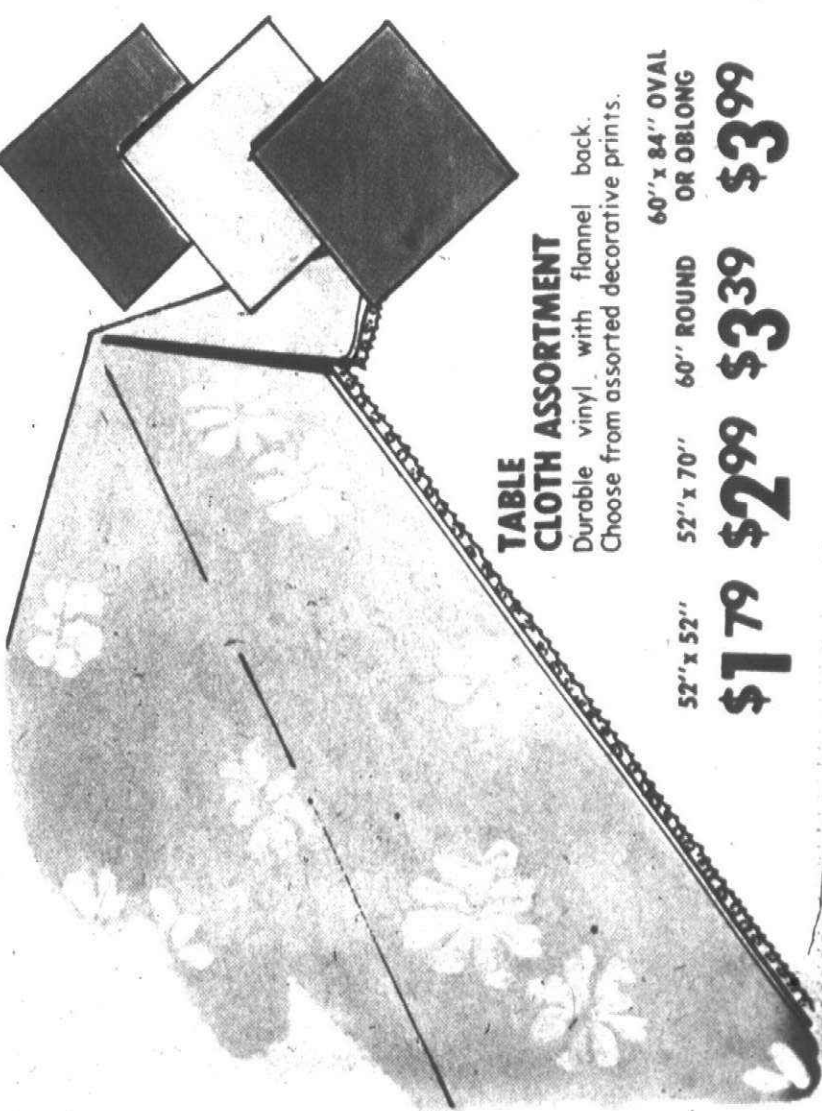

TABLE CLOTH ASSORTMENT

Durable vinyl, with flannel back. Choose from assorted decorative prints.

52" x 52" \$179 \$299 \$339 \$399
60" ROUND OR OBLONG
60" x 84" OVAL



Spring Homemaker-

White Sale!

IN OUR DOMESTICS DEPT...



DELICATE FLOWER SHEETS AND PILLOWCASES

By Pequot®. A beautiful no-iron muslin multi-color sheet and pillowcase. A new fresh spring design to compliment your bedroom's fashion look.

TWINS REG. \$2.68 \$197 ea.
FULL REG. \$3.58 \$297 ea.
QUEEN REG. \$5.58 \$497 ea.

STANDARD CASES REG. \$2.68 \$697 ea.
KING CASES REG. \$3.68 \$997 ea.

ROSE COORDINATES BY ST. MARY'S®

A classically styled sheet and pillowcase of roses, daisies, and other flowers. No iron percale of 50% cotton/50% polyester.

TWIN REG. \$4.63 \$337 ea.
QUEEN REG. \$8.97 \$677 ea.

STANDARD CASES REG. \$4.22 \$337 pr.
KING CASES REG. \$5.73 \$447 pr.

FULL REG. \$9.97 \$797 ea.

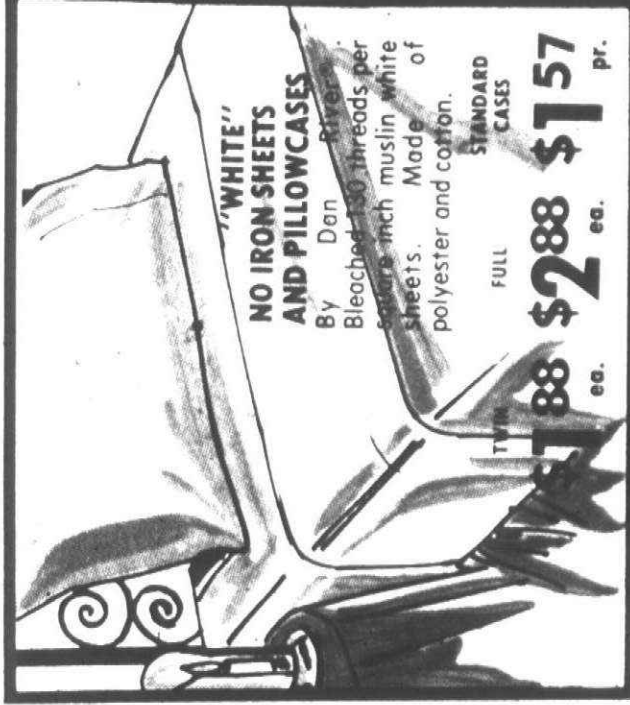

"WHITE" NO IRON SHEETS AND PILLOWCASES

By Dan Perrier®. Bleached 100 threads per square inch muslin white sheets. Made of polyester and cotton.

TWINS REG. \$1.88 \$188 ea.
FULL REG. \$2.88 \$288 ea.

STANDARD CASES REG. \$1.57 \$157 pr.



BLANKETS BY BEACON

Plaza style, 60% polyester/40% acrylic. Solid colors of blue, gold and green. 72" x 90" size fits twin or full size beds.

AFTER AD \$5.97 \$397



BATH TOWEL ENSEMBLE

Sheared velour-terry. Decorative Mum pattern in colors of blue, yellow or pink with co-ordinating solid colors.

BATH TOWEL REG. \$2.47 \$197

HAND TOWEL REG. \$1.67 \$137

WASH CLOTH REG. \$1.07 \$87¢

Spring Homemaker-White Sale!

MATTRESS PADS
100% polyester filled mattress pad with 100% polyester cover. Anchor band style.

TWIN **\$3.99** ea.
FULL **\$4.99** ea.
QUEEN **\$5.99** ea.

BEDSPREADS
Fully quilted. Permanent press. Machine washable. Many decorative prints and colors.

TWIN REG. \$17.96
SAVE **\$5.00**
\$12.96 EA.
FULL REG. \$18.96
\$13.96 EA.

PRICES
GOOD THRU
SAT. APRIL 23,
1977



BEDSPREADS
Special purchase. Choice of solids and florals. Quilt top. 100% taffeta. Twin or full size.
AFTER AD \$9.97
\$6.00 EA.

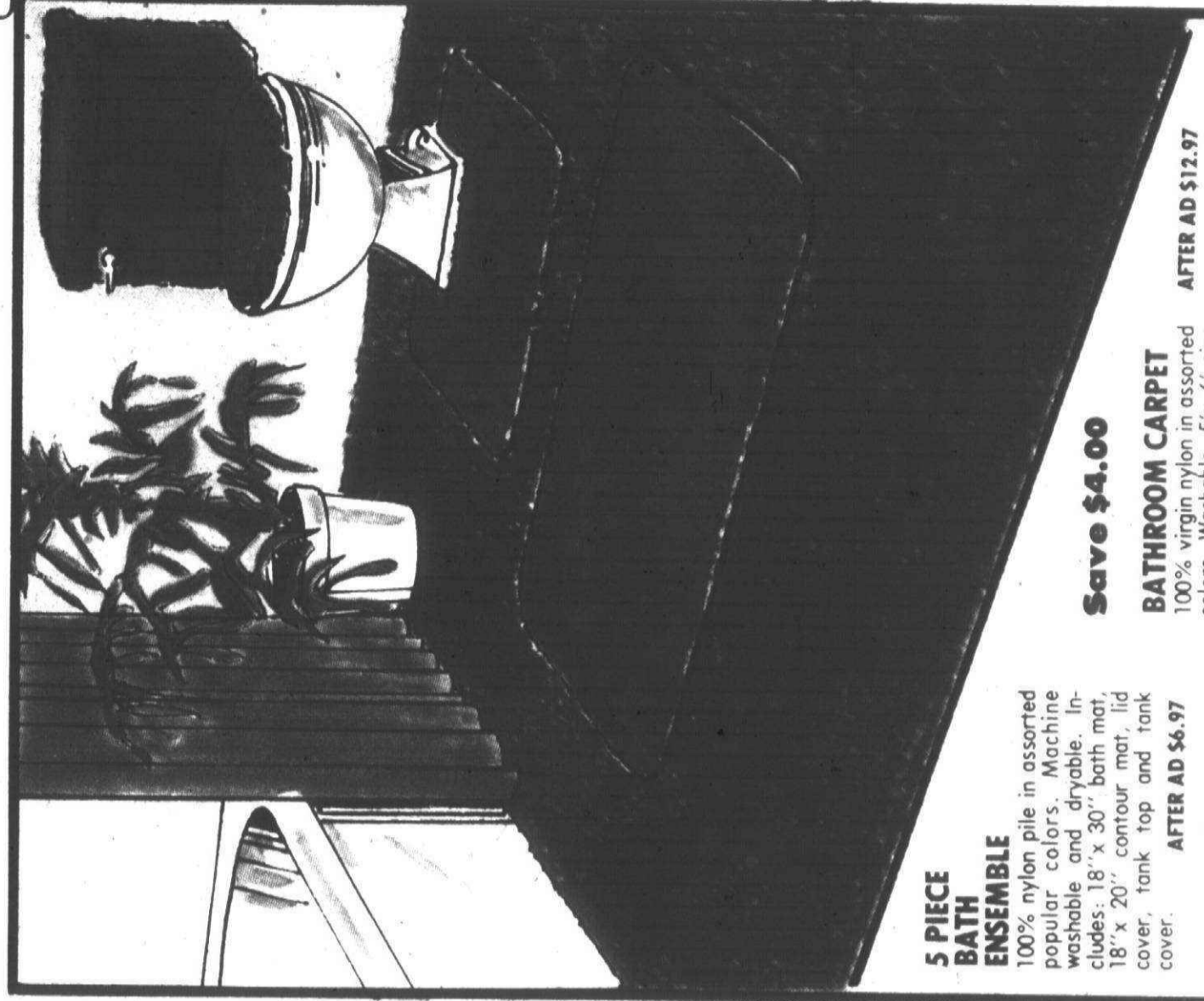
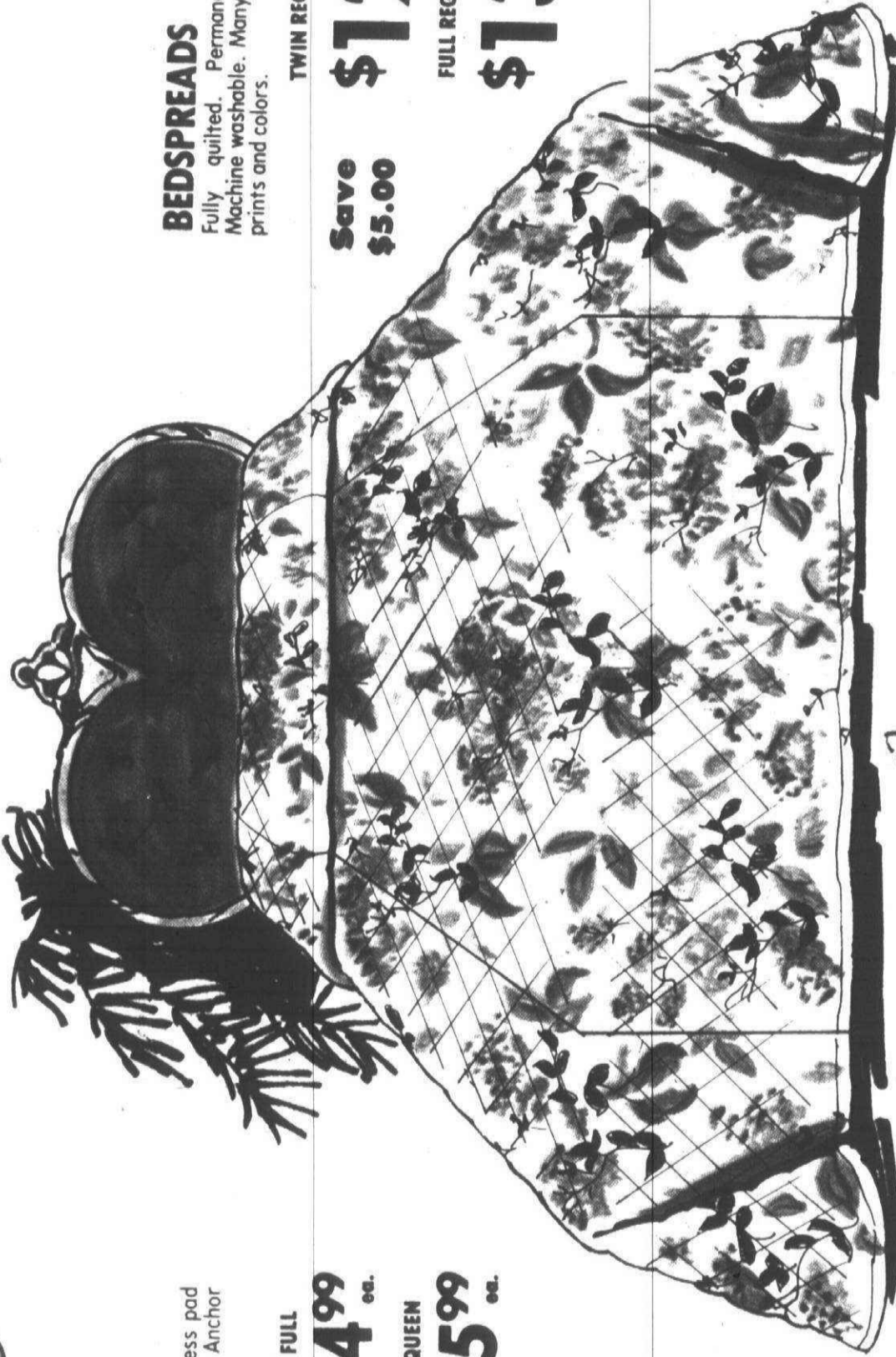

5 PIECE BATH ENSEMBLE
100% nylon pile in assorted popular colors. Machine washable and dryable. Includes: 18" x 30" bath mat, 18" x 20" contour mat, lid cover, tank top and tank cover.
AFTER AD \$6.97
\$5.44 set
BATHROOM CARPET
100% virgin nylon in assorted colors. Washable. 5' x 6' size with matching lid cover. Fits most bathrooms. Non-skid waffle back.
AFTER AD \$12.97
\$8.97

GOLD MEDAL[®] YARN
100% Dupont[™] orlon acrylic yarn in popular solid and ombre shades. 4 ply 4 ounce solid colors or 4-ply 3 ounce ombre shades.
69¢ SKIEN
OMBRE SHADES NOT AVAILABLE IN GREENVILLE, IOWA, HOLLAND OR GRAND HAVEN STORES.

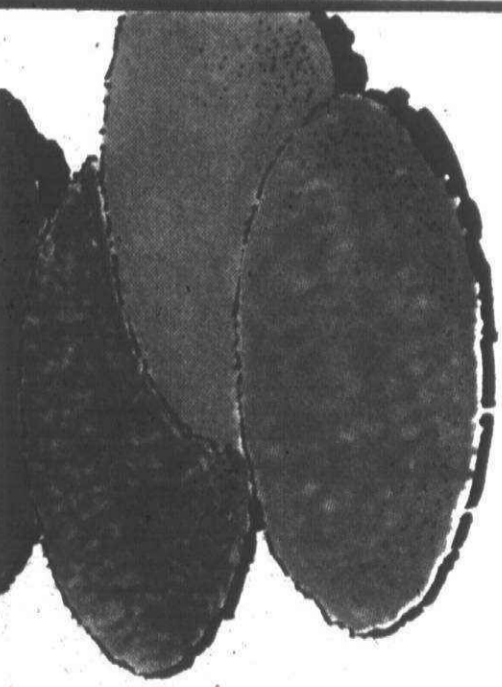

THROW RUG ASSORTMENT
Special purchase. Assorted types and pile combinations. 27" round and 21 x 34" oblong.
2/\$5

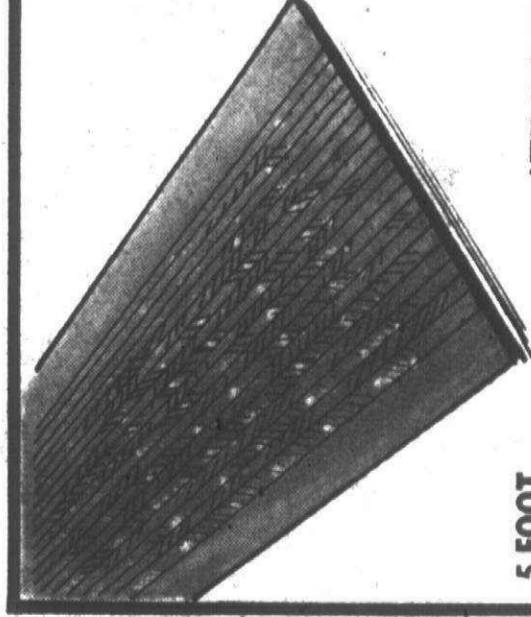

5 FOOT VINYL CARPET RUNNER
Protect your carpet from rain and mud of spring. 23" wide. Grippers on bottom assure positive holding power.
AFTER AD \$2.97
\$2.00

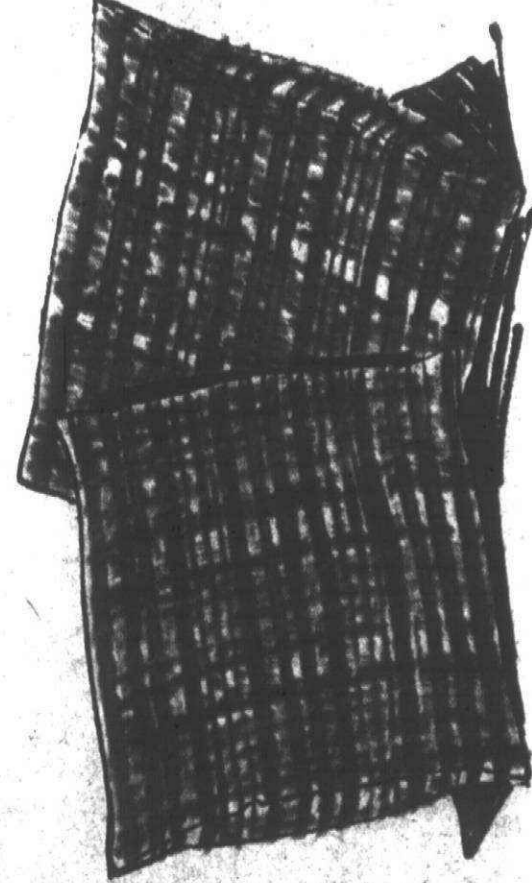

TOSS PILLOWS OR FLOOR SITTERS
Durable and decorative Her-culon fabric covers. Assorted colors and patterns.
14" SQUARE TOSS PILLOW **2/\$3.00**
27" SQUARE FLOOR SITTER **\$4.00** ea.



PILLOW PROTECTORS
Fits standard size bed pillows. Made of no iron white muslin.
AFTER AD \$1.49
\$1.00 EA.

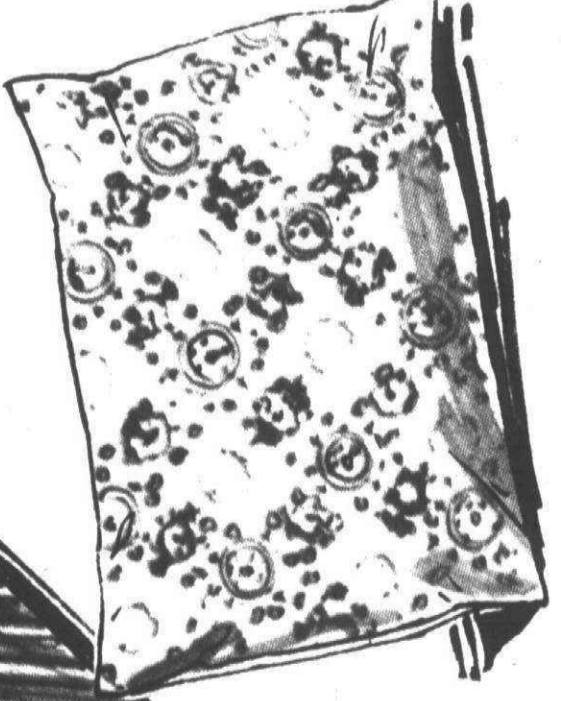

KODEL[®] PILLOWS
Kodel[®] 232 polyester bed pillows. Attractive fine quality ticking. Finished size: 20" x 27".
REG. \$5.27
\$3.88 EA.

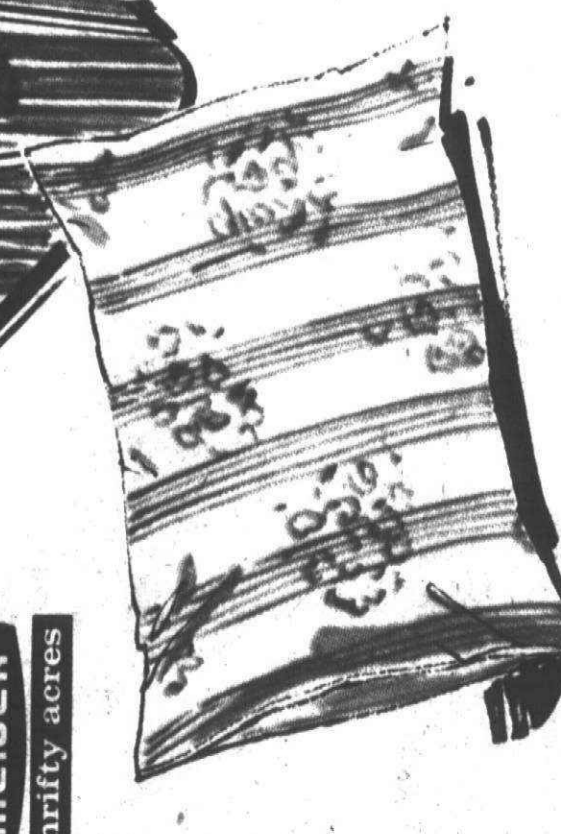

BED PILLOWS
Polyester filled. Assorted tickings. Standard finished size: 19" x 25".
REG. \$2.49
\$1.99 ea.



MEIJER

thrifty acres

LADIES' BRAS
 Good assortment of white and colors. A-B-C cups. Many styles to choose from.

Ladies' Dept.

LADIES' COMFORT-TOP KNEE-HIGH STOCKINGS
 100% nylon. Wide band comfort top. one size fits 8 1/2 to 11
 AFTER AD 39¢ PR.

Ladies' Dept.

CANNON KITCHEN TOWEL
 Popular check pattern, loop terry for greater absorbency. 15" x 26" size.
 OUR REG. \$1.47

Domestics Dept.

BOYS' ORLON CREW SOCKS
 75% orlon and 25% stretch nylon in medium and dark colors. One size fits 9-11.
 OUR REG. 58¢

Boys' Dept.

9-PAIR WIRE SHOE RACK
 Plastic tips on legs to prevent scratching.

Domestics Dept.

CANNON WAFFLE DISH CLOTH
 12" x 12" size.

Domestics Dept.

MEN'S HI-RISE TUBE SOCKS
 Solid whites and assorted stripe tops in 80% orlon acrylic/20% nylon. Size 9-14
 OUR REG. \$1.29 PR.
 SAVE 29¢ PR.

Men's Dept.

SPRINGCREST FEEDER BIBS
 OUR REG. 47¢

Infants' Dept.

GERBER PULL-ON VINYL PANTS
 Sizes S-M-L-XL. Special!
 OUR REG. 56¢ EA.

Infants' Dept.

BOOTIE SOCKS
 Sizes 6-8 1/2 - 8 7/8-11.
 OUR REG. 58¢ PR.

Girls' Dept.

MEIJER

thrifty acres

3 PIECE BBQ TOOL SET
 REG. \$1.47

Hardware Dept.

PVC ELECTRICAL TAPE
 • 3/4" x 60 ft.

Hardware Dept.

PROTEIN 21 SHAMPOO
 • 7 fl. oz.

Health & Beauty Aids Dept.

CRAYOLA 24'S
 • Non-toxic, safe
 • Handy tuck box

School Supplies Dept.

6' TAPE RULE
 • Model PC-6
 AFTER AD \$1.47

Hardware Dept.

FORD 10W30 QUARTS MOTOR OIL
 REG. 74¢

Auto Supply Dept.

2" MASKING TAPE

Paint Dept.

GENUINE MR. COFFEE FILTERS
 • Pkg. of 200
 • Limit 3 please!

Jewelry/Small Appliance Dept.

GENUINE HOVER VACUUM CLEANER BAGS
 • Assorted sizes

Jewelry/Small Appliance Dept.

CERTRON 50 MINUTE BLANK RECORDING CASSETTE
 • Pkg. of 3
 REG. \$1.78

Jewelry/Small Appliance Dept.

GENUINE MR. COFFEE FILTERS
 • Pkg. of 200
 • Limit 3 please!

Jewelry/Small Appliance Dept.

AMUROL GUM & MINTS
 • Assorted flavors
 REG. 14¢ EA.

Pharmacy Dept.

JUMBO BAT & BALL BY EMPIRE
 • Model 3113
 REG. \$1.47

Toy Dept.

PRACTICE HEAVY DUTY TENNIS BALLS
 • Bag of 3
 • Model T-106

Sporting Goods Dept.

HEAVY DUTY SMALL STEEL GARDEN TOOLS
 REG. 67¢ EA.

Garden Center

CACHE POT OR HANGING PLANTER
 • Style 8920/8901
 • 8 assorted styles
 REG. \$1.97

Floral Dept.

JUMBO BAT & BALL BY EMPIRE
 • Model 3113
 REG. \$1.47

Toy Dept.

GENUINE MR. COFFEE FILTERS
 • Pkg. of 200
 • Limit 3 please!

Jewelry/Small Appliance Dept.

GENUINE HOVER VACUUM CLEANER BAGS
 • Assorted sizes

Jewelry/Small Appliance Dept.

HEAVY DUTY SMALL STEEL GARDEN TOOLS
 REG. 67¢ EA.

Garden Center

CACHE POT OR HANGING PLANTER
 • Style 8920/8901
 • 8 assorted styles
 REG. \$1.97

Floral Dept.

JUMBO BAT & BALL BY EMPIRE
 • Model 3113
 REG. \$1.47

Toy Dept.

GENUINE MR. COFFEE FILTERS
 • Pkg. of 200
 • Limit 3 please!

Jewelry/Small Appliance Dept.

GENUINE HOVER VACUUM CLEANER BAGS
 • Assorted sizes

Jewelry/Small Appliance Dept.

ADVERTISING SUPPLEMENT TO:
 THE ANN ARBOR NEWS
 THE YPSILANTI PRESS
 THE FLINT JOURNAL
 THE DAILY NEWS

THE IONIA SENTINEL/STANDARD
 THE GRAND HAVEN TRIBUNE
 THE HOLLAND SENTINEL
 Saturday April 15, 1977

THE OBSERVER & ECCENTRIC
 Monday April 18, 1977

THE HOLLAND FLASHES
 Tuesday April 19, 1977

THE GRAND RAPIDS PRESS
 THE MUSKOGEE CHRONICLE
 THE BATTLE CREEK ENQUIRER & NEWS
 THE KALAMAZOO GAZETTE
 THE LANSING STATE JOURNAL

THE JACKSON CITIZEN PATRIOT
 Sunday April 17, 1977

PRICES: GOOD SUN
 APRIL 17 THRU SAT.
 APRIL 23, 1977

