

2016



SLK



Mercedes-Benz

# *RACING ROOTS, REACHING HIGH*

---

*IT'S A SPORTS CAR THAT TRULY KNOWS DRIVING IS A SPORT.  
AND A ROADSTER THAT LOVES WHEN YOU OPEN IT UP.*

---



## HUG THE ROAD, EMBRACE THE SKY

The soul of the SLK roadster traces directly to the first finish line, when a Daimler-powered car won history's first auto race in 1909. The engineers of Mercedes-Benz have always taken motoring quite seriously—but that's never stopped them from having a blast along the way. In fact, their unquenchable love of driving is what drives them. There may be no clearer evidence of this than the SLK. Its countless advancements make it an even purer sports car—the perfect union of unrelenting progress and undiluted passion. You don't just touch the road and the sky in an SLK. You feel them.



# *CLEAR YOUR HEAD*

---

*EVEN WITH THE TOP UP, THE SLK'S PANORAMA ROOF CAN SHOW YOU THE STARS. PUT THE POWER HARDTOP DOWN, AND IT'LL LET YOU REACH THEM.*

---



## COUPE TO ROADSTER IN 20 SECONDS

In less than a third of a minute, the SLK can transform your state of mind. That's all it takes to quick-change it from a sleek closed coupe to a wide-open roadster. Even more miraculous is what doesn't change in the process: the taut muscle of its lines and its perfect sports-car proportions. Unlike most hardtop convertibles, its shutlines and seams are well-concealed, and its folded top is remarkably compact. And even in closed form, there's an airy openness to an SLK, thanks to a standard Panorama roof that lets you view the stratosphere from a comfortably cozy atmosphere.



# MAKES YOU SHINE

---

*HOW YOU OUTFIT YOUR SLK'S CABIN REFLECTS YOUR SENSE OF STYLE—AND YOUR DRIVING STYLE. THE SLK'S LEATHER IS TREATED SO IT REFLECTS SOMETHING ELSE: THE HARSH RAYS OF THE SUN.*

---

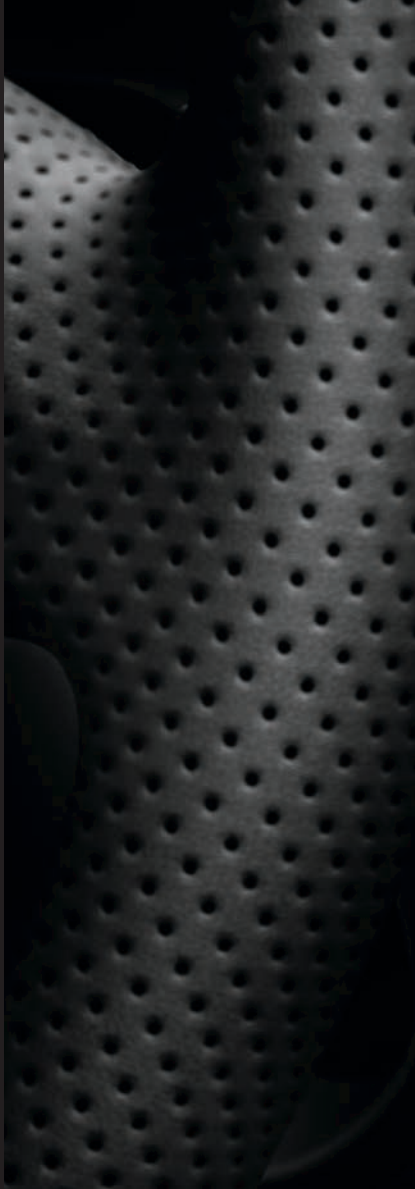



## ALWAYS IN SEASON

As summer-loving as the SLK is, your pleasure doesn't plummet when the thermometer takes a dive. The twin power seats can offer soothing heat in winter, and a virtual scarf that stretches your top-down driving season. AIRSCARF® can envelop your neck and shoulders in warm air that adapts automatically to your driving speed. Even with the power hardtop up, the standard Panorama roof's tinted skylight lets you bask in the sun without baking, or ride under a blanket of stars. Available MAGIC SKY CONTROL® even lets you darken the glass at a button's touch.

## FOREVER IN FASHION

The Mercedes-Benz tradition of craftsmanship is everywhere to be found in the SLK cockpit. Its upholstery is precisely double-topstitched in contrasting thread and hand-fitted to each seat. An advanced treatment of the available leather—even the smooth, supple Nappa leather—helps the seats reflect sunlight. Not only does it keep the seats appreciably cooler on summer days, it also enhances their enduring beauty. The wide palette of color choices lets you suit your style, from rich tone-on-tone Brown to bold Bengal Red leathers, along with console and door trim in either of two hand-finished woods or sleek, satin-finish aluminum. Genuine carbon fiber is a fourth option for the AMG SLK55. Beneath the surface, steam-expanded foams—a process Mercedes-Benz pioneered in the '90s—eliminate harmful chemicals, while products from flax, coconut and olives support the seats, many trim components in a more earth-friendly fashion.

# *RACES YOUR PULSE*

---

*WHAT'S GOOD FOR THE HEART IS GOOD FOR THE SOUL.  
ESPECIALLY IF YOU MEASURE YOUR PULSE IN RPM.*

---





## ELEVATE YOUR REFRESH RATE

There may be no better way to rejuvenate your spirit than a dose of heart-pumping horsepower. You'll find it in abundance under the SLK's hood—from a new 241-hp turbo-4 with a 9-speed automatic to a 415-hp AMG V-8. Just find your favorite road and press "go." Revel in the revs as they turn torque into thrust. Savor the grip as you untwist the curves. And as the rushing wind sings harmony to the tailpipes' baritone, go ahead—sing along. Or at least tap your fingers on the shift paddles. Before long, you'll feel not just refreshed but renewed. You'll remember why you love to drive. And why you drive an SLK.



# *HANDCRAFTED BY RACERS*

---

*MERCEDES-AMG IS NO MERE SPONSOR OF RACING. AMG IS PEOPLE WHO DEVELOP, BUILD AND RACE RACECARS. AND THEY WIN. THEN THEY DEVELOP AND CRAFT HIGH-PERFORMANCE STREET CARS. AND YOU WIN.*



“One man, one engine” is more than a motto for AMG. It’s a guiding philosophy and a process rooted in racing, where precision and endurance are proven in record time. The heart of a Mercedes-AMG SLK55 is its advanced V-8 engine. Each one is crafted by the hands of its own master engine builder, who visually inspects and records every component, and computer-verifies each torque spec. Only after the engine is individually bench-tested does it earn his signature—on a metal plaque that he affixes atop its cover. This degree of detail-obsession is evident throughout the car—from its mighty brake hardware to its range of driver-selected modes to its finely stitched, hand-fitted Nappa leather upholstery.

The AMG SLK 55’s V-8 unleashes 415 hp and 398 lb-ft of torque. While it can thrust you to 60 mph in 4.5 seconds,<sup>1</sup> its AMG Cylinder Management can seamlessly deactivate four cylinders when you don’t need its tremendous output. Make a demand of the throttle and they fire back to life in less than 30 milliseconds. Other racing-proven credentials include a 7-speed, 3-mode AMG SPEEDSHIFT<sup>®</sup> transmission, staggered 18" AMG<sup>®</sup> wheels,<sup>2</sup> and AMG-developed brakes and suspension. The standard multistage ESP<sup>®</sup> and Torque Vectoring Brake, plus an available AMG Handling Package with a limited-slip differential, deliver the agility that AMG drivers have cherished—on road and track—for decades.



**AMG**

DRIVING PERFORMANCE

# SETS THE PACE FOR SAFETY

*IN FORMULA 1® RACING, THE PACE CAR IS KNOWN AS THE SAFETY CAR. AND FOR YEARS, AN SLK FILLED THIS ROLE. AT WORK ON THE RACETRACK OR WITH YOU THE ROAD, AN SLK'S UNFLINCHING REFLEXES AND INNOVATIVE SYSTEMS ARE ALWAYS ON GUARD.*



## **ADAPTIVE BRAKING TECHNOLOGY**

A suite of advances pioneered by Mercedes-Benz sports cars have since set industry standards. If you lift off the accelerator pedal quickly, Predictive Brake Priming pre-charges the brakes for more immediate response when you apply them. In the rain, Automatic Brake Drying periodically sweeps water build-up from the discs. Hill-Start Assist helps prevent rollback in uphill starts. And a brake HOLD feature can make long red lights or stopped traffic a little easier.<sup>3</sup>

## **ATTENTION ASSIST**

By continuously monitoring as many as 70 parameters of driving behavior, ATTENTION ASSIST® can alert you both visually and audibly if it detects signs of driver-drowsiness on long trips. Its enhanced sensitivity helps the system detect drivers who begin their trip drowsy. A display in the gauge cluster can help you track your own attention level and driving time along your journey.<sup>4</sup>

## **EMERGENCY-SENSING BRAKE ASSIST**

The Brake Assist system (BAS®) senses emergency braking based on the speed at which you press the brake pedal. If it detects a panic situation, it immediately applies maximum available power boost. By eliminating the delay caused by a common human tendency not to brake hard enough, soon enough, Brake Assist can potentially reduce the overall stopping distance—a benefit that may help you avoid a collision. Letting up on the brake pedal releases Brake Assist.<sup>3</sup>

## **DUAL ROLL BARS**

Constructed from fiber-reinforced micro-alloy tubular steel, a pair of roll bars are affixed to the SLK's rigid rear bulkhead, to help preserve the occupant space in the event of a rollover.<sup>5</sup> High-strength steel also fortifies the framing of the windshield, while a magnesium hardtop frame is one of numerous ways the SLK roadster's body structure delivers high strength with light weight.



#### **BLIND SPOT ASSIST**

When you're driving at speeds above approximately 20 mph, optional radar technology helps sense when a vehicle enters the blind-spot area on either side of your vehicle, and alerts you by illuminating an icon in the appropriate side mirror. If you activate a turn signal before initiating a lane change while a vehicle is detected, the icon flashes and a warning tone sounds.<sup>6</sup>

#### **NECK-PRO ACTIVE HEAD RESTRAINTS**

In the event of a rear impact exceeding a preset threshold, NECK-PRO<sup>®</sup> active head restraints instantly move forward and slightly upward, to help reduce the distance between each head restraint and the seated occupant's head. This action helps to reduce the likelihood or severity of whiplash-type neck injuries.

#### **DISTRONIC PLUS**

Radar-based cruise control adapts your set speed to the flow of traffic ahead, automatically slowing until your path is clear again. If the vehicle ahead slows to a stop, optional DISTRONIC PLUS<sup>®</sup> can brake to a full halt. When the traffic starts to go, you can resume with just a tap of the accelerator pedal or cruise control lever—or it will resume automatically if the stop is less than a second.<sup>7</sup>

#### **LANE KEEPING ASSIST**

By monitoring visible road markings as you're driving at speeds above 37 mph, optional Lane Keeping Assist helps detect unintended drifting off-course. If it senses lane drift, the system alerts you by vibrating the steering wheel.<sup>4</sup>

# *MAKES IT PERSONAL*

---

*FROM HOW IT FEELS TO WHAT YOU HEAR IN AN SLK, IT REALLY IS ABOUT YOU.*



## ROOM TO ROAM, A PLACE TO BOND

The romance of a roadster comes to life in its two-seat cockpit. It's where you, the driver, cement an immediate, intimate connection to your SLK's controls, and through them to the road. For you and your passenger, everything feels like a custom fit. The power sport seats embrace your physique. Lush surround sound clears the air. Four round dash vents, artful enough for a private jet, twist closed with a uniquely satisfying click. And the entire sky feels like it's yours alone.



*EXTENDED SUMMER. UNLIMITED HEADROOM.  
ELECTRONIC SUNSCREEN. DIGITAL SOUND, AND  
AN ANALOG CLOCK. NEW WAYS TO GO ONLINE, OR  
THE CLASSIC ROADSTER GETAWAY FROM IT ALL.*

---

# *CONQUERS SPACE AND TIME*

---







## TRANSFORMATION HIGHWAY

The SLK is compact and nimble, yet the joys it'll bring you are as big as all outdoors. It's a coupe and a roadster. A cozy retreat and an energetic escape. It's craftsmanship and configuration are classic, yet it's brimming with innovative, intuitive technologies. In-car Internet and Cloud-based apps<sup>®</sup> let you reach out to the world, or find a nearby spot for lunch. AIRSCARF,<sup>®</sup> heated seats and a mesh wind deflector help you relax on an evening drive without literally chilling. A Sport Package adds AMG style outside, Solar Red LED lighting inside. And of course, there's the power top. As it retracts, the rear window flips so the roof nests neatly, saving trunk space. Bring it back up, and a clear tinted panel welcomes the sunshine but not the heat. And with MAGIC SKY CONTROL,<sup>®</sup> one button darkens the glass panel electrically. Any car is transportation. An SLK is a transformation. Actually, quite a few of them.



# TOGETHER WHEREVER

*IT'S PERFECTLY NATURAL TO DEVELOP AN EMOTIONAL ATTACHMENT TO YOUR MERCEDES-BENZ. WITH MBRACE, ENJOYING A TECHNOLOGICAL CONNECTION IS JUST AS EASY.*

With Mercedes-Benz mbrace®, your car is only a click away. Five years of mbrace Connect benefits and services<sup>8</sup> come standard with every new 2016 Mercedes-Benz, providing you with remote access to your vehicle from your smartphone or computer. With the mbrace Mobile App,<sup>9</sup> you can lock, unlock and locate your car—and more—from your phone. You can access Google and Yelp from your car with an ever-evolving variety of in-vehicle apps. You can send destinations to your car's available COMAND® navigation system from your computer or phone. Even your car can reach out, with remote diagnostics and a direct connection to Mercedes-Benz Roadside Assistance.<sup>10</sup> Three additional packages bring you even more connections—from added safety to a personal concierge to streaming music from all around the globe. With mbrace, your Mercedes-Benz helps you stay connected not just to your car, but to your world—from anywhere you are, and wherever tomorrow takes you.

## **mbrace Connect**

5 years included

*State-of-the-art convenience with remote vehicle access, in-vehicle apps and over-the-air updates*

### **Package includes:**

- mbrace Mobile App for Android or iPhone
- Remote lock/unlock and other vehicle features via Mobile App
- Access to mbrace Web services at mbrace.MBUSA.com
- Remote diagnostics with direct dealer connection
- Over-the-air updates of many mbrace features and apps
- An evolving selection of Mercedes-Benz Apps, such as:
  - Google™ Local Search
  - Yelp
  - Fuel station finder with prices
  - Weather reports locally and around the world
  - Airport flight status
  - Local movie theater showtimes
- Valet Protect
- Viewable traffic cams in many metro markets

## **mbrace Secure**

6-month trial included

Requires mbrace Connect

*Added peace of mind from safety and security features for you, your family, and your vehicle*

### **Package includes:**

- Automatic Collision Notification
- Emergency calling from your car's SOS button or the Mobile App
- Automatic Alarm Notification
- Stolen vehicle location assistance
- Agent-assisted remote locking and unlocking
- Dealer connect

## **mbrace Concierge**

3-month trial included

Requires mbrace Secure

*Personal assistance from highly knowledgeable professionals with access to a world of resources*

### **Package includes:**

- Personal concierges to help you stay more productive on the road, or from the Mobile App on your smartphone
- Expert recommendations and reservations for dining out, and for tickets to events
- Turn-by-turn directions from a live assistant or sent to your car
- Travel assistance, including reservations and changes for hotels, airlines and car rentals
- Answers to most any question, help with most any request

## **mbrace Entertain**

3-month trial included

Requires mbrace Secure

*Online, on-the-road enjoyment from streaming entertainment to online maps*

### **Package includes:**

- Streaming audio and data via widely available 3G coverage
- Online maps, powered by Google (requires Premium 2 Package)
- A selection of streaming audio apps, including:
  - TuneIn® radio
  - iHeart Radio® Available starting Fall 2015
  - Mercedes-Benz Radio



### CAR IN YOUR POCKET

The mbrace Mobile App on your iPhone or Android phone includes a number of remote vehicle controls among its many useful features. You can lock and unlock the doors from any distance. Locate your car on a map. Or flash its lights and sound the horn. You can even look up an address, and send it directly to your car's available COMAND navigation.

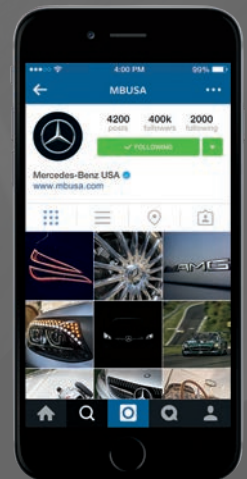

### OUR WORLD IS YOURS

The online world of Mercedes-Benz is one of many ways you can enjoy being part of the family. You can keep up to date with news and events, or take in an entertaining film. You can get more from your vehicle with helpful tutorial videos and downloadable manuals. And you can check out photos from other Mercedes-Benz drivers and fans, and best of all, share yours as well.



# BUILD YOUR OWN

MBUSA.com/SLK

## Specifications

|   | SLK 300   | SLK 350   | AMG SLK 55   |  |
|---|---|---|--|--|
| <b>Engine</b>                             | Type  | 2.0-liter turbo Direct Injection inline-4       | 3.5-liter Direct Injection V-6                           | Handcrafted AMG 5.5-liter Direct Injection V-8 |
|   | Power   | 241 hp @ 5,550 rpm                              | 302 hp @ 6,500 rpm                                       | 415 hp @ 6,800 rpm                             |
|   | Torque  | 273 lb-ft @ 1,300-4,000 rpm                     | 273 lb-ft @ 3,500-5,250 rpm                              | 398 lb-ft @ 4,500 rpm                          |
| <b>Transmission</b>                       | 9-speed automatic with shift paddles            | 7-speed automatic with shift paddles            | 7-speed AMG SPEEDSHIFT® PLUS with shift paddles          |  |
| <b>Acceleration, 0-60 mph<sup>1</sup></b> | 5.8 sec   | 5.4 sec   | 4.5 sec  |  |
| <b>Wheels</b>                             | Staggered-width 17" 10-spoke                    | Staggered-width 18" 5-spoke <sup>2</sup>        | Staggered-width 18" AMG® 5-spoke <sup>2</sup>            |  |
| <b>Suspension</b>                         | Sport-tuned 4-wheel multilink with Direct-steer | Sport-tuned 4-wheel multilink with Direct-steer | 4-wheel multilink AMG Sport suspension with Direct-steer |  |
| <b>Drivetrain</b>                         | Rear-wheel drive                                | Rear-wheel drive                                | Rear-wheel drive   |  |

## Dimensions

|                       | SLK 300              | SLK 350              | AMG SLK 55           |
|-----------------------|----------------------|----------------------|----------------------|
| <b>Wheelbase</b>      | 95.7"                | 95.7"                | 95.7"                |
| <b>Overall length</b> | 162.8"               | 162.8"               | 163.2"               |
| <b>Overall height</b> | 51.2" (w/top up)     | 51.2" (w/top up)     | 51.2" (w/top up)     |
| <b>Overall width</b>  | 79.0" (w/mirrors)    | 79.0" (w/mirrors)    | 79.0" (w/mirrors)    |
| <b>Curb weight</b>    | 3,384 lbs            | 3,472 lbs            | 3,583 lbs            |
| <b>Headroom</b>       | 39.1" (w/top up)     | 39.1" (w/top up)     | 39.1" (w/top up)     |
| <b>Legroom</b>        | 42.5"                | 42.5"                | 42.5"                |
| <b>Shoulder room</b>  | 52.2"                | 52.2"                | 52.2"                |
| <b>Cargo capacity</b> | 10.1 cu ft (top up)  | 10.1 cu ft (top up)  | 10.1 cu ft (top up)  |
|                       | 6.4 cu ft (top down) | 6.4 cu ft (top down) | 6.4 cu ft (top down) |

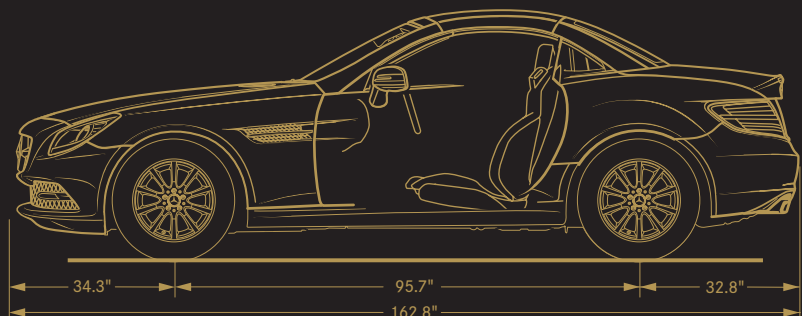
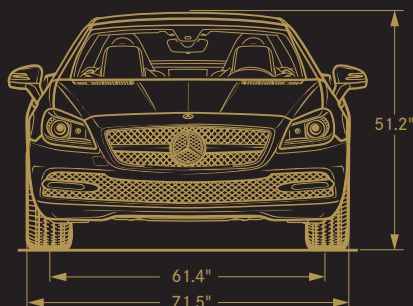

## KEY STANDARD FEATURES

SLK 300  
SLK 350  
AMG SLK 55

### Performance and efficiency

- ● ● ECO Start/Stop system
- ● ● Manual shift mode for transmission
- ● ● Torque Vectoring Brake

### Styling and design

- ● ● AMG body styling

### Safety and security

- ● ● High-strength steel-reinforced body structure
- ● ● ATTENTION ASSIST®
- ● ● Electronic Stability Program (ESP®)
- ● ● Adaptive braking technology: Predictive Brake Priming, Automatic Brake Drying, Hill-Start Assist, and Brake HOLD feature
- ● ● Emergency-sensing Brake Assist (BAS®)
- ● ● Advanced Tire Pressure Monitoring System
- ● ● 8-way air bag protection
- ● ● NECK-PRO® head restraints
- ● ● Dual fiber-reinforced high-strength steel roll bars<sup>5</sup>
- ● ● LED Daytime Running Lamps
- ● ● LED taillamps
- ○ ● Bi-Xenon headlamps with Active Curve Illumination
- ● ● SmartKey remote locking and starting system
- ● ● Infrared-remote hardtop operation
- ● ● KEYLESS-GO®
- ● ● Antitheft alarm system with remote panic feature

SLK 300  
SLK 350  
AMG SLK 55

### Comfort and convenience

- ● ● 8-way power sport seats with memory
- ● ● Heated front seats
- ● ● AIRSCARF® neck-level heating system
- ● ● Power tilt/telescoping steering column
- ● ● Multifunction steering wheel with Nappa leather trim
- ● ● Power retractable hardtop
- ● ● Panorama roof with heat-rejecting tinted polycarbonate panel
- ○ ● Direct ambient lighting of doors and console in Solar Red
- ● ● Air conditioning with dust and pollen filter
- ● ● Rigid mesh wind deflector (attaches between roll bars)
- ● ● Rain-sensing windshield wipers
- ● ● Heated power side mirrors with power fold-in
- ● ● Auto-dimming driver-side and inside rearview mirrors

### Entertainment and navigation

- ● ● Central controller with 5.8" in-dash color screen
- — ● IWC® "Ingenieur" dashtop analog clock
- ● ● Hands-free Bluetooth interface
- ● ● harman/kardon LOGIC7® sound system
- ● ● Media Interface cable
- ● ● Bluetooth® audio streaming
- ● ● USB audio port, in-dash CD player
- ● ● SiriusXM Radio with 6-month All Access trial<sup>11</sup>
- ● ● HD Radio™ receiver
- ● ● Mercedes-Benz mbrace®
- ● ● 5 years of mbrace Connect services<sup>8</sup>

● Standard ○ Optional — Not available

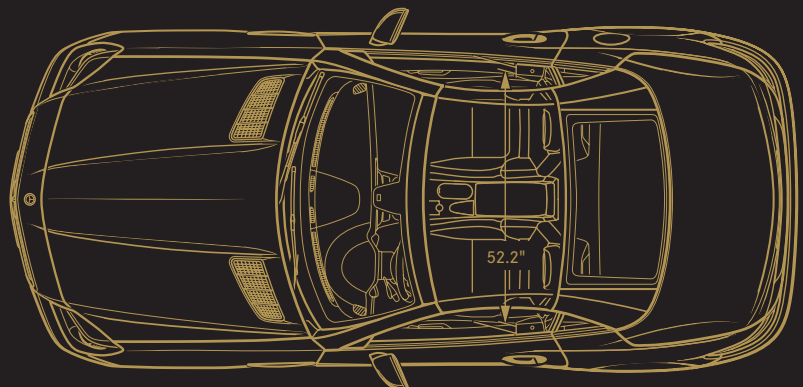
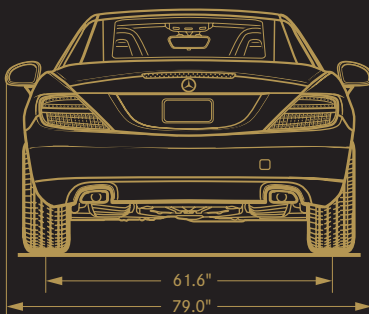



Mercedes-Benz

pm 4:26 Mercedes Dr  
Spring Valley Rd  
SPEED LIMIT 35  
0.2 mi  
NE  
0.20 mi

SLK 350

TEC 220

# OPTIONS AND ACCESSORIES

## Option Packages

### Premium 1 Package

- AIRSCARF® neck-level heating system
- Heated seats
- KEYLESS-GO®
- Infrared-remote hardtop operation
- harman/kardon LOGIC7® surround-sound system
- SiriusXM Radio<sup>11</sup> (with 6-month trial of All Access plan)
- Media Interface
- Prewiring for Becker® MAP PILOT navigation system

### Premium 2 Package *Includes items in Premium 1 Package*

- Bi-Xenon headlamps with Active Curve Illumination  
*Standard on AMG SLK 55*
- Blind Spot Assist<sup>4</sup>
- COMAND® navigation with 3 years of map updates<sup>13</sup>
- Dolby® Digital 5.1 sound
- 7" high-resolution in-dash color screen
- 5 years of Traffic and Weather service by SiriusXM<sup>11</sup>
- Voice control with learning feature for audio, telephone and navigation
- In-dash DVD/CD player and SD memory card slot
- Digital dual-zone climate control
- Dashtop analog clock *Standard on AMG SLK 55*

### Premium 3 Package *Includes items in Premium 2 Package*

- DISTRONIC PLUS<sup>97</sup> *Not available on AMG SLK 55*
- Lane Keeping Assist<sup>4</sup>
- PARKTRONIC with Advanced Parking Guidance
- Dynamic Handling suspension with adaptive damping and pushbutton Sport modes *Not available on AMG SLK 55*

### Sport Appearance Package

- 18" AMG® 5-spoke wheels<sup>2</sup>
- AMG body styling *Standard on SLK 350 and AMG SLK 55*
- Direct ambient lighting of doors and console in Solar Red  
*Standard on AMG SLK 55*

### AMG Handling Package

- 18" AMG multispoke wheels<sup>2</sup> (Silver or Matte Black)
- AMG Performance suspension
- AMG limited-slip differential
- Raised top speed limiter<sup>12</sup> (174 mph)
- AMG Performance steering wheel with DINAMICA side grips

### AMG Carbon Styling Package

- 18" AMG multispoke wheels<sup>2</sup> (Matte Black)
- Gloss Black hardtop, side mirrors, front air-dam vents, front fender vents, and rear spoiler
- AMG Performance steering wheel with DINAMICA side grips
- Carbon fiber interior trim
- Black Nappa leather with *designo* Titanium Grey Pearl accents, Neon Green piping, and carbon-fiber-pattern embossed head-restraint inserts

● Standard ○ Optional — Not available

## Individual options

### Panorama roof with MAGIC SKY CONTROL®

- 18" twin 5-spoke wheels<sup>2</sup> *Not available with Sport Appearance Package*

### MB-Tex upholstery

- Leather upholstery
- Nappa leather upholstery
- *designo* Nappa leather upholstery

### Aluminum trim on console and doors

- Black Ash wood trim on console and doors
- Burl Walnut wood trim on console and doors
- Carbon fiber trim on console and doors
- *designo* Black Piano Lacquer wood trim

### *Requires Sport Appearance Package on SLK 300 and SLK 350*

### Metallic paint

- 17" 10-spoke wheels
- Rear spoiler
- Chrome hood fins

### Becker® MAP PILOT navigation system

- All-season floor mats
- Illuminated door sills
- AMG illuminated door sills

### *Requires Premium 1 Package; not available with Premium 2 Package*

## Accessories *Selected items shown at left*

### 17" 10-spoke wheels

- Rear spoiler
- Chrome hood fins

### Becker® MAP PILOT navigation system

- All-season floor mats
- Illuminated door sills
- AMG illuminated door sills

### *Requires Premium 1 Package; not available with Premium 2 Package*

# COLOR AND TRIM

## UPHOLSTERY STYLES



MB-*Tex*, leather or Nappa leather  
SLK 300 and SLK 350



*designo* Nappa leather  
Available on all models<sup>13</sup>



AMG Nappa leather  
AMG SLK 55

## UPHOLSTERY COLORS

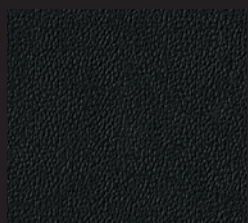

Black  
MB-*Tex*, leather, Nappa or  
AMG Nappa leather



Sahara Beige  
MB-*Tex*, leather, or  
AMG Nappa leather



Ash/Black  
MB-*Tex* or leather

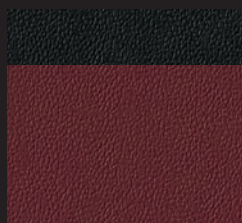

Bengal Red/Black  
Nappa leather or  
AMG Nappa leather

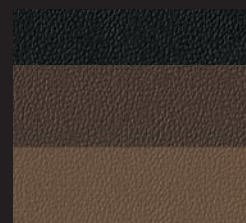

Two-tone Brown/Black  
Nappa leather or  
AMG Nappa leather

## *designo* UPHOLSTERY COLORS<sup>13</sup>



*designo* Auburn Brown  
Nappa leather

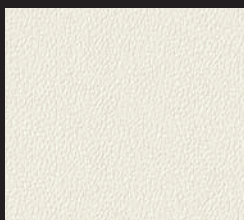

*designo* Deep White  
Nappa leather

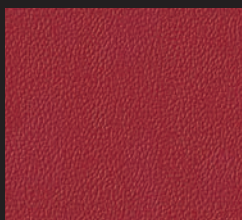

*designo* Classic Red  
Nappa leather



*designo* Jet Black  
Nappa leather



*designo* Light Brown  
Nappa leather

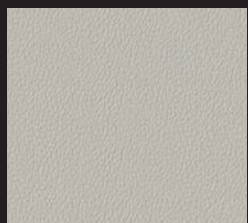

*designo* Platinum White  
Nappa Leather

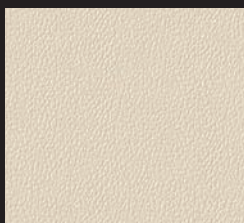

*designo* Porcelain  
Nappa leather

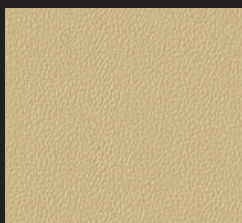

*designo* Saffron Beige  
Nappa leather



*designo* Sand  
Nappa leather

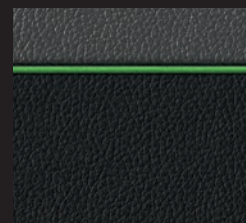

Black/*designo* Titanium  
Grey Pearl Nappa leather  
with Neon Green piping  
(AMG Carbon Styling Pkg.)



**INTERIOR TRIM**



Aluminum

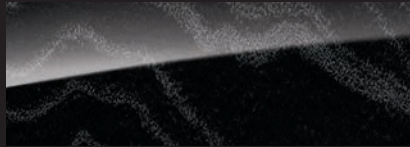

Black Ash wood

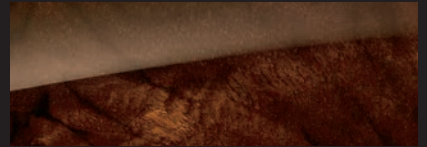

Burl Walnut wood



Carbon fiber  
(AMG SLK 55 only)



*designo* Black Piano Lacquer wood  
(*designo* Interior Packages)<sup>13</sup>

**PAINTWORK**



Black

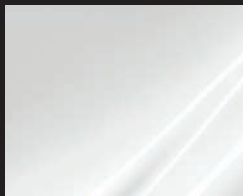

Polar White

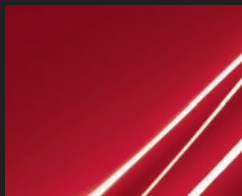

Mars Red



Obsidian Black metallic



Selenite Grey metallic



Iridium Silver metallic



Lunar Blue metallic

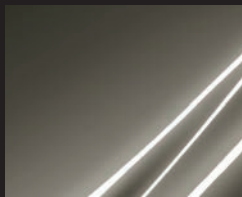

Indium Grey metallic

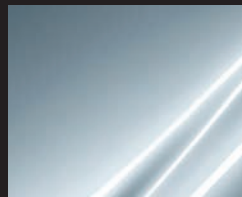

Diamond Silver metallic

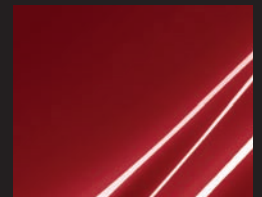

*designo* Cardinal Red metallic<sup>13</sup>



*designo* Diamond White metallic<sup>13</sup>

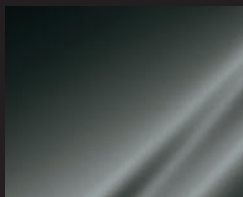

*designo* Magno Shadow Grey (matte)<sup>13</sup>



*designo* Mocha Black metallic<sup>13</sup>

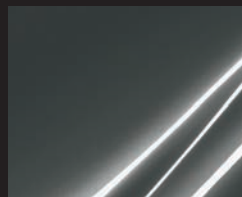

*designo* Graphite metallic<sup>13</sup>



*designo* Mystic Blue metallic<sup>13</sup>

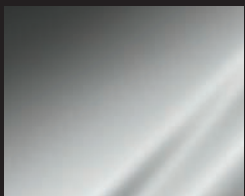

*designo* Magno Alanite Grey (matte)<sup>13</sup>



*designo* Magno Cashmere White (matte)<sup>13</sup>

## WHEEL CHOICES



17" 10-spoke  
● SLK 300



18" 5-spoke<sup>2</sup>  
● SLK 350



18" AMG<sup>®</sup> 5-spoke<sup>2</sup>  
○ SLK 300, SLK 350 (Sport Appearance Package)



18" twin 5-spoke<sup>2</sup>  
○ SLK 300, SLK 350



18" AMG 5-spoke<sup>2</sup>  
● AMG SLK 55



18" AMG multispoke<sup>2</sup> (Silver or Black)  
○ AMG SLK 55 (AMG Handling Package)

©2015 Mercedes-Benz USA, LLC • One Mercedes Drive, Montvale, NJ 07645 • 1-800-FOR-MERCEDES • MBUSA.com

Marketing Communications. All illustrations and specifications contained in this brochure are based on the latest product information available at the time of publication. Mercedes-Benz reserves the right to make changes at any time, without notice, to colors, materials, equipment, specifications and models. Any variations in colors shown are due to reproduction variations of the printing process. Illustrations may include test situations. Some vehicles may be shown with non-U.S. equipment. Some vehicles are shown with optional equipment. iPad, iPhone and iPod are registered trademarks or service marks of Apple Inc. Bluetooth is a registered trademark of Bluetooth SIG, Inc. Android and Google Maps are registered trademarks of Google Inc. Becker, harman/kardon and LOGIC7 are registered trademarks of Harman International Industries, Inc. HD Radio is a proprietary trademark of iBiquity Digital Corporation. Sirius, XM and all related marks and logos are trademarks of Sirius XM Radio Inc. Tuneln is a registered service mark of Tuneln, Inc. Twitter is a registered trademark of Twitter, Inc. Yelp is a registered trademark of Yelp Inc.

## ENDNOTES

- 1 Stated rates of acceleration are estimated based upon manufacturer's track results and may vary depending on model, environmental and road surface conditions, driving style, elevation and vehicle load.
- 2 Lower aspect ratio tires and accompanying wheels provide substantially increased treadwear, increased tire noise and reduced ride comfort. Serious wheel and tire damage may occur if the vehicle is operated on rough or damaged road surfaces or upon encountering road debris or obstacles. These tires are not designed for use on snow and ice. Winter tires mounted on appropriately sized and approved wheels are recommended for driving in those conditions.
- 3 Braking effectiveness also depends on proper brake maintenance, and tire and road conditions.
- 4 Driving while drowsy or distracted is dangerous and must be avoided. ATTENTION ASSIST<sup>®</sup> and/or Lane Keeping Assist may be insufficient to alert a fatigued or distracted driver of lane drift and cannot be relied on to avoid an accident or serious injury. Lane Keeping Assist operates at speeds above approximately 37 mph.
- 5 The roll bar system is designed to enhance the level of rollover protection compared to a vehicle without one. No system, regardless of how advanced, can eliminate the chance of injury in an accident. Please always wear your seat belt.
- 6 Blind Spot Assist may not be sufficient to avoid all accidents involving vehicles in your blind spot and does not estimate the speed of approaching vehicles. It must not be used as a sole substitute for driver awareness and checking of surrounding traffic conditions. Blind Spot Assist operates at speeds above approximately 20 mph.
- 7 DISTRONIC PLUS<sup>®</sup> adaptive cruise control is no substitute for active driving involvement. It does not adapt cruising speed in response to stationary objects, nor does it predict the curvature and lane layout of the road ahead or the movement of vehicles ahead. It is the driver's responsibility at all times to be attentive to traffic and road conditions, and to provide the steering, braking and other driving inputs necessary to retain control of the vehicle. Drivers are cautioned not to wait for the DISTRONIC Proximity Warning System before braking, as that may not afford sufficient time and distance to brake safely.
- 8 All Mercedes-Benz mbrace<sup>®</sup> services operate only where cellular and Global Positioning System satellite signals are available, which are provided by third parties and not within the control of Mercedes-Benz USA, LLC. Five years of the mbrace Connect package are included, starting on the original retail sale or lease date from an authorized Mercedes-Benz dealer. Subscriber Agreement is required for service to be active. Some services are only available on select vehicles. Your PIN is required in order to use certain services. Some services may be limited or restricted in some areas. Apps may be introduced, updated or removed at varying dates, and may also require a vehicle software update. Driver is responsible for complying with traffic and other laws. See your dealer or MBUSA.com/mbrace for details, including a list of compatible smartphones. Streaming Internet-based features require an active subscription to the mbrace Entertain Package. Connection may be limited by cellular signal.
- 9 The mbrace Mobile App is compatible with Apple iPhone<sup>®</sup> models running iOS 7.0 or later, and Android-based phones running OS 2.3 or later. Please visit MBUSA.com/mbrace for more information.
- 10 Roadside Assistance repairs may involve charges for parts, service and towing. Vehicle must be accessible from main roads. Depending on the circumstance, these services may be provided by an outside provider, courtesy of Mercedes-Benz Roadside Assistance. Restricted roadways, acts of nature and vehicle accessibility may limit our ability to provide services to you. For full details, eligibility requirements, and limitations/exclusions of Sign and Drive services, as well as the Roadside Assistance Program, please see your dealer.
- 11 The purchase or lease of a new, satellite radio-enabled vehicle includes a 6-month introductory subscription to the Sirius All Access package, as well as a 5-year introductory subscription to SiriusXM Traffic and SiriusXM Weather when equipped with the Premium 2 Package. SiriusXM Traffic and Weather services are available for select markets. SiriusXM Satellite Radio, SiriusXM Traffic and SiriusXM Weather subscriptions are sold separately or as a package after trial period. If you decide to continue your subscription after your trial, the plan you choose will automatically renew and you will be charged according to your chosen payment method at then-current rates. Fees and taxes apply. To cancel you must call SiriusXM at 1-866-635-2349. See SiriusXM Customer Agreement for complete terms at siriusxm.com. All fees and programming subject to change.
- 12 Obey local speed and traffic laws.
- 13 Extra-cost option. Some *designo* paint and interior options may require additional production time. Please see your dealer.



The personal rewards of striving to be the best are even more meaningful in the development of young people than they are for automobiles. Instilling the values of leadership, goal-setting, discipline and teamwork in youth is an investment in everyone's future. It's why Mercedes-Benz USA is collaborating with the Laureus Sport for Good Foundation, with an ongoing commitment to train and place hundreds of coaches for after-school and in-school sports programs in communities around the country. Sports offer kids more than the chance to be physically active and have fun. It's also an opportunity to have a mentor who can guide them, help them learn how to deal with major life issues, and help them grow stronger not just physically but in their character. As a Mercedes-Benz driver, you become a part of this effort to give hundreds of thousands of kids a better life today, and all of us a brighter tomorrow.

Learn more about how Mercedes-Benz USA believes in giving back at [MBUSA.com/community](http://MBUSA.com/community)