



**BODY
SERVICE
MANUAL**

Hudson

480 - 490 SERIES

This manual provided by
HET Club member
Drew Meyer

FOREWORD

ORGANIZATION

Much has been written and spoken about the proper operation of a service department and the factors which make such an operation profitable and successful.

Some of these operating factors, tried and proven by successful dealers, will bear repetition frequently. We all know them but are prone to overlook and even disregard them unless they are occasionally called to our attention.

Some of the more important factors are:

1. Shop Appearance
2. Proper Service Equipment
3. Personnel - Proper dress
Neat appearance

APPEARANCE IS IMPORTANT

Customers are inclined to judge the quality of your work by the appearance of your shop. In looking over your operation from an appearance standpoint, the first thing to check is identification. The Hudson Service sign is designed to identify your place of business as an authorized Hudson service station and will not only create confidence in the minds of the owners but will guide transient owners and new customers to your door.

Next in order is an inspection of the service department and shop. Is it as clean and attractive as soap and water and paint can make it? Hot water, cleaning compound, and a few gallons of paint will work wonders in the appearance of a service department and will return their cost many times in increased customer satisfaction and comfort.

An accumulation of junk and broken and discarded parts and tools is an eyesore in any shop. An easily accessible junk box outside the building, near an alley for easy unloading, is the best answer. Make each member of the service staff responsible for removing his own junk parts. Remember - - - - - first impressions are lasting.

EQUIPMENT

Adequate equipment provides the means for good service men to perform first class service work at a minimum of cost. Car owners, thru costly experience with poorly equipped shops, have become tool and equipment conscious. Therefore, proper tools and equipment are a strict necessity. We must show our customers that we have the equipment by proper arrangement and display.

INTRODUCTION

The series 480 and 490 Hudson is built of a completely new principal and design, and is not just another motor car. The "Monobilt" body and frame construction differs greatly from the conventional motor car employing separate body and frame units. Naturally being so totally different, a new approach to the repair of body damage is necessary. These differences, however, do not make the repair job more difficult or more costly to complete. In many instances the time required on a specific operation is less than that required on previous models.

Once you are completely familiar with the Monobilt body and frame construction of the 480 and 490 series Hudson, when you have learned the placement of all of the various parts and assemblies and how they fit together to make the rugged and sturdy Monobuilt all steel unit, then you will go about each job with complete confidence.

The information contained in this body manual is to be used as a guide for servicing the 480-490 series Hudson.

The manual has been divided into four parts:

Part one - includes technical information, model designations, body paint color code, estimating and ordering of repair parts, car serial number identification, and trim material color chart. Illustrated in this section are the various body types, positions of body welds and top panel soldering.

Part two - includes removal and installation of sheet metal parts: viz., fenders, rocker panels, hood, grille, rear compartment; also interior hardware, trim, instruments, headlining, door locks, handles, and regulators; and front wheel alignment.

Part three - includes body repair and metal finishing, consisting of tool application, bumping, dinging, solder filling, shrinking, fender welding, filing, sanding, and removing minor dents. Part three also includes body alignment checking, door repairs, and door alignment.

Part four - comprises the convertible 480-490 series, consisting of complete information on repairs of hydraulic and electrical units, removal and installation of component assemblies and parts, top adjustments, and trouble shooting.

Illustrations and pages of this manual are numbered consecutively.

An alphabetical index is placed in the front of the manual for easy reference.

A thorough study of the operations and necessary tools and equipment will enable the Hudson Service dealer to perform reliable service at reasonable cost.

INDEX

	Page		Page
Adjustment, door striker	27,60	Door lock lubrication	83
folding top	74	Door straightening	59
hood	23	Door trim panel - Convertible .	81
radio	38	Door window regulator hydraulic	75-77
weather control	40	convertible	77
door window	88	cylinder	77
windshield wiper arms	36	Elastic metal	47
top control rod	74	Electrical system checks - convertible	91
Alignment, body	48,62-64	Fender, front	20
door	58	rear	19
frame	60-61	Fender and grille side support	23
front wheel	1,41-43	Fender stone guard and panel - front	20
rear curtain, convertible	85	Fender tie panel	24
Battery gravity	90	Filing	52,53,57
Bleeding the hydraulic system	94	Finish, care of	45
Body aligning	62	Fluid, hydraulic	76,90-91, 94
Body repair	47	Fluid pressure	70,76,93
Breaker, circuit	32,41,88,91	Flux	54
Brazing	54	Forging welds	57
Bumping	47-54	Frame alignment	60
Camber	1,41-43	Front suspension	1,41-43
Caster	1,41-42	Fuel gauge	35
Cigar lighter	33	Fuses	41
Circuit breaker	32,41,88,91	Glass, door	31,77
Circuit breaker- check, convertible	91	quarter window	31,32
Cleaning upholstery	44	rear window	32
Clock	34	windshield	26
Coil spring sag	43	Grille, radiator	22
Cold shrinking	53,55	radio speaker	37
Construction, body	50	Ground, cylinder solenoid . . .	77,93
Color guide	9,25	pump motor	70,71,72
Colors, body	3-5	Gauge, fuel	35
Convertible brougham	13,67-96	rear curtain	85
Curtain, rear	84-86	temperature	35
Cylinder, door lock	27,83	Handle, door	28,82
Cylinder, hydraulic	69,74-78	Headlining	24-27
Cylinder, solenoid	77,92-93	Heat shrinking	53,55
Dimensions	2	Hood	23
Dinging	52,53	Hood adjustment	23
Door aligning	58	lock upper support	23
Door lock cylinder	27,83	lock lower support	23
glass front	31,77	Hydraulic pump prime	94
glass rear	31,77	Hydraulic system check - convertible	93
lock	27,29,83	Hydro-Lectric Motor and pump assy	70,72
outside handle	28-82	Hydro-Lectric, service	90
remote control	30,83	system	67-96
striker plate adjustment	27-60	Ignition switch	32
striker plate	27	Instruments	32
trim panel	28,31,81,82	Instrument panel	32
ventilator wing	30,78	Insulation	65
ventilator wing regulator	30	Jacks, body	49,51-52
window regulator front	28	Lamps	2,33,34
window regulator rear	29	Lock, door	27,29,83

IV

	Page		Page
Lubrication, body	16	Spindle pin inclination	1, 41-42
hydraulic cylinder	75, 77	Splash guard	22, 23
lock	83	Spot weld positions	13-15
Metal finishing	47-58	Springs, front	2 43
Model designations	1	rear	2
Monobuilt body	II, 10	window regulator	69, 75, 76
Motor, pump	68, 69,70-72, 90	Starter switch	32
Motor solenoid switch check-convertible	92	Stone guard	20
Normalizing	64	Striker, door	27, 60
Paddle, solder	9, 54	Switch, ignition	32
Paint	3-6,45	light	32
Paint - care of finish	45	motor solenoid	68, 69, 70, 92
Panel, instrument	32,34,37	starter	32
switch	34	top operating	72, 73, 90, 91-92
trim	28,31,81,82	window operating	69, 79-81, 88, 91
Parts, repair	6, 19	Technical Information	1
Pivot pin inclination	42	Temperature gauge	35
Pulley adjustment	36	Tie rods	1
Pump hydraulic	70,72,90,94	Tools - application of	50
Quarter trim panel	82	Tools - body	49
Quarter window	31	clip removing	78
trim panel	31	headlining	25
window regulator	32, 79	switch removing	80, 81, 91
Quarter window - convertible	79	Toe-in	1, 41, 43
Quenching	54,56	Toe-out	43
Radiator	22	Top adjustment	86 87
Radiator grille baffle (upper) .	22	Top control rod	73, 74, 91
front splash guard and moulding	22	Top covering installation	84
grille center bar (upper)	22	Top, folding	68, 70-75, 84, 16
Radiator splash guard moulding	23	Top operating cylinder	74, 75
Radiator "U" channel	22	Top operating switch check	91
Radio	36, 39	Top operating valve and switch	72, 73, 74, 93
Radio - installation	36	Torch soldering	52, 53, 54
automatic tuning	38	Tramming	62
Rear window	32	Trim material	7
Refilling the hydraulic system convertible	94	Trim panels	28, 31, 81, 82
Remote control, door	30, 83	Trouble shooting	95-96
Regulator, door wing	30, 78	Upholstery cleaning	44
front door	28	Upholstery material	7
hydraulic	69,75-78,86,88	Valve, cylinder solenoid	77, 92-93
quarter window	32,79	pressure relief	70 93
rear door	29	top operating	68, 72, 73, 90, 93
Resealing	64	Weather control	39, 41
Reservoir, fluid	70,71,90-91	Wedge, hydraulic	49
Rheostat, lamp	33	Welding	53, 54, 57
Riding height and coil spring sag	43	Wheel bearings	1
Roof bows	9, 25	Window adjustment	88 89
Roughing	48, 58	Window lift switch-check-convertible	91
Sanding	53,58	Window operating switches-convertible	79, 80
Sealing	65	Window regulator solenoid check	92
Seat cushion front and rear	82	Windshield	26
back, front and rear	82	Windshield wiper	33
Serial numbers	1,6	Windshield wiper control	33
Shrinking - cold	55	wiper cable tension	36
hot	55	Wing, door ventilator	30, 79
Solder filling	52,53,54	Wiring	88, 89, 90, 91, 93
Speedometer	34		

MODEL DESIGNATIONS AND SERIAL NUMBERS

The new Hudson models are produced in the Super and Commodore Series and carry the following designations:

Hudson Super Six Series - Model 481 - 491

BODY TYPES	STARTING SERIAL NO'S
Brougham	481101 - 491101 and up
4 Door Sedan	
3 Passenger Coupe	
Club Coupe	
Convertible Brougham	

Hudson Commodore Six Series - Model 482 - 492

4 Door Sedan	482101 - 492101 and up
Club Coupe	

Hudson Super Eight Series - Model 483 - 493

4 Door Sedan	483101 - 493101 and up
Club Coupe	

Hudson Commodore Eight Series - Model 484 - 494

4 Door Sedan	484101 - 494101 and up
Club Coupe	
Convertible Brougham	

The car serial number, which is also the engine number, is stamped on a metal plate attached to the right front door hinge pillar post. In the car numbering system, the first three digits of the serial number indicate the series and model while the remaining digits represent the actual car number. As the cars leave the production line, they are numbered in consecutive order, regardless of series or model. As an example, the car built after serial number 491999 would be numbered 4911000 instead of 492000. Code letters or numbers indicating the car paint color

TECHNICAL INFORMATION

FRONT SUSPENSION

SIX CYLINDER

EIGHT CYLINDER

Type	Independent Coil Springing	Independent Coil Springing
Camber	1/2° to 1-1/2°	1/2° to 1-1/2°
Caster	1/2° to 1-1/2°	1/2° to 1-1/2 ° sides

NOTE: Caster must not vary more than 1/2 between sides

Toe-in	0" to 1/16"	0" to 1/16"
Spindle pin inclination	3° - 36'	3° - 36'
Spindle pin thrust bearing	Ball	Ball
Wheel Bearing - Type	Adjustable tapered roller	Adjustable tapered roller
End Play	.001 to .003	.001 to .003
Tie Rod End (Type)	Plain Bearing	Plain Bearing
Number of Tie Rods	2	2
Tie Rod End Adjustment (As seen from right side of car):		
To lengthen	Turn clockwise	Turn clockwise
To shorten	Turn counter-clockwise	Turn counter-clockwise

FRONT SPRINGS

Type
Free Height
Height under curb weight

SIX CYLINDER

Coil
16-5/16"
9-9/16"

EIGHT CYLINDER

Coil
16-5/16"
9-9/16"

REAR SPRINGS

Type

Covers
Length and Width
Number leaves
Shackles
Lubricant-Shackles and Leaves

Semi-elliptic
Covered
Uncovered
Metal
54" - 1-3/4"
8
Silent "U" Threaded
Viscous chassis lube

Semi-elliptic
Covered
Uncovered
Metal
54" - 1-3/4"
8
Silent "U" Threaded
Viscous chassis lube

LAMP BULBS

	<u>No.</u>	<u>C.</u>	<u>P.</u>	<u>Base</u>
Headlight (Sealed Beam Type)	4030		Sealed	Sealed
Hood Light	55	2		Single
Parking Light with Direction Indicator	1154		21-3	Double
Tail and Stop Light	1154		21-3	Double
License Light	63		3	Single
Dome Light-Front	87		15	Single
Rear Quarter Lights (2)	81		6	Single
Clock	55		2	Single
Speedometer	55		2	Single
Instrument Cluster	55		2	Single
Direction Indicator	55		2	Single
Ignition Lock	55		2	Single
Courtesy Lights	87		15	Single
Fog Light (Sealed Beam)	4015-A		Sealed	Sealed
Spot Light Sealed Beam)	4535		Sealed	Sealed
Parking Light	63		3	Single
Generator and Oil Indicator	55		2	Single
Radio	55		2	Single
Headlight Beam Indicator	55		2	Single

DIMENSIONS (6 Passenger 4 Door Sedan)

SIX CYLINDER

EIGHT CYLINDER

Wheel Base	124"	124"
Overall Length (Including Bumpers and Guards)	207-1/2"	207-1/2"
Overall Width (Including Fenders)	77"	77"
Tread		
Front	58-1/2"	58-1/2"
Rear	55-1/2"	55-1/2"
Road Clearance		
Front	8"	8"
Rear	8"	8"
Overall Height-Road to Roof	60"	60"

1948 HUDSON BODY COLORS			
Standard Single Body Colors	Option	Special Two-Tone Combinations	Option
Banner Blue	B	Upper Body Color	JB
Jockey Blue	J	Lower Body Color	
Gallant Gray	G	Upper Body Color	QG
Quartermaster Gray	Q	Lower Body Color	
Piedmont Green	P	Upper Body Color	SP
Savoy Green	S	Lower Body Color	
Maroon-Deep	M	Upper Body Color	RM
Ruby Red*	RR	Lower Body Color	
Navahoe Bronze	N	Upper Body Color	HN
Harness Tan	H	Lower Body Color	
Ebony Black	K		

* Ruby red is a special body color and is listed above only to complete the two-tone combination with maroon-deep.

SPECIAL SINGLE BODY COLORS		
Body Colors	Option	Option on Models
Ruby Red*	RR	481-P - 482 - 483 - 484 Broughams
Platinum	CC	Sedans, Bus. Coupes, Club Coupes, and 481-P - 482 - 484 Convertible Brougham

ORDERING PAINT OR PAINTED PARTS

When ordering paint or painted parts, special care should be exercised in listing the paint option code and the paint color or colors. This information is valuable, especially when the automobile has a two-tone color combination. Always use the charts furnished herein and be sure that every repair order including paints has the complete, detailed information.

Hudson body colors are pure virgin lacquers. For the maintenance and protection of these high quality finishes refer to Page 45 of this manual under the heading "Paint - care of finish."

CHART No. 1

1949 HUDSON BODY COLORS

Standard Single Body Colors	Option	Special Two-Tone Combinations	Option
Brigantine Blue**	B	Upper Body Color	JB**
Jersey Blue	J	Lower Body Color	
Glowing Gray	G	Upper Body Color	KG
Queenstown Gray	Q	Lower Body Color	
Piedmont Green**	P	Upper Body Color	SP**
Savoy Green**	S	Lower Body Color	
Nomad Bronze**	N	Upper Body Color	HN**
Holster Tan**	H	Lower Body Color	
Maroon - Deep**	M	Upper Body Color	RM**
Ruby Red*	RR	Lower Body Color	
Ebony Black	K		

* Ruby red is a special body color and is listed above only to complete the two-tone combination with maroon-deep.

**Not available on convertible brougham.

SPECIAL SINGLE BODY COLORS

Body Colors	Option	Option on Models
Ruby Red*	RR	491-P - 492 - 493 - 494 Broughams
Platinum	CC	Sedans, Bus. Coupes, Club Coupes, and 491-P - 492 - 494 Convertible Brougham

*Refer to Page 5 for 1949 body color option information.

CHART No. 2

1949 HUDSON BODY COLORS

Standard Single Body Colors	Option	Special Two-Tone Combinations	Option
Pacemaker Green Opalescent	8	Upper Body Color	14
Sierra Green Opalescent	10	Lower Body Color	
Naples Tan Opalescent	7	Upper Body Color	11
Hardwood Tan Opalescent	3	Lower Body Color	
Gull Gray Opalescent	2	Upper Body Color	13
Quebec Gray Opalescent	9	Lower Body Color	
Burgundy Maroon Opalescent	6	Upper Body Color	15
Radiant Red Opalescent*	16	Lower Body Color	
Brazilian Blue Opalescent	1	Upper Body Color	12
Jet Blue Opalescent	4	Lower Body Color	
Ebony Black	5		

SPECIAL SINGLE BODY COLORS		
Body Color	Option	Option on Models
Radiant Red Opalescent Gray Gold (light) Opalescent	16 17	491P - 492 - 493 - 494 Broughams, Sedans, Bus. Coupes, Club Coupes, and 492-P - 492 - 494 Convertible Brougham.

1949 BODY COLOR OPTION INFORMATION

It will be noted that the 490 Series Hudson has two methods of paint option identification. On approximately the first 100,000 490 Series cars an ALPHABETICAL paint option was stamped into the right hand front door upper hinge, body half. (See 1949 Body Color Chart No. 1)

Body color Chart No.2 lists the new body colors and the NUMERICAL options used on the 490 Series Hudson after approximately the first 100,000 cars. This numerical paint option is also stamped into the body half of the right hand front door upper hinge.

EXAMPLE: (Chart No. 1)

Single Body Color	Option	Two-Tone Combination	Option
Brigantine Blue Jersey Blue	B J	Brigantine Blue Jersey Blue	JB

Either brigantine blue or jersey blue may be used as an all over body color in which case a single "B" or "J" will be stamped into the right hand front door upper hinge. When both brigantine blue and jersey blue are used together as a two-tone combination, the letters "JB" will be stamped into the right hand front door upper hinge.

EXAMPLE: (Chart No. 2)

Single Body Color	Option	Two-Tone Combination	Option
Pacemaker Green Opalescent Sierra Green Opalescent	8 10	Pacemaker Green Opalescent Sierra Green Opalescent	14

The application of the numerical option colors is handled in the same manner as is the alphabetical options outlined above.

In the event a new NUMERICAL body color is used in two-tone combination with an old ALPHABETICAL body color, the option stamping will appear as below:

Brazilian Blue Opalescent (New)	<u>1</u>
Jersey Blue (Old)	J

This will be the only occasion when both SINGLE body color options used in two-tone combinations will appear stamped in the right hand front door upper hinge.

ESTIMATING AND ORDERING OF REPAIR PARTS

Like any other automobile repair operation, the damaged body must have a preliminary survey to determine the over all extent of the damage. When the survey has been completed, the answer to three vital questions will be necessary before work can begin.

Can you repair the damage?
How much will it cost?
How soon can it be ready?

The accuracy of your answers to these vital questions determines whether or not your shop gets the repair job and whether or not you make any profit on the job if you do get it. Guessing won't do----that way you lose repair jobs, or lose money on them if you do get them. A successful future for your business depends upon the correctness with which you answer those three important questions.

The service departments of all Hudson distributors and dealers are supplied with current service parts catalogues from which a listing, by PROPER NAME and PART NUMBER, of the parts required can be formulated.

From this list, which includes the proper car IDENTIFICATION NUMBER taken from the car serial number plate, the Hudson parts manager will be able to arrive at an estimate of the cost of the job, from which a definite decision can be made before ordering the necessary parts.

To be certain that the proper repair parts are received with the least possible delay, it is important that the following car identification be included with each repair order.

CAR SERIAL NUMBER PAINT CODE MARKINGS *

*The paint color code is the alphabetical stamping on the right hand front door upper hinge, body half.

By supplying this information you are enabling those who make up the repair parts order to include the correct parts. Thus delays, such as would be encountered upon the receipt of the wrong parts, are eliminated, and considerable time is saved.

DESCRIPTION OF PARTS

The correct description of the parts as they are listed in the service parts catalogue is all-important, as is the location of the part on the automobile.

For example fenders, doors, windshield glass, and rocker panels should be referred to as left or right, front or rear.

ORDERING TRIM MATERIAL

The following chart on the Hudson upholstery options in relation to paint options will prove helpful when the need arises to order upholstery material.

The paint option chart is also included and will serve to clarify the alphabetical paint code stamping on the upper hinge of the right hand front door and as a cross reference guide when ordering upholstery materials. See Page 4.

CHART No. 3

Use This Chart In Conjunction With Chart No. 1, Paint Option Codes

1948 COMMODORE SERIES UPHOLSTERY OPTIONS			
Option	Model	Upholstery Color	Standard with Body Colors
W-1	482-484	Tan Broadcloth	H,K,M,N,P,RR,S,HN,SP,RM
W-2	482-484	Gray Broadcloth	B,CC,G,J,K,Q,JB,QG
1949 COMMODORE SERIES - EXCEPT CONVERTIBLES			
W-1	492-494	Tan Broadcloth	H,M,N,P,RR,S,HN,SP, and RM
W-2	492-494	Gray Broadcloth	B,CC,G,J,K,Q,JB, and QG
W-3	492-494	Brown Cloth and Maroon Leather Trim	(Optional)
W-4	492-494	Gray Cloth and Maroon Leather Trim	(Optional)
CONVERTIBLE BROUGHAM UPHOLSTERY			
Models		Color	
491, 492, 494		Maroon Leather antique grain is standard	
SUPER SERIES UPHOLSTERY			
Models		Color	
481, 491, 483, 493		Bedford Cord cloth, Blue-Green shade, is standard	

CHART No. 4

Use this chart in conjunction with chart No. 2, 1949 "Paint Option Code s"

COMMODORE SERIES - EXCEPT CONVERTIBLES			
Option	Model	Upholstery Color	Standard with Body Colors
W-1	492-494	Tan Cloth Trim	M-6, RM-15, RR-16 and CC-17 H-3, N-7, HN-11, P-8, S-10, SP-
W-2	492-494	Gray Cloth Trim	<u>14</u> B-1, G-2, J-4, Q-9, JB-12, QG-13 and K-5
CONVERTIBLE BROUGHAM UPHOLSTERY			
Models		Models	
491-492-494		Maroon full leather trim is standard. Brown cloth and maroon leather combination trim - optional. Gray cloth and maroon leather combination trim - optional.	
SUPER SERIES - EXCEPT CONVERTIBLES			
Model		Color	
491, 492, 494		Gray cloth trim is standard Gray leather trim - optional	
LEATHER TRIM			
ALL BROUGHAMS, SEDANS, BUSINESS COUPES, AND CLUB COUPES			
Material		Color	
Russet Leather Trim		Standard with body colors S-10, P-8, SP-14, H-3, HN-11, M-6, RR-16, RM-15, and CC-17. Optional with body colors B-1, G-2, J-4, Q-9, JB-12, QG-13, and K-5	
Gray Leather Trim		Standard with body colors B-1, G-2, J-4, Q-9, JB-12, QG-13, and K-13. Optional with S-10, P-8, SP-14, H-3, HN-11, M-6, RR-16, RM 15, and CC-17	
Maroon Leather Trim		Optional	

Hudson upholstery materials are of the finest broadcloth and Bedford Cord available, however, this fact does not create immunity to spots and stains. For details on the removal of spots and stains, please refer to Page 44 of this manual under the heading "General Information on Appearance."

CHART No. 5

ROOF BOW COLOR GUIDE						
Bow No.	Part Number	Up to and Including Serial No.	Color	Part Number	Serial No. and upward	Color
4 DOOR SEDAN						
1	210761	483115172	Black	216220	48311517*	Black
2	210762	"	Light Gray	216221	"	Light Green
3	210763	"	Tan	216222	"	Yellow
4	210764	"	Light Blue	215223	"	Light Red
5	210765	"	Dark Red	216224	"	Dark Green
6	210766	"	Pink	216225	"	Dark Brown
*Except car numbers 115221 thru 115722 inclusive						
2 DOOR BROUGHAM						
1	210761	4912700	Black	216220	4912701	Black
2	210768	"	Light Gray	215226	"	Light Gray
3	210769	"	Tan	216227	"	Cream
4	210774	"	Light Blue	216228	"	Light Blue
5	210775	"	Dark Red	216229	"	Dark Red
6	210776	"	Pink	216230	"	Pink
COUPE AND CLUB COUPE						
1	210751	4912700	Black	216220	4912701	Black
2	210768	"	Light Gray	216226	"	Light Gray
3	210769	"	Tan	210769	491127	
4	212954	"	Silver	216231	4912701	Silver
5	212955	"	Gold	215232	"	Gold
6	212956	"	Dark Gray	212956	4912701	Gold

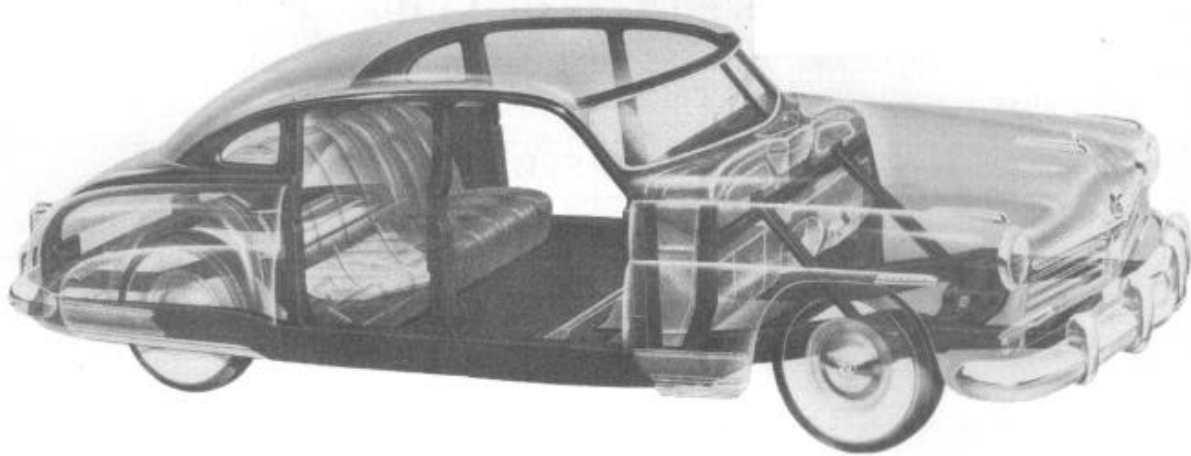

FIGURE 1

PHANTOM VIEW OF 480-490 SERIES MONOBILT BODY AND FRAME CONSTRUCTION

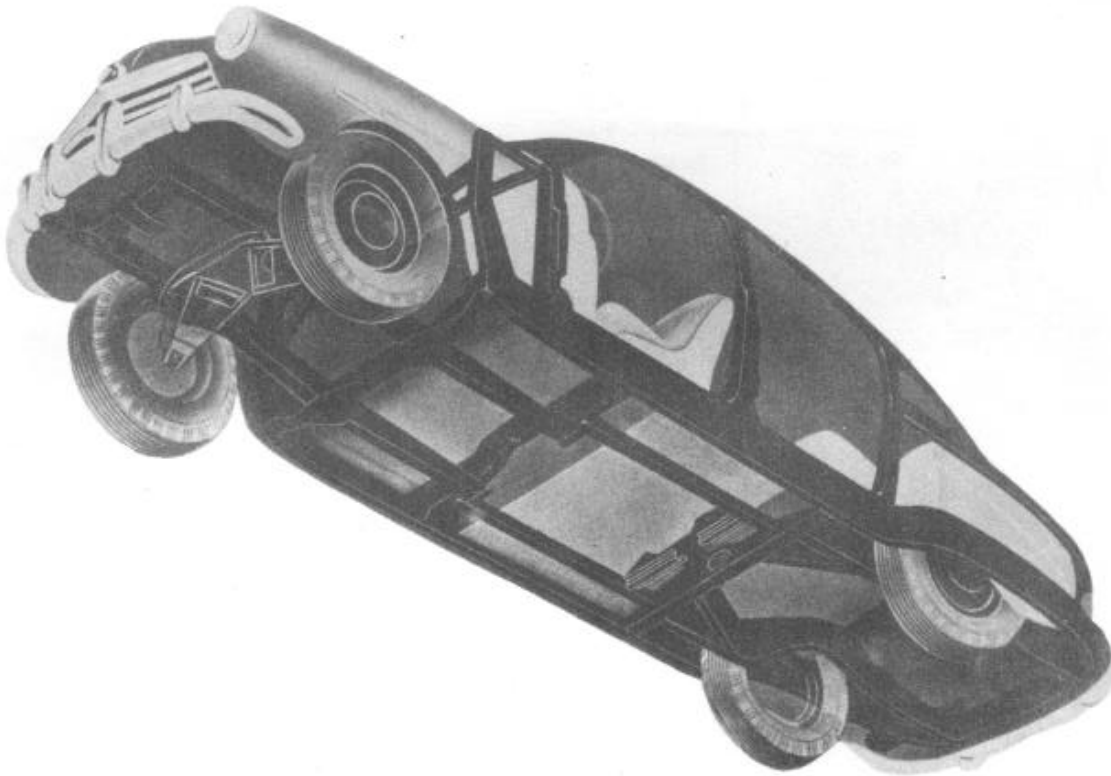

FIGURE 2

UNDER BODY VIEW OF 480-490 SERIES MONOBILT BODY AND FRAME CONSTRUCTION AND FRONT FRAME ASSEMBLY

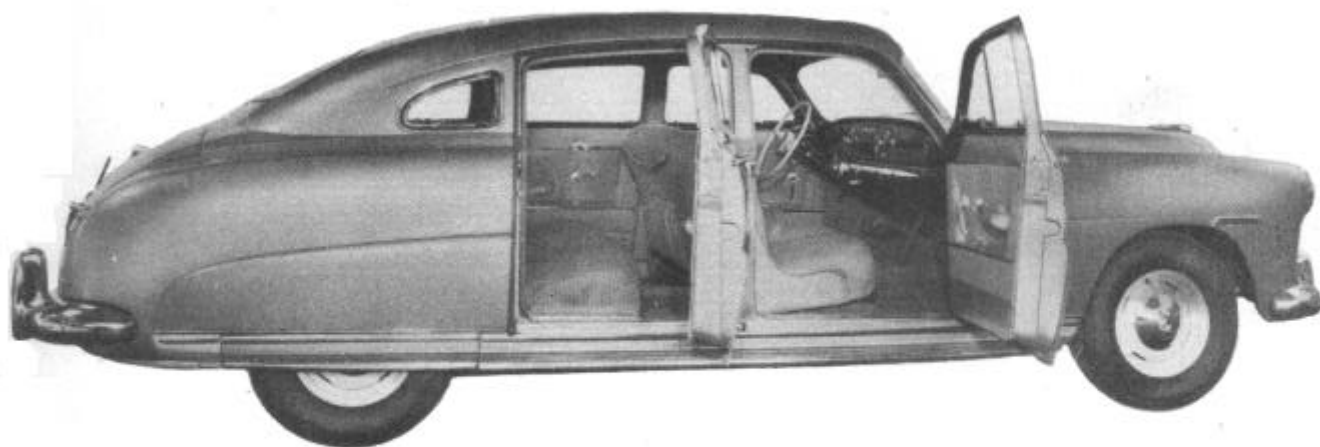

FIGURE 3
SUPER 480-490 SERIES FOUR DOOR SEDAN

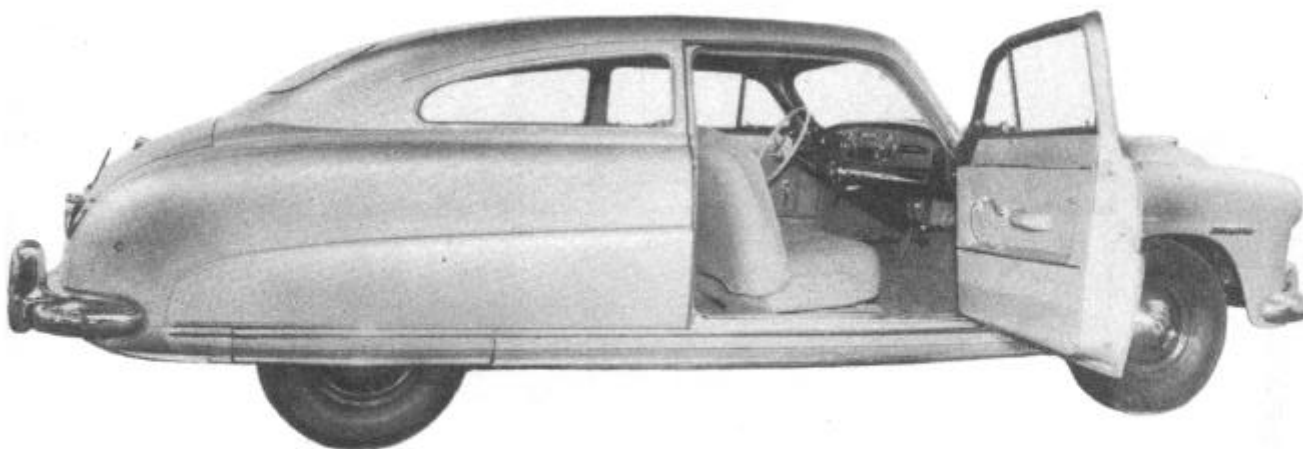

FIGURE 4
SUPER 480-490 SERIES TWO DOOR BROUGHAM

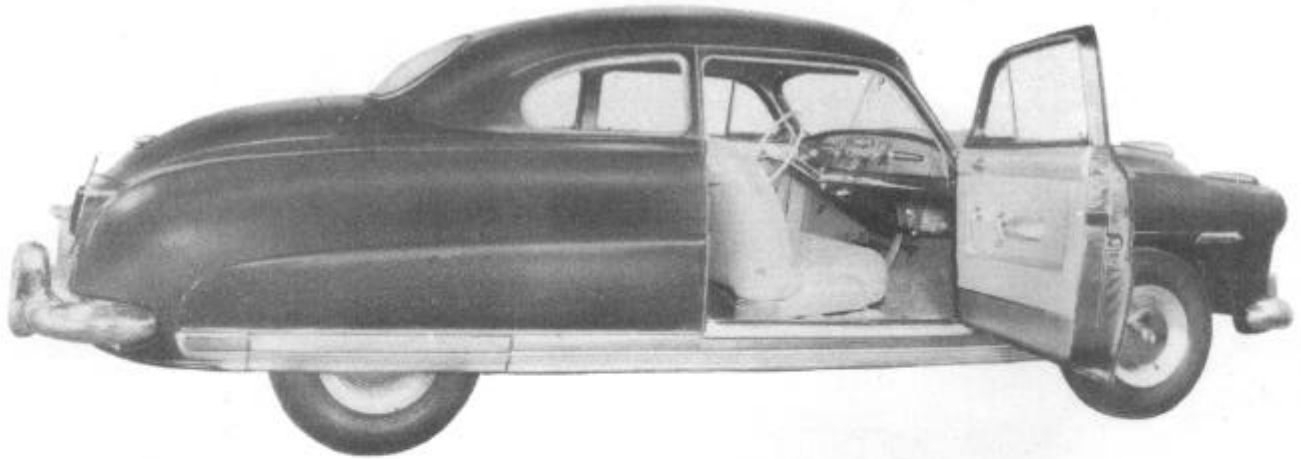

FIGURE 5
COMMODORE 480-490 SERIES SIX PASSENGER CLUB COUPE

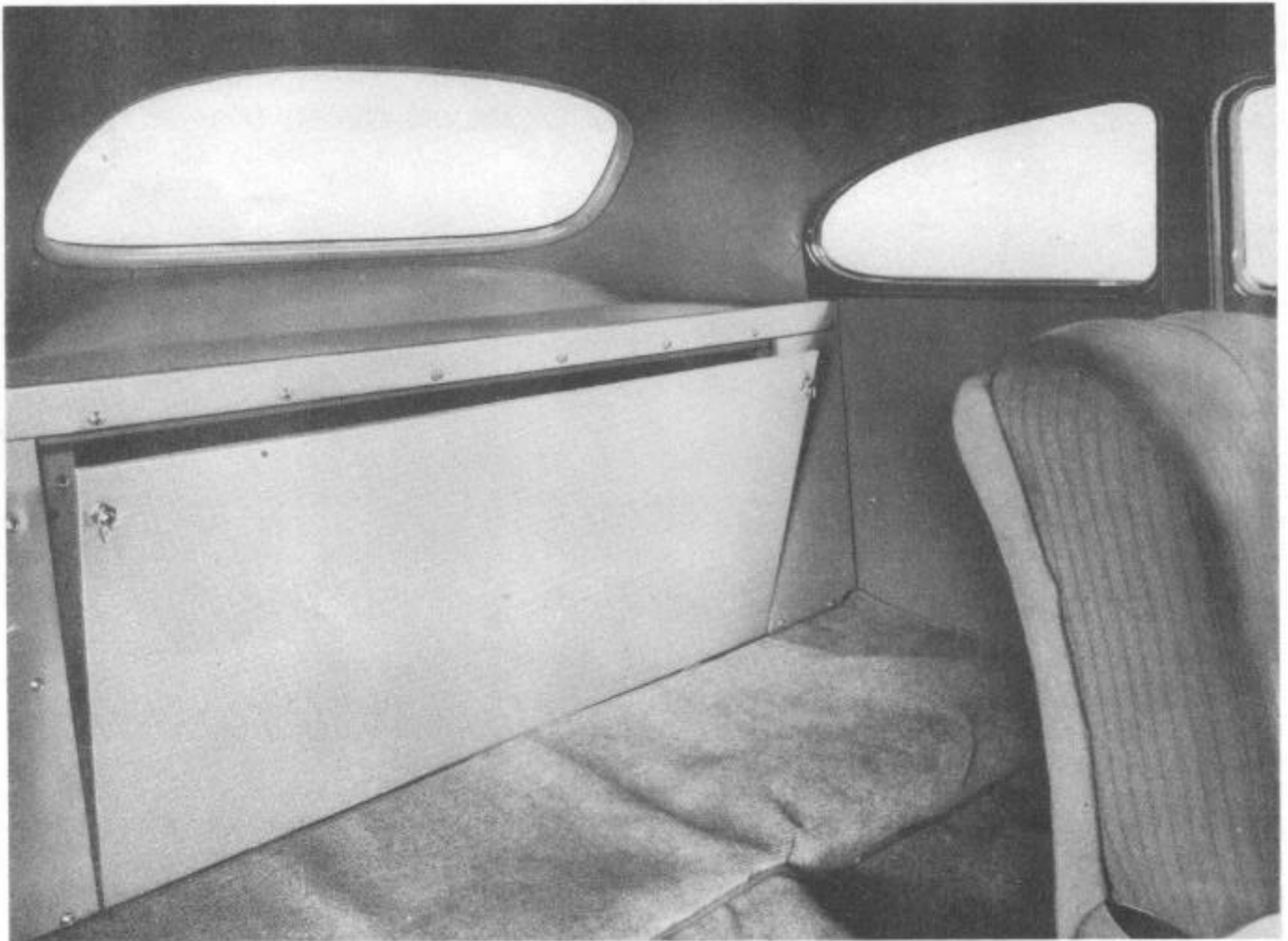

FIGURE 6
INTERIOR VIEW OF SUPER 480-490 SERIES BUSINESS COUPE

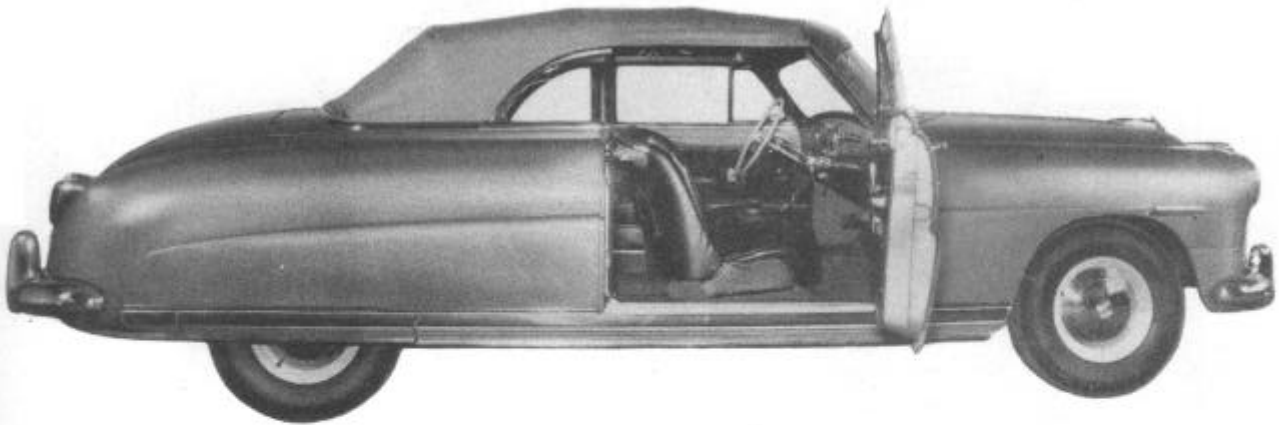

FIGURE 7
COMMODORE 480-490 SERIES SIX PASSENGER CONVERTIBLE BROUGHAM

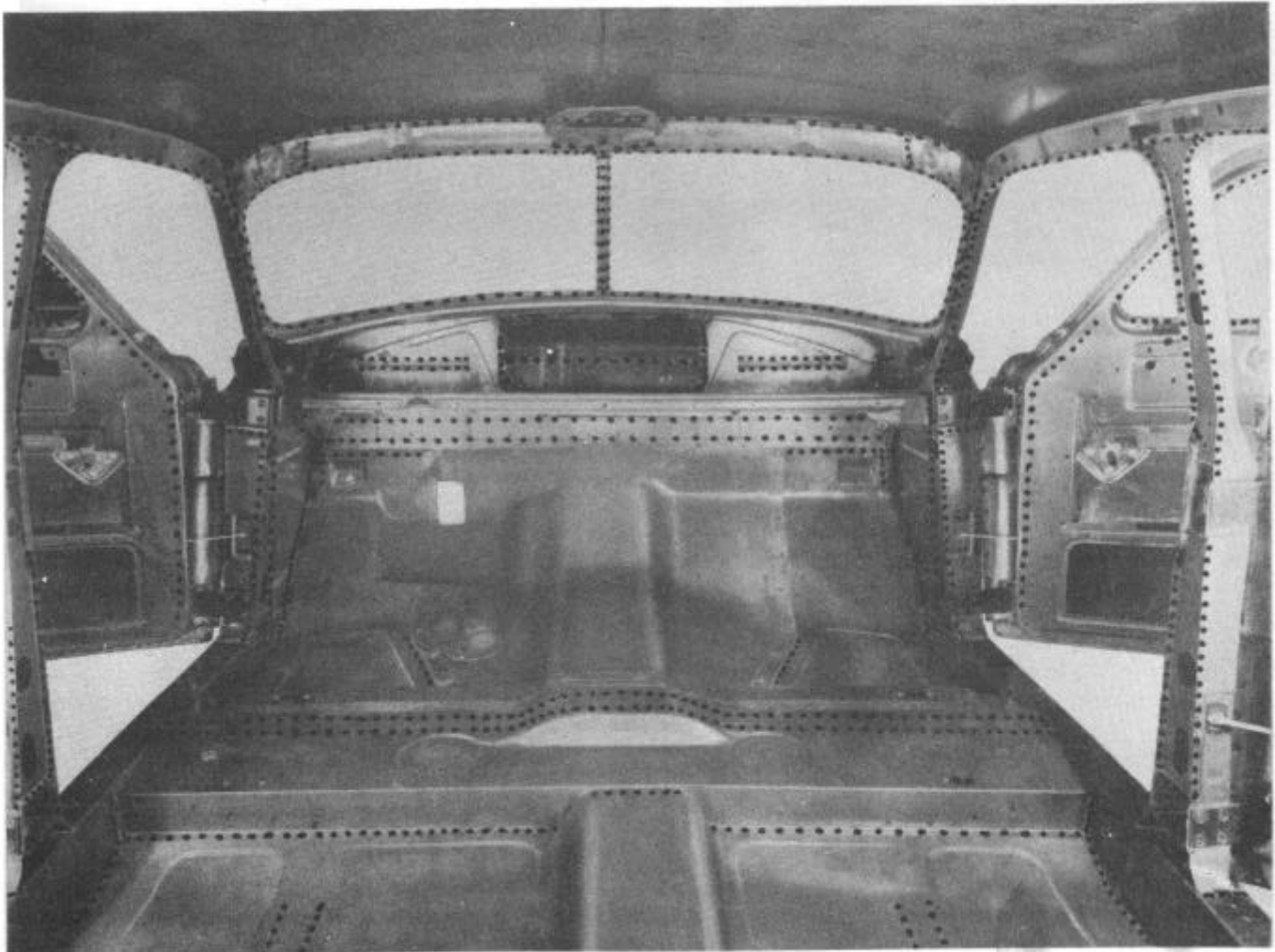
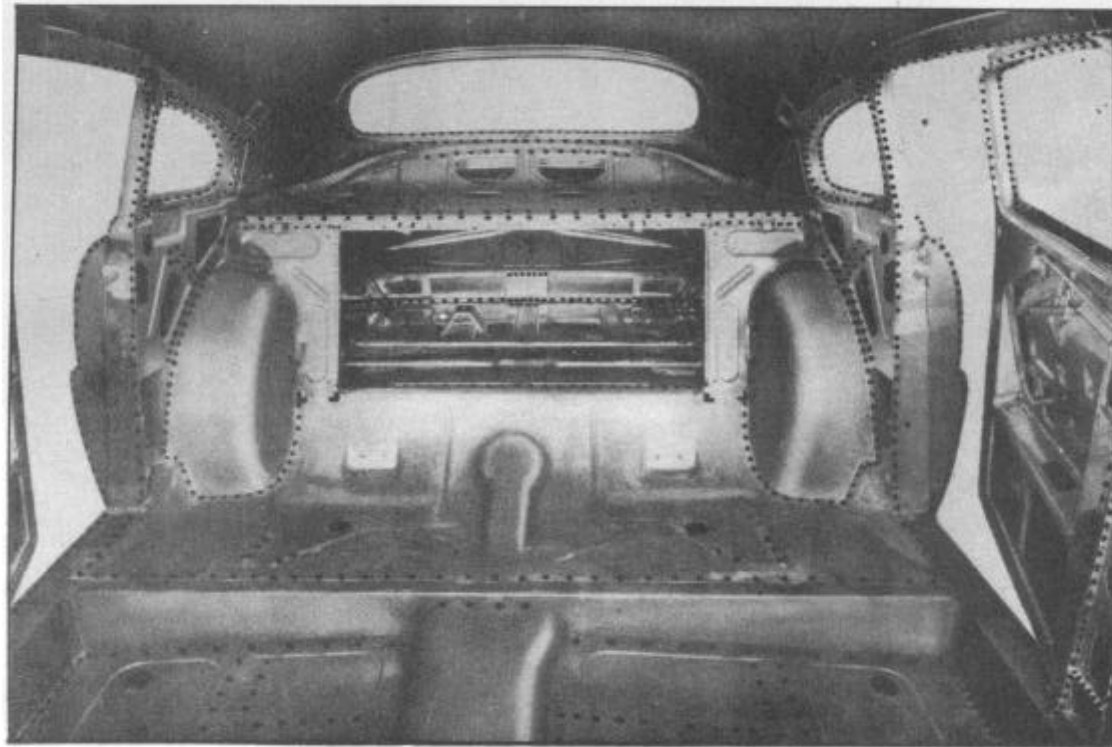
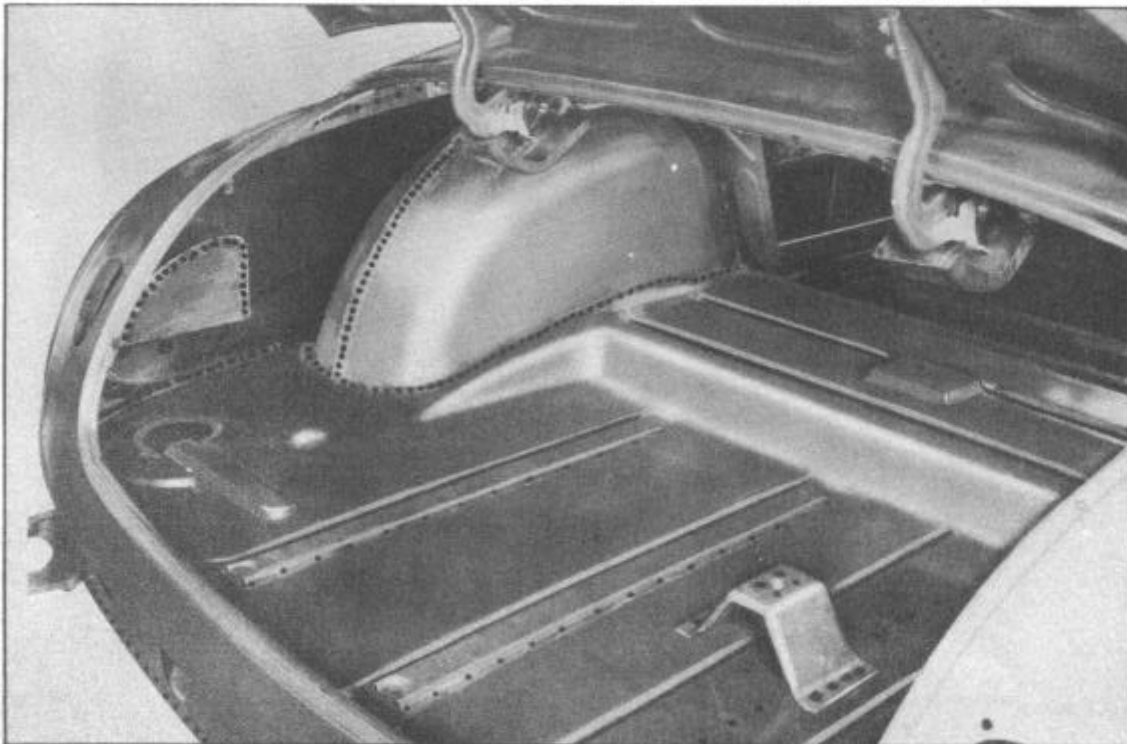

FIGURE 8
INSIDE FORWARD VIEW OF SKELETON BODY OF 480-490 SERIES FOUR DOOR SEDAN SHOWING ALL BODY SPOT WELD POSITIONS

**FIGURE 9**

INSIDE REAR VIEW OF SKELETON BODY OF 480-490 SERIES FOUR DOOR SEDAN SHOWING ALL BODY SPOT WELD POSITIONS

**FIGURE 10**

INSIDE VIEW OF REAR COMPARTMENT OF CLOSED BODY SHOWING SPOT WELD POSITIONS, SPARE WHEEL MOUNT, GAS TANK FILLER HOUSING, AND REAR WHEEL HOUSING

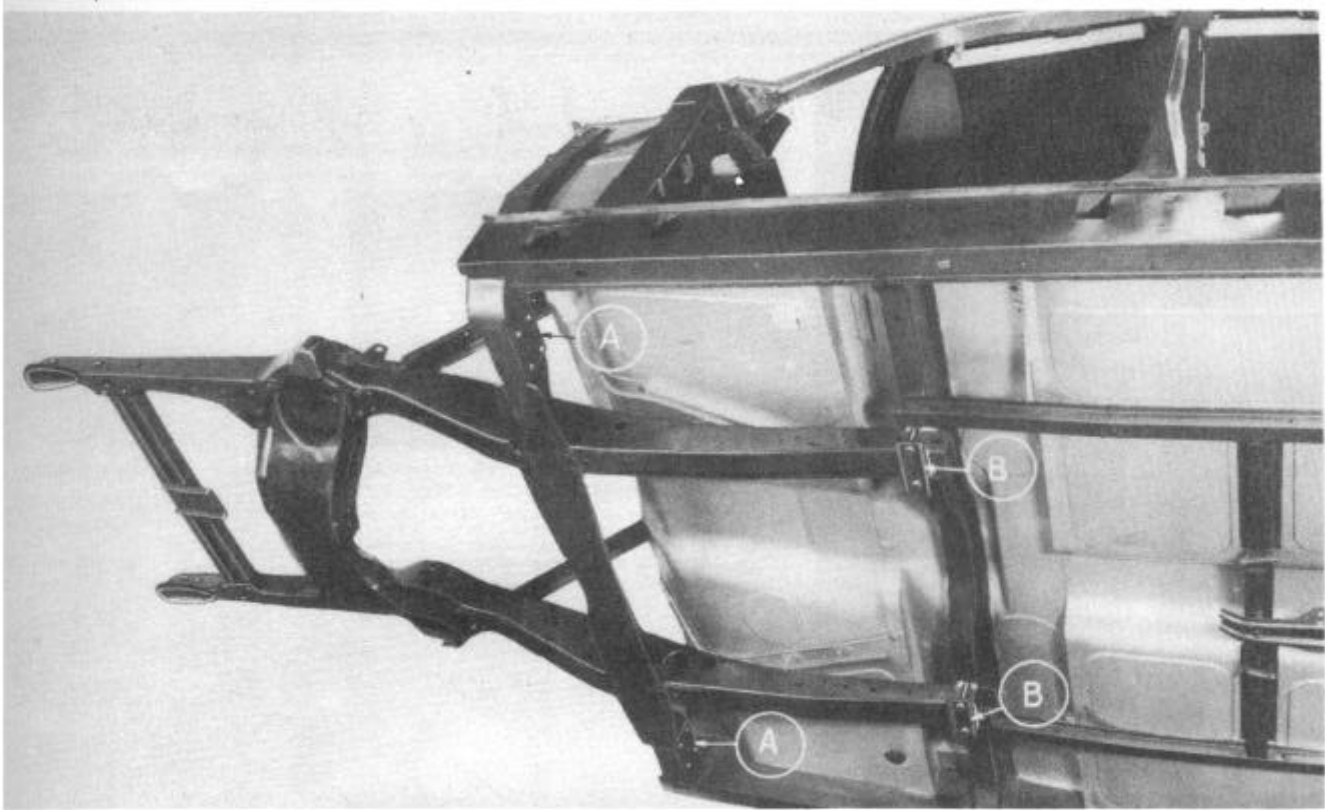

FIGURE 11
UNDER BODY VIEW OF FRONT FRAME ASSEMBLY AND METHOD OF ATTACHMENT TO BODY AND FRAME ASSEMBLY
"A"-RIVETED AND WELDED, "B"-BOLTED AND WELDED

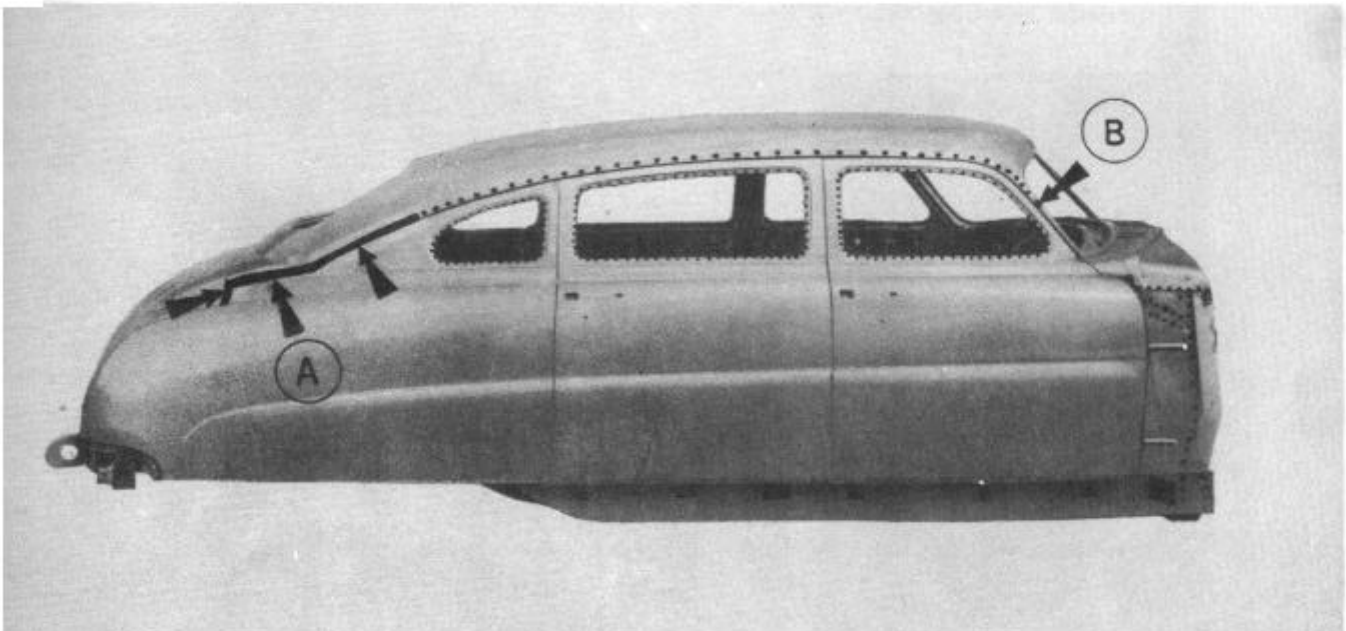
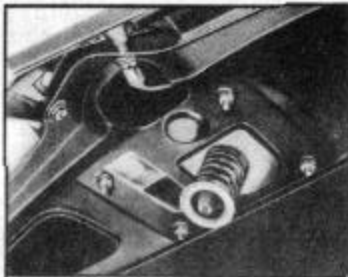

FIGURE 12
PROFILE VIEW OF 480-490 SERIES FOUR DOOR SEDAN BODY SHOWING TOP SOLDER POSITIONS AT "A" AND "B" AND EXTERIOR SPOTWELD POSITIONS

Figure 13



Hudson Lub



HOOD LOCK—UPPER

WATER RESISTANT GREASE ON DOVE-TAIL AND LIFT SPRING.

1 POINT.

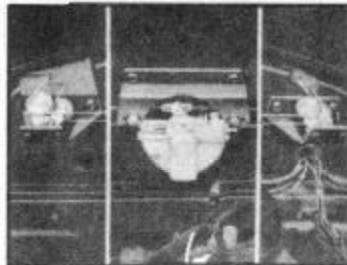

WINDSHIELD WIPER PULLEYS, CABLES AND CABLE PIVOTS

LIGHT OIL ON WIPER MOTOR PIVOT AND PULLEY BEARINGS. WATER RESISTANT GREASE ON CABLES. 3 POINTS EACH SIDE.

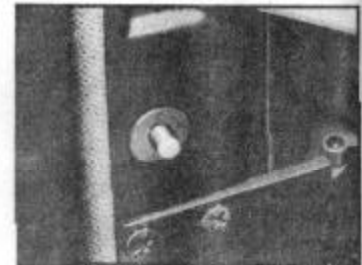

COURTESY LIGHT SWITCH

WATER RESISTANT GREASE ON SWITCH PLUNGER.

1 POINT EACH DOOR.



HOOD PROP

WATER RESISTANT GREASE ON SPRING. ENGINE OIL ON PROP ARM ATTACHING BOLTS.

3 POINTS EACH SIDE.



HOOD LOCK—LOWER

WATER RESISTANT GREASE ON LOCK CATCH AND CONTROL WIRE. ENGINE OIL ON SAFETY HOOK HINGE PIN.

3 POINTS.

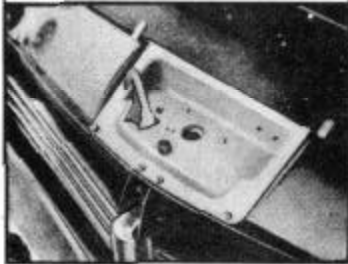

HOOD HINGE

ENGINE OIL ON HINGE LINK PIVOT PINS.

4 POINTS EACH SIDE.



DOOR HINGE

LIGHT ENGINE OIL IN HOLE PROVIDED AT HINGE JOINT.

2 POINTS EACH DOOR.

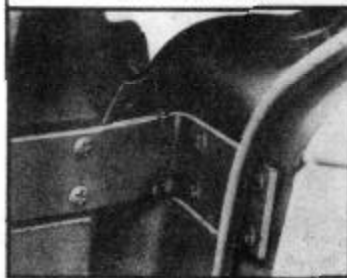

DOOR CHECK ARM

WATER RESISTANT GREASE ON ARM AND PIVOT.

2 POINTS EACH DOOR.

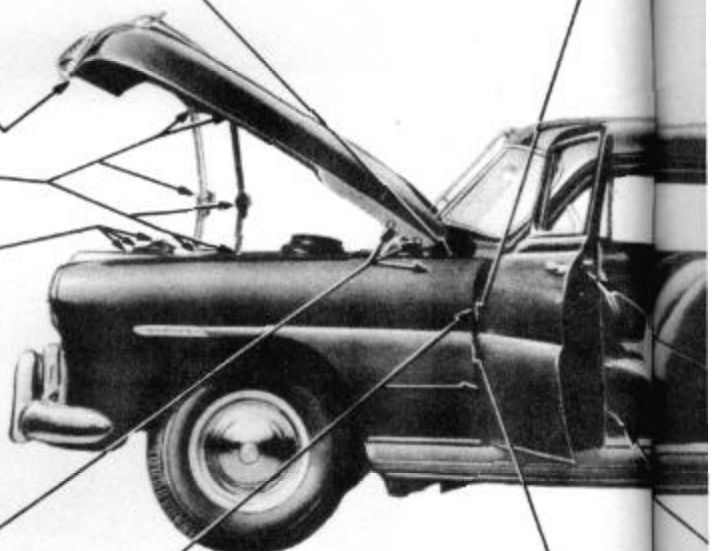
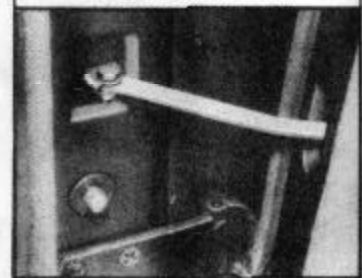

lubrication



REAR COMPARTMENT DOOR HINGE
WATER RESISTANT GREASE ON HINGE PIVOT PIN AND SPRING.
2 POINTS EACH SIDE.

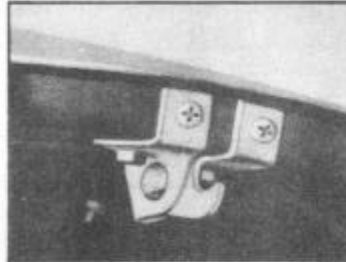

REAR COMPARTMENT DOOR LATCH CLAMPING LEVER
WATER RESISTANT GREASE ON CLAMPING LEVER. ENGINE OIL ON LATCH LINK AND PIVOT PIN. 3 POINTS EACH SIDE.



REAR COMPARTMENT DOOR LATCH OPERATING LEVER
ENGINE OIL ON EACH END OF LATCH ROD.
2 POINTS.

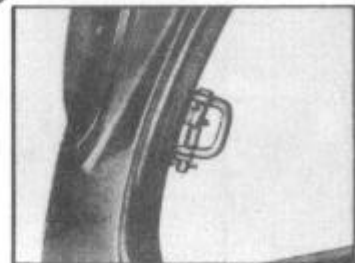

REAR COMPARTMENT DOOR STRIKER
ENGINE OIL ON STRIKER HINGE PIN AND SPRING.
2 POINTS EACH SIDE.

FUEL TANK FILLER DOOR
LIGHT ENGINE OIL ON HINGE PIN.
2 POINTS.



DOOR STRIKER
WATER RESISTANT GREASE ON TOP SURFACE AND IN LOCK BOLT GROOVE.
1 POINT EACH DOOR.



SEAT ADJUSTER
WATER RESISTANT GREASE ON SEAT TRACKS.
ENGINE OIL ON BEARING POINTS, TIE RODS AND LATCHES.

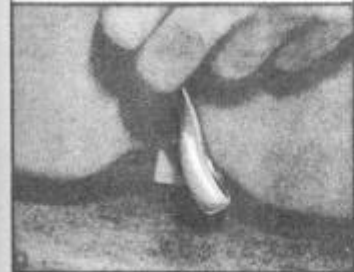

DOOR LOCK BOLT
WATER RESISTANT GREASE ON LOCK BOLT AND SLIDE.
1 POINT EACH DOOR.

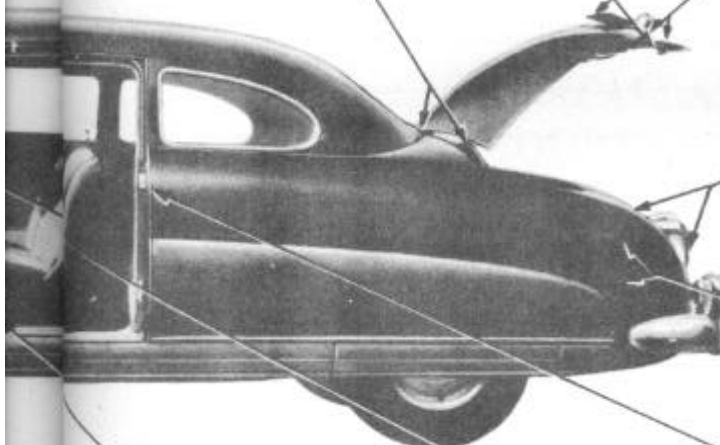
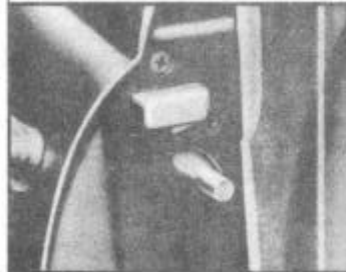

REMOVAL AND CARE OF PARTS

With most damaged bodies, there are parts that have to be removed to facilitate the repair of the damaged sections. These parts, whether they are damaged or not, should be kept in some suitable container or storage bin to prevent further damage and eliminate the possibility of parts becoming lost.

Where severe body damage is encountered, it is best to remove body trim parts, all of which are easily removed, and store them in a clean, dry place. By approaching the actual repair job in this manner, more freedom and better visibility during the repair operation is possible. Considerable time, and patience, too, is thus saved in the aligning operation and in the effective placing of body jacks.

With the body trim parts safely stored out of the way, the possibility of burning, tearing, or soiling of upholstered parts is negligible.

REMOVAL & INSTALLATION PROCEDURES

REAR FENDER

REMOVAL:

- 1, Remove rear wheel cover and rod assembly.
2. Remove rear seat cushion and remove the end section of the rear seat back from same side from which fender is to be removed.
3. Remove rear quarter window garnish moulding and the valance reveal moulding.
4. Remove rear quarter inside trim panel.
5. Remove 3 Phillips head screws and two self tapping screws at door pillar post.

NOTE: On Broughams and Coupes it is necessary to remove the rear quarter window to allow removal of the three fender attaching screws located behind the glass. See "Quarter Window Glass Removal," Page No. 31.

6. Remove the spare tire from rear compartment to permit better accessibility.

7. Remove 7 screws inside rear compartment which fasten fender to rear quarter panel.

8. Remove rear bumper extension at side of fender.
9. Pry off fender panel lower moulding.
10. Remove the two self tapping screws attaching rear fender panel and moulding retainers to the rocker panel.
11. Remove the 7 bolts and nuts attaching the fender panel and moulding retainers to the rocker panel.
12. Lift off rear fender. See Figure 14.

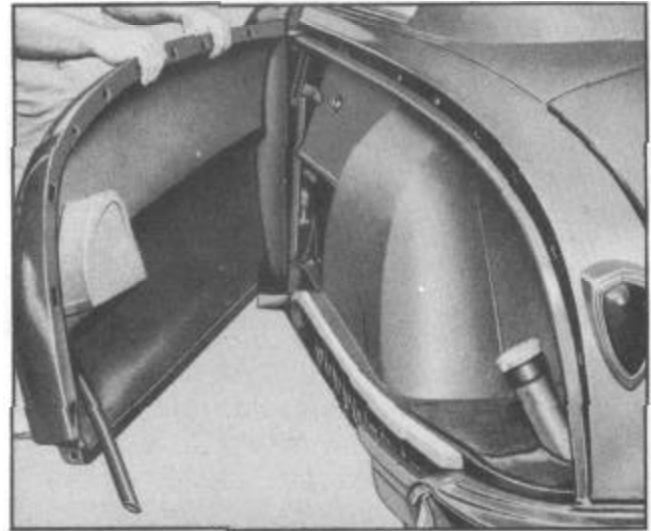

FIGURE 14

INSTALLATION:

NOTE: Before installing rear fender apply a bead of Permagum No. 576, Part No. 175356 Sealer, starting from base of rear door hinge pillar and crossing quarter panel flange to frame at rear and to area at 2 as shown in Figure 15. Care must be taken to assure that the bead of sealer is unbroken and does not cross any fender attaching bolt holes.

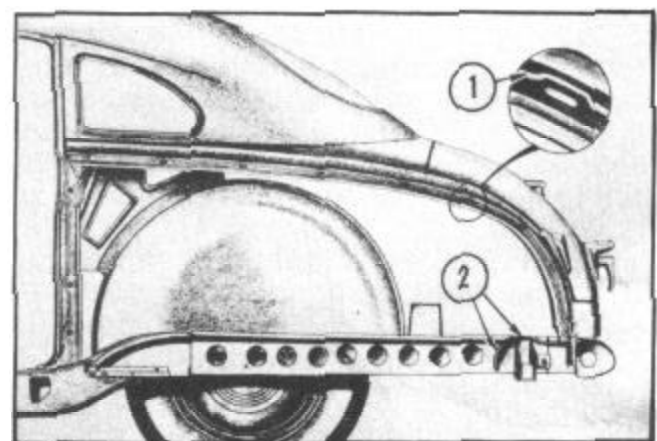

FIGURE 15

1. Align fender at door hinge pillar and install attaching screws. **DO NOT TIGHTEN.**

2. Attach all upper bolts at quarter panel flange before attaching fender to rocker panel. **DO NOT TIGHTEN.**

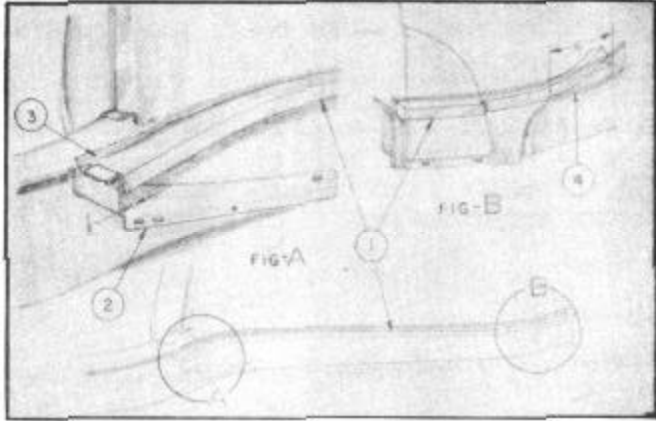

FIGURE 16

3. Install rear fender seal flush with frame flange, raising the front end 1/8" to interfere with rocker panel filler, Figure 16, No. 1 and No. 2. Cement seal tightly and allow approximately 6" from the end of the seal to remain loose until the fender is completely installed, No. 4, Figure 16. Then cement seal securely to frame flange, No. 3, and fender. **TIGHTEN ALL ATTACHING BOLTS AND SCREWS SECURELY.**

FRONT FENDER

REMOVAL:

1. Raise hood and disconnect headlight wires at junction block on radiator support.
2. Remove headlight rim (3 Phillips head screws) and remove the headlight housing (4 screws).
3. Remove the attaching bolts from the fender and side dust shield.
4. Remove two bolts attaching fender tie panel and hood lock lower support to fender.
5. Remove the upper hood prop bolt and allow hood prop to be removed with fender side dust shield. Support hood during this operation.
6. Raise car and remove front wheel.
7. Remove 3 bolts attaching fender to radiator baffle side shield.
8. Remove 3 bolts attaching fender to lower radiator splash guard.

NOTE: Front fender front extension is spot welded to the fender and will have to be removed with the fender.

9. Remove moulding and 4 self-tapping screws attaching fender and moulding clips to front rocker panel.

10. Remove kick pad in the front seat compartment at the dash panel.

11. Remove the screw attaching the door opening belt weatherstrip to fender and front cowl panel.

12. Remove the 4 bolts from behind the kick pad which attach the fender to the dash panel and front hinge pillar.

13. Lift off front fender.

14. Remove all trim and useable parts from damaged fender and install on new fender.

INSTALLATION:

1. With help of an assistant, align fender at cowl panel and attach screws at kick panel opening and front door hinge pillar.

2. Attach fender to radiator baffle side shield, fender side dust shield, and radiator splash guard.

3. Reverse procedure of removal on balance of installation.

NOTE: Reseal fender at cowl panel and at belt moulding with dolphinite sealer No. 2465,

Part No. 175367. If necessary to replace the weatherstrip, proceed as follows:

A. Apply a coating of rubber cement to the surfaces of the front pillar face and the belt weatherstrip.

B. Press weatherstrip into position then insert and tighten attaching screws.

FRONT FENDER STONE GUARD AND PANEL ASSEMBLY

REMOVAL:

1. Remove 4 bolts attaching stone guard and panel to front quarter dash panel under the fender, 2 bolts under rubber pad, and one located to the left of hood hinge.

2. Remove 3 Phillips head screws and speed nuts at dust shield extension rubber shield.

3. Remove the panel and stone guard.

INSTALLATION:

Reverse procedure of removal.

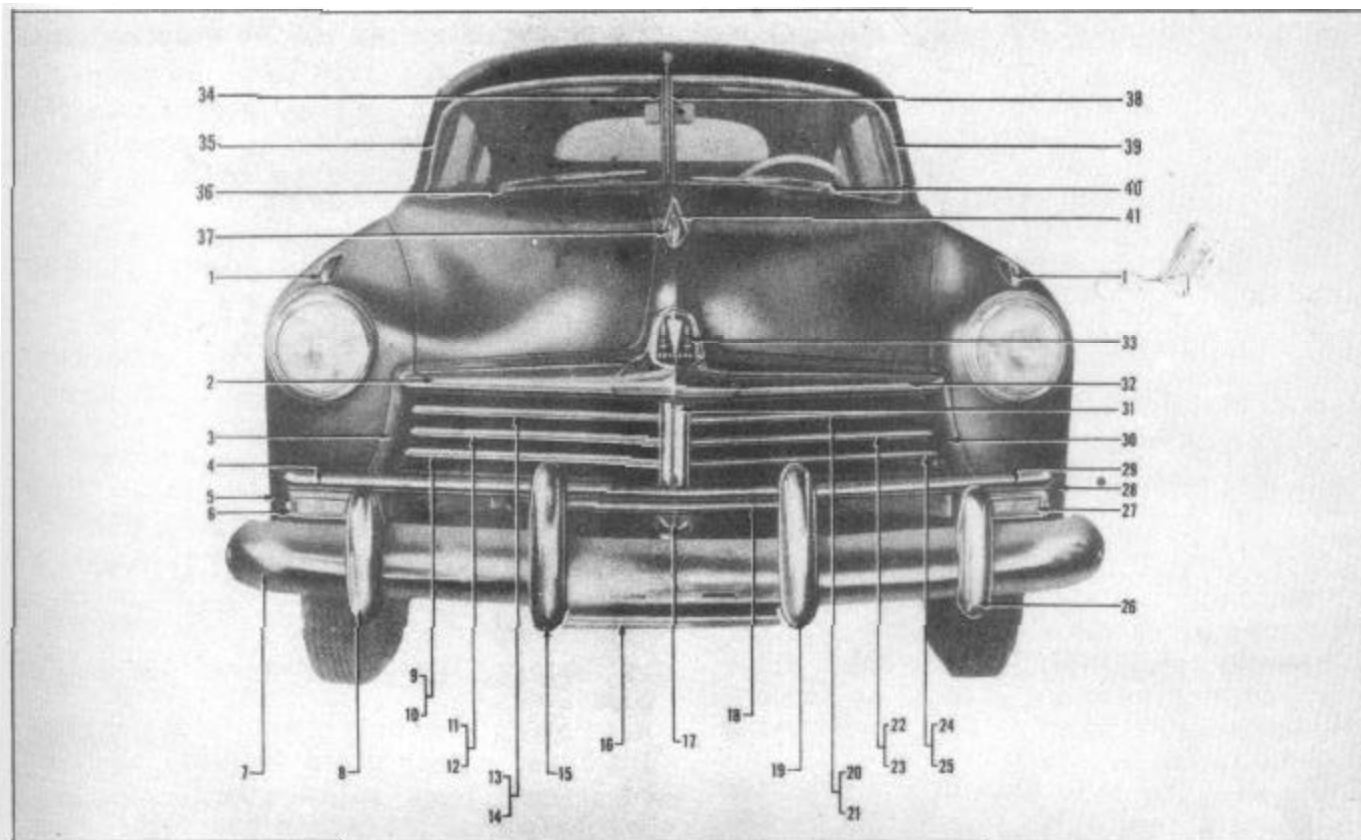

FIGURE 17

- | | |
|---|--|
| 1. Front fender ornament. | 22. Radiator grille moulding (center L.H.) |
| 2. Hood louver (R.H.) | 23. Radiator grille baffle (center L.H.) |
| 3. Radiator grille baffle side support (R.H.) | 24. Radiator grille moulding (lower L.H.) |
| 4. Front splash guard moulding | 25. Radiator grille baffle (lower L.H.) |
| 5. Front fender extension assembly (front R.H.) | 26. Front bumper guard (outer L.H.) |
| 6. Parking light assembly | 27. Parking light assembly |
| 7. Front bumper impact bar | 28. Front fender extension assembly (front L.H.) |
| 8. Front bumper guard (outer R.H.) | 29. Front splash guard moulding |
| 9. Radiator grille moulding (lower R.H.) | 30. Radiator grille baffle side support (L. H.) |
| 10. Radiator grille baffle (lower R.H.) | 31. Radiator grille center bar |
| 11. Radiator grille moulding (center R. H.) | 32. Hood louver (L.H.) |
| 12. Radiator grille baffle (center R.H.) | 33. Hood front ornament assembly |
| 13. Radiator grille moulding (upper R.H.) | 34. Center windshield reveal moulding (R. H.) |
| 14. Radiator grille baffle (upper R.H.) | 35. Windshield reveal moulding (R.H.) |
| 15. Front bumper guard assembly (inner R.H.) | 36. Pulley housing and cable assembly (R. H.) |
| 16. Front bumper license guard (lower) | 37. Hood crest assembly |
| 17. Radiator grille center bar (lower) | 38. Center windshield reveal moulding (L. H.) |
| 18. Front bumper license guard (upper) | 39. Windshield reveal moulding (L.H.) |
| 19. Front bumper guard assembly (inner L.H.) | 40. Pulley housing and cable assembly (L.H.) |
| 20. Radiator grille moulding (upper L.H.) | 41. Hood crest ornament. |
| 21. Radiator grille baffle (upper L.H.) | |

RADIATOR

REMOVAL:

1. Drain radiator and disconnect hoses.
2. Remove two sheet metal screws attaching deflector shield to fender tie panel.
3. Remove headlight wiring from retaining clips at the front of radiator.
4. Remove 4 hex head bolts attaching radiator to "U" channel and remove radiator.

INSTALLATION:

Reverse procedure of removal.

RADIATOR "U" CHANNEL WITH RADIATOR REMOVED

REMOVAL:

1. Remove headlight junction blocks; leave wires attached.
2. Remove two attaching bolts (each side) from radiator mounting channel to fender.
3. Remove attaching bolts from mounting channel to fender tie panel.
4. Remove the bolt attaching the bottom of mounting channel to frame front cross-member. Remove channel from car.

INSTALLATION:

Reverse procedure of removal.

RADIATOR GRILLE BAFFLE (UPPER) (Right or Left)

REMOVAL:

1. Remove center support bar moulding.
2. Remove screw at front and rear of center bar.
3. Remove one screw from under fender and one screw at grille baffle side supports. Remove baffle from car.

INSTALLATION:

Reverse procedure of removal.

RADIATOR SPLASH GUARD (Right or Left)

REMOVAL:

NOTE: The splash guard consists of two pieces joined at center support. Either right or left side may be removed

separately.

1. Remove complete front bumper assembly.
2. Remove three bolts at each side attaching splash guard to radiator grille panel.
3. Remove bolt at grille lower center bar and the bolt attaching center plate to right and left hand splash guard.
4. Slide splash guard out.

INSTALLATION:

Reverse procedure of removal.

RADIATOR FRONT SPLASH GUARD AND MOULDING

REMOVAL:

1. Remove front bumper center grille guard.
2. Remove one bolt (each side) attaching front splash guard (center) to front fender and lower splash guard.
3. Remove two brass nuts and clips (each side) under fender attaching fender to splash guard moulding.
4. Remove bolt attaching splash guard to grille lower center bar and remove splash guard.

INSTALLATION:

Reverse procedure of removal.

RADIATOR GRILLE CENTER BAR (UPPER)

REMOVAL:

1. Remove two screws and remove the center bar support moulding.
2. Remove bolts attaching grille baffles to center bar.
3. Remove two bolts attaching center bar to fender tie panel and to front splash guard.
4. Remove center support and splash guard center plate. Remove bar from car.

INSTALLATION:

Reverse procedure of removal.

FENDER AND GRILLE SIDE SUPPORT

(Right or Left Hand)

REMOVAL:

1. Remove the screws attaching the radiator grille baffles to side and center support. Remove baffles.
2. Remove five bolts under fender attaching the side panel to fender.
3. Remove the three bolts, nuts, and shakeproof washers attaching the side support to the radiator mounting channel.
4. Remove three bolts, nuts, and shake-proof washers attaching the side support to the lower front splash guard.
5. Remove the front splash guard and moulding and remove the side support from the car.

INSTALLATION:

Reverse procedure of removal.

RADIATOR SPLASH GUARD

REMOVAL:

1. Remove two brass nuts and clips (each side) under fender attaching moulding to front fender lower extension.
2. Pry off moulding with a screwdriver. Use care if moulding is to be used again.

INSTALLATION:

Snap moulding into place and attach to fender in reverse procedure of removal.

ENGINE HOOD

REMOVAL:

1. Raise and place prop under front of hood (1), Figure 18.
2. Remove two hood prop bolts (2), (one on each side). Hood props (3) remain attached to fender side dust shields (11).
3. Remove the two hood hinge bolts, (7 and 8), from each side at rear of hood.
4. With a helper, remove hood from car.

INSTALLATION:

Reverse procedure of removal and adjust at hood hinge bolts.

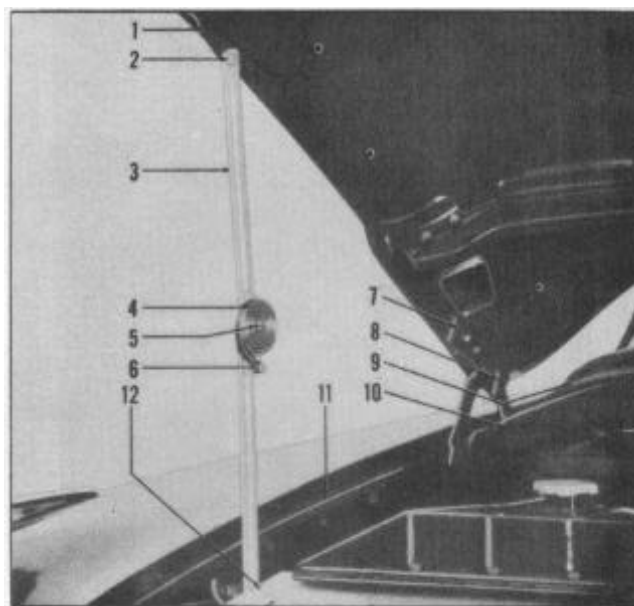

HOOD ADJUSTMENT

1. Loosen the two bolts, (9 and 10), which attach the hood hinge to the cowl just enough to allow for backward or forward movement.
2. Loosen screws (7 and 8) attaching hinge arm to hood, (each side).

NOTE: Forward and backward adjustments and up and down adjustments can now be made at the rear of the hood. Up or down adjustments at the front of the hood can be made by raising or lowering the three rubber bumpers mounted on the front fender tie panel and adjusting the spring retainer bolt mounted on the hood lock upper support.

3. After all adjustments have been made, tighten all bolts and lock nuts securely.

HOOD LOCK UPPER SUPPORT

REMOVAL:

1. With a screwdriver remove the spring retainer bolt (2) from the attaching nut and remove retainer and spring, Figure 19.
2. Remove the four attaching nuts and washers (1) from lock support plate. 3. Remove the two sheet metal screws from bracket at rear of assembly and slide assembly to one side and remove.

INSTALLATION:

Reverse procedure of removal. Adjust locking spring by turning slotted retainer assembly to left or right.

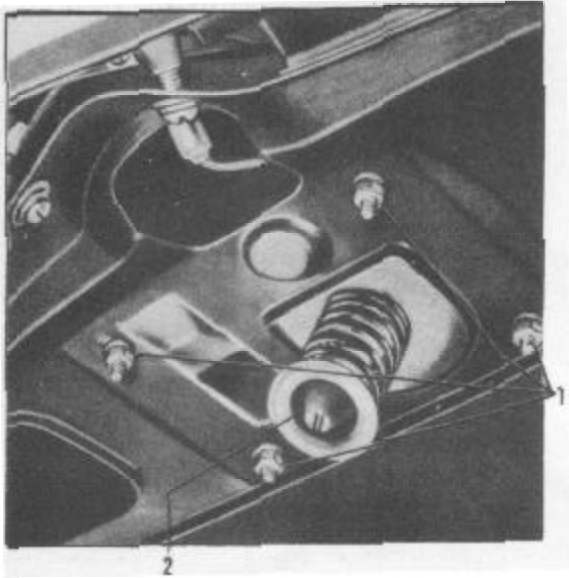

FIGURE 19

HOOD LOCK LOWER SUPPORT

REMOVAL:

1. Disconnect hood lock control wire.
2. Remove 4 bolts attaching hood lock lower support to fender tie panel and remove lower support from car.

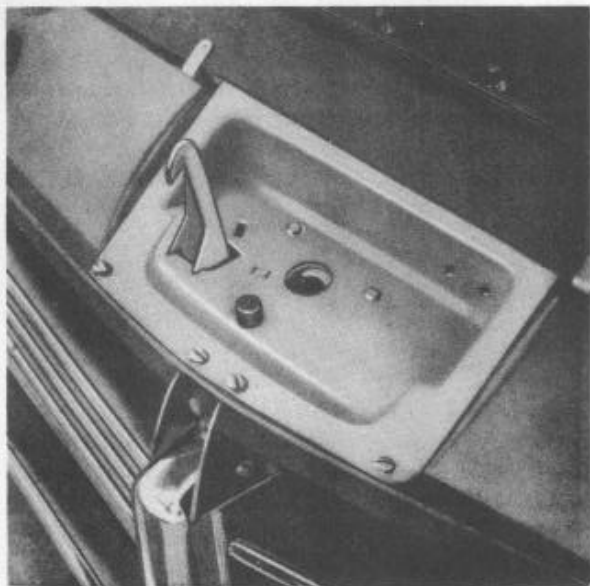

FIGURE 20

INSTALLATION:

Reverse procedure of removal. Lock hood control wire securely and apply water resistant grease to hood lock release catch.

FENDER TIE PANEL AND HOOD LOCK LOWER SUPPORT

REMOVAL:

1. Raise hood and disconnect hood lock control wire.
2. Remove two bolts (each side) attaching fender tie panel and hood lock support to fender bracket.
3. Remove two bolts attaching the fender tie panel and hood lock support to radiator mounting channel.
4. Remove two bolts attaching fender tie panel to the front fender skirt.
5. Removing one bolt attaching hood lock support to radiator grille center support and remove the support assembly from the car.

INSTALLATION:

Reverse procedure of removal.

HEADLINING

Preparatory to headlining removal, remove the following trim parts:

- A Sun visors
- B Rear view mirror
- C Front dome lamp lens assembly
- D Upper and lower windshield garnish moulding
- E Windshield inside center trim bar
- F Windshield retainers
- G Windshield glass
- H Rear seat cushion, back rests, and center arm rest
- I Rear window
- J Rear package shelf
- K Rear quarter window garnish mouldings
- L Rear dome lamp lens assembly

NOTE: HANDS MUST BE CLEAN AT ALL TIMES WHEN WORKING ON THE INTERIOR TRIM OF A BODY.

REMOVAL:

1. Remove upholsterer's tacks from around rear window opening and rear quarter window openings and the cardboard tacking strips at the extreme rear edge of the headlining on the package shelf. Pull headlining loose from cement.

2. Remove headlining from glazier's points around upper windshield opening. Use a screwdriver to pry open these glazier's points to facilitate installation of new headlining.
3. With a sharp knife slit the headlining on both sides, front to rear, along the side retainers; remove roof bows from rubber grommets and remove headlining from body.
4. Loosen screws in the headlining slide retainers and remove scrap material from glazier's points. **RETIGHTEN SCREWS SECURELY.**
5. Remove all old cement from around rear window and rear quarter window openings and windshield opening. Apply new cement to these areas and allow it to become tacky before beginning the new installation.

INSTALLATION:

NOTE: BEFORE REMOVING ROOF BOWS FROM OLD HEADLINING, CONSULT ROOF BOW COLOR CHART ON PAGE 9 FOR THE CORRECT PLACEMENT OF THE BOWS IN THE NEW HEADLINING. THE CORRECT PLACEMENT OF THE ROOF BOWS IN THE HEADLINING IS VERY IMPORTANT.

1. After double checking to make certain that the roof bows have been installed in their proper sequence in the new headlining, start the installation into the body with the rear bow. (Leave the first two bows hanging loosely in their grommets. Do not snap up into the support brackets. This prevents undo stretching of the material at this point.) Work progressively toward the front installing each roof bow into its rubber grommet and support bracket, leaving the front bow hanging loosely in the rubber grommets.
2. Move to the rear of the body and snap the two rear roof bows into the support brackets. Press headlining temporarily into the cement at the top center of the rear window opening. (This holds the headlining out of the way for installation of the cardboard tacking strips.) Pull headlining down evenly at cardboard tacking strips on both sides and tack the strips securely at the rear package shelf.
3. Pull headlining tight and press into cement around rear window opening. Snip the material at the corners of the opening to assure a smooth fit and prevent pleats.

- Replace upholsterer's tacks in rear window opening. Trim surplus material from around rear window opening. Cut a separate piece of headlining material approximately 24 inches long and 10 inches wide and install into cement at bottom edge of rear window opening. Tuck material under the edges of the headlining and secure with upholsterer's tacks. (This separate piece of material covers the panel between the lower edge of the rear window and the rear package shelf. Material should be wide enough to extend to the package shelf and be held in place by the rear package shelf trim board.)
4. Cut the headlining material at the corners of the rear quarter windows and press firmly into the cement. Secure with upholsterer's tacks.
 5. Re-install rear package shelf trim board. Cement and tack into place at the front edge.
 6. Now move to the front of the body and snap the front roof bow into the support brackets. Stretch the headlining forward and, beginning at the center of the windshield opening, attach headlining to glazier's points in the upper windshield opening. After the headlining is securely hooked on the glazier's points, hammer the points flush with the windshield opening. (This assures perfect fit of windshield sealing strip and prevents leaks at this point.) Trim away surplus material.
 7. Next, using Tool J-2772, carefully tuck the edges of the headlining up under the side retainers. (Before starting this operation check to be sure that the side retainers are fastened securely.) Use the tool carefully in this operation. Start at the front and work toward the rear, stretching the headlining as the work progresses.
 8. Carefully slit the headlining at the dome lights and install the dome light lens assemblies. **NOTE: Trim away only enough material at the dome lights to clear the bulb recess in the lamp base. Headlining is held in place at this point by the dome lamp lens assembly; therefore do not trim away more material than is absolutely necessary.**
 9. Re-install windows and all trim parts removed prior to headlining removal operations.

REPLACING BROKEN WINDSHIELD

NOTE: On radio equipped cars it is necessary to remove the radio antenna lead wire assembly prior to the windshield installation.

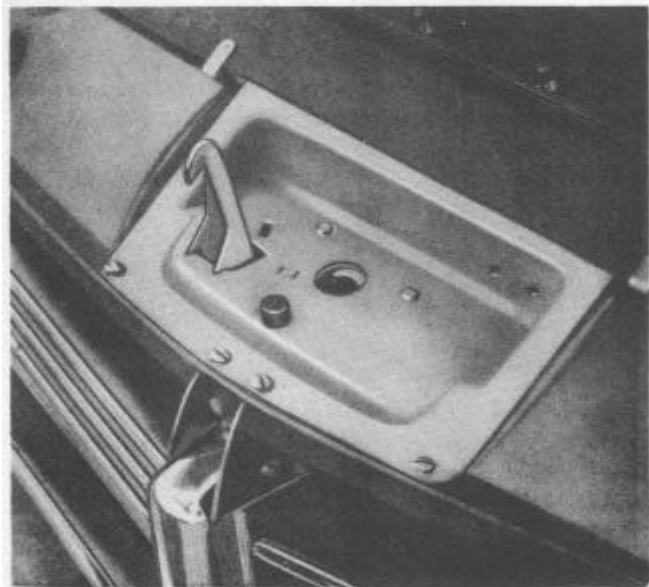

FIGURE 21

REMOVAL:

1. Remove the rear view mirror (A), Figure 21, and antenna control knob.
2. Remove antenna lead plug from radio. Loosen lock nut (C) at joint cover (E), and remove nut under dash attaching lead rod assembly at moulding joint cover (E). Lower the lead rod and detach from lead wire on control. Remove windshield inside center bar.
3. Remove antenna windshield inside center bar (D), moulding joint cover (E), upper and lower windshield garnish mouldings (H and F), and four steel windshield retainers (G and H).

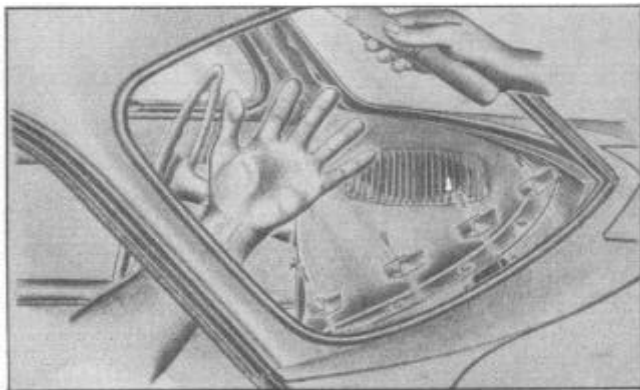

FIGURE 22

4. Using a dull putty knife, Figure 22, pry between the rubber weatherstrip and the chrome reveal moulding to loosen and remove the windshield glass and weatherstrip.

NOTE: Glass is removed from the inside.

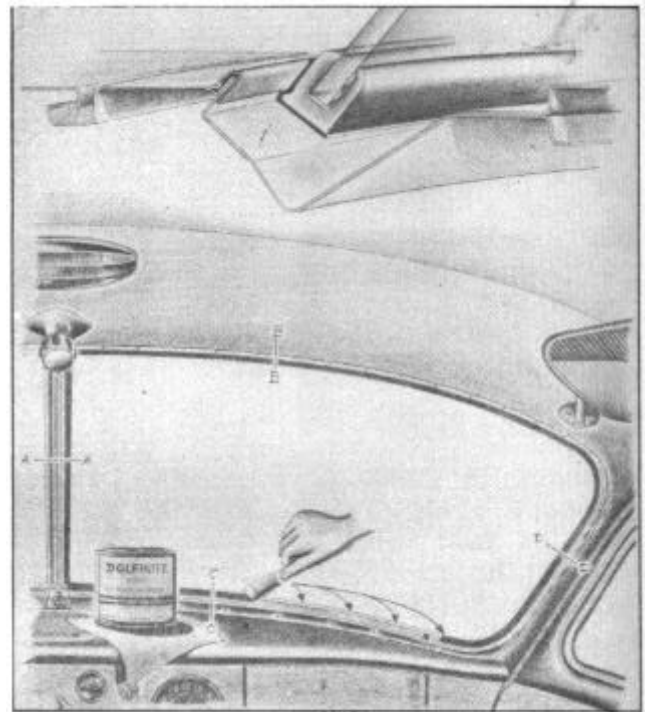

FIGURE 23

INSTALLATION:

1. Remove all old windshield sealer. With a putty knife apply enough new sealer around windshield opening to squeeze out when glass is installed, Figure 23. Mask off the upholstery material around the windshield opening to prevent soiling during the installation.

NOTE: Right and left hand rubber seals are used. When proper seal is on glass, ribbed surface will be forward and rubbers will fit properly at inner corners of glass.

2. Place rubber weatherstrip on new glass and place glass in the windshield opening from the inside of the car. 3. Maneuver glass into position by carefully lifting inside lower corner with a tapered wood wedge. Shim as required along bottom of weatherstrip and glass assembly to bring inner edge parallel to center bar. Locate shims so that they will not interfere with installation of windshield retainers (G and H), Figure 21.

4. Install one center windshield retainer to secure windshield in proper position.

NOTE: When installing windshield retainers do not install the outside retainer (next to front hinge pillar).

5. Install the remaining retainers and apply soap stick to the curved portion of the retainer that contacts the windshield rubber weatherstrip. The retainers will then slide down into position when tightened.

6. Remove masking from upholstery and install all trim and radio parts removed prior to removing windshield.

7. Carefully remove all excess sealer with Hudson fabric cleaner.

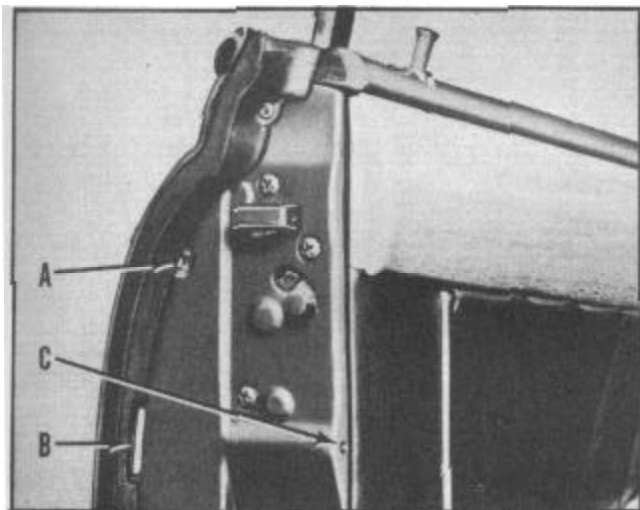

FIGURE 24

FRONT DOOR LOCK CYLINDER

REMOVAL:

Insert a screwdriver under the flanged edge of the lock retainer (B), Figure 24, and pry outward. This will release the lock assembly for removal from the door. (Leave lock retainer in the door.) Pull out lock assembly.

INSTALLATION:

1. From the inside of the door, push a stiff wire, or an awl, thru the hole (C) in the door and lock retainer to the outside panel. Place recessed end of lock shaft on the point of the awl and, keeping the two firmly together, press the lock assembly into the door, using the awl as a guide.

2. Press the lock retainer back into position by hand as far as possible; then, using a fiber driving tool and a hammer, drive the retainer in flush with the edge of the door.

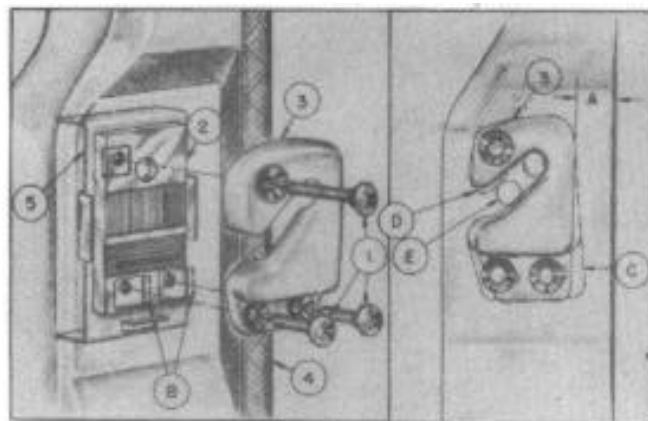

FIGURE 25

DOOR STRIKER PLATE

The door striker plate (3), Figure 25, is mounted on the body pillar and is attached to a tapping plate on the inside of the pillar.

REMOVAL:

Remove three Phillips head screws (1) from striker plate and remove plate.

NOTE: With the striker plate removed, to remove tapping plate (2), loosen trim (4) at pillar and lift plate out of retainer (5).

ADJUSTMENT:

1. Loosen the three Phillips head screws (1) sufficiently to allow striker plate to be moved easily with the fingers.
2. Adjust height of striker plate to give correct alignment with the door latch bar.
3. Adjust inward position of striker plate to hold door firmly against weatherstrips.

NOTE: When making inward adjustment, be sure that back of striker plate is parallel to the inside flange of the body pillar (A).

4. Tighten screws (1) securely.
5. Close door to bring latch bar into safety catch position. Door should not open when a reasonable pull is exerted.

6. If door opens easily without pushing the handle button, loosen screws as in step one and rotate bottom of striker plate inward. (C). Tighten screws and re-check.

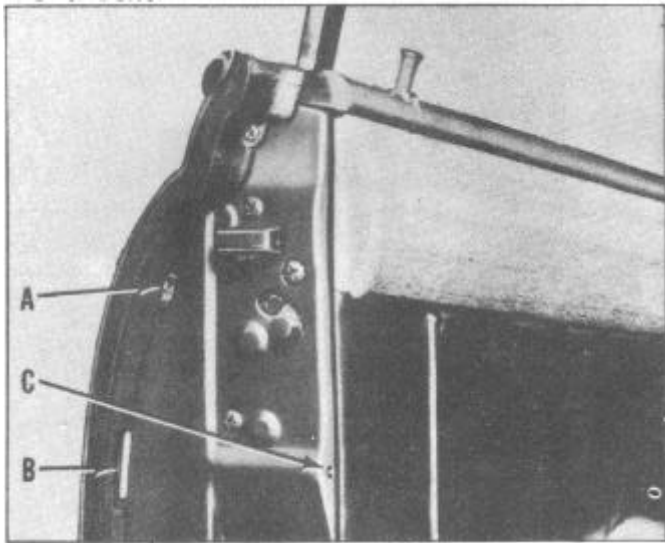

FIGURE 26
DOOR OUTSIDE HANDLE

REMOVAL:

To remove the door outside handle, remove Phillips head screw (A), Figure 26, from edge of door. Push handle forward and lift handle out of door.

INSTALLATION:

To install, reverse procedure of removal.

DOOR TRIM PANEL (Front and Rear)

REMOVAL:

1. Remove inside door handles.
2. Remove lock release knob and garnish moulding.
3. Remove two screws from underside of arm rest and remove arm rest.
4. Remove valance by extracting exposed screws and sliding valance up from between door and trim panel.
5. Remove door pocket trim board (clips).
6. Remove door trim panel (clips).

INSTALLATION:

1. Repair any damage to door inside liner with Mystik tape before replacing trim panel.
2. Install door trim panel by engaging the bottom retainer and aligning the clips before driving in place.

3. Install pocket trimboard.

4. Install valance by inserting lower flange between door and pocket trimboard; and, with slots in line with trimboard clips, force valance down into position and install screws.

5. Install arm rest, garnish moulding, lock release knob, and door handles.

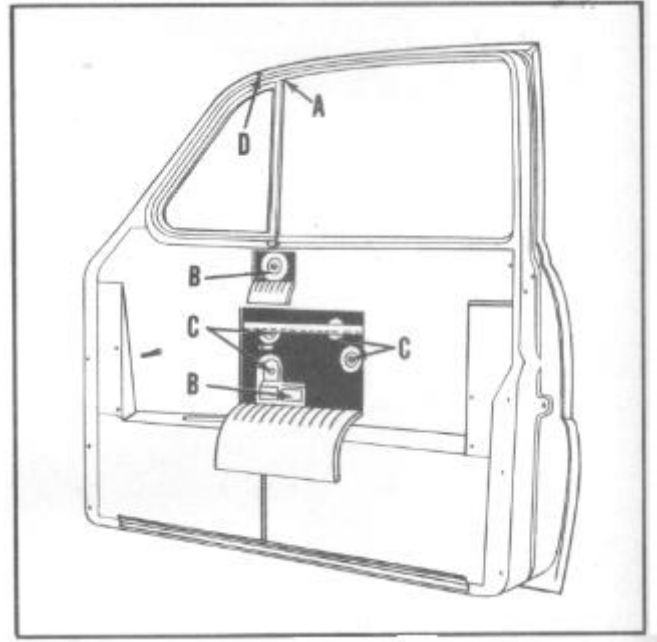

FIGURE 27

DOOR WINDOW REGULATOR (Front)

REMOVAL:

1. Remove trim panel. See Page 28.
2. Remove garnish moulding spacer wood block.
3. Cut inner liner as shown in Figure 27 for sedans and Figure 28 for coupes and broughams.
4. Remove screw (A) from inside upper end of center glass channel and screws (B) which attach center glass channel to door inner panel. (Do not remove center glass channel from door.)
5. Remove screws (C) attaching regulator to door inner panel.
6. Lower window to bottom of door and release regulator cross arms from glass channel on sedans. On coupes and broughams disconnect regulator from cross arm assembly. (A stud on the regulator arm is retained in the cross arm assembly by a spring clip.)
7. Remove regulator through opening in bottom of door.

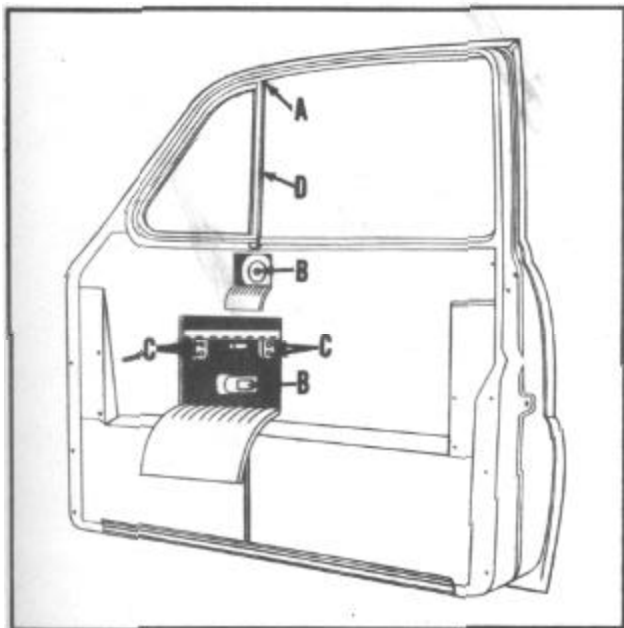

FIGURE 28

INSTALLATION:

Reverse procedure of removal and repair damage to door inner liner with Mystik tape.

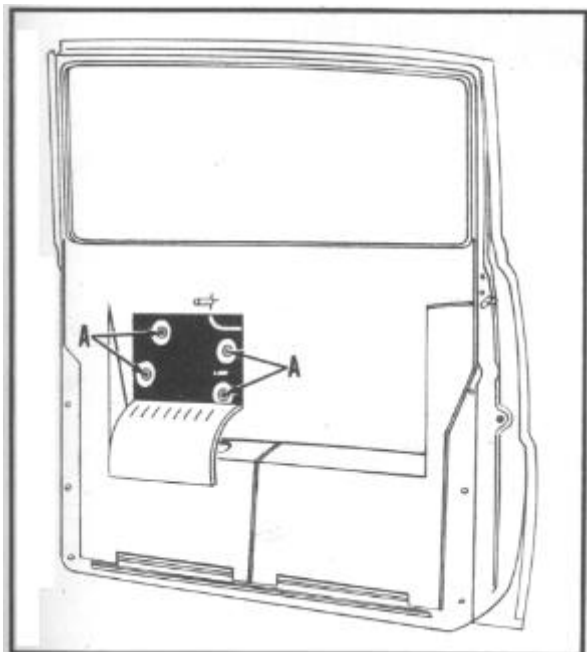

FIGURE 29
DOOR WINDOW REGULATOR
(Rear)

REMOVAL:

1. Remove trim panel. See page 28.
2. Remove garnish moulding spacer wood block.
3. Cut door inner liner as shown in Figure 29.

4. Remove 4 screws (A) holding regulator to door inner panel.
5. Lower window to bottom of door and release regulator from glass channel.
6. Remove regulator through opening at bottom of door.

INSTALLATION:

Reverse procedure of removal and repair damage to door inner liner with Mystik tape.

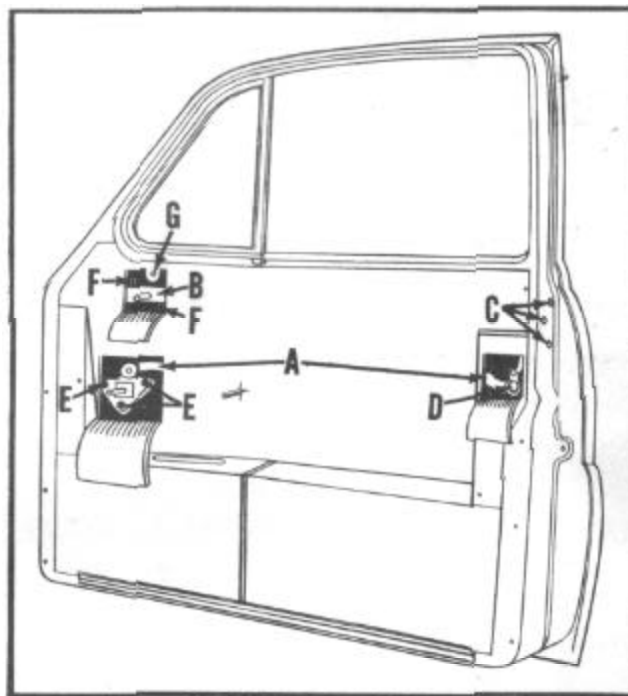

FIGURE 30
DOOR LOCK
(Front and Rear)

REMOVAL:

1. Remove outside door handle.
2. On front doors, remove door lock cylinder.
3. Remove door trim panel. See page 28.
4. Cut door inner liner at (A), Figure 30, front door; or Figure 31, rear door, and disconnect remote control arm from lock at D.
5. Remove window channel from lock side of door.
6. Remove three large Phillips head screws (C) from edge of door and remove lock assembly down and out through lower opening in door inner panel.

INSTALLATION:

Reverse the procedure for removal. Repair any damage to inner liner with Mystik tape.

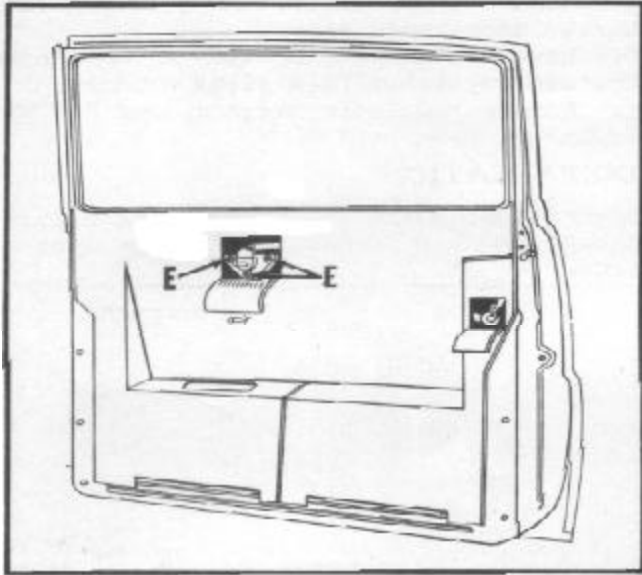

FIGURE 31
DOOR REMOTE CONTROL
(Front and Rear)

REMOVAL:

1. Remove door trim panel. See page 28.
2. Cut door inner liner as shown at A, Figure 30, for front door or Figure 31, for rear door.
3. Remove three Phillips head screws (E) from triangular bracket at handle end of remote control arm.
4. Remove anti-rattle spring and pin (D) from lock end of remote control and withdraw remote control toward the hinge side of the door.

INSTALLATION:

Reverse procedure of removal. Repair door inner liner with Mystik tape.

DOOR VENTILATOR WING
REGULATOR
(Commodore)

REMOVAL:

1. Remove door trim panel. See page 28.
2. Cut door inner liner at B in Figure 30.
3. Remove screw from regulator clevis.
4. Remove two screws (F) attaching regulator to door inner panel and remove regulator down and out through opening

in bottom of door inner panel.

INSTALLATION:

Reverse procedure of removal and repair door inner liner with Mystik tape.

DOOR VENTILATOR WING
(Commodore)

REMOVAL:

1. Remove safety lock knob and garnish moulding.
2. Remove ventilator regulator handle and valance.
3. Remove garnish moulding spacer wood block.
4. Cut hole in door inner liner as shown at B in Figure 30 to expose clevis (G) connecting wing to regulator and remove screw from clevis.
5. Open ventilator wing and press down on top of frame to release it from upper pivot and lift out ventilator.

INSTALLATION:

Reverse procedure of removal. Make sure ventilator weatherstrip lip is over garnish moulding. Repair inner liner.

DOOR VENTILATOR WING
(Super)

REMOVAL:

1. Remove safety lock knob and garnish moulding.
2. Remove wood spacer block.
3. Remove screws (B), Figure 27, attaching wing frame to inner panel.
4. Remove small Phillips head screw (D), Figure 27, from top of door.
5. Remove screw (A), Figure 27, from inside upper end of center glass channel.
6. Tilt ventilator assembly and lift out.
7. Remove nut and spring from friction pivot.
8. Remove screw from top of channel to release wing from channel.

INSTALLATION:

Reverse procedure of removal. Make sure lip of weatherstrip is over garnish moulding.

DOOR GLASS

(Front)

REMOVAL:

1. Remove safety lock knob and garnish moulding.
2. Remove small wood block.
3. Remove pocket trim panel.
4. Cut door inner liner as shown in Figure 28.
5. Remove Phillips head screw (A),
6. Remove two screws (B).
7. Remove center glass channel (D) or lower it into the door.
8. Tilt glass inward and raise to upper limit of regulator.
9. Release regulator cross arms from glass channel and remove glass and glass channel.

INSTALLATION:

Reverse procedure of removal.

DOOR GLASS

(Rear)

REMOVAL:

1. Remove safety lock knob and garnish moulding.
2. Remove small wood block.
3. Run glass to within 2" of the top and pull inward on top of glass to release glass from glass runs.
4. Tip glass inward and further raise window until glass channel can be released from regulator.
5. Remove glass and glass channel.

INSTALLATION:

1. Insert channel and glass through opening and engage regulator.
2. Run regulator up and down to force glass into position.
3. Replace wood block.
4. Replace garnish moulding and safety lock knob.

QUARTER TRIM PANEL

(Broughams and Coupes)

REMOVAL:

1. Remove rear seat cushion and rear seat back.
2. Remove quarter window regulator handle.

3. Remove garnish moulding.
4. On Commodore models remove valance.
5. Remove two screws from under side of arm rest and remove arm rest.
6. Remove pocket trim panel and lower trim panel, attached by clips to inner panel.

INSTALLATION:

Reverse procedure of removal.

QUARTER WINDOW GLASS

(Broughams and Coupes)

REMOVAL:

1. Remove garnish moulding and small wood block.
2. Lower window and release three clips attaching glass run channel to top of window opening by pulling in on channel.
3. Remove glass run channel.
4. Pull in on top of glass and raise glass to limit of regulator.
5. Release regulator from glass channel and remove glass and channel.

INSTALLATION:

1. Pull in on top of inner panel to enlarge opening between inner and outer panels.
2. Insert glass and glass channel through opening and engage regulator.
3. Lower the window and apply a coating of cement to window opening to seal glass run channel.
4. Insert glass run channel and engage clips in top of window opening.
5. Raise window and replace wood block and garnish moulding.

QUARTER WINDOW GLASS

(Business Coupes)

REMOVAL:

1. Removal garnish moulding.
2. Remove small wood block.
3. Remove two screws holding window support to inner panel. Hold window in position and remove support.
4. Lower glass to free it from glass run channel and lift out.

INSTALLATION:

Reverse procedure of removal.

QUARTER WINDOW GLASS

(Sedans)

REMOVAL:

1. Remove garnish moulding.
2. Remove four sheet metal screws attaching glass frame to window opening and remove glass and
3. Remove nut And spring from friction pivot.
4. Remove screw from upper pivot and remove window from frame.

INSTALLATION:

Reverse procedure of removal.

QUARTER WINDOW REGULATOR

(Broughams and Coupes)

REMOVAL:

1. Remove quarter trim panel. See page 31.
2. Remove quarter panel inner liner.
3. Remove quarter window glass.
4. Remove four Phillips head screws attaching regulator to inner panel and remove regulator through lower opening in inner panel.

INSTALLATION:

Reverse procedure of removal.

REAR WINDOW GLASS

REMOVAL:

Insert a headlining installer tool or a dull putty knife under the inner lip of the rubber weatherstrip and pry up and out. At the same time pound outward on the glass with a rubber hammer.

INSTALLATION:

1. Clean all old cement from around rear window opening.
2. Install new rubber weatherstrip around rear window glass. (On Commodore models install chrome reveal moulding on rubber weatherstrip and clip in position).
3. Tie a stout cord around the center recess in the rubber channel. Tie tightly enough to draw the inner edges of the rubber channel within the limits of the rear window opening.

4. Apply a ribbon of sealer to the rubber channel and insert the window from the outside. Tap the window sharply around the outside edge to seat firmly into window opening.

5. From the inside of the car, remove the cord holding the rubber channel and let the channel inside lip settle into position around the inside window opening. Clean off all excess sealer carefully with Hudson fabric cleaner.

INSTRUMENTS AND INSTRUMENT PANEL

STARTER SWITCH

REMOVAL:

1. Turn ignition switch (27), Figure 32, to "off" position.
2. Remove Phillips head screw from the under side of instrument panel and remove switch (3).

INSTALLATION:

Reverse procedure of removal.

LIGHT SWITCH AND CIRCUIT BREAKER ASSEMBLY

REMOVAL:

1. Disconnect negative battery cable at battery.
2. Loosen Allen set screw in control knob (32) and remove knob.
3. Using a suitable spanner, remove escutcheon nut and escutcheon.
4. Remove switch and remove wires from switch.

INSTALLATION:

Reverse procedure of removal. Keep battery disconnected until operation is completed.

IGNITION SWITCH

REMOVAL:

1. Disconnect negative battery cable at the battery to prevent accidental short circuits.
 2. Remove Phillips head screw from underside of instrument panel, and remove switch (27).
 3. Remove wires from switch terminals.
-

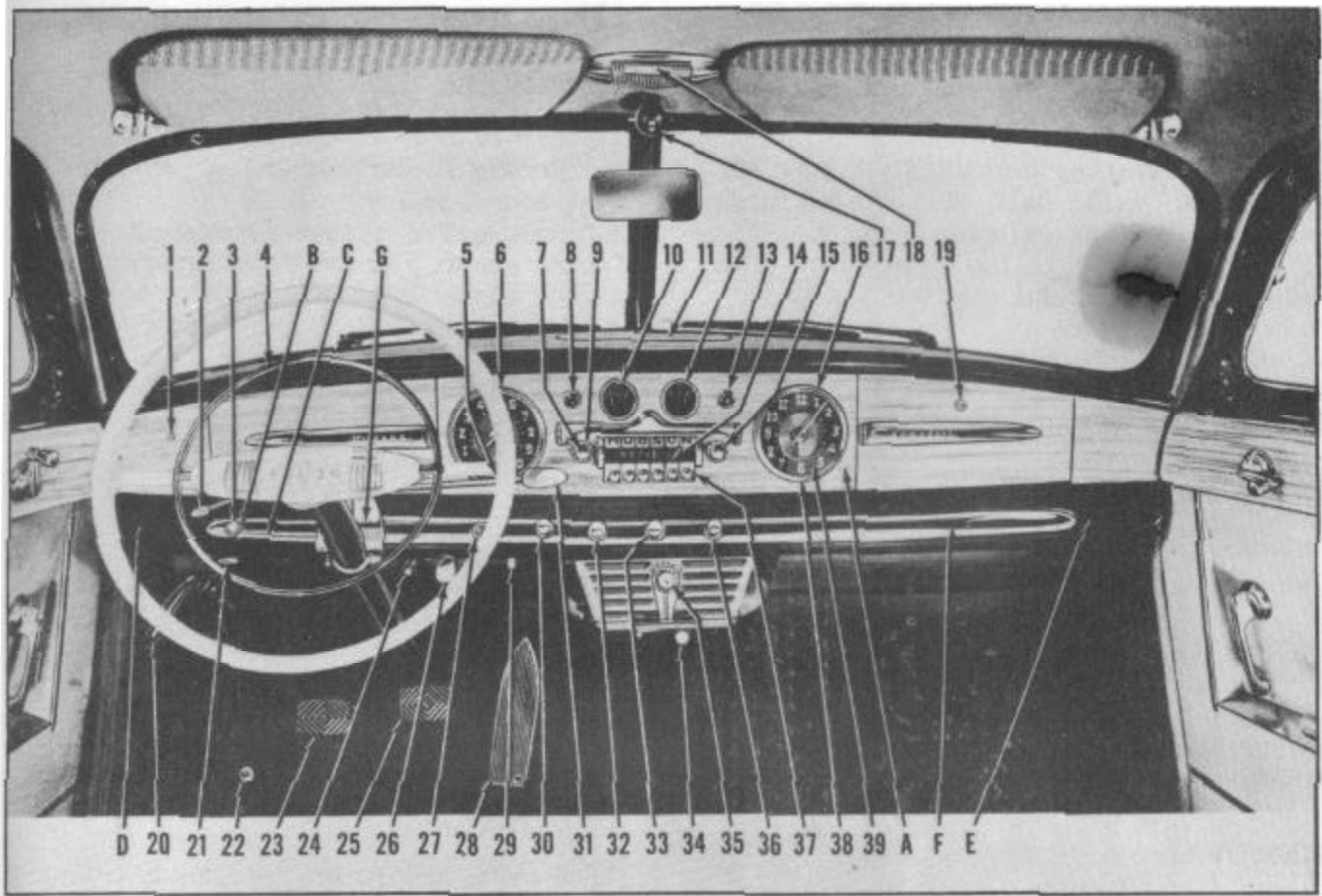

FIGURE 32

INSTALLATION:

Reverse procedure of removal. Keep battery disconnected until operation is completed.

**INSTRUMENT PANEL LAMP
RHEOSTAT**

REMOVAL:

1. Turn light switch to "off" position.
2. Remove two screws from under side of instrument panel and remove rheostat (29).
3. Remove wires from rheostat.

INSTALLATION:

Reverse procedure of removal.

WINDSHIELD WIPER CONTROL

REMOVAL:

1. Loosen screw attaching control wire to wiper motor and remove wire from motor.

2. Loosen Allen set screw in control knob and remove knob (36).
3. Using a suitable spanner, remove escutcheon nut and escutcheon.
4. Remove wiper control from panel and pull control wire through dash.

INSTALLATION:

Reverse procedure of removal.

CIGAR LIGHTER

REMOVAL:

1. Disconnect lighter wire from light switch.
2. Depress springs on lighter cylinder at rear of instrument panel and push out of instrument panel.

NOTE: Cigar lighter knob may be unscrewed from lighter.

INSTALLATION:

Reverse procedure of removal.

INSTRUMENT SWITCH PANEL

(Left)

REMOVAL:

1. Remove starter switch (3), Figure 32.
2. Remove left half of chrome finish strip at steering column.
3. Remove Phillips head screw from left end and one from the underside at right end.
4. Remove one 3/8 nut from bolt in top of panel. Bolt extends under locker box.
5. Remove panel and ornament (D).

INSTALLATION:

Reverse procedure of removal.

INSTRUMENT SWITCH PANEL

(Right)

NOTE: Disconnect negative battery cable at battery before removing switches.

REMOVAL:

1. Remove ignition switch (27), Figure 32.
2. Remove instrument lamp rheostat (29).
3. If car is equipped with Drive-master, remove Drivemaster control switch (30).
4. Remove light switch (32).
5. Remove cigar lighter (33).
6. Remove windshield wiper control (36).
7. Remove three screws from the underside of switch panel and one from the right end of the panel.
8. Upper edge of panel is attached to instrument panel by three bolts; one is located under the locker box, one under the radio, and one under the inner corner of the glove compartment. Remove the nuts from these bolts using a 3/8" socket and extension.
9. Remove right hand half of chrome finish strip (G) at steering column.
10. Remove switch panel (E) and panel ornament (F).

INSTALLATION:

Reverse procedure of removal.

INSTRUMENT FINISH PANEL

REMOVAL:

1. Remove ornamental trim.
2. Remove locker box and glove compartment door bumpers.
3. Remove two screws from each end of finish panel. Screws are exposed when glove-compartment and locker box doors are open. On models not equipped with locker box, remove screw from inside upper edge of left section of finish panel to release hinged panel and expose screws. On earlier models three screws hold this section of the panel in place.

NOTE: On radio equipped cars it is necessary to remove control knobs and escutcheon nuts.

INSTALLATION:

Reverse procedure of removal.

SPEEDOMETER

REMOVAL:

1. Remove instrument finish panel (A), Figure 32.
2. Remove four screws attaching speedometer to instrument panel and remove speedometer from panel.
3. Pull the beam indicator and instrument lamps and sockets from the speedometer and unscrew the cable.

INSTALLATION:

Reverse procedure of removal.

CLOCK

REMOVAL:

1. Remove instrument finish panel (A), Figure 32.
2. Remove four screws attaching clock to instrument panel and remove clock (39) from panel.
3. Pull the instrument lamp and socket from the clock.
4. On electric clocks, disconnect feed wire at fuse connector.

INSTALLATION:

Reverse procedure of removal.

FUEL GAUGE

REMOVAL:

1. Remove instrument finish panel (A), Figure 32.
2. Remove four screws attaching instrument cluster to instrument panel and pull out cluster.
3. Remove two mounting screws from base of gauge and disconnect wires.

4. Remove gauge (10) from back of cluster.

INSTALLATION:

Reverse procedure of removal.

TEMPERATURE GAUGE

Remove and install same as fuel gauge.

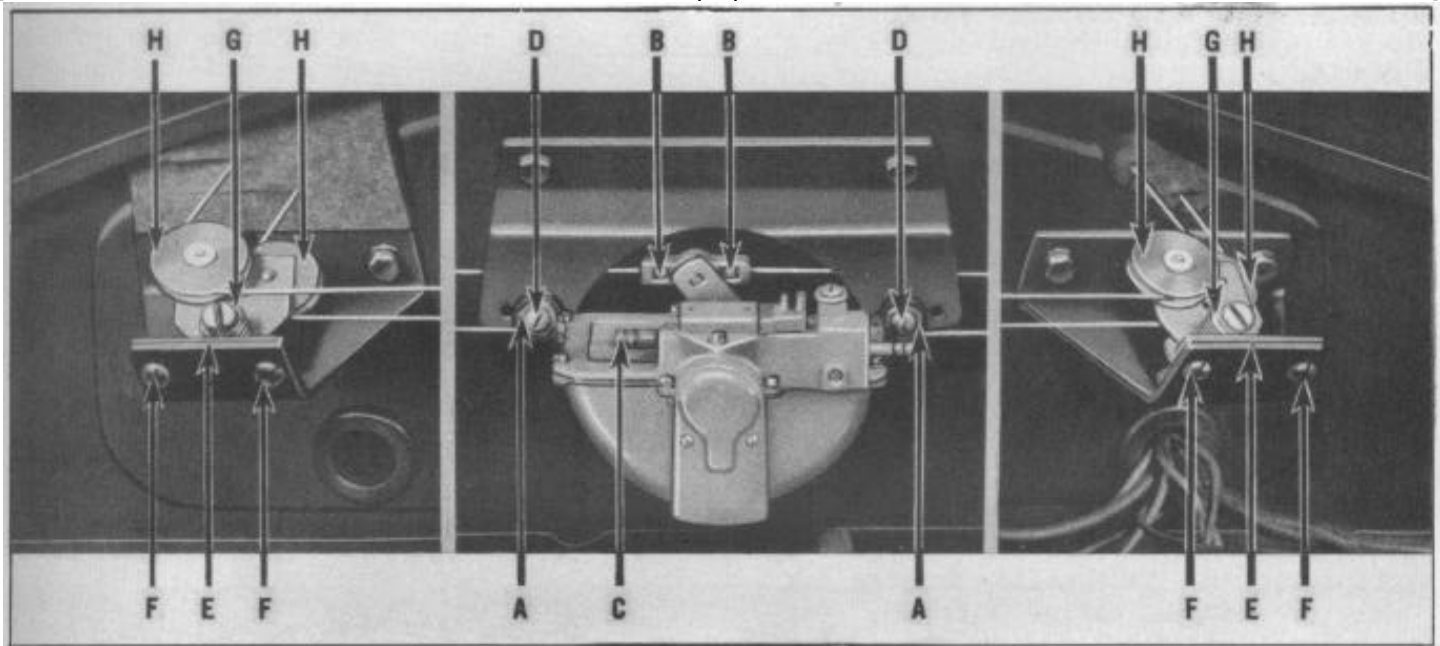

FIGURE 33

WINDSHIELD WIPER

The windshield wiper mechanism consists of a vacuum operated motor assembly, two spring loaded cable tension assemblies, two pulley housing and cable assemblies, wiper arms, blades, and cables.

WINDSHIELD WIPER MOTOR ASSEMBLY

The windshield wiper motor assembly is mounted in the center of the dash under the hood. The motor is connected by cables to the wiper arms. A vacuum hose connects the wiper motor directly to the intake manifold or to a vacuum booster pump. The motor is controlled by a slide valve operated by a wire connected to the dash control.

REMOVAL:

1. Disconnect pulley cables from the wiper motor at (B), Figure 33.

2. Loosen retaining screw and remove control wire from slide.
3. Disconnect vacuum hose from motor at C.
4. Remove two bolts (D) attaching wiper motor to mounting bracket and remove motor.

INSTALLATION:

Reverse procedure of removal. Adjust cable tension and wiper arm travel.

PULLEY HOUSING AND CABLE ASSEMBLY

The windshield wiper pulley housing and cable assemblies, right and left, are inserted in the openings in the front cowl panel at the base of the windshield and are retained on the inside by a bolt and clamp. A burred bushing is provided for attachment and adjustment of the wiper arm. The small brass tube in each housing is for use

with a windshield washer attachment.

REMOVAL:

1. Disconnect cables at the wiper motor and lift free of the tension assemblies.
2. Remove wiper arms and blades. The wiper arms are retained on the burred bushings by a spring clip which is released by pulling the arm up and away from the windshield.
3. Remove the bolt and clamp from the underside of the cowl panel.

NOTE: To remove right hand assembly, glove compartment must be removed to gain access to this bolt and clamp.

4. Draw cables through dash to the inside of car.
5. From the outside, lift out pulley housing and cables.
6. Remove gasket.

INSTALLATION:

Reverse procedure of removal. Adjust tension and wiper arm travel.

NOTE: Right and left pulley housing and cable assemblies differ slightly. See that small brass tube is on the inside of the assembly toward the center of the car.

CABLE TENSION PULLEY ASSEMBLY

Cable tension pulley assemblies (E), Figure 33, are mounted under the hood on the right and left side of the dash panel. These cable tension pulley assemblies are spring loaded to maintain approximately 14 pounds tension in the cables.

REMOVAL:

1. Disconnect cables from wiper motor at B, Figure 33, and lift cables free from pulleys.
2. Remove two screws (F) attaching assembly to support bracket and remove assembly.

INSTALLATION:

Reverse procedure of removal and adjust cable tension.
NOTE: Right and left cable tension pulley assemblies are different. An identification mark is stamped on the top of the plate on which the pulleys are mounted.

ADJUSTMENT:

Windshield wiper cable tension is set at the factory but requires adjustment whenever an over-travel of the blade occurs at high speed or a reduction of travel occurs on dry or snow packed glass.

To adjust the tension, insert a 1/2" socket through the hole provided in the bracket support and loosen the nut at the bottom of the spring shaft sufficiently to free the lockwasher between the pulley base and the mounting bracket. The spring (G) will automatically move the pulleys (H) and take up any slack in the cables. Hold the pulleys in the new position and retighten the nut. If necessary after adjustment of cable tension, relocate the wiper arms on the burred bushings so that the wiper blades rest against the windshield moulding with wiper in "off" position.

RADIO

INSTALLATION INSTRUCTIONS

1. Install the antenna. (Complete instructions are furnished with each kit.) Remove door on left hand side of instrument panel by removing the three screws from the back.
3. Remove ornament from center of trim panel (above radio opening) by removing the two face screws.
4. Remove the instrument finish panel and remove the escutcheon plug from the panel. (See Page 34.)
5. Remove the two bolts from the fire wall and install the rear mounting bracket. Do not tighten the bracket at this time.
6. With the dial end of the receiver up, push the receiver up between the instrument panel and the air duct. Turn the radio until the knob shafts slide through the openings in the instrument panel and the tapped spacers provided on the front plate of the set line up with the two corresponding holes in the instrument panel. Bring the receiver forward as far as it will go.
7. With the receiver held in this position, start the two 1/4 x 20 hex head bolts with lockwashers into the holes.
8. Slip the elongated hole in mounting bracket over the stud on the set and install lockwasher and nut.

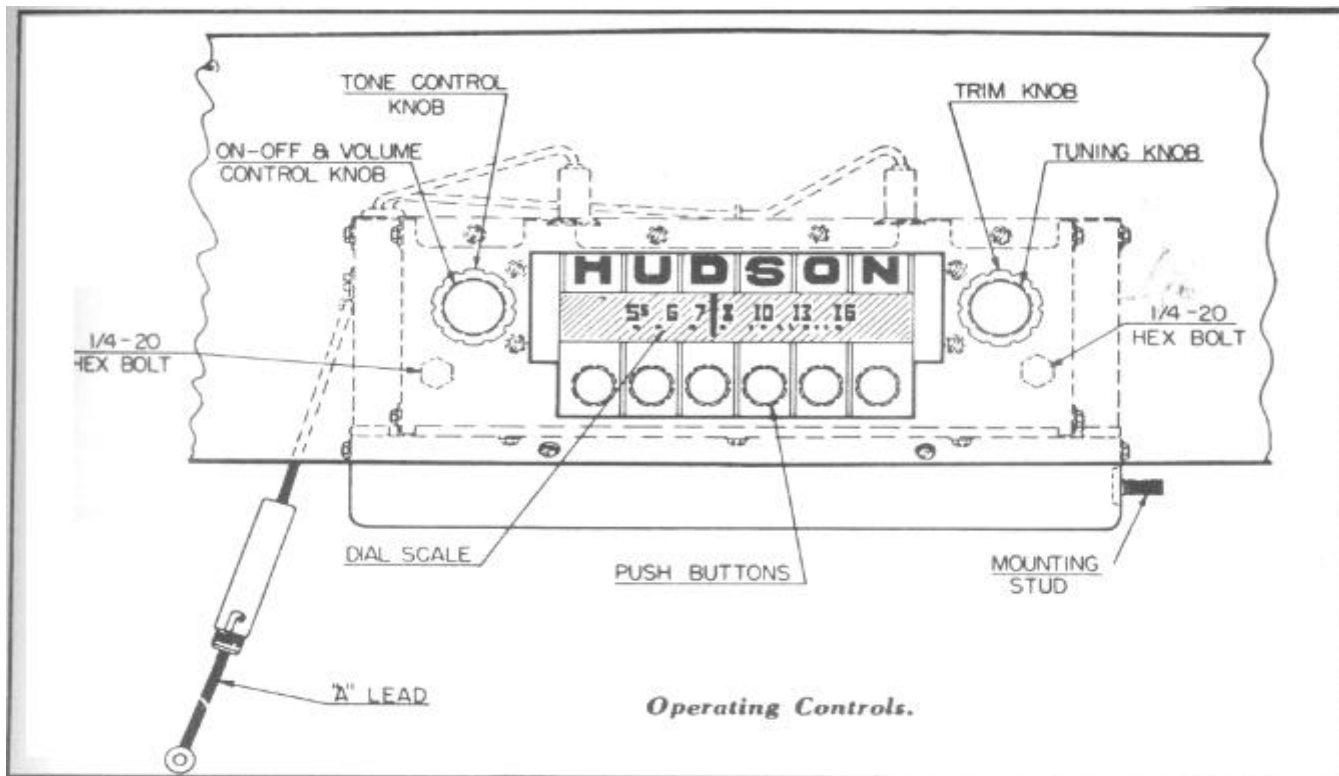

FIGURE 34

9. Before locking the receiver securely in position, place the instrument finish panel into position over the clock and note whether or not the radio and trim panel are centered correctly. If not, move the radio until the dash trim panel and radio dial escutcheon assembly are in alignment. Then permanently fasten set in position by tightening the two front screws and the nut and bolts on

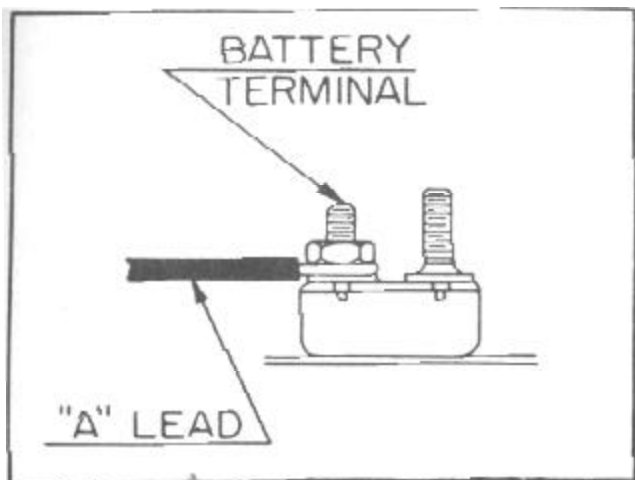

FIGURE 35

the rear mounting bracket. Replace instrument finish panel and fasten securely.

10. Connect the "A" lead of the set to the battery terminal of the circuit breaker, Figure 34, mounted on the instrument panel brace over the steering column (Figure 35).

11. Plug in antenna cable (Figure 36).

12. Remove speaker cover plate, and pull speaker leads through opening in dash.

13. Plug speaker leads into pin socket mounted on speaker. Make sure green wire plugs into green spotted pin socket.

14. Lower speaker into position, and line up with holes in the instrument panel. Place speaker grille, included in radio package, over speaker, making sure the mounting holes line up; then fasten securely with the four chrome plated screws provided in kit.

15. Place tone control knob onto shaft; put on volume control knob, and tighten set screw (Figure 34). Be sure there is no binding.

16. Place knob tension spring over the tuning shaft. Put on trim ring and press on tuning control knob as far as it will go. Tighten set screw (Figure 34).

17. Replace ornament and door.

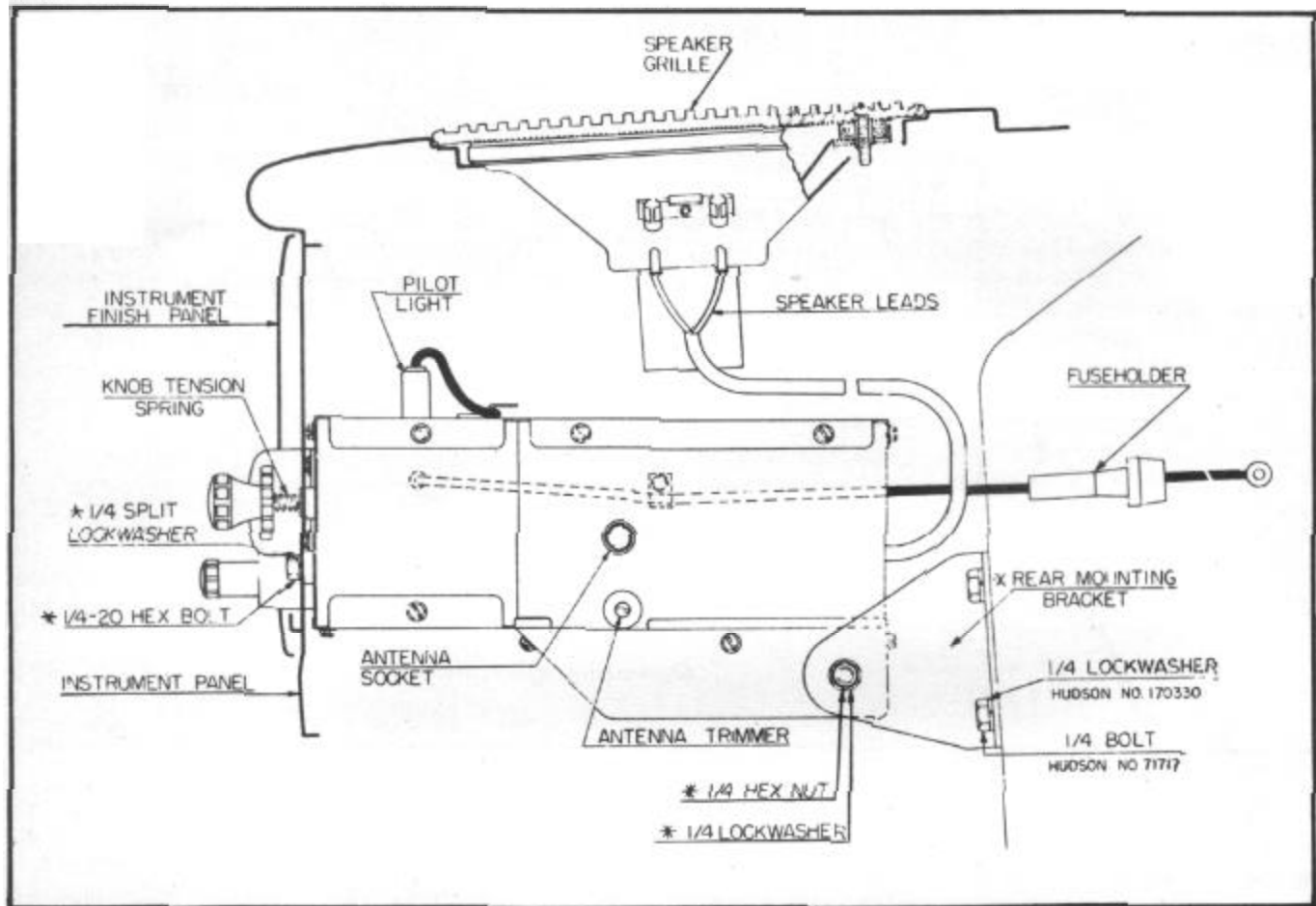

FIGURE 36

18. **IMPORTANT:** Turn the receiver on and allow it to operate for approximately fifteen minutes in order for it to reach normal operating temperature. Tune in a weak station near 1200 KC. With a small screwdriver adjust the antenna trimmer, located on the right side of the receiver, for maximum volume (Figure 36).

AUTOMATIC TUNING

There are six automatic tuning positions, each of which may be adjusted to any desired station. In order to simplify the identification of the stations, it is advisable to set the automatic tuning mechanism in sequence according to frequencies of the stations, beginning with the station broadcasting on the lowest frequency and progressing to the station broadcasting on the highest frequency.

If the positions have not been previously adjusted, proceed as follows:

1. Loosen the first push button by turning it counter clockwise with your fingers.
2. Turn the manual tuning control knob (Figure 34) to tune in the desired station. Carefully tune to the middle of the signal for clearest reception.
3. Push the first push button in as far as it will go. Release the button, and tighten securely by turning it clockwise with the fingers.
4. Repeat the above procedure for the remaining five push buttons.

NOTE: See next page for instructions on radio interference elimination.

**INTERFERENCE
ELIMINATION**

IMPORTANT: Use the utmost care in the following operations to insure freedom from motor noise. Be sure that good ground contacts are made between the interference condensers and the car body. If necessary, clean away paint or dirt with emery paper. Tighten all nuts and bolts securely.

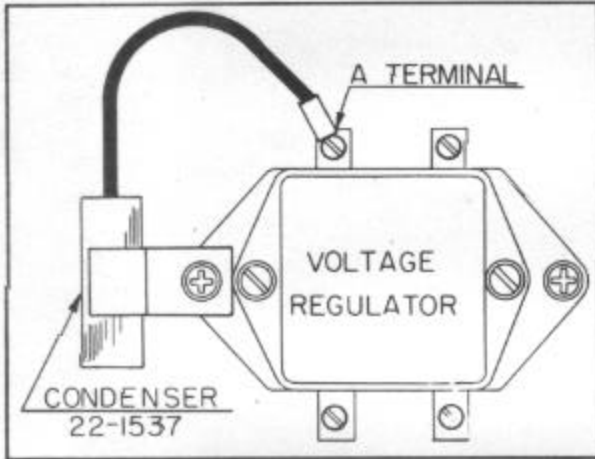

FIGURE 37

1. Remove the mounting screw of the voltage regulator and under this screw mount a condenser. Connect the lead to the voltage regulator "A" terminal. (Figure 37).

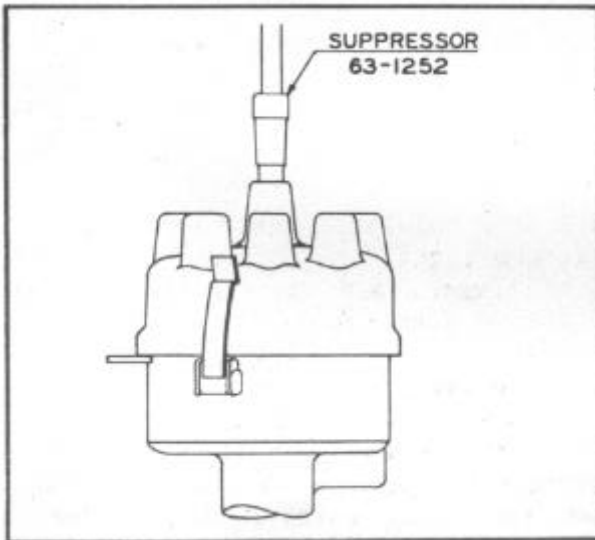

FIGURE 38

2. Install suppressor in center of hole of distributor cap. Place high tension lead in top of suppressor. Be sure the suppressor and the lead are fastened securely. (Figure 38).

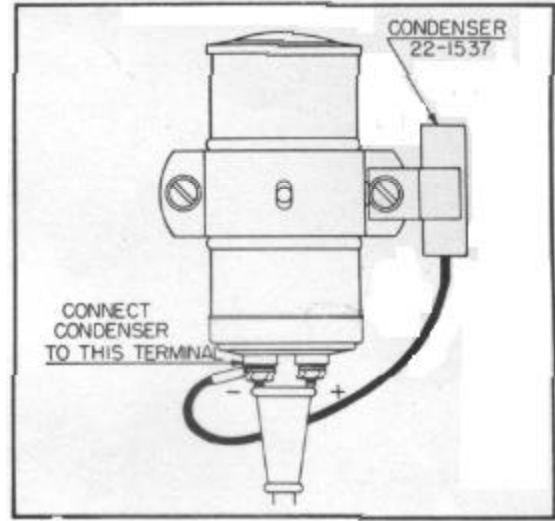

FIGURE 39

3. Remove bolt on the right side of the ignition coil. Mount a condenser under this bolt. Connect lead to coil terminal marked (-). (Figure 39).

**HUDSON WEATHER
CONTROL**

The Hudson "Weather Control" system is partially built into every Monobilt body. With the addition of the accessory subunit, a new kind of living comfort is experienced within the automobile. Fresh, clean, cool air is available on the hottest or rainiest days, as is comforting warmth available on the coldest days.

Body Built -In Features:

- Adjustable cowl ventilator, no need for a ventilator cover.
- Air duct under the cowl for connection of the accessory unit.
- Rain water drain, located in air duct.

Accessory Unit Consists of:

- Assembled core shroud and fans with mounting parts.
- Air filter for cowl inlet.
- Water control valve and thermostat unit.
- Control shaft.
- Defroster nozzles, R.H. and L.H.
- Defroster tubes.
- Defroster fan operating switch.
- Water hoses and nipples with attaching parts.

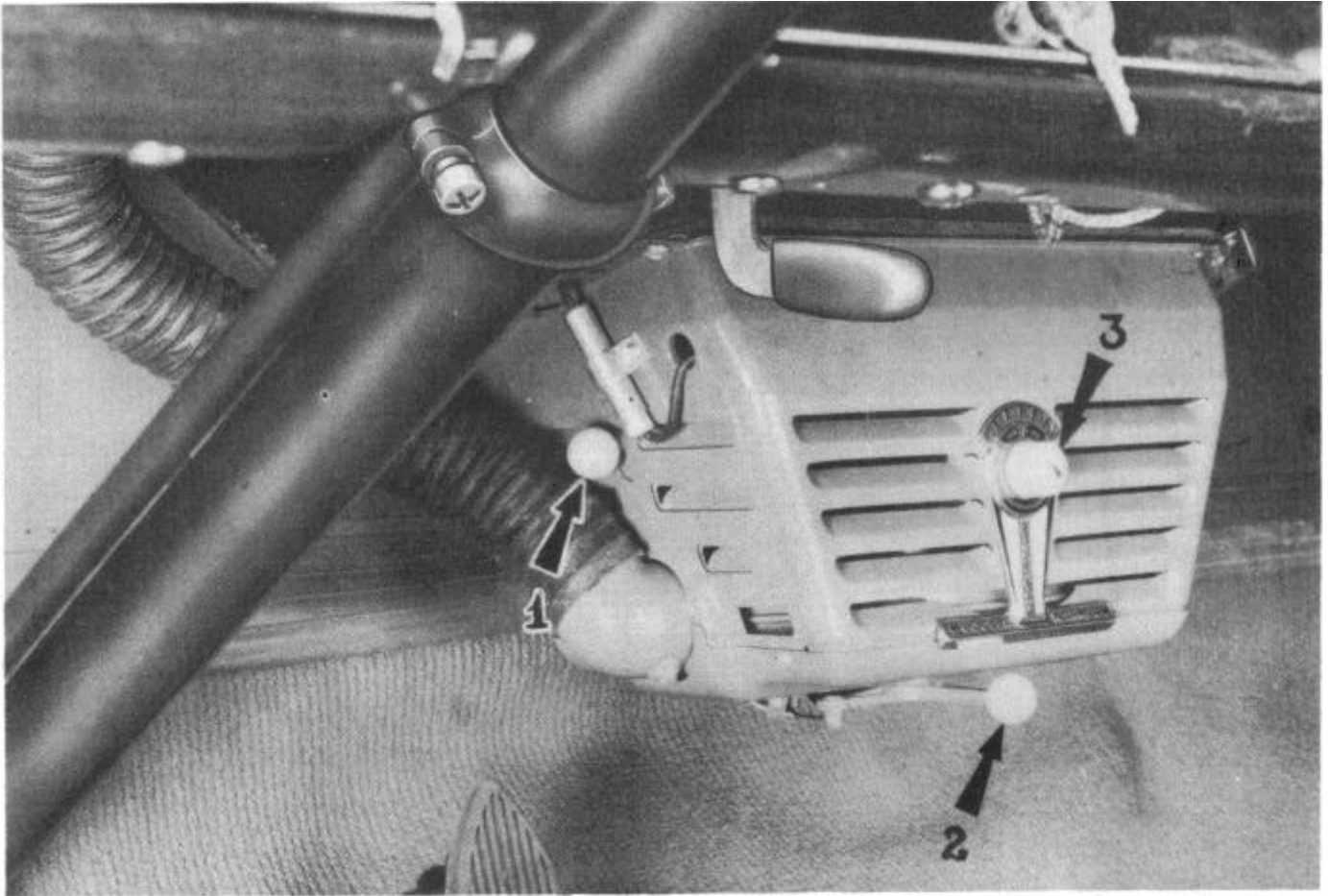

FIGURE 40

USING THE HUDSON WEATHER CONTROL

The proper use of the Hudson Weather Control is something that everyone who works on Hudson automobiles should know. The following are instructions for its

While driving the car with the cowl ventilator open and all windows closed, set the regulator lever (No. 2), Figure 40, at the bottom of the heater in about mid-position. If this produces too much heat to meet individual requirements, move the lever to the left gradually until the desired amount of heat is attained. Likewise, if more heat is desired, move the lever to the right. After this setting is made, there will be little need for readjustment as the heat is thermostatically controlled.

If cold air is delivered by the heater while the engine is warming up, close the cowl ventilator until the engine heat indicator begins to show that the engine is warming up; then open the cowl ventilator.

Do not adjust the heat control during the engine warm-up period in an attempt to get quicker heat. The thermostatic control valve remains wide open until the temperature rises to the regulated setting; therefore, moving* the control lever will not increase the delivery of heat.

When the regulator lever is moved to the extreme right, the thermostatic valve is locked open, and maximum heat output is attained regardless of car temperature. When the regulator lever is moved to the extreme left, the valve is locked closed, and no water flows thru the heater. This position is used for summer driving and permits the opening of the cowl ventilator in hot or rainy weather. The cowl duct is fitted with a trap to prevent water entering the car thru the open cowl ventilator.

When starting out in a cold car with a full passenger load, some window fogging may occur.

This may be reduced by turning on the defroster fan, which

is controlled by the switch knob (No.3), Figure 40, on the front of the heater. The fan should then be turned off after the windows are clear.

The defroster fan should be also turned on while standing or while driving at low speeds (either summer or winter driving) when the forward movement of the car is not sufficient to supply the required air flow thru the cowl ventilator. The cowl ventilator must be open when the defroster fan is being used.

Excessive air flow encountered at high speeds may be reduced by partially closing the cowl ventilator. This in turn increases the temperature of the air delivered by the heater.

A vertical sliding knob (No.1), Figure 40, located on the left side of the heater case, controls the amount of air directed on the driver's feet.

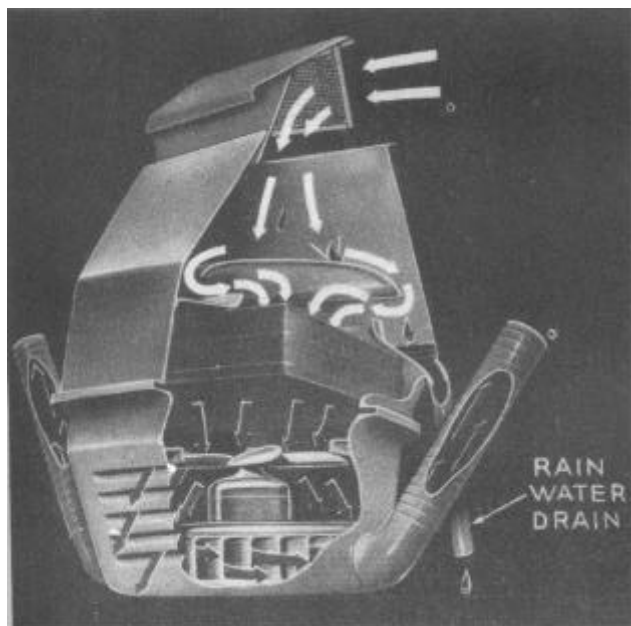

FIGURE 41

Maximum heat is obtained with this knob in the "up" position.

NOTE: In addition to the rain water drain which is in the cowl duct, there is a secondary drain at the extreme bottom of the Weather Control unit. This secondary drain takes care of any rain water or snow that may be blown in, in the event the car is left standing with the cowl vent open.

CAUTION: When installing the front floor mat, be sure that enough clearance is allowed so that this secondary drain hose is not pinched together.

ELECTRICAL SYSTEM SAFETY FEATURES

Fuses	Capacity	Where Located
Heater	10 amp.	Heater Lead Wire
Radio	10 amp.	Radio Lead Wire
Cigar Lighter	14 amp.	Lead Wire
Elec. Clock	3 amp.	Lead Wire
Direction Ind.	14 amp.	Fuse block - Left side, rear compartment.

CIRCUIT BREAKERS

Headlights	30 amp.	On lighting switch
Auxiliary Lights	30 amp.	Forward of steering column
Top Power Unit	30 amp.	

FRONT WHEEL ALIGNMENT

There are five general factors to front wheel alignment:

- Pivot Pin Inclination**
- Caster**
- Camber**
- Toe-in**
- Toe -out**

All of these factors are very closely related, and each has a very definite purpose. They control the front wheels and steering under varying conditions of weight and speed.

When the angle of adjustment of any one of these factors is changed due to wear or accident, the relationship between them is destroyed. Each angle depends upon the proper setting of the other four to make the front wheels lead properly.

In making corrections to front wheel alignment, or when installing new front wheel suspension parts, all five angles in both front wheels should be checked in the following order.

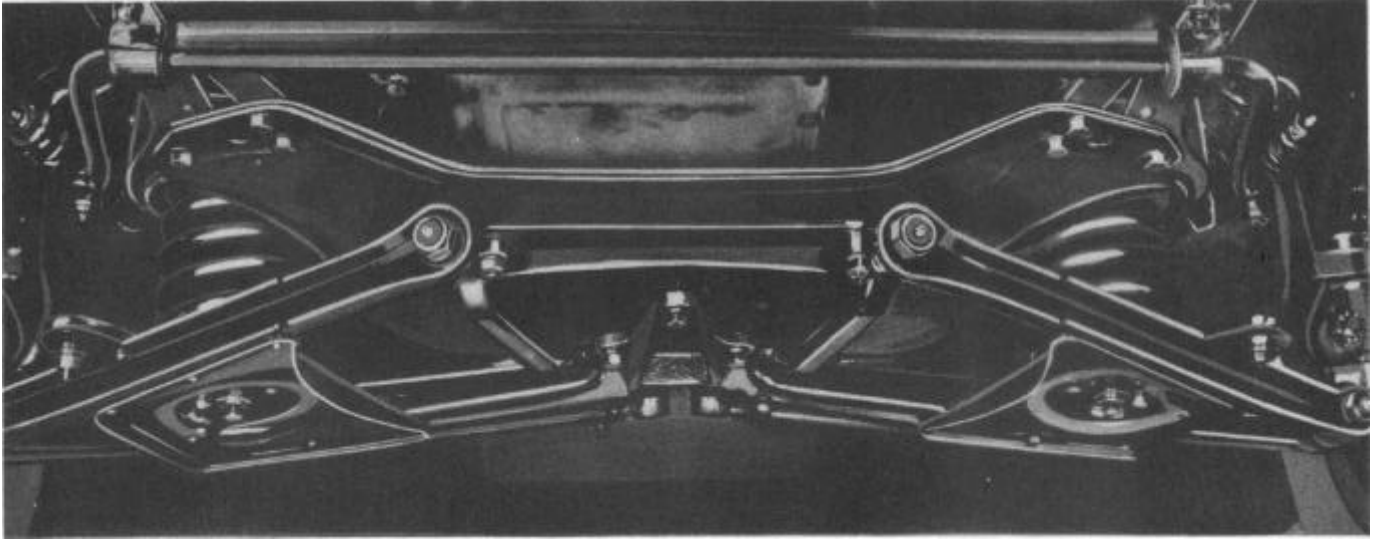

FIGURE 42

PIVOT PIN INCLINATION:

Pivot Pin Inclination is the inward tilt of the steering spindle pivot pin at the top. The correct degree of pivot pin inclination is $3^{\circ}36'$. If the pivot pin inclination and the camber are incorrect, it is likely due to worn pivot pin bushings. If the camber is incorrect and the pivot pin inclination is correct, the spindle is bent. Camber should not be more than specified $1-1/2^{\circ}$; however, a decrease in camber if pivot pins are not loose in the bushings, is not detrimental to steering unless an actual reverse camber exists.

CASTER:

Caster is the backward tilt of the steering spindle pivot pin. Positive caster is obtained by tilting the top of the pivot pin toward the rear of the car. Negative or reverse caster is the tilting of the top of the pivot pin toward the front of the car.

Positive caster imparts a trailing action. The correct amount of caster helps to keep the front wheels in the straight ahead position. When turning the wheels away from the straight ahead position, caster and pivot pin inclination act as a lever in returning the front wheels to the straight ahead position. No caster correction should be made until after the camber angle and pivot pin inclination angle have been checked.

WHEN CHECKING THE CASTER THE WHEELS SHOULD BE TURNED ON THEIR BEARINGS TO BRING THE HIGH SPOT, OR THAT PORTION OF THE TIRE WITH THE GREATEST RUNOUT, TOWARD EITHER THE FRONT OR THE REAR OF THE CAR.

The amount of caster the front wheels require depends on the friction in the pivot pins, tie rod ends and the steering linkage. A well lubricated car requires less caster than does one that is frequently lubricated.

One complete turn of the eccentric bushing changes caster $1/2^{\circ}$. Set caster to 1° preferred, plus or minus $1/2^{\circ}$. Setting must be equal on both front wheels if possible, but never allow over $1/2^{\circ}$ variation between right and left wheels.

CAMBER:

Camber is the outward tilt of the front wheels at the top and is generally measured in inches or degrees. It is seldom necessary to turn the eccentric bushing more than one half turn to obtain $1/2^{\circ}$ camber adjustment. This half turn should be all that is ever necessary for camber adjustment and will also cause a minimum of caster change.

WHENEVER THE ECCENTRIC BUSHING IS TURNED, THE CASTER, CAMBER, AND PIVOT PIN INCLINATION MUST BE CHECKED, AS ALL THREE ARE AFFECTED.

When camber is increased, pivot pin inclination is decreased. Decreasing camber increases pivot pin inclination.

TOE -IN:

Toe-in is the drawing together of the front wheels at the front. This is accomplished by making adjustments at the tie rod ends which establish a shorter distance between the wheels at the front than at the rear. Camber tends to cause the wheels to separate or spread at the front, and sufficient toe-in is necessary to compensate for this tendency and make the wheels run straight. Accurate toe-in is of great importance in obtaining maximum tire life. Toe-in must be within the definite limits of 0" to 1/16" **MEASURED AT THE WHEEL RIM.**

TOE -OUT:

Toe-out on turns is controlled by the movement and angularity of the steering arms. Toe-out is checked by turning the wheels to the right or left as far as possible. When the front wheels are turned to the right or left, they separate slightly at the front. This separation increases as the turn is increased from the straight ahead position. The wheel making the inside turn turns at a greater angle than does the outside wheel; thus toe-out is very necessary to keep the two front wheels turning together properly around curves and corners. The amount of toe-out increases due to the change in angle between the tie rods and steering arms.

TOE-OUT MUST ALWAYS BE CHECKED WITH THE WEIGHT OF THE CAR ON THE WHEELS.

Front wheels must rest on full floating turntables, and the turning angles should read as follows:

	Left Turn		
Left Wheel 30°		Right Wheel 25°	
	Right Turn		
Right Wheel 30°		Left Wheel 25°	

The difference between the left and right wheel angle must not vary more than 30° minutes, plus, or minus, from specifications.

RIDING HEIGHT AND COIL SPRING SAG

When the car does not seem to be level, and a check of the coil spring height is desired, place the car so that the front end is level crosswise and then rock the car sidewise several times and allow the car to settle. This will remove any binding that might cause a dimensional difference.

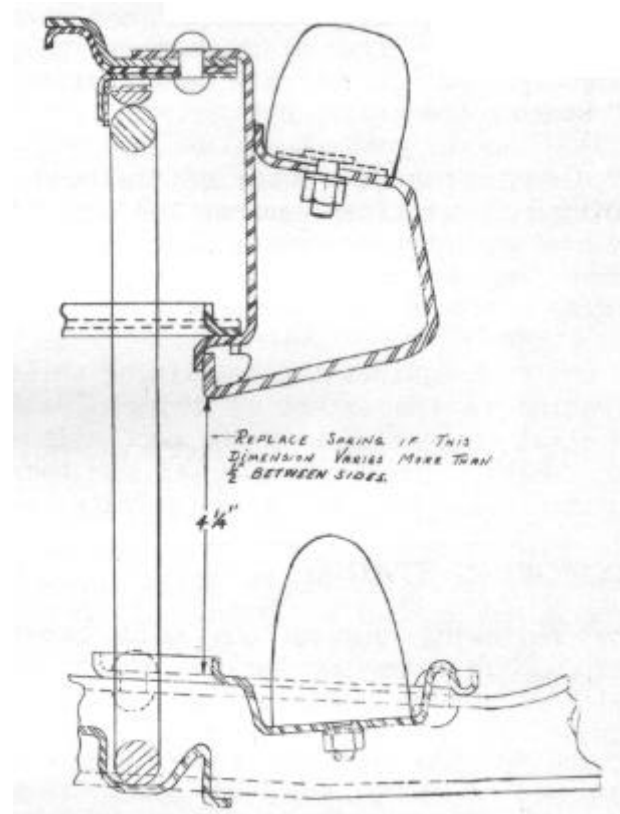

FIGURE 43

Measure the distance from the top of the lower arm rubber bomber seat to the bottom of the upper rebound bracket, which should be 4-1/4" on each side, Figure 43.

If the two measurements vary more than 1/2" between sides, it is advisable to replace one or both coil springs.

The light and heavy coil springs may be identified by the part number stamped on the top coil of spring.

GENERAL INFORMATION ON APPEARANCE

CLEANING UPHOLSTERY:

There are a few items of a general nature to keep in mind when cleaning upholstery fabrics.

When reference is made to cleaning fluids, use a good non-inflammable fluid in which carbon tetrachloride is the principal ingredient.

When cleaning seat cushions and seat backs use a clean cloth dampened only slightly. Do not saturate to the extent of soaking the seat pads.

In cleaning soiled areas of the headlining, do not clean against the nap. If this does happen, smooth the material while damp by rubbing with the nap with a damp cloth.

Do not push against the headlining while cleaning to the extent of bringing the material in contact with the roof silencer panels. The damp material may take further stain from the silencer panels.

REMOVING STAINS:

The following suggestions will prove helpful in removing various stains to which automobile upholstery is frequently subjected. In using cleaning fluids, always follow the procedure that is commonly used in removing spots from clothing; that is, dampen a clean cloth with the fluid and start cleaning lightly around the OUTSIDE of the spot, gradually working towards the CENTER. This method keeps the spot from spreading and is less likely to leave a ring.

BATTERY ACID:

Pour household ammonia or a solution of baking soda directly on the spot and allow it to remain for one minute. Rinse with cold water. It is very important that this treatment be applied at once as the acid will eat thru the material within a very short time.

GREASE AND OIL STAINS:

Use reliable cleaning fluid. If the fabric is saturated with oil, pour the fluid directly on the spot and soak it up by pressing a white blotter against the spot before cleaning with a cloth dampened with the fluid.

BLOOD STAINS:

Use cold water. If this does not entirely remove the stain, pour ammonia on the spot and rub with a clean cloth. **NOTE: DO NOT USE HOT WATER ON BLOOD STAINS AS IT WILL SET THE STAIN.**

CANDY STAINS:

Use hot water on all candy stains that do not contain chocolate. With chocolate stains, first rub the stain with a clean cloth dampened with cleaning fluid. Then scrape with a dull knife and rinse with cold water. In both cases, after the spot has dried, it is advisable to finish the job by using cleaning fluid.

CAUTION: AVOID THE USE OF HOT WATER EXCEPT WHERE SPECIFICALLY RECOMMENDED.

FRUIT STAINS:

Rub vigorously with a cloth dampened in hot water. When dry, finish with cleaning fluid.

ICE CREAM:

Follow the same procedure as for fruit stains.

LIPSTICK:

Pour a small quantity of cleaning fluid directly on the spot. Press a clean white blotter over the stain. Repeat this process, using a clean blotter each time, until the stain disappears.

NAUSEA STAINS:

Use warm soap suds. Sponge the stained area until the stain is removed. Brush with a whisk broom. Brush with the fabric pile when wet and against the pile when dry.

MILK STAINS:

Follow the same procedure as for nausea stains.

WATER SPOTS:

Sponge the entire panel with a cloth dampened with cold water. Then sponge with cleaning fluid.

CHEWING GUM:

Moisten the gum with cleaning fluid. Remove with a dull knife and then finish with a cloth dampened with cleaning fluid.

CLEANING LEATHER:

Stickiness and loss of luster on leather upholstery is due largely to the use of polishes or preparations which injure the surface finish. To maintain a bright and clean finish on leather upholstery is comparatively simple when correctly handled. We suggest the following:

Apply a damp (not wet) cloth with castile soap or a good grade of saddle soap and rub briskly. Next apply a moist cloth without soap and go over surface thoroughly. Finish by rubbing dry with a clean cloth. The gloss finish of the leather may disappear during the first application. However, it will be restored by the friction produced in polishing with the dry cloth.

Under no circumstances use furniture polishes, oils, or varnishes on leather upholstery.

CLEANING RUG MATERIALS:

For general cleaning, use a whisk broom or vacuum cleaner. When the rug is new, it will be noted that a small quantity of the nap is loose and comes out. This is not a fault in the rug but is merely the loose clippings left in the pile during the manufacture. Usually after the first cleanings this condition disappears.

REMOVING SPOTS FROM RUG:

Use Ivory soap suds with a sponge, wiping off the suds with a second dampened sponge as the cleaning progresses.

Do not use water excessively. When dry, brush with a whisk broom.

NOTE: RUG MATERIAL IS SET INTO A RUBBER BASE, AND THE USE OF ANY FABRIC CLEANER OR GASOLINE SERVES AS A SOLVENT WHICH WILL CAUSE THE NAP TO BE LOOSENED AND COME OUT.

PAINT - CARE OF FINISH**POLISHING:**

While this type of finish will retain a high gloss for a long period, it will be necessary at definite intervals, depending entirely on climate conditions, to give the finish a more thorough cleaning than is obtained by merely washing. When the surface film, which will naturally accumulate, cannot be removed by washing, clean the surface thoroughly with Hudson Liquid Glaze Cleaner, rubbing sufficiently to clean the surface thoroughly. Follow with a brisk back and forth rubbing with a soft cloth. Follow the cleaning operation with a protective coat of Hudson Liquid Glaze Sealer.

RUST:

For the removal of rust, when it occurs, use Hudson Rust remover, following closely the directions on the container. After rust has been removed from painted surfaces, refinish according to standard practice. Consult a Hudson dealer when paint is needed.

ROAD TAR OR OIL:

A good standard brand of tar remover can safely be used to remove tar and oil without injury to the finish. However, if tar has hardened, it should be softened first with light grease or gasoline. If gasoline is used, be sure it does not contain coloring matter or Ethyl fluid. After removing the tar, it is advisable to polish the surface immediately.

SALT AIR:

Cars that are operated near the seashore should have extra attention to the painted and chromium parts. Weekly washing is strongly recommended and a thorough cleaning and waxing at three month intervals will greatly assist in preserving the finish.

BODY REPAIR AND METAL FINISHING

One characteristic of sheet metal is its elasticity; that is, the ability of the metal to spring back to its original shape after having been bent. Each type of sheet metal has a definite "limit of elasticity" depending upon its chemical composition, method of manufacture, and heat treatment. Metal bent or formed beyond this limit of elasticity assumes a new permanent shape and loses most of its elasticity. It becomes non-elastic. To restore such metal to its original shape, it is necessary to re-work it by bumping or otherwise. Similarly, if it is desired that sheet metal retain a bend or curve within its limit of elasticity, it is necessary to reduce the elasticity and work the curve into the metal by hammering or heating, or both.

The ability of sheet metal to resist bending depends to a certain extent on its physical shape. Metal shaped into sharp V's or ridges is more difficult to re-work than is metal shaped in curves or U's. Such sharp V's or ridges are said to be "locked" into the metal. In manufacturing the elastic, flat steel sheets into body panels, the forming dies draw and bend the steel at strategic points to stiffen the flat steel sheet and give it rigidity.

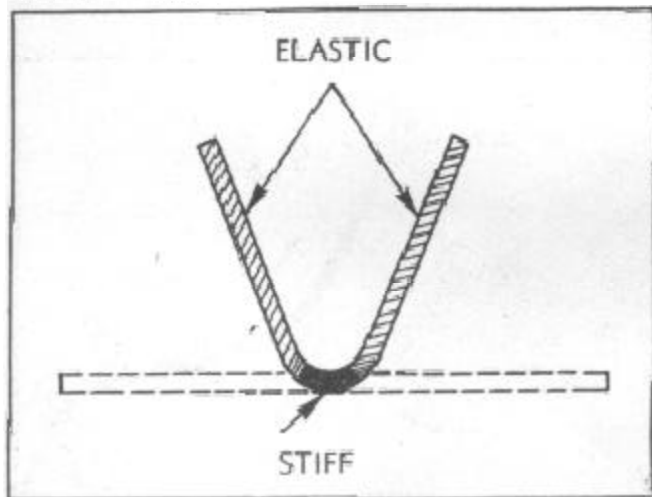

In Figure 44, shown above, a flat sheet is bent in a short arc beyond the normal elastic limits of the metal. The metal at the bend becomes stiff and holds its new position, while the metal on either side of the bend remains elastic.

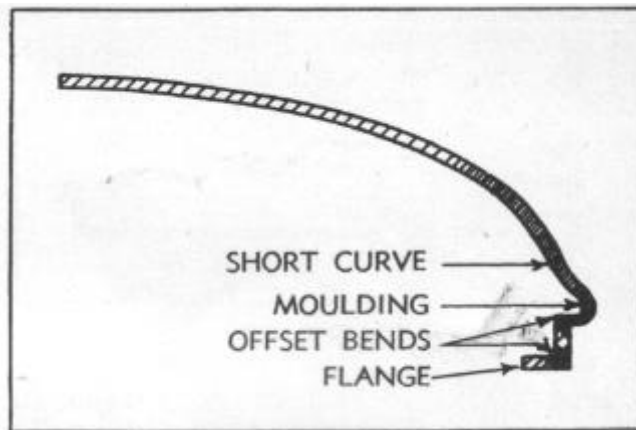

FIGURE 45

In the above Figure Number 45, the elastic metal in the large panels is held in position by stiff metal flanges, off-set bends, mouldings, and short curves.

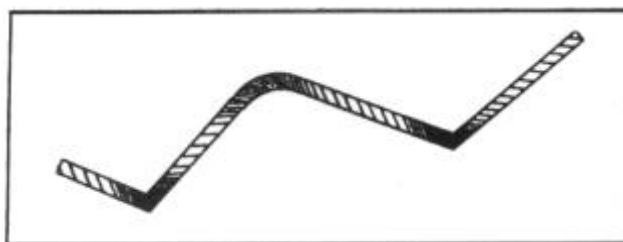

FIGURE 46

Accidents often create buckles like those shown in Figure 46. The metal is stiffened in the short bends at the valley and the surrounding ridges. The metal in the slopes still has most of the elasticity that it had before the accident.

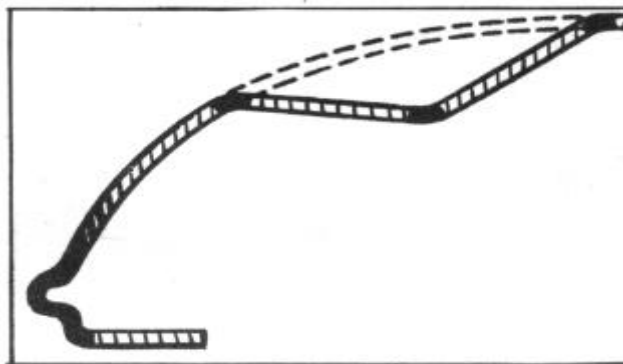

FIGURE 47

Metal made stiff and non-elastic by severe impact, Figure 47, must be reshaped over a dolly block; and, therefore, bumping and metal finishing is going to require more time and skill than does the reshaping of elastic metal.

Elastic metal will nearly reshape itself once the stiff areas of the damage are forced into their original position by the

forced into their original position by the aligning and roughing operation.

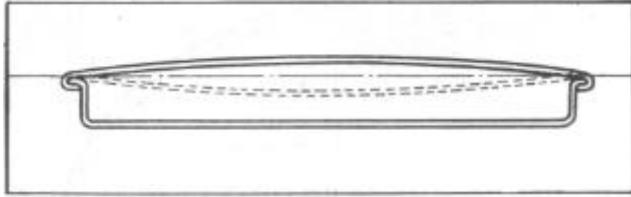

FIGURE 48

A true "oil can" dent can only occur in a low crowned panel having elastic metal. The metal has been forced inward (concave) to no greater extent than the metal was curved outward (convex) in its original shape. See Figure 48. No buckle is formed, and such a true "oil can" dent is reshaped by the internal strains that are in the metal just as soon as the pressure of the blow or impact is released. The most to be expected from an "oil can" dent is minor surface scratches. There can be no buckles as the metal hasn't been reformed.

ALIGNING AND ROUGHING

Aligning consists of reshaping a distorted body so that it is "square" when checked from front to rear, horizontally and vertically.

Roughing consists of reshaping damaged panels to their approximate original contour as is shown in the following two illustrations. Roughing operations are frequently necessary where excess body damage prevents proper body alignment.

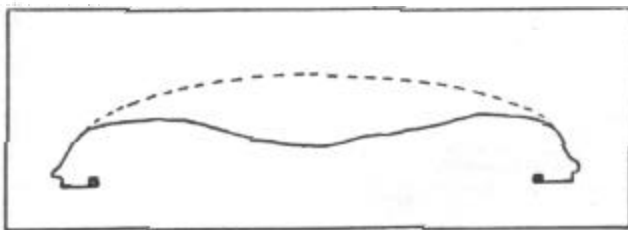

FIGURE 49

A roughing operation on an "open" panel that does not contain reinforced sections is illustrated in Figure 49.

A roughing operation to a damaged body panel that is a combination of open panel and reinforced construction is shown in Figure 50.

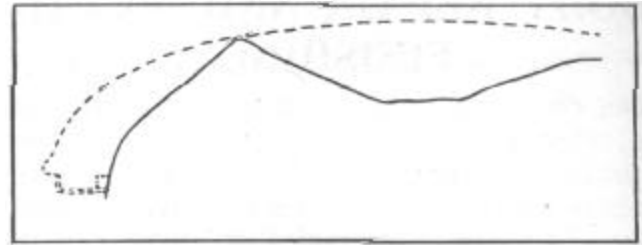

FIGURE 50

The standard practice in beginning to reshape a damaged body is to remove the dents and buckles in a reverse sequence to which they occurred -- remove the last dent or buckle first, Figure 51.

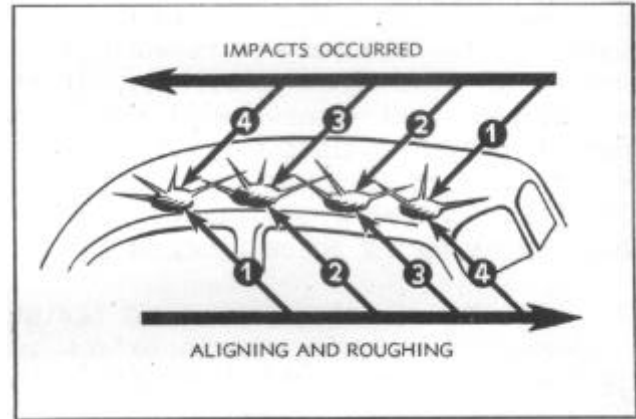

FIGURE 51

The last buckle to form will, when removed, relieve any strains extending through buckles that were previously formed. One combined aligning and roughing operation will correct each buckle, and the manner in which the operation is performed will vary according to the elasticity of the damaged metal.

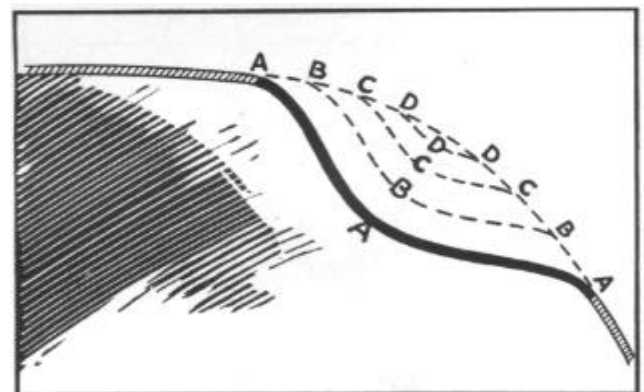

FIGURE 52

Figure 52 shows a case where the metal was made non-elastic in manufacture, and pressure at valley (A) must be constantly maintained with a body jack while simultaneous pressure is applied against both ridges and slopes of the buckle.

The stiff slopes are corrected at the same time with the valleys and ridges. The dent is in stages A to B to C to D.

TOOL EQUIPMENT

The proper alignment and repair of doors, cowls, tops, luggage compartments, and inner body construction cannot be accomplished without a complete, modern set of the proper body repair tools for reaching all of the open and closed areas in the modern automobile body.

Body jacks, which are the backbone of all heavy body repair, are available in a variety of styles and sizes.

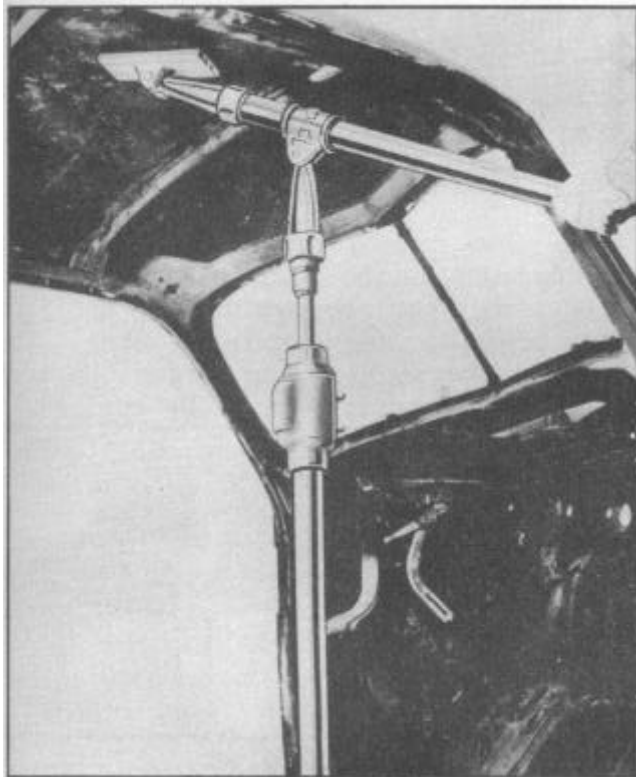

FIGURE 53

Past experience in the repair of steel bodies has definitely established the fact that major body damage requires the application of more than one body jack. Unless pressure is applied simultaneously to direct and indirect damage, further damage, stretched metal, and excessive metal finishing are the results.

Hydraulic body jacks should be light in weight for easy maneuverability.

Jacks have to be moved frequently in order to apply pressure at the proper places and good workmanship requires ease of handling.

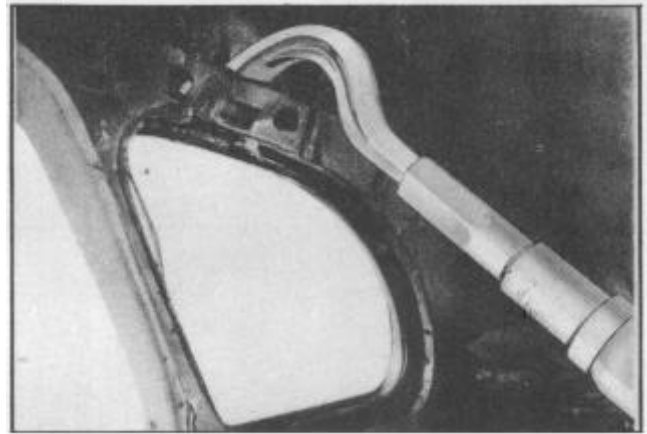

FIGURE 54

A power body jack must be adaptable for reaching all areas in the body -- behind inner reinforcements, crowned panels, door headers, and body pillars. It must be constructed to offer easy, simple operation by one man in any position in the body.

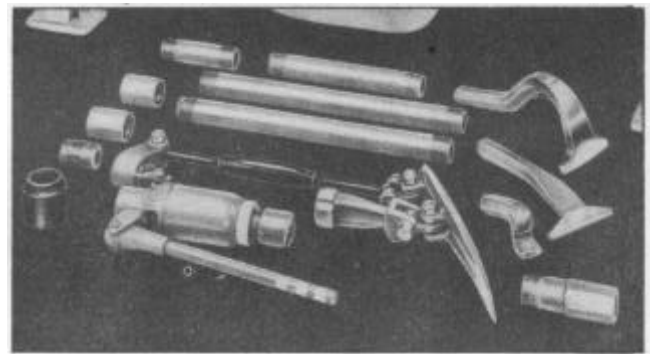

FIGURE 55

Fittings and attachments are a large part of the answer to the jack that will go where you want it and how you want it. Fittings must have quick change features with instant wide-range adjustment for each jack. All fittings should be interchangeable.

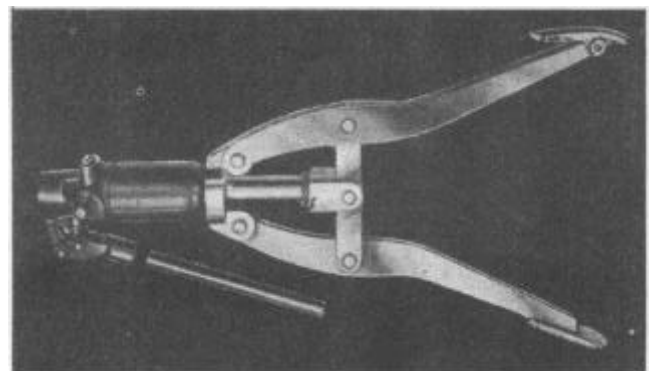

FIGURE 56

A hydraulic spreader or wedge, Figure 56, is readily adapted to getting into close, narrow places (closes to approximately 1-1/2" at the working end).

A maximum spread of 15 1/2" may be obtained with the arms full open. One arm may be fitted with a hinged dolly which follows changing contours and allows the spreader to be used in connection with both spring and direct hammering.

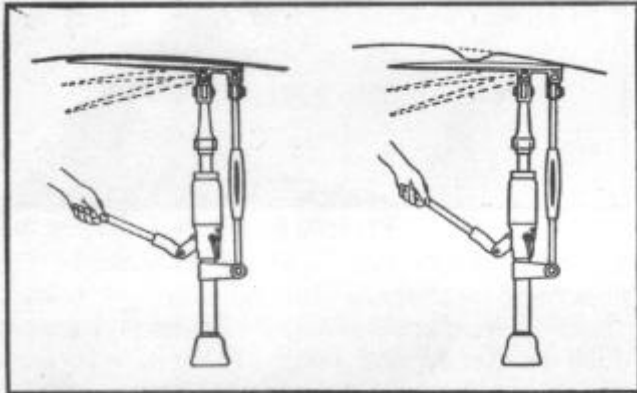

FIGURE 57

The rocker action spoon assembly is valuable for pushing out and finishing large damaged areas and is particularly adapted to working behind inner reinforcements and construction.

BODY CONSTRUCTION

The most rigid areas in the body assembly are found in sections reinforced by inner panels, braces, mouldings, and flanges. If the stiffest part of a buckle is in a reinforcement, the first pressure must be applied at that point, even though the buckles in the surrounding open panel may be deeper.

Enough pressure is exerted against a reinforcement to place a draw on the less resistant areas. Aided by the draw, the buckles in the open panel can be reduced by raising the valley and lowering the ridges. The progressive repetition of these operations corrects both the reinforcement and the open panel without stretching or buckling.

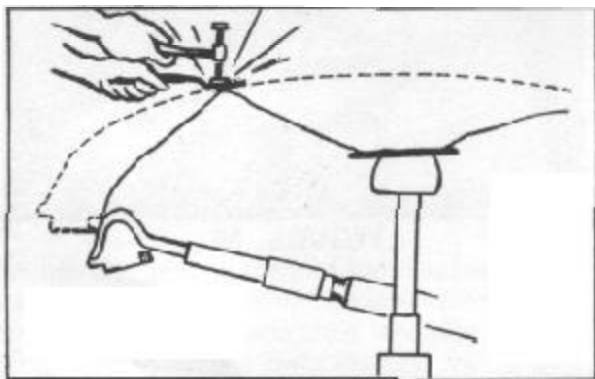

FIGURE 58

Pushing against a buckle in an open panel which is being held in by a stiff reinforcement serves only to stretch the panel at the jack head and buckle the panel where it is crowded into a space which has not been made large enough for it to pass through, Figure 59.

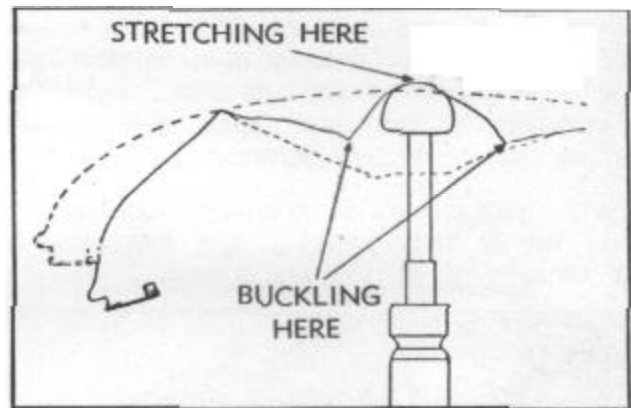

FIGURE 59

TOOL APPLICATION

Tool marks, resulting from the pressure applied during the roughing and aligning operation, can be avoided by applying the pressure over a large area. The stiffer the buckle, the larger the area to which the pressure must be applied.

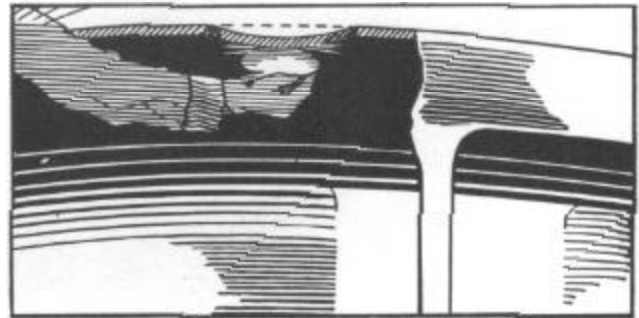

FIGURE 60

A minor low spot can be raised by striking the underbody side of the direct impact with the broad face of a dolly block, Figure 60.

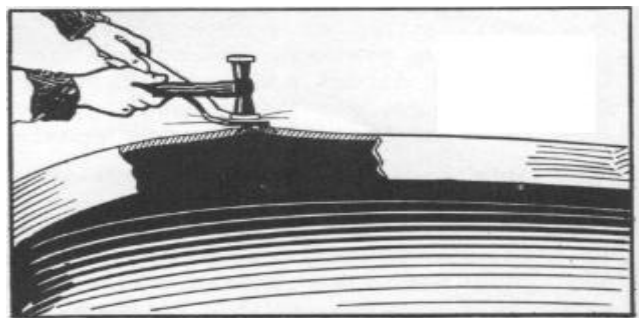

FIGURE 61

Stiffer buckles can be removed by laying the face of a broad spoon against the ridge or valley and striking the spoon with a hammer. The face of the spoon spreads the force of the hammer blow. This application is commonly known as "Spring Hammering," because no backing up tool is used.

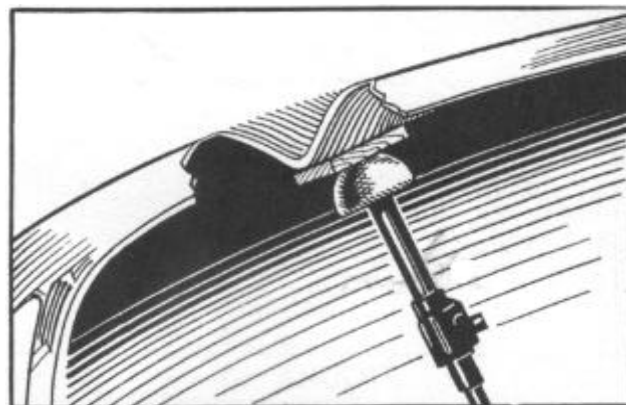

FIGURE 64

For pressing out a broad flat surface, a length of wide plank or board used with the body jack is found satisfactory, Figure 64.

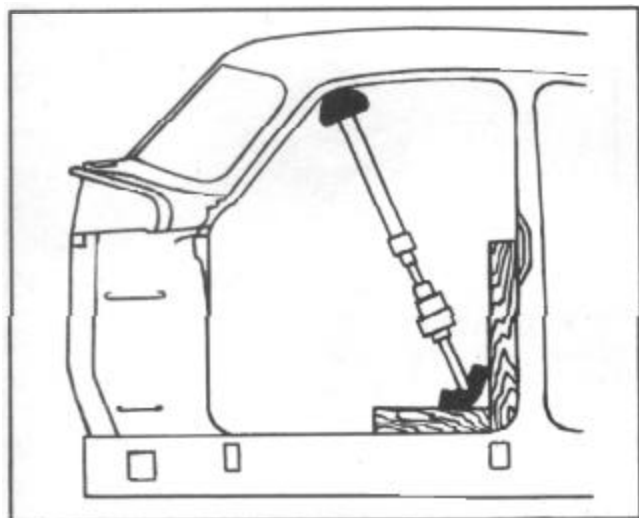

FIGURE 62

A body jack will supply the required pressure in the event the buckle is of a major nature and too stiff to be handled in the manner previously mentioned. A jack exerts pressure in both directions so the body must be protected against damage from the base of the jack. The conventional base furnished with jack equipment is sufficient for low pressure application. When the buckle is very stiff, it is general practice to use wood blocks under the base as an added precaution, Figure 62.

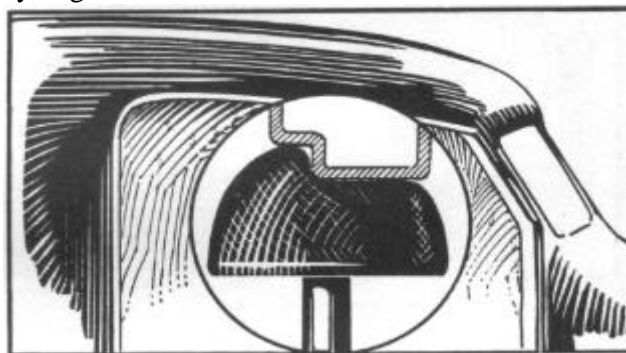

FIGURE 65

The rubber head attachment for body jacks is used to spread pressures over irregular surfaces. Rubber heads must not be used to hold pressures against areas that are to be heated, Figure 65.

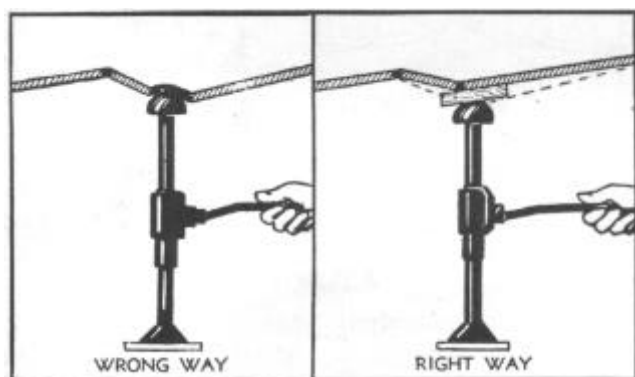

FIGURE 63

The tool face pushing against the damage should be broad enough to spread the pressure through the entire buckle rather than just against the immediate area above the working face, Figure 63.

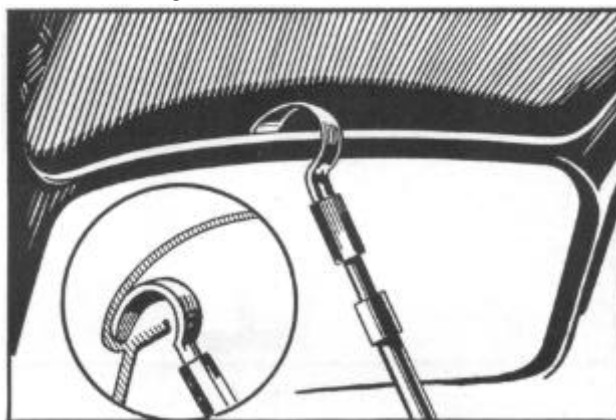

FIGURE 66

Body spoon attachments for jacks are used against high crowned surfaces and to reach behind inner body construction, Figure 66.

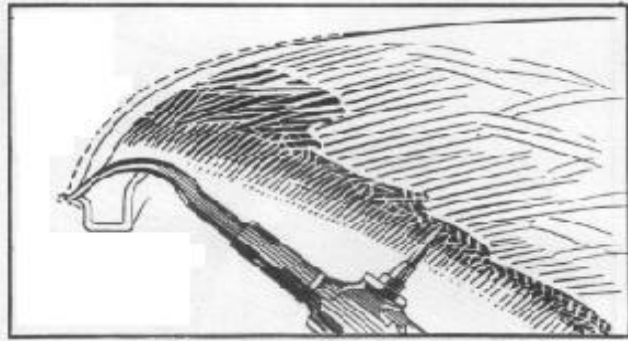

FIGURE 67

Often a single body jack will provide sufficient pressure over a small area of damage, Figure 67.

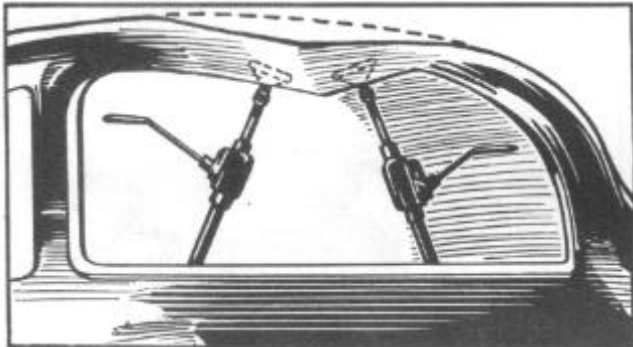

FIGURE 68

Two body jacks are needed to jointly apply pressure to very large stiff areas which contain direct and indirect buckles resulting from one impact, Figure 68.

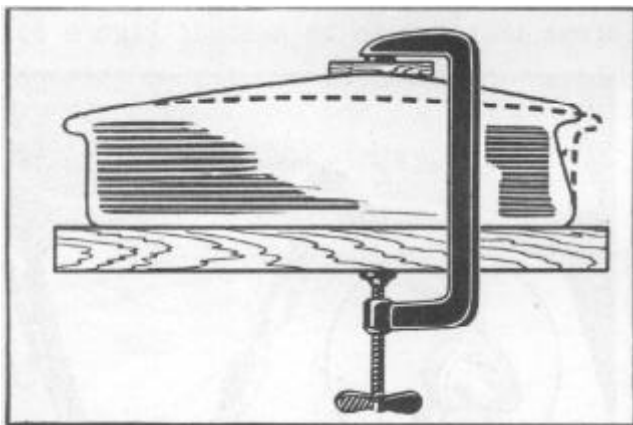

FIGURE 69

In some cases where the damage is confined to a small area, bar or "C" clamps may be used to place a bulged panel under constant pressure, Figure 69.

BUMPING

Bumping consists of reshaping each panel to its original contour.

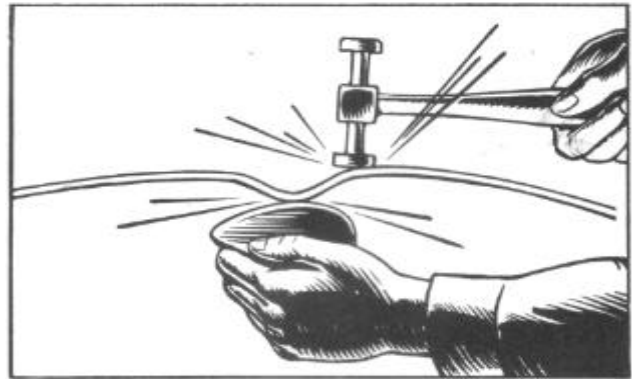

FIGURE 70

This is accomplished by holding a dolly block (of the same original contour of the panel being bumped out) against the LOW spot and striking the HIGH spot with a hammer. This allows the dolly block to rebound against the low spot, bringing it back to its approximate original position, from which the finish bumping operation is completed.

The hammer and dolly must have broad, smooth faces that will spread the blows without leaving tool marks. The dolly is the forming die; therefore, it must have the same contours as the original, undamaged panel. Figures 70 and 71.

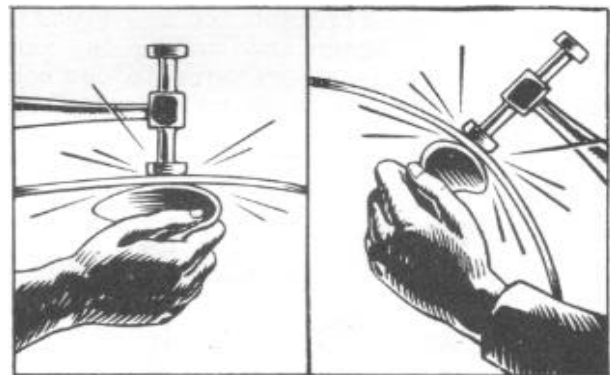

FIGURE 71

Surface blemishes are not removed by bumping; they are removed by metal finishing with a file or torch soldering. Torch soldering is recommended as filing removes too much metal unless the dinging (the removal of small dents) has been very carefully done.

Bumping is started from the edges toward the center of a buckled area.

Use the undamaged area of a panel as a pattern for reshaping the damaged metal. The damaged metal, having been reshaped, becomes the pattern for reshaping the damaged metal beyond it.

A repairman must frequently check his progress by sighting over the last area Winced to the undamaged or repaired section beyond. The importance of this frequent check in the various stages of progress is readily apparent in that it assures the body mechanic that he is returning the damaged area back to its exact original contour.

Wear a cotton glove on the hand when checking for high and low spots. The glove renders the hand more sensitive because the friction from the moisture on a bare hand reduces sensitivity considerably.

CAUTION: As the reshaped areas are brought closer together, it is necessary to carefully watch the contours that are being formed because **THEY MUST MEET SQUARELY.**

METAL FINISHING

Metal finishing consists of a variety of operations; all of which are used to smooth the surfaces of damaged panels, as follows:

- | | |
|--------------------------|-----------------------|
| Dinging | Heat shrinking |
| Pulling out dents | Welding |
| Solder filling | Filing |
| Cold shrinking | Sanding |

DINGING:

Dinging is a method used to pick out small dents in areas where the underside of the panel is not obstructed by reinforcements. It proceeds from the borders or edges to the center of the damaged area, again using the undamaged areas as a pattern for reshaping the edges of the damage. After the edges are reshaped, they

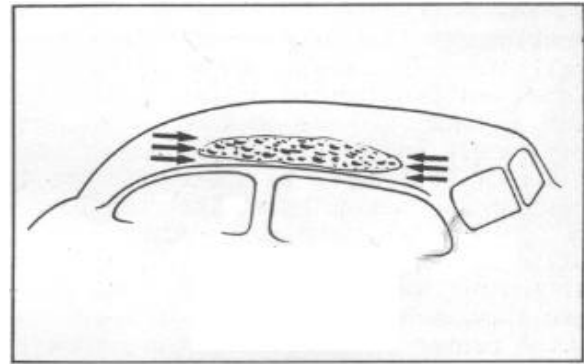

FIGURE 72

become the pattern for correcting the central damage.

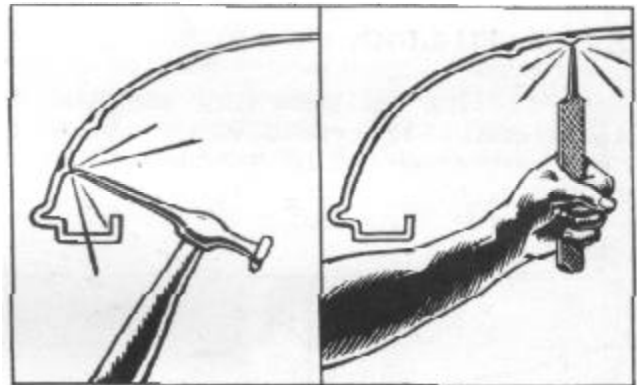

FIGURE 73

Dinging is done with the pointed end of a file or with a pick hammer. The pick hammer is better adapted to reaching behind inside reinforcements. A file will show up the high spots when drawn lightly over the surface of the panel. The pick end of the file can then be used to pick out the low spots.

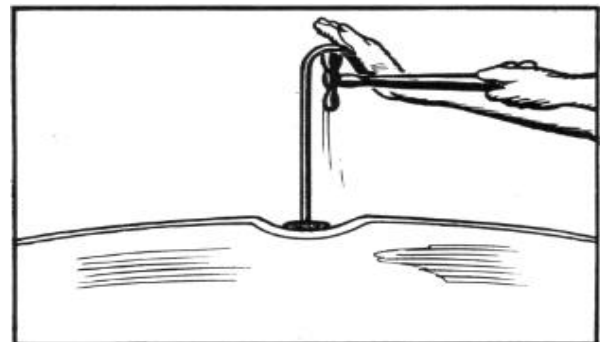

FIGURE 74

PULLING OUT DENTS:

Occasionally the body mechanic encounters small dents or depressions which cannot be pushed out from behind unless considerable time is spent in the removal of interior trim panels and trim. In such cases a looped bar of solder can be sweated to the low spot; and by hammering against the loop in the solder bar, the depression will be pulled out to its normal position, Figure 74. Another method that may be used to remove such dents is to drill a small hole at the center of the recessed area and insert a hooked wire to pull out the dent. If the recessed area is large, it may be necessary to repeat the operation. Fill the drilled holes with solder.

SOLDER FILLING:

Solder filling is generally employed in filling small low spots which cannot be dinged out from behind because of reinforcements, etc. Solder filling is strongly recommended instead of filing in these areas.

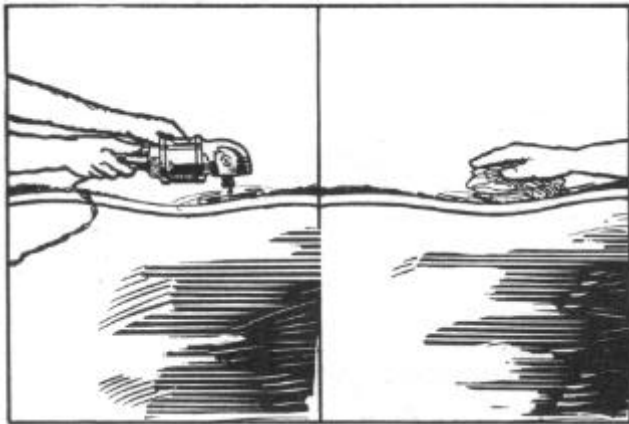
**FIGURE 75**

Clean and sand all paint, rust, and scale from the area to be filled, Figure 75. Extend the cleaning and sanding about 2" around the area. When the area has been reduced to bright metal, heat the area lightly with the torch and apply the soldering flux.

CAUTION: whenever possible, protect surrounding undamaged areas with wet asbestos before applying heat. This will keep the metal from buckling due to heat expansion and prevent painted surfaces becoming spotted with drops of hot solder.

To further prevent buckling due to expansion, quench the soldered area with a wet sponge as soon as the solder has hardened.

The flux usually employed in soldering is muriatic (hydrochloric) acid, cut with zinc and diluted 50% with water. Uncut muriatic acid may be used with extreme care. The flux is applied to the heated area with an acid brush.

After the flux is applied, tin the area by re-heating and rubbing with the end of a solder bar until a thin film of solder adheres to the metal. To fill the depression, heat the end of the solder bar until the solder becomes soft, then force the soft solder against the tinned area with a wood paddle. Do not allow the solder to melt. Solder once melted becomes hardened and is difficult to spread.

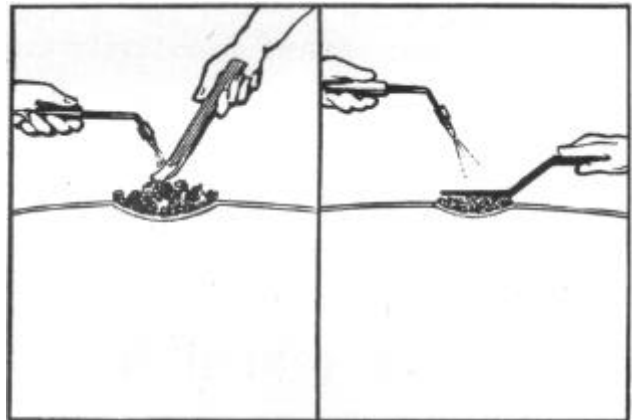
**FIGURE 76**

Use no more solder than is required to fill the depression, Figure 76. When applying solder, use enough heat so that no air holes occur. Keep the solder to a spreading consistency with a torch and shape it with an oil treated wood paddle. (A maple paddle soaked in linseed oil is recommended. The oil treatment prevents solder from sticking to the paddle.)

NOTE: Neither soldering nor brazing should be used to join metal that is subject to stress or road shock. Such a joint should be made by either arc or acetylene welding.

Large depressions require the heat from a torch to keep the solder at a spreading consistency, but on small dents and

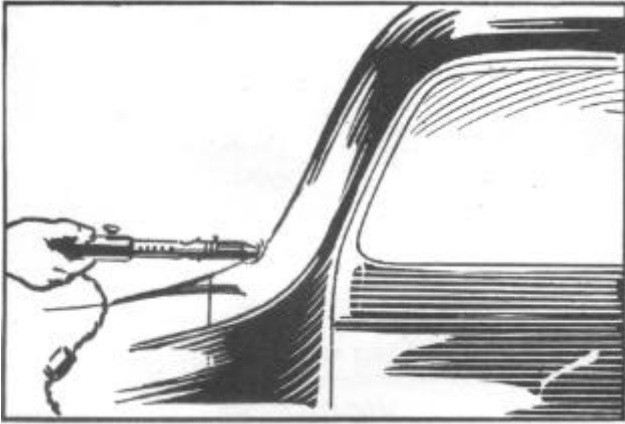

FIGURE 77

depressions a soldering iron will perform best, Figure 77.

Before painting a surface that has been solder filled, neutralize any traces of acid flux by washing with a solution of baking soda and water.

COLD SHRINKING:

Whenever ridges or humps cannot be flattened by bumping or dinging, a method of cold shrinking may be used. Cold shrinking consists of driving a high spot down, Figure 78, and filling the depression with solder. If the area to be shrunk is large, a series of "V" grooves may be hammered into the panel and filled with solder.

This method is often used to smooth a welded seam. The weld is backed up with a grooved dolly or block, and the seam is hammered until it is just below the original contour. The resulting groove is then solder filled.

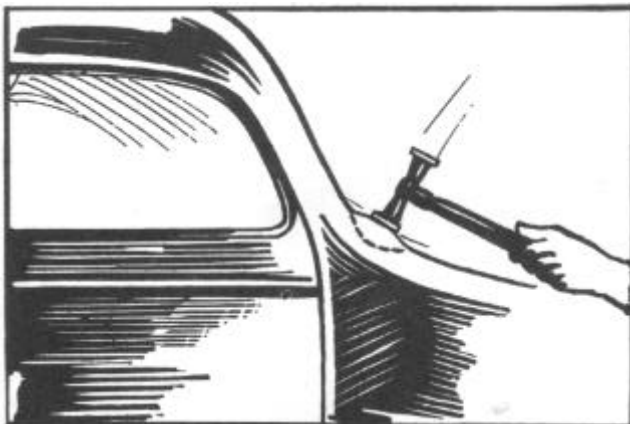

FIGURE 78

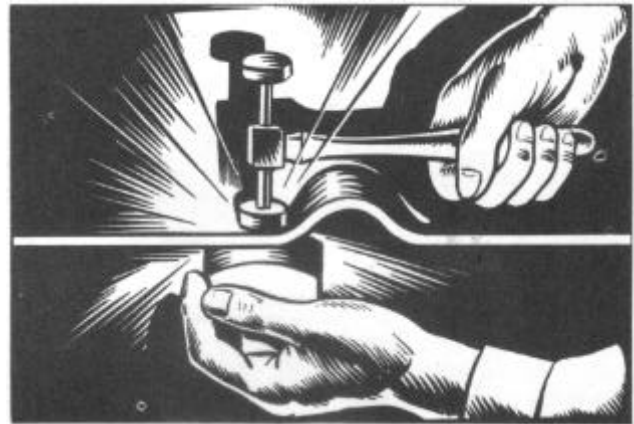

FIGURE 79

HEAT SHRINKING

Excess metal may accumulate in a hump, Figure 79, after the bumping and dinging operations. The hump will be firmly bound in at its base by the circle of reshaped metal that surrounds it. Such excess metal

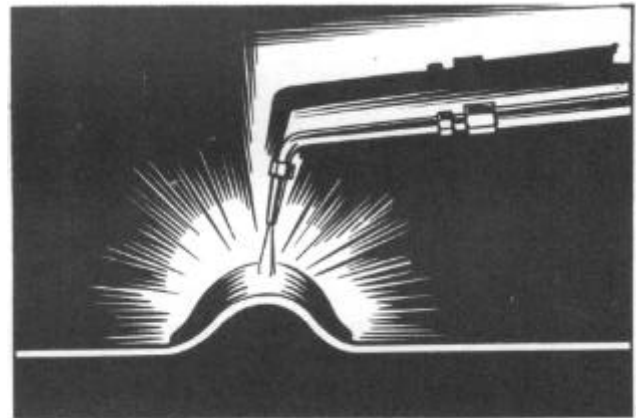

FIGURE 80

should be kept to a minimum by constant reference to the original contour of the metal adjacent to the damaged area while bumping and dinging. Metal stretched by excessive bumping and dinging is just as difficult to reduce as a metal stretched in a collision. To reduce this excess metal, a system of heat shrinking may be used. Using a No. 2 or 3 sheet metal tip on an acetylene torch, heat to a cherry red a spot no larger than 5/8" at the top of the hump.

Keep the torch moving around in a rotary motion to heat evenly. As the spot is heated, it will rise in a peak.



FIGURE 81

Upset the metal in the peak by striking the heated area a sharp blow with a mallet or broad face hammer. Use a dolly block to back up the hammer blows. The heated area is soft and pliable, and the force of the blows will center themselves on the heated area only. The surrounding areas, being cool and rigid will hold the heated area within its limits and any excess metal will pile up in the heated, softened area. The result is a compressing of the metal within the heated area.

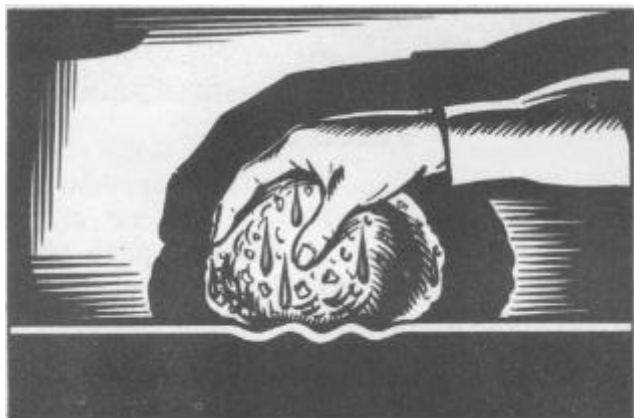

FIGURE 82

After upsetting the peak, soak a sponge in cold water and apply to the heated spot. The cold water coming in contact with the heated metal causes a quick contraction.

CAUTION: DO NOT WATER QUENCH THE METAL WHILE IT IS RED HOT, WAIT UNTIL IT HAS TURNED BLACK.

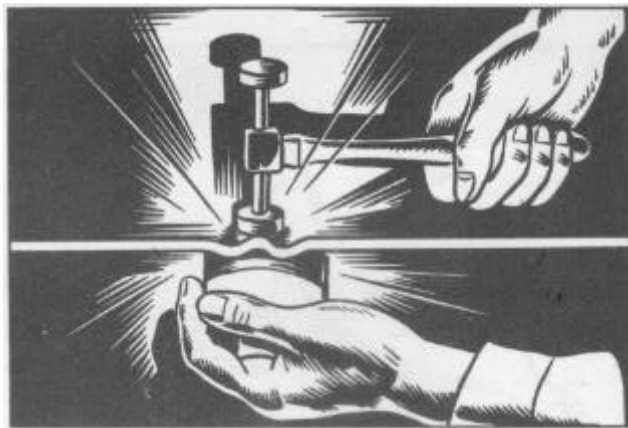

FIGURE 83

After water quenching, the remaining irregularities in the shrunken area are smoothed out by bumping with a body hammer and dolly block, Figure 83.

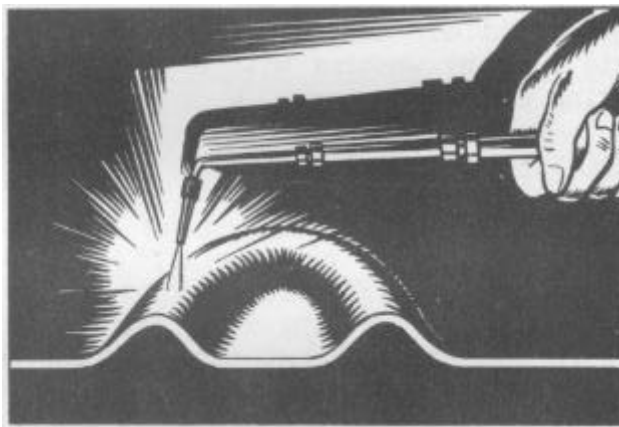

FIGURE 84

Where a large excess of metal exists, the first shrinking operation may flatten the center of the hump, leaving an outer ridge. In this event, the excess metal remaining is given the same heating, hammering, and quenching operation as was used in the beginning, Figure 84.

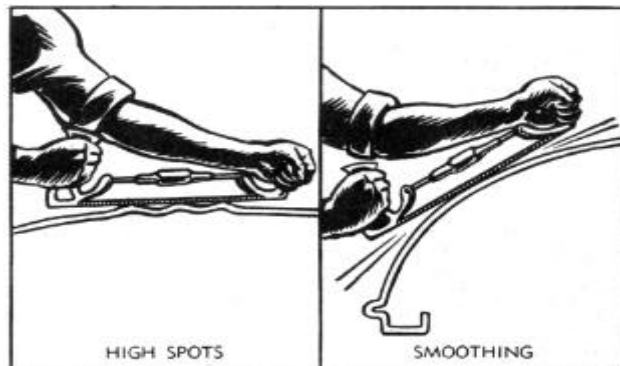

FIGURE 85

Heat shrinking may be done without using a dolly block at all, simply by heating, upsetting, and quenching; but it is better to bump the upsets smooth as the work progresses.

FENDER WELDING:

(See CAUTION, Page 54)

Cuts and tears in fenders may be repaired by acetylene welding. Align the edges to be welded by bumping, and remove all paint, rust, and scale. With pliers or clamps hold the cut together and tack weld every two or three inches. Then, using the forehand method of welding, with a 1/16" soft iron rod and a No. 1 tip, weld from the inside of the cut toward the edge of the fender.

NOTE: Do not weld all the way to the edge. On the inside of the fender, the surrounding metal absorbs much of the welding heat. At the edge of the fender this heat is concentrated and may burn the metal away.

To finish the weld, hold a heavier rod above the cut and heat about 1/2" of the rod until it melts and drops into the cut. Using a heavier rod provides enough additional molten metal to pre-heat the fender and fuse the metal. This method makes unnecessary any reinforcements of the weld.

When the position of the weld makes it impossible to drop molten metal into the cut, hold the welding rod against the edges of the cut with about 3/8" of the rod extending beyond the fender. Heat the rod and the edges of the cut at the same time. This allows molten metal from the end of the rod to flow back onto the fender and reinforce the edge.

Do not attempt to weld a fender that has been filed thin or brazed. Cut out the thin or brazed material and weld in a patch of new metal of the same thickness as the original fender.

FORGING A WELD:

After a panel or fender has been welded, some method of smoothing the bead of the weld is necessary before

painting. It is not advisable to file the bead because this weakens the weld. The welded seam may be smoothed by cold shrinking (Page 55) and solder filling (Page 54). A more economical method is forging the weld as it is made.

To forge a weld, weld about in at a time; then quickly drop the rod and hammer the bead smooth, using a bumping hammer and a dolly. Repeat this process along the entire length of the break. Forging the weld leaves a strong, smooth seam ready for sanding.

FILING:

The body file ordinarily used in body and fender work is the Vixen file. The Vixen file is flexible and may be adjusted to the contour of the area being filed. The file should be held at an angle of 30° to the line of travel and worked with long, even strokes, using the adjacent undamaged metal as a guide. Short, choppy strokes gouge the metal and make the sanding operation difficult.

Filing is used before and during the bumping and dinging operations to mark the high spots and to smooth dinged and solder filled surfaces. Care must be used in filing solder filled areas since the solder is relatively soft and easily cut. Use the Vixen file lightly over the soldered area to establish the contour; then finish filing with an open-cut solder float file.

CAUTION: DO NOT FILE HIGH POINTS TO BRING THEM DOWN TO THE LEVEL OF THE LOW SPOTS---BRING THE LOW SPOTS UP TO THE LEVEL OF THE HIGH POINTS BY SOLDER FILLING. EXCESSIVE FILING WEAKENS SHEET METAL AND SHOULD BE AVOIDED. DINGING WILL TAKE OUT SMALL DENTS OR SOLDER WILL FILL THEM. IT IS FAR BETTER TO HAVE A LITTLE TOO MUCH METAL AS A RESULT OF SOLDER FILLING THAN IT IS TO HAVE A THIN AND WEAKENED AREA CAUSED BY TOO MUCH FILING.

SANDING:

The use of sand paper is generally restricted to removing old paint and to provide a finished smoothness to all surfaces. Use an open grain type of sandpaper for removing paint, as it will reduce clogging. To prevent gouging of solder filled areas, the sand paper should be wrapped around a wood block or a file, Figure 86. The surrounding finished areas serve as a guide.

A disk sander provides a fast and convenient means for sanding body and fender work. The sander should be moved in parallel overlapping strokes as slowly as possible without burning the metal. Hold the disk flat against the work so that a maximum of the disk contacts the metal. Tilting the disk at an angle gouges the metal. Use a No. 24 grit disk for removing paint and a No. 50 disk for finish sanding. No. 36 disk is suitable for intermediate work -- removing file marks and scratches left by the coarser grit disks.

Never use the disk sander on solder filled areas. The easily cut solder will be sanded below the level of the surrounding metal and show up when painted.



FIGURE 86

DOOR ALIGNING AND ROUGHING

The aligning of the door assemblies is very necessary because these assemblies will be used for checking the alignment of the door openings in the body shell.

1. The damaged flanged section at the belt of any door presents the stiffest buckle of a door and is first put

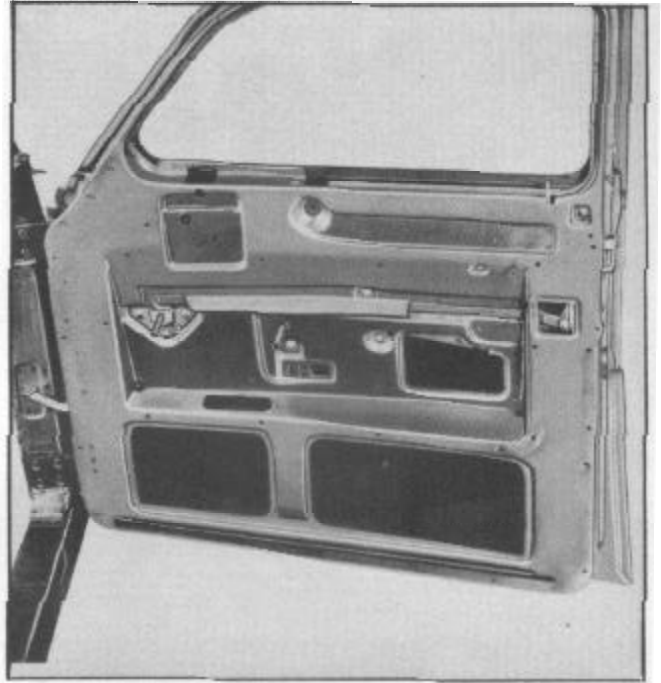

FIGURE 87

buckle of a door and is first put under pressure with a "C" clamp, pulling against a beam placed across both pillars.

2. The stiff metal damage in the reinforced top rail of the door is put under pressure by a jack placed diagonally in

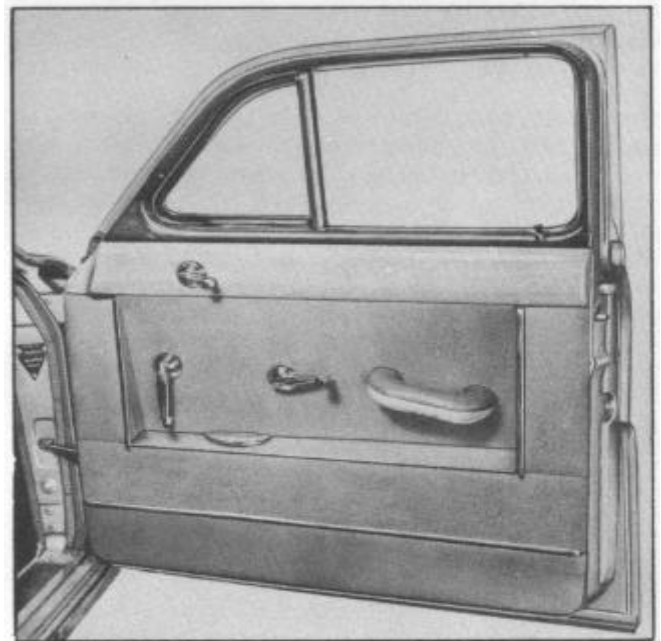

FIGURE 88

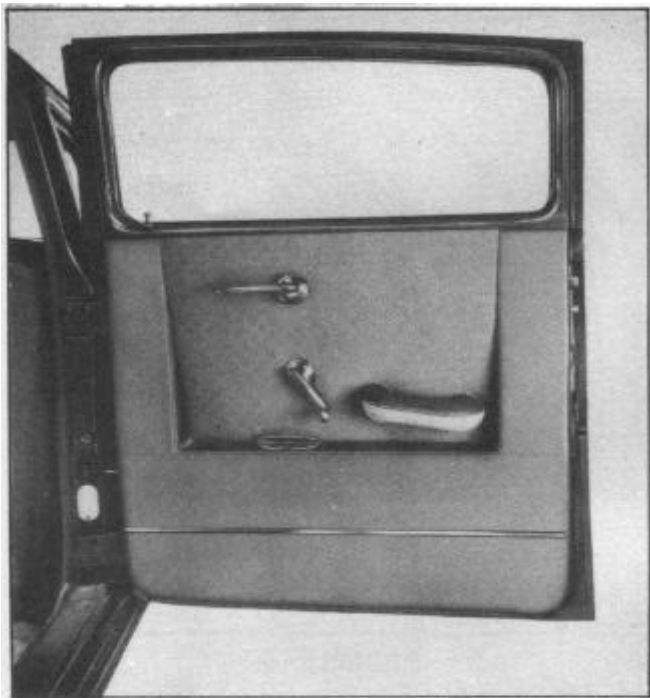

FIGURE 89

the window opening. The jack must Have a rubber head at both the head and base so they may conform to the irregular contour of the window reveal and spread the needed pressure without leaving tool marks.

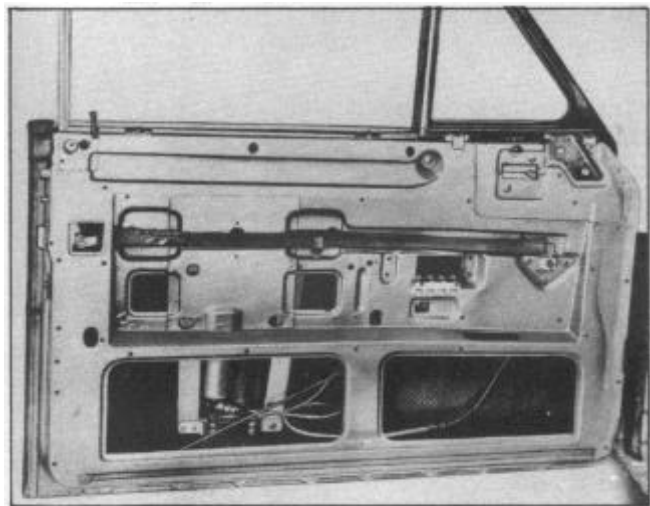

FIGURE 90

3. The pressure exerted by the "C" clamp and the jack is just enough to maintain a draw on the buckles so that they can be flattened with a bending iron and spring hammering.

4. When the strains in the small buckles are released, the jack can be extended, and roughing of the panel continued. All strains can be removed without additional stretching or buckling by the alternate

application of pressure to the misaligned door frame and roughing out of the buckles. Check the repaired door by mounting it into the door opening of an undamaged body of the same year and model as the car from which it came.

DOOR STRAIGHTENING SUGGESTIONS

A door header rail that is found to be too low can be pulled up by gripping it with a clamp and raising with a jack harnessed to pull. The flange is raised and any collapsed box section of the inner panel is opened in one operation.

A twist in the door is corrected by blocking it open at the point where the door touches the body opening first in a closed position and forcing inward, on that part of the door that is farthest from the body opening. When a door has too low a crown from top to bottom, the crown may be increased by using a door straightener.

Fit the doors to the body and perform any metal finishing on the doors after they are fitted. The door flange low spots can be filled with a length of welding rod which is first tack welded to the flange for correct position and then permanently fuse welded. A power grinder may then be used to shape the rod to the normal original contour. Solder fill any remaining irregularities.

Adjust the drip moulding to conform to the line of the repaired door, using a wood block to spread the pressure.

DOOR TO BODY ALIGNMENT

Proper door alignment prolongs the life of the door locks, striker plates, check arms, and hinges and assures ease of door operation.

If the door does not properly contact the weatherstrips at the door header weatherstrip, door opening weatherstrip and/or the door bottom weatherstrip proceed to adjust the door as follows:

1. Examine all weatherstrips to make sure they are firmly and evenly attached to doors and door openings.

2. If door is away from the pillar at the lock side of door, move the striker plate inward according to instructions on Page 27.

3. A door that is out of alignment at the top or bottom may be adjusted by loosening the screws attaching the hinge to the hinge pillar and moving the hinges in or out as required. (Replace any shake-proof washers damaged in the adjustment process.)

4. Further adjustment at the lock side of the door may be made by placing a small block of wood or a rubber mallet against the top or bottom of the door opening and closing the door on the block. This will spring the door out slightly where it bears against the block. It may be necessary to close the door against the block several times while pressing firmly on part of the door that must be sprung inward.

5. Door flanges may be adjusted inward by hammering with a rubber mallet. It is advisable to protect painted surfaces with masking tape before hammering.

6. In severe cases of door misalignment it may be necessary to bend or straighten the hinge, using a suitable hinge bending tool.

NOTE: Be sure hinge attaching screws are tight before applying the hinge bending tool.

To raise the door at the lock pillar, bend the top hinge outward; to lower the door, bend hinge inward.

7. Re-adjust striker plate upon completion of door adjustment.

CHECKING BODY DOOR OPENINGS

Check the front door openings first. Measure back 7" from the front hinge pillar (A), Figure 91, on the underbody panel and mark this point as indicated.

Place one end of the rule on this 7" mark and measure upward to 12", 24" and 34" on the front hinge pillar. Use a chalk for marking and mark accurately. Mark these points B, C, and D. Measure 12", 24", and 34" upwards on the lock pillar starting from the bottom of the pillar where it is welded to the underbody sill (E), Figure 91.

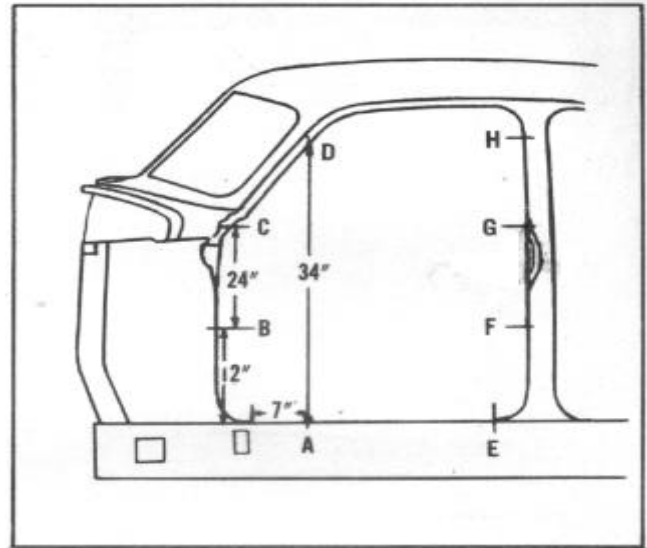

FIGURE 91

Mark these points F, G, and H.

Repeat the measurements on the opposite door.

An actual rectangle is thus laid out that will check the body opening of any door. The use of the body checking tram at these fixed points will give a true indication of door and body alignment.

Refer to paragraphs on vertical, horizontal and diagonal measurements for full details of checking body door openings and body squaring up.

FRAME ALIGNMENT

Figure 92 shows the various dimensions that may be used as a guide in checking frame alignments. This illustration shows the more important diagonal measurements that should be checked; however, many more diagonal measurements may be made in the same manner.

Diagonal measurements should be taken when straightening a frame, and the measurements from similar points on the right and left side should be equal. These measurements make an excellent check for any out-of-square condition and misalignment and will quickly determine which section of the frame is bent and where pressure should be applied to restore correct alignment.

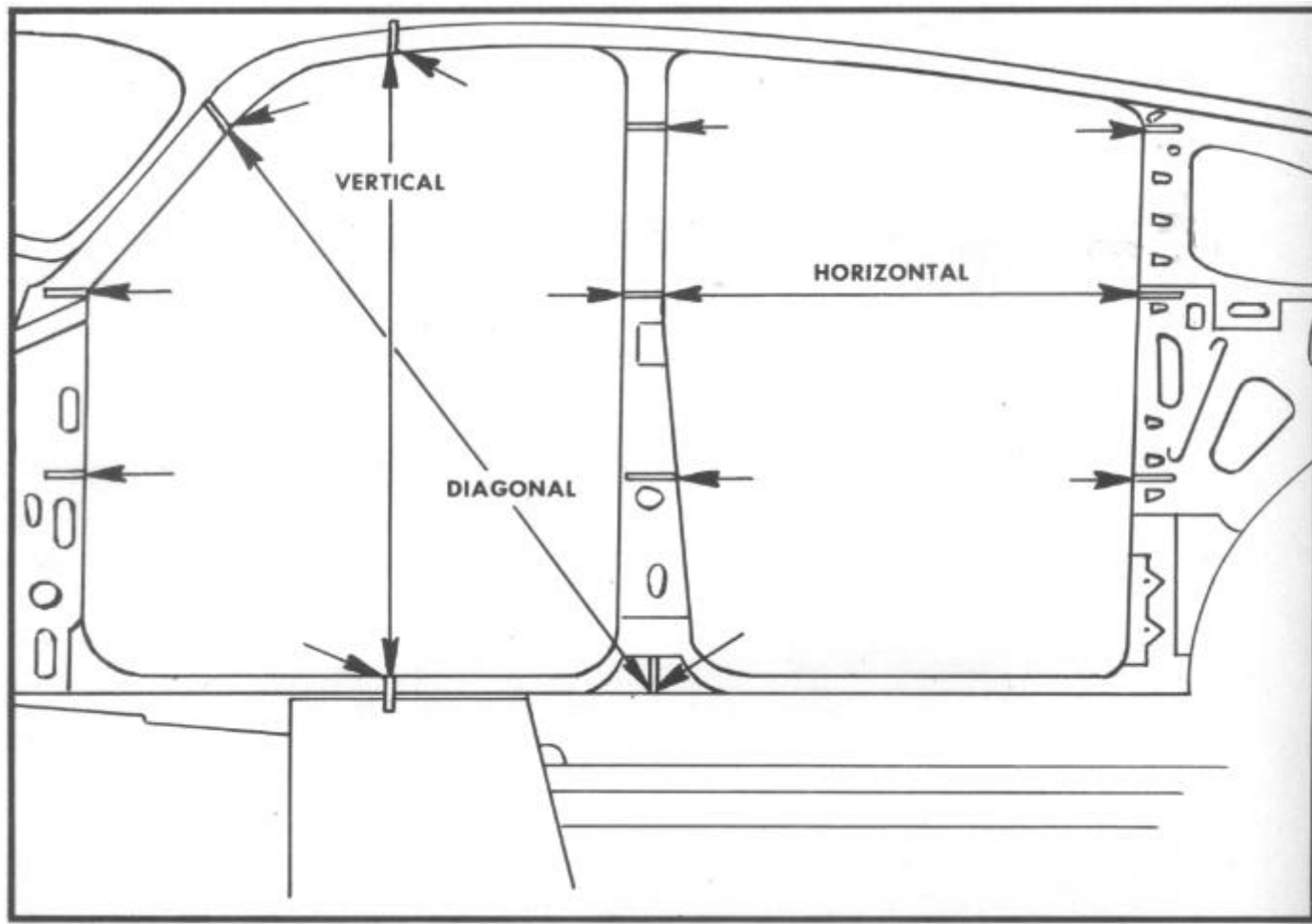

FIGURE 93

BODY ALIGNING AND TRAMMING

MEASURING:

The measurements required for squaring up operations are vertical, diagonal, and horizontal, Figure 93. The measurements taken on one side of the body should check with the measurements taken between identical points on the opposite side of the body.

When differences are found in each of the vertical, diagonal, and horizontal measurements in the relation of one side of the body to the other between identical points, the exact position of any misalignment is readily indicated. It can then be easily determined in what position the body jack or jacks should be placed to produce the proper results. All measurements may be taken and checked with a body checking tram. The tram

is of telescopic construction that permits adjustment to the desired length. A convenient thumb screw is used to lock the tram exactly on the marks and in the position at which the first or opposite measurement was taken.

VERTICAL MEASUREMENTS:

Vertical measurements should be made first, Figure 94. They are taken from the top of the body floor at the sill upward the same distance on each of the front, center, and rear quarter panel body pillars -- on both sides of the body. Chalk should be used to mark the sill and the body pillars at the exact points where the measurements were taken. Depending on the type and location of the damage, it may be found practical to make two or three measurements on each body pillar. These additional marks and measurements will greatly assist in checking the correct contour of the pillars and in taking horizontal and diagonal measurements.

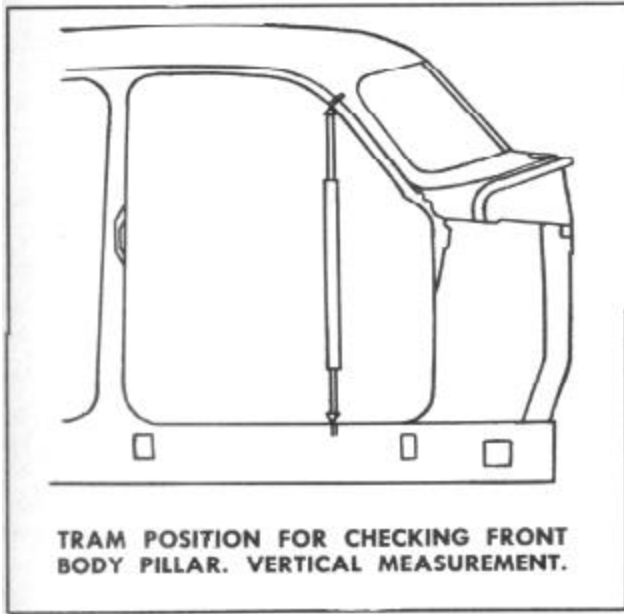

FIGURE 94

HORIZONTAL MEASUREMENTS:

Horizontal measurements are taken on a level at the markings set by the vertical measurements, Figure 95 and 96. They are taken parallel to the floor or roof assemblies to check the width of the door, windshield, or rear window openings.

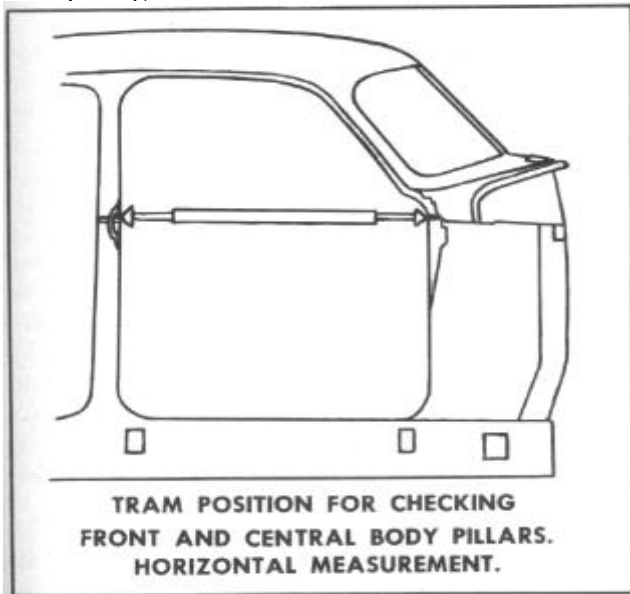

FIGURE 95

For example, the vertical measurements on both front body pillars and the center body pillars are marked at 12", 24" and 37" upward from the top of the side sill. The horizontal measurement then would be the distance

between the two center body pillars at marks which are the same distance from the sill. These measurements are used in checking the correct distance or spacing between the body pillars for proper and true openings.

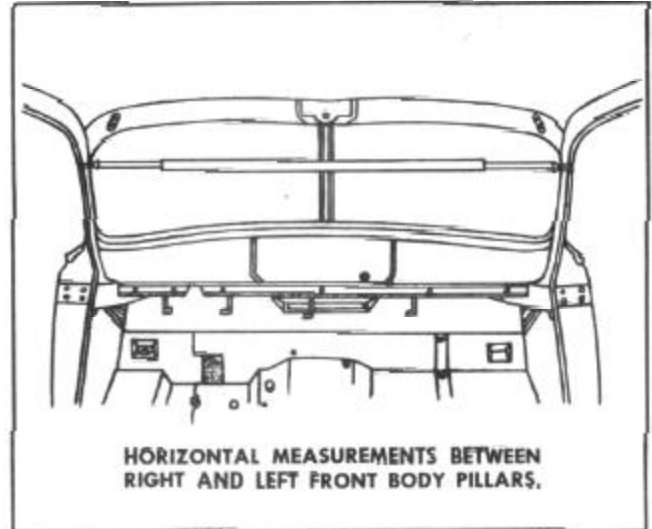

FIGURE 96

DIAGONAL MEASUREMENTS:

The diagonal measurements used in the squaring-up operations are taken at the markings set by the vertical measurements.

For example:

1. Set one end of the tram on the fixed location at the bottom of the right front body pillar and adjust the other end of the tram to the top vertical marking on the top of the left front body pillar. Lock the tram at this measurement. Then check between a similar fixed location at the bottom of the left front body and the top vertical marking on the right front body pillar: These two measurements should be the same. If it is found that there is a difference, it will indicate that this part of the body has been forced sideways.

To square up this section of the body, apply the body jack or power tools to the shortest measurements and force the body in that direction a little more than one-half the distance between the two measurements. An approximate additional 3/16" should be allowed to compensate for the internal strains pulling the damaged area back after removal of the forcing tools.

2. Set one end of the tram on the top vertical marking of the right front body pillar and adjust the other end of the tram to contact a fixed location at the bottom of the left center body pillar. Lock the tram at this measurement. Then check between the top vertical marking on the left front body pillar and a similar fixed location at the bottom of the right center body pillar. The tram should touch all four fixed locations exactly. If it is found that there is a difference, it will indicate that the body has been forced sideways and back. Then the body jack should be placed in the same angle as measured to force the body out in the direction of the shortest measurement.
3. Set one end of the tram on the top vertical marking of the right front body pillar and adjust the other end of the tram to contact the bottom vertical marking on the right center body pillar. Check with the measurement on the left side of the body. This will indicate to what degree force should be applied to maintain the correct measurement in the event it is found necessary to apply force at another angle on the same body pillar.

FINAL CHECK OF BODY REPAIR

Check the body carefully for minor misalignments. Check the alignment of the windshield opening by using an undamaged windshield glass. Use a feeler gauge between the glass and the glass channel to locate the irregularities and high spots. **BE SURE TO REMOVE ALL HIGH SPOTS IN THE GLASS CHANNEL TO PREVENT GLASS BREAKAGE.**

Check the door openings by using the repaired doors and use a feeler gauge to locate high or low spots between the door and door opening. Cross-checking with a tram will determine the squareness of the body cross sections. Check the fit of the quarter windows by using an undamaged glass as a template. With the use of a feeler gauge, locate and mark all low spots. A wooden block or a caulking tool will raise the low spots.

Check the body alignment to be certain that the repair work has not caused any distortion. Check the squareness of the top at the front section. Check the vertical cross section of the cowl assembly.

FINAL CHECK REPAIR SUGGESTIONS

If, in final checking, a front body pillar is found to be too far forward with the roof and too high over the front pillar, proceed as follows: Place the body jack diagonally across the door opening. Tightening the jack will then pull the pillar back and lower the top all in one operation. All existing strains in the body that might tend to draw the body out of alignment must be normalized with alternate light applications of heat and hammering. It is particularly important that reinforcements be thoroughly and completely normalized to prevent their springing back and causing a buckle.

NORMALIZING:

Normalizing is a heating process to reduce the internal strains set up in the metal by the bending and re-aligning operations. It can be applied to any part of the body where internal strains must be relieved by heating at the bent or buckled areas. This is accomplished while the body jack or forcing tool is in place and after that part of the damaged area has been forced to its proper location. The torch should be applied to heat those parts that are buckled and wrinkled to a dark red color. The body jack or forcing tool should be left in place while the metal is allowed to cool slowly.

This process will remove the wrinkles and will relieve the internal strains.

CAUTION: DO NOT USE A RUBBER HEAD ON THE BODY JACK WHEN APPLYING HEAT. THE HEAT WILL NATURALLY CAUSE RAPID DETE-RIORATION OF THE RUBBER.

RESEALING AFTER REPAIR

After the body has been repaired and before the trim materials are installed, the body should be thoroughly inspected and resealed to prevent leakage of air, dust, and water. The places to inspect and reseal are:

Joint between body floor assembly and side panels from front of dash to rear of trunk.

Joints between roof panel and side panel main roof rail drain troughs.

Rear deck drain trough corners. All weather seal rubber strips. Hinges.

Scuff plates and rocker panels. Door front pillar seals.

Tail light mounting.

Fender bolts at cowl and rear quarter.

Windshield and rear window sealer rubbers.

Rear fender gasoline filler well.

Dash panel and miscellaneous holes in dash.

Cowl side panel and frame joint.

Cowl panel to frame and pillar.

REPLACING INSULATING MATERIAL

On the underside of the roof panel and on the body floor panel and rear wheel house, heavy insulating pads are used as sound deadeners.

Various cements are used for attaching these sound deadeners and below are listed these cements and their application.

Code	USAGE
Flintkote No. 74	Roof panel Silencer to Under-side of Roof.
EC-345	Rear compartment Door Silencers. Front and Rear Door Panel. Silencers. Hood Rear Reinforcement Silencers.
EC-308	Door Inner Liners. Quarter Panel Liners, Upper and Lower. Quarter Panel Upper Liner Reinforcement.
EC-232	Under Body Panel Silencers. Wheelhouse Inner Panel Silencers. Wheelhouse Carpet Assembly. Toe-Board Risers and Transmission open-

NOTE: SURFACES TO WHICH SEALER IS TO BE APPLIED MUST BE FREE FROM WATER, DIRT, GREASE AND OIL TO OBTAIN SATISFACTORY ADHESION.

480-490 SERIES HUDSON CONVERTIBLE

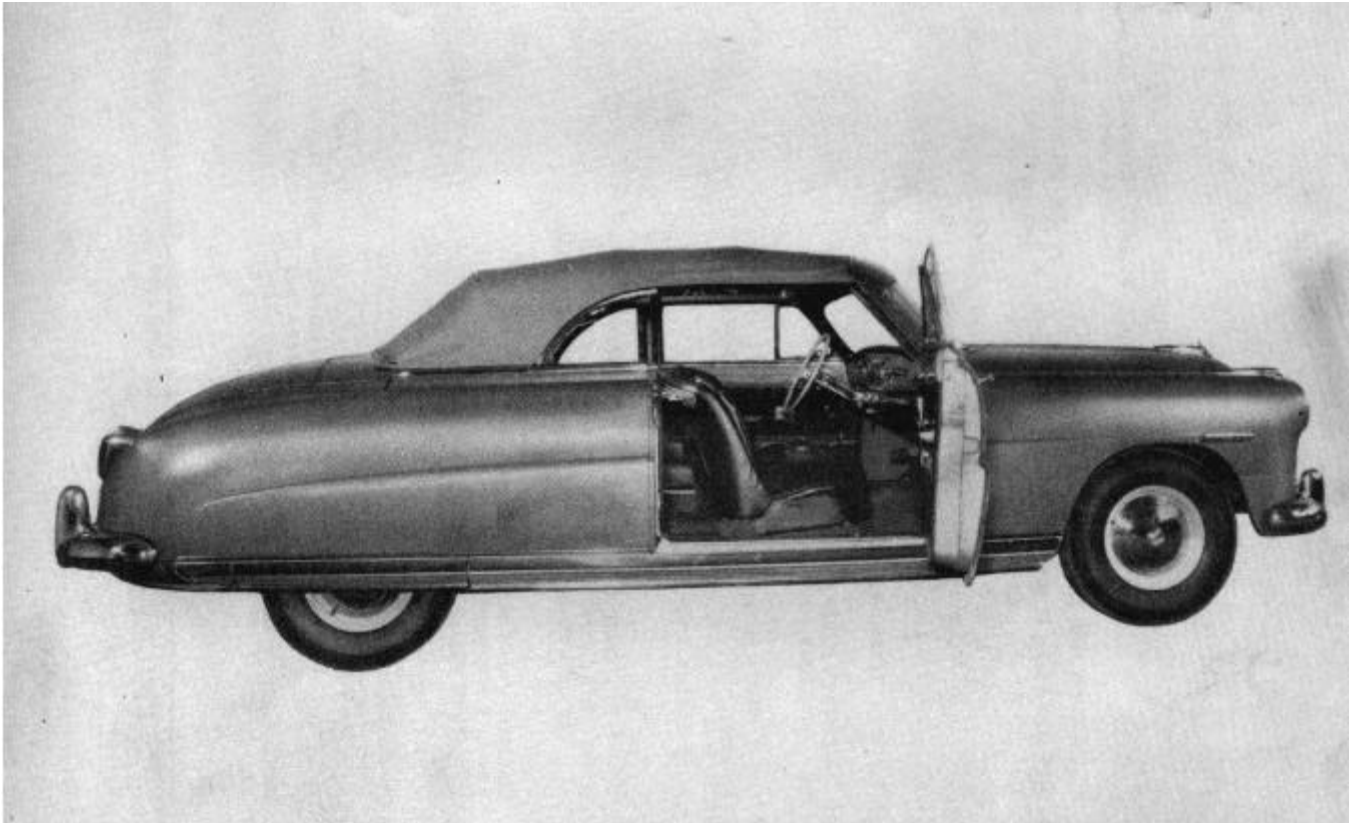

FIGURE 97

The 480-490 Hudson Commodore Convertible Brougham has as standard equipment, the Hydro-Lectric power system for raising and lowering the folding top and the windows. The 480-490 Hudson Super Convertible Brougham features only the hydraulically operated folding top with manually operated windows.

The operation of the Hydro-Lectric System is accomplished through the combined use of electrical energy from the battery and hydraulic fluid pumped under pressure to the various operating units.

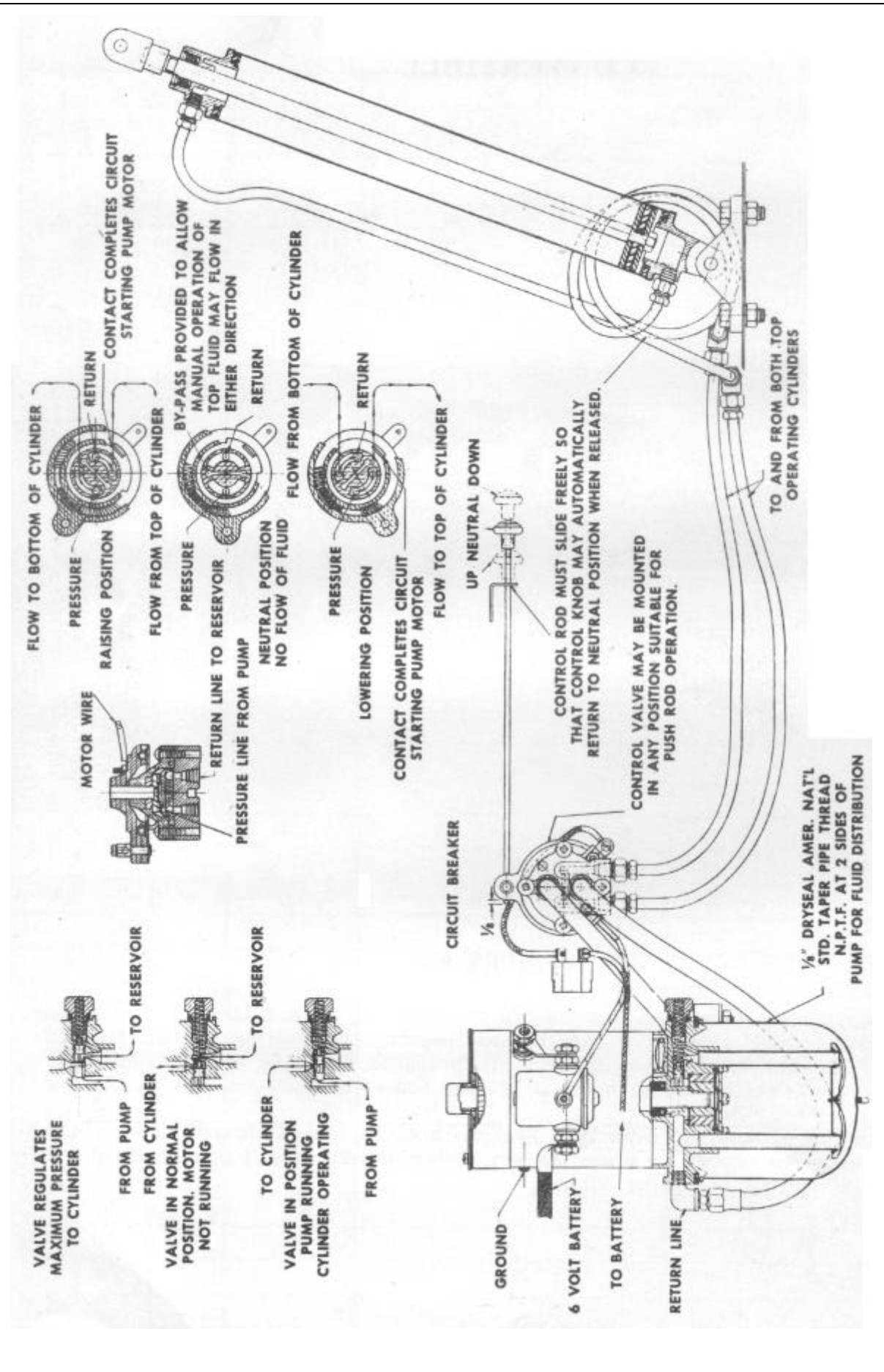

FIGURE 98

Figure 98 is a schematic diagram of the convertible top operating system; actual location of the unites in the car may differ from the position shown in the illustration. Operation of the folding top is accomplished with a convenient, dash mounted operating knob which operates through an operating valve assembly to the master hydraulic

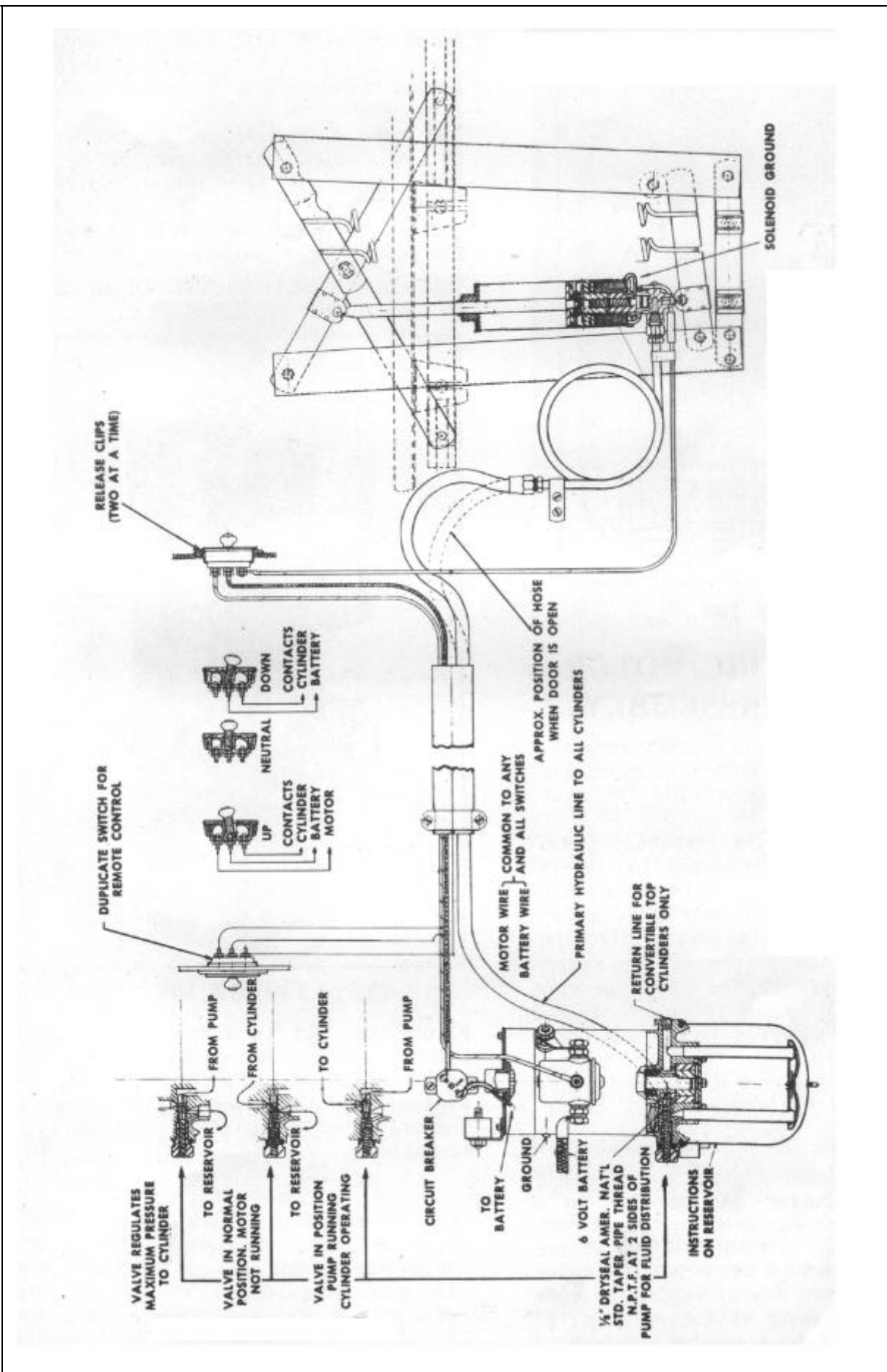

FIGURE 99

Figure 99 is a schematic diagram of the window regulator and cylinder system. The door windows and the rear quarter windows are operated by a single action hydraulic cylinder mechanism. The cylinder piston pushes the window upward to a closed position; spring tension lowers the window to an open position. Individual electrical window control switches are conveniently located at each window. A master control switch panel for all windows is located on the left door, handy for driver operation.

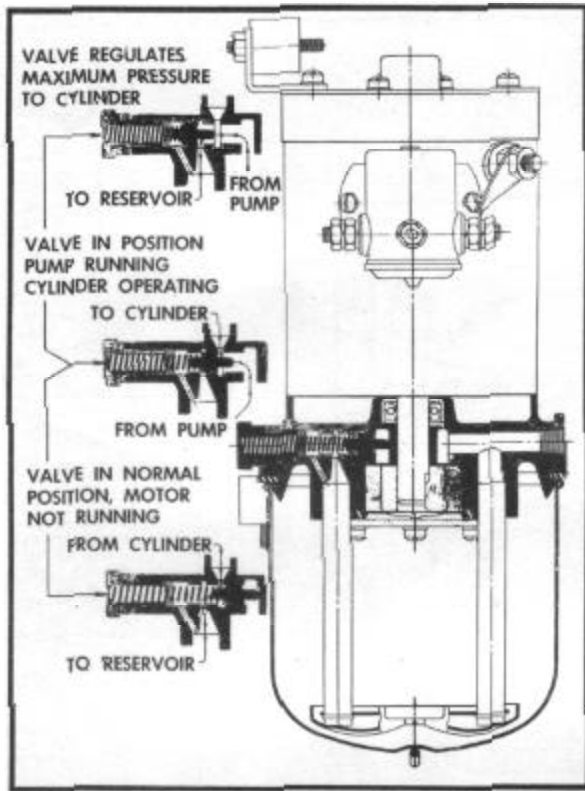

FIGURE 100

HYDRO-LECTRIC MOTOR AND PUMP ASSEMBLY

This assembly is a single unit consisting of an electric motor, a hydraulic pump, and a fluid reservoir.

The fluid reservoir is correctly positioned on the pump housing by dowels in the pump casting and is held in place by a "U" shaped spring wire bail. A detent in the bail fits into a circular depression in the bottom of the reservoir and firmly anchors the reservoir to the pump. A synthetic rubber gasket fitted into an undercut in the pump base seals the reservoir to the pump. A hole in the pump casting near the relief valve plug vents the reservoir to the atmosphere.

The motor and pump assembly is cushioned on synthetic rubber and mounted in a well behind the rear seat in the 480-490 series Hudsons. Flexible rubber tubing connects the pump to the metal hydraulic tubing to prevent any loosening of connections or breaking of tubing from vibration of the pump assembly.

A solenoid switch on the outside of the motor housing activates the unit. An electrical ground is provided through a ground strap to the car body.

The pump is provided with a combination spring loaded maximum pressure relief and piston type flow control valve. See 11 in Figure No. 102. This valve is adjusted to a minimum fluid pressure of 250 pounds and a maximum of 260 pounds.

THIS PRESSURE SETTING MUST NOT BE CHANGED TO GIVE HIGHER PRESSURES.

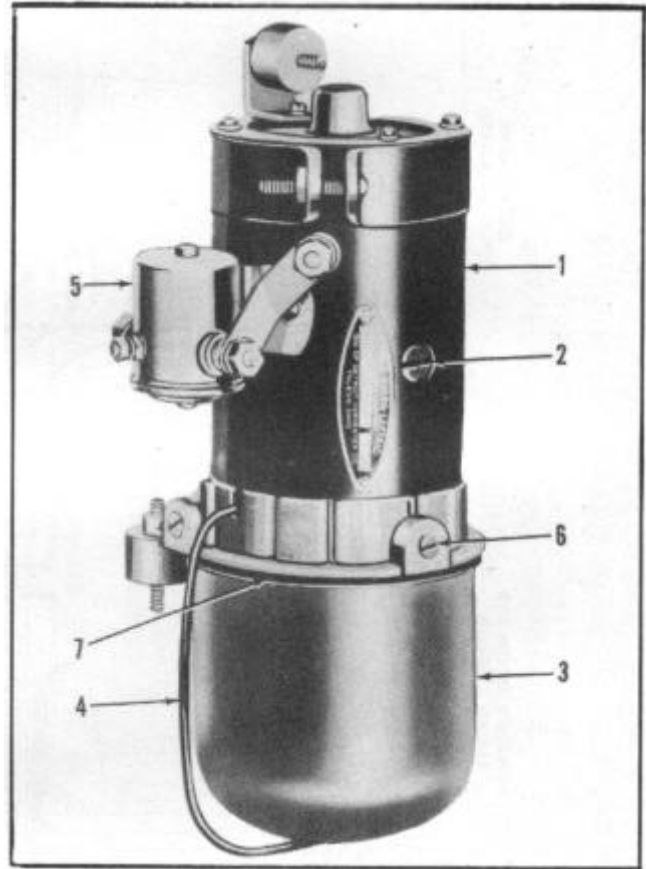

FIGURE 101

Figure No. 101 is a front view of the hydraulic motor and pump assembly used for raising and lowering the top and windows on the convertible brougham. The principal units of the assembly are as follows:

1. Motor
2. Hydraulic pump
3. Pump reservoir
4. Spring wire bail
5. Solenoid
6. Fluid port
7. Reservoir gasket

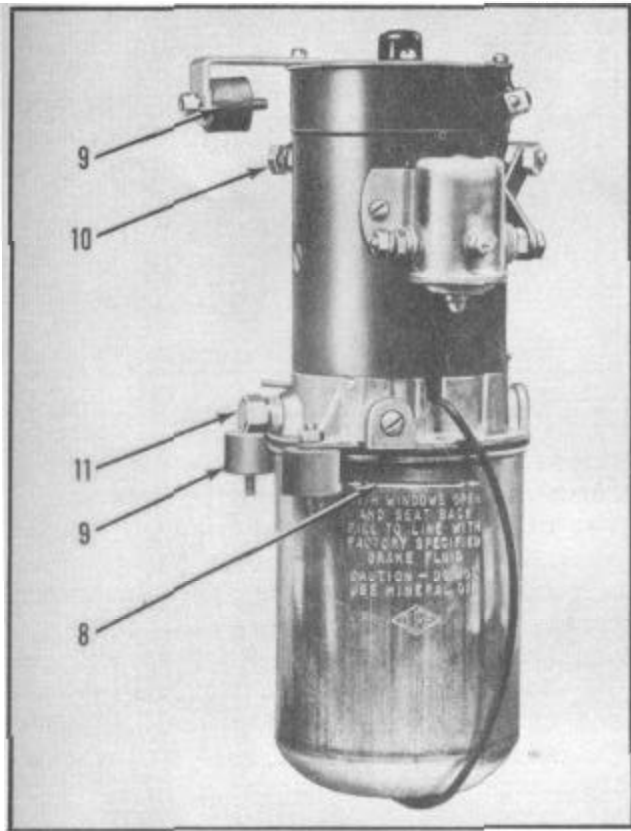

FIGURE 102

Figure No. 102 is a side view of the motor and pump assembly.

- 8. Fluid Level marker
- 9. Rubber cushioned mounting brackets
- 10. Ground strap terminal
- 11. Pressure relief valve

MAJOR HYDRAULIC UNITS, 480-490 SERIES

REMOVAL AND INSTALLATION:

NOTE: Before removing any hydraulic unit, two precautionary steps are to be taken.

1. All hydraulic fluid must be removed from the system.
2. Disconnect negative battery cable at battery.

CAUTION: This fluid is extremely injurious to painted or lacquered surfaces, and it is highly inflammable. Sparks from accidental grounding of electrical connections may ignite the fluid.

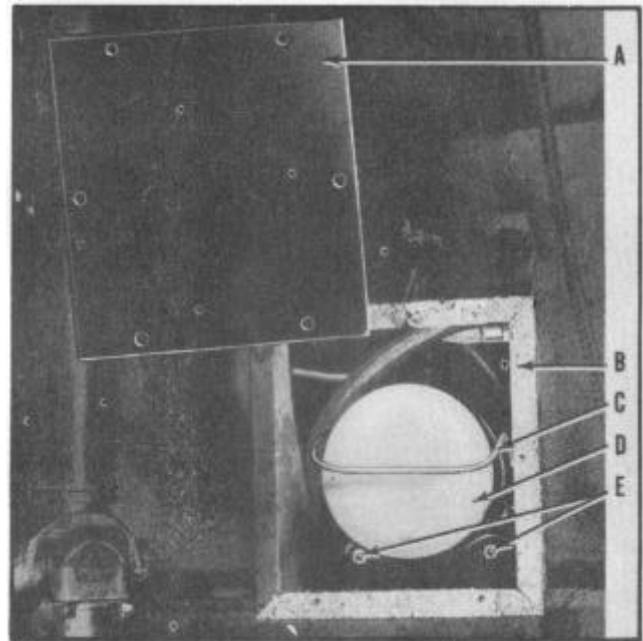

FIGURE 103

To remove hydraulic fluid, raise the car on a hoist and remove cover plate (A) from the bottom of the well containing the Motor and Hydraulic Pump Assembly. See Figure 103. Remove the reservoir bail (C) and the reservoir (D), and empty the contents into a clean dust-free container

With a helper in the car to operate the top, hold the empty reservoir in position on the bottom of the motor and pump assembly so that the fluid pick-up is two to three inches from the bottom of the reservoir. This prevents fluid being drawn back into the system during the bleeding operation.

Using the dash mounted top operating button, move the top up and down manually until all fluid is expelled from the system. Top must be moved slowly and steadily to prevent excess strain on top parts or top operating cylinders.

When all fluid is out of the system, empty the reservoir and replace it on the pump.

Before disconnecting any hydraulic lines, place clean rags under the connection to soak up any fluid that may drip from the line when the connection is broken.

When all fluid is out of the system, empty the reservoir and replace it on the pump.

Before disconnecting any hydraulic lines, place clean rags under the connection to soak up any fluid that may drip from the line when the connection is broken.

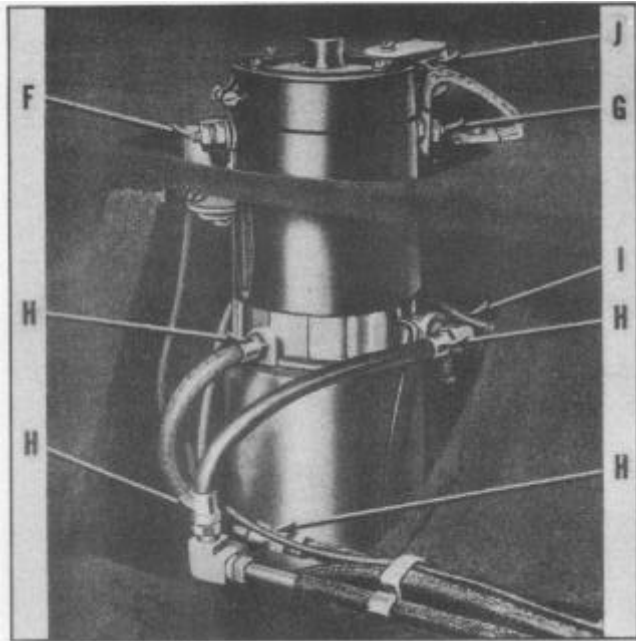

FIGURE 104

MOTOR AND PUMP ASSEMBLY

REMOVAL:

1. After all fluid has been completely removed from the hydraulic system and while the car is still raised on the hoist, remove the two nuts (E), Figure 103, and lockwashers from the lower motor and pump assembly support.
2. Lower the car and remove the rear seat cushion and seat back. (See Page 82 for seat back removal.) Remove motor and pump assembly cover.
3. Disconnect battery cable and wires at motor solenoid (F), Figure 104.
4. Disconnect ground strap at B on motor.
5. Disconnect hydraulic inlet and outlet flexible hoses at H and remove vent tube (C) from rear of pump.
6. Remove nut and lockwasher from upper motor support (D) and lift complete unit up and out of well.

INSTALLATION:

To install, reverse procedure of removal.

FOLDING TOP OPERATING VALVE AND SWITCH ASSEMBLY

The top operating valve and switch assembly, Figure 105, is mounted on a support under the left end of the instrument panel. The valve connects the

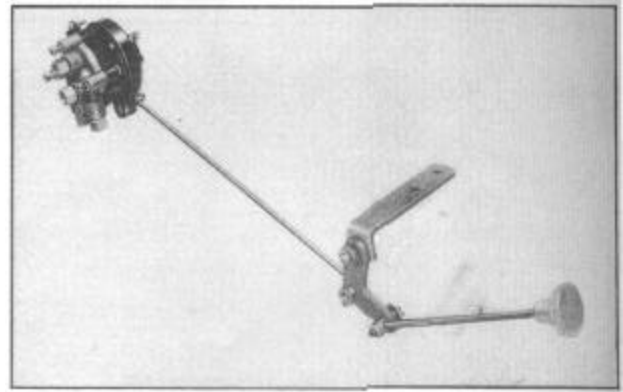

FIGURE 105

motor and pump assembly to the top or bottom of the double action top operating cylinders, depending on the position of the control knob on the instrument panel. Operation of the valve is controlled by a push-pull knob at the left of the steering column. At the extreme end of the knob operation, in and out, the valve switch is closed to activate the motor and pump assembly.

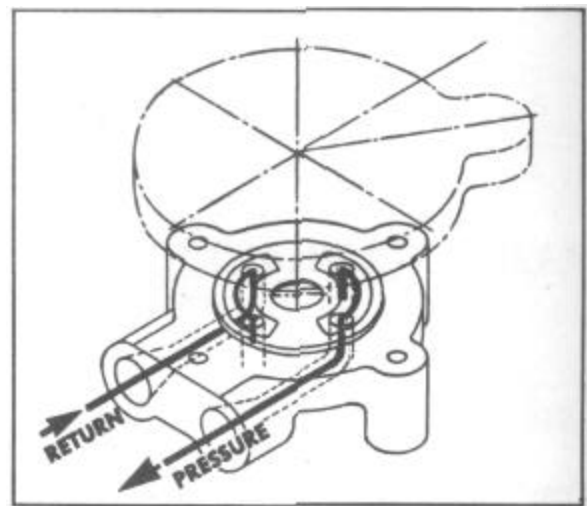

FIGURE 106

With the operating knob pulled out, fluid from the pump is directed to the top of the cylinders, and fluid from the bottom of the cylinders is returned to the fluid reservoir, Figure 106. With the valve in this position, the top is lowered. When the knob is released, springs inside the valve return it to a neutral position, Figure 107.

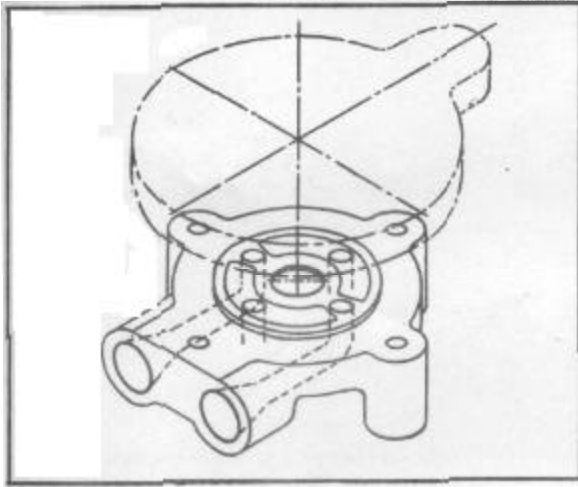

FIGURE 107

To raise the top, the knob is pushed in. In this position, Figure 108, fluid from the pump is directed to the bottom of the cylinders, and fluid from the top of the cylinders flows back to the fluid reservoir.

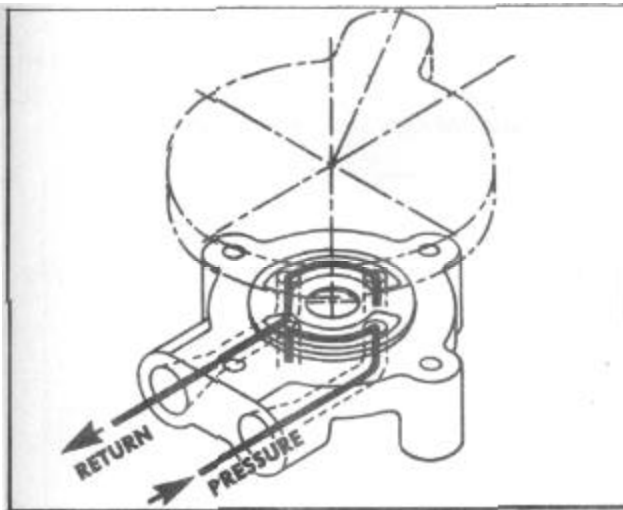

FIGURE 108

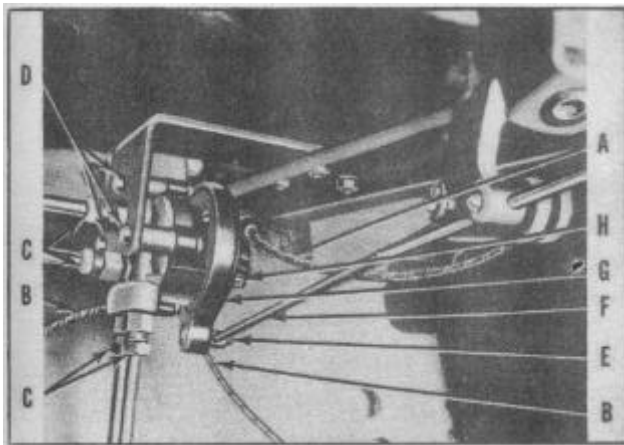

FIGURE 109

VALVE AND SWITCH ASSEMBLY

REMOVAL:

1. Loosen set screw (E), Figure 109, and remove control rod (F) from cap of valve (G).
2. Remove wires from valve cover (A) and valve body (B).
3. Disconnect four hydraulic inlet and outlet tubes (C) from valve body.
4. Remove screws (D) attaching valve body to support bracket.

The valve and switch assembly is now completely disconnected for removal from the car.

NOTE: The Phillips head screws attaching the valve and switch assembly to the support bracket are best removed with an offset Phillips head screw driver. The moulded plastic cover is held in place by four attaching screws and is sealed from leakage by a synthetic rubber gasket. A second rubber gasket installed between the plastic valve and inner cover seals the valve operating shaft against leakage. The switch assembly is held to the operating valve shaft by a Phillips screw (H). Figure 110 shows the top control valve with cover removed. Operating the top control rod moves the cover until contact is made between 1 and either 2 or 3, completing the circuit to the pump motor.

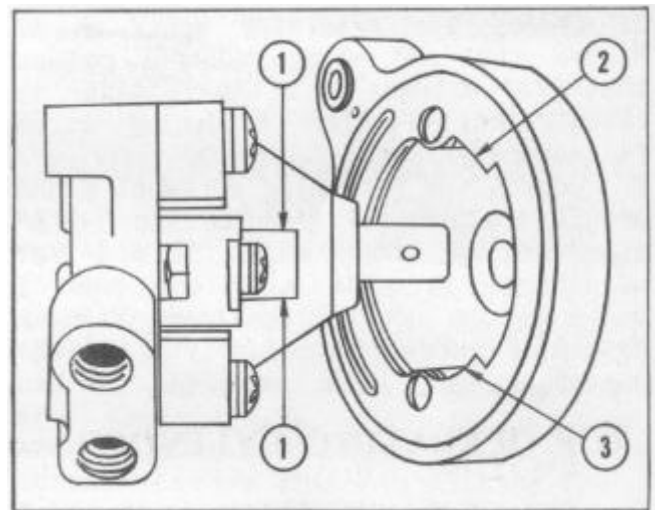

FIGURE 110

INSTALLATION:

To install, reverse procedure of removal.

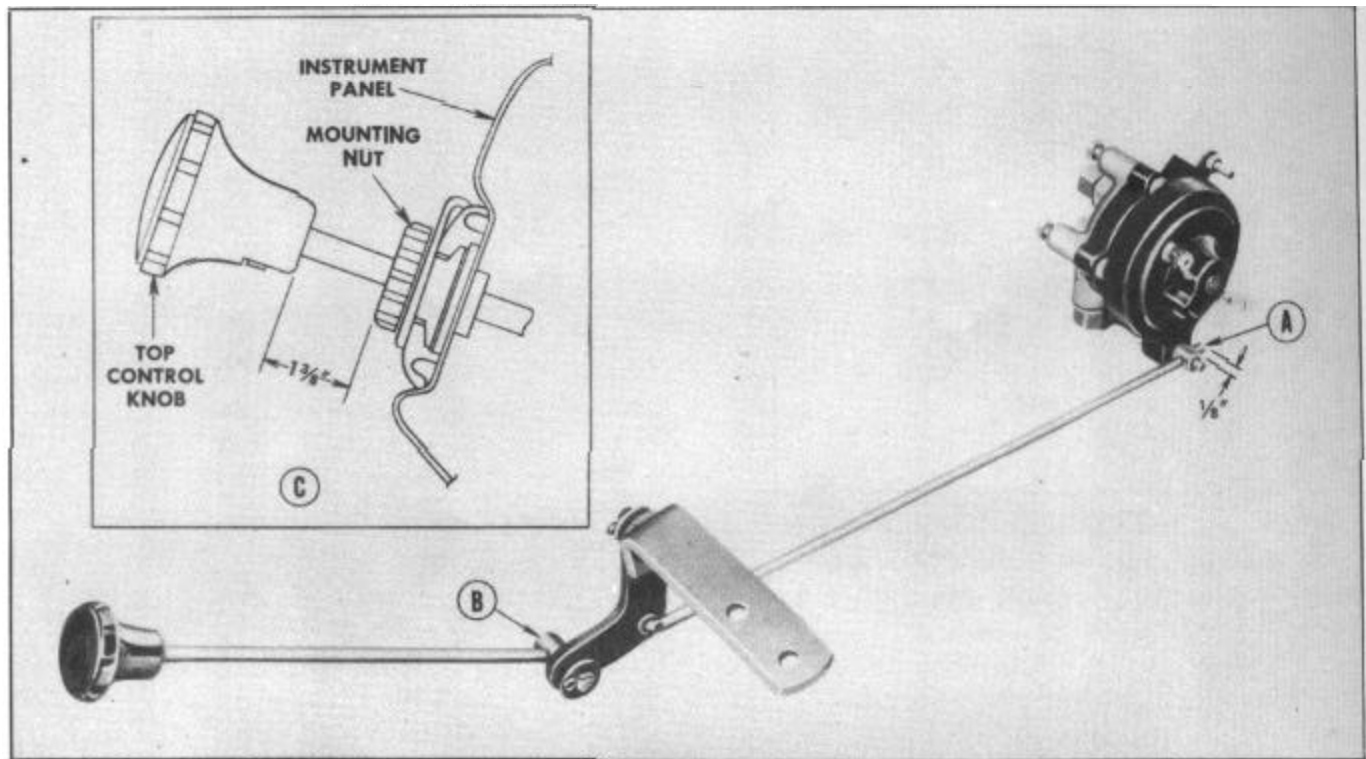

FIGURE 111

FOLDING TOP CONTROL ROD ADJUSTMENT

Proper adjustment of the folding top control rod is very important to insure full and complete operation of the folding top to either the up or down positions.

To properly adjust the top control rod, proceed as follows:

1. Loosen the retaining screw at A, Figure 111, and adjust control rod so that 1/8" extends thru the retainer as illustrated. Tighten retaining screw (A) securely.
2. Loosen the retaining screw at B and adjust the control knob to the 1-3/8" clearance as shown at C. This 1-3/8" adjustment is made with the control valve in the neutral position. Tighten retaining screw (B) securely after adjustment has been made.

TOP OPERATING CYLINDERS

The Top operating cylinders of steel tube construction are fitted at each end with crimped-in die castings which, together with synthetic rubber seals, form a fluid tight assembly, Figure 112.

The lower casting forms a yoke which, together with a clevis pin, provides secure anchorage to the floor bracket.

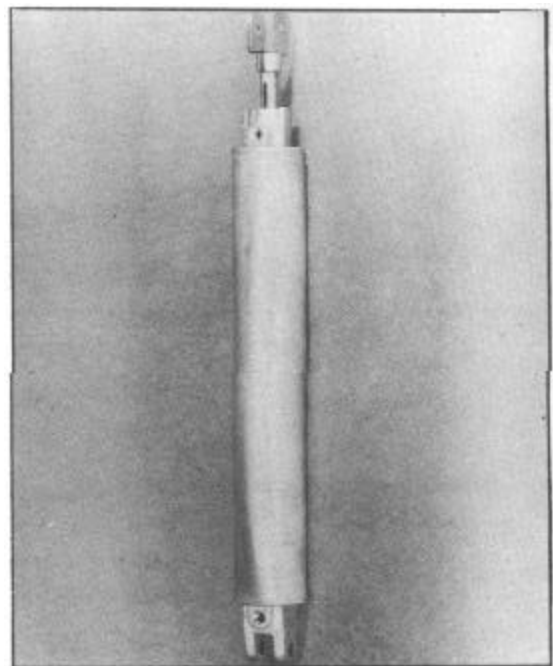

FIGURE 112

The upper casting provides a bearing for the piston rod and a cavity for the replaceable synthetic rubber fluid seal and

and felt. These parts are held in place by metal washers and a snap ring.

The piston rod is chrome plated and contains at its inner end an assembly of metal and synthetic rubber washers which seal the inner piston chamber against a by-pass of fluid during the raising or lowering operation, Figure 113.

Dryseal pipe threaded holes in the upper and lower castings are provided for the fluid line connections. The piston rod, fluid, seal, and felts are the only serviceable parts of the cylinder assembly. In the event that the replacement of these parts does not result in satisfactory operation, the cylinders must be replaced as a unit.

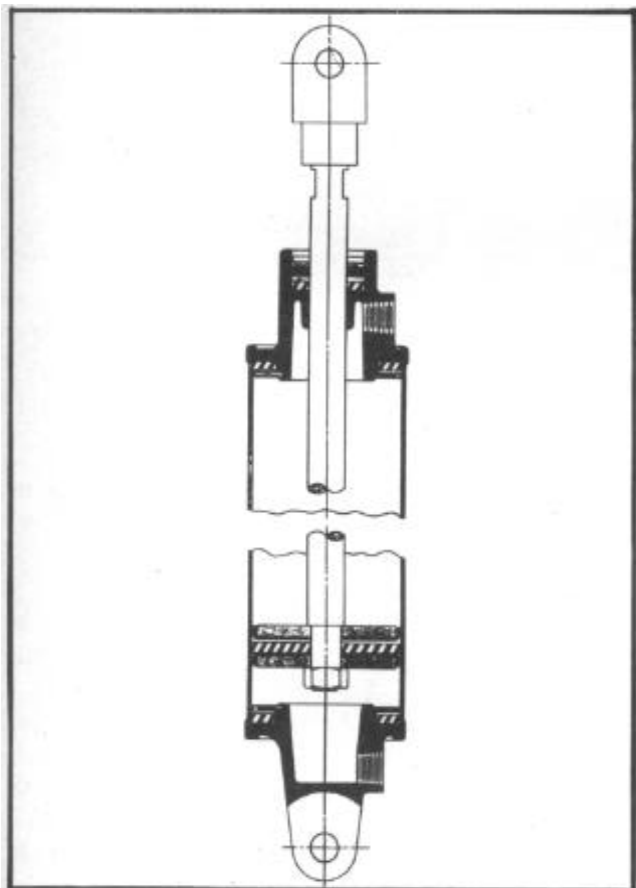

CAUTION: MINERAL OIL MUST NOT BE USED ON THE PISTON ROD OR UPPER SEAL AS SWELLING AND PREMATURE DETERIORATION OF THE SYNTHETIC RUBBER WILL OCCUR. USE A FEW DROPS OF CASTER OIL OR BRAKE FLUID WHEN LUBRICATION AT THESE POINTS IS NECESSARY.

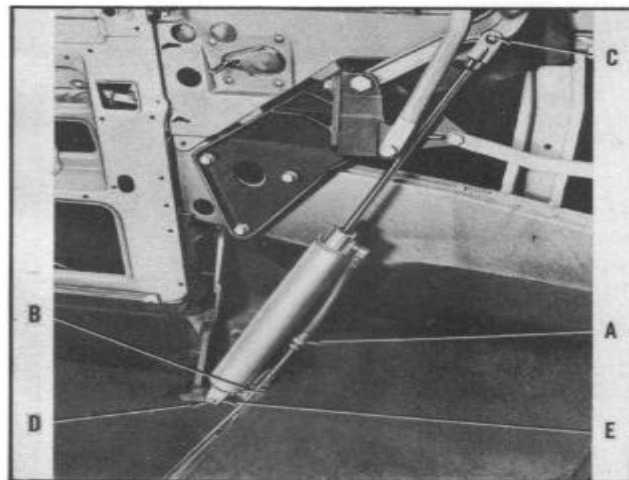

**FIGURE 114
TOP OPERATING CYLINDERS**

REMOVAL:

1. Remove rear seat cushion and rear seat back. See page 82.
2. Remove all rear quarter panel trim on side on which work is to be performed. See page 82.
3. Remove upper (A) and lower (B) hydraulic flexible hoses. Figure 114.
4. Remove upper (C) and lower (D) clevis anchor pins and remove cylinder from car.

NOTE: When replacing top operating cylinders, be sure to replace the two rubber bushings (E) in the lower clevis.

INSTALLATION:

To install, reverse procedure of removal.

**DOOR WINDOW REGULATOR
ASSEMBLY**

The window regulator frame assembly, Figure 115, is designed as a unit to provide a mounting for the cylinder assembly (1) and retracting springs (2), and for the cross arms (3), which control the window and hold it in alignment. The cross arms are conventionally connected to the window by sliding studs.

The cylinder is mounted at the lower end on a spherical seat formed in an expansion arm (4), which is pivoted to the fixed stanchion (5), and is held

from upward movement by a hardened steel roller, which fits over a hardened bushing, riveted in place.

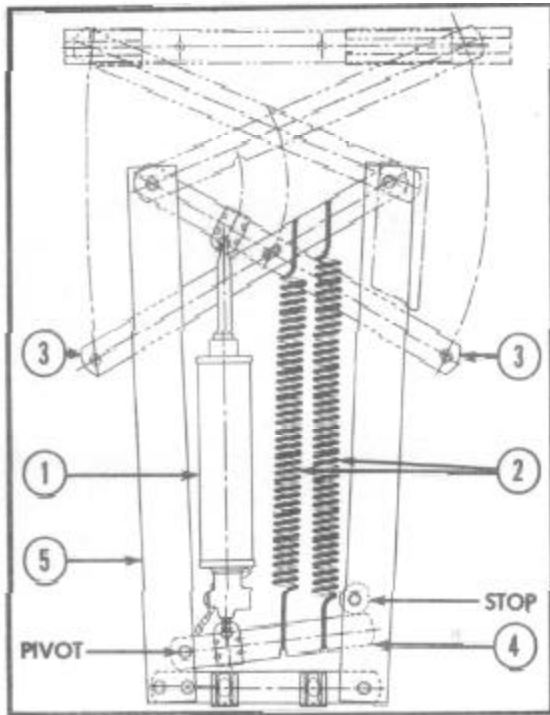

FIGURE 115

The retraction springs, at the lower ends are connected to this same expansion arm (4), Figure 115, between the cylinder and the stanchion side member. The upper ends of the retraction springs are connected to the moveable cross arm (3).

The purpose of this method of construction is as follows: When the window is raised to its upper limit, fluid is trapped in the cylinder by the action of the solenoid valve at the bottom of the cylinder. Expansion of the trapped fluid may occur if it becomes heated through a rise in temperature. Since the piston rod is rigidly connected to the glass channel through the regulator assembly, no upward movement of the piston can occur. Provision for a downward movement of the cylinder body is made by connecting the lower end of the cylinder to the pivoted expansion arm. Any expansion of fluid forces this arm down against the tension of the retraction springs.

The tension of the springs and the leverage of the expansion arm have been chosen so that in their extended position the springs just overbalance the normal thrust of the cylinder.

For this reason pump pressure must not be raised above 260 P.S.I. With any higher pressure the expansion arm would be moved downward in normal operation, allowing no movement of the expansion arm in event the fluid became heated. Any expansion of the fluid under such conditions would undoubtedly damage the regulator assembly.

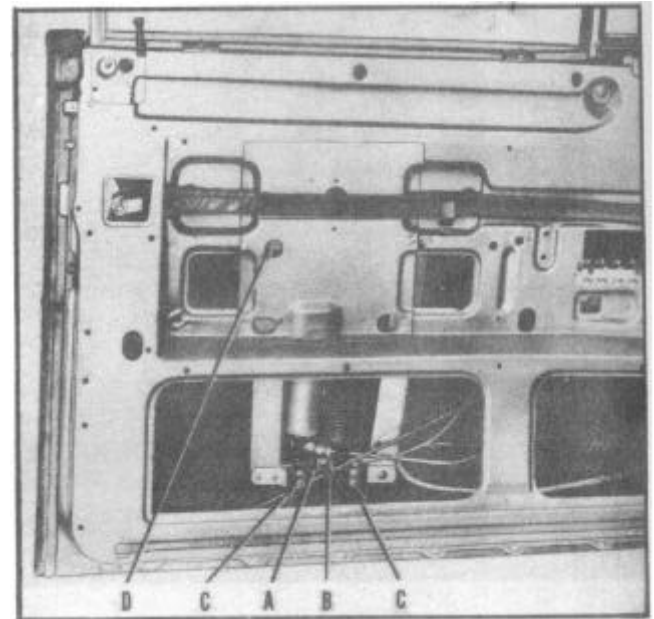

FIGURE 116

DOOR WINDOW REGULATOR ASSEMBLY

REMOVAL:

1. Remove inside trim and hardware. See Page 81.
2. Remove window glass and frame assembly. See Page 77.
3. Disconnect hydraulic tube (A), Figure 116, and solenoid electrical connection (B).
4. Loosen two 1/2" hex nuts (C) and remove upper retaining screw (D).
5. Remove regulator assembly thru bottom opening in door inner panel.

INSTALLATION:

1. Replace in reverse procedure of removal. Adjust regulator and glass. See Page 88.

NOTE: Manually operated regulator is removed as above except that it is fastened by screws to the inner panel near the regulator handle and behind the remote control arm.

DOOR WINDOW AND GLASS FRAME ASSEMBLY

REMOVAL:

1. Remove all inside trim and hardware from door. See Page 81.
2. With window in lowered position, loosen the 7/16 hex head bolts attaching window rest channel to regulator upper cross member. These bolts are located behind the side members of the regulator assembly and are accessible thru the bottom opening of the inner panel.

NOTE: These bolts need only be loosened as the tabs on the lower glass rest channel are slotted.

3. Slide window and frame assembly up and out of the top of the door.

INSTALLATION:

Reverse procedure of removal and adjust window as described under "Convertible Top and Window Adjustment," Page 86.

NOTE: Removal and installation procedure is the same for both hydraulically and manually regulated windows.

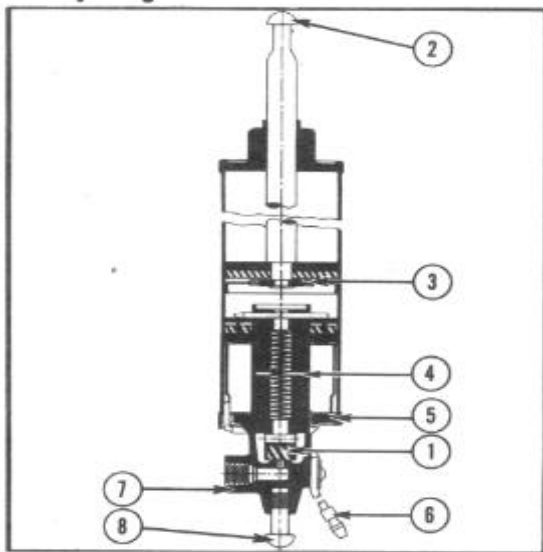

FIGURE 117

DOOR WINDOW REGULATOR CYLINDER

The door window regulator cylinder unit, Figure 117, consists of a tubular cylinder which is closed at one end

by a crimped-in formed cup which houses a saturated felt. This felt prevents the entry of dirt or water to the upper portion of the cylinder and lubricates the piston rod. The upper end of the piston rod (2) is mushroom shaped and fits into a formed seat on the cross arm. It is held in position by a spring steel retaining clip. At the lower end of the rod (3), an assembly of metal and synthetic rubber washers form the piston assembly. The lower end of the rod is riveted over to form a unit construction.

The lower end of the cylinder is closed by a spring seated, normally closed, solenoid operated valve (4), which, when electrically energized, opens to allow fluid to flow in or out of the cylinder. When closed, this valve traps the fluid in the cylinder, retaining the window in any desired position.

The piston in its extreme position is stopped on the solenoid sleeve to limit the movement of the window glass when fully lowered.

The solenoid assembly is provided with a synthetic rubber sealing ring at its upper end above the winding. This ring makes a leakproof seal for the lower end of the cylinder. The cylinder is crimped over to provide unitary construction.

A short wire lead extending from the lower end of the cylinder is provided with a bullet type terminal to which an electrical connection is made to operate the solenoid. The solenoid is grounded thru a wire soldered to the outside of the cylinder.

A boss (7) containing 1/8" internal dry-seal pipe threads for the hydraulic line connection is formed at the lower end of the sleeve. A mushroom-shaped, pressed in stud (8) at the extreme lower end provides a ball joint mounting identical to that at the upper end of the piston rod.

The upper end of the cylinder barrel is lubricated permanently with a synthetic graphite compound, and since the cylinder assembly is sealed with crimped-in ends, no repairs to the internal parts are possible.

When service is required the entire cylinder unit must be replaced.

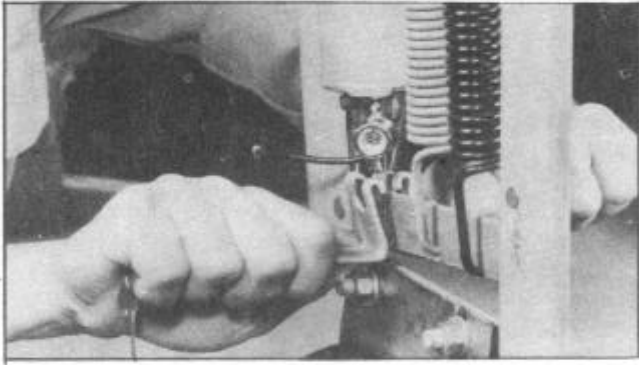

FIGURE 118

DOOR REGULATOR CYLINDER

REMOVAL:

1. Remove door regulator assembly, Page 76.
2. Clamp the regulator cross arm in a vise and remove upper and lower spring steel retaining clips, using tool KM0-623, Figure 118, and remove cylinder.

INSTALLATION:

Reverse procedure of removal. See NOTE for wing regulator assembly installation

2. Remove two hex head bolts (E), Figure 119, from wing mounting bracket.
3. Remove wing pivot to regulator screw (F).
4. Remove Phillips head screws (G and H) and lift door wing assembly up and out of door.

INSTALLATION:

1. Insert wing assembly in the door so that lower pivot fits into regulator shaft.
2. Insert pivot to regulator screw (F).
3. Insert, but do not tighten screw (G) and bolts (E).
4. Carefully raise door window and check alignment at wing assembly with door window. Then tighten screw (G) and bolts (E).
5. Insert and tighten screw (H) (Use a screwdriver to align bracket.)

DOOR VENTILATOR WING REGULATOR ASSEMBLY

REMOVAL:

1. Remove inside door trim and hardware, Page 81.
2. Remove pivot to regulator screw (F), Figure 119.
3. Remove two regulator mounting screws (I). Regulator may now be removed down thru forward end of door and out through bottom opening in inner panel.

INSTALLATION:

Reverse procedure of removal.

NOTE: To assure a water tight seal around the windows of the convertible, it is essential that the windows and top be properly aligned. Whenever any regulator unit or glass is removed and replaced, it is necessary to check the alignment and make adjustments before replacing interior trim.

Instructions for making adjustments to top and windows may be found on Pages 86 and 88.

Water test the windows after adjustment and correct if leaks are found.

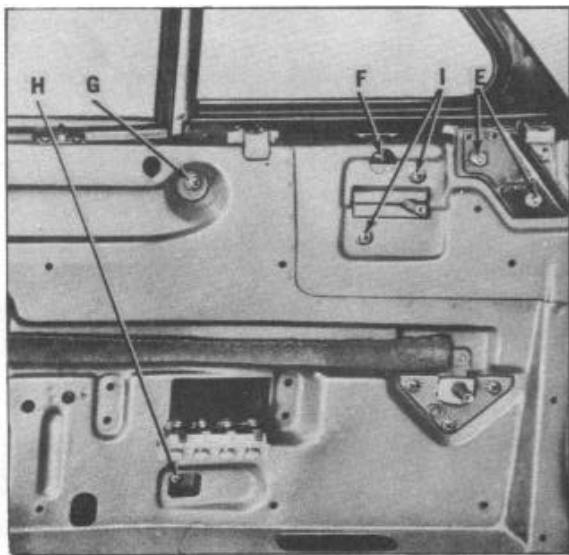

DOOR VENTILATOR WING GLASS AND FRAME ASSEMBLY

REMOVAL:

1. Remove inside door trim and hardware, Page 81.

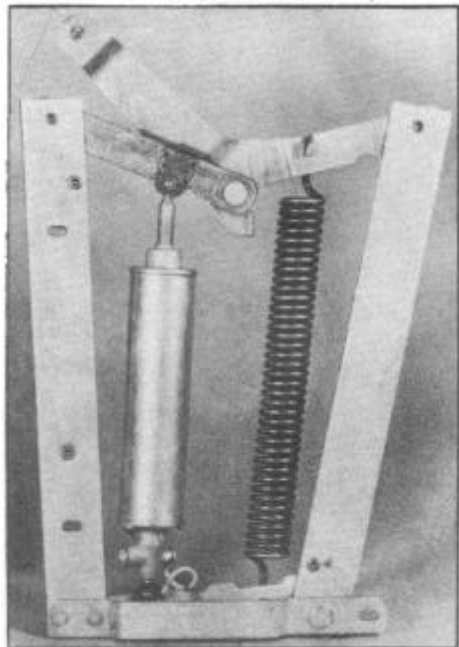

FIGURE 120

REAR QUARTER WINDOW REGULATOR ASSEMBLY

REMOVAL:

1. Remove rear seat cushion and rear seat back. See Page 82.
2. Remove all rear quarter panel trim on side on which work is to be performed. See Page 82.
3. Remove the windlace and tacking strips as a unit. Tacking strip is retained by two clips (A), Figure 121.
4. Remove screws (B) and one Phillips head screw (C) and quarter inner panel (G).

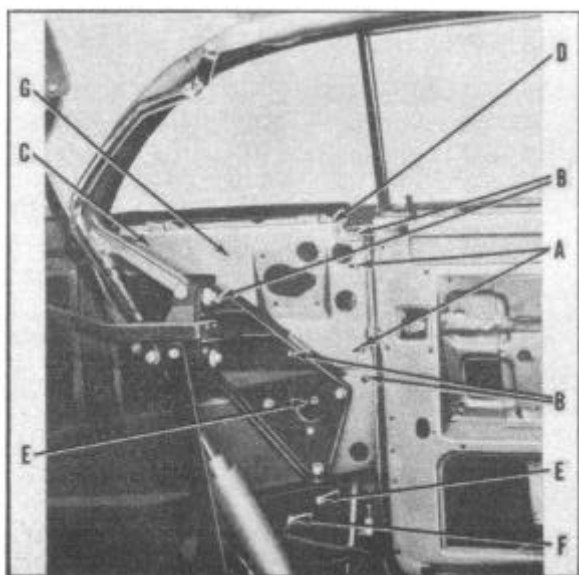

FIGURE 121

5. Remove quarter window pivot bolt (D) and three (3) hex head cap screws (E) from quarter window regulator. Disconnect hydraulic inlet-outlet tube (F) and solenoid lead wire and lift window and regulator assembly up and out of top of quarter panel.

NOTE: Manually operated regulator may be removed without removing quarter inner panel. With window removed, remove cap screw (B) and spring panel out until regulator may be lifted out.

WINDOW OPERATING SWITCHES

The double acting electrical window operating switches are provided with three terminal posts, each marked to indicate the correct wire connections. The operating knob is self centering and must be mounted so that there is no interference with the free movement of the knob.

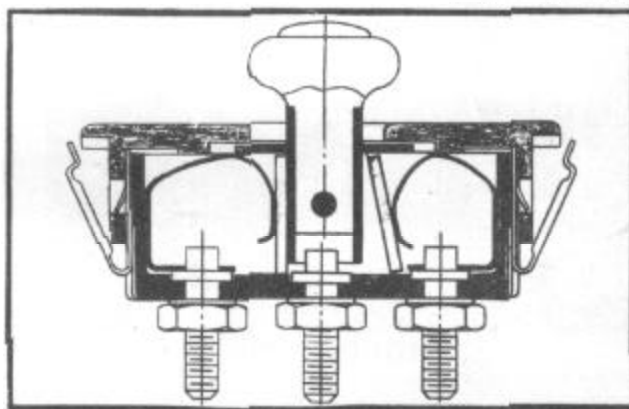

FIGURE 122

Figure 122 shows the position of the knob in the neutral position.

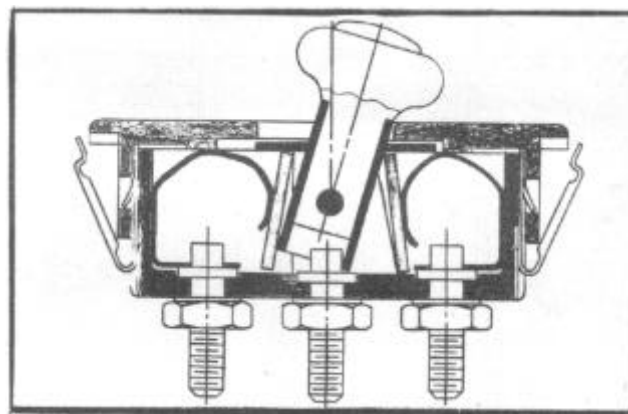

FIGURE 123

Figure 123 shows the knob in the window raising position.

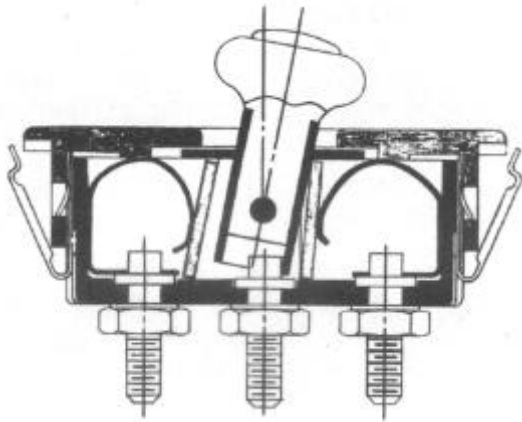

FIGURE 124

Figure 124 shows the knob in the window lowering position.

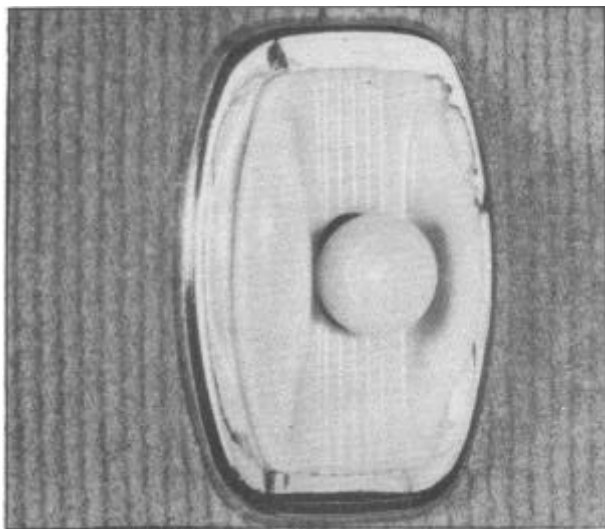

FIGURE 125

One single switch, Figure 125, is located at each rear quarter window and the right hand door window for independent operation; and one multiple switch, Figure 126, is mounted on the left door for the control of all windows.

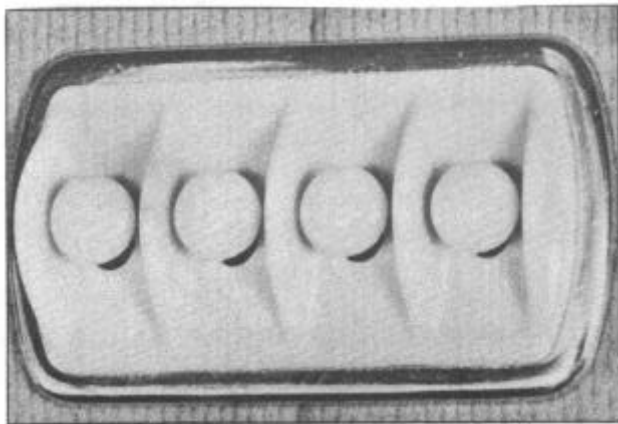

FIGURE 126

Spring clips at either end of the switch housing serve to hold the switch together, and to provide snap locks for holding the switch in position when mounted.

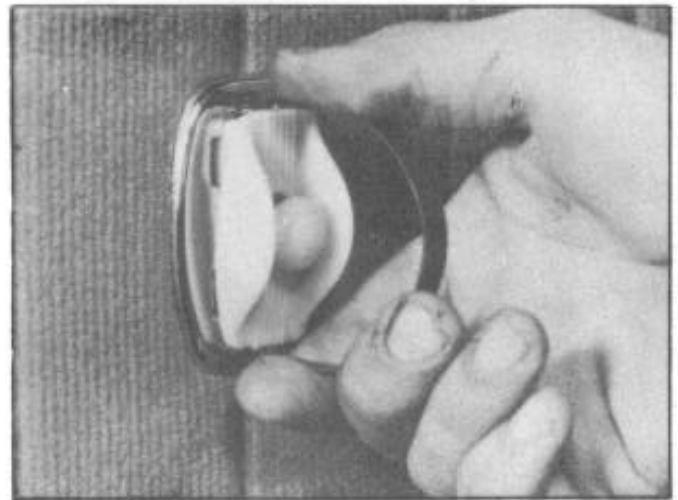

FIGURE 127

To remove a switch from its mounting, a special tool, KMO-685, is available. This tool fits in a notch at either end of the housing, Figure 127, to unlock the snap locks, releasing the switch assembly for removal straight out from its mounting in the door panel

Removal of switches must be done carefully as the switch housings are moulded of plastic.

When defective single switches are encountered, it is advisable to replace them as a complete unit.

MULTIPLE SWITCH UNITS

Separate switch units are replaceable in the multiple switch, eliminating the necessity of replacing the whole quadruple unit.

If one of the center switches has to be replaced, first remove the end unit next to the defective center unit. This is necessary since the control knob pivot pin can not be removed from either of the center switches without first removing the end switch:

REMOVAL:

1. Remove the two parallel buss bars attached to the motor and battery terminals of the switch units.

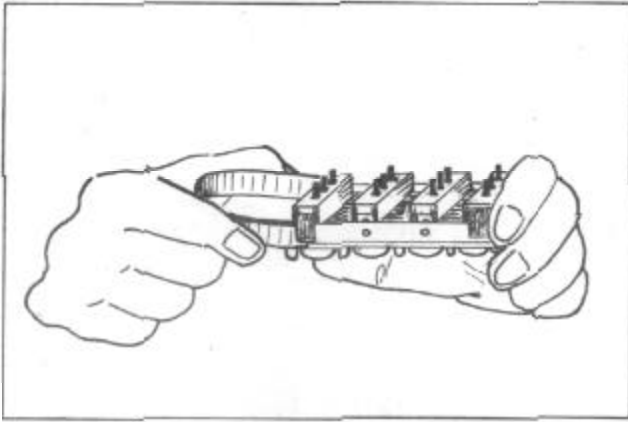

FIGURE 128

2. Depress the unit spring retaining clips with tool KMO-685 while pressing in on the control knob, Figure 128.
3. With a wire, push the brass pivot pin out toward the end of the switch case and remove the pin, Figure 129.

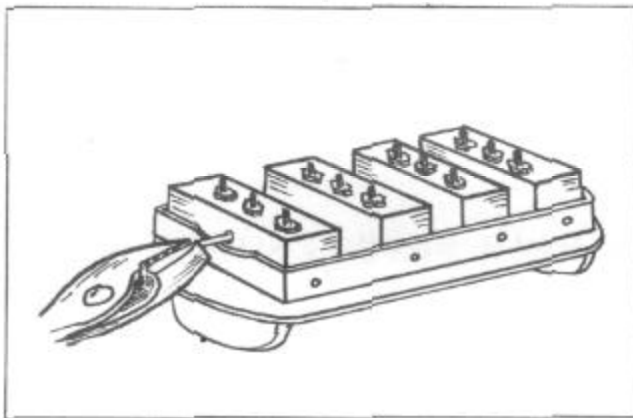

FIGURE 129

INSTALLATION:

Reverse procedure of removal, placing the insulator into the opening in the plastic case before starting the switch unit into the switch case.

The unit should be assembled in the case with terminal post marked "MOT" toward the top of the case.

**DOOR TRIM PANEL
(Commodore Series - Convertible)**

REMOVAL:

1. Disconnect battery cable at negative battery terminal.
2. Remove vent wing regulator handle and inside door handle.
3. Remove remote control knob (unscrew), garnish moulding, and valance

4. Remove two screws from under side of arm rest and remove arm rest.
5. Remove window regulator switch (electric) using tool KMO-685, Figure 127.

NOTE: The door trim can be removed at the left door without disconnecting wires from the switch by tipping the switch sideways and pushing the switch through the panel opening. At the right side, the switch must be disconnected before the panel can be removed'.

6. Remove door pocket trim panel, (clips).
7. Remove door trim panel ash receptacle and pocket moulding (clips). Pocket moulding is retained by the same clips that hold the door trim board.
8. Remove door pocket corner trim and fillers front and rear (cemented). Care must be taken in the removal of the front and rear corner fillers and trim leather to allow reassembling with good appearance.

**DOOR TRIM PANEL
(Super Series - Convertibles)**

REMOVAL:

Follow the same procedure as outlined for the Commodore Series, except as follows:

1. The trim cloth or leather cemented to the pocket bottom and front and rear corners are also part of the door trim-boards (held by staple clips) and care should be used in removal.
2. Window regulator and inside door handles are held in place by pin retainers. Depressing the escutcheon and spring will allow removal of the retainer pins.

DOOR TRIM PANEL INSTALLATION:

1. Cement pocket front and rear corner fillers to the door with trim cement.
2. Apply coating of trim cement over corner fillers and apply corner trim.
3. Lay pocket moulding in place.
4. On left-hand door draw the window regulator switch through the opening in pocket panel and install pocket panel. 5. Install the door trim board by engaging the bottom retainer and aligning the clips before driving in place.

6. Install valance panel by inserting lower flange between door and pocket trimboard with slots in line with the trimboard clips. Force down into position and install screws.
7. Install arm rest, garnish moulding, lock release knob, and window regulator switch.

QUARTER TRIM PANEL

The quarter trim panel consists of two separate panels; the forward (triangular) panel is held in place by two screws (B), Figure 130, under the garnish moulding (A) and two screws (C) and countersunk washers at the door pillar. A clip at the rear of the panel enters behind the rear half of the quarter trim panel.

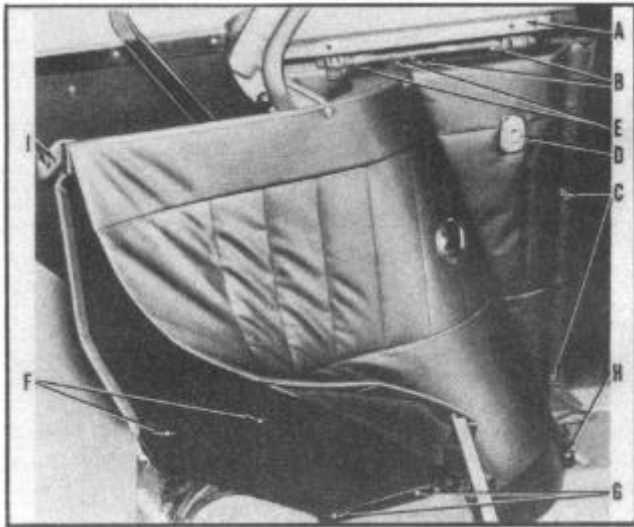

FIGURE 130

REMOVAL:

To remove the front half of the quarter trim panel, remove the garnish moulding (A), screws (B) and (C), and switch or regulator handle (D), Figure 130.

To remove the rear half of the quarter trim panel, proceed as follows:

1. Remove rear seat cushion.
2. Remove garnish moulding (A) and screws (E).
3. Remove rear seat back.
4. Remove two screws (I) from bracket in seat back.
5. Snap bottom trim strip from base of quarter panel and remove screw (H)

6. Raise rear corner of trim panel facing and remove screws (F) and (G).
7. Remove screw behind panel. This screw is located under the carpet that covers the pillar to wheelhouse brace.

INSTALLATION:

To install, reverse procedure of removal.

FRONT SEAT CUSHION AND SEAT BACK

REMOVAL:

1. Remove front seat cushion by raising front of cushion slightly and pulling cushion up and out.
2. Remove the four bolts attaching the bottom of front seat frame to seat track.
3. Remove two screws attaching seat adjusting lever to seat frame and remove seat back from car.

INSTALLATION:

To install, reverse procedure of removal.

REAR SEAT CUSHION AND SEAT BACK

REMOVAL:

1. Rear seat cushion is removed by lifting the forward edge and pulling the seat cushion forward.
2. Removal of seat exposes four hex head screws at bottom of seat back. Remove these screws.
3. Remove two Phillips head screws from each side of the top of the back at rear quarter trim panel support and remove seat back.

INSTALLATION:

To install, reverse procedure of removal.

DOOR OUTSIDE HANDLE

To remove the door outside handle, remove Phillips head screw (A), Figure 131, from edge of door. Push handle forward and lift handle out of door.

To install, reverse procedure of removal.

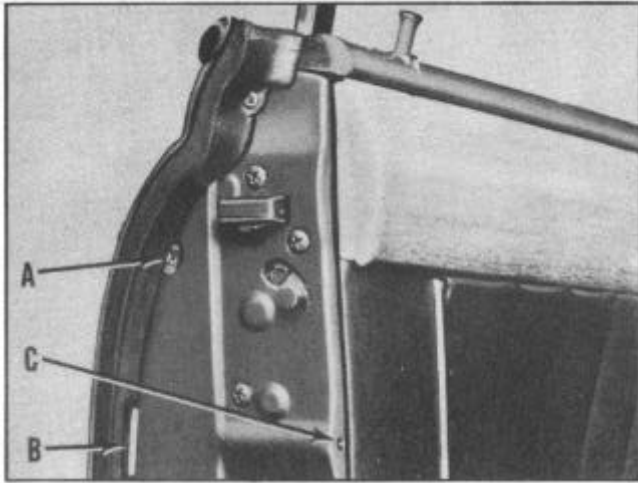

FIGURE 131

DOOR LOCK CYLINDER

REMOVAL:

Insert a screwdriver under the flanged edge of the lock retainer (B), Figure 131, and pry outward. This will release the lock cylinder assembly for removal from the door. (Do not remove lock retainer.)

INSTALLATION:

1. Insert a stiff wire or an awl through the hole (C) on the inside of the door opposite the cylinder opening.
2. Place recessed end of lock shaft on the end of the wire and, keeping the two firmly together, press the lock assembly into the door using the wire as a guide.
3. Press the lock retainer into position by hand as far as possible, then, using a fibre hammer, drive the retainer in flush with the door.

DOOR LOCK REMOTE CONTROL

REMOVAL:

1. Remove all door trim panels. Page 81.
2. Remove three screws (E), Figure 132, from triangular bracket (F) at the handle end of remote control arm.
3. Remove anti-rattle spring (D) and pin from lock end of remote control arm and remove remote control.

INSTALLATION:

To install, reverse procedure of removal

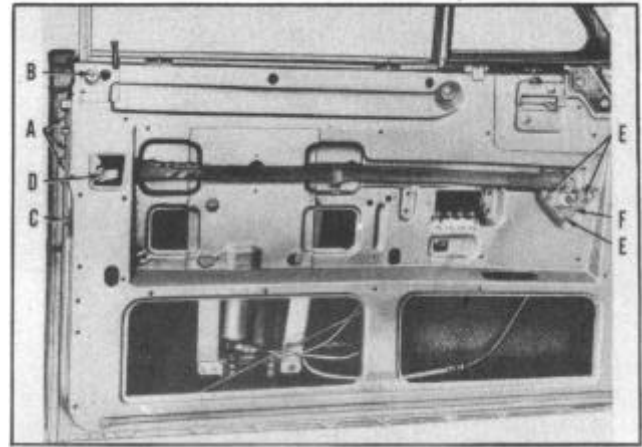

FIGURE 132

DOOR LOCK

REMOVAL:

1. Remove door outside handle, Page 82.
2. Remove door lock cylinder assembly. (Above).
3. Remove all door trim panel. Page 81.
4. Raise window and remove window guide channel screws (B and C), Figure 132, and remove channel by pulling channel down.
5. Remove three large Phillips head screws (A) attaching lock to edge of door.
6. Remove remote control anti-rattle spring (C) and pin connecting remote control arm to lock.
7. Remove lock down through lower opening of door inner panel.

INSTALLATION:

To install, reverse procedure of removal.

LOCK LUBRICATION

Whenever door locks, lock cylinders, or remote control arms are removed, they should be cleaned and lubricated before replacement. Special Hudson "Lock Ease" lubricant should be used to insure operation in cold weather. Ordinary oils and greases are not suitable for lock mechanisms. To prevent the remote control arm from freezing and sticking, lubricate the arm under the silencer sleeve and the outside of the sleeve that contacts the door inner panel.

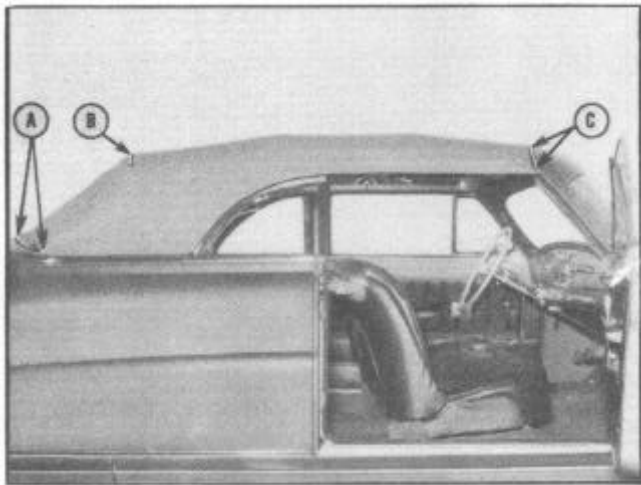

FIGURE 133

CONVERTIBLE TOP AND REAR CURTAIN

REMOVAL:

Rear curtain removal includes items thru 6. Top and rear curtain removal includes items 1 thru 8. Removal of top decking only includes items 1,2,3,4,7, and 8.

1. Remove snap fasteners and chrome moulding from rear belt line (A), Figure 133.
2. Remove 6 Phillips head screws and tacks from top and rear curtain at belt line (A).
3. Remove chrome moulding and retainer from top at rear bow (B).
4. Remove all tacks from top at rear bow (B). Fold top material forward over bows.
5. Remove tacks from top side pads at rear bow (B). Fold pads forward over bows.
6. Remove tacks from rear curtain at rear top bow (B) and remove rear curtain.
7. Remove top, front header rear chrome moulding (C) (narrow) and retainer.
8. Remove all tacks from top at front header (C). Remove top material and clean all sealing compound from area between two top front header chrome mouldings. Lightly hammer down all tack holes in all tacking strips.

INSTALLATION

Rear curtain installation includes items

1,2,3,4 and items 7,8, and 9.

Top and rear curtain installation includes items 1 thru 11.

Top decking only includes items 3 thru 11.

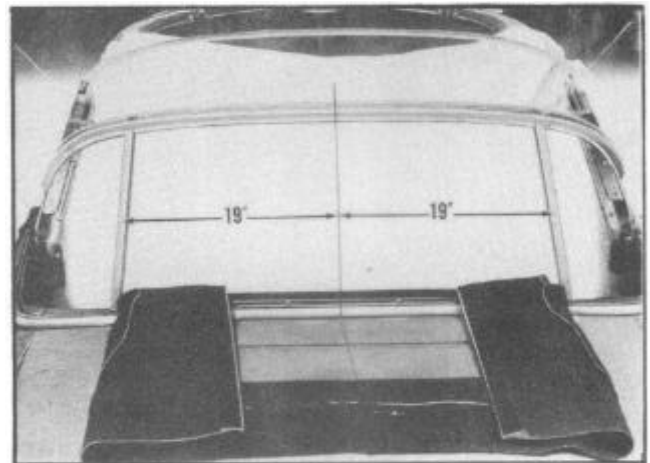

FIGURE 134

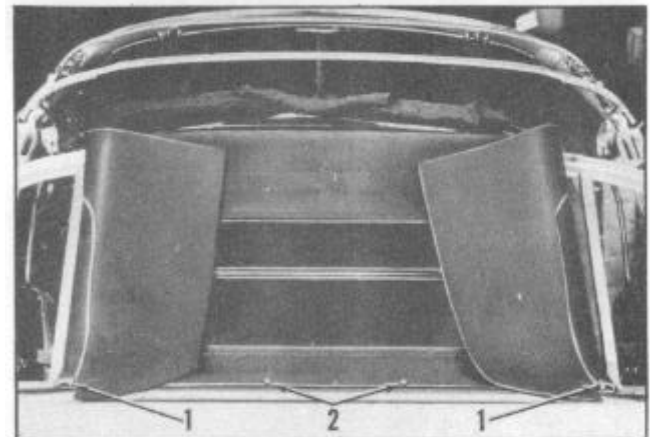

FIGURE 135

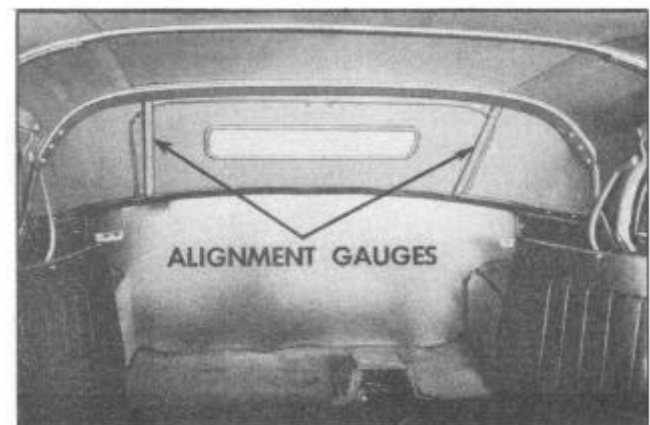

FIGURE 136

1. Install two rear curtain alignment gauges with the slotted ends engaging the rear bow and the tapered end (with the metal retaining strap on) braced against the rear belt line of the body, one on each side, 19" from center line of body, Figure 134.

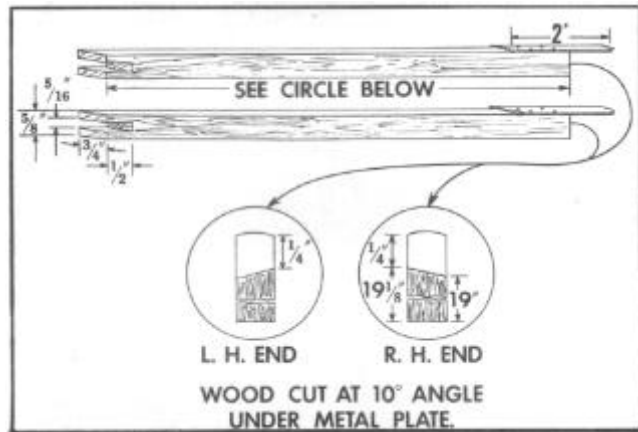

FIGURE 134

NOTE: The rear curtain alignment gauges can be made up in your shop. See Figure 137 for details.

2. Insert two sharp-pointed tools thru the two outer screw holes at the bottom of the rear curtain and into corresponding two screw holes in the body at belt line, Figure 135. Remove the tools and install the two Phillips head screws at 1 and the two screws at 2. (This procedure will position and center the rear curtain for tacking, at the top rear bow.) Pull the rear curtain straight

and snug to top rear bow and securely tack in place. Trim excess material

closely. Allow the alignment gauges to remain in place until top decking and curtain are installed, Figure 136.

3. Tack top pads in place on top rear bow, making certain that the lower outside edge joins the outer end of the rear curtain at the top rear bow. Pull top pads securely to produce a clean, smooth contour and tack to front header. Tack pad to each bow with one tack through upper and one through the lower edge of pad.

4. Unfold top over rear top bow and rear curtain. Secure rear ends of top at the belt line with the two awls used for the rear curtain. Be certain that the top fits squarely in line with the body.

5. Insert stiff top retaining flaps into retainers at side belt line, and at rear quarter windows. At this point, move forward and pull top material into position at each front corner. Secure with an awl on each side inserted into the top front header rear chrome moulding (narrow) screw holes. Stretch and tack material to top front header, starting at the outside edge and continuing upwards along top front header for approximately 6" on both sides. Fit and tack rear edge of slotted opening in top material to rear bow first and trim excess material closely. Then overlap front edge of opening and tack securely to rear bow. Trim excess material to form smooth joint over rear bow and cover tacked area thoroughly with waterproof top sealer.

NOTE: The tacking operation must be done carefully at the rear top bow to produce a smooth contour.

6. Finish stretching and tacking at front header and trim off all excess material. Apply water proof top sealer liberally over tacking area of the top material at front header.

7. Install top rear bow chrome moulding and retainer.

8. Install a Phillips head screw and necessary tacks to secure curtain and top at belt line.

9. Install chrome moulding at rear belt line.

10. Install top front header rear chrome moulding (narrow) and retainer. This moulding must be spaced 3/16" from top front header front chrome moulding (wide) to allow sufficient area between the mouldings for proper application of sealing compound. Apply gray Dolfinite sealer between two top header chrome mouldings. Apply slowly and with enough pressure to force sealer into the bottom of the opening. After sealer is applied the full width of the top, wipe the sealer in thoroughly to remove air bubbles. Wipe carefully so as to remove only the excess sealer and produce a smooth well sealed joint.

11. Allow Dolfinite to set 1/2 hour

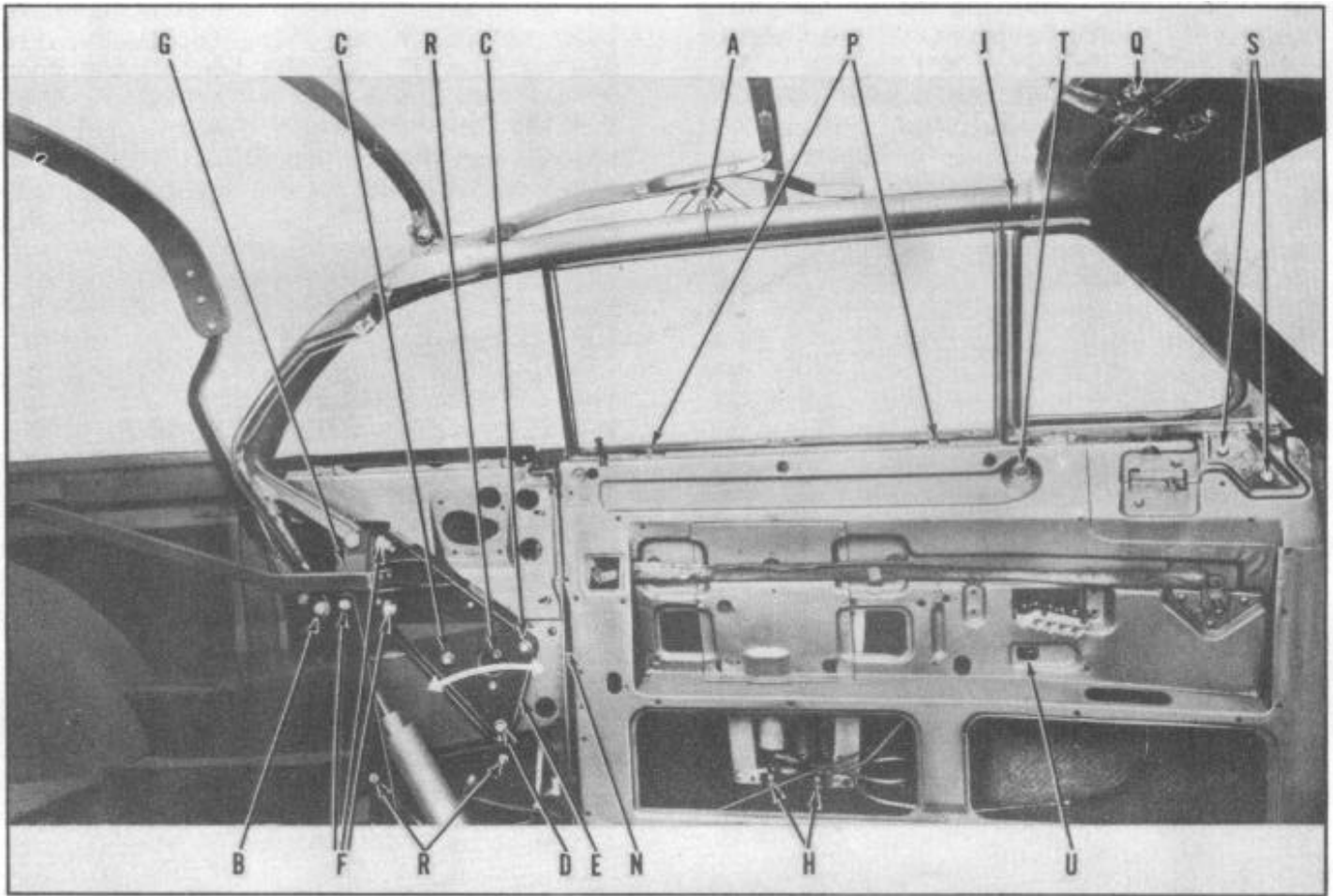

FIGURE 138

before water test. Wet top thoroughly and allow to dry completely in a warm room. This will shrink out any minor wrinkles which may have occurred due to the top material being folded before installation.

CONVERTIBLE TOP AND WINDOW ADJUSTMENTS

Proper adjustment of the Convertible folding top is important in assuring satisfactory operation.

Following procedures and measurements are to serve as a guide in making proper adjustments.

TOP ADJUSTMENT:

1. Raise top and clamp securely to the windshield header.
2. Raise rear quarter windows to full closed position.

3. Back out the side rail adjusting screw at A, Figures 138 and 139. This screw must not be making contact inside of the side rail hinge when starting a major top adjustment.
4. Loosen anchor bolt attaching top balance link to top pivot bracket at B, Figure 138.

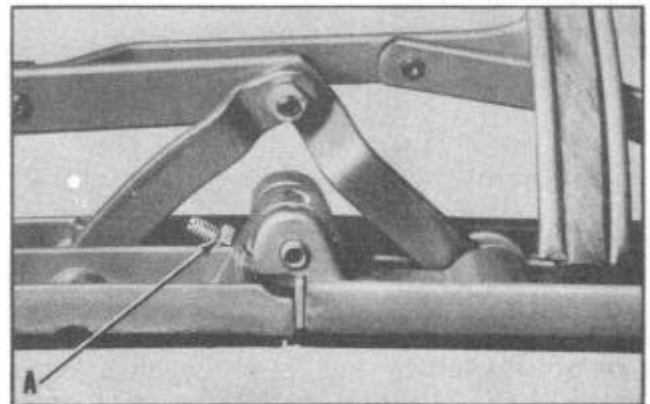

FIGURE 139

5. Loosen the hex head bolts attaching top pivot bracket support to rear pillar to wheelhouse brace at (C) and (D). Bolt holes at (C) are slotted. Bolt (D) is a pivot bolt for movement of bracket (E) forward or backward in an arc to lengthen or shorten the top assembly in relation to the windshield header. Make necessary lateral adjustment and tighten bolts (C) and (D) securely.

6. Loosen bolts (F) and move bracket (G) up or down, in or out, until 5/8" clearance is obtained between the top front corner of the rear quarter window and the top side rails, and 5/8" between the lower rear corner of the rear quarter window and the side rails at the belt line, Figure 140. Use a 5/8" wood gauge as shown. This 5/8" measurement is important in producing correct operation of the top.

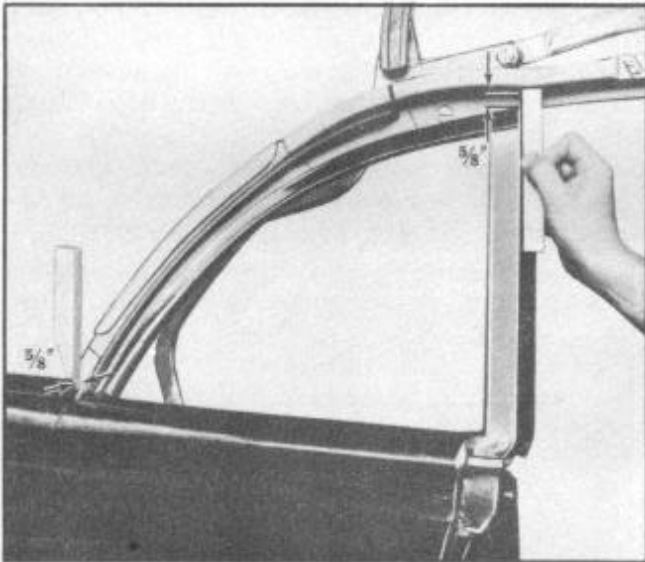

FIGURE 140

7. Unhook top from windshield header and raise top about 6" from header. Cut two wooden blocks to fit over top of the quarter window and hold side rail 4" off the quarter window (highest point with window raised). Locate blocks on quarter windows and allow side rails (weatherstrip removed) to rest on the blocks. With the blocks in position, the balance link anchor bolt is correctly positioned in the slotted hole of the top pivot bracket. Tighten bolt (B) securely. Remove adjusting blocks and again clamp the top to the windshield header. Raise door windows to the closed position.

8. If, after these adjustments have been carefully made, the top side rails are not level with the top of the door window, adjust screw at A, Figure 138. Turning the screw in lowers the side rails; turning the screw out raises the side rails. Re-tighten jam nut on adjusting screw.

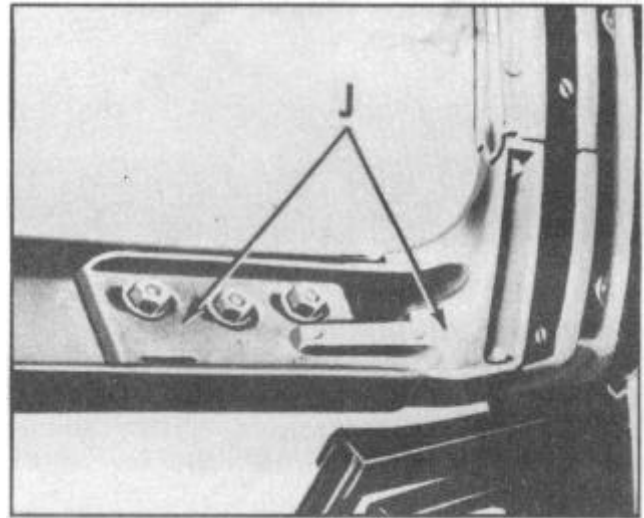

FIGURE 141

9. The top side rail front corner bracket, (J), Figures 138 and 141, is pre-adjusted at the factory with three bolts set midway in the adjustment slots.

NOTE: THIS SETTING IS NOT TO BE ALTERED UNLESS ALL OTHER POSSIBLE ADJUSTMENTS HAVE FAILED TO PRODUCE THE DESIRED RESULTS.

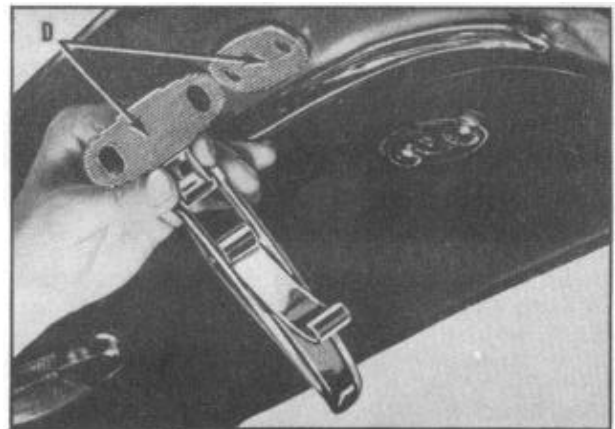

FIGURE 142

10. The top hold-down clamps (Q), Figures 138 and 142, are attached with a serrated mounting plate to allow suitable spring tension adjustment and top front header sealing.

WINDOW ADJUSTMENTS

QUARTER WINDOW:

Before attempting any door window adjustments, the quarter window must be properly positioned as follows:

1. Loosen screws (R) Figure 138, to obtain the proper forward adjustment.
2. Insert rubber shims under the front edge of the rear quarter window to align the rear quarter window with the door glass.

NOTE: In the fully raised position, the front edge of the quarter window rests on the rubber weatherstrip on the door lock pillar.

DOOR WINDOW:

The door glass has four, adjustments to provide proper alignment with the top side rails and the rear quarter window as follows:

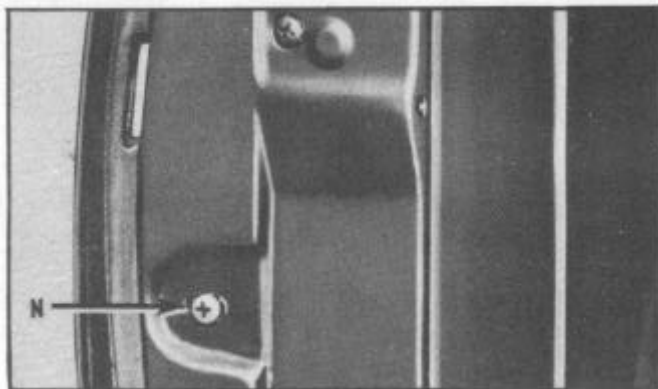

FIGURE 143

1. To bring the rear of the door glass into alignment with the rear quarter window, the glass run channel may be adjusted in or out by moving screw (N) Figure 143, attaching the channel to the lock edge of door.
2. If satisfactory adjustment cannot be made at this point due to bottom of channel striking the door outer panel, it will be necessary to remove the channel and cut off part of the lower outer corner of the channel to allow outward adjustment of the channel to the limit of the adjusting screw slot. In extreme cases it may be necessary to extend the screw slot by filing the slot with a round file.
3. The adjustable window stops shown at (P) Figure 144, which are accessible when the door garnish moulding is removed, are for the purpose of making minor adjustments

of the door window travel to assure full contact with the side rail weatherstrip.

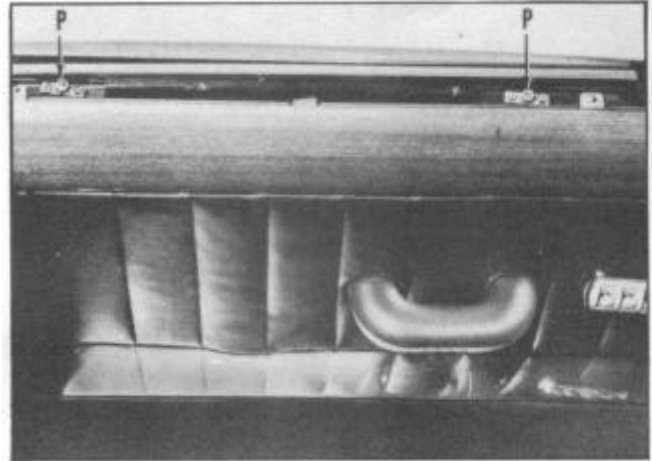

FIGURE 144

4. The hydraulic window regulator mounting is slotted to allow raising, lowering, or tilting forward or rearward of the regulator as required see (H), Figure 145.
5. The door window glass rest channel is also slotted and may be adjusted in the same manner as the regulator assembly.

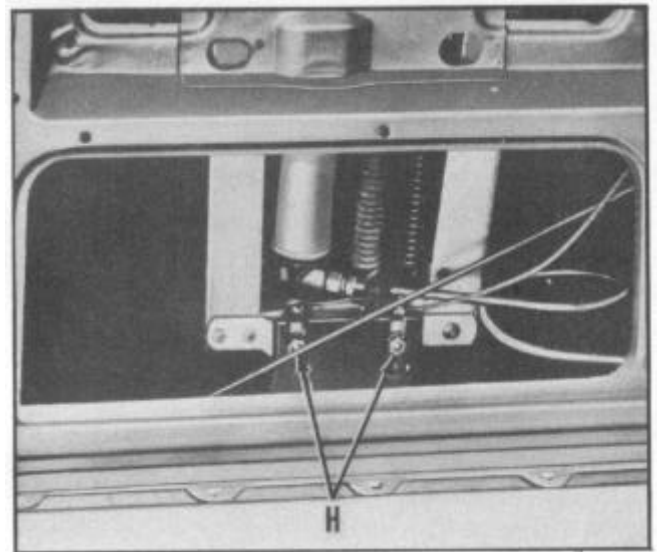

FIGURE 145

VENT WING:

1. Remove two screws (S) Figure 138, attaching the wing cradle to inner panel.
2. Loosen screw (T) attaching center glass channel to upper edge of inner panel and remove screw (U) attaching lower end of center channel to inner panel.

3. To tilt vent wing inward insert a washer or washers between wing cradle and inner panel at the upper wing cradle attachment screw (S). Install and tighten both screws. (To tilt outward, insert washers at lower attaching screws (S)).

4. Tilting the glass inward moves the bottom of the center glass channel away from the inner panel. Washers should be inserted between the lower end of the channel (U) and the inner panel, to hold channel in position. Retighten screws (T) and (U).

HYDRO-LECTRIC SERVICE INFORMATION

The operation of the hydraulic top and window units in the Hudson Convertible Brougham is accomplished through the use of a electrically operated hydraulic pump, single action hydraulic window cylinders, and double action hydraulic top operating cylinders. The electric pump motor is operated through a solenoid switch on the side of the motor, and each window cylinder is operated through a solenoid switch incorporated in the cylinder.

To make a complete check, both the ELECTRICAL system and the HYDRAULIC system must be considered. The hydraulic system includes the hydraulic pump, pressure relief valve and fluid reservoir, the top operating valve, top and window operating cylinders, fluid lines, and the hydraulic fluid. The electrical system includes the

battery, circuit breakers, top operating valve and switch assembly, window switches, motor solenoid, motor, window cylinder solenoid valves, and all connecting wires.

The first step in checking any Hydro-Lectric system that fails to operate, or which operates slowly, is to check the battery gravity reading, Figure 146. For efficient operation, the battery reading should not be lower than 1225. A low battery may result in slow operation of the pump motor or faulty operation of the motor solenoid switch and the window cylinder solenoid valves.

CAUTION: Before any check of fluid level, disconnect negative cable at negative battery terminal. Since the hydraulic fluid is inflammable, any accidental sparks may ignite spilled fluid.

If the pump motor operates and the battery gravity reading is at least 1225, unsatisfactory operation may be due to low fluid level in the fluid reservoir. Low fluid level is usually indicated when the pump operation is noisy or when it is impossible to raise all the windows; that is, one, two, or three windows may go up satisfactorily, but pump may become noisy and only partially close the fourth window while the other three are up.

To check the fluid level in the reservoir, lower all windows and raise the car.

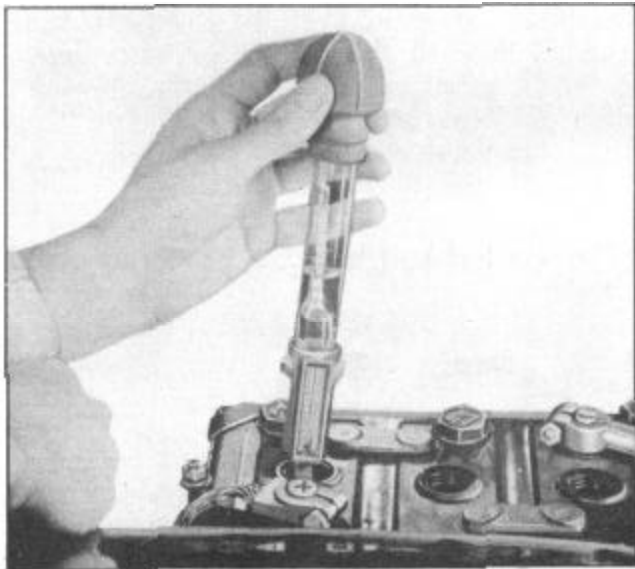

FIGURE 146

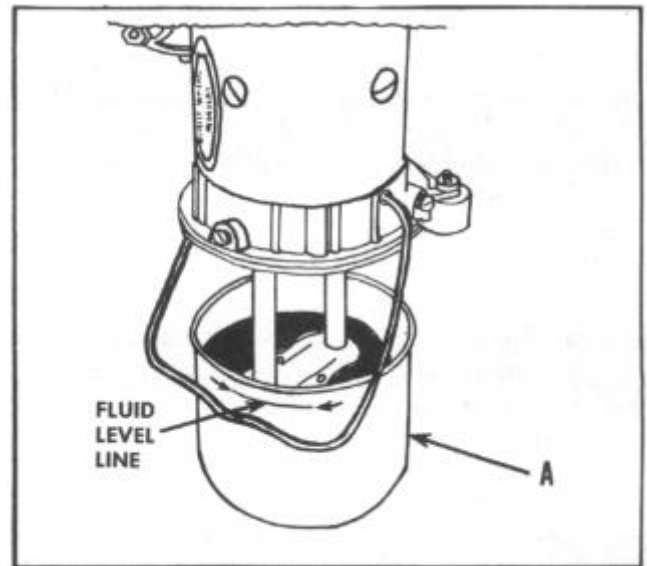

FIGURE 147

NOTE: It is not necessary to lower the top to check fluid level. Since the top operating cylinders are double action cylinders, the amount of fluid in the cylinders remains constant.

Remove the plate from bottom of pump well and remove fluid reservoir, Figure 147, If the fluid level is low, add enough fluid to bring the fluid level up to the line on the fluid reservoir. If the fluid is dirty, the system should be drained as explained on Page 71, and new fluid substituted.

ELECTRICAL SYSTEM CHECK

Inoperative solenoids or switches shorted, grounded, or open circuits will cause failure of the electrical system as will a low battery.

CIRCUIT BREAKER CHECK

If the hydraulic pump motor fails to operate when the top operating knob is moved in or out, or when window switches are moved to "up" position, electrical current may not be entering the system. Use a test lamp to check the current at the circuit breaker located under the instrument panel to the left of the steering column. On Convertible Broughams equipped with hydraulic window regulators, a 30 ampere circuit breaker is provided in addition to the standard 20 ampere circuit breaker. Apply one lead of the test lamp to the battery (forward) terminal of the standard circuit breaker, which is located above the 30 ampere circuit breaker, and ground the other lead. If the lamp fails to light, no current is reaching the system and the power lead to this terminal from the "BAT" terminal of the voltage regulator should be checked for short or open circuit.

If the lamp lights, move the test lead to the auxiliary (rear) terminal. Failure of the lamp to light here indicates the circuit breaker is faulty and should be replaced. Move test prod to rear terminal of 30 ampere circuit breaker if car is equipped with hydraulic window regulators. No light at this point indicates faulty connection between "BAT"

terminal of 20 ampere, circuit breaker and "BAT" terminal of 30 ampere circuit breaker.

When the test lamp lights from the rear terminal of the 30 ampere circuit breaker move probe to forward or "AUX" terminal. No light at this point indicates faulty circuit breaker.

WINDOW LIFT CONTROL SWITCH CHECK

With current reaching the "AUX" side of the 30 ampere circuit breaker, the pump motor should operate when window switches are moved to "up" position. If motor fails to operate, or if windows fail to open with switch in "down" position, each switch should be removed and checked.

NOTE: If motor operates when quarter window switches are moved "up" but fails to operate from door switches, a loose connection or broken wire at the forward terminal on the top operating switch is indicated.

The window control switches are held in place by spring clips and may be removed by using Switch Removing Tool No. KM0 685.

With terminals on back of switch exposed, ground one lead of the test lamp and attach one lead to the center terminal, marked "BAT". This terminal is normally "hot", and the light should light with the switch control knob in any position. With the knob in "up" position, the upper or "MOT" terminal should light the test lamp. Current should reach the lower or "CYL" terminal with the control knob in both "up" and "down" positions.

TOP OPERATING SWITCH TEST

If top is up, unhook top from windshield header before testing top operating switch.

Check adjustment of top control rod. The rod should extend 1/8" through the retainer on the switch, and there should be 1 3/8" clearance between the base of the top control knob and the face of the

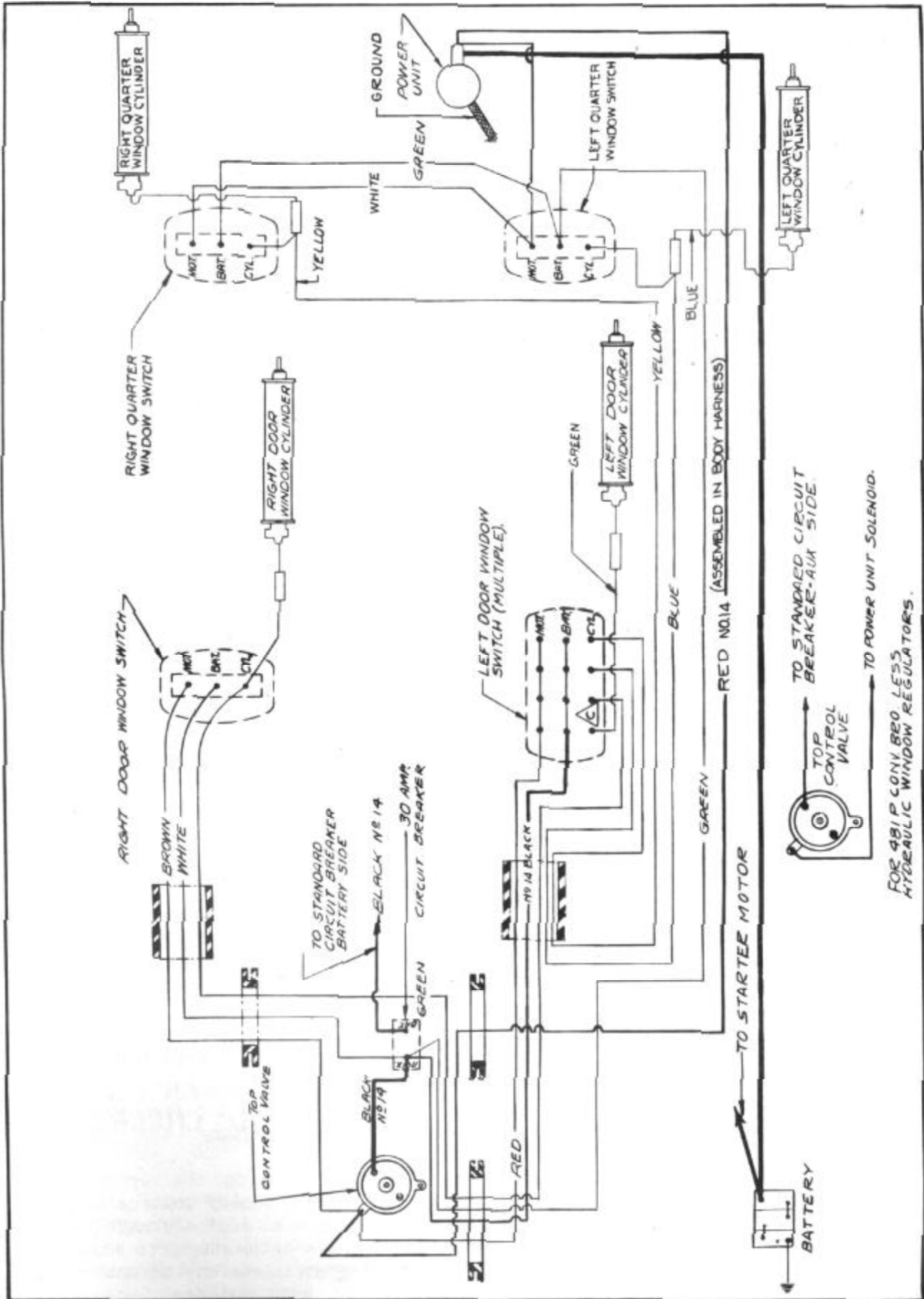

FOR 481 P CONV BEO LESS HYDRAULIC WINDOW REGULATORS.

FIGURE 148

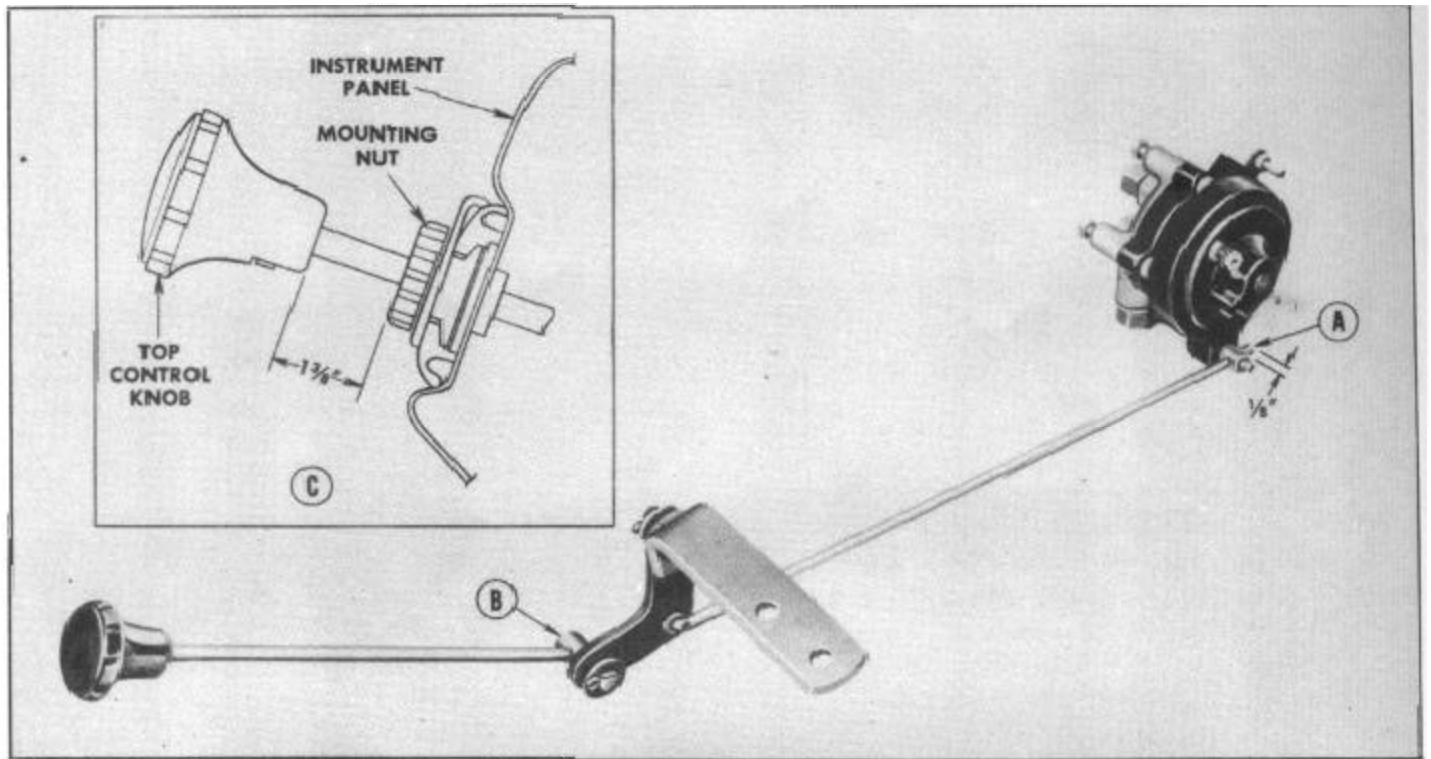

FIGURE 149

retaining nut on the instrument panel. See Figure 149. The pump motor should operate when the top operating knob is pulled out or pushed in. If motor fails to operate, use the test lamp to check whether current is reaching the switch. Current is carried to a terminal on the face of the switch from the "AUX" terminal on the circuit breaker. If current is reaching the switch, failure of the test lamp to light from the side terminal when the top operating knob is pulled in or pushed out indicates that the switch is inoperative and should be replaced.

MOTOR SOLENOID SWITCH CHECK

If the foregoing tests indicate correct battery gravity, and if window and top operating switches operate satisfactorily, but motor fails to operate, it will be necessary to remove the rear seat cushion and rear seat back to gain access to the well containing the Hydro-Lectric unit.

Check the connections from the battery to the solenoid switch and from the solenoid to the motor.

Current should reach the switch (center) terminal of the motor solenoid when window switches are moved up or top control knob is moved in or out. A distinct "click" will be heard if solenoid is operating satisfactorily.

If current does not reach the switch terminal, wires from the window and top operating switches should be checked for open or short circuit. Operation of the solenoid may be checked by disconnecting the wires from the switch terminal and connecting a jumper from the battery terminal to the switch terminal. If solenoid is satisfactory, the solenoid will "click", and the motor will operate. If no click is heard with the jumper in place, the solenoid switch should be replaced.

WINDOW POWER VALVE SOLENOID CHECK

In normal operation the window power valve solenoid should make a distinct "click" when the window control switch knob is moved up or down. If this click is not heard, check the window control switch.

When the window control switch operates satisfactorily, remove the trim panel to expose the window operating cylinder. The solenoid valve can frequently be freed by several sharp taps on the base of the cylinder. If the solenoid continues inoperative, check the small copper ground wire on the base of the cylinder to see that it is not broken or unsoldered. Break the snap connection in the wire from the switch to the cylinder and connect a jumper from the cylinder wire to the hot (BAT) terminal of the window operating switch. If the click is still not heard, the solenoid is defective and cylinder must be replaced. If the click is heard with the jumper in place, the wire between the window operating switch and the cylinder should be replaced.

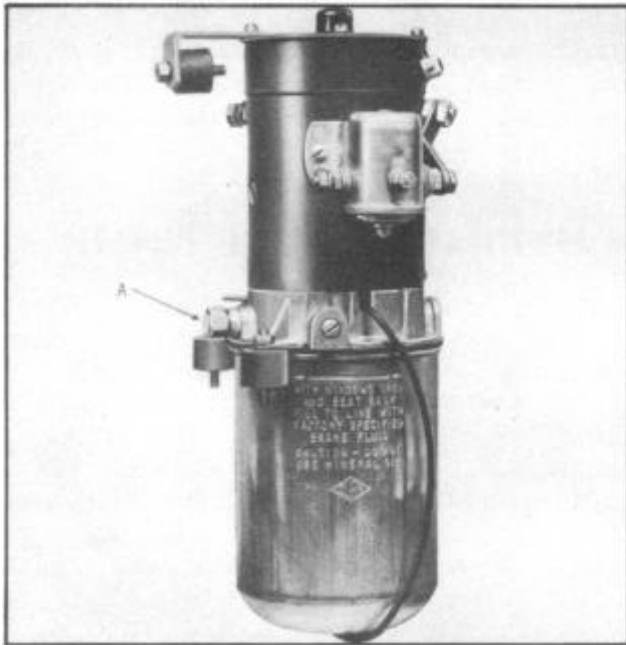

FIGURE 150

HYDRAULIC SYSTEM

PRESSURE RELIEF AND FLOW CONTROL VALVE

A piston type, spring loaded pressure relief and flow control valve controls the fluid pressure of the hydraulic pump, Figure 150. The valve is adjusted to a minimum of 250 pounds and a maximum of 260 pounds per square inch, and under no circumstances should it be changed to provide a higher pressure. In conjunction with the tension spring on the valve, washers are also added

under the head of the plug to allow for necessary adjustment or variation in pressure. The addition of washers reduces the pressure while the removal of washers increases the pressure. When cleaning and servicing this valve, USE THE SAME WASHERS THAT WERE REMOVED, AND ALWAYS BE SURE THAT THE SAME NUMBER OF WASHERS ARE REPLACED WHEN REINSTALLING THE PLUG.

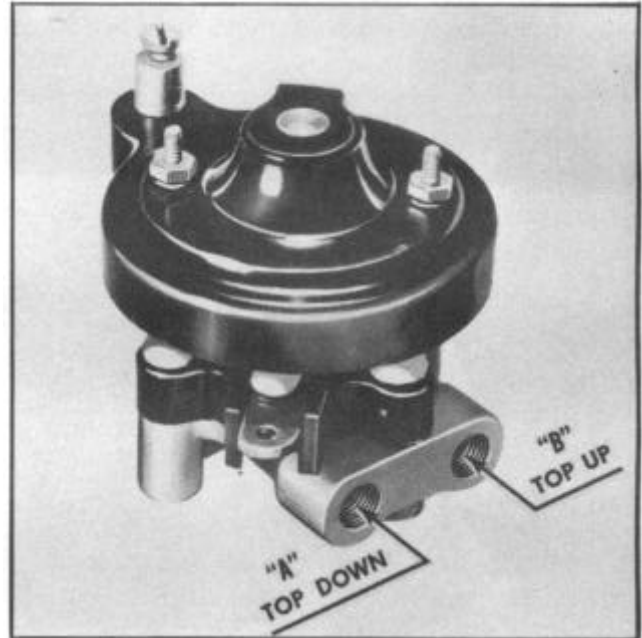

FIGURE 151

TOP OPERATING CONTROL VALVE

Unsatisfactory operation of the hydraulic system may result from scored or worn faces in the top operating valve, allowing internal leakage from one port to another. A check of this condition may be made at the top operating valve. First make sure the top control rod has proper clearance and that the self centering springs in the valve return it properly to a neutral position. Then, holding a cloth below the connection to catch any spilled fluid, disconnect the fluid return line at the top operating valve. (The fluid return line is the lower of two lines entering the left side of the top operating valve.) DO NOT MOVE TOP OPERATING KNOB WHILE THIS LINE IS OPEN.

With the fluid return line open, raise one or two windows. Any internal leakage or pressure loss in the valve will

be indicated by a discharge of fluid from the valve port. Such discharge indicates a defective valve and replacement should be made.

FLUID LEVEL

Procedure for checking the fluid level in the fluid reservoir is to be found on Page 90.

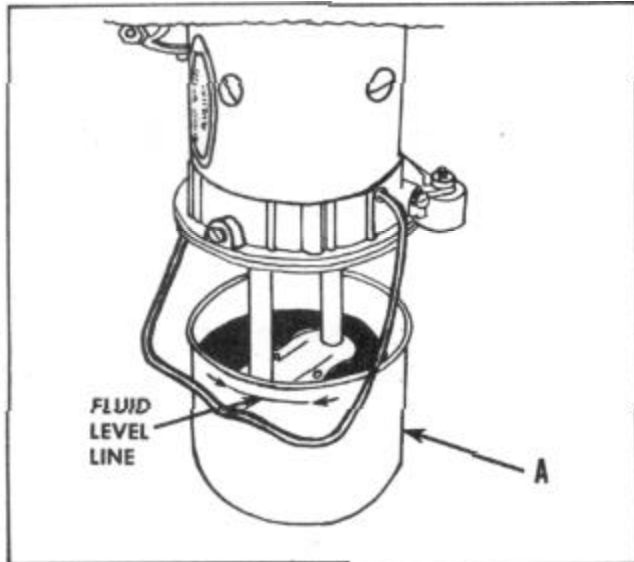

FIGURE 152

REFILLING THE HYDRAULIC SYSTEM

1. With the car raised on a hoist, remove the reservoir (A), Figure 152, and fill to the fluid level line with hydraulic fluid.

NOTE: Inasmuch as the two top operating cylinders have a fluid capacity nearly double that of the reservoir, more than one filling is necessary before the folding top can be raised or lowered with the exclusive use of the hydraulic system.

2. Raise and lower the top several times to admit fluid and expel air from the system. It will be necessary to assist the movement of the top manually until sufficient fluid has entered the system to afford independent hydraulic operation.

3. Remove reservoir and refill as necessary to fluid level line. Operate all windows several times to expel air from that part of the system.

4. With all hydraulic units operating satisfactorily, lower all windows and the folding top and again check the hydraulic fluid level in the reservoir. The fluid in the reservoir should now be up to the fluid level line.

5. Check all hydraulic connections for leaks.

BLEEDING HYDRAULIC SYSTEM

Bleeding, as ordinarily meant by the term, is unnecessary with the Hydro-Lectric system. An air vent is provided

in the pump body to allow air to enter and escape from the system. Operating the units several times while refilling the system frees the lines and cylinders of air.

HYDRAULIC PUMP PRIME

When the motor and pump operate, but top and windows fail, lack of "prime" in the pump is indicated. Make sure the fluid level is up to the line on the fluid reservoir. To check for priming, remove seat cushion and disconnect flexible line from TEE in front of pump. This flexible line is the pressure line from the side of the pump. Insert this flexible line into a container to avoid spilling fluid and operate pump briefly two or three times. No fluid flow from this line indicates the pump lacks prime.

To prime the pump, disconnect the fluid return line at the front of the pump. Fold thumb tightly over return port in pump and run pump a few seconds until fluid is expelled from the pressure line. Reconnect lines and check the fluid level in the reservoir, Figure 152.

If pump frequently loses prime, a leak is indicated at some point in the return line.

TROUBLE SHOOTING

Condition	Hydraulic	Electrical	Mechanical
1. Top will operate in one direction only.	(A) Top control valve shaft and rotor not assembled properly.	(A) Top control valve switch contacts at one point only.	(A) Top valve control rod improperly adjusted.
2. Top will not operate.	(A) Foreign material in fluid lines. (B) Broken port plate in control valve. (C) Broken or disconnected fluid line. (D) Defective top operating cylinder. (E) Pump has lost "prime".	(A) battery low. (B) Motor solenoid not operating. (C) Pump motor inoperative. (D) Short or ground in switch circuit. (E) Switch connection loose or broken. (F) Defective ground connection to motor. (G) Defective breaker. (H) Connection from battery to solenoid defective.	
3. All units operate slowly.	(A) Pump pressure relief valve stuck. (B) Crimped fluid lines. (C) Internal leakage in top operating valve. (D) Improper hydraulic fluid in system.	(A) Low battery. (B) Oilite bearing in top of motor binding.	(A) Units possibly misaligned.
4. Window raises when top control valve is operated.	(A) Defective window cylinder solenoid valve.	(A) Window switch shorted. (B) Battery wire in contact with cylinder wire	
5. One window will not fully close.	(A) Insufficient hydraulic fluid.		(A) Glass run channel misaligned. (B) Stops improperly adjusted. (C) Glass misaligned.
6. Window lifts operate downward slowly	(A) Pump pressure relief valve stuck. (B) Hydraulic fluid containing sludge. (C) Improper hydraulic fluid in system		

TROUBLE SHOOTING			
Condition	Hydraulic	Electrical	Mechanical
7. Window lifts operate upward slowly.	(A) Pump pressure relief valve stuck. (B) Internal leak in top operating valve. (C) Top operating valve not returning to neutral.	(A) Low battery (B) Ollite bearing on top of motor binding.	(A) Top control rod improperly adjusted. (B) Units possibly binding. (C) Window run channels excessively wet.
8. Two windows operate from one window control switch.	(A) Defective window cylinder solenoid valve.	(A) Short circuit in window operating switch. (B) Battery wire in contact with cylinder wire.	
9. Window lift inoperative.	(A) Insufficient fluid. (B) Defective cylinder. (C) Broken port plate in top operating valve. (D) Pressure relief valve stuck. (E) Fluid line crimped or plugged. (F) Pump has lost "prime".	(A) Low battery. (B) Defective motor ground or battery connection. (C) Motor solenoid inoperative. (D) Pump motor inoperative. (E) Defective circuit breaker. (F) Improperly grounded circuit. (G) Window lift cylinder inoperative. (H) Solenoid ground connection to base of cylinder broken or unsoldered.	(A) Glass run channel misaligned. (B) Glass guide misaligned (C) Window lift not connected to lower sash.
10. Window will not stay up.	(A) Defective window cylinder solenoid valve.	(A) Short in window operating switch. (B) Short circuit between battery and cylinder wires.	
11. Top operating cylinders operate when window is raised.	(A) Internal leak in top operating valve. (B) Top operating valve not properly returning to neutral position.		(A) Top operating control rod improperly adjusted.
12. Motor noisy	(A) Insufficient hydraulic fluid		

