

2011



LAND-ROVERTEAM



BRITPART

The quality parts for Land Rovers



CATALOGO ACCESSORI

Edizione n.

5

www.landroverteam.it

BRITPART

The quality parts for Land Rovers



Our commitment to you!



For 30 years Britpart has been supplying quality parts and accessories for Land Rover users across the world and now

we are very proud to announce that from 1st October 2010 all* Britpart parts and accessories will be backed by an industry leading **24 month guarantee**.

With a recent multi-million pound investment in the best Land Rover products and with extensive investment in new staff, equipment and procedures we are convinced this new guarantee will give consumers more confidence in Britpart products. This is backed up with our approval by Lloyd's Register Quality Assurance to BS EN ISO 9001:2008.

This pioneering guarantee will cover over 12,000 parts from our extensive parts catalogue, from springs to clutches and from winches to shock absorbers, confidence in the products we supply is assured. If any part is found to be defective following an inspection by our quality team due to faulty materials or workmanship then that part will be replaced free of charge.

With this significant development in Britpart's philosophy we are now confident that the parts the end users fit to their Land Rovers will deliver time after time, whether the customer is buying a part for a Series 3 or a new Range Rover, they are backed by the same 24 month guarantee.

Look out for the Britpart Guarantee Logo which will be gracing all our products in the forthcoming months as a constant remind to the customer they are fitting the best available parts and accessories to their Land Rover.



*Subject to our standard terms and conditions. Proof of purchase required by the original point of purchase. Excludes Genuine Land Rovers parts, reconditioned gearboxes & engines. This guarantee does not affect your statutory rights.

Welcome to Version 5 of the Britpart Accessory Catalogue. Since the last issue we have added plenty of new products and now offer an industry leading guarantee - **24 months!** Full details in the panel opposite.

At Britpart we are always adding new and exciting products to our accessories range, so remember to look at www.britpart.com for all the latest additions. Also worth remembering is that if there is no picture in the catalogue of a product in the catalogue, go to our website as there are plenty more product pictures on-line.

Exterior Protection	5 - 18
Side & Rear Steps	19 - 24
Racks & Luggage Boxes	25 - 30
Wheels	31 - 38
Lighting Equipment	39 - 44
Towing Equipment	45 - 52
Interior Protection	53 - 62
Seats & Trim	63 - 70
Off-Road Equipment	71 - 80
Winching Equipment	81 - 92
Performance Equipment	93 - 102
Suspension Equipment	103 - 118
Exhausts	119 - 122
Repair & Service Parts	123 - 140
Service Kits & Filters	141 - 144
Vehicle Enhancements	145 - 156
Miscellaneous	157 - 163

Front cover picture courtesy of Martin Price
Opposite picture courtesy of Wayne Williams

ABOUT BRITPART



*innovation, quality
& style on demand*

Picture courtesy of Pascal Perrier

The Marque

Britpart is the leading independent wholesaler of parts and accessories for Land Rover vehicles, supplying in excess of 800 customers worldwide from government agencies to trade outlets.

The name 'Britpart' is synonymous with quality parts for Land Rovers and the company has earned a truly enviable reputation around the globe. For 30 years, Land Rover enthusiasts the world over have come to identify Britpart as a brand to be trusted.

The Britpart logo has become a widely recognised and highly respected marque; it embodies excellence in the field, both in quality and commitment to meeting the needs of the customer.

Products

Britpart has always reacted swiftly to the demands of the parts market for all Land Rover vehicles, aiming to provide customers with exactly what they want, when they want it. Parts have long been the mainstay of Britpart's business, with many parts simply being unavailable from other sources; however, accessories are now becoming a major part of the business as owners of Land Rovers, old and new, are customising their vehicles to suit their individual tastes and lifestyles; everything they need is now available from Britpart.

The vast array of Britpart accessories ensures that no two Land Rovers are ever identical!

Land Rover appointed Britpart as an 'Approved European Parts Distributor' for all Land Rover Genuine Parts; this, together with Britpart's own vast range of parts and accessories, along with their extensive inventory of O.E.M. product, has resulted in Britpart becoming the ultimate 'One-Stop-Shop' providing everything its customers could possibly require, all ordered and delivered from one dedicated source.

Quality

Britpart is approved by Lloyd's Register Quality Assurance to BS EN ISO 9001:2008.

Britpart is renowned for quality parts at very competitive prices and takes pride in its excellent customer service, maintaining high stock levels with the aim of fulfilling orders promptly.

Distribution

Parts and accessories for Land Rover vehicles continually flow in and out of the massive state-of-the-art warehouse. Britpart's fleet of vans and trucks all sport the undeniably eye-catching Britpart blue and white livery. Between them they cover the length and breadth of the United Kingdom, including Northern Ireland, delivering directly to Britpart customers on a regular basis, adding to the personal touch that customers have come to associate with Britpart.

Service

Britpart has an enthusiastic and highly knowledgeable team so that you deal with people who have in-depth knowledge of the business. In addition to major government contracts, we successfully support individual parts retailers, supplying spares for Land Rover models old and new including Series, Defender, Range Rover, Discovery and Freelander.

The lively Sales operation boasts three highly trained teams; one each for Home Sales, European Sales and Export Sales with technical experts and sales advisors in each, eager to answer the telephone and organise despatch of goods to their customers within the shortest possible time.

Handmade

The highly skilled team in the Trim Shop make a wide range of seats, seat covers, bases, backs and benches etc for Land Rover vehicles by hand.

Equally skilled is the team in the Lock Shop where a wide range of light engineering work is carried out.

In keeping with the Britpart philosophy, all products leaving the Trim Shop and the Lock Shop are produced to the highest standards and meet with the strictest safety regulations.

Global

When Land Rover finally severed its association with Santana Motor SA it was Britpart who bought up all the existing stock from the factory in Spain and shipped it to their UK headquarters in Shropshire. The shipment included everything from small components to body panels and new engines, along with all the original drawings and tooling. Some of the stock was found to be interchangeable with Land Rover parts and a proportion of the rest is gradually making the journey back home with the assistance of our partner in Spain, Britpart España, Estanfi Automoción.

Britpart's other partners around the globe include: Britpart France, Britpart Belgium, Britpart Brazil, Britpart USA and Britpart Poland.

Britpart is seeking to further expand its comprehensive customer base overseas and is continually looking for well established independent stockists of Land Rover parts to work closely with.



Picture courtesy of Darren Whiley

Quality Parts

Britpart hold in excess of 17,000 stock items from o-rings and oil seals to engines and exhaust systems. Customers can choose from Britpart quality parts, O.E.M. products and Land Rover Genuine Parts; all delivered promptly at competitive prices.

Everything required for servicing, repairing, restoring or even rebuilding any Land Rover can be supplied by Britpart, thus enabling customers to order all they need on just one order sheet making it easy to keep track of stock and take delivery.

Quality Accessories

Britpart have all the latest accessories you need to customise your Land Rover; whatever the model, to look great on the road and work better off it! From wheels to roof racks, Britpart have everything to ensure that no two Land Rovers need ever look identical.



Certification No. 910885



01

exterior protection

EXTERIOR PROTECTION

Going off-road?
Then here's where to find
all the protection
equipment your
Land Rover will need from
front to back and top to
bottom.

Section contents -

Chequer plate	6
Front protection	
A Bars	7
Bumpers & bumperettes	8
Lamp guards	9 - 13
Mirrors	13
Mud flaps	14
Rear protection	
Bumpers & bumperettes	15
Parking sensors	15
Side protection	
Rubbing strips	16
Wheel arch kits	16
Underside protection	
Diff guard	17
Steering/sump guards	17
Swivel housing gaiter kits	17
Transmission guard	18
Wind deflectors	18

Through the jungle
Picture courtesy of Cyril Mischler

CHEQUER PLATE



DA2070



DA4073 / DA4072



DA3080 / DA3078



DA3079

Defender

DA2054	Bumper plate		Single
DA2062	Bumper tops		Pair
DA2060	Mud flap brackets		Pair
DA2061	Rear cross member		Single
DA2063	Rear floor - 110 County Station Wagon		Single
DA2064	Rear sides - 110 County Station Wagon		Pair
DA2066	Bonnet protector		Single
DA2067	Rear door	Without wiper	Single
DA2068	Rear door	Wiper - late	Single
DA2069	Rear door	Wiper - early	Single
DA2070	Load bay liner		Kit
	90/Pickup/Hard top/County Station Wagon		
DA4049	Wing top		Pair
DA4072	Sills	90	Pair
DA4073	Rear wing	90	Pair
DA4100	Sills	110	Pair
DA4071	Rear wing	110	Pair

Britpart Chequer Plate - Defender

DA3078	Wing tops		Pair
	Natural aluminium finish		
DA3080	Bonnet protector	Defender - 1983 - 2006	Single
	Natural aluminium finish		
DA4342	Bonnet protector	Defender - 2007 - onwards	Kit
	Natural aluminium finish		
DA3079	Wing tops		Pair
	Satin black finish		
DA3081	Bonnet protector	Defender - 1983 - 2006	Single
	Satin black finish		
DA4343	Bonnet protector	Defender - 2007 - onwards	Kit
	Satin black finish		

Chequer Plate Kit - Defender

Kit contains - bonnet, wing, sill & rear corner protection

DA4296	Defender 90
DA4297	Defender 110

Series

DA2004	Wing top		Pair
DA2050	Rear cross member		Single
DA2051	Load bay liner	Short wheel base	Kit
DA2052	Sills	Short wheel base	Pair
DA2053	Sills	Long wheel base	Pair
DA2054	Bumper plate		Single
DA2067	Rear door	Without wiper	Single
DA4074	Rear wing	Short wheel base	Pair

Miscellaneous

DA2065	1,200mm x 2,500mm Chequer plate steel	Single
---------------	---------------------------------------	--------



DA4296



DA2052

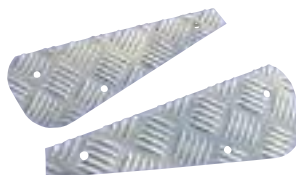

DA2060

Add some **heavy-duty** protection to your Land Rover!

FRONT PROTECTION

A BARS



LR005235



LR005742



LR005237

IMPORTANT NOTICE
Please check local legislation before fitting a frontal protection device to a vehicle that is to be used on public roads.

Add some front end protection to your vehicle with an A Bar - also a great addition if you'd like to add spot lights to your Land Rover!



STC50413



STC53129



LR003319



VUB501980



LR005239

Defender

LR005235	Defender - up to 2007	Black rubber	Includes spot lamp brackets
LR005742	Defender - 2007 onwards	Black rubber	Includes spot lamp brackets

Discovery

LR005237	Discovery 3	Moulded black rubber	Includes spot lamp brackets
-----------------	-------------	----------------------	-----------------------------

Freelander

STC50413	Freelander 1	Preformed plastic & foam	No spot lamp brackets
STC53129	Freelander 1 - V6	Preformed plastic & foam	No spot lamp brackets
VUB501330	Freelander 1 - from VIN4A00001	Moulded grey rubber	No spot lamp brackets
LR003319 NEW	Freelander 2	Black bumper styling cover	No spot lamp brackets

Range Rover

VUB501980	Range Rover Sport	Moulded grey plastic	Includes spot lamp brackets
LR005239	Range Rover L322	Moulded black plastic	Includes spot lamp brackets

BUMPERS & BUMPERETTES

DPB000270

Defender military front bumper

RRC6681

Centre pin for bumper

RRC6682

'R' Clip for centre pin

DA5626

Bumper kit - contains all the above

RTC4769

Defender/Series

Front bumperette

Single

Galvanised

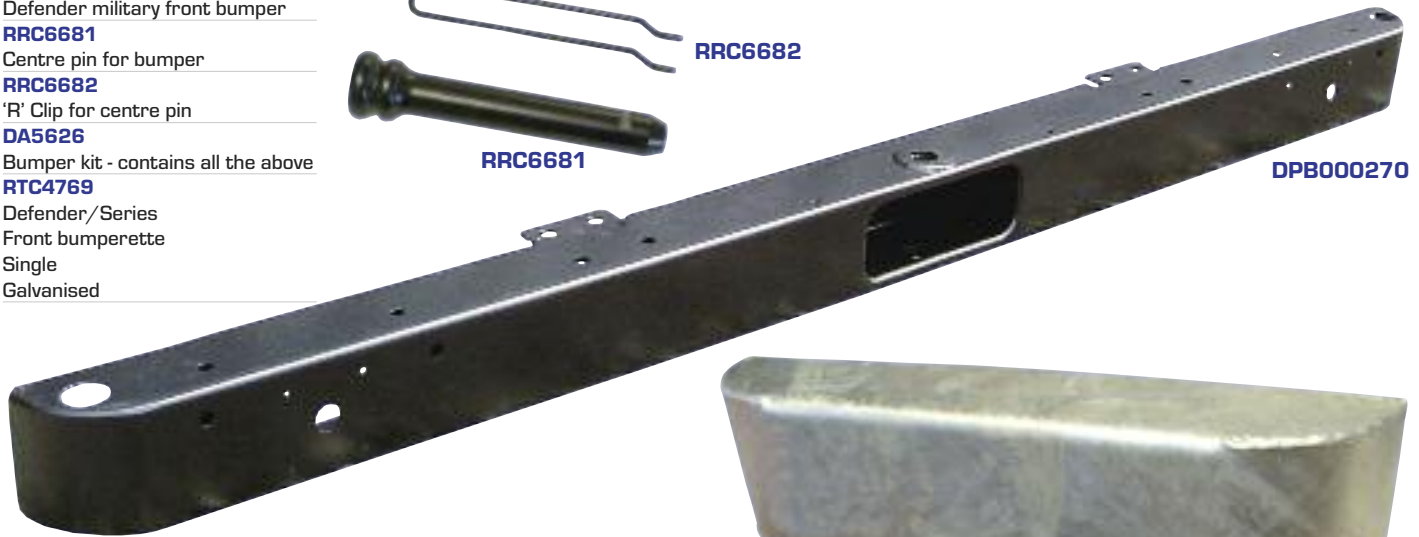

Winch Bumpers
- see winching equipment section



Courtesy of Jon Wilson

LAMP GUARDS

Defender

DA4077	Defender - all models	Front	Wolf style	Pair
DA1079	Defender - all models	Rear	Wolf style - rectangular & round	Pair
DA4400	Defender - Td5 - 2003 on	Front & rear	Wolf style	Kit
RTC8969	Defender - up to 2A622423	Front	Rectangular	Pair
STC53161	Defender - from 2A622424	Front	Rectangular	Pair
RTC8860AA	Defender - to VIN 2A	Rear	1 x Square & 1 x L-shape	Pair
STC53157	Defender - from VIN 2A	Rear	1 x Square & 1 x L-shape	Pair
DA4133	Defender - Td5	Rear	Rectangular	Single
DA4134	Defender - Td5	Rear	Round	Single
STC53158	Defender - all models	Rear	Square hinged	Pair
VUB504110	Defender - all models	Rear	Round	Pair
STC8056	Defender 110 - Hi Capacity	Rear	Rectangular	Pair
DA4349	Defender - all models	Rear	Round ABS plastic tail light	Single



DA4077



DA1079



DA4400

Protect those **valuable headlights** from accidental damage either on or off-road!



RTC8969



STC53161

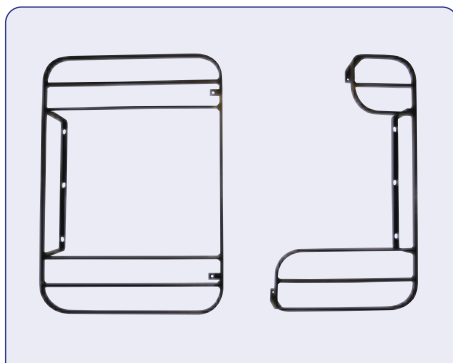

RTC8860AA

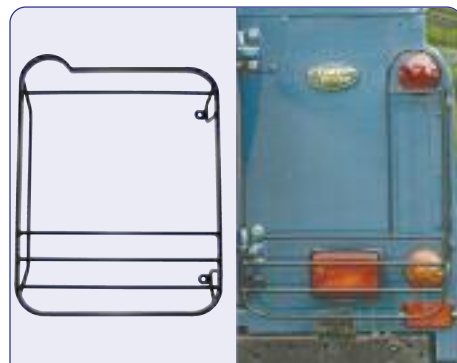

STC53157

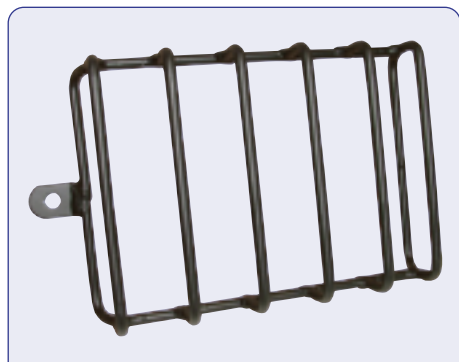

DA4133



DA4134

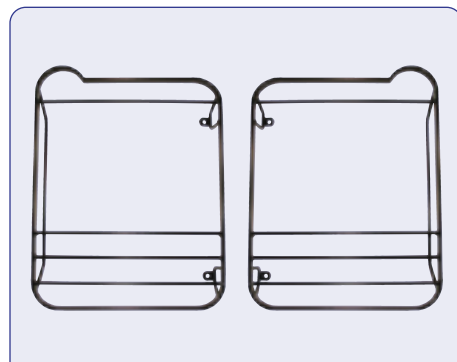

STC53158

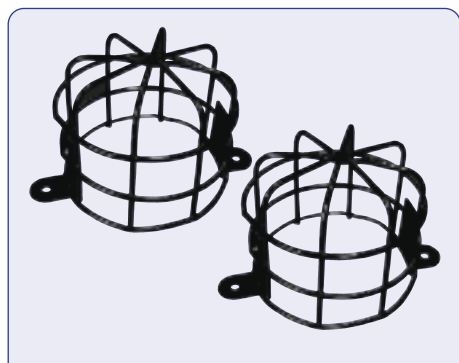

VUB504110



STC8056



DA4349

LAMP GUARDS - continued

Discovery

DA4130	Discovery 1 - to 1995	Front	Pair
STC8452	Discovery 1 - 1995 - 1999	Front	Pair
DA4172	Discovery 1 - 300Tdi	Front - acrylic headlamp protectors	Pair
STC8453	Discovery 1 - to 1999	Rear bumper - no drill	Pair
RTC9503AA	Discovery 1 - to 1999	Rear wing	Pair
STC50026	Discovery 2 - all models	Front - plastic	Pair
STC53181	Discovery 2 - from VIN 3A	Front	Pair
Note - For fitment with nudge bar (STC53176)			
STC53193	Discovery 2 - 2003 onwards	Front	Pair
STC50064	Discovery 2 - 1999 - 2002	Front - acrylic headlamp protectors	Pair
STC50027	Discovery 2 - all models	Rear bumper & rear upper set - plastic	Pair
STC53194	Discovery 2 - all models	Rear wing	Pair
VUB500520	Discovery 2 - all models	Rear low	Pair
VUB501200	Discovery 3 - all models	Front <i>(picture on next page)</i>	Pair
VUB501380	Discovery 3 - all models	Rear <i>(picture on next page)</i>	Pair



Need a dog guard?
See interior protection section!

LAMP GUARDS - continued



VUB501200



VUB501380

Freelander

STC7962AA	Freelander 1 - to 2004	Front	Pair
STC7960	Freelander 1 - to 2004	Rear kit - no drill	Set of 4
VUB501390	Freelander 1 - 2004 on	Front	Pair
VUB501400	Freelander 1 - 2004 on	Rear	Pair
LR002408	Freelander 2	Front	Pair
LR003685	Freelander 2	Rear	Pair



STC7962AA



STC7960



VUB501390



VUB501400



LR002408



LR003685



Courtesy of Armando Pantarotto

LAMP GUARDS - continued



STC8026

Range Rover

STC8026	Range Rover Classic	Front - hinged	Pair
STC8027	Range Rover Classic	Rear - hinged	Pair
STC8503AA	Range Rover P38	Front - drill fit	Pair
STC8504AB	Range Rover P38	Rear - drill fit	Pair
DA4173	Range Rover P38 - up to 1999	Front - acrylic headlamp protectors	Pair
VUB501930	Range Rover Sport	Front	Pair
VUB501920	Range Rover Sport	Rear	Pair
VUB001070	Range Rover L322 - up to 6A	Front	Pair
Note - Front lamp guards not compatible with wraparound protection bar			
VUB502610	Range Rover L322 - from 6A	Front	Pair
VUB001080	Range Rover L322	Rear	Pair



STC8027



STC8503AA



STC8504AB



DA4173



VUB501930



VUB501920



VUB001070

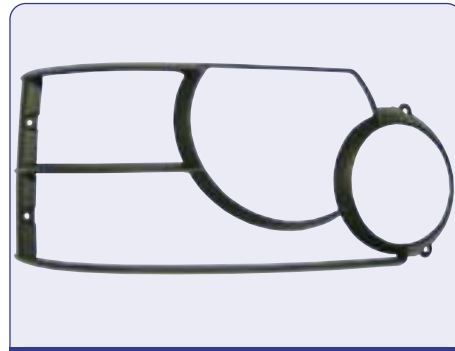

VUB502610



VUB001080



Courtesy of Jon Wilson

LAMP GUARDS - continued



345985



MRC316



345985P



MRC316

Series			
345985	Series		Front
MRC316	Series		Rear
345985P	Series	Plastic coated	Front
MRC316P	Series	Plastic coated	Rear



MIRRORS

Unbreakable Mirrors for Defenders

- > Optical quality polycarbonate lens - will not shatter like glass or discolour in sunlight
- > Strong, flexible polypropylene casing - will absorb hard blows without breaking
- > Universal - can be fitted to either left or right of vehicle
- > Lightweight - puts less strain on body fixings
- > Hard lacquer coating on lens - will repel condensation and surface water
- > Excellent reflectivity - superb daylight and night time vision



DA4405



DA4406

		Head Dimensions	Arm Length	
DA4404	Flat mirror	204 x 140mm (8 x 5 1/2")	No arm	Flat with fixing kit
DA4405	Flat mirror	204 x 140mm (8 x 5 1/2")	170mm	Flat with fixing kit and short arm
DA4406	Flat mirror	204 x 140mm (8 x 5 1/2")	290mm	Flat with fixing kit and long arm
DA4407	Convex mirror	204 x 140mm (8 x 5 1/2")	No arm	Convex with fixing kit
DA4408	Convex mirror	204 x 140mm (8 x 5 1/2")	170mm	Convex with fixing kit and short arm
DA4409	Convex mirror	204 x 140mm (8 x 5 1/2")	290mm	Convex with fixing kit and long arm

Mirrors & Fittings

Series

DA2128	Mirror arm	7"	Standard
DA2130	Mirror head	7 x 5"	Standard
DA2301	Mirror glass	7 x 5"	Standard

Defender

MTC5084	Mirror head	5 x 8"	Standard
DA4034	Mirror head	6 x 10 1/2"	Large
MTC5083	Mirror arm	7"	Standard
RRC8443	Mirror arm	11 1/2"	Large
MTC5217	Mirror assembly		Standard

Good visibility is imperative on today's highways and byways so these new high impact resistant mirror heads are essential stock items.



MTC5217

MUD FLAPS



CAT500540PMA



DA4531

Britpart Branded Defender Rear Mudflaps

CAT500410PMA	Defender - 90 - universal fitment RHS	Black Britpart logo	Single
CAT500450PMA	Defender - 90 - no exhaust cut-out LHS	Black Britpart logo	Single
CAT500540PMA	Defender - 90 - no exhaust cut-out LHS	Black Britpart logo	Single
DA4531	Defender - 90 - exhaust cut-out	Yellow Britpart logo	Pair
DA4532	Defender - 90 - no exhaust cut-out	Yellow Britpart logo	Pair
DA4533 NEW	Defender - 90 - universal fitment - no exhaust cut-out <i>Wide mudflaps</i>	Yellow Britpart logo	Pair
CAT500340PMA	Defender - 110/130 Crew Cab Pickup NEW RHS	Black Britpart logo	Single
CAT500350PMA	Defender - 110/130 Crew Cab Pickup NEW LHS	Black Britpart logo	Single
DA4534 NEW	Defender - 110/130 Crew Cab Pickup	Yellow Britpart logo	Pair
DA4536 NEW	Defender - 110/130 Crew Cab Pickup <i>Wide mudflaps</i>	Yellow Britpart logo	Pair
DA4535 NEW	Defender - 110/130 High Capacity Pickup	Yellow Britpart logo	Pair

DA4532



Other Mudflaps

RTC9479	Defender - 90/110 - from 2007	Front	Pair
RTC6820	Discovery 1	Front	Pair
RTC6821	Discovery 1	Rear	Pair
CAS500010PCL	Discovery 3	Front	Pair
CAT500010PCL	Discovery 3	Rear	Pair
LR003324	Freelander 2	Front	Pair
LR003322	Freelander 2	Rear	Pair
CAS500070PCL	Range Rover Sport	Front	Pair
CAT500120PCL	Range Rover Sport	Rear	Pair
CAS000150PMA	Range Rover L322 - up to VIN 5A999999	Front	Pair
CAT000180PMA	Range Rover L322 - up to VIN 5A999999	Rear	Pair
CAS500060PMA	Range Rover L322 - from VIN 6A198416	Front	Pair
CAT500070PMA	Range Rover L322 - from VIN 6A198416	Rear	Pair

Reduce those muddy splashes from over your Land Rover!
Britpart now offer a wider than standard mudflap, ideal for Defenders fitted with wheel spacers.



RTC6821



CAS500010PCL



CAT500010PCL



LR003324



CAS500070PCL



CAT500120PCL

REAR PROTECTION

BUMPERS & BUMPERETTES

DA2071	Defender/Series	
Rear	Pair	Black
RRC2970	Defender/Series	
Rear	Single - RHS	Black
RRC2971	Defender/Series	
Rear	Single - LHS	Black



DA2071



RRC2970 / RRC2971

Added protection!



DA5647

DA5647 NEW Discovery 1 - 300Tdi - will also fit 200Tdi see note below
 > One piece rear heavy-duty bumper manufactured from 5mm steel with incorporated steel end caps, finished in black
 > Provision for nato/recovery point in centre of bumper
 > Fixed to standard mounting points and for added strength, extra fixings in centre where tow bar mounts
Note - Tow bar and rear lights not included.
 Will fit 200Tdi if 300Tdi lamps are used.
 Right lamp - AMR6510; left lamp - AMR6509



DA5646

DA5646 NEW Discovery 2
 > One piece rear heavy-duty bumper manufactured from 4mm steel with incorporated steel end caps, finished in black
 > 2 Recovery points and 2 Hi-Lift jacking points included
 > Fixed to standard mounting points and for added strength, extra fixings in centre where tow bar mounts
Note - Tow bar and rear lights not included
 Up to 3A771194 - right lamp - XFB101480; left lamp - XFB101490
 From 3A771195 - right lamp - XFB000720; left lamp - XFB000730

PARKING SENSORS

These bumper* mounted sensors will detect the distance between your vehicle and any rear obstruction and warn the driver to any potential obstructions.

Add an extra set of 'eyes' when reversing...



DA4510
 Three stage alarm sound warning system
 Kit contents include -
 > 4 x Bumper fit sensors
 > 1 x Warning buzzer
 > 1 x Control unit
 > 1 x Wiring harness
 > 1 x Cutting tool
 > 1 x Fitting accessories
 > 1 x Installation instructions

DA4511
 Three stage alarm sound warning system with LED display
 Kit contents include -
 > 4 x Bumper fit sensors
 > 1 x Warning buzzer and LED display
 > 1 x Control unit
 > 1 x Wiring harness
 > 1 x Cutting tool
 > 1 x Fitting accessories
 > 1 x Installation instructions

*Note - Sensors do not work with metal bumpers

SIDE PROTECTION

RUBBING STRIPS



DGJ500020PCL

Protect your bodywork from dents and scrapes with a smart set of 4 solid and durable bodyside moulding strips.

- | | |
|---------------------|-------------------|
| DGJ500020PCL | Range Rover Sport |
| DGJ500140PMA | Range Rover L322 |



DGJ500140PMA

WHEEL ARCH KITS



DA1059



DA1140

Standard

- | | | |
|-------------------|-----------------------|-----------------------|
| DA1059 | Defender - all models | 4 eyebrows and rivets |
| DA1140 NEW | Discovery 2 | Front/Rear & RHS/LHS |

Replace any faded or damaged wheel arches with this OEM replacement wheel arch kit



DA2364



DA2366

Off-Road

2.5" wheel arch kits. Wings need cutting for fitment.

- | | | |
|---------------|---------------------------------|--------|
| DA2364 | Discovery 1/Range Rover Classic | 3-door |
| DA2365 | Discovery 1/Range Rover Classic | 5-door |

2" wider than standard enabling tyres up to 14" wide and/or wheel spacers to be fitted while being legal for MOT testing. Made from an unbreakable plastic - ideal for extreme off-road use.

- | | |
|---------------|--|
| DA2366 | Defender - 90 & 110 - from 1984 to present |
|---------------|--|

These two Discovery 2 wheel arches enable larger tyres to be fitted while still being legal as these arches cover the tyres when wider tyres are fitted. The 50mm ones are required for large off set wheels while the 75mm arches will cover the tyres when wheel spacers are used. They are virtually indestructible and all fixings are supplied with the kit. Up to 35" diameter tyres are ok with a 2" lift and these arches as just over 40mm is cut out of the wings when fitting them.

- | | | |
|---------------|-------------|------|
| DA1960 | Discovery 2 | 50mm |
| DA1961 | Discovery 2 | 75mm |



DA2365

DA1960

UNDERSIDE PROTECTION

DIFF GUARD



Give your vehicle some extra protection with a diff guard. This guard is simple to fit (no drilling) and has the added advantage of having the fill plug accessible at all times.

DA2250B
Defender/Discovery 1/Range Rover Classic
Electroplate finish



DA2250B

STOP PRESS...
DA2240 NEW
Steering Guard
> Discovery 2
> RHD & LHD
> 6mm steel, powder-coated
> For use with wish-bumper DAG840



DA2228



DA5507



DA5507LHD

STEERING / SUMP GUARDS

Added **protection** from those hidden dangers when off-roading!

These guards from Britpart are manufactured from high-quality, hard-wearing and corrosion resistant materials to counteract any unforeseen obstacles your Land Rover may encounter whilst off-roading. All fixings are supplied and the guards fit into the vehicle's pre-existing holes. Each guard has holes at the front to allow for water drainage and also to help with ventilation for the cooling system.

DA2228	Defender - 1985 onwards Galvanised steel - main plate - 4mm thick; brackets - 6mm thick	RHD & LHD
DA5507	Defender - 1985 onwards Aluminium - main plate - 8mm thick; brackets - 8mm thick	RHD
DA5507LHD	Defender - 1985 onwards Aluminium - main plate - 8mm thick; brackets - 8mm thick	LHD
DA5508	Discovery 1/Range Rover Classic Aluminium - main plate - 8mm thick; brackets - 8mm thick	RHD & LHD



DA5508

SWIVEL HOUSING GAITER KITS

- > Bond in place under existing flange
- > Completely seals against dust, water and grit
- > Moulded in high performance neoprene rubber
- > Kit includes two gaiters, metal straps, bonding agent, gloves and full instructions
- > No special tools required
- > Proven tongue and groove for easy assembly
- > Two year guarantee

DA3056 Series
DA3057 Defender/Discovery 1/Range Rover Classic
DA3057GLUE Additional bonding agent for DA3057

- > For easier fitment of gaiter without dismantling the axle assembly

Permanent protection for swivels, spheres and joints!



DA3056 / DA3057

TRANSMISSION GUARD



DA5625

Reduce damage to your Defender 90. Made from galvanised steel, this transmission guard protects your 90's gear box and cross members from snagging and reduces damage to your vehicle. Bolts on and is easy to fit and importantly it is also easy to remove when your vehicle needs servicing. Fits pre-Td5 or can be fitted to Td5 with centre exhaust removed and pipe fitted.



DA5625

WIND DEFLECTORS



DA6070



DA6071



DA4175



DA6072



DA6073



DA6077



DA6074



DA6075



DA6076

DA6078 NEW	Defender	Front	2 piece kit
DA6070	Discovery 1	Front & rear	4 piece kit
DA6071	Discovery 2	Front & rear	4 piece kit
DA4175	Discovery 2	Front	2 piece kit
DA6072	Discovery 3	Front & rear	4 piece kit
VUB502390	Discovery 3	Front & rear	4 piece kit
DA6073	Freelander 1 - 2 door	Front	2 piece kit
DA6077	Freelander 1	Front & rear	4 piece kit
DA6074	Freelander 2	Front & rear	4 piece kit
DA6070	Range Rover Classic	Front & rear	4 piece kit
DA4177	Range Rover P38	Front	2 piece kit
DA6076	Range Rover Sport	Front & rear	4 piece kit
VUB502520	Range Rover Sport	Front & rear	4 piece kit
DA6075	Range Rover L322	Front & rear	4 piece kit

Allows for fresh air to enter the vehicle by enabling the driver to have the windows open whilst being shielded from the wind and rain. Custom designed for each vehicle and easily attached using the fitting kit supplied - no drilling required for install.

02

side & rear steps

SIDE & REAR STEPS



Add some smart new steps to your Land Rover for assistance with getting in and out.

Section contents -

Side & rear steps	
Defender	20
Discovery	21
Freelander	22
Range Rover	23

DEFENDER



DA7012

- DA7012** Defender - 90 - all models
Side steps - pair Black with chequer plate
- DA7012SS** Defender - 90 - all models
Side steps - pair Stainless steel
- DA7011** Defender - 110 - all models
Side steps - pair Black with chequer plate
- DA7011SS** Defender - 110 - all models
Side steps - pair Stainless steel
- DA4101** Defender - 90 - all models
Side steps - pair Rubber top
- DA4060** Defender - 110 - all models
Side steps - pair Rubber top
- DA4070** Defender - all models
Rear tow ballstep - double Zinc plated
- DA4070B** Defender - all models
Rear tow ballstep - double Black
- STC50269AA** Defender - 90 from XA onwards
Rear step - includes regulation tow bracket
- STC50301** Defender - 110 from XA onwards
Rear step - includes regulation tow bracket
- STC7631** Defender - all models
Side step - folding
- STC7632** Defender - all models
Rear door step - folding



DA7012SS



DA4070



DA4070B



DA7011



DA7011SS



STC7631



DA4101

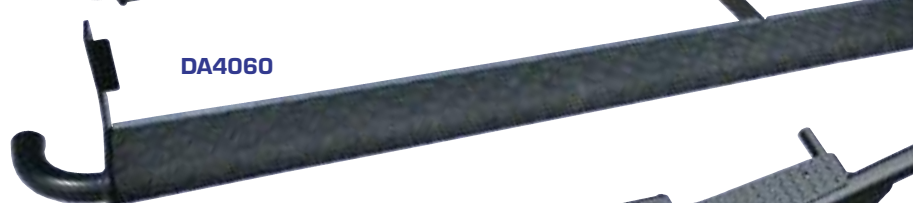

DA4060



STC50269AA



STC7632

DISCOVERY



STC8130AB



Courtesy of Kristjan Kristjansson



STC50030



STC50032



VTD500010



VTD500020



VTK500010 / VPLAP0035

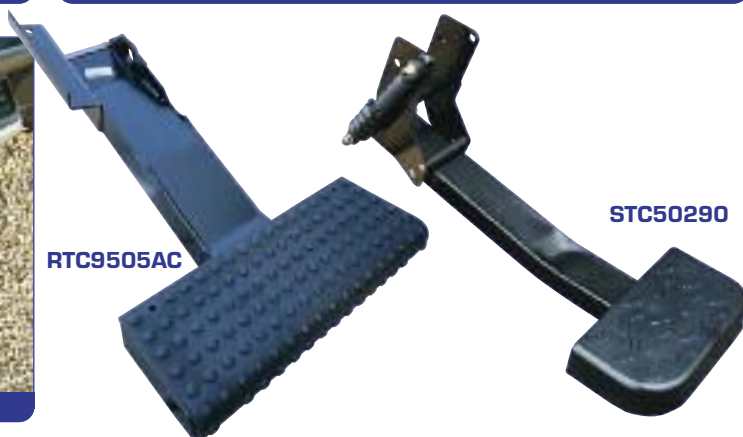

RTC9505AC

STC50290

RTC9505AC	Discovery 1	Rear retractable step		
RTC9593AA	Discovery 1	Spare shock absorber for rear retractable step (RTC9505AC)		
STC8130AB	Discovery 1	Side steps	Chevron tread	Pair
STC50290	Discovery 2	Rear retractable step - up to 1A298103		
KVL100040	Discovery 2	Spare shock absorber for rear retractable step (STC50290)		
STC50030	Discovery 2	Side steps - including mudflaps	Chevron tread	Pair
STC50032	Discovery 2	Side steps - including mudflaps	Stainless steel	Pair
VTD500010	Discovery 3	Black steel side protection tubes		Pair
VTD500020	Discovery 3	Stainless steel side protection tubes		Pair
VTK500010	Discovery 3	Side steps		Pair
VPLAP0035		With polypropylene side step top and a brushed aluminium side trim		



FREELANDER

STC53077

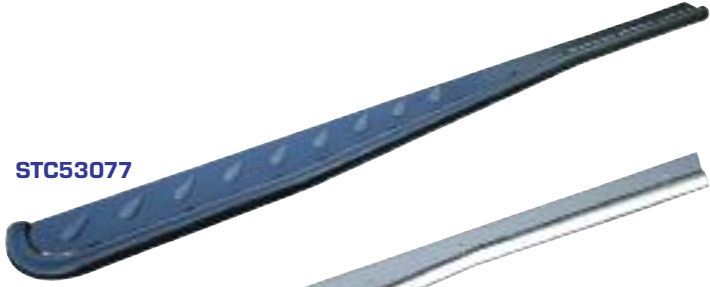

STC53078



LR002773



LR003318



LR003840

STC53077	Freelander 1 - from 2002 onwards		
	Side steps	Black	Pair
STC53078	Freelander 1 - from VIN2A000001		
	Side steps	Stainless steel	Pair
LR002773	Freelander 2		
	Side steps		Pair
	With thermo plastic elastomer side step top and a brushed aluminium side trim		
LR003318	Freelander 2		
	Side protection tubes	Stainless steel	Pair
LR003840	Freelander 2		
	Side protection tubes	Black	Pair



Courtesy of Marco Simola

RANGE ROVER

STC8130AB

Range Rover Classic Pair
Side steps - black rubber

STC8505AA

Range Rover P38 Pair
Side steps Oasis pattern
Not including mudflaps - front STC8535

VTK500020

Range Rover Sport Pair
Side steps
With thermo plastic elastomer side step top and a brushed aluminium side trim

VUB001230

Range Rover L322 Pair
Stainless steel side protection tubes

VUB002510

Range Rover L322 Pair
Black steel side protection tubes
Note - Both above tubes can be fitted with or without front mudflaps



STC8505AA



VTK500020



STC8130AB

VUB503660

Range Rover L322 Pair
Side steps including front mudflaps with EPDM (synthetic rubber) top and hard plastic trimming

VUB001300

Range Rover L322 Single
Side step replacement insert moulding for VUB503660
Right hand side

VUB001310

Range Rover L322 Single
Side step replacement insert moulding for VUB503660
Left hand side



VUB001230



VUB002510

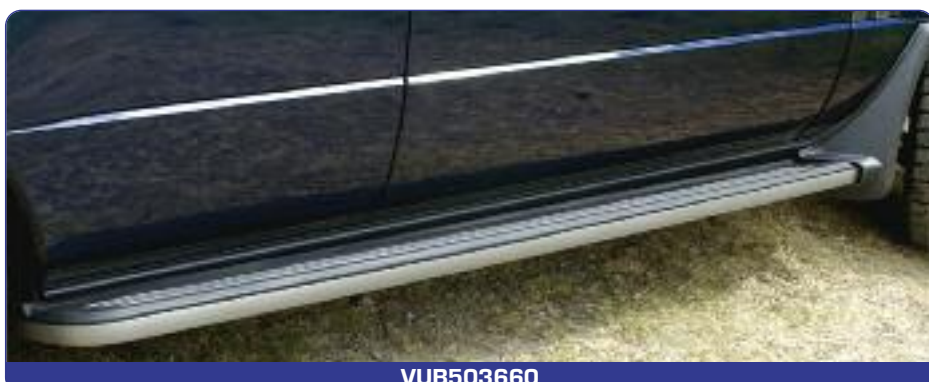

VUB503660





Courtesy of Cyril Mischler

03

racks & luggage boxes
RACKS & LUGGAGE BOXES

Got a load to carry?
We've got racks and
luggage boxes to suit all
Land Rovers and all loads.

Section contents -

Bike racks	26
Ladders	26
Roof racks & boxes	
Galvanised roof rack kits	27
Mont Blanc	28
Roof racks & bars	29
Thule	30

Haast Beach, New Zealand
Picture courtesy of John Brunsdon

BIKE RACKS



DA4118



DA4119



DA4121



STC7929



STC50063

These bike racks mount to the spare wheel carrier and are easy to fit.

DA4118	Discovery 1	4 Bikes
DA4119	Discovery 2	4 Bikes
DA4121	Freelander 1	3 Bikes
STC7929	Freelander 1/Freelander 2	2 Bikes
STC50063	Discovery 2/Discovery 3 & Range Rover Sport	2 Bikes

LADDERS



DA3073



STC50417



DA3071



STC50134



DA3073B



AGP780020

DA1089	Defender - 90/110	Galvanised
(see picture in next section)		
DA3073	Defender - 90/110	Grey
DA3073B	Defender - 90/110	Black
STC50417	Defender - 90/110	Black
DA3071	Discovery 1 & 2	Black
STC50134	Discovery 2	Black
AGP780020	Discovery 3 & 4	Black

ROOF RACKS & BOXES

GALVANISED ROOF RACK KITS



DA1089

DA1093	Defender - 90/Series - SWB	Flat floor
DA1091	Defender - 90/Series - SWB	Contour floor
DA1090	Defender - 110/Series - LWB	Flat floor
DA1092	Defender - 110/Series - LWB	Contour floor
DA1089	For above kits	Ladder

Note - Contour racks must **NOT** be used on vehicles fitted with a sunroof.

Note -

SWB flat packed roof racks - length 1,990mm (78 1/2"); height 420mm (16 1/2"); width 120mm (5"); weight 25kgs
 LWB flat packed roof racks - length 2,800mm (110 1/2"); height 420mm (16 1/2"); width 120mm (5"); weight 30.5kgs



DA1091

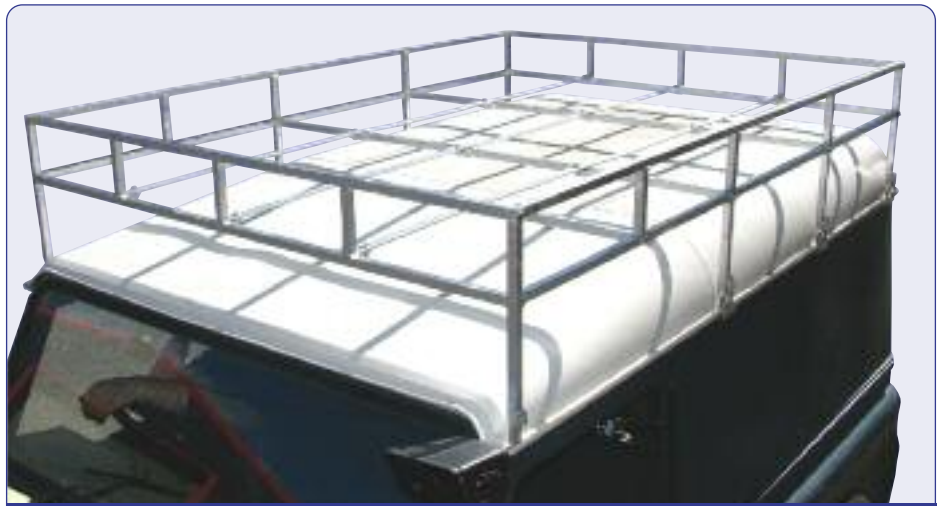

DA1093



Courtesy of Matthew Russell

MONT BLANC



DA4332

Roof Boxes

DA4331	Vista 380	Half width	
380 litres	2,000 x 650 x 450mm (LxWxH)		Weight 15kg
DA4332	Vista 540	Full width	
540 litres	2,000 x 950 x 420mm (LxWxH)		Weight 17kg

- > Secure-Assure - keys cannot be removed until locks securely engaged
- > 2 or 3 point central lock system
- > Lock up struts - new improved design with side opening for ease of loading
- > 80mm width fixings to suit most roof bar sizes
- > UV resistant, high impact ABS
- > Load securing straps included



DA4333

DA4333	Triton 450	430 litres	2,240 x 940 x 430mm (LxWxH)
DA4334	Triton 650	620 litres	1,970 x 830 x 380mm (LxWxH)

- > Premium roof box range with modern design for all kind of activities
- > Made of UV-resistant ABS plastic with gas struts for soft opening and closing of box
- > Three point central locking
- > Load securing straps included
- > Flexible attachment to the load bar
- > Unique quick attachments - the box is attached from the inside
- > Fits both square bars and aluminium bars with C-slots



SYSTEM 400 - STANDARD

Roof Bars & Rails

DA2312	Discovery 1	System 400 - Standard
DA2310	Freelander 1	System 400 - Standard
DA4313	Range Rover P38	System 400 - fits to gutter

- > Easy to fit, good value load carrier system with fully galvanised roof bars

MONT BLANC



SYSTEM 3000 - PREMIUM

DA2311	Defender	System 3000 - Premium
DA4312	Discovery 3	System 3000 - Premium - fits to gutter, includes crossbars
DA4311	Freelander 1	System 3000 - Premium
DA2315	Range Rover P38	System 3000 - Premium
DA4314	Range Rover Sport	System 3000 - Premium
DA4319	Range Rover L322	System 3000 - Premium

- > Premium roof bar system with quick fit and release feature and integrated lock system (excluding gutter fit) with max load range 75-100kg
- > Manufactured to DIN standard 75302/15011154



DA4315



DA4316

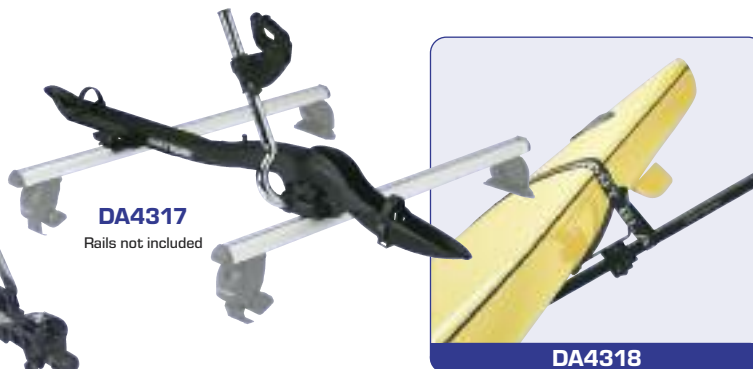

DA4317

Rails not included



DA4318

Carriers

DA4315 Discovery - cycle carrier
 • Roof mounted with stylish aluminium profile • Wheels fit into moulded profile which holds the cycle upright leaving both hands free to secure the frame and wheels • Locking the cycle into frame holder secures carrier to load carrier • Black-painted frame holder tube in special steel • Base unit made of aluminium and UV-resistant composite material • Takes frame diameters from 20 up to 80mm • Max. tyre width 2.2 inches • Manufactured in accordance with DIN75302 • Will fit to both standard and aluminium bars • Weight: 4.2 kg

DA4316 Scott - cycle carrier
 • Stable easy-to-use roof mounted cycle holder • Frame holder with quick attachment for easy fitting without tools • Takes frame diameters from 25 up to 80mm • Wheels rest in adjustable wheel holders and are fastened with strong securing straps • Lockable to roof rack as well as bicycle • Can be fitted on all standard load bars and aluminium profiles.

DA4317 Barracuda - cycle carrier
 • Wheels locate in a moulded profile, which holds the cycle in an upright position - you can use both hands when securing the wheels and the frame
 • When the cycle is attached to the frame holder, the cycle holder is secured to the load carrier • Cycle is secured in the frame holder • Chromium-plated frame holder tube in special steel • Base unit made of UV-resistant composite material • Takes frame diameters from 20 up to 80mm • Max tyre width 2.2 inches • Manufactured in accordance with DIN 75302 • Max weight capacity 17kg

DA4318 Tahiti 6 - surfboard and canoe carrier
 • Stable and gentle holder for surfboards, canoes, kayaks, etc. • Holder comes complete with cradles, straps and a holder for a mast or paddle
 • Rubber-covered cradles are kind to the hull and allow the boat/surfboard to lie steadily during transport

ROOF RACKS & BARS

All aluminium construction, fully welded



- > All aluminium construction, fully welded
- > Powder coated finish
- > Patented slat, with grooves to accommodate 8mm bolt head
- > Modular design – allow accessories to be mounted and removed as need without drilling
- > Rail towards the rear, open in the front
- > Gutter mount stainless steel clamps

DA3072	Defender - 90	Full rack	Black
DA3070	Defender - 110	Full rack	Black
DA3075	Discovery 1/Discovery 2	Short rack	Silver
DA3077	Freelander 1	Full rack	Silver
DA3086	Freelander 1	Full rack - original mountings	Silver

Defender

LR004101	Defender - 90	Roof rack	1,600mm
LR004100	Defender - 110	Roof rack	2,400mm
LR004102	Defender - 110/ 130 Crew cab	Roof rack	
STC7582	Defender - all models	Roof bars	Sports

Discovery

RTC9539AB	Discovery 1	Roof rack	Standard
STC8057AC	Discovery 2	Roof bars	Sports
VPLAR0001	Discovery 3/Discovery 4	Roof rack cross bars	
LR006848	Discovery 3/Discovery 4	Roof rack luggage carrier	
		Use in conjunction with roof cross bars	
LR006849	Discovery 3/Discovery 4	Roof ski carrier	
		Use in conjunction with roof cross bars	

Freelander

STC50327AA	Freelander 1 - 3-door	Roof rack cross bars	
STC50433	Freelander 1	Roof rack	Expedition
LR002417	Freelander 2	Roof rack cross bars	
LR006848	Freelander 2	Roof rack luggage carrier	Use in conjunction with roof cross bars
LR006849	Freelander 2	Roof ski carrier	Use in conjunction with roof cross bars

Range Rover

STC50176AA	Range Rover Classic	Luggage cross bars	
LR006848	Range Rover Classic	Roof rack luggage carrier	Use in conjunction with luggage cross bars
STC8506	Range Rover P38	Roof rails	Side
LR006849	Range Rover P38	Roof ski carrier	
CAB500130PMA	Range Rover Sport	Roof rack luggage carrier	Expedition
LR006848	Range Rover Sport	Roof rack luggage carrier	Use in conjunction with roof cross bars and rails
VUB502130	Range Rover Sport	Roof rack cross bars and rails	
LR006849	Range Rover Sport	Roof ski carrier	
CAB500070PMA	Range Rover L322	Roof rack luggage carrier	Expedition
CAB000040PMA	Range Rover L322	Roof rack cross bars & rails	
LR006848	Range Rover L322	Roof rack luggage carrier	Use in conjunction with roof cross bars
LR006849	Range Rover L322	Roof ski carrier	Use in conjunction with roof cross bars



DA3075



DA3077

THULE

Roof Boxes

DA4321 X1 450 litres
1,900 x 900 x 380 (LxWxH) Load capacity 75kg Weight 23kg

- > Rugged design for those who want to stand out from the crowd
- > Quick-Snap mounting system, for easy fitting of the box
- > Dual-Side opening for convenient mounting, loading and unloading
- > Central safety locking system
- > Unique and spacious design in special tech silver colour



DA4321

DA4322 Atlantis 600 340 litres
1,900 x 630 x 410 (LxWxH) Load capacity 75kg Weight 16kg

- > Spacious roof boxes featuring exciting design and smart functions
- > Patented Power-Grip quick mount system, for fast and secure fitting using one hand
- > Aerodynamic design for great stability, reduced air resistance, wind noise and vibrations
- > Dual-Side opening for convenient mounting, loading and unloading
- > Central safety locking system with grip-friendly key



DA4322

THULE[®]
SWEDEN
CAR RACK SYSTEMS

Roof Bars

DA2990	Discovery 1	Roof bars
DA2991	Discovery 2 - with modified trim	Roof bars
DA4323	Discovery 2	Roof bars
DA4325	Discovery 3 - T-Profile	Roof bars - for vehicles with no roof rails
DA4324	Discovery 3	Roof bars - for vehicles with roof rails
DA4328	Freelander 1 - 1998 - 2003 - 3-door and 5-door	Roof bars
DA4329	Freelander 1	Roof bars
DA4326	Freelander 2 - mounts to gutter	Roof bars & rails
DA4327	Freelander 2	Roof bars
DA3002	Range Rover Classic	Roof bars
DA2993	Range Rover P38	Roof bars
DA2996	Range Rover Sport	Roof bars
DA4330	Range Rover L322 NEW	Roof bars



DA4323



DA4326



DA4327



DA4329



DA4330



DA2996



Carrier

STC7969 Cycle carrier

- > The smartest, most elegant solution for loading and transporting a bike on the roof
- > The self-adjusting and upright frame holder into which the bike automatically slides, makes bike loading easy
- > Adjusting and securing is done comfortably and quickly, with a turning knob, at roof height
- > Quick-release straps, adjustable for different wheel sizes, hold the wheels securely in place
- > Light and convenient aluminium design
- > Can easily be fitted on either side of the car roof
- > Lockable - bike to bike carrier, bike carrier to load carrier
- > Best in test
- > Fits frame dimensions up to 100mm



STC7969

Freshen up your Land Rover with a new set of wheels, then secure them with a set of locking wheel nuts.

Section contents -

Spare wheel carriers 32

Tyre monitoring & repair

Inner tube 32

Tyre pressure monitoring system 32

Tyre repair kit & air compressors 33

Wheel protection

Locking wheel nuts, keys & caps 34

Spare wheel covers 33

Wheel spacers, adaptors & tools

Wheel spacers & adaptor kits 35

Wheel wrenches 34

Wheels

Alloy 36

Steel 37

Zu 38



SPARE WHEEL CARRIERS



DA2232

DA2232
Defender/Series
Swing away rear door mount



DA2259

DA2259
Defender - 2002 - 2007
Swing away rear door mount

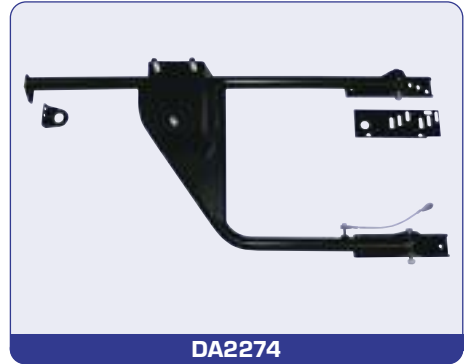

DA2274

DA2274
Defender - with half door tailgate
Swing away rear door mount

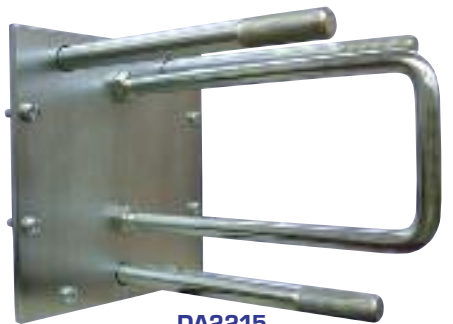

DA2215

DA2215
Defender/Series
Fixed rear door mount

TYRE MONITORING & REPAIR

INNER TUBE



DA3000
750 x 16



TYRE PRESSURE MONITORING SYSTEM



Are your tyres at the right pressure?

DA4512

This system is an advanced monitoring & alert system of tyre conditions. It monitors tyre pressure and temperature then relays the state of each tyre to a display unit. When any abnormalities are detected, the system will display the status of the affected tyre and sound an alarm to ensure you take action to remedy the problem. Keeping your tyres in good condition at the right pressure can extend the life of your tyres, reduce fuel consumption and improve handling.

- Tyres that are at the right pressure will -
- > Improve fuel consumption
 - > Increase the tyre life span
 - > Help enhance vehicle handling & braking
 - > Reduce susceptibility to hydroplaning

System contents -

- 1 x Display
- 1 x Receiver
- 4 x Tyre sensors
- 3 x Display brackets
- 2 x 3M stickers
- 1 x Instruction manual

Note - This system will only measure up to a maximum of 3.5 bar.

TYRE REPAIR KIT & AIR COMPRESSORS

Don't get caught out with a flat tyre or two!

*Pack and leave an easy to use Britpart tyre repair kit in your vehicle**

DA2390 - Tyre repair kit in travel case

How It Works

1. Find and remove the item that caused the puncture
2. Apply rubber solution to the reamer tool then push the reamer into the puncture and work up and down until the reamer moves easily in the hole
3. Thread one rubber tyre plug in the hook tool
4. Push the rubber tyre plug into the hole until 1/2" of the tyre plug remains outside the tyre then turn the hook tool a quarter turn and pull out slowly
5. Cut off the excess tyre plug as close to the tyre as possible
6. If the puncture is too big have the tyre fixed by a professional



DA2390

**Recommended for off-road use only*

It's no good being able to repair your tyre if you can't inflate it!

DA2392 Double-pump air compressor

> Air flow - 150ltr/min

DA2354 Single-pump air compressor

> Air flow - 72ltr/min

See the off-road section for more details on the portable air compressors from Britpart.



DA2392



DA2354

WHEEL PROTECTION

SPARE WHEEL COVERS



DA2026

DA2021	750 x 16	Plain black
DA2022	600 x 16	Plain black
DA2026	205 x 16	Plain black



Courtesy of Armando Pantarotto

LOCKING WHEEL NUTS, KEYS & CAPS



STC3420



KBM100450



STC3415



STC3582



STC7623



STC3601



RTC9535



STC8843AA



RRB100510



STC50080



STC8513



RRB500100

Locking wheel nut keys for

Defender/Discovery 1/Discovery 2/Range Rover P38

Code A	STC3420
Code B	STC3421
Code C	STC3422
Code D	STC3423
Code E	STC3424
Code F	STC3425
Code G	STC3426
Code H	STC3427
Code I	STC3428
Code J	STC3429

Protect your
valuable wheels and
tyres from theft!

Locking wheel nuts and keys for Freelander 1 - up to 2006

	Locking wheel nut	Locking wheel nut key
Code A	RRD100520	KBM100450
Code B	RRD100530	KBM100460
Code C	RRD100540	KBM100470
Code D	RRD100550	KBM100480
Code E	RRD100560	KBM100490
Code F	RRD100570	KBM100500
Code G	RRD100580	KBM100510
Code H	RRD100590	KBM100520
Code I	RRD100600	KBM100530
Code J	RRD100610	KBM100540

Locking wheel nuts keys for Defender 1987-2006 & 2006 -/Discovery 1

Code F	STC3415
Code H	STC3417

ANR6094L	Freelander 1	Locking wheel nut cap
KBP10001	Freelander 1	Universal nut cover removal tool
RRD000100	Range Rover L322 - Locking wheel nut - 35	
RRD000110	Range Rover L322 - Locking wheel nut - 36	
RRD000120	Range Rover L322 - Locking wheel nut - 37	
RRD000130	Range Rover L322 - Locking wheel nut - 38	
RRJ000030	Range Rover L322 - Wheel nut cap	
STC3582	Discovery 2/Range Rover P38	Locking wheel nut key - code C
STC7623	Defender with deep dish alloy wheels	
Kit contains -	5 x nuts; 5 x caps; 1 x key	
STC3601	Defender/Discovery 1 with alloy wheels	
Kit contains -	5 x nuts; 5 x caps; 1 x key; 1 x black bag for key	
RTC9535	Defender/Discovery 1/Range Rover Classic 1989 to 1994 with steel wheels	
Kit contains -	5 x nuts; 1 x key (black finish)	
STC8843AA	Defender/Discovery 1/Range Rover Classic 1989 to 1994 with alloy wheels (not deep dish wheels)	
Kit contains -	5 x nuts; 5 x caps; 1 x key	
RRB100510	Discovery 2 with alloy wheels	
Kit contains -	1 x nut; 1 x cap; 1 x key; 1 x removal tool	
STC50080	Discovery 2 - Full set of wheel nuts	
Kit contains -	4 x locking nuts; 4 x spare caps; 18 x normal nuts (inc. caps); 1 x key; 1 x remover tool	
STC8513	Range Rover P38A with alloy wheels	
Kit contains -	4 x nuts; 4 x caps; 1 x key	
RRB500100	Discovery 3/Range Rover Sport/Range Rover L322	
Kit contains -	4 x nuts; 1 x key	

WHEEL SPACERS, ADAPTORS & TOOLS

WHEEL WRENCHES



537179



DA4026



NTC7829



NTC7829HD

537179 Wrench size - 15/16"

DA4026 Wrench size - 27mm

NTC7829 Wrench size - 27mm

NTC7829HD Wrench size - 27mm

WHEEL SPACERS & ADAPTOR KITS



DA2075



DA5005



DA5006

Wheel Adaptor Kits

DA2075

To fit Range Rover L322 wheels to Range Rover P38
 To fit Range Rover Sport wheels to Discovery 2

DA5005

To fit Range Rover P38 wheels to Range Rover Classic

DA5006

To fit Discovery 2 wheels to Defender

Wheel Spacers

DA5004

Defender/Discovery 1/Range Rover Classic
 30mm thick, steel machine finish complete with wheel nuts and OEM studs



DA5004



Courtesy of Matt Tester

WHEELS

ALLOY



ANR3631MNH



ANR5307MNH



RRC503400MNH



RRC501470MCM



RRC505360MNH



RRC505370MNH



RRC503400MNH - FITTED

Smarten up your Land Rover with a smart new set of alloy wheels.

Note - Centre caps and wheel nuts not included



ANR3631MNH - FITTED

Defender		
ANR3631MNH		16" x 7 - Deepdish alloy
ANR5307MNH	From TA	16" x 7 - Tornado alloy
RRC503400MNH	1994 onwards	16" x 7 - Boost alloy
Discovery		
ANR3631MNH	Discovery 1	16" x 7 - Deepdish alloy
ANR5307MNH	Discovery 1	16" x 7 - Tornado alloy
RRC501470MCM	Discovery 2	18" x 8 - Hurricane alloy
RRC505360MNH	Discovery 3	18" x 8 - 10-spoke alloy - silver sparkle finish
Range Rover		
RRC501470MCM	Range Rover P38	18" x 8 - Hurricane alloy
RRC505360MNH	Range Rover Sport	18" x 8 - 10-spoke alloy - silver sparkle finish
RRC505370MNH	Range Rover Sport	19" x 9 10-spoke alloy - silver sparkle finish

STEEL



ANR1534PM



ANR4583PM



ANR4583SILVER



ANR4635PM



ANR4636PM



ANR5593PM



RRC503600PM



NTC5193PM



RRC114560MUW

Defender

ANR1534PM		1 ton 569204 welded 16" x 6.5 primed
ANR4583PM		Wolf rim welded tubeless 16" x 6.5J black - use longer studs (FRC7577)
ANR4583SILVER		Wolf rim welded tubeless 16" x 6.5J silver - use longer studs (FRC7577)
ANR4635PM		16" x 6 Ro-Style NTC2165 primed
ANR4636PM		Standard welded tube type 16" x 5.5F primed
ANR5593PM		Wolf rim welded tube type 16" x 6.5J primed
RRC503600PM	1987 on	Steel tubeless - 16" x 5.5

Discovery

NTC5193PM	Discovery 1	Steel 16" x 7 primed
RRC114560MUW	Discovery 2	Steel silver 16" x 7J

Freelander

ANR3973	Freelander 1	Steel 15" x 5.5J
----------------	--------------	------------------

Range Rover Classic

ANR4635PM		16" x 6 Ro-Style NTC2165 primed
------------------	--	---------------------------------

Series

ANR1534PM		1 ton 569204 welded 16" x 6.5 primed
ANR4636PM		Standard welded tube type 16" x 5.5F primed



ANR3973

ZU



BLACK - MATT



BLACK - GLOSS



ANTHRACITE - MATT



ANTHRACITE - GLOSS



SILVER



HIGH POWER SILVER



WHITE

Super strong
Super light



- > Super strong
- > Super light
- > TÜV approved and meets or exceeds UK - European - U.S. - Canadian - Australian - South African and Japanese wheel manufacturing specifications
- > Uses standard Land Rover alloy wheel nuts
- > Easy to balance
- > Manufactured in the UK

**Defender / Discovery 1
Range Rover Classic**

16 x 7 Rims

- > 11mm offset
- > 1,400kg rating
- > 10.4kg each

DA2434	White
DA2435	Silver
DA2436	Black - gloss
DA2439	Black - matt
DA2437	Anthracite - gloss

Note - Wheel nuts not included

ANR2763MMM Alloy wheel nut
Defender - up to 2006/Discovery 1/
Range Rover Classic

RRD500560 Alloy wheel nut
Defender - 2007 onwards

Discovery 2 / Range Rover P38

16 x 8 Rims

- > 38mm offset
- > 1,400kg rating
- > 12.0kg each

DA2430	White
DA2431	Silver
DA2432	Black - gloss
DA2438	Black - matt
DA2433	Anthracite - gloss

18 x 8 Rims

- > Part number includes wheel adaptor ring
- > 36mm offset
- > 1,400kg rating
- > 12.0kg each

DA2456 NEW	Black - gloss
DA2457 NEW	Black - matt
DA2458 NEW	Anthracite - gloss
DA2459 NEW	Anthracite - matt
DA2460 NEW	Silver
DA2461 NEW	High Power Silver

Note - Centre caps and wheel nuts not included

ANR3679 Alloy wheel nut
Discovery 2/Range Rover P38

RRJ500030MNH Wheel cap
Discovery 2/Range Rover P38

**Discovery 3 / Range Rover Sport
Range Rover L322**

18 x 8 Rims

- > 36mm offset
- > 1,400kg rating
- > 12.0kg each

DA2450 NEW	Black - gloss
DA2451 NEW	Black - matt
DA2452 NEW	Anthracite - gloss
DA2453 NEW	Anthracite - matt
DA2454 NEW	Silver
DA2455 NEW	High Power Silver

Note - Centre caps and wheel nuts not included

RRD500590 Alloy wheel nut
Discovery 3/Range Rover Sport

RRD000011 Alloy wheel nut
Range Rover L322

RRJ500030MNH Wheel cap
Discovery 3/Range Rover Sport/
Range Rover L322

05

LIGHTING EQUIPMENT

Be seen and light the way with a decent set of driving lamps.

Section contents -

Exterior lights

Driving lights	40
Fog lights	41
Light kits	41
NAS lights	41
Roo-lites	42

Interior lights

Map reading lamp	42
------------------	----

Light conversion & upgrades

Light conversion kits	43
Light upgrade kits	43

Light mounting

Light bar	43
Light mounting kits	43

EXTERIOR LIGHTS

DRIVING LIGHTS

- > High power halogen lamps
- > Fits all 12 volt vehicles
- > Easy installation
- > Universal fitting
- > Armoured cable
- > Fitted plastic stone guards
- > Excludes wiring kit

DA4088	8" Light - 100 watt		Black	Pair
DA4088C	8" Light - 100 watt		Chrome	Pair
DA4088W	Wipac 8" Light - 100 watt		Black	Pair
DA4088BULB	Replacement 100 watt bulb for DA4088/DA4088C/DA4088W			
DA4088COVER	Replacement 8" spot light cover for DA4088/DA4088C/DA4088W			
DA4099	Hella Rallye 3000		Black	Single
PRC8238	Spoiler lamps classic		Black	Pair
STC7644	Hella Rallye 1000 long range		Black	Single
STC8480	Safari 5000 - Defender - 1987-2006/Discovery 1/Discovery 2/Range Rover Classic - 1992-1994/Range Rover P38		Black	Single
STC8842	Lamp guard for Land Rover Safari 5000 driving & fog lamp		Grey	Pair
VUB001090	Range Rover L322	Driving light kit - includes electrics	Black	Pair
XQB500080	Discovery 3	Driving light kit - includes electrics	Black	Pair
VUB500870	Freelander 1 - from 4A00001	Long range driving lamp kit - inc lamps, brackets, switch, looms & instructions	Black	Pair



DA4088



DA4088C



DA4088W



DA4088COVER



DA4099



PRC8238



STC7644



STC8480



STC8842



VUB001090



XQB500080



VUB500870

FOG LIGHTS

RTC8922

Defender/Range Rover Classic
Hella Comet 550 rectangular - pair
Black
12 volt

Note - 195mm wide x 96mm high x 83mm deep

STC7643

Hella Rallye 10000
Black



STC7643



RTC8922

LIGHT KITS



DA1077

Series/Defender



DA1080

Defender - 300Tdi

NAS LIGHTS



AMR6526



AMR6527



AMR6528

Defender lights with North American specification...

AMR6526

Round Red Stop or tail lamp

AMR6527

Round Amber Indicator lamp

Note - Supplied without mounting plinth and screws

AMR6528

Round Clear Reverse or side lamp

Note - Supplied with mounting plinth but without screws



XFD500010



XFE500010

XFD500010

Round Clear Reverse or side lamp

XFE500010

Round Red Rear fog lamp

Note - Supplied with mounting plinth and screws

Sundry items

AMR3850

Mounting plinth

SE105161L

Screws

STC1188

Link leads

2 wire for indicator, side, reverse and fog lamp

STC4637

Link leads

3 wire for stop and tail lamp

ROO-LITES

Exclusive to Britpart

High performance lighting with super strength construction



DA1062



DA1062AMBER

DA1062BLUE



DA1062COVER



DA1064

DA1062

Roo-lite

- > High performance lighting with super strength construction
- > 7 1/4" round long range spot lamps with "stone-proof" clear polycarbonate lens
- > Super strength housing with an Osram 100 watt Xenophot long life technology bulb
- > Variable focus from spot to fog beam pattern
- > Lightweight for reduced vibration
- > Reflector unit is screw-on for easy bulb change
- > 12V - 100W - 8 amps

Note - Roolites sold individually

DA1062AMBER Amber coloured cover

DA1062BLUE Blue coloured cover

DA1062COVER Protective cover

Note - Roolites covers sold individually

DA1063 Spare bulb

DA1064 Harness

- > Harness is of a heavy gauge wire to ensure safe operation of high wattage lamps. It includes digital switch, in-line fuse, built-in relay and wiring harness.

INTERIOR LIGHTS

MAP READING LAMP



Flexible interior lamp!

AMR4910
Defender
24 volt



Got something to tow?

Towing gear for all Land Rovers - see towing equipment section!

LIGHT CONVERSION & UPGRADES

LIGHT CONVERSION KITS

Crystal halogen headlamp
Series/Defender/Range Rover Classic
> Clear lenses and profiled back reflector offer brilliant lighting
> Fully E-marked
Note - Bulb not included
RTC4615K
Right hand drive
Pair



RTC4615K

Sealed beam to halogen
Series/Defender/Range Rover Classic
RTC4615K
Right hand drive
Pair
PRC7994K
Left hand drive
Pair



RTC4615C

LIGHT UPGRADE KITS

STC50383



STC50383
Range Rover P38
Right hand drive lamp upgrade kit
Note - Does not include headlamps

STC50408
Range Rover P38
Left hand drive lamp upgrade kit
Note - Does not include headlamps

LIGHT MOUNTING

LIGHT MOUNTING KITS

DA3010
Series/Defender
8" Headlamp
Chrome
DA3010B
Series/Defender
8" Headlamp
Black



DA3010B

LIGHT BAR

DA5624 Defender - non air-con models Black finish
Note - Light bar exclude lights



DA5624



DA5624 - FITTED

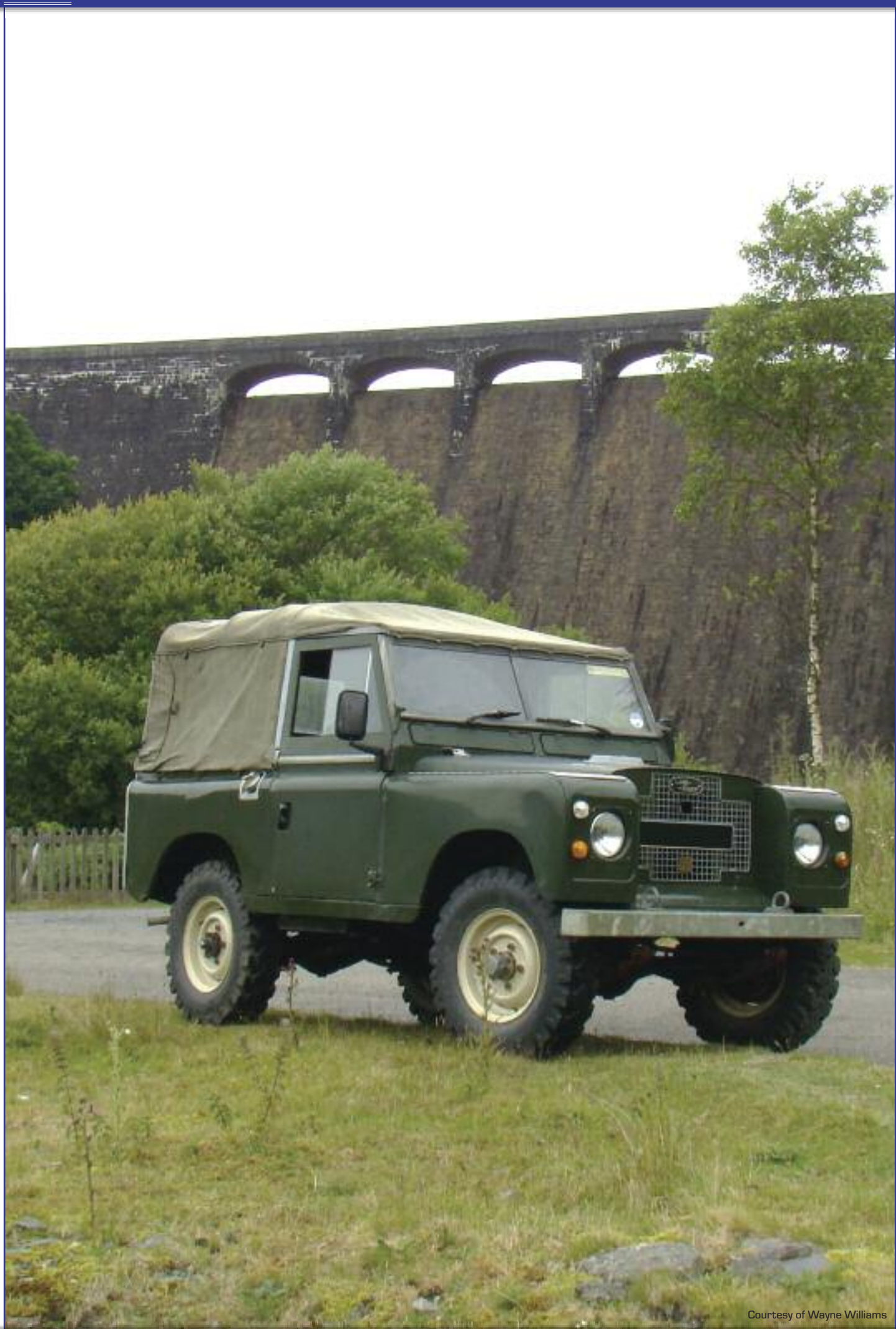

Courtesy of Wayne Williams

06

towing equipment

TOWING EQUIPMENT

Haul that load - towing equipment for all Land Rover models.

Section contents -

Towing equipment

All models	46
Defender	47
Discovery	48
Freelander	49
Range Rover	50
Series	51



Farmyard Defender
Picture courtesy of Greg Mawson

ALL MODELS



201691



DA2123



DA5100



KNB100640



NRC2051



67187



DA2194



ANR3635



579408



DA2195



DA2118



RTC8831



DA2123A

Towing - hitches

201691	All	Ball, jaw & pin HD 4 bolt mounted (ball 3 1/2 ton/jaw 5 ton)
DA2123	All	Ball, jaw & pin (RTC8159/LR008244)
DA5100	All	Tow hitch - to tow 3,500kgs gross
KNB100640	All	Towing jaw (3 1/2 ton)
NRC2051	NATO	Tow hitch

Towing - ancillary parts

67187	All	Pin universal coupling HD (201691)
DA2194	All	Replacement pin for DA2123
ANR3635	All	50mm Tow ball cover
579408	All	7-Pin trailer plug
DA2195	All	Replacement slider bracket - 1-pin
DA2118	All	Replacement slider bracket - 2-pin
RTC8831	All	Saddle slider - fits all Dixon Bates kits
DA2123A	All	Replacement chain, tag & clip
DA2196	All	Replacement slider pin
DA2197	All	Replacement slider pin 'R Clip'



DA2196



DA2197

DEFENDER



DA2121



DA2136



DA2137



LR007221 & DA2123



LR007222



LR007223



VUB105450



STC50269AA / STC50301



242139



RTC8891AA



NRC8208



LR005919



LR005920



LR005921



STC4286



YWJ101500

Towing - hitches

DA2121	Defender - all models	Adjustable kit (RTC8828)
DA2136	Defender - 90 - from WA	Towbar assembly (VUB105460) - no electrics
DA2137	Defender - 110 - from WA	Towbar assembly (VUB105470) - no electrics
LR007221	Defender - 90 - Td5 & 2007 onwards	Adjustable tow kit
LR007222	Defender - 110 - Td5 & 2007 onwards	Adjustable tow kit
LR007223 NEW	Defender - 110 & 130 - from 1998 onwards	High capacity pickup adjustable tow kit (STC50257AB)
VUB105450 NEW	Defender - 110 & 130 - from WA138480 up to WA159806	High capacity pickup tow kit
STC50269AA	Defender - 90 - from XA onwards	Rear step - includes regulation tow bracket Note - Does not include drop plate and tow ball
STC50301	Defender - 110 - from XA onwards	Rear step - includes regulation tow bracket Note - Does not include drop plate and tow ball
242139 NEW	Defender - all models	Front towing eye
RTC8891AA	Defender - all models	50mm Tow ball

Towing - ancillary parts

NRC8208 NEW	Defender - all models - except High Capacity Pickup up to VA138479	Bracket to rear cross member
LR005919 NEW	Defender - 2007 onwards - all models	13-Pin socket electrics kit
LR005920 NEW	Defender - 2007 onwards - all models	'N' Type electrics kit
LR005921 NEW	Defender - 2007 onwards - all models	'S' Type electrics kit - front
STC4286 NEW	Defender - all models	12N 7-pin socket
YWJ101500	Defender - Td5	'N' Type electrics plug

DISCOVERY

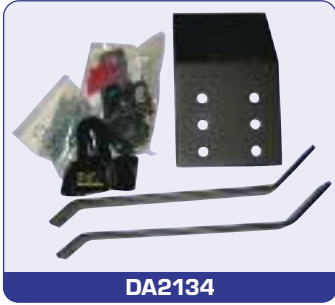

DA2134



DA2125



RTC8891AA



DA2138



STC50287AB



STC50289AB



STC50319



KNB500070



LR007484



STC8919AA



STC4286



STC8875



YWT10002L



STC50081



STC50181



STC50389

Towing - hitches

DA2134	Discovery 1 - up to 1994 Tow kit - includes electrics (not plug-in) (STC8816)
DA2125	Discovery 1 - 1994 onwards Adjustable coupling (RTC8830, STC8060)
RTC8891AA	Discovery 1 50mm Tow ball
DA2138	Discovery 2 Towing kit - includes electrics (not plug-in), excludes tow ball
STC50287AB	Discovery 2 Tow kit - coil suspension - no electrics
STC50289AB	Discovery 2 Tow kit - air suspension - no electrics
STC50319	Discovery 2 Multi-height tow kit (none sliding adjuster) - no electrics
KNB500070	Discovery 3 & Discovery 4 Towing hook assembly - quick disconnect without height adjustment - Less Canada, Mexico & USA
LR007484	Discovery 3 & Discovery 4 Adjustable tow hook kit - Less Canada, Mexico & USA
STC8919AA	Discovery 3 Tow strap



DA2602



YWJ500201

Towing - ancillary parts

STC4286	Discovery 1	12N 7-pin socket
STC8875	Discovery 1 - from MA081881	12S socket
YWT10002L	Discovery 1	Electronic flasher unit for towing
STC50081	Discovery 2	'N' Type electrics socket
STC50181	Discovery 2	'N' Type electrics socket - less front fog lamps
STC50389	Discovery 2	Socket - split charge 'S' type post 1999 caravan
DA2602	Discovery 3	Tow bar electrics kit - 13-Pin (YWJ500160)
YWJ500201	Discovery 3	Tow bar electrics kit 'N' & 'S' type - For Great Britain & Ireland

FREELANDER



KNK500060



KNK500070



STC50391



VUB501500



LR007479



LR007481



VPLFT0009

Towing - hitches

KNK500060 NEW	Freelander 1	Towing kit - European style fixed swan neck
KNK500070	Freelander 1	Towing kit - UK style 50mm ball fitted (VUB501490) Note - This has a plug connection to the vehicle loom - with electrics
STC50391	Freelander 1	Towing kit - includes electrics but not plug-in electrics or tow ball
VUB501500	Freelander 1	Towing kit - swan neck detachable - with plug-in electrics (KNK500080)
LR007479	Freelander 2	Tow bracket kit (LR002738)
LR007481	Freelander 2	Tow bracket kit - swan neck (LR002742)
VPLFT0009	Freelander 2	Tow bracket kit - detachable ball tow bar

Towing - ancillary parts

STC50459 NEW	Freelander 1	Electrical assembly kit - 12S pre-1999 caravan auxiliary electrics
STC50460 NEW	Freelander 1	Electrical assembly kit - 12S post-1999 caravan auxiliary electrics
YMZ101030 NEW	Freelander 1	Electrical assembly kit - 7-pin 12N lighting
YWJ500070 NEW	Freelander 1	Electrical assembly kit - 13-pin auxiliary electrics
YWT10002L NEW	Freelander 1	Electronic flasher unit for towing
VPLFT0001 NEW	Freelander 2	Electrics kit - 12N/12S 7-pin socket (LR003106)
VPLFT0002 NEW	Freelander 2	Electrics kit - 13-pin socket (LR003107)



STC50459



STC50460



YMZ101030



YWJ500070



YWT10002L



VPLFT0001



VPLFT0002

RANGE ROVER



DA2125



DA2134



RTC8829



DA4030



KNB500070



LR007484



STC8919AA



VUB000720



VUB000730

BRITPART

The quality parts for Land Rovers

Towing - hitches

DA2125	Range Rover Classic	Adjustable coupling (RTC8830/STC8060)
DA2134	Range Rover Classic	Tow kit (STC8816) to 1994 - includes electrics but not plug-in electrics
RTC8829	Range Rover Classic	Tow kit
DA4030	Range Rover P38	Tow kit Note - No tow ball included. It is not a Swan neck type, a standard 50mm tow ball is required (RTC8891AA). Electrics are included but not plug-in.
KNB500070	Range Rover Sport	Towing hook assembly - quick disconnect without height adjustment - Less Canada, Mexico, USA & Australia
LR007484	Range Rover Sport	Adjustable tow hook kit - Less Canada, Mexico & USA
STC8919AA	Range Rover Sport	Tow strap
STC8919AA	Range Rover L322	Tow strap
VUB000740	Range Rover L322	Tow bar armature - towing subframe - pre-2006 Europe model Note - The tow bar armature accepts quick release, multi-height tow bars and bike carrier
VUB000720	Range Rover L322 & 2010	Multi-height tow bar - includes carry bag - Less Canada, Mexico & USA
VUB000730	Range Rover L322 & 2010	Quick release tow bar - Less Canada, Mexico & USA
VUB503960	Range Rover L322 & 2010	Tow bar armature - towing subframe - From 6A000001

RANGE ROVER - continued



YWT10002L



DA2602



YWJ500150



YWC000840



YWJ500450



YWJ500460

Towing - ancillary parts

YWT10002L NEW	Range Rover Classic - 1992 - 1994	Electronic flasher unit for towing
DA2602 NEW	Range Rover Sport	Tow bar electrics kit - 13-Pin (YWJ500160)
YWJ500150 NEW	Range Rover Sport	Tow bar electrics kit 12'N' & 12'S' type - 7-pin - Less Canada, Mexico, USA
YWC000840	Range Rover L322	Towing electrics control unit - module
YWJ500450	Range Rover L322	Tow bar electrics kit 12'N' & 12'S' type - 7-pin - Less Canada, Mexico & USA from 6A000001
YWJ500460 NEW	Range Rover L322	Tow bar electric 13-pin socket & harness from 6A000001 up to 2009MYR - Less Canada, Mexico & USA

SERIES



242139



DA2122



RTC8891AA



DA2129



DA2012



DA2133

Towing - hitches

242139 NEW	Series - all models	Front towing eye
DA2122	Series - all models	Adjustable kit
RTC8891AA	Series - all models	50mm Tow ball
DA2129	Lightweight	Adjustable tow hitch

Towing - ancillary parts

DA2012	Series - SWB	Plate and bracket (short)
DA2133	Series - all models	Drop plate extension

Britpart have the equipment to get you hitched up and towing!

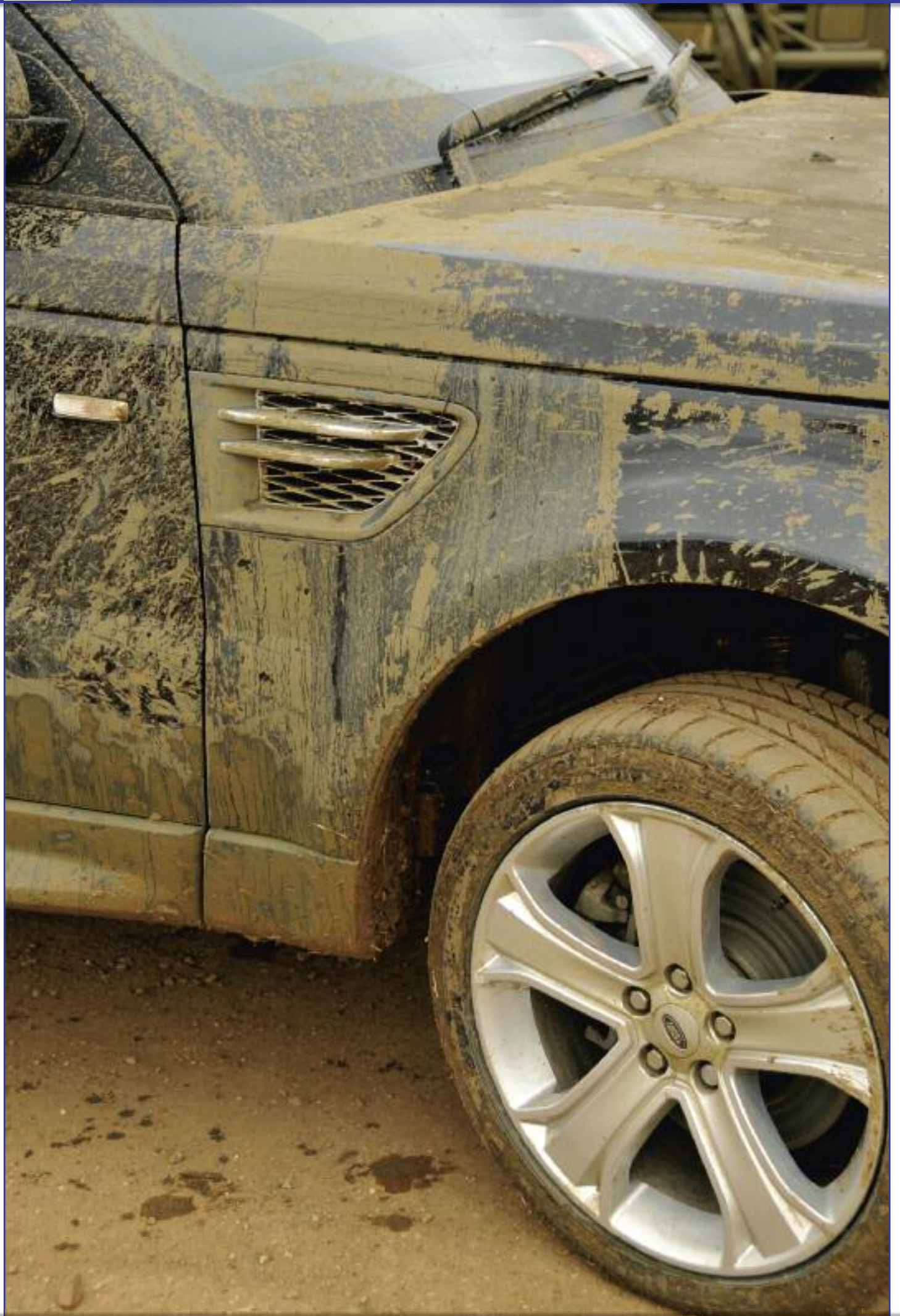

07

interior protection

INTERIOR PROTECTION

Loadspace liners, mats and of course, dog guards - all that you need to protect and keep your Land Rover looking great inside.

Section contents -

Dog guards	54 - 55
Gear box gaiters	55
Loadspace	
Loadspace liners	56 - 57
Loadspace nets & retention kits	58
Mats	
Carpet	58
Premium	59
Rubber	60
Waterproof seat covers	61 - 62

"I'm going to get very muddy in a minute - once you get me down from up here"
Picture of Kelo courtesy of Richard Reid

DOG GUARDS

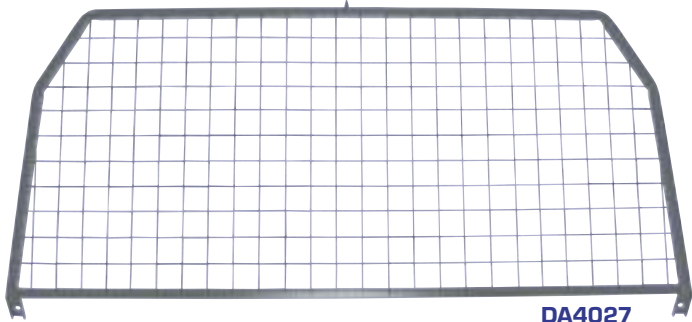

DA4027

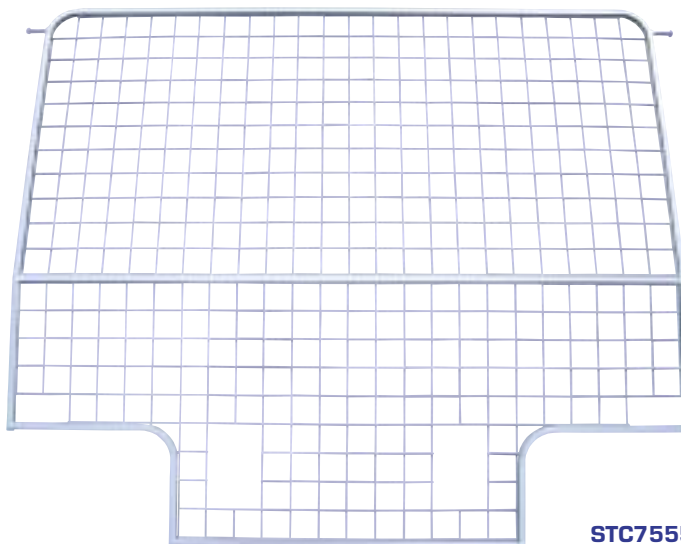

STC7555

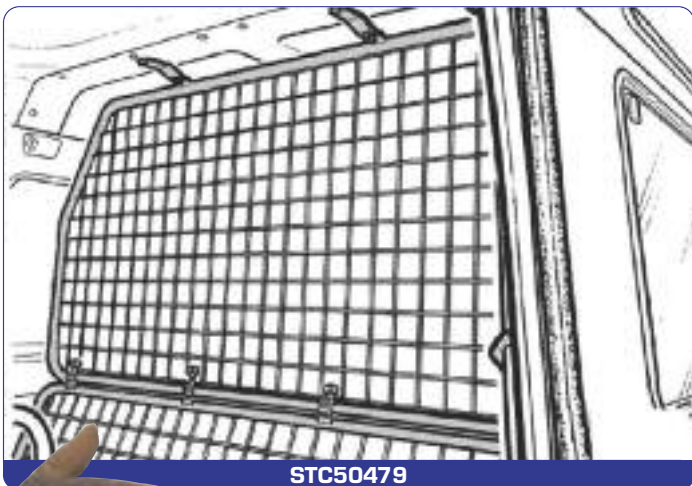

STC50479

Defender/Series

DA4027	Series/Defender - up to 2002 - not County Mesh type	Grey
STC7555	Defender - 110 County Station Wagon Mesh type	Grey
STC50479	Defender - 90 Full height guard for vehicles without a bulkhead Mesh type	Grey



Keep Rover in his place!

Discovery

STC7570	Discovery 1	Half height	Bar type	Grey
STC8414	Discovery 1	Half height	Mesh type	Grey
STC50323	Discovery 2	Half height	Mesh type	Grey
STC50082AA	Discovery 2	Half height	Bar type	Grey
DA5511	Discovery 3/Discovery 4	Half height	Mesh type	Grey
VUB501170	Discovery 3/Discovery 4	Full height	Mesh type	Black



STC7570

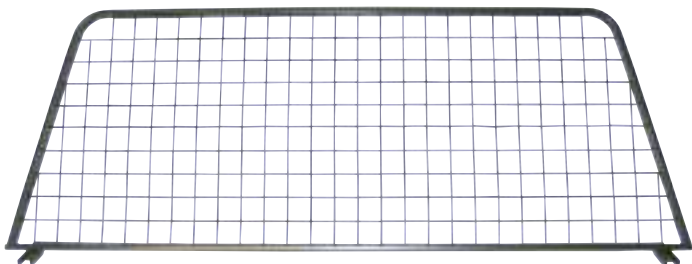

STC8414

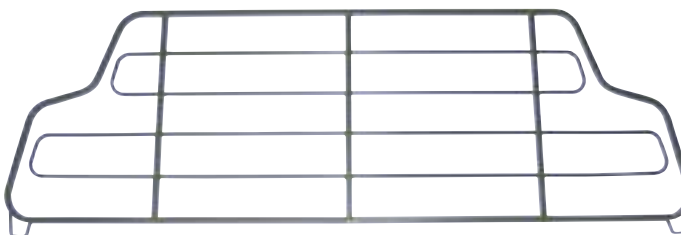

STC50082AA



STC50323



DA5511



VUB501170

DOG GUARDS - continued



STC7939AB



DA5801

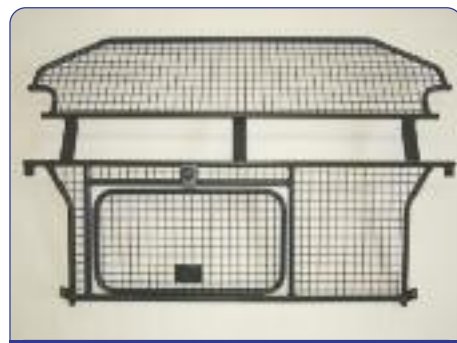

LR002521

Freelander

STC7939AB	Freelander 1	Full height	Bar & mesh type	Grey
DA5801	Freelander 2	Half height	Mesh type	Grey
Easy to fit and remove. No vehicle modifications needed.				
LR002521	Freelander 2	Full height/full width	Mesh type	Black

Range Rover

DA4141	Range Rover Classic - 1986 - 1994	Mesh type	Black
RTC8093	Range Rover Classic - up to 1994	Bar type	Grey
STC8524	Range Rover P38	Bar type	Grey
DA1081	Range Rover Sport	Mesh type	Grey
DA1082 NEW	Range Rover Sport - dog guard divider. Use with DA1081	Mesh type	Grey
VUB002120	Range Rover L322	Mesh type	Black



DA1081

DA4141

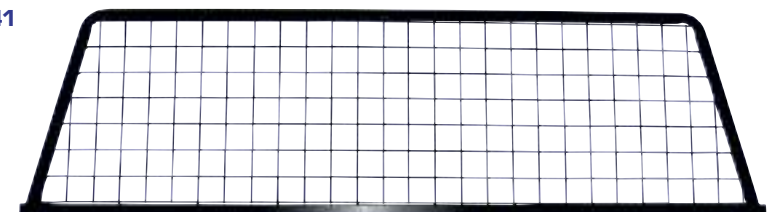

RTC8093



STC8524



DA1082



VUB002120

GEAR BOX GAITERS

Got a Defender with a tatty gear box gaiter? Well replace it with a smart new hard wearing one from Britpart!

DA5498	Grey
DA5499	Black

For details of the alloy gear stick knobs (DA5500) see the Vehicle Enhancement section.

Smarten up your Defender's interior!



DA5498



DA5499 - FITTED

LOADSPACE

LOADSPACE LINERS



331401



DA4470



DA4503

Series/Defender

331401	Series - SWB/Defender - 90	Rear loadspace mat
DA4470	Defender - 90	Rear loadspace mat
DA4503	Defender - 110 - Hard top & truck cab	Rear loadspace mat

5mm rubber with 6mm foam backing - 93 x 198cm

BRITPART

The quality parts for Land Rovers

Britpart's *unique premium* loadspace mats are manufactured from a high-specification material. Designed to be durable with an anti-slip, matt look finish. **These quality mats will protect your Land Rover's loadspace for years to come!**



DA4183



DA4169



STC50050



STC50052AA



STC50053AA



DA5602



EBF500010

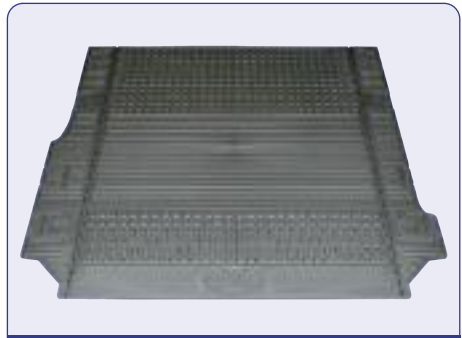

LR006401

Discovery

DA4183	Discovery 1	Loadspace liner	2" deep sides	Semi-rigid
DA4169	Discovery 2	Loadspace liner - Premium	3" deep sides	Semi-rigid
STC50050	Discovery 2 Note - Trim required for air-con models	Loadspace liner	5" deep sides	Rigid
STC50052AA	Discovery 2	Loadspace mat	Half length	Rubber
STC50053AA	Discovery 2	Loadspace mat	Full length	Rubber
DA5602	Discovery 3/Discovery 4	Loadspace liner - Premium	3" deep sides	Semi-rigid
EBF500010	Discovery 3/Discovery 4	Loadspace liner	6" deep sides	Rigid
LR006401	Discovery 3/Discovery 4	Loadspace mat	Half length	Rubber

LOADSPACE LINERS - continued



DA4171



STC50434



DA5554



LR002516



LR002424



Shown here fitted to a Range Rover Sport

VPLFS0014



Freelander

DA4171	Freelander 1	Loadspace liner - Premium	2" deep sides	Semi-rigid
STC50434 NEW	Freelander 1	Loadspace mat		Rubber
DA5554	Freelander 2	Loadspace liner - Premium	2" deep sides	Semi-rigid
LR002516	Freelander 2	Loadspace mat		Rubber
LR002424	Freelander 2	Loadspace liner	3" deep sides	Semi-rigid
VPLFS0014	Freelander 2	Luggage compartment protection		



DA4170



DA5555



VPLSS0016



DA5556



EBF000040

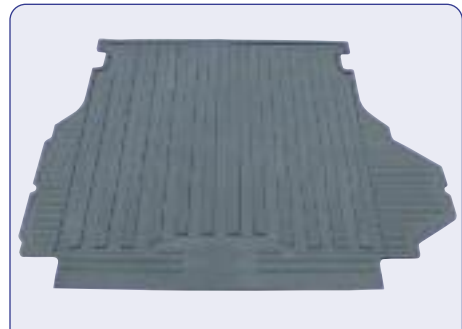

LR003894

Range Rover

DA4170	Range Rover P38	Loadspace liner - Premium	3" deep sides	Semi-rigid
DA5555	Range Rover Sport	Loadspace liner - Premium	2" deep sides	Semi-rigid
VPLSS0016	Range Rover Sport	Luggage compartment protection		
DA5556	Range Rover L322	Loadspace liner - Premium	2" deep sides	Semi-rigid
EBF000040	Range Rover L322	Loadspace liner	6" deep sides	Rigid
LR003894	Range Rover L322	Loadspace mat		Rubber

LOADSPACE NETS & RETENTION KITS



LOADSPACE RETENTION KIT



LR017770

Loadspace retention kits

Restricts the movement of goods in the rear of the vehicle

Contents - 1 x floor net & 2 x ratchet straps

VUB000700 Range Rover L322

VUB503130 NEW Discovery 3/Discovery 4 /Range Rover Sport

Loadspace nets

A convenient way of storing luggage to maximise load space

LR017770 Range Rover L322

Contents - 2 x nets

LR003852 NEW Freelander 2

Contents - 1 x net

Can be used in two positions within the loadspace



POSITION 1

LR003852

POSITION 2



Courtesy of Natasha Bridges

MATS

CARPET



DA4022BLACK



DA4023GREY



DA4024BLUE

DA4022BLACK	Defender - all models - front only	Black
DA4023BLACK	Discovery 1	Black
DA4023BLUE	Discovery 1	Blue
DA4023GREY	Discovery 1	Grey
DA4024BLUE	Range Rover Classic - 1986 on	Blue

Note - Front and rear carpet sets with rubber backing

Protect your vehicle interior with a set of smart floor mats...

PREMIUM

Premium Mats - Carpet With Rubber Backing

LR002484	Freelander 2	Front & rear contour set	RHD	Ebony black
LR002486	Freelander 2	Front & rear contour set	LHD	Ebony black
LR002485	Freelander 2	Front & rear contour set	RHD	Alpaca beige
LR002497	Freelander 2	Front & rear contour set	LHD	Alpaca beige
LR006431	Discovery 3	Front & rear contour set	RHD	Ebony black
LR006432	Discovery 3	Front & rear contour set	LHD	Ebony black
EAH500010PVJ	Discovery 3	Front & rear floor set	RHD	Ebony black
EAH500080PVJ	Discovery 3	Front & rear floor set	LHD	Ebony black
LR006433	Discovery 3	Front & rear contour set	LHD	Alpaca beige
VPLAS0022PVJ	Discovery 4	Front & rear contour set	RHD	Ebony black
VPLAS0023PVJ	Discovery 4	Front & rear contour set	LHD	Ebony black
LR006434	Range Rover Sport	Front & rear contour set	RHD	Aspen
LR006436	Range Rover Sport	Front & rear contour set	LHD	Aspen
EAH500012LUP	Range Rover Sport	Front & rear floor set	RHD	Aspen
EAH500011LUP	Range Rover Sport	Front & rear floor set	LHD	Aspen
LR006435	Range Rover Sport	Front & rear contour set	RHD	Ebony black
LR006437	Range Rover Sport	Front & rear contour set	LHD	Ebony black
EAH500012PVJ	Range Rover Sport	Front & rear floor set	RHD	Ebony black
EAH500011PVJ	Range Rover Sport	Front & rear floor set	LHD	Ebony black
LR006438	Range Rover Sport	Front & rear contour set	LHD	Alpaca beige
EAH500015SMS	Range Rover Sport	Front & rear floor set	LHD	Alpaca beige
EAH000300JMN	Range Rover L322 up to 6A	Front & rear contour set	RHD	Navy
EAH000310JMN	Range Rover L322 up to 6A	Front & rear contour set	LHD	Navy
EAH500280JMN	Range Rover L322 from 7A	Front & rear contour set	RHD	Navy
EAH500290JMN	Range Rover L322 from 7A	Front & rear contour set	LHD	Navy
EAH000300LUP	Range Rover L322 up to 6A	Front & rear contour set	RHD	Aspen
EAH000310LUP	Range Rover L322 up to 6A	Front & rear contour set	LHD	Aspen
EAH500280LUP	Range Rover L322 from 7A	Front & rear contour set	RHD	Aspen
EAH500290LUP	Range Rover L322 from 7A	Front & rear contour set	LHD	Aspen
EAH000300PVA	Range Rover L322 up to 6A	Front & rear contour set	RHD	Jet
EAH000310PVA	Range Rover L322 up to 6A	Front & rear contour set	LHD	Jet
EAH500280PVA	Range Rover L322 from 7A	Front & rear contour set	RHD	Jet
EAH500290PVA	Range Rover L322 from 7A	Front & rear contour set	LHD	Jet
EAH000300SUN	Range Rover L322 up to 6A	Front & rear contour set	RHD	Sand
EAH000310SUN	Range Rover L322 up to 6A	Front & rear contour set	LHD	Sand
EAH500280SUN	Range Rover L322 from 7A	Front & rear contour set	RHD	Sand
EAH500290SUN	Range Rover L322 from 7A	Front & rear contour set	LHD	Sand

Premium Mats - Rubber

LR002481	Freelander 2	Front & rear contour set	RHD	Black
LR002483	Freelander 2	Front & rear contour set	LHD	Black
LR006237	Discovery 3/Discovery 4	Front & rear contour set	RHD	Black
LR006238	Discovery 3/Discovery 4	Front & rear contour set	LHD	Black
EAH500100PMA	Discovery 3/Discovery 4	3rd Row floor mat	N/A	Black
EAH500052PMA	Discovery 3	Front & rear floor set	RHD	Black
EAH500050PMA	Discovery 3	Front & rear floor set	LHD	Black
EAH500058PMA	Discovery 3	Front contour set	RHD	Black
EAH500057PMA	Discovery 3	Front contour set	LHD	Black
LR006241	Range Rover Sport	Front & rear contour set	RHD	Black
LR006242	Range Rover Sport	Front & rear contour set	LHD	Black
VPLSS0020	Range Rover Sport	Front & rear floor set	RHD	Black
EAH500051PMA	Range Rover Sport	Front & rear floor set	LHD	Black
EAH500320PMA	Range Rover L322	Front & rear contour set	RHD	Black
EAH500330PMA	Range Rover L322	Front & rear contour set	LHD	Black
EAH000261PMA	Range Rover L322	Front & rear floor set	RHD	Black
EAH000271PMA	Range Rover L322	Front & rear floor set	LHD	Black

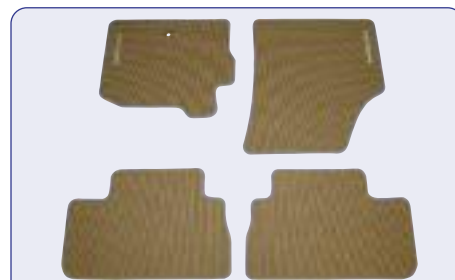

LR002485



LR006435

Premium protection for
your Land Rover..



EAH500052PMA



VPLSS0020



RUBBER



BTR7895



BTR7896



BTR7897



BTR7898

Defender Rubber Mats

Individual Mats

BTR7895	Defender - LT77 Gearbox	Front floor left hand	Heavy duty with foam backing
BTR7896	Defender - LT77 Gearbox	Front floor right hand	Heavy duty with foam backing
BTR7897	Defender - 1993 on	Front floor left hand	Heavy duty with foam backing
BTR7898	Defender - 1993 on	Front floor right hand	Heavy duty with foam backing

Mat Sets

DA4501	Defender - LT77 Gearbox	Front right & left hand	Contains - BTR7895 & BTR7896
DA4502	Defender - 1993 on	Front right & left hand	Contains - BTR7897 & BTR7898
STC50172	Defender - Pre-2007 MY	Front right & left hand	
LR005039	Defender - 2007 MY onwards	Front right & left hand	



Keep your Land Rover interior clean with a set of mats from Britpart

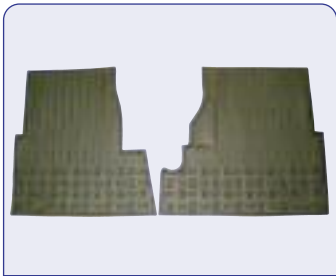

DA4422



DA4423



DA4426



DA4427

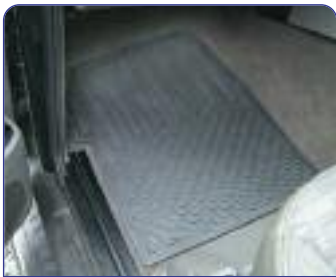

DA4424



DA4425



DA4428



DA4429



DA4430



DA4431

Quality Rubber Over Mats

DA4422	Series 2/Series 3	Front	Black	Pair
DA4423	Defender - all models	Front	Black	Pair
DA4426	Discovery 1	Front	Black	Pair
DA4427	Discovery 1	Rear	Black	Pair
DA4424	Discovery 2	Front	Black	Pair
DA4425	Discovery 2	Rear	Black	Pair
DA4428	Freelander 1	Front	Black	Pair
DA4429	Freelander 1	Rear	Black	Pair
DA4430	Range Rover P38	Front	Black	Pair
DA4431	Range Rover P38	Rear	Black	Pair

WATERPROOF SEAT COVERS



DA2815GREY

Defender - up to 2007

3 Seats - Front

DA2815BLACK **DA2815BLUE**

DA2815GREEN **DA2815GREY**

Covers in kit -

3 x full seat (excludes headrest covers)



DA2816GREY

Defender - up to 2007 - 2nd Row

110 Station Wagon - 60/40

DA2816BLACK **DA2816BLUE**

DA2816GREEN **DA2816GREY**

Covers in kit -

1 x two-seat back & cushion

1 x one-seat back & cushion

Note - Will fit 110 Crew Cab with minor modification to seat covers

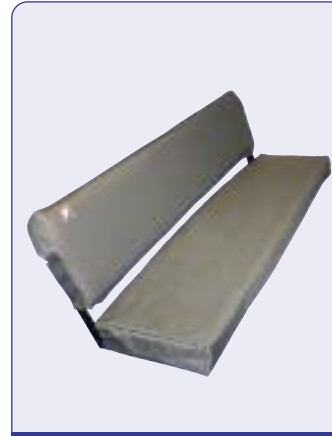

DA2817GREY

Defender - up to 2007

110 Station Wagon

- Bench Rear Inward Facing

DA2817BLUE **DA2817GREEN**

DA2817GREY

Covers in kit -

2 x bench-seat back & cushion

Note - For 1,200mm long seat



DA2818BLACK

Defender - 2007 - onwards

Front

DA2818BLACK

Covers in kit -

2 x full seat

2 x headrest



DA2807GREY

Discovery 1 - Front

DA2807BLACK **DA2807BLUE**

DA2807GREEN **DA2807GREY**

Covers in kit -

2 x full seat



DA2808GREY

Discovery 1 - Rear

DA2808BLACK **DA2808BLUE**

DA2808GREEN **DA2808GREY**

Covers in kit -

1 x two-seat back & cushion

1 x one-seat back & cushion



DA2809GREY

Discovery 1 - Boot

DA2809BLUE **DA2809GREEN**

DA2809GREY

Covers in kit -

2 x full seat

What better way to protect your Land Rover seats than these waterproof covers from Britpart?



- > An extensive range of quality and stylish waterproof seat cover sets.
- > Front and rear sets available with headrests and armrests included in the Range Rover and Freelander range. Rear inward facing sets are also available for the 7-seater Discovery models.
- > The hard-wearing washable covers are made from waterproof woven polyester with a PVC backing.
- > Snug fit covers available in 4 stylish colours.
- > Easy to put on the seats and just as easy to remove again.



DA2800BLUE

Discovery 2 - Front

DA2800BLACK **DA2800BLUE**

DA2800GREEN **DA2800GREY**

Covers in kit -

2 x full seat

2 x headrest

2 x armrest

Note - Discovery 2 seat covers will not fit vehicles with leather seats



DA2801BLUE

Discovery 2 - Rear

DA2801BLACK **DA2801BLUE**

DA2801GREEN **DA2801GREY**

Covers in kit -

1 x two-seat back & cushion

1 x armrest

1 x full seat

3 x headrest



DA2802BLUE

Discovery 2 - Boot

DA2802BLUE **DA2802GREEN**

DA2802GREY

Covers in kit -

2 x full seat

2 x roof headrest (not shown)

Discovery 3 - Front

DA2822BLACK

Covers in kit -

2 x full seat

2 x headrest

2 x armrest

Note - Suitable for vehicles with side air bags but not leather seats

WATERPROOF SEAT COVERS - continued



DA2810GREEN

Freeland 1
3 Door - Front
DA2810BLACK **DA2810BLUE**
DA2810GREEN **DA2810GREY**

Covers in kit -
 2 x back, cushion & headrest

Freeland 1
3 Door Sport - 2 Rear Seats
DA2812BLUE **DA2812GREEN**
DA2812GREY

Covers in kit -
 2 x back, cushion & headrest



DA2811BLUE

Freeland 1
5 Door - Front
DA2811BLACK **DA2811BLUE**
DA2811GREEN **DA2811GREY**

Covers in kit -
 2 x back, cushion & headrest

Freeland 2
Front
DA2821BLACK

Covers in kit -
 2 x full seat 2 x headrest
 2 x armrest



DA2813GREEN

Freeland 1
3 or 5 Door - Rear
60/40 split without armrest
DA2813BLUE **DA2813GREEN**
DA2813GREY

Covers in kit -
 1 x two-seat back & cushion
 1 x one-seat back & cushion
 3 x headrest



DA2814BLUE

Freeland 1
3 or 5 Door - Rear
60/40 split with armrest
DA2814BLUE **DA2814GREEN**
DA2814GREY

Covers in kit -
 1 x two-seat back & cushion
 1 x one-seat back & cushion
 3 x headrest* *pre-Td4 only



DA2803GREY

Range Rover Classic
4 Door - Front
DA2803BLACK **DA2803BLUE**
DA2803GREEN **DA2803GREY**

Covers in kit -
 2 x back, cushion, armrest & headrest



DA2804GREY

Range Rover Classic
4 Door - Rear
DA2804BLUE **DA2804GREEN**
DA2804GREY

Covers in kit -
 1 x two-seat back & cushion
 1 x one-seat back & cushion
 3 x armrest



DA2805BLUE

Range Rover P38 - Front
DA2805BLUE **DA2805GREEN**
DA2805GREY

Covers in kit -
 2 x full seat, headrest & armrest
Note - Not suitable for vehicles with rear air bags mounted in the front seats



DA2806BLUE

Range Rover P38 - Rear
DA2806BLUE **DA2806GREEN**
DA2806GREY

Covers in kit -
 1 x two-seat back & cushion
 1 x one-seat back & cushion
 3 x headrest 1 x armrest

Range Rover Sport - Front
DA2819BLACK

Covers in kit -
 2 x full seat 2 x headrest
 2 x armrest

Range Rover L322 - Front
DA2820BLACK

Covers in kit -
 2 x full seat 2 x headrest
 2 x armrest



Helping you protect your Land Rover!

Waterproof Seat Covers - Other

LR005058	Freeland 2	Front	Pair	Aspen
LR005059	Freeland 2	Front	Pair	Sand
DA4083	Range Rover Classic	Front & rear	Set	Grey/Navy
HBD000320JMN	Range Rover L322	Front	Pair	Navy
	Standard seats including head and arm rest			
HBD000320LUP	Range Rover L322	Front	Pair	Aspen
	Standard seats including head and arm rest			
HBD000320LYR	Range Rover L322	Front	Pair	Charcoal
	Standard seats including head and arm rest			
HBD000320SUN	Range Rover L322	Front	Pair	Sand
	Standard seats including head and arm rest			



Saggy old seats? Get a set of smart new ones. We've plenty to choose from in a multitude of materials and colours. Also keep your vehicle clutter free with a cubby box.

Section contents -

Cubby boxes

Defender & Series **62 - 63**

Freelander **62 - 63**

Extended slide seat rails & bulkhead bars

64

Fume curtain

64

Hoods

64

Seats

Defender & Series **66**

Re-trim kits **65**

Techno style **67**

XS style **67**

Trim

Dash trim **63**

Door trim **68**



Inside view of the Britpart Trim Shop

CUBBY BOXES

DEFENDER & SERIES



RANGE IMPROVED
NOW WITH DOUBLE CUP HOLDER

Defender/Series 3 Cubby Boxes

With a Britpart cubby box in your Land Rover you can ensure your vehicle remains clutter free with these handy storage devices. Now with a double cup holder as standard, spilt drinks are a thing of the past. If security is a worry, then peace of mind can be achieved with our cubby box made from metal with a padded lid which is lockable.

	Top	Body
DA2035	Black	Black
DA2035LCS	Grey	Grey
DA2035RPI	Vinyl twill	Grey
DA2035T	Techno	Grey
DA2149	Grey	Black

Security box - 2 keys & 3 removable cup holders

Defender Cubby Box Cup Holder

FWJ500020PMA

Double cup holder for both old and new model Defenders - ideal for holding a Britpart travel mug or two!! **Note** - To fit to existing carpet lined cubby box the lining may have to be taken out. Fits XS Style cubby boxes too.

Excludes travel mug -

DA8015



FWJ500020PMA



DA2035



DA2035LCS



DA2035RPI



DA2149

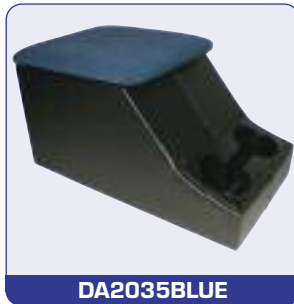

DA2035BLUE



DA2035BROWN



DA2035CHAR



DA2035GREEN



DA2035GREY

Keep your Defender & Series 3 clutter free!

XS Style Cubby Boxes

Hand-built in the UK, these quality XS style cubby boxes are suitable for Series 3 and Defenders. Well crafted with precision tools using a hard wearing leatherette outer and velour trim inner. Each box has locking stay brass hinges. These XS Style cubby boxes match our range of XS Style seats - see this section. Now with a double cup holder as standard, spilt drinks are a thing of the past.

	Top	Body
DA2035BLUE	Blue	Black
DA2035BROWN	Light brown	Dark brown
DA2035CHAR	Charcoal	Black
DA2035GREEN	Green	Black
DA2035GREY	Light grey	Dark grey



Courtesy of Sergio Coelho

FREELANDER



DA5101



DA5103



DA5113

Add some extra storage space in a Freelander 2 with one of these stylish cubby boxes.

- > Innovative design
- > Strong ABS storage base
- > Large storage capacity
- > Easy do-it-yourself installation in only 5 minutes in the original point
- > Boxes for vehicles with no factory fitted armrests have adjustable sliding tops

Freelander 2 with no factory fitted armrests

DA5101	RHD	Black real leather
DA5102	RHD	Black eco leather
DA5103	RHD	Alpaca leather
DA5113	RHD	Almond leather
DA5104	LHD	Black real leather
DA5105	LHD	Black eco leather
DA5106	LHD	Alpaca leather
DA5114	LHD	Almond leather

Freelander 2 with factory fitted armrests

DA5115	Black real leather
DA5109	Black eco leather
DA5111	Alpaca leather
DA5112	Almond leather

Note - For both RHD & LHD vehicles



DA5111

Freelander 1 - 2001 - 2006

Add some support to your Freelander with one of these stylish adjustable armrests.

- > Innovative design
- > Easy do-it-yourself installation

DA5118



DA5116

Black eco leather

DA5117

Black real leather

DA5118

Smokestone real leather



DA5116



Courtesy of Marco Simola

EXTENDED SLIDE SEAT RAILS & BULKHEAD BARS



DA2148

DA2148

Give your Defender seats 3" of extra slide with a pair of these seat rails. Ideal for the taller driver to give a more practical and comfortable driving position. One pair of rails is suitable for one seat.

- > Ideal for the taller driver
- > A more practical and comfortable driving position



DA2351

DA2351

Up until recently, Land Rover hasn't catered (in the Defender) for the people with stature. The bulk head removal bar alleviates the problem without compromising strength. The bulk head removal bar allows an extra 105mm of seat rake at the top and 50mm of travel on the seat base. The tubular bar creates a rigid bracing for the front of the Defender tub. As well as the added benefits of extra room in the vehicle due to the seats been more manoeuvrable, access to the rear of the Defender is now not compromised by a higher bulk head. Powder coated and supplied complete with all the necessary fixings.

FUME CURTAIN



MRC3519

MRC3519

Series/Defender

Note - Hood stick not included - 330553

HOODS

Got a Land Rover with a hood that has seen better days? Tears? Frayed fixings? Scratched windows? Well give your vehicle a quick facelift with a new canvass hood from Britpart.

- > Hoods are made from the original 18oz canvas and made to OEM specifications
- > All fittings are brass and made to OEM specifications
- > Webbing is made the same way as the original
- > Polypropylene rope is the same construction as the original rope
- > Ropes are all inserted into the hood to help customers
- > Care instruction are included

Other hoods available on request - please ask for details.

331110AG	Series - SWB	Full hood	Khaki	Without windows
331113AG	Series - SWB	Full hood	Khaki	With windows
331110SA	Series - SWB	Full hood	Sand	Without windows
331113SA	Series - SWB	Full hood	Sand	With windows
331371AG	Series - SWB	Three quarters hood	Khaki	Without windows
331259AG	Series - LWB	Full hood	Khaki	Without windows
331260AG	Series - LWB	Full hood	Khaki	With windows
331259SA	Series - LWB	Full hood	Sand	Without windows
331260SA	Series - LWB	Full hood	Sand	With windows
331308AG	Series - LWB	Three quarters hood	Khaki	With windows
MUC2437	Series - LWB	Three quarters hood	Khaki	Without windows
		V8 High capacity pick-up		
MUC4122ABE	Defender - 90	Full hood	Sand	With windows



Courtesy of Darren Whiley



331110AG - SIDE VIEW



331110AG - REAR VIEW



331113AG



331371AG

SEATS

DEFENDER & SERIES

Defender Seats

DA4028	Seat cover	Base outer	Black
DA4041	Seat cover	Back outer	Black
MWC3302	Seat	Back RH	Black
MWC3303	Seat	Back LH	Black
MWC4535	Seat	Base outer	Black
MWC1010	Headrest assembly		Black
DA4029	Seat cover	Base outer	Grey
DA4042	Seat cover	Back outer	Grey
MWC5670LCS	Seat	Base outer	Grey
MWC9843LCS	Seat	Back LH	Grey
MWC9844LCS	Seat	Back RH	Grey
MWC5628LCS	Headrest assembly		Grey
AWR5701RPI	Seat cover	Base outer	Vinyl twill
AWR5702RPI	Seat cover	Back outer	Vinyl twill
AWR5708RPI	Headrest assembly		Vinyl twill
AWR5700RPI	Seat	Base outer	Vinyl twill
BTR8140RPI	Right hand assembly	Less headrest	Vinyl twill
BTR8141RPI	Left hand assembly	Less headrest	Vinyl twill
DA4031	Seat foam	Base outer	
DA4055	Seat foam	Back outer	
DA4056	Seat foam	Centre to 07/95	



Defender & Series Seats

320737	Bench seat	Rear assembly SWB	Black
DA3059	Bench seat	Rear assembly LWB	Black
DA4067	Rear seat	Individual inward facing	Black
320737CB	Bench seat	Rear assembly SWB	County brown
320737CG	Bench seat	Rear assembly SWB	County grey
320737LCS	Bench seat	Rear assembly SWB	Grey
DA4075	Rear seat	Individual inward facing	Grey
320737T	Bench seat	Rear assembly SWB	Techno style
DA4075T	Rear seat	Individual inward facing	Techno style
320737RPI	Bench seat	Rear assembly SWB	Vinyl twill
DA4075RPI	Rear seat	Individual inward facing	Vinyl twill

Series Seats

320698	Seat back - pin fitment - adjustable	Standard outer	Black
320699	Seat base - adjustable	Standard outer	Black
320726	Seat base	Standard centre	Black
349967	Seat base	Standard outer	Black
MUC1488	Seat back	Standard centre	Black
MUC1520	Seat back - pin fitment	Standard outer	Black
MUC1520G	Seat back - bolt fitment	Standard outer	Black
DA4305	Standard seat kit		Black
Note - Kit contains - 2 x 349967; 2 x MUC1520; 1 x 320726 & 1 x MUC1488			
MRC6980	Seat base	Deluxe outer	Black
MRC6982	Seat back	Deluxe outer	Black
MRC6982H	Seat back with headrest	Deluxe outer	Black
MRC6985	Seat base	Deluxe centre	Black
MTC3181	Seat back	Deluxe centre	Black
DA4298	Deluxe seat kit		Black
Note - Kit contains - 2 x MRC6982; 2 x MRC6980; 1 x MTC3181 & 1 x MRC6985			

All products leaving the Trim Shop are produced to the highest standards!

The skilled team in the Trim Shop make a wide range of seats and seat covers for Land Rover vehicles by hand. The material arrives in vast reams and has to be cut with great precision before being stitched together and then assembled into seat bases, seat backs, seat benches etc. In keeping with the Britpart philosophy, all products leaving the Trim Shop are produced to the highest standards and meet with the strictest safety regulations.



DA4298



DA4067



A COMPLETE BRITPART SEAT



320737



MRC6982H

RE-TRIM KITS



DA5628

Going off-road? Got a working Land Rover? Well the chances are your seats won't be in showroom condition, luckily here at Britpart we have the answer - a Defender re-trim kit.

Outer Seats - Defender - up to 2007

An outer Britpart re-trim kit includes:

1 x Fitment guide CD - This 20 minute tutorial will give you a detailed step-by-step guide to disassembling and assembling your Defender seat and information on the correct use of the included parts.

- 1 x Can of contact adhesive spray
- 1 x Squab foam
- 1 x Squab cover
- 6 x Plastic nails
- 3 x Cable ties
- 1 x Cushion foam
- 1 x Cushion cover
- 1 x Headrest cover
- 2 x Metal rods
- 1 x Rubber retainer

DA5627	Vinyl twill
DA5628	Techno
DA5629	Black
DA5630	Grey
DA5636	XS style Outer - Black / Inner - Charcoal

Centre Seats - Defender - 1990 onwards

A centre Britpart re-trim kit includes:

- 1 x Can of contact adhesive spray
- 1 x Squab foam
- 1 x Squab cover
- 1 x Metal rods
- 1 x Cushion foam
- 1 x Cushion cover
- 6 x Plastic nails
- 1 x Rubber retainer

DA5632	Vinyl twill
DA5633	Techno
DA5634	Black
DA5635	Grey



DA5634

Breathe life back into your old saggy Defender seats with a Britpart re-trim kit.

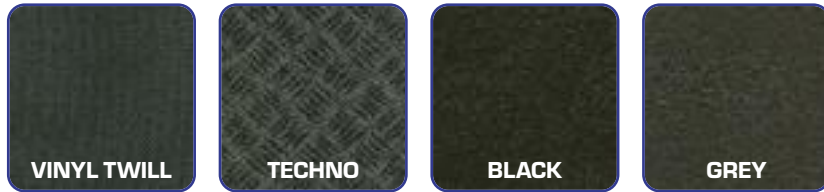

Swatches

Material colours are an approximate match. Sample swatches of the actual material are available on request.



Courtesy of Paul Sainsbury

TECHNO STYLE

Hand-built in the UK, these quality seats with the ever popular 'Techno' pattern are suitable for Defenders. Well-crafted with precision tools using a hard wearing velour trim. Comfort is ensured with injection moulded foam.

HAG100970LOY	Base	
HCA106010LOY	Cover base	
HAJ101400LOY	Squab assembly - no pockets	Right hand side
HAJ101410LOY	Squab assembly - no pockets	Left hand side
HBA106190LOY	Squab cover - no pocket	
HBA106180LOY	Squab cover - with pocket	
HAH103510LOY	Headrest	
320737T	Rear seat assembly	
DA4075T	Rear seat individual inward facing	
HHD102280	Runner & sub-frame	Right hand side
HHD102290	Runner & sub-frame	Left hand side



320737T

Swatches
Material colours are an approximate match. Sample swatches of the actual material are available on request.



TECHNO



XS STYLE

Hand-built in the UK, these quality XS style seats are suitable for Defenders. Well-crafted with precision tools using a hard wearing leatherette outer and velour trim inner. Comfort is ensured with injection moulded foam. Seats complete with base, back and headrest but the runners are not included.

	Outer	Inner	Side
DA5610	Dark grey	Light grey	Right
DA5611	Dark grey	Light grey	Left
DA5614	Black	Blue	Right
DA5615	Black	Blue	Left
DA5616	Dark brown	Light brown	Right
DA5617	Dark brown	Light brown	Left
DA5618	Black	Charcoal	Right
DA5619	Black	Charcoal	Left
HHD102280	Runner & sub-frame		Right hand side
HHD102290	Runner & sub-frame		Left hand side

Re-trim Kit

A Britpart XS Style re-trim kit includes:

- 1 x Fitment guide CD - This 20 minute tutorial will give you a detailed step-by-step guide to disassembling and assembling your Defender seat and information on the correct use of the included parts.
- 1 x Can of contact adhesive spray
- 1 x Squab foam
- 1 x Squab cover
- 6 x Plastic nails
- 3 x Cable ties
- 1 x Cushion foam
- 1 x Cushion cover
- 1 x Headrest cover
- 2 x Metal rods
- 1 x Rubber retainer

DA5636	Outer - Black	Inner - Charcoal
---------------	---------------	------------------



DA5610 / DA5611



DA5614 / DA5615



DA5616 / DA5617



DA5618 / DA5619

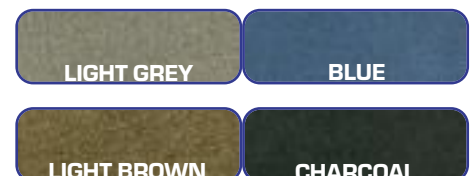

TRIM

DASH TRIM

DA2090	Discovery 1	Dash trim kit	Black
DA2091	Discovery 1	Dash trim kit	Blue
DA2096	Discovery 1	Dash trim kit	Grey
DA2098	Discovery 1	Dash trim kit	Brown

Put a stop to the dreaded dash peel!

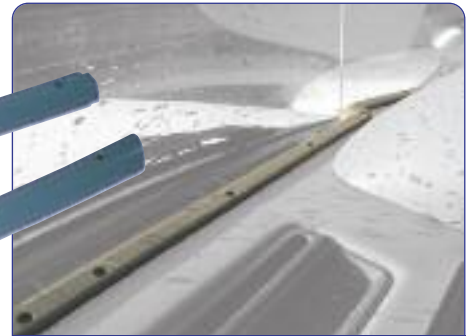

DA2098 - FITTED

DOOR TRIM



DA2124



DA2029



DA2441

DA2124	Series /Defender	Door trim safari	Rear		
DA2029	Series	Door trim lower	RHS		
DA2030	Series	Door trim lower	LHS		
DA2440	Defender	Door casing	Manual window	Black	RHS
DA2441	Defender	Door casing	Manual window	Black	LHS
DA2442	Defender	Door casing	Manual window	Grey	RHS
DA2443	Defender	Door casing	Manual window	Grey	LHS
DA2444	Defender	Door casing	Electric window	Black	RHS
DA2445	Defender	Door casing	Electric window	Black	LHS
DA2446	Defender	Door casing	Electric window	Grey	RHS
DA2447	Defender	Door casing	Electric window	Grey	LHS

Replace your Defender's old tatty door cards with one of these smart plastic replacements. Easy to fit they are also easy to keep clean with a wipe clean finish.



09

OFF-ROAD EQUIPMENT

Be prepared for the unexpected when exploring the exotic far flung corners of the globe - or even down your local greenlane.

Section contents -

Air compressors & tyre repair kit	72
Diff lockers	
ARB	73
Detroit	74
Emergency equipment	
Fire extinguishers	74
First aid kit	74
Hammer	75
Fuel tanks & jerry cans	
Fuel tanks	75
Jerry cans	75
Jacks	
Hi-Lift	76
Jackall	77
Jacking equipment	77
Ladders - sand & bridging	78
Land meters	78
Raised air intakes	
Britpart	78
Safari	79

AIR COMPRESSORS & TYRE REPAIR KIT

Double pump

DA2392



DA2392 - double-pump
> Air flow - 150ltr/min

DA2354 - single-pump
> Air flow - 72ltr/min

Features for both air compressors

- > 12 volt / 30 amp
- > Max. pressure - 150psi
- > Automatic cut off to prevent overheating
- > 2 metre electric hose with heavy-duty clamps
- > 10 metre air hose with heavy-duty gauge and brass fittings
- > Integrated sand tray
- > Blow moulded carrying case
- > Also great for camping and outdoor use

DA2394

Replacement cap and filter for DA2392 & DA2354

Ideal for 4x4 use!

Great features...



Heavy-duty gauge



3 nozzles

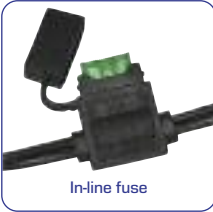

In-line fuse



DA2354

Single pump



Screw in air filter
DA2394



Built-in sand tray



Anti-vibration rubber feet



10m coiled hose



Heavy-duty battery clips



Blow moulded case

Don't get caught out with a flat tyre or two!

*Pack and leave an easy to use Britpart tyre repair kit in your vehicle.**



DA2390

DA2390

Tyre repair kit in travel case
See the wheels section for more details on the tyre repair kit from Britpart.

* Recommended for off-road use only



Picture courtesy of Kristjan Kristjansson

DIFF LOCKERS

ARB



ARB Diff Lockers

- > Provides 100% traction on demand without affecting on road driveability or driveline wear
- > Vastly improved traction means less reliance on momentum, thus reducing the likelihood of vehicle damage and environmental impact
- > Easy, convenient operation allows the driver to concentrate on the terrain without leaving the comfort and safety of their seat
- > Ultra durable and extremely strong - only the highest quality materials used in construction
- > Incredibly simple yet effective design that employs minimal moving parts, thereby ensuring maximum reliability
- > Thoroughly tested and proven design - trusted and used in over 80 countries around the world
- > Easy installation and maintenance - no special tools, skills or additives required
- > Two year warranty guarantees the Air Locker will be free of defects in materials



Air Locker locking differentials allow you to tackle the toughest terrain. As the world's premier traction aid, ARB Air Lockers keep you moving in all conditions.

DA4191

Ultra durable and extremely strong - only the highest quality materials used in construction

Part Number	Vehicle/Model	Year	Axle Location	Shaft Description	Shaft Diameter	Spline	Ratio
DA4191 ^{2,3}	Series 1/Series 2/Series 3	1948 - 1985	Front	Rover type	28.2 (1.11")	10	4.7
DA4191 ^{2,3}	Series 1/Series 2/Series 3	1948 - 1985	Rear	Rover type	28.2 (1.11")	10	4.7
DA4345	Series 1/Series 2/Series 3	1948 - 1985	Rear	Salisbury type	31.5 (1.24")	24	4.7
DA4191 ¹	Defender - 90	1984 - 1993	Front	Rover type	28.2 (1.11")	10	3.54
DA4193 ^{1,5}	Defender - 90	1993 on	Front	Rover type	31.5 (1.24")	24	3.54
DA4191 ¹	Defender - 90	1983 - 1993	Rear ^e	Rover type, 4 cyl. petrol & diesel engines	28.2 (1.11")	10	3.54
DA4193 ^{1,6}	Defender - 90	1993 on	Rear	Rover type	31.5 (1.24")	24	3.54
DA4344 ⁶	Defender - 90	2002 on	Rear	Rover type, P38A	31.5 (1.24")	24	3.54
DA4191 ¹	Defender - 110 & 130	1983 - 1993	Front	Rover type	28.2 (1.11")	10	3.54
DA4193 ^{1,5}	Defender - 110 & 130	1993 on	Front	Rover type	31.5 (1.24")	24	3.54
DA4192	Defender - 110 & 130	1983 - 2002	Rear	Salisbury type	31.5 (1.24")	24	3.54
DA4193 ⁶	Defender - 110 & 130	2002 on	Rear	Rover type	31.5 (1.24")	24	3.54
DA4344 ⁶	Defender - 110 & 130	2002 on	Rear	Rover type, P38A	31.5 (1.24")	24	3.54
DA4191 ¹	Discovery 1	Up to 1993	Front	Rover type	28.2 (1.11")	10	3.54
DA4193 ^{1,5}	Discovery 1	1993 - 1998	Front	Rover type	31.5 (1.24")	24	3.54
DA4191 ¹	Discovery 1	Up to 1993	Rear	Rover type	28.2 (1.11")	10	3.54
DA4193 ^{1,5}	Discovery 1	1993 - 1998	Rear	Rover type	31.5 (1.24")	24	3.54
DA4193 ^{1,5}	Discovery 2	All	Front	Rover type	31.5 (1.24")	24	3.54
DA4193 ⁶	Discovery 2	All	Rear	Rover type	31.5 (1.24")	24	3.54
DA4344 ⁶	Discovery 2	2002 on	Rear	Rover type, P38A	31.5 (1.24")	24	3.54
DA4191 ^{1,4}	Range Rover Classic	Up to 1992	Front	Rover type	28.2 (1.11")	10	3.54
DA4193 ^{1,5}	Range Rover Classic	1993 - 1996	Front	Rover type	31.5 (1.24")	24	3.54
DA4191 ^{1,4}	Range Rover Classic	Up to 1992	Rear	Rover type	28.2 (1.11")	10	3.54
DA4193 ^{1,5}	Range Rover Classic	1993 - 1996	Rear	Rover type	31.5 (1.24")	24	3.54
DA4344 ⁵	Range Rover P38	1996 - 2002	Front	Rover type, P38A	31.5 (1.24")	24	3.54
DA4344 ⁵	Range Rover P38	1996 - 2002	Rear	Rover type, P38A	31.5 (1.24")	24	3.54

Notes - 1 If vehicle was manufactured during 1993, check spline count. 2 Air Locker not available for vehicles equipped with high load option. 3 Ring gear spacer required. Longer ring gear bolts (not supplied) are also necessary - (Land Rover part no. 576521). 4 When an DA4191 Air Locker is to be installed in Range Rovers manufactured prior to 1980 (approx.), special carrier bearings (No. K11300/K11162) may also be necessary - Land Rover part no. RTC3426. 5 Some vehicles have crown wheel bolts which cannot be reused and must be replaced. Consult service manual. 6 P38A is most commonly found in traction control equipped vehicles. Identify P38A type diff by large 205mm [8.07"] flange diameter. P38A was not used on North American delivered Discoverys - use DA4193.

ARB Compressor

- > Designed for Air Locker use
- > High flow, compact 12v compressor
- > Sealed for moisture and dust resistance
- > Hard anodised cylinder bore and Teflon impregnated carbon fibre piston seal for reduced friction and maximum trouble free life
- > Heavy-duty maxi-fuse equipped for professional in-line circuit protection
- > Quality components for quiet operation and extra long life
- > Anodised mounting brackets dissipates motor heat and allows compressor to be repositioned 180°
- > Constructed entirely of lightweight, high strength engineering grade materials
- > Over-pressure safety valve equipped
- > Motor is internally thermal protected against extreme temperature damage



DA4194



DA4190



SWITCH COVERS

DA4190 Compressor assembly 12 volt

DA4194 Dash switch for compressor and lockers

Dash switch covers - **DA4360** - Front locker; **DA4361** - Rear locker; **DA4362** - Compressor

DETROIT

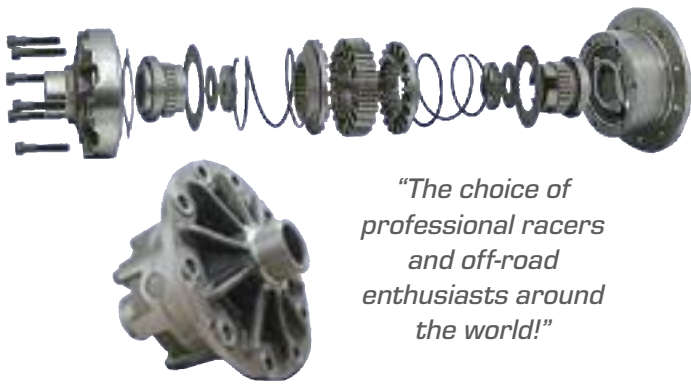

"The choice of professional racers and off-road enthusiasts around the world!"

Detroit Locker

- > 100% locking differential
- > Legendary traction
- > Ultimate performance

The legendary Detroit Locker began the revolution in performance differentials and still leads the industry today as an Eaton brand. The Detroit Locker is the most durable and dependable locking differential available. The Detroit Locker maximises traction by delivering 100% of the torque to both drive wheels. It is engineered to keep both wheels in a constant drive mode, and has the ability to automatically allow wheel speed differentiation when required. No other performance differential has the reputation for delivering traction in mud, snow, rocks and on the track. The choice of professional racers and off-road enthusiasts around the world! The durability of the Detroit Locker is unmatched!

DA5700	Series 3/Defender/Discovery 1/Range Rover Classic	Detroit Locker	24 spline	Rear
DA5701	Series 3/Defender/Discovery 1/Range Rover Classic	Detroit Locker	10 spline	Rear
DA5704	Defender - Salisbury axle	Detroit Locker	24 spline	Rear

Detroit Truetrac

- > Smooth operation
- > Performs open until needed
- > Fully automatic limited slip

Note - When fitting to non-metric diff casings 2 x RTC3095 bearings are required

The Detroit Truetrac was the first helical gear differential ever introduced into the automotive aftermarket as an Eaton brand. It remains the leading helical gear-type limited slip differential in the industry. Detroit Truetrac's proven helical gear design eliminates the need for wearable parts, resulting in maintenance free traction. Recognised not only for its toughness but also it's smooth and quiet operation. Engineered to work efficiently in front and rear axles, semi-floating (C-clip axles) and transfer cases. Power transfer is so smooth, it literally goes unnoticed by the driver - even in front wheel drive axles. Proven design, low cost and effective performance, all make the Detroit Truetrac limited slip differential the ideal choice for a wide variety of vehicle applications. No maintenance - just traction!

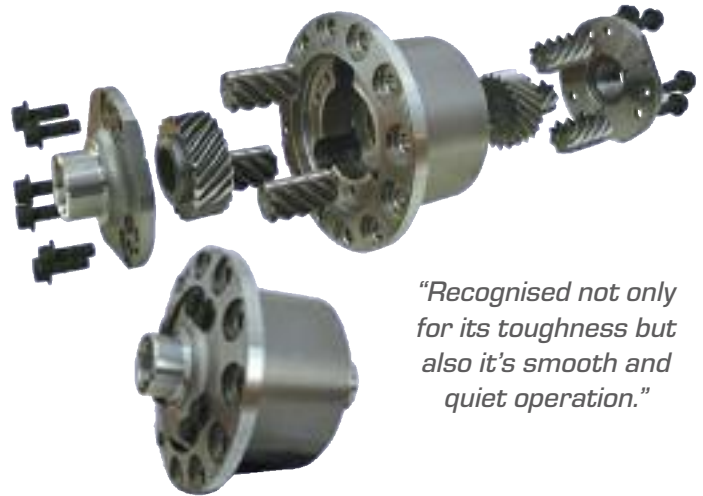

"Recognised not only for its toughness but also it's smooth and quiet operation."

DA5705	Series 3/Defender/Discovery 1/Range Rover Classic	Detroit Truetrac	10 spline	Rear
DA5706	Series 3/Defender/Discovery 1/Discovery 2/Range Rover Classic	Detroit Truetrac	10 spline	Front
DA5709	Series 3/Defender/Discovery 1/Discovery 2/Range Rover Classic	Detroit Truetrac	24 spline	Rear
DA5710	Series 3/Defender/Discovery 1/Discovery 2/Range Rover Classic	Detroit Truetrac	24 spline	Front
DA5711	Defender - Salisbury axle	Detroit Truetrac	24 spline	Rear

EMERGENCY EQUIPMENT

FIRE EXTINGUISHERS



- ◀ **STC8529AA**
- > 1kg kit
- > One-handed operation fire extinguisher
- > High rating
- > Checkable & re-chargeable
- > With crash-tested bracket
- > Attractive design
- > Controlled discharge



- STC8138AB**
- > 2kg kit
- > Long-life - 100% polyester resin coated fire extinguisher
- > Safe handling & crash proof fastening
- > Readiness to operate displayed by manometer
- > Precision brass valve

FIRST AID KIT



- STC7642**
- First aid kit - Land Rover
- To DIN 13164, the industry standard first aid kit solution for cars, vans and commercial vehicles when on the move.

HAMMER

DA6500

Life Hammer - The Original

- > Double-sided steel hammer for shattering windows quickly and easily for a safe and quick exit from any vehicle
- > Razor sharp blade cuts through seatbelts to ease escape
- > Fluorescent button allows hammer to be located in the dark
- > Installation mounting bracket ensures hammer is accessible when you most need it



DA6500



FUEL TANKS & JERRY CANS

FUEL TANKS

DA4545

Defender - 110 up to 1999 - metal tank pre-Td5 models

- > Rear arch spare fuel tank - right hand side
- > 45 litres
- > Supplied with all the necessary fittings to install and use

DA4546

Defender - 110 after 1999 - plastic tank Td5 and the new Td4 models

- > Rear arch spare fuel tank - right hand side
- > 45 litres
- > Supplied with all the necessary fittings as well as a replacement filler neck and specifically engineered bulkhead fitting for the balance pipe, having these makes the fitting of the tank quicker and easier as well as it working better too.

The best way of getting more fuel into your Defender 110 without using valuable space or complex pumping systems!



DA4545



DA4546

Note - Both tanks are not suitable for use in a Defender 130

JERRY CANS



DA2170



DA2171



DA2172



DA2182

Jerry can not included

"Don't get caught short!"

DA2166

Jerry can 20ltr

DA2170

Jerry can 20ltr stainless steel

DA2171

Jerry can 10ltr stainless steel

DA2172

Jerry can spout stainless steel

DA2182

Jerry can holder for 20ltr cans



DA2166

JACKS

HI-LIFT



*rugged,
highly versatile jack*

DA3120

- DA2243 48" Jack (4ft)
- DA3120 60" Jack (5ft)

The Hi-Lift jack is a rugged, highly versatile jack that puts you in command of situations requiring lifting, pushing, pulling, winching, and clamping. Although light in weight and easy to manoeuvre, the Hi-Lift jack offers a rated lifting capacity of 2¹/₃ tons (2,114kgs).

Specifications

- > Approximate weight: 30lbs (14 kg)
- > 4,660lbs (2,113kgs) rated capacity
- > Climbing pins of specially processed steel with 125,000psi tensile strength and 100,000psi yield
- > Steel bar is manufactured of specially rolled extra high carbon steel with 80,000lbs minimum tensile and carbon 0.69 to 0.82
- > Steel handle of 14-gauge high-yield structural tubing with minimum yield of 55,000psi - 1⁵/₁₆" diameter x 30" long

Features

- > Every jack comes complete with an adjustable top clam clevis for use in clamping and winching
- > For speedy disengaging, lifting unity automatically drops away when load is removed
- > 4¹/₂" (11cm) long lifting nose for positive contact with load
- > Safety bolt is designed to shear at 7,000lbs (3,175 kg)
- > Steel bar can be reversed for extra long life
- > Low pickup of 4¹/₂" (11cm)
- > 28" square base plate

DA2243

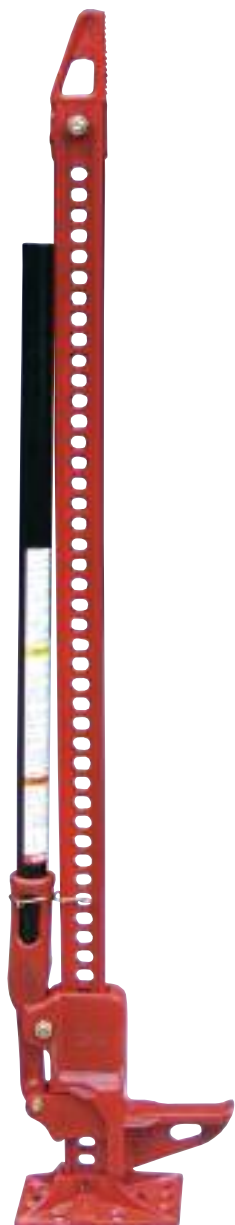

DA2174



DA2243EYE



DA2248



DA4350



DA4355



DA4351



DA4353



DA4356

DA4352



DA4357 & DA4358

DA4354

Accessories

DA2174	Off-road base	Alleviates jack sinkage on soft surfaces - suits all models
DA2243EYE	Jacking eye	Spare jacking eye
DA2248	Fix-it-kit	The maintenance kit contains all the key components for servicing all Hi-Lift jacks
DA4350	4XRAC	Heavy-duty mounting system for the serious off-roader
DA4351	Loc-Rac	Conveniently mounts and locks your Hi-Lift jack. Includes lock and suits all models
DA4352	Jack protector	The jack protector vinyl bag protects your jack from the elements - one size fits all
DA4353	Lift mate	Designed to provide a lift point from most wheels for quick and easy lifting - Lifting capacity is 5,000lbs/2,273kgs
DA4354	Off-road kit	The Hi-Lift winching kit includes a winch attachment, winch tensioner, tree strap, d-ring shackle, Hi-Lift gloves and gear bag. Winch time is reduced significantly using the winch attachment and tensioner together.
DA4355	Bumper lift	Designed to fit curved steel bumpers. Rugged design of the bumper lift has a lifting capacity of 3,000lbs/1,361kgs
DA4356	Neoprene jack cover	This jack cover offers a level of mud and dirt protection for the main lifting mechanism of the jack when not in use. It zips on easily over the foot of the jack and provides a tight fit.
DA4357	Adjustable tube jack mount Small set	Designed for mounting a Hi-Lift jack to round and square tube bumpers, bull bars, roll cages and roof racks, this accessory allows for easy and adjustable mounting on tubes from 1" to 3" in diameter Is for use on round tubes from 1 to 2" in diameter, which works on many roof racks. It can also be used on ATV/UTV bars, bumpers and roll cages
DA4358	Large set	Is intended for round tubes from 2 to 3" in diameter that will work on most vehicle bull bars and roll cages

8,000lbs capacity Jacks - Versatile! Rugged! Pow'R-ful!



Built with a patented 'Safety Link', the Maasdam Jackall is the 'Jack with More!' Larger base for greater stability. 'Safety Link' mechanism that prevents abuse, misuse and makes operations safer. Jacks come with a lifetime warranty and are built to current ANSI/ASME specifications. When safety and dependability matter most, continue to rely on Jackall.

Features

- > Patented "safety link" mechanism
- > Heavy ribbed, extra large base
- > Cast components
- > Hot roll-formed, alloy steel beam
- > Steel handle locks against beam
- > Powder coated through and through

Benefits

- > Prevents abuse and misuse
- > Provides strength and greater load stability
- > Assures long life, trouble free operation
- > Strong and reliable
- > For convenient storage
- > Reduces scratching, greater corrosive resistance

DA3121	48" Jack (4ft)	DA3122	60" Jack (5ft)
DA3130	Top clamp	DA4058	Maintenance kit
DA4059	Jacking point adaptor	DA4061	Mounting kit jack rack



Patented "Safety Link" pitman mechanism prevents abuse and misuse. "Safety Link" yields when capacity exceeded — load can no longer be lifted. Operational safety at its best.

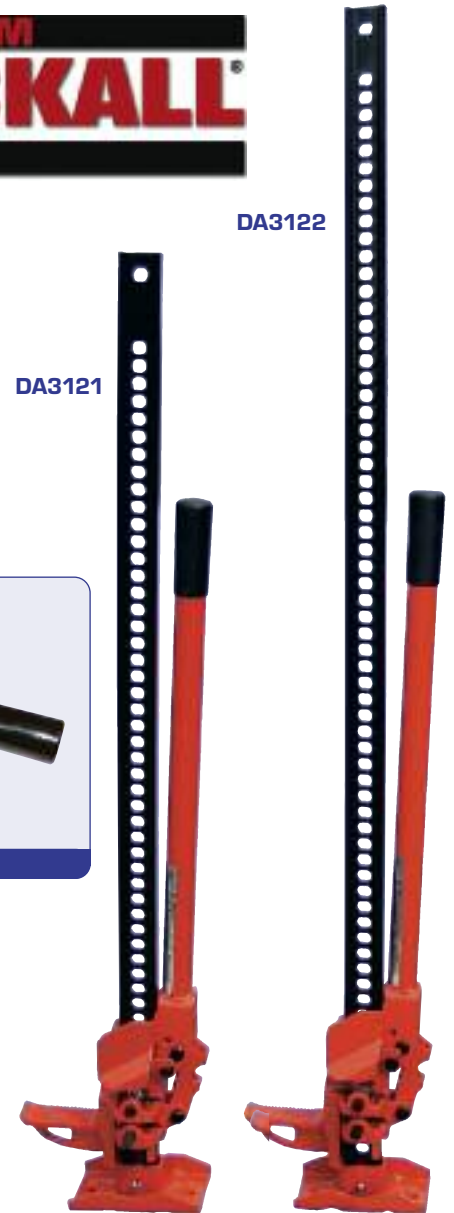

JACKING EQUIPMENT

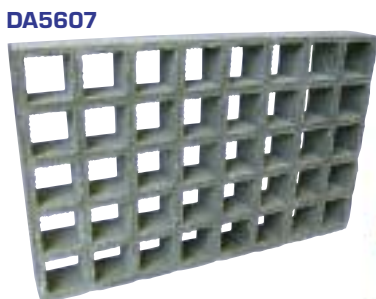

ANR4489 (kit), KAJ100570 & KAH000050 (individual)



Anti-rattle jack clamps



DA3153 / DA3154 / DA3155

ANR4489	Jack and handle (KAJ100570 & KAH000050)	
KAJ100570	Standard bottle jack	
KAH000050	Handle for KAJ100570 Note - Defender only	
DA2244	Jacking point adaptor	
DA3153	Anti-rattle jack clamp	Red
DA3154	Anti-rattle jack clamp	Black
DA3155	Anti-rattle jack clamp	Yellow
DA5607	Jack base - 310 x 195 x 38mm	Grey



LADDERS - SAND & BRIDGING



DA2231



DA5601

DA2231	Sandtrack	Aluminium	1,500 long x 390 wide x 4mm thick		Pair
DA5600	Bridging ladders	Fibreglass	1,220 long x 260 wide x 50mm deep	Grey with gritted surface for extra traction	Pair
DA5601	Bridging ladders	Fibreglass	1,220 long x 270 wide x 38mm deep	Grey with gritted surface for extra traction	Pair

LAND METERS



DA1003
Double incline land meter
Black finish

DA1004
Double incline land meter
Carbon fibre effect finish

DA1003

- > Independent twin meter
- > Convenient for seeing the pitching and rolling of the vehicle body or terrain
- > Transparent illumination for easy-to-see readings at night



DA1004

RAISED AIR INTAKES

BRITPART

If you're likely to be driving your Land Rover in circumstances which could mean wading deep water or driving in very dusty conditions then you should consider fitting a raised air intake to your vehicle. This version from Britpart is a classic mushroom-top snorkel for Defender. Featuring heavy-duty metal pipe work, cyclone pre-cleaner and a durable attractive matt black finish.

DA2225	Defender - 300Tdi/Td5
PHD500340	Defender - 2007 onwards
NRC6920	Raised air intake cleaner for DA2225 & PHD500340



NRC6920



DA2225

SAFARI



Pioneered in Australia in the early 1980's, Safari Snorkels were born out of a need to protect 4WD engines from the hazards of dust and water commonly encountered in touring and off road applications. Safari snorkels are manufactured to the highest standards in durable, UV stable, cross linked polyethylene material, using stainless steel hardware where appropriate. Each system includes quality fixtures and fittings, which offer superior sealing, presentation and long-term durability.

In arguably the best, if not toughest environment, Safari Snorkel Systems are thoroughly researched, tested and tooled for each model of Land Rover. The Safari Snorkel delivers a continuous and cooler supply of air for maximum engine performance. It is positively sealed as well to ensure the best protection against deep water crossings and dust.



DA3069



DA3024

Defender

- DA3024**
Defender - 200Tdi - 1990 - 1994 LHS
- DA3025**
Defender - V8 - 1984 - 1994 RHS
- DA3026**
Defender - 300Tdi - 1994 - 1999 RHS
- DA3027**
Defender - Td5 - 1999 onwards - right hand drive RHS
- DA3027LH**
Defender - Td5 - 1999 onwards - left hand drive RHS
- DA3069**
Defender - 2007 onwards RHS

Stainless steel air ram grille
(shown attached to air ram - grille only)

Note - Will not fit DA3069 snorkel

- DA3141**
3" replacement air ram for DA3024
- DA3142**
3 1/2" replacement air ram for DA3025, DA3026, DA3027, DA3027LH

Note - Fitment from seated internal view - RHS - right hand side and LHS - left hand side.



DA2374

Discovery

- DA3015**
Discovery 1 - 200Tdi - 1990 - 1994 LHS
- DA3018**
Discovery 1 - V8 1990 - 1994 LHS
- DA3020**
Discovery 1 - 300Tdi (none EGR)/ V8 - 1994 - 1999 - Non ABS LHS
- DA3022**
Discovery 1 - 300Tdi (none EGR)/ V8 - 1994 - 1999 - ABS LHS
- DA3023**
Discovery 2 - Td5/V8 - 1999 on LHS
- DA3021**
Discovery 3 - TdV6 SE/Discovery 4 - TdV6 RHS

Stainless steel air ram grille
(shown attached to air ram - grille only)

- DA3141**
3" replacement air ram for DA3015, DA3018, DA3020, DA3022, DA3023
- DA3142**
3 1/2" replacement air ram for DA3021

Note - Fitment from seated internal view - RHS - right hand side and LHS - left hand side



DA3141 / DA3142



DA3021

For more Safari Snorkel pictures visit - www.britpart.com/safari

Safari snorkels are manufactured to the highest standards in durable, UV stable, cross linked polyethylene material



Courtesy of Jon Wilson

10

winching equipment

WINCHING EQUIPMENT

Never get stuck again with a Britpart winch and winching accessories - we've all you need to get out of that sticky situation.

Section contents -

Batteries

Lucas	82
Optima	82
Battery charger	86

Britpart Pulling Power Winches

DB12000i winch	83
DB9500i winch	83
DB9000C winch	84
DB8000 winch	84
DB6000 winch	85
DB2000 winch	85
Winch spare parts	86

Winch bumpers

Winch bumper kits	87
Winch bumpers	88

Winching accessories & kits

Winching accessories	89 - 91
Winching accessory kits	91



BATTERIES

LUCAS

- > Batteries are manufactured on the same equipment as OE batteries and use the same components to give consistent quality and performance
- > Original equipment (OE) quality standards, giving assurance that the batteries will not let the user down
- > The confidence of the Lucas brand
- > Lucas batteries are recyclable, helping to protect the environment
- > 3-Year warranty

	Voltage	Capacity	Cold Cranking Amps (CCA)
LR018608	12v	80Ah	770
LR018609 NEW	12v	100Ah	855
LR018680 NEW	12v	100Ah	800
STC4757	12v	70Ah	500
STC8587	12v	110Ah	750
YGD000271	12v	110Ah	920
YGD100860	12v	115Ah	900
YGD500100	12v	70Ah	750
YGD500130	12v	95Ah	855



YGD500100

OPTIMA



DB1018



DB1020



DB1019



DB1021

With its patented Spiralcell® Technology, Optima batteries offer 15 times the vibration resistance and up to twice the life of ordinary batteries. The Optima is like no other battery found in today's market. Optima's unique patented Spiralcell® design offers the best technology by providing a strong and clean power source that far surpasses any of today's traditional lead acid batteries. With Optima as your choice, you can count on a longer lasting battery.



**SPIRALCELL®
TECHNOLOGY**



OPTIMA®
BATTERIES
THE ULTIMATE POWER SOURCE™

> Twice the life of ordinary batteries

> 15 times the vibration resistance

Yellow Top

Demand more from your vehicle? Then get more from your battery. Optima Yellow Top batteries are made for the extremes. If your vehicle is designed to take the abuse of off-road driving, you need increased performance and reliability from your battery. Optima batteries combine patented Spiralcell® Technology to deliver that performance. The deep cycle characteristics of this technology coupled with its extreme resistance to vibration provides performance vehicles with the repetitive power they need, packaged in a spill-proof compact design.

If your vehicle is fitted with high drain accessories such as additional lighting, tracking devices, ICE systems, winches, hydraulics etc, then this ultimately demands more from your battery. Optima Yellow Top batteries provide the extra performance and deep cycling capability that your vehicle demands.

Voltage - 12v Capacity - 55Ah Cold Cranking Amps (CCA) - 765

DB1018	Yellow Top	Top terminals
DB1020	Yellow Top	Side terminals

Red Top

Optima Red Top batteries are built to withstand the abuse 4x4's experience on and off-road. Spiralcell® Technology immobilises the internal components of the battery, enabling Optima batteries to withstand incredible amounts of vibration.

Vehicles modified for improved engine performance demand more from a battery. Optima batteries withstand the high engine bay temperatures associated with these performance vehicles. The sealed construction makes the battery spill-proof, even if you install it on its side! This prevents external gassing and leaking which can damage engine components and reduce battery performance.

If your battery is used in applications that demand extra reliability endurance and performance, or if you just take pride in getting the best performance out of your vehicle, Optima Red Top batteries deliver the performance you demand.

Voltage - 12v Capacity - 50Ah Cold Cranking Amps (CCA) - 815

DB1019	Red Top	Top terminals
DB1021	Red Top	Side terminals

BRITPART PULLING POWER WINCHES

DB12000i - 12 & 24 VOLT WINCH

Features

- > 3.6Kw (4.8Hp) heavy duty series wound DC motor
- > Weather and dustproof contactor controls for longer life and improved amperage draw
- > Planetary gear system for fast line speed
- > Automatic load-holding brake
- > Free spooling
- > Power in and power out
- > Low electric current
- > Hardened drum
- > Thermal overload protection

Don't forget a DB1014!
When fitting a winch to a Defender don't forget to order the extended winch wiring kit with cut-off switch.

Specification

> Rated line pull - single line	5,443kgs	12,000lbs
> Gear reduction ratio	294:1	
> Motor (series wound)	3.6Kw	4.8Hp
> Drum size (D x L)	63 x 228mm	2 1/2" x 9"
> Cable supplied	9.53mm x 30.5m	3/8" x 100'
	<i>(Galvanised aircraft cable with minimum break force 14,400lbs)</i>	
> Overall dimension (L x W x H)	548 x 160 x 254mm	21.57 x 6.3 x 10"
> Net weight	41.7kgs	92.0lbs
> Mounting bolt pattern	254 x 114.3mm	10 x 4 1/2"



DB12000i

Performance of 1st Layer

Line Pull		Line Speed				Motor Current	
		12 volt		24 volt		12 volt	24 volt
Lbs	Kgs	Fpm	Mpm	Fpm	Mpm	Amp	Amp
0	0	14.60	4.45	16.40	5.00	90	58
2,000	907	12.81	3.90	14.43	4.40	145	95
4,000	1,814	9.68	2.95	12.46	3.80	185	120
6,000	2,722	7.90	2.41	10.83	3.30	230	160
8,000	3,629	7.07	2.15	9.50	2.90	270	190
10,000	4,536	5.06	1.54	7.87	2.40	315	230
12,000	5,443	4.45	1.36	5.90	1.80	375	280

DB12000i Britpart Pulling Power 12,000lbs 12 volt winch
DB12000i24 Britpart Pulling Power 12,000lbs 24 volt winch

Line Pull & Cable Capacity by Layer

Cable Layer	Rated Line Pull		Cable Capacity	
	Lbs	Kgs	Feet	Meters
1	12,000	5,443	15	5.0
2	10,200	4,627	38	11.5
3	8,400	3,810	64	19.5
4	7,300	3,310	95	29.0
5	6,500	2,948	100	30.5

DB9500i - 12 & 24 VOLT WINCH

Features

- > 3.6Kw (4.8Hp) heavy duty series wound DC motor
- > Weather and dustproof contactor controls for longer life and improved amperage draw
- > Planetary gear system for fast line speed
- > Automatic load-holding brake
- > Free spooling
- > Power in and power out
- > Low electric current
- > Hardened drum
- > Thermal overload protection

Don't forget a DB1014!
When fitting a winch to a Defender don't forget to order the extended winch wiring kit with cut-off switch.

Specification

> Rated line pull - single line	4,309kgs	9,500lbs
> Gear reduction ratio	212:1	
> Motor (series wound)	3.6Kw	4.8Hp
> Drum size (D x L)	63 x 228mm	2 1/2" x 9"
> Cable supplied	9.53mm x 30.5m	3/8" x 100'
	<i>(Galvanised aircraft cable with minimum break force 14,400lbs)</i>	
> Overall dimension (L x W x H)	548 x 160 x 254mm	21.57 x 6.3 x 10"
> Net weight	41.7kgs	92.0lbs
> Mounting bolt pattern	254 x 114.3mm	10 x 4 1/2"



DB9500i

Performance of 1st Layer

Line Pull		Line Speed				Motor Current	
		12 volt		24 volt		12 volt	24 volt
Lbs	Kgs	Fpm	Mpm	Fpm	Mpm	Amp	Amp
0	0	18.70	5.70	21.30	6.50	85	58
2,000	907	13.12	4.00	16.70	5.10	150	110
4,000	1,814	10.50	3.20	13.12	4.00	210	135
6,000	2,722	7.90	2.41	10.17	3.10	270	185
8,000	3,629	5.91	1.80	7.71	2.35	320	220
9,500	4,309	4.32	1.32	5.90	1.80	365	240

DB9500i Britpart Pulling Power 9,500lbs 12 volt winch
DB9500i24 Britpart Pulling Power 9,500lbs 24 volt winch

Line Pull & Cable Capacity by Layer

Cable Layer	Rated Line Pull		Cable Capacity	
	Lbs	Kgs	Feet	Meters
1	9,500	4,309	15	5.0
2	7,500	3,402	38	11.5
3	6,200	2,812	64	19.5
4	5,300	2,404	95	29.0
5	4,630	2,100	100	30.5

DB9000C WINCH



DB9000C

DB9000C Britpart Pulling Power 9,000lbs 12 volt winch

Features

- > 3.3Kw (4.5Hp) permanent magnet motor
- > Dustproof contactor controls for longer life and improved amperage draw
- > Planetary gear system for fast line speed
- > Automatic load-holding brake
- > Free spooling
- > Power in and power out
- > Low electric current
- > Hardened drum

Don't forget a DB1014!
When fitting a winch to a Defender don't forget to order the extended winch wiring kit with cut-off switch.

Specification

- > Rated line pull - single line 4,082kgs 9,000lbs
- > Gear reduction ratio 212:1
- > Motor (permanent magnet) 3.3Kw 4.5Hp
- > Drum size (D x L) 63 x 228mm 2 1/2" x 9"
- > Cable supplied 9.53mm x 30.5m 3/8" x 100'
(Aircraft cable with minimum break force 14,400lbs)
- > Overall dimension (L x W x H) 560 x 160 x 280mm 22 x 6.3 x 11"
- > Net weight 38.0kgs 84.0lbs
- > Mounting bolt pattern 254 x 114.3mm 10 x 4 1/2"

Performance of 1st Layer

Line Pull		Line Speed		Motor Current
Lbs	Kgs	Fpm	Mpm	Amp
0	0	13.0	4.0	30
4,000	1,814	7.5	2.3	130
6,000	2,722	6.3	1.9	180
8,000	3,629	5.0	1.5	240
9,000	4,082	4.3	1.3	300

Line Pull & Cable Capacity by Layer

Cable Layer	Rated Line Pull		Cable Capacity	
	Lbs	Kgs	Feet	Meters
1	9,000	4,082	15	5.0
2	7,300	3,311	38	11.5
3	6,200	2,812	64	19.5
4	5,400	2,449	95	29.0
5	4,200	1,905	100	30.5



DB8000 WINCH



DB8000

DB8000 Britpart Pulling Power 8,000lbs 12 volt winch

Features

- > 3.0Kw (4.1Hp) heavy duty electric permanent magnetic DC motor
- > Weather and dustproof contactor controls for longer life and improved amperage draw
- > Planetary gear system for fast line speed
- > Automatic load-holding brake
- > Free spooling
- > Power in and power out
- > Low electric current
- > Hardened drum

Don't forget a DB1014!
When fitting a winch to a Defender don't forget to order the extended winch wiring kit with cut-off switch.

Specification

- > Rated line pull - single line 3,632kgs 8,000lbs
- > Gear reduction ratio 210:1
- > Motor (permanent magnet) 3.0Kw 4.1Hp
- > Drum size (D x L) 63 x 228mm 2 1/2" x 9"
- > Cable supplied 9.53mm x 30.5m 3/8" x 100'
(Galvanised aircraft cable with minimum break force 14,400lbs)
- > Overall dimension (L x W x H) 564 x 179 x 295mm 22.2 x 7.0 x 11.6"
- > Net weight 36kgs 80lbs
- > Mounting bolt pattern 254 x 114.3mm 10 x 4 1/2"

Performance of 1st Layer

Line Pull		Line Speed		Motor Current
Lbs	Kgs	Fpm	Mpm	Amp
0	0	8.2	2.5	35
2,000	900	7.8	2.4	100
4,000	1,810	7.2	2.2	180
6,000	2,710	6.5	2.0	230
8,000	3,620	5.0	1.5	300

Line Pull & Cable Capacity by Layer

Cable Layer	Rated Line Pull		Cable Capacity	
	Lbs	Kgs	Feet	Meters
1	8,000	3,620	15	5.0
2	6,335	2,876	38	11.5
3	5,243	2,380	64	19.5
4	4,473	2,030	95	29.0
5	3,900	1,770	100	30.5

DB6000 WINCH

Features

- > 2.7Kw (3.6Hp) permanent magnet motor
- > Dustproof contactor controls for longer life and improved amperage draw
- > Planetary gear system for fast line speed
- > Automatic load-holding brake
- > Free spooling
- > Power in and power out
- > Low electric current

Don't forget a DB1014!
When fitting a winch to a Defender don't forget to order the extended winch wiring kit with cut-off switch.

Specification

- > Rated line pull - single line 2,724kgs 6,000lbs
- > Gear reduction ratio 210:1
- > Motor (permanent magnet) 2.7Kw 3.6Hp
- > Drum size (D x L) 63 x 140mm 2 1/2" x 5.51"
- > Cable supplied 7.94mm x 26m 5/16" x 85'
(Aircraft cable with minimum break force 10,000lbs)
- > Dimensions (L x W x H) 438 x 158 x 185mm 17.24 x 6.22 x 7.28"
- > Net weight 31.8kgs 70.0lbs
- > Mounting bolt pattern 166 x 114.3mm 6.535 x 4 1/2"



DB6000

DB6000 Britpart Pulling Power 6,000lbs 12 volt winch

Performance of 1st Layer

Line Pull		Line Speed		Motor Current
Lbs	Kgs	Fpm	Mpm	Amp
0	0	15.0	4.6	30
1,000	454	11.5	3.5	80
3,000	1,361	9.0	2.7	120
5,000	2,268	7.0	2.0	170
6,000	2,722	4.9	1.5	210

Line Pull & Cable Capacity by Layer

Cable Layer	Rated Line Pull		Cable Capacity	
	Lbs	Kgs	Feet	Meters
1	6,000	2,722	12.7	3.87
2	5,000	2,268	27.5	8.38
3	4,250	1,928	44.0	13.41
4	3,720	1,687	64.0	19.51
5	3,330	1,497	85.0	25.91



Get to where you want to go!

DB2000 WINCH

Features

- > 1.0Kw (1.5Hp) heavy duty electric permanent magnetic motor
- > Planetary gear system for fast line speed
- > Free spooling
- > Power in and power out
- > Low electric current
- > Tension plate to prevent rope entanglement

Specification

- > Rated line pull - single line 907kgs 2,000lbs
- > Gear reduction ratio 153:1
- > Motor (permanent magnet) 1.0Kw 1.5Hp
- > Drum size (D x L) 32 x 71mm 1.26 x 2.8"
- > Cable supplied - 4mm x 15.2m 5/32" x 50'
(minimum break force 4,000lbs)
- > Dimension (L x W x H) 320 x 105 x 110.5mm 12.6 x 4.13 x 4.35"
- > Net weight 6.6kgs 14.6lbs
- > Mounting bolt pattern 48 x 76mm 1.89 x 3"



DB2000

DB2000 Britpart Pulling Power 2,000lbs 12 volt winch

Performance of 1st Layer

Line Pull		Line Speed		Motor Current
Lbs	Kgs	Fpm	Mpm	Amp
0	0	14.0	4.3	14
1,000	454	9.0	2.7	60
1,500	680	7.5	2.3	90
2,000	907	5.9	1.8	115

Line Pull & Cable Capacity by Layer

Cable Layer	Rated Line Pull		Cable Capacity	
	Lbs	Kgs	Feet	Meters
1	2,000	907	6	1.8
2	1,636	742	13	4.0
3	1,385	628	22	6.7
4	1,200	544	33	10.0
5	1,059	480	44	13.4
6	947	430	50	15.2

WINCH SPARE PARTS



DB1301



DB1302



DB1303



DB1304



DB1307



DB1326



DB1328



DB1330

Part	Winch					
	DB12000i	DB9500i	DB9000C	DB8000	DB6000	DB2000
Winch motor	DB1300	DB1300	DB1332	DB1301	DB1337	N/A
Solenoid assembly	DB1303	DB1303	DB1302	DB1302	DB1336	N/A
Brake service kit	DB1304	DB1304	DB1333	N/A	DB1338	N/A
Roller fairlead	DB1307	DB1307	DB1307	DB1307	DB1341	N/A
Remote control	DB1326 - 15mm socket DB1327 - 20mm socket	DB1326 - 15mm socket DB1327 - 20mm socket	DB1327	DB1326 - 15mm socket DB1327 - 20mm socket	DB1334	DB1343 NEW
Winch cable	DB1328	DB1328	DB1328	DB1328	DB1339	N/A
Brush and holder set	DB1330	DB1330	DB1331	DB1331	DB1340	N/A

Note - Early models of DB12000i & DB9500i were fitted with an external thermal cut-off switch. Replacements are still available - **DB1305**

BATTERY CHARGER NEW

DA3185

Universal battery charger
MULTI XS 7000 is a charger that provides complete battery care for those needing to charge normal size and slightly larger batteries, for example, in caravans, boats and cars.

It is fully-automatic with unique 8-step charging that supplies 7A and which is suitable for 12V batteries between 14-150Ah and is suitable for maintenance charging up to 225 Ah.

The MULTI XS 7000 analyses whether the battery can accept and retain the charge, it removes harmful lead sulphate crystals, charges quickly and efficiently and automatically switches to maintenance charging when the battery is fully charged.

It also has a practical Recond mode that balances the acid concentration in deep discharged batteries. It features a special cold mode to give optimal charging on cold winter days and to demanding AGM batteries (type Optima).

Supply mode allows the charger to be used as a power supply if you need to disconnect batteries from the vehicle. It is fully protected from producing voltages that can damage the vehicle's electronics. It is also non-sparking and features reverse polarity and short circuit protection.



STOP PRESS...

DA3185

Specification

Input voltage	220 - 240VAC, 50 - 60Hz
Output voltage	14.4V, 14.7V, 13.6V/Supply, 15.8V/Recond
Charging current	7A
Ripple	Max 150mV rms, 0.3A
Ambient temperature	-20°C to +50°C, output power is reduced automatically at higher temperatures
Charger type	Eight step, fully automatic switch mode with pulse maintenance
Batteries	12V lead-acid batteries (Wet, MF, AGM, Calcium/Calcium and GEL)
Battery size	14 - 150Ah (14 - 225Ah maintenance charging)
Dimensions	191mm long x 89mm wide x 48mm high
Insulation	IP 65
Weight	0.8kg

WINCH BUMPERS
WINCH BUMPER KITS



DB1310	Defender - non air-con	Standard bumper	DB9500i winch	Extended wiring kit including safety cut-off switch
DB1313	Defender - non air-con	Standard bumper	DB12000i winch	Extended wiring kit including safety cut-off switch
DB1324	Discovery 1/Range Rover Classic	Standard bumper	DB9500i winch	
DB1325	Discovery 1/Range Rover Classic	Standard bumper	DB12000i winch	
DB1319	Defender - non air-con	Tubular bumper	DB12000i winch	Extended wiring kit including safety cut-off switch
DB1321	Defender - air-con	Tubular bumper	DB12000i winch	Extended wiring kit including safety cut-off switch
DB1320	Discovery 1	Tubular bumper	DB12000i winch	



DB1320



DB1324 / DB1325



WINCH BUMPERS

Tubular winch bumpers

- > Stylish tubular steel space-frame construction for strength
- > Suitable for DB12000i, DB9500i, DB9000C & DB8000 winches
- > Extremely close fitting for maximum approach angle. **Note** - grille will need modifying
- > Compatible with many steering guards
- > Built-in high-lift jacking points
- > Integral rock guard
- > Supplied with full fitting kit

DA5609 Defender - air-con

DA5622 Defender - non air-con

DA5604 Discovery 1 - non air-con

Heavy-duty steel winch bumpers

DA5620 Defender - non air-con

- > Suitable for DB12000i, DB9500i & DB9000C winches

DA5623 Defender - air-con

- > Suitable for DB12000i, DB9500i & DB9000C winches

DA5643 Defender - air-con

- > Suitable for Warn 9000 and 9.5 Series winches

DA5621 Discovery 1 & Range Rover Classic

Note - Not suitable for V8 automatic vehicles

- > Suitable for DB12000i, DB9500i, DB9000C & DB8000 winches

DA5645 NEW Discovery 2

- > Suitable for DB12000i, DB9500i, DB9000C & DB8000 winches

- > One piece bumper manufactured from 5mm steel with wrap around sides to protect the wings

- > Fixed to standard mounting points with provisions for 2 swivel recovery points and 2 Hi-Lift jacking points



Winch and A bar not included

DA5620



DA5609



DA5622



DA5604



DA5623



DA5643



DA5621

Winch not included

A range of winch bumpers to suit your vehicle!

STOP PRESS...
DA5645 NEW
 Steering Guard
 > Discovery 2
 > RHD & LHD
 > 5mm steel, powder coated
 > For use with winch bumper DA5645

NEW



DA5645



WINCHING ACCESSORIES & KITS

WINCHING ACCESSORIES



DB1003



DB1004

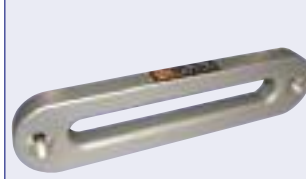

DB1315



DB1317

Fairleads

255mm Mounting holes

DB1003	Hawse fairlead	Steel	215mm aperture
DB1004	Hawse fairlead	Steel	130mm aperture
DB1315	Hawse fairlead	Aluminium	205mm aperture
DB1317	Hawse fairlead	Stainless steel	205mm aperture
DB1316	Roller fairlead	Stainless steel	180mm aperture

125mm Mounting holes

DB1005	Hawse fairlead	Steel	80mm aperture
--------	----------------	-------	---------------



DB1316



DB1005

More winching accessories over the page...

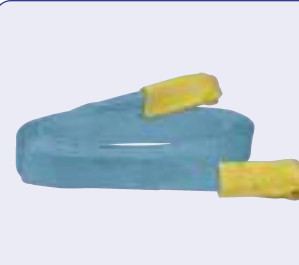

DB1006



DB1011



STC8919AA



DA3028



DA3030

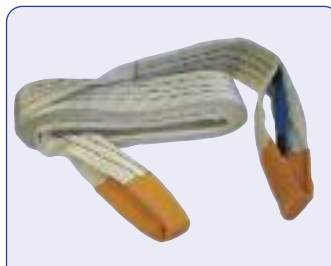

DA3034



DB1007

Ropes & Strops

DA2246	Tow strop	2t WLL	5m x 60mm
DB1006	Tow strap - with a breaking strength of 8,000kgs & reinforced eyes		9m x 60mm
DB1011	High elasticity tow sling - 9 metre with a 10 ton pulling capacity. Complete with reinforced eyes and overload warning tag.		
STC8919AA	Tow strap	Discovery 3/Range Rover L322/Range Rover Sport	
DA3028	Rope - polypropylene	2t WLL/8t MBL	5m x 24mm
DA3029	Rope - nylon	2t WLL/12t MBL	5m x 24mm
DA3030	Kinetic recovery rope - octoplait	2t WLL/12t MBL	5m x 24mm
DA3031	Kinetic recovery rope - octoplait	2t WLL/12t MBL	8m x 24mm
DA3032	Tree strop	2t WLL/14t MBL	3m x 90mm
DA3033	Tree strop	2t WLL/14t MBL	4m x 90mm
DA3034	Tree strop	2t WLL/14t MBL	6m x 90mm
DB1007	Tree protection belt	1.6 metre	4 ton

Note - WLL = working load limit (lifting), MBL = minimum breaking load



WINCHING ACCESSORIES - continued



DA3160



DB1002



DB1008



DB1009



DB1012



DB1322



DB1323



DB1329

Shackles & Pulleys

DA3160	Swivel recovery eye - stainless steel - 36mm diameter & shackle (3.25 tons) Note - Not suitable for standard Land Rover bumpers
DB1002	Snatch block - high quality tempered steel suitable for winch ropes from 5mm to 10mm Maximum head load - 16,000lbs
DB1008	Pulley hook - SWL loads - Pulling - 1,500kgs / Lifting - 750kgs
DB1009	Shackle - 1.4 ton
DB1012	Shackle - 4.7 ton
DB1322	Swivel shackle
DB1323	Non-forged jate ring
DB1329	Forged jate ring



DA2037



DA3156



DB1000



DB1010



DB1016



DB1308

Safety Equipment

DA2037	Battery isolator switch universal
DA3156	Winch In Safety - A5 guide from Land Rover
DB1000	Wheel chocks - pair
DB1010	Gloves - for protection winch operation
DB1016	Winch blanket - manufactured from heavy-duty vinyl, the blanket will absorb most of the recoil in the unlikely event of the cable breaking. It's also very useful to kneel on in the mud!
DB1308	Winch remote control - operate your winch from a safe distance with this wireless remote control <ul style="list-style-type: none"> > High frequency circuit using SMD design for reliability > The transmitter uses FM technology for frequency stability and greater control distance > Receiver output is protected against voltage spikes

WINCHING ACCESSORIES - continued



DB1001



DB1014



DB1309

Other Essential Winching Accessories

- DB1001** Winch bag - a heavy-duty black and green bag
- DB1014** Extended winch wiring kit - 1 x red, 1 x black wire, each 1.8m in length with end connectors and cut-off switch for Defender vehicles
- DB1309** 'Dyneema Bowrope' - 12 strand synthetic fibre replacement winch rope - 11mm x 90ft
- > For use with DB9000C, DB9500i and DB12000i winches
 - > CE certified
 - > Easy to handle
 - > Floats
 - > Does not kink
 - > Very light
 - > Easily spliced
 - > Highly visible
 - > Less effort in use
 - > Very strong
 - > Does not curl
 - > Compact
 - > Safety in use
- DB1314** Ground anchor set
- DB1318** Ground anchor bag set - 2 x Pulling Power bags, ground anchor not included (DA1314)
- DB1328** Replacement winch cable with hook - 30.5m x 9.5mm



DB1318



DB1314



DB1328



WINCHING ACCESSORY KITS



DB1017



DB1015

- DB1017** Contents -
- 1 x DB1001 Winch kit bag
 - 1 x DB1002 Snatch block - 16,000lbs
 - 1 x DB1006 Tow strap - 8 ton, 60mm x 9m
 - 1 x DB1007 Tree strap
 - 1 x DB1010 Winching gloves
 - 2 x DB1012 Alloy bow shackle - 4.75 ton
- DB1015** Contents - as per DB1017 plus
- 1 x DB1000 Wheel chocks (pair)
 - 1 x DB1011 Snatch tow sling - 10 ton
 - 1 x DB1016 Winching blanket

Britpart Pulling Power winching recovery kits come with all the basic items needed to ensure your winch can be used to the best effect. There is a choice of a starter or professional kit depending on your needs.



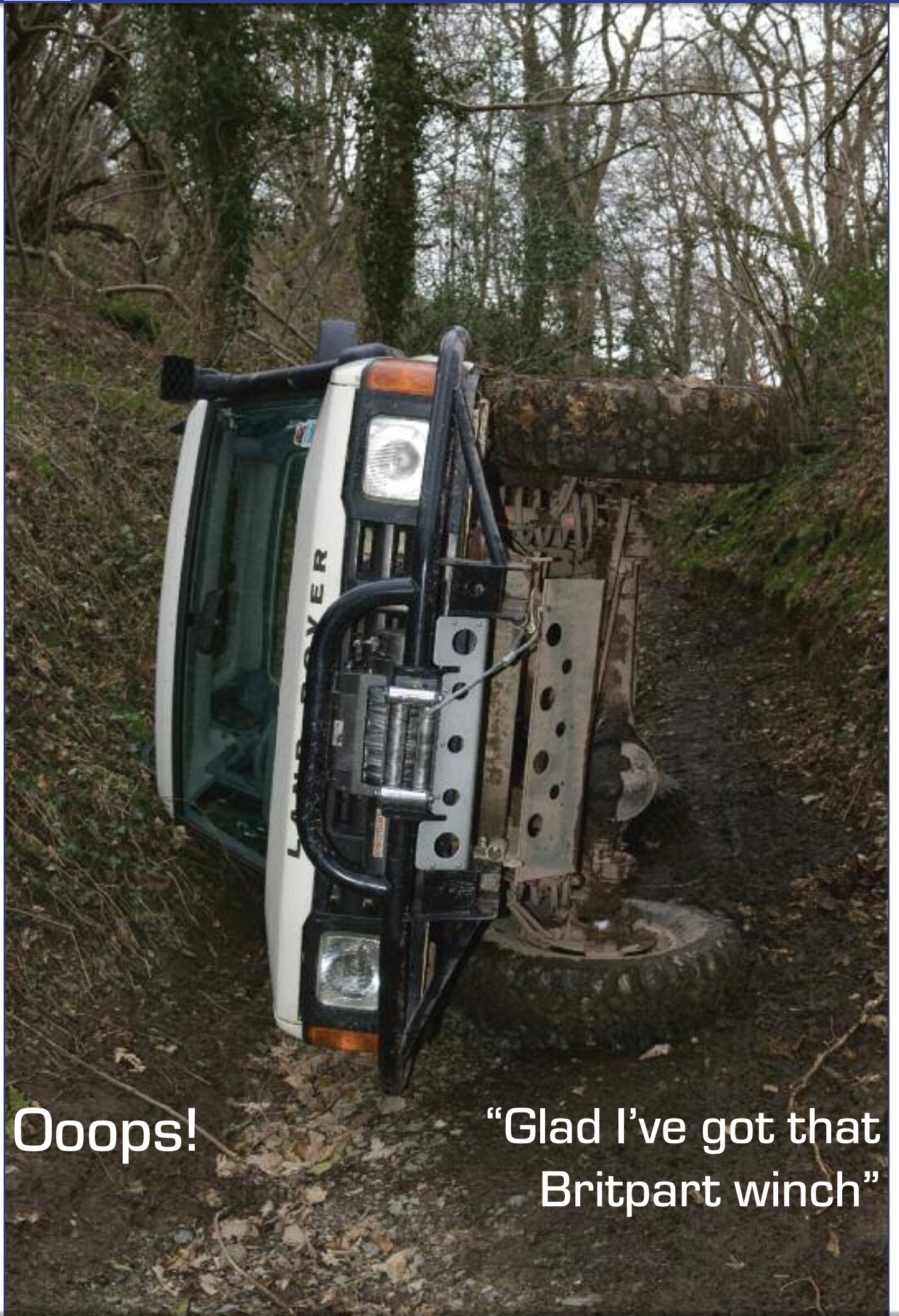

Ooops!

“Glad I’ve got that Britpart winch”

11

performance equipment
PERFORMANCE EQUIPMENT

Upgrade your Land Rover from its standard spec into something a bit more special.

Section contents -

Braking

Brake anti-squeal pads	94
Brake discs - Britpart Performance	94
Brake discs & pads - EBC	95
Brake hose kits	96
Brake lubrication	96
Handbrake conversion kits	97

Engine

Air filters - Britpart Performance	98
Air filters - K&N consumables	97
EGR blanking kits	97
Filter guards	99
Intercooler silicone hoses	99
Intercoolers - performance	100
PSI power tuning products	101
Weber carburettors	101



BRAKING

BRAKE ANTI-SQUEAL PADS



Universal self adhesive noise dampening shims



DA1141

The shims are manufactured from wolverine and cut to shape and applied to the backing plate of the Brake pads prior to fitting to help eliminate any noise issues (should the pad be unshimmed). When used in conjunction with Mintex CeraTec silicon based lubricant, most brake noise related issues will be eradicated. Pack quantity 4

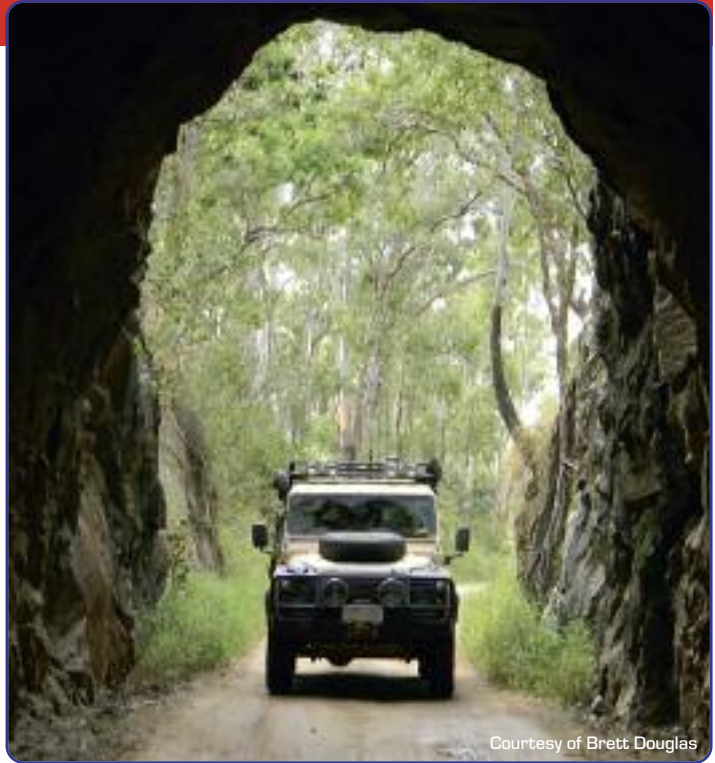

Courtesy of Brett Douglas

BRAKE DISCS - BRITPART PERFORMANCE



- > Slotted design to increase braking efficiency by reducing dust, debris, water and gas on the disc
- > To improve brake cooling, reduce weight and to offer an escape route for dirt and gasses these performance discs are drilled with rows of holes
- > Excellent upgrade for your Land Rover to aid braking, especially under a heavy load
- > Ideal for off-road use
- > Manufactured to British Standard BS1452 Grade 220 and DIN1691 GG20
- > Supplied in pairs



DA4600

BRITPART

Part Number	Corresponds to	Fitment	Type
DA4600	FRC7329	Front	Solid
DA4607	SDB100830	Front	Solid
DA4602	FTC902/LR017952	Front	Vented
DA4603	NTC8780	Front	Vented
DA4606	SDB000380	Front	Vented
DA4608	SDB101070	Front	Vented
DA4609	SDB000201	Front	Vented
DA4611 NEW	SDB000614	Front	Vented
DA4612 NEW	SDB000604	Front	Vented
DA4617 NEW	LR000470	Front	Vented
DA4618 NEW	LR007055	Front	Vented
DA4619 NEW	SDB500182	Front	Vented
DA4622 NEW	SDB500193	Front	Vented

Part Number	Corresponds to	Fitment	Type
DA4601	FTC1381/LR017953	Rear	Solid
DA4604	SDB000470	Rear	Solid
DA4605	SDB000330/LR018026	Rear	Solid
DA4610	SDB000211	Rear	Solid
DA4616 NEW	LR001018	Rear	Solid
DA4613 NEW	SDB000646	Rear	Vented
DA4614 NEW	SDB000636	Rear	Vented
DA4615 NEW	LR001019	Rear	Vented
DA4623 NEW	SDB500202	Rear	Vented

Quality manufactured slotted performance brake discs!

IMPORTANT BRAKE INFORMATION

For exact change over points with vehicle applications please contact your local Britpart distributor with the full chassis number for the correct application. These references are intended as a guide only.

BRAKE DISCS & PADS - EBC

EBC

BRAKES

EBC Brake Discs - Pairs

Part No.	Corresponds to	Fitment	Type
DA4165	FRC7329	Front	Solid
DA4166	571762	Front	Solid
DA4147	NTC8780	Front	Vented
DA4151	FTC902	Front	Vented
DA4158	ANR4582 & SDB000380	Front	Vented
DA4187	SDB000614	Front	Vented
DA4474	SDB000201	Front	Vented
DA4475	SDB000604	Front	Vented
DA4476	SDB500193	Front	Vented
DA4477	SDB101070	Front	Vented
DA4148	NTC8781 & SDB000470	Rear	Solid
DA4152	FTC1381/LR017953 & 571912	Rear	Solid
DA4472	SDB000211	Rear	Solid
DA4188	SDB000646	Rear	Vented
DA4473	SDB000636	Rear	Vented
DA4488	SDB500201 NEW	Rear	Vented



- > 100% British cast and machined high quality product
- > Wide aperture slots that draw cool air under the pad surface
- > Slots that expel all dirt dust and debris from the braking area
- > Blind drilled dimples that eliminate cracking common with through drilled sport rotors whilst helping maintain perfect pad contact
- > Gold zinc corrosion resistant coating

EBC Ultimax Heavy-duty Brake Pads - Sets

DA3300	SFP100460	Front
DA3301	SFP500100	Front
DA3302	SFP100360	Front
DA3303	SFC500050	Front
DA3304	SFP500010	Front
DA3306	LR004936	Front
DA3307	STC9186	Front
DA3308*	STC2950	Front
DA3309*	STC9187	Front
DA3310*	STC2952	Front
DA3311*	STC9191	Front
DA3312*	STC9190	Front
DA3313*	STC1601	Rear
DA3314	SFP100470	Rear
DA3315	SFP000120	Rear
DA3316	SFP500140	Rear
DA3318	SFP000270	Rear
DA3319*	STC9189	Rear
DA4196	SFP500021 NEW	Rear



- > New AF42/66 friction material which completely eliminates brake judder and produces a high friction long lasting brake pad
- > Unique powder coat finish to both pad and back plate gives lifetime resistance to corrosion and prevents moisture ingress
- > Unique Brake-In surface coating provides instant brake efficiency on installation and conditions the brake rotor removing glaze, black spotting etc from disc surface
- > All pads feature centre line slot which prevents heat expansion cracks and reduces brake noise
- > All pads feature edge chamfers which have major technical benefits;
 - Significant reduction in brake noise
 - Prevents 'edge lifting' under left and right extremities of pad which can cause corrosion ingress and eventual pad de-bond
 - Can extend pad life by virtue of improved pad efficiency
- > Most pads in the Ultimax range features factory fitted noise reduction shims

*pad sets excludes shims

Ultimax

EBC Green Stuff High Performance Brake Pads - Sets

DA4149	SFP100460 & SFP100480	Front
DA4153	STC9186 & STC9187	Front
DA4156	STC9190	Front
DA4157	STC9191	Front
DA4159	STC2952 & SFP000260	Front
DA4478	SFP500100	Front
DA4479	SFP100360	Front
DA4480	SFC500050	Front
DA4481	SFP500010	Front
DA4482	SFP500070	Front
DA4150	SFP100470 & SFP500130	Rear
DA4154	STC9189	Rear
DA4155	SFP500200	Rear
DA4185	STC1601 & SFP000280	Rear
DA4483	SFP000120	Rear
DA4484	SFP500140	Rear
DA4485	SFP000270	Rear

GREEN STUFF

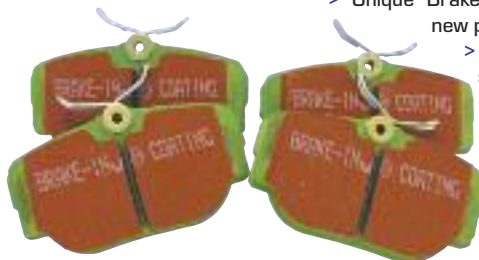

- > 100% British design and manufacture
- > Superb gloss powder coat paint finish to reduce corrosion
- > Unique engineering finish with noise reduction slots and edge chamfers
- > Extra high friction compounds for better stops, these pads will improve your stopping power by up to three vehicle lengths
- > Special compound ingredients that prevent "Outline Etching" eliminating brake stiction onto the rotor in damp conditions
- > Unique "Brake-In" surface coating to accelerate pad bed in after installing new pads which also guarantees brake efficiency from install
 - > Super quiet braking with rubber-steel-rubber noise reduction shims on the reverse, this dampens all possible noise
 - > Extra heavy duty compound lasts longer than low cost standard pads
 - > Fully ECE R 90 approved and legal for road and off road use

EBC Yellow Stuff Performance Race Brake Pads - Sets

DA4335	SFP500010	Front
DA4336	SFP500150	Front
DA4337	SFP500070	Front
DA4338	SFC500050 & SFC500080	Front
DA4339	SFP500130	Rear
DA4340	SFP500140	Rear
DA4341	SFP500210	Rear

Yellow STUFF



- EBC Yellowstuff brake pads are British made with Aramid fibres such as Kevlar and Twaron and are one of the highest friction brake pad compounds on today's market. Not only high in friction from first application when brakes are cold but extremely effective at higher brake temperatures as encountered in faster driving and towing/trailing. These pads are a favourite with the military and are used on armoured vehicles in several countries to handle the higher loads and heat and offer a good brake upgrade. Fitted with shims chamfers, centre slots and the unique EBC Brake in coating for fast bedding in of new brakes these pads are also long lasting and silent in operation.
- > High friction compound which is effective from cold up to high heat
 - > Effective brake upgrade for heavy-duty braking
 - > Long lasting powerful brakes
 - > Shims, edge chamfers and slots for silent braking

IMPORTANT BRAKE INFORMATION

For exact change over points with vehicle applications please contact your local Britpart distributor with the full chassis number for the correct application. These references are intended as a guide only.

BRAKE HOSE KITS

	Standard		Plus 40mm	
	Goodridge	Britpart Stainless Steel	Goodridge	Britpart Stainless Steel
Defender				
90 - 1984 to 1998 WA159806		DA2400S		DA240040S
90 - 110 - 1999 to 2004 from XA159807 metric non-abs		DA2401S		DA240140S
110 - 1983 to 1998 WA159806		DA2402S		DA240240S
Discovery 1				
1989 to 1992 to JA034313	DA2410	DA2410S		DA241040S
1992 to 1995 KA034314 to LA081991	DA2411	DA2411S		DA241140S
1995 to 1999 from MA018992 non-abs	DA2412	DA2412S		DA241240S
1995 to 1999 from MA018992 abs	DA2413	DA2413S		DA241340S
Discovery 2				
ABS		DA2414S		DA241440S
Range Rover Classic				
Up to 1981 UNF non-abs				DA240340S
1981 to 1990 metric non-abs				DA240440S
1970 up to 1981 UNF non-abs			DA240540	
1990 to 1992 abs				DA240640S
1992 abs				DA240740S
1992 to 1995 non-abs			DA240840	
Range Rover P38				
1995 to 2001		DA2409S		
Series 2/Series 3				
SWB - Imperial - 1960 to 1979		DA2418S	DA241840	DA241840S
SWB - Metric - 1980 to 1984	DA2419	DA2419S	DA241940	DA241940S
LWB - Imperial - 1971 to 1979 approx	DA2420	DA2420S	DA242040	DA242040S
LWB - Metric - 1980 to 1984	DA2421	DA2421S	DA242140	DA242140S



BRITPART

The quality parts for Land Rovers

*Increase your
braking efficiency*

These brakelines are constructed from the finest quality hose, consisting of a PTFE inner and stainless steel overbraid and both the Britpart and Goodridge brands offer -

- > Eliminates sponginess under heavy braking
- > Increases braking efficiency
- > Abrasion and corrosion resistant



GOODRIDGE



BRAKE LUBRICATION

Cera-Tec Advanced Lubricant

Mintex Cera TEC is an advanced non-metallic universal lubricant that provides many benefits over traditional copper-based grease.

DA2389

- > Non-metallic content - ABS and ESP friendly
- > Operates to a high temperature (1,000°C)
- > Non-conductive
- > Free of copper and acid
- > More effective at reducing any brake squeal
- > Protects against corrosion and dirt
- > Neutral colour prevents any visible residue or staining



DA2389



Courtesy of Louise Thompson

HANDBRAKE CONVERSION KITS

Beef up your handbrake!



DA5526

DA5513 Defender - 1987 - 2006

DA5526 Discovery 1/Discovery 2 & Range Rover Classic

Note - Will not fit a Range Rover Classic with a Borg Warner or LT95 transfer box.

The standard Land Rover hand brake can easily get bunged up with dirt if you drive off-road a lot and once the mechanism gets clogged up it doesn't work as efficiently as it should. Britpart now offer a solution to that problem - a drum to disc conversion kit.

DA5513

This kit uses a powerful caliper whose mechanism is sealed to prevent the access of mud! The special pads provide greater friction than the standard ones and are resistant from abrasion from mud.

ENGINE

AIR FILTER - K&N CONSUMABLES



DA4275

DA4276

DA3136

DA3137

K&N Dirt Retention Lubricating Oil

DA4275 200ml aerosol

DA4276 250ml bottle

K&N Cleaning Solution

DA3136 1ltr Bottle

DA3137 Cleaning kit - 200ml cleaning fluid & 200ml lubricating oil

EGR BLANKING KITS

A Britpart EGR (exhaust gas recirculation) blanking kit enables you to remove the original mechanical EGR from the vehicle resulting in better fuel economy and improved performance.

DA1108 300Tdi

DA1109 Td5

DA1112 TdV6 up to 7A (not EU4)



DA1108

DA1109

DA1112



DA1108 - FITTED



DA1109 - FITTED

AIR FILTERS - BRITPART PERFORMANCE

DA3138 Series 3 - 4-cylinder - fits Zenith and Weber carbs



DA3139 Corresponds to PHE000112

Discovery 3 - 2.7 V6 diesel, 4.0 V6 petrol & 4.4 V8 petrol
Range Rover Sport - 2.7 V6 diesel, 4.0 V6 petrol & 4.4 V8 petrol



DA4259 Corresponds to PHE000040

Range Rover L322 - Td6



DA4260 Defender - 90/110/130 - 2.5 Td5 1999 - 2007

Discovery 2 - Td5 1999 - 2004
Discovery 2 - 4.0i 1999 - 2004
Freelander 1 - V6 petrol
Range Rover P38 - 2.5DSE diesel (BMW engine) 1998 - 2002
Range Rover P38 - 4.0i V8 1994 - 2002
Range Rover P38 - 4.6i V8 1994 - 2002



DA4261 Corresponds to ESR1445

Discovery 1 - 2.0i Mpi petrol
Discovery 1 - 2.5 300Tdi 1994 - 1997
Discovery 1 - 3.9i V8 1994 - 1997
Range Rover Classic - 2.5 300Tdi 1992 - 1994
Range Rover Classic - 3.9i V8 Efi 1994



DA4262 Corresponds to NTC1435 & ESR2623

Defender - 90/110/130 2.5 300Tdi 1994 - 1997
Discovery 1 - 2.5 200Tdi 1989 - 1992
Range Rover Classic - 2.4D VM Turbo 1986 - 1992
Range Rover Classic - 2.5D VM Turbo 1986 - 1992



DA4263 Corresponds to PHE100500L

Freelander 1 - 2.0 Td4 (BMW engine) 2001 - 2006



DA4264 Corresponds to ESR1049

Discovery 1 - 2.5 200Tdi 1992 - 1994
Range Rover Classic - 2.5 200Tdi - 1992 - 1994



DA4265 Corresponds to ESR341

Range Rover Classic - 4.0i V8 1990 - 1995
Range Rover Classic - 4.2i V8 1990 - 1995
Range Rover Classic - 4.6i V8 1990 - 1995
Range Rover P38 - 2.5DSE diesel (BMW engine) 1994 - 1997



DA4266 Range Rover Classic - 3.5 carb V8

Cone type - replaces 605191 - 2 filters required



DA4267 Corresponds to ESR4103

Freelander 1 - 1.8 16v 1997 - 2000
Freelander 1 - 2.0i Tc1e diesel (Rover engine) 1997 - 2000



DA4268 Corresponds to RTC4683

Discovery 1 - 3.5i V8 Efi 1990 - 1993
Range Rover Classic - 3.5i V8 Efi 1985 - 1989
Range Rover Classic - 3.9i 1989 - 1994



DA4269 Corresponds to NRC9238

Defender - 90/110/130 - 2.5 petrol 1983 - 1990
Defender - 90/110/130 - 2.5 D & Td 1983 - 1990



DA4270 Corresponds to NTC6660

Defender - 90/110/130 - 2.5 200Tdi 1990 - 1993



DA4271 Corresponds to ESR4238

Defender - 90/110/130 - 2.5 Td5 1999 - 2007
Discovery 2 - Td5 1999 - 2004
Discovery 2 - 4.0i 1999 - 2004



DA4272 Range Rover Classic - 3.5 carb V8

Cone type off-road extreme power filter - 2 filters required



DA4274 Corresponds to 605191

Series 3 - 109 3.5 V8 1979 - 1982 - 2 filters required
Discovery 1 - 3.5 V8 carb 1989 - 1990 - 2 filters required
Range Rover Classic - 3.5 V8 carb 1972 - 1986 - 2 filters required



A breath of
fresh air
for your
Land Rover

> A range of performance filters tailored to fit your Land Rover

> Maximum breathing efficiency for your engine means more power or better fuel mileage

> No compromise on quality - the engine gets more air but the dirt particles are trapped by the quality filters

> No need to replace as easy cleaning means maximum performance guaranteed

> Easy fit, directly replaces standard air filter

> Ideal for use in hot dusty conditions to reduce engine wear

> Compatible with snorkels, ideal for use in conjunction with other performance modifications

> Filters don't need pre-oiling and if the filter gets dirty there is no need to use a cleaner to clear the dirt on the filter - just use air, water or detergent



"breathing efficiency for your engine means more power or better fuel mileage"

FILTER GUARDS NEW



Britpart Filter Guard removes potential engine damaging metal particles from your oil.



DA6081

Clean oil works better than dirty oil with reduced friction and less wear.

Britpart's Filter Guard is an inexpensive way of removing the harmful contaminants that conventional oil filters can miss. The contaminants are fine metal particles which act like an abrasive on the fast moving parts in your vehicle's engine - dramatically shortening engine life.

Filter Guard works by magnetic filtration technology resulting in cleaner oil which your engine will thank you for by running better now and in years to come. The Filter Guard will never clog or restrict the all important oil flow.

Note - Filter not included with Filter Guard

- > Improves fuel economy
- > Extends engine life
- > No vehicle modification needed
- > Added protection for stop & go driving and towing
- > Cleans engine oil for 50,000 miles/80,000kms
- > Does not effect your Land Rover's warranty

Added protection for your engine!

Part Number	Body	Thread/Insert	Part Number	Body	Thread/Insert
DA6080	3.70" (94mm)	3/4" x 16	DA6082	3.00" (76mm)	13/16" x 16
Fits filters - AEU2218L & ERR3340			Fits filters - LPW100180L, LPW100230, STC974 & CDU1268		
DA6081	3.70" (94mm)	13/16" x 16	DA6084	3.00" (76mm)	1.0" x 12
Fits filter - RTC3186			Fits filter - LR007160		



Courtesy of Marco Simola

INTERCOOLER SILICONE HOSES

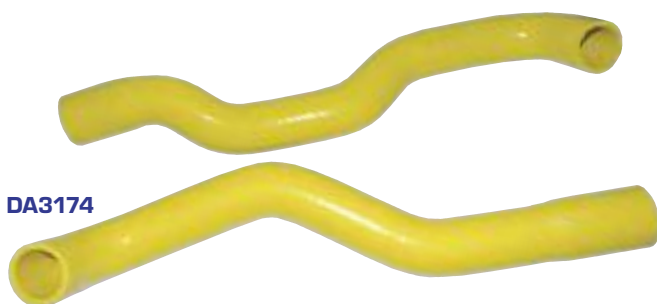

DA3174



DA3176

Britpart Yellow Silicone Hose Kits

Quality silicone intercooler hoses designed to operate at a higher temperature than the original hoses. Fits with both standard and performance intercoolers.

DA3170	Defender - 200Tdi	4 piece kit
DA3171	Defender - 300Tdi	3 piece kit
DA3173	Defender - Td5	3 piece kit
DA3174	Defender - 2007 onwards	2 piece kit
DA3175	Discovery 1 - 200Tdi	3 piece kit
DA3176	Discovery 1 - 300Tdi	3 piece kit
	Note - Remove EGR valve and pipe	
DA3177	Discovery 2 - Td5	3 piece kit
	Note - Non-A.C.E. vehicles only	
DA3182	Freelander 1 - Td4	2 piece kit



DA3170



DA3173

INTERCOOLERS - PERFORMANCE

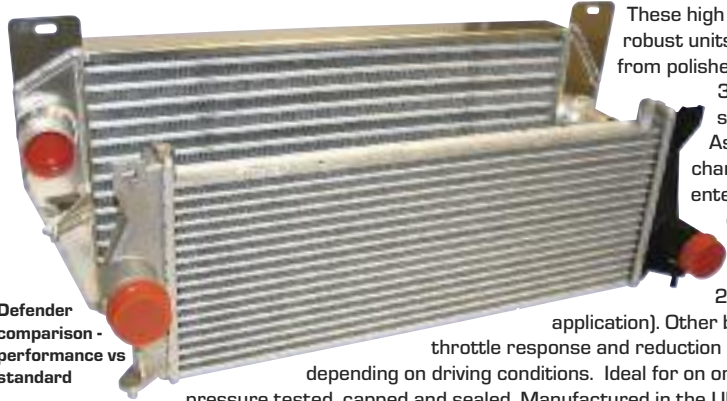

These high performance and robust units are constructed from polished aluminium and are 30% larger than the standard intercooler. As a result air has a chance to cool before entering the engine. This cooler air can increase engine power by up to 25bhp (subject to

Defender comparison - performance vs standard

application). Other benefits include better throttle response and reduction in fuel consumption depending on driving conditions. Ideal for on or off road use. Fully pressure tested, capped and sealed. Manufactured in the UK

increase engine power & reduce fuel consumption

DA4630	Defender - 90/ 110 - Td5 - 1998 - 2006 inc. air-con vehicles	60mm deep x 300mm high
DA4634	Defender - 90/ 110 - 2007 onwards - Puma NEW	60mm deep x 300mm high
DA4631	Discovery 2 - Td5 - Automatic - 1999 - 2004	60mm deep x 235mm high
DA4632	Discovery 2 - Td5 - Manual - 1999 - 2004	60mm deep x 300mm high
DA4633	Range Rover P38 - DSE	60mm deep x 280mm high

Note - Dimensions for main intercooler body only. If you have a winch fitted please check clearance before fitment.



DA4630



DA4634



DA4631



DA4632



DA4633

PSI POWER TUNING PRODUCTS



The Power Box houses a digital microprocessor which intercepts the fuelling signals being transmitted from the ECU to the fuel pump; it then modifies them to ensure the exact amount of diesel required for enhanced performance. Such efficient use of the fuel optimises consumption, reduces smoke emissions and there is less engine stress, enhancing engine life in many cases.

The Power Box improves torque enabling the vehicle to change gears earlier and hold higher gears at lower speeds, making driving more pleasurable.

The unit fits using the original manufacturers plugs; these existing plugs are opened and the Power Box is secured in between. Full fitting instructions are included with every unit.

DA4419



Benefits

- > Can be removed prior to sale or used as a selling point
- > Traceless
- > Peace of mind
- > Quality product which is legal & safe
- > Unobtrusive in interior of vehicle
- > No worries off road
- > A good investment

Performance improvement - (before/after)

	Power - HP	Power - Kw	Torque - Nm
DA4418	112/ 129	82/ 95	260/ 300
DA4419	136/ 160	100/ 118	268/ 310
DA4420	136/ 160	100/ 118	268/ 310
DA4421	177/ 203	130/ 149	390/ 440
DA4433	122/ 155	90/ 114	300/ 365
DA4436	122/ 150	90/ 110	360/ 415
DA4435	245/ 260	180/ 191	600/ 640

DA4418

Freelander 1 - Td4 2000 - 2006

DA4419

Range Rover P38 - 2.5Td 1995 - 1999

DA4420

Range Rover P38 - 2.5Td 2000 - 2001

DA4421

Range Rover L322 - Td6 2002 onwards

DA4433

Defender & Discovery 2 - Td5 1995 - 2007

DA4436

Defender 2007 onwards

Note - Will not override speed restrictor

DA4435 NEW

Discovery 4 & Range Rover Sport - 3.0 TdV6

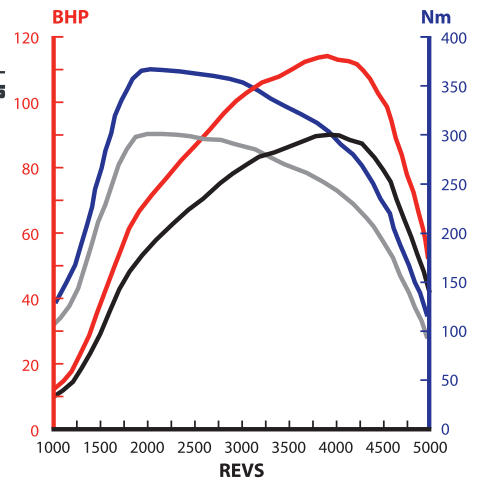

Performances for Defender Td5:

Standard:	122 HP	90 kW	300 Nm
PSI:	155 HP	114 kW	365 Nm

Features

- > Plug-in unit
- > No intervention with the original ECU
- > TUV approval
- > Compact size
- > Shock resistant & waterproof
- > Competitively priced

Improves m.p.g

Improves torque

WEBER CARBURETTORS

DA3049

V8 4-Barrel conversion kit including manifold
 The Webcon 4 barrel replacement carburettor kit is a direct replacement for the twin Stromberg or SU carbs fitted to the Rover V8. Calibrated to work perfectly on the 3.5 and 3.9 engines, the Webcon kit is the most complete on the market and features a Webcon modified Weber 4 barrel 500cfm carburettor, intake manifold, air filter and every single nut, bolt washer, gasket and hose that could possibly be needed. The kit adds up to 20bhp at the wheels and transforms the driveability and economy. Starting becomes instant either hot or cold and with no balance adjustment to worry about with twin carbs, the engine is simply superbly smooth as indeed a V8 should be.

DA3049AF

Replacement air filter for DA3049

DA2126

Series

To replace Solex use also STC541 adaptor

DA2206

Service kit for DA2126

DA2126A

Choke cable for DA2126

ERC2886W

Series

Replacements for the Zenith 36IV

Available for LHD, RHD, with or without fuel shut off solenoid, the Weber range of carburettor kits to replace the Zenith 36IV offer the optimum balance of power and economy together with the legendary quality and reliability of Weber. Shipped as complete turnkey solutions, all kits are supplied with every nut, bolt, washer and gasket required and comprehensive, easy to follow instructions ensure that installation can be carried out with no specialist carburettor knowledge.

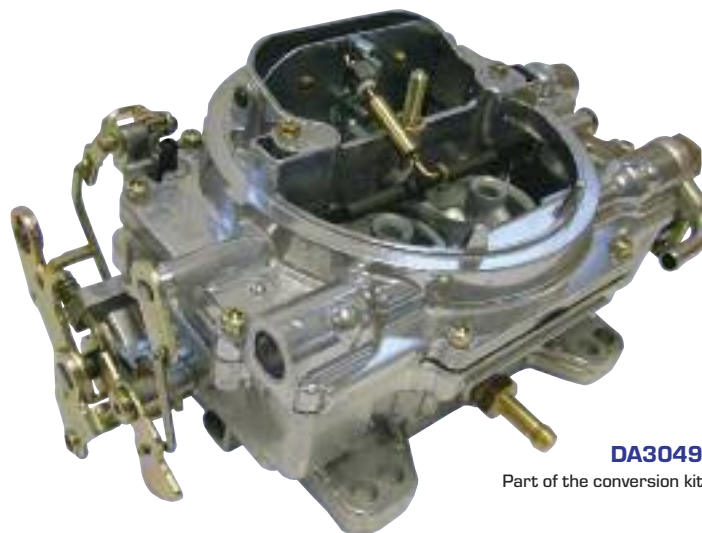

DA3049

Part of the conversion kit



DA2126



ERC2886W



Britpart DB2000
 fitted to a working
 model of a Land Rover



12

SUSPENSION & AXLE EQUIPMENT

Firm up your ride with some new shockers and springs or raise your game with a lifted suspension kit.

Section contents -

Axle

Anti-roll bar kits	104
Panhard rod	104
Radius arms	104

Bushes

Bump stops	105
Bush fitting tool	105
Bush sets - Britpart	105
Bush sets - Britpart polyurethane	106
Bush sets - Polybush	105

Shock absorbers

Ancillary suspension products	110
Bilstein	109
Britpart Cellular Dynamic	107
Britpart Super Gaz	108
Delphi De Carbon	109
Heavy-duty	109
Shock absorber brackets	109

Springs

Air lift kits	110
Air spring conversion kits	111
Dislocation cones	111
Spring retainers	112
Springs - air	112
Springs - coil	113
Springs - parabolic	112

Steering

Steering arms - heavy-duty	114
----------------------------	-----

Suspension kits

	115
--	-----

Suspension matrices

Performance springs	116
Shock absorbers & kits	117

Wide angle propshafts

	118
--	-----



AXLE

ANTI-ROLL BAR KITS

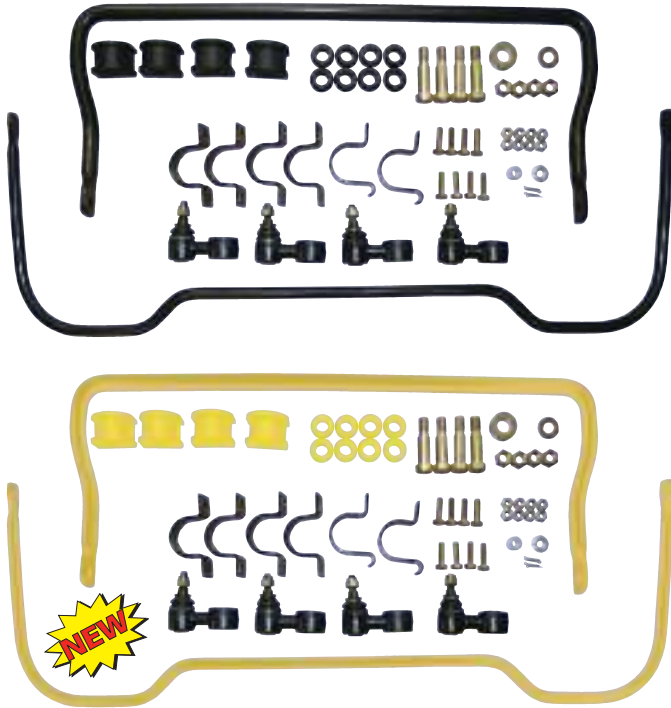

Anti-roll bars for stiffening up your vehicle.

Front and rear kit complete with fitting instructions.

- | | | |
|------------------------|--|-----------------------|
| STC8156AA | Defender - 90/Discovery 1 | Black anti-roll bars |
| | Kit includes rubber bushes | |
| STC8156AAPY NEW | Defender - 90/Discovery 1 | Yellow anti-roll bars |
| | Kit includes Britpart yellow polyurethane bushes | |

PANHARD ROD

DA1130

Adjustable panhard rod for Defender - Td5 and 2007 onwards
If your Defender has raised suspension it is wise to use an adjustable panhard rod to correct the axle position which will in turn maintain and restore the steering geometry.



DA1130

Polyurethane bushes to fit panhard rod
RBX101340PY or **RBX101340PY-YELLOW**



BRITPART

The quality parts for Land Rovers

RADIUS ARMS

Designed for vehicles with an extended 1 to 3" lift



DA5505 / DA5506

RADIUS ARMS FITTED

- > Designed for Defender/Discovery 1/Range Rover Classic with an extended 1 to 3" lift
- > Front radius arms correct castor alignment which in turn ensures safe driving
- > Rear radius arms provide full rear axle articulation
- > Fitting the radius arms will contribute to much better off-road capability for your vehicle by fully utilising your spring and shock absorber set
- > Zinc passivated with a yellow heavy-duty powder coating finish to complement each component and the Britpart coil springs

DA5505	3° Heavy-duty	Narrow	Use with NTC7307 & DA2353 bushes	38mm
DA5506	3° Heavy-duty	Wide	Use with NTC6781 & DA2353 bushes	45mm
DA5510	2" Lift rear radius arm			

DA5510



Wide Angle Propshafts...

See the end of this section for full details

BUSHES

BUMP STOPS

Extended polyurethane bump stops should be used on vehicles with raised suspension to prevent the shock absorbers from bottoming out.

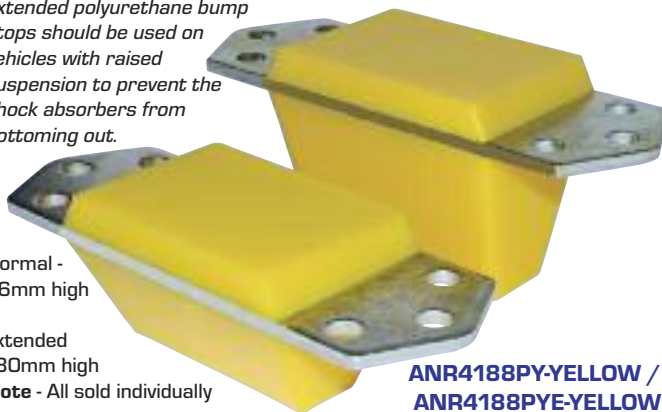

Normal - 56mm high

Extended - 80mm high

Note - All sold individually

ANR4188PY-YELLOW / ANR4188PYE-YELLOW

ANR4188PY	Defender/Discovery 1	Front	Normal	Black
ANR4188PY-YELLOW	Defender/Discovery 1	Front	Normal	Yellow
ANR4188PYE	Defender/Discovery 1	Front	Extended	Black
ANR4188PYE-YELLOW	Defender/Discovery 1	Front	Extended	Yellow
ANR4189PY	Defender/Discovery 1	Rear	Normal	Black
ANR4189PY-YELLOW	Defender/Discovery 1	Rear	Normal	Yellow
ANR4189PYE	Defender/Discovery 1	Rear	Extended	Black
ANR4189PYE-YELLOW	Defender/Discovery 1	Rear	Extended	Yellow

BUSH FITTING TOOL



LRT-60-004

Bush Fitting Tool - for ANR3332

Fitting new front radius arm bushes (part number ANR3332) for the Range Rover 38A is impossible to do without using the Land Rover special tool.

LRT-60-004
Land Rover special tool

BUSH SETS - BRITPART

Britpart - Blue

DA4035BLUE
Defender - 90/110/130 to 1993 with drum brakes

DA4036BLUE
Defender - 1994 onwards/Discovery 1/Range Rover Classic - 1986 onwards

Britpart - Other

DA2353
Front radius arm to chassis kit
Defender - 1987 - 1997/Discovery 1/Range Rover Classic - 1986 - 1994

DA4035YELLOW
Defender - 90/110/130 to 1993 with drum brakes



DA4035BLUE



DA2353



Courtesy of Ben Gresswell

BUSH SETS - POLYBUSH

Polybush sets available from Britpart - full details supplied on request.



DA3144
Polybush Classic
Full kit for Discovery 3
Kit includes -

- > Front lower wishbone - front bushes
- > Front lower wishbone - rear bushes
- > Front upper wishbone bushes
- > Rear lower wishbone - front bush
- > Rear lower wishbone - rear bush
- > Rear upper wishbone - front bush
- > Rear upper wishbone - rear bush



BUSH SETS - BRITPART POLYURETHANE

Britpart - Individual bush sets

548205PY	Shackle bush set
548205PY-YELLOW	Shackle bush set
552818PY	Shock absorber bush set
552818PY-YELLOW	Shock absorber bush set
552819PY	Shock absorber bush set
552819PY-YELLOW	Shock absorber bush set
568858PY	Washer - steering damper
568858PY-YELLOW	Washer - steering damper
569746PY	Chassis bush set
569746PY-YELLOW	Chassis bush set
572068PY	Radius arm/chassis outer bush set
572068PY-YELLOW	Radius arm/chassis outer bush set
572180PY	Mounting
572180PY-YELLOW	Mounting
575580PY	Panhard rod bush set
575580PY-YELLOW	Panhard rod bush set
90577434PY	Bush chassis
90577434PY-YELLOW	Bush chassis
ANR1721PY	Shock absorber bush set
ANR1721PY-YELLOW	Shock absorber bush set
ANR2563PY	Bush
ANR2563PY-YELLOW	Bush
ANR3285PY	Bush rear radius
ANR3285PY-YELLOW	Bush rear radius
ANR3305PY	Bush
ANR3305PY-YELLOW	Bush
ANR3332PY	Bush - radius arm
ANR3332PY-YELLOW	Bush - radius arm

ANR3410PY	Panhard rod bush set
ANR3410PY-YELLOW	Panhard rod bush set
ANR6947PY	Rear radius arm to axle bush
ANR6947PY-YELLOW	Rear radius arm to axle bush
NRC4514PY	Bush set - radius arm to chassis
NRC4514PY-YELLOW	Bush set - radius arm to chassis
NRC5593PY	Shock absorber bush set
NRC5593PY-YELLOW	Shock absorber bush set
NTC1772PY	Bush set - lower link/axle
NTC1772PY-YELLOW	Bush set - lower link/axle
NTC1773PY	Bush set - upper mounting
NTC1773PY-YELLOW	Bush set - upper mounting
NTC1775PY	Bush - steering damper
NTC1775PY-YELLOW	Bush - steering damper
NTC6781PY	Bush set - radius arm/axle
NTC6781PY-YELLOW	Bush set - radius arm/axle
NTC6828PY	Bush
NTC6828PY-YELLOW	Bush
NTC7307PY	Bush set - radius arm/axle
NTC7307PY-YELLOW	Bush set - radius arm/axle
NTC7394PY	Bush
NTC7394PY-YELLOW	Bush
RBX101240PY	Bush - anti-roll bar
RBX101240PY-YELLOW	Bush - anti-roll bar

RBX101340PY	Front panhard rod kit
RBX101340PY-YELLOW	Front panhard rod kit
RBX101680PY	Front radius arm to axle
RBX101680PY-YELLOW	Front radius arm to axle
RBX101690PY	Bush - anti-roll bar front
RBX101690PY-YELLOW	Bush - anti-roll bar front
RBX101730PY	Radius arm to chassis
RBX101730PY-YELLOW	Radius arm to chassis
RBX101780PY	Bush - lower arm
RBX101780PY-YELLOW	Bush - lower arm
RBX101790PY	Bush - lower arm
RBX101790PY-YELLOW	Bush - lower arm
RDB100080PY	Bush
RDB100080PY-YELLOW	Bush
RGX100970PY	Bush Assy
RGX100970PY-YELLOW	Bush Assy
RGX101000PY	Bush - trailing link
RGX101000PY-YELLOW	Bush - trailing link
RGX101010PY	Bush
RGX101010PY-YELLOW	Bush
RGX101020PY	Bush - outer
RGX101020PY-YELLOW	Bush - outer
RGX101440PY	Bush
RGX101440PY-YELLOW	Bush
RNF100090PY	Mounting - rubber
RNF100090PY-YELLOW	Mounting - rubber
STC618PY	Bush kit
STC618PY-YELLOW	Bush kit

Britpart - Black suspension bush sets

DC7103	Series 1, 2 & 3 - excluding 3 LWB (see DC7104)
DC7104	Series 3 - LWB
DC7109	Defender - up to 1993
DC7110	Defender - 1994 - 1999
DC7108	Defender - 1999 - 2007
DC7111	Defender - 2007 onwards
DA2426	Defender - steering damper bush set
DC7100	Discovery 1
DC7101	Discovery 2*
DC7102	Freelander 1
DC7105	Range Rover Classic - up to 1986
DC7106	Range Rover Classic - 1986 - 1994
DC7107	Range Rover P38

Britpart - Yellow suspension bush sets

DC7003	Series 1, 2 & 3 - excluding 3 LWB (see DC7004)
DC7004	Series 3 - LWB
DC7009	Defender - up to 1993
DC7010	Defender - 1994 - 1999
DC7008	Defender - 1999 - 2007
DC7011	Defender - 2007 onwards
DA2425	Defender - steering damper bush set
DC7000	Discovery 1
DC7001	Discovery 2*
DC7002	Freelander 1
DC7005	Range Rover Classic - up to 1986
DC7006	Range Rover Classic - 1986 - 1994
DC7007	Range Rover P38

Note - Part numbers without yellow as a suffix indicate the bush colour is black.



DC7008

*Note - Kit includes front anti-roll bar bushes but these bushes aren't suitable for vehicles with ACE fitted

- > Britpart are proud to present an exclusive range of Yellow and Black polyurethane bushes
- > Manufactured exclusively for Britpart using the latest Vulkollan™ polyurethane technology
- > Machined to exact tolerances once cast to produce the highest finish available
- > Produced in both yellow and black they are both the same compound which gives similar ride characteristics to the standard rubber bushes, but they offer improved articulation, vibration damping and last longer
- > The black bushes are ideal for replacing individual bushes as they can be fitted without a press
- > The DC range of kits include shock absorber and A-frame bushes

Manufactured exclusively for Britpart using the latest Vulkollan™ polyurethane technology

also available in **black**



SHOCK ABSORBERS

BRITPART CELLULAR DYNAMIC

including



BRITPART

CELLULAR DYNAMIC

- > cellular technology tube
- > sintered 18mm rod
- > piston diameter 41mm
- > polyurethane bush
- > teflon piston with multi-lip seal
- > single piece eye ring



The Britpart Cellular Dynamic Shock Absorber represents a significant advance in Land Rover suspension systems. It features a cellular foam insert instead of a normal nitrogen gas or air; this is to stop the oil from boiling. The foam takes up less room which means more room for oil, 50% more, which offers maximum heat dispersion. This heat dispersion translates to a very subtle but controlled ride that will not fade no matter how hard you push them. They are ideal for a driver who needs more control to complement performance improvements or to enhance a standard vehicle.

The unique design ensures ride comfort and cornering ability is maximised and of course they are superb off-road.

2 year
WARRANTY
50,000
miles*

Note

* Terms & conditions apply

** Dimensions are +/- 5mm

*** The Plus 5" Cellular Dynamic Shock Absorbers are specialist suspension products and to install them additional fabrication work or brackets may be required. Please ensure that they are fitted by a competent expert.

Part Number	Application	Lift	Fitment	Open/Closed Dimensions**
DC6000	Defender/Discovery 1/Range Rover Classic		Front	600/380mm
DC6001	Defender/Discovery 1/Range Rover Classic		Rear	590/375mm
DC6000L	Defender/Discovery 1/Range Rover Classic	50mm/2"	Front	665/425mm
DC6001L	Defender/Discovery 1/Range Rover Classic	50mm/2"	Rear	625/385mm
DC6000LL	Defender/Discovery 1/Range Rover Classic	125mm/5" (see note***)	Front	765/455mm
DC6001LL	Defender/Discovery 1/Range Rover Classic	125mm/5" (see note***)	Rear	750/440mm
DC6010	Discovery 2		Front	590/370mm
DC6011	Discovery 2		Rear	585/365mm
DC6002	Range Rover P38 - air suspension		Front	560/365mm
DC6003	Range Rover P38 - air suspension		Rear	505/340mm
DC6004	Defender		Steering Damper	
DC6005	Discovery 1/Range Rover Classic/Series		Steering Damper	
DC6009	Discovery 2		Steering Damper	
DC6006	Range Rover P38		Steering Damper	



BRITPART SUPER GAZ

Super Gaz Shock Absorbers



Part Number	Application	Lift	Fitment	Open/Closed Dimensions**
DC5002	Defender/Discovery 1/Range Rover Classic		Front	605/385mm
DC5003	Defender/Discovery 1/Range Rover Classic		Rear	590/375mm
DC5002L	Defender/Discovery 1/Range Rover Classic	50mm/2"	Front	655/405mm
DC5003L	Defender/Discovery 1/Range Rover Classic	50mm/2"	Rear	640/400mm
DC5000	Discovery 2		Front	590/370mm
DC5001	Discovery 2		Rear	585/365mm
DC5000L	Discovery 2	50mm/2"	Front	640/400mm
DC5001L	Discovery 2	50mm/2"	Rear	635/390mm
DC5004	Defender		Steering damper	
DC5005	Discovery 1/Range Rover Classic/Series		Steering damper	

24 month / 50,000 mile Warranty*

*Super Gaz Shock Absorbers
Terms and conditions apply

** +/- 5mm

Britpart Super Gaz Shock Absorbers offer a 35mm bore tube filled with Fuchs shock absorber fluid, using the best seal available, single piece eye rings, polyurethane bush mounts and a very durable powder coated finish. These offer a vast improvement in ride quality and damping performance. They are ideal for use with either of the Britpart Yellow Spring range or standard Land Rover Springs. Please ask for a CD of the shock absorbers in use or see the suspension section on the Britpart website!



DELPHI DE CARBON



Shock Absorbers **Note** - Boxed as a pair, priced individually

DA4162	Series - LWB/SWB	Front
DA4163	Series - SWB	Rear
DA4090	Defender - to 1999/Discovery 1 - to 1994/Range Rover Classic - inc. air suspension	Front
DA4091	Defender - to 1999/Discovery 1 - to 1994/Range Rover Classic - inc. air suspension	Rear
DA4092	Discovery 1 - 1994 - 1999	Rear
DA4181	Defender - to 1999/Discovery 1 - to 1994/Range Rover Classic	Front +2"
DA4182	Defender - to 1999/Discovery 1 - to 1994/Range Rover Classic	Rear +2"

Steering Dampers

DA4160	Series/Discovery 1 - to 1998/Range Rover Classic
DA4161	Defender

BILSTEIN NEW

- > Gas pressure technology with increased power reserves and service life, even when pulling trailers or during frequent journeys with loads
- > Optimum adhesion and enhanced lane change stability in both day-to-day and extreme situations
- > Marked improvement in safety and sportiness without additional spring changes (lowering)
- > BILSTEIN mono-tube /Upside-Down technology, made in Germany



DA1067 Discovery 3 Front
DA1068 Discovery 3 Rear

HEAVY-DUTY

Heavy-duty oil filled shock absorbers



DA4211 Defender - 90/110 Front
DA4210 Defender - 90/110 Rear

SHOCK ABSORBER BRACKETS



DA6322



DA6322L



DA6323



Kit includes nuts, bolts & washers

DA6324



DA6323L

Any extreme force encountered is divided between the two shock absorbers for a more comfortable ride for you and your passengers.

Sometimes off-road conditions can be serious enough to test the standard equipment on your Land Rover to its maximum. One of the critical components that takes most of the abuse is the suspension system. When using the standard single shock absorber configuration it is not unknown for the shock absorber to break the factory fitted turret mount. These new shock absorber brackets from Britpart give you confidence that your vehicles suspension will tackle the terrain you take it through with greater ease.

The single shock absorber bracket is manufactured from heavy-duty steel and replaces the existing turret mount which is susceptible to corrosion by allowing a build up of dirt inside which is hard to clean thoroughly. The new design is harder wearing and easier to clean.

The twin shock absorber bracket is manufactured from the same quality steel as the single shock absorber bracket but allows for the fitment of an additional shock absorber. The benefits of having extra shock absorbers fitted to your Land Rover is that any extreme force encountered is divided between the two shock absorbers for a more comfortable ride for you and your passengers. Using twin shocks is also beneficial when carrying loads both on and off-road as it improves the load carrying ability of the vehicle. An additional benefit is that when changing shock absorbers there is no need to remove the brackets. **Note** - Rear brackets involve some welding to fit.

DA6322	Defender/Discovery 1/Range Rover Classic*	Twin shock brackets	Front	Standard height
DA6322L	Defender/Discovery 1/Range Rover Classic*	Twin shock brackets	Front	2" Lift
DA6323	Defender/Discovery 1/Range Rover Classic*	Single shock brackets	Front	Standard height
DA6323L	Defender/Discovery 1/Range Rover Classic*	Single shock brackets	Front	2" Lift
DA6324	Defender/Discovery 1/Range Rover Classic*	Twin shock brackets - kit	Rear	

*Note - Fitting shock absorber brackets may require some vehicle modification, please ask distributor for full details.

NEW ANCILLARY SUSPENSION PRODUCTS

STOP PRESS...

DA6337

- > Long travel rear shocker absorber mounting kit
- > Suitable for Defender 90/110/130 / Discovery 1 & Range Rover Classic
- > To be used in conjunction with DC6000LL
- > Laser cut, jigged and computer welded with zinc plated and powder coated finish

The standard pin and eye shock absorbers don't have the necessary articulation for extreme off road conditions and the answer is to use pin and pin shock absorbers. If you use our Cellular Dynamic Plus 5 shock absorbers they offer better articulation. **Note** - On Defender Td5 the fuel filter must be moved

DA6338

- > Heavy-duty front shock absorber turret rings
- > Suitable for Defender/Discovery 1 & Range Rover Classic

These robust & heavy-duty turret rings are made to replace the existing standard turret rings.

DA6339

- > 15mm prop shaft spacer kit
- > Suitable for Defender/Discovery 1 & Range Rover Classic
- > Machined from billet aluminium and anodised deep blue

When suspension lift kit is fitted it increases the distance between the transfer box flange and the diff flange. This increased distance can cause the prop shaft to run out of spline travel. Fitting this 15mm prop spacer helps return the prop shaft to its normal operating length therefore allowing full spline travel which also helps reduce the characteristic "binding" of the yokes when a prop shaft is over extended.

DA6341

- > +2" Spacer blocks
- > Front
- > Discovery 2
- > Machined from high quality aluminium and anodised deep blue
- > With this kit you are able to retain the standard springs and shock absorbers
- > Use in conjunction with DA6342

DA6342

- > +2" Spacer blocks
- > Rear
- > Discovery 2
- > Machined from high quality aluminium and anodised deep blue
- > Use in conjunction with DA6341

This kit enables you to retain your air springs yet give your vehicle the desired 2" lift. This kit is complete with everything needed to convert; it even includes the tap and die set! We recommend that this kit be fitted in conjunction with DA6341, DA4198 or DA4199. Please look at the shock absorbers suitable for this vehicle and at 40mm braided brake hoses.



DA6337

DA6338



DA6339



DA6341

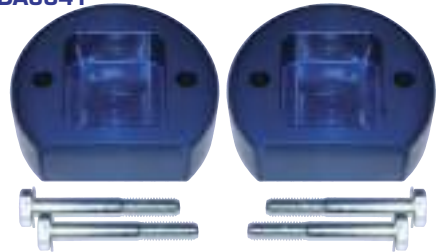

DA6342

SPRINGS

AIR LIFT KITS

Adjustable Air Helper Springs

The load and towing problem solver

Air adjustability is the difference! Stiff steel factory suspensions must compromise between ride comfort and load hauling capacity. Smooth ride suspensions can't carry heavy loads; heavy springs ride rough, especially when the vehicle is unloaded. Air Lift adjustable air springs solve these problems by allowing you to tune your suspension under all load and road conditions. Just add air when towing or hauling and then remove air for a softer ride when unloaded.

Features and benefits of Air Lift 1000

- > Improve ride, handling and stability by reducing roll, sway and "bottoming out"
- > Fits open coil springs, front or rear
- > Up to 1,000lbs of levelling capacity
- > Tough long-lasting moulded polyurethane construction
- > Quick connecting easy-to-use engineered polymer air fittings

Air Lift 1000

DA5010

Defender - 110 & 130

DA5011

Defender - 90/Discovery 1 & Range Rover Classic

DA5012

Load Controller II

The economical, popular, basic on board air system

This system controls the rear bags equally. All kits include wiring harness for fast, easy installation. To eliminate the major cause of air spring failure, the low pressure sensor automatically activates if pressure falls below the minimum safe level.



DA5010 / DA5011



DA5012

AIR SPRING CONVERSION KITS

Discovery 2

It is a sad fact that it's likely the air suspension on your Discovery 2 will fail - probably at the most inconvenient time possible. You then have a choice to make. Do you replace it with a new air spring system which is comfortable but not so comfortable on your wallet or replace with an equally comfortable but much more affordable and reliable coil spring system? Well Britpart have the complete kit for air to coil spring conversion making your decision that little bit easier.

DA5136 Discovery 2 - standard ride height Rear kit

DA5137 Discovery 2 - 2" lift ride height **NEW** Rear kit

DA5007 Discovery 2 - 2" lift ride height - **heavy-duty**

NEW Ideal if winch is fitted Front & rear kit

DA5008 Discovery 2 - 2" lift ride height **NEW** Front & rear kit

Air to coil spring conversion kits from Britpart - get a reliable and maintenance-free ride for your Land Rover!



Range Rover

The EAS (Electronic Air Suspension) System found on Range Rover 4.0 and 4.6 vehicles can present expensive, recurring maintenance problems. If you've had an air spring failure before, you know this first hand. Britpart now has a coil spring conversion kit for Range Rover 4.0 and 4.6 that makes switching to coil springs seamless and error-free. Conversion to coil springs provides a better, maintenance-free ride that will save you significant money over time. The EAS Override Module suppresses all typical false dashboard display errors and buzzers seen when converting to coil springs. Any mechanic or Range Rover owner can install this coil spring conversion kit without having to go to a Land Rover dealer or Autologic-equipped repair shop to eliminate false dash warning light errors. The kit features:

- > Detailed step-by-step instructions
- > The EAS Override Module overrides all typical computer errors seen when converting to a coil springs
- > Eliminates the need for a costly shop visit
- > Aluminium spring perch adapters
- > Britpart custom made coil springs provide standard ride height and maximum articulation
- > Affordable alternative to expensive, recurring air suspension failures
- > Trip computer compatibility - maintains operation of your vehicle's trip computer
- > Kit provides everything needed to complete a professional installation

DA4136 Range Rover P38 - 1995 - 2002 Petrol models and diesel light duty

DA4136HD Range Rover P38 - 1995 - 2002 Heavy-duty 1" lift including diesel models

DA4179 Range Rover Classic No module



DA4136HD

DISLOCATION CONES

DA1962

Defender - 110

Rear Pair

DA2186

Defender - 90/Discovery 1

Rear Pair

These clever products ensures your springs relocate correctly when using your Land Rover in extreme conditions. Manufactured from stainless steel. Use in conjunction with spring retainers.



DA1962

DA2186



Courtesy of Kevin Masson

SPRING RETAINERS



DA2362



DA2363

DA2362	Front
DA2363	Rear

SPRINGS - AIR

Air springs can be susceptible to air leaks due to the fact the rubber seals dry out. Why not firm up your suspension and replace them with these quality air springs from Britpart?

Note - All sold individually.

DA2371	Discovery 2 - with self levelling	Rear
RKB101200	Discovery 2	Rear
NTC9819	Range Rover Classic	Front
NTC9820	Range Rover Classic	Rear
DA2372	Range Rover P38	Front
DA2373	Range Rover P38	Rear
REB101740	Range Rover P38	Front
RKB101460	Range Rover P38	Rear



DA2371

DA2373

DA2372



NTC9819 & NTC9820



RKB101200



REB101740 / RKB101460

SPRINGS - PARABOLIC



DA4106



DA4107

DA4106	2 Leaf	Series - SWB/LWB	Front kit pair
DA4107	3 Leaf	Series - SWB	Rear kit pair
DA2003	4 Leaf	Series - LWB	Rear kit pair



DA2003

High quality replacement parabolic springs from Britpart. Designed to match the original Santana specification, giving a very comfortable and controlled ride.
Note - Includes 'U' bolts and nuts.

SPRINGS - COIL

Britpart Performance - Lifted Springs

Britpart performance springs are high quality, versatile and competitively priced - the right choice when replacing the old sagging original springs.

Developed by one of the world's top spring manufacturers these high quality, powder coated yellow springs have been designed with the needs of today's Land Rover owners in mind. Britpart performance lifted springs have the added benefit of improving your vehicles approach and departure angles which in turn allows you to overcome more obstacles when off-roading.

As Land Rovers are often working vehicles as well as the family car, uprated springs must offer the ability to carry loads, handle off-road terrain and provide a good ride on road. The progressive springs offer a compliant ride when lightly loaded, but firm up as the load increases.

Note - Spring quantity 1 = 1 pair

The right choice when replacing the old sagging original springs!



			Bar Diameter	Load	Rate lbs/in	Free Height
Defender						
DA4201	Defender - 90 & 110	Front	16mm	25kg	200	420mm
DA4202	Defender - 90, 110 & 130	Front	16mm	50kg	230	390mm
DA4203	Defender - 90	Rear	17mm	Light	220	435mm
DA4204	Defender - 90	Rear	18mm	100kg	300 - 340	425mm
DA4205	Defender - 90	Rear	19mm	200kg	360	430mm
DA4206	Defender - 110	Rear	17mm	100kg	270 - 295	445mm
DA4208	Defender - 110 & 130	Rear	21mm	500kg	420	445mm
Discovery						
DA4201	Discovery 1	Front	16mm	25kg	200	420mm
DA4202	Discovery 1	Front	16mm	50kg	230	390mm
DA4199	Discovery 2	Front	15mm	20 - 50kg	180	390mm
DA4198	Discovery 2	Front	16mm	50 - 100kg	220	390mm
DA4203	Discovery 1 & 2	Rear	17mm	Light	220	435mm
DA4197	Discovery 2	Rear	18mm	Medium	290	430mm
DA4204	Discovery 1	Rear	18mm	100kg	300 - 340	425mm
DA4205	Discovery 1 & 2	Rear	19mm	200kg	360	430mm
Range Rover						
DA4201	Range Rover Classic	Front	16mm	25kg	200	420mm
DA4202	Range Rover Classic	Front	16mm	50kg	230	390mm
DA4203	Range Rover Classic	Rear	17mm	Light	220	435mm
DA4204	Range Rover Classic	Rear	18mm	100kg	300 - 340	425mm
DA4205	Range Rover Classic	Rear	19mm	200kg	360	430mm

Britpart Performance - Standard Height Springs

Britpart yellow springs are designed for the enthusiast who wants a performance spring without having to raise the vehicle. They offer a firmer ride with less body roll, ideal for a vehicle with uprated performance or one used for carrying heavy loads. The springs are designed to offer full articulation off-road with a compliant ride. Developed by one of the world's top spring manufacturers these high quality, powder coated yellow springs have been designed with the needs of today's Land Rover owners in mind.

Note - Spring quantity 1 = 1 pair

			Bar Diameter	Rate lbs/in	Free Height
Defender					
DA4277	Defender - 90 & 110	Front	16mm	225	390mm
DA4278	Defender - 90	Rear	18mm	285	385mm
DA4279	Defender - 110	Rear	19mm	330	415mm
Discovery					
DA4277	Discovery 1 - up to 1999	Front	16mm	225	390mm
DA4278	Discovery 1	Rear	18mm	285	385mm
Range Rover					
DA4277	Range Rover Classic	Front	16mm	225	390mm
DA4278	Range Rover Classic	Rear	18mm	285	385mm



*Terms & conditions apply

STEERING

STEERING ARMS - HEAVY-DUTY



DA5501	Series	4 track rod ends
DA5502	Defender - 90 & 110	3 track rod ends
DA5503	Discovery 1 / Range Rover Classic	3 track rod ends
DA5504	Discovery 1	4 track rod ends
DA5509	Discovery 2	4 track rod ends

- > All OEM track rod ends
- > Solid heavy-duty arms which are suitable for off-road use
- > Improves steering response
- > Zinc plate finish to increase corrosion resistance

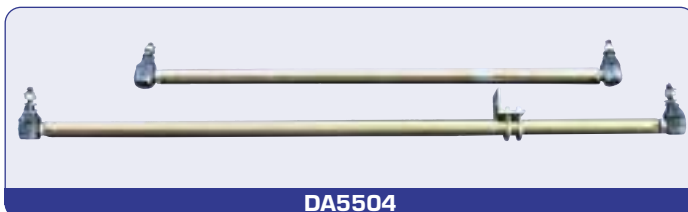

Improves steering response



DA5502



SUSPENSION KITS

Super Gaz

Shock Absorber & Spring Kits

DA4284	Defender - 90/Discovery 1/Range Rover Classic	Heavy-duty	Standard height
DA4301	Defender - 90/Discovery 1/Range Rover Classic	Light-duty	25mm Lift
DA4286 NEW	Defender - 90/Discovery 1/Range Rover Classic	Light-duty	40mm Lift
DA4286MD NEW	Defender - 90/Discovery 1/Range Rover Classic	Medium-duty	40mm Lift
DA4286HD NEW	Defender - 90/Discovery 1/Range Rover Classic	Heavy-duty	40mm Lift
DA4285	Defender - 110	Heavy-duty	Standard height
DA4287	Defender - 110	Heavy-duty	40mm Lift
DA4369 NEW	Discovery 2 (full front & rear kit - front springs rated at 20 to 50kg load)	No winch	40mm Lift
DA4347 NEW	Discovery 2 (full front & rear kit - front springs rated at 50 to 100kg load)	With winch	40mm Lift

Full Suspension Kits

DA4288	Defender - 90 - to 1994/Range Rover Classic - to 1986 - narrow bush	Light-duty	40mm Lift
DA4288MD NEW	Defender - 90 - to 1994/Range Rover Classic - to 1986 - narrow bush	Medium-duty	40mm Lift
DA4288HD NEW	Defender - 90 - to 1994/Range Rover Classic - to 1986 - narrow bush	Heavy-duty	40mm Lift
DA4289 NEW	Defender - 90 - from 1994/Discovery 1/Range Rover Classic - from 1986 - wide bush	Light-duty	40mm Lift
DA4289MD NEW	Defender - 90 - from 1994/Discovery 1/Range Rover Classic - from 1986 - wide bush	Medium-duty	40mm Lift
DA4289HD NEW	Defender - 90 - from 1994/Discovery 1/Range Rover Classic - from 1986 - wide bush	Heavy-duty	40mm Lift
DA4299	Defender - 110 - to 1994 - narrow bush	Heavy-duty	40mm Lift
DA4300	Defender - 110 - from 1994 - wide bush	Heavy-duty	40mm Lift

Britpart can offer a complete or partial suspension package suitable for whatever you intend to use your Land Rover for.



CELLULAR DYNAMIC - FULL SUSPENSION KIT



SUPER GAZ - SHOCK ABSORBER & SPRING KIT

Kit contents

Shock absorber & spring kits

- > Springs - front & rear
- > Shock absorbers - front & rear

Full suspension kits

- > Springs - front & rear
- > Shock absorbers - front & rear
- > Radius arms - front & rear
- > Spring retainers - front & rear
- > Bush sets

**24 month /
50,000 mile
Warranty on
Super Gaz &
Cellular Dynamic
Shock Absorbers****

**Terms and conditions apply

Cellular Dynamic

Shock Absorber & Spring Kits

DA4284C	Defender - 90/Discovery 1/Range Rover Classic	Heavy-duty	Standard height
DA4301C	Defender - 90/Discovery 1/Range Rover Classic	Light-duty	25mm Lift
DA4286C NEW	Defender - 90/Discovery 1/Range Rover Classic	Light-duty	40mm Lift
DA4286CMD NEW	Defender - 90/Discovery 1/Range Rover Classic	Medium-duty	40mm Lift
DA4286CHD NEW	Defender - 90/Discovery 1/Range Rover Classic	Heavy-duty	40mm Lift
DA4363	Defender - 90/Discovery 1/Range Rover Classic	Light-duty	Plus 5" Shock*
DA4285C	Defender - 110	Heavy-duty	Standard height
DA4287C	Defender - 110	Heavy-duty	40mm Lift
DA4364	Defender - 110	Heavy-duty	Plus 5" Shock*

Full Suspension Kits

DA4288C NEW	Defender - 90 - to 1994/Range Rover Classic - to 1986 - narrow bush	Light-duty	40mm Lift
DA4288CMD NEW	Defender - 90 - to 1994/Range Rover Classic - to 1986 - narrow bush	Medium-duty	40mm Lift
DA4288CHD NEW	Defender - 90 - to 1994/Range Rover Classic - to 1986 - narrow bush	Heavy-duty	40mm Lift
DA4365	Defender - 90 - to 1994/Range Rover Classic - to 1986 - narrow bush	Medium-duty	Plus 5" Shock*
DA4289C NEW	Defender - 90 - from 1994/Discovery 1/Range Rover Classic - from 1986 - wide bush	Light-duty	40mm Lift
DA4289CMD NEW	Defender - 90 - from 1994/Discovery 1/Range Rover Classic - from 1986 - wide bush	Medium-duty	40mm Lift
DA4289CHD NEW	Defender - 90 - from 1994/Discovery 1/Range Rover Classic - from 1986 - wide bush	Heavy-duty	40mm Lift
DA4366	Defender - 90 - from 1994/Discovery 1/Range Rover Classic - from 1986 - wide bush	Medium-duty	Plus 5" Shock*
DA4299C	Defender - 110 - to 1994 - narrow bush	Heavy-duty	40mm Lift
DA4367	Defender - 110 - to 1994 - narrow bush	Heavy-duty	Plus 5" Shock*
DA4300C	Defender - 110 - from 1994 - wide bush	Heavy-duty	40mm Lift
DA4368	Defender - 110 - from 1994 - wide bush	Heavy-duty	Plus 5" Shock*

*Note - The Plus 5" Cellular Dynamic Shock Absorbers are specialist suspension products and to install them additional fabrication work or brackets may be required. Please ensure that they are fitted by a competent expert. Open and closed dimensions - DC6000LL - 765-455mm & DC60001LL - 750-440mm

SUSPENSION MATRICES

PERFORMANCE SPRINGS

Table contents - Part Number/ Spring Load	<i>Defender 90</i>	<i>Defender 110</i>	<i>Defender 130</i>	<i>Discovery 1</i>	<i>Discovery 2</i>	<i>Range Rover Classic</i>
Front						
Standard	DA4277	DA4277		DA4277 - up to 1999		DA4277
25mm lift	DA4201 - 25kg	DA4201 - 25kg		DA4201 - 25kg		DA4201 - 25kg
40mm lift	DA4202 - 50kg	DA4202 - 50kg	DA4202 - 50kg	DA4202 - 50kg	DA4199 - 20 - 50kg DA4198 - 50 - 100kg	DA4202 - 50kg
Rear						
Standard	DA4278	DA4279		DA4278		DA4278
40mm lift	DA4203 - Light	DA4206 - 100kg		DA4203 - Light	DA4203 - Light DA4197 - Medium	DA4203 - Light
50mm lift	DA4204 - 100kg DA4205 - 200kg	DA4208 - 500kg	DA4208 - 500kg	DA4204 - 100kg DA4205 - 200kg	DA4205 - 200kg	DA4204 - 100kg DA4205 - 200kg



Courtesy of Janine Goss

SHOCK ABSORBERS & KITS

	<i>Defender 90</i>	<i>Defender 110</i>	<i>Discovery 1</i>	<i>Discovery 2</i>	<i>Range Rover Classic</i>	<i>Range Rover P38</i>	<i>Series</i>
Super Gaz Shock Absorbers							
Front							
Standard	DC5002	DC5002	DC5002	DC5000	DC5002		
50mm lift	DC5002L	DC5002L	DC5002L	DC5000L	DC5002L		
Rear							
Standard	DC5003	DC5003	DC5003	DC5001	DC5003		
50mm lift	DC5003L	DC5003L	DC5003L	DC5001L	DC5003L		
Steering damper							
Standard	DC5004	DC5004	DC5005		DC5005		DC5005
50mm lift	DC5004	DC5004	DC5005		DC5005		DC5005
Super Gaz Shock Absorber Suspension Kits							
Shock Absorber & Spring Kits							
Standard - heavy-duty kit	DA4284	DA4285	DA4284		DA4284		
25mm lift - light-duty kit	DA4301		DA4301		DA4301		
40mm lift - light-duty kit	DA4286		DA4286		DA4286		
40mm lift - medium-duty kit	DA4286MD		DA4286MD		DA4286MD		
40mm lift - heavy-duty kit	DA4286HD	DA4287	DA4286HD		DA4286HD		
40mm lift - no winch - kit				DA4369			
40mm lift - with winch - kit				DA4347			
Full Suspension Kits							
40mm lift - narrow bush - light-duty kit	DA4288				DA4288		
40mm lift - narrow bush - medium-duty kit	DA4288MD				DA4288MD		
40mm lift - narrow bush - heavy-duty kit	DA4288HD	DA4299			DA4288HD		
40mm lift - wide bush - light-duty kit	DA4289		DA4289		DA4289		
40mm lift - wide bush - medium-duty kit	DA4289MD		DA4289MD		DA4289MD		
40mm lift - wide bush - heavy-duty kit	DA4289HD	DA4300	DA4289HD		DA4289HD		
Cellular Dynamic Shock Absorbers							
Front							
Standard	DC6000	DC6000	DC6000	DC6010	DC6000	DC6002	
50mm lift	DC6000L	DC6000L	DC6000L		DC6000L		
Plus 5" shock absorber	DC6000LL	DC6000LL	DC6000LL		DC6000LL		
Rear							
Standard	DC6001	DC6001	DC6001	DC6011	DC6001	DC6003	
50mm lift	DC6001L	DC6001L	DC6001L		DC6001L		
Plus 5" shock absorber	DC6001LL	DC6001LL	DC6001LL		DC6001LL		
Steering damper							
Standard	DC6004	DC6004	DC6005	DC6009	DC6005	DC6006	DC6005
50mm lift	DC6004	DC6004	DC6005		DC6005		
Plus 5" shock absorber	DC6004	DC6004	DC6005		DC6005		
Cellular Dynamic Shock Absorber Suspension Kits							
Shock Absorber & Spring Kits							
Standard height - heavy-duty kit	DA4284C	DA4285C	DA4284C		DA4284C		
25mm lift - light-duty kit	DA4301C		DA4301C		DA4301C		
40mm lift - light-duty kit	DA4286C		DA4286C		DA4286C		
40mm lift - medium-duty kit	DA4286CMD		DA4286CMD		DA4286CMD		
40mm lift - heavy-duty kit	DA4286CHD	DA4287C	DA4286CHD		DA4286CHD		
Plus 5" shock absorber - light-duty kit	DA4363		DA4363		DA4363		
Plus 5" shock absorber - heavy-duty kit		DA4364					
Full Suspension Kits							
40mm lift - narrow bush - light-duty kit	DA4288C				DA4288C		
40mm lift - narrow bush - medium-duty kit	DA4288CMD				DA4288CMD		
40mm lift - narrow bush - heavy-duty kit	DA4288CHD	DA4299C			DA4288CHD		
Plus 5" shock - narrow bush - medium-duty kit	DA4365				DA4365		
Plus 5" shock - narrow bush - heavy-duty kit		DA4367					
40mm lift - wide bush - light-duty kit	DA4289C		DA4289C		DA4289C		
40mm lift - wide bush - medium-duty kit	DA4289CMD		DA4289CMD		DA4289CMD		
40mm lift - wide bush - heavy-duty kit	DA4289CHD	DA4300C	DA4289CHD		DA4289CHD		
Plus 5" shock absorber - wide bush - medium-duty kit	DA4366		DA4366		DA4366		
Plus 5" shock absorber - wide bush - heavy-duty kit		DA4368					

WIDE ANGLE PROPSHAFTS

If your Land Rover has raised suspension or been modified for extreme axle articulation then the joints on the existing prop shaft will become strained. This will cause the prop shaft to lock up or vibrate and wear the universal joints prematurely.

reduces vibration, universal joint 'bind-up' and premature wear



DA6353

Dropping the axle further away from the chassis is great for looks, articulation and off-road performance - a neat solution is to fit a wide angle prop shaft. This allows drivetrain angles of up to 32 degrees which reduces vibration, universal joint 'bind-up' and premature wear on the joints. These wide angle shafts have greasable universal joints which are more desirable where longer life is required.

DA6350	Front	Defender - from MA - 300Tdi/Discovery 1/Range Rover Classic - 1986 - 1991	FRC8386
DA6352	Front	Defender - up to LA (1993)	FRC8390/FRC5566
DA6351	Rear	Defender - 90 - 4 cylinder - up to 2007	FRC8392
DA6353	Rear	Defender - 90 - V8 - up to 2007 & diesel from MA	FRC8393
DA6354	Rear	Discovery 1 - 1989 - 1994 and V8 from 1997	FRC8387

DA6356
Replacement heavy-duty universal joint for wide angle propshafts



Courtesy of Armando Pantarotto

13 exhausts

EXHAUSTS

An exhaust that'll last a life time? We've got them here.

Section contents -

Exhausts - stainless steel	120
Exhausts - stainless steel sports systems	121
Utility link & rear pipes	122



EXHAUSTS - STAINLESS STEEL

Double 'S' is recognised as one of Europe's leading manufacturers of stainless steel automotive components with a wide selection of systems for off-road.

Using only the finest austenitic and ferritic stainless steels and employing the latest in CNC mandrel and empty tube bending, measuring and inspection equipment, means increasingly high levels of product quality.

All Double 'S' exhaust systems carry a lifetime guarantee. Double 'S' will replace or repair any part of their Stainless Steel Exhaust Systems found defective through corrosion during the period that the system remains the property of the original owner. Provided that the system is inspected by a garage or exhaust fitting centre annually to ensure that the rubber and other mountings are in good condition.

Series

Series	Model	Engine	Kit contents
DA4251	Series 3	2.25 Diesel	Front pipe Link pipe Rear silencer
DA4528	Series 3	2.25 Petrol	Front pipe Link pipe Rear silencer

Defender

DA4231	Defender - 90	200Tdi	Front pipe Centre box Rear silencer
DA4232	Defender - 90 - 1994 - 1995	300Tdi	Front pipe Centre box Rear silencer
DA4233	Defender - 90 - 1995 - 1997	300Tdi	Front pipe Centre box Rear silencer
DA4234	Defender - 90 - 1997 - onwards	300Tdi	Centre box Rear silencer
DA4235	Defender - 90	Td5	Centre box Rear silencer
DA4244	Defender - 110	Td5	Centre box Rear silencer
DA4228	Defender - 110	200Tdi	Front pipe Centre box Rear silencer
DA4229	Defender - 110	300Tdi	Front pipe Centre box Rear silencer

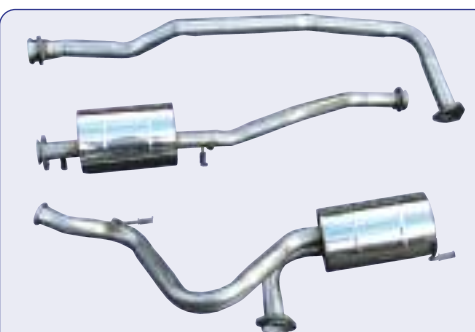
DA4528

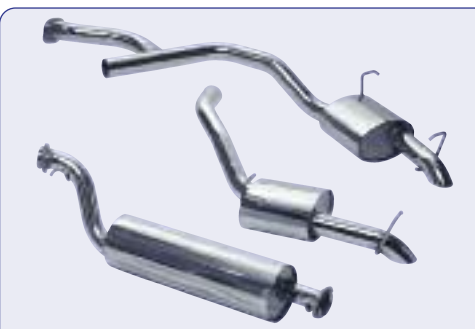
DA4233

DA4240

DA4241

All Double 'S' exhaust systems carry a lifetime guarantee.

DA4246

Discovery

DA4221	Discovery 1	2.5Td & 200Tdi Manual	Front pipe Centre box Rear silencer
DA4222	Discovery 1	200Tdi Automatic	Centre box Rear silencer
DA4223	Discovery 1	300Tdi	Centre box Rear silencer
DA4224	Discovery 2	2.5 Td5	Centre box Rear silencer

Freelander

DA4226	Freelander 1	1.8 Petrol	Centre box Rear silencer
DA4227	Freelander 1	2.0 Diesel	Link pipe Rear silencer
DA4246	Freelander 1	1.8 Petrol	Transplex rear silencer (2 x 3" roll tailpipe)

Range Rover

DA4237	Range Rover Classic	3.9 V8 cat back	Centre box non-cat Rear silencer cat
DA4238	Range Rover P38	2.5 BMW diesel single tailpipe	Centre box Rear silencer
DA4239	Range Rover P38	4.0/4.6 single tailpipe	Centre box Rear silencer
DA4240	Range Rover P38	4.0/4.6 twin tailpipe	Centre box LH rear silencer RH rear silencer
DA4241	Range Rover P38	2.5 BMW twin tailpipe	Centre box LH rear silencer RH rear silencer

EXHAUSTS - STAINLESS STEEL SPORTS SYSTEMS

Defender

Part No.	Vehicle	Engine	Kit contents
DA4236	Defender - 90	3.5 V8 Sports system	LH manifold RH manifold Y-Pipe Rear silencer Tailpipe Fitting bracket & kit
DA4230	Defender - 110	3.5 V8 Sports system	LH manifold RH manifold Y-Pipe Extension pipe Centre box Tailpipe Fitting bracket & kit
DA4249	Defender - 90	Td5 - Sports system	Sports centre link pipe Rear silencer

Discovery

DA4225	Discovery 1	3.9 V8 Japanese spec sports system	Centre box Link pipe Rear silencer
---------------	-------------	--	--

Range Rover

DA4242	Range Rover Classic	3.5 V8 Efi Sports system with tubular manifold	LH manifold RH manifold Y-Pipe Centre box Rear silencer
DA4243	Range Rover Classic	3.9 V8 Efi Sports system with tubular manifold	LH manifold RH manifold Y-Pipe Centre box Link pipe Rear silencer
DA4245	Range Rover P38	4.0/4.6 Sports system with twin tailpipe	LH rear silencer RH rear silencer Y-Pipe Centre box
DA4247	Range Rover P38	2.5 diesel Sports system with twin tailpipe	LH rear silencer RH rear silencer Y-Pipe Centre box



DA4236

All Double 'S' exhaust systems carry a lifetime guarantee.

DA4249



DA4225



DA4243



DA4245



Picture courtesy of Kristjan Kristjansson

UTILITY LINK & REAR PIPES

Britpart Link Pipe Part No.	Vehicle	Model	Double 'S' Rear silencer Part No.
Defender			
DA4348	Defender - 90	Td5 - downpipe less cat Note - Not stainless steel	
DA4359	Defender - 90	Puma - downpipe less cat Note - Not stainless steel	
DA4371	Defender - 90	2007 onwards NEW	DA3250
DA4292	Defender - 90	Td5	DA3250
DA4294	Defender - 90	300Tdi 1994-1995	DA3251
DA4294	Defender - 90	300Tdi 1995-1997	DA3252
DA4304	Defender - 90	300Tdi 1997-1999	DA3253
DA4295	Defender - 90	200Tdi	DA3254
DA4372	Defender - 110	2007 onwards NEW	DA3255
DA4293	Defender - 110	Td5	DA3255
DA4302	Defender - 110	300Tdi	DA3256
DA4306	Defender - 110	200Tdi	DA3257

Discovery

DA4291	Discovery 1	300Tdi Note - Will only fit with Double 'S' rear silencer (DA3258)	DA3258
DA4223S	Discovery 1	300Tdi Note - Kit includes Double 'S' rear silencer (DA3258)	N/A
DA4303	Discovery 1	200Tdi	DA3259
DA4290	Discovery 2	Td5	DA3260



Quick and easy
to install with
more power



These stainless steel exhaust silencer replacement pipes. They are designed to directly replace the front silencer in your exhaust system.

Once replaced the pipe will give your vehicle more power or reduced fuel consumption with only a small increase in cabin noise. CNC mandrel formed for a perfect fit with laser cut flanges, the pipes have a sateen finish, deep luster appearance. Quick and easy to install.

Reduced fuel
consumption



14

REPAIR & SERVICE PARTS

From a new complete chassis to a jubilee clip - we've got the lot.

Section contents -

Axle	
Swivel housing kits	124
Swivel pin kits	124
Wheel bearing kits	124
Wheel hub & bearing	124
Braking	
Brake kits	125
Chassis & body components	
Chassis' - complete	125
Chassis & body components	
- Defender	126
- Discovery 1	127
- Freelander	127
- Range Rover Classic	128
- Series 2 & 3	129
Door hinge kits	130
Window kits	130
Consumables	
Clips, clamps & nipples	130
Fluids	131
Hand barrier cream	130
Hylomar sealants & compounds	131
Land Rover genuine consumables	131
Loctite consumables	132
Swivel housing grease	132
Touch up paint pens	133
Electrics	
Electronic conversion kits	133
Ignition lead sets	133
Ignition module & link lead	134
Engine	
Cylinder heads	134
Cylinder liner kit	134
Engines	135
Gasket kits	134
Head bolt sets	134
Heater plug upgrade kit	134
Oil pump gear set	136
Pressure relief valve kit	136
Timing kits	136
Heating	
Heater blower motor kit & resistor kit	136
Heater matrixes	136
Tools & protection	
Tools	137
Wing protectors	137
Transmission	
Automatic transmission service kit	138
Clutch kits	139
CV joint kits	138
Damper kit	138
Diff coupling shaft	138
Diff repair pans	140
Gear boxes	140
Propshaft bearings	140
Propshaft kit	140
Transfer boxes	140



AXLE

SWIVEL HOUSING KITS



DA3165

DA3163

- Discovery 1 - to JA32850 / Range Rover Classic
- to JA624516 - with 12mm seals
- > Swivel housing
 - > Gasket
 - > Plate
 - > Joint washers
 - > Swivel housing grease sachet
 - > Swivel pin bearing
 - > Seals
 - > Shims
 - > Swivel pin upper

DA3164

- Discovery 1 - to JA32850 / Range Rover Classic
- to JA624516 - with 8mm seals
- > Swivel housing
 - > Gasket
 - > Plate
 - > Joint washers
 - > Swivel housing grease sachet
 - > Swivel pin bearing
 - > Oil seals
 - > Shims
 - > Swivel pin upper

DA3165

- Discovery 1 - from JA32851 / Range Rover Classic - from JA624517 - non-ABS
- > Swivel housing
 - > Gasket
 - > Plate
 - > Joint washers
 - > Swivel housing grease sachet
 - > Swivel pin bearing
 - > Seals
 - > Shims
 - > Swivel pin upper - non-ABS

DA3166

- Discovery 1 / Range Rover Classic - with ABS
- > Swivel housing
 - > Gasket
 - > Plate
 - > Joint washers
 - > Swivel housing grease sachet
 - > Swivel pin bearing
 - > Seals
 - > Shims
 - > Swivel pin kit - upper - ABS

DA3167

- Defender - to KA930455
- > Swivel housing
 - > Thrust washer
 - > Joint washers
 - > Shims
 - > Swivel housing grease sachet
 - > Housing and bush
 - > Swivel pin bearing
 - > Seals
 - > Swivel pin upper

DA3178

- Defender - from LA to WA
- > Swivel housing
 - > Gasket
 - > Plate
 - > Joint washers
 - > Swivel housing grease sachet
 - > Swivel pin bearing
 - > Seals
 - > Shims
 - > Swivel pin upper - non-ABS

DA3179

- Defender - from XA non-ABS
- > Swivel housing
 - > Gasket
 - > Plate
 - > Swivel pin kit
 - > Swivel pin bearing
 - > Seals
 - > Joint washers
 - > Swivel housing grease sachet

DA3180

- Defender - from XA with ABS
- > Swivel housing
 - > Gasket
 - > Plate
 - > Swivel pin kit
 - > Swivel pin bearing
 - > Seals
 - > Joint washers
 - > Swivel housing grease sachet

DA3169

- Series 2
- > Swivel housing
 - > Railko bush
 - > Swivel pin bearing
 - > Lock washer
 - > Shims
 - > Retainer for oil seal
 - > Swivel housing grease sachet
 - > Swivel pin
 - > Thrust washer
 - > O-ring
 - > Locker
 - > Oil seal
 - > Joint washers

DA3181

- Series 2A & 3
- > Swivel housing
 - > Railko bush
 - > Swivel pin bearing
 - > Lock washer
 - > Shims
 - > Retainer for oil seal
 - > Swivel housing grease sachet
 - > Swivel pin
 - > Thrust washer
 - > O-ring
 - > Locker
 - > Oil seal
 - > Joint washers

Note - Each kit is for one side only.
For full details of each kit list - www.britpart.com/swivelkits

These ten swivel housing kits from Britpart are a convenient way to ensure you have all the quality parts needed to replace a Land Rover's swivel housing.

Corroded, worn or leaking swivel housings?



DA3167

SWIVEL PIN KITS



DA2178



DA2211

- DA2211** Defender - up to KA930455
DA2210 NEW Defender - from LA930456

- 532268** Series 2 - conversion
DA2178 Series 3

WHEEL HUB & BEARING



LR014147

- Wheel hub & bearing assembly kit - front
> Discovery 3 & Discovery 4
> Range Rover Sport

LR014147

WHEEL BEARING KITS



RTC3534

RTC3534	Series 2 & Series 3 - SWB up to 1980 imperial	Front & rear
RTC3537	Series 2 & Series 3 - LWB & SWB from 1980 metric	Front & rear
DA2379	Defender - up to KA	Front
DA2380	Defender - up to KA	Rear
DA2381	Defender - from LA	Front & rear
DA2382	Discovery 1 - up to JA032850	Front & rear
DA2383	Discovery 1 - from JA032851	Front & rear
DA2384	Range Rover Classic - non-ABS from JA624517	Rear
DA2385	Range Rover Classic - non-ABS up to JA624516	Rear
DA2386	Range Rover Classic - ABS	Rear
DA2387	Range Rover Classic - ABS	Front
DA2388	Range Rover Classic - non-ABS	Front
FTC1507	Range Rover P38	Front & rear

Note - Bearing only

BRAKING

BRAKE KITS

Series - SWB

DA6042	Front	Up to June 1980
DA6043	Rear	Up to June 1980
DA6044	Front	From July 1980
DA6046	Rear	From July 1980

Series - LWB

DA6044	Front	4 cylinder except 1 ton
DA6045	Front	6 cylinder & 109 V8 Stage 1
DA6047	Rear	Including V8

Kits include - Brake shoes, wheel cylinders, brake springs & screws (where applicable)



DA6042



DA6047

CHASSIS & BODY COMPONENTS

CHASSIS' - COMPLETE

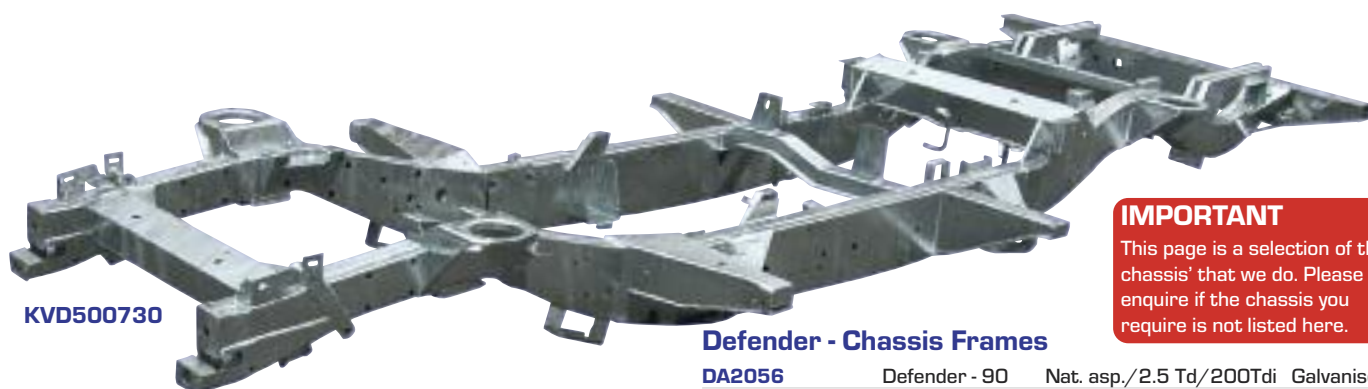

KVD500730

IMPORTANT
This page is a selection of the chassis' that we do. Please enquire if the chassis you require is not listed here.

Defender - Chassis Frames

DA2056	Defender - 90	Nat. asp./2.5 Td/200Tdi	Galvanised
DA2056-300TDI	Defender - 90	300Tdi	Galvanised
KVD500710	Defender - 90	Td5	Galvanised
DA2057*	Defender - 110	Nat. asp./2.5 Td/200Tdi	Galvanised
DA2057-300TDI*	Defender - 110	300Tdi	Galvanised
KVD500730	Defender - 110	Td5	Galvanised
KVD500140	Defender - 130	Td5	Galvanised

*suitable for pick-up and station wagons

Series - Chassis Frames

NRC4642G	Series - SWB	Galvanised
NRC4356	Series - LWB	Galvanised



DA2056



DA2057



DA2057-300TDI



KVD500710



KVD500140



NRC4356



NRC4624G

CHASSIS & BODY COMPONENTS - DEFENDER

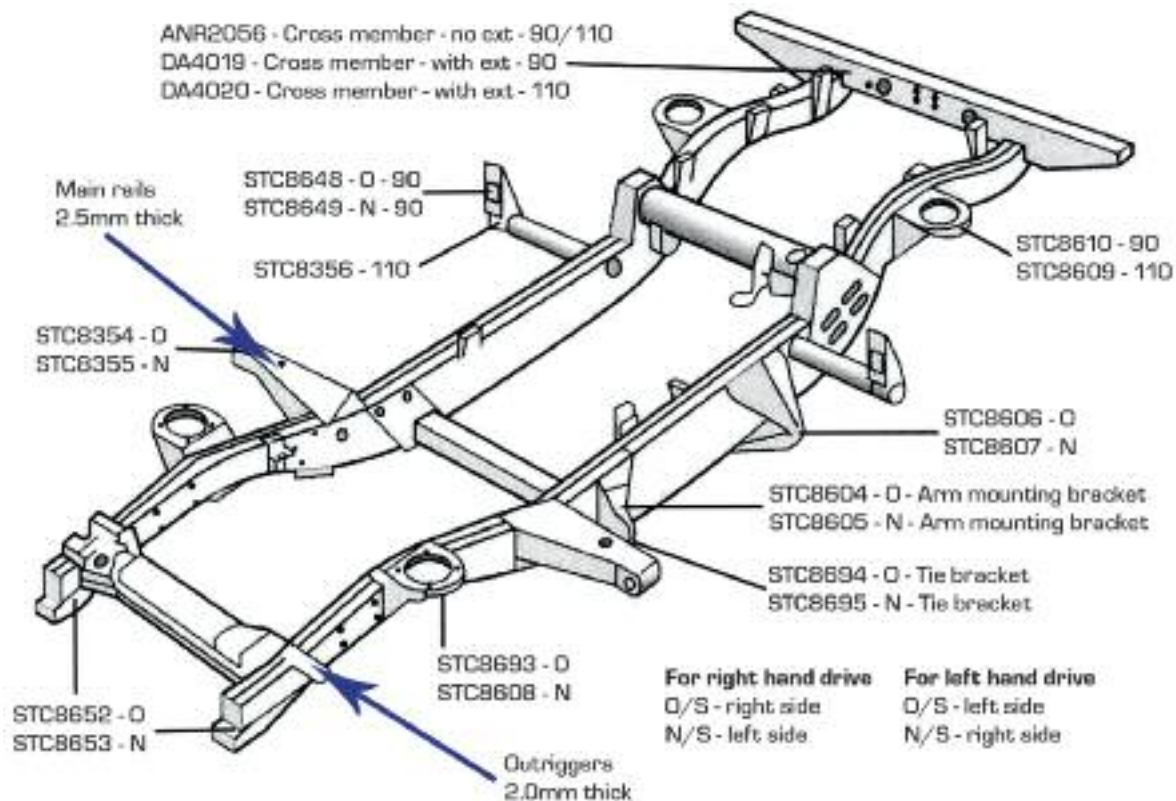

ABS Plastic Wings

- DA2397** 90 & 110 Front outer wing RHS
 Replacement for ALR6678 & ASB710280
- DA2399** 90 & 110 Front outer wing RHS
 Replacement for
 ALR6122, RTC6351 & ASB710260
- DA2396** 90 & 110 Front outer wing LHS
 Replacement for
 RTC6352, ALR6677 & ASB710290
- DA2398** 90 & 110 Front outer wing LHS
 Replacement for
 RTC6350, ALR6121 & ASB710270



Defender - 90

- | | | |
|----------------|----------------------------------|---------|
| DA4019 | Rear crossmember plus extensions | Not Td5 |
| STC8610 | Rear spring seat | RHS/LHS |
| STC8648 | Rear tubular outrigger | RHS |
| STC8649 | Rear tubular outrigger | LHS |

Defender - 110

- | | | |
|----------------------|--|---------|
| DA4020 | Rear crossmember plus extensions | Not Td5 |
| KVB500230 NEW | Crossmember assembly - 2nd row seats
Defender - 2007 onwards - crew cab | |
| STC8356 | Rear outrigger | RHS/LHS |
| STC8609 | Rear spring seat | RHS/LHS |

Defender - 90 & 110

- | | | |
|------------------|--|-----|
| ANR2056 | Rear crossmember no extensions | |
| KVB000290 | Rear crossmember no extensions from VIN 2A627496 | |
| DA40650 | Bulkhead upper repair panel | RHS |
| DA4065N | Bulkhead upper repair panel | LHS |
| STC8354 | Bulkhead outrigger | RHS |
| STC8355 | Bulkhead outrigger | LHS |
| STC8604 | Front radius arm mount | RHS |
| STC8605 | Front radius arm mount | LHS |
| STC8606 | Rear radius arm mount | RHS |
| STC8607 | Rear radius arm mount | LHS |
| STC8693 | Front spring seat | RHS |
| STC8608 | Front spring seat | LHS |
| STC8652 | Front chassis leg | RHS |
| STC8653 | Front chassis leg | LHS |
| STC8695 | Tie bracket from bulkhead rigger | RHS |
| STC8694 | Tie bracket from bulkhead rigger | LHS |

- | | | |
|---------------------|---|---------------|
| DA4515 | Shock absorber bracket - pair | |
| DA4516 | Tie bar mounting bracket - single | |
| DA4514 | Front axle spring mount - standard | RHS |
| DA4513 | Front axle spring mount - standard | LHS |
| DA4509 | Front axle spring mount - 40mm lift | RHS |
| DA4508 | Front axle spring mount - 40mm lift | LHS |
| DA4518 | Rear axle spring mount - 40mm lift | |
| DA4527 | Rear axle spring mount - standard | |
| MTC2248 | Floor panel - front | LHS |
| ALR1742 | Floor panel - front - Tdi/V8/Td5 | RHS |
| ALR1743 | Floor panel - front - Tdi/V8/Td5 | LHS |
| BIC710260 | Rear door - 1 piece | |
| CQB000140 | Glass for BIC710250 | |
| CQB000150 | Heated glass for BIC710250 | |
| CVW500010 | Glazing rubber for BIC710250 | |
| ALR6852 | Rear door - less spare wheel carrier
From MA939976 to 1A622423 | |
| STC1424 | Rear door - less spare wheel carrier
From AA242000 to KA929577 | |
| DA4143 | Front door skin - push button handle | RHS |
| DA4144 | Front door skin - push button handle | LHS |
| DA2024 | Safari rear door skin | |
| RTC6247 | Safari rear door - unglazed with spare wheel | |
| RTC6248 | Safari rear door - glazed without spare wheel | |
| RTC6248NG | Safari rear door - unglazed without spare wheel | |
| DA4032 | Window kit - standard | Clear |
| DA4032GREY | Window kit - standard | Grey tinted |
| DA4032BRONZE | Window kit - standard | Bronze tinted |
| DA4033 | Window kit - deluxe | Clear |
| DA4033GREEN | Window kit - deluxe | Green tinted |
| DA4033BRONZE | Window kit - deluxe | Bronze tinted |

CHASSIS & BODY COMPONENTS - DISCOVERY 1

ASR1186	Rear floor plate		
ASR1594	Floor panel		RHS
ASR1595	Floor panel		LHS
ALR6272	Bulkhead - from MA081991		Front
MWC6702	Bonnet assembly		
ALR8519	Front floor crossmember		
ASR1187	Rear floor crossmember		
ALR8520	Rear crossmember		
STC1066	Crossmember assembly rear floor		
DA4530	Rear crossmember end repair panels for crossmember STC1066		Pair
STC2814	Outer sill	3-Door	RHS
STC2813	Outer sill	3-Door	LHS
STC2816	Outer sill	5-Door	RHS
STC2815	Outer sill	5-Door	LHS
MWC9060	Inner sill	3/5-Door	RHS
MWC9061	Inner sill	3/5-Door	LHS
ALR5822	Door outer skin - from MA163103	Front	RHS
ALR5823	Door outer skin - from MA163103	Front	LHS
ALR8576	Door outer skin - from TA163104	Front	RHS
ALR8577	Door outer skin - from TA163104	Front	LHS
ALR8572	Door outer skin - from TA163104	Rear	RHS
ALR8573	Door outer skin - from TA163104	Rear	LHS
MWC9084	Door outer skin - from MA112622	Rear	RHS
MWC9085	Door outer skin - from MA112622	Rear	LHS
ALR6682	Wing - from MA	Front	RHS
ALR6681	Wing - from MA	Front	LHS
ALR9878	Wing - from VA	Front	RHS
ALR9877	Wing - from VA	Front	LHS
MWC6754	Wing - to LA081991	Front	RHS
MWC6755	Wing - to LA081991	Front	LHS
MWC4840	Wheel arch panel	5-Door	RHS
MWC4841	Wheel arch panel	5-Door	LHS
DA4515	Shock absorber bracket		Pair
DA4516	Tie bar mounting bracket		Single
DA4519	Rear body mount		
DA4509	Front axle spring mount - 40mm lift		RHS
DA4508	Front axle spring mount - 40mm lift		LHS
DA4514	Front axle spring mount - standard		RHS
DA4513	Front axle spring mount - standard		LHS
DA4518	Rear axle spring mount - 40mm lift		
DA4527	Rear axle spring mount - standard		



STC1066



DA4530



MWC4840



DA4519



DA4513 / DA4514

CHASSIS & BODY COMPONENTS - FREELANDER 1

ALR8710	Bulkhead
	Front
ASR2512	Bonnet assembly



CHASSIS & BODY COMPONENTS - RANGE ROVER CLASSIC

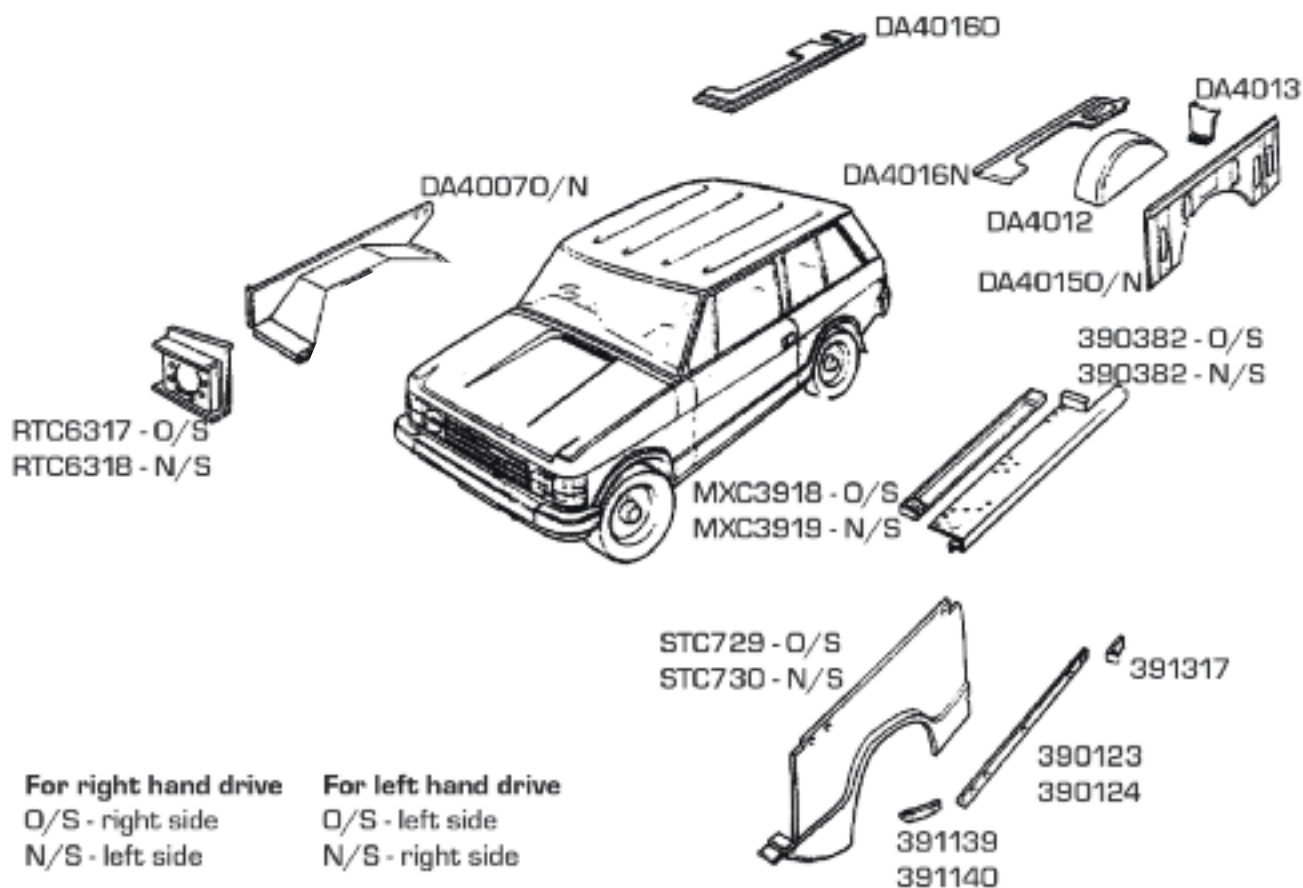

For right hand drive
O/S - right side
N/S - left side

For left hand drive
O/S - left side
N/S - right side

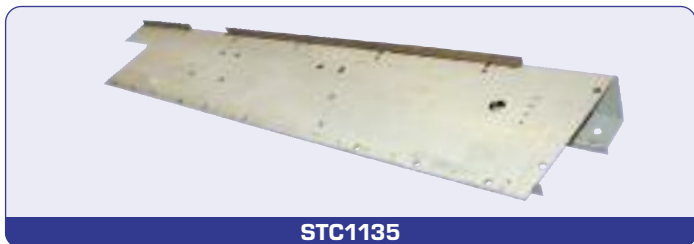

STC1135



DA3017



NRC4717



DA4515



DA4527

STC1136	Outer sills	4-door	RHS
STC1135	Outer sills	4-door	LHS
DA3016	Outer sills	2-door	RHS
DA3017	Outer sills	2-door	LHS
MXC3918	Sill inner	2-door	RHS
MXC3919	Sill inner	2-door	LHS
390381	Complete sill	2-door	RHS
	Outer, no mounts		
390382	Complete sill	2-door	LHS
	Outer, no mounts		
DA41200	Half sill (repair) - outer	4-door	RHS
DA4120N	Half sill (repair) - outer	4-door	LHS
DA40070	Inner wing		RHS
DA4007N	Inner wing		LHS
RTC6317	Headlamp box		RHS
RTC6318	Headlamp box		LHS
DA40130	Rear arch extension - rear		RHS
DA4013N	Rear arch extension - rear		LHS
NRC4717	Tailgate crossmember - rear		
ALR5596	Door assembly - front		RHS
ALR5595	Door assembly - front		LHS
MXC1408	Wing - front		RHS
MXC1409	Wing - front		LHS
MXC2064	Door outer skin - front	4-door	RHS
MXC2063	Door outer skin - front	4-door	LHS
RTC6203	Light panel - rear		RHS
RTC6204	Light panel - rear		LHS
STC1653	Bonnet assembly - from MA647605		
STC729	Wing - front		RHS
STC730	Wing - front		LHS
DA4515	Shock absorber bracket - pair		
DA4516	Tie bar mounting bracket - single		
DA4514	Front axle spring mount - standard		RHS
DA4513	Front axle spring mount - standard		LHS
DA4509	Front axle spring mount - 40mm lift		RHS
DA4508	Front axle spring mount - 40mm lift		LHS
DA4518	Rear axle spring mount - 40mm lift		
DA4527	Rear axle spring mount - standard		
ALR8520	Rear crossmember - from 1990		

CHASSIS & BODY COMPONENTS - SERIES 2 & 3

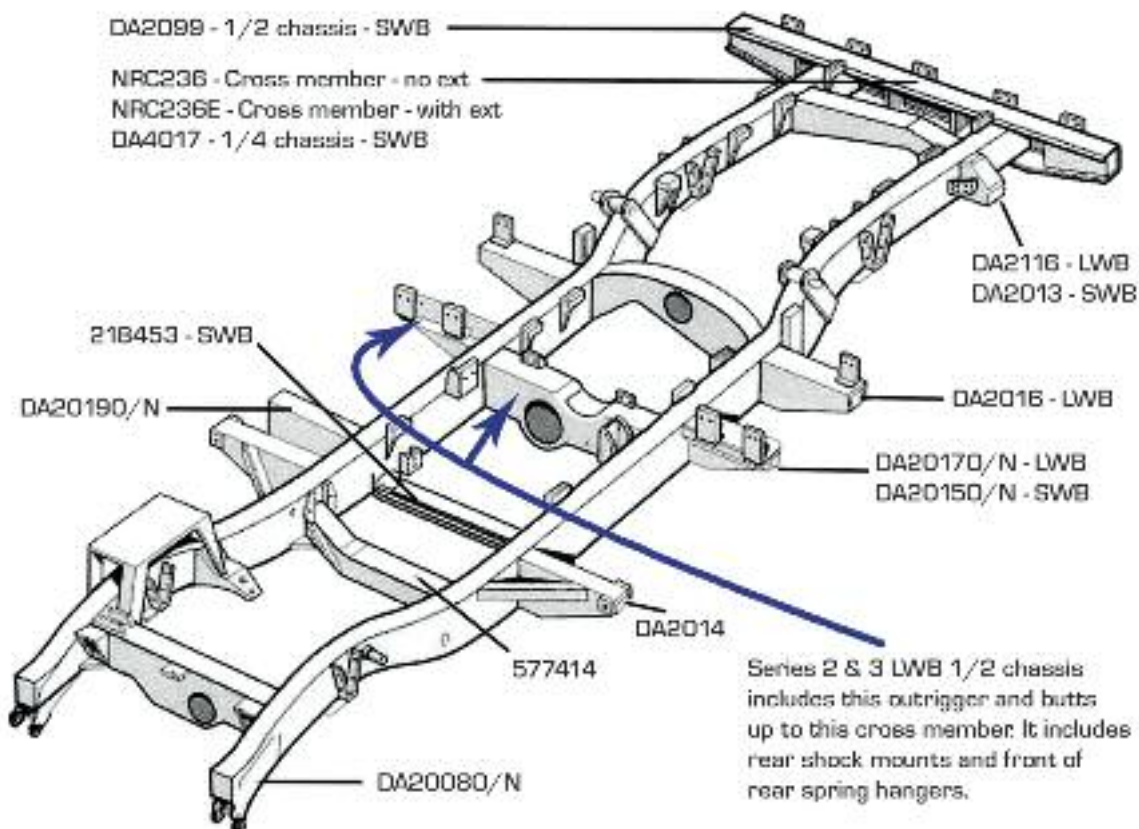

For right hand drive
O/S - right side
N/S - left side

For left hand drive
O/S - left side
N/S - right side

Series 2 & 3 LWB 1/2 chassis includes this outrigger and butts up to this cross member. It includes rear shock mounts and front of rear spring hangers.



DA20260



DA4017



DA20010



DA2156

Series - Short Wheelbase

NRC4642G	Chassis frame - galvanised	
DA2013	Spring hanger	
DA20190	Front tank outrigger	RHS
DA2019N	Front tank outrigger	LHS
DA20150	Rear tank outrigger	RHS
DA2015N	Rear tank outrigger	LHS
DA2099	1/2 Chassis	
DA4017	Rear crossmember / 1/4 chassis With extensions and hangers	
218453	Gearbox crossmember - weld on	

Series - Long Wheelbase

DA2016	Spring hanger - front	
DA2116	Spring hanger - rear	
DA20170	Rear tank outrigger	RHS
DA2017N	Rear tank outrigger	LHS

Series - Short & Long Wheelbases

DA20080	Chassis leg - front	RHS
DA2008N	Chassis leg - front	LHS
DA2014	Bulkhead outrigger	
NRC236	Rear crossmember - no extensions	
NRC236E	Rear crossmember - with extensions, no hangers	
559822	Rear crossmember - military	
DA2009	Extension piece (2 x 'U' shape sections) For rear crossmember	

DA40180	Footwell	LHD	RHS
DA4018N	Footwell	LHD	LHS
DA20010	Footwell	RHD	RHS
DA2001N	Footwell	RHD	LHS
DA20260	Door pillar repair - bulkhead/bracket		RHS
DA2026N	Door pillar repair - bulkhead/bracket		LHS
DA4054	Bracket for DA2026	Pair	RHS/LHS
MTC2248	Floor panel - front		LHS
DA2156	Glazing kit - door top	Series 3	
DA2024	Safari rear door - skin		
RTC6247	Safari rear door - unglazed with spare wheel		
RTC6248	Safari rear door - glazed without spare wheel		
RTC6248NG	Safari rear door - unglazed without spare wheel		
395529	Door bottom		RHS
395530	Door bottom		LHS
DA20230	Door skin		RHS
DA2023N	Door skin		LHS
DA2169	Door top seal and caulk		
DA4086	Door bottom repair		
MTC5382	Door top - unglazed		RHS
MTC5383	Door top - unglazed		LHS
MTC5382G	Door top - glazed		RHS
MTC5383G	Door top - glazed		LHS
DA2002	Window channel		2m length
DA2007	Door rubber		30m roll
DA4032	Window kit - standard		Clear
DA4032GREY	Window kit - standard		Grey tinted
DA4032BRONZE	Window kit - standard		Bronze tinted
DA4033	Window kit - deluxe		Clear
DA4033GREEN	Window kit - deluxe		Green tinted
DA4033BRONZE	Window kit - deluxe		Bronze tinted

DOOR HINGE KITS



NEW
 Defender stainless steel fixings added to catalogue. See vehicle enhancement section for full details.



DA1069
 Front door hinge kit for Series 3 & Defender - 90 & 110
 Kit includes washers - not shown

DA1131
 Series & Defender
 Replacement aluminium door hinges with stainless steel hinge pins
 > 4 hinges per set
 > Natural finish
 > Complete with fixings

WINDOW KITS



DA4033

Standard - Defender & Series

DA4032	Clear
DA4032GREY	Grey tinted
DA4032BRONZE	Bronze tinted

Standard kits have metal catch.

Deluxe - Defender & Series

DA4033	Clear
DA4033GREEN	Green tinted
DA4033BRONZE	Bronze tinted

Deluxe kits have rubber mounting strips to cover rivets and plastic catch.

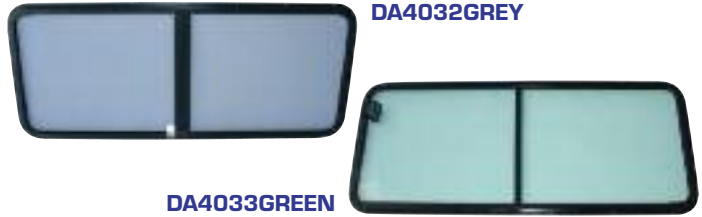

DA4032GREY

DA4033GREEN

CONSUMABLES

CLIPS, CLAMPS & NIPPLES



JUBILEE CLIPS

CN100208L	20mm	Qty 10
CN100508L	32 - 52mm	Qty 5
CN100909	70 - 90mm	Qty 1



EXHAUST CLAMPS

DA4062	45mm	Qty 1
DA4063	60mm	Qty 1
DA4064	65mm	Qty 1



GREASE NIPPLES

TYL100030	Short thread	Qty 10
234532	Long thread	Qty 10

HAND BARRIER CREAM



DA5650

Britpart Liquid Gloves Hand Barrier Cream. No need to use hot water, soap or chemicals, easily removed with cold water!
 Biodegradable. Protects hands from grease and grime.
 Prevents ingrained dirt, cracks and calluses. Moisturises and softens hands. Specially designed for the automotive industry. Viable alternative to latex gloves.
 1 litre bottle.

No need to use hot water, soap or chemicals to protect your hands!



FLUIDS NEW

DA1122

Castrol - 1 litre - A1 5W-20

SLX Professional Fuel Saver

Co-engineered in partnership with Land Rover for new engine applications. Over the full service interval it keeps the engine clean and provides outstanding fuel economy.

LRO03156

Castrol - 1 litre - SAE 80W-90

Differential EPX

Mineral based multi-grade extreme pressure gear oil for the lubrication of spiral bevel and hypoid differentials. The product is also suitable for the lubrication of manual transmissions where the manufacturer recommends the use of an oil to API GL5.

TYK500010

Castrol - 1 litre - SAE 75W-90

Differential SAF-XO

Fully synthetic final drive lubricant recommended for most passenger car final drives.



TYK500070

Castrol - 1 litre - SAE 75W-90

Differential SAF Carbon Mod Plus

Fully synthetic gear oil which can be used for axles with limited slip differentials.

STC4862

Texamatic 7045E - 1 litre

Automatic transmission fluid

Provides top-tier protection to all applications where Dexron IIG type products are specified, offering excellent protection to automatic transmission and power steering systems.

STC4863

Mobil - 1 litre

ATF LT 71141

Automatic transmission fluid

Suitable for use in automatic transmissions and power steering systems.



HYLOMAR SEALANTS & COMPOUNDS

RTC3347

Hylomar Universal Blue - gasket & jointing compound - 100g tube

- > Non setting universal jointing compound
- > Resistant to fuels, coolants and lubricants
- > Use on gaskets and machined metal surfaces
- > High temperature capability up to 250°C
- > Unlimited assembly time
- > Easy disassembly for service maintenance
- > Allows for differential thermal expansion of components
- > Excellent vibration resistance



RTC3254

Hylomar 101 Silicone Sealant - gasketing, sealing & bonding compound - 85g tube

- > Engineering grade
- > Forms any size or shape of gasket instantly
- > Remains flexible, will not shrink
- > Bonds to metal, glass, ceramics, plastics, fibres and wood
- > Resists most solvents
- > Electrical insulator
- > Maximum constant operating temperature 250°C
- > Neutral curing
- > Ensure surfaces are free from oil and grease



STC4404

Hylomar 607 Silicone Sealant - 300ml cartridge

- > Excellent gap filling properties
- > Engineering grade
- > Forms any size or shape of gasket instantly
- > Remains flexible, will not shrink
- > Bonds to metal, glass, ceramics, plastics, fibres and wood
- > Resists most solvents
- > Good fluid resistance - not petrol or diesel
- > Electrical insulator
- > Maximum constant operating temperature 250°C
- > Neutral curing
- > Tolerant of some oil and grease, ensure surfaces are clean



STC4600

Hylomar 3400 Anaerobic Gasket Compound - 300ml cartridge

- > Excellent resistance to automotive fluids including fuels
- > Operating temperature -40°C to 150°C
- > Machined metal to metal surface only, not suitable for pressed steel
- > No gap filling
- > Latest generation anaerobic gasket compound
- > Single part product
- > Suitable for K-series engines
- > Ensure surfaces are free of oil and grease



LAND ROVER GENUINE CONSUMABLES

Antifreeze

PDA500300	Antifreeze	1 litre
PDA500310	Antifreeze	5 litres
STC50529	Antifreeze - extended life	1 litre
STC50530	Antifreeze - extended life	5 litres

Cleaners

STC8972	Brake cleaner	500ml
STC50543	General purpose/brake cleaner	200ml
STC50544	General purpose/brake cleaner	400ml
STC50549	Paint and resin hand cleaner	400ml
BAC500490	Leather & vinyl cleaner - contents 1 x 150ml leather protection cream 1 x 150ml leather soft cleaner 1 x sponge and cloth	

Fluids & Oils

SIJ500030	Brake fluid	500ml
SIJ500040	Brake fluid - Dot 4	1 litre
STC50531	Automatic transmission fluid 402	1 litre
STC4861	Transmission fluid - transfer box	500ml
STC9157	Manual transmission fluid 94	5 litres
STC9158	Manual transmission fluid 94	1 litre
STC50519	Power assisted steering fluid	1 litre
VYK000010	Gear oil - MTF94	2.5 litres

Miscellaneous

STC4676	De-icer	500ml
STC4672	Screen wash	250ml
STC4687	Screen wash	500ml
STC9155	Specialised lubricant	250ml
STC50550	Loctite 5900 gasket adhesive	50ml
STC50551	Flexible adhesive sealant	300ml
CES500020	Glass repair kit	

Paints

STC2862A	Aerosol	Monza red	150ml
RTC6401VA	Aerosol	Windjammer blue	150ml

Touch up kits - contains paint stick and clear lacquer

RTC6870VT

Alpine white

STC2864VT

Oxford blue

STC2828VT

Rioja red

STC1774VT

Epsom green

STC4235VT

Blenheim silver

STC4596VT

Oslo blue



LOCTITE CONSUMABLES



DA6300



DA6303



DA6309



DA6311



DA6314



DA6317

DA6300	Super Glue	3g tube	High performance instant adhesive with thousands of applications
DA6301	Super Glue Brushable	5g bottle	Brushable version for extra accuracy and greater coverage
DA6302	Spray Adhesive	500ml aerosol	Rapid bonding spray adhesive for bonding various materials
DA6303	Repair Express Power Putty	Blister pack	Fills, sticks, seals and re-builds thousands of items without tools
DA6304	Rear View Mirror Bonder	1 shot tube	Unique bonding system for rear view mirrors, car telephone aerials and all window mounted material
DA6305	Lock 'N Seal	24ml bottle	Fast acting thread lock and sealant. Replaces traditional locking methods.
DA6306	Stud 'N Bearing Fit	24ml bottle	Locks and seals studs into position. Seals against leaks and vibration.
DA6307	Lock 'N Seal 243	50ml bottle	Fast-acting thread lock and sealant. Prevents bolts, screws & nuts from vibrating loose.
DA6308	Stud 'N Bearing Fit 2701	50ml bottle	Retains bearings into new and used housings
DA6309	Instant Adhesive 401	20g tube	Surface insensitive formulation creates a permanent bond with virtually any material
DA6310	Freeze and Release	400ml aerosol	Shock freezing (-43°C) is a quick and convenient method for releasing seized and corroded parts
DA6311	Quick Gasket	200ml aerosol	Permanently flexible flange sealant for non-rigid flanges and for plastic-to-plastic and metal-to-metal assemblies
DA6312	Chemical Metal	Mini blister pack	The original rock-hard multi-purpose repair paste
DA6313	Leak Fix	Mini blister pack	Seals and repairs leaks in petrol tanks, radiators and sumps
DA6314	Super Steel Epoxy-Weld	2 x 25g tube	Sets like steel. Seals, repairs, bonds, fixes and replaces
DA6316	Terodicht Elastic Window Sealant	310ml cartridge	Ideal for re-sealing rubber mounted windscreens
DA6317	Terolon Special Sealant	1.4kg can & brush	Vehicle body sealant for application with special brush
DA6318	Fast Set Epoxy 3430	24ml syringe	Two part general purpose epoxy adhesive
DA6319	Terolon Etch Primer	500ml aerosol	Provides excellent adhesion to steel, galvanised steel and aluminium
DA6320	Glass Adhesive	3ml tube	Glass to glass or glass to metal. Adhesive is triggered by UV rays in normal daylight. Clear bond line, water and detergent resistant.
DA6326	Zinc Spray	400ml aerosol	Sprayable anti-corrosion primer paint for vehicle body repairs. Electrically conductive (wet and dry). Allow to cure for 8-12 hours before over painting.
DA6327	Terotex HV 350	1 litre bottle	A solvent containing anticorrosive agent based on waxes, polymers and anti-corrosive additives. Contains high percentage of rust-proofing additives. Good creeping qualities. Penetrates to a depth of >35mm. Mild odour.
DA6328	Terotex Record 2000	1 litre bottle	Non-bituminous coating material for permanently flexible corrosion protection of under bodies. To complement factory-applied under body sealant coats. For coating replacement parts like bumpers or wheel arches and for anti-drum coating.



DA6319



DA6326



DA6327



DA6328

The Loctite® brand, is renowned for the excellence of its adhesives and sealants. Since the original development of a unique anaerobic technology more than fifty years ago, Loctite® products have become vital components in many of the machines and products that are at the core of everyday life.



SWIVEL HOUSING GREASE



STC3435



STC3435S

- STC3435** 370gm bottle
- STC3435S** 370ml sachet
- > Formulated for all leaf & coil spring Land Rover, Discovery and Range Rover models - 1951 - to date
- > Lubricates swivel pins and housing seals, protects spheres
- > A semi-fluid grease designed to withstand shock loading in oscillating joints
- > Reinforced with solid lubricants, highly resistant to water and salt corrosion
- > Better lubrication while driving, less leaks while standing
- > One shot gives 'filled for life' protection

TOUCH UP PAINT PENS

Exclusive to Britpart in the UK!!

The best you can get without repainting!

These superior touch up pens are made in the US and are as easy to use as a fine felt tip marker. They use a quality urethane paint for a superior colour match. The AutoSharp Pen has many unique features not otherwise available:

The Pen - Paint is held in a barrel and automatically dispensed through a fine felt tip, providing the user unparalleled control over their painting instrument.

The Paint - High quality urethane paint is used which is the same as your vehicles manufacturer. This paint provides the user with a much closer colour match than other companies which primarily use lacquer (old technology) paints.

The Results - The best you can get without refinishing the damaged areas.

More details and FAQs can be found at www.britpart.com/paintpens

Note - If your colour is not listed then please contact us.



Part Number	Colour	Code(s)	DA6239	Kent Green	647
DA6217	Adriatic Blue	731	DA6231	Kinver Sand	609 (EAB)
DA6237	Alaska White	909	DA6241	Lucerne Green	966
DA6202	Alpine White	456 (NUC)	DA6219	Maya Gold	846
DA6212	Alveston Red	696	DA6228	Narvik Black	921
DA6226	Arctic Frost	962	DA6240	Niagra Grey	574
DA6223	Atacama Sand	916	DA6213	Oslo Blue	644
DA6233	Atlantis Blue	632 (JYW)	DA6205	Oxford Blue	602
DA6230	Belize Green	756	DA6201	Portofino Red	390 (CUF)
DA6200	Beluga Black	416 (PUE)	DA6227	Rimmi Red	889
DA6236	Biarritz Blue	965	DA6206	Rioja Red	601
DA6214	Bonatti Grey	659	DA6207	Rutland Red	607
DA6243	Borrego Yellow	757 (FUQ)	DA6234	Silver Sparkle -	MNH
DA6203	British Racing Green	617		<i>Ideal for touching up alloy wheels</i>	
DA6220	Buckingham Blue	588 (796)	DA6235	Stornoway Grey	907 (LEL)
DA6221	Cairns Blue	849	DA6238	Tangiers Orange	761
DA6229	Caledonia Blue	507	DA6222	Tonga Green	904
DA6210	Chawton White	603	DA6224	Vesuvius Orange	811
DA6244 NEW	Cobar Blue	624 (JAV)	DA6215	Vienna Green	751
DA6204	Epsom Green	961	DA6208	White Gold	618
DA6218	Giverny Green	734	DA6209	Woodcote Green	623 (HPE)
DA6232	Icelandic Blue Mica	621 (JEL)	DA6216	Zambezi Silver	737
DA6242	Ipanema Sand	GAQ	DA6225	Zermatt Silver	798
DA6211	Java Black	697	PENBOX1 NEW	Counter display - holds 50 pens	



PENBOX1

Counter display unit - holds 50 pens.

Note - Pens not included



ELECTRICS

ELECTRONIC CONVERSION KITS



ERC4536K

ERC4536K

This electronic conversion kit is for V8 points and has built in dwell adjustment with rpm protection when not running.



ETC5835K

ETC5835K

The Britpart electronic conversion kit replaces the existing points and condenser with a new reliable electronic module. For 4-cylinder petrol engines the Britpart electronic ignition module has been developed to work with the standard ignition coil and provides service free and accurate ignition timing. The kit can be easily fitted to standard points type 45D4 distributors without having to fit a new electronic ignition coil.

We'd recommend fitting a new coil at the same time - PRC9858. Also available a new distributor with points to which this kit can be fitted - ETC5835.

Dodgy points and condenser?

IGNITION LEAD SETS

DA4102

Defender - 4.0 V8
Range Rover P38 - V8 - up to 1999

DA4104

Discovery 1 - V8
Range Rover Classic - V8

Note - Includes king lead STC9124

NGC103740/810

Range Rover P38
Discovery 2 - from 1999

NGC500370/410

Freelander 1 - 1.8K



DA4104



NGC103740/810

IGNITION MODULE & LINK LEAD

STC1184K

Module for V8 distributor
Kit to convert 3-pin to 2-pin applications



STC1184K



ENGINE

CYLINDER HEADS NEW



LDF500180COM

Complete cylinder heads. Supplied with valves and springs assembled, pressure tested and with heat tell tale stickers on.

ERR5027COM 300Tdi
LDF500180COM 300Tdi

Note - This head has additional waterways for improved cooling. Use multi-leaf metal head gasket (LVB500220 - 3-hole) with this head.

CYLINDER LINER KIT

LCJ000050LKIT
Liner and piston
for 1.8 litre K series engines



GASKET KITS

DA2112B



STC2802B

DA2112

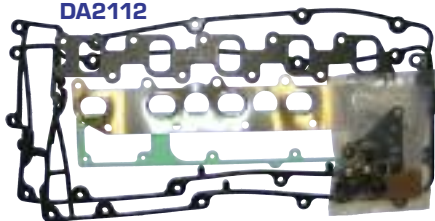

DA2113

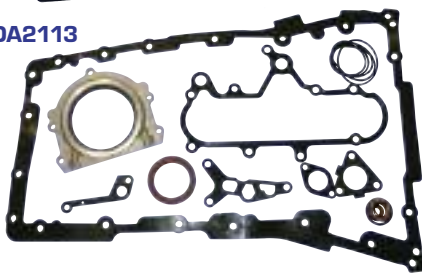

Td5

DA2112	Head set	No gasket
DA2112-1	Head set	1-hole gasket
DA2112-2	Head set	2-hole gasket
DA2112-3	Head set	3-hole gasket
DA2112B	Head set & bolts	No gasket
DA2113	Bottom set	

300Tdi

STC2802B	Head set & bolts	No gasket
-----------------	------------------	-----------

Freelander 1 - 1.8 16v

DA2114	Head set
DA2115	Bottom set

HEAD BOLT SETS



DA2005

DA2005 300Tdi **DA2141 NEW** 4.0 & 4.6 V8 ten bolt heads
DA2006 200Tdi

HEATER PLUG UPGRADE KIT



DA1057
Series - 2¹/₄ diesel engine

DA1057

Complete Engines

Include fuel pump, injectors, injector pipes, timing assembly and bell housing. Complete engines are tested prior to despatch. Once tested the flywheel and manifolds are removed and the engine is packed without these parts. Outer timing covers, pulleys, manifolds, flywheel and turbo charger are not included.

Stripped Engines

Include sump, block, cylinder head, rocker cover, inner timing cover, camshaft and crankshaft gear.

Short Engines

Consist of block, crank, con-rods and pistons only.

A full range of engines available from Britpart

Re-conditioned Engines

These engines have been through the following rigorous processes:

- > Complete strip down
- > Removal of all core plugs
- > Thorough cleaning in environmentally-friendly, solvent-free washing machines
- > Removal of all parts subject to wear
- > Inspection of casings for signs of damage and corrosion
- > Crack-testing of camshafts before and after re-grinding
- > Re-boring of blocks and machining of decks to the correct surface finishes
- > Fitting of perfectly-balanced, machined con-rods in accordance with manufacturers recommended piston protrusions
- > Meticulous re-building of engines in individual, contaminant-free workstations
- > Renewal of all bearings and gaskets throughout the engine
- > Renewal/overhaul of oil pumps
- > Replacement of all core plugs
- > Dyno-testing of complete engines
- > Final inspection
- > Wrapping in cellophane and fitting into rigid, steel transportation frames



STC4723N



LBB110410N



DA4220

Engines - New

STC4723N	Defender/Discovery 1/ Range Rover Classic	300Tdi	Stripped
DA2082	Range Rover Classic Also need DA2999 crank spacer	V8 4.0	Short
STC4526	Freelander 1	Td4	Complete
DA2039	Freelander 1	1.8K	Complete
LBB110410N	Freelander 1	2.0 D	Stripped

Engines - Reconditioned

DA4220	Defender	2.5 NA	Short
DA4215	Defender	2.5 NA	Stripped
DA4217	Defender	2.5 Td	Short
DA4218	Defender	2.5 Td	Stripped
DA4219	Defender	2.5 Td	Complete
DA4249DEF	Defender	200Tdi	Stripped
DA4250DEF	Defender	200Tdi	Complete
DA4249DIS	Discovery 1	200Tdi	Stripped
DA4250DIS	Discovery 1	200Tdi	Complete
STC8678	Defender/Discovery 1/Range Rover Classic	300Tdi	Complete
LBB001200	Defender/Discovery 2	Td5	Short

Please enquire on availability for all these reconditioned engines.



OIL PUMP GEAR SET



DA4189
Oil pump gear set for V8 engines
Discovery 1/Discovery 2 & Range Rover P38

PRESSURE RELIEF VALVE



DA2376
300Tdi oil pump relief valve kit for
Defender/Discovery 1 & Range Rover Classic

TIMING KITS



DA1200	200Tdi	
DA1300	300Tdi	
Contents -		
> Timing belt tensioner	> Gaskets	
> Timing belt - OEM	> Seals	



HEATING

HEATER BLOWER MOTOR KIT & RESISTOR KIT



DA4178

DA4178
Range Rover Classic 1990 - 1994 & Discovery 1 - 200Tdi with air con
Atlantic British has developed this all inclusive kit designed and engineered
to replace failed heater motors. The kit includes heater blower motor;
blower wheel, motor mounting bracket and mounting screws, heater
assembly seals, nylon ties, solder, shrink tubing (for soldered connections)
and complete instructions.

Note - When replacing the heater blower motor the vehicle's resistor must
be upgraded to DA4178RESISTOR

DA4178RESISTOR

The air con blower motor resistor controls the speed of the blower motor
and the force of the airflow out of the dash vents, it features a thermal-sink
aluminium mounting plate that dissipates circuit heat effectively.

DA4178RESISTOR



HEATER MATRIXES



DA2155



AAP817



UTP1725



STC250



STC3135



JEF100150

DA2155	Series 3
AAP817	Defender - downward facing pipes
UTP1725	Defender - horizontal inlet/outlet pipes
JEF100220	Defender - LHD from XA159807
STC250	Discovery 1/Range Rover Classic - 1986 - 1994
STC3135	Discovery 1/Range Rover Classic - 1992 - 1994
JEF100150	Freelander 1 - to YA999999
STC3261	Range Rover P38

TOOLS & PROTECTION

TOOLS

Prop shaft fastener tools

Specialist socket for prop shaft fasteners on most Land Rovers. The 9/16" socket end is a perfect hexagon with rounded tip profiles to ensure the whole turning power is transferred onto the flanks of the nuts instead of on the corners. The socket's slim wall construction and wine glass profile, coupled to an integral slimline extension means it fits perfectly between the UJ yokes and over the prop shaft nuts without fouling. The 9/16" AF nuts are common to Series Land Rovers, Defenders (90 & 110 up to latest vehicles), Discoverys (up to and including Discovery 2 model) and Range Rovers (up to and including P38 model).

- > Size: 9/16" 6 point (hexagon)
- > Total length: 150mm
- > Outside diameter: 20mm

DA1065

Specialist socket for propshaft Drive - 3/8" square drive

DA1119

Specialist socket for propshaft Drive - 1/2" square drive



- 606435** Hub nut spanner
- DA1111** Viscous fan coupling spanner
Two sizes - 32 & 36mm
- DA1118** 1/2" drive 52mm deep socket

DA1120

Flywheel locking tools & camshaft timing pins
Discovery 3 - 2.7TdV6/
Range Rover Sport - 2.7TdV6

DA1121

Timing tool kit for LR KV6 engines
The Land Rover KV6 quad cam engine has one front and two rear camshafts and these tools cover the replacement of all three belts

DA3140 Timing kit - 2.5D/Tdi - 12 piece

LRT-12-093 Viscous coupling holding tool
V8 petrol/Td5 diesel/2.5L Td diesel/
300 Tdi Diesel

LRT-12-094 Viscous fan coupling wrench
V8 petrol/Td5 diesel/V6 2.7L diesel/
2.5L Td diesel/Td6 diesel/300Tdi diesel

LRT-12-058

Timing pin (short) - Td5

LRT-12-158

Timing pin (long) - Td5

LRT-60-004

Bush fitting tool for front radius arm bushes (part number ANR3332) for the Range Rover P38A - impossible to do without using this Land Rover special tool.



DA1111



DA1118



DA1120



DA1121



LRT-12-093



LRT-12-094



LRT-12-058 & LRT-12-158



LRT-60-004

WING PROTECTORS

DA5631

Protect your Defender's wings with a pair of these sturdy easy to fit wing protectors.



DA5631

TRANSMISSION

AUTOMATIC TRANSMISSION SERVICE KIT

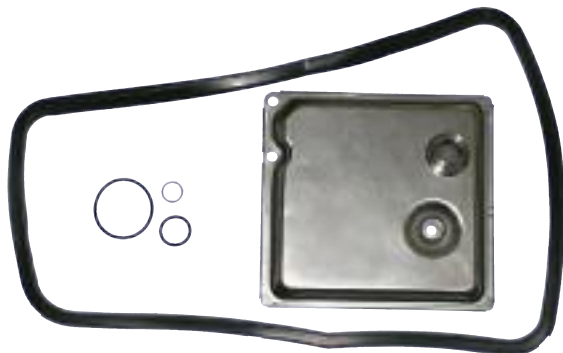

DA4500

DA4500

Automatic transmission service kit for ZF 4-speed gearbox. Kit comprises of oil screen, seals, o-rings and sealing washer.

Suitable for -

- > Defender - up to 2007
- > Discovery 1
- > Discovery 2
- > Range Rover Classic
- > Range Rover P38

CV JOINT KITS

Britpart has put together these boxed kits to help the fitter have all the necessary parts to do the job in one hit, saving time and money trying to find the necessary parts to do the job. These kits are also helpful to pass over the trade counter instead of having to hunt for the individual parts. One kit does one CV joint.

Save time and money with a Britpart CV Joint kit

DA6050

Range Rover Classic - up to 1985

DA6051

Range Rover Classic - 1986 to 1988 non-ABS axle suffix A to VIN EA305589

DA6052

Range Rover Classic - 1989 to 1991 non-ABS axle suffix B from VIN EA305590 to HA610293

Range Rover Classic - 1992 on non-ABS to VIN JA624755

DA6053

Range Rover Classic - 1986 to 1991 with ABS to VIN HA610293

DA6054 **Note** - 10 spline on half shaft to diff end

Range Rover Classic - 1992 on non ABS from VIN KA624756 to P38

Range Rover Classic - 1992 on with ABS to P38

DA6055 **Note** - 24 spline on half shaft to diff end

Range Rover Classic - 1992 on non ABS from VIN KA624756 to P38

Range Rover Classic - 1992 on with ABS to P38

DA6056

Range Rover P38 - 1995 to 2002



DA6061

DA6057

Defender - non ABS with 23 internal splines

DA6058

Defender - 1986 on non ABS with 32 internal splines

DA6059

Defender - non ABS and ABS models from VIN LA930456

DA6060

Discovery 1 - non ABS to VIN JA32850

DA6061 **Note** - 10 splines axle shaft to diff end

Discovery 1 - non ABS from VIN JA032851

DA6062 **Note** - 24 splines axle shaft to diff end

Discovery 1 - non ABS from VIN JA032851

Discovery 1 - ABS models from VIN JA032851

DA6063

Discovery 2

DA6064

Freelander 1 - to VIN YA999999 TCIE diesel and 1.8 petrol

DAMPER KIT

DA2352

Freelander 1
- pre-2006 4-cylinder

Not all viscous coupling problems are the fault of the unit itself, sometimes the damper is at fault, this kit prevents buying the whole coupling, just to replace the damper.

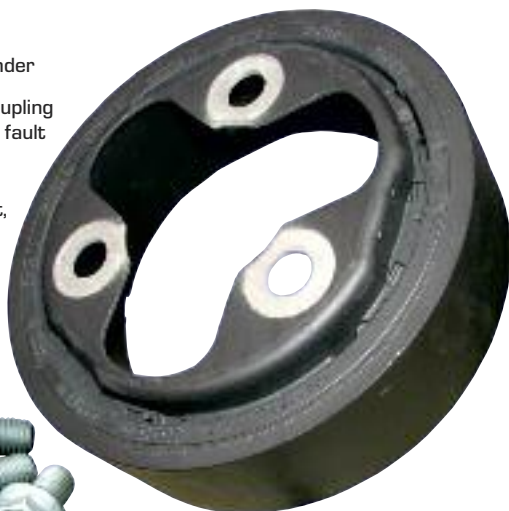

DIFF COUPLING SHAFT

We are now able to offer a cheaper alternative!

**DA2355**

The Range Rover L322 - 2002 onwards, suffer from a common problem with the coupling shaft spline wearing between the front propshaft and front differential, thus losing drive to the differential. The problem purely relates to the coupling shaft and the differential itself is not affected. Currently the only solution offered by Land Rover is to replace the propshaft and the whole complete front differential assembly - a very expensive option! Using this new coupling shaft will enable you to replace just the propshaft and coupling shaft and leave the differential in place, therefore reducing both time (the differential need not be removed from the vehicle) and cost.

Changing your clutch?

Then demand your dealer
uses a clutch kit from Britpart!

Heavy-Duty Britpart Clutch Kits

EXTREME USE CLUTCH KIT

Defender/Discovery 1/Range Rover Classic - 200 & 300Tdi

DA5551 Clutch kit - plate, cover & bearing

DA5551KIT NEW Heavy-duty kit - plate, cover, heavy-duty bearing & heavy-duty clutch fork

DA5552 Clutch kit - plate, cover



DA5551

DA5550	Defender/Discovery 2 - Td5	Clutch kit - plate, cover & bearing
DA2357HD	Defender/Discovery 2 - Td5 <small>Note - Fitment of this kit will increase gearbox noise</small>	Clutch kit - plate, cover, heavy-duty flywheel & bearing
DA2357	Defender/Discovery 2 - Td5	Clutch kit - plate, cover, flywheel & bearing
STC8358	Defender - diesel (non Td5)/Discovery 1 - diesel/Range Rover Classic (non VM)	Clutch kit - plate, cover & bearing
STC8363	Series 3	Clutch kit - plate, cover & bearing
DA2369	Series 2A	Clutch kit (9") - plate & cover
DA2370	Series 2A	Clutch kit (9 ^{1/2} ") - plate & cover
URB500060	Freelander 1 - 1.8 petrol	Clutch kit - plate, cover & bearing
FTC2957HD	Various applications - Defender/Discovery 1/Range Rover Classic	Clutch fork - heavy-duty
FTC5200HD	Defender 1987 - 2006; Discovery 1 & 2 and Range Rover P38	NEW Clutch release bearing - heavy-duty

TEAM BRITPART.COM

> Extensive testing determined the ultimate specification - see a video of the Britpart V8 in action at www.britpart.com/v8



Team Britpart recommend Britpart clutches -

- > Premier friction material gives longer life
- > Self centering bearing provides smooth operation
- > Intense quality control ensure fit first time



DA2357HD

Heavy-duty one-piece dual mass replacement flywheel designed to outlast the original. Kit also includes modified release bearing.

HEAVY-DUTY



FTC2957HD

DIFF REPAIR PANS



DA1043

DA1043 Front - includes filler plug



DA1044

DA1044 Rear - includes filler plug



DA1045

DA1045 Front & rear - excludes filler plug

GEAR BOXES



Gear Boxes - New

TRC103150	Defender	LT77 - 50A suffix L
TRC103270	Discovery 2	V8 efi
TRC103350	Discovery 2	Diesel - less oil cooler
TRC102900	Freelander 1	Petrol 1.8K16

Gear Boxes - Reconditioned

DA3050	Defender	4-cylinder up to 200Tdi	LT77/S	50G/H
DA3051	Defender	200Tdi	LT77/S	56G/H
TRC103160E	Defender	300Tdi	R380	56J
DA3058	Defender	Td5	R380	68A
DA3052	Discovery 1	200Tdi	LT77/S	55G/H
DA3054	Discovery 1	300Tdi	R380	55J
DA3055	Range Rover P38	Diesel	R380	65J

PROPSHAFT BEARINGS

Centre bearing assembly for rear propshafts

DA2395
Discovery 3 - TVB500360

DA2427
Range Rover Sport - TVB500390
DA2428
Range Rover L322 - TVB500400



DA2395

Instead of replacing your whole propshaft - just replace the centre bearing!

PROPSHAFT KIT



DA6355
Defender/Discovery 1/Range Rover Classic

- > 300Tdi models onwards
- > Double cardan extreme use front propshaft with flange and fitting kit
- > For vehicles with L230 transfer boxes
- > Ideal for use with lifted vehicles
- > Helps to reduce driveline vibration where diff and transfer flanges are not in-line

Note - Flange must be fitted to transfer box

TRANSFER BOXES

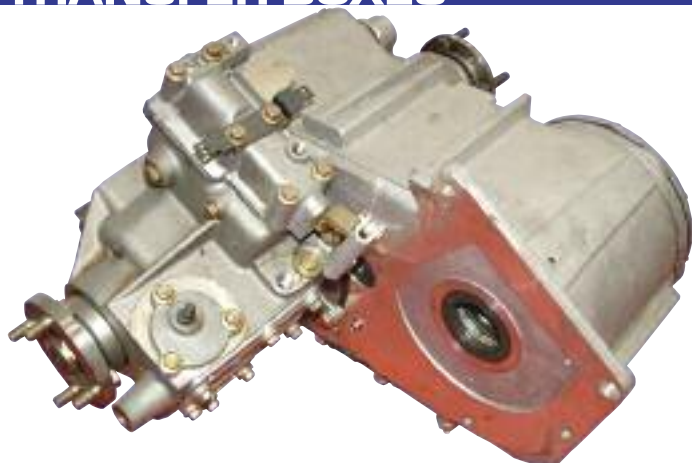

IAB500104E	Defender	Prefix 57D Td5 from 3A
IAB500106	Defender	Prefix 58D 4-cylinder petrol from 3A
IAB000010	Discovery 2	Less diff lock
IAB500090	Discovery 2	Prefix 70D
IAB500100E	Discovery 2	Prefix 68D & 69D

15

service kits & filters

SERVICE KITS & FILTERS

Don't forget that filter again with a Britpart service kit - all you'll need to complete the job.

Section contents -

Britpart bulk filters	144
Service kits	
Defender	142
Discovery	142
Freelander	142
Range Rover	143
Series	144



BRITPART SERVICE KITS



DEFENDER



DISCOVERY



FREELANDER

DA6000
Defender - 2 1/2 petrol 7:1 compression ratio
 1 x ERR3340 Oil filter
 1 x NRC9238 Air filter
 1 x JS660L Fuel filter
 1 x 243959 Sump plug washer
 1 x FRC4808 Sump plug washer
 4 x RTC3571 Spark plugs
 7:1 compression ratio

DA6001
Defender - Turbo D
 1 x ERR3340 Oil filter
 1 x NRC9238 Air filter
 1 x RTC6079 Fuel filter
 1 x FRC4808 Sump plug washer

DA6002
Defender - 200Tdi
 1 x ERR3340 Oil filter
 1 x NTC6660 Air filter
 1 x AEU2147L Fuel filter
 1 x 213961L Sump plug washer
 1 x ETC7398 Sump plug washer

DA6003
Defender - 300Tdi
 1 x ERR3340 Oil filter
 1 x ESR2623 Air filter
 1 x AEU2147L Fuel filter
 1 x UAM2857L Sump plug washer
 1 x ALU1403L Sump plug washer

DA6004
Defender - Td5
 1 x LPX100590 Oil filter
 1 x ESR4238 Air filter
 1 x ERR6299 Rotor filter
 1 x ESR4686 Fuel filter
 1 x CDU1001L Sump plug washer

DA6040
Defender - 2007 Duratorq Tdci
 1 x LRO04459 Oil filter
 1 x WJ1500040 Fuel filter
 1 x PHE500060 Air filter
 1 x 1013938 Oil drain plug inc rubber seal

DA6005
Discovery 1 - 200Tdi to VIN JAO18272
 1 x ERR3340 Oil filter
 1 x NTC1435 Air filter
 1 x AEU2147L Fuel filter
 1 x 213961L Sump plug washer

DA6006
Discovery 1 - 200Tdi from VIN JAO18273
 1 x ERR3340 Oil filter
 1 x ESR1049 Air filter
 1 x AEU2147L Fuel filter
 1 x 213961L Sump plug washer

DA6007
Discovery 1 - 300Tdi
 1 x ERR3340 Oil filter
 1 x ESR1445 Air filter
 1 x AEU2147L Fuel filter
 1 x UAM2857L Sump plug washer
 1 x ALU1403L Sump plug washer

DA6008
Discovery 1 - 3.5 Efi
 1 x ERR3340 Oil filter
 1 x RTC4683 Air filter
 8 x ERR3799 Spark plugs
 1 x ESR4065 Fuel filter (in-line)
 1 x 213961L Sump plug washer

DA6009
Discovery 1 - 3.9 Efi
 1 x ERR3340 Oil filter
 1 x ESR1445 Air filter
 1 x ESR4065 Fuel filter
 1 x ETC7398 Sump plug washer

DA6004
Discovery 2 - Td5
 1 x LPX100590 Oil filter
 1 x ESR4238 Air filter
 1 x ERR6299 Rotor filter
 1 x ESR4686 Fuel filter
 1 x CDU1001L Sump plug washer

DA6010
Discovery 2 - V8 4.0
 1 x ERR3340 Oil filter
 1 x ESR4238 Air filter
 8 x NLP100320 Spark plugs
 1 x ALU1403L Sump plug washer

DA6035
Discovery 3 - 2.7 diesel to 6A999999
 1 x 1311289 Oil filter
 1 x PHE000112 Air filter
 1 x LR010075 Fuel filter
 1 x JKR500010 Cabin filter
 1 x JKR500020 Cabin filter
 1 x LR009705 Fuel filter
 1 x 1013938 Oil drain plug inc rubber seal

DA6041
Discovery 3 - 2.7 diesel from vin 7A
 1 x 1311289 Oil filter
 1 x PHE000112 Air filter
 1 x JKR500010 Cabin filter
 1 x JKR500020 Cabin filter
 1 x LR009705 Fuel filter
 1 x 1013938 Oil drain plug inc rubber seal

DA6037
Discovery 3 - 4.4 petrol
 1 x LR007160 Oil filter
 1 x PHE000112 Air filter
 8 x LR005253 Spark plugs
 1 x JKR500010 Cabin filter
 1 x JKR500020 Cabin filter
 1 x 1013938 Oil drain plug inc rubber seal

DA6011
Freelander 1 - 1.8 petrol to VIN YA999999
 1 x CDU1268 Oil filter
 1 x ESR4103 Air filter
 1 x JKR100200 Pollen filter
 1 x ALU1403L Sump plug washer
 4 x NLP100290L Spark plugs

DA6012
Freelander 1 - 1.8 petrol from VIN 1A000001
 1 x CDU1268 Oil filter
 1 x ESR4103 Air filter
 1 x JKR100280 Pollen filter
 1 x ALU1403L Sump plug washer

DA6013
Freelander 1 - 2.0 diesel TCIE
 1 x ERR5542 Oil filter
 1 x ESR4103 Air filter
 1 x WJN10046 Fuel filter
 1 x JKR100200 Pollen filter
 1 x ALU1403L Sump plug washer

DA6014
Freelander 1 - Td4 to VIN 2A209830
 1 x LRF100150L Oil filter
 1 x PHE100500L Air filter
 1 x JKR100280 Pollen filter
 1 x ALU1403L Sump plug washer
 1 x MUN000010 Fuel filter

DA6015
Freelander 1 - Td4 from VIN 2A209831
 1 x LRF100150L Oil filter
 1 x PHE100500L Air filter
 1 x JKR100280 Pollen filter
 1 x ALU1403L Sump plug washer
 1 x WJN000080 Fuel filter

DA6038
Freelander 2 - 2.2 diesel
 1 x LR001247 Oil filter
 1 x LR005816 Air filter
 1 x LR001313 Fuel filter
 1 x LR000899 Cabin filter
 1 x LR000901 Cabin filter
 1 x LR006295 Drain plug gasket

DA6039
Freelander 2 - 3.2 petrol
 1 x LR001419 Oil filter
 1 x LR005816 Air filter
 6 x LR005483 Spark plugs
 1 x LR000899 Cabin filter
 1 x LR000901 Cabin filter
 1 x LR000506 Drain plug gasket

Servicing a Land Rover just got a whole lot easier with Britpart!

Ever started servicing a Land Rover and then suddenly realised you haven't ordered a filter or forgot the sump plug washers?

Well now thanks to Britpart with one simple part number you can order your Land Rover service kit safe in the knowledge that all the parts you need will be there for you to complete the job. No more frustrating half finished services!

The Britpart service kits contain quality products which are -

- > Manufactured to O.E. specification
- > Competitively priced
- > Available from stock



DA6004

BRITPART SERVICE KITS - continued



RANGE ROVER

DA6016

Range Rover Classic - 3.5 1970 - 1975

1 x	RTC3186	Oil filter
2 x	605191	Air filters
1 x	JS660L	Fuel filter
8 x	RTC3573	Spark plugs
1 x	213961L	Sump plug washer
2 x	603330	Flame traps
1 x	RTC6623	Points (fixed)
1 x	RTC3472	Condenser

DA6017

Range Rover Classic - 3.5 1975 - 1982

1 x	ERR3340	Oil filter
2 x	605191	Air filters
1 x	JS660L	Fuel filter
8 x	RTC3573	Spark plugs
1 x	213961L	Sump plug washer
2 x	603330	Flame traps
1 x	RTC6623	Points (fixed)
1 x	RTC3472	Condenser

DA6018

Range Rover Classic - 3.5 1982 - 1983

1 x	ERR3340	Oil filter
2 x	605191	Air filters
1 x	JS660L	Fuel filter
8 x	RTC3570	Spark plugs
1 x	213961L	Sump plug washer
2 x	603330	Flame traps
1 x	RTC6626	Points (sliding)
1 x	RTC3472	Condenser

DA6019

Range Rover Classic - 3.5 1984 - 1986

1 x	ERR3340	Oil filter
2 x	605191	Air filters
1 x	JS660L	Fuel filter
8 x	RTC3570	Spark plugs
1 x	213961L	Sump plug washer
2 x	603330	Flame traps

DA6020

Range Rover Classic - 3.5 carb 1986 - 1991

1 x	ERR3340	Oil filter
2 x	605191	Air filters
1 x	JS660L	Fuel filter
8 x	RTC3812	Spark plugs
1 x	213961L	Sump plug washer
2 x	603330	Flame traps

DA6021

Range Rover Classic - 3.5 & 3.9 Efi
1986 - 1991 to GA464553

1 x	ERR3340	Oil filter
1 x	RTC4683	Air filter
1 x	NTC5958	Fuel filter
1 x	213961L	Sump plug washer

DA6022

Range Rover Classic - 3.9 Efi 1986 - 1994 from
HA464554 to LA647644

1 x	ERR3340	Oil filter
1 x	RTC4683	Air filter
1 x	ESR4065	Fuel filter
1 x	213961L	Sump plug washer

DA6023

Range Rover Classic - 3.9 Efi 1992 - 1994 from
MA647645

1 x	ERR3340	Oil filter
1 x	ESR1445	Air filter
1 x	ESR4065	Fuel filter
8 x	ETC7244	Spark plugs
1 x	213961L	Sump plug washer

"..all the parts you need will be there for you to complete the job."

DA6024

Range Rover Classic - 4.2 1992 - 1994

1 x	ERR3340	Oil filter
1 x	ESR1445	Air filter
1 x	ESR4065	Fuel filter
8 x	ERR3799	Spark plugs
1 x	213961L	Sump plug washer

DA6006

Range Rover Classic - 200Tdi

1 x	ERR3340	Oil filter
1 x	ESR1049	Air filter
1 x	AEU2147L	Fuel filter
1 x	213961L	Sump plug washer

DA6007

Range Rover Classic - 300Tdi

1 x	ERR3340	Oil filter
1 x	ESR1445	Air filter
1 x	AEU2147L	Fuel filter
1 x	UAM2857L	Sump plug washer
1 x	ALU1403L	Sump plug washer

DA6025

Range Rover P38 - 4.0 & 4.6 to TA346793 &
from WA376580 to WA385948

1 x	ERR3340	Oil filter
1 x	ESR341	Air filter
1 x	ESR4065	Fuel filter
8 x	ERR3799	Spark plugs
2 x	BTR8037	Pollen filters
1 x	UAM2857L	Sump plug washer
1 x	ALU1403L	Sump plug washer

DA6026

Range Rover P38 - 4.0 & 4.6 from VA346794
to VA376579 & from WA385949 onwards

1 x	ERR3340	Oil filter
1 x	ESR4238	Air filter
1 x	ESR4065	Fuel filter
8 x	ERR3799	Spark plugs
2 x	BTR8037	Pollen filters
1 x	UAM2857L	Sump plug washer
1 x	ALU1403L	Sump plug washer

DA6027

Range Rover P38 - 2.5 DT to engine no.
33978348 to (Dec 1995) type A oil filter

1 x	STC2180	Oil filter type A
1 x	ESR341	Air filter
1 x	STC2827	Fuel filter
2 x	BTR8037	Pollen filters
1 x	VYX000040	Sump plug washer

DA6028

Range Rover P38 - 2.5 DT from engine no.
33988348 from (Dec 1995) to VIN TA346793
type B oil filter

1 x	STC3350	Oil filter type B
1 x	ESR341	Air filter
1 x	STC2827	Fuel filter
2 x	BTR8037	Pollen filters
1 x	VYX000040	Sump plug washer



DA6026

DA6029

Range Rover P38 - 2.5 DT from engine no.
33988348 from (Dec 1995) from
VIN TA346794 type B oil filter

1 x	STC3350	Oil filter type B
1 x	ESR4238	Air filter
1 x	STC2827	Fuel filter
2 x	BTR8037	Pollen filters
1 x	VYX000040	Sump plug washer

DA6030

Range Rover L322 - 3.0 diesel

1 x	LPZ000020	Oil filter
1 x	PHE000040	Air filter
1 x	WFLO00070	Fuel filter
1 x	JMO000010	Pollen filter
1 x	VYX000040	Sump plug washer

DA6031

Range Rover L322 - 4.4 V8 M62

1 x	LPW000010	Oil filter
1 x	PHE000050	Air filter
1 x	JMO000010	Pollen filter
1 x	VYX000040	Sump plug washer
8 x	NLP000030	Spark plugs

DA6035

Range Rover Sport - 2.7 diesel

1 x	1311289	Oil filter
1 x	PHE000112	Air filter
1 x	LRO10075	Fuel filter
1 x	JKR500010	Cabin filter
1 x	JKR500020	Cabin filter
1 x	1013938	Oil drain plug inc rubber seal

DA6036

Range Rover Sport - 3.6 diesel

1 x	LRO02338	Oil filter
1 x	PHE000112	Air filter
1 x	LRO09705	Fuel filter
1 x	JKR500010	Cabin filter
1 x	JKR500020	Cabin filter
1 x	1013938	Oil drain plug inc rubber seal

DA6037

Range Rover Sport - 4.2 & 4.4 petrol

1 x	LRO07160	Oil filter
1 x	PHE000112	Air filter
8 x	LRO05253	Spark plugs
1 x	JKR500010	Cabin filter
1 x	JKR500020	Cabin filter
1 x	1013938	Oil drain plug inc rubber seal

BRITPART SERVICE KITS - continued



SERIES

DA6032

Series 2^{1/4} petrol - from 1964

- Lucas ignition (fixed points)

1 x RTC3184	Oil filter
1 x 606168	Fuel filter (in-line)
4 x RTC3570	Spark plugs
1 x RTC3270	Points (fixed)
1 x RTC3472	Condenser
1 x 243959	Sump plug washer

DA6033

Series 2^{1/4} petrol - from 1964

- Lucas ignition (sliding points)

1 x RTC3184	Oil filter
1 x 606168	Fuel filter (in-line)
4 x RTC3570	Spark plugs
1 x RTC364	Points (sliding)
1 x RTC3288	Points (sliding)
1 x RTC6621	Condenser
1 x 243959	Sump plug washer

DA6034

Series 2^{1/4} petrol - from 1964

- (Ducellier ignition)

1 x RTC3184	Oil filter
1 x 606168	Fuel filter (in-line)
4 x RTC3570	Spark plugs
1 x RTC6625	Points
1 x RTC6620	Condenser
1 x 243959	Sump plug washer

*Get the best in service
from **Britpart's** range
of service kits!*

BRITPART BULK FILTERS

ESR1445X	Air	Discovery 1/Range Rover Classic
ESR2623X	Air	Defender - 1987 - 2006
ESR4238X	Air	Defender - 1987 - 2006/Discovery 2 - 1998 - 2004/Freelander 1/Range Rover P38
AEU2147LX	Fuel	Defender/Discovery 1/Range Rover Classic - 1986 - 1994
ESR4686X	Fuel	Defender/Discovery 2
ERR3340X	Oil	Defender/Discovery 1/Discovery 2/Range Rover Classic/Range Rover P38
LPX100590X	Oil	Defender/Discovery 2
RTC3184X	Oil	Series 2/Series 3
BTR8037X	Pollen	Range Rover P38
JKR500010X	Pollen - air intake	Discovery 3/Range Rover Sport
JKR500020X	Pollen - odour & particles	Discovery 3/Range Rover Sport
JKR100200X	Pollen	Freelander 1 - pre 1A
JKR100280X	Pollen	Freelander 1 - 1A onwards
ERR6299X	Rotor	Defender/Discovery 2

**Minimum order
quantity - 50**



Courtesy of Saul Underwood

16

vehicle enhancements
VEHICLE ENHANCEMENTS

Give your Land Rover that extra special look with some accessories from Britpart.

Section contents -

Vehicle enhancements

Defender	154 - 155
Discovery 3	150 - 151
Freelander 2	152 - 153
Range Rover Sport	148 - 149
Range Rover L322	146 - 147



RANGE ROVER L322



DA1071



REAR

DA1073

FRONT



DA1072



DA5108



DA5653 / DA5654



JAK500300LQV / JAK500310LQV



VUB503650

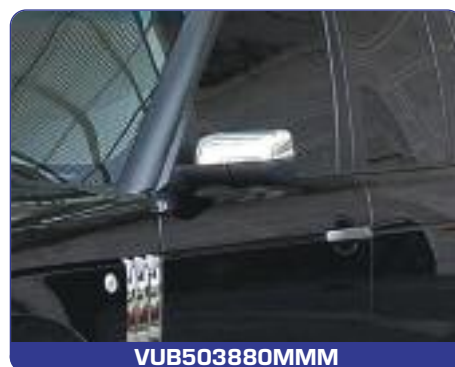

VUB503880MMM

RANGE ROVER L322 - continued



Shown here fitted to Discovery 3

VUB503880MMM / LR003905



LR005239



VUB001070



VUB001080



VUB001230



VUB002510



VUB503660



DA1071	Rear bumper cover			Stainless steel	Single
DA1072	Oval rear badge surround			Metal - chrome finish	Single
DA1073	Lower sill step covers - front & rear			Brushed finish	Pair
DA5108	Replacement grille - same as DHB500550LQV but with Brunel outer and chrome inner from VIN 6A				Single
DA5653	Door handle cover			Plastic - chrome finish	Set of 4
DA5654	Door handle surround			Plastic - chrome finish	Set of 4
JAK500300LQV	Air intake grille			Right hand side	Single
JAK500310LQV	Air intake grille			Left hand side	Single
VUB503650	Air intake grille			Plastic - chrome finish	Pair
VUB503880MMM	Wing mirror covers (from 5A onwards) - top			Plastic - chrome finish	Pair
LR003905	Wing mirror covers (from 5A onwards) - bottom (adhesive STC50551)			Plastic - chrome finish	Pair
LR005239	A Bar - moulded plastic includes spot lamp brackets			Black	Single
VUB001070	Lamp guard - pre 2006 - not compatible with wraparound protection bar	Front		Black	Pair
VUB502610	Lamp guard - 2006 onwards	Front		Black	Pair
VUB001080	Lamp guard	Rear		Black	Pair
VUB001230	Side protection tubes			Stainless steel	Pair
VUB002510	Side protection tubes Note - Tubes can be fitted with or without front mudflaps			Black steel	Pair
VUB503660	Side step including front mudflaps with EPDM (synthetic rubber) top and hard plastic trimming				Pair
VUB001300	Side step replacement insert moulding for VUB503660			Right hand side	Single
VUB001310	Side step replacement insert moulding for VUB503660			Left hand side	Single

RANGE ROVER SPORT



Enhance the look of your *Range Rover Sport*...

vehicle enhancements

RANGE ROVER SPORT - continued



VTK500020



VUB501930



VUB501920



VUB501980



DA1072	Oval rear badge surround	Metal - chrome finish	Single
DA3350	Air intake grille - left hand side	Plastic - chrome finish	Single
DA3351	Air intake grille - right hand side	Plastic - chrome finish	Single
DA3352	Air intake grille kit (DA3350 & DA3351)	Plastic - chrome finish	Pair
DA5667 NEW	Air intake grille kit - 2010 Autobiography style for 2002 - 2009 models	Chrome finish	Pair
DA5668 NEW	Air intake grille kit - 2010 Autobiography style for 2002 - 2009 models	Silver finish	Pair
JAK500320WWH	Air intake grille - right hand side	Tungsten/Titan finish	Single
JAK500330WWH	Air intake grille - left hand side	Tungsten/Titan finish	Single
LR006304	Air intake grilles	Metal - chrome finish	Pair
DA5658	Door handle cover	Plastic - chrome finish	Set of 4
DA5659	Door handle bowl	Plastic - chrome finish	Set of 4
DA5661	Headlight washer jet caps	Plastic - chrome finish	Pair
	Headlight washer jet caps		Pair
DA7600 - Java Black;	DA7601 - Stornoway Grey; DA7602 - Zermatt Silver; DA7603 - Buckingham Blue; DA7604 - Alaska White		
DA7610	Indicator lamp with orange bulb	Clear	Single
DA7611	Indicator lamp with orange bulb	Smoked	Single
EBN500040	Side sill tread plate kit - from AA000001 to AA218728	Stainless steel	Set of 8
VPLSS0042	Side sill tread plate kit - from AA218729 onwards	Stainless steel	Set of 8
VUB503880MMM	Wing mirror covers - top	Plastic - chrome finish	Pair
LR003905	Wing mirror covers - bottom (adhesive STC50551)	Plastic - chrome finish	Pair
LR008713	Pedal set	Stainless steel & rubber	Set of 3
VTK500020	Side steps with thermo plastic elastomer side step top and brushed aluminium side trim		Pair
VUB501930	Lamp guards	Front	Pair
VUB501920	Lamp guards	Rear	Pair
VUB501980	A Bar - moulded plastic - includes spot lamp brackets	Grey	Single



Courtesy of David Orritt

DISCOVERY 3



EBN500041



Enhance the look of your *Discovery 3*...

vehicle enhancements

DISCOVERY 3 - continued



VUB501380

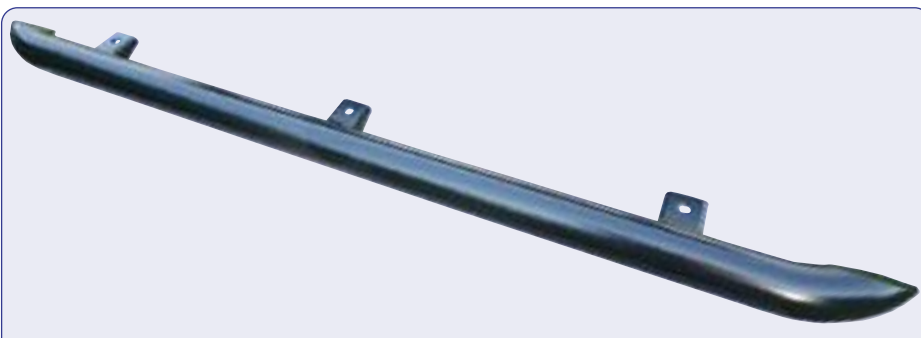

VTD500010



VTD500020



VTK500010



DA5662 NEW	Fog lamp surrounds	Plastic - chrome finish	Pair
DA5658	Door handle cover	Plastic - chrome finish	Set of 4
DA5661	Headlight washer jet caps	Plastic - chrome finish	Pair
	Headlight washer jet caps		Pair
DA7600 - Java Black;	DA7601 - Stornoway Grey;	DA7602 - Zermatt Silver;	DA7603 - Buckingham Blue;
			DA7604 - Alaska White
DA7610	Indicator lamp with orange bulb	Clear	Single
DA7611	Indicator lamp with orange bulb	Smoked	Single
EBN500041	Side sill tread plate kit	Stainless steel	Set of 4
DA5669 NEW	Side vent trim - Discovery 4 style	Chrome finish	Single
DA5670 NEW	Side vent trim - Discovery 4 style	Silver finish	Single
JAK000065MMM	Side vent trim	Stainless steel	Single
VUB503880MMM	Wing mirror covers - top	Plastic - chrome finish	Pair
LR003905	Wing mirror covers - bottom [adhesive STC50551]	Plastic - chrome finish	Pair
LR005237	A Bar includes spot lamp brackets - moulded rubber	Black	Single
LR008713	Pedal set	Stainless steel	Set of 3
VTD500010	Side protection tubes	Black steel	Pair
VTD500020	Side protection tubes	Stainless steel	Pair
VTK500010	Side runners with polypropylene side step top and a brushed aluminium side		Pair
VUB501200	Lamp guards - front	Black	Pair
VUB501380	Lamp guards - rear	Black	Pair



Courtesy of Paul Wade

FREELANDER 2



Picture courtesy of Darren Whiley



Shown here fitted to Discovery 3
DA7610



DA7611



Picture courtesy of Darren Whiley



LR002408



LR003685



LR002525



LR002773



FREELANDER 2 - continued

Enhance the look of your
Freelander 2!

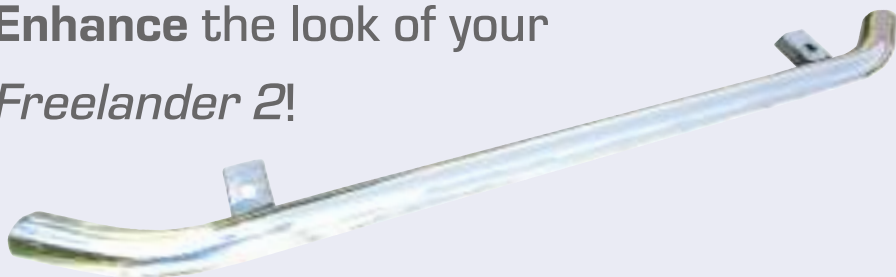

LR003318



LR003319



LR003840



Shown here fitted to Discovery 3

VUB503880MMM / LR003905

DA7610	Indicator lamp with orange bulb		Clear	Single
DA7611	Indicator lamp with orange bulb		Smoked	Single
LR002408	Lamp guards	Front	Black	Pair
LR003685	Lamp guards	Rear	Black	Pair
LR002525	Front and rear sill tread plate kit		Polished stainless steel	Set of 4
LR002773	Body side step with thermo plastic elastomer side step top and a brushed aluminium side trim			Pair
LR003318	Body side step - tube type		Stainless steel	Pair
LR003840	Body side step - tube type		Black	Pair
LR003319 NEW	Black bumper styling cover	No spot lamp brackets		
VUB503880MMM	Wing mirror covers - top		Plastic - chrome finish	Pair
LR003905	Wing mirror covers - bottom (adhesive STC50551)		Plastic - chrome finish	Pair



Courtesy of Darren Whiley

DEFENDER

Enhance the look
of *your* Defender

See exterior protection
section for our range of
A bars, lamp guards,
chequer plate etc.



Picture courtesy of Adam Rosenberg



DA2356B



DA4000 / DA4001



DPT100070



DA5500 WITH DA5499 ALSO FITTED



DA1131

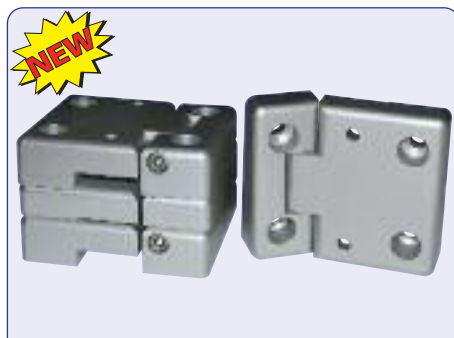

NEW



XGB100310L



Shown with
boss kit fitted

DA4653 / DA4657



DA4650 / DA4654

DEFENDER - continued

DA2356	Front grille - stainless steel		Natural finish	
DA2356B	Front grille - stainless steel		Black finish	
DA4000	Air intake grille	Left hand side	Black	Single
DA4001	Air intake grille	Right hand side	Black	Single
DA5498	Replacement gear box gaiter		Grey	Single
DA5499	Replacement gear box gaiter		Black	Single
DA5500	Gear lever and transfer gear lever set for R380 gearbox		Anodised alloy	
DPT100070	Bumper end cap does not include fixings DZM100080		Rubber	Single
DA1131 NEW	Replacement aluminium door hinges with stainless steel hinge pins for Defender & Series - complete with fixings		Natural finish	4 hinges per set
XGB100310L	Indicator lamp with orange bulb NEW	2007 onwards	Clear	Single

Steering Wheels

DA4650	15" 3-spoke sports wheels	Black vinyl	Black centre
DA4653	15" 3-spoke sports wheels	Black leather	Polished centre
DA4654	14" 3-spoke sports wheels	Black vinyl	Black centre
DA4657	14" 3-spoke sports wheels	Black leather	Polished centre

Note - To fit steering wheel to vehicle you'll need a new boss kit

DA4661	90/110 & Defender up to HA and from 1A	16mm shaft/36 splines
DA4659	90/110 & Defender up to HA and from 1A	16mm shaft/36 splines
DA4660	Defender from JA to 1A/ Series 2, 2A & 3	19mm shaft/48 splines

Stainless Steel Bolt & Screw Kits NEW



DA1133

DA1133 Bolt kit
 Door kit - Front & rear - 4-door
The J-clips are carbon and phosphor coated to give 450 salt hour life
 > 4 x M8 x 100mm countersunk allen head bolts
 > 4 x M8 x 80mm countersunk allen head bolts
 > 8 x M8 x 35mm countersunk allen head bolts
 > 16 x M8 x 55mm countersunk allen head bolts
 > 8 x M8 J-clips
 > 16 x nyloc nuts
 > 16 x M8 flat washers



DA1132

DA1132 Bolt kit
 Door kit - Front - 2-door
The J-clips are carbon and phosphor coated to give 450 salt hour life
 > 8 x nyloc Nuts
 > 8 x M8 x 35mm countersunk allen head bolts
 > 8 x M8 x 55mm countersunk allen head bolts
 > 8 x M8 J-clips
 > 16 x M8 flat washers (not pictured)



DA1134

DA1134 Bolt kit
 Door kit - Rear - Safari
 > 6 x M8 x 55mm allen head bolts
 > 6 x M8 x 30mm allen head bolts
 > 12 x M8 nyloc nuts
 > 12 x M8 flat washers



DA1135

DA1135 Bolt kit
 Bonnet hinge kit
 > 6 x bolts
 > 6 x nyloc nuts
 > 6 x washers



Banish rusty bolts & screw heads!
 Using these smart stainless steel replacement bolt and screw kits will prevent rust from spoiling your Defender's bodywork - ideal for smartening up your vehicle or a restoration project.



DA1139

DA1139 Bolt kit
 Bumper kit
 > 4 x M10 x 120mm bolts
 > 4 x 3mm x 30mm flat washers
 > 4 x plastic head caps



DA1136

DA1136 Bolt kit
 Rear cross member to body kit
 > 10 x M8 x 25mm socket cap bolts
 > 10 x M8 nyloc nuts
 > 10 x M8 flat washers



DA1137

DA1137 Screw kit
 Light lens kit - sidelights, indicators and rear lights
 > 16 x 3.5 x 25mm self tap pozi screws



DA1138

DA1138 Screw kit
 Front grill kit
 > 8 x 6.3 x 19mm self tap pozi screws



Courtesy of Daniel Taw



Courtesy of Tracy Rawcliffe

Britpart merchandise,
Land Rover gear,
workshop books
and more...

Section contents -

Air conditioning kits	158
Books, manuals & technical publications	
Haynes books & manuals	158
Original technical publications	159
Parts & general interest books	159
Gifts & merchandise	
Britpart merchandise & clothing	160
Haynes internal combustion engine	162
Land Rover Gear	161 - 162
Radiator muffs	163
Wiper blades - heavy-duty	163



Old Land Rover badge
Picture courtesy of Kristjan Kristjansson

AIR CONDITIONING KITS

KEEP IT COOL

DA2343R	Defender - 90/110 - 300Tdi	RHD
DA2342R	Defender - 90/110 - Td5	RHD
DA2342L	Defender - 90/110 - Td5	LHD
DA2344	Defender - 90/110 - 2007 onwards	RHD & LHD

- > As OE fitment, no drilling required
- > Once fitted the system is indistinguishable from factory fitted units
- > Plugs straight into the existing Land Rover wiring loom and fuse board
- > Easy to install as components are pre-assembled
- > Kit uses high performance condenser which eliminates need for an extended nose cone
- > Parts interchangeable with Land Rover parts

BOOKS, MANUALS & TECHNICAL PUBLICATIONS

HAYNES BOOKS & MANUALS

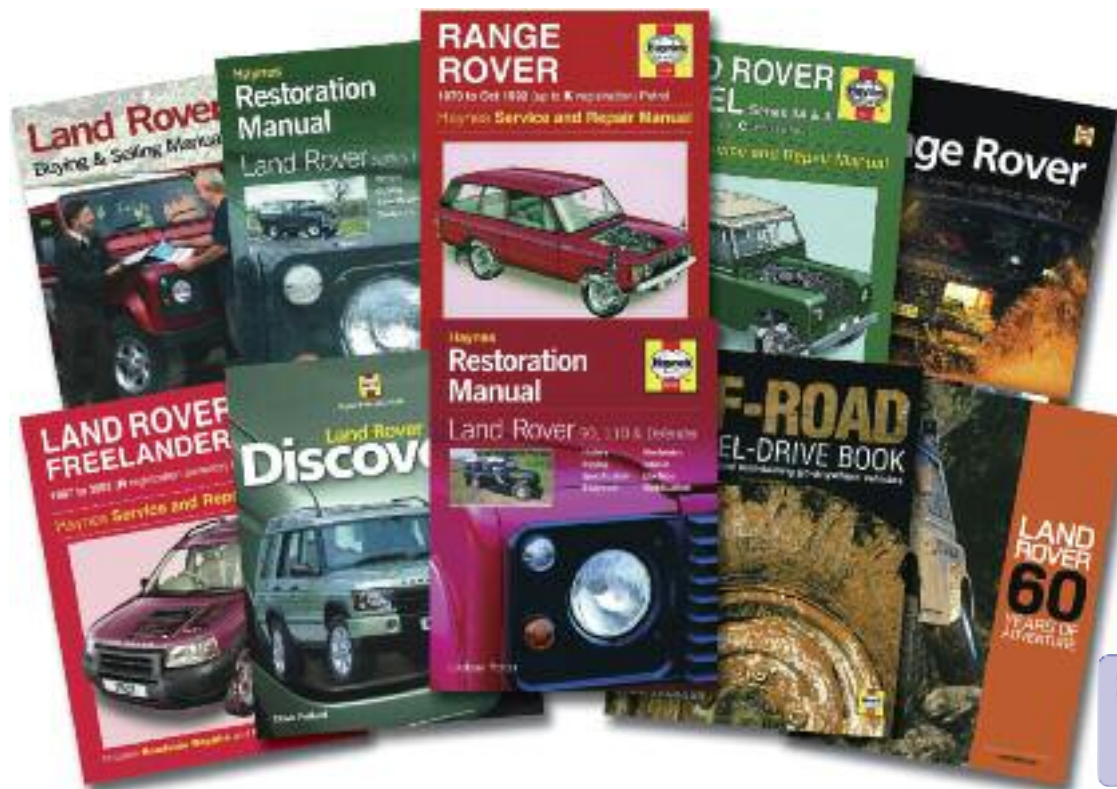

the worldwide market leader in automotive repair manuals



Free stand with 10 manuals!

Ask for full details

Defender

DA3035	Owners Workshop Manual	90, 110 & Defender - 1983 - 2007 (up to 56 reg) - Diesel
DA3040	Restoration Manual	90, 110 & Defender - By Lindsay Porter
DA3046	You and Your	90, 110 & Defender - Buying, enjoying, maintaining & modifying - By Martin Hodder

Discovery

DA2093	Haynes Extreme	Discovery - The definitive guide to modifying
DA3036	Haynes Service & Repair Manual	Discovery - 1989 - 1998 (G to S reg) - Petrol & Diesel
DA3106	Enthusiast Guide	Discovery - By Dave Pollard
DA4493	Owners Workshop Manual	Discovery - Nov 1998 - July 2004 (S to O4 reg) - Diesel

Freelander

DA2980	Haynes Service & Repair Manual	Freelander - 1997 - Sept 2003 (R to 53 reg) - Petrol & Diesel
DA4494	Owners Workshop Manual	Freelander - Oct 2003 - Oct 2006 (53 to 56 reg) - Petrol & Diesel

Range Rover

DA3042	Restoration Manual	Range Rover Classic - By Dave Pollard
DA3048	Haynes Service & Repair Manual	Range Rover Classic - 1970 - Oct 1992 (up to K reg) - Petrol
DA3105	You and Your	Range Rover - Buying, enjoying, maintaining & modifying - By Dave Pollard

Series

DA3037	Haynes Service & Repair Manual	Series 2a & 3 - 1958 - 1985 (up to C reg)
DA3038	Haynes Service & Repair Manual	Series 2, 2a & 3 - 1958 - 1985 (up to C reg) 4-cylinder - Petrol
DA3041	Restoration Manual	Series 1, 2 & 3 - By Lindsay Porter

General Interest

DA3043	Land Rover - Simply The Best - By Martin Hodder	
DA3044	The Off Road 4-Wheel Drive Book - Choosing, using and maintaining go anywhere vehicles - By Jack Jackson	
DA3108	4x4 Book - The essential guide to buying, owning, enjoying & maintaining an off road vehicle - By Paul Guinness	
DA3159	Land Rover Expeditions - Where to go off-roading in the UK	
DA4490	Buying & Selling Manual	Land Rover - How to do the best deals - By Les Roberts
DA4491	Land Rover - 60 Years of Adventure - By Nick Dimbleby	

ORIGINAL TECHNICAL PUBLICATIONS

These are a range of original technical publications on DVD. On the DVD you'll get original parts books, workshop manuals and handbooks. Each DVD focuses on one model as shown and each has the same format:

the original parts catalogues (from parts book and/or microfiche, as appropriate) are followed by the workshop manuals and driver's handbooks, all reproduced in an easy-to-use and easy-to-print PDF format.



Handy and easy to use!



Screen shot for illustrative purposes only

Note - Minimum system requirements - Compatible with Windows operating systems from 2000 through to Seven as well as all versions of Adobe Acrobat from version 6 through 9. The DVDs can also be run on Apple Macs ONLY when running Windows. A virtualization software like VMware Fusion 3 will need to be used to do this.

LHP19	Series 1 - 1948 to 1958	Parts publications/service publications/owners literature
LHP20	Series 2 - 1958 to 1961	Parts publications/service publications/owners literature
LHP21	Series 2A & 2B - 1961 to 1971	Parts publications/service publications/owners handbooks
LHP22	Series 3 - 1971 to 1985	Parts publications/service publications/owners literature
LHP26	Defender - 90, 110 & 127 - 1983 to 1989	Parts publications/service publications/owners handbooks
LHP27	Defender - 90, 110 & 130 - 1990 to 1999	Parts publications/service publications/owners handbooks
LHP28	Defender - 90 & 110 (North America) - 1993 to 1997	Parts publications/service publications/owners handbooks/supplementary information/sales brochures
19LHP3	Discovery 1 - 1989 to 1994	Parts publications/service publications/owners handbooks
LHP32	Discovery 1 - 1994 to 1998	Parts publications/service publications/owners literature
LHP33	Discovery 1 (North America) - 1994 to 1998	Parts publications/service publications/owners literature/supplementary information/sales brochures
LHP29	Range Rover Classic (North America) - 1987 to 1995	Parts publications/service publications/owners literature/supplementary information/sales brochures
19LHP1	Range Rover Classic - 1970 to 1985	Parts publications/service publications/owners literature
19LHP2	Range Rover Classic - 1986 to 1995	Parts publications/service publications/owners literature
LHP23	Military - 88 Half Ton - 1968 to 1984	Parts publications/service publications/owners handbooks
LHP24	Military - 101 One Tonne Military - 1975 to 1978	Parts publications/service publications/owners handbooks
LHP25	Military - 90, 110 & XD Military - 1984 to 1999	Parts publications/service publications/owners handbooks

PARTS & GENERAL INTEREST BOOKS

Parts catalogues

RTC9841CE	Series 3
STC9021CC	Defender - 90/110/130 - covering 1987 - 2006 MY
RTC9947CF	Discovery 1 - covering 1989 - 1998 MY - 2.0 Mpi & 3.5 & 3.9 V8 petrol and 200Tdi & 300Tdi diesel engines
STC9049CA	Discovery 2 - covering 1999 - 2003 MY
RTC9970CE	Range Rover P38 - covering 1995 - 2001 MY - 4.0 & 4.6 petrol and BMW 2.5 diesel engines

Handbooks

DA3162	Defender - 90/110/130 covering 1991 MY - February 1994 - 2.5 & 3.5 V8 petrol and 2.5 & 200Tdi diesel engines
LRL0087ENG	Defender - 90/110/130 covering March 1994 - 1998 MY - 2.5 & 3.5 V8 petrol and 2.5 & 300Tdi diesel engines
DA3161	Discovery 2 - covering 1999 - 2004 MY

Other publications

DA3157	Defender - Td5 1999 - 2006 MY Includes workshop manual and electrical manual
DA3147	Freelander 1 - 2001 - 2003 on workshop manual
DA3156	Winch In Safety - A5 hand book by Land Rover with pictures throughout, over 100 pages
LRL0178ENG	Replacement service portfolio



RTC9841CE

GIFTS & MERCHANDISE

BRITPART MERCHANDISE & CLOTHING



DA8000



DA8002



Note - Picture shows both sides

DA8023



DA8003



Note - Picture shows both sides

DA8004



Note - Picture shows both sides

DA8015



DA8017



DA8022



DA8024



DA8025



DA8013



DA8021

Britpart Merchandise

DA8000	Mouse & mug mat set
DA8002	Key ring - karabiner style
DA8023	Key ring - plastic
DA8003	Ball point pen
DA8004	Mug - single
DA8015	Stainless steel travel mug
DA8016	5" Teddy bear
DA8017	Drawstring bag

DA8022	Tax disc holder - pair
DA8024	300mm Ruler
DA8025	Ice scraper

Britpart Clothing

DA8005	Polo shirt - medium
DA8006	Polo shirt - large
DA8007	Polo shirt - x large
DA8008	Polo shirt - xx large

DA8020	T-shirt - x large
DA8009	Sweat shirt - medium
DA8010	Sweat shirt - large
DA8011	Sweat shirt - x large
DA8012	Sweat shirt - xx large
DA8018	Fleece - x large
DA8019	Fleece - xx large
DA8013	Ski hat
DA8021	Baseball cap



POLO SHIRT



SWEATSHIRT



LOGO ON BACK OF POLO & SWEATSHIRT



T-SHIRT



FLEECE



We offer a wide range of Britpart branded merchandise for you or your customers!

DA8016

LAND ROVER GEAR



HTS 0589



HTS 2073



HTS 2356



HTS 2567



HTS 2035



HTS 2036



SOX 0593



LRO 1768



LRO 2295



LRO 2296



LRO 2470



LRO 2049



LRO 0754



LRO 1685



LRO 1867



LRO 2054

Many more gift ideas over the page...

Clothing

- HTS 0589 NEW** Classic cap
Cotton twill cap with an adjustable strap for comfort - one size
- HTS 2073 NEW** Pathfinder cap
Stone washed adventure cap - one size
- HTS 2356 NEW** Mohawk cap
Lightweight hot climate cap in grey soft fabric
- HTS 2567 NEW** Baseball cap
Black polyester cap with logo and orange trim on peak
- HTS 2035 NEW** Skarfr
Fusion - wear as a neckerchief, hat or myriad of other styles of headwear with Land Rover logo - one size
- HTS 2036 NEW** Skarfr
World adventure - versatile headwear with adventure design - one size
- SOX 0593** Socks
Navy, green & black sports socks with cushion foot - pack of 3

Drinking vessels

- LRO 1768 NEW** Beyond fashion mug
Large ceramic mug - 473ml
- LRO 2295 NEW** Dictionary mug
Black mug with Land Rover definition on both sides - 330ml
- LRO 2296 NEW** 3D mug
Deep impact mug with Trade Mark oval and Go Beyond



LRO 2071

- LRO 2470** Travel mug
Insulated stainless steel for hot or cold drinks
- LRO 2049 NEW** Explorer water bottle
Traditional shape water bottle with rugged pig skin hide covering - 1ltr

Key rings

- LRO 0754** Karabiner style made from aluminium alloy
- LRO 1685** A key chain made from webbing, with a silicon badge Land Rover badge one side, Go Beyond on the reverse
- LRO 1781 NEW** Range Rover key ring designed to partner the Range Rover key fob
- LRO 1867** Clip it compass & thermometer on clip-on key ring
- LRO 2054** Silver with wire attachment
- LRO 2071 NEW** Go beyond black leather key fob

Ideal for any Land Rover enthusiast - whatever their age!

LAND ROVER GEAR - continued



LRO 1075



LRO 1986



LRO 0008



LRO 0784



LRO 1355



NEW

LRO 1517



LRO 1621



NEW

LRO 1733



LRO 2033



NEW

LRO 2048



LRO 2090



LRO 2565

Soft toys

LRO 1075	Safari bear	A bear destined for an African safari
LRO 1986	Orang-utan	Loveable resident of Borneo

Other Land Rover Gear

LRO 0008	Pin badge	Small pin badge of famous logo
LRO 0784	Pencils	Made from recycled materials - pack of 10
LRO 1355	Parking sign	Heavy-duty metal sign
LRO 1517 NEW	Bottle opener	With laser etched Land Rover logo
LRO 1621	Dog tags	Circular metal with full colour Land Rover logo; suitable for engraving on the reverse
LRO 1733 NEW	Pen	Roller ball pen with twist action cap
LRO 2033	Eco-lanyard	Earth friendly - made with organic inks and plant material
LRO 2048 NEW	Alberta sunglasses	Black sports sunglasses with polarised lens and carry case
LRO 2090	Ripper wallet	Alberta style with multi-sectioned interior suitable for all currency and credit cards
LRO 2565	Umbrella	Sturdy golfing size with carbon fibre shaft

Ideal birthday or Christmas gifts

HAYNES INTERNAL COMBUSTION ENGINE

DA4310

Build a realistic working model of a combustion engine. Includes light and sound features, light up spark plugs and moving pistons, valve gear and fan belt. Includes a 'Haynes Manual'. Finished model size 180 x 270 x 140 mm (H x W x D)



Build a working model of an engine!



DA4310

RADIATOR MUFFS



DA4025BLACK

Series 2 & Series 2A - early models

DA4025BLACK	Black edging
DA4025BLUE	Blue edging
DA4025BROWN	Brown edging
DA4025GREEN	Green edging



DA2160BLACK

Series 2A - late models & Series 3

DA2160BLACK	Black edging
DA2160BLUE	Blue edging
DA2160BROWN	Brown edging
DA2160GREEN	Green edging



DA2161BLACK

Defender

DA2161BLACK	Black edging
DA2161BLUE	Blue edging
DA2161BROWN	Brown edging
DA2161GREEN	Green edging

Note - The radiator muffs are black with either black, blue, brown or green coloured edging.

Control the flow of air into your radiator with a quality British made radiator muff!

WIPER BLADES - HEAVY-DUTY

Heavy-duty winter wiper blades

DKC500010PMD

Discovery 2

Front

Pair

VUB500900

Freelander 1

Front

Pair



VUB500900

DKC500010PMD



Courtesy of Louise Thompson

PART NUMBER FINDER - continued

Part No.	Page No.	Part No.	Page No.	Part No.	Page No.	Part No.	Page No.	Part No.	Page No.	Part No.	Page No.
NTC6781PY-YELLOW	106	RRD000011	38	STC1424	126	STC50287AB	48	STC8354	126	VPLSS0042	149
NTC6828PY	106	RRD000100	34	STC1653	128	STC50289AB	48	STC8355	126	VTDS00010	21 & 151
NTC6828PY-YELLOW	106	RRD000110	34	STC1774VT	131	STC50290	21	STC8356	126	VTD500020	21 & 151
NTC7307PY	106	RRD000120	34	STC250	136	STC50301	20 & 47	STC8358	139	VTK500010	21 & 151
NTC7307PY-YELLOW	106	RRD000130	34	STC2802B	134	STC50319	48	STC8363	139	VTK500020	23 & 149
NTC7394PY	106	RRD100520	34	STC2813	127	STC50323	54	STC8414	54	VUB000610	18
NTC7394PY-YELLOW	106	RRD100530	34	STC2814	127	STC50327AA	29	STC8452	10	VUB000700	58
NTC7829	34	RRD100540	34	STC2815	127	STC50383	43	STC8453	10	VUB000720	50
NTC7829HD	34	RRD100550	34	STC2816	127	STC50389	48	STC8480	40	VUB000730	50
NTC9819	112	RRD100560	34	STC2828VT	131	STC50391	49	STC8503AA	12	VUB000740	50
NTC9820	112	RRD100570	34	STC2862A	131	STC50408	43	STC8504AB	12	VUB001070	12 & 147
PDA500300	131	RRD100580	34	STC2864VT	131	STC50413	7	STC8505AA	23	VUB001080	12 & 147
PDA500310	131	RRD100590	34	STC3135	136	STC50417	26	STC8506	29	VUB001090	40
PENBOX1	133	RRD100600	34	STC3261	136	STC50433	29	STC8513	34	VUB001230	23 & 147
PHD500340	78	RRD100610	34	STC3415	34	STC50434	57	STC8524	55	VUB001300	23 & 147
PRC7994K	43	RRD500560	38	STC3417	34	STC50459	49	STC8529AA	74	VUB001310	23 & 147
PRC8238	40	RRD500590	38	STC3420	34	STC50460	49	STC8587	82	VUB002120	55
RBX101240PY	106	RRJ000030	34	STC3421	34	STC50479	54	STC8604	126	VUB002510	23 & 147
RBX101240PY-YELLOW	106	RRJ500030MNH	38	STC3422	34	STC50519	131	STC8605	126	VUB105450	47
RBX101340PY	106	RTC3184X	144	STC3423	34	STC50529	131	STC8606	126	VUB500520	10
RBX101340PY-YELLOW	106	RTC3254	131	STC3424	34	STC50530	131	STC8607	126	VUB500870	40
RBX101680PY	106	RTC3347	131	STC3425	34	STC50531	131	STC8608	126	VUB500900	163
RBX101680PY-YELLOW	106	RTC3534	124	STC3426	34	STC50543	131	STC8609	126	VUB501170	54
RBX101690PY	106	RTC3537	124	STC3427	34	STC50544	131	STC8610	126	VUB501200	10 & 151
RBX101690PY-YELLOW	106	RTC4615C	43	STC3428	34	STC50549	131	STC8648	126	VUB501380	10 & 151
RBX101730PY	106	RTC4615K	43	STC3429	34	STC50550	131	STC8649	126	VUB501390	11
RBX101730PY-YELLOW	106	RTC4769	8	STC3435	132	STC50551	131	STC8652	126	VUB501400	11
RBX101780PY	106	RTC6203	128	STC3435S	132	STC53077	22	STC8653	126	VUB501500	49
RBX101780PY-YELLOW	106	RTC6204	128	STC3582	34	STC53078	22	STC8678	135	VUB501920	12 & 149
RBX101790PY	106	RTC6247	126 & 129	STC3601	34	STC53129	7	STC8693	126	VUB501930	12 & 149
RBX101790PY-YELLOW	106	RTC6248	126 & 129	STC4235VT	131	STC53157	9	STC8694	126	VUB501980	7 & 149
RDB100080PY	106	RTC6248NG	126 & 129	STC4286	47 & 48	STC53158	9	STC8695	126	VUB502130	29
RDB100080PY-YELLOW	106	RTC6317	128	STC4404	131	STC53161	9	STC8842	40	VUB502390	18
REB101740	112	RTC6318	128	STC4526	135	STC53181	10	STC8843AA	34	VUB502520	18
RGX100970PY	106	RTC6401VA	131	STC4596VT	131	STC53193	10	STC8875	48	VUB502610	12 & 147
RGX100970PY-YELLOW	106	RTC6820	14	STC4600	131	STC53194	10	STC8919AA	48 & 89	VUB503130	58
RGX101000PY	106	RTC6821	14	STC4637	41	STC618PY	106	STC8972	131	VUB503650	147
RGX101000PY-YELLOW	106	RTC6870VT	131	STC4672	131	STC618PY-YELLOW	106	STC9021CC	159	VUB503660	23 & 147
RGX101010PY	106	RTC8093	55	STC4676	131	STC729	128	STC9049CA	159	VUB503880MMM	147 & 153
RGX101010PY-YELLOW	106	RTC8829	50	STC4687	131	STC730	128	STC9155	131	VUB503960	50
RGX101020PY	106	RTC8831	46	STC4723N	135	STC7555	54	STC9157	131	VUB504110	9
RGX101020PY-YELLOW	106	RTC8860AA	9 & 48	STC4757	82	STC7570	54	TRC102900	140	YFK000010	131
RGX101020PY-YELLOW	106	RTC8922	41	STC4861	131	STC7582	29	TRC103150	140	XFD500010	41
RGX101440PY	106	RTC8969	9	STC4862	131	STC7623	34	TRC103160E	140	XFE500010	41
RGX101440PY-YELLOW	106	RTC9479	14	STC4863	131	STC7631	20	TRC103270	140	XGB100310L	155
RKB101200	112	RTC9503AA	10	STC50026	10	STC7632	20	TRC103350	140	XQB500080	40
RKB101460	112	RTC9505AC	21	STC50027	10	STC7642	74	TYK500010	131	YGD000271	82
RNF100090PY	106	RTC9535	34	STC50030	21	STC7643	41	TYK500070	131	YGD100860	82
RNF100090PY-YELLOW	106	RTC9539AB	29	STC50032	21	STC7644	40	TYL100030	130	YGD500100	82
RRB100510	34	RTC9593AA	21	STC50050	56	STC7929	26	URB500060	139	YGD500130	82
RRB500100	34	RTC9841CE	159	STC50052AA	56	STC7939AB	55	UTP1725	136	YMWZ101030	49
RRC114560MUW	37	RTC9947CF	159	STC50053AA	56	STC7960	11	VPLAP0035	21	YWCC000840	51
RRC2970	15	RTC9970CE	159	STC50063	26	STC7962AA	11	VPLAR0001	29	YWJ101500	47
RRC2971	15	SE105161L	41	STC50064	10	STC7969	30	VPLAS002PVJ	59	YWJ500070	49
RRC501470MCM	36	SIJ500030	131	STC50080	34	STC8026	12	VPLAS0023PVJ	59	YWJ500150	51
RRC503400MNH	36	SIJ500040	131	STC50081	48	STC8027	12	VPLFS0014	57	YWJ500201	48
RRC503600PM	37	SOX 0593	161	STC50082AA	54	STC8056	9	VPLFT0001	49	YWJ500450	51
RRC503600MNH	36	STC1066	127	STC50134	26	STC8057AC	29	VPLFT0002	49	YWJ500460	51
RRC505370MNH	36	STC1135	128	STC50172	60	STC8130AB	21 & 23	VPLFT0009	49	YWT10002L	48 & 51
RRC6681	8	STC1136	128	STC50176AA	29	STC8138AB	74	VPLSS0016	57		
RRC6682	8	STC1184K	134	STC50181	48	STC8156AA	104	VPLSS0020	59		
RRC8443	13	STC1188	41	STC50269AA	20 & 47	STC8156AAPY	104				

INDEX

A Bars	7	Brake discs	94 - 95	Chassis & body components - Discovery 1	127
Accessories, winching	89 - 91	Brake fluid	131	Chassis & body components - Freelander	127
Adaptor kits, wheel	35	Brake hose kits	96	Chassis & body components - Range Rover Classic	128
Air compressors	33 & 72	Brake kits	125	Chassis & body components - Series 2 & 3	129
Air compressors & tyre repair kit	72	Brake lubrication	96	Chequer plate	6
Air conditioning kits	158	Brake pads	95	Clamps, exhaust	130
Air filters - Britpart	98	Brake parts	94 - 95	Cleaners	131
Air filters - K&N consumables	97	Bridging ladders	78	Clips, clamps & nipples	130
Air filters - Performance	98	Britpart bulk filters	144	Clips, Jubilee	130
Air intake grilles	154 - 155	Britpart Cellular Dynamic shock absorbers	107	Clothing	160 - 162
Air lift kits	110	Britpart clothing	160	Clutch kits	139
Air spring conversion kits	111	Britpart merchandise	160	Coil springs	113
Air springs	112	Britpart Super Gaz shock absorbers	108	Compounds, Hylomar	131
Alloy wheels	36	Britpart winches	83 - 85	Compressors, air	33 & 72
Antifreeze	131	Bulkhead bars	66	Cones, dislocation	111
Anti-roll bar kit	104	Bump stops	105	Consumables, Land Rover	131
Anti-squeal brake pads	94	Bumper	8	Consumables, Loctite	131
ARB diff lockers	73	Bumper kits, winch	87	Conversion kit, handbrake	97
Automatic transmission service kit	138	Bumperettes	8	Conversion kit, light	43
Batteries	82	Bumpers, winch	88	Conversion kits, air spring	111
Battery charger	86	Bush fitting tool	105	Conversion kits, electronic	133
Bearing, wheel	124	Bush sets - Britpart other	105	Cosmetic enhancements	154 - 155
Bearings, propshaft	140	Bush sets - Britpart polyurethane	106	Covers, waterproof seat	61 - 62
Bike racks	26, 28 & 30	Bushes	105 - 106	Covers, wheel	33
Bilstein, shock absorbers	109	Cans, Jerry	75	Cubby boxes	64 - 65
Blanking kits	97	Carburettors, Weber	100	Cup holder	64 - 65
Blocks, spacer	110	Carpet mats	58 - 60	CV joint kits	138
Books	158 - 159	Carriers, wheel	32	Cycle carrier	26, 28 & 30
Boot liner	56 - 57	Cellular Dynamic shock absorbers	107	Cylinder heads	134
Boxes, cubby	64 - 65	Charger, battery	86	Cylinder liner kit	134
Boxes, roof	28	Chassis - complete	125	Damper kit	138
Brake anti-squeal pads	94	Chassis & body components - Defender	126	Dash trim	70

INDEX - continued

Defender service kits	142	Kits, CV joint	138	Sealants, Hylomar	131
Defender vehicle enhancements	154 - 155	Kits, electronic conversion	133	Seat covers	61 - 62
Deflectors, wind	18	Kits, re-trim	68	Seat rails	66
De-icer	131	Kits, suspension	115	Seats	67
Delphi, shock absorbers	109	Kits, swivel housing gaiter	17	Seats - Defender & Series	67
Detroit diff lockers	74	Kits, swivel pin	124	Seats - Techno style	69
Diff coupling shaft	138	Kits, timing	136	Seats - XS style	69
Diff guard - bolt on	17	Kits, wheel bearing	124	Sensors, parking	15
Diff lockers - uprated - ARB	73	Ladders - off-road	78	Series service kits	144
Diff lockers - uprated - Detroit	74	Ladders - roof	26	Service kits	142
Diff repair pans	140	Lamp guards	9 - 13	Shackle	89 - 91
Discovery 3 vehicle enhancements	150 - 151	Land meters	78	Shock absorber brackets	109
Discovery service kits	142	Land Rover gear	161 - 162	Shock absorbers - Bilstein	109
Dislocation cones	111	Land Rover genuine consumables	131	Shock absorbers - Cellular Dynamic	107
Dog guards	54 - 55	Lead sets, ignition	133	Shock absorbers - Delphi De Carbon	109
Door hinge kits	130	Light bar	43	Shock absorbers - heavy-duty	109
Door trim	70, 126 & 129	Light conversion kits	43	Shock absorbers - Super Gaz	108
Down pipes	122	Light kits	41	Side & rear steps	20 - 23
Driving lights	40	Light mounting kits	43	Side runners	20 - 23
Dyneema rope	89 - 91	Light upgrade kits	43	Side steps	20 - 23
EBC brake parts	95	Lights - driving	40	Silencers	122
EGR blanking kits	97	Lights - fog	41	Silicone hoses	99
Electronic conversion kits	133	Lights - NAS	41	Snatch block	89 - 91
Emergency hammer	75	Lights - Roo-lites	42	Snorkels	78 & 79
Engines - new	135	Liner kit, cylinder	134	Spacer blocks	110
Engines - reconditioned	135	Liner, boot	56 - 57	Spare parts, winch	86
Exhaust clamps	130	Link lead	134	Spare wheel carriers	32
Exhausts - stainless steel	120	Loadspace liners	56 - 57	Spare wheel covers	33
Exhausts - stainless steel sports systems	121	Loadspace nets & retention kit	58	Spring retainers	112
Extended slide seat rails & bulkhead bars	66	Locking wheel nuts, keys & caps	34	Springs - air	112
Extinguishers, fire	74	Loctite consumables	131	Springs - coil	113
Fairleads	89 - 91	Lubrication, brake	96	Springs - parabolic	112
Filter Guards	99	Lucas batteries	82	Steel wheels	37
Filters	144	Manuals	158	Steering arms - heavy-duty	114
Fire extinguishers	74	Map reading lamp	42	Steering guards	17
First aid kit	74	Matrix, heater	136	Steering wheels	154 - 155
Fluids	131	Mats	58 - 60	Stops	105
Fog lights	41	Merchandise	160 - 162	Sump guards	17
Freelander 2 vehicle enhancements	152 - 153	Mirrors & fittings	13	Super Gaz shock absorbers	108
Freelander service kits	142	Mud flaps	14	Suspension kits - Britpart	115
Front bumper	8	Muffs, radiator	163	Swivel housing gaiter kits	17
Front bumperettes	8	NAS lights	41	Swivel housing grease	131
Fuel tanks	75	Net, loadspace	58	Swivel housing kits	124
Fume curtain	66	Nipples, grease	130	Swivel pin kits	124
Gaiter kits	17	Oil	131	Tanks, fuel tanks	75
Gaiters, gear box	55	Oil pump gear set	136	Techno style seats	69
Gasket kits	134	Optima batteries	82	Timing kits	136
Gear box gaiters	55	Original technical publications	159	Tools	105 & 137
Gear boxes - new	140	Paints	131 & 133	Touch up paint pens	133
Gear boxes - reconditioned	140	Panhard rod	104	Tow bars	46 - 51
Gear lever set	154 - 155	Pans, diff repair	140	Tow electrics	46 - 51
Gloves	89 - 91	Parabolic springs	112	Tow hitches	46 - 51
Glue	131	Parking sensors	15	Tow kits	46 - 51
Grease nipples	130	Parts & general interest books	159	Tow ropes	89 - 91
Grilles	154 - 155	Pens, touch up	131 & 133	Towing equipment	46 - 51
Guard, transmission	18	Performance brake discs	94	Transfer boxes	140
Guards, dog	54 - 55	Polybush sets	105	Transmission fluid	131
Guards, lamp	9 - 13	Premium mats	58 - 60	Transmission guard	18
Guards, steering	17	Pressure relief valve kit	136	Tree straps	89 - 91
Guards, sump	17	Prop shaft spacer kit	110	Trim, dash	70
Hammer - emergency	75	Propshaft bearings	140	Trim, door	70, 126 & 129
Hand barrier cream	130	Propshaft kit	140	Tuning products	100
Handbrake conversion kits	97	Propshafts, wide angle	118	Turret rings	110
Haynes internal combustion engine	162	Protection tubes	20 - 23	Tyre pressure monitoring system	32
Haynes manuals & books	158	PSI power tuning products	100	Tyre repair kit & air compressors	33
Head bolt sets	134	Radiator muffs	163	Utility link and rear pipes	122
Heads, cylinder	134	Radius arms	104	Vehicle enhancements	146 - 155
Heater blower motor kit & resistor kit	136	Raised air intakes	78 - 79	Vents	154 - 155
Heater matrixes	136	Range Rover L322 vehicle enhancements	146 - 147	Waterproof seat covers	61 - 62
Heater plug upgrade kit	134	Range Rover service kits	143	Weber carburettors	100
Hi-Lift jacks	76	Range Rover Sport vehicle enhancements	148 - 149	Wheel arch kits	16
Hinge kits, door	130	Rear bumper	15	Wheel bearing kits	124
Hoods	66	Rear bumperettes	15	Wheel carriers	32
Hoses	99	Rear exhaust pipes	122	Wheel covers	33
Hylomar sealants & compounds	131	Rear steps	20 - 23	Wheel hub & bearing	124
Ignition lead sets	133	Recovery eye	89 - 91	Wheel keys	34
Ignition module	134	Remote control	89 - 91	Wheel nuts & caps	34
Inner tube	32	Repair kit, tyre	33 & 72	Wheel spacers & adaptor kits	35
Intercooler silicone hoses	99	Retainers, spring	112	Wheel wrenches	34
Intercoolers - performance	100	Re-trim kits	68	Wheels, alloy	36
Interior lamp	42	Rims	38	Wheels, steel	37
Jackall jacks	77	Rings, turret	110	Wide angle propshafts	118
Jacking equipment	77	Roof boxes	29 & 30	Winch bumper kits	87
Jacks - Hi-Lift	76	Roof rack ladder	26	Winch bumpers	88
Jacks - Jackall	77	Roof racks	28 - 30	Winch spare parts	86
Jerry cans	75	Roof racks - galvanised flat pack kits	27	Winches	83 - 85
Jubilee clips	130	Roof racks & boxes - Mont Blanc	28	Winching accessories	89 - 91
K&N consumables	97	Roof racks & boxes - Thule	30	Winching accessory kits	91
Keys, wheel nut	34	Roof rails	28 - 30	Wind deflectors	18
Kit, automatic transmission service	138	Roo-lites	42	Window kits	130
Kit, damper	138	Ropes, tow	89 - 91	Wing protectors	137
Kit, heater plug upgrade	134	Rubber mats	58 - 60	Wiper blades - heavy-duty	163
Kit, tyre repair	33 & 72	Rubbing strips	16	Wrenches	34
Kits, brake hose	96	Sand ladders	78	XS style seats	69
Kits, clutch	139	Screen wash	131	Zu rims	38

NOTES

UK REGISTRATION YEARS

Suffix letter series 1963 - 1983

Letter	Dates of issue
A	1st January 1963 - 31st December 1963
B	1st January 1964 - 31st December 1964
C	1st January 1965 - 31st December 1965
D	1st January 1966 - 31st December 1966
E	1st January 1967 - 31st July 1967
F	1st August 1967 - 31st July 1968
G	1st August 1968 - 31st July 1969
H	1st August 1969 - 31st July 1970
J	1st August 1970 - 31st July 1971
K	1st August 1971 - 31st July 1972
L	1st August 1972 - 31st July 1973
M	1st August 1973 - 31st July 1974
N	1st August 1974 - 31st July 1975
P	1st August 1975 - 31st July 1976
R	1st August 1976 - 31st July 1977
S	1st August 1977 - 31st July 1978
T	1st August 1978 - 31st July 1979
V	1st August 1979 - 31st July 1980
W	1st August 1980 - 31st July 1981
X	1st August 1981 - 31st July 1982
Y	1st August 1982 - 31st July 1983

Prefix letter series 1983 - 2001

Letter	Dates of issue
A	1st August 1983 - 31st July 1984
B	1st August 1984 - 31st July 1985
C	1st August 1985 - 31st July 1986
D	1st August 1986 - 31st July 1987
E	1st August 1987 - 31st July 1988
F	1st August 1988 - 31st July 1989
G	1st August 1989 - 31st July 1990
H	1st August 1990 - 31st July 1991
J	1st August 1991 - 31st July 1992
K	1st August 1992 - 31st July 1993
L	1st August 1993 - 31st July 1994
M	1st August 1994 - 31st July 1995
N	1st August 1995 - 31st July 1996
P	1st August 1996 - 31st July 1997
R	1st August 1997 - 31st July 1998
S	1st August 1998 - 28th February 1999
T	1st March 1999 - 31st August 1999
V	1st September 1999 - 29 February 2000
W	1st March 2000 - 31st August 2000
X	1st September 2000 - 28th February 2001
Y	1st March 2001 - 31st August 2001

New style series 2001 - onwards

Year	1st March to 31st August	1st September to 28th February
2001/2002	N/A	51
2002/2003	02	52
2003/2004	03	53
2004/2005	04	54
2005/2006	05	55
2006/2007	06	56
2007/2008	07	57
2008/2009	08	58
2009/2010	09	59
2010/2011	10	60
2011/2012	11	61
2012/2013	12	62

KEEP UP TO DATE

Keep up to date with all the latest developments from Britpart by e-mail.

Simply log on to www.britpart.com and register your details in the 'Mailing List' section or simply send an e-mail to - marketing@britpart.co.uk



WE'D LOVE TO SEE YOUR PICTURES



If you have a great picture of your Land Rover and would like to see it featured in the next Britpart catalogue, then please send it to marketing@britpart.co.uk with all your details. We look forward to seeing them and for each one we feature we'll send you a small thank you gift! Freelander 2 picture courtesy of Darren Whiley

THE SMALL PRINT

- > Part numbers used for identification purposes only and do not imply or indicate the identity of a manufacturer.
- > Genuine Land Rover parts and accessories are for sale in EU countries only.
- > Parts are subject to stock and supply.
- > Pictures are for reference only and specifications may alter without notice.
- > Colour swatches are for reference only - samples are available on request.
- > All products available at time of printing and we reserve the right to withdraw any product at any time.
- > Land Rover logos and trade names are for reference only.
- > No part of this catalogue may be used or reproduced by any means without the express permission of Britpart.
- > Product specifications are given but it is up to the end user to ensure that the product is fit for that purpose.
- > E&OE



LAND ROVER TEAM S.r.l.

Via Virgilio 8 - 20833 Birone di Giussano (MB) Italy

Tel: +39 0362 311 370

Fax: +39 0362 335 845

www.landroverteam.it

email: info@landroverteam.it