

wheego LiFe owner's manual

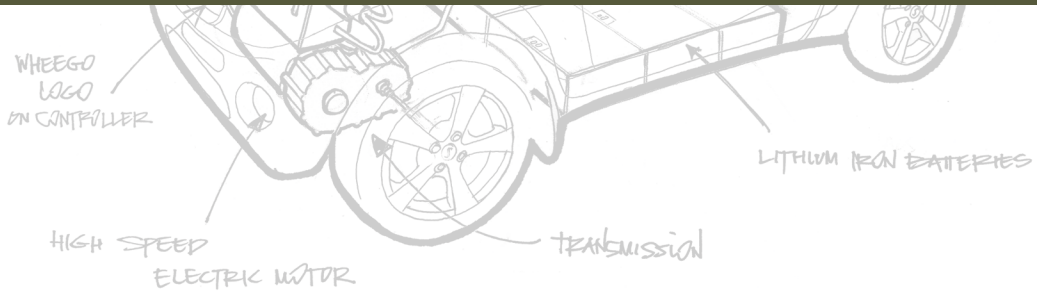

2011-2013 Wheego LiFe Owner's Manual

wheego.net

My Wheego Dealer's Telephone number: _____

The vehicle identification number (VIN) can be found on the VIN plate, located on the driver's side of the dashboard. Record the VIN in the space below for easy reference.

Vehicle Identification Number (VIN): _____

Key # _____ (stamped on key finger)

Date purchased: ____ / ____ / ____

Private online driver forum for Wheego Drivers wheegodriver.com

Login: Your first and last name (case sensitive)

Password: the last 4 digits of your VIN

CAUTION

Keep your car plugged in when not in use.

The Wheego LiFe is designed to be plugged in when not in use; the batteries gradually discharge when the car is not plugged in. Damage due to failure to keep batteries properly charged is not covered under your warranty. Batteries must not be allowed to fully discharge; if the batteries fully discharge, your warranty is void. Refer to "Charging Your Car" for details.

All cars are tested for a minimum of 60 miles prior to being shipped to dealers. Your odometer will reflect this.

All new Wheego vehicles come with 12 months of The Wheego Advantage EasyCare, offering 24 hour roadside assistance. Provided by Road America, Wheego Roadside Assistance offers 24-Hours dispatch, emergency towing and flat tire assistance. This service is only available in the US.

Roadside Assistance: 866.882.3374

EasyCare: 800.230.2434

Table of Contents

1. Introduction	05 - 07
2. Consumer Information/ Reporting Safety Issues	08
3. Things to Know Before You Operate Your Car	09 - 10
4. Understanding Your Car's Features	11 - 59
5. Charging Your Car	60 - 65
6. Driving Your Car	66 - 67
7. Vehicle Maintenance	68 - 98
8. Diagnostics/Troubleshooting	90 - 94
9. Customer Service and Warranty	95 - 102
10. Vehicle Identification and Specifications	103 - 105
11. Index	106 - 111

1. INTRODUCTION

- A. About this Owner's Manual
 - B. Introduction to the Safe Ownership of a WHEEGO
 - C. Cautions, Warnings and Notes
-

You can be badly injured while working on an electric vehicle. Take your vehicle to your dealer or call WHEEGO Customer Service at 678-904-4795 Ext. 3 for help.

WARNING

Any modifications or alterations to this vehicle could seriously affect its road worthiness and safety and may lead to an accident resulting in serious injury or death.

A. ABOUT THIS MANUAL

Thank you for purchasing your electric vehicle from WHEEGO.

Your vehicle is designed to operate exclusively on battery power. It is an emission-free vehicle. WHEEGO's objectives include customer safety, product satisfaction and pride of ownership. This Owner's Manual is designed to acquaint you with the proper and safe operation of your WHEEGO. Please take the time to read and understand the manual before operating your vehicle.

Maintenance schedules and general care instructions are included in the Maintenance section. This manual is applicable to the following WHEEGO line of vehicles:

LiFe 2011-2013 Model Years

NOTE: All information and specifications in this Owner's Manual are current at the time of printing. However, due to WHEEGO's policy of continuous improvement, we reserve the right to make changes to the manual, at any time, without written notice or obligation.

B. INTRODUCTION TO SAFE OWNERSHIP OF WHEEGO ELECTRIC VEHICLES

WHEEGO battery-electric vehicles are different from vehicles you might be accustomed to driving. Special precautions should be followed when owning and operating a WHEEGO. Please pay particular attention to the cautions and warnings in this manual as well as those placed as notices on the vehicle in various locations. Electric cars provide a great amount of torque when the accelerator is pressed. This may cause the car to spin its tires particularly on wet or slippery pavement.

Specific to WHEEGO models, the following safe habits should always be followed:

- Safety belts should always be worn by all occupants while the vehicle is in operation.
- WHEEGO battery-electric vehicles should be recharged from a standard 120VAC 15amp electrical outlet or an approved 240VAC Charging Station. Charging from a circuit of

lesser capacity and/or using a cord from an outlet to the WHEEGO that is not sufficient in wire gauge could create a fire hazard. Please consult this manual for the proper extension cord gauge and length.

- The lithium battery pack is what you charge and provides the "energy" to the WHEEGO electric drive system. The voltage in a WHEEGO battery pack is sufficient to cause death by electrocution. For this reason, no one should EVER attempt to do any maintenance or repair work on their WHEEGO electric drive system, including the battery pack, unless they have had special training or are authorized by WHEEGO to do so.
- Please read, understand and abide by the above safety precautions for years of safe operation and enjoyment of your WHEEGO.

C. CAUTIONS, WARNINGS AND NOTES

Throughout this Owner's Manual you will find the words WARNING, CAUTION and NOTE. These serve as reminders that special attention is required.

WARNING - indicates a direct hazard which could result in an accident causing bodily injury.

CAUTION - identifies something that could result in damage to your vehicle.

NOTE - marks information to make procedures easier to understand.

2. CONSUMER INFORMATION/ REPORTING SAFETY ISSUES

If you believe that your vehicle has a defect which could cause a crash or could cause injury or death, you should immediately inform the National Highway Traffic Safety Administration (NHTSA) in addition to notifying Wheego Electric Cars.

If NHTSA receives similar complaints, it may open an investigation, and if it finds that a safety defect exists in a group of vehicles, it may order a recall and remedy campaign.

However, NHTSA cannot become involved in individual problems between you, your dealer, or Wheego Electric Cars.

To contact NHTSA, you may:

call the Vehicle Safety Hotline toll-free at 1-888-327-4236 (TTY: 1-800-424-9153);

go to <http://www.safercar.gov>

or write to: Administrator, NHTSA, 1200 New Jersey Avenue, S.E., Washington, DC 20590.

You can also obtain other information about motor vehicle safety from

<http://www.safercar.gov>

3. THINGS TO KNOW BEFORE YOU OPERATE YOUR CAR

A. Driving and alcohol

B. Safty Information

A. DRIVING AND ALCOHOL

Your ability to drive your WHEEGO can be seriously impaired with blood alcohol levels far below the level allowed by law. If you are drinking alcohol, don't drive. Ride with a designated non-drinking driver, call a cab, or use public transportation.

Driving after drinking alcohol can lead to an accident. Your perceptions are less sharp, your reflexes are slower, and your judgment is impaired when you have been drinking. Never drink alcohol and drive.

WARNING

Drinking alcohol can seriously impair your ability to operate this vehicle.

B. SAFETY INFORMATION

- Read the Owner's Manual before operating this vehicle.
- Charge the vehicle in a well-ventilated area only.
- Keep children away from the vehicle during charging.
- Never use (or substitute for) any battery other than the original factory supplied batteries that come in your Wheego or those authorized by Wheego as aftermarket replacements.

Your vehicle is battery powered. If handled improperly, batteries can be dangerous. During charging operations, follow the precautions provided in the Charging and Maintenance section of this manual to avoid personal injury or damage to electrical components in the vehicle.

WARNING

Your Wheego LiFe's 12V battery under the front hood powers the accessories such as headlights and horn. Electrolytes can leak from damaged or defective batteries. Avoid contact with skin, eyes, or clothing.

- Batteries contain acid, which can cause severe burns. If battery fluid comes in contact with your skin, flush the affected areas with water for at least 15 minutes and then seek medical assistance.
- If battery acid is ingested, seek immediate medical assistance.
- Contact with eyes: Flush with water and get medical assistance as soon as possible. While you are being driven to get medical assistance, continue to rinse your eyes by using a sponge or soft cloth saturated with water.
- Battery posts, terminals, and related accessories contain lead and lead compounds.

WARNING

Improper handling of high voltage wiring, batteries or control systems could result in serious or fatal injury by electric shock. Only qualified technicians should repair or access high voltage wiring, battery packs, and associated systems.

4. UNDERSTANDING YOUR CAR'S FEATURES

- A. Key Fob
 - B. Dashboard and Controls
 - C. Shifter and Parking Brake
 - D. Foot Pedals & Hood Release
 - E. Seats and Safety Features
-

A. Key Fob

Your key fob allows remote locking and unlocking of the driver and passenger doors and the rear hatch. Press the round silver button to release the ignition key.



Lock doors



Unlock doors



Open rear hatch
(press and hold for 3 seconds)

3 BUTTON KEY FOB



B. DASHBOARD AND CONTROLS

- Instrument Panel
 - Speedometer
 - Odometer/Trip Meter/Miles on Charge
 - BDI Gauge
 - Amp Meter
 - Volt Meter Eco-Meter
 - Indicator Lights
 - Setting Clock, Metric/English, Contrast Level
- External Lights, Turn Signals and Hazard Warning Flashers
- Windshield Wipers and Washer
- Horn
- Key Switch
- Tire Pressure Monitoring System
- Ventilation Controls
- Rear Defroster
- Airbag Controls
- 12V Accessory Jack
- Dome Light
- Radio
- Windows, Doors and Mirrors

INSTRUMENT PANEL



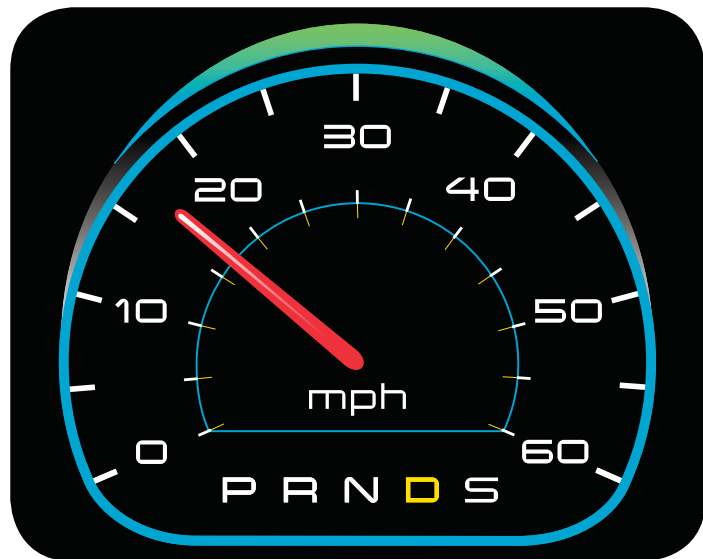

SPEEDOMETER

The Speedometer shows the current driven speed of the vehicle in miles per hour.

The display beneath the speedometer shows the status of the shifter: Park, Reverse, Neutral, Drive and Sport. If the Econo button by the shifter is depressed, a green E is displayed.

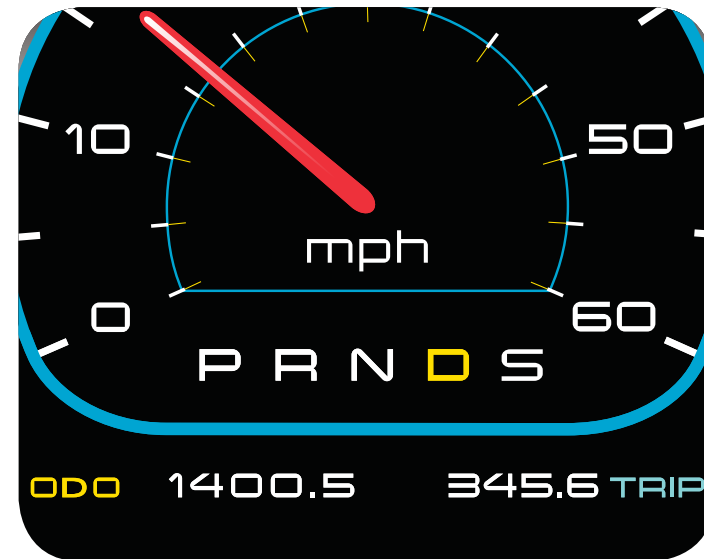

ODOMETER/TRIP METER/ MILES ON CHARGE

Press the stem on the lower right of the console to access the Odometer (miles), Trip Meter (miles), and Miles remaining on Current Charge Meter. The odometer indicates the total distance the vehicle has been driven. The Trip Meter is useful for keeping track of specific distances traveled.

While viewing the Trip Meter, press the stem for 3-4 seconds to reset the Trip Meter. The Miles Remaining on Current Charge Meter will automatically reset each time the vehicle completes a charging cycle.

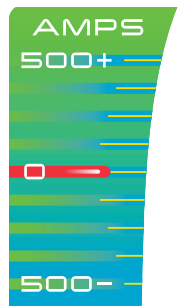

AMP METER

The AMP Meter indicates how many amperes are being drawn in order to move the car. This is a rough indication of the amount of electrical energy being used.

BDI GAUGE

The BDI (Battery Discharge Indicator) is similar to a fuel gauge on a gas-fueled vehicle. It gives the current state of charge of the battery pack while the key is in the ON position. The 100% charged position is all the way to the top and the fully discharged position is on the bottom. When the indicator reaches about 10% remaining charge, the Power Conservation Mode feature will begin to help economize battery usage for the remainder of the discharge cycle.

Note: in order to safeguard your batteries, only the top 90% of your charge is shown on this gauge. When you hit 0% on the BDI gauge, you actually have 10% battery charge left. Your car will shut down at this point so that you do not void your warranty. You need to recharge your car as soon as possible so it does not drain below this point.

Note: If you have left your car unplugged for more than a few days the BDI Gauge will not accurately reflect the remaining charge.



VOLT METER

The VOLT Meter indicates the voltage of the lithium battery pack. This is a rough measure of the present charge status of the battery pack.

ECO-METER

The ECO-METER provides feedback as to how your driving habits (and the terrain) are affecting the draw on the batteries, which affects your driving range. The more green that is showing, the more you are driving in a fashion that is economical on the battery pack. The Wheego LiFe utilizes regenerative braking, which captures kinetic energy normally lost during braking, and feeds it back into the battery pack.



INDICATOR LIGHTS

The following indicator lights may be displayed on your dash. In general, they will be displayed briefly when the car is turned on to indicate the lights are working properly. After the initial startup sequence, the lights indicate the following conditions:

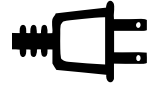

Charge Light - Indicates the car is being charged.
The car must be unplugged before it can be driven.

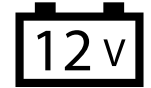

12V Battery Light - Indicates the 12V battery needs service. Contact your Wheego dealer.



Hazard Light - Indicates the hazard lights are on. Press the hazard button on top of the steering column to turn the hazard lights on or off.



Service Light - indicates your car needs service. Contact your Wheego dealer.



Turn Signal - indicates left or right blinker activation.



A/C Light - indicates the air conditioning is on.

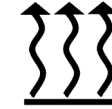

Heater Light - indicates the heater is on.



Apply Brake Light - reminds you to depress the brake pedal.



EPS Light - indicates the Electronic Power Steering needs service. Contact your Wheego dealer for service as soon as possible.



Tire Pressure Monitoring Light - Indicates a tire is low on pressure. Check tire pressure on all of your tires



(Flashing) Tire Pressure Monitor Failure Indicator - Indicates the Tire Pressure Monitoring system is not working. Contact your Wheego dealer for service.



Seatbelt Light - Reminds you to fasten your seatbelt.



Low Charge Light – Indicates your lithium batteries are low on charge. You need to charge your batteries immediately.



Bright Light Indicator – Indicates the bright lights/ high beams are on.



Door Open Light – Indicates one of the car doors is open.



Low Brake Fluid Light – Indicates you are low on brake fluid.



Airbag Light – Indicates the airbag may not be working properly; you need to have it checked immediately.



Parking brake on – indicates the parking brake is pulled up/engaged.



Anti-lock Braking System – indicates a problem with the anti-lock braking system. Contact your Wheego dealer for service immediately.

CAUTION

Electrical wiring, circuit boards, and components are located under and behind the upper and lower dash. Liquids can damage electrical components and the circuit board. Handle liquids with care. Do not spray water directly into the dash.

CONSOLE SETTINGS

You can change the settings of the console by using the 5-way D-pad, located in front of the parking brake.

With the car in Park and the key in the “on” position, press and hold the center button of the 5-way switch. A screen displays the following four options:

OEM Settings – for manufacturer use only (password protected)

Maintenance/Service – for Wheego technicians only (password protected)

User Functions – Allows you to set clock, metric/English, contrast levels

Exit Menu – exits screens

The four sides of the 5-way switch allow you to move up/down and right/left within a menu. The center of the switch “selects” a field. Use up/down to move to the User Functions option, and press the center button to select it.

CONSOLE CONTROL D-PAD

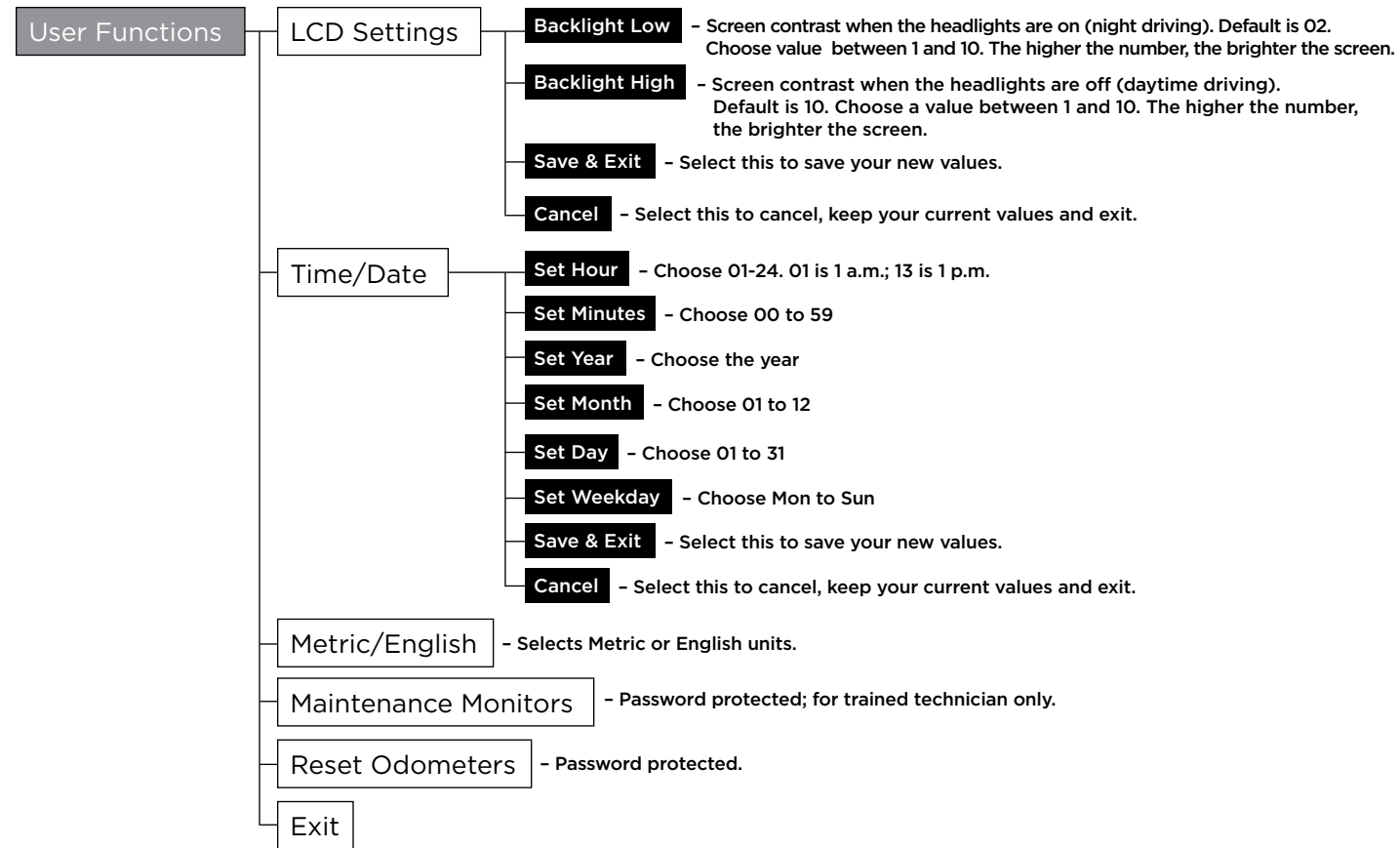

EXTERNAL LIGHTS AND TURN SIGNALS



The left lever controls the turn signals and lights. To turn on the parking lights, instrument panel lights and other external lights, rotate the lever knob up one click. To turn on the headlights, rotate the lever knob up one more click. You should turn off the lights before exiting the vehicle. If you accidentally leave the lights on, a buzzer will sound to remind you to turn them off.

To turn on the bright lights (hi-beams), push the lever away from you while the headlights are on. The bright light indicator will illuminate on the dash. To temporarily turn on the hi-beams, pull the lever toward you. When you release the lever, the hi-beams will turn off. For a left turn move the lever down until it clicks. For a right turn move the lever up until it clicks.

Below the steering column to the left is the Fog Lights switch. When the taillights or headlights are turned on, pressing this switch will activate the fog lights.





HAZARD WARNING FLASHER

Your vehicle's hazard warning flasher is an emergency warning system. When you activate it, front and rear directional signals will flash intermittently. Use it when your vehicle is disabled on or near the road. It warns other drivers to steer clear of you and your vehicle. To activate the warning flashers, press the red button on the top of of the steering wheel. To turn the warning flashers off, press the red button again.

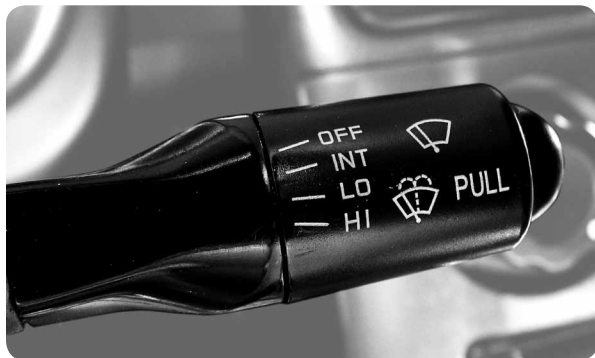

WINDSHIELD WIPERS AND WASHER

The wiper lever to the right of the steering column controls the windshield wipers and washer. Move the wiper signal lever down to turn on the windshield wipers (1-click intermittent, 2-clicks low speed, 3-clicks high speed). Move the wiper lever back up to turn off. Pull the wiper lever momentarily toward the driver to spray the windshield with fluid from the washer reservoir.

CAUTION

A damaged or worn wiper blade may reduce vision and impair you from seeing well enough to drive safely. A worn wiper blade could damage windshield glass. If your wiper blades become damaged or worn, please replace them immediately.

HORN

Press one of the buttons on the steering wheel to activate the horn.





KEY SWITCH

Unplug cord before inserting the key into switch. The car must be in park before you begin the starting sequence. When the key is turned clockwise to the first "ACC" position the accessory circuits will be on (radio, lights, etc.). Turn the key past "ACC" to "ON", press the brake, turn key to "START" (the red hazard symbol on the dash turns off) after starting it will spring back to on. There is no audible sound when the car is on. (If the key is in the "ON" position and a buzzer sounds, there is an alert condition such as a door open or seatbelt not fastened.)



If the charging light is illuminated, unplug the charger before starting to drive.

CAUTION

Do not leave the key in the "ON" position when not in use. Doing so will discharge the batteries.

WARNING

Never turn the key to the "OFF" position while the vehicle is in motion. This could lead to loss of speed and loss of control of the vehicle. This can cause a serious accident.

TIRE PRESSURE MONITORING SYSTEM

Each tire should be checked monthly when cold and inflated to the inflation pressure recommended by the vehicle manufacturer on the vehicle placard or tire inflation pressure label. (If your vehicle has tires of a different size than the size indicated on the vehicle placard or tire inflation pressure label, you should determine the proper tire inflation pressure for those tires.)



As an added safety feature, your vehicle has been equipped with a tire pressure monitoring system (TPMS) that illuminates a low tire pressure telltale when one or more of your tires is significantly under-inflated.

Accordingly, when the low tire pressure telltale illuminates, you should stop and check your tires as soon as possible, and inflate them to the proper pressure. Driving on a significantly under-inflated tire causes the tire to overheat and can lead to tire failure. Under-inflation also reduces fuel efficiency and tire tread life, and may affect the vehicle's handling and stopping ability. Please note that the TPMS is not a substitute for proper tire maintenance, and it is the driver's responsibility to maintain correct tire pressure, even if under-inflation has not reached the level to trigger illumination of the TPMS low tire pressure telltale.



Your vehicle has also been equipped with a TPMS malfunction indicator to indicate when the system is not operating properly.

The TPMS malfunction indicator is combined with the low tire pressure telltale. When the system detects a malfunction, the telltale will flash for approximately one minute and then remain continuously illuminated. This sequence will continue upon subsequent vehicle start-ups as long as the malfunction exists.

When the malfunction indicator is illuminated, the system may not be able to detect or signal low tire pressure as intended. TPMS malfunctions may occur for a variety of reasons, including the installation of replacement or alternate tires or wheels on the vehicle that prevent the TPMS from functioning properly. Always check the TPMS malfunction telltale after replacing one or more tires or wheels on your vehicle to ensure that the replacement or alternate tires and wheels allow the TPMS to continue to function properly.

VENTILATION CONTROLS



There are 3 knobs to control the ventilation system. The left knob controls the temperature. Turn it counterclockwise to increase the temperature and clockwise to decrease the temperature.

The center knob controls the volume of air. Turn it clockwise to increase airflow and counterclockwise to decrease airflow. If the vehicle is equipped with Air Conditioning, after selecting the volume of air you desire by turning the center knob, you may press the center knob to turn on the AC compressor. A red light comes on in the center of the knob to indicate the AC is on. Pressing the center knob a second time will turn the AC off.

To turn the heat on, turn the temperature knob on the left to red (warm air) and the adjust the volume of air using the center knob. The heater icon will illuminate on the dash.

The right knob controls the airflow. By selecting different positions you can choose where to have the air enter the passenger compartment. Turning the knob to defrost allows the air to blow across the face of the windshield to de-fog it.

Below the center knob is a control that slides from left to right. Moving it to the left position will recirculate the air in the vehicle and moving it to the right position will allow outside air to enter the vehicle through the ventilation system.

To defog the front windshield, press the button to turn on the A/C and adjust the temperature to room temperature or above using the temperature selection knob. Set the fan speed to your preference, turn the vent knob clockwise to defrost, and turn off recirculation by sliding the selector to the right.

To defrost, press the button to turn off the A/C, set the temperature to hot, turn on recirculation by moving the slider to the left, and select the defrost mode on the vent knob by rotating it to clockwise. After a few minutes, you may want to use the wipers to assist.

REAR DEFROSTER/12V ACCESSORY JACK/AIRBAG SYSTEM

Below the radio are 2 console- mounted Accessory controls. On the left is the Rear Defroster, and on the right is the 12V accessory jack.

REAR DEFROST



Press the rear defroster button to turn on the rear window defroster. The indicator light will come on. Press the button a second time to turn it off.

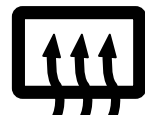

12V ACCESSORY JACK



The 12 volt accessory jack can be used to provide power for 12 volt accessories that have a "lighter plug" style connector. The maximum power available is 10 Amps of 12 Volt power. Lift the cover to expose the 12 Volt accessory jack.

AIRBAG SYSTEM CONTROLS

Your vehicle is equipped with driver and passenger airbags. The driver airbag is located in the center of the steering column; the passenger airbag is located in the console in front of the passenger.

When infants in rear-facing child safety seats and children who are unrestrained are placed in the front seat with an airbag, they may be too close to an inflating airbag in the event of a crash. An airbag will inflate at speeds up to 200 mph, which can hurt passengers who are too close to the airbag. In addition, because of the child's size, the airbag can strike him/her on the head or neck, resulting in serious or fatal injuries.

To ensure your child is as safe as possible in a vehicle, never place him/her in front of an airbag. If your child rides in the WHEEGO, move the seat as far back as possible, away from the airbag. Infants will only be safe in their rear-facing child safety seats if the airbag has been switched off.

The passenger airbag may be turned on or off by inserting the ignition key into the switch located on the right side of the lower dash and turning it to the appropriate position. When the passenger airbag feature is turned off, the airbag will not deploy in the event of an accident.



INTERIOR DOME LIGHT

The interior dome light illuminates the passenger compartment of the vehicle. There are three switch positions:

Forward (toward you) = On

Center = Door activated (on when a door is open)

Back (away from you) = Off

RADIO - JVC AM/FM/CD/USB/MP3 RECEIVER



Included in this section are the basics for operating the radio/CD player. Please refer to the **JVC Owner's Manual** for a detailed description of its operation. The ON-OFF/Source button is in the upper left corner of the display, just below the Eject button. Press and hold the Source button to turn the radio on or off. The round knob controls the volume. Press the controls to the left of the Menu button to change the station tuner. Press the up or down arrow to scroll through the preset stations. Press the Source button to change the source (AM/FM/AUX/etc.). The USB input jack will communicate with iPhones, iPods, and thumb drives.

WINDOWS, DOORS AND MIRRORS



- A. Power assisted windows
- B. Power assisted outside mirrors
- C. Door locks
- D. Remote charging door release
- E. Rear window and tailgate



A. POWER ASSISTED WINDOWS

The windows in your WHEEGO vehicle are motor operated. Push on the button located on the inner door handle to roll the window down and pull it gently to roll the window up.



B. POWER ASSISTED OUTSIDE MIRRORS

The power controls for the outside mirrors are located on the driver's side inner door handle at the top. Move the selector to choose the left or right hand mirror and then press one of the four directional buttons to change the position of the mirror.



C. DOOR LOCKS

Press the electronic lock/unlock button to electronically lock or unlock the doors. You may also manually push down or pull up the door lock buttons.

There are lock and unlock buttons on the vehicle key that will electronically lock and unlock the doors. The doors can also be locked and unlocked manually with the key. If the doors are locked using the remote control, they should also be unlocked using the remote control. Otherwise, the hazard warning lights will begin to flash.

NOTE: Should the hazard flashers start to automatically flash after turning the vehicle ON, remove the key from the switch, press the lock button on the key, then press the unlock button, put the key back into the switch and turn the vehicle back ON to restore normal operation of the vehicle.



D. REMOTE CHARGING PORT DOOR RELEASE

The charging port door is released when you pull up on the remote lever located on the floor next to the driver's door (toward the rear of the driver seat).



HOOD RELEASE

The hood release is located to the left of the brake pedal in front of the driver's door. Pull it gently toward you to open the hood.



E. REAR WINDOW AND TAILGATE

To unlock and open the rear window, press the open tailgate icon on the key fob for three seconds. Raise the window using the finger lift. Pull the left and right red latch releases at the top corners of the tailgate simultaneously to release and open the gate. Close the tailgate before lowering and latching the rear window. Alternately the tailgate can be opened by using the key.

TAILGATE LATCH RELEASES





C. SHIFTER AND PARKING BRAKE

The transmission positions are:

P - Park Stop / out of gear

R - Reverse Go backward

N - Neutral Stay in place / remain in gear

D - Drive Forward using 550 amps of motor controller power

2 - Sport Forward using 650 amps of motor controller power generating additional low end power or torque for faster off-the-line acceleration

While in “Drive,” you can press the “Econo” button on the right side of the shifter to go into Econo Mode to increase range: Forward using 475 amps of motor controller power, limiting acceleration and increasing regenerative braking upon accelerator pedal release. When you are in Econo mode, a green “E” and the words “Econo Mode” appear on the console. To get out of Econo mode, press the button again.

Park (P)

With the key turned ON and the brake depressed, push in the button on the left of the shifter knob and move the shifter to Park (P) position. Pull up on the emergency brake. The car is now ready to be turned off.

Reverse (R)

With the key turned ON and the brake depressed, release the emergency handbrake. Push in the button on the left of the shifter knob and move the shifter to Reverse (R) position. Release the brake and push down on the accelerator to move the vehicle in reverse. The top speed in the reverse direction is limited for safety.

Neutral (N)

With the key turned ON and the brake depressed, push in the button on the left of the shifter knob and move the shifter to Neutral (N) position. The car will remain in gear. It will roll forward if the brake is released, but will not accelerate if the accelerator is pressed.

Drive (D)

With the key turned ON and the brake depressed, release the emergency handbrake. Push in the button on the left of the shifter knob and move the shifter to the Drive (D) position. Release the brake and push down on the accelerator pedal to move the vehicle forward.

Sport (2)

With the key turned ON and the brake depressed, release the emergency handbrake if it is engaged. Push in the button on the left of the shifter knob and move the shifter to the Sport (S) position. Release the brake and push down on the accelerator pedal to move the vehicle forward in Sport mode (using 650 amps of motor controller power, generating additional low end power or torque for faster off the line acceleration). You can also shift into Sport mode while you are driving in D.

EconoMode (E)

Depress the Econo Mode button on the right side of the shifter while in Drive to put the car in Econo mode to increase range: Forward using 475 amps of motor controller power, limiting acceleration and increasing regenerative braking upon accelerator pedal release. When you are in Econo mode, a green “E” and the words “Econo Mode” appear on the console. To get out of Econo mode, press the button again.

PARKING BRAKE

On the floor between the seats is the hand actuated parking brake. This brake must be engaged when parking the vehicle or prior to exiting the vehicle. Grasp the brake and pull up to engage. Press the silver button on the end and lower the brake handle to release the parking brake.

NOTE

The parking brake is adjustable and should be checked periodically by a trained service technician as shown in the vehicle maintenance schedule.

WARNING

Always turn the vehicle OFF, put the car in Park and engage the parking brake prior to exiting the vehicle or it could roll and cause damage or injury.

Leaving children unattended in a vehicle is dangerous. Children should be warned not to touch the parking brake or the shifter lever. Don't leave the keys in the ignition. A child could operate controls or move the vehicle.

Be sure the parking brake is fully disengaged before driving. Failure to do so can lead to brake problems due to excessive heating of the rear brakes.

D. FOOT PEDALS

BRAKE PEDAL

The brake pedal is located on the driver's floor to the left of the accelerator pedal. To slow or stop the vehicle, firmly press the foot brake pedal.

Riding the brakes can lead to brake failure and possibly an accident. Driving with your foot resting or riding on the brake pedal can result in abnormally high brake temperatures, excessive lining wear, possible brake damage, and reduced driving range. Excessive brake wear could lead to not having full braking capacity in an emergency. Your vehicle is equipped with Regenerative Braking. This allows the kinetic energy recovered from the motion of the car during braking to be stored in the battery pack for later use.

ACCELERATOR PEDAL

The accelerator pedal is located on the driver's floor next to the center console and is used to control your speed. Pressing down on the pedal will increase vehicle speed.

WARNING

Always accelerate carefully to prevent possible injury to yourself or others.

E. SEATS



1. Adjustable Bucket Seats
2. Head Rests
3. Seat Belts
4. Child Restraints
5. Airbag System
6. Impact Sensor



1. ADJUSTABLE BUCKET SEATS

The driver and passenger seats have a metal bar located under the front edge of the seat to allow the seats to be moved toward the front or rear of the vehicle as needed by the passengers.

They have a lever on the outside rear of the seat base to adjust the angle of the seat back.



The 2 knobs on the front outside edge of the seat base adjust the angle of the seat base. The front knob controls the angle of the front of the seat base and the rear knob controls the same adjustment on the rear of the seat base.



2. HEAD RESTS

Your vehicle is equipped with driver and passenger head rests which are designed to help protect the seat occupant in the event of a crash. All occupants, including the driver, should not operate the vehicle or sit in a vehicle's seat until the head restraints are placed in their proper positions.

The head rest should be adjusted to fit the occupant of the seat: the center "hole" in the head rest cushion should line up with the back of the occupant's head for the maximum cushion and protection during a crash.

The head rest is composed of the upper cushion and two adjustable placement bars. To raise the upper cushion, put your fingers under it and pull it up to the desired height.



To remove the cushion completely, press the lever down and lift the cushion all the way off. Always replace the head cushion before operating the car: line up the placement bars into the holes at the top of the seats, depress the lever at the base, and lower the cushion into position so it "clicks" and locks into place.

All head rests must be reinstalled to properly protect vehicle occupants.

3. SEAT BELTS

The WHEEGO is equipped with safety belts for driver and passenger. Research has shown that safety belts save lives. Safety belts can reduce the seriousness of injuries in a single vehicle accident. Some of the worst injuries happen when people are thrown from the vehicle. Safety belts provide protection and they reduce the risk of injury caused by striking the inside of the vehicle. Everyone needs to buckle up all the time, even for short trips.

WARNING

Wearing a safety belt incorrectly is dangerous. Wearing your safety belt incorrectly could increase your risk for injury in a collision. You could suffer internal injuries or even slide out of part of the belt. Use the instructions in this manual to insure you and your passengers are wearing the safety belts properly.

Two people should never be belted into a single safety belt. People belted together can crash into one another in an accident, causing injury. Never use a lap/shoulder belt for more than one person, regardless of the size of the person.

PROPER USE OF YOUR LAP AND SHOULDER BELT

1. Enter the vehicle and sit back.
2. The safety belt buckle is located just behind the outer side edge of the seat. Grasp the buckle and pull out the belt. Slide the buckle up the webbing as far as necessary to make the belt go across your lap.
3. When the safety belt is long enough, insert the buckle into the latch until you hear a click.
4. Position the lap belt across your thighs and below your abdomen. To remove slack in the lap belt portion of the belt, pull up on the shoulder belt. A snug belt reduces the risk of sliding under the belt in a collision. Make sure the button on the latch faces upward or outward so that you are able to unbuckle your safety belt quickly.
5. Position the shoulder belt on your chest so that it is comfortable and not resting on your neck. The retractor will withdraw any slack in the belt.
6. To release the belt, push the red button on the latch. If necessary, slide the buckle down the webbing to allow it to retract fully. A frayed or torn belt could rip apart in a collision and leave you with no protection. Inspect the belt system periodically, checking for cuts, frays or loose parts. Damaged parts must be replaced immediately. Do not modify or disassemble the system. Seat belt assemblies must be replaced after a collision if they have been damaged (bent retractor, torn webbing, etc.).

WARNING

In a collision, you and your passenger can suffer injuries, including fatalities, if you do not have your seat belts securely and properly latched. You can strike the interior of your vehicle or your passenger, or you can be thrown out of the vehicle. Always be sure you and others in your vehicle have their seat belts securely and properly latched.

Maximum occupancy is limited to 2 people (including the driver) in the WHEEGO LiFe.

It is extremely dangerous to ride in a cargo area of a vehicle. In a collision, people riding in these areas are more likely to be seriously injured or killed.

Do not allow people to ride in any area of your vehicle that is not equipped with seats and seat belts.

Be sure everyone in your vehicle is in a seat and wearing a seat belt.

SEAT BELTS AND PREGNANT WOMEN

We recommend that pregnant women use seat belts throughout their pregnancy. Keeping the mother safe is the best way to keep the baby safe. Pregnant women should wear the lap part of the belt across the thighs and as snug across the hips as possible. Keep the belt low so that it does not come across the abdomen. That way the strong bones of the hips will take the force if there is a collision.

WARNING

Using a seat belt extender when not needed can increase the risk of injury in a collision. Only use when the seat belt is not long enough when it is worn low and snug and in the recommended seating positions.

4. CHILD RESTRAINTS

WARNING

Everyone in your vehicle needs to be buckled up at all times—babies and children, too. Every state in the United States and all Canadian provinces require that small children ride in proper restraint systems. This is the law, and you can be prosecuted for ignoring it. There are different sizes and types of restraints for children from newborn size to the child almost large enough for an adult safety belt. Always check the child seat owner's manual to ensure you have the correct seat for your child. Use the restraint that is correct for your child. In a collision, an unrestrained child, even a tiny baby, can become a missile inside the vehicle. The force required to hold an infant could become so great during an accident that you could not hold the child no matter how strong you are. The child and others could be badly injured. Any child riding in your vehicle should be in a proper restraint for the child's size.

Refer to the airbag section for important information regarding passenger airbags. If you have a child or infant on the passenger seat, turn the passenger airbag off.

INFANTS AND CHILD RESTRAINTS

Safety experts recommend that children ride rearward-facing in the vehicle until they are at least one year old and weigh at least 20 lbs (9 kg). Two types of child restraints can be used rearward-facing: infant carriers and "convertible" child seats. The infant carrier is only used rearward-facing in the vehicle. It is recommended for children who weigh up to about 20 lbs (9 kg). "Convertible" child seats often have a higher weight limit in the rearward-facing direction than infant carriers do so they can be used rearward-facing by children who weigh more than 20 lbs (9 kg) but are less than one year old. Both types of child restraints are held in the vehicle by the lap/shoulder belt. This vehicle is equipped with a LATCH (Lower Anchors and Tethers for Children) child restraint anchorage system on the passenger seat. Fasten the child safety seat's lower attachments to the vehicle's lower anchors. Tighten and adjust according to the instructions and check for a secure fit. If the child seat has an upper tether, pull the tether strap over the seat and secure it to the tether anchor on the lower back of the vehicle seat. Improper installation can lead to failure of an infant or child restraint. It could become loose in a collision. The child could be badly injured or killed. Follow the child seat manufacturer's directions exactly when installing an infant or child restraint.

Turn the passenger airbag system off if you have a child or infant in the passenger seat; refer to the airbag section.

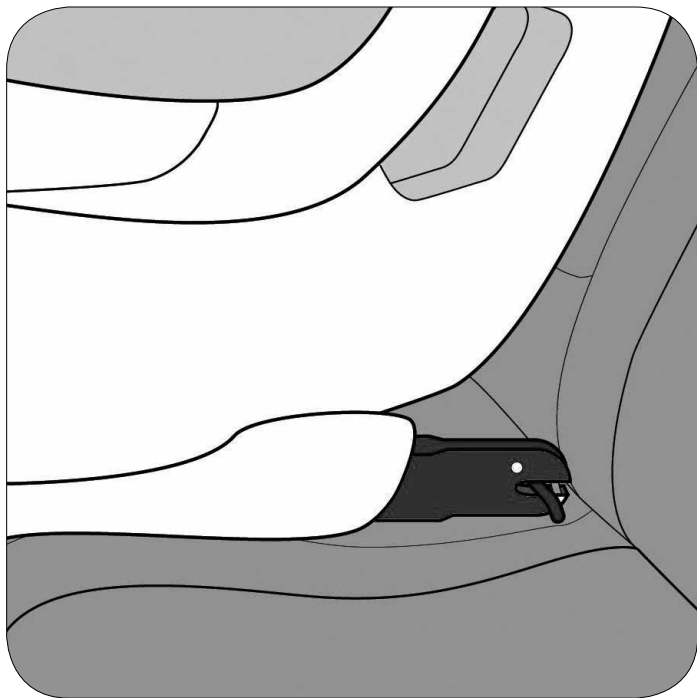

1. Attach the lower anchor strap to the two anchor points located between the bottom cushion and the back support.



2. Raise the head rest, put the strap(s) under it, then attach to the rear anchor point on the lower back side of the seat.

TIPS FOR GETTING THE MOST OUT OF YOUR CHILD RESTRAINT

- Before buying any restraint system, make sure that it has a label certifying that it meets all applicable Safety Standards. The manufacturer also recommends that you try a child restraint in the vehicle seats where you will use it before you buy it.
- The restraint must be appropriate for your child's weight and height. Check the label on the restraint for weight and height limits.
- Carefully follow the instructions that come with the restraint. If you install the restraint improperly, it may not work when you need it.
- All passenger seat belts are equipped with cinching latch plates.
- Seat belts are designed to keep the lap portion tight around the child restraint so that it is not necessary to use a locking clip. If the seat belt has a cinching latch plate, pulling up on the shoulder portion of the lap/shoulder belt will tighten the belt (the cinching latch plate will keep the belt tight; however, any seat belt system will loosen with time so check the belt occasionally and pull it tight if necessary).
- If the belt still cannot be tightened, or if pulling and pushing on the restraint loosens the belt, disconnect the latch plate from the buckle, turn the buckle around and insert the latch plate into the buckle again. If you still cannot make the child restraint secure try a different seating position.
- Buckle the child into the restraint exactly as the manufacturer's instructions tell you.
- When your child restraint is not in use, secure it in the vehicle with the seat belt or remove it from the vehicle. Do not leave it loose in the vehicle. In a sudden stop or collision it could strike the occupants or seat backs and cause serious personal injury.

NOTE

For additional information refer to seatcheck.org or call 1-866-SEATCHECK.

OTHER CHILDREN AND CHILD RESTRAINTS

Children who weigh more than 20 lbs (9 kg) and who are older than one year can ride forward-facing in the vehicle. Forward-facing child seats and convertible child seats used in the forward-facing direction are for children who weigh 20 to 40 lbs (9 to 18 kg), and who are older than one year. These child seats are also held in the vehicle by the lap/shoulder belt. The belt-positioning booster seat is for children weighing more than 40 lbs (18 kg), but who are still too small to fit the vehicle's seat belts properly. If the child cannot sit with knees bent over the vehicle's seat cushion while the child's back is against the seat back, they should use a belt-positioning booster seat. The child and belt-positioning booster seat are held in the vehicle by the lap/shoulder belt.

CHILDREN TOO LARGE FOR BOOSTER SEATS

Children who are large enough to wear the shoulder belt comfortably, and whose legs are long enough to bend over the front of the seat when their back is against the seat back, should use the lap/shoulder belt.

- Make sure that the child is upright in the seat.
- The lap portion should be low on the hips and as snug as possible.
- Check belt fit periodically. A child's squirming or slouching can move the belt out of position.
- If the shoulder belt contacts the face or neck, move the child closer to the center of the vehicle. Never allow a child to put the shoulder belt under an arm or behind their back. Not all child restraint systems will be installed as we have described here. Again, carefully follow the instructions that come with the child restraint system.

Transporting Pets

Pets should be restrained in a pet harness or in a pet carrier that is secured by seat belts.

5. AIRBAG SYSTEM

Your vehicle is equipped with driver and passenger front airbags. The driver airbag is located in the center of the steering column; the passenger airbag is located in the console in front of the passenger. Do not place any object over or near the airbag on the instrument panel, because any such objects could cause harm if the vehicle is in a crash severe enough to cause the airbag to inflate. The airbag system is a supplemental safety system; the driver and passenger should always wear their lap/shoulder belt to minimize the risk of severe injury or death in the event of a crash.

The passenger airbag may be turned on or off by inserting the ignition key into the switch below the dash on the passenger side, and turning it to the appropriate position. When the passenger airbag feature is turned off, the airbag will not deploy in the event of an accident.

To turn the passenger airbag back on, insert the key and turn it to the “on” position.

When infants in rear-facing child safety seats and children who are unrestrained are placed in the front seat with an airbag, they may be too close to an inflating airbag in the event of a crash. An airbag will inflate at speeds up to 200 mph, which can hurt passengers who are too close to the airbag. In addition, because of the child’s size, the airbag can strike him/her on the head or neck, resulting in serious or fatal injuries.

To ensure your child is as safe as possible in a vehicle, never place him/her in front of an airbag. If your child rides in the WHEEGO LiFe, move the seat as far back as possible, away from the airbag, and turn the passenger airbag off. Infants will only be safe in their rear-facing child safety seats if the airbag has been switched off.

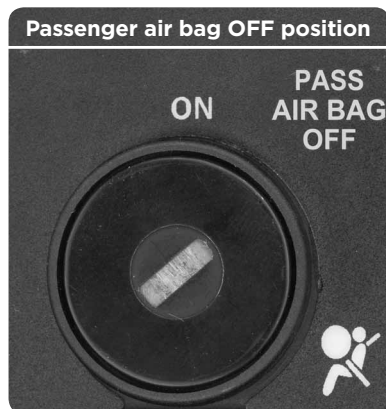
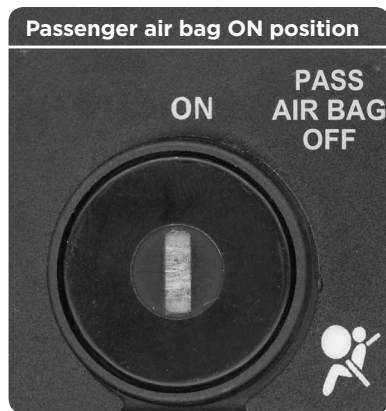

6. IMPACT SENSOR / BATTERY DISCONNECT

The LiFe is equipped with an Impact Sensor that disconnects all power from the lithium battery pack in the event of an impact of 30G or greater, and/or airbag deployment. This enables emergency responders arriving at an accident scene to work on victims without worrying about the danger of shock (to either the victims or to themselves) from the lithium battery pack. Emergency personnel should turn the ignition key off and take it out to make sure the car is turned off. Only a Wheego authorized service technician should reconnect the battery.

5. CHARGING YOUR CAR

- A. Charge cables and options
 - B. Charging the vehicle
 - C. Long term storage
 - D. Range information
-

CAUTION

Do The Wheego LiFe is designed to be plugged in when not in use; the batteries gradually discharge when the car is not plugged in. Damage due to failure to keep batteries properly charged is not covered under your warranty. Batteries must not be allowed to fully discharge; if the batteries fully discharge, your warranty is void.

A. CHARGING CABLES AND OPTIONS



Your WHEEGO vehicle is equipped with three on-board chargers totaling 27amps. You can charge the LiFe using either a 110V/120V or 220V/240V power supply.

Your car comes with a 120V cable with a standard plug on the end. We offer the 120V charging option so that you can charge your car anywhere there is standard 120V power. If you are only driving your car about 30 miles a day, you can recharge overnight using 120V power. If however, you are driving greater distances each day, it is recommended that you purchase a 220V charging station for your home. It takes approximately 5 hours to charge the car from 50% to 100% using 220V power.

If you purchase the recommended 220V charging station, it comes equipped with a hardwired charging cord with J1772 standard connection as shown.

The J1772 charge port receptacle on the car is an industry standard, so your car can be charged from any 120V or 240V public charging station equipped with the J1772 connector.

B. CHARGING THE VEHICLE

To charge the batteries, park the vehicle, put it in Park, set the parking brake, and turn the key OFF. Open the charge port door by pulling up the release lever to the left of the driver's seat on the floor. If you are using a charging station, line up the pins and plug the cord from the station into the car.

If you are using the 120V cord, plug the power cord into the power source first and then plug the cord into the vehicle. (You may use a UL listed 120-Volt 3-wire grounded extension cord if needed. Use a 14-gauge cord for lengths 25 feet or less and a 12-gauge cord for lengths 50 feet or less.)

WARNING

Use only the correct gauge 120V extension cords as listed above. An incorrect gauge extension cord could result in fire or heat damage.

The charging status lights are located in the charging port. When the vehicle is charging, the three LEDs in the charge port will flash, indicating power input to the charger. (If you are using the 120V cord, only one LED will flash green, indicating that only one of the three on-board chargers are being used.)

If the car is turned on during charging, an indicator light will be activated to remind you to disconnect the charge cord.

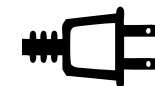

When the charging cycle has completed, the green LED(s) in the charging port will stay lit. A storage bag has been provided for your 120V power cord so it can be easily kept in the vehicle at all times.

Whenever possible, you should charge your car. Lithium batteries are different from lead acid in that lithium batteries will lose their charge if they are sitting idle. If you plan to go on vacation and leave your car in your garage, it must be plugged in. The charging system will "wake up" periodically and recharge the battery if needed. If the car is left unplugged, your batteries will gradually lose their charge. If your batteries are allowed to fully discharge, your battery warranty will be voided.

It is your responsibility to keep your batteries charged at all times. You cannot accidentally “overcharge” your batteries; the charging system will shut itself off when the car is fully charged. Note: in order to safeguard your batteries, only the top 90% of your charge is shown on the BDI gauge. When you hit 0% on the BDI gauge, you actually have 10% battery charge left. Your car will shut down at this point so that you do not void your warranty. You need to recharge your car as soon as possible so it does not drain below this point.

CAUTION

Only use approved power stations, and power cords supplied with your WHEEGO vehicle or replacement cords purchased from your Dealer when recharging your battery pack. Should your cord become misplaced or damaged, you should obtain a replacement power cord from the Dealer.

LONG TERM STORAGE

Should you need to store your WHEEGO vehicle for a period of more than a week, you will need to make sure it is plugged in. Do not store your car at extreme high or low temperatures as this will decrease the life of your battery pack.

D. RANGE INFORMATION (Driving Range between Charges)

How far you can travel on a full charge is subject to a lot of factors. You may be able to get as much as 100 miles or more. Depending on how you drive, you may get far fewer miles. Factors that will reduce your range include higher average speeds, local driving terrain (hills), use of the heater and air conditioner, fast starts and stops, and the local ambient temperature. Running your air conditioner or heater in a normal mode will reduce your maximum range by about 8%-15%.

As an alert to having limited range remaining and to help maximize your range when the battery pack capacity is low, your car has a Power Conserve Mode. When the battery pack is down to 10% capacity on the BDI gauge, the air conditioner and the heating system will automatically shut off. At 5% remaining capacity, the maximum speed of the vehicle will be reduced to about 45 mph. This should give you enough power to get off the road and either drive somewhere to recharge or call to have the vehicle towed.

6. DRIVING YOUR CAR

- A. Operating sequence
 - B. Power Conserve modes
 - C. Transporting your vehicle
-

A. OPERATING SEQUENCE

1. Disconnect the power cord, and store it in a safe place (or return cord to charging station holder).
2. Enter the vehicle and close both doors.
3. Adjust height of head rests.
4. Have all occupants buckle their seat belts.
5. Confirm the shifter is in Park.
6. Release the parking brake.
7. Insert key into ignition and turn clockwise to the first AAC position the accessory circuits will be on (radio, lights, etc.) Turn the key past AAC to ON.
8. Press the brake.
9. Turn the key to START (red hazard symbol on the dash turns off), then turn key back to ON. There is no audible sound when the car is on.
10. Move the shifter to drive, sport or reverse.
11. Release the brake pedal, press the accelerator and begin to drive.

B. POWER CONSERVE MODE

The Power Conserve Mode is designed to protect the batteries and the motor. Battery low voltage would coincide with a low charge reading on the BDI gauge on the dash. When the battery pack has been discharged to 10% remaining power, the controller will disable the heating and optional AC system to conserve power. At 5%, the controller will limit the motor to a top speed of about 45 mph. This will allow an increase in range on the remaining battery power and assist the driver in getting the vehicle to a safe location to recharge the batteries.

C. TRANSPORTING YOUR VEHICLE

Should you need to transport your WHEEGO vehicle, the best way is to use a car carrier or a trailer. Secure the vehicle properly to the trailer and tow the trailer at speeds no greater than 55 mph. Secure any loose items that may be inside the vehicle. You may also use a tow dolly that lifts the front 2 wheels off of the ground. Do not tow the vehicle on all 4 wheels; this car is different from an internal-combustion vehicle. Towing it on all 4 wheels affords significant wear and tear on the car as the drive train would be spinning the entire time the car is towed. Use a trailer, car carrier or tow dolly.

7. VEHICLE MAINTENANCE

- A. Batteries and charging
- B. Battery disposal
- C. Brakes and fluid level
- D. Tires
- E. Tire changing
- F. Fuse blocks
- G. Key replacement, Key fob battery replacement
- H. Care and cleaning
- I. Maintenance schedule
- J. Fluids and lubricants

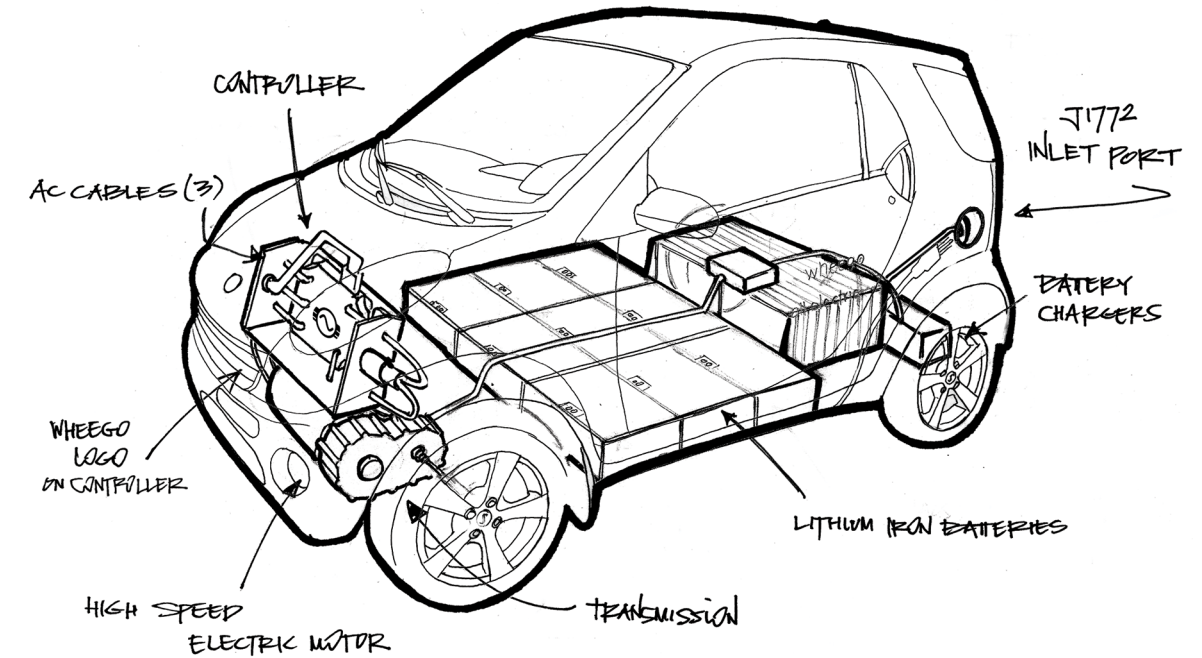

A. BATTERIES AND CHARGING

CAUTION

The Wheego LiFe is designed to be plugged in when not in use; the batteries gradually discharge when the car is not plugged in. Damage due to failure to keep batteries properly charged is not covered under your warranty. Batteries must not be allowed to discharge below 10% (this shows as 0% on your BDI gauge); if the batteries discharge below 10%, your warranty is void.

The type of batteries used in this vehicle are Lithium Iron Phosphate. They will perform better when kept fully charged and do not have to be discharged to any specific point prior to recharging. Therefore, whenever possible, recharge the batteries without regard to the state of charge. These batteries are sealed and maintenance free so they do not need to have fluid added to them like some other types of batteries. The traction battery pack of 36 batteries is under the car and under the rear storage compartment. You should never open the compartment or try to perform any type of maintenance on your car without the advice of an authorized service technician. The battery pack is very high voltage and the chance of a severe electrical shock is very real.

The 12 Volt AGM accessory battery is located under the front hood of the vehicle. This battery provides power to the vehicle's 12 Volt system for items such as lights, windshield wipers and the radio. It is automatically maintained by a DC to DC converter that draws its power from the traction battery pack and constantly charges the 12 Volt battery. This insures that it will not become discharged if an accessory were to be left on overnight. It is a sealed, maintenance free lead-acid battery.

Your WHEEGO vehicle has a battery monitoring and charging system especially designed for electric vehicle usage.

A full recharge cycle can take approximately 8 hours with a Level 2 charging system (240V), or 24 hours with a standard household outlet (120V). "Opportunity" recharge cycles will be shorter. Charge the batteries after each use of the vehicle. Any time it is possible to have the vehicle plugged in, you should do so.

WARNING

- Improper handling of high voltage wiring, batteries or control systems could result in serious or fatal injury by electric shock.
- Only qualified technicians should repair or access high voltage wiring, battery packs and associated systems.
- Do not attempt to use jumper cables on battery packs.

CAUTION

- Batteries can be permanently damaged (and the warranty voided) if they are allowed to remain 30 days or more with a low charge, or to discharge to under 10% (0% on the BDI gauge).

WARNING

- Improper handling of high voltage wiring, batteries or control systems could result in serious or fatal injury by electric shock.
- Always use insulated tools when working with or near 12v accessory battery.
- Battery fluid is a corrosive acid solution and can burn or even blind you.
- Always wear safety glasses or approved eye protection when servicing the vehicle. Wear a full-face shield and gloves when working with or around batteries and electrical connectors.
- Do not allow battery fluid to contact eyes, skin, or clothing. If acid splashes in eyes or on the skin, flush the area immediately with large quantities of water.
- Battery gas is flammable and explosive. Keep flame or sparks away from the battery or any other booster source.
- Do not allow cable clamps to come in contact with each other.
- 12v battery posts, terminals, and related accessories contain lead and lead compounds. Wash your hands after handling.
- It is essential when replacing the cables on the 12v battery that the positive cable is attached to the positive post and the negative cable is attached to the negative post. Battery posts are identified on the 12v battery case as positive (red ; +) and negative (black ; -). Cable clamps should be tight on the terminal posts and free of corrosion.
- When replacing the 12v battery, always use exactly the same battery model that was removed. Changing the battery type, size, or manufacturer can result in on-standard performance and could void the vehicle warranty.

B. BATTERY DISPOSAL

The 12Volt AGM sealed lead-acid accessory batteries are recyclable. Contact your Wheego dealer for information on recycling your battery. If a battery becomes punctured and leaks, neutralize the spill by placing residue in acid-resistant containers with absorbent material, sand, or earth and dispose in accordance with local, state, and federal regulations for acid and lead compounds.

The Lithium batteries are also recyclable - contact a certified Wheego technician for removal.

Contact your local and/or state environmental officials regarding battery disposal information.

C. BRAKES AND FLUID LEVEL

The vehicle is equipped with a four-wheel hydraulic braking system. The fluid level of your brake system is a very important safety component. The brake fluid reservoir is located under the hood next to the accessory battery.

If the fluid level is below the "MAX" mark, add DOT-3 brake fluid from a sealed container to the reservoir as needed. Always clean the reservoir cap before removing to prevent foreign material from entering the brake lines.



Inspections of the front and rear brakes should be performed according to the maintenance schedule. Brake pads and shoes should be replaced before the thickness is reduced to 1.0mm. The brake pads have built in wear indicators that make a high pitched noise to indicate that the pads are worn and need to be replaced.

The parking brake is adjustable and should be checked periodically by a trained service technician as shown in the vehicle maintenance schedule.

D. TIRES

The standard tire delivered on your Wheego LiFe is a Triangle Tire Talon Sport tubeless steel belted radial tire, Model TR918. The size is 195/50R15. Proper tire inflation is essential to the safe and satisfactory operation of your vehicle.

Three areas are affected by improper tire inflation:

1. Safety

Under-inflation increases tire flexing and can result in tire failure. Over-inflation causes a tire to lose its ability to cushion shock. Objects on the road and potholes could cause tire damage that may result in tire failure. Unequal tire pressure can cause steering problems.

2. Economy

Improper inflation pressures can cause uneven wear patterns to develop across the tire tread. These abnormal wear patterns will reduce tread life, resulting in premature replacement. Under-inflation increases tire rolling resistance, resulting in lower vehicle range.

3. Ride Comfort and Stability

Proper tire inflation contributes to a comfortable ride. Both over-inflation and under-inflation affect the stability of the vehicle and can produce a feeling of sluggish response or over-responsiveness.

WARNING

Improperly inflated tires are dangerous and can cause accidents. Always drive with each tire inflated to the recommended pressure that is shown on the sidewall of the tire. The tires on your WHEEGO vehicle are specifically chosen for this electric vehicle. They should be inspected regularly for damage, wear, and correct inflation pressure as shown in the maintenance schedule. WHEEGO strongly recommends that you use tires equivalent to the originals in quality and performance when replacement is needed. Failure to use equivalent replacement tires may adversely affect the safety, handling, and ride of your vehicle. We recommend that you contact your dealer or WHEEGO customer service regarding any questions you may have on tire specifications or capability. The tire information for your vehicle can be found on the VIN sticker located in the driver's door jamb.

WARNING

- Do not use a tire size other than the one specified on your vehicle's tire label.
- Improperly sized tires can cause vehicle components to wear out prematurely and may change your vehicle's ride, handling, and steering behavior. In addition, it may affect the accuracy of your speedometer and odometer. Using tires sized other than specified on your vehicle's tire label could cause you to lose control, resulting in serious injury or death.
- Never use a tire smaller than the minimum tire size listed on your vehicle's tire label. Using a smaller tire could result in tire overload and failure.
- Failure to equip your vehicle with tires having adequate speed capability can result in sudden tire failure and loss of vehicle control.
- Overloading your tires is dangerous. Like under-inflation, overloading can cause tire failure. Use tires of the recommended load capacity for your vehicle and never overload them.

Tire inflation pressure is shown on the sidewall of the 195/50R15 tires and in the following table:

TIRE AND LOADING INFORMATION			
SEATING CAPACITY	TOTAL 2	FRONT 2	REAR 0
The combined weight of occupants and cargo should never exceed 284kg or 627lbs*			
TIRE	SIZE	COLD TIRE PRESSURE	SEE OWNER'S MANUAL FOR ADDITIONAL INFORMATION
FRONT	195/50R15	51 PSI	
REAR	195/50R15	51 PSI	
SPARE	NONE	NONE	

This table can also be found on a label on the frame of the car inside the driver door.

The following chart shows the recommended tire inflation pressure

Term	Definition	Reading
Cold inflation pressure	Inflation pressure of tire before the car is driven and the tire warms up	51psi
Maximum inflation pressure	The maximum pressure which should be put in the tire	51psi
Recommended inflation pressure	The tire pressure recommended by the tire manufacturer for optimal performance and safety	51psi

Use a tire pressure gauge to determine the pressure of your tires.

When tires are rotated the insides of the tires should stay inside and the outsides on the outside. Left tires should stay on the left side, right side tires on the right. Keep spare as spare.

The following information is imprinted on your tire

Label	Value	Meaning
Tire Manufacturer	Triangle Tire	
Tire Model	Talon Sport	
US DOT Compliance Code	DOT 2VXD wwyj	DOT compliant 2V= Manufacturer is Triangle Tires XD = Manuf. code for this tire Made in "ww" week of "yy" year
Tire construction materials	Tread 4 plies: 1 polyester, 2 steel 1 nylon Sidewall: 1 ply polyester	Describes the content of the "plies" (or layers) of the tire
Tire Size Designation	195/50R15	195 mm wide /Aspect ratio 50 , Radial tire, for 15" rim. Aspect ratio is the ratio of the height of the tire's cross-section to its width. 50 means that the height of the cross-section is equal to 50% of the tire's width
Service Description	82V	82 indicates max load per tire is 1047 lbs V indicates Laboratory max speed 149mph
Construction Type	Tubeless steel belted radial	In Radial tires, the plies run 90° to the direction the tire is rolling
Performance	M+S	Mud + Snow
Treadwear	400	Rating of wear rate in lab tests; 100 is baseline; above 100 is better
Traction	A	Rating of tire's ability to stop on wet pavement in lab tests; A is best.
Temperature	A	Rating of tire's resistance to heat in lab tests; A is best.
N. Amer. Load & Pressure Marking: Max Load Rating	475Kg (1047 lbs)	Load supported by 1 tire at cold inflated pressure under lab conditions
Cold Inflated pressure	51psi	Inflated pressure before car is driven and tires are warmed up (by driving or by sun)
Standard Rim	6J	Fits standard 6" wide rim

TIRE CHANGING/ EMERGENCY REPAIR

Your car comes standard with an emergency tire repair kit rather than a spare tire.

You do not need to jack up the car in order to use the kit. Follow the instructions provided in the tire repair kit to inject a sealant into the tire and re-inflate it while the tire is still on your car.

At the earliest opportunity, you should have the tire inspected and repaired or replaced; the emergency sealant is designed to allow you to safely get off the road and drive to a gas station or other repair location. Contact your WHEEGO Dealer for a replacement tire.

Should you choose instead to change the tire yourself, you need to observe the following precautions:

- Park the vehicle on a firm level surface, avoiding icy or slippery areas.
- Set the parking brake and block both the front and rear of the tire diagonally
- opposite the jacking position. For example, if the left front tire is being changed, block the right rear wheel.
- Use a small floor-style jack or low-profile scissor jack.
- Jack the vehicle only from the side of the vehicle on the main frame rail or from the rear axle.

WARNING

Getting under a jacked-up vehicle is dangerous. The vehicle could slip off of the jack and fall on you. Never get any part of your body under a vehicle that is on a jack. Never start or run the motor when the vehicle is on the jack. If you need to get under the vehicle, make sure the vehicle is first located on a flat solid surface and is supported securely by automotive jack stands of appropriate capacity or take the vehicle to a service center where a technician can put it on a hoist.

Jacking at any location other than a proper jacking point may cause major vehicle body damage.



F. FUSE BLOCKS

The fuse block is located under the hood on the driver's side next to the firewall. A sticker is attached to the inside of the fuse block cover that shows the function and amp rating of the fuses. Should one of the fuses need to be replaced, use a fuse of the same type and amperage rating. The use of a fuse with a rating other than indicated may result in a dangerous electrical system overload. If a properly rated fuse continues to blow, it indicates a problem in the circuit that must be corrected.



A second fuse box is located inside the car, on the driver's side under the dash. A sticker on the cover indicates the function and amp rating of each fuse.

G. KEY REPLACEMENT / KEYFOB BATTERY REPLACEMENT

To obtain an extra or replacement key for your vehicle, please contact your WHEEGO dealer. You will need to have your key code and VIN available when you call. Your local locksmith will not be able to provide a duplicate key.

The key fob uses three CR2016 batteries. To replace the batteries, open the case using a small phillips-head screwdriver. The batteries are stacked discs; slide the batteries out to replace them.



1. Remove screw on the back of the key fob and open the housing.



2. Separate interior circuit board from back housing.



3. Slide out batteries (3) and replace.

H. CARE AND CLEANING

Windows and windshield glass can be cleaned using a liquid household glass cleaner. Do not use abrasive cleaners on the vehicle glass as it can cause scratches. On the interior vinyl panels use a clean damp cloth to remove dust and debris. The seats and carpet may be cleaned using an upholstery cleaner and a clean damp cloth. Test the cleaner in an inconspicuous area to insure compatibility with the vehicle's interior before using on high visibility areas. The best way to preserve your vehicle's exterior finish is to wash and wax the vehicle regularly. Use mild liquid detergents only (no strong soaps or chemical detergents) and rinse promptly. Dry the finish with a soft clean chamois or towel to avoid water scratches and water spotting. To avoid spotting, do not wash the vehicle in direct sunlight.

CAUTION

Do not spray the interior of the vehicle. Water contact with the dash and instrument area could damage the gauges and the electrical system.

I. MAINTENANCE SCHEDULE

Miles in thousands	2.5	5	10	15	20	25	30	35	40	45	50
Parking brake & cable adjustment	I	I	I	I	I	I	I	I	I	I	I
Brake pedal clearance	I	I	I	I	I	I	I	I	I	I	I
Rear wheel brake shoe/drum	I	I	I	I	I	I	I	I	I	I	I
Front wheel brake pad/disc	I	I	I	I	I	I	I	I	I	I	I
Tire pressure and condition	I	I	I	I	I	I	I	I	I	I	I
Tire rotation and balance		I	I	I	I	I	I	I	I	I	I
Traction battery pack	I	I	I	I	I	I	I	I	I	I	I
Accessory battery	I	I	I	I	I	I	I	I	I	I	I
Windshield wiper blades and fluid	I	I	I	I	I	I	I	I	I	I	I
Headlight, taillight and interior bulbs	I	I	I	I	I	I	I	I	I	I	I
Seat belt condition and function	I	I	I	I	I	I	I	I	I	I	I
Brake fluid	I	I	I	I	I	R	I	I	I	I	R
Transmission lubricant	I	R		I		R		I		I	R
Grease fittings	I	L	L	L	L	L	L	L	L	L	L
Steering system	I		I		I		I		I		I
Wheel and lug nuts	I		I		I		I		I		I
AC system, refrigerant and oil	I		I		I		I		I		I
Brake lines	I		I		I		I		I		I
Shock absorbers			I		I		I		I		I
CV shafts and boots				I			I			I	
Airbags – *Replace at 10 years											R*

I = inspect
R = replace
L = lubricate

J. FLUIDS AND LUBRICANTS

Brake fluid DOT-3
Transmission lubricant - 75W85 Castrol PD oil (should not need to be refilled)
AC refrigerant 134a

8. DIAGNOSTICS/TROUBLESHOOTING

NOTE: Should the hazard flashers start to automatically flash after turning the vehicle ON, remove the key from the switch, press the lock button on the key, then press the unlock button, put the key back into the switch and turn the vehicle back ON to restore normal operation of the vehicle.

To access the Diagnostic Screens, place car in Park and turn the car off. Turn the key to **“On”** while pressing the stem on the dashboard for several seconds. Once the Diagnostic Screens are displayed, you can cycle through the screens by pressing the stem. To get out of the Diagnostics, turn the key to Off.

Diagnostic Screens

Battery Diagnostics 1

Field	Value/Range	Meaning/Notes
Pack Voltage	0 to 130V	Normal range is 80 to 130V
DC Current	-500 to 1000 Amps	DC Amps
SOC (State of charge)	0 to 100%	State of Battery Pack Charge, normal is 20 to 100
High Cell Volts	2.00 to 4.55 volts	Highest volt reading of 36 batteries; normal is 2.50 to 3.90V
High Cell	1 to 36	Which battery cell has high volts
Low Cell Volts	2.00 to 4.55 volts	Lowest volt reading of 36 batteries; normal is 2.50 to 3.90V
Low Cell	1 to 36	Which battery cell has low volts
Highest Cells Temp	-50 to 150 °F	Highest battery cell temperature; normal is 1 to 120
Highest Temp Cell ID	1 to 36	Which battery cell has highest temp

Battery Diagnostics 2

Watts per Mile Raw	0 to 32767 W/m	Real time watts per mile calculation without filtering
Watts per Mile	0 to 32767 W/m	Average watts per mile
Miles Remaining	0 to 300 Miles	Estimated miles remaining on charge
Ahrs Remaining	0 to 234 A hrs	Amp-hours remaining in the battery calculated from a maximum of 234 Ahrs
Auxiliary Battery	0 to 20 DC Volts	Reading of auxiliary (accessory) battery: 12.5 to 13.9 volts is normal

Drive System Diagnostics

Motor Temp	-40 to 200°C	Temperature of the motor in °C; normal range max 140
Controller Temp	-40 to 100°C	Temperature of the controller in °C; normal range max 85
Motor RPM	0 to 9000 RPM	Revolutions per minute of the motor in real time
Encoder A	0 to 9000 RPM	Phase A encoder signal
Encoder B	0 to 9000 RPM	Phase B encoder signal
Throttle 1 Voltage	0 to 5.0 Volts	Normal range is .9 to 3.8 Volts
Throttle 2 Voltage	0 to 5.0 Volts	Normal range is .6 to 2.0 Volts
Brake Voltage	0 to 10 Volts	Indicates amount of brake pressure
Controller Fault	0 to 99	Indicates fault code

Climate Control Diagnostics

Temp Set Point	68 to 95°F	Sets desired cabin temperature
Cabin Temperature	0 to 150°F	Shows estimated cabin temperature
Evaporator Temp	-20 to 75°F	Shows the temperature of the AC evaporator
Low Pressure Switch	ON/OFF	ON indicates AC pressure is greater than 15 PSI
AC High Side	0 to 300psi	Shows high side pressure in the AC conditioning system
Compressor Speed	0 to 100%	Indicates the speed of the AC compressor
Condenser Fan	ON/OFF	When ON, the condenser fan is being commanded to run
Blower Input	ON/OFF	Should indicate ON when the cabin blower is running

Charging Diagnostics

J1772 PWM	0 to 50%	Indicates the pilot PWM coming from the charging station
-----------	----------	--

I/O Diagnostics

Field	Value	Meaning
Brake Light Switch	ON/OFF	Should be ON if brake pedal is pressed
Start Switch	ON/OFF	Should be ON when ignition switch is in the Start position
Accel Switch	ON/OFF	Should be ON when Accelerator pedal is pressed
Econo Mode Sw	ON/OFF	Should be ON when E button is pressed
Park Sw	ON/OFF	Should be ON when shifter is in the Park position
Reverse Sw	ON/OFF	Should be ON when shifter is in the Reverse position
Drive Sw	ON/OFF	Should be ON when shifter is in the Drive position
Sport Mode Sw	ON/OFF	Should be ON when shifter is in the Sport position
Motor Cooling Fan	ON/OFF	When ON the motor cooling fan is being commanded to run

Faults

Field	Value	Meaning
Controller Fault	0 to 99	Indicates motor controller fault code
BMS Module Fault	0 to 9	Indicates Battery Management System Module fault
Cell Fault	0 to 36	Indicates a battery module failure
CAN Node Fault	0 to 14	Identifies node failure on the CAN bus

Software

Field	Value	Meaning
OS		Operating System Version in the motor controller
Build Number		Identifies the build number of the operating system
VCL Version		Shows the VCL version installed in the controller
Date code		Shows date the motor controller was manufactured
Serial Number		Unique serial of motor controller

9. CUSTOMER SERVICE & WARRANTY

- A. Wheego LiFe Warranty – 2011/2012/2013 Model Year
 - B. How to obtain service and make a warranty claim
 - C. Scope and limitation on warranty
 - D. Impact of state laws and regulations
 - E. Transfer of warranty
 - F. Disclaimer
-

Owners of a WHEEGO can obtain maintenance and warranty service, if required, from a local WHEEGO Authorized Service Provider, which typically will be the Dealer from whom you purchased your car.

A. WHEEGO LiFe WARRANTY–2011/2012/2013 MODEL YEAR

This information may change. Please refer to the valid warranty in place at the time of your vehicle purchase.

1. WARRANTY COVERAGE

The WHEEGO warranty is that each car will be free from any original defect in parts, materials and workmanship when normally and properly used in accordance with the maintenance and service program contained in the Owner's Manual. This warranty does not in any way cover the normal and usual maintenance of the car including common wear items such as bulbs, wiper blades, brake shoes, brake fluid nor does it cover road hazard damage to glass or tires. Any warranty repair work not performed by an authorized Wheego dealer must be pre-approved by the manufacturer.

2. PARTS WARRANTY

All car parts which are found to be defective under normal use and maintenance will be repaired or replaced through an authorized dealer without charge for parts during the **36 Month, 36,000 miles** (whichever comes first) PARTS warranty period. The lithium battery pack is covered for **48 months, 60,000 miles** (whichever comes first) PARTS warranty period. An extended warranty is available offering an additional **24 months/40,000 miles** (whichever comes first) warranty for the battery pack at an MSRP of \$1995.00.

3. LABOR WARRANTY

All car labor which is required to repair the car other than normal use and maintenance items will be covered through an authorized dealer without charge for labor during the **36 Month, 36000 miles** (whichever comes first) LABOR warranty period.

The lithium battery pack is covered for **48 months, 60,000 miles** (whichever comes first) LABOR warranty period. An extended warranty is available offering an additional **24 months/40,000 miles** (whichever comes first) warranty for the battery pack at an MSRP of \$1995.00.

4. WARRANTY PERIOD RENTAL USE OWNERS

The entire car warranty (parts and labor) shall run for a period of 90 days from the date of delivery to rental use owners. Extended Service Contracts are not available to rental use owners.

5. EXCLUSIONS FROM WARRANTY COVERAGE

Warranty coverage will not in any event cover:

- o Damage, loss or failure by reason of uses of the car for which it was not intended or designed by the manufacturer.
- o Events occurring or damage or failure by reason of alteration of the car in any way whatsoever.
- o Damage, loss or failure occasioned by dangerous or reckless use.
- o Events occurring or damage or failure by reason of not following the maintenance and service suggestions and requirements set forth in the Owner's Manual.

- o Wear, tear and failure through normal operation to parts such as wiper blades, trims or decals, light bulbs, mats, carpeting, upholstery, seat coverings, tires and brake shoes.
- o Parts which may rust or deteriorate or deterioration of finish or surfaces due to exposure to the elements.
- o Damage or failure from unauthorized repairs or use of non-genuine parts.
- o Damage or loss resulting from causes force majeure, accident, theft, fire, collision or acts of war, terrorism or vandalism.
- o Misuse or tampering with the car or any of its constituent parts.
- o All normal wear and tear and scratches or damage to plastic or metal finish.
- o Use of the car to tow trailers or other cars or to push other vehicles.
- o Damage or loss caused by tire puncture or failure to maintain correct tire pressure.
- o Road hazard damage to glass or tires.
- o The cost of manufacturer's suggested initial and periodic check up and maintenance procedures (see Owner's Manual Maintenance section).
- o Lack of achieving advertised performance parameters due to the variability of driving conditions.
- o Damage due to airborne chemicals, tree sap, road debris (including stone chips), rail dust, salt, hail, floods, wind storms, lightening and other environmental conditions, or water contamination.
- o Failure to keep batteries properly charged.
- o Damage caused by water or other liquid entering the battery compartment.
- o Discharged batteries that can be recharged and returned to service.
- o Rust on the body of the vehicle.

Scope & Limitation on Warranty

WHEEGO makes no warranty of any kind express or implied which exceeds the warranty or time limits expressly stated herein and no representation or agreements to the contrary by any person may vary or alter the terms of this warranty. Our only liability under this warranty is limited to the repair and replacement described herein, and WHEEGO shall not be held liable for any implied warranty or incidental or consequential damages including loss to person or property or loss of use of the car.

Impact of State Laws & Regulations

Some states have laws which may impact limitation of warranties, exclusions for incidental or consequential damages or fees upon transfer of warranty. Accordingly, some limitations or exclusions or fees contained herein may not apply to you or your car.

Transfer of Warranty

Upon the sale or transfer of a Wheego, the original owner may transfer this Warranty in accordance with Company procedures for a fee of \$100.00. Please see your dealer for details.

Disclaimer

In no event shall Wheego Electric Cars or any of its affiliates be liable for any incidental, special, consequential or punitive damages, or for any costs, attorney fees, expenses, losses or delays alleged to be as a consequence of any damage to, failure of, or defect

in any product including, but not limited to, any claims for loss of profits. This warranty is exclusive and in lieu of all other warranties or conditions, written or oral, expressed or implied. Without limiting the generality of the foregoing, Wheego Electric Cars disclaims any implied warranty of merchantability or fitness for a particular use or purpose, and all other warranties, and any implied warranty of merchantability or fitness for a particular purpose applicable to the vehicle. The remedy provided above is the exclusive remedy under this written warranty or any implied warranty.

B. HOW TO OBTAIN SERVICE

Warranty Service can be obtained from your local authorized Wheego Electric Cars Dealer and it may be the dealer from whom you purchased your vehicle, or from an authorized Wheego Electric Cars service provider.

Fleets and other multiple vehicle owners can elect to have warranty repairs and remediation performed by their own or designated mechanics who have been certified by the company to perform warranty services.

Warranty Parts and prior approval of Warranty Service can be obtained by contacting the Company in the manner set forth under “Making a Warranty Claim” below.

HOW TO OBTAIN SERVICE AND MAKE A WARRANTY CLAIM

Warranty service can be obtained from your local authorized WHEEGO Dealer which typically will be the Dealer from whom you purchased your car. Owners desiring to make a warranty claim may do so through an authorized WHEEGO dealer, service provider or by contacting Wheego Electric Cars. Manufacturer is not responsible for loss of use or transportation costs to dealer or repair facility.

Owners desiring to make a Warranty Claim directly to WHEEGO should do so at:

National Parts and Service Department
Wheego Electric Cars, Inc.
888 3rd Street NW
Atlanta, GA 30318

Phone 678 904 4795 x3
Fax 678 904 4791
warranty@wheego.net
wheego.net

Please send requests to the Wheego National Parts and Service Manager by email to **warranty@wheego.net** to obtain faster service.

Wheego Electric Cars will promptly address the matter and take the necessary remedial action under the terms and conditions of its warranty policy.

C. SCOPE AND LIMITATION ON WARRANTY

WHEEGO makes no warranty of any kind express or implied which exceeds the warranty or time limits expressly stated herein and no representation or agreements to the contrary by any person may vary or alter the terms of this warranty.

Our only liability under this warranty is limited to the repair and replacement described herein, and WHEEGO shall not be held liable for any implied warranty or incidental or consequential damages including loss to person or property or loss of use of the car.

D. IMPACT OF STATE LAWS AND REGULATIONS

Some states have laws which may impact limitation of warranties, exclusions for incidental or consequential damages or fees upon transfer of warranty. Accordingly, some limitations or exclusions or fees contained herein may not apply to you or your car.

E. TRANSFER OF WARRANTY

Upon the sale or transfer of a Wheego, the original owner may transfer this Warranty in accordance with Company procedures for a fee of \$100.00. Please see your Dealer for details.

F. DISCLAIMER

In no event shall Wheego Electric Vehicles or any of its affiliates be liable for any incidental, special, consequential or punitive damages, or for any costs, attorney fees, expenses, losses or delays alleged to be as a consequence of any damage to, failure of, or defect in any product including, but not limited to, any claims for loss of profits. This

warranty is exclusive and in lieu of all other warranties or conditions, written or oral, expressed or implied. Without limiting the generality of the foregoing, Wheego Electric Cars disclaims any implied warranty of merchantability or fitness for a particular use or purpose, and all other warranties, and any implied warranty of merchantability or fitness for a particular purpose applicable to the vehicle. The remedy provided above is the exclusive remedy under this written warranty or any implied warranty.

10. VEHICLE IDENTIFICATION AND SPECIFICATIONS

VEHICLE IDENTIFICATION

For all model vehicles, the vehicle identification number (VIN) can be found on the VIN plate, located on the driver's side of the dashboard. The VIN indicates the model year, model type and the serial number of the vehicle. It can also be found on the information label inside the driver's door jamb.

NOTE

Record the VIN on the first page of this manual for easy reference.

GENERAL SPECIFICATIONS WHEEGO LiFe

Motor: AC50 Brushless

Radial Tires: 195/50/R15

Battery Pack: 115V Lithium; 36 cells, 3.2V each; 260 AH; 30 kwh

Onboard Chargers: Three Delta-Q Fully Automatic; 27 amps combined

Vehicle Width: 63.19 inches

Vehicle Length: 118.90 inches

Vehicle Height: 62.99 inches

Wheelbase: 79.74 inches

Turning Circle (the diameter of a circle required to make a U-turn maneuver): 362.2 inches

The curb weight, GVWR and payload may be found on the placard on the frame of the car inside the driver's door.

The Federal Motor Vehicles Safety Standards provide the following Steps for Determining Correct Load Limit:

- (1) Locate the statement "The combined weight of occupants and cargo should never exceed XXX kg or XXX lbs." on your vehicle's placard.
- (2) Determine the combined weight of the driver and passengers that will be riding in your vehicle.
- (3) Subtract the combined weight of the driver and passengers from XXX kg or XXX lbs.
- (4) The resulting figure equals the available amount of cargo and luggage load capacity. For example, if the "XXX" amount equals 1400 lbs. and there will be five 150 lb. passengers in your vehicle, the amount of available cargo and luggage load capacity is 650 lbs. (1400-750 (5 x 150) = 650 lbs.)

(5) Determine the combined weight of luggage and cargo being loaded on the vehicle. That weight may not safely exceed the available cargo and luggage load capacity calculated in Step 4.

(6) If your vehicle will be towing a trailer, load from your trailer will be transferred to your vehicle. Consult this manual to determine how this reduces the available cargo and luggage load capacity of your vehicle.

For the Wheego Life, the following load limits apply.

Curb Weight (weight of the car with no passengers or cargo): approximately 2,828 lbs.

Gross Vehicle Weight Rating (GVWR): approximately 3,300 lbs. Must not be exceeded. The GVWR is the actual weight of the vehicle including the weight of the entire payload of options, passengers, and cargo.

Payload Capacity: approximately 627 lbs. (options + passengers + cargo). For example, if the driver and passenger each weigh 175 pounds for a total of 350 pounds, the cargo space may hold a maximum of 277 pounds. If there is no extra passenger, the driver may pack 452 pounds of cargo. Exceeding the weight restrictions will have a negative impact on the handling of the car, and on the ability of the car to stop quickly. It will also impact the reliability and life of the tires. Do not exceed the GVWR.

Maximum passengers: 2, including the driver. Passengers may not ride in the cargo area.

INDEX

12V Battery Jack - 20, 34

A

A/C Light - 21

Adjustable Bucket Seats - 48

Airbag Light - 22

Airbag System - 35, 59, 60

Amp meter - 18

Anti-lock Braking System - 22

Apply Brake Light - 21

B

Battery - 6, 7, 9, 10, 30, 61, 72-76

Battery Disposal - 76

BDI Gauge - 18

Brakes - 76-78

Brake Fluid - 76, 77

Bright Light Indicator

C

Cautions - 7, 23, 29, 30, 62, 66, 72, 74, 89

Charging - 62-67

Charging Cable - 62, 63

Charge Light - 20, 30

Child Restraints - 54-59

Cleaning - 89

Console D-pad controller - 24

Console Menu - 25

Console Settings - 23-25

Consumer Information - 8

Customer Service - 97-107

D

Dashboard - 14-25

Diagnostics - 92-96

Diagram - 71

Door Locks - 39

INDEX

Door Open Light - 22

Drivers forum - 2

E

EasyCare - 3

Eco-Meter - 19

F

First Responder Info - 111

Fluids - 91

Foot Pedals - 46

Fuses - 86, 87

EPS Light - 21

H

Hazard Light - 20, 28

Head Rests - 49

Heater Light - 21

I

Impact Sensor - 61

Indicator Lights - 20-22

Interior Dome Light - 36

Introduction - 5, 6, 7

K

Key Fob - 12, 13, 88

Key Switch - 30

L

Lights - 26

Long Term Storage - 66

Low Brake Fluid Light - 22

Low Charge Light - 22

Lubricants - 91

INDEX

M

Maintenance - 90

Mirror Controls - 39

N

Notes - 7, 45

O

Odometer - 17

Operating Sequence - 68

P

Parking Brake On Light - 22

Power Assisted Windows - 38

Power conserve Mode - 69

R

Radio - 37

Range - 67

Rear Defrost - 34

Roadside Assistance - 3

S

Safety Information - 9, 10

Seatbelts - 21, 50-54

Seats - 47-49

Service Light - 20

Shifter - 42-45

Specifications - 106, 107

Speedometer - 16

T

Table of Contents - 4

Tires - 21, 31, 78-85

Tire Changing - 84

Tire Pressure Monitoring Light - 21, 31

Transporting Your Vehicle - 69

Troubleshooting - 92-96

Turn Signal - 20, 26, 27

INDEX

V

Vehicle Identification Number (VIN) - 2, 105

Vehicle Maintenance - 70

Ventilation Controls - 32, 33

Volt Meter - 19

W

Warnings - 5, 7, 9, 10, 11, 30, 45, 46, 50,
52-54, 66, 74, 75, 79, 80, 85

Warranty - 97-107

Window Controls - 38

Windshield Wipers - 28



NOTICE TO FIRST RESPONDERS

Emergency Power Disconnect Instructions for EMT Personnel

- Always assume the vehicle is powered-up despite no engine noises.
- Never touch, cut, or open any orange cable or components protected by orange shields.

To disconnect main power in the Wheego LiFe:

1. Put vehicle in park, turn ignition off, and remove key.
2. Open the hood. The hood release is located to the left of the brake pedal in front of the driver's door.
3. Locate the disconnect on the passenger side of the control box, shown circled in the picture.
4. Squeeze latch and remove disconnect jumper.



The power from the lithium battery pack has now been disconnected from the main power cables that run from the back to the front of the car.
(no pack voltage power is present in the front of the car)

Note: This car is equipped with an Impact Sensor that automatically cuts off power in the event of an impact of 30G or greater, and/or airbag deployment.
If the Impact Sensor was tripped during the collision, the power will already be disconnected.

The 12 volt accessory battery is located in the front of the car; the 12 volt circuits will not be affected by disconnecting the jumper.

Wheego wants to make the best electric cars in the world and educate everyone as to the practical benefits of owning and driving one. We don't aspire to be the biggest car company, or make the fastest cars. We want to make safe, reliable and fun products without compromise. We won't hype or exaggerate the capabilities of our electric cars. We want our customers to be happy and smart advocates for electric cars.

wheego.net

wheego electric cars inc

Drive Change

888 3RD STREET NW ATLANTA GA 30318 678 904 4795 INFO@WHEEGO.NET

