

# African Journal of Agricultural Research

Volume 11 Number 3 21 January 2016

ISSN 1991-637X



*Academic  
Journals*

## ABOUT AJAR

The African Journal of Agricultural Research (AJAR) is published weekly (one volume per year) by Academic Journals.

African Journal of Agricultural Research (AJAR) is an open access journal that publishes high-quality solicited and unsolicited articles, in English, in all areas of agriculture including arid soil research and rehabilitation, agricultural genomics, stored products research, tree fruit production, pesticide science, post harvest biology and technology, seed science research, irrigation, agricultural engineering, water resources management, marine sciences, agronomy, animal science, physiology and morphology, aquaculture, crop science, dairy science, entomology, fish and fisheries, forestry, freshwater science, horticulture, poultry science, soil science, systematic biology, veterinary, virology, viticulture, weed biology, agricultural economics and agribusiness. All articles published in AJAR are peer-reviewed.

### Contact Us

**Editorial Office:** [ajar@academicjournals.org](mailto:ajar@academicjournals.org)

**Help Desk:** [helpdesk@academicjournals.org](mailto:helpdesk@academicjournals.org)

**Website:** <http://www.academicjournals.org/journal/AJAR>

**Submit manuscript online** <http://ms.academicjournals.me/>

## Editors

### **Prof. N.A. Amusa**

Editor, African Journal of Agricultural Research  
Academic Journals.

### **Dr. Panagiota Florou-Paneri**

Laboratory of Nutrition,  
Faculty of Veterinary Medicine,  
Aristotle University of Thessaloniki,  
Greece.

### **Prof. Dr. Abdul Majeed**

Department of Botany, University of Gujrat, India,  
Director Horticulture,  
and landscaping.  
India.

### **Prof. Suleyman TABAN**

Department of Soil Science and Plant Nutrition,  
Faculty of Agriculture,  
Ankara University,  
06100 Ankara-TURKEY.

### **Prof. Hyo Choi**

Graduate School  
Gangneung-Wonju National University  
Gangneung,  
Gangwondo 210-702,  
Korea.

### **Dr. MATIYAR RAHAMAN KHAN**

AICRP (Nematode), Directorate of Research,  
Bidhan Chandra Krishi  
Viswavidyalaya, P.O. Kalyani, Nadia, PIN-741235,  
West Bengal.  
India.

### **Prof. Hamid AIT-AMAR**

University of Science and Technology,  
Houari Bouemdiene, B.P. 32, 16111 EL-Alia, Algiers,  
Algeria.

### **Prof. Sheikh Raisuddin**

Department of Medical Elementology and  
Toxicology, Jamia Hamdard (Hamdard University)  
New Delhi,  
India.

### **Prof. Ahmad Arzani**

Department of Agronomy and Plant Breeding  
College of Agriculture  
Isfahan University of Technology  
Isfahan-84156,  
Iran.

### **Dr. Bampidis Vasileios**

National Agricultural Research Foundation (NAGREF),  
Animal Research Institute 58100 Giannitsa,  
Greece.

### **Dr. Zhang Yuanzhi**

Laboratory of Space Technology,  
University of Technology (HUT) Kilonkallio Espoo,  
Finland.

### **Dr. Mboya E. Burudi**

International Livestock Research Institute (ILRI)  
P.O. Box 30709 Nairobi 00100,  
Kenya.

### **Dr. Andres Cibils**

Assistant Professor of Rangeland Science  
Dept. of Animal and Range Sciences  
Box 30003, MSC 3-I New Mexico State University Las  
Cruces,  
NM 88003 (USA).

### **Dr. MAJID Sattari**

Rice Research Institute of Iran,  
Amol-Iran.

### **Dr. Agricola Odoi**

University of Tennessee, TN.,  
USA.

### **Prof. Horst Kaiser**

Department of Ichthyology and Fisheries Science  
Rhodes University, PO Box 94,  
South Africa.

### **Prof. Xingkai Xu**

Institute of Atmospheric Physics,  
Chinese Academy of Sciences,  
Beijing 100029,  
China.

### **Dr. Agele, Samuel Ohikhena**

Department of Crop, Soil and Pest Management,  
Federal University of Technology  
PMB 704, Akure,  
Nigeria.

### **Dr. E.M. Aregheore**

The University of the South Pacific,  
School of Agriculture and Food Technology  
Alafua Campus,  
Apia,  
SAMOA.

## Editorial Board

**Dr. Bradley G Fritz**

Research Scientist,  
Environmental Technology Division,  
Battelle, Pacific Northwest National Laboratory,  
902 Battelle Blvd., Richland,  
Washington,  
USA.

**Dr. Almut Gerhardt**

LimCo International,  
University of Tuebingen,  
Germany.

**Dr. Celin Acharya**

Dr. K.S.Krishnan Research Associate (KSKRA),  
Molecular Biology Division,  
Bhabha Atomic Research Centre (BARC),  
Trombay, Mumbai-85,  
India.

**Dr. Daizy R. Batish**

Department of Botany,  
Panjab University,  
Chandigarh,  
India.

**Dr. Seyed Mohammad Ali Razavi**

University of Ferdowsi,  
Department of Food Science and Technology,  
Mashhad,  
Iran.

**Dr. Yasemin Kavdir**

Canakkale Onsekiz Mart University,  
Department of Soil Sciences,  
Terzioğlu Campus 17100  
Canakkale  
Turkey.

**Prof. Giovanni Dinelli**

Department of Agroenvironmental Science and  
Technology  
Viale Fanin 44 40100,  
Bologna  
Italy.

**Prof. Huanmin Zhou**

College of Biotechnology at Inner Mongolia  
Agricultural University,  
Inner Mongolia Agricultural University,  
No. 306# Zhao Wu Da Street,  
Hohhot 010018, P. R. China,  
China.

**Dr. Mohamed A. Dawoud**

Water Resources Department,  
Terrestrial Environment Research Centre,  
Environmental Research and Wildlife Development Agency  
(ERWDA),  
P. O. Box 45553,  
Abu Dhabi,  
United Arab Emirates.

**Dr. Phillip Retief Celliers**

Dept. Agriculture and Game Management,  
PO BOX 77000, NMMU,  
PE, 6031,  
South Africa.

**Dr. Rodolfo Ungerfeld**

Departamento de Fisiología,  
Facultad de Veterinaria,  
Lasplaces 1550, Montevideo 11600,  
Uruguay.

**Dr. Timothy Smith**

Stable Cottage, Cuttle Lane,  
Biddestone, Chippenham,  
Wiltshire, SN14 7DF.  
UK.

**Dr. E. Nicholas Odongo,**

27 Cole Road, Guelph,  
Ontario. N1G 4S3  
Canada.

**Dr. D. K. Singh**

Scientist Irrigation and Drainage Engineering Division,  
Central Institute of Agricultural Engineering  
Bhopal- 462038, M.P.  
India.

**Prof. Hezhong Dong**

Professor of Agronomy,  
Cotton Research Center,  
Shandong Academy of Agricultural Sciences,  
Jinan 250100  
China.

**Dr. Ousmane Youm**

Assistant Director of Research & Leader,  
Integrated Rice Productions Systems Program  
Africa Rice Center (WARDA) 01BP 2031,  
Cotonou,  
Benin.

# African Journal of Agricultural Research

Table of Contents: Volume 11 Number 3, 21 January, 2016

## ARTICLES

- Infection, colonization and growth-promoting effects of tea plant (*Camellia sinensis* L.) by the endophytic bacterium *Herbaspirillum* sp. WT00C** 130  
Guiting Zhan, Wei Cheng, Weilin Liu, Yadong Li, Kunming Ding, Huifu Rao, Wenhua Wu and Xingguo Wang
- Evolution and impacts of groundnut research and development in Malawi: An ex-post analysis** 139  
Takuji W. Tsusaka, Harry W. Msere, Moses Siambi, Kizito Mazvimavi and Patrick Okori
- Study of an electromechanical system for solid fertilizer variable rate planting** 159  
Joao Roberto Sartori Moreno, Conrado Di Raimo, Romeu Rony da Costa Cavalcanti, Marcio Aurelio Montezuma and Edson Antonio Capello de Souza
- Tomato (*Solanum lycopersicum*) hybrid Hermosa indeterminate study of yield and fruit quality under greenhouse conditions responding at organic manure application** 166  
Pedro V. Vázquez, Manuel E. Morales Rubio and Merle C. Navarro Cortez
- Agricultural extension for enhancing productivity and poverty alleviation in small scale irrigation agriculture for sustainable development in Ethiopia** 171  
Aklilu Nigussie, Abiy Adisu, Kidane Desalegn and Arkebe Gebreegziabher
- Treatment of sewage sludge with the use of solarization and sanitizing products for agricultural purposes** 184  
Amilton Alves Filho, Reginaldo de Camargo, Regina Maria Quintão Lana, Márcia Regina Batistela Moraes, Alírio Coromoto Daboin Maldonado and Roberto Terumi Atarasi
- Correlation of viral load with lesion severity in field pigs affected with porcine circovirus type 2** 192  
Yong Li, Kenji Kawashima and Ken Katsuda

ARTICLES

**Nitrogen metabolism in sorghum under salinity and silicon treatments in Brazil** 199

Luma Castro de Souza, Ellen Gleyce da Silva Lima, Risely Ferraz de Almeida, Myriam Galvão Neves, Glauco Andre dos Santos Nogueira and Cândido Ferreira de Oliveira Neto

**Quality index method (QIM) and quantitative descriptive analysis (QDA) of Nile tilapia (*Oreochromis niloticus*) quality indices** 209

Tatiana Pacheco Rodrigues, Eliane Teixeira Mársico, Robson Maia Franco, Sílvia Conceição Reis Pereira Mello, Ivone Costa Soares, Natália Oliveira Cavalcanti Zúniga and Mônica Queiroz de Freitas



Full Length Research Paper

# Infection, colonization and growth-promoting effects of tea plant (*Camellia sinensis* L.) by the endophytic bacterium *Herbaspirillum* sp. WT00C

Guiting Zhan<sup>1</sup>, Wei Cheng<sup>1</sup>, Weilin Liu<sup>1</sup>, Yadong Li<sup>1</sup>, Kunming Ding<sup>2</sup>, Huifu Rao<sup>2</sup>, Wenhua Wu<sup>1</sup> and Xingguo Wang<sup>1\*</sup>

<sup>1</sup>The Faculty of Life Science, Hubei Collaborative Innovation Center for Green Transformation of Bioresources, Hubei University, China.

<sup>2</sup>Xianning Academy of Agricultural Science, Xianning city, Hubei province, China.

Received 2 September, 2015; Accepted 16 October, 2015

The endophytic *Herbaspirillum* sp. WT00C, isolated from tea plant, seems to have a potential ability to promote tea-plant rooting and budding due to its capability of producing indole-3-acetic acid (IAA), ammonia and siderophores. Thus, the present study was aimed to verify whether this bacterium could be used for tea cultivation as an environment-friendly bioaccelerator. To evaluate its potential use in promoting tea-plant rooting and bud growth, *Herbaspirillum* sp. WT00C was characterized using several methods. Observation by bacterial infection found that the bacterium only went into plants via plant vulnus when irrigation, sprinkling and traumatic infection were applied. Whatever irrigation, sprinkling or traumatic infection was applied, all tea plant, vegetables, rice and wheat tested in this study did not show any growth inhibition or disease symptom. Observation by bacterial count test also found that the bacterium colonized only in tea plant, but not in vegetables, rice or wheat. To test the effect of *Herbaspirillum* sp. WT00C on tea-cutting rooting and budding, tea cuttings were soaked with the diluted bacterial culture. Observation at 280 day postinoculation found that the tea-seedling rate approached to 100%, and average newborn shoot length and lateral root number of tea seedlings increased 88% compared to control groups. In addition, the bacterium was found only in those tea cuttings treated with the bacterium, but not in their newborn shoots and leaves. Inoculating the bacterium to the upper incision of tea twigs in the field also enhanced the growth of newborn shoots. Our studies demonstrated that *Herbaspirillum* sp. WT00C was a tea-specific endophyte with the ability to stimulate the lateral root formation and bud growth of tea cuttings, and paved the way for its application in propagation of tea cuttage as a novel bioaccelerator.

**Key words:** Endophytic bacterium, bioaccelerator, tea cottage, traumatic infection, adventitious root formation.

## INTRODUCTION

*Herbaspirillum* sp. WT00C, isolated from *Camellia sinensis* L., was classified as a novel member in the genus

*Herbaspirillum* based on its physiochemical characteristics and 16S ribosomal DNA (rDNA) sequence (Wang et al.

\*Corresponding author. E-mail: [xgwang@hubu.edu.cn](mailto:xgwang@hubu.edu.cn), Tel: +027-88661237-8066. Fax: +027-88663110.

Author(s) agree that this article remain permanently open access under the terms of the [Creative Commons Attribution License 4.0 International License](https://creativecommons.org/licenses/by/4.0/)

2014). Different from *Herbaspirillum seropedicae*, *Herbaspirillum frisingense* and *Herbaspirillum lusitanum* able to fix nitrogen (Baldani et al., 1986; Kirchhof et al., 2001; Valverde et al., 2003), *Herbaspirillum* sp. WT00C did not exhibit any nitrogen-fixing activity. However, this endophytic bacterium was able to produce indole-3-acetic acid (IAA), ammonia and siderophores (Wang et al., 2014). IAA, ammonia and siderophores have been thought to play a role in inducing adventitious root formation in dicots or monocots and improving plant growth and development (Glick 2012; Phillips et al., 2011; McSteen, 2010; Dubis et al., 2003; Temple et al., 1998; Neilands, 1995; Barton and Hemming, 1993). In view of its physiochemical properties, *Herbaspirillum* sp. WT00C may perhaps be useful in tea cultivation.

*C. sinensis* (L.) is native to East, South and Southeast Asia, but it is today cultivated across the world in tropical and subtropical regions. Two principal varieties, the small-leaved Chinese variety plant (*C. sinensis* var. *sinensis*) and the large-leaved Assamese plant (*C. sinensis* var. *assamica*), are mainly used for production of white tea, yellow tea, green tea, black tea or twig tea. Although *C. sinensis* can perform sexual reproduction, farmers usually propagate them via asexual manner in order to maintain genetic homogeneity of tea offspring. Many strains and clonal varieties used currently in tea gardens have been established with the superior clones selected from native population. Since 1960s, vegetative propagation has widely been used for rapid production of tea seedlings in tea plantations (Choubey et al., 2013). However, a major problem faced by farmers is low seedling rate during vegetative propagation. Raising success rate in tea-cuttage propagation is a crucial issue, especially for those high-quality tea strains. Thus, there is an urgent need for new environmental-friendly techniques.

Although the endophytic *Herbaspirillum* sp. WT00C had a great potential as a bio-accelerator, its efficient route of infection, host-spectrum, pathogenicity, and effectiveness of promoting tea-plant rooting and budding were unclear. In this study, our aims were twofold: first, to investigate the infection mode, host-spectrum and pathogenicity of *Herbaspirillum* sp. WT00C, and second, to examine effectiveness of inducing lateral-root formation and bud growth in order to verify whether the bacterium can be really used as an environment-friendly bioaccelerator for tea cultivation. In our study, we found that *Herbaspirillum* sp. WT00C entered plants via traumatic infection, but did not cause any noticeable disease symptom. The bacterium colonized only in tea plant, other than in other crops. Furthermore, we also showed that *Herbaspirillum* sp. WT00C significantly enhances rooting and bud growth of tea cuttings. These characteristics of *Herbaspirillum* sp. WT00C appear to satisfy basic conditions required for a green bioaccelerator. Our study paves the way for application of the endophytic bacterium *Herbaspirillum* sp. WT00C to raise the success rate in tea cuttage or stimulate bud

growth in tea cultivation.

## MATERIALS AND METHODS

### Bacterial culture

*Herbaspirillum* sp. WT00C was isolated from *C. sinensis* (L.) and stored in our laboratory. It was routinely cultured in Luria Bertani (LB) medium supplemented with 10 µg/ml spectinomycin and 10 µg/ml ampicillin at 37°C unless otherwise stated. In a large-scale preparation, the stock culture was inoculated into 5 ml LB medium with two specific antibiotics, and incubated at 37°C overnight. Then bacterial culture was transferred into 500 ml fresh LB medium containing the same antibiotics and grown at 37°C until OD<sub>600</sub> (optical density at 600 nm) of 1.0.

### Construction of the *Herbaspirillum* sp. WT00C strain with strong ampicillin resistance

*Herbaspirillum* sp. WT00C only displayed low resistance (10 µg/ml) against spectinomycin and ampicillin. Such low antibiotic resistance was not suitable for investigating bacterial invasion route and colonization. To enhance the ampicillin resistance of *Herbaspirillum* sp. WT00C, a pUC18 plasmid was introduced into the bacterium via electroporation. Competent cells were made using glycerol according to the standard process (Sambrook et al., 2001). Electroporation was performed on an electroporator (Electroporator 2510, Eppendorf). After electroporation, bacterial cells were incubated in nutrient broth (0.5% peptone, 0.3% beef extract, 0.5% NaCl) at 37°C for 1 h, spread on nutrient agar plates (nutrient broth plus 1.5% agar) containing 10 µg/ml spectinomycin and 100 µg/ml ampicillin, and grown at 37°C for 24 h. Bacterial colonies with ampicillin and spectinomycin resistance were picked out, and further confirmed by checking the pUC18 DNA. The plasmid DNA was extracted from each colony and examined on 10% agarose gel according to the standard method (Sambrook et al., 2001). The strain with strong ampicillin resistance was only used to investigate the route of bacterial invasion or colonization in this study.

### IAA color assay

IAA was determined *in vitro* based on the method reported previously (Brick et al., 1991; Holt et al., 1994). Briefly, bacterial culture was inoculated in LB broth containing 10 µg/ml spectinomycin and 10 µg/ml ampicillin at 37°C until OD<sub>600</sub> of 0.6. Then, 50 µl bacterial culture was inoculated into 5 ml LB medium described above plus 1 µg/ml L-tryptophan. After incubated at 37°C until OD<sub>600</sub> of 1.0, bacterial cultures were centrifuged at 3000 rpm for 30 min. The supernatant (1 ml) was taken and mixed with 4 ml of Salkowski's reagent (35% perchloric acid, 10 mM FeCl<sub>3</sub>), and then the mixture was placed in a dark room for 20 min. The color intensity was recorded at 530 nm on a spectrophotometer (Shimadzu UV-2550). All data were collected from three replications.

### Test of inoculation modes

Three different methods, irrigation, sprinkling and traumatic infection were used to test how *Herbaspirillum* sp. WT00C invaded tea plants. Tea plants were cultivated in pots located in a greenhouse. All experiments were divided into 4 groups, and each group had 10 tea seedlings. When the height of tea seedlings in pots approached to 15 to 20 cm, equal amount of bacteria (3.02 ×



$10^{10}$ cfu) was poured into pots at tea roots or sprayed over tea leaves. In traumatic infection, a hole on the tea stem at 4 cm above the roots was firstly made using a sterile needle, and then the wound was covered by a piece of cotton wool containing the bacterial culture ( $2.72 \times 10^8$ cfu). Equal volume of deionized water (dH<sub>2</sub>O) was used in each control group. The bacterial dosage was used referring to previous research reports (Berta et al., 2014; Straub et al., 2013; Stefan et al., 2013). After treatments, the roots, leaves and stems including upper stem (2 cm above the inoculation point), lower stem (2 cm below the inoculation point) and inoculation-point zone were collected at predefined intervals, and *Herbaspirillum* sp. WT00C inside different organs of tea seedlings was examined according to the standard protocol used for isolation of an endophytic bacterium. In brief, tea samples were firstly soaked in 75% ethanol for 4 min, washed 3 times with sterile water, and then soaked in 0.1% mercuric chloride for 1 min. Finally, all samples were washed 5 times with sterile water until no bacterium grew in the final wash. For qualitative assay, the sterilized roots, stems or leaves were cut into thin slices (0.5 cm thickness) by a blade, and then thin slices were placed on LB plates containing 10 µg/ml spectinomycin and 100 µg/ml ampicillin. After incubation at 37°C for 48 h, bacterial growth around each thin slice was observed by eye. For quantitative assay, different parts of tea plants were grinded in PBS (phosphate buffer saline) to homogenate in a glass grinder under aseptic condition, and then 200 µl of homogenate was taken to spread LB plates with two antibiotics, and all plates were incubated at 37°C for 48 h. Finally, bacterial colonies were counted. Bacterial content was calculated based on the following formula, in which the colony number was an average obtained from triplicate tests.

$$\text{Number of bacteria per gram of tissue} = \frac{\frac{\text{the number of colony-forming units}}{\text{the volume for plating (ml)}} \times \text{total volume of sample (ml)}}{\text{the weight of tissue (g)}}$$

### Inoculation test of tea cuttings

The experiment was conducted at the tea farm of Xianning Academy of Agriculture Science. *C. sinensis* cv. Echa 1 was used as parent materials in tea-cuttage propagation. Tea shoots were cut into two parts: tender green-cutting (upper part) and hard red-cutting (lower part). Each cutting carried a single node with a leaf and its length was about 5 cm. Tea cuttings including tender green-cutting in group A and hard red-cutting in group B were separately soaked in the bacterial culture diluted by H<sub>2</sub>O (2:1) for 1 to 3 h. In the control group, tea cuttings were soaked in water under the same condition. In each group, 200 tea cuttings were used. After treated, all tea cuttings were taken out and dried for a while until no liquid dropped down. Finally, tea cuttings were immediately planted in the nursery, and the field management was done according to the routine method for tea-cuttage propagation. The growth of tea seedlings was observed and recorded at predefined intervals. Data were analyzed via SPSS software, and analysis of variance (ANOVA) gave P values of less than 0.05 in each case.

### Inoculation test of tea twigs

To further confirm if the bacterium really stimulates growth of tea buds, tea twigs in the tea garden were pruned with a trimmer, and then 20 µl of the bacterium culture with different dilutions (0.5 to 2:1) was inoculated to each incision on the top of 500 twigs of tea bush. Initial concentration of bacterial cells was  $7.14 \times 10^7$  cfu/ml. The content of bacterial cells inoculated in each group was  $9.5 \times 10^5$ cfu for 2:1 dilution,  $7.14 \times 10^5$ cfu for 1:1 dilution, and  $4.76 \times 10^5$ cfu for 1:2 dilution. In the control group, the same amount

of LB medium diluted with H<sub>2</sub>O (2:1) was used. The field management was done according to the routine method for tea cultivation. The growth of lateral buds of the pruned tea twigs was observed and recorded. The experiment was conducted in a randomized design with five replicates, and each replicate containing 100 samples. Experimental data were analyzed via SPSS software, and analysis of variance gave P values of less than 0.05 in each case.

## RESULTS

### Invasion of *Herbaspirillum* sp. WT00C into tea plant via traumatic infection

Three different methods, irrigation, sprinkling and traumatic infection were tested to know how *Herbaspirillum* sp. WT00C invaded tea plants. In this study, the *Herbaspirillum* sp. WT00C carrying a pUC18 plasmid was used owing to its strong ampicillin resistance. After tea plants were treated with different processes, the bacteria inside roots, leaves and stems were examined. The results were summarized in Table 1. As expected, the bacterium within tea leaves, stems and roots was not found in control group. In group A and B, the bacterium inside the tea seedlings was also undetectable whether irrigation or sprinkling was applied. Different from group A and B, the bacterium appeared in the stem of tea seedlings in group C when traumatic infection was applied. Moreover, bacterial cells were found to migrate upward and downward inside the stem of tea seedlings (Table 1).

### Colonization of *Herbaspirillum* sp. WT00C in other farm crops

Like tea plant, *Brassica campestris*, *Brassica rapa*, *Oryza sativa* and *Triticum aestivum*, were also tested. All seedlings of four crops were firstly planted in pots and grown for 30 days in a greenhouse. Then, three methods described above were applied to test if *Herbaspirillum* sp. WT00C infected these plants. After treatment, data were consecutively collected for 40 days. During our experiments, all plants in experimental groups grew as well as those in control groups. Similar to the control group, *Herbaspirillum* sp. WT00C within roots, stems or leaves of four crops was not detectable whether irrigation or sprinkling was applied. In traumatic infection, the bacterium was only found in stems of four plants. The detailed results were summarized in Table 2. In those stems of *B. campestris* and *B. rapa*, the bacterium survived until the 15<sup>th</sup> day postinoculation, but bacterial numbers decreased progressively by an order of magnitude. After 15 day postinoculation, the bacterium disappeared completely from those stems. In *O. sativa* and *T. aestivum*, the bacterium was detectable until the 5<sup>th</sup> day postinoculation with a rapid decrease of its number. After 5 days postinoculation, the bacterium was not detectable inside the stems of either rice or wheat.

**Table 1.** Bacterial distribution in different parts of tea plants treated by different inoculation methods. Group A: irrigation; Group B: sprinkling; Group C: traumatic infection; Control group: no treatment.-: undetectable; +: bacterial growth. In this study, 5-10 thin slices for each part were tested at different posttreatment times. Data were recorded from three replications.

Position		1 day	5 days	11 days	33 days
Group A	Roots	-	-	-	-
	Upper stem	-	-	-	-
	Lower stem	-	-	-	-
	Leaves	-	-	-	-
Group B	Roots	-	-	-	-
	Upper stem	-	-	-	-
	Lower stem	-	-	-	-
	Leaves	-	-	-	-
Group C	Roots	-	-	-	-
	Upper stem	-	+	+	+
	Inoculation point	+	+	+	+
	Lower stem	+	+	+	+
	Leaves	-	-	-	-
Control group	Roots	-	-	-	-
	Upper stem	-	-	-	-
	Lower stem	-	-	-	-
	Leaves	-	-	-	-

**Table 2.** Bacterial content inside the stems of four crops. After traumatic infection, plant stems were collected from 1 to 40 days and grinded to homogenate. Bacterial numbers were quantitatively counted as described in experimental section. Here, bacterial content was expressed as colony-forming units (cfu) per gram wet weight of plant stems.

Plants	1 day	5 days	10 days	15 days	20 days	30 days	40 days
<i>Brassica campestris</i>	$1.71 \times 10^8$	$1.18 \times 10^4$	$1.33 \times 10^3$	332	0	0	0
<i>Brassica rapa</i>	$1.73 \times 10^8$	$5.88 \times 10^4$	$1.04 \times 10^3$	360	0	0	0
<i>Oryza sativa</i>	$1.14 \times 10^8$	$1.83 \times 10^2$	0	0	0	0	0
<i>Triticum aestivum</i>	$1.70 \times 10^8$	$8.15 \times 10^2$	0	0	0	0	0

Meanwhile, the thin-slice method described above was also used to test which part of the stem in four crops contained the bacterium. At the 4<sup>th</sup> day of bacterial infection, the bacterium mainly remained around the inoculation point region (data not shown).

#### Effects of *Herbaspirillum sp.* WT00C in propagation of tea cuttage

After treated with *Herbaspirillum sp.* WT00C for different times, tea cuttings were planted in the tea nursery. The tea-seedling rate in three experimental groups approached to 100%. Figure 1 showed tea seedlings growing for 160 days in the nursery after treatment. Clearly, those tea seedlings in all three experimental

groups were in vigorous growth with dark green colors. The number of lateral roots in experimental groups was  $26 \pm 3$ , 63 more than that ( $16 \pm 4$ ) for those control groups. Average newborn shoot length and root length were  $15 \pm 1.4$  cm and  $9 \pm 1.2$  cm for experimental groups and  $13 \pm 1.8$  cm and  $8 \pm 1.8$  cm for control groups. In addition, those tea seedlings from the tea-cuttings soaked in bacterial culture for 1, 2 or 3 h did not show significant deference as shown in Figure 1. One-hour treatment could be enough for bacterial inoculation.

Data were also collected at the 280<sup>th</sup> day post treatment and shown in Figure 2. Although, root length did not show significant difference, newborn shoot length and root number were significantly different between three experimental groups and control groups. As compared to the control groups, average newborn shoot



**Figure 1.** Comparison of tea seedlings between experimental groups and control groups. All seedlings were randomly chosen at the 160th day postcuttage. (A) Seedlings from tender green-cutting; (B) Seedlings from hard red-cutting. a, c, e: tea cuttings soaked in water for 1, 2 and 3 h; b, d, f: tea cuttings soaked in the bacterial culture for 1, 2 and 3 h.

length and lateral root number in the experimental groups increased 87.5%. In addition, effects of *Herbaspirillum sp.* WT00C on tea-seedling growth between the tender green-cutting group and the hard red-cutting group were similar. Data for those tea seedlings derived from those tea-cuttings treated with the bacterial culture for 1, 2 or 3 h also did not show significant difference. The bacterium displayed the same effect on promoting lateral root formation or bud growth whatever hard red cuttings or tender green cuttings were used.

Bacterial distribution in tea seedlings growing for either 160 or 280 days was examined. *Herbaspirillum sp.* WT00C was verified by growing the thin slices from different parts of tea-seedlings on the LB plates, and then further confirmed by IAA color reaction. The bacterium was only found in those tea cuttings treated with the bacterial culture. In newborn shoots, leaves and roots, the bacterium was undetectable.

#### Effects of *Herbaspirillum sp.* WT00C on promoting growth of lateral buds

To further confirm bacterial effects on promoting growth of

tea buds, we pruned tea twigs at the top of tea bush with a trimmer, and then inoculated the bacterium with different dilutions to the incision on the upper part of tea twigs. At the 60<sup>th</sup> day post treatment, length and weight of lateral buds were measured, and the results were shown in Figure 3. Average length of newborn lateral shoots and weight of 100 lateral shoots in all experimental groups increased 4.6 cm and 18 g respectively as compared to the control group. Bacterial test also showed that *Herbaspirillum sp.* WT00C existed in those pruned old tea twigs, but not in newborn tender shoots (data not shown).

#### DISCUSSION

In this study, microbiological characteristics of *Herbaspirillum sp.* WT00C were further investigated to verify whether it can be really used as a novel bioaccelerator. Our study found that this endophytic bacterium entered into plants via traumatic infection, but did not infect plants through irrigation or sprinkling. It colonized only in tea plants but not in vegetables, rice and wheat. These results demonstrated the entry of

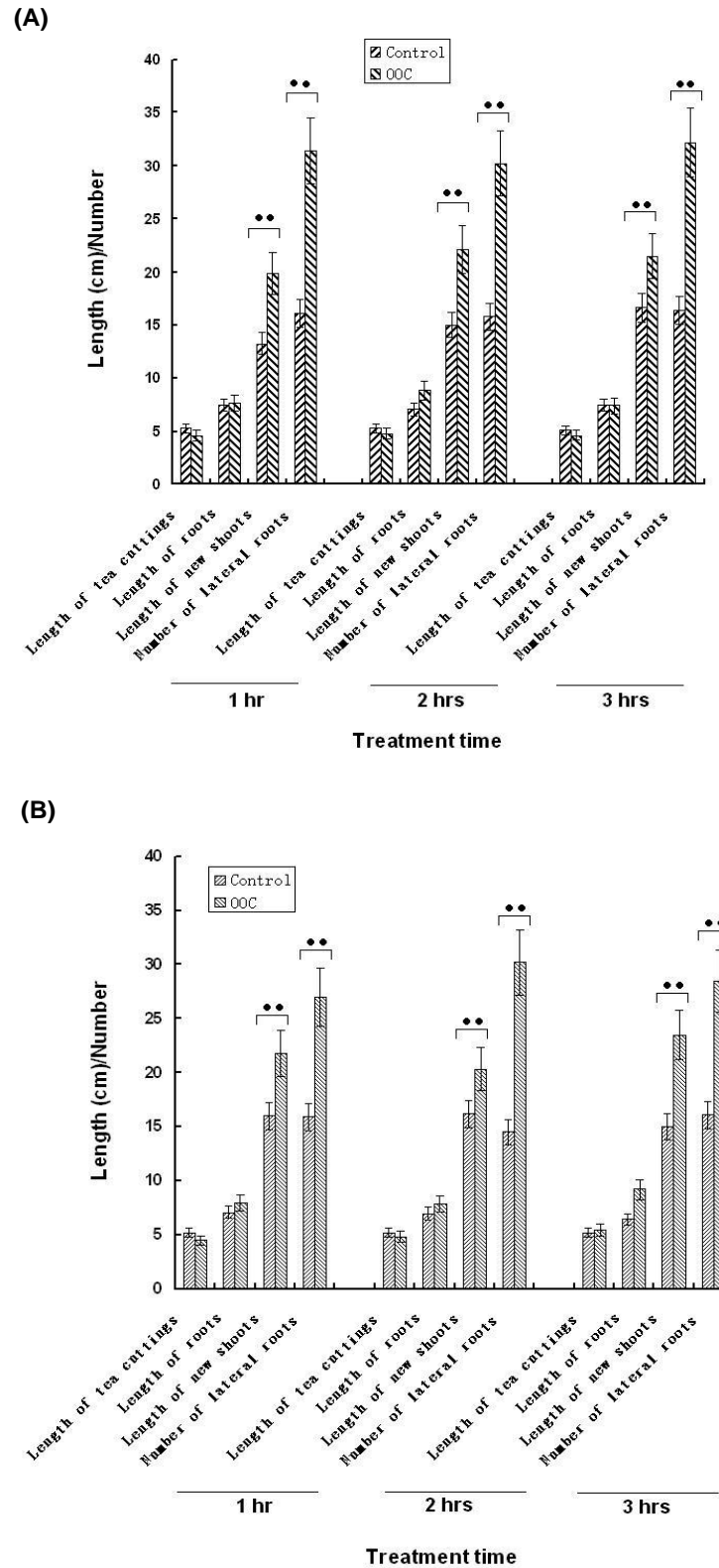

**Figure 2.** Effects of *Herbaspirillum* sp. WT00C on the growth of newborn roots and shoots of tea cuttings. The data were collected from 100 tea seedlings in each group, which were randomly chosen in the nursery at the 280th day postcuttage. Significant difference between experimental groups and control groups was labeled. (A) tender green-cutting; (B) hard red-cutting.

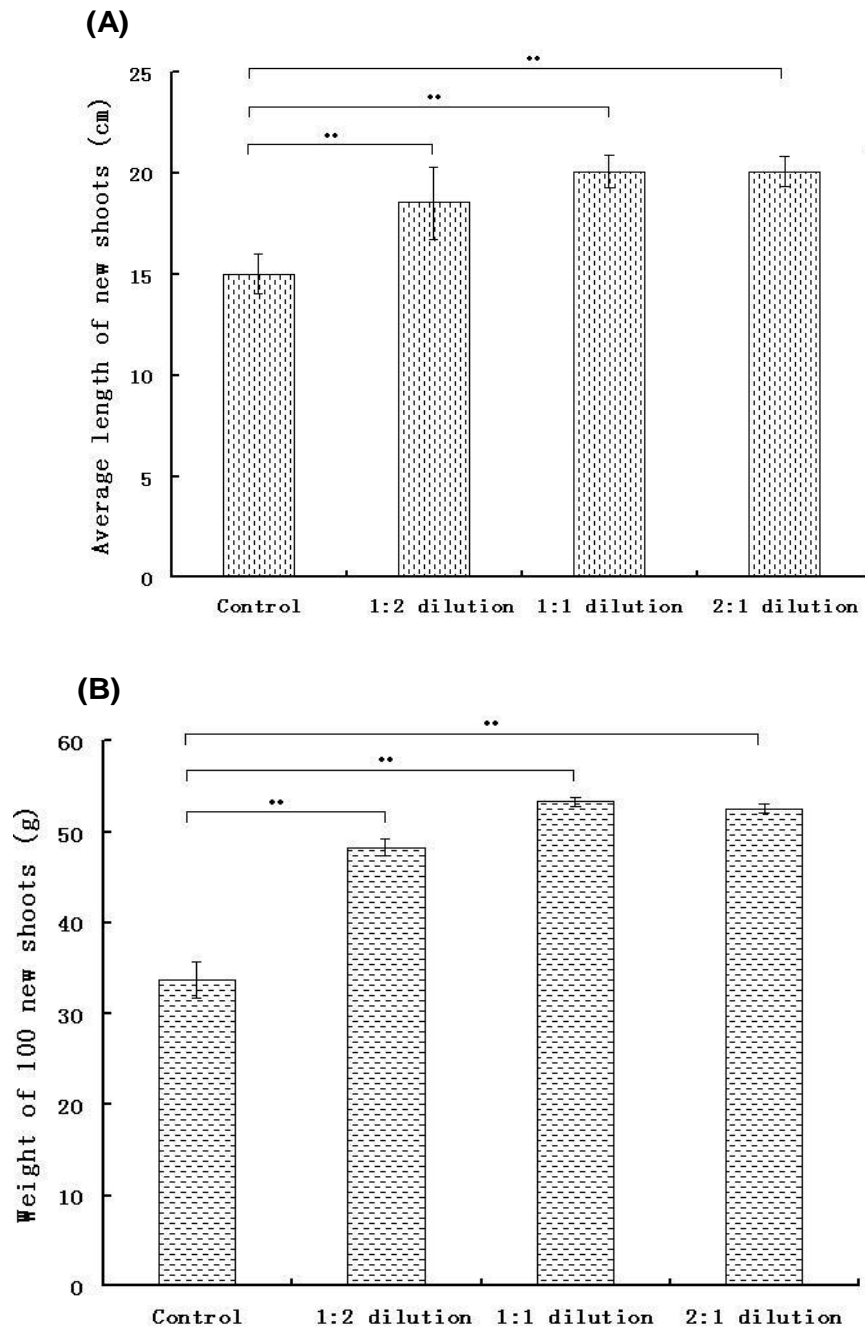

**Figure 3.** Effects of *Herbaspirillum* sp. WT00C on the growth of lateral buds of tea twigs. Data were collected from 500 tea buds in each group, which grew 60 days after bacterial inoculation. Significant difference between experimental groups and control groups was labeled. (A) average length of 100 lateral buds; (B) average weight of 100 lateral buds.

*Herbaspirillum* sp. WT00C into plants via plant vulnus, and suggested that the bacterium might not colonize in either brassicaceous vegetables or gramineous plants although it could survive for a period of time. More importantly, the bacterium did not cause any noticeable disease symptom or growth inhibition in all tests. These characters of the bacterium could satisfy those basic

conditions required for a green bioaccelerator. Once it entered into tea plants through incisions at the double ends of tea cuttings or at the top of tea twigs, *Herbaspirillum* sp. WT00C was able to colonize in tea plants and produce IAA, ammonia and siderophores. Bacterial cells of *Herbaspirillum* usually colonized in vascular tissues (James et al., 1997). Our studies clearly

showed that vegetative growth, length of newborn shoots, number of lateral roots in the infection group were superior to those in the uninfected group. Our data suggested that this bacterium indeed had the ability to stimulate lateral root formation and bud growth of tea cuttings. More adventitious root formation was certainly favorable for raising the seedling rate of tea cuttings. In addition, the bacterium was only found in tea cuttings, but not in their newborn shoots and leaves. This finding could rule out the possibility that bacterial existence in newborn shoots or leaves may affect quality characteristics of tea. Accordingly, *Herbaspirillum* sp. WT00C appears to be a good candidate for a bioaccelerator applicable for tea-cutting propagation in the fields.

Cutting propagation is a common technique used widely for a rapid production of tea seedlings in tea plantations (Choubey et al., 2013). To raise tea-seedling rate, people often use artificial indole-3-butyric acid (IBA) and sodium naphthalene-1-acetate (NAA) to induce adventitious root formation (Samartin et al., 1986; Gunasekare and Evans, 2000; Zhou et al., 2005). However, tea-bud growth is more or less inhibited when auxins are applied. In addition, auxin residues in soil likely change soil microbial ecosystem, because auxins modulate bacterial stress resistance (Repar et al., 2013). Given that bacterial accelerator substitutes artificial phytohormones in tea-cutting propagation, there are many advantages: (a) unlike artificial phytohormones, *Herbaspirillum* sp. WT00C can permanently promote tea-seedling growth and development, and does not inhibit tea-cutting budding; (b) it is an environment-friendly bioaccelerator, and does not cause plant disease; (d) its usage is simple and easy to handle; (e) its preparation is easy via bacterial fermentation.

IAA, produced by *Herbaspirillum* sp. WT00C, may perhaps be a major factor in stimulating lateral root formation. Ammonia and siderophore, together with IAA, may improve tea budding, tea-seedling growth and development. IAA plays an important role in cell division, elongation, coordinating cambial growth and vascular development, and initiates roots, leaves and flowers, specifically adventitious root formation in dicots or monocots (Phillips et al., 2011; McSteen, 2010). Glutamate synthase and DNA (H)-dependent glutamate dehydrogenase convert  $\alpha$ -ketoglutarate and ammonia to glutamate in plants. This inorganic nitrogen assimilation and the subsequent steps involved in organic nitrogen supply allow the optimal growth and development of a plant (Dubis et al., 2003; Hirel, 2003; Temple et al., 1998). Siderophores, ferric ion specific chelating agents, are thought to be associated with improvement of plant growth either through a direct effect on the plant, through control of noxious organisms, or via some other routes (Neilands, 1995; Barton and Hemming, 1993). In addition, *Herbaspirillum* sp. WT00C may perhaps produce other unknown substances promoting tea-plant growth and development. There is still plainly more to be learnt about the detailed molecular mechanism of the

bacterial role in microbe–host interactions. Further study on the functional genomics of *Herbaspirillum* sp. WT00C will give us a clue to fully understand its role in microbe–host interactions.

### Conflict of Interests

The authors have not declared any conflict of interests.

### ACKNOWLEDGEMENTS

This work was supported by the grant (2015CFA089 to XW) from Science and Technology Department of Hubei Province, China.

### REFERENCES

- Baldani JI, Baldani VLD, Seldin L, Dobereiner J (1986). Characterization of *Herbaspirillumseropedicae* gen. nov., sp. Nov., a root-associated nitrogen-fixing bacterium. *Int. J. Syst. Bacteriol.* 36(1):86-93.
- Barton LL, Hemming BC (eds) (1993). *Iron Chelation in Plants and Soil Microorganisms*, Academic Press, New York.
- Berta G, Copetta A, Gamalero E, Bona E, Cesaro P, Scaragoni A, Agostino GD (2014). Maize development and grain quality are differentially affected by mycorrhizal fungi and a growth-promoting pseudomonad in the field. *Mycorrhiza* 24:161-170.
- Brick JM, Bostock RM, Silverstone SE (1991). Rapid in situ assay for indoleacetic acid production by bacteria immobilized on a nitrocellulose membrane. *Appl. Environ. Microbiol.* 57(2):535-538.
- Choubey M, Kumar R, Chakraborty A, Bisen JS, Singh AK, Singh M (2013). Performance of tea clones in the nursery through vegetative propagation in Darjeeling. *Int. J. Sci. Res. Publ.* 3(11):1-4.
- Dubis F, Tercé-Laforgue T, Gonzalez-Moro M, Estavillo J, Sangwan R, Gallais A, Hirel B (2003). Glutamate dehydrogenase in plants: is there a new story for an old enzyme? *Plant Physiol. Biochem.* 41:565-676.
- Glick BR (2012). Plant growth-promoting bacteria: mechanisms and applications. *Scientific pp.* 1-15.
- Gunasekare MTK, Evans PK (2000). *In vitro* rooting of microshoots of tea (*Camellia sinensis* L.). *Sri Lanka J. Tea Sci.* 66:5-15.
- Holt JG, Krieg NR, Sneath PHA, Staley JT, Williams ST (1994). *Bergey's Manual of determinative bacteriology* (9<sup>th</sup>ed). Williams & Wilkins, Baltimore, MS, USA.
- James EK, Olivares FL, Baldani JI, Dybereiner J (1997). *Herbaspirillum*, an endophyticdiazotroph colonizing vascular tissue of Sorghum bicolor L. Moench. *J. Exp. Bot.* 48(1):785-798.
- Kirchhof G, Eckert B, Stoffels M, Baldani JI, Reis VM, Hartmann A (2001). *Herbaspirillum frisingense* sp. Nov., a new nitrogen-fixing bacterial species that occurs in C4-fibre plants. *Int. J. Syst. Evol. Microbiol.* 51(1):157-168.
- McSteen P (2010). Auxin and monocot development. *Cold Spring Harb. Perspect. Biol.* 2:1-27.
- Neilands JB (1995). Siderophores: structure and function of microbial iron transport compounds. *J. Biol. Chem.* 270(45):26723–26726.
- Phillips KA, Skirpan AL, Liu X, Christensen A, Slewinski TL, Hudson C, Barazesh S, Cohen JD, Malcomber S, McSteen P (2011). Vanishing tassel2 encodes a grass-specific tryptophan aminotransferase required for vegetative and reproductive development in maize. *Plant Cell.* 23:550-566.
- Repar J, Šu'curovi'c S, Zahradka K, Zahradka D, Ćurkovi'c-Perica M (2013). Stress resistance of *Escherichia coli* and *Bacillus subtilis* is modulated by auxins. *Can. J. Microbiol.* 59:766-770.
- Samartin A, Vieitez, AM, Vieitez E (1986). Rooting of tissue cultured *Camellia*. *J. Hort. Sci.* 61:113-120.
- Sambrook J, Fritsch EJ, Maniatis T (2001). *Molecular cloning: a*



- laboratory manual (3<sup>rd</sup>ed). Cold Spring Harbor, NY: Cold Spring Harbor Laboratory.
- Stefan M, Munteanu N, Stoleru V, Mihasan M, Hritcu L (2013). Seed inoculation with plant growth promoting rhizobacteria enhances photosynthesis and yield of runner bean (*Phaseolus coccineus* L.) Sci. Hortic. 151:22-29.
- Straub D, Yang H, Liu Y, Tsap T, Ludewig U (2013). Root ethylene signalling is involved in *Miscanthus sinensis* growth promotion by the bacterial endophyte *Herbaspirillum frisingense* GSF30<sup>T</sup>. J. Exp. Bot. 64(14):4603-4615.
- Temple SJ, Vance CP, Gantt JS (1998). Glutamate synthase and nitrogen assimilation. Trends Plant Sci. 3(2):51-56.
- Valverde A, Velazquez E, Gutierrez C, Cervantes E, Ventosa A, Igual JM (2003). *Herbaspirillum lusitanum* sp. Nov., a novel nitrogen-fixing bacterium associated with root nodules of *Phaseolus vulgaris*. Int. J. Syst. Bacteriol. 53(6):1979-1983.
- Wang T, Yang S, Chen Y, Hu L, Tu Q, Zhang L, Liu X, Wang X (2014). Microbiological properties of two endophytic bacteria isolated from tea (*Camellia sinensis* L.). Acta. Microbiol. Sin. 54(4):424-432.
- Zhou J, Cheng H, Wang L (2005). Effect of phytohormone induction on direct rooting of tea plant (*Camellia sinensis*) microshoots in greenhouse. J. Tea Sci. 25(4):265-269.

*Full Length Research Paper*

## Evolution and impacts of groundnut research and development in Malawi: An ex-post analysis

Takuji W. Tsusaka\*, Harry W. Msere, Moses Siambi, Kizito Mazvimavi and Patrick Okori

International Crops Research Institute for the Semi-arid Tropics (ICRISAT) Malawi.

Received 15 July, 2015; Accepted 20 October, 2015

Groundnut is currently the second income earner for smallholder farmers in Malawi, and an inexpensive source of balanced protein. Owing to the continued crop improvement research and extension efforts, production has risen by more than 15 times in the past two decades. Despite the dramatic growth, no impact assessment has ever been conducted to date. This study aims to assess the economic impacts of investments in groundnut research and development (R&D) in Malawi, covering the period 1982-2013. Relevant information on investments and changes in outputs was gathered from a range of sources including a smallholder household survey and secondary data provided by international and national agricultural research programmes, and non-governmental organisations. The economic surplus approach (the PEDPIS method and the Akino-Hayami method) was employed to compute the internal rate of return (IRR) and the net present value (NPV). It was found that the IRR for the base scenario was 22%, higher than the opportunity cost of capital being 11%, indicating that the investment was competitive as well as profitable. The NPV ranged from USD 204 million to USD 206 million, depending on the calculation method. With sensitivity analyses, the NPV remained positive and the IRR stayed above 11% in all scenarios except when the research and extension costs were raised by 50%. The IRR compares well among impacts of crop research in sub-Saharan Africa. The result implies the need for policy formulation towards long term commitment to developing improved seeds, reinforcement of the seed systems, and enhancement of extension services to smallholders.

**Key words:** Groundnut, economic surplus, Akino-Hayami, internal rate of return, net present value, Malawi.

### INTRODUCTION

Malawi ranks among the world's least developed countries. The country's economy is predominantly agrarian, in which agriculture accounts for 27% of gross domestic product and 85% of export revenues. About

90% of the population reside in rural areas, and are engaged in small-scale farming activities (World Bank, 2014). Despite the economy's heavy dependence on agriculture, the government has been allocating less and

\*Corresponding author. Email: [takuji.tsusaka@gmail.com](mailto:takuji.tsusaka@gmail.com) Tel: +265 1 707297.

**JEL classification:** C81, O11, O13, O55

Author(s) agree that this article remain permanently open access under the terms of the [Creative Commons Attribution License 4.0 International License](https://creativecommons.org/licenses/by/4.0/)

less resources in real terms to agricultural research programmes (Pardey et al., 2006). The funding has also been irregular and inconsistent over the years, rendering it difficult for researchers to rely on the government support. Nonetheless, public financial supports from the government and international donors have led to visible improvement in seed performance such as higher yields, drought tolerance, and pest and disease resistance (Alene and Coulibaly, 2009).

Organised agricultural research in Malawi began a century ago. The main focus of research during that time was variety-screening trials on experimental farms. In 1948, the Chitedze Agricultural Research Station was established, followed by the launch of the Mbawa Station in 1950 and the Chitala Station in 1955 (Beye, 2002; Department of Agricultural Research Services - DARS, 2011). DARS, formerly known as DARTS (Department of Agricultural Research and Technical Services), has been the largest research institution in the country in terms of staffing (Ministry of Economic Planning and Development, 2011).

The major legume crops in Malawi are groundnut, pigeonpea, common bean, cowpea, and soybean, among which groundnut is the most widely grown, with nearly 27% of the total land under legume production sown to the crop. In 2009, area under groundnut was about 14% compared with area planted to maize, the dominant staple crop (Simtowe et al., 2009a, b). Around 93% of groundnut production in Malawi is realised by smallholder farmers as the crop provides considerable benefits to smallholders. First, it is valuable for improving food security through its low-cost provision of balanced protein, unsaturated fatty acids, vitamins, and minerals, added to the predominantly maize-based Malawian diet. In agro-pastoral communities, groundnut is used as feed, which enhances livestock productivity as the haulm and seed cake are rich in digestible crude protein. Second, it is the second income earner for smallholders in Malawi after tobacco. Approximately 40% of total groundnut production is marketed, generating about 25% of household's agricultural income (Diop et al., 2003; Derlagen and Phiri, 2012). The export channel represents 10% of total production. Third, it fixes atmospheric nitrogen into the soils and thus improves soil fertility, saving fertiliser costs for subsequent crops (Derlagen and Phiri, 2012).

Sporadic research activities on groundnut started in the 1950's. However, the first organised research initiatives on groundnut improvement kicked off in 1982 under the auspices of the International Crops Research Institute for the Semi-Arid Tropics (ICRISAT), which was termed Groundnut Improvement Programme (GIP). Since its inception, sizable resources from donors and the government have been invested in GIP. A simple and effective field screening technique was developed to evaluate germplasm and breeding lines for desirable traits. Several high-yielding breeding lines with stress

resistance were developed for evaluation and utilisation by the National Agricultural Research System (NARS).

Crop improvement efforts materialised in the release of six improved varieties during the period. Those varieties are equipped with favourable traits such as pest resistance, high yields, and drought tolerance. The dissemination of these improved varieties was a major driver of the dramatic increase in national groundnut production from 18 000 tons in 1990 to 280 000 tons in 2010.

Without doubt, the groundnut technologies have improved the status of production over the decades. Yet, there has been no attempt of impact assessment of groundnut R&D to date. Since public spending on agricultural R&D has been declining all these decades, the need for efficient resource allocation and the justification of resource utilisation necessitated the assessment of economic impacts of GIP. Without the evidence of economic impact, it would be difficult to recognise the social value of technologies and to make judgments as to the trade-offs in the allocation of scarce resources for research (Alston et al., 1998). Given the importance of the crop to the country, the outcomes of such assessment would inform policy makers for the food and agricultural sector, and would also serve as inputs for evidence-based policy dialogue at country or regional level.

The objective of this study is to assess the socioeconomic impacts of groundnut research and complementary services during the period 1982 to 2013. The rest of the paper is organised as follows: details of the groundnut subsector; a description of the evolution of groundnut research initiatives; an introduction of the methodology for assessing the impacts; discussion of the results; and concluding remarks.

## GROUNDNUT SUBSECTOR IN MALAWI

### Area and production

In the past two decades, area sown to groundnut has steadily expanded and the productivity per area has also significantly increased, which resulted in a dramatic boost in production over the years. The groundnut area grew from nearly 50 000 ha in 1990 to 270 000 ha in 2010, while the yield rose from almost 400 kg/ha in 1990 to 1026 kg/ha in 2010. As a result, the production in 2010 was close to 300 000 tons, which was almost ten times the level in the early 1990s (Figure 1).

Much of the yield improvement is attributed to the adoption of improved varieties that are higher yielding, drought tolerant, and pest and disease resistant. The traditional groundnut variety in Malawi is Chalimbana, a Virginia-type large size cultivar with relatively high levels

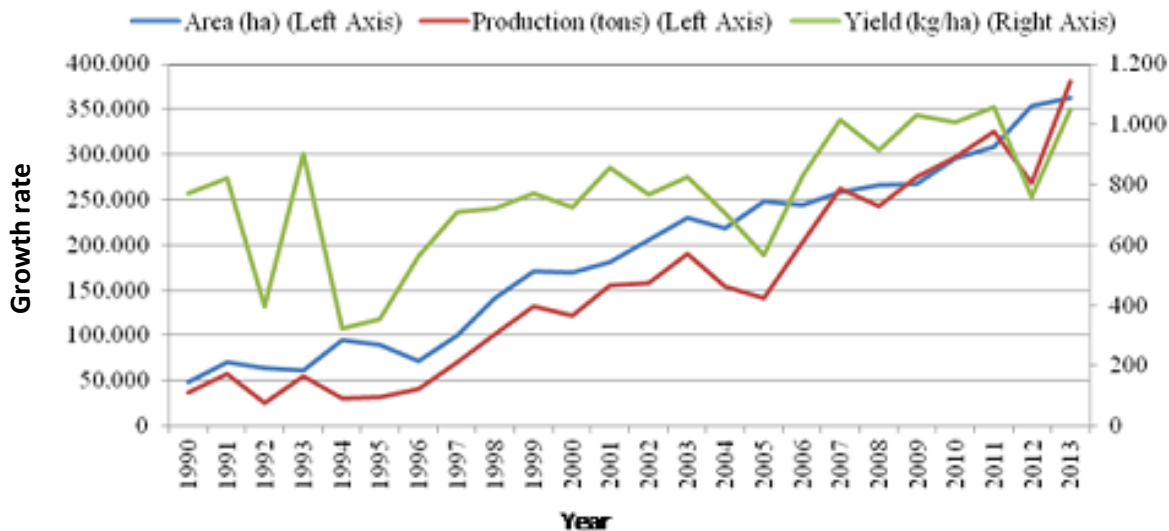

**Figure 1.** Growth of groundnut production, area, and yield in Malawi, 1990-2013. Source: Authors' creation from Ministry of Agriculture and Food Security (2012a) and FAOSTAT (2015).

of protein.<sup>1</sup> In 1990, ICRISAT introduced an improved Chalimbana-type variety named CG7, characterised by drought tolerance and yield potential 60% higher than that of Chalimbana. CG7 has become popular in markets due to its rich oil content and preferred colour of red. Other improved varieties released and promoted for commercial production since 1982 are Chitala, Chalimbana 2005, ICGV-SM 90704 (Nsinjiro), JL 24 (Kakoma), and IGC 12991 (Baka). Farmers' awareness and preferences determine the extent to which these varieties would be adopted.

While the production and yield have increased to a great extent, the yield potential has yet to be fully attained due to a number of constraints on production (ICRISAT and DARS, 2007; MoAFS, 2008). Groundnut is predominantly grown by smallholder farmers operating on an average of 1.2 ha of land (CYE Consult, 2009), and the average area allocated to groundnut is 0.5 ha per grower (Msere et al., 2015). In general, smallholders in Malawi focus fertiliser use on maize production and do not apply it to groundnut, which is added to by poor crop management. They also resort to use of recycled seeds because improved seeds tend to be either unavailable or unaffordable, which affects the yield performance. Furthermore, the yield kept fluctuating over the decades due to unpredictable drought events as smallholder

agriculture in the country is based on rainfed conditions without access to irrigation. Stakeholders, especially in the processing sector, consider the unstable yields and supply of groundnut as an impediment to both domestic marketing and exports. The labour intensiveness is also a disincentive to increase production of groundnut (Minde et al., 2008).

## Consumption

33% of groundnut production is consumed by farm households (Msere et al., 2015). Although the higher yielding CG7 is not as preferred for local consumption as Chalimbana, it has spread as a cash crop through seed loans and seed bank projects operated by non-governmental organisations (NGOs) and international institutions. On the other hand, the lower yielding Chalimbana has remained as the choice for home consumption and for snacks in local markets (Goyder and Mang'anya, 2009).

The per-capita groundnut consumption was 4.7 kg per annum in 2007 (FAOSTAT Food Balance Sheets, 2007).<sup>2</sup> Due to its nutritional significance, Malawi's Agricultural Sector Wide Approach (ASWAp) specifies groundnut among the crops whose production and consumption should be vigorously promoted. The total domestic human consumption of groundnut rose from 11 000 tons in 1990 to 68 000 tons in 2007 (Figure 2). The per capita consumption also showed a similar trend rising from 1.5 kg in 1990 to 4.7 kg in 2007, and further to 7.3 kg in 2013 (Derlagen and Phiri, 2012; Tsusaka et al., 2015a, b).

<sup>1</sup> There are four major cultivar groups of groundnut in the world: Spanish, Runner, Virginia, and Valencia. Certain cultivar groups are preferred for particular uses because of differences in flavor, oil content, size, shape, and disease resistance. Most of the marketed groundnut is of the Virginia type, along with some Valencias selected for large size and the attractive appearance. The large seeded Virginia group groundnut is grown in the US states of Virginia, North Carolina, and others. They are gaining popularity due to demand for large peanuts for salting, confections, and roasting in the shells.

<sup>2</sup> Shelled weight

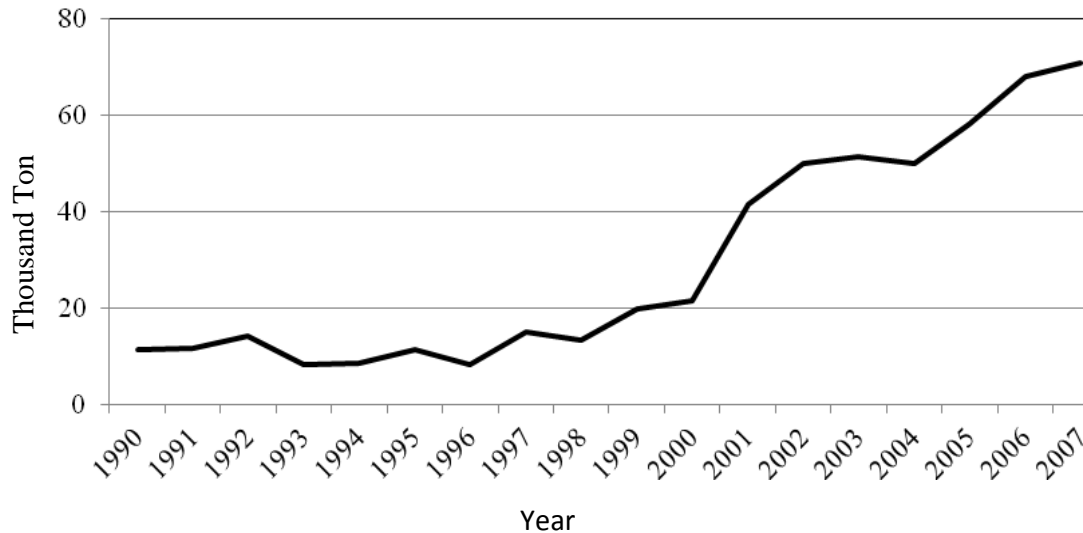

**Figure 2.** Groundnut consumption in Malawi, 1990-2007. Source: Adapted from Derlagen and Phiri (2012).

### Marketing and export

Many smallholder groundnut growers sell part of their groundnut production to markets. It is estimated that about 35% of the production is used as an input to the agro-processing industry for production of peanut snacks, cake, oil, and butter, and about 10% is exported (Derlagen and Phiri, 2012).

Back in the 1960s to 1980s, all other major export crops were grown only by estates, under the Special Crops Act. During that period, groundnut was the only viable export alternative for smallholder farmers, and Malawi was a major exporter of confectionery Chalimbana variety. The farmers sold groundnuts via the Agricultural Development and Marketing Corporation (ADMARC), a parastatal that was the only trader of groundnut until 1987. Government policies were in effect to control prices of inputs (both seed and fertiliser) and outputs, and to subsidise credit.

However, the export prospects for groundnut declined for several reasons. First, the kernel shape was less suitable for processing compared with varieties from China. Importers were against the bigger size 'Malawi nuts' (e.g. Chalimbana). Second, with the liberalisation of tobacco production, smallholder farmers started obtaining licenses to grow tobacco. Growers, particularly in central Malawi, shifted from groundnut to burley tobacco as their main cash crop. At the same time, the role of ADMARC as the main buyer was taken over by private traders in an inefficient way. Third, producers faced strict aflatoxin standards imposed by Europe. The aflatoxin issue undermined production and export capabilities of Malawi groundnut, resulting in losing overseas markets (Sangole et al., 2010). As a consequence of all these, groundnut exports stayed minimal in the early 1990s (Figure 3).

From the mid-1990s, production and export began recovering slowly, and 2007 saw 9.3% of production being exported (Derlagen and Phiri, 2012). This experience in Malawi suggests how massive markets can be lost easily by not keeping up with the competitive trade environments. It was also learned that there would be potential in proactive innovations for the aflatoxin control, which would require sustainable incentives for farmers to achieve and maintain quality standards (Goyder and Mang'anya, 2009).

While in the 1970s and 1980s groundnut was predominantly exported to Europe, recently the main export destinations are regional markets in Africa. The shares of individual export destinations vary from year to year. In 2005, the key destinations were South Africa (56%) and Zimbabwe (20%), and in 2010, Tanzania (49%) and Kenya (28%) were the main importers of groundnut from Malawi (Ministry of Economic Planning and Development, 2011).

### Extension system

Government extension agents are the main agricultural extension service providers in Malawi.<sup>3</sup> The government extension service is housed in the Department of Agricultural Extension and Services (DAES) within the Ministry of Agriculture, Irrigation and Water Development (MoAIW). While CGIAR (the Consultative Group for International Agricultural Research) institutions as well as NGOs also provide extension advice to farmers, MoAIW, through DAES, remains the largest agricultural extension

<sup>3</sup> The most prevalent type of extension service provider in the least developed countries is the government extension services (Arnon 1989).

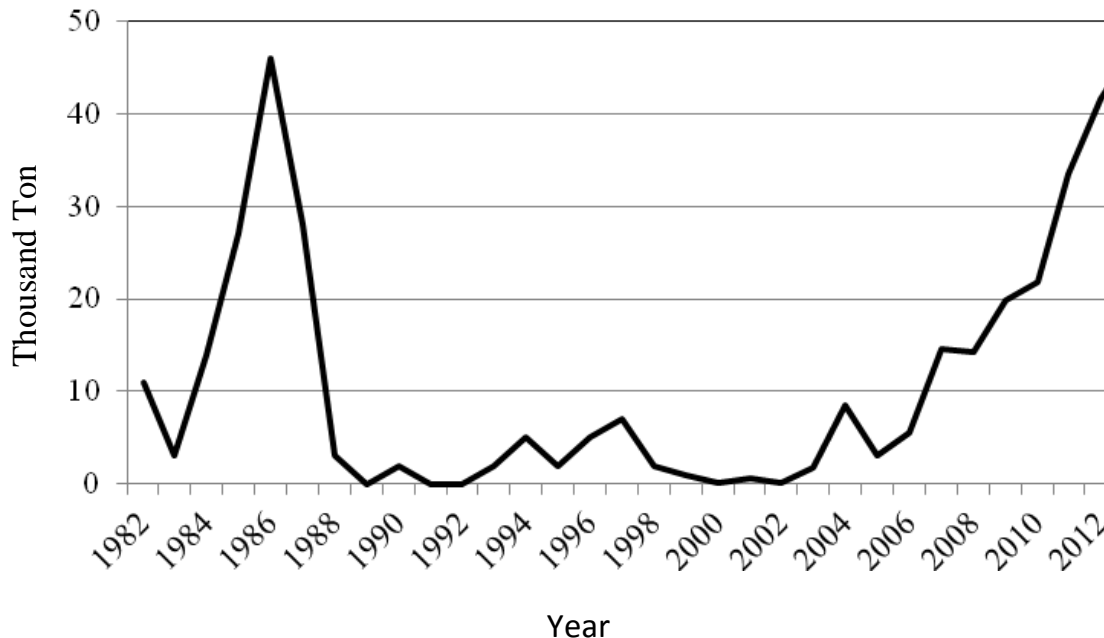

**Figure 3.** Groundnut export volume from Malawi, 1961-2009. Source: Authors' creation from Derlagen and Phiri (2012) and data provided by Ministry of Industry and Trade.

service provider in the country (Masangano and Mthinda, 2012). Members of the extension staff offer services to seed and grain producers an average of three times a year. The frequency increases when farmers face problems.

For groundnut, the efforts of extension staff are complemented by ICRISAT's field activities, especially for seed production. ICRISAT engages with NGOs such as Concern Universal and Plan International through a number of seed production projects. The government's Farm Input Subsidy Programme (FISP) largely contributed to scaling up the seed production by these NGOs over the years, while ICRISAT has been the supplier of certified seeds to the FISP via different seed companies.

Women in Agribusiness in Sub-Sahara Africa Alliance (WASAA) is an NGO that promotes female traders to steer economic independence of women. It was formed in 2010 and registered in each country in Eastern and Southern Africa. The basic role is to secure big contracts and share information. In Malawi, WASAA has more than 3600 members. The main activities are (1) seed multiplication for legumes, (2) commodity trading both locally and internationally, and (3) agro-dealership. WASAA borrows money from FDH Bank Limited, with collateral being the groups of traders and the warehouse crop.

The Rural Market Development Trust (RUMARK) is a non-state actor aiming to develop the agro-dealers network to expand access to smallholder farmers. The agro-dealers are trained in subjects of business management, demand creation, and linkage to input

suppliers in rural areas. The agro-dealers' input package is tailored to each farmer's requirement (e.g., 5 kg of fertiliser). When farmers achieve production beyond subsistence level, they sell to the agro-dealers. Agro-dealers assist in collecting outputs for further marketing. RUMARK offers agro-dealers competitive and profitable prices in rural areas. The agro-dealers provide RUMARK with statistics on their monthly operation.

Seedco's Malawi Office deals with products associated with legumes value chains, and supplies 845 to 1000 tons of groundnut seeds per year, which is larger than any other company in Malawi. Prior to the enforcement of FISP, Seedco marketed groundnut seeds through supermarket chains. When the supermarkets pulled out of rural areas, it started using Farmers World's network to distribute seeds in rural areas. Seedco now uses agro-dealers accounting for 70% of sales, while supermarkets account for 30%. These agro-dealers have been successful in delivering inputs into remote areas. Seedco's groundnut seed production is based on contractual arrangements with commercial farmers through Mbadzi Estate, Press Agriculture, Mc Ferson, and Exagris. Seedco currently has 145 agro-dealers for legumes, each with a minimum of five shops.

With all the aforementioned extension forces, it is worth noting that a considerable proportion of smallholder groundnut farmers receive no extension advice at all. The government extension service faces such serious resource constraints that the workforce has an estimated vacancy rate of 40 to 60%. The current farmer-to-extension worker ratio stands at 3000:1 compared with



the recommended level of 1000:1.

## Policies

Malawi's post-independence policies focused on attaining national food self-sufficiency through the enhancement of smallholder agriculture and rapid economic growth. Almost all agricultural programmes were guided by the food security agenda, which promoted the staple maize production at the expense of other crops. Consequently, close to all households (97%) engaging in farming grow maize. Maize is grown on over 50% (almost 1.5 million hectares) of the available arable land (MoAIW, 2012).

From the mid-1980s, restrictions on production of some strategic commodities such as burley tobacco by smallholder farmers were lifted to allow for enhanced income by smallholders. Other important policy reforms included the price decontrols, the commercialisation of parastatals, and the removal of controls over agricultural input and output marketing.

In 1995, the government developed the Agriculture and Livestock Development Strategy and Action Plan (ALDSAP), though the implementation registered limited success because, among other factors, the sector's policies and strategies were so numerous and overlapping that no visible impact was obtained. In 1999, the government undertook a comprehensive review of agricultural policies under the Malawi Agricultural Sector Investment Programme (MASIP). Nonetheless, the review did not yield a coherent policy, which resulted in many sub-sector policy documents. To tackle the situation, Ministry of Agriculture and Food Security (MoAFS, one of the institutional precursors to MoAIW), in cooperation with MASIP, developed the Agricultural Development Plan (ADP) in 2006. The ADP sought to enhance coordination among the sector priority programmes by working with stakeholders. In 2007 to 2009, MoAFS, guided by a Cabinet directive, focused on developing ASWAp, to harmonise investment and support programmes in agriculture based on the assessment of potential contribution to food security and agricultural growth. In combination with the National Agricultural Policy (NAP), the ASWAp serves as the policy administration guideline.

Regarding agricultural inputs, fertiliser and seed subsidies for smallholders have been the major policy instruments in Malawi. The government reintroduced subsidies in 1998 through the Starter Pack Initiative Scheme (SPIS), distributing fertiliser and improved seeds to all smallholder farmers for free. The SPIS intended to reverse the negative effects of liberalisation and abolition of subsidies. Each starter pack contained 5 kg of basal fertiliser, 5 kg of top dressing fertiliser, 2 kg of maize seed, and 1 kg of legume seed. In 1999, the programme covered all smallholder households, providing a total of 2.86 million packs. In 2000, the SPIS was scaled down

and renamed Targeted Input Programme (TIP), distributing complimentary agricultural inputs to 1.5 million targeted households in its first year. To curtail administrative and operational costs, TIP was further scaled down to target around 1 million households in 2001. The prioritised households were those with elderly, disabled, widows, widowers, and other vulnerable members of society. TIP registered production surpluses and yield gains. The extended TIP was undertaken in 2002 to mitigate the adverse effect of food insecurity following the poor harvest. The evaluation showed TIP's contribution of 13% to total maize production in 1999 and 10% in 2002.

Attention to legume seeds increased when FISP was introduced in 2005 in response to the severe food shortage in 2004. The programme gave resource poor smallholders access to fertiliser and quality legume seeds in addition to maize. FISP contributed to the output growth of 7% per annum on average for the 5 years, after 25 years of stagnation. The programme also led to lower food prices, higher rural casual wage rate, and enhanced household resilience. Use of drought tolerant varieties had a positive impact on crop productivity and resilience to harsh weather events (MoAFS, 2011). A downside was that as farmers hinged heavily on FISP for groundnut and other legume seeds, commercial entities felt reluctant to rely on growers, in fear of an unexpected demise of FISP. In the long-run, the government plans to reduce free distribution and promote the adoption of improved technologies without subsidies.

## GROUNDNUT RESEARCH IN MALAWI

### Evolution of agricultural research systems

As in many other countries, Malawi continued reorganizing its NARS. The Department of Agriculture (DAR) was the main organisation mandated to conduct research on broad range of agricultural themes. DAR was reorganised in 1985 into seven research groups: (1) Cereals, (2) Horticulture, (3) Grain Legumes, Fibers, and Oilseeds, (4) Livestock and Pastures, (5) Soils and Agricultural Engineering, (6) Technical Services, and (7) Adaptive Research. Each group was led by a national research coordinator responsible for research without administrative responsibilities. The research groups operated at three major research stations: Chitedze in the Central Region; Bvumbwe in the Southern Region; and Lunyangwa in the Northern Region. These are supplemented by four experimental stations and eight sub-stations located across the nation.

In November 1985, Agricultural Research Council (ARC) was established as a high level policy body to determine research priorities. The council consisted of 15 selected members from relevant departments, institutions, and private sector entities. ARC was authorised to orient the direction of research and approve

research programmes, budgets, and funding levels. In 1988, DAR was restructured into DARTS (Beye, 2002; Beintema et al., 2004; Ministry of Economic Planning and Development, 2011). Bunda College of Agriculture and Chancellor College were the two main academic institutions to carry out research on agriculture in close collaboration with DARTS. DARTS transformed over the years as a professional institution. As of 1998, it had 87 researchers of which 17 held Ph.D and 46 held MSc. degrees.

In 2002, DARTS was transformed into DARS (Beintema et al., 2004). By 2011, DARS had 70 Malawian scientists and a network of 16 research stations, experimental stations, and sub-stations (MoAFS, 2012b). The major research thrusts for DARS include the followings:

- 1) High yielding and early maturing crop varieties that are tolerant to drought, pests and diseases and the evaluation of animal breeds suitable for various production systems;
- 2) Integrated pest management strategies for crops and, disease and parasite control measures for livestock;
- 3) Evaluation of feeding technologies for increased livestock production;
- 4) Improved soil fertility techniques, appropriate land husbandry and improved soil and water conservation practices;
- 5) Appropriate farm machinery, irrigation, storage, processing and post-harvest technologies.

Research is conducted both on station and on farm throughout the country. A major requirement is that field trials must be conducted for at least three seasons before technologies are accepted for release by the Agricultural Technologies Clearing Committee.

Apart from DARS, the followings are regarded as part of NARS: higher education institutions whose mandate is research and teaching of agriculture; technical departments of some ministries; development agencies that undertake research programmes on agriculture and natural resources; and NGOs and the private sector entities engaged in agricultural research activities.

The international agricultural research centers of the CGIAR consortium are not considered as part of NARS, because these centers are committed to regional and global agenda where the national interest is implicit. However, their research results are extremely important as they represent a broader group of international and regional research coalition.

### Evolution of groundnut research

DARS in collaboration with ICRISAT is tasked to conduct research on groundnut in Malawi. The focus of groundnut research is on cultivar development and identification of appropriate crop management techniques. Nearly all the varieties that are traditionally grown are landraces well

adapted to the climate but with low yields. Such varieties have yields as low as 400 to 800 kg/ha, whereas yields as high as 3,000 kg/ha have been recorded on research stations using improved technologies. On-farm yields are low because of such factors as use of low-yielding varieties, continued cultivation on marginal land, and outbreaks of pest infestations and diseases, unreliable rains in non-irrigated cultures, traditional small-scale farming with minimal mechanisation.

International collaboration on groundnut research (that is, GIP) began, following the establishment of the ICRISAT office in Malawi in 1982. ICRISAT complements the activities of NARS especially in the area of varietal development and breeder/foundation/certified seed multiplication. The original involvement of ICRISAT was production of foundation seeds for distribution to farmers for further multiplication. Over time, ICRISAT engaged into forward integration by undertaking certified seed production for distribution to farmers for commercial production. Contract growers started seed multiplication in 2000. In 2005, the government introduced the FISP, which has led to the expansion of ICRISAT seed production programme. ICRISAT is currently the main supplier of groundnut and pigeonpea foundation seeds in the country, supplying to nearly all stakeholders engaged in seed production programmes.

There is also capacity within ICRISAT to test for aflatoxin contamination in groundnuts. Export markets require that nuts be produced from certified seeds with low levels of aflatoxin contamination. To reduce the contamination, ICRISAT has intensified trainings of farmers in post-harvest seed handling. The training is held once a year and is mounted jointly with DAES extension staff, NASFAM, and field staff of other collaborating partners, where participants learn how to harvest and store at the right level of moisture content.

On the whole, the development and release of six improved varieties has been a major milestone marked by GIP.<sup>4</sup> These varieties have contributed to alleviating some of the constraints on production. Tremendous progress was made on introgression of desirable yield attributes into Chalimbana, Malimba, and other released groundnut varieties.

Emerging issues such as aflatoxin and biotechnology are being addressed and incorporated into the research agenda. To maintain or increase marketing, breeders need to adapt the seed traits to buyer and consumer requirements. Table 1 summarises the production of basic seeds and certified seeds by ICRISAT for the period 2007-2010.

### Bilateral funding

USAID is a key player for groundnut R&D activities and

<sup>4</sup> Seven new varieties were released in 2015. This study does not incorporate the impacts of these varieties as they are not yet disseminated to a significant extent.

**Table 1.** ICRISAT's Groundnut seed production in Malawi, 2007- 2010.

Season	Area (ha)		Average Yield (Ton/ha)		Production (Ton)	
	Basic seeds	Certified seeds	Basic seeds	Certified seeds	Basic seeds	Certified seeds
2007/08	20	167	1.5	0.8	30	133
2008/09	149	344	1.0	0.8	149	275
2009/10	195	459	1.0	0.8	195	367

Source: Data from ICRISAT.

has been operating the Feed the Future Programme in seven districts of Malawi. The programme aims to integrate nutrition in the value chains through partners such as NASFAM, Catholic Development Commission in Malawi (CADECOM), Agrishare, RUMARK, Afri-Save, and IITA. The programme also works with banks such as FDH, EcoBank, FMB, OIMB, and Standard Bank on credit related issues.

Irish Aid has recently made a significant commitment to supporting the Malawi Seed Industry Development Project. This initiative was launched in 2009, and has been contributing to seed availability of groundnut and pigeonpea for the FISP. In 2010, smallholder farmers accessed about 500 tons of improved seed of the two legumes through the project. Together, Irish Aid, ICRISAT, NASFAM, and STAM (the Seed Trade Association of Malawi) launched MASA (the Malawi Seed Alliance), an umbrella brand that could be used by small-scale seed producers to promote certified seed.

McKnight Foundation is another key contributor to groundnut R&D in Malawi. Its Collaborative Crops Research Programme (CCRP) has made significant impacts on the livelihoods of Malawian farmers, particularly in Mchinji District. Initiated in 2006 in partnership with NASFAM, the project successfully developed community seed banks and involved farmers in participatory variety selection. Majority of the farmers in the target area currently plant a minimum of 0.5 ha of Nsinjiro variety through the programme, compared to 0.1 to 0.2 ha before the project started.

GIZ (Deutsche Gesellschaft für Internationale Zusammenarbeit) was a significant donor between 1987 and 2003. The funding schedule was DM 2.34 million for the first phase (1987-1988), DM 5.0 million for the second phase (1989-1992), DM 4.5 million for the third phase (1992-1994), DM 2.7 million for the fourth phase (1995-2000), and DM 2.7 million for the final phase (2001-2003) (Maredia et al., 2000). The Malawi NARS participated in regional evaluations while selecting elite materials for adaptation to local conditions through incorporation of the pre-bred materials into national yield testing.

## METHODOLOGY FOR IMPACT ASSESSMENT

### Defining 'impact' in this study

The 'impact' of R&D encompasses (1) people level impact, (2)

direct product (effectiveness) of research, and (3) intermediate/institutional impact (Anderson and Herdt, 1990; Anandajayasekeram et al., 1996; Moshi et al., 1998; IAASTD, 2009). The people level impact consists of economic impact (efficiency analysis), socio-cultural impact, and environmental impact (Anandajayasekeram et al., 1996). The main focus of this study is the economic impact. Thus, the economic impact assessment undergoes quantitative analysis, whilst other types of impacts are described in a qualitative manner.

Our analysis examines the 'aggregate' impacts of groundnut R&D. In other words, disaggregation of the analytical outcome at different levels is not presented. More specifically, the term 'aggregate' refers to the following six dimensions:

- (1) NARS and ICRISAT: Since it is almost impossible to separate the R&D activities by the government and by ICRISAT as they were very closely linked and interconnected, this study in effect investigates the impact of the joint investment by the ICRISAT projects and the NARS programmes (that is, GIP). Although minor, there are some actors indirectly involved in groundnut R&D. It is not possible to accurately incorporate their investment in our analysis.
- (2) Research and Extension: It is difficult to separate the effect of research from that of extension and other support services needed to generate the developmental impacts. Thus, the estimated rates of return (ROR) and net present value (NPV) are with respect to the entire investment on research and extension, as well as marketing.
- (3) 5 varieties or 6 varieties: Although six varieties were released by GIP since 1982, the five most successful ones are incorporated in the analysis. That is, the success case method is used (Brinkerhoft, 2003) on the premise that if the five varieties can generate a positive net benefit from the investment, then the entire range of outputs should generate a greater cumulative benefit to the society.
- (4) Varieties: It is difficult to track down the costs for individual varieties and recommendations. Hence, our analysis employs the costs for all the varieties under consideration instead of costs for individual varieties.
- (5) Seeds and Agronomy: The yield gains are assumed to be due to both the adopted improved varieties and the recommended crop management practices. That is, the impacts of technology packages are estimated.
- (6) Purity of Seeds: Another important note is that farmers' practice of recycling improved seeds makes it difficult to clearly separate pure improved varieties from contaminated improved varieties.

To account for all these data constraints, sensitivity analysis is performed to examine the potential effects of missing data on benefits and costs.

Another important consideration in impact analysis is comparison between the 'with' and 'without' situations, where 'with' refers to the actual case with the intervention while 'without' corresponds to the counterfactual scenario. In our study, the 'without' scenario is the situation that would have prevailed if the R&D investments had been missing. The point is that there may have been endogenous changes taking place in any society even without research

intervention, and thus some improvement in productivity. In our study, however, the assessment incorporates a whole range of technologies generated since 1982, and all the changes in productivity are assumed to have resulted from the intervention and its spillover. In this regard, the situation prior to 1982 is regarded as an adequate proxy for the 'without' scenario. The five year moving average yields for 1977-1981 (that is, the baseline) is taken to represent the yields in the 'without' case, for which estimates of farm-level yields regularly recorded by MoAIW are used. The yield gain is then computed from the difference between the 'with' and 'without' cases for the relevant years.

### Economic impact (efficiency analysis)

Economic impact assessment examines effects of a given set of R&D activities by systematically comparing the streams of costs (including adoption and transfer costs) with the stream of project benefits. The premise is that research is an investment which is expected to generate some benefits, for which ROR can be defined and computed. The ROR is used as a summary indicator of benefits from and costs of the investment, which can be readily compared with ROR from alternative investment options.

The common approaches to estimating the ROR belong to three main categories: the partial equilibrium economic surplus approach, the econometric approach, and the programming approach (Masters et al., 1996).

The economic surplus approach measures the aggregated social benefits of a project by considering benefits and costs to calculate the average rate of return (ARR). The whole expenditure regime is regarded as given, so that the ROR to the global set of expenditures can be computed. This approach incorporates changes in consumer and producer surplus caused by a technological change due to R&D. The ARR provides for a measure of whether the entire investment package is worthwhile, though it does not indicate whether the allocation of resources across investment components is optimal (Oehmke, 1992). The economic surplus together with the research costs is utilised to calculate the net present value (NPV) and the internal rate of return (IRR) (Maredia et al., 2000). The advantage of the economic surplus method is that the model requires less information than do the other models.

In contrast, the econometric approach entails estimation of the production function, the cost function, or the total factor productivity by regression analysis, to derive marginal rates of return (MRR) of R&D during a long period. The MRR is the return associated with the last dollar invested in each component of research. The difficulty is that a reasonable estimate of the MRR requires high quality time series data for all relevant variables, which is usually not easy to obtain in developing countries.

The programming approach aims to identify one or more optimal technologies or research activities from a set of options. In other words, the approach attempts to maximise one objective, that is, farmers' profit subjected to constraints such as availability of land, labour and other inputs (Wander et al., 2004).

Given the data quality and availability in Malawi, our study adopts the economic surplus approach to estimate the ARR for investments in groundnut R&D programmes. To obtain the ARR, the net benefits for each year need to be computed by netting out R&D expenditures from the gross benefits for the year under consideration.

### Gross benefits

The economic surplus approach presumes that new technologies lead to increased productivity, causing the aggregate supply curve to shift outward. Assuming market equilibrium and linear demand

and supply curves, the gross benefits from the supply shift are captured by the area ABCD in Figure 4. The area represents the gross benefits resulting from research and related investments in the given technology. The gross benefits are shared between consumers and producers. Price elasticities of demand and supply determine the relative gain by producers and consumers. An export parity price, adjusted for distortions, is used in the analysis since Malawi has been a net exporter of groundnut during the study period.

There are different versions of calculation of the gross benefits in empirical work, corresponding to varying assumptions on the nature of demand and supply curves and the expected type of supply shift. The most concise means of obtaining the gross benefit is the Perfectly Elastic Demand - Perfectly Inelastic Supply (PEDPIS) method as we dub it, which is also simply referred to as the benefit-cost method (Anandajayasekeram et al., 1996; Fleischer and Felsenstein, 2002; Wander et al., 2004). The PEDPIS method does not explicitly incorporate the price elasticities of demand and supply, assuming the simple case of a perfectly inelastic supply curve and a perfectly elastic demand curve. The perfectly elastic demand curve represents the case where the country in question is a price taker and the intervention does not change the status of the country from a net importer to a net exporter of the commodity or vice versa. The perfectly inelastic supply curve is possible when inputs such as land and labour resources are fixed and fully utilised, and the commodity under evaluation is the main user of these resources. The change in supply is represented by a parallel shift. In the PEDPIS method, welfare gains from R&D investments are expressed by the area abcd in Figure 5. This rectangular area is computed as the increase in outputs ( $Q_1 - Q_0$ ) multiplied by the price ( $P^*$ ) which is constant. The great advantage of this method is that elasticity estimates are not required, which makes the computation terse.

One of the most widely adopted approaches in ex-post assessment of gross benefits from R&D is the Akino-Hayami (AH) method (Akino and Hayami, 1975). The precursor to this model was developed by Schultz (1953) and Griliches (1958), which was later modified and adapted by Akino and Hayami and has been used in hundreds of agricultural research impact assessments and became well established within the discipline of agricultural economics as the main analytical approach in assessing the gross benefits of agricultural R&D investments, as illustrated by Norton and Davis (1981), Masters et al. (1996), Walker et al. (2008), Maredia et al. (2014), and so forth. The high IRRs emanating from studies based on the AH method demonstrated the large economic benefits generated by public investments in agricultural R&D (Evenson, 2001; Alston et al., 2000). The AH method allows for non-linear demand and supply curves (with constant elasticities), and a pivotal (that is, conservative) shift of the supply curve in response to the technological change. Since this method explicitly incorporates demand and supply elasticities, it is more data demanding than the PEDPIS method. Still, the data requirements are modest as the elasticities are assumed constant. Therefore, the method is widely adopted in empirical studies in countries where quality data are limited. The AH method employs a formula for estimation of the welfare gains expressed as area ABO in Figure 6.

The surplus area ABO is the sum of area AOC and area ABC. Area AOC is computed as follows:

$$\text{Area AOC} = K \text{ Factor} \times \text{Total Production Value}$$

Where

$$K \text{ Factor} = \left[ \frac{\text{Proportion of Area Planted to MVs}}{\text{Yield for MVs}} \right] \times \frac{\text{Yield Gains from MVs}}{\text{Yield for MVs} - (\text{Yield for TVs})}$$

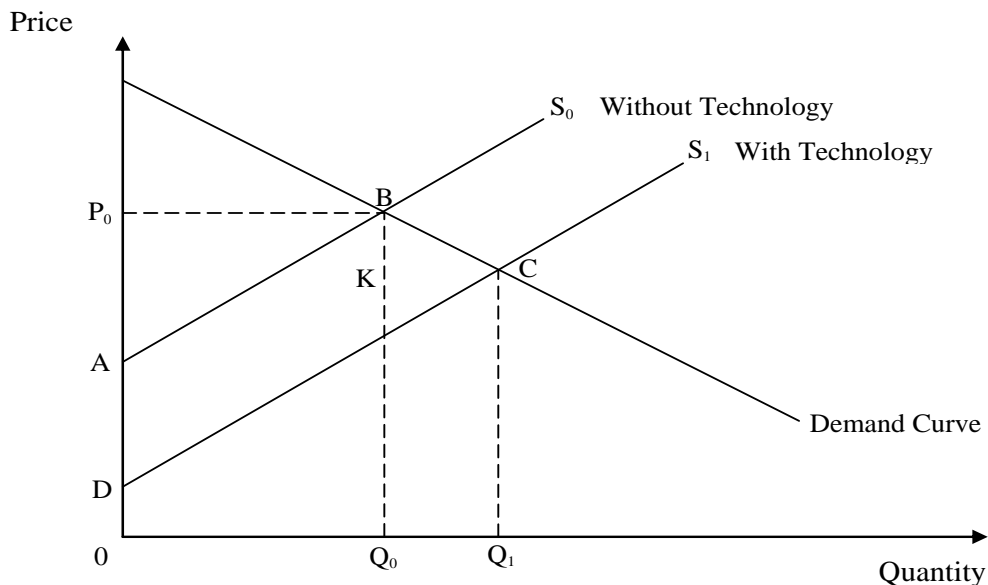

**Figure 4.** Producer surplus and consumer surplus with and without new technology. Source: Anandajayesekeram et al. (1996).

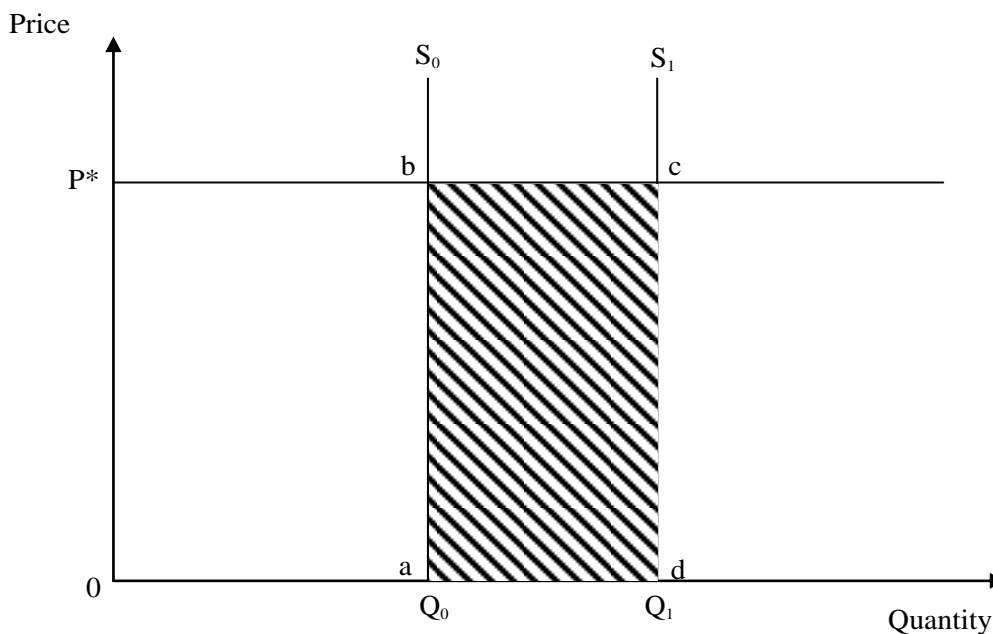

**Figure 5.** Perfectly inelastic supply curve and perfectly elastic demand curve. Source: Anandajayesekeram et al. (1996).

with MV and TV standing for modern variety and traditional variety, respectively.

Area ABC is calculated as follows:

$$Area\ ABC = 0.5 \times Area\ AOC + K\ Factor \times \frac{(1 + Price\ Elasticity\ of\ Supply)^2}{(Price\ Elasticity\ of\ Supply) + (Price\ Elasticity\ of\ Demand)}$$

The yields in the above formulae are weighted when there are

multiple varieties.

The most notable alternative model is the Alston-Norton-Pardey (ANP) method developed by Alston et al. (1998) as a modification of the AH method. The ANP constructs the K shift in a sophisticated way, incorporating the supply elasticity at a particularly crucial point in the calculation. The sensitivity of the result to supply elasticity estimates implies that the ANP method is advantageous when highly reliable elasticity estimates are available (Oehmke and

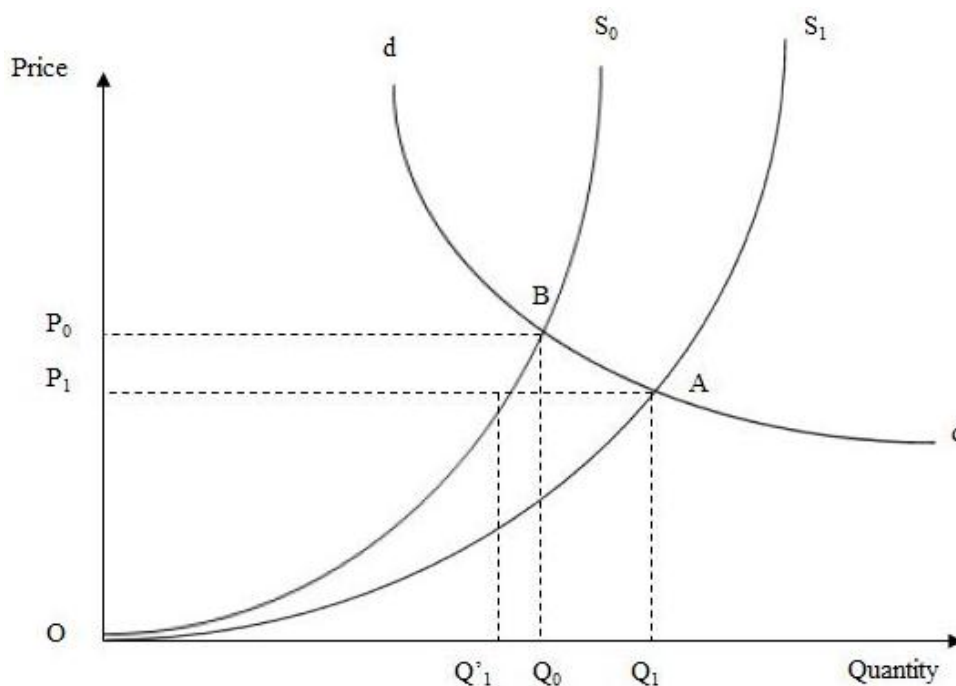

**Figure 6.** Demand and supply curves in Akino and Hayami method. Source: Adapted from Anandajayesekeram et al. (1996).

Crawford, 2002). Since precise estimates of supply elasticities are difficult to obtain in least developed countries, the AH method still maintains certain popularity for studies in developing countries; for instance, as used by Hasan and Islam (2014) and Miah et al. (2015).

Based on this discussion, our study applies the PEDPIS and AH methods and juxtapose the outcomes to examine the robustness of the result.

### Costs of R&D

The R&D costs consist of three key components: (1) research (technology development) costs, (2) extension (technology transfer) costs, and (3) adoption costs incurred by farmers and other service providers. These cost components emanates from the major cost items as listed below.

#### (1) Research Costs:

- i) Personnel costs (staff salaries and benefits);
- ii) Recurrent expenditures;
- iii) Overheads and administration expenditures; and
- iv) Depreciation of capital assets.

#### (2) Extension Costs:

- i) On-farm research and demonstration trials;
- ii) Costs of running the Commodity Training Center;
- iii) Expenditures by public extension institutions on extension activities for a particular commodity (estimates);
- iv) Expenditures by chemical and other input companies on extension and promotion activities;
- v) Expenditures by public and private product marketing firms on extension;

- vi) Expenditures by farmer organisations (commodity associations and farmers' unions) on extension; and
- vii) Expenditures of NGOs on research and extension.

#### (3) Adoption Costs:

- i) Difference in the cost of seeds between MVs and TVs;
- ii) Difference in the cost of chemicals between new and old pest and disease control methods;
- iii) Difference in the use of labour and equipment between the new and old production practices;
- iv) Difference in fertiliser usage between the MVs and TVs; and
- v) Difference in the costs of harvesting, shelling, and other processes.

The personnel costs (that is, salaries and benefits) for the government and ICRISAT were summed up to obtain the figure for personnel costs incorporated in the analysis. The costs of salaries and benefits for ICRISAT staff associated with groundnut research were collected from human resources records and progress reports. The salaries and benefits for government staff working on groundnut were estimated and supplied by Chitedze Agricultural Research Station. The estimates are derived from the annual allocation of DARS budget to groundnut research by taking into account the number of staff working on groundnut and the proportion of their time spent on groundnut.

The figures for annual recurrent expenditures and depreciation costs allocated to groundnut were obtained from the annual reports compiled by researchers working on GIP. ICRISAT provided its annual recurrent figures associated with groundnut, which were combined with the figures from NARS.

Overhead and administration costs figures were derived from the accounting records provided by ICRISAT. These figures were given as percentages of the total costs of individual projects in which ICRISAT was involved. The percentage varied from 10 to 20%



depending on the project.

For the adoption of new technologies, the major cost items were seeds, labour, and other farm inputs that went with the recommendations. These costs were estimated by NGOs such as Concern Universal engaged in GIP.

A considerable number of stakeholders were involved in the diffusion of groundnut technologies. The major ones were the government department of extension, seed companies, NGOs, and community based development groups. However, it was not possible to obtain technology transfer costs from the DAES. In consultation with researchers and extension staff, it was agreed that the estimates from Concern Universal would provide a reasonable guide for the government spending on groundnut extension. Their estimate was therefore taken and adjusted for the zones of the country to present the national average for each year. Some donor projects were also involved in extension programmes, whose costs were incorporated under research costs.

### NPV and IRR

The benefits and costs of research, which is a long-term investment, are realised over time, and are measured in a common unit at any given point in time to facilitate comparison. This means that the analyst needs to convert the entire flow of benefits and costs into a single number. Discounting is considered to estimate the present value of flows of benefits and costs at any particular point in time. The most commonly adopted measures of a project's net worth are NPV and IRR.<sup>5</sup>

The NPV of a project is the sum of the discounted incremental net benefits, expressed as follows:

$$NPV = \sum_{i=0}^T \frac{B_i}{(1+r)^i} - \sum_{i=0}^T \frac{C_i}{(1+r)^i} = \sum_{i=0}^T R(B_i - C_i)$$

where  $r$  is the discount rate,  $T$  is the number of years,  $i$  is the year in which the costs and benefits occur,  $B_i$  is the benefit in year  $i$ ,  $C_i$  is the cost in year  $i$ , and  $R = \frac{1}{(1+r)^i}$  is a discount factor. The

IRR is defined as the threshold discount rate that renders the NPV equal to zero. In other words, at  $r = \text{IRR}$ , the discounted incremental benefit is equal to the discounted incremental cost.

### Other types of impacts

Although this study focuses on the economic impact, other types of impacts are discussed to a certain extent in a qualitative manner. This subsection outlines those other types of impacts, namely, spill-over effects, direct product (effectiveness) of research, intermediate/institutional impact, socio-cultural impact, and environmental impact.

### Spill-over effects

Research results are often utilised over a range of agricultural production conditions or environments that can span across commodities, sectors, geographical and national boundaries.

<sup>5</sup> One other measure is benefit-cost ratio (BCR) which represents the relation between the present value of the benefits and the present value of the costs. The investment is considered profitable if the BCR is higher than 1.

### Direct products of research (Effectiveness analysis)

Direct products of research include improved technology and specialised information. Effectiveness analysis assesses the performance of a project by focusing on the degree to which the project achieved its desired objectives. The emphasis is on evaluating the results against clearly defined goals, which requires measurable indicators, and some standard for measurement of success.

### Sociocultural impact

Sociocultural impact is the final effects of research outputs on the attitude, beliefs, resource utilisation patterns, status of women and minorities, income distribution, nutrition status, empowerment of the target group, and so forth. The common method for assessing sociocultural impacts is to conduct socioeconomic surveys. In our study, an adoption survey is used to explore the sociocultural impacts of groundnut R&D investments.

### Environmental impact

From time to time, the adoption of technologies leads to positive or negative externalities through impacting the surrounding environment. For instance, while chemicals such as pesticides and insecticides are used to reduce crop damage, some chemicals may harm biodiversity and/or cause pollution of water sources.

### Data sources

Both published and unpublished sources were used to collect quantitative and qualitative information. The base scenario in the economic impact analysis is based on the data from the following sources: MoAFS (2010, 2011, 2012a, b), MoEPD (2011, 2012), NSO (2012), FAOSTAT (2015), ICRISAT's unpublished records and documentations, and unpublished reports by other researchers. These documents and records provide information on acreage, production, CPI, interest rates, export parity prices, price elasticities, costs of research and transfer, input and output prices, and other relevant indicators.

In addition to these, primary data are collected to feed into the sensitivity analysis as well as to provide insights in understanding the different types of impacts. The sources of the primary data are focus group discussions (FGDs), key informant interviews, and a household survey with groundnut farmers. The survey was conducted immediately after the 2012/2013 crop season, covering 1129 households.<sup>6</sup>

## RESULT

### Yield gains

Figure 7 shows proportions of yield gains from new technologies over the years, where the yields prior to 1982 are taken to be due to old technologies. Until 1995, the yield gain fluctuated largely and registered a negative gain in four of these years. The fluctuation was largely due to the unstable weather conditions. Since 1995,

<sup>6</sup> To keep the paper focused and succinct, most of the findings from the survey are not presented in this paper but are summarized in Appendix B of Tsusaka et al. (2015b).

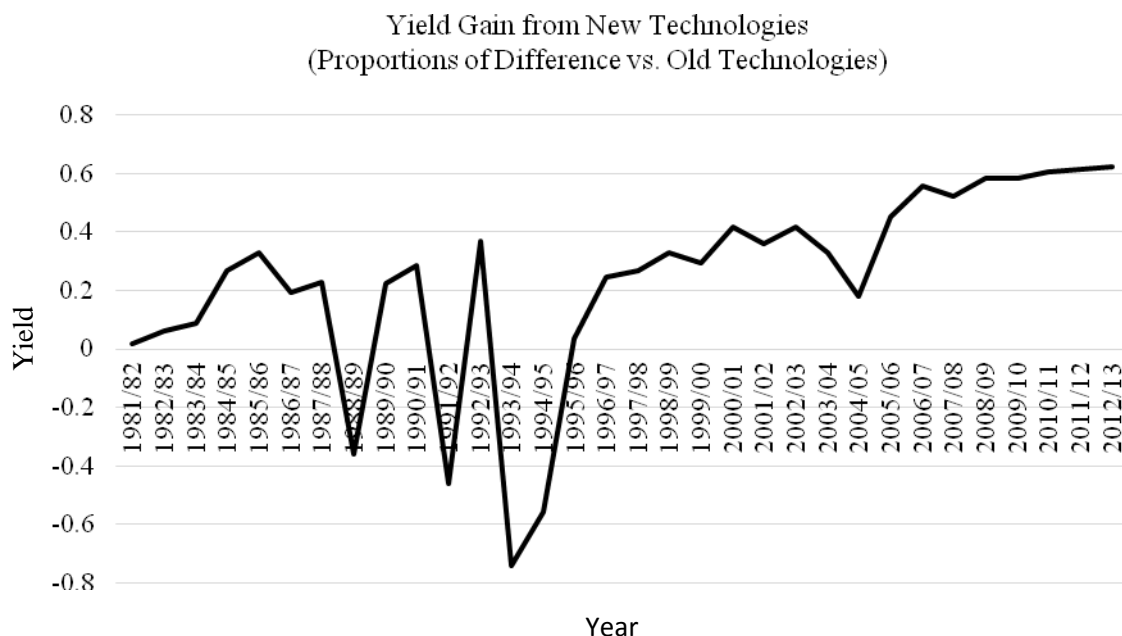

**Figure 7.** Yield advantage of improved groundnut varieties in Malawi, 1982-2013. Source: Authors' creation with data from MoAIW.

**Table 2.** Mean labor allocation to groundnut (person days, adult equivalent) by activity and area, 2012/13.

Labor type	Activity	Lakeshore				Central			Mzimba	Overall	
		MH	KK	SA	Mean	KU	MC	LL	Mean	MZ	mean
Family	Ploughing	23	22	17	21	24	33	21	26	24	23
	Planting	3	4	3	4	4	4	4	4	5	4
	Weeding	17	19	13	16	20	27	17	21	22	19
	Harvesting (Lifting)	15	15	12	14	17	19	13	16	16	15
	Stripping and Shelling	12	18	12	14	21	21	14	19	26	18
Hired		14	21	24	19	30	24	36	31	41	26
Total		84	99	81	87	116	129	104	116	135	105

Source: Authors' calculation with the adoption survey 2013 data.

however, the gain has been constantly positive and growing at a steady pace, while stress-tolerant technologies disseminated.<sup>7</sup>

### Reduction in opportunity cost

According to the adoption survey, the sampled farmers allocated a total of 105 (adult equivalent) days to cultivate the improved varieties (Table 2), which was considerably smaller than the 135 days typical for traditional varieties. Adoption of improved varieties therefore led to saving 30

person days of labour, and this saving was considered as an additional benefit to adoption. To convert the labour saving into monetary terms, US\$ 0.90/day was used as the opportunity cost of labour.

### Economic impacts

#### Base scenario

Figures 8 and 9 present the calculated net benefits for the period 1982 to 2013 by the AH method and the PEDPIS method, respectively. In both methods, the net benefits were negative in the first 10 years during the study period, and later turned positive. In addition to the adoption factor, land allocation to groundnut is another

<sup>7</sup> This observation is consistent with Tsusaka et al. (2015a)'s finding that it can take about one decade for popular improved varieties to adequately disseminate after their launch.

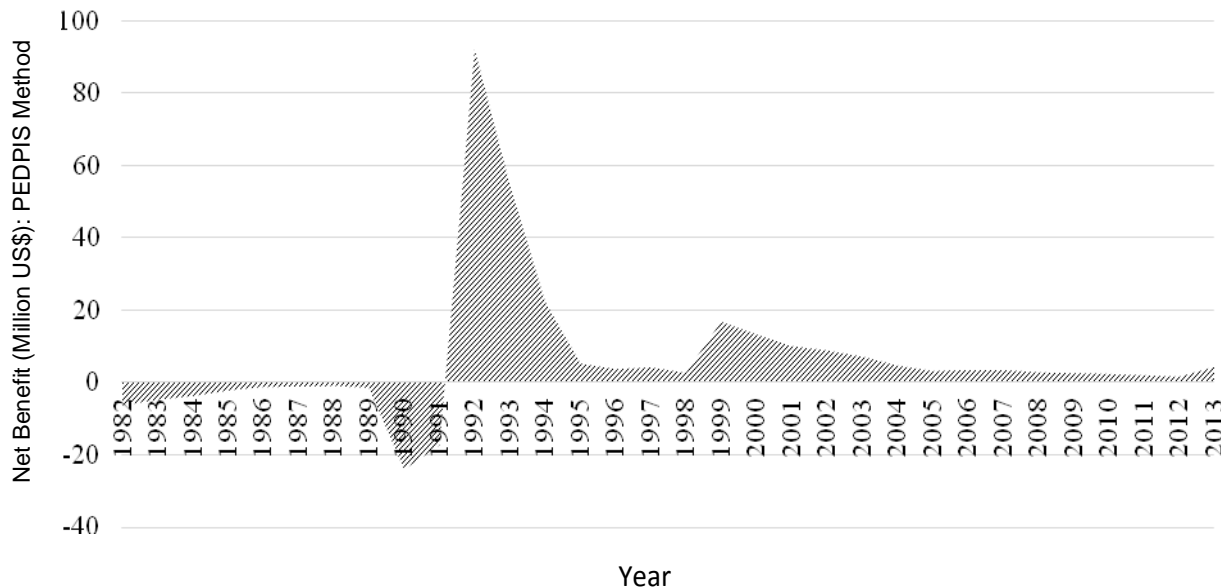

Figure 8. Estimated net benefits for groundnut R&D in Malawi, under the PEDPIS method, 1982-2013.

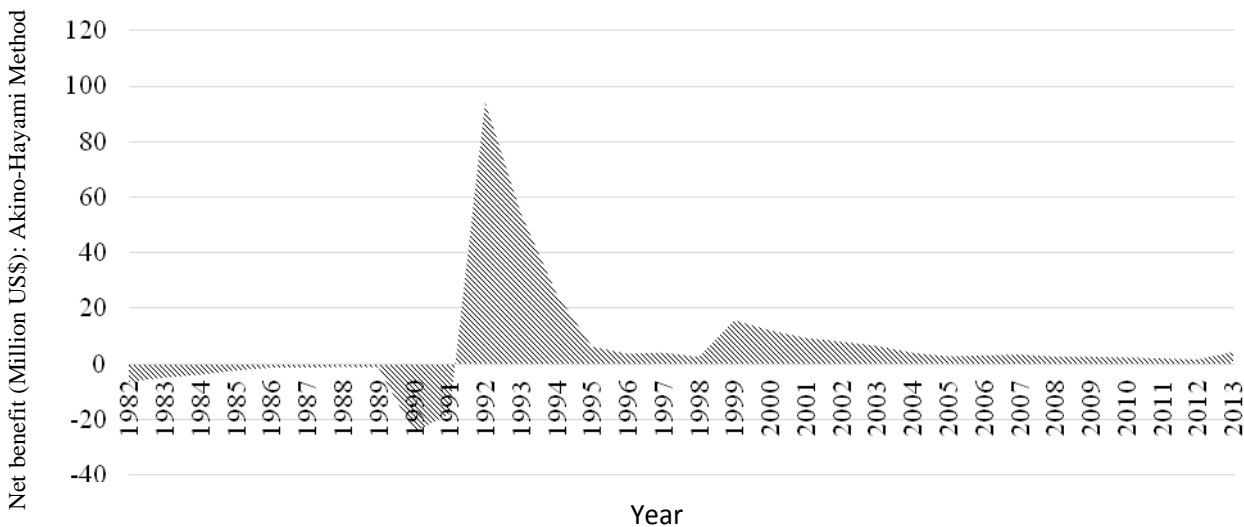

Figure 9. Estimated net benefits of groundnut R&D in Malawi, under the Akino-Hayami method, 1982-2013

factor affecting the benefits. When tobacco prices are relatively high, farmers allocate more land to tobacco at the expense of groundnut, and vice-versa.

As for the price elasticities of demand and supply for groundnut required in the AH method, reliable data were not available in Malawi, and we thus decided to find proxies. For the elasticity of demand, the case of groundnut in South Africa was adopted, which was -0.72 as estimated by van Schalkwyk (2003). For the elasticity of supply, Schiff and Montenegro (1995) and Chhibber (1989) argue that elasticities of supply in developing countries where farming rely on traditional tools such as

hoes range from 0.3 to 0.5. Our study took the middle point (that is, 0.4) between the borders. Nonetheless, according to Masters et al. (1996) and Akino and Hayami, social benefits defined as the change in economic surplus in this method are not highly sensitive to the choice of elasticity parameters, which is also implied by the small difference in results between the two methods presented here.

Based on the stream of benefits and costs accruing over the years, the overall NPV and IRR of the groundnut R&D investment were calculated. The nominal long-term bond rate (social time preference) in Malawi was 36.5%

**Table 3.** Estimated net present value and internal rate of return for groundnut R&D investment in Malawi, 1982-2013: Base scenario.

Discount rate (%)	Net present value (Million US\$)		Internal rate of return (%)	
	AH	PEDPIS	AH	PEDPIS
10.53	203.8	205.9	22	22
12.00	164.0	165.4	20	20
15.00	106.3	106.8	17	17

Source: Authors' calculation.

**Table 4.** Estimated net present value and internal rate of return for groundnut R&D investment in Malawi, 1982-2013: With increased research and extension costs.

Discount rate (%)	Net present value (Million US\$)				Internal rate of return (%)			
	AH		PEDPIS		AH		PEDPIS	
	20% increase	50% increase	20% increase	50% increase	20% increase	50% increase	20% increase	50% increase
10.53	185.1	157.0	187.2	159.1	18	14	18	14
12.00	147.1	121.7	148.5	123.1	17	12	17	12
14.00	92.2	71.2	92.8	71.8	13	9	14	9

Source: Authors' calculation.

while the annual inflation rate was 23.5%.<sup>8</sup> From these, the computed real interest rate (opportunity cost of capital) was 10.53%. Table 3 presents the NPV and the associated IRR, calculated at 10.53, 12.00, and 15.00% real discount rates.

At the 10.53% discount rate, the IRR for both methods was found to be 22%, indicating that the investment in groundnut R&D in Malawi was not only profitable but also competitive against other investment options. The NPV at the same discount rate was estimated to be US\$ 204 million with the Akino-Hayami method and US\$ 206 million with the PEDPIS method, where the difference between the two methods was within 1%. As expected, the NPV decreased as the discount rate was raised. Nonetheless, the value remained positive at all considered discount rates, suggesting that the investment in GIP was profitable even at the higher end of discount rate assumption.

### Sensitivity analysis

As previously mentioned, both the yields and costs data used in the analysis generally involved some assumptions on missing information. Taking this into account, a sensitivity analysis was conducted to examine the influence of modifying the assumptions for yields and costs on the economic impact estimates.

### Modifying research costs

The sensitivity to altering research costs (that is, personnel, recurrent expenditures, depreciation, adoption, and extension) was examined by increasing the research costs by 20 and 50%. As Table 4 shows, the increases in research costs led to decreases in NPV and IRR from the base scenario. Even so, the investments in groundnut research remained more or less profitable in view of the opportunity cost of capital in Malawi. However, as the discount rate was set at 14% and the research costs were raised by 50%, the IRR became 9%, indicating that the investment under this assumption was still profitable but lost its competitive edge over other investment options.

### Modifying overheads and administration costs

Another sensitivity test was performed by doubling the overheads and administration costs (Table 5). Both the NPV and IRR exhibited sensitivity to this alteration. The NPV dropped to US\$ 104 million and US\$ 105 million for the respective methods. The IRR also decreased but remained higher than the opportunity cost of capital.

### Using the yields from the adoption survey

The preceding analysis used the historical data provided by MoAIW to generate the yield advantage of the new

<sup>8</sup> According to Standard Bank Malawi in 2013.

**Table 5.** Estimated net present value and internal rate of return for groundnut R&D investment in Malawi, 1982-2013: With doubled overheads and administration costs.

Discount rate (%)	Net present value (Million US\$)		Internal rate of return (%)	
	AH	PEDPIS	AH	PEDPIS
10.53	200.8	202.9	21	21
12.00	161.3	162.7	19	20
15.00	104.1	104.6	16	16

Source: Authors' calculation.

**Table 6.** Estimated net present value and internal rate of return for groundnut R&D investment in Malawi, 1982-2013: With the yield advantage based on the adoption survey.

Discount rate (%)	Net present value (Million US\$)		Internal rate of return (%)	
	AH	PEDPIS	AH	PEDPIS
10.53	179.9	185.2	21	22
12.00	146.4	151.0	20	21
15.00	96.6	100.0	17	18

Source: Authors' calculation.

technologies over the old ones. This time, we take the yields computed from the survey data. According to the survey, the yield was 552 kg/ha for CG7, 619 kg/ha for Nsinjiro, 406 kg/ha for Kakoma, 533 kg/ha for Baka, 700 kg/ha for Chitala, and 509 kg/ha for traditional varieties. The weighted average yield for improved varieties was derived using the proportion of area planted to each variety: 54% of the total area devoted to improved varieties was sown to CG7, 31% to Nsinjiro, and 5% to each of the remaining three varieties. As a result, the weighted average yield for the five improved varieties turned out to be 572 kg/ha, which translated to the yield advantage of 63 kg/ha. Table 6 presents the result based on the yield gain from the survey data. The result was largely similar to that in Table 3. Therefore, the investment in groundnut R&D remained profitable and competitive, under this assumption.

### **Increasing the yield to 1500 kg/ha**

Lastly, the sensitivity to a rosy assumption of the new yield achieving 1500 kg/ha was tested (Table 7). Achieving this yield level would further boost the profitability and competitiveness of investments in groundnut R&D. The IRR jumped to over 30% for both methods. The NPV increased by US\$ 49 million (Akino-Hayami Method) and US\$ 78 million (PEDPIS Method) from the base scenario, at the 10.53% discount rate.

### **Other types of impacts**

#### **Spill-over effects**

Table 8 presents the groundnut varieties originally

released in Malawi, along with the countries benefited from the spillover of each variety. In principle, cultivars that have been extensively tested and evaluated in one country can be considered for accelerated release in neighbouring countries. For example, it took almost seven years for CG7 to proceed from the initial varietal testing to final release. When it was introduced in other countries, however, this period was shortened to 2 to 3 years. The reduction in lead time greatly curtails the cost of varietal development and release in spillover countries.<sup>9</sup> As this type of spillover leads to resource savings enjoyed outside Malawi, the benefits from this effect were not incorporated in the economic impact in Malawi.

Another dimension of spillover occurs through capacity development. Under GIP, both short-term and long-term trainings have remarkably benefited farmers, scientists, and technicians. Over time, many of these scientists as well as technicians have worked on other commodities, especially legume crops.

Thus, it can safely be said that the knowledge gained from training on groundnut has rendered positive inter-commodity spillovers. Citation analysis is often used as a proxy for knowledge spillover through research publications. In our study, an attempt was made to compile the summary statistics of the publications cited by other publications during the 1994 to 2001 period.<sup>10</sup> There were 147 citations of the different publications, demonstrating the knowledge spillovers of groundnut R&D into other commodities.

<sup>9</sup> Note that technologies other than germplasm such as cultural practices and fertiliser management tend to be more site-specific and offer limited opportunities for spillover.

<sup>10</sup> The citation analysis is based on Google Scholar.

**Table 7.** Estimated net present value and internal rate of return for groundnut R&D investment in Malawi, 1982-2013: With the new yield of 1,500 kg/ha.

Discount rate (%)	Net present value (Million US\$)		Internal rate return (%)	
	AH	PEDPIS	AH	PEDPIS
10.53	253.0	283.4	35	36
12.00	206.1	232.0	33	34
15.00	138.2	157.4	30	31

Source: Authors' calculation.

**Table 8.** Groundnut R&D technology spillovers.

Variety selected in Malawi	Spill-over country
Chipego	Zambia
ICGM 286	Rwanda
ICGMS 42	Zambia
ICGV-SM 86066	Rwanda
ICGV-SM 85038	Rwanda
ICGV-SM 86080	Rwanda
Stella	Mauritius
Veronica	Mauritius
CG7	Zambia (MGV4)
ICGV-SM 90704	Zambia (Chishango), Mozambique (Mamane)
JL 24	Zambia (Leuna)
ICG 12991	Mozambique (Nametil)

Local names are in parentheses. Source: Data from ICRISAT.

### **Direct product of research**

Broad output categories that are common to most agricultural R&D programmes are (1) seed improvement, (2) crop management, (3) publications, (4) capacity development, and (5) dissemination schemes, among others (Peterson et al., 2003). This paper refrains from presenting the list of outputs of GIP as the list is extremely long.<sup>11</sup>

### **Socio-cultural impacts**

**Food and Nutritional Security:** About 77% of the sampled farmers indicated that the adoption of improved groundnut varieties had improved the food security status. 82% of the farmers experienced an increase in groundnut consumption. 19% exchanged groundnut with other food. Almost 50% used income from groundnut to buy food, and 40% used it to purchase farm inputs. Farmers also used this additional income to purchase livestock. These findings demonstrate that the new technologies of groundnut have significantly contributed

to improving the food and nutrition security in Malawi.

**Gender:** Much of the processes in groundnut production are handled by women (Orr et al., 2014), especially the labour intensive post-harvest processes. For instance, while the traditional groundnut varieties are of spreading type, involving considerable labour in harvesting, the improved varieties are of the 'bunch' type and easier to harvest. Thus, the adoption of new technologies is expected to have reduced women's drudgery at harvest. Besides, CG7 is also easy to strip (that is, separate pods from the harvested plant), which must have led to labour saving for women.

### **Environmental impacts**

Many of the recommended groundnut management practices have positive impacts on the environment. As a common practice in Malawi, groundnut is grown on ridges formed across the slope of land. This helps control the flow of rain water and to prevent the soil erosion. Other common practices are intercropping, crop rotation, and ploughing beneath crop residues, which contribute to

<sup>11</sup> The list of direct outputs of groundnut R&D can be found in Appendix A of Tsusaka et al. (2015b).



improving soil structure, texture, and fertility. Screening and selection of early-maturing groundnut cultivars for production in areas prone to rust disease and late leaf spot as well as pests help reduce the need for chemicals that tend to pollute the natural environment.

One of the negative externalities of groundnut production is the effect of aflatoxin on human health. Aflatoxin is carcinogenic to human beings.

### Concluding remarks

The study provides for the first impact assessment of groundnut R&D over the past three decades in Malawi, with a focus on economic impacts. Using the economic surplus approach, the NPV estimated at the discount rate equivalent to the opportunity cost of capital was more than US\$ 200 million with the IRR being 22%, under the base scenario. The result is in line with the observed increase in groundnut production led by improved technologies developed and disseminated by the R&D activities. The NPV and IRR are somewhat sensitive to varying assumptions on discount rate, groundnut yield, and cost items. Yet, in most cases, the estimated IRR suggests that investment in groundnut R&D has been profitable and competitive, and thus benefited consumers and producers in Malawi. Our estimated IRR is slightly lower than the aggregate IRR to agricultural R&D in Africa (27 to 44%) as calculated by Alene (2010). Nonetheless, the majority of the investments were made for staple crops including star crops such as wheat and rice. As for long-term crop-specific R&D for legumes in sub-Saharan Africa, there are a couple of notable cases found for cowpea: the IRR was estimated to be 15% for the 20-year investment in Cameroon (Sterns and Bernsten, 1994) and 13% for the 38-year investment in Senegal (Boys et al., 2007), with which our result compares favourably. Furthermore, Maredia et al. (1998) argue that in many cases, the immediate benefit from agricultural R&D is negative while it turns positive in the long run. Figures 8 and 9 imply a similar story, and continued investment is therefore suggested.

The social and environmental impacts cannot be divorced from the economic impact to the society. This study showed that so many beneficiaries of groundnut technologies perceived improved food security and reduced poverty. From the gender perspective, the early maturing varieties with the shapes easier for lifting and stripping must have alleviated drudgery, particularly for women. The improved crop management practices helps in conserving the environment through better control over rain water flow, prevention of soil erosion, and retention of soil fertility. The crop resistance to diseases and pests contributes to reducing the need for applying chemicals that may pollute the environments.

Given the limited public funding, the following intervention areas are suggested based on the

information gathered in this study: (1) Developing improved seeds remains to be an essential vehicle for generating impacts on society. It is however worth noting that it may take about a decade for released technologies to start benefiting the society. (2) Groundnut farmers heavily recycle seeds of improved varieties, limiting the crop performance. The ability of the seed markets to provide sufficient seeds is critical in promoting the adoption of available technologies among smallholders. (3) 70% of the farmers never received extension services on groundnut production since the government extension service faces serious resource constraints including the shortage of extension staff. Provision of extension services to smallholders should be given a high priority in the agricultural policy agenda.

The major limitation to precise assessment of the impact of R&D investments is the lack of reliable data and consistent record keeping, which is true of the entire research system in Malawi and many other developing countries. The dearth of classified data prevents the estimation of the benefits of individual technologies. Although external partners contributed to the R&D at different periods, there is no office where all the information is centralised and maintained. In addition, the unavailability of reliable supply elasticity estimates hampered the use of the ANP method in estimating the gross benefits of R&D. In this study, the data limitation was basically addressed by conducting a sensitivity analysis with varying assumptions on costs and benefits. In all likelihood, there is a need to establish an effective monitoring and evaluation system to assess the performance of technologies and improve the accountability of agricultural research programmes.

### Conflict of Interests

The authors have not declared any conflict of interests.

### ACKNOWLEDGEMENTS

The study was funded by CGIAR (Consultative Group for International Agricultural Research) Research Program on Grain Legumes, and was assisted by three collaborators: Julius H. Mangisoni, Ponniah Anandajayasekeram, and Davies H. N'gon'gola. The authors are grateful to Geoffrey Kananji and Albert Chamango for their material support rendered throughout the course of the study. The Ministry of Agriculture, Irrigation and Water Development, the Ministry of Industry and Trade, and the private sector of Malawi could not be thanked enough for generously providing data and useful insights into the groundnut subsector. Lastly, we recognise and appreciate the efforts of the enumerators for data collection, and those farmers who were willing to provide us with the required information.

## REFERENCES

- Akino M, Hayami Y (1975). Efficiency and equity in public research: Rice breeding in Japan's economic development. *Am. J. Agric. Econ.* 57:1-10.
- Alene AD (2010). Productivity growth and the effects of R&D in African agriculture. *Agric. Econ.* 41:223-238.
- Alene AD, Coulibaly O (2009). The impact of agricultural research on productivity and poverty in sub-Saharan Africa. *Food Policy* 34:198-209.
- Alston JM, Norton GW, Pardey PG (1998). *Science under Scarcity. Walling for, UK: Cab International.*
- Alston JM, Chan-Kang C, Marra MC, Pardey PG, Wyatt TJ, (2000). A meta-analysis of rates of return to agricultural R&D, Ex Pede Herculem? IFPRI Research Report 113, International Food Policy Research Institute, Washington, D.C.
- Anandajayasekaram P, Martella DR, Rukuni M (1996). A training manual on research and development: Evaluation and impact assessment of investments in agricultural and natural resources research. SADC-SACCAR, Gaborone, Botswana, October 1996.
- Anderson JR, Herdit RW (1990). Reflections on impact assessment. Proceedings of the ISNAR/Rutgers Agricultural Technology Management Workshop, 6-8 July 1988, Rutgers University, New Jersey, Volume II: Assessing the Impact of Agricultural Research, ISNAR, The Hague, The Netherlands.
- Beintema NM, Mwenda ARE, Mtukuso AP (2004). *Agricultural Science and Technology Indicators (ASTI) Country Brief No. 22 Malawi, IFPRI, Washington D.C.*
- Beye G (2002). Impact of foreign assistance on institutional development of national agricultural research systems in Sub-Saharan Africa. FAO Research and Technology Paper 10, Rome.
- Brinkerhoff R (2003). *The success case method: Find out quickly what's working and what's not.* Berett-Koehler Publishers, INC. San Francisco.
- Boys K, Faye M, Fulton J, Lowenberg-DeBoer J (2007). The economic impact of cowpea research in Senegal: an ex-post analysis with disadoption. *Agric. Econ.* 36:363-375.
- Chhibber A (1989). The aggregate supply response: A survey, In Simon Commander, ed. *Structural Adjustment and Agriculture: Theory and Practice in Africa and Latin America.* ODI London.
- CYE Consult (2009). Value chain analysis of selected commodities, Institutional development across the agri-food sector, Final Report, Brussels, Belgium.
- Derlagen C, Phiri H (2012). Analysis of incentives and disincentives for groundnuts in Malawi. Technical Notes Series, MAFAP, FAO, Rome.
- Diop N, Beghin J, Sewadeh M (2003). Groundnut policies, global trade dynamics and the impact of trade liberalization. Mimeo. The World Bank, Washington, D.C.
- Evenson RE (2001). Economic impacts of agricultural research and extension. In: B. Gardener, G. Rausser, *Handbook of Agricultural Economics*, vol. 1, Elsevier Science B.V.
- FAOSTAT (2015). *United Nation's Food and Agriculture Organization.* Rome, Italy. Available at: <http://faostat.fao.org/default.aspx>
- FAOSTAT Food Balance Sheets (2007). *United Nation's Food and Agriculture Organization.* Rome, Italy.
- Fleischer A, Felsenstein D (2002). Cost-Benefit Analysis Using Economic Surpluses: A Case Study of a televised event. *J. Cult. Econ.* 26:139-156.
- Goyder H, Mang'anya M (2009). *Legumes platform baseline study. Research Into Use Program-Malawi.*
- Griliches Z (1958). Research costs and social returns: hybrid corn and related innovations. *J. Polit. Econ.* 66:419-431.
- Hasan MK, Islam MS (2014). An Ex-Post Analysis of Ginger (*Zingiber officinalis*) Research and Extension Investment in Bangladesh. *The Agriculturists* 12(2):103-115.
- IAASTD (International Assessment of Agriculture Knowledge, Science and Technology for Development) (2009). *Agriculture at cross road: Synthesis report. International Assessment of Agricultural Knowledge, Science and Technology for Development (IAASTD): Global report/* edited by Beverly D. Mc Intyre, et al. Island press, 1718 Connecticut Avenue, NW, Suite 300, Washington D.C, 2009.
- ICRISAT DARS (2007). Constraints, challenges and opportunities in production and marketing of groundnuts in Malawi. International Crops Research Institute for the Semi-arid Tropics, Lilongwe, Malawi.
- Maredia M, Byerlee D, Anderson J (2000). Ex Post Evaluation of Economic Impacts of Agricultural Research Programs: A Tour of Good Practice. Paper presented to the Workshop on "The Future of Impact Assessment in CGIAR: Needs, Constraints, and Options", Standing Panel on Impact Assessment (SPIA) of the Technical Advisory Committee, Rome, May 3-5, 2000, Rome.
- Maredia M, Byerlee D, Pee P (1998). Impacts of Food Crop Improvement Research in Africa. SPAAR Occasional Papers Series, No.1. Special Program for African Agricultural Research, Washington D.C.
- Maredia MK, Shankar B, Kelley TG, Stevenson JR (2014). Impact assessment of agricultural research, institutional innovation, and technology adoption: Introduction to the special section. *Food Policy.* 44:214-217.
- Masangano C, Mthinda C (2012). Pluralistic Extension System in Malawi. IFPRI Discussion Paper 01171. IFPRI Eastern and Southern Africa Regional Office, P. O. Box 5689, Addis Ababa, Ethiopia.
- Masters WA, Coulibaly B, Sidibe M, Williams A (1996). *The Economic Impact of Agricultural Research: A Practical Guide.* Department of Agricultural Economics, Purdue University, West Lafayette, IN.
- Miah MAM, Shiblee SMA, Rashid MA (2015). Economic Impacts of Oilseed Research and Development in Bangladesh. *Bangladesh Dev. Stud.* XXXVIII(1):1-31.
- Minde I, Madzonga O, Kanthiti G, Phiri K, Pedzisa T (2008). Constraints, Challenges, and Opportunities in Groundnut Production and Marketing in Malawi. Report No. 4. ICRISAT, 2008.
- MoAFS (Ministry of Agriculture and Food Security) (2012a). National Crop Estimates for 2007/08, 2008/09, 2009/10, 2010/11 and 2011/12. Lilongwe, Malawi: Planning Department.
- MoAFS (Ministry of Agriculture and Food Security) (2012b). Guide to agricultural production and natural resources management in Malawi. Lilongwe: Agricultural Communication Branch. Malawi.
- MoAFS (Ministry of Agriculture and Food Security) (2011). *Malawi Agricultural Sector Wide Approach: A Prioritised and Harmonised Agricultural Development Agenda: 2011-2015.* Lilongwe, Malawi.
- MoAFS (Ministry of Agriculture and Food Security) (2010). *The Agriculture Sector Wide Approach (ASWAp): Malawi's Prioritised and Harmonised Agricultural Development Agenda.* Lilongwe, Malawi.
- MoAFS (Ministry of Agriculture and Food Security) (2008). *Food Security Action Plan Volume I.* Lilongwe, Malawi.
- MoAIW (Ministry of Agriculture, Irrigation and Water Development) (2012). *Global Agriculture and Food Security Programme: Support to Malawi's Agricultural Sector Wide Approach (ASWAp): Proposal from Malawi Government.* Lilongwe: Agricultural Communication Branch. Malawi.
- MoEPD (Ministry of Economic Planning and Development) (2012). *Annual Economic Report.* Lilongwe, Malawi.
- MoEPD (Ministry of Economic Planning and Development) (2011). *Malawi Growth and Development Strategy 2006-2011.* Lilongwe, Malawi.
- Moshi A, Anandajayasekaram P, Kaliba A, Martella D, Mwangi W, Shao F (1998). Economic impact of maize research in Tanzania. SADC-SACCAR, Gaborone, Botswana.
- Msere HW, Tsusaka TW, Okori P, Twanje G, Botha R, Ndolo P (2015). Groundnut Production, Consumption, and Trade in Malawi. International Crops Research Institute for the Semi-arid Tropics, Lilongwe, Malawi.
- Norton GW, Davis JS (1981). Evaluating returns to agricultural research: a review. *Am. J. Agric. Econ.* 63(4):685-699.
- Oehmke JF (1992). Technology, impact and agricultural transformation: Lessons learned from impact studies. Paper presented at the Symposium of the Impact of Technology on Agricultural Transformation in Africa, October 14-16, 1992, Washington, D.C.
- Oehmke JF, Crawford EW (2002). The Sensitivity of Returns to Research Calculations to Supply Elasticity. *Am. J. Agric. Econ.* 84(2):366-369.
- Orr A, Tsusaka TW, Homann-KeeTui S, Msere HW (2014). What do we mean by 'Women's Crops'? A Mixed Methods Approach. ICRISAT SocioEconomic Discussion Paper Series 23: Patancheru, India. 44 pp. Available at: [http://oar.icrisat.org/8331/1/ISEDPS\\_23\\_2014.pdf](http://oar.icrisat.org/8331/1/ISEDPS_23_2014.pdf)

- Pardey PG, Beintema NM, Dehmer S, Wood S (2006). *Agricultural Research: A Growing Global Divide?* IFPRI Food Policy Report Series. No. 17. Washington, DC: IFPRI.
- Peterson W, Gijsbers G, Wilks M (2003). An organizational performance assessment system for agricultural research organisations: concepts, methods, and procedures. ISNAR research management guidelines No.7. The Hague: International Services for National Agricultural Research.
- Sangole N, Magombo T, Kalima D (2010). Groundnut value chain analysis report, African Institute of Corporate Citizenship, Lilongwe, Malawi.
- Schiff M, Montenegro CE (1995). Aggregate agricultural supply response in developing countries. A survey of selected issues. Policy Working Paper 1483. Washington, D.C.: The World Bank.
- Schultz TW (1953). *The Economic Organization of Agriculture*. McGraw-Hill Book Company, New York.
- Simtowe F, Shiferaw B, Abate T, Kassie M, Monyo E, Madzonga O, Silim S, Muricho G (2009a). Assessment of the current situation and future outlooks for the groundnut Sub-Sector in Malawi, International Crops Research Institute for the Semi-Arid Tropics, Lilongwe, Malawi.
- Simtowe F, Shiferaw B, Asfaw S, Tsedeke A, Monyo E, Siambi M, Muricho G (2009b). Socioeconomic assessment of baseline pigeonpea and groundnut production conditions, farmer technology choice, market linkages, institutions and poverty in Rural Malawi. Baseline Research Report for Treasure Legumes and TL-II. International Crops Research Institute for Semi-Arid Tropics, Nairobi, Kenya.
- Sterns JA, Bernstein RH (1994). *Assessing the Impact of Cowpea and Sorghum Research and Extension in Northern Cameroon*, MSU International Development Working Paper No. 43, East Lansing: Department of Agricultural Economics, Michigan State University.
- Tsusaka TW, Velasco ML, Yamano T (2015a). Expert Elicitation for Assessing Agricultural Technology Adoption: The Case of Improved Rice Varieties in South Asian Countries. *Asian J. Agric. Dev.* 12(1):19-33.
- Tsusaka TW, Msere HW, Siambi M, Mazvimavi K, Okori P (2015b). *The Economic Impacts of Groundnut Research and Development in Malawi: 1982-2013*. International Crops Research Institute for the Semi-arid Tropics, Lilongwe, Malawi, mimeo.
- van Schalkwyk HP (2003). Demand relations of oilseed products in South Africa. MCom thesis. Department of Agricultural Economics, University of the Free State, Bloemfontein.
- Walker T, Maredia M, Kelley T, La Rovere R, Templeton D, Thiele G, Douthwaite B (2008). Strategic guidance for Ex Post Impact Assessment of Agricultural Research. CGIAR Science Council. Science Council Secretariat, Rome, Italy.
- Wander AE, Magalhães MC, Vedovoto GL, Martins EC (2004). Using the Economic Surplus Method to Assess Economic Impacts of New Technologies: Case Studies of EMBRAPA. Conference on International Agricultural Research for Development. Berlin, October 5-7, 2004.
- World Bank (2014). *World Development Indicators 2014*. Washington D.C.

*Full Length Research Paper*

## Study of an electromechanical system for solid fertilizer variable rate planting

Joao Roberto Sartori Moreno<sup>1\*</sup>, Conrado Di Raimo<sup>1</sup>, Romeu Rony da Costa Cavalcanti<sup>1</sup>, Marcio Aurelio Montezuma<sup>1</sup> and Edson Antonio Capello de Souza<sup>2</sup>

<sup>1</sup>Mechanical Department, Federal Technological University of Paraná, Cornelio Procopio, PR, Brazil.

<sup>2</sup>Bauru School of Engineering (UNESP), Mechanical Department – Bauru- SP- Brazil.

Received 17 November, 2014; Accepted 29 October, 2015

The work aimed to study the behavior of a prototype planted simultaneously three times with solid fertilizers, nitrogen, phosphorus and potassium, of variable rates and desired quantities. For the evaluation of the prototype, a test bench was built where helical doses and their respective direct current electric motors; three tanks for storage of fertilizers were used. Also used were: A source (12 V-DC), three power drivers (MOSFET), acquisition board and control software. The tests were performed with LabVIEW®8.6 to control the rotation of the axes, record data in maps of soil fertility and geographical location. The results showed that application values showed an error of 3:56% at the rate of 45 kg/ha and an error of 1.78% at the rate of 85 kg/ha. However, the slightest mistake was on rotation of 26 to 30 rpm because the ratio flow rates had error <1%. Therefore, the dosing speed became maximum of 35 rpm; making the variation of the theoretical flow rate from 2.6 to 93.7 kg/ha. But with low flow rate, the error was 8.3% to 4 rpm on products of 9.79 kg/ha.

**Key words:** Data acquisition board, flow rate, helical feeders, varying rates, power drivers.

### INTRODUCTION

The use of fertilizers has over time been increasingly important for the evolution of cultures. Through research and experimental procedures, this practice has been associated with soil needs. In correcting the soil, tools and devices have been used that control systems of manure deposition according to the nearest ideal needs of plants. The term precision agriculture is used to describe the use of several advanced technology to reduce costs of production and preserve the environment (Blackmore et al., 2007).

According to several authors, precision agriculture can

be divided into three major steps: collecting of data, mapping of spatial and temporal variability of the field; data analysis for decision making and localized application in agriculture. Precision agriculture involves using equipment with capacity to apply accurately inputs at variable rates. The application of fertilizers in variable rate aims to maximize their use and reduce the negative impacts of agriculture on the environment.

In localized treatments, precision agriculture does not involve direct consequence of the use of equipment with sensors, positioning systems and computer

\*Corresponding author. E-mail: joaosartori@utfpr.edu.br. Tel: +55-43-3520-4083.

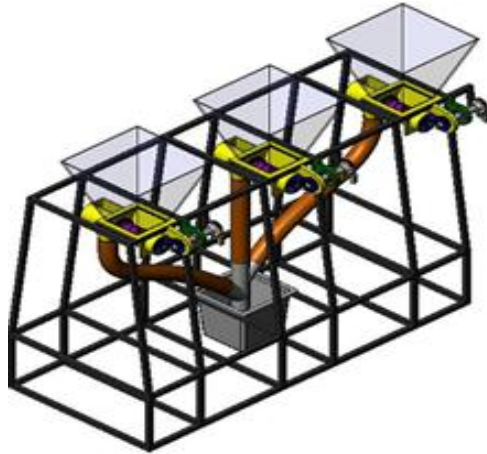

Figure 1. Design of 3D test bench.



control systems application of supplies, but of other systems in the generation, analysis and use of information that reflects the variation that can be treated in a localized manner (Lamb and Brown, 2001).

One of the main features of modern agriculture and precision is the use of scientific knowledge associated with rigorous control of the application of fertilizer at variable rates. With modern equipment having granular applicators capable of altering the fertilizer distribution rate for small rate and tractor speed of 5-8 km/h, the required rate of application cannot be achieved over the area to be fertilized (Yu et al., 2006).

The various deposition rate of fertilizer through the equipment used is achieved by varying the speed of the machine, e.g., directly without much computational electronic device. However, it is an important resource for the geostatistical analysis of the spatial variability; the sensor systems yield mapping, geographic information system.

The new tools of this technology are being incorporated to manage the variability of soil attributes and support the improvement of soil and crop management. The increase in efficiency is based on different management based on the variability in the area. The integration of computing and electronics is the means to raise levels of control and monitoring of agricultural activity in specific locations of crops.

Through detailed analysis of crops and improvement of management techniques, new levels of quality and quantity of crop production efficiency can be achieved successively (Silva and Azevedo, 2009).

The implementation of control systems for automation can generate increase of 15 to 20% in operating efficiency of agricultural tractor. In addition to greater efficiency in mechanical operation, the implementation of control systems helps reduce the mental effort of the operator, and fatigue.

A large number of traditional concepts of production

plant are being reconsidered for developing intelligent machines. In planting on lines which requires a simpler type of machine, the seeds is placed along each line.

If the location of each seed is known and the position of each cultivated plant is estimated, we can identify each plant by its spatial location.

Better information about the characteristics of the plant allows better management and decision making, which in turn brings a number of improvements that can increase the overall efficiency of agricultural production.

## MATERIALS AND METHODS

The prototype of the study consists of a reservoir of fertilizer, a helical dosing, an electric motor of 12V - DC for activating the dosing and a hose to lead the fertilizer to the soil. The tests were performed to control two variables directly, e.g., rotation and displacement, and consequently indirect control of flow rate and time. Figure 1 shows the schematic diagram of the electromechanical system supply fertilizer.

This system was designed and constructed in the laboratory to change the mechanical system actuated by gear wheel planter electrical system which is coupled to a variable source (Figure 2). It is used to convert electrical energy alternating continuously to feed motors (12V) and encoders (5V), ICEL Brand: Mod PS - 6100.

The power voltage supply (Tabile et al., 2011) was done through dragging, which was generated by a computer system with its respective data acquisition via LabView 8.6 (Bishop, 2007). Its function is to control rotation and mass flow. An important issue to be clarified is that the method of applying the variable rate fertilizer was the VRA (Variable-Rate Application) with GPS, based on maps preparation. Map-based VRA adjusts the application rate through an electronic map, also called prescription map. Using the field position from a GPS receiver and a prescription map of desired rate, the concentration of input is changed as the applicator moves through the field.

The control system was generated in closed loop and consisted of comparing the input signal with response, which in this case is the estimated mass flow rate to be released into the soil. This comparison is performed through feedback to the data system reference of supplies suitable for the soil (Figure 3). In general, in



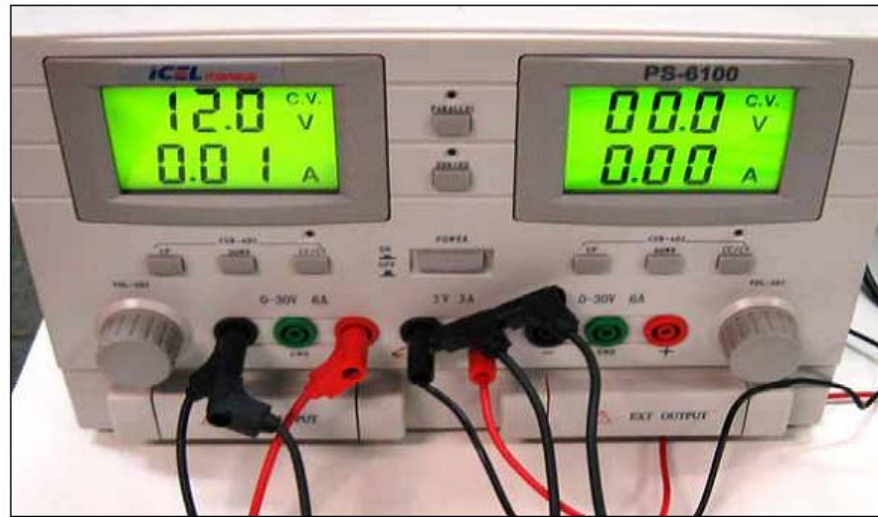

Figure 2. Variable power supply.

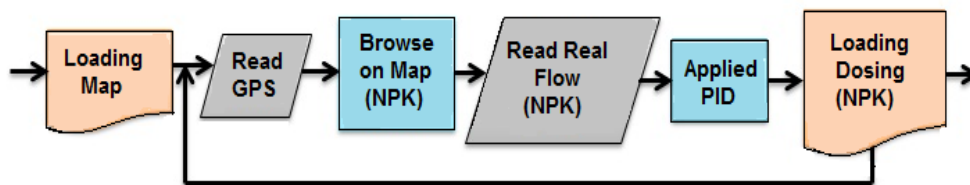

Figure 3. Flowchart of steps for simulating the LabView 8.6 (Lawrence et al., 2007).

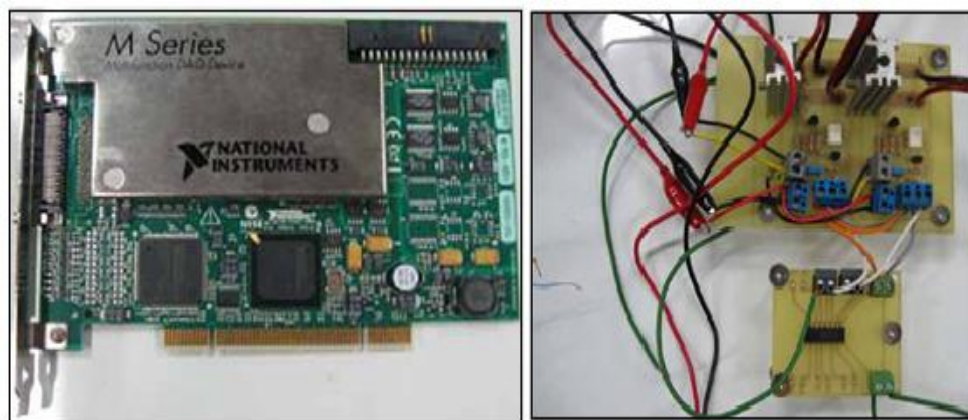
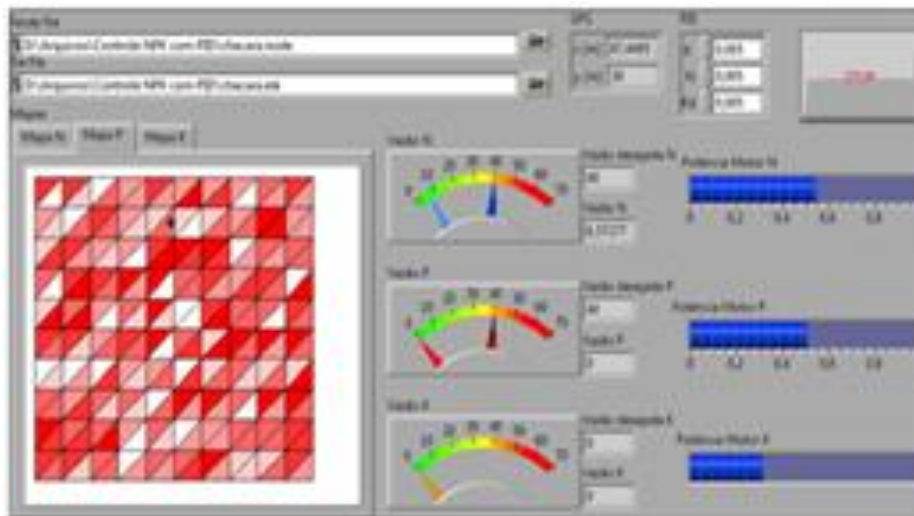

Figure 4. Acquisition board and power drive.

order to make more precise and cause it to respond to external disturbances system, the output signal is compared with a reference signal and the difference between these two signals is used to determine the reference signal. The device that uses the error signal to determine or calculate the control signal to be applied to the plant is called the controller or compensator.

The Sensor Ion Selective Field Effect Transistors (ISFETs) was used to measure phosphate level, temperature and humidity of the

environment in agricultural experiment (Ramdas and Galande, 2014). The NPK Micro-sensor used is accurate to assist in the collection of spatial data in the variable rate technology (automated fertilizers). All this control was performed by LabView 8.6 software. It operates based on a graphical platform that enables both simulations and controls data acquisition through acquisition board from NATIONAL INSTRUMENTS. For this case is the NI-PCI6251 plate (Figure 4), that allows the interface between the engine and



**Figure 5.** Interface/Control Panel of the rate of nitrogen (N), phosphorus (P) and potassium (P) with closed mesh.

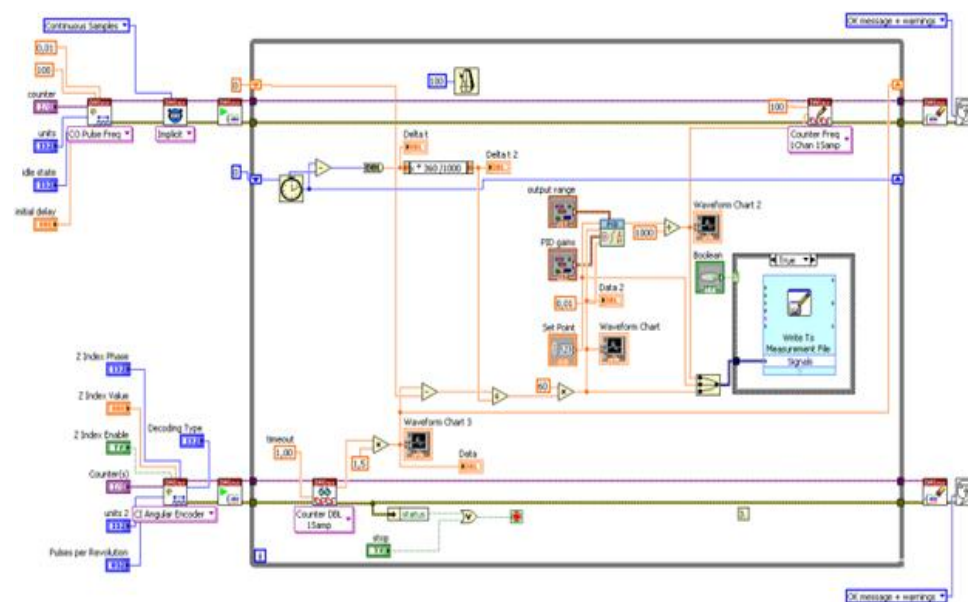

**Figure 6.** Motor simulation with PID control (Block Diagram).

the virtual simulation software. For the simulation it was constructed a map with cells of 50 by 50 m according to the information of references soil. Therefore, we used the method of Delaunay triangulation for mesh creation and their respective geographic map and doses of N, P and K.

This was done to synchronize the GPS machine control system with fertilization (Lawrence and Yule, 2007), with the need to move the machine in accordance with the predetermined geographical coordinates in programming the array. The offset is shown by a point (black) in the map (Figure 5), giving the exact position of the machine on the map, with the flow desired and actual flow rate.

This system could be significantly used for variable-rate applications with overall system errors in the range of  $\pm 5\%$  (Tola et al., 2008). The PID control type (Birkus, 2012), as shown in Figure 6, is used in closed-loop systems. It takes into account the behavior

of the engine speed, controlling it through a rotation sensor (ENCODER); its function is to measure the frequency by rotating shaft engine with the feedback system. It adjusts the engine speed according to the required reference (Malik et al., 2014).

Only the automation of fertilization systems is not enough, as there is a need for a whole set of interrelated and interdependent systems. However, currently there is a well-founded and consolidated technological apparatus (GPS technologies best, better development of information technologies, maps for soil fertility, etc.) that enables and supports the development of the project. So for the tests were also used: centesimal balancing with precision, digital thermo-hygrometer, a computer and all electronic device to control motor rotation, stopwatch to time the manure deposition in their respective rotations. The time was estimated based on the speed of 1.6 m/s; 31.25 s is hypothetically the



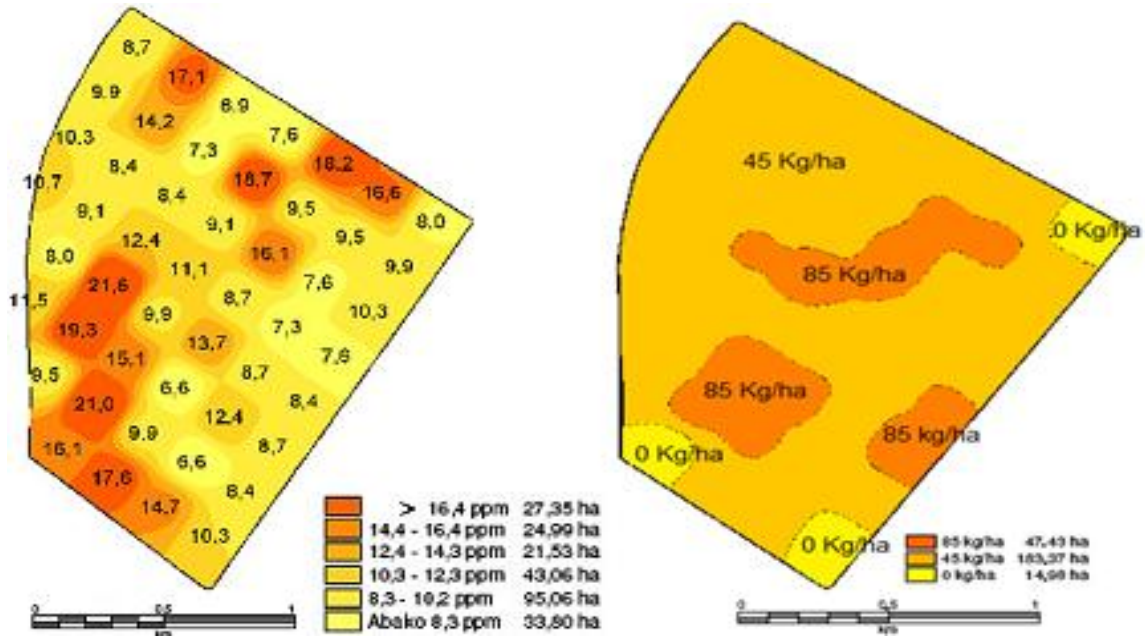

Figure 7. Map of application and fertility in the distribution of fertilizer (Potter et al., 2010).

time which it takes to traverse fifty meters (50 m) and pounds (5 kg); fertilizer (potassium - P) reused as the experimental system was a fertilizer tank just below dose.

During the test, the mass flow rate with the fertilizer was monitored at room temperature (21.9°C), and relative humidity of 81.5%, since they interfere in the management of fertilizer because of its hygroscopic nature. A map with a range of 0-85 kg/ha potassium (Figure 7) was used in the planned route for moving the machine and going through eight sample cells. These were followed with constant speed of 1.6 m/s for product application with spacing between rows in 0.7 m.

So to meet the needs of the data raised by the maps of soil fertility implies varying the rotation of the dose. However, we calculated the theoretical values of the mass flow rate, according to Equation 1 to the desired amount of fertilizer per area to be worked with the dose rotating at 1 rpm. This is necessary for calculation and determination of the:

1. Amount of fertilizer per line  $q_{F/L} = 18.75$  g/line in 100 m,
2. Number of lines,
3. The dose of fertilizer applied per rotation, 18 g/min.

According to the reference value of 45 kg/ha of fertilizer raised in the map application, the rotation was 17 rpm, because it is not interesting to study with fractions rotation operation of the dose.

$$q_L = \frac{W_A}{e_L}$$

$$q_{Fd} = \frac{q_{F/L} \cdot q_L}{1000} = \frac{q_{F/L} \cdot W_A}{1000 e_L} = 2.6786 \frac{kg}{rpm \cdot ha} \tag{1}$$

where:  $q_L$  = number of lines;  $q_{Fd}$  = required quantity of fertilizer of an area to be fertilized/rpm;  $q_{F/L}$  = quantity of fertilizer/line;  $W_A$  = width of the area to be fertilized [m];  $e_L$  = line spacing [m].

This amount of fertilizer was defined with the aid of  $q_{Fd}$  required quantity of fertilizer/area/rpm = 2.6786 kg/ha.rpm at 17 rpm. Reference was made to 85 kg/ha of fertilizer application map. Theoretical value of 85.72 kg/ha.rpm was obtained at the place

where the map marked the initial value (zero), the starting point without rotation. These values were obtained for an engine which used helical dose with 1" of pass.

## RESULTS AND DISCUSSION

The values of the rotation, the required amount of product in accordance with map application, the theoretical and actual amount of product applied by doses used are listed in Table 1; they were obtained by the application of fertilizer map by Equation 1 and the performance of the experimental tests in the laboratory (Rambas et al., 2014; Sivasoundari and Kalaimani, 2013). The legend of the table is based on:

- i. Cell - the cell number in soil fertility map;
- ii. Reference - Need of the map required in kg/ha in the respective cell of the map;
- iii. Theory - Product desired in kg/ha;
- iv. Real - Product obtained from doses in kg/ha;
- v. Rotation - Rotation of the axis (rpm).

Analyzing the values in Table 1 it can be noticed that the error associated to the theoretical values with respect to reference values occurs because of the approximations in the use of rotations; e.g., considering only entire rotations.

In the comparison of reference values relative to the experimental values, it is shown that the error for the application of fertilizer is around 3.56% compared to the reference value of 45 kg/ha, which has an error of 1.78%, (Figure 8); for more on fertilizer application for the

**Table 1.** Values of the mass flow rate helical dosing.

Cell	Reference (kg/ha)	Theory (kg/ha)	Real (kg/ha)	Rotation (rpm)
1	0	0	0	0
2	45	45.54	43.40	17
3	45	45.54	43.40	17
4	45	45.54	43.40	17
5	85	85.72	86.51	32
6	85	85.72	86.51	32
7	45	45.74	43.40	17
8	0	0	0	0

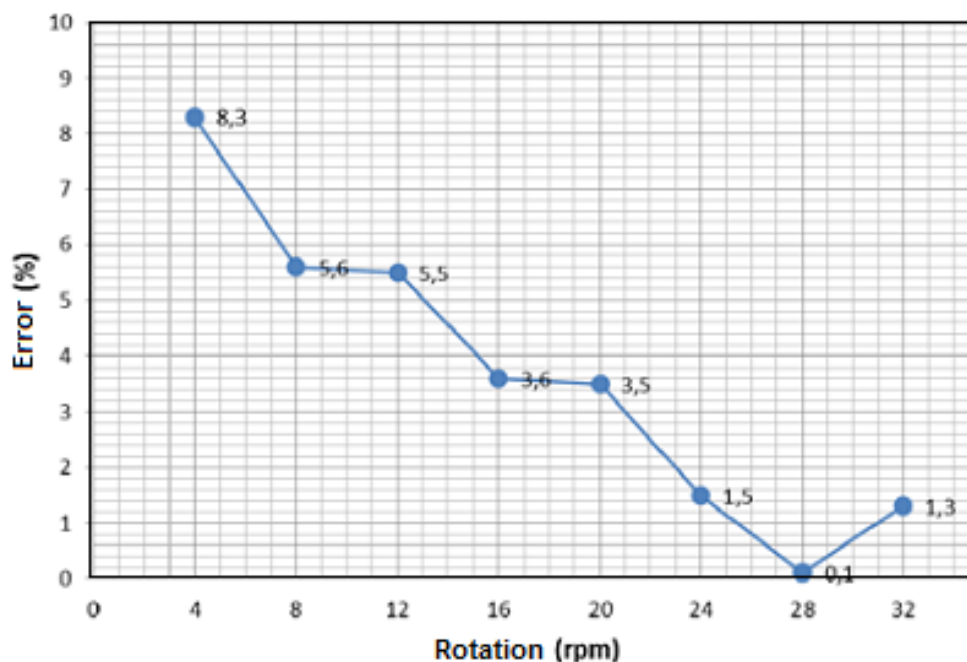
**Figure 8.** Application error versus rotation of the doses.

reference value of 85 kg/ha, which is quite acceptable in relation to the precision employed in agriculture today.

The survey of theoretical curve by varying the rotation at rpm versus  $q_{Fd}$  (theoretical) was made together with the experimental results; it verified the amount of fertilizer applied to the system during 31.25 s in order to verify the behavior of the system in controlling the amount of fertilizer at variable rates (Scarlett, 2001).

Thus, it can be seen in Figure 9 that the system presents the greatest errors for low speed (4 rpm presents an error of 8.3%). This suggests (Yuan et al., 2010) that when the helical type dose operates at higher rotations, graphic displays a decrease in the interval between the peak maximum and minimum amounts used. This indicates that helical dosing projects operating at higher speeds of rotation may have more uniformity.

However in Figure 9, the theoretical curve rotation has

a range of  $q_{Fd}$  versus rpm at the same time with the experimental results of varied rotation at four rpm.

## Conclusion

The values of mass flow rate determined by time were compared with the fertilizer mass values given in the application map.

In the tests, the results for high, medium and low flow were achieved with little variation around the reference values. The computational application developed could, within a range considered acceptable for the practice of precision agriculture machine; control for variation in dosage of fertilizer, as proposed in early labor and that could be confirmed in the tests.

The LabVIEW®8.6 software proved sufficient for the

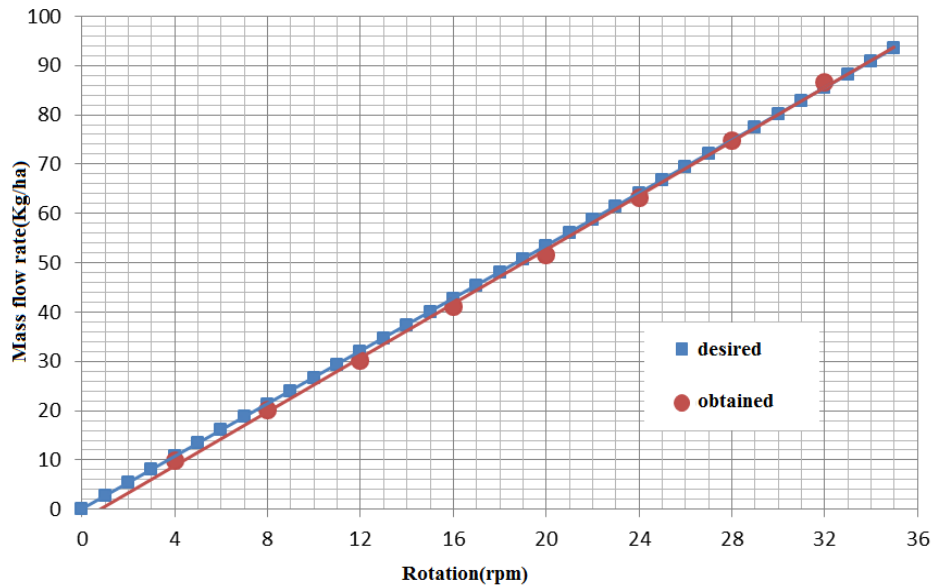

Figure 9. Chart rotation of the doses versus mass flow rate.

general control equipment, being a very fast and accurate tool, allowing simulation that reproduces situation close to the actual situation of the equipment.

The prototype tested was efficient in the dose range, as the results showed that application values present an error of 3.56% at the rate of 45 kg/ha and an error of 1.78% at the rate of 85 kg/ha. However, the slightest mistake was in rotation of 26 to 30 rpm because the ratio flow rates had error <1%.

Therefore, the dosing speed became maximum 35 rpm, so that the variation of the theoretical flow rate is from 2.6 to 93.7 kg/ha.

### Conflict of Interests

The authors have not declared any conflict of interests.

### ACKNOWLEDGEMENT

The authors would like to thank the Department of Mechanical Engineering, UTFPR - Cornélio Procópio - PR; BRAZIL and Faculty of Engineering, UNESP, Bauru for the incentive to carry out this work.

### REFERENCES

- Birkus P (2012). Control of linear continuous systems, Master Thesis, FEI STU, Slovak Republic.
- Bishop RH (2007). National Instruments, Learning with LabView 8, by Pearson Education, Inc. Upper Saddle River, NJ07458.
- Blackmore BS, Griepentrog H, Fountas S, Gemtos TA (2007). A Specification for an Autonomous Crop Production Mechanization System, Agricultural Engineering International: the CIGR E Journal.

- Manuscript PM 06 032 Vol. IX.
- Lamb DW, Brown RB (2001). PA - Precision Agriculture: Remote-Sensing and Mapping of Weeds in Crops. *J. Agric. Eng. Res.* 78(2):117-125, doi: 10.1006/jaer.2000.0630
- Lawrence HG, Yule IJ (2007). Modeling of Fertilizer Distribution using Measured Machine Parameters. *Am. Soc. Agric. Biol. Eng.* 50(4):1-7.
- Malik S, Dutta P, Chakrabarti S, Barman A (2014). Parameter Estimation of a PID Controller using Particle Swarm Optimization Algorithm. *Int. J. Adv. Res. Comput. Commun. Eng.* 3(3):5827-5830.
- Potter P, Ramankutty N, Bennett EM, Donner SD (2010). Characterizing the Spatial Patterns of Global Fertilizer Application and Manure Production. *Earth Interact.* 14(2):1-22, doi: <http://dx.doi.org/10.1175/2009EI288.1>.
- Ramdas BY, Galande SG (2014). Green Growth Management by Using Arm Controller. *Int. J. Eng. Res. Appl.* 4(3):360-363.
- Scarlett AJ (2001). Integrated control of agricultural tractors and implements: A review of potential opportunities relating to cultivation and crop establishment machinery. *Comput. Elect. Agric. Amsterdam* 30(1-3):167-191.
- Silva ASE, Azevedo CAV (2009). Principal Components Analysis in the Software Assistat-Statistical Attendance In: WORLD CONGRESS ON COMPUTERS IN AGRICULTURE, 7 Reno-NV-USA: American Society of Agricultural and Biological Engineers.
- Sivasoundari A, Kalaimani S (2013). Wireless Surveillance Robot with Motion Detection and Live Video Transmission. *Int. J. Emerg. Sci. Eng.* 1(6).
- Tabile RA, Godoy EP, Pereira RRD, Tangerino GT, Porto AJV, Inamasu RY (2011). Projeto e desenvolvimento da arquitetura de um robô agrícola móvel. *Engenharia Agrícola, Jaboticabal - Brazil.* 31(1):130-142.
- Yu JH, Kim YJ, Ryu KH (2006). Development of a controller for variable-rate application of granular fertilizer in paddy farming. *Am. Soc. Agric. Biol. Eng.* doi:10.13031/2013.2059
- Yuan J, Cheng LL, Yan ML, Qingbing Z, Xuan FZ (2010). Gaussian processes based bivariate control parameters optimization of variable-rate granular fertilizer applicator. *Comput. Electron. Agric.* 70:33-41.

Full Length Research Paper

# Tomato (*Solanum lycopersicum*) hybrid Hermosa indeterminate study of yield and fruit quality under greenhouse conditions responding at organic manure application

Pedro V. Vázquez<sup>1\*</sup>, Manuel E. Morales Rubio<sup>2</sup> and Merle C. Navarro Cortez<sup>1</sup>

<sup>1</sup>División de Ingenierías en Ciencias Agropecuarias; Universidad Tecnológica de la Costa, Santiago Ixcuintla, Nayarit, México.

<sup>2</sup>División de Ingenierías Económico Administrativa; Universidad Tecnológica de la Costa, Santiago Ixcuintla, Nayarit, México.

Received 19 September, 2014; Accepted 12 November, 2015

The organics alternatives in the vegetables production are a strategy to produce free chemical polluted foods that endanger human health. In the present study, the Hermosa indeterminate tomato variety was used and the following treatments were evaluated in a completely randomized design: Compost 2 tons/ha + VAM and BAC + Compost tea 50% (Treatment 1), Compost 4 tons/ha + VAM and BAC + Compost tea 50% (Treatment 2), Compost 6 tons/ha + VAM and BAC + Compost tea 50% (Treatment 3), VAM and BAC + Compost tea 50% (Treatment 4) and Absolute control (Treatment 5). The results indicate that Treatment 3 (Compost 6 ton/ha + VAM and BAC + Compost tea 50%) had the highest plant height at 120 days after planting (414.07 cm). Regarding the number of fruits per plant, fruit weight per experimental unit, fruit weight per m<sup>2</sup> and fruit weight per plant, no significant differences were identified. The five treatments show no significant difference in polar and equatorial diameter of the fruit weight, fruit density and unit volume. For five treatments evaluated, the pH, Brix and fruit firmness variables do not show significant difference.

**Key words:** Tomato, *Lycopersicum*, manure.

## INTRODUCTION

The organic production alternatives in vegetable, is currently one of the better strategies to produce chemical polluted free food healthier for the human consumption. According to Marquez and Cano (2005) and Marquez-

Hernández et al. (2006), organic production is a free contaminant food generation option; it is a farming method that does not use synthetic fertilizers or pesticides. In Latin America, organic agriculture is

\*Corresponding author. E-mail: [pvarez70@hotmail.com](mailto:pvarez70@hotmail.com), [pvarez70@utdelacosta.edu.mx](mailto:pvarez70@utdelacosta.edu.mx) Tel: (+52 323) 23 5 80 00 al 29. Fax: (+52 323) 23 5 42 25.

**Table 1.** Physical-chemical analysis of the compost.

Moisture (%)	pH	CE (mS)	N-NO <sub>3</sub> (mg/L)	N Ammonia (mg/L)	Nitrite (mg/L)	P (mg/L)	K (mg/L)	C Org. (%)	Ca + Mg (meq/100 g)	Mg (mg/L)	Mn (mg/L)
37.38	8.6	3.9	180	2	2	198	735	4	40	4	0

understood in its broadest form, to not only include restricting inputs of chemical synthesis, but also pursues the conservation of the environment as a whole. (Céspedes, 2005).

An alternative to reducing land degradation is the use of compost obtained from the composting process consisting of degrading organic matter to stabilize biologically controlled experiment under aerobic conditions, and can be applied to improve soil and crop (Widman et al., 2005). The process of composting opens another market for waste producers, as it is a potential and inexpensive source of organic matter and fertilizers (Iwegbue et al., 2006; Iwegbue et al., 2007), thereby supporting the production of chemical pesticides and fertilizer particles free food (De la Cruz et al., 2009).

Raviv et al. (2005) found that the compost covered the nutritional requirements during the four months following transplantation of tomato. Likewise, Cano and Marquez (2005) determined that the nutrients contained in the compost, were sufficient to obtain acceptable yields in cherry tomato.

The importance of endomycorrhizae has increased in the past decade due to numerous reports of beneficial effects on plants, such as increases in absorption of nutrients in the soil, water relations influence, protection against pathogens and important ecological roles these associations appear to play in the succession of species in natural plant communities (Aguilera, 2007). This is because mycorrhiza is an association formed by a group of fungal hyphae (mycelium) that upon contact with the roots of the plants allows a free flow of nutrients to them, offering to host plant and the ecosystem, different benefits in terms of survival and functioning (Camargo et al., 2012).

## MATERIALS AND METHODS

In the present study, the Hermosa indeterminate tomato hybrid is identified by its excellent performance potential, having an enviable quality in comparison with market requirements. Its better response to high temperatures enables them to achieve an excellent development of plant and fruit quality. This hybrid can produce 6 to 7 bunches per plant between 11 and 13 fruits each. The fruit ripening is very uniform so there is greater percentage of packaging. Relative maturity is intermediate type, ranging from 72 to 74 days after transplantation. The fruit is medium to large, bright red color, is likewise resistant: HR: Aal/Fol: 1, 2/ToMV: 0-2/Vd: 1.

The experiment was established in a greenhouse shade mesh conditioner on the roof to reduce the heat incidence. During the course of the experiment, average temperatures of 25 to 28°C,

minimum temperature of 16°C and maximum temperature up to 36°C was observed outside the greenhouse. The greenhouse has a width of 10.80 m, length of 30 m, maximum height of 5 m and a 2.40 m tutoring cable. The plant production was made in styrofoam trays of 242 cavities on October 31, 2013 and before transplanting, trenching was performed incorporating compost and the installation of drip irrigation system. Complete randomized design was used with five treatments and three replications. Transplantation experiment was realized on 20th November of the same year.

The compost employed before transplantation was produced in the period from May to July 2013 based on bean straw, cattle manure, yeast, brown sugar and mature compost. The physicochemical analysis of the compost (Table 1) was performed using the methodology of saturation extract by vacuum filtration of the saturated paste compost, obtaining the liquid extract to make the following determinations: pH by potentiometric method; Nitrate-N (mg/l), N (mg/L), Ammonia (mg/L), Nitrite (mg/L), Phosphorus mg/L, Potassium (mg/L), conductivity (mS), Ca + Mg (meq/100 g), magnesium (mg/L) Mn (mg/L) by the HACH method; Moisture (%) by the gravimetric method; Organic carbon (%) by the method of wet combustion of Walkley-Black (Brito et al., 1990) as amended.

The treatments were: 1) Compost 2 ton/ha + VAM and BAC. + Compost tea 50%, 2) Compost 4 ton/ha + VAM and BAC + Compost tea + 50%, 3) Compost 6 tons / ha + VAM and BAC + Compost tea 50%, 4) VAM and BAC + Compost tea 50% and 5) Absolute control. The compost incorporation into the soil was done on the same day of planting with VAM and BAC being a complex product containing mycorrhizal fungi belonging to *Glomus intraradices* varieties, *G. mosseae* and *G. aggregatum* as well as beneficial bacteria such as *Bacillus cereus*, *B. pumilus*, *B. megaterium*, *B. licheniformis*, *B. subtilis* and *B. amiloquefaciens*.

It was applied to the base of the plant by mixing 1.5 L of the product in 4 L of water, applying 20 ml of the solution per plant 8 days after transplantation. The compost tea was applied weekly to each plant providing 100 ml of solution (1:1 ratio of compost tea and water) resulting from the mixture of 25 kg of compost per 100 L of water. The experimental unit size was a twin row of 5 m long planted "staggered" formation with the following dimensions: 0.75 m bed width, distance between beds of 1.50 m, and distance between pairs of grooves 0.40 m, and plant spacing of 0.50 m. The plant density was 2.6 plants per m<sup>2</sup>. Pest control was performed with *Bacillus thuringiensis* and disease control with Cupravit applications. Tomato water supply was performed using drip irrigation, with two tracts bed (one tract per row) whose emitters were 15 cm distant from them.

The intensity and frequency of irrigation was 1 h everyday during the first two months and after that, it was increased to two hours a day. When the plant reached a height of 0.30 m, the tutoring was performed using black raffia, tying the base of the plant with the end of raffia around it and in the other hand holding onto cable tutoring, located 2.40 m. The removal of outbreak activity began when the first shoots were present in plants, ensuring that they do not reach a larger size than 3 cm. Shoots were removed using scissors or a knife. At the beginning of flowering, the crop began to perform the "pollination" which is based on pressurized air application just in the flowers using a motorized sprayer dorsal mark Toru 3 WF-3S, with 25 L capacity, performing during all flowers formation period, during

**Table 2.** Mean values of the variables: Plant height (cm) at 60, 75, 90, 105 and 120 DDT (days after planting).

Treatments	Plant height (cm)				
	60 DDT	75 DDT	90 DDT	105 DDT	120 DDT
1) Compost 2 tons/ha + VAM Y BAC + Compost tea 50%	178.8 <sup>a</sup>	246.80 <sup>bc</sup>	286.60 <sup>b</sup>	327.53 <sup>b</sup>	377.73 <sup>bc</sup>
2) Compost 4 tons/ha + VAM Y BAC + Compost tea 50%	178.0 <sup>a</sup>	261.13 <sup>b</sup>	311.73 <sup>a</sup>	359.27 <sup>b</sup>	407.67 <sup>b</sup>
3) Compost 6 tons/ha + VAM Y BAC + Compost tea 50%	186.07 <sup>a</sup>	275.27 <sup>a</sup>	323.07 <sup>a</sup>	372.20 <sup>a</sup>	414.07 <sup>a</sup>
4) VAM y BAC + Compost tea 50%	152.73 <sup>b</sup>	223.4 <sup>c</sup>	262.67 <sup>b</sup>	309.47 <sup>b</sup>	358.6 <sup>c</sup>
5) Absolute control	168.6 <sup>b</sup>	235.47 <sup>bc</sup>	289.80 <sup>b</sup>	335.67 <sup>b</sup>	369.13 <sup>bc</sup>

Means followed by the same letter in the column do not differ significantly by the Tukey test ( $p < 0.05$ ).

**Table 3.** Mean values of the variables: Fruits numbers per plant, fruit weight (kg) per experimental unit (7.5 m<sup>2</sup>), fruit weight per m<sup>2</sup> and fruit weight per plant.

Treatments	Fruit number	Fruit weight (kg)	Fruit weight (kg per m <sup>2</sup> )	Fruit weight (kg per planta)
1) Compost 2 tons/ha + VAM Y BAC + Compost tea 50%	344.67 <sup>a</sup>	28.17 <sup>a</sup>	3.76 <sup>a</sup>	1.41 <sup>a</sup>
2) Compost 4 tons/ha + VAM Y BAC + Compost tea 50%	374.33 <sup>a</sup>	30.93 <sup>a</sup>	4.12 <sup>a</sup>	1.55 <sup>a</sup>
3) Compost 6 tons/ha + VAM Y BAC + Compost tea 50%	405.67 <sup>a</sup>	34.46 <sup>a</sup>	4.59 <sup>a</sup>	1.72 <sup>a</sup>
4) VAM y BAC + Compost tea 50%	323.67 <sup>a</sup>	24.93 <sup>a</sup>	3.32 <sup>a</sup>	1.25 <sup>a</sup>
5) Absolute control	322.67 <sup>a</sup>	24.49 <sup>a</sup>	3.27 <sup>a</sup>	1.22 <sup>a</sup>

Means followed by the same letter in the column do not differ significantly by the Tukey test ( $p < 0.05$ ).

the fruiting stage, fruit filling and plant leaves removal using scissors, pliers or pruning shears.

The variables dimensions are randomly selected between five different plants treatments; in every treatment and measurement a tape measured mark was realized. Truper of 5 m was used, at 30, 45, 60, 90, 105 and 120 days after transplantation, from the base to the apex of the plant. The fruits number per plot was calculated in every cut; when they had an orange to red color, fruits were cut. Fruit weight (kg) per plot in each cut was determined, using a ToroRey digital scale; fruit yield (kg/m<sup>2</sup>) and yield in kg/plant was calculated, using the density as a planting base; fruit size (mm) was determined by measuring the polar diameter and equatorial diameter on every plot and every cut, using a vernier; evaluating firmness (N) by using a penetrometer. Weight was also determined using the ToroRey scale and individual fruit size (g) by the water displacement technique. Density was determined using the weight and unit volume. Brix was determined using a refractometer (Method 920.39 AOAC, 1990) while the pH was measured with a potentiometer (Method 16,023 AOAC 1990). Acidity was determined through titratable acidity method (Method 30,071 AOAC, 1990) while statistical evaluated variables analysis was determined with SAS 9.1.

## RESULTS AND DISCUSSION

Table 2 shows that for the variable plant height, analysis of variance reflects the significant difference between treatments, noting that Treatments 3, 1 and 2 are statistically equal and have the highest plant height at 60 days after transplantation, with 186.07, 178.8 and 178

cm, respectively, compared with Treatments 4 and 5 (absolute control). At 75 days after transplantation, the tallest plants was obtained by Treatment 3 (275.27 cm), resulting in significantly different compared with Treatments 1, 2, 4 and 5. Also, at 90 days after transplantation, greater heights (323.07 and 311.73 cm) were observed for Treatments 3 and 2, respectively. At 105 and 120 days after transplantation, treatment 3 shows greater plant height, compared to the other treatments. These results reflect that reported by Allen et al. (2003) and Camargo et al. (2012), who note that in mycorrhizal association, the fungus promotes better plant uptake of water and mineral nutrients with low availability in the soil (mainly phosphorus) directly influencing the growth of plants. It is also similar to that noted by Mujica et al. (2010) who evaluated different doses of liquid mycorrhizal inoculant in growing tomato and found positive effects on plant height, leaf dry mass and performance. It also creates a synergistic effect with compost tea, which according to Ingham (2005), can be used as fertilizer because it contains soluble nutrients and beneficial microorganisms that promote plant growth.

Regarding the fruits number per plant, fruit weight per experimental unit, fruit weight per m<sup>2</sup> and fruit weight per plant (Table 3), treatments evaluated were not significantly different; however, these outcomes are similar to those found by De la Cruz et al. (2009) who evaluated compost as a substrate prepared with bovine



**Table 4.** Mean values of the variables: Polar and equatorial (cm) diameter, weight unit (g) and volume unit (ml) and fruit density (g/mL).

Treatments	Polar diameter (cm)	Equatorial diameter (cm)	Weight unit (g)	Volume unit (ml)	Fruit density (g/mL)
1) Compost 2 tons/ha + VAM Y BAC + Compost tea 50%	5.17 <sup>a</sup>	3.62 <sup>a</sup>	85.49 <sup>a</sup>	112.33 <sup>a</sup>	0.894 <sup>a</sup>
2) Compost 4 tons/ha + VAM Y BAC + Compost tea 50%	5.19 <sup>a</sup>	3.63 <sup>a</sup>	93.89 <sup>a</sup>	107.00 <sup>a</sup>	0.932 <sup>a</sup>
3) Compost 6 tons/ha + VAM Y BAC + Compost tea 50%	5.28 <sup>a</sup>	3.84 <sup>a</sup>	98.69 <sup>a</sup>	113.00 <sup>a</sup>	0.979 <sup>a</sup>
4) VAM y BAC + Compost tea 50%	5.19 <sup>a</sup>	3.48 <sup>a</sup>	96.44 <sup>a</sup>	111.83 <sup>a</sup>	0.937 <sup>a</sup>
5) Absolute control	5.19 <sup>a</sup>	3.64 <sup>a</sup>	90.62 <sup>a</sup>	104.17 <sup>a</sup>	0.907 <sup>a</sup>

Means followed by the same letter in the column do not differ significantly by the Tukey test ( $p < 0.05$ ).

**Table 5.** Mean values of the variables of fruit quality.

Treatments	pH	Degree Brix	Firmness (N)
1) Compost 2 tons/ha + VAM Y BAC + Compost tea 50%	4.6 <sup>a</sup>	4.2 <sup>a</sup>	0.192 <sup>a</sup>
2) Compost 4 tons/ha + VAM Y BAC + Compost tea 50%	4.4 <sup>a</sup>	4.3 <sup>a</sup>	0.196 <sup>a</sup>
3) Compost 6 tons/ha + VAM Y BAC + Compost tea 50%	4.5 <sup>a</sup>	4.6 <sup>a</sup>	0.176 <sup>a</sup>
4) VAM y BAC + Compost tea 50%	4.3 <sup>a</sup>	4.5 <sup>a</sup>	0.184 <sup>a</sup>
5) Absolute control	4.4 <sup>a</sup>	4.2 <sup>a</sup>	0.192 <sup>a</sup>

Means followed by the same letter in the column do not differ significantly by the Tukey test ( $p < 0.05$ ).

manure, corn stover, elephant grass and black earth, in the hybrid tomato production SUN 7705 under greenhouse conditions, obtaining an average yield of 3.98 kg/m<sup>2</sup>, and found by Preciado et al. (2011), in assessing compost tea production, genotype Cid greenhouse tomato, earning yields of 1.45 kg per plant.

As regards the variables, polar and equatorial diameter, weight and unit volume of the fruit and fruit density (Table 4), the Treatment 5 do not reflect significant difference between them; however, a slight tendency of superiority is observed at Treatment 3 for the five characteristics observed above. In the present study, the polar diameter results are similar to those obtained by Preciado et al. (2011), who obtained a polar diameter of 5.8 cm fruit in assessing compost tea production, genotype Cid greenhouse tomato and De la Cruz et al. (2009), who reported diameters of 5.9 cm polar and equatorial diameters of 4.7 cm, the evaluation of compost as substrates for the production of hybrid tomato SUN 7705 under greenhouse conditions.

However, these results reflect lower values than those reported by Ochoa et al. (2009) who evaluated four types of fertilization (nutrient solution enriched with compost tea humic acids, organic nitrogen and phosphorus, compost tea and diluted application fractional compost) in three genotypes of tomato and a density of 4.2 plants per square meter, and found values of 7.2 to 7.4 cm in equatorial diameter, and 164 to 184 g of unit weight of the fruit.

Analyzing the variables of pH, brix and fruit firmness

(Table 5), the five treatments evaluated do not reflect significant difference between them, however, data Brix (4.1 to 4.5) reported by De la Cruz et al. (2009) and Preciado et al. (2011) respectively, are similar to those obtained in this study (4.2 to 4.6), and found by Ochoa et al. (2009), who report values from 4.3 to 4.6, when assessing compost tea enriched with humic acids, nitrogen and phosphorus in the organic cultivation of tomato under greenhouse conditions.

### Conflict of Interests

The authors have not declared any conflict of interests.

### REFERENCES

- Association of official analytical chemists (1990). Official Methods of Analysis. Fifteenth Edition. USA.
- Aguilera GLI, Olalde PV, Rubí AM, Contreras AR (2007). *Micorrizas Arbusculares. Ciencia Ergo Sum*. Universidad Autónoma del estado de México. Toluca, México.
- Allen MF, Swenson W, Querejeta JI, Egerton-Warburton LM, Treseder KK (2003). "Ecol. of Mycorrhizae: A Conceptual Framework for Complex Interactions Among Plants and Fungi", *Ann. Rev. Phytopatol.* P 41.
- Alvajana MCR, Hoppin JA, Kamel F (2004). Health effects of chronic pesticide exposure: cancer and neurotoxicity. *Annu. Rev. Public Health* 25:155-197.
- Blanco FA, Salas EA (1997). *Micorrizas en la agricultura: Contexto mundial e Investigación realizada en Costa Rica*. *Agronomía costarricense* 21(1):55-67. Costa Rica.



- Camargo RSL, Manuel MN, De la Rosa MCJ, Arias MSA. (2012). Micorrizas: Una gran unión debajo del suelo. Revista Digital Universitaria. 13:7. Coordinación de Acervos Digitales. Dirección General de Cómputo y de Tecnologías de Información y Comunicación. UNAM.
- Céspedes LMC (2005). Agricultura Orgánica. Principios y prácticas de producción. Boletín INIA No. 131. Ministerio de Agricultura. Instituto de Investigaciones Agropecuarias. Centro Regional de Investigación Quilamapu. Chillán, Chile.
- Claassen VP, Carey JL (2004). Regeneration of nitrogen fertility in disturbed soils using composts. *Compost Sci. Util.* 12(2):145-152.
- De la Cruz LE, Estrada BMA, Robledo TB, Osorio OR, Márquez HC, Sánchez HR (2009). Producción de tomate en invernadero con composta y vermicomposta como sustrato. *Universidad y Ciencia. Trópico Húmedo.* 25(1):59-67.
- Ingham RE 2005. *The Compost Tea Brewing Manual*. 5th Edition. Soil Foodweb Inc, Corvallis, Oregon. USA. 79 p.
- Iwegbue, CMA, Egun AC, Emuh, FN, Isirimah NO (2006). Compost. Maturity evaluation and its significance to agricultura. *Pak. J. Biol. Sci.* 9(15):2933-2944.
- Iwegbue CMA, Emuh FN, Isirimah NO, Egun AC (2007). Fractionation, characterization and speciation of heavy metals in composts and compost-amended soils. *Afr. J. Biotechnol.* 6(2):67-78.
- Márquez HC, Cano P (2005). Producción orgánica de tomate cherry bajo invernadero. *Actas Portuguesas de Horticultura* 5(1):219-224.
- Márquez-Hernández C, Cano-Ríos P, Chew-Madinaveitia YI, Moreno-Reséndez A, Rodríguez-Dimas N. (2006). Sustratos en la producción orgánica de tomate cherry bajo invernadero. *Revista Chapingo Serie Horticultura* 12(2):183-189.
- Mujica PY, De la Noval B, Amico RJD (2010). Respuesta del cultivo de tomate a la aplicación de dos inoculantes de hongos micorrícicos arbusculares por vías diferentes de inoculación. *Agronomía Trop. La Habana, Cuba* 60(4):381-387.
- Ochoa ME, Figueroa VE, Cano RP, Preciado RP, Moreno RA, Rodríguez DN (2009). Té de Composta como fertilizante orgánico en la producción de tomate (*Lycopersicon esculentum* Mill.) en invernadero. *Revista Chapingo. Serie Horticultura.* 2009. Torreón Coahuila, México. 15(3):245-250.
- Preciado RP, Fortis HM, García HJL, Rueda PE, Esparza RJR, Lara HA, Segura CMA, Orozco VJ (2011). Evaluación de soluciones nutritivas orgánicas en la producción de tomate en invernadero. *INTERCIENCIA.* 36:9.
- Raviv M, Medina S, Krasnovsky A, Ziadna H (2004). Organic matter and nitrogen conservation in manure compost for organic agriculture. *Compost Science and Utilization* 12:6-10.
- Raviv M, Oka Y, Katan J, Hadar Y, Yogev A, Medina S, Krasnovsky A, Ziadna H (2005). High nitrogen compost as a medium for organic container-growth crops. *Bioresour. Technol.* 96:419-427.
- SAS. Institute Inc. (2004). *SAS/STAT Guide to personal Computers.* SAS Institute Inc. Cary NC.
- Widman AF, Herrera RF, Cabañas VD (2005). El uso de composta proveniente de residuos sólidos municipales como mejorador de suelos para cultivos en Yucatán. *Estudios preliminares. Ingeniería Revista Académica* 9(3):31-38.

*Full Length Research Paper*

# **Agricultural extension for enhancing productivity and poverty alleviation in small scale irrigation agriculture for sustainable development in Ethiopia**

**Aklilu Nigussie\*, Abiy Adisu, Kidane Desalegn and Arkebe Gebreegziabher**

Ethiopian Institutes of Agricultural Research, Werer Agricultural Research Center, Department of Agricultural Economics, Extension and Gender Research, P. O. Box 2003, Addis Ababa Ethiopia.

Received 23 January, 2015; Accepted 15 October, 2015

---

The combination of agricultural extension system with small scale irrigation development helps to reduce poverty, and now utmost attention is given to it. Extension system development can increase the production and income of the households and helps to improve their overall economic welfare. This study was conducted to assess the strengths and constraints of the public extension system and to provide suggestions on “best fit” solutions and their scale-up opportunities in the small scale irrigation user; furthermore it examines the impact of agricultural extension system on small-scale irrigation on total income, and the probability of being poor or not at household level. Survey was carried out involving 900 extension users’ households and 875 non-extension users in Afar, Oromia and Somali regional states of Ethiopia which was a total of 1775 households. The result of the study by taking indicators of family size extension service users had more families 6.3 to 5.6 in non-user. The total crop income for one season was 41,282 Ethiopian birr while it was 16,276 for non-users. At the time of the data collection the exchange rate for a dollar was 19.67 Ethiopian Birr. Using a Tobit model to determine the total income parameters of education, extension service access, total land holding had a significant level of increment, while with marginal analysis ( $dy/dx$ ) factors like household leaders’ age, access to credit and dependency ratios were negatively related with total income. In general, the average annual income of extension users with application of small scale irrigation households was significantly greater than non-extension users. This shows that extension users in small-scale irrigation significantly promote total income of a household. The poverty incidence in non-extension user households is by far greater than user households. Thus, for the agrarian country, Ethiopia, extension system development in small-scale irrigation districts has significant impact on poverty reduction, so agricultural extension development should be given emphasis in development planning.

**Key words:** Income, poverty, small-scale irrigation, extension service, Logit, Tobit, marginal effect.

---

## **INTRODUCTION**

The quality of agricultural extension services is an especially important issue in Ethiopia, where agriculture dominates the economy, accounting for 85% of employment, 50% of exports, and 43% of gross domestic

product (GDP). Over 80% of the country’s 91 million people live in rural areas (FAO, 2010; CIA, 2011), and most are extremely poor, with a daily per capita income of less than \$0.50, and access to one hectare or less of

---

land (IFAD, 2011). In recognition of the centrality of agriculture in most Ethiopians' lives, government policy emphasizes what it calls agricultural development-led industrialization (ADLI).

The extension service has historically been top-down with inadequate adaptation to local agro ecological conditions and needs. The government of Ethiopia has taken diverse initiatives to advance agricultural development in the last two decades. The agricultural sector is developing with increasing participation from the private sector, including progressive farmers and farmer cooperatives, and this participation requires revisiting the extension system to better fit it to emerging demands in the agricultural sector (from small farmers, farmer investors, and the private sector) (Cohen and Lemma, 2011).

Agriculture is central to the federal government's national development plan through the ADLI policy (MOFED, 2010), and indeed, development and agriculture are often used as synonyms in Ethiopia. The share of public expenditures devoted to agriculture and natural resources was 21% in 2005, well above the Sub-Saharan African average of 4% and more than double the African Union target of 10% (Mogues et al., 2008). Nevertheless, at present most Ethiopian farmers do not use modern agricultural technology, and the innovation system (agricultural research, extension, and education) is poorly integrated (Lemma, 2007).

The literature on agricultural extension in Ethiopia emphasizes the top-down approach to extension service provision. DAs have received relatively hard quotas for enrolling farmers in technology packages, and their supervisors evaluate them on the basis of how well they meet these quotas. Extension also works through "model" or "progressive" farmers, who tend to be better off and males. Communication is mostly one-way, with agents transferring knowledge to farmers. There is little effort to marry new agricultural research and development with farmers' own knowledge or to learn what kind of services farmers themselves would like to receive (Buchy and Basaznew, 2005; EAA and EEPRI, 2006; Lemma, 2007). Most agents have been men, except in the field of home economics, and have provided services mainly to heads of household, regardless of gender (Buchy and Basaznew, 2005; EAA and EEPRI, 2006). Historically, extension policy was made in Addis Ababa and merely implemented in the field. Changing the delivery mode can have positive benefits: Deployment of extension teams to kebeles can facilitate communities' ability to plan and manage development activities for themselves on a sustainable basis (Cohen et al., 2008). Extension services

generally have positive impacts on nutrition and poverty reduction (Dercon et al., 2009).

Poverty alleviation has been largely a result of economic growth (Roemer and Gugerty, 1997). Because Ethiopia is an agrarian country, agriculture is the leading sector as source of income, employment and foreign exchange and national economic growth is determined by the performance of agriculture. Irrigation plays the key role in the performance of agriculture, which increases income growth. Income growth is essential for economic growth (Hussain and Biltonen, 2001). Developing countries that ensure sustainable economic growth can reduce their poverty levels, building up their democratic and political stability. They also improve the quality of natural environment and even reduce their incidence of crime and violence (Loayza and Soto, 2002).

### The goal of the research

The goal of this research is to evaluate the economic impact of selected extension user agro-pastoral communities who apply small-scale irrigation on income and poverty reduction at household level. It compares households with and without access to extension systems.

The specific objectives of this research are as follows:

- To examine the major constraints encountered in the use of extension users and non-users in small-scale irrigation systems
- To examine the effects of extension on the gross income at household level
- To determine the difference in prevalence of poverty between extension users and non-user households.

### Hypotheses

The hypotheses of this research are:

- (i) Extension information has a positive impact on household gross income, cropping income and livestock income but has a negative impact on non-farm incomes.
- (ii) Extension information has a negative impact on poverty. The probability of being poor is lower among users compared to non-users in the small scale agricultural sector.
- (iii) Extension users have more agricultural productive assets

\*Corresponding author. E-mail: [aklii2002@yahoo.com](mailto:aklii2002@yahoo.com).

Author(s) agree that this article remain permanently open access under the terms of the [Creative Commons Attribution License 4.0 International License](https://creativecommons.org/licenses/by/4.0/)

**Table 1.** Summary of variables.

Variable	Variables definition and measurements	Expected sign
IH <sub>h</sub>	Annual household gross income in ETB	Dependent
EX <sub>s</sub>	Extension service (1=extension service user 0= non users)	+
TL <sub>h</sub>	Total cultivated land in hectares	+
FS <sub>h</sub>	Family size of the household in adult equivalent	+
ED <sub>u</sub>	Education level of the household head (1= read and write 0= does not)	+
AG <sub>e</sub>	Age of a household head in years	-
Al <sub>p</sub>	Access to input <sup>1</sup> ( 1=access to inputs 0 = no access)	+
LI <sub>v</sub>	Livestock number owned in TLU	+
DR <sub>h</sub>	Dependency ratio of the household	-
AC <sub>s</sub>	Access to credit service ( 1 = access to credit and 0 =no access)	+
AO <sub>h</sub>	Asset owned by household in ETB	+
SH <sub>h</sub>	Sex of the household head ( 1= male and 0 = female)	+

N.B. <sup>1</sup>Access to input means the application of agricultural inputs like improved seed, fertilizer, pesticide etc.

and non-agricultural asset holdings than non-extension users.

## METHODOLOGY

### Approach for data collection, entry and checking

Household data collection was undertaken in six woredas from each woredas three PAs were selected that have access to extension services and non-extension users. Data collection methods included a survey, semi-structured interviews and focus group discussions. Data were collected at household and community level with the assistance of development agents. Each PA has three developmental agents who live and work with the agro pastorals. Using development agents as assistance for data collection is important for the reliability of the data because the communities are more likely to report accurate information to development agents, especially on income, land size and other assets.

The sample households were selected by utilizing the following three-stage stratified sampling procedure. The first stage involved consultation with District Agricultural offices, and eighteen PAs were selected purposively on the basis of their similarity in agricultural practices, potential for irrigation, and the type of small-scale irrigation they used.

In the second stage, household lists in the selected PAs were obtained from village administration and Development agents' office. Extension service users and non-users households were selected from this list.

In the final stage, households were listed by each small-scale irrigation category with extension service users and non-users then the random sampling technique was used to select sample households from each household type using a random number table. The aim is to carefully examine and compare the income and poverty level of small-scale irrigation users with extension service users and non-users.

Based on these multi-stages sampling processes the total sample households were selected on a random sampling basis from eighteen villages in the six district of Afar (Amibara, Chifira), Oromia (Meiso and Fentale) and Somalia (Kebribeyah, Aware and Lagahida).

### Data analysis

To control for other factors that influence household incomes this study uses an econometric modeling approach. As stated by Zhou *et al.* (2009), household gross income is a function of many determinants including household characteristics, asset holding, village location characteristics, and the prices of goods and services. Mathematically, this can be written as (Table 1):

$$IH_h = f(EX_s, TL_h, FS_h, ED_u, AG_e, Al_p, LI_v, DR_h, AC_s, AO_h, SH_h) \quad (1)$$

Following previous studies, the determinants of household gross income were analyzed by multiple regression models. The model is of this form:-

$$Y = \alpha + hx + gx + \dots + \varepsilon \quad (2)$$

Where:-  $\alpha$  = intercept, h and g are parameter estimates

Some households may not derive income from livestock, off-farm and other activities; therefore in this study, the impacts of extension service on income were estimated using a Tobit model. This approach was developed by Nobel laureate economist James Tobin in 1958 for analyzing situations whenever dependent variable can take zero values. There are many previous studies with similar works (Zhou *et al.*, 2009; Aschalew, 2009; Barket *et al.*, 2002). The specific form of the Tobit model is described as follows:

$$Y_i^* = \beta x_i + \varepsilon \quad (3)$$

We define a new random variable Y transformed from the original one,  $y^*$ , by

$$Y^* = 0, \text{ if } y \leq 0 \\ Y^* = y, \text{ if } y \geq 0$$

Where:-  $Y_i$  is the observed dependent variable measuring combined livestock income, off-farm income, cropping income and household total income,  $y^*$  is a latent variable,  $x$  is a vector of explanatory variables that influence incomes,  $\beta$  is a vector of parameters to be estimated, and  $\varepsilon$  is a random disturbance term with mean 0 and variance  $\sigma^2$ . On the basis of the Tobit model specification, the unknown parameters of the explanatory variables can be estimated

by maximizing the corresponding likelihood function.

$$L(\beta, \sigma) = \prod_{Y_i=0} \left[ 1 - \alpha \left( \frac{\beta x_i}{\sigma} \right) \right] \prod_{Y_i>1} \frac{1}{\sigma} \phi \left( \frac{Y_i - \beta x_i}{\sigma} \right)$$

Where:

$Y_i$  = income of a household

$X_i$  = explanatory variables create influence on household income

$\beta$  = Coefficient of the independent variables

$\alpha$  = the normal density function

$\phi$  = the normal distribution function

$\sigma^2$  = Variance of the error term epsilon in the third equation

The coefficients of dependent variables in Tobit model are not directly proportional with change of the independent variable. Therefore, to understand the change of household income as a result of a unit change of the coefficient of independent variables, the estimators of the variables should be transformed in to the vector of first derivatives. The marginal effect in Tobit model illustrate that the change of the dependent variables as a result of the changes of respective independent variable ( $X_i$ ) by a unit. On the basis of the above Tobit model specification. The marginal effects of the independent variables on household income are represented as:

$$E \left[ \frac{Y_i}{X_i} \right] = \beta \cdot \alpha \left( \frac{\beta x_i}{\sigma} \right) \quad (4)$$

The marginal value helps to understand the direct impact of irrigation on household income. The hypothesis of extension service user household is better-off in income than non-user household is observed by the marginal analysis of the variable for extension service access. This marginal value is easy to interpret, because it indicates the impact of extension on household income, controlling for other factors. That is, it fulfills a main aim of this study to analyze the marginal effect of the service on user household income compared with non-user household income being other things constant. This helps policy makers to understand the value of future extension service development and research.

### Poverty level estimation

Poverty is a multidimensional concept and its definition and measurement has been the subject of much debate. The household poverty line often is represented as a very basic living standard. Poverty indicators are often constructed by comparing household income with the mean income or median income (midpoint). Poverty usually is analyzed on the basis of income or consumption indicators. The World Bank uses poverty line of one dollar (PPP<sup>2</sup>-adjusted) per day, but this has been criticized for being too narrow. According to Bergh and Nilsson (2010), there is no obvious best way to calculate measures of absolute purchasing power that are comparable both across time and space when relative prices vary both over time and between countries. Following previous literature, combined sample households (both users and non-users) are ranked according to their current income. This ranking is then used to determine which quartile a household is in based on current income. The households in the lower quartiles are relatively poor where as those in the upper quartiles are relatively well-off.

### Poverty line

Although the relative poverty approach has some advantages, it is

also possible to develop more specific absolute poverty, typically defining a somewhat arbitrary "poverty line" on the basis of income or consumption indicators. Ethiopia has not established any official poverty lines, so Schreiner and Chen (2009) used the international poverty lines in dollars at 2005 purchase-power parity, with the lowest of their thresholds at 1.00 USD per person per day. According to Dercon (1997), the threshold for absolute poverty is 0.45 USD per day and the moderate poverty level is 0.60 USD per day.

### Poverty level comparison

The poverty level comparison between extension service users and non-users households is valuable to estimate the impact of extension access or scaling up of technologies on poverty reduction. Poverty level comparison helps to estimate the extent of extension impact on rural poverty alleviation. Poverty level comparisons between households were done by following poverty measures developed by Foster et al. (1984).

$$P\alpha = \frac{1}{n} + \sum_{i=1}^m \left\{ \frac{(z-y_i)\alpha}{z} \right\} \quad (5)$$

Where:-  $P_\alpha$  = poverty level indicator for a sample of households

<sup>2</sup>PPP (purchasing power parity) means the application of one price across countries for all goods and services, or representative groups (baskets) of goods and services. PUS = (EUS\$ /ETB\$) x (P ETB ) PUS = Price of goods in USA PETB = Price of goods in Ethiopia EUS\$ /ETB\$ = US dollar/Ethiopian birr exchange rate.

M= number of households below the poverty line

N= number of households

Z= poverty line

$Y_i$  = income per adult equivalent of  $i^{\text{th}}$  household

$\alpha$  = poverty sensitivity parameter

Poverty sensitivity parameter that can take on a variety of values when  $\alpha = 0$ , the result is the prevalence of poverty or the head count ratio, that is the proportion of people falling below the poverty line. When  $\alpha = 1$ , the equation gives the depth of poverty. It is also called poverty gap index. This shows the amount of income necessary to bring everyone in poverty up to the poverty line, divided by total population. This can be thought of as the amount of income that an average person in the economy would have to contribute for poverty to be eliminated.

### Econometrics model specification

Assessing the impact of extension scaling out of technologies on the likelihood that; a household is in poverty is one of the objectives of this study. Thus, poverty is the dependent variable, and determined by independent variables such as education, household characteristics, asset holdings and access to services. In this analysis, the independent variable is binary (1 if the household is classified as poor when its annual income is in the lowest quartile, and 0 if the household is classified as non-poor). Under this limited dependent variable model, the probability that the  $i^{\text{th}}$  household is being poor is given by:

$$\text{Prob}(y = 1/x) = f(x_i, \beta) = \frac{e^{z_i}}{1 + e^{z_i}} \quad (6)$$

$Z_i$  = function of explanatory variables ( $x_{ki}$ ), and expressed as:-

$Z_i = \beta_0 + \beta_1 x_{1i} + \beta_2 x_{2i} + \beta_3 x_{3i} + \beta_4 x_{4i} + \dots + \beta_k x_{ni} + \mu_i$

$\mu_i$  = error term

**Table 2.** Summary of variables.

Variable	Variables definition and measurements	Predictable sign
PO <sub>v</sub>	Probability to being poor (1= poor 0 = non- poor)	Dependent
EX <sub>s</sub>	Extension service (1=extension service users 0= non users)	-
TC <sub>i</sub>	Total cultivated land, hectares	-
FS <sub>h</sub>	Family size of a household in adult equivalent	-
ED <sub>u</sub>	Education level ( 1= read and write 0= does not read and write)	-
AG <sub>e</sub>	Age of a household head, years	+
AI <sub>p</sub>	Access to input service( 1= access to inputs 0 = no access)	-
DR <sub>h</sub>	Dependency ratio of the household	-
AC <sub>s</sub>	Access to credit service (1= get credit, 0= no credit)	-
AO <sub>h</sub>	Asset owned by household in ETB per capita	-
SH <sub>h</sub>	Sex of the household head ( 1= male 0 = female)	-

If  $P_i$  is the probability of the  $i^{\text{th}}$  household is being poor, then  $(1-P_i)$  is the probability of not being poor. Since the dependent variable, poverty, is unobserved and the resulting model is nonlinear, it cannot be estimated by using OLS so maximum likelihood can be used. Green (2002) indicates that either Probit or Logit models are mainly used for the dependent variable that takes dichotomous values (e.g.yes or no) or a choice between two alternatives. Both the logit and probit models guarantee that the estimated probabilities lies in the range 0 to 1 and that they are non-linearly related to the explanatory variables. Following Habitamu (2009) and Haile (2008), the dichotomous dependent variable poor or non-poor is estimated by logit model, for the sake of its mathematical convince. So this study applied logit model (Table 2).

The probability of being poor can be expressed in binary choice models or a logistic distribution function as:

$$\text{Prob}(y_i=1) = \frac{e^{\beta x_i}}{1+e^{\beta x_i}} \quad (7)$$

Where:-  $e$  = value of  $e$ , the base of natural logarithm.

In the nonlinear dependent variable, the marginal effect of each independent variable is not straight forward to interpret. In the logit model the marginal effect of each independent variable on poverty should be transformed in to Log odd ratio coefficients. Therefore, the regression equation of odd ratio is:

$$\frac{\text{pro}(y=1)}{1-\text{pro}(y=1)} = \frac{e^{\beta x_i}}{1+e^{\beta x_i}}$$

The log odd ratio coefficient shows change of the probability that a household is being poor or non-poor as a result of the respective independent variable ( $x_i$ ) changes by a unit.

## RESULT and DISCUSSION

### Socio-economic characteristics

#### Family size

Family size is useful for formulating various development plans and for monitoring and evaluating their implementation. Average family size at the national level

in Ethiopia was 4.7 (CSA, 2007). In the study area, the average family size was 5.9 with a minimum 2 and maximum of 11. The t-test shows that there is significant difference in family size between the irrigating and non-irrigating households at 5% level of significant (Table 3).

In rural Ethiopia, household family is the main source of labor for all income sources. Family size in adult equivalents helps to understand the sample household's average family labor force for agricultural production and other income sources activities. The average family size in adult equivalent in the study area was 4.6 with a minimum 1.7 and maximum of 8.2. The t-test shows that there is significant difference between irrigating and non-irrigating households at 1% level of significant (Table 3). Thus, irrigating households have owned better labor input than non-irrigating households.

The dependency ratio shows the ratio of economically inactive compared to economically active. Economically active members of a household, whose age is from 15 to 64, were source of income for the household. The member of a household whose age is under 15 and over 65 are economically inactive and dependent on economically active members of a household for education, clothing and health care (John, 2002). The dependency ratio of agricultural households provides planners and policy makers with an indication of agricultural labor availability in male and female managed holdings and their abilities to actively participate in agricultural programs and projects.

Members of holdings with high dependency ratios might not be able to participate in programs and projects due to time, labor and/or financial constraints, that is, dependency ratio is thought to be negatively related to income of households (FAO, 2010). In the study area, the average dependency ratio was 140%, which means every 100 economically active persons had 140 extra persons to feed, cloth, educate and medicate. Economically active members (45%) were less than non-active household members (55%). This can have

**Table 1.** Family size, family labor and dependency ratio at household level.

Characteristics	Extension service user households (N=900)	Non user Households (N=875)	Total Households (N=1775)	t-value
Family size	6.3	5.6	5.9	2.5 **
Family size in AE (family labor)	4.9	4.3	4.6	3.1 ***
Dependency ratio	1.5	1.4	1.4	0.6

\*\*\*, \*\* and \* are significant at 1%, 5% and 10% significant level, respectively.

**Table 2.** Characterization.

Characteristics	Extension service user households (N=900)	Non user households (N=875)	Total Households (N=1775)	$\chi^2$
<b>Gender</b>				
Male	93	83	88	
Female	7	17	12	
Total	100	100	100	4.4 **
<b>Education level</b>				
Illiterate	21	65	43	
Read and write	48	23	35	
Elementary	27	11	19	
High school	3	1	2	
Diploma	1	0	1	
Total	100	100	100	24.7 ***
<b>Spouse education</b>				
Illiterate	54	66	63	
Read and write	35	27	31	
Elementary	11	7	6	
High school	0	0	0	
Diploma	0	0	0	
Total	100	100	100	1.4
<b>AgeHH</b>				
15-30	17	14	16	
31-45	53	47	50	
46-64	28	34	31	
65 and above	2	5	3	
Total	100	100	100	1.9

\*\*\*, \*\* and \* are significant at 1, 5 and 10% significant level, respectively.

important implications for poverty alleviation efforts. No statistically significant difference was observed between irrigating and non-irrigating households for the dependency ratio (Table 3).

#### Characteristics of household

In the study area, the head of the household is responsible for the co-ordination of the household

activities. As such it is pertinent to examine attributes such as sex and education of the head as one component of extension participation decisions. Of the 1775 sampled respondents, about 88% were male headed. There is a significant difference in the sex of the sampled household heads for irrigating and non-irrigating households at a 5 % significant level (Table 4).

Economic growth is driven by change in people's capabilities or their human capital, as affected particularly by their education. Educated people can more easily



**Table 3.** Average landing.

Characteristics	Extension service user households (N=900)	Non user households (N=875)	Total households (N=1775)	t-value
Land holding	1.8	1.00	1.5	2.5**
Cultivated land	1.8	0.8	1.3	4.4***
Grazing land	0.3	0.1	0.2	2.1**
Land share in	0.4	0.2	0.3	2.8***
Land share out -	0.1	0.2	0.1	2.4**
Land rent in	0.1	0.1	0.1	0.8
Land rent out	0.0	0.0	0.0	-
Fallow and woodlot	0.2	0.1	0.2	1.8

\*\*\*, \*\* and \* are significant at 1, 5 and 10% significant level, respectively.

**Table 4.** Average cost of land rent/ha.

Characteristics	Extension service user households (N=900)	Non user households (N=875)	t-test
Cost of land rent, ETB/ha	5,816	2,867	3.9***

\*\*\*, \*\* and \* are significant at 1%, 5% and 10% significant level, respectively. N.B1 USD = 19.69 ETB.

whether the household benefits from the experience of an older person, or has to base its decisions on the risk-taking attitude of a younger farmer. There is no significant difference in the distribution of household head age of the sampled households between irrigating and non-irrigating household heads (Table 4).

Land is the major productive asset in agrarian countries like Ethiopia. Cultivated land appears to be the most important scarce factor of production. In the study area, own land, rented and shared lands were used for cultivation. The average land holding size of the sample households in the study area is 1.1 ha, which is comparable to the national land holding of 1.0 hectares. There is no significant difference between irrigating and non-irrigating households in average land holding size (Table 5). Thus the overall land holding per household among the study group is similar. However, there is a significant difference in their cultivated land size. Irrigating households have larger cultivated land area than non-irrigating households. Irrigation may generate income and allow accumulation of other productive assets by irrigating households, which facilitate cultivation of additional land through share in and rent in from non-irrigating households.

The average grazing land for irrigating and non-irrigating households was 0.21 and 0.16 ha, respectively. Irrigating households have also use more grazing land holding than non-irrigating, the difference between them is statistically significant at the 1% significant level.

Sharing of farmland from any other households is commonly practiced in the study area. Share in of farmland is practiced by 70 and 40% of irrigating and non-

irrigating households; respectively. Irrigating households share in more farm-land compared with non-irrigating households, whereas sharing out of farm land was done by only 12 and 21% for irrigating and non-irrigating households, respectively. Non-irrigating households share out more their own farm land compared with irrigating households (Table 6). Irrigating household participation was higher for land share in but less for land share out. The converse is true for non-irrigating households which may due to that irrigating household have better potential to cultivate additional land than non-irrigating households. The proportions of households, who share in, share out and rent in were 62, 16 and 15%, respectively. The share in, share out and rent in land size were 0.2, 0.1 and 0.1 ha, respectively.

Rent in of farmland is practiced by 21 and 11 % of extension user and non-user households, respectively. The mean rented in farm-land from any other household for both irrigating and non-irrigating households were 0.09 and 0.04 ha, respectively. Non-user household (7%) participates in rent out of their farm land where as irrigating households did not rent out any farm land. Irrigating household participation was higher for land share in but less for land share out. The other type of land tenure is fallow and woodlot land. The average fallow and woodlot land size of the sample households 0.16 ha, which is 0.19 and 0.14 ha for irrigating and non-irrigating, there is no significant difference between them.

In Ethiopia land is a public property. Sale of land is not allowed, but, land rental and sharing through agreement between users for one or two cropping seasons is common in the study area. The rental value of the land

**Table 7.** Mean value of agriculture production assets in ETB.

Characteristics	Extension service user households (N=900)	Non user households (N=875)	Total households (N=1775)	t-test
Production assets, ETB	110,243	49,867	80,055	3.9***

\*\*\*, \*\* and \* are significant at 1, 5 and 10% significant level, respectively. N.B. 1 USD = 19.69 ETB.

**Table 5.** Total Mean annual cropping income in ETB.

Characteristics	Extension service user households (N=900)	Non user households (N=875)	Total Households (N=1775)	t-test
Mean annual cropping income	157,231	98,874	128,053	8.9***

\*\*\*, \*\* and \* are significant at 1%, 5% and 10% significant level, respectively. N.B1 USD = 19.69 ETB.

depends on the quality of the land and the access to irrigation.

The average rental values of land accessed with irrigation and land without access to irrigation were ETB 5,816 and ETB 2,867 per ha per one crop season, respectively. This is consistent with the hypothesis that extension user households keep their land management in fertility that increases the value of net returns to land. Households who have farm plots with access to irrigation water thus will have higher incomes per ha from land rent (Table 6).

Agricultural production assets include motor pumps, treadle pumps, plough sets and equipment necessary for agricultural activities. The production assets in extension service users and non-extension households are valued by considering the salvage value of each asset. As mentioned in the literatures review section of this paper, irrigation development has several benefits and roles, one of these benefits are increasing wealth of households. Extension service users have, on average, more agricultural production assets than non-user households. This difference is statistically significant at the 1 % significant level (Table 7).

### Total cropping income

Total cropping income is the amount of mean annual income of a household obtained from both types of sample households, user and non-user (Table 8).

The mean annual income of a household from cropping income in the sample PAs was ETB 22,824. The total mean annual cropping income of extension service user households was substantially higher than that for non-user households. The t-test shows that there is significant difference between them at 1 % level of significant (Table 8). This suggests that extension intervention with scaling out of technologies markedly increases income, but this

will be more appropriately tested using econometric analysis.

### Income sources at household level

The total mean annual household income in the study area was ETB 26,251 (Table 9), which is roughly equal to the average per capita income for Ethiopia as a whole. From the total mean annual income of a household, cropping contributes the highest income share (86%) followed by livestock (11%) and off-farm (3%), respectively.

Scaling up technology user households earn higher income from cropping than non-user households. However, there is no significant difference between user and non-user households in their off-farm incomes. The total income significant difference arises from the cropping income difference, which is suggestive of the both the mechanism and the degree to which technologies access increases household incomes. The next section discusses the results of econometric analysis that assesses the impact of extension service controlling for other factors that influence income.

### Econometrics model analysis

The income analysis was estimated using a Tobit (censored regression) model. The analysis was carried out using STATA software. Multi-collinearity was examined using Variance inflation factor (VIF) and correlation coefficients. The values of the VIF for explanatory variables were found to be less than 10 and total of eleven explanatory variables were entered in to the regression analysis.

On the basis of this alternative, the observed total

**Table 9.** Total Mean annual cropping income in ETB.

Characteristics	Extension service user households (N=900)	Non user households (N=875)	Total households (N=1775)	%	t-test
Crop income	32,282	13,366	22,824		8.9***
Livestock income	3,132	2,433	2,783	11	1.4
Off-farm income	622	667	645	3	- 0.3
Total income	36,036	16,466	26,251	100	7.6 ***

\*\*\*, \*\* and \* are significant at 1, 5 and 10% significant level, respectively. N.B1 USD = 19.69 ETB.

**Table 10.** Tobit estimates of the determinants for total income.

Variable	Coef.	Std. Err.	P> t
AG <sub>e</sub>	-16.54	50.7	0.74
ED <sub>u</sub>	4915.29 ***	1487.4	0.0
EX <sub>s</sub>	3359.46***	1222.01	0.01
TL <sub>h</sub>	10291.91***	1607.31	0.00
FS <sub>h</sub>	1554.59 ***	505.83	0.00
AI <sub>p</sub>	4688.55***	1738.96	0.01
LI <sub>v</sub>	2285.07 ***	374.29	0.00
DR <sub>h</sub>	-1031.12	692.57	0.14
AC <sub>s</sub>	-894.16	1052.57	0.39
AO <sub>h</sub>	2.81***	.34	0.00
SH <sub>h</sub>	98.65	1755.29	0.96
Constant	-1696.12	3561.15	0.00
Sigma	6778.27	358.72	
Number of obs.	1775		
Prob > chi <sup>2</sup>	0.00		

\*\*\*, \*\* and \* are significant at 1, 5 and 10% significant level, respectively.

minimum income at household level is ETB 1,256; it is non-zero value. By considering the above revised approaches Tobit regression model was used with 1255 as lower limit. The estimates of coefficients by the Tobit regression model as tool of parameter estimation are depicted in Table 10.

The Tobit analysis suggests that several variables have a statistically significant impact on the total income of the household, many of which are consistent with the hypothesized relationships. The analysis indicates which determinants are more important for the improvement of total household income. Some variables appear to be insignificant; this may be due to the relatively small sample size involved.

Education (ED<sub>u</sub>) has significant positive impact on income. This seems rational; educated human capital can more easily adopt technologies and make more informed production decision. This can increase the marginal productivity of labor. The increase in productivity of labor is one of the important factors to increase income of a

household (Table 10).

Household family size in adult equivalent (FS<sub>h</sub>) and livestock holding in TLU (LI<sub>v</sub>) are positively associated with household total income; both of them are significant. Household family size in adult equivalent means a larger amount of labor available to the household. Labor increases productivity per ha of land, and in turn, household total income increases for a given land base. The positive association between labor and household total income seems reasonable. Livestock holding in have high contribution on total household income by directly sale of livestock and their products, and by used as source of draught power for ploughing in crop production activities.

Access to extension service (EX<sub>s</sub>) influences the household total income significantly with a positive sign as expected. As Norton et al (1970) suggest, access of technology shifts the production function and offsets the diminishing marginal return by doing so increases income and used as a source of economic growth. According to Makombe and Dawit, (2007), the production function analysis of irrigated and non-irrigated farm plots, the result shows that irrigation shifts the agricultural production frontier to a higher level. The marginal productivities of land and labor for the irrigated farms are almost four, and five times more, respectively. Thus, access to irrigation is one among many factors that increase household incomes.

Household production asset value (AO<sub>h</sub>) influences the household total income significantly with a positive sign. This tells us households with high production assets can produce more and increase their total income. This is consistent with the economics of transformation and growth principles (Norton et al, 1970) as people accumulate physical capital allows the people to expand production by changing the marginal productivity of inputs like land and labor.

Education (ED<sub>u</sub>) is also the important factor that influences the annual total income of a household. The analysis shows that access to education significantly increases the household's total income by ETB 4,903.3 (1USD = 19.67 ETB at the time the study) (Table 11).

The previous discussion indicated the sign and statistical significance of the coefficients from the Tobit

**Table 11.** Marginal effects of determinants on household total income.

Determinant	dy/dx	Std. Err.	P> z
AG <sub>e</sub>	-12.1	50.4	0.7
ED <sub>u</sub>	4203.7	11.1	0.0
EX <sub>s</sub>	3843.9	2.5	0.0
TL <sub>h</sub>	12744.9	6.4	0.0
FS <sub>h</sub>	1457.0	5.9	0.0
AI <sub>p</sub>	4359.4	2.1	0.0
LI <sub>v</sub>	2811.9	3.7	0.0
DR <sub>h</sub>	-102.3	91.43	0.2
AC <sub>s</sub>	-992.6	87.5	0.9
AO <sub>h</sub>	2111.8	0.4	0.0
SH <sub>h</sub>	8.8	72.0	0.8

model. However, in that model the coefficients do not directly represent the marginal-effect, that is, the impact on household income from a one-unit change in the independent variables. The marginal effect estimates reveal that the land size (TL<sub>h</sub>) has the largest impact. That is, a one ha land change has an impact on income for 10,274.9 ETB per year (Table 11). Thus, land holding size is very important input in rural poor households to increase their annual income. Since, the agrarian nature of the country; agriculture is the main source of income and livelihood for more than 85% of the country's population. Thus, land is critical and sensitive political issue in contemporary history of Ethiopia (Helland, 1999). In the study area, land is very scarce resource. Land share in/out and rent in/out is common. Even though the cost in cash of land is not far from the estimated marginal impact of land, the additional costs such as transaction cost and monitoring cost are high. Therefore, it is not easy to increase a land as required.

Extension service (EX<sub>s</sub>) has a significant impact on the total income of a household, ETB 3843.9 per year. This supports the initial hypothesis that extension service use increases households' income. Households who have access to agricultural extension service can cultivate their irrigated land two or more times a year. Although the econometric analysis cannot indicate directly why the increase in income occurs, extension allows the farmers to practice crop intensification<sup>2</sup> and diversification, which increases crop yields and revenues from crop sales. Irrigation likely also increases the marginal land and labor productivity, increases the crop production and then promotes household income.

Livestock holding (LI<sub>v</sub>) also affects annual total income of a household. An increase of household's livestock holding by one TLU is estimated to increase the total income of a household by ETB 2811.9 per annum. As expected, the value of productive assets owned by the household (AO<sub>h</sub>) also increases total income of a

household. The increase in asset holding of a household by ETB1000 significantly increases the household total income by ETB 2800. This suggests that households should invest in more productive assets. There should be credit or surplus income to invest on these production assets. The source of credit in the study area is ACSI, the interest rate is high (18%) compared to the Commercial bank of Ethiopia (5%). Thus, both surplus income and credit are unaffordable by subsistent farmers. Household size in adult equivalent (FS<sub>h</sub>) also increases the annual income of a household. A one-unit increase family size in adult equivalent increases the total income of a household by about ETB 1,600.

### Multivariate logit regression

The estimated coefficient for dummy variable access to extension service with the odd of being poor over non-poor was negatively correlated and significant. This suggests that the probability to being poor decreases if one has access to extension services, other factors being constant. This probably is due to the influence that extension service on agricultural intensity and diversification. Agricultural intensity is higher in extension service user household as compared to non-user households. Because the definition of the poverty threshold in this study is based on current income, and previous results suggest that access to extension services increases income, it is not particularly surprising that the likelihood of poverty is lowered by extension service implementers.

However, other factors also influence the likelihood that a household is in poverty. As expected, the coefficient of household education is negatively correlated with poverty and significant. The result suggests that household head who is literate had a lower probability of being poor compared with those who are illiterate. Education is assumed to increase productivity and thereby lead to higher levels of welfare for the household (Table 12).

The estimated coefficient for dummy variable access to extension service with the odd of being poor over non-poor was negatively correlated and significant. This suggests that the probability to being poor decreases if one has access to extension service technologies, other factors being constant. This probably is due to the influence that extension on agricultural production intensity and diversification. Production intensity is higher in extension user household as compared to non-user households (Table 12).

The coefficient of land holding per capita was negatively correlated with the probability of a person being poor and statistically significant. The odds ratio illustrates that a one-ha increase in land holding per capita, the odds of being poor decrease markedly(although this is not surprising given that it would result in a doubling of average farm size).

**Table 12.** Parameter estimates of a logit model for determinants of a household poverty.

Variables	Coef.	St. error	Odds ratio	Std. Err.
AG <sub>e</sub>	0.02	0.0	1.0	0.0
ED <sub>u</sub>	-1.73 ***	0.2	0.2	0.1
EX <sub>s</sub>	-1.95 ***	0.5	0.1	0.0
TL <sub>h</sub>	-1.95 **	0.5	0.1	0.0
DR <sub>h</sub>	0.08	0.3	1.1	0.3
AO <sub>h</sub>	-0.01	0.0	1.0	0.0
SH <sub>h</sub>	-1.58 **	0.7	0.2	0.1
Cons.	3.26	1.6	-	-
LR chi <sup>2</sup>	92.4	-	-	-
Prob > chi <sup>2</sup>	0.0	-	-	-
Log likelihood	61.8	-	-	-
Pseudo R <sup>2</sup>	0.43	-	-	-

\*\*\*, \*\* and \* are significant at 1, 5 and 10% significant level, respectively.

**Table 13.** Poverty comparison in %.

Parameter	Absolute poverty line		Moderate poverty line	
	Head count ratio (P <sub>0</sub> )	Poverty gap (P <sub>1</sub> )	Head count ratio (P <sub>0</sub> )	Poverty gap (P <sub>1</sub> )
EX <sub>s</sub> - users	0.07	0.01	0.10	0.01
Non-EX <sub>s</sub> users	0.43	0.09	0.50	0.10

A number of variables had no statistically significant impact on the odds ratio. Asset holding per capita was negatively correlated with the probability of a person being poor, but somewhat surprisingly was not statistically significant. Household head age also had no statistically significant impact on the probability of a person being poor which contrasts with findings of previous studies such as Bigsten and Shimeles (2002).

Consistent with the initial hypothesis, the Logit regression analysis indicates that access to irrigation markedly reduces the odds that a household will be in poverty, at least based on the poverty definition used in this study. Also reducing the likelihood of poverty are household head education, per capita land holding, ownership of oxen and male headed of household head.

### Poverty analysis

The absolute poverty head count ratios of irrigating and non-irrigating households were 7 and 43%, respectively (Table 13). The moderate poverty head count ratios of irrigating and non-irrigating households were 10 and 50%, respectively. In the study area, of the sample population who live below the absolute poverty level, 88% are non-irrigating households and only 12% are irrigating households. This suggests that irrigation may have a significant impact on rural poverty alleviation.

For irrigating households, the gap was only 1%, but was significantly larger for non-irrigating households (9 and 10% for the absolute and moderate poverty thresholds, respectively). Thus, the poverty gap is much larger for non-irrigating households, which again suggests that irrigation may play a role in poverty reduction (Table 13).

The average income gap of extension households was lower than non-irrigating households. This suggests that access to irrigation reduces the poverty gap (and thus reduces poverty). The numbers of households below the moderate poverty line are fifty four (based on the thirtieth %ile of current income and N=1600 total households). Of these 54, 49 (91%) are non-irrigating households. The number of irrigating households below the poverty line is small, which makes it difficult to assess the impact of irrigation types on the likelihood of a household being in poverty. The overall income gap of poor people was ETB 1,338 (Table 14).

### Conclusion

Access to irrigation increases the opportunity for crop intensity and diversification, which increase cropping income. Irrigation is becoming a practice to increase total annual income for many households in the study area. In addition to their normal rain-fed cultivation, irrigating

**Table 6.** The average income poverty gap.

Parameter	Mean income per adult equivalent of the poor in ETB	Mean of income poverty Gap in ETB
Extension service users	2282	943
Non-user	1826	1399
Total	1887	1338

households cultivate cash crops using small-scale irrigation. The main irrigated crops were onion, tomato, potato, maize, oat and vetch. Irrigated crops were selected due to good production potential, economic returns and ease of cultivation, respectively. Onion and rice were the major income source crops for irrigating and non-irrigating households, respectively.

Econometric analyses that control for other factors that influence household income indicate that accesses to small-scale irrigation increases mean household income significantly (about ETB 3,353 per year, or a 27% increase over non-irrigating household), which is hypothesized to occur primarily through crop intensification and crop diversification. It is important to note that other factors (such as input access) also had large effects on household income, and this study did not explore in detail the complementarities between irrigation access and other input use.

The other objective of this study is to assess the impact of irrigation on the likelihood that a household was in poverty. The results indicate that irrigation development has a profound impact in alleviating poverty. The poverty analysis indicates that a much higher proportion of those who are poor are non-irrigating rather than irrigating households. Thus, the poverty prevalence in non-irrigating households is by far greater than irrigating households. This suggests that irrigation has an important influence on rural poverty alleviation. Additional econometric analyses indicate that use of irrigation reduces the probability of a household being poor.

## RECOMMENDATIONS AND POLICY IMPLICATION

This study has found that extension service development helps to increase household income and reduces the incidence of poverty at the household level. Based on these findings as well as the outcomes of focus group discussions and key informant interviews, further development and refinement of small-scale irrigation systems appears merited. This, of course, raises the question about this might best be undertaken. Although a formal analysis of strategies for future scaling out development is beyond the scope of this research, following actions are suggested to facilitate future extension service development.

1. Equip the research wing with: materials, human resource and other facilities because the generation

technologies lie on the research institutes. Research institutes are the power house and key for development (thoughts, economical, technologies...) sustainability, Economic growth, poverty eradication, invention and innovation incubating different ideas that can upgrade the extension system.

2. Ensure extension services development: extension needs to address vulnerability as well as productivity and to offer new options from which poor households can choose according to their circumstances. The design of extension strategies must take account of differing degrees of market integration, which determine the degree to which the poor can take advantage of market opportunities.

3. Access to quality service of extension out of political influences in a manner of professional dimension and service access Extension strategies need to differentiate between highly and weakly integrated areas and acknowledge the need to take difficult decisions between supporting production strategies, on the one hand, and broader based livelihood extension, on the other.

4. Renewed and improved the existed irrigation canal development for small irrigation

5. Supply access to technologies: Extension should offer a wider range of services, some focused on support to production and others focused on wider livelihood support, targeted according to an analysis of a particular area's market integration, degree of vulnerability, and production prospects.

6. Strengthen education and training (adult training and farmers training).

## Future studies questions

This study focuses on the impact of extension service access on gross income and poverty reduction at household level. However, there are limitations which need further and depth analysis in net income of technologies using cost-benefit.

Choice of scaling out technology types for small-scale, medium scale or large scale irrigation and their impact on income and poverty. The impact of extension scaling out technologies on actual livelihood change on the community like feeding habit, nutritional contribution and urbanization.

Scaling out technologies were cultivated and harvested by all farmers at the same time which cause the problems

of marketing and post-harvest handling in the study area.

## Conflict of Interests

The authors have not declared any conflict of interests.

## REFERENCES

- Aschalew D (2009). Soil and water. Articles of Cornell University. In Partial Fulfillment of the Requirements for the Degree of. Master of Professional Studies.
- Barket A, Khan S, Rahman M, Zeman S (2002). Economic and social impact evaluation study on the rural electrification program in Bangladesh, HDRC, Dhaka.
- Bergh A, Nilsson T (2010). The globalization and absolute poverty-a panel data study Version to be presented at Nationell konferens nationalekonomi, October 1-2, 2010, Lund University.
- Bigsten A, Shimeles A (2002). Growth and Poverty Reduction in Ethiopia: Evidence from Household Panel Surveys, Working Papers in Economics no 65, January 2002, Department of Economics; Göteborg University.
- Buchy M, Basaznew F (2005). Gender-Blind Organisations Deliver Gender-Biased Services: The Case of Awasa Bureau of Agriculture in Southern Ethiopia. *Gend. Technol. Dev.* 9(2):235-251.
- CIA (US Central Intelligence Agency). (2011). World Factbook: Ethiopia. Available at: [www.cia.gov/library/publications/the-world-factbook/geos/et.html](http://www.cia.gov/library/publications/the-world-factbook/geos/et.html).
- Cohen MJ, Lemma M (2011). Agricultural Extension Services and Gender Equality an Institutional Analysis of Four Districts in Ethiopia. Ethiopia Strategy Support Program II (ESSP II) ESSP II Working Paper 28 August 2011. Available at: <http://www.ifpri.org/sites/default/files/publications/esspwp28.pdf>
- Cohen MJ, Roc chigiani M, Garrett JL (2008). Empowering Communities through Food Based Programs: Ethiopia Case Study. World Food Program Discussion Paper. Rome: World Food Programme. Available at: [www.wfp.org/sites/default/files/WFP\\_Discussion\\_Paper-Empowering\\_communities\\_Ethiopia\\_0.pdf](http://www.wfp.org/sites/default/files/WFP_Discussion_Paper-Empowering_communities_Ethiopia_0.pdf).
- CSA (Central statistics agency) (2007). Central statistics agency of Ethiopia.
- Dercon S (1997). Poverty and deprivation in Ethiopia, Center for the study of African economies, department of economics and Jesus College, Oxford University. FAO (Food and Agricultural Organization) (1997) Irrigation technology transfer in support of food security proceeding of a sub-regional workshop, Harare, Zimbabwe, 14-17 April, water report 14.
- Dercon S, Gilligan DO, Hoddinott J, Woldehanna T (2009). The Impact of Agricultural Extension and Roads on Poverty and Consumption Growth in Fifteen Ethiopian Villages. *Am. J. Agric. Econ.* 91(4):1007-1021.
- EEA (Ethiopian Economic Association) and EEPRI (Ethiopian Economic Policy Research Institute). 2006. Evaluation of the Ethiopian Agricultural Extension with Particular Emphasis on the Participatory Demonstration and Training Extension System (PADETES). Addis Ababa, Ethiopia: EEA and EEPRI.
- FAO (2010). Agricultural populations and households. Available at: [www.fao.org/fileadmin/templates/gender/agrigender\\_docs/t1.pdf](http://www.fao.org/fileadmin/templates/gender/agrigender_docs/t1.pdf)
- Foster J, Greer J, Thorbecke E (1984). A Class of Decomposable Poverty 113 Measures. *Econometrical* 52(3):761-766.
- Greene W (2002). *Econometric analysis*, fifth edition, William, New York University, Upper Saddle River, New Jersey 07458.
- Habitamu T (2009). Payment for environmental service to enhance resource use efficiency and labor force participation in managing and maintain irrigation infrastructure, the case of Upper Blue Nile basin, Cornell University MPS Thesis.
- Haile T (2008). Impact of irrigation development on poverty reduction in Northern Ethiopia.
- Helland J (1999). Land alienation in Borena: Some land tenure issues in a pastoral context of Ethiopia. *East. Afr. Soc. Sci. Res. Rev.* 15(2):1-15.
- Hussain I, Biltonen E (2001). Irrigation against Rural Poverty: An Overview of Issues and Pro-Poor Intervention Strategies in Irrigated Agriculture in Asia, Proceedings of National Workshops on Pro-Poor Intervention Strategies in Irrigated Agriculture in Asia Bangladesh, China, India, Indonesia, Pakistan, and Vietnam, IWMI, August, 2001.
- IFAD (2011). Rural Poverty in Ethiopia. Available at: [www.ruralpovertyportal.org/web/guest/country/home/tags/ethiopia](http://www.ruralpovertyportal.org/web/guest/country/home/tags/ethiopia).
- John M (2002). Dependency ratio. Available at: <http://www.scalloway.org.uk/popu13.htm>.
- Lemma M (2007). The Agricultural Knowledge System in Tigray, Ethiopia: Recent History and Actual Effectiveness. Weikersheim, Germany: Margraff Publishers.
- Loayza N, Soto R (2002). Economic Growth: Sources, Trends, and Cycles, Santiago, Chile, 2002 Central Bank of Chile.
- Makombe G, Dawit D (2007). A comparative analysis of rainfed and irrigated agricultural production in Ethiopia. *J. Article Irrigat. Drainage Syst.* Springer, Netherlands. 21(1):35-44.
- MOFED (2010). The Federal Democratic Republic of Ethiopia, Growth and Transformation Plan (GTP), 2010/11-2014/15 Draft, September 2010, Addis Ababa.
- Mogues T, Ayele G, Paulos Z (2008). The Bang for the Birr: Public Expenditures and Rural Welfare in Ethiopia. Research Report 160. Washington, DC: International Food Policy Research Institute.
- Norton GW, Jeffrey A, William A (1970). *Economic progress and Policy in Developing countries*, New York: Norton GW, Jeffrey A, William A. P 34.
- Roemer M, Gugerty M (1997). Does economic growth reduce poverty? Technical Paper, Harvard Institute for International Development, March 1997.
- Schreiner M, Chen M (2009). A Simple Poverty Scorecard for Ethiopia. Available at: <http://www.microfinance.com/#Ethiopia>.
- Zhou Y, Zhang Y, Abbaspour CK, Yang H, Mosler JH (2009). Economic Impacts on farm households due to water reallocation in China's Chaobai Watershed.



*Full Length Research Paper*

## Treatment of sewage sludge with the use of solarization and sanitizing products for agricultural purposes

Amliton Alves Filho\*, Reginaldo de Camargo, Regina Maria Quintão Lana, Márcia Regina Batistela Moraes, Alírio Coromoto Daboin Maldonado and Roberto Terumi Atarasi

Federal University of Uberlândia, Institute of Agricultural Sciences, CEP: 38.400-902 Uberlândia, Minas Gerais, Brazil.

Received 23 October, 2015; Accepted 20 November, 2015

Recycling of sewage sludge for agricultural purposes is recommended as one of the most adequate forms of final disposal of this waste. This study evaluated the effectiveness of solarization combined with chemical treatments by acid and alkali during different periods of cleaning. The experiment was conducted at the Experimental Farm of the Federal University of Uberlândia (UFU) in Uberlândia-MG. The experimental design used randomized blocks in a 5x3+1 factorial arrangement with four replications. The factor plots consisted of sanitizing products (260 mg L<sup>-1</sup> peracetic acid, 2400 mg L<sup>-1</sup> quaternary ammonium compounds, hydrated lime equivalent to 30% of the dry mass of the sewage sludge, 2500 mg L<sup>-1</sup> sodium hypochlorite, and pure sludge) for different times: T1 = 7 days, T2 = 14 days, and T3 = 21 days. Data were also collected from the pure mud at time zero. The concentration of fecal coliforms, pH, N (Nitrogen), Na (Sodium), Al (Aluminium), Ca (Calcium), Mg (Magnesium), K (Potassium), OM (Organic Matter), C (Carbon), Cr (Chromium), Ni (Nickel), Cd (Cadmium), Pb (Lead), Cu (Copper) and Zn (Zinc) were all evaluated. Lime increased the concentration of Ca and Mg in the biosolids, reduced the level of fecal coliforms below the limits specified by environmental standards from seven days and decreased the levels of available N, Al, OM, C, Na, Cr, Ni, Cd, Cu and Zn in the biosolids.

**Key words:** Environment, heavy metal, mineral nutrient, micro-organism.

### INTRODUCTION

Sewage, processed in treatment plants (STPs), undergoes chemical, physical, and biological processes in order to achieve the standards determined by the Brazilian environmental legislation. After treatment, the liquid is usually released into local bodies of water. The semisolid material is called sewage sludge.

Agricultural recycling of sewage sludge is one of the most adequate methods of disposing of this waste in terms of technical, economic and environmental requirements (Barbosa et al., 2007). For Camargo et al. (2013), the use of sewage sludge in agriculture, as organic fertilizer, is the most promising alternative for the final disposal

\*Corresponding author. E-mail: [amiltonaf@yahoo.com.br](mailto:amiltonaf@yahoo.com.br) Tel: + 55 (34) 999-9261.

of this waste. De Maria et al. (2007) found that the application of sewage sludge during two successive years resulted in an increase in the organic matter content and aggregate stability of the oxisol in the 0-10 cm layer.

Studies conducted by Franco et al. (2010) showed that raw sewage, when supplemented by mineral fertilizer, increased the productivity of sugarcane as compared to conventional fertilization. The sewage did not change the technical quality of the plants. Melo et al. (2007) observed that the use of sewage sludge as fertilizer on corn increased productivity as compared to the application of mineral fertilizer. Santos et al. (2014) found that sewage sludge increased fertility for seedling production, mainly in terms of nitrogen, calcium and phosphorus.

However, the principal factor limiting the use of sewage sludge in agriculture is the presence of high levels of heavy metals, various organic pollutants and pathogenic micro-organisms (Barros et al., 2011; Thomas-Soccol et al., 2000). Sewage sludge can present various pathogens capable of causing disease in humans and animals (Thomaz-Soccol et al., 2000). Among the pathogens, the following groups may be present in sewage sludge: helminths, protozoa, fungi, viruses and bacteria (Sidhu and Toze, 2009). The quantity of pathogens in sewage sludge depends on its origin, the time of year and the treatment process (Thomaz-Soccol et al., 2000). With regard to the bacterial content, the CONAMA (National Council of the Environment) Resolution nº 375/2006 of the Brazilian Environmental requires the analysis of fecal coliforms and the bacteria being used as a bacterial indicator for assessing the quality of the sewage sludge for agricultural use (Brazil, 2006).

The processing methods most commonly used include aerobic and anaerobic digestion, chemical treatment with an alkaline medium, composting, solar radiation and thermal drying (Andreoli et al., 2001).

Solarization is the process by which sewage is subjected to the heat and rays of the sun in containers covered by film. This is an alternative for sanitizing sewage at a low cost.

The chemical cleaning of sewage sludge using an alkaline product, normally lime, capable of raising the pH of the sludge deactivates most of the pathogenic microorganisms (Dores-Silva et al., 2011). There are also other possibilities for processing sludge, including the use of acetic acid, peracetic acid, sodium hypochlorite and quaternary ammonium salts (Barros et al., 2011; Barros et al., 2006; Daschner, 1997).

Recycling of sewage sludge for use in agriculture thus requires cleaning according to the standards established by the requirements of CONAMA, Resolution nº 375/2006, to ensure health and environmental safety (Brazil, 2006).

The objective of this study was to evaluate the efficiency of solarization combined with chemical treatment using acid and alkaline during different cleaning times.

## MATERIALS AND METHODS

The experiment was conducted at the Glória Experimental Farm of the Federal University of Uberlândia (UFU) during 21 days of August, 2013. The sewage sludge was collected from the Uberabinha Sewage Treatment Plant of DMAE - Department of Water and Waste water, located in Uberlândia, MG. The sewage sludge was extracted from an anaerobic reactor UASB type (Upflow Anaerobic Sewage Sludge Blanket) from domestic sources after passing through a dewatering process by adding cationic polymers ( $\text{FeCl}_3$ ) and centrifuging to a moisture level of 71.21 and 28.79% dry matter. The material was collected at the exit of the reactor.

The experimental design was a randomized block in a factorial  $5 \times 3 + 1$ , with four replications of factor plots consisting of sanitizing products ( $260 \text{ mg L}^{-1}$  peracetic acid,  $2400 \text{ mg L}^{-1}$  quaternary ammonium compounds, hydrated lime equivalent to 30% of the dry mass of the sewage sludge,  $2500 \text{ mg L}^{-1}$  sodium hypochlorite, and pure mud) for different times: T1 = 7 days, T2 = 14 days, and T3 = 21 days. Data were also collected from the pure sewage sludge at time zero. The total experiment thus consisted of 64 subplots (Table 1).

The plots consisted of metal boxes of  $0.30 \times 0.23 \times 1.0$  meters on pedestals in order to eliminate as much interference (humidity and temperature) from the ground, as possible. Each drug treatment with peracetic acid, sodium hypochlorite, quaternary ammonium compounds and hydrated lime, with the addition of pure sludge, was blended in a mixer for three minutes. In each metal box, corresponding to one experimental unit (plot), 30 kg of the mixture, containing sewage sludge and sanitizing material, was placed for processing to pure mud. Instruments to measure temperature were implanted in each box at a depth of five cm in the sludge mass and 40 cm from the end of the receptacle. Data were stored in a datalogger, model CR 1000 (Campbell Scientific®), calibrated to record daily temperatures at 30 min intervals throughout the experimental period.

Each unit, composed of five boxes, was covered with transparent glass of a thickness of 5.0 mm, in order to form a greenhouse and prevent the entrance of moisture, such as rainfall, from the external environment. A ribbon was used between the glass and the enclosures to prevent the entrance of air and moisture. A spatula that had been autoclaved was used for the collection of each sample. Within each plot, four sub-samples were collected at different depths of the sludge, extending to the bottom of the box. The analysis of thermo tolerant fecal coliforms was carried out in the Environmental Microbiology Laboratory of the Federal University of Uberlândia using the technique of multiple pipes, recommended by the United States Environmental Protection Agency for sludge analysis (USEPA, 2006) (Table 2).

Sewage sludge samples were submitted to nitroperchloric digestion. The total contents of P, K, Ca, Mg, Cu, Zn, In, Ni, Cd, Pb, Al and Mg were determined in the extract by means of atomic absorption spectrophotometry with an acetylene flame and via spectrometer examination of the plasma - ICP/OES, simultaneously, according to the methodology proposed by EMBRAPA (2009) (Table 2). In order to determine the total nitrogen, sulfuric acid digestion was performed (Kjeldahl method). To determine the pH and humidity at  $105^\circ\text{C}$ , the methodology of EMBRAPA (2009) was used. The method for determining the organic carbon was based on the oxidation of the organic matter

**Table 1.** Treatments used in the sewage sludge cleaning process and their concentrations at 7, 14 and 21 days.

Treatments	Chemical concentration
Sludge + peracetic acid	260 mg L <sup>-1</sup>
Sludge + Quaternary compounds of amonium <sup>1</sup>	2400 mg L <sup>-1</sup>
Sludge + Hydrated lime	30% of the sludge dry matter
Sludge + Sodium hypochlorite	2500 mg L <sup>-1</sup>
Pure sludge without chemical	-

<sup>1/</sup> Dicetyl ammonium chloride, alkyl amido propyl chloride, dimethylbenzyl ammonium, alcohol and water.

**Table 2.** Characteristics of anaerobic sewage sludge from the treatment plant STP- Uberabinha, Brazil.

Determinations	Units	Analytical Results <sup>1</sup>	References
Thermo tolerant coliforms	MPN g <sup>-1</sup> of ST	2.87 × 10 <sup>7</sup>	USEPA, Method (1681)
pH CaCl <sub>2</sub> 0.01 mol L <sup>-1</sup>	-	8.62	EMBRAPA <sup>2</sup> (2009)
Nitrogen – N	g kg <sup>-1</sup>	30.01	EMBRAPA (2009)
Sodium – Na	g kg <sup>-1</sup>	0.75	EMBRAPA (2009)
Aluminum – Al	g kg <sup>-1</sup>	39.34	EMBRAPA (2009)
Phosphorus – P	g kg <sup>-1</sup>	9.60	EMBRAPA (2009)
Calcium – Ca	g kg <sup>-1</sup>	17.30	EMBRAPA (2009)
Magnesium – Mg	g kg <sup>-1</sup>	2.60	EMBRAPA (2009)
Potassium – K	g kg <sup>-1</sup>	1.0	EMBRAPA (2009)
Organic matter - OM	g kg <sup>-1</sup>	573.91	EMBRAPA (2009)
Organic carbon – C	g kg <sup>-1</sup>	332.89	EMBRAPA (2009)
Chromium – Cr	mg kg <sup>-1</sup>	166.72	EMBRAPA (2009)
Nickel – Ni	mg kg <sup>-1</sup>	31.93	EMBRAPA (2009)
Cadmium – Cd	mg kg <sup>-1</sup>	0.94	EMBRAPA (2009)
Lead – Pb	mg kg <sup>-1</sup>	ND	EMBRAPA (2009)
Copper – Cu	mg kg <sup>-1</sup>	211.00	EMBRAPA (2009)
Zinc – Zn	mg kg <sup>-1</sup>	1500.00	EMBRAPA (2009)
Humidity to 105°C	-	71.21	EMBRAPA (2009)
MS at 105° C	-	28.79	EMBRAPA (2009)
C/N – Total	-	9.91	EMBRAPA (2009)

<sup>1</sup> = value on a dry matter basis; MPN: Most Probable Number; MS - Dry Mass; ND-Not Detected. <sup>2/</sup> EMBRAPA (Brazilian Agricultural Research Corporation).

with a solution of 0.17 mol L<sup>-1</sup> of potassium dichromate, and titration of the excess dichromate with a ferrous ammonium sulfate solution of 0.5 mol L<sup>-1</sup> (EMBRAPA, 2009). All of the analyses were performed at the Soil Analysis Laboratory (LABAS) of the Institute of Agricultural Sciences, Federal University of Uberlândia (UFU). Analyses of the data variances were developed using the SISVAR (statistical program (Ferreira, 2008) and ASSISTAT (Smith, 2002).

When findings were significant, the averages for that unit were compared by the Scott and Knott test (1974) using a 5% significance level. In order to test the time factor, the Tukey test was applied, also using a 5% significance level. Additional analysis examined the means by the Dunnett test applying the same level of significance.

## RESULTS AND DISCUSSION

The average concentration of thermo tolerant coliforms in the sewage sludge before cleaning was 2.87 × 10<sup>7</sup> g MPN ST<sup>-1</sup>, an amount within the range established by Sidhu and Toze (2009) (Table 3).

The hydrated lime, with an increase in pH (12.65) and production of NH<sub>3</sub>, reduced the concentration of fecal coliforms to acceptable values according to the CONAMA Resolution n<sup>o</sup> 375/2006, established for 10<sup>3</sup> MPN g<sup>-1</sup> at seven days after mixing with the sewage sludge (Table 3).

**Table 3.** Thermo tolerant coliform concentrations in (MPN) g<sup>-1</sup> ST, following treatment with different sanitizer products and evaluation times.

Source of variation	Incubation period (days)			
	0	7	14	21
Control	2.87 × 10 <sup>7</sup> *	-	-	-
Peracetic acid	-	*1.02 × 10 <sup>5</sup> Bb	*1.86 × 10 <sup>4</sup> Bb	*8.50 × 10 <sup>3</sup> Ab
Quaternary ammonium	-	*4.26 × 10 <sup>5</sup> Bc	*1.41 × 10 <sup>4</sup> Ab	*2.04 × 10 <sup>4</sup> Ab
Hydrated lime	-	*0.71 <sup>Aa</sup>	*0.23 <sup>Aa</sup>	*0.23 <sup>Aa</sup>
Sodium hypochlorite	-	*2.1 × 10 <sup>5</sup> Bb	*2.00 × 10 <sup>5</sup> ABb	*1.5 × 10 <sup>4</sup> Ab
Pure sludge	-	*7.07 × 10 <sup>5</sup> Bc	*1.38 × 10 <sup>5</sup> Bc	*6.15 × 10 <sup>4</sup> Ab

Means followed by the same lower case letters in the (Scott-Knott) column and the same capital letters in the (Tukey) column did not differ at the 5% significance level. \* Significant at 5% by the Dunnett test.

Fia et al. (2005) reported that the liming process, which raises the pH of the sludge to slightly more than 12 through the addition of hydrated lime (Ca (OH)<sub>2</sub>), eliminated most of the pathogens present in the residue.

There was no significant difference in the reduction of fecal coliforms in the treatment with hydrated lime among the seven, 14 and 21 days. The concentration of coliforms in the limed sludge after 14 and 21 days was unchanged, indicating that even the coliforms still present in the residue showed no regrowth. In the external environment micro-organisms do not, typically, multiply, requiring an intermediate host (Thomaz-Soccol et al., 2000). Quaternary ammonium salts produced no efficient reduction in coliforms. The measured values did not reach the standard set by the Brazilian Environmental Standard for fecal coliforms as elaborated in CONAMA Resolution n° 375/2006. Similar results have been reported by Daschner (1997) and Miyagi et al. (2000), noting that the quaternary ammonium compounds do not exhibit effectiveness in reducing microorganisms in conditions of a high level of organic matter or media with high salt contents. It was noted that these compounds have low inhibitory effects on gram-negative bacteria such as those belonging to the group of fecal coliforms. The sludge, without the addition of sanitizing products, presented decreased levels of fecal coliforms on days 7, 14 and 21, but did not reach the limits established in CONAMA Resolution n° 375/2006 (Table 3) for agricultural use. Regardless of the method of sanitation, a decrease was observed in the concentration of fecal coliforms at 21 days, influenced mainly by the reduction of moisture in the residue.

Sodium hypochlorite, at a concentration of 2500 mg L<sup>-1</sup>, did not reduce the fecal coliform values to the level recommended by CONAMA Resolution n° 375/2006, due mainly to the amount of solids in the sewage sludge, the high content of organic matter, low moisture content and the initial pH of the alkaline sludge (Table 3). Aisse et al. (2001) pointed out that the presence of large quantities of

solids can protect micro-organisms from disinfecting action and, under conditions of elevated pH; the germicidal effect of chlorine is reduced. The presence of a high moisture content in the sewage sludge permits a longer time of contact of the disinfecting agent with micro-organisms. Barros et al. (2011) observed, however, that sludge with 98% humidity, sanitized with sodium hypochlorite at 2500 mg L<sup>-1</sup>, produced material that was free of pathogens.

Peracetic acid, also, did not reduce the level of fecal coliforms to the limits established by the CONAMA Resolution of the Brazilian Environmental Standard (Table 3). With the application of organic acids such as peracetic acid, the cleaning process of sewage sludge is normally conducted in liquid sludge with high moisture content and therefore a high potential for inactivation of micro-organisms, thus requiring only 10 minutes for a complete reduction (Barros et al., 2006). In the present study the acid was mixed with semi-pasty sludge, with 71.21% moisture and pH of 8.62, resulting in a low efficiency in reducing fecal coliforms. Peracetic acid has a higher efficiency in the inactivation of micro-organisms when the sludge has an acid pH and high humidity conditions (Barros et al., 2011).

The average temperature of the sewage sludge ranged from 19.66°C to 22.88°C from the initial to the final time of each day, with peak temperatures at 13 h and 16°C of variation between 35.24 to 39.98°C among the treatments evaluated (Figure 1).

The temperatures recorded in the experimental plots helped reduce the thermo tolerant fecal coliform level of 1.67 log but did not reach the thresholds required by CONAMA Resolution n° 375/2006 for agricultural use. Additional cleaning processes for adequate reduction of fecal coliforms were thus necessary. For Tchobanoglus et al. (1993), the lethal temperature for *Escherichia coli*, principal representative of the thermo tolerant coliforms, is 55°C for 60 min. The time of year, characterized by shorter days and lower daily temperatures, contributed to

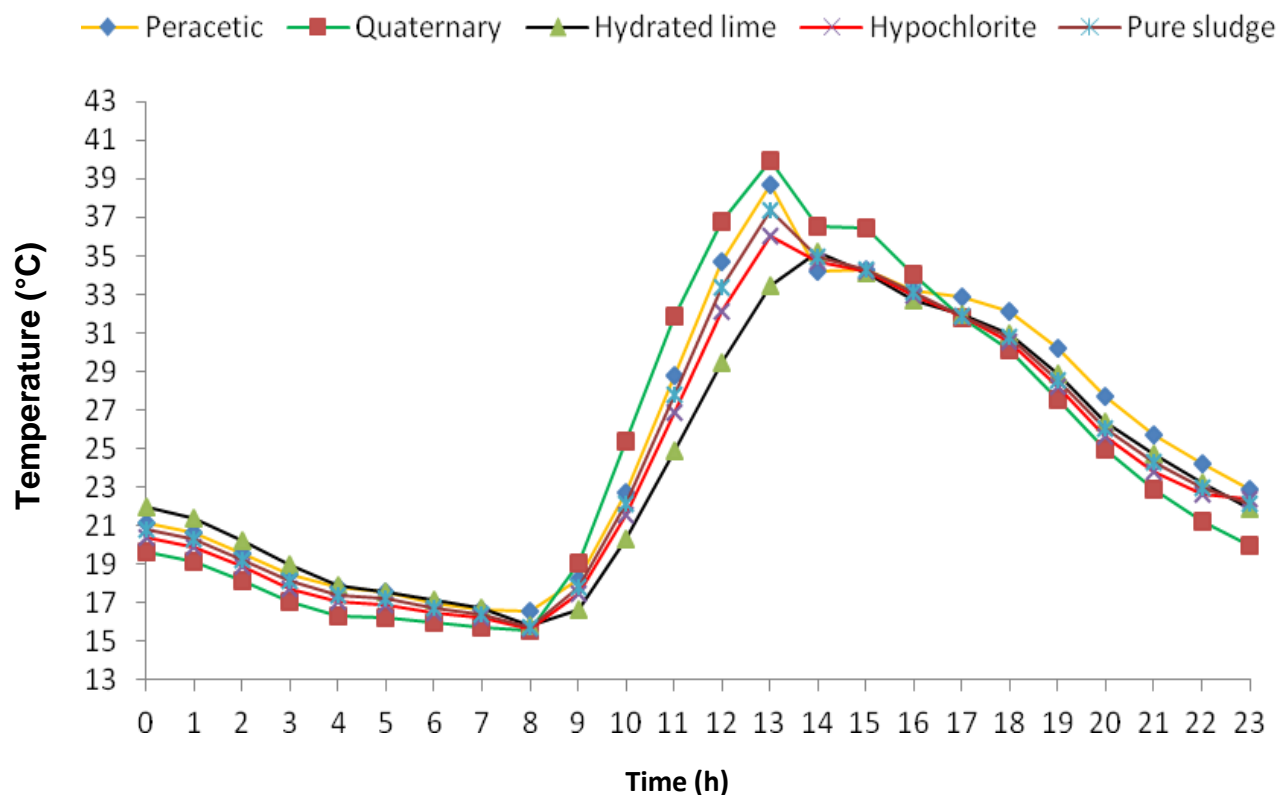

Figure 1. Temperature profiles of the sewage sludge during the time period.

lower average temperatures in the mass of the mud.

The statistical model, which analyzed the split plots for inorganic zinc, copper, cadmium and nickel, yielded significant differences between the main treatments (pure mud and sludge homogenized with sanitizing products) on average, compared by the Scott-Knott Test (Table 4). Pronounced effects among secondary treatments (time differences) were only found for zinc and cadmium. There was no significant interaction between the main factor and the secondary factor for all of the analyzed inorganic substances.

The concentration of lead in the sewage sludge was below the detection limit and therefore excluded from statistical analysis. The additional (control) treatment, when compared with each of the primary and secondary treatments, did not yield significant differences, indicating that additions of sanitizing products had no effect on the sewage sludge attributes: zinc, copper, cadmium, chromium and nickel (Table 4). The times of evaluation did not demonstrate influence on the concentrations of copper, chromium or nickel present in the sanitized sewage sludge (Table 4). The sludge mixed with hydrated lime, on the other hand, significantly reduced the availability of zinc, copper, cadmium, chromium and nickel in relation to other means tested. The Ni, Cd, Zn,

Cr and Cu levels were also influenced by the pH and basic conditions, which favored the passage of soluble forms over those with lower solubility. In general heavy metals are less soluble under intense alkaline conditions ( $\text{pH} > 12.0$ ). Hydrated lime was used to raise the pH above 12.0. This provoked precipitation of the heavy metals in the form of insoluble compounds, hydroxides, phosphates and carbonates with the organic matter of the sewage. Similar results have been reported by Akrivos et al. (2000), who observed smaller amounts of Ni, Zn, Cr, Cd and Cu in limed sludge. For Matos and Matos (2012), the limed sludge complies with environmental legislation. It had low concentrations of heavy metals readily available for plants, indicating a lower risk of environmental contamination.

The values found indicated that the sludge subjected to cleaning did not exceed the limits of metals set by environmental standards for agricultural recycling. Even the pure sludge, without the addition of chemicals, was below the required limits. According to Rocha et al. (2003), sewage sludge, of exclusively domestic origin, has low levels of heavy metals. Levels of zinc had the highest concentration at 21 days, with a value of 2,670  $\text{mg kg}^{-1}$ . For Haynes et al. (2009) and Houhou et al. (2009) domestic sewage sludge is generally rich in Zn

**Table 4.** Heavy metals in the sewage sludge by the treatments and times evaluated<sup>1</sup>.

Incubation period (days)	Zn	Cu	Cd	Cr	Ni	Pb
	mg kg <sup>-1</sup>					
Control (0)	1500.00 <sup>NS</sup>	211.00 <sup>NS</sup>	0.94 <sup>NS</sup>	166.72 <sup>NS</sup>	31.93 <sup>NS</sup>	Nd
7	1620.00 <sup>A</sup>	195.45 <sup>NS</sup>	0.98 <sup>A</sup>	157.83 <sup>NS</sup>	28.68 <sup>NS</sup>	Nd
14	1750.00 <sup>A</sup>	199.00 <sup>NS</sup>	0.72 <sup>A</sup>	149.23 <sup>NS</sup>	29.45 <sup>NS</sup>	Nd
21	2670.00 <sup>B</sup>	192.00 <sup>NS</sup>	0.90 <sup>A</sup>	153.48 <sup>NS</sup>	28.65 <sup>NS</sup>	Nd
Source of variation peracetic acid	1840.00 <sup>b</sup>	210.16 <sup>b</sup>	1.05 <sup>c</sup>	176.25 <sup>b</sup>	32.60 <sup>b</sup>	Nd
Quaternary ammonium	2700.00 <sup>b</sup>	209.00 <sup>b</sup>	1.08 <sup>c</sup>	171.52 <sup>b</sup>	31.15 <sup>b</sup>	Nd
Hydrated lime	1180.00 <sup>a</sup>	157.91 <sup>a</sup>	0.45 <sup>a</sup>	85.34 <sup>a</sup>	19.86 <sup>a</sup>	Nd
Sodium hypochlorite	2340.00 <sup>b</sup>	201.00 <sup>b</sup>	0.83 <sup>b</sup>	162.41 <sup>b</sup>	30.12 <sup>b</sup>	Nd
Pure sludge	1990.00 <sup>b</sup>	199.33 <sup>b</sup>	0.93 <sup>b</sup>	172.07 <sup>b</sup>	30.90 <sup>b</sup>	Nd
MAC	2800	1500	39	1000	420	300

<sup>1</sup>/NS = not significant, Nd not detected. Means followed by the same lower case letters in the (Scott-Knott) columns and upper case letters in the (Tukey) columns, within the same feature, did not differ at the 5% significance level. MAC = Maximum Allowable Concentration.

**Table 5.** Attributes of sewage sludge.

Incubation period (days)	pH	OM	C	N	Na	Al	Ca	Mg	P	K
	g kg <sup>-1</sup>									
Control (0)	8.62*	573.91*	332.89*	30.01*	0.75*	39.33*	17.3*	2.6*	9.6*	1.0 <sup>NS</sup>
7	9.37 <sup>A</sup>	523.83 <sup>NS</sup>	310.05 <sup>NS</sup>	29.64 <sup>NS</sup>	1.38 <sup>NS</sup>	30.33 <sup>NS</sup>	79.3 <sup>NS</sup>	3.3 <sup>NS</sup>	7.7 <sup>NS</sup>	0.9 <sup>NS</sup>
14	8.79 <sup>B</sup>	531.97 <sup>NS</sup>	303.84 <sup>NS</sup>	32.30 <sup>NS</sup>	1.52 <sup>NS</sup>	29.90 <sup>NS</sup>	79.4 <sup>NS</sup>	3.2 <sup>NS</sup>	8.3 <sup>NS</sup>	0.9 <sup>NS</sup>
21	8.80 <sup>B</sup>	534.54 <sup>NS</sup>	308.56 <sup>NS</sup>	31.92 <sup>NS</sup>	1.52 <sup>NS</sup>	29.56 <sup>NS</sup>	87.2 <sup>NS</sup>	3.3 <sup>NS</sup>	7.0 <sup>NS</sup>	0.8 <sup>NS</sup>
Source of variation Peracetic acid	8.17 <sup>b</sup>	570.36 <sup>b</sup>	330.83 <sup>b</sup>	33.48 <sup>a</sup>	0.94 <sup>b</sup>	33.59 <sup>b</sup>	21.5 <sup>b</sup>	3.1 <sup>b</sup>	10.2 <sup>a</sup>	0.9 <sup>NS</sup>
Quaternary ammonium	7.88 <sup>b</sup>	559.65 <sup>b</sup>	324.62 <sup>b</sup>	34.21 <sup>a</sup>	0.83 <sup>b</sup>	32.31 <sup>b</sup>	22.7 <sup>b</sup>	3.1 <sup>b</sup>	9.4 <sup>a</sup>	0.9 <sup>NS</sup>
Hydrated lime	12.65 <sup>*a</sup>	368.60 <sup>*a</sup>	213.80 <sup>*a</sup>	20.88 <sup>*b</sup>	0.61 <sup>a</sup>	20.10 <sup>*a</sup>	302.0 <sup>*a</sup>	4.2 <sup>*a</sup>	1.6 <sup>*b</sup>	0.6 <sup>NS</sup>
Sodium hypochlorite	8.05 <sup>b</sup>	568.91 <sup>b</sup>	329.99 <sup>b</sup>	30.86 <sup>a</sup>	4.10 <sup>*c</sup>	32.80 <sup>b</sup>	22.2 <sup>b</sup>	3.1 <sup>b</sup>	9.0 <sup>a</sup>	1.0 <sup>NS</sup>
Pure sludge	8.15 <sup>b</sup>	583.05 <sup>b</sup>	338.19 <sup>b</sup>	36.84 <sup>a</sup>	0.88 <sup>b</sup>	30.85 <sup>b</sup>	41.4 <sup>b</sup>	3.0 <sup>b</sup>	8.1 <sup>a</sup>	0.8 <sup>NS</sup>

Means followed by the same lower case letters in the (Scott-Knott) columns and upper case letters in the (Tukey) columns, within the same feature, did not differ at 5% significance level. \* Significant at 5% significance, by Dunnett's test. O M – Organic matter. C – Carbon.

since this element is present in many products of domestic origin.

The hydrated lime, in a proportion of 30% of the dry mass of the sludge, produced the highest mean pH with 12.65 (Table 5). Similar results have been reported by Fia et al. (2005) and Matos and Matos (2010).

Regarding the time periods evaluated, it was found that the seven day values had the highest average pH. At 14 and 21 days, there was a decline in mean pH values. No significant differences were found between 14 and 21 days (Table 5). The other tested treatments: peracetic acid, quaternary ammonium compounds, sodium hypochlorite and pure mud, did not differ among themselves for the pH parameter, as tested by the Scott-Knott Test at 5% significance.

The limed sludge had the lowest mean values of organic matter: 368.60 g kg<sup>-1</sup>, with 213.8 g kg<sup>-1</sup> organic carbon and 20.88 g kg<sup>-1</sup> nitrogen (Table 5). According to

Nascimento et al. (2014) and Pedroza et al. (2006), oxidization of the organic matter and loss of nitrogen are associated with the volatilization of ammonia, under alkaline conditions.

The times analyzed did not influence the total concentration of the OM, C or N parameters studied. According to these parameters, the additional (control) treatment had higher averages than the limed sludge values for the cleaning processes evaluated (Table 5).

Regarding aluminum (Al), calcium (Ca) magnesium (Mg) and phosphorus (P), it was found that the limed sludge, in a proportion of 30% of the sludge dry matter, had the highest average values of calcium (302.0 g kg<sup>-1</sup>) and magnesium (4.2 g kg<sup>-1</sup>) because hydrated lime has calcium and magnesium in its composition. It also has, however, lower total levels of aluminum (20.10 g kg<sup>-1</sup>) and phosphorus (1.6 g kg<sup>-1</sup>). The reduced availability of aluminum and phosphorus can also be explained by the

formation of less soluble compounds such as calcium phosphate and aluminum hydroxide. According to Andreoli et al. (2001), limed sludge, with a pH above 12.0, causes the fixing of heavy metals and phosphorus insolubility.

Considering the secondary factor (times), there was no significant difference in the parameters of Al, Ca, Mg and P, but significant change was found in the further treatment (control) by the Dunnett test at a 5% level of significance. Thus, the limed sludge increased the calcium and magnesium, reducing the availability of phosphorus, aluminum and sodium. Regarding the total content of sodium, it was found that the sludge subjected to treatment with sodium hypochlorite at a dosage of 2500 mg L<sup>-1</sup> had increased levels, with mean values of 4.10 g kg<sup>-1</sup>, different from the initial mean values of 0.75 g kg<sup>-1</sup> (Table 5). No significant differences were observed among the other means tested and there was no influence of time on the total sodium concentration. Barros et al. (2011), by applying 50 t ha<sup>-1</sup> of sewage sludge, sanitized with sodium hypochlorite (2500 mg L<sup>-1</sup>), obtained a concentration of 1200 mg kg<sup>-1</sup> sodium in the stalks of corn without any observed phytotoxicity. However, high levels of sodium in the sludge can cause problems of phytotoxicity to the crop and continued use could lead to an increase in sodium levels in the soil. Andreoli et al. (2001) reported that 1.4g kg<sup>-1</sup> of sodium in the sludge is considered high and, in the soil, can lead to problems of salinity.

The average concentration of potassium in the sewage sludge was low, with mean values of 1.0 g kg<sup>-1</sup> (Table 5). Similar results have been reported by Franco et al. (2010), who found values of 1.0 kg<sup>-1</sup> potassium in sewage sludge, indicating the need for mineral supplementation if it is to be used in agriculture. The values for potassium showed no significant effect from treatment with peracetic acid, sodium hypochlorite, hydrated lime or clean mud during the times evaluated. There was also no difference between the control treatment and the main and secondary factors. Thus, it was observed that the treatments to produce hygienic material did not influence the total potassium concentration. The times also showed no effect on the average concentrations of these sanitizing products.

## Conclusion

Sewage sludge, homogenized with quaternary ammonium compounds, sodium hypochlorite and peracetic acid, subjected to heat did not reduce the concentration of fecal coliforms below 1,000 MPN g<sup>-1</sup> of total solids (TS). The heavy metal (Zn, Cu, Cd, Cr, Ni and Pb) contents, however, were below the limits established by CONAMA Resolution n<sup>o</sup> 375/2006.

The lime, applied in a quantity equal to 30% of the

weight of the dry matter of the sludge, showed strong alkalinity and decreased the concentration of fecal coliforms below the limits established by the CONAMA Resolution. The increase in the pH of limed sludge resulted in lower availabilities of N, P, Na, MO, C, Al, Zn, Cu and increases in Ca and Mg.

## Conflict of Interests

The authors have not declared any conflict of interests.

## ACKNOWLEDGEMENTS

The authors thank the Foundation for Research of the State of Minas Gerais and the National Council for Scientific and Technological Development (CNPq) for financial support.

## REFERENCES

- Aisse MN, Coraucci Filho, Andrade Neto, Jur GD, Lapolli FR, Melo HNS, Piveli RP, Lucca SJ (2001). Chlorination and Dechlorination. In: Gonçalves RF (Coord.). Purification of waste water. Prosab Project, Rio de Janeiro: Abes/RJ 4:113-168.
- Akrivos J, Mamais D, Katsara K, Andreadakis A (2000). Agricultural utilisation of lime treated sewage sludge. *Water Sci. Technol.* 42(9):203-210.
- Andreoli CV, Lara AI, Fernandes, F (2001). Biosolids recycling: Turning problems into solutions. 2 ed. Curitiba: Sanepar, Finep. P 80.
- Barbosa GMC, Tavares Filho J, Brito OR, Fonseca ICB (2007). Residual sewage sludge effect on productivity of winter maize. *J. Soil Sci.* (31):601-605.
- Barros IT, Andreoli CV, Souza Junior IG, Costa ACS (2011). Agronomic evaluation of biosolids treated by different chemical methods for application in corn. *J. Agric. Environ. Eng.* 15(6):630-638.
- Barros IT, Costa ACS, Andreoli CV (2006). Evaluation of the sanitation of sewage sludge using anaerobic acid and alkaline treatments. *J. Sanepar* 24:61-69.
- Brazil (2006). National Council on the Environment (CONAMA). President of the National Environmental Council. Ministry of the Environment. Resolution, n. 375 of August 29, 2006. Official Gazette, Brasilia (DF), 2006. August 30. Section N. 167, Section 1, pp. 141-146.
- Camargo R, Maldonado ACD, Dias PAS, Souza MF, França MS (2013). Leaf analysis of *Jatropha* seedlings (*Jatropha curca L.*) produced with sewage sludge. *J. Agric. Environ. Eng.* 17(3):283-290.
- Daschner F (1997). The hospital and pollution: Role of the hospital epidemiologist in protecting the environment. In: Wenzel R, ed. Prevention and control of nosocomial infection, 3 ed. Baltimore, (MD) William & Wilkins. pp. 595-605.
- De Maria IC, Kocssi MA, Dechen SC (2007). Soil aggregation in an area that received sewage sludge. *Bragantia* 66(2):291-298.
- Dores-Silva PR, Landgraf MD, Rezende MOO (2011). Chemical monitoring of sewage sludge vermicomposting. *New Chem. J.* 34(6):956-961.
- EMBRAPA (Brazilian Agricultural Research Corporation) (2009). Guide for chemical analyzes of soils, plants and fertilizers, 2 ed. Brasília, DF: EMBRAPA Information Technology. P 627.
- Ferreira DF (2008). Program for analysis and educational statistics. *Symp. J. Lavras* 6:36-41.
- Fia R, Matos AT, Aguirre CI (2005). Chemical characteristics of soil



- treated with increasing doses of limed sewage sludge. *Eng. Agric.* 13(4):287-299.
- Franco A, Abreu Júnior CH, Perecin D, Oliveira FC, Granja ACR, Braga VS (2010). Sewage sludge as a nitrogen and phosphorus source for cane plants and first ratoon crops. *J. Soil Sci.* 34(2):553-561.
- Haynes RJ, Murtaza G, Naidu R (2009). Inorganic and organic constituents and contaminants of biosolids: Implications for Land Application. *Adv. Agron.* 104:165-237.
- Houhou J, Lartiges BS, Montarges-Pelletier E, Sieliechi J, Ghanbaja J, Kohler A (2009). Sources, nature and fate of heavy metal-bearing particles in the sewer system. *Sci. Total Environ.* 407(23):6052-6062.
- Matos AT, Matos MP (2012). Hydrated lime dosage and chemical characteristics of domestic sewage sludge submitted to liming. *Eng. Agric.* 20(4):357-363.
- Melo WJ, Aguiar PSS, Melo GMP (2007). Nickel in a tropical soil treated with sewage sewage sludge and cropped with maize in long-term field study. *Soil Biol. Biochem.* Elmsford 39:1341-1347.
- Miyagi F, Timenestsky J, Alberthum F (2000). Evaluation of bacterial contamination in disinfectants for domestic use. *Public Health J.* 34(5):444-448.
- Nascimento AL, Sampaio RA, Cruz SF, Junio GRZ, Barbosa CF, Fernandes LA (2014). Heavy metals in sunflower fertilizer with sewage sludge submitted to different stabilization processes. *J. Agric. Environ. Eng.* 18(7):694-699.
- Pedroza JP, Van Haandel AC, Beltrão NEM, Dionísio JA, Duarte MEM (2006). Technological quality of upland cotton plume grown with biosolids. *J. Agric. Environ. Eng.* 10(3):586-592.
- Rocha REM, Pimentel MS, Zago VCP, Rumjanek NG, Polli H (2003). Biosolids assessment of household waste water with fertilizer in collard. *Braz. Agric. Res.* 38(12):1435-1441.
- Santos FEV, Kunz SH, Caldeira MVW, Azevedo CHS, Rangel OJP (2014). Chemical characteristics of substrates used with sewage sludge for seedling production. *J. Agric. Environ. Eng.* 18(9):971-979.
- Sidhu JPS, Toze, SG (2009). Human pathogens and their indicators in biosolids: A literature review. *Environ. Int.* 35(1):187-201.
- Smith FS, Azevedo CAV (2002). Version of the computer program ASSISTAT for the Windows operating system. *J. Agro-Ind. Prod.* 4(1):71-78.
- Tchobanoglous G, Theisen H, Vigil S (1993). *Integrated Solid Waste Management – Engineering Principles and Management Issues*. Ed. McGraw Hill. New York, USA. P 978.
- Thomaz-Soccol V, Paulino RC, Castro EA (2000). Methodology for parasitological analysis of sewage sludge. *In: Andreoli CV, Bonnet BRP (Coord.). Guide for methods of microbiological and parasitological analysis in agricultural recycling of sewage sludge*. Curitiba: Sanepar. pp. 27-41.
- USEPA (2006). United States Environmental Protection Agency. Method 1681: Fecal Coliforms in Sewage Sewage Sludge (Biosolids) by Multiple-Tube Fermentation using A-1 medium. Office of Water, EPA-821-R-06-013, Washington, DC 20460, July, 2006, 45 pp.

Full Length Research Paper

# Correlation of viral load with lesion severity in field pigs affected with porcine circovirus type 2

Yong Li<sup>1\*</sup>, Kenji Kawashima<sup>2</sup> and Ken Katsuda<sup>2</sup>

<sup>1</sup>College of Animal Science and Technology, Jiangxi Agricultural University, Nanchang 330045, Jiangxi Province, China.

<sup>2</sup>Environmental/Enzootic Diseases Research Team, Tohoku Research Station, National Institute of Animal Health, National Agriculture and Food Research Organization, Shichinohe, Aomori 039-2586, Japan.

Received 23 December, 2013; Accepted 12 November, 2015

Porcine circovirus type 2 (PCV2) is an important infection factor causing post weaning multisystemic wasting syndrome (PMWS). The amount of PCV2 viral load may mainly give rise to clinical symptom and pathological lesion of PMWS. In order to investigate the relationship between PCV2 viral load and the lesion severity of lymph tissues, and search further for some clues of pathologic diagnosis of PMWS, thirty pig cases affected with PCV2 and aged 30~90 days old were collected from swine farms and their lymph tissues were treated by quantitative Real Time PCR, immunohistochemistry (IHC) and histopathology examination. Four various groups were classified according to their evaluation scores for lesion severity, and it is shown that the higher the score for pathological lesion of lymph tissues, the more there is viral load in tonsil. Especially, the amount of PCV2 DNA in group one was 1/1000 lower than other three groups. It is supposed that group one is considered as subclinical case and the other three groups as clinical PMWS cases. Furthermore, it is likely presumed whether PCV2 infection is subclinical or clinical PMWS case can be helpfully diagnosed by these criteria.

**Key words:** Correlation, PCV2 load, Real Time polymerase chain reaction (PCR), immunohistochemistry (IHC).

## INTRODUCTION

Post weaning multisystemic wasting syndrome (PMWS) is a kind of complex disease causing late nursery and fattening pigs affected by main pathogen PCV2. It is characterized by clinical fever, progressive weight loss and respiratory and digestive disorders (Clark, 1997; Harding, 1997). The disease has been reported worldwide, including Spain (Segales et al., 1997; Segales et al., 2005), France (Blanchard et al., 2003), United States (Allan et al., 1998; Yu et al., 2007), and other countries.

As a member of the *Circoviridae* family, porcine circovirus type 2 (PCV2), a widespread, circular and single-stranded DNA virus (Allan and Ellis, 2000), is a ubiquitous agent which can infect domestic swine as a crucial infectious cause of PMWS (Segales et al., 2005). PMWS is considered as a multifactorial disease in which the occurrence of PCV2 infection is necessary but not sufficient in a number of cases (Segales et al., 2005). PCV2 can infect most tissues in domestic pigs and give

\*Corresponding author. E-mail: liyong@mail.jxau.edu.cn.

rise to an extensive lesion. The identification results displayed that PCV2-positive cells are presented in heart, liver, lung, spleen and lymph node (Sanchez et al., 2003). Nowadays, PCV2 detection is not sufficient to establish a diagnosis of PMWS which sometimes is complicated and difficult. An accurate diagnosis for individual pigs is currently based on the presence of all of the following three conditions: clinical signs including progressive wasting after weaning, characteristic microscopic lesions, and detection of PCV2 within the lesions. Quantitative Real Time PCRs have recently been described in experimental and field cases of PCV2 infections (Brunborg et al., 2004; Olvera et al., 2004; Reiner et al., 2010). The more severe lesions and the higher amounts of viral genome by *in situ* hybridization were correlated with the higher PCV2 load in serum and swab specimens in the quantification of Real Time PCR (Segales et al., 2005). Given the complexity of PMWS diagnosis, it is essential to find a more beneficial and subsidiary diagnostic or evaluation method. The objective of this study is to assess the correlation of viral load in the tonsil with the lesion severity of pig cases affected with PCV2 by combining the results of quantitative Real Time PCR with histopathology as well as immunohistochemistry (IHC).

## MATERIALS AND METHODS

### Tissue samples

Thirty pig cases affected with PCV2 by PCR diagnosis, aged 30~90 days old, were collected from swine farms and used in this study. Seven kinds of tissues including tonsil, mesenteric lymph node, mandibular lymph node, ileum, spleen, pulmonary lymph node and inguinal lymph node were taken and fixed by immersion in 10% neutral buffered formalin and embedded in paraffin; these tissues were made sections for examination of PCV2 antigen and histopathology by IHC and hematoxylin and eosin (H&E) staining respectively. In addition, tonsil in each case was taken out and stored in refrigerator at minus 20°C and was used for the quantitation of PCV2 DNA by Real Time PCR.

### Histopathology examination

According to the conventional staining procedure, H&E staining was conducted to observe histopathology in these tissues. On the basis of lesion content which contains lymphocyte depletion, necrosis, inclusion bodies, and so on, a set of evaluation criteria was made in order to evaluate the lesion severity as below. Briefly, these tissue sections were evaluated by the presence of lymphocyte depletion ranging from 0 to 3 (0, Normal; 1, Mild lymphocyte depletion or dispersed single cell necrosis of histiocyte or macrophage lineage cells in lymphoid follicle; 2, Moderate lymphocyte depletion or aggregated necrotic cells in follicles; 3, Severe lymphoid depletion with loss of lymphoid follicle structure) (Opriessnig et al., 2004). Moreover, cytoplasm inclusion bodies or histiocytic-to-granulomatous inflammation in these tissues were scored, and evaluation on presence of cytoplasm inclusion bodies ranged from 0 to 3 (0, No detected; 1, A few number of inclusion bodies or mild histiocytic-to-granulomatous inflammation; 2, Inclusion bodies in multiple follicles or moderate histiocytic-to-granulomatous inflammation; 3, Inclusion bodies in

almost all of follicles or severe histiocytic-to-granulomatous inflammation with replacement of follicles).

### IHC detection

In order to detect PCV2 antigen of these cases, IHC for PCV2-specific antigen was performed on tissue sections of formalin-fixed, paraffin-embedded blocks of selected organ samples. The fixed tissues were pretreated with protease and antiserum as previously (Onuki et al., 1999; Kawashima et al., 2003), then the staining assessment on PCV2 antigen was run in a blinded fashion and its scores ranged from 0 to 3 (0, Negative; 1, Less than 10% of the lymphoid follicles contain cells with PCV2 antigen staining; 2, 10~50% of the lymphoid follicles contain cells with PCV2 antigen staining; 3, More than 50% of the lymphoid follicles contain cells with PCV2 antigen staining) (Opriessnig et al., 2004).

The total score for evaluation of tissue lesion can be expressed by the following format: Score = (A + B) / 2 + C (A: The score from the presence of lymphocyte depletion; B: The score from presence of cytoplasm inclusion bodies; C: The score from the presence of PCV2 antigen).

### Extraction of DNA

Among these lymph tissues, tonsils were especially selected to detect the amount of PCV2 DNA. Firstly, the stable suspension was made from these tonsils by weighing 100 mg exactly, shocking with shocker at 2000 rpm for 10 s, centrifuging at 2000 rpm for 30 s, homogenizing with shocker at 2000 rpm for 10 s, centrifuging at 2000 rpm for 30 s. Then DNA was extracted from the stable suspension using QIAampR DNA Mini Kit according to the manufacturer's instructions (QIAGEN GmbH, Germany). At last the lysate was taken and stored in refrigerator at minus 20 °C.

### Quantitation by Real Time PCR

The lysate extracted from tonsils was run to quantify PCV2 DNA by an optimized TaqMan PCR. Reactions were carried out in 96-well plates, including sample and standard (from 10<sup>-5</sup> to 10<sup>-1</sup> PCV2 plasmid copies/ml), both by duplicates. A negative control was used by DNase and RNase-free distilled water. Amplification and detection of fluorescence was carried out in Sequence Detection System (ABI PRISM 7000, USA).

The TaqMan PCR reaction was performed in 25 µl reaction volume containing 12.5 µl universal master mixtures, 2.25 µl forward primer, 2.25 µl reverse primer, 0.5 µl TaqMan probe, 5 µl template of DNA and 2.5 µl distilled water. The concentrations of primers and TaqMan probe were 0.9 pM and 0.25 µM respectively. The reaction parameters were set at 1 cycle of 50°C for 2 min, 1 cycle of 95°C for 10 min, 40 cycles of 95°C for 15 s and 60°C for 1 min.

TaqMan MGB probe: 5'-FAM-CTGTAGTATTCAAAGGGT-MGB-3'  
The forward primer: 5'-GAGCAGGGCCAGAATTC AAC-3'  
The reverse primer: 5'-TCCCGCACCTTCGGATATACT-3'

### Statistical analyses

In order to normalize the data for statistical comparisons, the PCV2 Cap protein mRNA copy numbers and viral DNA copy numbers obtained from Real Time PCR and its assays, respectively, were transformed by log<sub>10</sub><sup>n</sup> (n: PCV2 DNA in tonsil). Data were assessed by analysis of variance (ANOVA) software.



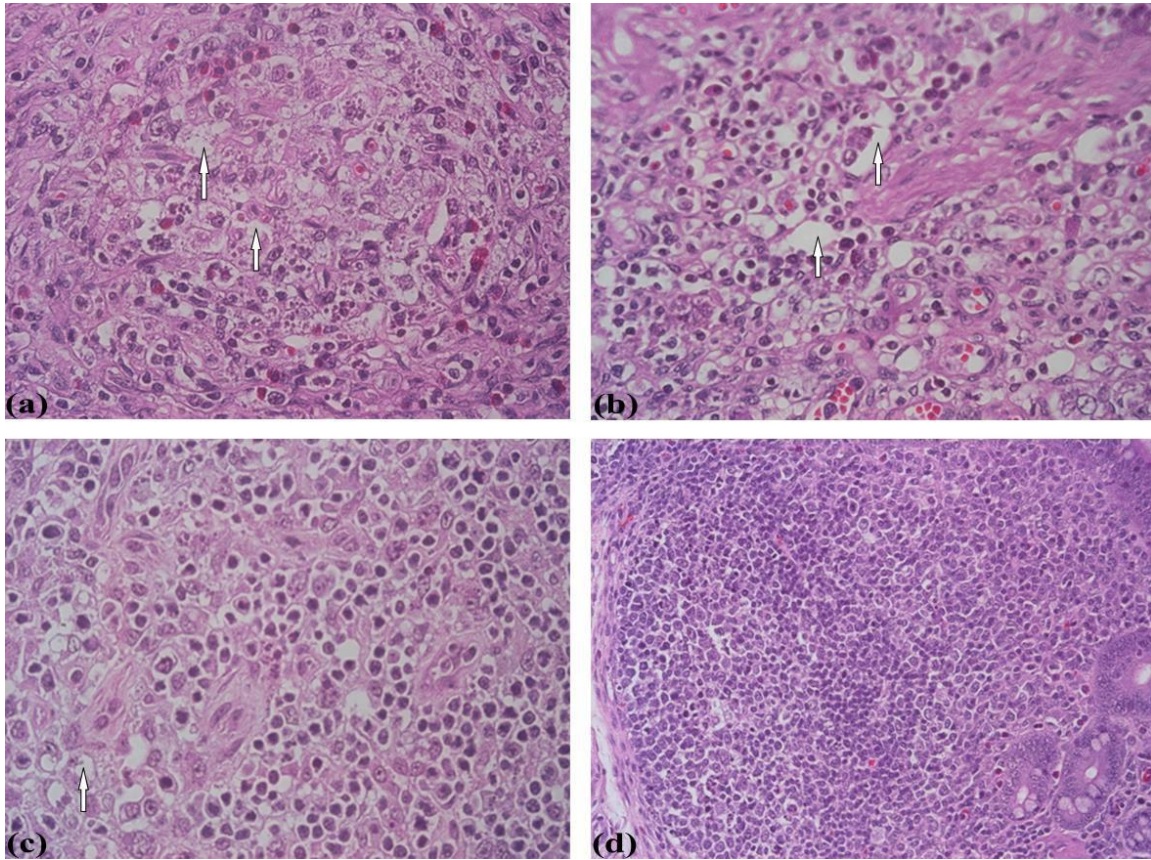

**Figure 1.** Various lesions of lymph tissues in PMWS cases with HE stain, showing lymphocyte depletion and necrotic cells as arrows. (a) Ileum (severe lesion: +3); (b) Mesenteric lymph node (moderate lesion: +2); (c) Inguinal lymph node (light lesion: +1); (d) Control: ileum (normal case: 0). Magnification: (a) 40×10; (b) 40×10; (c) 40×10; (d) 10×10.

## RESULTS

### Histopathologic lesion

Various lesions were present in these detected tissues according to microscope observation (Figure 1). Firstly, lymphocytes in these tissues disappeared at different extent, for some severe cases, most lymphocytes disappeared in groups, and it was difficult to find intact tissues because of severity. Furthermore, inclusion bodies emerged with different global sizes in the cytoplasm of these tissues. Epithelioid cell also presented in the cytoplasm with groups or single. The cytoplasm started to dissolve and disappear; it only remained the membrane. In addition, while karyopycnosis emerged, the nucleus was much smaller than normal cells, leading to lots of vacuoles in these tissues.

### Antigen distribution

According to observation and analysis on IHC of six kinds of tissues, the extent of tissue staining color was

coincident to the lesion extent of these tissues. The extent and depth varied accordingly with the lesion severity (Figure 2). Three kinds of groups can be classified according to the positive staining color and represent various extents infected by PCV2 viral antigen. The staining region appeared commonly in the lymph follicles or center of the lymph tissues from severe and moderate organs. Moreover, there is a trend for the positive staining being present in the center whether it is slight or severe samples.

### The correlation between pathologic lesion and PCV2 load

With the purpose of investigating the exact correlation between pathologic lesion and PCV2 load for field pig cases, these tested samples were divided into four groups according to the integrative evaluation score (Table 1). The first group was lower than 10, the second was between 10 and 20, the third was between 20 and 30, the last group was between 30 and 40. The analysis result shows a significant association in four groups (Figure 3),



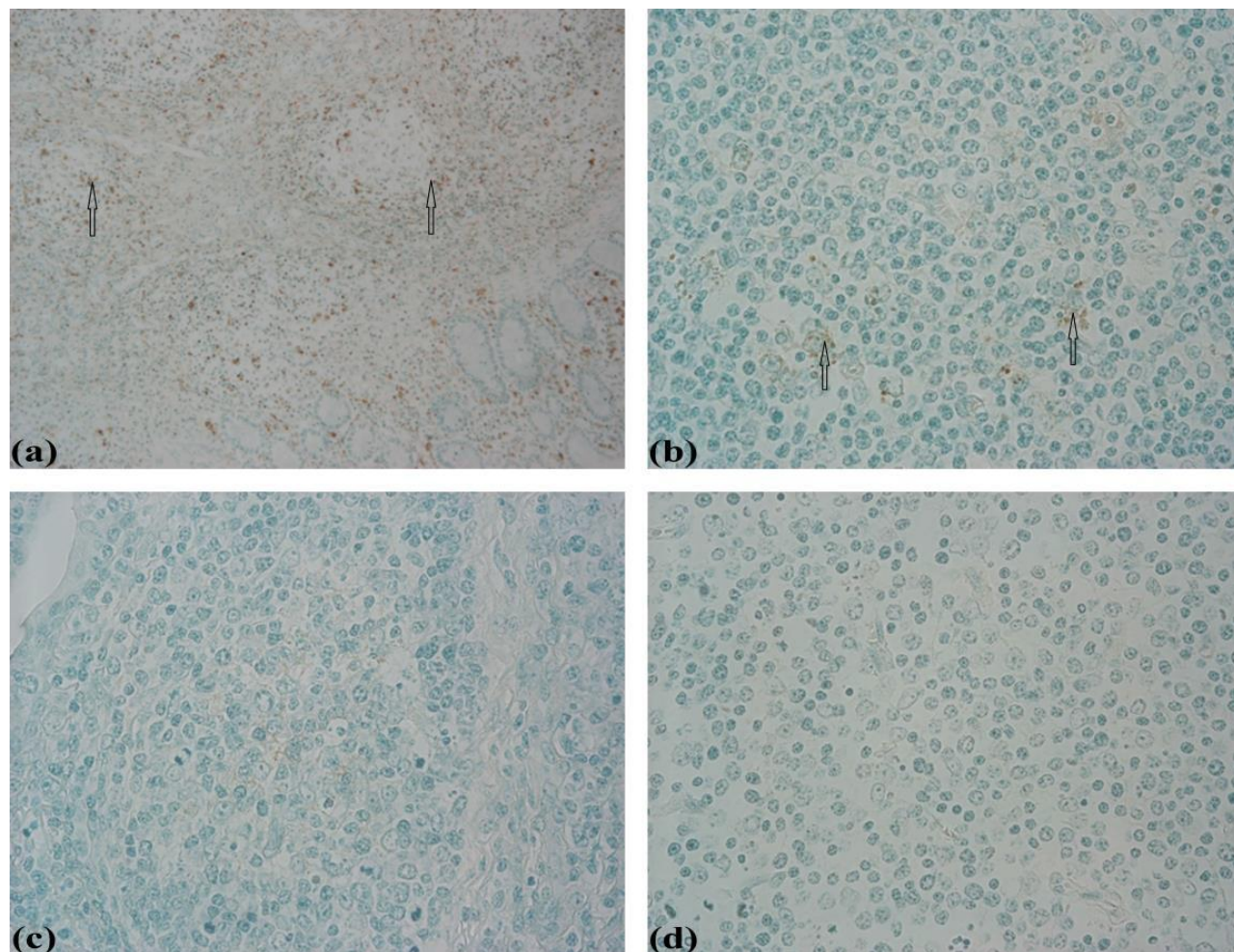

**Figure 2.** The various extent of color stain in PMWS cases with IHC, showing positive PCV2 antigen as arrows. (a) Ileum (severe lesion: +3); (b) Ileum (moderate lesion: +2); (c) Tonsil (light lesion: +1); (d) Control: ileum (normal case: 0). Magnification: (a) 10×10; (b) 40×10; (c) 40×10; (d) 40×10.

**Table 1.** Four various groups classified by the evaluating score for pathological lesion.

Groups (Total score)	Group 1 (0~10)	Group 2 (10~20)	Group 3 (20~30)	Group 4 (30~40)
No. of pigs	6	8	7	9
The average score	7 ± 2.22	15 ± 2.82	25.8 ± 2.42	38.2 ± 3.12
Log <sub>10</sub> PCV2 DNA(*)	- 0.18 ± - 0.35	2.94 ± 1.33	4.17 ± 1.24	5.76 ± 1.19

An asterisk (\*) indicates the values with  $p < 0.001$  among four groups.

which indicates that there is more viral load in tonsil with higher score for pathologic lesion ( $P < 0.001$ , ANOVA). It can provide a cue that PCV2 can directly cause the severe pathology with increasing viral load. Furthermore, comparing with other three groups, the integrative evaluation score for the first group is 1/1000 lower than other three groups. It is shown that there is a significant difference between group one and the other three groups.

## DISCUSSION

PCV2 is associated with PMWS and other syndrome diseases collectively known as porcine circovirus-associated disease (PCVAD). PCV2 infection and PMWS have great impact on pig production (Ge et al., 2012; Chae, 2012). PCVAD continues to be an important differential diagnosis on pig farms (Opriessnig et al.,

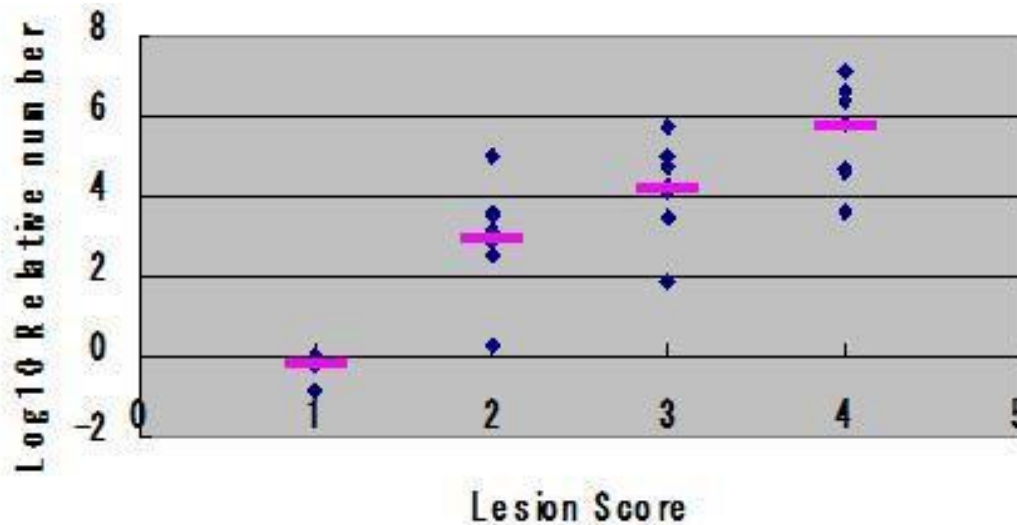

**Figure 3.** Correlation between the lesion severity and the amount of  $\log_{10}$ PCV2 DNA in tonsil.  $r = 0.84$  ( $P < 0.001$ ,  $n = 30$ ). Amount of  $\log_{10}$ PCV2 DNA in tonsil from four groups divided by lesion severity ( $P < 0.05$ , ANOVA).

2007). The precise mechanisms by which a PCV2 infected pig develops a PCV2 subclinical infection or a clinical PCVAD are still to be fully elucidated, but inferences based upon clinical, gross and histologic findings from field cases of disease have been useful to suggest the pathogenesis of this viral infection (Segales, 2012). The ubiquity of PCV2 and the lack of specificity of the PCV2 tests indicate that PCV2 may be a necessary but not sufficient cause of PMWS disease (Turner et al., 2009).

In pathogenesis of PCV2 infection aspect, organelles may play an important role in the replication of PCV2, indicating that virus replicates within the histiocytes of lymph nodes (Rodriguez-Carino et al., 2010). A certain proportion of macrophages may support PCV2 replication, because Cap antigen was shown to be present in macrophages and less often in lymphocytes (Becskei et al., 2010); but main cells where PCV2 replicates are of epithelial/endothelial origin (Perez-Martin et al., 2007). Meanwhile, the presence of typical granulomatous lesions with multinuclear giant cells was also recorded in the lymphatic tissue (Becskei et al., 2010). PCV2 inclusion bodies were demonstrated to be located in the cytoplasm of epithelial cells by immunohistochemical staining for PCV2 and cytokeratin antigens and by ultrastructural demonstration of viral particles in the inclusion bodies within renal tubular epithelium (Huang et al., 2008).

Some recent advance on diagnosis of PCV2 infection is as follows: besides tissues were examined by pathohistology, IHC, nested PCR and quantitative PCR (Reiner et al., 2010), a method for detection of both strands of PCV2 *in situ* can be useful for studies of replication and *in situ* detection of PCV2 as well as of DNA viruses in general (Henriksson et al., 2011). Indirect *in situ*

PCR is a more effective, cell-based diagnostic tool with good specificity to detect limited PCV2 infection in formalin-fixed and paraffin-embedded tissue specimens and it would be a useful tool to further explore the pathogenesis of PCV2 infection (Lin et al., 2009). *In situ* hybridization was also demonstrated to prove more sensitive than IHC for the detection of PCV2 in formalin-fixed, paraffin-embedded lymph node tissues (Kim et al., 2009). Due to better image quality after staining, IHC became a reliable and useful technique for PMWS diagnosis (Szczotka et al., 2011). Microarray results validated by quantitative Real Time PCR show the characterization of the early and late molecular events taking place in response to a subclinical PCV2 infection (Tomas et al., 2010).

In reality, PMWS was usually caused due to diverse clinical symptoms when pigs are affected by PCV2 and other factors; otherwise pigs only are in infected condition. Owing to complexity of PMWS diagnosis, some various criteria on PMWS diagnosis were established as following. PMWS case definition contains three different criteria including clinical signs, moderate to severe lymphoid lesions and moderate to high amount of PCV2 antigen or genome in these lymphoid lesions (Segales, 2002). The suggested  $10^7$  PCV2 genome copies/ml of serum was reinforced as a threshold for PMWS diagnosis (Brunborg et al., 2004; Olvera et al., 2004). Besides, mean viral concentration values of 7, 6 and 5  $\log_{10}$  DNA copies/ng ( $10^7$ ,  $10^6$  and  $10^5$  PCV2 DNA copies/ng of total DNA) from tracheo-bronchial, tonsillar and faecal swabs, respectively, could also be considered potential thresholds in these locations to help establish PMWS diagnosis. This approach would not be useful for the results from the nasal cavity and urine, since subclinically infected pigs

had similar or higher viral loads than PMWS affected pigs (Segales et al., 2005).

Given PMWS caused by PCV2 belong to a kind of respiratory disease; tonsil is a critical immune organ at the entrance of piglets' respiratory tract. Therefore, its viral load indicates quite considerable for diagnosis on PMWS. According to experimental results, these samples show various pathologic character and presence of PCV2 antigen. When pig cases were divided into four groups according to the lesion severity, there is the significant correlation between the lesion severity and the amount of  $\log_{10}$  PCV2 DNA in tonsil ( $R=0.84$ ,  $P < 0.001$ ). The amount of PCV2 DNA in group one (score  $< 10$ ) was 1/1000 lower than the other three groups. Pig case in group one was thought as in subclinical infection on account of having slight lymphoid lesions. Therefore, it is supposed that group one with lower 10 is considered as subclinical cases and other three groups with higher 10 as clinical PMWS cases by this significant correlation. It is likely presumed that whether it is subclinical and clinical PMWS case can be helpfully diagnosed by these criteria.

### Conflict of Interests

The authors have not declared any conflict of interests.

### ACKNOWLEDGEMENTS

We thank all members of Tohoku Research Station of NIAH (National Institute of Animal Health) for their help and other support. This work was supported by Jiangxi Provincial Technological Supporting Project (2007-No. 173), National Natural Science Foundation Project of China (No. 31360592), and China Scholarship Council (No. 201408360136).

### REFERENCES

- Allan GM, Ellis JA (2000). Porcine circoviruses: A review. *J. Vet. Diagn. Invest.* 12:3-14.
- Allan GM, McNeilly F, Kennedy S, Daft B, Clarke EG, Ellis JA, Haines DM, Meehan BM, Adair BM (1998). Isolation of porcine circovirus-like viruses from pigs with a wasting disease in the USA and Europe. *J. Vet. Diagn. Invest.* 10:3-10.
- Becskei Z, Aleksic-Kovacevic S, Rusvai M, Balka G, Jakab C, Petrovic T, Knezevic M (2010). Distribution of porcine circovirus 2 cap antigen in the lymphoid tissue of pigs affected by postweaning multisystemic wasting syndrome. *Acta Vet. Hung.* 58:483-498.
- Blanchard P, Mahe D, Cariolet R, Truong C, Le Dimna M, Arnaud C, Rose N, Eveno E, Albina E, Madec F, Jestin A (2003). An ORF2 protein-based ELISA for porcine circovirus type 2 antibodies in post-weaning multisystemic wasting syndrome. *Vet. Microbiol.* 94:183-194.
- Brunborg IM, Moldal T, Jonassen CM (2004). Quantitation of porcine circovirus type 2 isolated from serum/plasma and tissue samples of healthy pigs and pigs with postweaning multisystemic wasting syndrome using a TaqMan-based real-time PCR. *J. Virol. Methods* 122:171-178.
- Chae C (2012). Porcine circovirus type 2 and its associated diseases in Korea. *Virus Res.* 164:107-113.
- Clark EG (1997). Postweaning multisystemic wasting syndrome. *Proc. Am. Assoc. Swine Pract.* 28:499-501.
- Ge X, Wang F, Guo X, Yang H (2012). Porcine circovirus type 2 and its associated diseases in China. *Virus Res.* 164:100-106.
- Harding JC (1997). Postweaning multisystemic wasting syndrome: preliminary epidemiology and clinical findings. *Proc. Am. Assoc. Swine Pract.* 28:502.
- Henriksson S, Blomstrom AL, Fuxler L, Fossum C, Berg M, Nilsson M (2011). Development of an in situ assay for simultaneous detection of the genomic and replicative form of PCV2 using padlock probes and rolling circle amplification. *Viol. J.* 8:37.
- Huang YY, Walther I, Martinson SA, Lopez A, Yason C, Godson DL, Clark EG, Simko E (2008). Porcine circovirus 2 inclusion bodies in pulmonary and renal epithelial cells. *Vet. Pathol.* 45:640-644.
- Kawashima K, Tsunemitsu H, Horino R, Katsuda K, Onodera T, Shoji T, Kubo M, Haritani M, Murakami Y (2003). Effects of dexamethasone on the pathogenesis of porcine circovirus type 2 infection in piglets. *J. Comp. Pathol.* 129:294-302.
- Kim D, Ha Y, Lee YH, Chae S, Lee K, Han K, Kim J, Lee JH, Kim SH, Hwang KK, Chae C (2009). Comparative study of in situ hybridization and immunohistochemistry for the detection of porcine circovirus 2 in formalin-fixed, paraffin-embedded tissues. *J. Vet. Med. Sci.* 71:1001-1004.
- Lin CM, Jeng CR, Hsiao SH, Chang CC, Liu CH, Tsai YC, Chia MY, Pang VF (2009). Development and evaluation of an indirect in situ polymerase chain reaction for the detection of porcine circovirus type 2 in formalin-fixed and paraffin-embedded tissue specimens. *Vet. Microbiol.* 138:225-234.
- Olvera A, Sibila M, Calsamiglia M, Segales J, Domingo M (2004). Comparison of porcine circovirus type 2 load in serum quantified by a real time PCR in postweaning multisystemic wasting syndrome and porcine dermatitis and nephropathy syndrome naturally affected pigs. *J. Virol. Methods* 117:75-80.
- Onuki A, Abe K, Togashi K, Kawashima K, Taneichi A, Tsunemitsu H (1999). Detection of porcine circovirus from lesions of a pig with wasting disease in Japan. *Vet. Med. Sci.* 61:1119-1123.
- Opriessnig T, Meng XJ, Halbur PG (2007). Porcine circovirus type 2 associated disease: update on current terminology, clinical manifestations, pathogenesis, diagnosis, and intervention strategies. *J. Vet. Diagn. Invest.* 19:591-615.
- Opriessnig T, Thacker EL, Yu S, Fenaux M, Meng XJ, Halbur PG (2004). Experimental reproduction of postweaning multisystemic wasting syndrome in pigs by dual infection with *Mycoplasma hyopneumoniae* and porcine circovirus type 2. *Vet. Pathol.* 41:624-640.
- Perez-Martin E, Rovira A, Calsamiglia M, Mankertz A, Rodriguez F, Segales J (2007). A new method to identify cell types that support porcine circovirus type 2 replication in formalin-fixed, paraffin-embedded swine tissues. *J. Virol. Methods* 146:86-95.
- Reiner G, Bronnert B, Hohloch C, Fresen C, Haack I, Willems H, Reinacher M (2010). Qualitative and quantitative distribution of PCV2 in wild boars and domestic pigs in Germany. *Vet. Microbiol.* 145:1-8.
- Rodriguez-Carino C, Sanchez-Chardi A, Segales J (2010). Subcellular immunolocalization of porcine circovirus type 2 (PCV2) in lymph nodes from pigs with post-weaning multisystemic wasting syndrome (PMWS). *J. Comp. Pathol.* 142:291-299.
- Sanchez RE Jr, Meerts P, Nauwynck HJ, Pensaert MB (2003). Change of porcine circovirus 2 target cells in pigs during development from fetal to early postnatal life. *Vet. Microbiol.* 95:15-25.
- Segales J (2002). Update on postweaning multisystemic wasting syndrome and porcine dermatitis and nephropathy syndrome diagnostics. *J. Swine Health Prod.* 10:277-281.
- Segales J (2012). Porcine circovirus type 2 (PCV2) infections: clinical signs, pathology and laboratory diagnosis. *Virus Res.* 164:10-19.
- Segales J, Allan GM, Domingo M (2005). Porcine circovirus diseases. *Anim. Health Res. Rev.* 6:119-142.
- Segales J, Calsamiglia M, Olvera A, Sibila M, Badiella L, Domingo M (2005). Quantification of porcine circovirus type 2 DNA in serum and tonsillar, nasal, tracheo-bronchial, urinary and faecal swabs of pigs with and without postweaning multisystemic wasting syndrome. *Vet. Microbiol.* 111:223-229.
- Segales J, Sitjar M, Domingo M, Dee S, Del Pozo M, Noval R, Sacristan



- C, De las Heras A, Ferro A, Latimer KS (1997). First report of post-weaning multisystemic wasting syndrome in pigs in Spain. *Vet. Rec.* 141:600-601.
- Szczotka A, Stadejek T, Pejsak Z (2011). A comparison of immunohistochemistry and in situ hybridization for the detection of porcine circovirus type 2 in pigs. *Pol. J. Vet. Sci.* 14:565-571.
- Tomas A, Fernandes LT, Sanchez A, Segales J (2010). Time course differential gene expression in response to porcine circovirus type 2 subclinical infection. *Vet. Res.* 41:12.
- Turner MJ, Medley GF, Woodbine KA, Slevin JA, Green LE (2009). The relationship between porcine circovirus 2 antigen score and antibody titre and histology of lymph nodes in 375 euthanased sick and healthy pigs from 113 British pig farms with and without postweaning multisystemic wasting syndrome. *Prev. Vet. Med.* 88:213-219.
- Yu S, Opriessnig T, Kitikoon P, Nilubol D, Halbur PG, Thacker E (2007). Porcine circovirus type 2 distribution and replication in tissues and immune cells in early infected pigs. *Vet. Immunol. Immunopathol.* 115:261-272.

Full Length Research Paper

## Nitrogen metabolism in sorghum under salinity and silicon treatments in Brazil

Luma Castro de Souza<sup>1\*</sup>, Ellen Gleyce da Silva Lima<sup>2</sup>, Risely Ferraz de Almeida<sup>1</sup>, Myriam Galvão Neves<sup>3</sup>, Glauco Andre dos Santos Nogueira<sup>2</sup>, Cândido Ferreira de Oliveira Neto<sup>2</sup>, Andresa Soares da Costa<sup>2</sup>, Liliane Corrêa Machado<sup>2</sup>, Silvia Mara Coelho do Nascimento<sup>2</sup>, and Ana Ecídia de Araújo Brito<sup>2</sup>

<sup>1</sup>Departamento de Solos e Adubos, Universidade Estadual Paulista Júlio de Mesquita Filho/UNESP, Brazil.

<sup>2</sup>Departamento de Produção Vegetal, Universidade Federal Rural da Amazônia, Brazil.

<sup>3</sup>Departamento de Produção Vegetal, Universidade Federal de Santa Maria, Santa Maria, Brazil.

Received 28 September, 2015; Accepted 9 December, 2015

The objective of the present research was to study nitrogen metabolism in sorghum plants subjected to salt stress and silicon concentration. The experiment was conducted at the Amazon Federal Rural University, Capitão Poço Decentralized Unit for 1 month, in 2013, using the cultivar BR 700 of forage sorghum plants (*Sorghum bicolor* [Moench.]). The experimental design was completely randomized, in a 5 × 3 factorial arrangement (0, 50, 100, 150 and 200 µM of silicon) and saline concentrations (0, 1.5 and 2.0 M), consisting of 4 replications. Analyses were conducted of amino acids, proteins, free ammonium, nitrate and nitrate reductase. Nitrate content increased in the leaves and root in the treatments 0 and 1.5 µM of Si, but decreased in treatments with the 0.5 and 1.0 µM doses of Si. In leaves and roots, the treatments 1.5 and 2.0 of SC caused reduction and increase, respectively, of ammonium levels. The silicon doses attenuated the negative effects of the treatments on the biochemical compounds caused by higher salt concentrations in sorghum plants.

**Key words:** Abiotic stress, *Sorghum bicolor*, salinity, silicon, nitrogen metabolism.

### INTRODUCTION

The accumulation of salt in the soil solution causes salt stress because plants subjected to such stress cannot absorb water easily, especially the most sensitive plants. This is because excess salt in the soil solution can cause plasmolysis. In addition, with the expansion of irrigation throughout the world, the problem of secondary

salinization has become severe, particularly in tropical regions where severe weather conditions prevail (for example, evaporation and high temperatures). These problems are often associated with inadequate water and soil management and use of water with a high salt content, which sorely aggravates the soil salinization

\*Corresponding author. E-mail: [lumasouza30@hotmail.com](mailto:lumasouza30@hotmail.com), [rizely@gmail.com](mailto:rizely@gmail.com). Tel: +55 (16) 3209-2672.

problem (Silveira et al., 2010).

Salinity can cause two types of stress in tissues and organs of higher plants: water deficit, as a result of a high concentration of solutes in the root environment, and ionic stress, which stems largely from changes in the  $\text{Na}^+$ / $\text{K}^+$  relationships and excessive concentration of salt ions ( $\text{Na}^+$ ,  $\text{Cl}^-$ ), which are detrimental to cell metabolism, especially in the leaves (Horie and Schroeder, 2004).

Knowledge of salt interactions with the plant and the soil and the effect of silicon can provide plant tolerance to salinity. According to Gunes et al. (2008), this chemical element plays a role in activities related to metabolism or to the physiology of plants under abiotic stresses, such as salt and water. Crusciol et al. (2013) observed that soybean, bean and peanut yields increased with foliar application of silicic acid. In addition, the beneficial effects of the use of silicon in plants subjected to salt stress have been reported in the literature (Dai et al., 2005; Liang et al., 2006), as in *Anacardium occidentale* and *Moringa oleifera* (Miranda et al., 2002), *Triticum aestivum* L. (Tuna et al., 2008), *Oriza sativa* L. (Kraska and Breintenbeck, 2010) and *Zea mays* L. (Lima et al., 2011).

Although silicon is not one of the essential elements for growth and development of plants (Lima et al., 2011), this chemical element promotes plant resistance under saline conditions, since it helps to maintain the integrity and stability of cell membranes (Zuccarini, 2008). Under high salinity conditions, the capacity of this chemical element to maintain cell-wall integrity is maintained by its efficiency in stimulating the antioxidant system (Rodrigues et al., 2011). Silicon can promote the growth and production of plants because it increases chlorophyll content in leaves and modifies plant structure, enabling plants to become more upright and avoiding excess self-shading and delaying senescence (Ma and Yamaji, 2008).

The mechanisms of action of salt stress in plants and tolerance in environments with silicon content are methods scarcely known in agriculture, and further research is required in this area of study (Lacerda et al., 2006). Moreover, this culture can exclude ions considered as toxic, reducing ion storage in the leaf (Trindade et al., 2006). This in-depth knowledge can establish soil and crop management strategies, to enable, for example, the selection of more salinity-tolerant cultivars, so that sorghum can express its productive potential even under salt stress. In Brazil, this culture is not widely used as food; its grains are produced for animal feeding purposes, in order to meet the demand of both the animal feed and the forage industries (Dykes et al., 2005; Tabosa et al., 1993).

However, studies related to Si contribution in reducing salinity are still incipient, especially as regards nitrogen metabolism in sorghum. Therefore, further studies are needed to demonstrate the efficiency of Si in order to mitigate this type of abiotic stress, thus contributing to

increased sorghum production. Most studies, in order to evaluate final productivity, refer to the nutritional aspects and the beneficial role of silicon in abiotic stress resistance (Pozza et al., 2009).

The objective of this work was to study the nitrogen metabolism of sorghum plants subjected to salt stress and silicon concentration.

## MATERIALS AND METHODS

### Location of the experiment

The experiment was conducted in a greenhouse at the Amazon Federal Rural University, Capitão Poço Decentralized Unit, geographic coordinates 01° 44' 04"S and 47° 03' 28"W, at an average altitude of 96 m (Figure 1), for 1 month in 2013. The study used forage sorghum (*Sorghum bicolor* [Moench.]), cultivar BR 700 obtained from the company Empresa Brasileira de Pesquisa Agropecuária (Embrapa Milho e Sorgo) from the 2010 season. The pots were arranged in a spacing of 0.60 m between rows and 0.40 m between plants in a random distribution. The sorghum plants were grown in Leonard fabric pots containing silica substrate: vermiculite (1:2) and irrigated with Hoagland and Arnon nutrient solution (1950).

### Experimental design

The experimental design for plants subjected to salt stress was completely randomized (RCD) in a 5 × 3 factorial arrangement, referring to five doses of silicon (0, 50, 100, 150 and 200  $\mu\text{M}$  of silicon) and three saline concentrations (0, 1.5 and 2.0 M) with 4 repetitions, totaling 60 experimental units, in which each experimental unit was composed of two plants/pot. The application of salt stress was carried out at 18 days after germination and the silicon concentrations were applied after seedling emergence (11 days after germination). The application of Si was performed daily, and the applications were performed in the afternoon (17 h). The nutrient solution was replaced at five days after application and pH was adjusted to 6.0 as necessary. Destructive sampling of plants at the vegetative stage (33 days after germination) was conducted at 9:00 am, when the plants were separated into roots and leaves. Samples of each were reserved for determination of moisture percentage by determining dry weight in a forced circulation air oven at 70°C ( $\pm 5^\circ\text{C}$ ).

### Analyzed variables

Nitrate reductase activity was determined using the method described by Hageman and Hucklesb (1971). Hole punch leaf disks (0.5  $\text{cm}^2$  in diameter) were removed and then approximately 200 mg of these leaf discs were weighed. In order to obtain the extract, the leaf discs were transferred to test tubes and subjected to vacuum containing 5.0 ml of phosphate buffer (assay medium) for 2 min. The test tubes were then placed in a water bath at 300°C for 30 min and protected from light (kept in the dark). In order to obtain the soluble proteins, the method described by Bradford (1976) was used. Using 15 ml test tubes, lyophilized DM 100 mg/5.0 ml extraction buffer (25  $\mu\text{M}$  Tris-HCl pH 7.6) were added and stirred for 2 h in a shaker (with properly sealed tubes) in order to obtain the extract. The soluble amino acids were obtained using the method of Peoples et al. (1989), when 50 mg of lyophilized DM were

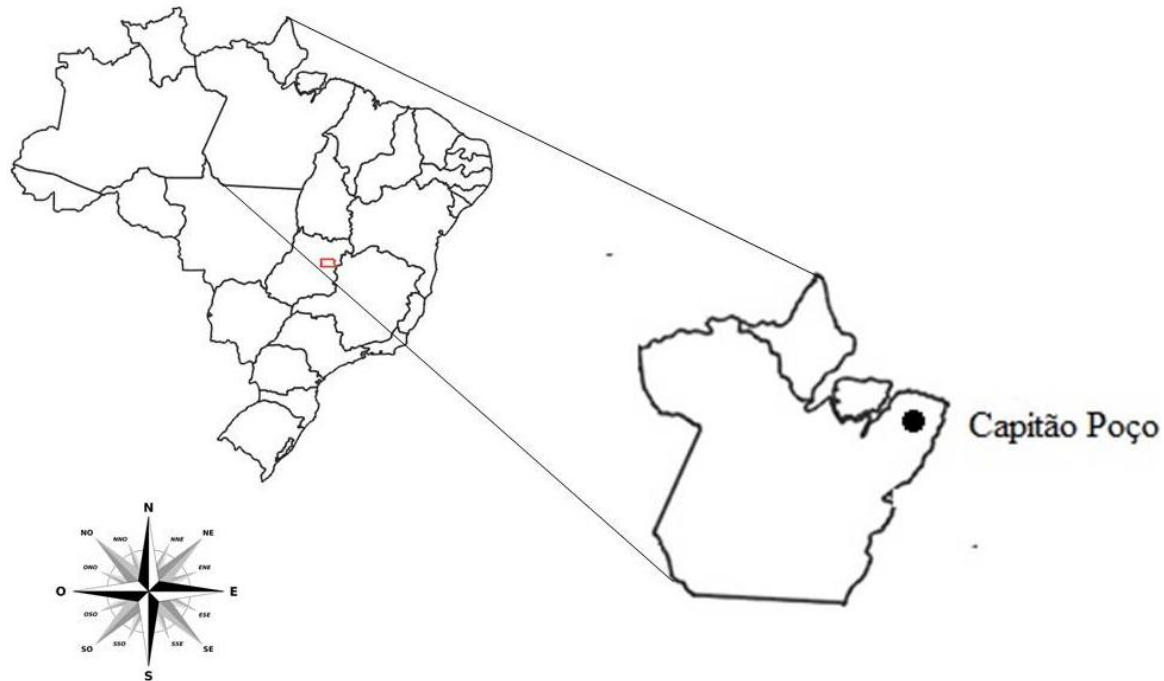

**Figure 1.** Location of the experiment at the Amazon Federal Rural University, Capitão Poço, Pará, Brazil.

transferred to a 15 ml test tube, adding 5 ml of distilled water. The tubes were then placed in a water bath for 30 min at 100°C in order to obtain the crude extract.

Free ammonia was obtained according to the method of Weatherburn (1967). A 50 mg sample of powdered root and leaf dry matter (DM) was weighed and placed in 15 ml test tubes, then 5 ml of distilled water was added, and placed in the water bath for 30 min at 100°C, in order to obtain the total extract. The nitrate concentration was obtained by the method described by Cataldo et al. (1975) in which 50 mg samples of previously freeze-dried leaves and roots were added to test tubes containing 5.0 ml distilled water and incubated in a water bath for 30 min at 100°C. This was then centrifuged at 3,000 rpm for 10 min in order to obtain the crude extract.

#### Statistical analysis

The results were submitted to normality tests (Shapiro-Wilk test, SPSS Inc., USA) and homogeneity of variances (Bartlett test, SPSS Inc., USA), and the significant  $H_0$  was obtained. The effect of doses of silicon (Si) and salt concentration (SC) were analyzed by adjusting regression to the equations to adequately express the behavior of the variables (Sisvar Inc., Brazil) and considering the regressions significant at  $p \leq 0.01$  (Ferreira, 2011).

## RESULTS AND DISCUSSION

### Nitrate content

Si levels influenced ( $p \leq 0.01$ ) the biochemical variables,

as well as the salt concentrations (SC), and showed different behavior towards the variables nitrate, nitrate reductase activity, ammonium, amino acids and proteins, since there was interaction between Si doses and salt concentrations for all variables in leaves and roots (Table 1). The 0 SC treatment showed higher nitrate content, both in the leaf and in the root (Figure 2). In the leaf, nitrate content in the 0 SC and 1.5 SC treatments increased at the 0.5 and 1.0  $\mu\text{M}$  Si doses, respectively, and reduced at the Si doses of 1.5 and 2.0  $\mu\text{M}$ , respectively. In the 2.0  $\mu\text{M}$  SC treatment the nitrate levels became higher as the Si doses increased (Figure 2A). The 1.5 and 2.0  $\mu\text{M}$  salt concentrations were attenuated by the 1.0  $\mu\text{M}$  dose of Si and at all Si doses, respectively, which favored the increase in nitrate content. In the root, nitrate content was reduced in the SC 0 and 1.5  $\mu\text{M}$  SC treatment for all silicon doses, while in the SC 2.0  $\mu\text{M}$  treatment, the nitrate levels were higher as the silicon levels increased (Figure 2B).

The decrease in nitrate concentration in leaves and roots at doses of 0 SC (1.5 and 2.0  $\mu\text{M}$  of Si) and 0 SC and 1.5 SC (0, 0.5, 1.0, 1.5 and 2.0  $\mu\text{M}$  of Si), respectively, can be attributed to the antagonistic effect of salts on nitrate absorption, as they reduced with the intensification of NaCl doses for both the root and leaf. This occurs when the presence of large amounts of nitrate salts, particularly  $\text{Cl}^-$ , decreases their quantities, and a large amount of  $\text{Cl}^-$  will favor nitrate reduction. This

**Table 1.** Analysis of variance for nitrate, amino acid, ammonia, protein and NRA of sorghum leaf and root under salinity and silicon doses.

Source of variation	DF	Nitrate	
		Leaf	Root
Silicon doses (Si)	4	**	**
Salt concentration (SC)	2	**	**
Si × SC	8	**	**
CV (%)	-	7.24	15.30

Source of variation	DF	Amino acid	
		Leaf	Root
Silicon doses (Si)	4	**	**
Salt concentration (SC)	2	**	**
Si × SC	8	**	**
CV (%)	-	0.44	0.07

Source of variation	DF	Ammonium	
		Leaf	Root
Silicon doses (Si)	4	**	**
Salt concentration (SC)	2	**	**
Si × SC	8	**	**
CV (%)	-	3.56	0.51

Source of variation	DF	Protein	
		Leaf	Root
Silicon doses (Si)	4	**	**
Salt concentration (SC)	2	**	*
Si × SC	8	**	**
CV (%)	-	2.52	5.36

Source of variation	DF	NRA	
		Leaf	Root
Silicon doses (Si)	4	**	**
Salt concentration (SC)	2	**	**
Si × SC	8	**	**
CV (%)	-	3.48	10.17

CV = Coefficient of variation; DF: Degree of freedom; NRA = Nitrate reductase activity; \*\* = significant ( $p \leq 0.01$ ).

result is in agreement with Ding et al. (2010) who worked sorghum plants and found that higher amounts of nitrate ( $\text{NO}_3^-$ ) decreased the  $\text{Cl}^-$  uptake, which is considered a toxic ion, thereby increasing the resistance of plants to stress caused by excess salts. This effect is possibly due to direct competition between  $\text{Cl}^-$  and  $\text{NO}_3^-$  ions for the same carrier and/or alterations in membrane integrity (Mansour and Salama, 2004; Rubinigg et al., 2005; Aragão et al., 2010).

The 0.5 and 1.0  $\mu\text{M}$  concentrations of Si provided greater resistance to the decrease of nitrate concentration in leaves. For Lima et al. (2011), silicon

added directly in the nutrient solution at a dose of 1  $\mu\text{M}$  mitigated the negative effects on the growth parameter of corn seedlings (*Zea mays*) submitted to salt concentration (NaCl), while there were no beneficial effects for cowpea.

#### Ammonium content

Ammonium levels were higher in the 0 SC treatment in the leaf than the other treatments. In this treatment, ammonium levels increased until the 1.5  $\mu\text{M}$  Si dose and

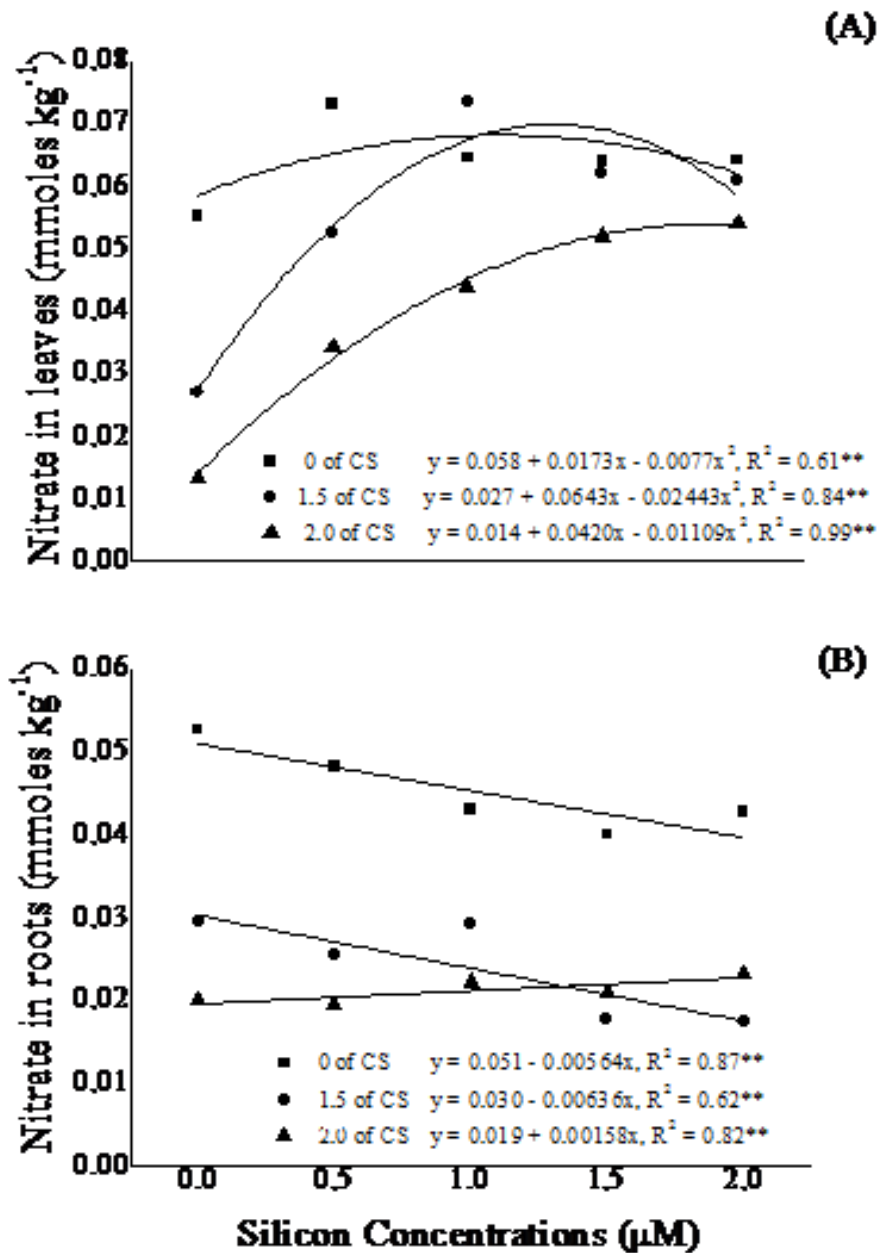

**Figure 2.** Nitrate concentrations in leaves (A) and roots (B) of sorghum under salinity and silicon concentrations. **\*\***Significant ( $p \leq 0.01$ ) by the F-test.

reduced under the 2.0  $\mu\text{M}$  Si dose, while in the 1.5 and 2.0 SC treatments, ammonium levels reduced as the Si dose increased (Figure 3A). The ammonium concentration in leaves was lower when there was an increase in salt concentration, which can be attributed to the positive effect of silicon. The roots presented the lowest ammonium content under the 0 SC treatment. In the 1.5 and 2.0 SC treatment, ammonium levels were

higher when Si doses increased, but at a dose of 2.0  $\mu\text{M}$ , these levels began to decrease (Figure 3B). In the root, there was an increase of ammonium content at higher salt concentrations. This is probably due to possible problems caused by the enzyme glutamine synthetase, which transforms ammonium to glutamate, because with a decrease in the activity of this enzyme, ammonium buildup may have occurred, which can cause problems

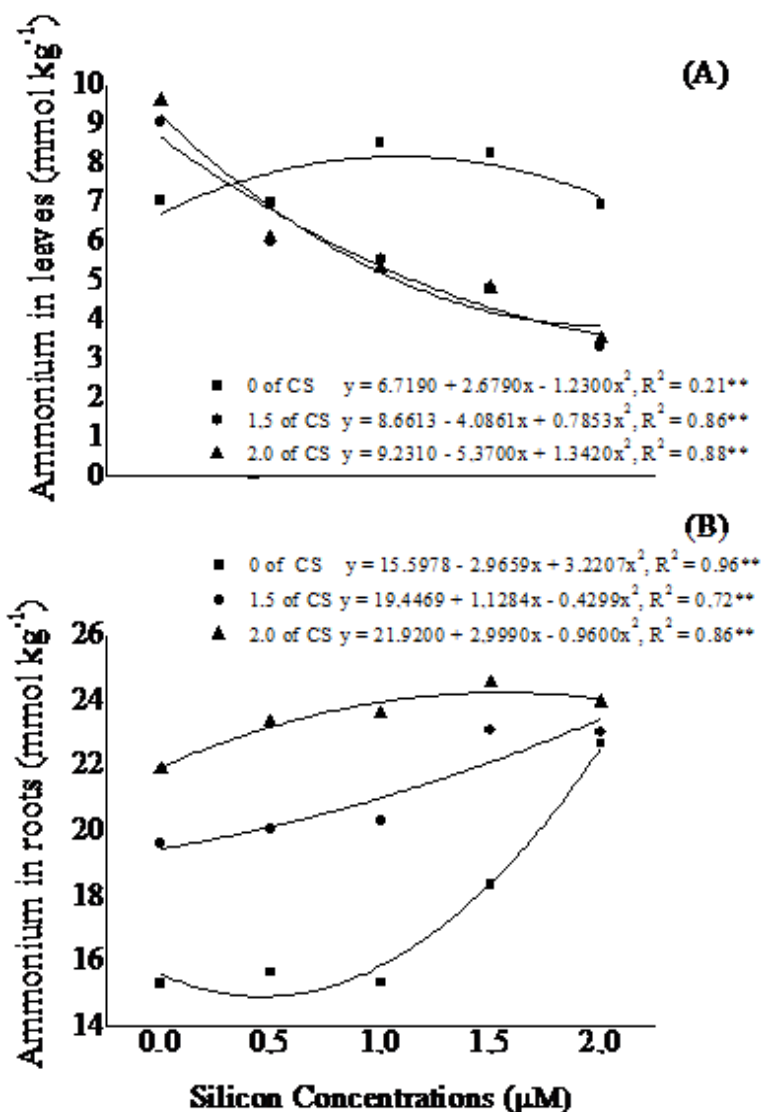

**Figure 3.** Ammonium concentrations in leaves (A) and roots (B) of sorghum under salinity and different silicon concentrations. \*\* Significant ( $p \leq 0.01$ ) by the F-test.

for plants, since large amounts of ammonium can cause toxicity in plants.

#### Nitrate reductase activity - NRA content

The 0 SC treatment showed higher nitrate reductase activity (NRA) content, both in the leaf and in the root, when compared to 1.5 and 2.0 SC treatments. However, in the leaf, the 0 SC treatment decreased the NRA content as the Si doses increased (Figure 4A), while in the root, for the same treatment, there was an increase until the 1.5  $\mu\text{M}$  Si dose (Figure 4B). In treatments with

1.5 and 2.0 SC, the NRA levels increased and decreased at the 2.0  $\mu\text{M}$  Si dose, respectively. When there is a decrease in RNA, the formation of amino acids, proteins and chlorophyll is compromised, thus affecting the growth of plants (Souza et al., 2014). The root system tends to keep the  $\text{Na}^+$  and  $\text{Cl}^-$  levels constant during stress exposure time, through the export of these ions into the soil or to the aerial part in studies with sorghum (Willadino and Camara, 2010). This result is due to the NRA reduction at higher salt concentrations, and the 2.0  $\mu\text{M}$  silicon dose showed no positive effect because this dose is toxic to plants. In general, the reduction in nitrate reductase activity in the leaf may have been caused by



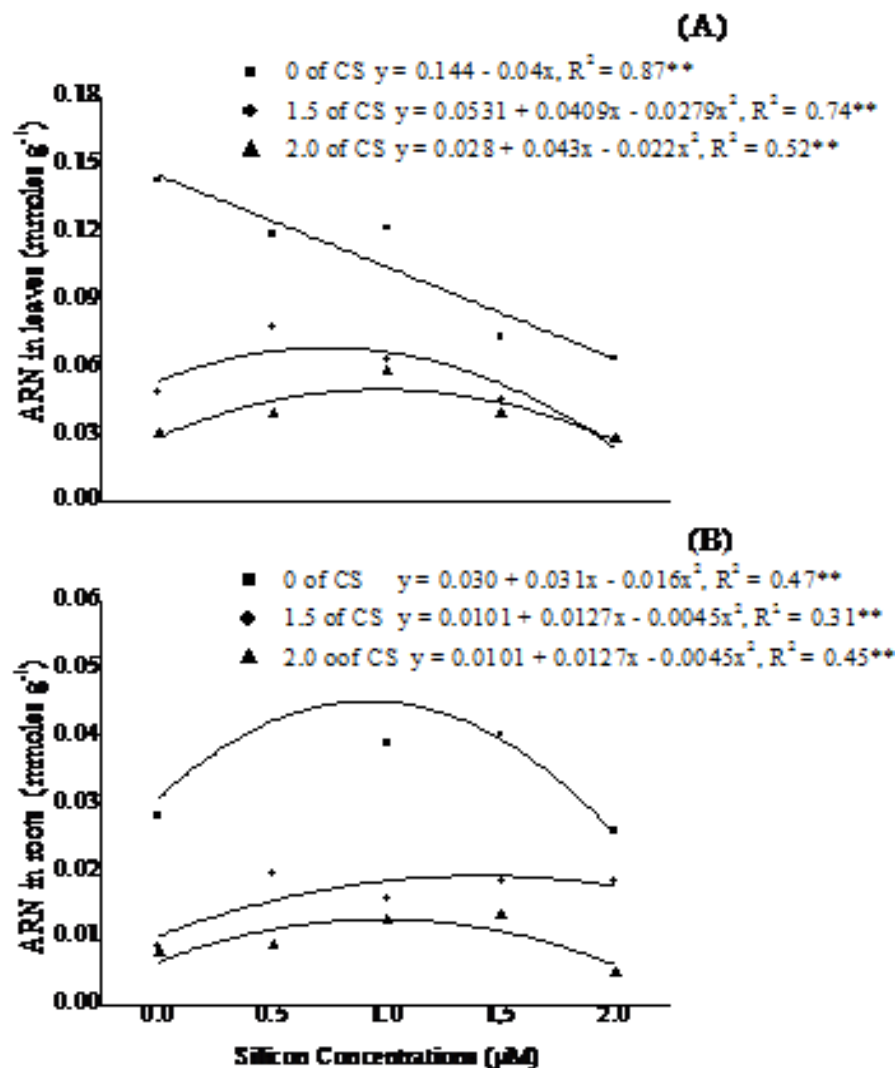

Figure 4. Nitrate Reductase Activity (ARN) in leaves (A) and roots (B) of sorghum under salinity and different silicon concentrations. \*\*Significant ( $p \leq 0.01$ ) by the F-test.

the imbalance of salts that may have occurred in cells, promoting a reduction in the activity of this enzyme.

#### Amino-acid content

For Amino-acid content, the 0 SC treatment showed higher contents in both the leaf and the root for the 1.5 and 2.0 SC treatments. Furthermore, the Amino-acid content decreased with the increase in the Si dose in the 0 SC treatment. In the 1.5 and 2.0 SC treatments, the amino-acid levels in the leaf and root increased until the 1.0  $\mu\text{M}$  Si dose and reduced at the 2.0  $\mu\text{M}$  Si dose (Figure 5). Sodium content of the plant leaf is reduced when silicon is applied in substrates that lack this element (Faria, 2000). In soil salinity conditions

(substrate) without the presence of silicon, there is a reduction in osmotic potential that causes water deficiency and subsequent toxicity to plants (Debouba et al., 2006; Munns and Tester, 2008). Silicon becomes effective in minimizing the effect of salinity on several plant species (Tuna et al., 2008), because Si acts by reducing the permeability of the plasma and the lipid membranes and keeps these membranes active for integrity and functionality (Zhu et al., 2004). The reductions in the amino-acids concentrations can be the result of inhibition or decrease of the deamination processes, which transformed these amino acids present in the plant parts. Under saline conditions, there was the breakdown of water and ionic homeostasis. This disruption of homeostasis occurs at the cellular level and

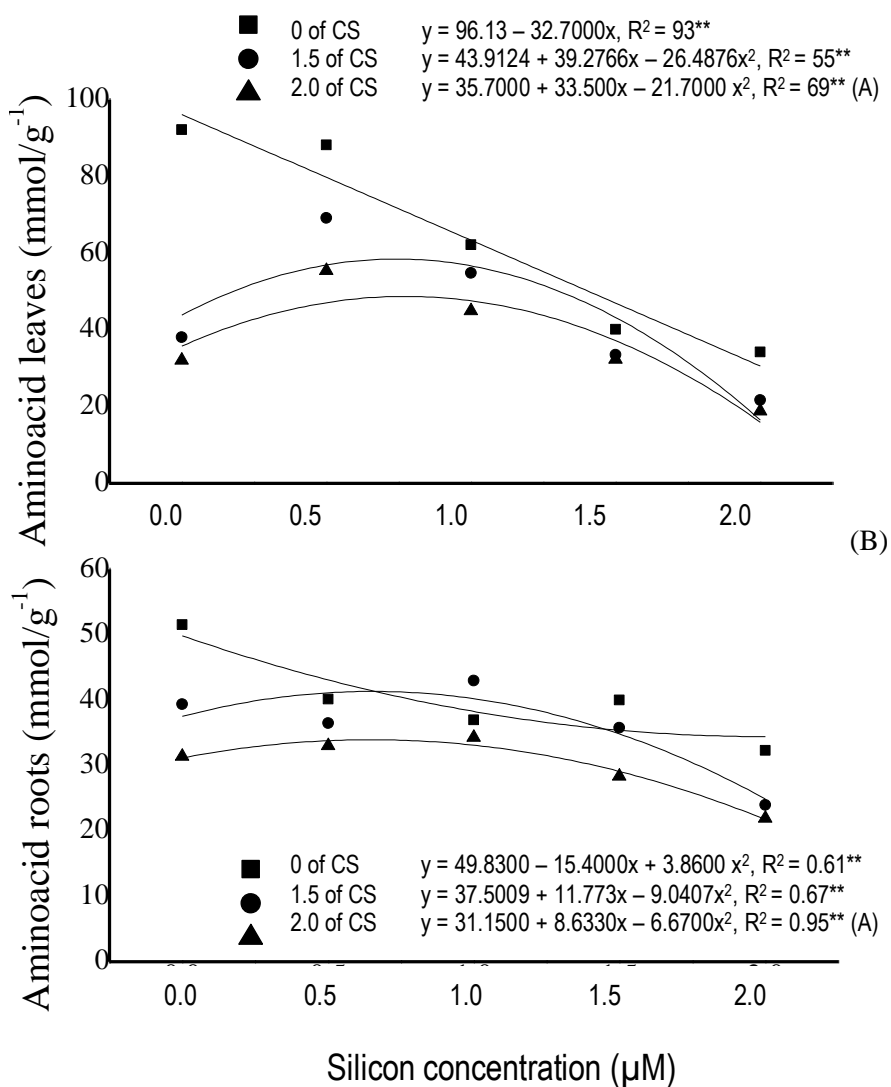

**Figure 5.** Total soluble amino-acids concentrations in leaves (A) and roots (B) of sorghum under salinity and different silicon concentrations. \*\* Significant ( $p \leq 0.01$ ) by the F-test.

throughout the whole plant, causing molecular damage, restricting growth and perhaps even leading to plant death (Willadino and Camara, 2010).

### Protein content

The 0 SC treatment showed higher protein content in the leaf as well as in the root (Figure 6). In the 1.5 and 2.0 SC treatments, there was an increase in protein in the leaf and root up to a Si dose of 1.5 μM and then a reduction at the 2.0 μM Si dose. The increase in the salt quantity reduces the amount of protein, and this may be due to the transformation of these proteins into amino

acids and possibly ammonia, or even as a consequence of the protein denaturing when in the presence of large amounts of salts. The maximum silicon dose reduced protein concentrations. This occurred because very high doses of this element can promote stress rather than act as a controller (Debouba et al., 2006). In general, the addition of N improves the production and the growth of plants, whether or not submitted to salt stress (Barhoumi et al., 2010).

### Conclusion

The silicon doses attenuated the negative effects of the

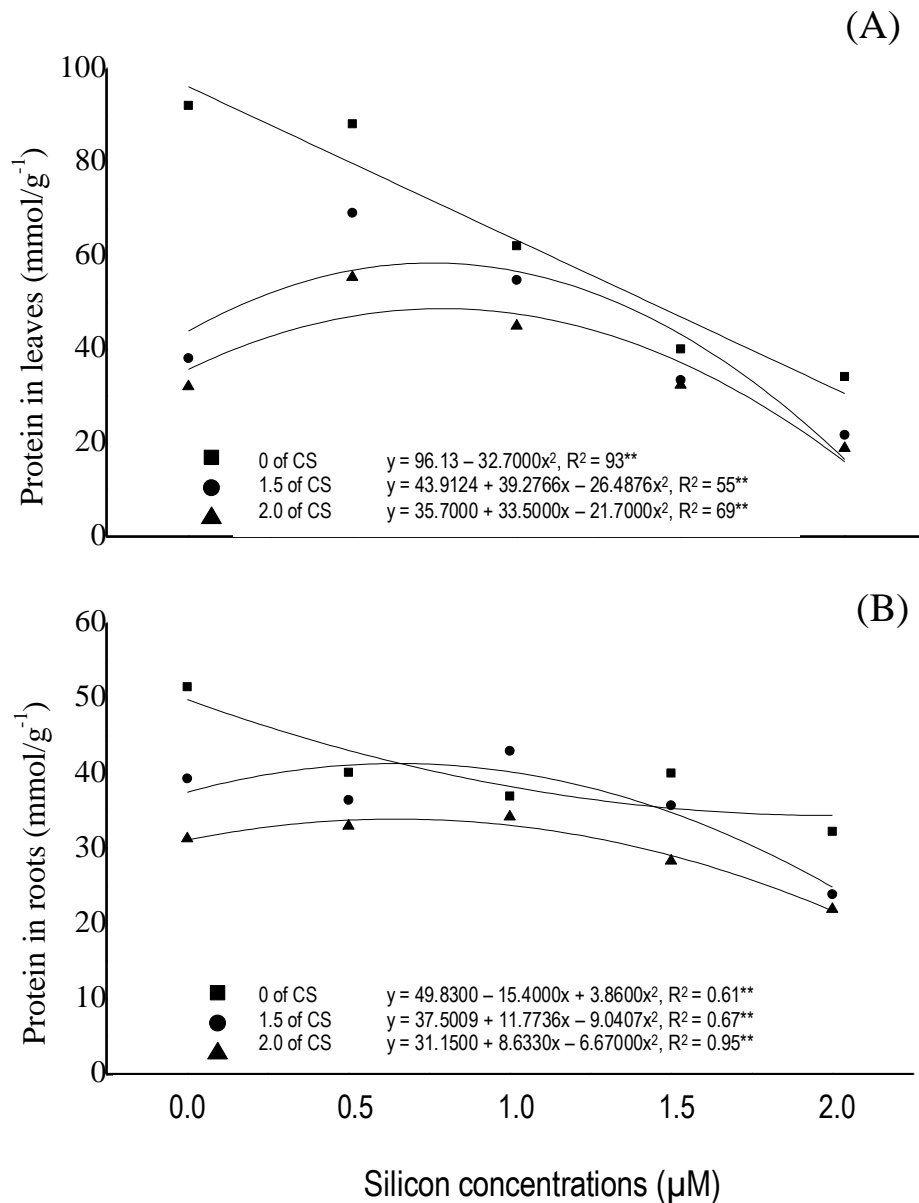

**Figure 6.** Total soluble protein concentrations in leaves (A) and roots (B) of sorghum under salinity and different silicon concentrations. \*\* Significant ( $p \leq 0.01$ ) by the F-test.

treatments on the biochemical compounds caused by higher salt concentrations in sorghum plants. Nitrate content increased in the leaves and root in the treatments 0 and 1.5  $\mu\text{M}$  of Si, but decreased in treatments with the 0.5 and 1.0  $\mu\text{M}$  doses of Si. The treatment 2.0  $\mu\text{M}$  of Si, nitrate levels had higher concentrations of both in the leaf and in the root with increasing doses of Si. Leaves and roots, the treatments 1.5 and 2.0 of SC caused reduction and increase, respectively, of ammonium levels. Thus, the dose of 1.0  $\mu\text{M}$  of Si is recommended to lessen the effect of salt concentrations of 1.5 and 2.0  $\mu\text{M}$ .

### Conflict of Interests

The authors have not declared any conflict of interests.

### ACKNOWLEDGEMENTS

The authors would like to recognize the Brazilian agencies CNPq (National Council for Scientific and Technological Development) and CAPES (Coordination for the Improvement of Higher Education Personnel) for

their support.

## REFERENCES

- Aragão RM, Silveira JAG, Silva EN, Lobo AKM, Dutra ATB (2010). Absorção, fluxo no xilema e assimilação do nitrato em feijão-caupi submetido à salinidade. *Rev. Ciênc. Agron.* 14:100-106.
- Bradford MM (1976). A rapid and sensitive method for the qualification of microgram quantities of protein utilize the principle of protein dye binding. *Anal. Biochem.* 7:248-254.
- Barhoumia Z, Atia A, Rabhi M, Djebal W, Abdelly C, Smaqui A (2010). Nitrogen and NaCl salinity effects on the growth and nutrient acquisition of the grasses *Aeluropus littoralis*, *Catapodium rigidum*, and *Brachypodium distachyum*. *J. Plant Nutr. Soil Sci.* 173:149-157.
- Cataldo DA, Haroon M, Schrader LE, Youngs VL (1975). Rapid colorimetric determination of nitrate in plant tissue by nitration of salicylic acid. *Commun. Soil Sci. Plant Anal.* 6:71-80.
- Crusciol CAC, Soratto RP, Castro GSA, Costa CHM, Ferrari Neto J (2013). Aplicação foliar de ácido silícico estabilizado na soja, feijão e amendoim. *Rev. Ciênc. Agro.* 44:404-410.
- Dai WM, Zhang KQ, Duan BW, Zheng KL, Zhong JY (2005). Genetic dissection of silicon content in different organs of rice. *Crop Sci.* 45:1345-1352.
- Debouba M, Gouia H, Valadier M-H, Ghorbel MH, Suzuki A (2006). Salinity-induced tissue-specific diurnal changes in nitrogen assimilatory enzymes in tomato seedlings grown under high or low nitrate medium. *Plant Physiol. Biochem.* 44:409-419.
- Ding X, Tian C, Zhang S, Song J, Zhang F, Mi G, Feng G (2010). Effects of NO<sub>3</sub>-N on the growth and salinity tolerance of *Tamarix laxa* Willd. *Plant Soil* 331:57-67.
- Dykes L, Rooney LW, Waniska RD, Rooney WL (2005). Phenolic compounds and antioxidant activity of sorghum grains of varying genotypes. *J. Agric. Food Chem.* 53:6813-6818.
- Faria R (2000). Efeito da acumulação de silício e a tolerância das plantas de arroz do sequeiro ao déficit hídrico do solo. 2000. 125f. Dissertação (Mestrado) – Departamento de Solos, Universidade Federal de Lavras, Viçosa, 2000.
- Ferreira DF (2011). Sisvar: A computer statistic analysis system. *Ciênc. Agrotec.* 35:1039-1042.
- Gunes A, Pilbeam DJ, Inal A, Coban S (2008). Influence of silicon on sunflower cultivars under drought stress, in growth, antioxidant mechanisms, and lipid peroxidation. *Commun. Soil Sci. Plant Anal.* 39:1885-1903.
- Hageman RH, Hucklesby DP (1971). Nitrate reductase from higher plants. *Meth. Enzymol.* 17:491-503.
- Hoagland DR, Arnon DI (1950). The water culture method for growing plants without soils. 1. ed. Berkeley: California Agricultural Experimental Station 347 p.
- Horie T, Schroeder JI (2004). Sodium transporters in plants. Diverse genes and physiological functions. *Plant Physiol.* 136:2457-2462.
- Kraska JE, Breitenbeck GA (2010). Survey the silicon status of flooded rice in Louisiana. *Agron. J.* 102:523-529.
- Lacerda CF, Morais HM, Prisco JT, Gomes-Filho E, Bezerra MA (2006). Interação entre salinidade e fósforo em plantas de sorgo forrageiro. *Rev. Ciênc. Agron.* 37:258-263.
- Liang Y, Hua H, Zhu Y, Cheng C, Romheld V (2006). Importance of plant species and external silicon concentration to active silicon uptake and transport. *New Phytol.* 172:63-72.
- Lima MA, Castro VF, Vidal JB, Enéas Filho J (2011). Aplicação de silício em milho e feijão-de-corda sob estresse salino. *Rev. Ciênc. Agron.* 42:398-403.
- Ma JF, Yamaji N (2008). Functions and transport of silicon in plants. *Cell Mol. Life Sci.* 65:3049-3057.
- Mansour MMF, Salama KHA (2004). Cellular basis of salinity tolerance in plants. *Environ. Exper. Bot.* 52:113-122.
- Miranda JRP, Carvalho JG, Santos DR, Freire ALO, Bertoni JC, Melo JRM, Caldas A (2002). Silício e cloreto de sódio na nutrição mineral e produção de matéria seca de plantas de moringa (*Moringa oleifera* LAM.). *Rev. Bras. Ciênc. do Solo.* 26:957-965.
- Munns R, Tester M (2008). Mechanisms of salinity tolerance. *Annu. Rev. Plant Biol.* 59:651-681.
- Peoples MB, Faizah AW, Reakasem BE, Herridge DF (1989). Methods for evaluating nitrogen fixation by nodulated legumes in the field. 1. ed. Australian Centre for International Agricultural Research Canberra, 76 p.
- Pozza AAA, Carvalho JG, Guimarrães PTG, Figueredo FC, Araújo AR (2009). Suprimento do silicato de cálcio e a eficiência nutricional de variedades de cafeeiro. *Rev. Bras. de Ciênc. Solo.* 33:1705-1714.
- Rodrigues FA, Oliveira LA, Korndorfer AP, Korndorfer GH (2011). Silício: um elemento benéfico e importante para as plantas. *Informações agronomicas.* no. 134.
- Rubinigg M, Posthumus FS, Elzenga JTM, Stulen I (2005). Effect of NaCl salinity on nitrate uptake in *Plantago maritima* L. *Phyton*, 45:295-302.
- Silveira JAG, Silva SLF, Silva EM, Viegas RA (2010). Mecanismos biomoleculares envolvidos com a resistência ao estresse salino em plantas. Manejo da salinidade na agricultura: Estudos básicos e aplicados. capt. 11. [http://www.researchgate.net/publication/259481450\\_Mecanismos\\_biomoleculares\\_envolvidos\\_com\\_a\\_resistencia\\_ao\\_estresse\\_salino\\_em\\_plantas](http://www.researchgate.net/publication/259481450_Mecanismos_biomoleculares_envolvidos_com_a_resistencia_ao_estresse_salino_em_plantas)
- Souza LC de, Siqueira JAM, Silva JLS, Silva JNS, Coelho CCR, Neves MG, Oliveira Neto CF, Lobato AKS (2014). Compostos nitrogenados, proteínas e aminoácidos em milho sob diferentes níveis de silício e deficiência hídrica. *Rev. Bras. Milho Sorgo* 13:117-128.
- Tabosa JN, França JGE, Santos JPO, Maciel GA, Lira MA, Araújo MRA, Guerra NB (1993). Teste em linhas de sorgo no semi-árido de Pernambuco para consumo humano. *Pesqui. Agropecu. Bras.* 28:1385-1390.
- Trindade AR, Lacerda CF, Gomes Filho E, Bezerra MA, Prisco JT (2006). Influência do acúmulo e distribuição de íons sobre a aclimação de plantas de sorgo e feijão-de-corda, ao estresse salino. *Rev. Bras. Eng. Agríc. Amb.* 10:804-810.
- Tuna AL, Kaya CD, Murilo-Amador B, Aydemir S, Girgin AR (2008). Silicon improves salinity tolerance in wheat plants. *Environ. Exp. Bot.* 62:10-16.
- Weatherburn MW (1967). Phenol-hypochlorite reaction for determination of ammonia. *Anal. Chem.* 39:971-974.
- Willadino L, Camara TR (2010). Tolerância das plantas à salinidade: Aspectos fisiológicos e bioquímicos. *Encic. Biosf.* 6:1-23.
- Zhu Z, Wei G, Li J, Qian Q, Yu J (2004). Silicon alleviates salt stress and increases antioxidant enzymes activity in leaves of salt-stressed cucumber (*Cucumis sativus* L.). *Plant Sci.* 167:527-533.
- Zuccarini P (2008). Effects of silicon on photosynthesis, water relations and nutrient uptake of *Phaseolus vulgaris* under NaCl stress. *Biol. Plant.* 52:157-160.

Full Length Research Paper

## Quality index method (QIM) and quantitative descriptive analysis (QDA) of Nile tilapia (*Oreochromis niloticus*) quality indices

Tatiana Pacheco Rodrigues<sup>1\*</sup>, Eliane Teixeira Mársico<sup>2</sup>, Robson Maia Franco<sup>2</sup>,  
Sílvia Conceição Reis Pereira Mello<sup>3</sup>, Ivone Costa Soares<sup>2</sup>, Natália Oliveira Cavalcanti  
Zúniga<sup>2</sup> and Mônica Queiroz de Freitas<sup>2</sup>

<sup>1</sup>Federal University of Reconcavo of Bahia, Rui Barbosa Street 710, Cruz das Almas, Bahia, Brazil.

<sup>2</sup>Federal Fluminense University, Vital Brazil Filho Street, 64, Niterói, Rio de Janeiro, Brazil.

<sup>3</sup>Foundation Institute for State Fishing in Rio de Janeiro, Praça Fonseca Ramos, Niterói, Rio de Janeiro, Brazil.

Received 29 January, 2015; Accepted 20 November, 2015

The aim of this study was to develop specific criteria for evaluating freshness in farmed Nile tilapia (*Oreochromis niloticus*), eviscerated and stored on ice, by employing sensorial, physicochemical and bacteriological analyses. Sensorial analyses were composed of quantitative descriptive analysis (QDA) for cooked fish and quality index method (QIM) for raw fish evaluation in samples stored for 22 days. Psychrotrophic aerobic heterotrophic bacteria were counted in muscles with and without skin stored for 28 days. Total volatile bases (TVB) were also determined in samples stored for 22 days. TVB analyses were within legal limits during the 22 days. Although psychrotrophic countings remained within acceptable limits until 18 days of storage, increased intensity in the perception of undesired alterations was observed on the 15th day of storage in the Nile tilapia as evaluated by QDA and by QIM. Based on the results of this trial, a shelf-life of 15 days is suggested for farmed tilapia, eviscerated and stored in ice.

**Key words:** *Oreochromis niloticus*, sensorial analyses, total volatile bases (TVB), psychrotrophic countings.

### INTRODUCTION

In the last decades, with overfishing and the decreases in the commercial fish stocks, planned fresh water fish farming began to play an important role in the Brazilian pisciculture/agroindustry. In this context, Nile tilapia (*Oreochromis niloticus*) is an important species for aquaculture due to its great production potential

(Sabbag et al., 2007). For instance, the Brazilian Ministry of Fisheries and Aquaculture estimated tilapia production in Brazil to be 253,824.1 tons in 2011 (Brasil, 2011). However, since not all the fishes captured and/or produced are sold at once, there is always the need for storage and therefore the attendant problem of quality

\*Corresponding author. E-mail: [tatiana\\_pacheco@ufrb.edu.br](mailto:tatiana_pacheco@ufrb.edu.br).

control, particularly in the determination of fish freshness. In this context, sensorial methods, although old, are still the most effective means of determining, in a quick manner, fish freshness (Martinsdóttir, 1997). Quality index method (QIM) is based on the characteristics of surface, eyes and gills appearance, in addition to the odour of the iced fish (Luten and Martisdóttir, 1997). QIM system is precise because it is adapted for each species and since it also considers many characteristics of the fish, permitting the development of a score system referred to as quality index. This method has been employed for many fish species such as *Clupea harengus* (Jónsdóttir, 1992), *Spaurus aurata* (Huidobro et al., 2001), *Salmo salar* (Sveinsdóttir et al., 2002), *Merluccius merluccius* (Baixas-Nogueras et al., 2003), *Sardina pilchardus* (Triqui and Bouchriti, 2003), *Octopus vulgaris* (Barbosa and Vaz-Pires, 2004), *Gadus morhua* (Esaïassen et al., 2004; Kent et al., 2004; Bonilla et al., 2007), *Micropogonias furnieri* (Teixeira, 2005), *Salvelinus alpinus* (Cyprian et al., 2008), *Litopenaeus vannamei* (Oliveira et al., 2009), *Sepia officinalis*, L. (Sykes, 2009), *Boops boops*, L. (Bogdanovic et al., 2012) among others. Quantitative descriptive analysis (QDA) is a sensorial method which employs trained evaluators selected for the description and quantification of descriptive sensorial attributes of flavour, odour, texture, appearance and it is statistically supported, representing an important tool in quality control of food processing industries (Stone and Sidel, 1998).

Determination of total volatile bases (TVB) is one of the most widely used methods for evaluating the quality of fish products. It involves evaluation of trimethylamine (TMA), produced by bacterial deterioration, dimethylamine (DMA), produced by autolytic enzymes during frozen storage, ammonia, which is produced by amino acid deamination, nucleotides catabolism and other volatile basic nitrogenated compounds associated with fish deterioration. Although TVB analysis is relatively simple to perform, its main drawback is that the test presents consistent increases only when fish is close to rejection and is therefore not suitable for making prognosis on commercial validity from intermediary data, being only useful, as an indicator of maximum shelf-life period (Contreras-Guzmán, 1994; Huss, 1998).

Tests based on total countings can be useful for measuring raw material conditions, and efficiency of procedures like thermal treatment, processing hygiene conditions, sanitary conditions of equipment and tools and, furthermore, the profile of the binomial, time x temperature, during storage and distribution (Huss, 1997).

Microorganisms that grow in refrigerated food between 0 and 7°C have optimal growing temperature of 20°C and are called psychrotrophic. This microbiota produces a visible growth in 7 to 10 days. Psychrotrophics are considered as a subgroup of mesophiles which are more common in refrigerated food, besides being responsible for food deterioration. Some psychrotrophics can be

pathogenic like *Aeromonas hydrophila*, some strains of *Bacillus cereus*, *Clostridium botulinum* type E, B and F, *Listeria monocytogenes*, *Vibrio cholera*, *Yersinia enterocolitica* and some enteropathogenic strains of *E. coli*, as well as other organisms like *Salmonella*, *Clostridium perfringens* type C, some strains of *Bacillus cereus* and *Staphylococcus aureus* which grow slowly at temperatures between 7 and 15°C, but are able to grow if temperature abuse takes place during storage (Cousin et al., 2001).

In Brazil the criteria for considering fresh fish suitable for human consumption are determined by different National Laws and Regulations among which are the Regulations for Industrial and Sanitary Inspection of Products of Animal-Origin (RIISPOA) of art. 442 (Brasil, 1997a), Government Directive no. 185 of the Ministry of Agriculture (Brasil, 1997b), and by norms such as those of the Brazilian Association of Technical Standards (ABNT, 1993). Nevertheless, such criteria do not consider diversity among the different species and do not offer sensorial quality scores that could express fish freshness.

The aim of this research was to develop the QIM protocol, as well as to describe sensorial characteristics of cooked flesh, for the fresh water species, *Oreochromis niloticus* (Nile tilapia) at different periods of storage on ice.

## MATERIALS AND METHODS

### Sample collection and storage

Tilapias were obtained from a fish farm located in the state of Rio de Janeiro, Brazil. Collection included: 135 male, 4 to 6 months old, with an average weight of 412.1 kg (total of 55.6 kg), in the period of August 2005 to September 2006. After 24 h of depuration, fish were exposed to thermal shock with ice, eviscerated and washed. They were then transported in ice filled isothermal boxes, at the proportion of 1 kg of ice for 1 kg of fish. On reaching the laboratory, the fishes were packed in containers with ice at the proportion of 1 kg of ice for 2 kg of fish, stored and kept in a domestic refrigerator at a temperature of  $0.3 \pm 0.35^\circ\text{C}$ , until the analyses.

### Quantitative descriptive analysis (QDA)

QDA was performed according to the method described by Stone and Sidel (1998) which included recruitment, using a questionnaire; pre-selection by means of a triangular test for salty taste, training and selection of evaluators and further evaluation of the test-product with a sensorial team composed of nine evaluators. During training, cooked samples were offered to the evaluators and the attributes of appearance, odour, taste and texture were assessed by means of an open discussion among evaluators, moderated by a leader. QDA was performed under laboratory conditions where each evaluator examined samples at 1, 8, 15 and 22 days of storage. At day 22, only odour and appearance analyses were performed. Cooked samples, under controlled conditions, were individually presented on disposable plates, served with water and sample evaluation forms.

**Table 1.** Quality index method (QIM) scheme developed for farmed Nile tilapia (*Oreochromis niloticus*), eviscerated and stored in ice.

Parameter	Characteristics	pt		
General aspect	Skin	With brightness, greyish colour, with darker well defined interpolated stripes.	0	
		Less intense brightness, stripes less defined	1	
		No brightness, loss of stripes definition, faded colour	2	
	Scales	Adhered	0	
		Scale loss	1	
	Fish hardness	Tense	0	
		Less tense	1	
	Flesh firmness	Supple	2	
		Firm	0	
	Eyes	Cornea transparency	Limpid	0
Slightly opaque			1	
Milky, opaque			2	
Pupil		Black, well delineated	0	
		Veiled, still delineated	1	
		Veiled, not delineated	2	
Form		Protruding, convex	0	
		Flat, even	1	
Gills		Odour	Concave, hollowed	2
			Metallic	0
	Blood / Oily		1	
	Color	Rancid	2	
		Intense red colour	0	
Abdomen	Internal abdominal wall	Dark wine colour	1	
		Opaque brownish wine colour to discoloured	2	
		Bright silver colour with black dots	0	
		Bright mother of pearl colour with black dots	1	
Muscles	Colour	Brightless yellowish white, with black dots	2	
		Bright clear pink	0	
		Opaque, old pink, "chicken thigh colour"	1	
Total quality index 0-19				

### Quality index method (QIM)

For evaluation of samples with the QIM, selection and training of the team were done according to the methodology used by Sveinsdottir et al. (2003). Whole and raw fish, stored on ice during different time periods of 1, 8, 15 and 22 days were individually presented on a clear colour tray. The trained team, composed of nine evaluators, took part in the evaluation of samples using QIM scheme produced during the training sessions as presented in Table 1.

### Determination of total volatile bases

For TVB analyses, 11 specimens of Nile tilapia with average weight

of 376.3 g were used. TVB quantifications were done on 1, 4, 8, 11, 15, 18 and 22 days of storage, using the Conway microdiffusion dish method (Brasil, 1981).

### Psychrotrophic and heterotrophic bacteria counting

For bacteriological analyses, 11 specimens of Nile tilapia with average weight of 376.3 g were used. Counting was performed on storage days 01, 04, 08, 11, 15, 18, 22 and 28 in muscle samples with or without skin. The methodology for psychrotrophic aerobic heterotrophic bacteria counting was according to the descriptions of Morton (2001) and Cousin et al. (2001). Standard count agar was used and sowed plates were incubated at 7°C for 10 days.



**Table 2.** Averages ( $\bar{X}$ ) and standard deviation ( $s_x$ ) of intensity in the perception of odour, appearance, taste and quantitative descriptive analysis (QDA) texture in Nile tilapia (*O. niloticus*), eviscerated and stored in ice.

Attributes	Storage period ( $\bar{X} \pm s_x$ )			
	1 day	8 days	15 days	22 days
Colour of flesh	0.6 <sup>a</sup> ( $\pm 1.9$ )	2.0 <sup>b</sup> ( $\pm 1.72$ )	5.6 <sup>c</sup> ( $\pm 4.90$ )	10.5 <sup>d</sup> ( $\pm 3.8$ )
Orange pigment (I)	0.05 <sup>a</sup> ( $\pm 0.7$ )	0.1 <sup>a</sup> ( $\pm 0.34$ )	0.8 <sup>a</sup> ( $\pm 2.32$ )	2.8 <sup>b</sup> ( $\pm 4.21$ )
Brightness (D)	12.4 <sup>a</sup> ( $\pm 4.3$ )	11.9 <sup>a</sup> ( $\pm 4.2$ )	9.2 <sup>b</sup> ( $\pm 4.79$ )	4.0 <sup>c</sup> ( $\pm 3.08$ )
Fresh water fish characteristic odour (D)	13.0 <sup>a</sup> ( $\pm 3.4$ )	12.2 <sup>a</sup> ( $\pm 3.9$ )	9.6 <sup>b</sup> ( $\pm 5.17$ )	3.3 <sup>c</sup> ( $\pm 4.51$ )
Sea water fish characteristic odour (I)	0.56 <sup>a</sup> ( $\pm 2.9$ )	0.1 <sup>a</sup> ( $\pm 2.35$ )	2.2 <sup>b</sup> ( $\pm 4.05$ )	2.1 <sup>b</sup> ( $\pm 3.31$ )
Rancid odour (I)	0.3 <sup>a</sup> ( $\pm 1.4$ )	0.3 <sup>a</sup> ( $\pm 0.82$ )	1.8 <sup>b</sup> ( $\pm 3.57$ )	7.6 <sup>c</sup> ( $\pm 6.05$ )
Fresh water fish taste (D)	12.8 <sup>a</sup> ( $\pm 4.04$ )	11.8 <sup>a</sup> ( $\pm 4.21$ )	7.8 <sup>b</sup> ( $\pm 5.56$ )	-
Sea water fish taste (I)	0.6 <sup>a</sup> ( $\pm 2.62$ )	1.3 <sup>b</sup> ( $\pm 2.41$ )	2.2 <sup>b</sup> ( $\pm 3.34$ )	-
Bitter taste (I)	0.2 <sup>a</sup> ( $\pm 0.30$ )	0.2 <sup>a</sup> ( $\pm 0.27$ )	1.1 <sup>b</sup> ( $\pm 2.08$ )	-
Softness (D)	12.9 <sup>a</sup> ( $\pm 2.88$ )	12.8 <sup>a</sup> ( $\pm 2.32$ )	10.8 <sup>b</sup> ( $\pm 3.36$ )	-
Juiciness (D)	12.5 <sup>a</sup> ( $\pm 2.62$ )	12.3 <sup>a</sup> ( $\pm 2.84$ )	9.9 <sup>b</sup> ( $\pm 4.05$ )	-

<sup>a, b, c,</sup> averages on the same line followed by distinct letters are significantly different ( $p < 0.05$ ). (-) Analyses not performed on the 22<sup>nd</sup> storage day; (I) Undesired attribute; (D) Desired attribute.

### Statistical analysis

For statistical treatment of QDA results, One-way ANOVA and Tukey's test ( $p < 0.5$ ) were used. Regression analyses were performed on TVB results and on bacterial counts, previously transformed into base 10 logarithms. All statistical tests were done by SAS statistical system (SAS Institute, Inc., 1985).

## RESULTS AND DISCUSSION

### Quantitative descriptive analysis (QDA)

The sensorial team, composed of nine evaluators, defined eleven sensory attributes of appearance, odour, taste and texture in order to describe the characteristics of cooked flesh of Nile tilapia, eviscerated and stored on ice for 22 days. Average values for perception intensities and the definition of each of the attributes are presented in Tables 2 and 3, accordingly.

Fish stored for 1 and 8 days did not present significant difference ( $p > 0.05$ ) in the attributes of "softness", "juiciness", "brightness", "fresh water characteristic odour" and "fresh water fish taste". During this storage period, attributes considered as desirable by the team, such as delicate and mild odour and taste characteristic of fresh water fish, together with softness, juiciness and bright attractive appearance were preserved. This demonstrates that, under adequate conditions, sensorial characteristics of tilapias are conserved in recently captured and stored fishes until the eighth day of storage with the alteration being slight traces of a smell of sea water fish noticed.

In fish stored for 15 days, the team observed loss in sensorial quality of flesh after cooking, presenting lower brightness, softness and juiciness intensity. In this storage period, attributes considered as undesirable began to be noticed, such as "sea water fish odour and

taste", reminding of sea-smell, and traces of "bitter taste" and "rancid taste", related to fat oxidation.

Fish stored for 22 days that were analyzed only for appearance and odour, presented sharp undesirable attributes, especially rancid odour and the presence of an orange pigment, both associated with the oxidation process of fatty acids.

"Flesh colour" attribute was important for evaluating freshness in this species of fish as it gradually varies from the first to the last day of storage, from being milky white colour to a dark greyish colour. Besides the initial clear colour, delicate taste also stood out as an attribute of sensorial quality for the cooked flesh of this fish species.

### Quality index method (QIM)

The team selected attributes which sensorially characterized Nile tilapia in the different storage periods. Based on this, a QI protocol was developed and used in sample analysis. With the average quality indexes of the different storage periods, a calibration curve was drawn (Figure 1).

The analyzed fish species initially presented bright skin, greyish colour and well defined stripes. Aspects observed in eyes, such as cornea transparency, pupil delineation and shape stood out in the evaluation of freshness. Besides those aspects, odour and gill colour were remarkable aspects that suffer significant alterations during the storage period. Loss of transparency and delineation of pupils were highlighted by the evaluation team, as well as the change in the shape from concave to convex. The gill colour, initially bright red, changed into a brownish wine shade. Gills, initially characterized by a metallic odour, changed to a blood smell with traces of oil and, finally, a rancid odour, then considered as undesirable by the evaluators.

**Table 3.** Descriptive vocabulary used in QDA of farmed Nile tilapia (*O. niloticus*) eviscerated and stored in ice.

<b>Appearance attributes</b>	<b>Definition</b>
Colour of flesh	Colour going from white to light brown during storage period, not considering dark flesh
Brightness	Limpidity of colour, varying from opaque to bright, represented on the scale by “no brightness” to “a lot of brightness”, accordingly
Orange pigment	Clear pigment, associated to fat oxidation
<b>Odour attributes</b>	<b>Definition</b>
Characteristic of fresh water fish	Strong fresh water fish odour; fresh water algae
Characteristic of sea water fish	Odour associated with fish stored for a long time in ice or beginning to deteriorate; sea smell
Rancid	Odour associated to deteriorated fat
<b>Taste attributes</b>	<b>Definition</b>
Characteristic of fresh water fish	Strong fresh water fish taste; fresh water algae
Characteristic of sea water fish	Taste associated with fish stored for a long time in ice or beginning to deteriorate
Bitter	Taste associated with rancidity – deteriorated fat (not consider dark flesh bitter taste)
<b>Texture attributes</b>	<b>Definition</b>
Softness	Force necessary to tear the flesh with the first bite
Juiciness	Amount of humidity in the mass liberated during mastication

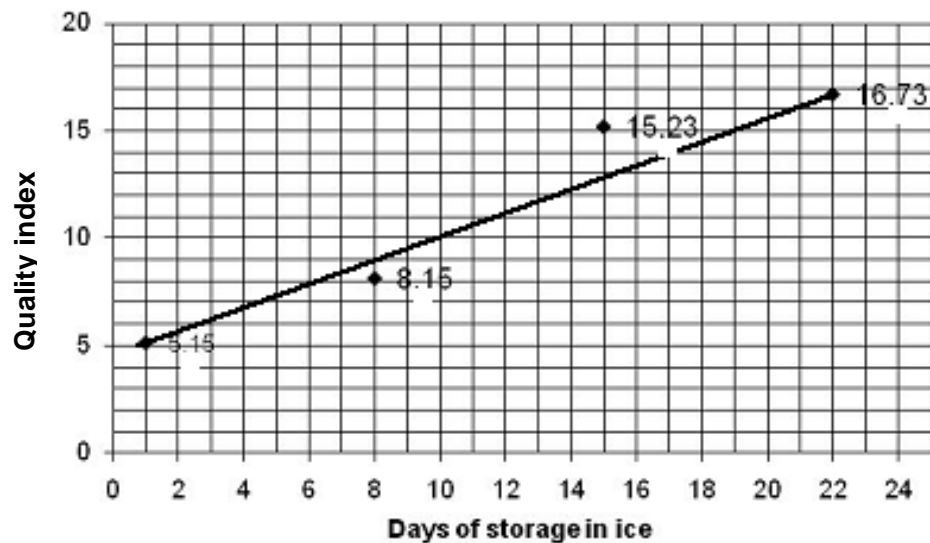
**Figure 1.** Calibration curve for quality index method of farmed Nile tilapia (*Oreochromis niloticus*) eviscerated and stored in ice for 22 days.

It was apparent based on these results that evaluators find it difficult in differentiating between samples of 15 and 22 days. Based on the results obtained here, it can be concluded that the most important sensorial alterations in Nile tilapia took place during this storage

period, when evaluators were able to notice undesirable attributes in the samples obtained at 15 to 22 day of storage.

Similar results were obtained from trials performed by Netto (1984) and Guimarães et al. (1988) who employed

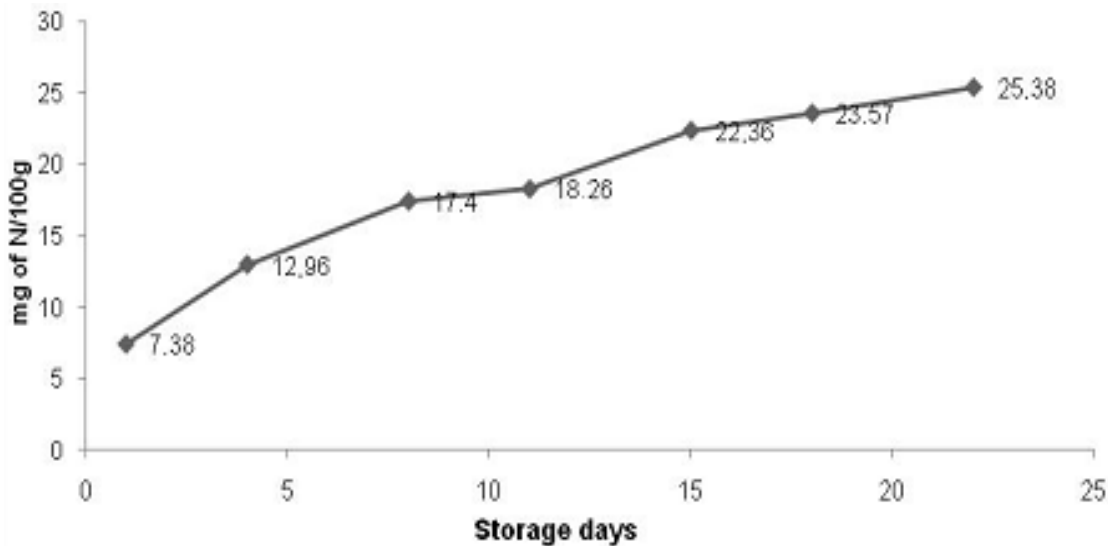

**Figure 2.** Results of determination of total volatile bases for farmed Nile tilapia (*O. niloticus*) eviscerated and stored in ice for 22.

methodologies that differed from those in the present research, by evaluating sensorial characteristics of whole hybrid tilapia (*Tilapia hornorum* x *O. niloticus*) and whole eviscerated Nile tilapia (*O. niloticus*). These authors observed that deterioration of the prepared fish samples reached unacceptable levels for consumption at 15 and 16 days of storage, respectively.

Albuquerque et al. (2004) used QIM and verified that Nile tilapias, desensitized by two different methods ( $\text{CO}_2$  and ice) and stored for 17 days, showed optimal freshness until the storage day (7), developing more significant alterations between the 12 and 17 days of storage. Likewise, Soares and Gonçalves (2012) using QIM observed that the maximum life of the Nile tilapia fillet stored on ice was estimated at 15 days.

Comparing QIM results with QDA, it can be noticed that exactly in the 15 days storage period, Nile tilapia presented loss of sensorial quality. Hence, a QI between 0 and 8 indicates that fish quality can be guaranteed up to 8 storage days, QI between 9 and 15 indicates storage time between 9 and 15 days, and QI between 16 and 19 indicates storage above 22 days which is considered unsuitable for consumption.

### Total volatile bases

With the results obtained in this research, it can be noticed that during storage (Figure 2) TVB value did not go beyond acceptable limits for the Brazilian legislation, which is 30 mg of N/100 g of flesh (Brasil, 1997a). Similar findings have been previously reported in trials with Nile tilapia. Guimarães et al. (1988), Sales et al. (1988), Elisabetta et al. (2001), Soccol (2002) and Albuquerque

et al. (2004) observed low TVB values when fish were sensorially rejected, in concordance with Beraquet and Lindo (1985) and Contreras-Guzmán (1994), who reported that fresh water fish present low TVB. The need to re-evaluate the acceptable limits of this legal parameter for this species is thus demonstrated.

It was evident on day 4 of the storage as there was a pronounced increase in TVB value, a demonstration of the effect of biochemical events that reduce quality in the initial phases of storage, while bacteria counts are still low, however, their metabolites would be responsible for deterioration in the fish freshness in a second phase as reported by Contreras-Guzmán (1994).

### Psychrotrophic aerobic heterotrophic bacteria counting

Figure 3 shows that psychrotrophic bacteria reached the exponential growth phase in samples with and without skin on the 28 day of storage, with respective values of log 9.40 and 7.90. Counts remained within the limits recommended by ICMSF (1986) of 107 UFC/g for aerobes total counts, until the day 18 of the storage in both samples.

According to the description by Huss (1997), tilapia fish is kept under good storage conditions, if bacterial counts results exceeded the acceptable limits only from the 22nd day of storage, and thus showing the good sanitary conditions under which the fishes were handled and kept. The present results was not in accordance with those obtained by Pullela et al. (1998), Martins et al. (2002) and Bartolomeu et al. (2011) who observed higher bacterial counts of above log 3.0 of the psychrotrophic bacteria in

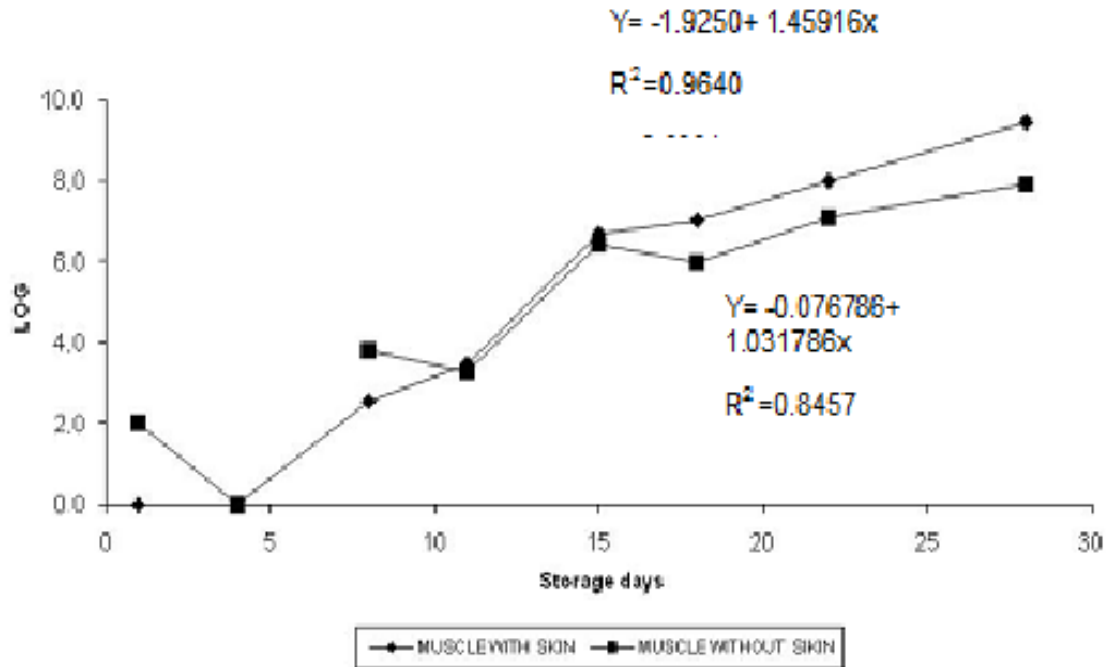

**Figure 3.** Logarithm results for the counting of psychrotrophic aerobic heterotrophic bacteria in farmed Nile tilapia (*O. niloticus*) eviscerated and stored in ice for 28 days.

a recently captured tilapia, while in the present work, bacterial counts approached these values only at the eighth day of storage on counts that reached this value.

### Conclusions

Based on the results obtained with QIM, QIs between 0 and 15 were considered as acceptable values for consumption. Although bacteria counts remained within acceptable limits for human consumption until the 18th day, QDA showed an increase in the perception of undesired attributes from 15th day of storage. A shelf-life of 15 days is suggested for eviscerated Nile tilapia stored on ice.

### Conflict of Interests

The authors have not declared any conflict of interests

### ACKNOWLEDGEMENTS

The authors thank the Coordenação de Aperfeiçoamento de Pessoal de Nível Superior (CAPES/Brasil) for providing the doctorate fellowship, and the Secretaria de Agricultura do município de Casimiro de Abreu [Department of Agriculture of Casimiro de Abreu], in the state of Rio de Janeiro, for supplying the tilapia samples.

### REFERENCES

- ABNT-Associação Brasileira de Normas Técnicas (1993). Normas ABNT – Definições das etapas básicas dos fluxos de operações em estabelecimentos produtores/fornecedores de alimentos. NBR 12806/93.
- Albuquerque WF, Zapata JFF, Almeida RS (2004). Estado de frescor, textura e composição muscular da tilápia do Nilo (*Oreochromis niloticus*) abatida com dióxido de carbono e armazenada em gelo. Revista Ciência Agronômica, número especial 35:264-271.
- Baixas-Nogueras, Bover-Cid, Veciana-Nogués, Nunes, Vidal-Carou (2003). Development of quality index method to evaluate freshness in Mediterranean hake (*Merluccius merluccius*). J. Food Sci. 68(3):1067-1071.
- Barbosa A, Vaz-Pires P (2004). Quality index method (QIM): development of a sensorial scheme for common octopus (*Octopus vulgaris*) de processamento de filé de tilápia (*Oreochromis niloticus*). Arch. Vet. Sci. 16(1):21-30.
- Bartolomeu DAFS, Dallabona BR, De Macedo REF, Kirschnik PG (2011). Contaminação microbiológica durante as etapas freshness in Mediterranean hake (*Merluccius merluccius*). J. Food Sci. 68(3):1067-1071.
- Beraquet NJ, Lindo MMK (1985). Transformações bioquímicas “post mortem” em pescado. Boletim do ITAL 22:169-192.
- Bogdanovic T, Simat V, Frka-Roić A, Marković K (2012). Development and Application of Quality Index Method Scheme in a Shelf-Life Study of Wild and Fish Farm Affected Bogue (*Boops boops* L.). J. Food Sci. 77(2).
- Bonilla AC, Sveinsdottir K, Martinsdottir E (2007). Development of Quality Index (QIM) scheme for fresh cod (*Gadus morhua*) fillets and application in shelf life study. Food Control 18:352-358.
- Brasil- Ministério da Agricultura (1981). Secretaria Nacional de Defesa Agropecuária. Laboratório Nacional de Referência Animal. Métodos analíticos oficiais para controle de produtos de origem animal e seus ingredientes: II – Métodos físicos e químicos. Brasília - DF.
- Brasil-Ministério da Agricultura (1981). Secretaria Nacional de Defesa Agropecuária. Laboratório Nacional de Referência Animal. Métodos

- análiticos oficiais para controle de produtos de origem animal e seus ingredientes: II – Métodos físicos e químicos. Brasília - DF.
- Brasil- Ministério da Agricultura e do Abastecimento (1997a). Secretaria Nacional de Defesa Agropecuária. Lei nº30691 de 29/03/97. Regulamento da Inspeção Industrial e Sanitária de Produtos de Origem Animal. Brasília – DF.
- Brasil- Ministério da Agricultura e do Abastecimento (1997b). Secretaria Nacional de Defesa Agropecuária. Portaria nº 185 de 13/05/97. Regulamento Técnico de Identidade e Qualidade de Peixe Fresco (Inteiro e Eviscerado). Brasília – DF.
- Brasil- Ministério da Pesca e Aquicultura. BOLETIM ESTATÍSTICO DA PESCA E AQUICULTURA (2011). <Available in [http://www.mpa.gov.br/files/docs/Boletim\\_MPA\\_2011\\_pub.pdf](http://www.mpa.gov.br/files/docs/Boletim_MPA_2011_pub.pdf) > Accessed on Jan. 19, 2015.
- Consin MA, Jay JM, Vasavada PC (2001). Psychrotrophic Microorganisms. In: APHA. American Public Health Association. Compendium of methods for the microbiological examination of foods. 4 Ed. APHA: Washington – DC. Chap. 13:159-165.
- Contreras-Guzmán ES (1994). Bioquímica de pescados e derivados. Jaboticabal: FUNEP, 409 pp.
- Cyprian OO, Sveinsdóttir K, Magnússon H, Martinsdóttir E (2008). Application of Quality Index Method (QIM) scheme and effects of short-time temperature abuse in shelf life study of fresh water arctic char (*Salvelinus alpinus*). J. Aquatic Food Product Technol. 17(3):303-321.
- Elisabetta T, Maybelyn I, Makie K, Jaime V (2001). Efecto del tiempo de retardo en la refrigeración sobre la frescura de la Tilapia (*Oreochromis* spp) cultivada. Anales Venezolanos de Nutrición 14(1):3-8.
- Esaiassen M, Nilsen H, Joensen S, Skjerdal T, Carlehog M, Eilertsen G, Gundersen B, Elvevoll E (2004). Effects of catching methods on quality changes during storage of cod (*Gadus morhua*). Lebensm. Wiss. U. Technol. 37:643-648.
- Guimarães OJ, Sales RO, Monteiro JCS (1988). Análise química, microbiológica e organoléptica da tilápia do Nilo (*Sarotherodon nilotic*), conservada em gelo. Ciência Agronômica 19(1):147-151.
- Huidobro A, Pastor A, Tejada M (2001). Quality index method developed for raw gilthead seabream (*Spaurus aurata*). J. Food Sci. 67(7):1202-1205.
- Huss HH (1997). Garantia da qualidade dos productos da pesca. FAO – Organização das Nações Unidas para Agricultura e Alimentação – Documento técnico sobre as pescas 334. Rome, 176 pp.
- Huss HH (1998). El pescado fresco: su calidad y cambios de su calidad. FAO – Organización das Nações Unidas para Agricultura e Alimentação – Documento técnico de pesca 348, Rome 202 pp.
- ICMSF. International Commission on Microbial Specifications for Foods (1986). Microorganisms in foods.2. Sampling for microbiological analysis: Principles and specific applications. 2 Ed. Blackwell Scientific Publications.
- Jónsdóttir SM (1992). Quality index method and TQM system. In: HUSS HH, El pescado fresco: su calidad y cambios de su calidad. FAO – Organización das Nações Unidas para Agricultura e Alimentação – Documento técnico de pesca 348. Rome, 1998. 202 pp.
- Kent M, Oehlenschläger J, Mierke-Klemeyer S, Manthey-Karl M, Knöchel R, Daschner F, Schimmer O (2004). A new multivariate approach to the problem of fish quality estimation. Food Chem. 87:531-535.
- Luten JB, Martinsdóttir E (1997). QIM: A European tool for fish freshness evaluation in the fishery chain. In Proceedings of the final meeting of the concerted action “evaluation of fish freshness”. Methods to determine the freshness of fish in research and industry. Paris:International Institute of Refrigeration. pp. 287-296.
- Martins CVB, Vaz SK, Minozzo MG (2002). Aspectos sanitários de pescados comercializados em “pesque-pagues” de Toledo (PR). Hig. Aliment. 16:51-56.
- Martinsdóttir E (1997). Sensory evaluation in research of fish freshness. In Proceedings of the final meeting of the concerted action “evaluation of fish freshness”. Methods to determine the freshness of fish in research and industry Paris: International Institute of Refrigeration. pp. 306-312.
- Morton RD (2001). Aerobic Plate Count. In: APHA. American Public Health Association. Compendium of methods for the microbiological examination of foods. 4 Ed. APHA: Washington – DC. Cap. 7:63-67.
- Netto FM (1984). Modificações químicas, bioquímicas e sensoriais do híbrido de tilápia estocado em gelo. Campinas, 1984. 87 f. Thesis (Masters on Food Technology), Universidade Estadual de Campinas. Campinas.
- Oliveira VM, Clemente SCS, Mársico ET (2009). Método do índice de qualidade (MIQ) desenvolvido para camarão (*Litopenaeus vannamei*) cultivado. Rev. Ciênc. Vida 29(1):60-67.
- Pullela S, Fernandes CF, Flick GJ, Libey GS, Smith SA, Coale CW (1998). Indicative and pathogenic microbiological quality of aquacultured finfish grown in different production system. J. Food Prot. 61(2):205-210.
- Sabbag OJ, Dos Rangel RR, Tarsitana MAA, Silveira AN (2007). Análise econômica da produção de tilápias (*Oreochromis niloticus*) em um modelo de propriedade associativista em Ilha Solteira/SP. Custos e @gronegocio on line -3(2) - Jul/Dez .<Disponível em <http://www.custoseagronegocioonline.com.br> > Access on Jan 27 2015.
- Sales RO, Oliveira JAP, Costa FJL, Sales AM (1988). Avaliação do estado de frescor do pescado capturado em água doce e mantido sob refrigeração, no açude de Orós, Ceará. Ciência. Agronômica 19(2):109-115.
- SAS. Statistical Analyses Systems (1985). SAS® User's Guide. Carry: SAS Institute Inc. 959 p.
- Soares KM, Gonçalves A (2012). Aplicação do método do índice de qualidade (MIQ) para o estudo da vida útil de filés de tilápia do Nilo (*Oreochromis niloticus*) sem pele, armazenados em gelo. Semina: Ciências Agrárias 33(6):2289-2300.
- Soccol MCH (2002). Otimização da vida útil da tilápia cultivada (*Oreochromis niloticus*), minimamente processada e armazenada sob refrigeração. Piracicaba (2002). 141 f. Dissertação (Mestrado em Ciência e Tecnologia de Alimentos), Universidade de São Paulo. Piracicaba.
- Stone L, Sidel JL (1998). Quantitative descriptive analysis: developments, applications, and the future. Food Technol. 52(8):48-52.
- Sveinsdóttir K, Hyldig G, Martinsdóttir E, Jørgensen B, Kristbergsson K (2003). Quality Index Method (QIM) scheme developed for farmed Atlantic salmon (*Salmo salar*). Food Qual. Pref. 14:237-245.
- Sveinsdóttir K, Martinsdóttir G, Hyldig B, Jørgensen B, Kristbergsson K (2002). Application of quality index method (QIM) scheme in shelf-life study of farmed Atlantic Salmon (*Salmo salar*). J. food Sci. 67(4).
- Sykes AV (2009). Assessment of European cuttlefish (*Sepia officinalis* L.) nutritional value and freshness under ice storage using a developed Quality Index Method (QIM) and biochemical methods. Food Sci. Technol. 42(1):424-432.
- Teixeira MS (2005). Estudo das características sensoriais da corvina (*Micropogonias furnieri*) eviscerada e estocada em gelo. Niterói, 2005. 80 f. Thesis (Masters on Veterinarian Hygiene and POA Technological Processing), Universidade Federal Fluminense, Niterói.
- Triqui R, Bouchriti N (2003). Freshness assessments of Moroccan sardine (*Sardina pilchardus*): comparison of overall sensory changes to instrumentally determined volatiles. J. Agric. Food Chem. 51:7540-7546.

# African Journal of Agricultural Research



## Related Journals Published by Academic Journals

- *African Journal of Environmental Science & Technology*
- *Biotechnology & Molecular Biology Reviews*
- *African Journal of Biochemistry Research*
- *African Journal of Microbiology Research*
- *African Journal of Pure & Applied Chemistry*
- *African Journal of Food Science*
- *African Journal of Biotechnology*
- *African Journal of Pharmacy & Pharmacology*
- *African Journal of Plant Science*
- *Journal of Medicinal Plant Research*
- *International Journal of Physical Sciences*
- *Scientific Research and Essays*

**academicJournals**