

F I A T 1 2 4 S P I D E R



O W N E R H A N D B O O K

This Owner Handbook is intended to show the vehicle's operating conditions.

For the enthusiast user who wants to have insights, curiosities and detailed information about the characteristics and functions of the vehicle, Fiat gives the opportunity to consult a dedicated section which is available in electronic format.

ONLINE VEHICLE OWNER HANDBOOK

The following symbol  is reported within the text of the Owner Handbook, next to the subjects for which details are provided.

Go to the www.mopar.eu/owner website and access your personal area.

The “Maintenance and care” page includes all the information about your vehicle and the link to access *eLUM*, where you will find all the details of the Owner Handbook.

Alternatively, to access this information, go to the Internet website at <http://aftersales.fiat.com/elum/>.

The *eLUM* website is free and will allow you, among many other things, to easily consult the on-board documents of all the other vehicles of the Group.

Have a nice reading and happy motoring!

Dear Customer,

We would like to congratulate and thank you for choosing a Fiat 124 Spider.

We have written this handbook to help you get to know all the features of your vehicle and use it in the best possible way.

Here you will find information, advice and important warnings regarding use of your vehicle and how to achieve the best performance from the technical features of your vehicle.

You are advised to read it right through before taking to the road for the first time, to become familiar with the controls and above all with those concerning brakes, steering and gearbox; at the same time, you can understand the vehicle behaviour on different road surfaces.

This document also provides a description of special features and tips, as well as essential information for the safe driving, care and maintenance of your vehicle over time.

After reading it, you are advised to keep the handbook inside the vehicle, for an easy reference and for making sure it remains on board the vehicle should it be sold.

In the attached Warranty Booklet you will also find a description of the Services that FCA offers to its customers, the Warranty Certificate and the detail of the terms and conditions for maintaining its validity.

We are sure that these will help you to get in touch with and appreciate your new vehicle and the service provided by the people at FCA.

Enjoy reading. Happy motoring!

IMPORTANT This Owner Handbook describes all versions of the vehicle; please consider only the information relevant to your vehicle's trim level, engine and version. All data contained in this publication are purely indicative. FCA Italy S.p.A. can modify the vehicle model described in this publication at any time, for technical or commercial purposes. For further information, contact a Fiat Dealership.

READ THIS CAREFULLY

REFUELLING



Only refuel with unleaded petrol with octane rating (RON) not less than 95 in compliance with the European specification EN228. Do not use petrol containing methanol or ethanol E85. Using these mixtures may cause misfiring and handling issues, as well as damage fundamental components of the supply system.

STARTING THE ENGINE



Versions with manual transmission: make sure that the handbrake is engaged; set the gear lever to neutral, fully depress the clutch pedal without pressing the accelerator, then press the ignition device button.

Versions with automatic transmission: make sure that the handbrake is engaged and that the gear lever is in P (Park) or N (Neutral), depress the brake pedal, then press the ignition device button.

PARKING ON FLAMMABLE MATERIAL



The catalytic converter develops high temperatures during operation. Do not park the vehicle on grass, dry leaves, pine needles or other flammable material: fire hazard.

RESPECTING THE ENVIRONMENT



The vehicle is fitted with a system that carries out a continuous diagnosis of the emission-related components in order to help protect the environment.

ELECTRICAL ACCESSORIES



Contact a Fiat Dealership if you decide to add electrical accessories (with the risk of gradually draining the battery) after buying the vehicle. They can calculate the overall electrical requirement and check that the vehicle's electric system can support the required load.

SCHEDULED SERVICING



Correct maintenance of the vehicle is essential for ensuring that it maintains its performance and its safety features, its environmental friendliness and low running costs unchanged over time.

HOW TO USE THIS MANUAL

ESSENTIAL INFORMATION

Each time directions are given in the instructions (left/right or forward/backwards), these must be intended as referred to the point of view of an occupant in the driver's seat. Special cases not complying with this rule will be properly specified in the text.

The figures in the Owner Handbook are provided by way of example only: this might imply that some details of the image do not correspond to the actual arrangement of your vehicle. In addition, the Handbook has been conceived considering vehicles with steering wheel on the left side; it is therefore possible that on vehicles with steering wheel on the right side, the position of some controls or elements is not exactly mirror-like with respect to the figure.

To identify the chapter with the information needed you can consult the index at the end of this Owner Handbook.

Chapters can be rapidly identified by graphic tabs, at the side of each odd page. A key showing the order of the chapter and the corresponding tab symbols appears on another page.

SYMBOLS

While reading this Owner Handbook you will find a series of **WARNINGS** to prevent procedures that could damage your vehicle.

There are also **PRECAUTIONS** that must be carefully followed to prevent incorrect use of the components of the vehicle, which could cause accidents or injuries.

Therefore, all **WARNINGS** and **PRECAUTIONS** must always be carefully followed.

WARNINGS and **PRECAUTIONS** are recalled in the text with the following symbols:



personal safety



vehicle safety



environmental protection

GETTING TO KNOW YOUR VEHICLE



KNOWING THE INSTRUMENT PANEL



SAFETY



STARTING AND OPERATING



IN CASE OF EMERGENCY



MAINTENANCE AND CARE



TECHNICAL SPECIFICATIONS



MULTIMEDIA



INDEX



GETTING TO KNOW YOUR VEHICLE

In-depth knowledge of your new vehicle starts here.

The handbook that you are reading simply and directly explains how it is made and how it works.

That's why we advise you to read it seated comfortably on board, so that you can see immediately what is described here for yourself.

DASHBOARD8
KEYS9
IGNITION SWITCH11
ADVANCED KEYLESS ENTRY SYSTEM14
VEHICLE SECURITY ALARM15
DOORS16
SEATS19
HEAD RESTRAINTS21
STEERING WHEEL22
MIRRORS22
EXTERIOR LIGHTS24
WINDSCREEN WIPERS / WASHER30
CLIMATE CONTROL SYSTEM32
POWER WINDOWS38
INTERNAL EQUIPMENT39
BOOT LID40
BONNET42
CONVERTIBLE TOP (SOFT TOP)43

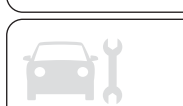

DASHBOARD

02010200-123-555

1 – Side adjustable vents; 2 – Exterior light control stalk; 3 – Instrument panel; 4 – Windscreen wiper washer stalk; 5 – Center adjustable air vents; 6 – Hazard warning lights button; 7 – Radio 3"/Radio 7" system (where provided); 8 – Passenger Air Bag; 9 – Center adjustable air vents (passenger side); 10 – Climate control system; 11 – Ignition switch; 12 – Driver Air Bag; 13 – Control buttons (TPMS system/DSC system)

KEYS



KEYS



A code number is stamped on the plate attached to the key set; detach this plate and store it in a safe place (not in the vehicle) for use if you need to make a replacement key (auxiliary key).

Also write down the code number and keep it in a separate safe and convenient place, but not in the vehicle. If your key (auxiliary key) fig. 2 is lost, consult Fiat Dealership and have your code number ready (1 = auxiliary key /2 = transmitter/3 = key code number plate).



2

04010100-361-002

IMPORTANT Always keep a spare key in case one is lost. If a key is lost, go to a Fiat Dealership as soon as possible.

IMPORTANT The driver must carry the key to ensure the system functions properly.

KEYLESS ENTRY SYSTEM

This system uses the key buttons to remotely lock and unlock the doors and the boot lid, fuel-filler flap, and opens the boot lid.

The system can start the engine without having to take the key out of your purse or pocket.

Note

□ The keyless entry system operation may vary due to local conditions.

□ The keyless entry system is fully operational (door/boot lid/fuel-filler flap lock/unlock) when the ignition is switched off. The system does not operate if the ignition is switched to any position other than off.

□ If the key does not operate when pressing a button or the operational range becomes too small, the battery may be dead.

□ Battery life is about one year.

Replace the battery with a new one if the  warning light (green) flashes in the instrument cluster. Replacing the battery about once a year is recommended because the warning light/indicator light may not illuminate or flash depending on the rate of battery depletion.

□ Additional keys can be obtained at Fiat Dealership. Up to 6 keys can be used with the keyless functions per vehicle. Bring all keys to Fiat Dealership when additional keys are required.

TRANSMITTER

Buttons

□ **Lock button:** to lock the doors, the boot lid and the fuel filler flap, press the  button. The hazard warning lights will flash once. The doors and the boot lid, fuel filler flap cannot be locked by pressing the lock button while any other door is open. The hazard warning lights will also not flash.

□ **Unlock button:** to unlock the doors and the boot lid, press the  button. The hazard warning lights will flash twice.

□ **Boot button:** to open the boot lid, press and hold the  button until the boot lid opens.

KEY SUSPEND FUNCTION

If a key is left in the vehicle, the functions of the key left in the vehicle are temporarily suspended to prevent theft of the vehicle.

To restore the functions, press the unlock button on the functions-suspended key in the vehicle.

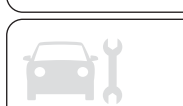

KEY BATTERY REPLACEMENT



2)



1) 2) 3) 4) 5)



1)

If the buttons on the transmitter are inoperable and the operation indicator light does not flash, the battery may be dead.

Replace with a new battery (CR2025 type) before the transmitter becomes unusable.

The following conditions indicate that the battery power is low:

- indicator light (green) flashes in the instrument cluster for about 30 seconds after the engine is turned off;
- the system does not operate and the operation indicator light on the transmitter does not flash when the buttons are pressed;
- the system's operational range is reduced.

NOTE Replacing the battery at a Fiat Dealership is recommended to prevent damage to the key. If replacing the battery by yourself, follow the instruction below.



WARNING

1) Do not leave the key in your vehicle with children and keep them in a place where your children will not find or play with them: leaving children in a vehicle with the key is dangerous. This could result in someone being badly injured or even killed. Children may find these keys to be an interesting toy to play with and could cause the power windows or other controls to operate, or even make the vehicle move.

2) There is the danger of explosion if the battery is not correctly replaced.



IMPORTANT

1) The electronic components inside the key may be damaged if the key is subjected to strong shocks. In order to ensure complete efficiency of the electronic devices inside the key, it should never be exposed to direct sunlight.

2) Make sure the battery is installed correctly. Battery leakage could occur if it is not installed correctly.

3) When replacing the battery, be careful not to touch any of the internal circuitry and electrical terminals, bend the electrical terminals, or get dirt in the transmitter as the transmitter could be damaged.

4) Dispose of used batteries according to the following instructions: insulate the plus and minus terminals of the battery using cellophane or equivalent tape. Never disassemble. Never throw the battery into fire or water. Never deform or crush.

5) Replace only with the same type battery (CR2025 or equivalent).



IMPORTANT

1) Used batteries may be harmful to the environment if not disposed of correctly. They must be disposed of as specified by law in the special containers or taken to a Fiat Dealership, which will take care of their disposal.

IGNITION SWITCH



PUSH BUTTON START POSITIONS

The system operates only when the key is within operational range.

Each time the push button start fig. 3 is pressed, the ignition switches in the order of OFF, ACC, and ON. Pressing the push button start again from ON switches the ignition off.



3

05010101-L12-001

Note

- ❑ The engine starts by pressing the push button start while depressing the clutch pedal (manual transmission) or the brake pedal (automatic transmission). To switch the ignition position, press the push button start without depressing the pedal.
- ❑ Do not leave the ignition switched ON while the engine is not running.

Doing so could result in the battery going dead. If the ignition is left in ACC (for automatic transmission, the selector lever is in the P position, and the ignition is in ACC), the ignition switches off automatically after about 25 minutes.

OFF



The power supply to electrical devices turns off and the push button start indicator light (amber) also turns off. In this position the steering wheel is locked.

Locked steering wheel

If the push button start indicator light (green) is flashing and the beep sound is heard, this indicates that the steering wheel is not unlocked. To unlock the steering wheel, press the push button start while moving the steering wheel left and right.

ACC (Accessory)

Some electrical accessories will operate and the indicator light (amber) illuminates. In this position the steering wheel is unlocked. The keyless entry system does not function while the push button start has been pressed to ACC, and the doors will not lock/unlock even if they have been locked manually.

ON

This is the normal running position after the engine is started. The indicator light (amber) turns off (the indicator light amber illuminates when the ignition is switched ON and the engine is not running).

STARTING THE ENGINE



Proceed as follows:

- ❑ make sure you are carrying the key;
- ❑ occupants should fasten their seat belts;
- ❑ make sure the parking brake is on. Continue to press the brake pedal firmly until the engine has completely started;
- ❑ **manual transmission:** continue to press the clutch pedal firmly until the engine has completely started.
- ❑ **Automatic transmission:** put the vehicle in park (P). If you must restart the engine while the vehicle is moving, shift into neutral (N);
- ❑ verify that the indicator light (green) in the instrument cluster fig. 4 and the push button start indicator light (green) illuminate;
- ❑ press the push button start after both the indicator light (green) in the instrument cluster and the push button start indicator light (green) illuminate;
- ❑ after starting the engine, let it idle for about 10 seconds.

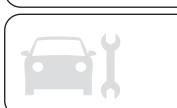





4



05020106-12A-001

Manual transmission: the starter will not operate if the clutch pedal is not depressed sufficiently.

Automatic transmission: the starter will not operate if the selector lever is not in P or N and the brake pedal is not depressed sufficiently.

IMPORTANT If the  warning light (red) illuminates, or the push button start indicator light (amber) flashes, this could indicate a problem with the engine starting system and the inability to start the engine or switch the ignition to ACC or ON. Contact a Fiat Dealership as soon as possible.

Under the following conditions, the  warning light (red) flashes after the push button start is pressed to inform the driver that the push button start will not switch to ACC even if it is pressed from off:

- the key battery is dead;
- the key is out of operational range;
- the key is placed in areas where it is difficult for the system to detect the signal;
- a key from another manufacturer similar to the key is in the operational range;
- forced engine starting method:** if the  warning light (red) illuminates, or the push button start indicator light (amber) flashes, this could indicate that the engine may not start using the usual starting method. Contact a Fiat Dealership as soon as possible. If this occurs, the engine can be force-started. Press and hold the push button start until the engine starts. Other procedures necessary for starting the engine such as having the key in the cabin, and depressing the clutch pedal (manual transmission) or the brake pedal (automatic transmission) are required;
- when the engine is force-started, the  warning light (red) remains illuminated and the push button start indicator light (amber) remains flashing;
- automatic transmission:** when the selector lever is in the neutral (N) position, the  indicator light (green) and the push button start indicator light (green) do not illuminate.

NOTE Whether the engine is cold or

warm, it should be started without the use of the accelerator.

NOTE If the engine does not start the first time, refer to “Starting a flooded engine under emergency starting” paragraph. If the engine still does not start, contact a Fiat Dealership.

Engine start function when key battery is dead

When starting the engine by holding the transmitter over the push button start due to a dead key battery or a malfunctioning key, be careful not to allow the following, otherwise the signal from the key will not be received correctly and the engine may not start: metal parts of other keys or metal objects touch the key/spare keys or keys for other vehicles equipped with an immobilizer system touch or come near the key/devices for electronic purchases, or security passage touch or come near the key.

If the engine cannot be started due to a dead key battery, the engine can be started using the following procedure:

- continue to depress the brake pedal firmly until the engine has completely started;
- manual transmission:** continue to depress the clutch pedal firmly until the engine has completely started;

- verify that the push button start indication light (green) flashes;
- touch the push button start using the backside of the key (as shown in fig. 5) while the push button start indicator light (green) flashes;
- verify that the push button start indicator light (green) turns on;
- press the push button start to start the engine.



5

05010201-L12-001

When touching the push button start using the backside of the key as shown in the illustration, touch the push button start with the lock switch side of the key facing up.

The engine cannot be started unless the clutch pedal is fully depressed (manual transmission) or the brake pedal is fully depressed (automatic transmission).

If there is a malfunction with the push

button start function, the push button start indicator light (amber) flashes. In this case, the engine may start, however contact a Fiat Dealership as soon as possible.

If the push button start indicator light (green) does not illuminate, perform the operation from the beginning again. If it does not illuminate contact a Fiat Dealership.

To switch the ignition position without starting the engine, perform the following operations after the push button start indicator light (green) turns on:

- release the clutch pedal (manual transmission) or brake pedal (automatic transmission);
- press the push button start to switch the ignition position. The ignition switches in the order of ACC, ON, and OFF each time the push button start is pressed. To switch the ignition position again, perform the operation from the beginning.

TURNING THE ENGINE OFF



Proceed as follows:

- stop the vehicle completely;
- manual transmission:** shift into neutral and set the parking brake.
- Automatic transmission:** shift the

selector lever to the P position and set the parking brake.

- press the push button start to turn off the engine. The ignition position is OFF.

IMPORTANT When leaving the vehicle, make sure the push button start is off.

Emergency engine stop

Continuously pressing the push button start or quickly pressing it any number of times while the engine is running or the vehicle is being driven will turn the engine off immediately. The ignition switches to ACC.



WARNING

3) Before leaving the driver's seat, always switch the ignition off, set the parking brake, and make sure the selector lever is in P (automatic transmission) or in 1st gear or R (manual transmission). Leaving the driver's seat without switching the ignition off, setting the parking brake, and shifting the selector lever to P (automatic transmission) or to 1st gear or R (manual transmission) is dangerous. Unexpected vehicle movement could occur which could result in an accident. In addition, if your intention is to leave the vehicle for even a short period, it is important to switch the ignition off, as leaving it in another position will disable some of the vehicle's security systems and run the battery down.



- 4)** Radio waves from the key may affect medical devices such as pacemakers. Before using the key near people who use medical devices, ask the medical device manufacturer or your physician if radio waves from the key will affect the device.
- 5)** Do not stop the engine while the vehicle is moving. Stopping the engine while the vehicle is moving for any reason other than in an emergency is dangerous. Stopping the engine while the vehicle is moving will result in reduced braking ability due to the loss of power braking, which could cause an accident and serious injury.
- 6)** Always take the key with you when you leave your vehicle to prevent someone from accidentally operating the controls. Remember to engage the parking brake. Never leave children unattended in the vehicle.

ADVANCED KEYLESS ENTRY SYSTEM

(where provided)



6)

The advanced keyless function allows you to lock/unlock the door and the boot lid, fuel filler flap, or open the boot lid while carrying the key.

IMPORTANT Radio waves from the key may affect medical devices such as pacemakers: before using the key near people who use medical devices, ask the medical device manufacturer or your physician if radio waves from the key will affect the device.

IMPORTANT The advanced keyless entry system functions can be deactivated to prevent any possible adverse effect on a user wearing a pacemaker or other medical device. If the system is deactivated, you will be unable to start the engine by carrying the key. Contact a Fiat Dealership for details. If the advanced keyless entry system has been deactivated, you can start the engine by following the procedure indicated when the key battery goes dead.



IMPORTANT

6) The operation of the recognition system depends on various factors, such as, for example, any electromagnetic wave interference from external sources (e.g. mobile phones), the charge of the battery in the electronic key and the presence of metal objects near the key or the vehicle. In these cases it is still possible to unlock the doors by using the metal insert in the electronic key (see description on the following pages).

VEHICLE SECURITY ALARM



(where provided)



IMMOBILIZER SYSTEM

The immobilizer system allows the engine to start only with a key the system recognises. If you have a problem with the immobilizer system or the key, contact a Fiat Dealership.

Arming the system: the system is armed when the ignition is switched from ON to OFF. The  warning light in the instrument cluster flashes every 2 seconds until the system is disarmed.

Disarming the system: the system is disarmed when the ignition is switched ON with the correct programmed key. The  warning light illuminates for about 3 seconds and then turns off. If the engine does not start with the correct key, and the  warning light remains illuminated or flashing, try the following:

- ❑ make sure the key is within the operational range for signal transmission;
- ❑ switch the ignition off, and then restart the engine. If the engine does not start after 3 or more tries, contact a Fiat Dealership.

If the  warning light flashes

continuously while you are driving, do not shut off the engine. Contact a Fiat Dealership and have it checked. If the engine is shut off while the warning light is flashing, you will not be able to restart it.

THEFT DETERRENT SYSTEM

(where provided)

Intrusion sensor

(where provided)

The intrusion sensor fig. 6 uses ultrasonic waves to detect movement inside the vehicle and to raise an alert of an intrusion into the vehicle.

The intrusion sensor detects certain kinds of movement inside the vehicle, however, it may also respond to phenomenon outside the vehicle such as vibrations, loud noise, wind, and air currents.

In order for the intrusion sensor to operate appropriately, be aware of the following:

- ❑ do not hang clothing or objects from a head restraint;
- ❑ return the sunvisors to their original positions;
- ❑ do not blind the intrusion sensor by covering it or placing objects over it;
- ❑ do not allow the intrusion sensor to get soiled or wipe it with a liquid;

❑ do not shock or cause an impact to the intrusion sensor or the intrusion sensor bezel;

- ❑ do not install seats or seat covers that are not FCA genuine products;
- ❑ to prevent obstruction of intrusion sensor, do not place objects or cargo near the intrusion sensor that are higher than the head restraints.



6

04080300-12A-001

How to arm the system

Proceed as follows:

- ❑ close the windows and the convertible top securely, switch the ignition OFF and make sure the bonnet, convertible top, the doors, and the boot lid are closed;
- ❑ press the lock button on the transmitter or lock the driver's door from the outside with the auxiliary key. The hazard warning lights will flash once. **With the advanced keyless function:** press a request switch. The



 warning light in the instrument panel flashes twice per second for 20 seconds. After 20 seconds, the system is fully armed.

With the intrusion sensor: the intrusion sensor function can be armed only when the convertible top is closed. Even with a window open, the system can be armed, however, leaving the windows even partially open can invite theft, and wind blowing into the vehicle could trigger the alarm. The intrusion sensor function can also be cancelled.

DOORS



LOCK / UNLOCK WITH AUXILIARY KEY



Both doors and the boot lid, fuel filler flap lock automatically when the driver's door is locked using the auxiliary key.

They both unlock when the driver's door is unlocked using the auxiliary key. Turn the auxiliary key toward the front to lock, toward the back to unlock.

MANUAL LOCK / UNLOCK

Operation from inside

Both doors and the boot lid, fuel filler flap lock automatically when the driver's door-lock knob is pressed. They both unlock when the driver's door-lock knob 1 fig. 7 is pulled out.



7

04030107-L21-001

IMPORTANT The red indication 2 can be seen when the door-lock knob is unlocked.

Operation from outside

To lock the passenger door with the door-lock knob from the outside, press the door-lock knob to the lock position and close the door (holding the door handle in the open position is not required).

This does not operate the other door locks.

IMPORTANT When locking the door this way: be careful not to leave the key inside the vehicle. The driver's door lock knob cannot be used while the driver's door is open.

DEAD LOCK DEVICE

(where provided)

Dead lock device is designed to prevent someone who has broken into your vehicle from opening the door from the inside. If you have any problems with the dead lock device, contact a Fiat Dealership.

System activation

Proceed as follows:

- close both the windows and the convertible top;
- switch the ignition off and take the key with you;
- close both doors and boot lid;

- ❑ insert the auxiliary key in the driver's door, turn the auxiliary key to the lock position fig. 8, and return it to the centre position. Then turn it to the lock position again within 3 seconds;
- ❑ the  indicator light illuminates for about 3 seconds to indicate that the system has been activated.



8

04030102-12A-001

You can also activate the system by pressing the “lock” button on the transmitter twice within 3 seconds.

With the advanced keyless function: you can also activate the system by pressing the “door locking” switch twice within 3 seconds.

NOTE The system cannot be activated when any door is open.

System deactivation

Unlock the driver's door or switch the ignition ON. If the power supply is interrupted (fuse blows or the battery is

disconnected), the system can only be deactivated by unlocking a door with the auxiliary key.

PASSIVE ENTRY

(with Advanced Keyless function)

Both doors and the boot lid, fuel filler flap can be locked/unlocked by pressing the “door locking” button on the handlefig. 9 while the key is being carried.



9

04000098-121-555

To lock

To lock the doors and the boot lid, fuel filler flap, press the “door locking” switch and the hazard warning lights will flash once.

To unlock

To unlock the doors and the boot lid, fuel filler flap, press the “door locking” switch and the hazard warning lights will flash twice.



NOTE Confirm that both doors and the boot lid, fuel filler flap are securely locked.

NOTE Both doors and the boot lid, fuel filler flap cannot be locked when any door is open.

NOTE It may require a few seconds for the doors to unlock after the “door locking” switch is pressed.

The setting can be changed so that a beep sound is heard for confirmation when the doors and the boot lid, fuel filler flap are locked/unlocked using a “door locking” switch.

The volume of the beep sound can also be changed. Use the following procedure to change the setting:

- ❑ switch the ignition off and close both of the doors and the boot lid;
- ❑ open the driver's door;
- ❑ within 30 seconds of opening the driver's door, press and hold the  button on the key for 5 seconds or longer. Both of the doors and the boot lid, fuel filler flap lock and the beep sound activates at the currently set volume (if the beep sound is currently set to not activate, it will not activate).
- The setting changes each time the  button on the key is pressed and the beep sound activates at the set volume (if the beep sound has been set to not activate, it will not activate);



- The setting change is completed by doing any one of the following:
- switching the ignition to ACC or ON;
 - closing the driver's door;
 - opening the boot lid;
 - not operating the key for 10 seconds;
 - pressing any button except the  button on the key;
 - pressing a “door locking” switch.

With theft-deterrent system

The hazard warning lights flash when the theft-deterrent system is armed or turned off (refer to “Theft-deterrent system” in “Vehicle security alarm” paragraph).

With dead lock device

Pressing the “door locking” switch twice within 3 seconds will activate the dead lock device. The setting can be changed so that the doors and the boot lid, fuel filler flap are locked automatically without pressing the “door locking” switch.

Auto-lock function

A beep sound is heard when both doors are closed while the advanced key is being carried.

Both doors and the boot lid, fuel filler flap are locked automatically after about

three seconds when the advanced key is out of the operational range.

Also, the hazard warning lights flash once (even if the driver is in the operational range, both doors and the boot lid, fuel filler flap are locked automatically after about 30 seconds).

If you are out of the operational range before the doors and the boot lid are completely closed or another key is left in the vehicle, the auto-lock function will not work.

Always make sure that both doors and the boot lid are closed and locked before leaving the vehicle. The auto-lock function does not close the power windows.

Auto re-lock function

After unlocking with the “door locking” switch, both doors and the boot lid, fuel filler flap will automatically re-lock if any of the following operations are not performed within about 30 seconds:

- Opening a door or the boot lid.
- Switching the ignition to any position other than off.

If your vehicle has a theft-deterrent system, the hazard warning lights will flash for confirmation.

The time required for the doors and the boot lid, fuel filler flap to lock automatically can be changed (refer to

“Personalisation features” paragraph in “Knowing the instrument panel” chapter).

LOCKING / UNLOCKING WITH TRANSMITTER

Both doors and the boot lid, fuel filler flap can be locked/unlocked by operating the keyless entry system transmitter: refer to “Keyless entry system” in “Keys” paragraph.



WARNING

7) Always take all children and pets with you or leave a responsible person with them: leaving a child or a pet unattended in a parked vehicle is dangerous. In hot weather, temperatures inside a vehicle can become high enough to cause brain damage or even death.

8) Do not leave the key in your vehicle with children and keep them in a place where your children will not find or play with them: leaving children in a vehicle with the key is dangerous. This could result in someone being badly injured or even killed.

9) Always close both the windows and convertible top, lock the doors and take the key with you when leaving your vehicle unattended: leaving your vehicle unlocked is dangerous as children could lock themselves in a hot vehicle, which could result in death. Also, a vehicle left unlocked becomes an easy target for thieves and intruders.

10) After closing the doors, always verify that they are securely closed: doors not securely closed are dangerous, if the vehicle is driven with a door not securely closed, the door could open unexpectedly resulting in an accident.

11) Always confirm the safety around the vehicle before opening a door: suddenly opening a door is dangerous. A passing vehicle or a pedestrian could be hit and cause an accident.

12) Always confirm the conditions around the vehicle before opening/closing the doors and use caution during strong winds or when parked on an incline. Not being aware of the conditions around the vehicle is dangerous because fingers could get caught in the door or a passing pedestrian could be hit, resulting in an unexpected accident or injury.

13) If the power window does not go up or down automatically because the battery is dead, slowly open/close the power window while pressing the glass inward. Otherwise, the power window may contact the convertible top and the door cannot be opened/closed resulting in damage to the window.

14) Never activate the double locking system with passengers, especially children, still inside the vehicle: activating the system with passengers, especially children, still inside the vehicle is dangerous. The passengers cannot open the doors from inside. They would be trapped and subjected to extreme temperatures. This could result in serious injuries or even death.

SEATS

MANUAL ADJUSTMENT

 15) 16) 17) 18) 19) 20) 21) 22) 23) 24) 25) 26) 27) 28) 29)

 7)

Forward / Rearward

To move a seat forward or backward, raise the lever 1 fig. 10 and slide the seat to the desired position and release the lever.



10

03010202-12A-003

Make sure the lever returns to its original position and the seat is locked in place by attempting to push it forward and backward.

Height

To adjust the height for front edge of the seat bottom, rotate the dial 2 to the desired position.

Seat recline

To change the seatback angle, lean forward slightly while raising the lever 3. Then lean back to the desired position and release the lever.

Make sure the lever returns to its original position and the seatback is locked in place by attempting to push it forward and backward.

HEATED SEATS

(where provided)

 29) 30) 31) 32)

The seats are electrically heated. The ignition must be switched ON.

Press the seat warmer switch fig. 11 to illuminate the indicator light while the ignition is switched ON.

The mode changes as follows each time the seat warmer switch is pressed.



11

03010203-L12-002



IMPORTANT Do not use organic solvents to clean the seat. It may damage the seat surface and the heater.

Note

- If the ignition is switched off while the seat warmer is operating (High, Mid or Low) and then switched ON again, the seat warmer will automatically operate at the temperature set before switching off the ignition.
- Use the seat warmer when the engine is running. Leaving the seat warmer on for long periods with the engine not running could cause the battery power to be depleted.
- The temperature of the seat warmer cannot be adjusted beyond High, Mid and Low because the seat warmer is controlled by a thermostat.



WARNING

15) Make sure the adjustable components of a seat are locked in place. Adjustable seats and seatbacks that are not securely locked are dangerous. In a sudden stop or collision, the seat or seatback could move, causing injury. Make sure the adjustable components of the seat are locked in place by attempting to slide the seat forward and backward and rocking the seatback.

16) Never allow children to adjust a seat. Allowing children to adjust a seat is dangerous as it could result in serious injury if a child's hands or feet become caught in the seat.

17) Do not drive with the seatback unlocked. All of the seatbacks play an important role in your protection in a vehicle. Leaving the seatback unlocked is dangerous as it can allow passengers to be ejected or thrown around and baggage to strike occupants in a sudden stop or collision, resulting in severe injury. After adjusting the seatback at any time, even when there are no other passengers, rock the seatback to make sure it is locked in place.

18) Adjust the driver's seat only when the vehicle is stopped. Adjusting the driver's seat while the vehicle is moving is dangerous. The driver could lose control of the vehicle and have an accident.

19) Do not modify or replace the seats. Modifying or replacing the seats such as replacing the upholstery or loosening any bolts is dangerous. The seats contain air bag components essential to the supplementary restraint system. Such modifications could damage the supplementary restraint system and result in serious injury. Consult a Fiat Dealership if there is any need to remove or reinstall the seats.

20) Do not drive with damaged seats. Driving with damaged seats, such as seat cushions torn or damaged down to the urethane, is dangerous. A collision, even one not strong enough to inflate the air bags, could damage the seats which contain essential air bag components. If there was a subsequent collision, an air bag may not deploy which could lead to injuries. Always have a Fiat Dealership inspect the seats, seat belt pretensioners and air bags after a collision.

21) Do not drive with either seats reclined. Sitting in a reclined position while the vehicle is moving is dangerous because you do not get the full protection from seat belts. During sudden braking or a collision, you can slide under the lap belt and suffer serious internal injuries. For maximum protection, sit well back and upright.

22) Do not place an object such as a cushion between the seatback and your back. Putting an object such as a cushion between the seatback and your back is dangerous because you will be unable to maintain a safe driving posture and the seat belt cannot function at its full capacity in a collision, which could result in a serious accident, injury or death.

23) Do not place objects under the seat. The object could get stuck and cause the seat to not be fixed securely, and result in an accident.

24) Do not stack cargo higher than the seatbacks. Stacking luggage or other cargo higher than the seatbacks is dangerous. During sudden braking or a collision, objects can fly around and become projectiles that may hit and injure passengers.

25) Make sure luggage and cargo is secured before driving. Not securing cargo while driving is dangerous as it could move or be crushed during sudden braking or a collision and cause injury.

26) Always leave your vehicle locked and keep the car keys safely away from children. Leaving your car unlocked or the keys in reach of children is dangerous. Children who find their way into the boot through an open boot can become accidentally locked in the boot. This could result in death or brain damage from heat prostration, particularly in the summer. Always lock the doors and the boot.

27) When operating a seat, be careful not to put your hands or fingers near the moving parts of the seat or on the side trim to prevent injury.

28) When moving the seats, make sure there is no cargo in the surrounding area. If the cargo gets caught it could damage the cargo. When moving the seats forward and rearward or returning a rear-reclined seatback to its upright position, make sure you hold onto the seatback with your hand while operating. If the seatback is not held, the seat will move suddenly and could cause injury.

29) Be careful when using the seat warmer. The heat from the seat warmer may be too hot for some people, as indicated below, and could cause a low temperature burn. Infants, small babies, elderly people, and physically challenged people, people with delicate skin, people who are excessively fatigued, people who are intoxicated, people who have taken sleep-inducing medicine such as sleeping pills or cold medicine.

30) Do not use the seat warmer with anything having high moisture retention ability such as a blanket or cushion on the seat. The seat may be heated excessively and cause a low-temperature burn.

31) Do not place objects on the seat or on the backrest that may isolate the heat, such as a cover or a pillow. It may cause the seat heating device to overheat. Sitting on an overheated seat may cause severe burns due to the increase in temperature of the seat surface.

32) Do not place heavy objects with sharp projections on the seat, or insert needles or pins into it. This could cause the seat to become excessively heated and result in injury from a minor burn.



IMPORTANT

7) The fabric upholstery for the seats has been designed to withstand long-term wear deriving from normal use of the vehicle. Nevertheless, some precautions are required. Avoid prolonged and/or excessive rubbing involving clothing accessories such as metal buckles, bosses, Velcro strips and the like, which, by applying a high pressure on the fabric in a limited area, could cause it to break, thereby damaging the upholstery.

HEAD RESTRAINTS



Non-Adjustable Head Restraints

Your vehicle is equipped with non adjustable head restraints on the driver's and passenger's seatbacks.

The non adjustable head restraints consist of a trimmed foam covering over the upper structure of the seatbacks and are intended to help protect you and the passenger from neck injury.

Adjust the seatbacks to their upright, on-road positions so that the head restraint is positioned as close as possible to the back of your head.



WARNING

33) Make sure the seatbacks are properly adjusted to their upright, on-road positions before the vehicle is driven. Driving with the seatbacks not adjusted properly is dangerous. With no support behind your head, your neck could be seriously injured in a collision.



STEERING WHEEL

STEERING WHEEL ADJUSTMENT



34) 35) 36)

To change the angle of the steering wheel:

- stop the vehicle, and then pull down the lock release lever 1 under the steering column fig. 12;
- tilt the steering wheel to the desired positions, then push the lever up to lock the column;
- attempt to push the steering wheel up and down to make sure it's locked before driving.



12

04050101-12A-001



WARNING

34) Any adjustment of the steering wheel position must be carried out only with the vehicle stationary and the engine turned off. Adjusting the steering wheel while the vehicle is moving is dangerous. Moving it can very easily cause the driver to abruptly turn to the left or right. This can lead to loss of control or an accident.

35) It is absolutely forbidden to carry out any aftermarket operation involving steering system or steering column modifications (e.g. installation of anti-theft device) that could adversely affect performance and safety, invalidate the warranty and also result in the vehicle not meeting type-approval requirements.

36) Before exiting the vehicle, ALWAYS engage the parking brake, steer the wheels, engage the first gear if uphill and the reverse if downhill. If the vehicle is parked on a steep slope, chock the wheels with wedges or stones. When leaving the vehicle, always lock all the doors by pressing the button on the key.

MIRRORS



OUTSIDE MIRRORS



37)

Driver's side wide angle mirror

The wide angle mirror has two curvatures on its surface separated by a region line 1 fig. 13 into outer and inner regions.

The inner region is a standard convex mirror whereas the outer region allows for a wider range of visibility within the same sweep. This combination allows for better assurance when making lane changes.



13

04060101-12A-001

Objects appearing in the outer region are actually further away than they are in the inner region.

INSIDE DAY / NIGHT MIRROR



Rearview mirror adjustment

Before driving, adjust the rearview mirror fig. 14 to center on the view through the rear window.



14

04060102-ADJ-001

Reducing glare from headlights

Adjust the mirror with the day/night lever in the day position.

Push the antidazzle lever 1 fig. 15 forward for day driving (A position).

Pull it back to reduce glare of headlights from vehicles at the rear (B position).



15

04060102-MAN-002

POWER MIRRORS

The ignition must be switched to ACC or ON position.

To adjust proceed as follows:

- rotate the mirror switch fig. 16 to the left 1 (L = left) or right 2 (R = right) to choose the left or right side mirror;
- press the mirror switch in the appropriate direction.

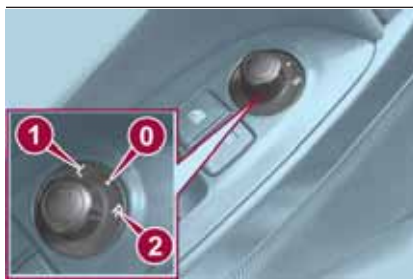

16

04060101-L12-001

After adjusting the mirror, lock the

control by rotating the switch to the center position 0 to prevent accidental movements.

FOLDING MIRRORS



Fold the outside mirror rearward fig. 17 until it is flush with the vehicle.



17

04060101-12R-001



WARNING

37) Be sure to look over your shoulder before changing lanes. Changing lanes without taking into account the actual distance of the vehicle in the convex mirror is dangerous. You could have a serious accident. What you see in the convex mirror is closer than it appears.

38) Always return the outside mirrors to the driving position before you start driving: driving with the outside mirrors folded in is dangerous. Your rear view will be restricted, and you could have an accident.



39) Do not stack cargo or objects higher than the seatbacks: cargo stacked higher than the seatbacks is dangerous. It can block your view in the rearview mirror, which might cause you to hit another car when changing lanes.

EXTERIOR LIGHTS



HEADLIGHTS

Turn the headlight switch 1 fig. 18 to turn the headlights, other exterior lights and dashboard illumination ON or OFF.

When the headlight switch is turned to the  or  position, the  lights-on indicator light in the instrument cluster turns on.

With auto-light control

When the headlight switch is turned to the **AUTO** position, the lights-on indicator light in the instrument cluster turns on/off in conjunction with the automatic on/off operation of the headlights.



18

05030101-121-001

IMPORTANT To prevent discharging the battery, do not leave the lights on while the engine is off unless safety requires them.

DAYTIME RUNNING LIGHTS (DRL)



Some countries require moving vehicles to have their lights on (running lights) during the daytime.

The running lights turn on automatically when the vehicle starts moving.

They turn off when the parking brake is operated or the selector lever is shifted to the P position (versions with automatic transmission).

HIGH BEAMS

The headlights switch between high and low beams by moving the lever forward or backward.

When the headlight high-beams are on, the  warning light is turned on.

FLASH TO PASS

Can be used when the ignition is switched ON.

To flash the headlights, pull the lever fully towards you (the headlight switch does not need to be on).

The  warning light in the instrument cluster illuminates simultaneously.

The lever will return to the normal position when released.

AUTOMATIC LIGHTING

(where provided)

Light sensor

When the headlight switch is in the **AUTO** position and the ignition is switched ON, the light sensor senses the surrounding lightness or darkness and automatically turns the headlights, other exterior lights and dashboard illumination on or off.

IMPORTANT The light sensor also works as a rain sensor for the auto-wiper control. Keep hands and scrapers clear of the windshield when the wiper lever is in the AUTO position and the ignition is switched ON as fingers could be pinched or the wipers and wiper blades damaged when the wipers activate automatically. If you are going to clean the windshield, be sure the wipers are turned off completely (this is particularly important when clearing ice and snow) when it is particularly tempting to leave the engine running.

COMING HOME LIGHT SYSTEM

The coming me home light system turns on the headlights (low beams) when the lever is operated.

System activation

When the lever is pulled with the ignition switched to ACC or OFF, the low beam headlights turn on.

The headlights turn off after a certain period of time has elapsed after the doors are closed.

The time until the headlights turn off after all of the doors are closed can be changed. If no operations are done for 3 minutes after the lever is pulled, the headlights turn off.



The headlights turn off if the lever is pulled again while the headlights are on.



FRONT FOG LIGHTS

The front fog light can be used when the ignition is switched to ON.

The front fog lights improve visibility at night and in presence of fog.

Activation

Turn the headlight switch 1 fig. 19 in  or  position before activate front fog lights.

Rotate the fog light switch 2 fig. 19 to  or  position (switch automatically turns in  position).





19

05030101-121-001

The warning light in the instrument cluster illuminates while the front fog lights is on.

Deactivation

Perform one of the following operations to turn off the front fog lights:

- switch the fog light switch 2 to OFF position;
- turn the headlight switch 1 to OFF position;
- switch the ignition to a position other than ON.

The warning light in the instrument cluster goes off when the front fog light is turned off.

With auto-light control

When the fog light switch 2 is in or position and the headlight switch is in AUTO position, the front fog lights will light up together with the headlights, the exterior lights and the dashboard.

If the fog light switch 2 is turned to position (the front fog light switch 2 returns to position automatically), the rear fog light and the respective indicator on the instrument panel will also light up.

REAR FOG LIGHTS

The rear fog lights can be used when the ignition is switched ON.

The rear fog light helps your vehicle to be seen. When the lights are turned on, the rear fog lights indicator light in the instrument cluster turns on.

Versions with front fog lights

Activation

The headlight switch 1 must be put in or position before turning on the rear fog lights.

To turn the rear fog light on, rotate the fog light switch 2 to the position (the fog light switch automatically returns to position).

The warning light in the instrument cluster illuminates while the rear fog light is on.

Deactivation

To turn the rear fog light off, do any of the following:

- rotate the fog light switch 2 to the position again (the fog light switch automatically returns to the position);

- turn the headlight switch 1 to the OFF position;
- switch the ignition to a position other than ON.

The warning light in the instrument cluster goes off when the rear fog light is turned off.

When you turn on the rear fog light, the front fog lights will also turn on.

If the fog light switch 2 is rotated to the position (the fog light switch automatically returns to the position) the front fog light indicator lamp on the instrument cluster will also illuminate.

With auto-light control

When the headlight switch is in the **AUTO** position, the rear fog light will turn on once the headlights, the exterior lights and instrument panel illumination are on.

Versions without front fog lights

The headlights must be turned on to turn on the rear fog light.



Activation

To turn on the rear fog light on, rotate the fog light switch 2 to the position (the fog light switch returns to its original position automatically).

The rear fog light indicator light in the instrument cluster illuminates while the rear fog light is on.

Deactivation

To turn the rear fog light off, do any of the following:

- rotate the fog light switch 2 to the  position again (the fog light switch automatically returns to the  position);
- rotate the fog light switch 2 to the OFF position;
- turn the headlight switch 1 to the OFF position.

TURN SIGNALS

The ignition must be switched ON to use the turn and lane-change signals.

Move the signal lever down (for a left turn) or up (for a right turn) to the stop position. The signal will self-cancel after the turn is completed.

If the indicator light continues to flash after a turn, manually return the lever to its original position.

The turn signal indicators (green)  in the instrument cluster flash according to the operation of the turn signal lever to show which signal is working.

If an indicator light stays on without flashing or if it flashes abnormally, one of the turn signal bulbs may be burned out.

LANE CHANGE SIGNALS

Move the lever halfway toward the direction of the lane change (until the indicator flashes) and hold it there. It will return to the off position when released.

Three-flash turn signal

After releasing the turn signal lever, the turn signal indicator flashes three times.

The operation can be cancelled by moving the lever in the direction opposite to which it was operated.

Adaptive Front Lighting System (AFS) (where provided)

The adaptive front lighting system (AFS) automatically adjusts the headlight beams to the left or right in conjunction with the operation of the steering wheel after the headlights have been turned on.

A system malfunction or operation conditions are indicated by a warning. Refer to “Warning lights on instrument panel” paragraph in “Knowing the instrument panel” chapter.

NOTE

- Headlights are equipped which do not blind drivers approaching in the opposite direction no matter what side of the road you must drive your vehicle (left-hand or right-hand traffic). Therefore, it is not necessary to adjust

the optical axis of the headlights when switching temporarily to driving on the opposite side of the road (left-hand or right-hand traffic).

- The Adaptive Front Lighting System (AFS) function can be switched to operable/ inoperable using the personalisation function. Refer to “Personalisation features” paragraph in “Knowing the instrument panel” chapter.



HEADLAMP LEVELLING

The number of passengers and weight of cargo in the luggage compartment change the angle of the headlights.

Auto type

The angle of the headlights will be automatically adjusted when turning on the headlights.

Manual type

The headlight levelling switch is used to adjust the angle of the headlights manually. To regulate, turn the ring 1 fig. 20 located on the left side of the instrument panel (left hand drive version) or on the right side (right hand drive version).



20

04030001-120-134



WARNING

- 40)** *The daytime running lights are an alternative to the dipped beam headlights for driving in countries where it is compulsory to have lights on during the day; where it is not compulsory, the use of daytime running lights is permitted.*
- 41)** *Daytime running lights cannot replace dipped beam headlights when driving at night or through tunnels. The use of daytime running lights is governed by the highway code of the country in which you are driving. Comply with legal requirements.*

Select the proper headlight angle from the following chart:

Front seat		Load	Switch position
Driver	Passenger		
X	—	—	0
X	X	—	1
X	X	X	2
X	—	X	3



WINDSCREEN WIPERS / WASHER



42) 43) 44)

8) 9) 10) 11)

The ignition must be switched ON to use the wipers.

WINDSCREEN WIPERS

Turn the wipers 1 fig. 21 on by pressing the lever up or down.



21

05030101-122-001

With intermittent wiper

Switch positions:

- or **MIST**: operation while pulling up lever;
- OFF**: stop;
- or **INT**: intermittent operation;
- or **LO**: low speed operation;
- =** or **HI**: high speed operation.

Variable-speed intermittent wipers

Set the lever to the intermittent position and choose the interval timing by rotating the ring 1.

With auto-wiper control

Switch positions:

- or **MIST**: operation while pulling up lever;
- OFF**: stop;
- AUTO**: auto control operation;
- or **LO**: low speed operation;
- =** or **HI**: high speed operation.

Auto-wiper control

When the wiper lever is in the **AUTO** position, the rain sensor senses the amount of rainfall on the windshield and turns the wipers on or off automatically (off/intermittent/low speed/high speed).

Adjusting rain sensor sensitivity

The sensitivity of the rain sensor can be adjusted by turning the switch on the wiper lever.

From the center position (normal), rotate the switch 1 fig. 21 downward for higher sensitivity (+) (faster response) or rotate it upward for less sensitivity (-) (slower response).

When the wiper lever is in the **AUTO** position and the ignition is switched ON, the wipers may move automatically in the following cases:

- if the windshield above the rain sensor is touched or wiped with a cloth;
- if the windshield is struck with a hand or other object from either outside or inside the vehicle.

Switching the auto-wiper lever from the **OFF** to the **AUTO** position while driving activates the windshield wipers once, after which they operate according to the rainfall amount.

The auto-wiper control may not operate when the rain sensor temperature is about -10°C or lower, or about 85°C or higher.

If the windshield is coated with water repellent, the rain sensor may not be able to sense the amount of rainfall correctly and auto-wiper control may not operate properly.

If dirt or foreign matter (such as ice or matter containing salt water) adheres to the windshield above the rain sensor or if the windshield is iced, it could cause the wipers to move automatically.

However, if the wipers cannot remove this ice, dirt or foreign matter, the auto-wiper control will stop operation. In this case, set the wiper lever to the low speed position or high speed position for manual operation, or remove the ice, dirt or foreign matter by hand to restore the auto-wiper operation.

IMPORTANT Because heavy ice and snow can jam the wiper blades, the wiper motor is protected from motor breakdown, overheating and possible fire by a circuit breaker. This mechanism will automatically stop operation of the blades, but only for about 5 minutes. If this happens, turn off the wiper switch and park off the right-of-way, and remove the snow and ice. After 5 minutes, turn on the switch and the blades should operate normally. If they do not resume functioning, contact a Fiat Dealership as soon as possible. Drive to the side of the road and park off the right-of-way. Wait until the weather clears before trying to drive with the wipers inoperative.

WINDSCREEN WASHER

Pull the lever toward you and hold it to spray washer fluid.

With the wiper lever in the **OFF** or intermittent position/ **AUTO** position, the wipers will operate continuously until the lever is released.

If the washer does not work, inspect the fluid level. If the fluid level is normal, contact a Fiat Dealership.



22

04110109-115-001

With headlight washers

When the headlights are on, the headlight washers operate automatically once every fifth time the windshield washer operates.

HEADLIGHT WASHER (where provided)

The ignition must be switched ON and the headlights must be turned on.

The headlight washers fig. 23 operate automatically once every fifth time the windshield washer operates. If you want to operate headlight washers, double flick the wiper lever.



23

04110102-L37-007



WARNING

42) Use only windshield washer fluid or plain water in the reservoir. Using radiator antifreeze as washer fluid is dangerous. If sprayed on the windshield, it will dirty the windshield, affect your visibility, and could result in an accident.

43) Only use windshield washer fluid mixed with anti-freeze protection in freezing weather conditions. Using windshield washer fluid without antifreeze protection in freezing weather conditions is dangerous as it could freeze on the windshield and block your vision which could cause an accident. In addition, make sure the windshield is sufficiently warmed using the defroster before spraying the washer fluid.

44) Make sure the device is switched off whenever the windscreen must be cleaned.



**IMPORTANT**

8) Do not use the screen wiper to remove layers of snow or ice from the windshield. In such conditions, the windshield wiper may be subjected to excessive stress and the motor cut-out switch, which prevents operation for a few seconds, may intervene. If operation is not subsequently restored, even after the vehicle is restarted, contact a Fiat Dealership.

9) Do not operate the windshield wiper with blades lifted from the windshield.

10) Do not activate the rain sensor while washing the vehicle in an automatic washing system.

11) If ice is found on the windshield, make sure that the device was disconnected properly.

CLIMATE CONTROL SYSTEM**OPERATING TIPS**

Operate the air-conditioning system with the engine running.

To prevent the battery from being discharged, do not leave the fan control dial on for a long period of time with the ignition switched ON when the engine is not running.

Clear all obstructions such as leaves, snow and ice from the bonnet and the air inlet in the cowl grille to improve the system efficiency.

Use the air-conditioning system to defog the windows and dehumidify the air.

The recirculate mode should be used when driving through tunnels or while in a traffic jam, or when you would like to shut off outside air for quick cooling of the interior.

Use the outside air position for ventilation or windshield defrosting.

If the vehicle has been parked in direct sunlight during hot weather, open the windows to let warm air escape, then run the air-conditioning system.

Run the air conditioner about 10 minutes at least once a month to keep internal parts lubricated.

Have the air conditioner checked before the weather gets hot. Lack of refrigerant may make the air conditioner less efficient. The refrigerant specifications are indicated on a label (A or B depending on the market) attached to the inside of the engine compartment fig. 24. Check the label before refilling the refrigerant. If the wrong type of refrigerant is used, it could result in a serious malfunction of the air conditioner. For details contact a Fiat Dealership.

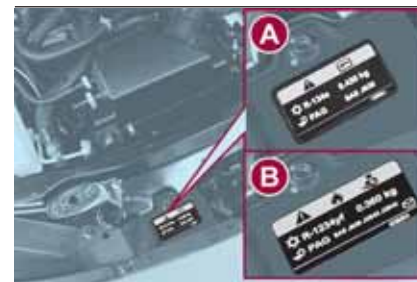

24

06010100-121-001



IMPORTANT

2) The system uses a coolant that is compatible with the laws in force in the countries where the vehicle is sold, R134a or R1234yf (indicated on a specific plate in the engine compartment). The use of other coolants affects the efficiency and condition of the system. Also the compressor coolants used must be compatible with the indicated coolant.



MANUAL CLIMATE CONTROL SYSTEM



25

06010300-122-099

CONTROL SWITCHES

- 1 – Temperature control dial. Turn it clockwise for hot and anticlockwise for cold.
- 2 – Fan control dial. The fan has seven speeds.
- 3 – Mode selector dial. Turn the mode selector dial to select air flow mode. The mode selector dial can be set at the intermediate positions (●) between each mode.
- 4 – Rear window defogger switch. Press the switch to turn on the rear window defogger. The rear window defogger operates for about 15 minutes and then turns off automatically.
- 5 – Air intake selector. Outside or recirculated air positions can be selected. Press the switch to select outside/recirculated air positions.
- 6 – A/C switch. Press the A/C switch to turn the air conditioner on.

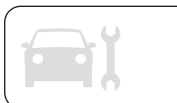

AUTOMATIC CLIMATE CONTROL SYSTEM



26

06010900-122-990

CONTROL SWITCHES

1 – Temperature control dial.

2 – Fan control dial. The fan has seven speeds. **AUTO position:** the amount of air flow will be automatically controlled in accordance with the set temperature. **Except AUTO position:** the air flow amount can be adjusted to the desired level by turning the dial. **0 position:** to turn off the system, set the dial to 0 position.

3 – Mode selector dial. Turn the mode selector dial to select air flow mode. **AUTO position:** the air flow mode automatically adjusts to the selected temperature. **Except AUTO position:** the desired air flow position can be selected by turning the dial.

4 – Rear window defogger switch. Press the switch to turn on the rear window defogger. The rear window defogger operates for about 15 minutes and then turns off automatically.

5 – Air intake selector. Outside or recirculated air positions can be selected. Press the switch to select outside/recirculated air positions.

6 – A/C switch. The air conditioning (cooling/dehumidifying functions) can be turned on or off by pressing the switch while the fan control dial is at a position other than 0.



POWER WINDOWS



CONTROLS



The ignition must be switched ON for the power windows to operate.

If the power window does not open/close, wait a moment and then operate the switch again.

Passenger control switches

The passenger window can also be operated using the master control switches on the driver's door fig. 27: **1** (driver's window) / **2** (passenger's window).



27

04070103-LN2-002

Opening / closing power windows

1 - Closing fig. 28: lightly pull up the switch. **2** - Opening: lightly hold down the switch.



28

04070103-L12-001

Auto-opening power windows

To fully open the window automatically press the switch completely down. To stop the window partway pull or press the switch in the opposite direction and then release it. The power window cannot be fully closed while the door is open.

Power window system initialization procedure

If the battery was disconnected during vehicle maintenance, or for other reasons (such as a switch continues to be operated after the window is open/closed), the window will not fully open automatically.

Resetting of the automatic function can be performed using the master control switches or each passenger door switch.

The power window auto function reset

procedure can be done on both door switches. The power window auto function will only resume on the power window that has been reset:

- close the doors and the convertible top;
- switch the ignition ON;
- make sure that the power window lock switch located on the driver's door is not depressed;
- press the switch and fully open the window;
- pull up the switch to fully close the window and continue holding the switch for about 2 seconds after the window fully closed;
- repeat steps 4-5 for the passenger power window while seated in the passenger seat;
- make sure that the power windows operate correctly using the door switches.

After the system has been re-initialized, passenger window can be fully opened automatically using the master control switches. If the automatic power window operation does not operate normally while the doors or convertible top are opened/closed, reset it using the above procedures.

POWER WINDOW LOCK SWITCH

This feature prevents the passenger's power window from operating. Keep this switch in the locked position while children are in the vehicle.

1 - Locked position (button depressed) fig. 29: only the driver's power window can be operated.

2 - Unlocked position (button not depressed): both power windows on each door can be operated.



29

04070104-LE2-001

IMPORTANT When the power window lock switch is in the locked position, the light on the passenger power window switch turns off.



WARNING

45) Make sure the opening is clear before closing a window: closing a power window is dangerous. A person's hands, head, or even neck could be caught by the window and result in serious injury or even death. This warning applies especially to children.

46) Never allow children to play with power window switches: power window switches that are not locked with the power window lock switch would allow children to operate power windows unintentionally, which could result in serious injury if a child's hands, head or neck becomes caught by the window.

INTERNAL EQUIPMENT



ACCESSORY SOCKET

The accessory socket is located deep in the back of the footwell on the passenger side fig. 30.



30

06040400-L12-002

Only use genuine FCA accessories or the equivalent requiring no greater than 120 W (DC 12V, 10A).

The ignition must be switched to ACC or ON.

To prevent accessory socket damage or electrical failure, pay attention to the following:

- do not use accessories that require more than 120 W (DC 12V / 10A);
- do not use accessories that are not genuine FCA accessories or the equivalent;



- ❑ close the cover when the accessory socket is not in use to prevent foreign objects and liquids from getting into the accessory socket;
- ❑ correctly insert the plug into the accessory socket;
- ❑ do not insert the cigarette lighter into the accessory socket;
- ❑ noise may occur on the audio playback depending on the device connected to the accessory socket;
- ❑ depending on the device connected to the accessory socket, the vehicle's electrical system may be affected, which could cause the warning light to illuminate. Disconnect the connected device and make sure that the problem is resolved. If the problem is resolved, disconnect the device from the socket and switch the ignition off. If the problem is not resolved, contact a Fiat Dealership.

IMPORTANT To prevent discharging of the battery, do not use the socket for long periods with the engine off or idling.

BOOT LID



OPENING



IMPORTANT Before opening the boot lid, remove any snow and ice accumulation on it. Otherwise, the boot lid could close under the weight of the snow and ice resulting in injury.

IMPORTANT Be careful when opening/closing the boot lid during strong winds. If a strong gust blows against the boot lid, it could close suddenly resulting in injury.

IMPORTANT Fully open the boot lid and make sure that it stays open. If the boot lid is only opened partially, it could slam shut by vibration or wind gusts resulting in injury.

IMPORTANT When loading or unloading luggage in the boot, turn off the engine. Otherwise, you could get burned by the heat of the exhaust gas.

Using the remote release button (where provided)

Unlock the doors and boot lid, then press the electric boot lid opener fig. 31 and raise it when the latch releases.

NOTE **With the advanced keyless**

function: a locked boot lid can also be opened while the key is being carried.



31

04030201-12A-001

With the advanced keyless function

A locked boot lid can also be opened while the key is being carried.

When opening the boot lid with the doors locked, it may require a few seconds for the boot lid latch to release after the electric boot lid opener is pressed.

The boot lid can be closed when the doors are locked with the key left in the vehicle. However, to prevent locking the key in the vehicle, the boot lid can be opened by pressing the electric boot lid opener. If the boot lid cannot be opened despite doing this procedure, press the electric boot lid opener to fully open the boot lid after pushing the boot lid completely closed.

If the vehicle battery is dead or there is

a malfunction in the electrical system and the boot lid cannot be unlocked, the boot lid can be opened by performing the emergency procedure (refer to “When the boot lid cannot be opened” paragraph in this chapter).

WHEN BOOT LID CANNOT BE OPENED

If the battery is dead, the boot cannot be unlocked and opened. In this case, the boot can be unlocked by taking care of the dead battery situation.

If the boot cannot be unlocked even if the dead battery situation has been resolved, the electrical system may have a malfunction.

Proceed as follows:

- close the convertible top and remove the windblocker fig. 32;
- remove the fasteners on the right side of the vehicle fig. 33;



32

08080100-125-002

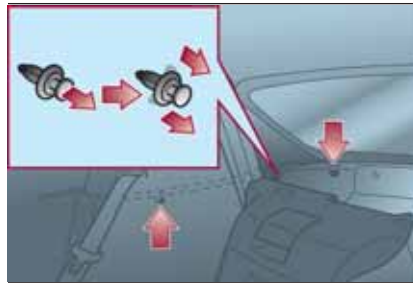

33

08080100-121-004

- partially peel back the cover on the right side of the vehicle fig. 34;



34

08080100-122-001

- turn and loosen the cap screws fig. 35 until the screws start to spin free;
- pull out the cap and open the boot lid fig. 36. After performing this emergency measure, contact a Fiat Dealership as soon as possible.

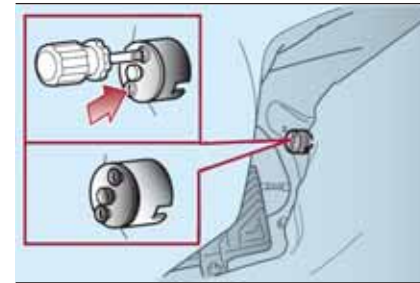

35

08080100-999-400

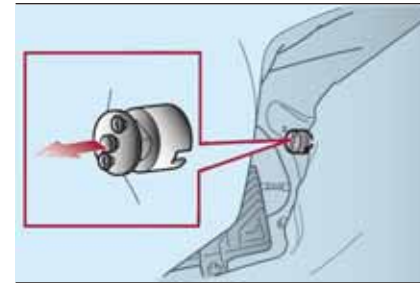

36

08080100-124-003

IMPORTANT Do not pull the screw when pulling the cap. Otherwise, the screw may fall off and become lost.

CLOSING

 49) 50)

Use both hands to push the boot lid down until the lock snaps shut. Do not slam it.



Pull up on the boot lid to make sure it is secure.



WARNING

47) Never allow a person to ride in the boot: allowing a person to ride in the boot is dangerous. The person in the boot could be seriously injured or killed during sudden braking or a collision.

48) Do not drive with the boot lid open: exhaust gas in the cabin of a vehicle is dangerous. An open boot lid in a moving vehicle will cause exhaust gas to be drawn into the cabin. This gas contains CO (carbon monoxide), which is colourless, odourless, and highly poisonous, and it can cause loss of consciousness and death. Moreover, an open boot lid could cause occupants to fall out in an accident.

49) Close the boot lid, do not allow children to play inside the boot lid. Leaving the trunk lid open or leaving children in the vehicle with the keys is dangerous. Children could open the boot lid and climb inside resulting in possible injury or death from heat exposure.

50) Always keep the car from being a tempting place to play by latching the doors and the boot lid, and keeping the keys where children can not play with them. Leaving children or animals unattended in a parked vehicle is dangerous. Babies left sleeping and children who lock themselves in cars or trunks can die very quickly from heat prostration. Do not leave your children or pets alone in a car at any time. Do not leave the car, the boot lid unlocked.

BONNET

OPENING

51) 52) 53) 55)

Proceed as follows:

with the vehicle parked, pull the release handle 1 fig. 37 to unlock the bonnet;



37

07030201-L88-088

insert your hand into the bonnet opening, slide the latch lever 2 to the right fig. 38, and lift up the bonnet;

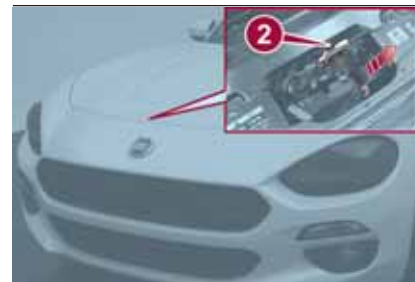

38

07030201-122-001

release support rod 3 fig. 39 from its locking device, then insert it in the padded area 4 fig. 40 and secure it in the support rod hole indicated by the arrow to hold the bonnet open.

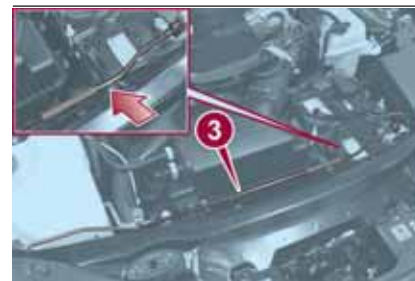

39

07030201-130-888

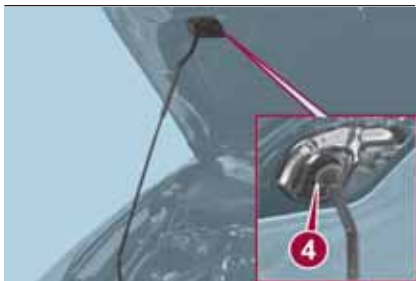

40

07030201-123-002

CLOSING



54)

Proceed as follows:

- check under the hood area to make certain all filler caps are in place and all loose items (e.g. tools, oil containers, etc.) have been removed;
- lift the hood, grasp the padded area on the support rod, and secure the support rod from its locking device. Verify that the support rod is secured in the clip before closing the hood;
- lower the hood slowly to a height of about 20 cm above its closed position and then let it drop.

IMPORTANT When closing the hood, do not push it excessively such as by applying your weight. Otherwise, the hood could be deformed.



WARNING

51) Perform these operations only when the car is stationary.

52) The bonnet may drop suddenly if the supporting rod is not positioned correctly.

53) Use both hands to lift the bonnet. Before lifting, check that the windscreen wiper arms are not raised from the windscreen, that the vehicle is stationary and that the parking brake is engaged.

54) Always check that the bonnet is closed and securely locked. A bonnet that is not closed and securely locked is dangerous as it could fly open while the vehicle is moving and block the driver's vision which could result in a serious accident.

55) With active bonnet: do not pull the bonnet's release handle after the active bonnet has activated. Pulling the release handle while the active bonnet is operating is dangerous as it will raise the bonnet further and obstruct vision. In addition, the bonnet cannot be lowered manually, therefore do not attempt to forcefully push the bonnet back down. Otherwise, it could deform the bonnet or cause injury. If the active bonnet has activated, always consult an expert repairer, contact a Fiat Dealership immediately.

CONVERTIBLE TOP (SOFT TOP)



LOWERING THE CONVERTIBLE TOP

IMPORTANT Do not sit on the folded convertible top. Otherwise, the convertible top could be damaged or you may fall off and be injured.

Proceed as follows:

- make sure the parking brake is applied. If the engine is running, turn it off;
- make sure there are no objects which have been placed in the area where the convertible top is to be retracted;
- with the lock release button 1 fig. 41 depressed forward (red mark 2 visible), pull back the top latch lever 3 fig. 42 to unlock it;

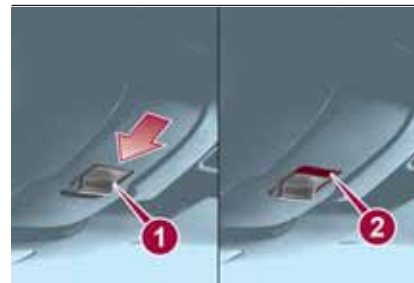

41

04110102-L36-006





42

04110102-L21-001

□ remove the striker 4 from the anchor 5 fig. 43;



43

04110102-L22-002

IMPORTANT If the power windows do not go down automatically, fully open the windows.

□ standing outside of the vehicle, hold the convertible top along the front edge 6 and pull it toward the vehicle rear;



44

04110102-123-002

IMPORTANT To lower the convertible top from inside the vehicle, use the convertible top's handles 6 fig. 44.

□ move the convertible top rearward and fold it while pressing the rear glass lightly with your hand;

□ with the back end of the convertible top pressed, press the front end until a latch sound is heard fig. 45. Lightly rock the retracted convertible top to make sure it is securely locked.



45

04110102-126-001

RAISING THE CONVERTIBLE TOP

Proceed as follows:

□ make sure the parking brake is applied. If the engine is running, turn it off;

□ pull up the unlock lever 1 to disengage the lock fig. 46;

□ standing outside of the vehicle, hold the convertible top along the front edge and pull it towards the vehicle front;



46

04110103-121-004

IMPORTANT If the power windows do not go down automatically, fully open the windows.

IMPORTANT To raise the convertible top from inside the vehicle, use the convertible top's handles 2 fig. 47.



47

04110103-L23-002

□ sitting in a seat, grasp the convertible top's handles 3 fig. 48, and press the convertible top against the windscreen. Make sure the striker 4 engages with the anchor 5, move the top latch slowly, and then push the top latch upward until a latch sound is heard.

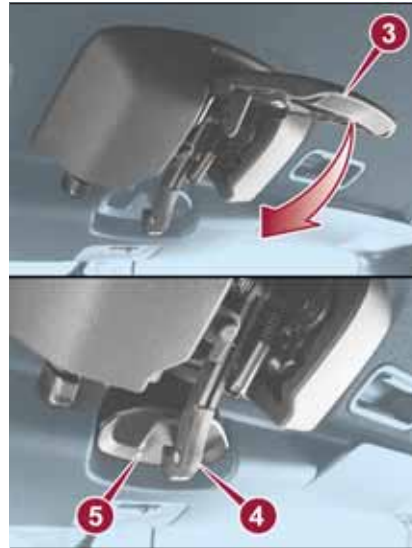

48

04110103-L24-003

IMPORTANT Driving with the convertible top not fully locked could damage the convertible top. If the red indicator is visible on the lock release button fig. 49, the convertible top is not locked. After locking the convertible top, verify that the red indicator 6 is not visible (7 = locked position / 8 = unlocked position).

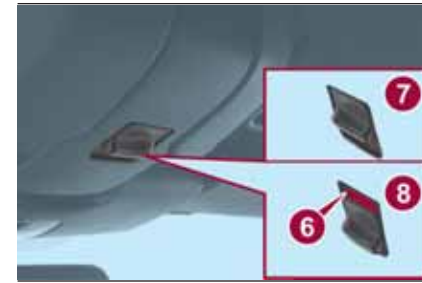

49

04110103-124-001

IMPORTANT Do not spray water directly near the seam of the window and convertible top when flushing away dirt on the soft top with water. Otherwise, water may enter the vehicle (see paragraph "Convertible top maintenance" in "Maintenance and care" chapter).

CONVERTIBLE TOP PRECAUTIONS

 56) 57) 58) 59) 60)

 12) 13) 15) 15) 16) 17) 18) 19) 20) 21)

□ Remove leaves or other matter that may accumulate on and around the convertible top. If leaves or other matter block the drain filter, water may enter the vehicle. Clean the drain filter at least once a year.

□ Before opening the convertible top, make sure the rear window defogger switch is turned off. Otherwise the heat



generated from the defogger could damage the convertible top and the internal material.

- ❑ Before lowering or raising the convertible top, stop in a safe place off the right-of-way and park on a level surface.
- ❑ Make sure nothing is on the convertible top or near the back window when raising or lowering the convertible top.
- ❑ Even small objects may interfere and cause damage.
- ❑ When lowering the convertible top, make sure objects inside the vehicle are not blown away by the wind.
- ❑ Secure all loose objects inside before driving with the convertible top down.
- ❑ To help prevent burglary or vandalism and to ensure that the passenger compartment stays dry, close the convertible top securely and lock both doors when leaving the vehicle.
- ❑ Do not drive through an automatic car wash; it may damage the convertible top.
- ❑ Do not raise or lower the convertible top when the temperature is below 5 °C (41 °F); this will damage the convertible top material.
- ❑ The convertible soft top is made of high quality material and if it is not maintained correctly, the material could

harden, becomes stained, or have an uneven gloss.

- ❑ Do not lower the convertible top when it's wet. If the convertible top dries while folded, it will deteriorate and mold.
- ❑ Lowering the convertible top while it's wet can also cause water to drip into the cabin.
- ❑ Do not raise or lower the convertible top in a strong wind as it could damage the convertible top or cause an unexpected accident.
- ❑ The power windows go down automatically in conjunction with the convertible top opening/closing. However, this is a function for improving the operability, and it does not mean there is a problem. If the vehicle battery is disconnected for vehicle maintenance or other reasons, the power windows will not go down automatically. If the power windows do not go down, the automatic open/close mechanism for the windows must be reset.
- ❑ The windblocker reduces the amount of wind coming into the cabin from behind when driving with the convertible top opened.



WARNING

- 56)** Before starting the vehicle make sure the convertible top is correctly locked.
- 57)** Sit in the seat with the seat belt correctly fastened when the vehicle is moving: standing in the vehicle, or sitting on the convertible top storage area or center console when the vehicle is moving is a dangerous way to ride. During a sudden manoeuvre or collision you could be seriously injured or even killed.
- 58)** Always keep your hands and fingers away from the fastening mechanisms when moving the convertible top: it is dangerous to place your hands or fingers near the fastening mechanisms. Your hands or fingers could be caught and injured by the mechanism.
- 59)** Be careful while installing/removing the soft top to prevent any damage or injury.
- 60)** Keep children away from the area in which the soft-top is folding while installing/removing it.



IMPORTANT

- 12)** Never open the soft top in presence of snow or ice to prevent damage.
- 13)** Loads may not be secured on the roof.
- 14)** Bird droppings and plant resins must be washed off the soft top immediately as they can damage its fabric.
- 15)** Never use high-pressure washing systems.
- 16)** When using steam washers or high-pressure water washers, maintain a suitable distance and do not exceed a maximum temperature of 60°C. Damage, alterations and water infiltration may occur if the distance is too small or if pressure is too high.
- 17)** If a water jet is used, direct away from the edges of the fabric and the windscreen surround to prevent water infiltration.
- 18)** Never use alcohol, petrol, chemical products, detergents, stain removers, wax, solvents and “wash and polish” products.
- 19)** Rinse immediately to remove soap to prevent stains and blots. Repeat the operation if needed.
- 20)** Follow the instructions on the waterproofing product container for perfect results.
- 21)** The rubber seals of the soft top must be washed with water only. If you notice that seals are dry or sticking, apply talcum powder or products specifically for rubber (silicone spray).



KNOWING THE INSTRUMENT PANEL

This section of the owner handbook gives you all the information you need to understand, interpret and use the instrument panel correctly.

CONTROL PANEL AND INSTRUMENTS49
WARNING LIGHTS AND MESSAGES54

CONTROL PANEL AND INSTRUMENTS

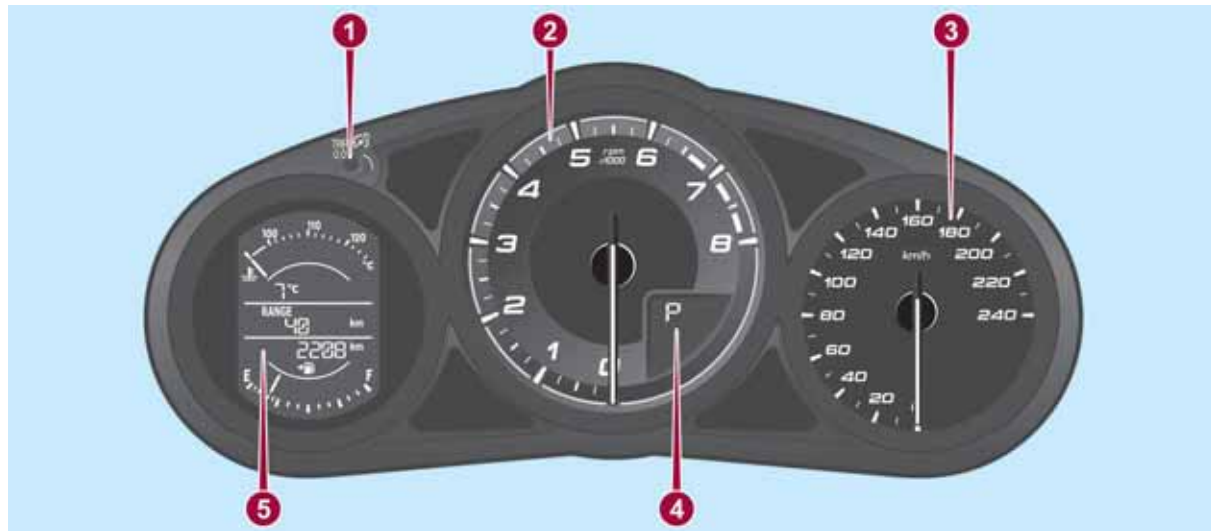

50

05020100-121-001

1. Odometer/Trip meter and Trip computer button/Dashboard illumination - 2. Tachometer - 3. Speedometer - 4. Automatic transmission info display - 5. Odometer/Trip computer info/Engine coolant temperature gauge/Fuel gauge/Outside temperature/Speed limiter/Cruise Control/INFO switch display



RIGHT-HAND DRIVE VERSIONS

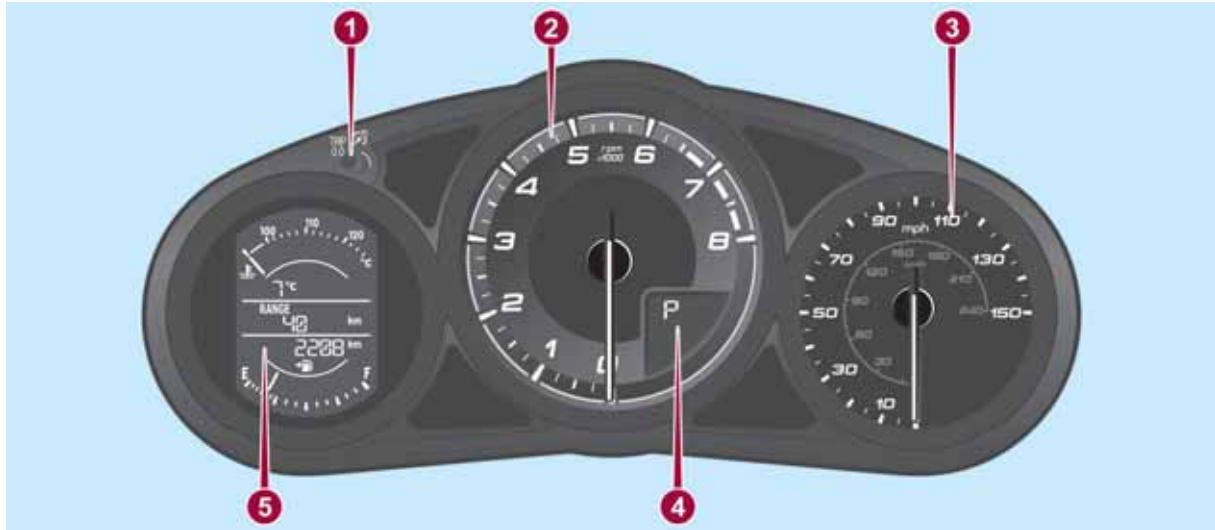

51

05020100-667-888

- 1. Odometer/Trip meter and Trip computer button/Dashboard illumination - 2. Tachometer - 3. Speedometer - 4. Automatic transmission info display - 5. Odometer/Trip computer info/Engine coolant temperature gauge/Fuel gauge/Outside temperature/Adjustable speed limiter/Cruise Control/INFO switch display

ODOMETER / TRIP METER

The display mode can be changed from odometer to "Trip meter A" to "Trip meter B" and then back to odometer by pressing the selector 1 fig. 52 while one of them is displayed. The selected mode will be displayed.



52

05020102-121-001

When the ignition is switched to ACC or OFF, the odometer or trip meters cannot be displayed, however, pressing the selector can inadvertently switch the trip meters or reset them during an approximate ten-minute period in the following cases:

- after the ignition is switched to off from ON;
- after the driver's door is opened.

Trip meter

The trip meter can record the total distance of two trips. One is recorded in "Trip A", and the other is recorded in "Trip B".

For instance, "Trip A" can record the distance from the point of origin, and "Trip B" can record the distance from where the fuel tank is filled.

Use this meter to measure trip distances and to compute fuel consumption.

Versions with Radio 7™: if the fuel economy data is reset using the fuel economy monitor, or Trip A is reset using the trip meter when the function which synchronizes the fuel economy monitor and the trip meter is on, the fuel economy data and Trip A are reset simultaneously.

NOTE Only the trip meters record tenths of kilometers (miles).

Trip meter reset

The trip meter will be erased when the power supply is interrupted (blown fuse or the battery is disconnected) or when the vehicle is driven over 9999.9 km (mile).

INSTRUMENT PANEL ILLUMINATION

Brightness adjustment

The brightness of the instrument cluster and dashboard illuminations can be adjusted by rotating the knob 1 fig. 53:

- the brightness decreases** by rotating the knob to the left. A beep sound will be heard when the knob has been rotated to the maximum dim position;
- the brightness increases** by rotating the knob to the right.



53

05020102-121-001

Canceling illumination dimmer

Rotate the knob to the right until a beep sound is heard while the instrument cluster is dimmed with the ignition switched ON. If the instrument cluster's visibility is reduced due to glare from surrounding brightness, cancel the illumination dimmer.



When the illumination dimmer is canceled, the instrument cluster cannot be dimmed even if the position lights are turned on. When the illumination dimmer is canceled, the screen in the center display switches to constant display of the daytime screen.

TRIP COMPUTER AND INFO SWITCH

The following information can be selected by pressing the INFO switch fig. 54 with the ignition switched ON:

- Distance-to-empty (approximate distance you can travel on the available fuel);
- Average fuel economy;
- Current fuel economy;
- Average vehicle speed;
- Vehicle speed alarm.

If you have any problems with your trip computer, contact a Fiat Dealership.



54

0620500-122-001

Vehicle speed alarm mode

In this mode, the current setting for the vehicle speed alarm is displayed. You can change the vehicle speed setting at which the warning is triggered.

IMPORTANT The vehicle speed alarm display is activated at the same time the beep sound is heard. The set vehicle speed flashes several times.

The vehicle speed alarm can be set using the INFO switch.

The vehicle speed alarm function can be set between 30 and 250 km/h.

IMPORTANT Always set the vehicle speed according to the laws and regulations of the country/city in which the vehicle is driven. In addition, always verify the speed of the vehicle using the speedometer.

The vehicle speed alarm can be set using the following procedure:

- press the INFO switch to display the vehicle speed alarm mode;
- press the INFO switch continuously until a beep sound is heard. The set vehicle speed display flashes the third digit (hundredths place) fig. 55;

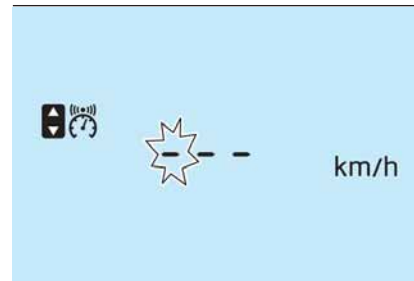

55

05020110-121-002

- press the INFO switch and set the third digit (hundredths place) to the desired vehicle speed. The numerical value changes each time the INFO switch is pressed;
- press the INFO switch continuously until a beep sound is heard. The set vehicle speed display flashes the lower two digits (tenths and ones place) fig. 56;

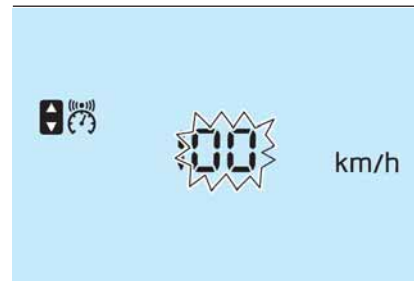

56

05020110-121-003

❑ press the INFO switch and set the two lower digits (tenths and ones place) to the desired vehicle speed. The numerical value changes each time the INFO switch is pressed;

❑ press the INFO switch continuously until a beep sound is heard. The set vehicle speed is displayed on the vehicle speed alarm screen.

GEAR SHIFT INDICATOR

The gear shift indicator supports you to obtain optimum fuel economy and smooth driving.

It displays the selected gear position 1 fig. 57 in the instrument cluster as well as notifies the driver to change to the most suitable gear position 2 corresponding to the actual driving condition.

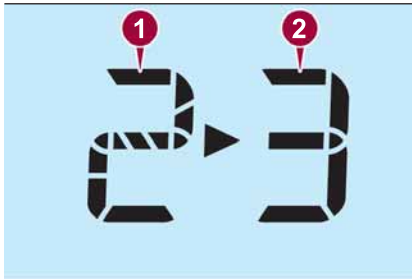

57

05210102-12A-001

Indication	Condition
Numeral	The selected gear position is displayed
 and numeral	Shift up or down to the indicated gear position is recommended

IMPORTANT Do not rely solely on the shift-up/shift-down recommendations by indications. The actual driving situation might require shift operations different from indication. To avoid the risk of accidents, the road and traffic conditions have to be judged correctly by the driver before shifting.

Versions with manual transmission

The gear shift indicator turns off when the following operations are performed:

- ❑ the vehicle is stopped;
- ❑ the vehicle is put in neutral;
- ❑ the vehicle is driven in reverse;
- ❑ the clutch is not fully engaged when accelerating from a stop;
- ❑ the clutch pedal remains depressed for 2 seconds or longer while driving.

Versions with automatic transmission

The gear shift indicator turns off when the following operations are performed:

- ❑ the vehicle is stopped;
- ❑ manual shift mode is cancelled.

Manually shifting up

(versions with automatic transmission)

Using selector lever: to shift up to a higher gear, tap the selector lever back + once.



WARNING LIGHTS AND MESSAGES

IMPORTANT The indication of the warning light in the instrument panel is indicative and precautionary and as such must not be considered as exhaustive and/or alternative to the information contained in the Owner Handbook, which you are advised to read carefully in all cases. Always refer to the information in this chapter in the event of a failure indication.

IMPORTANT The display cycle of both categories can be interrupted. The instrument panel warning light will stay on until the cause of the failure is eliminated.

Vehicles with Radio 7™

The warning contents can be verified on the audio system.

Proceed as follows:

- if the warning light is turned on, select  icon on the home screen to display the application screen;
- select “ **Warning Guidance** ” to display the current warnings;
- select the applicable warning to view the warning details.

For the following warning/indicator lights:

- Master warning light;
- Brake system warning light;
- ABS warning light;
- Charging system warning light;
- Engine oil warning light;
- Check engine light;
- High engine coolant temperature warning light;



- Automatic transmission warning light;
- Power steering malfunction indicator light;
- Air Bag/Seat Belt pretensioner system warning light;
- Active bonnet warning light;
- Low fuel warning light;
- Seat belt warning light;
- Door-ajar warning light;
- Low washer fluid level warning light;
- Tyre Pressure Monitoring System warning light;
- KEY warning light;
- LED headlight KEY warning light;
- Wrench indicator light;
- TCS/DSC indicator light;
- DSC OFF indicator light;
- Security indicator light;
- Passenger Air Bag deactivation indicator light (where provided).

The light turns on when the ignition is switched on for an operation check, and turns off a few seconds later or when the engine is started. If the light does not turn on or remains turned on, have the vehicle inspected at Fiat Dealership.

Only for “Brake system warning light”: the light turns on continuously when the parking brake is applied.



WARNING LIGHTS ON INSTRUMENT PANEL**Red warning lights**

Warning light	What it means
	<p>PARKING BRAKE WARNING - WARNING LIGHT INSPECTION / LOW BRAKE FLUID LEVEL WARNING</p> <p>Parking brake warning / Warning light inspection The light illuminates when the parking brake is applied with the ignition switched to START or ON. It turns off when the parking brake is fully released.</p> <p>Low brake fluid level warning If the brake warning light remains illuminated even though the parking brake is released, the brake fluid may be low or there could be a problem with the brake system. Park the vehicle in a safe place immediately and contact a Fiat Dealership.</p> <p>IMPORTANT Do not drive with the brake system warning light illuminated. Contact a Fiat Dealership to have the brakes inspected as soon as possible. Driving with the brake system warning light illuminated is dangerous. It indicates that your brakes may not work at all or that they could completely fail at any time. If this light remains illuminated, after checking that the parking brake is fully released, have the brakes inspected immediately.</p> <p>IMPORTANT In addition, the effectiveness of the braking may diminish so you may need to depress the brake pedal more strongly than normal to stop the vehicle. Stop the vehicle in a safe place immediately and contact a Fiat Dealership.</p>
	<p>EBD (Electronic Brake-force Distribution) SYSTEM WARNING</p> <p>If the EBD (Electronic Brake-force Distribution) control unit determines that some components are operating incorrectly, the control unit may illuminate the brake system warning light and the ABS warning light simultaneously. The problem is likely to be the electronic brake force distribution system. Stop the vehicle in a safe place immediately and contact a Fiat Dealership.</p> <p>IMPORTANT Do not drive with both the ABS warning light and brake warning light illuminated. Contact a Fiat Dealership to have the brakes inspected as soon as possible. Driving when the brake system warning light and ABS warning light are illuminated simultaneously is dangerous. When both lights are illuminated, the rear wheels could lock more quickly in an emergency stop than under normal circumstances.</p>
	<p>ALTERNATOR FAILURE</p> <p>If the warning light illuminates while driving, it indicates a malfunction of the alternator or of the charging system. Drive to the side of the road and park off the right-of-way. Stop the vehicle in a safe place immediately and contact a Fiat Dealership.</p> <p>IMPORTANT Do not continue driving when the charging system warning light is illuminated because the engine could stop unexpectedly.</p>

Warning light

What it means



LOW ENGINE OIL PRESSURE

This warning light indicates low engine oil pressure.

IMPORTANT Do not run the engine if the oil pressure is low. Otherwise, it could result in extensive engine damage.

If the light illuminates or the warning indication is displayed while driving:

- drive to the side of the road and park off the right-of-way on level ground;
- turn off the engine and wait 5 minutes for the oil to drain back into the sump;
- inspect the engine oil level. If it's low, add the appropriate amount of engine oil while being careful not to overfill;
- start the engine and check the warning light.

IMPORTANT Do not run the engine if the oil level is low. Otherwise, it could result in extensive engine damage.

If the light remains illuminated even though the oil level is normal or after adding oil, stop the engine immediately and contact a Fiat Dealership.







DOOR-AJAR WARNING LIGHT

The light turns on if any door is not closed securely.

Close the door securely.



Warning light	What it means
	<p>ACTIVE BONNET The light turns on when the ignition is switched on for an operation check, and turns off a few seconds later. A problem in the system may be indicated under the following conditions:</p> <ul style="list-style-type: none"> <input type="checkbox"/> the light does not turn on when the ignition is switched ON; <input type="checkbox"/> remains turned on/flashing; <p>Contact a Fiat Dealership.</p> <p> 62)</p>
	<p>HIGH ENGINE COOLANT TEMPERATURE WARNING LIGHT The light flashes when the engine coolant temperature is extremely high, and illuminates when the engine coolant temperature increases further. Stop the vehicle in a safe place immediately and contact a Fiat Dealership.</p> <p>Handling procedure</p> <ul style="list-style-type: none"> <input type="checkbox"/> Illuminated light: this indicates the possibility of overheating. Park the vehicle in a safe place immediately and stop the engine. Refer to “Overheating” paragraph in “In an emergency” chapter. <p>IMPORTANT Do not drive the vehicle with the high engine coolant temperature warning light illuminated. Otherwise, it could result in damage to the engine.</p>
	<p>AIR BAG / SEAT BELT PRETENSIONER SYSTEM WARNING A system malfunction is indicated if the warning light constantly flashes, constantly illuminates or does not illuminate at all when the ignition is switched ON. If any of these occur, contact a Fiat Dealership as soon as possible. The system may not operate in an accident.</p> <p> 61)</p>

Warning light

What it means



KEY WARNING LIGHT (illuminate)

If any malfunction occurs in the keyless entry system, it illuminates continuously.
IMPORTANT If the key warning indicator light illuminates or the push button start indicator light (amber) flashes, the engine may not start. If the engine cannot be started, try starting it using the emergency operation for starting the engine, and contact a Fiat Dealership as soon as possible. Refer to "Emergency operation for starting operation" in "Starting the engine" paragraph.

KEY WARNING LIGHT (flashing)

Advanced key malfunction

Take the appropriate action and verify that the warning light turns off.

- The advanced key battery is dead:** replace the key battery.
- The advanced key is not within the operation range/is placed in areas inside the cabin where it is difficult for the key to be detected:** bring the advanced key into the operation range.
- A key from another manufacturer similar to the advanced key is in the operation range:** take the key from another manufacturer similar to the advanced key out of the operation range.
- Without the ignition switched off, the advanced key is taken out of the cabin, and then all the doors are closed:** bring the advanced key back into the cabin.





VEHICLE SECURITY ALARM SYSTEM

The warning light switches on to report a failure of the vehicle security alarm system. Contact a Fiat Dealership as soon as possible.



Amber warning lights

Warning light	What it means
	<p>ABS WARNING LIGHT If the ABS warning light stays on while you're driving, the ABS control unit has detected a system malfunction. If this occurs, your brakes will function normally as if the vehicle had no ABS. Should this happen contact a Fiat Dealership as soon as possible. NOTE When the engine is jump-started to charge the battery, uneven rpm occurs and the ABS warning light may illuminate. If this occurs, it is the result of the weak battery and does not indicate an ABS malfunction. Recharge the battery. NOTE The brake assist system does not operate while the ABS warning light is illuminated.</p>
	<p>CHECK ENGINE LIGHT If this light illuminates while driving, the vehicle may have a problem. It is important to note the driving conditions when the light illuminated and contact a Fiat Dealership. The check engine light may illuminate in the following cases:</p> <ul style="list-style-type: none"> <input type="checkbox"/> the engine's electrical system has a problem; <input type="checkbox"/> the emission control system has a problem; <input type="checkbox"/> the fuel tank level being very low or approaching empty; <input type="checkbox"/> the phonic wheel learning, following disconnection of the battery, did not complete successfully.



Tire Pressure Monitoring System WARNING LIGHT

If the tire pressure monitoring system has a malfunction, the tire pressure warning light flashes for about 1 minute when the ignition is switched ON and then stay on. Contact a Fiat Dealership as soon as possible. When the warning light illuminates, and the warning beep sound is heard (about 3 seconds), tire pressure is too low in one or more tires. Inspect the tires and adjust to the specified inflation pressure.

Perform tire pressure adjustment when the tires are cold. Tire pressure will vary according to the tire temperature, therefore let the vehicle stand for 1 hour or only drive it 1.6 km or less before adjusting the tire pressures. When pressure is adjusted on hot tires to the cold inflation pressure, the warning light/beep may turn on after the tires cool and pressure drops below specification. Also, an illuminated TPMS warning light, resulting from the tire air pressure dropping due to cold ambient temperature will remain illuminated even if the ambient temperature rises. In this case, it will also be necessary to adjust the tire air pressures. If the TPMS warning light illuminates due to a drop in tire air pressure, make sure to check and adjust the tire air pressures.

Tires lose air naturally over time and the TPMS cannot tell if the tires are getting too soft over time or you have a flat. However, when you find one low tire in a set of four—that is an indication of trouble; you should have someone drive the vehicle slowly forward so you can inspect any low tire for cuts and any metal objects sticking through tread or sidewall. Put a few drops of water in the valve stem to see if it bubbles indicating a bad valve. Leaks need to be addressed by more than simply refilling the trouble tire as leaks are dangerous: take it to a Fiat Dealership which has all the equipment to fix tires, TPMS systems and order the best replacement tire for your vehicle.





POWER STEERING MALFUNCTION INDICATOR LIGHT





The light illuminates if the electric power steering has a malfunction. If the light illuminates, stop the vehicle in a safe place and do not operate the steering wheel. There is no problem if the light turns off after a while. Contact a Fiat Dealership if the light illuminates continuously.

NOTE If the indicator light illuminates, the power steering will not operate normally. If this happens, the steering wheel can still be operated, however, the operation may feel heavy compared to normal, or the steering wheel could vibrate when turning.





NOTE Repeatedly jerking the steering wheel left and right while the vehicle is stopped or moving extremely slowly will cause the power steering system to go into protective mode which will make the steering feel heavy, but this does not indicate a problem. If this occurs, park the vehicle safely and wait several minutes for the system to return to normal.



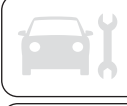





Warning light	What it means
	<p>AUTOMATIC TRANSMISSION WARNING LIGHT (where provided) The light illuminates when the transmission has a problem. IMPORTANT If the automatic transmission warning light illuminates, the transmission has an electrical problem. Continuing to drive your vehicle in this condition could cause damage to your transmission. Contact a Fiat Dealership as soon as possible.</p>
	<p>MASTER WARNING LIGHT</p> <p>Versions without Radio 7” The warning light turns on continuously if there is a malfunction in the battery management system or there is a malfunction in the brake switch. Contact a Fiat Dealership as soon as possible.</p> <p>Versions with Radio 7” The warning light turns on when the system has a malfunction. Operate the center display and verify the content. Refer to “Vehicles with Radio 7” paragraph in this chapter.</p>

Warning lights	What it means
	<p>LED HEADLIGHT WARNING LIGHT (where provided) This light illuminates if there is a malfunction in the LED headlight. Contact a Fiat Dealership as soon as possible.</p>
	<p>LOW FUEL WARNING LIGHT The light turns on when the remaining fuel is about 9.0 litres. The light illumination timing may vary because fuel inside the fuel tank moves around according to the driving conditions and the vehicle posture. Add fuel.</p>
	<p>LOW WASHER FLUID LEVEL WARNING LIGHT (where provided) This warning light indicates that little washer fluid remains. Add washer fluid</p>
	<p>CRUISE CONTROL ACTIVATION The warning light illuminates when the cruise control system is activated.</p>



Warning light	What it means
	<p>TCS / DSC SYSTEM INDICATOR LIGHT The warning light turns on when the in case of intervention of TCS/DSC systems. This means that the vehicle is in critical stability and grip conditions.</p>
	<p>DSC OFF INDICATOR LIGHT The warning light turns on when the ESC system is deactivated.</p>
	<p>REAR FOG LIGHT INDICATOR LIGHT The warning light switches on when the rear fog light is turned on.</p>
	<p>ADJUSTABLE SPEED LIMITER MAIN INDICATOR LIGHT The warning light switches on when the MODE switch on steering wheel is pressed and the adjustable speed limiter is activated (see “Speed limiter” paragraph in “Starting and driving” chapter).</p>
	<p>WRENCH INDICATOR LIGHT (where provided) When the ignition is switched ON, the wrench indicator light is illuminated and then turns off after a few seconds. The wrench indicator light is illuminated when the preset maintenance period arrives. Verify the content and perform maintenance. Refer to “Maintenance monitor” paragraph in this chapter.</p>



Green warning lights

Warning light	What it means
	<p>LEFT DIRECTION INDICATOR The warning light turns on when the direction indicator control stalk is moved downwards or, together with the right direction indicator, when the hazard warning light button is pressed.</p>
	<p>RIGHT DIRECTION INDICATOR The warning light turns on when the direction indicator control stalk is moved upwards or, together with the left direction indicator, when the hazard warning light button is pressed.</p>
	<p>SIDE LIGHTS AND DIPPED BEAM HEADLIGHTS The warning light turns on when side lights or dipped beam headlights are turned on.</p>
	<p>FOG LIGHTS The warning light turns on when the fog lights are turned on.</p>
	<p>CRUISE CONTROL (SET INDICATOR LIGHT) The warning light turns on when a cruising speed has been set.</p>
	<p>ADJUSTABLE SPEED LIMITER SET INDICATOR The indicator light illuminates green when a speed has been set (see “Speed limiter” paragraph in “Starting and driving” chapter).</p>



Warning light	What it means
	<p>KEY INDICATOR LIGHT</p> <p>Warning light flashing When the push button start is pressed from ON to ACC or OFF, the warning light may flash for approximately 30 seconds indicating that the remaining battery power of the key is low. Replace with a new battery before the key becomes unusable.</p>

Blue warning light

Warning light	What it means
	<p>MAIN BEAM HEADLIGHTS</p> <p>The warning light switches on when the main beam headlights are turned on.</p>
	<p>LOW ENGINE COOLANT TEMPERATURE INDICATOR LIGHT (for versions/markets where provided)</p> <p>The light illuminates continuously when the engine coolant temperature is low and turns off after the engine is warm.</p> <p>If the low engine coolant temperature indicator light remains illuminated after the engine has been sufficiently warmed up, the temperature sensor could have a malfunction. Contact a Dealership.</p>

Warning light (red color) on dashboard trim

Warning light	What it means
	<p>SEAT BELT WARNING LIGHT</p> <p>The seat belt warning light turns on if the driver or passenger's seat is occupied and the seat belt is not fastened with the ignition switched ON.</p> <p>If the driver or passenger's seat belt is unfastened (only when the passenger seat is occupied) and the vehicle is driven at a speed faster than about 20 km/h, the warning light flashes. After a short time, the LED stops flashing, but remains illuminated.</p> <p>If a seat belt remains unfastened, the LED flashes again for a given period of time.</p> <p>If the driver or passenger's seat belt is unfastened after the LED turns on, and the vehicle speed exceeds 20 km/h, the LED flashes again.</p> <p>Passenger occupant classification system: to allow the passenger occupant classification sensor to function properly, do not place and sit on an additional seat cushion on the passenger's seat. The sensor may not function properly because the additional seat cushion could cause sensor interference.</p>

Warning light (amber color) on dashboard trim

Warning light	What it means
	<p>PASSENGER AIR BAG DEACTIVATION INDICATOR LIGHT</p> <p>The light turns on when the ignition is switched on for an operation check, and turns off a few seconds later or when the engine is started. If the light does not turn on or remains turned on, contact a Fiat Dealership.</p>



MESSAGE INDICATED ON DISPLAY

(versions with Radio 7")

If a message is displayed in the center display, take appropriate action (in a calm manner) according to the displayed message.

If the following messages are displayed in the centre display, a vehicle system may be malfunctioning:

Engine Coolant Temperature

High: displays if the engine coolant temperature has increased excessively.

Changing System Malfunction: displays if the charging system has a malfunction.

Temperature Warning: the following message is displayed when the temperature around the centre display is high. Lowering the temperature in the cabin or the temperature around the centre display by avoiding direct sunlight is recommended.

Stop the vehicle in a safe place and contact a Fiat Dealership.

WARNING SOUND IS ACTIVATED



A warning sound is activated in following cases:

- Lights-on reminder;

- Air Bag/seat belt pretensioner system;
- Active bonnet (where provided);
- Ignition not switched off (STOP);
- Key removed from vehicle;
- "Door locking" switch inoperable (versions with advanced keyless function);
- Key left-in-boot compartment (versions with advanced keyless function);
- Key left-in-vehicle (versions with advanced keyless function);
- Vehicle speed alarm (where provided);
- Tire inflation pressure warning beep (where provided);
- Outside temperature (where provided);
- Electronic steering lock;
- Speed limiter (where provided);
- 120 km/h warning (where provided).



WARNING

61) Never tamper with the air bag/pretensioner systems and always contact a Fiat Dealership perform all servicing and repairs. Self-servicing or tampering with the systems is dangerous. An air bag/pretensioner could accidentally activate or become disabled causing serious injury or death.

62) Do not drive the vehicle with the active bonnet warning light turned on or flashing. Driving the vehicle with the active hood warning light turned on or flashing is dangerous as the active hood mechanism may not activate normally and function as intended in the event the vehicle were to contact a pedestrian.

63) If the TPMS warning light illuminates or flashes, or the tire pressure warning beep sound is heard, decrease vehicle speed immediately and avoid sudden maneuvering and braking. If the warning light illuminates or flashes, or the tire pressure warning beep sound is heard, it is dangerous to drive the vehicle at high speeds, or perform sudden maneuvering or braking. Vehicle drivability could worsen and result in an accident. To determine if you have a slow leak or a flat, pull over to a safe position where you can check the visual condition of the tire and determine if you have enough air to proceed to a place where air may be added and the system monitored again by Fiat Dealership or a tire repair station.

64) Do not ignore the TPMS warning light. Ignoring the TPMS warning light is dangerous, even if you know why it is illuminated. Have the problem taken care of as soon as possible before it develops into a more serious situation that could lead to tire failure and a dangerous accident.

SAFETY

The chapter that you are about to read is very important: it describes the safety systems with which the vehicle is equipped and provides instructions on how to use them correctly.

ACTIVE SAFETY SYSTEMS	70
AUXILIARY DRIVING SYSTEMS.	74
OCCUPANT PROTECTION SYSTEMS	78
SEAT BELTS	79
SBA SYSTEM (Seat Belt Alert).	81
SEAT BELT PRETENSIONER AND LOAD LIMITING SYSTEMS.	82
CHILD-RESTRAINT PRECAUTIONS .	83
SUPPLEMENTARY RESTRAINT SYSTEM SRS - AIR BAG	96
RECORDING OF VEHICLE DATA	109
CONSTANT MONITORING	110

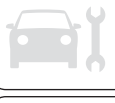

ACTIVE SAFETY SYSTEMS

The vehicle has the following active safety systems:

- ABS (Anti-lock Braking System);
- TCS (Traction Control System);
- DSC (Dynamic Stability Control);
- Active bonnet (active pedestrian protection).

For the operation of the systems, see the following pages.

ABS SYSTEM (Antilock Brake System)



The ABS control unit continuously monitors the speed of each wheel. If one wheel is about to lock up, the ABS responds by automatically releasing and reapplying that wheel's brake.

The driver will feel a slight vibration in the brake pedal and may hear a chattering noise from the brake system. This is normal ABS system operation. Continue to depress the brake pedal without pumping the brakes.

The warning light turns on when the system has a malfunction. Refer to "Warning lights and messages" paragraph in "Knowing the instrument panel" chapter.

NOTE Braking distances may be longer on loose surfaces (snow or gravel, for

example) which usually have a hard foundation. A vehicle with a normal braking system may require less distance to stop under these conditions because the tires will build up a wedge of surface layer when the wheels skid.

NOTE The sound of the ABS operating may be heard when starting the engine or immediately after starting the vehicle, however, it does not indicate a malfunction.

TCS SYSTEM (Traction Control System)

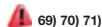

The Traction Control System (TCS) enhances traction and safety by controlling engine torque and braking. When the TCS detects driving wheel slippage, it lowers engine torque and operates the brakes to prevent loss of traction.

This means that on a slick surface, the engine adjusts automatically to provide optimum power to the drive wheels, limiting wheel spin and loss of traction.

The warning light turns on when the system has a malfunction. Refer to "Warning lights and messages" paragraph in "Knowing the instrument panel" chapter.

TCS / DSC indicator light

The  indicator light stays on for a few seconds when the ignition is switched ON.

If the TCS or DSC is operating, the indicator light flashes.

If the  light stays on, the TCS, DSC or the brake assist system may have a malfunction and they may not operate correctly. Contact a Fiat Dealership.

IMPORTANT In addition to the warning light flashing, a slight labouring sound will come from the engine. This indicates that the TCS/DSC is operating properly.

IMPORTANT On slippery surfaces, such as fresh snow, it will be impossible to achieve high rpm when the TCS is on.

DSC SYSTEM (Dynamic Stability Control)

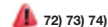

The Dynamic Stability Control (DSC) automatically controls braking and engine torque in conjunction with systems such as ABS and TCS to help control side slip when driving on slippery surfaces, or during sudden or evasive manoeuvring, enhancing vehicle safety. Refer to "ABS system (Antilock Brake System)" and "TCS system (Traction Control System)".

DSC operation is possible at speeds greater than 20 km/h.

The warning light turns on when the system has a malfunction. Refer to “Warning lights and messages” paragraph in “Knowing the instrument panel” chapter.

NOTE The DSC may not operate correctly unless the following are observed:

- ❑ use tires of the correct size specified for your vehicle on all four wheels;
- ❑ use tires of the same manufacturer, brand and tread pattern on all four wheels;
- ❑ do not mix worn tires.

IMPORTANT The DSC may not operate correctly when tire chains are used or a temporary spare tire is installed because the tire diameter changes.

TCS / DSC indicator light

The  indicator light stays on for a few seconds when the ignition is switched ON. If the TCS or DSC is operating, the indicator light flashes.

If the light stays on, the TCS, DSC or the brake assist system may have a malfunction and they may not operate correctly. Take your vehicle to a Fiat Dealership.

DSC OFF indicator light

The  indicator light stays on for a few seconds when the ignition is switched ON. It also illuminates when the DSC OFF switch is pressed and TCS/DSC is switched off.

If the light remains illuminated and the TCS/DSC is not switched off, contact a Fiat Dealership. The DSC may have a malfunction.

DSC OFF switch

Press the switch fig. 58 to turn off the TCS/DSC. The  warning light in the instrument cluster will illuminate.

Press the switch again to turn the TCS/DSC back on. The DSC OFF indicator light will turn off.



58

05060301-12A-987

IMPORTANT When DSC is on and you attempt to free the vehicle when it is stuck, or drive it out of freshly fallen snow, the TCS (part of the DSC

system) will activate. Depressing the accelerator will not increase engine power and freeing the vehicle may be difficult. When this happens, turn off the TCS/DSC.

IMPORTANT If the TCS/DSC is off when the engine is turned off, it automatically activates when the ignition is switched ON.

IMPORTANT Leaving the TCS/DSC on will provide the best traction.

IMPORTANT If the switch is pressed and held for 10 seconds or more, the DSC OFF switch malfunction detection function operates and the DSC system activates automatically. The DSC OFF indicator light turns off while the DSC system is operative.

ACTIVE BONNET PRECAUTIONS



In the unlikely event that the vehicle were to hit a pedestrian and a certain amount of impact is applied to the front of the vehicle, impact to the head of the pedestrian if it were to hit the bonnet is lessened by the rear area of the bonnet raising instantly to maintain a wide space between it and the parts in the engine compartment.

If the sensor 1 fig. 59 installed to the

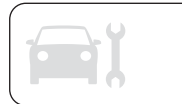

back of the front bumper detects a certain amount of impact by a collision with a pedestrian or other obstruction while the vehicle is being driven at a speed sufficient to activate the system, the system is activated and the bonnet is raised (3 = active bonnet warning light/4 = electronic control unit).

IMPORTANT Do not touch the actuator 2 fig. 59 directly after the active bonnet has activated. Otherwise, it could result in a burn as the actuator is hot directly after the activation.

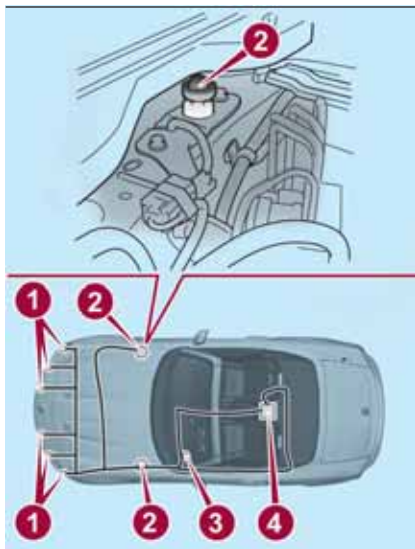

59

03060100-L12-888

Operation and handling

- ❑ Always make sure that the bonnet is closed completely before driving. Otherwise, the system may not operate normally.
- ❑ The system may not operate for about 8 seconds after the ignition is switched ON.
- ❑ Use tires of the same specified size on all four wheels. If tires with different sizes are used, the system may not operate normally.
- ❑ If something hits the area around the front bumper, the sensor could be damaged even if the active bonnet does not activate. Contact a Fiat Dealership to have the vehicle inspected.
- ❑ Do not remove or repair parts or wiring for the active bonnet. In addition, do not test the system's circuitry using an electric tester. Otherwise, the active bonnet may activate mistakenly or not operate normally. Contact a Fiat Dealership when repairs or replacement servicing is required.
- ❑ Do not replace the front bumper, bonnet, suspension, aero parts, or wheels with non-genuine FCA parts. Otherwise, the system may not operate normally.
- ❑ Do not install non-genuine FCA accessories to the front bumper. In addition, do not install objects on the

bonnet. Otherwise, the system may not operate normally.

- ❑ Do not close the bonnet excessively or apply a load to the actuator. Otherwise, the actuator could be damaged and cause the system to not operate normally.
- ❑ Do not modify the suspension. If the vehicle height or the damping force of the suspensions is changed, the system may not operate normally.
- ❑ When equipping parts, contact a Fiat Dealership. If parts are installed incorrectly, the active bonnet may not activate normally due to the inability to detect an impact.
- ❑ When disposing of the vehicle, contact a Fiat Dealership. If the vehicle is not handled correctly, it could result in injury.
- ❑ The active bonnet cannot be reused if it has been activated. Contact a Fiat Dealership.

If the active bonnet activates

The active bonnet activates under the following conditions:

- ❑ if the front of the vehicle hits a pedestrian or obstruction while the vehicle is being driven at a speed sufficient to activate the system, the system will activate if a certain amount of impact is applied in a collision even though no trace may remain on the

front bumper. In addition, it may activate depending on the level of impact from even a light object, small animal, or other small object;

❑ the system may also activate if the lower part of the vehicle or the front bumper receives an impact from one of the following situations:

- the vehicle hits a curb;
- the vehicle falls into a deep ditch or hole;
- the vehicle bounces and hits the ground;
- the front, bottom part of the vehicle contacts the slope of a parking garage, the surface of an even, undulating road, or a protruding or fallen object on the road.

Situations in which the active bonnet may not activate

The active bonnet may not activate in the following situations as an impact would be difficult to detect:

- ❑ the pedestrian gets hit at an angle or by the side areas on the left and right of the front bumper;
- ❑ the vehicle hits a pedestrian who is carrying something such as a bag which can absorb the impact.

Situations in which the system does not activate

The active bonnet does not activate under the following conditions:

- ❑ the front bumper gets hit while the vehicle is being driven at a speed insufficient to activate the system;
- ❑ the vehicle gets hit from the side or the rear;
- ❑ the vehicle rolls or turns over (the active bonnet may operate depending on the accident conditions).



WARNING

65) Do not rely on ABS as a substitute for safe driving. The ABS cannot compensate for unsafe and reckless driving, excessive speed, tailgating (following another vehicle too closely), driving on ice and snow, and hydroplaning (reduced tire friction and road contact because of water on the road surface). You can still have an accident.

66) When the ABS intervenes and you feel the brake pedal pulsating, do not reduce the pressure, but hold it down firmly and confidently; in doing so you will brake in the shortest distance possible, depending on the current road conditions.

67) For the correct operation of the ABS, the tyres must of necessity be the same make and type on all wheels, in perfect condition and, above all, of the prescribed type and dimensions.

68) If the ABS intervenes, this indicates that the grip of the tyres on the road is nearing its limit: you must slow down to a speed compatible with the available grip.

69) Do not rely on the Traction Control System (TCS) as a substitute for safe driving. The Traction Control System (TCS) cannot compensate for unsafe and reckless driving, excessive speed, tailgating (following another vehicle too closely), and hydroplaning (reduced tire friction and road contact because of water on the road surface). You can still have an accident.

70) Use snow tires or tire chains and drive at reduced speeds when roads are covered with ice and/or snow. Driving without proper traction devices on snow and/or ice-covered roads is dangerous. The Traction Control System (TCS) alone cannot provide adequate traction and you could still have an accident.

71) The capability of the TCS must never be tested irresponsibly and dangerously, in such a way as to compromise personal safety and the safety of others.

72) Do not rely on the DSC as a substitute for safe driving: the Dynamic Stability Control (DSC) cannot compensate for unsafe and reckless driving, excessive speed, tailgating (following another vehicle too closely), and hydroplaning (reduced tire friction and road contact because of water on the road surface). You can still have an accident.

73) For the correct operation of the DSC system, the tyres must necessarily be of the same make and type on all wheels, in perfect condition and, above all, of the prescribed type and size.



74) *The capability of the DSC system must never be tested irresponsibly and dangerously, in such a way as to compromise personal safety and the safety of others.*

75) *If the active bonnet has activated, always contact a Fiat Dealership. If the bonnet release handle is pulled after the active bonnet has activated, the bonnet will rise even further. If the vehicle is driven with the bonnet raised it will obstruct visibility and could result in an accident. In addition, do not attempt to push the bonnet back down. Otherwise, it could deform the bonnet or cause injury because the activated bonnet cannot be lowered manually. Before driving the vehicle contact a Fiat Dealership after the active bonnet has activated, make sure that the raised bonnet does not obstruct vision and drive the vehicle at a low speed.*

AUXILIARY DRIVING SYSTEMS

TPMS (Tire Pressure Monitoring System)

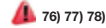

The Tire Pressure Monitoring System (TPMS) monitors the air pressure of all four tires. If the air pressure of one or more tires is too low, the system warns the driver by indicating the tire pressure monitoring system warning light (⚠) in the instrument cluster and operating a beep sound. The system monitors the tire pressures indirectly using the data sent from the ABS wheel speed sensors.

To allow the system to operate correctly, the system needs to be initialized with the specified tire pressure (value on the tire pressure label). Refer to “Tire Pressure Monitoring System Initialization” in this paragraph.

The warning light flashes when the system has a malfunction. Refer to “Warning lights and messages” paragraph in “Knowing the instrument panel” chapter.

IMPORTANT Each tire, including the spare (where provided), should be checked monthly when cold and inflated to the inflation pressure recommended by the vehicle

manufacturer on the vehicle placard or tire inflation pressure label (if your vehicle has tires of a different size than the size indicated on the vehicle placard or tire inflation pressure label, you should determine the proper tire inflation pressure for those tires).

IMPORTANT As an added safety feature, your vehicle has been equipped with a TPMS system that illuminates a low tire pressure telltale when one or more of your tires is significantly under-inflated. Accordingly, when the low tire pressure telltale illuminates, you should stop and check your tires as soon as possible, and inflate them to the proper pressure. Driving on a significantly under-inflated tire causes the tire to overheat and can lead to tire failure. Under-inflation also reduces fuel efficiency and tire tread life, and may affect the vehicle's handling and stopping ability.

IMPORTANT Please note that the TPMS is not a substitute for proper tire maintenance, and it is the driver's responsibility to maintain correct tire pressure, even if under-inflation has not reached the level to trigger illumination of the TPMS low tire pressure telltale. Your vehicle has also been equipped with a TPMS malfunction indicator to

indicate when the system is not operating properly.

IMPORTANT The TPMS malfunction indicator is combined with the low tire pressure telltale. When the system detects a malfunction, the telltale will flash for approximately one minute and then remain continuously illuminated. This sequence will continue upon subsequent vehicle start-ups as long as the malfunction exists. When the malfunction indicator is illuminated, the system may not be able to detect or signal low tire pressure as intended. TPMS malfunctions may occur for a variety of reasons, including the installation of replacement or alternate tires or wheels on the vehicle that prevent the TPMS from functioning properly. Always check the TPMS malfunction telltale after replacing one or more tires or wheels on your vehicle to ensure that the replacement or alternate tires and wheels allow the TPMS to continue to function properly.

IMPORTANT To avoid false readings, the system samples for a little while before indicating a problem. As a result it will not instantaneously register a rapid tire deflation or blow out. Because this system detects slight changes in tire conditions, the timing of

the warning may be faster or slower in the following cases.

- ❑ the size, manufacturer, or the type of tires is different from the specification;
- ❑ the size, manufacturer, or the type of a tire is different from the others, or the level of tire wear is excessively different between them;
- ❑ a run-flat tire (where provided), studless tire, snow tire, or tire chains are used;
- ❑ an emergency tire is used (tire pressure monitoring system warning light may flash and then continue illuminating);
- ❑ a tire is repaired using the emergency flat tire repair kit;
- ❑ the tire pressure is excessively higher than the specified pressure, or the tire pressure is suddenly lowered for some reason such as a tire burst during driving;
- ❑ the vehicle speed is lower than about 15 km/h (9 mph) (including when the vehicle is stopped), or the drive period is shorter than 5 minutes;
- ❑ the vehicle is driven on an extremely rough road or a slippery, icy road;
- ❑ hard steering and rapid acceleration/deceleration are repeated such as during aggressive driving on a winding road;
- ❑ load on the vehicle is applied to a tire such as by loading heavy luggage to

one side of the vehicle;

❑ system initialization has not been implemented with the specified tire pressure.

System error activation

When the TPMS warning light flashes, there may be a system malfunction. Contact a Fiat Dealership.

A system error activation may occur in the following cases:

- ❑ when there is equipment or a device near the vehicle using the same radio frequency as that of the tire pressure sensors;
- ❑ when a metallic device such as a non-genuine navigation system is equipped near the center of the dashboard, which may block radio signals from the tire pressure sensor to the receiver unit;
- ❑ when using the following devices in the vehicle that may cause radio interference with the receiver unit;
- ❑ a digital device such as a personal computer;
- ❑ a current converter device such as a DC-AC converter;
- ❑ when excess snow or ice adheres to the vehicle, especially around the wheels;
- ❑ when the tire pressure sensor batteries are exhausted;



- when using a wheel with no tire pressure sensor installed;
- when using tires with steel wire reinforcement in the side walls;
- when using tire chains.

Tires and wheels

IMPORTANT When inspecting or adjusting the tire air pressures, do not apply excessive force to the stem part of the wheel unit. The stem part could be damaged.

Changing tires and wheels

The following procedure allows the TPMS to recognize a tire pressure sensor's unique ID signal code whenever tires or wheels are changed, such as changing to and from winter tires.

IMPORTANT Each tire pressure sensor has a unique ID signal code. The signal code must be registered with the TPMS before it can work. The easiest way to do it is to have a Fiat Dealership change your tire and complete ID signal code registration.

When having tires changed at a Fiat Dealership: when a Fiat Dealership changes your vehicle's tires, they will complete the tire pressure sensor ID signal code registration.

When changing tires yourself: if you

or someone else changes tires, you or someone else can also undertake the steps for the TPMS to complete the ID signal code registration:

- after tires have been changed, switch the ignition ON, then back to ACC or OFF;
- wait for about 15 minutes;
- after about 15 minutes, drive the vehicle at a speed of at least 25 km/h for 10 minutes and the tire pressure sensor ID signal code will be registered automatically.

IMPORTANT If the vehicle is driven within about 15 minutes of changing tires, the  warning light will flash because the sensor ID signal code would not have been registered. If this happens, park the vehicle for about 15 minutes, after which the sensor ID signal code will register upon driving the vehicle for 10 minutes.

Replacing tires and wheels

IMPORTANT When replacing/repairing the tires or wheels or both, have the work done by a Fiat Dealership, or the tire pressure sensors may be damaged.

IMPORTANT The wheels equipped on your vehicle are specially designed for installation of the tire pressure sensors. Do not use non-genuine wheels,

otherwise it may not be possible to install the tire pressure sensors.

Be sure to have the tire pressure sensors installed whenever tires or wheels are replaced.

When having a tire or wheel or both replaced, the following types of tire pressure sensor installations are possible:

- the tire pressure sensor is removed from the old wheel and installed to the new one;
- the same tire pressure sensor is used with the same wheel. Only the tire is replaced;
- a new tire pressure sensor is installed to a new wheel.

IMPORTANT The tire pressure sensor ID signal code must be registered when a new tire pressure sensor is purchased. For purchase of a tire pressure sensor and registration of the tire pressure sensor ID signal code, consult a Fiat Dealership.

IMPORTANT When reinstalling a previously removed tire pressure sensor to a wheel, replace the grommet (seal between valve body/sensor and wheel) for the tire pressure sensor.

Tire Pressure Monitoring System initialization

(versions with conventional tires)

In the following cases, system initialization must be performed so that the system operates normally:

- a tire pressure is adjusted;
- tire rotation is performed;
- a tire or wheel is replaced;
- the battery is replaced or completely drained;
- the tire pressure monitoring system warning light is illuminated.

Initialization method

Proceed as follows:

- park the car in a safe place and firmly apply the parking brake;
- let the tires cool, then adjust the tire pressure of all four (4) tires to the specified pressure indicated on the tire pressure label located on the driver's door frame (door open);
- switch the ignition ON;
- while the vehicle is parked, press and hold the TPMS system set switch fig. 60 and verify that the tire pressure monitoring system warning light in the instrument cluster flashes twice and a beep sound is heard once.



60

05120101-12A-321

IMPORTANT If the system initialization is performed without adjusting the tire pressure, the system cannot detect the normal tire pressure and it may not illuminate the tire pressure monitoring system warning light even if a tire pressure is low, or it may illuminate the light even if the pressures are normal.

IMPORTANT Adjust the tire pressure on all four tires and initialize the system when the tire pressure monitoring system warning light is turned on. If the warning light turns on for a reason other than a flat tire, the tire pressure of all four tires may have decreased naturally.

IMPORTANT The system initialization will not be performed if the switch is pressed while the vehicle is being driven.

HLA (Hill Launch Assist) FUNCTION

Hill Launch Assist (HLA) is a function which assists the driver in accelerating from a stop while on a slope. When the driver releases the brake pedal and depresses the accelerator pedal while on a slope, the function prevents the vehicle from rolling. The braking force is maintained automatically after the brake pedal is released on a steep grade.

For vehicles with a manual transmission,

Hill Launch Assist operates on a downward slope when the shift lever is in the reverse (R) position, and on an upward slope when the shift lever is in a position other than the reverse (R) position.

For vehicles with an automatic transmission,

Hill Launch Assist operates on a downward slope when the selector lever is in the reverse (R) position, and on an upward slope when the selector lever is in a forward gear.

IMPORTANT Hill Launch Assist does not operate on a gentle slope. In addition, the gradient of the slope on which the system will operate changes depending on the vehicle's load.

IMPORTANT Hill Launch Assist does not operate if the parking brake is



applied, the vehicle has not stopped completely, or the clutch pedal is released.

IMPORTANT While Hill Launch Assist is operating, the brake pedal may feel stiff and vibrate, however, this does not indicate a malfunction.

IMPORTANT Hill Launch Assist does not operate while the TCS/DSC indicator light is illuminated. Refer to “Warning lights and messages” paragraph in “Knowing the instrument panel” chapter.

IMPORTANT Hill Launch Assist (HLA) does not turn off even if the DSC OFF switch is pressed to turn off the TCS/DSC.

IMPORTANT For vehicles with an automatic transmission although the Hill Launch Assist does not operate during idling stop, the vehicle roll prevention function operates to prevent vehicle roll.

IMPORTANT Do not rely completely on Hill Launch Assist. Hill Launch Assist is an auxiliary device for accelerating from a stop on a slope. The system only operates for about two seconds and therefore, relying only on the system, when accelerating from a stop is dangerous because the vehicle may move (roll) unexpectedly and cause an

accident. The vehicle could roll depending on the vehicle's load or if it is towing something. In addition, for vehicles with a manual transmission, the vehicle could still roll depending on how the clutch pedal or the accelerator pedal is operated. Always confirm the safety around the vehicle before starting to drive the vehicle.



WARNING

76) *The presence of the TPMS does not permit the driver to neglect regular checks of the tire pressure, including for the spare wheel, and correct maintenance: the system is not used to signal a possible fault to a tire. Tire pressure must be checked with tires rested and cold. Should it become necessary for whatever reason to check pressure with warm tires, do not reduce pressure even though it is higher than the prescribed value. Repeat the check when the tires are cold.*

77) *Replacing the normal tires with winter tires and vice versa requires an inspection of the TPMS, which should be carried out only by a Fiat Dealership.*

78) *Changes in outside temperature may cause tire pressures to vary. The system may temporarily indicate insufficient pressure. In this case check the tire inflation pressure with the tires cold and, if necessary top up the inflation pressure.*

OCCUPANT PROTECTION SYSTEMS

The most important safety equipment of the vehicle comprise the following protection systems:

- seat belts;
- SBA (Seat Belt Alert) system;
- head restraints;
- child restraint systems;
- front air bags and side air bags.

Read the information given the following pages with the utmost care.

It is of fundamental importance that the protection systems are used in the correct way to guarantee the maximum possible safety level for the driver and the passengers.

SEAT BELTS

SEAT BELT PRECAUTIONS



79) 80)

Seat belts help to decrease the possibility of severe injury during accidents and sudden stops. FCA recommends that the driver and passengers always wear seat belts.

All the seats have lap/shoulder belts. These belts have retractors with inertia locks that keep them out of the way when not in use.

The locks allow the belts to remain comfortable on users, but they will lock in position during a collision.

Belt retraction may become difficult if the belts and seat belt guides fig. 61 are soiled, so try to keep them clean.



61

03020100-12A-001

Pregnant women and persons with serious medical conditions

Pregnant women should always wear seat belts. Ask your doctor for specific recommendations.

The lap belt should be worn **SNUGLY AND AS LOW AS POSSIBLE OVER THE HIPS**. The shoulder belt should be worn across your shoulder properly, but never across the stomach area fig. 62.



62

06050100-CHD-003

Persons with serious medical conditions also should wear seat belts. Check with your doctor for any special instructions regarding specific medical conditions.

Emergency locking mode

When the seat belt is fastened, it will always be in the emergency locking mode.

In the emergency locking mode, the belt remains comfortable on the

occupant and the retractor will lock in position during a collision.

If the belt is locked and cannot be pulled out, retract the belt once, and then try pulling it out slowly. If this fails, pull the belt strongly one time and loosen, then pull it out again slowly.

USING THE SEAT BELTS



81) 82) 83) 84) 85)

Fastening the seat belt

- 1 fig. 63: seat belt tongue;
- 2 : seat belt buckle.

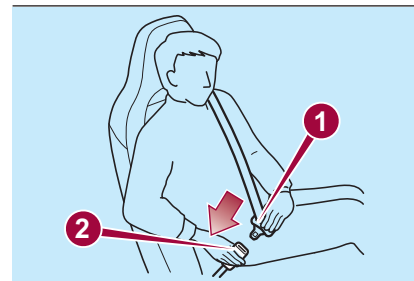

63

03020201-121-001

Position the lap belt as low as possible 1 fig. 64, not on the abdominal area 2, then adjust the shoulder belt 3 so that it fits snugly against your body.



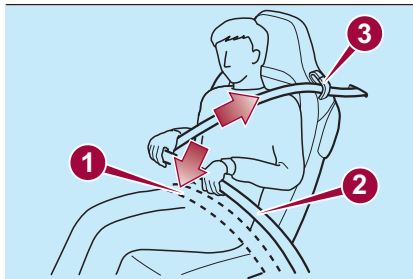

64

03020201-122-002

Unfastening the seat belt

Depress the button 1 fig. 65 on the seat belt buckle. If the belt does not fully retract, pull it out and check for kinks or twists. Then make sure it remains untwisted as it retracts.

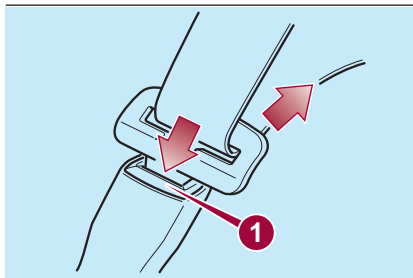

65

03020202-UNF-001

IMPORTANT If a belt does not fully retract, inspect it for kinks and twists. If it is still not retracting properly, have it inspected: contact a Fiat Dealership.

IMPORTANT Always wear the seat belt with it correctly routed in its guide 1 fig. 66. Wearing a seat belt without the seat belt routed in its guide is dangerous because the seat belt would not be able to provide adequate protection in an accident, which could result in serious injury.

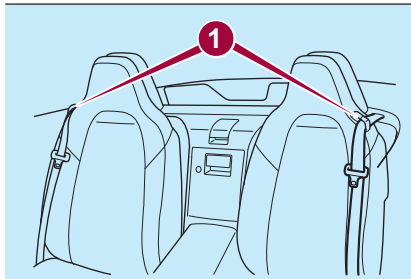

66

03020200-12A-001

SEAT BELT WARNING SYSTEMS

If it detects that the occupant seat belt is unfastened, the warning light or beep alerts the occupant.

Refer to “Warning lights and messages” paragraph in “Knowing the instrument panel” chapter.

Refer to “Seat belt warning beep” in “Knowing the instrument panel” chapter.



WARNING

79) Always wear your seat belt and make sure all occupants are properly restrained. Not wearing a seat belt is extremely dangerous. During a collision, occupants not wearing seat belts could hit someone or things inside the vehicle or even be thrown out of the vehicle. They could be seriously injured or even killed. In the same collision, occupants wearing seat belts would be much safer.

80) Do not wear twisted seat belts. Twisted seat belts are dangerous. In a collision, the full width of the belt is not available to absorb the impact. This puts more force on the bones beneath the belt, which could cause serious injury or death. So, if your seat belt is twisted, you must straighten the seat belt to remove any twists and to allow the full width of the belt to be used.

81) Never use one seat belt on more than one person at a time. Using one seat belt for more than one person at a time is dangerous. A seat belt used in this way cannot spread the impact forces properly and the two passengers could be crushed together and seriously injured or even killed. Never use one belt for more than one person at a time and always operate the vehicle with each occupant properly restrained.

82) Do not operate a vehicle with a damaged seat belt. Using a damaged seat belt is dangerous. An accident could damage the belt webbing of the seat belt in use. A damaged seat belt cannot provide adequate protection in a collision. Contact a Fiat Dealership to inspect all seat belt systems in use during an accident before they are used again.

83) Have your seat belts changed immediately if the pretensioner or load limiter has been expended. Always have an expert repairer, we recommend a Fiat Dealership immediately inspect the seat belt pretensioners and air bags after any collision. Like the air bags, the seat belt pretensioners and load limiters will only function once and must be replaced after any collision that caused them to deploy. If the seat belt pretensioners and load limiters are not replaced, the risk of injury in a collision will increase.

84) Positioning the shoulder portion of the seat belt. Improper positioning of the shoulder portion of the seat belt is dangerous. Always make sure the shoulder portion of the seat belt is positioned across your shoulder and near your neck, but never under your arm, on your neck, or on your upper arm.

85) Positioning the lap portion of the seat belt. The lap portion of the seat belt worn too high is dangerous. In a collision, this would concentrate the impact force directly on the abdominal area, causing serious injury. Wear the lap portion of the belt snugly and as low as possible.

86) Instructions for use of seat belt assemblies. Seat belts are designed to bear upon the bony structure of the body, and should be worn low across the front of the pelvis or the pelvis, chest and shoulders, as applicable; wearing the lap section of the belt across the abdominal area must be avoided. Seat belts should be adjusted as firmly as possible, consistent with comfort, to provide the protection for which they have been designed. A slack belt will greatly reduce the protection afforded to the wearer. Care should be taken to avoid contamination of the webbing with polishes, oils and chemicals, and particularly battery acid. Cleaning may safely be carried out using mild soap and water. The belt should be replaced if webbing becomes frayed, contaminated or damaged. It is essential to replace the entire assembly after it has been worn in a severe impact even if damage to the assembly is not obvious. Belts should not be worn with straps twisted. Each belt assembly must only be used by one occupant; it is dangerous to put a belt around a child being carried on the occupant's lap.

87) No modifications or additions should be made by the user which will either prevent the seat belt adjusting devices from operating to remove slack, or prevent the seat belt assembly from being adjusted to remove slack.

SBA SYSTEM (Seat Belt Alert)

SEAT BELT WARNING LIGHT

The LED on dashboard trim turns on if the driver or passenger's seat is occupied and the seat belt is not fastened with the ignition switched ON. If the driver or passenger's seat belt is unfastened (only when the passenger seat is occupied) and the vehicle is driven at a speed faster than about 20 km/h, the  LED flashes. After a short time, the LED stops flashing, but remains illuminated.

If a seat belt remains unfastened, the LED flashes again for a given period of time. In this case, fasten the seat belt. If the driver or passenger's seat belt is unfastened after the LED turns on, and the vehicle speed exceeds 20 km/h, the LED flashes again.



SEAT BELT PRETENSIONER AND LOAD LIMITING SYSTEMS

PRETENSIONERS



88) 89) 90) 91)

For optimum protection, the driver and passenger seat belts are equipped with pretensioner and load limiting systems. For both these systems to work properly you must wear the seat belt properly.

When a collision is detected, the pretensioners deploy simultaneously with the air bags. For deployment details, refer to the “SRS air bag deployment criteria” paragraph in this chapter.

The seat belt retractors remove slack quickly as the air bags are expanding. Any time the air bags and seat belt pretensioners have fired they must be replaced.

A system malfunction or operation conditions are indicated by a warning. Refer to “Warning lights and messages” and “Warning sound is activated” paragraph in “Knowing the instrument panel” chapter.

In addition, the pretensioner system for the passenger, like the front and side passenger air bag, is designed to only

deploy when the passenger occupant classification sensor detects a passenger sitting on the passenger’s seat. For details, refer to the passenger occupant classification sensor.

IMPORTANT The pretensioner system may not operate depending on the type of the collision. For details, refer to the “SRS Air Bag deployment criteria” paragraph.

IMPORTANT Some smoke (non-toxic gas) will be released when the air bags and pretensioners deploy. This does not indicate a fire. This gas normally has no effect on occupants, however, those with sensitive skin may experience slight skin irritation. If residue from the deployment of the air bags or the pretensioner system gets on the skin or in the eyes, wash it off as soon as possible.

LOAD LIMITER

The load limiting system releases belt webbing in a controlled manner to reduce belt force on the occupant’s chest.

While the most severe load on a seat belt occurs in frontal collisions, the load limiter has an automatic mechanical function and can activate in any accident mode with sufficient occupant movement.

Even if the pretensioners have not fired, the load limiting function must be checked by Fiat Dealership.



WARNING

88) *Wear seat belts only as recommended in this Owner Handbook. Incorrect positioning of the driver and passenger seat belts is dangerous. Without proper positioning, the pretensioner and load limiting systems cannot provide adequate protection in an accident and this could result in serious injury. For more details about wearing seat belts, refer to "Fastening the seat belts".*

89) *Have your seat belts changed immediately if the pretensioner or load limiter has been expended. Always have an expert repairer: contact a Fiat Dealership immediately for seat belt pretensioners and air bags inspections after any collision. Like the air bags, the seat belt pretensioners and load limiters will only function once and must be replaced after any collision that caused them to deploy. If the seat belt pretensioners and load limiters are not replaced, the risk of injury in a collision will increase.*

90) *Do not modify the components or wiring, or use electronic testing devices on the pretensioner system. Modifying the components or wiring of the pretensioner system, including the use of electronic testing devices is dangerous. You could accidentally activate it or make it inoperable which would prevent it from activating in an accident. The occupants or repairers could be seriously injured.*

91) Properly dispose of the pretensioner system. Improper disposal of the pretensioner system or a vehicle with non deactivated pretensioners is dangerous. Unless all safety procedures are followed, injury could result. Contact a Fiat Dealership for safely dispose of the pretensioner system or scrap a pretensioner system equipped vehicle.

CHILD-RESTRAINT PRECAUTIONS

 92) 69) 94) 95) 96) 97) 98) 99) 100) 101) 102)

FCA strongly urges the use of child-restraint systems for children small enough to use them.

FCA recommends use of a genuine child-restraint system or one that complies with the UNECE 44 (*) regulation. If you would like to purchase a FCA genuine child-restraint system, please contact a Fiat Dealership.

Check your local and state or provincial laws for specific requirements regarding the safety of children riding in your vehicle.

(*) UNECE stands for United Nations Economic Commission for Europe.

Whatever child-restraint system you consider, please pick the appropriate one for the age and size of the child, obey the law and follow the instructions that come with the individual child-restraint system.

A child who has outgrown child-restraint systems should use seat belts, both lap and shoulder. If the shoulder belt crosses the neck or face, move the child closer to the centre of the vehicle.

A rear-facing child-restraint system should **NEVER** be used on the passenger seat with the air bag system activated. In the event of an impact the air bag activation may cause fatal injuries to the transported child.

To reduce the chance of injuries caused by deployment of the passenger air bag, the passenger occupant classification sensor work as a part of the supplementary restraint system.

This system deactivates the passenger front and side air bags and also the passenger seat belt pretensioner system when the passenger air bag deactivation OFF indicator light illuminates.



When an infant or small child sits on the passenger seat, the system shuts off the passenger front and side air bags and seat belt pretensioner system, so make sure the passenger air bag deactivation OFF indicator light illuminates. For more details, refer to "Passenger occupant classification sensor" in "Front Air Bags" paragraph.

IMPORTANT A seat belt or child-restraint system can become very hot in a closed vehicle during warm weather. To avoid burning yourself or a child, check them before you or your child touches them.

NOTE Your vehicle is equipped with ISOFIX anchors for attachment of ISOFIX child-restraint systems. When using these anchors to secure a child-restraint system, refer to "Using ISOFIX anchor" paragraph in this chapter.

CATEGORIES OF CHILD-RESTRAINT SYSTEMS

NOTE When purchasing, ask the manufacturer of the child-restraint system which type of child-restraint system is appropriate for your child and vehicle.

Child-restraint systems are classified into the following 5 groups according to the UNECE 44 regulation.

Group	Age	Weight
0	Up to 9 months old	Less than 10 kg
0+	Up to 2 years old	Less than 13 kg
1	8 months to 4 years old	9 kg - 18 kg
2	3 to 7 years old	15 kg - 25 kg
3	6 to 12 years old	22 kg - 36 kg



CHILD-RESTRAINT SYSTEM TYPES

In this Owner Handbook, explanation of child restraint systems secured with seat belts is provided for the following three types of popular child-restraint systems: baby seat, child seat, junior seat.

IMPORTANT Installation position is determined by the type of child-restraint system. Always read the manufacturer's instructions and this Owner Handbook carefully.

IMPORTANT Due to variations in the design of child restraint systems, vehicle seats and seat belts, not all child restraint may fit all seating positions. Before purchasing a child-restraint system, it should be tested in the specific vehicle seating position (or positions) where it is intended to be used. If a previously purchased child-restraint system does not fit, you may need to purchase a different one that will.

Baby seat

Equal to Group 0 and 0+ of the ECE R-44 regulation fig. 67.



67

06070809-INF-001

Child seat

Equal to Group 1 of the ECE R-44 regulation fig. 68.



68

03030202-CHD-001

Junior seat

Equal to Group 2 and 3 of the ECE R-44 regulation fig. 69.

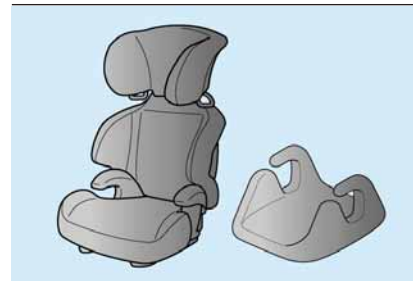

69

03030202-BOO-001

Baby seat installation position



104) 103)

A baby seat is used in the rear-facing position only. Refer to the table "Child restraint system suitability for various seat positions" for infant seat installation position.

CHILD SEAT INSTALLATION POSITION

 100) 104) 105) 106) 106)

A child seat is used in front-facing and rear-facing positions depending on the age and size of the child.

When installing, follow the manufacturer's instructions in accordance with the appropriate age and size of the child as well as the directions for installing the child-restraint system.

Refer to the table, "Child restraint system suitability for various seat positions" for child seat installation position.

Junior seat installation position

A junior seat is used in the front-facing position only.

Refer to the table "Child restraint system suitability for various seat positions" for child seat installation position.



CHILD RESTRAINT SYSTEM SUITABILITY FOR VARIOUS SEAT POSITION

Provided information in the table shows your child-restraint system suitability for various seating position.

For installation suitability of other manufacturer child-restraint system, carefully consult the manufacturer's instructions which accompany the child-restraint system.

ISOFIX anchor-secured child-restraint systems

When installing a child-restraint system to the passenger seat, refer to the child-restraint system manufacturer's instructions and the Using ISOFIX anchor.

Weight group	Size class	Fixture	Seat positions
			Vehicle ISOFIX positions
			Passenger seat
Carrycot	F	ISO/L1	X
	G	ISO/L2	X
		(1)	X
GROUP 0 Up to 10 kg	E	ISO/R1	X
		(1)	X
GROUP 0+ Up to 13 kg	E	ISO/R1	IL (1)
	D	ISO/R2	X
	C	ISO/R3	X
		(1)	X

Weight group	Size class	Fixture	Seat positions
			Vehicle ISOFIX positions
			Passenger seat
GROUP 1 9 kg – 18 kg	D	ISO/R2	X
	C	ISO/R3	X
	B	ISO/F2	IUF
	B1	ISO/F2X	IUF
	A	ISO/F3	X
		(1)	IL (2)
GROUP 2 15 kg – 25 kg		(1)	IL (3)
GROUP 3 22 kg – 36 kg		(1)	IL (3)

(1) For the CRS which do not carry the ISO/XX size class identification (A to G), for the applicable weight group, the car manufacturer shall indicate the vehicle specific ISOFIX child-restraint system(s) recommended for each position.

IUF = Suitable for ISOFIX forward child restraints systems of universal category approved for use in this mass group.

IL = Suitable for particular ISOFIX child restraint systems (CRS) given in the attached list.

These ISOFIX CRS are those of the “specific vehicle”, “restricted” or “semi-universal” categories.

(1) A CabrioFix child-restraint attached to an EasyFix Base, both sold by **MAXI-COSI®** can be installed.

(2) Pearl child-restraint attached to an FamilyFix Base, both sold by **MAXI-COSI®** can be installed.

(3) **BRITAX RÖMER®** KIDFIX can be installed (KIDFIX is no longer in production).

X = ISOFIX position not suitable for ISOFIX child-restraint systems in this mass group and/or this size class.



i-Size child restraint systems



An i-Size child-restraint system can be installed to the specified seat as follows:

	Passenger seat
i-Size child restraint systems	X

X = Seating position not suitable for i-Size “universal” child-restraint systems.

IMPORTANT An i-Size child restraint system refers to a child-restraint system which has acquired i-Size category certification for the UNECE 129 regulation.

Seat belt-secured child-restraint systems

System group	Age group	Weight group	Child restraint system type	Passenger seat	
				 ON (Air bag enabled)	 OFF (Air bag disabled)
GROUP 0	Up to approximately 9 months old	Less than 10 kg	Baby seat	X	U
GROUP 0+	Up to approximately 2 years old	Less than 13 kg	Baby seat	X	U
GROUP 1	Approximately 8 months to 4 years old	9 kg - 18 kg	Child seat	UF	U
GROUP 2	Approximately 3 to 7 years old	15 kg - 25 kg	Child seat	UF	U
GROUP 3	Approximately 6 to 12 years old	22 kg - 36 kg	Child seat	UF	U

U = Suitable for “universal” category restraints approved for use in this weight group.

UF = Suitable for forward-facing “universal” category restraints approved for use in this weight group.

Regarding child restraint systems which can be installed, refer to the accessories catalog.

X = Seat position not suitable for children in this weight group.



INSTALLING CHILD RESTRAINT SYSTEMS



107) 108)

Anchor bracket

Anchor brackets for securing child restraint systems are provided in the vehicle. Locate anchor position.

To install a child restraint system, always follow the instruction manual accompanying the child-restraint system.

Anchor bracket location

Use the indicated anchor bracket locations fig. 70 when installing a child restraint system equipped with a tether.



70

03030401-222-001

IMPORTANT When moving the seats forward and rearward, make sure you hold onto the seatback with your hand while operating. If the seatback is not

held, the seat will move suddenly and could cause injury.

Proceed as follows:

- open the convertible top;
- slide the passenger seat as far back as possible and then slide it forward about 100 mm so that your hand can be placed behind it;
- remove the cover fig. 71. Be careful not to lost the removed cover;
- place the child restraint on the passenger seat;
- pass the tether strap under the head restraint and install it to the tether anchor fig. 72. For the tether strap adjustment method, refer to the child-restraint seat manufacturer's instructions.



71

06070809-121-001



72

06070807-12A-001

Using the seat belt

IMPORTANT When moving the seats forward and rearward, make sure you hold onto the seatback with your hand while operating. If the seatback is not held, the seat will move suddenly and could cause injury.

When installing a child-restraint system, follow the installation instructions included with the product.

Also, open the convertible top and slide the seat as far back as possible, fold down the seatback as far as possible.

Using ISOFIX anchor



109) 110) 111)

IMPORTANT When moving the seats forward and rearward, make sure you hold onto the seat back with your hand while operating. If the seatback is not

held, the seat will move suddenly and could cause injury.

Proceed as follows:

- open the convertible top;
- make sure the ignition is switched off;
- slide the passenger seat as far back as possible. You may need to move the seat forward slightly and recline the back of the seat, in order to assist in the fitting of some child-restraint systems;
- make sure the seatback is securely latched by pushing it back until it is fully locked;
- expand the area between the seat bottom and the seatback slightly to verify the locations of the ISOFIX anchor fig. 73.

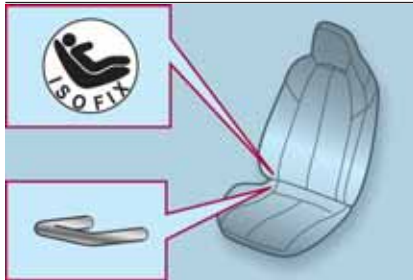

73

06070808-12A-001

IMPORTANT The markings above the ISOFIX anchors indicate the locations of

the ISOFIX anchors for the attachment of a child restraint system.

- secure the child restraint system using the ISOFIX anchor, following the child restraint system manufacturer's instruction;
- switch the ignition ON and make sure the OFF passenger air bag deactivation indicator light illuminates after installing a child restraint system on the passenger seat (see "Passenger Air Bag deactivation indicator lights" paragraph). If the passenger air bag OFF deactivation indicator light fig. 74 does not illuminate, remove the child restraint system, switch the ignition to OFF, and then reinstall the child restraint system;
- if your child restraint system came equipped with a tether, that probably means it is very important to properly secure the tether for child safety. Please carefully follow the child restraint system manufacturer's instructions when installing tethers.



74

06070432-121-001



- 92)** Use the correct size child-restraint system. For effective protection in vehicle accidents and sudden stops, a child must be properly restrained using a seat belt or child-restraint system depending on age and size. If not, the child could be seriously injured or even killed in an accident.
- 93)** Follow the manufacturer's instructions and always keep the child-restraint system buckled down. An unsecured child-restraint system is dangerous. In a sudden stop or a collision it could move causing serious injury or death to the child or other occupants. Make sure any child-restraint system is properly secured in place according to the child-restraint system manufacturer's instructions. When not in use, remove it from the vehicle or fasten it with a seat belt, or latch it down to BOTH ISOFIX anchors, and attach the corresponding tether anchor.



94) Always secure a child in a proper child-restraint system. Holding a child in your arms while the vehicle is moving is extremely dangerous. No matter how strong the person may be, he or she cannot hold onto a child in a sudden stop or collision and it could result in serious injury or death to the child or other occupants. Even in a moderate accident, the child may be exposed to air bag forces that could result in serious injury or death to the child, or the child may be slammed into an adult, causing injury to both child and adult.

95) Always make sure the passenger air bag deactivation OFF indicator light is illuminated when using a child restraint system. Seating a child in a child restraint system that is installed on the passenger seat with the passenger air bag deactivation OFF indicator light not illuminated is extremely dangerous. In an accident, an air bag could inflate and cause serious injuries or even death to the child seated in the child restraint system. Always make sure the passenger air bag deactivation OFF indicator light is illuminated.

96) Extreme Hazard! Never use a rear-facing child-restraint system on the passenger seat with an air bag that could deploy: NEVER use a rearward facing child restraint on a seat protected by an ACTIVE AIRBAG in front of it, DEATH or SERIOUS INJURY to the CHILD can occur. Vehicles with a passenger air bag have a warning label attached as shown below. This warning label is displayed in compliance with regulations.

97) Even in a moderate collision, the child-restraint system can be hit by a deploying air bag and moved violently backward resulting in serious injury or death to the child. If your vehicle is equipped with a passenger occupant classification system, always make sure the passenger air bag deactivation OFF indicator light is illuminated, when installing a rear-facing child restraint system on the passenger seat.

98) Before installing child-restraint system on the passenger seat, move the passenger seat as far back as possible. The rearmost position may not be suitable for the installation of some child-restraint systems. In a collision, the force of a deploying air bag could cause serious injury or death to the child. Make sure the passenger air bag deactivation OFF indicator light is illuminated.

99) Seating a child in a child-restraint system on the passenger seat is dangerous under certain conditions. Your vehicle is equipped with passenger occupant classification sensor. Even with the passenger occupant classification sensor, if you must use the passenger seat to seat a child, using a child restraint system on the passenger seat under the following conditions increases the danger of the passenger air bag deploying and could result in serious injury or death to the child. The passenger air bag deactivation OFF indicator light does not illuminate when seating a child in the child-restraint system / Luggage or other items are placed on the seat with the child in the child-restraint system / The seat is washed / Liquids are spilled on the seat / The passenger seat is moved backward, pushing into luggage or other items placed behind it / Luggage or other items are placed between the passenger seat and driver seat / An electric device is put on the passenger's seat / An additional electrical device, such as a seat warmer is installed to the surface of the passenger seat.

100) Do not allow a child or anyone to lean over or against the side window of a vehicle with side air bags. It is dangerous to allow anyone to lean over or against the side window, the area of the passenger seat from which the side air bags deploy, even if a child-restraint system is used. The impact of inflation from a side air bag could cause serious injury or death to an out of position child. Furthermore, leaning over or against the door could block the side air bags and eliminate the advantages of supplementary protection. Because the side air bag deploys from the outer shoulder of the seat, do not allow the child to lean over or against the side window, even if the child is seated in a child-restraint system.

101) Never use one seat belt on more than one person at a time. Using one seat belt for more than one person at a time is dangerous. A seat belt used in this way cannot spread the impact forces properly and the two passengers could be crushed together and seriously injured or even killed. Never use one belt for more than one person at a time and always operate the vehicle with each occupant properly restrained.

102) Use the tether and tether anchor only for a child-restraint system. Child restraint system anchorages are designed to withstand only those loads imposed by correctly installed child-restraint systems. Under no circumstances are they to be used for adult seat belts, harnesses, or for attaching other items or equipment to the vehicle.

103) Always install a rear-facing child seat in the correct seat position. Installing a rear-facing child seat without first consulting the table "Child restraint system suitability for various seat positions" is dangerous. A rear-facing child seat installed on the wrong seat position cannot be properly secured. In a collision, the child could hit something or someone in the vehicle and be seriously injured or even killed.

104) Never use a rear-facing child-restraint system on the passenger seat protected by an air bag. Extreme Hazard! Do not use a rearward facing child restraint on a seat protected by an airbag in front of it! The child-restraint system can be hit by the deploying air bag and knocked out of position. A child in the child-restraint system could be seriously injured or killed. If your vehicle is equipped with a passenger occupant classification system, always make sure the passenger air bag deactivation OFF indicator light is illuminated, if installing a rear-facing child-restraint system on the passenger seat is unavoidable.

105) Never install a front-facing child seat in the wrong seat position: Installing a front-facing child seat without first consulting the table "Child restraint system suitability for various seat positions" is dangerous. A front-facing child seat installed in the wrong seat position cannot be properly secured. In a collision, the child could hit something or someone in the vehicle and be seriously injured or even killed. Make sure the passenger air bag deactivation OFF indicator light is illuminated.

106) Before installing child-restraint system on the passenger seat, move the passenger seat as far back as possible: In a collision, the force of a deploying air bag could cause serious injury or death to the child. Make sure the passenger air bag deactivation OFF indicator light is illuminated.

107) Always attach the tether strap to the correct tether anchor position. Attaching the tether strap to the incorrect tether anchor position is dangerous. In a collision, the tether strap could come off and loosen the child restraint system. If the child restraint system moves it could result in death or injury to the child.

108) Always route the tether strap between the head restraint and the seat back. Routing the tether strap on top of the head restraint is dangerous. In a collision the tether strap could slide off the head restraint and loosen the child restraint system. The child restraint system could move which may result in death or injury to the child.

109) Follow the manufacturer's instructions for the use of the child-restraint system. An unsecured child restraint system is dangerous. In a sudden stop or a collision it could move causing serious injury or death to the child or other occupants. Make sure any child restraint system is properly secured in place according to the manufacturer's instructions.

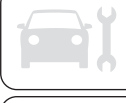

110) Make sure the child restraint system is properly secured. A child restraint system that is not secured is dangerous. In a sudden stop or collision, it can become a projectile and hit someone, causing serious injury. When not in use, remove it from the vehicle, put it in the trunk or at least make sure it is securely fastened to the ISOFIX anchors.

111) Make sure there are no seat belts or foreign objects near or around the ISOFIX anchor secured child restraint system. Not following the child restraint system manufacturer's instructions when installing the child restraint system is dangerous. If seat belts or a foreign object prevent the child restraint system from being securely attached to the ISOFIX anchors and the child-restraint system is installed improperly, the child restraint system could move in a sudden stop or collision causing serious injury or death to the child or other occupants. When installing the child restraint system, make sure there are no seat belts or foreign objects near or around the ISOFIX anchors. Always follow the child restraint system manufacturer's instructions.

SUPPLEMENTARY RESTRAINT SYSTEM SRS - AIR BAG

SUPPLEMENTAL RESTRAINT SYSTEM (SRS) PRECAUTIONS

 112) 113) 114)

The front and side supplementary restraint systems (SRS) include different types of air bags.

IMPORTANT Please verify which kinds of air bags are equipped on your vehicle by locating the “SRS AIR BAG” location indicators.

These indicators are visible in the area where the air bags are installed.

The air bags are installed in the following locations:

- the steering wheel hub (driver air bag);
- the passenger dashboard (passenger air bag);
- the outer sides of the seat backs (side air bags).

The air bag supplementary restraint systems are designed to provide supplementary protection in certain situations so seat belts are always important in the following ways.

Without seat belt usage, the air bags

cannot provide adequate protection during an accident. Seat belt usage is necessary to:

- keep the occupant from being thrown into an inflating air bag;
- reduce the possibility of injuries during an accident that is not designed for air bag inflation, such as roll-over or rear impact;
- reduce the possibility of injuries in frontal, near frontal or side collisions that are not severe enough to activate the air bags;
- reduce the possibility of being thrown from your vehicle;
- reduce the possibility of injuries to lower body and legs during an accident because the air bags provide no protection to these parts of the body;
- hold the driver in a position which allows better control of the vehicle.

A child who is too small to use a seat belt must be properly secured using a child restraint system.

Carefully consider which child restraint system is necessary for your child and follow the installation directions in this Owner Handbook as well as the child restraint system manufacturer's instructions.

SUPPLEMENTARY RESTRAINT SYSTEM COMPONENTS

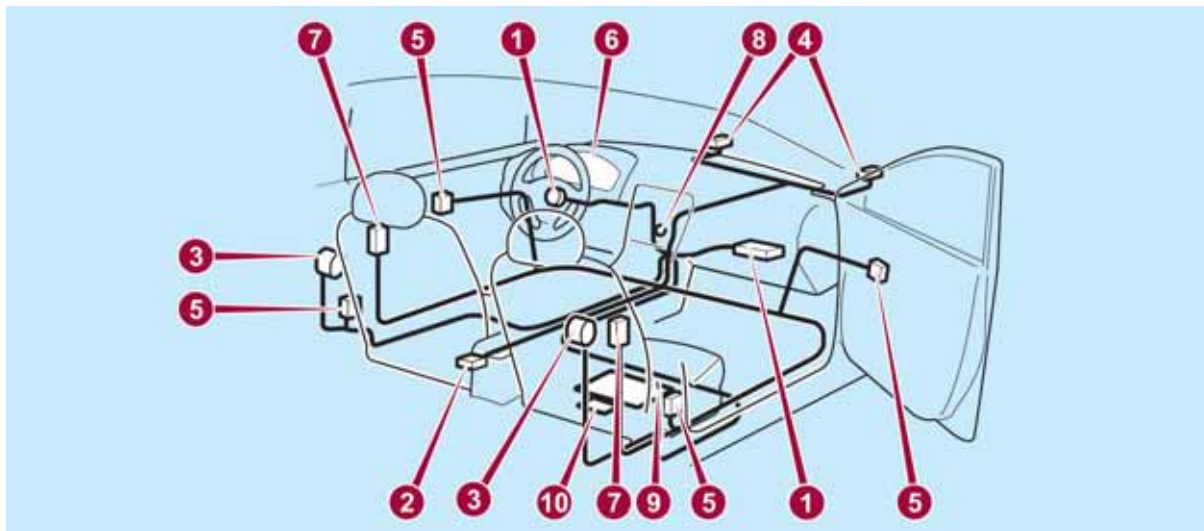

75

03040300-121-002

- 1 Driver/Passenger inflators and air bags
- 2 Crash sensors and diagnostic module (SAS unit)
- 3 Seat belt pretensioners
- 4 Front air bag sensors
- 5 Side crash sensors
- 6 Air bag/seat belt pretensioner system warning light
- 7 Side inflators and air bags
- 8 Passenger air bag deactivation indicator light
- 9 Passenger occupant classification sensor
- 10 Passenger occupant classification module



HOW THE SRS AIR BAGS WORK

 115) 116) 117) 118) 119) 120) 121) 122) 123) 124) 125) 128) 129) 22)

Your vehicle is equipped with the following types of SRS air bags. SRS air bags are designed to work together with the seat belts to help to reduce injuries during an accident. The SRS air bags are designed to provide further protection for passengers in addition to the seat belt functions. Be sure to wear seat belts properly.

Seat Belt Pretensioners

The seat belt pretensioners are designed to deploy in moderate or severe frontal, near frontal collisions. In addition, during a side collision, the pretensioner operates on the side in which the collision occurs. The pretensioners operate differently depending on what types of air bags are equipped. For details on the seat belt pretensioner operation, refer to the SRS Air Bag Deployment Criteria

Driver Air Bag

The driver's air bag is mounted in the steering wheel fig. 76.



76

06010203-126-123

When air bag crash sensors detect a frontal impact of greater than moderate force, the driver's air bag inflates quickly helping to reduce injury mainly to the driver's head or chest caused by directly hitting the steering wheel. For more details about air bag deployment, refer to "SRS Air Bag deployment criteria" in this chapter.

Passenger Air Bag (Single stage)

The passenger air bag is mounted in the passenger dashboard fig. 77.



77

06010204-126-123

The inflation mechanism for the passenger air bag is the same as the driver's air bag, as mentioned above. For more details about air bag deployment, refer to "SRS Air Bag deployment criteria" in this chapter.

In addition, the passenger air bag is designed to only deploy when the passenger occupant classification sensor detects a passenger sitting on the passenger's seat. For more details about air bag deployment, refer to "SRS Air Bag deployment criteria" in this chapter.

Side Air Bags

The side air bags are mounted in the outer sides of the seat backs fig. 78.

When the air bag crash sensors detect a side impact of greater than moderate force, the system inflates the side air

bag only on the side in which the vehicle was hit.



78

06010205-126-123

The side air bag inflates quickly to reduce injury to the driver or passenger's head and chest caused by directly hitting interior parts such as a door or window. For more details about air bag deployment, refer to "SRS Air Bag deployment criteria" in this chapter. In addition, the passenger side bag is designed to only deploy when the passenger occupant classification

sensor detects a passenger sitting on the passenger's seat.

Warning Light/Beep

A system malfunction or operation conditions are indicated by a warning. Refer to "Warning lights and messages" paragraph in "Knowing your instrument panel" chapter. Refer to "Warning sound is activated" paragraph in "Knowing your instrument panel" chapter.

Passenger side front air bag and child restraint systems

Rearward-facing child restraint systems must **NEVER** be fitted on the front seat with an active passenger side air bag since in the event of an impact the air bag activation may cause fatal injuries to the transported child.

ALWAYS comply with the instructions on the label stuck on the passenger side sun visor fig. 79.



79

03030100-133-555



SRS AIR BAG DEPLOYMENT CRITERIA

This chart indicates the applicable SRS equipment that will deploy depending on the type of collision (the illustrations are the representative cases of collisions).

SRS equipment	Types of collision		
	A severe frontal/near frontal collision	A severe side collision (**)	A rear collision
SRS equipment			
Seat belt pretensioner	X (**)	X (**)	No air bag and seat belt pretensioner will be activated in a rear collision
Driver air bag	X		
Passenger air bag	X (**)		
Side air bag		X (**)	

X: the SRS air bag equipment is designed to deploy in a collision.

(*) In a side collision, the seat belt pretensioners and the side air bags deploy (only on the side in which the collision occurs).

(**) The passenger front and side air bags and the seat belt pretensioner are designed to deploy when the passenger occupant classification sensor detects a passenger sitting on the passenger's seat.

IMPORTANT In a frontal offset collision, the equipped air bags and pretensioners may all deploy depending on the direction, angle, and rate of impact.

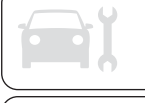

LIMITATIONS TO SRS AIR BAG

In severe collisions such as those described in "SRS Air Bag deployment criteria" paragraph, the applicable SRS air bag equipment will deploy.

However, in some accidents, the equipment may not deploy depending on the type of collision and its severity.

Limitations to front / near front collision detection

Front/near front collisions may not be detected as severe enough to deploy the SRS air bag equipment:

- impacts involving trees or poles A fig. 80;
- frontal offset impact to the vehicle B fig. 80;
- rear-ending or running under a truck's tail gate fig. 81.

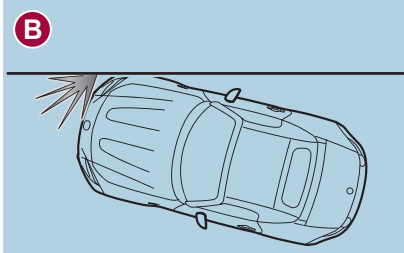
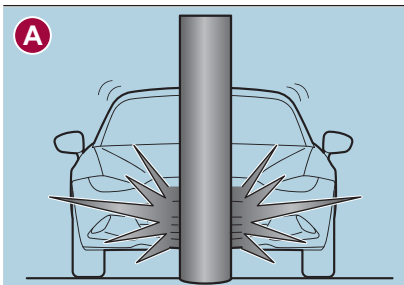

80

03040600-121-001

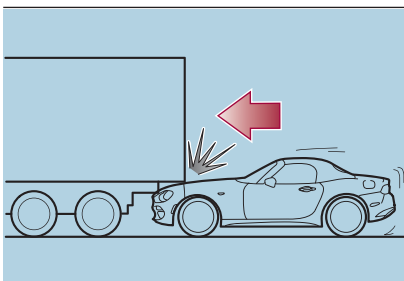

81

03040600-122-001

Limitations to side collision detection

Side collisions may not be detected as severe enough to deploy the SRS air bag equipment:

- side impacts involving trees or poles A fig. 82;
- side impacts with two-wheeled vehicles B fig. 82;
- roll-over fig. 83.

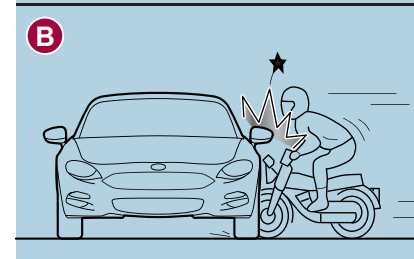
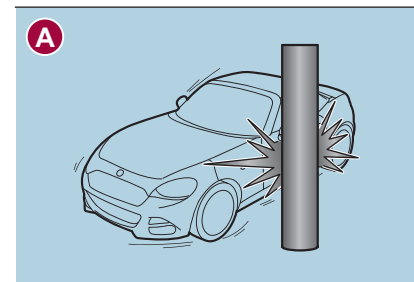

82

03040600-123-001

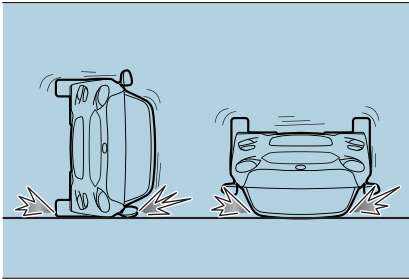

83

03040600-124-002

PASSENGER OCCUPANT CLASSIFICATION SYSTEM



First, please read "Supplemental Restraint System (SRS) Precautions" carefully.

Passenger occupant classification sensor

Your vehicle is equipped with a passenger occupant classification sensor as a part of the supplementary restraint system. This sensor is equipped in the passenger's seat cushion. This sensor measures the electrostatic capacity of the passenger's seat.

The SAS unit is designed to prevent the passenger front and side air bags and seat belt pretensioner system from

deploying if the passenger air bag deactivation indicator light turns on.

To reduce the chance of injuries caused by deployment of the passenger air bag, the system deactivates the passenger front and side air bags and also the seat belt pretensioner system when the passenger air bag deactivation indicator light turns on.

This system shuts off the passenger front and side air bags and seat belt pretensioner system, so make sure the passenger air bag deactivation indicator light turns on.

The air bag/seat belt pretensioner system warning light flashes and the passenger air bag deactivation indicator light illuminates if the sensors have a possible malfunction. If this happens, the passenger front and side air bags and seat belt pretensioner system will not deploy.

IMPORTANT If a passenger is seated as shown in the following fig. 84 the passenger occupant classification sensor cannot detect a passenger sitting on the passenger's seat correctly and the deployment/non-deployment of the air bags cannot be controlled as indicated in the passenger air bag deactivation indicator light on/off condition chart.

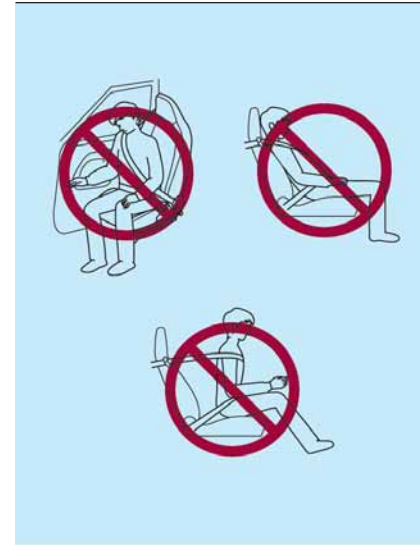

84

03040702-12A-001

Passenger air bag deactivation indicator lights

These indicator lights fig. 85 turn on to remind you that the passenger front and side air bags and seat belt pretensioner will or will not deploy during a collision.





85

06070400-121-001



22) 23)

Note



- The system requires about 10 seconds to alternate between turning the passenger front and side air bags and seat belt pretensioner system on or off.
- The passenger air bag deactivation indicator light may turn on repeatedly if luggage or other items are put on the passenger seat, or if the temperature of the vehicle's interior changes suddenly.
- The passenger air bag deactivation indicator light may turn on for 10 seconds if the electrostatic capacity on the passenger seat changes.
- The air bag/seat belt pretensioner system warning light might turn on if the passenger seat receives a severe impact.
- If the passenger air bag deactivation indicator light does not turn on after

installing a child restraint system on the passenger seat, first, reinstall your child restraint system according to the procedure in this Owner Handbook. Then, if the passenger air bag deactivation OFF indicator light still does not turn on, and contact a Fiat Dealership as soon as possible.

- If the passenger air bag deactivation indicator light turns on when an occupant is seated directly in the passenger seat, have the passenger readjust their posture by sitting with their feet on the floor, and then refastening the seat belt. If the passenger air bag deactivation indicator light remains turned on, slide the passenger seat as far back as possible. Contact a Fiat Dealership as soon as possible.

Passenger air bag deactivation indicator light on/off condition chart

If the passenger occupant classification sensor is normal, the indicator light turns on when the ignition is switched ON. The light turns off after a few seconds. Then, the indicator light turns on or is off under the following conditions:

Condition detected by the passenger occupant classification system	Passenger air bag deactivation indicator light	Passenger front and side air bags	Passenger seat belt pretensioner system
Empty (Not occupied)	 OFF	Deactivated	Deactivated
A child is seated in a child restraint system (*)	 OFF	Deactivated	Deactivated
Adult (**)	 ON (***)	Ready	Ready

(*) The occupant classification sensor may not detect a child seated on the seat, in a child restraint system, or a junior seat depending on the child's physical size and seated posture.

(**) If a smaller adult sits on the passenger seat, the sensors might detect the person as being a child depending on the person's physique.

(***) Turns off after a short period of time.

If both of the passenger air bag deactivation indicator lights do not turn on for a specified period of time when the ignition is switched ON or they do not turn on as indicated in the passenger air bag deactivation indicator light on/off condition chart, do not allow an occupant to sit in the passenger seat and contact a Fiat Dealership as soon as possible. The system may not work properly in an accident.



**WARNING**

112) Seat belts must be worn in air bag equipped vehicles. Depending only on the air bags for protection during an accident is dangerous. Alone, air bags may not prevent serious injuries. The appropriate air bags can be expected to inflate only in the first accident, such as frontal, near frontal or side collisions that are at least moderate. Vehicle occupants should always wear seat belts.

113) Always make sure the passenger air bag deactivation OFF indicator light is illuminated when using a child restraint system. Seating a child in a child-restraint system that is installed on the passenger seat with the passenger air bag deactivation OFF indicator light not illuminated is extremely dangerous. In an accident, an air bag could inflate and cause serious injuries or even death to the child seated in the child restraint system. Always make sure the passenger air bag deactivation OFF indicator light is illuminated.

114) **EXTREME HAZARD!** Never use a rear-facing child-restraint system on the passenger seat with an air bag that could deploy. NEVER use a rearward facing child restraint on a seat protected by an ACTIVE AIR BAG in front of it. DEATH or SERIOUS INJURY to the CHILD can occur. Even in a moderate collision, the child-restraint system can be hit by a deploying air bag and moved violently backward resulting in serious injury or death to the child. If your vehicle is equipped with on passenger occupant classification system, always make sure the passenger air bag deactivation OFF indicator light is illuminated.

115) Do not sit too close to the driver and passenger air bags. Sitting too close to the driver and passenger air bag modules or placing hands or feet on them is extremely dangerous. The driver and passenger air bags inflate with great force and speed. Serious injuries could occur if someone is too close. The driver should always hold onto only the rim of the steering wheel. The passenger should keep both feet on the floor. Seat occupants should adjust their seats as far back as possible and always sit upright against the seat backs with seat belts worn properly.

116) Do not sit too close to a door or lean against doors in vehicles with side air bags. Sitting too close to the side air bag modules or placing hands on them is extremely dangerous. A side air bag inflates with great force and speed directly out of the outer shoulder of the seat and expands along the door on the side the car is hit. Serious injury could occur if someone is sitting too close to the door or leaning against a window in the seats.

Furthermore, sleeping up against the door or hanging out the driver-side window while driving could block the side air bag and eliminate the advantages of supplementary protection. Give the side air bags room to work by sitting in the center of the seat while the vehicle is moving with seat belts worn properly.

117) Sit in the center of the seat and wear seat belts properly. Sitting too close to the side air bag modules or placing hands on them, or sleeping up against the door or hanging out the windows is extremely dangerous. The side air bags inflate with great force and speed directly expanding along the door on the side the car is hit. Serious injury could occur if someone is sitting too close to the door. Give the side air bags room to work by sitting in the center of the seat while the vehicle is moving with seat belts worn properly.

118) Do not attach objects on or around the area where driver and passenger air bags deploy. Attaching an object to the driver and passenger air bag modules or placing something in front of them is dangerous. In an accident, an object could interfere with air bag inflation and injure the occupants.

119) Do not attach objects on or around the area where a side air bag deploys. Attaching objects to the seat in such a way as to cover the outboard side of the seat in any way is dangerous. In an accident the object could interfere with the side air bag, which inflates from the outboard side of the seats, impeding the added protection of the side air bag system or redirecting the air bag in a way that is dangerous. Furthermore, the bag could be cut open releasing the gas. Do not hang net bags, map pouches or backpacks with side straps on the seats. Never use seat covers on the seats. Always keep the side air bag modules in your seats free to deploy in the event of a side collision.

120) Do not touch the components of the supplementary restraint system after the air bags have inflated. Touching the components of the supplementary restraint system after the air bags have inflated is dangerous. Immediately after inflation, they are very hot. You could get burned.

121) Never install any front-end equipment to your vehicle. Installation of front-end equipment, such as frontal protection bar (kangaroo bar, bull bar, push bar, or other similar devices), snowplow, or winches, is dangerous. The air bag crash sensor system could be affected. This could cause air bags to inflate unexpectedly, or it could prevent the air bags from inflating during an accident. Occupants could be seriously injured.

122) Do not modify the suspension. Modifying the vehicle suspension is dangerous. If the vehicle's height or the suspension is modified, the vehicle will be unable to accurately detect a collision resulting in incorrect or unexpected air bag deployment and the possibility of serious injuries.

123) Do not modify a door or leave any damage unrepaired. Always have an expert repairer, we recommend a Fiat Dealership inspect a damaged door. Modifying a door or leaving any damage unrepaired is dangerous. Each door has a side crash sensor as a component of the supplementary restraint system. If holes are drilled in a door, a door speaker is left removed, or a damaged door is left unrepaired, the sensor could be adversely affected causing it to not detect the pressure of an impact correctly during a side collision. If a sensor does not detect a side impact correctly, the side air bags and the seat belt pretensioner may not operate normally which could result in serious injury to occupants.

124) Do not modify the supplementary restraint system. Modifying the components or wiring of the supplementary restraint system is dangerous. You could accidentally activate it or make it inoperable. Do not make any modifications to the supplementary restraint system. This includes installing trim, badges, or anything else over the air bag modules. It also includes installing extra electrical equipment on or near system components or wiring. An expert repairer, we recommend a Fiat Dealership can provide the special care needed in the removal and installation of seats. It is important to protect the air bag wiring and connections to assure that the bags do not accidentally deploy, and that the passenger occupant classification system and the seats retain an undamaged air bag connection.

125) Do not place luggage or other objects under the seats. Placing luggage or other objects under the seats is dangerous. The components essential to the supplementary restraint system could be damaged, and in the event of a side collision, the appropriate air bags may not deploy, which could result in death or serious injury. To prevent damage to the components essential to the supplementary restraint system, do not place luggage or other objects under the seats.



126) Do not operate a vehicle with damaged air bag/seat belt pretensioner system components. Expended or damaged air bag/seat belt pretensioner system components must be replaced after any collision which caused them to deploy or damage them. Only a trained expert repairer, we recommend a Fiat Dealership that can fully evaluate these systems to see that they will work in any subsequent accident. Driving with an expended or damaged air bag or pretensioner unit will not afford you the necessary protection in the event of any subsequent accident which could result in serious injury or death.

127) Do not remove interior air bag parts. Removing any components such as the seats, front instrument panel, the steering wheel, containing air bag parts or sensors is dangerous. These parts contain essential air bag components. The air bag could accidentally activate and cause serious injuries. Always have a Fiat Dealership remove these parts.

128) Do not allow an occupant in the passenger's seat to sit with a posture which makes it difficult for the passenger occupant classification sensor to detect the occupant correctly. Sitting in the passenger's seat with a posture which makes it difficult for the passenger occupant classification sensor to detect the occupant correctly is dangerous. If the passenger occupant classification sensor cannot detect the occupant sitting on the passenger's seat correctly, the passenger front and side air bags and pretensioner system may not operate (deploy) or they may operate (deploy) accidentally. The passenger will not have the supplementary protection of the air bags or the accidental operation (deployment) of the air bags could result in serious injury or death.

129) Under the following conditions, the passenger occupant classification sensor cannot detect a passenger sitting on the passenger's seat correctly and the deployment/non-deployment of the air bags cannot be controlled as indicated in the passenger air bag deactivation indicator light on/off condition chart. For example: luggage or other items placed under the passenger seat or between the passenger seat and driver seat that push up the passenger seat bottom / An object, such as a seat cushion, is put on the passenger's seat or between the passenger's back and the seat back / A seat cover is put on the passenger's seat / Luggage or other items are placed on the seat with the child in the child restraint system / The seat is washed / Liquids are spilled on the seat / The passenger seat is moved backward, pushing into luggage or other items placed behind it / Luggage or other items are placed between the passenger seat and driver seat / An electric device is put on the passenger's seat. The passenger front and side air bags and seat belt pretensioner systems will deactivate if the passenger air bag deactivation OFF indicator light turns on.



IMPORTANT

22) To assure proper deployment of the front air bag and to prevent damage to the sensor in the seat cushion: do not place sharp objects on the seat cushion or leave heavy luggage on them. Do not spill any liquids on the seats or under the seats.

23) To allow the sensors to function properly, always perform the following: adjust the seats as far back as possible and always sit upright against the seatbacks with seat belts worn properly. If you place your child on the passenger seat, secure the child-restraint system properly and slide the passenger seat as far back as possible within the position in which the child-restraint system can be installed.

RECORDING OF VEHICLE DATA

This vehicle is equipped with a computer which records the following main vehicle data related to vehicle controls, operation, and other driving conditions.

Recorded data

- Vehicle conditions such as engine speed and vehicle speed.
- Driving operation conditions such as accelerator and brake pedals, and information related to the environmental circumstances while the vehicle is driven.
- Malfunction diagnosis information from each on-vehicle computer.
- Information related to controls of other on-vehicle computers.

The recorded data may vary depending on the vehicle grade and optional equipment. Voice and images are not recorded.

Data handling

FCA and its subcontracting parties may obtain and use the recorded data for vehicle malfunction diagnosis, research and development, and quality improvement.

FCA will not disclose or provide any of the obtained data to a third party unless:

- an agreement from the vehicle owner (agreements from lessor and lessee for leased vehicle) is obtained;
- officially requested by the police or other law enforcement authorities;
- for statistical processing by a research institution after processing the data so that identification of the owner or the vehicle is impossible.



CONSTANT MONITORING

The following components of the air bag systems and the active bonnet are monitored by a diagnostic system:

- Crash sensors, and diagnostic module (SAS unit)
- Front air bag sensors
- Air bag modules
- Side crash sensors
- Air bag/Seat belt pretensioner system warning light
- Seat belt pretensioners
- Related wiring
- Passenger air bag deactivation indicator light
- Passenger occupant classification sensor
- Passenger occupant classification module (where provided)
- Active bonnet sensors
- Active bonnet modules
- Active bonnet warning light

The diagnostic module continuously monitors the system's readiness. This begins when the ignition is switched ON and continues while the vehicle is being driven.

STARTING AND OPERATING

Let's get to the "heart" of the vehicle: seeing how you can exploit all of its potential to the full.

We'll look at how to drive it safely in any situation, so that it can be a welcome companion, with our comfort and our wallets in mind.

STARTING THE ENGINE	112
PARKING	112
PARKING BRAKE	113
MANUAL TRANSMISSION	114
AUTOMATIC TRANSMISSION	115
CRUISE CONTROL	118
SPEED LIMITER	120
PARKING SENSOR SYSTEM	121
REFUELLING THE VEHICLE	123
REAR CAMERA (PARKVIEW REAR BACKUP CAMERA)	125
TOWING TRAILERS	128

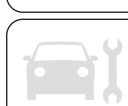

STARTING THE ENGINE



 130) 131) 132)

 24)

Before starting the engine, adjust the seat, the interior rear view mirrors, the door mirrors and fasten the seat belt correctly.

Never press the accelerator pedal for starting the engine.

For starting procedure see “Starting the engine” in “Getting to know your vehicle” chapter.

STOPPING THE ENGINE

Proceed as follows:

- park the car in a position that is not dangerous for oncoming traffic; engage a gear (versions with manual transmission) or position the gear lever to P (Parking) (versions with automatic transmission);
- turn the ignition device to STOP with the engine idling.



WARNING

130) *It is dangerous to run the engine in enclosed areas. The engine takes in oxygen and releases carbon dioxide, carbon monoxide and other toxic gases.*

131) *The brake servo is not active until the engine is started, so you would need to apply much more force than usual to the brake pedal.*

132) *Do not start the engine by pushing, towing or driving downhill. These manoeuvres may damage the catalytic converter.*



IMPORTANT

24) *A quick burst on the accelerator before turning off the engine serves absolutely no practical purpose; it wastes fuel and is damaging for the engine.*

PARKING

Keep away the key when leaving the vehicle and take it with you.

When parking and leaving the vehicle, proceed as follows:

- engage a gear (first gear if facing uphill or reverse if facing downhill) and leave the wheels turned;
- stop the engine and engage the handbrake.

Block the wheels with a wedge or a stone if the car is parked on a steep slope.

On versions equipped with automatic transmission, before releasing the brake pedal, wait for letter P to be displayed.

IMPORTANT NEVER leave the vehicle with the gearbox in neutral (or, on versions equipped with automatic transmission, before placing the gear lever at P).

PARKING BRAKE



 133) 134) 135)

IMPORTANT Driving with the parking brake on will cause excessive wear of the brake parts.

Setting the parking brake

Depress the brake pedal and then firmly pull the parking brake lever fully upwards with sufficient force to hold the vehicle in a stationary position.

Releasing the parking brake

Depress the brake pedal and pull the parking brake lever 1 upwards fig. 86, then press the release button 2. While holding the button, lower the parking brake lever all the way down to the released position.



86

05050102-12A-001

Brake Assist

During emergency braking situations when it is necessary to depress the brake pedal with greater force, the brake assist system provides braking assistance, thus enhancing braking performance.

When the brake pedal is depressed hard or depressed more quickly, the brakes apply more firmly.

NOTE When the brake pedal is depressed hard or depressed more quickly, the pedal will feel softer but the brakes will apply more firmly. This is a normal effect of the brake assist operation and does not indicate a malfunction.

NOTE When the brake pedal is depressed hard or depressed more quickly, a motor/pump operation noise may be heard. This is a normal effect of the brake assist and does not indicate a malfunction.

NOTE The brake assist equipment does not supersede the functionality of the vehicle's main braking system.



WARNING

133) In the case of parking manoeuvres on roads on a gradient, the front wheels must be steered towards the pavement (when parking downhill), or in the opposite direction if the vehicle is parked uphill. If the vehicle is parked on a steep slope, it is advisable to block the wheels with a wedge or stone.

134) Never leave children unattended in the vehicle. Keep away the key when leaving the vehicle and take it with you.

135) Do not drive with worn disc pads. Driving with worn disc pads is dangerous. The brakes could fail and cause a serious accident. As soon as you hear a screeching noise contact a Fiat Dealership.



MANUAL TRANSMISSION

 136) 137) 138)

 25)

To engage the gears, press the clutch pedal fully and put the gear lever into the required position. The diagram for gear engagement is shown on the knob fig. 87.



87

05210101-12A-001

Depress the clutch pedal all the way down while shifting; then release it slowly.

Your vehicle is equipped with a device to prevent shifting to R (reverse) by mistake. Push the shift lever downward and shift to R.

A natural driving posture can be achieved by lightly gripping the shift

lever from the side without having to rest your elbow on the center console box.

If shifting to R is difficult, shift back into neutral, release the clutch pedal, and try again.

With Parking Sensor system

When the shift lever is shifted to the R position with the ignition switched ON, the parking sensor system is activated and a beep sound is heard.

IMPORTANT Keep your foot off the clutch pedal except when shifting gears. Also, do not use the clutch to hold the vehicle on an upgrade. Riding the clutch will cause needless clutch wear and damage.

IMPORTANT Do not apply any excessive lateral force to the shift lever when changing from 5th to 4th gear. This could lead to the accidental selection of 2nd gear, which could result in damage to the transmission.

IMPORTANT Make sure the vehicle comes to a complete stop before shifting to R. Shifting to R while the vehicle is still moving may damage the transmission.

IMPORTANT Reverse can only be engaged when the vehicle is completely stationary. With the engine running, wait

at least 2 seconds with the clutch pedal fully pressed before engaging reverse to prevent damage to the gears and grating.



WARNING

136) *Depress the clutch pedal fully to change gear correctly. Therefore, the floor area underneath the pedal unit must not be obstructed in any way. Ensure that the floor mat is always laid flat and does not interfere with use of the pedals.*

137) *Do not use sudden engine braking on slippery road surfaces or at high speeds. Shifting down while driving on wet, snowy, or frozen roads, or while driving at high speeds causes sudden engine braking, which is dangerous. The sudden change in tyre speed could cause the tyres to skid. This could lead to loss of vehicle control and an accident.*

138) *Always leave the shift lever in 1 or R position and set the parking brake when leaving the vehicle unattended. Otherwise the vehicle could move and cause an accident.*



IMPORTANT

25) *Do not drive with your hand resting on the gear lever as the force exerted, even if slight, could lead over time to premature wear of the gearbox internal components.*

AUTOMATIC TRANSMISSION

(where provided)



VARIOUS LOCKOUTS

To shift from P to R you must depress the brake pedal and hold in the lock-release button to shift (the ignition must be switched ON).

To shift from R to N, from N to D (or D to N), from D to M (or M to D) and from M to + and - the selector lever can be shifted freely into any position.

To shift from N to R and from R to P you must hold in the lock-release button fig. 88 to shift.

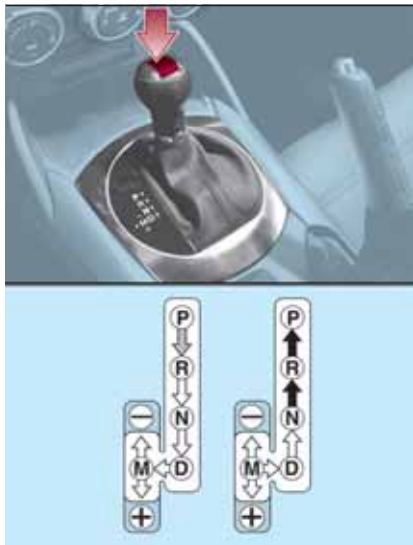

88

05210200-LHD12AT-001

GEAR LEVER POSITIONS

P (Park)



139) 140)

P locks the transmission and prevents the rear wheels from rotating. The selector lever must be in P or N to operate the starter.

IMPORTANT Shifting into P, N or R while the vehicle is moving can damage your transmission.

IMPORTANT Shifting into a driving gear or reverse when the engine is running faster than idle can damage the transmission.

R (Reverse)

In position R, the vehicle moves only backward. You must be at a complete stop before shifting to or from R, except under rare circumstances.

With Parking Sensor system: when the selector lever is shifted to the R position with the ignition switched ON, the parking sensor system is activated and a beep sound is heard.

N (Neutral)



141)

In N, the wheels and transmission are not locked. The vehicle will roll freely even on the slightest incline unless the parking brake or brakes are on.

IMPORTANT Do not shift into N when driving the vehicle. Doing so can cause transaxle damage. Apply the parking brake or depress the brake pedal before moving the selector lever from N to prevent the vehicle from moving unexpectedly.

D (Drive)

D is the normal driving position. From a stop, the transmission will automatically shift through a 6-gear sequence.



M (Manual)

M is the manual shift mode position. Gears can be shifted up or down by operating the selector lever. Refer to “Manual shift mode”.

SHIFT-LOCK SYSTEM

The shift-lock system prevents shifting out of P unless the brake pedal is depressed.

To shift from P:

- depress and hold the brake pedal;
- start the engine;
- press and hold the lock-release button;
- move the selector lever.

When the ignition is switched to ACC or the ignition is switched off, the selector lever cannot be shifted from P.

The ignition cannot be switched to OFF if the selector lever is not in P.

SHIFT-LOCK OVERRIDE

If the selector lever will not move from P using the proper shift procedure, continue to hold down the brake pedal.

Proceed as follows:

- remove the shift-lock override cover using a cloth-wrapped flat head screwdriver fig. 89;
- insert a screwdriver and push it down;



89

05210206-12A-002

- press and hold the lock-release button and move the selector lever;
- take the vehicle to a Fiat Dealership.

For some versions

Proceed as follows:

- press the lock-release button with the button pressed fig. 90;
- move the selector lever;
- take the vehicle to a Fiat Dealership.



90

005210206-122-001

MANUAL SHIFT MODE

To change to manual shift mode, shift the lever from D to M. To return to automatic shift mode, shift the lever from M to D.

IMPORTANT Changing to manual shift mode while driving will not damage the transmission.

IMPORTANT If you change to manual shift mode when the vehicle is stopped, the gear may shift to M1.

IMPORTANT If you change to manual shift mode without depressing the accelerator pedal when driving in D range, 5th gear/6th gear, the gear may shift to M4/M5.

Manually shifting up / down

To shift up to a higher gear, tap the selector lever back **+** once. **To shift down** to a lower gear, tap the selector lever forward **-** once.

Second gear fixed mode

When the selector lever is moved back while the vehicle speed is about 2 km/h or less, the gearbox is set in the second gear. The gear is set in second while in this mode for easier acceleration from a stop and driving on slippery roads such as snow-covered roads.

SHIFT GEAR (SHIFTING) SPEED LIMIT

Shift up

The gear does not shift up while the vehicle speed is lower than the speed limit.

Shift down

The gear does not shift down while the vehicle speed exceeds the speed limit.

Kickdown

When the accelerator pedal is depressed fully while driving, the gear shifts down.

Auto-shift down

The gear shifts down automatically depending on the vehicle speed during deceleration.

DIRECT MODE

(where provided)

Direct mode can be used for temporarily switching gears by operating the steering shift switch while the vehicle is being driven with the selector lever in the D range.

Direct mode is cancelled (released) when the vehicle is stopped.

IMPORTANT Shifting up and down while in direct mode may not be possible depending on the vehicle speed.

DRIVING TIPS



142) 143)

Passing

For extra power when passing another vehicle or climbing steep grades, depress the accelerator fully. The transmission will shift to a lower gear, depending on vehicle speed.

Climbing steep grades from a stop

To climb a steep grade from a stopped position depress the brake pedal, shift to D or M1, depending on the load weight and grade steepness, release the brake pedal while gradually accelerating.

Descending steep grades

When descending a steep grade, shift to lower gears, depending on load weight and grade steepness.

Descend slowly, using the brakes only occasionally to prevent them from overheating.



WARNING

139) Always set the selector lever to P and set the parking brake. Only setting the selector lever to the P position without using the parking brake to hold the vehicle is dangerous. If P fails to hold, the vehicle could move and cause an accident.

140) If the engine is running faster than idle, do not shift from N or P into a driving gear. It's dangerous to shift from N or P into a driving gear when the engine is running faster than idle. If this is done, the vehicle could move suddenly, causing an accident or serious injury.

141) Do not shift into N when driving the vehicle. Shifting into N while driving is dangerous. Engine braking cannot be applied when decelerating which could lead to an accident or serious injury.

142) Do not use engine braking on slippery road surfaces or at high speeds. Shifting down while driving on wet, snowy, or frozen roads, or while driving at high speeds causes sudden engine braking, which is dangerous. The sudden change in tire speed could cause the tires to skid. This could lead to loss of vehicle control and an accident.

143) Do not let the vehicle move in a direction opposite to the direction selected by the selector lever. Do not let the vehicle move backward with the selector lever in a forward position, or do not let the vehicle move forward with the selector lever in the reverse position. Otherwise, the engine may stop, causing the loss of the power brake and power steering functions, and make it difficult to control the vehicle which could result in an accident.



CRUISE CONTROL



This is an electronically controlled driving assistance device that allows the desired vehicle speed to be maintained, without having to press the accelerator pedal.

This device can be used at a speed above 25 km/h on long stretches of dry, straight roads with few variations (e.g. motorways).

It is therefore not recommended to use this device on extra-urban roads with traffic. Do not use it in town.

ACTIVATION / DEACTIVATION



144) 145) 146) 147)

IMPORTANT When the ignition is switched off, the system status before it was turned off is maintained. For example, if the ignition is switched off while the cruise control is operating, the system will be operable when the ignition is switched ON the next time.

Activating the device

With Speed limiter: press the MODE switch. The warning light (amber) turns on.



91

05100101-877-877

IMPORTANT When the speed limiter is operating after pressing the MODE switch, press the MODE switch again to switch to the cruise control.

Without Speed limiter: press the ON switch. The warning light (amber) turns on.

Deactivating the device

With Speed limiter: press the OFF/CANCEL switch. The warning light (amber) turns off.

IMPORTANT When the MODE switch is pressed during cruise control system operation, the system switches to the adjustable speed limiter.

Without Speed limiter: press the OFF/CANCEL switch. The warning light (amber) turns off.

When a cruising speed has been set

warning light (green) turns on
Long-press the OFF/CANCEL switch or press the OFF/CANCEL switch 2 times.

When a cruising speed has not been set warning light (amber) turns on press the OFF/CANCEL switch.

SETTING A DESIRED SPEED

Proceed as follows:

- With Speed limiter:** activate the cruise control device by pressing the MODE switch. The cruise warning light (amber) turns on;
- Without Speed limiter:** activate the cruise control device by pressing the ON switch. The cruise warning light (amber) turns on;
- accelerate to the desired speed, which must be more than 25 km/h;
- set the cruise control by pressing the SET/- switch at the desired speed. The cruise control is set at the moment the SET/- switch is pressed. Release the accelerator pedal simultaneously. The

 warning light (green) turns on.

The cruise control speed setting cannot be performed under the following conditions:

- Automatic transmission:** the selector lever is in the P or N position;
- Manual transmission:** the shift lever is in the neutral position;
- The parking brake is applied;
- Vehicles with Speed limiter:** the MODE switch for the adjustable speed limiter is pressed.
- Release the SET/- switch at the desired speed, otherwise the speed will continue decreasing while the SET/- switch is pressed and held (except when the accelerator pedal is depressed);
- On a steep grade, the vehicle may momentarily slow down while ascending, or speed up while descending.
- The cruise control will cancel if the vehicle speed decreases below 21 km/h when climbing a steep grade.
- The cruise control may cancel at about 15 km/h below the preset speed such as when climbing a long, steep grade.

The vehicle speed preset using the cruise control is displayed in the instrument cluster.

INCREASING / DECREASING SPEED

To increase speed

With cruise control switch: press the RESUME/+ switch and hold it your vehicle will accelerate. Release the switch at the desired speed. Press the RESUME/+ switch and release it immediately to adjust the preset speed. Multiple operations will increase the preset speed according to the number of times it is operated.

Using accelerator pedal: depress the accelerator pedal to accelerate to the desired speed. Press the SET/- switch and release it immediately.

IMPORTANT Accelerate if you want to speed up temporarily when the cruise control is on. Greater speed will not interfere with or change the set speed. Take your foot off the accelerator to return to the set speed.

RESUME SPEED

If some other method besides the OFF/CANCEL switch was used to cancel cruising speed (such as applying the brake pedal) and the system is still activated, the most recent set speed will automatically resume when the RESUME/+ switch is pressed.

If vehicle speed is below 25 km/h, increase the vehicle speed up to

25 km/h or more and press the RESUME/+ switch.

TEMPORARILY CANCELLING THE SYSTEM

To temporarily cancel the system, use one of these methods: slightly depress the brake pedal/depress the clutch pedal (versions with manual transmission)/press the OFF/CANCEL switch.

If the RESUME/+ switch is pressed when the vehicle speed is 25 km/h or higher, the system reverts to the previously set speed.

Note

If any of the following conditions occur, the cruise control system is temporarily canceled:

- the parking brake is applied;
- Versions with Speed limiter:** the MODE switch for the adjustable speed limiter is pressed;
- Automatic transmission:** the selector lever is in the P or N position or on versions with **manual transmission:** the shift lever is in the neutral position;
- Automatic transmission:** the cruise control cannot be cancelled while driving in manual mode (selector lever shifted from D to M position). Therefore, engine braking will not be applied even

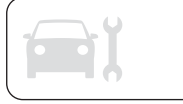

if the transaxle is shifted down to a lower gear. If deceleration is required, lower the set speed or depress the brake pedal;

When the cruise control system is temporarily canceled by even one of the applicable cancel conditions, the speed cannot be reset.



WARNING

144) Always turn off the cruise control system when it is not in use: leaving the cruise control system in an activation-ready state while the cruise control is not in use is dangerous as the cruise control could unexpectedly activate if the activation button is accidentally pressed, and result in loss of vehicle control and an accident.

145) While travelling with the device activated, do not move the gear lever to neutral.

146) In the event of device faults or failures, go to a Fiat Dealership.

147) The cruise control can be dangerous if the system cannot keep a constant speed. In specific conditions speed may be excessive, resulting in the risk of losing control of the vehicle and causing accidents. Do not use the device in heavy traffic or on winding, icy, snowy or slippery roads.

SPEED LIMITER

(where provided)



148) 149)

The speed limiter can be set between 30 km/h and 200 km/h.

The system consists of the speed limiter display and the switch on the steering wheel fig. 92.



92

05281500-12A-002

ACTIVATION / DEACTIVATION

Activation

Press the ON switch to operate the system. The adjustable speed limiter screen is displayed, and the speed limiter main indicator light (amber) turns on.

IMPORTANT When the cruise control is operating after pressing the ON switch, press the mode switch again to switch to the adjustable speed limiter.

Deactivation

To deactivate the system, do the following operations:

- When a cruising speed has been set** (warning light green turns on): long-press the OFF/CAN switch or press the OFF/CAN switch 2 times. The speed limiter screen is no longer displayed and the speed limiter set indicator light (green) turns off.
- When a cruising speed has not been set** (warning light amber turns on): press the OFF/CAN switch. The speed limiter screen is no longer displayed and the adjustable speed limiter set indicator light (amber) turns off.

When the ON switch is pressed during adjustable speed limiter operation, the system switches to the cruise control.

SETTING A DESIRED SPEED

Proceed as follows:

press the ON switch to turn the system on;

press the SET/- to set the speed.

When the current vehicle speed is 30 km/h or more, the speed is set to the current vehicle speed. When the current vehicle speed is less than 30 km/h, the speed is set to 30 km/h;

to increase the set speed: press the RES/+ switch continuously. **To decrease the set speed:** press the SET/- switch continuously.

NOTE When the vehicle set speed is displayed in the instrument cluster, press the RES/+ switch to set the displayed vehicle speed.

NOTE The vehicle speed may exceed the set speed on a down slope.

TEMPORARILY CANCELLING THE SYSTEM

The system is temporarily cancelled (stand-by status) when any of the following operations is done while the speed limiter is displayed:

OFF/CAN switch is pressed;

accelerator pedal is strongly depressed.

Press the RES/+ switch to resume the operation at the previous set speed.

The set speed can be set by pressing the SET/- switch while the system is in stand-by status.



WARNING

148) Always turn off the system when changing drivers. If the driver is changed and the new driver is unaware of the speed limiter function, the vehicle may not accelerate when the driver depresses the accelerator pedal, leading to an accident.

149) Always verify the safety of the surrounding area and keep a safer distance between vehicles ahead and behind you when setting the speed limiter. If the speed is set lower than the current vehicle speed, the vehicle speed is decreased to the set speed.

PARKING SENSOR SYSTEM

(where provided)



150) 151)

26) 27) 28)

The parking sensor system uses 4 ultrasonic sensors (2 rear sensors and 2 rear corner sensors) fig. 93 to detect obstructions around the vehicle while parking the vehicle in a garage or during parallel parking when the shift lever (manual transmission)/selector lever (automatic transmission) is in reverse (R).



93

05200100-121-001



SENSOR DETECTION RANGE

The sensors detect obstructions within the following range:

- **Lateral detection range:** about 50 cm
- **Rear detection range:** about 150 cm

SYSTEM OPERATION

When the ignition is switched ON and the shift lever (manual transmission)/ selector lever (automatic transmission) is shifted to the reverse (R), the beep sound activates and the system is enabled for use.



WARNING

150) Do not rely completely on the parking sensor system and be sure to confirm the safety around your vehicle visually when driving. This system can assist the driver in operating the vehicle in the forward and backward directions while parking. The detection ranges of the sensors are limited, therefore, driving the vehicle while relying only on the system may cause an accident. Always confirm the safety around your vehicle visually when driving.

151) Parking and other potentially dangerous manoeuvres are, however, always the driver's responsibility. When performing these operations, always make sure that there are no other people (especially children) or animals on the route you want to drive into. The parking sensors are an aid for the driver, but the driver must never allow their attention to lapse during potentially dangerous manoeuvres, even those executed at low speeds.



IMPORTANT

26) Only have interventions on the bumper in the area of the sensors carried out by a Fiat Dealership. Interventions on the bumper that are not carried out properly may compromise the operation of the parking sensors.

27) Only have the bumpers repainted or any retouches to the paintwork in the area of the sensors carried out by a Fiat Dealership. Incorrect paint application could affect the operation of the parking sensors.

28) The sensors must be clean of mud, dirt, snow or ice in order for the system to operate correctly. Be careful not to scratch or damage the sensors while cleaning them. Avoid using dry, rough or hard cloths. The sensors should be washed using clean water with the addition of car shampoo if necessary. When using special washing equipment such as high pressure jets or steam cleaning, clean the sensors very quickly keeping the jet more than 10 cm away.

REFUELLING THE VEHICLE

 152) 153) 154) 155) 156) 157)

Always stop the engine before refuelling.

FUEL REQUIREMENTS

Only use premium unleaded fuel (conforming to EN 228 specification within E10) with a number of octanes not lower than 95.

IMPORTANT USE ONLY UNLEADED FUEL. Leaded fuel is harmful to the catalytic converter and oxygen sensors and will lead to deterioration of the emission control system and or failures.

IMPORTANT The use of E10 fuel with 10% ethanol in Europe is safe for your vehicle. Damage to your vehicle may occur when ethanol exceeds this recommendation.

IMPORTANT Never add fuel system additives, otherwise the emission control system could be damaged. Contact a Fiat Dealership for details.

REFUELLING PROCEDURE

When the fuel filler flap end is pressed with the doors unlocked, the fuel filler flap rises fig. 94.



94

04040201-12A-002

The fuel filler flap operates in conjunction with the door locking/unlocking mechanism. To close, press the fuel filler flap until a click sound is heard.

IMPORTANT Make sure to lock both the doors when leaving the vehicle.

IMPORTANT Lock the doors after closing the fuel flap. If the fuel flap is closed after locking the doors, the fuel flap cannot be locked.

Fuel filler cap

To remove the fuel filler cap, turn it anticlockwise fig. 95. Attach the removed cap to the inner side of the fuel flap.

To close the fuel filler cap, turn it clockwise until a click is heard.



95

04040202-12A-001-high.jpg

EMERGENCY FLAP OPENING

In case of emergency (e.g. when the battery is dead), to open the fuel filler flap proceed as follows:

- open the boot lid and pull the center section of the plastic fastener 1 and remove the fastener fig. 96;
- partially peel back the cover 2 fig. 96 inside the boot, then pull the emergency release lever 3 fig. 97.

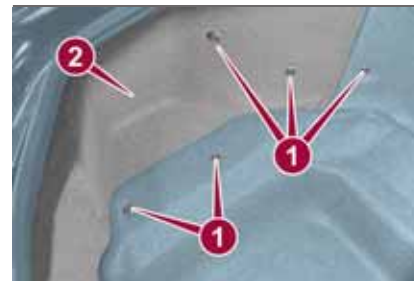

96

08100100-121-002





97

08100100-122-001

Fuels-identification of vehicle compatibility Symbol for consumer information in accordance with the EN16942 specification

The symbols shown below help you to recognise the correct type of fuel to use in your vehicle. Before proceeding with refuelling, check the symbols inside the fuel filler flap (where provided) and compare them with the symbols shown on the fuel pump (where provided).



E5: Unleaded petrol containing up to 2,7% (m/m) oxygen and with maximum 5,0% (V/V) ethanol compliant with the **EN228** specification

E10: Unleaded petrol containing up to 3,7% (m/m) oxygen and with maximum 10,0% (V/V) ethanol compliant with the **EN228** specification



WARNING

152) When removing the fuel filler cap, loosen the cap slightly and wait for any hissing to stop, then remove it: fuel spray is dangerous. Fuel can burn skin and eyes and cause illness if ingested. Fuel spray is released when there is pressure in the fuel tank and the fuel filler cap is removed too quickly.

153) Before refuelling, stop the engine, and always keep sparks and flames away from the filler neck: fuel vapour is dangerous. It could be ignited by sparks or flames causing serious burns and injuries. Additionally, use of the incorrect fuel filler cap or not using a fuel filler cap may result in a fuel leak, which could result in serious burns or death in an accident.

154) Do not continue refuelling after the fuel pump nozzle shuts off automatically: continuing to add fuel after the fuel pump nozzle has shut off automatically is dangerous because overfilling the fuel tank may cause fuel overflow or leakage. Fuel overflow and leakage could damage the vehicle and if the fuel ignites it could cause a fire and explosion resulting in serious injury or death.

155) Do not apply any object/plug to the end of the filler which is not provided for the car. The use of non-compliant objects/plugs could cause a pressure increase inside the tank, resulting in dangerous situations.

156) Do not bring naked flames or lit cigarettes near to the fuel filler: fire risk. Keep your face away from the fuel filler to prevent breathing in harmful vapours.

157) Do not use a mobile phone near the refuelling pump: risk of fire.

REAR CAMERA (PARKVIEW REAR BACKUP CAMERA)

(only versions with Radio 7" system)



OPERATION



158)



29)

The camera is located on the tailgate fig. 98.



98

07040110-124-008

Switching to the rear view monitor display

Shift the selector lever or shift lever to reverse (R) with the ignition switched ON to switch the display to the rear view monitor display.

IMPORTANT When parking, take the utmost care over obstacles that may be above or under the camera range.

IMPORTANT Always use extreme caution and verify the real conditions of the area behind the vehicle with your own eyes. Reversing while looking only at the screen is dangerous and can lead to an accident or collision with an object. The rear-view monitor is simply a system to aid reversing. The images on the screen can show a situation that differs from the real one.

When the display is cold, the images could scroll on the monitor or the screen and could be more blurred than usual, making it difficult to check the conditions of the area around the vehicle. Always use extreme caution and verify the real conditions of the area behind the vehicle with your own eyes.

IMPORTANT Do not apply excessive force to the camera. You could alter the position and angle of the camera. Do not disassemble, modify or remove it as this could compromise the hermetic seal.

IMPORTANT The camera cover is made of plastic. Do not apply degreasing agents, organic solvents, wax, or glass coating agents to the

camera cover. If any are spilled on the cover, wipe off with a soft cloth immediately.

IMPORTANT Do not rub the camera cover forcefully with an abrasive or hard brush. The camera cover or lens may be scratched which might affect the images.

IMPORTANT If water, snow or mud is deposited on the camera lens, clean it with a soft cloth. If this does not clean it, use a mild detergent.

IMPORTANT If the camera is subjected to abrupt temperature changes (from hot to cold or vice versa), the rear-view monitor may not work properly.

IMPORTANT When replacing tires, contact a Fiat Dealership. Replacing the tires can cause the guide lines that appear on the display to be diverted.

IMPORTANT If the vehicle has been involved in a frontal, lateral or rear collision, the rear parking camera's alignment (location or installation angle) may have been altered. Contact a Fiat Dealership.

IMPORTANT If the display shows "no video signal", there may be a problem with the camera. Contact a Fiat Dealership.



VIEWING THE DISPLAY

Guide lines which indicate the width of the vehicle (yellow)fig. 99 are displayed on the screen as a reference to the approximate width of the vehicle in comparison to the width of the parking space you are about to back into.

Use this display view for parking your vehicle in a parking space or garage.

vehicle width guide lines (yellow): these guide lines serve as a reference showing the width of the vehicle.

distance guide lines: these lines indicate the approximate distance of a point measured from the rear of the vehicle (from the end of the bumper).

The red and yellow line indicates the points at about 50 cm, for the red line and 1 m for the yellow line, from the rear bumper (central point of each line).

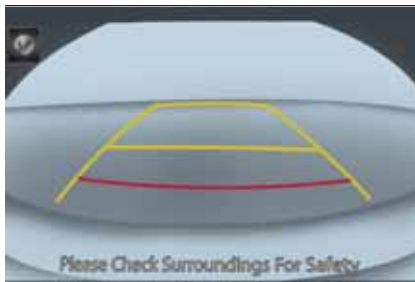

99

07080913-111-111

IMPORTANT The guide lines are fixed on the screen. They are not synchronized with the driver's actions on the steering wheel. Always use the utmost caution and check the area behind the vehicle and the surrounding area with your own eyes when reversing.

REAR VIEW MONITOR OPERATION

NOTE Images displayed on the monitor from the rear view parking camera are reversed images (mirror images).

Give due consideration to the above warnings before you use the rear-view monitor:

- shift the selector lever or shift lever to reverse (R) to switch the display to the rear view monitor display A fig. 100;
- confirming the surrounding conditions, reverse the vehicle B fig. 100;

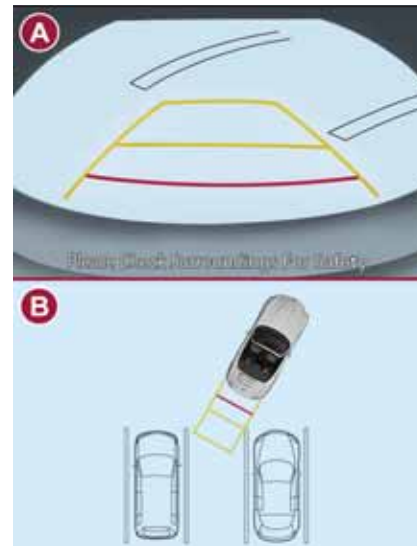

100

07080913-989-989

- after your vehicle begins entering the parking space, continue backing up slowly so that the distance between the vehicle width lines and the sides of the parking space on the left and right are roughly equal;
- continue to adjust the steering wheel until the vehicle width guide lines are parallel to the left and right sides of the parking space;
- once they are parallel Afig. 101, straighten the wheels and back your vehicle slowly into the parking space B

fig. 101. Continue checking the vehicle's surroundings and then stop the vehicle in the best possible position (if the parking space has division lines, check whether the vehicle width guide lines are parallel to them);

☐ when the selector lever or shift lever is shifted from reverse (R) to another selector lever or shift lever position, the screen returns to the previous display.

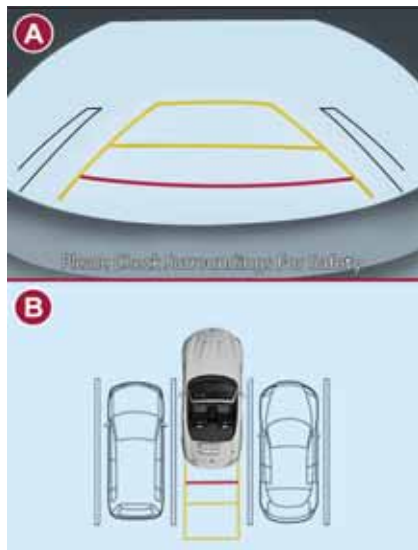

101

07080913-990-990

NOTE

Because there may be a difference

between the displayed image, such as indicated below, and the actual conditions when parking, always verify the safety at the rear of the vehicle and the surrounding area directly with your eyes:

☐ in the image of the parking space (or garage) displayed on the screen, the back end and distance guide lines may appear aligned in the monitor, but they may not actually be aligned on the ground;

☐ when parking in a space with a division line on only one side of the parking space, the division line and the vehicle width guide line appear aligned in the monitor, but they may not actually be aligned on the ground.

PICTURE QUALITY ADJUSTMENT



Picture quality adjustment can be done while the selector lever or shift lever is in reverse (R).

There are four settings which can be adjusted including, brightness, contrast, tint, and color. When adjusting, pay sufficient attention to the vehicle surroundings:

- ☐ select the icon  on the screen (see figure) to display the tabs;
- ☐ select the desired tab item;

- ☐ adjust the brightness, contrast, tint, and color using the slider. If you need to reset, press the reset button;
- ☐ select the icon on the screen to close the tab.

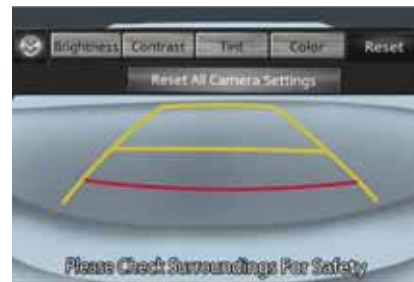

102

07080914-111-111

IMPORTANT Adjusting the rear-view monitor image quality must always be done when the vehicle is stationary. Do not adjust the rear-view monitor image quality while vehicle driving. Adjusting the image quality (brightness, contrast, colour and hue) of the rear-view monitor while driving the vehicle is dangerous since it could distract the driver and cause a serious accident.



**WARNING**

158) *Parking and other potentially dangerous manoeuvres are, however, always the driver's responsibility. While carrying out these manoeuvres, always make sure that no people (especially children) or animals are in the area concerned. The camera is an aid for the driver, but the driver must never allow his/her attention to lapse during potentially dangerous manoeuvres, even those executed at low speeds. Always keep a slow speed, so as to promptly brake in the case of obstacles.*

159) *Always adjust the picture quality of the rear view monitor while the vehicle is stopped: do not adjust the picture quality of the rear view monitor while driving the vehicle. Adjusting the picture quality of the rear view monitor such as brightness, contrast, color, and tint while driving the vehicle is dangerous as it could distract your attention from the vehicle operation which could lead to an accident.*

**IMPORTANT**

29) *It is vital, for correct operation, that the camera is always kept clean and free from mud, dirt, snow or ice. Be careful not to scratch or damage the camera while cleaning it. Avoid using dry, rough or hard cloths. The camera must be washed using clean water, with the addition of car shampoo if necessary. In washing stations which use steam or high-pressure jets, clean the camera quickly, keeping the nozzle more than 10 cm away from the sensors. Do not apply stickers to the camera.*

TOWING TRAILERS

Your car is not designed for towing.

IN CASE OF EMERGENCY

A punctured tyre or a burnt-out bulb?

At times, a problem may interfere with our journey.

The pages on emergencies can help you to deal with critical situations independently and with calm.

In an emergency we recommend that you call the freephone number found in the Warranty Booklet.

It is also possible to call the national or international universal freephone number to search for the nearest Dealership.

HAZARD WARNING LIGHTS	130
REPLACING A BULB	131
REPLACING FUSES	139
TIRE SERVICE KIT	146
JUMP STARTING	151
TOWING THE VEHICLE	153
EMERGENCY TOWING	155



HAZARD WARNING LIGHTS





CONTROL

Press button fig. 103 to switch the lights on/off.



103

05031100-L12A

Depress the hazard warning flasher and all the direction indicators will flash. The hazard warning indicator light  and  in the instrument cluster flash simultaneously.

EMERGENCY STOP SIGNAL SYSTEM

The system turns off when it determines that the brake pedal is released or that an emergency braking situation no longer exists based on the reduced vehicle speed.

If the system determines that such a situation is occurring, it flashes all the direction indicators rapidly to caution the driver of the vehicle following behind your vehicle of the sudden braking situation.

This system is designed to determine whether you are depressing the brake pedal with greater force than during normal braking such as in a situation requiring emergency braking.

If you bring your vehicle to a complete stop while all the direction indicators are flashing rapidly, the rapid flashing of all the direction indicators changes back to the normal flashing pattern.

The emergency stop signal system does not operate at vehicle speeds under about 60 km/h. If the brake pedal is depressed while driving on slippery roads, the emergency stop signal system could operate causing all the direction and lane change indicators to flash.

REPLACING A BULB



GENERAL INSTRUCTIONS

 160) 161) 162) 163)

 30) 31)

- Before replacing a bulb check the contacts for oxidation;
- replace blown bulbs with others of the same type and power;
- after replacing a headlight bulb, always check its alignment;
- to replace the bulb, contact a Fiat Dealership;
- use the protective cover and carton for the replacement bulb to dispose of the old bulb promptly and out of the reach of children;
- when a light is not working, check that the corresponding fuse is intact before replacing the bulb. For the location of fuses, refer to the paragraph “If a fuse blows” in this chapter.

IMPORTANT When removing the lens or light unit using a flathead screwdriver, make sure that the flathead screwdriver does not contact the interior terminal. If the flathead screwdriver contacts the terminal, a short circuit may occur.

IMPORTANT When the weather is cold or damp or after heavy rain or washing, the surface of headlights or rear lights may steam up and/or form drops of condensation on the inside. This is a natural phenomenon due to the difference in temperature and humidity between the inside and the outside of the glass which does not indicate a fault and does not compromise the normal operation of lighting devices. The mist disappears quickly when the lights are turned on, starting from the center of the diffuser, extending progressively towards the edges.



Exterior light

	Light bulbs	Type	Power
Front positions	(versions with Full-LED headlights)	Full-LED (*)	–
	(versions with halogen headlights)	W5W	5 W
High-beams	(versions with Full-LED headlights)	Full-LED (*)	–
High-beam/Daytime Running Lights (DRL)	(versions with halogen headlights)	H15	55/15 W
Daytime Running Lights (DRL)	(versions with Full-LED headlights)	Full-LED (*)	–
Low beams	(versions with Full-LED headlights)	Full-LED (*)	–
	(versions with halogen headlights)	H11	55 W
Front direction indicator lights		WY21W	21 W
Side direction indicator lights		WY5W(**)	5 W
Front fog lights		H11	55 W
Rear position lights		Full-LED (*)	–
Stop lights		Full-LED (*)	–
3 rd stop		Full-LED (*)	–
Rear direction indicator lights		WY21W	21 W
Rear fog light		W21W	21 W
Reverse light		W21W	21 W
Number plate lights		W5W	5 W

(*) LED is the abbreviation for Light Emitting Diode.

(**) Bulb replacement is not possible because it is built into the unit. Replace the unit.

Interior light

Light bulb	Category	
	Wattage	UNECE (*)
Overhead light	10	—
Boot lid light	5	—

(*) UNECE stands for United Nations Economic Commission for Europe.



REPLACING EXTERIOR LIGHT BULBS

Headlights (low beam) (versions with halogen bulb)

Proceed as follows:

- ❑ if you are changing the right bulb, start the engine, turn the steering wheel all the way to the right, and turn off engine. If you are changing the left bulb, turn the steering wheel to the left;
- ❑ make sure the headlight switch is off;
- ❑ remove the fasteners 1 fig. 104 in the seven locations and partially peel back the mud guard 2;
- ❑ turn the cover counterclockwise and remove it (fig. 105 3 = high beam / 4 = low beam), disconnect the connector from the unit by pressing the tab on the connector with your finger and pulling the connector;
- ❑ turn the socket and bulb assembly counterclockwise and remove it;
- ❑ disconnect the bulb from the socket;
- ❑ install the new bulb in the reverse order of the removal procedure.

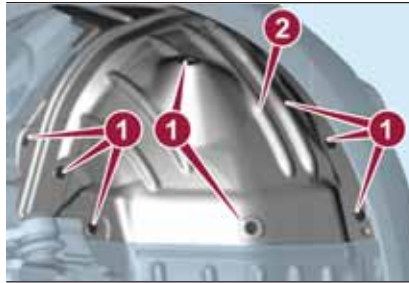

104

08020499-000-003

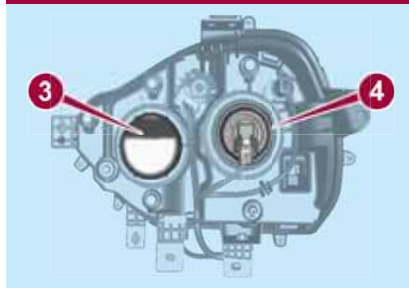
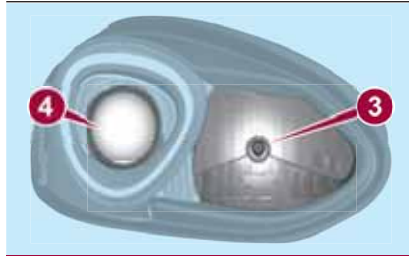

105

08020499-000-002

Headlights (high beam) with Daytime Running Lights (LED versions)

Proceed as follows:

- ❑ if you are changing the right bulb, start the engine, turn the steering wheel all the way to the right, and turn off engine. If you are changing the left bulb, turn the steering wheel to the left;
- ❑ make sure the headlight switch is off;
- ❑ remove the fasteners 1 in the seven locations and partially peel back the mud guard 2;
- ❑ turn the socket and bulb assembly counterclockwise and remove it;
- ❑ turn the cover counterclockwise and remove it (1 fig. 106 = head lamp / 2 = position lamp / 3 = Daytime Running Lights), disconnect the connector from the unit by pressing the tab on the connector with your finger and pulling the connector;
- ❑ turn the socket and bulb assembly counterclockwise and remove it;
- ❑ disconnect the bulb from the socket;
- ❑ install the new bulb in the reverse order of the removal procedure.



106

08020499-000-010

Front direction indicator lights

Proceed as follows:

- if you are changing the right bulb, start the engine, turn the steering wheel all the way to the right, and turn off engine. If you are changing the left bulb, turn the steering wheel to the left.

- make sure the ignition is switched off, and the headlight switch is off;

- remove the fasteners in the five locations fig. 107, and partially peel back the mud guard;

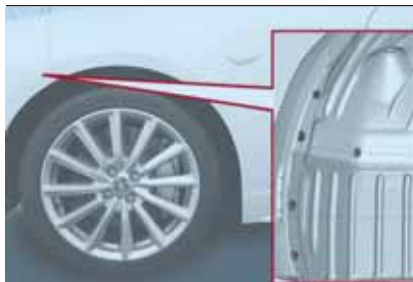

107

07031501-206-002

- disconnect the connector from the unit by pressing the tab on the connector fig. 108 with your finger and pulling the connector;



108

07031501-207-001

- turn the socket and bulb assembly 1 counterclockwise and remove it;

- disconnect the bulb 2 from the socket;

- install the new bulb in the reverse order of the removal procedure.

Fog lights

Proceed as follows:

- if you are changing the right bulb, start the engine, turn the steering wheel all the way to the right, and turn off engine. If you are changing the left bulb, turn the steering wheel to the left;

- make sure the ignition is switched off, and the headlight switch is off;

- remove the fasteners in the five locations and partially peel back the mud guard;

- disconnect the connector from the unit by pressing the tab on the connector with your finger and pulling the connector;

- turn the socket 1 fig. 109 and bulb assembly counterclockwise, extract the bulb 2 and remove it;

- disconnect the bulb from the socket;
- install the new bulb in the reverse order of the removal procedure.

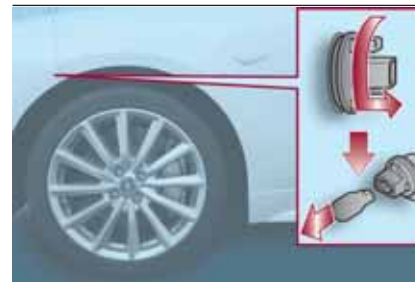

109

07031501-208-002



Brake lights / Tail lights

Go to a Fiat Dealership when the replacement of this lights is necessary.

Side direction indicator lights

Proceed as follows:

- ❑ make sure the ignition is switched off, and the headlight switch is off;
- ❑ if you are changing the right bulb, start the engine, turn the steering wheel all the way to the right, and turn off engine. If you are changing the left bulb, turn the steering wheel to the left;
- ❑ remove the fasteners in the five locations 1 fig. 110 and partially peel back the mud guard;
- ❑ disconnect the electrical connector from the bulb by pressing the tab on the connector with your finger and pulling the connector;
- ❑ remove the unit 2 fig. 111 by pressing the tab on the unit with your finger and pulling the unit forward to compress in the internal catch 3 fig. 112, then pull the cluster outwards;
- ❑ lift up the device 4, and then remove the cluster and install the new side direction indicator unit in the reverse order of the removal procedure.

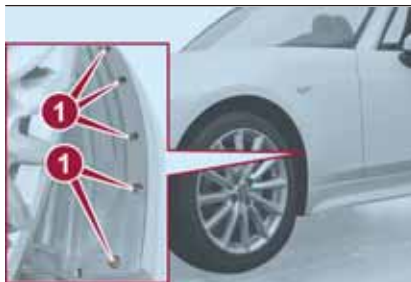

110

08020499-000-011

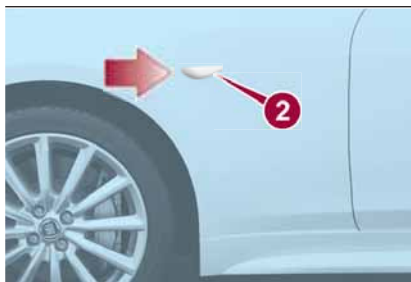

111

07031501-210-001



112

07031501-211-001

Position lights (LED versions)

Proceed as follows:

- ❑ remove the fasteners in the seven locations and partially peel back the upper side of the mud guard;
- ❑ turn the socket 1 fig. 113 and bulb assembly 2 counterclockwise and remove it;
- ❑ disconnect the bulb from the socket;
- ❑ install the new bulb in the reverse order of the removal procedure.

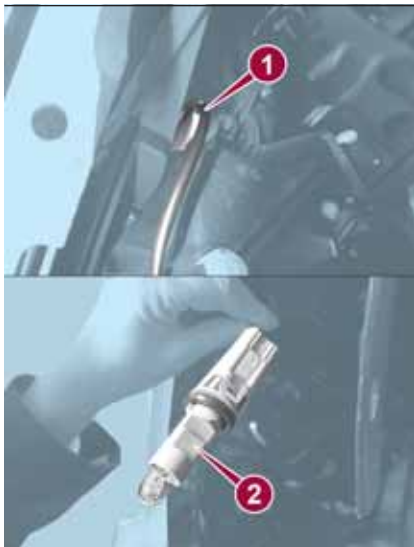

113

08070604-123-100

Rear direction indicator lights

Proceed as follows:

- remove the retainers 1 fig. 114 and the boot lid end trim;
- remove the retainers 2 fig. 115 and then partially peel back the boot lid side trim;

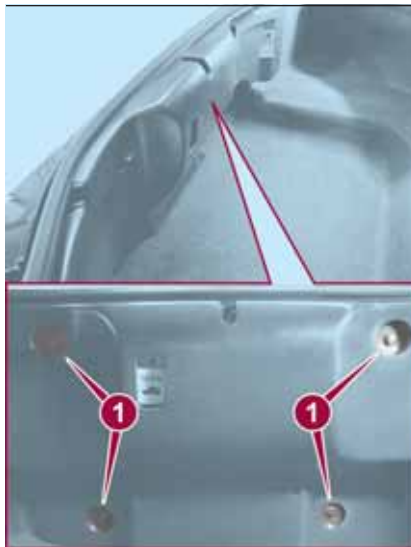

114

07031501-212-002



115

07031501-214-002

- disconnect the connector 3 ;

- remove the two nuts 5 fig. 117 and a screw 4;
- pull the unit rearward 6 fig. 118 to remove it;
- turn the socket and bulb assembly 7 fig. 119 counterclockwise and remove it.



116

07031501-213-002

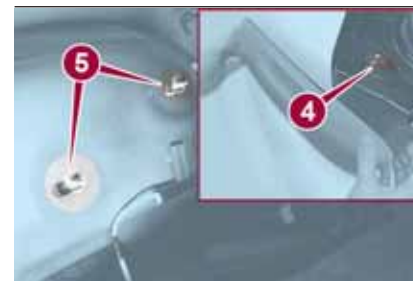

117

07031501-215-001





118

07031501-216-001



119

07031501-203-002

Reverse light / Rear fog light

Proceed as follows:

- make sure the ignition is switched off, and the headlight switch is off;
- disconnect the electrical connector from the bulb by pressing the tab on the connector with your finger and pulling the connector;
- turn the socket and bulb assembly counterclockwise and remove it: 1

fig. 120 = reverse light / 2 = rear fog light;

- disconnect the bulb from the socket;
- install the new bulb in the reverse order of the removal procedure.

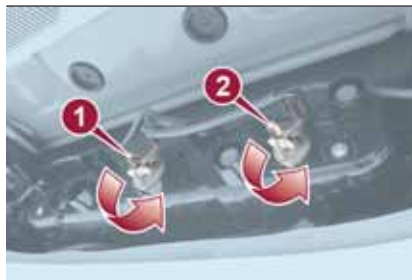

120

08020499-000-012

Number plate lights

Proceed as follows:

- make sure the ignition is switched off, and the headlight switch is off;
- slide the unit 1 fig. 121 as shown in the figure to remove it,
- disconnect the electrical connector from the unit;
- install the new unit in the reverse order of the removal procedure.

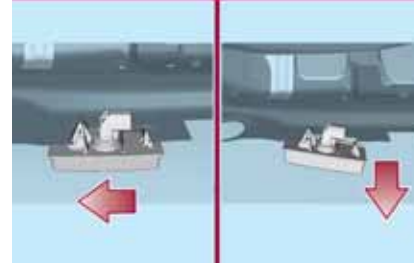

121

07031501-220-001



WARNING

160) Changes or repairs to the electrical system carried out incorrectly and without due consideration for the technical specifications of the system may lead to malfunctioning and generate a fire hazard.

161) Before replacing the bulb, wait for the exhaust ducts to cool down: DANGER OF SCALDING!

162) Halogen bulbs contain pressurised gas, in the case of breakage they may burst causing glass fragments to be projected outwards.

163) Only replace bulbs when the engine is off. Also ensure that the engine is cold, to prevent the risk of burns.



IMPORTANT

30) Where possible, it is advisable to have bulbs changed at a Fiat Dealership. Proper operation and direction of the external lights are essential for driving in safety and comply with law.

31) Halogen bulbs must be handled holding the metallic part only. Touching the transparent part of the bulb with your fingers may reduce the intensity of the emitted light and even reduce the lifespan of the bulb. In the event of accidental contact, wipe the bulb with a cloth moistened with alcohol and let the bulb dry

REPLACING FUSES



GENERAL INFORMATION

 164) 165) 166) 167) 168)

 32) 33)

Fuse location

Fuses are grouped together in two fuse boxes located on the left side of the vehicle and under the bonnet.

FUSES ON THE LEFT SIDE OF THE VEHICLE

Proceed as follows:

- make sure the ignition is switched off, and other switches are off;
- open the fuse panel cover fig. 122 (located near the door);



122

07031601-121-001

- press retaining clip and remove protection cover;

- pull the fuse straight out with the fuse puller provided on the fuse block located in the engine compartment fig. 123;

- inspect the fuse and replace it if it is blown;

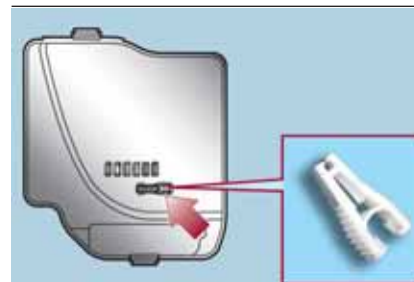

123

07031601-122-001

- insert a new fuse of the same amperage rating, and make sure it fits tightly. If it does not fit tightly, contact a Fiat Dealership. If you have no spare fuses, borrow one of the same rating from a circuit not essential to vehicle operation, such as the AUDIO or OUTLET circuit;
- reinstall the cover and make sure that it is securely installed.

IMPORTANT Always replace a fuse with a genuine FCA fuse or equivalent of the same rating. Otherwise you may damage the electric system.



FUSES UNDER THE BONNET

Make sure the ignition is switched off, and other switches are off and remove the fuse block cover. If the lock is forcefully opened, the fuse block cover may come in contact with the frame when it is removed and become scratched.

When removing the cover, remove it slowly according to the following procedure:

- disengage the rear lock 1 fig. 124 by pressing down on the front tab with your fingers;
- remove the front tab while slightly lifting the front of the cover 2;
- remove the cover while lifting it and sliding it to the rear;



124

07031601-123-001

- if any fuse but the MAIN fuse is blown, replace it with a new one of the same amperage rating;
- reinstall the cover and make sure that it is securely installed.

FUSE BLOCK (ENGINE COMPARTMENT)

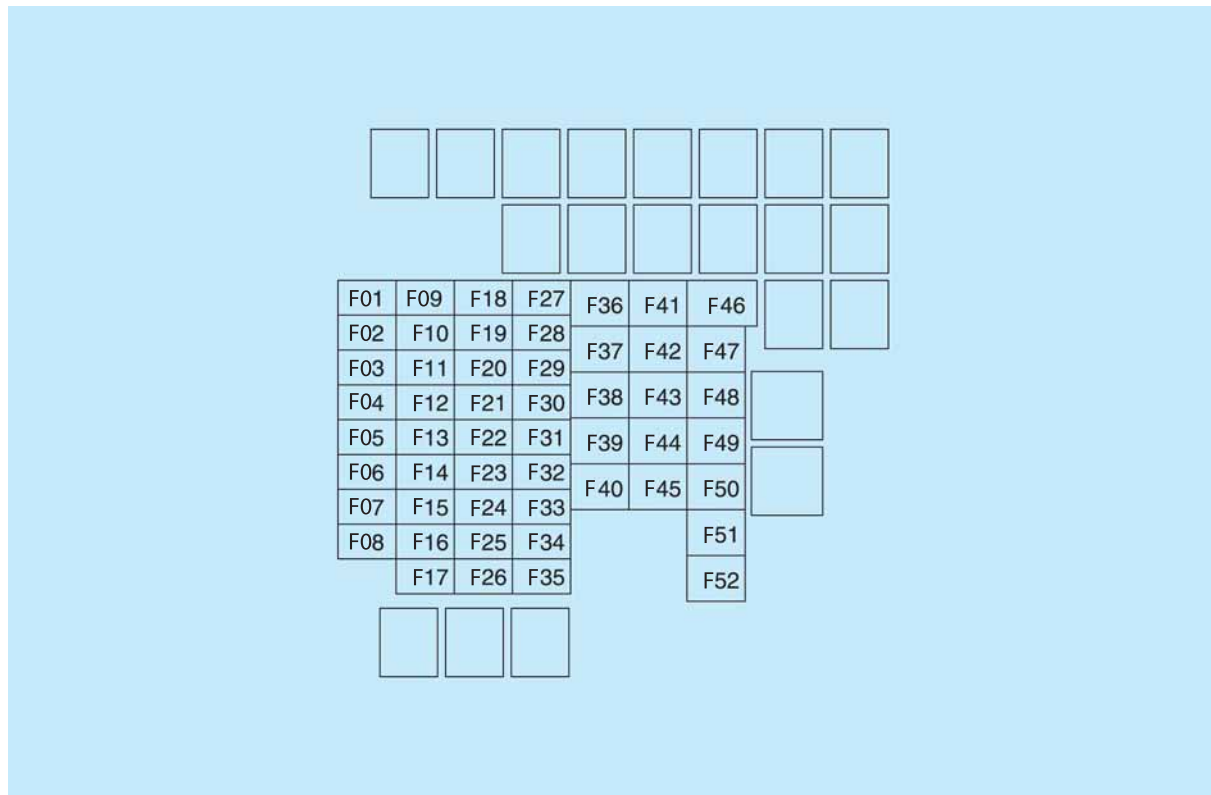

125

07031602-121-001



DESCRIPTION		FUSE RATING	PROTECTED COMPONENT
F03	HORN2	7.5 A	Horn
F06	—	—	—
F07	INTERIOR	15 A	Overhead light
F09	AUDIO2	15 A	Audio system
F10	METER1	10 A	Instrument cluster
F11	SRS1	7.5 A	Air bag
F12	—	—	—
F13	RADIO	7.5 A	Audio system
F17	AUDIO1	25 A	Audio system
F18	A/C MAG	7.5 A	Air conditioner
F20	AT	15 A	Transmission control system (where provided)
F21	D LOCK	25 A	Power door locks
F22	H/L RH	20 A	Headlight (RH)
F24	TAIL	20 A	Taillights/Number plate lights/Position lights
F25	DRL	15 A	Daylight Running Lights
F26	ROOM	25 A	Overhead light
F27	FOG	15 A	Fog lights
F28	H/CLEAN	20 A	Headlight washer (where provided)
F29	STOP	10 A	Stop lights/Rear fog light (where provided)
F30	HORN	15 A	Horn
F31	H/L LH	20 A	Headlight (LH)
F33	HAZARD	15 A	Hazard warning flashers/Direction indicators lights
F36	WIPER	20 A	Windshield wipers

DESCRIPTION		FUSE RATING	PROTECTED COMPONENT
F37	CABIN + B	50 A	For protection of various circuits
F38	—	—	—
F39	—	—	—
F42	EVPS	30 A	—
F43	FAN1	30 A	Cooling fan
F44	FAN2	40 A	Cooling fan
F47	DEFOG	30 A	Rear window defogger
F48	IG2	30 A	For protection of various circuits
F50	HEATER	40 A	Air conditioner
F51	—	—	—
F52	—	—	—



FUSES ON THE LEFT SIDE OF THE VEHICLE

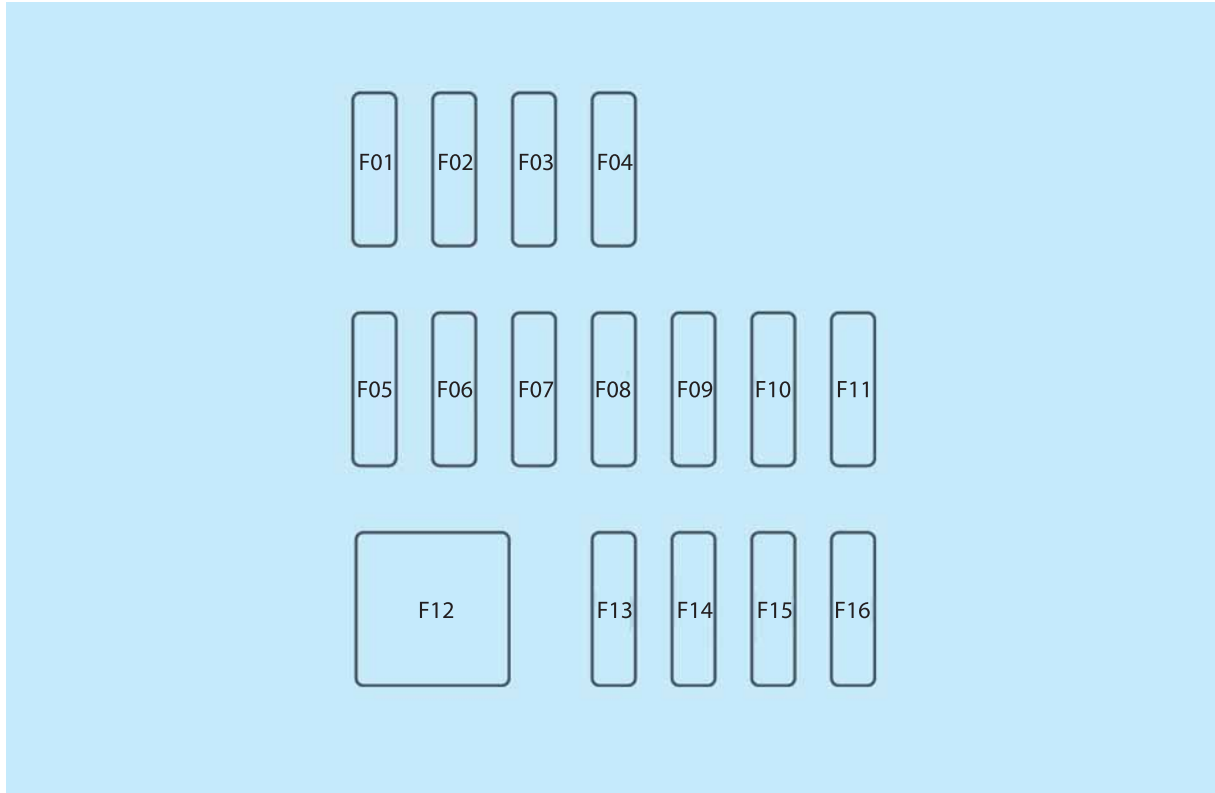

DESCRIPTION		FUSE RATING	PROTECTED COMPONENT
F01	RHT R	30 A	—
F02	RHT L	30 A	—
F03	—	—	—
F04	—	—	—
F05	F.OUTLET	15 A	Accessory sockets
F06	—	—	—
F07	AT IND	7.5 A	AT shift indicator (where provided)
F08	MIRROR	7.5 A	Power control mirror
F09	R_DECK R	30 A	—
F10	R_DECK L	30 A	—
F11	F.WASHER	15 A	Windscreen washer
F12	P.WINDOW	30 A	Power windows
F13	—	—	—
F14	SRS2/ESCL	15 A	Electronic steering lock
F15	SEAT WARM	20 A	Seat warmer
F16	M.DEF	7.5 A	—





WARNING

164) If the fuse blows again contact a Fiat Dealership.

165) Never replace a fuse with another with a higher amp rating; DANGER OF FIRE.

166) Contact a Fiat Dealership if a safety system (airbags, brakes), power unit system (engine, gearbox) or steering system general protection fuse blows.

167) Do not replace the main fuse and multiplex slow blow fuse by yourself. Contact a Fiat Dealership to perform the replacement. Replacing these fuses by yourself is dangerous because they are high current fuses. Incorrect replacement could cause an electrical shock or a short circuit resulting in a fire.

168) Before replacing a fuse, make sure that the ignition device is in OFF position and that all the other services are switched off and/or deactivated.



IMPORTANT

32) Never replace a fuse with metal wires or anything else.

33) If it is necessary to wash the engine compartment, take care not to directly hit the junction unit and the window wiper motors with the water jet.

TIRE SERVICE KIT

(where provided)

 169) 170) 171) 172) 173) 174) 175)



TOOL STORAGE

Your vehicle is not equipped with a spare tire, jack and wheel brace. For details, contact a Fiat Dealership.

Tools are stored in the locations illustrated in fig. 127:

- 1: jack lever;
- 2: towing eyelet

Inside the boot lid is also located the emergency flat tire repair kit.



127

08020100-733-733

TIRE SERVICE STORAGE

The tire service kit is located inside the boot lid fig. 128.

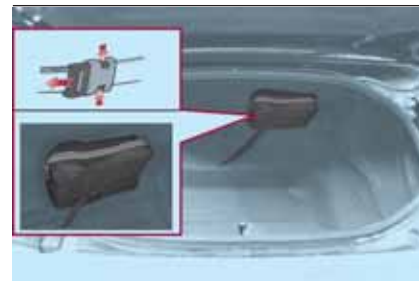

128

08020202-121-003

IMPORTANT Your vehicle is not equipped with a spare tire. In the event of a flat tire, use the tire service kit to repair the tire temporarily. When doing the repair, refer to the instructions included in the tire service kit. If an emergency repair was performed on a flat tire using the tire service kit, contact a Fiat Dealership, repair or replace the tire as soon as possible.

TIRE SERVICE USAGE PRECAUTIONS

Note

- The tire sealant cannot be reused. Purchase new tire sealant at a Fiat Dealership.
- The tire service kit cannot be used in the following cases. Consult a Fiat Dealership:
 - the period of effective use for the tire sealant has expired (the period

of effectiveness is indicated on the bottle label);

- the tear or puncture exceeds about 4 mm;
- the damage has occurred to an area of the tire other than the tread;
- the vehicle has been driven with nearly no air remaining in the tire;
- the tire has come off the wheel rim;
- damage to the wheel rim has occurred;
- the tire has two or more punctures.

SEALING A TIRE WITH TIRE SERVICE

Proceed as follows:

□ move the vehicle off the right-of-way to a safe place on a level and hard surface where the vehicle does not obstruct traffic;

□ shift the shift lever to the 1 or Reverse (R) position (manual transmission), and shift the selector lever to the P position (automatic transmission);

□ apply the parking brake with the brake pedal depressed and turn off the engine;

□ if necessary, flash the hazard warning lights and set up the roadside emergency triangle;

□ unload passengers and cargo and remove the tire service kit;

□ shake the tire sealant well. If the bottle is shaken after the injection hose is screwed on, tire sealant could spray out from the injection hose. Tire sealant contacting clothing or other objects may be impossible to remove. Shake the bottle before screwing on the injection hose;

IMPORTANT The sealant hardens easily and injecting it will be difficult under cold weather conditions (0°C or below). Warm the sealant inside the vehicle to facilitate injection.

□ remove the cap 1 from the bottle 2 fig. 129. Screw on the injection hose 3 with the bottle's inner cap left on to break the inner cap;

□ remove the valve cap 4 from the flat tire fig. 130. Press the back of a valve core tool 6 to the core of the tire valve 5 and bleed all the remaining air;



129

08020202-03A-003

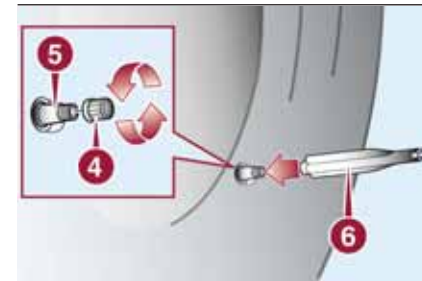

130

08020202-03A-004



IMPORTANT If there is air remaining in the tire when the valve core is removed, the valve core could fly out. Remove the valve core carefully.

☐ turn the valve core 7 counter clockwise with the valve core tool 8 and remove the valve core fig. 131;

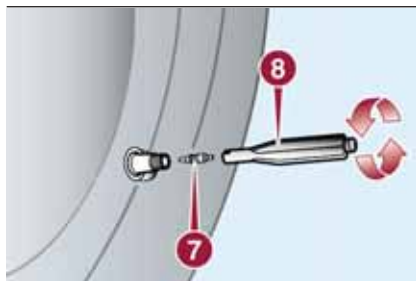

131

08020202-03A-005

IMPORTANT Store the valve core in a place where it will not get dirty.

☐ insert the injection hose 9 fig. 132 into the valve 10;

☐ hold the bottom of the bottle upright 11 fig. 133, squeeze the bottle with your hands, and inject the entire amount of tire sealant into the tire;

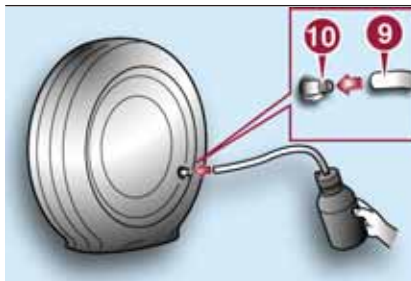

132

08020202-03A-006

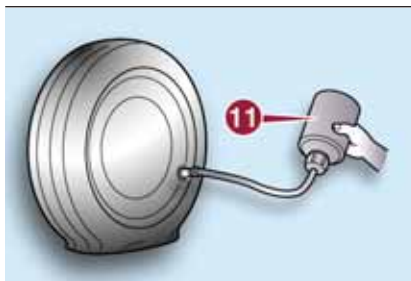

133

08020202-03A-008

☐ pull out the injection hose from the valve fig. 134;

☐ reinsert the valve core 12 fig. 134 into the valve 13 and turn it clockwise to install;

IMPORTANT The tire sealant cannot be reused. Purchase a new tire sealant kit at a Fiat Dealership.

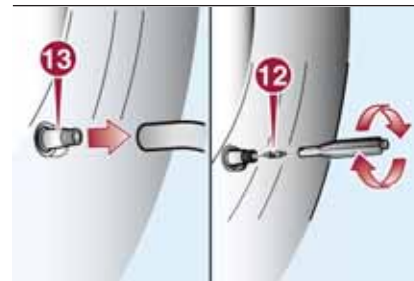

134

08020202-03A-007



135

08020202-03A-009

IMPORTANT Do not throw away the empty tire sealant bottle after use. Return the empty tire sealant bottle to a Fiat Dealership when replacing the tire. The empty tire sealant bottle will need to be used to extract and dispose of the used sealant from the tire.

☐ after that, install the injection hose to the tab 14 fig. 135 of the bottle to

prevent leakage of any remaining sealant;

❑ adhere the speed restriction sticker to an area where it can be viewed easily by the driver;

❑ pull out the air compressor hose and the air compressor plug from the air compressor 15 fig. 136;

❑ install the air compressor hose 16 to the tire valve 17 fig. 137;

❑ insert the air compressor plug into the accessory socket 18 fig. 138 inside the vehicle and switch the ignition to ACC;

❑ turn the air compressor switch on and inflate the tire carefully to the correct inflation pressure;

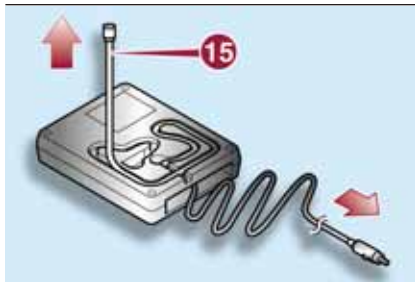

136

08020202-36A-004

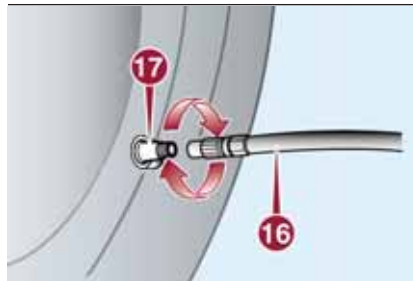

137

08020202-03A-00B

IMPORTANT When inserting the air compressor plug into or removing it from the accessory socket, make sure that the air compressor switch is off. When turning the air compressor on/off, use the air compressor switch.

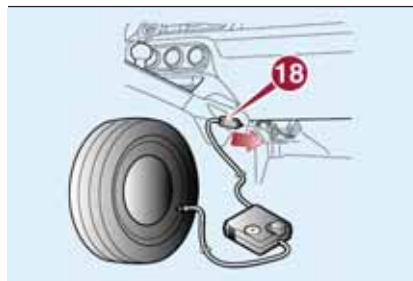

138

08020202-124-001

NOTE Check the tire inflation pressure label driver's door frame for the correct tire inflation pressure.

NOTE Do not operate the air

compressor for a continuous 10 minutes or longer because using it for long periods could cause a malfunction.

NOTE If the tire inflation pressure does not increase, repair of the tire is not possible. If the tire does not reach the specified tire inflation pressure within 10 minutes, it may have received extensive damage. In this case, the repair using the tire service kit was not successful. Contact a Fiat Dealership.

If the tire has been over-inflated, loosen the screw cap on the air compressor and bleed some of the air out;

❑ when the tire inflates to the specified tire inflation pressure, turn the air compressor switch off, turn the sleeve of the air compressor hose to the left, and pull it out of the tire valve;

❑ install the tire valve cap;

❑ put the tire service kit into the boot;

❑ start driving immediately to spread the sealant in the tire.

IMPORTANT Carefully drive the vehicle at a speed of 80 km/h or less. If the vehicle is driven at a speed of 80 km/h or more, the vehicle may vibrate.

If the tire is not properly inflated, the (!) warning light will illuminate.

❑ after driving the vehicle for about 10 minutes or 5 km (3 miles), connect the air compressor to the tire and check



the tire inflation pressure using the tire pressure gauge on the air compressor. If the tire inflation pressure is lower than the specified tire inflation pressure, turn the air compressor on and wait until it reaches the specified tire inflation pressure;

the emergency flat tire repair is completed successfully if the tire inflation pressure does not decrease. Carefully drive the vehicle to the nearest Fiat Dealership and have the flat tire replaced. Replacement with a new tire is recommended. If the tire is to be repaired or reused, contact a Fiat Dealership.

IMPORTANT Before checking the tire inflation pressure using the tire pressure gauge, turn the air compressor switch off.

NOTE

If an emergency flat tire repair has been performed using the tire service kit, FCA recommends that the tire be replaced with a new one as soon as possible. If the tire is to be repaired or reused, contact a Fiat Dealership.

The wheel can be reused if the sealant adhering to it is removed. However, replace the valve with a new one.



WARNING

169) Punctures on the sides of the tire may not be repaired. Do not use the kit if the tire was damaged as a result of being used when underinflated.

170) Do not adhere the speed restriction sticker to the padded area on the steering wheel. Adhering the speed restriction sticker to the padded area on the steering wheel is dangerous because the air bag may not operate (deploy) normally resulting in serious injury. In addition, do not adhere the sticker to areas where warning lights or the speedometer cannot be viewed.

171) If the tire inflation pressure has decreased below 130 kPa (1.3 kgf/cm² or bar, 18.9 psi), stop driving and contact a Fiat Dealership. The repair using the emergency at tire repair kit was not successful. If you see a decrease in the tire inflation pressure, stop driving. Contact a Fiat Dealership.

172) You must always indicate that the tyre was repaired using the kit. Give the booklet to the technicians who will be handling the tire that was treated using the kit.

173) Repairs are not possible in the case of damage to the wheel rim (bad groove distortion causing air loss). Do not remove foreign bodies (screws or nails) from the tire.

174) The information required by the applicable regulation is indicated on the tire service kit package label. Compliance with the indications on the label is an essential condition to ensure the safety and the effectiveness of the tire service kit. Carefully read the label before use, avoid improper use. Tire service kit is subject to expiration and must be replaced periodically. The kit should be used by adults and cannot be used by children.

175) Do not allow children to touch the tire sealant: ingestion of tire sealant is dangerous. In the event tire sealant is accidentally swallowed, drink large amounts of water immediately and seek medical assistance. Tire sealant that comes into contact with the eyes and skin is dangerous. If tire sealant enters the eyes or contacts the skin, flush immediately with large amounts of water and seek medical assistance.



IMPORTANT

3) Dispose of the bottle and the sealant liquid properly. Have them disposed of in compliance with national and local regulations.

JUMP STARTING

PREPARATIONS FOR JUMP STARTING

⚠ 176) 177) 178) 179) 180) 181) 182) 183) 184) 185)

⚠ 34)

Jump-starting is dangerous if done incorrectly. So follow the procedure carefully fig. 139. If you feel unsure about jump-starting, we strongly recommend that you have a competent service technician do the work.

IMPORTANT When using booster battery is used, comply with the utilisation and precaution instructions specified by the producer.

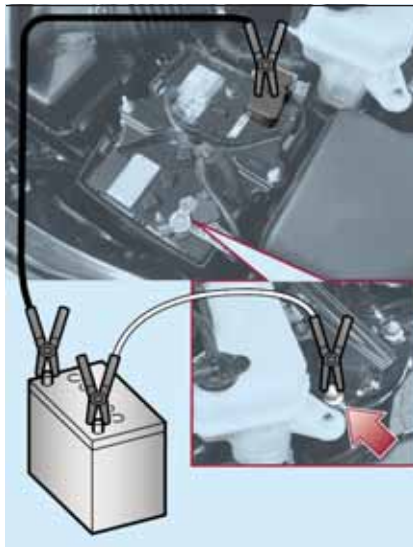

139

08030100-121-001

IMPORTANT Do not use the booster battery or any other source of external supply with a voltage above 12 V: the battery, the starter, the alternator and the electrical system of the vehicle could be damaged. You can damage a 12 V starter, ignition system, and other electrical parts beyond repair with a 24 V power supply (two 12 V batteries in series or a 24 V motor generator set).

IMPORTANT Do not attempt jump starting if the battery is wet. The battery could break and explode!

JUMP-STARTING PROCEDURE

IMPORTANT If the procedure below is carried out incorrectly can cause severe injuries to people or damage the recharging system of one or both vehicles. Carefully follow the instructions given below.

Proceed as follows to carry out a jump starting:

- ❑ remove the battery cover fig. 140;
- ❑ make sure the booster battery is 12 V and that its negative terminal is grounded;

- ❑ if the booster battery is in another vehicle, do not allow both vehicles to touch. Turn off the engine of the vehicle with the booster battery and all unnecessary electrical loads in both vehicles;





140

08030100-122-001

- ❑ connect the jumper leads in the exact sequence as in “Preparations for jump starting” paragraph:
 - connect one end of a lead to the positive terminal on the discharged battery;
 - attach the other end to the positive terminal on the booster battery;
 - connect one end of the other lead to the negative terminal of the booster battery;
 - connect the other end to the ground point indicated in the illustration away from the discharged battery.
- ❑ start the engine of the booster vehicle and run it a few minutes. Then start the engine of the other vehicle;
- ❑ when finished, carefully disconnect the leads in the reverse order as previously described;

❑ if the battery cover has been removed, install it in the reverse order of removal.

IMPORTANT Verify that the covers are securely installed.

IMPORTANT Perform the phonic wheel learning procedure described in the “Battery maintenance” section (see the “Maintenance and care” chapter).



WARNING

176) Before opening the bonnet, make sure that the engine is off and that the ignition switch is in OFF position. During refuelling, make sure that the engine is off (and that the ignition switch is in OFF position).

177) Do not get too close to the radiator cooling fan: the electric fan may start; danger of injury. Pay attention to scarves, ties and other loose clothing which might be pulled by moving parts.

178) Remove any metal objects (e.g. rings, watches, bracelets), that might cause an accidental electrical contact and cause serious injury.

179) Batteries contain acid which may burn skin and eyes. Batteries produce hydrogen, which is easily flammable and explosive. Thus keep away flames or devices which may cause sparks.

180) Do not allow the positive (+) terminal to contact any other metal object that could cause sparks. Flames and sparks near open battery cells are dangerous. Hydrogen gas, produced during normal battery operation, could ignite and cause the battery to explode. An exploding battery can cause serious burns and injuries. When working near a battery, do not allow metal tools to contact the positive (+) or negative (-) terminal of the battery.

181) Keep all flames, including cigarettes, and sparks away from open battery cells. Flames and sparks near open battery cells are dangerous. Hydrogen gas, produced during normal battery operation, could ignite and cause the battery to explode. An exploding battery can cause serious burns and injuries.

182) Do not jump-start a frozen battery or one with a low fluid level. Jump-starting a frozen battery or one with a low fluid level is dangerous. It may rupture or explode, causing serious injury.

183) Route the jumper leads away from parts that will be moving. Connecting a jumper lead near or to moving parts (cooling fans, belts) is dangerous. The lead could get caught when the engine starts and cause serious injury.

184) Never tow a vehicle to start it. Towing a vehicle to start it is dangerous. The vehicle being towed could surge forward when its engine starts, causing the two vehicles to collide. The occupants could be injured.

185) Connect the negative lead to a good ground point (see figure) away from the battery. Connecting the end of the second jumper lead to the negative (-) terminal of the discharged battery is dangerous. A spark could cause the gas around the battery to explode and injure someone.



IMPORTANT

34) Do not connect the cable to the negative terminal (-) of the flat battery. The following spark could lead to battery explosion and cause serious harm. Only use the specific earth point; do not use any other exposed metallic part.

TOWING THE VEHICLE

ATTACHING THE TOW HOOKS



Proceed as follows:

- remove the towing eyelet and the wheel brace from the luggage compartment;
- wrap a flathead screwdriver or similar tool with a soft cloth to prevent damage to a painted bumper, and open the cap located on the front 1 fig. 141 or rear bumper 2 fig. 142;

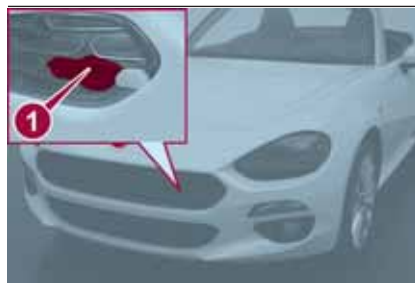

141

08060203-121-001

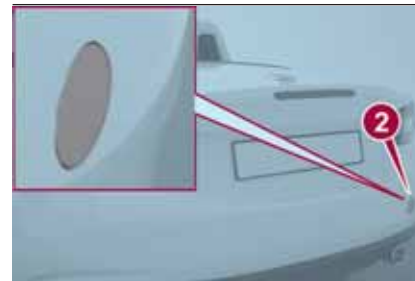

142

08060203-122-001

IMPORTANT Do not use excessive force as it may damage the cap or scratch the painted bumper surface.

IMPORTANT Remove the cap completely and store it so as not to lose it.

- securely install the towing eyelet using the wheel brace or equivalent front fig. 143 and rear fig. 144;
- hook the towing rope to the towing eyelet.



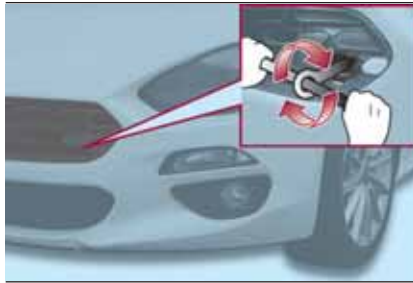

143

08060201-121-001

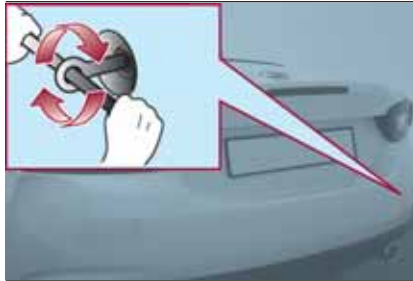

144

08060201-122-001

Note

Be careful not to damage the towing eyelet and towing hook, vehicle body, or transmission system when towing under the following conditions:

- do not tow a vehicle heavier than yours;
- do not suddenly accelerate your vehicle as it will apply a severe shock to

the towing eyelet and towing hook or rope;

- do not attach any rope other than to the towing eyelet and towing hook.

IMPORTANT The towing eyelet should be used in an emergency (to get the vehicle out of a ditch or a snow bank, for example).

IMPORTANT When using the towing eyelets, always pull the lead or chain in a straight direction with respect to the eyelet. Never apply a sideways force.

IMPORTANT When towing with chain or lead, wrap the chain or lead with a soft cloth near the bumper to prevent damage to the bumper.



IMPORTANT

35) Before starting towing operations, put the ignition switch to OFF position.

36) Before tightening the tow hook, clean the threaded housing thoroughly. Make sure that the tow hook is fully fastened in the housing before towing the vehicle.

37) The front and rear tow hooks should be used only for emergencies on the road. You are allowed to tow the vehicle for short distances using an appropriate device in accordance with the highway code (a rigid bar), to move the vehicle on the road in readiness for towing or transport via a breakdown vehicle. Tow hooks **MUST NOT** be used to tow vehicles off the road or where there are obstacles and/or for towing operations using ropes or other non-rigid devices. Respecting the above conditions, towing must take place with two vehicles (one towing, the other towed) aligned as much as possible along the same center line.

EMERGENCY TOWING

TOWING DESCRIPTION

Proper lifting and towing are necessary to prevent damage to the vehicle. Government and local laws must be followed.

A towed vehicle usually should have its drive wheels (rear wheels) off the ground. If excessive damage or other conditions prevent this, use wheel dollies.

When towing with the rear wheels on the ground, release the parking brake.

IMPORTANT Do not tow the vehicle pointed backward with driving wheels on the ground. This may cause internal damage to the transmission.

IMPORTANT Do not tow with sling-type equipment. This could damage your vehicle. Use wheel-lift or flatbed equipment.

If towing service is not available in an emergency, the vehicle may be towed with all four wheels on the ground using the towing hook at the front of the vehicle. Only tow the vehicle on paved surfaces for short distances at low speeds.

Follow these instructions when towing the vehicle with all wheels on the ground:

- shift to neutral (manual transmission), or the N position (automatic transmission);
- switch the ignition to ACC;
- release the parking brake.

NOTE Remember that power assist for the brakes and steering will not be available when the engine is not running.



MAINTENANCE AND CARE

Correct maintenance permits the performance of the vehicle to be maintained over time, as well as limited running costs and safeguarding the efficiency of the safety systems.

SCHEDULED SERVICING.157
ENGINE COMPARTMENT163
BATTERY RECHARGING167
WHEELS AND TIRES.168
BODYWORK.170
INTERIORS172

SCHEDULED SERVICING

INTRODUCTION

Be extremely careful and prevent injury to yourself and others or damage to your vehicle when using this manual for inspection and maintenance.

If you are unsure about any procedure it describes, we strongly urge you to have a reliable and qualified service shop perform the work, preferably at Fiat Dealership.

Factory-trained FCA technicians and genuine FCA parts are best for your vehicle. Without this expertise and the parts that have been designed and made especially for your vehicle, inadequate, incomplete, and insufficient servicing may result in problems. This could lead to vehicle damage or an accident and injuries.

For expert advice and quality service, contact a Fiat Dealership.

The owner should retain evidence that proper maintenance has been performed as prescribed.

A claim against a warranty will not qualify if it results from lack of maintenance and not from defective material or authorised workmanship.

Claims against the warranty resulting from lack of maintenance, as opposed

to defective materials or authorized FCA workmanship, will not be honored.

Scheduled maintenance

NOTE After the prescribed period, continue to follow the described maintenance at the recommended intervals.

Emission control and related systems

The ignition and fuel systems are highly important to the emission control system and to efficient engine operation. Do not tamper with them.

All inspections and adjustments must be made by an expert repairer, we recommend a Fiat Dealership.

OWNER MAINTENANCE PRECAUTIONS



Routine service

We highly recommend that these items be inspected daily, or at least every week:

- Engine oil level
- Engine coolant level
- Brake and clutch fluid Level
- Washer fluid level
- Battery maintenance
- Tire inflation pressure

Improper or incomplete service may result in problems. This section gives instructions only for items that are easy to perform.

As explained in the “Introduction” paragraph, several procedures can be done only by a qualified service technician with special tools.

Improper do-it yourself maintenance during the warranty period may affect warranty coverage. For details, read the separate Warranty statement provided with the vehicle. If you are unsure about any servicing or maintenance procedure, have it done by an expert repairer, we recommend a Fiat Dealership.

There are strict environmental laws



regarding the disposal of waste oil and fluids. Please dispose of your waste properly and with due regard to the environment.

We recommend that you entrust the oil and fluid changes of your vehicle to a Fiat Dealership.

PERIODIC CHECKS

Every **1,000 km** or before long trips check and, if necessary, top up:

- engine coolant level;
- brake fluid level;
- windscreen washer fluid level;
- tire inflation pressure and condition;
- operation of lighting system (headlights, direction indicators, hazard warning lights, etc.);
- operation of windscreen washer/wiper system and positioning/wear of windscreen window wiper blades.

Every 3,000 km, check and top up if required: engine oil level.

HEAVY-DUTY USE OF THE VEHICLE

If the vehicle is used under one of the following conditions:

- dusty roads;
- short, repeated journeys (less than 7-8 km) at sub-zero outside temperatures;
- engine often idling or driving long distances at low speeds or long periods of inactivity;

the following checks must be carried out more often than indicated in the Scheduled Servicing Plan:

- check front disc brake pad condition and wear;
- check cleanliness of bonnet and luggage compartment locks, cleanliness and lubrication of linkage;
- visually inspect conditions of: engine, gearbox, transmission, pipes and hoses (exhaust/fuel system/brakes) and rubber elements (gaiters/sleeves/bushes, etc.);
- check battery charge and battery fluid level (electrolyte);
- visually inspect conditions of the accessory drive belts;
- check and, if necessary, change engine oil and replace oil filter;
- check and, if necessary, replace pollen filter;
- check and, if necessary, replace air cleaner.

SCHEDULED SERVICING PLAN

The checks listed in the Scheduled Servicing Plan, after reaching 120,000 km/8 years, must be cyclically repeated starting from the first interval, thus following the same intervals as before.

Thousands of miles	9	18	27	36	45	54	63	72	81	90
Thousands of kilometers	15	30	45	60	75	90	105	120	135	150
Years	1	2	3	4	5	6	7	8	9	10
Check tire condition/wear and adjust pressure, if necessary. Check quick tire repair kit recharge condition and expiry date (where provided)	•	•	•	•	•	•	•	•	•	•
Check operation of lighting system (headlights, direction indicators, hazard warning lights, boot, passenger compartment, glove compartment, instrumental panel warning lights, etc.)	•	•	•	•	•	•	•	•	•	•
Check and, if necessary, top up fluid levels (1)	•	•	•	•	•	•	•	•	•	•
Check exhaust emissions/smokiness	•	•	•	•	•	•	•	•	•	•
Use the diagnosis socket to check engine management system operation, emissions and, for versions/markets where provided, engine oil degradation	•	•	•	•	•	•	•	•	•	•
Visually inspect conditions of: exterior bodywork, underbody protection, pipes and hoses (exhaust, fuel system, brakes), rubber elements (gaiters, sleeves, bushes, etc.) and fasteners in sight		•		•		•		•		•
Visually inspect conditions of steering elements and check their operation		•		•		•		•		•

(1) Always only use the liquids shown in the handbook for topping up after having checked that the system is not damaged.



Thousands of miles	9	18	27	36	45	54	63	72	81	90
Thousands of kilometers	15	30	45	60	75	90	105	120	135	150
Years	1	2	3	4	5	6	7	8	9	10
Check endfloat of wheel bearings and front and rear joints		●		●		●		●		●
Check windscreen wiper blade position/wear	●		●		●		●		●	
Check operation of the wiper/washer system and adjust jets, if necessary	●		●		●		●		●	
Check cleanliness of bonnet and boot locks, as well as cleanliness and lubrication of linkages		●		●		●		●		●
Check handbrake lever travel and adjust, if necessary	●	●	●	●	●	●	●	●	●	●
Visually inspect conditions and wear of front/rear disk brake pads and integrity of pad wear indicator	●	●	●	●	●	●	●	●	●	●
Visually inspect condition of evaporation control system			●			●			●	
Visually inspect condition and tensioning of accessory drive belt(s)				●						
Visually inspect conditions of toothed timing drive belt				●						
Change transmission oil					●					
Change engine oil and replace oil filter	●	●	●	●	●	●	●	●	●	●

Thousands of miles	9	18	27	36	45	54	63	72	81	90
Thousands of kilometers	15	30	45	60	75	90	105	120	135	150
Years	1	2	3	4	5	6	7	8	9	10
Replace spark plugs (2)			●			●			●	
Replace accessory drive belt(s)	(3)									
Replace toothed timing drive belt	(3)									
Replace air filter cartridge (4)			●			●			●	
Change the brake fluid	(5)									
Replace air cabin filter (4) (o) (●)	○	●	○	●	○	●	○	●	○	●

(2) For 1.4 Turbo Multiair versions, to guarantee correct operation and prevent serious damage to the engine, it is essential to proceed as follows: only use spark plugs specifically certified for these engines; all spark plugs should be of the same type and brand (see the "Engine" paragraph in the "Technical specifications" chapter); strictly comply with the replacement intervals in the Scheduled Servicing Plan. It is advisable to contact a Fiat Dealership for spark plug replacement.

(3) Areas that are not dusty: recommended maximum mileage 120.000 km. Regardless of the mileage, the belt must be replaced every 6 years. Dusty areas and/or demanding use (cold climates, town use, long periods of idling): recommended maximum mileage 60.000 km. Regardless of the mileage, the belt must be replaced every 4 years.

(4) If the vehicle is used in dusty areas, this cleaner must be replaced every 15.000 km.

(5) The brake fluid replacement has to be done every two years, irrespective of the mileage.

(o) Recommended operations

(●) Mandatory operations



**WARNING**

186) Do not perform maintenance work if you lack sufficient knowledge and experience or the proper tools and equipment to do the work. Have maintenance work done by a qualified technician. Performing maintenance work on a vehicle is dangerous if not done properly. You can be seriously injured while performing some maintenance procedures.

187) If you must run the engine while working under the bonnet, make certain that you remove all jewelry (especially rings, bracelets, watches, and necklaces) and all neckties, scarves, and similar loose clothing before getting near the engine or cooling fan which may turn on unexpectedly. Either can become entangled in moving parts and result in injury.

188) Switch the ignition to off and make sure the fan is not running before attempting to work near the cooling fan. Working near the cooling fan when it is running is dangerous. The fan could continue running indefinitely even if the engine has stopped and the engine compartment temperature is high. You could be hit by the fan and seriously injured.

**IMPORTANT**

38) Do not leave items in the engine compartment. After you have finished checking or doing servicing in the engine compartment, do not forget and leave items such as tools or rags in the engine compartment. Tools or other items left in the engine compartment could cause engine damage or a fire leading to an unexpected accident.

ENGINE COMPARTMENT

CHECKING LEVELS

! 189) 190)

! 39)



145

07030300-121-003-high.jpg

1. Window and headlight washer fluid 2. Engine oil dipstick 3. Engine oil cap 4. Engine coolant fluid 5. Brake/clutch fluid 6. Battery



ENGINE OIL



191)



40)



4)

Inspecting engine oil level

Proceed as follows:

- be sure the vehicle is on a level surface;
- warm up the engine to normal operating temperature;
- turn it off and wait at least 5 minutes for the oil to return to the sump;
- pull out the dipstick 1 fig. 146, wipe it clean, and reinsert it fully;
- pull it out again and examine the level. The level is normal if it is between Low and Full. If it is near or below Low, open the engine oil cap/filler 2 and add enough oil to bring the level to Full;
- make sure the O-ring on the dipstick is positioned properly before reinserting the dipstick;
- reinsert the dipstick fully.

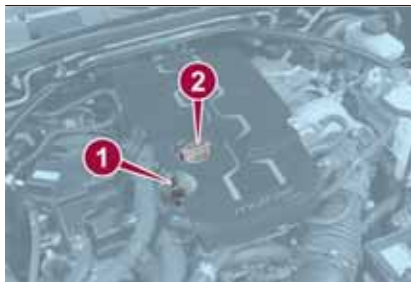

146

07030403-121-001

IMPORTANT Do not overfill the engine oil. This may cause engine damage.

Engine oil consumption

During the initial period of use the engine oil consumption conditions should be considered as having stabilised after the first 5000 – 6000 km.

NOTE It is normal for all engines to consume engine oil under normal driving conditions. Engine oil consumption may be as high as 400 g/1000 km. This may be as a result of evaporation, internal ventilation or burning of the lubricating oil in the working engine. Oil consumption may be higher when the engine is new due to the running-in process. Oil consumption is also dependant on engine speed and engine load. Under

extreme driving conditions, oil consumption may be higher.

Engine oil changing

NOTE Changing the engine oil should be done by Fiat Dealership.

ENGINE COOLANT



192) 193) 194)



41) 42) 43) 44) 45) 46)

The coolant should be at full in the radiator and between the F (Full) and L (Low) marks on the coolant reservoir fig. 147 when the engine is cool.



147

07030501-121-001

If it is at or near L (Low), add enough coolant to the coolant reservoir to provide freezing and corrosion protection and to bring the level to F (Full).

Securely tighten the coolant reservoir tank cap after adding coolant.

If the coolant reservoir is empty or new coolant is required frequently, contact a Fiat Dealership.

BRAKE / CLUTCH FLUID

197)

47)

It should be kept between the MAX and MIN lines fig. 148.

The level normally drops with accumulated distance, a condition associated with wear of brake and clutch linings. If it is excessively low, have the brake/clutch system contact a Fiat Dealership.

NOTE On right-hand drive versions the reservoir is located on the left side of the engine compartment.



148

07030601-121-002

WINDOW AND HEADLIGHT WASHER FLUID

203)

Inspect fluid level in the washer fluid reservoir fig. 149; open the cap and add fluid if necessary.



149

07030901-121-001

AUTOMATIC TRANSMISSION CONTROL UNIT

5)

The transmission control oil level should only be checked at a Fiat Dealership.

BATTERY MAINTENANCE

198) 199) 200) 201)

48)

6)

To get the best service from a battery:
 keep it securely mounted;

- keep the top clean and dry;
- keep terminals and connections clean, tight, and coated with petroleum jelly or terminal grease;
- rinse off spilled electrolyte immediately with a solution of water and baking soda;
- if the vehicle will not be used for an extended time, disconnect the battery leads and charge the battery every six weeks.

NOTE

Every time the battery is reconnected after being disconnected, it is necessary to perform the following procedure:

- warm up the engine;
- with the vehicle stationary, the engine running and the transmission in the neutral or N/P (for automatic transmission) position, press the accelerator down fully to bring the engine speed to over 6000 rpm;
- release the accelerator pedal and wait for the engine to return naturally to idling speed.

If this procedure is not performed, the  warning light could turn on: in this case, contact Fiat Dealership.

IMPORTANT If, after the first press of the accelerator pedal to bring the engine to over 6000 rpm, another follows immediately after

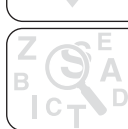

without the engine naturally reaching idling speed, the learning procedure is invalidated and the  warning light on the instrument panel will turn on. If the engine is not brought to over 6000 rpm, or it is not warmed up, the control unit will keep open the possibility to repeat the described procedure.

Inspecting electrolyte level

A low level of electrolyte fluid will cause the battery to discharge quickly.

Inspect the electrolyte level at least once a week. If it is low, remove the caps and add enough distilled water to bring the level between the upper and lower level fig. 150 (1 = upper level / 2 = lower level). **Do not overfill.**

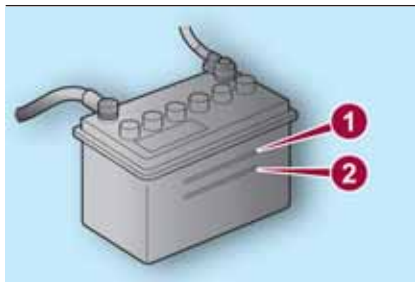

150

07031202-ALL-001

Examine the specific gravity of the electrolyte with a hydrometer, especially

during cold weather. If it is low, recharge the battery.

Battery replacement

Contact a Fiat Dealership for a battery replacement purchase.

After replacing the battery, perform the phonic wheel learning procedure described in the “Battery maintenance” chapter.



WARNING

189) Never smoke when performing operations in the engine compartment. Flammable gases and fumes may be present and risk igniting.

190) Be very careful when working in the engine compartment when the engine is hot: you may get burned. Do not get too close to the radiator cooling fan: the electric fan may start; danger of injury. Scarves, ties and other loose clothing might be pulled by moving parts.

191) If the engine oil is being topped up, wait for the engine to cool down before loosening the filler cap, particularly for vehicles with aluminium cap (where provided). **IMPORTANT:** risk of burns!

192) Do not use a match or live flame in the engine compartment. **DO NOT ADD COOLANT WHEN THE ENGINE IS HOT:** a hot engine is dangerous. If the engine has been running, parts of the engine compartment can become very hot. You could be burned. Carefully inspect the engine coolant in the coolant reservoir, but do not open it.

193) Do not remove either cooling system cap when the engine and radiator are hot. When the engine and radiator are hot, scalding coolant and steam may shoot out under pressure and cause serious injury.

194) The cooling system is pressurized. If necessary, only replace the cap with another original one or the operation of the system may be adversely affected. Do not remove the reservoir cap when the engine is hot: risk of burns.

195) Do not travel with the windscreen washer fluid reservoir empty: the washer operation is essential for improving visibility. Repeated operation of the system without fluid could damage or cause rapid deterioration of some system components.

196) Certain commercial additives for windscreen washer fluids are inflammable. The engine compartment contains hot components which may set it on fire.

197) Brake fluid is poisonous and highly corrosive. In the event of accidental contact, immediately wash the affected parts with water and mild soap. Then rinse thoroughly. Call a doctor immediately if swallowed.

198) Battery fluid is poisonous and corrosive. Avoid contact with the skin and eyes. Keep open flames away from the battery and do not use objects that might create sparks: risk of explosion and fire.

199) Using the battery with insufficient fluid irreparably damages the battery and may cause an explosion.

200) If the vehicle must remain unused for a long time at a very low temperature, remove the battery and take it to a warm place, to avoid freezing.

201) When performing any operation on the battery or near it, always protect your eyes with special goggles.

202) If the brake/clutch fluid level is low, have the brakes inspected. A low brake/clutch fluid level is dangerous. A low level could indicate brake lining wear or a brake system leak which could cause the brakes to fail and lead to an accident.

203) Use only windscreen washer fluid or plain water in the reservoir. Using radiator antifreeze as washer fluid is dangerous. If sprayed on the windscreen, it will dirty the windscreen, affect your visibility, and could result in an accident.



IMPORTANT

39) Be careful not to confuse the various types of fluids while topping up: they are not compatible with each other! Topping up with an unsuitable fluid could severely damage your vehicle.

40) The oil level should never exceed the MAX mark.

41) Do not add oil with specifications other than those of the oil already in the engine.

42) Do not add only water. Always add a proper coolant mixture. For coolant fluid type refer to "Fluids and lubricants" table in "Technical specifications" chapter.

43) Use only soft (demineralised) water in the coolant mixture. Water that contains minerals will cut down on the coolant's effectiveness.

44) Do not use coolants containing alcohol, methanol, borate or silicate. These coolants could damage the cooling system.

45) Do not mix alcohol or methanol with the coolant. This could damage the cooling system.

46) Do not use a solution that contains more than 60% antifreeze. This would reduce effectiveness.

47) Avoid allowing brake fluid, which is extremely corrosive, to come into contact with painted areas. Should it happen, wash immediately with water.

48) Incorrect assembly of electrical and electronic accessories may cause severe damage to your vehicle. Go to a Fiat Dealership if you want to install accessories (e.g. anti-theft, radio phone, etc.): they will suggest the most suitable devices and advise you whether a higher capacity battery needs to be installed.



IMPORTANT

4) Used engine oil and oil filters contain substances which are harmful to the environment. You are advised to contact a Fiat Dealership to have the oil and filters changed.

5) Used transmission fluid contains substances that are harmful to the environment. It is advisable to contact a Fiat Dealership to have the fluid changed.

6) Batteries contain substances which are very dangerous for the environment. For battery replacement, contact a Fiat Dealership.

BATTERY RECHARGING

 204) 205)



BATTERY RECHARGING PROCEDURE

Charge battery as follows:

- remove the caps before recharging the battery;
- connect the charger cables to the battery terminals, observing the polarity;
- turn on the charger;
- when finished, turn the charger off before disconnecting the battery;
- reconnect the negative battery terminal.

IMPORTANT Before recharging the battery, turn off all accessories and stop the engine.

IMPORTANT Make sure that the cables of the electrical system are correctly reconnected to the battery, i.e. the positive cable (+) to the positive terminal and the negative cable (-) to the negative terminal. The battery terminals are marked with the positive (+) and negative (-) symbols, and are shown on the battery cover. The battery terminals must also be corrosion-free and firmly secured to the terminals. If a "quick-type" battery charger is used



with the battery fitted on the vehicle, before connecting it disconnect both cables of the battery itself. Do not use a “quick-type” battery charger to provide the starting voltage.

IMPORTANT The battery recharging procedure is given as information only. You are advised to contact a Fiat Dealership to have this operation carried out.

IMPORTANT Charging should be slow at a low ampere rating for approximately 24 hours. Charging for a longer time may damage the battery.

IMPORTANT After reconnecting the battery, perform the phonic wheel learning procedure described in the “Battery maintenance” in this chapter.



WARNING

204) *Battery fluid is poisonous and corrosive: avoid contact with skin and eyes. The battery recharging operation must be performed in a ventilated place, away from naked flames or possible sources of sparks to avoid the risk of explosion and fire.*

205) *Do not try to recharge a frozen battery: it must be thawed first, otherwise it may explode. If the battery was frozen, have it inspected by specialized personnel before recharging to check that the internal elements are not damaged and that the casing is not cracked, which causes the risk of leakage of poisonous, corrosive acid.*

WHEELS AND TIRES



SAFETY INFORMATION

 206) 207) 208)

 49) 50)

Before embarking on a long trip, and approximately every two weeks, check the tire inflation pressure, including the spare wheel, if present. Check the tires when cold.

It is normal for the pressure to increase when the vehicle is used due to tire heating; for the correct tire inflation pressure, see the “Wheels and tire specifications” paragraph in the “Technical specifications” chapter.

The tires must be replaced when the tread is less than 1.6 mm thick.

REPLACING A TIRE

 209)

If a tire wears evenly, a wear indicator fig. 151 will appear as a solid band across the tread. Replace the tire when this happens: 1: new tread/2: worn tread (3 = tread wear indicator).

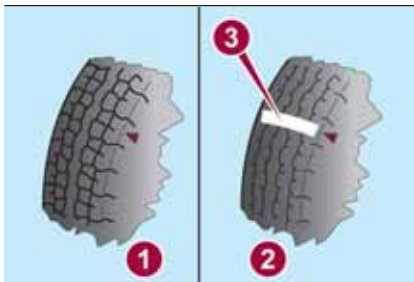

151

07031403-ALL-001

You should replace the tire before the band crosses the entire tread.

After adjusting the tire pressure, initialization of the tire pressure monitoring system is necessary to make the system operate normally. Refer to “Tire Pressure Monitoring System Initialization” paragraph in “Safety” chapter.

SNOW CHAINS



The snow chains may be applied only to the rear wheel tires. Check the tension of the snow chains after the first few metres have been driven.

IMPORTANT Using snow chains with tires with non-original dimensions may damage the vehicle.

IMPORTANT Using different size or type (M+S, snow, etc.) tires between front

and rear axle may adversely affect vehicle driveability, with the risk of losing control of the vehicle and resulting accidents.

TIRE ROTATION RECOMMENDATIONS



IMPORTANT The following rotation methods must NOT be used with one-way tires! This type of tires can only be switched from the front axle to the rear axle and vice versa, keeping them on the same side of the vehicle.

IMPORTANT Rotate tires periodically. Irregular tire wear is dangerous. To equalize tread wear for maintaining good performance in handling and braking, rotate the tires every 10,000 km, or sooner if irregular wear develops.

IMPORTANT Because your vehicle is not equipped with a spare tire for tire rotation contact Fiat Dealership.

After adjusting the tire pressure, initialization of the tire pressure monitoring system is necessary to make the system operate normally. Refer to “Tire Pressure Monitoring System Initialization” paragraph in “Safety” chapter.

IMPORTANT Rotate unidirectional tires and radial tires that have an asymmetrical tread pattern or studs only from front to rear, not from side to side. Tire performance will be reduced if rotated from side to side.

With limited-slip differential (where provided)

Do not use the following:

- tires not of the designated size;
- tires of different sizes or types at the same time;
- tires not sufficiently inflated.

If these instructions are not followed, the rotation of the left and right wheels will be different and will thus apply a constant load on the limited-slip differential. This will cause a malfunction.



WARNING

206) *If the tires are “unidirectional”, do not switch tires from the right-hand side of the vehicle to the left-hand side, and vice versa. This type of tires can only be switched from the front axle to the rear axle and vice versa, keeping them on the same side of the vehicle.*

207) *Travelling with partially or completely flat tires can cause safety problems and irreparable damages to the tire.*



208) Always use tires that are in good condition. Driving with worn tires is dangerous. Reduced braking, steering, and traction could result in an accident.

209) Replace all four tires at the same time. Replacing just one tyre is dangerous. It could cause poor handling and poor braking resulting in loss of vehicle control.

210) Always use wheels of the correct size on your vehicle. Using a wrong-sized wheel is dangerous. Braking and handling could be affected, leading to loss of control and an accident.



IMPORTANT

49) Road holding depends also on the correct tire inflating pressure.

50) If the pressure is too low the tire overheats and this can cause it serious damage.

51) Keep your speed down when snow chains are fitted; do not exceed 50 km/h (30 mph). Avoid potholes, steps and pavements and avoid driving for long distances on roads not covered with snow to prevent damaging the vehicle and the road surface.

BODYWORK



PRESERVING THE PAINTWORK

52) 53)

7)

Touch up abrasions and scratches immediately to prevent the formation of rust.

To correctly wash the vehicle, follow these instructions:

- is the vehicle is washed remove the aerial;
- if high pressure jets or cleaners are used to wash the vehicle, keep a distance of at least 40 cm from the bodywork to avoid damage or alteration. Build up of water could cause damage to the vehicle in the long term;
- wash the bodywork using a low pressure jet of water if possible;
- wipe a sponge with a slightly soapy solution over the bodywork, frequently rinsing the sponge;
- rinse well with water and dry with a jet of air or a chamois leather.

Dry the less visible parts (e.g. door frames, bonnet, headlight frames, etc.) with special care, as water may stagnate more easily in these areas. Do not wash the vehicle after it has been

left in the sun or with the bonnet hot: this may alter the shine of the paintwork.

Exterior plastic parts must be cleaned in the same way as the rest of the vehicle.

IMPORTANT Avoid parking under trees; the resin dropped by trees makes the paintwork go opaque and increases the possibility of corrosion.

IMPORTANT Bird droppings must be washed off immediately and thoroughly as the acid they contain is particularly aggressive.

Paint chipping

Paint chipping occurs when gravel thrown in the air by another vehicle's tires hits your vehicle.

Keeping a safe distance between you and the vehicle ahead reduces the chances of having your paint chipped by flying gravel.

IMPORTANT The paint chipping zone varies with the speed of the vehicle. For example, when travelling at 90 km/h, the paint chipping zone is 50 m.

IMPORTANT In low temperatures a vehicle's finish hardens. This increases the chance of paint chipping.

IMPORTANT Chipped paint can lead to rust forming on your vehicle. Before this happens, repair the damage by using FCA touch-up paint according to the instructions in this section. Failure to repair the affected area could lead to serious rusting and expensive repairs.

MAINTAINING THE FINISH

Washing

To help protect the finish from rust and deterioration, wash your vehicle thoroughly and frequently, at least once a month, with lukewarm or cold water.

IMPORTANT FCA is not responsible for scratches caused by automatic car washes or improper washing. Scratches are more noticeable on vehicles with darker paint finishes.

IMPORTANT Keep hands and scrapers clear of the windscreen when the wiper lever is in the AUTO position and the ignition is switched ON as fingers could be pinched or the wipers and wiper blades damaged when the wipers activate automatically. If you are going to clean the windscreen, be sure the wipers are turned off completely (when it is most likely that the engine is left running) this is particularly important when clearing ice and snow.

IMPORTANT Do not spray water in the engine compartment. Otherwise, it could result in engine-starting problems or damage to electrical parts.

IMPORTANT When washing and waxing the vehicle, be careful not to apply excessive force to any single area of the vehicle bonnet. Otherwise, you could dent the vehicle.

IMPORTANT Do not use automatic car washing machines and car washing devices using high water pressure.

IMPORTANT Make sure that the fuel flap is closed and lock the doors. Otherwise, the fuel flap may be forcefully opened by water pressure causing damage to the vehicle or fuel flap.

IMPORTANT Do not use steel wool, abrasive cleaners, or strong detergents containing highly alkaline or caustic agents on chromeplated or anodised aluminium parts. This may damage the protective coating; also, cleaners and detergents may discolour or deteriorate the paint.

Thoroughly rinse off all soap with lukewarm or cold water. Do not allow soap to dry on the finish.



WARNING

211) *Dry off brakes that have become wet by driving slowly, releasing the accelerator pedal and lightly applying the brakes several times until the brake performance returns to normal. Driving with wet brakes is dangerous. Increased stopping distance or the vehicle pulling to one side when braking could result in a serious accident. Light braking will indicate whether the brakes have been affected.*



IMPORTANT

52) *In order to preserve the appearance of the paint abrasive products and/or polishes should not be used for cleaning the vehicle.*



53) *Avoid washing with rollers and/or brushes in washing stations. Wash the vehicle only by hand using neutral pH detergents; dry it with a wet chamois leather. Abrasive products and/or polishes should not be used for cleaning the car. Bird droppings must be washed off immediately and thoroughly as the acid they contain is particularly aggressive. Avoid (if at all possible) parking the vehicle under trees; remove vegetable resins immediately as, when dried, it may only be possible to remove them with abrasive products and/or polishes, which is highly inadvisable as they could alter the typical opaqueness of the paint. Do not use pure windscreen washer fluid for cleaning the front windscreen and rear window; dilute it min. 50% with water. Only use pure screen washer fluid when strictly necessary due to outside temperature conditions.*



IMPORTANT

7) *Detergents cause water pollution. Only wash your vehicle in areas equipped to collect and treat wastewater from this type of activity.*

INTERIORS



SEATS AND FABRIC PARTS

Seat belt maintenance



213) 214) Clean the soiled area by lightly dabbing it with a soft cloth soaked in a mild detergent (approx. 5%) diluted with water.

Wipe off the remaining detergent using a cloth soaked in clean water and wrung out well.

Before retracting seat belts which have been pulled out for cleaning, dry them off thoroughly and make sure there is no remaining moisture on them.

NOTE Clean seat belts diligently if they get dirty. Leaving them uncleaned will make it difficult to clean them later, and it may affect the smooth retracting of the seat belt.

PLASTIC PART MAINTENANCE



Instrument panel top maintenance



Wipe the soiled area with a soft cloth soaked in a mild detergent (approx. 5%) diluted with water.

Wipe off the remaining detergent using a cloth soaked in clean water and wrung out well.



WARNING

212) *Do not spray water into the vehicle cabin. Spraying water into the vehicle cabin is dangerous as electrical devices such as the audio and switches could get wet resulting in a malfunction or vehicle fire.*

213) *If a seat belt appears frayed or has abrasions, have it replaced by a Fiat Dealership. If a seat belts is used under such a condition, it cannot function at its full capacity which could result in serious injury or death.*

214) *Use a mild detergent to remove soiling from a seat belt. If organic solvents are used for cleaning the seat belts or they become stained or bleached, there is the possibility of them becoming weakened and as a result, they may not function at their full capacity which could cause serious injury or death.*

215) Never use flammable products, such as petrol ether or rectified petrol to clean the inside of the car. The electrostatic charges which are generated by rubbing during the cleaning operation may cause a fire.

216) Do not keep aerosol cans in the car: they might explode. Aerosol cans must not be exposed to a temperature exceeding 50°C. When the vehicle is exposed to sunlight, the internal temperature can greatly exceed this value.

217) There must be no obstacles on the floor underneath the pedals; make sure that mats are always flat and do not interfere with the pedals.



IMPORTANT

54) Never use alcohol, petrols and derivatives to clean the dashboard and instrument panel lens.



TECHNICAL SPECIFICATIONS

Everything you may find useful for understanding how your vehicle is made and works is contained in this chapter and illustrated with data, tables and graphics.

For the enthusiasts and the technician, but also just for those who want to know every detail of their vehicle.

IDENTIFICATION DATA.175
ENGINE176
WHEEL AND TIRE SPECIFICATIONS177
WEIGHTS180
DIMENSIONS181
FLUID CAPACITIES182
FLUIDS AND LUBRICANTS.183
PERFORMANCE185
FUEL CONSUMPTION.186
CO EMISSIONS187
PRESCRIPTIONS FOR HANDLING THE VEHICLE AT THE END OF ITS LIFE188

IDENTIFICATION DATA

MODEL PLATE

Model plate is located on the left side of door pillar fig. 152.



152

10010103-121-001

CHASSIS NUMBER / VEHICLE IDENTIFICATION NUMBER (Ireland / U.K.)

Chassis number: open the cover shown in fig. 153 to check the chassis number.



153

10010109-333-333

Vehicle Identification Number fig. 154.



154

10010104-122-001

TIRE PRESSURE LABEL

Tire pressure label is located on the left side of door pillar for left-hand drive versions fig. 155 or on the right side of door pillar for right-hand drive versions.



155

10010109-321-321

ENGINE NUMBER

Engine number label is located on the engine.



ENGINE



218)

Version	1.4 Turbo Multi Air 140HP
Cycle	Otto
Number and position of cylinders	4 in line
Piston bore and stroke (mm)	72.0 x 84.0
Total displacement (cm ³)	1368
Compression ratio	9.8:1
Maximum power (EEC) (kW)	103
Maximum power (EEC) (HP)	140
corresponding engine speed (rpm)	5000
Maximum torque (EEC) (Nm)	240
Maximum torque (EEC) (kgm)	24,5
corresponding engine speed (rpm)	2250
Spark plugs	NGK SIKR9A7
Fuel	Unleaded petrol 95 R.O.N. (EN 228 specifications)

IMPORTANT When cleaning the iridium plugs, do not use a wire brush. The fine particulate coating on the iridium alloy and platinum tips could be damaged.



WARNING

218) Modifications or repairs to the fuel supply system that are not carried out correctly or do not take the system's technical specifications into account can cause malfunctions leading to the risk of fire.

WHEEL AND TIRE SPECIFICATIONS

RIMS AND TIRES



219)



55)

NOTE The tires have been optimally matched with the chassis of your vehicle. When replacing tires, FCA recommends that you replace tires of the same type originally fitted to your vehicle. For details, contact a Fiat Dealership.

Check the tire pressure label for tire size and inflation pressure (refer to “Tire inflation pressure” paragraph in “Maintenance and care” chapter). After adjusting the tire pressure, initialization of the TPMS system is necessary to make the system operate normally (refer to “Tire Pressure Monitoring System initialization” in “Safety” chapter).

IMPORTANT If there are any discrepancies between the Owner Handbook and the registration document, take the information from the latter. For safe driving, the vehicle must be fitted with tires of the same make and type on all wheels.

IMPORTANT Do not use tubes with tubeless tires.



WARNING

219) *If winter tyres with a lower speed rating than that indicated in the Registration Document are used, do not exceed the maximum speed corresponding to the speed rating of the tyres used.*



IMPORTANT

55) *Keep your speed down when snow chains are fitted; do not exceed 50 km/h (30 mph). Avoid potholes, steps and pavements and avoid driving for long distances on roads not covered with snow to prevent damaging the vehicle and the road surface.*



RIMS AND TIRES PROVIDED

Rims	Standard tire	Winter tire
6 1/2 J x 16	195/50 R16 84V (*)	195/50 R16 84 M+S (**)
7J x 17	205/45 R17 84W (*)	205/45 R17 84 M+S (***)

(*) 3-season type

(**) Load index and speed symbol: 84Q/84S/84H/84V

(***) Load index and speed symbol: 84Q/84S/84H/84V/84W

COLD TIRE INFLATION PRESSURE

Add +0.3 bar to the prescribed pressure when the tires are warm. Recheck pressure value with cold tires. With snow tires, add +0.2 bar to the pressure recommended for standard tires.

Tire size	Front	Rear
195/50 R16 84V	2.0	2.0
205/45 R17 84W	2.0	2.0



WEIGHTS

Curb weight: 1050 kg

DIMENSIONS

Dimensions are expressed in mm and refer to the vehicle equipped with its standard-supplied tyres. Height is measured with vehicle unladen.

BOOT VOLUME: 140 litres

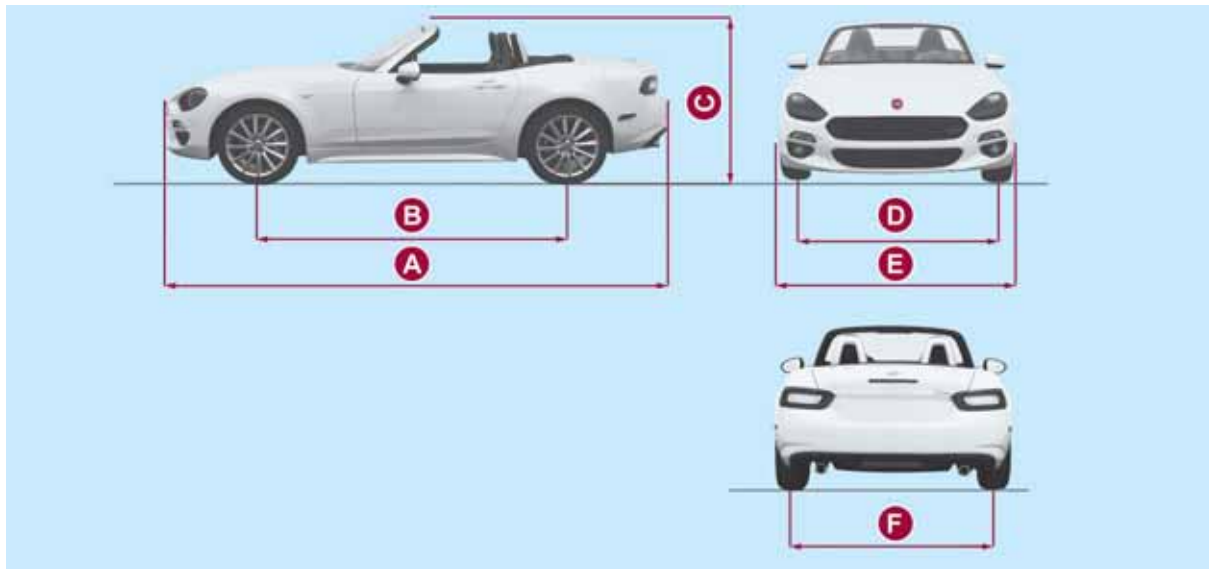

156

10000555-122-333

A	B	C	D	E	F
4,055 (*) / 4,075 (**)	2,310	1,230	1,495	1,740	1,505

(*) Without license plate holder.

(**) With license plate holder.



FLUID CAPACITIES

Item	Capacities
Fuel tank (litres)	45
Engine oil (without oil filter replacement) (litres)	3.2
Engine oil (with oil filter replacement) (litres)	3.8
Coolant (versions with manual transmission) (litres)	7.2 (*) / 6.7 (**)
Coolant (versions with automatic transmission) (litres)	7.1 (*) / 6.5 (**)
Manual transmission oil (litres)	2.1
Automatic transmission fluid (litres)	7.5
Rear differential oil (litres)	0.6
LSD oil (litres)	0.6
Brake oil (& Clutch oil) (litres)	0.55

(*) Left-hand drive versions.

(**) Right-hand drive versions.

FLUIDS AND LUBRICANTS



Your vehicle is equipped with an engine oil that has been thoroughly developed and tested in order to meet the requirements of the Scheduled Servicing Plan.

Constant use of the prescribed lubricants guarantees the fuel consumption and emission specifications. Lubricant quality is crucial for engine operation and duration.

Lubricant	Characteristics	Specification	Original fluids and lubricants	Replacement interval
Engine oil	SAE 5W-40 ACEA C3 / API SN	9.55535-S2 or MS-12991	SELENIA K P.E. Contractual Technical Reference N° F603.C07	According to Scheduled Servicing Plan
Engine coolant	Red protective agent with antifreeze action, based on inhibited monoethylene glycol with organic formula. Exceeds CUNA NC 956-16, ASTM D 3306 specifications.	9.55523 or MS-90032	PARAFLU^{UP} Contractual Technical Reference N° F101.M01	Cooling circuit usage percentage: 50% water 50% PARAFLU ^{UP} (*)

(*) When the vehicle is used in particularly harsh weather conditions, we recommend using a mixture of 60% PARAFLU^{UP} and 40% demineralised water.



Lubricant	Characteristics	Specification	Original fluids and lubricants	Applications
Lubricants and greases for drive transmission	SAE 75W-90 grade. API GL4 specification	9.55550-MZ11	TUTELA TRANSMISSION GEAR SYNTH LL Contractual Technical Reference N° F004.C16	Manual transmission oil
	JWS 3309, type T-IV.	9.55550-AV1	TUTELA TRANSMISSION GI/V Contractual Technical Reference N° F333.I05	Automatic transmission oil
	Long Life synthetic lubricant for differentials.	9.55550-DA14	TUTELA TRANSMISSION HYPOIDE LL Contractual Technical Reference N° F006.C16	Rear axle with limited sleep differential oil
Brake fluid and clutch fluid	Synthetic fluid for brake and clutch systems. Exceeds specifications: FMVSS no. 116 DOT 4, ISO 4925 SAE J1704.	9.55597 or MS-90039	TUTELA TOP 4/S Contractual Technical Reference N° F005.F15	Hydraulic brakes and hydraulic clutch controls
Windscreen window washer fluid	Mixture of spirits and surfactants. Exceeds CUNA NC 956-11 specifications.	9.55522 or MS-90043	PETRONAS DURANCE SC 35 Contractual Technical Reference N° F001.D16	To be used diluted or undiluted in screen washer/wiper systems

If lubricants compliant with the required specifications are not available, products that comply with the minimum required characteristics can be used for topping up; in this case optimal performance of the engine is not guaranteed.



IMPORTANT

56) *The use of products with specifications other than those indicated above could cause damage to the engine not covered by the warranty.*

PERFORMANCE

Top speed after the initial period of usage of the vehicle.

Version	km/h
1.4 Turbo Multi Air 140HP	215



FUEL CONSUMPTION

The fuel consumption value given in the table below are determined on the basis of the type-approval tests laid down by specific European Directives.

IMPORTANT The type of route, traffic conditions, weather conditions, driving style, general condition of the vehicle, trim level/equipment/accessories, use of the climate control system, vehicle load, presence of roof racks and other situations that adversely affect the aerodynamics or wind resistance lead to different fuel consumption values than those measured. The fuel consumption will get more regular only after having driven the first 3000 km.

FUEL CONSUMPTION ACCORDING TO THE CURRENT EUROPEAN DIRECTIVE (litres/100 km)

Version	Urban	Extra-urban	Combined
1.4 Turbo Multi Air 140HP	8.5	5.1	6.4

CO₂ EMISSIONS

The CO₂ emission level given in the following table refer to combined consumption.

Version	CO ₂ EMISSIONS ACCORDING TO THE EUROPEAN DIRECTIVE IN FORCE (g/km)
1.4 Turbo Multi Air 140HP	148



PRESCRIPTIONS FOR HANDLING THE VEHICLE AT THE END OF ITS LIFE

(where provided)

FCA has been committed for many years to safeguarding the environment through the constant improvement of its production processes and manufacturing products that are increasingly "eco-compatible". To grant customers the best possible service in terms of respecting environmental laws and in response to European Directive 2000/53/EC governing vehicles at the end of their life, FCA is offering its customers the chance to hand over their vehicle at the end of its life without incurring any additional costs. The European Directive sets out that when the vehicle is handed over, the last keeper or owner should not incur any expenses as a result of it having a zero or negative market value.

To hand your vehicle over at the end of its life without extra cost, contact one of our dealerships if you are purchasing another vehicle or a FCA-authorized collection and scrapping center. These centers have been carefully chosen to offer high quality service for the collection, treatment and recycling of vehicles at their end of life, respecting the surrounding environment.

You can find further information on these collection and scrapping centers either from a FCA dealership or by calling the number in the Warranty Booklet or by consulting the websites of the various FCA brands.

MULTIMEDIA



This chapter describes the main functions of Radio 3" and Radio 7" systems that can be fitted on the vehicle.

TIPS, CONTROLS AND GENERAL INFORMATION.	190
RADIO 3"	191
RADIO 7"	196



TIPS, CONTROLS AND GENERAL INFORMATION

ROAD SAFETY



220) 221)

Learn how to use the various system functions before setting off.

Read the instructions for the system carefully before setting off.

RECEPTION CONDITIONS

Reception conditions change constantly while driving.

Reception may be interfered with by the presence of mountains, buildings or bridges, especially when you are far away from the broadcaster.

IMPORTANT The volume may be increased when receiving traffic alerts and news.

CARE AND MAINTENANCE



57) 58)

Observe the following precautions to ensure the system is fully operational:

the display lens should not come into contact with pointed or rigid objects which could damage its surface; use a soft, dry anti-static cloth to clean and do not press;

never use alcohol, petrols and derivatives to clean the display lens;
 prevent any liquid from entering the system: this could damage it beyond repair.

IMPORTANT INFORMATION

Look at the screen only when it is necessary and safe. If you need to look at the screen for a long time, pull over to a safe place so as not to be distracted while driving.

Immediately stop using the system in the event of a fault. Otherwise the system might be damaged.

Contact a Fiat Dealership as soon as possible to have the system repaired.



WARNING

220) Follow the safety rules below: otherwise serious injuries may occur to the occupants or the system may be damaged.

221) If the volume is too loud this can be dangerous. Adjust the volume so that you can still hear background noises (e.g. horns, ambulances, police vehicles, etc.).



IMPORTANT

57) Only clean the front panel and the display lens with a soft, clean, dry, anti-static cloth. Cleaning and polishing products may damage the surface. Never use alcohol, petrols and derivatives.

58) Do not use the display as a base for supports with suction pads or adhesives for external navigators or smartphones or similar devices.

RADIO 3"

FRONT PANEL

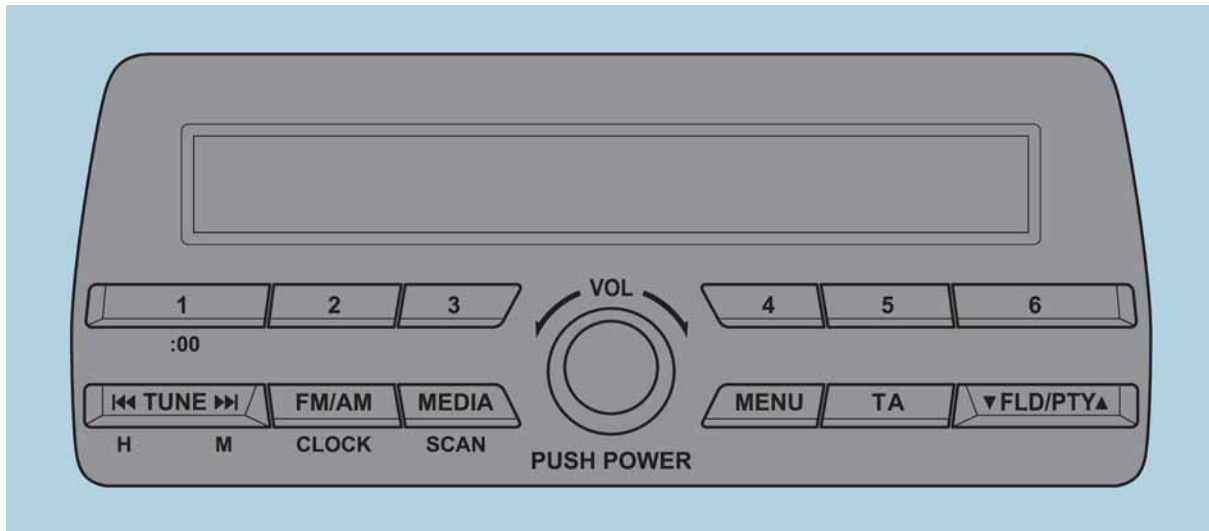

157

06020300-121-001



STEERING WHEEL CONTROLS

The controls for the main system functions are present on the steering wheel fig. 158 (versions without

Bluetooth® hands-free) and fig. 159 (versions with **Bluetooth®** hands-free) to make control easier.



158

0620500-122-001



159

0620500-121-001

VOLUME SWITCHES

Press up the volume switch **+** to increase the volume. Press down the volume switch **-** to decrease the volume.

SEEK SWITCH

MW/LW/FM radio

Press the seek switch **◀◀◀/▶▶▶**. The radio switches to the next/previous stored station in the order that it was stored.

Press and hold the seek switch **◀◀◀/▶▶▶** to seek all usable stations at a higher or lower frequency whether programmed or not.

Radio stations which have been previously stored in the auto memory tuning can be called up by pressing the seek switch **◀◀◀/▶▶▶** while any radio station stored in the auto memory tuning is being received.

Radio stations can be called up in the order they were stored with each press of the switch **◀◀◀/▶▶▶**.

USB Audio / Bluetooth® Audio

Press the seek switch **▶▶▶** to skip forward to the beginning of the next track. Press the seek switch **◀◀◀** within a few seconds after playback begins to track down to the beginning of the previous track.

Press the seek switch **◀◀◀** after a few

seconds have elapsed to start playback from the beginning of the current track.

MUTE SWITCH

Press the mute switch **⏸** once to mute audio, press it again to resume audio output.

If the ignition is switched off with the audio muted, the mute will be cancelled. Therefore, when the engine is restarted, the audio is not muted. To mute the audio again, press the mute switch **⏸**.

POWER / VOLUME SOUND CONTROLS

Power ON / OFF

Switch the ignition to ACC or ON. Press **PUSH POWER** button to turn the audio system on. Press the **PUSH POWER** button again to turn the audio system off.

Volume adjustment

Turn the **VOL** dial. Turn the **VOL** dial clockwise to increase volume, anticlockwise to decrease it.

Audio sound adjustment

Press the **MENU** button to select the function. The selected function will be indicated.

Turn the **VOL** control dial to adjust the selected functions:

AF (Alternative Frequency);

- REG (Regional Programme);
- ALC (Automatic volume adjustment);
- BASS (Low pitch sound);
- TREB (Treble sound);
- FADE (Front/back volume balance);
- BAL (Left/right volume balance);
- BEEP (Audio operation sound);
- 12Hr < > 24Hr (12 Hr/24 Hr time adjustment).

CLOCK

Setting the time

The clock can be set at any time when the ignition is switched to ACC or ON.

To adjust the time, press the clock button **FM/ AM** for about 2 seconds until a beep is heard. The clock's current time will flash.

Time adjustment

To adjust the time, press the hour/minute set button **◀◀/ ▶▶** while the clock's current time is flashing.

The hours advance while the hour set button **◀◀** is pressed. The minutes advance while the minute **▶▶** set button is pressed.

Press the clock button **FM/ AM** again to start the clock.

OPERATING THE RADIO

Radio ON: press a band selector button FM/AM to turn the radio on.

Band selection: press the band selector button **FM/ AM** to switch the bands as follows: M1–FM2–MW/LW

Manual tuning: select the station by pressing the tuning button **◀◀/ ▶▶** lightly.

Seek tuning: press tuning button **◀◀/ ▶▶**. The search stops when a station is found.

Scan tuning: press and hold the scan button **MEDIA** to automatically sample strong stations. Scanning stops at each station for about 5 seconds. To hold a station, press and hold the scan button **MEDIA** again during this interval.

Preset channel tuning

The 6 preset channels can be used to store 6 MW/LW and 12 FM stations.

To set a channel first select MW/LW, FM1, or FM2. Tune to the desired station.

Press a channel preset button for about 2 seconds until a beep is heard. The preset channel number or station frequency will be displayed. The station is now held in the memory.

Repeat this operation for the other stations and bands you want to store. To tune one in the memory, select

MW/LW, FM1, or FM2 and then press its channel preset button. The station frequency or the channel number will be displayed.

AUX / USB / iPod MODE

Auxiliary jack / USB port

Audio can be heard from the vehicle's speakers by connecting a commercially available portable audio unit to the auxiliary jack. A commercially-available, non-impedance (3.5 Ø) stereo mini plug lead is required. In addition, audio can be played from the vehicle audio device by connecting a USB device or an iPod to the USB port.

How to use AUX mode

Switch the ignition to ACC or ON, press the power/volume dial to turn the audio system on and press the **MEDIA** button of the audio unit to change to the AUX mode.

How to use USB mode

This unit does not support a USB 3.0 device. In addition, other devices may not be supported depending on the model or OS version.

Playback

Switch the ignition to ACC or ON, press the power/volume dial to turn the audio system on and press the **MEDIA**



button to switch to the USB mode and start playback.

Track search

Press the track up button **▶▶▶** once to skip forward to the beginning of the next track.

Press the track down button **◀◀◀** within a few seconds after playback begins to track down to the beginning of the previous track.

Press the track down button **◀◀◀** after a few seconds have elapsed to start playback from the beginning of the current track.

How to use iPod mode

An iPod may not be compatible depending on the model or OS version. In this case, an error message is displayed.

NOTE The iPod functions on the iPod cannot be operated while it is connected to the unit because the unit controls the iPod functions.

Track search

Press the track up button **▶▶▶** once to skip forward to the beginning of the next track.

Press the track down button **◀◀◀** within a few seconds (depends on iPod software version) after playback

begins to track down to the beginning of the previous track.

Press the track down button **◀◀◀** after a few seconds (depends on iPod software version) have elapsed to start playback from the beginning of the current track.

Category search: press the category down button **5** to select the previous category and press the category up button **6** to select the next category. The types of categories include Playlist, Artist, Album, Song, Podcast, Genre, Composer, and Audio book.

List search: press the list down button **▼** to select the previous list and press the list up button **▲** to select the next list. When the selected category is Song or Audio book, there is no list.

Bluetooth® HANDS FREE

Device pairing

To use **Bluetooth®** audio and Hands-Free, the device equipped with **Bluetooth®** has to be paired to the unit using the following procedure. A maximum of seven devices including **Bluetooth®** audio devices and hands-free mobile phones can be paired.

NOTE The **Bluetooth®** system may not operate for 1 or 2 minutes after the ignition is switched to ACC or ON. However, this does not indicate a

problem. If the **Bluetooth®** system does not connect automatically after 1 or 2 minutes have elapsed, make sure that the **Bluetooth®** setting on the device is normal and attempt to reconnect the **Bluetooth®** device from the vehicle side.

Pairing code setting

The 4-digit pairing code setting for registration of your cell phone (pairing) can be set beforehand. The initial setting value is "0000".

Proceed as follows:

- 1:** press the pick-up button or talk button with a short press;
- 2Say:** [Beep] "Setup"
- 3Prompt:** "Select one of the following: Pairing options, confirmation prompts, language, passcode, select phone or select music player."
- 4Say:** [Beep] "Pairing options"
- 5Prompt:** "Select one of the following: Pair, Edit, Delete, List, or Set Pairing Code."
- 6Say:** [Beep] "Set pairing code"
- 7Prompt:** "Your current pairing code is XXXX. Do you want to change it to a different pairing code?"
- 8Say:** [Beep] "Yes"
- 9Prompt:** "Please say a 4-digit pairing code."
- 10Say:** [Beep] "YYYY"
- 11Prompt:** "YYYY is this correct?"

□ **12Say:** [Beep] “Yes” or “No”. If “Yes”, go to next step. If “No”, the procedure returns to Step 9

□ **13Prompt:** “Your new pairing code is YYYY. Use this pairing code when pairing devices to the Hands free system. Do you want to pair a device now?”

□ **14Say:** [Beep] “Yes” or “No”. If “Yes”, the system switches to the device registration mode. If “No”, the system returns to standby status.

Device pairing

Proceed as follows:

□ **1** activate the **Bluetooth®** application of the device;

□ **2** press the pick-up button or talk button with a short press;

□ **3Say:** [Beep] “Setup”

□ **4Prompt:** “Select one of the following: Pairing options, confirmation prompts, language, passcode, select phone or select music player.”

□ **5Say:** [Beep] “Pairing options”

□ **6Prompt:** “Select one of the following: Pair, Edit, Delete, List, or Set Pairing Code.”

□ **7Say:** [Beep] “Pair”

□ **8Prompt:** “Start the pairing process on your **Bluetooth®** device. Your pairing code is 0000 (XXXX). Input this on your **Bluetooth®** device when prompted on the device. See device manual for instructions.”

□ **9** using the device, perform a search for the **Bluetooth®** device (Peripheral device)

□ select “124 Spider” from the device list searched by the device and input the 4-digit pairing code to the device;

□ **10Prompt:** “Please say the name of the device after the beep.”

□ **11Say:** [Beep] “XXXX - - -” (say a “device tag”, an arbitrary name for the device.). Example: “Stan’s device.”

□ **12Prompt:** “XXXXXX - - - (Ex. “Stan’s device”) (Device tag). Is this correct?”

□ **13Say:** [Beep] “Yes”

□ **14Prompt:** “Pairing complete”

After a device is registered, the system automatically identifies the device.

NOTE Say a paired “device tag” within 10 seconds. If more than two devices are to be paired, they cannot be paired with the same or similar “device tag”.



RADIO 7"

STEERING WHEEL CONTROLS

The controls for the main system functions are present on the steering wheel fig. 160 to make control easier.



160

0620500-121-001

VOLUME SWITCHES

Press up the volume switch + to increase the volume. Press down the volume switch - to decrease the volume.

SEEK SWITCH

AM/FM radio

Press the seek switch \lll / \ggg . The radio switches to the next/previous stored station in the order that it was stored.

Press and hold the seek switch \lll / \ggg to seek all usable stations at a

higher or lower frequency whether programmed or not.

Radio stations which have been previously stored in the favourite radio can be called up by pressing the seek switch \lll / \ggg while any radio station stored in the favourite radio is being received.

Radio stations can be called up in the order they were stored with each press of the switch \lll / \ggg .

DAB radio

(where provided)

Press the Seek switch \lll / \ggg while listening to DAB radio to call up a station previously stored to the favourites list.

Press and hold the seek switch \ggg to go to the next station, \lll to return to the previous station.

USB Audio / Bluetooth® Audio

Press the seek switch \ggg to skip forward to the beginning of the next track.

Press the seek switch \lll within a few seconds after playback begins to track down to the beginning of the previous track. Press the seek switch \lll after a few seconds have elapsed to start playback from the beginning of the current track.

MUTE SWITCH

Press the mute switch M once to mute audio, press it again to resume audio output.

If the ignition is switched off with the audio muted, the mute will be cancelled. Therefore, when the engine is restarted, the audio is not muted. To mute the audio again, press the mute switch M .

AUDIO SET

Commander switch operation

NOTE For safety reasons, some operations are disabled while the vehicle is being driven.



161

06020400-122-002

The following operations can be done by pressing the switches around the commander knob fig. 161:

H displays the home screen.

 displays the Entertainment screen.

NAV displays the Navigation screen (only navigation-equipped vehicles). If the SD card for the navigation system is not inserted, the compass indicating the direction in which the vehicle is moving is displayed.

 displays the Favourites screen. Long-press to store particular items in “Favourites” (radio, phonebook and destination of the navigation system can be programmed).

 returns to previous screen.

Volume dial operation

Press the **VOL** dial to switch the audio MUTE on and off.

Turn the volume dial to adjust the volume. The volume increases by turning the dial clockwise, and decreases by turning it anticlockwise.

Selection of icons on screen

Tilt or turn the commander knob and move the cursor to the desired icon. Press the commander knob and select the icon.

NOTE Long-press operation of the commander knob is also possible for some functions.

Touch panel operation

Touch & Tap: touch or tap on the item indicated on the screen. The operation is launched and the next item is displayed.

Slide: touch the setting item displaying a slider bar. Touch the slider with your finger and move to the desired level.

Swipe: touch the screen with your finger and move up or down. Items which were not displayed can be displayed.

IMPORTANT Do not press the screen strongly or press it with a sharp-pointed object. Otherwise, the screen could be damaged.

NOTE For safety reasons, touch panel operation is disabled while the vehicle is moving.

AUDIO SOUND ADJUSTMENT

Select the  icon on the home screen to display the Settings screen.

Select the **Sound** to select the item you would like to change:

Bass (Low pitch sound): + Side low pitch enhancement/- Side: low pitch reduction;

Treble (Treble sound): + Side: treble enhancement/- Side: treble reduction;

Fade (Front/rear volume balance): Front (front speaker volume

enhancement)/Rear (rear speaker volume enhancement);

Balance (Left/right volume balance): Left (left speaker volume enhancement)/Right (right speaker volume enhancement);

ALC (Automatic volume adjustment) (standard audio): Off-Adjustment at seven levels;

Bose® AudioPilot (Automatic volume adjustment) (Bose® Sound System, where provided): On/Off;

Beep (Audio operation sound): On/Off.

HOME SCREEN

Icons visualized on home screen are:



Applications: information such as average fuel economy, maintenance, and warnings can be verified. Depending on the grade and specification, the screen display may differ.



Entertainment: operates audio such as the radio. The audio source most recently used is displayed. An audio source which cannot be used at that time is skipped and the previous audio source is displayed. To change the audio source, select the icon displayed at the bottom of the screen.





Communication: Bluetooth® related functions are available.



Navigation: Navigation screen (where provided) is displayed. If the SD card for the navigation system is not inserted, the compass indicating the direction in which the vehicle is moving is displayed. The compass may not indicate the correct bearing when the vehicle is stopped or travelling at a slow speed.



Settings: overall setting menu (such as display, sound, **Bluetooth®** and Language). Depending on the grade and specification, the screen display may differ.

OPERATING THE RADIO

Select the icon  on the home screen to display the “Entertainment” screen. When selecting the desired radio, the following icons are indicated in the lower part of the display:



displays the “Entertainment” menu. Use to switch to a different audio source;



displays the list of receivable RDS radio stations (FM only);



displays the station list (AM only). Select “**Update Station List**” to display the frequencies of up to ten radio stations on the auto memory preset list. Select the desired frequency.







displays the Favourites list. Long-press to store radio station currently being aired.



you can search for receivable radio stations. Scanning stops at each station for about five seconds. Select again to continue receiving the radio station.



you can change the radio frequency manually. Rotate the commander knob, slide the screen, or touch the radio frequency. Press  or  to change the radio frequency one step at a time. When  or  is long-pressed, the radio frequency changes continually. It stops when you remove your hand from the icon or the commander knob.



switches the TA mode on and off.



Automatic radio station selection. When long-pressed, the radio frequency changes continually. It stops when you remove your hand from the icon or the commander knob.



Displays the FM settings screen (FM only). On/Off of Alternative frequency and Region lock can be set.



Displays sound settings to adjust audio quality level.

NOTE When the  or  icon is selected while FM is selected, each programme is selected.

Digital Audio Broadcasting (DAB) Radio

(where provided)

Select the icon  on the home screen to display the “Entertainment” screen. Select **DAB** the following icons are displayed at the bottom of the screen:



Displays the “Entertainment” menu. Use to switch to a different audio source.



Displays the station list (ensemble and station). Select “Update List” to update the station list. Select “Select Ensemble” to select the ensemble you want to display.

 Displays the favorites list. Press and hold to store the currently tuned station to the favorites list.

 Searches your desired station from the station list. Tunes to each station in the station list for 10 seconds. Select again when your desired station is tuned. If the station list is not available, it switches to the station list update screen. Perform the station list updating.

 Switches the TA mode on and off.

 Returns to the previous/next station. Touch and hold to return to the top station in the previous/next ensemble.

 Displays the DAB radio setting screen.

 Displays sound settings to adjust audio quality level.

SETTINGS

NOTE Depending on the grade and specification, the screen display may differ.

Select the  icon on the home screen to display the Settings screen. Switch the tab and select the setting item you want to change.

You can customize settings in the setup display as follows:

 **“Display”**: refer to “Volume/Display/Sound controls” paragraph in Radio 7” supplement;

 **“Sound”**: refer to “Volume/Display/Sound controls” paragraph in Radio 7” supplement;

 **“Clock”**: “Adjust Time”, “GPS Sync”, “Time Format”, “Time Zone Select”, “Daylight Savings Time”;

 **“Vehicle”**: rain sensing Wiper/Door Lock/Other;

 **“Devices”**: select **Bluetooth®** or “Network Management”;

 **“System”**: “Tool Tips”, “Language”, “Temperature”, “Distance”, “Music Database Update”, “Factory Reset”, “About (agreements and disclaimers)”, “About (version Information)”

AUX / USB / iPod MODE

Audio can be heard from the vehicle’s speakers by connecting a commercially available portable audio unit to the auxiliary jack. A commercially-available, non-impedance (3.5 Ø) stereo mini plug lead is required.

In addition, audio can be played from the vehicle audio device by connecting a USB device or an iPod to the USB port fig. 162 (**1** = USB ports/ **2** = auxiliary jack).



162

06020700-122-001

How to connect USB port / auxiliary jack

Connecting a device: if there is a cover on the AUX jack or USB port, remove the cover. Connect the connector on the device to the USB port.

Connecting with a connector lead: if there is a cover on the AUX jack or USB port, remove the cover. Connect the device plug/connector lead to the auxiliary jack/USB port

How to use AUX mode

Select the  icon on the home screen to display the Entertainment screen. Select **AUX** to switch to the AUX mode.

Playable data: MP3/WMA/AAC/OGG file.

NOTE If a device is not connected to the auxiliary jack, the mode does not switch to the AUX mode.



NOTE Adjust the audio volume using the portable audio device, commander switch, or audio control switch. Audio adjustments can also be made using the portable audio device's volume setting.

NOTE If the connection plug is pulled out from the auxiliary jack while in AUX mode, noise may occur.

NOTE This unit does not support a USB 3.0 device. In addition, other devices may not be supported depending on the model or OS version. USB devices formatted to FAT32 are supported (USB devices formatted to other formats such as NTFS are not supported).

Bluetooth® HANDS FREE

Device pairing

To use **Bluetooth®** audio and Hands-Free, the device equipped with **Bluetooth®** has to be paired to the unit using the following procedure. A maximum of seven devices including **Bluetooth®** audio devices and hands-free mobile phones can be paired.

NOTE The **Bluetooth®** system may not operate for 1 or 2 minutes after the ignition is switched to ACC or ON. However, this does not indicate a problem. If the **Bluetooth®** system does not connect automatically after 1 or 2 minutes have elapsed, make

sure that the **Bluetooth®** setting on the device is normal and attempt to reconnect the **Bluetooth®** device from the vehicle side.

NOTE To consult the list of compatibles mobile phones visit the <http://124spiderinfotainment.com> website.

Pairing procedure

Proceed as follows:

- select the  icon on the home screen to display the “Settings” screen;
- select the **Devices** tab;
- select **Bluetooth®** and turn the **Bluetooth®** setting on;
- select **Add New Device** to display the message and switch to the device operation. Using your device, perform a search for the **Bluetooth®** device (peripheral device);
- select “**124 Spider**” from the device list searched by the device;
- Device with **Bluetooth®** version 2.0 input the displayed 4-digit pairing code into the device. Device with **Bluetooth®** version 2.1 or higher make sure the displayed 6-digit code on the audio is also displayed on the device, and touch the **Yes**. Connection permission and phonebook access permission for your mobile device may be required depending on the mobile device. If pairing is successful, the functions of the device connected to **Bluetooth®** are displayed;

□ devices compatible with SMS function SMS messages is downloaded automatically. A download permission operation for your device may be required depending on the device. After a device is registered, the system automatically identifies the device.

Device selection

If several devices have been paired, the **Bluetooth®** unit links the device last paired. If you would like to link a different paired device, it is necessary to change the link. The order of device priority after the link has been changed is maintained even when the ignition is switched off.

Connecting other devices

Proceed as follows:

- select the  icon on the home screen to display the “Settings” screen;
- select the **Devices** tab then select **Bluetooth®**. Turn the **Bluetooth®** setting on and select the name of the device you would like to connect;
- **Phone And Audio selection** connects both devices as hands-free and **Bluetooth®** audio. **Phone Only selection** connects as a hands-free device. **Audio Only selection** connects as **Bluetooth®** audio.

Making a call

Telephone calls can be made by saying the contact name in the downloaded

phonebook or the name of a person whose phone number has been registered in the **Bluetooth®** hands-free. Press the talk button and wait for the beep sound, say: “Call XXXX... (Ex. “John”) Mobile” and follow the voice guidance to place the call.

Import contact (download Phonebook)

Phonebook data from your device (Mobile phone) can be sent and registered to your **Bluetooth®** hands-free phonebook using **Bluetooth®**.

Automatic downloading: the “Auto Download Contacts” setting must be on. When hands-free is connected to the device, the phonebook is downloaded automatically.

Manually downloading: if the “Auto Download Contacts” setting is off, download the phonebook using the following procedure:

- select the  icon on the home screen to display the “Communication” screen;
- select **Contacts** to display the contact list;
- select **Edit Contacts**;
- select **Import All Contacts** or **Import Selected Contact** to switch to the device operation. If **Import All Contacts** is selected, select **Download**. Download will be started

from the mobile phone.

NOTE A maximum of 1000 contacts can be registered to the phonebook.

Receiving an incoming call

When an incoming call is received, the incoming call notification screen is displayed. The “Incoming Call Notifications” setting must be on.

To accept the call press steering wheel button on the audio control switch or select **Answer** on the screen.

To reject the call press the hang-up button on the audio control switch or select **Ignore** on the screen.

NAVIGATION SD CARD

To use the navigation system, the SD card containing the map information needs to be inserted in the SD card slot 1 fig. 163.

When inserting the SD card, never move the slider on the side of the SD card to the LOCK position. If the slider is set to LOCK, the SD card cannot be read and the navigation system will not operate.



163

06020777-177-077

This SD card is valid for use in only one vehicle. Never use it in another vehicle. If the SD card is used first in one vehicle and then in another, the navigation system for either one of the vehicles may become inoperable.

NOTE For navigation map updates visit the <http://124spiderinfotainment.com> website or contact a Fiat Dealership.

NAVIGATION MENU

Select  and open the navigation menu.

You have the following options fig. 164:





164

11000001-121-112

/ **Open / close.** Opens and closes the UMP (menu bar). The UMP (menu bar) is displayed on the lower part of the screen.

Adds a destination. Select your destination by entering an address or selecting a POI (Point Of Interest), a location on the map or one of your Favourite destinations. You can also look up your recent destinations from the Smart History by entering the coordinates. If an internet connection is available, Local Search can be of further help to find your destination.

Displays the screen where traffic information and the GPS reception conditions can be set and verified.

Cancels waypoint/route.

Finds Places nearby. You can search for Points Of Interest (POI) near the vehicle position.

Displays the route parameters and the route in its full length on the

map. You can also perform route-related actions such as editing or cancelling your route, picking route alternatives, avoiding parts of the route, simulating navigation or adding the destination to your Favourites.

Changes View mode. The map view mode can be changed (2D north up/2D heading up/3D).

Switches to the Settings screen where you change navigation settings.

NOTE Some functions are not available depending on some countries and regions.

NAVIGATING ON THE MAP

The data fields fig. 165 are different when you are navigating an active route and when you have no specified destination (the burgundy line is not displayed).



165

11000001-121-111

48: shows the speed limit of the current road if the map contains it.

2.0km / 8:31: shows the distance you need to travel on the route before reaching your final destination and the estimated arrival time at the final destination of the route.

NOTE Some functions are not available depending on some countries and regions.

OBJECTS ON THE MAP

Streets and roads: the navigation system shows the roads in different widths and colours so that they can be easily identified. A motorway will be thicker and a different colour than a small street.

Turn preview and Next street: when navigating a route, the top section of the Map screen shows information about the next manoeuvre, street or town. There is an area at the top left part of screen which indicates the next operation. Displays both the event type (such as turning, detouring, exiting expressways) and the distance from the current position.

Lane information and Signposts: when navigating on multilane roads, it is important to take the appropriate lane in order to follow the recommended route. If lane information is available in the map data, the navigation system displays the lanes and their directions using small arrows at the bottom of the

map. Highlighted arrows represent the lanes and direction you need to take.

Junction view: if you are approaching a motorway exit or a complex intersection and the needed information exists, the map is replaced with a 3D view of the junction.



Motorway exit services: you may need a petrol station or a restaurant during your journey. This feature displays a new button on the map when you are driving on motorways. Select this Open button to open a panel with the details of the next few exits or service stations.

Elements of the active route: the navigation system shows the route in the following way.

SELECTING THE DESTINATION OF A ROUTE

Entering an address

To enter an address as the destination, do as follows:

- ❑ Select  after selecting  on the MAP screen.
- ❑ Select **Find Address**. By default, the navigation system proposes the country and town where you are. If needed, select **Country**, enter the first few letters of the country name on the keyboard, and select one country from the list of results.

- ❑ If needed, select a new town: select **Town** and start entering the name of the town on the keyboard. Find the town you need: the most likely town name is always shown in the input field. To accept it, select. If the desired name does not show up, the names that match the string appear in a list after entering a couple of characters (to open the list of results before it appears automatically, select  and select the town from the list).

- ❑ Enter the street name: select **<Street Name>** and start entering the name of the town on the keyboard. Find the street you need: the most likely street name is always shown in the input field. To accept it, select. If the desired name does not show up, the names that match the string appear in a list after entering a couple of characters (to open the list of results before it appears automatically, select  and select the street from the list).

- ❑ Enter the house number: select **House Number** then enter the house number on the keyboard (to enter letters, select **QWE**). Select to finish entering the address. (If the entered house number cannot be found, the midpoint of the street is selected as the destination.



- ❑ The selected location is shown on the map. Navigation **Start** if is selected, or after 10 seconds of no user interaction. By touching the location displayed on the screen, you can verify the route. Additionally, the route can be revised by selecting other options.

Selecting the destination from the POI

(Point Of Interest)

If the name for a POI (Point Of Interest) is input, a search candidate list is displayed.

Proceed as follows:



- ❑ Select  after selecting  on the MAP screen.
- ❑ Select **Find Places**.
- ❑ Select **Filter by Name**.
- ❑ Using the keyboard, enter the name of the POI (Point Of Interest). After entering a few letters, select to open the list of POI with names containing the entered character sequence.

- ❑ The selected location is shown on the map. The system transitions to the next screen by selecting **Navigate To**, or it returns to the previous screen by selecting the **<** button. By touching the location displayed on the screen, you can change the destination to anywhere on the map.



Selecting the destination from your Favourites

Proceed as follows:



- ❑ Select  after selecting  on the MAP screen.
- ❑ In the Navigation menu, select **Favourites**. When **Favourites** is selected, the screen transfers to the Favourites screen. Select your registered favourite.
- ❑ The selected location is shown on the map. The system transitions to the next screen by selecting **Navigate To**, or it returns to the previous screen by selecting the **<** button. By touching the location displayed on the screen, you can change the destination to anywhere on the map.
- ❑ Navigation starts if **Start** is selected, or after 10 seconds of no user interaction. By touching the location displayed on the screen, you can verify the route. Additionally, the route can be revised by selecting other options.

SELECTING A NEW DESTINATION

Proceed as follows:

- ❑ Select **New Route** to plan a new route to the newly selected location. The previous destination and waypoint(s) are deleted.
- ❑ Select **Waypoint** to add the newly selected location as an intermediate destination to your route. The other destinations of the route remain intact. Note: the new waypoint is placed among destinations to keep the route optimal. To decide where a waypoint to appear, use the Edit Route feature.
- ❑ Select **Final Destination** to append the newly selected destination at the end of the route. The other destinations of the route remain intact. The previous final destination is now the last waypoint.

SETTINGS MENU

Select  icon after selecting  on the MAP screen.

Settings menu options:

- ❑ **Map Settings:** you can fine-tune the appearance of the Map screen. Adjust the map view to your needs, show or hide 3D buildings, and manage POI (point of interest) display settings (which POI to show on map).
 - ❑ **Guidance Settings:** a guidance-related setting is available during route guidance.
 - ❑ **Warning Settings:** a setting related to warnings is available.
 - ❑ **Route Settings.**
 - ❑ **Traffic Settings:** a setting for traffic information is available.
 - ❑ **Connected Settings:** a setting for online service is available
- NOTE Some functions are not available depending on some countries and regions.

MAP SETTINGS

The map is always shown on the screen. Scroll the screen downward to display the setting behind the lower part of the screen:

View Mode: when this button is selected, the map view mode can be changed. **3D** displays things such as actual construction sites three dimensionally on the map. **2D** the map is rotated so that the direction of travel is displayed in the upward direction/ **2D N** the map is displayed so that north is up regardless of the direction of travel).

Viewpoint: adjust the basic zoom and tilt levels to your needs. Three levels are available.

Automatic Zoom: during route guidance in any map view mode, the function for zooming in on approaching intersections turns on/off automatically.

Buildings: show or hide 3D town models, 3D artistic or block representation of all town building data containing actual building sizes and positions on the map.

Motorway Overview: when enabled, the map zooms out to show an overview of the surrounding area if the next route event (manoeuvre) is far away. The system goes back to the normal map view when you approach the next event.

Place Markers: select which Places to show on the map while navigating. Too many Places make the map crowded, so it is a good idea to show as few as possible. You have the following possibilities: select the checkbox to show or hide the Place category or Select the name of the Place category to open the list of its subcategories.



IMPORTANT INFORMATION AND RECOMMENDATIONS



WARNING

BRAKE SYSTEM

- Do not coast with the engine stalled or turned off, find a safe place to stop. Coasting with the engine stalled or turned off is dangerous. Braking will require more effort, and the brake's power-assist could be depleted if you pump the brake. This will cause longer stopping distances or even an accident.
- Shift to a lower gear when going down steep hills. Driving with your foot continuously on the brake pedal or steadily applying the brakes for long distances is dangerous. This causes overheated brakes, resulting in longer stopping distances or even total brake failure. This could cause loss of vehicle control and a serious accident. Avoid continuous application of the brakes.

INTERNAL EQUIPMENT

- Never use a cup holder to hold hot liquids while the vehicle is moving. Using a cup holder to hold hot liquids while the vehicle is moving is dangerous. If the contents spill, you could be scalded.
- Do not put anything other than plastic bottles, cups or drink cans in cup holders. Putting objects other than plastic bottles, cups or drink cans in a cup holder is dangerous. During sudden braking or manoeuvring, occupants could be hit and injured, or objects could be thrown around the vehicle, causing interference with the driver and the possibility of an accident. Only use a cup holder for plastic bottles, cups or drink cans.
- Keep storage boxes closed when driving. Driving with the storage boxes open is dangerous. To reduce the possibility of injury in an accident or a sudden stop, keep the storage boxes closed when driving.
- Do not put articles in storage spaces with no lid. Putting articles in storage spaces with no lid is dangerous as they could be thrown around the cabin if the vehicle is suddenly accelerated and cause injury depending on how the article is stored.

DRIVING TIPS

- Never stop the engine when going down a hill: stopping the engine when going down a hill is dangerous. This causes the loss of power steering and power brake control, and may cause damage to the drivetrain. Any loss of steering or braking control could cause an accident.
- Be extremely careful if it is necessary to downshift on slippery surfaces: downshifting into lower gear while driving on slippery surfaces is dangerous. The sudden change in tyre speed could cause the tyres to skid. This could lead to loss of vehicle control and an accident.
- Make sure the floor mats are secured with the grommets or the retainers to prevent them from bunching up under the foot

pedals (driver's side): using a floor mat that is not secured is dangerous as it will interfere with the accelerator and brake pedal operation (driver's side), which could result in an accident.

❑ Only use a floor mat which conforms to the shape of the floor on the driver's side and make sure it is oriented correctly. Secure the floor mat using the grommets or retainers. There are various ways to secure floor mats depending on the type used, therefore secure the mat according to the type. After installing the floor mat, make sure that it does not slide from side to side or back and forth, and that there is sufficient clearance with the accelerator and brake pedals on the driver's side.

❑ After removing the floor mat for cleaning or some other reason, always securely reinstall it while paying attention to the precautions just mentioned.

❑ Do not install two floor mats, one on top of the other, on the driver's side: installing two floor mats, one on top of the other, on the driver's side is dangerous as the retention pins can only keep one floor mat from sliding forward.

❑ Loose floor mat(s) will interfere with the foot pedals and could result in an accident.

❑ When using a heavy duty floor mat for winter, always remove the original floor mat.

❑ Do not spin the wheels at high speed, and do not allow anyone to stand behind a wheel when pushing the vehicle: when the vehicle is stuck, spinning the wheels at high speed is dangerous. The spinning tyre could overheat and explode. This could cause serious injuries.

❑ Use only the same size and type tyres (snow, radial, or non-radial) on all four wheels: using tyres different in size or type is dangerous. Your vehicle's handling could be greatly affected and result in an accident.

PETRONAS
SELENIA
MOTOR OIL

In the heart of your engine.



Always ask your mechanic for **PETRONAS**
SELENIA
MOTOR OIL

Oil change? The experts recommend Petronas Selenia

*The engine of your car is factory filled with **Petronas Selenia**,
This is an engine oil range which satisfies the most advanced
international specifications. Its superior technical characteristics
allow **Petronas Selenia** to guarantee the **highest performance
and protection of your engine.***

The Petronas Selenia range includes a number of technologically advanced products:

SELENIA K PURE ENERGY

Fully synthetic lubricant designed for latest generation, low emission, petrol engines. Its specific formulation warrants the utmost protection also for high performance turbocharged engines with high thermal stress. Its low ash content helps to maintain the total cleanliness of modern catalysts.

SELENIA WR PURE ENERGY

Fully synthetic lubricant that can meet the requirements of the latest diesel engines. Low ash content to protect the particulate filter from the residual products of combustion. High Fuel Economy System that allows considerable fuel saving.
It reduces the danger of dirtying the turbine to ensure the protection of increasingly high performance diesel engines.

SELENIA MULTIPower GAS PURE ENERGY

Fully-synthetic lubricant designed for petrol engines also turbocharged, powered with methane or LPG. Its exclusive formulation improves valve protection against wear, neutralises the acid compounds formed by combustion and keeps engine performance levels unchanged.

SELENIA K POWER

Fully synthetic lubricant developed for American design petrol engines, specially formulated to allow an excellent resistance to oxidation and high level fuel economy.
Excellent protection at high temperatures.

SELENIA DIGITEK PURE ENERGY

Fully synthetic lubricant for petrol engines. High fuel economy characteristics. Specific formulation for the TwinAir two-cylinder engines, Selenia Digitech Pure Energy allows maximum protection of the engine even under high mechanical stress caused by severe stop and go conditions of city traffic.

The range also includes Selenia K, Selenia 20K, Selenia Turbo Diesel,
Selenia Sport, Selenia Sport Power, Selenia Racing.

For further information on Petronas Selenia products visit the web site www.pli-petronas.eu

**MAINTAIN YOUR VEHICLE IN
TIP TOP CONDITIONS WITH**



Mopar Vehicle Protection offers a series of service contracts that are designed to give all our customers the pleasure of driving their vehicle without any hitch's and concerns.

Our product portfolio consists of a wide and flexible range of **extended warranty and maintenance plans** endorsed by FCA. Each with a series of **different coverage tiers, in terms of durability and mileage**, built to accommodate you're driving needs.

Service contracts are made by experts that know every part of your vehicle, and commit themselves to **maintain it in tip top conditions**. Our knowledge and passion is tailored around designing products that promises all our drivers “worry-free driving”.

Only with Mopar Vehicle Protection you are ensured that all service operations are performed by **highly qualified and specialized technicians in authorized FCA repair facilities, using the right tools, equipment and only original parts, all over Europe**.

Check which Service Contract plans are available on your market today and choose the Service Contract that suits your driving habits best.

Ask your local dealer for further information.

INDEX

A BS system	70
Accessory socket	39
Active bonnet precautions.	71
Active safety systems.	70
Advanced Keyless Entry System.	14
AFS (Adaptive Front Lighting System).	27
Attaching the tow hooks	153
Auto-wiper control	30
Automatic climate control system	36
Automatic lighting	25
Automatic transmission.	115
Auxiliary driving systems	74
B attery (maintenance)	165
Battery recharging.	167
Bodywork (care and maintenance)	170
Bonnet	42
Boot lid	40
Boot lid (opening)	40
Brake Assist.	113
Brake/clutch fluid (level check)	165
C hecking levels	163
Child restraint system suitability for various seat position	88
Child seat installation position	87
Child-restraint precautions	83
Child-restraint system types	86

Climate control system	32
CO2 emissions	187
Coming Home light system	25
Constant monitoring	110
Control panel and instruments	49
Convertible Top (lowering)	43
Convertible Top (Soft Top)	43
Cruise Control	118
D ashboard	8
Dead lock device	16
Dimensions	181
Doors.	16
Driver Air Bag.	98
DRL (Daytime Running Lights)	24
DSC system	70
E mergency flap opening	123
Emergency stop signal system	130
Emergency towing.	155
Engine	176
Engine compartment	163
Engine coolant (level check).	164
Engine oil (level check)	164
Essential information	3
Exterior lights	24
F lash to pass	25
Fluid capacities.	182
Fluids and lubricants	183
Front fog lights	25
Fuel consumption	186

Fuel filler cap	123
Fuse.block.(engine.compartment)	141
Fuse.block.(left side of the vehicle).	144
Fuses (under the bonnet).	140
Fuses (vehicle's left side).	139
G ear lever positions	115
Gear Shift Indicator	53
H azard warning lights	130
Hazard warning lights (control)	130
Head restraints.	21
Headlight washer	31
Headlights.	24
Heated seats	19
Heavy-dute use of the vehicle (scheduled servicing)	158
High beams.	25
HLA function	77
How the SRS Air bags work	98
How to use this manual	3
I dentification data	175
Ignition switch	11
Immobilizer system	15
INFO switch.	52
Installing child restraint systems	92
Interiors	172
Internal equipment	39
J ump starting	151
Jump starting (procedure)	151
K ey battery replacement	10



Keyless Entry System	9	Prescriptions for handling the vehicle at the end of its life	188	Shift-lock override (automatic gearbox)	116
Keys	9	Pretensioners	82	Shift-lock system (automatic gearbox)	116
L ane change signals	27	R adio 3"	191	Side Air Bags	98
Load limiter (pretensioner)	82	Radio 7"	196	Snow chains	169
M aintaining the finish	171	Read this carefully	2	Speed limiter	120
Manual climate control system	34	Rear camera (ParkView rear backup camera)	125	Starting the engine	11 , 112
Manual transmission	114	Rear fog lights	26	Steering wheel	22
Message indicated on display	68	Refuelling procedure	123	Supplementary restraint system (SRS) - Air bag	96
Mirrors	22	Refuelling the vehicle	123	Symbols	3
Multimedia	189	Replacing a bulb	131	T C (Traction Control System)	70
N avigation	201	Replacing a tire	168	Theft deterrent system	15
O ccupant protection systems	78	Replacing exterior light bulbs	134	Tips, controls and general information	190
Odometer/Trip meter	51	Replacing fuses	139	Tire service kit	146
Outside mirrors	22	Rims and tires	177	Tires rotation (recommendations)	169
Owner maintenance precautions	157	Rims and tires provided	179	Tool storage	146
P aintwork (preserving)	170	S BA system (Seat Belt Alert)	81	Towing the vehicle	153
Parking	112	Scheduled servicing	157	Towing trailers	128
Parking brake	113	Scheduled servicing plan	159	TPMS (Tire Pressure Monitoring System)	74
Parking Sensor System	121	Seat belt precautions	79	Turn signals	27
Passenger Air Bag	98	Seat belt pretensioner and load limiting systems	82	Turning the engine off	13
Passenger occupant classification system	103	Seat Belt Pretensioners	98	V ehicle security alarm	15
Performance	185	Seat belts	79	W arning lights and messages	54
Periodic checks (scheduled servicing)	158	Seat belts (fastening/unfastening)}	79	Weights	180
Power mirrors	23	Seats	19	Wheel and tire specifications	177
Power window lock switch	39	Seats (manual adjustment)	19	Wheels and tires	168
Power windows	38	Seats and fabric parts (cleaning)	172		

Window and headlight washer
fluid (level check)165
Windscreen washer31
Windscreen wipers30
Windscreen wipers/washer30



FCA Italy S.p.A. - MOPAR - Technical Services - Service Engineering
Largo Senatore G. Agnelli, 3 - 10040 Volvera - Turin (Italy)
Print no. 603.91.156 - 01/2017 - 2 Edition

WHY CHOOSING GENUINE PARTS

We really know your car because we invented, designed and built it: we really know every single detail.

At **Fiat Service authorised workshops** you can find technicians directly trained by us, offering quality and professionalism for all service operations.

Fiat workshops are always close to you for the regular servicing operations, season checks and practical recommendations by our experts.

With Original Parts distributed by MOPAR®, you maintain the reliability, comfort and performance features that you bought your new car for over time.

Always ask for Genuine Parts for the components used on our cars; we recommend them because they come from our steady commitment in research and development of highly innovative technologies.

For all these reasons: **rely on Genuine Parts, because they are the only ones designed by FCA for your car.**

SAFETY:
BRAKING SYSTEM

ENVIRONMENT: PARTICULATE FILTERS,
CLIMATE CONTROL MAINTENANCE

COMFORT: SUSPENSION
AND WINDSCREEN WIPERS

PERFORMANCE: SPARK PLUGS,
INJECTORS AND BATTERIES

LINEACCESSORI
ROOF RACK BARS, WHEEL RIMS

The data contained in this publication is intended merely as a guide. FCA Italy S.p.A. reserves the right to modify the models and versions described in this booklet at any time for technical and commercial reasons.

If you have any further questions please consult your FIAT dealer.

Printed in recycled paper without chlorine.