

ALL AT SEA

CARIBBEAN

AUGUST 2023

FREE



ST. CROIX'S
LIONESSE
SPORTFISHING
TOPS CHARTS

+ Top 10 Barbuda Hot Spots
Women on the Water: PR's Ortiz

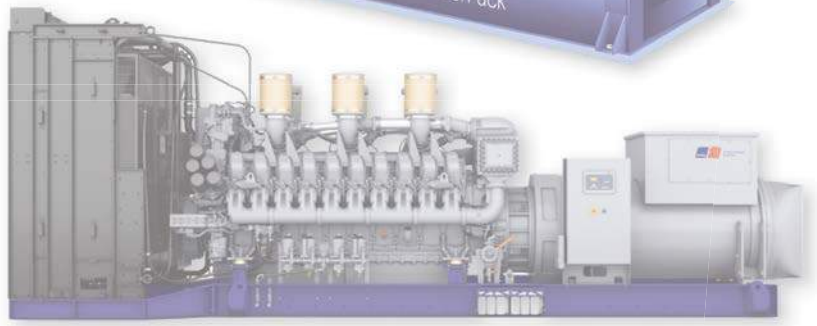

Important Reminder: IT IS HURRICANE SEASON!

- Don't wait until the last minute to purchase or repair your generator.
- Ensure you are prepared for any emergency and avoid being left without power during critical moments.
- Protect your power generation system with preventive and predictive maintenance from **Antilles Power**.

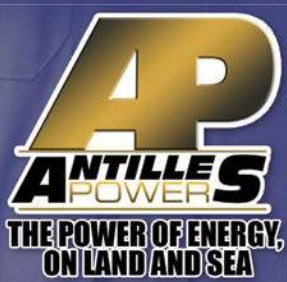

Puerto Rico / St. Thomas / St. Croix
St. Maarten / Dominican Republic
Caribbean

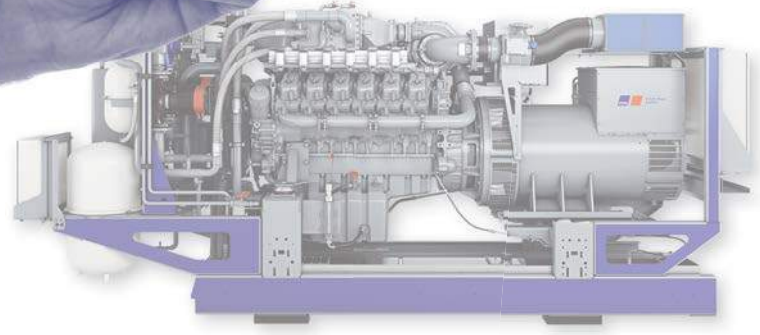

Contact us for commercial and industrial power generation, predictive and preventive maintenance services, turn-key projects, and more



A Rolls-Royce solution

Puerto Rico
787-622-9330
787-APD-HELP

St. Thomas, St. Croix,
Virgin Islands
844-622-9330
(Free Call)

Dominican Republic
809-565-4751

St. Maarten
721-585-2661

The Caymans,
Jamaica, Caribbean
844-622-9330
(Free Call)

Unrivaled Marine Services for boats and yachts, for the smooth cruise you want.

ARE YOU IN THE CARIBBEAN, OR PASSING THROUGH?

*Contact us for marine service, parts, engines,
maintenance, and equipment.*

**VOLVO
PENTA**



KOHLER.
IN POWER. SINCE 1920.

LIFELINE

Puerto Rico Stores in  Carolina and  Puerto del Rey Marina in Fajardo

 www.antillespower.com

Puerto Rico – Dominican Republic – St. Thomas – St. Croix – St. Maarten

Dehler 38 'FRIDA', Doyle Sails
Photo Credit // Johnny Crowe



CRUISE WITH CONFIDENCE

For close to four decades Doyle Sails has supported cruising sailors, and while the world continues to change, our commitment to sailors who seek the same enjoyment, performance and adventure as we do, hasn't.

Doyle Sails is home to the best sailors and sailmakers in the world. In every sailing hub, you will find your local Doyle Sails loft nearby, where the quality, performance and customer service you have come to expect from Doyle Sails can be found.

From dinghies, club racers and cruising yachts, through to Grand Prix campaigns and Superyachts, we are your sailing experts.

By sailors, for sailors.

doylesails.com





Try us, you'll like us!



ONSITE AMENITIES:

- Diesel Fuel
- Free Wifi
- 24 Hour Security
- Clean Restrooms, Showers and Laundry
- Laura's Restaurant
- Island Water World Chandlery
- Transportation to Town Twice a Week
- Dockage

SERVICES:

- Haul and Launch Services up to 32 ft beam
- Insurance Approved Hurricane Plan, Including Tiedowns
- Long- and Short-Term Storage
- Controlling Depth of 12 ft at Low Water

REFITS, REPAIRS & MAINTENANCE:

- ABYC, Ray Marine & Volvo Certified Technicians
- Electronic Installations and Repairs
- Electrical, Woodworking, Rigging
- Painting: Below and Above the Waterline
- Welding, Metal Fabrication, Machining Work
- Composite Repairs

info@grenadamarine.com

+1-473-443-1667

www.grenadamarine.com

We are dealers:



Sail, Service, Stay!

SAIL away from the hurricane zone and make T&T your home away from home.

SERVICE your yachts with a range of world-class premier yacht repair and maintenance, inclusive of polishing, painting, finishing, joinery, stainless fabrication, marine engineering, and other ancillary services all within a one-mile cluster.

STAY at local boat yard and marina accommodations and experience the lure of adventure, natural wonders, fine dining, entertainment and diverse cultural experiences.

MAKE TRINIDAD & TOBAGO
YOUR NEXT STOP!





36

DEPARTMENTS:

- 10 **Caribbean News**
- 16 **August 2023 Events**
- 20 **Cruising** | The Plane Truth
- 28 **Top 10 Must-Visit Places in Barbuda**
- 36 **Happy Cruising**
- 42 **Women On The Water** | Puerto Rico's Gretchen Ortiz
- 48 **Rum Review** | Don Q Signature Release Single Barrel 2009
- 76 **Caribbean Cooking** | Some Like it Hot!

RESOURCES:

- 50 **Island Real Estate**
- 56 **Caribbean Marinas**
- 58 **Caribbean Boatyards**
- 59 **Southeast U.S. Marinas & Boatyards**
- 60 **Caribbean Brokerage**
- 67 **Marketplace**
- 74 **Sponsor Directory**
- 75 **Classifieds**

ON THE COVER: Captain Ryan Higby with a client on his Lioness Charters





25% OFF

WHAT'S ON SALE IN STORE?

islandwaterworld.com



ALL JOTUN PRODUCTS

While stock lasts, 25% discount on all Jotun products. Topcoats, primers, antifouling, thinners and polish & wax.

Priced from **\$11.44**

SHOP ONLINE!

WE'RE THERE FOR YOU, WHEREVER YOU ARE!

- ✓ FLEXIBLE, HASSLE FREE SHIPPING OPTIONS – CARIBBEAN WIDE & BEYOND!
- ✓ GREAT SHIPPING RATES
- ✓ 10% DISCOUNT ON ALL EXPORT SALES*
- ✓ KNOWLEDGEABLE & FRIENDLY STAFF

🛒 islandwaterworld.com 📞 +1 (721) 581 8461
✉ export@islandwaterworld.com



WATER TOYS

All Towables, Subs and Kayaks!

Priced from **\$146.33**



15% OFF

POLY-PLANAR SPEAKERS

Fully waterproof speakers with ultra-low magnetic fields for a crisp stereo sound without interference to your navigation.

Priced from **\$78.12**



WHAT'S NEW?



DELTA – INFLATABLE LIFEJACKET BELT-PACK

Certified per SOLAS, for ultimate safety while on board. Twin chambers as per SOLAS requirements. Provides the maximum safety thanks to its fast inflation ability (automatic & manual). Extra user-friendly life jacket, ideal for saving valuable space on board. Available in one adult size.

Priced at **\$233.30**

Earn Miles for discount!
Get your **FREE** Advantage Card now
- Valid in all Island Water World stores!



Island Water World

keeps you sailing!

St Maarten, Cole Bay + 721 544 5310, VHF 74 • Bobby's Marina + 721 543 7119 • St Martin, Marigot + 590 590 51 32 06
St Lucia + 758 452 1222 • Grenada, St Georges + 473 435 2150, St David's Harbour + 473 443 1028

islandwaterworld.com • Store prices good while stocks last and for the month of August only.
* through recognized shipping companies only



**ELECTRICALLY
BEST IN THE CARIBBEAN
since 1992**

Address

29 Wellington Road, Cole Bay,
St. Maarten/SXM

Contact

1-721-544-2051
sales@electecsxm.com



ALL AT SEA CARIBBEAN

Publisher:

CHRIS KENNAN

publisher@allatsea.net

Editor:

editor@allatsea.net

Art Director:

AMY KLINEDINST

amyk@allatsea.net

Advertising Inquiries:

advertising@allatsea.net

(410) 929-2248

Client Relations:

publisher@allatsea.net

Accounting, Subscriptions:

accounting@allatsea.net

Owned and Published by
Kennan Holdings, LLC
382 NE 191st Street #32381
Miami, Florida 33179-3899
phone (410) 929-2248

The views and opinions of the contributors to this publication are not necessarily those of the publishers or editors. Accordingly, the publishers and editors disclaim all responsibility for such views and opinions.

Check us out online at:
www.allatsea.net



Like us on Facebook

www.facebook.com/ALLATSEACaribbean



Follow us on Twitter

<https://twitter.com/allatseacarib>

Protecting You

At unmatched Prices

Type I, II, III, ISO and Inflatable PFDs for crew of all sizes.



caribmarine
Caribbean Tough

Prices shown are based on St Maarten Retail Price List - Prices may vary per location area.
You can now see each location's product pricing in its local currency on our website.



The Caribbean's
Leading Chandlery

STARTING AT **US\$ 15.⁷⁵**

Scan me to see
all products



ANTIGUA | ARUBA | BONAIRE | CARRIACOU
COLOMBIA | CURAÇAO | GRENADA | ST. KITTS
ST. MAARTEN | ST. THOMAS | TRINIDAD

www.budgetmarine.com



If you have a
NEWS STORY,
please email the editor:
editor@allatsea.net

Caribbean News

FREEDOM BOAT CLUB ANNOUNCES PUERTO RICO EXPANSION - FIRST LOCATION IN FAJARDO

Go boating for a day without owning a boat. That's the beauty of membership in boat clubs. In March, Freedom Boat Club, the world's oldest and largest boat club operator and a division of Brunswick Corporation, announced its expansion into Puerto Rico. Freedom's first and flagship club on the island is in Fajardo. Members have unlimited access to its Puerto Rico-based fleet as well as fleets globally across Freedom's 380 locations in 34 U.S. States, Canada, and Europe, through its reciprocal access program.

Puerto Rico has many world-class beaches and endless small islands to explore making it a boater's paradise," says Mike Centeno, a native of Puerto Rico, successful entrepreneur, and water sports enthusiast who owns and operates the island's Freedom Boat Club franchise. "Currently we are located at Puerto Del Rey Marina. We plan to open 7 to 10 other locations throughout the island of Puerto Rico. The plan is to give members access to navigate anywhere on the island, covering the North, East, South, and West coasts. Moving forward,

and I can't give details yet, however, we will be looking to plant the Freedom Boat Club flag in the surrounding islands of Puerto Rico and the Caribbean.

The present fleet includes 10 boats, from 21- to 27-foot in length representing brands like Bayliner Trophy, Sailfish, Release, and Sea Ray. Centeno projects he'll have about 100 boats in Puerto Rico within the next year or two contingent on the volume of the membership sign-up. Additional makes, models, and sizes will be introduced as locations on the island expand to more marinas. www.freedomboatclub.com/franchises/fbc-of-puerto-rico/fajardo.html

SUPERYACHT 'ABANDONED' IN ANTIGUA BOUGHT BY EX-GOOGLE EXEC

It's sold! Former Google CEO Eric Schmidt is the new owner of the 267-foot superyacht, Alfa Nero, after he successfully bought the vessel at a live-streamed auction in June for \$67.6 million. Built in 2007 by the Dutch shipbuilder Oceanco

Yachts, the yacht was most recently owned by Russian billionaire, Andrey Guryev, who was sanctioned by the U.S. Treasury because Russia invaded Ukraine last year. The Alfa Nero was blocked from leaving Falmouth Harbour, Antigua, in February 2022. A year later, its ownership was transferred to the Antigua & Barbuda government. Maintenance costs of over \$110,000 per month have made it an albatross for the island government. It was finally in June when Ronald Sanders, Antigua & Barbuda Ambassador to the U.S. got Washington to remove the superyacht from the Specially Designated Nationals and Blocked Persons List of the U.S. Department of the Treasury's Office of Foreign Assets Control and it could be sold. In the nail-biting few hours before the auction, news reports broadcast that Guryev's daughter filed an emergency application to stop the sale and keep the boat in the family, but this was rejected by the Eastern Caribbean Court of Appeal.

The incredible private superyacht should prove a lot of fun for Schmidt, who was Google's CEO for a decade in the early 2000s and rates a \$25 billion net worth as valued by Bloomberg's Billionaires Index. Striking amenities on the Alfa Nero include a baby grand piano and staircase that wraps around a glass lift shaft inside and a swimming pool that converts either into a dance floor or helipad on the outside.



Yacht Alfa Nero in 2008

CARIBBEAN SAILING ASSOCIATION LOOKS AHEAD TO 2024 AT CONFERENCE

The past, present, and future of Caribbean regatta season are what 25-plus Caribbean Sailing Association (CSA) members discussed at the organization's Annual General Meeting and Conference held the last weekend in May at the Antigua Yacht Club in Falmouth Harbour, Antigua. Members represented more than 10 islands either in person or virtually. The date change from October served to give the organization and its members a jump-start on planning and preparing for the 2024 season. Key topics on the agenda were the CSA rating rule, how to better accommodate the different classes at events, race committee development, sailing development, inclusivity in sailing, foiling developments, and marketing of the region.

Tomorrow's Antifouling Available Today



- **Triple-Biocide Antifouling Power** – Ecomea, Zinc Omadine, Copper Thiocyanate
- **Vibrant Colors** – 6 Base Colors Can Be Mixed to Create Thousands of Custom Colors
- **Multi-Season Performance** – Fresh, Brackish and Saltwater Conditions
- **California Air Quality Compliant** – 330 Grams per Liter VOC
- **Compatible With All Hull Types** – Fiberglass, Aluminum, and Steel/Iron

DEEP BLACK 4905	BLUE 4902	RED 4901
GREEN 4903	YELLOW 4904	BRIGHT WHITE 4910



727-523-8053 • ContactUs@SeaHawkPaints.com
www.SeaHawkPaints.com

Hand Crafted in *America!*TM



COURTESY CSA

"I think all the regattas are looking at catering more closely to the needs of our sailors. I think the quality of racing is on everyone's agenda, especially when it comes to courses and communications. We are also all looking to add that fun factor, when the racing is done, to offer the full Caribbean experience," says Michele Korteweg, CSA president. "One key point for participants is that we will be sending out a survey to collect feedback on their Caribbean racing experiences. This allows us to better accommodate those who come to the region, and their race needs, and to develop our overall product."

Looking ahead, more regattas and sailing programs are focusing on inclusivity, youth, women, and the lesser abled, Korteweg adds. Giving back to the community has always been important, and it will intensify.

"What's important to note is that the CSA is working on the rating rule, making it easier to get an appointment for measuring boats and getting the payment process online. It's all about the ease of participating, so we will continue our efforts there," she says.

A separate training session alongside the Conference was held by CSA measurers, including potential new measurers from Barbados and Antigua. Information about the rating rule was shared so attendees could better understand the challenges and opportunities they are facing while developing the rule.

Looking ahead, says Korteweg "foiling is developing rapidly and with stand-alone foiling events in St. Maarten, Marti-

nique, and several other islands, it's now growing with foiling classes being added at regattas like Antigua Sailing Week did this year. We had discussions with those prominent in the field of foiling to see how we can bring more foiling to the Caribbean. It's not a matter of if, but when." caribbean-sailing.com

PUERTO RICO'S MARINA PUERTO CHICO SECURES \$1.1 MILLION TO BOOST ITS TRANSIENT MARINA PROJECT

Niceties like great sightseeing, shopping, and dining, plus necessities such as chandleries, boat yards, and airports with easy airlift to the mainland make Puerto Rico a popular destination for cruisers. Soon, it will also be easier to find slip space in the popular east coast boating community of Fajardo. Marina Puerto Chico, in partnership with the Puerto Rico Department of Natural and Environmental Resources, has received a Boating Infrastructure Grant (BIG) of \$1.137 million for the construction of new docks to increase transient dockage. This grant is part of the U.S. Fish and Wildlife Service's BIG program, which was recently awarded over \$20 million for 2023. The BIG initiative facilitates states and territories in developing, refurbishing, and maintaining marinas and other boating infrastructure to boost outdoor recreation.

The grant will facilitate the construction of 41 slips, including 19 transient slips, via a floating wave attenuator. The slips will accommodate various boat sizes up to 50 feet. There will also be amenities such as a restroom/shower building, sanitary

Charter a Historic Brigantine in the Caribbean

She's back! *Florette*, the 131-foot brigantine launched in 1921 by Italy's famous Picchiotti Shipyard and one of the last wooden windjammers that still sails actively, will return to the Caribbean this winter. She'll arrive in Barbados in December and offer one-week and multi-week charters for up to 22 guests in her 11 cabins while sailing between the islands of St. Lucia, St. Vincent and the Grenadines, Grenada, and Martinique until May 2024. The cost per berth or cabin is less than typical skippered charters where guests hire the whole boat, making this chance to blast into the past an affordable opportunity.

"*Florette* has sailed the Caribbean before and was stuck there during COVID but has not been back since. Unlike other charter vessels, she does not go to the Caribbean every winter. The family who owns and lives on the *Florette* want guests to experience different locations with them, so that is why they are now planning new adventures and destinations for 2024/25," says Jo Downie, managing director for VentureSail Holidays who works with *Florette*.

Florette boasts a fascinating history. One particularly interesting chapter is her time spent as a Q/guard ship for the Italian Navy during World War II where she took part in the battle of Taranto. In September of 1943, she was stopped by the Germans who ordered her captain to return to the Port of Livorno where she would be loaded with ammunition for transport. Rather than help the enemy, the captain scuttled her the evening before during an air raid. Her masts were still showing in the fall of 1944 when the American military raised and restored her. In 2007, Ron Haynes Jr and his wife Nicole formed Historical Tall Ship Sailing Ltd and conducted a major rebuild. Today, *Florette* is home for the Haynes family, which includes two daughters they 'ship school' onboard, as they sail around the world with charter guests. www.svflorette.com





Captain Ryan Higby with a client on his Lioness Charters

pump-out facilities, an ADA-compliant gangway, and a fuel dock. Moreover, the construction of the docks and floating wave attenuator will aid in mitigating the impact of waves and storms. This marina investment aims to entice both local and out-of-state boaters for short-term stays, thus not conflicting with local marinas catering to long-term tenants.

Marina Puerto Chico, which is owned by Grand Caribbean Marinas, has pledged to contribute an additional \$968,582, to assure the project's successful completion.

Marlon Mellado, CEO of Grand Caribbean Marinas, the largest marina company in Puerto Rico, disclosed that the project's total estimated cost stands at \$4.5 million as of January. He says this transformative project signifies a significant stride

in enhancing boating infrastructure and promoting tourism in the Fajardo community. www.gcmarinas.com

USA TODAY RANKS ST. CROIX FISHING CHARTER #3 ON ITS TOP 10 LIST

He's the son of a sailor, but St. Croix's Ryan Higby's ability to bend a rod has earned him recognition. Specifically, Higby, born and raised on the U.S. Virgin's 'Big Island', and his Lioness Sportfishing charters ranked #3 on USA Today's Top 10 Fishing Charters in the U.S. Lioness is the only charter operation outside of the continental U.S. to be included on this list.

"Unbeknown to me, we had one of their editors out on charter and hooked him or her up with some great fishing," says Higby, whose resume includes commercial fishing in Alaska. "I can't say that I do anything special. But, over the years, I learned from the best from some of the old timers here on St. Croix like Bobby McKay and Mike Fuller. I just soaked up all they taught me and dialed in my own operation."

Lioness, a 42-foot Viking, offers 4-, 6- and 8-hour deep sea fishing charters, and is based on the Christiansted Boardwalk. www.fishinginstcroix.com

COURTESY GRAND CARIBBEAN MARINAS



Marina Puerto Chico

CARIBBEAN MULTIHULL CHALLENGE VI

RACE • RALLY • PLAY

ST. MAARTEN • ST. MARTIN • ST. BARTH



RACING PHOTO Fujin • Bieker 53 Photo: Laurens Morel - Salty Colours



1-4 FEBRUARY 2024

All Multihulls Welcome

CaribbeanMultihullChallenge.com



GOLD: Oris • Moorings • Caribbean Multihulls Brokerage • Fope • Yacht Club Port De Plaisance • St. Maarten Tourism

SILVER: Budget Marine • Eagle Tours • Ballerina Jewelers • FKG Rigging

BRONZE: The Multihull Company • Sint Maarten Yacht Club Bar & Restaurant • Amstel Bright

PARTNERS: All At Sea • Lagoon Marina • Island 92 • Multicoques & Multihulls World

RealEstateSXM • Artemia • Imagen Graphics



COURTESY CARRIACOU REGATTA FESTIVAL

If you have any **EVENTS TO SHARE**, please email the editor: editor@allatsea.net

August 2023 Events

AUGUST 4-7 | Carriacou Regatta Festival.

This three-day celebration of sailing, first started in 1965 and the Caribbean's longest-running regatta festival in the region, takes place annually on the first weekend in August. On full display are the island's world-famous wood-build Carriacou sloops, as well as other classes including Optimist and Sunfish sailing. Winners receive prizes and bragging rights. The fun continues ashore with a Queen Show, Donkey Racing, and a Greasy Pole competition. www.facebook.com/CarriacouRegattaFestival/

AUGUST 19 | The Great Race.

Some 25 high-speed vessels are expected to compete in this event, one of the world's longest-running offshore powerboat races. Drivers and crews depart from the Gulf of Paria in Trinidad and cross the finish line in Store Bay, Tobago, or some 80 miles. Classes are Cruiser, Spec, 60mph, 70mph, 80mph, 95mph, 120mph and 130mph classes. "We have introduced a new class this year called the Spec Class, which consists of boats of the same make, model, length, and engine, along with configuration. This class is the only class that is not governed by speed," says Jonathan Tardieu, president of the Trinidad and Tobago Powerboat Association (TTPBA). "The Cruiser class will also be brought back to allow anyone that



COURTESY ANGIILLA POKER RUN

AUGUST 12 | Anguilla Poker Run.

Part boat cruise, part poker game, and all party is the way organizers describe this 7th annual event. Over 100 power boats are expected to launch from Sandy Ground and head around the island with stops at places like Crocus Bay, Rendezvous Bay, Little Bay, and Meads Bay, to pick up a card and enjoy live music, food, games, and a party. The prize for the top poker hand is US \$5000. The event enjoys a spotless safety track record. www.facebook.com/anguillapokerrun

has a vessel and that meets the TTPBA's safety requirements to take part." Follow the action via live updates on Facebook during the race. Or spectators can view parts of the race along the course from Maracas Bay, on the north shore of Trinidad, and the finish in Store Bay. www.thettpba.com

COURTESY OF TRINIDAD AND TOBAGO POWERBOAT ASSOCIATION



AUGUST 21-26 | International Billfish Tournament (IBT).

It's the 70th anniversary of this longest consecutively run big game fishing tournament in the world. Hosted by Club Nautico de San Juan, in Puerto Rico, over 60 sportfishing boats and 250-plus anglers, including more than 50 international guests, are set to fish for Atlantic Blue Marlin in 'Marlin Alley' a deep natural trench where anglers can start fishing and catching within 20 minutes of leaving the dock. "The IBT has a system that allows international anglers to get acquainted with Puerto Rico's culture: The IBT rotation system. It assigns a different visiting angler every day to different competing boats, so they get to fish with different groups, a unique practice that visitors appreciate," says Richard Henry Christiansen, tournament chairman. In 1999, Marlin Magazine listed the IBT as one of the 'Ten Favorite Tournaments in the World.' sanjuaninternational.com/



IBT Shootout 2022 — Here they GO!

OFFSHORE

M A R I N E

BOSTON WHALER

Outboards, Waverunners, Motorcycles, Inverter Generators:

Authorized Dealer

Diesel Engines, Diesel Generators:

Authorized Dealer

Boats:

Authorized Dealer

Inflatables:

Authorized Dealer

SCOUT BOATS... the latest addition to our quality line of boats

Scout BOATS

Tel (340) 776-5432 • Fax (340) 775-4507
WWW.OFFSHOREVI.COM

Aruba International Regatta -

CREDIT HELFRICH-AVONTUUR



AUGUST 25-27 | Aruba International Regatta.

Two action-packed days of sailing take place on the 26th and 27th, with a Regatta Party on the 25th. of August. The regatta attracts participants and spectators from around the world and features a diverse range of sailing classes to cater to all skill levels and interests. This includes Optimists, Quebes, F11, Beachcats, Sunfish, Lasers, Racing and Cruising Yachts, Liveaboard Yachts, Multihulls, Kiteboarders, and Windsurfers.

In addition to sailing, there’s food, beverages, and entertainment by local reggae bands. The Regatta places a strong emphasis on the region’s youth sailors and promotes the conservation of the marine environment. “This is an event that brings together sailing enthusiasts, the local community, and visitors alike for an unforgettable experience,” says Rik van der Vaart, organizer. www.aruba-regatta.org

The start PCYC Rount the Island Race in Grenada

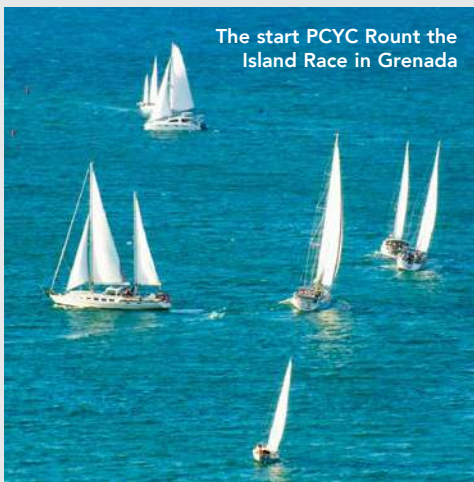

COURTESY PCYC

AUGUST 26-27 | Round Grenada Regatta.

Whether you sail a cruising monohull or catamaran, a sporty performance yacht, or a Caribbean classic, there’s room at the start line of this annual event hosted by Grenada’s Petite Calvigny Yacht Club (PCYC). Day one begins at Le Phare Bleu on Grenada’s southern coast and finishes in Tyrell Bay, Carriacou, where there’s dinner and drinks on shore. On day two, the fleet sails out of Tyrell Bay for a dash back to the finish at Le Phare Bleu for the final awards ceremony and after-party. “The number one goal we have for the Round Grenada Regatta is that everyone has fun. The event is a great way for resident racers and cruisers who have settled in Grenada for the season to get together for some casual, off-season fun,” says Richard St. John, PCYC’s Commodore. “Protests are highly frowned upon and the camaraderie between past yachts and their crews often extend beyond the weekend.” pcycgrenada.com

Caribe Marine is your place to find the perfect Jeanneau Powerboat!

4900 Route 3 Km. 51.4, (Suite 107) Fajardo PR 00738



www.caribemarine.com



info@caribemarine.com



(787) 803-9235 (787) 400-0977

CARIBE
MARINE



JEANNEAU
POWERBOATS





Fatty replaced seven planks and 15 frames (and some of the deadwood) on *Corina* at 17 years of age



The Plane Truth

CRUISING | BY CAP'N FATTY GOODLANDER

“Never trust a man who leaves his wood plane on its sole,” my father often told me. I grew up covered in wood chips and sanding dust in shipyards during the 1950s. Our medium was wood. We had no power tools—our extension cords were primarily for light bulbs. We were our own source of energy; our bodies, our brawn, our sturdy backs. And our vessels were the direct products of our muscles and, well, perhaps a few brain cells as well.

Take the lowly block plane, as example. We were careful with its blade, especially around used timber. If we hit a nail and nicked the blade, it would take a long time to grind, polish, and sharpen out.

Planes were all about the blade. That’s why we never set a plane on its sole—because continuously setting it on its fragile, thin cutting edge soon dulled it. And, of course, increased the chances of the blade getting nicked.

And, yes, nomenclature was important. Planes had soles, not bottoms or downsides. We knew that if we wanted to do precise work, we needed to have precise words to nurture it.

Sharpening the blade of a block plane was an art for two reasons. First, the blade had to be sharpened at the precise angle it was machined so it would be parallel with the sole. Second, it couldn’t be sharpened with a circular motion because that would, eventually, slightly round-the blade—making it more difficult to plane a truly flat surface.

Silly? These tools-with-blades weren’t throw-aways. I still have planes I used with my father on the schooner *Elizabeth* (mid-1950s) and chisels my father used on the sloop *Dorothy* (late-1920s), nearly a hundred years ago.

We were so protective of our plane blades back in the day, that we carried in our toolbox a *second* plane with a damaged

blade in case we had to plane some used timber that *might* have a hidden fastening lurking within.

Up until now, we've only mentioned small block planes—but there were also bench planes, jack planes, jointer planes, and more. Molding planes, intended to make multi-surfaced trim pieces often had numerous blades.

Want to shape your round spar? Then a compass plane with a curved blade (oh, what a bitch to sharpen!) was just the thing. Bullnose planes could be finely adjusted and were great for delicate trim work. Rabid Filister planes had adjustable fences. If you wanted to prepare the edges of some Sitka Spruce for a glued box mast, a jointer plane was just the thing. And we haven't even mentioned dovetail, router, chisel, or plow planes. Bench planes were called that because every shipwright had one on his work bench, within easy reach.

Even the lowly block plane came in two versions—a 20-degree angle blade for general application, a 12-degree blade for hardwoods like teak.

And some wood butchers (an affectionate name for a master carpenter) scoffed at metal. They had a whole tool chest of wooden-bodied planes with metal blades, but wood bodies. These were said to be 'kinder to the surface' and 'less sticky.' Yes, the soles of planes were sometimes waxed, especially if you were planning sappy, just-cut timber.

The wood itself was of utmost importance—the elm you'd steam for a deck beam was different than the oak you'd steam for a frame. (Boats don't have ribs—and you'd be tossed out of a shipyard for such blasphemy.)

Mahogany was just soft and stable enough for planking—but not too soft, like the spruce that was perfect for spars.

Other considerations were: strength and rot resistance. Did the wood split at the fastenings? Did it warp? Could it hold paint? If the vessel was headed for the tropics, how did it stand up to teredo worms? Or, even worse, in some waters were the boring gribbles? (Great name for a marine rock group: the Boring Gribbles!)

For example: teak is wonderful because of its sturdy oils—which, alas, makes it a poor wood for laminating.

Everything on a boat is a compromise.

And we haven't even talked about chisels. I still carry over a dozen on *Ganesh*—which is about half the number of differ-



**Supporting the
yachting community
since 1984**

Contact Us

tel: 1.473.444.4257

whatsapp: 1.473.534.6996

simsco@spiceislandmarine.com

www.spiceislandmarine.com

Grenada, West Indies 12°N, 61°W



Services + Amenities

Hurricane Storage · 70-Ton Marine Travelift (25ft beam)
Dockage + 24hr Security
Antifouling · Painting · Carpentry · Electrical · Mechanical
Fiberglass + Composite Work
Budget Marine Chandlery · Restaurant
Studio Apartments · Laundry

About Us

We are a family owned, full service boatyard, with an experienced team ready to give your yacht the love + attention it deserves!

We look forward to meeting you.



Building a 36 foot 20,000 pound ketch from scratch isn't easy

ent types in regular use when I was a child. Nowadays buyers at Walmart are usually limited to the flat chisel—good luck finding a firmer, mortise, paring, or construction chisel.

Yes, of course, paring chisels were used to gently pare joints. (Sounds quaint, doesn't it?)

And we haven't gotten to a cold chisel yet—those were usually used on metal.

Shapes of chisels were important: flat, cross cut, side cut, round nose, diamond point, and cow mouth were common.

A close cousin to the chisel to a 1950s shipwright was a caulking iron.

Both chisels and caulking irons weren't hit by hammers but rather hardwood mallets. These came in different varieties and weights. For carving, I used a large, round wooden shape—if made of *Lignum Vitae*, all the better. Rubber tipped hammers and bumping hammers were okay for chiseling, if the head was big enough.

Caulking mallets and irons were a 'hole 'nother story. I was

taught to caulk seams by professionals at Rentner's Boat Yard, every one of which had a large portable wooden bin with a long bar handle that he'd carry up onto the scaffolding with him while caulking. Inside were dozens of irons and at least six mallets.

Each seam varied in width. You caulked by sound, not sight and the wider the seam, the shorter the 'tucks' or 'nips' of cotton were. You didn't fill the entire seam with cotton. You made the cotton into a tight ball towards the rear of the seam and used Woolsey's seam compound to flush it out. (I still smell that seam compound in my dreams!)

That's right—strands of cotton caulking were never laid upon each other. A single strand of cotton was used and the trick was getting the 'packing' tight yet not blowing out the inside edge of the seam.

If done right, the wood would squeeze around the cotton. When you removed a well-caulked plank, you'd be able to clearly see the round indentation of the cotton in the plank edges.

Caulking is nearly a lost art now in the West. Luckily, I can occasionally still hear the sound of mallets from Malaysia, where wooden boat building still thrives.



YACHT SERVICES

Chaguaramas Bay, Trinidad
VHF CHANNEL 69



***160 Ton Marine Travelift - Maximum Beam 31 ft
No Forestay Removal On Most Yachts Below 60 ft***

Fully stocked chandlery, hotel and restaurant on site

- The most experienced, most professional yard in the Caribbean with the most comprehensive list of onsite marine services and contractors – **FACT!!**
- At the best prices – **FACT!!**
- **FREE** water - **FREE** fully functional WIFI
- All this in the least extreme weather zone in the region – **FACT!!**

Treat your beautiful boat to the best. You know she deserves it!

CONTACT US TO LEARN ABOUT OUR SUBSTANTIAL DISCOUNT SPECIALS.

P.O. Box 3168 Carenage Trinidad • Tel (868) 235 4PYS (797)
reservations@peakeyachts.com • www.peakeyachts.com



Bill Edinger



Fatty still has tools used to build this boat in 1930s. Aboard is his mother, Marie Goodlander

There's a problem with wood—it is milled straight and flat but nothing on a boat is. I've Spanish-windlassed (wound two strands of wire with an inserted stick) my planks onto my frames. However, in the area where the garboard meets the horn timber, not only must the planks bend *in*, they must also *twist*.

Luckily, most shipyards in the 1950s had an old discarded metal/porcelain bathtub hanging around just for this purpose. We'd haul it near our vessel, fill it with water, then build a raging fire underneath. Next, we jammed heating ducts just above the water—and cover the whole mess with a tarpaulin, careful not to allow the tarred canvas to ignite.

Complicated? Difficult? Time-consuming?

You bet!

Then we'd slip our planks into those heating ducts and 'cook' them for just the right amount of time. Then we'd snatch them out and bend/twist them into place before they cooled.

On *Corina*, my 1932 Atkins double-ender, I steam-bent all my deck beams using a heavily constructed frame that was two

inches greater than the crown of my deck. Once off the frame, the beams relaxed into the perfect crown. (Deck crowns are a whole different subject—just be aware that they are not a fair curve, even to this day.)

All this stuff wasn't easy. It was fun to learn in the abstract but difficult to master in the practical. In fact, paying the deadwood seam on a wooden carvel vessel was so *extremely* difficult that the seam became widely known as the Devil.

This is where we get the saying, "...the devil to pay!"

And if a sailor falls overboard and starts drowning, he might be saved if still splashing on the surface—but he's a goner if he's '...between the Devil and the deep blue sea.'

I could, of course, go on and on. Drawspokes, anyone? Do you know how to swing an adze? Both were common in my day—as was splicing your own rigging wire, arming your own sounding lead with wax, and rocking the lower limb of the sun in your sextant mirror.

But if you added all of the skills above together, you could



NOW Available for Sailboats!

PropGlide™ is a foul-release coating that when applied to your propeller(s) and running gear will increase fuel efficiency and the performance of any vessel. This super slick coating keeps your propellers clean from marine growth for extended periods of time. Gain the advantages by applying PropGlide™ to your vessel.

- Increase in Prop Speed Means a Faster Vessel
- Improved Fuel Efficiency
- Biocide-Free and Environmentally Friendly
- Ease of Application



Available at:



Antigua, Aruba, Bonaire, Curaçao, Grenada, St Kitts, Carriacou, St Maarten, St Thomas, Trinidad



Florida



St Maarten, St Lucia, Grenada

www.PropGlide.com

©2017 PropGlide-USA Corp ALL RIGHTS RESERVED

Roodberg®

The choice of professionals

www.roodberg.com

The Original



Fatty's first vessel. *Corina* was built in 1932 out of Port Oxford cedar

take on the second biggest challenge—to build a vessel from scratch.

I'll never forget in 1971, after sending in my \$25, unrolling the blueprints of a ferrocement Endurance 35 ketch, designed by Peter Ibold. Here were a dozen pieces of thin paper—and all my hopes and dreams within. Just paper. Nothing else. Just paper, mixed with dreams and irrigated with sweet sweat and grim determination. Three years later, we splashed. Three years after that, we sailed *Carlotta* across an ocean.

There's nothing like that feeling. The poet John Masefield expressed boatbuilding best, "...built out of chaos, brought to law!"

If the Good Lord had taken me as I luffed up into Long Bay on St. Thomas, I'd have died a happy, fulfilled man.

So, dear reader, allow me the occasional secret smile of an old man.

Yesterday while dock strolling, I met an earnest young fella standing in the companionway of a Westsail 32. The Westsail is an extremely seaworthy design. Eight hundred and thirty were built during the '70s—from a discarded mold purchased cheap from the defunct Kendall Boat Corporation.

"Nice boat," I said, being a great admirer of both William Atkins and Colin Archer.

"Thanks," he said.

I started to move on but stopped when he said, "I built her." I wanted to keep going but could not.

"Really?" I said, and resisted the temptation to ask if he'd built her in the womb.

"Well, the original bare hull was built in California," he said, "and a previous owner slapped together the interior—but when we got the ole gal she was a *total* mess! She needed new curtains, new chart plotter, new Bimini—hell, we even had to replace the refrigeration system!"

I looked at him. And nodded.

"Good on ya," I said as I sauntered away, "Good on ya!" 🍷

Editor's note: Cap'n Fatty has penned many books about cruising—ten of which are still in print.

clean-exhaust^{COM}

SYSTEMS

APPLICABLE WITH GAS/ WATER SEPARATOR MUFFLERS

PROCESS: clean-exhaust's dosing pump injects the specifically formulated ecoBrew™ into the generator /engine raw water cooling system before the spray ring. The ecoBrew™ emulsifies the diesel particulate matter and soot as it passes through the piping and muffler, much like the agitation action in a washing machine. No back pressure is created in the process.

RESULT: The exhaust gas is expelled with little or no particulate, facilitating cleaner air, cleaner harbors, cleaner oceans, cleaner hulls and boot stripes with no floating sheen or sludge.



Captain Ted Sputh | +1 317-445-3873
capt.ted@clean-exhaust.com

Rodger Stone | +1 518-378-6546
res2itrmarine@gmail.com

Yacht-Mate Products | +954-527-0112
sales@yachtmate.com

**One Captain,
One Engineer,
One Great Idea!**



U.S. PAT. #US 20130283768
INT. PAT. PENDING #61/638, 669

www.clean-exhaust.com



RELIABILITY & DURABILITY

Official distributors in Antigua & St. Maarten

Carrying the full line in both Aluminium & Fiberglass

www.outdoorworldsxm.com

Call Eric at 1.721.588-6007
info@rkmanagement.net

Quality,
Performance
Comfort & Design





Top 10 Must-Visit Places in Barbuda

BY CAPT. SHANE McCLELLAN

Back in the spring of 2017 I was fortunate to sail to the rarely visited island of Barbuda. Sadly, a few months later the island was hammered so hard by Hurricane Irma that every resident was evacuated to its sister island of Antigua. This was the first time in hundreds of years that the island was uninhabited. As we approach the six year anniversary of their hardship I want to focus this month's Top 10 on Barbuda to celebrate the strides the locals have made in their recovery.

10 George Jeffery – Mr. George was my contact on the island and helped in every way possible. When we needed a water taxi across the lagoon from the anchorage off 11 Mile Beach to the town of Codrington, he was there. Frigate bird colony tour, check. A guide to the sinkhole, yep. Just general information, again he was the man. He can be reached at phone # 268-788-7067 or on the VHF with Garden of Eden call sign.



Is Your Motor Choking to Death?

Don't Let Dirty Fuel Kill Your Cruise

Dirty fuel is the most common cause of unexpected diesel engine shutdown!

Take control of your fuel system with a modern fuel management system. Far more than a basic fuel filter, our MK60SP premium filter system cleans and polishes up to 60 gallons of fuel per hour and incorporates everything you need to keep your fuel pure and motor running.

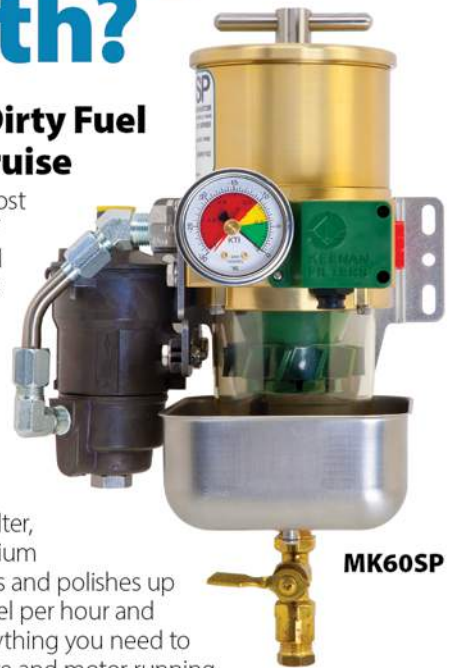

MK60SP

- Filters & Polishes Stored Fuel
- Remote Warning of Water & Filter Clogs
- Top Loading Clean Change Filter Design
- Internal Priming & Back Up Fuel Pump
- Uses Easy to Find Racor™ Filters
- Built-in System Testing
- Compact Design



Includes Remote Control & Warning Panel

Single & Dual Filter Systems Available
With Up to 1500 GPH Flow Rates

9 Codrington – This is the only settlement on the island and it sits on the lagoon instead of the ocean, making it impossible to get to it with the big boats. This is why a water taxi across the lagoon is needed. The cool thing about Barbuda is that the entire island is communally owned and has been since the day of emancipation. There is an elected council that everyone must get approval from before doing any improvements on the island, which in turn helps keep the island from being over developed.

8 11 Mile Beach – As the name implies this beach goes on forever and it is absolutely gorgeous. When I was anchored off of it there might have been four boats all along the entire 11-mile stretch. The one caveat is not to be here if the north swell is rolling!



Is Your Fuel Keenan Clean?

KEENAN FILTERS®

By KTI Systems, Inc.

800.336.0315 | www.ktisystems.com



Shop Now & Save \$200
Use Discount Code - 7AAS3



Biking With Goats

7 Bike Riding – There are several dirt roads around this flat island and a bike is the best way to explore the various sites. Besides a couple cars passing you, the only thing you have to worry about is the herds of goats getting in your way. :)

6 Highland House Ruin – From 1685 until the local slaves were emancipated in 1834, the entire island was owned by the Codrington family and used as a hunting retreat, to grow food for plantations on Antigua, and to sell slaves. Their great house is now the Highland House Ruins and it is worth poking around the foundations of the various buildings in this compound.



Gravenors Bay

5 Gravenors Bay – Another beautiful bay on the southern coast due to the coral and reefs. This is a great bay to weave your boat in behind some patch reefs and find even more seclusion. The bay is protected from the north swell and wind from the southeast and north. If you want to take the dinghy a mile or so further south there is a large reef to explore. Otherwise hop ashore and walk the trails among the scrub bush and wild sage.



JCB 1CX Backhoe Loader

The world's first skid steer backhoe which is the
PERFECT BOATYARD machine!



The versatile attachments on the 1CX can fit any skid-steer loader

Contact Parts & Power for all your JCB machinery, parts and service needs!



www.partsandpower.com
Tel: 1-284-494-2830
Email: info@partsandpower.com



Caribbean Distributors for JCB

Call Now!
284-494-7749
E-mail: ghc@surfbvi.com

Road Town - Tortola - British Virgin Islands

DINGHIES & OUTBOARDS
for Limin

GOLDEN HIND CHANDLERY



Cave - To The Sea



My New Friend

4 The Highlands – A few paragraphs ago I said Barbuda is flat and that is true...except for the Highland, which is a large oval area that is jugged up around 115 feet. From a distance I simply found the geology and topography very interesting. On top it is as flat as the rest of the island and home to the next two entries.

3 Two Foot Bay Caves – A couple miles along the road heading east from Codrington you will come to Two Foot Bay. The beach is nice, but wild. Due to it being on the windward side of the island, my favorite part of this area is the caves. There is one cave called the Indian Cave that has a sand bottom, holes in the ceiling for light, and some cool rock formations. One of the formations looks like a giant skull you can enter. Another cave is a bit higher up the cliff forming the Highland and provides a great view out to sea. My favorite of the caves is an angled shaft that takes you from the beach up to the top of the Highland. Incredible!

Island Marine Outfitters



CONTINENTAL *Trailers*

CONTINENTAL TRAILERS AND PARTS:

- Springs
- Axles
- Spindles
- Bearing Kits
- Hub Kits
- Tires & Wheels



*TRAILER SHOWN WITH OPTIONAL FRONT FLAT BUNK EXCHANGE

PROVIDING TOP QUALITY PRODUCTS, KNOWLEDGE
AND SERVICE IN THE VIRGIN ISLANDS FOR OVER 35 YEARS!

Crown Bay Marina & American Yacht Harbour | St. Thomas USVI
T: 340 714 5311 | T: 340 775 6621

Edward William

CARIBBEAN BOAT INSURANCE

Any Craft, Any Use,
Any Age, Full Storm Coverage
Available!

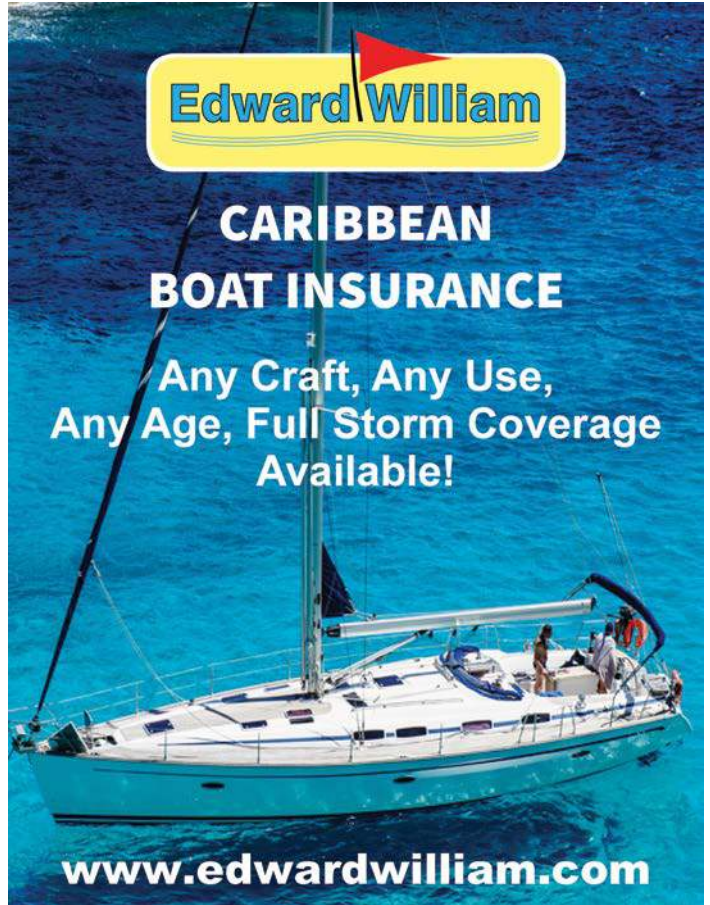

www.edwardwilliam.com



Kubota

Your Authorized Kubota Distributor

Your authorized Kubota distributor is as reliable as your equipment powered by Kubota. Offering Genuine Kubota engines, generators, parts service and warranty support, Parts & Power is your local Kubota expert in the British Virgin Islands.



Parts & Power
Fish Bay, Tortola
British Virgin Islands

(284) 494-2830/440-2830 • www.partsandpower.com • info@partsandpower.com



Frigate Birds - Red Male

2 Darby Sinkhole – The Highlands is a hot and scrub brush filled arid plateau, but in the middle is a sinkhole filled with palm trees. There is no way you are going to find this gem without a local guide, but it is worth it for the view across the hole. Going down into the sinkhole is otherworldly and feels as if you are entering The Lost World. All around the rim is a 60+ foot cliff protecting this oasis.



Darby Sink Hole

1 Frigate Bird Colony – When you add the largest frigate bird colony in the Caribbean with a remote island you get a must-see location. It is against the rules to go without a local guide, so we had Mr. George take us to the far end of the lagoon to see these amazing birds. He informed us of several facts. First, the males have a large football size red sack under their throats they use to court mates. Second, the young males and females are indistinguishable until their second year when the males' heads change from white to black. Third, they cannot land on the water, so they usually steal fish from other species of birds.

Captain Shane & Lily are currently in the Western Caribbean checking out the north coast of Panama from the canal to historic forts to the San Blas Islands. Join the adventure at svGuidingLight on the web or social media!

ORM

Offshore
Risk
Management



Better Boat Insurance
Better Aviation Insurance
Specialty Risks Insurance
Anywhere. Anytime.

www.offshorerisk.com



Island Marine, Inc.

Quality Yacht Services
Marina Puerto del Rey

Tel: 787-633-3088

or 787-885-2760

Fax: 787-885-2428

NEW

P.O. Box 259

Ceiba, PR 00735

islandmarincinc@gmail.com

www.islandmarincinc.net

AWLGRIP
Interlux



Reliable Power ALWAYS



LIFELINE
NEW PRODUCT
LITHIUM

Call us at
909-599-7816
800-527-3224



SCAN ME

www.lifelinebatteries.com

LIFELINE

Premium AGM Batteries



Happy Cruising

TEXT & PHOTOS BY BIRGIT HACKL AND CHRISTIAN FELDBAUER

There is no general recipe for a happy cruising life. Everyone has different predilections: a lonely anchorage that seems a pristine paradise to one sailor may appear as a desolate wasteland to another. Some enjoy racing and being out on the ocean, others prefer to linger in anchorages or marinas. Therefore it is difficult to give advice to would-be-cruisers, but cruising all-year-round for eleven years, talking to fellow sailors and watching some crews succeed while others quit in frustration (or get a divorce or both), we have concluded that there are some general pillars on which a happy cruising life-style is based.

Realistic expectations

The cruising life is more than daysails with a warm breeze on the beam, happy snorkeling in crystal-clear waters and cocktails on a sandy beach. It also means spending 24/7 confined in a small space, dealing with mechanical failures just with your onboard resources, facing foul weather, tricky anchorages and often unhelpful officials. Sometimes the challenges may feel overwhelming, but the beautiful sides of this alternative life-style make up for the annoyances (at least for us). Setting out with too high expectations can only end in disappointment.



Prepare yourself

Doing sailing courses and accumulating miles is certainly a good idea for all crew members. But boating life requires more than just sailing skills. We need to be able to fix things or at least improvise solutions until a professional repair is necessary. Getting some knowledge about engines, electri-



instagram.com/alexsealpaint
fb.com/AlexsealYachtCoatings

Performance Matters

Acrylic Topcoat X is the latest addition to the ALEXSEAL® product portfolio, combining exceptional flow with excellent gloss — now available at your local distributor.



← Scan QR Code for more information



ALEXSEAL®

Yacht Coatings



Helmswoman



cal and electronic systems, plumbing, sewing, cooking—it's not always necessary to do courses, but at least doing some reading and watching experts before setting out raises the self confidence immensely.

Know you can do it

Having the right mindset is even more important. Sailing on an ocean, doing long passages as a short-handed crew means relying on each other. Out on the ocean we're on our own and

have to deal with whatever might come up. Reading tales of the cruising pioneers helps to put things into perspective: Hal Roth and his Margaret calmly tackling hair-raising emergencies. Lyn Pardey describing how they faced hurricanes in their tiny, engineless boat. The Smeeton's didn't panic just because their boat had lost the mast and was full of water in the Southern Ocean after doing a somersault. We are capable of much more than we think.

Make the dream yours

Christian and I were lucky as we discovered sailing together and shared the dream of setting out towards the horizon. We have met many couples where only one partner was a sailor, while the other one was (reluctantly) dragged along without ever having the chance to gain more experience and confidence, resulting in general disharmony on the boat and finally deserting crew. Of course it's hard for a skipper to watch the other one try a clumsy attempt at a maneuver, but nobody has ever learned without trying! On *Pitufa* each one of us has specialized tasks and duties the other one respects. E.g. I'm the helmswoman, so Christian wouldn't try to take the wheel in a tricky situation, while I wouldn't question his choice of an anchoring spot when he's the lookout on the bow.



Need a
COOLER Helm?

99% ULTRA-VIOLET
VISIBLE LIGHT

FADING

94% INFRARED

HEAT

Block the **HEAT...**not your view!



CLEAR Heat Blocking Film for Glass
954.761.8463 • www.vkoolyacht.com



TORTOLA'S WATERTOY AND WATERSPORTS EXPERTS

WATER TOY RENTALS FOR YOUR CHARTER!

Kayaks • Surfboards • SUPS • Fishing Gear
Snorkel Gear • Windsurfing Equipment • Water Floats

ALSO PRIVATE DAY TRIPS THROUGH THE BVI!

Island Surf and Sail Ltd • Soper's Hole Marina

For all your rental and/or lesson enquiries, please contact Scott or Debs:
info@bviwatertoys.com • Head Office: (284) 494-0123

www.bviwatertoys.com • www.daytripsbvi.com



Sam Taxi Tours

ST. VINCENT & THE GRENADINES

Direct USA #: (703) 738-6461

St. Vincent: (784) 456-4338

Bequia: (784) 458-3686

Union Island: (784) 456-4338

Canouan: (784) 456-4338

Mustique: (784) 456-4338

Fax: (784) 456-4233 • VHF channel 68/16
sam-taxi-tours@vincysurf.com



GRENADA

Direct USA #: 347 721 9271

Phone: (473) 444-5313

Mobile: (473) 407-0522

Fax: (473) 444-4460

VHF channel 68

Email: safari@spiceisle.com

Get It Done
& Have Some
Fun!
ON 7 ISLANDS

Ben's Yacht Services
Professional Shoreside Agents

SOUFRIERE, ST. LUCIA

Direct USA #: (347) 634 3037

Tel: (758) 459 5457

Cell: (758) 484 0708

Office Cell: (758) 714 8217

Magic Jack: 951 582 6147

Magic Jack: 321 220 8961

VHF channel 16

Email: saltibus@slucia.com

SERVICES INCLUDE: Customs/Immigration Clearance • Dock Space Reservation • Bunkering of Duty Free Fuel • Refueling • Engineering Supplies
Mechanical Assistance • Sail Washing • Carpet Cleaning • Provisioning • Floral Arrangements • Laundry Service • Courier Service • Mooring Service in
Young Island Cut • Dining/Activity Reservations • Island Tours • Helicopter Rides • Discounted prices on tours • Shopping • Shore Transportation
Airport Transfers • Taxi Service • Car & Jeep Rental • Reconfirm Airline Tickets • VIP & Crew Accommodations • Wedding Arrangements



Sail work is men's work on *Pitufa*



Nasty projects in remote places

Keep learning

We're always eager to hear how other cruisers deal with situations and learn new techniques to enhance our system. A different way to store the dinghy or just a more energy-efficient method to cook rice—we're open for improvements. We get the impression that some old salts are too stuck in their ways to contemplate new (and maybe quicker or more efficient) ways. For us cruising means learning that never ends, tackling new challenges and growing with them.

Keep busy

Often people ask whether we don't get bored living all-year-round on a boat. On the contrary, the days are never long enough to fit everything we want to do on top of what we have to do. We prefer to keep constantly up with maintenance instead of doing a repair-marathon once a year in a marina or boatyard. Firstly, it's nicer to jump into turquoise waters after a dirty, sweaty project than to just dive straight into the next one without a break. Secondly, many issues turn from minor to major when ignored, e.g. a small seam repair can prevent major damage to a sail.

Many of the amenities we enjoy (fresh bread, yogurt, sprouts, a boat garden, self-brewed beer and ciders, etc.) are rather labor-intensive, but they enable us to spend lots of time autonomously in remote areas.

Of course life can't be all work and no play: we try to do at least one fun activity per day—going for a hike, taking the dinghy out for a snorkel or a sundowner on the beach. Being flexible and spontaneous is the key: in perfect weather and conditions we don't hesitate, drop a project and head out to play with the fishies, as there are always enough gray days to keep up with tasks. We don't mind the day of the week: any sunny day can be declared a lazy Sunday on *Pitufa* whereas a rainy Sunday may be the perfect time to change the seals on the toilet! 🐾

Birgit and Christian have been cruising on their S&S41 Pitufa for 11 years from the Med via the Atlantic and Caribbean to the South Pacific. Visit their blog www.pitufa.at for more info, follow SY Pitufa on facebook or order "Sailing Towards the Horizon," the book about their journey, on amazon.com!



MARINE WAREHOUSE
YOUR GLOBAL CHANDLERY
PANAMA • CURAÇAO • TRINIDAD • MIAMI • GRENADA • MALAYSIA • POLYNESIA • AUSTRALIA

METRIC AND IMPERIAL ANCHOR CHAIN IN STOCK



VITRIFRIGO
COOL AND BEYOND



SPECTRA
WATERMAKERS



isotherm



HIGHFIELD
strength · integrity · style

Marine Warehouse - Your Global Chandlery
Email our experts: sales@marinewarehouse.net
ph: 305-635-0776
www.marinewarehouse.net



\$30K PRICE REDUCTION



FOR SALE: \$235,000 ONO
SUNSEEKER CAMARGUE 47
Great weekender for the family, day cruiser or charter vessel currently in SXM. She is well cared for - only one in the Caribbean. Private Sale.

PHONE: +17215813965 | WHATSAPP: +12687718934
EMAIL: kushtisxm@gmail.com

THE ONLY PLACE **SAFE** FROM HURRICANES IS ONE OUTSIDE THEIR PATH!



Varadero ARUBA
MARINA & BOATYARD

Welcome to ARUBA!
"One Happy Island"
South of the Hurricane Belt

For hundreds of years, Aruba has been blessed with no direct hit by a hurricane, while still closer to the BVI than Miami, FL.

Varadero Aruba Marina is the LARGEST FULL-SERVICE Marina in the Dutch Caribbean.

Whatever you want to do: store safely, maintain or repair your boat, we are the place to be.

+(297) 588-3850
www.varaderoaruba.com
info@varaderoaruba.com
facebook.com/VaraderoAruba
12° 29' 54.27" N - 70° 01' 01.51" W

Nous sommes aussi la seule Marina  au Sud du 14e parallèle ou l'on parle français



Gretchen Ortiz, above and far right on rail - Smile and Wave - STIR

CREDIT DEAN BARNES

Women on the Water: Puerto Rico's Gretchen Ortiz

BY CAROL M. BAREUTHER, RD | PHOTOS COURTESY TEAM OCEAN GROWN

There are not many sports where you can move from beginner to Olympian in a decade. An even bigger feat is a woman doing so in what has long been the male-dominated sport of sailing. Yet, that's just what Puerto Rico's Gretchen Ortiz has accomplished, getting her feet wet first on a Beneteau

40.7 in local and Caribbean regattas and then reaching the pinnacle of the sport as crew in the Mixed Nacra 17 representing her home island at the 2020 Summer Olympic Games.

"I started sailing later in life, at age 24," says Ortiz, who lives

in San Juan, yet had never tried any water sports despite being surrounded by sea. "I used to play soccer and in one of the games I had an ACL (knee) injury. While I was recovering from surgery, I read many of my boyfriend's books. These were about rogue waves, being lost at sea, sailing around the world, and these types of topics. Somehow that translated into 'I want to learn how to sail'.

Learning to Sail

Ortiz studied the basics of sailing by book. However, it was sailboat racing and a real love of the sport that she learned from Jaime Torres. It was 2011 and Torres had purchased a Beneteau 40.7, called her Smile and Wave, and was putting a team together to compete in the Caribbean regatta circuit.

"I asked him if I could join. I told him straight up, 'I don't know much about sailing, but I can put in the time, and I learn fast,'" Ortiz tells.

Her first regatta, the 600 nautical mile Caribbean 600 around 11 Caribbean Islands, was a long-distance baptism by sail. She got seasick. The entire three days and nights of sailing she spent on the rail. Eating, sleeping, everything on the rail. All the while Ortiz was sick, she looked out and the ocean was comforting. The sound of the water rushing by the boat when going downwind, the pounding of the boat with the waves when going upwind, the sparkling water at night, the dolphins, the turtles, and a shark or two were all part of the scene. Ironically, between her sailing tasks and being sick, and with everything else going on out on the sea, as Ortiz says, "I just fell in love with the sweet and sour of it all."

She continued crewing onboard Smile and Wave for a half dozen northern Caribbean regattas – including the St. Maarten Heineken Regatta, Puerto Rico Heineken Regatta, St. Thomas International Regatta, and BVI Spring Regatta – over the next three months. She started midbow, learned from the bowman, and soon took over the bow position. A decade later, with Torres trading in his Beneteau for a Melges 32 along the way, it's safe to say that Ortiz has been on the podium every year in almost every regatta she's sailed in the Caribbean.

"One of the most important things I learned while sailing on Smile and Wave is the importance of the joy of sailing on a 'Drama Free Zone' boat. No yelling, other than because of wind noise, no cursing at others, and we all do our best at all times and in whatever way it means that day," she says.



Gretchen Ortiz
on the bow,
St Maarten
Heineken Regatta

CREDIT LAURENS MOREL



Gretchen Ortiz
in the front

CREDIT NACRA 17 SAILING



Gretchen Ortiz, far right on
rail 2, Smile and Wave - STIR

CREDIT DEAN BARNES



CREDIT DEAN BARNES

Gretchen Ortiz and Jaime Torres, at left, of Smile and Wave at the podium at the St Thomas International Regatta

Olympic Opportunity

Ortiz's path to the Olympics came via mutual friend and fellow Puerto Rican sailor, Enrique 'Keki' Figueroa. The two knew of each other but hadn't sailed together. Ortiz raced keelboats while Figueroa, a five-time Olympian, raced multihulls. Half-way into Figueroa's 2020 Olympics campaign, he found himself in need of crew.

"The sailing director where I teach sailing (Club Nautico de

San Juan) recommended me. We did a tryout, and the rest is history," she says.

One big difference between racing one hull versus two, Ortiz tells, is that "Everything is so fast. I used to joke that I would hoist the spinnaker at the windward mark and by the time I finished getting out on the trapeze it was time to put the spinnaker away again. It took me a while to get used to the pace, but it is doable."



Charterbiz

Charter Insurance from Offshore Risk Management

USA 800-773-0105
Caribbean 284-494-8925
International 305-743-7711

Insurance for Charter & Watersports Operators

CALL OR CLICK
www.CharterBiz.com

The CharterBiz website caters to Charter & Tour Operators including bareboat and crewed charters, dive-boat and tour operators, daily rental and PWC renters.

No fees, no hassles and no Prima Donnas. Just common sense!

GET A
PERSONALIZED
INSURANCE
QUOTATION
FOR

Charter Yacht Insurance - Bareboat or crewed
Captain & Crew - Personal Accident +Weekly
Income+Medical Expense Insurance
Health Insurance - call for more info
Watersports Operators - contact us

The CharterBiz insurance program is managed by



Offshore Risk Management
Marine & Specialty Insurance
Services Worldwide



Voted **BEST** Marine Service & Marina in the Virgin Islands!



- Mercury Dealership
- Full Service Department with Certified Mechanics
- Full Chandlery
- Dockage - 44 Fixed Slips
- 5 Available Moorings
- Maximum Vessel Size: 125 Feet
- 40 Ton, 17.5' Max Beam Travelift
- Marine Store and Yard Services
- Haul and Launch
- Fuel Dock - Gasoline and Diesel
- WIFI
- Washrooms and Showers
- Ice and Beverages



5063 Gallows Bay, Christiansted, VI 00820
Tel: 340-773-0289 | Hail VHF 16
info@stcroixmarinecenter.com
www.StCroixMarineCenter.com



OUTLAND HATCH COVERS



- Rigid cover protects hatch lens
- No more hazing and crazing!
- Easy, no-holes installation
- Unique cover fastener for easy on-off
- No adjustments needed to open or close hatch
- Comfortable cabin interiors
- More efficient heating & cooling
- Great privacy
- Stores easily behind or under seat cushions
- It floats!



For more information, watch our videos on YouTube

"The new generation in hatch covers"



www.OutlandHatchCovers.com
Phone: 910.467.2882





Caribbean Sailors in 2020 Olympics. Gretchen Ortiz is kneeling second from left.

The Nacra 17 class for the 2020 Summer Olympics was mixed, meaning one male and one female crew. It was also full foiling. Figueroa, whose competed-on Tornados, Hobie Tigers, Hobie 16s, and Formula 18's, only had a one-month head start on Ortiz when it came to getting the foiling aspect down pat. Training, on the water, at the gym, running, reading up, sailing seminars, and more proved a full-time job.

"The greatest part of the Olympics is to be able to represent your country against the best of the best of other countries. It fills you with pride and puts your game in a gear that you don't even know you had. You can get a real high, but you also can get a real low if you don't perform as you thought you should," she says.

Looking Ahead

Since the Olympics, Ortiz has been teaching youth sailors, especially beginners, in the Optimist, Laser, 420, Open Bic, and IC24.

"I love teaching the kids. I love seeing their progress from being attached to their parents to being able to rig their boats,

launch them, sail them, and de-rig them all by themselves and take pride in doing so," she says.

Ortiz continues to race keelboats. In 2023, she raced with fellow Puerto Rico sailor, Sergio Sagramoso, on his Melges 32, Lazy Dog, which won its class at the St. Maarten Heineken Regatta. With Torres and the Smile and Wave team, she enjoyed podium-placing finishes at the St. Thomas International Regatta and BVI Spring Regatta, and Antigua Sailing Week.

Looking ahead, Ortiz plans to keep racing keelboats, teaching sailing, and practicing wing-foiling. Off the water, she enjoys completing mini building projects on her house and garden, and taking care of her chickens and her 17-year-old dog, Almendra.

For women who would like to follow in Ortiz's footsteps, her advice is this: "Just get out there and sail. Sail, meet people, and sail some more. No matter where you start, or what boat position they put you in, you can always learn and prove your worth in the other positions you aim for. Just sail and meet people." 

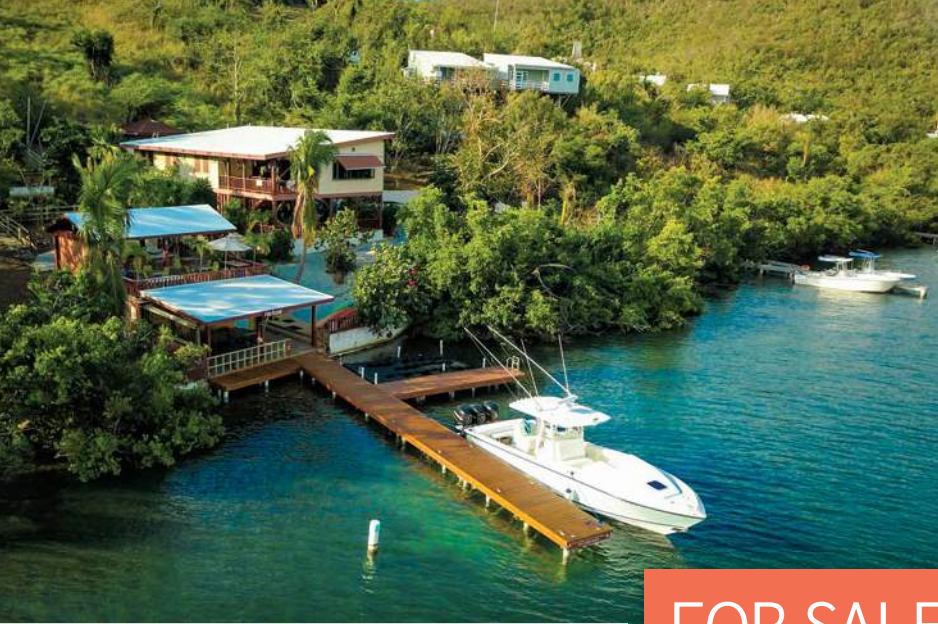

FOR SALE:

OCEANFRONT VILLA & DOCK FACILITIES

CULEBRA ISLAND - PUERTO RICO

Tropical Paradise

Numerous attributes characterize the property's secluded & privileged coastal location, surrounded by Dakity Nature Reserve & boundary to 'Playa Punta Soldado'. Comfortable maritime access to property's dock with a draft of 6' in depth. Two-level main Villa with multiple adjoining Oceanfront Terraces, hardwood 'embulla' & tile floors, half acre + of land, 6k water cistern, 13 kw power generator, jacuzzi-gazebo, 6/bdrms & 3/bthrms, laundry & storage rooms. Established 10 yrs + short-term Tourism Vacation Rental, rated #1 TripAdvisor-Specialty Lodgings. Additional info/details for the latter available upon request. By Appointments only! Asking price: \$2.350M.



Please inquire for specs regarding its Offering Details:
artetropical3@gmail.com, pelicangroup@prw.net
Alex Carbonell #787-398-8635

www.zillow.com/homedetails/Bo-Culebra-PR-00775/2059843265_zpid/



Grupo Pelicano Culebra
Oceanfront Cabaña Rentals





Don Q Signature Release Single Barrel 2009

RUM REVIEW | BY CLINT AND TERRY BORAM

We always say yes when friends tell us they have a unique rum and ask us to share it with them. It allows us to share our love of rum tasting with others while discovering new rums. Don Q Signature Release Single Barrel 2009 was a rum we've been looking forward to tasting.

In a past Don Q article, we highlighted the Serrallés family's arrival in Ponce, Puerto Rico, in 1820, and the production of the family's first cask of rum using an imported copper pot still. The rum was distributed privately until 1934, when the Don Q brand, named after Don Quixote, was launched for general consumption. The company produced aged rums until 1978, when the popular Don Q Cristal was introduced.

Don Q is distilled from boiled sugar cane, producing molasses that retains 50% of the sugar from the cane juice. The unique 75-year-old yeast is used in fermentation to transform sugars into alcohol.



Exceptional
PUERTO RICAN RUM

The liquid is distilled five times in a continuous still to remove any impurities, then aged in oak barrels for up to a year per Puerto Rican law.

In 2005, Don Q created a Signature Release Single Barrel using rum from their private stock, which is blended by the master distiller before going into charred American barrels to rest for 10 years. They continued the same in 2007, releasing nine years later and again in 2009, which was released in 2019.

What began as a teaching moment with our friends led to discovering nuances our friends never knew rum had.

REVIEW

For a rum aged 10 years in charred oak barrels, we expect a deeper hue than the golden liquid that clung to the glasses, creating tiny lacing. On the nose, we immediately picked up caramel, with our friends noting a slight alcohol note. As we continued to explore and discuss, Terry noted golden raisins, while Clint noted vanilla. We all felt there was another fruit on the nose that we couldn't define.

After a long, contemplative first sip, our friends noted how smooth the rum was, even with a slight alcohol burn on the palate. Clint liked that the notes on the palate were the same as the nose but with a hint of oak. As we took additional sips, Terry identified the mysterious fruit as dark cherries, and there was a debate about the ever-present spice. We concluded the char of the barrel created it.

But it was the finish where we greatly differed. Some had a harsh experience with the spice burning the throat, while Terry said the finish was a non-event, and Clint enjoyed the smooth and lasting finish.

OVERALL

Don Q Signature Release Single Barrel 2009 is a great rum to share and experience with novice and seasoned rum drinkers. The character and complexion allow everyone to notice the subtleties a fine rum can offer. At \$50/bottle, this is definitely worth finding.

4.5 OUT OF 5



ABOUT CLINT AND TERRY: We have sampled many a dram over our 33 years of marriage and quite often we don't fully agree. Could be the difference is male/female taste buds. Or, somebody is just wrong.

LARGEST DEALER NETWORK
Larger than Tohatsu & Suzuki Marine combined
in the Caribbean

25+ dealers
in the Caribbean

The industry's
BEST WARRANTY

WHY CHOOSE ANY OTHER!?

VISIT US AT
2 LOCATIONS

St. Vincent Marine Center 784-593-BOAT(2628)SVG
Dominica Marine Center 767-440-BOAT(2628)DOM

CARIBBEAN MARINE SURVEYORS LTD.

Above the chandlery at Nanny Cay Marina, Tortola BVI

- Purchase
- Insurance
- Phase-out
- Damage
- Tonnage
- Stability
- Audio Gauging
- MCA SCV & MLC

+1 284 494 2091 Office
+1 284 499 1576 B. Bailey
+1 284 346 1518 B. Baker
+1 284 346 8105 N. McLoughlin
+1 284 346 2092 P. O'Loughlin

SAMS; IIMS; MECAL; RYA
www.caribsurveyors.com
info@caribsurveyors.com

Read what you love...
all the time, any time!

Subscribe to
ALL AT SEA

U.S. Subscriber
12 issues - \$29.95

Canada Subscriber
12 issues - \$39.95

Non-U.S./Canada Subscriber
12 issues - \$64.95

www.allatsea.net
subscribe@allatsea.net

ULTRA
★ YACHT REFIT ★

Marine Joinery
★
Teak Decking
★
AC/Refrigeration
★
Engineering
★
Composites
★
Metal Fabrication

English Harbour, Antigua
+1 268 736-3881
michael@ultrarefit.com
www.ultrarefit.com

Island Real Estate

WATERFRONT PROPERTY

Caribbean Sea

To display your Real Estate in *All At Sea* contact advertising@allatsea.net



1

FORT LAUDERDALE, FLORIDA. Stunning custom 6 BR/7 BA Santa Barbara-inspired Estate on 120 ft of protected deep water. Almost 10,000-sq-ft, every luxury amenity is included from the open Chef's kitchen, breakfast area, large butler's pantry, elegant formal dining room for 12, large family and formal living room with fireplace, 1,800 bottle wine cellar, club/theatre room, and library/home office. Expansive covered balcony captures water and Intercoastal Waterway views. Price: US \$15,995,000
JULIE JONES, Douglas Elliman
Julie.jones@elliman.com | www.elliman.com
 Cell: (954) 328-3665



2

AGUADA, PUERTO RICO. Prime position across the street from the beach in this picturesque seafront town, this lavish 3 BR/2 BA, two-story gated property offers comfort and privacy. A spacious master suite, custom kitchen cabinets, high ceilings, a double garage, and a rooftop terrace with breathtaking ocean views are key features. The manicured grounds and a nice-sized pool create a private oasis. Price: US \$1,300,000
ISLAND WEST PROPERTIES
www.islandwestsales.com | Office: (787) 823-2323



3 **WATER ISLAND, U.S. VIRGIN ISLANDS.** Ownership within coveted Sprat Bay on Water Island (directly across from St. Thomas) is now possible. We are offering this 1-acre lot in a gated community with neighborhood secluded beaches, gazebo, tennis court, and a boat dock. Phenomenal views and ideal orientation for this lot near the crest of the mountain. Your dream home awaits you at this perfect location. Price: US \$149,000

CARA HINTON, Real Solutions Real Estate
carajohinton@gmail.com | www.stthomasre.com
 Cell: (340) 690-2849



4 **ST. THOMAS, U.S. VIRGIN ISLANDS.** Perched on a sea-surrounded point on the island's premier East End, this 7 BR/8.5 BA residence consists of 5 buildings and is ideal for work-at-home and play. There's a 50-foot lap pool, within walking distance to the beach and restaurants at Secret Harbor. Built like a fortress with poured concrete steel reinforced walls, solar, Tesla, 70kw generator and backup water system, and 2-car garage. Price: US \$4,950,000

BARBARA BIRT, Seaglass Properties
Barbara@seaglassproperties.com
www.seaglassproperties.com | Cell: (340) 690-9995



5 **ST. CROIX, USVI.** The gated beach neighborhood of Enfield Green is where this beautifully constructed is on the market for the first time. Completed in 2017, with 19-foot-high cypress ceilings, an oversized custom kitchen, a grand open living/dining space, a large, covered gallery in the back, a spacious yard, and huge ocean views; Big is an understatement. Some noteworthy features of this 4 BR/3 BA residential property include a convenient indoor laundry room, rust-resistant Galvalume roof, impact-resistant windows, a hi-tech security camera system, and a 22kw diesel generator with auto transfer switch in a matching concrete house. Price: US \$949,000

STEPHANIE HODGE, Blue Sky Real Estate | info@BlueSkyVI.com
www.homebuyvi.com
 Office: (340) 719-1409
 Cell: (340) 626-2318

CHRISTIE'S

INTERNATIONAL REAL ESTATE

— the Saints —

Private Islands & Infinite Possibilities



Enjoy private island ownership in the heart of the U.S. Virgin Islands, east of Puerto Rico in the Lesser Antilles. St. Thomas enjoys a modern international airport with direct flights from Atlanta, Boston, Chicago, New York, and Miami. From the FBO, a short helicopter ride or boat trip will have you at your door in minutes. With their unique location, the Virgin Islands serve as an exceptional launch pad to travel the BVI and down island all while returning home in minutes to the us flag.

One of the last privately owned islands in the U.S. Virgin Islands, Thatch Cay is comprised of 230 acres+/- of completely undeveloped land, a 5 mile+/- coastline, and panoramic ocean vistas in every direction. With significant subdivision capabilities, Thatch cay is the ideal place to explore its nearly limitless potential for development.

LP//**\$25M**

www.usvirealestate.com

CHRISTIE'S

INTERNATIONAL REAL ESTATE

— the Saints —

Private Islands & Infinite Possibilities



GREAT SAINT JAMES

Great Saint James, the larger of the two Jameses at 161.3 acres+/-, presents significant subdivision capabilities just 5 minutes across the bay from St. Thomas, with awe-inspiring views of the turquoise waters from Christmas Cove on the western coast to charming islets, sailboats, and seabirds in all directions.

LP//\$55M



LITTLE SAINT JAMES

Marked by palm tree lined beaches and cliffs overlooking scenic panoramas, Little Saint James offers 71.6 acres+/- including a helipad, private dock, transfer facility, high capacity water filtration, 2 pools, a main compound, 4 guest villas, 3 secluded beaches, gym, tiki hut, and additional maintenance structures and viewing pavilions.

LP//\$55M



Nick Bailey
340-642-9072
Nick@USVIREalEstate.com



Margo S. Lynch
340-626-5516
Margo@USVIREalEstate.com

6



COLE BAY, ST. MAARTEN. Serene 3 BR/3 BA villa boasts an incredible panoramic view of the Caribbean Sea and the islands of St Barts, Nevis, St Kitts, St. Eustatia, and Saba. Unlike most places, there is an abundance of green lawn and many fruit trees. Private large pool, plus outdoor dining or lounging area equipped with a barbecue, outdoor bar, and pool table. Inside, the living room features cedar-finished cathedral ceilings, a fully equipped kitchen, and a Master Suite with twin Jacuzzis. Price: US \$1,800,000

JONATHAN SCHAEDE, Sunshine Properties | jonathan@sunshine-properties.com

www.sunshine-properties.com | Cell: (721) 520-5445

7



COLQUHOUNS, NEVIS. Located on the West 'Gold Coast' of the island, the property is part of the original Colquhouns Estate and contains beach lands next to the famous Nelson Springs where Admiral Nelson watered his naval vessels. This 19-acre property, with 220-ft of golden sand beachfront, slopes up to an elevation of 100-ft from the sea. Spectacular views of sister island, St. Kitts, sunsets over the water, and Mount Nevis in the island's center. Perfect for villa or resort development. Price: US \$15,000,000

JOHN YEARWOOD, Oualie Realty

John.yearwood@oualierealty.com

www.oualierealty.com

Office: (869) 469-9403 | Cell: (869) 662-9740

8



ST. PAUL, ANTIGUA. Overlook picturesque Willoughby Bay from nearly every room of this luxury 3 BR/3 BA property situated in the exclusive expat community of Savannah 5 minutes from Falmouth Harbour. A master suite with vaulted ceilings, a modern fully equipped kitchen that connects seamlessly to the living and dining areas, and a swimming pool with coral stone sun deck perfect to relax or entertain are only a few of the amenities. Price: US \$1,795,000

ALISTAIR FORREST, Stanley's Estate Agents Ltd.

alistair@stanleyestates.com | www.stanleyestates.com

Office: (268) 562-7599 | Cell: (268) 764-6565



9
OLD TOWNE, MONTSERRAT. Located on a 1.55-acre property of three lots, half of which is landscaped with beautiful palms and flowering shrubs and fenced, the 2 BR/2 BA main house offers a spacious kitchen, and a large living area that is up four steps, opening out onto a fabulous veranda and spectacular panoramic ocean and mountain views. There's a pool, laundry facilities are in a separate building, and parking for several vehicles plus a carport that holds two cars. Fully furnished. Price: US \$650,000

SUSAN EDGECOMBE, Tradewinds Real Estate
susan@tradewindsmontserrat.com
www.tradewindsmontserrat.com
 Office: (664) 491-2004 | Cell: (664) 495-2004



10
KRALENDIJK, BONAIRE. Enjoy a harmonious blend of luxury, comfort, and tranquility in this stylish 3 BR/3 BA waterfront villa that sits on the serene inland waterways of the Saramaca peninsula, which connect directly to the harbor and sea. Features include a partly covered terrace, a private swimming pool with sundeck, a private docking pier for a boat, and a tropical garden with a beautiful mix of plants and palm trees. Just a 10-minute drive from the vibrant town center and close to public beaches. Price: US \$1,850,000

CORINE VAN DER HOUT, Sunbelt Realty
corine@sunbeltbonaire.com | www.sunbeltbonaire.com
 Office: (+599) 717-6560



11
ROATAN, HONDURAS. Nothing compares to this remodeled 2 BR/2 BA condominium in Parrot Tree Plantation. Overlooking a private marina with views out to the open water and reef, surrounding Roatan, Bay Islands. This turnkey condo has new appliances, LVT flooring, plumbing fixtures, Quartz countertops, a water filtration system, tiled showers, split system AC and is fully furnished. There is 24/7 security at the gate and throughout the community. A deep-water boat slip is also available for purchase. Price: US \$375,000

AMY MURPHY, Russ Lyon Sotheby's International Realty | amy.murphy@russlyon.com
www.russlyon.com | Office: (480) 269-2830 | WhatsApp (602) 291-7653

Caribbean Marinas

ALL AT SEA'S CARIBBEAN MARINAS GUIDE

				Maximum Draft	Maximum Length	# of Slips	Fresh Water	Electrical Supply	Cable / Satellite TV	Diesel	Gas	Shower / WC	Laundry	Provisioning	Bar / Restaurant	Security	VHF Channel	Wireless Internet
Antigua	Falmouth Harbour Marina www.antigua-marina.com	268-460-6054	20'	380'	60	●		110/220/380 3 phase	●	●	●	●	●	●	●	68/10	●	
Antigua	Jolly Harbour Marina www.jhmarina.com	268-462-6042	13'	200'	160	●		110/220		●	●	●	●	●	●	68	FREE	
Aruba	Renaissance Marina Aruba	297-588-0260	13'	200'	50	●		110/220		●				●	●	16/69	●	
Aruba	Varadero Caribe www.varaderoaruba.com	297-588-3850	8'	120'	75	●		50/30 amp				●		●	●	68	●	
Curaçao	Curaçao Marine	5999 465 8936	13'	120'	30	●		110/220/380		●		●	●		●	67	FREE	
Curaçao	Curaçao Yacht Club www.curaçaoyachtclub.com	5999-767-4627	16'	160	120	●		110/220 v; 50 hrz		●	●			●	●	68	FREE	
D.R.	Casa de Campo Marina	809.523.8646/ 8647	16'	250'	350	●		110/220 v to 60 hrz	●	●	●	●	●	●	●	68	●	
D.R.	Marina Zar Par	809-523-5858	12'	120'	110	●		110/220, 308	●	●	●	●	●	●	●	5	FREE	
D.R.	Ocean World Marina	809-970-3373	12' +	250'	104	●		110/220	●	●	●	●	●	●	●	16/68	●	
Grand Cayman	Barcadere Marina	345-949-3743	8'	150'	83	●		30, 50, 100 & 200 amp single phase; 100 & 200 amp 3 phase; 60hz		●	●	●		●	●	16	FREE	
Grenada	Clarks Court Boatyard & Marina	473-439-3939	11'	150'	20	●		110/220; 50hrz				●	●	●	●	68	FREE	
Grenada	Grenada Marine	473-443-1667	15'	70'	4	●		110/220		●		●	●	●	●	16	FREE	
Grenada	Le Phare Bleu Marina	473-444-2400	15'	120'	60	●		110/220/480		●	●	●	●	●	●	16	FREE	
Grenada	Port Louis Marina	473-435-7431	14.7'	90m	170	●		110/208/220/230/240/400/480/630V	●			●	●	●	●	14	FREE	
Grenada	Whisper Cove Marina www.whispercovemarina.com	473-444-5296	15'	100'	18	●		110/220, 50hrz				●	●	●	●	68	●	
Guadeloupe	Marina Bas-du-Fort	590 590 936 620	15.5'	210'	1,100	●		110/220/380		●	●	●	●	●	●	9	FREE	
Jamaica	Errol Flynn Marina & Shipyard	876-715-6044	32'	600'	33	●		110/220/480 1&3PH 50/60HZ	Cable	●	●	●	●	●	●	16/9	FREE	
Panama	Bocas Marina www.bocasmarina.com	507-757-9800	20'	150'	83	●		110 -220v		●		●	●	●	●	68	FREE	
Panama	Red Frog Beach Marina redfrogbeach.com an IGY destination™	+507 6726-4500	20'	300'	84	●		50 Amp 110/220V 60 Hz, 100 Amp 220V 60 Hz, 200 Amp 480V 60 Hz 3-phase		●	●	●	●	●	●	68	●	
Panama	Shelter Bay Marina	507-433-3581	20'	320'	192	●		60 HZ, 120/240V 50-Amp, 100 Amp Single Phase, 208V	●	●	●	●	●	●	●	74	●	
Puerto Rico	Club Nautico de San Juan	787-722-0177	31'	250'	121	●		110 volts / 220 / 480 for megayachts		●	●	●			●	16/10 68	●	
Puerto Rico	Marina de Salinas	787-824-3185	10'	65'	103	●		120/220V, 30/50 amp		●	●	●	●	●	●	16	●	
Puerto Rico	Marina Pescaderia www.marinapescaderia.com	787-717-3638	8'	115'	99	●		30, 50, and 100 amp		●	●	●	●	●	●	16	FREE	
Puerto Rico	Ponce Yacht & Fishing Club	787-842-9003	20'	150'	169	●		110/220V, 30A, 50A and 100A		●	●	●	●	●	●	68	FREE	
Puerto Rico	Puerto Del Rey Marina	787-860-1000	15'	260'	1,000	●		120/208V single & 3 phase; 30, 50,100 & 200 amps; 60 Hz	Cable	●	●	●	●	●	●	16/71	FREE	
Scrub Island, BVI	Scrub Island Resort, Spa & Marina www.scrubisland.com	(284) 394-3440	30'	160'	55	●		30, 50 & 100 amp				●	●	●	●	74	●	

			Maximum Draft	Maximum Length	# of Slips	Fresh Water	Electrical Supply	Cable / Satellite TV	Diesel	Gas	Shower / WC	Laundry	Provisioning	Bar / Restaurant	Security	VHF Channel	Wireless Internet
St. Croix	Green Cay Marina at Tamarind Reef Resort	340-718-1453	8'	100'	154	●	110/220V - 30A, 50A, 200A	●	●	●	●	●	●	●	●	16	FREE
St. Croix	St. Croix Marine www.stcroixmarinecenter.com	340-773-0289	11'	150'	23	●	110/220 - 30A, 50A, 100A		●	●	●				●	16/06	FREE
St. Lucia	Rodney Bay Marina www.igy-rodneybay.com an IGY destination™	758-458-7200	14'	285'	253	●	120V- 480V, 30/50/100/125/200 amps at 60 Hz, 240V- 440V, 32/63/125 & 200 amps at 50Hz	●	●	●	●	●	●	●	●	16	FREE
St. Lucia	The Marina at Marigot Bay	758-451-4275	16'	250'	40	●	110/220/380, 50/60 Hz	Cable	●	●	●	●	●	●	●	16/12	●
St. Maarten	Bobby's Marina www.bobbysmarina.com	721-542-2366	12'	130'	80	●	110/220V		●	●	●				●	16/69	●
St. Maarten	Island Water World Marina	+1 721-544-5310	8'	60'	47	●	110/220V, 60Hz		●	●	●				●	74	FREE
St. Maarten	Lagoon Marina Cole Bay Waterfront	599-544-2611	9'	100'	45	●	110/220	●		●	●	●	●	●	●	16	FREE
St. Maarten	Simpson Bay Marina www.igy-simpsonbay.com an IGY destination™	721-544-2309	13'	196'	114	●	480V 3-phase 100 amps/leg; 220V 3-phase 100 amps/leg; 220V 50 amps; 110V 30 amps 60hz	●	●	●	●	●	●	●	●	16/79A	FREE
St. Maarten	The Yacht Club at Isle de Sol www.igy-isledesol.com an IGY destination™	721 544 2408	18'	320'	45	●	480V 3-phase 100 amps/leg; 220V 3- & single-phase; 100 amps/leg; 220V 50 amps 60hz	●	●	●	●	●	●	●	●	16/78A	FREE
St. Thomas	American Yacht Harbor www.igy-americanyacht harbor.com an IGY destination™	340-775-6454	10'	110'	134	●	120/208Y/240 VAC 30 to 100 amps, 60 Hz	Cable	●	●	●	●	●	●	●	16/6	FREE
St. Thomas	Crown Bay Marina www.crownbay.com	340-774-2255	24'	200'	99	●	30, 50, 100amp 120v, 208v, 220v, 480v	Cable	●	●	●	●	●	●	●	11	FREE
St. Thomas	Yacht Haven Grande www.igy-yachthaven grande.com an IGY destination™	340-774-9500	18'	656'	48	●	120/208Y/240/480Y VAC 50 to 600 amps, 60 Hz Ability to hard wire	Cable	●	●	●	●	●	●	●	16/10	FREE
Tortola, BVI	Nanny Cay Marina	284-494-2512	12'	125'	200	●	110/220		●	●	●	●	●	●	●	16	●
Tortola, BVI	Soper's Hole	284-495-4589	25'	170'	50	●	110/240	Cable	●	●	●	●	●	●	●	16	Cafe
Tortola, BVI	Village Cay Marina	284-494-2771	12'	200'	106	●	110/220/308	Cable	●	●	●	●	●	●	●	16/71	FREE
Trinidad	Peake Yacht Services Marina	868-634-4420/3/7	20'	90'	17	●	110/220			●	●	●			●	69	FREE
Trinidad	Power Boats Ltd	868-634-4346	13'	65'	40	●	115/220		●	●	●	●	●	●	●	72	●
Turks & Caicos	Caicos Marina & Shipyard www.caicosmarina.com	649-946-5600 649-232-1905	9'	150'	100+	●	30/50/100 amp		●	●	●				●	16	FREE
Virgin Gorda	Virgin Gorda Yacht Harbour	284-495-5500	10'	180'	94	●	110/220		●	●	●	●	●	●	●	16/11	●
Colombia	Marina Santa Marta www.marinasantamarta.com an IGY destination™	+574363601	11.5'	132'	256	●	110/220V, 60hz		●	●	●	●	●	●	●	16/72	FREE

OUTSIDE OF CARIBBEAN:

Boston, MA	Boston Yacht Haven	617-367-5050	22'	300'	100	●	480V, 100 and 200 amps; 240V single-phase; 208V 3-phase, 100 amps; 240V, 50 amps; 120V, 30 amps	Cable	●	●	●	●	●	●	●	09/16	FREE
Cabo San Lucas, Mexico	Marina Cabo San Lucas www.igy-cabosanlucas.com an IGY destination™	+52 624 173 9140	26'	350'	380	●	110V 30 amps; 220V 50 amps; 100 amp 3-phase, 480V 150 3-phase		●	●	●	●	●	●	●	88A	FREE
NY Harbor - Manhattan	North Cove Marina at Brookfield Place www.igy-northcove.com an IGY destination™	917-677-7680	16'	175'	18	●	110V, 220V; 480V 3-phase				●	●	●	●	●	69	FREE

ASK ABOUT ADDING YOUR MARINA TO THE ALL AT SEA MARINA GUIDE **CONTACT ADVERTISING@ALLATSEA.NET**

Caribbean Boatyards

ALL AT SEA'S CARIBBEAN BOATYARDS GUIDE

		Latitude	Longitude	Phone Number	Maximum Draft	Maximum Length	Maximum Beam	Maximum Air Draft	Power Supply	Arrival Hours	Lift 1 Type / Capacity (Tons)	DIY Friendly	Electronic Shop	Carpentry Shop	Electrical Shop	Prop Shop	Paint Shop	Onsite Crew Facilities
Antigua	Jolly Harbour Marina / Boat Yard	17 04 46.4 N	61 54 37.0 W	(268) 462-6041	13'	80'	19'	no limit	110/220	8am-5pm	70	•	•	•	•	•	•	•
Antigua	North Sound Marine	17.1167	-61.7500	(268) 562-3499 \ (268) 764-2599	15'	no limit	31'	no limit	Anything	24x7	150	•	•	•	•	•	•	•
Aruba	Varadero Caribe	12 32 N	70 02 W	297-588-3850	8'	120'	45'	no limit	50/30 amp	8am-5pm	60	•	•	•	•	•	•	•
Freeport, Grand Bahamas	Bradford Marine Bahamas	26° 31.189 N	78° 45.566 W	242-352-7711	35	400	50	no limit	30/50/100/480	24/7	150	•	•	•	•	•	•	•
Tortola, BVI	Nanny Cay Hotel & Marina	18 25 0 N	64 37 0 W	(284) 494-2512	11'	160'	45'	no limit	110v 30amp/220v 50amp/ 3phase 100 amp	7am-6pm	70	•	•	•	•	•	•	•
Tortola, BVI	Soper's Hole	18° 23' 46"	-64° 41' 53"	(284) 495-3349	7'	65'	18' & 40'	no limit	110/220	8-5, Mon-Sat	45	•	•	•	•	•	•	•
Tortola, BVI	Tortola Yacht Services	18 25 N	64 37 W	(284)-494-2124	10'	68'	20'	no limit	220V, 50A, 110V, 30A	7-4, 7days	70	•	•	•	•	•	•	•
Virgin Gorda, BVI	Virgin Gorda Yacht Harbour	18.45222	-64.43750	284-495-5318	10	150	34	no limit	110/120	7am-6pm	70	•	•	•	•	•	•	•
Curaçao	Curacao Marine	12' N	68' W	599 9 562-8000	9'	120'	33'	193	110/220 380	8am-5pm	60	•	•	•	•	•	•	•
La Romana, D.R.	IBC Shipyard	18° 23' 55" N	68° 53' 55" W	+809 449 3321/3323	12'	110'	26'	no limit	110/220 3 phase 100/50/30' amp	8-5 M-F	120	•	•	•	•	•	•	•
Grenada	Clarks Court Boatyard & Marina	12° 00.6' N	061° 44.0' W	473-439-3939	11'	150'	37'	0	110/220; 50Hz	7:30am-4:30pm	242	•	•	•	•	•	•	•
Grenada	Grenada Marine	12° 01:20	61° 40:42	00-1-473-443-1667	12'	75'	31.5'	0	110/220	8-5, M-F, 8-12, Sat	70	•	•	•	•	•	•	•
Grenada	Spice Island Marine Services	12.041 N	61.45 W	473-444-4257	12'	70'	25.4'	0	110/220	8-4 M-F	70	•	•	•	•	•	•	•
Panama	Bocas Yacht Services	09° 17.3' N	082° 23.06 W	507-6619-5601	10'	65'	20'	no limit	120/220	7:30-3:30pm	60	•	•	•	•	•	•	•
Panama	Shelter Bay Marina	09° 22' 12" N	79° 56' 51" W	507-6813-5327	11'	100'	28'	no limit	60 HZ, 120/240V 50-Amp, 100 Amp Single Phase, 208V and 480V Tri Phase	24x7	100	•	•	•	•	•	•	•
Puerto Rico	Varadero @ Palmas	18 04' 37" N	65 47' 57" W	787-656-9211	11'	110'	26'	no limit	50/30 amp	8-5, 7days	110	•	•	•	•	•	•	•
Puerto Rico	Puerto Del Rey Marina	18° 17.3 N	65° 38 W	787-860-1000	15'	150'	33	no limit	120/208V single & 3 phase; 30, 50, 100 & 200 amps; 60 Hz	8am-5pm	155	•	•	•	•	•	•	•
Sint Maarten	Megayard	18°02' 13.24 N	63°05' 08.52 W	1-721-5444-060	12'	200'	33'	12'	110/220	8-5 M-F	150	•	•	•	•	•	•	•
St. Lucia	Rodney Bay Marina <small>an IGY destination</small>	14°04 '32.72" N	60°56 '55.63" W	758-458-7200	11'	75'	28'	no limit	120V- 480V, 30/50/100/125/200 amps at 60 Hz, 240V- 440V, 32/63/125 & 200 amps at 50Hz	8am-5pm	75	•	•	•	•	•	•	•
St. Croix, USVI	St. Croix Marine	17° - 45' N	64° - 42' W	340 773-0289	11'	68'	13'-8"	no limit	110v 30amp; 220v 50amp; 3 phase 100amp	8-4:30, Mon-Sat	40	•	•	•	•	•	•	•
St. Kitts	St. Kitts Marine Works	17° - 20.3' N	62° - 50.1' W	1-869-662-8930	12'	120'	35'	no limit	110/220/3 phase 100amp	7-4 M-F	150	•	•	•	•	•	•	•
St. Thomas, USVI	Subbase Drydock	18 N	65 W	340-776-2078	16.5'	190'	50'	no limit	440 three phase/220/110	8-5, Mon-Sat	1000	•	•	•	•	•	•	•
Trinidad	Peake Yacht Services Boatyard	10.4' N	61.38' W	868-634-4420/3/7	14'	130'	30.5'	no limit	110/220	8-4 Mon-Sat	150	•	•	•	•	•	•	•
Turks & Caicos	Caicos Marina & Shipyard	21.45.57N	72.10.47W	649-946-5600	9	150			30/50/110 amp	24x7	75	•	•	•	•	•	•	•

ASK ABOUT ADDING YOUR BOATYARD TO THE ALL AT SEA BOATYARD GUIDE **CONTACT ADVERTISING@ALLATSEA.NET**



Southeast U.S. Marinas

ALL AT SEA'S SOUTHEAST U.S. MARINAS GUIDE

					Maximum Draft	Maximum Length	# of Slips	Fresh Water	Electrical Supply	Cable / Satellite TV	Diesel	Gas	Shower / W/C	Laundry	Provisioning	Bar / Restaurant	Security	VHF Channel	Wireless Internet
Washington D.C. / MD	VA MD	National Harbor Marina www.igy-nationalharbor.com an IGY destination™	301-749-1582	Call	160'			●	30/50/100 single and 3 phase	●	●	●	●	●	●	●	●	71/16	●
Beaufort	NC	Jarrett Bay Boatworks	252-728-7100	10'	135'	30		●	30/50/100 Amp		●	●						16	FREE
Fort Pierce	FL	Fort Pierce City Marina	772-464-1245	7'	150'	240		●	30/50/100 Amp		●	●	●	●	●	●	●	16/78	FREE
Miami Beach	FL	One Island Park www.igy-miami.com an IGY destination™	754-701-4020	40'	150-800'	8		●	100 single & 3 phase/ 200/480/600 Amp	●	●		●	●				11/16	FREE
Marathon	FL	Marlin Bay Yacht Club www.marlinbay.com/marina	305-731-2207	7'	60'	28		●	30/50 Amp				●					16	FREE
St Petersburg	FL	Maximo Marina & Boatyard www.igy-maximomarina.com an IGY destination™	727-867-1102	8'	110'	300		●	30/50/100 single phase	●	●	●	●					6/16	FREE

ASK ABOUT ADDING YOUR MARINA TO THE ALL AT SEA MARINA GUIDE **CONTACT ADVERTISING@ALLATSEA.NET**

Southeast U.S. Boatyards

ALL AT SEA'S SOUTHEAST U.S. BOATYARDS GUIDE

					Maximum Draft	Maximum Length	Maximum Beam	Maximum Air Draft	Power	Arrival Hours	Lift Type/Capacity	DIY Friendly	Electronic Shop	Carpentry Shop	Electrical Shop	Prop Shop	Paint Shop	Onsite Crew Facility
Beaufort	NC	Jarrett Bay Boatworks	252-728-2690	10'	130'	30'		no limit	30/50/100 Amp	24x7	50/75/200 ton travelift	●	●	●	●	●	●	
Thunderbolt	GA	Thunderbolt Marine Inc.	912-352-4931	14'	180'	36'		no limit	30/50/100 single and 3 phase	24x7	150 ton travelift/ 1150 ton Syncrolift	●	●	●	●	●	●	
Key Largo	FL	Catamaran Boatyard & Storage	305.852.2025	5'	80'	27'4"			220V, 100 Amp	M-F	80 tons		●	●	●	●		
Fort Lauderdale	FL	Bradford Marine Inc.	954-791-3800	11'	180'	35'	55'		208v/240v/480v	24/7	300 ton Syncrolift	●	●	●	●	●	●	
Fort Lauderdale	FL	Cable Marine (1517 SE 16 St Location)	954-462-2822	6'	60'	16.5	25'		110/240	8-4:30	40 ton			●	●		●	
Fort Lauderdale	FL	Cable Marine (2491 W State Rd 84 Location)	954-587-4000	9'	120'	22		no limit	120/50/100 Amp	24/7	100 straddle crane			●	●		●	
St. Petersburg	FL	Progressive Marine Service/Boat Yard	727-822-2886	10'	100'	26'		no limit	50 Amp	8-4:30 M-F; Sa-Su by app't.	40/94 ton travelift		●	●	●	●	●	●
St. Petersburg	FL	Maximo Marina & Boatyard www.igy-maximomarina.com/ boatyard an IGY destination™	727-867-1102	8'	62'	18'		no limit	Outboard, I/O, Inboard	8am M-F	50 ton travelift		●	●	●	●	●	●
Gulf Shores	AL	Saunders Yachtworks	251-981-3700	10'	130'	28'	74'		30/50/100 Amp 3 phase	24x7	165 ton travelift		●	●	●	●	●	
Mobile	AL	Dog River Marina	251-471-5449	8'	85'	22.5'	75'		30/50/100 Amp 3 phase	24x7	70 ton travelift		●	●	●	●	●	
Orange Beach	AL	Saunders Yachtworks	251-981-3700	6'	85'	21.5'		no limit	30/50 Amp	7-5 M-F/ Sa-Su by app't.	60 ton travelift		●	●	●	●	●	

ASK ABOUT ADDING YOUR BOATYARD TO THE ALL AT SEA BOATYARD GUIDE **CONTACT ADVERTISING@ALLATSEA.NET**



"The Informative Brokers"

YOU HAVE THE BOATS, WE HAVE THE BUYERS!



2016 Nautitech 40 Open
Spacious Modern Cat
Tortola, BVI
USD \$280,000



2016 Beneteau 60
3 Cabin Owners Version
Antigua
USD \$599,000



1985 Cape George 36
Cutter. Round the World
Ready. Soon to be in BVI,
Dominica. USD \$129,000



2017 World Cat 320 CC
Ideal Island Hopper
St Thomas, USVI
USD \$230,000



2017 Custom Ramcat
Fast Day Cruiser
Mustique Island
USD \$125,000



1981 Dyer 29 Hardtop
Classic Lobster Boat
St Thomas, USVI
USD \$79,000



1988 Contest 38 S
Strong Short Handed Yacht
Actively Cruising, Antigua
& Barbuda. USD \$77,500



1987 Warwick 46
Performance Cruiser
St. John's, Antigua &
Barbuda. USD \$175,000



2006 Hallberg-Rassy 53
Premier Offshore Voyage
Tortola, BVI
USD \$629,000



2014 Dufour 335 Grand
Large. Fully Rebuilt
Nanny Cay, BVI
USD \$65,000



2007 Jeanneau Sun
Odyssey 39 DS
Modern Simply Cruiser
Tortola, BVI. USD \$89,000



2000 Jeanneau Sun
Odyssey 45.2. Loaded &
Ready. Nanny Cay, BVI.
USD \$119,000



2004 Glacier Bay 3470
Ocean Runner
Comfortable Cruiser
Tortola, BVI. USD \$279,000



2016 Jeanneau Sun
Odyssey 479
Davits, Solar, and More
Tortola, BVI. USD \$239,000



1981 Westsail 43
Fully Outfitted Voyager
Trinidad
USD \$139,000



2023 Fountaine
Pajot Isla 40
3 Cabin Owners Version
Tortola, BVI. USD \$729,000



1967 Breaux Breaux's Bay
Craft Inc. Custom Dive Boat
Efficient Day Tour Boat
Tortola, BVI. USD \$140,000



2000 Zodiac 633
Hurricane. New Tubes,
Fast. St Thomas, USVI
USD \$79,000



1990 Island Packet 38
New Chainplates
Nanny Cay, BVI
USD \$119,000



1986 Hinterhoeller
Niagara 35
Well Kept & Clean
Cruising, BVI. USD \$59,000



1985 Cookson Frers
Kevlar/Carbon Custom 43
Fast CSA Racer
Chaguaramas. USD \$79,500



1989 Nautor Swan 61
Ocean Greyhound
Nanny Cay, BVI
USD \$479,000



1913 Wright and Harris
Gaff Cutter. Save a Classic
Carriacou, Grenada
USD \$15,000



1999 Contender Open 23
Classic Runabout
Great Camino, BVI
USD \$69,000



2000 Nordlund Raised
Pilot House
Profitable Charter Trawler
BVI. USD \$995,000

FIND US ONLINE AT WWW.BVIYACHTSALES.COM | CALL US AT +1 (941) 900-4510



"The Informative Brokers"

Do you want to get the best possible sale of your boat, in the Caribbean?

BVI Yacht Sales are THE Caribbean yacht sales experts, selling more pre-owned boats in the region than any other brokerage, year after year!

Get all the knowledge and expertise of a brokerage working for you, in your best interest. A brokerage that has proven their trustworthiness, dedication, and dependability for over 40 years!

CONTACT US TODAY TO SELL YOUR BOAT!



1980 Bruno & Stillman Bruno 55
Strong, Classic and Powerful
475 hp CAT 3408T, Tortola, BVI.
USD \$260,000



1997 Island Packet 45
Modern Classic. Yanmar 4jh2-te
Puerto Rico
USD \$255,000



2018 Leopard 4800
4 cabin 4 head. Yanmar 4JH57
2000 hrs. Tortola, BVI
USD \$599,000

FIND US ONLINE AT WWW.BVIYACHTSALES.COM | CALL US AT +1 (941) 900-4510

VIRGIN ISLANDS

YACHT BROKERS

THE
Gold Standard
in Yacht Brokerage,
Professional
Experience You
Can RELY On

We are a company built by sailors for sailors, pure and simple we are not salespeople, all brokers at VIYB Ltd are professional mariners with extensive blue-water miles. If you are looking for guidance and support on your path to become a successful yacht owner with no high pressure sales tactics, we would be happy to help you achieve and exceed your goals and expectations.

- Highest levels of ethical standards and integrity
- A deep technical understanding in our specialised sector of the yacht market.
- Friendly and professional service.
- A growing network of regional locations focused in the Caribbean, Bahamas and East Coast USA.
- Professional documentation and closing department ensuring highly confidential and secure offshore yacht purchase transactions.

Meet the Team:



STEVE VARROW takes the natural progression to a professional yacht broker after spending the last 17 years in the Caribbean as a well known Charter skipper and RYA Instructor. His experience sailing, running and managing crewed yachts has given him a unique insight into the industry, he holds an RYA 200T Ocean license and is an RYA Instructor. He has 5 transatlantic catamaran deliveries as skipper and numerous European, Caribbean and East coast USA trips on his extensive sailing resume including 100,000+ miles of blue water experience, he has a deep technical understanding of all yacht mechanical, hydraulic, electrical and electronic systems and specializes in helping clients navigate through the path to become a yacht owner and owner operator in the charter yacht industry. **He is based between the London and the Caribbean and can be contacted by email Steve@virginislandsyachtbroker.com or phone +1 786 246 0809**

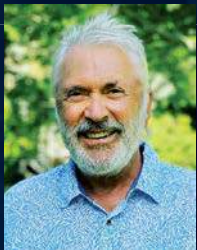

GEORGE DECSY started his life at sea with a brief spell in the Merchant Marine, learned the ropes sailing the busy waters of the English Channel, he has extensive transatlantic experience as well as thousands of miles logged US coastal waters, Caribbean and the Bahamas, he currently holds an MCA 200T Unlimited and 100T USCG license as well as being an IYT instructor and examiner. Licensed and bonded by the state of Florida as a Yacht Broker, whether you are a seller or looking for your next adventure he is ready to handle your transaction with a professional touch. His specialist fields are classic monohulls and performance cruisers. **He is based out of the Fort Lauderdale office and can be contacted by email George@virginislandsyachtbroker.com or phone +1 954 909 3536**



CHRISTIAAN LIEBENBERG grew up in a small surf town called Jeffreys Bay in South Africa. Having sailed more than 100,000 NM around the world delivering, running, and managing Luxury Catamarans and Monohulls anywhere from 30 feet to 150 feet. Living aboard in the Caribbean, Mediterranean, and the Bahamas for the past 12 years providing memorable experiences for his guests. His experience has created a vast knowledge of live-aboard yachts and the equipment needed to make life a pleasure at sea. Having worked alongside the builders of Lagoon in Bordeaux and La Rochelle, France, he has the understanding of what goes into creating a safe and comfortable vessel. **He is based out of the Wilmington, North Carolina office and can be contacted by email Christiaan@virginislandsyachtbroker.com or phone +1 954 257 6567**



GLEN HURD is a Canadian born, American expat who has been based out of the Virgin Islands as a professional USCG Master Captain for 25 years, and calls his world circumnavigating sailing yacht home. Extensive charter yacht management, design, refitting, and outfitting has developed exceptional insight and skill set with intimate knowledge of all boats systems, on a broad range of vessels from power to sail, including most major brands of catamarans from Lagoon, Leopard, Fountaine Pajot, Voyage, to Sunreef's. His diversity ensures an ability to understand and identify particular features and attributes that meet client's individualistic needs and desires. **He is based between the US Virgin Islands office and the Mediterranean, and may be contacted directly: glen@virginislandsyachtbroker.com or phone +1 340 474 1759**

EXPERIENCE THE NEW WAY TO SELL YOUR YACHT



BODHISATTVA

Jeanneau 64 2018

A very special sailing yacht, designed with the live aboard circumnavigator in mind, full equipped and no expense spared, yachts of this pedigree dont come to market very often, now lying in the Beautiful BVI awaiting any inspection, close winded, stylish and comfortable on all tacks, dont miss her!

\$1,299,000 US

Lying West End, Tortola.



MAHASATTVA

Lagoon 620 2018

Award winning galley down Essence version of this 8pax luxury sailing catamaran, she can be a cash-flowing charter business or the ultimate floating home, can be purchased with charters booked for the 2024 season to the value of \$400,000, more details available on request.

\$2,195,000 US

Currently chartering in the USVI/BVI



SERENITY NOW

Lagoon 620 4 Cabin

The most sought after galley down version of this top of the line luxury performance catamaran by Lagoon, currently dry stored in the British Virgin Islands this beautiful boat has the potential to carry on cash-flowing as a crewed charter boat or the ultimate floating home! We can finance this boat! Call for details!

Price reduced to \$1,080,000 US

Lying Tortola, BVI.



LEOPARD 58 2019

Five Cabin Catamaran with cash-flowing charter business. Maintained since day one by owner and crew. The most successful Leopard 58 charter yacht in the USVI and BVI. Perfect business for someone who has either retired, sold their company, needs a tax write off and loves to sail. \$250,000-\$350,000 profit per year.

Price: Charter business is \$2,100,000 which includes our Leopard 58 worth \$1,600,000.

Lying US Virgin Islands



ADVENTURE

Near Perfection!

This massive custom-built 64' catamaran built by Squall Marine Intl is beautiful inside and out, with innovative engineering from top to bottom. Four (4) large suites plus 2 crew cabins. No detail was missed. She is pure luxury. Built for speed, the entire construction of the hulls and superstructures is in aluminum.

Price: \$1,850,000

Lying St. Thomas



KITE RUNNER

Lagoon 42 2019

3 cabin owners version brought over from England. Never chartered. Always maintained to the highest standards. 580 engine hours. Upgraded 57 HP engines, solar panels, wind generator, teak floor, helm surround, generator, water-maker, B&G navigation & radar, Code 55 sail, asymmetrical spinnaker, 2 TV's, etc.

Available for viewing between Antigua & the Bahamas. Handover in the Bahamas-May 2023.

Office Locations:

LONDON – International House, 10 Beaufort Court | Admirals Way, Canary Wharf, London E14 9XL

US VIRGIN ISLANDS – 6501 Red hook Plaza, Suite 210, St. Thomas, VI 00802

BRITISH VIRGIN ISLANDS – PO Box 3111 | Road Town, Tortola

FLORIDA – 1500 Cordova Rd, Suite 200 | Fort Lauderdale, FL 33316

NORTH CAROLINA – 105 Meares Street | Wilmington, NC 284012

www.virginislandsyachtbroker.com

+44 161 931 9070 | +1 786 246 0809 | info@virginislandsyachtbroker.com



INTRACOASTAL YACHT SALES

LITTLE RIVER

720 Hwy 17 - Suite 201, Little River, SC 29566
Office: 843-340-0080 | Fax: 888-566-5886



**1989 Hatteras 80
Cockpit Motor Yacht**

- Five Stateroom-
Five Head Layout
- 12V-92 Detroit Diesels
- Two Generators
- MUCH, MUCH More!

Asking \$500,000



Contact: CAPT DOUG FORD
843-340-0080 • DFord@IntracoastalYachtSales.com



Grove Yacht Sales

KAIZEN
2019 JEANNEAU 490
MIAMI, FL - \$479,000

*Low hours and ready to
cruise. Loaded including
washer/dryer*



ALMOST NEW: 2021 Jeanneau 349 – Miami - \$242,500
OCEAN CRUISER: 2019 Jeanneau 389 – Key West - \$265,000
DAY SAILOR: 2021 Jeanneau 319 – St. Pete - \$215,000
See other listings available by visiting our website

Grove Yacht Sales
www.groveyacht.com

Contact David: 305-781-2581 | david@groveyacht.com
OFFICES IN MIAMI, FT. LAUDERDALE, KEY WEST, & ST. PETE!



**"DINGO"
FOR SALE**



NEW PRICE!

Ker 11.3, 2005. 1st St. Maarten regatta 2016, 2nd St. Barth's, 1st Antigua 2018, 1st Grenada, ready to race with full wardrobe of near new sails, new engine, excellent condition after recent professional makeover, **NOW \$75K ONO.** All offers considered. Email: mr.chappo@gmail.com

**ON WATER EMERGENCIES
DIAL 767
(SOS ON PHONE PAD)**



**24 hours a day, 7 days a week
No matter what!**

VISAR is a non-profit, fully trained volunteer operated, organization that does not charge for their services.
Based in Tortola and Virgin Gorda.
Donate at:
www.visar.org



ATLAS YACHT SALES

AUTHORIZED DEALER FOR FLORIDA EAST COAST AND PUERTO RICO



LAGOON 46



LAGOON 42



JEANNEAU SUN ODYSSEY 380



JEANNEAU SUN ODYSSEY 410



JEANNEAU SUN ODYSSEY 440



JEANNEAU SUN ODYSSEY 490

MIAMI - FORT LAUDERDALE - SAINT AUGUSTINE - PUERTO RICO

WWW.ATLASYACHTSALES.COM

(305) 390-2999 | INFO@ATLASYACHTSALES.COM

Mandatory photo credit of Lagoons by Nicolas Claris

GOLD COAST YACHTS



SAILING MULTIHULLS

- Advanced Composites
- High Performance
- Commercial Day Charter
- Private Luxury Yachts

POWER MULTIHULLS

- Innovative Hulls & Layouts
- Commercial & Private
- Up to 104ft Length
- 100% Custom Designed!



NEW SERVICES

- Consultation & Inspections
- USCG Approved Plans
- Emergency Repairs
- Major Refit & Modifications



Gold Coast Yachts is the leader in custom composite multihulls with over 35 years of innovation and quality. We have built over 135 custom multihulls in the US Virgin Islands, which offer their owners decades of service.

FOR SALE



Commercial cargo boat with a ramp, built in 1984.

Monohull steel and superstructure aluminum, size 24.90 x 7.60 meters. French flag bureau Veritas.

Engine 2 x 350CV CUMMINS type NTA 855M, speed 10 nautical knots and consumption 17 gal/h.

PRICE \$360,000

CONTACT: TI-COLIS@ORANGE.FR

ALL AT SEA Brokerage/Classified Order Form

TO PLACE A CLASSIFIED AD, PLEASE SUBMIT THE FOLLOWING INFORMATION:



BROKERAGE CATEGORIES:

- | | | |
|-----------------------------------|---------------------------------------|--------------------------------------|
| <input type="checkbox"/> Charter | <input type="checkbox"/> Dinghy | <input type="checkbox"/> Powerboat |
| <input type="checkbox"/> Sailboat | <input type="checkbox"/> Boat Sharing | <input type="checkbox"/> Boat Wanted |

CLASSIFIED CATEGORIES:

- | | |
|--|--|
| <input type="checkbox"/> Boat Gear/Parts | <input type="checkbox"/> Business Opportunity |
| <input type="checkbox"/> Dock Space | <input type="checkbox"/> Employment Opportunity |
| <input type="checkbox"/> Personal | <input type="checkbox"/> Real Estate <input type="checkbox"/> Services |

Ad Copy: _____

We accept payment by cash, check or:  

Account #: _____

Exp: ____ / ____ Security Code (back of card): _____

Name on Card: _____

Phone: _____

Billing Address: _____

City: _____ State: _____ Zip: _____

Email Address: _____

1-40 words: \$35 per issue OR 40-80 words: \$70 per issue

Photos are the SIZZLE THAT SELLS

Add a picture for only \$15 more per issue!

(All high resolution images must be emailed to advertising@allatsea.net)

DEADLINE IS THE 1ST OF THE MONTH PRIOR

Payment must be received before placement

Complete this form and mail to: **ALL AT SEA, 382 NE 191st Street #32381, Miami, Florida 33179-3899**
 OR Fax this form to: **(815) 377-3831**



COPPERCOAT

The 10+ Year Anti-Fouling Bottom Paint®



Available around the world for 34 years

Legal everywhere, even California and New Zealand

To get Coppercoat throughout the Caribbean, contact:

www.coppercoatusa.com
321-514-9197

COPPERCOAT APPLICATORS IN THE CARIBBEAN

BVI

BVI painters 284-494-4365

B&G Marine 284-245-2656

Grenada

Driftwood Ltd 473-459-9859

Panama

Shelter Bay Marina 507-443-3581

Stocking Dealer in BVI

BVI Speed Services 284-494-2405



COMPLETE SOLUTIONS FROM A TRUSTED MANUFACTURER



With Northern Lights generators YES! You can have it all

High Reliability, Amazing Durability and Maintenance Simplicity combine to ensure your onboard power requirements are always met. Coupled with super-silent capability and a region-wide Caribbean service network, it's easy to see why with Northern Lights generators, yes, you can have it all.

- Antigua**
Marine Power Services
268-460-1850
- British Virgin Islands**
CRC Engines & Fabricating
284-499-7128
Marine Maintenance Services Ltd.
284-542-2413
tim@mmsvg.com
- Curaçao**
MRC
+5999-738-1700
- Grenada**
Grenada Marine
473-443-1667
Palm Tree Marine
473-443-7256
- Guadaloupe**
Fred Marine
+590-590-907-137
- Martinique**
Inboard Diesel Service
+596-596-787-196

- St Lucia**
Marintek
758-450-0552
- St Maarten**
Electec, NV
+1-721-544-2051
- St Martin**
Caraibes Diesel Services
+590-590-870-373
- Trinidad**
Dockyard Electrics Ltd
868-634-4272
LP Marine & Industrial Supplies
+868-632-3441
info@lpmarinett.com
- US Virgin Islands**
Import Supply
340-774-1679
Coral Bay Marine
340-776-6665

CARIBBEAN-WIDE DEALER NETWORK
www.CaribbeanNorthernLights.com
284-494-2830 info@partsandpower.com





MARINE TRAVELIFT®

A global reputation for safe boat handling and exceptional performance.

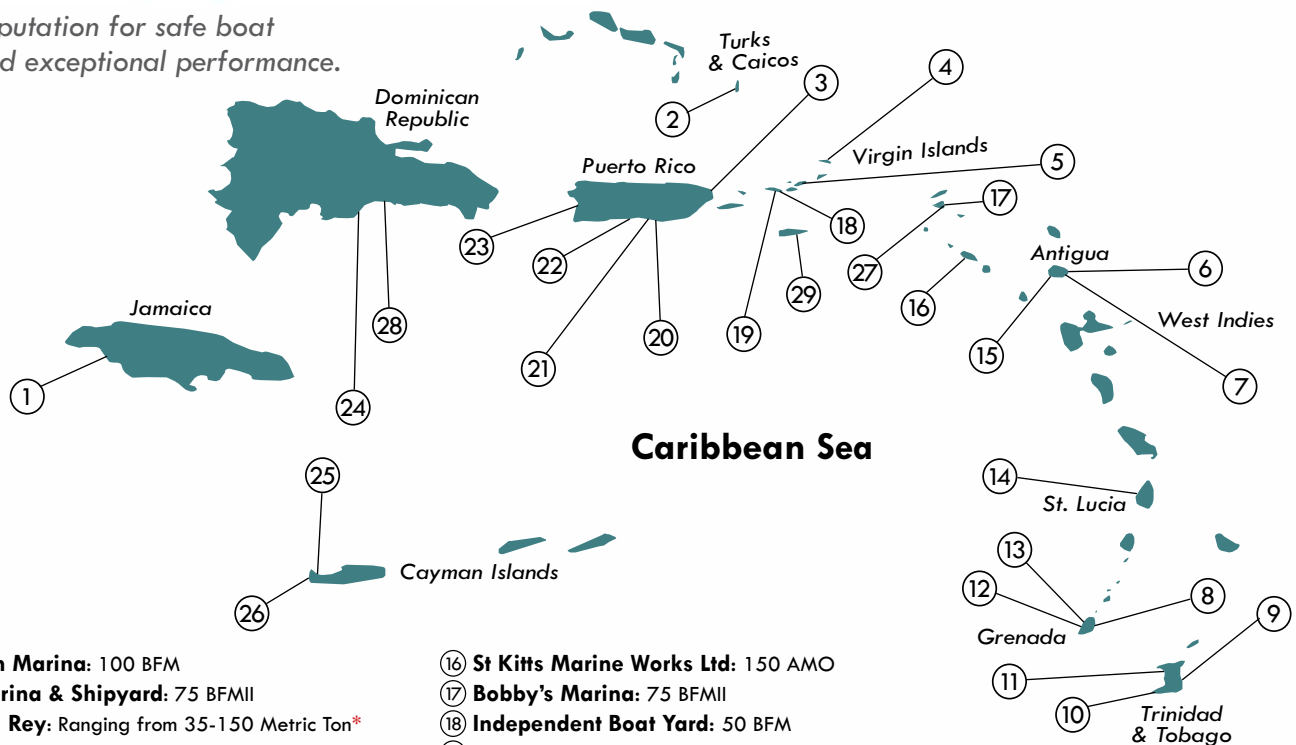

Caribbean Sea

- ① **Errol Flynn Marina:** 100 BFM
- ② **Caicos Marina & Shipyard:** 75 BFMII
- ③ **Puerto Del Rey:** Ranging from 35-150 Metric Ton*
- ④ **Virgin Gorda Yacht Services:** 70 BFM, Inspection*
- ⑤ **Tortola Yacht Services Ltd:** 70/75 BFM, Inspection*
- ⑥ **Jolly Harbour Marina:** 75 BFMII, Inspection*
- ⑦ **Stanford Development:** 150 C
- ⑧ **Grenada Marine:** 60-70 BFM*
- ⑨ **Crews Inn:** 200 BFM
- ⑩ **Industrial Marine Services:** 70 BFM
- ⑪ **Peake Marine Ltd:** 150 AMO
- ⑫ **Spice Island Marine Service:** 70 BFM*
- ⑬ **Carriacou Development Corp:** 150 AMO
- ⑭ **Rodney Bay Marina:** 70 BFMII
- ⑮ **Hugh Bailey's Boat Yard:** 70 BFM
- ⑯ **St Kitts Marine Works Ltd:** 150 AMO
- ⑰ **Bobby's Marina:** 75 BFMII
- ⑱ **Independent Boat Yard:** 50 BFM
- ⑲ **Nanny Cay Marina:** 70 BFM*
- ⑳ **Plaza Del Varadero Shipyard:** 100 BFMII
- ㉑ **San Juan Bay Marina:** 60 BFM*
- ㉒ **Ponce Yacht Club:** 70 BFM*
- ㉓ **Villa Marina Yacht Harbour:** 70 BFM
- ㉔ **Club Nautico De Santo Domingo Inc:** 100 BFMII & 70 BFM*
- ㉕ **The Barcadere:** 100 BFM
- ㉖ **Harbour House Marina:** 70 BFM/150 AMO
- ㉗ **Bobby's Megayard:** 150 C
- ㉘ **Marina Zar Par:** SL70
- ㉙ **St. Croix Marine:** 60 AMO/TM40*

*equipment inspected in 2022



MULTI AWNINGS

- Stretched Between Cap Shrouds, Mast & Headstay
- Hoisted with Spinnaker Halyard
- Sewn with Gore Tex Thread
- 8-Year Warranty

SERIOUS SAILING EQUIPMENT
1 800 874 3671 | atninc@hotmail.com
www.atninc.com

FAJARDO CANVAS & SAIL

Full Service Sail Loft
Custom Canvas
Cushions & Enclosures
Shade Sails & Awnings

(787) 863-3761
Villa Marina, Fajardo, PR
fajardocanvasandsail@gmail.com

FREE

Kayak, SUP, Sail, Fish, Snorkel, Bike
++ Eco Tours, Learn to Sail & Dive
[Key Largo Cottages.com](http://KeyLargoCottages.com)
FLORIDA KEYS
Call 305-451-3438

BEST VACATION EVER

STRIKE MARINE
— SALVAGE SALES, INC. —

GENUINE PARTS,
COMPETITIVE PRICES

BUYS and SELLS
New, Used, Surplus, and
Rebuilt Marine Diesel:
ENGINES
TRANSMISSIONS
GENERATORS
PROPELLERS
ANY YACHT RELATED PARTS

3635 SW 30th Ave.
Fort Lauderdale, FL 33312
Phone: 954 584 6544
www.marinesalvagesale.com
bs@marinesalvagesale.com

Every Mack Sail Is *Proudly Made* in our Stuart, Florida, Sail Loft

Our 47th Year

*See us at
The Annapolis
Boat Show
Booth K11*

Bristol 47 Project

Our rigging department converted this Hood roller furling mast to a new Schaefer Gamma boom on this Bristol 47 that is currently cruising in the BVI's. Our riggers also built new rod rigging and upgraded all the wiring and new light fixtures to LED. Our sail loft built a new full batten main & code 0 as well as a furling genoa to fit the existing Harken furler. Our extensive experience with off shore cruising boats and furling booms has provided our customers with a great-integrated system.

Photo: Starboard Films

MACK SAILS
The Biggest Small Loft in the USA
Call 800-428-1384
info@macksails.com · www.macksails.com

WE SHIP EVERYWHERE AND PAY THE FREIGHT OF NEW SAILS AND MACK PACKS.

ALL AT SEA

is printed only on **RECYCLABLE PAPER**
sourced from Sustainable Forests.

ALL AT SEA's printer and paper supplier comply with the requirements of recognized forest certification standards, such as FSC®, SFI®, PEFC and CSA Z809, and the wood fibre is not sourced from conflict timber or from controversial sources.

**LOVE OUR PLANET.
DO YOUR PART!**

Pass along the love to another reader OR recycle the magazine when done



HORIZON YACHTS INTERNATIONAL

YACHT BROKERS

ST LUCIA - GRENADA - ST VINCENT

gary@horizongrenada.com

1 (473) 415 0431

www.horizonyachtsgrenada.com

Horizon Yachts International is a small company with a big, global reach! Being small means you get a personal service throughout the process of buying or selling your yacht. Having a global reach means your yacht is seen by many. We offer an easy, stress-free experience with your financial security in mind, and you will be assisted throughout by a friendly, professional team with integrity. Why not get in touch with us today?

WELDING TEC GRENADA

Custom Marine Welding & Fabrication

- Top quality 316 stainless fabrication and repairs
- Davits, arches, pulpits, pushpits.
- Stanchions and safety rails
- Solar panel frames and arches, wind generator poles
- Chain plates, anchor rollers, fairleads and more
- Other metalwork fabrication and repairs

LOCATED AT CLARKE'S COURT MARINA & BOATYARD

EMAIL: INFO@WELDINGTECGRENADA.COM

Call: 1 (473) 232 7833

www.weldingtecgrenada.com

FIBER TEC
YACHT SERVICES

CLARKE'S COURT MARINA & BOATYARD

**Complete Boat Hull
Maintenance
& Repairs**
Now offering Sand & Wet
Blasting Services!



www.fibertecgrenada.com

info@fibertecgrenada.com

1 (473) 416 5574

TIME TO REPLACE YOUR MULTIHULL TRAMPOLINE?

- From France
- ATN Multihull Trampoline Netting
- High UV Resistance
- Racing or Cruising
- Custom Made or Factory Replacement
- Several Styles to Choose From

EMAIL FOR A QUOTE!



SERIOUS SAILING EQUIPMENT
1 800 874 3671 | atninc@hotmail.com
www.atninc.com



your source for **marine supplies** at low prices

Marine Safety Equipment
Yacht Chandlery and Supplies
Saltwater Fishing Tackle | Life Raft Sales and Service
Inflatable Boat Sales and Service | Marine Paints
Fire and Safety Equipment

2827 River Drive, Thunderbolt, GA 31404
912-354-7777 | toll free: 800-673-9391 | info@riverssi.com
www.riverssupply.com

TURBOCHARGERS !!!

And Water Cooled Elbows

- CAT
- IHI
- KKK
- MAN
- MTU
- EMD
- ABB
- Holset
- Volvo
- Rajay
- Toyota
- Garrett
- Yanmar
- Cummins
- Detroit Diesel
- Perkins
- Mitsubishi
- Schwitzer

Worldwide Service & Exchange Program - 1 Year Warranty

Ram Turbos Inc. **305-743-2920**
ramturbo@bellsouth.net

www.hydrovane.com

FEEL THE FREEDOM

With Hydrovane: Independent Self Steering Windvane AND Emergency Rudder



Jeanneau 50 43

- Your best crew: steers 24/7...
- Install with davits, swim step, etc.
- Steering catamarans too!



HYDROVANE
SINCE 1968

STEERING THE DREAM

www.FlopStopper.com

We built a better ~~mousetrap~~ flop stopper!



- ✓ Largest Resistance Platform (8.4 ft²)
- ✓ Fastest Engaging (dampens even 1" waves)
- ✓ Smallest Stow Size (10"x36"x4" tuck away)
- ✓ Fast & Easy to Deploy (<2 minutes)
- ✓ Clean & Durable (marine-grade aluminum)

Anchoring, Mooring, Drift Fishing. No more sleepless nights!

ESSENTIAL CRUISING EQUIPMENT



BOCAS MARINA
Everything you need in Paradise!
Reservations: www.bocasmarina.com



BOCAS YACHT SERVICES
60 Ton Travelift
Reservations: www.bocasboatyard.com or call (507) 757-9800

Bocas del Toro, Panama • www.bocasmarina.com • Ph: (507) 757-9800

BRIDGE OPENING TIMES - Dutch & French St. Martin

DUTCH SIDE -		FRENCH SIDE -	
Bridge Operator VHF Ch. 12		Bridge Operator VHF Ch. 16 / Tel: (590) 87 20 43	
SIMPSON BAY BRIDGE:			
Outbound	Inbound	Outbound & Inbound (Outbound Traffic proceeds Inbound Traffic)	
0830 hours	0930 hours	0900 hours	<i>Sundays & Public Holidays</i>
1030 hours	1130 hours	1430 hours	0900 hours
1600 hours	1500 hours	1730 hours	1730 hours
CAUSEWAY BRIDGE:			
Inbound & Outbound Traffic		1515 hours <i>On Call for In & Outbound traffic</i>	
0815 hours	0945 hours		
1015 hours	1145 hours		
1545 hours	1715 hours		

The above times are now in affect. After a period of three months, an assessment will follow to determine if changes need to be made or whether the bridge times will remain as published.



SECURE STORAGE FOR YOUR BOAT HAS NEVER BEEN SO EASY

SAIL LOFT & CANVAS REPAIR ON SITE

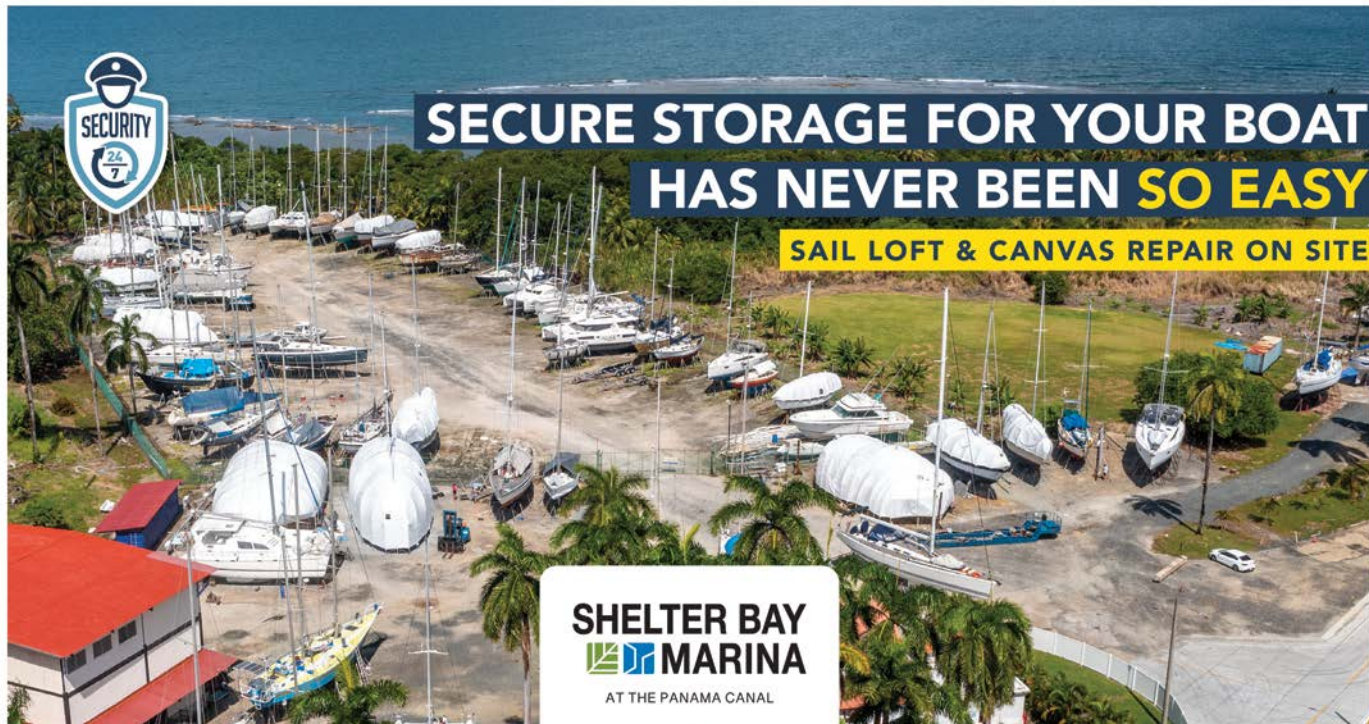

**SHELTER BAY
MARINA**
AT THE PANAMA CANAL

www.shelterbaymarina.com ☎ +507 433-3581 ☎ +507 6781-6631

BOAT YARD / CHANDLERY / FULL SERVICE MARINA / HOTEL - BAR- RESTAURANT

➔ **DOMETIC** **OUTDOOR**

MOVE UP TO QUIET EFFICIENCY



VOYAGER SERIES TX TURBO VARIABLE CAPACITY SELF-CONTAINED SYSTEM

Climate comfort is key to having a relaxing day on the water. With Dometic's Turbo Variable Capacity self-contained air-conditioner, you get a system that regulates compressor speed based on the cooling demand in your vessel. Once the boat has reached the desired set point, the compressor will run at a reduced speed. This results in a quiet operation, less power consumption, improved dehumidification and a constant temperature for ultimate comfort.

Located at Fish Bay, Tortola

www.partsandpower.com – info@partsandpower.com – 284-494-2830 – 284-440-2830



MIAMI PALM BEACH
FORT LAUDERDALE

AC COOL BOAT

954 504 2080

www.accoolboat.com

all labor **\$105** per hour

-  REFRIGERATION
-  AIR CONDITIONING
-  CHILLER SYSTEMS
-  WATER MAKERS
-  ELECTRICAL

ALWAYS
THE BEST SERVICE



SUPER DECK TANKS

DIESEL &
GASOLINE

Go
Further!

Fold
Up
Compact

Troll
Longer!

Tough
Tanks!

Beat the doldrums!

Ph Int: 617 5598 1959
US Toll Free: 1866 310 2992
Fax Int: 617 5598 1959
www.turtlepac.com

In St John:
USVI

High Speed Internet

Boat Charter Bookings

Phone, Fax Messaging

VHF Monitoring All Day

connections

CRUZ BAY
(340) 776-6922

CORAL BAY
(340) 779-4994

A SHORT WALK FROM BOTH DINGHY DOCKS

ATL
FUEL BLADDERS

**GOT
RANGE?**

TRAVEL FARTHER &
FISH HARDER!

ALSO IDEAL FOR
REFUELING
TENDERS & PWC!

MADE IN THE
USA

**ATL
FUELÖCKER**

- Rugged, Reliable, & Safe Auxiliary Fuel Bladders
- Available in 9 Standard Sizes, 25 to 500 Gallons
- Gas & Diesel Compatible, Simply Unfold & Fill
- Always In-Stock & Ready to Ship WORLDWIDE

BOATBLADDERS.COM

TOLL FREE:
800-526-5330

INT'L:
+1-201-825-1400

ATL

SPONSOR DIRECTORY: ALL AT SEA would like to thank its sponsors for their patronage and support. We encourage our readers to help keep us a community-focused, free publication by supporting our sponsors. Tell them you saw their company information or product in ALL AT SEA.

AC Cool Boat.....74	Dometic - Parts & Power.....73	KTI Systems, Inc.....29	Shelter Bay Marina Boatyard.....73
Aero Tec Laboratories74	Dominica Marine Center49	Lifeline Batteries, Inc.....35	Spice Island Marine Services21
ALEXSEAL37	Doyle Sails.....2-3	Mack Sails.....70	St. Croix Marine45
Antilles Power.....C2, 1	Edward William33	Marine Travelift69	St. Maarten Sails & Canvas NV.....75
Atlas Yacht Sales & Charters65	Electec8	Marine Warehouse41	St. Vincent Marine Center.....49
ATN Inc70, 72	Fajardo Canvas & Sail70	Northern Lights.....68	Strike Marine.....70
Ben's Yacht Services39	FlopStopper.....72	Offshore Marine.....17	Trinidad & Tobago.....5
Bocas Marina & Yacht Services.....72	Gold Coast Yachts66	Offshore Risk Management.....35, 45	TurtlePac74
Bonefish & Tarpon Trust.....C3	Golden Hind Chandlery31	Outdoor World.....27	Ullman Sails75
Budget Marine.....9, C4	Grenada Marine4	Outland Hatch Covers45	Ultra Yacht Refit.....49
BVI Yacht Sales.....60-61	Grove Yacht Sales64	Parts & Power.....31, 33, 68, 73	Varadero Marina & Boatyard Aruba.....41
Caribbean Marine Surveyors Ltd ..49	Horizon Yachts.....71	Peake Yacht Services23	VI Custom Refits.....70, 72
Caribbean Multihull Challenge15	Hydrovane.....72	PropGlide.....25	Virgin Gorda Yacht Harbour75
Caribe Marine19	Intracoastal Yacht Sales.....64	Quantum Sails75	Virgin Islands Yacht Brokers.....62-63
Christie's International Real Estate52-53	Island Marine, Inc.35	Ram Turbos Inc.....72	Visar64
Clean Exhaust Systems.....27	Island Marine Outfitters33	River Supply72	V-Kool39
Connections74	Island Surf & Sail39	Roodberg25	
CopperCoat68	Island Water World.....7	Sailrite.....67	
	Key Largo Cottages.com.....70	SeaHawk Paints.....11	

Business Opportunity

INVESTMENT OPPORTUNITY UNDER THE HURRICANE BELT. This sea tour company provider is located in the ABC islands and provides amazing trips to some beautiful places, including an unforgettable romantic sunset trip experience, snorkeling tours and private charters. An impressive catamaran will attract visitors on one of the most visited beaches on the island. This tour company has long-term contracts with many different cruise ship lines, & makes it easier to attract potential clients.

Possibility to book and pay online is a comfortable option for the client to plan the trip and furthermore some days in the next year are already sold out! An ideal investment under the hurricane belt.

Sales price Usd 595.000 includes:

- Catamaran
- Cruise ships contracts
- Selling point on the beach high traffic hotel area
- Trained staff
- Strong brand name recognition
- Resident permit
- Normalized EDBITA usd 150.000

If you are interested, please contact: lauracaribbean@gmail.com.

BIZ FOR SALE. Well established (20 years) and unique mobile catering business in Antigua for sale, fully equipped turnkey operation with low overheads, high profitability and a strong loyal customer base with plenty of scope for expansion. For details please contact catervan@hotmail.com

CELTIC POWERBOATS BASED ON TORTOLA IS FOR SALE AS OWNER/OPERATOR IS RETIRING. A very well established business which is rated #1 of 103 Outdoor Activities in the BVI on TripAdvisor. Business has huge potential for growth as trade license includes island tours, water taxi, and boat rentals. The sale includes a 2018 Worldcat 320CC powered by twin Yamaha's which is commercially licensed for 12 passengers and 2 crew. Website: celticboats.com Interested parties should email: celticboats@gmail.com

Employment

DREAM YACHT CHARTER- St. Thomas USVI base is hiring for ALL POSITIONS. For consideration, please forward resume to base.usvi@dreamyachtcharter.com



SAGE GROUP OF COMPANIES
*General Manager-
Virgin Gorda Yacht Harbour*

We are seeking an experienced hospitality industry professional to take a leadership role as part of our dynamic management team. The successful applicant for this position will become the General Manager of Virgin Gorda Yacht Harbour.

Responsibilities include: direct management of the day to day operations of the Marina, Shopping Centre, Town Centre buildings and Boatyard, ensuring the highest level of customer and employee satisfaction while maximizing profitability and efficiency. The applicant will be accountable for developing annual operating budgets, marketing plans and capital plans. Successful applicant will participate actively in the recruitment, training, development and leadership of all employees as well as providing feedback and assistance thus enabling them to achieve the highest standard of performance. A competitive compensation and benefits package is offered.

For more information and if you are interested in this challenging career opportunity, please forward a copy of your resume and cover letter quoting reference *OMVGYH BVI* by October 30,2022 to erichardson@bviinvestmentclub.com and bviic1992@gmail.com.

YACHT MANAGEMENT COMPANY BASED IN THE BVI IS LOOKING FOR A QUALIFIED MARINE SERVICE TECHNICIAN to join our team. Experience and training specifically in marine electronics and refrigeration would be preferred; as well as a good general working knowledge and ability to troubleshoot and work on marine sub systems and marine diesel engines and generators. Work references would be needed, and remuneration would be provided on application. Please make contact with Graeme on bridgraem@surbvi.com

FAST GROWING YACHT MANAGEMENT COMPANY IN GRENADA SEEKS QUALIFIED MARINE MECHANIC / TECHNICIAN. ABYC certification in

Employment

one or more of systems / marine diesel / marine electrical / AC refrigeration preferred. Applicant should also possess several years work experience in the marine industry. Preference will be given to applicants from OECS countries. A competitive remuneration package will be offered. Please apply with a detailed CV including education and qualifications, work experience and references to gary@honzongrenada.com

MARINE RETAIL SALES POSITION. Island Water World, a Caribbean retailer of boating supplies and marine leisure equipment, is seeking a knowledgeable sales person for our St. Maarten stores. Candidates must have some experience in boats and marine systems, retail sales and customer service experience, and good computer skills. Ability to speak French or Spanish a plus. This is a full time, year round position with growth potential. Email CV or resume to: info@islandwaterworld.com



QUANTUM SAILS Tortola, BVI

is looking for an experienced and professional sailmaker with at least 5 years in the sail making and repair industry.

RESPONSIBILITIES INCLUDE:
Building new sails; Repairing Dacron, Laminate and Nylon sails; Filling out work orders and accounts receivable; Maintenance of industrial sewing machines.

Please email resume and references to kwrigley@quantumsails.com

Employment

ULTRA YACHT REFIT LTD ANTIGUA IS LOOKING FOR MARINE JOINERS, TEAK DECKERS AND MARINE ENGINEERS. If you are looking for an opportunity to join a dynamic service oriented company please send your resume/information to: michael@ultrarefit.com



ST MAARTEN SAILS & CANVAS NV
We are looking for an experienced marine canvas fabricator to join our team. Offering full time employment for the coming Caribbean season 2019-2020. Candidate must be experienced with commercial sewing machines.

CONTACT:
Kzillmann@ullmansails.com
sxmsails@caribserve.net

For Sale

FOR SALE - 94 FT LORIMA CARBON FIBER rotating wing mast, with boom, full rig with Mainsail (3 reefs) & Genoa (Kevlar) and all rigging & hardware connections. Antigua: Contact Patrick Ryan pryan@brysonsgroup.com or Neil Keeling rendezvousantigua@gmail.com

FOR SALE: 2006 CORSAIR SPRINT 750 TRIMARAN. New Long shaft Tohatsu 9.8. New standing rigging. 2 Mainsails, 2 Jibs, 2 Spinnakers all in good condition. Trailer. Winner Corsair National's, BVI Spring Regatta and St. Croix International Regatta. In Tortola. \$45,000 OBO. Contact eddie@doylecaribbean.com or call 284 340 3385 for more details.

Insurance

MARINE INSURANCE

- Storms on the way - we can cover you
- Basic Liability - we can cover you
- Comprehensive policy - we can cover you
- Over 120 years experience - Worldwide specialists

Here at www.edwardwilliam.com - We have you covered



Some Like it Hot!

CARIBBEAN COOKING | BY CAP'N JAN ROBINSON

Some like it hot, others do not, so turn off the stove and prepare some fresh delicious dishes. Enjoy an awesome August!

BOW TIE PASTA WITH CHERRY TOMATOES, PEPPERS, AND BASIL

Prep time: 10 min. Serves: 4

- 4 cups cooked bow tie pasta**
- 4 cups halved cherry tomatoes (about 2 pints)**
- 1/3 cup thinly sliced basil**
- Red, yellow, or orange bell pepper, diced**
- 2 Tbsp. extra-virgin olive oil**
- 3/4 tsp. freshly ground Himalayan salt**
- 1/2 tsp. crushed red pepper**
- 1/4 tsp. freshly ground black pepper**
- 2 garlic cloves, minced**
- Red wine vinegar (optional)**

In a large bowl, combine first nine ingredients. Toss well. Serve into individual dishes and sprinkle with the red wine vinegar.

ONION AND TOMATO SALAD

Prep time: 10 min. Marinating time: 30 min. or longer. Serves: 4

- 2 large ripe tomatoes, sliced**
- 1 sweet white onion, thinly sliced**
- Fresh chopped herbs, oregano, basil**
- Apple Cider Vinegar**
- Olive oil**
- Salt and pepper**

Layer onions and tomatoes in flat shallow dish, sprinkle with sugar. Add herbs. Pour over a little vinegar and oil, sprinkle with salt and pepper.

SHREDDED CARROTS WITH CILANTRO AND FRESH LIME JUICE

Prep time: 10 min. Serves: 4

- 6 medium size carrots (about 1 lb)**
- 1/4 cup extra virgin olive oil**
- 3 Tbsp fresh lime juice**

Sea salt and freshly ground pepper

1/2 cup coarsely chopped fresh cilantro

OPTIONAL: Cooked shrimp

Peel and grate the carrots. Use either the large holes on a box grater or a medium fitting on a food process. Put the grated carrots in a large bowl. In a small bowl, whisk the oil and lime juice and season to taste with salt and pepper. Add the dressing and chopped cilantro to the carrots and toss.

CORN SALSA

Prep time: 10 min. Cooking time: 15 min.

Cooling time: 20 min. Makes: 4 cups

- 2 cups fresh corn kernels (from about 4 large ears corn)**
- 1 Tbsp. canola oil**
- 1 large onion, coarsely chopped (1 cup)**
- 1 large green or red sweet pepper, coarsely chopped (1 cup)**
- 1 fresh jalapeño pepper, seeded and finely chopped**
- 1 cup chopped, peeled tomatoes**
- 1/4 cup lime juice**
- 1/2 tsp. salt**
- 1/2 tsp. ground cumin**
- 1 tsp freshly ground black pepper**

Cook corn kernels in enough lightly salted boiling water to cover for 3 minutes or until tender; drain. Let cool. In a large saucepan, heat oil over medium-high heat. Add the onion, sweet pepper and jalapeño pepper. Cook until onion is tender but not brown. Stir in corn, tomatoes, lime- juice, salt, cumin, and black pepper. Cook and stir over medium heat until heated through. Let cool. Transfer to a storage container. *HINT: Serve or cover and chill up to 1 week. Serve with chicken, pork, beef, etc.*

Jan Robinson, Health Coach, Charter Yacht Consultant, CYBA Hall of Fame 2019, Chef Competition Coordinator/Judge, and author of the Ship to Shore Cookbook collection; available on Amazon or email CaptJan2@gmail.com

Where you fish, Bonefish & Tarpon Trust is at work.

Conserving habitat and protecting fisheries is what we're all about, so please join our network of anglers and sportsmen just like you. Make a donation to Nurture Belize or any of these programs and become a Bonefish & Tarpon Trust member.

Nurture Belize — protecting fishing areas from development and destruction

Florida Keys — working with guides/anglers to protect and improve fisheries for the future

Bahamas — flats and mangrove conservation

Project Permit — population study, what, when, and how they tick

Boca Grande, Florida — juvenile tarpon habitat restoration



BONEFISH & TARPON TRUST

To donate, join, learn more about us, or identify a project you'd like to be involved in, visit us on the web at www.bonefishtarpontrust.org or email us at info@tarbone.org.

Stock

Widest range of RIBS

LEADER

in the Caribbean

FIBERGLASS SINGLE FLOOR

2 MODELS 8'6" AND 10'2"



ALUMINUM DOUBLE FLOOR

9 MODELS FROM 8'2" TO 13'9"
WITH AND WITHOUT
BOW LOCKERS



**NEW MODELS
AVAILABLE**
10 and 12 footers
with Bow Lockers



ALL OUR MODELS
ARE BUILT-IN PENNEL
ORCA® 215 OR 820
HYPALON MATERIAL

FIBERGLASS DOUBLE FLOOR

7 MODELS FROM 9'8" TO 15'5" WITH
AND WITHOUT BOW LOCKERS



FOLDABLE RIBS

3 MODELS FROM 9'6" TO 12'5"



The Caribbean's
Leading Chandlery

Scan me to see
all products



ANTIGUA | ARUBA | BONAIRE | CARRIACOU
COLOMBIA | CURAÇAO | GRENADA | ST. KITTS
ST. MAARTEN | ST. THOMAS | TRINIDAD

www.budgetmarine.com