



SILENT AUCTION

AMOSKEAG
AUCTION COMPANY, INC.

AUCTION NO. 102
AUGUST 2, 2014

ECLIPSE NEAR SMOKELESS POWDER

SHOT GUN and METALLIC AMMUNITION and SMOKELESS POWDER
They SHOOT Further KICK LESS

AMOSKEAG AUGUST 2, 2014 - SALE NO. 102 - SILENT

TERMS AND CONDITIONS OF SALE

GENERAL STATEMENTS

- The Silent Auction is by absentee bidding only. Absentee bidders must register by filling out and signing an absentee bid sheet.
- The highest bidder acknowledged by the auctioneer shall become the owner upon the fall of the hammer. The auctioneer has sole discretion in the case of a dispute among bidders.
- Amoskeag Auction Company, Inc. has taken great care in the preparation of the descriptions in this catalog. Although we believe everything in the descriptions to be true, we do not guarantee any part of any description. We recommend that the bidders view the items in person and form their own opinions as to condition, originality, origin, etc. Amoskeag Auction Company, Inc. will consider all requests for refunds. If a customer is unhappy with a purchase we will be happy to discuss a remedy with them.
- Amoskeag Auction Company, Inc. reserves the right to reject any bid in order to protect our consignors interests.
- Bidding on any item in the sale indicates the bidder's full acceptance and understanding of all terms and conditions of sale.

PAYMENT POLICY

- Amoskeag Auction Company, Inc. will accept cash, check, MasterCard, Visa, and American Express as payment for items purchased by those customers who attend the sale. Amoskeag Auction Company, Inc. reserves the right to demand cash or hold merchandise until funds are collected in full. THERE WILL BE A \$35.00 CHARGE FOR ALL RETURNED CHECKS.
- There will be a Buyer's Premium of 17.5% added to all purchases. A discounted Buyer's Premium of 15% will apply to all purchases paid by cash or check.

GUIDELINES FOR FIREARM PURCHASES

- All Federal, State and Local firearms laws will be observed. FFL holders may take possession of any firearm on day of sale when they present a signed copy of their Federal Firearms License. New Hampshire residents over the age of 21 may take possession of any firearm on day of sale providing the proper paperwork is filled out and the transfer has been approved either through the NH State Police or the FBI NICS System. While most NICS and State approvals are immediate, approvals could take up to 3 days. Most non-residents may take possession of long guns on day of sale after completing the proper forms and successfully completing a NICS check; modern handguns will need to be shipped to an FFL holder in the buyer's home state. Buyer is responsible for any and all shipping charges and all items must be paid for on day of sale. Bidders should be familiar with their local and state laws.

Firearms are marked as follows:

ANTIQUE - no paperwork required

C&R - for firearms that fall under the ATF Curio & Relics licensing and if purchased by a person with a "C&R License" no paperwork is required. **NOTE:** Items that meet the age requirements but have been altered from their original configuration may NOT be delivered on a C&R License.

Firearms that are not marked with one of these notations are considered to be "MODERN" and all proper paperwork is required unless you are an FFL Dealer.

WARNING

Amoskeag Auction Company, Inc. **does not** warranty the safety of any article it sells. Therefore, we recommend that, before you use any firearm, purchased here or anywhere else, you have it examined by a qualified gunsmith to determine whether or not it is safe to use.

250 commercial street - suite 3011 - manchester, new hampshire 03101
603/627-7383 fax 603/627-7384 www.amoskeagauction.com
jason & melissa devine - nh license no. 2555

NOTE: ALL BIDS ARE DUE BY 2:00PM, AUGUST 2, 2014. IF YOU ARE BIDDING ON AN EXCESSIVE AMOUNT OF ITEMS WE REQUEST THAT YOU SUBMIT YOUR BID SHEETS BY FRIDAY, AUGUST 1, 2014.

RESULTS FOR THE SILENT AUCTION WILL BE AVAILABLE WEDNESDAY, AUGUST 6, 2014.

1100. **COLT MODEL 1903 DOUBLE ACTION REVOLVER** serial #266466, 32-20 Winchester, 6" barrel with an excellent bore. This 1906-manufactured, civilian version of the New Army revolver, retains about 55% of its original blue finish with most of the loss on the sides of the barrel and the grip frame. The areas of loss have worn to a light gunmetal gray with some scattered handling marks also visible. The hammer has traces of Nitre blue on the top with the remainder having worn to silver. The trigger retains most of its Nitre blue with the face worn to gunmetal gray. The hard rubber grips are not correctly numbered to the revolver and are of the Navy configuration with the word "Colt" in an oval. Overall, the grips are in very good to excellent condition with some of the wear to the diamond points on the right panel. All the appropriate parts except the grips have matching assembly numbers and the markings remain crisp. The revolver still times and locks up well and includes an unmarked flap holster. The holster shows some light crazing at the top of the flap with overall light handling wear. The seam is starting to separate at the top. (86617-1) {C&R} (250/450)
1101. **SMITH & WESSON MODEL 36 CHIEFS SPECIAL REVOLVER** serial #446813, 38 Special, 1 7/8" pinned barrel with an excellent bore. This square butt J-frame revolver retains about 99% of its original blue finish with a turn ring on the cylinder and a few light handling blemishes. The case-hardened colors remain robust on the trigger and hammer with a few sparse operation marks. The checkered diamond centered walnut grips with S&W medallions are correctly numbered to the gun and are in near excellent condition with a few light handling marks noted. This is a fine example of a Chief's Special. (86229-223) [Elliott Riggs Collection]. (350/550)
1102. **SMITH & WESSON MODEL 36 CHIEFS SPECIAL REVOLVER** serial #J279037, 38 Special, 1 7/8" pinned barrel with an excellent bore. This square butt J-frame revolver retains about 97% of its original blue finish with light silvering of the high edges, faint scratches and a turn ring on the cylinder. The case-hardened colors remain full-bodied on the trigger and hammer with light operation and wear marks. The checkered walnut grips with S&W medallions are correctly numbered to the gun and are in very good to excellent condition with light flaking of the finish and handling wear observed. This is a fine paradigm of a Chief's Special. (86229-328) [Elliott Riggs Collection]. (350/550)
1103. **SMITH & WESSON MODEL 36 CHIEFS SPECIAL REVOLVER** serial #AFW5411, 38 Special, 1 7/8" barrel with an excellent bore. This round butt J-frame revolver retains about 99% of its original blue finish with a faint turn ring on the cylinder. The case-hardened colors remain vigorous on the smooth combat trigger and standard hammer. The unnumbered checkered walnut grips with S&W medallions are in like new condition. This Chief's Special has seen very little use in its life cycle. (86229-221) [Elliott Riggs Collection]. (350/550)
1104. **SMITH & WESSON MODEL 60 CHIEFS SPECIAL REVOLVER** serial #ADA1356, 38 Special, 1 7/8" barrel with an excellent bore. The stainless steel surfaces on this round butt J-frame revolver rate about 99% with a faint turn ring visible on the cylinder. The hard chrome finish on the smooth combat trigger and standard hammer are in excellent condition. The unnumbered checkered walnut grips with S&W medallions are in like new condition. This little revolver has seen little if any use and is a nice crisp example of Chief's Special. (86229-202) [Elliott Riggs Collection]. (350/550)
1105. **U.S. NAVY VICTORY MODEL REVOLVER BY SMITH & WESSON**, serial #V102814, 38 Special, 4" pinned barrel with an excellent bore. This revolver retains about 97% of its re-applied Parkerized finish with scattered light dents and dings visible under the finish. The current finish is worn on the high edges, has some light handling and holster wear with a faint turn ring on the cylinder and light oxidation blemish on the sideplate. The case-hardened colors on the hammer and trigger remain rich with light operational wear. The incorrectly numbered walnut grips rate near excellent with light handling marks especially around the butt. All appropriate parts have correct matching numbers and the revolver is equipped with a lanyard ring. The top left side of the topstrap is marked: "U.S. NAVY" but no other marks appear. (86520-2509) {C&R} [Richard "Stretch" Kennedy Collection]. (350/550)
1106. **SMITH & WESSON MODEL 439 SEMI-AUTO PISTOL** serial #A723179, 9mm, 4 1/8" barrel with an excellent bore. The pistol retains about 99% of its nickel finish with some light freckling around the end of the slide. The checkered walnut grips are in near excellent condition with light handling wear but the S&W medallion on the right grip panel rotates in its setting. The pistol is equipped with a blued adjustable rear sight with protective ears and nickelled ramp front sight. Included is a single blued magazine. (86520-256) [Richard "Stretch" Kennedy Collection]. (350/550)
1107. **RUGER NEW MODEL BISLEY SINGLE SIX REVOLVER** serial #262-14623, 22 S, L, LR, 6 1/2" barrel with an excellent bore. This revolver retains 99% plus of its original blue finish and the lightly polished stainless steel grip frame remains in excellent condition with a faint turn ring on the cylinder. The smooth walnut grips with black Ruger Phoenix are in like new condition. This revolver features drift adjustable rear sight and under-cut front sight. Included are a hinged factory box, manual and paperwork. The contrasting grip frame gives this near-new revolver a striking image. (86520-2954) [Richard "Stretch" Kennedy Collection]. (350/550)
1108. **COLT 32 POLICE POSITIVE MODEL REVOLVER** serial #202797, 32 Police, 2 1/2" barrel with an excellent bore. This 1924-manufacture Police Positive retains about 95% of its original blue finish with scattered oxidation blemishes on the metal surface and a light cylinder turn ring present. The aftermarket checkered walnut grips by Sile are in excellent condition with faint handling wear. This revolver features a square butt grip frame. (86520-4061) {C&R} [Richard "Stretch" Kennedy Collection]. (350/550)
1109. **SMITH & WESSON 32 HAND EJECTOR 1ST MODEL DOUBLE ACTION REVOLVER** serial #7220, 32 S&W, 3 1/4" barrel with a lightly pitted bore. This Model of 1896 revolver retains about 99% re-applied nickel finish with a turn ring on the cylinder and some scattered light scratches the only blemishes observed. The hammer retains strong case-hardened colors with some light operational wear but the trigger has worn to a predominant silver color. The diamond centered checkered hard rubber factory grips are in very good condition with some light handling wear but the right panel has a hairline crack radiating from the escutcheon toward both edges on the back of the panel. All appropriate parts are correctly numbered to the revolver but the grips are not. (86520-452) {C&R} [Richard "Stretch" Kennedy Collection]. (350/550)



1110. **CUSTOM HIGH-STANDARD MODEL C SEMI-AUTO PISTOL** serial #728, 22 Short, 7 1/4" barrel with an excellent bore. This pistol retains about 95% of its original and re-applied blue finishes with most of the loss on the backstrap from handling with additional high edge and handling wear observed. The replacement barrel has drifted to a plumb color and the frame may have possibly been re-blued to finish the cut checkering on the front strap. The top of the barrel is cross hatch checkered with a custom Patridge front sight installed into the barrel and held with screws. The front strap is checkered with a small raised banner left for the serial number. The home-made walnut thumbrest grips are in near excellent condition with light handling marks present. The checkering on the right panel is quite well done and it features a palm and finger rest. The right panel extends about 3/4" below the frame. The left panel is flush with the bottom of the frame to allow access to the single provided magazine and is smooth with a pronounced thumb rest. There is no indication who may have done the work to the pistol. (86520-2933) [Richard "Stretch" Kennedy Collection]. (350/550)
1111. **WINCHESTER MODEL 100 SEMI-AUTO RIFLE** serial #165558, 308 Win, 22" barrel with an excellent bore. The metal surfaces retain about 99% of the original blue that has a few very light handling marks. The basketweave pattern checkered walnut stock rates excellent and has a few light ding and light scratches. The original swivels are intact and the stock is equipped with a red "W" pistolgrip cap. The rifle is equipped with the original sights, the front sight hood is missing, and the receiver has a Weaver base and 1" rings mounted to it. A single convex base magazine is included. A great 1967 vintage sporting rifle in excellent condition overall. (46642-41). (350/550)



1112. **SIG ARMS SHR 970 SYNTHETIC BOLT ACTION RIFLE** serial #R11086, 30-06, 22" barrel with a bright excellent bore. Metal surfaces retain 99% plus original blue finish. The checkered pistolgrip black synthetic stock rates excellent with no visual marks anywhere. Included with this like-new rifle is the original black plastic factory hard case and tool kit. (156520-536) [Richard "Stretch" Kennedy Collection]. (350/550)

1113. **SMITH AND WESSON MODEL 10 DOUBLE ACTION REVOLVER** serial #C459737, 38 Special, 4" pinned barrel with a bright excellent bore. The metal surfaces retain 99% original blue finish with a faint turn ring on the cylinder. This 4-screw square butt has a color case-hardened finished magna-trigger and standard hammer which rates excellent. The diamond checkered walnut grips with silver Smith and Wesson medallions rate excellent as well with a couple of very minor handling marks. The original two-piece box with matching end label is included. An overall excellent condition Smith and Wesson Model 10. (156624-14). (350/550)
1114. **SMITH AND WESSON MODEL 669 SEMI-AUTO PISTOL** serial #TAH7881, 9mm, 3 1/2" barrel with a bright excellent bore. The stainless steel surfaces rate excellent with the exception of some very light handling marks. The black Delrin molded grips rate excellent with no visual blemishes. This pistol is equipped with a red post front sight and white outline rear sight. An overall excellent condition Model 669. (6706-1) (350/550)

1115. **SMITH AND WESSON MODEL 63 22/32 KIT GUN REVOLVER** serial #M152356, 22 LR, 4" barrel with a bright excellent bore. The stainless steel surfaces are in excellent condition with no visible handling marks. The checkered walnut stocks rate excellent with no visual blemishes. This revolver features a hard chromed magna trigger and standard hammer as well as a black adjustable rear sight and red ramp front sight. The original two-piece box with correct end label, tool kit and original paperwork are included. (156683-27). (350/550)



1116. **KIMBER OF AMERICA MODEL 98 SPORTER BOLT ACTION RIFLE** serial #7264Z4, 7mm Remington Magnum, 25" barrel with an excellent, bright bore. The stainless steel match grade fluted barrel rates very good plus overall, with a few scattered light scratches and other minor wear present. The receiver and triggerguard rate near excellent and have retained about 98% of their factory blue finish. The bright polished bolt assembly rates very good but exhibits moderate pinprick pitting, with the action being somewhat stiff at times. The checkered black fiberglass Monte Carlo stock rates very good overall, but does exhibit light handling marks and some minor nicks. Full panel checkering largely remains crisp on both the buttstock and forend, but some areas have dulled due to handling. Rifle features installed scope rings, sling mounts, and a factory included recoil pad. (136610-9). (300/500)
1117. **COLT LAWMAN MK III DOUBLE ACTION REVOLVER** serial #04083U, 357 Magnum, 2" barrel with an excellent, bright bore. The frame and barrel both rate very good plus, although with much of their factory original nickel finish having become dull and faded, as well as exhibiting some minor light handling marks. The recessed cylinder also rates very good plus but is subject to the same dulled status and faint handling marks as the frame, with a bright turn ring also present. The trigger and hammer retain most of their nickel finish and display bright metal surfaces with negligible faint handling marks or wear. The factory original checkered walnut grips have since been replaced by a one-piece checkered black rubber grip by Pachmayr. The grip feels excellent and rates near excellent, with some minor wear from handling; featured on both sides of the grip is a golden medallion of the Colt logo. (136692-20). (300/500)
1118. **GLOCK 22 RTF2 GEN 3 SEMI-AUTO PISTOL** serial #NYM550, 40 S&W, 4 1/2" barrel with an excellent, bright bore. The barrel rates excellent and retains 98% of its factory original blued finish, showing extremely minimal light use-related wear at the chamber. The slide rates excellent and retains about 98% of its factory original blued finish with negligible faint handling marks. The black polymer frame rate excellent and exhibits no discernible instances of either handling or wear. The pistol features its original sights, integral accessory rail, a grip checkering texture and fish gill slide serrations factory exclusive to the RTF2 model. Included with the pistol are two 10 round magazines, manual, and factory original hardcase. (136695-1). (300/500)
1119. **GLOCK 23 GEN 3 SEMI-AUTO PISTOL** serial #G80010, 40 S&W, 4" barrel with an excellent, bright bore. The frame rates excellent and exhibits no discernible handling marks. The barrel and slide both feature a serial number non-matching to the frame. The barrel rates near excellent and retains about 95% of its factory original blued finish, but does exhibit some use-related wear. The slide rates near excellent and retains about 97% of its factory original matte blued finish, with some minor fading due to handling; the slide features initials along the right side which denote the pistol as having belonged to the Knox County Sheriff's Office. The pistol features its original sights and an integral accessory rail. Included is a single 13 round magazine. (136692-18). (300/500)

1120. **GLOCK 23 GEN 4 SEMI-AUTO PISTOL** serial #RKZ168, 40 S&W, 4" barrel with an excellent, bright bore. The frame rates excellent and exhibits no discernible handling marks. The barrel rates near excellent and retains about 96% of its factory original blued finish, but does exhibit some use-related wear. The slide rates near excellent and retains about 95% of its factory original matte blued finish, with some minor fading due to handling. The pistol features three-dot night sights and an integral accessory rail. Included is a single 13 round magazine. (136692-17). (300/500)
1121. **SMITH & WESSON MODEL 39-2 SEMI-AUTO PISTOL** serial #A588031, 9mm, 4" barrel with an excellent, bright bore. The barrel rates near excellent and retains about 95% of its factory original finish, although with some light use-related wear. The slide rates very good plus and retains about 97% of its factory original blued finish, with some instances of light handling marks and having acquired a slight purplish tint. The alloy frame rates excellent and retains about 98% of its factory original black finish. The checkered walnut grips rate excellent and exhibit negligible faint handling wear. The pistol features a front ramp and adjustable white outline rear sight, as well as a slide mounted decocker safety, and grip mounted lanyard loop. Included with the pistol are two 8 round blued magazines, cleaning kit, manual, and factory original box. (136683-26). (300/500)
1122. **SMITH & WESSON MODEL 66-3 DOUBLE ACTION REVOLVER** serial #BKV0412, 357 Magnum, 2 1/2" barrel with an excellent, bright bore. The stainless steel metal surfaces rate excellent, with negligible faint handling marks. The stainless steel fluted 6 round cylinder also rates excellent, exhibiting an extremely faint turn ring. The checkered black rubber Pachmayr "Gripper" one-piece grip rates very good but shows noticeable handling wear. The revolver features a red ramp front sight and adjustable rear sight. (136520-4145) [Richard "Stretch" Kennedy Collection]. (300/500)
1123. **COLT POLICE POSITIVE SPECIAL (THIRD ISSUE) DOUBLE ACTION REVOLVER** serial #883865, 38 Special, 4" barrel with an excellent, bright bore. The metal surfaces rate excellent and retain about 98% plus of their factory original blued finish, with negligible faint handling marks. The fluted 6 round cylinder rates excellent and retains about 98% plus of its factory original blued finish, with an extremely faint turn ring. The checkered walnut grips feature a silver type medallion of the Colt logo on both sides and rate excellent with minor instances of lightly flattened checkering. (136520-4136) [Richard "Stretch" Kennedy Collection]. (300/500)
1124. **SMITH & WESSON MODEL 14-3 DOUBLE ACTION REVOLVER** serial #6K8021, 38 Special, 8 3/8" pinned barrel with an excellent, bright bore. The metal surfaces rate near excellent and retain about 95% of their factory original blued finish, but do exhibit several light handling marks. The fluted 6 round cylinder rates excellent and retains about 97% of its factory original blued finish, with a faint turn ring. The factory case-hardened target trigger and hammer both rate excellent and retain 95% of their original finish, with some minor light handling marks and wear. The checkered walnut grips feature a golden medallion of the Smith & Wesson logo on both sides and rate excellent. The revolver features its original fixed front and adjustable rear sights. (136520-4143) [Richard "Stretch" Kennedy Collection]. (300/500)
1125. **SMITH & WESSON MODEL 60-10 CHIEF'S SPECIAL DOUBLE ACTION REVOLVER** serial #CBA4622, 357 Magnum, 3" full-lug barrel with an excellent, bright bore. The satin stainless steel metal surfaces rate excellent. The fluted 5 round satin stainless steel cylinder rates near excellent, with a faint turn ring and one of the leading edges of the cylinder having been lightly ground. The original checkered black rubber Uncle Mike's combat grips rate excellent. The revolver features its original black blade front sight and adjustable rear sight. Included with the revolver are the manual and papers, and factory original hardcase. (136520-4148) [Richard "Stretch" Kennedy Collection]. (350/550)
1126. **SMITH & WESSON MODEL 66-2 COMBAT MAGNUM DOUBLE ACTION REVOLVER** serial #AZB2661, 357 Mag, 4" barrel with a bright excellent bore. The satin stainless steel surfaces rate excellent with some very small handling marks on the K-size grip frame. Pachmayr presentation two piece rubber grips have been installed and are in as new condition. Factory white line adjustable rear and red ramp front sights are present. The gun has been fitted with a Magna Trigger safety device and will not function without corresponding Magna Ring which is not included. (166520-2021) [Richard "Stretch" Kennedy Collection]. (350/450)
1127. **REMINGTON MODEL 541THB BOLT ACTION RIFLE** serial #A1068053, 22LR, 27" heavy target barrel with bright excellent bore. The metal surfaces retain 99% original blue finish. The target style hardwood stock with oil finish is in excellent condition. Factory globe type front sight with six inserts is present. The peep sight and rear swivel issued with the rifle are missing. Original factory box serial numbered to the gun with single detachable magazine and instruction book are included. This U.S. marked military training rifle was never issued and likely a factory over-run sold through Lew Horton. (166520-1685) [Richard "Stretch" Kennedy Collection]. (350/450)



1128

1128. **WINCHESTER MODEL 94 LEVER ACTION CARBINE** serial #5115777, 32 Win Spl, 16" round tapered barrel with bright excellent bore. The metal surfaces retain 99% original blue finish. The satin finish plain walnut straight grip buttstock and forend both rate excellent with only one very small blemish on the left side of the forend at the barrel band. Both sides of the receiver are laser engraved with old west scenes. There is slot damage on three of the receiver screws, one screw is incorrect and the saddle ring is missing on the left side; the rear sight's blade is missing. Factory box that is not serial numbered to the gun, manual and papers are included. This is an unusual item very similar to the "Wrangler" model but not marked as such. (166520-486) [Richard "Stretch" Kennedy Collection]. (350/550)

1129. **WINCHESTER MODEL 94 LEVER ACTION RIFLE** serial #1141958, 30 WCF, 20" barrel with a bright excellent bore. The barrel and magazine retain 70% blue with areas thinning to a gray-brown patina, silvering on the barrel bands and at the muzzle, several tiny scratches, and a couple of spots of oxidized pitting. The receiver is 30% blue thinning to a brown patina with the bulk of the metal surface being pewter gray with some scattered light freckling. The hammer and breech bolt show strong blue with some contact wear and minor scratching. The buttplate is pewter with a few spots of oxidation staining, some light freckling and remnants of blue in the grooves. The walnut stock and forearm rate very good with several light scratches, dings, minor handling marks, and an added finish. The right side of the wrist is stamped "C Bickford". (126653-4) {C&R} (350/550)
1130. **SMITH & WESSON MODEL 60 CHIEF SPECIAL REVOLVER** serial #R277735, 38 Special, 1 7/8" pinned barrel with an excellent bore. The stainless steel surfaces of this round butt J frame are in excellent condition with a slight turn ring present on the cylinder and a few light handling marks on the metal exterior for an overall rating of about 99%. The Magna trigger and standard hammer retain their full hard chrome finish. The checkered walnut Magna grips are in excellent condition and correctly numbered to the gun. This great CCW carry gun includes a two piece factory box with correct end label that is numbered to the gun. (86703-3). (350/550)

1131. **BROWN MANUFACTURING COMPANY SOUTHERNER DERINGER** serial #9510, .41 cal. RF, 2 1/2" octagon barrel with a fair oxidized bore. The metal surfaces on this iron frame Deringer are an overall dark brown patina. They show some light oxidation and overall light pitting. The smooth rosewood grips rate good to near very good with some traces of original varnish and minor dings and handling marks still fitting to frame very well, they are stamp-numbered to the gun. Barrel-to-frame fit is quite loose but the mechanism functions well. The "Southerner" marking is only partially present, sight blade has worn down slightly and the manufacturer's marking is no longer legible on the left barrel flat; the screw slots show some damage. Overall a good "example" piece for the budding Southerner collector. (36229-421) {ANTIQUÉ} [Elliott Riggs Collection]. (300/500)



1131

1132. **COLT POCKET POSITIVE TRANSITIONAL MODEL FIRST ISSUE REVOLVER** serial #37097, 32 S&W (Colt), 3 1/2" barrel with a near excellent bore, exhibiting a ring of pits about 1" from the forcing cone and some very light scattered frosting. This 1907-manufactured revolver retains about 85-88% of its original blue finish with silvering present on the barrel, cylinder and high edges. The metal surfaces also have scattered oxidation blemishes and freckling in addition to some light surface pits. The polished sides of the hammer exhibit light blemishes but the remainder of the fire bluing on the top of the hammer and the trigger remain in near excellent condition. The hard rubber grips are scratch-numbered to the revolver (assembly number) and feature the word "Colt" in an oval on each grip panel. They are in near excellent condition with some very light scratches and scuff marks. This early production revolver retains the Rampant Colt circled by "Colt's New Pocket" on the frame. The assembly numbers on the frame and crane match but the number under the extractor on the cylinder does not. (86153-10) {C&R} (300/500)

1133



1133. **A. H. FOX STERLINGWORTH BOXLOCK DOUBLE SHOTGUN** serial #53949, 12 ga, 30" barrels with bright very good bores showing some light frosting ahead of the chambers. The barrels retain 80% plus original blue showing nicks and scratches with some oxidation spotting, particularly around the muzzles. The frame exhibits a mottled gray and brown patina with remnants of case color showing under the top lever and a few scattered specks of oxidation. The pistolgrip stock and snap-on splinter forearm rate good having a few dings and scratches over a smooth but thin and worn varnish and exhibiting somewhat worn and soiled checkering. There is a brass gripcap fitted to the grip and a Pachmayr rubber recoil pad is installed providing a length of 14 1/4" with drops of 1 1/2" at the comb and 2 3/4" at the heel. The gun features double triggers, extractors, and an automatic safety. The action is tight and functions fine. Made in 1911, this gun remains in good working order. (116225-40). (350/550)

1134. **NEW YORK STATE BACK ACTION PERCUSSION TARGET RIFLE BY H.A. CASWELL**, Nelson Lewis modified .44 cal., 32 3/4" octagon barrel with a bright about excellent bore which shows some minor oxidation within some of the grooves. The barrel is primarily a pleasing plum brown patina with some scattered light oxidation and some light toning to pewter on the sharp edges. The barrel is maker marked on its top flat "HA Caswell/Lansingburg" ahead of this reading in the opposite direction is "Recut By/N. Lewis/Troy/NY". The front dovetail features a simple scant post while the rear dovetail features a flat-top sporting-style sight with coarse step elevator, the tang is drilled and tapped for a peepsight which is not present. The patent breech shows some very light borderline engraving as does the long iron tang. The back action lock and hammer also show some light engraving with some light pitting on the hammer and in the area of the patent breech; the hammer itself shows the beginning of a slight crack, it is old and stable in nature. There are simple German silver escutcheons with a single iron wedge, a single spur brass triggerguard with the rearward grip swirl, a brass crescent buttplate and a brass New York style patchbox. The stock rates about very good with much original varnish, some drying checks, a crack on the left stock flat through the stock screw escutcheon, a crack on the right upper edge of the forearm toward the wedge and there is a 2 1/2" sliver missing ahead of the lock and breech bolster. The muzzle is turned for starter and there is no provision for a ramrod, clearly the gun was intended as a target rifle, the current sights suggest its later use as a sporter. An interesting New York State rifle with connections to two famous gunsmiths. HA Caswell was actually a son of JM Caswell to whom Nelson Lewis was apprenticed. (35856-21) {ANTIQUÉ} (300/500)

1135

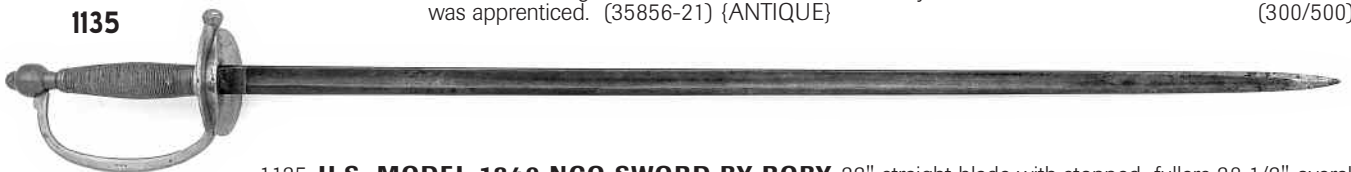

1135. **U.S. MODEL 1840 NCO SWORD BY ROBY** 32" straight blade with stopped fullers 38 1/2" overall length. The blade is marked "U.S./1863/F.S.S." on the obverse ricasso and "C. Roby/W. Chelmsford, MS" on the reverse side. The blade is fine bearing an overall pewter gray with some specks of light freckling and pinprick pitting closest to the tip. The solid brass hilt has a nice goldenrod patina with a few light handling marks and is marked "F.S.S." about mid-length of the knuckle bow. No scabbard present, a fine example NCO sword. (56358-3). (300/500)

1136. **AMERICAN STANDARD TOOL POCKET REVOLVER** serial #26426, 22 RF, 3" ribbed octagon barrel with a very good to near excellent lightly frosted bore. The barrel retains 90% nickel finish with some light freckling, spotty oxidation, and light pitting. The cylinder has about 40% nickel retention with areas thinning to a brown patina with light pinprick pitting. The cylinder's engraving is good though hard to discern where the nickel finish has faded. The brass frame is ochre with scattered hints of the original silver plate. The trigger and hammer show moderate case-hardened colors fading to a gray patina with a few spots of light oxidation and pitting. The frame and barrel are lightly New York scroll engraved with about 80% coverage on the sides of the frame and 30% on the barrels sides with a couple of small areas on the top of the frame also. The frame, barrel, and cylinder are numbered alike. This pistol functions mechanically. The barrel-to-frame fit has slight play; the right barrel hinge is cracked. The cylinder also fits slightly loose. (126229-44) {ANTIQUÉ} [Elliott Riggs Collection]. (275/375)

1137. **GLOCK MODEL 22 SEMI-AUTO PISTOL** serial #DDS544US, 40 S&W, 4 1/2" barrel with an excellent bore. The Tenifer finish on the slide and the polymer frame are in excellent condition with some light handling marks for an overall rating of 98%. The most noteworthy loss is about half of the finish is worn away on the slide stop. This Gen 3 Glock includes a factory hardcase that is correctly end labeled and numbered to the gun. The case contains a pair of magazines, magazine loader, manual, paperwork, cleaning brush and cleaning rod. This is a very popular gun in a fine caliber. (86703-12). (350/550)

1138. **U.S. MODEL 1842 PERCUSSION PISTOL BY ASTON** .54 cal., 8 1/2" barrel with an oxidized bore also having specks of light pitting. The metal surfaces are mainly in-the-white with brush marks from being cleaned along with scattered pinprick pitting and light oxidation staining. The inspector proofs on the barrel and 1851 tang date have been lightly disturbed but remain visible. The lock has proper maker markings and matching 1851 date. The brass hardware's bright finish has mellowed lightly with light handling marks acquired over the years. The walnut stock rates very good overall with two fading, but still visible inspector cartouches, lightly rounded edges, a modest chip at the lower left corner of the lock, ample light handling marks and blemishes. The hammer spring remains strong and the lock functional. An overall very good plus condition model 1842 martial pistol. (56352-2B) {ANTIQUE} (300/500)



1139. **SMITH & WESSON MODEL 33-1 38 REGULATION POLICE** revolver serial #114834, 38 S&W, 4" pinned barrel with an excellent bore. Overall, the revolver retains about 99% original blue finish with a slight turn ring on the cylinder. The standard hammer and trigger retain robust case-hardened colors with light wear marks. The checkered factory target grips are in near excellent condition with a few lightly compressed diamond points. (86520-1583) [Richard "Stretch" Kennedy Collection]. (350/550)
1140. **SAVAGE MODEL 1907 SEMI-AUTO PISTOL** serial #211755, 32 ACP, 3 1/2" barrel with a dark oxidized bore. The metal surfaces show 85-90% original matte blue with the loss due to light silvering at the muzzle as well as on the high edges of the frame, predominately on the butt. A few light scuffs are visible on the sides of the barrel and above the ejection port. Strong case-hardened color remains on the sides of the trigger with the trigger face showing as gray. This late model 1907 pistol features a spur style hammer with fine slide serrations. The hard rubber grips with Savage logo remain in excellent condition with no cracks, and showing only slight wear adjacent to the safety. The left side of the frame bears a neatly engraved marking "S.P. No. 9" directly above the left grip panel. One original unmarked Savage magazine is included. (146623-6) {C&R} (300/500)

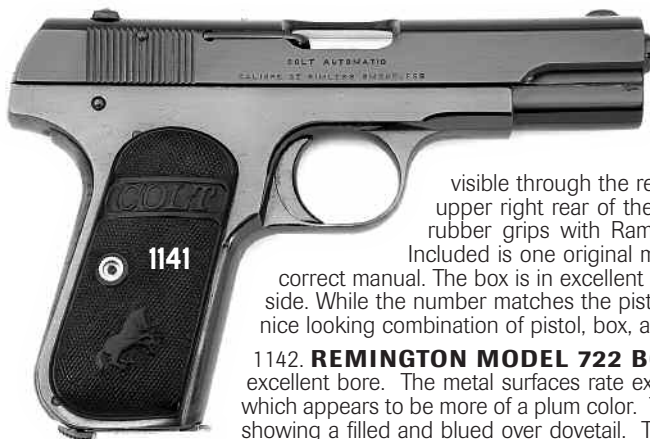

1141. **COLT MODEL 1903 POCKET HAMMERLESS SEMI-AUTO PISTOL** serial #260868, 32 ACP, 3 3/4" barrel with a near excellent bore showing some light roughness within the grooves. The metal surfaces show 98% bright professionally reblued finish. The refinishing is quite well done, with all factory markings remaining intact and edges still mostly sharp. A few tiny areas of earlier pinprick pitting remain visible through the refinished surface, most notably on the sides of the triggerguard and at the upper right rear of the frame adjacent to the grip safety. The later replacement checkered hard rubber grips with Rampant Colt are correct in appearance and remain in excellent condition. Included is one original magazine with CAL. 32/COLT marking, as well as an original Colt box with correct manual. The box is in excellent condition with no splits, and bears a penciled serial number on the underside. While the number matches the pistol, it appears to have been applied over a previous number. Overall a very nice looking combination of pistol, box, and manual as later-assembled. (146685-12) {C&R} (400/600)

1142. **REMINGTON MODEL 722 BOLT ACTION RIFLE** serial #356529, 222 Rem, 26" barrel with a bright excellent bore. The metal surfaces rate excellent and retain 99% original blue finish on the receiver and bolt handle which appears to be more of a plum color. The barrel has been reblued and retains 99% of its polished blue finish; also showing a filled and blued over dovetail. The checkered walnut Monte Carlo stock with checkered forend and black forend tip and grip cap rates excellent with some handling marks and scratches present. This rifle features a custom target trigger and a Bishop Niedner-style buttplate. A one-piece Leupold scope base and pair of rings are mounted to the top of the rifle. (156706-35). (300/500)

1143. **SMITH AND WESSON MODEL 37 CHIEFS SPECIAL AIRWEIGHT REVOLVER** serial #J57749, 38 Special, 3" pinned barrel with a bright excellent bore. The metal surfaces on this square butt J-Frame retain 98% original blue finish with some minor silvering on the leading edge of the triggerguard, frame and front ramp sight as well as a slight turn ring on the cylinder. The checkered walnut grips with gold colored Smith and Wesson medallions rate about excellent with some handling marks present. The color case-hardened magna trigger and standard hammer are in excellent condition as well. A grip enhancer is included with this revolver. An overall excellent condition Model 37 Chiefs Special Airweight. (156520-4146) [Richard "Stretch" Kennedy Collection]. (350/550)
1144. **RUGER NEW MODEL BLACKHAWK SINGLE ACTION REVOLVER** serial #34-35318, 357 Mag, 4 5/8" barrel with a bright excellent bore. The metal surfaces retain 97-98% original blue finish with some silvering at the muzzle-end of the ejector rod housing and on the blade of the front sight, as well as a turn ring on the cylinder. The left side of the breech face edge has some silvering beginning to show as well, most likely from holster wear. The faux ivory grips are in excellent condition overall. This revolver is outfitted with a red ramp front sight and a black adjustable rear sight. This New Model Blackhawk is in excellent condition overall. (156706-2). (350/550)
1145. **SMITH AND WESSON MODEL 14-3 DOUBLE ACTION REVOLVER** serial #1K30333, 38 Special, 6" barrel with a bright excellent bore. The metal surfaces retain 99% original blue finish with some faint holster-wear, mainly of the left side of the muzzle, and a couple of small handling marks present as well. There are a few light spots of surface oxidation beginning to emerge also. The walnut checkered stocks with gold Smith and Wesson medallions rate excellent showing a few dings and dents. The color case-hardening on the magna trigger and standard hammer rates excellent exhibiting vibrant coloration. Featured on this revolver are a black adjustable rear sight and a Patridge front sight. This is a fine example of a Smith Model 14-3 revolver, in excellent condition overall. (156678-15). (350/550)
1146. **SMITH & WESSON MODEL 38 BODYGUARD AIRWEIGHT DOUBLE ACTION REVOLVER** serial #BRE0425, 38 Special, 2" barrel with an excellent, bright bore. Both the stainless steel barrel and clear anodized alloy frame rate excellent. The fluted 5 round stainless steel cylinder rates near excellent, but does exhibit some minor faint handling marks as well as a light turn ring. The factory case-hardened trigger rates excellent and retains about 98% plus of its original color. The checkered black rubber grips rate very good but do display some light handling wear. Included with the revolver is an additional set of checkered wood grips which feature a silver colored medallion of the Smith & Wesson logo on both sides and rate near excellent, manual, and factory original box. (136520-4173) [Richard "Stretch" Kennedy Collection]. (350/550)

1147. **SMITH & WESSON MODEL 640 DOUBLE ACTION REVOLVER** serial #BSA0792, 38 Special, 1 7/8" barrel with a bright excellent bore. This J-frames brushed stainless steel surfaces are in excellent condition showing a few faint handling marks and a light turn ring on the five shot cylinder. The rubber Uncle Mike's boot grips rate excellent also. Comes with two speed loaders, manual, and its original box. (126642-14). (350/550)

1148. **MEDITERRANEAN MIQUELET CATALAN LOCK CARBINE**

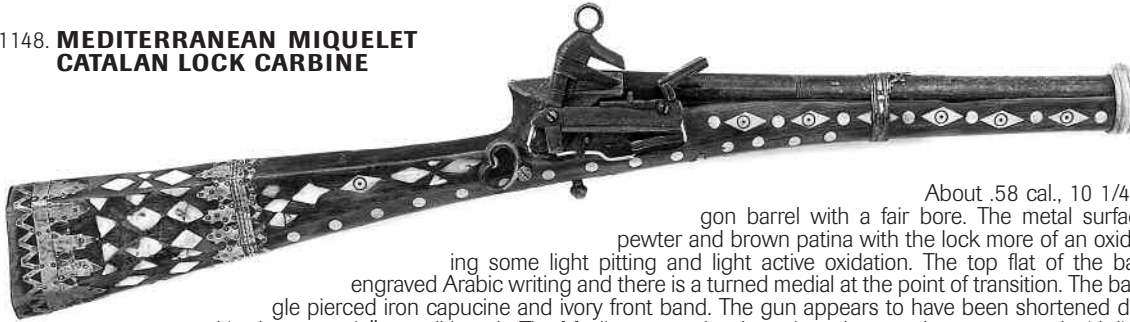

1148

About .58 cal., 10 1/4" part round part octagon barrel with a fair bore. The metal surfaces are an overall dull pewter and brown patina with the lock more of an oxidized light brown showing some light pitting and light active oxidation. The top flat of the barrel shows some light engraved Arabic writing and there is a turned medial at the point of transition. The barrel is retained by a single pierced iron capucine and ivory front band. The gun appears to have been shortened during the period of use and is about 22 1/2" overall length. The Mediterranean hardwood stock rates about very good with light handling marks and good original varnish. The stock features circular and diamond-shaped inlays of bone and genuine mother-of-pearl. There are hammered brass decorations at the butt and midway down the wrist with a hammered brass reinforcing overlay at the tang. There is a later-added, pierced, heart-shaped hanger on the right hand side of the stock. The lock is mostly functional. (36674-3) {ANTIQUE} (350/550)

1149. **BRITISH FOLDING TRIGGER CENTER HAMMER FLINTLOCK COAT PISTOL BY R. WILSON** .48 cal. flint, 2 1/4" part octagon part round barrel with a good bore. The metal surfaces are deep gray-blue patina with light pinprick pitting and active oxidation nearer the muzzle. The frame is very lightly, loosely engraved with the left side marked "R. Wilson" in oval. The smooth bag-shaped European walnut grip rates very good to near excellent with an oval gold-washed monogram plate atop the wrist, it is un-engraved. There is some light shrinking at the frame and the grip appears original and unmolested. The gun is mechanically functional and features a pan-locking sliding safety. The upper tang screw at the grip is a modern replacement. (36674-7) {ANTIQUE} (300/500)

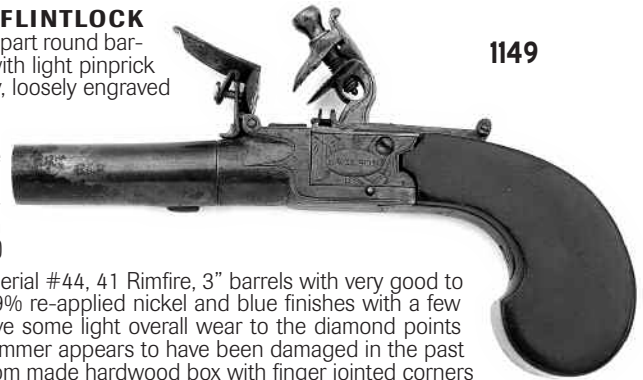

1149

1150. **REMINGTON MODEL 3 DOUBLE DERINGER PISTOL** serial #44, 41 Rimfire, 3" barrels with very good to excellent but lightly frosted bores. This type II pistol retains about 99% re-applied nickel and blue finishes with a few light handling marks present. The checkered hard rubber grips have some light overall wear to the diamond points with some of the high spots worn smooth. The checkering on the hammer appears to have been damaged in the past and was crudely repaired but the gun still functions perfectly. A custom made hardwood box with finger jointed corners is included. The box is blue felt lined and divided into four compartments with a broken keyed latch. Inside the box is a loading block for four cartridges and storage areas that holds 32 cartridges or tools. The box also contains a key, 34 rounds of Navy Arms (V headstamp) brand and 2 rounds of Western (diamond headstamp) brand 41 Rimfire ammunition. The ammunition is in excellent condition. (86625-7) {C&R} (350/550)
1151. **SPRINGFIELD ARMORY DEFENDER MODEL 45 SEMI-AUTO PISTOL** serial #NM52138, 45 ACP, 5" barrel with an excellent bore. Overall, the pistol retains about 97% original blue finish with most of the loss on the arched mainspring housing and muzzle. Some light scratches and handling blemishes are also present. The diamond checkered walnut grips are in near excellent condition with light handling wear present. This model features three dot fixed sights, extended thumb safety and lightly beveled magazine well. A single magazine with Pachmayr bumper pad is included. This is a good basic 1911A1 pistol. (86628-3). (350/550)

1152. **SAVAGE MODEL 99A LEVER ACTION RIFLE**

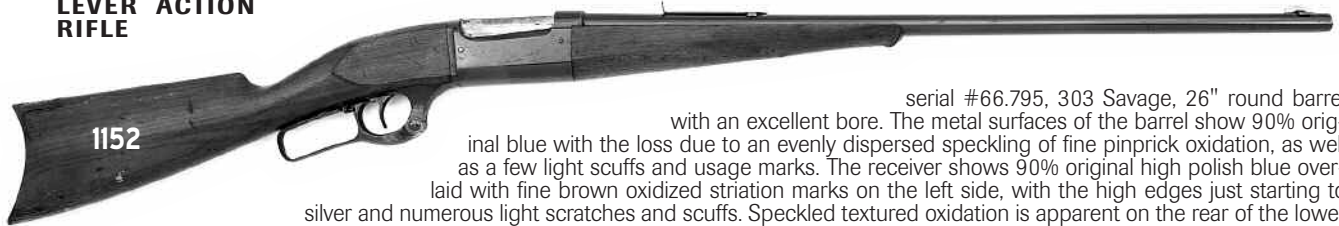

serial #66.795, 303 Savage, 26" round barrel with an excellent bore. The metal surfaces of the barrel show 90% original blue with the loss due to an evenly dispersed speckling of fine pinprick oxidation, as well as a few light scuffs and usage marks. The receiver shows 90% original high polish blue overlaid with fine brown oxidized striation marks on the left side, with the high edges just starting to silver and numerous light scratches and scuffs. Speckled textured oxidation is apparent on the rear of the lower tang. The bolt remains in-the-white, now turning to light brown patina. The lever shows strong case-hardened color on the forward surfaces, with the loop showing a finely textured brown oxidized surface. The walnut forend and straight grip buttstock show 90% original varnish, now showing a dry faded surface and starting to lift around scattered dark scratches and surface impressions. Dark water staining and shrinkage is visible where the wood contacts the buttplate, with several shrinkage cracks apparent at the toe. The crescent steel buttplate shows heavy textured brown oxidation on the heel and tang, with the remainder showing speckled fine oxidation. Overall a very nice 1906 manufactured 99A that has suffered from storage in a damp environment. The gun functions fine and would benefit from some careful cosmetic attention. (146623-18) {C&R} (300/600)

1153. **SMITH & WESSON MODEL 14-2 DOUBLE ACTION REVOLVER** serial #K527270, 38 Special, 6" pinned barrel with a near excellent, bright bore. The metal surfaces rate very good plus and retain about 95% of their factory original blued finish, but with a few light handling marks as well as minor silvering around the muzzle and ejector rod. The fluted 6 round cylinder rates very good plus and retains about 95% of its factory original blued finish, although exhibiting a faint turn ring. The case-hardened target hammer and trigger both rate very good plus and retain much of their factory original color, but are subject to some wear and fading. The checkered walnut grips feature a gold colored medallion of the Smith & Wesson logo on both sides and rate near excellent, but exhibit two slight chips in the wood at the base of the right panel; the grips also display matching serial numbers. (136680-6). (350/550)

1154. **STEVENS OFFHAND TARGET NO. 35 SINGLE SHOT PISTOL**

serial #42185, 25 Stevens, 6" octagon to round barrel with a near excellent bore showing one small pit forward of the chamber. The metal surfaces of the barrel show 95% smooth original blue just starting to thin to a faintly mottled appearance with light silvering at the muzzle. Finely peppered pinprick oxidation is scattered across the surface. The left barrel flat bears the two line "J. S. STEVENS A. & T. CO./CHICOPEE FALLS MASS. U.S.A." barrel address without patent date. The metal surfaces of the frame, triggerguard, and hammer show 95-97% smooth original blue with the loss due to light silvering at the edges of the weighted and flared buttcap. A few tiny oxidation specks and pinprick handling marks are scattered across the surface. The smooth walnut grips remain in excellent condition, showing clean original varnish with no chips or cracks and a few light handling marks. The pistol wears the original blade front sight with extended bead, and the original open rear sight adjustable for elevation. The elevator remains intact. Overall a very fine Offhand No. 35 in seldom seen condition. (146691-22) {C&R} (250/350)

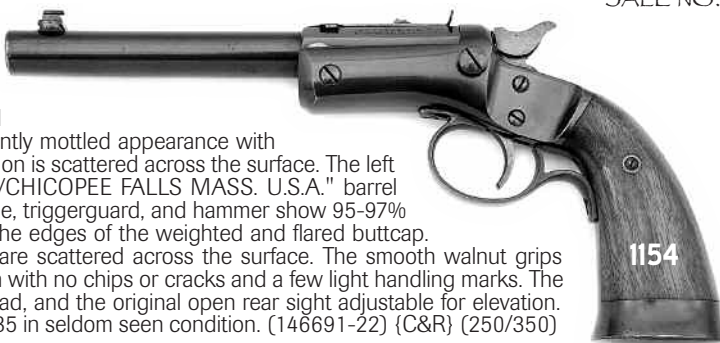

1155. **VICKERS-ARMSTRONG CHAMPION MARTINI ACTION SINGLE SHOT RIFLE** serial #V9245, 22 LR, 26 1/2" barrel with a bright excellent bore. The metal surfaces retain 95-97% original blue with scattered light freckling and minor handling marks. The custom thumbhole target stock with cheekpiece rates good with several small dings, a few light handling marks, and a repaired crack running back from the action on the right side. The rifle features a Vaver rear aperture sight, a front sight base with no sight, an adjustable front sling swivel rail, and a Pachmayr White Line rubber recoil pad. There is a 1 1/2" long dovetail cut into the barrel about 4 1/4" forward of the receiver, and a pair of scope bases mounted on non-factory drilled and tapped holes on the barrel and receiver. One screw on the rear scope base is broken off flush with the receiver. (126518-26). (300/400)

1156. **WINCHESTER MODEL 63 SEMI-AUTO RIFLE** serial #144482, 22 LR, 23" barrel with a bright excellent bore. The metal surfaces retain 80% original blue with scattered spotty light oxidation, scattered freckling, a few small areas of superficial oxidation, and some light scratches. The checkered buttplate shows strong blue with a few spots of oxidation. The walnut pistolgrip stock and forearm rate good with multiple light scratches and dings, a check in the wrist on the left side, and a flaking finish. (126520-2810) {C&R} [Richard "Stretch" Kennedy Collection]. (400/600)

1157. **REMINGTON MODEL 513-T MATCHMASTER BOLT ACTION RIFLE** serial #141594, 22LR, 27" barrel with a bright excellent bore. The metal surfaces retain 98% original blue with a few areas of light freckling, a few minor handling marks and a spot or two of superficial oxidation on the triggerguard. The pistolgrip walnut stock rates near excellent with a few light dings, several light scratches, and a couple of spots of fading finish. The rifle features a Redfield rear aperture sight, a front globe sight with insert, an adjustable sling swivel rail, and sling swivels. (126680-14) {C&R} (350/450)

1158. **REMINGTON MODEL 11-87 SPECIAL PURPOSE SHOTGUN** serial #PC240655, 12ga, 27 1/2" ventilated rib barrel with a bright excellent bore. The metal surfaces on the bright polished blue barrel and matte black receiver retain 98% original blue with a spot or two of light oxidation along the barrel, and a few faint handling marks. The checkered pistolgrip stock and forearm rate excellent with a few minor scratches and light handling marks. The gun features a ventilated rubber recoil pad with a 14 1/2" length of pull. It comes with five chokes including skeet, full, modified and improved cylinder, and two choke wrenches. (126680-21). (350/550)

1159



1159. **CUSTOM GERMAN MAUSER SPORTING MAGAZINE RIFLE**

serial #4863, 8mm Mauser, 24" barrel with a very good plus to near excellent bore which shows a little scattered light frosting. The metal surfaces of barreled action are primarily a faded deep gray-blue original maker-applied blue. The small ring 98 action is Danzig-marked and the barrel is likely an original military barrel which was slightly sporter-contoured. The bottom metal is primarily a mix of plum brown and pewter patina with minor oxidation staining. The checkered classic style walnut buttstock has a left-side rounded cheekpiece and features a nice Schnabel forend tip and Oberndorf sidepanels; it rates about very good. The round knob pistolgrip buttstock is neatly checkered, there is a steel buttplate fitted for a 13 1/2" length of pull and European-style swivels on underside of barrel and at toe-line. The German sporting ramp has a later Lyman sight installed, the rear sight seat is now vacant and there is a Lyman receiver sight affixed over the boltstop. The gun features double set triggers and a nice knurled bolt knob and retains the conventional safety. An excellent rainy day small ring Mauser, very light and handy. (36392-7) {C&R} (350/550)

1160. **NEW ENGLAND STYLE PILL LOCK-CONVERTED FOWLER BY NOCK**



About 20 bore, 44 1/2" part octagon part round barrel with a turned medial at the point of transition and an oxidized bore. The barrel is an overall oxidized plum brown patina with

some areas of light pitting and has a simple steel bead front sight with no provision for rear. There are British proofs on the left diagonal barrel flat, flanked by a number of tool marks and many small dings, the muzzle as well showing impact marks and is slightly

flared from being dropped or impacted. The lock shows some very light engraving and a small rear teat and is "H Nock" marked. The gun is converted to pill lock by a square drum with a cone-shaped recess, and a sharp conical striking portion on the blacksmith-made hammer. There is a simple brass tailpipe and an acorn front-extension on the triggerguard; the bow of the guard is lightly engraved. The brass buttplate shows some light engraving on its upper tang; all the brass is a tarnished goldenrod patina. The English walnut stock rates about very good showing a 3" chip missing from atop the rear portion of the lock, with a couple of cracks emanating from the tang. At some point the stock was cracked in half, with visible cracks below the lockplate, through the guard and up the left stock flat; it appears as though a satisfactory repair has been made and is sound. There is an antique ramrod affixed which is certainly from the period of use and the noseclip to the stock is not present. The lock seems to operate well mechanically. (36623-41) {ANTIQUÉ} (350/550)

1161



1161. NEW ENGLAND FLINT-LOCK SMOOTHBORE MUSKET MARKED PRATT 50 caliber, 35 3/4" part octa-

gon part round barrel with a heavily oxidized bore. The barrel is an overall brown and gray patina showing light oxidation with some spots of moderate oxidation about halfway down its length. There is a simple brass blade scant dovetailed front sight and simple flat-top wide v-notch rear sight in place. The top flat features a brass inlay which is marked "A Pratt Concord Mafs". The lockplate and swan neck cock are lightly borderline engraved with the plate marked "A Pratt". The frizzen spring has collapsed with age and no longer acts upon the tail of the frizzen and the hammer does not hold on cock. The gun is fitted with two brass thimbles, brass nose-cap, tailpipe, triggerguard, patchbox and butt and toe plates. All the brass is a dull ocher patina and the triggerguard is broken at the front portion of its bow. Patchbox features light engraving and a bottom-release which is no longer functional as the catch on the rear side of the patchbox lid has come on soldered and is not present.



The American walnut stock rates about very good with numerous dings and dents from the years and a scant left-side cheekpiece. The left side cheek rest shows a German silver monogram plate engraved "Presented To/1837/Elijah Stepp/of the/Texan Republic/with the/Compliments/of/Alvin Pratt". While it is possible this is actually a period Alvin Pratt musket, it is doubtful it was ever presented to Elijah Stepp (Stapp) of Texas (it was consigned from the Western Finger Lakes Region of New York). The musket is fitted with double set triggers and there is a rudimentarily engraved monogram plate atop the wrist with "ES". An interesting, likely New England-made, musket overall. The gun does show some traits of an actual Alvin Pratt rifle, similar to examples he produced in the 1812-era. (36623-45) {ANTIQUE} (400/600)

1162



1162. INDIAN MATCHLOCK TALWAR MUSKET About .52 cal., 56 1/2" barrel with an oxidized

bore. The barrel is an overall dark gray and brown patina and shows a lightly swamped muzzle with turned medial and the remnants of some gold, damascening. The flared breech section as well shows a turned medial and a small central rib running ahead of the flat-top rear sight and geometric gold damascening about 5 1/2" in coverage. The stock itself rates about good and is missing the fore stock section for about 18". The capucines which remain are of woven cord over-which was a black lacquer. The stock showed extensive floral and geometric lacquer and enamel work which has largely been lost and flaked to the years. The pivoting cover over the powder reservoir is no longer present however the match lock pivot mechanism itself is still functional. An interesting example which was rather fancy in its day. (36126-1) {ANTIQUE} (300/500)

1163. AFGHANI JEZAIL TOURIST MUSKET This is a somewhat interesting looking Afghan-style flintlock musket, normally seen with match or flint lock. The octagon barrel is about 28 1/2" in length and is overall oxidized showing some remnants of what was likely a black enamel. The lockplate is very rudimentarily constructed and shows overall light oxidation, a few spots which are moderate. It is affixed with nails and looks very loosely to be patterned after a British Brown Bess lockplate. The gun was never vented and the lock is only loosely mechanically functional. The stock rates poor and shows numerous bone inlays, it was broken in half through the wrist forward and is still loose, an old glued repair, poorly done has come loose. The butt is deeply curved downward and then curves upward again, the butt end itself flaring widely as well. There is a single iron capucine and two smaller brass ones affixing barrel-to-stock, the last 6" of the stock is missing and warped downward somewhat. (36136-1) {ANTIQUE} (40/80)

1164. AFGHANI JEZAIL PERCUSSION CONVERTED MUSKET About 60 cal. 42 1/4" hendecagon barrel with an oxidized bore. The barrel is an overall silvery patina with geometric inlays its full-length of both damascened brass and black enamel. The barrel is retained with 5 hammered brass capucines, most of which also show some light engraving. The gun is converted to percussion with a large square bolster on its right side, a simple flat, bar under-style lockplate with a lightly engraved hammer; these now a dull gray patina. The unusual Sind-shaped stock rates about very good with much original varnish crazing neatly with the years in the area of the butt. There are a couple of older glued cracks and the last 15" of the forend is newly-replaced wood. The lock is not mechanically functional and will not hold on cock. A somewhat interesting Afghani jezail overall which actually appears to have been a usable firearm. (36485-5) {ANTIQUE} (200/400)

1165

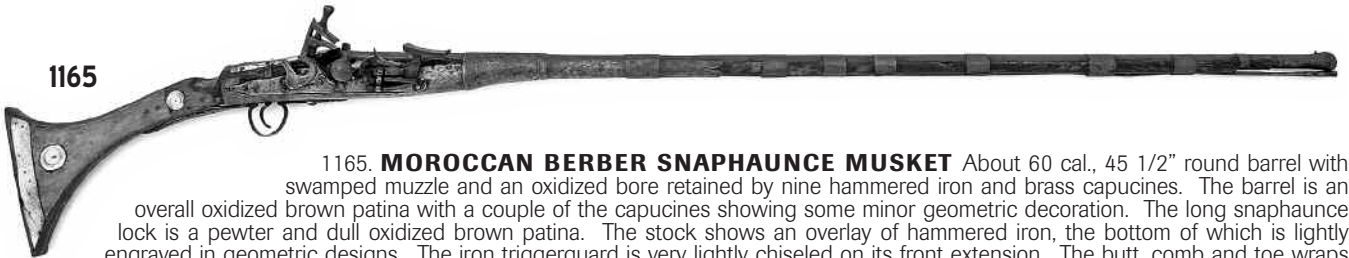

1165. MOROCCAN BERBER SNAHPAUNCE MUSKET About 60 cal., 45 1/2" round barrel with swamped muzzle and an oxidized bore retained by nine hammered iron and brass capucines. The barrel is an overall oxidized brown patina with a couple of the capucines showing some minor geometric decoration. The long saphaunce lock is a pewter and dull oxidized brown patina. The stock shows an overlay of hammered iron, the bottom of which is lightly engraved in geometric designs. The iron triggerguard is very lightly chiseled on its front extension. The butt, comb and toe wraps are all affixed with simple iron brads and are an oxidized pewter-plum. The exposed Mediterranean hardwood stock rates about very good and shows a half-dozen or more bone inlays with dual bone straps at the butt. The lock is currently not mechanically functional however there is an iron ramrod present. An interesting example overall. (36131-16) {ANTIQUE} (400/600)

1166. **MOROCCAN BERBER SNAPHAUNCE MUSKET** About 65 cal., 46" part octagon part round barrel with cannon-belled muzzle and an oxidized bore retained by ten hammered iron and brass capucines. The barrel is primarily a pewter and lightly oxidized brown patina with the iron capucines showing some minor geometric decoration; there are indecipherable impressed touch marks on the top and left diagonal barrel flats. The long snaphaunce lock is a pewter and dull oxidized brown patina and shows some very light incise engraving. The stock shows an underside overlay of hammered iron which is now overall lightly pitted. The brass triggerguard is a dull ochre patina and shows some very light geometric engraving. The comb and toe wraps are all affixed with simple iron brads and are an oxidized brown patina with pewter undertones. The exposed Mediterranean hardwood stock rates about very good and is somewhat spartan, also showing repaired chips around the barrel tang. The lock is currently not mechanically functional however there is an iron ramrod present. An interesting, somewhat plain example overall. (36680-10) {ANTIQUÉ} (300/500)

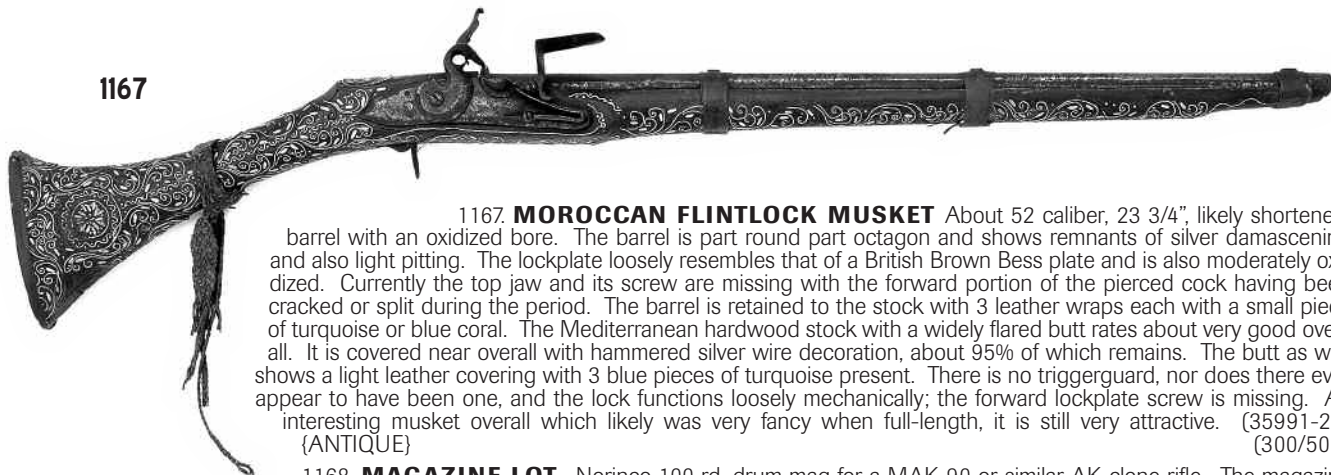

1167

1167. **MOROCCAN FLINTLOCK MUSKET** About 52 caliber, 23 3/4", likely shortened, barrel with an oxidized bore. The barrel is part round part octagon and shows remnants of silver damascening and also light pitting. The lockplate loosely resembles that of a British Brown Bess plate and is also moderately oxidized. Currently the top jaw and its screw are missing with the forward portion of the pierced cock having been cracked or split during the period. The barrel is retained to the stock with 3 leather wraps each with a small piece of turquoise or blue coral. The Mediterranean hardwood stock with a widely flared butt rates about very good overall. It is covered near overall with hammered silver wire decoration, about 95% of which remains. The butt as well shows a light leather covering with 3 blue pieces of turquoise present. There is no triggerguard, nor does there ever appear to have been one, and the lock functions loosely mechanically; the forward lockplate screw is missing. An interesting musket overall which likely was very fancy when full-length, it is still very attractive. (35991-20) {ANTIQUÉ} (300/500)

1168. **MAGAZINE LOT** Norinco 100 rd. drum mag for a MAK-90 or similar AK-clone rifle. The magazine rates excellent retaining about 95-97% original blue, loss mainly from gun insertion; magazine is marked with a 36 in triangle above winding handle. (56686-1)

1169. **MAGAZINE LOT** Four MAK-90 or similar AK style steel body magazines total: (1) unmarked 35 rd. and (1) unmarked 30 rd. magazine retaining about 92-95% original blue with light scuffs and silvering along the edges, there is one spot of surface rust on the left side of the 35 rd. mag; (2) five round magazines marked "China" on the floorplate retaining 95-98% original blue with light silvering along the top edges. (56686-1A)

1170. **BOOK LOT** *The Colt Pocket Hammerless Automatic Pistols II* by John W. Brunner, second edition, Copyright 2009, 244 pages with full color dust jacket. Well illustrated and informative on the various Colt pocket hammerless pistols. Excellent condition. (56686-4)

1171. **AMMUNITION LOT** One green ammo can containing (2) 20 rd. boxes of Wolf 7.62x39 mm, 122 gr. FMJ; (2) 20 rd. boxes of Sapsan 7.62x39 mm, 124 gr. HP, hunting cartridges; (1) plastic bag containing approximately 80 rds. of loose assorted 7.62x39 mm cartridges. (56686-3)

1172. **AMMUNITION LOT** Ten 20 rd. boxes of Sapsan 7.62x39 mm, 124 gr. HP, hunting cartridges in excellent condition overall. (56686-3A)

1173. **AMMUNITION LOT** Ten 20 rd. boxes of Sapsan 7.62x39 mm, 124 gr. HP, hunting cartridges in excellent condition overall. (56686-3B)

1174. **AMMUNITION LOT** Ten 20 rd. boxes of Wolf 7.62x39 mm, 122 gr. FMJ in excellent condition overall. (56686-3C)

1175. **AMMUNITION LOT** Ten 20 rd. boxes of Wolf 7.62x39 mm, 122 gr. FMJ in excellent condition overall. (56686-3D)

1176. **AMMUNITION LOT** Ten 20 rd. boxes of Wolf WPA Military Classic 7.62x39 mm, 124 gr. FMJ, in excellent condition overall. (56686-2A)

1177. **AMMUNITION LOT** Ten 20 rd. boxes of Wolf WPA Military Classic 7.62x39 mm, 124 gr. FMJ, in excellent condition overall. (56686-2B)

1178. **AMMUNITION LOT** Ten 20 rd. boxes of Wolf WPA Military Classic 7.62x39 mm, 124 gr. FMJ, in excellent condition overall. (56686-2C)

1179. **AMMUNITION LOT** Ten 20 rd. boxes of Wolf WPA Military Classic 7.62x39 mm, 124 gr. FMJ, in excellent condition overall. (56686-2D)

1180. **AMMUNITION LOT** Ten 20 rd. boxes of Wolf WPA Military Classic 7.62x39 mm, 124 gr. FMJ, in excellent condition overall. (56686-2E)

1181. **UNMARKED BELGIAN SINGLE SHOT WARNANTS PATENT BREECH STOCK AND ACTION** There is no barrel present. The European walnut stock rates very good showing some minor and moderate wear with relief-carved scroll on each stock flat and beneath the forend with a ribbed, fluted grip and is equipped with a faceted steel buttcap having light scroll engraving and a ball finial. The metal surfaces show light scroll engraving and are an overall deep gray and pewter engraved with light oxidation staining. The hammer remains strong but will not stay cocked. (56675-1)

1182. **UNMARKED BRITISH BAR HAMMER PERCUSSION PISTOL** serial #184, .36 cal. percussion, 2" part octagon, part round barrel with a very good bore. The metal surfaces are an overall dull gray patina with remnants of light brown oxidation staining and some scattered pinprick pitting, more moderate along the butt. The frame shows very light scroll engraving with British proofs on the bottom left diagonal barrel flat; there is light engraving along the top of the bar hammer. The bag shaped English walnut grips rate good to near very good as cleaned with no original varnish. The gun is mechanically functional. (6675-2) {ANTIQUÉ} (100/200)



1183

1183. **REMINGTON NO. 2 VEST POCKET DERINGER** serial #13728, .30 cal. RF, 3 1/2" part octagon part round barrel with a poor bore. The metal surfaces are lightly and moderately cleaned showing some remnants of light pitting with most of the maker's markings removed. There are remnants of an older restored blue with light toning to brown. The smooth rosewood grips rate good as lightly cleaned with minor handling marks and are slightly undersized. A number of the screw heads show slot damage and the gun needs mechanical attention. (56675-3) {ANTIQUÉ} (400/600)

1184. **UNMARKED BELGIAN CENTER HAMMER BRASS DOUBLE-BARRELED FLINTLOCK PISTOL** .44 cal. flint, 3 1/4" round barrels with very good bores. The frame is lightly engraved with a loose floral motif with a left-hand side Belgian proof. The metal surfaces are an overall tarnished ocher patina. The iron triggerguard has faded to gray with the hammer and frizzen a dull pewter-gray patina. The European walnut bag-shaped grip rates very good plus with good original varnish and features fully checkered left and right panels with scallop-shell carved flats at the rear of the frame. The gun is mechanically functional and there is a pan-locking sliding safety. The gun is equipped with a pivoting barrel selector which will allow just the top barrel, or both barrels to be fired simultaneously. (56674-6) {ANTIQUÉ} (600/800)



1184

1185. **HOOD FIREARMS COMPANY SINGLE ACTION SPUR TRIGGER "ALEXIS" MODEL REVOLVER** serial #4093, 22 RF, 2 1/2" octagon barrel with a poor bore. The metal surfaces show light New York style engraving and retain about 95% original nickel with light surface oxidation, primarily at the flash areas of the cylinder. The hammer and trigger have toned to a brown patina. The smooth rosewood grips rate very good showing a light cleaning. The gun will function mechanically but is slightly loose. (56674-2) {ANTIQUÉ} (150/250)
1186. **LOT OF AMMUNITION** (12) 20 rd. boxes of Chinese CJAIE 7.62x39 mm ball ammunition in green boxes with white print; excellent condition overall. (65155-1A)
1187. **LOT OF AMMUNITION** (12) 20 rd. boxes of Chinese CJAIE 7.62x39 mm ball ammunition in green boxes with white print; excellent condition overall. (65155-1B)
1188. **LOT OF AMMUNITION** (11) 20 rd. boxes of Chinese CJAIE 7.62x39 mm ball ammunition in green boxes with white print; excellent condition overall. (65155-1A)
1189. **LOT OF AMMUNITION** Five boxes total: (3) 20 rd. boxes containing four, 5 rd. packages of Speer Nitrex 30-30 Win., 150 gr. Big-Game bullets; (1) 20 rd. box of Remington Accelerator 30-30 Win., 55 gr. SP.; (1) 20 rd. box of Winchester Western 30-30 Win., 170 gr. Power-Point SP. In excellent condition overall, Remington box shows light wear. (54287-3I)
1190. **LOT OF AMMUNITION** Three boxes total: (2) 20 boxes of Winchester FailSafe 308 Win., 180 gr. FS; (1) 20 rd. box of Winchester Ballistic Silvertip 150 gr. ballistgic silvertip. In excellent condition overall. (54287-3H)
1191. **LOT OF AMMUNITION** Two boxes total, one partial: (1) 20 rd. box of Remington Hi-Speed 45-70 Govt., 405 gr. SP.; (14) rds. of Winchester Western 45-70 Govt., 405 gr. SP. In excellent condition overall. (55497-7C)
1192. **LOT OF AMMUNITION** Four boxes total, some partial: (1) 20 rd. box of Remington High Velocity 357 Rem. Max., 158 gr. Semi-Jkt. HP; (15) rds. of Remington High Velocity 308 Win., 150 gr. SP Core-Lokt; (11) rds. of Remington High Velocity 308 Win., 168 gr. BTHP Match; (1) 20 rd. box of PMC 3006C, .30 M2, 150 gr. FMJ in camouflage box. In excellent condition overall with light wear to the boxes. (54287-3H)
1193. **LOT OF AMMUNITION** Two boxes total: (1) 50 rd. box of Bullseye 45 ACP, 230 gr. RN Lead; (1) 20 rd. box of Federal Premium Hydra-Shok 38 Special +P, 129 gr. jacketed HP. In excellent condition overall with light wear to the boxes. (54281-9E)
1194. **LOT OF RIMFIRE AMMUNITION** Three boxes total: (1) 100 rd box of Remington High Velocity 22 LR High Velocity Solid Bullet; (1) 100 rd. box of Remington 22 LR High Velocity HP; (1) 100 rd. of Remington Target 22 LR Standard Velocity Solid Bullet. In excellent condition overall. (54281-9C)
1195. **LOT OF AMMUNITION** Two partial boxes total: (15) rds. plus (3) fired cases of Remington High Velocity 7mm Rem. Mag., 150 gr. Core-Lokt PSP; (13) rds. plus (3) fired cases of Federal Classic 7mm Rem. Mag., 150 gr. Hi-Shok SP. In excellent condition overall with light wear to boxes. (55155-2)
1196. **LOT OF AMMUNITION** Three boxes total, one partial: (1) 20 rd. box of Winchester Super-X 303 British, 180 gr., Power Point SP; (1) 20 rd. box of Yugoslavian Century 6.5mm, 139 gr. FMJ; (12) rds. of Italian 6.5mm in two stripper clips with 1953 dated headstamps and brown box with Italian writing. In excellent condition overall. (54281-9B)
1197. **LOT OF AMMUNITION** Three boxes total, two are partial: (1) 20 rd. box of Remington Hi-Speed 30-40 Krag, 180 gr. PSP Core-Lokt; (12) rds. of Remington Kleanbore 32 Winchester Special, 170 gr. SP Core-lokt; (17) 32 Win. Special fired cases. (55497-7E)
1198. **LOT OF AMMUNITION** Four boxes total, one is partial (1) 50 rd. box of Federal High Velocity 357 Mag., 158 gr. JSP; (1) 50 rd. box of Western Super-Match 38 Special Mid-Range Match, 148 gr. clean-cutting lead; (26) rds. of Western 38 Special, 158 gr. Lubaloy Bullet; (50) asst. 38 Special fired cases. In excellent condition overall. (55497-7A)
1199. **LOT OF AMMUNITION** Six boxes total, three are partial: (2) 20 rd. boxes of C-I-L Imperial 38-55 Win., 255 gr. SP; (1) 20 rd. box of C-I-L Dominion 38-55 Win. 255 gr. SP; (9) rds. plus (2) fired cases of C-I-L Dominion 38-55 Win., 255 gr. SP; (16) rds. of Winchester 38-55 Win., 255 gr. SP; (17) rds. of Remington Kleanbore 38-55 Win., 255 gr. SP with light tarnish on the cases. In otherwise excellent condition overall. (55497-7B)
1200. **LOT OF SHOT SHELLS** Four boxes containing approximately 95 assorted 16 ga. and 20 ga. paper and plastic hull shotshells of various sizes both slug and pellet from various manufactures. In fine condition overall with light oxidation and dirt stains to some of the shells. (54281-8B)
1201. **U.S. AIR FORCE ACADEMY SWORD BY EICKHORN** 31 5/8" blade, 36 5/8" overall length. The polished stainless steel remains bright with a few light scuffs and a very faint bend about 5" from the tip and is acid etched with winged "U.S. Air force Academy" in ribband on the reverse side of the blade and Eickhorn squirrel makers mark on the obverse ricasso. The antique nickel silver plated hilt with has a double eagle head guard and molded wire wrapping. The bright nickel silver plated scabbard with antique silver plated throat and drag shows a few light scuffs and some fine oxidation staining. A fine condition German Made U.S. Air Force Academy sword. (56242-10). (75/150)
1202. **U.S. MODEL 1902 CADET OFFICERS SWORD BY MEYER** 32" blade with unstopped fullers measuring 37 5/8" overall. The blade remains bright with a few light scuffs from scabbard removal and is etched with martial and foliate panoplies and second type crest federal "e pluribus unum" eagle with ribband. The ricasso is "N.S. Meyer Spartan" trade marked, leather washer is present. The hilt shows some minor light handling marks and oxidation staining, the pommel shows some faint traces of brass. The synthetic fingergroove grip rates excellent. The nickel plated scabbard has mellowed with scattered fine oxidation staining and a few pinprick pits here and there and is engraved "Cadet Commanding Officer Best Company" between the double hangers. A neat Cadet Officers sword in very good plus to fine condition overall. (56312-14). (150/250)



1203. **LEATHER COVERED POWDER FLASK BY BARTRAM & CO.** 6 3/4" plain leather wrapped body with fixed maker- marked brass patent top and two position adjustable charger. The leather shows some spots of light flaking on the body along with a few shallow dents, some light chips and a small tear along the throat and a separating seam along one side. The brass top shows a darkened tarnish patina with makers mark fully visible. The cut-off spring is broken and the thumbpiece is no longer present. An honest, good to very good condition flask from a scarce maker. Similar to Riling's No. 1093. (55461-40)

1204. **STAGS POWDER FLASK BY BATTY** 6 1/2" brass bodied flask with singled sided paneled stags with fawn motif, common brass top with three position adjustable charger. The flask shows a majestic stag standing above a recumbent stag and fawn centered between oaks with mountains in the background and is maker-marked along the bottom. The body is in fine shape with a few shallow dings and dents and a mellowed patina with some minor oxidation staining and is equipped with dual hangers and tight seams. The brass top remains intact, functional and has acquired a mellowed tarnished patina with some light handling marks and fine oxidation staining. The top spring remains strong and intact. A nice overall fine condition Batty flask, Riling's No. 981. (55784-4)
1205. **COPPER POWDER FLASK BY HAWKSLEY** 6 3/4" copper bodied flask with dual sided shell motif, brass collar with maker-marked patent top and removable four position adjustable charger. The body shows a handful of light dings and spots of tarnish and lightly separating seams with dual hangers but no rings. the brass top and charger show a dark tarnish patina. The charger remains fully functional, the slightly bent topspring is a bit sluggish but still functions. An overall good example Sheffield shell pattern flask. Riling's No. 388. (55461-34)
1206. **PLAIN BODY POWDER FLASK BY BOWER** 4 3/4" plain brass bodied flask with brass maker-marked removable patent top and low profile three position charger. The body rates fine with tight seams, a handful of light dings and scuffs in a dark patina finish. The brass collar and top have a dull goldenrod patina. The charger remains functional, the cutoff spring does not seat properly prohibiting it from functioning properly. An overall good to very good flask from a scarces, seldom-encountered maker. Rilings No. 150. (55461-30).
1207. **LEATHER COVERED POWDER FLASK BY GREAVES** 6 1/2" steel bodied flask with black leather covering, brass maker-marked removable patent top with three position Sykes style charger. The body shows a shallow 2" dent in the center of one of the sides with one separated seam and light surface oxidation. The leather is also separated on the same side along with modest flaking and crazing. The brass collar and top have a dark tarnished patina along with some faint oxidation staining. The charger remains functional, the topspring however is missing. A fair condition example similar to Riling's No. 1090. (55461-41)
1208. **ZINC BODIED POWDER FLASK** 5" Zinc bodied flask with dual sided eagle and medallion with man carrying what looks to be an opened umbrella with longarm, pack basket and sword with wooded field in the background. The body remains in good shape equipped with tight seams and hangers with a couple shallow indentations, a couple spots of oxidation staining. The unmarked brass common top and four position adjustable Sykes style charger has a dark tarnish patina with a ring of heat discoloration where it was soldered to the body. The topspring shows light oxidation staining but remains strong and functional along with the charger. The top does seem a bit oversized and may be a latter replacement. An overall very good example of a French style zinc powder flask. (53149-8)
1209. **U.S. MODEL 1850 OFFICERS SWORD** 31 3/4" blade with unstopped fullers, 36 3/4" overall length. The blade is an overall pewter patina with scattered pinprick pitting and some areas of fine oxidation. The obverse ricasso is marked "C Co." with crown/crossed swords above "GARANTLE" and the leather washer is no longer present leaving the blade a bit loose. The brass curved single hilt with curved quillion has a dark rich goldenrod patina and the black resin handle has a small chip at the inside pommel with braided brass wire intact and tight. The steel scabbard's blue finish is toning to brown with with some scatted pinprick pitting, oxidation staining and a couple shallow dents. The drag is marked "CK&C". An overall good example officers sword possibly imported from France. (56312-13). (100/200)
1210. **U.S MODEL 1860 STAFF AND FIELD SWORD** 35 3/8" overall with a 29 7/8" blade. The double edge is an overall pewter gray with scattered pinprick pitting and fine oxidation staining and a few spots of more moderate oxidation on the ricasso. The martial etching on both sides of the blade remains strong and there is no makers mark other than a small King's head mark in the obverse ricasso. The brass hilt has a nicely darkened tarnished patina with areas of fine oxidation in the corners and joints and features a federal eagle with panoplies of flags on the obverse counterguard; the reverse counterguard is plain and the pommel and single branch guard are decorated with federal eagles and foliate panoplies. The handle appears to be a dark brown horn with a few light chips and broken loose braided wire wrap. The nickel plated scabbard is moderately flaking to gray and is decorated with antique silver plated mounts and three hanging rings; the finish is flaking on the mounts with traces of brass visible along with some light oxidation staining. An honest overall good example staff and field sword. (56131-20). (100/200)
1211. **IMPORTED CIVIL WAR NON-REGULATION STAFF AND FIELD OFFICERS SWORD** 35" blade with wide and narrow fullers, 40 3/4" overall length. The blade is an overall mottled gray patina with scattered spots of oxidation staining and pinprick pitting and is not maker marked. The washer shows modest wear but remains intact and the pierced scroll and eagle pattern basket hilt with bird-shead pommel and decorative backstrap bear a mellow goldenrod patina with spots of light tarnish and oxidation along some of the edges and is slightly loose fitting on the blade. The brown ray skin handle shows some light scuffs but remains mostly intact with only one wire band remaining; there are remnants of what appears to be a brown leather knot strap and there is a slight gap between the handle and the grip strap. The steel scabbard has a smoky gray patina with a few pinprick pits and brass mounts. The brass has a nicely mellowed patina with some light dents, handling marks and a missing pin on the collar. (55529-60). (200/400)

1212. **KNIGHTS OF TEMPLAR FRATERNAL SWORD** This fraternal sword measures 37 5/8" overall with a 37" straight, unfullered blade remaining bright overall having some minor light scabbard scuffs with 2/3 length fading gold washed etched panels on both sides. The obverse panel has name in Gothic Letters, "Lorne R. Fowler" and the reverse forte is marked, "Worcester Co, Commandery No. 5, K.T." The typically ornate brass hilt has a nicely mellowed patina with traces of silver plate in protected areas of the double guard, cross-guard and knight's head pommel; the chain knuckle-bow is present. The turned black hardwood handle has some flaking along the edges. The scabbard shows scattered spots of flaking black enamel and is equipped with a brass throat and decorative mount and suspension rings having a nicely tarnished patina with faint traces of fading silver plate in protected areas. An overall very good condition Knights of Templar sword. (55800-28). (150/250)
1213. **KNIGHTS OF GOLDEN EAGLE FRATERNAL SWORD BY WILSON** This fraternal sword measures 34 1/2" overall with a 28" straight, unfullered blade with 2/3 length etched eagle and foliate panopies on one side and foliate panels on the other side. The blade is an overall pewter gray with scattered pinprick pitting and spots of modest oxidation. The obverse panel has name in Gothic letters "Grand Castle" next to a smaller plain font " Massachusetts Knights of Golden Eagle"; the ricasso is maker marked with a fading gold washed background "D.Wilson & Co./ Boston/Mass.". The gold washed brass hilt is fading to a dull tarnished patina; the langet bushing and handle cap are missing leaving the langet and eagle pommel loose fitting on the blade and handle. The reddish-brown leather handle shows moderate crazing and flaking and the braided wire wrapping and chain knuckle-bow are missing as well. The engraved brass scabbard has a tarnished patina with light handling marks and oxidation staining, the collar and drag are missing. (55872-23B). (50/100)
1214. **U.S. MODEL 1860 STAFF AND FIELD OFFICERS SWORD** 30" double edge blade is not maker marked. The blade is primarily a deep pewter gray with scattered pinprick pitting and fine oxidation staining with more modest surface rust in the ricasso area. The forte shows light foliate etch with "A.O.K." etched on the reverse side. The one-piece brass hilt has a dark ochre patina with cast federal eagle on the counter-guard and foliate scroll on the guard, the decorative pommel is a same ochre patina. The leather handle shows some light crazing and flaking with light dirt staining and wire wrapping no longer present. The steel scabbard has a dark patina with a couple very light dings and a covering of light surface oxidation. The brass suspension rings and drag have a dark ochre patina with a couple light dings and handling marks. A good example overall. (55872-23A). (100/200)
1215. **COLLECTIBLE METAL BOX OF GERMAN PINFIRE AMMUNITION** This is an open but full two piece metal box with tan top label containing 50 rounds of 7 mm pinfire cartridges. The label remains fully intact with modest brown oxidation staining but the black border print remains legible and reads "50 Stuck/Metallpatroneu von 7 millimetres/mit Stiftungung./Fabrik von Braun & Bloem in Dusseldorf". The pewter finish sheet metal box rates excellent with sharp intact corners and seams. The cartridges rate excellent as well with light oxidation on the lead bullets. (55658-12A1)
1216. **COLLECTIBLE BOX OF FRANK ARSENAL ROLLING BLOCK PISTOL AMMUNITION** This is an opened but full one piece natural colored box with matching paper wrapping containing ten rounds of 50 cal. cartridges from Remington's Army rolling block pistol. The box remains sealed along the rear edge and has some lightly rounded corners and edges. The label has a protective lacquer coating and light tears along the corners and edges with a slightly modest tear along the lower right corner leaving some of the label unreadable. The cartridges rate very good overall with light oxidation on the copper cases and lead bullets. (55658-12A2)
1217. **LOT OF FRANCOTTE PINFIRE AMMUNITION** This lot contains a two piece natural colored box with green wrapping and remnants of a white paper top label containing 25 rds. of 9 mm pinfire cartridges. The box rates fine overall with sharp corners; readable remnants of label read "sulerie Liege/COTTE MA". The cartridges rate near excellent with some fine oxidation on the copper cases and some of the lead bullets. (55658-12A3)
1218. **LOT OF PINFIRE AMMUNITION** This lot contains an opened but full two-piece red tartan colored box with no label containing 24 rds. of 11 mm pinfire cartridges, the bases are not marked. The box rates good to very good with old dried cellophane tape repaired corners, one of which has since separated on the lid, box shows some rounded edges, scuffs, light stains and faded tartan color. The cartridges rate very good with light oxidation on the copper cases and lead bullets. (55658-12A4)
1219. **LOT OF AMMO CANS** This lot contains (3) empty 50 cal. M2A1 cans in very good condition overall with added flaking black paint and remnants of cellophane tape and a couple paper labels. (55658-12A5)
1220. **EUROPEAN PERCUSSION DOUBLE PISTOL** serial # 11, about 36 cal., 3 1/2" octagon barrels with good dark bores. The metal surfaces are an overall brown patina with some scattered pinprick pitting and oxidation staining slightly more prominent along the breech and hammers. The walnut stock rates very good with light scratches and handling marks. The right hammer does not stay fully cocked and one side of the lower tang stock bolt has broken at the slot. A good to very good example overall. (56258-57) {ANTIQUÉ} (200/400)
1221. **UNMARKED UNDER LEVER DOUBLE BARREL PINFIRE PISTOL** 7 mm pinfire, 3 5/8" round barrels with fine bores having good rifling with some light frosting and a few pinprick pits within the grooves. The bright finished metal surfaces are toning to pewter with some scattered pinprick pitting and oxidation staining. The walnut stock has been cleaned to a light brown with generous amounts of original dark finish on the stock flats and protected areas, more-so on the left side of the stock. The lever has become somewhat loose, the action remains crisp and functional. (56313-5) {ANTIQUÉ} (175/275)
1222. **EUROPEAN PERCUSSION DOUBLE PISTOL** 32 cal., 4" octagon damascus barrels with good dark bores. The barrels retain 98% slanted damascus pattern with remnants of a dried protective coating. The frame and action are an overall gun metal with a few pin size specks of fine oxidation and similar dried protective coating mostly in the the protected areas. The walnut grips rate fine with a handful of light dents and handling marks. The action remains crisp and functional. A very good plus example overall. (55948-13) {ANTIQUÉ} (300/500)
1223. **EUROPEAN DOUBLE BARREL FOLDING TRIGGER PINFIRE PISTOL** 7 mm pinfire, 6 1/2" round barrels with good bores having light pinprick pitting and a few spots of modest oxidation. The damascus barrels and light scroll engraved action are an overall brown patina with pinprick pitting and oxidation staining along with a few spots of surface rust on the hammers and barrel release lever. The fluted dark rosewood stock with ball finial buttcap rates very good overall with light scuffs and blemishes. The barrel release and action do not function properly and two of the lower tang stock screws are missing. A fair condition example long barrel pinfire pistol. (56265-4) {ANTIQUÉ} (100/200)
1224. **REMINGTON NEW MODEL PERCUSSION REVOLVER** serial #13690, 44 cal., 8" octagon barrel with a good to very good bore with scattered pinprick pitting and oxidation. The barrel retains about 60% original blue toning to brown with light silvering along the edges and some scattered fine oxidation staining, the action and remaining metal surfaces are an overall pewter gray brown with some scattered pinprick pitting and oxidation staining and some areas of pale blue on the front top and sides of the frame along with a small spot on the rear of the frame and hammer where heat was applied. The brass triggerguard is a lightly tarnished goldenrod patina. The walnut grips rate good to very good with light handling marks and are a bit shy of the metal. (56422-11) {ANTIQUÉ} (300/500)
1225. **REMINGTON MARK III SIGNAL PISTOL** serial #19-431, 10 ga., 9" barrel with a good bore having modest pitting the entire length. The barrel is mainly in-the-white with scattered fine oxidation staining. The brass frame has been lightly cleaned to a mellow patina with a few light handling marks and some scattered specks of fine oxidation staining. The walnut grips rate good with a couple of light blemishes on an added heavy varnish also present on the screw bushings. (56416-1) {C&R} (100/200)

1226. **HARRINGTON & RICHARDSON MARK IV SIGNAL PISTOL** serial #436, 1 7/16, 7 5/8" barrel with a bright bore. The barrel is mainly in-the-white with some traces of original blue in protected areas along the frame along with some spots of light oxidation staining and a few light handling marks. The cast bronze frame with checkered grip rates excellent with a few light handling marks. (56416-2) {NON-GUN} (75/150)
1227. **WINCHESTER RUN-AROUND-SUSAN GUN RACK** This rotating gun long gun rack with safely hold up to twelve rifle and shotguns and measures 22" dia. x 34" h. and is constructed of a black painted steel center pole with white Winchester trademark logo and a 3/4" plywood base and top with felt covered stock supports and silicone barrel and butt retention supports. A great looking excellent condition gun rack. (56625-53)



1228. **U. S. FEDERAL PERIOD ARTILLERY OFFICERS SWORD** 32" overall with a 27" blade with a three-quarter length un-stopped fuller with gold gilt etched floral and martial panoplies. The blade is an overall pewter gray with generous traces of original pale blue on the forte with scattered pinprick pitting and oxidation staining with more moderate pitting at the tip commonly associated with blood protein. The rear of the blade is marked "G.H. Lamberd" on one side and "Philadelphia" on the other side in panels under the martial panoply. The brass hilt with Phrygian cap pommel and slightly bent up quillion has a dark aged patina with some light oxidation and ingrained dirt staining. The brown leather handle shows light crazing but remains intact with light ingrained dirt within the grooves; the braided wire wrapping has separated and un-raveled but remains present. The leather scabbard with brass tip with drag and collar with stud rates fine overall, the leather moderately crazed with some spots of light flaking and oxidation, the seam remains intact; the brass shows a darkened tarnished patina with a few light dents and spots of oxidation staining. A good to very good example federal period officers sword. (56131-22). (400/600)
1229. **SOUVENIR JAPANESE WAKIZASHI** 20" unmarked blade with plain brass habaki, 35 1/2" overall. The blade has toned to an overall gun metal with a moderate covering of fine oxidation staining and pinprick pitting with a few light scratches and handling marks. The matching handle and scabbard is constructed of wood covered with bone carved with decorative oriental figures and foliate designs. The bone consists of eight segmented sections fastened by wood pegs which are no longer present. The handle and scabbard rate fair at best with numerous cracks and chipped and broken ends. (56298-9). (75/150)
1230. **EUROPEAN SIX SHOT PINFIRE DOUBLE ACTION REVOLVER**, 36 Cal., 4 3/4" octagon barrel with an oxidized bore. The metal surfaces show mottled gray brown patina overlaid with finely textured brown surface oxidation. Loose foliate scroll engraving appears on the frame, as well as on the top barrel flat. The pistol appears as Belgian in origin, although no proof marks are present. The cylinder is marked "THE GUARDIAN* AMERICAN MODEL OF 1878" in an engraved band surrounded by loose foliate scroll. The pistol times and locks up somewhat loosely, with the cylinder pin retaining screw no longer present and old grease present on interior surfaces. A lanyard ring with turned finial is present on the bottom of the grip frame, with a turned post and bead front sight on the barrel. The original checkered wood grips are in good condition with a lightly soiled surface and a few flattened points. An interesting pistol that should display well after some judicious cleaning. (146518-13) (150/250)



1231

{ANTIQUÉ}

1231. **WM. S. BUTLER SINGLE SHOT PERCUSSION PISTOL**, 28 Cal., 2 1/2" barrel with an oxidized bore. The metal surfaces of the barrel show a mottled gray brown patina freckled with areas of older surface oxidation. The one piece cast iron frame, shotgun type hammer and bag shaped iron grip all show about 20% older black paint, now chipped and worn with exposed metal showing as gray brown patina. Slot damage is visible on all three frame screws. The right frame side bears the raised cast-in marking "Wm S. BUTLER'S PATENT/PATENTED FEB. 3, 1857". The pistol cocks and locks loosely, with no hammer spring tension present. An interesting representative example in about good overall condition. (146131-11) (200/300)

1232. **EUROPEAN SIX SHOT PINFIRE DOUBLE ACTION REVOLVER**, 36 Cal., 5" octagon barrel with an about good bore showing strong rifling with pitting throughout. The metal surfaces show about 80% dark reblued finish, with silvering at the muzzle and high edges. Areas of pinprick surface oxidation are scattered across the surfaces, with areas of older fine pitting and buffing marks visible under the added blue. The smooth wood grips are in good condition with numerous light impressions visible. A lanyard ring is present on the butt, with a simple triangular front sight dovetailed into the top barrel flat. Mechanical attention is required, as the pistol does not time or lock up, with the hammer no longer holding at full cock. The pistol appears as Belgian in origin, although no proof marks are present. An interesting display piece in fair condition. (146258-32) (100/200)

1233. **PAIR OF VICTORIAN REPRODUCTION HALBERDS** measuring 92 1/2" in overall length. The metal surfaces show gray patina overlaid with patches of brown surface oxidation. The heads measure 21 1/2" overall with square sockets tapering to spear tips diamond in cross section. The crescent blades each show three simple cross style piercings, with four round piercings appearing on the beaks. All bladed edges remain dull and unsharpened. The wooden hafts show dark finish with lighter scuffs across the surfaces, and measure 71 1/2" in length. Both are loosely screw mounted to the sockets. Iron straps with four screws serve ornamental purposes only, being separate from the heads and providing no added strength. Leather collars are tacked at the sockets as well as at the base of the straps, and are now dry and cracking with age. Loosely styled after Revolutionary War period halberds, this pair will make a nice ornamental display. (145087-5)

1234



1234. UNMARKED SINGLE SHOT PERCUSSION POCKET PISTOL, 38 Cal., 4" octagon barrel with a very good smooth bore. The metal surfaces show a smooth pewter patina as cleaned, with older speckled brown pinprick oxidation remaining visible. The delicately swamped barrel is mounted with the original nickel silver dovetailed front sight. The pistol features a diminutive back action lock with nicely styled hammer and pleasing snail bolt-

ster, as well as a delicate triggerguard with flared bow and nicely filed forward finial. The smooth walnut stock with round grip remains in excellent condition as lightly cleaned, with pleasing figure and a carved schnabel tip. A very well made little pocket pistol in overall very good plus condition as lightly cleaned. (146313-4) {ANTIQUE} (300/400)

1235. ANTIQUE SOUTH AFRICAN ASSEGAI measuring 64" in overall length. The metal surfaces of the hand forged symmetrical leaf-shaped blade and open sided forged socket measure 30" in overall length, and show mottled gray brown patina toning to dark chocolate brown at the socket. The blade shows two hand struck cruciform decorations on each side, and measures 15 1/2" before tapering to a square shaft with hand struck crosshatched decoration and forged medial rings. A few older nicks are present on the edges of the blade, with the tip being slightly bent and missing about 1/8" at the point. The wooden shaft measures 33 1/2" in length and is possibly original, showing a dark aged surface with a carved and flared birdcage ornamentation about 15" from the butt. Numerous usage marks and age cracks are apparent across the wood surface. One structural crack is present 13" from the butt, remaining tight but showing slight movement under pressure. Overall a very nice Assegai ready to display with your Martini-Henry, or to simply wave about during the next rerun of "Zulu Dawn". (146312-6A)

1236. ANTIQUE BOARDING PIKE measuring 75 1/2" in overall length. The iron head shows a smooth mottled dark brown patina and measures 8" to the tip of the staff, with a leaf shaped blade of flattened diamond section. No markings are present. The head is attached to the staff with a rat tail tang imbedded in the wood rather than with the iron socket and strap mounting usually seen. The dark hardwood staff is antique in appearance with smooth surfaces, measuring 67 1/2" in length and tapering from 1 1/8" in diameter at the head to 5/8" at the butt. Several spatters of older red paint are visible towards the butt. Four shrinkage cracks surround the imbedded tang, with older glue stabilization evident. Overall a pleasing display piece with a well-aged if not original appearance. (146312-6B)

1237. MODERN REPRODUCTION HALBERD measuring 87" in overall length. The steel head measures 28 1/2" from the tip of the tapered spear point to the squared socket and is of welded construction with simulated forge marks and an overall faux patina. The crescent blade and beak have both been crudely sharpened with a grinding wheel. An ash staff has been fitted, remaining new in appearance with a clear oil finish and measuring 58 1/2" to the edge of the socket. The staff is square in cross section with roughly rounded corners and no taper. An interesting if somewhat crudely executed modern interpretation of a Revolutionary War period halberd. (146312-6C)

1238. ANTIQUE BARBED HARPOON OR FISH SPEAR measuring 67 3/4" in overall length. The round iron shaft measures 35" in length, 7/16" in diameter, and shows a rough forged metal surface with older surface pitting and dark patina. The pointed tip is square in cross section and has been pierced to allow forge welding of two rearward facing "U" shaped barbs, giving a total of four 1 1/2" curved tines each extending from one facet of the point. The arrangement and fitting of the barbs appears original, although the purpose remains a mystery as there is no way to remove the barbs or whatever the original user may have impaled. The wood staff measures 32 1/2" in length by 1 7/8" in diameter and is fitted with a forged iron collar to prevent splitting where the iron shaft is set into the wood. The wood appears original with an overall brown surface patina as well as scuffs and marks acquired through the years. The butt shows more substantial aging, with a diagonal section about 1/2" long having been worn away. An interesting and wicked looking piece that displays well, but remains of unknown purpose. (146312-6D)

1239. AUSTRIAN MARTINI ACTION SCHUETZEN RIFLE BY PETERLONGO 8.15x46R, 31 1/2" octagon barrel with a very good bore showing light roughness within the grooves. The metal surfaces of the barrel show decorative radial milling on the flats, now aged to primarily a brown patina with patches of pinprick oxidation; areas of textured orange oxidation are evident beneath the forearm. The frame is a dark blue gray patina with areas of pinprick pitting overlaid with patches of dried grease or varnish. More prominent pitting is visible adjacent to the wood of forearm. The right side of the frame bears the makers name "JOH. PETERLONGO" within an engraved banner, with the left side showing a similar banner engraved "INNSBRUCK". The breechblock shows a brown patina with pewter tones in recessed areas and features a milled hole extending through the rear of the frame to facilitate cleaning from the breech. The high comb rams-head schuetzen buttstock rates about good with checkered panels and soiled surfaces showing numerous scuffs and dings. An open structural crack appears at the right side of the wrist, extending from the top tang through to the triggerplate. The heavy schuetzen buttplate shows a mottled gray patina with peppered surface oxidation. The forearm rates about good and shows checkered panels now worn mostly smooth with a dry lightly soiled surface. A one inch chip is missing from the left rear edge with a 1" crack appearing above the right barrel wedge escutcheon. The rifle requires mechanical repair, as the action no longer cocks upon opening and the double set trigger no longer functioning. Both the adjustable rear schuetzen sight and the front sight are missing. In overall about fair condition this is a high quality rifle that has suffered from neglect over the years. (146599-67) {C&R} (300/500)

1240. UNMARKED GERMAN MARTINI ACTION SCHUETZEN RIFLE 8.15x46R, 30 3/4" octagon barrel with an excellent bore. The metal surfaces of the barrel show a mottled dark blue brown patina overlaid with areas of lightly textured surface oxidation along the entire length. The frame and ornate schuetzen triggerguard show about 50% dark blued surfaces, with spots of surface oxidation and pinprick pitting evident. The high comb rams head schuetzen buttstock rates about good and features a broad checkered panel with simple scroll edges on the right side as well as a carved thumb rest and simple floral carvings on the cheeks. A chip on the comb shows a poorly executed repair with expanding glue having lifted the chip about 1/4" from the original surface. Scuffs and dings from careless storage are apparent across the lightly soiled wood surfaces. The original heavy schuetzen buttplate with acorn finial remains intact but needs refitting as the adjoining wood has shrunken through the years. The forearm rates fair, with checkered panels and simple floral carvings adorning both cheeks. The barrel wedge remains intact but no longer secures the forearm to the barrel, with a band of clear heat shrink plastic now performing that function. The upper edges of the barrel channel show missing wood at all four corners, the largest being a 4" sliver missing from the left rear edge. Both the original adjustable schuetzen rear sight and the original adjustable front sight are intact, showing overall brown patina with light surface oxidation. A tired rifle with a great bore and a nice set of sights. (146599-72) {C&R} (300/500)

1241. LUGER HOLSTER LOT This lot consists of a WWI German Luger holster marked "N. BURGHARD/PASING 1918". The smooth brown leather remains in very good plus condition with a dry surface showing scattered scuffs and light soiling. Stitching remains intact except at the base of the magazine pouch which shows loose threads as well as holes in the leather at both corners. The closure strap is intact with age cracking at the buckle and surface damage to the tip. The interior of the flap is marked B.A.XI, with the tool pouch intact and showing wear at the closure stud. The interior leather lifting strap is missing. Included is one original nickel plated steel Luger magazine in excellent condition with wood base marked 8292 over "a", as well as one original Luger tool with crown over "4" proof. A very nice WWI Luger rig. (146623-64)

1242. **GERMAN WWI PHOTOGRAPH ALBUM LOT** This lot consists of one early photograph album documenting the travels and experiences of a German soldier during the Great War. The album consists of 24 pages bound in a heavy textured gray paper cover featuring an embossed Iron Cross with silver outline and bearing an interior 1914 date, as well a crown over centered "W" symbolic of the reign of Kaiser Wilhelm. The cover is bound with thin twisted cord in alternating red, black, and white Germanic colors, with small knotted tassels now frayed with age. The cover shows light soiling wear to the edges with age cracking and fold wear at the binding, the rear cover being absent entirely. Interior photographs are pasted on both sides of each page, and comprise a total of 208 images, ranging in size from 2"x3" to 8"x10", with all larger images postdating the war. All images are gelatin silver prints on paper and remain in excellent fully visible condition, with some images showing fading and yellowing from silver oxidation and/or sodium thiosulphate staining. Most pages have been carefully annotated in neat Germanic script with dates and place names fully legible but difficult to decipher unless the reader is German fluent. The album begins with the soldier's departure from Munich in 1914, showing a troop train and regimental group photo on the first page. From there the album progresses through various field postings at the front, documenting Christmas celebrations, field gun emplacements, burials, and fellow soldiers. Three photographs on page six document are dated 1915 and show soldiers in the trenches of St. Mihiel with Mausers trained across the lines as artillery bursts in the background. Several images are humorous in nature, with comrades in arms mugging over a cask of wine. One image pokes fun at several soldiers urinating in a trough latrine. Numerous images of communication stations show early telephone systems at the front. Daily trench life is documented with images of soldiers at rest in trench bunkers or cooking meals. One particularly poignant series of nine photos documents the interment of one J. Toten in 1917, showing soldiers with bayonets and shouldered gas-mask cannisters laying a wreath on the rough board casket. Another series documents a visit to the town of Allgau in the Bavarian Alps, and features actual sprigs of Edelweiss still pressed between the pages. The war images end in 1918, with the last seven pages of the album dedicated to documenting an electric generating plant in the early 1920's, indicating the original owner's probable occupation as an electrical engineer. Altogether a fascinating and historic collection of images that will please the discriminating WWI collector. (145984-115). (400/600)

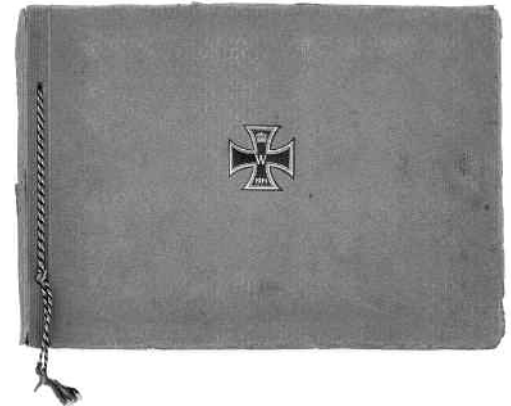

1243. **LUGER HOLSTER LOT** This lot consists of one WWII German Luger holster marked "P.08" with bcb/42 code as well as WaA170 waffenamt. The smooth black leather surface remains in very good plus condition showing a dry aged surface with light surface cracking and numerous scuffs and light abrasions. All stitching remains intact, with one lower corner of the magazine pouch flattened but unbroken. The closure strap shows a dry cracked surface but remains functional, as does the interior lifting strap. The interior is in near excellent condition with tool pouch appearing unused. No tool is present. Overall a very nice 1942-dated holster by Otto Graf of Leipzig. (146363-53)

1244. **LUGER HOLSTER LOT** This lot consists of one WWII German Luger Holster crisply marked "C. HEINICHEN/DRESDEN/1939" with a clear WaA706 waffenamt. The smooth black leather remains in excellent condition, showing 90% original finish with only light scuffs and impressions scattered across the surface. All stitching remains intact and tight. The closure strap remains supple, showing only light age cracking. The interior is in equally excellent condition with intact lifting strap and tool pouch. Overall a very nice holster in hard to find condition. (146335-19)

1245. **WWI MARK III FLARE PISTOL BY W. W. GREENER** serial #2070, 1" flare, 4" barrel with an excellent bore. The metal surfaces of the brass barrel and frame remain in excellent condition, showing smooth uncleaned ochre patina with slightly darker patina at the grip frame. A few scattered small dings and handling marks are present and remain unobtrusive. The left side of the frame bears the W. W. GREENER BIRMINGHAM marking as well as the mark III designation, '16 date, broad arrow mark, and British proofs. The right side of the frame bears the serial number as well as Greener elephant trade mark. The barrel latch, trigger and hammer show mottled gray brown patina peppered with older pinprick surface oxidation. The smooth walnut grips rate very good plus showing strong original finish with the left panel having one 1" tight crack at the cheek as well as a 1/2" crack at the toe. Both grip panels are numbered to the pistol on interior surfaces. Some slot damage is evident to both the grip screw and the barrel pivot screw. The original steel lanyard ring is present on the butt. The pistol is housed upright in a period mahogany case with nickel plated fleur-de-lis style hinges. The varnished wood surfaces are in near excellent condition with solid joints and show some shelf wear with a few splatterings of white paint. The front swing latch is no longer present. Bordering the pistol are two mahogany inserts containing a total of twelve period 1" paper hulled flares with brass bases marked "J. P & S.". The flares remain loaded with unfired primers, but no claim can be made as to current viability. In overall excellent condition, this nicely cased flare pistol belongs in a comprehensive WWI collection. (146120-63) {NON-GUN} (400/600)



1245



1246

1246. **LOVELY WINCHESTER MODEL 1894 LOADING TOOL** The metal surfaces of this original 32-40 Winchester model 1894 reloading tool show 95% original blued finish with the loss due to light silvering on the knurling as well as light thinning on the barrel of the seating die. Scattered light handling marks and several tiny spots of older pinprick surface oxidation are evident upon close inspection. All Winchester markings and patent dates remain crisp and sharp. No decapping pin is present. Overall an extremely fine example in rarely seen condition, this loading tool will please the discriminating Winchester collector. (146328-46)

1247. **WINCHESTER MODEL 1894 BULLET MOLD** This is a lovely blued steel Winchester bullet mold with walnut handles, casting a 32 caliber 165 grain flat point bullet for the 32-40 WCF cartridge. The mold retains 90% original blue with the loss due to usage marks on edges of the sprue plate and a few spots of older pinprick surface oxidation. Some light dings and tool marks are visible on the exterior surface of the right mold half. The interior faces and cavity surfaces remain clean and smooth. The walnut mold handles remain smooth and solid, showing only the lightest of handling marks. The brass ferrules remain tight and show a smooth ochre patina. Overall a very fine Winchester 32-40 mold that will pair excellently with the preceding model 1894 loading tool. (146328-47)

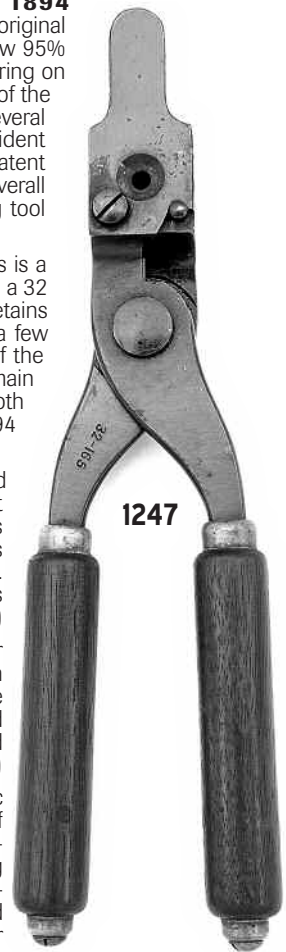

1247

1248. **MARLIN MODEL 39A LEVER ACTION RIFLE** serial #P6997, 22 S.L.L.R., 24" barrel with a very good bore that is mostly bright but has a ring and bulge about 3/4" from the muzzle. The metal surfaces retain about 80% of an added blue finish that covers areas of light pitting and is flaking to brown and mixing with a few areas of light surface oxidation throughout. The walnut beavertail forearm rates excellent, the pistolgrip buttstock has a few cracks; the buttplate is slightly proud. The original sights are intact, the front sight is missing the hood. The action appears to function correctly and with some work and proper fitting from a qualified gunsmith this could be a very useable shooter. (46540-12) {C&R} (200/400)

1249. **SILE "PROTECTOR" SINGLE SHOT SHOTGUN** serial #210697, 20 ga., 20" barrel choked cylinder with an excellent bore. This Italian made, folding pistolgripped shotgun retains about 99% of its dull blue finish with some light freckling observed on the barrel. The hardwood pistolgrip stock has vertical serrations on the pistolgrip and is in near excellent condition with light handling wear. The forend has horizontal serrations and also exhibits light handling wear. This single shot shotgun utilizes a barrel release forward of the triggerguard and is designed to fold in half reducing overall storage length to 20 1/4". (86586-D29175). (100/200)

1250. **WALTHER SP22 DEALER ACCESSORY KIT LOT** This lot consist of 13 1/2" X 21 3/4" hard plastic case with cut out foam interior for guns and accessories. The case holds a Walther PZ 2 X 20mm long eye relief scope with lens covers, rings with grooved receiver bases, silver finish and clear optics. Next item is a functioning Walther Nanopoint miniature red dot sight, functioning frame-mounted laser, a 9 1/4" and a 7 3/8" long Picatinny style rail that mounts on the topstrap, a 2 1/4" and 4 1/8" Picatinny style rails that fit the slot in the pistols dust cover, a 1 7/8" filler for the dust cover rail, weight bar for the dust cover rail, grip frame, screws and Allen wrenches and various manuals and instructions. Lastly, two styles of fiber optic front sights and one fiber optic rear sight. A very nice kit for the SP22 owner. (84299-54)

1251. **PIETTA MODEL 1851 NAVY PERCUSSION REVOLVER** serial #414668, .44 cal. percussion, 7 3/8" barrel with an excellent bore. The metal surfaces retain 99% of their nickel and gold colored plating. The frame and barrel have been factory machine-engraved with tight scroll engraving that covers about 50% of these surfaces. The gold plated cylinder has crisp roll engraved naval battle scenes with slight operational wear to the front and the nickel plating is starting to cloud on the barrel, grip frame and frame. The smooth faux ivory grips are in near excellent condition with light storage wear evident. Included is an excellent condition hardwood case containing a brass two cavity (round ball and conical ball) mold, powder flask, wood handled nipple wrench and brass cap box. (86343-67) {ANTIQUÉ} (300/500)
1252. **ERMA'S FIREARMS MANUFACTURING CO. M-1 CARBINE** serial #2413, 30 Carbine, 18" barrel with an excellent bore. This rifle retains about 99% of its mixed polished and dull blue finishes. The receiver has been drilled and tapped for a side scope mount and the stock was relieved to accommodate it. The walnut stock is in good to very good condition with numerous scattered dents, scratches and handling marks. The back of the trigger has an Allen head overtravel screw installed. Erma Firearms were made in Sterling Mo. from 1962 to 1965. Springfield Model 1903 barrels were used and this version utilized a swaged gas collar. E.F.M. made M-1's utilized a cast receiver that is known to be soft and careful inspection by a qualified professional is highly recommended. The rifle includes a 15 round magazine, side scope mount and three mounting screws. (86601-2). (200/400)
1253. **SMITH & WESSON MODEL NO.1 3RD ISSUE REVOLVER** serial #126769, 22 Short, 3 3/16" barrel with a heavily corroded bore. The metal surfaces retain only about 25% of its factory nickel finish. The side plate and portions of the frame and grip frame are spot bubbling throughout. The remaining metal is a light gun metal gray interspersed with oxidation blemishes, pitting and dents. The rosewood grips are correctly numbered to the gun and rate good displaying light handling wear with a crack visible on the inside of the right grip panel. The ejector rod is broken off and the bolt stop assembly is missing. The revolver still cocks and de-cocks correctly and the pawl still rotates the cylinder. (86556-5) {ANTIQUÉ} (25/75)
1254. **SMITH & WESSON SCHOFIELD SECOND MODEL SINGLE ACTION REVOLVER**, 45 Schofield, 7" barrel with a heavily oxidized bore and several dents on the end of the muzzle. All metal surfaces are now a chestnut brown hue from oxidation with scattered pitting, dents and handling wear. The smooth grips are incorrect for this model with the left one displaying a vertical crack on the backside that runs 3/4 of the grip length. The end of the mainspring and mainspring screw have broken off and some rather interesting frontier style gunsmithing involving steel and wooden wedges were used to get it working again. Despite those efforts the mainspring is weak, the firing pin is broken off, the cylinder catch is missing parts and all markings including the serial number are no longer visible. Surprisingly the action still functions but the cylinder stop no longer does. (86258-19) {ANTIQUÉ} (200/400)
1255. **COLT MODEL 1903 DOUBLE ACTION REVOLVER** serial #266466, 32-20 Winchester, 6" barrel with an excellent bore. This 1906-manufactured civilian version of the New Army revolver retains about 55% of its original blue finish with most of the loss on the sides of the barrel and the grip frame. These areas have worn to a light gunmetal gray with some scattered handling marks also visible. The hammer has traces of Nitre blue on the top with the remainder having worn to silver. The trigger retains most of its Nitre blue with the face worn to gunmetal gray. The hard rubber grips are not correctly numbered to the revolver and are of the Navy configuration with the word Colt in an oval. Overall, the grips are in very good to excellent condition with some wear to the diamond points on the right panel. All the appropriate parts except the grips have matching assembly numbers and the markings remain crisp. The revolver still times and locks up well. (86617-1) {C&R} (250/450)
1256. **SPANISH COPY OF MERWIN HULBERT & CO. LARGE FRAME OPEN TOP SINGLE ACTION REVOLVER BY ANITA Y CHAROLA** serial #5933, .44 Merwin & Hulbert, 7" barrel with a very good but oxidized bore. The barrel displays some oxidation blemishes on the re-applied nickel finish around the barrel and by the barrel latch area. The finish on the cylinder has oxidized in the bolt stops, part of the cylinder face and some of the flutes. The frame has light oxidation blemishes around the loading gate and recoil shield for an overall retained finish of about 95%. The revolver was heavily buffed during the preparation for re-finishing and removed all markings and rounded the edges. The smooth Gutta Percha grips are in very good to excellent condition with light handling wear but are not correctly numbered to the gun. The barrel, cylinder and cylinder pin are correctly numbered to the gun. This first issue style Merwin copy has seen some frontier gunsmithing that includes a fabricated replacement triggerguard, several chambers have been hand reamed or polished leaving them out of round and the cylinder release has been cross hatched for better purchase. The saddest alteration is the removal of the retention collar at the front cylinder and a spacer soldered onto the barrels cylinder pin hole effectively removing its multiple ejection capability. (86298-2) {ANTIQUÉ} (300/500)
1257. **REPLICA COLT 1851 NAVY REVOLVER** serial #E23650, .44 cal. percussion, 7 1/2" barrel with an excellent bore. The blue finish on the barrel and cylinder are in near excellent condition with a few light scratches present. The brass frame and grip frame are slightly tarnished from handling and the case-hardened colors on the hammer and loading lever remain robust. The smooth walnut grips are in near excellent condition with light handling wear but have shrunk slightly leaving the backstrap slightly proud of the wood. This is a nice condition 1851 ready for the range or reenacting. (86543-6) {ANTIQUÉ} (100/150).
1258. **REPLICA REMINGTON MODEL 1858 REVOLVER BY PIETTA** serial #B4220, .36 cal. percussion, 7" barrel with an excellent bore. This 1996 manufactured revolver retains about 99% of its blue finish with a few light scratches and operation marks noted. The brass grip frame and frame have lightly tarnished from handling and the hammer retains bold case-hardened colors. The smooth walnut grips are in excellent condition. (86543-5) {ANTIQUÉ} (75/125)
1259. **REPLICA MODEL 1863 REMINGTON POCKET REVOLVER BY ARMI SAN MARCO** serial #E54290, .31 cal. percussion, 3 1/2" barrel with an excellent bore. This revolver retains about 99% of its finish with a light turn ring present on the cylinder and light tarnish on the brass frame and grip frame. The hammer retains rich case-hardened colors as does the trigger with a few light operation marks. The hardwood grips are in excellent condition. (86543-4) {ANTIQUÉ} (75/125)
1260. **TRADITIONS TRAPPER PISTOL** serial #14-13-000002-99, .50 cal. percussion, 9 3/4" barrel with a near perfect bore displaying a slight amount of surface oxidation that should clean up nicely. The barrel retains 99% of its factory blue finish and the case-hardened colors of the lock remain robust with a slight amount of oxidation around the hammer nose. The hardwood stock is in excellent condition as is the brass furniture on the barrel and stock. Most of the brass is now a pleasing straw color. A wooden ramrod with brass fittings is included. (86300-4) {ANTIQUÉ} (150/200)
1261. **CLASSIC ARMS ETHAN ALLEN PEPPER BOX PISTOL** serial #04873P, .36 cal. percussion, 3 1/2" smooth bore barrels that are in excellent condition. The single monobloc barrel unit with four bores is a brown color with light freckling present. The hammer, trigger and guard are a blue / silver color with some trace case-hardened colors seen on the hammer. The brass frame remains near excellent as does the walnut grip. The double action mechanism functions but is in need of professional attention. (86543-7) {ANTIQUÉ} (50/100)
1262. **CLASSIC ARMS "SNAKE EYES" DOUBLE BARREL DERRINGER** serial #7063S, 3 1/8" smooth bore brass barrel with excellent bores. The hammer, trigger and triggerguard remain arsenal bright with some light oxidation stains. The walnut grip panels are in excellent condition. The pistol includes a brass ramrod. (86543-8) {ANTIQUÉ} (50/100)

1263. **FOREHAND & WADSWORTH DOUBLE ACTION REVOLVER** serial #154111, 32 CF, 2 1/2" barrel with a very good but lightly oxidized and pitted bore. The metal surfaces have been completely cleaned and are now even gunmetal gray with considerable pitting present. The hard rubber grips are in near excellent condition and feature the F&W logo with a shield below it and an eight pointed star around the escutcheon. The revolver is still fully functional. The revolver includes a brown leather flap holster with light crazing, nicks, scratches and handling wear. The belt loop is marked with three illegible numbers / 38 / PP. There are a number of hand-scratched words appearing on the holsters front and rear. (86258-62). (50/100)
1264. **MANUEL ESCODIN MODEL 1924 DOUBLE ACTION REVOLVER** serial #M265487, 38 Special, 4 1/4" barrel with an excellent bore. Overall, the revolver retains about 97% of its original blue finish with scattered oxidation and freckling present. The hammer and trigger retain fairly strong case-hardened colors with the trigger starting to thin from use. The checkered walnut grips are in very good to excellent condition with some light handling wear and evidence of the right escutcheon starting to pull through. The revolver includes a Red Head Brand #406B Mexican loop style holster in good to very good condition with light to moderate crazing present. (86549-1) {C&R} (75/125)
1265. **IVER JOHNSON THIRD MODEL SAFETY AUTOMATIC HAMMER DOUBLE ACTION REVOLVER** serial #C95619, 38 S&W, 3 1/4" barrel with a near excellent bore displaying one small area of oxidation. The nickel plated finish on this top break revolver is in near excellent condition with about 99% remaining. The case-hardened colors remain strong on the hammer and trigger with light oxidation blemishes present and the blue triggerguard has some light freckling. The revolver is equipped with hard rubber grips featuring the IJ logo around the escutcheon and an owl-head at the top of the grips. (86564-8) {C&R} . (200/400)
1266. **FRENCH MODEL 1892 DOUBLE ACTION REVOLVER BY ST. ETIENNE** serial #. I2529, 8mm Lebel, 4 1/2" barrel with a near excellent bore displaying scattered light oxidation marks. This revolver retains about 97% of its dull blue finish with most of the loss due to scattered light freckling and oxidation blemishes. The checkering on the walnut grips remains strong with scattered dents and light handling wear. The barrel has no date or proof marks indicating a mid war or commercial model. (86556-3){C&R} (300/500)
1267. **SMITH & WESSON SAFETY HAMMERLESS 1ST MODEL DOUBLE ACTION REVOLVER** serial #2136, 38 S&W, 3 1/4" barrel with a near excellent bore displaying slight oxidation in the edges of the grooves. About 85% of the nickel finish remains with scattered flaking and oxidizing of the finish on the metal surfaces with the heaviest concentration around the grip frame. The bluing remains strong on the triggerguard and the case-hardened colors on the trigger remain good. The mother-of-pearl grips are in very good condition with some scattered scratches observed. The left grip panel has a monogram engraved that appears to be an "A" encircled by possibly a "B". The grip screw and the grip safety are frozen but should free up with some Kroil or other good penetrating oil. Currently the trigger mechanism does not work due to the frozen grip safety. (86363-54) {ANTIQUE} (200/400)
1268. **LOT OF HOLSTERS** This lot consists of a single leather holster for a French Model 1892 revolver. This flap holster is unmarked but features three ammunition loops under the flap. It also features a single belt loop and two lanyard loops. The holster is very good to excellent condition with light scratches, handling wear and marks. The stitching remains strong and there is some moderate crazing on the front of the holster. (86556-3A)
1269. **ASTRA 400 SEMI-AUTO PISTOL** serial # 86403, 9x23mm Bergmann Bayard, 6" barrel with a good to very good bore exhibiting moderate frosting. Overall this Model 1921 pistol retains about 95% of its blue finish with some light silvering on the left side of the barrel and receiver. The walnut grips are in fair to good condition presenting lightly worn diamond points, scratches and dents with the worst damage a broken left grip panel (both pieces are present). The numbers on the slide, barrel and magazine all correctly match. A single magazine is included. (86534-14) {C&R} (200/400)
1270. **MAUSER MODEL 1914 SEMI-AUTO PISTOL** serial #299772, 32 ACP, 3 3/8" barrel with heavily worn rifling that still has traces present toward the muzzle. This pistol retains about 75% of its factory finish with the remainder a mix of blues and browns with scattered oxidation blemishes and some sparse pitting. The flat diamond-checkered walnut grips are in good to very good condition with moderate wear present and combination of handling wear and dents. The pistol has correct matching numbers and includes a single magazine with moderate oxidation. (86534-12) {C&R} (200/400)
1271. **IVER JOHNSON SECOND MODEL AUTOMATIC SAFETY HAMMER DOUBLE ACTION REVOLVER** serial #88175, 32 S&W, 3" barrel with a few scattered oxidation blemishes. The revolver retains about 80% of its original factory blue finish with the grip frame mostly silver and scattered silvering appearing on the frame and other metal surfaces. The hammer and trigger have faded to mostly gunmetal gray with faint traces of case-hardened color. The owl-head hard rubber grips are in near excellent condition and the little gun still functions. The numbers on the barrel assembly match the frame. (86599-15) {C&R} (100/200)
1272. **IVER JOHNSON SECOND MODEL AUTOMATIC SAFETY HAMMER DOUBLE ACTION REVOLVER** serial #E70267, 32 S&W, 3" barrel with scattered oxidation blemishes. The revolver retains about 97% of its original factory nickel finish with some scattered light flaking and bubbling observed. The hammer and trigger have strong traces of case-hardened color. The owl-head hard rubber grips are in near excellent condition and the revolver still functions. The numbers on the barrel assembly match the frame. (86599-14) {C&R} (100/200)
1273. **SPANISH PARAMOUNT SEMI-AUTO PISTOL** serial #1262, 32 ACP, 3 1/4" barrel with very good but lightly oxidized bore. The metal surfaces of the Spanish made "Ruby" pistol are gunmetal gray with random oxidation blemishes and pitting. Traces of bluing are still present around the right grip in the protected areas. The smooth wood grips are in very good condition with scattered light scratches, dents and dings. The back of the right panel is marked "O.H. Whall Co. Boston Mass." and the screws protrude above these replacement grips. The right side of the pistol is stamped "Spain" but there is no indication which of the many makers was the original manufacturer. The website ForgottenWeapons.com lists two makers that used the name Paramount. The pistol is equipped with a lanyard swivel and includes a single unmarked magazine. (86357-S17251) {C&R} (75/125)
1274. **HARTFORD ARMS NEW 32 NO. 2 REVOLVER** serial #1028, 32 RF, 2 1/2" barrel with a very good bore with some light oxidation and pits. The nickel plating is in near excellent condition with about 97% remaining exhibiting scattered light oxidation stains. The checkered hard rubber grips feature a shamrock at the top and crossed flags at the bottom with light handling wear and a crack on the back side of the right panel. They are correctly numbered to the gun as is the barrel and cylinder. The gun still functions. (86596-3) {C&R} (100/200)
1275. **LOT OF LUGER PARTS** This lot consists of the following parts: (1) complete receiver with barrel, toggle and all related parts - barrel has lightly frosted bore; (1) magazine with synthetic base and letter P on rear, (1) set of checkered walnut grips in good to very good condition with heavy wear to the diamond points on the right panel, (1) trigger with trigger spring attached, (1) side plate with trigger lever and trigger lever pin attached, (1) mainspring with mainspring guide, (1) recoil lever, (1) locking bolt, (1) safety bar, (2) grip screws, (1) magazine catch spring, (1) hold open catch with hold open catch spring attached, (1) magazine catch, (1) lanyard loop from rear of frame, (1) safety catch, (2) unidentified straight pins for a Luger and (1) unidentified "L" shaped pin. The appropriate receiver parts, side-plate and locking bolt have correctly matching number 22 on them. The receiver and other parts have been re-blued and some exhibit light pits under the new finish. There is no indication who manufactured these parts but the top of the toggle has what appears to be a flattened c with legs and feet attached when viewed from the right. (86540-15)

1276. **STEVENS OFFHAND NO. 35 TARGET PISTOL** serial #26005, 22 RF, 11 3/4" barrel with a near excellent bore exhibiting light frosting. The blue finish on barrel, trigger and hammer are in very good condition but showing signs of thinning to a brown color. The nickel plated receiver is dull pewter gray with scattered freckling, tiny bubbling and wear along the backstrap that has turned brown for an overall rating of 95%. The plain walnut grips are in very good to excellent condition with light dents and handling wear. The butt cap, barrel and grips are correctly numbered to the gun. This pistol is equipped with a globe bead front sight, tangent rear sight and two line address on the octagonal receiver. (86535-6) {C&R} (350/550)
1277. **CUTAWAY CZ MODEL 52 ARMORERS TRAINING PISTOL** serial #CUT264, 7.62x25mm, 4 3/4" barrel with an excellent cut away bore. The phosphate finish on this importer-marked pistol is in near excellent condition with about 99% remaining. The slide has some light horizontal wear marks while the paint in the cut away sections remains in excellent condition. The synthetic stocks are in near excellent condition as are the cut outs. This interesting pistol also includes a magazine. This is a must have pistol for any military collector. (86593-36) {C&R} (200/400)
1278. **STEYR-HAHN MODEL 1912 SEMI-AUTO PISTOL** serial #9359a, 9mm Steyr, 5 1/8" barrel with a lightly frosted bore. The arsenal re-applied finish is in good to very good condition. The pistol appears to have had some markings ground off the slide and there is evidence they were cold blued. The slide surfaces are heavily covered with varying size pits and there is evidence of pitting under the new finish. The wood grips are in excellent condition and are similar to the variety used by Austria after the World War I. The only remaining markings other than the serial number are "Steyr" on the slide with a 1913 manufacture date next to it. (86556-4) {C&R} (200/400)
1279. **HOPKINS & ALLEN X.L. NO. 5 SAFETY LOCK SINGLE ACTION REVOLVER** serial #4045, 38 RF, 2 1/2" barrel with a lightly oxidized and pitted bore. The metal surfaces are predominately gunmetal gray with traces of nickel finish on the barrel, flutes and protected areas. The smooth rosewood grips are in very good to excellent condition with light scratches and dents present. The revolver is fully functional with the only part needing attention the cylinder pin latch spring. (86416-24) {ANTIQUÉ} (500/150)
1280. **FOREHAND & WADSWORTH TOP BREAK REVOLVER** serial #15570, 32 S&W, 3 1/4" barrel with a lightly pitted bore. The nickel plated finish remains in excellent condition but the blued triggerguard has thinned on the outer bow. The case-hardened colors remain strong but lightly faded on the hammer and trigger. Overall, the gun rates about 95% with a few light scratches and minor dents present. The hard rubber grips have the correct logo but the right panel is broken in two with some light damage to the right escutcheon. All appropriate parts have matching numbers and the grips are unnumbered. Overall, the revolver functions well with the single action in need of professional attention. (86556-6) {ANTIQUÉ} (50/150)
1281. **MOISIN NAGANT MODEL 1891 BOLT ACTION CARBINE** serial #742, 7.62x54R, 24" barrel with a near excellent bore with slight frosting present but strong rifling. This rifle retains about 80% of its arsenal black finish with fairly evenly distributed wear on the barrel, receiver and magazine. The worn areas are a mottled mix of gunmetal gray with the barrel bands turning a brown color and scattered pits and oxidation blemishes on the surfaces. The walnut stock is in good to very good condition with a nice smooth finish overall, a few handling marks and dents, and the stock is rack numbered 294. The stock exhibits a 2" visible horizontal crack on the right side that is even with the tang. This early version of the Nagant has no top handguard and has been possibly arsenal refurbished into a Finnish Model 91/24 carbine configuration. The front sight is a Finnish Model 28 that is held by a set screw instead of solder, the rear sight is an arched Model 1891 and the bolt is a Tula with a mismatched serial number. The rifle lacks any significant markings to indicate country of origin or retrofit. The rifle includes a woven sling with leather attachment points. (86599-73). (75/100)
1282. **JAPANESE ARISAKA TYPE 38 SPORTER BOLT ACTION CARBINE BY KOISHIKAWA ARSENAL** serial #1979193, 6.5 Arisaka, 22" barrel with a dark frosted bore. The rifle retains about 95% of its original factory finish with some silvering on the wrist metal, browning of the magazine floorplate and the chamber areas from oxidation. A note provided with the rifle indicates the stock started life as a Model 97 sniper rifle stock but markings and alteration do not allow positive identification. The stock has separated in the butt where the two pieces were joined and it moves back and forth. There is a repair to the belly of the buttstock and numerous dings, dents chips and rough handling marks present. There is also a screw hole that extends from the belly to the comb probably to repair the separated pieces. The mum is still present as are the original military sights. (86599-62). (50/75)
1283. **COLT NEW LINE 22 SECOND MODEL REVOLVER** serial #34191, 22 RF, 2 1/4" barrel with a good but oxidized and pitted bore. The receiver and barrel of this 1876 manufactured revolver have flaking nickel plate with light oxidation blemishes on the barrel and cylinder and brass visible on the frame for an overall rating of about 85% plus. The smooth rosewood grips are in very good to excellent condition with light handling wear and scratches. The right grip panel, barrel and cylinder are numbered to the gun. The cylinder retaining pin spring is missing, the cylinder pin is lightly bent near the knurled end and the knurled cylinder pin head is damaged from forceful removal with pliers. This fully functional second model has "Colt New 22" etched on the barrel, Colt Hartford address line and the single patent date at the bottom of the barrel. (86387-35) {ANTIQUÉ}. (300/500)
1284. **COLT 25 AUTOMATIC SEMI-AUTO PISTOL** serial #OD14495, 25 ACP, 2 1/4" barrel with an excellent bore. This pocket sized pistol retains about 98% of its original blue finish with the frame drifting to plum and the slide has several pitted areas that were cleaned. The checkered walnut stocks with silver Colt medallion are in near excellent condition. The pistol includes a single magazine and an original Colt box correctly end labeled and numbered to the gun. The box contains an advertising tag and manual. (86520-1570) [Richard "Stretch" Kennedy Collection]. (300/500)
1285. **RUGER STANDARD MODEL SEMI-AUTO PISTOL** serial #41398, 22 LR, 4 3/4" barrel with an excellent bore. This 1952 made pistol retains about 90% of its original blue finish with most of the loss due to thinning and silvering finish on the grip frame and some scattered areas of cleaned pitting on the frame. The checkered black Delrin grips with black Ruger Phoenix are in very good to excellent condition with light to moderate handling wear. This pistol includes a single magazine, original hinged box that exhibits considerable repair on the hinge and a manual. (86520-1570) {C&R} [Richard "Stretch" Kennedy Collection]. (250/350)
1286. **CRUSHED U.S. M13 LIGHTWEIGHT DOUBLE ACTION REVOLVER BY SMITH & WESSON** serial #C291222, 38 Special, 2" barrel with a lightly oxidized and crushed bore. On September 21, 1959 the U.S. Air Force issued a directive to destroy all M13 revolvers as they consider them unsafe and all but a few suffered the same fate as this gun. Destruction was accomplished by crushing the barrel and the cylinder. This four screw revolver has the standard S&W markings on the barrel and frame in addition to "Revolver, Lightweight, M13" on the left side of the topstrap and "Property of U.S. Air Force on the backstrap. Surprisingly about 96% of the finishes remain exhibiting light handling and holster wear before it met its fate at the hands of the crusher. Light oxidation blemishes are present on the hammer and trigger. The diamond-checked walnut grips are not numbered to this gun but remain in very good condition. (86520-302) [Richard "Stretch" Kennedy Collection]. (300/500)

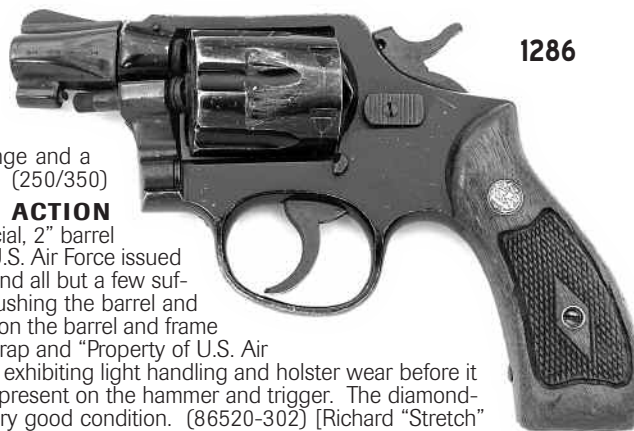

1287. **RUGER CYLINDER LOT** This lot consist of a single cylinder for a Ruger Single Six revolver that is chambered in 22 Magnum. It retains 99% of its original factory finish and has minor handling wear and a faint turn ring. The cylinder is engraved with "Colorado * The Centennial State * 1876 - 1976". It also includes scenes depicting that 100 year period of the state. (86520-2954-A).
1288. **BUSHNELL RED DOT SIGHT LOT** This lot consist of a single Bushnell Trophy red dot sight with rings for a grooved receiver or Weaver mount. The sight has eleven brightness settings and 1X four pattern reticle that includes 3 M.O.A. dot, 10 M.O.A. dot, crosshair and circle with 3 M.O.A. dot in the center. The optics are clear and a set of lens cap covers are included. (86520-775A)
1289. **SMITH & WESSON BARREL LOT** This lot consist of a single complete barrel for a Model 1891 first model single shot pistol; this barrel will also fit a second model. The barrel measures 6" with an excellent bore chambered in 32 S&W. The barrel retains about 99% factory finish with some slight wear seen on the front sight. The serial number on the barrel latch is 7256. The barrel is complete and ready to install on an appropriate frame. (86520-3966A)
1290. **BROWNING NOMAD SEMI-AUTO PISTOL** serial #41196P71, 22 LR, 4 1/2" barrel with an excellent bore. Overall this pistol retains about 98% of its original blue finish with a cleaned oxidation blemish at the muzzle and a few light handling marks. The black "Novadur" plastic grips are in near excellent condition with a light blemish on the right panel where a right handed shooter's trigger finger would lie. This later production pistol has the all steel frame and is equipped with a serrated Patridge style front sight and the adjustable Nomad rear sights. This Belgium-made pistol should make a great shooter or starter gun for a Browning collector. (86520-3986) [Richard "Stretch" Kennedy Collection] (300/500)
1291. **LOT OF BROWNING NOMAD MAGAZINES** This lot consist of a pair of magazines for a Browning Nomad pistol. The magazines exhibit lightly cleaned oxidation blemishes and pitting at their base but this should not affect functioning. (86520-3986A)
1292. **LOT OF GRIPS FOR SMITH & WESSON REVOLVER** This lot consist of a single pair of oversized checkered walnut grips for a Smith & Wesson K frame square butt revolver. The grips are designed to fully enclose the backstrap of the revolver and the checkering completely wraps around them. Overall, they are in very good to excellent condition with light handling wear that includes some scratches, dents and nicks. The maker is not marked on the grips but they appear to be Herrett's. These grips will be great for target work or for shooters with large hands. (86520-3979A)
1293. **LOT OF S&W MAGAZINES** This lot consist of (4) Smith & Wesson Model 39 eight round magazines that are in excellent condition with light handling wear. They have seen little if any use. (86520-4050A)
1294. **SMITH & WESSON 4TH MODEL TOPBREAK DOUBLE ACTION REVOLVER** serial#466920, 38 S&W, 3 1/4" barrel with an excellent bore. Overall, the revolver retains about 99% of its factory blue finish with a turn ring visible on the cylinder. The hammer and trigger retain bold case-hardened colors with some light wear to the face of the trigger and light operation wear on the hammer. The correctly numbered diamond-checked hard rubber grips are in excellent condition. There is slight play between the barrel and frame but all appropriate parts are correctly numbered to the gun. The revolver is housed in an incorrect S&W two piece box that contains a spare set of S&W diamond centered checkered walnut extension grips that are in excellent condition with light handling wear. (86624-19) {C&R} (300/500)
1295. **THOMPSON CENTER PATRIOT SINGLE SHOT PERCUSSION PISTOL** serial #21410, 45 cal. percussion, 9" octagonal barrel with an excellent bore. Overall this fine target pistol retains about 99% original blue and case-hardened colors. The brass hardware remains in excellent condition and has mellowed to a pleasing straw hue. The one piece walnut stock is in exceptional condition with a few light handling marks. This pistol features double set triggers, fully adjustable rear sight and post front sight with 2/3 sun shade. The pistol includes the original ramrod and an unmarked nylon holster that can also be adapted to a shoulder holster but the shoulder straps are not present. (86712-1) {ANTIQUE} (200/400)
1296. **ARDESA WILLIAM PARKER SINGLE SHOT PERCUSSION PISTOL** serial #61587, 44 cal., 10" fluted barrel with an excellent bore that features fine multi groove rifling reminiscent of Marlin's Micro groove rifling. The nickel plated barrel and lockwork are lightly embellished with scroll engraving. The finely checkered walnut stock remains in excellent condition as does the brass buttcap giving this pistol an overall rating of 99%. The pistol is housed in a walnut presentation case that exhibits scattered light scratches, scuffs and dents. The case is blue felt lined with cut outs for the gun and accessories with un-covered compartment in the upper left corner. The box contains a small powder flask with spout, a 10 7/8" machined stainless steel ramrod, wood cap box, round ball mold and a single key for the presentation case. (6070-43) {ANTIQUE} (300/500)
1297. **MAUSER MODEL 1896 1930 COMMERCIAL BROOMHANDLE SEMI-AUTO PISTOL** serial #878680, 7.63x25mm Mauser, 5 1/2" barrel with an excellent bore. The metal surfaces are devoid of any finish but have been glass bead finished to pleasing dull gunmetal gray. The slide, hammer and several other small parts have been given a high polished finish. There is evidence of past pitting on the metal surfaces and it is heaviest on the bolt. The unmarked walnut stocks have 12 grooves cut into them that appear to have been done by hand as the lines are not straight or even. The ladder rear sight is regulated to 1000 meters and the pistol is equipped with the "Mauser Universal Safety Lock". The markings and proof marks remain remarkably strong despite the refinish. The pistol appears to still function properly. (86625-2) {C&R} (300/500)
1298. **RUGER MK I TARGET MODEL SEMI-AUTO PISTOL** serial #215374, 22 LR, 6" standard barrel with a very lightly frosted bore. Overall this 1961-made pistol retains about 90% original blue finish with thinning grip frame, high edge wear and scattered handling marks. The black checkered Delrin grips with black Ruger Phoenix exhibit light rounding of the diamond points, compression damage to the points, dents and dings. The pistol features Ruger adjustable rear sight and Patridge style front sight. A single magazine is included with the gun. (86691-21) {C&R} (250/350)
1299. **RUGER STANDARD MODEL SEMI-AUTO PISTOL** serial #171481, 22 LR, 4 3/4" barrel with an excellent bore. Overall this 1961-made pistol retains about 96% original blue finish with a slightly thinning grip frame, high edge wear and scattered light handling marks. The black checkered Delrin grips with black Ruger Phoenix are in near excellent condition with light handling wear. A single magazine is included with the gun. (86678-14) {C&R} (200/300)
1300. **LLAMA MAXI-I 45 L/F SEMI-AUTO PISTOL** serial #71-04-06354-01, 45 ACP, 5" barrel with an excellent bore. The pistol retains about 99% matte black finish with some scattered light handling wear. The black composite grips are in near excellent condition with light scratches and marks. The pistol is basically a 1911 clone and even uses the same magazine. It features three dot fixed sights, beavertail grip safety with Schwartz type safety and extended slide stop to name a few features. A single magazine and a manual is included. (86676-3). (250/350)
1301. **HARRINGTON & RICHARDSON SPORTSMAN DOUBLE ACTION REVOLVER** serial #M1352, 22 S, L, LR, 6" barrel with an excellent bore. Overall this 1952 revolver retains about 99% factory blue finish with slight silvering at the muzzle and scattered light handling marks. The smooth walnut grips are in very good to excellent condition with scattered light dents, dings and scratches. This topbreak revolver is missing the "hook" to actuate the automatic ejection but it should not be a difficult part to replace and repair. There is slight play between the barrel and frame. (86706-6) {C&R} (250/350)

1302. **NORTH AMERICAN ARMS MINI REVOLVER** serial #D33886, 22 Magnum, 1 5/8" barrel with an excellent bore. The polished and matte stainless steel surfaces are in excellent condition. The smooth rosewood grips rate excellent. This tiny revolver includes a suede inside-the-pants holster with belt clip of unknown make. The holster has some light staining and wear from use. This little gun can be used for personal defense, repelling recalcitrant reptiles or as a general trail gun. (86691-10). (150/250)
1303. **HIGH STANDARD MODEL D-101 THIRD SERIES DOUBLE DERRINGER** serial #D42794, 22 LR, 3 1/2" barrels with excellent bores. The electroless nickel finish is in near excellent condition with light holster wear at the muzzle and a few high edges for an overall rating of about 97%. The black synthetic grips are in near excellent condition with random but minor scuffs. (86691-17). (200/400)
1304. **COLT AUTOMATIC CALIBER 25 SEMI-AUTO PISTOL** serial #OD53874, 25 ACP, 2 1/4" barrel with an excellent bore. The blue finish on this pistol has scattered light freckling, oxidation blemishes and light handling wear for an overall rating of about 97%. The checkered walnut grips with silver Rampant Colt medallions are in excellent condition. This early 1970's era pistol includes a single nickel plated magazine and was the successor to the Junior model. (86691-19). (250/350)
1305. **BERETTA MODEL 950B MINX SEMI-AUTO PISTOL** serial #D17622, 22 Short, 3 3/4" barrel with an excellent bore. Overall, this pistol retains about 99% of its original blue and anodized finishes with some light handling marks present. The plastic factory grips are in excellent condition. This pistol features a tip-up barrel and a single magazine is included. (86691-16). (100/200)
1306. **BERETTA MODEL 21A BOBCAT SEMI-AUTO PISTOL** serial #BCS29431U, 22 LR, 2 1/2" barrel with an excellent bore. Overall this pistol retains about 99% of its original blue and anodized finishes with some light handling marks present. The smooth walnut factory grips with Beretta medallions are in excellent condition. This pistol features a double action mechanism, thumb safety and tip-up barrel. A single magazine is included. (86712-3). (150/250)
1307. **BERETTA MODEL 21A BOBCAT SEMI-AUTO PISTOL** serial #BAS17606U, 22 LR, 2 1/2" barrel with an excellent bore. Overall this pistol retains about 99% of its original blue and anodized finishes with some light handling marks present. The smooth walnut factory grips with Beretta medallions are in excellent condition. This pistol features a double action mechanism, thumb safety and tip-up barrel. A factory box, cleaning kit, manual and a single magazine are included. (86712-2). (150/250)
1308. **CASED PAIR OF COLT THUER 4TH MODEL LORD DERRINGERS** serial #28360D & 28361D, 22 Short, 2 3/8" barrels with excellent bores. Both pistols exhibit some light scattered scratches, clouding of the gold finish on the frame, the hard chrome barrels are a medium gray color and general light handling wear is present for an overall rating on both guns of about 98%. The smooth walnut grips have some faint handling wear but rate excellent overall. The included hardcase has moderate handling wear with some light dents and a noticeable tear on the covering. The excellent condition interior is crimson-lined satin and crushed velvet. (86625-6). (200/400)
1309. **STERLING 25 AUTO SEMI-AUTO PISTOL** serial #068188, 25 ACP, 2 5/16" barrel with a slightly frosted bore. Overall the pistol retains about 99% of its original blue finish but the frame has drifted to a plum color. The black synthetic grips have light handling wear. A single magazine is included. (86678-18). (50/150)
1310. **MAUSER COMMERCIAL MODEL HSC SEMI-AUTO PISTOL** serial #743522, 32 ACP, 3 3/8" barrel with an excellent bore. This 1941-made pistol retains about 99% original blue finish with scattered but light freckling on the slide and some light handling wear. The checkered walnut grips exhibit some light dents and scratches but rate near excellent overall. The appropriate parts have correct matching serial numbers and eagle / N proof marks. This pistol includes a single magazine. (86634-3) {C&R} (350/550)
1311. **SAVAGE MODEL 1907 SEMI-AUTO PISTOL** serial #223483, 32 ACP, 3 3/4" barrel with a near excellent but slightly frosted bore. Overall this pistol retains about 96% re-applied blue finish with high edge wear, thinning grip frame, and light dents and nicks on the slide near the muzzle. There are a few scattered light pits with some visible under the bluing. The trigger still has case-hardened colors visible. The plastic checkered factory grips with Savage logo are in near excellent condition. A single magazine is included. (86625-12) {C&R} (150/350)
1312. **JENNINGS MODEL J-22 SEMI-AUTO PISTOL** serial #210800, 22 LR, 2 1/2" barrel with an excellent bore. Overall the pistol retains about 99% of its original painted finish with scattered light scratches present. The plastic grips have light handling wear and a single magazine is included. (86691-20). (50/100)
1313. **HARRINGTON & RICHARDSON MODEL 733 SIDE-KICK DOUBLE ACTION REVOLVER** serial #U30488, 32 S&W, 2 1/2" barrel with an excellent bore. The nickel plated finish remains in near excellent condition with light handling wear and rates about 99%. The white plastic stocks with H&R logo also rate about near excellent. The hammer and trigger have engine turned jewellery and left in-the-white. This is the earlier version with rebounding hammer. (86691-13). (150/250)
1314. **GERMAN MODEL 27 SEMI-AUTO PISTOL BY CZ** serial #27929, 32 ACP, 3 7/8" barrel with an excellent bore. Overall this fnh marked pistol retains about 97% of its re-applied finish with scattered light oxidation and freckling blemishes observed. This Bohmische marked pistol has near excellent condition checkered brown plastic grips with CZ logo. The grips have light handling wear and small hair-line fracture over 1/4" long on the upper right panel. The pistol has correct matching serial numbers including on the frame above the safety catch and the bears correct eagle / WaA76 Waffenamts marks. The Waffenamts mark on the frame is partially washed out but still legible. The pistol includes a single magazine. (86634-4) {C&R} (100/200)
1315. **SMITH & WESSON MODEL SW380 SEMI-AUTO PISTOL** serial #RAA0406, 380 ACP, 3" barrel with a near excellent bore showing slight traces of frosting. The painted slide retains about 90% painted black finish while the polymer frame has light handling wear. The pistol includes a single magazine. (86623-5). (150/250)
1316. **HIGH STANDARD MODEL D-100 DOUBLE DERRINGER PISTOL** serial #D03678, 22 LR, 3 1/2" barrels with excellent bores. This third series derringer retains about 99% of its factory blue finish on the barrels and crackle paint finish on the frame. The white plastic grips contrast nicely with the dark colored frame and rate excellent overall. This double action derringer includes a green zippered gun rug that is in first-rate condition. (86642-9). (250/350)
1317. **HIGH STANDARD CAMP GUN CONVERTIBLE DOUBLE ACTION REVOLVER** serial #S77501, 22 LR/Magnum, 6" barrel with an excellent bore. This revolver retains about 99% polished, brush blue and anodized finishes with scattered light handling marks, high edge wear on the triggerguard and a visible turn ring on both cylinders. The checkered factory hardwood grips are in near excellent condition with light handling wear. This pistol features fully adjustable black rear sight, modified Partridge front sight and quick change cylinders that only require a small punch or stick to depress the "link pivot" pin. This gun includes a spare 22 LR cylinder assembly. This will make a dandy revolver for hiker, hunter or trapper. (86623-12). (250/350)
1318. **MAUSER MODEL 1910 SEMI-AUTO PISTOL** serial #246656, 25 ACP, 3" barrel with an excellent bore. This pistol retains about 97% of its original blue metal finish with silvering forming on the front strap from handling, scattered high edge wear and light handling marks. The Nitre blue trigger has flaked off the front and part of the right side from use but the remaining finish is bright. The checkered one piece wrap-around stocks appear to have been re-varnished but remain in near excellent condition with a few dents and scratches visible under the coating. All the appropriate numbers correctly match and a crown / U proof is present on the slide. A single magazine is included with this pistol. (86694-23) {C&R} (350/550)

1319. **IVER JOHNSON FIRST MODEL SAFETY HAMMERLESS REVOLVER** serial #48820, 32 S&W, 3" barrel with a near excellent bore with a few isolated pits. The little revolver has been completely refinished with about 99% of the applied finish remaining and slight wear present at the muzzle. The most striking feature of the new finish is the frame has taken on a maroon / purple hue with all remaining parts a deep blue. The hard rubber grips are in good to very good condition with heavy wear evident on the left panel and to a lesser degree on the right. This single latch black powder frame revolver still functions properly and the barrel-to-frame fit is tight. (86656-2) {ANTIQUE}. (75/150)
1320. **F.I.E. TITAN SEMI-AUTO PISTOL** serial #284312, 25 ACP, 2 7/16" barrel with a lightly frosted bore. The metal surfaces of the pocket pistol are devoid of finish with the steel slide gunmetal gray and the frame an even light gray. The black plastic grips are in very good to excellent condition with light to moderate handling wear. This single action pistol includes a single magazine. (86642-31). (50/100)
1321. **JENNINGS MODEL J-22 SEMI-AUTO PISTOL BY BRYCO ARMS** serial #309055, 22 LR, 2 1/2" barrel with an excellent bore. This pistol retains about 90% plus original painted finish with most of the loss to the backstrap. The black synthetic grips are in excellent condition. The pistol includes original box, manual and a single magazine. (86691-7). (40/80)
1322. **IVER JOHNSON MODEL TP-22 SEMI-AUTO PISTOL** serial #AE54966, 22 LR, 2 7/8" barrel with an excellent bore. The black painted and anodized finishes are in near excellent condition with about 98% remaining. There are scattered light scratches and handling wear present on the slide and frame. The black plastic checkered factory grips are in near excellent condition with scattered light scratches present. The pistol is equipped with slide mounted patented firing pin block safety and three dot sights. The pistol includes a factory box, manual and two magazines. (86691-8). (200/400)
1323. **BARREL LOT** Includes a Traditions Inc., 24", 32 cal., muzzle loading barrel with very good bore showing scattered spots of oxidation staining predominately around the rear sight and nipple lug. There are a couple of bare metal spots and the barrel rates good overall. (105458-7)
1324. **AR-15 CONVERSION KIT LOT** This lot consist of an Atchisson 22 caliber conversion kit for AR-15 & M-16 rifles that was manufactured by Jonathan Arthur Ciener, Inc. Overall the kit appears to be in near excellent condition exhibiting light use and some oxidation blemishes on the rear of the bolt carrier. The kit includes the bolt and chamber insert mounted on a carrier, a magazine, factory plastic hard case, manual, Colt AR-15 manual and an Allen wrench. (86623-54)
1325. **COLT CALIFORNIA SCOUT BICENTENNIAL COMMEMORATIVE REVOLVER** serial #334CBI, 22 S, L, LR, 6" barrel with an excellent bore. The gold and nickel plated finishes on this commemorative revolver are in excellent condition with about 99% remaining. A faint turn ring on the cylinder and a few minor scratches and handling marks are observed on the gold plated parts with the nickel plated small parts excellent overall. The smooth rosewood grips with gold Colt medallions are in near excellent condition with a few minor dents. The revolver is marked "1769-California Bicentennial-1969" on the left side of the barrel. The gun is housed in a wood presentation box with the same markings burned into the lid plus the Colt logo, an outline of the state of California and a side view of the first mission established in the state. The box has considerable dents, dings, scratches and handling marks and only rates good to very good on the exterior with the interior in near excellent condition. Also included is a gold plated metal outline of the state with major geographical features in relief form and the back also marked the same as the revolver. (86708-8) {C&R} (400/600)
1326. **USFA MODEL ZIP 22 SEMI-AUTO PISTOL** serial #AAF354, 22 LR, 5 1/4" barrel with an excellent bore. This polymer pistol is in excellent condition. This uniquely designed pistol does not look nor handle in a conventional manner and is designed to use the ubiquitous Ruger 10/22 family of magazines. The pistol utilizes a preloaded striker similar to those used by a variety of recently designed striker fired pistols and is equipped with a simple cross bolt safety. It has dual cocking rods projecting from the front of the pistol with the left designed to cock the gun and load a cartridge and the right designated a "restrike" rod that allows re-cocking without ejection of misfired cartridge. The pistol includes take down tools stored in the "standard top", manual, a spare pair of "general purpose target springs" that are factory approved to use with CCI Blazer ammo, chamber flag and paperwork. This gun was factory shipped with no magazine. (86706-36). (150/250)
1327. **AMERICAN FIREARMS MFG. CO. MODEL 25 AUTO SEMI-AUTO PISTOL** serial #18317, 25 ACP, 2 1/8" barrel with an excellent bore. The polished stainless steel surfaces rate excellent with light handling marks. The smooth hardwood grips are in excellent condition. The magazine spring is in need of attention but still functions. A single magazine is included. (86694-20). (40/80)
1328. **HARRINGTON & RICHARDSON SECOND MODEL LARGE FRAME HAMMERLESS TOP BREAK REVOLVER** serial #152911, 32 S&W, 6" barrel with a pitted bore. Overall this fourth variation revolver retains about 95% of its original blue and nickel finishes with most of the loss to oxidation on the cylinder, grip frame, muzzle and barrel by the cylinder. The checkered hard rubber grips are in near excellent condition with light handling wear and correctly numbered to the gun. All appropriate parts have correct matching numbers. The trigger return spring is in need of professional services but the gun remains functional otherwise. (86708-6) {C&R} (150/350)
1329. **IVER JOHNSON SAFETY HAMMER BICYCLE MODEL REVOLVER** serial #G64366, 32 S&W, 2" barrel with a near excellent bore exhibiting faint frosting near the forcing cone. This third model revolver retains about 99% of its re-applied nickel plating with old pitting and surface blemishes visible under the finish. The black hard rubber grips are in near excellent condition with light handling wear. All appropriate parts have correct matching numbers with no visible markings left on the grips. The barrel locks tightly to the frame and the revolver functions correctly except the top latch tends to bind. (86706-3) {C&R} (75/150).
1330. **IVER JOHNSON FIRST MODEL SAFETY HAMMERLESS REVOLVER** serial #18372, 32 S&W, 4" barrel with a near excellent bore with a few pits. Overall this revolver retains about 99% of its re-applied nickel finish with some old pits and surface blemishes visible under the finish. The unmarked owl's head hard rubber grips are in good to very good condition with only slight handling wear but the top corner of the left panel is chipped. The number on the barrel matches the frame. This single latch black powder frame revolver still functions properly and the barrel-to-frame fit exhibits slight play. (86625-16) {ANTIQUE}. (50/100)
1331. **IVER JOHNSON SAFETY HAMMER REVOLVER**, 32 S&W, 4" barrel with a lightly frosted and pitted bore. This third model revolver retains about 55% of its original nickel plated finish with heavily flaked finish on the barrel, cylinder and parts of the frame. The extended checkered wrap-around hardwood grips are in very good condition with scuffs, dents, scratches and flaking finish present. This revolver features the "hammer the hammer" action and coil springs. The barrel-to-frame fit has loosened considerably and the automatic ejection no longer functions. (86717-5) {C&R} (30/70)
1332. **HARRINGTON & RICHARDSON AUTOMATIC EJECTING TOP BREAK REVOLVER** serial #393030, 38 S&W, 5" barrel with a near excellent bore with a few pin prick pits running along the edge of one land. This third model top break retains about 20% original blue with most of the remaining on the cylinder. The hammer retains partial case-hardened colors that have thinned to a predominate gray hue with a few colors visible. The two piece unnumbered extended diamond checkered hard rubber factory grips are in very good to excellent condition with light handling wear, scratches and dents. All appropriate parts have correct matching numbers. The revolver still functions but there are noticeable play between barrel and frame. (86708-3) {C&R} (30/70)

1333. **HARRINGTON & RICHARDSON AUTOMATIC EJECTING SECOND MODEL POLICE TOP BREAK REVOLVER** serial #8739, 38 S&W, 3 1/4" barrel with a lightly pitted bore. Overall this first variation of the Police Top Break retains about 99% original nickel finish with some light oxidation blemishes on the cylinder, barrel and frame. The case-hardened colors on the special spurless hammer have faded but are still visible with minor oxidation blemishes present. The checkered hard rubber grips are hand numbered to the gun and rate near excellent overall with a few light scratches and scuff marks. All appropriate parts have correct matching numbers. The barrel-to-frame fit is slightly loose. (86708-4) {ANTIQUE} (200/400)
1334. **HARRINGTON & RICHARDSON AUTOMATIC EJECTING SECOND MODEL TOP BREAK REVOLVER** serial #5535, 32 S&W, 3 1/4" barrel with a lightly frosted bore. Overall this first variation top break retains about 99% original nickel finish with a few very light oxidation blemishes on the cylinder and scattered light scratches also present. The hammer is predominately gunmetal gray and this revolver has the nickel plated trigger and triggerguard. The checkered hard rubber factory grips are hand numbered to the gun and rate near excellent overall with a few light scratches and scuff marks. All appropriate parts have correct matching numbers. The barrel-to-frame fit is slightly loose. (86625-15) {ANTIQUE} (150/250)
1335. **MIROKU SHARPS MODEL 1859 PEPPERBOX PISTOL** serial #3802, 22 S, L, LR, 2 1/2" barrels with excellent bores. The barrel and hammer retain their dull blue finish and the frame's gold colored plating is in overall near excellent condition with some bubbling evident along with light scratches, nicks and dings for a rating of about 99%. The smooth maroon synthetic grips are in near excellent condition with a few light scratches. This is a nice replica of the Sharps pepperbox that would be perfect for the S.A.S.S. shooter. A box is included. (86020-38). (50/150)
1336. **IVER JOHNSON THIRD MODEL SAFETY HAMMERLESS REVOLVER** serial #129266, 32 S&W, 3" barrel with a lightly pitted bore. Overall this revolver is nearly devoid of its original blue finish with some scattered remnants observed in protected areas and the remaining metal surfaces a dark gunmetal gray for a rating of about 20%. The unmarked owl's head hard rubber grips are in very good to excellent condition with only slight handling wear present. The number on the barrel matches the frame. This revolver still functions properly and the barrel-to-frame fit exhibits slight play. (86625-17) {C&R}. (30/70)
1337. **FOREHAND ARMS CO. TOP BREAK DOUBLE ACTION REVOLVER** serial #313772, 38 S&W, 3 1/4" barrel with a lightly frosted bore. The re-applied nickel finish is in near excellent condition with some light scratches, scattered flaking and freckling observed. The checkered hard rubber grips feature the Forehand & Wadsworth logo and remain in very good to excellent condition with light scratches and dents. All appropriate parts have correct matching serial numbers, barrel-to-frame fit remains tight and the revolver is still fully functional. There is an unknown marking in black on the left side of the frame that is no longer legible. (86680-2) {C&R} (40/80)
1338. **HARRINGTON & RICHARDSON VICTOR SOLID FRAME DOUBLE ACTION REVOLVER** serial #9893, 32 RF, 2" barrel with an excellent bore. Overall, this revolver retains about 99% original nickel and blue finishes with scattered light scratches and freckling. Faded case-hardened colors are still present on the hammer and the blued triggerguard and trigger are near excellent. The hard rubber grips are hand numbered to the revolver and remain in excellent condition. The trigger return spring is in need of professional attention. Overall, this gun is in fine condition considering its age. (86694-24) {C&R} (75/150)
1339. **NATIONAL ARMS CO. TOP BREAK DOUBLE ACTION REVOLVER** serial #11330, 32 S&W, 3" barrel with a pitted bore. The revolver has flaked to a gunmetal gray with traces of blue finish in a few protected areas and scattered oxidation stains. The smooth hardwood grips are replacements that in near excellent condition and appear to be well made and fitted except for the screw. Assembly numbers on the frame, barrel and top latch match. The mainspring is in need of professional services. (86625-18) {C&R} (30/60)
1340. **PIETTA LEMAT PERCUSSION REVOLVER** serial #10575, 44 cal. percussion and 20 gauge percussion, 6 3/4" .44 caliber barrel and 5" smooth bore barrel, both having excellent bores. This revolver retains about 99% original blue finish with light scroll engraving on the cylinder, and the loading lever and part of the frame is starting to drift to plum. The hammer and trigger retain strong case-hardened colors. The checkered hardwood grips are in like-new condition. The locking stud spring screw exhibits slot damage. This LeMat does not appear to have been fired much, if at all. (86628-2) {ANTIQUE} (500/700)

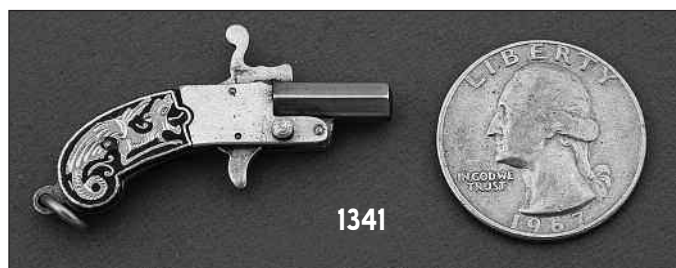

1341. MINIATURE FRENCH G & B TIP UP PIN FIRE REPORT

PISTOL, 2 mm pinfire, .543" brass barrel with a rough cut but surprisingly clean bore. The gold finish on this miniscule report pistol are in very good to excellent condition with light scratches and light corrosion around the hammer and breech block. The wood grip panels have a gold colored dragon inlaid into each panel and they rate excellent. Ten rounds of 2 mm blank pin fire ammunition are included in addition to a small jewelry box to hold the pistol. The top of the barrel is marked G & B and there is a small ring at the butt to attach to a key ring. Caution is advised in handling the ammunition. (86020-232) {ANTIQUE}

1342. **REDJACKET NO. 3 SPUR TRIGGER REVOLVER** serial #38564, 32 RF, 2 1/4" barrel with a few scattered pits observed. The revolver retains about 99% original nickel finish and has been factory embellished with an unremarkable combination of scroll, punch dot and jagged lined engraving. The genuine mother-of-pearl grips have some light stains and handling wear. The mainspring is broken but the parts remain under the grips and the hand is also in need of attention. This spur trigger revolver is fashioned after the Colt New Line revolver. (86020-237) {C&R} (100/200)
1343. **BELGIAN GUARDIAN AMERICAN 1878 MODEL PINFIRE DOUBLE ACTION REVOLVER** serial #33, 7.5mm pinfire, 2 15/16" barrel with a lightly pitted bore. This folding trigger revolver retains about 85% original nickel finish with scattered flaking, oxidation blemishes and handling wear. The hard rubber grips are embellished with loose scroll and foliate pattern that remains crisp with an overall condition of near excellent. The revolver is covered with a varying pattern of factory engraving that covers about 75% of the gun. The trigger return spring is weak and in need of attention but the firearm still functions. (86020-163) {ANTIQUE} (50/150)

1344. **HOPKINS & ALLEN XL 8 FOLDING SPUR HAMMER DOUBLE ACTION REVOLVER** serial 2985, 32 Centerfire, 1 1/2" barrel with a lightly frosted bore. This revolver retains about 98% original nickel finish with most of the loss to oxidation blemishes on the cylinder in addition to some scattered light freckling on other metal parts. The genuine mother-of-pearl grips are in poor condition with the top of the right panel broken off and the left panel exhibiting a stress crack that runs across the width of the grip at the escutcheon. It appears that all the broken pieces may be present as is the grip screw. The revolver remains functional and all appropriate parts are correctly numbered to the gun. (86287-43) {ANTIQUE} (50/150)
1345. **BELGIAN BRITISH BULL DOG DOUBLE ACTION REVOLVER**, 44CF, 2 3/4" barrel with an oxidized bore. The metal surfaces are devoid of any finish and have oxidized to a brown hue with scattered pitting present. The checkered walnut grips are in very good condition with light to moderate handling wear. The revolver remains fully functional and the cylinder and barrel bear Belgian proofs and / or inspector marks. (86462-24) {ANTIQUE} (20/40)
1346. **COLT MODEL 1849 POCKET REVOLVER** serial #163427, .31 cal. percussion, 6" barrel with an oxidized and pitted bore. All metal surfaces have been poorly refinished with numerous old pits, dents and blemishes visible under the re-applied bluing. The grip frame and triggerguard retain about 70% of their silver plated finish with most of the loss to the backstrap and butt area for an overall rating of about 90%. Many of the numbers and markings are heavily worn or absent from wear and buffing. The engraving on the cylinder is still visible but the barrel markings are absent. The cylinder is not numbered to the gun but the remaining parts are correct. The smooth walnut grips have no numbers visible and rate about poor overall. They show heavy handling wear and there is considerable damage to the toe section of both panels from a rasping force that has left the front section worn or broken off. There are also heavy gouges and dents to the butt section of the grip frame from this same force. The revolver remains functional. (86422-12) {ANTIQUE} (100/200)



1347. **LARGE METAL REPLICA OF A COLT WALKER REVOLVER** This is a neat large scale cast metal "revolver" made of a light-weight alloy which measures 27 1/4" long, 11" high (to the top of the hammer spur), and a 14 1/2" barrel. The barrel, loading lever, cylinder, and hammer retain most of the original black painted finish with a few scattered light scuff marks visible. The triggerguard and grip frame have a gold painted finish and the grips are an off-white. The whole piece, despite its size, weighs slightly less than 11 lbs. and would make a fantastic display piece for a shop or gun room. (86688-5)
1348. **LOT OF PERIODICALS** This lot consist of three complete sets (36) of Combat magazine encompassing January through December for the years 1999, 2002 and 2009. These magazines have English titles but all remaining text is in Japanese. From viewing major titles, photos and drawings it is obvious the magazine is dedicated to all things military and firearms related topics from around the world. All books are in excellent condition. (85853-2)
1349. **LOT OF PERIODICALS** This lot contains (57) magazines with (54) consisting of Combat Magazine, (2) Arms Magazine and (1) magazine entitled Gun. All of these magazines have English titles but all remaining text is in Japanese. The magazines include issues from 1981 (9), 1982 (8), 1988 (2), 1989 (1), 1990 (1), 1992 (2), 1994 (2), 1995 (1), 1996 (3), 1997 (7), 1998 (4), 2000 (9), 2001 (3), 2003 (4) and 2007 (1). From viewing major titles, photos and drawings it is obvious the magazine is dedicated to all things military and firearms related topics from around the world. All books are in excellent condition. (85853-1)
1350. **LOT OF PERIODICALS** This lot consist of (12) soft cover periodicals and (1) hard cover. Included are the 5th, 6th and 7th edition of Flayderman's Guide; numbers 72, 74, 75, 76, 78 and 79 Shooters Bible; and the 20th Anniversary hard cover Gun Digest. Also included is the Hunters Bible by W.K. Merrill, Beginners Guide to Guns and Shooting by Clair F. Rees and Big Game Hunter's Digest by Tom Brakefield. All books are in near excellent condition with light handling wear. (85853-4)
1351. **LOT OF PERIODICALS** This lot consist of (102) assorted monthly and specialty publications and a few catalogues. All appear to be in excellent condition. Some of the magazines and catalogues have single or multiple duplicates. Included are (23) assorted publications and catalogues ranging from Handloader magazine to Ruger Collector's Journal to name a few, (3) Gun Annual, (3) American Handgunner, (10) Guns Magazines, (3) American Firearms Industry, (2) Petersen's Hunting, (3) International Arms Collectors, (6) Shooting Times Handgun Quarterly, (1) Shooting Times Stainless Steel Handguns, (29) Shooting Times Magazine, (9) Guns & Ammo magazines, (1) Guns & Ammo Annual (6) Magnum Guns and Shooting, and (3) Guns & Ammo Handguns Annual. (85853-29)
1352. **LOT OF SHOTSHELL AMMUNITION** This lot consist of (24) Winchester AA 12 ga., 2 3/4", 1 ounce, #7 1/2 shotshells, (9) assorted 12 ga. 2 3/4" Buckshot, (15) Winchester 12 ga. 2 3/4", 1 ounce slugs, (5) Winchester 3" sabot slugs, (15) Remington 12 ga. 2 3/4" lead sabot slugs, (25) Winchester 410 bore 3", 11/16 ounce, #6, (25) Winchester 410 bore 3", 11/16 ounce, #7 1/2, (25) Winchester AA 20 ga. 2 3/4", 7/8 ounce #8, (25) Winchester Upland 20 ga. 2 3/4", 1 ounce #7 1/2, (50) Winchester Upland 20 ga. 2 3/4", 1 ounce #6, (25) Poly Wad Spred-R 20 ga. 2 3/4", 7/8 ounce #8, (8) Remington 2 3/4" #4 and (9) mixed Remington, Winchester and Federal 20 ga. 2 3/4" & 3" #2 & #3 buckshot and slug loads (one slug). All ammunition is in very good to excellent condition with the exception of the Remington 12 ga. lead sabot slugs which exhibit some corrosion and verdigris on the heads. (84287-29AA)

1353. **AMMUNITION LOT** This lot consist of four boxes of fifteen rounds each of IK (Igmad Zavod of Konjic, Yougoslavia) M2 ball ammunition (30-06) for a total of 60 rounds. Three of the four boxes remain unopened and the cartridges in the open box are in excellent condition. Also included is an elastic cartridge sleeve with 6 rounds of Remington 221 Fireball ammunition. (84287-29BB)

1354. **RELOADERS LOT** This lot consist of (9) 308 Winchester cartridge cases that have been reformed to what appears to 358 Winchester. Also included is an MTM Caseguard plastic container with (35) empty Remington 45 Auto Rim cases and three unopened boxes of fifty each Combined Technologies .308" 150 grain Fail Safe bullets for a total of (150) bullets. These bullets are very highly regarded for their deep penetration on game. (84287-29CC)

1355. **CUSTOM DUSTY MOULTON NIGHT WING KNIFE ENGRAVED BY SUTHERLAND**

This one-of-a-kind fixed blade offering by Dusty Moulton of Tennessee measures 9 3/8" overall with a 4 1/8" tapered full tang quenched CPM 154CM steel blade equipped with dual thumb serrations and finger rest. The blade remains unsharpened and bright. The curved finger grip palmwood handle has attractive black highlights and is secured by four small mosaic pins. The nickel silver bolsters have been engraved by Doug Sutherland of Illinois with a nice flowing scroll with gold inlays and black contrasting highlights. Knife includes a hand stitched black dyed leather sheath with handle snap and black belt clip. A fantastic custom knife for carry or display. (56237-4). (200/400)



1356. **LEFEVER G GRADE DOUBLE SHOTGUN** serial #17855, 12 ga, 30" damascus barrels choked improved cylinder and modified with bright good bores showing some fouling and a dent about 5" from the muzzle in the left barrel. The barrels exhibit a mottled gray and brown patina with very little pattern showing and having scattered areas of oxidation spotting. The plain frame and sideplates show some remnants of case color in protected areas with the balance turning to a brownish patina. The pistolgrip stock and splinter forearm rate good displaying numerous dings and scratches, the forearm with less wear as refinished all over a flaking finish. Checkering on the grip is worn and soiled but remains crisp on the forearm. The forearm has a unique push button release which has been reblued but has oxidation spotting and there is a plain steel decorative tip. A fluted hard rubber grip cap is in place and the original checkered hard rubber buttplate is present, both turning slightly brown and showing some wear. The stock has a length of 13 7/8" with drops of 1 5/8" at the comb and 2 1/2" at the heel. The gun features double triggers, extractors, and an automatic safety and the action is tight. With a little TLC and light loads this might be a good gun to use. (116225-44) {C&R} (275/375)

1357. **PERCUSSION FOWLER BY WILLIAM READ OF BOSTON** This fowler is a 16 bore and has a part round part octagon barrel with oxidized bore. It is marked with British proofs and has a banner on the top flat next to the breech marked "William Read Boston". The barrel shows good damascus pattern under the forearm but the remainder has been painted black. The under rib which holds the two ramrod thimbles is unattached but the thimbles are solid. The lock is also marked with Read's name and it has some worn simple foliate engraving and the brass triggerguard displays similar engraving and has a nice detailed pineapple finial. The straight stock rates fair as sanded showing proud metal around the tangs and buttplate. It is cracked on the left side around the action screw and remains unfinished. A brass buttplate with comb extension exhibits flaking black paint. There is a pewter nose cap and what appears to be the original ramrod is present missing the small cleaning or patch pulling end. A worthy project. (116271-6) {ANTIQUÉ} (100/200)

1358. **AMERICAN STANDARD TOOL HERO SINGLE SHOT PERCUSSION PISTOL** serial #4591, 34 cal, 2" barrel with a very good partially mildly pitted smooth bore. The brass frame rates about fine with a light tarnish, a couple of small dings, and "HERO" stamped on its left side. The iron barrel is primarily a pewter gray with some small areas of gray-brown patina showing and a few minor handling marks present. The hammer is gray with some scattered mild pitting and a few spots of oxidation. The bag shaped maple grips rate excellent, are ill-fitting, and are likely a later replacement. (126229-557) {ANTIQUÉ} [Elliott Riggs Collection]. (175/275)

1359. **STAR MODEL B SEMI-AUTO PISTOL** serial #229211, 9 mm, 5" barrel with an excellent bore. This Colt 1911A1 clone retains about 95% of its original finish with light oxidation marks on the slide and some scattered light scratches on the firearm. The double diamond- checkered wood grips rate good to very good, exhibiting heavy wear on the diamond points, some light chips on the edges, scratches and scuff marks. The pistol features a thumb safety, slide release and lanyard ring mounted on the lower left side of the grip frame. Two, 9-round magazines are included. One magazine has "STAR" marked on the base and the number 211 hand engraved on the back. The other does not have the STAR mark, but is hand engraved with the number 401. This is an inexpensive variant of the 1911A1 in a light recoiling caliber and generally makes a good shooter. (86220-1). (200/300)

1360. **COLT ROUND BARREL CARTRIDGE CONVERTED REVOLVER**

serial #299916, .32 cal. CF, 4 1/2" percussion barrel with an about good bore. The barrel and loading lever on this cartridge-converted revolver are numbered to a different gun and are primarily a deep gun metal gray with a near overall freckling of light brown oxidation and some pinprick pitting. The cylinder is a gun metal gray patina with brown oxidation speckling nearly overall and some generous traces of factory nickel plate; the cylinder scene is about 95% intact. The frame retains only traces of original nickel and is a dull gun metal gray with near overall oxidation speckling and some light pitting. The straps have toned primarily to a dull ocher patina, retaining perhaps 20% silver plate. The smooth one-piece walnut grip rates very good plus with some added varnish, showing perhaps an old light cleaning leaving the front edges soft showing light dings and handling marks; they are numbered in antique ink pen "9916". The gun seems to function mechanically although the hammer spring is somewhat weak. All the numbers on the back half of the gun are matching. An interesting cartridge-converted revolver with a percussion front end. (36258-51) {ANTIQUÉ} (275/375)

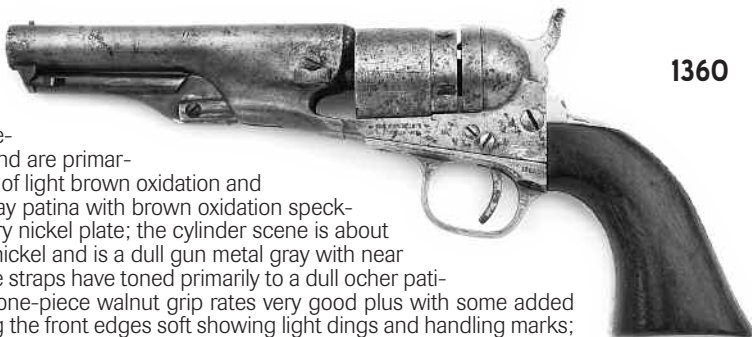

1361. **AMERICAN ARMS COMPANY MODEL 1890 HAMMERLESS REVOLVER** serial #1995, 32 S&W, 3 1/4" ribbed barrel that has a very good bore with a few areas of light pitting throughout. The metal surfaces retain about 85% of the original nickel finish that is lightly flaking and has some specks of light surface oxidation and a few small handling marks as well. The checkered hard rubber grips rate excellent, there is a small gap at the base between the left grip panel and the frame and the grips are scratch-numbered to match. The top strap is marked with patent dates of "May 28 '86 / Mar. 11 '89 / June 17 '90". An interesting turn-of-the-century made revolver that incorporates a grip safety and is in excellent overall condition. (46120-21) {C&R} (150/250)

1362

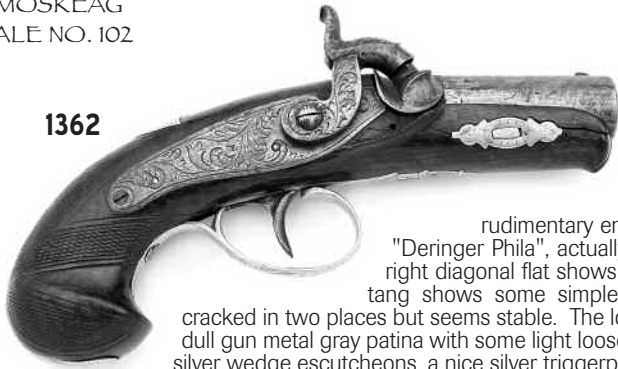

1362. BELGIAN COPY OF PHILADELPHIA DERINGER PERCUSSION POCKET PISTOL .44 caliber, 2 1/2" barrel with an oxidized bore. This is a rather nice copy of an actual Henry Deringer-made Philadelphia percussion pistol. The barrel is now a pewter gray patina with some brown oxidation speckling and features a brass blade front sight. The patent breech

shows extremely light, somewhat rudimentary engraving and the top flat is marked "Deringer Phila", actually stamped two or three times; the right diagonal flat shows a Belgian "view" proof mark. The tang shows some simple loose engraving and is actually cracked in two places but seems stable. The lockplate and hammer as well as a dull gun metal gray patina with some light loose flowing scroll. There are German silver wedge escutcheons, a nice silver triggerplate and triggerguard which closely approximates Deringer's work. The front extension of the triggerplate is chiseled into a pineapple finial and neatly engraved as-is the bow of the guard. There is a German silver sideplate, teardrop buttcap and shield-shaped monogram plate atop the wrist; the German silver flash guard below the nipple bolster, normally seen ahead of the lock is not present. The stock itself rates good plus to very good with much original varnish, light dings and handling marks and small cracks left and right; one at the nose and the other just above the wedge escutcheon. The lock is crisp and mechanically functional, the barrel wedge is a common steel replacement. A really interesting example overall of a glaring attempt to capitalize on the quality products made by Henry Deringer. (36258-67) {ANTIQUE} (275/375)



1363. **GARATE ANITUA EL LUNAR DOUBLE ACTION REVOLVER** serial #80320, 8 mm Lebel, 5 1/8" barrel with bright but lightly pitted bore. The barrel and frame retain 70% of a high polish blue with scattered scratches and broad areas of fine pitting. The cylinder exhibits 60 to 70% of a nitre blue with an obvious turn ring and fine pitting. The checkered wood grips have a dull finish with scratches but with robust checkering and no cracks. The serial number is stamped around the lanyard ring on the bottom of the grip. An obscure but decent revolver. (115308-32){C&R} (100/200)
1364. **JAPANESE TYPE 38 ARISAKA NAVY BOLT ACTION TRAINING RIFLE** serial #19327, 6.5 Blank, 31" barrel with a very good, but lightly pitted smooth bore. The metal surfaces retain about 80% original blue that is fading and flaking to brown. The top of the receiver has a crisp naval anchor with chrysanthemum in center logo and is otherwise unmarked. The hardwood stock rates excellent and has several light dings and handling marks and is marked on either side of the butt with bordered Japanese characters, one is a box, the other a circle. The rifle appears to be complete and included is a correct cleaning rod. A nice, interesting example of a Japanese Navy training rifle. (46120-99) {C&R} (100/200)
1365. **CONESTOGA RIFLE WORKS FULL STOCK PERCUSSION RIFLE**, .50 cal., 35" octagonal barrel with an oxidized and pitted bore. The metal surfaces are predominately a brown patina with scattered dents and scratches especially around the breech end of the barrel. The lock is a dark smoky gray patina with hammer mostly a lighter gunmetal gray. The brass furniture has turned to a pleasing golden straw color and remains in near excellent condition. The lock and the barrel are both marked Conestoga Rifle Works Lancaster PA. The hardwood stock rates good overall with a thin 3" crack through the wrist and long repairs approximately 16" from the muzzle along the barrel with a modest amount light handling marks, dents, scratches and crazed flaking finish. Some of the stock pins and hardware are modern replacements and do not fit the wood properly. The lock still functions but the ramrod is obviously not correct for the rifle and is too short. These rifles were reported to be economy rifles for the local trade marketed by Henry Leman under his trade name Conestoga Rifle Works. (86190-4) {ANTIQUE} (100/200)
1366. **LOT OF MILITARY PHOTOGRAPHS AND MILITARY MEDALS** Five pieces total; (1) tintype of a seated, clean-shaven young man in civilian dress. The wooden case is missing the cover; (1) c.d.v. portrait of a young woman seated in a chair wearing a plain black dress. The photo measures 4" by 2 1/2" and is backed with a heavy paper; (1) photo of a sailor wearing an 1850 Naval Officers Sword; (1) medal for the "Marietta Commandery No. 50 K.T." which is gold colored with a black and white ribbon holding a shield depicting a double walled fort and with the date of 1788; (1) U. S. enlisted man's dress hat shield from the post WW II era. (43892-4A,4B)
1367. **LOT OF WESTERN SUPER-X EIGHT BORE PAPER HULLS** This lot contains six once-fired No. 8 industrial reduced velocity paper shot shells. The shells rate near excellent with light ingrained dirt on the salmon colored hulls and lightly mellowed high brass bases. (55497-8A)
1368. **CIVIL WAR FROCK COAT BUTTON FROM SCOVILL MANUFACTURING CO.** attributed to James Gregg, 5th Rhode Island heavy artillery This is a Scovill Manufacturing Company frock coat button with a domed face which shows a crisp image of a federal eagle, wings spread with shield on its chest. The rear of the button is marked "Scovill Mfg Co./Waterbury." with a flat outer edge and concave center to which is soldered the button eyelet. There is included a copy of an eBay listing in which the seller states he purchased this button from the family of Capt. James Gregg. Included is a color scan of a CDV of Capt. James Gregg, Rhode Island Artillery, showing a seated gentleman, his frock coat unbuttoned and vest partially unbuttoned, wearing his campaign hat. The shoulder boards are present but cannot be seen clearly. The rear shows the typical U.S. two cent revenue stamp. James Gregg enlisted into company B., 5th Rhode Island Heavy Artillery December of 1861. He was promoted to second Lieut. June of 1862 and Capt. in February of 1863, he was discharged for disability December of 1863. There is no other provenance nor connection to Capt. Gregg other than the eBay listing. The button rates excellent overall. (34962-145)
1369. **KNIFE LOT** This lot consists of an unmarked automatic opening folding knife. The knife measures 4 3/8" closed and has a 3" stainless steel, drop point blade. The knife features a black rubber grip and is in excellent condition. Please note this item can be sold to NH residents only. (45684-9AS)
1370. **LOT OF AMMUNITION** A total of 2 boxes One partial box containing approximately 22 rounds of Remington Kleanbore 22 Short with light tarnish and moderately oxidized lead in a green box with red lettered Kleanbore dog-bone logo; the box is in very good to excellent condition with a couple of impact marks, lightly worn edges and handling wear. One UMC BB Caps box with a variety of 22 ammunition totaling 44 rounds, including BB Caps, CB Caps, Short, LR and shotshell in mixed condition with some tarnishing and heavy lead oxidizing. The box is in good to very good condition with worn edges and moderate handling wear. (124132-2D)
1371. **LOT OF RIMFIRE AMMUNITION** This is a full 50 rd. box of Remington UMC Kleanbore 22 LR in an excellent "dog bone" box. The ammunition is very good to excellent with faint traces of oxidation on the tips and fairly bright casings. (75877-4)
1372. **MAGAZINE LOT** This lot consists of a single, unmarked five round magazine for an Anschutz 22 Magnum bolt action rifle. This blued magazine is in like new condition and is sealed in a small plastic bag. (46076-8)
1373. **WINCHESTER 1922 CATALOG** (1) "Winchester Pocket Catalog of Guns and Ammunition 1922" that has been stored flat and opened to pages 14 and 15. The booklet is in excellent overall condition. (106080-48A)

1374. **COLT COMMEMORATIVE MEDALLION** serial #30,000, this is a sterling silver medallion weighing approximately 3 oz and measuring approximately 5" in circumference. The surfaces exhibit an uneven light pewter-gray patina with light storage wear. The front of the medallion bears the title "SAMUEL COLT-SEAMAN-AGE 16-1830" with a detailed figure of a young Samuel Colt in a sailor's uniform whitening the prototype of his soon to be legendary revolver. The reverse exhibits the Colt crest with the title, "THE MAN" "THE HERITAGE" above. This medallion commemorates the early beginnings of Samuel Colt while serving aboard the ship "Corvo". Colt had been sent to sea by his father to learn a trade and it is reported that while at sea, Colt envisioned the idea of his revolver. The serial number and proof mark are on the medallions outside edge. This highly desirable medallion is in excellent condition overall and includes an original hardwood display stand. (64528-115). (200/400)



1375. **MARBLES CLEANING KIT LOT** This lot consists of a Marbles No.99 pistol cleaning kit. The partial kit includes nicked brass handle, 4" brass rod, patch holder, .22 caliber mop and a .38 caliber jag. All that is missing is the double female adapter to connect the rod section and tips together. A very good example overall. (44278-5E3)
1376. **LOT OF COLT PISTOLGRIPS** One set of excellent condition, checkered, black plastic factory Colt Mustang grips. One set of excellent condition, checkered, black plastic factory Colt Government 380 grips. (86294-18A)
1377. **LOT OF PRINTS** Includes two; first is a 26"x20" print from the Nation Muzzle Loading Rifle Association titled "Return to the High Country" by R. Dorman in very good plus condition. Second is a print of the portrait titled "Sierra Nevada Morning" by Albert Bierstadt. The print is numbered 936 and is in excellent overall condition. (103559-64)

1378. **FLUERSCHEIM BOLT-ACTION AIR PISTOL FROM GAGGENAU IRONWORKS** .177 cal., 6 1/8" barrel with a very good bore. The metal surfaces on this antique air pistol retain about 90% original nickel, the loss is due to a few flakes on the top of the action but more prominently on the left and right side of the grips and some of the sharp edges. The metal beneath has toned to a dark pewter-gray with some flaking to brown. The top of the receiver flat shows 2 of this model of air pistol, crossed, with the "E.G." of Eisenwerke Gaggenau (Gaggenau Ironworks in English). The right side of the frame is marked only "patent" and the bolt seems to operate properly; it cannot be ascertained whether the gun will cock (the cocking tool is not present with the gun). There is a crack at the top of the grip at the rear of the frame, it is old and appears stable. The front sight is intact, there is a simple v-notch rear sight atop the frame. The gun comes in an antique presentation or storage box, fitted for the gun with a spare compartment for accessories. Really a lovely 1880s-era air pistol, very seldom encountered today. (35678-2). (300/500)



1379. **BROWNING TAKEDOWN SHOTGUN LUGGAGE CASE** This hard-sided luggage style case by Browning will fit an over-under Citori or Superposed style shotgun. Case will handle barrels to 30" and has a recess for accessories. The case is a pebbled, mottled faux leather exterior, most likely vinyl or Naugahyde. It is faux-fur-lined with brown fur. The case is lockable, the keys are not included. Case rates excellent overall. (3720-11A)
1380. **LOT OF MODEL AIRPLANES** Two Soviet bloc model aircrafts total: 1) Sukhoi Su-25 "Frogfoot" 1:50 scale model display aircraft. This quality display model is in good condition as it retains its entire original paint scheme, although lightly coated in a layer of dust. However, there exists a minor chip in the right wing stabilizer, something appears to have shorn off along the rear right portion of the frame, the left rear tail wing is missing, the portion behind the tail is beginning to split away, the under-wing fin on the right wing is missing, and two (2) of the armaments meant for the underside of the left wing are missing. Note: any and all missing parts are not included with the lot. The rear tail wing is capable of articulation. The model features a transparent canopy with a pilot figurine present. The model comes with a painted black wooden display stand; 2) Mikoyan-Gurevich MiG-21 "Fishbed" 1:35 scale model hardwood display aircraft. This quality display model is in good condition as it retains its entire original paint scheme. However, there exists chipping at the ends of the left wing and rear right tail wing, and around the nosecone area; as well as a slight but significant crack forming along the upper portion of the tail. Additionally, the under-wing missile armament for the right wing is extremely loose and should be secured, also the under-wing weapons pod armament intended for the right wing is absent and not included with the lot. The model comes with a painted black wooden display stand. (134299-72D,E)
1381. **LOT OF MODEL AIRPLANES** Two "British Airways" plastic model aircrafts total: (1) Boeing 747 "British Airways" 1:288 scale model plastic aircraft. This model is in excellent condition as it retains its entire original paint scheme and lacks any appreciable signs of damage or diminished condition. The wings and tail wing can become somewhat loose but should not produce any considerable issues as they can be easily re-secured to the frame. The model comes with a plastic stand, but if it was once removable it has since been secured to the model; 2) Lockheed L-1011 TriStar "British Airways" 1:250 scale model plastic aircraft. This model is in very good condition as it retains its entire original paint scheme; however, the under-wing engine belonging to the left wing has snapped off from the rest of the model, but is included with the lot should it be possible, and buyer be willing, to make repairs to the model. The model comes with a removable plastic stand. (134299-72 M,N)
1382. **LOT OF DUTY BELTS** Includes two leather belts with accessories. First is a black colored Service Mfg., belt that measures 2"x43" with a Bucheimer B3 holster and Cart West No.38 marked combination cartridge and handcuff caddy. The items are in very good overall condition with light scattered scratches, scuffing and spots of mildew staining. Second is a Service Mfg., black colored belt that measures 2"x46" with accessories. They include an unmarked 12 loop cartridge caddy, Bucheimer handcuff holster with Astra-manufactured handcuffs (keys not included) and a brown colored George Lawrence Co., No. 250/528 holster. The items are in good overall condition with appropriate wear from use. (105750-1)

1383. **UNMARKED HAND TOOLED GUN BELT RIG** This is a right-handed hand-tooled gun belt and leather flap holster. The holster will accommodate medium frame Colt Single Action Army revolvers with 4 3/4"-5 1/2" barrels. The holster and belt show hand-tooled floral and foliate decoration with background punch-dot shading. The holster features a single retention buckle and full flap and rides in a wide slot, drop-down Buscadero-style. The belt has eighteen 38 caliber loops and will accommodate a waist of 44"-47" measured from the buckle to the buckle holes in the strap billet. In addition to the holster slot there are two additional slots on the left side of the belt about 1 1/4" in length each, perhaps to accommodate some type of knife scabbard or machete-hanger, they are vacant. There is a lightly scroll-embossed nickel silver buckle and keeper while the strap billet has a lightly embossed nickel silver tip. The belt itself is 3 1/4" wide and is overall supple and flexible with only very light drying and light scuffs from the years of use. It is quality-made and possibly Mexican manufacture. A nice flap holster for your Colt Single Action Army revolver overall. (35420-23) (400/600)
1384. **MODEL 1903 MILLS INFANTRY CARTRIDGE BELT** This belt shows some fabric wear but is completely intact and is constructed of Mills webbing, which is now a greenish tan color and has nine pucker ammunition clip pouches to house 30 caliber cartridges. Each pouch has a brass snap adorned with Federal eagle. Belt is replete with brass grommets and two-piece interlocking "T" closure. One pouch contains a stripper clip full of five 30-06 cartridges. Belt in about good plus condition overall. (25360-3)
1385. **LOT OF COLT AND WINCHESTER LITERATURE** Includes eleven related items: (1) copy of "Colt Pistol and Revolver Targets Price List" dated 1948 in excellent condition; (2) copies of the pamphlet "Colt Engraving Fancy Stocks", price list one has a fold near through the middle in good overall condition, the other is near excellent; (1) fold out pamphlet "Colt Revolvers & Automatic Pistols" with some light fading but remains in excellent condition; (2) copies of "List of Component Parts for Obsolete Colt Models". Both are in very good to excellent condition one has two small ink spots on it; (2) copies of "Colt Revolvers and Automatic Pistols Parts and Price List" both show light staining in near excellent condition; (3) portraits of Buffalo Bill with attached letters on Olin letterhead announcing the release of the 1873 commemorative. One photo shows a collage of four views of the rifle and the inlaid medallion, another is a sitting pose with his rifle, and the third is him standing next to his horse holding his Winchester. Also included are eight pages of literature corresponding to the line of commemoratives and a single copy of "The Story of Winchester- The Gun That Won The West" all items are in very good plus to near excellent condition. (103559-37,38)
1386. **LOT OF GUS LEHNERT EPHEMERA** First is an insurance policy from Northwestern Mutual Life for Gustave A. Lehnert dated November 20, 1879. The policy, for \$47.35 each year insures the life of the Gustave A. Lehnert, gunsmith, of Louisville Kentucky for \$1000, for a 20 year period. An interesting read, it shows Gustave was born in Prussia in January of 1849, he has never had the smallpox but he has been vaccinated. He had two brothers and three sisters, it would appear both brothers died as infants. He has never used alcoholic beverages or other stimulants nor is he engaged in the sale of such. Additionally there are two receipts for payment of premium on this policy, one dated November 20, 1881 the other dated November 11, 1880. The receipts are from the Northwestern Mutual Life Insurance Company's agents in Louisville Kentucky, Cowen & Robinson. These papers were tucked in a ledger book which shows dates from 1883-1887 and while Lehnert's name does not appear anywhere in the book it is likely his, showing numerous entries for normal everyday household goods but also entries for barreled actions and machine tools, the only real firearms names mentioned are "AG Spalding Brothers" and "Pittsburgh firearms" as well as "E. E. Eaton". The stock of guns pistols and supplies and materials on hand was worth \$8800. Tools, lathes, drills and reamers were worth \$800. The very last page also shows payment to the Hanover Fire Insurance Company of New York for insurance on his tools, this for the year ending 1888. The life insurance policy is very readable and mostly bright with light foxing on one of the pages and a small tear along one of the folds with some mildew and darkening on the eras of the policy that would've been exposed to the air when it was folded. The ledger book shows a separating spine, some mildew, light foxing and an antique stain on the cover which has affected a number of the pages beneath. A neat grouping overall relating to this famous and well-thought-of gunsmith. (34217)
1387. **LOT OF SIX BOOKS** First is an illustrated 192 page hardcover titled Old Forts of the Far West, by Herbert M. Hart, copyright 1967 in fair to good condition. Includes a moderately scuffed dust cover. Second is an illustrated 160 page hardcover titled Wild Bill and Deadwood, by Mildred Fielder, copyright 1965 in fair condition. The book has suffered damage from liquids and now has heavily wrinkled pages red stains and mildew stains but remains complete and legible. Third is a 256 page illustrated hardcover titled Before Barbed Wire, by Mark H. Brown and W.R. Felton, copyright 1956. The book is in very good condition with a mostly complete dust cover that has several tears and scuffs. Fourth is a 128 page illustrated soft cover titled Guns of the Old West an illustrated history, by Dean K. Boorman, copyright 2004 in near excellent condition. Fifth is a 348 page illustrated hardcover titled Picture Maker of the Old West, by Clarence S. Jackson, copyright 1947 in good overall condition. There light foxing present on some of the pages and the spine is starting to weaken but remains intact. Sixth is a 280 page illustrated hardcover titled The Hunters and the Hunted, by George Laycock, copyright 1990 in very good overall condition complete with dustcover. (105458-1B)
1388. **LOT OF MATTED SKETCHES OF COLT REVOLVERS** Six 7 1/8" X 10 1/2" facsimile pencil drawings total: (1) left side of a Colt Paterson .40 caliber Revolver prominently displayed. On the lower left portion is a smaller vignette of a mounted Texas Ranger (perhaps Captain John Coffee) on the prairie in pursuit of hostiles; (1) left side of a Walker Colt revolver prominently displayed. Below this rendition is a smaller vignette of several mounted Texas Rangers on the prairie in search of hostiles--revolvers at the ready; (1) right side of a Colt Model 1860, .44 caliber Army revolver prominently displayed. On the lower right portion is a smaller vignette of hundreds of Union soldiers in battle, one soldier with a Colt revolver at the ready; (1) right side of a Colt Model 1851 Navy revolver. To the lower left is a vignette showing sailors having just shot a large cannon round at a ship in the distance; (1) left side of a Colt .31 caliber pocket model without loading lever and commonly referred to as a Wells Fargo Colt. A background vignette shows a Pony Express rider just having changed his exhausted horse for a fresh one and wasting no time remounting and hurrying away; (1) right side of a Model 1873 Colt Single Action Army "Peacemaker" .45 caliber revolver prominently displayed. On the lower right portion is a sketched vignette of a showdown in a barroom, the town sheriff having drawn both Colts on desperados. The outside dimensions of the mattes measure 16" X 20". A little smudging is evident but lot in about good plus condition. (25330-9)
1389. **LOT OF FRAMED COLT REVOLVERS BY DAGLEY** This lot consists of (4) 7 1/4"x11" facsimile pencil and charcoal drawings of famous Colt revolvers (two are missing the glass) (1) left side of a Walker Colt revolver prominently displayed. Below this rendition is a smaller vignette of several mounted Texas Rangers on the prairie in search of hostiles--revolvers at the ready. (1) right side of a Colt Model 1860, .44 caliber Army revolver prominently displayed. On the lower right portion is a smaller vignette of hundreds of Union soldiers in battle, one soldier with a Colt revolver at the ready; (1) left side of a Colt Paterson .40 caliber Revolver prominently displayed. On the lower left portion is a smaller vignette of mounted Texas Rangers (perhaps Captain John Coffee and his men) on the prairie in pursuit of hostiles; (1) 11" facsimile pencil and charcoal drawing of the right side of a Model 1873 Colt Single Action Army "Peacemaker" .45 caliber revolver prominently displayed. On the lower right portion is a smaller sketched vignette of a showdown in a barroom, the town sheriff having drawn both Colts on desperados. The framed prints show a bit of brown near the edges. The economy metal frames measure 11 1/8"x14 1/8". Lot is in overall good plus condition. (24449-5D)
1390. **RUGER 10/22 SEMI-AUTO RIFLE** serial #248-73875, 22 LR, 18 1/2" barrel with a very good, bright bore. The stainless steel barrel rates very good and remains bright overall; however, the barrel does exhibit some sparse scattering of faint oxidation development. The alloy receiver, trigger group, and barrel band all rate very good, but do show some cases of slight discoloration. The checkered black plastic skeletonized pistolgrip stock rates very good plus with only extremely minimal signs of previous handling. The rifle features a mounted Simmons 4x32 scope with lens covers; the rifle comes with a single 10 round rotary magazine. (136416-40). (100/200)

1391. **C.S. SHATTUCK AMERICAN SIDE SNAP SINGLE BARREL SHOTGUN** serial #2196, 16 ga., 32" barrel that is choked modified and has a very good bore with light pitting. The metal surfaces are a mottled gray and brown with light handling marks and scattered specks of light oxidation present. The frame has some traces of original case colors still visible. The barrel has an integral forearm base extension which is chipped along the lower edge. The walnut stocks rate about very good and feature a splinter forearm and pistol-grip buttstock. The buttstock has several cracks through the wrist area and has a replacement dog's head hard rubber buttplate. The action appears to function correctly but the barrel sits a bit loose in the frame. A unique design where the lever acts as the triggerguard as well, a good to about very good example overall. (46264-13) {ANTIQUE} (100/200)
1392. **U.S. MODEL 1902 OFFICERS SWORD** 32" blade with three-quarter-length unstopped fullers. Blade is oxidized overall with most of its plating intact but showing overall very tiny oxidized spots. Obverse and reverse show martial and foliate panoplies with "e pluribus unum" Federal Eagle with riband and U.S. The ricasso is un-marked. The hilt rates about very good with minor oxidation, the pommel showing some faint traces of brass at the terminus of the guard; the outer branch of the bow slightly misshapen. The synthetic finger-groove grip rates very good and appears to be hard rubber. An incorrect, slightly too-large scabbard with a thin crack at the throat is included. (34395-3)
1393. **UNMARKED BELGIAN PERCUSSION SINGLE BARREL FOWLER** About 11 bore, 36" part octagon part round barrel with a turned medial at the point of transition and a fair oxidized bore. The barrel is an overall deep brown patina with light oxidation nearly it's full-length, the top flat shows a Belgian proof mark. The lockplate is unmarked and is a dull pewter patina with oxidation overall, the hammer is an oxidized brown. There are iron ramrod thimbles and tailpipe with a simple iron triggerguard and buttplate. The European Walnut buttstock rates about very good with minor handling marks and dings from the years, coarse checkering and a 12" crack along the left side of the forearm area. The lock is mechanically functional however the hammer is very loose on the lock as the hammer screw is an improper replacement. An excellent hanger for above the fireplace. (35134-3) {ANTIQUE} (100/200)
1394. **LOT OF BAIT CASTING FISHING RODS** There are three rods total, all with removable handles. The first is a Heddon Pal serial #3151 measuring 5' made of steel painted tan with soiled cork grip and includes a canvas case marked "True Temper". The second is a Heddon Pal Deluxe serial #260-6 measuring 6' made of brown colored fiberglass with soiled cork grip and includes a vinyl case marked "Heddon Deluxe". The third is a Heddon Pal yellow fiberglass rod with soiled cork grip measuring 5' and includes a canvas case marked "True Temper". All are serviceable rods. (116282-8,9,10)
1395. **DAISY MODEL 96 CARBINE** .175/BB caliber, This lever-cocking carbine is little used, displaying 98% of the barrel and action blue showing some flaking on the front of the lever. The wood Monte Carlo stock and beavertail forearm rate very good exhibiting a few scuffs and scrapes over a strong varnish. The plain wood butt has been crudely etched with the name "Steve". Sights include a blade front and adjustable rear. Included is a paper pamphlet titled Daisy B-B Rifle Instruction Program dated 1959. (115660-9)
1396. **DAISY 853 POWERLINE TARGET AIR RIFLE** .177 caliber. The black painted metal surfaces retain 98% finish and the target style pistolgrip stock rates very good showing a few scratches over a thin varnish. The rifle is equipped with a plastic buttplate adjustable for length and sights include a globe front sight and a receiver sight mounted on a grooved receiver. In addition there is a faux muzzle-brake and a simple metal loop is installed on the cocking lever providing a hand stop. Overall a neat target gun. (115798-644)
1397. **J.C. HIGGINS SEARS ROEBUCK MODEL 583.20 BOLT ACTION REPEATING SHOTGUN**, 12 Ga., 28" plain barrel choked full with bright excellent bore. Metal surfaces retain 90% of a reapplied paint finish over surface oxidation throughout. Satin finish plain walnut stock with pistolgrip and original recoil pad rate very good with numerous blemishes. (116357-S17206). (20/40)
1398. **SAVAGE MODEL 220A BREAK ACTION SINGLE BARREL SHOTGUN** 12 Ga., 28" barrel choked full with fine bore showing just a hint of pitting beyond the chamber. Metal blue and color case-hardened finishes rate 85% fading to brown with visible fine surface oxidation. Satin finish plain walnut buttstock and forend rate very good as cleaned with small crack at the wrist and blemishes filled and smoothed. (116599-75). (40/60)
1399. **SEARS ROEBUCK RANGER MODEL 105-20 BOLT ACTION REPEATING SHOTGUN** 16 Ga., 26" plain barrel choked full with bright excellent bore. The metal surfaces retain 98% original blue finish fading to plum brown with scattered fine surface oxidation. Smooth satin finish hardwood buttstock with recoil pad rates excellent as lightly sanded and refinished. There is a small crack at the top of the wrist and another ahead of the bottom ejector port. Replacement hardware used to secure the stock to the barreled action and to secure the magazine tube to the hanger. Front sight bead is missing. (116568-1). (25/75)
1400. **SPANISH MODEL 1916 BOLT ACTION SHORT RIFLE** serial #3003, 7mm Mauser, 21 3/4" barrel with an about good, dark bore showing strong rifling with fine pitting throughout. The metal surfaces show a smooth reblued surface overlaid with lightly peppered specks of oxidation, as well as scattered light scuffs and usage marks. The receiver bears the Oviedo Arsenal marking as well as manufacture date of 1913, indicating the use of a Model 1895 carbine receiver at the time of arsenal conversion to the Model 1916. No import marks are evident. The matching bolt (safety lever non-matching) shows a later polished bright surface, with the bent bolt handle showing light brown oxidation with light pitting visible at the knob. The smooth walnut stock is correctly numbered and shows a lightly sanded surface with numerous impressions and usage marks scattered across the surface. A 1" crack is visible at the wrist, emanating from the upper tang. The cleaning rod remains intact. The rifle wears an eared blade front sight, as well as the tangent leaf rear sight and buttstock mounted sling bar indicative of the second pattern Model 1916 Short Rifle. In overall good plus condition. (146599-70) {C&R} (100/200)
1401. **MUZZLE LOADING ARMORY PLAINSMAN PERCUSSION MUZZLE LOADING RIFLE** serial #88-563215, 50 Cal, 28" octagonal barrel with very good bore. Metal surfaces retain 50% original blue finish with heavy surface oxidation throughout. Brass furniture is tarnished turning a dark goldenrod color. Satin finish plain hardwood halfstock is in excellent condition with only minor handling marks. Adjustable rear, dovetail blade front sights, double set triggers and ramrod provided. (116587-S17687A) {ANTIQUE} (25/75)
1402. **RIFLE STOCK AND SHOOTING ACCESSORIES LOT** Three items total: (1) modified checkered wood pistolgrip stock for bolt action rifle. The stock rates good, demonstrating substantial faint scratching and dings, as well as some instances of scuffing. The checkering along the forend rates near excellent, but the original pistolgrip checkering remains negligibly intact. The wood comprising the pistolgrip area has been whittled down to a rough condition with wood putty present along the grip area on the right side. The stock does not include a buttplate or pad, but does come with a canvas gun sleeve; (1) C.C. Filson Co. tin cloth convertible shooting bag; (1) Unidentified cartridge belt. Both the shooting bag and cartridge belt rate very good plus with some minor signs of wear. (135045-8)
1403. **CROSMAN MODEL 2250B SINGLE SHOT CO2 AIR RIFLE** serial #N99B17395, 22 cal, 14 3/4" barrel with a bright excellent bore. The metal surfaces rate near excellent with scattered light freckling. The plastic stock rates excellent with a couple of light handling blemishes. (126496-11)
1404. **AIR RIFLE LOT** Includes a Crosman 1077 Repeater; Co2 powered .177 cal., repeater with bright excellent bore. The metal surfaces show light oxidation staining mostly near the muzzle and the one piece checkered plastic stock rates very good overall. Included with the rifle are the original box and owner's manual (no magazine included). (105458-17)

1405. **CROSSMAN MODEL 760B STARTER KIT AIR RIFLE**, .177 caliber. The blued barrel and air tube show heavy oxidation spotting while the alloy receiver shows all of its black coloration. The plastic pistolgrip stock and square fluted forearm rate excellent with crisp molded checkering and an unmarked grooved buttplate. The gun is equipped with a blade front sight and an open rear sight missing its elevator. The original blister-pac wrapper is opened but included, containing a pair of shooting glasses, a box of pellets, and a trigger lock. (116357-S17151A)
1406. **LOT OF RIFLE SOFT CASES** This lot consists of two zippered 52" long rifle soft cases. First is an Allen case with a vinyl exterior and fabric interior that shows a little soiling and is zippered only at the end. Second is a full zip GunMate with fabric inside and out. Both are in excellent condition. (126605-5A)
1407. **CABELAS TAKEDOWN GUN CASE** This green canvas case provides two padded fleece lined compartments, one for up to 30" barrels and the other for the stock and action. The bottom is reinforced with leather and there is a leather carry strap with zippered opening. The case shows some very light soiling but remains in very good condition. (115783-2)
1408. **OLD LEATHER TAKEDOWN SHOTGUN FOLDING CASE** This case is the old style two part case where one part houses up to a 30" barrel and forearm and the other holds the action. The action side shows lots of scuffs and marks with a hole evident at the bottom whereas the barrel sleeve is actually in very good condition with a clean surface and reinforced toe. The fleece lining is flat but intact in the barrel sleeve but it is more worn away in the action compartment. All the straps and buckles are good including the handle. A neat old case which could easily be resurrected. (114420-2)
1409. **LOT OF THREE HOLSTERS** This lot consists of one Smith & Wesson black nylon right hand holster for a semi auto pistol measuring 7" overall in excellent condition, a small black quality leather holster with strap measuring about 6" overall in very good condition, and a tooled leather Redhead brand right hand holster with strap measuring 8" overall and showing a few scuffs and some edge wear. (116363-60)
1410. **HOLSTER LOT** This lot consists of 6 leather holsters including a French Police MAS Model 1950 black leather holster in excellent condition, a Marbles 10 1/2" flap holster showing scuffs and stains with some repaired belt loop fasteners, an unmarked 11" leather flap holster with worn tooled border showing some staining, a tooled leather Black Sheep 10 1/2" holster with strap in good condition, an 8" Red Head holster with strap showing some scuffs, and a small custom leather open top holster with leather lacing in good condition. (116372-9)
1411. **MAGAZINE LOT** This lot consists of four unmarked, aftermarket magazines for the UZI 9mm pistols and carbines. The magazines are blued and each is similar to the 32 round factory magazine. Also included is an unmarked, ventilated blued steel barrel shroud, possibly for the UZI as well. All are in excellent condition. (46490-2)
1412. **BELT LOT** Includes a 33 1/2" leather belt with Waffen SS belt buckle with eagle over swastika over the phrase "Meine Ehre heist Treue". The die cast buckle is in very good condition retaining only 20% of its painted finish with spots of light oxidation along the edges. (103615-1D)
1413. **CARTRIDGE BOARD OF MISCELLANEOUS SHOT SHELLS** This 12"x16" heavy cardboard display case has 20 compartments done in a red velvet and holds 22 old shot shells. There are twelve 12 gauge paper shells from Remington, Winchester, American Eagle, J. C. Higgins, Peters, and one Polish shell. There is one 16 gauge Peters cartridge, one .410 Remington Peters plastic cartridge, one unmarked paper case dummy shell, and seven 20 gauge cartridges from Remington, Peters, Canuck, Federal, and one Rottweil. This case has a glass cover and there is plenty of room for more shells. (115300-15)
1414. **LOT OF MISCELLANEOUS TOOLS** The lot includes, but is not limited to: 1) unknown ordnance gauges marked .303 and .306; 2) another British ordnance gauge which may be throat wear; 3) a Parker Hale striker point and radius gauge; 4) a 65 degree dovetail cutter; 5) unidentified reamer for unknown caliber in a capped plastic tube; 6) what is likely a bullet mold cherry. Items rate in very good to near excellent condition. Also included are six tools from the Brown & Sharpe Manufacturing Company 1) five (5) end mills for Morse taper; 2) one (1) counter bore. The end mills measure: 1/4"; two (2) end mills in 5/16"; 3/8"; 7/16". The tools range in condition from very good to near excellent, with most having acquired minor to moderate oxidation. The lot comes in wooden case with a sliding cover, marked H&M Tool Co. (131096-1AN)
1415. **PAIR OF GRIP PANELS FOR SINGLE ACTION ARMY REVOLVERS** The smooth walnut or rosewood panels rate very good plus, but do exhibit several light dings as well as a couple of faint scuffs and an extremely minor shallow crack on the upper portion of the right panel. Two piece grips for a Colt Single Action Army revolver or similar revolver. (135706-43)
1416. **THAMES DOUBLE ACTION TOP BREAK REVOLVER** serial #3543, 38 cal, 3 1/8" barrel with a dark mild to moderately pitted bore. The metal surfaces retain 60% original nickel finish with the bulk of the areas of loss faded to a dull ochre and a small area of bright copper with some flaking, freckling, and a few spots of oxidation. The hammers case-hardened colors are strong; the trigger and guard have faded to a gray-brown patina. The hard rubber grips rate near excellent with some soiling and a couple of light handling marks. The barrel, frame, cylinder, tip-up lever, and grips are numbered alike. This gun needs mechanical attention. (126363-39). (10/20)
1417. **HARRINGTON & RICHARDSON 32 TOP BREAK BICYCLE MODEL SPURLESS HAMMER REVOLVER** serial #313601, 32 CF, 2" barrel with a very good bore with a couple of small spots of pitting. The metal surfaces on this second model revolver retain 80-85% original blue with scratches and impact marks, spotty freckling and oxidation; the hard rubber grips rate very good with some wear to the checkering and base of the grips. The frame, cylinder and barrel are numbered alike. This revolver needs mechanical attention, the hammer spring is broken. (126251-13) {C&R} (25/75)
1418. **CAVALRY LOT** This lot consists of a brown leather standard or flag holder. The boot measures 10 1/2" long and has a tapered opening with an about 1" inside diameter opening. The bottom flap is marked "Made In England" and has a loop which may be to secure to a stirrup strap. The top strap has some light crazing and is stiff and will need proper oiling before use. There are remnants of a smaller strap from the top of the boot that is now missing. An excellent example otherwise. (45535-6A)
1419. **LOT OF 1911 MAGAZINES** Three blued magazines marked "19200- / ASSY 550694 /MFR. 1M291" along the floorplate. The magazines range in condition from good to very good with each showing different amounts of scratches and light oxidation scattered over their body. (106417-7D)
1420. **VINTAGE UNMARKED POCKET REAMER** (1) unmarked older pocket reamer for military crimps and rough edges from primer pockets. In fine condition overall with a lightly turned wooden handle and brass ferrule. (56106-666)
1421. **CROSMAN MODEL AUTO AIR II CO2 AIR PISTOL** Single shot .177 cal. pellet, repeater 4.5mm BB. Gun is gray plastic with black grips and is in very good condition. (126416-46)
1422. **CROSMAN MODEL 1088 CO2 AIR PISTOL** 4.5mm BB/.177 cal pellet. Silver plastic with a couple of handling blemishes and black plastic grips in very good overall condition. (126357-S17140C)
1423. **UNMARKED BELGIAN TOP BREAK FOLDING TRIGGER VELO DOG REVOLVER** 22 cal. velo dog, 2 1/4" round barrel with a poor bore. The metal surfaces are an overall dull gun metal gray with light oxidation staining and near overall pinprick pitting, some light, the butt quite a bit more moderate. The checkered ebony grips rate about very good. The mechanism seems to function well however the top latch spring is either broken or missing. (36310-2) {C&R} (75/150)

1424

VETERAN.

1424. **VETERAN LOT** This lot consists of a blue silk ribbon type banner or sash marked "VETERAN." in block white letters. The white paint is flaking and the blue silk has several small tears, creases and light stains. A very good example overall. (45798-B180)
1425. **LOT OF AMMO** The lot consists of nine (9) rounds of what is likely 43 Spanish round nose, centerfire ammunition. All of the ammo appears to have held up very well, with the exception of one round which exhibits some deterioration of its bullet. The ammo rates very good, overall with light tarnishing. (135867-7)
1426. **COLT BARREL LOT** This lot consists of (1) Colt, first generation, Single Action Army barrel that has been reamed to a tapered smooth bore. The barrel tapers from approximately .470" at the rear to approximately .445" at the muzzle. The barrel still has the ejector rod stud attached and the front sight. There are no visible markings on the barrel and the threads appear in excellent condition. The finish is gunmetal gray with light oxidation blemishes, and scattered dents, dings and scratches. A good smoothbore barrel for an Antique-only S.A.A. (85896-11A)
1427. **BRITISH COAT OF ARMS HELMET BADGE** This lot consists of a cast bronze British coat of arms hat or helmet badge that measures 5" across and about 3 1/2" high. The coat of arms of the Queen and Monarchy features the lion on left and unicorn on right and with lion on crown on top of the seal in center with inscription and latin inscribed banner along the bottom. The metal has a light tarnish and there are six short loops for attachment on the back. An excellent example overall. (45798-B179)
1428. **JOHN PETTY & SONS FOLDING KNIFE** The knife rates very good with the blade retaining much of its edge and featuring a "Barrel trademark" along the left side of the blade; however, the knife does exhibit significant chips in both wooden panels as well as a few cracks running along the length of both panels. (135461-55)
1429. **LOT OF REVOLVER GRIPS** The lot consists of two rubber grips for Smith & Wesson J Frame revolvers; included are: 1) checkered black rubber grip by Pachmayr in near excellent condition, as well as both looking and feeling excellent; 2) checkered black rubber grip by Uncle Mike's in very good plus condition. Both grips come with necessary frame retention screws. (135190-43)
1430. **LOT OF MEDALS** The lot consists of two medals for "Eastern Mass. Rifle League". The first medal was awarded for "High on Team: League Matches" and is dated 1964; while the second medal was awarded for "High on Team: Iron Sights" and is dated 1967. Both of the medals rate very good plus to near excellent in condition, with each housed in an individual case. (133746-7D13)
1431. **FOREHAND ARMS COMPANY DOUBLE ACTION TOPBREAK REVOLVER** serial #267635, 32 S&W, 3 1/4" barrel with a pitted bore. Overall the revolver retains about 90% of its nickel finish with a scattering of oxidation blemishes and some light flaking on the high edges. The case-hardened colors of the trigger and hammer have softened and the blued triggerguard has flaked to a brown hue. The hard rubber grips feature the Forehand and Wadsworth logo with an eight pointed star around the escutcheons. The grips are in near excellent condition with light handling wear. This late-manufactured revolver is mechanically sound except for the cylinder retention button which is in need of attention. Included with this revolver is a leather, open top holster by an unknown maker but is marked "1929" & "4 1/2" on the rear. The holster has some light scuffs, crazing and general wear. (86258-63) {C&R} (25/75)
1432. **LOT OF AMMO CRATES** (1) M2 ball wooden ammo crate measuring approximately 15"x10 1/2" with black lettering still clearly visible denoting contents. The crate also exhibits the flaming bomb denoting ordnance and Springfield Armory symbols. This crate contained 30-06 ammo on five round stripper clips inside bandoleers. The exterior exhibits scuffs and the occasional bruise consistent with age. The lid is absent, with this lot in very good condition overall; (1) empty wooden ammo crate measuring approximately 15 1/2"x8 1/2". The crate's exterior has light overall wear and exhibits black paint with yellow stenciled lettering addressed to the Century Arms in St. Albans, VT. The crate features two rope handles with the lid absent. This lot is in very good condition overall and would make an excellent storage bin for the reloader or collector. (66129-4 A8,A4)
1433. **AMMO BOX** This lot consists of a wooden box for ammo storage measuring approximately 16"x10"x8 1/2" with a decorative scene of a 12 point buck along a fence line. The box features dovetail construction and rope handles. The exterior wood surfaces exhibit minor wear with the lot in excellent condition overall. (64404-S13906J1A1)
1434. **MILITARY LOT** (1) 1948-dated U.S. Fiber Record Chest. This uncommon item, essentially a portable field desk, has a metal reinforced outer shell/carry case painted OD green and a structurally sound, three section fiberboard interior composed of two wider sections abutting a taller narrower section to their left. The varnished wood surfaces exhibit an uneven patina and areas of stains and wear. The two side snaps are present and intact as is the leather carry handle, however the top main snap is missing. The outer case retains about 85% finish with nearly all the loss at the top which has had contact with some liquid. The overall condition is very good; (1) Grimes Model K-2 signal light lamp with original power cord and excellent condition Bakelite plastic body. Included are four attachable colored lenses rating excellent and contained in their own original hinged box in excellent condition and marked "N.A.F. 311389-6". (73634-43A)
1435. **LOT OF MILITARY GEAR** This lot consists of two canvas U.S.A.A.F. Flight Bags. The first one measures approximately 24"x20" when in carry (folded) mode. It features large auxiliary pockets at both its front and rear. Both have dual leather straps that are present but brittle and the top has an intact carry handle, but the shoulder strap is torn and nearly all is missing. The khaki-colored canvas surface displays mild to moderate staining and some areas have become misshapen from storage. One of the side pockets is stamped in large text "JOEL B. HILL/01100592/1ST. LT. CE". The overall condition is about good plus. The second bag is in considerably better condition and shows very little wear at all. It is almost identical in construction to the one described above but is OD green in color with all leather straps present but brittle, with the top leather strip that acts as a binding showing wear marks particularly on one edge. The canvas surface shows light ingrained dirt and other light stains and one of the pockets bears an 8"x5" patch with the U.S. Army Aviation insignia; (1) Pararaft M-641 manufactured by U.S. Rubber Co. of Woonsocket R.I. and dated 8/31/45. This survival raft measures approximately 62"x38" when deflated and is a deep yellow color with an teal colored bottom. It appears unused but has some areas of stains, mainly ingrained dirt and comes complete with carbon dioxide canister and rubber tube. Also included for transportation and protection is a U.S. issued Duffel Bag. The lot rates near excellent overall. (73634-32A,27B)



1427

1436. **LOT OF SHOOTING COLLECTIBLES** Five items total; (1) Smith & Wesson blue cardboard box for a Model 10, round butt, 38 Military & Police revolver measuring approximately 11" in length by 4 1/2" in width by 1 1/2" in height. The cover exhibits a small patch of blue covering missing from the center as well as minor crazing at the seams. The label denoting serial number is absent with the box exhibiting wear consistent with age. The lid bears the Springfield, Mass. factory in the lower right corner with the lot in very good condition overall; (1) set of hard rubber grips believed to fit the Colt New Service revolver. The grips exhibit the Colt name at the top, finished with near overall checkering. These grips exhibit roughly finished panels and are in very good to excellent condition overall; (1) cast metal rifle resembling an M1 Garand measuring approximately 7" in length exhibiting wear and scuffing; (1) a large green plastic machine gun round measuring 6 1/2". The round is warped slightly due to heat but is in good condition overall; (2) metal cast figurines measuring approximately 3" in height. One figure is of a fireman and one is of a soldier. The figures retain approximately 90% original painted finish with light chips and nicks due to age. The fireman is by Barclay and the soldier is unmarked both are good condition overall. (65538-6A3)
1437. **FOOT LOCKER** Includes a modern made Seward chest measuring 30"x16"x12" with reinforced brass corners over plastic edge guards. The chest is lockable and would need to have a key made for it as one is not present. It is in good overall condition. (104299-32)
1438. **AMMO BOX** This lot consists of a wooden military ammo box measuring approximately 14 3/4"x10"x10 1/2". The exterior wooden surfaces exhibit a majority of added green paint with original stenciling partially visible. The lid has an added hasp to secure contents with the box in very good condition overall. (64390-3)
1439. **CLOTHING LOT** This lot consists of four items. Included are a U.S. GI woodlands camo size small blouse, a U.S. GI woodlands camo size medium pair of pants, one Cabela's size XXL Dry-Plus camo hoodie pullover and a black synthetic cover. All are in excellent condition, the cover has snaps for securing to a base, but its purpose is unknown. It would make a great shooting mat. (44457-6A)
1440. **WINCHESTER MODEL 1885 BARREL AND FOREARM** 45-70 Govt., 28" octagon barrel with a bright fine bore. The metal surfaces retain 95-98% professionally added blue with a few minor nicks and specks of fine oxidation. The smooth walnut schnabel forearm rates fine with a few light handling marks and two holes drilled in the belly of the forearm. The top of the barrel has three sets of drilled and tapped holes and a solid Weaver base is installed, no front sight present. (56106-682)
1441. **GERMAN HEBEL MODEL 1894 FLARE PISTOL** serial #266, 26.5mm, 6 1/8" barrel with an excellent bore. This Belgian-proofed gun retains about 97% of its original dull blue finish with silvering of the high edges, areas of cleaned pitting on the right side below the barrel and some light freckling. The case-hardened colors of the hammer remain strong with light flaking on the hammer spur. The smooth factory grips are in very good condition with light handling wear observed. The barrel is believed to have been shortened from its original 9" length. (86393-382). (100/200)
1442. **LOT OF OPTICS AND MACHINE GUN LINKS** This lot consists of two optical devices and one steel box. Included are one "Loca-Scope" in the original box with instructions. This mirrored device allows the user to locate two landmarks at once to aid in land navigation. The second optic consists of a pair of Chevalier Opticien of Paris binoculars that are in poor condition. The brass framed binoculars are missing the left objective lens assembly and the right exhibits a crack in the glass. The focus adjustment still functions. Included is a metal "Yankee Reflector-Flare" box that is in near excellent condition with light scratches and scuff marks. The box measures 8 1/2" x 3 3/8" x 3 3/8" but is missing its original contents. It would make a great little "parts" box. Also included are approximately (25) 30 caliber steel, disintegrating, machine gun links with NATO cross. (85682-19C5)
1443. **LOT OF PARA ORDNANCE MAGAZINES** Total of two 45ACP mags: the first mag is stainless steel for an unknown model exhibiting minor overall wear; the second mag. is a higher capacity for an unknown model retaining approximately 97% original blue finish with minor wear and a few patches of oxidation. In very good condition overall. (66417-7B)
1444. **WINCHESTER BOX OF SUPER SPEED RIFLED SLUGS** This is a five rd. natural colored box with blue and red printing of 12 ga., 2 3/4" Winchester Super Speed Long Range Rifled Slugs loaded with Progressive Burning Smokeless Powder. The box rates excellent with only slighted rounded corners and the shells rate excellent as well with minor light staining on the paper hulls and brass. (55658-12MY3)
1445. **BULLET LOT** This lot consists of a small box containing about 30 conical lead bullets in .45 caliber. The bullets have some light oxidation but are in excellent condition otherwise. Also included are a few round balls. (45535-1)
1446. **COLT SCOPE LOT** This lot consists of non-maker marked Colt style 3X scope for the AR-15 style rifles. The scope features a standard duplex reticle and has bright, excellent optics. Though not maker-marked it is identical to the Colt-made examples and is designed to fit a carry handle. Lens covers are included. An excellent example overall. (46450-1A)
1447. **KNIFE LOT** Includes a Joseph Allen & Sons bone handled fixed blade knife. The knife has a 4 1/2" double edged blade with an overall measurement of 8 1/2". The blade shows spots of moderate oxidation staining and appears unsharpened. It would make a great letter opener. (102880-46C)
1448. **BULLET MOULD LOT** This lot consists of a Lyman single cavity bullet mould #311413 in its original box. The mould is for a .30 caliber 169 grain spitzer bullet and is equipped with a sprue cutter. It is in excellent condition overall and has a few areas of light surface oxidation. (44471-1BR12)
1449. **LOT OF COLLECTIBLE AMMUNITION** Two boxes total: (1) full box of 20 Winchester .30 Army Full Patch 220 grain ammunition for the Krag Jorgensen and Winchester Model 95 repeating arms. The two-piece manila box rates excellent and the included ammunition has a light tarnish; (1) box of Winchester 25 ACP 50 grain Full Patch "FMJ" (K2541T). The red and yellow box rates excellent and has some mild foxing and contains 23 rounds of correct ammunition. The ammunition has some mild tarnish but rates excellent as well. (44435-7D,C)
1450. **LOT OF COLLECTIBLE ITEMS** Three items total: (1) camp cot consisting of wood legs, supports with metal brackets and aged white canvas measuring approximately 46"Hx76"Lx25 1/2"W. The canvas exhibits wear consistent with age as well as soiling. The cot is structurally sound with all the parts included in very good condition overall; (1) vintage steam gauge, a Pierce Butler & Butler Mfg. Corp of New York pressure gauge with the face exhibiting an approximate 4 1/2" radius. The glass is intact with a brass lid exhibiting wear and tarnish. The base retains approximately 50% original black finish with patches of oxidation showing through. This interesting piece of history has a number of uses and is in very good condition overall; (1) saddle surcingle measuring approximately 90" in length, 3 1/2" in width. The surcingle is constructed of tan leather billet and chape with blue wool webbing. The lot exhibits light wear from limited use and is in excellent condition overall. (65538-12,7M)
1451. **CHILEAN MODEL 1935 MAUSER CARABINEROS BOLT ACTION CARBINE BY OBERNDORF** serial #39, 7mm Mauser, 21 1/2" barrel with an excellent bore. The metal surfaces are a mottled gray overall with traces of original blue that are mixing with areas of light pitting and brown oxidation staining. The receiver markings are all crisp including the "(crown)B", "U", "G", and "N" proofs. The walnut stocks rate near excellent and have several light dings and small divots. The cartouches are still mostly visible on the left side of the butt. The parts appear to be all matching and included are a cleaning rod and correct style leather sling with quick-detach loop swivel. Rifle was imported by Sarco and is in near excellent condition overall with a super low serial number. (46635-3) (C&R) (500/700)

1452. **FRENCH BERTHIER-MANNLICHER MODEL 1907-15 BOLT RIFLE BY REMINGTON** 8mm Lebel, 31 1/2" barrel with a dark, oxidized and pitted bore. The metal surfaces retain about 90% original blue lightly blending with brown patina and areas of light surface oxidation. The bolt is a mottled gray-brown. The walnut stock rates near excellent and has a few light dings and small cracks with repaired chip at the upper tang. The original sights are intact and target blocks have been added to the barrel. Two holes have been tapped for a rear receiver sight and the stock has been modified as well. A correct style leather sling is included. An excellent example overall save the few small apologies listed. (46556-14). (400/600)
1453. **H.W.Z. MODEL 21 MARTINI FALLING BLOCK RIFLE** serial #12215, 22 LR, 27 1/2" barrel with an excellent bore. The metal surfaces retain about 80% original blue that is flaking to a rich plum brown. The bolt, lever, trigger and guard, barrel bands, retention springs and serrated buttplate all retain about 95% of a polished nickel finish. The walnut stocks rate near excellent, buttstock is checkered and is tapped for a sling swivel stud, the forearm has a small crack along the rod channel and separate repair at the base near the frame. The barrel is equipped with a globe style front sight, the area just forward the chamber to the first band is milled flat with grooved edges, likely for a mount or sight base. Rear of the frame is a square key rear sight which is fitted with a cup style aperture. There is no cleaning rod present. An excellent pre-war example built by Hermann Weirauch in Zell-Mehlis that has "(crown)/B" and "(crown)/U" proofs along the right side and looks like it would make a terrific shooter. (46625-49). (400/600)
1454. **SPRINGFIELD ARMORY MODEL 1882 CHAFFEE-REESE BOLT RIFLE** 45-70, 24" barrel with an about good bore with light pitting and light oxidation throughout. The metal surfaces are a mottled brown overall with some traces of a black enamel finish and have areas of light of minor surface oxidation. The modified walnut stock rates about very good and has a checkered wrist and starburst patterns on either side. The stock has several long cracks through the wrist. The sights are missing and the rear sight base holes have been filled. Modified for sporting use quite some time ago, this is an about good condition example overall. (46100-1) (ANTIQUE) (400/600)
1455. **BERETTA SILVER SNIPE MODEL OVER UNDER SHOTGUN** serial #25274, 12 Ga., 28" plain barrels that are choked full and improved modified with excellent bores showing minor plastic buildup beyond the chamber. Metal surfaces retain about 85% of the original blue finish that is fading to brown with scattered, light oxidation throughout on barrels. The blued triggerguard has more moderate surface oxidation and the forearm iron is fading to a gray. The alloy frame has about 99% of the satin silver finish and has a few small scratches. The checkered walnut stocks rate good and have numerous abrasions, cracks and light handling marks. The pistolgrip buttstock has a 3" sliver missing where stock meets the upper tang on the right side, a chip missing at the toe and buttplate, and a split is opening up from the buttplate forward which is visible along both sides. The forearm has a small silver medallion depicting a snipe in flight and is in the same general condition with a few cracks. Features include a ramp style front sight, a single non-selective trigger and tang mounted thumb safety. A good to very good condition example that would make a good rainy day field gun with the proper stock repairs. (46587-S16669). (200/400)
1456. **WINCHESTER MODEL 62 SLIDE ACTION RIFLE** serial #3674, 22 Short, 24" mail order proofed Model 1890 octagon barrel that is mostly bright but has a ring about 3/4" from the muzzle. The metal surfaces retain about 85% of the factory blue finish that is flaking to brown overall and mixing with areas of light surface oxidation. The magazine tube loading port is made for 22 Short but is not the triangular "gallery" style. The smooth walnut stock and ten groove walnut forearm rate excellent and have several light handling marks with some staining and discoloration from use. The buttstock appears to be from a Model 1890 rifle and is fitted with a steel crescent buttplate. The stocks have what appear to be their original varnish that has some minor flaking overall. The barrel is equipped with a low profile Lyman front sight, the rear sight is missing leaving the dovetail vacant. A Lyman combination rear aperture sight is mounted on the tang. An interesting little rifle that at first glance would make you think that it was a Model 1890, but seeing that it has a takedown receiver with a four-digit serial number, it is clearly a Model 62 that has been modified to appear as such. May make a great "gallery" shooter still, or be bought for the value of its parts. (46526-1). (400/600)
1457. **INTERARMS MARK X VISCOUNT MINI BOLT ACTION RIFLE** serial #2565, 223 Rem, 20" barrel with a bright, excellent bore. The metal surfaces retain about 99% original blue that has some light wear and a few specks of light surface oxidation present. The checkered hardwood Monte Carlo stock rates excellent and has a few light dings. The original sights are intact and mounted to the receiver by a set of Weaver bases and rings is a Weaver Marksman 3-9X riflescope. The scope features a duplex reticle and has excellent optics. An excellent condition rifle package perfect for small game, varmint or predator hunting. (46520-3648) [Richard "Stretch" Kennedy Collection]. (300/500)
1458. **BROWNING A-BOLT GRADE I RIMFIRE BOLT ACTION RIFLE** serial #05383PN136, 22 WMR, 22" barrel with an excellent bore. The metal surfaces retain about 95-97% original blue that has some light fading along the bottom metal and is mixing with sparse areas of scattered light surface oxidation. The checkered walnut stock rates excellent and has a few light dings. The stock features a contrasting forend tip and pistolgrip cap and retains the original hard rubber buttplate. The original sights are intact and included is a single detachable magazine. An excellent example of these rimfire A-Bolt series rifles. (46520-3696) [Richard "Stretch" Kennedy Collection]. (300/500)
1459. **ANSCHUTZ MODEL 1451E SPORTER BOLT ACTION RIFLE** serial #397840, 22 LR, 22" barrel with an excellent bore. The metal surfaces retain about 99% original blue that has a few, very light handling marks. The checkered hardwood stock rates excellent and has a few very light dings. The original hooded front sight and adjustable rear sight are intact as are the sling swivels. A factory mount with rings is included and is mounted to the grooved receiver. Built on a Model 64 action, this is an excellent single shot sporting 22 overall. (46680-12) (C&R) (200/400)
1460. **REMINGTON NYLON 66 SEMI-AUTO RIFLE** 22 LR, 19 1/2" barrel with a bright bore that has a small ring and bulge about 3" from the muzzle. The metal surfaces retain about 97-98% original blue that has a few light handling marks and some areas of light surface oxidation that are blending through. The alloy front sight has some minor flaking to the enamel finish. The Mohawk brown composite Zytel stock rates excellent and has a few light scratches. The original sights are intact and included is a set of 1" Weaver Tip-Off rings to fit the grooved receiver. An excellent example overall minus the few apologies listed. (46642-47). (150/250)
1461. **REMINGTON MODEL 513-T MATCHMASTER BOLT ACTION RIFLE** serial #202598, 22 LR, 27" barrel with a bright excellent bore. The metal surfaces retain 85% original blue with some overall light surface oxidation and handling marks. The oil finished walnut target stock rates near excellent and has several light dings and light scratches. The rear sling swivel is missing. The rear of the receiver is marked "U.S." and rifle is equipped with a Redfield aperture rear sight and a front globe sight. The barrel is factory tapped for mounts and is date coded for 1966. There is a 4-H sticker on the buttstock and no magazine is included. A great target 22 that would likely make a terrific shooter. (46661-1). (200/300)
1462. **MARLIN MODEL 336CS LEVER ACTION RIFLE** serial #11086993, 35 Rem, 20" barrel with an excellent bore. The metal surfaces retain about 95-97% of the original blue that has some light handling marks, spots of very light surface oxidation and some light silvering along a few of the edges. The smooth walnut stocks rate near excellent and have several light dings throughout and some very nice figure along the comb. The original sights are intact, including the front sight hood, and mounted to the receiver by a set of see-through mounts is a Tasco Pronghorn 2.5X32 riflescope. The scope features a duplex reticle and has near excellent optics. Also included is a Hunter leather sling. A great sporting rifle in excellent condition and in a great caliber capable of harvesting most of the large game found in North America. (46505-1). (300/500)

1463. **BRITISH ENFIELD NO.5 MK I BOLT ACTION CARBINE** serial #C9368, 303 British, 20 1/2" barrel with flash hider and an excellent bore. The metal surfaces retain about 60-70% of the arsenal black enamel finish that shows moderate flaking and is mixing with areas of light surface oxidation and brown patina. The receiver is dated "11/44" and there are no importer markings visible. The walnut stocks have a dark oil finish and rate excellent overall having a few light dings and tool marks. The buttstock has a black circle with white line carved and painted into the left side of the butt. A green canvas sling and a single detachable magazine are included. An excellent example of these popular "Jungle Carbines". (46696-5) {C&R} (250/450)
1464. **BRITISH ENFIELD NO.5 MK I BOLT ACTION CARBINE** serial #E5036, 303 British, 20 1/2" barrel with flash hider and an excellent bore. The metal surfaces are a mottled gray with traces of original blue present. Carbine is equipped with a set of Bishop walnut sporting stocks that rate excellent. The original rear sight has been removed and installed is a Redfield rear aperture peep sight. A single detachable magazine is included. A great sporting carbine in very useable condition. (46564-55). (200/300)
1465. **BRITISH ENFIELD NO.4 MK 1/3(*) BOLT RIFLE BY LONG BRANCH** serial #41L0869, 303 British, 25" barrel with a bright, excellent bore. The metal surfaces retain about 95-97% of an arsenal black finish that has some light wear along a few of the bearing surfaces. The hardwood stocks rate excellent and have a few light dings. Rifle was converted from the No.4 Mk I* with addition of the newer Mk II trigger assembly and is neatly electric pencil marked on the side of the receiver along with "751", possibly when the conversion was completed. Included are a U.S. style leather sling, a detachable magazine, a spike bayonet and a plastic oiler. An excellent condition example overall that was imported by IAC. (46625-37) {C&R} (250/450)
1466. **BRITISH ENFIELD NO.4 MK I* BOLT RIFLE BY SAVAGE** serial #35C2522, 303 British, 25" barrel with an excellent bore. The metal surfaces retain about 98% of an arsenal parkerized finish with some light handling wear. The hardwood stocks rate excellent and have a few light dings. The stocks are likely the originals and have boxed "S" proofs. The receiver is "U.S. PROPERTY" marked and dated "1942". The magazine is numbered to a different rifle. An excellent example overall that was imported by IAC. (46635-1) {C&R} (250/450)
1467. **BRITISH ENFIELD NO.1 SMLE MK III* BOLT ACTION RIFLE** serial #A1900, 303 British, 25" barrel with an excellent bore. The metal surfaces retain about 95% of an arsenal matte blue finish with light wear along a few of the edges. The hardwood stocks rate very good and have several dings, the handguards have a few arsenal repairs. The left side of the butt has "AIE" carved in the side. A single detachable, matching magazine and a canvas sling are included. A near excellent example that was imported by Century Arms. (46625-35) {C&R} (200/400)
1468. **BRITISH ENFIELD NO.1 SMLE MK III BOLT RIFLE BY L.S.A.** serial #M50791, 303 British, 25" barrel with an excellent bore. The metal surfaces retain about 75% of an arsenal blue finish that is fading to a mottled gray-brown overall. The hardwood stocks rate very good and have several dings and a few small cracks. A single magazine and a canvas sling are included. A near excellent 1916 dated example overall that was imported by Century Arms. (46556-26) {C&R} (200/300)
1469. **EGYPTIAN HAKIM SEMI-AUTO RIFLE** serial #46014, 8mm Mauser, 24" barrel with an excellent bore. The metal surfaces retain about 85% of an arsenal type blue finish blending with areas of light surface oxidation and having a few minor tool marks and some very light pitting. The hardwood stock rates excellent and has some minor flaking along with a few minor dings and other light handling marks. The right side of the butt is marked "63" in Arabic in white paint. The original sights have been removed and a flat rail has been added to the top of the receiver. Rifle was imported by Century Arms and includes a single detachable magazine. (46707-10) (200/400)
1470. **AUSTRIAN STEYR MODEL 1886/1890 MANNLICHER BOLT RIFLE** serial #6642E/77657, 8x50R, 30" barrel with a dark bore that has strong rifling present. The metal surfaces are a mottled brown with overall light surface oxidation. The hardwood stock rates very good and has been cleaned, and has several light dings; finish has been added. There is no cleaning rod present, but rifle appears to complete and functional otherwise. A very good example overall that is not import marked. (46587-S16668) {C&R} (200/400)
1471. **AUSTRIAN STEYR MODEL 1895 MANNLICHER BOLT RIFLE** serial #769R, 8x56R, 30" barrel with an excellent bore. The metal surfaces are a mottled gray with a few areas of very light pitting and some light surface oxidation present. The walnut stocks rate near excellent and have several light dings and handling marks consistent with service use. There is a faint cartouche visible on the left side of the butt, the original serial number has been stuck out and the stock has been renumbered to match on the right side. Rifle is not import marked and the rear sight is missing. A U.S. style leather sling and a bayonet with scabbard are included. The bayonet appears to be the model 1888/93 and has been modified at theommel to fit he 95 series rifles. The bayonet is unmarked with the exception of numbering and measures 14 1/8" long with a 14 3/4" blade. The metal is lightly mottled gray and has a few light handling marks. The wood grip panels have a few small dings and chips. The included steel scabbard has a few small dings and has remnants of a black or green enamel finish. A near excellent overall. (46518-37) {C&R} (150/250)
1472. **SWISS SCHMIDT-RUBIN MODEL 1911 BOLT ACTION RIFLE** serial #414694, 7.5 Swiss, 30 1/2" barrel with an excellent bore. The rear sight retains about 60-70% original blue that is fading to gray overall. The walnut stocks rate near excellent and have several light dings, divots and other light handling marks consistent with service use. The rifle appears to be complete and operational and a leather sling is included. The rifle is not importer marked and is in near excellent condition overall. (46556-15) {C&R} (250/350)
1473. **GERMAN MODEL 98 MAUSER BOLT RIFLE BY HAENEL** serial #4337u, 8mm Mauser, 29" barrel with a near excellent bore that is lightly freckled in the grooves. The 1916 dated receiver is in the white and still remains mostly bright with a few areas of light pitting. The remaining metal surfaces retain about 85% original blue, the bottom metal is flaking to a mottled brown and the buttplate is gray. There are areas of light pitting and surface oxidation throughout. The walnut stocks rate excellent and show evidence of having been cleaned with finish added over a few light dings. The numbers appear to be all matching and rifle is not importer marked. A leather sling and bright steel cleaning rod are included. An excellent example overall that should make a great shooter as well. (46638-1) {C&R} (350/550)
1474. **POLISH MODEL 98 AZ MAUSER BOLT ACTION RIFLE** serial #6879E, 8mm Mauser, 24" barrel with a gray, lightly pitted bore. The metal surfaces are a rich mottled brown and have light handling wear throughout. The receiver is unmarked and appears to have been scrubbed leaving only the serial number and "K98" visible. The buttplate has some minor surface oxidation. The walnut stocks rate very good and have several dings, divots and other handling marks, many consistent with service use. The left side of the butt has several small cracks, likely a result of the wood drying, and the handguard has two small arsenal repairs. The bolt is not matching, but the remaining numbered parts appear to be. A very good example overall that does not appear to have any importer markings. (6676-13) {C&R} (300/500)
1475. **GERMAN MODEL 98K MAUSER BOLT RIFLE BY GUSTLOFF-WERKE** serial #344v, 8mm Mauser, 24" barrel with a bright, excellent bore. The metal surfaces retain about 90% of an arsenal blue finish that has some light handling marks along with areas of light brown patina and lightly flaking black enamel. The receiver is marked "bcd" and both it and the barrel are dated "43" and have several Waffenamts present. The laminate hardwood stocks rate excellent and have a few light dings. The stock appears to have been lightly cleaned with finish added and has a single Waffenamt present along the toe line. The parts appear to be all matching however the action screw set screws are missing. A cleaning rod and front sight hood are included. An excellent example overall that is not importer marked. (46641-4) {C&R} (400/600)

1476. **GERMAN MODEL 98K MAUSER BOLT RIFLE BY GUSTLOFF-WERKE** serial #3706i, 8mm Mauser, 24" barrel with a bright, excellent bore. The metal surfaces retain about 75-80% of the original blue which is fading to gray and mixing with areas of very light surface oxidation and a few light pits. The receiver is marked "337" and dated "1940", all of the parts appear to be matching and rifle is complete. The laminate hardwood stocks rate excellent and have a few light dings. Rifle has a later style welded barrel band and forend cap and modern sling swivel has been added to the left side of the butt. An excellent example otherwise that should make a terrific shooter. (46707-14). (400/600)
1477. **GERMAN MODEL 98K MAUSER BOLT RIFLE BY GUSTLOFF-WERKE** serial #9331i, 8mm Mauser, 24" barrel with an excellent bore. The metal surfaces retain about 90% of an arsenal blue finish that is lightly flaking to a brown patina. The receiver is marked "bcd" and both it and the barrel are dated "42" and have Waffenamts present. The laminate hardwood stocks rate excellent and have a few light dings and small divots. The numbered parts appear to be all matching and the cleaning rod, a leather sling and front sight hood are included. The sling has some minor crazing and small cracks along the edges. An excellent example overall that does not appear to be importer marked. (46678-44) {C&R} (450/650)
1478. **GERMAN KAR 98 MAUSER BOLT RIFLE BY DANZIG** serial #6105, 8mm Mauser, 24" barrel with an excellent bore. The metal surfaces are a rich, mottled brown mixing with a few areas of light surface oxidation. The bottom metal and buttplate are a mottled gray and have light pitting as well. The walnut stocks rate very good and have been cleaned with an oil finish added. The forend has been "duffle cut" and there are multiple light dings, divots and minor bruises. Rifle is not all matching, but does not appear to be importer marked and otherwise is complete. A very good example overall that is dated "1910" and has good receiver markings. (46635-2) {C&R} (200/400)
1479. **GERMAN MODEL 98K MAUSER BOLT RIFLE BY BRNO** serial #762d, 8mm Mauser, 24" barrel with a very good bore that has some light pitting in the grooves. The metal surfaces retain about 80% original blue that is flaking to brown with the balance fading to gray. The laminate hardwood stocks rate excellent and have a few light dings. The receiver is "dou" marked and has several Waffenamts. The numbers are not all matching but the rifle does not appear to be importer marked either. There is no cleaning rod, but rifle does include a front sight hood and a newer, period style leather sling. A near excellent example of these Czech-built Model 98k rifles. (46599-65) {C&R} (400/600)
1480. **CZECH VZ24 MAUSER BOLT ACTION RIFLE** serial #6193P3, 8mm Mauser, 23" barrel with a bright excellent bore. The metal surfaces retain about 90% of an arsenal blue finish that is lightly flaking to gray and mixing with areas of light surface oxidation. The bolt and buttplate are a mottled gray. The receiver has crisp markings. The walnut stocks rate excellent and have a few light dings. The stocks have a dark oil stained finish and the buttstock is numbered to the receiver. Rifle appears to be complete and a cleaning rod is included. No import markings are visible and rifle is in excellent condition overall. (46706-34) {C&R} (400/600)
1481. **GERMAN MODEL 98 MAUSER BOLT ACTION RIFLE BY ERFURT** serial #4591l, 8mm Mauser, 29" barrel with a very good bore that is lightly pitted toward the muzzle. The "1902" dated receiver and bolt are in-the-white and have been lightly polished, the markings are still present but some are faint. The buttplate is a mottled gray and the remaining metal surfaces retain about 85-90% blue that is lightly flaking to brown and blending with a few areas of very light surface oxidation. The walnut stocks rate excellent and show evidence of having been lightly cleaned and has an added oil finish and a few light dings. The numbers appear to be all matching and there are no visible import markings. A cleaning rod is included that has some light surface oxidation. A near excellent example overall. (46625-43) {C&R} (300/500)
1482. **FINNISH MODEL 1928/30 CIVIL GUARD SHORT RIFLE** serial #35403, 7.62x54R, 27" barrel dated "1937" with a very good bore that is gray and lightly pitted in the grooves. The metal surfaces are a mottled gray overall with traces of original blue present. The barrel markings are crisp. The hardwood stocks rate very good and have several light dings. The buttstock is numbered to a different receiver and appears that is may have been lightly sanded and finish added. The numbers are not matching, but rifle does include a cleaning rod and a canvas sling. Rifle was imported Marathon Products and is in very good to near excellent overall. (46556-27) {C&R} (250/350)
1483. **CZECH MODEL 52 SEMI-AUTO RIFLE** serial #C34315, 7.62x45, 20 1/2" barrel with a dark, oxidized bore. The metal surfaces retain about 95% of an arsenal parkerized finish that has light handling wear throughout. The hardwood stocks rate excellent and have dings and other minor handling marks overall. Included are the folding bayonet, a canvas sling and a detachable magazine. A near excellent example overall that might make a good shooter still. (46556-18) {C&R} (250/450)
1484. **FRENCH MAS MODEL 1949 SEMI-AUTO RIFLE** serial #F35290, 7.5 French, 23" barrel with an excellent bore. The metal surfaces retain about 90% original gray parkerized finish with light handling wear toward the muzzle and light silvering along the edges. The buttplate is mottled gray with light abrasions. The hardwood stocks rate very good and have several light dings and other light impact marks. There is a faint cartouche visible on the right side of the buttstock. The sights are intact and included are a detachable magazine, a leather sling and the spike bayonet. A near excellent example overall that was imported by Century Arms. (46556-24) {C&R} (300/500)
1485. **FRENCH MAS MODEL 1936 BOLT ACTION RIFLE** serial #K55071, 7.5 French, 23" barrel with an excellent bore. The metal surfaces retain about 90% of an arsenal gray parkerized finish that has light handling wear throughout. The hardwood stocks rate excellent and have a few light dings. A leather sling and a spike bayonet are included. An excellent example overall that was imported by Century Arms. (46556-19) {C&R} (200/400)
1486. **GREEK MODEL 1903/14 MANNLICHER-SCHOENAUER INFANTRY RIFLE BY STEYR** serial #762r, 6.5x54, 28 1/2" barrel with a dark oxidized bore. The metal surfaces are a mottled brown with areas of gray blending through and mixing with light surface oxidation and staining. The military walnut stocks rate near excellent and have light added finish over several dings and other handling marks. The buttstock has some faint markings on either side of the butt, many which were added by previous owners. The receiver bears the Greek crest and "Y" along with the model designation and there are a few Greek proofs still visible. The bolt is not matching and the cleaning rod is not present. The rifle appears to be otherwise complete and is not import marked. Added to the bolt release is a Lyman rear sight with pivoting aperture, the stock has been modified to accept the sight. A very good example overall. (46556-32). (300/500)
1487. **TURKISH MODEL 1903/38 MAUSER BOLT ACTION RIFLE** serial #11606, 8mm Mauser, 29" barrel with a gray bore that is lightly pitted in the grooves but has strong rifling present. The receiver and bottom metal retain about 90% of an arsenal blue finish, while the barrel and remaining metal surfaces are a mottled gray. The walnut stocks rate excellent with several light dings. The buttstock has some minor drying cracks above the bolt disassembly lug due to a knot and burled grain. The cleaning rod and a leather sling is included. The markings are all crisp however the numbers are not matching and there is no visible importer marking. A very good example of these converted 1903 rifles. (46698-4) {C&R} (150/250)
1488. **EDDYSTONE MODEL 1917 BOLT ACTION SPORTER** serial #667833, 30-06, 22 1/2" barrel with a bright, excellent bore. The metal surfaces retain about 95% of a professionally applied blue, the rear of the receiver has been modified for sporting use and receiver is tapped for scope mounts. Rifle is equipped with a modified walnut Monte Carlo sporting stock which features a vented recoil pad and has sling swivel studs. The stock rates excellent and has a few light dings. Sporting sights have been added and included are a set of Weaver bases and rings. A great modified military sporting rifle in excellent overall condition. (46664-2). (200/300)

1489. **REMINGTON MODEL 1903-A3 BOLT ACTION SPORTER** serial #3371584, 30-06, 24" barrel dated "1-43" with an excellent bore. The receiver and bolt body retain about 99% of an arsenal green parkerized finish while the remaining metal surfaces have a hastily applied black enamel type finish that has some minor flaking. Rifle is equipped with a Bishop walnut sporting stock which has been modified and rates very good overall. The cheek rest has been removed and the stock has an ebony forend tip. The original military rear sight has been removed and a Lyman folding leaf rear has been added to the barrel. A very good example overall that will likely make a terrific large game rifle for someone on a modest budget. (46680-13) (200/300)
1490. **SPRINGFIELD ARMORY MODEL 1903 BOLT ACTION SPORTER** serial #962124, 30-06, 24" barrel with a bright, excellent bore. The metal surfaces retain about 99% of a commercially applied blue finish which has a few light handling marks present. Rifle is equipped with a walnut Monte Carlo sporting style stock that rates excellent and has a few light dings and minor flaking to the applied varnish. The stock features an ebony forend tip and has a vented recoil pad. A Lyman ring style front ramp sight is mounted to the barrel and a double male dovetail adapter sits at the rear. Mounted to the receiver is a Bushnell Sportview 1.5-4.5X21 rifle scope. The scope features a duplex reticle and has excellent optics. A fine inexpensive sporting rifle package overall. (46623-26) (200/300)
1491. **FINNISH MODEL 1891 MOSIN-NAGANT BOLT RIFLE** serial #09789, 7.62x54R, 31 1/2" barrel with a near excellent bore that is mostly bright but has some very light pitting toward the muzzle. The metal surfaces retain about 95% of an arsenal type blue finish that is lightly flaking to brown. The hardwood stocks rate near excellent and have several light to minor dings and handling marks. The barrel and receiver markings are crisp and dated "1941". A leather sling and a cleaning rod are included. A near excellent example overall. (46625-32) {C&R} (200/300)
1492. **GERMAN GEW 88 MAUSER BOLT RIFLE BY AMBERG** serial #7538e, 8mm Mauser, 29 1/2" shrouded barrel with a fair pitted bore. The metal surfaces are a mottled brown and gray with areas of light surface oxidation and light pitting present. The receiver markings are light but still visible and there are a few minor dings in the barrel shroud. The hardwood stock rates about good and has several small cracks and chips. The stock also has several light dings and Asian type, possibly Chinese, markings on either side of the butt. The bolt head is missing the extractor and the cleaning rod is not present. An about good example overall that is importer marked on the left side of the rear sight. (46556-35) {ANTIQUÉ} (150/250)
1493. **FRENCH MODEL 1866-74 CHASSEBOT/GRAS BOLT ACTION RIFLE** serial #FG22188, 11mm Gras, 32" barrel with a near excellent bore that is mostly bright but has a few small pits toward the muzzle. The metal surfaces are a rich mottled brown that is blending with areas of light surface oxidation. The receiver markings are crisp and barrel is dated "1871" and is also marked 1880, likely when the update to the Gras specs took place. The walnut stock rates near excellent and has a dark, oil finish with several light dings, small chips and handling marks. There are two cartouches present on the butt, one on either side, the right side is missing its center insert. The numbers appear to be all matching, including the stock, and there are no importer marks visible. A cleaning rod and the sling swivels are included. An about very good example of these vintage black powder cartridge service rifles. (46556-33) {ANTIQUÉ} (300/500)
1494. **FRENCH MODEL 1874 M80 GRAS BOLT ACTION RIFLE** serial #C60463, 11mm Gras, 32" barrel with a near excellent bore that is mostly bright but has some light pitting at the muzzle. The metal surfaces are a mottled gray-brown throughout that is mixing with areas of minor oxidation and pitting. The dark, oil stained walnut stocks rates very good and have several dings and a few small cracks. One of the parts are matching and the cleaning rod is missing. A good condition example overall. (46556-38) {ANTIQUÉ} (200/400)
1495. **ITALIAN MODEL 1870/87/15 VETTERLI-VITALI BOLT ACTION RIFLE** serial #XW9738, 6.5 Carcano, 33 3/4" barrel with an excellent bore. The metal surfaces are a mottled brown with areas of gray bleeding through and mixing with spots of light surface oxidation. The walnut stock rates very good and has several light dings and handling marks and a few small arsenal repairs which took place during the conversion to the 1915 specs. There is a crisp arsenal cartouche on the left side of the butt and the stock has been renumbered to match the receiver. A cleaning rod is present and there are no visible importer marks. A very good example overall. (46623-22) {ANTIQUÉ} (150/250)
1496. **ITALIAN MODEL 1870/87/15 VETTERLI-VITALI BOLT ACTION RIFLE** serial #CH7849, 6.5 Carcano, 33 3/4" barrel with dark oxidized bore. The metal surfaces retain about 85% original blue that is flaking to brown and mixing with areas of light surface oxidation. The walnut stock rates about very good and has several light dings, a few cracks and minor handling marks and a few small arsenal repairs which took place during the conversion to the 1915 specs. There is an arsenal cartouche on the left side of the butt that is faded on one edge and the stock has been renumbered to match the receiver. A U.S. GI canvas sling and a cleaning rod are present and there are no visible importer marks. A very good example overall. (46680-9) {ANTIQUÉ} (150/250)
1497. **ITALIAN MODEL 1870/87/15 VETTERLI-VITALI BOLT ACTION RIFLE** serial #AF2690, 6.5 Carcano, 33 3/4" barrel with an excellent bore. The metal surfaces are a mottled brown with areas of gray bleeding through and mixing with spots of light surface oxidation and staining. The walnut stock rates very good and has several light dings and handling marks and a few small arsenal repairs which took place during the conversion to the 1915 specs. There is a fading arsenal cartouche on the left side of the butt along with a more crisp cartouche on the right side and the stock has been renumbered to match the receiver. The rear sling swivel is missing but a cleaning rod is present and there are no visible importer marks. A very good example overall. (46556-37) {ANTIQUÉ} (150/250)
1498. **MOSSBERG MODEL 44 U.S. BOLT ACTION RIFLE** serial #124421, 22 LR, 26" barrel with a bright excellent bore. The metal surfaces retain about 95% original blue with areas of light surface oxidation present. The bolt and inner receiver area has more minor to moderate oxidation with pitting. The hardwood stock rates very good and has a few cracks along the left side that run the length of the forend and butt. The original sights are intact and included are a Brownell's replacement magazine and a canvas GI sling. Rifle comes in a Civilian Marksmanship Program shipping box that contains a copy of the original receipt of purchase and a Lyman #17 front aperture sight with spare inserts. The box has some moderate moisture damage. The trigger mechanism does not reset and it appears that the trigger spring is missing. A very good example of these "U.S. Property" marked rifles. (46518-5) {C&R} (75/150)
1499. **MOSSBERG MODEL 44 U.S. BOLT ACTION RIFLE** serial #120687, 22 LR, 26" barrel with a near excellent bore that is mostly bright but has a few minor pits. The metal surfaces retain about 75% original blue mixing with areas of light to minor surface oxidation and pitting throughout. The bolt and inner receiver area has more minor to moderate oxidation with pitting. The hardwood stock rates excellent and has a few light dings. The original sights are intact and included are magazine and a green canvas GI sling. Rifle comes in a Civilian Marksmanship Program shipping box that contains a copy of the original receipt of purchase and a Lyman #17 front aperture sight with spare inserts. The box has some moderate moisture damage. An about very good example of these "U.S. Property" marked rifles. (46518-4) {C&R} (75/150)
1500. **AUSTRIAN STEYR MANNLICHER MODEL 1895 BOLT ACTION RIFLE** serial #1104, 8x50R, 30" barrel with a very good, lightly pitted and oxidized bore. The metal surfaces are a rich brown with areas of light surface oxidation blending through. The hardwood stocks rate very good and have light dings and a few minor chips, divots and bruises. The stock is numbered to the receiver and shows evidence of drying with raised end grain and a few light cracks. The stacking hook is missing but rifle appears otherwise complete and is not import marked. An about very good example overall. (46568-3) {C&R} (150/250)

1501. **AUSTRIAN STEYR MANNLICHER MODEL 1895 BOLT ACTION SHORT RIFLE** serial #501, 8x50R, 19 1/2" barrel with a gray, pitted bore. The metal surfaces are a rich brown with scattered light surface oxidation and some fine pitting present. The hardwood stocks rate very good and have added finish over several small dings and chips and a few minor cracks. There is a small amount of white paint on the left side of the butt. The stacking hook is missing but the carbine appears otherwise complete. There are no importer markings visible and carbine is in very good condition overall. (46518-21) {C&R} (150/250)
1502. **AUSTRIAN STEYR MANNLICHER MODEL 1895 BOLT ACTION SHORT RIFLE** serial #6162X, 8x56R, 19 1/2" barrel with a dark, oxidized bore. The metal surfaces are a mottled gray throughout and have a few areas of light surface oxidation. The hardwood stocks rate very good and have been lightly cleaned with added finish remaining over several light dings and handling marks and a few small cracks. The left side of the butt is marked "K.A.B.". The barrel is "H" stamped and not numbered to the receiver. The buttplate is numbered "Y-5287". The carbine appears to be complete and includes a front sight hood. No importer markings are present and carbine is in very good condition overall. (46625-45) {C&R} (75/150)
1503. **AUSTRIAN STEYR MANNLICHER MODEL 1895 BOLT ACTION SHORT RIFLE** serial #8769F, 8x50R, 19 1/2" barrel with a dark, oxidized bore. The metal surfaces are a rich brown with mottled gray and mixing with areas of light surface oxidation and light pitting. The hardwood stock rates very good and has added finish over several light dings, minor chips and a few small cracks and repairs. The stock has several arsenal type markings on either side of the butt. The carbine appears to be complete and is not importer marked. An about very good example overall. (46556-40) {C&R} (100/200)
1504. **AUSTRIAN STEYR MANNLICHER MODEL 1895 BOLT ACTION SHORT RIFLE** serial #9012, 8x56R, 19 1/2" barrel with what appear to be an excellent greased bore. The metal surfaces retain about 95% of an arsenal type blue finish with light handling wear along the edges and a brown patina that is lightly flaking through. The blonde hardwood stocks rate excellent and have been lightly cleaned. The buttstock has some light dings and is numbered to a different rifle. Carbine appears to be complete and was imported by Century Arms. (46556-16) {C&R} (100/200)
1505. **WINCHESTER M1 SEMI-AUTO CARBINE** serial #1064435, 22 Spitfire (5.7 Johnson), 18" barrel with an excellent bore. The barrel and vented handguard retain about 99% original blue while the receiver and trigger assembly retain about 80% of an arsenal parkerized finish that is silvering along the edges. The bayonet lug barrel band, action lug and buttplate have a bright chrome finish. The buttstock has been cleaned and has a blonde color and an added lacquer finish with a few light scratches. There are no sights and the rear sight dovetail has been filled with an adapter. The action's parts appear to all be Winchester and receiver is equipped with an M2 round bolt. A green canvas sling and an oiler are included. There is no magazine included, but any GI issue mag should work. An excellent condition sporterized Carbine in an interesting caliber offering. (46520-3495) (300/500)
1506. **JAPANESE TYPE I CARCANO BOLT ACTION RIFLE** serial #H7726, 6.5 Arisaka, 30 1/2 barrel with an excellent bore. The metal surfaces retain about 95% of an arsenal type blue finish that is blending with a few areas of light surface oxidation and flaking to a brown patina. The hardwood stocks rate excellent and have a few light dings. The right side of the butt is marked "3/13" in black paint. A cleaning rod is included and rifle is not importer marked. An excellent example overall. (46568-4) {C&R} (200/400)
1507. **JAPANESE TYPE 38 ARISAKA BOLT ACTION RIFLE BY NAGOYA** serial #(series ?)57195, 6.5 Arisaka, 31 1/2" barrel with an excellent bore. The metal surfaces are an overall rich brown patina with areas of light surface oxidation blending through. The hardwood stocks rate fair to good and have several long cracks, chips and slivers missing along with the usual other light handling marks. The top of the receiver has a clean, crisp mum present and the other markings are crisp as well with the exception of the series marking which appears to have been struck. The bolt and included dust cover are not matching and there is no cleaning rod or sling swivels present. The forward swivels mount screw and forend tip are missing as well and there is a replacement screw holding the bottom metal in place. An about good example overall that has wonderful markings but needs help in other areas. (46658-5) {C&R} (150/250)
1508. **JAPANESE TYPE 38 ARISAKA BOLT ACTION TRAINING RIFLE** serial #49, 6.5 Blank, 31 1/2" smoothbore barrel with a very good lightly pitted bore. The metal surfaces retain little original blue and are a mottled brown throughout that is mixing with areas of light surface oxidation and light pitting. The hardwood stocks rate good to about very good and have added finish, a chip at the toe and a few substantial cracks running through the wrist area on either side. There is no cleaning rod present and parts are missing from the bolt release mechanism. An about very good example overall. (46629-3) {C&R} (75/125)

1509



1509. **JAPANESE TYPE 99 ARISAKA BOLT ACTION RIFLE BY NAGOYA**

serial #(series 2)54587, 7.7 Arisaka, 26" barrel with an excellent bore. The metal surfaces retain about 60-70% of an arsenal blue finish that is fading to gray and flaking to a brown patina. The receiver markings are crisp and the mum is intact and unmolested. The hardwood stocks rate near excellent and have light dings. The wrist area of the buttstock has been narrowed slightly. Included are the original sights with rear aircraft sights, a cleaning rod, monopod, leather sling and matching dust cover. The bolt is matching as well. An excellent condition example overall. (46595-1) {C&R} (400/600)

1510. **JAPANESE TYPE 38 ARISAKA BOLT ACTION RIFLE BY TOKYO** serial #1188057, 6.5 Arisaka, 31 1/2" barrel with a dark, lightly oxidized bore. The metal surfaces retain about 90% of an arsenal blue finish that is mixing with areas of light surface oxidation and flaking to a mottled brown and gray on the bottom metal and buttplate. The receiver markings are mostly crisp, the mum is clean and unmolested, there is some light pitting along the left side. The hardwood stocks rate excellent with several light dings. The buttstock has a gap forming between its two sections. A dust cover and cleaning rod are included. Also included is a type 30 bayonet by Toyoda Jido Shiocki Seisaku-jo arsenal. The bayonet measures 20" long with a 15 1/2" blade that has gray, lightly pitted metal and a few nicks along the edge near the tip. The bayonet features a straight guard, bird's head pommel and wood grips that rate excellent. No scabbard is included. A near excellent example overall that has some great markings. (46629-2) {C&R} (300/500)
1511. **ITALIAN MODEL 1938 CARCANO BOLT ACTION CAVALRY CARBINE** serial #1444, 6.5 Carcano, 17 1/2" barrel with a very good bore that is lightly freckled in the grooves. The metal surfaces retain about 95% original blue that is lightly flaking to brown and mixing with areas of light surface oxidation and some light tool marks. The hardwood stocks rate very good and have light dings, there is a small crack forming at the upper tang and a larger crack on the left side of the butt. Included are a folding bayonet, a two-section cleaning rod and a canvas sling. Carbine does not appear to have any visible import markings and is in very good to near excellent condition overall. (46706-33) {C&R} (75/150)
1512. **ITALIAN MODEL 1938 T.S. CARCANO BOLT ACTION CARBINE** serial #RA77272, 6.5 Carcano, 17 1/2" barrel with an excellent bore. The metal surfaces retain about 95% of an arsenal type blue finish with some light handling wear and a few specks of light surface oxidation present. The hardwood stocks rate excellent with a few light dings. The butt is numbered to the receiver on the left side. The original front sight blade has been replaced with a Lyman brass bead sight. A leather sling and a cleaning rod are included. An excellent example overall. (46556-39) {C&R} (100/200)

1513. **ITALIAN MODEL 1938 CARCANO BOLT ACTION SHORT RIFLE** serial #N5350, 7.35 Carcano, 21" barrel with an excellent bore. The metal surfaces retain about 90% arsenal blue with light silvering along the edges and light handling marks throughout. The hardwood stocks rate excellent and have several light dings and divots and a few minor bruises. The left side of the butt bears a crisp cartouche and the stock is numbered to the receiver. A leather sling and cleaning rods are included. An excellent example overall. (46706-32) {C&R} (150/250)
1514. **ITALIAN MODEL 1941 CARCANO BOLT ACTION RIFLE** serial #QB8253, 6.5 Carcano, 27" barrel with an excellent bore. The metal surfaces retain about 99% of an arsenal blue finish with a few light handling marks visible. The hardwood stocks rate excellent with a few light dings. The left side of the butt has a faint cartouche and is renumbered to the receiver, the right side is marked "MADE IN ITALY". A cleaning rod and leather sling are included. An excellent example overall. (46625-46) {C&R} (150/250)
1515. **ITALIAN MODEL 1891 CARCANO BOLT ACTION RIFLE** serial #ORL225, 6.5 Carcano, 30 1/2" barrel that is packed in grease. The metal surfaces are covered in packing grease as well but the visible areas seem excellent. The hardwood stocks rate excellent with a few minor dings and are saturated in protective grease as well. Rifle was imported by Century Arms and appears to be in excellent condition. The cleaning rod is not present. (46556-10) {C&R} (150/250)
1516. **SPRINGFIELD MODEL 1899 KRAG BOLT ACTION CARBINE** serial #353225, 30-40 Krag, 22" barrel with a very good, lightly pitted bore. The metal surfaces retain about 90% original blue that is flaking to a rich brown patina. The sideplate and magazine box are a mottled gray. The walnut stock rates near excellent and has a small repair just forward of the sideplate. The stock is devoid of any military markings nor does it have a channel for a barrel band retention spring. The carbine is equipped with a Model 1902 rear sight and is in very good to near excellent overall condition. (46543-12) {C&R} (300/500)
1517. **SWISS MODEL 1878 VETTERLI BOLT ACTION RIFLE** serial #203189, 41Swiss RF, 24" barrel with an excellent bore. The metal surfaces retain about 90% of what appears to be original blue that is lightly flaking to brown. The walnut buttstock and modified forearm rate excellent and have a few light dings. The original rear swivel slot has been filled and the magazine tube port in the forearm has been plugged, sling swivels have been added. A new sporting front sight has been added at the muzzle and a sporting rear added in place of the original military sight. A nifty sporterized Model 1878. (46676-16) {ANTIQUÉ} (100/200)
1518. **GERMAN MODEL 79 G.A.G. BOLT ACTION SPORTER** serial #610, 11mm RF, 25 1/2" barrel with an excellent bore. The metal surfaces are a mottled brown with areas of gray blending through. The barrel has a few minor tool marks and the bolt is missing the top washer. The barrel markings are crisp and include several proofs. The walnut stock has been modified and sporterized and has several light dings under a coat of added varnish. The sling mounts have been removed and the cleaning rod channel is still present but vacant. An interesting rifle that was made for German Border Guards and was lightly modified for use as a hunting or stalking rifle. (46518-33) {ANTIQUÉ} (350/550)
1519. **WINCHESTER MODEL 1895 LEVER ACTION RIFLE** serial #31581, 38-72, 26" octagon barrel with an about good bore that is pitted throughout. The barrel retains about 75% blue that is flaking to a rich brown and is silvering along the edges, the 1901 vintage receiver is a mottled gray-brown patina with light staining and oxidation throughout. The barrel has good markings and a few light tool marks. The rifle retains the bolt, lever, trigger, sights and buttstock and has been stripped of all other parts. The walnut buttstock appears original and has a crescent steel buttplate and a few light dings and a small repaired chip along the right side near the edge of the frame. The sights appear original as well, the front sight is missing its bead. A great restoration project or an interesting curio on its own. (46643-2) {C&R} (150/250)
1520. **FRENCH MODEL 1895 BUFFALO CARBINE TRI-BORE BOLT RIFLE** serial #15788X52, 22 LR, 26" barrel with three excellent bores. The barrel has traces of original blue but has mostly flaked to brown while the remaining metal surfaces are a mottled gray and all areas of light surface oxidation. The steel buttplate has a slightly heavier concentration of oxidation and the top of the barrel has what appears to be a small repair. The walnut forearm appears to be the original and has several light dings. The buttstock is a newer hardwood replacement and is unfinished. Carbine is equipped with a single ring style front blade sight and has a three blade folding rear. The rear barrel band has a small sling swivel, likely a 1/2" size and the rear swivel is missing. A unique rifle that is marked "MANUFACTURE FRANCAISE / D' ARMES / DE ST. ETIENNE" and "MODELE 1895 / CARBINE BUFFALO / BREVETE S.G.D.G." and is a very good to near excellent condition buffalo-mitraille style rifle overall. (46556-22) {C&R} (300/500)
1521. **BELGIAN MODEL 1842 PERCUSSION SPORTING RIFLE** .58 Caliber, 28" barrel with a good oxidized bore. The metal surfaces have all been polished and have light pitting throughout. The lock retains a small proof that is still partially visible and is marked "861". The military hardwood stock has been modified and shortened as well and has added finish over light dings. A ramrod, likely the original, has been modified as well and is included. The lock still functions correctly though the nipple has some minor damage. A very good example overall. (46496-9) {ANTIQUÉ} (150/250)
1522. **BELGIAN ZULU PIVOT BREECH SHOTGUN** 16 ga., 33" barrel with a poor bore. The metal surfaces are a rich brown with areas of minor to moderate pitting throughout. The Snider pivot breech block bears Belgian proofs along the top but is missing small parts and springs. The wood stock rates fair and has several minor cracks and is heavily "weathered". The lock does not function. A fair to good example overall that would make a good display piece. (46190-3) {ANTIQUÉ} (50/150)
1523. **BRITISH SNIDER CONVERSION PATTERN II** PIVOT BREECH RIFLE BY BSA** serial #550, 577 Snider, 36 1/2" barrel with a very good bore that has minor pitting about midway down. The metal surface have a rich brown patina with areas of light pitting throughout. The walnut stock rates very good and has added finish over several light dings and divots. The cartouche on the buttstock is prominent on the right side. The sling swivels are intact, the cleaning rod is no longer present. A very good example overall of these early cartridge military rifles. (46568-2) {ANTIQUÉ} (300/500)
1524. **AUSTRIAN MODEL 1867 WERNDL PIVOT BREECH RIFLE** 11.15mm Werndl, 33 1/4" barrel with a bright excellent bore. The metal surfaces are a mottled brown overall and have a few light handling marks and some areas of very light surface oxidation. The walnut stock rates very good and has a light added lacquer finish over light dings, small divots and a few small cracks. The back-action lock is marked "870" and functions correctly. There is no cleaning rod present and the forend cap screw is severely malformed. A modern style leather sling that has moderate crazing and light cracks is included. A very good example overall. (46568-5) {ANTIQUÉ} (300/500)
1525. **MODERN 20TH CENTURY REPLICIA FLINTLOCK FOWLER** .75 Caliber (10 Bore), 36 1/2" barrel with a moderately oxidized bore. The metal surfaces are in the white and have light handling marks and some scattered specks of light brown patina. The barrel is marked with a "(crown)/PB" and a "(crown)/BV" proof, the back-action lock has "871" with a small Austrian type eagle proof and a Belgian (lion) with a "(crown)/FR" marking. The frizzen plate has some light grind marks and is crude in appearance. The breech and tang area is squared off and the triggerguard is very Austrian looking. The hardwood stock rates very good and is checkered around the lock area. The stock has a few small cracks and some light staining. The rear swivel is missing and the heel of the buttplate is marked "8.A.R.(underline)/287.". An interesting looking piece with a blend of ethnic European origins. (46052-2) {ANTIQUÉ} (300/500)

1526. **NEW ZEALAND ENFIELD MARTINI FALLING BLOCK ARTILLERY CARBINE BY ACI** 303 British, 21 1/2" barrel with a dark, heavily oxidized bore. The metal surfaces retain most of their original arsenal blue finish that is mixing with areas of minor surface oxidation. The wood stocks rate near excellent and have been lightly cleaned. There are circular cartouches on either side of the buttstock that are faint but still visible. The markings on the right side of the frame are somewhat polished and portions of "Enfield" and "ACI" are missing. The carbine appears complete and is in about very good condition overall. These carbines were arsenal conversions of the original Martini-Henry rifles and were issued to New Zealand regulars and volunteers during the Boer wars and when supplies of the regular Enfield bolt rifles were needed elsewhere in the realm. (46518-7) {ANTIQUÉ} (200/400)
1527. **NEW ZEALAND ENFIELD MARTINI FALLING BLOCK RIFLE BY ACI** 303 British, 30" barrel with a heavily oxidized bore. The metal surface retain about 70% of the arsenal blue finish which is blending with areas of minor to moderate surface oxidation and minor pitting. The receiver markings have been polished and some are partially obscured. The hardwood stocks rate about very good and are quite faded with several small cracks and some minor chips. The action was frozen but was able to be freed up and has oxidation issues as well. The cleaning rod is missing but the rifle appears to be otherwise complete. A fair to good example of these converted, then reconverted New Zealand issued Martini rifles. (46223-54) {ANTIQUÉ} (100/200)
1528. **LEUPOLD SCOPE LOT** This lot consists of a Leupold M8 2.5X compact riflescope in excellent condition. The scope features a standard duplex reticle and has bright, excellent optics. The glossy blue finished tube has a few light ring marks from being mounted. A terrific scope for most sporting rifles, shotguns or muzzleloaders. (46520-2777A)
1529. **REDFIELD SCOPE LOT** This lot consists of a Redfield Frontier 2-7x30mm riflescope. The scope features a duplex reticle and has excellent optics. The ocular lens has a very small nick that is barely noticeable when the scope is brought up for viewing. The tube has a few light ring marks from having been mounted, an excellent example overall of these vintage scopes. (46642-47A)
1530. **PENTAX SCOPE LOT** This lot consists of a Pentax Lightseeker XL 3-9x50 riflescope. The scope features a BallisticPlex reticle and has bright excellent optics. The matte finished tube has a few light ring marks from having been mounted but scope remains in excellent condition otherwise. Included are a set of see-thru flip-up lens covers. (46660-3A)
1531. **LEUPOLD SCOPE LOT** This lot consists of a glossy blue Leupold Vari-XII 3-9x40 riflescope. The scope features a standard duplex reticle and has excellent optics. The tube has some minor ring marks from having been mounted but the scope remains in excellent condition overall. Included is a Butler Creek flip-up eye piece lens cover. (46623-24)
1532. **LEUPOLD SCOPE LOT** This lot consists of a Leupold M8 2.5X Compact riflescope in gloss blue. The scope features a standard duplex reticle and has excellent optics. Included are a set of rings to fit a tip-off or 22 rail mount and a rubber bikini scope cover. An excellent condition example perfect for a higher end 22 rifle, slug barrel shotgun, muzzleloader or wherever a quality compact low power scope would be appropriate. (46680-21A)
1533. **LEUPOLD SCOPE LOT** This lot consists of a gloss blue Leupold Vari-XIII 1.5-5X riflescope. The scope features a standard duplex reticle and has bright, excellent optics. The tube has a few light ring marks from having been mounted but the scope remains in excellent condition overall. (46520-3735A)
1534. **REDFIELD SCOPE LOT** This lot consists of a classic Redfield 3/4" 2 3/4X rimfire rifle scope. This popular scaled-down scope features a standard duplex reticle and has excellent optics. The original 3/4" rings are included and will fit a 22 rail or grooved receiver. An excellent example of these desirable little scopes. (46520-3769A)
1535. **LEUPOLD SCOPE LOT** This lot consists of a Leupold Vari-XII 3-9x40 gloss blue riflescope. The scope features a standard duplex reticle and has bright excellent optics. The tube has a few light ring marks from having been mounted but the scope remains in excellent condition overall. (46703-19A)
1536. **LEUPOLD SCOPE LOT** This lot consists of a Leupold M8 4X blued riflescope. The scope features a standard duplex reticle and has bright, excellent optics. The blued finish is flaking to a pleasing aged plum and the tube has a few light ring marks from having been mounted. The scope is in excellent condition overall and includes a rubber bikini scope cover. (46703-21A)
1537. **LEUPOLD SCOPE LOT** This lot consists of a Leupold VX-1 4-12x40 gloss blue riflescope. The scope features a standard duplex reticle and has bright, excellent optics. The tube has some very light rings marks from having been mounted but the scope is in excellent condition overall. A set of Butler Creek flip-up lens covers are included. (46703-20A)
1538. **LEUPOLD SCOPE LOT** This lot consists of a Leupold Vari-XIII 3.5-10x40 adjustable objective riflescope. The gloss blue scope features a standard duplex reticle and has bright excellent optics. The tube has some light rings marks from having been mounted but the scope is in excellent condition overall. (46520-3733A)
1539. **LEUPOLD SCOPE LOT** This lot consists of a Leupold Vari-XIII 1.5-5x20 gloss blue riflescope. The scope features a standard duplex reticle and has bright excellent optics. The gloss blue scope has a few light ring marks from having been mounted but rates excellent overall. (46520-3758A)
1540. **LEUPOLD SCOPE LOT** This lot consists of a Leupold Vari-XIII 2.5-8 gloss blue riflescope. The scope features a standard duplex reticle and has bright excellent optics. An excellent condition example overall. (46520-620A)
1541. **LEUPOLD SCOPE LOT** This lot consists of Leupold Vari-XIII 1.5-5x20 matte finish riflescope. The scope features a standard duplex reticle and has bright excellent optics. The tube has a few light ring marks from having been mounted but is in excellent condition overall. (46520-2878A)
1542. **BAUSCH & LOMB SCOPE LOT** This lot consists of a Bausch & Lomb 6-24x40 adjustable objective riflescope. The scope features a duplex reticle and has excellent optics. The glossy blue tube has a few light ring marks but is in excellent condition overall. A set of factory lens covers is included. (46520-3695A)
1543. **LEUPOLD SCOPE LOT** This lot consists of a Leupold Vari-XIII 3.5-10x40 adjustable objective riflescope. The gloss blue scope features a standard duplex reticle and has bright, excellent optics. The tube has a few light ring marks from having been mounted, but the scope is in excellent condition overall. (46520-3499A)
1544. **LEUPOLD SCOPE LOT** This lot consists of a Leupold M8 4X compact scope. The gloss blue scope features a standard duplex reticle and has excellent optics. The tube has a few light ring marks from having been mounted, but the scope is in excellent condition overall. (46606-2A)
1545. **LEUPOLD SCOPE LOT** This lot consists of a gloss blue Leupold M8 4X riflescope. The scope features a standard duplex reticle and has excellent optics. The tube has some light ring marks from having been mounted, but the scope is in excellent condition overall. A set of Butler Creek flip-up lens covers are included. (46694-10)
1546. **REDFIELD SCOPE LOT** This lot consists of a Redfield 2-7X riflescope. This vintage scope features a duplex reticle and has excellent optics. The body of this blued scope has remnants of paper shim and label materials present, but rates excellent otherwise. (46520-3536A)

1547. **REDFIELD SCOPE LOT** This lot consists of a Redfield Lo-Profile 3-9X riflescope. The scope features a 4-plex reticle and has excellent optics. The tube has a few light ring marks from having been mounted but the scope is in excellent condition overall. (46520-3551A)
1548. **SIMMONS SCOPE LOT** This lot consists of a Simmons Aetec 2.8-10x44 riflescope. The scope features an illuminated duplex reticle and has bright excellent optics. This matte finish scope has a few light ring marks from having been mounted but is in excellent condition overall. A set of factory lens covers are included. (46520-882A)
1549. **LYMAN SCOPE LOT** This lot consists of a Lyman All-American 20X adjustable objective riflescope. The scope features a fine crosshair reticle and has excellent optics. The scope is in excellent condition and includes a set of Uncle Mikes lens covers. (46520-1872A)
1550. **REDFIELD SCOPE LOT** This lot consists of a Redfield 4X riflescope. This vintage Redfield scope features a post and crosshair reticle and has excellent optics. Included are a set of Weaver rings and a set of see-through lens covers. An excellent example overall. (46694-15A)
1551. **THOMPSON/CENTER SCOPE LOT** This lot consists of a Thompson/Center 2.5-7x28 extended eye relief scope. The scope features a lighted duplex reticle and has excellent optics. There are a few light ring marks on the tube from the scope having been mounted but it is in excellent condition overall. (46520-685A)
1552. **KOLLMORGEN SCOPE LOT** This lot consists of a 6X Kollmorgen Bear Cub riflescope in excellent condition. This fixed power scope features a fine crosshair reticle and has excellent optics. Mounted on a set of Buehler rings and bases for a Winchester Pre-64 Model 70 rifle. (46950-1856A)
1553. **REDFIELD SCOPE LOT** This lot consists of a Redfield 2-7X riflescope. The scope features a post and crosshair reticle and has bright, excellent optics. The blued tube has a few light ring marks from having been mounted but the scope remains in excellent condition overall. (46520-3656A)
1554. **LYMAN SCOPE LOT** This lot consists of a Lyman All-American 2.5X riflescope. The scope features a post and crosshair reticle and has excellent optics. The tube has a few light ring marks from having been mounted but the scope is in excellent condition overall. (46642-41A)
1555. **WEAVER SCOPE LOT** This lot consists of a Weaver Challenger USA 2.5X rifle scope (C2.5). The scope features a duplex reticle and has very good optics. Included are a set of see-through rings to mount to a grooved receiver. An excellent example overall. (46520-3731A)
1556. **LYMAN SCOPE LOT** This lot consists of a Lyman All-American 3X riflescope. The scope features a post and crosshair reticle and has excellent optics. The tube has a few light ring marks from having been mounted, but the scope is in excellent condition overall. (46664-4A)
1557. **SPRINGFIELD SCOPE LOT** This lot consists of a Springfield Armory Mil-Dot Government Model 10x56 adjustable objective rifle-scope (GE5089). The matte finish scope features a lighted mil-dot rangefinding reticle, internal bubble level and has bright excellent optics. This 30mm tube scope is in like new condition and includes the original box, lens covers and papers. (46247-1)
1558. **SPRINGFIELD SCOPE LOT** This lot consists of a Springfield Armory 4-14X56 Government Model 1st Generation 7.62mm riflescope. The scope has a matte blue finish and features a rangefinding reticle with internal bubble level and has bright excellent optics. This 30mm scope is in like new condition and included are the original box and two sets of factory lens covers, one set is flip-up style. (46247-2)
1559. **SPRINGFIELD SCOPE LOT** This lot consists of a Springfield Armory 4-14x56 3rd Generation Government Model 7.62mm adjustable objective riflescope (GE5095). The scope has a matte finish and features an illuminated target tracking and rangefinding reticle with an internal bubble level and bright excellent optics. The scope has a 30mm tube and is in like new condition. Included are the original box, sunshade and two sets of factory lens covers, one is a flip-up style. (46247-3)
1560. **NIKON SCOPE LOT** This lot consists of a Nikon ProStaff 3-9x40 riflescope. The matte finished scope features a duplex reticle and has bright excellent optics. The scope is in like new condition and includes the original box and factory lens covers. (46247-4)
1561. **LOT OF COLT 1911 PARTS** This lot consists of a barrel, slide and assorted Colt 1911 parts. The parts are in very good condition overall with most having faded blue and there is some light pitting present on some. The slide is marked on the left side "PATENTED APR. 20,1897. SEPT. 9,1902/DEC.19,1905. FEB.14,1911. AUG.19,1913" and "COLT'S P.T.F.A. MFG CO/HARTFORD, CT U.S.A." and has a Rampant Colt, the right side is unmarked. The 5" barrel has an excellent bore and is marked with a "P" and what appears to be an "H" above the chamber, which has been polished. Other parts include the recoil spring, barrel bushing, trigger, mainspring, mainspring housing with lanyard loop, safety, grip safety, slide stop, hammer and an assortment of small pins and springs and other parts. Most of the parts are in excellent condition, a few have some minor damage (ie the magazine release plunger has a broken tip and some of the grip screw bushings are malformed. There is no frame, or magazine present and it is not know if all of the parts needed to reassemble a complete 1911-A1 are present. A good ensemble of parts to spruce up your tired 1911 or provide a correct frame to build your own. (46600-2A)
1562. **1911 LOT** This lot consists of two 1911 Colt magazines and a set of custom 1911 grips. The magazines are blued and have "COLT/45 AUTO" stamped on each floorplate. The custom grips are mother-of-pearl and feature an ornately carved Chinese dragon on each side. The dragon has small inserts for its eyes and there are a few small age cracks. The right panel includes a thin wood spacer to match the thickness of the left when assembled. A few excellent accessories to complement your trusty 1911. (46600-2B)
1563. **LOT OF ASSORTED LEAD** This lot consists of various cast lead and lead shot and some muzzleloading accessories. Included are a 25 lb bag of Lawrence Brand No.9 magnum shot, a bag of .357/9mm 125 grain lubricated round nose bullets, four tubes of Thompson Center .50 cal 240 grain lead sabots (8232) and about 30 .454 Hornady lead round balls (6070). Also included are a brass inline capper, a TDC capper and a container of RWS no.1075 #11 percussion caps. All are in excellent condition, the brass has some light tarnish. ** Please note that due to the combined weight of this lot extra shipping will apply**. (45155-6)
1564. **MAGAZINE LOT** This lot consists of three metal magazines for the Golani Sporter rifle in excellent condition. The magazines appear to be 30 round capacity and have a lightly flaking parkerized finish. They are unmarked except for "0/34" and "0/35" stamped near the bottom. (46631-1A)
1565. **MAGAZINE LOT** This lot consists of three Tapco composite magazines for the Golani Sporter rifle. The black composite magazines appear to be 30 round capacity and are in excellent condition. (46631-1B)
1566. **M1 CARBINE STOCK LOT** This lot consists of a newer, reproduction M1 Carbine paratrooper folding stock. The stock rates excellent and has a few small dings but no serious blemishes and includes a matching wood handguard and green canvas sling. The perfect accessory to dress up your shooter carbine or replace your tired GI stock. (46402-8)
1567. **AMMUNITION LOT** This lot consists of two 100 round boxes of Winchester/USA 40 S&W 165 grain FMJ target ammunition. One is full, the other contains 95 rounds. The boxes have some small tears and other minor damage, the ammunition rates excellent and remains bright. (44404-S31906J1)

1568. **AMMUNITION LOT** This lot consists of an assortment of 12 gauge shotshell ammunition. Included are a partial box of Charles Daly 2 3/4" #8 with 17 rounds, a partial box of Federal 2 3/4" #8 paper hull with nine rounds, a full box of 25 Winchester 3" #BB steel shells, a full box of 25 Winchester 2 3/4" #8 dove & quail loads, a partial box of Winchester 2 3/4" steel with 14 #4 and one #2 shells, a full box of 25 Remington 3" #1 steel shells and a full box of 25 Remington 2 3/4" #6 game loads. Also included is a bag of assorted 12 gauge shells that includes Winchester, Peters and RST Express field loads. Some of the boxes are frayed and torn but the ammunition remains in excellent condition. (44404-S31906J2)
1569. **AMMUNITION LOT** This lot consists of three boxes of assorted 20 gauge shotshells. Included are two boxes of FIOCCHI 2 3/4" #7 1/2 Golden Pheasant loads and a partial box of Remington 2 3/4" # 7 1/2 Game loads. One of the FIOCCHI boxes is full with 25 rounds the other contains 22 rounds, the Remington box contains 12 rounds. All are in excellent condition. (44404-S31906J3)
1570. **AMMUNITION LOT** This lot consists of three boxes of pistol ammunition. Included are a full box of 50 Winchester/USA 380 ACP 95 grain FMJ and two boxes of Wolf 9mm 115 grain MC. One box of the Wolf ammunition is full with 50 rounds the other is partial containing 26 rounds. The boxes have some tears and other minor damage but the included ammunition remains in excellent condition. (44404-S31906J4)
1571. **AMMUNITION LOT** This lot consists of a small assortment of 22 Rimfire ammunition. Included are a full box of 50 Remington Kleanbore 22 Short (1022), a partial box of 44 CCI Blazer 22 LR ammunition, a partial box of 89 CCI 22 LR FMJ, a partial box of 66 CCI Mini-Mag 22 LR HP and about 20 rounds of loose 22 Short ammunition. The red and green Remington box has some minor fraying along the edges and corners, the rest remain in excellent condition. (44404-S31906J5)
1572. **SHOOTERS LOT** This lot consists of loose ammunition and various shooting accessories. First is a set of S&W checkered gonzalo alves factory wood grips for the K/L frame revolver. The grips feature silver S&W medallions and are in excellent condition. Next is a U.S. WWII G1 green canvas M1 carbine magazine pouch with a 15 round blued magazine. The magazine rates very good and has some minor surface oxidation. The magazine is marked "OI-S'G". Lastly is a bag of loose centerfire ammunition which contains 30 Carbine, 38 Spl+P, 380 ACP and 9mm rounds. Also included are a partial box of Crosman Challenger .177 pellets and a vintage canvas and leather soft rifle case. (44404-S31906J6)
1573. **1919 BARREL LOT** This lot consists of an Israeli 7.62 NATO barrel dated "6-78" for the Browning 1919A4 machine gun. This quality 24" replacement barrel has a bright excellent bore and is in excellent condition overall. A great opportunity to retire or replace your tired 1919 barrel. (46383-1A)
1574. **1919A6 ACCESSORY LOT** This lot consists of two 1919A6 accessory items to fit the 1919A4 machine gun. Included are an Israeli made bipod and buttstock. Both have gray parkerized finish with areas of light surface oxidation and minor flaking. The perfect way to lighten up your beefy 1919A4 rifle and convert it to the A6 "shoulder carry" design. (46383-1B)
1575. **SHARPS BULLET MOLD LOT** Consists of a single bullet mold for the 40-70 Sharps 330 grain cartridge. The metal surfaces rates very good with only some minor light wear marks as well as isolated light oxidation. The wooden handle rates very good but exhibits numerous light handling marks. (134749-3)
1576. **BUSHMASTER EARLY MODEL SEMI-AUTO RIFLE** serial #F01728, 5.56mm, 18 1/2" barrel with an excellent bore. The metal surfaces retain 97% original matte blue finish with minor overall wear. Equipped with wood buttstock and forend painted black and an AR pistolgrip that rate excellent. This unusual design features an AK style gas system while accepting AR 30 round magazines. Equipped with adjustable sights, the rifle has been stored in Cosmoline and will require a through cleaning before use. In excellent condition overall. (66492-13). (400/600)
1577. **OLYMPIC ARMS CAR 15 BARREL ASSEMBLY** This lot is a 223 Rem. /5.56mm, 11 1/2" barrel with permanently attached 5 1/2" CAR flash suppressor with an excellent bore and remnants of grease. The metal surfaces retain 97% original phosphate finish with minor wear, most notably a scuff on the flash suppressor as well as a heavy coating of Cosmoline inside and out. The lot features A2 sights, forward assist, ejection port cover, complete barrel nut assembly and handguard cap. This upper is in excellent condition overall and will require some easily obtainable parts. (66492-9A)
1578. **CAR 15 BARREL ASSEMBLY** This lot is a 9mm, 11 1/2" barrel with permanently attached 5 1/2" CAR flash suppressor with an excellent bore and traces of grease. The metal surfaces retain 97% original phosphate finish with minor wear as well as a small blemish on the left side on the flash suppressor as well as a heavy coating of Cosmoline inside and out. The lot features A1 sights, forward assist, ejection port cover, handguards, complete barrel nut assembly and handguard cap. This upper is in excellent condition overall and will require some easily obtainable parts. (66492-9B)
1579. **OLYMPIC ARMS CAR-AR LOWER RECEIVER** serial #F4737, 223 Rem./5.56mm, This lot is a stripped lower retaining 97% original matte blue finish with wear from handling and storage. In excellent condition overall. (66493-5)
1580. **OLYMPIC ARMS CAR-AR LOWER ASSEMBLY** serial #F3164, 223 Rem. /5.56mm, lower assembly with collapsible stock but no pistolgrip. The metal surfaces retain 96% original matte blue finish with wear from handling and storage and noticeable wear on the trigger assembly plate. In excellent condition overall. (66492-9).
1581. **INTRATEC TEC-9 SEMI-AUTO PISTOL** serial #130204, 9mm, 5" threaded, shrouded barrel with an excellent bore exhibiting heavy grease. The metal surfaces retain 97% original matte blue/black finish with wear from handling and storage. The grip is integrated into the polymer lower rating excellent. Equipped with fixed sights, the magazine is absent but obtainable. The pistol has been stored with a generous amount of Cosmoline and will need a thorough cleaning, in excellent condition overall. (66493-1). (400/600)
1582. **SITES SPECTRE SEMI-AUTO PISTOL BY AMERICAN ARMS** serial #K4490, 9mm, 6" barrel with an excellent bore exhibiting heavy grease. The metal surfaces retain 97% original matte blue finish with light handling wear. The pistol is missing the magazine and pistolgrip but is in excellent condition otherwise. (66493-3). (300/500)
1583. **INTRATEC TEC-22 LOWER RECEIVER** serial #044593, 22 LR. This lot is the black polymer receiver with the trigger group only which exhibits minor wear, in excellent condition overall. (66493-2)
1584. **LOT OF MILITARY BIPODS** This lot consists of three bipods retaining the majority of original arsenal finish with handling and storage wear. Two of the bipods appear complete with the third believed to be missing the top barrel attachment. The first bipod is believed to fit the German G3/H&K91 rifle with the other two believed to fit European or former Communist bloc firearms. In very good to excellent condition overall. (66492-3A)
1585. **AR-15 LOT** This lot consists of : (2) recoil springs; (1) pair of carbine forend stocks without metal inserts; collapsible stock with end plate and receiver end nut; (3) sets of pistolgrips without attachment screws; (1) barrel handgrip; (1) charging handle; (1) carbine recoil buffer; (1) collapsible stock cheek riser. All the items in this lot are in excellent condition overall exhibiting minor wear. (66493-5A)

1586. **MILLS SINGLE LOOP CARTRIDGE BELT** This lot consists of a cartridge belt in amazing condition featuring a single row of 35 loops for 30 caliber ammunition. The belt is made of tan canvas with black metal fixtures. The belt is secured with a "T" closure exhibiting a very crisp patent date of April 18, 1905. The metal surfaces retain 97% original black finish with the fabric exhibiting light fading and only mild soiling. This piece of history is in excellent condition overall. (65538-6C1)
1587. **LOT OF HATS** This lot consists of 10 military or shooting related hats: (1) white, "Dog Bowl" sailors hat, size unknown; (2&3) black and red baseball caps with USMC related subject matter, one size fits all; (4) black baseball caps with an embroidered M2 machine gun, one size fits all; (5) USMC tan garrison cap, size unknown; (6) USMC green utility cover, size unknown; (7) straw cowboy hat with braided hat band; (8) U.S. Army Campaign hat believed to be a size 7 1/2; (9) USMC "Boonie Hat" in tan digital camo size 7; (10) military style mosquito net hat, one size fits all. This lot exhibits varying degrees of wear and soiling with the lot in very good to excellent condition overall. (65538-13&20)
1588. **ANTIQUE AMMO LOT** This lot is 25 rounds of Winchester 32 caliber short, rimfire ammo in the original box. The ammo exhibits tarnish and wear consistent with age. The box is green with black lettering and a red seal running around the circumference. The graphics remain crisp with mild weathering. This ammo and box are in very good to excellent condition overall. (65538-7C1)
1589. **CAVALRY LOT** This lot consists of a replica cavalry shirt and suspenders. The long sleeve shirt is the style that was worn under the trooper's blouse, made of blue and black stripes, size XXL. The suspenders are white cotton canvas. The lot exhibits minor wear, light soiling and is in very good to excellent condition overall. (65538-21)
1590. **MISCELLANEOUS LOT** This lot consists of an olive green metal tin measuring 10 1/4" in diameter and 4 1/2" in height as well as a cedar jewelry box measuring 11" X 6" X 3 1/2". The tin is decorated with U.S. Army ranks and branches of service. The metal surfaces exhibit silvering on the high edges as well as scuffs and oxidation stains due to age and handling. The jewelry box exhibits light scuffs and scratches overall with a repair at the base from a split. The lid is secured by a small brass hasp. The items in this lot will serve a variety of uses and are in good to very good condition overall. (65538-13A)
1591. **BAYONET LOT** This lot is a U.S. Military M7, M16 bayonet with M8A1 scabbard. The metal surfaces of the bayonet retain only traces of original phosphate finish with the guard exhibiting the manufacturer's initials "BOC" for the Bauer Ordnance Corp. The blade has been sharpened and exhibits wear with the tip intact. The guard and pommel exhibit scattered oxidation staining. The checkered black plastic scales exhibit wear and soiling with a small chip on the left scale near the pommel and a few of the checkered diamonds missing rating good to very good. The scabbard is stamped at the throat with the maker's initials "PWH" indicating the Philadelphia Work Home and also features protective metal covering at the chape. The metal surfaces on the scabbard retain 50% original black color with generalized wear. The canvas is faded and soiled with the security strap intact. The bayonet and scabbard exhibit overall wear consistent with age and use and is in good to very good condition overall. (66168-1)
1592. **LOT OF AMMO** This lot consists of 48 rounds of 32 S&W, lead round nose ammo in a Styrofoam tray and 9 rounds of 308 Winchester ammo in a leather Koplín belt attachment. The lot exhibits mild tarnishing and is in excellent condition overall. (66168-3)
1593. **LEUPOLD SCOPE** This lot consists of a, M8-4X scope, serial #372711. The tube measures 12" in length with the metal surfaces exhibiting mild ring wear. The ocular lens and objective lens exhibit light scuffs from honest use. The scope features a duplex reticle with the optics remaining sharp. The scope includes incorrect Leupold box, papers and is in very good condition overall. (66168-2)
1594. **LOT OF HOLSTERS** This lot consists of three military style holsters: 1) Is a USMI cross-draw holster for the Colt or S&W 1917 revolver. The main body retains the majority of the "U.S." stamp on the front as well as the manufacturer, Textan and date 1942 on the reverse, there are no other markings visible. The leather surfaces exhibit creasing and crazing at the stress points with the color a dark chocolate brown. The stitching is intact with the holster in very good to excellent condition overall; 2) Is an M7 leather converted shoulder holster for a 1911A1. This holster began as a shoulder holster and has been converted to fit on a belt. The brass studs, shoulder strap and securing strap have been removed. The front exhibits only a portion of the "U.S." stamp. The leather surfaces exhibit a chocolate color with the stitching intact. In good condition overall; 3) Is an unmarked, flap holster believed to fit a 1917 revolver. The leather exhibits moderate to heavy cracking and crazing as well as worn surface areas. The stitching intact with the holster in fair to good condition overall. (65538-6C2)
1595. **CIVIL WAR LOT** This lot consists of two reproduction Civil War belts: (1) is an 1874 style belt with cross-draw flap holster and cap pouch. The belt measures 36" in length and 1 1/2" in width. The leather surfaces retain 98% original black finish with minor wear from limited use, the buckle is well polished. This belt and accessories are in excellent condition overall and is an excellent accessory for the Civil War enthusiast; (2) Civil War style belt with Cavalry sling swivel measuring 57" in length and 2 1/4" width. This belt is an authentic reproduction with correct style buckle and swivel. The leather surfaces retain 98% original black finish with minor wear from limited use. The brass belt buckle and rivets exhibit mild tarnishing with 2-3 areas of verdigris, in excellent to almost new condition overall. (65538-6C3)
1596. **LAW ENFORCEMENT LOT** This lot consists of a black leather duty belt, size 38, with right handed holster, cuff case, ammo carrier, (2) keepers, flash light holder, ammo holder. The belt is made by S&W with the accessories by Hume as well as Gould & Goodrich. The holster is model B501/34 for a revolver. The leather surfaces exhibit wear from honest use with the duty rig in excellent condition overall. (65538-6C3)
1597. **WESTERN LOT** This lot features a custom leather, right handed western rig, size 38, by Charles Davis of West Chester, PA. The brown leather rig features 30 ammo loops that will fit 44 caliber cartridges and holster for a SAA revolver with up to a 5" barrel. The leather surfaces exhibit wear and minor scuffs from honest use with the majority of wear on the tongue. In excellent condition overall. (65538-6C4)
1598. **CZECH ZK-383 SMG PARTS LOT** This lot consists of an approximately 10 3/4" shrouded barrel with an excellent bore chambered in 9mm. The lot includes (1) magazine & magazine housing, rear sight, bipod, bolt assembly, buttstock & front handguard assembly, dismounting lever and pivot housing as well as trigger assembly. The metal surfaces retain 80% original blue finish exhibiting wear consistent with a vintage military arm. The wood surfaces exhibit wear and weathering consistent with age. This parts lot is in excellent condition overall. (66247-16F)
1599. **STEN MKV SMG PARTS LOT** This lot consists of a shrouded 8" barrel with a fair to good bore, chambered in 9mm. The lot includes the lower trigger housing, magazine housing, bolt, (1) magazine and pistolgrip. The metal surfaces retain patches of original finish combined with oxidation staining and light surface pitting. The wooden pistolgrip exhibits normal wear for a military arm rating very good to excellent. This parts lot is in good condition overall. (66247-16G)



1588



1600

1600. **PPSH-41 SMG PARTS LOT** This lot consists of a 10 1/2" barrel with a lightly fouled bore. The metal surfaces retain portions of original blue finish with exception of the barrel which retains approximately 85% original finish. The metal surfaces exhibit wear consistent with age. The lot includes the stock with buttplate rating excellent, 71 round drum magazine, trigger group and guard. The shrouded receiver has been cut just forward of the magazine lip with the lot in very good condition overall. (66247-16C)

1601. **STERLING MKIV SMG PARTS LOT** This lot consists of a 8 1/2" shrouded barrel with an excellent bore chambered in 9mm. The majority of metal surfaces retain 80% arsenal reapplied black finish with wear predominately on the shroud. The folding metal buttstock has been cut along with the receiver exhibiting sporadic patches of arsenal finish and wear. The lot includes the bolt and trigger assembly as well as (1) 34 round magazine. This is a fine parts lot in very good to excellent condition overall. (66247-16D)



1602

1602. **AN/PVS-4 STARLIGHT SCOPE** This is an American made, 2nd generation scope designed to fit the carry handle of the AR15/M16 rifle, measuring approximately 12". This scope was made for the Israeli military with the operating instructions in Hebrew but the adjustment dials are easily decipherable. The scope is used and includes the original case, adapter mount and batteries. The scope is operational but here are no guarantees except any that may be offered by the manufacturer, in very good to excellent condition overall. (66247-18A). (400/600)

1603. **ANPVS-2 STARLIGHT SCOPE** This is a U.S. made, 1st generation scope made for the Israeli military with markings in Hebrew. The scope measures approximately 17" with 4X magnification. The scope is used and includes the original case as well as an adapter pack to use (4) AA batteries. The scope is operational but there are no guarantees except any that may be offered by the manufacturer, in very good to excellent condition overall. (66247-18B). (200/400)



1603



1604

1604. **SOLA SUPRA SMG PARTS LOT** This lot consists of an 8 1/2" barrel with a good to very good bore exhibiting light fouling, chambered in 9mm. The lot includes the lower frame with trigger group, bolt, and (1) 32 round magazine. The metal surfaces retain 60-70% original phosphate finish, exhibiting wear consistent with age. This is an excellent parts lot for this Luxembourg made submachine gun. (66247-16E)

1605. **BERETTA MODEL 1938A SMG PARTS LOT** This lot consists of the 12 1/4" shrouded barrel with an excellent bore, trigger group exhibiting single and full triggers, triggerguard, 40 round magazine and stock. The metal surfaces retain approximately 50% original blue finish with overall wear consistent with age. The stock includes the buttplate exhibiting overall wear rating very good to excellent. This early model Beretta includes the barrel band with sling swivel and bayonet lug on the barrel shroud. The receiver has been cut behind the ejection port with the lot in very good condition overall. (66247-16A)



1605

1606. **MP-41 SMG PARTS LOT** This lot consists of a 9 1/2" barrel with a very good bore chambered in 9mm. The lot includes the wooden stock with trigger assembly, buttplate, (1) magazine and magazine housing as well as the bolt and firing pin. The metal surfaces retain 80% original blue finish with wear consistent with a military arm as well as oxidation staining. The wooden stock exhibits wear and bruises normally found on a vintage WWII-era arm, in excellent condition overall. (66247-26D)



1607

1607. ISRAELI UZI SMG PARTS LOT This lot consists of a 10" barrel with a lightly fouled bore in 9mm. The metal surfaces retain between 60%-80% original phosphate finish on the various parts. The lot includes the top cover, stripped bolt, select fire trigger group assembly, (1) 25 round magazine, and handguards. The receiver has been cut in two places and the black plastic handguards exhibit wear consistent with age rating very good. This is an excellent parts lot for the UZI owner, in very good to excellent condition overall. (66247-16B)

1608. LOT OF MP-40 SMG BOLT PARTS This lot consists of a bolt assembly with firing pin as well as rear sight. The metal surfaces retain 50% original blue finish mixed with oxidation staining. The extractor appears intact with the lot in excellent condition overall. (66247-26C)

1609. MADSEN M-1950 SMG PARTS LOT This lot consists of an 8" barrel with a good to very good bore chambered in 9mm. The lot consists of the rear quarter of the stamped metal main body including the folding buttstock and fixed rear sight. The lot also includes the front quarter including main section of the bolt and (1) magazine. The metal surfaces exhibit overall oxidation staining with the lot in serviceable condition overall. (66247-26B)

1610. BREN MACHINE GUN PARTS LOT This lot consists of a 23" barrel with a very good to excellent bore chambered in 303 British. The receiver has been torch cut per BATF regulations leaving this lot as an excellent source for the replacement of worn or broken parts for the BREN owner. The metal parts retain a majority of original phosphate finish with wear consistent for a vintage Man-O-War. There are likely some small parts absent, in excellent condition overall. (66247-26A)

1611. RELOADING LOT This lot is a RCBS Rock Chucker reloading press in the original box. The press is by itself, contrary to the box's label and appears unused with the lot in virtually new condition overall. (66247-25A)

1612. NIGHT VISION LOT This lot is an AN/TVS-2 crew served night vision scope. This 1st generation scope is made by VARO of Texas for the Israeli military, originally designed to fit the M2, 50 caliber machine gun and now has a Weaver adapter to fit on a tripod. The scope measures approximately 26" in length and weighs approximately 10 lbs. The lot includes the original aluminum case, adapter packs to accept AA batteries. The scope is used but in excellent condition overall. The scope appears operational with no guarantees with regard to operation. (66247-18C). (400/600)



1612

1613. MG 34/42 BASKET BELT DRUM MAGAZINE This is an authentic German issue MG-42, 8mm, 75 round drum magazine. The metal surfaces retain approximately 70% original Afrika Corps tan with wear consistent with age and use. The lid exhibits the markings "h.q.u.44" just above the retaining clip. The magazine appears to be complete and in working order as well as in very good to excellent condition overall. (66519-557A)



1613

1614. BRITISH PIAT GRENADE LAUNCHER This WWII grenade launcher measures 39" in length and weighs 32 pounds. Designed and implemented in 1942, the grenade had an effective firing range of 115 yards with the velocity of approximately 250 ft per second. The metal surfaces retain approximately 60-70% original brown finish with wear and scuffing consistent with a vintage military weapon system. The aperture sights are intact with the internal parts believed to be present. This is an excellent item for the WWII enthusiast, in very good to excellent condition overall. (66247-13)

1615. REPLICAS GERMAN MP40 SMG This replica features a 9 1/4" barrel with a plugged bore. The metal parts are cast aluminum retaining 85% original black finish with light overall wear. The receiver is black plastic exhibiting minor overall scuffing. The lot includes folding metal stock, OD green sling but not a magazine which is easily obtainable. The bolt will retract and lock exactly as the original. This is an excellent accessory for the WWII enthusiast in very good to excellent condition overall. (66519-321A)



1614

1616. **M1917 TRIPOD** This original tripod does not exhibit any markings or plate and is mated with a cradle assembly which exhibits a 1944 date. The leg leveler and leather strap are absent. The screw that retains the cradle assembly is absent leaving the cradle loose and it would appear there is an additional part missing at the socket. The metal surfaces on the tripod exhibit portions of original green finish with areas of brass showing through at the top as well as scuffing along the exposed areas consistent with age and use. The tripod exhibits an arsenal refinished surface from the distant past. The cradle assembly is stamped "MG MIV" retaining a strong portion of original green finish. The lot may need a few parts and is in very good condition overall. (66247-42)



1617. **RUGER 10/22 LOT** This lot consists of a Timney trigger for the Ruger 10/22 rifle. The trigger is new, in the unopened wrapper complete with instructions. (66247-22A)

1618. **BROWNING M1919 LOT** This lot consists of a barrel and shroud for the Browning M1919 machine gun. The barrel is 24" with an excellent bore. The threads are in excellent condition. The metal surfaces retain 90-95% original phosphate finish with wear and light surface scuffing from storage and handling. The shroud retains 95% original phosphate finish with wear and scuff marks from storage. The barrel is stamped 762, 1-68 with two Hebrew letters in between, in excellent condition overall. (66247-27)



1619. **RUSSIAN PM1910 MACHINE GUN LOT** This lot features the skeleton plus a majority of internal parts as well as the wheeled Sokolov mount. The top is stamped "KORJ 1942" The side plates and spade trigger assembly as well as a few other parts are absent. The metal parts retain a majority of original green finish with wear and scuffing most notably on the fluted barrel jacket. This is an excellent parts lot for the Maxim owner, in very good condition overall. (66239-2)

1620. **U.S. AT-4 ROCKET TUBE** This lot consists of a fiberglass shell measuring approximately 39" in length and designed to hold an anti-tank round. The tube retains 97% original green finish with light wear from handling and storage. The instructions and sighting devices are still attached. This lot is an excellent addition to a "man cave" or the military historian. In excellent condition overall, appropriately de-milled per BATFE regs. (66627-5A)

1621. **MAUSER LOT** This lot consists of a Boyd's walnut stock for the Mauser 98 rifle. The stock appears unused and features two swivel studs and rubber buttplate. The stock is in the original box rating excellent to virtually new. (66627-9A)

1622. **RUGER LOT** This lot consists of a Ram-line Ruger Mini-14/30 folding stock. The black synthetic material exhibits minimal wear from handling and storage with the lot in excellent condition overall. (66627-9B)

1623. **J.C. HIGGINS MODEL 20 SLIDE ACTION SHOTGUN** 12 Ga., 26" ventilated rib barrel with an excellent bore. The metal surfaces retain 85-90% original blue finish exhibiting wear consistent with age. There is oxidation staining on the receiver as well as silvering on the high edges. The checkered forend and buttstock exhibit an added oil finish with heavy overlapping on the buttstock and patches of exposed wood on the forend. The barrel features an adjustable Poly-choke making this shotgun an excellent choice for the beginner. In very good to excellent condition overall. (66717-2). (300/500)

1624. **IVER JOHNSON TOP BREAK REVOLVER** 32 S&W, 4" barrel with a fair bore retaining strong rifling. The metal surfaces retain small portions of original nickel finish with areas of bare metal and oxidation staining. The checkered hardwood grips are intact with areas of moderate wear. The revolver is in fair to good condition overall and would make an excellent source for parts. (66717-5) {C&R} (20/40)

1625. **REMINGTON MODEL 51 SEMI-AUTO PISTOL** serial #PA4045, 380 ACP, 3 1/2" barrel with a near bright very good plus bore. The metal surfaces retain 95% original blue thinning to plum-brown with some scattered light freckling, silvering on high edges, a couple of scuffs, and a spot or two of oxidation. The checkered hard rubber grips rate near excellent with a few light handling marks and mild rounding of the checkering. This gun comes without a magazine. (126534-8) {C&R} (350/550)

1626. **REMINGTON MODEL 51 SEMI-AUTO PISTOL** serial #PA65485, 32 ACP, 3 1/2" barrel with a lightly frosted very good bore. The metal surfaces retain 90-95% original blue with some areas thinning to gray, silvering on high edges, and a few minor handling blemishes. The checkered hard rubber grips rate very good with a few light handling marks and some flattening of the checkering. Comes with a single magazine in very good condition. (126534-10) {C&R} (350/550)
1627. **HIGH STANDARD MODEL HB SEMI-AUTO PISTOL** serial #286112, 22 LR, 4 1/2" barrel with a bright excellent bore. The barrel is primarily a brown and gray patina with a healthy amount of original blue present. The frame retains 70% blue with the gripframe and triggerguard thinning to gray, and a few minor handling marks. The checkered hard rubber grips with HS monogram rate good with the right side grip showing a repaired crack running its length. This gun needs mechanical attention. (126534-4) {C&R} (100/200)
1628. **MARLIN GOLDEN 39A LEVER ACTION RIFLE** serial #15253235, 22 S,L,LR, 24" barrel with a bright excellent bore. The metal surfaces retain 99% original blue with a few light scratches and minor handling blemishes. The walnut pistolgrip stock and forearm rate excellent with a couple of light scratches and minor handling marks. (126653-2). (300/500)
1629. **WINCHESTER MODEL 94 TRAPPER LEVER ACTION CARBINE** serial #4901438, 30-30 Win, 16" barrel with a bright excellent bore. This saddle ring carbine's refinished metal surface retains 99% blue with a couple of faint handling blemishes. The walnut stock and forearm rate excellent with a couple of small dings on the forearm and also on the buttstock. Comes with its manual and original box that is showing a bit of wear with torn corners and edges. (126691-32). (300/500)
1630. **WINCHESTER MODEL 94 LEVER ACTION RIFLE** serial #3902122, 30-30 Win, 20" barrel with a bright excellent bore. The metal surfaces retain 99% original blue with a few faint handling marks. The walnut stock and forearm rate excellent with a couple of very light handling blemishes. A very nice rifle that appears to have seen little use. Comes with an Uncle Mike's leather sling. (126680-18). (250/450)
1631. **COLT WOODSMAN 1ST SERIES TARGET MODEL**, serial #131744, 22 LR, 6 5/8" barrel with a bright excellent bore. The metal surfaces retain 99% refinished blue with a few minor handling marks and scattered pinprick pitting under the refinished surface. The checkered hardwood grips rate good with a few dings and moderate handling wear showing rounding to the checkering. This pistol comes with its correct adjustable front and rear sights. (126634-1) {C&R} (350/550)
1632. **SMITH & WESSON MODEL 32 HAND EJECTOR DOUBLE ACTION REVOLVER** serial #60607, 32 S&W, 4 1/4" pinned barrel with a fine bore showing a slight frosting. The metal surfaces on this five screw revolver retain 75% original blue with flaking to gray and brown patinas, scattered pinprick pitting, spotty light oxidation, and a light turn ring on the cylinder. The hammer and trigger exhibit excellent case-hardened colors with a little fading to gray on high contact areas. The black checkered hard rubber grips with S&W monogram rate excellent. The grips are stamp-numbered to the gun. The cylinder, frame, barrel and extractor are numbered alike. (126684-27) {C&R} (200/400)
1633. **MOSSBERG BROWNIE DERRINGER PISTOL** serial #6383, 22 LR, 2 1/2" barrel with four very good bores showing light pitting and moderately strong rifling. The metal surfaces retain 50% original blue with the remainder of the surface fading to a gray and gray-brown patina with a few scattered spots of oxidation and light freckling. The hardwood grips are pencil-numbered to the gun and rate very good with strong grip serrations, a few minor handling marks and an added finish. The barrel, frame and top-break lever are numbered alike. (126684-18) {C&R} (200/400)
1634. **RUGER NEW MODEL BLACKHAWK SINGLE ACTION REVOLVER** serial #37-15990, 357 Magnum, 4 3/4" barrel with a bright excellent bore. The metal surfaces retain 99% original blue with a couple of faint handling marks and a very light turn ring on the cylinder. The walnut grips rate excellent. (126520-4141) [Richard "Stretch" Kennedy Collection]. (300/500)
1635. **KOLB BABY HAMMERLESS DOUBLE ACTION REVOLVER** serial #406, 22 Short, 1 1/4" barrel with a lightly pitted bore. The metal surfaces nickel plate rates very good with scattered light flaking and turn rings on the six shot fluted cylinder showing some mild oxidation on some spot where the nickel has flaked off. The checkered hard rubber grips with "K" logo are scratch-numbered to the gun and are in excellent condition with a few faint handling marks. This revolver requires mechanical attention. (126684-15) {C&R} (20/50)
1636. **BSA MODEL 12 MARTINI SINGLE SHOT RIFLE** serial #A24885, 22 LR, 29" barrel with a bright excellent bore. The barrels metal surface is a thinning blue turning to a brown patina with some light handling blemishes and a couple of specks of oxidation near the muzzle. The receiver is a freckled blue with light scratches and a couple of spots turning to a brown patina. The triggerguard and lever are a brown patina with scattered spotty oxidation. The hardwood stock and checkered forearm rate about very good with multiple dings and scratches, an added finish, and some faint paint splatter. The hard rubber buttplate shows a few handling blemishes. This rifle features Parker-Hale front and rear sights. (126693-1) {C&R} (300/500)
1637. **MARLIN GOLDEN 39A LEVER ACTION RIFLE** serial #21255630, 22 S,L,LR, 24" barrel with a bright excellent bore. The barrels metal surface is primarily a gray-brown patina with remnants of blue in protected areas, scattered pinprick pitting, and oxidation and pitting primarily towards the breech. The magazine tube is 60% blue with the remainder a gray-brown patina. The receiver and action show 80% original blue with thinning to gray and gray-brown patinas, and some scattered oxidation with mild pitting. The walnut stock and forearm rate good with a few light handling blemishes and an added finish that ran over onto the receiver during application. The bullseye in the bottom of the stock is missing, as is the front sight hood. This rifle requires mechanical attention as a screw is missing in the center of the left side of the receiver and the cartridge catch it holds in place is also missing. (126632-4). (100/200)
1638. **SHOTGUN BARREL LOT** Remington model 11-87 12ga shotgun barrel, 21" matte black with a cantilever scope mount showing a few specks of oxidation and a little light wear. It comes fitted with a rifled choke tube. (126680-21A)
1639. **COLT GRIP LOT** This lot consists of a pair of Colt Single Action Army Eagle grips. The checkered hard rubber grips with a Colt Rampant Horse logo and embossed eagle are in excellent condition showing only a few faint handling marks and a couple of spots of light soiling. They are scratch-numbered 36187 and an inverse impression of SA36187 is found on the inside edges of the left side. Comes with the grip screw. (126684-36)
1640. **PEARL GRIP LOT** This lot consists of a pair of mother-of-pearl grips that fit a Remington style Derringer. The grips are unmarked and in near excellent condition showing a small area of cracking on the outside of the left grip. (126684-37)
1641. **HOPKINS & ALLEN XL NO 2 SPUR TRIGGER REVOLVER** serial #954, 30 RF, 2 3/8" octagon barrel with good bore showing light pitting and moderately strong rifling. The metal surfaces retain 90% original nickel with areas of flaking to gray and brown patinas with some light pitting. The walnut bird's head grips rate near excellent with a couple of light handling blemishes. This pistol functions mechanically. The cylinder fits a bit loosely in the frame. (126684-11) {ANTIQUÉ} (125/225)
1642. **GERMAN FLARE & TEARGAS SCHEINTOD PISTOL** serial #51, 12 mm, 3" barrel with a good bore. This German proof marked pistol's metal surfaces are primarily a gunmetal gray showing some areas of oxidation, oxidation staining, and light freckling. The spur trigger shows some remnants of blue. The hammer has an evident crack at the base of its head. The hardwood bird's head grips rate very good with a repair to the right side, some light handling marks and an added finish. The left side grip is pencil-numbered to the gun. The frame and barrel are numbered alike. (126684-32) {NON-GUN} (75/150)

1643. **HARRINGTON & RICHARDSON M5 FLARE PISTOL** serial #7768, 10 ga, 4 1/2" barrel with a near excellent bore showing some scattered light pitting. The metal surfaces are gray and brown patinas with some light pitting and strong remnants of blue. The checkered hardwood grips rate good with strong checkering, a crack in the base by the front gripstrap, and another at the top rear. This gun is marked "United States Property" on the right side of the frame and is serial number marked on the barrel, barrel release lever and frame. There is a lanyard ring on the base of the grip. (126684-9) {NON-GUN} (150/250)
1644. **WINCHESTER MODEL 94 LEVER ACTION CARBINE** serial #1055636, 30 WCF, 20" barrel with a bright excellent bore. The barrel and magazine tubes metal surfaces retain 70% blue showing some thinning to gray with an area of mottled gray-brown patina on the magazine tube. The receiver is gray with an undertone of a mottled brown patina, some light freckling, and a few hints of the original blue. There are two drilled and tapped holes added to the left side of the receiver. The lever, hammer, and trigger are blue toning to gray-brown. The front barrel band is gray with some blue and spots of oxidation; the rear barrel band is primarily gray. The walnut stock and forearm rate good with multiple light impact marks and other light handling blemishes. They have non-factory checkering and an added finish that has spilled over onto the metal during application. There is a crack running up from the toe and a couple of other short cracks in the same area. The initials "FRM" are etched into the bottom of the stock. The plastic buttplate is cracked with signs of an attempt to repair it. The gun comes with a carbine post front sight and a ladder rear sight. (126680-15) {C&R} (300/500)
1645. **PALM REST LOT** This lot consists of an Al Freeland finger groove wood palm rest with rail attachment. It is in near excellent condition with a couple of scratches and some fading finish. (126699-4A)
1646. **SMITH & WESSON MODEL 622 SEMI-AUTO PISTOL** serial #UAN0565, 22LR, 4 1/2" barrel with a bright excellent bore. The matte stainless steel slide and alloy frame rate near excellent with a little oxidation on the slide. There is also some oxidation on the outside of the barrel visible when the action is open. The checkered rubber grips rate excellent. This gun appears to have had little if any use and comes with its original blue plastic case, manual, extra magazine and lock. (126691-3). (100/200)
1647. **BROWNING CHALLENGER SEMI-AUTO PISTOL** serial #117276U8, 22LR, 6 3/4" barrel with a bright excellent bore. This Belgian-made pistols metal surfaces retain 99% refinished blue with some scattered light pitting. The original gold trigger has been refinished blue. The wraparound checkered walnut grips rate very good with lightly worn checkering, a couple of chips and dings, and a few light handling marks. (126691-14). (300/500)
1648. **HOLSTER LOT** This lot consists of a single black snap flap holster in very good condition showing some light wear and soiling with a few scattered scuffs, and crazing along most of its length. The holster measures 22"x4" overall, has a single belt loop, and is likely for a medium-frame revolver with approximately 15" barrel. (126684-38)
1649. **BENJAMIN MODEL 130 AIR PISTOL** serial #B254176, .177 cal, 8 1/2" barrel with a bright excellent smooth bore. The metal surfaces retain 95% original matte black finish with some soiling, light oxidation, and a little wear on the top of the barrel. The checkered plastic grips rate excellent as does the grooved wood pump handle. Comes with its original box, manual, and other miscellaneous paperwork. (126684-1) {NON-GUN}
1650. **CROSSMAN MODEL 600 SEMI-AUTO CO2 PISTOL** serial #146033, 22 cal, 5" barrel with a bright excellent bore. The metal surfaces are 95% original black enamel with a few scuffs and minor handling marks. The checkered target grips with thumb rest rate excellent with a few minor handling marks. Comes with its original box, an empty CO2 cartridge, and a partial tin of pellets. (126684-6) {NON-GUN}
1651. **SMITH & WESSON MODEL 78G CO2 PISTOL** serial #0009562, 22 cal, 8 1/4" barrel with a bright excellent bore. The metal surfaces retain 97% original black enamel finish with a few light handling marks. The checkered plastic grips rate excellent with a little soiling and cracked on both sides by the lower retention screw. This pistol features an adjustable trigger and comes with its original foam lined cardboard box, a partial S&W tin of pellets, and four CO2 cartridges in their original 5-pack box. (126684-25) {NON-GUN}
1652. **WINCHESTER MODEL 60 BOLT SINGLE SHOT ACTION RIFLE** 22 S,L,LR, 23" barrel with a bright excellent bore. The metal surfaces are a brown and gray patina with some scattered light pitting and a few remnants of original blue. The refinished hardwood pistolgrip stock rates near excellent with multiple light dings and scratches. (126703-13) {C&R} (200/300)
1653. **RANGER MODEL M34 SINGLE SHOT BOLT ACTION RIFLE** 22 S,L,LR, 24" barrel with a bright excellent bore. The metal surfaces retain 75-80% original blue with a fair amount of scattered mostly light oxidation. The trigger and triggerguard are oxidized with some remnants of nickel plating still present. There is oxidation on the bolt and bolt chamber; the bolt functions a little stiffly. The hardwood pistolgrip stock rates good to very good with multiple light dings and scratches, some paint splatter, and a fading and thinning finish. (126691-44). (25/75)
1654. **STEVENS SPRINGFIELD MODEL 82 SINGLE SHOT BOLT ACTION RIFLE** 22 S,L,LR, 22" barrel with a near bright excellent bore. The metal surface retain 70% original blue with some fading to brown and scattered light spotty oxidation. The hardwood pistolgrip stock with finger groove forend rates very good with a short crack in the forend, some light handling blemishes, and mild wear. Both sling swivel studs are missing. (126691-38). (50/100)
1655. **REMINGTON MODEL 41 TARGETMASTER SINGLE SHOT BOLT ACTION RIFLE** serial #83104, 22 S,L,LR, 27" barrel with a bright excellent bore. The metal surfaces are a mixture of blue and a brown patina with a few spots of oxidation. The hardwood pistolgrip stock rates very good with a few scattered handling marks, a couple of specks of paint splatter and an added finish that was also applied to the barrel. (126698-6) {C&R} (75/150)
1656. **REMINGTON MODEL 33 SINGLE SHOT BOLT ACTION RIFLE** serial #246135, 22 S,L,LR, 24" barrel with a bright excellent bore. The metal surfaces retain 85% original blue with the barrel showing scattered freckling and a few spots of light oxidation, and the receiver exhibiting a fading blue turning to a brown patina. The hardwood pistolgrip stock rates good to very good with multiple light dings, several minor scratches, and a finish that is thinning in places and beginning to chip in a couple of spots. (126698-12) {C&R} (75/175)
1657. **SPRINGFIELD ARMS CHALLENGE MODEL SINGLE SHOT BOLT ACTION RIFLE** 22 S,L,LR, 22" barrel with a bright excellent bore. The metal surfaces retain 30% blue fading to a brown patina with a couple of spots of oxidation and several light handling marks. The refinished hardwood pistolgrip stock rates very good with a chip in the pistolgrip, and a few light dings and scratches. The sling swivel stud holes have been filled. (126698-10). (50/100)
1658. **UNITED ARMS CHICAGO 20 SINGLE SHOT BOLT ACTION RIFLE** 22 RF, 19 1/2" barrel with a near excellent bore showing a light frosting and strong rifling. The metal surfaces on this German-made rifle are an original blue fading to a brown patina with multiple light handling marks. The bolt handle fits loose in the bolt resulting in difficult action movement, a slightly loose bolt to breech fit, and some damage to the receiver. The hardwood pistolgrip stock rates very good with multiple light scratches, a few small dings, a little paint splatter, and a repaired chip at the toe. This rifle should be checked out by a qualified gunsmith prior to using. (126678-20). (20/40)
1659. **WESTERNFIELD MODEL SB808B SEMI-AUTO RIFLE** 22 S,L,LR, 20" barrel with a bright excellent bore. The metal surfaces retain 90% original blue fading to brown with some freckling and a few spots of oxidation. The triggerguard is coated in a light multi-colored epoxy paint. The refinished walnut pistolgrip stock rates excellent with a couple of dings and minor handling marks. The hard rubber buttplate shows a few light scuffs and sits proud of the wood. (126691-45). (75/150)

1660. **MARLIN GLENFIELD MODEL 60 SEMI-AUTO RIFLE** serial #24535663, 22LR, 22" barrel with a bright excellent bore. The metal surfaces retain 90% blue with scattered light spotty oxidation and a little silvering on some edges of the alloy receiver and trigger-guard. The press-checked pistolgrip hardwood stock rates very good with multiple light scratches, a few dings, and a few spots of discoloration. The plastic buttplate exhibits a few light scuffs. This rifle comes with a Kmart All-Pro 4x15 scope and is missing its front sight. A soft case is included. (126691-33). (50/100)
1661. **HARRINGTON & RICHARDSON MODEL 1915 SINGLE BARREL SHOTGUN** serial #A117846, 410 bore, 26" barrel with a bright excellent bore. The barrels metal surface retains 90% original blue lightly fading to brown with a few scratches and rub marks. The frame exhibits excellent case-hardened colors with a few light handling marks. The walnut pistolgrip stock and forearm rate excellent with multiple light scratches and a few other minor blemishes. (126703-22) {C&R} (250/350)
1662. **REMINGTON NO 4 ROLLING BLOCK SINGLE SHOT RIFLE** serial #J228328, 32 RF, 24" octagon barrel with a good lightly pitted bore. The barrels metal surfaces and the lever release take-down are a lightly pitted brown patina with remnants of blue. The frame is a gray-brown patina with a few scattered areas of light pitting and a couple of spots of oxidation. The walnut stock and forearm rate very good with multiple light dings most prominent on the buttstock, a replaced section on the heel, an added finish on the buttstock, and a speck of green paint on the comb. The sights are not present leaving two dovetail grooves on the barrel. (126676-14) {C&R} (125/275)
1663. **WINCHESTER MODEL 60A SINGLE SHOT BOLT ACTION RIFLE** 22 S,L,LR, 23" barrel with a bright excellent bore. The metal surfaces are a gray-brown patina with a few scant remnants of blue and some scattered light pitting. The walnut pistolgrip stock with finger groove forend rates very good to excellent showing some old handling blemishes and an added finish. The hard rubber buttplate shows a couple of scuffs, a chip, and moderate wear. (126703-14) {C&R} (125/250)
1664. **REMINGTON MODEL 550-1 SEMI-AUTO RIFLE** 22 S,L,LR, 24" barrel with a bright near excellent bore showing a little light oxidation towards the muzzle. The metal surfaces retain 85% original blue with a little thinning towards gray, light superficial oxidation, and a few minor handling blemishes. The pistolgrip hardwood stock rates very good with scattered light handling blemishes and a couple of checks on the left side of the forend. This gun is fitted with a shell deflector and a hooded Lyman front ramp sight. The receiver was drilled and tapped and the stock slightly modified for the instillation of a Lyman aperture sight. (126680-19) {C&R} (100/200)
1665. **WINCHESTER MODEL 04A SINGLE SHOT BOLT ACTION RIFLE** 22 S,L,LR, 21" barrel with a moderately pitted bore. The metal surfaces are blue thinning to gray with areas of oxidation and some light pitting. The walnut stock rates very good with multiple impact marks, light scratches, and an added finish. (126706-28) {C&R} (100/200)
1666. **REMINGTON MODEL 121 FIELDMASTER SLIDE ACTION RIFLE** serial #178066, 22 S,L,LR, 24" barrel with a bright excellent bore. The metal surfaces are an even mix of blue and fading blue turning gray-brown with some scattered light freckling and a few spots of oxidation staining. The walnut pistolgrip stock and forearm rate very good with multiple light scratches, a few small dings, a small chip in the toe, and an added finish. The checkered buttplate is blue with silvering on the tops of the points and around the edges with some of the stocks refinish spilled over onto the edge. The buttplate fits a little off center. (126707-8) {C&R} (200/300)
1667. **REMINGTON MODEL 552 SPEEDMASTER SEMI-AUTO RIFLE** 22 S,L,LR, 23" barrel with a bright excellent bore. The metal surfaces retain 95% original blue with scattered light freckling, and a couple of spots of oxidation. The alloy receiver shows a few light scratches and handling marks. The walnut pistolgrip stock and forearm rate very good with several light scratches, a few light dings, and a couple of specks of paint splatter. This rifle comes with a Weaver 3-6x scope mounted on the grooved receiver. (126706-31). (150/250)
1668. **WINCHESTER MODEL 67 SINGLE SHOT BOLT ACTION RIFLE** 22 S,L,LR, 27" barrel with a bright excellent bore. The metal surfaces are a thinning blue turning to brown with light freckling and a few scattered spots of oxidation staining. The walnut pistolgrip stock rates very good with multiple light to moderate dings, light scratches, and a flaking added finish. (126703-17) {C&R} (100/200)
1669. **REMINGTON MODEL 41P SINGLE SHOT BOLT ACTION RIFLE** 22 S,L,LR, 27" barrel with a bright excellent bore. The metal surfaces are a brown patina with remnants of blue in protected areas. The walnut pistolgrip stock rates very good with multiple light handling marks. Comes with a hooded front sight, rear aperture sight, and sling swivels. (126707-9) {C&R} (100/200)
1670. **SPRINGFIELD M6 SCOUT COMBINATION RIFLE/SHOTGUN** serial #MM620803, 22LR/410 bore, 18 1/4" barrels with bright excellent bores. The black parkerized finish on this CZ made gun rates very good with scratches and handling wear on the left side of the stock, a little light freckling along the barrels, and a small spot or two of oxidation. The rubber cheekpiece along the top of the buttstock storage area is intact as are the original sights. This gun comes with its original box, lock, and manual. (126690-1). (250/350)
1671. **SPRINGFIELD M6 SCOUT COMBINATION RIFLE/SHOTGUN** serial #M10135, 22LR/410 bore, 18 1/4" barrels with bright excellent bores. The black parkerized finish rates near excellent with a few specks of light oxidation and a couple of scattered spots of light freckling. The rubber cheekpiece along the top of the buttstock storage area is intact with a couple of abrasions. Comes with its box and manual. (126604-3). (300/400)
1672. **REMINGTON IMPROVED MODEL 6 FALLING BLOCK RIFLE** serial #464457, 22 S,L,LR, 20" barrel with a lightly frosted very good bore. The metal surfaces are a mottled blue/brown with some scattered spots of oxidation. The refinished walnut stock and forearm rate very good with multiple light dings and scratches, and a few spots of flaking finish. The gunmetal gray buttplate shows a few spots of oxidation and hangs proud of the wood. (126680-17) {C&R} (150/350)
1673. **ITHACA MODEL M-66 SINGLE BARREL SHOTGUN** serial #660363875, 20 ga, 28" barrel with a bright excellent bore. The metal surface of the barrel is blue lightly fading towards brown with scattered spotty oxidation and a few paint marks. The alloy receiver and lever show very good original black finish wearing to gray on some high edges and high contact areas with some scattered flaking. The press checked hardwood stock and smooth forearm rate good to very good with multiple scratches, a few dings, a scuff on the left side of the forearm, and a couple of paint marks. (126691-29). (40/80)
1674. **HIGH STANDARD FLITEKING CITATION MODEL K100 SLIDE ACTION SHOTGUN** 12 ga, 26 1/2" barrel with compensator and adjustable choke, and a bright excellent bore. The metal surfaces retain 95-97% original blue with multiple light handling marks, a couple of scuffs, a few light scattered freckles and a couple of spots of light oxidation. The checkered pistolgrip hardwood stock and forearm rate very good with a couple of scuffs and light handling marks. This gun has a Pachmayr rubber recoil pad with a 14 1/2" length of pull. The adjustable choke is integral with the compensator and has 6 settings from extra full to cylinder. (126691-40). (100/200)
1675. **TECH-FORCE UNDER LEVER AIR RIFLE** serial #Z423781, .177 cal, 17 3/4" barrel with a bright excellent bore. The metal surfaces retain 98% original blue with a few minor handling marks. This refinished hardwood Monte Carlo stock rates very good with a few minor handling blemishes and a couple of cracks in the pistolgrip. The gun features a 3/4 length under lever, adjustable rear sight, hooded front sight, and includes a Tech-Force scope mounted on the grooved receiver. (126549-6) {NON-GUN}
1676. **SHERIDAN BLUE STREAK AIR RIFLE** 20 cal. (5mm), 19" barrel with a bright excellent bore. The metal surfaces retain 98% original blue with a couple of small handling marks. The hardwood pistolgrip stock and forearm rate very good with several small scratches and dings. Comes with a 4x15 scope. (126543-15) {NON-GUN}

1677. **WINCHESTER MODEL 190 SEMI-AUTO CARBINE** serial #B1627178, 22 S,L,LR, 20 1/2" barrel with a bright excellent bore. The barrel and magazine tube are blue with about 50% coverage of spotty oxidation. The alloy receiver is 95% blue with multiple light handling marks. The hardwood pistolgrip stock rates very good with several light handling blemishes and a couple of small paint marks. The handle on the bolt is missing. (126691-49). (50/100)
1678. **REMINGTON MODEL 1902 ROLLING BLOCK CARBINE** serial #2061, 7mm, 20 1/2" barrel with a good moderately pitted bore showing moderately strong rifling. The metal surfaces retain 70% refinished blue thinning to brown in places with light pitting and a few scattered spots of oxidation. The hardwood stock and forestock rate very good with multiple light handling marks, a couple of small repairs, and a chip in the lower forestock by the barrel band. The buttstock is likely not original and has a flat buttplate showing strong blue and some light oxidation that hangs proud of the wood. The gun is marked "2277" and "Cal. 7mm" on the barrel and the upper tang is marked "REMINGTON ARMS CO./ILION, N.Y. U.S.A./PATENTED OCTR, 22nd, 1901". This gun is likely a Uruguayan military contract carbine as it matches in description though has no markings indicating so. (126556-9). (300/500)
1679. **IVER JOHNSON SAFETY AUTOMATIC HAMMERLESS DOUBLE ACTION BICYCLE REVOLVER** serial #486, 32 CF, 2" barrel with a good bore showing some oxidation and pitting. This third model top-break revolvers metal surfaces original nickel finish rates good with scattered freckling, areas of cloudiness, light handling marks, a light turn ring on the five shot fluted cylinder, and areas of flaking to an underlying oxidized surface. The trigger shows good case colors thinning to gray; the triggerguard exhibits very good blue with a little light spotty oxidation. The mother-of-pearl grips rate excellent and are numbered to a different gun. The barrel, frame and triggerguard are numbered alike. (126656-3) {C&R} (75/175)
1680. **HOWARD ARMS TOP-BREAK REVOLVER** serial #59969, 38 S&W, 5" ribbed barrel with a very good lightly pitted bore. The metal surfaces retain about 70% nickel finish with the bulk of the loss due to flaking leaving an oxidized underlying surface. The extended checkered hard rubber grips rate very good with a few minor handling blemishes and light wear. The grips are scratch-numbered to the gun. The frame, barrel, cylinder and tip-up latch are numbered alike. This pistol is missing the firing pin assembly and some other internal parts. (126678-17) {C&R} (40/80)
1681. **IVER JOHNSON SAFETY AUTOMATIC DOUBLE ACTION REVOLVER** serial #I14377, 38 CF, 3 1/4" ribbed barrel with a partially oxidized bore. This second model top-break revolvers metal surface is gray with scattered light oxidation and a few remnants of original nickel. The checkered hard rubber grips with owls head logo rate good showing handling wear and soiling. The barrel and frame are numbered alike. This revolver requires mechanical attention; the cylinder fits slightly loose in the frame, and the trigger pivot pin and possibly other parts are missing or broken. (126682-3) {C&R} (20/40)
1682. **IVER JOHNSON SAFETY AUTOMATIC HAMMERLESS DOUBLE ACTION BICYCLE REVOLVER** serial #B33122, 32 CF, 2" ribbed barrel with a lightly pitted bore. The metal surfaces on this third model revolver are gray with a few hints of the original nickel and scattered light oxidation. The checkered hard rubber grips rate fair with moderate wear, a piece broken off on the right side, and a repair to the left side. The barrel and frame are numbered alike. The cylinder fits slightly loose in the frame. (126656-4) {C&R} (50/100)
1683. **IVER JOHNSON SAFETY AUTOMATIC HAMMERLESS DOUBLE ACTION REVOLVER** serial #H26196, 32 CF, 3" ribbed barrel with a moderately pitted bore. This second model top-break revolvers metal surface retain about 60% original nickel flaking to a gray and brown patina with some oxidation pitting. The checkered hard rubber grips rate very good showing some light wear and a few mild handling marks. The cylinder fits slightly loose in the frame; the barrel to frame fit has slight play. The barrel and frame are numbered alike. (126708-7) {C&R} (50/150)
1684. **HOPKINS & ALLEN BLUE JACKET NO. 2 SPUR TRIGGER SINGLE ACTION REVOLVER**, serial #7140, 32 RF, 2 3/4" barrel with a lightly oxidized bore. The metal surfaces retain about 50% original nickel with the remainder flaking to a part gray and a part oxidized surface. The hammer exhibits good case colors fading to gray in places. The hard rubber grips rate very good showing some light wear, a few minor handling marks, and a little soiling. The barrel and frame are numbered alike. The cylinder fits slightly loose in the frame. (126682-2) {ANTIQUÉ} (50/100)
1685. **IVER JOHNSON SAFETY AUTOMATIC DOUBLE ACTION REVOLVER** serial #H85583, 38 CF, 2 1/4" ribbed barrel with a very good bore showing a little light pitting. This barrel has been shortened from its original length. The metal surface is a gray-brown patina with scattered freckling, some light pitting, a few spots of oxidation, and a few hints of the original blue in protected areas. The trigger exhibits good case colors fading to gray on the high contact areas with some spotty oxidation. The stag grips rate near excellent with a little light soiling. The barrel, frame, and triggerguard are numbered alike. The cylinder-to-frame fit is slightly loose. (126656-1). (50/175)
1686. **ANSCHUTZ KARABINER SINGLE SHOT BOLT ACTION RIFLE** serial #510636, 22LR, 23 1/2" barrel with a bright excellent bore. The metal surfaces retain 99% refinished blue. The refinished hardwood checkered pistolgrip stock with schnabel forend rates excellent. The buttplate is blue with some thinning to a gray patina that hangs slightly proud of the wood. Marked "Original JGA Karabiner" on the top of the barrel. Comes with sling swivels mounted to a barrel mount and on the bottom of the buttstock. (126634-5). (75/200)
1687. **SWING MODEL M5 SINGLE SHOT BOLT ACTION TARGET RIFLE** serial #1283, 7.62 mm, 27 1/2" barrel with a bright excellent bore. The metal surface retains near excellent blue except along the top of the barrel where there are several areas of moderate oxidation. The oil finished target style stock rates fine featuring a palm swell pistolgrip that is showing some staining from use, a slightly raised cheekpiece, a ventilated forend, a near full length aluminum handstop rail, and an aluminum triggerguard. The Schultz & Larsen barrel is fitted with a front sight mounting block. The receiver is factory drilled and tapped and is fitted with a single short scope rail on the front set of holes, and a bracket for a side mount rear sight. Included with this gun is a Swenson Precision rear aperture target sight that is partially covered with oxidation, a front globe sight with level, a Mo's round handstop, and a Plano Airglide hard case. (126518-9). (350/550)
1688. **SMITH & WESSON MODEL NO 1 SPUR TRIGGER SINGLE ACTION REVOLVER** serial #110121, 22 short, 3 3/16" ribbed barrel with a moderately frosted bore. This third issue revolvers metal surfaces retain 85% nickel finish with some flaking, freckling, and scattered light spotty oxidation. The rosewood birds head grips rate fair with a few chips and obvious repairs. This revolver does not function and will require some mechanical attention. (126600-11) {ANTIQUÉ} (50/100)
1689. **SMITH & WESSON MODEL NO 1 SPUR TRIGGER SINGLE ACTION REVOLVER** serial #125301, 22 short, 3 3/16" ribbed barrel with a lightly pitted bore. This third issue revolvers metal surfaces retain 80% original nickel with areas of flaking and oxidation. The rosewood birds head grips rate good with a couple of large chips and some light handling wear. The sideplate is included but not affixed to the gun. This revolver requires mechanical attention. (126600-12) {ANTIQUÉ} (50/100)
1690. **SMITH & WESSON MODEL 1 1/2 SECOND ISSUE SPUR TRIGGER REVOLVER** serial #46036, 32 RF, 3 1/2" ribbed barrel with a lightly pitted bore. The barrels metal surface retains about 50% original blue thinning to a brown patina with some light oxidation, oxidation staining and light pitting. The frame and cylinder are gray with some areas of brown patina, some spotty oxidation, some light pitting, and a few remnants of original blue in protected areas. The rosewood birds head grips are stamp-numbered to the gun and rate near excellent with some light handling marks and an added finish. The barrel to frame fit has some play as does the cylinders fit into the frame. (126623-3) {ANTIQUÉ} (100/250)

1691. **SMITH & WESSON MODEL 1 1/2 SECOND ISSUE SPUR TRIGGER REVOLVER** serial #46281, 32 RF, 3 1/2" ribbed barrel with a near excellent bore showing a very light frosting. The metal surfaces retain 95% original nickel finish with some scattered flaking, light freckling, and a little light spotty oxidation. The fluted five shot cylinder also shows a light turn ring. The rosewood birds head grips are stamp-numbered to the gun and rate near excellent with a few light handling marks and an added finish. Frame-to-barrel fit and cylinder lock-up are tight; action is crisp. A very nice example. (126694-25) {ANTIQUÉ} (350/550)
1692. **SMITH & WESSON MODEL 1 1/2 SECOND ISSUE SPUR TRIGGER REVOLVER** serial #42060, 32 RF, 3 1/2" ribbed barrel with a lightly pitted bore. The metal surfaces retain about 50% original blue with the barrel showing a gray patina with oxidation staining and a few spots of minor pitting; the frame exhibits strong blue with scattered flaking, some light oxidation, a few spots of mild pitting, several scratches, and the backstrap fading to a gray patina. The fluted five shot cylinder is a gray patina with spotty oxidation staining and a little light pitting. The rosewood birds head grips are stamp-numbered to the gun and rate near excellent with a few light handling marks and an added finish. The barrel to frame fit is slightly loose. (126680-1) {ANTIQUÉ} (200/300)
1693. **SMITH & WESSON MODEL 36-7 LADY SMITH DOUBLE ACTION REVOLVER** serial #BNB6008, 38 Spl, 1 7/8" barrel with a good bore that is bright with a couple of spots of oxidation. The metal surfaces retain 90% original blue with a few light freckles, silvering on some high edges, a couple of spots of oxidation, a light turn ring, and a couple of spots worn to gray on the five shot fluted cylinder. The trigger and hammer exhibit excellent case colors with a little oxidation on the back of the trigger. The hardwood grips rate excellent with a few light handling blemishes. (126623-2). (200/400)
1694. **HOPKINS & ALLEN CAPT. JACK SPUR TRIGGER SINGLE ACTION REVOLVER** serial #3762, 22 RF, 2 1/8" barrel with a dark lightly oxidized bore. The metal surface is a brown patina on the barrel and cylinder with some light pitting; the frame exhibits 90% original nickel with some flaking to an oxidized brown. The hammer and trigger are gray with a few hints of case-hardened colors, some light oxidation, and mild pitting. The hardwood birds head grips rate near excellent with a few minor handling blemishes. (126623-1) {ANTIQUÉ} (50/100)
1695. **HOPKINS & ALLEN BLUE JACKET NO 1 SPUR TRIGGER SINGLE ACTION REVOLVER** serial #1359, 22 RF, 2 3/16" barrel with a good lightly pitted bore. The metal surfaces are a faded blue turning to a blue-brown patina with some small areas of mild pitting. The hardwood birds head grips rate near excellent with several light handling blemishes and an added finish. The frame, cylinder and barrel are numbered alike. (126416-27) {ANTIQUÉ} (100/200)
1696. **JOHNSON & BYE DEFENDER SPUR TRIGGER REVOLVER** serial #417, 32 RF, 2 1/2" barrel with a very good lightly oxidized bore. The metal surfaces retain 80% original nickel with some flaking, areas thinning to gray, some freckles, and small areas of oxidation. The hammer exhibits good case colors fading to gray with a little light oxidation and a chip in the spur. The hard rubber grips with embossed eagle rate near excellent with some light wear. This revolver requires mechanical attention. Comes with a well worn leather holster. (126422-17) {ANTIQUÉ} (40/80)
1697. **IVER JOHNSON SAFETY AUTOMATIC HAMMERLESS DOUBLE ACTION REVOLVER** serial #U19569, 32 CF, 1 3/4" ribbed barrel with a lightly pitted bore. This second model revolvers barrel has been shortened from its original length. The metal surfaces retain 95% original nickel with a couple of spots thinning to gray, some light freckling and multiple light handling blemishes. The pearl grips rate very good with a couple of chips, and a crack on the right side. This pistol requires mechanical attention. (126564-9). (40/80)
1698. **RANGER MODEL 101.11 SEMI-AUTO RIFLE** 22LR, 24" barrel with a bright excellent bore. The metal surfaces are brown with scattered light spotty oxidation. The smooth pistolgrip hardwood stock rates very good with multiple light handling blemishes and a fading finish. The triggerguard is missing and the magazine tube insert fits very firmly in the tube. (126691-41). (40/80)
1699. **HARRINGTON & RICHARDSON THE AMERICAN DOUBLE ACTION REVOLVER** serial #4, 44 CF, 4 1/2" octagon barrel with a gray moderately pitted bore. The metal surfaces are in-the-white with some scattered light pitting, a couple of spots of mild oxidation. The fancy scroll checkered hard rubber grips are scratch-numbered to the gun and rate near excellent with some light handling marks, mild wear, and light soiling. (126556-7) {C&R} (50/150)
1700. **COLT 1908 VEST POCKET HAMMERLESS SEMI-AUTO PISTOL** serial #89402, 25 ACP, 2" barrel with a moderately frosted bore showing a couple of small pits. The metal surfaces retain 95% original blue with scattered light pitting and mild oxidation. The checkered hard rubber grips rate near excellent with some light handling wear. (126623-4) {C&R} (400/600)
1701. **DAISY MODEL 25 PUMP-SLIDE COCKING BB GUN** .175 Cal, 18" barrel. The metal surfaces rate near excellent showing 95% original blue with a couple of spots of rub wear, some scattered freckling, and some light superficial oxidation on the pump arm. The frame and a small portion of the top of the barrel are stencil engraved and near fully intact. The plastic pistolgrip stock and grooved pump handle also rate near excellent showing a few light handling marks. (126569-3) {NON-GUN}
1702. **CROSSMAN MODEL 180 PELLGUN CO2 RIFLE** 22 Cal, 18" barrel with bright excellent bore. The metal surfaces retain 70% original blue with areas thinning to brown, some scattered freckling, and some light oxidation mostly on the barrel. The wood pistolgrip stock rates very good to near excellent with multiple light handling marks. This rifle features a cross bolt safety. (126519-539) {NON-GUN}
1703. **BARREL AND STOCK LOT** This lot consists of an unmarked barrel and a Bishop sporter style stock that fits an 03-A3 action. The 19 1/2" round barrel with a bright excellent bore is chamber for 30-06 and retains 95% refinished blue with a couple of scuffs and a few light scratches. The barrel measures 1.18" diameter and tapers to 0.65" at the muzzle. The treads are 10 TPI on a 3/4" long 1.04" shank. The Bishop sporter style pistolgrip stock with cheekpiece rates near excellent with a chip at the rear of the action, a modification cut in the right side for a bolt handle, and a scuff along the top of the comb. It comes with both sling swivel studs. (126613-1)
1704. **CUGIR AIR RIFLE** serial #0013, 177 cal, 19 1/2" barrel with a bright excellent bore. The metal surfaces on this side lever Romanian made Haenel style air rifle retain 97% original blue with a few light scratches and a couple of spots of minor oxidation. The pistolgrip target style wood stock rates near excellent with multiple light dings, a couple of scratches, and an added finish. The gun features a front globe sight, grooved receiver, handstop rail, target sling, and an adjustable buttplate. The barrel and action have some play in its fit to the stock. (126578-26) {NON-GUN}
1705. **MASS ARMS SINGLE BARREL SHOTGUN** serial #C555, 12 ga, 30" barrel with a lightly pitted bore. The metal surfaces retain 30-40% blue with the remainder being speckled superficial oxidation. The hardwood pistolgrip stock rates good with multiple light to moderate blemishes and a little paint splatter. The forearm is held on with black tape. The hard rubber buttplate is well worn and has a repaired crack towards the toe. (126691-36). (20/50)
1706. **RELIC TRAPDOOR RIFLE** serial #283133, 45-70 govt., 32 1/2" barrel with a very good lightly frosted bore. The metal surfaces are primarily an oxidized brown patina with remnants of blue scattered within. The stock is in fair condition with multiple handling marks and a crack in the forend. The gun is missing its lock, forestock, and associated hardware. (126497-16A) {ANTIQUÉ} (50/100)
1707. **RELIC TRAPDOOR RIFLE** 45-70 govt., 32 1/2" barrel with a dirty bore. The loading gate is frozen shut and there is a crack through the receiver by the front of the breech. The metal surfaces are primarily oxidized with some remnants of blue. The stock is fair with cracks and other damage by the wrist. This gun is held together with tape around the wrist and is missing its lock and associated hardware. (125497-16B) {ANTIQUÉ} (50/100)

1708. **HARD CASE LOT** This lot consists of a single light brown GunGuard hard case with foam liners. This rectangular case measures 51"x13"x4". It is in overall near excellent condition showing a few minor exterior blemishes and a little light soiling. No key included. (125071-7)
1709. **LOT OF 5 SOFT CASES** This lot consists of five zippered long gun soft cases of various manufacturers ranging from 48" to 51" in length and 7" to 8" at their widest point. They are in good to very good condition with a variety of vinyl, leather, and fabric exteriors. Three have full zippers, one has a 3/4 zipper, and one has an end zipper. (126516-4)
1710. **LEATHER SOFT CASE LOT** This lot consists of a single Bracken Creek heavy leather zippered soft case 46" long x 10" at its widest point. This dark brown lamb's wool lined case is in near excellent condition showing a few scuffs and minor exterior handling blemishes. It comes with a leather shoulder strap affixed to the case with brass hardware. (125045-7A)
1711. **HARD CASE LOT** This lot consists of a single unmarked black plastic hard case with foam liners. This rectangular case measures 52"x13"x4" and is in overall very good condition showing a few minor handling marks, a dent in one end, and a little light soiling. No key included. (126045-7B)
1712. **LOT OF SOFT CASES** This lot consists of ten long gun soft cases of various manufacturers ranging from 46" to 51" in length with one measuring 55" long, and 6" to 8" at their widest point. They are in good to very good condition with a variety of leather, vinyl, and fabric exteriors. One case has a string tied end flap, nine are zippered with 1/4 length to full length zippers. (126045-7C)
1713. **HARD CASE LOT** This lot consists of a single black plastic GunGuard hard case with foam liners. This rectangular case measures 52"x13"x4" and is in overall near excellent condition with a couple of minor scuffs and some light soiling. No key included. (126407-9)
1714. **HARD CASE LOT** This lot consists of a single gray plastic GunGuard hard case with slide latches and foam liners. This rectangular case measures 48"x9"x4" and is in overall near excellent condition with a few minor exterior blemishes. (126120-183)
1715. **SOFT CASE LOT** This lot consists of a single green fabric GunMate padded soft case. This tapered case measures 49" long by 9" at its widest point. This full zippered case is in excellent condition with a little light soiling. (126300-1)
1716. **LOT OF SOFT CASES** This lot consists of two padded zippered fabric soft cases. One is a green camo tapered case that measures 43"x7". The other is a tan tapered case that measures 50"x8". Both are in excellent condition. (126357-S17285)
1717. **HARD CASE LOT** This lot consists of a single tan plastic GunGuard hard case with foam liners. This rectangular case measures 51"x13"x4" and is in near excellent condition with a couple of oil stains on the foam liners, and a few scuffs and scratches on the exterior. (125824-1F)
1718. **HARD CASE LOT** This lot consists of a single unmarked green plastic hard case with foam liners. This rectangular case measures 52"x10"x3 1/2" and is in excellent condition. (125033-5)
1719. **SOFT CASE AND HOLSTER LOT** This lot consists of a black Ace fabric soft case and four holsters. The full zippered soft case includes a zippered pocket, five Velcro flap magazine pockets, and a shoulder sling. This tapered case measures 42"x12" and is in excellent condition. The four holsters include: one Lawrence 1CB538 heavy leather holster with broken stitching in very good condition, one unmarked black leather flap holster in good condition, one Blackhawk pocket holster size 4 in near excellent condition, and one small Bulldog nylon holster in excellent condition. (126623-61)
1720. **RELIC TRAPDOOR RIFLE** 45-70 grovt, 32 1/2" barrel with a heavily oxidized bore. The metal surfaces are an oxidized pitted brown. The stock is broken at the wrist with the buttstock section missing. The lock, trigger, and loading gate are present, though the trigger and guard are not attached to the gun. Comes with an oxidized pitted bayonet. (126627-14) {ANTIQUE} (25/75)
1721. **LOT OF HARD CASES** This lot consists of one long gun case and three pistol cases. The tapered black plastic long gun case by GunGuard measures 52"x8"x3 1/2" with a foam liner. It is in excellent condition with a couple of oil stains on the foam liner and a few handling marks on the exterior. The three black plastic handgun cases are in near excellent condition with foam liners. First one is by Plano; it shows a few handling marks on its exterior and a little light oil staining in the foam. Second one is a GunGuard in like new condition. Third is by DoskoSport showing a couple of minor handling marks on its exterior and a little light oil staining in the foam. (126490-1)
1722. **LOT OF SHOTGUN ACCESSORIES** This lot consists of three pieces designed for use on a Remington Model 870. First is a Mesa Tactical pistolgrip adapter with textured black rubber Ergo Grip. This item comes with assembly guide, blank plate and hex wrench. Second is a Hogue forend constructed of a polymer body and textured black rubber over-mold. Third is an Eagle Industries stock pouch. The hook and loop removable pouch body has interior loops for six rounds. (166367-2)
1723. **ITHACA MODEL 37 SLIDE ACTION SHOTGUN** serial #12948, 16 Ga, 28" plain barrel choked full with bright excellent bore. The metal surfaces retain approximately 95% blue finish thinning to brown with scattered light oxidation throughout. The satin finish checkered walnut pistolgrip buttstock and forearm rate very good with most of the original finish present under numerous surface abrasions and handling marks. A Red Head recoil pad has been installed resulting in a 14 3/4" pull length. A 3/16" diameter ivory colored front sight bead is provided. (166601-18). (250/350)
1724. **WINCHESTER MODEL 1894 PARTS LOT** This composite lot consists of an incomplete takedown rifle front assembly. The 26" tapered octagonal barrel has a bright excellent bore and strong rifling. The barrel is marked 30 WCF with Winchester and mail order proof mark present. Barrel retains 98% blue finish silvering slightly on the edges with scattered light surface oxidation present. The barrel extension lead threads are slightly worn. The finish on the takedown boss has worn to gunmetal grey. The full length magazine tube with spring loaded follower has been cleaned and all finish removed with the exception of the remaining blue on the takedown lever. Smooth walnut forend rates very good as cleaned with a chip missing on the right side at the noscap. The finish on the noscap has worn to a grey brown patina and the mounting screw slots have been damaged slightly. The front and rear sights and magazine ring pin are missing. (166573-3)
1725. **LOT OF SIX SOFT LONG GUN CASES** Items range in size from 44" to 52" in length. Five of the six are designed to accommodate scoped rifles. One is better suited for shotgun or rifles without scope. Five cases are constructed with vinyl exterior with the sixth made of leather. All cases have soft cloth interiors, functional zippers and shoulder or hand carry straps. (166573-4)
1726. **DEXTER SMITH ROLLING BLOCK SINGLE BARREL SHOTGUN** serial #1843, 12 Ga, 30" plain barrel choked full with rough, pitted bore. The receiver finish appears to have been cleaned leaving behind grey metal with moderate oxidation scars. The barrel finish has thinned and faded unevenly to a medium grey-brown patina also exhibiting light surface oxidation and handling marks. The plain straight grip walnut buttstock with original metal buttplate has been sanded and refinished. The tapered walnut forend appears to have been refinished as well with less aggressive sanding prior-to. The block operating lever is broken and the action is not operational. This item will require the services of a qualified gunsmith for inspection and repair. (166328-27) {ANTIQUE} (50/100)

1727. **WINCHESTER MODEL 90 SLIDE ACTION RIFLE** serial #689710, 22 Short, 24" tapered octagonal barrel with very good bore pitted on the lands and in the grooves midway between the breech and muzzle. The metal surfaces retain 60% original thinning blue finish that has faded to a grey brown patina with light surface oxidation throughout and silvering on most high edges. The satin finish plain walnut buttstock with crescent buttplate and grooved forend rate very good with evidence of gentle cleaning and numerous blemishes accumulated over the years. The wrist area of the buttstock has been repaired or reinforced with a pin. This is a composite gun with a different serial number located behind the triggerguard. As such, the fit between top and bottom receiver components is substandard. It is difficult to determine the extent of parts integration without further investigation which should be undertaken by a qualified gunsmith prior to use. (166633-1). (250/450)
1728. **UNMARKED REPRODUCTION FLINTLOCK BLUNDERBUSS**, 70 Cal, 18" brass half octagon half round barrel with excellent bore. Brass barrel and furniture show signs of recent polishing with tarnish forming around the lock area, buttplate and triggerguard. Chrome plated lock work and trigger have scattered pinprick oxidation. The satin finish full length stock with unique profile rates about very good with numerous blemishes from less-than-careful handling. The lock and trigger do not function properly so this gun is better suited for decorative purposes rather than use. This reproduction gun was possibly built from a kit. (166587-S17559A). (50/100)
1729. **RUGER 10/22 SEMI-AUTO CARBINE** serial #252-46183, 22LR, 18 1/2" barrel with a bright excellent bore. Metal surfaces retain 99% plus original blue finish. The black synthetic stock is in excellent shape with the exception of a few small blemishes on left side of the buttstock. Original box and paperwork are included. (156520-1380) [Richard "Stretch" Kennedy Collection]. (150/250)
1730. **RUGER 10/22 SEMI-AUTO CARBINE** serial #248-33530, 22LR, 18 1/2" barrel with a bright excellent bore. The stainless steel receiver and barrel are in excellent condition showing no signs of wear. The black synthetic pistolgrip buttstock is excellent with no visible markings. Original box and paperwork are included. This 10/22 is in near perfect condition. (156520-1379) [Richard "Stretch" Kennedy Collection]. (150/250)
1731. **RUGER 10/22 SP SEMI-AUTO CARBINE** serial #230-99735, 22LR, 18 1/2" barrel with a bright excellent bore. Metal surfaces retain 99% plus original blue finish. The checkered walnut stock and recoil pad are in excellent condition. This rifle is in near perfect condition and includes its original box and paperwork. (156520-1948) [Richard "Stretch" Kennedy Collection]. (200/300)
1732. **LANBER MODEL 533 VICTORIA II SEMI-AUTO SHOTGUN** serial #13-03-04836-96-12-70, 12 gauge, 28" barrel with a bright excellent bore. Metal surfaces retain 99% plus original blued finish. The hardwood checkered stock and forend are in excellent condition with no visual blemishes or marks. Improved cylinder, modified, and improved modified choke tubes come standard with this firearm. The original box and manual are included as well. (156520-709) [Richard "Stretch" Kennedy Collection]. (200/400)
1733. **STEVENS 'FRIENDS OF NRA' FAVORITE MODEL 30 FALLING BLOCK RIFLE** serial #379532, 22LR, 21" barrel with a bright excellent bore. All metals retain 99% original blue finish. The smooth hardwood stock rates excellent with no visible dents or dings. "Friends of NRA" emblem and squirrel are displayed on receiver. Original box and paperwork are included. This collector's item is #235 out of 725 made and is in near perfect condition. (6520-1378) [Richard "Stretch" Kennedy Collection]. (200/400)
1734. **WINCHESTER MODEL 290 DELUXE SEMI-AUTO RIFLE** serial #B879396, 22 S, L, LR, 21" barrel with a bright excellent bore. All metals retain 99% original blue finish. The checkered walnut Monte Carlo stock with a left side flared cheekpiece rates excellent. The gold plated safety and trigger, along with the jeweled finish bolt, add a nice touch to this like-new rifle. The original box and paperwork are included. (156520-1390) [Richard "Stretch" Kennedy Collection]. (150/250)
1735. **WINCHESTER MODEL 310 SINGLE SHOT BOLT ACTION RIFLE** serial #D41154, 22 S, L, LR, 22" barrel with a bright excellent bore. All metal surfaces retain 99% plus original blue finish. The checkered walnut Monte Carlo stock and forend rate excellent showing a small scuff on the left side of the stock just behind the base of the pistolgrip. There is also a bead of yellow glue along the top left side of the stock about 2 1/2" in front of the end of the receiver. The original box and manual are included. (156520-1930) [Richard "Stretch" Kennedy Collection]. (150/250)
1736. **REMINGTON NYLON 66 SEMI-AUTO RIFLE** serial #A2392276, 22 LR, 19 1/2" barrel with a bright excellent bore. All metal surfaces retain 99% original blue finish with a few minor blemishes scattered amongst the receiver and barrel. The "Mohawk Brown" Zytel plastic stock and forend rate excellent. A Tasco 4x15mm scope is included with the original box and manual. This rifle is in like-new condition. (156520-1687) [Richard "Stretch" Kennedy Collection]. (250/350)
1737. **BUSHNELL ELITE 4200 8-32X40MM SCOPE** with an adjustable objective lens. Featured is a Multi-X reticle with bright excellent optics. The scope body rates excellent showing only a few ring marks having previously been mounted. Included is a pair of flip-up Butler Creek scope caps. (156520-3132A) [Richard "Stretch" Kennedy Collection].
1738. **HENRY MODEL H001 LEVER ACTION RIFLE** serial #113855H, 22LR, 18 1/4" barrel with a bright excellent bore. Metal surfaces retain 99% plus original blue finish. The hardwood straight grip buttstock and forend are in excellent condition with no visual blemishes or marks. Factory sights are intact along with the original box and paperwork. This firearm appears to be unfired and is in excellent condition overall. (156520-1681) [Richard "Stretch" Kennedy Collection]. (150/250)
1739. **RUGER AMERICAN BOLT ACTION RIFLE** serial #690-18334, 308 Win, 22" barrel with a bright excellent bore. The metal surfaces retain 99% original matte blue finish. The black synthetic pistolgrip stock and forend rate excellent displaying a few small blemishes along the top of the pistolgrip. The factory sticker is still displayed on the right side of the stock. Included with this rifle is the original factory box, manual and padlock. (156520-3137) [Richard "Stretch" Kennedy Collection]. (200/400)
1740. **ZEISS DIATAL-C 4X32MM SCOPE**. Featured is a Z-Plex reticle with bright excellent optics. The scope body rates excellent showing a couple of ring marks having previously been mounted. An overall excellent condition Zeiss Diatal-C scope. (156520-1790A) [Richard "Stretch" Kennedy Collection]
1741. **ZEISS DIAVARI-Z 3-12X56MM T* SCOPE**. Featured is a "Reticle 8" with bright excellent optics. The scope body rates excellent showing very faint ring marks having been previously mounted. Factory scope caps are included. An overall excellent condition Zeiss Diavari-Z scope. (156520-2741A) [Richard "Stretch" Kennedy Collection]
1742. **REMINGTON MODEL FIVE BOLT ACTION RIFLE** serial #ZA220605949, 22 LR, 22" barrel with a bright excellent bore. The metal surfaces retain 99% original blue finish. The satin finished brown laminated pistolgrip stock rates excellent with no visual dents or dings. Included is the original manual and lock. (156664-3). (150/250)
1743. **BUSHNELL BANNER LITE-SITE 3-9X40MM SCOPE**. Featured is a Multi-X reticle with bright excellent optics. An on/off switch sits on top of the ocular lens with the capability to illuminate the reticle, however it does not light up in its current state (perhaps a battery is all that is needed). The scope body rates excellent with no visual blemishes or marks. A pair of weaver rings and factory scope caps are included with the scope. (156520-1864A) [Richard "Stretch" Kennedy Collection]
1744. **LEUPOLD VARI-X IIC 3-9X40MM SCOPE**. Featured is a duplex reticle with bright excellent optics. The scope body rates excellent showing light ring markings having previously been mounted. An overall excellent condition Leupold Vari-X II scope. (156520-1493A) [Richard "Stretch" Kennedy Collection]

1745. **LEUPOLD VARI-X III 2.5-8X32MM SCOPE.** Featured is a duplex reticle with bright excellent optics. The scope body rates excellent displaying minor ring wear having been previously mounted. An overall excellent condition Leupold Vari-X III scope. (156520-2871A) [Richard "Stretch" Kennedy Collection]
1746. **REDFIELD WIDEFIELD LO-PRO 3-9X40MM SCOPE.** Featured is a duplex reticle with bright optics. The scope body rates very good with some handling marks and ring marks having previously been mounted. A very good Redfield Lo-Pro overall. (156706-13B)
1747. **SMITH & WESSON MODEL 1500 BOLT ACTION RIFLE** serial #PN65409, 270 WCF, 22" barrel with a bright excellent bore. The metal surfaces retain 97-98% original blue finish with some handling marks present as well. There is a small amount of oxidation staining along the bolt handle. The checkered pistolgrip stock and forend rate excellent showing some light dings and dents. Included are a leather sling and a pair of Weaver scope mounts which are currently mounted to the receiver. (156520-3611) [Richard "Stretch" Kennedy Collection]. (200/300)
1748. **REDFIELD WIDEFIELD 2-7X32MM SCOPE.** Featured is a duplex reticle with bright optics. The scope body rates very good with some handling marks and includes a pair of rings that are currently mounted. A very good Redfield Widefield overall. (156520-3611A)
1749. **KEL-TEC SUB-2000 SEMI-AUTO CARBINE** serial #EAN74, 9mm, 16" barrel with a bright excellent bore. The metal surfaces retain 99% original blue finish with some handling marks present. The checkered black synthetic pistolgrip with extended black synthetic stock and forend rate excellent showing some minor handling marks as well. This Sub-2000 comes with two 17 round Glock magazines, an easy-loader and original paperwork. (156706-8). (250/350)
1750. **RUGER SINGLE-SIX SINGLE ACTION REVOLVER** serial #60-83279, 22 LR, 5 1/2" barrel with a bright excellent bore. The metal surfaces retain 99% original blue finish with some very light silvering beginning to show at the muzzle and a slight turn ring on the cylinder. The smooth hardwood grips with silver Ruger medallions rate excellent with a few small handling marks. This revolver features a standard hammer and target trigger. Included is a black hardcase. An excellent example of a Ruger Single-Six. (156691-5). (250/350)
1751. **RUGER MARK III 22/45 SEMI-AUTO PISTOL** serial #220-43575, 22 LR, 5 1/2" barrel with a bright excellent bore. The stainless steel surfaces rate excellent with a few minor scratches present. The black synthetic Zytel frame and grips rate excellent showing only a few small blemishes. This target pistol is equipped with a black adjustable rear sight and a black post front sight. Included is a black plastic hardcase and a single magazine. (156691-4). (250/350)
1752. **WINCHESTER MODEL 69A BOLT ACTION RIFLE,** 22S, L, LR, 25" barrel with an excellent bore. The metal surfaces retain 97-98% original blue finish with some scattered spots of light oxidation staining. The pistolgrip walnut stock and forend rate about excellent with some dings and handling marks present. This rifle is outfitted with a rear aperture sight and front bead sight with hood. A single factory magazine is included. (156703-16) {C&R} (200/300)
1753. **BROWNING BUCK MARK TARGET SE SEMI-AUTO PISTOL** serial #655NM22690, 22 LR, 5 1/2" bull barrel with a bright excellent bore. The metal surfaces retain 99% original matte blue finish with a few light scratches on the barrel present. The smooth walnut grips with thumbrest and Browning logo rate excellent showing a few small handling marks. This pistol is equipped with a black adjustable rear sight and front post sight, as well as a gold plated target trigger. An overall excellent example of a Browning Buck Mark Target SE. (156706-5). (250/450)
1754. **NORINKO MODEL 59 SEMI-AUTO PISTOL** serial #B09555, 3 1/2" barrel with a bright excellent bore. The metal surfaces retain 99% original blue finish with some slight silvering on the thumb safety. The checkered brown plastic grips with thumb rest rate excellent with a few handling marks present. Featured is a black adjustable rear sight and black post front sight. The original factory cardboard box, a single mag and a cleaning rod are included. (156653-8). (150/250)
1755. **DAEWOO PRECISION INDUSTRIES DP51 SEMI-AUTO PISTOL** serial #O7222, 9mm, 4" barrel with a bright excellent bore. The metal surfaces retain 99% original blue finish with a few light handling marks present. The sand-blasted black finish on the frame rates excellent overall. The checkered black synthetic grips are in excellent condition as well with a few minor blemishes. A single 13 round magazine is included along with the original black plastic hardcase. (156642-13). (250/350)
1756. **WALTHER P22 SEMI-AUTO PISTOL** serial # L338402, 22 LR, 3 1/2" barrel with a bright excellent bore. The metal surfaces retain 99% original blue finish on the barrel and the Olive Drab green slide rates excellent overall. The black polymer frame rates excellent as well with no visual blemishes. Featured are adjustable white 3-dot front and rear sights. Included are a single factory magazine and the original factory black plastic hardcase. This P22 is in near perfect condition overall. (156691-2). (250/350)
1757. **HARRINGTON & RICHARDSON MODEL 649 DOUBLE ACTION REVOLVER** serial #AX020561, 22 LR, 5 1/2" barrel with a bright excellent bore. The metal surfaces retain 92-95% original blue finish showing some light surface oxidation primarily along the pistolgrip and underside of the triggerguard. There is some pitting on both sides of the frame behind the cylinder, and the cylinder surface has progressed to a light brownish blue patina showing a slight turn ring as well. The smooth hardwood western-style grips rate about excellent with a few light handling marks present. Featured are a windage-adjustable dovetailed rear sight and front blade sight. (156632-5). (125/250)
1758. **TAURUS PT-99 AF SEMI-AUTO PISTOL** serial #TJK72173, 5" barrel with a bright excellent bore. The metal surfaces retain 98% original matte blue finish with some silvering on the barrel where there is contact with the slide. There are some light handling marks and small scratches present as well amongst the slide and frame. The smooth hardwood grips with gold Taurus medallions rate about excellent with some scratches and dings present. This pistol features white 3-dot front and rear sights, the rear is adjustable. The bottom right grip screw is missing. A single magazine is included. (156676-2). (350/550)
1759. **CUSTOM HIGH STANDARD MODEL "A" SEMI-AUTO PISTOL** serial #52369, 22 LR, 4" replacement barrel with a bright excellent bore. The metal surfaces are in-the-white and rate excellent with the exception a couple of impact marks surrounding the barrel pin, most likely made when swapping out barrels. The fully checkered walnut grips rate near excellent as well with some handling marks and dings present. This pistol comes with a single factory magazine and a Bianchi Ranger Series holster. (156642-10). (350/550)
1760. **REMINGTON MODEL 1100 MAGNUM SEMI-AUTO SHOTGUN** serial #L64272M, 12 Ga., 26" ventilated rib barrel with an excellent bore. The metal surfaces retain about 97-98% original blue finish showing some silvering on the high edges and muzzle as well as some handling marks and spots of light surface oxidation. There is a good amount of finish that has thinned out along the right side of the triggerguard. The checkered pistolgrip stock and forend rate good to very good showing several handling marks and dings. There are some small patches of what appears to be a greenish-gray paint lightly scattered on the stock and forend. The underside of the pistolgrip and a spot on the forend have remnants of some sort of adhesive, perhaps from having been previously camo-wrapped. An orange fiber optic front bead is present. (156623-58). (150/250)
1761. **REMINGTON 1100 LW-20 SEMI-AUTO SHOTGUN** serial #L392161K, 20 Ga., 26" ventilated rib barrel choked improved with a bright excellent bore. The metal surfaces retain 99% original blue finish with a few light scratches and dings present. The checkered walnut pistolgrip buttstock and forend rate near excellent with some scattered dings and dents and a few spots where the high gloss finish is thinning. An overall excellent Model 1100 Lightweight. (156623-57). (250/350)

1762. **STEVENS MODEL 22-410 COMBINATION GUN** 22 LR/410 bore, 24" barrels with excellent bores. The metal surfaces on the barrels retain 98-99% reapplied blue finish with some pinprick pitting at the muzzle that's been filled in and some light handling marks present. The color case-hardened frame rates excellent exhibiting vibrant colors. The smooth walnut pistolgrip stock and forend rate excellent overall with a couple of small dings and dents. An overall excellent condition Stevens Model 22-410. (156642-32). (150/250)
1763. **CZ USA MODEL 452 BOLT ACTION RIFLE** serial #A372273, 22 LR, 25" barrel with a bright excellent bore. The metal surfaces retain 99% plus original blue finish. The checkered pistolgrip walnut stock and forend with schnabel forend tip rates excellent overall with no visual dings or blemishes. A single factory magazine is included. An overall like-new condition CZ Model 452. (156683-7). (350/450)
1764. **WINCHESTER MODEL 74 SEMI-AUTO RIFLE** serial #346382A, 22 LR, 22" barrel with a bright excellent bore. The metal surfaces retain 98-99% original blue finish with very light silvering at the muzzle and a few small handling marks present. The checkered pistolgrip walnut stock rates excellent displaying a few small dings and dents. An overall excellent Winchester Model 74. (156642-39) {C&R} (200/300)
1765. **SAVAGE MODEL 24C COMBINATION GUN** serial #D040267, 22 LR/20 Ga., 20" barrels with bright excellent bores. The metal surfaces on the barrels retain 98-99% original blue finish with a few light handling marks and some impact marks present on both sides of the hinge pin. The color case-hardened receiver rates excellent retaining 98% of its bright colors with some thinning on the tang. The smooth high gloss hardwood pistolgrip stock and forend rate about excellent with a few scratches and dings present. A very good to near excellent Model 24C "Camper's Companion" combination gun. (156706-23). (300/500)
1766. **SMITH & WESSON MODEL 3000 POLICE SLIDE ACTION SHOTGUN** serial #FC54321, 12 Ga., 18" barrel choked cylinder with a good bore showing some pitting and oxidation staining along the lands and grooves. The metal surfaces retain about 80-85% original blue finish with some light oxidation staining scattered amongst the barrel and receiver as well as some thinning along the magazine tube and slight silvering at the muzzle and triggerguard. The black synthetic Davis Co. pistolgrip buttstock and ribbed forend rate very good with some scratches and handling marks present. The bottom screw on the recoil pad has pulled through the pad and is screwed in the stock therefore no longer supporting the pad. The Davis buttstock had two cutout slots, one on each side, for extra shell storage. (156691-27). (75/150)
1767. **MOSSBERG 500 REGAL SERIES SLIDE ACTION SHOTGUN** serial #J839393, 12 Ga., 28" ventilated rib barrel choked modified with a bright excellent bore. The metal surfaces retain 95-97% original blue finish with some scattered spots of surface oxidation primarily on the barrel and rib, as well as some silvering on the magazine tube and a bit at the muzzle. There are some scattered handling marks present as well. The select checkered walnut stock and forend rate about excellent showing some minor handling marks and dings. There is some residue where a sticker had been previously stuck on the right side of the receiver. Also mounted to the rib is a pair of front and rear red and green fiber optic sights. (156691-50). (150/200)
1768. **MOSSBERG 385KB BOLT ACTION SHOTGUN** serial #09012B, 20 Ga., 26" C-lect Choke plain barrel with a bright excellent bore. The metal surfaces retain 97-98% original blue finish with most of the thinning on the bolt handle and floorplate as well as some other spots of light loss. There are a few light scratches and handling marks present as well. The smooth hardwood pistolgrip stock and forend rate about excellent overall displaying some small dings and dents. A single factory box magazine is included. (156664-4). (100/200)
1769. **BROWNING AUTO-5 GRADE 1 SEMI-AUTO SHOTGUN** serial #82109, 12 Ga., 30" plain barrel choked full with a bright excellent bore. The metal surfaces retain 95-97% original blue finish with silvering on the high edges and a few spots of blue that are beginning to thin out. There are some very small spots of light surface oxidation and scratches, primarily located on the receiver. The checkered fiddleback walnut round knob pistolgrip stock and forend rate very good displaying some handling marks and dents. This pre-war Belgian Auto-5 is in very good condition overall. (156642-49) {C&R} (200/400)
1770. **ITHACA MODEL 37 FEATHERLIGHT SLIDE ACTION SHOTGUN** serial #581671, 16 Ga., 28" barrel choked modified with a bright excellent bore. The metal surfaces retain 98-99% professionally reapplied matte blue finish showing some operational loss along the magazine tube and remnants of sparse oxidation staining. The smooth pistolgrip walnut stock and ribbed forend rate about excellent with some handling marks and scratches present. This Model 37 Featherlight is in excellent condition overall. (156623-59). (200/400)
1771. **ITHACA MODEL 37 FEATHERLIGHT SLIDE ACTION SHOTGUN** serial #643045, 16 Ga., 28" plain barrel choked modified with a bright excellent bore. The metal surfaces retain 92-95% original blue finish with some scattered light surface oxidation as well as silvering on the high edges and a patch of pitting on the top of the receiver and bottom left side near the ejection port. The checkered walnut buttstock and ribbed forend are in good to near very good condition showing some dings and scratches as well as a 1/2" by 3/4" chip missing on the left underside of the pistolgrip where the stock meets the triggerguard and a 1" crack mirroring the missing chip on the right side. There is a 3/4" by 2" section on the toe of the buttstock that has been glued back on, and a 1/2" section of the bottom of the black plastic buttplate is missing. (156678-35). (150/250)
1772. **J.C. HIGGINS MODEL 20 SLIDE ACTION SHOTGUN** 12 Ga., 28" barrel with a bright excellent bore. The metal surfaces retain 95% original blue finish with some operational wear on the magazine tube and some thinning and handling marks on the receiver as well as some silvering on the high edges. The smooth walnut pistolgrip buttstock and ribbed forend rate about excellent showing some dents and dings as well as some patches where the semi-gloss finish has worn off. An overall very good example of a J.C. Higgins Model 20 shotgun. (156698-8). (75/150)
1773. **STEVENS MODEL 315 BOXLOCK DOUBLE SHOTGUN** serial #E26952, 12 Ga., 28" barrels choked improved cylinder and modified with bright excellent bores. The metal surfaces on the barrels retain 95-97% original blue finish with some slight silvering at the muzzles and some light thinning along both barrels in various spots. The triggerguard shows some flaking and minor scratches as well. The color case-hardened receiver rates very good exhibiting about 70% of its original coloration with most of the loss located on the underside of the receiver. The smooth walnut pistolgrip stock and forend rate very good to near excellent displaying some handling marks and dents throughout. The length of pull is 14 1/4" and the drops are 1 3/4" and 2 3/4". This Model 315 is manufactured under the trade name Springfield and is in near excellent condition overall. (156623-55). (100/200)
1774. **MARLIN MODEL 512 SLUGMASTER BOLT ACTION SHOTGUN** serial #04455893, 12 Ga., 21" Deer barrel with rifle sights with a bright excellent bore. The metal surfaces retain 99% original blue finish with some operational marks on the bolt as well as a few small blemishes and scratches. The press checkered pistolgrip birch stock and forend rate excellent overall. A single 2 round detachable box magazine is included. (156635-7). (150/250)
1775. **WINCHESTER MODEL 120 RANGER SLIDE ACTION SHOTGUN** serial #L599113, 12 Ga., 28" ventilated rib barrel choked improved cylinder with a bright excellent bore. The metal surfaces retain 99% original blue finish with some light scratches and handling marks on the receiver and a small amount of surface oxidation near the forend cap. The checkered pistolgrip buttstock and forend rate excellent displaying only a couple of minor dings and dents. An overall excellent condition Model 120 Ranger. (156691-28). (100/200)
1776. **AMERICAN GUN COMPANY VICTOR PLAIN SINGLE SHOT SHOTGUN** serial #321296, 12 Ga., 30" plain barrel choked modified with an excellent bore. The metal surfaces exhibit a brownish-blue patina with some scattered remnants of original blue finish and a few spots of surface oxidation. The receiver is more of a mottled gray with some hints of brown as well and rates very good with some handling marks present. The smooth walnut pistolgrip stock and forend rate good to near very good with some scratches and dents present as well as a custom grip cap. (156518-20) {C&R} (50/100)

1777. **SAVAGE MODEL 220 SINGLE SHOT SHOTGUN** 12 Ga., 30" ventilated rib barrel choked improved modified with a good to very good bore showing some frosting towards the breech end of the barrel. The metal surfaces on the barrel retain 97% reapplied blue finish showing some surface oxidation along both sides of the rib as well as a few other spots. The triggerguard is beginning to flake and the receiver is a grayish brown patina displaying some spots of oxidation staining as well. The smooth pistolgrip Monte Carlo stock and semi-beavertail forend rate very good overall showing some handling marks and dings. (156623-56). (50/100)
1778. **J.C. HIGGINS MODEL 583.22 BOLT ACTION SHOTGUN** 20 Ga., 26" plain barrel with a bright excellent bore. The metal surfaces retain 98% original blue finish with some loss on the bolt handle and a few small handling marks. The smooth pistolgrip walnut stock and forend rate about excellent displaying a few dings and dents. An overall near excellent condition Model 583.22 shotgun. (156698-9) {C&R} (75/150)
1779. **REMINGTON MODEL 1100 SEMI-AUTO SHOTGUN** serial #M857152V, 12 Ga., 26" ventilated rib barrel choked skeet with a bright excellent bore. The metal surfaces retain 99% original blue finish with a couple of very light spots of oxidation staining along the edges of the forend. The checkered pistolgrip walnut stock and forend rate near excellent displaying a few dings and a crack at the toe of the stock that perpendicularly extends out 3 1/2" from the buttplate on both sides. This Model 1100 is in near excellent condition overall. (156691-54). (150/250)
1780. **REMINGTON MODEL 11 SEMI-AUTO SHOTGUN** serial #1565979, 16 Ga., 28" plain barrel choked full with a bright excellent bore. The metal surfaces retain 98-99% original blue finish with some handling marks and light spots of oxidation staining scattered throughout. The pistolgrip walnut stock and forend rate very good displaying some scratches and dings, primarily on the buttstock. The front bead sight has been painted bright orange. An overall very good to near excellent condition Model 11 Shotgun. (156706-24) {C&R} (150/250)
1781. **SAVAGE MODEL 30 SERIES D SLIDE ACTION DEER BARREL SHOTGUN** serial #B625965, 12 Ga., 22" deer barrel choked with a very good to near excellent bore with the exception of some light frosting towards the breech end of the barrel. The metal surfaces retain 97-98% original blue finish with some operational wear along the magazine tube and silvering on the high edges as well as some light spots of surface oxidation. The checkered walnut pistolgrip buttstock and smooth forend rate very good with some handling marks and scratches present. The barrel has "Savage Model 30 Series E" printed on the side therefore making it a replacement barrel and not the original. (156691-30). (75/150)
1782. **MOSSBERG 500AT SLIDE ACTION SHOTGUN** serial #G268929, 12 Ga., 28" plain barrel choked improved cylinder with a near excellent bore despite some minor frosting towards the muzzle end of the barrel. The metal surfaces retain about 85-90% original blue with some operational loss along the magazine tube, scattered scratches and marks and silvering on the high edges as well as a 3/8" by 1/4" bare metal spot on the left side of the receiver. There are some patches of surface oxidation as well, primarily on the barrel and magazine tube as well as a few light streaks of white paint that are present on the barrel. The hardwood pistolgrip stock and ribbed forend rate good to very good with some handling marks and scratches including a chip missing from the left side of the stock where it meets the receiver. There are spots and streaks of white paint also present on both the buttstock and forend. (156691-46). (75/150)
1783. **SEARS ROEBUCK AND CO. MODEL 200 SLIDE ACTION SHOTGUN** serial #P202192, 12 Ga., 21" Deer barrel with rifle sights with a bright excellent bore. The metal surfaces retain 97% original blue finish with some handling marks present and some patches of light oxidation staining. The smooth pistolgrip hardwood buttstock and forend rate near excellent with a few small dings and dents present. This Sears Model 200 shotgun was originally manufactured by Winchester and categorized as a Model 1200 and in near excellent condition overall. (156691-35). (100/200)
1784. **CALICO M-100 SEMI-AUTO CARBINE** serial #006168, 22 LR, 16 1/8" barrel with a bright excellent bore. The metal surfaces retain 98-99% original black finish with some handling marks and scratches present as well as some thinning around the rear forend iron. The synthetic black pistolgrip and ribbed forend with aluminum folding buttstock rates excellent overall with a few dings and blemishes. This carbine comes with a single 100 round magazine as well as a magazine pouch. An overall excellent condition Calico M-100 rifle. (156706-7). (350/550)
1785. **REMINGTON MODEL 1100 DEER GUN SEMI-AUTO SHOTGUN** serial #110566V, 12 Ga., 21" Deer barrel with rifle sights choked improved cylinder with a very good bore displaying some oxidation and frosting on the lands and grooves. The metal surfaces retain 98% original blue finish with some small dings and handling marks as well as a few spots of surface oxidation on the receiver. The gloss finished checkered walnut pistolgrip stock and forend rate very good to near excellent showing a few dents and spots where the finish is thinning out. Included with this shotgun is black nylon Mil-tech sling with cartridge loops. An overall near excellent condition Model 1100 Deer Gun. (156691-53). (150/250)
1786. **MOSSBERG 385K BOLT ACTION SHOTGUN** 20 Ga., 26" C-lect choke plain barrel with a bright excellent bore. The metal surfaces retain 98-99% original blue finish with some operational wear on the bolt and a few scattered handling marks as well as some very light patches of surface oxidation. The smooth hardwood Monte Carlo stock and forend rate excellent overall with only a couple of small dings and dents. A single factory box magazine is included. (156664-5). (100/200)
1787. **SMITH & WESSON MODEL 1000 SEMI-AUTO SHOTGUN** serial #FSO3654, 12 Ga., 28" ventilated rib barrel choked modified with a bright excellent bore. The metal surfaces retain 98-99% original blue finish displaying scroll engraving on the receiver with a few small areas of surface oxidation and some light scratches and handling marks present. The high gloss finished checkered pistolgrip buttstock and forend rate about excellent with the exception of a few dings and scratches as well as some spots where the finish is thinning out. An overall excellent condition Smith & Wesson Model 1000. (156676-7). (250/350)
1788. **ITHACA FIELD GRADE BOXLOCK DOUBLE SHOTGUN** serial #190517, 12 Ga., 26" open cylinder barrels with bright excellent bores. The metal surfaces on the barrels retain about 92% original blue finish showing some fading and remnants of light oxidation staining and some handling marks present. The receiver has traces of case-hardened color remaining, primarily on the water table, while the rest displays light and dark gray tones. The checkered round knob walnut buttstock and forend rate very good showing some dings and dents. The length of pull is 13 3/4" to the buttplate and the drops are 1 3/4" and 2 3/4". A nice example of an Ithaca Field Grade double shotgun. (156544-1) {C&R} (400/600)
1789. **ITHACA MINIER FIELD GRADE BOXLOCK DOUBLE SHOTGUN** serial #135634, 12 Ga., 28" barrels choked modified and open cylinder with excellent barrels showing a few small pits towards the breech end. The metal surfaces on the barrels retain about 95% original blue finish showing some scattered oxidation staining as well as a few handling marks. The receiver and triggerguard has some surface oxidation throughout and exhibits a brownish gray patina with the words "Ithaca Hammerless" inscribed on both sides surrounded by light scroll engraving. The checkered round knob walnut pistolgrip buttstock and forend rate good to near very good showing some scratches and dents as well as some spots where the finish is thinning. The length of pull is 14 1/4" to the buttplate and the drops are 1 1/2" and 2 3/4". (156664-6) {C&R} (400/600)

1790. **UNION MACHINE CO. BELGIAN DOUBLE HAMMERMUN** serial #114023, 12 Ga., 30" damascus barrels choked modified and improved modified with bright excellent bores showing a few small remnants of some very light pitting. The laminated steel barrels show nice contrasting pewter and brown twist damascus patterning leaving the closest 2 1/2" sections towards the breech plain steel with lightly engraved bands. The gray frame and sideplates show large amounts of wear with little traces of case-hardened color showing and some spots of brown patina. The checkered round knob English walnut stock and forend rate near excellent with all of its original varnish showing some small dings and dents and a 3/4" crack starting at the rear of the tang and drifting to the right side of the grip. The length of pull is 14 1/8" to the black plastic buttplate with drops of 2" and 3 1/2". A very good example of a Union Machine double. (156565-6) {C&R} (150/250)
1791. **ITHACA FIELD MODEL BOXLOCK SHOTGUN** serial #252843, 12 Ga., 28" barrels choked modified and cylinder with very good bores that are lightly frosted and have a few small dents near the muzzles. The barrels have an overall brown patina with light fading at the muzzles, while the frame has little original finish left due to having steel plate welded to either side. It is unknown why these plates were added. Most of the welds have been polished, but are still rough on the left side. The hand checkered walnut stock is in good condition overall with the buttstock missing chips on either side of the tang with a 2" crack in the wrist. The butt does have the original hard rubber buttplate and the stocks sit loose overall on the frame. A good "parts only" candidate. (156664-7). (50/75)
1792. **SIMSON DSM-34 SINGLE SHOT BOLT ACTION RIFLE** serial #131125, 22 LR, 26" barrel with a bright excellent bore. The metal surfaces retain 95-97% original blue finish with some silvering at the muzzle and a bit of operation loss on the bolt with some scratches and handling marks present as well as light spots of surface oxidation. The checkered round knob Monte Carlo walnut replacement stock with left side flared cheekpiece and black forend tip rate excellent with the exception of a few dings and dents present. This Simson rifle was a German pre-WWII training rifle that appears to have been outfitted with a custom stock. An adjustable leather sling is included. An overall excellent condition Simson DSM-34 rifle. (156698-13). (75/150)
1793. **ITHACA DOUBLE HAMMERMUN** serial #18624, 12 Ga., 28" damascus barrels with open cylinders with good to very good bores showing remnants of pitting along the entire lengths of both barrels. The steel barrels show nice contrasting pewter and brown twist damascus patterning with some dark brown spots due to oxidation staining. The gray receiver shows some wear primarily along the carry point of the front of the receiver and the lower portions of each side. The original engravings "New Ithaca Gun" with loose foliate scrolls on either side are beginning to thin as well. The checkered round knob buttstock and forend rate very good showing some dings and dents acquired over the years. The hard rubber buttplate has a 1/2" by 1/16" chip missing where the toe of the stock meets the buttplate. The length of pull is 14" with drops of 1 7/8" and 3 1/4". A nice example of a "New Ithaca Gun" in its original configuration. (156707-22) {ANTIQUE} (100/200)
1794. **MAUSER MODEL GEW. 98 SPORTER BOLT ACTION RIFLE** serial #8847j, 20" barrel with a bright excellent bore. The metal surfaces retain about 95% original blue finish with some silvering on the muzzle and high edges as well as some spots of surface oxidation. There is some dark blue residue on the left side of the receiver where it is drilled for a scope mount and is most likely leftover thread locking material from a previous installment. The smooth pistolgrip walnut custom sporter buttstock with left side flared cheekpiece rates about very good displaying some scattered dings and dents as well as some spots where the finish is thinning and a few white streaks located on the left side behind the cheekpiece. This rifle is outfitted with a DuPont neoprene recoil pad and comes with a Weaver K3 scope and sidemount. (156623-19). (100/200)
1795. **REMINGTON SPORTSMAN 48 SEMI-AUTO SHOTGUN** serial #3026631, 12 Ga., 30" ventilated rib barrel with a good to about very good bore showing some patches of frosting and surface oxidation. The metal surfaces retain about 90% original blue finish displaying patches of surface oxidation giving the receiver a brown patina color with some spots beginning to thin to bare metal, mainly along the edges. The checkered pistolgrip walnut stock and forend rate good with some dents and dings present as well as a 1/8" crack running underneath the entire length of the forend. There is a 2" by 4" rectangular area on the right side of the buttstock with some residue left over from where a sticker was placed at one point. (156691-31) {C&R} (50/100)
1796. **ACME ARMS BELGIAN DOUBLE HAMMERMUN** serial #18, 12 Ga., 30" barrels with open cylinders with near bright excellent bores exhibiting a few small remnants of pitting. The metal surfaces on the barrels have been stripped of their finish showing some spots of surface oxidation. The receiver and sideplates are a light gray color with some darker spots of oxidation staining. The checkered round knob walnut stock and replacement forend rate very good with some dings and dents from the years. The length of pull to the steel buttplate is 14 1/4" with drops of 1 7/8" and 2 3/4". The firing pin is missing in its current state of condition. (156691-34) (50/100)
1797. **AGUIRRE Y ARANZABAL IBERIA BOXLOCK SHOTGUN** serial #114948, 28" barrels choked modified and full with bright excellent bores. The metal surfaces retain 98% original blue finish with some light scattered surface oxidation, primarily at the muzzles. The coined receiver with light engraving rates about excellent with some darker spots of oxidation staining present on top of the action. The checkered straight grip English style European Walnut stock and forend rate about excellent with a few minor dings and dents present and the remnants of a sticker that was once on the right side of the buttstock. There is a hole drilled out for a swivel stud on the underside of the buttstock as well. The length of pull to the hard plastic buttplate is 14 1/2" with drops of 1 1/2" and 2 1/2". (156706-21) (150/250)
1798. **LOT OF M1A PARTS** Included is a bright excellent M1A barrel with D.O.D. mark, which retains about 97-98% original blue finish with some surface oxidation in a few spots but mostly on the flash suppressor, with a factory mark "NM" for National Match on top of the barrel. Also included is an original walnut M14 stock with selector cut, with brown fiberglass handguard which rates excellent overall displaying a few dings and dents. The receiver was cut and removed from about 5" from the rear forward and is no longer present. The trigger assembly, bolt operating slide and its attendant parts and rear sight aperture are all included. An adjustable brown leather sling is attached as well. (156519-535)
1799. **THOMPSON CENTER ARMS G2 CONTENDER SINGLE SHOT RIFLE** serial #G17270, 18" barrel with a bright excellent bore. The metal surfaces retain 99% plus original polished blue finish. The smooth pistolgrip Monte Carlo stock rates excellent with the exception of a few light scratches and dings present. A scope rail is currently mounted to the barrel as well as a pair of scope rings. The forend is not included with the rifle. An overall excellent condition G2 Contender. (156520-3124) (250/350)
1800. **J. MANTON & CO. BELGIAN DOUBLE HAMMERMUN** serial #B7, 30" damascus barrels choked modified and cylinder with bright excellent bores. The contrasting brown and pewter damascus twist patterned barrels rate very good with some oxidation staining present as well as some light scratches. The receiver has some spots of case-hardened color still remaining, mostly on the sideplates and breech edges with other spots showing dark oxidation stains. The checkered pistolgrip walnut stock and forend rate good to very good with some scattered dings and dents as well as a 2" fine crack on the left side of the pistolgrip and a 5" crack along the left side of the forend. The length of pull to the metal buttplate is 14 1/4" with drops of 1 5/8" and 3". (156625-44) {C&R} (100/200)
1801. **SCOPE LOT** Consists of a two red dot sights. The first is a Tasco ProPoint 1x30mm red dot sight, which operates on a single CR-1/3N 3-Volt battery, with the second being an Aimpoint 3000 1x25.4mm red dot sight, which operates on a single 2L76 3-Volt battery. Both sights are operational and feature manually adjustable brightness levels. Both red dot sights include mounted scope rings. Tasco ProPoint red dot sight also comes with transparent lens covers. (136235-1; 2)

1802. **REAMER LOT** Includes a finishing reamer for 303 British and 30 Caliber throater, both manufactured by Redford Reamer Company. Both items rate excellent and exhibit no noticeable signs of any damage or deterioration. Lot items come housed in a protective cardboard case which rates in near excellent condition. (131096-1AP)
1803. **REAMER LOT** Consists of a single L. E. Wilson finisher reamer for 30-40 Krag, which rates very good plus, but does exhibit some minor wear. Additionally, the attached bolt exhibits moderate brown oxidation, but the reamer body would appear to be free of any such development. The finisher is housed in a capped protective plastic tube, and stored in a cardboard case. (131096-1AQ)
1804. **REAMER LOT** Consists of a reamer for 45-70 Government, which rates near excellent, but does exhibit some extremely minor wear. The reamer is housed in a capped protective plastic tube. Additionally, the lot includes a reamer stone by Carbondum, which rates excellent and comes in its factory original cardboard box. The factory box for the reamer stone rates near excellent and shows minimal faint signs of wear. (131096-1AR)
1805. **LOT OF 12 GAUGE SHOTSHELLS** Consists of two boxes of Remington Express, one box of Remington Express Long Range, two boxes of Western Super X Mark 5, two boxes of Remington Shur Shot, one box of Remington Dove/Quail Load, one box of Remington Western Super X, one box of Western Xpert, and one box of Power Mate; totaling 219 shells. The boxes of Remington Dove/Quail Loads 2 3/4" #8shot, and one box of Remington Express 2 3/4" #7 1/2 shot each, and the box of Remington Express Long Range 2 3/4" #6 shot contain 25 of what would appear to be their original shells. The box of Power Mate 2 3/4" #8 shot contains 13 shells, while the remaining box of Remington Express 2 3/4" # 7 1/2 shot contains 21 shells; the contents of both appear to be shells original to their respective boxes. Additionally, both boxes of Western Super X Mark 5 each contain 25 assorted shells. The box of Western Super X contains 16 shells, while the box of Western Xpert contains 10 shells, and with both boxes of Remington Shur Shot containing 16 and 18 shells respectively; the contents of the boxes are all assorted shells. The conditions of the boxes range from near very good to near excellent, and exhibit various degrees of wear accordingly. (135045-6A1)
1806. **LOT OF 20 GAUGE SHOTSHELLS** Consists of three boxes of Remington Dove/Quail Load, two boxes of Remington Game Load, one box of Remington ShurShot Field Load, one box of Remington ShurShot Heavy Dove, one box of Remington Express, one box of Remington Slugger Hollow Point rifled slugs, one box of Western Xpert, one box of Western Super X Mark 5, one box of Winchester Dove & Quail, and one box of Federal Field Load; totaling 293 shells. The boxes of Remington ShurShot Field Load 2 3/4" #8 shot, Remington ShurShot Heavy Dove 2 3/4" # 8 shot, Remington Slugger 2 3/4" Hollow Point rifled slugs, both boxes of Remington Game Loads 2 3/4" #7 1/2 shot and two boxes of Remington Dove/Quail 2 3/4" # 8 shot Load each contain 25 shells which would appear to be original to their respective boxes, except for the box of Remington Slugger Hollow Point rifled slugs which contain 5 slugs. The box of Remington Express 2 3/4" #7 1/2 shot contains 21 shells which appear to be original to the box. The boxes of Federal Field Load, Western Xpert, and one box of Remington Dove/Quail each contain 25 assorted shells. The remaining box of Western Super X Mark 5 contains 17 shells, 16 of which appear to be original to the box. The conditions of the boxes range from near very good to near excellent, and exhibit various degrees of wear accordingly. (135045-6A2)
1807. **LOT OF 16 GAUGE SHOTSHELLS** Consists of two boxes of Remington Shur Shot Field Load, two boxes of Winchester Dove & Quail, two boxes of Federal Hi-Power, one box of Remington Game Loads, one box of Remington Express, one box of Western Upland, and one box of Peters Victor Field Loads, totaling 234 shells. The boxes of Remington Game Loads 2 3/4" #7 1/2 shot, Peters 2 3/4" #6 shot Victor Field Loads, Western Upland 2 3/4" #9 shot, one box of Federal Hi-Power 2 3/4" 7 1/2 shot, and one box of Remington Shur Shot 2 3/4" #9 shot Field Load each contain 25 shells which would appear to be original to their respective boxes. The box of Remington Express 2 3/4" #7 1/2 shot contains 24 shells which appear to be original to the box. Both boxes of Winchester Dove & Quail as well as the remaining box of Federal Hi-Power each contain 25 assorted shells. The remaining box of Remington Shur Shot Field Load contains 10 assorted shells. The conditions of the boxes range from near very good to near excellent, and exhibit various degrees of wear accordingly. (135045-6A3)
1808. **REDFIELD SCOPE LOT** Consists of a single 6-18x Redfield Revenge Varmint scope, featuring a duplex reticle with bullet drop indicators and Accu-Ranger measurement system. Scope retains about 98% of its factory blue finish, although with some faint marks from previous mounting in scope rings. The scope demonstrates crisp, clear optics. Included with the lot is a set of rubber lens covers. (136610-9A)

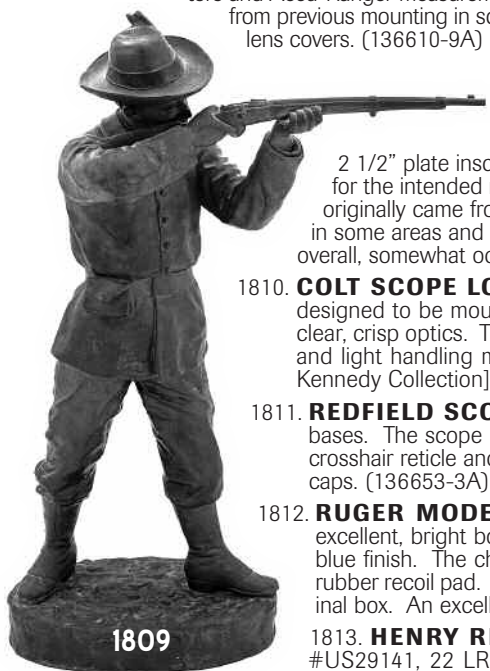

1809. **BRONZE SHOOTING CLUB TROPHY STATUE** This hollow bronze statue depicts a man shouldering an 1886 French Lebel rifle and peering down the sights. Standing 20" high with a 5 1/2" by 8 1/2" oval base, this bronze was intended to be awarded to the winner of a handicap trap shooting exhibition. Screwed into the front of the base is a 1" by 2 1/2" plate inscribed "W.H.S.C Handicap Trap Shooting Sept. 1913 Won By" with a blank space underneath for the intended recipient. West Houston Shooters Club in Houston Texas is believed to be where this bronze originally came from. This statue is in very good to near excellent condition overall showing a yellowish patina in some areas and what appears to be light mildew along the base embedded in the creases. A neat depiction overall, somewhat odd to present a rifleman to shotgunner. (156263-1)

1810. **COLT SCOPE LOT** Consists of a single 3rd generation Colt marked 3x20mm scope for AR-15 style rifles, designed to be mounted to the rifle's carry handle. The scope features a standard duplex reticle and exhibits clear, crisp optics. The scope retains about 98% of its factory original blued finish and despite some minor wear and light handling marks, proves to be a near excellent example overall. (136520-3384A) [Richard "Stretch" Kennedy Collection]
1811. **REDFIELD SCOPE LOT** Consists of a single 2 3/4x Redfield 1" Tube scope mounted on a set of Redfield bases. The scope rates excellent and exhibits no discernible handling marks. The scope features a post-and-crosshair reticle and displays clear, crisp optics. Included with the scope lot is a set of Butler Creek flip-up lens caps. (136653-3A)
1812. **RUGER MODEL 10/22 CARBINE** semi-auto rifle serial #231-15588, 22 LR, 18 1/2" barrel with an excellent, bright bore. The metal surfaces rate excellent and have retained about 99% of their factory original blue finish. The checkered walnut stock rates excellent and exhibits minimal wear. The stock features a hard rubber recoil pad. The rifle comes with a single 10 round rotary magazine, manual, accessories, and factory original box. An excellent example overall of these deluxe checkered 10/22 rifles. (136520-1963) (250/450)

1813. **HENRY REPEATING ARMS U.S. SURVIVAL SEMI-AUTO TAKEDOWN RIFLE** serial #US29141, 22 LR, 16" barrel with an excellent, bright bore. The metal surfaces rate very good plus and retain about 95% of their original silver weather resistant finish. The smooth silver plastic stock rates very good, but does exhibit some light handling marks and a few cracks in the plastic. The removable buttplate also exhibits a fairly sizable crack along its lower right side. The rifle comes with two 8 round magazines, manual, and factory original case. (136520-1376) [Richard "Stretch" Kennedy Collection] (75/150)

1814. **HENRY REPEATING ARMS U.S. SURVIVAL SEMI-AUTO TAKEDOWN RIFLE** serial #US01148, 22 LR, 16" barrel with an excellent, bright bore. The metal surfaces rate very good plus and retain about 93% of their original silver weather resistant finish, with noticeable handling marks prevalent along the barrel. The smooth silver plastic stock rates very good plus, but does exhibit some light handling marks. The removable buttplate also exhibits a few light handling marks, but likewise rates very good plus overall. The rifle comes with two 8 round magazines, factory included paperwork, as well as factory original case and tag. (136520-1523) [Richard "Stretch" Kennedy Collection] (75/150)
1815. **REMINGTON LIMITED EDITION MODEL 597 SEMI-AUTO RIFLE** serial #A2670268, 22 LR, 20" barrel with an excellent, bright bore. The barrel and receiver both rate excellent and retain about 99% of their respective factory original matte blue an enameled finishes. The smooth red synthetic stock rates near excellent, with a few minor light handling marks present. The stock features a lithographed Dale Earnhardt JR signature over the number 8 car logo. The rifle comes with a single 10 round detachable magazine, manual, and factory original box. Overall an excellently maintained rifle and must have item for the #8 fan. (136520-1386) [Richard "Stretch" Kennedy Collection] (150/250)
1816. **THOMPSON CENTER HOT SHOT SINGLE SHOT BREAK-ACTION RIFLE** serial #HS26011, 22 LR, 19" barrel with an excellent, bright bore. The barrel and aluminum frame both rate excellent and retain about 98% of their respective factory original matte blue and satin black finish, with a few light handling marks present, particularly along the receiver's left side. The black synthetic forend and Monte Carlo stock both rate excellent, with negligible handling or wear marks. The rifle comes with a manual, accessories, and factory original box. (136520-712) [Richard "Stretch" Kennedy Collection] (75/150)
1817. **THOMPSON CENTER HOT SHOT SINGLE SHOT BREAK-ACTION RIFLE** serial #HS25232, 22 LR, 19" barrel with an excellent, bright bore. The barrel and aluminum frame both rate excellent and retain about 98% of their respective factory original matte blue and satin black finish. There is a single light handling mark present along the receiver's right side, as well as a few light marks on the barrel toward the muzzle. The black synthetic forend and Monte Carlo stock both rate excellent, with negligible handling or wear marks. The rifle comes with a manual, accessories, and factory original box. (136520-711) [Richard "Stretch" Kennedy Collection] (75/150)
1818. **REMINGTON NYLON APACHE 77 SEMI-AUTO RIFLE** serial #A2342766, 22 LR, 19 5/8" barrel with an excellent, bright bore. The parkerized metal surfaces rate excellent and do not exhibit any particular signs of either damage or wear. The checkered green laminate synthetic stock rates near excellent, but with some minor light handling marks. The rifle comes with a single 10 round detachable box magazine, manual, and factory original box. (136520-1688) [Richard "Stretch" Kennedy Collection] (100/200)
1819. **WINCHESTER MODEL 70 HEAVY VARMINT BOLT ACTION RIFLE** serial #G2135116, 223 Remington, 26" barrel with an excellent, bright bore. The rifle features a woodland camouflage pattern which exhibits moderate flaking. The receiver and factory heavy barrel both rate near very good and retain about 80% plus of the woodland finish, with numerous bright handling marks on the barrel particularly toward the muzzle. The jeweled bolt rates near excellent and actions smoothly. The smooth synthetic stock rates very good, although exhibiting more extensive flaking of the camo finish than is present on the metal surfaces. The stock features a factory rubber recoil pad. (136520-3131) [Richard "Stretch" Kennedy Collection] (300/500)
1820. **MARLIN MODEL 1894C CARBINE LEVER ACTION RIFLE** serial #21049335, 357 Magnum, 18 1/2" barrel with an excellent, bright bore. The metal surfaces rate very good and retain about 96% of their factory original blue finish, with some light handling marks as well as minor oxidation around the muzzle. The rifle features a hammer extension to assist with manually cocking the trigger. The smooth walnut forend and straight stock both rate very good but exhibit extensive noticeable handling marks. The rifle features a set of installed sling mounts, as well as a Bushnell 4x Banner scope. The scope features a duplex reticle and crisp, clear optics. This particular rifle does not feature a hammer block safety. (136623-1) (350/550)
1821. **MARLIN MODEL 336RC CARBINE LEVER ACTION RIFLE** serial #V21477, 35 Remington, 20" barrel with bright, although lightly oxidized, bore. The metal surfaces rate very good and retain about 89% overall of their factory original blue finish, with some areas along the receiver turning to a mottled or gunmetal gray tint. The rifle features a hammer extension to assist with manually cocking the trigger. The smooth walnut forend and straight stock both rate very good plus and exhibit minor light handling marks. The rifle features an installed Bushnell 2.5x Banner scope which displays a post-and-crosshair reticle with crisp, clear optics. (136641-2) (300/500)
1822. **CHERRY'S IMPORT YUGOSLAVIAN M48BO "EGYPTIAN" MAUSER BOLT ACTION RIFLE** serial #V58043, 8mm Mauser, 24" barrel with an excellent, bright bore. The metal surfaces rate near excellent and retain about 96% of their arsenal-type reblued finish, with a few minor light handling marks. The bright polished bolt assembly rates near excellent and exhibits some light use-related wear. The smooth walnut stock rates very good plus although with several handling marks, including an extremely shallow chip measuring about 3/4" in length running along the right side of the stock near the forward-most barrel band. The rifle features a hooded front sight and cleaning rod; comes with a leather sling, cleaning kit, double pocketed ammo pouch, bayonet with scabbard and frog, and original importer box. The bayonet is stamped "Preduzece 44" on the right side of the blade and displays the serial number 3098 on the hilt, with the scabbard non-matching. The bayonet exhibits a substantial deep crack running the entire length of the left grip panel, as well as some other more minor instances of damage. The receiver, bolt, magazine floorplate, and stock all display matching stamped serial numbers, however the rifle exhibits no other factory markings; indicative of this particular model of Yugoslavian Mauser. There is a single marking from Cherry's on the underside of the barrel. Supplemental research indicates that M48BOs (Bez Oznake--"without markings") lacked factory markings as they were intended chiefly for export, mostly to Middle Eastern states, with the box denoting that the rifle originally wound up in Egypt. An included sheet specifies that some such unmarked specimens were reputedly used by Egypt during the 1956 Suez crisis. (136520-1683) [Richard "Stretch" Kennedy Collection] (250/450)
1823. **WINCHESTER MODEL 1894 SADDLE RING CARBINE LEVER ACTION RIFLE** serial #210633, 25-35 WCF, 20" round barrel with a near excellent, bright bore. The metal surfaces rate very good and retain about 90% of their reblued finish, with some light scratches along the barrel as well as wear and handling marks on the receiver; including, but not limited to: pinprick pitting, light oxidation, and a minor scuff. The smooth walnut straight stock and forend both rate very good but exhibit numerous faint to light handling marks and several noticeable dings. The rifle has been non-factory drilled and tapped and features a saddle ring on the left side of the receiver. Winchester factory records indicate that this particular Model 1894 was manufactured in 1901 and it remains in very good condition overall. (136520-3126) [Richard "Stretch" Kennedy Collection] (C&R) (300/500)
1824. **WINCHESTER LOT** consists of a standard checkered walnut stock and blued barrel chambered in 30-06 Springfield, both of which originally comprised a Pre-64 Model 70 bolt action rifle and rate very good overall. The stock exhibits moderate handling marks, including a slight chip in the right side of the wood running parallel to the barrel. The barrel, meanwhile, features an excellent bright bore and retains about 91% of its factory original blued finish, although exhibiting several light handling marks as well as some minor fading of the blue. Also of note concerning the barrel, "BELDING" has been lightly etched along the top of the barrel near the breech. All other major parts aside from the barrel and stock have been removed from the rifle, however sling mounts and iron sights remain installed. (136033-1)

1825. **PARTS KIT FOR STAR Z-45 SPANISH SUBMACHINE GUN** Chambered for the 9x23mm Largo cartridge and manufactured by Bonifacio Echeverria, S.A. The lot items rate near very good overall, particularly considering their age, and consist of: wood and metal stock, with the wire stock's folding feature remaining in excellent operating condition; bolt assembly and charging handle group, which has been stamped 21624; magwell, which has been stamped Z-21580; telescoping bolt; two portions of the receiver, one of which features the rear sight block; and the barrel assembly, which features a near excellent bright bore. The parts retain very little of their factory original finishes, and exhibit extensive use and handling related marks as well as some instances of light oxidation. The barrel shroud displays a general conversion to a mottled gray finish with brown patina, while the visible portions of the actual barrel would seem that it has managed to retain most of its factory original finish. Additionally most of the parts exhibit hardened grease build-up from their packing and long storage. (136029-9)
1826. **PARTS KIT FOR BREN LIGHT MACHINE GUN.** The items rate near very good overall, particularly considering their age, and consist of: stock assembly section; Mk. II barrel assembly with carry handle and Mk. II bipod; additional Mk. II barrel with carry handle, although exhibiting a substantial crack running the entire length of the wood on either side of the handle; piston assembly; and additional small parts. The parts retain very little of their factory original finishes, and exhibit extensive use and handling related marks as well as most of the parts exhibiting hardened grease build-up from their packing and long storage. The wood stock and pistolgrip both exhibit extensive handling marks. The barrels, for their part, both feature near excellent bright bores. The lot also includes two 30 round steel magazines for the Bren Gun. (136029-10)
1827. **PARTS KIT FOR BREN LIGHT MACHINE GUN.** The items rate near very good overall, particularly considering their age, and consist of: wood and metal stock; Mk. II barrel assembly with carry handle and Mk. III bipod; additional Mk. I barrel without carry handle and with damaged front sight block; piston assembly; and additional small parts. The parts retain very little of their factory original finishes, and exhibit extensive use and handling related marks as well as most of the parts exhibiting hardened grease build-up from their packing and long storage. The wood stock and pistolgrip both exhibit extensive handling marks, as well as the presence of cracks along both the top of the stock near the absent receiver and a more significant crack along the right side of the stock; additionally the trigger group is absent from the stock assembly section. The barrels, for their part, both feature near excellent bright bores. The lot also includes two 30 round steel magazines for the Bren Gun. (136029-11)
1828. **LOT OF 7.62X54R AMMO** Consists of six boxes of Czechoslovakian military surplus 7.62x54R steel cased FMJ ammunition and two boxes of 7.62x54R steel cased Soft Point hunting ammunition. The lot totals 156 rounds and is comprised of five boxes of Czech ammo and two boxes of hunting ammo, with each box containing 20 rounds. An additional box of Czech ammo contains 16 rounds. It should be noted that while the hunting ammo is labeled as "non-corrosive", the ammo of military surplus origin is assumed to have corrosive primers, thus necessitating a prompt and thorough cleaning after use. Nonetheless, the lot is a sizeable cache of this popular caliber. (136033-3A)
1829. **LOT OF 7.62X54R AMMO** Consists of ten boxes of East German military surplus 7.62x54R steel cased FMJ ammunition. The lot totals 200 rounds and is comprised of ten boxes of East German ammo, each containing 20 rounds. It should be noted that the ammo is of military surplus origin and as such is assumed to have corrosive primers, thus necessitating a prompt and thorough cleaning after use. Nonetheless, the lot is a sizeable cache of this popular caliber. (136033-3B)
1830. **LOT OF 5.56X45MM NATO AMMUNITION** Consists of 50 like-new unopened packages containing 20 rounds each, totaling 1000 rounds. All of the boxes rate excellent. The sealed cartridges come in an OD Green metal ammo can which rates in near excellent condition. The lot represents a sizeable cache of this popular caliber. (136033-2)
1831. **LOT OF 6.5X55MM SWEDISH AMMUNITION** Consists of 15 boxes of CBC FMJ containing 20 rounds each, one partial box of Norma Soft Point hunting ammo which contains 19 live cartridges as well as a single fired case, one partial box of Lake City Army Ammunition Plant FMJ Match ammo which contains 9 live cartridges as well as a single fired case, and two loaded stripper clips with 5 rounds each; totaling 338 live cartridges and 2 fired cases. Additionally, the lot includes 28 non-loaded stripper clips housed in a repurposed CBC ammo box. The conditions of the boxes range from very good plus to excellent. (136033-4)
1832. **LOT OF 7.62X51MM NATO AMMUNITION** Consists of 25 individual plastic containers holding 20 rounds each, totaling 500 rounds. The ammo is FMJ and appears to be of British and Argentine military surplus origins. The ammo rates excellent overall and would seem to remain in operational condition; however it should be noted that as the ammo is of military surplus origin it may feature corrosive primers. Included with the lot is a sheet which details how to properly clean a firearm after using corrosive ammo. Nonetheless, the lot is a sizeable cache of this popular caliber. (136033-8A)
1833. **LOT OF 7.62X51MM NATO AMMUNITION** Consists of 25 individual plastic containers holding 20 cartridges each, totaling 499 live cartridges and a single fired case. The ammo is FMJ and appears to be of British and Argentine military surplus origins. The ammo rates excellent overall and would seem to remain in operational condition; however it should be noted that as the ammo is of military surplus origin it may feature corrosive primers. Included with the lot is a photocopied sheet which details how to properly clean a firearm after using corrosive ammo. Nonetheless, the lot is a sizeable cache of this popular caliber. (136033-8B)
1834. **LOT OF 22LR AMMUNITION** Consists of a single 500 round brick of Winchester Super X T22 Target standard velocity 40 grain, lead round nose 22LR ammo. The box rates in very good plus condition overall. The lot represents a sizeable cache of this popular and, as of late, highly sought after caliber. (136033-5A)
1835. **LOT OF 22LR AMMUNITION** Consists of a single 500 round brick of Winchester Super X T22 Target standard velocity 40 grain, lead round nose 22LR ammo. The box rates in very good plus condition overall. The lot represents a sizeable cache of this popular and, as of late, highly sought after caliber. (136033-5B)
1836. **LOT OF 22LR AMMUNITION** Consists of a single 500 round brick of Winchester Super X T22 Target standard velocity 40 grain, lead round nose 22LR ammo. The box rates in very good plus condition overall. The lot represents a sizeable cache of this popular and, as of late, highly sought after caliber. (136033-5C)
1837. **LOT OF 22LR AMMUNITION** Consists of a single 500 round brick of Winchester Super X T22 Target standard velocity 40 grain, lead round nose 22LR ammo. The box rates in very good plus condition overall. The lot represents a sizeable cache of this popular and, as of late, highly sought after caliber. (136033-5D)
1838. **LOT OF 22LR AMMUNITION** Consists of a single 500 round brick of Winchester Super X T22 Target standard velocity 40 grain, lead round nose 22LR ammo. The box rates in very good plus condition overall. The lot represents a sizeable cache of this popular and, as of late, highly sought after caliber. (136033-5E)
1839. **LOT OF 22LR AMMUNITION** Consists of a partial brick of Winchester Super X T22 Target standard velocity 40 grain, lead round nose 22LR ammo. Advertised as containing 500 rounds, 4 of the smaller individual boxes are missing, bringing the total count down to only 300 rounds. The box rates in very good plus condition overall. The lot represents a sizeable cache of this popular and, as of late, highly sought after caliber. (136033-5F)

1840. **LOT OF 32 WINCHESTER SPECIAL AMMUNITION** Consists of one box of Winchester Super-X 170 grain silvertip containing 20 rounds which appear to be original to the box, there is also one box of Winchester Super-Speed Power-Point 170 grain soft point containing an assortment of 13 rounds; additionally, there are two boxes of Western Super-X which both contain 20 fired casings. The lot totals 33 live cartridges and 40 fired casings. The boxes rate in very good plus to near excellent condition, and exhibit minor age-related wear. (136396-1)
1841. **LOT OF RELOADING COMPONENTS** Consists of a case of 1000 230 grain FMC 45 ACP bullets by Winchester. The case has been opened and there is a slight, deliberate tear present in the protective bag. The box rates in very good plus condition overall. (136033-7)
1842. **LOT OF MAGAZINES** Consists of four 5 round polymer magazines for Remington Model 541 bolt action 22LR rifle. Three of the magazines rate in excellent condition, with the remaining magazine rating near excellent. (136033-6)
1843. **LOT OF MAGAZINES** Consists of one 3 round and one 10 round box magazine for the HK 940 rifle chambered in 30-06 Springfield, as well as a single 30 round magazine for the M3 Grease Gun chambered in 45 ACP. The HK magazines both rate near excellent and minor exhibit faint wear and handling marks; while the M3 magazine rates very good, but with more noticeable wear and handling marks. (136277-10)
1844. **LOT OF MAGAZINES** Consists of two magazines for Winchester Model 52/56/57/69/75 bolt action rifles. Included is one regular 10 round magazine and one 5 round magazine designed for 22 Short. The magazines both rate very good plus and retain about 89% of their factory original blued finishes, but exhibit some noticeable use-related wear as well as some extremely minor and isolated light oxidation on the rear of the 10 round magazine. (136257-62A)
1845. **LOT OF MILITARY DECORATIONS** Consists of US military ribbons. Included are: Commendation ribbon (Navy & Marine Corps), two National Defense Service Medal ribbons, Southwest Asia Service Medal ribbon, Sea Service Deployment Ribbon (Navy), Achievement Medal ribbon (Army), Good Conduct Medal ribbon (Army), Non-Commissioned Officer Professional Development Ribbon (Army), Army Service Ribbon, and Army Overseas Service Ribbon. Also included are rank insignias for the following: one Private, two Specialists, one Corporal, one Second Lieutenant, four Lieutenants, one Major, one Lieutenant Colonel, and one Brigadier General. In addition, there are also six U.S. insignias of various design. There are also insignias designating Infantry (2), Military Police, Army Engineer, US Army Signal Corps, and ROTC. Additionally there are three pins by N.S. Meyers: two US Air Force ROTC pins, and one US Army ROTC pin. Several unit pins are also featured in the lot, included are: 2nd infantry regiment, 15th infantry regiment (2), 82nd Airborne Division Distinctive Unit Insignia, 276th Engineer Battalion, Signal Corps Regimental Insignia, and United States Army Infantry School Insignia. Other items include pins from Fork Union Military Academy; The Baylor School of Chattanooga, TN Rifle Team; Aviation Challenge Program; and a Great Seal of the United States with a lyre adorning the eagle instead of the usual 13 stars. Completing the lot, there are five unidentified ribbons, one unidentified medal, and one unidentified pin. (134836-1)
1846. **RUGER 10/22 SEMI-AUTO RIFLE** serial #132085, 22 LR, 18 1/2" barrel with an excellent, bright bore. The metal surfaces rate very good and retain about 85% of their factory original blued finish, with some minor light handling marks and extremely faint oxidation present along the barrel. The smooth walnut stock rates very good but exhibits numerous handling marks, particularly along the left side. The rifle features a Weaver V22 3-6x scope mounted on a set of Weaver rings. The scope rates very good plus and retains about 90% of its factory original blued finish, with minimal faint handling marks and some age-related fading. The optic displays a fine crosshair reticle with crisp, clear sight picture. Included with the rifle is a single 10 round rotary magazine. (136680-16) (100/200)
1847. **STAR BONIFACIO ECHEVERRIA, S.A MODEL 110 SEMI-AUTO RIFLE** serial #2327, 22 LR, 22 1/2" barrel with an excellent, bright bore. The metal surfaces rate very good plus and retain about 91% plus of their factory original blued finish, with some minor light handling marks. The checkered walnut Monte Carlo stock rates very good but exhibits numerous faint to light handling marks, particularly a few slight chips in the wood. The rifle features a hooded front sight, with the rear sight missing from its dovetail slot. Mounted atop the receiver is a "Bushnell 4x Custom 22" scope which rates very good plus and retains about 90% of its factory original blued finish, with minimal light handling marks. The optic displays a fine crosshair reticle with crisp, clear sight picture. Included with the rifle is a single 10 round magazine. (136676-9) (75/150)
1848. **MARLIN MODEL 89C SEMI-AUTO RIFLE, 22 LR, 24" barrel** with an excellent, bright bore. The metal surfaces rate very good and retain about 90% of their factory original blued finish, with some minor light handling marks and light oxidation on some portions of the receiver as well as extremely faint sparse oxidation along the underside of the barrel. The smooth walnut stock rates very good plus and exhibits several minor faint handling marks. The rifle features a hooded front sight, with the rear adjustable sight also still present. Mounted is a J.C. Higgins 4x scope which rates very good plus and retains about 95% of its factory original blued finish, with negligible faint handling marks. The optic displays a fine crosshair reticle with crisp, clear sight picture. Included with the rifle is a single 5 round detachable magazine. (136671-2) {C&R} (75/150)
1849. **WINCHESTER MODEL 69 TARGET BOLT ACTION RIFLE, 22 S, L, LR, 25" barrel** with an excellent, bright bore. The metal surfaces rate very good and retain about 85% of their factory original blued finishes, but do exhibit moderate noticeable oxidation and instances of isolated pitting. The chromed bolt rates very good, although exhibiting use-related and age-related wear. The smooth walnut stock rates very good but does exhibit numerous light handling marks. The rifle features a Winchester No. 97A Hooded Front Ramp Sight and No. 96B Winchester Adjustable Rear Peep Sight. Included is a single 5 round detachable magazine. (136672-2) {C&R} (250/350)
1850. **SMITH & WESSON M&P15-22 SEMI-AUTO RIFLE** serial #DTU4253, 22LR, 16" barrel with an excellent, bright bore. This particular rifle is a compliant model, and as such features a non-threaded barrel and fixed stock. The barrel rates near very good and retains about 85% factory original matte blue finish, but exhibits numerous handling marks and some minor light oxidation. The receiver rates very good and retains about 93% of its factory original matte blued finish, with only a few minor faint handling marks. The rifle features an OD green pistolgrip and stock by Magpul, both of which rate very good plus and exhibit a few minor light handling marks and wear. Mounted to the rifle is a Center Point 4-16x illuminated reticle scope which rates very good plus and retains about 93% of its factory original blued finish, with minimal light handling marks. The optic displays a mil-dot reticle with crisp, clear sight picture and features 5 brightness settings for both red and green illumination options. The rifle comes with a single 10 round magazine and also includes an attached folding bipod. (136676-4) (250/450)
1851. **ORDNANCE LAMP LOT** Consists of a single table lamp designed to resemble a mortar round. While a Leviton Socket Holder is featured, the lamp is most likely of custom construction. The main body of the lamp rests on a two-tier square wooden base. No shade is included with the lamp, nor is any bulb; however, the light has been tested to ensure continued function and has proven to operate properly. Overall the lamp rates in very good plus condition, although with its fair share of light handling marks, and would make an excellent addition to the home décor of any military enthusiast. (136110-2)
1852. **REMINGTON MODEL 742 CARBINE SEMI-AUTO RIFLE** serial #B7219509, 308 Winchester, 18 1/2" barrel with a near excellent, bright bore. The metal surfaces rate near excellent and retain about 95% of their reblued finish, with a few minor faint handling marks. The rifle features a smooth wood replacement forend and stock. The forend rates excellent, while the stock rates very good plus and exhibits some light handling marks; featured with the stock is a Pachmayr "White Line" recoil pad. The rifle features a set of iron sights, with the front sight being somewhat loose, and is factory drilled and tapped. Included with the rifle is a single 4 round detachable box magazine. (136520-3493) [Richard "Stretch" Kennedy Collection] (200/400)

1853. **MARLIN MODEL 336CS LEVER ACTION RIFLE** serial #01073666A, 30-30 Win, 20" barrel with an excellent, bright bore. The metal surfaces rate excellent and retain about 98% plus of their factory original blued finish. The checkered walnut forend and pistolgrip stock both rate excellent and retain crisp factory checkering, with negligible light handling marks; featured with the stock is a light brown recoil pad. The rifle maintains its original hooded ramp front and adjustable folding leaf rear sight; additionally, a 2.5x32 Bushnell rifle scope has been mounted atop the receiver. Included with the rifle is an installed hammer extension and nylon sling by Browning. (136691-55) (300/500)
1854. **ATI IMPORTED GSG-522SD SEMI-AUTO RIFLE** serial #A478432, 22 LR, 16 5/16" barrel with an excellent, bright bore. Overall, the rifle rates excellent to like new and retains 99% of its black finish, exhibiting only minimal faint to light handling marks. The barrel features a faux suppressor shroud. The rifle features a picatinny optic rail, ribbed rubber forend, fixed synthetic stock, textured pistolgrip, and bolt hold open. Included with the rifle is a single 22 round magazine, tools and other accessories, lock and key, manual, and factory original box. (136707-5) (200/400)
1855. **REMINGTON MODEL 591M BOLT ACTION RIFLE** serial #1032040, 5mm Remington Rimfire Magnum, 24" barrel with an excellent, bright bore. The metal surfaces rate very good plus and retain about 89% of their factory original blued finish, although with the barrel exhibiting some noticeable handling marks. The bolt rates near excellent and retains about 93% of its factory original blued finish, but does exhibit some silvering due to wear. The smooth walnut Monte Carlo stock rates very good plus and retains its original pistolgrip cap, but exhibits several light handling marks as well as a pronounced chip in the wood of the pistolgrip. The rifle maintains its original fixed front sight, however its rear sight has since been removed to allow for the installation of a 3-9x Center Point illuminated reticle scope. The scope exhibits a mil-dot reticle which displays a crisp, clear sight picture. The scope features both red and green illumination settings; however the feature does not currently work, with the most likely cause being a dead battery. Included with the scope is a set of flip up lens caps. The rifle also comes with a single 5 round detachable magazine. (136706-27) (200/300)
1856. **NORINCO MODEL EM-332 BOLT ACTION RIFLE** serial #0200144, 22 LR, 18 1/2" barrel with an excellent, bright bore. The metal surfaces rate excellent and retain about 98% of their factory original blued finish, with a few faint handling marks. The smooth walnut Monte Carlo stock with Schnabel forend rates very good plus but exhibits several noticeable handling marks and is also missing both of its sling mount studs; featured with the stock is a recoil pad and dual magazine holder. The rifle maintains its original ramp front sight, but its adjustable rear sight is missing from the dovetail slot; additionally, the receiver features an integral base. Included with the rifle are three 5 round detachable box magazines. (136520-3496) [Richard "Stretch" Kennedy Collection] (100/200)
1857. **MOSSBERG 715T FLAT TOP SEMI-AUTO RIFLE** serial #EMD3729729, 22 LR, 16 1/4" barrel with an excellent, bright bore. The barrel features an A2 style muzzle brake, rating excellent to like new and retaining about 99% of its factory original blued finish. The plastic portions of the rifle likewise rate excellent to like new and retain 99% of their black finish, exhibiting only minimal faint to light handling marks. The rifle features a picatinny quad rail, AR-15 style six-position telescoping buttstock, checkered pistolgrip, bolt hold open, and removable iron sights. Included with the rifle is a single 25 round magazine, speedloader, lock and key, manual, and factory original box. (136707-12) (150/250)
1858. **MOSSBERG 715T FLAT TOP SEMI-AUTO RIFLE** serial #EMD3729884, 22 LR, 16 1/4" barrel with an excellent, bright bore. The barrel features an A2 style muzzle brake, rating excellent to like new and retaining about 99% of its factory original blued finish. The plastic portions of the rifle likewise rate excellent to like new and retain 99% of their black finish, exhibiting only minimal faint to light handling marks. The rifle features a picatinny quad rail, AR-15 style six-position telescoping buttstock, checkered pistolgrip, bolt hold open, and removable iron sights. Included with the rifle is a single 25 round magazine, speedloader, lock and key, manual, and factory original box. (136707-11) (150/250)
1859. **REMINGTON NYLON 66 SEMI-AUTO RIFLE** serial #2294314, 22 LR, 19 5/8" barrel with an excellent, bright bore. The barrel rates near excellent and retains about 97% of its factory original blued finish, with only a few light handling marks. The black Zytel plastic receiver rates near excellent, although exhibiting some light handling marks. The checkered brown Zytel plastic stock and forend both rate very good plus and exhibit numerous light handling marks. The rifle features its original open sights but also exhibits a 4x Ted Williams scope. The scope exhibits a crosshair reticle which displays a crisp, clear sight picture. Included with the rifle is a single 14 round tube magazine located in the buttstock. Remington factory records indicate that this particular Nylon 66 was produced in 1972. (136678-34) (200/400)
1860. **WINCHESTER MODEL 77 SEMI-AUTO RIFLE** serial #56649, 22 LR, 22" barrel with an excellent, bright bore. The metal surfaces rate very good plus and retain about 93% of their factory original bright bore, although with scattered faint oxidation and light handling marks. The smooth walnut stock rates very good plus but does exhibit several light handling marks. The rifle maintains its original open sights and includes a single 10 round detachable box magazine. (136707-6) (C&R) (150/250)
1861. **HENRY REPEATING ARMS COMPANY LEVER ACTION RIFLE** serial #M022801H, 22 Magnum, 19 1/4" round barrel with an excellent, bright bore. The metal surfaces rate excellent to like new and retain about 99% plus of their factory original blued finish. The checkered deluxe American walnut forend and straight stock both rate excellent to like new, with the factory checkering remaining crisp overall. The rifle maintains its original hooded ramp front and adjustable rear sights, as well as featuring a receiver with integral base. Included with the rifle is a factory manual. (136698-15) (350/450)
1862. **RUGER POLICE SERVICE SIX DOUBLE ACTION REVOLVER** serial #159-77351, 357 Magnum, 4" barrel with an excellent, bright bore. The stainless steel metal surfaces rate excellent, although with minimal faint handling marks. The fluted 6 round stainless steel cylinder rates excellent but does exhibit a faint turn ring. The non-original checkered black rubber Pachmayr one-piece grip rates near excellent and exhibits only light handling. The revolver features its original ramp front and fixed rear sight. An overall excellent example of these ruggedly-built revolvers which tend to be highly sought-after on the second hand market. (136691-11) (250/450)
1863. **RUGER SPEED SIX DOUBLE ACTION REVOLVER** serial #157-76945, 38 Special, 2 3/4" barrel with an excellent, bright bore. The stainless steel metal surfaces rate excellent, although with minimal light handling marks. The fluted 6 round stainless steel cylinder rates excellent but does exhibit a faint turn ring. The checkered walnut grips feature a silver colored medallion of the Ruger logo on both sides and rate excellent and exhibit only faint handling. The revolver features its original ramp front and fixed rear sight, as well as a factory spur-less speed hammer. An overall excellent example of these ruggedly-built revolvers which tend to be highly sought-after on the second hand market. Included with the revolver is the manual and factory original box with shipping sleeve. (136520-4156) [Richard "Stretch" Kennedy Collection] (250/450)
1864. **REMINGTON MODEL 722 BOLT ACTION RIFLE** serial #305540, 222 Remington, 20" barrel with a slightly dark, oxidized bore. The metal surfaces rate very good plus and retain about 95% of their factory original blued finish with some minor light handling marks and scattered light surface oxidation. The smooth walnut stock rates very good but exhibits numerous noticeable handling marks and a chip in the base of the pistolgrip wood. The rifle features an adjustable rear sight, although no front sight is present as the barrel previously had its length reduced; however, a 6x38 Weaver K6 scope has been installed, featuring a fine crosshair reticle which displays a crisp, clear sight picture. The scope rates very good plus and retains about 89% of its factory original blued finish, with some light handling marks. Also featured with the rifle is a folding bipod. (136623-28) (200/300)

1865. **REMINGTON MODEL 121 FIELDMASTER SLIDE ACTION RIFLE** serial #69887, 22 S, L, LR, 24" round barrel with an excellent, bright bore. The metal surfaces rate very good plus and retain about 95% of their factory original blued finish, although exhibiting some minor light handling marks and scattered extremely faint surface oxidation. The ribbed walnut forearm rates very good plus and exhibits several light handling marks; however, the smooth walnut pistolgrip stock rates very good but exhibits slightly more noticeable handling marks as well as a reattached chip measuring approximately 5" and emanating about 1 1/2" from the bottom of the buttplate. The rifle maintains its original open sights. (136673-2) {C&R} (200/400)
1866. **SAVAGE MODEL 23 SPORTER BOLT ACTION RIFLE** serial #109386, 22 LR, 23" barrel with an excellent, bright bore. The metal surfaces rate very good plus and retain about 85% of their factory original blued finish, with some minor light handling marks and areas of fading. The smooth walnut pistolgrip stock with Schnabel forend rates near excellent, with only negligible light handling marks; the stock also maintains its factory original metal buttplate. Featured with the rifle is its original open sights; additionally, an aftermarket Lyman aperture rear sight has been installed. (136698-7) {C&R} (100/200)
1867. **MOSSBERG MODEL 340B BOLT ACTION RIFLE**, 22 S, L, LR, 24" barrel with an excellent, bright bore. The metal surfaces rate near excellent and retain about 91% of their factory original blued finish, with a few instances of light surface oxidation. The smooth walnut Monte Carlo stock rates very good plus although with several light handling marks and a chip in the left side below the receiver. The rifle maintains its original hooded front ramp sight, although the aperture rear sight has since been removed to allow for the installation of 4x32 Bushnell Sportview scope which features a duplex reticle and displays a crisp, clear sight picture. The scope rates near excellent and retains about 95% of its factory original black finish, but does exhibit some minor light handling marks. The rifle features integral finger grooves at the pistolgrip and includes a single 7 round detachable box magazine. (136623-15) (75/150)
1868. **MARLIN MODEL 60 SEMI AUTO RIFLE** serial #17350733, 22 LR, 22" barrel with an excellent, bright bore. The barrel and receiver surfaces both rate near excellent and retain about 97% of their factory original finish, with a few light handling marks and minimal isolated light surface oxidation. The smooth walnut Monte Carlo stock rates very good plus but exhibits some noticeable handling marks. The rifle maintains its original open sights and includes a single 14 round tube magazine. (136691-56) (75/150)
1869. **RUGER 10/22 RSI SEMI-AUTO RIFLE** serial #244-05177, 22 LR, 18 1/2" barrel with a bright excellent bore. The barrel and receiver surfaces both rate near excellent and retain about 98% of their factory original finish, although with a few light handling marks. The checked walnut Mannlicher stock with black forend cap rates excellent with negligible extremely faint handling marks and maintaining crisp checkering; featured with the stock is a factory recoil pad. The rifle features its original open sights. The rifle does not include a magazine, however replacements are readily available. (136691-42) (200/400)
1870. **WINCHESTER MODEL 74 SEMI-AUTO RIFLE** serial #13183, 22 LR, 24" barrel with an excellent, bright bore. The metal surfaces rate near excellent and retain about 85% of their factory original blued finish, with a few minor faint handling marks as well as extremely faint scattered surface oxidation. The smooth walnut stock rates very good plus, with several light handling marks. The rifle maintains its original open sights as well as its tube magazine located in the buttstock. Winchester factory records indicate that this particular Model 74 is a pre-WWII rifle, manufactured in 1939. (136642-34) {C&R} (200/300)
1871. **WINCHESTER MODEL 74 SEMI-AUTO RIFLE** serial #94804, 22 LR, 24" barrel with an excellent, bright bore. The metal surfaces rate near excellent and retain about 93% of their factory original blued finish, with a few minor faint handling marks. The smooth walnut stock rates very good plus, with some minor light handling marks. The rifle maintains its original open sights as well as its tube magazine located in the buttstock. Winchester factory records indicate that this particular Model 74 is most likely a pre-WWII rifle, as it was manufactured in 1941. (136642-38) {C&R} (200/300)
1872. **WINCHESTER MODEL 74 SEMI-AUTO RIFLE** serial #143288, 22 LR, 24" barrel with an excellent, bright bore. The metal surfaces rate near excellent and retain about 91% of their factory original blued finish, with a few minor faint handling marks. The smooth walnut stock likewise rates near excellent, with only a few minor faint handling marks. The rifle maintains its original open sights as well as its tube magazine located in the buttstock. Winchester factory records indicate that this particular Model 74 was manufactured in 1946. (136642-36) {C&R} (150/250)
1873. **WINCHESTER MODEL 74 SEMI-AUTO RIFLE** serial #369208A, 22 LR, 22" barrel with an excellent, bright bore. The metal surfaces rate near excellent and retain about 89% of their factory original blued finish, with a few minor faint handling marks. The smooth walnut stock rates very good plus, with several light handling marks. The rifle maintains its original open sights as well as its tube magazine located in the buttstock. Winchester factory records indicate that this particular Model 74 was manufactured in 1954. (136642-37) {C&R} (150/250)
1874. **MARLIN GLENFIELD MODEL 25 BOLT ACTION RIFLE** serial #22699439, 22 S, L, LR, 22" barrel with an excellent, bright bore. The metal surfaces rate very good plus and retain about 89% of their factory original blued finish, with several light handling marks. The bolt rates very good and is of a sturdy construction, but does exhibit some loss of finish due to wear. The smooth walnut Monte Carlo stock rates near excellent, with a few light handling marks. The rifle maintains its original open sights and includes a single 7 round detachable box magazine. (136691-57) (75/150)
1875. **NORINCO TYPE 56 SKS SEMI-AUTO RIFLE** serial #240262, 7.62x39mm, 20 1/4" chrome-lined barrel with an excellent, bright bore. The metal surfaces rate near excellent overall and retain about 95% of their factory original blued finish, with only the barrel exhibiting some light surface oxidation; other light handling marks are also present, but draw considerably more minor attention. The smooth honey colored wood stock rates very good, although with several light to noticeable handling marks. The rifle features its original sights as well as its Chinese underfolding spike bayonet. The stock, triggerguard, magazine, receiver, receiver cover, bolt carrier, and bolt all display matching serial numbers. Some small deposits of cosmoline still remain that could use cleaning. The rifle displays a stamping on the left side of the receiver which shows that it was imported by China Sports Inc. of Ontario, California (CSI ONT CA.). Also on the left side is a factory designation which indicates that the rifle was produced in arsenal 143. Included with the rifle are the cleaning rod and a nylon sling, a cleaning kit is also found in the trap of the buttstock. (136698-2) (300/500)
1876. **RUSSIAN SKS-45 SEMI-AUTO RIFLE** serial #KP1167/RH033609, 7.62x39mm, 20 1/4" barrel with an excellent, bright bore. The metal surfaces rate near excellent overall and retain about 95% of their factory original blued finish, with some general light handling marks as well as instances of brighter wear along the bolt carrier. The smooth wood stock rates very good, although with several light handling marks. The rifle features its original sights as well as its Russian underfolding blade bayonet. The magazine, receiver, receiver cover, bolt carrier, and bolt all display matching serial numbers; with the stock having been renumbered and the triggerguard electro-penciled to match. The receiver cover dates the rifle as having been produced in 1956 at the Tula arsenal; however, the renumbering of the stock denotes that the rifle is also an arsenal rebuild. The rifle displays a stamping on the left side of the receiver which shows that it was imported by KBI Inc. Included with the rifle are the cleaning rod and a nylon sling, no cleaning kit is found within the trap of the buttstock. (136676-10) {C&R} (300/500)

1877. **MARLIN MODEL A-1DL SEMI-AUTO RIFLE**, 22 LR, 24" barrel with an excellent, bright bore. The metal surfaces rate very good plus and retain about 95% of their applied chrome finish, with the factory markings still largely visible as well as some minor tool marks. The smooth wood stock appears to be factory original and rates very good plus although with numerous light handling marks as well as some repaired cracks in the forend. The rifle maintains its original open sights; although the front ramp sight has been chrome plated, while the adjustable rear sight retains its factory original blued finish. The rifle does not include any magazine, although it would have originally shipped from Marlin's factory with a 7 round detachable box magazine. (136556-20) (40/60)
1878. **SCOPE LOT** Consists of a single Weaver K4-1 4x38 rifle scope. The scope rates very good plus and retains about 93% of its factory original blued finish, although with some faint handling marks and minor fading. The duplex reticle exhibits excellent optics which displays a crisp, clear sight picture. Included with the scope is an installed set of scope rings as well as a set of rubber lens covers. An overall near excellent example of these older, quality built, American scopes. (136691-58)
1879. **ZEISS SCOPE LOT** Consists of a single Zeiss Diavari-C 3-9x36 rifle scope. The scope rates near excellent and retains about 97% of its factory original black finish, although with some light marks from previous mounting in scope rings. The "Z-plex" (duplex) reticle exhibits excellent optics which displays a crisp, clear sight picture. Included with the scope is a set of factory lens cover. An older line of Zeiss sporting scope, this particular model was produced in West Germany but has since been discontinued; nonetheless it remains an excellent example of Zeiss's products which are known for their superb quality and as such are highly desired. (136520-1913A)
1880. **KAHLES SCOPE LOT** Consists of a single Kahles 3-9x42 rifle scope. The scope rates excellent to like new and retains about 99% of its factory original matte black finish. The duplex reticle exhibits excellent optics which displays a crisp, clear sight picture. Included with the scope is a set of Swarovski transparent lens cover. This is an excellent example of Kahles's products which are known for their superb quality and as such are highly desired. (136698-16A)
1881. **REDFIELD SCOPE LOT** Consists of a single Redfield 2 3/4x Bearcub rifle scope. The scope rates very good and retains about 89% of its factory original blued finish. The post-and-crosshair reticle exhibits excellent optics which displays a crisp, clear sight picture. An overall very good example of these older, quality-built, American scopes. (136520-3732A)
1882. **BURRIS SCOPE LOT** Consists of a single Burris 10x rifle scope. The scope rates excellent and retains about 98% of its factory original black finish. The duplex reticle exhibits excellent optics which displays a crisp, clear sight picture; but features an exceptionally long eye relief. Included with the scope is a factory set of lens covers. (136653-7A)
1883. **STARLIGHT SCOPE LOT** Consists of a single Starlight 1x red dot sight. The sight operates on a single CR2 battery. The sight is operational and features a manually adjustable brightness level. The sight includes mounted scope rings. The sight rates very good plus but does exhibit some light handling marks as well as a slight depression on its front portion, but is nonetheless a near excellent and functional red dot optic. (136706-5A)
1884. **COLT SCOPE LOT** Consists of a single 3rd generation Colt marked 3x20mm scope for AR-15 style rifles, designed to be mounted to the rifle's carry handle. The scope features a standard duplex reticle and exhibits clear, crisp optics. Included with the scope is a set of leather lens covers. The scope retains about 98% of its factory original blued finish, and, despite some light handling marks, proves to be a near excellent example overall. (136678-49)
1885. **LEUPOLD SCOPE LOT** Consists of a single Vari-X III 3.5-10x Leupold rifle scope. The scope rates excellent and retains about 98% of its factory original black finish, with minimal light handling marks. The duplex reticle exhibits excellent optics which displays a crisp, clear sight picture. Included with the scope is a set Butler Creek flip-up lens caps. (136706-35A)
1886. **SHEPHERD SCOPE LOT** Consists of a single 3-10x Shepherd 310 rifle scope. The scope rates excellent and retains about 98% of its factory original black finish, with a few faint handling marks. The stadia range finding circles P-2 reticle exhibits excellent optics which displays a crisp, clear sight picture. The variable magnification is somewhat reluctant to adjust, but overall still an excellent choice of optic. (136520-4123A)
1887. **THOMPSON CENTER OMEGA MUZZLE-LOADING RIFLE** serial #21307, 50 Caliber, 28" barrel with a very good bore, showing light oxidation throughout. The metal surfaces rate near excellent and retain about 95% of their factory original blued finish, with a few light handling marks as well as slight pitting around the muzzle. The checkered black synthetic Monte Carlo stock rates near excellent, although with some minor light handling marks; featured with the stock is a recoil pad. The rifle maintains its original red fiber optic front and adjustable rear sights; additionally, a Bushnell Sportman 1.5-4.5x rifle scope has also been installed. The scope rates excellent and retains about 99% of its factory original matte black finish. The featured duplex reticle displays a crisp, clear sight picture. The ignition system is accessed via a lever action operation. Included with the rifle is its original ramrod. (136691-24) {ANTIQUE} (150/250)
1888. **THOMPSON CENTER OMEGA MUZZLE-LOADING RIFLE** serial #Z79591, 50 Caliber, 28" barrel with a very good bore, showing light oxidation throughout. The stainless steel metal surfaces rate near excellent, with some light handling marks. The smooth Realtree "hardwoods" camo synthetic Monte Carlo thumbhole stock rates near excellent, although with some minor light handling marks; featured with the stock is a recoil pad. The rifle maintains its original fiber optic front and rear sights, as well as having been factory drilled and tapped. The ignition system is accessed via a lever action operation. Included with the rifle is its original ramrod. (136691-25) {ANTIQUE} (100/200)
1889. **MILLENNIUM DESIGNED MUZZLELOADERS INC. BUCKWACKA MUZZLE-LOADING RIFLE** serial #MDM550-49572, 50 Caliber, 23" barrel with a very good bore, showing light oxidation throughout. The metal surfaces rate near excellent and retain about 98% of their factory original blued finish. The smooth gray laminated walnut forend and Monte Carlo thumbhole stock both rate near excellent, although with some minor light handling marks; featured with the stock is a recoil pad. The rifle does not feature any iron sights, although it appears mounting areas are present for their installation, instead an MDM Series BTS VI BuckTracka 1.5-6x44 rifle scope has been installed. The scope rates excellent and retains about 99% of its factory original matte black finish. The featured German-type reticle displays a crisp, clear sight picture. The scope is intended to have an illumination feature; however, this feature does not currently function and is most likely the result of a dead battery. The ignition system is accessed via a break-open-action operation. Included with the rifle is its original ramrod. (136632-2) {ANTIQUE} (150/250)
1890. **CONNECTICUT VALLEY ARMS INC. HUNTERBOLT MUZZLE-LOADING RIFLE** serial #61-13-071006-00, 50 Caliber, 24 1/2" barrel with a near excellent bore. The metal surfaces rate near excellent and retain about 97% of their factory original blued finish. The checkered black synthetic Monte Carlo stock with Schnabel forend rates near excellent, with only a few minor faint handling marks; featured with the stock is a recoil pad. The rifle maintains its original fiber optic sights, as well as having been factory drilled and tapped. The ignition system is accessed via a bolt action operation. Included with the rifle is its original ramrod. (136623-14) {ANTIQUE} (75/150)

1891. **CONNECTICUT VALLEY ARMS INC. FIREBOLT MUZZLE-LOADING RIFLE** serial #61-13-025387-99, 50 Caliber, 24 1/2" barrel with a very good plus bore. The stainless steel metal surfaces rate very good plus, but do exhibit several light handling marks. The checkered black synthetic Monte Carlo stock with Schnabel forend rates very good plus, with several noticeable handling marks; featured with the stock is a recoil pad. The checkered portions of the stock display a non-factory applied woodland camo pattern; additionally, the original pistolgrip cap has since been replaced with one made out of horn. The rifle maintains its original fiber optic sights, and has an installed Bushnell Sportview 2.5x32 rifle scope. The scope rates excellent and retains about 98% of its factory original matte black finish. The featured crosshair and circle reticle displays a crisp, clear sight picture. The ignition system is accessed via a bolt action operation. Included with the rifle is a non-original ramrod. (136623-14) {ANTIQUÉ} (100/200)
1892. **THOMPSON CENTER BLACK DIAMOND MUZZLE-LOADING RIFLE** serial #S8319, 50 Caliber, 22 1/2" barrel with a very good plus bore. The stainless steel metal surfaces rate very good, but exhibit extensive light oxidation and handling marks. The checkered black synthetic stock rates near excellent, although likewise covered with light handling marks; featured with the stock is a recoil pad. The rifle maintains its original fiber optic sights; additionally, a Simmons BP400M 4x20 rifle scope has also been installed. The scope rates very good and retains about 85% of its factory original matte black finish, but exhibits moderate handling marks. The featured duplex reticle displays a crisp, clear sight picture. The ignition system is accessed via a bolt action operation; however, the bolt is absent from the rifle. The rifle does not include any ramrod, but does come with a black nylon sling. (136587-S17603B) {ANTIQUÉ} (50/100)
1893. **INVESTARM HAWKEN PERCUSSION RIFLE** serial #290317, 45 Caliber, 28" octagon barrel with a very good bore, showing light oxidation throughout. The barrel rates very good plus and retains about 93% of its factory original blued finish, with some scattered light surface oxidation as well as a few minor faint handling marks. The factory case-hardened hammer and lock both rate near excellent and retain most of their original color, although slightly dulled. The brass metal surfaces all rate near excellent and retain much of their original bright nature. The smooth walnut stock rates near excellent, although exhibiting a few light handling marks. The rifle maintains its original open sights and includes its original ramrod. (136578-21) {ANTIQUÉ} (100/200)
1894. **THOMPSON CENTER RENEGADE PERCUSSION RIFLE** serial #L4254, 50 Caliber, 26" octagon barrel with a very good bore, showing light oxidation throughout. The barrel rates very good plus and retains about 93% of its factory original blued finish, with some minor faint surface oxidation as well as a few minor light handling marks. The hammer and lock both rate very good but retain little of their factory original blued finish, exhibit more of a gunmetal gray tint. The smooth walnut stock rates near excellent, although exhibiting several light handling marks. The rifle maintains its original open sights and includes its original ramrod. This particular rifle is configured for left-handed shooters. (136578-22) {ANTIQUÉ} (100/200)
1895. **THOMPSON CENTER HAWKEN PERCUSSION RIFLE**, 50 Caliber, 32" octagon barrel with a near excellent bore. The barrel rates very good plus and retains about 89% of its factory original blued finish, with some scattered faint surface oxidation as well as light handling marks and silvering on high edges. The factory case-hardened hammer and lock both rate near excellent and retain most of their original color, although slightly dulled. The brass metal surfaces all rate near excellent, although slightly dulled. The smooth walnut stock rates near excellent, but exhibits some light handling marks. The rifle maintains its original open sights and includes its original ramrod. Also included with the rifle is a set of tools which were found inside the patchbox. (136623-42) {ANTIQUÉ} (200/300)
1896. **MOWREY PERCUSSION RIFLE** serial #3727, 58 Caliber, 32" octagon barrel with a near excellent bore. The barrel rates very good plus and retains about 93% of its factory original blued finish, with some scattered faint surface oxidation as well as light handling marks. The brass metal surfaces all rate near excellent, although slightly dulled. The smooth walnut drop comb stock rates excellent to like new. The rifle maintains its original open sights and includes its original ramrod. (136585-2) {ANTIQUÉ} (200/300)
1897. **CONNECTICUT VALLEY ARMS INC. MISSOURI PERCUSSION RIFLE** serial #87421425, 50 Caliber, 28" barrel with a very good bore, showing oxidation throughout. The metal surfaces rate very good, although with much of the factory original blued finish being obscured by a layer of oxidation. The factory case-hardened hammer and lock both rate very good and retain some of their original color, although largely dulled and exhibiting light oxidation. The smooth walnut stock rates very good plus, but does exhibit some light handling marks. The rifle maintains its original open sights but does not include any ramrod. Additionally, the wedge key is absent from its slot and packing tape is being used to keep the barrel seated to the stock. (136587-S17603A) {ANTIQUÉ} (40/60)
1898. **TAURUS PT-709 G2 SLIM SEMI-AUTO PISTOL** serial #TDP23393, 9mm, 3 3/16" barrel with an excellent, bright bore. The blued barrel rates very good plus and retains about 90% of its factory original blued finish, although with bright silvering along the top of the chamber area due to wear. The slide rates near excellent and retains about 97% of its factory original blued finish. The black polymer frame with grip texturing rates excellent and exhibits only negligible light signs of handling. The pistol features its original low profile three-dot sights and features loaded chamber indicator. Included with pistol are two 7 round blued single stack magazines with yellow followers, tools, and factory soft case serial numbered to the pistol. (136623-11) (250/350)
1899. **KBI INC. IMPORTED HUNGARIAN FEG R61 SEMI-AUTO PISTOL** serial #A7879, 9x18mm Makarov, 3 1/4" barrel with an excellent, bright bore. The blued barrel rates very good plus and retains about 93% of its factory original blued finish, although with some light wear marks. The slide rates very good plus and retains about 89% of its factory original blued finish, with light handling marks as well as areas of light silvering and fading. The stainless steel frame and checkered black synthetic grips rate excellent and exhibit only negligible light signs of handling. The pistol features a decocker safety and includes two 6 round single stack magazines which display non-matching serial numbers, manual, and factory original box. (136534-17) (200/300)
1900. **"KHYBER PASS" MARTINI-ENFIELD FALLING BLOCK RIFLE** serial #555, 303 British, 23" barrel with a very good bore, showing light oxidation throughout. The non-original barrel appears to possibly be from a Hotchkiss M1909 machine gun and rates very good, although retaining extremely little of its likely original blued finish as well as exhibiting several light handling marks. The frame rates very good plus and retains about 85% of blued finish with several light handling marks, with the stampings still largely visible and seeming to indicate that this particular model was an artillery carbine produced in 1890. The smooth walnut straight stock rates very good and exhibits a "repair" in the wood with the inclusion of a gold colored section of metal at the frame. The sights, like the rest of the rifle, appear to be the result of available parts rather than focused craftsmanship. In addition to being an antique, the nature of Khyber Pass construction makes this rifle a display piece only and not a working functioning arm. Nonetheless, this rifle would make for a unique display piece. (136698-14) {ANTIQUÉ} (150/250)
1901. **ITALIAN MODEL 1938 SHORT BOLT ACTION RIFLE** serial #P7375, 7.35 Carcano, 22" barrel with an excellent, bright bore. The metal surfaces rate very good but retain very little of their factory original blued finish as well as exhibiting some faint to light surface oxidation. The stainless steel bolt rates very good plus but does exhibit some wear, as well as faint oxidation on the handle. The smooth walnut straight stock rates very good plus, although the sling bar section has been removed and a wooden plug installed and the stock's length has been reduced. Additionally, the top handguard and barrel band have both been removed. Despite the previously mentioned modifications, the rifle still maintains its original open sights. (136556-23) (50/75)
1902. **CAI IMPORTED SPANISH DESTROYER BOLT ACTION RIFLE** serial #21250, 9mm Bergmann (9x23mm Largo), 21 1/2" barrel with a very good bore, showing light oxidation throughout. The metal surfaces rate very good and retain about 80% of their factory original blued finish, but exhibit light surface oxidation and fading. The bolt rates very good plus, however the bolt operates somewhat rough in the action. The smooth walnut stock rates very good plus, although with several light handling marks and the buttplate slightly loose. The rifle maintains its original iron sights and includes a single detachable box magazine. (136556-28) {C&R} (100/200)

1903. **JAPANESE TYPE 38 ARISAKA SPORTER BOLT ACTION RIFLE** serial #80278 (series 4), 6.5 Arisaka, 19" barrel with a near excellent, bright bore. The metal surfaces rate very good plus, but retain extremely little of the factory original blued finish having since converted to a more gunmetal gray tint. The bolt rates very good plus and retains about 91% of its factory original blued finish, although showing areas of silvering from wear. The smooth walnut Monte Carlo Mannlicher stock rates very good but exhibits some light handling marks; featured with the stock is a recoil pad. The rifle's original sights have since been replaced with a ramp front and aperture rear set; however, the mum of the Imperial Chrysanthemum Seal remains intact despite most of these seals having often been ground off of the rifle. This particular Type 38 originated as a fourth series model from the Nagoya Arsenal. (136623-27) (150/250)
1904. **JAPANESE TYPE 38 ARISAKA BOLT ACTION RIFLE** serial #11595 (series 4), 6.5 Arisaka, 19" barrel with a dark, heavily oxidized bore. The metal surfaces rate good and retain some of their factory original blued finish although exhibiting a layer of moderate oxidation. The bolt rates good but retains little of its factory original blued finish, showing areas of silvering from wear as well as a moderate oxidation. The smooth walnut sporterized military stock rates fair but exhibits numerous handling marks, extensive cracks, and a non-original buttplate; additionally, the handguard has been shorted. The barrel and receiver are extremely loose and separating from the stock, only being retained by two sections of paper tape which has yellowed with age. The rifle maintains its original sights; in addition, the mum of the Imperial Chrysanthemum Seal remains intact despite most of these seals having often been ground off of the rifle. This particular Type 38 is a fourth series model and was produced at the Nagoya Arsenal. (136556-31) (50/150)
1905. **US MODEL 1903-A3 SPORTER BOLT ACTION RIFLE BY SMITH-CORONA** serial #4794152, 30-06 Springfield, 24" barrel with an excellent, bright bore. The metal surfaces rate near excellent and retain about 95% of an arsenal type blued finish, with some bright handling marks as well as minor instances of light surface oxidation. The Smith-Corona barrel is stamped with the production date of 10-43. The bolt rates near excellent and retains about 97% of its arsenal type blued finish, although with some minor silvering from wear. The smooth walnut military straight grip stock has been modified for sporting use and exhibits several light handling marks as well as a faint crack measuring approximately 2" and radiating rearward from the tang. Additionally, the butt trap is somewhat loose and tends to open of its own accord. The rifle retains its original iron sights and would likely make for an adequate and economical hunting rifle. (136568-8) (150/250)
1906. **MOSSBERG MODEL 83D BOLT ACTION SHOTGUN** 410 bore, 24" plain barrel with a very good bore, showing some light oxidation. Parts are missing from the shotgun, making it incapable of firing. The metal surfaces rate very good plus and retain about 85% of their factory original blued finish, but with some light handling marks and scattered light surface oxidation. The stainless steel bolt rates very good but exhibits light surface oxidation. The smooth walnut stock rates very good plus, although exhibiting several light handling marks as well as an extremely minor faint crack in the right side of the stock at the rear of the receiver measuring approximately 1/4". The shotgun features a bead front sight and a threaded full choke, as well as integral finger grooves in the pistolgrip. (136643-1) {C&R} (20/40)
1907. **STEYR MODEL 1897 CARBINE BOLT ACTION RIFLE** 8x56mm, 17 1/2" barrel with a dark, heavily oxidized bore. The metal surfaces rate good and retain some of their factory original blued finish although exhibiting a layer of moderate oxidation. The bolt rates good but retains little of its factory original blued finish, showing areas of silvering from wear as well as a moderate oxidation. The smooth walnut military straight grip stock rates good but exhibits extensive handling marks as well as a crack radiating rearward from the tang and measuring approximately 1 1/2"; additionally, the letters "A N" have been crudely carved in the right side of the stock. The rifle maintains its original sights. (136556-34) (100/200)
1908. **CHINESE HANYANG M-88 BOLT ACTION RIFLE** serial #68002, 8mm Mauser, 29 1/2" barrel with a dark, heavily oxidized bore. The metal surfaces rate good and retain some of their factory original blued finish although exhibiting a layer of moderate to heavy oxidation. The bolt rates good but exhibits moderate to heavy oxidation. The smooth walnut military straight grip stock rates good but exhibits extensive handling marks as well as several cracks in the area of handguard surrounding the installed metal "repair" section. The rifle maintains its original sights. (136556-34) (50/150)
1909. **TURKISH MODEL 1893 BOLT ACTION RIFLE** serial #4490, 7.65 Argentine, barrel with a dark, heavily oxidized bore. The metal surfaces rate good but have largely converted to a more gunmetal gray tint and exhibit a layer of moderate oxidation. The bolt rates good but exhibits moderate to heavy oxidation. The smooth walnut military stock rates good but exhibits extensive handling marks as well as a section of repaired wood and a crack in the top handguard near the rear barrel band which measures approximately 1". The rifle maintains its original sights. Included with the rifle are a cleaning rod, and a worn and extremely brittle military leather sling. (136556-12) (50/150)
1910. **UNMARKED AIR-RIFLE LOT** consists of a single air-rifle which lacks any markings save for an extremely faint serial number #04-16-481836-06. The rifle is believed to be .177 Caliber, and features a 20" barrel. The metal surfaces rate near excellent and retain about 97% of their black finish, with a few light handling marks. The textured black synthetic Monte Carlo stock rates excellent and features a recoil pad. The rifle's original iron sights have since been removed, but a Center Point 4x32 scope has been installed in their absence. However, the Mil-Dot reticle crosshairs have broken, and the scope should be replaced. (136632-6) {NON-GUN} (25/50)
1911. **CROSMAN AIR-RIFLE LOT** consists of a single Crosman Model CF1K77X "Fury" air-rifle serial #312X14055, .177 Caliber, 18 1/2" barrel. The metal surfaces rate very good plus and retain about 96% of their factory original blued finish, but do exhibit some minor light surface oxidation. The smooth wood Monte Carlo thumbhole rates excellent and features a recoil pad as well as applied texture patches around the handguard. The rifle lacks iron sights, but a 3-9x Center Point scope has been installed. The scope features an illuminated Mil-Dot reticle which displays a crisp, clear sight picture. The scope features both red and green illumination options, with five settings per color; however the feature does not currently work, with the most likely cause being a dead battery. Included with the rifle is a black nylon sling. (136632-8) {NON-GUN} (75/125)
1912. **C.G. HAENEL MODEL III AIR-RIFLE** serial #331, .177 Caliber, 19 1/4" barrel. The metal surfaces rate very good plus and retain about 96% of their factory original blued finish, but do exhibit some fading as well as a few light handling marks and minor light surface oxidation. The smooth walnut stock with integral finger-grooved forearm rates very good but exhibits several light to noticeable handling marks; the left side of the stock exhibits a small stamping which reads "KEENFIRE". The rifle maintains its original iron sights. (136678-32) {NON-GUN} (75/150)
1913. **DIANAWERK MODEL 6 AIR PISTOL** serial #0025500, .177 Caliber, 7 1/8" barrel. The metal surfaces rate very good plus but retain little of their factory original blued finish, instead converting to a more gunmetal gray tint. The checkered gray plastic palm rest grips rate very good plus but exhibit signs of previous handling. The pistol maintains its original iron sights. (136496-12) {NON-GUN} (150/250)
1914. **RWS GAMO MODEL PR-45 AIR PISTOL** serial #0549563, .177 Caliber, 8 1/4" barrel. The metal surfaces rate very good plus and retain about 96% of their factory original blued finish, with a few faint handling marks and negligible scattered light oxidation. The black plastic surfaces rate excellent and lack any discernible handling marks. The checkered black plastic grips likewise rate excellent, with the factory checkering remaining crisp. The pistol maintains its original sights; however, the front sight features applied orange paint. Included with the pistol are its factory manual, photocopied parts diagram, and its factory original box. (136496-13) {NON-GUN} (50/100)
1915. **TECH FORCE 99 PREMIER AIR RIFLE** serial #Z655976, 22 Caliber, 19" barrel. The metal surfaces rate very good plus and retain about 93% of their original finish, although with a few light handling marks. The checkered walnut Monte Carlo stock rates near excellent but does exhibit a few light handling marks; featured with the stock is a recoil pad. The rifle does not include a rear sight or its front sight post, nor is any scope included. (136632-7) {NON-GUN} (75/150)

1916. **SPANISH FULL STOCK PERCUSSION SPORTING RIFLE**, 45 Caliber, 33" barrel with a very good bore, showing some light oxidation. The metal surfaces rate good but are almost completely obscured by a layer of oxidation. The brass surfaces rate very good but have become somewhat dulled with age. The smooth walnut full length stock rates very good plus, but does exhibit some light handling marks. The rifle features iron sights and includes its original ramrod. (136466-16) {ANTIQUE} (75/150)
1917. **UNMARKED HALF STOCK PERCUSSION RIFLE**, 45 Caliber, 34" barrel with a very good bore, showing some light oxidation. The metal surfaces rate very good but are subject to a light layer of oxidation. The smooth walnut half length stock rates very good, but does exhibit several light handling marks as well as a slight crack in the butt of the stock which measures about 2". The stock features brass tacks both on the forend as well as the butt; additionally the stock features a patchbox on the right side, and displays an etching on the right side which reads "1936". The rifle features iron sights as well as an installed front sight hood; however, no ramrod is included with the rifle. Although the rifle is unmarked, the lock appears similar to those used on Thompson Center rifles. (135823-150) {ANTIQUE} (50/100)
1918. **SHOTGUN BARREL LOT** Consists of a single Mossberg 12 Gauge, 24" ported rifled barrel with an excellent, bright bore. The barrel rates very good plus and retains about 96% of its factory original blued finish, but exhibits a few faint handling marks and wear as well as scattered areas of light oxidation. The barrel features an integral optic rail, with a mounted Bushnell Sportsman 3-9x scope. The scope rates excellent and retains about 98% of its factory original matte black finish with negligible faint handling marks. The optic features a duplex reticle which displays a crisp, clear sight picture. (136691-51)
1919. **BURRIS SCOPE LOT** Consists of a single Burris 4x pistol scope installed on a B-Square pistol mount. The mount itself rates excellent and retains about 98% of its factory original matte black finish. The scope rates excellent and retains about 97% of its factory original black finish with a few faint handling marks. The optic features a duplex reticle which displays a crisp, clear sight picture. Included with the scope is a set of factory lens covers. (134281-6C)
1920. **BURRIS SCOPE LOT** Consists of a single Burris 2 1/2-7x scope. The scope rates near excellent and retains about 96% of its factory original black finish with a few light handling marks. The optic features a duplex reticle which displays a crisp, clear sight picture. The scope exhibits an extremely long eye relief and is likely intended for use with a pistol. Featured with the scope is an installed set of rings, also included is a set of Butler Creek flip-up lens caps. (134281-6A)
1921. **BUSHNELL SCOPE LOT** Consists of a single Bushnell Magnum Phantom 1.3x20mm scope. The scope rates very good plus and retains about 93% of its factory original black finish, although exhibiting a few light handling marks as well as the remnants of what was likely a factory sticker along the bottom of the scope. The optic features a fine crosshair reticle which displays a crisp, clear sight picture. The scope exhibits a rather long eye relief and is likely intended for use with a pistol. (134281-6D)
1922. **BUSHNELL SCOPE LOT** Consists of a single Bushnell Phantom II 1.3x20mm scope. The scope rates very good plus, with the plastic surfaces largely remaining free of any handling marks. The optic features a fine crosshair reticle which displays a crisp, clear sight picture. The scope exhibits a rather long eye relief and is likely intended for use with a pistol. Included with the scope is a set of factory lens covers, as well as its factory original box and warranty card. (15497-4B)
1923. **LARGE GI CAN FILLED WITH ASSORTED MUNITIONS COMPONENTS.** The OD Green GI can measures 17 1/4"L x 7 1/2"W x 14"H and houses numerous items, including: a spent 40mm casing produced in 1942, an fired M9 flare round with parachute dated July 1941, three demilled Mk 2 "pineapple" grades with respective pins and spoons, a cross-section cut M104 nose bomb fuze, glass jar of shrapnel pieces, what appears to be a German WWII timed munition, as well as a variety of other related parts. (136110-3)
1924. **ORDNANCE LOT** Consists of a single OD Green wooden crate marked "STAM STAFF" and measuring 46 1/2"L x 13"W x 8 1/2"H. The crate contains four large inert projectiles. The projectiles include a single 90mm M71A1 HE-T (High Explosive - Tracer) cartridge, 105mm perforated cartridge for M40 recoilless rifle, what appears to be a WWII M41A1 20 lb. Aerial Fragmentation Bomb, and a 40mm dummy cartridge. Both the M71A1 and M41A1 cartridges appear to be in near excellent condition, only exhibiting some minor fading of their respective factory original finishes; while the 105mm and 40mm cartridges rate very good and exhibit more pronounced loss of finish as well as moderate oxidation. The crate itself rates very good but exhibits numerous instances of noticeable handling marks and fading of its OD Green finish. (136110-1)
1925. **LOT OF AMMO CANS** Consists of four empty OD Green GI ammunition cans measuring 11 3/4"L x 6 1/8"W x 7 1/4"H. Each ammo can is capable of storing up to 100 cartridges of 50 BMG ammunition. All of the ammo cans rate very good plus to near excellent but do exhibit a few light handling marks and some minor fading of their OD Green finishes. Ammo cans such as these can make for an excellent and durable storage solution. (136627-1A)
1926. **LOT OF AMMO CANS** Consists of four empty OD Green GI ammunition cans measuring 11 3/4"L x 6 1/8"W x 7 1/4"H. Each ammo can is capable of storing up to 100 cartridges of 50 BMG ammunition. All of the ammo cans rate very good plus to near excellent but do exhibit a few light handling marks and some minor fading of their OD Green finishes. Ammo cans such as these can make for an excellent and durable storage solution. (136627-1B)
1927. **LOT OF AMMO CANS** Consists of four empty OD Green GI ammunition cans measuring 11 3/4"L x 6 1/8"W x 7 1/4"H. Each ammo can is capable of storing up to 100 cartridges of 50 BMG ammunition. All of the ammo cans rate very good plus to near excellent but do exhibit a few light handling marks and some minor fading of their OD Green finishes, as well as one of the cans exhibiting minor light oxidation at its hinge. Ammo cans such as these can make for an excellent and durable storage solution. (136627-1C)
1928. **LOT OF AMMO CANS** Consists of four empty OD Green GI ammunition cans measuring 11 3/4"L x 6 1/8"W x 7 1/4"H. Each can is capable of storing up to 100 cartridges of 50 BMG ammunition. All of the ammo cans rate very good plus to near excellent but do exhibit a few light handling marks and some minor fading of their OD Green finishes, as well as one of the cans exhibiting some light oxidation. Ammo cans such as these can make for an excellent and durable storage solution. (136627-1D)
1929. **LOT OF AMMO CANS** Consists of three empty OD Green GI ammunition cans measuring 11 3/4"L x 6 1/8"W x 7 1/4"H. Each can is capable of storing up to 85 cartridges of 50 BMG ammunition. All of the ammo cans rate very good plus to near excellent but do exhibit a few light handling marks and some minor fading of their OD Green finishes. Ammo cans such as these can make for an excellent and durable storage solution. (136627-1E)
1930. **CASE KNIFE LOT** Consists of a single Case Kodiak Hunter fixed blade knife with a 6" clip point blade which rates near excellent and exhibits minimal light wear and handling marks. The blade retains its sharp edge and on the left side features an etching of the Kodiak bear logo with its detailing remaining largely crisp, although with some extremely minor fading; while the reverse states: "HAND MADE IN U.S.A.". The solid brass finger guard & pommel both rate very good plus and retain much of their original bright nature, but do exhibit some minor instances of light oxidation. The knife features a genuine stag handle which rates excellent. Included with the knife is a brown leather sheath. (135497-1A)

1931. **LOT OF KNIVES** Consists of two items. 1) A J. Marttiini Lapland Hunting Knife Model 13 with 4 1/4" straight-back blade which rates near excellent and exhibits negligible light wear and handling marks. The blade retains its sharp edge and on the right side features an etching of the company name and reindeer scene with its detailing remaining largely crisp. The solid brass spacer & pommel both rate very good plus and retain much of their original bright nature, although the spacer exhibits some verdigris staining. The knife features a European hardwood handle which rates excellent. Included with the knife is a light brown leather sheath and factory original box. 2) A J. Marttiini Lapland Hunting Knife Model 13 with 4 1/4" straight-back blade which rates near excellent and exhibits minimal light wear and handling marks. The blade retains its sharp edge and on the right side features an etching of the company name. The solid brass spacer rates very good plus but does exhibit some verdigris staining. The knife features a European hardwood handle which rates excellent. Included with the knife is a light brown leather sheath with a patch of reindeer fur, and factory original box. (135497-1C)
1932. **LOT OF KNIVES** Consists of three items. 1) A J. Marttiini Lapland Hunting Knife Model 10 with 6" straight-back blade which rates very good plus but exhibits some light wear and handling marks. The blade retains its sharp edge and on the right side features an etching of the company name and reindeer scene with its detailing remaining largely crisp, although slightly tarnished by some intruding light handling marks. The solid brass spacer & pommel both rate very good plus and retain much of their original bright nature, although the spacer exhibits some verdigris staining on the left side. The knife features a European hardwood handle which rates near excellent but has been lightly stained by the verdigris. Included with the knife is a light brown leather sheath and factory original box. 2) A custom handmade fixed blade knife with a 7" recurved blade which rates very good plus, but exhibits some light wear and handling marks. The blade retains its sharp edge and on the left side features a small etching of what appears to be a winged horse shoe. The solid brass finger guard & pommel both rate very good plus and retain much of their original bright nature. The knife features a checkered walnut handle which rates excellent, although the checkering does not appear to be professional work. Included with the knife is a light brown leather sheath which features the same winged horse shoe design. 3) A Cattaraugus fixed blade knife with a 4" upswept blade which rates very good, but exhibits moderate light wear and handling marks. The blade retains its sharp edge and on the left side features a small etching of the company's name; while the reverse states: "MADE IN U.S.A.". The knife features a smooth walnut handle which rates very good but exhibits several light handling marks. Included with the knife is a brown leather sheath which rates good but is exhibiting some early signs of deterioration; also of note, the sheath displays the name "Forest Queen". (135497-1E)
1933. **LOT OF CASE KNIVES** consists of three items. 1) A Case XX folding blade knife with a 3 1/4" clip point blade and a 2 1/2" drop point blade, both of which rate near excellent although exhibiting minimal light wear and handling marks. The knife features a textured wood handle which rates excellent. 2) A Case XX folding blade knife with a 3" drop point blade, punch tool, bottle opener, and can opener with screwdriver head; all of which rate very good plus, but do exhibit some wear and handling marks. The knife features a textured wood handle which rates excellent. 3) A Case XX folding blade knife with a 2 1/2" clip point blade and a 2" drop point blade, both of which rate very good but exhibit considerable wear and handling marks. The knife also exhibits light oxidation along its spine. The knife features a textured wood handle which rates very good plus. (135497-9B)
1934. **LOT OF KNIVES** consists of seven items. 1) An unmarked fixed blade knife with a 2 1/4" clip point blade which rates very good but exhibits several wear and handling marks, and has a dull edge. The white plastic handle rates excellent. The knife measures 4" in overall length. 2) A Union Cutlery Company folding blade knife with a 4 1/2" clip point blade which rates very good but exhibits numerous wear and handling marks. The pearl handle rates very good overall, although a 1/2" x 7/8" portion has broken off from the rear of the left side panel. The release spring is extremely difficult to operate. 3) A Camillus folding blade knife with a 3 3/4" sheep's foot blade and bottle opener, both of which rate near excellent but with minimal light handling marks and wear. The white plastic handle rates excellent. 4) A Boy Scouts of America multi-tool by Remington UMC whose metal surfaces rate good plus overall, but exhibit wear and handling marks as well as oxidation. The textured wood handle rates excellent, although the embedded BSA logo has become slightly faded. 5) A Solingen Rostfrei multi-tool whose metal surfaces rate very good overall, but exhibit some light handling marks and wear as well as some loss of the tools' factory original blued finish. The black plastic handle features the faded logo of the Special Air Service on the left side and rates very good, but with numerous light wear and handling marks. 6) An Alpine Gear "Swiss Army"-type multi-tool whose metal surfaces rate very good plus overall despite some minor light wear and handling marks. The black synthetic handle rates near excellent, with minimal faint handling marks or wear. 7) A Swiss Army multi-tool whose metal surfaces rate excellent to like new. The red plastic handle also rates excellent to like new. Included with the Swiss Army Knife is its factory original box and paperwork. (135497-9C)
1935. **LOT OF TRIPLE K MAGAZINES** Includes four as new in the package high capacity (15 round), 9mm blue finished, steel magazines marked for Beretta 92 / Taurus. The magazines are in as near new condition. (106382-1B)
1936. **LOT OF POWDER CANS** First is a DuPont 1/2 lb. Golden Pheasant powder can with paper label, in fine condition overall with 90-95% lightly chipping black paint, tight seams but no cap present. Second is a 1/2 lb. red painted King's Quick Shot powder can with paper labels in fine condition overall with light flaking to paint, on the top and bottom of the can. A proper cap is present. Third is a DuPont 1 lb. red painted Smokeless Powder can with painted labels in fine condition showing light chips to paint and the cap present. Fourth is a 1/2 lb. Lafin & Rand Smokeless Powder can with full color painted label in good to very good condition showing moderate paint crazing and light oxidation staining on top of can. There is a proper cap is present. Fifth is a DuPont Sporting Rifle Powder can with green, white and red paper label in fine condition overall with a few scuffs and tears to label. (106106-523A)
1937. **LOT OF MAGAZINES** Includes four aftermarket Beretta 9mm 15 round magazines from two manufacturers. There are three stainless steel bodied magazines in blister packaging from U.S.A. Magazines, all appear in as new condition. Also included is a single stainless magazine in its original unopened packaging from Ram-Line in as-new condition as well. (106382-1)
1938. **LOT OF AR-15 MAGAZINES** Includes three Colt-marked 5.56mm 20 round magazines. The magazines show numerous light scratches, are free of dents and are in excellent overall condition. (106382-2A)
1939. **LOT OF AR-15 MAGAZINES** Five 30 round aluminum after market magazines to include: (3) from O Kay Industries and (2) from Defense Procurement Manufacturing Services. The magazines show several light scratches consistent from use and are in excellent condition. (106382-2C)
1940. **LOT OF SKS MAGAZINES** Includes three: first is a 30 round Zytel nylon magazine in its original packaging with loading tool. Second are (2) made-in-China marked steel magazines in original packaging all in as near new condition. (106382-2G)
1941. **LOT OF MAGAZINES** Includes four aftermarket high capacity Beretta style magazines. There are (2), Pro Mag 32 round 9mm magazines in original packaging intended for use in a 92F pistol. Also included are (2), U.S.A. Magazines 32 round 9mm in original packaging also intended for use in the 92F pistol. These magazines are in as near new condition. (106382-1D)
1942. **LOT OF AR-15 MAGAZINES** Includes three Colt 5.56mm marked 20 round magazines. All three magazines show minor scratches in the finish consistent with use and appear to be in excellent working condition. (106382-2)
1943. **LOT OF MAGAZINES** Five total: first is an unmarked steel 30 round Mini-14 style magazine in a sealed plastic wrap showing some light scratches in the finish with one moderate spot on the floorplate that has light oxidation staining present. Second are four plastic 30 round Ram-Line "combination" magazines designed for use in either a Mini-14 or AR-15 rifle. These magazines are in original un-opened packaging and all are in excellent condition. (106382-2B)

1944. **LOT OF AR-15 MAGAZINES** Includes four 30 round aluminum magazines in original packaging from two manufacturers. There are two from Defense Procurement manufacturing services and two from Center Industries Corporation all in as near new condition. (106382-2D)
1945. **LOT OF MINI-14 MAGAZINES** Includes six aftermarket 30 round steel magazines in un-opened original packaging from Precision Mag in near as new condition. (106382-2E)
1946. **LOT OF MAGAZINES** Includes five polymer "combination" Mini-14 / AR-15 30 round magazines from Ram-Line. These magazines are in their original packaging and are in as near new condition. (106382-2F)
1947. **DRUM MAGAZINE LOT** Includes a 75 round MDG1 Chinese manufactured AK-47 magazine with instruction booklet. The magazine is sealed in what is likely the original arsenal plastic wrap with protective Cosmoline coating. (106382-3C)
1948. **DRUM MAGAZINE LOT** Includes a 75 round MDG1 Chinese manufactured AK-47 magazine with instruction booklet. The magazine is sealed in what is likely the original arsenal plastic wrap with protective Cosmoline coating. (106382-3)
1949. **LOT OF MAGAZINES** Includes five steel AK-47 style magazines. First are (3) unmarked 40 round magazines showing several scratches and spots of light oxidation staining in very good to near excellent condition. Second are (2) 30 round steel magazines showing a few light scratches in the painted finish in excellent overall condition. Also included is a steel magazine coupler that has spots of oxidation staining in several areas. (106382-5B)
1950. **LOT OF GLOCK MAGAZINES** Includes five total: first are (2) aftermarket 33 round 9mm magazines likely for a Model 17 pistol. One of the magazines is in its original paper wrapped packaging, both are in excellent condition. Second are (3) Glock marked 15 round 9mm magazines likely for a model 17 as well all in excellent condition. (106382-4C)
1951. **DRUM MAGAZINE LOT** Includes a Chinese manufactured 120 round 5.56mm MDG3 AR-15 magazine with instruction booklet. The magazine is in excellent condition and comes in its original opened packaging with a protective layer of Cosmoline. (106382-3A)
1952. **DRUM MAGAZINE LOT** Includes a Chinese manufactured 120 round 5.56mm MDG3 AR-15 magazine. The magazine is in excellent condition and comes in its original un-opened packaging with a protective layer of Cosmoline. (106382-3B)
1953. **LOT OF MAGAZINES** Includes four U.S.A. Magazines Glock style 9mm magazines. There are two 17 round and two 15 round all in original plastic packaging in excellent condition. (106382-4E)
1954. **DUM MAGAZINE LOT** Includes a 75 round MDG1 Chinese manufactured AK-47 magazine. The magazine is sealed in what is likely the original arsenal plastic wrap with protective Cosmoline coating. (106382-3E)
1955. **LOT OF MAGAZINES** Includes five aftermarket Glock style 9mm magazines. There are three 30 round and two 15 all in very good to excellent condition. (106382-4C)
1956. **DRUM MAGAZINE LOT** Includes a Chinese manufactured 120 round 5.56mm MDG3 AR-15 magazine. The magazine is in excellent condition and comes in its original un-opened packaging with a protective layer of Cosmoline. (106382-3D)
1957. **LOT OF TAPCO POLYMER MAGAZINES** Four 30 round AK-47 style magazines in original plastic packaging (1) in olive drab, (1) black, and (2) dark earth colored all in near as new condition. (106382-5D)
1958. **LOT OF AK-47 STYLE MAGAZINES** Six unmarked steel 30 round magazines showing light scratches and spots of faint oxidation staining in very good to excellent condition. Also included with this lot is a two place steel coupler. (106382-5E)
1959. **LOT OF TAPCO POLYMER MAGAZINES** Five 30 round AK-47 style magazines with (3) in original plastic packaging (2) in olive drab, (2) black, and (1) dark earth colored all in excellent to near as new condition. (106382-5C)
1960. **LOT OF GLOCK MAGAZINES** Three total: first are (2) 9mm 10 round double stack compact magazines in excellent condition. Second is a 9mm 10 round single stack magazine in excellent condition. (106382-4)
1961. **LOT OF MAGAZINES** Includes four sealed Korean manufactured 33 round 9x19mm Glock style magazines presumed to be in excellent to near as new in condition. (106382-4D)
1962. **LOT OF MAGAZINES** Includes four: first are three aftermarket 30 round Glock style 9mm magazines in excellent condition. Second is a 15 round 9mm Glock style magazine also in excellent condition. (106382-4A)
1963. **LOT OF MIXED MAGAZINES** Includes four: first is a PB marked 15 round 9mm magazine in very good condition. Second are (2) 17 round after market steel 9mm magazines. The magazines are marked S&W on the floorplate with an elongated ampersand and appear to be in very good condition. Third is a single Ram-Line magazine for an S&W 469 pistol in nickel finish still in its original packaging. (106382-1A)
1964. **LOT OF MAGAZINES** Includes five aftermarket Beretta 92FS style magazines. First are (3) 15 round stainless steel finished U.S.A. Magazines in their original un-opened packaging. Second are (2) 17 round nickel finish Eagle International magazines in their original packaging. All magazines are in excellent condition. (106382-1C)
1965. **LOT OF TOMMY GUN LITERATURE** Includes two booklets: first is a War Department TM 9-1215 technical manual for the Thompson submachine gun dated March 1, 1942. The cover shows some light ingrained dirt staining and has separated from the single staple that holds it in place. The pages have slightly yellowed and there is evidence of light foxing scattered throughout aside from that this booklet is in very good condition. Second is a promotional print titled the Thompson Gun, for the Auto-Ordnance Corporation. The booklet is in excellent condition and provides a basic understanding of the versatile application for the model 1921-23 Thompson Submachine Gun. (105210-11)
1966. **30 CALIBER T&E DEVICE** Intended for use with the M1919A4 or M1919A6 machine gun in conjunction with the M2 tripod that allows traverse and elevation adjustments. The device appears complete in excellent working condition and is covered in a protective layer of Cosmoline. (106119-2)
1967. **50 CALIBER T&E DEVICE** A Browning M2 50 cal. T&E device intended for use on the M2 tripod. The device is in excellent working condition and appears complete. (106119-3)
1968. **M2 TRIPOD** U.S. 30 Cal. tripod serial# 329322 that is R.I.A. marked and dated 1956 with Pintle. The metal surfaces are mostly void of finish and are a mix of grey and brown where spots of oxidation are blending. The base and all parts appear to be properly marked and the unit functions mechanically. Paired with one of the previously mentioned T&E Devices this could make a great addition to ones collection. (106119-1)

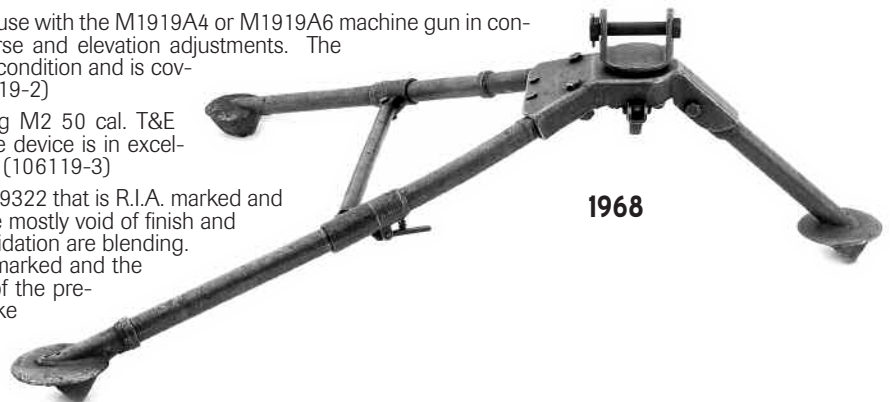

1968

1969. **CUSTOM TOMMY GUN CASE** A modern violin style foam-lined case measuring roughly 43" long by 26" at its widest point. The case is dressed with brass hardware to include five clasps one is lockable (key included). This is a neat, well made case, in excellent condition that would add a vintage "Gangster" flare when transporting ones Tommy gun to the range. (106278-4B)
1970. **BOOK LOT** Includes two hardcover titles by David Darom, first is an illustrated 256 page selection titled Custom Folding Knives, copyright 2006. The book is in excellent condition showing only minor handling marks with the most prominent being a small section along one edge of the dust jacket that has crinkled slightly. Second is an illustrated 276 page selection titled Custom Fixed-Blade Knives, copyright 2005. This book is in excellent condition complete with dust jacket. These books would make a great addition to ones library. (106237-24, 25)
1971. **LOT OF TWO BOOKS** First is an illustrated 254 page hardcover title Art of the Knife-custom creations from the world's top knife makers, by Joe Kertzman, copyright 2007. The book is in very good to near excellent condition with intact but slightly damaged dust cover that has crinkled edges and a small tear. Second is an illustrated 288 page hardcover title The Great Collection, by David Darom, copyright 2007. The book is in excellent condition with a few minor handling marks on the dust jacket. (106237-23, 26)
1972. **LOT OF SEVEN BOOKS** A selection of soft cover annual edition books titled Knives edited by Joe Kertzman dating from 2005 through 2011. The books are all in excellent condition and filled with wonderful color illustrations and informative text. These books would make a great start for a young or beginning knife collector. (1096237-22)
1973. **BARRETT 50 CAL. AMMUNITION** Includes two ten round boxes of M-33 Ball, 661 gr., .50 BMG rifle cartridges. The boxes show minor damage that has been repaired by clear tape and the cartridges are in excellent overall condition. (106719-3)
1974. **BARRETT 50 CAL. AMMUNITION** Includes two ten round boxes of M-33 Ball, 661 gr., 50 BMG rifle cartridges. The boxes and ammunition both are in excellent condition. (106719-3A)
1975. **BARRETT 50 CAL. AMMUNITION** Includes two ten round boxes of M-33 Ball, 661 gr., 50 BMG rifle cartridges. The boxes are slightly damaged and reinforced with clear tape and the ammunition remains in excellent condition. (106719-3B)
1976. **BARRETT 50 CAL. AMMUNITION** Includes two ten round boxes of M-33 Ball, 661 gr., 50 BMG rifle cartridges. The boxes rate very good overall with one tape reinforced bottom and the cartridges rate excellent. (106719-3C)
1977. **BARRETT 50 CAL. AMMUNITION** Includes two ten round boxes of M-33 Ball, 661 gr., 50 BMG rifle cartridges. The boxes have tape repaired bottoms and the cartridges are in excellent condition. (106719-3D)
1978. **BARRETT 50 CAL. AMMUNITION** Includes two ten round boxes of M-33 Ball, 661 gr., 50 BMG rifle cartridges. The boxes are in good overall condition with tape reinforced ends and the cartridges are in presumably excellent condition. (106719-3E)
1979. **BARRETT 50 CAL. AMMUNITION** Includes two ten round boxes of M-33 Ball, 661 gr., 50 BMG rifle cartridges. The boxes are in good to very good condition with a tape repaired bottom on one and the cartridges rate excellent. (106719-3F)
1980. **BARRETT 50 CAL. AMMUNITION** Includes two ten round boxes of M-33 Ball, 661 gr., 50 BMG rifle cartridges. The boxes are in good to very good condition and have had repairs made in clear tape over a tear or separated seam. The cartridges are in excellent condition. (106719-3G)
1981. **BARRETT 50 CAL. AMMUNITION** Includes two ten round boxes of M-33 Ball, 661 gr., 50 BMG rifle cartridges. The boxes are in good overall condition with tape repaired seams and the cartridges rate excellent. (106719-3H)
1982. **BARRETT 50 CAL. AMMUNITION** Includes two ten round boxes of M-33 Ball, 661 gr., 50 BMG rifle cartridges. The boxes rate very good overall with tape reinforced bottoms and the cartridges are in excellent condition. (106719-3I)
1983. **LOT OF 50 CAL. ACCESSORIES** Includes three items: first is approximately 12 lbs. of loose links in excellent condition. Second is an M-12 Linker / De-linker tool in excellent working condition. Third are nine linked rounds of 50 Cal. F.N.B. 83 head stamp marked cartridges in very good to excellent condition showing light tarnish along the brass. (106719-2)
1984. **BARRETT 50 CAL. AMMUNITION** Includes three ten round boxes of M-33 Ball, 661 Gr., 50 BMG rifle cartridges. The boxes have clear tape reinforced bottoms and the cartridges are in excellent condition. (106719-3J)
1985. **BARRETT 50 CAL. AMMUNITION** Includes two ten round boxes of M-33 Ball, 661 gr., 50 BMG rifle cartridges. The boxes have tape reinforced seams and edges and appear to have been mishandled at some point but the cartridges remain in excellent condition. (106719-3K)
1986. **BARRETT 50 CAL. AMMUNITION** Includes two ten round boxes of M-33 Ball, 661 gr., 50 BMG rifle cartridges. The boxes and cartridges are in excellent condition. (106719-3L)
1987. **BARRETT 50 CAL. AMMUNITION** Includes two ten round boxes of M-33 Ball, 661 gr., 50 BMG rifle cartridges. The boxes have clear tape reinforced bottoms and the cartridges are in excellent condition. (106719-3M)
1988. **BARRETT 50 CAL. AMMUNITION** Includes two ten round boxes of M-33 Ball, 661 gr., 50 BMG cartridges. The boxes and cartridges are both in excellent condition. (106719-3N)
1989. **BARRETT 50 CAL. AMMUNITION** Includes two ten round boxes of M-33 Ball, 661 gr., 50 BMG rifle cartridges. The boxes are in very good condition with clear tape reinforced bottom flaps and the cartridges rate excellent. (106719-3O)
1990. **BARRETT 50 CAL. AMMUNITION** Includes two ten round boxes of M-33 Ball, 661 gr., 50 BMG rifle cartridges. The boxes are in good condition with tape reinforced bottoms and have lightly pushed in corners and the cartridges remain in excellent condition. (106719-3P)
1991. **BARRETT 50 CAL. AMMUNITION** Includes two ten round boxes of M-33 Ball, 661 gr., 50 BMG rifle cartridges. The boxes are in very good condition with added clear tape to reinforce the perforated seams at the bottom and the cartridges are in excellent condition. (106719-3Q)
1992. **BARRETT 50 CAL. AMMUNITION** Includes two ten round boxes of M-33, 661 gr., 50 BMG rifle cartridges. The boxes are in good condition showing some light scuffing, a pushed in corner and tape reinforced bottoms. The cartridges remain in excellent condition. (106719-3R)
1993. **BARRETT 50 CAL. AMMUNITION** Includes two ten round boxes of M-33 Ball, 661 gr., 50 BMG rifle cartridges. The boxes are in very good condition and have had clear tape added to the bottom flaps for stability and the cartridges rate excellent. (106719-3S)
1994. **BARRETT 50 CAL. AMMUNITION** Includes two ten round boxes of M-33 Ball, 661 gr., 50 BMG rifle cartridges. The boxes are in good overall condition with light impressions on the sides near the bottom and have had clear tap added for strength. The cartridges are in excellent condition. (106719-3T)

1995. **SPOTTING SCOPE LOT** Three items in all: first is an unmarked olive drab painted brass bodied spotting scope measuring 29" overall with spotted clear optics. It appears to be a 5X with 1" objective opening. The tube measures 38mm and has an integral mount near halfway down its length. Included with the spotting scope is a yolk-style quick detachable stand and carry case. The case measures 1 1/2" X 5" X 5" and secures with leather straps. The items in this lot are in excellent usable condition. (105865-230)
1996. **COLLECTIBLE AMMUNITION LOT** Includes a partial 20 round box (19 cartridges) of Winchester John Wayne commemorative 32-40 ammunition. The "Duke" is pictured in front of a waving American flag on the box front. There are areas along the seams that show light scuffing and a few spots of light staining along the end flap. Aside from a couple of small blemishes this would make a great candidate for a presentation alongside one of the guns that helped tame the west. (106694-13A)
1997. **REMINGTON RIMFIRE AMMUNITION** Includes a full 500 round brick of Hi Speed hollow point 22 LR cartridges. Aside from light ingrained dirt staining and a few pencil marks the outer sleeve rates excellent and the green and red individual 50 round boxes do as well. The cartridges are clean and bright. The items in this lot are in excellent or one could almost say "Golden" condition. (106671-3)
1998. **AR-15 HEAVY BARREL** 5.56 mm marked, 20 1/2" with threaded muzzle and bright excellent bore. The barrel retains 90% plus of its original dark phosphate finish with several light scratches near its entire length. The front sight insert is missing, making this an overall near excellent condition accessory. (104807-8)
1999. **MG 42 BARRELS** This lot consists of two MG 42 spare barrels, 8mm, 20 3/4" barrel, 22 3/8" overall length. The first barrel is numbered 57879 and retains 85% of its original blue with a dark lightly pitted bore. The second barrel is numbered 50946 and retains near 75% of its original blue with a large area of loss just ahead of the number. The bore is dark and pitted near its full length and there is a bulge near halfway down its length. Neither barrel bears any visible Waffenamts markings. (104849-38A)
2000. **MG 42 BARRELS** This lot consist of two MG 42 (MG3) spare barrels, 308 Win. (7.62x51 mm NATO), 20 3/4" barrel 22 3/8" overall length. The first barrel is numbered 2428 / C with a bright excellent bore. It is maker coded "avf" on the barrel extension and has some light oxidation staining present near the muzzle. The second barrel is not numbered with a smokey bore with spotted pitting over its length. It has a "dot" code on the barrel extension which is predominantly grey. (104940-38O, 38H)
2001. **MG 42 BARRELS** This lot consists of two MG 42 (MG3) spare barrels, 308 Win. (7.62x51 mm NATO), 20 3/4" barrel, 22 3/8" overall length. The first barrel is numbered 1040 / B and has a small amount of oxidation staining near the muzzle and a bright excellent bore. The barrel extension is Waffenamts marked and maker coded "dfb / 12". The second barrel is numbered 6509 / A with a bright bore that has a tiny spot of pitting halfway down its length. The barrel extension is maker coded "dfb / 11". Both bear the same firing proofs. (104940-38M, 38J)
2002. **MG 42 BARRELS** This lot consists of two Steyr-marked MG 42 (MG3) spare barrels, 308 Win. (7.62x51 mm NATO), 20 3/4" barrel, 22 3/8" overall length. The first barrel is numbered 3684 / A, and has a bright excellent bore. The second barrel 6840 / B, with a bright excellent bore. (104940-38L, 38S)
2003. **50 CAL. AMMUNITION LOT** Includes 100 linked rounds of PMC .50 Cal, 660 gr., FMJ-BT cartridges in an olive drab painted ammo can in excellent condition. The cartridges are head stamp marked PSD / 07. (106719-1)
2004. **50 CAL. AMMUNITION LOT** Includes an olive drab colored ammo can containing 100 linked rounds of PMC 50 Cal., 660 gr., FMJ-BT cartridges. The cartridges are head stamp marked PSD / 07 and all are in excellent condition. (106719-1A)
2005. **50 CAL. AMMUNITION LOT** Includes 100 linked rounds of PMC 50 Cal., 660 gr., FMJ-BT cartridges in an olive drab colored ammo can. The cartridges are head stamp marked PSD / 07 and are in excellent condition. (106719-1B)
2006. **50 CAL. AMMUNITION LOT** Includes 100 linked rounds of PMC 50 Cal., 660 gr., FMJ-BT cartridges in a metal olive drab colored ammo can. The cartridges are head stamp marked PSD / 07 and are in excellent condition. (106719-1C)
2007. **50 CAL. AMMUNITION LOT** Includes 100 linked rounds of PMC 50 Cal., 660 gr., FMJ-BT cartridges in an olive drab colored ammo can. The cartridges are head stamp marked PSD / 07 and are in excellent condition. (106719-1D)
2008. **MG 34 ANTI AIRCRAFT TRIPOD** This lot includes a German MG 34 tripod with canvas carry strap. The tripod is numbered 12-135-6809 and measures roughly 46" overall when folded. It is marker coded NHW and dated 12/63. The base is an olive drab color and appears to be a quality repaint and the yolk is green-apple with spots of flaking and oxidation present. This is a very good to near excellent condition working tripod that would make a fantastic addition to ones MG 34. (106606-14A)
2009. **LOT OF MIXED AMMUNITION** Includes 71 loose hand gun and rifle cartridges and a partial box to include the following: (1) partial 20 round box (13 cartridges) Federal Hi-Power 308 Winchester, 180 gr., SP, Hi-Shok cartridges in excellent condition, (26) mixed manufacturer 22 LR cartridges in excellent condition, (7) mixed manufacturer 9 mm cartridges with varying levels of verdigris, (21) mixed configuration and manufacture 45 ACP, (17) assorted bore shotshells in .410, 20, 16, and 12. Cartridges range in condition from fair to excellent. (105942-17)
2010. **THOMPSON TYPE "L" DRUM MAGAZINE** A fourth model 50 round type "L" drum magazine retaining near 90% plus of its original finish showing light surface scratches with some minor loss due to silvering along the edges and on the lower portion of the face. This is a Universal Metal Stamping Co. magazine with the Bridgeport address. It has the Thompson bullet logo with white highlighted lettering. The magazine is in excellent condition. (106229-A69A)



2011. **THOMPSON TYPE "L" DRUM MAGAZINE** A first model Auto Ordnance 50 round type "L" drum magazine showing some added finish along the edges retaining most of its original finish. This is a "Standard" New York address magazine without the Thompson logo on the front and is has the amended faceplate with the addition of instructions for the model 1928. Manufactured by Worcester Press Stamping Co., this magazine is in excellent overall condition. (106229-A69B)
2012. **FOREND LOT** Includes one walnut vertical fore grip for a Thompson submachine gun. The grip shows a few light scratches and some minor handling marks but remains in excellent condition. (104392-40A)
2013. **MAGAZINE LOT** Includes two Romanian PSL style ten round steel magazines. The magazines are electric pencil numbered C-4938 and H-4994 along the front flat and are in excellent condition. (105988-S16768A-B)
2014. **MAGAZINE LOT** Includes two Romanian PSL style ten round steel magazines. The magazines are electric pencil numbered C-5296 and C-8389 along the front flat and are in excellent condition. (105988-S16768A-A)
2015. **MAGAZINE LOT** Includes three Romanian PSL style ten round steel magazines. The magazines are electric pencil numbered C-5418, and R-6686 along the front flat and are in excellent condition. (105988-S16768A-C)
2016. **RUGER PARTS LOT** Includes a 5 1/2" 22 caliber barrel likely for a bear cat or similar revolver. The barrel retains near all of its original blue finish and has a bright bore however at some point someone drilled and tapped a hole 1 1/4" down from the muzzle on the right side almost all the way through. Also included are three blued front sight blades and a hammer and 22 caliber cylinder. (105053-16G)
2017. **KNIGHTS ARMAMENT TOP RAIL** Measures 12" overall in length with the following attachments; an M203 grenade launcher sight and side mount bracket for a small flash light. Items are in excellent working condition. (105478-12)
2018. **HOTCHKISS TRAY** Includes a single tray for a Japanese type 3 Hotchkiss machine gun. The moderate to heavily oxidized 7.7 mm cartridges are stored in the tray that comes in a missed matched cardboard and fabric covered box that retains a partial label in Japanese. (105478-13)
2019. **MAGAZINE LOT** Includes five U.S.A. Magazines Mini-14 high capacity magazines. There are four 30 round to include (1) stainless steel and (3) blued in original packaging. Also included is (1) stainless steel 40 round in its original packaging all in excellent condition. (105732-19)
2020. **MIXED AMMUNITION LOT** Includes four full boxes: first is a 50 round box of Blazer Brass 9 mm 115 gr., FMJ cartridges in excellent condition. Second is a 50 round box of Norinco 9 mm, 124 gr., ball cartridges in excellent condition. Third is a full 20 round box of PMC 223 Rem., 55 gr., FMJ-BT cartridges in excellent condition. Fourth is a full 20 round box of American Eagle 223 Rem., 55 gr., FMJ-BT cartridges in excellent condition. (105732-13)
2021. **LOT OF MINI-14 ACCESSORIES** Six items total: first is an NoStar scope mount for the Mini-14 or Mini 30 rifle. Also included are (5) 6.8 mm SPC magazines, there are (3) Ruger five round magazines in original sealed packaging and (2) 20 round Pro Mag in original sealed packaging. (106691-59)
2022. **LOT OF MIXED CALIBER AMMUNITION** Includes a full 50 round box of Western 32 Automatic, 71 gr., FMC cartridges in excellent condition, a partial 50 round tray (48) of Remington 25 ACP, cartridges and a small bag of 12 mixed 22 caliber (long and short) and (5) 32 ACP cartridges all ranging in condition from good to excellent. (105732-11)
2023. **RPD ACCESSORIES** Includes an assortment of canvas carry cases and one 100 round drum magazine. There are two drum magazine cases and one rifle case all in excellent condition. Also included is a RPD saw bag adapter. (106593-6A)
2024. **LOT OF MITCHELL M90 MAGAZINES** Four total to include (2) 20 round and (2) 30 round magazines in their original packaging all in excellent condition. (106667-2)
2025. **LOT OF MITCHELL M90 MAGAZINES** Four total to include (3) 20 round and (1) 30 round magazines in their original packaging all in excellent condition. (106667-2A)
2026. **M-14 MAGAZINES** Included are three sealed paper-wrapped military spec. 20 round M-14 magazines presumably in excellent condition. The packaging is marked "1005-00-628-9048 / Magazine / 1 EA / BR4-A-5/80" (106247-49)
2027. **M-14 MAGAZINES** Included are three sealed paper-wrapped military spec. 20 round M-14 magazines presumably in excellent condition. The packaging is marked "1005-00-628-9048 / Magazine / 1 EA / BR4-A-5/80" (106247-49A)
2028. **LOT OF LINKED DUMMY ROUNDS** Includes about 300 +/- rounds of 8mm dummy cartridges for use in an MG 34 or MG42 machine gun. There are 97 rounds on disintegrating links and the rest are on continuous non-disintegrating links. (106627-10)
2029. **CALICO MAGAZINE LOT** Includes an M100, 22 LR, magazine in its original box with instruction sheet. The magazine appears unused and is in excellent condition. (106247-49B)
2030. **M-14 MAGAZINES** Included are three military spec. 20 round M-14 magazines (2) are sealed in paper and (1) is foil wrapped all presumably in excellent condition. The packaging is marked "1005-00-628-9048 / Magazine / 1 EA / BR4-A-5/80" (106247-49C)
2031. **LOT OF RUGER MAGAZINES** Includes three sealed original package Mini-14 magazines. There are (2) 20 round and (1) 30 round all in as new condition. (106247-49D)
2032. **LOT OF RUGER MAGAZINES** Includes three sealed original package Mini-14 magazines. There are (2) 20 round and (1) 30 round all in as new condition. (106247-49E)
2033. **LOT OF RUGER MAGAZINES** Includes two sealed package Mini-30 7.62x39mm 20 round magazines in as new condition. (106247-49F)
2034. **LOT OF MAGAZINES** Includes three aftermarket Mini-30 magazines from U.S.A. Magazines. They are 30 round mags (2) are blued and (1) is stainless all in excellent condition. (106247-49G)
2035. **LOT OF RUGER MAGAZINES** Includes three sealed original package Mini-14 magazines. There are (2) 20 round and (1) 30 round all in as new condition. (106247-49H)
2036. **LOT OF AR-15 MAGAZINES** Includes five aftermarket 30 round magazines. There are (3) OrLite Engineering Co., molded magazines in excellent condition and (2) Cooper Industries steel magazines on a coupler in excellent condition. (106247-49I)
2037. **LOT OF AFTERMARKET AR-15 MAGAZINES** Includes six OrLite- Engineering Co., molded plastic 30 round magazines, four with dust covers all in excellent condition. (106247-49J)



2038. **LOT OF M1 CARBINE MAGAZINES** Three unmarked 30 round magazines all in excellent condition. (106247-49K)
2039. **LOT OF AR-15 MAGAZINES** Includes six 30 round steel magazines by Okay Industries all in plastic packaging and in excellent condition. (106247-49L)
2040. **LOT OF AR-10 MAGAZINES** Includes three Armalite phosphate finished magazines (1) ten round and (2) 20 round both in excellent condition. (106247-49M)
2041. **LOT OF AR-10 MAGAZINES** Includes three Armalite phosphate finished magazines (2) ten round and (1) 20 round all in excellent condition. (106247-49N)
2042. **LOT OF AR-10 MAGAZINES** Includes three Armalite phosphate finished magazines (2) ten round and (1) 20 round all in excellent condition. (106247-49O)
2043. **LOT OF AR-15 MAGAZINES** Includes six 30 round steel magazines. There are (5) Center Industries Corp., and (1) Parsons Precision Corp., most in plastic packaging all in excellent condition. (106247-49P)
2044. **LOT OF AR-15 MAGAZINES** Includes six total. First are (2) Colt 20 round 5.56 mm marked magazines wrapped in foil paper in excellent condition. Second are four aftermarket steel 30 round magazines (2) from Parsons Precision, (1) Okay Industries, and (1) Center Industries all in excellent condition. (106247-49Q)
2045. **LOT OF AR-10 MAGAZINES** Includes two Armalite 20 round magazines in their original packaging in excellent condition. (106247-49R)
2046. **LOT OF AR-10 MAGAZINES** Includes three Armalite phosphate finished magazines (1) ten round and (2) 20 round both in excellent condition. (106247-49S)
2047. **LOT OF AR-10 MAGAZINES** Includes three Armalite phosphate finished ten round magazines. The magazines are in their original packaging and are in excellent condition. (106247-49T)
2048. **LOT OF MINI-14 MAGS** Includes three steel magazines first is a 30 round Ruger marked in excellent condition in its original cardboard box that is missing part of the bottom flap. Second are (2), Precision Mag 40 round Mini-14 style magazines in sealed packages in excellent condition. (106247-49U)
2049. **LOT OF AR-15 MAGAZINES** Includes five; first are (2) Colt marked 20 round phosphate finished magazines showing multiple light scratches in the finish in excellent condition. Second are (3) unmarked 30 round magazines in excellent condition. (106247-49V)
2050. **LOT OF AR-15 MAGAZINES** Includes three: first is an unmarked steel 20 round magazines in excellent condition. Second are (2) sealed package Magpul PMAG30 magazines with clear window in as near new condition. (106247-49W)
2051. **LOT OF AR-15 MAGAZINES** Includes three aftermarket 30 round steel AR style magazines. There are (2) unmarked 7.62x39mm steel magazines in excellent condition. Also included is a sealed U.S.A. Magazines 30 round 7.62x39mm AR style magazine in as near new condition. (106247-49X)
2052. **LOT OF NAZI MEMORABILIA** A total of seven items to include a red cotton arm band with swastika, a small red pennant measuring 6 1/2" across the back and 9" at the point with swastika; both appear to be modern reproductions. Next are three badges: (2) wounded service and an Iron Cross first class with uniform ribbon, all well done reproductions in excellent condition. Last is a Russian front medal missing its ribbon in excellent condition. (103615-1F, 1G, 1K, 1H, 1I, 1J, 1E)
2053. **LOT OF GERMAN MILITARY BELT BUCKLES** Two in all first is a die cast police badge with swastika and "Gott mit uns" motto. The buckle is complete showing some wear along the edges and high points and is in near excellent condition. Second is a die cast Luft Waffe belt buckle with flying eagle clutching a swastika showing edge wear and smoothing of the pebble finish along the face. On the back face there is an A 39 visible along the flat. Buckle has a 3" long section of leather attached to it and remains in very good overall condition. (103615-1C, 1B)
2054. **GERMAN BELT LOT** Includes a leather belt measuring 33 1/2" over all with a post war "Gott Mitt Uns" with crown buckle. The leather is supple and in very good condition showing spots of light crazing. The buckle retains near 80% of its painted finish with loss due to flaking. (103615-1A)
2055. **LOT OF MAGAZINES** Consists of two 5 round detachable box magazines for Winchester Model 52/56/57/69/75 rifles. Both of the magazines rate very good although with much of their factory original blued finish having faded; additionally, the magazines exhibit light handling marks and wear as well as scattered oxidation. (134749-9R)
2056. **U.S. MODEL 1840 NIPPES CONTRACT PERCUSSION-CONVERTED "BLANKET GUN"**



.69 cal. bolster-type percussion conversion, 14" barrel with an oxidized bore. All

the metal surfaces are an overall dull brown

oxidized patina showing some light pitting, more moderate in the flash areas surrounding the nipple, bolster and barrel and lockplate adjacent to it. The muzzle shows a slight bit more silvering and an attempt at some artificial aging

through multiple peen and impact marks with some tool. The stock rates very good showing nice crazing,

old antique varnish; it is sound and there are no remnants of any cartouches. The stock has been decorated with

the addition of 4 brass tacks in the shape of a star on both the left and right side of the butt, with 6 brass tacks in line on

both left and right of the forearm. The lock is crisp and mechanically functional and a shortened ramrod from the period of use

is present, it appears to be a trapdoor rifle cleaning rod. The hammer screw is a replacement. (36364-4) {ANTIQUE} (350/550)

2057. **ANTIQUE BRITISH NON-XLL BOWIE BY JOESPH ALLEN & SONS** This knife measures 9 1/2" overall with a 5 1/2" tapered full tang blade marked "NON-XLL" along the obverse top edge and Allen & Sons Sheffield makers mark on the ricasso. The blade is an overall pewter gray with scattered spots of oxidation staining more prevalent on the reverse side with more moderate oxidation and pinprick pitting on the ricasso; the edge shows light silvering and scratching from being sharpened. The oval German Silver guard has nicely mellowed with a few specks of light oxidation and the cream colored jugged bone handles have darkened nicely with age and are fastened by three small iron brads. Knife includes a brown leather sheath with metal tip and thin leather belt loop stamped "Made In Germany" in the rear of the loop. The leather shows some light crazing but remains supple with previous owners name scratched in the front of the sheath and a stitched and glue repair to the rear of the belt loop which started to separate once again. A good to very good condition Sheffield bowie. (55706-45) (200/400)

2058. **ETCHED IRON INDIAN DAHL SHIELD** This is a hammered iron shield with rolled edge and an overall etch-engraved face. Remnants of some light colored damascening can be seen, likely some type of a silver wash or plate, but predominantly the shield is a soft lightly brown oxidized patina. There are images of tiger, elephants and what appear to be Durga, in some cases riding her Tiger; Shiva may be present as well. The edge of the shield shows geometric riveted appliques and there appears to be Hindi writing in 4 different panels. The shield had four hammered rondelles, 3 of which remain present which serve as anchors for the handle rings on the backside of the shield. The rings are present, the handles are not. The center textile cushion remains intact showing remnants of its burgundy baize covering, much of which has worn away; the stitching remains intact. The shield is an overall 17 1/2" in diameter, the back showing a bit more active oxidation. Very pleasing overall with the etching still fully visible. (35393-2)



2059. **LOT OF WINCHESTER PROMOTIONAL PAPER** This lot consists of 19 copies of Winchester Western 1980 Sporting Arms and Ammunition catalog. Catalogs are all very good plus to excellent, perhaps with some very light foxing here and there, most are likely unread. They feature the 101 line, the 23 XTR line, the Super X Model 1's all manner of 94 and model 70, the commemorative for that year was the Oliver F Winchester Model 94. A single Winchester Western 1976 Sporting Arms Ammunition Reloading Components catalog is included as well. It rates very good with the complete product line, the 101 and 21 shown with the model 52 in the International Match with laminated stock and D-handle palm rest included as well; the commemorative for that year was of course the Winchester Bicentennial 76. Three copies of the Winchester 1973 Sporting Arms and Ammunition catalog are included, they rate very good showing a couple minor wrinkles here and there, showing the full product line with the introduction of the Model 37 single shot shotgun and introducing the Win-Choke system at no extra cost rather than as an added extra. The model 94 Antique is shown as are Winchester air rifles and pistols. Next is a Winchester ammunition promotional poster. "What America Shoots", showing all manner of centerfire rifle, pistol, rimfire and shotshell ammunition, promoting Super X, and Supreme brand lines (likely 80's-era). The poster rates excellent and was likely not even unfolded before being consigned. Measures 33 1/2"x22". Last are (2) Winchester BRI sabot slugs promotional posters measuring 22 1/4"x15"; they too rate excellent. (36512-5)

2060. **LOT OF WINCHESTER IN-STORE PROMOTIONAL POSTERS** This lot consists of some interesting Winchester ammunition posters. The first is a large black-and-white poster promoting Winchester Supreme Ammunition. The poster reads "Winchester Supreme Frees Your Time to Pursue Other Things" with a photograph of a large bull moose amidst a woodland high country backdrop, likely Alaska; copyright-dated 1988. The poster rates about excellent with a couple little minor wrinkles and one light scuff on the right edge, it would still look wonderful framed. Measures 21"x30". Next is a Winchester ammunition promotional poster. "What America Shoots", showing all manner of centerfire rifle, pistol, rimfire and shotshell ammunition, promoting Super X, and Supreme brand lines. The poster rates excellent and was likely not even unfolded before being consigned. Measures 33 1/2"x22". The next poster is Winchester Ammunition and 1989-dated. Again centerfire pistol, rifle and shotshells promoting Super X, AA Plus, Super X Buckshot and Super Steel. The poster rates about excellent with a few very minor wrinkles. Last are (2) Winchester BRI sabot slugs promotional posters measuring 22 1/4"x15"; they too rate excellent. The moose poster comes in an original outer cardboard shipping sleeve from Winchester which reads "If You Could Put Up with More Ammo Sales Put Up These Materials in Your Store" "Winchester Fall Promotion Materials" along with the horse and rider logo. Really a neat set of posters, the moose very seldom encountered these days. (36512-12)

2060



2061. **SAVAGE STEVENS FOX PROMOTIONAL PRINT**

This is a colorful promotional print from Savage-Stevens-Fox, "First In the Field" by artist Henry "Hy" Hintermeister (amusingly normally Remingtons slogan). Printed on textured paper, no doubt from the 50s or 60s, the depiction of two English Setters on point remains vivid. The white outer border does show some light soiling from the years but overall the print rates very good plus to near excellent, the 4 corners each show pinholes from being displayed at one point, one of those torn out towards the outer edge, they would disappear when framed and matted. Measures 26"x19 3/4". A very nice depiction overall. (36512-12A)



2062. **LOT OF WINCHESTER IN-STORE PROMOTIONAL MATERIALS** This lot consists of an enameled tin sign for one of Winchester's "Ammunition Advisory Center" promotional stores. Designed to be hung suspended, the sign features the Winchester Ammunition Advisory Center logo on both sides beneath the horse and rider logo. The sign rates excellent and features a lightly stamped or beaded edge and is unblemished but shows an extremely light bend along one top edge, likely could easily be rectified. Included with the sign is a print of the famous 1923 Winchester calendar top showing the Philip Goodwin print of a hunter with Winchester model 1895 rifle straddling a rocky outcropping looking down on bighorn sheep. This is printed on textured paper and features a "High Country Classics" ink stamping on its back backside. The poster rates excellent with each corner having a tiny hole from a tack; they would disappear when framed. A very nice lot of Winchester accessories overall for your gun room or Winchester display. (36512-11)

2062



2063. **LOT OF WINCHESTER MODEL 1894 100TH YEAR ANNIVERSARY EDITION POCKETKNIVES**

serial #1422, This lot consists of a Bluegrass Cutlery commemorative edition of 3 pocketknives. This was the 100th year anniversary of the introduction of the Winchester model 1894 rifle, the set issued in 1994. Includes a set of 3 pocketknives with specially etched 100 year anniversary blades and embossed depictions of Winchester model 94's on their scales. The copper-colored scales feature the "Winchester Model 94 Rifle". The silver-tone scales feature the "Winchester Model 94 Rifle Takedown" while the gold-tone scales feature the "Winchester Model 94 Carbine", each showing an identical "100 Years of Model 94 Excellence/Winchester/1894-1994" legend adjacent to the horse and rider on their reverse scales. Each blade is marked Winchester/Trademark/Made in USA" with the knife's model number "1994-2", "1994-3", and "1994-4". The knives are as-new, as-received and are serial numbered 1422 out of 2000. A couple of the blades do show some minor scuffs but they are as-received from Bluegrass Cutlery. The knives come in an attractive gold and black tone flip-top box with black-baize lining the interior while the lid shows a depiction of the A.B. Frost painting of 2 hunters shooting at a distant deer, which was the bottom edge of the 1895 calendar. Included with the knives are a Certificate of Authenticity, numbered to the knives and signed and one-year warranty statement. The outer edge of the lid as well features a sticker "1422" with the serial number of the knives. An excellent set of 1894 Commemorative Knives for the 120th anniversary of the introduction of what is arguably Winchester's most famous and most popular model lever gun. (36512-16)



2064. **LOT OF BB/PELLET PISTOLS AND RELATED ACCESSORIES**

This lot consists of 2 air pistols. One is a Crossman Arms Company Model 454. The gun is CO2-powered and shoots BBs only. It is metal and appears very good plus with minor holster wear and high edge wear retaining likely 98% plus original enamel. The mottled red-black-brown grips rate about excellent with only minor scuffs. The gun appears complete and the parts seem to work well. The tab which operates the feed plunger has had the protruding portion break off but will still work with proper manipulation (some small tool like a bobby pin is required to push the plunger along and lock it down while the BBs are loaded); included with the gun is the Crossman speed loader BB loading-tube. Next is a Crossman Model 357 .177 caliber CO2-powered pellet revolver. The gun rates about very good and retains perhaps 85 to perhaps 90% original enamel, the most loss due on the high edges of the "cylinder"; it is of metal and plastic construction. The rifled barrel appears very good plus to perhaps excellent. There is some light residue which may be hardened oil or some kind of paint overspray in some places on the gun but it likely would clean easily. The faux wood-scale grips rate very good. The rear sight blade seems to be missing from the pistol but it seems to operate mechanically properly. The revolver cylinder which is included is the gray-tone 10-shot version. Included are 18 CO2 powerlets, being a mix of Daisy and Crossman, a partial box of Crossman pellets and BBs and what would appear to be an over-full box of Daisy .177 cal. premium grade "Max Speed" airgun pellets. A good lot overall which likely would still perform well in the backyard, basement or afield. (36512-3)

2065. **MISCELLANEOUS SHOOTERS ACCESSORY LOT**

This lot consists of a Remington refreshment tray of varnished softwood. The tray features dual handles and measures 17 3/4 x 11" overall. The tray portion features a deeply impressed "Remington UMC/First in The Field/Long-Range High Velocity Loads", superimposed over the image of a flying Canada goose over a green circle, perhaps trying to be the moon or sun. The tray rates about excellent overall with some minor scuffs and handling marks. The next item is a Scotch game call; this particular example is the number 1401 duck call. This is a bellows style call, hand operated without the necessity of blowing into the call. It rates excellent to very nearly as-new and comes in its original box. The next item is an Olt model A-5 goose call. It rates about very good and comes with instructions and its original sleeve. There are 3 VCR tapes included: Woods Wise Callmasters Afield "Screaming Gobblers 2 the Right Place" tape on turkey hunting; a Remington Arms Company instructional tape on the safe use and care of your Remington firearm; last a New Hampshire Public Television episode of the New Hampshire Crossroads television program "Just up the Road/North of the Notches with Fritz Weatherby". A nice somewhat eclectic lot overall. (36512-18)



2066. **MISCELLANEOUS SHOOTERS LOT**

This lot consists of screw-in choke tubes and stripper clips. There are five Win-choke 12 ga. choke tubes with a knurled exposed portion. They are: (2) full, (2) improved cylinder and one modified. There are two Browning 12 ga. Invector choke tubes: (1) cylinder-lead shot/improved cylinder-steel shot; (1) modified-lead shot/full-steel shot. There are two Weatherby IMC 12 ga. choke tubes: (1) improved cylinder and (1) modified. There is an unmarked 12 ga. tube which seems to be of the same thread pitch as the Browning tubes with a .710" inside diameter. There is a Sears 20 ga. Flex choke with tightening wrench in plastic pouch. This is a Winchester Win-choke, made for Sears, it is full. The chokes are as-new and appear unused. There are 2 brass stripper clips, appear to be 5 round for 30-06 or similar; two steel stripper clips, similar to the brass, one steel and brass lined stripper clip for .223/5.56 cartridges; a rubber M-1 carbine magazine dust cover and (5) Italian Carcano stripper clips marked on their base: "SMI (star) 39". They are 6 round for both 6.5mm & 7.35mm and will fit models 1891, 91/38, and 38 carbines. They are as-new unused condition. (36512-17)

2067. **MEDITERRANEAN MIQUELET BELT PISTOL**

About .79 cal., 10 3/4" swamped octagon barrel with an oxidized bore. The barrel is an overall oxidized brown patina with silver damascened appliques of scroll, toned now to a blue-gray tarnish. The patilla style lock is also an oxidized brown patina with a single star-shaped touch mark on the lockplate and a lightly engraved brass accent plate in the flash area of the pan. There are light silver inlays on both hammer and frizzen which are the same tarnished dull gray-blue patina. The Mediterranean hardwood stock rates very good plus and shows overall light silver hammered floral and scroll inlays, about 98% of which are present. The ramrod thimble, tailpipe and triggerguard are crudely cast brass. The lock is not completely functional mechanically and requires manipulation to drop the hammer completely. What is likely the original ramrod is present. An interesting and rather attractive, likely North African, belt pistol overall. (36535-2A) (ANTIQUE) (350/550)

2068. **LOT OF LOOSE SPENCER AMMUNITION** 28 rds. of antique rimfire cartridges appearing to be for Spencer rifles and carbines; (15) rds. with crimped cases measuring 1.62 overall with a .5085 bullet diameter and .5620 base diameter with "J.G. and C.D.L." marked headstamps; (13) rds. measuring 1.529 overall with a .5375 bullet diameter and .5560 base diameter and headstamps marked "H". The cartridges rate very good to fine overall with lightly age tarnished copper cases and white oxidation on the lead bullets which has transferred to some of the cases from storage. (55658-12A6)
2069. **LOT OF ASSORTED LOOSE AMMUNITION** Two piece olive card board box containing 39 rds. of what appears to be 32 S&W Long. The headstamps are unmarked and the cases are straight, the overall length is 1.0365 with a .3005 bullet diameter and .3175 base diameter. The box has no top or side labels and has modest scuffing and dirt staining, a label on the inside of the lid states to use only U.M.C. No. 0 primers when reloading; (50) rds. of Peters .38 Short Rim Fire cartridges loaded with lead round nose bullets and "P" marked headstamps. Both boxes of cartridges show areas of tarnish on their cases and oxidation on the projectiles. (55658-12A7)
2070. **SOUVENIR JAPANESE KNIFE** Made for the tourist market this knife has a Tanto style appearance when closed but is equipped with an unmarked clip point style blade. The knife measures 10 7/8" overall with a 6 7/8" plain blade having an overall pewter gray patina with scattered fine oxidation staining and light scuffs and scratches from being sharpened. The handle and matching scabbard is constructed of bone carved with foliate and oriental figures and designs having some light chips and cracks. There is a filled in chip in the front of the handle and the wooden pin the secures the handle to the knife tang is missing leaving the handle loose and the two piece scabbard has an old glue repaired crack at the seams which loose and separated and only half of the wood liner is present. There is a small drilled hole in the handle and a nicely carved grooved in the scabbard possibly as a cord or wrap provision. (55736-6) (100/200)
2071. **WWII USN G1 FLYING JACKET** This size 40 brown leather flying jacket is stamped "USN" in silver under the fur collar. The left breast of the jacket has sewn black patch with gold naval wings and "JAKE WAHL/LT[fading]JG USN"; sewn on the right sleeve is a lightly fading "Taskforce 77 USS Kearsarge CVA-33" patch and sewn on the back is a yellow, blue and red post-WWII USN CVA-33 Air Group Five Japanese made Cutedge; there are small holes in a circular pattern on the left sleeve where patch was removed. The collar is intact, the leather shows some very light crazing but remains supple, interior pockets are intact and the zipper is intact and functional. A nice Lieutenant Junior Grade flight jacket from the earlier days of the aircraft carrier USS Kearsage. (56364-14)
2072. **U.S. NAVY DRESS UNIFORM** This is a size 40L U.S. Navy "dress blues" consisting of a navy blue three button coat with Lieutenant ranking on cuffs with a National Defense Service medal ribbon and China Service Medal ribbon pinned on left breast above the pocket. Carried inside the pockets are a China Service Medal, dark gray gloves and a black beret. Also included are a pair matching navy blue pants with a dark blue dress belt. The suit is in very good condition overall with a small hole in the inside collar and a small tear along the left seam above the pocket which can be easily stitched. (56364-15A)
2073. **U.S NAVY AVIATOR GREEN DRESS UNIFORM** This is a complete 1950's era green dress uniform consisting of a four pocket three button coat with Lieutenant ranking on cuffs and naval wings pin on left breast above pocket, khaki colored shirt with Lieutenant bars on collar, navy blue tie, green head cover with navy eagle pin on one side and Lieutenant bars on the other, green pants with khaki belt with nickel plated beltplate. The beltplate is gold wash background engraved with naval wings in center and "JAPAN PHILIPPINES HAWAII" above and just below "VC-77" and "55-56" above "JAKE WAHL". The suit appears to be in excellent condition overall. (56364-15B)
2074. **LYMAN ALL-AMERICAN PERMA-CENTER RIFLE SCOPE** This 10x36 mm scope measures 15 1/2" overall and is equipped with a crosshair reticle and crisp optics. The scope is in excellent condition overall with a few very small nicks and scratches. Scope includes an original cardboard board box with cloth lined interior and card supports. The box is completely separated along the top rear seam, left endflap on box and endflaps of lid. (56349-4) (100/200)
2075. **LYMAN SUPER TARGETSPOT RIFLE SCOPE** Serial #4371, 15 power, 24 1/4" overall with a 3/4" tube. The scope retains about 95% original blue with some minor mount travel wear, a few light pin-size scuffs and a spot or two of fine oxidation staining here and there. The scope is equipped with thin crosshair reticle, standard adjustable target mounts and spring stop (but no recoil spring), rubber eyecup and threaded lens covers. (56677-2)
2076. **THOMPSON CENTER CONTENDER BARREL** 45 Colt/.410 bore, 10" stainless steel barrel with a bright excellent bore. The barrel is equipped with open sight and a special choke tube for .410 shells and includes a worn factory Styrofoam box insert and spanner wrench. Barrel is in excellent condition overall. (56403-8)
2077. **CALICO MODEL 900/950 MAGAZINE** This lot is a 100 rd., 9 mm factory polymer magazine in excellent condition with plain white factory cardboard box. (56349-65A)
2078. **CALICO MODEL 900/950 MAGAZINE** This lot is a 100 rd., 9 mm factory polymer magazine in excellent condition with plain white factory cardboard box. (56349-65B)
2079. **SPRINGFIELD ARMORY GOVERNMENT MODEL RIFLE SCOPE** This 6x40 mm rifle scope measures 13 1/8" overall and is equipped with a 7.62 mm patented reticle and crisp optics capable of range finding out to 700 meters. The scope is in as-new condition retaining 99% matte black finish and includes an original factory cardboard box and lens covers. (56247-43B)
2080. **NIKON MONARCH UCC RIFLE SCOPE** This 4-12x40AO rifle scope measures 13 5/8" overall and is equipped with a duplex reticle and crisp optics. The scope is in as-new condition retaining 99% matte black finish and includes lens covers and an original factory cardboard box with papers. (56247-43C)
2081. **BUSHNELL ELITE 4200** This early 6-24x40 mm scope still has Baush & Lomb markings, measures 16 5/8" overall and is equipped with a fine crosshair reticle and crisp optics and extended turret target style adjustment knobs. The scope is in excellent condition retaining 99% gloss black finish and includes a factory box top to a matte finish scope with Styrofoam insert and outer cardboard sleeve, 5" matte finish sun shade, finger adjustment knobs with allen wrench and threaded lens covers. (56247-43A)
2082. **BUSHNELL ELITE 3200 RIFLE SCOPE** This 5-15x40 mm scope measures 14 1/2" overall and is equipped with a duplex reticle and crisp optics. The scope is in as-new condition and includes an original factory cardboard box with outer cardboard sleeve, 5" sunshade, lens covers and manual. (56247-43D)
2083. **COLT/LEUPOLD M8-2 EXTENDED EYE RELIEF HANDGUN SCOPE** This 2x20 mm extended eye relief scope measures 8" overall and is equipped with a duplex reticle and crisp optics, an extended turret elevation knob and special Rampant Colt/Leupold medallion. The scope is in excellent condition with a very small scratch on the right side of the ocular bell and two small dings in the underside of the tube from base mounting. (56247-43E)
2084. **LEUPOLD M8-4 EXTENDED EYE RELIEF HANDGUN SCOPE** This 4x28 mm extended eye relief scope measures 8 7/16" overall and is equipped with a duplex reticle and crisp optics. The scope is in excellent condition retaining 99% matte silver finish. (56247-43F)
2085. **LEUPOLD GILMORE LG35 RED DOT SIGHT** This two-tone black and silver 35mm, 4 minute dot reticle is in new condition still factory sealed in protective plastic wrapping. The sight includes lens caps, battery, mount extension tube and rings. (56247-43G)

2086. **LEUPOLD VARI-X III RIFLE SCOPE** This 3.5-10x40 mm scope measures 12 3/8" overall and is equipped with a duplex reticle and crisp optics. The scope is in as-new condition retaining 99% matte black finish and includes an original factory cardboard box, protective cloth roll and manual. (56247-43G)
2087. **REDFIELD GOLDEN FIVE STAR RIFLE SCOPE** This 6x40 mm scope measures 12 1/2" overall and is equipped with a duplex reticle and crisp optics with Redfield Butler Creek flip-up lens covers. The scope is in as-new condition retaining 99% gloss black finish and includes an original factory box and manual. (56247-43H)
2088. **BURRIS SIGNATURE SERIES RIFLE SCOPE** This 6x40 mm scope measures 12 3/4" overall and is equipped with a duplex reticle and crisp optics. The scope is in as-new condition retaining 99% matte black finish and includes an original factory cardboard box, protective cloth roll, lens caps and papers. (56247-43I)
2089. **WEAVER T-SERIES RIFLE SCOPE** This 36x40 AO scope measures 15" overall and is equipped with a fine crosshair reticle and crisp optics and extended turret knobs. The scope is in as-new condition retaining 99% matte black finish and includes an original factory cardboard box, 4" sunshade, short calibrated finger knobs, threaded lens caps and papers. (56247-43J)
2090. **LOT OF BEC GOLD LABEL RIFLE SCOPES** This lot consists of a 4x42 mm and a 6x42 mm scope measuring 12 3/8" overall and equipped with Mil-Dot reticles and crisp optics. The scopes are in as-new condition both retaining 99% matte black finish and include original 6x42 factory cardboard boxes with lens caps, cleaning cloth and instruction sheets. (56247-43K)
2091. **LOT OF BUSHNELL TROPHY HANDGUN SCOPES** This lot consists of two 2-6x32 mm scopes measuring 9 1/4" overall and equipped with duplex reticles. The scopes are in as-new condition one retaining 99% matte silver and one retaining 99% matte black finish and include original factory cardboard boxes with black lens caps and papers. (56247-43L)

2092. **GERMAN KNIFE LOT** This lot consists of a Hitler Youth knife with scabbard by WKC. The knife measures 9 3/8" long with a 5" blade has a fading WKC knight's helmet logo with "GES.GESCHUTZT" above. The blade is not dated nor does it have the "Blud und Ehre" etched logo on the reverse side. The nickel plated grip features black bakelite panels with the red/white diamond with swastika logo on one side. The blade is unsharpened and there is some light flaking to the nickel and light impact marks on the pommel. The included steel scabbard features a black enamel finish and leather frog. Both are in excellent condition. (46318-2)



2093. **GERMAN KNIFE LOT** This lot consist of a German World War II vintage paratrooper gravity knife by SMF. The knife measures 6" closed and has a 4" blade marked with the SMF (sitting king) logo and a 3 1/2" folding spike. The nickel bolstered grip has walnut panels that rate excellent. The knife has some light handling wear but has not been sharpened or have any major areas of concern. A lanyard is attached. This is an excellent example of these Luftwaffe issued knives. (46318-1)

2094. **COMMEMORATIVE KNIFE LOT** This lot consists of a commemorative George Wostenholm & Son Washington Works I*XL bowie knife with sheath. The knife measures 14" with a 9 1/4" blade and stag grip. The blade is etched in large block letters "CALIFORNIA KNIFE" along the side with "Geo. Wostenholm & Son's Celebrated" above. The blade is also marked with the maker's name both along the top edge and on the ricasso. The top edge is also marked with a Federal eagle and "I*XL" "The Hunter's Companion" and "The Real I*XL Knife" in a banner. The ricasso also has inscribed "None Are Genuine But Those Marked I*XL". The steel is bright with a few specks of light oxidation staining present, the guard is polished aluminum. The stag grip panels have scalloped brass liners and brass pins. One grip has a small nicked shield numbered "428/1000". These hefty knives were produced in the mid 1970's in Sheffield, England this one being #428 of a 1000 piece special run. The included sheath is lightly crazed black leather and in excellent condition as well with a nicked tip and throat. (46494-2) (300/500)



2095. **CIVIL WAR KNIFE LOT** This lot consists of a Civil War-era bowie knife by Wostenholm. The knife measures 12 3/4" long with an 8 1/4" clip point bowie style blade that was lightly sharpened many years ago. The ricasso is marked "G. WOSTENHOLM & SON / WASHINGTON WORKS / SHEFFIELD / IXL". The metal surfaces are overall a mottled gray with areas of light to minor surface oxidation and light pitting blending throughout. The knife features an oval shaped nickel guard and has stag grips. One grip panel has a small plate that had a name inscribed upon it but has been lightly ground removing the identity of the previous owner. An original sheath is included that has a hardened and crazed outer leather cover. The reverse side of the sheath has small drops of white paint. A very good example overall that most likely was carried by a brave soldier during the most tumultuous time in our nation's history, that sadly can no longer be identified to its bearer. (45990-2) (400/600)



2096. **U.S. BAYONET LOT** This lot consists of a U.S. M5A1 German made bayonet with scabbard. The bayonet measures 11 1/4" long and has a 6 1/2" blade. It rates in excellent to as-new condition and features a black composite checkered grip. Included is a German made OD green composite scabbard. (45988-S16768C-B)

2097. **LOT OF RUSSIAN BAYONETS** This lot consists of two Russian military bayonets. First is a Model 1891/30 spike bayonet that measures 19 3/4" overall and has a 17" cruciform blade. The second is a Model 1968 SVD bayonet with wire cutter scabbard and frog that measures 10 3/4" long and has a 5 3/4" blade. The 91/30 bayonet is in excellent condition while the SVD bayonet has some light dings and nicks along the blade and serrated edges and minor flaking to the resin grip. The steel bodied scabbard has some light dents and some light surface oxidation as well. (45988-S16768C)

2098. **JAPANESE BAYONET LOT** This lot consists of a Japanese Type 30 Arisaka first pattern bayonet with scabbard by the Tokyo arsenal. The bayonet measures 20" long and has a 15 1/2" blade. The metal surfaces are mottled gray with brown patina blending in, the wood grips have minor dings and a few chips. The bayonet features a hooked quillion guard and a bird's head pommel. The guard is marked on the underside with Japanese characters. The steel scabbard is in similar condition and has several small dents, and is missing the frog attachment set screw. A very good example overall. (46595-2)
2099. **GERMAN BAYONET LOT** This lot consists of a modified German 1898/05 bayonet with scabbard that was made by Mauser in Oberndorf. The 1917 dated blade was modified to the 84/98 configuration and the bayonet measures 14 7/8" long with a 9 1/2" blade. The metal surfaces are a light mottled gray that is blending with brown, the edge has been sharpened but not recently. The wood grip panels rate about very good and are quite faded with a few chips missing, the affected areas are smoothed over. The included steel scabbard has been painted with a black enamel finish and has a few small dents. A very good example overall that was likely modified for use prior to World War II. (46638-2)
2100. **U.S. BAYONET LOT** This lot consists of a U.S. Model 1905 bayonet by Rock Island Arsenal with a Model 1905/42 scabbard. The bayonet measures 20 1/2" long with a 16" gray steel blade, the metal has remnants of a gray parkerized finish. The blade is dated "1907" and has a few light dings along the edge. The grip has the rough finished wood panels which rate excellent. The included scabbard has an OD green composite body. An excellent example overall. (46518-17A)
2101. **MILITARY LOT** This lot consists of two items. First is a German K98 bayonet by P. Weyersberg that measures 14 3/4" long and has a 9 1/4" blade which has been polished and sharpened and has some specks of light surface oxidation. The grip features Plexiglas replacement panels. The second item is a swagger stick made from inert steel case 30-06 and 45 ACP cartridges which are held together with a narrow threaded rod. Two interesting personalized relics in very good to near excellent overall condition. (45155-8C)
2102. **LOT OF EDGED WEAPONS** This lot consists of three military style edged weapons with scabbards. First is a Czech Model 1895 (1918/22) bayonet. The bayonet measures 14" with a 9 1/2" blade and was made by Steyr in Austria. The metal surfaces are a mottled, gunmetal gray with light handling marks throughout. The blade has a faint crest marking on the ricasso and has a Czech lion with "33" on the side of the pommel. The wood grip panels rate very good, one side has a minor chip and characters carved into it. The included steel scabbard is in similar condition and has a few small dents. The remaining two knives consist of a reproduction Hitler Youth knife and a reproduction Luftwaffe dagger. Both are similar to the original designs and are in excellent condition. (45988-S16768C-A)
2103. **GERMAN KNIFE LOT** This lot consists of a reproduction Hitler youth knife with scabbard. The knife measures 9 1/2" long with a 5 1/4" bright steel blade. The ricasso is marked "PIC" along with a mountain log and is numbered on the reverse. The blade has some light wear marks and does not bear the "Blud und Eher" inscription. The nicked bodied grip features composite checkered panels one with a raised diamond swastika logo in center. The scabbard is the correct style and is in similar condition to the knife. An excellent reproduction, very true to the style of the original. (45990-3A)
2104. **GERMAN DAGGER LOT** This lot consists of a German Firemans Dagger by Tiger with scabbard and frog. The knife measures 13 3/4" long with a 9 1/2" blade marked with a (tiger) logo on the ricasso. The knife has a bright nickel finish with some minor flaking on the pommel and grip. The grip has checkered, black composite panels that rate excellent. The included steel scabbard has some minor flaking and the black leather frog rates excellent. An excellent example of these German dress daggers. (45990-3B)
2105. **GERMAN MILITARY BELT LOT** This lot consists of a World War II era German Army brown leather belt with buckle. The belt is roughly sized 34 and the leather is supple and rates excellent. The only visible marking on the belt is "86". The buckle has some light tarnish and features a right facing eagle in center with the inscription "GOTT MIT UNS". The clasp has a small diamond logo with "OLC" in center for Overhof & Cie, Ludenscheid. The leather fob attached to the belt has an oval shaped logo that is quite faded and may be dated "1935". The first few letters in the logo are "SCHM" the rest is illegible and there is also a small "2" stamped below. An excellent example overall. (45990-3C)
2106. **ROMANIAN SCOPE LOT** This lot consists of an IOR LPS 4x6 TIP2 riflescope for the PSL Dragunov style rifle. This lightweight optic is similar to the Russian PSO-1 scope but had a self illuminating reticle versus a battery powered one but is designed to fit the same side rail system. It will also fit the Saiga series firearms. The scope has the military reticle which is lightly canted in the housing, and the rear amber eye lens is cracked. The scope is housed in a military canvas bag which contains a canvas cover and a set of cleaning tools. An excellent Romanian-built example in need of some minor attention. (45988-S16768B)
2107. **LEUPOLD SCOPE LOT** This lot consists of a Leupold Vari-XII 3-9x40 riflescope. The scope features a standard duplex reticle and has bright excellent optics. The gloss blue tube has a few light handling and ring marks but is in otherwise excellent condition. (46622-7A)
2108. **LEUPOLD SCOPE LOT** This lot consists of a Leupold 4X RF Special riflescope. This compact gloss blue scope features a fine duplex reticle and has bright excellent optics. The scope is in excellent condition overall and would be perfect for that classic sporting rimfire that you have been awaiting the right set of quality optics for. (46622-7B)
2109. **LEUPOLD SCOPE LOT** This lot consists of a Leupold Vari-X 2-7 Compact riflescope. This gloss blue scope features a standard duplex reticle and has bright, excellent optics. Included are a set of Weaver scope rings. An excellent condition example, ready for use. (46622-7C)
2110. **LEUPOLD SCOPE LOT** This lot consists of a Leupold M8 6X gloss finish riflescope. The scope features a fine crosshair reticle and has bright, excellent optics. The scope has a few, very light handling marks and is in overall excellent condition. (46622-7D)
2111. **LEUPOLD SCOPE LOT** This lot consists of a Leupold Vari-XII 3-9x40 riflescope. The scope's gloss blue finish is flaked to a rich copper color and the scope features a fine crosshair with target dot reticle. There are a few light ring marks from the scope having been mounted, but the scope is in otherwise excellent condition. (46622-7E)
2112. **LEUPOLD SCOPE LOT** This lot consists of a Leupold VX-I 3-9x40 gloss blue riflescope. The scope features a standard duplex reticle and has bright, excellent optics. There are some light ring and handling marks on the tube but scope is in excellent condition overall. Included are a set of Butler Creek flip-up lens covers. (46622-7F)
2113. **REDFIELD SCOPE LOT** This lot consists of a vintage Redfield 4X Tracker style riflescope with gloss blue finish. The scope features a crosshair reticle and has excellent optics. The tube has a few minor handling marks and included are a set of rings to fit a grooved receiver. An excellent example overall. (46622-7G)
2114. **REDFIELD SCOPE LOT** This lot consists of a Redfield 4X Widefield gloss blue riflescope. The scope features a "TV view" duplex reticle and has excellent optics. The tube has a few very light ring marks and is in excellent condition overall. (46622-7H)
2115. **REDFIELD SCOPE LOT** This lot consists of a Redfield Lo-Pro 4X gloss blue riflescope. The scope features a "TV view" duplex reticle and has excellent optics. There are a few very light handling marks present but the scope is in excellent condition overall. (46622-7I)
2116. **REDFIELD SCOPE LOT** This lot consists of a vintage Redfield 4X Tracker gloss blue riflescope. The scope features a duplex reticle and has excellent optics. There are a few light ring and handling marks on the tube from having been mounted but scope is in excellent condition overall. (46622-7J)

2117. **REDFIELD SCOPE LOT** This lot consists of a Redfield 2-7X Widefield gloss blue riflescope. The scope features the "TV view" duplex reticle and has excellent optics. There are a few light ring marks present but scope is in excellent condition overall. (46622-7K)
2118. **REDFIELD SCOPE LOT** This lot consists of a vintage Redfield 6-18X adjustable objective Tracker style riflescope. The gloss blue scope features a duplex reticle and has excellent optics. An excellent example overall that includes a factory rear lens cover. (46622-7L)
2119. **REDFIELD SCOPE LOT** This lot consists of a vintage Redfield 3-9X Bearcub riflescope. The gloss blue scope features a crosshair reticle and has excellent optics. The tube has a few light ring marks present and is in excellent condition overall. (46622-7M)
2120. **WEAVER SCOPE LOT** This lot consists of a vintage Weaver K4-W fixed power riflescope. The gloss blue scope features a "wide-field" style duplex reticle and has excellent optics. A set of Weaver rings are included. A great scope in excellent condition. (46622-7N)
2121. **SCOPE LOT** This lot consists of a Charles Daly 3-9x40 WA riflescope. This gloss blue finish scope features a duplex reticle and has bright, excellent optics. The tube has a few light handling marks, but the scope is in overall excellent condition. (46622-7O)
2122. **U.S. BAYONET LOT** This lot consists of a U.S. M1905 E1 bayonet by Union Fork & Hoe with scabbard. The bayonet measures 14 1/4" long with a 9 1/2" lightly sharpened blade, the ricasso is marked "U.F.H. / U.(ordnance bomb)S. / 1942". The metal surfaces retain most of the original gray parkerized finish that is fading to gray steel. The black composite grip rates excellent. The M7 OD green scabbard is in similar condition and has some minor fading. A very good to near excellent example overall. (45105-2F)
2123. **GERMAN KNIFE LOT** This lot consists of a German Model 1871 infantry dress knife with leather scabbard. The knife measures 15 1/4" long and has a 10 3/4" lightly etched blade that appears to have been modified from its original length and has been sharpened, the tip is malformed. The blade bears the WKC knight's helmet logo on the ricasso, and the etching is quite faded, there are no other markings present. The guard features an s-swept design with a "muzzle ring" on one side. The brass grip has a green finish and a few light handling marks. The grip is not cut for a lug but does have a false spring inlaid to the grooved side, the smooth side has a round discolored area where a small medallion or label may have been. The included sheath is not the original but fits and has a brass tip, the throat is missing. The leather is lightly crazed and marked "A.R.E.T. 1935" on the reverse, some of the stitching is coming apart. These knives were privately purchased for use while off-duty and were used by Cadets in military schools as well. This piece, although not in its original state, is still an interesting find. (46140-57C)
2124. **SPANISH BAYONET LOT** This lot consists of a Spanish Model 1969 CETME bayonet with scabbard. The bayonet measures 13 1/4" long and has a 9 3/4" blade. The bayonet retains most of its original black finish and has some light wear along the edges. The included scabbard has a green composite body and a canvas, attached frog. An excellent example overall. (46402-5)
2125. **ZOUAVE BAYONET LOT** This lot consists of a U.S. 1862 Zouave bayonet that measures 25" long and has a 20" bright steel blade. The bayonet is unmarked with the exception of a "B.H." acceptance marking along the flat side and a small "C" on the side of the guard. The blade has some light staining and light handling marks, the brass grip has some light tarnish. An excellent example overall, no scabbard is included. (45984-103)
2126. **BRITISH BAYONET LOT** This lot consists of a British Model 1907 bayonet with scabbard and frog. The bayonet measures 21 1/2" long with a 16 3/4" blade. The metal surfaces are a lightly mottled gray with some mild staining throughout. The ricasso is marked with the British (crown) over "1907 / 11'15 / JAC". The reverse side has several British proofs and acceptance markings. The wood grip panels have a few minor dings. The leather bodied scabbard rates excellent and has a steel throat and tip. A tan canvas frog is included which is marked "M.E. CO. 1918 (broad arrow)" on the reverse. An excellent example overall. (46195-3A)
2127. **U.S. BAYONET LOT** This lot consists of a U.S. Model 1913/17 bayonet by Remington with scabbard. The bayonet measures 21 3/4" long with a 17" blade. The ricasso is marked with "1913 / 10 17 / (Remington logo)" while the reverse bears the (eagle head) and (ordnance bomb) acceptance marks along with "U.S.". The blade has some light staining mixing with a mottled gray, the grip has most of its blue finish with areas of light surface oxidation. The grooved wood grips rate excellent. The included green, leather bodied scabbard rates excellent and has a steel throat and tip. The hanger is marked "C.&K. / 1917" on the reverse. An excellent example overall. (46195-7A)
2128. **GERMAN BAYONET LOT** This lot consists of a German 1884/98 bayonet with scabbard for the K98 rifle. The bayonet measures 14 7/8" long and has a 15" blade. Both the bayonet and scabbard have a post-war added nickel finish and all identifying marks have been removed. The wood grip panels rate excellent and there are areas of light flaking and surface oxidation present. (45105-2G)
2129. **LOT OF CZECH BAYONETS** This lot consists of two Czech VZ-24 bayonets with scabbards. Each measures 17" long and have 11 1/2" reverse edge blades. The metal surfaces are a mottled gray with light oxidation staining and pitting present and the wood grips rate very good with minor dings and small chips. The steel bodied scabbards are in similar condition. Two very good examples overall. (46140-57E,G)
2130. **BAYONET LOT** This lot consists of two bayonets. First appears to be a Uruguayan Model 1894 bayonet by Coppel of Germany. The bayonet is in about good condition and is 16 1/2" long with an 11 1/2" blade. The metal surfaces are mottled with areas of light surface oxidation, the grips are cracked and have slivers and chips missing. The lug retention system is missing as well and there is no scabbard. The second is a Turkish Model 1935 bayonet with scabbard. The bayonet measures 14 3/4" long with a 9 3/4" unmarked blade. The pommel is marked "ASFA" and the metal is a mottled gray throughout. The oil soaked wood grips rate excellent. The included steel scabbard has moderate handling wear and a few light dents. (46140-57B,D)
2131. **BAYONET LOT** This lot consists of two bayonets. First is a Yugoslavian M1924 bayonet with steel scabbard that measures 15" long with a 9 3/4" blade. The wood grip panels have a few small dings and bayonet rates excellent overall. Second is a Russian 91/30 spike bayonet that measures 19 3/4" long with a 17" cruciform blade. It too is in excellent condition. (46140-57A,H)
2132. **ARCHERY LOT** This lot consists of a PSE Nova compound bow with accessories. This camo pattern bow has a draw length of 30" and draw weight of 60 lbs.. It is equipped with a quiver, Top Gun fiber optic sights and whiskers. Included are a Dosko Sport Pro 44 hard case and about 20 practice arrows, mostly Easton, in varied conditions. A great ensemble for the upcoming fall archery season. (46357-S17140F)
2133. **RUGER LOT** This lot consists of an 18", Ruger 10/22 replacement barrel with a virtually new bore. The metal surfaces retain 99% original blue finish with negligible wear. The barrel is from the Ruger factory and is complete with front and rear sights. In almost new condition overall. (66247-29A)
2134. **UZI LOT** This lot consists of a walnut buttstock for the UZI SMG. The stock is complete with metal buttplate, sling swivel and attachment screws. The wood exhibits minor wear from storage and the metal parts retain 99% original arsenal black finish. This stock is in virtually new condition overall. (66247-29B)
2135. **STOCK LOT** This lot consists of a French MAS 36 buttstock. The stock is complete with sling swivel and metal buttplate. The wood appears to have been refinished exhibiting a military oil finish. The buttplate exhibits wear and scattered impact marks consistent with a military arm. In very good to excellent refinished condition overall. (66247-29C)
2136. **STOCK LOT** This lot consists of an M1A/M14 rifle stock. The stock is synthetic, brown in color with complete buttplate assembly and sling swivels. The exterior surfaces exhibit light overall wear from handling and storage. The buttplate assembly retains 99% original phosphate finish with splashes of orange paint on the shoulder lever. In excellent condition overall. (66627-9C)

2137. **AK-47 PARTS LOT** This lot consists of a torch cut Zastava AK. The lot includes the barrel, cleaning rod, folding stock, front and rear sights as well as grenade launcher sight. Also included is the rail cover, pristolgrip, bolt assembly and recoil spring. The metal surfaces retain portions of original phosphate finish combined with oxidation staining as well as patches of bare metal. The upper and lower handguards exhibit wear consistent with a well used military arm, in good condition overall. (66627-4A1)
2138. **STOCK LOT** This lot consists of a German MP-18 Bergmann/Schmeisser stock. The stock exhibits wear and bruises consistent with a vintage military arm. The stock includes the barrel retaining screw, rear tensioning screw as well as brass buttplate and sling swivel. The metal surfaces exhibit wear and impact marks retaining portions of original finish. In good to very good condition overall. (66627-9D)
2139. **CASTING LOT** This lot consists of (7) Century Arms R1A1, 308 Winchester, raw receiver castings. The castings are unfinished and need extensive machining to make operational. The metal surfaces are in prefabricated as-cast condition as well as wear from handling and storage. This is the perfect lot for the accomplished metal machinist, in very good to excellent condition overall. (66627-4B1)
2140. **AR-15 LOT** This lot consists of: (1) set of full length, mil-spec, black synthetic handguards; (1) black synthetic after market pristolgrip; (2) mil-spec buttstocks; (1) black metal collapsible stock with recoil spring; (1) full length recoil buffer; (1) round, handguard. One of the mil-spec buttstocks is missing the top buttplate screw and the black plastic inner sleeve. The collapsible stock exhibits wear on the high edges as well as the stock threads. This is the perfect lot for the AR owner, in excellent condition overall. (66627-4C1)
2141. **ARGENTINEAN FMK-3 SMG PARTS LOT** The lot consists of a torch cut receiver, complete lower receiver with retractable stock, barrel with an excellent bore and synthetic handguard. The metal surfaces retain a majority of original blue/black finish exhibiting wear consistent with a military arm. The lot is in excellent condition overall but does not include a magazine. (66627-4D1)
2142. **MACHINE GUN LOT** This lot consists of an M60 machine gun barrel with flash suppressor, gas cylinder, front sight, bipod pivot mount and a very good bore. The barrel retains 90% original phosphate finish with scattered oxidation staining as well as light overall scuffs and wear. The flash suppressor and bipod pivot mount exhibit heavy oxidation staining. (66519-4B2A1)
2143. **DISPLAY LOT** This lot consists of an ammunition box to be mounted on a machine gun and two linked belts of 30 caliber ammo that are inert. The first belt has 44 rounds and the second has 42. The ammo box measures 9" x 12 1/4" retaining 97% refinished O.D. green paint with minor wear. This is a good lot for the military historian, in very good to excellent condition overall. (66006-5)
2144. **AR-15 LOT** This lot consists of a 21" AR barrel with a very good bore. The lot includes front sight, triangular handguard cap and barrel nut. The metal surfaces retain 85-90% original phosphate finish with overall wear from handling and storage, in very good condition overall. (66006-6)
2145. **AR-15 LOT** This lot consists of a totally stripped A1 style upper receiver with forward assist retaining 90% refinished black color. The metal surfaces exhibit light overall scuffs and silvering on the high edges. In excellent refinished condition overall. (66006-7)
2146. **AR-15 LOT** This lot consists of: (1) bolt & carrier assembly, stamped with capital "C" on left front; (2) bird cage flash suppressors; (1) charging handle; (1) set of handguards; (1) handguard slip ring; (1) handguard ring; (1) weld spring; (1) ejection port door; (2) forward assist buttons; (1) M-16 bolt & carrier assembly; carrier handle scope mount. The items in this lot exhibit various degrees of wear with the lot in very good to excellent condition. (66006-8)
2147. **AR-15 LOT** This lot consists of a 21" barrel with an excellent bore and a stripped A1 upper receiver. The metal surfaces retain 90-95% original phosphate finish with light overall scuffing from handling and storage. The upper receiver has a small piece of wire retaining the rear sight. The barrel is missing the handguards and flash suppressor. In very good to excellent condition overall. (66006-9)
2148. **BROWNING BAR MACHINEGUN PARTS LOT** This lot consists of a BAR barrel with a good bore. The lot includes (2) wood handguards; trigger assembly; magazine; an assortment of other parts. The metal surfaces retain traces or original finish with a majority of bare metal showing through. The lot exhibits wear consistent with a vintage military arm. There are numerous parts but not a complete inventory. This is a great replacement lot for the BAR owner and is in good to very good condition overall. (66247-16H1)
2149. **AIRGUN LOT** This lot consists of a Beeman pellet trap measuring approximately 9" X 14". The metal surfaces retain 90% original black finish with wear from light use. The trap features (4) metallic figurines of animals colored in repainted white finish. The trap is in excellent condition overall and should not be used with anything other than an airgun. (66247-45)
2150. **DUX 53 SMG LOT** This lot consists of a torch cut, Spanish made, German issue DUX 53. The lot consists of the barrel, lower receiver, bolt, folding stock and recoil spring. The metal surfaces retain 85% original blue/black finish exhibiting wear consistent with age and handling. The bore is excellent with the lot in very good condition overall. (66427-16I1)
2151. **AK-47 LOT** This lot consists of: (2) TAPCO 30 round magazines and (3) COM-BLOC 30 round magazines for the 7.62x39mm AK47. The exterior surfaces exhibit light wear with the lot in excellent condition overall. (66006-10)
2152. **MAGAZINE LOT** This lot consists of (4) HK-91/G3, 7.62x51mm Nato, 20 round magazines. The lot retains a majority of original black paint with general wear and scuffs from handling and storage, in very good to excellent condition overall. (66627-11A)
2153. **MAGAZINE LOT** This lot consists of (4) HK-91/G3, 7.62x51mm Nato, 20 round magazines. The lot retains a majority of original black paint with general wear and scuffs from handling and storage, in very good to excellent condition overall. (66627-11B)
2154. **MAGAZINE LOT** This lot consists of (4) HK-91/G3, 7.62x51mm Nato, 20 round magazines. The lot retains a majority of original black paint with general wear and scuffs from handling and storage, in very good to excellent condition overall. (66627-11C)
2155. **MAGAZINE LOT** This lot consists of (4) HK-91/G3, 7.62x51mm Nato, 20 round magazines. The lot retains a majority of original black paint with general wear and scuffs from handling and storage, in very good to excellent condition overall. (66627-11D)
2156. **MAGAZINE LOT** This lot consists of (4) HK-91/G3, 7.62x51mm Nato, 20 round magazines. The lot retains a majority of original black paint with general wear and scuffs from handling and storage, in very good to excellent condition overall. (66627-11E)
2157. **MAGAZINE LOT** This lot consists of (4) HK-91/G3, 7.62x51mm Nato, 20 round magazines. The lot retains a majority of original black paint with general wear and scuffs from handling and storage, in very good to excellent condition overall. (66627-11F)
2158. **STEN SMG MKIII PARTS LOT** This lot consists of a torch cut parts lot for the English Sten MK3 smg; (1) shrouded barrel with a good to very good bore. The bore retains strong rifling with patches of oxidation; recoil spring, metal stock; sling; lower receiver and bolt assembly. The barrel and magazine attachment exhibit the torch cut. The metal parts retain strong portions of original green finish exhibiting wear consistent with a vintage military arm. This is a good replacement parts for the Sten owner, in good to very good condition overall. (66627-4D1)
2159. **U.S. MILITARY SMALL ARMS RACK** This lot consists of an M12 small arms rack for the M16/M16A1 rifle. The metal surfaces retain 85% original O.D. green finish, exhibiting generalized wear consistent with a military surplus item. The rack holds (12) rifles and measures approximately 42 1/2" in height and 36" wide. This lot is complete with locking bars and is the perfect item for a club or shooter with numerous AR's. In very good condition overall, extra shipping will apply. (66627-6)



2160

2160. **ISRAELI R-83 ROCKET LAUNCHER** This lot consists of the Belgian-made, 82mm launcher which folds in half, measuring approximately 63 1/2" extended. The tube is dark sand color with the metal parts exhibiting original brown finish. The metal parts exhibit wear and scuffing consistent with a military arm. The launcher is equipped with sights, sling and blast shield as well as exhibiting Hebrew writing. The launcher is inert and is an excellent piece of military history. In very good to excellent condition overall. (66627-5B)



2161. **BROWNING M1919A4 MACHINE GUN LOT** This lot consists of an inert, FN made, 30 caliber machine gun with a 24" shrouded barrel and a fair bore, serial #7102077. The metal surfaces retain small traces of original finish with a majority of base metal exposed. The machine gun has been parted together and is exposed on the right side with a view of the interior for instruction and reference (no sideplate). The machine gun retains the removable handle with trigger, cover and some internal parts. This is a good lot with numerous usable parts for the 1919 owner, in good condition overall. (66627-12A)



2162. **BROWNING M1919A4 MACHINE GUN LOT** This lot consists of an inert, 30 caliber machine gun with a 24" shrouded barrel and a fair to good bore. The metal surfaces retain portions of original green finish and a majority of arsenal refinished color. The gun has been parted together from a Browning 1919 parts kit with the right side exposed and portions held together with a "C-Clamp". The kit includes numerous usable parts. The lid and a few internal parts exhibit light to heavy oxidation. This is a good parts lot for the 1919 owner or reference for the historian. In fair to good condition overall. (66627-12B)

2163. **GUNSMITHING LOT** This lot consists of: (1) brass punch set containing eight brass punches, two nylon punches and one hammer with brass heads; (1) Brownell's gunsmithing screwdriver set with approximately 51 bits; (1) set of aluminum vise barrel blocks for securing gun barrels. The screw driver set exhibits one broken bit with the remainder of the lot exhibiting light wear from limited use. In excellent condition overall. (66247-34)

2164. **LOT OF SHOOTING ACCESSORIES** This lot consist of the following twenty six items: (1) U.S. 1951 MRT I-52 black leather holster, (1) Reliable Electro Plating sample packet, (1) Boonie Packer Products 2+2 camouflaged sling, (1) brass flask with a Walker dispensing spout, (1) Safariland black single speed loader pouch, (1) Safariland steel belt clip speed loader holder, (1) HKS Model 10-A speed loader (38 / 357, K frame Smith), (1) HKS Model 36-A speed loader (38/357, J frame Smith), (1) Pachmayr 5S grip adapter (small size adaptor for possibly a Ruger Security Six - this size not listed on the chart), (1) Pachmayr 6M grip adapter (medium size adaptor for K frame Smith), (2) chamber flags, (1) Allen wrench, (1) Gunslick 30 cal. rifle cleaning brush, (1) 12 ga. snap cap, (1) Pro Hunter string peep sight, (1) Thompson / Center rear sight contoured to fit a round barrel that is missing the elevation spring and the windage adjustment is non-functioning, (1) No-go gauge for a .303 British, (1) B-Square mount with rings in an unopened package for a S&W Model 41 pistol, (1) firing pin for unknown firearm with general dimensions of approximately .200 diameter and 3.5" long with several cut out on the pin and includes a spring and retention pin all in a sealed bag, (5) unidentified gun parts, (1) bag of parts for LaserMax laser that includes what appears to be a S&W Sigma spring assembly, LaserMax battery pack, LaserMax slide lock laser switch spring, LaserMax manual for Sigma series laser and LaserMax battery cap / shock buffer. All items are in very good to excellent condition. (84287-29DD)

2165. **SIGNAL CANNON LOT** This lot consist of a smooth bore cast iron signal cannon that measures approximately 18 1/2" from the cascable to the muzzle face, about 9" from cascable to center of the trunnions, a cascable diameter of about 2 3/4" and a bore diameter of approximately 1.060" with a depth of 14 5/8". The bore is rough with numerous heavy pits visible and the muzzle face exhibits light dents and chips from rough handling. The vent is clear to the chamber. The tube shows the rough texture typical of cast Iron cannons that have been exposed to weather but retains about 50% of its black finish with oxidation blemishes that have burnished to brown and are evenly mixed with the finish. There are no foundry or ordnance marks found on this piece and it is overall lightly pitted. This piece of ordnance should be checked by a professional before firing but will make a great attention getter at sporting events or on the Fourth of July. (86164-8B)

2166. **SIGNAL CANNON LOT** This lot consists of a smooth bore cast iron signal cannon that measures approximately 15 1/2" from the cascable to the muzzle face, about 7 7/8" from cascable to center of the trunnions, a cascable of about 2 1/8", and a bore diameter of approximately 1.435" with a depth of 12 1/4". The bore is smooth with light oxidation present; the vent is clear to the chamber. The tube shows a fairly smooth finish with some slight casting imperfections and light surface pits from exposure to weather. It retains about 70% of its black finish with oxidation blemishes that have burnished to brown and are most prevalent at the muzzle, bottom of the tube and the cascable area. There are no foundry or ordnance marks found on this piece. This piece of ordnance should be checked by a professional before firing but will make a great attention getter at sporting events or on the Fourth of July. (86164-8A)

2167. **BRITISH SIGNAL TELESCOPE LOT** This lot consist of a British Telescope Signal (Mk IV) also GS (general service) telescope manufactured by R. & J. Beck Ltd., London that is dated 1917, has the British broad arrow and bears serial #20014. The main body of the tube and the sliding sun-screen are leather covered and remain in very good to excellent condition considering its age. The stitching on the sun shade is starting to separate in several areas. The tube has three expanding sections made of brass with focus adjustment accomplished by sliding the rear ocular lens section in and out trombone-style. The optical quality of this telescope remains excellent. Leather storage and transportation caps are included with the telescope. These pieces are in fair to good condition with heavy crazing and cracking on one of the retention straps and the stitching on the carry strap gussets are in need of repair. The carry strap is not present. (86164-7)

2168. **U.S. M2 MORTAR** serial #12227, 60mm Mortar (2.36"), 26" smooth bore barrel that is in excellent condition. The tube (barrel) is a reproduction with a bore diameter of 56.85mm (2.23") to comply with Federal law. It retains about 94 - 96% of its olive drab paint with most of the loss to the base cap of the tube. There are also light scratches and scuff marks present on the body of the tube. The tube has nicely reproduced markings that include the serial number, the letters "U.S."; an ordnance bomb and a proof mark (P in a circle). There are no markings on the nicely reproduced base cap. The M5 mount is in very good to excellent condition. It consist of a base plate that has a fairly even coating of paint with approximately 85 - 90% remaining but, does exhibit light handling wear and scattered light flaking of the paint. There are no markings present except, for some casting numbers on the latch lever. The second part is the bi-pod and it retains about 75 - 80% of its finish on the painted parts with the unpainted brass casting having mellowed to a golden yellow patina with streaks of dark stain from a mixture of dirt and oil. This original M5 bi-pod is marked: "Mount Mortar 60mm M5 No.27515 Ord. Dept. USA..." It continues with manufacturer information exhibiting a 1945 manufacture date and bears U.S. inspector initials A.C.R. All parts remain fully functional on the bi-pod. No mortar would be complete without the proper sight and this one includes a M4 Collimator sight with its original M14 carrying case. The sight bears serial #116405 and a number of casting and assembly numbers. The sight retains about 94 - 96% of its original black paint finish and appears to be fully functional. As the sight is set up it can be used for both direct and indirect fire. The leather M14 carrying case is in very good to excellent condition with all seams and parts intact. The leather on the case has darkened from handling and use; and there are numerous small scratches, dents and scuff marks present. Every mortar needs ammunition and five rounds are provided with this one. They consist of (1) U.S. M49A3 HE round with shipping plug and no fuse, (1) U.S. M49A3 HE round with fuse assembly, (1) U.S. M49A2 HE round with fuse assembly, (1) U.S. M83 Illumination round with fuse assembly and (1) U.S. M320 White Phosphorous round with fuse assembly. All are in very good to excellent condition and properly painted except, for the M49A2 which is "in the white" with light oxidation blemishes present, of course they are all inert. This would make a great center piece for any WW II collection or the basis to start a new area of focus for your collection (WW II mortar men). Many of the trials and tribulations of the U.S. mortar men such as, Eugene Sledge who fought on Peleliu and Okinawa were portrayed in the HBO miniseries "The Pacific". The M2 mortar was also seen in the miniseries Band of Brothers. (86287-209)

2169. **MORTAR TRAINING DEVICE LOT** This lot consist of a U.S. Subcaliber Mortar Trainer, device number 3-F-8, serial #918. This National Guard Trainer was manufactured by Dellenbarger Machine Co. Inc. of New York, N.Y. The device is housed in an olive drab wood box measuring 30 3/4" x 9 1/2" x 3 15/16" with a unit rack number of B 148 stenciled on the lid and the original equipment identification plate is still attached. The box retains about 90% painted finish with light wear to the paint on the edges from handling. The blue steel subcaliber mortar tube is 26 3/4" long with an outside diameter of 1.256" and a bore diameter of 1.01". The smooth bore is in excellent condition and the tube retains about 95% blue finish with some light wear marks, especially toward the ends. The tube has a removable striking anvil set into its base and three collars are provided to center the tube in 60mm, 81mm and 4.2" mortar tubes. Also provided are an Allen wrench, O ring, two split rings, 1" bore brush with pull through chain, spare tail fin and special tool for mounting in the larger 4.2" mortar. (20) 6" long blue steel subcaliber projectiles are provided that consist of eight separate parts each. They generally break down into four major parts for loading: tail assembly, body with inertia and fixed firing pin, gas regulator and projectiles head. In use, a 22 caliber propellant round is placed in the base and second 22 cal. short blank marking round placed in the nose. A box of Winchester 22 cal. propellant blanks with 38 remaining is included. Also included in this lot is a U. S. M2 Mortar tube that has been repainted in Olive Drab and retains about 96% of the paint with a few light scratch and scuff marks. The tube measures 23 5/8" long with a bore diameter of approximately 60.6mm. The tube still bears a clear ordnance bomb with U S stamped below it. The tube has been properly de-milled deactivated by a metal bar welded inside the tube about 5 1/2" from the muzzle and a hole was cut with a torch into the side about 4" from the breech end. There has been a small cover-piece tacked over this and the outside surfaces ground and finished to look original. Both of these alterations are very visible inside the tube. This is very unique military collectible. An interesting internet article is included as it explains the subcaliber kit in easy to understand terms. (86515-1)

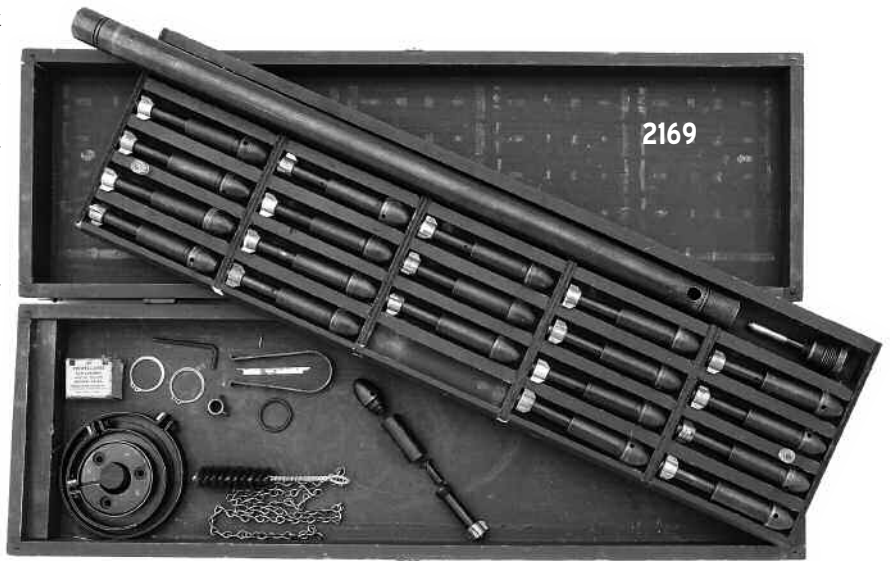
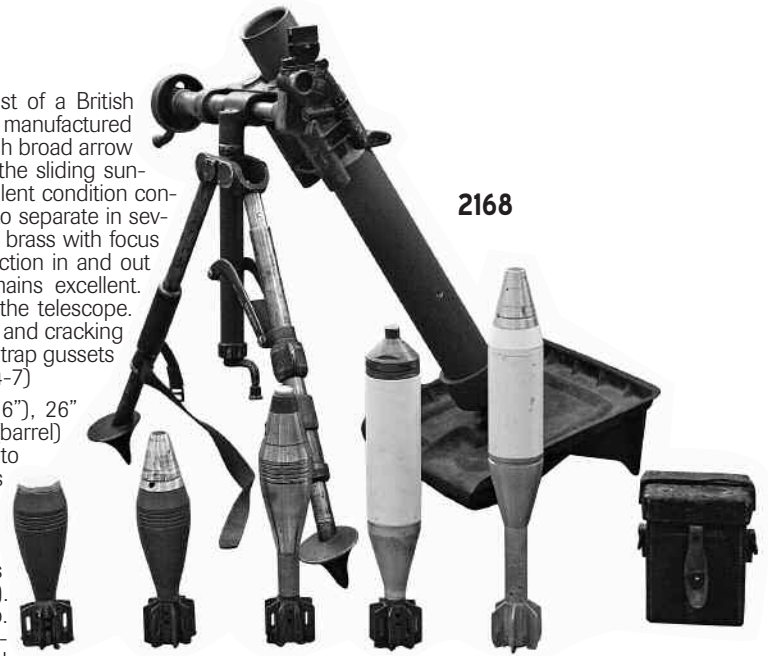

2170. **LOT OF COLLECTIBLE AMMUNITION** This lot consists of eighteen rounds of 45 ACP ammunition with brass case and steel jacketed bullet set in six half moon clips for a 1917 revolver. Included are (4) rounds with Frankford Arsenal headstamp dated 1917, (8) rounds with Frankford Arsenal headstamp dated 1918, (1) round with Remington - UMC headstamp dated 1917 and (5) rounds with Remington - UMC headstamp dated 1918. The brass cases have tarnished and some light oxidation or verdigris is forming. Overall they rate about very good. (86234-2)
2171. **LOT OF COLLECTIBLE AMMUNITION** This lot consist of a single box of 45 ACP ammunition. The box is marked: "20 Pistol Ball Cartridges, Cal. 45 Model of 1911" along with other descriptive information and were manufactured by the Peters Cartridge Co. This box has been opened but the cartridges are in generally near excellent condition with a few exhibiting small spots of verdigris. The cases are headstamped "P.C.CO. 1918". The primers are sealed with purple lacquer and there is a heavy cannelure pressed into the case at the base of the bullet. Interestingly three stab crimps were utilized to hold the bullet in place. The bottom of the box is date stamped April 23 but the year is not legible. (86234-3A)
2172. **LOT OF COLLECTIBLE AMMUNITION** This lot consists of a single box of 45 ACP ammunition. The box is marked: "20 Pistol Ball Cartridges, Cal. 45 Model of 1911" along with other descriptive information and were manufactured by the Peters Cartridge Co. This box is unopened but the right side of the cover has started to separate and the last two cartridges are accessible. The cases are headstamped "P.C.CO. 1918" and the primers are sealed with purple lacquer. There is a heavy cannelure pressed into the case at the base of the bullet and three stab crimps were utilized to hold the bullet in place. The bottom of the box is date stamped May 1 but the year is not legible. (86234-3B)
2173. **LOT OF COLLECTIBLE AMMUNITION** This lot consists of a single box of 45 ACP ammunition. The box is marked: "20 Pistol Ball Cartridges, Cal. 45 Model of 1911" along with other descriptive information and were manufactured by the Peters Cartridge Co. This box is unopened but the left side of the cover has started to separate. The bottom of the box is date stamped April 23 but the year is not legible. (86234-3C)
2174. **LOT OF COLLECTIBLE AMMUNITION** This lot consists of a single box of 45 ACP ammunition. The box is marked: "20 Pistol Ball Cartridges, Cal. 45 Model of 1911" along with other descriptive information and were manufactured by the Peters Cartridge Co. This box is unopened but the left side of the cover has started to separate. The end flap on the right side has separated allowing access to the cartridges. The cases are headstamped "P.C.CO. 1918" and the primers are sealed with purple lacquer. There is a heavy cannelure pressed into the case at the base of the bullet and three stab crimps were utilized to hold the bullet in place. The bottom of the box is date stamped April 23 but the year is not legible. (86234-3D)
2175. **LOT OF COLLECTIBLE AMMUNITION** This lot consists of a single box of 45 ACP ammunition. The box is marked: "20 Pistol Ball Cartridges, Cal. 45 Model of 1911" along with other descriptive information and were manufactured by the Peters Cartridge Co. This box is unopened but the left side of the cover has started to separate. The bottom of the box is date stamped April 23, 1918. (86234-3E)
2176. **LOT OF COLLECTIBLE OILERS** This lot consists of two oilers. The first is an original second pattern oiler and thong case for a U.S. Model 1903 Springfield, 1903A3 Springfield and 1917 Enfield rifles. The kit includes a pull through patch holder with thong and a bore brush. The oiler and contents are in near excellent condition with light handling wear and about 99% of the nickel finish remains. The second item is a British Enfield SMLE oiler with the letters FFD and a broad arrow stamped on the base. The oiler is in very good to excellent condition overall with a few small areas of verdigris and the surface areas having tarnished dark brown color. (6234-4)
2177. **MILITARY HOLSTER LOT** This lot consists of a single U.S. Model 1909 revolver holster that is marked G.&K. (Graton & Knight) on the rear with manufacture date of 1917 below it and A. G. (inspector stamp) below that. The front is embossed with US in an oval. The condition is very good to excellent overall with strong stitching, light wear to the finish and light verdigris forming on the brass rivets and hardware. The holster has the correct brass leg thong loop on the bottom and includes a lanyard with nickel finished snap swivel attached with a split ring. The cord shows light wear from handling and use. (86234-1)
2178. **LOT OF MODEL 1911 PARTS** This lot consists of the following parts: (2) complete sets of Caspian heavy weight pewter metal grips. One set is still sealed in the bag with instruction and the other is in an open bag but in excellent condition. (5) unmarked black flat main-spring housings that appear new, (4) unmarked black 1911A1 style hammers that appear new, (1) Browning Hi-Power barrel for 40 S&W that appears new, (1) used Caspian 38 Super 1911 barrel with fully supported chamber with about 1 15/16" of the muzzle threaded, (1) used Fusion 38 Super 1911 barrel with fully supported chamber with about 1 7/16" of the muzzle threaded, (1) used Nowlin 38 Super 1911 barrel with fully supported chamber, (1) used Nowlin 38 Super 1911 barrel with fully supported chamber and unmarked compensator, (1) used Colt 45 Auto marked 1911 barrel with link and link pin, (1) used 45 ACP marked barrel that has been heavily throated and may not be safe to use as the base of the cartridge will no longer be supported and (1) unmarked 1911 slide in the white that is machined to match the profile Sig currently uses and is cut for an external spring loaded extractor. All barrels have excellent bores and the slide also rates near excellent with a few oxidation blemishes. (6164-6A)
2179. **LOT OF 1911 GRIPS** This lot consist of ten pair of grips for the Model 1911. These checkered walnut grips are in near excellent to excellent condition with some of the panels exhibiting light compression damage to the diamond points from storage and handling. They do not appear to have been used. None of the panels are marked with a maker or identification number. (6164-6B)
2180. **THOMPSON CENTER CONTENDER BARREL** This 16" satin stainless steel barrel is marked 7x30 Waters with the manufacturer's name and "Super 16" all on the left side of the barrel. The barrel shows a bright excellent bore and the surfaces rate excellent as well with the exception of a few light scratches and some oxidation staining along both sides of the forend catch. A blued barrel mount swivel stud is attached just in front of the black synthetic forend, as well as a stainless set of Leupold base and rings. An overall excellent condition Contender barrel. (156403-9)
2181. **LOT OF AMMUNITION** This lot consists of four boxes: (1) full 50 rd. and (1) partial containing 32 rds. of Fiocchi 357 Mag, 158 gr. CMJFP; (2) full 50 rd. boxes of Fiocchi 38 Special, 110 gr. FMJTC. The ammunition is bright and in excellent condition overall. (156475-4,5,6)
2182. **LOT OF AMMUNITION** This lot consists of four boxes: (2) full 20 round boxes of Winchester Super X 30-30 Win, 170 gr. Power Point; (1) full 20 round box of Federal Deer Thugs 30-30 Win, 150 gr. bonded soft point; (1) full 20 round box of Fiocchi 30-30 Win, 150 PSP. The ammunition rates excellent overall and is in like new condition. (156475-1,2,3)
2183. **LOT OF AMMUNITION** This lot consists of three full 50 rd. boxes of Ted Williams 22 LR by Sears, 40 gr. copper plated round nose. The ammunition and boxes are in excellent condition overall. There are price stickers on each box from Sears. (156569-1)
2184. **LOT OF AMMUNITION** This lot consists of three boxes: (1) full 20 rd. box and (1) partial containing 17 rds. with 3 shell casings of Sellier & Bellot 9.3x74R, 285 gr. SP and (1) partial 18 rd. box of RWS 9.3x74R, 285 gr. SP. The ammunition is in near excellent condition overall with some light wear on the boxes. (156689-3)
2185. **LOT OF AMMUNITION** This lot consists of four full 20 rd. boxes of Hornady Leverrevolution 35 Rem, 200 gr. FTX. The ammunition and boxes are in excellent condition overall. (156697-2)

2186. **LOT OF AMMUNITION** This lot consists of five boxes: (4) full 50 rd. boxes of Remington Express 25-20 Win, 86 gr. SP and (1) partial 49 rd. box of Remington High Velocity 25-20 Win, 86 gr. lead. The partial box as well as one of the full boxes have some significant wear along the edges and have been taped at one time. The remaining three boxes are in excellent to like new condition overall. (156697-3)
2187. **LOT OF AMMUNITION** This lot consists of 6 factory sealed 50 rd. boxes of CCI 22 WRF, 45 gr. HP. The boxes are in excellent condition overall with a few of the labels showing some very minor wear. (156697-4)
2188. **MAGAZINE LOT** Includes an Israeli IMI Uzi 25 round magazine. This magazine retains 99% original parkerized finish with a star located on the bottom left side indicating it was manufactured for military use. It is in excellent condition overall. (156697-1)
2189. **LOT OF HOLSTERS** Three holsters total. One is an Uncle Mike's Sidekick size 5 right handed nylon hip holster in excellent condition. Next is a Bianchi right handed leather hip holster marked #5BHL with .38/.357 Colt underneath it in very good condition overall with some scuff marks and signs of usage. Lastly is a Gould & Goodrich X340 Phoenix right handed nylon duty holster in excellent condition with a couple of scuffs present. (154501-6)
2190. **LOT OF HOLSTERS** Four holsters total. First is a Bianchi size no. 1 left handed nylon hip holster in near excellent condition overall. Second is an Uncle Mike's Sidekick size 15 ambidextrous nylon hip holster with mag pouch and rates excellent overall. Third is a Blackhawk size 6 left handed nylon hip holster in excellent condition. Lastly is a Safariland black leather double magazine holster in about excellent condition overall with the exception of some verdigris present around the buttons. (154328-4A)
2191. **LOT OF BINOCULARS** 2 pairs of German WWI Emil Busch A.G. Rathenow binoculars. One pair has bright excellent optics with the serial #120508 and the body is in very good condition overall with some of the OD green paint missing where the user would hold the binoculars. A leather strap with a metal one-piece ocular lens cover is included. The other pair has bright excellent optics as well with no serial number displayed and the body is in very good condition with some small spots of loss and some light handling marks present. Both pairs come with their original hard black leather cases with leather straps attached to the cases. (156503-5)
2192. **BINOCULAR LOT** Included is a pair of Winchester WP-103025R 10-30x25mm magnifying binoculars with bright excellent optics. The OD green body rates excellent with a few blemishes and handling marks present. A black nylon strap and black waterproof factory soft case are included. (154278-5W1)
2193. **ASSORTED KNIFE LOT** Six knives total. First is a black Taiwan-made survival style knife with serrations on the back edge including a leather sheath, wetstone, compass, needles, matches, fishing hooks, sinkers, line and wire inside the handle. Its blade measures 5 1/2" long with an overall length of 11" and rates very good with some handling marks and scuffs present. Next is another Taiwan made unmarked survival knife with stainless blade measuring 5 1/2" with a total length of 10 1/2" including a hard plastic sheath with intergrated wetstone on the back rating very good overall with some wear on the knife handle. The next three knives are all unmarked black synthetic gripped sporting knives with one being a 10 1/2" fillet knife with a 6" blade with serrated back edge rating excellent overall. The other two are 7 1/2" knives with 3 1/4" blades rating excellent as well. Lastly is an unmarked black double edged sporting knife with a small black leather sheath with a blade length of 3 1/2" and an overall length of 6 7/8". The grip has some dings and dents with a part of the grip missing and the blade has some light green oxidation staining on both sides. (154260-4)
2194. **ASSORTED KNIFE LOT** Four knives included. First is a Pakistan made folding buck style knife in excellent condition overall with a 3" drop point blade and a 7" overall length. Second is an unmarked Taiwan made folding knife with a 3" serrated hawkbill blade with an overall length of 7" in excellent condition. Third is a Cub Scouts BSA multi-blade folding knife with a closed length of 4" and 6 1/2" open length in good to very good condition with some oxidation staining present. Lastly is an Imperials multi-blade folding knife with a closed length of 4" and an open length of 6 1/2" rating very good with the exception of the grips which have come apart and are no longer present on the handle. (154260-4A)
2195. **LOT OF MIXED CALIBER AMMUNITION** This lot consists of three boxes: (1) partial 10 rd. box of Remington Hi-Speed Core-Lokt 30-06 Springfield, 180 gr. PSP; (1) full 20 rd. box of Browning 30-06 Springfield, 180 gr. round nose lead and (1) full 50 rd. box of Ultramax Remanufactured 9mm, 125 gr. round nose lead. The ammunition and boxes are in near excellent condition overall with a little bit of wear around the edges of the boxes. (154284-6A,D)
2196. **ASSORTED KNIFE SHEATHS LOT** This lot consists of eight different folding knife sheaths including G96 and Schrade leather sheaths as well as other unmarked nylon and leather sheaths measuring anywhere from 4" to 6" in length and exhibit different colors like black, brown, green and camo. They are all in excellent condition overall. (154260-1)
2197. **OPTICS LOT** This lot consists of an Aimpoint 2000 red dot scope equipped with a pair of steel rings and a base as well as scope caps. The optic does not currently function in its present state due to a dead battery however the scope body is in excellent condition overall. (154284-1)
2198. **ASSORTED SLING LOT** This lot consists of six different rifle and shotgun slings, all brown leather except for one which is padded nylon with a camouflage pattern on it. Examples of manufacturers are Uncle Mike's and Hunter. The slings are in very good to excellent condition overall and all slings include swivels. (154445-10A)
2199. **LOT OF SCOPE MOUNT BASES AND SLING SWIVELS** 16 Weaver base mounts and 5 Uncle Mike's swivel packets total. Included are 13 pivot mount bases featuring three model 114 bases, three model 119 bases, two model 146 bases, two model 161 bases, one model 162 base, one model 163A base and one model 170 base. The remaining three bases are top mount bases including one model 66 base and two model 67 bases. Included for swivels are two packets of Set 1002-2, one packet of Set 1002-3, and two packets of Set 1541-2. All of the bases and swivels remain in their original packaging and rate very good overall with some marks and stains on the plastic bags. (154138-16A1-7)
2200. **MAGAZINE LOT** Included is a Calico M-100 22 LR 100 rd. rotary magazine. There are a few blemishes and operational marks however it remains in excellent condition overall. These M-100 magazines are hard to come by and would make a great addition for any Calico owner. (156706-7A)
2201. **SHOTGUN ACCESSORIES LOT** Included are a pair of 12 ga. Win-Chokes, one modified and one improved cylinder; a Carlson's Sporting Clay Speed Wrench for a 12 ga. and a Winchester stock spacer. The improved cylinder choke tube comes with an original factory plastic canister and both choke tubes are in excellent condition overall. The Carlson's speed wrench and the stock spacer are also in excellent condition with the exception of what looks like some dried brown glue on the handle of the wrench. (154138-16B)
2202. **MAGAZINE LOT** Included are two black polymer detachable box magazines for an SKS type rifle. They are both 5 round magazines and rate excellent overall. (154138-16H)
2203. **MAGAZINE LOT** Included is a single blued steel detachable short action box magazine for a Remington 750 & 7400. On the right hand side it lists the following calibers: 7mm-08 Rem, 257 Roberts, 308 Win, 6mm Rem, 243 Win and 260 Rem. The metal surfaces retain 97% original blue finish with some silvering on the edges and some operational marks. This magazine is in very good to near excellent condition overall. (154138-16H2)

2204. **SHOOTERS ACCESSORIES BOX LOT** Included in this lot are several items all confined within a tan and brown plastic MTM Case-Gard A-760 case. Some of the items include a Williams front sight pusher, a Bushnell Tri-Scope bore sighter, a pair of Safariland earmuffs, a Grace Metals punch set, staples, 5 tools, 6 rolls of assorted tape, 10 cleaning solvents, cleaning patches and attachments, multiple assorted brass casings, a few 12 ga. slugs and some other miscellaneous items. (154567-4)
2205. **LOT OF 6.5 CARCANO AMMUNITION** Consists of seven boxes of FNM non-corrosive, soft-point 123 grain ammo as well as several loose cartridges. The loose ammo also features soft-point bullets and would appear to also possess non-corrosive primers. Each box rates excellent and contains 20 unfired cartridges, with the bag of loose ammo containing an additional 39 unfired rounds; for a total of 179 rounds. (136625-52A)
2206. **LOT OF 6.5 CARCANO AMMUNITION** Consists of eight boxes of FNM non-corrosive, soft-point 123 grain ammo. Each box rates excellent, with seven of the boxes containing their full 20 unfired cartridges while the remaining box only contains 14 rounds; for a total of 154 rounds. (136625-52B)
2207. **LOT OF 20 GAUGE AMMUNITION** Consists of nine boxes of ammo as well as several loose shells. Five boxes are Remington Slugger 2 3/4" hollow point rifled slugs, with each box containing 5 unfired slugs. Two boxes are Remington Express 2 3/4" rifled slugs, both of which contain 5 unfired slugs. One box is Winchester Super-X 2 3/4" hollow point rifled slugs, containing 5 unfired slugs. The remaining box is Remington Game Load 2 3/4" 7 1/2 shot and contains 24 shells. Additionally, there are also 4 loose assorted unfired shells. The lot contains a total of 68 unfired shells. All of the boxes rate in near excellent condition. (135891-17B)
2208. **LOT OF 357 MAGNUM AMMUNITION** Consists of three boxes of ammo. Two of the boxes are 158 grain Hornady's Frontier aluminum cased hollow point ammo, both of which contain their full 50 unfired cartridges; as well as a single box of Sampson Match Grade 125 grain jacketed soft point ammo, which also contains its full 50 unfired cartridges. The lot contains a total of 150 live rounds. All of the boxes rate in very good plus condition. (135891-17C)
2209. **LOT OF 38 SPECIAL AMMUNITION** Consists of three boxes of ammo as well as several loose cartridges. One of the boxes is Winchester Super-X Silvertip 110 grain hollow point ammo, and contains its full 50 unfired cartridges. Second is a single box of Winchester Super-X semi-wad cutter 158 grain ammo, which contains 33 live cartridges and 17 fired casings. Finally, the remaining box is 125 grain Sampson Match Grade jacketed hollow point ammo, with a reduced count of 35 unfired cartridges. Additionally, there are also 3 loose aluminum fired casings. The lot contains a total of 118 live rounds and 20 fired cases. All of the boxes rate in near excellent condition. (135891-17D)
2210. **LOT OF COLLECTIBLE BLANK FIRING AMMUNITION** Consists of five boxes of ammo. Two are unopened 20 round boxes of blank ammo by Lake City Arsenal and are listed as being intended for an M1909 Hotchkiss machine gun. One of the boxes is an unopened 20 rounds of blank ammo by Remington Arms Company and is listed as being intended for an 1898 M3 Krag-Jorgensen bolt action rifle. The two remaining boxes are both unopened 10 rounds of "rifle grenade" ammo, listed as being intended for an M3 Krag-Jorgensen bolt action rifle. All of the boxes rate very good plus in condition. (135891-17E)
2211. **LOT OF ASSORTED CALIBER AMMUNITION** Consists of three boxes of ammo. One box is Speer DWM 180 grain expanding pointed soft point 30-06 Springfield ammo, which contains 12 live cartridges and 8 fired casings. One box is American Eagle 150 grain boat tail 308 Winchester ammo, which contains 20 unfired cartridges. The remaining box is Federal 170 grain soft point 30-30 WCF ammo, containing 20 unfired cartridges. The lot contains a total of 52 live rounds and 8 fired cases. All of the boxes rate near excellent in condition. (135891-17F)
2212. **LOT OF 32 ACP AMMUNITION** Consists of three boxes of ammo. All three boxes are Winchester 71 grain full metal jacket, all of which contain their full 50 unfired cartridges. The lot contains a total of 150 live rounds. All of the boxes rate near excellent in condition. (135891-17G)
2213. **LOT OF COLLECTIBLE AMMUNITION** Consists of two boxes of 45 ACP ammo. Both boxes are Remington Match full metal jacket; while one of the boxes features its full 50 unfired cartridges, the second box contains a slightly reduced capacity of 49 unfired cartridges. The lot contains a total of 99 live rounds. Both boxes rate very good plus in condition. (135891-17H)
2214. **BB GUN PELLET LOT** Consists of a single Daisy Red Ryder Jr. Treasure Chest. The "treasure chest" includes 19 sealed packs, with each pack containing 152 BBs. The box remains in excellent condition and contains a total of 2888 BBs. (135891-17I)
2215. **LOT OF ASSORTED CALIBER AMMUNITION** Consists of two boxes of ammo. One box is 71 grain Remington High Velocity full metal jacket 32 ACP ammo, which contains 50 unfired cartridges. The second box is Winchester-Olin 50 grain full metal jacket 25 ACP ammo, which contains 50 unfired cartridges. The lot contains a total of 100 live rounds. Both boxes rate in very good plus condition. (135891-17J)
2216. **45 ACP AMMUNITION LOT** Consists of a single box of ammo. The box of Federal Premium 200 grain aluminum cased full metal jacket 45 ACP (+P) ammo contains its full 50 unfired cartridges. The box rates in near very good condition but has split among some of the edges and has been reattached with a small section of clear cellophane tape. (135891-17K)
2217. **COLLECTIBLE AMMUNITION LOT** Consists of a single box of 45 ACP ammo. The box of round nose 45 ACP ammo by Winchester features 24 unfired cartridges for US Model of 1911 semi-auto pistol and US Model of 1917 double action revolver. 21 of the rounds are stored in half moon clips, with the remaining 3 simply resting inside of the box. The box is in very good condition overall; however the top has separated from the rest of the box and has since been reattached with a strip of clear cellophane tape. (135891-17L)
2218. **COLLECTIBLE AMMUNITION LOT** Consists of a single tin of 22 LR ammo. The collectible Remington tin of Kleanbore high velocity round nose 22 LR ammo is believed to contain 475 loose unfired cartridges. The tin is in excellent condition and retains about 97% of its original paint scheme, with only some minor fading along the metal edges and only a couple other extremely faint handling marks. (135891-17M)
2219. **LOT OF COLLECTIBLE AMMUNITION** Consists of two boxes of 45 ACP ammo. The two boxes by the United States Cartridge Company both appear to have remained unopened and as such should each contain 20 unfired cartridges of round nose 45 ACP ammo; totaling 40 unfired rounds for the lot. Both boxes rate very good plus overall, and considering their age exhibit only minor instances of wear. (135891-17N)
2220. **LOT OF 223 REMINGTON AMMUNITION** Consists of two boxes of ammo. Both boxes of 55 grain Winchester-Western Super-X feature full metal jacket 223 Remington; however, one box contains its full 20 unfired cartridges while the second only contains 18 unfired cartridges. The lot totals 38 live rounds. Both boxes rate in very good plus condition. (135891-17P)
2221. **COLLECTIBLE AMMUNITION LOT** Consists of a single box of 7.62x54R ammo. The box of Remington/17 full metal jacket 7.62x54R ammo contains its full 20 unfired cartridges. The box is in near excellent condition, with only a few light marks. (135891-17Q)
2222. **LOT OF 22LR AMMUNITION** Consists of three boxes of ammo as well as several loose cartridges. One box is 40 grain Winchester-Western round nose containing its full 50 unfired cartridges. One box of 50 grain Remington Yellow Jacket hyper velocity hollow point, which also contains its full 50 unfired cartridges. The remaining box of Peters Target standard velocity, which remains sealed and thus likewise contains its 50 unfired cartridges. Additionally, there are also 8 loose round nose unfired cartridges. The lot totals 158 live rounds. The boxes rate in near excellent condition. (135891-17R)

2223. **COLLECTIBLE AMMUNITION LOT** Consists of a single box of 22 WMR ammo. The box of 40 grain Winchester-Western Super-X jacketed hollow point expanding bullet 22WMR contains its full 50 unfired cartridges. The box rates in very good plus condition. (135891-17S)
2224. **LOT OF COLLECTIBLE AMMUNITION** Consists of two boxes of 22 LR ammo. The box of Western 40 grain cartridges is sealed thus contains its original 50 unfired rounds. The box by Olin Mathieson Chemical Corporation also contains its full 50 unfired cartridges. The lot totals 100 live rounds. Both boxes rate in near excellent condition. (135891-17T)
2225. **LOT OF ASSORTED AMMUNITION AND COMPONENTS** Consists of various types of ammo and related parts. Included amongst the ammunition are 13 unfired rounds of 30 Carbine ammo, 11 unfired rounds of 45 ACP ammo, 10 blank rounds of 30-06 Springfield, as well as a less sizeable of other ammo types. Amongst the components are two stripper clips each with 5 fired casings of 30-06 Springfield, a bag containing numerous bullets, and a few other items. (135891-17U)
2226. **LOT OF 30 REMINGTON AMMUNITION** Consists of two boxes of ammo. Both boxes are 170 grain Remington High Velocity soft point ammo and both rate very good plus; however, one box contains its full 20 unfired cartridges, while only 4 unfired rounds remain in the second box. The lot totals 24 live rounds. (134749-9A)
2227. **LOT OF COLLECTIBLE 45-70 GOVERNMENT AMMUNITION** Consists of two boxes of ammo. The first box is Remington 40 grain soft point 45-70 Government ammo which contains 15 fired casings and only 1 unfired cartridge. The second box is Winchester 40 grain soft point 45-70 Government ammo which contains 13 fired casings and 7 unfired cartridges. The lot totals 8 live rounds and 28 fired cases. Both boxes rate very good considering their age, but nonetheless exhibit some light wear. The box of 30-30 WCF rates very good plus, while the box of 35 Remington rate very good and exhibits more wear as well as the loose of one of its side flaps. (134749-9B)
2228. **LOT OF COLLECTIBLE ASSORTED AMMUNITION** Consists of two boxes of ammo. The first box is Remington Hi-Speed 170 grain hollow point 30-30 WCF ammo which contains its full 20 unfired cartridges. The second box is Remington Express 200 grain soft point 35 Remington ammo which contains 10 unfired cartridges as well as 1 fired casing. The lot totals 30 live rounds and 1 fired case. (134749-9C)
2229. **LOT OF COLLECTIBLE ASSORTED AMMUNITION** Consists of two boxes of ammo. The first box is Remington Hi-Speed 45 grain soft point 22 Hornet ammo and contains 51 unfired cartridges. The second box is Remington 50 grain full metal jacket 25 ACP ammo containing 35 unfired cartridges. The lot totals 76 live rounds. The box of 25 ACP rates near excellent with only minor light wear; while the box of 22 Hornet rates very good but exhibits more pronounced wear. (134749-9D)
2230. **COLLECTIBLE 44-40 WINCHESTER AMMUNITION LOT** Consists of a single box of ammo. The box of Winchester 500 grain soft point ammo contains 12 unfired cartridges. The box itself rates very good but does exhibit some wear from age. (134749-9E)
2231. **380 ACP AMMUNITION LOT** Consists of a single box of ammo. The box of Winchester-Western 95 grain full metal jacket 380 ACP ammo contains its full 50 unfired cartridges. The box itself rates excellent and exhibits only minimal light wear. (134749-9F)
2232. **COLLECTIBLE 45-70 GOVERNMENT AMMUNITION LOT** Consists of a single box of ammo. The box of Winchester 330 grain hollow point ammo contains 7 original unfired cartridges as well as an additional 9 unfired round nose cartridges by UMC. The box rates near very good and retains a good portion of its original side coverings; however, the box has been subjected to moderate wear. (134749-9G)
2233. **COLLECTIBLE 45 ACP AMMUNITION LOT** Consists of a single box of ammo. The box of full metal jacket ammo contains 20 original unfired cartridges by the United States Cartridge Company. The box rates very good and retains a very good portion of its original side coverings; however, the top of the box has separated away from the box and been lost. (134749-9H)
2234. **COLLECTIBLE 30-06 SPRINGFIELD AMMUNITION LOT** Consists of a single box of ammo. The box of full metal jacket ammo contains 20 original unfired cartridges by Lake City Arsenal. The box rates very good and retains a very good portion of its original side coverings; however, the left side has begun to separate away from the rest of the box. (134749-9I)
2235. **30-06 SPRINGFIELD AMMUNITION LOT** Consists of a single box of ammo as well as an additional full en bloc clip. The box of full metal jacket ammo contains 20 original unfired cartridges produced by Des Moines Ordnance Plant in 1942. The 8 unfired cartridges loaded into the clip are also full metal jacket and likewise appear to have been manufactured by Des Moines Ordnance Plant in 1942. The box rates very good with some extremely light wear; however, the box is missing its top and any side coverings. (134749-9J)
2236. **SURPLUS 8MM MAUSER AMMUNITION LOT** Consists of two boxes of Israeli ammo. Each box possesses full metal jacket ammo and features 20 unfired cartridges. One of the boxes rates very good plus although missing its top cover flap, while the second box rates good but is quickly falling apart at the seams. (134749-9K)
2237. **30-40 KRAG AMMUNITION LOT** Consists of a single bag of ammo. The bag contains 13 rounds of unfired soft point cartridges. Manufacturers of the ammo include Remington-UMC and Western. (134749-9L)
2238. **COLLECTIBLE AMMUNITION BOX LOT** Consists of a single empty Winchester box for 50-70 Government cartridges which would have originally stored 20 rounds. The box rates very good plus overall, especially considering its age, and retains an excellent amount of its original side coverings. There is some light wear, but such instances are relatively negligible. (134749-9M)
2239. **COLLECTIBLE AMMUNITION BOX LOT** Consists of a single empty Remington-UMC box for 25 Steven R.F. cartridges which would have originally stored 50 rounds. The box rates very good plus overall, especially considering its age, and retains an excellent amount of its original side coverings. There is some light wear, but such instances are relatively negligible. (134749-9N)
2240. **KNIFE LOT** Consists of a single Nepalese Kukri knife with a 9" blade. The blade rates very good and features an artistic ethnic pattern design along its right side, but exhibits a dulled edge as well as several light wear and handling marks and an isolated instance of oxidation. The wooden handle rates very good but does exhibit some light wear and handling marks as well as some light fading of its painted finish. The pommel features a lion's head; however, the portion of the face above the nose has broken off. Included with the blade is a black leather sheath and small tool, although the tool exhibits extensive oxidation of its metal. The sheath features a metal tip which remains sharp in its own right. (134749-1)
2241. **BAYONET LOT** Consists of a single German M1884/98 Third Pattern Bayonet by Rich A. Herder intended for use with the Mauser 98k rifle with a 9 1/2" blade. The blade rates very good, but with a dulled edge and exhibiting some scattered light oxidation. The left side of the blade displays the stamping "Rich A. Herder", and on the reverse "8731". The non-blade metal surfaces display a general dark brown patina. The wooden handle rates very good but exhibits numerous wear and handling marks. No scabbard is included with the blade. (134749-7A)
2242. **BAYONET LOT** Consists of a single reproduction No. 1 U.S.N Dahlgren Bowie Bayonet with a 12" drop point blade. The blade rates very good and retains its sharp edge, but exhibits a moderate layer of light oxidation. The left side of the blade displays the stamping "AMES MFG CO/CHICOPEE/Mass.", and on the reverse "U S N/D.R./1862". The "D.R." initials designate Navy inspector Daniel Reynolds; the hilt also features the initials in script form as his acceptance marking. The brass guard rates near excellent but exhibits some light wear and handling marks. The brass bound smooth walnut handle with finger grooves rates excellent. The Dahlgren bayonet is a sturdy knife bayonet, with original examples having been used during the Civil War on the Model 1861 Plymouth Whitneyville rifle. No scabbard is included with the blade. (134749-7B)

2243. **LOT OF MAGAZINES** Consists of five 15 round detachable box magazines for M1 Carbine rifles. Two of the magazines feature the circled letters "IU" on their spine, with an additional magazine displaying the letters "LU"; all of which were manufactured by Underwood. Another of the magazines exhibits the letters IA and was manufactured by Inland Division of General Motors. The final magazine shows the letters KSG, having been produced by Saginaw Steering Division of G.M. All of the magazines rate very good but exhibit some fading of their factory original blued finish as well as light handling marks, wear, and scattered light oxidation. (134749-90)
2244. **OIGEE BERLIN SCOPE LOT** Consists of a single OIGEE Berlin Gnomet 2 1/2x scope. The scope is mounted on a one-piece Redfield base. The metal surfaces rate very good plus, although some of the factory original blued finish has faded and exhibits several light handling marks. The optic features a German reticle and displays a clear but slightly dimmed sight picture. (134749-9P)
2245. **MARLIN SCOPE LOT** Consists of a single Marlin Micro-Vue 4x scope. Included with the scope is a set of rings. The metal surfaces very good plus, although some of the factory original blued finish has faded and exhibits several light handling marks. The optic features a fine crosshair reticle and displays a clear but slightly dimmed sight picture. (134749-9Q)
2246. **LOT OF FLAGS AND MEDALS** Includes seven assorted sized Nazi flags and two German military medals. The flags measure as follows; one arm band 2"x16", 24"x29", 8 1/2"x16", 56"x58", 44"x88", 48"x90", 46"x97" all showing mildew staining and signs of poor storage. Also included are two medals; one is an iron cross and the other is a close combat medal both appear to be reproductions and are in excellent condition. (101683-8)
2247. **CETME PARTS LOT** Includes an instructional sheet, one piece base, sight tool, and bayonet lug for a Cetme rifle from Tapco. Parts are in sealed plastic packages and appear in excellent condition. (101683-8A)
2248. **SCOPE LOT** Includes five: first is a Weaver B6 with side mount showing some light oxidation staining on the tube with standard crosshair and clear optics. Second is a 3-9x40 Vista Scope with duplex reticle and clear crisp optics. The 1" tube shows light ring marks with a few scratches and spots of oxidation staining. Third are three BSA cats eye scopes; one 3-10x44 IR with rubberized finish missing the plunger for illuminating the reticle with crisp clear optics and two 1.5-4.5x32 rubberized finish post and duplex reticle scopes with crisp clear optics. The scope bodies show signs of heavy use with multiple handling marks to include nicks and abrasions but remain in good working condition. (106164-1, 2, 3, 4, 5)
2249. **LOT OF COLT PRINTS** Six prints in a folder titled A Collection of Colt Historical Prints 1836-1873. Each print measures 11"x14" and are in very good to near excellent condition. They all are individually titled and wonderfully illustrated. The titles are as follows; Colt Texas Patterson .40 cal-1836, Colt Walker Model .44 cal-1847, Colt Wells Fargo Model .31 cal-1848, Colt Navy Model .36 cal-1851, Colt Army Model .44 cal-1860, and Colt Peacemaker .45 cal-1873. These would make a great addition if framed to ones gun room, den or rustic designed interior. (101981-J12)
2250. **LOT OF MAGAZINES** Includes three 15-round .40 cal Glock marked magazines in excellent condition. (106704-2)
2251. **LOT OF MAGAZINES** Includes (2) five-round 218 Bee Winchester Model 43 rifle magazines. Both magazines show typical scratches and wear consistent with use and are in very good to excellent condition. (106704-1)
2252. **LOT OF AMMUNITION** Includes one full 20 round box and four loose Remington Hi-Speed .222 Rem., 50 gr., SP cartridges. The box rates very good overall, showing only light scuffing along a couple of the edges. The cartridges rate good overall with white oxidation present on the lead tips. (106704-4)
2253. **LOT OF COLT MAGAZINES** Includes two blued steel seven round 380 Government magazines. The magazines are in excellent condition showing only a few spots of light silvering along high contact areas. (106704-3A)
2254. **LOT OF COLT MAGAZINES** Includes two blued steel seven round 380 Government magazines. The magazines are in excellent condition showing only a few spots of light silvering along high contact areas. (106704-3)
2255. **LOT OF AMMUNITION** Includes two full 50 round boxes of American Eagle 9x18 Makarov, 95 gr., FMJ cartridges in excellent condition. (106704-5A)
2256. **LOT OF AMMUNITION** Includes two boxes of 338 Win. Mag. First is a full 20 round box containing six cartridges and 14 casings of Winchester Super-X 338 Win Mag., 200 gr., Power-Point cartridges in excellent condition. Second is a full 20 round box of Federal Premium 338 Win. Mag., 225 gr., Trophy Bonded cartridges in excellent condition. (106704-5)
2257. **LOT OF MIXED CALIBER AMMUNITION** Includes three 20 round boxes. First is a full 20 round box of Remington 270, 115 gr., Core-Lokt PSP cartridges in excellent condition. Second is a partial 20 round box (11) of Remington Express 303 British, 180 gr., SP Core-Lokt cartridges in excellent condition. Third is a partial 20 round box (17) of Remington Managed Recoil 30-06 Springfield, 125 gr, Core-Lokt, PSP cartridges in excellent condition. All three boxes have a white previously owned ammunition sticker from a local gun store. (106704-6A)
2258. **LOT OF AMMUNITION** Includes four 20 round boxes of 7mm-08 Rem. First is a full 20 round box of Federal Power Shok 150 gr., Speer Hot-Cor SP cartridges in excellent condition. Second are two full 20 round boxes of Federal Vital Shok 140 gr., Nosler Ballistic Tip cartridges in excellent condition. Third is a full 20 round box of Remington Managed Recoil 140 gr Core-Lokt PSP cartridges in excellent condition. (106704-6)
2259. **LOT OF GUN RELATED PAMPHLETS** 92 assorted advertising packets auction catalogs and manuals all relating to the gun industry. The items date from the 70's and are in very good to near excellent condition to include some Winchester / Western Hunting Guides, Norman Flayderman catalogs and many more. (106503-4)
2260. **LOT OF POWDER FLASKS** Includes three large traditional shaped brass flasks. First is a 9" oak-leaf and antler design with common style spout that appears frozen tight. The flask has tight seams and is missing a single loop on the bottom right side, it remains very good condition. Second is an 8" game scene with a rabbit and pheasant design having a fixed spout with several small dents in the body and a split seam along one side in good overall condition. Third is an 8" clam shell design with common top marked AM Flask & Cap Co. in excellent condition. (106317-3)
2261. **HOLSTER LOT** Includes two leather Argentine Army Uniform Pouch holsters. First is an unmarked painted green leather holster missing a brass rivet on the back with dry crazed leather. The stitching remains tight and the holster is in good overall condition. Second is a brown leather holster that appears complete with three small paint markings on the inside flap. The stitching is starting to separate but would be an easy repair if one had a little time to offer. (106129-3)
2262. **HOLSTER LOT** Includes two tanned green leather Argentine Military 1911 holsters. First is an adjustable drop flap holster. The leather is supple and the stitching tight a very good example of this dual purpose holster. Second is a long drop flap holster with magazine pouch. The holster is in excellent condition. These flap holsters were intended for use with either the Colt model 1927 pistol or the Ballester Molina 1911. (106129-3A)
2263. **LOT OF HOLSTERS** Includes two green Argentine Military hi-power pistol holsters. The flap style holsters are in excellent condition. (106129-3B)

2264. **LOT OF HOLSTERS** Includes two green Argentine Military hi-power pistol holsters. The flap style holsters are in very good to excellent condition. (106129-3C)
2265. **LOT OF HOLSTERS** Includes two green leather Argentine Military Ballester Molina 1911 holsters. Both holsters show dried slightly crazed but still supple leather with some light scuffing and minor mildew staining with one having a 1" square hole in the back bottom. The holsters rate very good overall. (106129-3D)
2266. **LOT OF FLAP HOLSTERS** Includes two commercial-made flap holsters with shoulder straps likely for a Colt Systema Model 1927 pistol. One holster is black the other brown both in very good to excellent condition. (106129-3E)
2267. **LOT OF CLAM SHELL HOLSTERS** Includes two Argentine M1905 leather holsters. The holster vary in condition slightly with one showing a few popped stitches along the supple brown leather with remnants of a leather cleaner left deep in the nicks and scratches. The second holster is in excellent condition with light handling marks one would expect from use. (106129-3F)
2268. **SUOMI M31 MAGAZINE LOT** Includes two unmarked blued steel 50 round Suomi casket magazines both showing faint traces of oxidation staining with several light surfaces scratches in excellent overall condition. (106247-49Y)
2269. **COBRAY M-11/9 MAGAZINES** Includes two polymer 32 round stick magazines for the SWD M-11/nine pistol. The magazines are Cobray marked and are in very good to excellent condition. (106247-49Z)
2270. **SITES PATENTED SPECTRE MAGAZINES** Includes two: one 30 round and one 50 round blued steel magazines. The 30 round has a strong spring and shows light surface scratches consistent with use and is in excellent condition. The 50 round magazine is in similar condition with two spots of silvering above the follower and is also in excellent condition. (106247-49AA)
2271. **COBRAY M-11/9 MAGAZINES** Includes two polymer 32 round stick magazines for the SWD M-11/nine pistol. The magazines are Cobray marked and are in very good to excellent condition. (106247-49AB)
2272. **MAGAZINE LOT** Includes four 36 round unmarked steel magazines likely for the Suomi M31 submachine gun. They are in excellent working condition. (106247-49AC)
2273. **LOT OF 10/22 MAGAZINES** Includes five, first is a Ruger ten round magazine with glue residue on the bottom flat in good overall condition. Second are (3) Ram-Line high capacity magazines in excellent condition. There are two 50 round and one 30. Third is a Mitchell Arms Inc., 50 round drum magazine in excellent condition. (106247-49AE)
2274. **LOT OF UZI MAGAZINES** Includes three unmarked 25 round blued steel magazines in excellent condition. Also includes a U.S.M.C. marked three pocket canvas magazine pouch dated 1944 also in excellent condition. (106247-49AF)
2275. **AK-47 MAGAZINES** Includes three unmarked steel magazines. There are (2) 40 round and (1) 30 round all in excellent condition. (106247-49AG)
2276. **AK-47 MAGAZINES** Includes four unmarked 40 round steel magazines. The magazines have been lightly oiled and wrapped in plastic and remain in excellent condition. (106247-49AH)
2277. **SKS MAGAZINES** Includes four, first is a fixed 20 round box magazine complete in excellent condition. Second are three 30 round detachable magazines. There are (2) steel and (1) polymer all in excellent condition. (106247-49AI)
2278. **THOMPSON SMG MAGAZINES** Includes (2) blued steel 30 round stick magazines in excellent working condition. (1049AJ)
2279. **SHOOTERS LOT** Includes three items first is a Colt Baby Dragoon / 49 Pocket eagle flask measuring 4 1/2" overall. The flask is complete with much of the brown lacquer finish still present. It has tight seams and a few tiny impressions in the body but remains in excellent condition. Also included in this lot is a paper-wrapped package of patches and a small brown leather pouch likely for carrying a tin of caps or snuff. (105891-17W)
2280. **SANFORD 50 LOT** Includes a 50 round drum magazine by Eaton Supply Company for use in the Ruger 10/22 and AMT Lightning rifles. The magazine is in excellent condition and comes with its original box and papers. (106247-49AK)
2281. **SANFORD 50 LOT** Includes a 50 round drum magazine by AMT for use in the Ruger 10/22 and AMT Lightning rifles. The magazine is in excellent condition and comes with its original box and papers. (106247-49AL)
2282. **LOT OF AR-18 MAGAZINES** Includes six: first are (2) unmarked aftermarket 30 round magazines in excellent condition. Second are (4) Armalite marked 20 round magazines in excellent condition. (106247-49AM)
2283. **LOT OF CIENER STYLE MAGAZINES** Includes three unmarked .22 caliber magazines for use in a Ciener converted AR-15 / M16 rifle. The magazines are in excellent condition. (106247-49AN)
2284. **LOT OF HOHREIN STYLE MAGAZINES** Includes (2) unmarked 30 round .22 caliber magazines for use in a Ruger Mini-14 that has a Hohrein 22 caliber conversion. The magazines are in excellent condition. (106247-49AO)
2285. **STEN MAGAZINES** Includes (4) 32 round phosphate finished magazines in excellent condition. (106247-49AP)
2286. **STEN MAGAZINES** Includes (4) 32 round phosphate finished magazines in excellent condition. (106247-49AQ)
2287. **STEN MAGAZINES** Includes four: first is a blued steel 32 round in very good condition. Second are (3) Phosphate finished 32 round magazines in excellent condition. (106247-49AR)
2288. **MAGAZINE LOT** Includes three: first is a 50 round Lancaster submachine gun magazine in very good to excellent condition. Second are (2) 32 round blued steel Sten magazines in very good overall condition. (106247-49AS)
2289. **DANISH SHOOTING MEDAL LOT** This lot consists of one solid coin silver Danish shooting prize medal, 31mm in diameter, with lovely high relief obverse design featuring a raised shield with mythologic figure of Heracles, surrounded by crossed rifles and pistols, draped flags, and laurel branches. The reverse side bears a radial inscription in Danish, with a center dedication to one "LOJTNANT GYLLENGAHM" for his skill with "32 CM MED REVOLVER". The Medal is dated 1894. Condition is XF with high surfaces remaining bright and lovely silver toning in recessed areas. A rare and collectable piece of Scandinavian shooting exonumia. (144056-8C)

2289





2290



2291



2292



2293



2294



2295 FRONT



2295 BACK

2290. **SWEDISH SHOOTING MEDAL LOT** This lot consists of one solid coin silver Swedish military shooting prize medal, 36mm in diameter, with high relief obverse featuring crossed Swedish model 1896 Mauser rifles surrounded by the three crowns of Sweden and the crown of the King of Sweden in the upper quadrant, all resting upon a wreath of laurel. The reverse with attachment pin intact bears an inscription in Swedish designating the medal as a prize for prowess in "MED HANDVAPEN", or medium handgun. Condition is XF with raised areas remaining bright and showing dark toning at the edges of recessed areas. Overall a fine piece of shooting exonomia dating to the turn of the century as evidenced by the model 1896 mauser rifles. (144056-8D)
2291. **SWEDISH SHOOTING MEDAL LOT** This lot consists of one silver alloy shooting medal with the obverse bearing a raised motif showing a perching eagle clutching crossed rifles. Surrounding the design is the inscription "WERMLANDS SKYTTEFORBUND" which translates to "Wermlands Shooters Association", with an 1891 date. The reverse bear the raised inscription in script "For Hem och Hard" surrounded by a wreath of oak leaves. The medal measures approximately 27mm in diameter as the planchet is slightly out of round and showing squashed edges from an overly heavy die strike. The medal remains in very good condition with only light surface wear, but showing knocks and bright marks to most surfaces. Overall an interesting piece of shooting memorabilia showing a unique mint error. (144056-8B)
2292. **SWEDISH SHOOTING MEDAL LOT** This lot consists of one solid coin silver Swedish shooting medal measuring 37mm in diameter. The obverse bearing a high relief design showing a knicker-clad youth holding a Mauser rifle in the right hand and extending a laurel branch with the left. The right elbow rests on a plinth bearing the dates 1868-1918 over a scrolling banner showing the three crowns of Sweden. The field to the right of the figure bears the inscription "FORENINGEN/FOR/BEFRAMJANDE/AF SKOLUNG-/DOMENS/VAPENHOF-/NINGAR", which roughly translates to "Association For Promoting Of Judgement and Problem Solving In Schoolchildren". The reverse bears a lovely high relief design of evergreen boughs with pinecones surrounding a raised rectangle with indented corners. Intended for inscription, the rectangle remains blank. In overall XF/AU condition, both faces show light silvering of the raised surfaces with pleasing silver gray toning in recessed areas. A great piece of shooting history harking back to the days when Mausers and schoolchildren were considered a positive combination. (144056-8F)
2293. **SWEDISH SHOOTING MEDAL LOT** This lot consists of one solid coin silver Swedish shooting medal measuring 37mm in diameter. The obverse bears a high relief design showing a raised target over crossed rifles with draped flags and laurel branches. The upper quadrant bears the relief Swedish Crown with the inscription "RIKSSKYTTETAFLINGEN", which translates to "National Shooting Contest". The plain reverse is mounted with a silver pin clasp bears a raised two line inscription reading "ANDRA PRIS/1897" indicating this medal was awarded as second prize. Both faces remain in XF/AU condition with crisp detail and silvering on the high surfaces. Recessed areas show pleasing dark gray silver toning. A fine and collectable piece of shooting exonomia. (144056-8A)
2294. **GERMAN SHOOTING MEDAL LOT** This lot consists of one silver plated German shooting medal measuring 42mm in diameter. The obverse bears a high relief design showing a draped female mythologic figure with raised goblet in the left hand and pointing to a target with the right. A laurel branch extends above the figures head. The low relief background shows a horizon with small castle behind which the sun is rising with radiating rays. Surrounding the design is the inscription "V. FESTSCHIessen D. UNTERLAND.ZIMMERSCHUETZEN-VEREINIGUNG" which roughly translates to "Fixed Shoot, Lowland Shooting Association". The reverse bears the edge inscription "HEILBRONN 20. & 21. MAI 1900" over a high relief design showing St. Kilian's Church bordered by laurel branches and showing a raised heraldic shield with imperial eagle. The medal remains in bright XF/AU condition, with a few light knocks and some tarnishing at the edges. Overall a lovely piece of German schuetzen shooting history. (144056-13H)
2295. **GERMAN SHOOTING MEDAL LOT** This lot consists of one solid coin silver German shooting medal by Balmberger from the 12th national all-states shooting festival at Nuernberg in 1897. The medal measures 41mm in diameter with the obverse featuring a high relief design depicting an old-time shooter in dapper shooting garb with elegantly plumed hat and shouldering what appears to be an early German wheel-lock musket in the left hand and carrying a target in the right hand. Fronting the figure are crossed muskets, draped flags and laurel leaves under the city shield of Nuernberg with heraldic eagle. The The surrounding inscription reads "XII. DEUTSCHES BUNDESSCHIessen/NUERNBERG 1897". The reverse features a city view of Nuernberg in an ornamented window, with high relief frontal design depicting attributes of competition. Overall condition is XF/AU with crisp sharp detail and lovely deep dark toning. Overall a wonderful and historic piece of German schuetzen shooting history. (144056-14)



2296



2297



2298



2299



2300



2301



2302

2296. **GERMAN SHOOTING MEDAL LOT** This lot consists of one silver alloy German shooting medal measuring 41mm in diameter. The obverse features a high relief design depicting a church, possibly the Chapel of St. Hubert, with the raised inscription "PREIS LUTTINGEN" or "Luttingen Award". The raised border reads "TREU ZUR DEUTSCHEN FAHN U. WEHR/STEHT DES HAUENSTEINERS MANN U. EHR", which roughly translates to "Faithful to German Defense Is The Honest Hauensteiner Man". The reverse features a lovely high relief stag with a crucifix and radiating rays between the antlers representing St. Hubertus. Hubertus was honored among German sport hunters, and considered as the originator of ethical hunting behavior. Overall condition is XF/AU with silvering at the high surfaces, and pleasing gray toning in protected areas. (144056-13F)
2297. **PRUSSIAN SHOOTING MEDAL LOT** This lot consists of one coin silver Prussian shooting medal measuring 37mm in diameter. The obverse features a high relief bust of King Frederick William III of Prussia with the border inscription reading "FRIEDR. WILHELM III KOENIG VON PREUSSEN". The reverse bears the inscription "DEM BESTEN SCHUTZEN" with an oak leaf surround. Overall condition is VF/XF with sharp crisp designs and showing numerous light dings and peck marks across all surfaces. Silvering is visible on the high surfaces, with protected areas showing pleasing violet to green toning. A fine example of Prussian exonomia. (144056-13G)
2298. **GERMAN SHOOTING MEDAL LOT** This lot consists of one silver alloy German shooting medal measuring 41mm in diameter and commemorating the schutzenfest at Hannover Germany in July of 1872. The obverse features a high relief design showing an oak tree flanked by sign boards reading "WIR WOLLEN SEIN EIN EINIG/VOLK VON BRUDERN" roughly translating to "We Want To Be A United Nation Of Brothers". The reverse features a raised relief central design depicting a castle with oak leaf surround and is bordered by the German inscription commemorating the event. Overall condition is VF/XF with crisp sharp details and showing several dings to the raised edges. Traces of bright mirror luster remain in protected areas, with raised surfaces toning to pewter. A very nice early schutzen medal. (144056-13E)
2299. **AUSTRIAN SHOOTING MEDAL LOT** This lot consists of one silver plated Austrian shooting medal dated 1899 and measuring 37mm in diameter. The obverse bears a right side inscription in German commemorating the 30 year anniversary of the "Vienna Fixed Shoot" (rough translation), with the left half featuring a raised high relief design showing a castle over lion on shield emblem surrounded by draped flags and oak leaves. The reverse relief design depicts a landscape featuring a castle with crumbling battlements and the inscription "MODLING/AUGUST/1899". In overall VF condition with sharp detail and showing some dings and peck marks, as well as some areas of flaked plating at the edges. A pleasing turn of the century shooting medal. (144056-13D)
2300. **FRENCH SHOOTING MEDAL LOT** This lot consists of one octagonal French shooting medal measuring 34mm in diameter and minted in solid coin silver. The obverse bears a high relief heraldic shield showing a three-towered castle over an oared galleon under sail, beneath which lay crossed early rifles and flowing banners. Between the butts of the rifles the date of 1846 is visible in tiny raised numerals as well as the name "E. ROGAT", likely the designer of the medal. An inscription surrounds the shield reading "ANCIENNE ARQUEBUSE DE PARIS". The reverse bears the inscription "CERCLE DES CARABINIERS/1840", surrounded by oak leaves on the left side and laurel leaves on the right. Overall condition is XF with sharp crisp detail and showing scattered light dings and peck marks. Protected surfaces show pleasing dark toning. An interesting French shooting medal with two somewhat conflicting dates. (144056-13I)
2301. **AUSTRIAN SHOOTING MEDAL LOT** This lot consists of one coin silver Austrian shooting medal measuring 37mm in diameter. The obverse features a high relief bust of Austrian Emperor Franz Josef I with a surrounding inscription glorifying his reign. The reverse features a high relief design depicting an old time shooter in dapper period garb and plumed hat holding an early rifle at rest, standing next to an ornate heraldic shield. The surrounding inscription in German commemorates the 300th anniversary of the "Troppauer Schutzen Society 1593-1893". Condition is XF/AU with crisp sharp details and showing scattered bright marks and tiny pecks. Exposed surfaces are toning to pewter, with gray toning visible in protected areas. A very fine piece of Austrian shooting history. (144056-13B)
2302. **AUSTRIAN SHOOTING MEDAL LOT** This lot consists of one solid coin silver Austrian shooting medal measuring 36mm in diameter. The obverse features a relief bust of Austrian Emperor Franz Joseph I with the surrounding inscription being an abbreviated version of his full title. The reverse features a relief two-headed imperial eagle with a surrounding inscription commemorating the 40th anniversary of a shoot in Wien, Austria and dated "18 48/88". In overall XF/AU condition showing scattered bright marks and pecks as well as a few edge dings. Details remain crisp and sharp with silvering visible on raised surfaces and protected areas toning to dark gray. A fine Austrian shooting medal with a classic two-headed imperial eagle design. (144056-13A)



2303



2304

2303. NEW YORK NATIONAL GUARD COMMEMORATIVE MEDALLION LOT This lot consists of one heavy metal medallion with gold-tone plating commemorating the centennial anniversary of the seventh regiment, New York National Guard. The medallion measures 2" in diameter by 3/16" in thickness. The obverse features a relief depiction of the goddess Columbia seated at the base of a marble column and holding an oval shield bearing the numeral 7 and the Latin motto "PRO PATRIA ET GLORIA", or "For Country And Glory". The background bears a depiction of what appears to be the 7th regiment armory building on Park Avenue in New York City, along with date of 1906. An inset window bordered by laurel branches is dated 1806 and depicts what is likely an earlier version of the same building. The reverse bears a flat field with raised inscription commemorating the centennial anniversary of the 7th New York New York National Guard, with a relief depiction of an eagle clutching an oversized laurel branch extending along the entire right border. Overall condition is F/VF with sharp details and the original plated surface now showing a mottled tarnishing gold brown patina. A small gouge mark is evident just above the head of Columbia, with scattered scratches and marks showing on both faces. An appealing piece of New York National Guard history. (144056-6)

2304. NAPOLEONIC MEDAL LOT This lot consists of one alloy medal measuring 41mm in diameter. The metal surfaces remain very good condition showing traces of original silver gilding, with the majority of the medal showing a tarnished bronze tone. Scuffs and light dings are evident, with one more prominent ding or cut mark showing about 20 mm to the right of the eyelet. The obverse features a high relief bust of Napoleon with the surrounding inscription "NAPOLEON EMPEREUR" The reverse depicts a Napoleonic crown in high relief over the inscription "Couronne A Milan-LE-XXIII-MAI-M-DCCCV.", with the surrounding inscription reading "NAPOLEON-ROI-D'ITALIE". An interesting medal commemorating Napoleon's Italian campaign of 1796-1797. (144056-10)

2305. POWDER CAN LOT This is an unusual size can by the Robin Hood Powder Co. measuring 9" in height with a diameter of 8". The can rates about near excellent, exhibiting strong seams and retaining about 95% of its bright green paint with loss due to scattered handling marks where surface oxidation is present and it exhibits minor dings in an isolated area. The bottom reveals excellent graphics with red print over a white background including large text of the company name displayed in a circular layout around a large inner section that includes warnings and directions. The cap is missing. A fine acquisition for the powder can collector. (76679-25A)

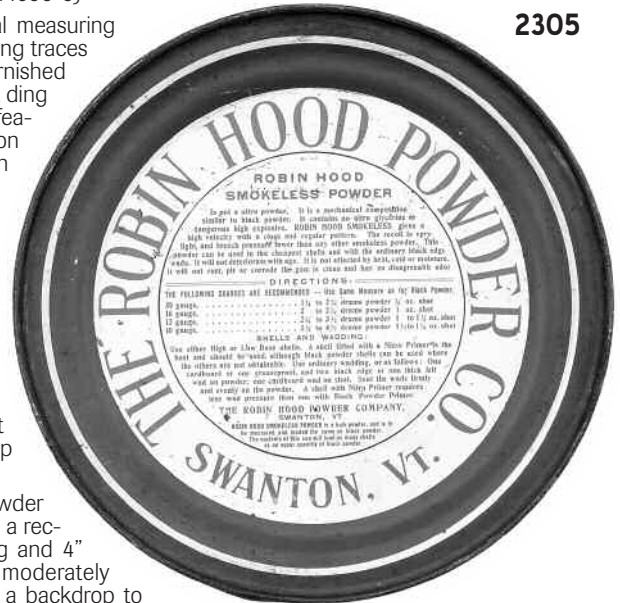

2305

2306. POWDER CAN LOT This is a five lb. size can by the Robin Hood Powder Co. measuring 6 1/4" tall with a rectangular body that is 6" long and 4" wide. The sides exhibit moderately crazed forest green paint as a backdrop to the dull and faded graphics comprised of the Robin Hood logo on the front and all three sides and an information panel on the back that exhibits illegible blurry text. Purportedly the crazed paint is characteristic for the manufacturer's cans of this size. The top shows mottled oxidation over most of the surface and that of the included original cap which has a small hole at the top edge due to oxidation. The bottom retains about 90% of an original gold or copper like lacquer finish showing scattered oxidation staining. The can is still strong with virtually no dings or dents and light scattered scratches. An interesting fully intact piece with an almost pebble grain like appearance. (76779-25B)



2306

2307. POWDER CAN LOT This is 1/2 lb. size can by the Robin Hood Powder Co. measuring 4 1/2" tall with a rectangular

body that is 3 1/2" long and 1 1/4" wide. The intact can features a dark green painted surface with faded white print on the front panel that exhibits a blurry red image of Robin Hood against a white background to form the company logo. Above the image, the text reads "Half Bulk Pound/Robin Hood" and below it: "Smokeless Powder/For Shot Guns./Manufactured By/The Robin Hood Powder Co./Swanton, VT." The back of the can consists of red print against an even more faded white, almost close to yellow, panel serving as a warning and directions for use. The text on the front is legible with the exception of the left side of "Pound" and the image of Robin Hood is faded with a dark spot towards the top. The back panel of this fully intact can also shows similar spots and the overall mottled spotting including some of light oxidation leaves the small print on the back difficult to discern. Also evident in scattered areas are handling marks and light dings. The bottom shows mottled oxidation staining while the top is a more consistent dark tone that extends to the included original cap. A nice 1890's era can from the Vermont maker. (76779-25C)

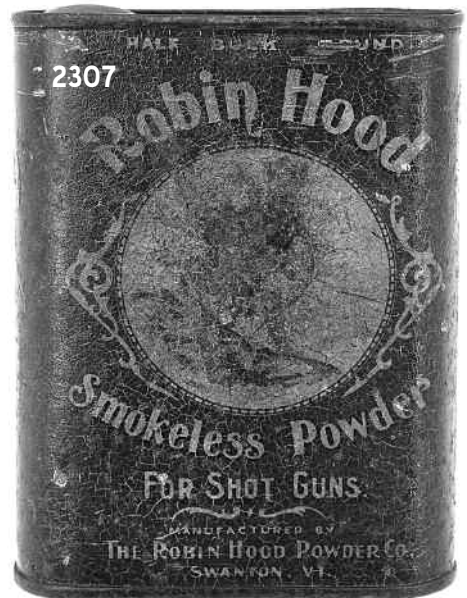

2307



2308

2309

2310

2308. **POWDER CAN LOT** This is a 1/2 lb. size can by the Robin Hood Ammunition Co. measuring 4 1/2" x 3 1/2" with a diameter of 1 1/4". The fully intact can is green with red and white graphics including a front featuring a crisp company logo and above it: "Half Bulk Pound./Robin Hood" while below it is "Smokeless Powder/For Shot Guns/Manufactured By/The Robin Hood Ammunition Co./Swanton, Vt.". The back reveals a warning message and general directions in the form of red print over a white background with a decorative rectangular border. This panel exhibits a yellowed tone with the exception of a small area that apparently made contact with some liquid as it cleaned it to a whiter tone with a brown surrounding outline. The text is clearly legible as is that on the front which also reveals some reddish and darker spots and within the logo, some handwritten notes, likely in pencil. Also evident along the sides are scattered spots of loss that reveal a glistening silvery surface. The bottom retains about 70% of a gold like lacquer finish with loss due to surface oxidation that is progressing to pin prick pitting in some areas. The top exhibits a dark almost even patina of surface oxidation including that of the included cap. A fine addition to your powder can collection from the period when the Vermont company also manufactured ammunition. (76779-25D)
2309. **POWDER CAN LOT** This is a 1 lb. size can measuring 6"x4"x1 1/2" from Robin Hood Powder Co. The can is painted green with the red image of Robin Hood standing on a sloped landscape with bow and arrow ready, against a white background. The white print above it reads "One Bulk Pound/Robin Hood". Below the logo is: "Smokeless Powder/For Shot Guns/Manufactured By/The Robin Hood Powder Co./Swanton, Vt.". The back consists of the guarantee and general directions in red print over a white rectangular backdrop outlined by a decorative border. Overall, the paint exhibits a crazed texture with somewhat dull graphics on the front showing mild staining of dirt and grime while the back shows more of the same, along with some darker discoloration, likely from contact with liquid. Some scattered small handling marks are also evident revealing a bright silver body beneath. The top and bottom panels retain about 90% of their original gold lacquer finish, a correct cap is included. Your chance to acquire this infrequently available can from this desirable New England maker. (76779-25E)
2310. **POWDER CAN LOT** This is a 1lb. size can measuring 6"x4"x1 1/2" by the King Powder Company. The mint green painted can exhibits a front center design with the trademark "King's" within the image of a crown above a yellow banner reading "Semi-Smokeless/Pat. Jan. 17, 1899" and beneath that is "A New Composition/Mechanically Incorporated/For Rifles and Shot Guns.". All of this is contained within a red circular border containing "High-Velocity-Low Pressure/Manufactured By/The King Powder Co., Cincinnati, O. U.S.A.". In addition, the upper top reads "One Pound Bulk/12 Ozs. Net". The sides of the intact can each feature black print in the form of ribbon like banners with the left stating "Extreme Cleanliness" and the right "Quick Ignition". The back of the can consists of another circular design, this one in black print with general information within an outer ring that reads "King's Semi-Smokeless for Rifles and Shot Guns" and at the very bottom in tiny print: "A.C.CO.10AM" The can retains about 92% original paint with only light fading, some spots of white pitting and black grime and scattered scratches. The bottom retains about 85% gold lacquer finish with loss due to scattered oxidation staining with some pitting evident. The top which exhibits a correct cap retains about 15% finish with the balance a consistent brownish oxidation. A rare can with bright crisp graphics. (76779-25F)
2311. **POWDER CAN LOT** This is a powder can measuring 7 1/2" tall with a diameter of 6 1/4" by the King Powder Co. The maroon painted can features a bottom label encompassing nearly the entire panel with a virtually redundant smaller (2 1/2" diameter) label placed at its center. This smaller one includes the trade mark company logo as its center focal point and consists of the image of a crown with a front that reads "King's" and within its interior, "FFFFG". Below it is a light teal-colored ribbon-style banner proclaiming: "Quick Shot" and below that is "An Improved/Black Powder/For/Rifles & Shotguns.". All of this is enclosed by a light yellow ring consisting of "Quick, Clean, Strong, Light Smoke" as a top section and at its bottom: "Manufactured By/The King Powder Co., Cincinnati, O.U.S.A.". The label shows light dirt and fading with minor peeling evident at the circumference. The larger label beneath it is identical in graphics with the exception of the banner which in this case is a bright blue with a matching blue serving as the color of gemstones decorating the crown and the same blue making up the two outer rings serving as a border. A few sections towards the outside of this label are missing with others peeling back a bit with small tears in isolated areas. The colors and black print are quite bold. The top also includes a label identical in design to the smaller one on the bottom. This one reveals a portion of the outer area missing at the upper right including a small amount of text, as is the case with a smaller one below it that extends slightly further into the label that shows more peeling on the left side and overall light fading and mild staining from dirt and possibly oxidation transfer from the top panel marked "I.C.C.1.3". The can retains nearly 90% surface paint that could almost be described as brick red with most of the loss at the top. There is light scattered pitting evident including within the outline of where a 4 1/2"x3" label was once placed. Also evident is a small white spot caused by some chalky substance, a few dings and dents and just the beginning of separation at the side seam. Also included is a properly fitting cap. An opportunity to obtain an obscure piece. (76779-25G)



2311

2312. **ADVERTISING LOT** This is a point of sale display counter mat promoting the Robin Hood Powder (later Ammunition) Co. of Swanton, Vt. The 21"x13" felt cloth piece consists of a red border and lettering stitched over a forest green backdrop. The 4 1/2" tall letters simply and boldly read "ROBIN HOOD" encompassing the entire length at its center. The red areas exhibit a somewhat uneven light fading as does the green but with some bright almost fade-free areas including several round spots where items were likely displayed. Also evident at some of these locations are impressions and some nearby areas with light brown staining that blends inconspicuously with the green, and some pin-head size holes, with maybe one or two having penetrated entirely through. The back reveals fully intact stitching over a robust forest green that is characteristic of items from this highly desirable maker. A very rare piece in about near excellent condition. (76779-51A)



2313. **WINCHESTER CATALOG LOT** This original copy of Catalogue No. 81 measures 8 1/2"x5 1/2" and features a light brown paper-back cover bound by glue at its spine and consists of 213 pages plus an index, bound by two fully intact staples. The cover is highlighted by the trademark company name towards the top in raised red letters with black borders, the back with the big bold red trademark "W" in raised lettering towards the bottom. The spine also contains the same style Winchester name, and like the front also identifies this as "Catalogue No. 81", in this case in red as opposed to the black print used on the front bottom right. The front and back each exhibit matching decorative red borders near the perimeters. The top and bottom of the front each have splits at the spine measuring about 1" on the top and 2" at the bottom where there is also a small section that has become unglued but is still faintly attached at the back. The top of the spine reveals less separation and some light creasing, the middle area with minor darker discoloration. The front reveals barely visible isolated areas of discoloration and also exhibits faint scuffing and a couple of creases at the bottom. The back reveals a couple of areas of light grime and creases with more light dirt evident where it meets the spine. The top edge of the body reveals light foxing and dirt with even lesser amounts at the side and bottom edges. The cover opens to reveal a title page that includes "Repeating and Single Shot/Rifles, Repeating Shotguns, Metallic Cartridges, Empty/and Loaded Shells, Brass/Shot Shells, Gun Wads, Primers, Percussion Caps, Shot, etc.". This page also contains a small penciled in note at the upper right consisting of an old price and the year of this catalog: "1918". This page also reveals some light foxing originating from and more pronounced at the spine. The foxing continues but decreases onto the ensuing pages until it is barely detectable at about page 15. The back pages exhibit similar characteristics in this regard. The balance rates near excellent with very faint discoloration along the interior edges, and a slight crease on the upper right of some pages. As mentioned on the title page, this catalog covers a wide range of products and includes hundreds of illustrations including cutaways and component parts of iconic models such as 86, 95, 12 and 97. A true collector's item in near excellent condition. (76679-18A)

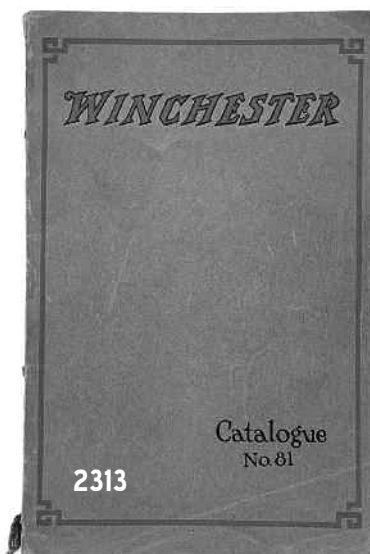

2314. **WINCHESTER CATALOG LOT** This original copy of Catalogue No. 80, 1916 is the Fiftieth Anniversary issue and measures 8 1/2" x 5 1/2". The paperback book has a brown vinyl cover with a front that reads "Winchester/Repeating Arms Co./New Haven, Ct./80 (with-

in a circle) 1916" in gold embossed print with scroll type font and decorative accents. The spine also features embossed print in the form of the trademark bold W as end caps for the company trademark name and "No. 80", the back cover is plain. The cover exhibits mild to moderate wear most prominently where the binding webbing is exposed where the front meets the spine at the midsection, the extreme top and bottom of the spine where it is exposed, and the front lower right corner which is missing a small section. The book opens to reveal a title page with red, green and gold embossed graphics that also constitute the back page. The catalog consists of 224 pages of information including hundreds of detailed illustrations of the multitude of items available through Winchester at the time. The most prominent characteristic of this collector's item may very well be the uncommon indexing tabs at the far right of their respective pages: tabs marked with iconic models such as 1873, 1886, 1894, and categories such as Rifle Ctgs., Shot Shells, and Pistol Ctgs. The tabs do exhibit wear with several folding back somewhat, a scant amount with corners having worn off slightly. With all pages present and showing near excellent condition and the back cover rating excellent through most of its surface, the overall condition of this scarce item comes in at about near very good. (76678-78)

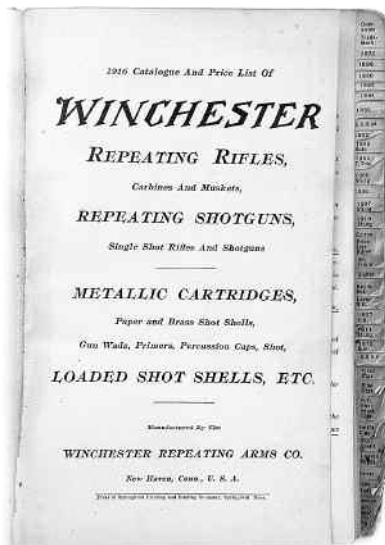
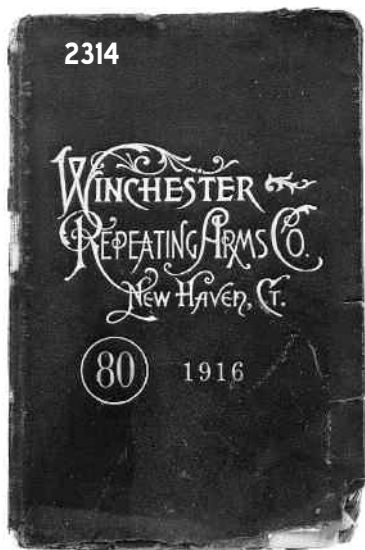

2315. **AMMUNITION CRATE LOT** This wood crate by the Robin Hood Ammunition Co. measures 15"x9 1/2"x9" with front and back each stamped in black with the Robin Hood logo at its center with scroll like accents at its sides and comprised of an outer ring that reads "Loaded With High Grade Sporting Powder". The top of the panel reads "Small Arms Ammunition/Loaded Shotgun Shells" and below the logo resides "Manufactured By/Robin Hood Ammunition Co./Swanton, Vt.". One side reads "500 R.H.A.Co. 12 ga./Load No.224/Eclipse/Loaded With/Near Smokeless/Powder/3-1". The opposite side includes the categories but is not stamped with the specifics. It is also worth mentioning that the top line is partially devoid of ink, retaining however slight impressions at the point of contact. All other stamps are legible, albeit somewhat faded and the wood shows very little finish present. The box, which is of finger joint construction and features inset handles, shows slight separation at one upper corner, chips at several corners and edge areas, and light wear in scattered areas. The interior reveals large areas of a mild white discoloration, the exterior with a few spots of maybe white paint in one isolated area, but overall the crate is intact with a pleasing honest appearance and rates very good to excellent. (76678-42A)



2316. **AMMUNITION CRATE LOT** This wood crate by the Robin Hood Ammunition Co. measures 15"x9 1/2"x9" with a front and back stamped in the trademark forest green with the company logo at its center including an outer ring that reads "Loaded with Robin Hood Smokeless Powder" around the image of a sloping landscape only, as the originally stamped Robin Hood figure has faded away. Also included is "Robin Hood Shells" above the logo and below it is "Manufactured By/The Robin Hood Powder Co./Swanton, Vt.". Each side panel includes the logo with one side devoid of any marking within the inner circle and the other without Robin Hood himself, and also included within the rectangular border is "500" and "12 Ga.", each within a circle and located at the top and at the bottom is "Drs. Oz. No. Shot" all stamped in green. The box is of finger joint construction with inset handles and shows a few chips and handling marks and may have been previously cleaned with a light added finish applied. The interior is quite clean but it does reveal a nail protruding slightly from the bottom to the inside of the wall. Overall a nice looking intact collectible box from this Vermont maker. (76678-42B)

2317. **LOT OF BOOKS** Total of three. This is a group of outstanding condition hard covers (Vols. III-V) from the popular series The Pistols of Germany and Her Allies in Two World Wars by Jan C. Still. Vol. III consists of Third Reich Lugers and their Accessories; c. 1988 Jan C. Still. 291 pages. Vol. IV is titled Imperial Lugers and their Accessories; c. 1991 Jan C. Still, 2nd. Printing c. 1994 Jan. C. Still. 219 pages. Vol. V is Weimar and Early Nazi Lugers and their Accessories; c. 1993 Jan C. Still. 312 pages. The books share similar layouts featuring frontispieces including Vols. IV & V that have multiple pages of color photos making up these beginning sections. The balance of these illustration oriented books is graced with outstanding professional photography with close ups on many, informative tables and explanations of stamps and markings. The covers are of a bright and bold red with black inlayed print and graphics free of fading or wear. Vol. V shows minor white spots on the front and a couple of dark ones on the back and the corners of Vol. III have a bit of an inward slope, otherwise near new condition overall. (76678-21A)

2318. **LOT OF BOOKS AND BOOKLETS** Total of ten. Guns of the World: The Complete Collectors' & Trader's Guide, introduction by Hans Tanner; c. 1972, 1977 Peterson Publishing Co. 400 pages illustrated hardcover with jacket. The Luger Book: The Encyclopedia of the Borchartd and Borchartd-Luger handguns, 1885-1985, by John Walter; c. 1986 John Walter, 287 pages illustrated hardcover with jacket. Rommel: Battles and Campaigns, by Kenneth Macksey; c. 1979 Kenneth Macksey. 224 pages illustrated hardcover with jacket. The Luger Pistol: Its History and Development from 1893-1945, by Fred A. Datig; c. 1955 Fred Datig, 208 pages illustrated hardcover signed by the author as #350 of 2000, with jacket. Mauser Rifles and Pistols, by W.H.B. Smith; c. 1946, The Military Service Publishing Company. 233 pages illustrated hardcover signed and dated "March 20 1947" by the author, with jacket. Walther Pistols and Rifles: Revised & Enlarged, by W.H.B. Smith; c. 1946, 1948, 1951 Military Service Publishing Company, c. 1962 The Stackpole Company. 198 pages illustrated hardcover with jacket. German Rifle Company: Military Intelligence Service Information No. 15, U.S. Government Printing Office Washington 1942. 376 pages hardcover. The "Parabellum" Automatic Pistol.: its Construction, its Manipulation and its Use. "A reprint of the original book". 42 pages illustrated staple bound booklet including the three gate-fold disassembly charts. The last two items are large 48 page illustrated booklets written in German, each featuring a category of small mechanized Nazi era vehicles. Also included is an unused WWII German postcard depicting an artillery crew. The individual conditions vary somewhat but overall this lot rates very good plus with some of the jackets showing small tears and some books with small handwritten notes or labels applied. (76679-21B)

2319. **LOT OF BOOKS AND BOOKLETS** Total of six. The Illustrated Encyclopedia of Pistols & Revolvers: An illustrated history of hand guns from the sixteenth century to the present day, by Major Frederick Myatt M.C.; c. 1980 Salamander Books Ltd. 208 pages hardcover with moderately torn jacket. United States Martial Pistols and Revolvers, by Major Arcadi Gluckman, United States Army; c. 1939 Otto Ulbrich Co. Inc., 2nd. printing. 249 pages (plus appendixes and index) hardcover with jacket. The W.H.B. Smith Classic Book of Pistols and Revolvers, completely updated by Joseph E. Smith; c. 1946, 1948, 1951, 1953 N.R.A. c. 1960, 1962, 1965, 1968 Stackpole Co. 816 pages illustrated hardcover. Collector's Guide to American Cartridge Handguns, by Dewitt E. Sell Ph.D.; c. 1963 Dewitt E Sell Ph.D. 244 pages hardcover with jacket. Modern American Pistols and Revolvers, by A. C. Gould ("Ralph Greenwood"); c. 1888 A. C. Gould & Co., 1894 Bradlee Whidden, re-published 1946. 222 pages illustrated hardcover. United States Single Shot Martial Pistols, by Charles Winthrop Sawyer; c. 1913 Charles Winthrop Sawyer. 100 pages paperback bound by three staples with a large tear to the front cover (98%) present, and a tape repaired spine with ID written in ink. This is likely the lowest condition of the lot with probably the most noteworthy characteristic being that each jacket shows tears with portions missing. Also evident on most is the usual foxing and areas of ingrained dirt. Overall, some collectible old examples, some in above average condition (particularly Modern American Pistols & Revolvers). (76679-21C)
2320. **LOT OF BOOKS AND BOOKLETS** Total of seven. Mauser Military Rifles of the World, second edition, by Robert W. D. Ball; c. 2000 Robert W. D. Ball. 300 pages excellent plus condition hardcover with jacket and hundreds of photos including some in color. The Collecting of Guns, edited by James E. Serven; c. 1964 Stackpole Co. 272 pages hardcover with jacket. Pictorial History of the Rifle, by G. W. P. Swenson; c. 1972 G. W. P. Swenson. 184 pages hardcover with jacket. Near excellent condition. The Book of Rifles, by W. H. B. Smith and Joseph E. Smith; c. 1948 N. R. A., c. 1960, 1963 The Stackpole Co. 656 pages hardcover with jacket. This is a near excellent condition older book with only light sun fading and wear, a small tear to the jacket. Custom Built Rifles: Their Design and Production, by Richard F. Simmons; c. 1949, 1955 Richard F. Simmons. 346 pages hardcover with jacket. Very good to excellent with a personalized label applied to end paper, light wear and staining. The Trap-Door Springfield in the Service, by Col. Philip M. Shockley; c. 1958 World-Wide Gun Report, Inc. 32 pages booklet. United States Military Muskets Rifles-Carbines and their Current Prices, by Martin Rywell; c. 1951, 1955, 1956, 1959 Martin Rywell. 49 pages booklet. The booklets rate about near excellent and the lot overall rating maybe just slightly under that unless specifically noted. A nice group of items for collecting and research. (76679-21D)
2321. **LOT OF TWO BOOKS** This is a complete two volume set of Gun Powder Cans & Kegs by Ted & David Bacyk & Tom Rowe; Vol. I: c. 1998 Rowe Publications, 266 pages. Vol. II: c. 2005 Tom Rowe & Ted Bacyk. The set is outstanding in every way as it is widely considered the quintessential reference on the topic and rates close to as new with Vol. I showing incidental discoloration on the end paper and light wear at the lower corner and the other nothing worth mentioning. The books feature detailed color photography and rarity and price estimates. An opportunity to acquire a very useful resource. (76679-21E)
2322. **LOT OF BOOKS** Total of three. The Powder Flask Book, by Ray Riling; c. 1953 Ray Riling. 495 pages hardcover with jacket that remains the universally accepted benchmark in this field. Condition-wise the book rates about very good with the jacket retaining its original blue/green color outside of the sun faded and tan spine. It shows some minor tears, also mostly around the spine and an ink signature on the front inside flap. The end paper has a small penciled in note at the upper right but the pages are clean with only very light fading on the edges. The inside front covering is splitting at the seam but the book is fully intact with only minor wear in scattered areas. This classic has held up very well and should serve as a useful aid for years to come. Peters & King: The Birth & Evolution of the Peters Cartridge Co. & the King Powder Co., by Thomas D. Schiffer; c. 2002 Thomas D. Schiffer. 255 pages hardcover with jacket. Excellent plus condition with a beautiful color section of dozens of collectibles. Also included is a 1985 antique gunpowder cans & kegs auction catalog of 672 lots with prices realized enclosed. Lightly stained, structurally sound with some prices written in ink. (76779-21F)
2323. **LOT OF BOOKS AND BOOKLETS** 12 total. Small Arms of the World: The Basic Manual of Military Small Arms, by W.H.B. Smith; c. 1943, 1945, 1948 W. H. B. Smith, fifth printing Feb. 1953. 500 pages hardcover. The MP40 Submachine Gun, by Mike Ingram; c. 2001 Amber Books. 96 pages excellent condition hardcover with jacket. Two versions of Military Small Arms of the Twentieth Century, by Ian Hogg and John Weeks; c. 1973 Ian Hogg and John Weeks, c. 1973 Lionel Leventhal Limited, approximately 280 pages paperback and fifth edition c. 1985: 303 pages paperback. The Machine Gun Vol. II, Part VII, prepared for the Bureau of Ordnance, U.S. Dept. of the Navy, 1952; 215 pages hardcover. The German MP40 Maschinenpistole, by Frank Iannamico; c. 1998 Frank Iannamico. 185 pages paperback. The New Illustrated Guide to Modern Rifles & Sub-Machine Guns, by Major Frederick Myatt M.C. & Gerard Ridefort; c. 1992 Salamander Books. 160 pages hardcover. Also included are two U.S. War Dept. Manuals: one for the "German 7.9-mm Dual Purpose Machine Gun MG34" and one for "Browning Machineguns Caliber .30". Next is a 30 page booklet issued by the U.S. Dept. of the Army and dated July 1, 1969 on the operation and preventive maintenance of the M16A1 Rifle. An April of 1977 issued manual on the same model is included also as is a 20 page booklet on proper headspacing for the Browning .50 cal. M2 Machine Gun. The overall condition of the lot is about very good. (76679-21G)
2324. **LOT OF BOOKS** 9 total. The American Gun: Vol. One-No. Three, Summer 1961, and Vol. One-No. One, Winter 1961, published by Madison Books Inc.; c. 1961 Madison Books Inc. 96 and 104 pages respectively, hard covers. The Age of Firearms: A Pictorial History, by Robert Held; c. 1957 Robert Held and Nancy Jenkins. 192 pages hardcover with jacket. The Muzzle-Loading Cap Lock Rifle, by Ned H. Roberts; c. 1940, 1944, 1947 Ned H. Roberts, fourth printing March, 1952. 308 pages hardcover with jacket. The Treasury of the Gun, by Harold L. Peterson; c. 1962 Golden Press. 252 pages hardcover with jacket. Guns: The Development of Firearms, Air Guns and Cartridges, "Told in Pictures" by Warren Moore; c. 1963 Warren Moore. 104 pages hardcover with jacket. Firearms Curiosa, by Lewis Winant; c. 1955 Lewis Winant. 281 pages hardcover with jacket. The Gun and its Development, by W.W. Greener; c. 2005 Adamant Media Corp. This Elibron Classics Replica Edition is an unabridged facsimile of the edition published in 1888 by Cassel & Co. Limited. Part 1: 384 pages paperback, Part 2: 383 pages paperback. These appear unused and rate excellent. The balance rates about very good with varying characteristics including foxing, torn jackets, applied stickers and general wear. (76679-21H)
2325. **LOT OF BOOKS** 9 total Trapdoor Springfield: The United States Springfield Single-Shot Rifle-1865-1893, by M. D. "Bud" Waite and B. D. Ernst; c. 1980 Beinfeld Publishing, Inc. 213 pages hardcover with jacket. Springfield Shoulder Arms: 1795-1865, by Claud E. Fuller; c. 1931 Francis Bannerman Sons. 176 pages hardcover that is green with gold embossing. This book remains in very good to excellent condition with light isolated discoloration to a few pages and a slightly bruised lower right corner and features an illustrated frontispiece in the form of a sketch of the upper water shops, Springfield Armory, in 1830. United States Firearms: The First Century 1776-1875, by David F. Butler; c. 1971 David F. Butler. 247 pages hardcover with jacket. Notes on United States Ordnance: Vol. I, Small Arms, 1776 to 1946, by Major James E. Hicks; c. 1946 James E. Hicks. Approximately 200 pages hardcover. The Rifled Musket, by Claud E. Fuller; c. 1958 Claud E. Fuller. 302 pages hardcover with jacket. Civil War Sharps Carbines & Rifles, by Earl J. Coates & John D. McAulay; c. 1996 Earl J. Coates & John D. McAulay. 108 pages staple bound paperback. United States Muskets, Rifles and Carbines, by Arcadi Gluckman, Colonel Infantry U. S. Army; c. 1948 Otto Ulbrich Co., Inc. Approximately 500 pages hardcover. '45-70 Rifles', by Jack Behn; c. 1956 Jack Behn. 137 pages hardcover with jacket. Also included is a four page pull out brochure from the C. Sharps Arms Co. The lot is in about very good overall condition. (76679-21I)

2326. **LOT OF BOOKS** 5 total. The Gun Digest Book of Combat Handgunnery, by Jack Lewis and Jack Mitchell; c. 1983 DBI Books. 288 pages paperback. The Complete Book of Modern Handgunning, by Jeff Cooper and the editors of Guns and Ammo magazine; c. 1961 Prentice-Hall, Inc. 262 pages hardcover with jacket. Book of Pistols and Revolvers, by W.H.B. Smith Classic, updated by Joseph E. Smith; c. 1946, 1948, 1951, 1953, N.R.A. c. 1960, 1962, 1965, 1968 Stackpole Company. 816 pages hardcover with jacket. Henry Deringer's Pocket Pistol, by John E. Parsons; c. 1948, 1952 John E. Parsons. 253 pages hardcover. History of Smith & Wesson, by Roy G. Jinks; c. 1977 Beinfeld Publishing, Inc. 290 pages hardcover with jacket. The overall condition of the books in this lot is very good to excellent with no significant condition issues on any. (76679-21J)
2327. **LOT OF BOOKS** 7 total Six Guns by Keith: The Standard Reference Work, by Elmer Keith; c. 1955 Elmer Keith. 308 pages hardcover with jacket. The Story of Colt's Revolver: The Biography of Col. Samuel Colt, by William B. Edwards; c. 1953 William B. Edwards. 470 pages hardcover with separated but 90% present jacket. Sam Colt's Own Record: of Transactions with Captain Walker and Eli Whitney, Jr. in 1847, foreword and notes by John E. Parsons. The Peacemaker and its Rivals: an Account of the Single Action Army, by John E. Parsons; c. 1949, 1950, 1953 John E. Parsons. 184 pages hardcover with separated but 90% present jacket. The N. R. A. Book of Small Arms: Vol. 1 Pistols and Revolvers, by Walter H. B. Smith; c. 1946 N. R. A., 2nd printing 1948. 638 pages hardcover. The Arms Collection of Colonel Colt, by R. L. Wilson; c. 1964 by Wadsworth Atheneum Hartford. 132 pages excellent condition hardcover with jacket and dedicated by Herb Glass. Yankee Arms Maker: The Story of Samuel Colt and his Six-Shot Peacemaker, by Jack Rohan; c. 1935, 1948 Harper & Brothers. 305 pages hardcover with jacket. Unless otherwise stated the books rate about very good with wear and spotting commensurate with their age. (76679-21K)
2328. **LOT OF BOOKS AND BOOKLETS** 15 total. Colt's S.A.A. Postwar Models, by George Garton; c. 1979 Beinfeld Publishing Inc. 166 pages excellent plus condition hardcover with jacket. A History of the Colt Revolver: and the Other Arms Made by Colt's Patent Fire Arms Manufacturing Company from 1836-1940, by Charles T. Haven and Frank A. Belden; c. 1940 Charles T. Haven and Frank A. Belden, this edition 1978 Bonanza Books. 711 pages excellent condition hardcover with jacket showing a sun faded spine. Colt's 100th Anniversary Fire Arms Manual: 1836-1936; c. 1937 Colt's Patent Fire Arms Mfg. Co. 96 pages hardcover. Colt Automatic Pistols 1896-1955, by Donald B. Bady; c. 1956 Fadco Publishing Co. 281 pages hardcover with jacket. Remington Handguns, by Charles Lee Karr, Jr. and Carol Robbins Karr; c. 1947, 1951 Charles Lee Karr Jr. and Carol Robbins Karr. 153 pages hardcover with jacket. The American Cartridge: An Illustrated Study of the Rimfire Cartridge in the United States, by Charles R. Suydam; c. 1960, second edition 1973. Next are four staple bound paperback issues based on Colt pistols dated 1946 including one dedicated by James E. Serven, one of the authors, 1947 and 1952, also signed by Serven. Additionally the lot also includes five other paperback issues including Field Manual FM23-35 for pistols and revolvers and a couple of reproduction Remington price lists. (76679-21L)
2329. **LOT OF COLLECTIBLE CATALOGS** This lot consists of two issues of Remington Catalogue No. 107 for the year 1923. The cover is a tan coated paperback with a front that features the trademark company name in red with a black outline and below it "Modern Firearms and Ammunition". "Catalogue No. 107" in orange print is displayed at the bottom amidst a forest scene in green. The spine contains a vertical layout of the company name in what is now a faded orange and the back reveals a Remington/UMC logo also in orange. The book contains 192 pages and hundreds of illustrations encompassing the full range of products and services that the iconic company had to offer in 1923. Examples are the "Model 11 Autoloading Shotgun", "Model 14 High Power Slide Action Repeating Rifle", "Repairs for Remington Firearms", a multitude of cartridges and shells, and "Remington Cutlery". One book rates about near very good as about 2/3 of the body is separated from the cover at the spine, the second showing more dirt and wear, is separated completely with tears to the cover at the spine and lower front and comes in at about good plus overall. A rare find for the Remington collector, and surprisingly available as a pair. (76679-21M)
2330. **LOT OF BOOKS AND BOOKLETS** Total of nine. Civil War Guns, by William B. Edwards; c. 1962 William B. Edwards. 444 pages hardcover with jacket. As described on the title page: "The complete story of Federal and Confederate small arms: design, manufacture, identification, procurement, issue, employment, effectiveness, and postwar disposal". Confederate Arms, by William A. Albaugh III and Edward N. Simmons; c. 1957 William A. Albaugh III and Edward N. Simmons. 278 pages hardcover containing six "parts": Handguns, Shoulder Arms, Edged Weapons, Armories, Accoutrement, and Directory. Echoes of Glory: Arms and Equipment of the Union, edited by Henry Woodhead; c. 1991 Time-Life Inc. 319 pages excellent condition hardcover from Time Life Books featuring cover with gold embossed title and accents and high resolution photos. Round Ball to Rimfire: A History of Civil War Small Arms Ammunition. Part One, by Dean S. Thomas; c. 1997 Dean S. Thomas. 333 pages excellent condition hardcover. The American Sword 1775-1945: A Survey of the Swords Worn by the Uniformed Forces of the United States from the Revolution to the Close of World War II, by Harold L. Peterson; c. 1954 Harold L. Peterson. 274 pages hardcover with jacket. Confederate Guns: and their Current Prices, by Martin Rywell; c. 1952-1955 Martin Rywell. 55 pages (separated at staples) hard cover with jacket (10% missing). Ready... Aim... Fire! Small Arms Ammunition in the Battle of Gettysburg, by Dean S. Thomas; c. 1981 Dean S. Thomas. 76 pages staple bound paperback. Also included is a 1979-dated National Parks Service issued Gettysburg visitor's pamphlet. Spencer Rimfire Cartridges: The Complete History and Development of Ammunition for Spencer Repeating Firearms, by Roy Marcot; c. 1983 Roy Martin Marcot. 47 pages paperback signed and dated (2/21/85) by the author. This is a monograph consisting of one chapter from Marcot's sold out book produced as a result of a tremendous amount of requests from collectors. Notes on Ammunition of the American Civil War 1861-1865, by Col. Berkley R. Lewis, Ordnance Corps, U. S. Army (Retired); c. 1959 American Ordnance Association. Approximately 40 pages booklet style staple bound paperback with silver embossed cover. Unless otherwise noted, the items rate about very good to excellent overall. (76679-16A)
2331. **LOT OF BOOKS AND BOOKLETS** Total of 15. Cartridge Catalogues, compiled and published by Armory Publications; 476 pages gold embossed excellent condition hardcover numbered 211 of 600 and signed by the publisher. The History and Development of Small Arms Ammunition, Vols. I & II, by George A. Hoyem; Vol. I c. 1981, Vol. II c. 1982 Armory Publications. 230 & 303 pages respectively, hard covers with jackets. Vol. II is copy 127 of 500 and dedicated by the author on 7/19/82. The Rimfire Cartridge in the United States and Canada: An Illustrated History of its Manufacturers and their Products 1857 to 1984, by John L. Barber; c. 1987 Armory Publications. 221 pages hardcover with jacket and is copy no. 201 as signed by the author. Cartridge Headstamp Guide, by Henry P. White and Burton D. Munhall; c. 1963 Henry Packard White and Burton D. Munhall. 264 pages hardcover with several pages having sections cut out and missing and some with notes written in blue ink. Also included are nine staple-bound booklets serving as 1960's and 70's era catalogs with the exception of one dated July, 1938 by P & M Collector's Supply. Last is Small Arms Ammunition at the International Exposition Philadelphia, 1876, by Berkeley R. Lewis; published 1972 Smithsonian Institution Press. 68 pages paperback. Unless otherwise noted the overall condition is very good to excellent. (76679-16B)
2332. **LOT OF BOOKS** Total of five. One Hundred Years of Winchester Cartridge Boxes 1856 -1956, by Ray T. Giles & Daniel L. Shuey; c. 2006 Ray T. Giles and Daniel L. Shuey. 312 pages hardcover with jacket. Excellent plus condition, appearing unused and signed and dated 8/8/06 by Giles. Winchester Two-Piece .22 Boxes 1873-1927 by Richard L. Rains; c. 2006 Richard Rains. 211 pages gold embossed hardcover that appears virtually unused. American .22 Rimfire Boxes: Featuring the Sam Stillwell Collection, by Robert T. Buttweiler; c. 1990 by Robert T. Buttweiler, Ltd. 192 pages paperback. A Catalog of the .22 Boxes of the U. S. A., by Tony Dunn. Photo copy and binder bound production consisting of approximately 250 pages including some with dates 1983, 1985 or 1987. .22 Boxes (U.S. Companies), compiled by Dale Hedlund and John Kuntz; published by H/K publishing. Introduction dated August, 1984. Approximately 250 pages of loose sheets contained in a large three ring binder. Unless otherwise noted, the items in this lot rate near excellent. (76679-16C)

2333. **LOT OF BOOKS AND BOOKLETS** Total of nine. Cartridges of South Coventry, by Frank Krasnickas; c. 2006 Frank Krasnickas. 419 pages excellent condition paperback. Chronicles those manufactured in Coventry Ct. Cartridges of the World, by Frank C. Barnes; c. 1965 and this second edition c. 1969 Frank C. Barnes and the Gun Digest Co. 378 pages paperback. Cartridges of the World, by Frank C. Barnes; 5th. Edition c. 1985 Frank C. Barnes and DBI Books. 416 pages paperback. Cartridges of the World, by Frank C. Barnes; c. 1965 Frank C. Barnes and the Gun Digest Company. 346 pages paperback. The History and Development of Small Arms Ammunition; Cartridge Value Guide, by George A Hoyem; c. 1982 Armory Publications. 16 pages staple bound paperback. Metallic Cartridges, (Regulation and Experimental,) as Manufactured and Tested at the Frankford Arsenal, Philadelphia, PA., prepared under the direction of the Chief of Ordnance. This is a Collectors Library reprint of the 1873 dated original of approximately 50 pages paperback. Next is an undated original copy of the Illustrated Catalogue of United States Cartridge Company's Collection of Firearms., published by United States Cartridge Company. 140 pages paperback. Next is an 1891 dated original price list of the United States Cartridge Company's ammunition. 29 pages intact staple bound paperback. The last item is a 1973 dated staple bound catalog of approximately 50 pages by A Cartridge Hound. Unless otherwise noted, the condition rating of the items in this lot is very good to excellent. (76679-16D)
2334. **LOT OF BOOKS** Total of nine. The Amateur Guncraftsman, by James V. Howe; c. 1938, 1953 Funk & Wagnalls Co. this first paperback edition, 1963. 306 pages. Home Gun Care & Repair, by P.O. Ackley; c. 1969 The Stackpole Co. 191 pages hardcover with jacket. Gun Owner's Book of Care, Repair and Improvement, by Roy Dunlap; c. 1974 Roy Dunlap. 336 pages hardcover with jacket. Early American Gunsmiths 1650-1850, by Henry J. Kauffman; c. 1952 The Telegraph Press. 94 pages hardcover with jacket. The Gun Digest Sporting Rifle Take Down & Reassembly Guide, by J. B. Wood; c. 1981 DBI Books Inc. The Gun Digest Book of Exploded Firearms Drawings, edited by Harold A. Murtz; c. 1982 DBI Books Inc. 480 pages paperback. The Gun Digest Book of Gun Care, Cleaning & Refinishing, Book One: Handguns, by J. B. Wood; c. 1984 DBI Books Inc. 160 pages paperback. Home Gunsmithing Digest, by Tommy L. Bish; c. 1970 Gun Digest Publishing Co. 319 pages paperback. The last item is the 50th. Anniversary Gun Stocks by Bishop catalog no. 68. 52 pages staple bound paperback. The overall condition of the lot is very good. (76679-16E)
2335. **LOT OF BOOKS** Total of eight. Guns of the Old West, by Charles Edward Chapel; c. 1961 Charles Edward Chapel. 306 pages hardcover with jacket. The Deer Hunter's Bible, by George Laycock; c. 1963, 1971 George Laycock. 154 pages paperback. The Complete Shooter, by Sam Fadala; c. 1984 DBI Books Inc. 448 pages paperback. Firearms in the Custer Battle, by John E. Parsons and John S. du Mont; c. 1953 John E. Parsons. 59 pages paperback. Winchester: The Gun that Won the West, by Harold F. Williamson; c. 1952 Association of the U.S. Army. 494 pages hardcover with jacket. Fighting Indians of the West, by Martin F. Schmitt and Dee Brown; c. 1958 Charles Scribner's Sons. 362 pages hardcover. Next is a 1985 dated copy of I.B.M.'s trade magazine Viewpoint that includes a full cover sketch of General George Armstrong Custer and an article on him titled 'The Last Cavalier' by Walt O'Connell and consisting of a four page pullout centerfold of "Here Fell Custer". Also included are three period 8"x10" photos. The last item in this lot which rates very good overall is a 40 page, staple bound copy of Catalog No. 18, a 1977 parts catalog for discontinued and obsolete models of Winchester rifles. (76679-16F)
2336. **LOT OF BOOKS** Five total. W.R.A. Co.: Headstamped Cartridges and their Variations, by Daniel L. Shuey; c. 1999 Daniel L. Shuey. 364 pages hardcover signed and dated 2/12/00 by the author. Standard Catalog of Winchester: The Most Comprehensive Price Guide Ever Published, edited by David D. Kowalski; c. 2000 Krause Publications. 750 pages paperback. Next is a 1996 dated reprint by R.L.D. Co. of the Winchester 1926-1927 Product Catalog; c. 1926 Winchester Repeating Arms Co. Also included are original Winchester Firearms Parts Catalogs for the years 1973 and 1978. The overall condition of the lot is excellent. (76679-16G)
2337. **LOT OF BOOKS AND BOOKLETS** Total of 14. World War II German War Booty: A Study in Photographs, by Thomas M. Johnson; c. 2003 Thomas M. Johnson. 368 pages excellent condition hardcover with outstanding detailed photography. Treasure is Where You Find It...The Thirty-Year Quest to Save the Royal Armoury of Nepal, by Christian Cranmer; c. 2004 Christian Cranmer. 95 page excellent condition hardcover featuring brilliant color photography. The Bluejackets Manual 1940; c. 1938, 1939, 1940 U. S. Naval Institute. 784 pages hardcover. U.S. M1 Carbines Wartime Production, by Craig Riesch; c. 1994, 1995, 1998 North Cape Publications. 132 pages paperback with some penciled in notes applied to charts. Fighting Gear of World War I: Equipment and Weapons of the American Doughboy, by C. B. Colby; c. 1961 C. B. Colby. 48 pages hardcover rating about good plus. Fighting Gear of World War II: Equipment and Weapons of the American G.I., by C. B. Colby. C. 1961 C. B. Colby. 48 pages hardcover rating near very good. A New Chapter in an Old Story; c. 1912 The Remington Arms-Union Metallic Cartridge Company. Approximately 90 page hardcover published by the iconic company on its history and ideology. This original copy features interesting period illustrations, including the front cover exhibiting a hunter at campsite with faint images of historical figures around him and an illustrated frontispiece. Also included is a 1932 dated signed note written to present this copy as a personal gift. This book rates about near very good as the spine portion of the cover is missing but the interior has held up nicely. Next are two copies of catalogs (Nos. 82 and 83) by N. Flayderman & Co., Inc., and one that reads: "NATO/Catalog No. 2/James C. Tillinghast/(address). Another item that is also a small booklet style staple bound offering is German Daggers and Dress Sidearms of World War II, by Dr. Kurt-Gerhard Klietmann; c. 1967 Field and Fireside, Inc. 50 pages. The next item is a staple bound 40 page narrative serving as a World War II 50th Anniversary commemorative edition titled Rock Island Arsenal: An Arsenal for Democracy, by Thomas J. Slattery and dated 1992. Also included is a 22 page paperback from the Public Relations Office of Fourth Service, Camp Davis, N. C. The last item is an Operation and Preventive Maintenance Manual for the M16A1 Rifle. (76679-16H)
2338. **LOT OF BOOKS** Total of eight plus two binders. Cartridges: A Pictorial Digest of Small Arms Ammunition, by Herschel C. Logan; c. 1959 The Stackpole Company. 204 pages hardcover with jacket. Digest of Cartridges for Small Arms Patented in the United States, England, and France, so Far as Patents Have Been Published., compiled by W. A. Bartlett and D. B. Galatin. Original edition 1878, this reproduction c. 1977 Museum Restoration Service. Approximately 90 pages hardcover identified as copy no. 9 of 200. Centerfire American and British Pistol and Revolver Cartridges (Vol. II of Cartridge Identification), by Henry P. White and William F. Wieman; c. information has been cut out. First edition 1950. 143 pages hardcover. Handloader's Digest, edited by Ken Warner; tenth edition c. 1984 DBI Books. 320 pages paperback. Cartridges for Breech-Loading Rifles: A Contribution to Firearms Instruction, by A. Mattenheimer; first published in German 1868. translated by Robert Hoyem. c. 1989 Armory Publications. 35 pages excellent plus condition hardcover with jacket and two small wall posters. Hornady Handbook of Cartridge Reloading: Rifle-Pistol Vol. II, c. 1973 Hornady Manufacturing Company, Inc. 512 pages hardcover with jacket. Next is a 1962 dated reproduction by JAYCO of the 1910 edition of the Illustrated Catalog, by The Union Metallic Cartridge Co. and Remington Arms Co. 192 pages paperback. The last of the eight is a Dec. 1974/Jan. 1975 copy of the International Cartridge Collector booklet comprised of about 20 pages. The first binder consists of 26 copied pages within plastic sleeves of U.S. Center Fire Metallic Rifle Cartridges: Over 200 - 1860-1960 with Drawings to Actual Size, by C. V. Hamilton; c. 1962 C. V. Hamilton. The other binder contains approximately 20 full size photos of interesting cartridge collecting items. The condition of the lot averages out to about very good plus. (76679-16I)
2339. **BOOK AND MANUALS LOT** Total of eight. History of Modern U.S. Military Small Arms Ammunition, Vol. I: 1880-1939, by F.W. Hackley, W.H. Woodin and E.L. Scranton; c. 1967 The Macmillan Co. 307 pages hardcover with jacket. The seven manuals are original U.S. Department of the Army issued and dated as early as 1962 and as late as 1978. They consist of Commercial Shotguns; Machinegun 7.62-mm, M60; Artillery Ammunition-Guns, Howitzers, Mortars, and Recoilless Rifles; Rifle, Caliber .30: M1, M1C, M1D; Rifle, 7.62-mm, M14, M14A1, Bipod, Rifle, M2; M16A1 Rifle and Rifle Marksmanship; Conversion Kit (caliber .22 Rimfire Adapter) M261 for Rifle, 5.56-mm, M16 and M16A1. The items are fully intact and rate about very good plus overall. (76679-16J)

2340. **LOT OF MANUALS AND BOOKLETS** This lot consists of approximately 30 assorted gun related items of printed material. Some examples are a summer of 2009 Gun Digest Collector's Guide, seven catalogs from N. Flayderman & Co., and a full size ring binder containing early 20th. century period items including targets, advertisements and photos of collectible cartridge boxes. Also included in the lot are old gun value books and specific model's owner's manuals. Very good condition lot overall. (76679-16K)
2341. **COLLECTIBLE REMINGTON LOT** This lot consists of two interesting factory sealed packages containing .22 cal. ammunition. First is the Remington 22 Ammunition & Playing Card Gift Set comprised of 200 rds. of High-Velocity LR cartridges with "Golden Bullets" contained in a decorative hinged antique style tin and two decks of poker-sized playing cards. Both the tin and the cards feature a wonderful illustration of mallard ducks inhabiting a grassy pond area with either a sunrise or sunset in the background and the Remington name and slogan "First in the Field" displayed at the top. The items are contained in a wood grain style decorative cardboard display box with the image of the cartridges and cards featured prominently at the bottom. The other gift pack is comprised of 300 rds. of "Golden Bullet" High Velocity 22 cartridges and a genuine Remington pocket knife. The ammunition is contained in six 50 rd. boxes with three displayed on either side of the knife housed in a dark wood grained cardboard box with a window exhibiting the knife reminiscent of the 1920's original with a dark stag handle. A fun lot for the Remington, ammunition or knife collector. (76679-17)
2342. **LOT OF COLLECTIBLE AMMUNITION** This is a factory sealed two piece cardboard box with a one piece yellow label with a faded top section that features an image of an enclosed round at its center and above it in black print: "50" at each upper corner bordering the trademark Winchester name and the line below that reading ".22 Long Rifle Cartridges". Beside the image is the head stamp "H" logo to the left and to the right is "Made in U.S.A.". Below that is "Lesmok" just above "Precision 75" which sits above the company name and address. There is a faded red stripe that runs up and down diagonally through the entire top. The side panels are identical, showing much more vibrant yellow, and feature the trademark big bold red "W" as a background to ".22 Long Rifle/Target Cartridge/Precision 75/Lesmok/Winchester Make". The label extends to cover about 2/3 of the bottom panel with a right side that includes the guarantee message along with the code "2532" and "5-20". The left side shows small round impressions to the extent that the box panel is visible. The label also shows minor scattered spots and very light wear. The front box panel exhibits mild spotting at the lower right and scattered light discolorations appear on the back as well. A rare item particularly in this condition and factory sealed. (76679-36A) **{This lot pictured on page 103}**
2343. **COLLECTIBLE AMMUNITION BOX** This is an opened two piece cardboard box containing 45 rds. of Winchester .22 Lr. The box has a one piece maroon label with a top section exhibiting black print including at the center an image of an enclosed round and to its left the trademark "H" logo and to the right is "Rim/Fire". The top of the label contains "50" on either side of the trademark "Winchester" name. Below that is ".22 Winchester Rim Fire" and below the image resides "Smokeless Rifle Cartridges/Adapted to Winchester Model 90 and Single shot Rifles/Made in U. S. A.". The bottom line consists of the company name and address. The sides are identical and read ".22 Winchester/Rim Fire/Smokeless/Rifle Cartridges/Winchester Make", all over the big bold "W" which in this case is formed as a result of a white outline. The bottom panel retains one side of the label only with it showing wear at the edge. The balance of the label also shows some scattered areas of loss with the graphics somewhat challenging to discern due to spattering of minute spots of label wear. The exposed parts of the box reveal a dark patina from what appears to be ingrained dirt and there are also scattered wear marks throughout the surfaces. The lid features thumb cutouts and the ammunition rates near excellent with nice dark gray tips and fairly bright cases. (76679-36B) **{This lot pictured on page 103}**
2344. **LOT OF COLLECTIBLE AMMUNITION** This is an opened two piece cardboard box containing the full 50 rds. of Winchester .22 Lr. The box has a teal colored top label with black print featuring an image of an enclosed round at the upper center and within it is ".22 Winchester/Rim Fire" with the trademark "H" as a head stamp. To its left is "50" and ".22" at the right. Below this is "Winchester/Rim Fire/Cartridges/7 1/2 Grs. Powder. 45 Grs. Bullet/Manufactured by the/Winchester Repeating Arms Co./New Haven, Conn., U. S. A.". The label exhibits light foxing and perhaps contact with grime or liquid but the text is easily read. The yellowish orange colored side sealing label has front and rear panels that read ".22 Caliber/Winchester/Rim Fire./Model 1890." and sides that read ".22 Winchester Rim Fire/Model 1890.". Portions of the word "Winchester" are missing from the unsealing process at the front and the label shows areas of minor loss, and ingrained dirt. The underside reveals a label as well, this one being in the form of a guarantee with the company name in cursive below, although much of the message has worn off. There are also spots of dirt particularly at the corners. The corners of the top show more wear but the box in general has fairly sharp edges. The ammunition has held up extremely well as it exhibits clean tips and cases and rates excellent, the box itself approaching that condition rating. (76679-36C) **{This lot pictured on page 103}**
2345. **LOT OF COLLECTIBLE AMMUNITION** This is a factory sealed two piece cardboard box containing 50 rds. of Winchester .22 short. The box has a top label that was originally a light green or teal color but has faded to an almost transparent green. The black print however remains strong and features an image of an enclosed round near the center of the label and within it lies ".22 Short" and the trademark "H" head stamp. To its left lies "Rim Fire" forming a semi circle above the head stamp logo. To the right of the cartridge is "Stetson's/Patent/Oct. 31, 1871". The top of the label exhibits "50" at each corner and bordering the trademark "Winchester" name, and below that is a line of a trademark statement. The lower half of the label reads "Lesmok (within quotations) Rifle Cartridges/Manufactured by the/Winchester Repeating Arms Co./New Haven, Conn., U. S. A.". The bottom left corner contains the code "8", while the right has "9-14". The bright yellow side label reads "50 .22 Short/Target Cartridges/Lesmok (within quotes) Powder/Winchester Make." On the front while the back contains an extensive statement of guarantee in small but still easily discernible font with a larger company name in cursive below it. To its left is the code "141" and beside that: "9-14". The sides each contain a big bold "W" as a backdrop to "50/.22 Short/Lesmok (once again in quotes)". This side label overlaps the tan sealing tape which is firmly attached to a plain buff colored and quite clean bottom panel which contrasts to the lid whose exposed edges reveal a darker but mostly even tone. The box has nice sharp edges and only one portion of the labels has any blemishes worth mentioning, that being some marks on the front that have obscured portions of some letters. A very collectible item indeed. (76679-36D) **{This lot pictured on page 103}**
2346. **LOT OF COLLECTIBLE AMMUNITION** This is a factory sealed two piece cardboard box containing 50 rds. of Winchester .22 short. The box has an emerald green label with black print that includes an image of an enclosed round bearing the "H" head stamp and "Short" along the case. A shadow effect is also presented in the illustration bordered by "50" at its left and ".22 cal." to the right just above the patent logo which includes an 1871 date. The line below reads "Rifle Cartridges." with "Smokeless" running diagonally over it in red. The lower portion of the label contains the company name and address, the "H" logo at its left and "15 10-8" to the right. The faded orange side label includes a front with the guarantee statement, a back with "50 .22 Short/Target Cartridges./Smokeless (in white within a pointed black oval)", a left panel with a red big bold "W" and trademark statement below it as a backdrop to "Smokeless (in white within a black oval)/.22 Short", and a right panel with the sunburst trademark logo containing "Winchester/Smokeless". The underside is plain and reveals a clean buff colored and fully intact seal over a surface showing the slightest of wear and maybe a minute spot or two. The exposed edge of the lid shows a darker, somewhat uneven patina with minimal wear. The labels show only very light blemishes overall with the exception of the back side with spots of dark discoloration. An example that has withstood the test of time remarkably. (76679-36E) **{This lot pictured on page 103}**

2347. **LOT OF COLLECTIBLE AMMUNITION** This is an opened one piece cardboard box with tray containing the original full 50 rds. of Winchester .22 Lr. The box features a mix of red, white and blue graphics including a top with an image of an enclosed cartridge as its centerpiece and the trademark Winchester name at the top and "Trade Mark Made in U. S. A." between them. The left of the drawing reads ".22/Long Rifle", the right "50/Lesmok" and below is "Precision 200". The front and back share identical graphics with text that includes "Precision 200/Target Cartridges" presented above the company name and address. Both side flaps have separated and the sole remaining one consists of a top that reads "Caution!/Dangerous within/1 Mile" and side with "Winchester/(trademark info.)/.22 Long/Rifle/Precision/200/K 2238 R". The bottom panel consists of the guarantee statement and "Made in U. S. A." below it. The edges show mild to moderate edge wear, the front left corner has a scuff that has obliterated a small portion of the address and the upper left corner of the top is beginning to tear and peel back a bit as is a smaller section at the upper center. The white sections of the graphics have faded to an uneven tan but the red and blue have held up quite well. The virtually blemish free tray has a split on one corner, and a bottom stamped "105 28". The ammunition rates very good to excellent with nice bright tips and light tarnish on some cases. (76679-36F) **{This lot pictured on page 103}**
2348. **COLLECTIBLE AMMUNITION BOX** This is a two piece cardboard box containing 24 rds. of Winchester 22 Lr. The box has a faded green label with black print consisting of the trademark Winchester name in quotation marks and "50" on either side of it, all forming the top line, and below it is "Trademark.". The next line includes a drawing of an enclosed cartridge with "H" and ".22 Winchester/Rim Fire" depicted on it, and to its left is "Pat. May/28, 1912." and at its right "45 Gr./Bullets". The lower half reads "Rifle Cartridges/Manufactured by the/Winchester Repeating Arms Co./New Haven, Conn., U. S. A.". Also included is the trademark "H" logo at the lower left corner and to its right is the code "18", while the lower right consists of "3-13". The orange sealing label includes a front that reads ".22 Caliber/Winchester/Rim Fire/Model 1890/Winchester Make.", and back with the guarantee statement and below the signature company name lies the code "112" and "1-10". The sides exhibit identical graphics consisting of a red big bold "W" as a backdrop to ".22/Winchester/Rim Fire/Model 1890/Winchester Make." in black and below that in red is "Trade Mark Reg. U. S. Pat./Off.and through't the world". This label has very small portions missing as is common at the point of separation on this style box and the top label shows light foxing that has had little effect on the still bold black print. The box shows very light overall wear and scattered areas of ingrained dirt, predominantly at the edges. The box is intact with the exception of the right edge of the lid which has split and the ammunition rates very good to excellent with a very light scattered film on the cases emitted from the tips. (76679-36G) **{This lot pictured on page 103}**
2349. **LOT OF COLLECTIBLE AMMUNITION** This is a factory sealed two piece cardboard box containing 50 rds. of Winchester .22 short. The box has a one piece wraparound label with a faded teal colored top section and black print that features a drawing of an enclosed cartridge as its main focal point. Also prevalent is the trademark Winchester name at upper center and "50" at each upper corner. Just above the cartridge is ".22 Short" and to its left lies the "H" head stamp logo and beside it is "Rim Fire". To the far right reads "Stetson's/ Patent/Oct. 31st, 1871". Below that is "Lesmok Rifle Cartridges/Made in U. S. A." above the company name and address. The balance of the label is a bright yellow including sides with identical graphics consisting of the big bold "W" in red as a background to ".22 Short/Rim Fire/Lesmok/Rifle Cartridges/K2254R". The label extends to the underside where the left side reveals the statement of guarantee and below the company signature lies the code "2538" and "7-20". The right extension is plain exhibiting small round spots revealing the buff colored panel below. The exposed sections that are not labeled show isolated dark spots predominantly at the front left but are virtually free of wear as is the label with the top showing whitish contact areas. All text remains bold black with the underside obscured slightly as a result of a small area of dark discoloration. (76679-36H) **{This lot pictured on page 103}**
2350. **LOT OF COLLECTIBLE AMMUNITION** This is a factory sealed one piece cardboard box with a buff colored wraparound label with a top section featuring red print that reads "Danger-High Pressure/S. A. A. M. I. Standard/ Definitive Proof Loaded Cartridges/50 22 Long Rifle/For Use Only In Proof Range/Gun to be fired only from a fixed rest with operator properly protected/Tinned cases with bullets lacquered red indicate high pressure/Winchester Repeating Arms Company/Division of Olin Industries, Inc./New Haven, Conn., U. S. A.". The box rates excellent with sharp edges and virtually no wear marks. There is a dark spot on the text that is the size of the period that it lies upon, a light impression at the top left seam, and a gray spot on the back panel that is very thin. The front panel shows traces of a light streak, likely just age spotting. A scarce item, factory sealed and rating excellent overall. (76679-36I) **{This lot pictured on page 103}**
2351. **COLLECTIBLE AMMUNITION BOX** This is a two piece cardboard box containing 29 rds. of Winchester .22 Lr. cartridges. The box has a faded yellow top label with a black outline and teal colored border. Featured is an accurate portrayal of an enclosed cartridge in the form of a drawing with copper case, "H" head stamps and dark gray tips. The cartridge is bordered on each side with an uncommon characteristic for a Winchester product: a dual bodied one headed image of a lion-like creature. At least one source suggests that it might be as a result of a collaboration with Sellier & Bellot. Above these illustrations is text consisting of "50" at both upper corners with the Winchester trademark name at their center. Below them lies ".22 Automatic Rifle" in white print over a red banner-like background. Below that is "Smokeless Powder Cartridges/Trade Mark Registered In U.S.A.". The lower left corner reads "Manufactured/By The", the center: "Winchester Repeating Arms Co.," and the lower right: "New Haven/Conn. U.S.A." The front panel displays the statement of responsibility, the back, the company trademark name above ".22 Automatic Rifle (in large red print)/Winchester Make". All of the back's text is background to bullets travelling in a diagonal pattern. The left side of the sealing label consists of red text as follows: "Winchester/Trademark/.22 Automatic (within a black oval)/Winchester/Make.". The left side exhibits the sunburst logo including "Winchester Smokeless" at its center. The top label is 99% intact, with the left lower corner missing a miniscule amount and the balance showing scattered light wear. The side sealing label is near excellent with the exception being the back has about 25% has peeled off. The exposed sections of the buff colored box show uneven fading and ingrained dirt but little wear. The ammunition rates near excellent with just the onset of tarnish on some. A rare box with interesting graphics. (76679-36J) **{This lot pictured on page 103}**
2352. **LOT OF COLLECTIBLE AMMUNITION** This is a factory sealed two piece box containing 50 rds. of Remington UMC .22 extra long cartridges. The box has a bright green top label with black print featuring an image of the cartridge along with a "U" head stamp and ".22 Ex. Long" on the case. Above it is ".22 Extra Long R. F./50 Rim Fire Cartridges". Also included is the red dot logo with "Remington/UMC" in white to the left of the drawing and "40 Grs./Bullet" to the right. The lower portion of the label reads "Remington Arms-Union Metallic Cartridge Co./Union Metallic Cartridge Works/Bridgeport, Conn., U. S. A." The code "25" is present at the extreme lower left. The front of the matching green sealing label features another red dot, this one housing only "UMC", and the Remington trademark name in red within a white oval. These form a border for "Specially adapted for fine Target/shooting,/also for/sporting purposes./ See Guarantee on bottom of box". The back reads "These cartridges are carefully/tested in all arms adapted to this/size. Their superior quality is/ guaranteed". Below this is the company name in cursive and above it is the code "25". The side panels have identical graphics consisting of the red dot logo with "Remington/UMC" within it and serving as a backdrop to ".22 extra Long R.F./black Powder". The bottom contains a pink label containing English and Spanish versions of the guarantee statement under a now illegible purple ink stamp. This label has crisp bold black print and pronounced pink color. There are small brown spots mainly along its edge that extend to the buff colored bottom section. The side sealing label has whitish areas that present an almost camo-like pattern and the top label is virtually perfect, though having been applied at a slight angle at the factory. All three labels and the box are fully intact with virtually no wear, the bottom showing a slight amount. The lid exhibits a couple of dark spots, but the box remains in remarkable condition. (76679-36K) **{This lot pictured on page 103}**

2353. **COLLECTIBLE AMMUNITION BOX** This is an opened two piece cardboard box containing six rds. of Remington UMC .22 Lr. The box has a green top label with a black border and print that reads ".22 Long Rifle R.F. Lesmok/50 Hollow Point Cartridges" over from left to right: the red dot logo containing "UMC", an image of the cartridge with head stamp "U" and ".22 Long/Rifle" on the case, and the Remington trademark name in red against a white backdrop. Below these resides the company name and address information. The matching green sealing label has a front that reads "Specially adapted for small/game shooting in all arms/adapted to this size./See Guarantee on bottom of box.". The back contains a similar message but the opened seal has obscured some of the text. The sides feature identical graphics that consist of the red dot trademark logo with "Remington/UMC" within it and serving as a backdrop for ".22 Long Rifle R.F./Hollow Point/ Lesmok Powder (in white print)". The bottom label is a faded pink and serves as a guarantee with the code "4-A" depicted at the upper left corner and a faint purple stamp at the center. All three labels are nearly completely intact with the loss comprised of a small section at the upper left portion of the top label at the first two letters of "Long" and the aforementioned nearly unavoidable minor loss where the seal is broken. The top and side labels exhibit some mild dark spotting and the right side has a small spot or two of light blue. The black unlabeled sections of the box show mild to moderate scuffing, mainly at the edges and the box has not been separated at the back, resulting in it acting as a hinge. When opened a nice white interior is revealed with minor spotting to the outer bottom compartment. The ammunition rates about very good with light tarnish and mild oxidation at the tips. (76679-36L) **{This lot pictured on page 103}**
2354. **LOT OF COLLECTIBLE AMMUNITION** This is a factory sealed two piece cardboard box containing 50 rds. of Winchester .22 Automatic. The box has a yellow top label with black, red/orange and white print that includes "50" at each upper corner bordering the trademark Winchester name and patent information. Below that is ".22 Automatic" within a red banner backdrop. The lower half of the label consists of "Rim Fire" with an image of the cartridge, with "H" and ".22 Automatic" depicted on it, presented between the two words and all of that above "Smokeless Powder Cartridges/29 For Winchester Rifle Model 1903 6-15/Manufactured By The Winchester Repeating Arms Co. (address partially missing)". The sealing label is comprised of the same color combination and includes a front section that reads "Winchester/22 Automatic/Smokeless Greaseless/Winchester Make" with a series of bullets resting atop it. The back contains the guarantee statement signed with the company name and the lower left shows what remains of an otherwise scuffed out code: "12(likely 0, scuff)15". The left side consists of the sunburst logo including "Winchester/Smokeless" and the right "Winchester/.22 Automatic (within a black oval)/Winchester Make" and all of that over the big bold "W". The labels have scattered spots of scuffing with the most noticeable being at the front left where the caliber is almost entirely missing. The side label exhibits brighter colors and bolder graphics than the more faded top. The box is fully intact with an impression evident at the upper left corner but the balance is quite sharp with minimal wear and minor scattered dark spots. (76679-36M) **{This lot pictured on page 104}**
2355. **LOT OF COLLECTIBLE AMMUNITION** This is an opened two piece cardboard box containing the full 50 rds. of Peters .22 Lr. The box has a one piece wraparound label with a top section consisting of a faded red border to a green main body with black print and the Peters name within a black oval at the top center. Also featured at the lower center is a facsimile of an enclosed cartridge in the form of a fine drawing with a copper colored case, a gray tip and a "P" head stamp. The text consists of "50" at each upper corner and below: ".22 Long Rifle R. F. Rifle Cartridges". "Semi-/Smokeless/Powder" resides at the left of the cartridge and to its right is "Non/Corrosive/Priming". Below the image is "The Peters Cartridge Co./Cincinnati, O., U. S. A.". The side panels contain identical graphics consisting of a large red "P" logo with "Peters" in white and No. 2221/.22Long Rifle R.F./N. R. A.)" in black. The underside consists of the extensive instructional and guarantee statement in black text over a green background with red border. It reveals mild scuffing particularly at the bottom and right side, with nearly all of the text remaining legible. The side sections of the label have small edge sections missing but virtually no wear or blemishes are evident. The top label has minor loss at the bottom but like the sides is clean. Where it differs from the balance is the red border has faded to contrast considerably to the other red areas, but all other graphics remain strong. The buff colored box has a lid with a split through the lower right half of the top, a couple of minor spots, and features thumb cutouts. The bottom compartment is intact with maybe the early stage of a split occurring at a lower edge but is clean with a darker tone at the cutouts. The original ammunition rates about very good with flaking forming at some tips and mild tarnish to the cases. (76679-36N) **{This lot pictured on page 104}**
2356. **LOT OF COLLECTIBLE AMMUNITION** This is a factory sealed two piece cardboard box containing 50 rds. of Peters .22 Win. cartridges. The box has a wraparound label with a top portion comprised of a red background to a light, almost turquoise main section with a yellow and black border. It consists of an image of an enclosed cartridge including a copper case with "P" head stamp and gray tip. Bordering it on each side is the company logo in the form of a "P" within a circle. Also included is the logo consisting of "Peters" in white within a black oval and "50" at either corner and below it is ".22 Win. R.F. Rifle Cartridges/Inside Lubricant". The lower portion reads "The Peters Cartridge Co./Cincinnati, O., U. S. A.". The label extends to the sides, each revealing identical graphics in the form of a large red "P" with "Peters" in white and within the top bar, and ".22 Win.R.F./Inside Lubricant/Semi-Smokeless" in black against the turquoise like background. A second label lies beneath it and wraps around the front and back. The upper front center features the same logo as the upper top and below it is ".22 Winchester R.F./Rifle Cartridges/Semi-Smokeless Powder" in black against a green background. The back has the same green and reads in black "Trade Mark (round logo with P) Reg. U.S. Pat. Off.". The bottom has its own single panel turquoise label with black text in the form of an informative message and guarantee. It shows mild scuffing mainly at the edges, leaving the text essentially unfaded. The front and back have larger areas of loss due to scuffing, the right side showing considerably less, and the left showing virtually no wear but a dark spot from contact with some liquid, possibly oil. The spot extends to the top where there are several others over about 50% of the surface, showing light wear as well. The box is fully intact without much edge wear and features thumb cutouts. (76679-36P) **{This lot pictured on page 104}**
2357. **COLLECTIBLE AMMUNITION BOX** This is an opened one piece buff colored box with printed graphics consisting of a dull orange body with red borders and logos and black text. The top portion reads "Peters/Rustless/.22 short R.F. Cartridges/Smokeless (image of cartridge) Powder/The Peters Cartridge Co./Cincinnati, O., U. S. A.". The upper left corner contains "50" in white and the lower right has the round logo with the "P". The front and back have identical graphics with a very similar layout as the top but with no drawing or address. The fully intact end flaps each feature the large "P" with the company name and ".22 Short", in white and within the upper and lower bars respectively. Also included is "No. 222028" and "Smokeless/Rustless". The bottom contains the information and guarantee statements. The box shows mild edge wear and a handling mark or two but is clean overall and fully intact with crisp graphics. The fully intact correct tray currently houses approximately 30 rds. of mismatched Peters .22 cal. rating about very good overall. (76679-36Q) **{This lot pictured on page 104}**
2358. **LOT OF COLLECTIBLE AMMUNITION** This is a factory sealed two piece cardboard box containing 50 rds. of Western .22 W.R.F. The box has a green top label with black print and the trademark Western diamond logo in red with white print and featured at the center. Also included is "50" at each upper corner above "Rim Fire Cartridges". To the left of the logo is ".22 Cal." and to the right "W.R.F.". The lower half of the label reads "Lesmok Powder/Manufactured By/Western Cartridge Company,/East Alton, Ill., U. S. A.". The deep red colored side sealing label has a front that reads "Adapted To/.22 Cal. Winchester/Repeating Rifle, Model 1890; Winchester/Stevens And Remington Single Shot Rifles;/Also Other Arms Of This Caliber." above the company address. The back contains a four line statement of guarantee followed by the company signature, and beside it to the left is the code "WT-20". The left side includes an image of an enclosed round with ".22 W.R.F." within it. Above it is "50/.22 Cal." and below it is "Winchester/Lesmok/Powder", all laid out in a diagonal pattern. The right side consists of "Western (in its trademark cursive)/.22 cal./W.R.F./Lesmok Powder". The bottom is stamped in purple "T27AO". This stamp, as is the case with all of the graphics on this box, is outstanding, bold and crisp. The box is fully intact with sharp edges, clean label surfaces, some minor discoloration along the buff colored top edge, and just a couple of small handling marks. This is a factory sealed box in truly outstanding condition. (76679-36R) **{This lot pictured on page 104}**

2359. **LOT OF COLLECTIBLE AMMUNITION** This is a factory sealed two piece cardboard box containing 50 rds. of Western .22 cal. extra long. The box has a green top label with black print and border and a red Western diamond logo with white text as the centerpiece. Each upper corner contains "50" and below them is "Rim Fire Cartridges". Also included and to the left of the logo resides ".22 Cal./Extra Long", to its right is "Lesmok Powder". The lower portion of the label reads "Manufactured By/Western Cartridge Company/East Alton, Ill., U. S. A.". Outside of the border, at the lower left corner is the code "WT-25". The red sealing label has a front that reads "Adapted To/.22 R. F. Extra Long/Repeating And Single Shot Rifles/Also Other Arms" above the company name and address. The back consists of a guarantee statement with the company signature in cursive below it, and perpendicular to it at the left is once again the code "WT-25". The left side features an image of an enclosed cartridge presented in a diagonal position with ".22 Extra Long" added to the length of the case. Provided as a backdrop to the drawing is a large and bold "22". The right side of the label consists of "Western" in its iconic cursive font and below it lies ".22 Extra Long/Rim Fire/Lesmok Powder". Under the labels lies an adhesive buff colored layer that covers the sides and overlaps the edges of the top and bottom which exhibits a strong purple ink stamp: "7U3L" over its plain gray surface. The labels show scattered small scuffs over the strong colors and print with the exception of the red within the aforementioned diamond logo which has faded considerably to almost pink. Structurally the box is outstanding with sharp edges and fully intact labels. (76679-36S) **{This lot pictured on page 104}**
2360. **LOT OF COLLECTIBLE AMMUNITION** This is an opened two piece cardboard box containing the full 50 rds. of C. I. L. 25 Stevens long cartridges. The box has a yellow wraparound label with red and white graphics and a top portion consisting of a yellow horizontal section between two red ones including an upper one featuring an image of an enclosed cartridge with the head stamp and caliber depicted on the case. To the left of it is "25 Long/Stevens" and to the right "Lesmok". The middle consists of the C. I. L./Dominion oval logo to the left of "Adapted To/Stevens, Marlin, Cooney, Remington and Winchester/Single Shot Rifles, Also Stevens And Marlin Repeating Rifles.". The lower portion has "Made in Canada By/Canadian Industries Limited/Dominion Ammunition Division/Montreal, Canada.". The side panels feature identical graphics consisting of "Fifty/25 Stevens Long/Super-Clean (within a small window)/R. (the company logo) F./Lesmok Powder", all within a red border. Below it is what originally read "Cut Seal Here" but is somewhat obliterated where that occurred and to the far right is the code "73". The bottom panel portion consists of a seven line message stating the product's reliability. The top of its left corner is peeling back but fully present and there is scattered light surface wear that has left the text essentially unfaded. The right side label has a small handwritten price sticker adhered diagonally at the left side of the logo but otherwise the sides are excellent. The top shows light foxing and is virtually free of wear with only slight fading. The buff colored fully intact box includes a front with very light isolated contact marks and is stamped "DN" in purple ink at its upper right. The back exhibits a darker overall patina particularly at the edges. The lid features thumb cutouts and when lifted reveals a clean bottom tray with darker areas at the cutouts, housing cartridges with bright cases and just the onset of light powder forming on most tips. Also enclosed is the original packer/inspector slip. (76679-36T) **{This lot pictured on page 104}**
2361. **LOT OF COLLECTIBLE AMMUNITION** This lot consists of two full one piece, 50 round boxes of Peters .22 Lr. The first one is yellow with blue, white and red graphics including a top section featuring the image of a law officer aiming a revolver at a target and above it is "Police Match/.22 Long rifle Lubricated/50 Rim Fire Smokeless Cartridges/Made in U. S. A./Peters Rustless". The front and back each read "Peters/Dupont (within oval)/Police Match (placed diagonally)/Ammunition". Each side consists of the "P" logo at each upper corner and between them is "Peters" and below that is "Rustless/Police Match/22 Long Rifle Lub./No.2223". When opened the end flaps reveal tops that read "Range-One Mile/Be Careful". The bottom is comprised of a message of reliability and a guarantee statement in addition to the company name and address. The fully intact box is in excellent condition with strong graphics (the white has faded to a pleasing off white), sharp edges and virtually no wear outside of maybe a corner or two. The ammunition rates bright excellent. The second box is green with red, blue and somewhat faded white graphics. The top reads "50" Peters/Outdoor/Tack Hole/.22 Long Rifle R. F. Cartridges/Special Lesmok Powder". Below this are two Dupont logos bordering one of Peters. The front and back have identical graphics consisting of three logos over: "Out Door Tack Hole (presented diagonally)/Special Lesmok Powder". The sides read "Peters/.22 Long/ Rifle" over the same diagonal presentation, and below that "No. 2226/For Ranges Up To 250 Yards". The flaps' tops contain "Dangerous/Within 1 mile". The bottom provides general information and a guarantee with the company name and address at the bottom. A portion of this text is difficult to discern due to light wear which is less prevalent throughout the balance of the fully intact box. The box has sharp edges and strong graphics overall with the top having faded down a notch or two. The ammunition rates near excellent with clean tips and the onset of dark spots on most cases. A great pair of Peters boxes. (76679-36U) **{This lot pictured on page 104}**
2362. **LOT OF COLLECTIBLE BOXES** This lot consists of two empty two piece cardboard boxes for Winchester .22 cal. cartridges. The first one has a one piece wraparound label with an olive green top that features an image of the enclosed round with no wording on it, but with the "H" head stamp. It is displayed at the center with the "H" logo and "Rim/Fire" at its sides. Above these is "50" at each upper corner and between them "Winchester/.22 Long Shot". The lower section has "Lesmok Rifle Cartridges/Made In U. S. A.". Below that in very small font is the company name and address. The balance of the label is yellow with the sides including a big bold red "W" under ".22 Long Shot/Rim Fire/Lesmok/Rifle Cartridges/K2232R/Winchester Make". The label extends to the underside with a left portion consisting of the guarantee, the right is missing. The label overall has a pleasing aged look with a light mixture of foxing, ingrained dirt, fading and handling marks. The fully intact buff colored box features thumb cutouts and mottled discoloration from dirt and grime, the interior is clean. The bottom compartment is mostly devoid of blemishes, with some at the cutouts and more where the bottom label separated. The second box has a top label that is also olive green and features a drawing of an originally enclosed cartridge, this one bearing the head stamp and ".22/Short" along the body. Beside it are the "H" logo and the Stetson's Patent Oct. 31, 1871 statement. Above these are "50" at each upper corner and the Winchester trademark name between them. The lower portion of the label consists of "Lesmok (in quotations)Rifle Cartridges./Manufactured by the/Winchester Repeating Arms Co./New Haven, Conn., U. S. A. 3-12". The yellow side label consists of the guarantee on the front, and "50 .22 Short/Target Cartridges/Lesmok (in quotes)/Winchester Make.", on the back. All that remains of the buff colored seal is most of the bottom portion and it reveals a spot of blue ink. About 40% of the left side label is missing, with the back of it showing a split at the word "Short". The label was originally applied at a slope running downwards from right to left. The top label is peeling a bit at the lower right corner and it exhibits light fading and foxing. The buff colored box shows a lid with an overall dark patina and mild edge wear, the bottom with lighter panels with a couple of spots and an underside nearly matching the shade of the lid. A nice pair of Winchester .22 boxes. (76679-36V) **{This lot pictured on page 104}**
2363. **COLLECTIBLE AMMUNITION BOXES** This lot consists of two empty two piece cardboard boxes for Winchester .22 cal. cartridges. The first one has a green top label with black print with "Smokeless" presented over it in bold red and in a diagonal layout. The upper portion consists of an image of an originally enclosed cartridge including shadow effect between "50" and ".22 cal./Stetson's Oct. 31, 1871 logo)/Rifle Cartridges". The lower half includes the "H" logo, the code "15 10-8" and the company name and address. The yellow side label consists of a front with the guarantee, a back that reads "50 .22 Short/Smokeless/Target Cartridges/Greaseless Bullets", a left side with "50/.22 Short/Smokeless/(trademark info.)" all over the big bold red "W", and a right with the round Winchester Smokeless logo. Most of the buff colored seal remains and is peeling back. The labels share a common amount of light foxing and wear, the lid showing mild edge wear, the bottom tray a relatively large area on the left interior that has made contact with what appears to be a greasy substance that has dried and subsequently clung to dark particles. The under panel seems to have absorbed some of it and also shows other light discoloration. The second box is in significantly better condition and has a light green top label with "50" at each upper corner and between them is the Winchester name in quotations with "Trade Mark" under it. Below that is ".22 Long Shot Cartridges/Loaded With/Soft Shot./Trade Mark Registered in U. S. Pat. Office./Manufactured by the/Winchester Repeating Arms Co./New Haven, Conn., U. S. A.". The far left lower corner contains "19", the far right "7-6". The label is fully intact with nice color and bold black print, essentially free of foxing or wear marks. The buff colored covering under it extends to the edges of the underside and is excellent with the exception of a spot on the bottom that appears to be paint, the oil from which has spread slightly to form a ring around it. There are also a couple of other minor spots and possibly faint ingrained dirt or just age fading. In addition it is handwritten in ink: "PR03-18". The bottom interior shows marks from the once enclosed cartridges. The lid has a split at the upper left corner but otherwise the box is fully intact with sharp edges and it appears to have been carefully cleaned up along the seal. (76679-36W) **{This lot pictured on page 104}**

2364. **LOT OF COLLECTIBLE AMMUNITION** This lot consists of two cardboard boxes of Remington UMC .22 cal. cartridges. The first one is a full 50 rd. one piece orange box with black print and a top that features an image of an enclosed cartridge as the center focal point with the red dot logo and trademark information at its sides. Above them is ".22 Long Rifle R.F. Lesmok/50 Cartridges". The lower half consists of the company name and address and in very small font on either side are "New York" and "London", respectively. The lower left corner has the code "54-N.S.". The front shows an image of a slide action rifle with sling hanging, the UMC and Remington logos, and "These Cartridges Are Specially Recommended For Use In Remington N R A Target Rifle". The back reads ".22 NRA Target/These Cartridges Are Specially Adapted For fine Target Shooting Up To 250 yards." With the company signature below it and "See Guarantee on Bottom Of Box" below that. The guarantee is in both Spanish and English. The sides are identical and read ".22 Long Rifle/(red dot logo) NRA Target/Lesmok". The box shows only light wear marks in scattered areas, a couple of spots of grime and fading isolated to the top and ensuing edges. The box is fully intact as is the bottom compartment housing cartridges with mild tarnish and oxidation. The second box is a two piece containing 47 rds. of .22 Win. It has a top label with blue print that includes an image of an enclosed cartridge at its center and "U" and ".22 Winchester/Smokeless" draped across it. To the left is the red dot logo and to the right "45 grs./Bullet". Above is ".22 Winchester Smokeless/50 Rim Fire Cartridges". The lower portion consists of the company name (in an almost semi circle configuration) over the address. Also included at the lower left is the code "28". The sealing label has a front that reads "Specially Adapted for Winchester Model 1890./Remington-UMC.", the back with the message that the cartridges are for the Model 1890. The left side consists of the red dot under ".22 W. R. F./Ungreased/Inside Lubricated/Smokeless". The bottom consists of the dual language guarantee. The surfaces exhibit an overall uneven tan/light brown patina with mild edge wear and much of the sealing label missing including portions with text and graphics. The ammunition rates very good to excellent with light tarnish. (76679-36X) **{This lot pictured on page 104}**
2365. **LOT OF COLLECTIBLE AMMUNITION** This lot consists of two boxes of C.I.L. Bisley .22 Lr. First is a full 50 rd. one piece box with multi colored graphics and a top section featuring the image of a shooter with forest backdrop and to the right is "Bisley (in quotations)/Target/Cartridges". The upper portion consists of ".22 Long/Rifle" to the left of "Dominion/Super-Clear" (both in quotes). The front features the company logo beside "Super-Clean"/Non-Corrosive" and below lies "Made in Canada By/Canadian Industries Limited/Dominion (in quotes) Ammunition Division/Montreal, Canada". The back provides nine lines of general information. The sides each read "Bisley/Super Clean (in quotes)/.22 Long Rifle/(company logo)/50 R.F./Smokeless Greased" and the tops of the flaps read "TT-55/Dangerous/Within 1 Mile". The bottom contains nine lines of maintenance advice. The box is in excellent condition with minor scattered edge wear and traces of light foxing to the top. The ammunition rates near excellent with the onset of flaking to the tips. The second item is also a one piece box, this one containing 49 rds. with green, red and white graphics over a yellow background. The top has a main section with "Bisley/22 Long Rifle" beside "50" and an image of an enclosed cartridge. Under that is "Intermediate/Velocity" to the left of the C-I-L logo and then "Greased". The front discusses the attributes of the product with the back providing a French version of it. The sides are identical and read "Bisley/(C-I-L logo)/22 Long Rifle/Greased", the top flaps: "RF-37/#". This box is also excellent with sharp edges and colors, very isolated edge wear and a little discoloration at the top extending to the back. The ammunition rates excellent as does the plastic yellow tray that it is housed in. (76679-36Y) **{This lot pictured on page 104}**
2366. **COLLECTIBLE AMMUNITION BOXES** This lot consists of two Winchester .22 Lr. two piece boxes. The first one has a forest green top label with black and red print with an image of one of the ten enclosed cartridges at the upper center with ".22 Long" presented along the case. To the left is "50" and to the right ".22 Cal.". Below that is "Rifle Cartridges"/Smokeless" over the company name and address. The far lower left reads "15", the right "9-15". The side label is of red, yellow and black with the front reading "50 .22 Long/Smokeless/Target Cartridges/Greaseless Bullets", the back with the guarantee and the sides with logos. The box rates about very good with a bold green label, the cartridges about that as well with lightly oxidized tips. The second box is empty and has a faded green label with diagonal red stripe and reads "Winchester/.22 Long Rifle Cartridges/"H" logo, image, Made in U.S.A./Lesmok/Precision 200/ (company address)". The side label is yellow with the right side mostly missing as are the bottom sections. The buff colored box has a pronounced spotted appearance at the front with areas of dirt and grime, but it is intact. (76679-36Z) **{This lot pictured on page 104}**



2367. **FN-FAL SEMI-AUTO RIFLE BY GUN SOUTH INC.** serial #2507886, 308 Winchester, 21" barrel with an excellent bore. The metal surfaces retain 97% arsenal refinished matte blue color. The buttstock is for another model FN rating very good with overall scuffs and scratches consistent with a used military buttstock. The forend and magazine are absent but easily obtainable. The rifle has been stored with a liberal coating of Cosmoline and will require a thorough cleaning. In excellent condition overall. (66492-3). (1800/2200)

End of Silent Auction - Thank you • All Silent Auction Bids are due by 2:00 pm on August 2, 2014.

Results will be available on Wednesday, August 6, 2014.



2342



2343



2344



2345



2346



2347



2348



2349



2350



2351



2352



2353



2354



2355



2356



2357



2358



2359



2360



2361



2362



2363



2364



2365



2366

Notes:

AMOSKEAG
SALE NO. 102

Notes:

TERMS AND CONDITIONS OF SALE

ABSENTEE BIDDING

- Bidders without prior credit approval are required to submit a 20% deposit prior to bids being accepted (credit cards may be used for absentee deposits). Absentee bids will be bid in a competitive manner and an absentee bidder needs only to outbid another buyer i.e. bidding will not be opened at the maximum bid unless that is the next competitive bid. Buyer is responsible for any and all shipping charges.
- Amoskeag Auction Co., Inc. will not be held responsible for errors or omissions of any type that may occur during this service.
- All Silent Auction bids are due by 2:00pm on the day of the sale. If you are planning on bidding on an excessive amount of items we request that your bid sheets be turned in on the Friday before the sale. Please do not call the gallery once the auction has started (after 10:00am) as we will not be able to make changes to bids. Faxed bid sheets will be accepted for the **silent auction** until 2:00pm.
- All absentee/telephone bidder invoices are mailed within a few days of the sale, are due upon receipt, and are to be paid either by cash, check or credit card. All items not paid for within 20 business days from sale date shall be considered abandoned as well as any deposit that was made on those items and Amoskeag Auction Company, Inc. shall have sole discretion as to their disposal.
NOTE: If paying by cash or check, the buyer's premium will be a discounted 15% versus 17.5% for those paying by credit card.

**IF YOU FAX YOUR BID SHEET INTO OUR OFFICE,
PLEASE CALL TO CONFIRM THAT WE DID RECEIVE IT. THANK YOU. 603/627-7383**

VIEWING

Viewing will be available from Monday, July 21st through Friday, August 1st, by appointment, as well as on the day of sale from 7:30am to 2:00pm. We do have a few select evenings available for viewing and those times and dates can be obtained by calling our office.

SHIPPING

- Amoskeag Auction Company, Inc. will make every effort to ship items in a timely fashion; most orders are shipped within 48 hours of payment. All items, with the exception of modern handguns, are shipped via UPS Ground unless other arrangements have been made.
- All modern handguns are shipped via UPS Next Day Air service.
- Buyer is responsible for any and all shipping charges.

PICKING UP MERCHANDISE

- **OUR OFFICE WILL BE CLOSED MONDAY AND TUESDAY FOLLOWING THE SALE.** No merchandise will be delivered on those days. We will resume normal business hours on Wednesday.
- Our office hours are Monday through Friday - 8:00 am to 4:00pm. Please call ahead prior to arriving to pickup your merchandise.

DIRECTIONS

FROM SOUTH: Rt. 93 North to Rt. 101 West in Manchester to Rt. 293 North to Exit 5 (Granite Street). At end of ramp go right onto Granite Street to first set of lights. Go left on Commercial Street and we are located in the Waumbec Commercial Center, which is 1/8 mile up on the left. OR Rte. 3 (Everett Turnpike) North through Bedford tolls then off at Exit 5 (Granite Street). At bottom of ramp go right, take first left onto Commercial Street, 1/8 mile on left. FROM NORTH: Rt. 93 South to Rt. 293 South to Exit 5 (Granite Street), at end of ramp turn left onto Granite Street to first set of lights. Go left on Commercial Street and we are located in the Waumbec Commercial Center, which is 1/8 mile up on the left. ELEVATOR: Go around to the back of the building (river side), there is a set of three stairs with a glass door, enter the lobby through the door that is marked "ELEVATOR", go to 3rd floor and follow signs. STAIRS: Enter South entrance, go up stairs and follow hallway and signs.

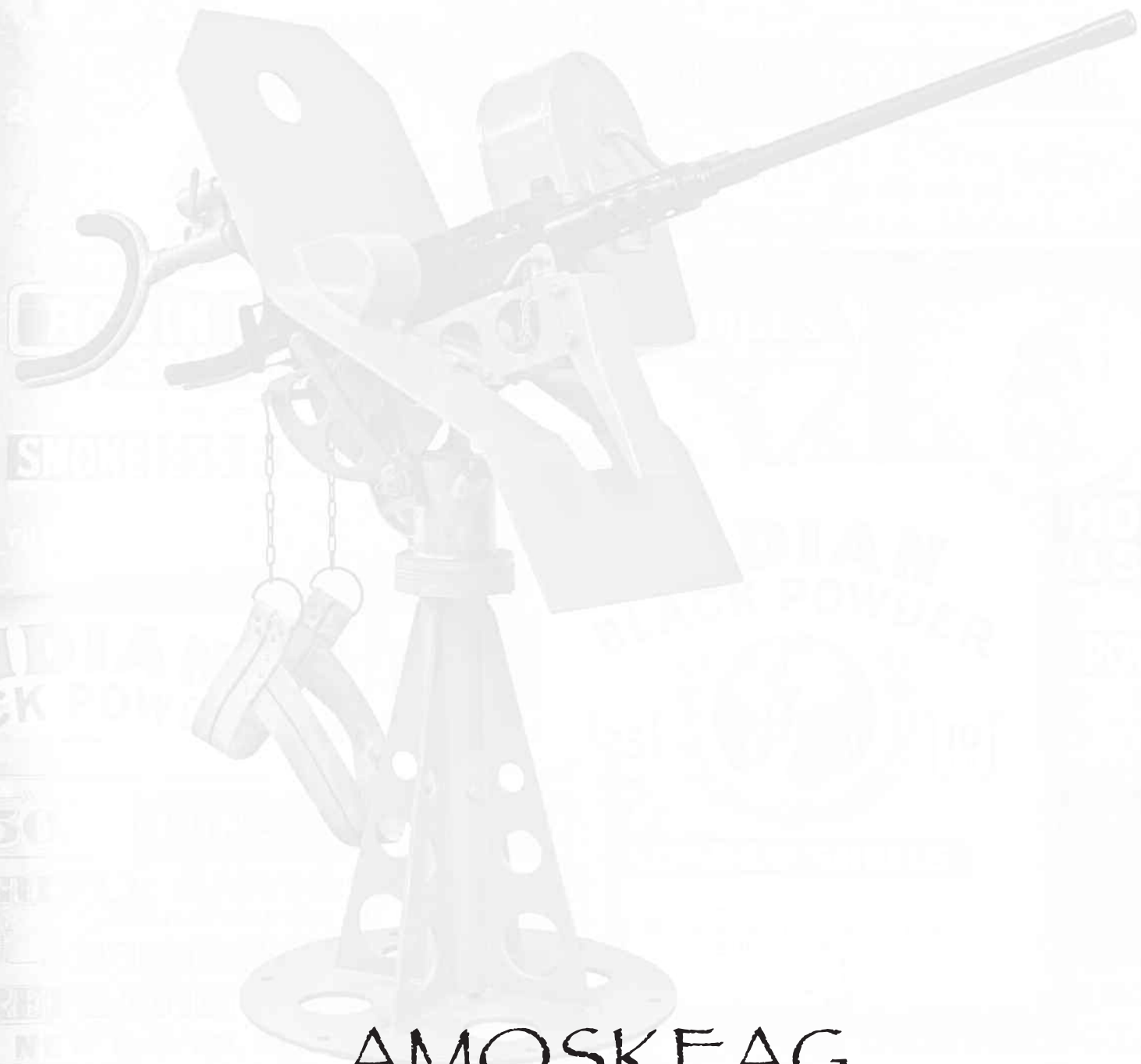

AMOSKEAG

AUCTION COMPANY INC.

250 commercial street • suite 3011 • manchester, new hampshire 03101
603/627-7383 fax 603/627-7384 • www.amoskeagauction.com
jason & melissa devine • nh license no. 2555